

# radio service dealer

OCTOBER, 1947

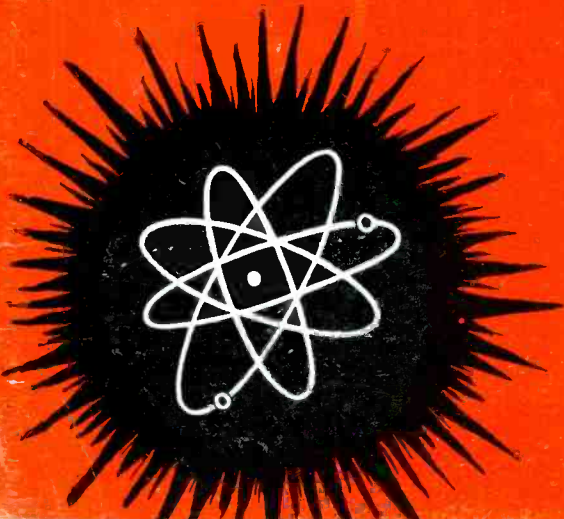

#### IN THIS ISSUE:

ADD RECORD-PLAYERS—MODERNIZE OLD SETS  
P-A FUNDAMENTALS & COMPLEXITIES  
MODERN TELEVISION KITS  
TECHNICAL QUIZ NO. 3  
GET YOURSELF FREE PUBLICITY

## What Kind of Tubular Paper Capacitor Do You Need?



## The MALLORY Line of capacitors is really complete

MALLORY makes 75 different paper tubular capacitors to supply your "every need" and for your convenience. They range in rating from 400 volts to 1600 volts—and in size from  $\frac{3}{8}$ " x 1" to  $1\frac{1}{4}$ " x  $2\frac{1}{2}$ ".

These paper tubulars are divided into two broad categories—wax impregnated and oil impregnated. Both are securely sealed to provide against atmospheric penetration. Both are carefully factory-tested so you get *all* the quality that Mallory puts into them.

Get the complete story from your Mallory Distributor or from the Mallory Catalog.

You save a lot of time if you check the Mallory Catalog for replacement parts as you need them. Do you have a copy? If not, see your Mallory Distributor.

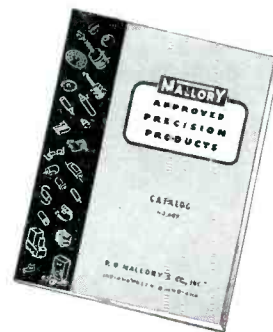

**YOU EXPECT MORE AND GET MORE . . . FROM MALLORY**

**P. R. MALLORY & CO., Inc.**  
**MALLORY**

VIBRATORS . . . VIBRAPACKS<sup>SM</sup> . . . CAPACITORS . . . VOLUME CONTROLS . . . SWITCHES . . . RESISTORS . . . FILTERS . . . RECTIFIERS . . . POWER SUPPLIES.

\*Reg. U. S. Pat. Off.

**APPROVED PRECISION PRODUCTS**

National Radio Week  
Oct. 26—Nov. 1

**P. R. MALLORY & CO., Inc., INDIANAPOLIS 6, INDIANA**



# This Book Makes You a Record Changer Service Expert!

## Ready Now! Your Howard W. Sams 1947 Automatic Record Changer Service Manual

Hundreds of you have written to me personally in the past year, describing your crying need for reliable service data on Automatic Record Changers. Long before these letters began to come in, we foresaw the tremendous expansion of the Record Changer service field and began working on the problem. NOW—I am proud to announce the publication of the Howard W. Sams 1947 AUTOMATIC RECORD CHANGER SERVICE MANUAL. There is no other book like it. It makes you a service expert on Changers—helps you tackle and lick any kind of mechanical Changer problem. The Manual covers MORE THAN 40 POST-WAR MODELS—all of them DIFFERENT. The information is absolutely accurate, complete, authoritative—based on our actual study of the equipment. Everything you need to know is presented in giant-size exclusive “exploded” views, photos from all angles, completely keyed parts lists, and full text explaining disassembly, adjustments, change cycle data, service hints and kinks, and parts replacement. And for the FIRST time in any publication, you get complete, accurate data on leading WIRE, RIBBON, TAPE, and PAPER DISC RECORDERS! I honestly believe that no progressive Serviceman can afford to be without this Manual. Your copy is ready now—see it at your local jobber. Own it. Use it. It's the best investment you can make today to increase your earning power.

*Howard W. Sams*

- ★ BIG PLUS VALUE—the only single source of timely, accurate Service Data on leading Wire, Ribbon, Tape, and Paper Disc Recorders.
- ★ DeLux Volume. Hard Cover; opens flat. 400 pages of clear, accurate data that makes you a Record Changer Service Expert!

**THERE'S NOTHING LIKE IT! ONLY . . . . . \$4.95**

## DON'T MISS PHOTOFACT SETS NOS. 23, 24 and 25!

PHOTOFACT Sets Nos. 23, 24 and 25 feature the exclusive new uniform “Standard Notation” schematics—the greatest service data development in 20 years! Each and every diagram is drawn to the same basic set of clear, uniform, easy-to-understand standards. Here's what the new “Standard Notation” Schematics mean to you: Makes circuit analysis simpler, quicker, fool-proof, more accurate! No more time wasted puzzling over odd-looking diagrams! No more trouble with varying symbols and confusing styles! Just ONE CLEAR STANDARDIZED STYLE FOR ALL CIRCUITS—SAVES YOU

TIME—HELPS YOU EARN MORE. Only PHOTOFACT offers you the “Standard Notation” Schematics. Order Sets Nos. 23, 24 and 25 today—and see the amazing advantages!

- FREE:** PHOTOFACT Cumulative Index—your guide to all post-war receivers.
- FREE:** How to File Folder—shows 5 good ways to file PHOTOFACT Folders. Get these PHOTOFACT Aids FREE at your parts jobber—or write us direct.

### WITH EXCLUSIVE NEW “Standard Notation” SCHEMATICS

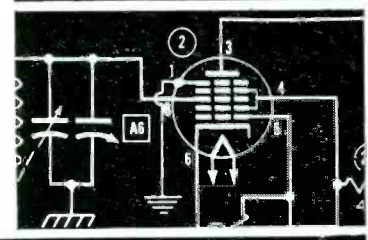

### NEW! Howard W. Sams DIAL CORD STRINGING GUIDE



There's only one right way to string a dial cord. And there's only one book that shows you how. It's the Howard W. Sams DIAL CORD STRINGING GUIDE. Here, for the first time, in one handy pocket-sized book, are all available dial cord diagrams and data covering 1938 through 1946 receivers. Licks the knottiest dial cord problem in a matter of minutes. This low-cost book is a “must” for servicing. You'll want two copies—one for your tool kit and one for your shop bench. Order them today. ONLY **75c**

### BOOST YOUR EARNING POWER!

- Mail This Order Form to Your Parts Jobber Today** or send directly to HOWARD W. SAMS & CO., INC., 2924 E. Washington St., Indianapolis 6, Ind.
- My (check) (money order) for \$..... enclosed
- Send SAMS' 1947 AUTOMATIC RECORD CHANGER MANUAL(S) at \$4.95 per copy.
  - Send PHOTOFACT Set No. 23.  No. 24.  No. 25 (at \$1.50 per Set).
  - Send SAMS' DIAL CORD STRINGING GUIDE(S), at \$0.75 per copy.
  - Send PHOTOFACT Volume 1 (including Sets Nos. 1 through 10) in Deluxe Binder, \$18.39.
  - Send PHOTOFACT Volume No. 2 (including Sets Nos. 11 through 20) in Deluxe Binder, \$18.39
  - Send FREE PHOTOFACT Aids.

Name.....  
 Address.....  
 City..... State.....

**HOWARD W. SAMS & CO., INC.**  
 INDIANAPOLIS 6, INDIANA

Export—Ad. Auriema—89 Broad St., New York 4, N. Y.—U. S. of America  
 Canada—A. C. Simmonds & Sons, 301 King St., East—Toronto, Ontario.

## PHOTOFACT SERVICE

“The Service that pays for itself over and over again!”

# SYLVANIA NEWS

## RADIO SERVICE EDITION

OCT. Prepared by SYLVANIA ELECTRIC PRODUCTS INC., Emporium, Pa. 1947

**ONLY \$139.50**  
(F.O.B. Grand Rapids, Mich.)

**BUYS THE BIG SYLVANIA  
TEST BENCH YOU'VE WAITED FOR!**

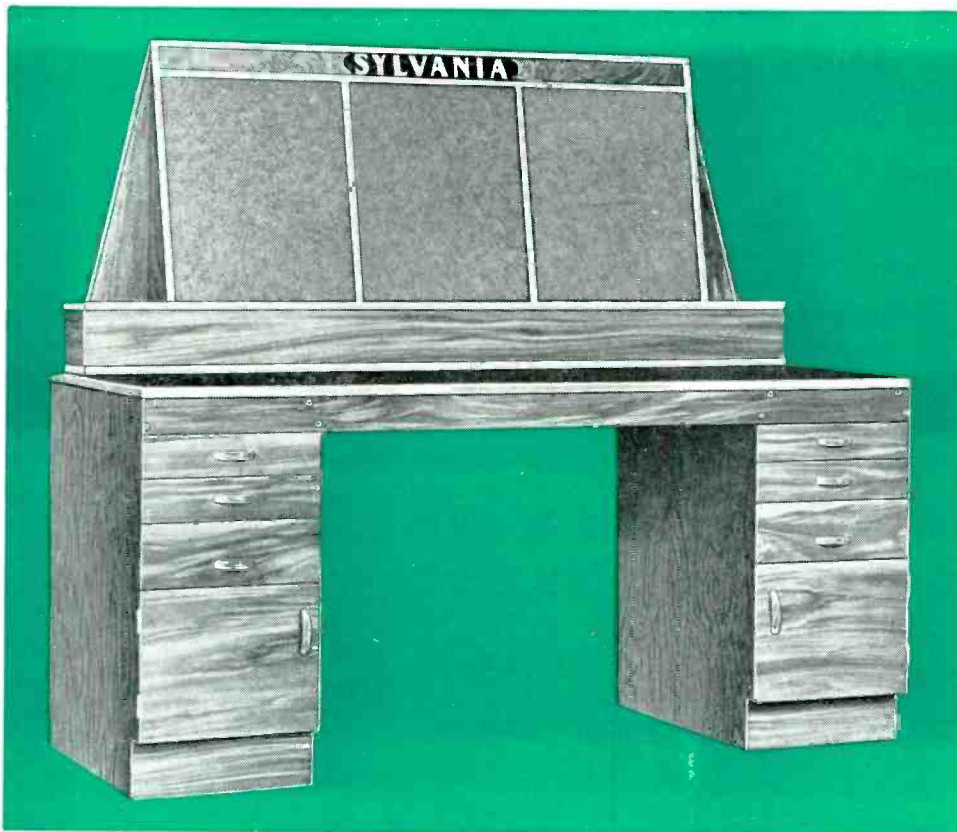

Don't wait another minute! Get on that phone and tell your Sylvania Distributor that you want this swell, new radio test bench—*pronto!* It's the kind of useful, sturdy piece of equipment you've been waiting for.

IT'S BIG! 7 feet long x 32 inches deep...69 $\frac{3}{4}$  inches high! 36 $\frac{3}{4}$  inches from floor to working surface. (Shipping weight is 310 pounds.) Ample knee space! Ample toe space... (note recessed feature at each end). Gumwood front... plywood sides! Bench surface hard, tough linoleum. Six big drawers—two large storage compartments!

Ask your Sylvania distributor for complete details about this modern, impressive test bench. *Sylvania Electric Products Inc., Radio Division, Emporium, Pa.*

COMPLETE PREFABRICATED PARTS  
COME READY TO ASSEMBLE



RECESSED BASES  
FOR CLOSE WORK



ALL METAL  
HARDWARE

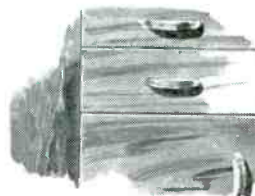

STRONG WOOD AND  
MASONITE CONSTRUCTION

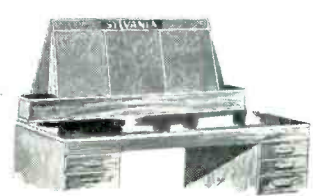

**SOLD ONLY THROUGH YOUR SYLVANIA DISTRIBUTOR!**

# SYLVANIA ELECTRIC

MAKERS OF RADIO TUBES; CATHODE RAY TUBES; ELECTRONIC DEVICES; FLUORESCENT LAMPS; FIXTURES; WIRING DEVICES; ELECTRIC LIGHT BULBS

# EDITORIAL

## The Outlook is Great!

To elucidate why, first we quote the RMA figures on radio set production for the first 8 months of this year: radio sets made—FM-AM types 588,226; television models 68,669; all other types 11,031,935. So, for the full year 1947 set production should approximate: FM-AM types 890,000; television models 118,000; auto radios 4,800,000; battery (farm) radios 260,000; all other types 8,427,000 for a grand total of all types 14,495,000.

Approximately 63 million sets of all types are now in use. Of these it's known that 50% are now over 7 years old. While the bulk of these old radios can be considered "obsolete" merely because of their age, experience proves that the owners intend to keep the great majority of them in operable condition for at least 3 more years.

Parts Jobbers' records show that a select group of only 20 thousand Service Dealer establishments account for over 93% of all radio repair work done in the U.S.A. annually. (We are proud to state that surveys show that over 18 thousand of the select 20 top-notchers subscribe to "RSD"). So, projected mathematically for our subscribers, it follows that each leading Service Dealer can reasonably anticipate getting an average of 5,170 repair jobs a year, each year, for the next 3 years on sets that now are over 7 years old.

What about the service potential on the 30 million radio sets that have been made and sold since war ended? Recently, while discussing this angle with Howard W. Sams, publisher of Sams "Photofact Service," (complete schematics and trouble-shooting data on all postwar radios, etc.), we learned that commencing in the Summer of 1947 an appreciable volume of postwar made sets started to show up on Service Dealer repair benches. Before the war it was axiomatic in the trade that "A new set will either break down and need repairs in the first 5 weeks of use or it won't need servicing for 5 years."

Note how times have changed! Already, in less than 26 months since war ended there are several million postwar-made radio sets—especially those produced by "Johnny Comelatelies"—and which sold at outrageous prices—are on the verge of requiring servicing. (Are you familiar with all those motley and mongrel circuits?) So, summarized, the average well-established Service Dealer can contemplate many excellent seasons ahead—servicing the bulk of the 60 million pre and postwar sets now in use; selling and installing the several million avidly wanted FM and television receivers; and in selling good standard brands of receivers for which there will always be a demand. In addition, the allied fields to radio selling and servicing, such as handling PA and sound, industrial electronic maintenance and electrical appliance repairing all add up to a Great Outlook.

S. R. COWAN, *Publisher*



Member of the  
Audit Bureau of  
Circulations



VOL.  
8  
NO.  
10

**SANFORD R. COWAN**

*Editor & Publisher*

OCTOBER, 1947

Editorial .....	3
In & Around The Trade .....	6
Adding Record-Players Modernizes Old Receivers, by Albert Loisch	13
Circuit revisions for sets having no phone jacks	
P-A Fundamentals & Complexities, by C. A. Tuthill .....	14
Heretofore unpublished data on tough P-A jobs	
Modern Television Kits, by S. L. Marshall .....	18
A course in television set service procedure	
Technical Quiz No. 3 .....	22
Check your knowledge of amplifiers and sound equipment	
Get Yourself Free Publicity, by Dan Valentine .....	23
A subject you will admit is timely	
Circuit Court .....	24
Thordarson t-31W50 Amplifier; Packard-Philco Model P-4635; Hoffman Model B-1000	
New Products .....	26
Book Reviews .....	28

SANFORD L. CAHN  
National Advertising Sales Manager

HARRY N. REIZES  
Advertising Manager

BRANCH: JAMES C. GALLOWAY, 816 W. 5th St., Los Angeles 13, Calif.  
Mutual 8335

Jean M. Wheeler  
Circulation Manager

David Saltman  
Adv. Production Manager

RADIO SERVICE DEALER (title registered U. S. Pat. Off.) is published monthly at 28 Renne Ave., Pittsfield, Mass. by the Cowan Publishing Corp. Executive & Editorial Offices, 342 Madison Avenue, New York City 17, New York. Subscription rates:—United States, U. S. Possessions and Canada, \$2.00 for 1 year, \$3.00 for 2 years; elsewhere \$3.00 per year. Single copies: 25c. Printed in U. S. A. Entered as Second Class Matter at the Post Office at Pittsfield, Mass., under the Act of March 3, 1879. All subscribers should allow at least three weeks for change of address. Copyright, 1947, by Cowan Publishing Corp.

# STANCOR

*really has something*

**to meet your servicing needs**



## POWER PACK ••• Model 752

**CONTINUOUS OUTPUT RATING**—6 Volts @ 12.5 Amperes D.C.—5% max. ripple at full load.

**INTERMITTENT OUTPUT RATING**—25.0 Amperes D.C. For use with push-button or floor-switch magnetic tuning of all popular car radio receivers.

**CONTINUOUS VOLTAGE CHECK**—Built-in voltmeter for visual checking of output voltage.

**ADJUSTABLE VOLTAGE CONTROL**—Tap switch provides selection of proper output voltage for various loads.

**CONSERVATIVE RATING**—Built with heavy duty components throughout.

**HIGH OVERLOAD CAPACITY**—Low internal resistance—good voltage regulation provide high output current capability for intermittent loads.

**CONTROL PANEL**—Readily accessible at front of case.

**STURDY STEEL CASE**—Featuring mechanical strength—neat appearance.

### FOR DEMONSTRATING AND SERVICING

AUTO RADIOS AND OTHER AUTO ACCESSORIES

BATTERY CHARGING

OPERATING RELAYS AND SOLENOIDS

REPLACING STORAGE BATTERIES

LABORATORY TESTING

BRUSH PLATING

*ask your jobber for the* STANCOR 752

**STANDARD TRANSFORMER CORPORATION**  
ELSTON, KEDZIE AND ADDISON • CHICAGO, ILLINOIS



# THE NEW Bendix Facto-Meter

OPENS THE DOOR TO GREATER FM SALES

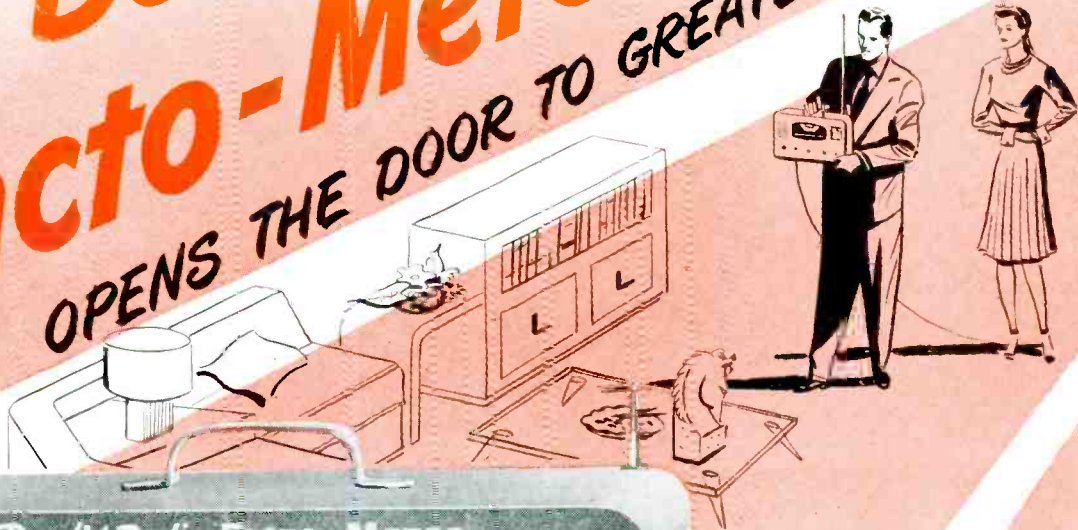
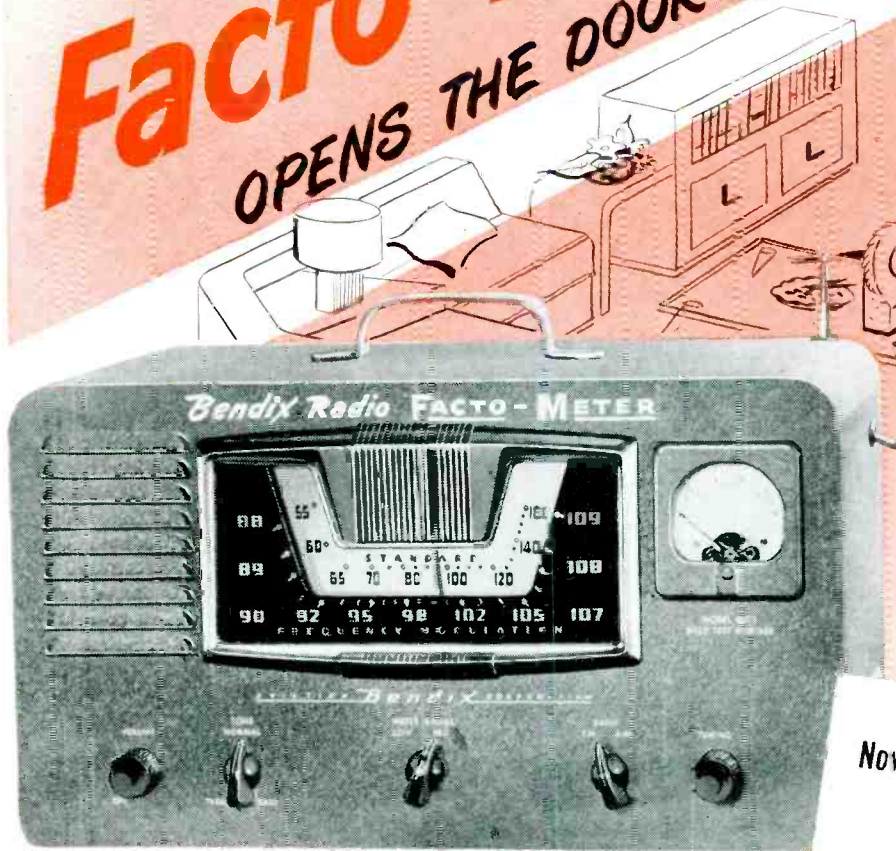

## EXPLAINS FM! . . . SELLS FM!

Now you can demonstrate clearly the vast difference in FM reception—right in the prospect's home! The Facto-Meter provides both AM and FM reception enabling the listener to make a direct comparison. Furthermore, you can show where the FM set should be installed for maximum power and efficiency—often making possible the elimination of an expensive antenna installation. Here's the ideal way to *Sell* FM by *Showing* FM! See it at your nearest Bendix Radio Distributor!

AVAILABLE TO ALL RADIO DEALERS EVERYWHERE FROM BENDIX DISTRIBUTORS . . . COMPLETE WITH SPECIAL COVER, FM MERCHANDISING KIT AND SELLING AIDS.

Now You Can Show Your Prospects  
IN THEIR OWN HOME . . .

1. Why they ought to have FM radio!
2. How it sounds right in their own home!
3. Whether they need an aerial!
4. Where to place the FM set for maximum range and reception!



BENDIX RADIO DIVISION of  
BALTIMORE 4, MARYLAND



# In & Around the Trade

Being a condensed digest of production, distribution and merchandising activities in the radio and appliance trade.

## FM's Steady Progress

Over 3,000 AM and FM radio broadcasting stations will be in operation in the United States by the end of 1948. Sol Taishoff, Publisher of *Broadcasting Magazine* predicted in an address before the Graybar-Western Electric Sales Conference on Sept. 8th.

## RCA Introduces "Sally Service"

"Sally Service," one of America's most beautiful models makes her bow for the RCA Tube Department's Renewal Sales Section in a new poster series designed for window and store display, according to Julius Haber, Tube Department Advertising Manager.



"Sally" appears on the four-color, stiff-board posters, which measure 21" high, advertising "reliable radio repairs," and one of the three-well-known brands of RCA Radiotron, Cunningham, or RCA Victor electron Tubes. In real life, "Sally Service," operates under the nom de trade of "Heidi" in the modeling industry.

## New Mallory Reps

Walter E. Harvey, Manager of the Wholesale Division, P. R. Mallory & Co. Inc., Indianapolis, Ind., announces the appointment of two new representatives to cover sales territories in Southern States.

Grady Duckett, Atlanta, Ga., will serve Mallory distributors in North Carolina, South Carolina, Georgia and Florida. Porter Holland, Dallas, Tex., has been assigned the territory including Texas, Oklahoma and Louisiana.

## Television Shown in Canada

More than 75,000 people saw television for their first time when RCA Victor mobile equipment was brought to the Canadian National Exhibition at Toronto August 22 through September 6 under joint auspices of the Exhibition and RCA Victor, Ltd. Crowds waiting to see the new entertainment

medium were so large that the television crews were required to present continuous programming from 10 a.m. to 10:30 p.m. throughout their stay there.

## Stewart-Warner's 1948 Line

Radios styled to meet popular home furnishing requirements were shown on Sept. 18th to distributors who handle the Stewart-Warner line.

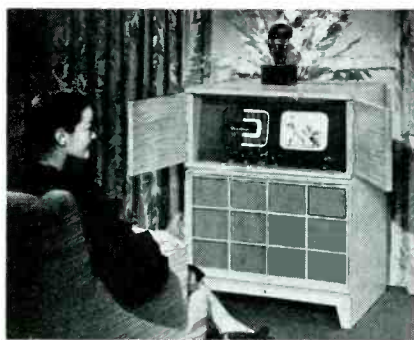

S-W "Videorama"- FM, Radio Combo

Among the models presented were the Interpreter, a radio-phonograph console in blond or mahogany finish styled to match modern furniture designs; a radio-phonograph for use with period furniture; the economical New Minstrel console and the compact Country Gentlemen table model battery set. The new models are available for immediate delivery.

The combination models have record players, which handle ten 12-inch or twelve 10-inch records or ten of both intermixed and which shut off automatically when the last record is played. They feature the electro-hush reproducer which eliminates needle noise and automatically retracts the needle point if dropped or pushed down on a record, thus preventing damage to records and assuring longer needle life.

In addition to the combination models, all in the moderate price bracket, a Stewart-Warner combination television, AM-radio and record player console was shown and two plastic table model AM-FM sets and a portable set were presented.

## NAB Sees Large Screen Television

An inter-city television network employing the largest chain of microwave relays ever used for the purpose carried daily television programs over a distance of two hundred miles for demonstrations of large-screen projection television for broadcasters attending the

annual convention of the National Association of Broadcasters at Atlantic City, N. J.

The demonstrations, presenting bright, clear pictures 6 by 8 feet in size were presented cooperatively by the American Broadcasting Co., the National Broadcasting Co., their affiliates WFIL-TV and WPTZ, and the RCA Victor Division of the Radio Corp. of America. ABC and NBC supplied the television programs and RCA the equipment.

Six relay units were used to beam the programs from the WNBT Station atop the Empire State Building, to Atlantic City. The signals were beamed from New York to the Philco relay point at Mt. Rose, N. J., to the Philco tower at Wyndmoor, Pa., to the RCA relay atop the Lincoln Liberty Building, Philadelphia, to special RCA relays installed at Blue Anchor and Batsto, N. J., and thence to Atlantic City.

Program material on the demonstration schedule included a water carnival, highlights of the Mineola State Fair on Long Island, baseball, football, horse racing, and tennis programs. Reception was fine and met with acclaim from all who witnessed it.

## New Rider Books

"FM Transmission and Reception" and the "Broadcast Operator's Handbook," books now being printed by John F. Rider of 404 Fourth Ave., New York 16, N. Y. will be available in late October. The "FM Transmission and Reception" book will embrace all the manufacturers' products in transmitters and full coverage of receivers. Wide-band, medium-band and narrow-band equipment will be thoroughly discussed, including regular broadcasting, "ham" and police equipment, etc. The book will present pictorial representations of FM as well as phase modulation, with the fundamental theory simplified. It will be a basic and complete analysis of FM transmission in general and will discuss all FM transmitters on the market, including "ham" equipment.

Sections will be given over to transmitting and receiving antennas, as well as all types and latest developments in detector circuits of FM. Special emphasis will be given to servicing the FM receiver and chapters will be given over to alignment and servicing problems.

"Broadcast Operator's Handbook" is intended for the broadcast station operator and for all persons studying this branch of electronics.

## Air King Appoints Cartwright

J. J. Clune, Merchandise Manager, Air King Products Co., Inc., Brooklyn, New York, manufacturer of Air King Radios has announced the appointment of J. M. Cartwright & Sons of Memphis Tennessee and Atlanta, Georgia, as





BUY RAYTHEON TUBES!



*Excellence in Electronics*

- RADIO RECEIVING TUBES
- SPECIAL PURPOSE TUBES
- TRANSMITTING TUBES
- HEARING AID TUBES

*Designed to give years of service*

*Plenty of Distributors to assure you service*

*Essential to perfect radio service*

**RAYTHEON MANUFACTURING COMPANY**  
 RADIO RECEIVING TUBE DIVISION  
 NEWTON, MASSACHUSETTS      CHICAGO, ILLINOIS

# FIVE POPULAR ASTATIC PICKUPS

Are now Available  
with the New  
"QT" CARTRIDGE



QT-508

QT-510

FP-QT

QT-400

HP-QT

## For Home or Studio TONE ARM REPLACEMENTS

The "QT" Cartridge, now famous for its rare beauty of tone reproduction and freedom from annoying needle scratch is, because of popular demand, being supplied in the five Astatic Low Pressure Pickups illustrated above. The specially designed needle with which the "QT" Cartridge is equipped is replaceable and is available with sapphire or precious metal playing tip.

Pickup Models QT-508, QT-510 and FP-QT, with standard mounting centers, may be used for reproduction of 10" and 12" Records. Transcription Models QT-400 and HP-QT may be used for reproduction of all lateral transcriptions. Needle pressure with all models is but one ounce.

See your local  
Radio Parts Jobber  
or write direct  
for Literature

**THE Astatic CORPORATION**  
ASTATIC  
IN CANADA CANADIAN ASTATIC LTD. TORONTO ONTARIO  
Astatic Crystal Devices Manufactured  
under Brush Development Co. patents

Sales Representatives for the states of Tennessee, Alabama, Mississippi, Arkansas, Louisiana, Florida, Georgia, South Carolina, North Carolina and Virginia.

### Micamold To Job Line Again

Micamold Radio Corp., Brooklyn, N. Y. has established a new Jobber Sales Division to supply the trade with a complete line of fixed capacitors for resale.

The appointment of William E. Boyce as Sales Manager of the division was announced by Mr. Edmond B. Tyler, General Sales Manager of Micamold. A catalogue is now available free and the new division is being supported by a series of ads in leading radio and service publications.

### Mallory Gets "Oscar"

The 1946 annual report of P. R. Mallory and Company was judged as the best of the Electronics and Radio industry in the final considerations of the Independent Board of Judges in the Financial World Annual Report Survey. The bronze "Oscar of Industry" trophy was formally presented to P. R. Mallory, Company Board Chairman, at the Annual Report Awards Banquet by Weston Smith in the Grand Ballroom of the Hotel Pennsylvania in New York on Friday, October 10th. In this industrial classification, Radio Corporation of America was runner-up for the "Best of Industry" award, while Stromberg-Carlson Company came in third.

### UST Drops Teleset Prices

Due to greater mass production and the absorption of development costs by heavy sales throughout the nation, price reductions up to \$480 have been announced for United States Television receivers. The lowered prices are now in effect.

All price changes concerned the bigscreen projection television models which sold around the two thousand dollar mark. The sets have screens up to 30 by 22½ inches and have proved to be great crowd-pleasers in public places such as taverns, hotels, restaurants, hospitals and clubs.

The greatest price drop, \$480, was on UST's home projection television console which includes FM and AM radio as well as two short wave bands and automatic record-changing phonograph. This model, which has a 21 by 16-inch screen, previously sold for \$2,275 and is now listed at \$1,795.

### Motorola Wins Fair Prize

Motorola car radio was acclaimed the "best made" automobile radio by popular vote of thousands of visitors at the Great Commercial and Industrial Fair held in Havana, Cuba recently.

People from all walks of life, inspected and heard many makes and models of

[Continued on page 28]

# Caught in a Tidal Wave of Batteries?

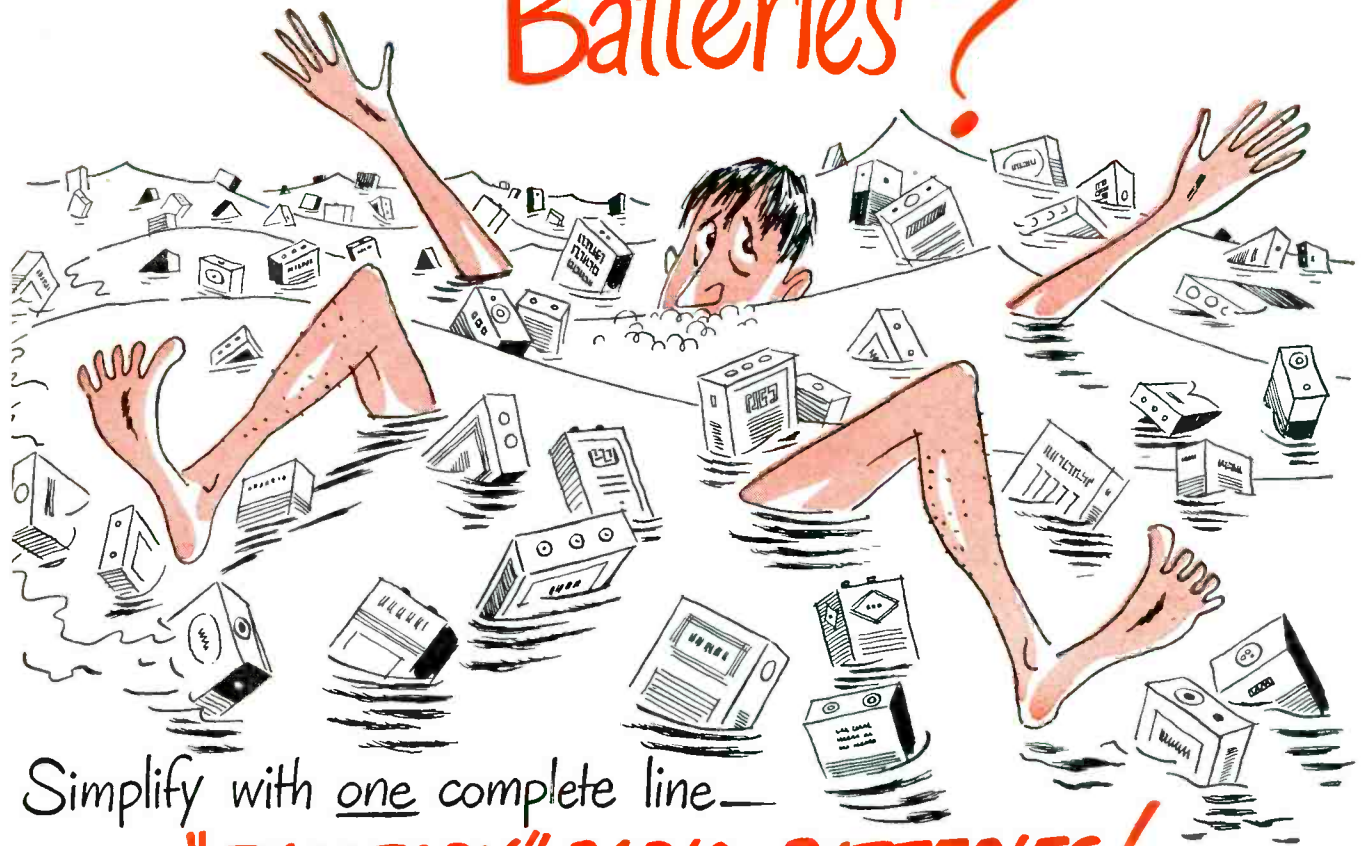

Simplify with one complete line—

## "EVEREADY" RADIO BATTERIES!

**I**F YOU feel you're being swamped by shelves full of odd brands, war babies, and newcomers to the radio-battery field, here's a life preserver for you: "Eveready" radio batteries will fit virtually *all* makes of sets. They're a *standard value* from coast to coast... you don't have to *turn on the heat* to sell them. Instead, you can set them out before your customers and say, "This is IT!"

*The registered trade-marks "Eveready" and "Mini-Max" distinguish products of National Carbon Company, Inc.*

And the customers **KNOW** it!

Why waste time, and money, and valuable shelf space with slow-moving odd-brand batteries? Sell the batteries that *sell themselves*; and remember, "Eveready" "Mini-Max" batteries outlast any other "B" batteries of comparable size.

They're available in quantity **NOW**. And you don't have to buy anything else to get them!



**NATIONAL CARBON COMPANY, INC.**  
30 East 42nd Street, New York 17, N. Y.  
Unit of Union Carbide and Carbon Corporation



**Go to a Radio Manufacturer for Radios — a Battery Manufacturer for Batteries!**

# Over 90% OF NEW MOBILE TRANSMITTER DESIGNS USE **HYTRON**

## THE ORIGINAL INSTANT-HEATING TUBE

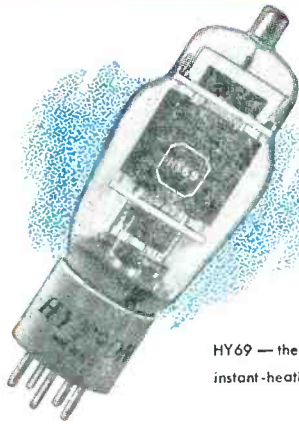

HY69 — the original instant-heating tube.

Because they fill a real need for conserving filament power, Hytron instant-heating tubes are in. Yes, the 2E25, 2E30, HY69, HY1269, and 5516 are in the new mobile transmitter designs of many famous friends—too many to thank in this small space. The 2E25 and 2E30 also appear on the Army-Navy Preferred List. Why so popular? With no standby current, battery drain can be cut to 4% of that with cathode types—attainable power output and range increase. Potentials of rugged filaments are centered for battery operation. Beam pentode versatility simplifies the spares problem—one type can power all stages. To you the distributor, the overwhelming popularity of Hytron instant-heating tubes means more profits. Make sure you get them by maintaining adequate replacement stocks.

**BENDIX RADIO**



Bendix MRT-3A, 152-162 mc f-m taxicab transmitter uses 2E30's generously.

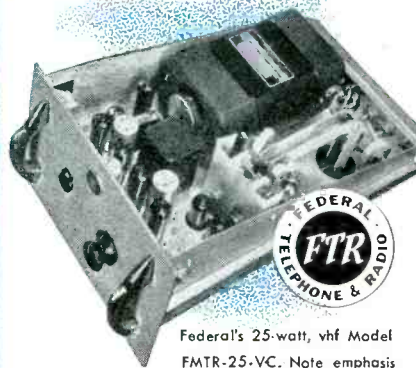

Federal's 25-watt, vhf Model FMR-25-VC. Note emphasis on 2E30 and 5516.



Harvey Laboratories chose 2E30's, 5516's for its Model 542 f-m transmitter.



Jefferson-Travis Model 351, 35-watt marine radio-telephone employs HY69's.

**K A A R ENGINEERING CO.**

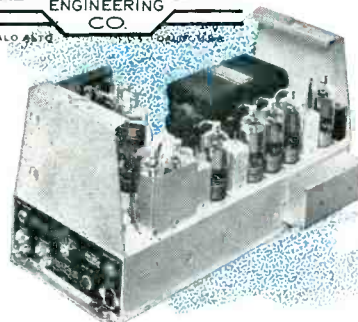

Kaar FM-50X features 2E25, HY69 throughout. Hytron instant-heating tubes since 1939.

**Motorola**

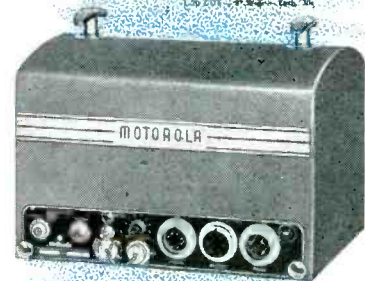

5516's power both driver-doubler and final of Motorola's Model FMTRU-30D.

WRITE FOR FREE NEW DATA SHEETS:  
2E25, 2E30, HY69, HY1269, 5516.

SPECIALISTS IN RADIO RECEIVING TUBES SINCE 1921

**HYTRON**  
RADIO AND ELECTRONICS CORP.



MAIN OFFICE: SALEM, MASSACHUSETTS

RADIO SERVICE DEALER ♦ OCTOBER, 1947

**READY**  
For immediate delivery

# AIR KING WIRE RECORDER

and RADIO-PHONO COMBINATION

## AIR KING OPENS AN EXCITING NEW FIELD IN HOME ENTERTAINMENT.

Air King was the first radio manufacturer to successfully combine the Wire Recorder, Radio and Phonograph into a smooth functioning, foolproof, home entertainment unit that even a child can operate. Another out-growth of Air King's Engineering "Know-How".

Consumer acceptance of the Wire Recorder, in combination with a radio phonograph at no extra cost has been sensational! It has proven itself in thousands of American homes and is considered by top merchandisers to be the hottest item of the year.

Smart dealers will insist upon the Wire Recorder in all future radio-phonograph combinations.

**FIRST AID PROGRAM for HEALTHY BUSINESS**  
Air King places its Advertising and Sales Promotion Department at your disposal. Write today for information on our First Aid Program to help you promote the Air King line in your community. A new idea in manufacturer dealer cooperation.

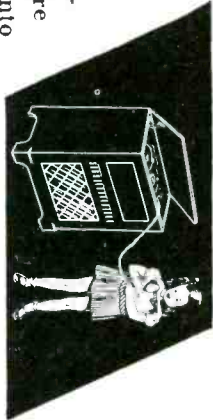

Records your voice, Disc Records or Radio Programs, simple, finger-tip controls.



The music lovers' dream comes true. Amazing high fidelity noise free recordings.

It's a Radio, Phonograph and Wire Recorder all in one!



One hour of recording on a small spool of wire. Replay or erase for new recording.

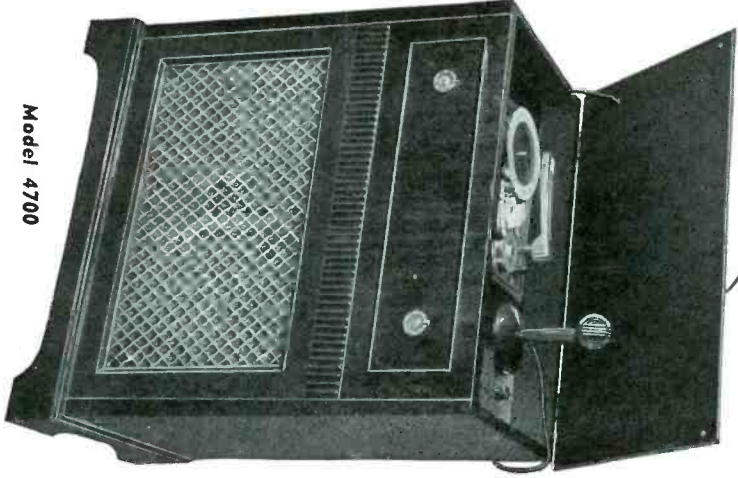

Model 4700

### FEATURES YOU CAN SELL!

- Records Voice on Wire, through Microphone.
- Records Phonograph Records on Wire.
- Records Radio Broadcasts on Wire.
- Powerful Super-Sensitive Radio.
- High Quality Phonograph.
- Amazing Air King "Wiretone" Reproduction.

★ WE HAVE A LIMITED NUMBER OF DISTRIBUTOR AND DEALER TERRITORIES OPEN. Write or wire (New Address): Air King Products Co., Inc., 170 53rd Street, Brooklyn 32, N. Y. Export Address: Air King International, 75 West Street, New York 6, N. Y.

*The Specialty of Radio Since 1920*  
**AIR KING RADIO.**  
Division of HYTRON RADIO & ELECTRONICS CORP.

# Here's Why Your Antenna Installations Will Give

## LONGER-LASTING PERFORMANCE

with Federal's



### H-F Transmission Lines

1. Their unusually low attenuation losses assure the most efficient transfer of energy between antenna and receiver or transmitter.
2. Their uniformity and permanence of characteristics permit peak receiver performance, without annoying distortion from locally-induced interference.
3. Their flexibility and outstanding resistance to weathering, moisture and abrasion contribute to years of trouble-free service.

IN THE FIVE ITEMS listed here, there's a high-frequency cable for practically every antenna application. The K-1128 75-ohm line, for transmitter use—the K-1079 and K-1046 lines for general FM and Television service. The smooth oval cross-section of these 75, 100, and 300-ohm lines prevents the accumulation of foreign matter, thereby maintaining stable capacity characteristics. The K-32 and KT-51 coaxial cables offer peak performance for applications where locally-induced interference is severe.

For complete information and prices on these cables, see your local distributor. For other high-frequency cables—write to Federal, Dept. D185.

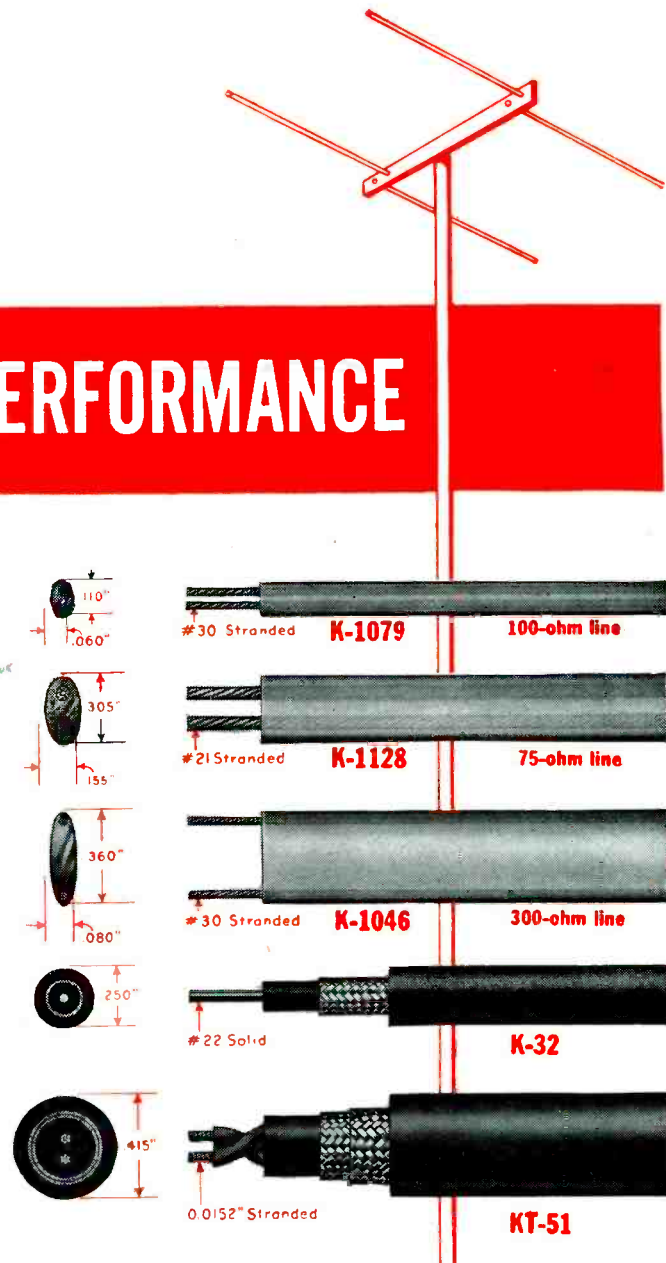

Type Number	Characteristic Impedance Ohms	Velocity of Propagation (in percent)	Capacitance Per Ft. mmf	Attenuation, Db per 100 Ft. Frequency in Megacycles				
				1.0	1.7	30	100	300
K-1079	100	71	15.5	.6	.75	2.8	5.2	8.8
K-1128	75	71	19.5	.3	.4	2.0	4.0	7.3
K-1046	300	81	4.0	.38	.57	.85	2.0	—
K-32	73	66	22	—	—	2.0	3.3	7.0
KT-51	95	56	16	—	—	1.8	3.8	7.5

\*Reg. U. S. Pat. Off



KEEPING FEDERAL YEARS AHEAD... is IT&T's world-wide research and engineering organization, of which the Federal Telecommunication Laboratories, Nutley, N. J., is a unit.

## Federal Telephone and Radio Corporation

100 KINGSLAND ROAD, CLIFTON, NEW JERSEY

In Canada: — Federal Electric Manufacturing Company, Ltd., Montreal.  
Export Distributors: — International Standard Electric Corp., 67 Broad St., N. Y. C.

# ADDING RECORD-PLAYERS

## Modernizes Old Receivers

**T**HE majority of the better class of radio receivers sold today have provisions, usually a jack at the rear of the chassis, for the connection of a phonograph pickup. In converting these sets for record-playing, the problems are comparatively simple. It is only necessary to add the record player or a turntable and plug in the pickup.

The small, inexpensive sets, on the other hand, often tax the ingenuity of the serviceman to the utmost because almost every type of circuit, from the regenerative to the superheterodyne is encountered, each with its own individual problems to be solved.

As the service difficulties are not greatly different from those ordinarily encountered when making original installations, this article will deal with installation problems.

The first step is to decide which part of the radio receiver circuit is the best and most logical one to which to connect the pickup. In the average small set with only one audio stage following the second detector, the gain is usually too low for satisfactory volume. So, in cases of this kind, it is best to place the pickup in the input circuit of the second detector itself, which means that the "radio-phonograph" switch must be arranged to remove the high bias as well as the

**Millions of homes having table model or midget radios are prospects for record-players. Selling the attachments is easy. Installing them will be no problem after you have read this article.**

by **ALBERT LOISCH**

radio signal from the detector grid and to cut in a resistor of the proper value.

### Connecting to Detector

Care should be exercised when connecting a pickup to an average detector because the signal if fed into the highly biased detector, will be distorted.

Several typical circuit arrangements for feeding the pickup voltage to the detectors commonly employed will be considered. *Fig. 1* shows how the connection is made to a detector tube, using the grid-bias method of detection.

It will be noticed that two separate bias resistors are used to obtain the proper operating conditions for either phonograph or radio reproduction. When the DPDT switch is thrown to the "R" (radio) position, the pickup is disconnected and the secondary of the i-f transformer is connected to the grid

of the tube as shown. As illustrated, the low bias resistor *R2* is simultaneously cut out of the circuit and the high bias resistor *R1* is connected to the cathode.

The circuit conditions when the switch is placed in the phonograph ("P") position are obvious from an examination of the schematic. The electrolytic condenser *C1* should be connected to the switch arm as shown and not across either of the resistors. If placed across the resistor, it will be necessary to use two separate condensers (or a dual) in order that the proper by-passing will take place in each position of the switch. The value of the low bias resistor *R2* may be calculated by dividing the bias voltage desired by the plate current of the tube. Thus, if 25 volts of bias is desired, and the plate current is 30 milliamperes when the bias is applied, then the value of *R2* will be 25 v. divided by 0.030 amps or 833 ohms. If the tube has a screen or other grids drawing current, these currents must be added to that of the plate circuit before making the calculation.

Most of the modern superhet receivers employ duplex-diode triode or duplex-diode pentode tubes as second detector, AVC and audio amplifiers. Connection to many of these circuits is quite simple. A typical circuit is illustrated in *Fig. 2*.

### Controlling Oscillation

When feeding the pickup voltage to this type of circuit care must be exercised to keep the leads from the grid to the volume control and switch as short

[Continued on page 38]

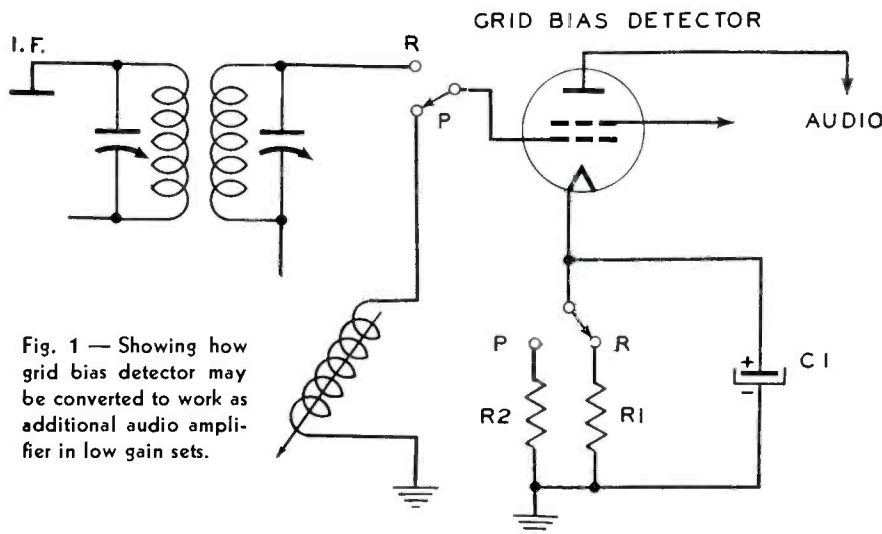
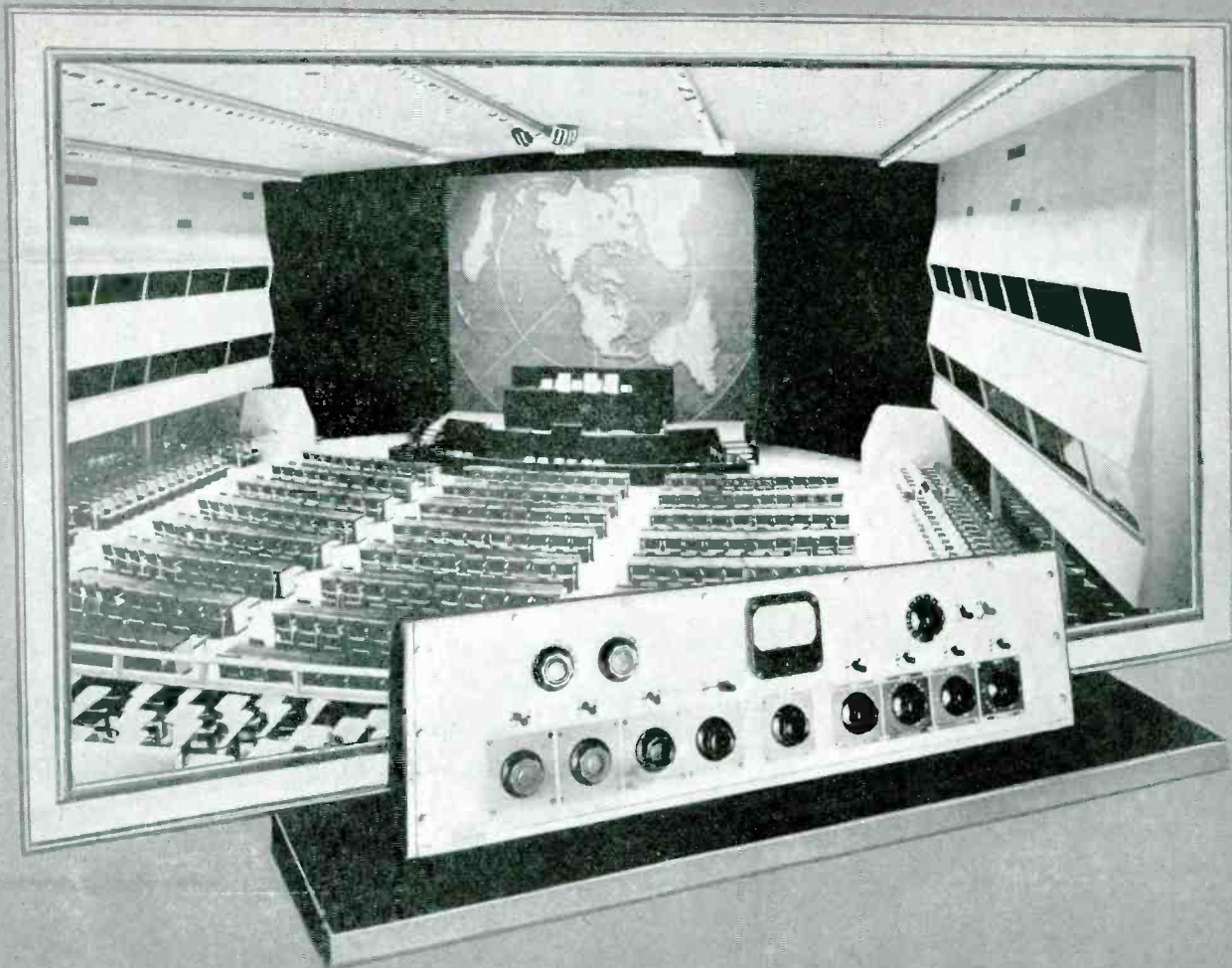

Fig. 1 — Showing how grid bias detector may be converted to work as additional audio amplifier in low gain sets.



**F**ROM the blaring horns of Madison Square Garden to the feeble chirps of the private office calling systems, the public-address or sound engineer runs his gamut. Some of them deserve citation for serving the public well. Others throw the stuff at 'em.

In the hope that this article may prove in some way helpful, our pen will be pushed through the simpler installations forward until we deal with probably the greatest public-address installation anywhere today,—the complex facilities at the United Nations. In addition to their fifty-five nation conference rooms and their huge General Assembly auditorium on the old World's Fair site at Flushing Meadows, New York, the United Nations activities call for constant voice re-enforcement in two large council chambers, four huge and several medium-sized conference rooms at Lake Success, New York.

There, six basic audio channels, apart from many auxiliaries, require a normal complement of approximately 200 microphones and 215 loudspeakers. This excludes their several radio studios, smaller conference rooms, and the simultaneous interpretation system and its vast ramification. It also excludes the General Assembly room.

Getting right down to cases, in this article we confine our treatment to the basic job,—projection of speech. There are four prime considerations which con-

# P-A FUNDAMENTALS

by C. A. TUTHILL

cern the sound engineer as he goes about his chores. They are:

- 1) *Equipment*—selection of a good, efficient, dependable grade; installation well thought out in advance of purchase.
- 2) *Pickup*—rugged uni-directional microphones; multiple inputs accommodating at least two microphones and two music turntables even in smaller and portable units.
- 3) *Acoustics*—never to be neglected where corrective treatment is possible.
- 4) *Projection*—efficient undistorted transmission to speakers spotted for best coverage and best appearance.

## EQUIPMENT

It pays to spend a few more dollars for better-grade, reliable equipment. It not only will serve longer at a lower maintenance cost but also it will endure the rougher handling always meted out to portable equipment.

Perhaps the strongest argument for better-grade equipment stems from the engineering side. First, it must be able to reproduce music with good fidelity.

This means a reasonable spread through the frequency spectrum. Most modern amplifiers do this but not necessarily without overmuch distortion. Their upper and lower capabilities should be checked. Presently owned equipment can be modified if out-moded. Second, and even more important, the main or final amplifier must be capable of sufficient undistorted wattage to drive horns more than enough for mere auditorium coverage. Excess power will win for you in two ways.

It will provide increased power for out-of-door calls while it will net you clean undistorted indoor projection well beneath the overload point. The writer cannot recommend specific units. Each job of installation presents its own individual requirements.

Portable indoor equipment, more frequently serving smaller assignments, can lean for its success upon the good-judgment gleaned from experience and the physical layouts discussed herein. Permanent installations require and deserve thoughtful, practical engineering.

Before one item is purchased, *the en-*



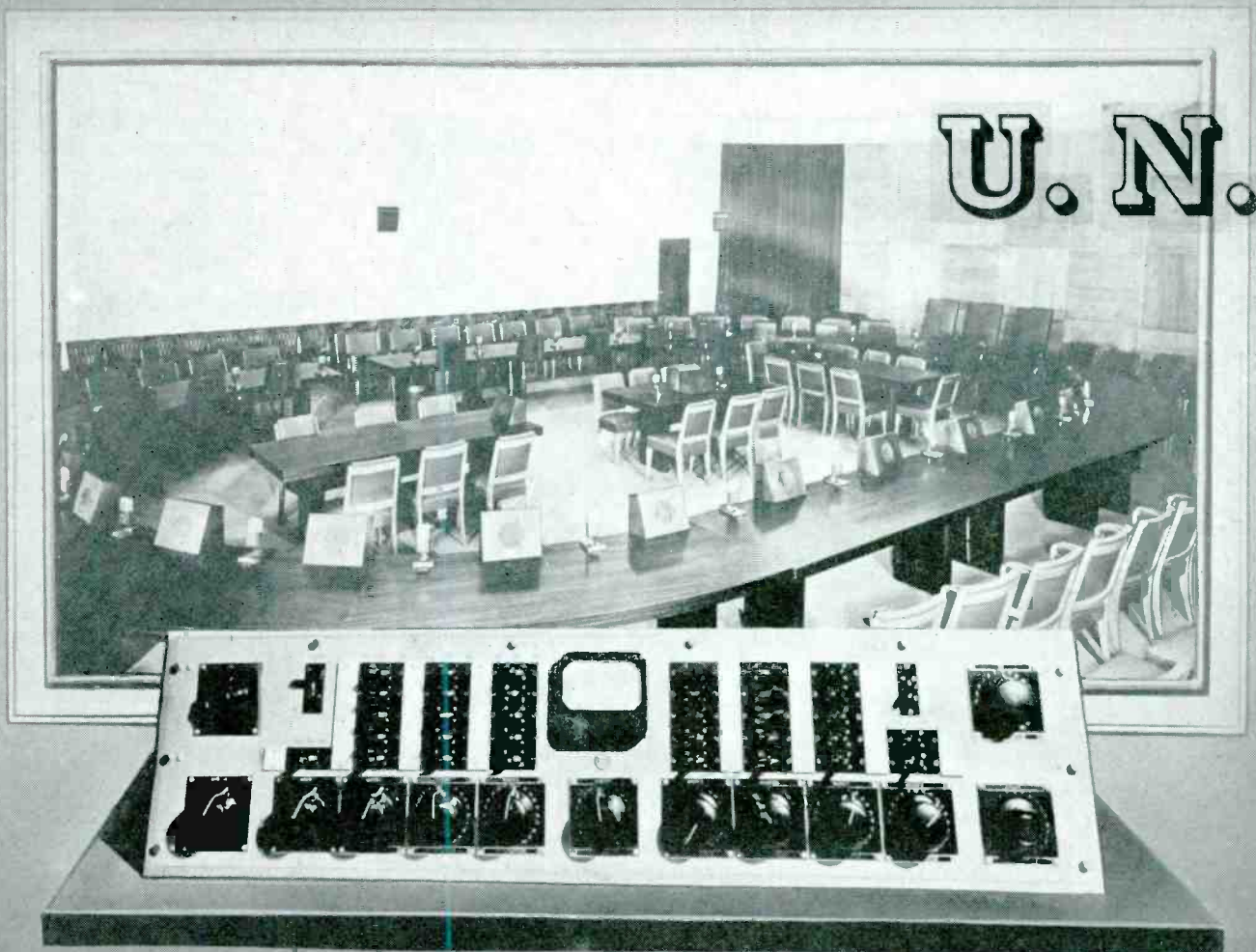

U. N.

## & COMPLEXITIES

Showing the intricate Sound Distribution system used at Lake Success by the United Nations.

*tire fundamental installation should be laid out on paper.* The most practical approach will not only be governed by the size and requirements of the job but also by the materials on hand which may be incorporated. For instance, if it is desired that different types of loudspeakers, now lying in stock, be used, the feasibility of this from an economic view will have to be figured out.

### HORNS & SPEAKERS

The physical placement of horns will have to be decided upon. A thoroughly balanced audience coverage, an adequate and safe means of horn support, and appearances are the main factors at this point. Once these are settled—the horns spotted—measure the length of transmission lines required for linking the horns with their final amplifier.

From this point forward impedance matching must never be lost sight of if a quality job is to result.

The only amplifier available may have one fixed output, say 500-ohms impedance. If that be so, the soundman's style need not be necessarily cramped. If the length of the lines be reasonable, he has little concern beyond using suffi-

ciently heavy conductors to deliver the required current to its destination at minimum loss.

Suppose the only horns available (if this job is to show a profit) are four similar 16-ohm units. If they are to be clustered rather closely together, one 500-to-4-ohm transformer of sufficient capacity will do nicely. Couple it between the horns clustered in parallel and their end of the 500-ohm line.

Often the best coverage may call for the horns being installed at some distance from each other about the room. Then, if the same 500-ohm output amplifier and the same four 16-ohm speakers be employed, a 2000-to-16-ohm transformer should be installed at each speaker. This will maintain the 500-ohm line. In either of the above cases service will not be interrupted through more than one speaker in the event of voice-coil failure.

Fortunately, the average amplifier marketed today for p-a use offers a choice of output impedance. Then, for another example, using the same 16-ohm horns rated at 15 watts, we have the choice of connecting the four horns in series for a value of 64 ohms; in parallel,

4 ohms; in series parallel, 16 ohms. One of these wiring arrangements will accommodate some one of the amplifier outputs without the need of an external transformer. The amplifier must be capable, of course, of a sufficient power output. Regardless of whichever wiring arrangement is used, each speaker calls for 15 watts—the total of four requiring 60 watts of power.

If, for some reason, speakers of different power ratings must be used, suitable load-dividing transformers must be introduced. This might prove to be a false economy. If it is a mere matter of level distribution, it is simpler to use similar speakers with local or internal volume controls. These may be inserted within any speaker inclined toward over-loudness. Variable controls may be used until the proper values are ascertained. They may then be replaced by cheaper fixed-level control elements. The latter will prohibit tampering with balances. Always respect the current-carrying values when purchasing these elements.

Discussion thus far has dealt with smaller assignments. It is well to investigate and study somewhat larger,



Henry Hudson Room (Hotel Roosevelt, N. Y.) P-A installation features an all-directional Gondola Speaker.

medium-sized rigs such as exist in our modern hotels. In large metropolitan areas, most of these have been designed and installed by bona-fide engineers who have specialized in audio equipment for years. Although these plants embrace more elegance than the small operator need take on, they nevertheless demonstrate proven methods of installation and offer ideas which the keen operator can incorporate as his business expands.

#### HOTEL ROOSEVELT INSTALLATION

A splendid example of a *smooth* job serves the patrons of the Hotel Roosevelt in New York City. In its case loudspeaker service is available in either the Grand Ballroom, the Henry Hudson Room or in the Foyer. Either room can be serviced individually or in tandem.

Three independent channels with power-plus are rack-mounted in a fire-proof control room which is also used at times as a picture projection booth. Ample spare units and accessories are at hand in case of failure. In larger installations this is a *must*.

At the Roosevelt, any one of the three channels can service any one of the three rooms via a twist-lock cross patching panel. This same panel centralizes all controls. Microphone outlets from all sides of the rooms, and small portable mixers, can be patched at this point. Here, too, the level of any one of four speaker groups can be raised or lowered. This permits the killing of any bank when a microphone is to be opened within its beam. Feedback is readily avoided by such centralized control. Remote mixers are available when needed.

The emphasis here is reliability with flexibility. Here again are sterling characteristics likewise imperative for smaller outfits if high-grade service is to be rendered.

Often an engineer tackles speaker placement as though it were a terrific problem. Study of the above case should decimate his worries. Sane engineering judgment at the Hotel Roosevelt proved simplicity itself the answer to the speaker problem.

The unobtrusive design of a ceiling-mounted, diamond-shaped speaker gondola melts into the sophisticated atmosphere of the Henry Hudson Room with such grace that only professional scrutiny unearths its presence. The Grand Ball Room receives similar treatment, and no side-wall re-enforcement is needed.

#### SOUND PICKUP

Uni-directional microphones instead of ribbons or non-directional ones will reduce the feed-back headaches, (horn to microphone) and reduce interference from outside noises, reflection and echo from nearby speakers and walls. Engineers owning salt-shaker mikes and the like, mostly find it profitable to apply baffles. Those having cardioids with a selective switch may find it best to use the narrower beam provided the orator can be kept back from the microphone a bit. Whether crystal or dynamic mikes be used is optional. Here again the pocketbook may decide the issue. Equalization should follow accordingly. In any event, if the leads (which should always be shielded and grounded) between the microphone and the main mixer amplifier be over-lengthy, some

pre-amplification should be introduced. A reduction in emission noise from over-worked amplifiers and better quality will result.

Under good acoustic conditions, the ideal sound pickup from a physical angle is an overhead microphone tilted down at and in front of the orator. His turning of head and leaning forward or backward becomes more elastic—felt less by the microphone itself. Hollywood pictures are shot that way. It is seldom, however, that any overhead frieze or aprons in P-A work are close enough to the orator to allow for this treatment. The chances of feedback are generally too great. In some remote cases where ears or flanges are added to reduce the beam width of the forward horns this pickup may be applied. In general, the regulation shock-mounted podium bracket or stand is safer. Even here allowance for a considerable amount of the delivery being read to the audience should be accommodated by having the microphones at such height and angle that they do not exaggerate mumbling while they still do justice to the speaker when he raises his head for an ad-lib session. It is a *must* that all microphones be shock-mounted. They should be on the far side of the podium from the orator, far enough to clear the turning of pages. The podium should be covered with a felt runner or any appropriate material which will reduce reflection from hard surfaces. Should there be no podium and a floor stand is employed, the orator sometimes needs repeated warnings that he should never, never, NEVER, touch the stand or the microphone. He should also be told that he will receive a much warmer reaction from his audience if he refrains from crowding the microphone at any time. Never hesitate to suggest a sober, sane idea to improve your show. The bigger a man the more he is willing to listen. Microphones of course should always be mounted in the clear, free from reflecting ledges or gutters, water pitchers and decorations.

#### SPEECH EQUALIZATION

It is well to borrow from the tried and true experience of motion picture engineers. Either on exterior newsreel shots or indoor studio recordings, they rool off (attenuate) the lower end of the spectrum rather appreciably from 200 cycles downward unless music is being recorded. There are many reasons for carrying over this practice into p-a work. Often p-a amplifiers come equipped with a l-f attenuation adjustment which may suffice. If not, and the microphone input is 30 ohms, a simple device is quickly constructed.

Parallel a 4  $\mu$ f capacitor across a 120-ohm variable resistor. Insert this combination in series with the high leg to your input transformer (see Fig. 1).

For a 250-ohm input the connections remain the same but the values become  $0.5 \mu\text{f}$  and 1000 ohms, respectively.

Once installed, such an equalizer should be operated discreetly. The thinner the voice, the less equalization is required. Never forget to fade to the minimum position while handling music so as to retain a flat channel. The use of an equalizer will reduce the rumble from such obnoxious sources as air-conditioning units, street noises, blowers and the like. Luckily, too, it reduces the tendency for horns to feed back into microphones.

### ACOUSTICS

The success of a sound engineer's efforts, either indoors or out, depends to a great extent upon the acoustic conditions under which he performs his duties. Even on exterior work he may adjust the angle of his horns to avoid troublesome reflection from buildings and other nearby hard surfaces. A severe secondary radiation, garbling the speech may so be avoided. Again the orator, always inclined to shout because he is out-of-doors, should be kept back a bit from a sensitive channel. And again the microphone should be shock-mounted in a dead area.

Indoors, even on one-night stands, the operator can frequently help himself and his show by casting an eagle eye about his assignment before placing

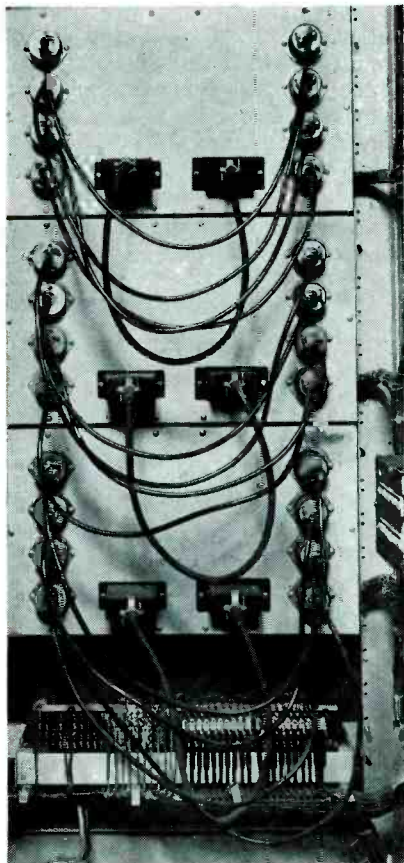

Rear view of main amplifier rack in Hotel Roosevelt. Made by Langevin, the feature is the manner in which quick substitution may be made in case of failure.

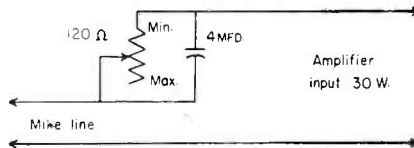

Fig. 1 — Speech equalizer changes are described in the text.

his speakers in order that he may avoid unnecessary pockets and reflections. He may even spy a folding screen which he can angle across some contrary curved or hard surface causing kick-back. Frequently there exist draperies which may be pulled to bring down the size of the room or reduce reverberation. Doors and windows should be closed whenever possible to keep out street noises which are only repeated by the system.

Permanent installations demand a more thorough study of the acoustic properties of the room, auditorium, or church which the sound engineer has been commissioned to service. He might do well in expensive setups to call in some consultant or friend connected with a recognized firm selling acoustic materials. The more he can clean up his show by having such a representative persuade his client of the need for correction, the better he can demonstrate the accomplishments of his installation to other clients.

Incidentally, when the p-a man is fortunate enough to land one of those assignments where everything jells, where the acoustics just naturally give out with kindness, it pays to have a high quality pickup-head, a turntable and some pleasing recordings handy for demonstrations. Such gear is also indispensable in speeding up one's work when balancing up the horn distribution in new installations.

No time is wasted if the findings of genuine authorities on acoustics are studied. Technical papers and the libraries are available. Often, however, we can help ourselves through very simple approach. An excellent example, proving its daily worth in one of New York's better-known hotels, is definitely "simplicity in the raw."

A major room of large cubic dimensions (not as often rentable as smaller ones) is quickly transposed into three more intimate gathering places by the simple trick of sliding leather curtains rippled from floor to ceiling. It took no genius to figure this one out yet in dollar return to the hotel he was worthy of the name.

Independent channels serve all three chambers and there is no cross-talk when they operate simultaneously at reasonable and yet comfortable levels. Carpets, of course, contribute greatly to the success here. Hollywood soundmen feel warm-all-over-inside when they see the property men roll a heavy oriental rug across the floor of the next set to be tackled.

### PROJECTION

Never over-project your sound indoors! If it is a noisy exterior political or strike rally,—that's different. Indoors, be smart. Keep your reproduction normal, soft and sweet.

Your prime purpose is to help your client,—help him send his audience home satisfied, impressed, happy. Audience comfort while listening, relaxed attention, is your goal. When the original speech is comfortably heard by an entire audience, unmindful of the presence of any reinforcement, you are indeed a success.

Before we can project clean speech or music through the best of loudspeakers, we must properly link them to the final amplifier,—not with any old twisted pair, but with lines whose impedance must be matched throughout their travel. These lines should be concealed, properly insulated, and protected against exposure from weather and open windows. Never should they be installed where wet floor-mopping can affect them.

Losses in transmission lines can be minimized by:

a.—Using large enough conductors to hold down their resistance.

b.—Using higher impedance lines carrying higher voltages and lower current flow. In this latter case we need transformers for coupling to voice coils. The additional cost may be balanced out through the flexibility afforded. For example, speakers of dissimilar values may be coupled to the lines.

[Continued on page 34]

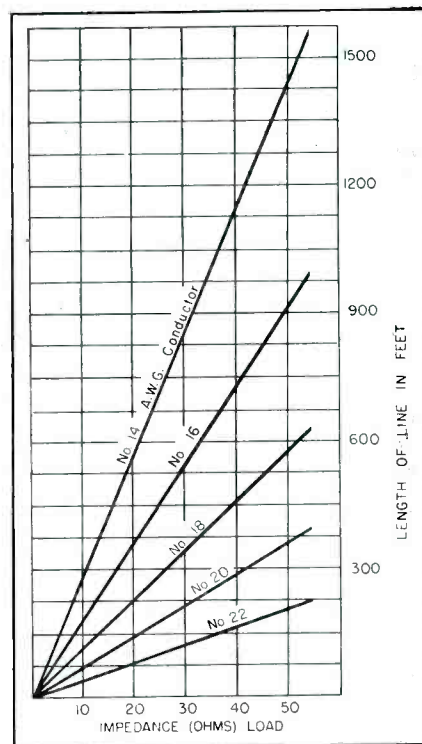
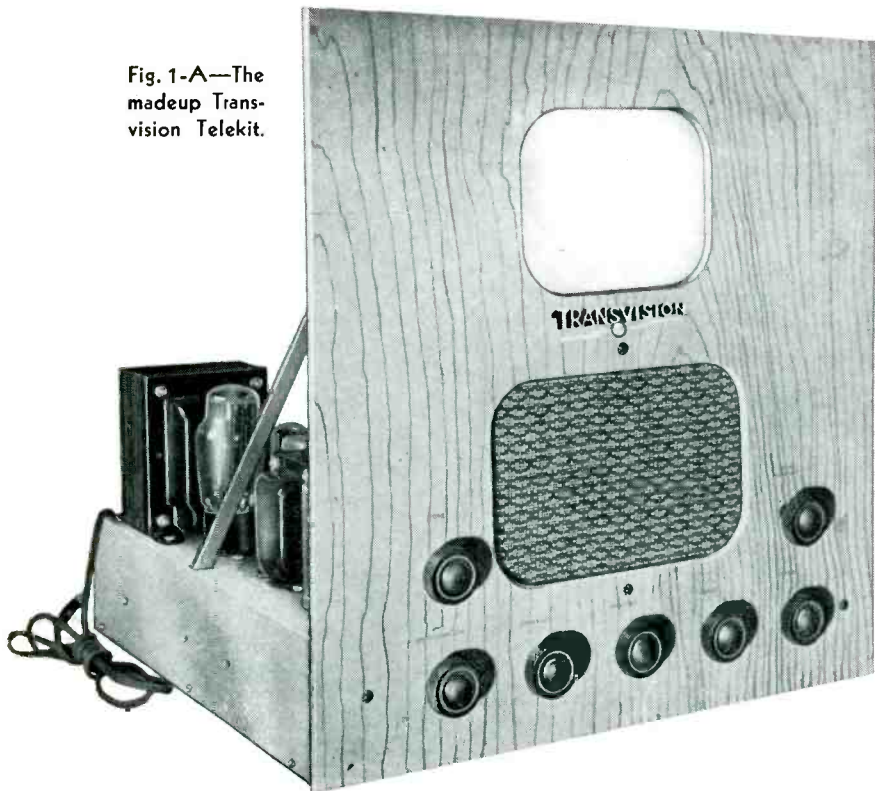

Figure 2

Fig. 1-A—The madeup Transvision Telekit.



# MODERN TELEVISION KITS . . . .

## 1 . . . . CERTIFIED TELEVISION LABORATORIES KIT

THIS is a 17 tube kit which includes a 7EP4 cathode ray tube. A side view of the completed kit is shown in Fig. 1. The selector switch may be set to four positions. The kit provides for the reception of 3 channels because, to quote the manufacturer, "there is at present no area with more than 3 operating channels, N.Y.C. being the only area of this type. Additional stations, when put into operation can easily be accommodated by installing additional trimmer condensers."

### Circuit Analysis—R. F.

The antenna transformer secondary inductance is designed to cover the lower frequency channels. At the higher frequency channels additional inductances are connected in parallel with the original inductance thereby reducing the total effective inductance and increasing the resonant frequency response. This is shown in Fig. 2, which is a breakdown of the R.F., oscillator, and mixer circuits.

Broad band-pass action is obtained by a loading resistance, 5,000 ohms, effectively connected across the tuned circuit through the 240- $\mu\text{mf}$  coupling condenser. The antenna primary is designed to work into a 72-ohm antenna.

### Oscillator

The oscillator circuit is a conventional Hartley with its output signal injected into the suppressor grid of the 1852 mixer. Observe that the complete coil is not connected across the trimmers. The reason for this will become apparent if we will recall that the amount of feedback in the oscillator circuit depends on the ratio of the cathode tapped portion of the coil to

the entire coil. Ordinarily, the number of turns required at the high frequencies are so few that the feedback obtained would be insufficient to insure reliable oscillations. By increasing the number of turns in such a manner as to increase the total feedback in the coil without affecting the resonant frequency of the condenser and the inductance connected across it, the stability of the oscillator is increased without any frequency limitations. The added portion of the coil connects to the oscillator grid through the 47- $\mu\text{mf}$  condenser and the 50,000-ohm resistor, whereas the original inductance of the coil, necessary to obtain the required frequency, is connected across the tuning capacitors.

These are temperature compensated ceramicon trimmers. See Fig. 2.

### Mixer Stage

The plate circuit of the mixer stage (see Fig. 2) contains an impedance-coupled i-f transformer, slug-tuned for maximum gain, and loaded with a 2,000-ohm resistor for wide band-pass action. The sound take-off is obtained from an additional winding on the same form. A 50,000-ohm loading resistor is connected across the coil as well as a ceramicon trimmer which is mounted on the top of the chassis for ease of adjustment.

Observe that the utmost simplicity of circuits have been incorporated in the

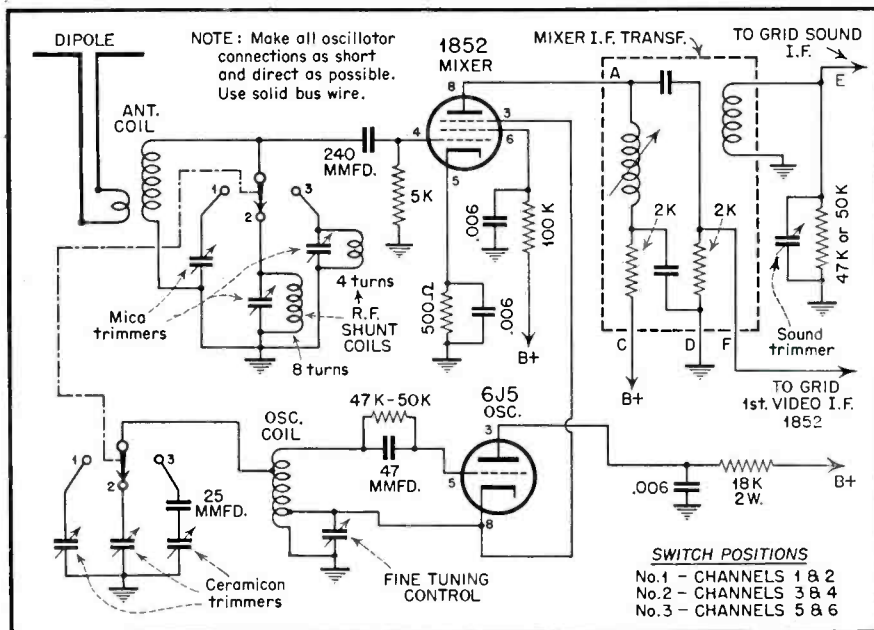

Fig. 2. Oscillator and Mixer circuit of Certified Model 47-71.

The variety of television kits available on the open market makes it possible for radiomen to learn, at first hand, the operations and service procedures associated with such video receivers. Besides, many Service Dealers are being called upon to make custom-built video-AM-FM and phono-combination models for their customers. This article will help appraise the complexities of television from a builder's view.

by S. L. MARSHALL

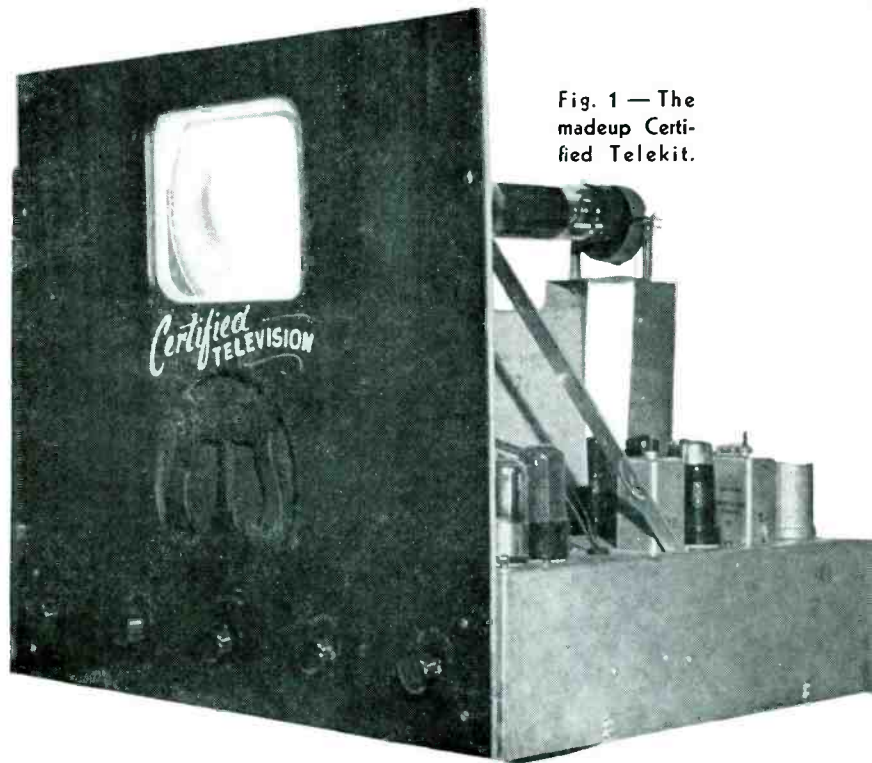

Fig. 1 — The madeup Certified Telekit.

design of this receiver so far. It will be found that this circuit simplicity reflects itself in the ease with which the receiver can be aligned.

**Video I.F.**

The video i-f stages, illustrated in Fig. 3 are slug-tuned for maximum gain, and impedance-coupled for simplicity. Band-pass action is obtained by staggering-tuning the stages, and loading the tuned i-f circuits with 2,000-ohm resistors. Video signal gain is varied by means of the contrast control which varies the bias on the first two i-f tubes.

**Video Detector and Amplifier**

Diode detection is employed, utilizing the first section of the 6SN7 (Fig. 4) as the detector, and the second section of

the tube as the amplifier. The peaking coil associated with the direct cathode coupled circuit of this stage enables the circuit to give a flat video response from 30 cycles to about 4 mc. The plate circuit is heavily filtered against any power supply interference.

The plate circuit of the first video amplifier feeds the grid circuit of the synch separator tube and the grid circuit of the second video amplifier tube; the synch separator tube being the first section of the 6N7 and the second video amplifier tube the second section of the 6N7. Clipping action in the synch separator tube is obtained by means of the low plate voltage on the tube. The output of the second video amplifier feeds the grid of the cathode ray tube through a .1  $\mu$ f coupling condenser.

**D-C Restoration**

The video signal containing the synch pulses and the picture signal which are fed to the grid of the cathode ray tube builds up an initial bias across the 2-meg. resistor (Fig. 4) which is proportional to the peak values of the signal, hence the synch level. The amplitude of the synch pulse being fixed, the actual picture signal amplitude may be varied with reference to this level by varying the contrast control. In this manner the d-c component is restored. The time constant of the 2-meg. resistor and the .1- $\mu$ f condenser insure background level light variations to well below the required lower limit of 30 per second.

One advantage of this system is that there is no positive voltage applied to the grid of the C.R.T., so that failure of any part of the video amplifier tube will not result in damage to the CRT.

**Horizontal Oscillator and Amplifier**

The circuit diagram of the horizontal oscillator and amplifier is shown in Fig. 5. The differentiating circuit consists of the network comprising the 125- $\mu$ f condenser, the .006- $\mu$ f condenser, the 2,000-ohm resistor, the 100K-ohm resistor, and the 3,000-ohm resistor. A cathode-coupled multivibrator circuit is used as the oscillator. The horizontal hold control stabilizes the frequency of this oscillator, and the width control controls its amplitude. Observe that phase-inverted push-pull output is obtained for balanced deflection.

**Vertical Oscillator and Amplifier**

The integrating circuit of this stage is made up of the network of resistors and condensers connected in the grid circuit

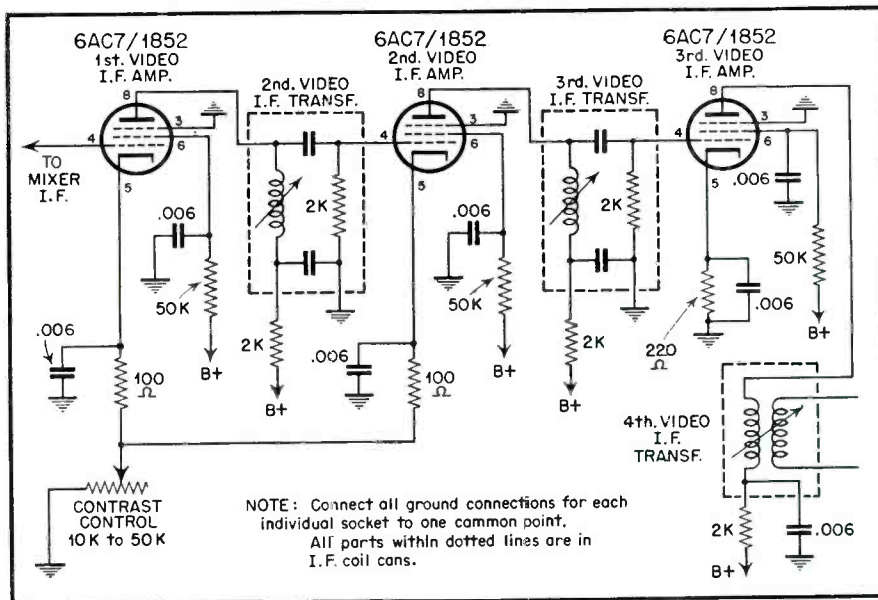

Fig. 3. Video I-F Amplifier.

of the first section of the 6N7 tube. See Fig. 6. As in the horizontal oscillator circuit a cathode-coupled multivibrator circuit is used, the frequency of which is adjusted by the vertical hold control, and the amplitude by the vertical height control.

In order to obtain improved sweep, amplifier performance degeneration is introduced by the signal action across the unbypassed cathode resistors. As in the horizontal sweep circuit, balanced output is obtained.

### Sound Section

The sound section consists of a single i-f sound stage which contains a slug-tuned sound i-f transformer for higher gain. Slope detection is used. This enables the constructor to obtain good F.M. results without resorting to intricate discriminator detector adjustments. A 6SQ7 first audio tube and 6V6 Power tube complete the audio section.

### Power Supply

The power supply contains separate high and low voltage power transformers. The low voltage 5U4G supply is conventional. The high voltage supply utilizes a 2X2 half-wave rectifier, and contains a 1/4 meg. resistor in the return lead of the H.V. transformer so that no damage to the tube or transformer will result in the event of a short-circuit in the rectified portion of the power supply.

All parts of the high voltage circuit are mounted on a special bakelite distribution strip. This confines the H.V. circuit to one section of the receiver, resulting in greater safety, as well as greater ease in wiring and testing. This distribution panel is also used as a tie point for the 'scope leads.

### Alignment

After assembling and testing, the following alignment procedure should be observed:

1. The first and second i-f sound transformers are adjusted for maximum response at the sound frequency.
2. The video i-f transformers are stagger-tuned according to the instructions contained in the kit.
3. The oscillator and antenna trimmers are adjusted for maximum response at the various channels; the sound trimmers being readjusted for maximum response at the first setting.

For purposes of stability, and in order to obtain optimum results under all conditions mica and ceramic dielectric capacitors have been incorporated throughout.

### Manufacturer's Service Policy

The manufacturer guarantees this kit to operate satisfactorily if the instructions are followed implicitly. Servicing of the completed unit and parts is done at the factory at factory cost. Parts are

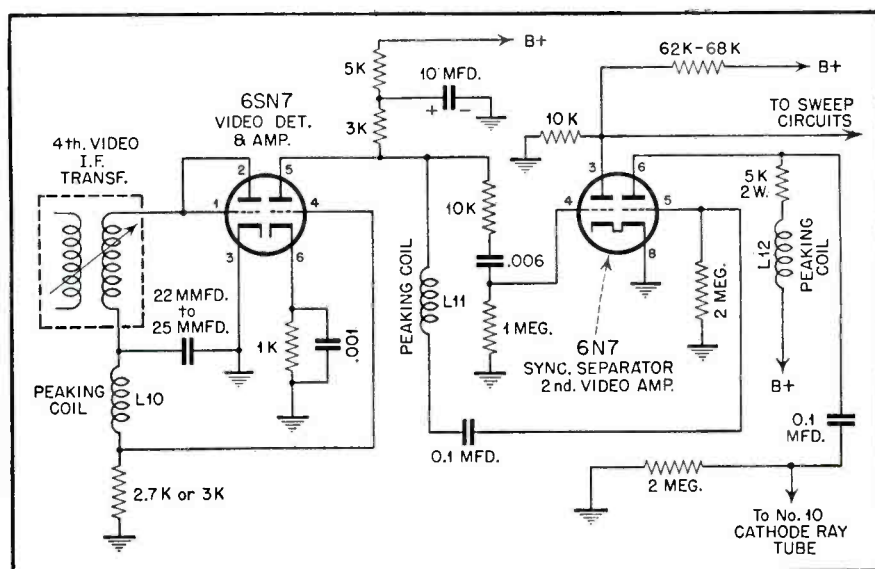

Fig. 4. Video detector and Sync. separator circuit.

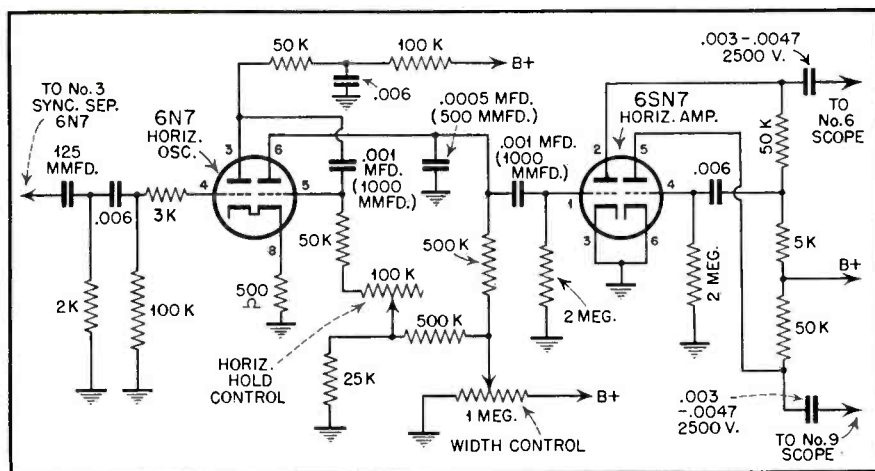

Fig. 5. Horizontal Oscillator and Amplifier.

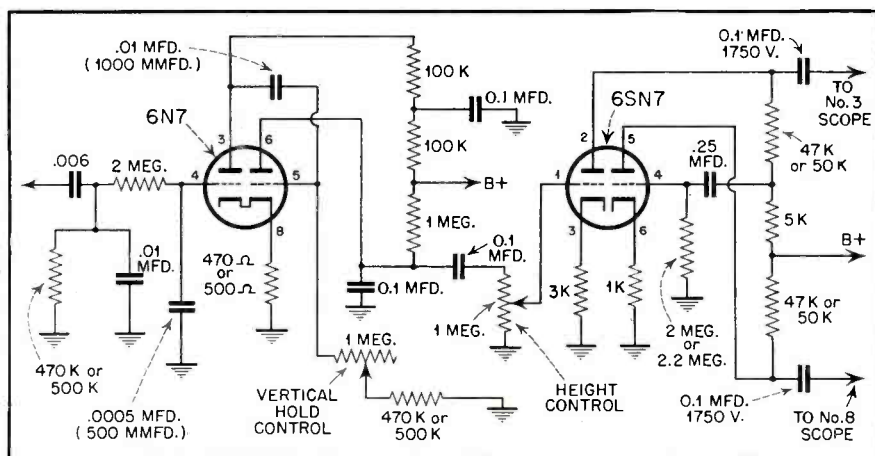

Fig. 6. Vertical Oscillator and Amplifier.

unconditionally guaranteed for 90 days.

All service data and improvements are forwarded regularly to registered owners. Newly designed components may be obtained in exchange for original components, in many cases free of charge, and in some cases for a small charge. This policy eliminates the need of any kit from becoming obsolete, and enables the user to take advantage of improvements as they are made.

### Sales Potential

Since there is a great sales potential for these kits as custom built units a hand-finished front panel has been made available in a choice of mahogany, walnut or maple. Lettering is decoratively done in gold by a silk screen process. The panel also includes a ledge to support the scope tube, as well as two tracks into which the viewing glass slides. The latter is an especially

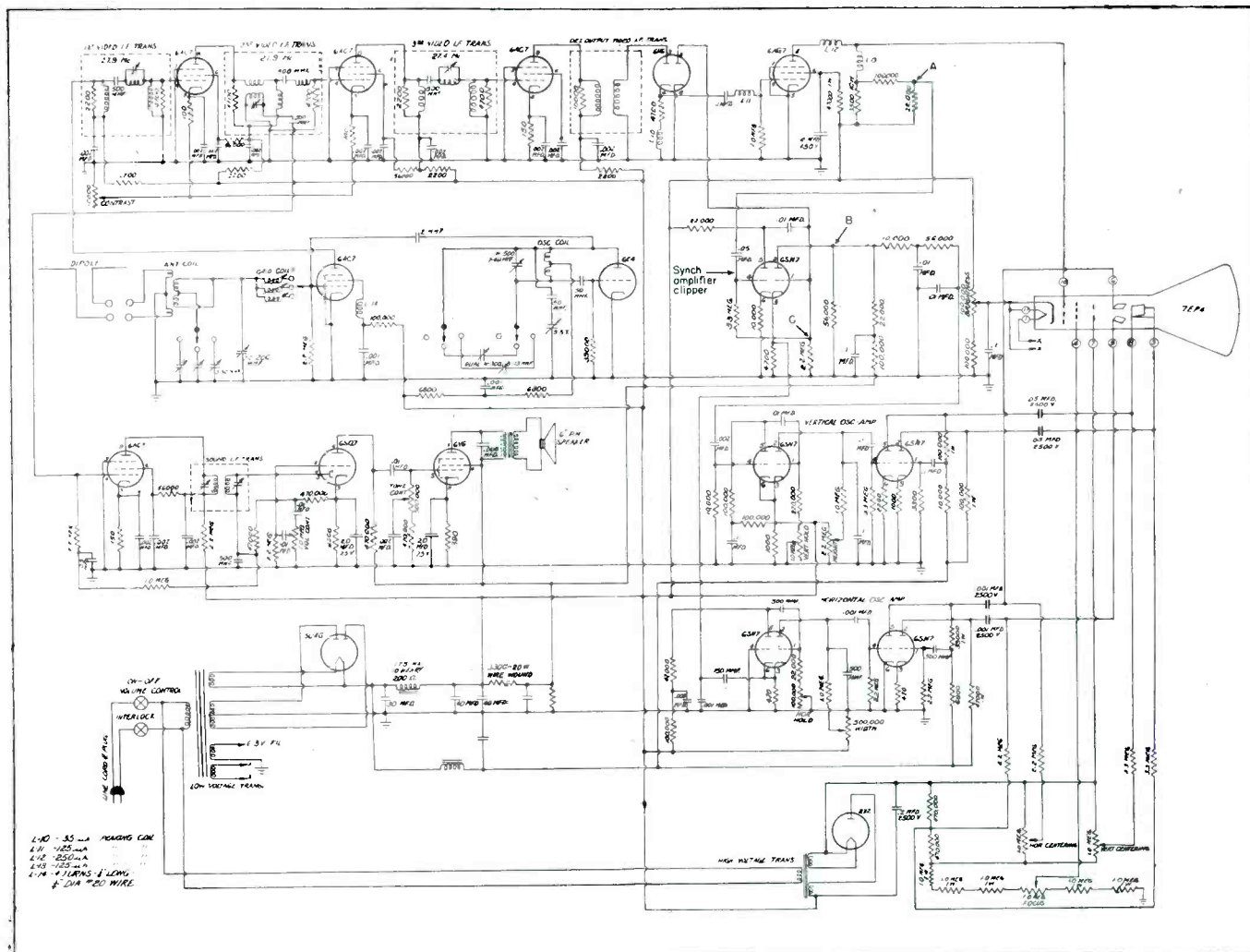

constructed optical glass surrounded by a masked border.

## 2 . . . . TRANSVISION KIT

This is an 8-tube kit, including a 71CP4 cathode ray tube. *Fig. 7* shows a view of the completed kit. Three channels are provided for, however, if the constructor desires, he may add as many channels as he wishes by utilizing the new r-f assembly made available by the manufacturer. The front panel contains 7 controls, these being: tone, volume contrast, brightness, focus, channel, and the vernier tuner.

### Circuit Analysis—R.F.

The antenna input circuit (See *Fig. 7* showing the complete circuit diagram) is designed to connect to a 300-ohm antenna. A folded dipole is exactly suited for this purpose. The r-f circuit is a conventional double tuned input arrangement, band switching taking place in the low end of the circuit. Over-coupling provides a 6 to 8 mc. bandwidth on all channels. The channel selection is optional with the buyer. Interestingly enough, image rejection is high (40 to 60 db.) due to the inherent characteristics of the 6AC7.

**Fig. 7. Complete schematic of Transvision kit. This covers 3 channels but builder may add others.**

### Oscillator

The oscillator is a conventional Hartley, heavily loaded with capacity, and stability-maintained with temperature compensating condensers. Back radiation is lower in this circuit than in the conventional circuit in which the band-switching is in the high impedance end. The output of the oscillator is fed to the mixer control grid through a 2- $\mu$ f capacitor.

### Mixer Stage

The plate circuit of the mixer stage is a trap-coupled i-f transformer which amplifies the full frequency range comprising the audio and video i-f frequencies. Broad band-pass is aided by the 2,200-ohm and the 4,700-ohm load-resistors.

### Video I. F.

Four stages of video I.F. are incorporated. The first stage, as previously mentioned is trap-coupled, the second stage is coupled by means of a low impedance link winding, the third stage is trap-coupled, and the fourth and final

stage is a mutually over-coupled transformer circuit. The video i-f carrier frequency is 26.4 mc., and the audio i-f carrier: 21.9 mc. The pass band of the picture in the i-f stages is nominally between 27.9 to 22.4 mc.

The i-f transformers are double fixed-tuned, heavily loaded units. Pre-tuned, and stagger-tuned to include the required i-f picture pass band, no adjustment of these stages are required except for the traps which form the guard reject points at the edges of the bands.

### Video Detector

Video detection is accomplished by using a slope detection circuit in which both AM and FM signals are demodulated. This enables the constructor to complete this phase of the receiver without recourse to complicated alignment procedures necessary with discriminator detectors.

### Video Amplifier

The video signal is taken off the first diode of the 6H6, and from there capacitively coupled into the 6AG7 video amplifier. The output of this tube is then coupled directly into the control grid of the cathode ray tube. Since the grid of the CRT is effectively at the

[Continued on page 32]

# TECHNICAL QUIZ NO. 3

*Subject: Amplifiers & Sound Equipment*

## BEFORE ANSWERING THE QUESTIONS—READ THESE RULES:

There are 25 questions. After each question, preceded by a letter *a, b* or *c* are optional answers. In each case one answer is basically correct. You are only allowed 20 minutes time in which to mark the letter *a, b* or *c* which you believe represents the correct answer.

For each correct answer to a question you are credited with 4 percentage points. Thus 23 correct answers would give you 92% or 17 correct answers would rate you 68% on the examination. Answers to the questions are given on Page 34.

**RATINGS FOLLOW:** 100% = Perfect, 90% = Excellent, 80% = Good, 70% = Fair, 60% = Passing  
Any score below 55% is failure. Tests must be completed within 20 minutes.

How much do you know about P-A, Sound and Recording Equipment? Listed below are a number of questions, each of which has but one correct answer. The accuracy of your answers, and the relative speed with which you can complete this quiz is a measure of your theoretical knowledge and practical experience.

### QUESTIONS 1 to 5

- Greater relative directional effects may be obtained with:
  - Velocity microphone
  - Dynamic microphone
  - Carbon microphone
- The following microphone has the greatest relative output:
  - Velocity microphone
  - Dynamic microphone
  - Carbon microphone
- Maximum linear frequency response is obtained with a:
  - Velocity microphone
  - Dynamic microphone
  - Crystal microphone
- An acoustically compensated volume control compensates for:
  - The natural impression a listener receives in which the low and very high frequencies are attenuated as the volume is reduced.
  - The accentuation of the low frequencies as the volume is increased.
  - The accentuation of the medium frequencies as the volume control is increased.
- A treble control generally consists of a network of capacitors and resistors in which the network is connected..... the signal load:

- Across
- In series with
- Neither across nor in series with the signal load, but rather across the voice coil connections of the loud speaker.

### QUESTIONS 6 to 10

- The turns ratio of an output transformer designed to match a tube designed to work into an 8,000-ohm load and a 2-ohm voice coil is:
  - 50 to 1
  - 4,000 to 1
  - 20 to 1
- Four 8-ohm loud speakers are connected across the terminals of an output transformer which are marked: 4 ohms, 8 ohms, 16 ohms. The most efficient method of connecting these speakers is in:
  - Parallel
  - Series-parallel
  - Series
- A group of speakers is to be connected several hundred feet from the amplifier. The most efficient installation calls for:
  - A 500-ohm line with matching transformers at the amplifier and the speakers.
  - Very low impedance line connected directly to the voice coils.
  - A long microphone connection with the amplifier located near the loud speakers.
- Speaker phasing.....
  - Involves the location of speakers so that a minimum of echo results.
  - Means connecting the speakers so that the movements of the cones

occur in phase with the current through the voice coils.

- Is the positioning of the speakers so that there is no cancellation of sound due to interference from one another.
- The baffle diameter of a loud speaker to permit maximum 60 cycle response is approximately.....feet.
    - 9 feet
    - 6 feet
    - 3 feet

### QUESTIONS 11 to 15

- The approximate resistance ratio in the tapped portion of a phase inverter circuit is:
  - 10 to 1
  - 50 to 1
  - 100 to 1
- Dynamic coupling is:
  - A form of impedance coupling
  - A form of transformer coupling
  - A form of direct coupling
- An example of voltage inverse feedback is:
  - A parallel network across the output load, the feedback energy being obtained from a tap on this network and fed back to a previous stage.
  - An un-bypassed audio cathode resistor.
  - A heavily bypassed cathode resistor.
- An example of current inverse feedback is:
  - A parallel network across the output load, the feedback energy being obtained from a tap on this network and fed back to a previous stage.



- B. An un-bypassed audio cathode resistor.  
 C. A heavily bypassed cathode resistor.
15. Scratch filters are usually designed for rapid attenuation above . . . . . cycles:  
 A. 3,000  
 B. 5,000  
 C. 7,000

**QUESTIONS 16 to 20**

16. High fidelity pickups are generally characterized by:  
 A. Low output  
 B. High output  
 C. Medium output
17. Home recordings are generally of the . . . . . type.  
 A. Vertical  
 B. Lateral-cut  
 C. Hill and dale
18. "Wow" in reference to recordings generally indicates:  
 A. An exceptionally fine record.  
 B. A recording with considerable background hiss.  
 C. A recording in which the speed is not constant.
19. A good recording is characterized by:

- A. The width of the groove being considerably wider than the spaces separating the grooves.  
 B. The width of the groove being considerably narrower than the spaces separating the grooves.  
 C. The width of the groove being about equal to the spaces separating the grooves.
20. Zero DB output across a standard 500-ohm impedance corresponds to a voltage output of approximately . . . . . volts:  
 A. 1.73  
 B. Zero  
 C. .006

**QUESTIONS 21 to 25**

21. Zero VU corresponds to:  
 A. 1 milliwatt of energy across a 600-ohm resistor.  
 B. 6 milliwatts of energy across a 500-ohm resistor.  
 C. Zero output across any resistor.
22. Zero DB corresponds to:  
 A. 1 milliwatt of energy across a 600-ohm resistor.  
 B. 6 milliwatts of energy across a 500-ohm resistor.  
 C. Zero output across any resistor.

23. A class "A" amplifier is one in which:  
 A. Plate current flows during one-half of the grid voltage cycle.  
 B. Plate current flows during less than one-half of the grid voltage cycle.  
 C. Plate current flows during the entire grid voltage cycle.
24. A class "B" amplifier is one in which:  
 A. Plate current flows during one-half of the grid voltage cycle.  
 B. Plate current flows during less than one-half of the grid voltage cycle.  
 C. Plate current flows during the entire grid voltage cycle.
25. A class "AB<sub>1</sub>" amplifier is one in which:  
 A. Plate current flows during more than one-half and less than a complete grid voltage cycle, in which the grid does not go positive.  
 B. The same as above, but during which signal the grid goes positive.  
 C. Plate current flows during a complete grid voltage cycle, and the grid goes positive.

# Get Yourself Free Publicity

by **DAN VALENTINE\***

**R**ADIO Service Dealers, especially if situated in smaller communities, have a golden chance these days to pick up some valuable free advertising just for the asking.

Millions of dollars are spent every year by large corporations for batteries of high-powered public relations men to keep their name and the name of the firm's products in the news columns of the nation's newspapers. And any modern radio serviceman can be his own public relations man these days—all it will cost is the price of a telephone call to your local newspaper.

One of the reasons is this: prices are front page news at the present time. The prices of most commodities—shoes, bread, radio sets and even radio parts—are fluctuating so madly today that any change in the price of any essential item (radio parts and service are essential) is worth a big play in the daily and weekly newspapers in the United States.

In other words, prices are news, and I'm speaking as the city editor of a daily paper in a town of 25,000. I know that any change in the price of anything,—radio parts and service included,—is worth a news story in my newspaper.

\*City Editor of "Rapid City Daily Journal"—Rapid City, S. Dakota.

The price angle is just one of the ways you can gain valuable gratis advertising in your local newspapers. If, for instance, you are a Service Dealer and there is a price slash in a line of receivers or component parts, let your local newspaper know. Call up the editor or the news room and tell what is happening. He probably doesn't know—and he's interested. The drop in the price of any commodity these days reveals a trend, and editors and newspapers are especially interested in trends at the present time.

By calling your local newspaper, the resulting news story will very likely look like this:

**Rapid City, S.D., July 30—Another indication of the falling off in prices was reported here today by John Jones, proprietor of the Jones Radio Company.**

**Jones said the wholesale price of radio parts has generally dropped some 10 percent in the past month while receiver prices are down 15 percent.**

**"In my opinion," he said, "this is just another sign that prices in general are on their way down. He added that the majority of radio parts, which were on the shortage lists during the war years, are coming in greater lots, and it is now possible to**

**give greater service to Rapid City radio owners . . . .**

**He went on to explain that . . . ."**

You get the idea. True, you wouldn't receive any direct advertising. Your name will only be mentioned once or twice, and you won't be able to plug your own shop too much. After all, it is a news story—not an advertisement.

But you will get across the idea that you are an important factor in the radio business in your community. By continually bombarding your local newspapers with similar small items like the above, you will be able to impress your name and the name of your firm on all radio set owners in your community.

And there are other ways to cash in on your own public relations work.

I want to emphasize, however, that as city editor and a working newspaperman, that I'm not going to sit at my desk in the news room and print *everything* you send in. My job is to get and print news that is of interest to the community. That means everything you send in will have to be legitimate news if it is to be used.

What I am trying to get across in this article is the fact that bona fide news stories are plentiful from the angle of a radio service and repair shop operator.

Now in our news room we receive bags full of mail from Washington

*(Continued on page 30)*

# CIRCUIT COURT

## Thordarson Model T-31W50

A new Thordarson 50-watt amplifier, model T-31W50, uses an interesting method of obtaining fixed bias for the push-pull parallel 6L6 tubes in the output stage. A partial schematic is shown illustrating the complete power supply for the amplifier.

A single power transformer provides all voltages for the 13 tubes. The high voltage rectifiers are 5X4 tubes and one is used on each side of the circuit with plates in parallel. A tap on the high voltage secondary connects to the cathode of a 6X5 tube. The plates are paralleled and the resultant output is negative with respect to the common ground.

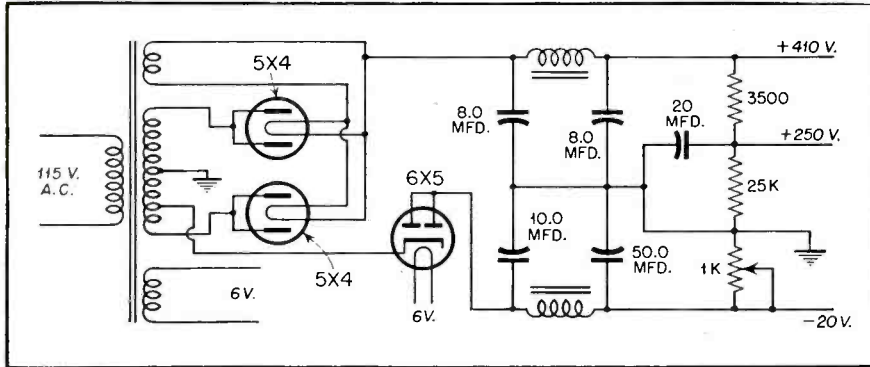

Power supply of Thordarson Model t-31W50 amplifier.

A complete filter consisting of input and output condensers and one choke is used in both the positive and negative rectifier outputs. A voltage divider drops the 410 volts applied to the 6L6 plates to 250 volts for the screens and all other tubes. The negative supply ends up in a 1000-ohm variable resistor which permits adjustment of the bias to the required 20 volts.

Provision for adjustment of the bias allows compensation for differing tube characteristics, including ageing, and wide variations in line voltage. Either of these variables can seriously effect the amount and quality of output from a well designed beam power output stage.

## Packard-Philco Model P-4635

The mixer circuit used in the Packard-Philco model P-4635 uses several unusual features which will bear discussion. The part of the schematic containing the pertinent details is illustrated.

The set employs variable inductance tuning, with three movable elements. One of these, not shown, tunes the grid

circuit of the 7A7 r-f stage. The output of this stage is resistance-capacity coupled to the second tuned circuit, in the grid of the mixer, and in addition will be seen to be tapped down on the tuned coil. This feature permits coupling the low impedance plate circuit into the higher impedance grid circuit with both improved gain and optimum selectivity.

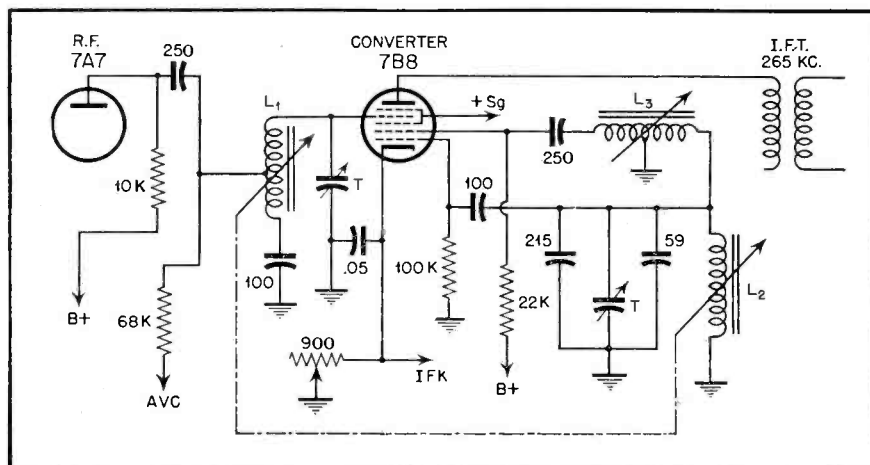

Mixer circuit of Packard-Philco Model P-4635.

The oscillator portion of the 7B8 converter circuit offers another interesting variation. Fundamentally, the oscillator is a variation of the grid-plate ultra-audion circuit. Coil  $L_3$  provides the required phase conditions with the grid connected to one end of the inductance, via the blocking condenser, and the plate similarly connected to the other end. The center of the coil, or an appropriate point thereon, is grounded. There is a movable slug in the coil but it is for low frequency trim rather than tuning.

The tuning control, ganged with the r-f and mixer grids, is seen to actuate a movable core in coil  $L_2$  from the grid circuit to ground. This coil is shunted by fixed padders and a trimmer condenser for high frequency alignment. A similar trimmer is used across the mixer grid tuned coil.

## Hoffman Model B-1000 (Scratch Filler Circuit)

Several interesting circuit details appear in the Hoffman Model B 1000. This 10-tube, 3-band instrument includes an automatic record changer,

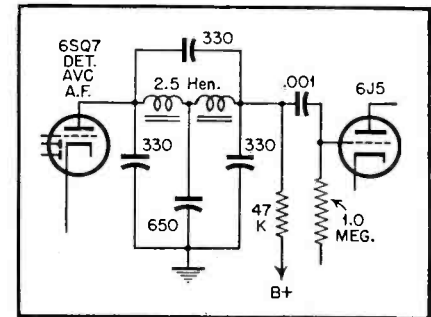

The Scratch Filter Circuit.

with crystal pick-up, and incorporates a scratch filter after the 6SQ7 stage. The portion of the schematic referred to is shown here.

It will be observed that the network which performs the function in question consists of a center tapped choke and four condensers. The total inductance of the choke is 2.5 heneries and the unit has a d-c resistance of 4000 ohms.

The combination of components would produce a modified type of low pass filter which should provide considerable attenuation to the bothersome scratch frequencies on commercial records. Some discrimination against sideband chatter and heterodynes in radio reception should also be obtained.

## Hoffman Model B-1000 (Tone Control Circuit)

Another interesting detail of the Hoffman Model B 1000 is the electronic tone control circuit. Separate adjustment of response at both high and low frequencies is provided for.

An inspection of the illustrated portion of the schematic will indicate the

[Continued on page 30]



*Why the smart technicians demand*  
**SILVER** test instruments

You . . . and every serious service technician . . . have long dreamed of your shop equipped with the same caliber of laboratory instruments found in the factories making the radios you must service. Today's complex AM, FM and Television receivers can't be efficiently serviced by anything less.

Under war pressure McMurdo Silver devised new techniques to lift the manufacture of laboratory-type instruments out of the costly model-shop. He discovered how to put them on the low-cost, high-volume production line. The result is instruments of laboratory precision, accuracy, dependability . . . at prices far below what you'd expect to pay. These are the same identical **Laboratory Caliber Electronic Test Instruments** the big manufacturers, universities and the government select.

Can you afford less than the best — when the best costs you less?

**MODEL 906 FM/AM SIGNAL GENERATOR:** 8 ranges calibrated  $\pm 1\%$  accurate, 90 kc. thru 210 mc. 0-100% variable 400 $\sim$ AM; 0-500 kc. variable FM sweep built-in. Metered microvolts; variable 0-1 volt. Strays lower than \$500 laboratory generators. Only \$99.50 net.

**"VOMAX" UNIVERSAL V.T.V.M.:** The overwhelming choice of experts. 51 ranges, d.c., a.c., a.f., i.f., r.f., current, db., and resistance. Visual signal tracing to 500 mc. New 5" pencil-thin flexible r.f. probe. Only \$59.85 net.

**MODEL 904 CONDENSER/RESISTANCE TESTER:** Measures accurately  $\frac{1}{4}$  mmfd. thru 1,000 mfd.;  $\frac{1}{4}$ " thru 1,000 meg $\Omega$ . Internal 0-500 V. variable d.c. polarizing voltage. Measures condensers with rated d.c. volts applied. Only \$49.90 net.

**MODEL 905 "SPARX" SIGNAL TRACER:** Visual and audible tracing; also tests phono pickups, microphones, speakers, PA amplifiers. Is your shop test-speaker, too. 20 $\sim$  thru 200 mc.; PM speaker; mains-insulated transformer power supply. Only \$39.90 net.

OVER 36 YEARS OF RADIO ENGINEERING ACHIEVEMENT

*McMurdo Silver Co., Inc.*

1249 MAIN ST., HARTFORD 3, CONNECTICUT

SEND FOR COMPLETE CATALOG. See these and Silver communication transmitters, receivers, "Micro-match", Xtal-controlled VFO, pre-tuned freq. multiplier at your jobber.

# NEW PRODUCTS

## Pray Folded Difan

This is a new type of antenna called the Folded Difan, with a substantially uniform impedance of 250 ohms over a 2.25/1 frequency range.

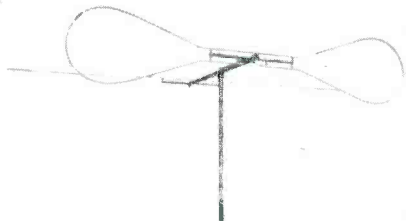

It has a very broad resonance characteristic, with a band width more than five times that of a folded dipole.

It operates with maximum efficiency over the frequency range of 48 to 108 N. C., and provides good reception beyond these limits.

Manufactured by the Tuck Electronic Corporation, 76 Montgomery St., Jersey City 2, N. J., further details will be sent on request.

## New RCA Test Oscillator

The new RCA portable test oscillator, Type WR-67A, is the first of its kind to provide three fixed frequencies for high speed servicing of super-hetrodyne and tuned radio-frequency receivers. The three channels provide the necessary

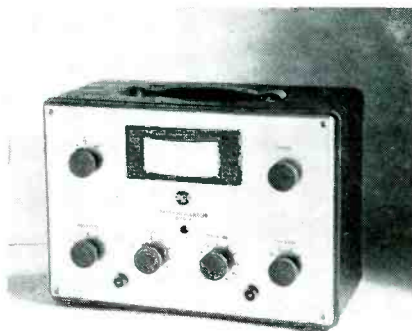

aligning signals without need for adjusting the tuning controls: 455-kw for i-f channels; 600-ke and 1500-ke for r-f local oscillator circuits. The WR-67A is housed in a blue-grey hammeroid case, and is styled with a brushed, anodized aluminum panel. It measures 13½" long, 9¾" high, and 7½" deep, and weighs 15 pounds. Full details available at all RCA jobbers.

## "Solder-Matic" Attachment

The new "Solder-Matic" solder feeding attachment made by Nelpin Manufacturing Company, 45-17

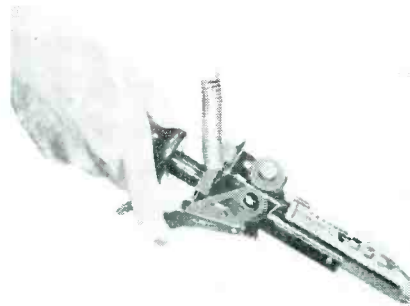

Davis St., Long Island City 1, N. Y. smoothly feeds solder at the touch of the finger-tip, easily clamps on to any standard electric soldering iron.

By freeing one hand to manipulate parts, pliers, or screw driver, the new "Solder-Matic" saves solder and time and improves quality of workmanship. It takes coil solder from 1/16" to 3/16" in diameter, and feeds up to 3/16" per stroke. Screw adjustment of the stainless steel nozzle guides solder exactly where needed. For price and literature write the manufacturer mentioning this item in "RSD."

## Meck FM Converter

The new Meck FM converter (center), developed by Meck Industries of Plymouth, Ind., when attached to an ordinary radio receiver makes it possible for the



listener to hear frequency modulation programs. The new device, which sells for \$19.95, can be attached by any radio serviceman in a few minutes. Design of the new unit which is 9½ inches by 7 inches and is housed in an attractive plastic case was worked out by Meck engineers in cooperation with the Hazeltine Laboratories. For further details write for manufacturer.

## Model 10 Range Master

The Bradshaw Instrument Co. announces the Model 10 Range Master.

In that addition to the usual volt-ohm-mill ranges, a special one-volt



a-c range has been incorporated for alignment work. Simply connected across the speaker voice coil, the receiver is tuned for peak output. Three direct reading capacity ranges permit immediate evaluation of suspected capacitors.

Also included in the instrument are three a-c ranges. Readings up to the limit of the house wiring (15 amps) may be made.

Complete information may be had by writing to the Bradshaw Instrument Co., 942 Kings Highway, Brooklyn 23, N. Y. Mention the model in requesting information.

## Variable Reluctance Pickup

Amplifier Corp. of America incorporates the new General Electric DL 1RM 6C Variable Reluctance Magnetic Pickup, complete with tone arm and permanent jewel-tipped needle.

The Studio Transcription Model 160GE, which will play records up to 16" in diameter, and the Program Phono Model 120GE, which

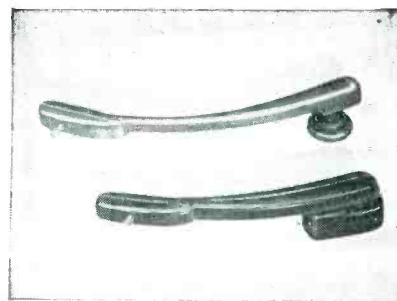

takes conventional records, these pickup units will perform with any sound system properly equipped with necessary pre-amplification and feature:

(1) Less record wear because of soft needle suspension; Less distortion because of the soft spring jewel mounting; Less needle scratch because of response only to lateral vibrations; Less needle talk because of the very light and small stylus assembly.

For printed literature and prices address inquiries to Amplifier Corp. of America, Dept. "RSD," 398-9 Broadway, New York 13, N. Y.



EASIER-TO-SELL

PROFITABLE

COMPLETE

# UNIVERSAL PARTS LINE

QUALITY

TESTED

TIME-SAVING



SPEAKERS

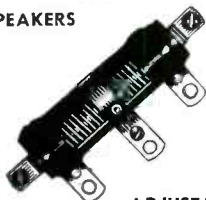

ADJUSTABLE WIRE-WOUND RESISTORS

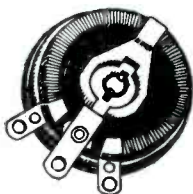

RHEOSTATS

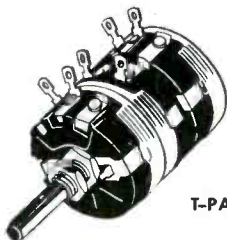

T-PAD



L-PAD

**B**UILD your parts business on a solid foundation—acceptance. General Electric Universal Parts have acceptance. They give you every possible advantage in making this a profitable line because—

- **G-E is the quality line**—exhaustive tests were employed to prove every unit before it was admitted to the line.
- **G-E is the complete line**—most of the items you need every day are in the line.
- **G-E is the profit line**—the line of quality products that give satisfaction—keep customers happy—bring business.
- **G-E is the easier-to-sell line**—every customer knows the name and reputation of the General Electric Company. Cash in on that acceptance.

Save time—build solidly—specify General Electric Universal Parts for bigger, more profitable parts business.

For full information, write: *General Electric Company, Electronics Park, Syracuse 1, New York.*



ATTENUATORS



FIXED WIRE-WOUND RESISTORS

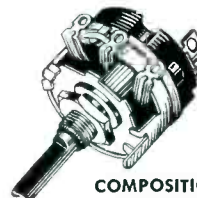

COMPOSITION CONTROL



2 WATT WIRE-WOUND CONTROL



ADJUSTABLE SWITCHES

# GENERAL ELECTRIC

LEADER IN RADIO, TELEVISION AND ELECTRONICS

## IN THE TRADE

[From page 8]

auto radios and other products during the period of this great Cuban Exposition. Popular voting was held to determine the first choice of many different kinds of products which were displayed. In the auto radio classification, Motorola took first place.

### Admiral Appoints Allen

W. C. Johnson, General Sales Manager, Admiral Corporation, Chicago, announced the appointment of Herbert J. Allen as Central Regional Sales Manager. He will handle both Admiral Radios, Dual-Temp Refrigerators and Electric Ranges.

## BOOK REVIEWS

### 1947 AUTOMATIC RECORD CHANGER SERVICE MANUAL

Howard W. Sams & Co., Inc., publishers of Photofact Folders, announces the publication of a "1947 Automatic Record Changer Service Manual."

This new 400 page volume covers more than 40 different Automatic Record Changers, including Wire, Ribbon, Tape and Paper Disc Recorders. Each unit is described fully in 8 to 12 pages of original photos, diagrams, and text. All the information is compiled from actual analysis of the equipment in the Sams' Photofact Laboratories.

Included are photo views of top, side, bottom and rear of each mechanism, and exclusive "exploded" view diagrams. Full data is provided on change cycle, adjustments, service hints, and kinks. All components are keyed to the text and to a complete replacement parts list for each unit. Uniform style and treatment is featured throughout the volume.



The manual is printed clearly and legibly on high quality paper; the strong Smythe-sewed, hard bound book opens flat for easy reference use on the work bench. It is available at all radio parts jobbers for \$4.95.

### DIAL CORD STRINGING GUIDE

There are many ways to string a dial cord—but only one way is right. This serviceman's headache is solved by the new "Dial Cord Stringing Guide", recently published by Howard W. Sams & Co., Inc.

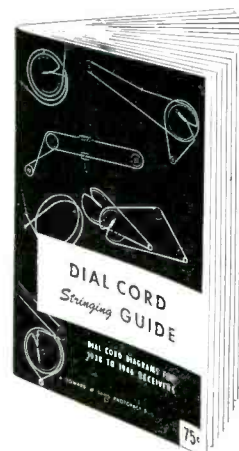

This handy, pocket-sized book illustrates clearly and easily how to repair dial cords in radio receivers produced from 1937 through 1946. Easy to follow diagrams and text show each step clearly and accurately. The knottiest dial cord repair job can be solved in a few minutes. The 100-page handy-sized

# MEISSNER

PRESENTS THE NEW *Brewster Line*  
OF TABLE MODEL RADIOS! . . .

Here at last is the outstanding line of table model radios you have been waiting for! Superbly designed, unmatched for sheer beauty of tone, these quality sets reflect the skill and craftsmanship that have made the name Meissner a byword for quality in the trade.

Smartly designed, quality engineered, these new Brewsters are being manufactured for exclusive distribution through parts jobbers only. No quotas, no high pressure tactics, no sales direct to dealers or special distributors . . . nothing that might interfere with your merchandising this exclusively-jobber line to the hilt. And Meissner unconditionally guarantees these new Brewsters against price reduction for the balance of the year.

*This line is available for delivery now. Write today for full information, catalog and prices.*



**Meissner**  
ELECTRONIC DISTRIBUTOR AND  
INDUSTRIAL SALES DEPARTMENT

**MAGUIRE INDUSTRIES, INCORPORATED**

500 W. HURON ST., CHICAGO 10, ILLINOIS

**EXPORT-SCHEEL INTERNATIONAL INC.**

4237 N. LINCOLN AVE., CHICAGO 18, ILL. • CABLE—HARSHEEL

# SPRAGUE TRADING POST

## SWAP—BUY OR SELL

**FOR SALE**—1946 model, 14-watt amplifier, with 2 mike inputs on switch, in good condition; 22 x Turner mike; 55c Shure uni-directional dynamic mike; 25-watt p.m. driver unit with transformer and projector in heavy duty metal baffle; and mike stand with standard  $\frac{3}{4}$ " 27 thread. \$100 for lot. Must be sold immediately, Joseph L. Freniève, 129 Natick Ave., Greenwood, R. I.

**FOR SALE**—Super meter, model 670 in carrying case; combination volt-ohm-milliammeter, plus capacity, reactance, inductance and decibel measurements, and quality electrolytic condenser test. Only slightly used, in perfect condition, \$20. T. E. Tyndall, 206 S. Front St., New Bern, N.C.

**SELL OR TRADE**—Volumes 1 & 2 Sam's Photofact folios complete with binders. Need late model tube checker or signal generator. E. O. Norman, 2021 N. Houston St., Fort Worth, Texas.

**WANTED**—Two 866 with filament transformer grid and plate; tuning cond. & coil for P.R. 807 in final 80 meters; also mod. transformer for it. Have for sale 32v Delco, also Super PW receiver, no batteries. \$75. James Dichiera, 135 Main St., West-ernport, Md.

**FOR SALE**—N. R. I. radio course with all lessons but not all kits. Lessons 39 to 60 not finished. You finish them and get diploma. Will sell this \$120 course for \$75—\$15 down, \$12 per month. Rollin L. Kreader, 1891 Humboldt, Denver 6, Colo.

**FOR SALE**—Superior signal tracer CA-11, \$10; also metal portable all wave receiver, made for army, can be used anywhere, \$50; little used, all instructions, both for \$55. H. C. Hasse, 166 White City Park, St. Petersburg, Fla.

**WILL TRADE**—Model gas engine with accessories, less timer contact points worth \$25. Want used signal tracer or signal generator or what have you. Will also trade 24 issues of Air Tracts for same number of issues of any radio magazine. Edward Ramirez, P. O. Box 516, Camarillo, Calif.

**FOR SALE**—Following tubes 70% off list, 1L6G, 1D7G, 1D8GT, 1E7G, 1G4, 1G6, 1H6, 1N6, 1S5, 1T4, 2B7, 14A7, 22, 32, 34, 38, 6B7, 6E6 and other rare tubes. What do you need? Charles Conley, Clearfield, Utah.

**SELL OR TRADE**—Log-Log Deci trig slide rule, new, never used; \$12.50 or will trade for 1500-0-1500 V. 300ma power transformer, or what have you? All inquiries answered. George Whitten, 213 W. Williams, Fort Wayne 6, Ind.

**FOR SALE**—Radio and Electrical Appliance business with store and apartment Reasonable. Hand & Halsey Radio Shop, Bridgehampton, New York.

## A REAL LABORATORY INSTRUMENT

.. Priced for the Service Market



**NEW De Luxe SPRAGUE TO-3 TEL-OHMIKE**

This new de luxe Tel-Ohmike is the ideal instrument for capacitance and resistance checking or analyzing. Smaller—easier to use than previous models. Checks capacitors and resistors **WITHOUT REMOVING THEM FROM THE CIRCUIT**. Has high-grade built-in D.C. volt-milliammeter.

Although designed and priced for servicemen, Tel-Ohmike is used in hundreds of laboratories where its accuracy and usefulness have been proved in the most exacting applications. It's a real *professional* instrument—for servicemen who take real pride in their work.

See it today at your Sprague jobber's store. Write for Bulletin M-414.

**WANTED**—Used correspondence courses and books on electrical radio and television engineering. E. Galaski, 944 51st St., Brooklyn 19, New York.

**FOR SALE**—First 12 issues Sam's Photofact Folders with binder \$15. West Side Radio & Appliance Co., 304 Ruby St., Joliet, Ill.

**FOR SALE**—Hickok 305 oscilloscope, used approximately 5 hours, \$110; also Riders Manuals I-V abridged, VI through XIV, like new, \$115. Both items f.o.b. Visalia, Calif. H. E. Stratton, Jr., 427 S. Garden St.

**SELL OR TRADE**—6" screw cutting Atlas lathe; headstock spindle equipped with Timken tapered roll bearings. Has been used, will trade for good 200-watt phone rig, 10 meters. Write for information. Hohn Radio, Box 173, Morristown, Minn.

**WILL TRADE**—Antique Grebe receiver, 1914 patent model, perfect condition, suitable for collection or window display. Will trade for SW3 outfit or Abbott transceiver TR3-TR4. G. Samkofsky, 527 Bedford Ave., Brooklyn 11, N. Y.

**FOR SALE**—Radio & Appliance Sales & Service store. Good stock of parts and new appliances. \$3,500 complete. Selling because of other enterprises. Circle Radio & Appliance, 416 Railroad St., South Fork, Pa.

**WILL TRADE**—Zeiss Ikon "Volta" camera, 2 1/4" x 3 1/2", rear ground glass range finder, Zeiss domnar anastigmat f4.5 lens, film pack

adapter and tripod with case; speeds to 1/100 sec. Want late model tube tester. John Barnello, 391 St. Johns Place, Brooklyn 17, N. Y.

**FOR SALE**—Lafayette 30-40 watt sound system amplifier 8 tubes, 2 mike inputs, 1 radio and 1 phono input; two 12" dynamic speakers with 100' cable; dynamic mike, 50' cable, adjustable stand, portable carrying case, \$125. C. G. Thomas, 175 Wilkinson Ave., Jersey City 5, New Jersey.

**FOR SALE**—Triplet signal generator No. 1230, \$15. John Piat, 1230 Lincoln St., North Chicago, Ill.

**WILL TRADE**—RTI radio course over 80 complete lessons; Drakes radio encyclopedia, Practical Radio Repairing Hints, Rider; Radio Manual, Servicing Super Sets, Rider; The Oscillator at Work, Rider; Radio Troubleshooters Handbook, Ghirardi. Want good typewriter or adding machine. J. L. Robert, Howard, Kans.

**FOR SALE**—Speedex wire strippers, slightly used, guaranteed, each pair will strip 3 sizes, \$2.50 postpaid; state largest size wire to be stripped. Frank M. Watts, DeQuincy, La.

**WANTED**—12A7 tube and tube tester transistorizer. R. M. Blomquist, 146 Beaugard, Maplewood, La.

**FOR SALE**—Oscilloscope, 5" Western Electric, has wide band sweep and amplifiers; complete chassis with all tubes, ready to operate, 110v, 60 cycle a-c, \$74.50. Paul H. Prokes, 9216 S. Menard Ave., Oak Lawn, Ill. F.O.B. Chicago.

**FOR SALE**—Transformer 115/220v primary, 25000/50,000v. 40 ma secondary. Shipping weight 100 lbs. \$40. Need hi-fi speaker or amplifier. Warren Preeshl, RFD2, New Richmond, Wis.

**FOR SALE**—Ohmmeter, soldering iron and correspondence courses with kits. James Morgan, 321 E. Central Ave., Griffin, Ga.

**WANTED**—Technical manuals for B-19, SCR 522, AN APG 5, BC 611, BC 1253, SCR 269, BC 645, and other surplus equipment. Send lists. F. T. Chambers, 614 Pyne, Princeton, N. J.

**FOR SALE**—German radio tubes, guaranteed perfect, 1-UY-11, 11-RV12P, 2000, 1-AB2, 3-DF-11, 1DAF-11, 1-UCH-11 and also several German precision electrical meters. Albert C. Hart, 4848 Linden Ave., Hammond, Ind.

**FOR SALE**—Hundreds of up to date receiving and transmitting tubes, transformers, power and audio. Also 30 watt audio amp. RCA regulated power supply. RCA crystal oven which cost over \$100; small electric welder, two 12" pm speakers. Will sell all or part. S. Palasek, 62 Main St., Port Washington, N. Y.

**SELL OR TRADE**—12 volt light plant, 250 watts used about 15 hours; good for trailer, boat or cabin, \$70. Want small gas engine or Spraver. Otto Barlow, Santa Margarita, Calif.

**FOR SALE**—Popular books on radio, electrical, physics and math. All like new. Send for lists and prices. S. Gerskberg, Oak Lane Towers, Apt. 3D, 13th St. & 68th Ave., Philadelphia 26, Pa.

**URGENTLY NEEDED**—Riders No. 3. Will pay cash. Wm. Bashta, 113 Bennett St., East Syracuse, N. Y.

**FOR SALE**—Complete radio shop, including condenser checker, tube and set checker, crystal controlled signal generator, DuMont oscillograph, power and output transformers, bypass and buffer condensers, volume controls, coils, belts, all kinds of resistors, etc. Wholesale value about \$1,200. Will sell for \$900. Everything new and in good condition. Down payment of \$100 and I will deliver to 100 miles. Jim's Radio Shop, 125 Chestnut St., Wrightsville, Pa.

**FOR SALE**—Complete file QST in binders, from 1933 to June, 1947, \$50. J. A. Kirk, 3524 Rolling Road, Baltimore 7, Md.

**SELL OR TRADE**—All kinds German radio equipment, receiving and transmitting tubes, meters, hand and throat mike, etc. Good for experimental work or collections. Also have Kalamazoo electric Hawaiian guitar, modified Hallcrafters S-19-R. What have you? Will answer all letters. L. A. Webster, 311 Fairmount Ave., Waynesboro, Pa.

**WANTED**—Radio correspondence course or books. Trade RAF officer's uniform with scotch wool great coat in new condition, size 40. L. Wilson, 1389 West 39th St., Los Angeles 37, Calif.

**FOR SALE**—RCP late No. 668 VIVM. New parts—Stancor A-3800 output and P-6314 power transformer; 175 ma. and 40 ma. filter chokes; tube tester trans; Sigma 8000 ohm sensitive relays. Also some new tubes—write for list. H. W. Schendel, 518 W. Main St., Sparta, Wis.

### YOUR OWN AD RUN HERE FREE

The Sprague Trading Post is a free advertising service for the benefit of our radio friends. Providing only that it fits in with the spirit of this service we'll gladly run your own ad in the first available issue of one of the six radio magazines in which this feature appears. Write CAREFULLY or print. Hold it to 40 words or less. Confine it to

radio subjects. Make sure your meaning is clear. No commercial advertising or offering of merchandise to the highest bidder is acceptable. Sprague, of course, assumes no responsibility in connection with merchandise bought or sold through these columns or for the resulting transactions.

Dept. RSD-107, SPRAGUE PRODUCTS COMPANY

North Adams, Mass.

(Jobbing distributing organization for products of the SPRAGUE ELECTRIC COMPANY)

ASK FOR SPRAGUE CAPACITORS and \*KOOLOHM RESISTORS by name!

\*Trademark Reg. U.S. Pat. Off.

book sells for 75c and is on sale at all radio parts jobbers.

#### VIBRATOR DATA BOOK

The first "Vibrator Data Book" ever published is now being distributed by P. R. Mallory & Co., Inc. This new work discusses fully a wide range of design and application problems for Vibrators and Vibrator Power Supply in its 135 pages of text illustrated with 64 charts and diagrams.

The Mallory "Vibrator Data Book" contains exhaustive descriptions of basic structures, designs and Vibrator characteristics. It discusses fully the selection of correct types for specific problems;

outlines the latest information on applications; describes and illustrates the circuits involved. The text is complete and easy to understand and is amplified with 16 pages of pertinent Tables, Charts, Graphs and Formulas.

Engineers and radio service men will find in the "Vibrator Data Book" the answers to "why" questions and clear explanations of the basic principles involved in designing and applying Vibrator equipment. The publication is particularly valuable to anyone working on auto radios and other equipment powered from a d-c source.

Loose-leaf Vibrator Characteristic Data Sheets are included with all copies

of the Data Book ordered by manufacturers' engineers. These sheets are supplied to Radio Service Men only on special request. The Data Book is available through all Mallory distributors or direct from P. R. Mallory & Co., Inc., 3029 E. Washington St., Indianapolis 6, Ind., at \$1.

#### GET PUBLICITY FREE

[From page 23]

agencies and large corporations concerning radio. However, these releases are not localized. Our readers are not too much interested in what a Washington bigwig or large radio corporation president has to say about radio. They are too far away. But you—Bill Jones—are well known in the community. Your customers and potential customers know you—they respect what you say.

So the thing to do is to take statistical material and localize it. That means have the figures come from you. But if you take the time to simplify the figures and put them in good readable English with a local angle, the local newspaper will more than likely make use of it.

And there are other ways: How about the science and radio classes at the local high school? Why not take an old radio—one of the very old models—to the class and explain to the students how radio has advanced in the past decade. School principals like this sort of educational speech-making. The pupils will be interested, and they will remember you. Remember, they are all potential customers.

How about a short talk about the care of a radio—this should go good with civic groups and clubs. Everyone has a radio, everyone is interested in radios.

If you have a collection of old-time radios, call your paper. It will make a good feature story with pictures. My bet is the editor will have a reporter and photographer in your shop in a short time. Also, the old radios can be used as a very effective window display when compared with modern receivers.

It's all public relations and it all pays off. By following a localized, carefully-planned program of public relations for a few years, your name and the name of your radio repair establishment will become synonymous with radio repair in your community.

#### CIRCUIT COURT

[From page 24]

method of achieving the desired results. The tube is a 6J5 triode. Note the small value of the input coupling condenser. This .001 unit will attenuate the lows to a great extent and provide plenty



## Sine or Square Wave at the Flick of a Switch!

Now—the General Electric Sine-Square Wave Generator YGA-2 provides you with greater facilities for better, more efficient service work. A top quality equipment, it incorporates two units in one; a high quality, stable oscillator and a square wave generator. It features a low distortion sine wave, stable RC oscillator and instantly available square waves.

#### SINE WAVE APPLICATIONS

Testing and adjustment of audio amplifiers, transformers, phase inverters, audio filters, etc.

#### SQUARE WAVE APPLICATIONS

Two point testing of response and characteristics in audio devices. Checking frequency response of wide band amplifiers. Determination of phase shift, distortion and high frequency peaks in audio equipments.

For complete information on the Sine-Square Wave Generator and other General Electric Service Test units write today to: General Electric Company, Electronics Park, Syracuse, N. Y.

**GENERAL  ELECTRIC**

164-F7



**RACONS** do more  
at lower cost than  
ordinary reproducers

**ACOUSTIC & STORMPROOF MATERIAL**

Only RACON makes speakers with Racon Acoustic Cloth which is processed by a patented method giving a non-vibratory wall, thereby increasing the output of the horn without loss due to wall vibration. Supplied as a part of all re-entrant horns, and on all straight horns when so ordered. Stormproof types are guaranteed for life in all kinds of weather and temperature, regardless of climatic conditions.



Straight Trumpet



Dwarf Re-entrant

**ADVANCED ENGINEERING & DESIGN**

RACON'S leadership in sound reproducer engineering has been recognized for almost three decades. RACON driver units have a rated output for peak and continuous performance far in excess of any other brands—continuous operating capacity 30 watts, peak capacity 60 watts. RACON speakers and driving units require less energy input yet they deliver more efficient sound reproduction output. All claims made by RACON as to cutoff frequencies and acoustic lengths of speakers, power handling capacity, efficiency and frequency range of driver units are substantiated by tests made at laboratories recognized as the foremost in the industry.

**COMPLETE LINE TO CHOOSE FROM**

There is a RACON driving unit, trumpet or speaker for every conceivable sound application—also the accessories (brackets and housings) that may be required for special purposes. Soundmen know that it pays to choose and use a speaker line that is complete. Yes—RACON makes every kind of sound reproducer from the giant 7 foot length auditorium horn down to the small 4 inch intercom cone speaker—from the super giant P.M. driving unit to the tiny driver for paging horns.

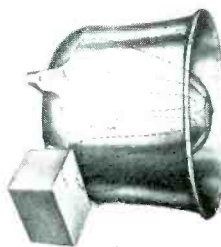

Marine Speaker



P-M Unit

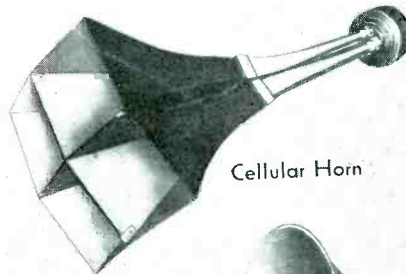

Cellular Horn

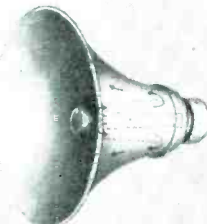

Re-entrant Trumpet



High Frequency Speaker

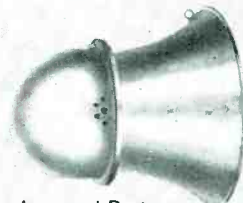

Armored Projector



Paging Horn



Radial Re-entrant



**RACON**

RACON ELEC. CO., INC., 52 E. 19 ST., NEW YORK, N. Y.

SEND FOR OUR NEW FREE CATALOG

Racon Elec. Co., Inc.  
52 E. 19th St., New York 3, N. Y.

Gentlemen: Please send me a copy  
of your new free catalog.

Name .....

Address .....

City & State .....

of highs for subsequent circuits.

The grid resistor of the tube returns the junction of the cathode resistors, providing normal bias voltage for the tube across the 2,200-ohm section, and high impedance for the bass boost circuit across the total of 24,200 ohms.

The large .02 shunt condenser serves to reduce the highs as the 250K-ohm control is moved down in the diagram. As the arm moves up it removes the shunting action and adds some by-pass for the cathode circuit to boost high response somewhat.

The 9 henry choke, in series with a large capacitor to prevent shorting the cathode for D.C., provides bass boost

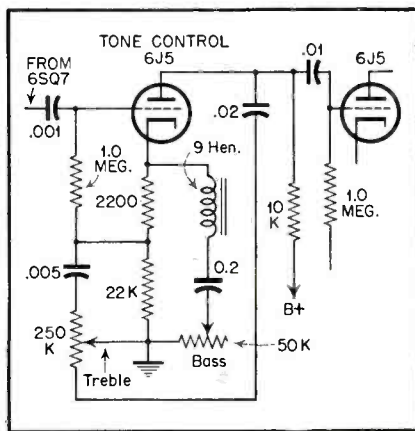

as the resistance in series with it is decreased.

There is a loss through the stage but adequate gain is provided in subsequent stages.

## MODERN TELEVISION KITS

[From page 21]

same d-c potential as the plate of the 6AG7, the cathode of the CRT should have a higher positive potential. This is accomplished by the voltage dropping resistor in the plate circuit of the 6AG7, the cathode of the CRT being connected to the B plus side of this resistor.

Since the video signal, which is developed in the plate circuit of the 6AG7, is directly transferred from this plate load to the CRT grid, no other d-c reinsertion circuit is required.

### Synchronizing Pulses

The synch pulses are taken off the voltage divider across the 3,500-ohm video load resistor at *point A*. They are then fed into the first section of the 6SN7 synch amplifier clipper. The phase of these pulses are inverted to a plus peak at high amplitude level. The second section of the 6SN7 is a limiter clipper which is backed up with the second diode section of the 6H6. This diode forms a bias voltage, and clipping occurs at the grid of second section of the 6SN7.

Separation of the synch pulses is done in the cathode and plate circuits of the same tube. The horizontal pulses, which are of positive polarity, are taken off the 4,700-ohm cathode resistance. They are then fed into the cathode of the cathode coupled multivibrator oscillator and discharge tube, which is a 6SN7. The 150  $\mu\text{mf}$  condenser, and the 470-ohm resistor in the cathode circuit of this tube form the differentiating network. The output of the discharge tube then is transferred into the 6SN7 phase-inverter, which in turn delivers a balanced horizontal set of pulses to the horizontal plates of the CRT.

The vertical pulses are taken from the plate of the 2nd section of the synch amplifier tube at *point B*, through the integrating filter, and into the grid of the first section of the 6SN7 vertical oscillator and amplifier. Brute force action which is present in the vertical and horizontal oscillators consists of firing the oscillators directly by the respective synch pulses as sent from the transmitter.

Stability of performance in the synch circuits is aided by the fact that noise interference is minimized by the limiting action of the 2nd diode of the 6H6 and the second section of the 6SN7 clipper. The negative voltage developed at *point C* is fed into the grid of the first section of the synch amplifier to give a

# AMPHENOL

## TWIN-LEAD TRANSMISSION LINE AND ACCESSORIES

### Assure low-loss FM and television antenna installations

• Expert electronic technicians quickly recognized the excellence of Amphenol Twin-Lead and accessories for FM and television lead-ins.

Designed to transmit signals with minimum loss, Twin-Lead is durable, simple to install and inexpensive. Its extruded polyethylene dielectric is full thickness edge to edge, and it is available in four impedances: 300, 150 and 75 ohm for lead-ins; and in a 75 ohm impedance for transmitting.

The uniform conductor spacing and dielectric thickness of Amphenol Twin-Lead holds noise pickup to a low level, and insures uniform impedance so important in eliminating ghosts in the reception of television. It also simplifies matching antenna and transmission line. Below are shown actual cross section diagrams of all four sizes of Twin-Lead, and more detailed information on Amphenol Twin-Lead accessories.

Radio Amateurs insist on Amphenol Twin-Lead for transmitting antennas.



AMPHENOL CLEAR PLASTIC WINDOW PANE ends broken glass and drilling through sash. It is easy to cut to size and drill, ordinary woodworking tools do the job. Of polystyrene, its dielectric properties are ideal. Available in 12"x16" sheets in 1/16 to 1/4 inch thicknesses.

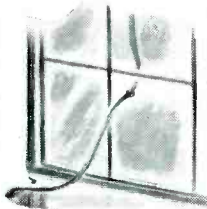

AMPHENOL SILICONE COMPOUND minimizes changes of impedance, and maintains high surface resistivity, on radio transmission lines. It causes surface moisture to break up into isolated drops. A thin coating does the job. Available now in one-ounce tubes (enough to last 6 months to a year on average antenna installations).

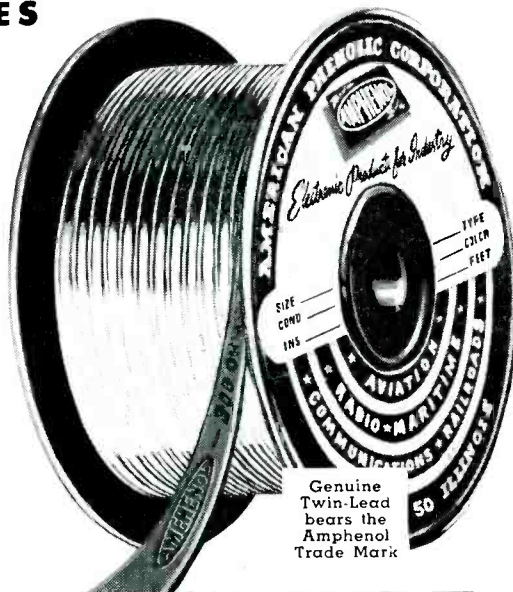

### Amphenol Polystyrene Insulators and Line Spreaders

Screw Eye Insulators with polystyrene insert are available in two types: one for Twin-Lead, one for coaxial cable. Twin-Lead types do not have to be strung. You merely insert the conductor in the slot, turn the insert and squeeze the screw eye closed with pliers. The No. 14 wood screw on both types is three inches long.

Stand-Off Insulators are of Amphenol low-loss polystyrene. Offset mounting hole permits easy mounting. Holds Twin-Lead in a strong, permanent grip.

Line Spreaders are used for separating feeder lines, and for constructing folded dipoles from wire. They are light weight and easy to use. Set screws keep the wires firmly in place. Wire holes are .085" D. Available for 2, 4, and 6 inch line spacing.



## AMERICAN PHENOLIC CORPORATION

1830 South 54th Street, Chicago 50, Illinois

COAXIAL CABLES AND CONNECTORS • INDUSTRIAL CONNECTORS, FITTINGS AND CONDUIT • ANTENNAS • RADIO COMPONENTS • PLASTICS FOR ELECTRONICS

**HOWICK'S RADIO SERVICE** *A Sign of Successful Servicing*

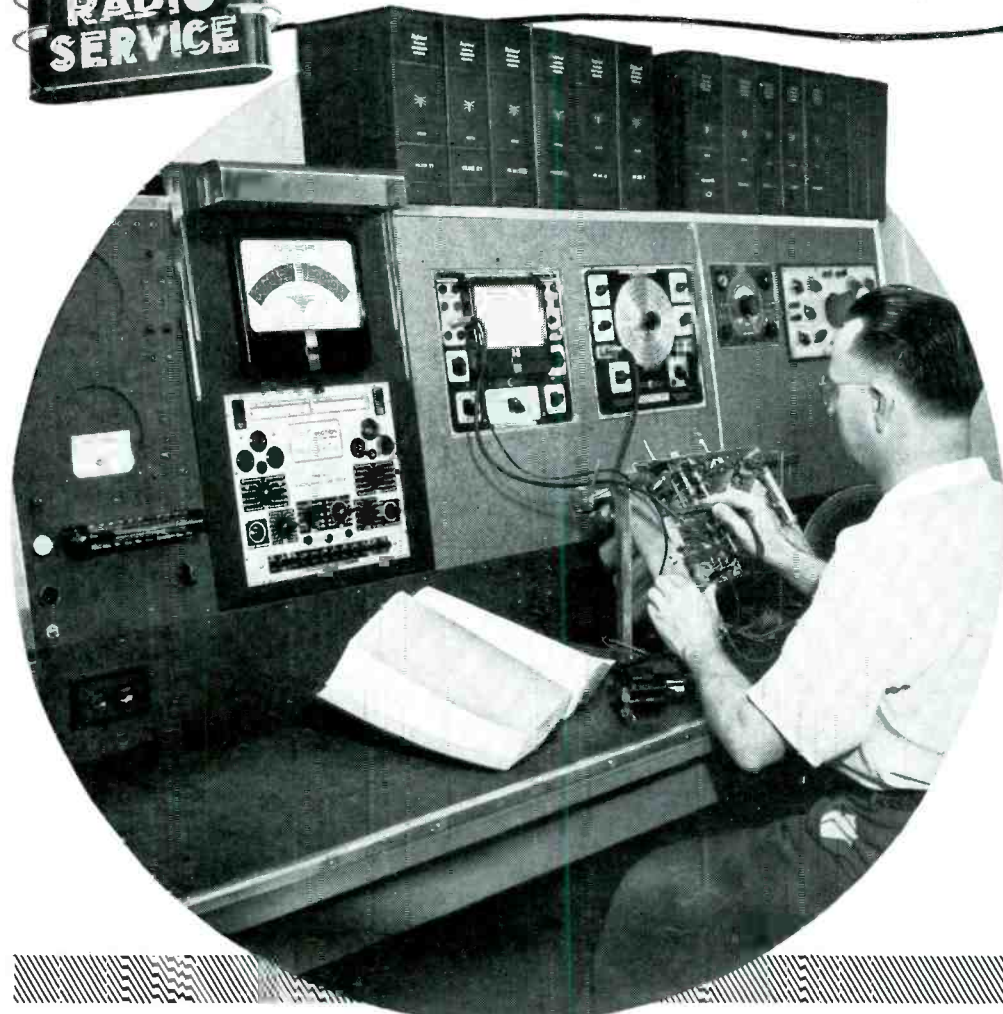

**Howick's has All Fifteen RIDER MANUALS**

*(and Vol. XVI on order)*

No one knows better than the local parts jobber those servicing shops in his territory which are outstandingly efficient and successful. Thus, it is significant that Standard Radio & Electronic Products Co. of Dayton and Springfield, Ohio, featured Howick's of Celina, Ohio, in their "Srepcu News", saying, "It is one of the most orderly it has been our pleasure to see, having up-to-the-minute test equipment and service manuals, which are paying dividends."

Efficient, profitable, successful, servicing shops are invariably equipped with a complete set of Rider Manuals; the only single source of authoritative\* information for data which is needed to diagnose quickly the ills of all receivers issued since 1920.

Rider Manuals are investments. Copies of Volume I, bought seventeen years ago, are still paying dividends to their owners. Be sure your shop has the sign of Successful Servicing—all sixteen Rider Manuals.

**NOW AT YOUR JOBBERS' VOL. XVI RIDER MANUAL**

Volume XVI is the first of the three-a-year Rider Manuals. Picking up where Volume XV leaves off, it inaugurates our new publishing schedule, which will bring you authentic servicing data on current receivers at the earliest possible moment.

Its 768 pages contain data from 94 manufacturers and include many private-brand name products.

In Volume XVI the percentage of time-saving, Rider-exclusive, "clarified schematics" has been increased because of the great number of new multiband receivers—and every one of these is broken down into its respective bands. Photographs of small table models are generously represented to aid in quick identification—and

the separate "How It Works" book explains the characteristic kinks of the newer receivers.

Thus the traditional understanding of your problems, which has characterized Riders' "Seventeen Years of Continuous Service to the Servicing Industry", carries on in Volume XVI, bringing you complete, authoritative servicing data at the earliest necessary date—at the minimum investment.

For, though the binding is the same custom-made binder that matches your other Rider Manuals, and the contents are of the usual high standard, supplemented with "clarified-schematics" (and the "How It Works" book is included at no extra cost) Volume XVI is yours at less than a penny a page.

**Your jobber has it in stock. Order it. Now!**

\*Rider Manual data is the OFFICIAL AUTHORIZED servicing data right from the servicing departments of the companies that made the sets. No one knows, better than the manufacturer, what servicing procedures are best for his products. That is the basis for the authority and success of Rider Manuals.



**768 PAGES PLUS "How It Works" Book \$6.60**

**BE SURE YOU HAVE ALL 16 RIDER MANUALS**

Volume XVI.....	\$ 6.60	Abridged Manuals I to V (one volume)....	\$17.50
Volume XV.....	18.00	Record Changers and Recorders.....	9.00
Volumes XIV to VII (ea. Vol.).....	15.00	Master Index, covering Rider Manuals, Volumes I to XV.....	1.50
Volume VI.....	11.00		

JOHN F. RIDER, PUBLISHER, Inc., 404 Fourth Avenue, New York 16  
Export Agent: Rocke International Corp. 13 E. 40th St., N.Y.C. Cable ARLAB

**RIDER MANUALS MEAN SUCCESSFUL SERVICING**

See the NOVEMBER Issue of "SUCCESSFUL SERVICING" for Winners in the \$4325 Rider Manual Contest

**Just Out!**

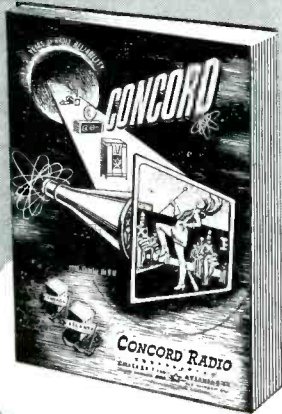

**GREAT NEW CONCORD Radio Catalog**

The ONLY Complete Up-to-the-minute Catalog of Radio Parts · Sets · Amplifiers Testers · Ham Gear · Electronic Equipment  
Mail Coupon for FREE Copy

Ready now—the greatest, latest complete presentation of radio, electronic and television equipment and supplies in Concord history! Packed from cover to cover with thousands of items—160 pages of everything in Radio and Electronics. Special bargain section of hundreds of money-saving values. Scores of NEW ITEMS from famous makers. Mail coupon for FREE copy at once!



**SPEAKERS**  
with 3 ohm VC's at real buys  
**X150M.** 6" Round P.M. . . . . \$1.14  
**X151M.** 4"x6" Oval Alnico V P.M. . \$1.19  
**X152M.** 4" Dynamic 450n field . . . \$1.29



**RF & DC Meter Values**  
0.4 Amp. RF. Built-in thermocouple. GE type DN-55. 2 1/2" round.  
**X168M**—Each . \$1.95  
0-35 V DC. Red mark at 28.5 V. Simpson type K25. 2 1/2" round. **SB420S**. \$1.95

**ELECTROLYTICS**  
All Nationally Known Makes

Number	Mf.	WV	Each	Number	Mf.	WV	Each
X154M	8	450	24c	X153M	20-20	150	49c
X155M	8	450	39c	X160M	40	450	65c
X156M	10	450	27c	X161M	60-30	150	29c
X157M	10-10	450	47c	X162M	16	500	39c
X158M	16	450	29c	X163M	100	60	15c
X159M	20	150	22c	X164M	100-100	60-20	60 19c

**CONCORD**  
RADIO CORPORATION  
CHICAGO 7 901 W. Jackson Blvd.  
ATLANTA 3 285 Peachtree Street  
LAFAYETTE RADIO CORPORATION

CONCORD RADIO CORPORATION, Dept. K-107  
901 W. JACKSON BLVD., CHICAGO 7, ILL.  
Yes, rush FREE COPY of the comprehensive new Concord Radio Catalog.

NAME \_\_\_\_\_  
ADDRESS \_\_\_\_\_  
CITY \_\_\_\_\_ STATE \_\_\_\_\_

certain amount of AVC control, and to help maintain a constant synch pulse level regardless of the setting of the contrast control.

**Sound Section**

The sound I.F. is taken off the plate circuit of the 2nd video i-f transformer by means of an absorption trap. From there it is fed into another stage of sound I.F. and thence into the second detector.

**Power Supply**

Containing a separate high and low voltage supply, the power circuit of this receiver is conventional in every aspect. A 5U4G is used as the low voltage rectifier, and a 2X2 as the high voltage rectifier.

**Alignment**

The manufacturer has designed this receiver so it may be aligned visually without the aid of alignment instruments, or with a signal generator, according to the desire of the constructor. In either case the alignment procedure involves setting the guard traps so that no adjacent channel interference is obtained, adjusting the sound trimmers to maximum response, and adjusting the oscillator and r-f trimmers to the channels desired.

**Manufacturers Service Policy**

The set is guaranteed to operate satisfactorily if the directions are followed exactly. All servicing of component parts and assembled sets are performed by the factory at factory cost. For the convenience of purchasers Transvision has a number of service agencies spread throughout the country.

**P-A FUNDAMENTALS**

[From page 17]

In p-a parlance, high-impedance lines generally are regarded as those from 50 to 600 ohms. Through their own capacitance, these higher lines attenuate

[Continued on next page]

**TECHNICAL QUIZ No. 3**

**ANSWERS**

Do NOT read or study these answers until you have finished marking down your answers to the "Quiz" given on pages 22 and 23 of this issue. When that is done, compare your answers to these correct ones.

**ANSWERS**

- 1-A; 2-C; 3-A; 4-A; 5-B; 6-C; 7-B; 8-A; 9-B; 10-A.
- 11-A; 12-C; 13-A; 14-B; 15-B; 16-A; 17-B; 18-C; 19-C; 20-A; 21-A; 22-B; 23-C; 24-A; 25-A.

**TRANSVISION**

Scores Another Great Scoop!

The DeLuxe

**7" TELEVISION KIT with a Complete FM RADIO**

covering the entire FM BAND 87.5 to 108.5 MC)



Now...build yourself a magnificent two-in-one receiver—**Television and FM Radio**—and save more than 50% on the comparative cost of a completed set.

Wire up the DeLuxe 7" Transvision Kit, install the FM Radio which comes with it and requires no assembly, and you have a receiver worth over \$100.00.

**Note These Outstanding Features**

- You get the famous 7" Transvision Television Kit, plus—
- A superb high quality, high fidelity FM Radio which covers the entire FM Band, from 87.5 to 108.5 MC. Radio comes assembled ready to install.
- FM front end as well as the television front end are completely wired and tuned.
- You get ALL the parts, including front panel, specially designed FOLDED DIPOLE ANTENNA and 60 ft. of low-loss lead in cable.
- **NO TECHNICAL KNOWLEDGE REQUIRED** for assembly. No instruments required.
- As easy to assemble as the standard 7" Transvision Television Kit.
- **DeLuxe 7" TRANSVISION TELEVISION KIT with FM RADIO RECEIVER.** LIST \$199.00  
Beautiful furniture finish cabinet list \$32.50

**FM CONVERSION KIT**

You can incorporate a complete FM radio into your present television receiver by means of the **Transvision FM conversion kit.** LIST \$29.95

If your kit already has FM sound, a conversion to FM radio will cost even less. Ask your distributor.

See your local distributor, or for further information write to:

**TRANSVISION INC.** Dept. R.S.D.  
385 North Ave., New Rochelle, N. Y.

**PRAY FOLDED DIFAN ANTENNA  
FOR TELEVISION AND F. M.**

(Patent Pending)

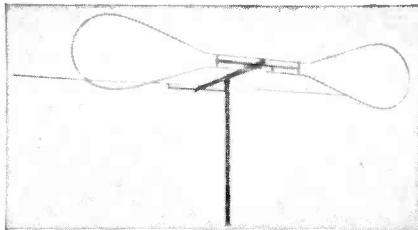

Your television, F.M., or short wave receiver is only as good as its antenna.

Do you know that your present simple or folded dipole antenna will operate efficiently on only *ONE* frequency? That it provides poorer reception on *ALL* other frequencies?

Give your receiver a chance to show what it can do on *ALL* stations.

Install a Pray Folded Difan, with a frequency range *MANY TIMES BROADER* than any other antenna on the market.

Price: With reflector **\$15.50** list  
Without reflector **\$10.50** list

See your local dealer  
or order direct from

**TUCK ELECTRONIC CORPORATION**  
76 Montgomery St. Jersey City 2, N. J.

somewhat the top end of the audio spectrum, but for reasonable feeder runs this is of slight import.

The voice-coil lines, directly feeding one or more speakers ranging from 32 ohms downward, are known as low impedance lines. In these latter, where currents are high and voltage low, line losses must be taken seriously, especially if the speaker impedance is low. For example, a 4-ohm speaker should not be fed over a line exceeding 18 feet if a conductor as small as No. 22 A.W.G. is used. This may be stretched to a run of 120 feet if the size of conductor is raised to No. 14 A.W.G. (See Fig. 1).

Speakers of higher impedance permit longer feeders. For example, if the same sized No. 22 conductor be used to feed a 16-ohm speaker, the feeders may be extended to a length of 75 feet. This distance can be rolled out to 475 feet if the No. 14 A.W.G., conductor is used. The graph shown as Fig. 2 will, if adhered to, hold low impedance lines within very tolerable limits. Never discount the importance of keeping power losses down in low impedance lines. See Fig. 1.

Now comes the \$64 much cussed and discussed question. "What shall we do with the frequency spectrum?" Another might be, "Who cares about highs anyway?"

Well, on page one of this blurb, the

**IT'S HERE  
AND IT'S AT—**

**NIAGARA  
TRANSVISION  
12" TELEVISION KIT**



This 12" television kit is tops in television. Set, less cabinet. . . . .

**\$289.00**

For this low cost you get a kit complete with 22 tubes, 12" picture tube, specially designed dipole antenna with 60 ft. of lead-in wire. Nothing more to buy. Easy-to-follow instructions come with each set. No tools or skills necessary.

De luxe with continuous tuning including FM Broadcasting reception . . . . . **\$359.00**

7" Kit also available . . . . . **\$159.50**

Write for Dealer Prices

**NIAGARA RADIO SUPPLY CORP.**

160 Greenwich St. Dept. RD. New York 6, N.Y.

**Increase your business now, with the fast selling**



**Perma-Power**

(THE IMPROVED PORTA-POWER)



**Convert Battery Radios  
to all electric operation**

Get the extra business from the hundreds of battery radio sets in your area. Perma-Power, the modern battery eliminator, is your answer—

1. when your customer asks how to convert a battery set to all electric operation.
2. when your customer has a battery set available and wants an extra radio in the kitchen, bedroom, playroom or workroom.
3. when you accept a battery set as trade-in, and you need to modernize the set for resale at a profit.

Dealers everywhere are finding these three methods profitable in adding new customers.

See Your Favorite Jobber . . . Today!

**Features that assure Customer Satisfaction**

- ★ GUARANTEED electrically for 3 years
- ★ YEAR AFTER YEAR trouble-free performance
- ★ SELENIUM RECTIFIERS—no tubes
- ★ UNDERWRITERS LABORATORIES approval
- ★ RADIO PLAYS INSTANTLY—hum-free
- ★ UNIVERSAL PLUGS for all battery radios



Manufactured by  
**GENERAL TRANSFORMER CORPORATION**  
4321 N. KNOX AVE. CHICAGO 14, ILL.

writer cranked up the gain and barked out for "Better Grade Equipment." Now we have one powerful argument. Good equipment can dish it out over a fairly wide spread throughout the spectrum and lends itself to modification. This gives the owner his choice. He can make his own decision here but, before he does, he is recommended to the June

1947 edition of "Audio Engineering." There happens to be several worthy discussions on *listenability* packed into that one issue,—including opinions from abroad.

This writer strings along with the idea of giving the customers what they want. That, in p-a work, generally means lopping off the highs from an FM

channel or leaving the top end of a normal one alone. When all the factors along the line are doing FM its rightful justice everything will be fine and dandy.

### POSITIONING SPEAKERS

The final location of horns or speakers may be quickly decided in some cases. In others, the mere lack of means for a safe and solid mechanical support of their weight may complicate matters. The simple solution previously described in the Hotel Roosevelt is encouragement toward our goal but the answer is not always so readily at hand. Appearances, too, must be well considered.

Smaller rooms may often be covered by overhead twin speakers angled somewhat downward and slightly back to back. They should be pulled forward from the microphone area until they still barely cover the audience front row and each becomes responsible for its lateral share of the room. Since rooms to be served will vary widely in size and shape, it is wise to make vertical and floor-plan sketches. A theoretical spotting and angling for coverage (keeping spill-over in mind) can be drawn up on these sketches. Plants the speakers accordingly on temporary support and listening tests can take up from there. Or, you might find that the use of a 360° radial horn will lick the spill-over problem.

Occasionally small rooms are troublesome when two or more microphones need be alive at the same time. Feedback may prove obstinate. A two-fold trick may be resorted to if the front audience row is at least fifteen feet from the nearest microphone and the floors are carpeted. Even two 6 x 8 feet rugs may serve. Try placing a variable level speaker on each side of the house directly on the floor (on the rug of course) well forward from the live microphone area and tilted and angled as though to spray the beams of headlights, across the audience. If the rear of these horns be covered, even with thick drapery, the chance of feedback is slight. Microphones carelessly and unintentionally turned sideways will still be 90 degrees or better off the beam.

In cases where this unorthodox trick proves helpful, two other well spotted and elevated speakers will generally suffice for the balance of coverage. The second gain from this trick emanates from the fact that the orator, hearing his voice amplified by speakers close to him, will not continue to shout the system into or beyond the fringe unless he's just a dyed-in-the-wool loud-shouter. Don't lean too heavily upon or attempt this trick if pressed for time as it only lends itself to certain physical setups.

In semi-circular layouts with reasonable ceilings a semi-gondola or the

## FINGERS are FASTER with VACO

Break-Proof Shock-Proof  
Screw and Nut Drivers

Nimble fingers using precision built tools do all kinds of radio assembly or servicing work faster, save both time and money. That's one good reason why radio men everywhere prefer Vaco products. Precision built for precision work, these delicately balanced screw and nut drivers "handle" perfectly... speed up every type of operation. Break proof, shock proof Vaco drivers are your assurance of the right tool for the job. Write today for descriptive catalog.

173 Types and Sizes



317 E. Ontario St.  
Chicago 11, Illinois

NO MATTER WHAT YOUR REQUIREMENTS... THERE'S A VACO TO FIT EVERY NEED!

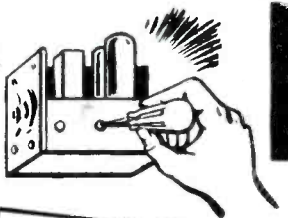
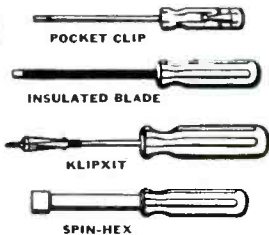

**NEW...**  
Colored Spin-Hex  
Amberly Handle Caps

Another Vaco extra! Color of removable cap indicates size of driver. No more hunting for the right size! Hollow handles hold reserve nut supply.

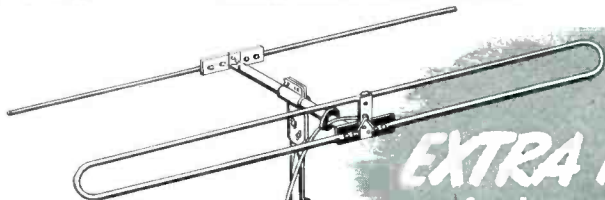

EXTRA PROFITS  
f.o.b. your doorstep

...VIA WARD  
*Magic Wand*

### NATIONAL ADVERTISING FOR FM AND TELEVISION AERIALS

Thanks to hard-hitting Ward advertising in the Saturday Evening Post and leading newspapers, millions of present and prospective FM and television receiver owners now know that a good outdoor dipole aerial is a necessity.

Suggest a Ward "Magic Wand" FM or Television Aerial to every purchaser of a receiver. You make a double profit by doing so; you sell an aerial, and an installation job. What's even more important, you win a satisfied customer who can enjoy the true beauty of FM or television reception.

See your Ward distributor today, or write direct for full information on how you share in the benefits of Ward's powerful national advertising drive.

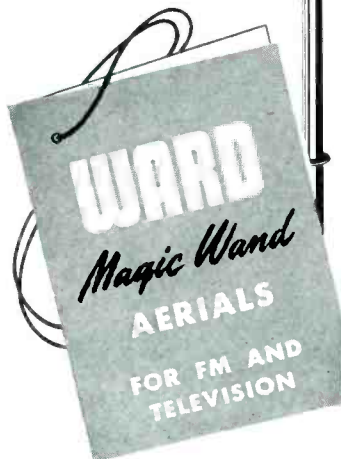

THE WARD PRODUCTS CORPORATION  
1523 East 45th Street, Cleveland 3, Ohio  
DIVISION OF THE GABRIEL COMPANY  
EXPORT DEPT.:  
C. W. Brandes, Mgr., 4900 Euclid Ave., Cleveland 3, O.  
IN CANADA:  
Atlas Radio Corp., 560 King St. W., Toronto, Ont., Can.

WORLD'S LARGEST MAKER OF AERIALS FOR CAR AND HOME

equivalent of one-half of the Hotel Roosevelt scheme may suffice. If not quite enough, it can be augmented with well spotted occasional speakers around the perimeter of the chamber.

Rectangular rooms with particularly low ceilings may lend themselves to flush-mounted ceiling speakers facing downward throughout all but the forward or microphone area. Between that and the audience a low-level local treatment may be required as an adjunct.

Conference rooms present a growing field for more and more business. Political or executive groups or bodies can be sold on the attributes of p-a installations immediately if shown any one of the five oval shaped United Nations conference tables. Each of these amply seat over fifty delegates. Open sessions can be visited by the public most any day.

In these conference rooms, where the chairman and his immediates are about forty feet from the seven delegates at the far end of the table, no attempt is made to shout to them. Everyone acts with decorum, talks in a conversational tone with little regard for microphones in front of or near them. A control engineer watches the delegates, keying their microphones in and out as they wish to speak. True, he has to be a bit of a mind reader but he gets to know his delegates. His microphones not only feed all radio, movie, television and interpreting channels, but also the indispensable p-a system.

Concealed completely within a continuous grill-faced turret facing all delegates from the inner edge of the long oval-shaped table, twenty-nine small PM speakers repose cooly. Not one can be seen. They are equi-spaced around the entire table with in the turret and operated just loudly enough to let the delegates hear comfortable yet distinctly.

Between these speakers are alternate microphones. As the control engineer keys in any one microphone, the loud-speaker on each side of it is automatically killed by relays,—result: no feedback. Seated behind the delegates and their advisers are members of the press and public. These people are serviced, again at low level, by ceiling-concealed speakers close to and around the three sides of the room excepting the chairman's end. His sector needs no re-enforcement beyond the turret speakers before him.

Again a beautiful example of simplicity. Sane engineering solved a knotty problem.

There are four of these fifty-five nation conference rooms at Lake Success and one at Flushing beside many lesser ones that are serviced. Topping all these with two major Council Chambers and the General Assembly Auditorium in Flushing, The United Nations really goes in for p-a facilities.

# Permoflux SPEAKERS



*An OLD name in Speakers  
a NEW high in Performance\**

**ANNOUNCES** . . . a COMPLETE JOBBER LINE of standard replacement and hi-fidelity de luxe loud speakers with both permanent and electro-magnet fields. These quality speakers embody the same skillfully engineered features used in the units that PERMOFLUX now supplies to major set manufacturers.

\* Sound room laboratory tests prove greater uniformity in frequency response, than other comparable makes.

TWO COMPLETE FACTORIES TO SERVE YOU **PERMO-FLUX** WRITE FOR FREE BULLETIN  
PIONEER MANUFACTURERS OF PERMANENT MAGNET DYNAMIC TRANSDUCERS

**PERMOFLUX CORPORATION**  
4900 WEST GRAND AVE., CHICAGO 39, ILLINOIS  
236 SOUTH VERDUGO ROAD, GLENDALE 5, CALIFORNIA

## ENDS *Miniature* TUBE BREAKAGE

**Avoids Burning of Hands - Saves Time and Work**



### New AMO Miniature TUBE PULLER

● With the growing use of miniature tubes . . . radio men have been seeking a handy tube-saver like this! Now . . . with the AMO . . . miniature tubes can easily be extracted from sockets or inserted . . . in hard-to-reach places . . . without fear of breakage, burning of hands, or loss of time!

Because the AMO is so handy and so durable . . . because it is so usable again and again and costs so little . . . *no radio man should be without one!* Let this marvelous tool build profits for you. Order now—or write for further information. Available at established distributors.

Made by Oliveri Tool Co., Chicago 39  
National Sales Representatives **SALESCRAFTERS, INC.**  
510 N. Dearborn St., Chicago 10, Ill.

Makes it Easy to Remove or Insert MINIATURE TUBES such as 6Ag5, 50B5, etc.

AMO is simple to operate. When extended in the finger tips, it can reach places where fingers alone would find difficulty. To extract tubes, simply press AMO down on tube, and lift up. Tube is then released by pressing release button. To insert tubes into hard-to-reach places, place tube in AMO holder, press into socket, and release. That's all!

Made with heat-resistant rubber cap, aluminum body, and handy thumb-operated plunger release.

**\$150 LIST**  
Subject to usual trade discount

**PAYS FOR ITSELF OVER AND OVER AGAIN!**

**STATEMENT OF THE OWNERSHIP, MANAGEMENT, CIRCULATION, ETC., REQUIRED BY THE ACTS OF CONGRESS OF AUGUST 24, 1912, AND MARCH 3, 1933**

OF RADIO SERVICE DEALER, published monthly at Pittsfield, Massachusetts, for October 1, 1947.

State of New York } ss:  
County of New York }

Before me, a Notary Public, in and for the State and county aforesaid, personally appeared Sanford R. Cowan, who, having been duly sworn according to law, deposes and says that he is the Publisher of RADIO SERVICE DEALER, and that the following is, to the best of his knowledge and belief, a true statement of the ownership, management, etc., of the aforesaid publication for the dates shown in the above caption, required by the Act of August 24, 1912, as amended by the Act of March 3, 1933, embodied in section 537, Postal Laws and Regulations, to wit:

1. That the names and addresses of the publisher, editor, managing editor and business manager are: Sanford R. Cowan, 1620 Ocean Ave., Brooklyn 30, N. Y.
2. That the owners are: Cowan Publishing Corp., 342 Madison Ave., New York 17, N. Y.; and Sanford R. Cowan, 1620 Ocean Ave., Brooklyn 30, N. Y.
3. That the known bondholders, mortgagees, and other security holders owning or holding 1 per cent, or more of total amount of bonds, mortgages, or other securities, are: None.
4. That the two paragraphs next above, giving the names of the owners, stockholders and security holders, if any, contain not only the list of stockholders and security holders as they appear upon the books of the company, but also, in cases where the stockholder or security holder appears upon the books of the company as trustee or in any other fiduciary relation, the name of the person or corporation for whom such trustee is acting, is given; also that the said two paragraphs contain statements embracing affiant's full knowledge and belief as to the circumstances and conditions under which stockholders and security holders who do not appear upon the books of the company as trustees, hold stock, and securities in a capacity other than that of a bona fide owner; and this affiant has no reason to believe that any other person, association, or corporation has any interest direct or indirect in the said stock, bonds, or other securities than as so stated by him.

(Signed) SANFORD R. COWAN, Publisher

Sworn to and subscribed before me, this 18th day of September, 1947.  
(Seal) HARRY N. REIZES, Notary Public  
In the State of New York, Residing in Kings County, Kings Co. Clk's No. 634, Reg. No. 612-R-9, N. Y. Co. Clk's No. 779, Reg. No. . . . . Term Expires March 30, 1949.

# SPEED

UP YOUR JOBS  
with **AEROVOX**

# DANDEE DUALS

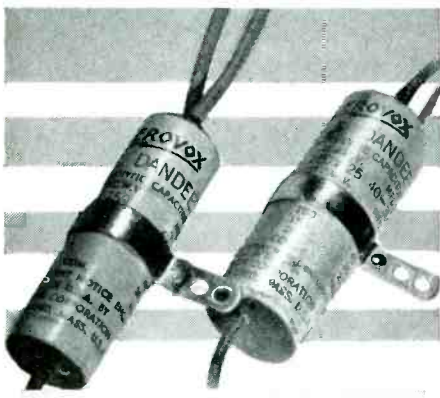

● Yes, speed up your work, with these handy general-purpose electrolytics.

Type PRS-A has concentrically-wound dual sections. Two insulated positive leads at one end, common negative lead at other. Type PRS-B has separate sections with separate positive and separate negative leads. Both types have riveted mounting straps.

Widest selection of combination capacities and voltages. All listed in latest Aerovox Catalog.

● Order those Dual Dandees from your favorite Aerovox jobber. Ask for latest catalog. Or write us . . .



**FOR RADIO-ELECTRONIC AND INDUSTRIAL APPLICATIONS**

**AEROVOX CORP., NEW BEDFORD, MASS., U.S.A.**  
Export: 13 E. 40th St., New York 16, N.Y. • Cable: 'ARLAB'  
In Canada: AEROVOX CANADA LTD., Hamilton, Ont.

## RECORD PLAYERS MODERNIZE OLD SETS

[From page 13]

and direct as possible in order to avoid oscillation or instability in the audio amplifier.

In some receivers, especially those in which high-gain audio amplifiers are employed, it may be necessary to shield all of the input leads to the audio tubes before stability can be secured.

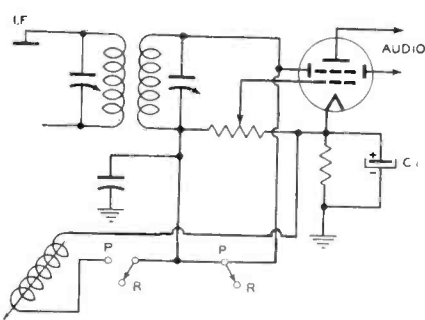

Figure 2

If this does not eliminate the trouble, any remaining instability can usually be removed by placing a small carbon resistor of from 10,000 to 50,000-ohms value in the input circuit of the first audio stage, as shown in Fig. 3. The resistor should not be used unless the shielding fails to clear up the difficulty.

It goes without saying that in all cases where audio oscillation is encountered, the by-pass condensers, especially the electrolytics, and the de-coupling filters, if these are employed, should be checked before making any kind of changes in the circuit itself. It has been found that in many instances the trouble was due to this cause even though the

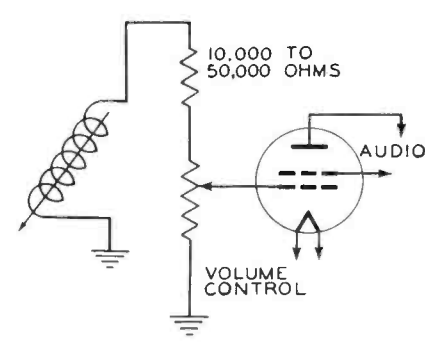

Figure 3

radio signal came through satisfactorily before the phonograph installation was made. In the majority of cases where oscillation is found, motor-boating or other difficulty will be encountered when the switch is thrown to the "radio" position due to the extended wiring and the capacity of the switch.

The serviceman must have patience when working with trouble of this kind,



Here's a new and highly profitable business that's a dead natural for the radioman who wants to supplement his income with a minimum investment in both time and money. Today, individuals like yourself, all over the country, are realizing big dividends with TRADIO, the radio functionally-designed for coin operation in hotel, tourist camps, hospitals, etc. And they're doing it right in their own backyards, too.

### ● BIG EARNINGS STEADY INCOME

TRADIO has pioneered in this new and flourishing postwar field. Get in on the ground floor and assure yourself of financial security for life.

### TRADIO ★ TRIED ★ TESTED PROVEN

TRADIO sells to operators only through franchised distributors. No routes are sold. We'll put you in touch with the distributor in your territory if you'll phone Asbury Park 2-7447 or write Dept. Q-10



**TRADIO, Inc.** ASBURY PARK  
NEW JERSEY

## IT'S HERE AND IT'S AT— NIAGARA TRANSVISION 12" TELEVISION KIT



This 12" television kit is tops in television. Set, less cabinet . . . . . **\$289.00**

For this low cost you get a kit complete with 22 tubes, 12" picture tube, specially designed dipole antenna, with 60 ft. of lead-in wire. Nothing more to buy. Easy-to-follow instructions come with each set. No tools or skills necessary.

De luxe with continuous tuning including FM Broadcasting reception **\$359.00**

Table model cabinet in walnut finish for 12" model . . . . . **\$14.95**

Write for Dealer Prices  
**NIAGARA RADIO SUPPLY CORP.**  
160 Greenwich St. Dept. RD. New York 6, N.Y.





**SIGNAL GENERATOR**  
Wide Range FM-AM Television

**Model 701**

Range: 170 K.C. to 115 M.C.—all fundamentals.  
Crystal calibrated, low loss permeability tuned coils. Internal 400 cycle sine wave modulation —to 100%. Follow-up shorting Turret coils with no dead spots. Tubes: 6C4, 6AU6, 6X4.  
Vernier drive — 9" easy-to-read scale.  
Ladder attenuator —triple shielded. **\$74 95 Net**



Write for catalog sheet

Dept. 10B

**Coastwise Electronics Co., Inc.**

130 North Beaudry Ave., Los Angeles 12, Calif.  
New York Office & Warehouse  
258 Broadway, New York 7, N. Y.



**REVOLUTIONARY NEW INSTRUMENT FOR COMPLETE RECEIVER TESTING!**  
CLIPPARD INSTRUMENT LABORATORY

**Signalette**

**MULTI-FREQUENCY GENERATOR**

Generates R. F., I. F. and AUDIO frequencies, 2500 cycles to over 20 megacycles, using new electronic multivibrator radar principle. Completely self-contained—fits coat pocket or tool chest. Just plug into A.C. or D.C. LINE AND CHECK RECEIVER SENSITIVITY, AUDIO GAIN, R. F. and I. F. alignment, auto radio aerial peaking or shielding, breaks in wires, stage by stage signal tracing, tube testing by direct comparison, etc., etc. Sturdy construction, handsome appearance! See at your dealers or write for details.

PRICE **\$9.95**  
at dealer  
or F.O.B.  
Cincinnati.

**CLIPPARD INSTRUMENT LABORATORY, INC.**  
1125 Bank Street  
Cincinnati 14, Ohio

if the oscillation cannot be eliminated, it is quite likely that sufficient volume will be obtained by feeding the pickup voltage to the second audio stage. If the gain is high enough to cause instability there is almost certain to be considerable amplification in the following stages.

In the circuit shown as *Fig. 2*, the radio volume control is also the phonograph volume control. In other circuits using the grid-bias method of detection, the radio volume control is usually connected somewhere in the r-f end of the set.

Obviously, since the pickup voltage is fed to the audio amplifiers, the r-f control will have no effect whatever on the phonograph reproduction. In cases of this kind if the pickup does not have a built-in volume control, it will be necessary to provide an external control which may be built into the radio chassis or installed somewhere near the pickup itself. If the pickup is of the high impedance type, the volume control may consist of a potentiometer connected directly across the pickup windings as shown in *Fig. 4*.

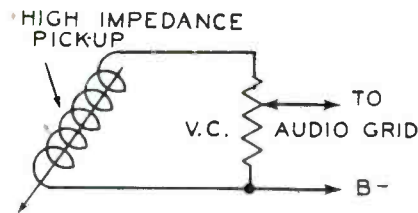

Figure 4

The exact value of the resistance will depend somewhat upon the impedance of the particular pickup in use, common values are from 50,000-ohms up to  $\frac{1}{4}$  or  $\frac{1}{2}$  meg. When the low impedance type of pickup is used, an impedance matching transformer must be utilized to effectively transfer the voltage to the amplifier. In this case the volume control may be connected across the secondary of the transformer as shown in *Fig. 5*.

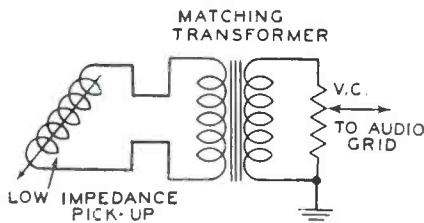
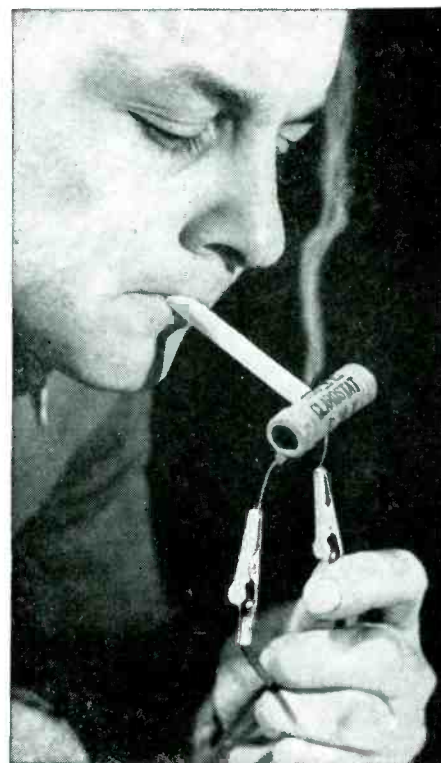

Figure 5

In the foregoing discussion and illustrations, it has been assumed that the pickup windings are of the high impedance type, the connections to low impedance units are exactly the same except for the matching transformer.

In low-impedance pickup installations the transformer will replace the actual pickup windings.



★ Try this overload test on your favorite power resistor. Here's a GREENOHM on 500% overload. It's hot enough to light a cigarette. Yet its special cold-setting inorganic cement coating doesn't soften, bubble or change. When cooled, it doesn't crack, peel, flake. Yes, GREENOHMS can take it. They're tough.

Other GREENOHM advantages are: Excellent heat-shock qualities. Minimum through-coating leakage. Wire winding unimpaired in manufacture. No wire corrosion because cement does not contain usual water glass. In fixed and adjustable types: 5 to 200 ohms; standard resistance values.

★ Ask Our Jobber . . .

Order Greenohms. Try them in your work. Give them any comparative tests you wish. You be the judge. Ask for bulletin "Why Cement-Coated Power Resistors?" Or write us.



CLAROSTAT MFG. CO., Inc. · 285-7 N. 6th St., Brooklyn, N. Y.

# A CAREER WITH A FUTURE! TELEVISION

Shop Work • Shop Techniques • Theory  
FULLY EQUIPPED LABORATORIES

- RADIO SERVICE & REPAIR
- F. M. & TELEVISION
- TRANSMITTER COURSES

Preparing for F.C.C. LICENSES

## • RADIO TECHNOLOGY

A Junior College Level Course preparing for positions in  
Radio-Electronic Engineering Field.

MORNING • AFTERNOON • EVENING CLASSES  
MODERATE RATES • INSTALLMENTS

Available Under G. I. Bill  
COME IN AND SEE OUR STUDENTS AT WORK

## DELEHANTY SCHOOL OF RADIO • ELECTRONICS • TELEVISION

105 EAST 13 ST., N. Y. 3, N. Y. • DEPT. U  
LICENSED BY STATE OF NEW YORK



## HOTEL STRAND

Atlantic City's Hotel of Distinction  
The Ideal Hotel for Rest and Relaxation. Beautiful Rooms. Salt Water Baths. Glass inclosed Sun Porches. Open Sun Decks atop. Delightful Cuisine. Garage on premises. Open all year.

Fiesta Grill and Cocktail Lounge  
Exclusive Pennsylvania Avenue  
and Boardwalk

## \$1.00 to \$5.00 PAID for "SHOP NOTES"

Write up any "kinks" or "tricks-of-the-trade" in radio servicing that you have discovered. We will pay from \$1 to \$5 for such previously unpublished "SHOP NOTES" found acceptable. Send your data to "Shop Notes Editor," RADIO SERVICE DEALER, 342 Madison Ave., New York 17, N. Y. Unused manuscripts cannot be returned unless accompanied by stamped and addressed return envelope.

## Ad Index

Aerovox Corporation	38
Air King Radio	11
American Phenolic Corp.	32
Astatic Corporation, The	8
Bendix Radio Div.	5
Certified Television Lab.	40
Clarostat Mfg. Co., Inc.	39
Clippard Instrument Lab.	39
Coastwise Electronics Co., Inc.	39
Concord Radio Corp.	34
Delehanty School	40
Federal Tel. & Radio Corp.	12
General Elec. Co. (Test Equip.)	30
General Elec. Co. (Speaker Div.)	27
General Transformer Corp.	35
Hytron Radio & Electronics Corp.	10
Maguire Industries, Inc.	28
Mallory & Co., Inc., P. R.	Cover 2
McMurdo Silver Co.	25
National Carbon Co., Inc.	9
Niagara Radio Supply	35, 38
Oliveri Tool Company	37
Permoflux Corporation	37
Precision Apparatus Co., Inc.	40
Racon Electric Co., Inc.	31
Raytheon Mfg. Co.	7
R C A (Tube Div.)	Cover 4
Rider, Publisher, Inc., John F.	33
Sams & Co., Inc., Howard W.	1
Simpson Electric Co.	Cover 3
Sprague Products Co.	29
Standard Transformer Corp.	4
Strand Hotel	40
Sylvania Electric Products Inc.	2
Radio, Inc.	38
Transvision, Inc.	34
Tuck Electronic Corp.	35
Vaco Products Co.	36
Ward Products Corp.	36
Wright, Inc.	40

## Certified TELEVISION LABORATORIES

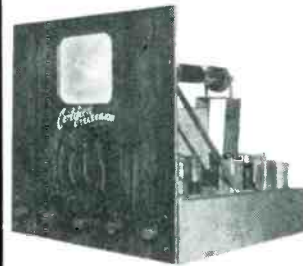

- Slug Tuned IF max. gain.
- Will Tune to any 3 of first 7 channels.
- Beautifully Finished Front Panel.
- Choice of Walnut, Mahogany or Blonde Maple.

- Steady Hold Synchronizing Circuits.
  - Removable Optical Glass Screen.
  - Price, less tubes, only **\$89.95**
  - Complete set of 17 tubes including 7" Cathode Ray Tubes **\$40.00**
- 20% deposit with order—balance C.O.D.  
We pay shipping charges if full amount accompanies order.

### TELEVISION COMPONENTS

- Chassis—Cadmium plated heavy steel, stamped and drilled, 17"x15"x4" **\$ 7.50**
- Coil Kit—5 slug tuned I.F. transformers in aluminum cans. 3 peaking coils. 2 R.F. shunt coils, R.F. coil and Osc. coil. Circuit diagrams included. **\$10.00**
- Front Panel hand rubbed finish. Engraved in gold lettering by silk screen process. Includes optical glass screen, slotted frame for glass and support shelf for picture tube. Beautifully designed speaker grille. Choice of Mahogany, Walnut or Blonde Maple. This panel will do justice to the finest custom-built console cabinet. **\$ 4.50**
- Certified Television Instruction Manual. Includes 17"x22", schematic and pictorial diagrams, alignment instructions and trouble shooting hints, voltage and resistance charts. **\$ 1.00**

Limited territory for distributorship still open.  
Write today.

**CERTIFIED TELEVISION LAB.**  
5507 13th Ave., Brooklyn 19, New York

## S.S.S.

"Servicing by Signal Substitution"

Learn about this modern dynamic approach to radio servicing with ONLY BASIC TEST EQUIPMENT.

... Fully described in a 120 page book available from your Precision Distributor or factory at 35¢.

... Schools are invited to inquire regarding quantity orders from our Educational Division.

**PRECISION**  
APPARATUS COMPANY INC.  
ELMHURST 3, N. Y.

Manufacturers of Fine Test Equipment  
RADIO • TELEVISION • ELECTRICAL • LABORATORY

## VERIFIED SPEAKERS

"Let The Guarantee Protect You Too"

**WRIGHT  
Inc.**

2235 University Avenue

St. Paul 4, Minnesota

# HERE ARE SIMPSON'S PROFIT-MAKERS FOR SERVICEMEN... "BASIC 3"

The serviceman who tries to "get along" with cheaply-made, run-of-the-mill test instruments is taking an outside chance on success. The business of radio servicing must be *built* from the bottom up on an endless succession of perfect jobs. Knowing what the trouble is, in a receiver, and knowing when that trouble is eliminated *can be no better than the test instruments that reveal them*.

The "Basic 3" Simpson instruments shown here are an extremely profitable investment for any serviceman. He needs all three and, in their price range, he cannot buy better anywhere else. In fact, in their price range they are unequalled. They will do more than many instruments selling for substantially more. These are facts easily demonstrable to any serviceman who will take the time to check up. And it is worth the time in the *cold cash of profits* to discover how Simpson engineering skill and uncompromising quality construction produce the *staying* accuracy for which Simpson instruments are famous.

**MODEL 315 SIGNAL GENERATOR.** Designed down to the most minute detail for highest accuracy, greatest stability, minimum leakage, and good wave form . . . . . **\$67.35**

**MODEL 305 RC TUBE TESTER.** Tests all tubes. Provides for filament voltages from .5 volts to and including 120 volts. Spare sockets for future tube developments . . . . . **\$59.50**

**MODEL 260 HIGH SENSITIVITY SET TESTER.** 20,000 ohms per volt, D.C. Voltage ranges to 5,000 volts A.C. and D.C. Resistance ranges to 20 megohms. Current ranges to 500 milliamperes, also 10 amperes D.C. . . . . **\$38.95**

In New Roll Top Safety Case . . . . . **\$43.75**

**SIMPSON ELECTRIC COMPANY • 5200-5218 West Kinzie Street, Chicago 44**

In Canada, Bach-Simpson, Ltd., London, Ont.

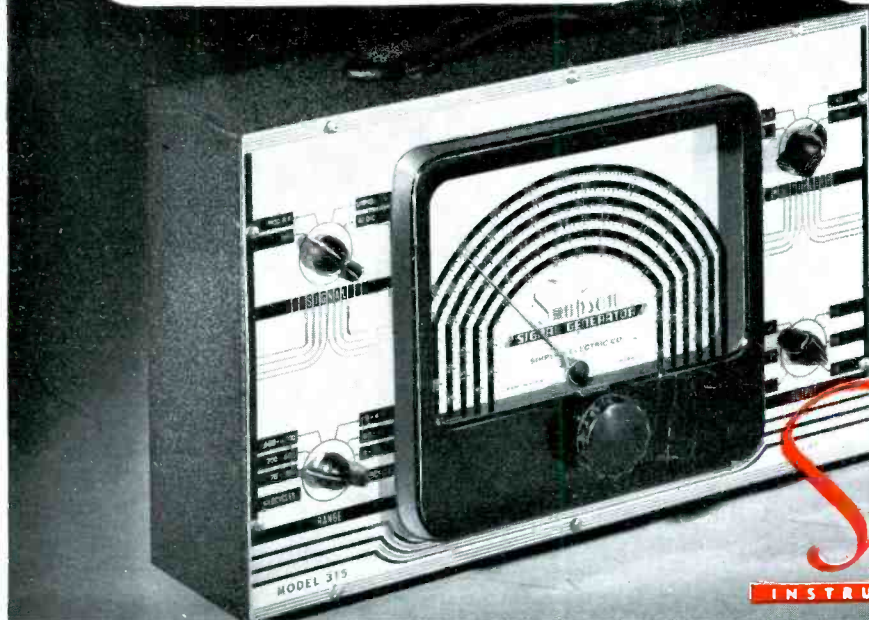

**Simpson**  
INSTRUMENTS THAT STAY ACCURATE

**You're in the lead with RCA...here's why**



*RCA sales and business aids work for "you and RCA" day in and day out.*

## Teamwork... RCA backs your every play for better business

"YOU and RCA" form the hardest-hitting selling team in the field. And, as a member of your team, RCA runs interference for you with an array of dynamic sales and business aids that *identify, serve, and remind.*

RCA Direct Mail Postcards, Ad Mats, Imprinted Stationery, Packaging Tape, and other business aids, all work toward promoting your business and making "you and RCA" the most influential

names in radio in your community.

Ask your RCA Distributor for a copy of the new RCA Sales Aid Booklet. It illustrates the latest business aids and advertising promotions designed to meet your individual requirements.

Point-of-sale support by RCA sales and business aids is one more powerful reason why *you're in the lead with RCA.* So, push RCA tubes and watch your business grow!



**THE FOUNTAINHEAD OF MODERN TUBE DEVELOPMENT IS RCA**



**TUBE DEPARTMENT**

**RADIO CORPORATION of AMERICA**

**HARRISON, N. J.**