

**RADIO**  
Retailing

# SERVICE ENGINEER

*Radio, Television and Audio Servicing*



Take a look at Mullard's little Gold Book... AT NO COST

TO YOU  
IT CAN  
BRING  
INVALUABLE  
EXTRA  
GOODWILL!

*This book will  
be kept by the  
customer  
- with your name  
and address  
here*

Here is a real builder of goodwill that can bring you lasting benefits. The little Gold Book is beautifully produced and will be kept by every 'Radiant Screen' replacement tube customer.

The little Gold Book gives useful and interesting information about 'Radiant Screen' tubes and reinforces your own sound judgment in recommending 'Radiant Screen' to your customer. On a special page, space is provided for your name and address - to your future profit.

A copy of the little Gold Book will be enclosed in an envelope with the guarantee card which accompanies every 'Radiant Screen' replacement tube. Make sure the service engineer passes it on to the customer.

**Mullard** *Radiant screen*

The Finest Picture Tube in the World



MULLARD LIMITED · MULLARD HOUSE · TORRINGTON PLACE · LONDON · W C 1



The kit-sets which give you the Best Possible Servicing Equipment at Absolutely Minimum Cost!

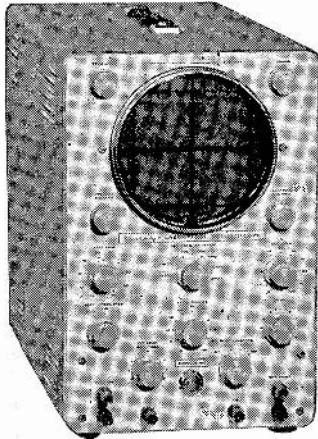

Heathkit 'Scope

**PORTABLE 2 3/4" SERVICE 'SCOPE, Model OS-1**

The OS-1 uses a 2 3/4" cathode ray tube and is a compact portable oscilloscope ideal for servicing and general laboratory work. Y amplifier sensitivity 10mV/cm; response  $\pm 3dB$  10 c/s-2.5 Mc/s. Time base 15 c/s-150 Kc/s. Features include Int. Ext. and 50 c/s sync; Sine sweep; time base output for wobulator; X amplifier socket; 1. 10 and 50 volt calibrator. Uses printed circuit board for consistency and ease of assembly. Case 7 3/8" x 4 1/2" x 12 1/2" long. Weight only 10 1/2 lbs. **£18. 19. 6.**

**5" FLAT-SCREEN OSCILLOSCOPE, Model O-12U**

Laboratory instrument at utility 'scope price. Exceptionally wide-range time-base (10 c/s to 500 Kc/s) "Y" frequency range 3 c/s to over 5 Mc/s, sensitivity 10mV RMS/cm. Electronically stabilised. Output for Wobulator. Voltage Calibrator (1 volt pk. to pk. source). Instantaneous shift, drift free. Automatic lock-in synchronism. Rise time 0.08  $\mu$  secs or less. "Z" modn. facilities. 2-gold-plated printed-circuit boards and pre-cut cable wiring harness greatly facilitate assembly. **£34. 15. 0.**

Besides this test equipment, we have a full range of "HAM" and HI-FI equipment including AMPLIFIERS, SPEAKER SYSTEMS and CABINETS.

**VALVE VOLTMETER, Model V-7A**

Because of the accuracy, reliability and sheer value of the Model V-7A it is outselling all other VVM's. The precision and quality of its first-class components cannot be duplicated elsewhere at this price. Indication is by a large 4 1/2" 200  $\mu$ A meter clearly calibrated for all ranges. The voltage divider networks use 1% precision resistors. A gold-plated printed-circuit board simplifies the assembly, saves time and eliminates the possibility of wiring errors. It also ensures duplication of laboratory performance.

This multi-function VVM measures A.C. Volts (RMS and pk. to pk.), D.C. Volts and Resistance. The 7, A.C. (RMS) and D.C. ranges are 1.5, 5, 15, 50, 150, 500 and 1500. The 7, A.C. pk. to pk. Voltage ranges are 4, 14, 40, 140, 400, 1400 and 4000. D.C. input impedance is 11M $\Omega$ . Seven Ohm-meter ranges have multiplying factors of X1, X10, X100, X1000, X10K, X100K and X1M $\Omega$ . Centre-scale resistance readings are 10, 100, 1000, 10K Ohms, 1M $\Omega$  and 10M $\Omega$ . A centre-zero dB scale is provided also for measuring audio amplifier performance. Test leads, prods and battery are included in the kit. **£13. 0. 0.**

PROBES: R.F. £1. 5. 6., H.V. (30kV d.c.) £2. 7. 6.

**Other Models Include :**

**OSCILLOSCOPE TRACE DOUBLER, Model S-3U.** Will extend application of single beam oscilloscope by enabling it to give simultaneous traces of two separate and independent signals. **£9. 18. 6.**

**RESISTANCE/CAPACITANCE BRIDGE Model C-3U.** Measures Capacitance 10pf (0.00001 $\mu$ F) to 1000 $\mu$ F; Power Factor; Resistance, 100 Ohms to 5 Megohms, and indicates leakage. **£7. 19. 6.**

**AUDIO SIGNAL GENERATOR. Model AG-9U.** 10 c/s to 100 Kc/s Sine-wave output, 10 volts down to 3 mV f.s.d. Less than 0.1% distn. Decade frequency selection. dB ranges, -60+22. **£19. 3. 0.**

**Multimeter, MM-1U.** Measures wide range of voltage, current, resistance and dB in over 20 ranges. Sensitivity 20,000 ohms/volt D.C. and 5000 ohms/volt A.C. 0-1.5, 1500 volts A.C. and D.C. 0-150  $\mu$ A, 15 A D.C. Resistance 0.2 ohms to 20 megohms. 4.5 in. meter, 50  $\mu$ A f.s.d. **£11. 8. 6.**

**WIDE-BAND AUDIO WATTMETER. Model AW-1U.** Ideal for audio power measurements. 10 c/s to 250 Kc/s; 25W. continuous 50W intermittent. Switch-selected non-inductive int. or ext. load. 1% multipliers. 200 $\mu$ A meter calibrated in Watts and Decibels. **£13. 18. 6.**

**WIDE BAND AUDIO VALVE-MILLIVOLTMETER. Model AV-3U.** This sensitive and highly stable VVM quickly measures A.C. mains, ripple and heater voltages, audio input/output, gain in volts and dB's. Range 10mV to 300V full scale deflection. **£13. 18. 6.**

**DIRECT READING CAPACITANCE METER. Model CM-1U.** 0-100pF to 0-0.1mFd, 4 ranges. **£14. 10. 0.**

**Power Supply Unit, MPG-1.** Provides 3 D.C. outlets 250-300 volts up to 90 mA., 170-220v. up to 30 mA, 150-200v. up to 10 mA and 6.3v. at 2.5 A A.C. **£4. 9. 0.**

**Decade Capacitance Box, DC-1.** Precision 1 per cent silver mica capacitors are used and switches are of the ceramic wafer type to ensure minimum loss. Three decade switches are used and cover a range of 100 pF to 0.111  $\mu$ F in increments of 100 pF. **£5. 18. 6.**

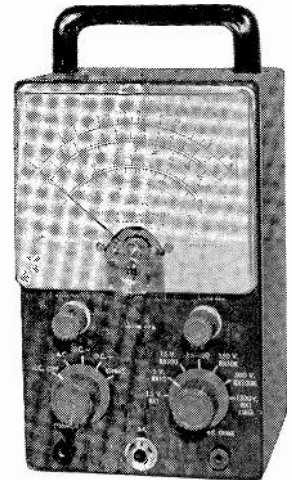

V-7A

Please send for **CATALOGUE** of whole range and terms to Trade

**DAYSTROM LTD.** DEPT. R10, GLOUCESTER, ENGLAND.

A Member of the Daystrom Group, manufacturers of

**THE FINEST AND LARGEST-SELLING ELECTRONIC KITS IN THE WORLD**

# SERVICE ENGINEER

Vol 3. No. 6. Oct., 1960

Edited by W. Norman Stevens

Issued as a special supplement with "Radio Retailing"

## In this issue:

Trade Notes .. .. .	81
Service Viewpoint .. .	82
Trade Topics (Letters to the Editor)	82
Modern Test Instruments, Part 5, by Gordon J. King	83
Technical Gen for Servicing Men	87
Apprentice at the Bench, No. 13, by G. L. A. Morgan	93
Laboratory Test Report—Beulah V-7A/F, by Gordon J. King	94
Service with a Grin, by H. W. Hellyer	96

### SERVICE DATA SHEETS

- TV164:** Peto Scott 1731 and 2131 TV receivers.  
**TV165:** Ekco T345 and Ferranti T1024 series TV receivers.  
**RI46:** G.E.C. 501 and 502 transistor portables.

## Labgear Attenuators

A range of r.f. attenuators is marketed by Labgear. These constant impedance attenuators are intended for general application in r.f. measurement up to 250 Mc/s and are suitable for bench use or incorporation in equipment. The basic unit comprises four pi-sections switched by latching push buttons and in the standard form where the numbers 1, 2, 3, and 4 occur, a decade in unit steps is obtained by the addition of appropriate numbers.

The specifications of the four models are:

Cat. number ..	101B	102B	103B	104B
Characteristic Imp	50Ω	50Ω	75Ω	75Ω
Insertion loss ..	0—10	0—100	0—10	0—100
range ..	1dB	10dB	1dB	10dB
	Step	Step	Step	Step
Accuracy @ 250	..0.3	3.0	0.3	3.0
Mc/s. ..	dB	dB	dB	dB
		max. error		

Price of these units is 10 gns. each. Also available is Model 108B, which is a wide band constant impedance attenuator with a characteristic impedance of 600 ohms, giving 0-111dB in 0-1dB steps and usable from d.c. to above 5 Mc/s. Price is £33 10s.

OCTOBER, 1960

## POCKET-SIZE TRANSISTOR TESTER FROM BEULAH

Latest addition to the Beulah range is Model D900 transistor test set, designed for quick and easy testing of transistors and transistor receivers, incorporating the novel feature of a self-contained power supply continuously variable from 0-25V centre tapped and supplying a current of up to 25mA, thus enabling transistorised equipment to be tested without the inconvenience of drawing batteries from stock.

A continuously variable base current is available (10μA-1mA) and leakage currents between collector-base and collector-emitter can be measured at any voltage between 0-25V, thereby enabling a transistor to be checked to maker's specification.

Leads and clips are provided for checking transistors in circuit. Transistor gain, under dynamic conditions, is shown directly on the instrument scale. An audio tone test is provided which is useful in miniature receivers where it is difficult or dangerous to remove the transistor.

Other uses for the D900 include matching output transistors, determining characteristic curves, batch testing and various general transistor tests. Although the instrument is completely self-contained, provision is made for

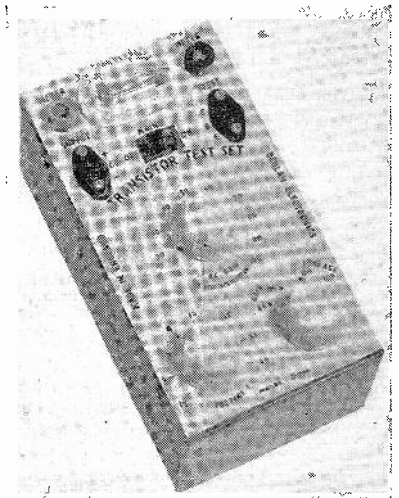

connecting an external meter so that leakage currents can be measured accurately at all voltages up to 25V.

Germanium and silicone diodes can be measured up to 25V peak inverse by adjusting the controls to the appropriate range. The instrument measures the forward carrying at +1V with the aid of an external meter.

This interesting instrument measures only 5½×3×2¼ in. and sells at £10 nett trade. A *Service Engineer* test report, giving fuller details and the results of actual tests, will appear in a future issue.

## GM2877 NEW PHILIPS WOBBULATOR

The Philips range of instruments, distributed in the U.K. by Research and Control Instruments Ltd., 207 Kings Cross Road, London, W.C.1, has been extended by a new wobulator, Type GM2877.

This is a portable instrument designed for checking response curves of f.m. and TV receivers and the extended frequency response of the main oscillator includes all TV transmission frequencies

in Bands I, III, IV and V. Marker facilities are incorporated.

The marker signal is mixed with the output signal of the equipment under test and amplified by means of a built-in marker adder, thus the amplitude of the marker pip is entirely independent of its position on the response curve. Frequency calibration of the main oscillator signal can be obtained by means of an incorporated crystal oscillator.

The GM2877 may be used with mains inputs between 110 and 245V and versions for either 50 c/s or 60 c/s are available. Price is £105 list.

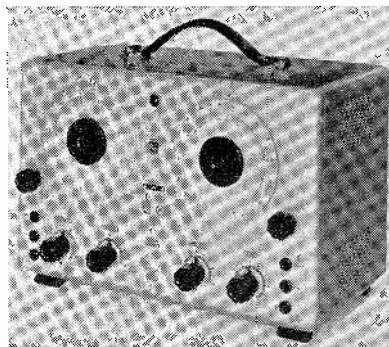

The Philips GM2877 which covers Bands I, III, IV and V and features built-in marker and calibration facilities.

## Radiospares Latest

The range of selenium rectifiers has been augmented by four new low voltage types covering most l.t. applications such as battery charging, transistor power supplies, fixed bias supplies and other low voltage medium current uses.

REC20 is rated at 22V r.m.s. 1A and costs 6s. 10d., REC21 is rated at 22V r.m.s. 2A and costs 11s. 4d., REC22 is rated at 33V 3A and costs 23s. 2d., and the REC23 is rated at 66V 1A and costs 13s. 8d. All are small units with rectangular plates and 4BA mounting studs (except REC21 which has ¼ in. Whitworth).

## TRADE TOPICS *Letters to the Editor*

The Editor welcomes letters on subjects of technical or trade interest, but does not necessarily endorse the views or opinions expressed by correspondents.

### Sales and Service

(Shop-based or independent service? The question was put in Service Viewpoint for September. Here is a selection of typical letters, representing different points of view).

AS manager of a department of a national trade service organisation, I feel it necessary to protest against the assumption that a large service organi-

sation is "out of touch" with the customer.

Our engineers are instructed to present themselves as direct agents of the particular dealer on whose behalf they are making the service call. Moreover, it is company policy for them to be clean, tidy, courteous and, above all, efficient. Can the same be said for the numerous "servicemen" that one sees up and down the country working for individual firms? I fear not.

Also, the large organisation has better service facilities, stocks and equipment. It can afford them. Dealers can turn over their whole worries to such organisations and concentrate on sales. We can both benefit from such a policy—sales and service—(Name and address supplied).

## Service Viewpoint

It was a refreshing experience to conduct a small party of apprentices around Earls Court on the opening day of the Radio Show.

Refreshing, because they saw the exhibits with an unprejudiced eye. Only one lad had been here before. Most were first or second year boys, in provincial businesses not over-blessed with expensive equipment. The panoply and display of the colourful show made them marvel—but the array of equipment in Stand 405 made them gasp.

### Apprentice View

Following the success of last year's Radio Servicing Stand, the British Radio Equipment Manufacturers' Association and RTRA had planned a bigger and better exhibit, to show the public what happened to their faulty set when taken to a workshop.

The variety of instruments in use by actual engineers from manufacturers' service departments was almost bewildering. Certainly no wet-finger approach here! Our apprentice visitors were remarkably impressed. For the first time some of them saw how servicing should be done. No doubt other visitors had a better idea why repairs were not cheap, even though faults could be caused by inexpensive components.

This year the stand was divided into cubicle-like divisions, with different aspects of service work to be seen from each angle. This is more like the well-run service department than last year's "idealised" layout.

Equipment was provided by the well-known names, such as Avo, Mullard, Taylor, AEI, Direct-TV and

Tequipment. From simple transistor testers, stock control systems, tool kits and valve cases, up through the familiar meters which our lads took great delight in pointing out to each other, all the way to the comprehensive scope and pattern generator set-ups that struck them into silent awe. Undoubtedly the best way of convincing an apprentice that—as we who preach say perhaps too often—oscilloscope testing speeds up service, is to show him an expert in action.

Here was a perfect demonstration that the 'scope is not just a toy. As domestic equipment becomes more complex, the "optional extra instruments" of yesterday will become the stand-by gear of today.

Stand 405 may also have shown a few dealers what they had been missing. The capital costs of equipping a workshop could be seen here. Undoubtedly this is expensive, but there are ways of planning a long-term improvement of test facilities that may not have occurred to some. This exhibit should help.

It should also have helped dealers and parents realise the need for apprentices in this side of the industry. Too often a conservative view is taken of the trade; the future will need highly skilled men. They can only be recruited from experienced apprentice ranks.

Although the RTRA operates a national apprentice scheme with more than 3,000 registered entrants, plus many other unregistered lads learning their trade the hard way with small dealers up and down the country, there is a crying need for apprentices.

Our boys showed great interest when a member of the Enquiry Counter Staff told us there was plenty of room for girls in the trade.

"That was no lady—that was my apprentice", paraphrased the oldtimer who had been here before and was itching to get to the Celebrity Stage where Humph Lyttleton was letting rip.

A refreshing experience, as we said, for it proved that whatever else alters, apprentices stay the same.

WHO said the "independent service set-up" could be more efficiently organised than the small shop? A dealer with a flair for service can provide far better and faster service than any large organisation. It is not a matter of size but of efficiency—and the two things are not necessarily the same.

True, many small dealers despise the service department, and usually fail to make it pay because of their own pinch-penny attitude. They are prepared to spend a small fortune on advertising, new shop-fronts, decoration, etc., but begrudge the money for good instruments, special tools or even the advantage of a decent place to work.

That is where your big boys score—they have to organise, or go out of business. But as for providing better service... the well-run small shop beats them every time.—J. Wilson, Leeds.

★

I WAS interested in the arguments you raised in Service Viewpoint and it is quite true that sales and service do not get on well together.

But whose fault is that? Often the salesman, who is prepared to promise the moon to a prospective customer, then expects the poor serviceman to explain why it is only made of green cheese. Or the shop manager who sticks a few bob on the bill and gets the service department a bad name.

The servicemen as a group are all for more sales. They realise that their jobs ultimately depend on the success of the retail side. But the salesman appear to think that service is a despicable business—best not thought about, and only mentioned to a customer as a last resort.—J. W. Allen, Plymouth.

### Unfair to Deep 17?

I HAVE read with interest, Technical Gen item 742, by E.L., on the RGD D17-502, p.23, and would like to offer the following criticism. I have serviced this particular model in large numbers and found the definition satisfactory with the maker's original circuit which, incidentally, has been retained in their later models. It should not, therefore, be necessary to introduce a mod.

The real point, however, is that V4 functions as a p.c. clamp diode in addition to being the vision i.f. amplifier. If its suppressor grid is disconnected from the a.g.c. line as suggested by E.L., there is nothing to prevent the a.g.c. line going positive under no-signal conditions and this is obviously detrimental to the controlled valves.—N. R. Stride, Cardiff.

E. L. replies: "Without getting involved in an academic discussion, this receiver had had poor definition since new. Two other dealers had failed to clear the trouble. Usual procedure was unavailing, but the modification described was highly successful and there have been no further complaints since the job was done last February."

# Modern Test Instruments

FOR THE SERVICE DEPARTMENT

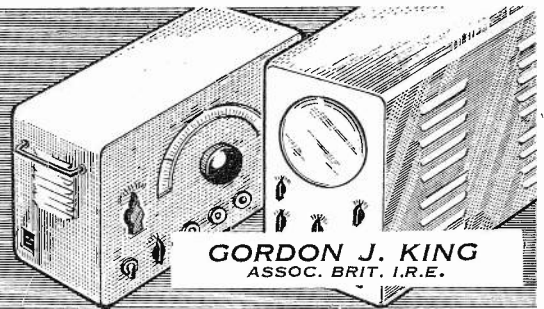

GORDON J. KING  
ASSOC. BRIT. I.R.E.

**O**SCILLOSCOPES for service technicians are comprised essentially of three primary sections: the c.r.t. and associated power circuits; the timebase to provide "X" (horizontal) deflection of the electron beam; the "Y" amplifier to magnify the small test signals sufficiently to give usable vertical deflection of the beam.

The screen of the c.r.t. may be almost any size up to about 5 in. in diameter (the most popular being about 3 in. diameter) and the power circuits are designed to suit. The trace should be bright and sharp, easy to focus and adjust brightness with some form of astigmatism correction—usually in the form of a main or pre-set control.

## Timebase

The timebase should have a fairly wide repetition range from, at least, 10 c/s to 50 kc/s. The repetition frequency should, preferably, be continuously variable, and most oscilloscopes feature two controls for this purpose. One giving switched frequencies over the range, and the other being more or less a fine adjustment which gives complete coverage between the switched ranges. These controls—coarse and fine—are sometimes known as "sweep controls", whose calibration is in terms of microseconds or milliseconds per centimetre of screen swept.

## Trace Expansion

Some oscilloscopes have means for expanding the horizontal trace, as produced by the "X" timebase, for detailed study of any part of an applied waveform. For example, a normal line of a Test Card signal can be produced on the screen, and by virtue of the expansion facility this can be lengthened horizontally so that in the centre of the screen can be revealed, say, the pulses which make up the 1.5 Mc/s frequency bars on Test Card C. This can be a very useful and interesting addition.

## Sync

The timebase must be synchronisable. Most oscilloscopes of modern design feature a sync select switch, allowing the timebase to be triggered either repetitively or as the result of a random occurring waveform. In the repetitive



## PART FIVE Oscilloscopes



state the timebase is synchronised by the incoming signal, while in the, so called, triggered condition, synchronisation is automatic, as the trace only occurs in the event of a signal.

The sync select switch can also cater for positive and negative going signals in terms of synchronisation. Other fittings include a built-in integrator for studying a complete TV waveform synchronised at frame frequency.

## Y Amplifier

The "Y" amplifier should have a good frequency response and gain. The response of one oscilloscope's "Y" amplifier is from d.c. to 6 Mc/s (at 3dB points). A good low-frequency response is desirable when checking

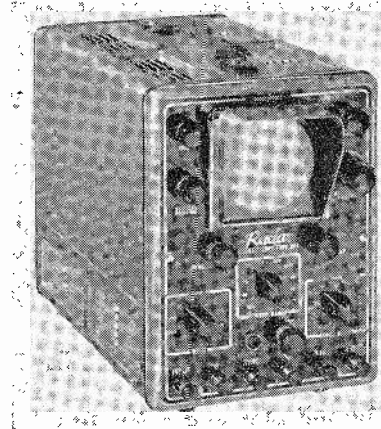

The Radar 303 by Waveforms with a Y sensitivity of 100mV/cm and bandwidth of d.c. to 6 Mc/s.

audio equipment and when using the instrument with a wobulator for visual alignment.

The gain may not be expressed in terms of dB, but in terms of sensitivity, related to so much signal input required for a deflection of 1 cm. on the screen. This is perfectly logical, of course, bearing in mind that the amplifier is always tied to the "Y" plates, and that sensitivity in terms of beam deflection is the primary consideration.

Other things to look for are: viewing hood and graticule ruled in centimetre squares for calibration and assessment of applied signal amplitude; polarising filter; tilting stand; "X" terminals for operating with wobulator. Now to look at a few 'scopes.

## Radar Type 303

Here is a high-quality instrument designed for radio and TV servicing as well as for use by engineers in development laboratories and production and test departments. The c.r.t. has a flat screen of 3 in. diameter, in front of which is a polarising filter, which prevents light being reflected from the tube face whilst allowing the display to pass through unhindered. Much after the style of the Polaroid implosion guard now incorporated in certain TV sets.

The timebase is designed around a Miller-Multivibrator circuit, and has d.c.-coupled paraphase output to the "X" plates of the c.r.t. The sweep range is from 1 microsecond/centimetre to 500 milliseconds/centimetre at minimum expansion.

An expansion control provides an effective sweep length from 6 to 60 centimetres continuously variable from centre of screen up to ten times the screen diameter. The maximum effective sweep of 60 centimetres could only otherwise be accommodated on a tube not less than 24 in. in diameter!

The "Y" or "signal amplifier" is of 8 balanced stages and is d.c. coupled throughout. It has a sensitivity of 100mV for 1 cm. deflection, while the bandwidth is from d.c. to 6 Mc/s at 3dB points, and is useable up to 10 Mc/s with a fall-off in gain. It is compensated for maximum pulse response, the rise time of which is 0.06 microseconds.

# NEW — for T/V and Radio Servicing

## OSCILLOSCOPE MODEL 33A

### SPECIAL FEATURES

**Vertical Deflection. DIRECT INPUT.**  
Sensitivity—12.5v R.M.S. per inch. Input resistance approximately 5 Megohms.

**'Y' AMPLIFIER.** 4 Valves. Cathode follower input, push-pull output. Sensitivity—80 mV R.M.S. per inch of symmetrical deflection. Frequency response, 10 c/s to over 6 Mc/s, within  $\pm 3$  db. Switched attenuator, independent of frequency, giving input ratios of 1, 10, 100.

**Time Base. FREQUENCY.** Continuously variable sweep, from 2 c/s to 100 Kc/s in 5 overlapping ranges, repetitive or triggered, approximately calibrated in frequency. A beam brightening circuit is incorporated to suppress the flyback trace.

**Horizontal Deflection. DIRECT INPUT.**  
Sensitivity 25v R.M.S. per inch. Input resistance approximately 5 Megohms.

**'X' AMPLIFIER.** Maximum sensitivity 0.4v R.M.S. per inch of symmetrical deflection. Switched for use with internal time base of external signal.

TRADE  
PRICE

**£63.15.0**

Or 9 monthly instalments  
of £7.15.0

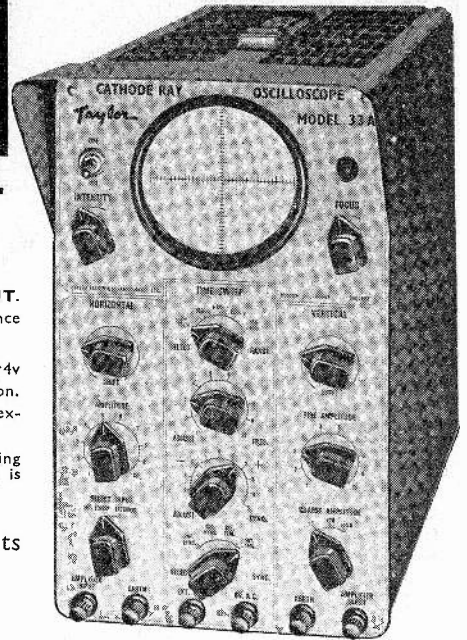

Write for full details and free catalogue

**TAYLOR ELECTRICAL INSTRUMENTS LIMITED**

MONTROSE AVENUE, SLOUGH, BUCKS. Telephone: SLOUGH 21381

Member of the METAL INDUSTRIES GROUP OF COMPANIES



**FIRST  
IN QUALITY—  
FOREMOST  
IN ECONOMY**

Suffolk's reputation for reliability accounts for the rapidly increasing popularity of Suffolk rebuilt tubes. Now you can obtain "NEW ALUMINA" C.R. Tubes of all types completely rescreened and aluminised—at an exceptionally low price! 12 in.—£5. 14 in.—£5. 5. 0. 15 in.—17 in.—£5. 10. 0. 21 in.—£8. 0. 0. Sensational value with the existing range of picture tubes at 12 in.—£4. 10. 0. 14 in.—£4. 15. 15 in.—17 in.—£5. 0. 0. 21 in.—£7. 0. 0. Suffolk's Full 12-Month Guarantee is your assurance of satisfaction. You get FREE, IMMEDIATE DELIVERY anywhere in the U.K. when you trade with Suffolk, the largest independent tube rebuilders in London.

**SUFFOLK TUBES LTD**

SUFFOLK HALL, 1-3 UPPER RICHMOND RD., PUTNEY, S.W.12 Tel. VAN 5267, 4304



There is an 8-stage calibrated attenuator giving up to a maximum of 300V/cm. in 1:3:10 steps. Input impedance is 1 megohm across 15 pF. An a.c./d.c. switch introduces an isolating capacitor on a.c. to the input circuit.

Sync is either repetitive or triggered and may be applied internally or externally at positive or negative polarity. There is also an inbuilt integrator for synchronising the trace to frame speed on a TV signal. The trigger sensitivity is of the order of 2 volts, and the application of a signal of this amplitude initiates the horizontal scan.

The instrument is for mains operation, 200-250V, a.c. 50 c/s, though other voltages and frequencies can be supplied to order. It is contained in a grey hammered stove-enamelled case of 9×6½×13 in. deep. Weight 20 lbs.

### Beulah Model O-12U-F

This is a reasonably-priced 'scope of the new range of Beulah instruments marketed by Direct TV Replacements Limited. Model O-12U-F provides a display on a 5 in. flat-face screen. The "Y" amplifier has a frequency response from 3 c/s to over 5 Mc/s, the response being 2.2dB down at 3.58 Mc/s. Rise time is better than 0.08μS, and the sensitivity is of the order of 10mV/cm. maximum.

The sweep circuit covers 10 c/s to in excess of 500 kc/s, in 5 steps. An "X" amplifier is incorporated and, like the "Y" amplifier, is push-pull with a response within 1dB from 1 c/s to 200 kc/s and 3dB down at 400 kc/s. "X" sensitivity is 0.12V/cm.

The unit is made up of gold-plated printed boards, and the power supply is electronically stabilised. The instrument is for a.c. mains operation and measures 8½×14½×18 in. deep.

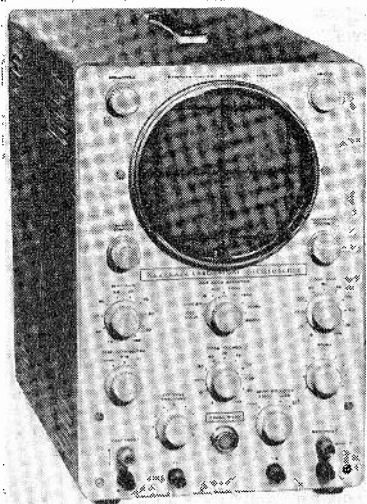

Appearance of the Beulah O-12U-F and Heathkit O-12U, an instrument in the medium price bracket using a 5 in. tube and printed circuit construction.

### Heathkit Model O-12U

This is the kit counterpart of the Beulah model described above, and whose characteristics are identical.

### Grayshaw Model SC30

This is a low-price instrument which uses a 3 in. tube. The timebase covers a repetition rate of 15 c/s to 600 kc/s in five overlapping ranges. Facilities are available for synchronising the timebase with the input signal to the "Y" amplifier or by any external source. A flyback suppression arrangement is also incorporated.

The "Y" amplifier has a frequency response from 8 c/s to 8 Mc/s, and the response is substantially flat from 15 c/s to 5 Mc/s, and falls by 3dB at 8 c/s and 8 Mc/s. The full vertical scan sensitivity is 300mV, but this may be increased to 10mV at the expense of bandwidth, which falls to 25 c/s and 100 kc/s. A two-stage attenuator enables r.m.s. voltages up to 250V to be directly applied to the "Y" input.

The instrument can be operated from a.c. 50 c/s supplies from 200-250V. It is housed in a metal case measuring 8×7×12 in. deep.

### Jason Kit Type OG10

This is a kit oscilloscope, suitable for the experimenter or radio and TV technician. The tube is Type DH7-91, and the timebase extends from 10 c/s to 100 kc/s in 4 ranges. There is also a position for 50 c/s sine wave sweep. Sweep width is continuously adjustable from 2 cm. to 20 cm. (approximately 3 screen diameters). Flyback suppression is incorporated, and the synchronisation can be internal, external or 50 c/s.

The "X" amplifier has a sensitivity of 1V/cm., and an "X" voltage, for wobulator application, is available at a socket on the front panel at a level of approximately 25V peak.

The "Y" amplifier has two sensitivity positions, one at 6mV/cm. up to 1 Mc/s (-1dB) or 2 Mc/s (-3dB), and the other 60mV/cm. over the same frequency range, the former having an input resistance of 1 megohm across 20 pF and the latter 10 megohm across 10 pF. For calibration, there are 50V and 10V 50 c/s peak voltages available at terminals on the front panel.

The instrument is mains operated, 200-250V a.c. (special transformer available for 110V operation), measures 12¼×5½×7½ in. and weighs 12½ lbs.

### Taylor Model 32A

This model uses a 4 in. tube with either green (standard) or blue trace. It is mainly intended for radio and TV servicing work, but also finds application in the laboratory. The timebase covers 2 c/s to 100 kc/s in 5 ranges,

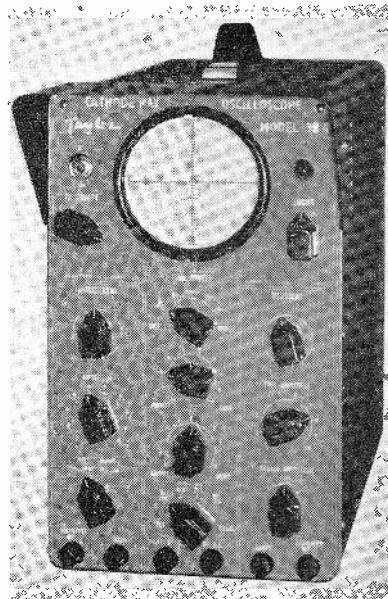

The new Taylor 33A, designed for radio and TV servicing applications.

either free-running or triggered. A sync switch allows for either internal or external sync signal. Flyback suppression is incorporated, but there is accommodation for observing the fly-back trace when required.

The "Y" sensitivity without amplifier is 12.5V r.m.s. per inch, and with the amplifier, which has a push-pull output, the maximum sensitivity is 80mV/inch over a frequency range of 10 c/s to over 6 Mc/s.

A switched attenuator, independent of frequency, gives input ratios of 1, 10, and 100. Maximum input 250V peak for undistorted trace; maximum input at maximum gain 1V r.m.s. for undistorted trace; maximum output effectively equal to more than three screen diameters at 6 Mc/s.

The 3-valve push-pull X amplifier has a maximum sensitivity of 0.4V r.m.s. per inch of symmetrical deflection and a frequency range of 10 c/s to 500 kc/s. Switched for use with internal timebase or external signal. Continuously variable sweep from 2 c/s to 100 kc/s in five overlapping ranges, repetitive or triggered, approximately calibrated in frequency.

The instrument is mains powered, 105-125V or 200-250V, 40-100 c/s. It measures 13×7½×19 in. and weighs 34 lbs.

### Heathkit Model OS-1

Model OS-1 is a portable oscilloscope for servicing and general laboratory work. The timebase generator is of the Miller transitron type with a range of 15 c/s to 150 kc/s and a sinusoidal sweep of 50 c/s at a fixed amplitude of 4 cm. Output is 20V p-to-p nominal.

Provision is made for internal, external and 50 c/s sync.

The Y amplifier (sensitivity 10mV r.m.s.) has a frequency response of  $\pm 1$ dB from 10 c/s to 1.5 Mc/s and  $\pm 3$ dB from 10 c/s to 2.5 Mc/s. The d.c. Type Y shift permits placement of undeflected trace at any horizontal level on usable area  $\pm 2$ cm. from centre of screen, positioning being instantaneous. The X-amplifier has a sensitivity of 1V r.m.s./cm. at 1 kc/s and a frequency response of  $\pm 3$ dB from 150 c/s to 500 kc/s.

Other features include 2 $\frac{3}{4}$  in. high sensitivity c.r.t., retrace blanking on all ranges, built-in voltage calibrator (1V, 10V and 50V, 50 c/s p-to-p nominal), anti-magnetic tube screen, compensated attenuator input and a polished aluminium visor to reduce the amount of direct light falling on the tube face.

### Beulah Model OS-1-F

The Beulah Model OS-1-F is an assembled version of the Heathkit instrument described above and has exactly the same specification.

### Furzehill Model O.140

This laboratory oscilloscope uses a 4 in. tube with astigmatism control and has a green viewing filter with an edge-lit graticule with direct-coupled shifts for instantaneous positioning.

The three-valve self-synchronising time base has sweep speeds ranging from 0.1 $\mu$ S to 0.5S/cm. The main control provides six steps of 0.5, 1, 10 and 100 $\mu$ S/cm., 1 and 10mS. A multiplier increases the sweep time by factors of 1, 2, 5, 10, 20 and 50 (so reducing the sweep speed) while the sweep expansion increases the sweep speed by factors of 1, 2 or 5.

The timebase is triggered via a separate sync amplifier which may be operated by signals of either polarity from an external source or from the Y amplifier, a signal of 0.5V being sufficient. Sync may be triggered or repetitive, with selective control of the trigger point if desired. The sweep waveform is available, via a cathode follower, for external use. Sweep controls are calibrated to an accuracy of 5 per cent; internal mains-frequency square wave provides a reference time

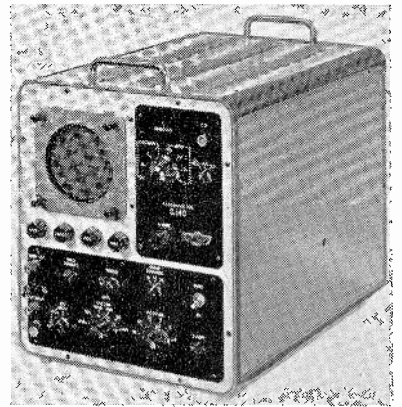

The Model O.140 is a new model by Furzehill with specification to laboratory standards.

interval accurate to within  $\pm 1$  per cent.

The X amplifier is direct-coupled with a.c. input coupling, intended primarily for feeding the timebase but available for use with external signals. Input impedance is 0.2M across 50pF and bandwidth is 10 c/s to 1 Mc/s. A 3-step input attenuator is calibrated in terms of sweep expansions (1, 2, 5) corresponding to approximate sensitivities of 20, 10 and 4V/cm.

The direct-coupled Y amplifier has an input impedance of 1M across 50pF and includes a calibrated 8-step input attenuator providing d.c. sensitivities of 15, 50, 150, 500mV/cm, 1.5, 5, 15 and 50V/cm. Calibration accuracy is better than 5 per cent and a stabilised internal square wave of 6V p-p at mains frequency is available for standardization.

Bandwidth is d.c. to 10 Mc/s at the 150mV to 50V/cm sensitivities, d.c. to 5 Mc/s at 50mV, d.c. to 1 Mc/s at 15mV. 3dB down at limit frequencies. Transient response: rise time is less than 40 milli-micro-seconds; overshoot less than 2 per cent.

Make/Model	Timebase F	C.R.T.	"Y" Sensitivity/ Bandwidth	List Price
Radar 303	<sup>1</sup> 0.3 c/s-100 kc/s	3"	100mV/cm d.c.-6 Mc/s	£60 0s. 0d.
Beulah 0-12U-F	10 c/s-500 kc/s	5"	10mV/cm 3 c/s-5 Mc/s	£44 0s. 0d.
Heathkit 0-12U	10 c/s-500 kc/s	5"	10mV/cm 3 c/s-5 Mc/s	<sup>2</sup> £34 15s. 0d.
Grayshaw SC30	15 c/s-600 kc/s	3"	30mV/cm 8 c/s-8 Mc/s	£17 10s. 0d.
Furzehill O.140	<sup>1</sup> 10 c/s-1 Mc/s	4"	15mV/cm d.c.-10 Mc/s	£150 0s. 0d.
Taylor 33A	2 c/s-100 kc/s	4"	80mV/inch 10 c/s-6 Mc/s	£63 15s. 0d.
Jason OG10	<sup>1</sup> 10 c/s-100 kc/s (limited)	3"	6mV/cm to 2 Mc/s	<sup>2</sup> £22 10s. 0d.
Heathkit OS-1	15 c/s-150 kc/s	2 $\frac{1}{2}$ "	10mV/cm to 2 Mc/s	<sup>2</sup> £18 19s. 6d.
Beulah OS-1-F	15 c/s-150 kc/s	2 $\frac{1}{2}$ "	10mV/cm to 2 Mc/s	£26 7s. 6d.

<sup>1</sup> Trace expansion  
<sup>2</sup> Kit Instrument.

### SUMMARY TABLE OF OSCILLOSCOPES DESCRIBED IN THIS ARTICLE

## New Geo-Pat Tool Box for Servicemen

### THE SLIMEASE

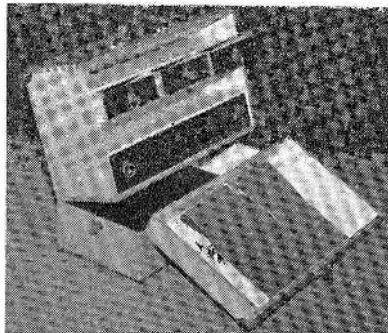

Now in production is a new addition to the range of combined valve, component and tool boxes, by Geo-Pat Suppliers, Ltd., Lambridge Street, Larkhall, Bath. The *Slimease*, shown in the photograph, has been introduced to keep in line with the general trend of the trade and has a storage capacity for valves and components the same as the established *Superb*, but with the addition of a full-width drawer.

Another new feature is a top side section designed for holding service manuals or other paper work, with a strong securing spring clip built in. This section can also be used for the fixing of a mirror, useful in much service work. An interesting feature is that the

two top-side sections can be instantly removed for easier access to contents.

The *Slimease* is available in a choice of four colours - blue, green, red or natural finish - and costs 4 gns. net trade (or 9 gns. complete with tools).

### COSSOR INSTRUMENTS

Our attention has been drawn to the fact that the Cossor Model 1323A, described in Part 4 of the series *Modern Test Instruments*, has now been superseded by Models 1322 and 1324.

The 1322 *Telecheck* and marker generator costs £27, and the 1324 f.m. receiver alignment generator £18. The total price for these two models compares very favourably with £72 for the now obsolete Model 1323A.

SERVICE ENGINEER



# TECHNICAL GEN for SERVICING MEN

## RADIO, TELEVISION and AUDIO FAULT FINDING

PRESENTING DETAILS OF FAULTS ENCOUNTERED, DIAGNOSED AND CURED BY SERVICE ENGINEERS ON RADIO, TELEVISION AND AUDIO EQUIPMENT, TOGETHER WITH HINTS AND TIPS OF USE TO OTHER SERVICEMEN IN DEALING WITH DAY-TO-DAY SERVICE WORK.

### Pilot TV107

**Trouble with Verticals** The customer's complaint with this receiver was bent verticals. After a fruitless check of the fly-wheel sync, time base and sync separator circuits, it was decided to investigate the video output stage, and this was where the trouble proved to be.

It was found that the  $27k\Omega$  resistor which is connected between the screen grid and cathode of the video output valve had decreased in value down to  $5k\Omega$ . A replacement resistor cured the trouble.

It is worth noting that definition and gain of the receiver was not greatly affected when the receiver was in the faulty condition, and that the frame hold remained normal.—J.A.B., Malton (807).

### Marconiphone VT157

**Vision Cut Out** The trouble here was that after five minutes running, the vision would cease, but the raster was visible and sound remained normal. Investigation showed that the c.r.t. cathode voltage fell to 75V from the normal 130V and that a weak picture was visible, but negative, when the brightness control was turned down so that the screen was only just illuminated.

No fault could be found in the c.r.t. or its associated circuit so the video output stage was checked. The video amplifier valve anode was found to be only 4V and the cause was the anode choke L23 being o/c.

Both ends of the winding, which are soldered to thick wire protruding from the paxolin former, were o/c, due to green spot. Cleaning and resoldering the wire ends cured the trouble.—J.A.B., Malton (808).

### G.E.C. BT2147

**Voice of Wisdom** This one should be a candidate for the "Was my face red" department. The complaint on this old 9 in. model was weak sound and hardly had I arrived at the customer's home when a voice from the kitchen called "I think it's the speaker, mister". Ignoring such unscientific diagnosis I

proceeded to check the sound valves and audio circuits in the normal way. The detector, a.f. amplifier and output stages seemed to be normal and a decent buzz could be obtained from the amplifier control grid, but the volume remained low. After about twenty minutes of fruitless searching I began to consider the advice of the unknown voice from the kitchen.

Checking the speech coil resistance showed that it was  $2k\Omega$  due to a dry joint on the tag panel. Resoldering restored normal sound and when I informed the customer of what was wrong I was told simply "But we told you that half an hour ago!"—J.A.B., Malton (810).

### Transistor Troubles

**Three Recent Failures** First was a Philips G75T transistor portable, a new stock set with loud background noise almost swamping signals. Examination showed that the OC44 had a small portion, the red spot, missing from case. Having had three of this type faulty before a new OC44 was fitted and after slight adjustment to trimmers, normal reception was restored.

The second one was a Pye Q5, which packed up the day after it was sold. On test it was "dead" and the battery consumption was 40mA instead of 10.5

mA. It was seen, by disconnecting various leads, that one of the matched output transistors was at fault. Replacing both effected a complete cure.

The third was an H.M.V. 1417, and this seemed to be a straightforward "won't go" job. A dry joint on the printed circuit panel was found and resoldered. The set worked quite well except for a noisy volume control which we cleaned and returned the set to the customer who seemed pleased with the performance.

Next day he brought it back, saying it worked for an hour and then faded out. On test it sounded as though the oscillator was inoperative but everything seemed to be OK. As a last resort, however, we replaced the OC44 oscillator-mixer—and the set worked normally again.

Who said that transistors are trouble free!—J.C.H., St. Ives (834).

### Philips 1796U

**Line Drive Varies** Trouble was picture intermittently fluctuating in size and momentarily collapsing completely. An oscilloscope check on the line output valve control grid revealed line drive amplitude varying. We thought this was going to be a tedious job of substitution but decided to start by eliminating supply voltages to the PCF80 line oscillator.

Metered anode with oscillations stopped by earthing control grid, and this voltage fluctuated. Checked the electrolytic C69 and found it to have an intermittent leakage. The h.t. feed resistor R75 looked discoloured and proved on test to be going high, so the trouble was really a combination of two faults.—W.D.G., Prestwick (816).

### Defiant MSH556

**Local Osc. Fault** Usually one only encounters two states of a local oscillator stage—oscillating and non-oscillating. But the exception cropped up in this receiver where the complaint was normal longwave reception but very low gain on the medium waveband.

The ferrite rod aerial was checked and found to be peaking, and the only change noted when switching from longwave to

(Continued on page 89)

### Items for publication

in this feature are welcome, particularly in regard to the more unusual type of faults. All contributions used will be paid for at our usual rates.

When sending in items for Technical Gen, please write (or type) on one side of paper only, adding rough sketches (where considered necessary) on a separate sheet of paper. Correspondence should be addressed to — RR Service Engineer, 46 Chancery Lane, London, W.C.2.

The Editor does not necessarily endorse the views expressed by contributors to this feature

# GOOD NEWS FOR SERVICE ENGINEERS



## TYPE 259

The ONLY complete Television Tester providing every facility needed for completely checking, repairing, overhauling and aligning T.V. sets. Covers Bands I and III, crystal calibration. Can be used with AC and AC/DC type sets. Completely portable. H.P. Terms available.

**66 GNS** Net trade

Send for leaflet No. 202

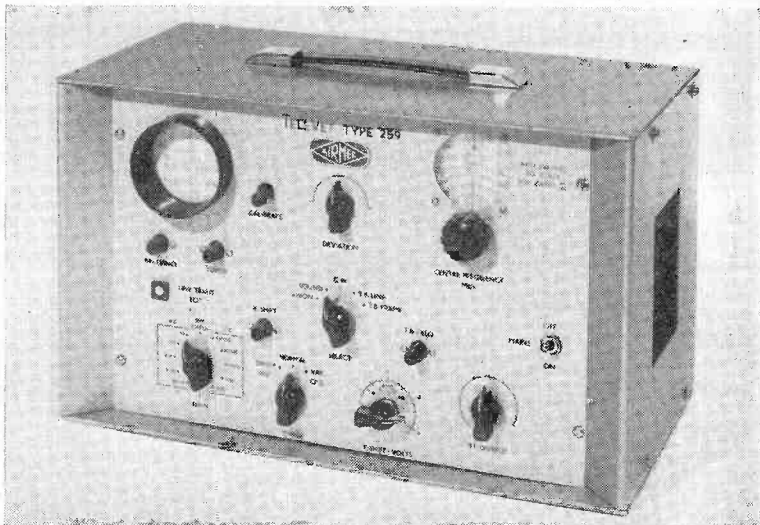

- Improved pattern—locks on all types of set.
- Wider band width oscilloscope—D.C. to 700 kc/s.
- New spiral tuning scale over 4 ft. in length—calibrated every 100 kc/s.
- Line transformer test incorporated.

**THIS AIRMEC DOUBLE WILL HALVE YOUR WORK**



## RADIVET

The complete Broadcast Receiver Tester, providing every facility for completely checking, repairing and aligning any Radio Receiver. Particularly useful for VHF testing. Covers Long, Medium and Short Waves, and Band II, crystal calibration, linear tuning scale, pre-emphasised signal available, usable with both a.c. and a.c.-d.c. Type Receivers. Fully portable. H.P. Terms available.

**66 GNS** Net trade

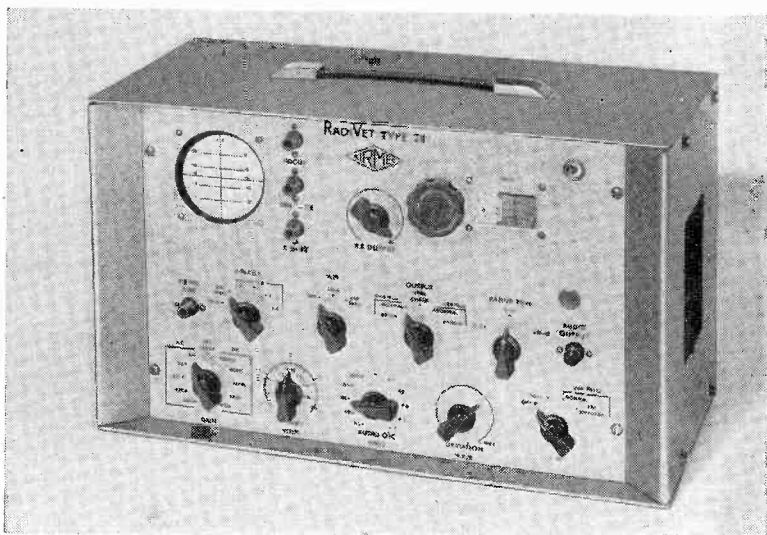

Send for fully descriptive literature

**AIRMEC LIMITED · HIGH WYCOMBE · BUCKS**

Telephone: High Wycombe 2501-7



# TECHNICAL GEN

continued

mediumwave was a distinct drop in the negative voltage on the oscillator grid. The same coil is used for both wavebands, as is common practice, but a 12k $\Omega$  resistor is shunted across the coil when the receiver is switched to mediumwave.

This resistor had dropped in value to 4k $\Omega$ , reducing the amplitude of the local oscillator output and so reducing the gain on mediumwave.—C.A.F., Clydebank (806).

## Dansette Plus-a-Gram

**Player Affects TV** One of these record players came in for servicing with the complaint of interference on TV. The player and a TV set were placed about 20 ft. apart, switched on and observed. The player reproduction was quite normal but for some unknown reason it was radiating r.f. which had a disastrous effect on channel 8 TV reception.

The picture was completely obliterated in horizontal tearing, with a harsh and distorted player sound coming through the TV receiver speaker. It was noticed that operation of the player volume control changed the oscillation frequency, consequently a 100pF capacitor was fitted between the volume control slider and chassis. This cured the fault. Incidentally, the record player valves were tested and found OK; replacement had no effect.—E.L., Long Eaton (826).

## RECEIVER

### SPOT

### CHECKS

#### No. 60: FERRANTI TI001/2

**No Sound or Vision:** Check R6, R8 or R12 for o/c and, respectively, C10, C12 or C17 for s/c. For no vision, check R59/C26, R23 and R24/C33, R38/C43 for o/c and s/c respectively; check for faulty CD1 or L24/L25 o/c. For no sound, check R27/C37, R33/C40 and R37/C41 for o/c and s/c respectively.

**Line Timebase Inoperative:** Check C98 for o/c or s/c. Check fuse F2. Check for faulty C105, C106 or C107. Check R112 for o/c and C103 for s/c.

**Frame Timebase Inoperative:** Check C109, C122 for s/c. Check for faulty C101 and C104. Check T2 primary for o/c.

**No Sync:** For no frame sync check for faulty MRI and C122. Check for s/c on C122. For no line sync, check for C120 o/c.

## Audio Circuit Fault

### Ferguson 406

The complaint with this receiver was sound distortion. The PCL82 a.f. amplifier-output valve was immediately changed, due to past experience with this type of valve, but in this case the fault persisted. The distortion was the same at all volume settings, so attention was turned to the sound interference limiter.

There was no voltage on the OA81 diode. The 2.7M $\Omega$  h.t. feed resistor was suspected but this was within its tolerance when measured. The diode itself was checked, as these sometimes go short circuit, removing the h.t. potential, but this time this was not the case.

Next, the 0.1 $\mu$ F capacitor C85, coupling the limiter to the detector circuit, was checked and this proved to be the trouble. It had gone s/c, thereby shorting out the diode h.t. voltage. A new capacitor restored normal sound.—V.D.C., Bristol (800).

## Philips N3G82VT

**Poor Weak Sound** The trouble on this hybrid car radio was distorted sound and weak output. Perfect sound was present at the input to the base of the output transistor when monitored with headphones. The 3-ohm emitter resistor was open circuit and badly burned and when substituted passed a current of 1.5A instead of 315mA. The transistor was found to be faulty and was replaced together with the 3-ohm resistor.

Since OC16 transistors cost 54s., a meter was fitted in the collector lead



Bertie bought a test-tape,  
Kept it in a tank,  
Forgot to switch to 'Playback'—  
Now his spool is blank.

Feste

before switching on. As the meter read over 1A we switched off hurriedly! Everything was again checked and a series of tests was made by connecting the collector for a second or two to avoid overheating.

The current could be cut to zero if the base lead was disconnected, indicating a bias defect. The base bias comes via

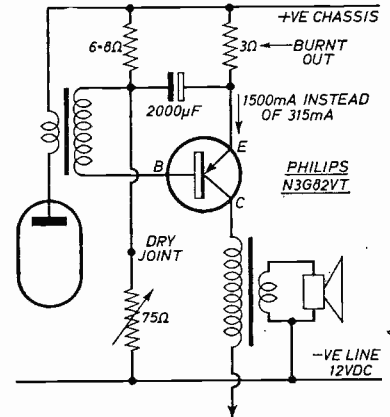

a 6.8/75-ohm potentiometer. The resistors were satisfactory but a dry joint was found between the 75-ohm resistor and base.—L.E.H., Edgware (811).

## Negative Picture on Peak Whites: Increase C95 to 150pF.

### No. 61: PILOT TV94 SERIES

**No Sound or Vision:** Check R24/C116 or C121, R104/C107 for o/c and s/c respectively. Check for C113 leakage and R107 h.r. or o/c.

**No Vision:** Check R26, R33, R44, R60 for o/c and C30, C44, C53 for s/c. Check for faulty C36 or C46. Check Chokes 2, 3, and 4 for o/c.

**No Sound:** Check R8, R14, R16, R18, R22 for o/c and C11, C15, C17, C19, C27 for s/c. Check C6, C8, C14, C25 for o/c or leakage.

**Line Timebase Inoperative:** Check C34 or C35 for s/c causing lack of boost voltage. Check R42 for o/c and C54 for s/c rendering line oscillator dead. Check C49 for leakage and C50 for s/c.

**Frame Timebase Inoperative:** Check for lack of boost voltage or s/c on C68. Check C74, C75 for s/c, C63 for o/c or s/c. Check T5 primary for o/c.

**Low Brilliance:** Check C45 for leakage.—E.L., Long Eaton (778,739).

## Pam 551

### Heater Chain Trouble

On this receiver there was no picture, sound being normal. On examination it was seen that although the valves were all glowing normally, the c.r.t. heater was cold. At first it was thought that the c.r.t. heater was s/c, but on disconnecting the tube base connector we discovered that the valve heater chain was still unbroken.

On referring to the circuit diagram it was seen that the c.r.t. heater is the last in the chain, one side being returned to chassis. It was thought that the PCC84 r.f. amplifier, next in the chain, had developed a heater-cathode s/c, but it was found to be in order.

Tracing the heater wiring back from the c.r.t. we came to a tag strip underneath the line output chassis. The heater tag was adjacent to an "earthy"

(Continued on page 91)

## 2 "Service Successes" from the Radio Show . . .

Direct T.V. Replacements Research has produced this revolutionary instrument for YOU . . .

the **D900**

### a new compact, dynamic TRANSISTOR TESTER/POWER SUPPLY

- Makes possible dynamic transistor testing in situ.
- Tests CURRENT GAIN (AC) ALPHA GAIN.
- Tests CURRENT GAIN (under D.C. conditions) BETA GAIN.
- Measures leakage Currents between Collector/Base and Collector/Emitter, at any voltage between 0-25v.

Tests transistors while in circuit. Has its own self-contained power supply providing smoothed D.C. 0-25, Size  $5\frac{1}{2} \times 3 \times 2\frac{1}{2}$  in.

See an exciting new T.V. development on our Stand No. 8, Industrial Photographic & Television Exhibition—21st-25th November

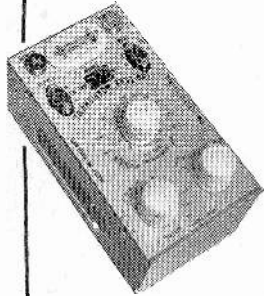

Price £10. Order or send for full details TODAY.



**THIS** will save you time & money!

The most efficient lowest priced time base component shorting turn tester

Tests-  
Line Output Transformers  
Deflector Coils  
Blocking Oscillator Transformers

for-  
Shorting Turns  
Open Circuit  
£7 : 10 : 0  
(Net Trade)  
Subject to quantity discount to wholesalers.

**Skantest**

Direct TV Replacements Service gives you  
• Same day despatch • Individual attention  
• Technical advice • Competitive prices • Britain's largest stocks of TV Replacements.

**direct TV Replacements LTD.**

(The Largest Stockists of specialised TV Replacements in Great Britain)

Dept. RR/10/60, 138 Lewisham Way, New Cross, London, S.E.14.  
TIDeway 6666 IPSOPHONE Tideway 6668



**THE  
DEPENDABLE TUBES  
AT A  
FAVOURABLE PRICE**

**REBUILT TELEVISION TUBES**

**NOW AVAILABLE**

Write at once for details to:—

**TRUVU (ELECTRONICS) LTD**

TRUVU WORKS, STRATHENDRY, LESLIE, FIFE

Telephone: Leslie 444-5-6

TEL 2

SERVICE ENGINEER

tag, on which was a large blob of solder which was just touching the heater tag. The strange thing about this fault was that it only developed after the set had been working faultlessly for 18 months. However, the fault occurred one afternoon after the set had been on since 9.30 a.m., so apparently the heat generated was sufficient to warp the tag strip enough to cause the short circuit. —G.C., Boroughbridge (819)

## R.G.D. 610

**Two Common Faults** Lack of, or intermittent variation in, width is quite a common fault on this series of receivers and I have found it is invariably due to the PL81 screen resistor decreasing or varying in value. On several occasions we have found it to be in the region of 500-ohms instead of the original 2.2kΩ.

The resistor (R46) is a carbon type rated at 1-watt and we replace it with a 5-watt wirewound resistor to avoid over-running, with no further trouble. A point to watch is that if the set has been used for a time by the customer with the resistor low in value (lacking width) the PL81 is usually damaged and needs to be replaced.

Another fault encountered on these models is usually due to faulty assembly. The preset control connecting tags are fitted on the extreme rear of the printed circuit panel. Unless care is taken in assembly, these tags come perilously near the edge of the main (metal) chassis and can short circuit to chassis if the chassis or panel warp slightly. —G.C., Boroughbridge (280).

## ● odd spot

On a Pye 123MBQ the customer's complaint was no output. Checks revealed that there was no voltage at the collector of the driver transistor. Closer inspection showed that a hole had been drilled through the narrow "isthmus" of the copper plate, although not right through the paxolin board, and this had open circuited the voltage supply to the driver.

The customer had drilled two 4BA holes in the cabinet to enable him to fit it in his car, but the drill had gone farther than intended and had made two holes in the printed circuit, one of which had been fatal. Bridging the gap with connecting wire cured this strange fault. —A.A.S., Mansfield (821).

## Ferguson 546T

**Frame Lin. Fault** A frame linearity fault on one of these sets proved rather obstinate. The valve was checked and found to be O.K. but a voltage check showed excessive cathode voltage on the PCL82. A component check showed that the 0.01μF capacitor (see diagram) was low insulation, but

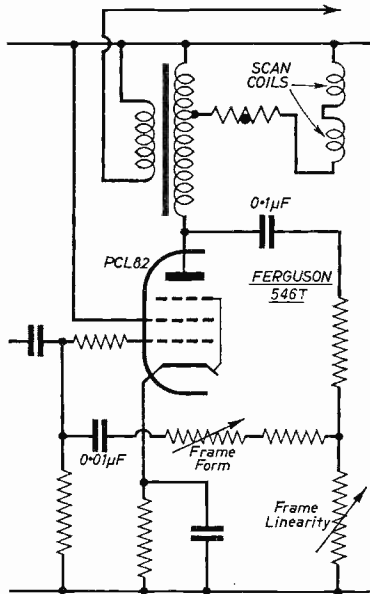

substitution did not entirely cure the fault.

A further component check revealed that the 0.1μF capacitor in the feedback circuit was also low insulation. Both of these components were of the type sealed in polythene, presumably to improve their insulation.

A fault of intermittent picture level with poor definition showed up on two of these receivers less than a month old. Valves and tube were checked and sound satisfactory. The sound was not

affected, thereby eliminating the tuner unit. In checking the video amplifier circuit, however, the compensating choke L39 was found to be intermittent. The enamelled copper wire had been partially cleaned but not tinned and soldered. —W.S., London (787).

## Murphy V430

**Arcing From Tube** In this rather unusual fault, the trouble was vicious arcing between the coating of the tube and the earthing clip. The first replacement tried was the U26 valve, this having no effect, however. As all the voltages were normal, the next suspect was the cathode ray tube itself, but this proved not to be the case. Finally the line output transformer was replaced, and this time the fault was cleared.

The reason we submit this is that to all intents and purposes it was a tube fault and yet, as shown, it proved to be otherwise after wasting rather a lot of time. —W.H.B., Tadcaster (813).

## Pye 17T

**Bias Line Fault** Symptoms were no sound or vision, although the raster was normal. When first switching on, however, sound came on but then faded out and this pointed to the bias being too high. On checking the a.p.c. bias line this was found to be too high.

Temporarily shorting the a.p.c. line to chassis had no effect, but shorting both the a.p.c. and sound a.g.c. lines to chassis resulted in both sound and picture reappearing. The sound was distorted and the contrast control had no effect as was to be expected.

By disconnecting the a.p.c. leads at different points, the excess voltage was found to be coming from the sound section. Further disconnecting revealed that when the sound detector diode was disconnected the bias became normal. Replacement of the V16 diode restored normal operation. —J.H., Ballymoney (829).

## 'Down to Earth'

Just over a year ago, Wolsey Electronics Ltd. produced a booklet *Bringing the Aerial down to Earth* which was compiled from a series of articles originally published in the *Wolsey Gazette*. Ten thousand copies were distributed exclusively to the trade and to Technical Colleges.

A second edition has now appeared, revised and with four new chapters. The aim of the booklet is summed up neatly in the Preface when the author, R. S. Roberts, M.BRIT.I.R.E., SEN.M.I.R.E., Technical Director of Wolsey Electronics Ltd., says:

*Some of us tend to take a lot for granted where aerial behaviour is concerned. Little-understood aspects of*

*operation are apt to be ignored providing the installation is easy to erect, is reasonably priced, and gives a good account of itself. It is the object of this booklet to offer some explanations, and show the basis of design considerations in as simple a manner as possible.*

In this, the author has succeeded. There are nine chapters, dealing with theoretical and practical aspects of propagation and reception. All are in the same conversational style, "readable" but not patronisingly so. This has been helped by lifting out the more indigestible material (formulae, etc.) and placing it in appendices at the end of chapters.

Copies of this useful booklet may be obtained from Wolsey Electronics Ltd., Cray Avenue, St. Mary Cray, Orpington, Kent.

*Do it the easy way—with*

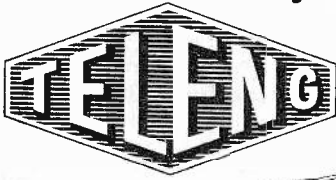

**CABLES**

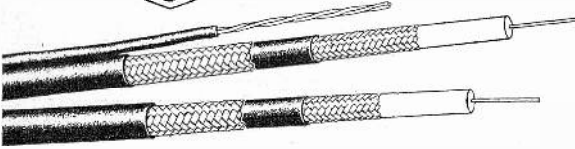

For the easy and rapid erection of Communal T/V-F.M. Distribution Networks, we offer a complete range of co-axial cables in single or double, woven screens in conductor sizes 1/·022" to 1/·108". Every coil is certificated as to H.F. performance. Special closely woven types are included in our ranges. Teleng easy fix cable clips are also listed. Prompt delivery from large stocks at keen prices.

## and **CABLE HARDWARE**

Teleng Hardware includes steel brackets and fittings for every erection need. Chimney, corner and wall brackets, strainer brackets, bolts, nuts, washers, etc., are all supplied to public utility specification and galvanised to B.S.729. Specially hardened masonry pins can be supplied for cable clips.

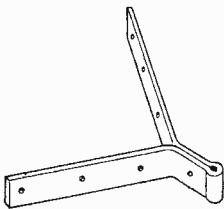

SINGLE TYPE  
CORNER BRACKET

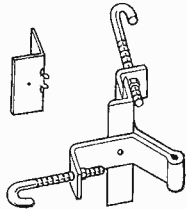

CHIMNEY BRACKET

Write for lists, 'C'—Cables and 'CH'—  
Cable Hardware to:

**TELENG LIMITED**

CHURCH ROAD, HAROLD WOOD, ROMFORD, ESSEX

Ingrebourne 42976-7-8

# TUNGSRAM VALVES

A QUALITY PRODUCT  
FOR  
SERVICE ENGINEERS

**ENSURE  
YOUR OWN  
REPUTATION**

BRITISH TUNGSRAM RADIO WORKS LTD.,  
WEST ROAD, TOTTENHAM,  
LONDON N.17.

Telephone: TOTtenham 4884

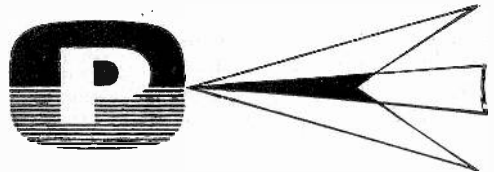

**YOUR GUARANTEE  
OF REBUILT TUBE QUALITY**

Regular buyers of Pitrie Rebuilt Picture Tubes have learnt to rely on their outstanding quality. When you are thinking of repaired tubes, remember Pitrie Tubes are of proved performance and reliability.

**PITRIE LIMITED**  
**REBUILT PICTURE TUBES**  
with a guarantee

PITRIE LTD., 21 NOEL STREET, LONDON, W.1

# The Apprentice Engineer

## AT THE BENCH

by G. L. A. MORGAN

A page of practical advice, hints and tips, short-cuts and workshop notes for the apprentice.

**S**HORT cuts come by experience. In every profession there are tricks of the trade, which the old hand applies automatically. The radio repair trade is certainly not the least blessed with these gimmicks.

At times the apprentice is led to despair when he finds he has slogged away at a laborious fault, met a dead-lock, appealed for help and found a simple short-cut would have guided him to a solution. He may think it impossible to learn the peculiarities of the legion of receivers his department handles. His mental filing cabinet may seem—to him—to be inadequate.

*But short cuts are no more than applied logic. They often derive from test procedure that has had to be ruthlessly whittled because of lack of time. Although some depend on the specifications of particular sets, many more are general. These are worth learning. They can usually be modified to fit a multitude of circumstances.*

### Disturbance Tests

Take disturbance testing, for example. This consists of "disturbing" the circuits to alter their operation, whilst observing the effect. It is a popular "wet-finger" approach to service with a minimum of instruments, and is extremely effective when used by the experienced engineer.

Taking the simplest example, a finger placed on the grid of an audio valve will induce a hum if the circuits are operating correctly. This is because of 50-cycle pickup from the a.c. field.

On the battery set, it follows, there will be less possibility of hum, because there is no such field. But in practice, the coupling effect of a finger on the grid disturbs the operation of the circuit and a little audio feedback is sufficient to induce enough hum to indicate the output stage is working. *Everything depends on the design and the conditions under which the set is working.*

### Random Noise

I.f. stages will reproduce random noise sufficiently to indicate gain. This noise can be induced by scratching the grid pin with a screw-driver or the positive probe of a meter. If there is no

### Short Cuts

voltage on the electrode, the meter can be switched to Ohms.

The meter battery will then provide an applied voltage which, when rapidly applied and removed by the scratching action, sends a useful square wave through the amplifying circuits. The result is a noise on sound and a series of "sparks" on a television picture.

Exciting the anode pins is not always so effective. Or, rather, is *apparently* more effective, but may be misleading. This is because the action of upsetting the anode may cause radiation of interference which can be picked up by subsequent stages.

If the meter lead is responsible for this radiation of r.f., there is little that can be done. Indeed, it is seldom necessary to check for gain across a valve by disturbing the anode circuit. If the engineer has a meter handy, a few measurements will prove this point.

### TV Tests

These rough tests can be pursued through the successive stages, from output toward aerial. In the case of a television receiver useful clues can be obtained about the performance of either sound or vision stages, which separate at or after the first i.f. amplifier.

A disturbance signal on both sound and vision from the aerial usually indicates that the frequency changer is at fault, or that the receiver is off tune. Do not be misled by the latter condition: it could be caused by a simple matter, such as a coil slug working loose.

Always check the tuning on adjacent channels if the range of the fine tuning control fails to bring in the signal.

This way, the strong vision signal will usually come through on sound or the sound carrier break up the raster as the tuning point approaches. This will prove the oscillator is working—in some fashion—and may save a certain amount of fruitless probing.

### Timebases

Disturbance testing in the timebases requires a different approach. Circuits vary widely, and unless it is known from experience what effect a test will have, it is wise not to form too hasty a judgement. In general, however, there are rough and rapid tests that apply to most sets.

Take the case of "No raster" which could be due to a failure in the line oscillator, line amplifier, output or e.h.t. circuits or in the biasing circuits of the tube (including the video stage) or even the tube itself. To the experienced engineer, the process of elimination is rapid—often automatic.

First, he is likely to inquire whether the tube is receiving e.h.t. Before testing for this, he will listen for the whistle of the line oscillator, perhaps turning the horizontal hold control to hear the changing note. If the whistle is strong he may then check for a.c. at the anode of the e.h.t. rectifier, drawing off a spark with a well-insulated screwdriver blade. *(The reminder to use only one hand, keeping the other away from the chassis or test leads, cannot be repeated too often.)*

### D.C. Test

If the a.c. is there, the next test is for d.c. This, too, can be checked with the screwdriver blade, but some experience may be necessary to distinguish between the two effects.

Generally, it can be said that d.c. tends to spit across the air gap—especially if a long blade is used and an outer portion of it held against a chassis point or the outer coating of the tube.

If e.h.t. is present and there is still no hint of a raster, the bias circuits to the tube may be tested by momentarily short-circuiting cathode and grid of the tube at the base pins. If a raster then appears, it is time to call in the voltmeter and discover why the c.r.t. is biased beyond cut-off.

### Other Causes

If the raster does not appear, remember that there are other likely causes of trouble beside the tube itself. Typical offenders are ion trap magnets and first anode voltages. *Take care to note the position of an ion trap magnet exactly before moving it.*

Then, if its displacement was not the cause of the lost picture, it can be returned to its former place while further tests are made.

This by no means exhausts the simple tests that the bench engineer will make before he touches a single instrument. The frame timebase, for example, can be checked in a similar way.

Here, things may be easier. A thin line of brightness indicates a failure of

(Continued on page 95)

# BEULAH

## Model V-7A/F

### Valve Voltmeter

By Gordon J. King, Assoc. Brit. I.R.E.

**T**HE Beulah V-7A/F Valve Voltmeter is the assembled version of the Heathkit instrument Type V-7A, and is marketed exclusively by Direct TV Replacements Limited, 138 Lewisham Way, New Cross, London, S.E.14.

The instrument is very attractively presented in a "feather grey" metal cabinet, having a charcoal grey front panel on which is mounted the full-vision  $4\frac{1}{2}$  in.  $200\mu\text{A}$  meter movement, adjusting knobs and selector switches. The dimensions are  $7\frac{3}{8}$  in. height,  $4\frac{1}{8}$  in. width and  $4\frac{3}{8}$  in. depth. The weight is 7 lbs. and full portability is maintained by a functional-size plastic handle fitted to the top of the cabinet.

The instrument is mainly operated over the range of 200-250 volts, 40-60 c/s (approximately 10 watts loading), and provides the following ranges: D.c. volts full-scale 1.5 to 1,500 in seven positions; a.c. volts full-scale 1.5 to 1,500 r.m.s., with scale also calibrated in peak-to-peak values; ohmmeter which measures from 0.1 ohm to 1,000 megohms in seven ranges.

The input resistance on d.c. is 11 megohms (with 1 megohm resistor incorporated in d.c. probe) on all ranges, and the accuracy is  $\pm 3$  per cent of full-scale. On a.c. the accuracy is  $\pm 5$  per cent of full-scale, and on the 5-volt range the response is 42 c/s to 7.2 Mc/s  $\pm 1\text{dB}$ , from a 600-ohm source, which makes the instrument extremely useful for audio, supersonic and r.f. tests.

Such tests are aided by the decibel scale, which extends from -20dB to +5dB with zero dB as 1 mW into 600 ohms when the instrument is switched to 1.5 volts a.c. The dB scale is extended progressively by 10dB by switching over the remaining 6 a.c. ranges. Thus, by switching to 1,500 volts a.c., the scale reads +80dB to -65dB.

### CONSTRUCTION

The inside of the instrument is built around an etched printed circuit board on which the conductors are formed of 0.0015 in. gold-plated copper foil. The selector and multiplier switches are mounted direct on to the rear of the front panel, while the meter movement is bolted to the printed circuit board by its connecting terminals, and the

board is secured by a substantial "U" bracket, which also serves to clamp the metal cabinet to the front panel of the instrument.

The Type U11 cell, which is used for resistance measurements, is held in excellent contact with the circuit terminals under spring tension, between the printed board and the underside of the "U" bracket. The hi-stability resistors are not fitted to the printed board, but are soldered directly to the tags of the three-bank multiplier switch.

Indeed, there are few components only on the actual printed board, three of which are pre-set controls which allow the user to re-calibrate the instrument at any time with the utmost facility. The metal cabinet is held tightly against the front panel by two self-tapping screws, and it is only a simple screwdriver operation to gain internal access to the instrument.

### CIRCUIT DETAILS

The d.c. side of the instrument is designed around a double-triode Type 12AU7 valve. The  $200\mu\text{A}$  meter move-

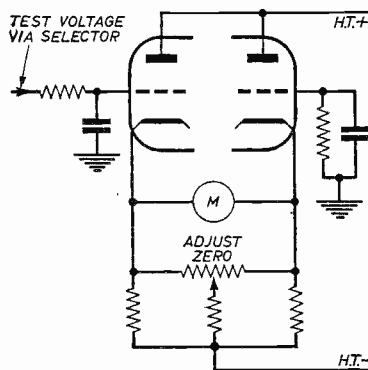
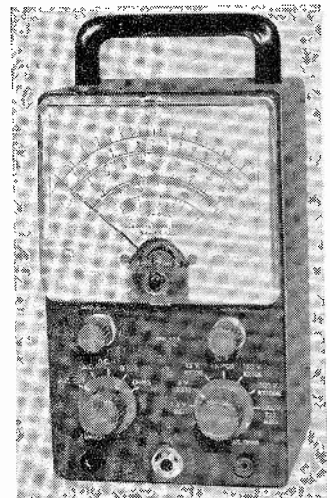

Fig. 1: The valve is arranged in a bridge circuit balanced by the adjust-zero control. At balance, no current flows in M, but balance is upset by the application of a test voltage, causing current to flow in M which gives an indication in direct proportion to the test voltage. The meter is thus calibrated with a linear scale.



ment is connected in the cathode circuit, between the two triodes. The "adjust zero" control is also in the cathode circuit, and this serves to balance the current in the two triodes, thus, giving zero reading on the meter.

The voltage to be measured is applied to the first triode, and as its application unbalances the two valves current flows in the cathode circuit and the meter indicates. The relationship between the test voltage applied to the first triode and the meter indicating current is linear and the meter is, therefore, calibrated with a linear scale (see Fig. 1).

The maximum test voltage which the first triode ever receives is in the region of 3 volts. Higher test voltages are first reduced accordingly by the voltage divider, on the multiplier switch, which has a total resistance of 10 megohms. An extra resistance of 1 megohm is incorporated in the d.c. test probe which allows measurements to be made in circuits carrying r.f. with the least disturbance to the test circuit.

For the measurement of a.c., a 6AL5 double-diode valve is employed as a full-wave rectifier to provide a d.c. voltage proportional to the applied a.c. test voltage. This d.c. voltage is applied, via the voltage divider/multiplier network, to the first triode to cause meter indication in the manner previously described. On a.c. ranges in excess of 150 volts, the input test voltage is applied to the 6AL7 valve through an additional voltage divider network in order to limit the voltage input to the rectifier to a safe level.

In order to prevent the inevitable contact potential developed in the diode from giving small readings in the absence of an applied a.c. voltage, a cancelling voltage is applied to the diode through one of the pre-set controls marked "AC BAL". This control is adjusted to eliminate zero



shift when switching from a.c. to d.c. It can, however, also be used purposely to bias the diode to improve linearity for test potentials below 1.5 volts r.m.s.

For resistance measurements, an internal 1.5-volt battery is switched across a chain of multiplier resistors in series with the resistance under test, thus forming a potential divider across the battery. A resultant portion of the battery voltage is applied to the first triode, as before, and the meter indication is then in terms of "ohms" taken from the resistance calibration on the movement scale.

The two remaining pre-set controls within the instrument are for "d.c. calibrate" and "a.c. calibrate". Calibration on d.c. is accomplished by the use of a single cell, such as that supplied for the instrument's "ohms" ranges. The instrument is simply switched to 1.5 volts d.c., and with the test cell applied, the "d.c. calibrate" control is adjusted until the pointer deflection coincides with a small red spot marked on the scale slightly in advance of the 1.5-volt reading, having in mind that an open-circuit cell measures 1.55 volts and not 1.5 volts as is often thought.

On a.c., the appropriate calibration pre-set is adjusted to set up the instrument on the a.c. line voltage, or a more accurate source of voltage if available.

## FEATURES

A very convenient feature of this instrument is the centre scale zero which can be provided by the panel "zero adjust" control. With the movement's pointer so adjusted, the instrument can be used as a null indicator in ratio detector and f.m. discriminator adjustments, for bias measurements or any application where polarity reversals may occur during alignment or adjustment.

This feature can be used when the panel "selector switch" is set to either positive or negative d.c., the latter function, of course, allowing the meter to register either positive or negative voltage without the bother of having to reverse the connecting leads.

An outstanding feature which is immediately obvious is the large easy-to-read meter. The whole face of the meter is visible. In fact the complete movement is encased in a dust-proof Polystyrene, transparent housing. An unobtrusive red pilot lamp at the top of the housing is illuminated when the instrument is switched on.

On the front panel are mounted the "adjust zero" and "adjust ohms" controls, the selector switch, giving "a.c. off", "a.c.", "d.c.-", "d.c.+" and "ohms", and the seven-position range switch. The d.c. test voltage is applied through a probe via a 1 megohm resistor and screened lead to a jack-

socket, while the a.c. test voltage is applied to an ordinary type instrument socket, both being relative to a common socket. The 1 megohm resistor in the d.c. probe avoids the test circuit being unduly disturbed in the event of r.f. or a.c. being present on the test voltage.

## NO ZERO DRIFT

Two factors are revealed as soon as the instrument is put into service. One, there is virtually no zero drift, and two, the movement is highly damped, there being no trace of oscillation of the pointer even if one attempts to promote the effect by quickly making and breaking a test voltage. The same factor is present by rotating to-and-fro the complete instrument in an endeavour to get the pointer to oscillate—it just will not oscillate!

On the face of it, the damping factor would appear to be just a little too great, since there is an unusually large time lag in the pointer rising from zero to indicate the test voltage. This could prove frustrating if a series of rapid tests are required; there is also a similar time lag in the pointer falling back to zero when the test voltage is removed. Nevertheless, there is little doubt that this is better by far than an oscillating pointer.

The response of the amplifier and rectifier circuits is surprisingly good for an instrument in this price bracket. A signal of constant voltage fed from a low impedance source did not deviate by more than 2dB over the range 50 c/s to 7 Mc/s. At 7 Mc/s the indicated voltage started to climb a little until at 10 Mc/s the reading was approximately 6dB above the applied voltage.

## UP TO 30 Mc/s

An indication was in fact possible up to 30 Mc/s, but was very inconsistent from 10 Mc/s to that frequency, possibly due to odd resonances of the test leads, etc., as no special precautions were taken over this test. The instrument definitely does what is claimed for it, even better, for 30 Mc/s is a high frequency for an instrument of this nature!

The accuracy on both d.c. and the ohms ranges is within the figures quoted for the instrument, but I would say that I calibrated the sample instrument accurately by means of the pre-sets before undertaking this test of accuracy.

There is little doubt of the usefulness of this instrument in the measurement of high resistance voltages, low and high value resistance and a.c. voltages in radio, audio and television work. It will find a place in the laboratory, but particularly in view of its competitive price and versatility it will possibly find its greatest application in the modern workshop of the service technician. The Beulah V-7A/F costs £19.

## APPRENTICE

—continued

the frame output stage, especially if no movement of hold, height or linearity controls affects its thickness or position.

But a line having some thickness, which alters in nature or position when controls are moved, gives the clue that the output stage is, at least, amplifying to some extent. If a full scan can be obtained by coupling an a.c. field to the grid of the output stage (a small capacitor from heater to grid will suffice) attention may be turned to the oscillator.

A distorted frame scan is more difficult to trouble-shoot by disturbance methods, without some knowledge of the particular circuit and its behaviour.

**A popular fault, however, is a change in output bias conditions, due to the cathode bypass capacitor failing. Short-circuiting the cathode to chassis should give an increase in scan.**

If the increase is only slight, it may be that this electrolytic is leaky. Less likely is an open-circuited capacitor, which causes reduced scan by increasing the bias. Then, the short-circuit will produce a drastic increase, providing the engineer with a clue. Rapidly touching another electrolytic across the suspected one will prove this fault.

*These are simple tests, mainly routine. Such short cuts are quite legitimate and not to be despised. The apprentice would do well to note them, and discover for himself the variations on the themes outlined above, applying to different circuits.*

Space precludes my being more specific, but perhaps in a later article we may collate a few of the short-cuts on particular circuits that readers have found useful.

## Electrician's Mate

We have received a most interesting booklet from British Insulated Callender Cables Ltd., specially produced to give a comprehensive coverage of mineral insulated cable work. B.I.C.C. call their book, most appropriately, *The Electrician's Mate*.

Primarily intended for those carrying out installation work it has been produced in pocket size. Contents include information on tools, cable handling, seals and glands, cable runs (bending and straightening, fixing methods, etc.), terminating cables, protection, repairs, and many other practical aspects. There are also seven comprehensive tables on accessories and tools.

The 82 pages are crammed with information and the book is admirably illustrated, mainly in three-colour drawings. The wireman will find it extremely useful. Copies may be obtained at any B.I.C.C. branch office.

**Say Aah! . . .**

SOME folk like to chew at a problem. Others swallow it whole. There are engineers like that, gulping at faults like an expert with an oyster. Now my friend Bernie is differently inclined: he nibbles away like a mouse at a piece of cheese. He swears by diagnosis.

"Swears by" not "swears at", like Joe and the wet-fingered brigade. Nor, like you and me and the most of us, probing tentatively for effects and then rationalising them to their causes.

Bernie is a logician. To him, diagnosis is almost an act of faith. Kirchhoff's Law ought to be the Fortieth Article. *Ergo Sum* is surely engraved on the graticule of his ever-inquisitive 'scope. There isn't a breakdown in the book that he does not want to know about. And those that are not in any book—the sort that are poison to you and me—are meat and drink to Bernie.

Sometimes I think that he is not so much interested in putting a set right as in proving why it went wrong. I remember he once got terribly peeved because an intermittent on which he had made a series of tentative tests had to go back to the customer—then failed to show its fault again!

On another occasion he had a customer champing at the bit while he spent three days on frame flutter on a Cossor 948. Once the PCL82, the oscillator transformer and the usual 0.25 $\mu$ F had been tried, you or I would be tempted to swop the printed circuit panel. Joe would probably have done it straight away.

But not Bernie, oh no! He plodded away with his logical tests until with delight he was able to show a resistor that increased 10k when its temperature rose slightly. And his triumph was even proof against the customer's ire.

When he is immersed in a problem Bernie is impervious to insult and indifferent to interruption. He has the abstracted look common to seekers after abstract truth—like a beatnik draped over a juke-box. The lips are parted, the tongue glints moistly, the

eyes gaze glassily into middle distance . . .

So must Galileo have looked as the swinging lamp hypnotised him. Even Joe gets like it sometimes—mostly when a customer launches into a long harangue.

Bernie, however, has little bother with customers. When he leaves his precious test gear and goes out to make a call he carries that air of abstraction with him like a protective cocoon.

He has been known to stand before a flickering picture for long minutes entranced, absorbed. Meanwhile the customer grows fretful and wonders whether perhaps he should have sent



The customer grows fretful.

for the plumber instead. This gives rise to the famous remark "The last bloke who called didn't seem to know what he was doing."

Bernie knows exactly what he is doing. Quite often he has a fair idea of what the set is doing, too. It is the "why and wherefore" that interests him. For example, he has a "low-gain" fault that is immediately cured by substituting the PCC84. Obviously, the valve was down a bit. That's fine, thinks Bernie, but *how much?* So he puts the old valve back again and spends half an hour making measurements and tests.

We have even caught him, in the workshop, putting specific faults on certain receivers to study the effects they caused. Each month he turns to "Technical Gen" and browses through the items. He is not looking for answers to his problems, as you and I may be doing. He is looking for more problems to answer.

It is not unusual to find him shaking his head and "Tck-tck"-ing as he sorts out those little discrepancies the editor has missed. Looking over Bernie's shoulder as he grimly describes how a certain fault could not possibly have been



There was a howl of wrath.

caused or cured by what the writer states, we begin to understand why long-suffering editors absolve themselves. . . . "The Editor does not hold himself responsible! . . . etc."

The RTEB and City and Guilds Examiners must have people like Bernie in mind when they frame those classic questions: "What happens when C3 goes open-circuited?" or "What would be the expected symptoms if . . . ?"

Joe has been known to sit morosely over an exam paper, then scribble in desperation: "There would be an almighty flash." I must confess a personal sense of challenge, almost like getting at a crossword puzzle. So that I have a deep sympathy for those unfortunates who were greeted with last year's Trainer-Tester and found that it could be spread over twenty feet of bench. That's what I call a puzzle—even better than Mephisto.

But to Bernie the whole of life is a challenge and even the most innocent fault an intrigue. Once the Service Manager arrived back early from lunch and discovered him happily involved in a disembowelled valve-tester. He wanted to find out just at what point the arbitrary division between "Good" and "Bad" should be drawn under differing external conditions. Like another Bernie he was "only arsking". He met with something of the same response, too.

Another time he picked up a rather unusual model from the floor near our entrance doors, bypassing the usual procedure of the "Incoming Rack" in order to get his paws on this choice bone.

Half an hour later there was a howl of wrath and an influential customer rattled the windows with invective. The set had not been brought us for repair. Aforesaid I.C. had just purchased it second-hand and brought it round for operational advice, we discovered later.

"Humph," said Bernie, after he had reassembled the I.C.'s precious status-symbol. "There were at least five faults on it."

There were. And poor Bernie got the blame for them all when they developed later. There must be a moral somewhere.



He sits impervious to insult and interruption.

# fine construction and advanced design

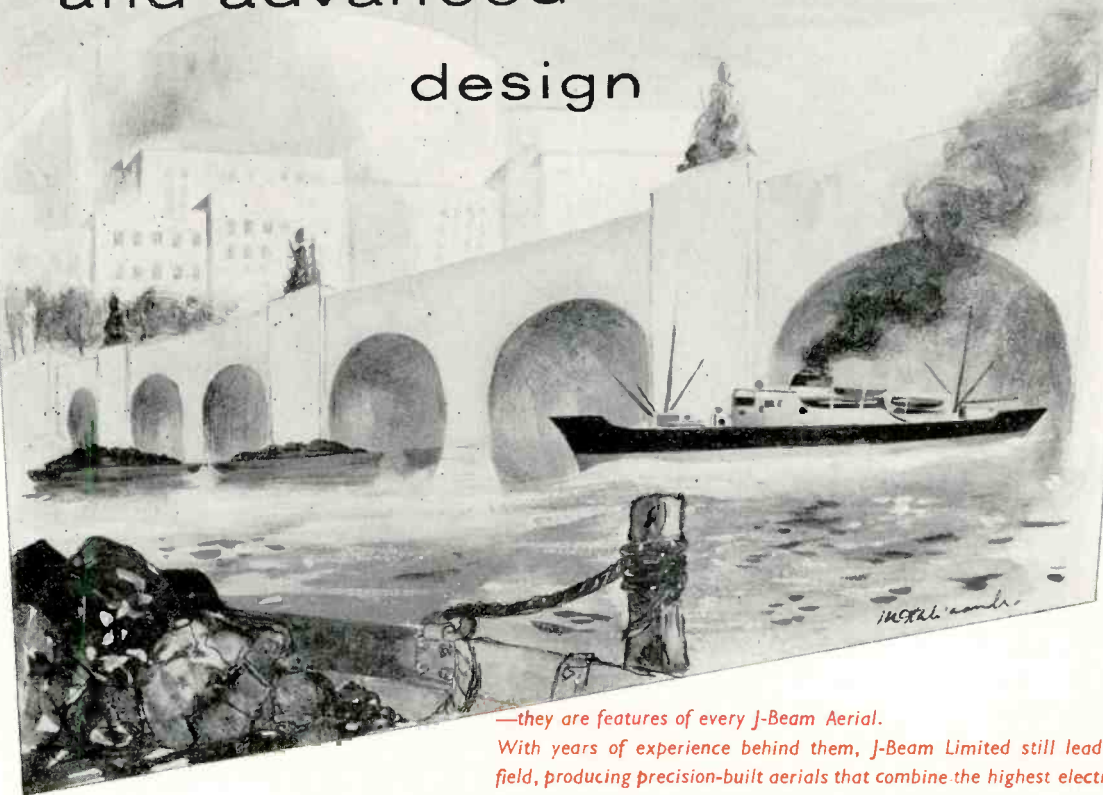

—they are features of every J-Beam Aerial.  
With years of experience behind them, J-Beam Limited still lead the field, producing precision-built aerials that combine the highest electrical performance with the soundest mechanical construction.

## NEW Additions to the Double Beam Range

*New design for better Mechanical Balance*

REF. DB. 4/1 (with folded Band 3 reflectors)  
REF. DB. 4/2 (with folded Band 3 reflectors)

High gain aerials for Bands 1 and 3.  
Band 1 Isolated Dipoles to eliminate any possible interaction.

The Skeleton Slot with Folded Reflectors, maintains a constant high gain throughout Band 3 Channels 6-13.

Robust Construction — Fully pre-assembled for instant alignment and fixing — High anti-corrosive property similar metals throughout.

True combining of bands obviates troublesome diplexers—Single down-lead only required.

A neat compact aerial—at remarkably low cost—Ideal for Rental Schemes. Can be sited vertical or horizontal for near co-sited signals.

TO TRANSMITTER

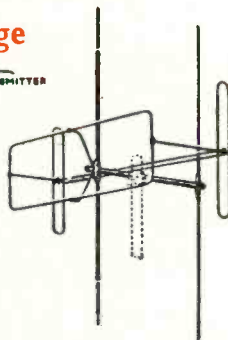

DB 4/1 Array with U/V bracket	£3 19s 6d retail
DB 4/2 Array with U/V bracket	£4 19s 6d "
1½" Cranked Arm Mast	17s 6d "
Set 12" Standard Chimney Lashings	£1 2s 6d

Note: New price reductions and regular road deliveries operating in most areas.  
Write for particulars:

Perfect Reception  
is Assured with



**J-BEAM AERIALS LTD., "Westonia," Weston Favell, Northampton**

Telephone: Northampton 33114/5

# AERIAL NEWS FROM TELERECTION

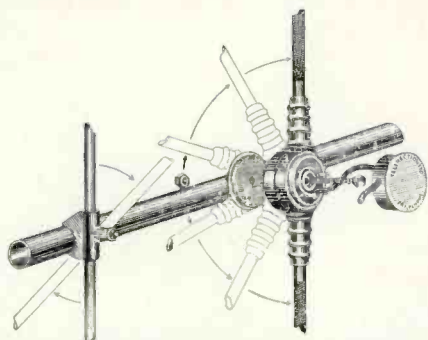

## THE NEW FOLDING INSULATOR and SPRING LOADED BAND III RODS

A major and unique development in Aerial pre-assembly and rapid fitting is Telerection's new "finger fix" folding Insulator. It is designed to fold down completely for transit and open out in pre-fixed positions for use as a straight dipole Insulator, or angled, as in Paravex or Primax. The remarkable cable connectors in which no nuts or bolts are used, operate by revolving the two ends of the dipole.

The cable is stripped as usual, the braid being laid in one connector with centre core in the other—twist the dipole—and Presto! your cable is fitted!

Telerection's Band III rods are now all spring loaded for "flick 'n' finish" assembly—robust and facile, one finger only is required to flick each rod out for rigid position.

## NEW PRIMAX



5/MA-Paravex plus 5 fold dipole Array with mast attachment unit. £3 10. 0.

5/CA-Array with cranked arm and L.10 Lashings. £4 17. 6.

8/MA-Paravex plus 8 folded dipole Array with mast attachment unit £4 10. 0.

8/M9-Array with 9 ft. mast and L.6 special lashings £7 15. 0.

Adapted from the popular and efficient Paravex, primax 5 and 8 element combined Array, factory matched and

wired—no filter box needed—for semi fringe areas. Available with or without the boom swivel for separate band orientation, Primax feature the new "Finger Fix" folding Insulator and spring loaded I.T.A. elements for fast fitting, and with the usual sturdy Telerection materials and construction unchanged—prices are down to earth—giving Rental Concerns the Ideal Aerial—well built, of top grade alloys, high performance, rapid assembly and inexpensive.

Adapted from the popular and efficient Paravex, primax 5 and 8 element combined Array, factory matched and wired—no filter box needed—for semi fringe areas. Available with or without the boom swivel for separate band orientation, Primax feature the new "Finger Fix" folding Insulator and spring loaded I.T.A. elements for fast fitting, and with the usual sturdy Telerection materials and construction unchanged—prices are down to earth—giving Rental Concerns the Ideal Aerial—well built, of top grade alloys, high performance, rapid assembly and inexpensive.

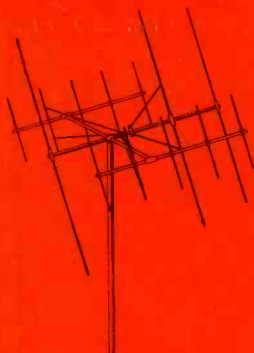

## NEW MAXIMA

### FRINGE AERIAL

A combined fringe Array comprising Telerection's mighty Magna and dutiful Double Delta, with fitted Filter Box. Maxima D5 and D6 really get down to an attractive price yet workmanship and quality remain unchanged. Completely pre-assembled, with new "flick 'n' finish"

Band III spring loaded rods, "put up" time is cut drastically.

For all round price, performance, high grade manufacture and quick, quick fitting, Maxima are a "must" for RENTAL installations.

#### MAXIMA

D5/M9 Combined 3 plus Double 5 Array with 9 ft. mast and L.6 special lashings ... £12 0. 0.

D6/M9 Combined 3 plus Double 6 Array with 9 ft. mast and L.6 special lashings ... £12 10. 0.

## NEW Loftee

### PRE-ASSEMBLED LOFT AERIAL

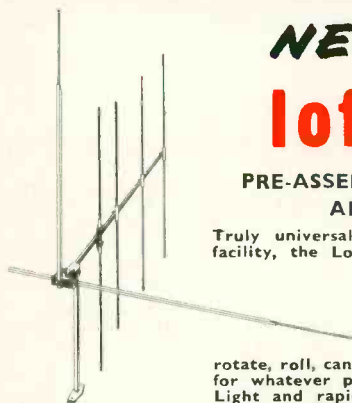

Truly universal for direction and facility, the Loftee Four and Five

rotate, roll, cant and elevate at will for whatever problem might arise. Light and rapidly assembled, both Arrays have telescopic, all channel Band I elements, with each channel plainly marked. The broad band width I.T.A. sections are channelled in 8/9 and 10/11, and can be rotated from vertical to horizontal as required. For the better Band I signal area Loftee Four/SD and Loftee Five/SD using a single "L" dipole only, retail 2/- less than their inverted "T" companions. Loftee prices are the best ever for reputable "Branded" loft Aerials and invaluable for RENTAL fixtures.

rotate, roll, cant and elevate at will for whatever problem might arise. Light and rapidly assembled, both Arrays have telescopic, all channel Band I elements, with each channel plainly marked. The broad band width I.T.A. sections are channelled in 8/9 and 10/11, and can be rotated from vertical to horizontal as required. For the better Band I signal area Loftee Four/SD and Loftee Five/SD using a single "L" dipole only, retail 2/- less than their inverted "T" companions. Loftee prices are the best ever for reputable "Branded" loft Aerials and invaluable for RENTAL fixtures.

**Telerection Limited, Antenna Works, Lynch Lane,  
Weymouth, Dorset. Telephone, 2140/1/2**