

ET/D

NOVEMBER 1981 • \$1.50

ELECTRONIC TECHNICIAN/DEALER
LEADING THE ELECTRONIC
SERVICE MARKETS

More TV antennas

OP amps

Alarm troubleshooting

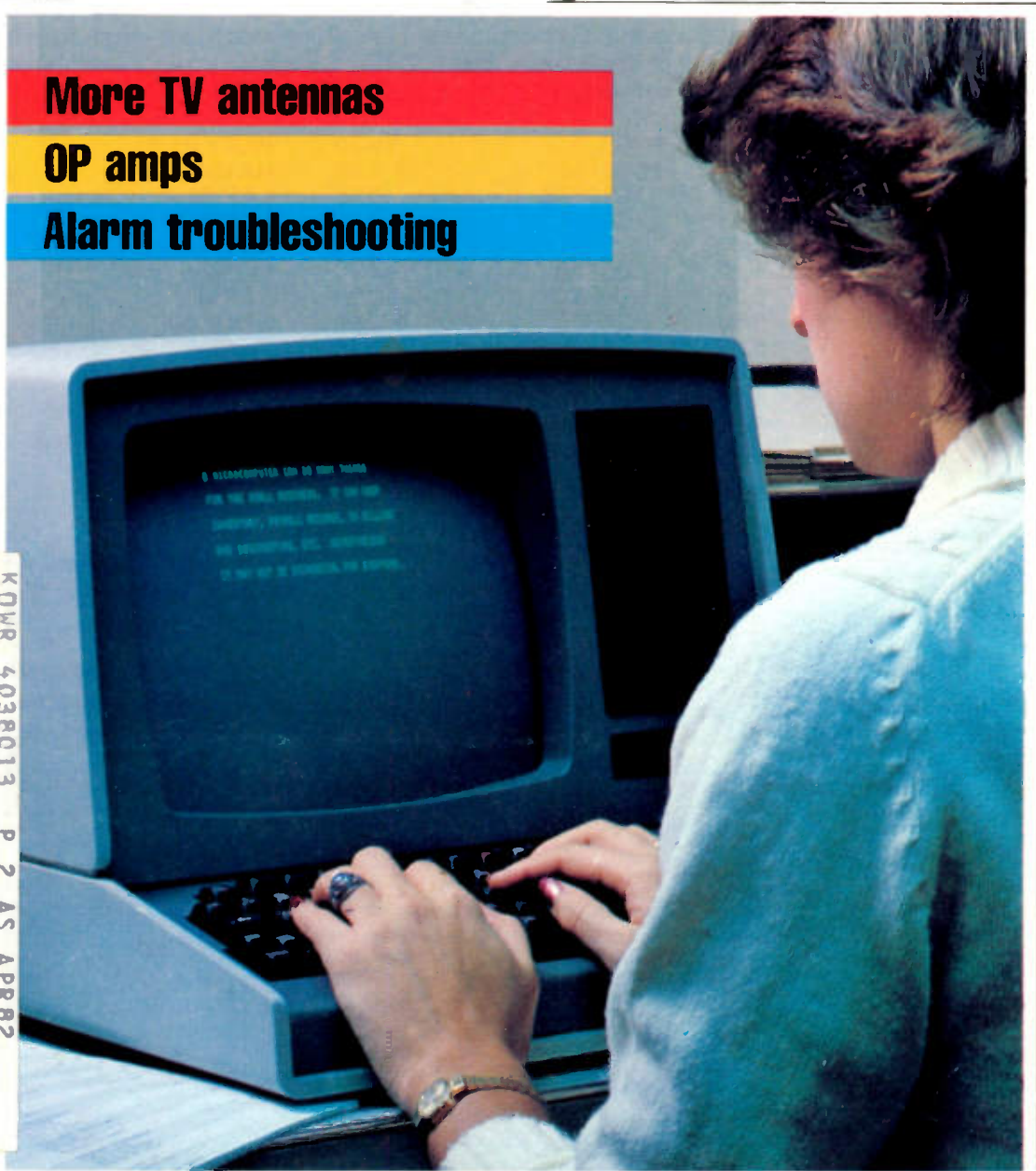

KQWR 4038013 P 2 AS APR82
RAY KDUCEK
27734 DENMAR
WARREN MI 48093 DIR

YOUR BUSINESS AND A COMPUTER?

Special

2SC1308K Horizontal Output Transistor







2.60

Minimum order of 10

MCM, one of the nation's top Japanese semiconductor importers also has a warehouse full of popular TV & Stereo replacement items ready to ship UPS anywhere in the U.S. Just call either toll-free hotline for immediate delivery.

PART #:	10-29	PART #:	10-29	PART #:	10-29
2SA747A	\$ 5.40	2SC1116	\$ 3.80	HA1342	\$ 2.70
A909	8.60	C1172B	3.60	LA1365	2.00
A1075	4.95	C1306	1.45	LM4558	1.90
A1106	4.00	C2581	4.00	M51515	4.00
B555	4.20	D386A	1.40	MRF455	17.80
B618	2.30	D425	3.20	SG613	7.40
B688	2.60	D478	.90	STK0050	7.40
B706A	6.40	AN214Q	2.10	TA7205	1.80
C458	.30	BUY69A	4.40	TIP31C	.90
C867A	4.80	DM98	7.40	UPC1025	2.10
C1114	4.40	GH3F	1.40	2N3055	1.20
				2SK30A	.50

CATV Parts and Accessories —at low, low MCM Prices.

<p>F59 Connector</p> <ul style="list-style-type: none"> ✓ For use with 59-U Cable ✓ Ferrule Included  <p>\$13⁹⁵ per 100 18^c each (10-99)</p>	<p>TVT-1 Matching Transformer</p> <ul style="list-style-type: none"> ✓ UHF/VHF/FM 75-300 Ohm matching transformer ✓ "F" Type input, 300 Ohm twinlead output  <p>55^c each (10-up) 65^c each (1-9)</p>	<p>TVI Interference Filter</p> <ul style="list-style-type: none"> ✓ Reduces Interference caused by auto ignition, CB's, neon signs, etc. ✓ Connects between set & antenna  <p>65^c each (10-up) 80^c each (1-9)</p>
<p>SPL-702 UHF/VHF/FM Splitter</p> <ul style="list-style-type: none"> ✓ 75 Ohm ✓ Three way splitter w/F59 connector  <p>\$1³⁵ (10-up) \$1⁵⁵ (1-9)</p>	<p>JB-2 Deluxe Coaxial Switch</p> <ul style="list-style-type: none"> ✓ A/B switch for CATV, MATV, MDS, STV & VCR applications ✓ Double backed tape included for easy installation  <p>\$7⁴⁰ (10-up) \$8⁹⁰ (1-9)</p>	<p>JB-300 Coaxial Switch</p> <ul style="list-style-type: none"> ✓ Quick selection from TV antenna & cable to VCR or other sources ✓ 2-Input, slide type A/B switch for CATV, MATV, MDS, STV & VCR applications  <p>\$2⁷⁰ (10-up) \$2⁹⁵ (1-9)</p>

**Get the whole
MCM Parts-Saving
Story.
Order today and
get our 64 page
catalog free!**

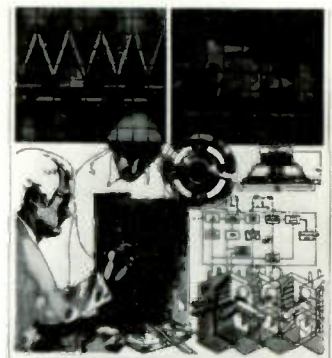

1981 Summer Catalog

Use these toll-free numbers for prompt shipment:
1-800-543-4330 National Watts Line 1-800-762-4315 Ohio Watts Line

CALL OUR TOLL-FREE LINES TODAY FOR IMMEDIATE DELIVERY!

1-800-762-4315
Ohio Watts Line

MCM
ELECTRONIC PARTS

1-800-543-4330
National Watts Line

858 Congress Park Drive, Centerville, Ohio 45459

READER SURVEY

Here is the part of the ET/D survey which could not be tabulated reliably because of missing numbers on the September return card. Please do us—and hopefully yourselves—a favor and answer the questions again. These are those very important questions about what you would like to see in ET/D, what you need, and what you expect to need, in the way of technical information. Answer carefully; what you see in ET/D may depend on your answers.
Thank you.

Walter H. Schwartz

Amount of coverage desired

Indicate the amount of coverage in ET/D you prefer for each of the items listed in 1-31. Circle either 1, 2 or 3 opposite the item number on the answer card.

	none	OK	more
1. TV circuit theory	1	2	3
2. TV troubleshooting	1	2	3
3. Test instrument operation and applications	1	2	3
4. Electronic security systems theory and installation techniques	1	2	3
5. Minicomputers	1	2	3
6. Tape player/recorder theory/troubleshooting	1	2	3
7. Communications equipment theory and troubleshooting	1	2	3
8. systems theory and installation techniques	1	2	3
9. Audio circuit theory and troubleshooting	1	2	3
10. Medical electronics theory/troubleshooting	1	2	3
11. Industrial control electronics theory and troubleshooting	1	2	3
12. Basic theory of solid-state devices	1	2	3
13. Record changer servicing	1	2	3
14. Auto radio troubleshooting	1	2	3
15. Business management	1	2	3
16. Service shop operation	1	2	3
17. Manufacturers' service tips	1	2	3
18. News of the industry	1	2	3
19. Association news	1	2	3
20. New products	1	2	3
21. Merchandising and sales techniques	1	2	3
22. TEKFAQ schematics	1	2	3
23. Test instrument report	1	2	3
24. Appliance servicing	1	2	3
25. Video disc/tape	1	2	3
26. Satellite TV	1	2	3
27. Teletext	1	2	3
28. Telephones, cordless/standard	1	2	3
29. Video games	1	2	3

30. Articles about other service shops 1 2 3
31. Articles about other electronic dealers 1 2 3
32. I use TEKFAQ
- 1) Regularly
 - 2) Occasionally
 - 3) Seldom
 - 4) Never 1 2 3 4
33. I have an FCC radio operator's license 1) yes 2) no
34. I have an amateur radio operator's license 1) yes 2) no

NEXT MONTH IN ET/D

- Legal aspects of the security business
- Satellite TV reception
- Setting service rates
- Annual index



It was twenty-five dollars for fixing the set. The other fifty is for explaining how I did it.

ET/D

ELECTRONIC TECHNICIAN/DEALER
LEADING THE ELECTRONIC
SERVICE MARKETS

November 1981 Vol. 103, No. 11

WALTER H. SCHWARTZ
Editor

THEODORE L. DECKER
Assistant Editor

RAY ALLEGREZZA
Contributing Editor

TOM GRENEY
Publishing Director

BARB JOHNSON
Production Manager

LILLIE PEARSON
Circulation Fulfillment



On The Cover:
Microcomputers are a popular, useful and necessary item of office equipment for many businesses. Should you have one? Could you use one to advantage? See page 16.

FEATURES

A Computer for your business? <i>Perhaps</i>	16
TV Antennas, part II <i>Circular polarization</i>	18
Alarm system troubleshooting, II <i>Intrusion detectors</i>	31
OP amps V <i>Applications</i>	34
CET quiz IX <i>Take that examination!</i>	38

DEPARTMENTS

Reader survey.....	3
Industry report.....	5
From the Editor's Desk.....	7
Service seminar.....	8
Letters.....	10
Newsline.....	12
Security viewpoint.....	14
TEKFAX.....	23
Test instrument report.....	40
Security products.....	41
Bulletin board.....	43
New products.....	46
Book reviews.....	47
Classified advertising.....	48
Advertising index.....	50
Reader service.....	51



A HARCOURT BRACE JOVANOVIICH PUBLICATION



ELECTRONIC TECHNICIAN/DEALER (ISSN 0192-7175) is published monthly by Harcourt Brace Jovanovich Publications. Corporate offices: 757 Third Avenue, New York, New York 10017. Advertising offices: 757 Third Avenue, New York, New York 10017 and 111 East Wacker Drive, Chicago, Illinois 60601. Accounting, Advertising Production and Circulation offices: 1 East First Street, Duluth, Minnesota 55802. Subscription rates: one year, \$12; two years, \$20; three years, \$26 in the United States and Canada; all other countries: \$40. Single copies: \$1.50 in the United States and Canada; all other countries: \$4.50. Second class postage paid at Duluth, Minnesota 55806 and additional mailing offices. Copyright © 1981 by Harcourt Brace Jovanovich, Inc. All rights reserved. No part of this publication may be reproduced or transmitted in any form or by any means, electronic or mechanical, including photocopy, recording or any information storage and retrieval system, without permission in writing from the publisher. ELECTRONIC TECHNICIAN/DEALER is a registered trademark of Harcourt Brace Jovanovich, Inc.

POSTMASTER: Send address changes to ELECTRONIC TECHNICIAN/DEALER, P.O. Box 6016, Duluth, Minnesota 55806.

INDUSTRY REPORT

Photovoltaic Power Systems Market To Reach \$1 Billion by Decade End

Some 90 companies around the world will soon manufacture, assemble, and market photovoltaic components and systems. The result, according to a major new analysis on the outlook for solar energy, will be the creation of a \$1 billion industry worldwide by 1989.

That includes \$300 million for photovoltaic cells alone, which is nearly triple that from the \$120 million market for this year, projected by Frost & Sullivan, Inc., publisher of the comprehensive 273-page study. "Photovoltaic installations will be as common then as air conditioning is today," the study says.

F&S adds that the need to service photovoltaic installations will have created a \$50 million service industry by 1990. Likewise, as plant capacity to manufacture solar cells expands, additional markets will be created for both cell production and testing and system assembly equipment. "These markets will also attain levels measured in the

hundreds of millions of dollars," the F&S report says.

Fueling this growing worldwide market will be continuing steep declines in the cost of photovoltaic cells that generate electricity directly from sunlight—specifically, in terms of installed cost, from \$10 per peak watt to less than one dollar. Also, energy conservation efficiency, now at about eight percent, will increase to an average of 10 percent during the decade.

These figures, moreover, are based on the use of single crystal silicon cells in flat-plate modules. If thin film technology comes to the forefront, then the economics suggest even greater markets than those projected. "Thin film cells, because they are simple to manufacture, would be very inexpensive," F&S points out.

Residential units, though limited primarily to new construction, will comprise the largest market segment. Photovoltaic systems here will be typically roof mounted and ranging between 2 and 2.5 kw peak power. Most interesting, they are likely to be owned, installed, and maintained by a third party, probably an electric utility.

Commercial-industrial-institutional systems, which will be about 100 kw peak power in size, will be used in heating, as well as to generate electricity.

Utility systems will range in size from

10 to 10,000 Mw peak power and be dispersed near major load centers. Designs for this application will be either of flat-plate photovoltaic cells or concentrating systems that employ dish or trough solar collectors.

Remote units will range from a few watts, when used to power unmanned equipment, to several Mw peak power to serve an isolated community.

Meanwhile, the oil-rich countries in the mid-East will attempt to acquire solar technology "lock, stock and barrel", preparing for the day when their oil wells run dry.

Alabama Alarm Association Sets Security Exposition

The Alabama Alarm Association will host the first annual Southeastern Security Exposition at the Birmingham Hyatt Hotel, Birmingham, AL, January 13-15, 1982.

According to the Association's President James B. Brothers, "The Alabama Association feels there is an unmet need in this part of the country for a forum at which alarm and security dealers can have an opportunity to have a hands-on experience with the latest products and technology in our industry. The Southeastern Security Exposition," notes Brothers, "will give members of the alarm industry in the Southeastern United States just such an opportunity."

PERFORMANCE PROVED MAGNETIC CONTACTS

Sentrol's 1085T Surface Mount magnetic switches are performance proved. They eliminate costly service calls and disrupting false alarms. Not subject to sticking or freezing and ruggedly designed for a life expectancy of 10,000,000 cycles. Easily and quickly installed and come complete with all mounting hardware including spacer and cover.

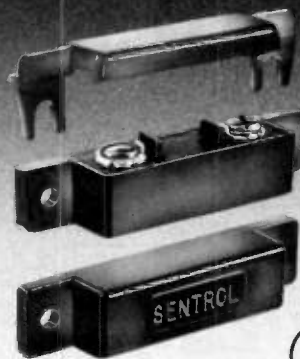

SENTROL®

Available in 4 gap distance ranges from 3/4" to 2" and in 3 colors to match any decor.

Low current switching superiority make them ideal for solid state systems.

Biased high security model available.

Send for Sentrol "Product Information Bulletin"

or call
Toll Free
1-800-547-2556.

10831 S.W. Cascade Blvd. Portland, OR 97223 Phone 503/620-8540

BUILDING THROUGH EXCELLENCE

Facilities at the Birmingham Hyatt Hotel will afford up to 50 exhibit booths, plus seminar and social areas to round out the two-day event. The exposition will open with a Reception in the Exhibit Area on Wednesday, January 13, at 6:00 p.m., and conclude with a "walking lunch" through the exhibit hall at noon Friday, January 15th.

In addition to the exposition and social opportunities, a special half-day optional seminar is being planned to address the educational needs of exposition attendees. An announcement of the seminar leader and program will be made shortly.

An exhibitor's prospectus and other information on the Exposition can be obtained by calling or writing:

James O. Yeaman, CAE
Executive Director
Alabama Alarm Association
P.O. Box 4277
Montgomery, AL 36101
205-834-2001

The Electronic Newspaper

New home information systems have made the electronic newspaper a reality already, according to a report from International Resource Development Inc. During the 1980's the market for electronic newspaper services will grow to more than \$500 million, divided about evenly between consumer-oriented and

business-oriented services, the report predicts. However, the news services will be used by only a relatively small percentage of the population—in general, those who have viewdata equipment or home computers.

Very little impact is expected on the paper versions of newspapers; the study indicates that more than 90% of newspaper readers will continue to buy their news in paper form. The real potential for the electronic news products lies in providing information in greater depth than the regular newspaper provides.

According to the report, the (scant) evidence available to date on consumer acceptance of such news products indicates that they will be profitable only to suppliers who already have an electronic news room of the type already in use by many U.S. newspapers. When the electronic newspaper is a byproduct of the electronic newsroom, the impact on the newspaper's profitability can be significant. In one example cited in the IRD report, newspaper profitability could be boosted as much as 40% by the successful marketing of electronic news products.

Because electronic news products are relatively easy to derive from electronic newsrooms, it is the newspaper companies which are expected to dominate the future market for electronic news products. However, the report ex-

amines the possibility that Ted Turner's Cable Network News, or perhaps the rival Westinghouse news network, will also compete in the delivery of electronic newspaper products.

In addition to the mainstream electronic news products, the report predicts the evolution of some "boutique" suppliers of news on specialized topics, including sports and hobbies. Some boutique news operations may specialize in off-beat or "kinky" news stories; others may focus on Hollywood gossip.

Strong growth is also predicted in the market for electronically-delivered newsletters for business subscribers, and for news research databases. The report points out that the business market for electronic news products is in a more advanced stage of development than the consumer market, and already accounts for more than \$40 million in annual revenues to suppliers, compared with less than \$1 million for consumer products.

NATESA Friends of Service Award to RCA

The National Association of Television & Electronic Servicers of America recently presented at its annual convention banquet, RCA its Friends of Service Award, noting RCA's willingness to respond to problems posed by NATESA on behalf of servicers.

OMNITRON: The Source for Quality at Low Cost

Silicon
H.V. Triplers

**HIGH VOLTAGE
MULTIPLIERS**



SYLVANIA Triplers

ECG-500A

212-139
212-139-01
212-139-02

\$12⁹⁵ ea.

ECG-523

212-141
212-141-01

\$15⁰⁰ ea.

ECG-526A

212-141-02
212-141-03
212-141-04

\$16⁹⁹ ea.

REMEMBER!

Sylvania
Tubes
70% + 10%
OFF
LIST

**Sylvania ECG
Replacement
Semiconductors
and Components**
Full line in stock.
The best quality
semiconductor.

**RG-59/U 75 OHM
Co-Axial Cable
Copper Braided
Shield**

White or Black

\$44⁵⁰/1000 ft.

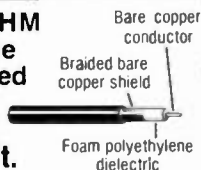

**F-59 Connector
with Separate Ferrule
10¢/100 lot**

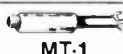

**Matching Transformer
75-300 Ohm
59¢ ea. \$49⁰⁰/100**



**2 Way - 75 Ohm Coupler
MT-2 \$1⁴⁹**



**2 SC1172B
\$1⁹⁹**

VERY POPULAR

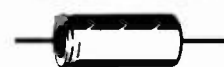

**80 MFD x 450 Volts... .99
100 MFD x 450 Volts... 1.09**

SOLDER (60/40 Rosin Core)



1 lb. .062 dia.
(regular size)

\$6⁹⁹ SOL-1

SILICON RECTIFIER 2.5 Amp/1000 PIV

100/\$9⁹⁵ SL-100

GLOBAR DISC - 120 Ohms Cold

107191 RCA **99¢**

10 ASSORTED CIRCUIT BREAKERS

10/\$6⁵⁰ Good Assortment

CB-10

CHEATER CORDS

Polarized C Clip

Price: 39¢ 24620

Standard C Clip

Price: 39¢ 24623

REPLACEMENT RODS

4 Section LAR-4 **69¢**

5 Section LAR-5 **89¢**

6 Section LAR-6 **99¢**

7 Section LAR-7 **99¢**

G.E. OM-300

\$1⁴⁹

PANASONIC OM-500

\$1⁵⁹

OMNITRON

ELECTRONICS

770 Amsterdam Ave., New York, NY 10025

Also ask for Free 100 Page Catalog

Send Purchase Order, Check or Money Order
or Call Toll Free **800-223-0826**

in NY STATE (212) 865-5580

ALL ORDERS SHIPPED UPS/COD F.O.B., N.Y.C.

MASTER CARD • VISA



Walter H. Schwartz, *Editor (Duluth)*

Theodore L. Decker,
Assistant Editor (Duluth)

Tom Greney, *Group Vice President
Publishing Director (Chicago)*

Barb Johnson, *Production Manager*

Diane Blesener, *Production Supervisor*

Lillie Pearson, *Circulation Supervisor*

Dave Peterson, *Reader Service*

Julie Laitin, *Promotion Director*

Dawn Anderson, *Classified Ad Mgr.*

Please submit editorial
manuscripts to:
Editor ET/D, 1 East First Street,
Duluth, Minn., 55802.

ADVERTISING SALES

Please send all advertising material to:
ET/D, Production Mgr.
120 West Second Street
Duluth, Minn. 55802
(218) 727-8511

EAST REGION

Steve Del Duca
757 Third Avenue
New York, N.Y. 10017
(212) 888-4382

MIDWEST REGION

Keith Lewis
111 East Wacker Drive
Chicago, Ill. 60601
(312) 938-2325

SOUTHERN REGION

Chuck Cummings
613 N. O'Connor
Irving, TX 75061
(214) 253-8678

WESTERN REGION

Joyce Amiri
10741 Moorpark St., Suite #21
North Hollywood, CA 91602
(213) 980-7750 or (213) 760-1684



HARCOURT BRACE JOVANOVICH PUBLICATIONS

Robert L. Edgell, *Chairman*
Richard Moeller, *President*
Lars Fladmark, *Executive Vice President*
Arland Hirman, *Treasurer*
Thomas Greney, *Group Vice President*
Ezra Pincus, *Group Vice President*
Lawrence Witchel, *Group Vice President*
Joe Bilderbach, *Vice President*
James T. Gherna, *Vice President*
George A. Glenn, *Vice President*
Harry D. Ramaley, *Vice President*

FROM THE EDITOR'S DESK

Miscellaneous rumblings and grumblings—I just had a long telephone conversation with a friend who has been in the television sales and service business for about 25 years in a small town—ever since he and I finished school together. His current complaint about manufacturer—or perhaps more properly distributor/dealer—relations, regards non-servicing dealers. The brand he sells and has sold for 20 years, now is sold by non-servicing dealers in most of the nearby towns. At times they will actually tell potential sales, as they underbid the servicing dealers, “XYZ TV in the next town will take care of service,” when no agreement for such service has ever been made between them.

The real complaint is that these furniture stores and such, will sell for \$35 or \$50 less than the servicing dealers feel they can and then exist as parasites on another's service. To complicate matters further, because this brand's manufacturer refuses to pay the dealer's going rate for warranty service, recently several of the furniture and appliance stores which previously did maintain service departments have closed them. Recently my dealer friend submitted revised rates to his manufacturer, many months after he had found it necessary to raise his charges generally, only to have them sent back slashed significantly—to below his cost of making a service call, for example—and even though his rates are, by most reasonable standards, rather low. I guess I was under the mistaken impression that this was not presently such a big problem, at least with the major manufacturers. I am sorry to see it appears as much a problem as ever.

What can be done about the situation? Given the “independence” of the average service/dealer, probably nothing. What will happen is: a few more of you will be forced out of business—and perhaps you should be. What could happen is: if all of you would resolve to make a decent wage from your labor and a reasonable return on your investment, you would simply increase your charges enough to stop subsidizing the parasite dealer and the manufacturer. I know that some service/dealers require purchase sales receipts for all warranty work. They then refuse to service those sets sold by discount houses and other sources of what they regard as unfair competition. If everyone does this, it works; if only a few do, it fails. Another tactic would be to look around at the other manufacturers/distributors and try to find one which emphasizes service, if any do. The long term result may be that there will be very little warranty service outside of large cities—as there is now with some of the imported brands. In a sense you small town dealers will then be getting even with your customers who always look for a “deal”, but at what a price? Your comments are welcome.

Please be sure to complete ET/D's Reader Survey again this month. Thank you.

Sincerely,

SERVICE SEMINAR

RCA

Chassis CTC 58. Narrow raster, high voltage measures only 8-10 kV. To correct: Check, by substitution, all sections of C104 filter capacitor. Ron's Service, Kimmel, IN.

Chassis CTC 72. Remote motor continues to run after start command is given. To correct: Check for shorted Q1202 skip detector transistor.

Chassis CTC 85. Shuts down at turn on. Reducing line voltage to 95vac produces oscillator squeal and double image. At 75vac, chassis operates but produces dark bars through picture. To correct: Check for open R437 (680K), reset pulse to regulator.

Chassis CTC 85. Erratic picture jumping and loss of horizontal frequency (X-ray protection circuit activated—may shut down). Related to brightness and/or line voltage. To correct: Check, by substitution, L402. The TV Guy, Woodsville, NH.

Chassis CTC 87. Intermittent vertical roll. To correct: Check for defective diode CR 3102 in vertical oscillator stage.

Chassis CTC 87. Top two to three inches of raster stretched. To correct: Check for open R3122 (33K) resistor in vertical output circuitry.

Chassis CTC 87. Top of raster compressed and contains retrace lines. To correct: Check for leaky or shorted CR 3103/3104 (crossover diodes).

Chassis CTC 87. No sound. To correct: Check for shorted CR 3008 diode in audio output stage.

Chassis CTC 87. At maximum brightness, four "blinking bars" are evident in picture. No symptom at normal brightness levels. To correct: Check for open R3044 in brightness limiter/blanker circuitry. Ogletree's TV, Phenix City, AL.

Chassis CTC 88. Intermittently loses vertical deflection, then shuts down. To correct: Check for leaky CR 3013, negative 30 volt supply diode.

Chassis CTC 88. Full raster at turn on but within 30 seconds has only about three inches of vertical sweep with severe foldover. Q3020 overheats. To correct: Check for open R3117 (220K) resistor in base of Q3021, top driver transistor.

Chassis CTC 92. Very intermittent shutdown. To correct: Check for loose terminal strip mounting screw—supplies "hot" ground from aluminum heat sink ring to pin 2 of MDR module.

Chassis CTC 93. Intermittent shutdown. To correct: Check for open gate on SCR 600, regulator.

Chassis CTC 97. Intermittent shutdown. Appears to be over-current shutdown because Q602 base goes high—but base remains high with CR601 disconnected. To correct: Check for open R620 (27K).

Chassis CTC 97. Difficulty in servicing vertical circuit. To correct: Q3020 "E" and "B" symbols reversed on bottom of printed circuit board. Ogletree's TV, Phenix City, AL.

Chassis CTC 101. Insufficient width. To correct: Check Q401 pin driver.

Checking B+ Regulator SCRs with an ohmmeter. If a defective SCR is indicated when servicing the B+ regulator

We wrote the book on reliability...

... the RCA SK Series Replacement Guide, featuring RCA's line of reliable solid state replacements, the line of integrity with unsurpassed engineering excellence. The accuracy of the Guide's cross-reference directory enables you to replace with complete confidence. So, reach for reliability with RCA SK Series replacements. We wrote the book on it. Pick up a copy at your local RCA SK Distributor.

Replace over 170,000 industry types with 1400 RCA types.

RCA SK Replacement Solid State

RCA Distributor and Special Products Division, Deptford, NJ 08096.



circuit, substitution of a known good device is the best test method. If a known good SCR is not available, the ohmmeter check below will give a reasonable evaluation of the device. This is true since, generally speaking, an SCR in the "OFF" state will either (1) block current (good device, high resistance reading anode to cathode, either direction) or (2) it will not block current (shorted device, low resistance reading anode to cathode, either direction). Gating action can be evaluated in a similar manner—if resistance between cathode and gate is drastically lower or higher than the normal 80 to 100 ohms the SCR will not function properly. Case to either pin should read typically greater than 10 megohms in either direction, while the pin to pin resistance should be less than 80 to 100 ohms in either direction.

SONY

Service manual corrections—KV8000. 1. In the schematic, pages 21 and 22, speaker SP-901 is rated at 8 ohms. Change this rating to 32 ohms. The part number is correct. (Fig. 1)

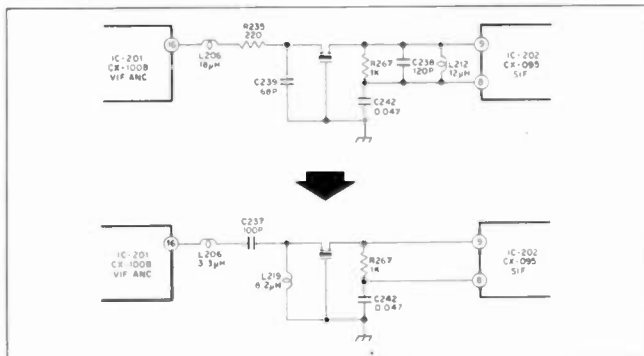
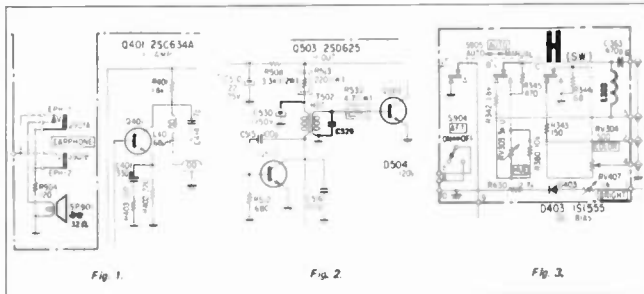

2. In the schematic, pages 21 and 22, add C529, a 0.0022 uF disc capacitor, across the secondary of T502, and indicate the same on the G board, page 19. Add this capacitor to the parts list as Part No. 1-102-121-11. (Fig. 2) 3. In the schematic, pages 21 and 22, show microinductor L308, a 56 uH coil, in place of the present bridge and indicate the same on the H board, page 17. Add this microinductor to the parts list as Part No. 1-407-166-00. (Fig. 3)

Buzz on cable system—Models: LV-1901; KV-1541R, -1711D, KV-1712D, -1723D, -1741R, KV-1910D, -1720D, -1941R, -2101. If buxx is audible when using the above models on a cable TV system, make the following modification.

Modified Parts List

Ref. No.	Formerly	New Value and Part No.
L206	18 μ H	3.3 μ H, 1-407-687-11
R235	220 Ω	—
C237	—	100 pF, 1-102-973-11
C239	68 pF	—
L219	—	8.2 μ H, 1-407-189-11
C238	120 pF	—
L212	12 μ H	—

COMPARE OUR LOW PRICES

(EXR) SAME EXACT PARTS AS SYLVANIA ECG* LINE.

AT 50% TO 80% OFF SYLVANIA PRICES.

SYLVANIA ECG* TYPE NO.	SYLVANIA SUGG. RESALE	OUR PRICE
ECG 165	13.50	2.95
ECG 238	15.75	2.95
ECG 276	10.95	5.95
ECG 500A	20.00	11.60
ECG 523	22.80	14.50
ECG 712	3.75	2.25
ECG 1168	12.85	8.55

SPECIAL (MIN. 5 PCS.)

2SC867A	3.95
2SC1034	9.00
2SC1308K	2.45
2SD350	4.60
AN214Q	2.00
GH3F	1.45
TA7205AP	2.10

COD ORDERS WELCOME (Min. Order \$25)

CALL TOLL FREE 800-526-4928

3 YEARS WARRANTY ON ALL PARTS.

DIGITRON ELECTRONIC Corporation

110 Hillside Ave. • Springfield, N.J. 07081

OFFER EXPIRES NOV. 30, 1981.

*ECG IS A TRADE MARK OF PHILIPS ECG, INC.

Circle No. 103 on Reader Inquiry Card

ARE YOU HAVING

"INTERMITTENT FITS"

OVER VERTICAL CIRCUITS?

Don't feel bad, a recent survey shows that technicians have more problems with vertical circuits than any other circuit in a color TV.

FOR THIS REASON

METS has published a separate in-depth manual on vertical circuits.

As stated by *ET/D* Editor Walter Schwartz (July '81 issue), "The METS vertical manual is much more than a re-hash of various vertical troubleshooting procedures. It presents an **overall approach to troubleshooting vertical deflection circuitry, in great detail, symptom by symptom, circuit by circuit.** It also contains enough information to help someone make the transition from tube-type to solid-state circuits. **METS**, by the way, stands for **Minimum Effort Trouble Shooting.**" (exact quote). The in-depth vertical manual is \$30.00.

METS, Box 8228, Amarillo, TX 79109

(Don't forget to include your name, address, city, state & zip code)

Circle No. 110 on Reader Inquiry Card

LETTERS

MAGNAVOX MICROTUNE

In your August 1981 issue, page 30, there's a photo of a 703954 micro tune assembly. The photo is not that of a micro-tune, but of an older videomatic touch-tune that doesn't use micro-processors at all!

The videomatic touch-tune in the photo uses current injection logic which has to have a source of current all the time. In the photo, the vertical black rectangular box to the left of the tuners in the middle is one of the batteries needed to "keep the memory" alive. That one is an alkaline with a life of about 2 years. Under the power transformer is the main Ni-Cad.

The micro-tune discussed in the article doesn't use any batteries. It uses a EAROM MOS IC for memory.

So remember if its got batteries, it's not a microtune.

John Russo
1057 Big Pine Dr.
Santa Maria, CA 93454

METS

I am a proud subscriber of your wonderful ET/D magazine. I read an article in your July issue about "Minimum Effort Troubleshooting" (METS). I was very impressed and would like immediate information on address and telephone number of company rendering this service.

I did mail "Reader Service Card."
Levi Murrell

327 Richmond Rd.
West Chester, PA 19380

Reader Service replies take several weeks. METS has been answering its inquiries. Unfortunately we cannot give you a telephone number—we don't know the METS number.

Editor

HELP

I am in need of a manual or schematic diagram, for an Eversonic AM/FM radio and tape player.

Model 100R made in Taiwan also two output IC TDA2611A. Write or call collect (404) 541-0230. Will pay asking price, or where one can be found.

Sammie L. Crawford
Rte. 1 Box A-112
Appling, GA 30802

I need information on a WWII surplus I-177 tube checker.

Peter R. Turchi, K21PK
1420 Maple Ave.

Haddon Heights, NJ 08035

TEKFAX

Please tell me how I can obtain TEKFAX schematics from Volume 8, and any other info about TEKFAX.

Russell H. Shaw
24 New St.
Upper-Darby, PA 19082

Being a newcomer in the TV service business I would like to purchase all available numbers of the TEKFAX series. Any reader wanting to donate or sell them at a reasonable price, please write, stating numbers of volumes and price.

G. Martinson
7132 E. 31st St.
Tucson, AZ 85710

I would like to sell the following TEKFAX Vol. 105, 106, 107, 108, 109, 110, 111, 112, 114, 115. No reasonable offer refused. Would like to sell as set.

R. D. Moore
RD #1
Robin Lane
Pattstown, PA 19464

How about printing some schematics of some popular American TV's? So far this year you have printed only the least popular foreign schematics. Please print some Zenith, RCA, GE, Sears, Magnavox, Sylvania, Quasar and other useful schematics or your magazine is practically useless to me.

James A. Ladnier
Route 1, Box 372
Saucier, MS 39574

Have been a reader for years but am a little disappointed how the usefulness to me of your magazine has decreased.

1. Not only have you cut down the TEKFAX to only 2 separate (full) pages from 4 but:

2. RCA, GE and other major manufacturers diagrams are no longer to be

found, it seems, in your TEKFAX. Just the few Japanese firms you now use makes it nearly useless to me.

3. Surely there is just as much room on top of most TEKFAX for the "parts list" as ever but this has long been omitted. It helped us know which small parts we needed without taking them out of circuit to look at them.

4. And important as anything—TV servicing is still the largest consumer need by far and you have omitted articles on this subject at a time when we need more understandable "how-to" articles on servicing the newer complicated TV circuits.

R.K. TV Service
Philadelphia, PA

TEKFAX are, first of all, very costly to print. Our feeling toward what we cover is this: RCA, Zenith, Sylvania, etc. data is quite easy to obtain. With limited space available we are trying to supply you with information you would have a problem finding. We want to help you fix those near orphans you encounter after the local discount store has a special sale. After all, complete RCA data is about \$40/yr. Zenith will sell you every schematic of the last several years for \$20 and, I believe, schematics of every TV set they have manufactured since 1960 for \$40. All of these manufacturers have subscription data services.

Answer the ET/D reader survey: If you want more popular set data, so indicate. Service articles: Yes, TV service is the major money maker for many of you, though I wonder for how long. But—as to specific how-to-fix articles—which chassis of the several hundred common should we cover? The latest or older sets? I believe our approach has to be to generalize our material with articles such as the current series on op amps—they appear in TV sets as well as audio, etc. If we can help you as good all-around technicians you can service a wide variety of products effectively. We do have several TV service articles scheduled for the near future.

Editor

J Electronics, Inc.
YOUR SOURCE FOR . . .

BONUS!
SEND US NAME OF
A DEALER PARTNO &
RECEIVE A FREE GIFT

SAVINGS

P.O. BOX 528 Lindenhurst, N.Y. 11757
516 226-2700

RNJ ELECTRONICS NEW 1982 CATALOG CAN GET YOU THE BEST PRICES ON THOUSANDS OF ELECTRONIC ITEMS.

- ★ Tremendous Savings
- ★ Bargain Prices On Everything
- ★ Fast Service, Call Toll FREE & Place Your Order By Phone.

WRITE OR CALL TOLL FREE (800) 645-5833 FOR FREE CATALOG AND GIFT.

RNJ Electronics, Inc.

IN N.Y.S. CALL 516-226-2700
P.O. BOX 528
LINDENHURST, N.Y. 11757

Circle No. 119 on Reader Inquiry Card

TELE-TECK PROUDLY ANNOUNCES:

— THE — SEMINAR

YOU CAN'T FORGET

AT LAST — A **PRINTED SEMINAR**
FOR USE WHILE YOU ARE FIXING THE SET

TELE-TECK SEMINARS

- (1) Give you a written **step-by-step** troubleshooting procedure that takes you right down to **specific resistors, capacitors, transistors, coils, diodes, etc.**
- (2) Show you **which** parts cause **what** problems when and **if** they fail.
- (3) Tell you which parts are **known** to fail.
- (4) Provide you with an **easy-to-follow**, oversize schematic (**one that makes sense**)
- (5) Give you both manufacturer and substitution part numbers.
- (6) Give you an **instant** parts location system (fast doesn't really describe it)
- (7) Provide you with an **on-going course** in electronics that is directly related to hands-on practical application.

Our exclusive sequential pictorials® tell you **everything** you need to know **and**, at the same time all but eliminate reading.

Just take the seminar manual to your bench and follow the pictorials
(You will actually LEARN the circuit WITHOUT studying it).

WE MAKE TV REPAIR EASY AND PROFITABLE

4 NEW SEMINARS EACH MONTH

ONLY \$9.95

Each 16-page manual covers a late model "problem circuit" for a special brand and chassis. Tele-Teck Seminars are the most effective **and** the most economical method of staying up to date in a changing industry. Tele-Teck is the **only** way you can **make money WHILE** you are staying up to date.

To subscribe on a monthly basis send \$9.95. We'll bill you each month thereafter. Quit anytime you wish. If you prefer you may purchase a full year's subscription for only \$104.00 and avoid the monthly hassle. Send your check, along with your name, address, city, state, zip and phone number, to Tele-Teck, P. O. Box 15108, Amarillo, TX 79105.

SENATE GIVES FCC AUTHORITY TO SET MINIMUM STANDARDS. The U.S. Senate recently passed a bill which would give the FCC authority to set minimum standards for TV sets and other electronic equipment. According to Television Digest, the standards would make these devices less susceptible to interference from amateur and CB radios. A similar measure (HR-2203) is pending in the House.

SONY PLANS SECOND U.S. COLOR TV PLANT. Sony will build its second U.S. color TV plant on a 330-acre site in Columbia, SC, the company recently announced. It will make a \$20 million investment, raising its total U.S. investment to \$150 million. The new plant, which will employ about 500, will turn out 20,000 sets per month when it begins operation late next year. The Columbia plant will raise Sony's U.S. production capacity to 820,000 sets per year.

WARDS TO SELL NAME BRAND TV. Montgomery Ward offers a number of "RCA XL" color TV receivers in its 1981 Christmas Catalog. The sets appear similar to the RCA Colortrak, but have somewhat reduced features and sell for slightly less (similar to those sold by JC Penney?). The 13" set reportedly sells for \$320. Montgomery Ward will soon feature the complete Sony line in its stores in Chicago, San Francisco, Los Angeles, Dallas, and Houston areas. According to TV Digest, all of these are areas where Sony is sold direct. Also, Wards has talked about featuring Zenith in some of its stores and catalogs, but Zenith has a policy against bypassing its distributors. However, Zenith Sales Co.'s President Walter Fisher has commented that manufacturers must consider new approaches to merchandising and sales (TV Digest. Vol. 21:37).

RCA VIDEO DISC PLAYER BUYERS BUY DISCS. RCA video disc player owners are buying discs at a greater rate than was anticipated. According to Herbert S. Schlosser of RCA, a survey indicates the player owners averaged purchases of fifteen albums in four months. Accordingly, RCA is expanding its disc production facilities rapidly.

ZENITH REDUCES CHICAGO OPERATIONS. Zenith will shift Chicago color TV assembly operations to Springfield, MO, by the end of March 1982, consolidating color assembly there. About 800 jobs will be eliminated in Chicago, and several hundred will be added in Springfield, where Zenith says it will have the most modern plant in the industry.

SERVICE SERVICE SERVICE SERVICE SERVICE SERVICE SERVICE SERVICE

No one likes to wait. Especially your customers. They come in for your service. And they'll return because of the speed and quality of that service. That's where PTS can help.

Service is what PTS is known for. Fast and dependable service. Across the country service shops turn to PTS for quality remanufacturing of tuners and modules. Speed is essential in service. PTS guarantees rebuilding in eight hours or less, and in many cases models are in stock for immediate exchange. PTS will service all brands and offers a full year limited warranty.

For your own productivity and good service depend on the people who put service first.



PTS CORPORATION

General Headquarters
P.O. Box 272
Bloomington, Indiana 47402

OPTIMA VALUE SALE

TO ORDER CALL TOLL FREE 1-800-327-0224

G.E. SYLVANIA, ZENITH 75% OFF LIST NEW-BOXED

<input type="checkbox"/> 3A3	5 for \$13.69	<input type="checkbox"/> 6JE6	5 for \$28.44
<input type="checkbox"/> 6BK4	5 for \$25.38	<input type="checkbox"/> 6LB6	5 for \$27.38
<input type="checkbox"/> 6CK3	5 for \$12.75	<input type="checkbox"/> 6LF6	5 for \$29.94
<input type="checkbox"/> 6FQ7	5 for \$10.56	<input type="checkbox"/> 17JZ8	5 for \$14.88
<input type="checkbox"/> 6GH8	5 for \$10.81	<input type="checkbox"/> 38HE7	5 for \$26.13

All Tubes Not Advertised. Write In at 75% off list. Sleeves Only. Singles 72% off list.

TRANSISTORS & I.C.'s . . . MIN. 5 3 Year Guarantee

<input type="checkbox"/> 2SC867A Sony	\$3.95	<input type="checkbox"/> 2SC1172B	\$2.00
<input type="checkbox"/> SG613 Sony	\$6.95	<input type="checkbox"/> 2SC1308K	\$2.00
<input type="checkbox"/> TA7222 Toshiba	\$1.50	<input type="checkbox"/> 2SC1358A	\$2.00
<input type="checkbox"/> TA7204P Toshiba	\$1.00	<input type="checkbox"/> 165	\$2.00
<input type="checkbox"/> 1166BA521	\$1.25	<input type="checkbox"/> 238	\$2.00

REPLACEMENT FOR ECG

<input type="checkbox"/> 130	\$.95	<input type="checkbox"/> 196	\$.79	<input type="checkbox"/> 791	\$1.85
<input type="checkbox"/> 152	\$.79	<input type="checkbox"/> 197	\$.79	<input type="checkbox"/> 792	\$1.85
<input type="checkbox"/> 153	\$.79	<input type="checkbox"/> 230	\$3.05	<input type="checkbox"/> 793	\$2.35
<input type="checkbox"/> 171	\$.79	<input type="checkbox"/> 291	\$.95	<input type="checkbox"/> 808	\$1.50
<input type="checkbox"/> 182	\$1.95	<input type="checkbox"/> 292	\$.95	<input type="checkbox"/> 819	\$1.50
<input type="checkbox"/> 183	\$1.95	<input type="checkbox"/> 329	\$1.60	<input type="checkbox"/> 822	\$2.10
<input type="checkbox"/> 186	\$.65	<input type="checkbox"/> 712	\$1.35	<input type="checkbox"/> 820	\$2.10
<input type="checkbox"/> 195A	\$.95	<input type="checkbox"/> 731	\$1.35	<input type="checkbox"/> 1167	\$1.95

ZENITH, RCA & SYLVANIA MODULES

<input type="checkbox"/> 9-79	\$ 2.95	<input type="checkbox"/> 145260	\$22.49
<input type="checkbox"/> 9-147	\$18.01	<input type="checkbox"/> 145261	\$27.94
<input type="checkbox"/> 150-190	\$12.95	<input type="checkbox"/> Rep. ECG500A	\$10.95
<input type="checkbox"/> 138697	\$20.79	<input type="checkbox"/> Rep. ECG523	\$13.95
<input type="checkbox"/> 139546	\$27.28	<input type="checkbox"/> Rep. ECG526	\$15.95
<input type="checkbox"/> 141154	\$30.80	<input type="checkbox"/> 32-39202-3	\$14.95
<input type="checkbox"/> 141427	\$30.69	<input type="checkbox"/> 32-43068-1	\$14.95
<input type="checkbox"/> 145259	\$19.63	<input type="checkbox"/> 32-41658-3	\$14.95

GENERAL

<input type="checkbox"/> Columbia Wire 59U Spools	5.9¢/foot
<input type="checkbox"/> 2 1/2 Amp 1000 PIV	100 for \$ 8.00
<input type="checkbox"/> 3 Amp 1000 PIV	100 for \$15.00
<input type="checkbox"/> STEREO Y ADAPTER 1/4"	10 for \$ 4.90
<input type="checkbox"/> 9 ft. 59U F-F 99¢	<input type="checkbox"/> 10ft 59U F-F \$ 1.09

Quantity Prices Available

Letters of credit and all checks placed on deposit with Bank of Hallandale, FL. VISA/Bank Americard & Master Charge accepted. Min. order \$75. FOB Dania, FL. Catalog \$3. refundable upon order.

SEND CHECK OR MONEY ORDER TO:

OPTIMA ELECTRONICS

2022 Tigertail Blvd., Dania, FL 33004
Phone (305) 920-3550
TOLL FREE 1-800-327-0224

Circle No. 117 on Reader Inquiry Card



U.S. Patent
No. 3,641,391

Beltron is the finest and easiest to use test equipment available. You can check all guns of a color tube simultaneously for tracking, emission and life conditions. You can determine before work is done on chassis how good the picture will be after it is completed. Beltron will also usually indicate if a brighter or other means of increasing brightness has been used, restricting satisfactory restoring of the picture tube.

AND WE'VE MOVED

Please make note of our new address

Edtron Instruments Inc.

136 Sherry Lane, Kalispell, MT 59901
(406) 755-8690

Circle No. 104 on Reader Inquiry Card

SECURITY VIEWPOINT

By Ray Allegrezza

As an installer/dealer of security equipment, it is taken for granted that an important part of your job consists of protecting the valuables of the subscriber.

But what would you recommend to someone who asked you to specifically protect the well-being of a given group of people?

Now this hypothetical situation may not be as far-fetched as you might imagine . . . especially if you were called in to provide security services to a local bank.

Let's for a moment assume the bank in question has a drive-in teller who spends her work day confined in one of those "glass houses" separated from the main building.

Naturally, you would install some type of two-way communication system to allow the teller outside the bank to converse with personnel inside. I'm sure you would also suggest adequate alarms, etc.

But what would you advise in terms of the type of glass used for the drive-up?

The two most popular types of transparent shielding currently being used today are laminated glass and acrylic sheets.

While many in the industry say that glass is the easier of the two to maintain (since it is difficult to scratch and relatively easy to clean), you've got to consider that since it is a much heavier substance, it requires more in the way of actual installation and structural support of the building it will be used in.

Acrylic sheets offer less weight and when unscratched, superior visibility. Many advocates of glass had, in the past, argued that acrylic sheets scratched and had a tendency to lose transparent appearance.

But since the introduction of coated acrylic sheets (such as DuPont Lucite SAR), many of those problems have been solved.

Statistics from the ANSI (American National Standards Institute) showed that the super abrasion resistant (SAR) had an abrasion resistance close to that of glass, and some 75 times greater than standard acrylic sheets.

Tests also show that the optical quality of SAR is excellent and since the sheets are bullet-resistant, easily cleaned and optically clear. The sheets can be easily shaped, cut, drilled or machined and cemented using the same techniques as standard acrylic sheets.

There will be some applications, however, where laminated glass will seem the better choice.

DuPont has also manufactured a substance called Butacite. Butacite is an ultra-violet absorbing polyvinyl butyral sheeting which is used to bond to glass to produce laminated glass. The Butacite is actually a strong high-tensile plastic interlayer which adds sufficient strength to the glass to make it bullet resistant.

Layers of glass and Butacite can be placed together to give any degree of security needed.

Both the laminated glass and the acrylic sheets can do the job. You must select the proper material.

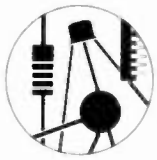

Into electronics, computers, or amateur radio?

Choose 6 informative books for only \$2.95

(total value to \$134.65)

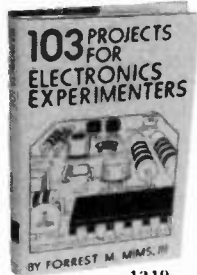

1249 List \$15.95

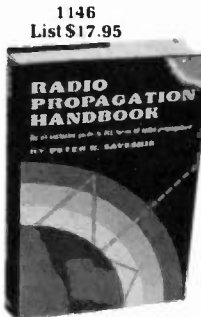

1146 List \$17.95

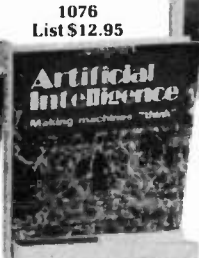

1076 List \$12.95



1251 List \$16.95



1265 List \$18.95

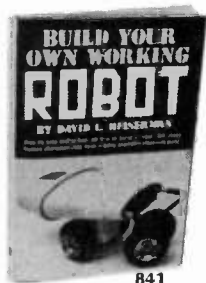

841 List \$9.95

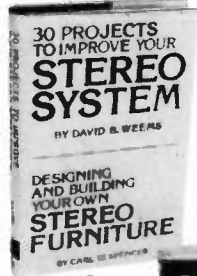

8434 List \$31.90 2 vol. count as 1



672 List \$8.95

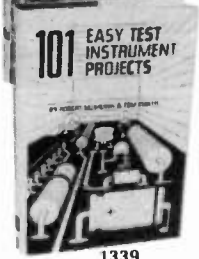

1339 List \$13.95

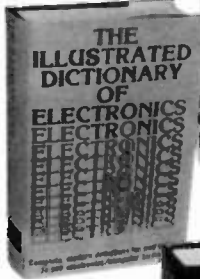

1066 List \$19.95



1097 List \$10.95



1211 List \$14.95



1120 List \$8.95

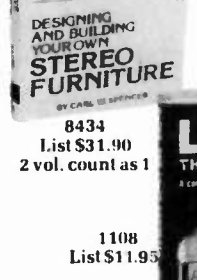

8434 List \$31.90 2 vol. count as 1

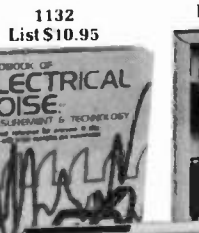

1300 List \$24.95



1155 List \$15.95 paper



1138 List \$9.95



836 List \$8.95



1288 List \$14.95



1277 List \$19.95



1290 List \$15.95



1330 List \$15.95



1258 List \$10.95

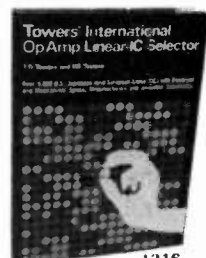

1216 List \$12.95

7 very good reasons to try Electronics Book Club...

- **Reduced Member Prices.** Save up to 75% on books sure to increase your know-how
- **Satisfaction Guaranteed.** All books returnable within 10 days without obligation
- **Club News Bulletins.** All about current selections—mains, alternates, extras—plus bonus offers. Comes 14 times a year with dozens of up-to-the-minute titles you can pick from
- **"Automatic Order"**. Do nothing, and the Main selection will be shipped to you automatically! But... if you want an Alternate selection—or no books at all—we'll follow the instructions you give on the reply form provided with every News Bulletin
- **Continuing Benefits.** Get a Dividend Certificate with every book purchased after fulfilling Membership obligation and qualify for discounts on many other volumes
- **Bonus Specials.** Take advantage of sales, events, and added-value promotions
- **Exceptional Quality.** All books are first-rate publisher's editions, filled with useful, up-to-the-minute info



ELECTRONICS BOOK CLUB Blue Ridge Summit, PA 17214

Please accept my Membership in Electronics Book Club and send the 6 volumes circled below. I understand the cost of the books selected is \$2.95 (plus shipping/handling). If not satisfied, I may return the books within ten days without obligation and have my Membership cancelled. I agree to purchase 4 or more books at reduced Club prices during the next 12 months, and may resign any time thereafter.

- 672 836 841 1066 1070 1076 1097 1108 1120
1132 1138 1146 1155 1211 1216 1249 1251 1258
1265 1277 1288 1290 1300 1330 1339 1345 8434

Name _____ Phone _____
 Address _____
 City _____
 State _____ Zip _____

(Valid for new members only. Foreign and Canada add 20%...)

ETD-1181

A Computer for your service business?

Do you need it?

A microcomputer can do many things for the small business. It can keep inventory, payroll records, do billing and book-keeping, etc. Nevertheless, it may not be economical for everyone.

By Sally M. DeFonzo, CSM

My husband and I spent an evening recently with Lani and Jim Kowal of Movin' Sounds in Franklinville, N. J. One of the major topics of conversation was the use, if any, of the computer in a small service shop.

Jim repairs and installs most brands of home and car audio equipment for their own customers and for the customers of several non-servicing stores in their area. Lani manages the business, orders the parts, handles the phone, waits on customers—oh, you know what the woman gets to do in most service shops.

They WANTED to computerize. We kicked it around for hours and finally convinced them it would not be cost-effective for them to do so.

Sheer blasphemy! I make most of my living these days SELLING computers! But I am a pragmatist and I've run a service shop for years—I know how hard it is for a small shop to earn its money.

A computer—any computer—is good at handling repetitive operations. There aren't many repetitive operations in a small shop.

There are only two of them getting paychecks so they don't need a payroll



system.

Or accounts receivable—the service business is usually COD.

There are fairly simple checkbook programs that permit you to enter each check written and put the expense into the appropriate category. It will reconcile your checkbook at the end of the month. That could be helpful, but I think using a one-write check system is more efficient. And a heck of a lot cheaper.

How about putting each unit received for service on the computer? When the customer calls, you just ask the computer for the status of the set. It can be done, of course. In the big shops it may be worthwhile, especially if it is tied in with the parts order entry system and an invoicing system. But we use a magnetic board with headings like "Awaiting Pickup", etc. The technician can move the magnetic tag around as the status of the set changes, and anyone in the store can tell the status of any set in the shop at a glance. And our computer is

available for other jobs.

Inventory—a computer CAN be invaluable. But a service shop that works on many brands—ESPECIALLY many brands of audio equipment—must special order most of its parts. Oh, there'll be some old faithfuls, of course, but it is likely that 5 or more of the parts required will never be needed again. It makes little sense entering one-shot parts into a computer data base. The computer will ask for part number, list price, cost, supplier, description, minimum stocking quantity, reorder quantity, etc. Then it will merge the item into the appropriate file. That part will appear on every printout you make until you get around to reorganizing the file a year or two later to eliminate parts that are no longer moving to make room for new parts. You can see that it is impractical to go through all that for a part you will likely never use again.

Special-order parts must usually be paid for in advance, so there is little use

for an accounts payable system.

Who really needs a computer?

You do, if you run a shop that services one or two brands, because you are likely to keep using the same part numbers. A computer can do a beautiful job of keeping track of parts sold, parts on order, replacement cost, etc. Either on a regularly scheduled basis, or because you need a specific part, you decide to place an order with XYZ Co. The computer prints out a purchase order for every part supplied by XYZ Co. that is at or below the reorder point. You mail or call in the purchase order to the supplier. When you tell the computer that the order has been received, it automatically enters the parts into inventory. Because it is so easy to place an order, you can probably stock smaller quantities of parts. Because you are scanning all the stock you purchase from a specific source, you will have less trouble meeting minimums, and fewer emergency runs to the supply house.

After about 6 months of being on the system, you start to get real information about quantities being used. I remember how it used to be back in the good old tube days: the technician would try a tube in a set. If it didn't fix the problem, he'd take it out—but mentally he incremented the number of tubes used. We used to go round and round about why we only stocked 2 of a specific tube until my index card system proved that 2 was a six month supply and that we were actually overstocked! My index card days are over, thank goodness. Now, about twice a year, I let the computer change the minimum stock requirements and the reorder quantities based on sales year-to-date. We no longer buy 6GH8's by the 100's. WE sell more 6U10's and 6LB6's than we do 6GH8's according to the computer.

We subscribe to the Sperry Parts Pricing System. We get updates on prices as the manufacturer changes them (which seems to happen every month) with all parts listed at the markup we have specified. We use different markups for different brands depending on cost, how much trouble we have to go through to get them, how much the manufacturer's handling charge is and what the minimum order is. The Sperry System covers all the fastest moving parts of all the major brands. We feed the new prices into the computer so we know instantly if a technician is charging properly for parts. The amount billed should agree with the price listed. If it doesn't, we check.

The computer keeps track of the amount billed by each technician today, month-to-date, and year-to-date. Doesn't take long to find who is earning his keep, who is losing money—or notice a change for the better or the worse.

The inventory program that we use prints out a list of part numbers (without quantities) that we use to take regular physical inventories which we then compare to the quantity the computer says we should have. Since parts are taken out of inventory when we enter service invoices, we SHOULD always know the quantity on hand. If we have differences, we start looking.

We get a valuation of our inventory, by the categories we select. Our insurance is based on real numbers—not guesstimates.

But we can only justify doing this stuff on a computer because we have a Radio Shack store and stock about 2500 items in the retail part of the business. Now and then a new product is added or one is discontinued, but they don't change much. I can't imagine running a store like that without a computerized inventory system.

We've been talking about cost-effectiveness. Everything changes if you have some money kicking around and just have a hankering to get into the computer age. You CAN do any of the above jobs. And there are some marvelous planning and budgeting programs—get a demonstration at your local Radio Shack of VisiCalc® and you will be hooked on the spot. A general ledger program can give you last month's financial statements the first of the month. Word processing systems make even a hunt and peck typist look like a pro. There are all kinds of general purpose data management systems that let you organize and analyze to your heart's content. Mailing lists are ideal computer subjects. A computer system forces organization into a business—which would do a lot of businesses a lot of good.

There's enough ammunition to put up a convincing argument to the IRS for a tax write off. And we haven't even mentioned the educational possibilities for the kids, the fun of games like Lunar Lander or Adventure, or the exhilaration when your first home-brew program works!

Be realistic

But too many people I talk to have unrealistic expectations. I have had to disillusion customers who came in to buy a computer so they could fire their office help. I've never heard of anyone being able to reduce the size of their

office staff when they computerized. That computer gobbles up information! Who do you think feeds it?

It WILL free people from many of the boring, repetitive jobs so they have more time to do the work that is best done by humans—analyzing, troubleshooting, marketing, MANAGING. An office that does a weekly payroll for 10 or 15 hourly-wage people is spending at least 4 hours a week on payroll. The computer will cut that down dramatically! If 100 statements are sent out every month, there's another big potential savings. But someone has to type in the changes.

The small service business is in trouble because the very nature of the business prohibits most methods of increasing productivity. Labor and overhead costs keep going up and none of the work can usefully be turned over to a computer. So we throw things away when they stop working—tape recorders, b-w TV's, things that can be replaced by a new mass-produced product for less than the cost of having one technician devote his time to one unit until it is working properly. I've been talking about the consumer electronics service business, but I'm sure the same principles apply to other types of small service businesses.

In the future

One thing WOULD help: a central data base service like The Source or Compuserve devoted to electronic servicing. We would happily pay access and hourly charges if we could dial a phone number, type in the make and model of a stereo or TV, and have a schematic appear on the video display or be printed out on the printer. An instant parts list. A cross reference of universal replacement parts. Parts source information like company name, address, 800 number, prices, terms, minimum order policy. Tips and updates on servicing that particular model. An electronic bulletin board where we could post notices appealing for parts no longer available that are probably dead stock for some other service dealer.

It would be completely impractical for any individual service dealer to maintain that kind of facility, but a trade association or manufacturer could make the service available. A manufacturer could even make it part of his order entry system so we could look up the part number, get the current price, place the order, transfer funds, be advised of back-order status and availability. Wow! Then we'd ALL need computers—or, at least, terminals. THAT computes!

TV Antennas, part II

Circular polarization and indoor antennas

Indoor antennas generally represent at best a poor compromise of performance vs. complexity. Circular polarization and some new designs have recently begun to make life easier, however.

By Stan Prentiss

CP—as circular polarization is familiarly known—presently does more for indoor rabbit ear antennas (Fig. 1) than anything else, because CP consumer outdoor arrays are not yet generally available, although several types are now undergoing tests in Illinois and New York. This is mainly because rabbit ears are primarily vertically and not horizontally polarized as are the standard outdoor receiving antennas.

Theoretically, antennas may be both radiators (transmitters) and receptors (receivers), and this is very true for relatively low-powered 2-way mobile radio and base stations. But the power difference between 4 and 100 watts, versus a 10- or 50-thousand watt broadcast station (Fig. 2) is such that you wouldn't want either the expense or the mammoth structure of such a radiator at or near your house. Therefore, relatively tiny receptors which can translate radiated electromagnetic energy into microvolts in the U/V spectrum between 54 and 890MHz, some or many miles distant from the various transmitters, are both satisfactory and sufficient.

Naturally, if your receptor is not cut to precise frequency and has only a pair of driven elements without directors or reflectors, any and all signals surround-

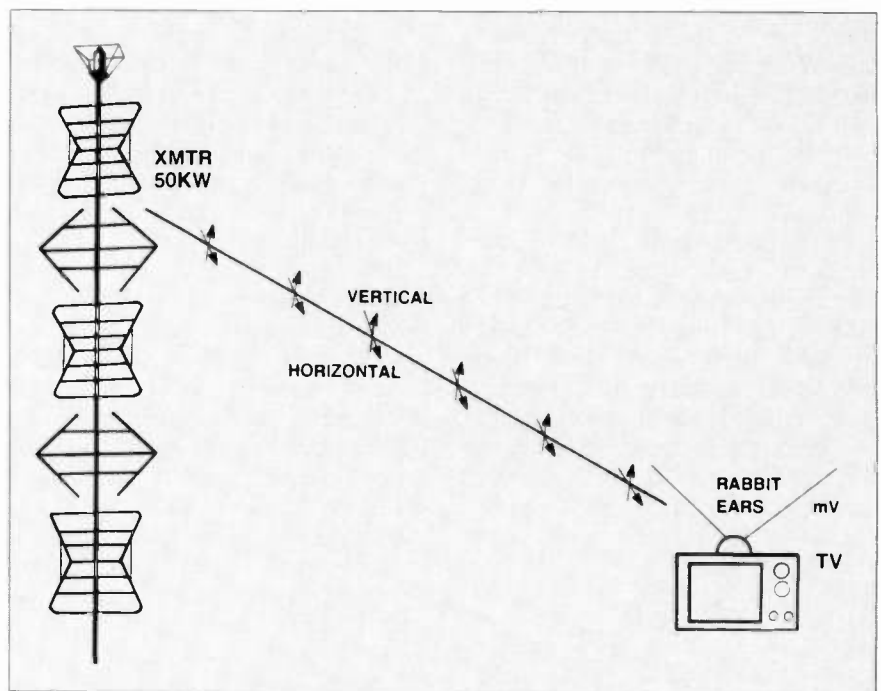

Fig. 1. A VHF circularly polarized signal showing both vertical and horizontal components reaching a standard pair of rabbit ears.

ing your resultant Vee-shaped ears are precious. So when a broadcast station reinforces its horizontal signal with another of equal power and intensity vertically, the "ears" are considerably more receptive. And this is especially true for uhf signals since they are of higher frequencies and will readily pass through smaller window and other entrance areas in residences and apartment buildings. CP, therefore, is of more than passing fancy in the more densely settled areas immediately. Later, after suitable outside arrays are designed and in the hands of consumers, many more broadcast stations will also adopt CP, and you can then expect at least a 3dB increase in received signal strength along with considerable ghost (often

called secondary image) cancellation. Seventeen stations already have CP and 14 more are installing. According to broadcast product manufacturers Harris and RCA, the following television stations are already equipped with CP: WESH-TV, Daytona Beach, Fla.; WCIX-TV, Miami, Fla.; WWL-TV, New Orleans, La.; KBYU-TV, Provo, Utah; WAST, Albany, N.Y.; WNET, New York, N.Y.; WOR-TV, New York, N.Y.; WLS-TV, Chicago, ILL.; XTEV, Tijuana, Mexico; WTTV, Indianapolis, Ind.; WRAL-TV, Raleigh, N.C.; WTVD, Durham, N.C.; WFMY-TV, Greensboro, N.C.; WITN-TV, Washington, N.C.; WPBT, Miami, Fla.; KCPQ-TV, Tacoma, Wash.; KSTW, Tacoma, Wash.

Others in the process of converting

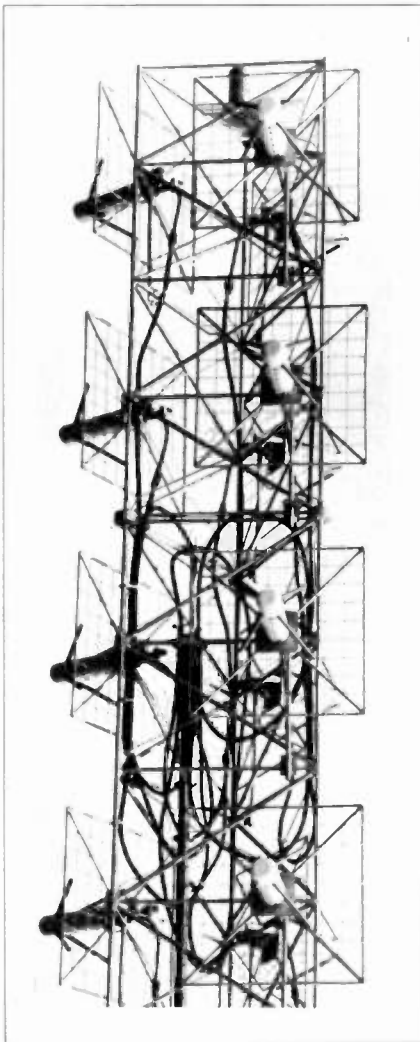

Fig. 2. RCA's TBJ type CP antenna for channels 7-13. (Courtesy RCA)

or under construction are: Radio Difusor, Sao Paulo, Brazil; TV National, Santiago, Chile; TV Litoral, S.A., Argentina; WECT-TV, Wilmington, N.C.; WCTI-TV, New Bern, N.C.; WVTM, Birmingham, Ala.; WBTW, Florence, S.C.; WXIA-TV, Atlanta, Ga.; WLNE, New Bedford, Mass.; WABC-TV, New York, N.Y.; WBNS-TV, Columbus, Ohio; WNCT-TV, Greenville, N.C.; KCRA-TV, Sacramento, Calif.; Radio Caracas, Venezuela.

Area coverage (Fig. 3) in some instances following CP installations is so good that figures showing these increases are difficult to come by. But what this means to the consumer is that he or she will have better signals, less ghosting, and new broadcast equipment (Fig. 4) which should deliver maximum 4MHz bandpass signals to the host of new receivers that now have 4MHz luminance passband comb filters and can produce a full 330 lines of horizontal resolution.

What is CP?

For those who are not yet familiar with

MEASURED HORIZONTAL RADIATION PATTERN MECHANICALLY ROTATING DIPOLE ILLUMINATION

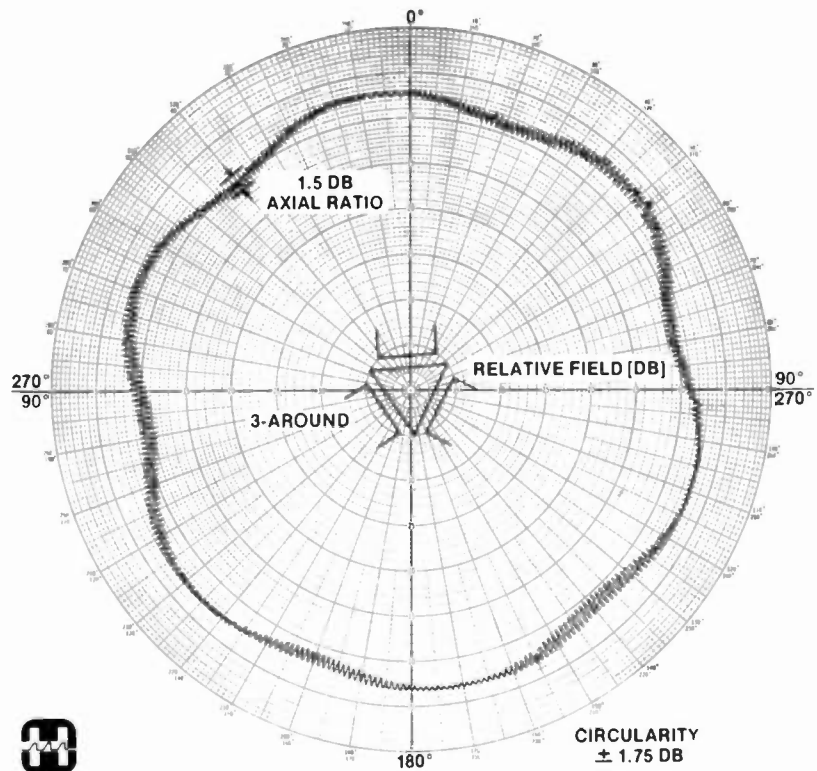

Fig. 3. A typical quality horizontal pattern from a HARRIS VHF broadcast antenna (Courtesy HARRIS Corp)

circular polarization, here is a brief description of what it does and a look at its broadcast transmission means.

First used in broadcasting during the 1960s to help FM rise from a severe economic slump, right hand circular polarization was finally approved by the Federal Communications Commission in 1978 for TV applications after extensive testing by WLS-TV in Chicago and KLOC-TV in California.

If a part of orthogonal dipoles (Fig. 5) are placed in near proximity and excited by signals 90 degrees out of phase, a constant magnitude field is created that rotates either right or left, depending on the phase of the two signals. Any antenna receiving these signals is subject to a constant signal level, regardless of its horizontal or vertical orientation (direction). These two fields, however, maintain their separate vertical and horizontal polarities, but travel along the same axis and in the same direction. Since both are equally strong and in-

dependent, separate and equal transmitters are required to generate their outputs.

In approving CP, the FCC opted for right hand polarization, and so all CP TV receiving antennas must also be similarly polarized. This means that any left hand "bounce" or secondary image, out of phase with the main signal, will usually either be substantially or totally rejected, considerably reducing ghosting effects. This does not mean that the present horizontally polarized antennas will be affected since one component of the CP signal is still travelling in the usual, standard horizontal plane. But it does mean that any and all vertically polarized whips (vertical dipoles), and the ordinary rabbit ears will benefit accordingly since they depend more on the signal's vertical component than on the horizontal. CP, then, will be good for both VHF and UHF where there is ghosting, co-channel or adjacent channel interference, poorly oriented anten-

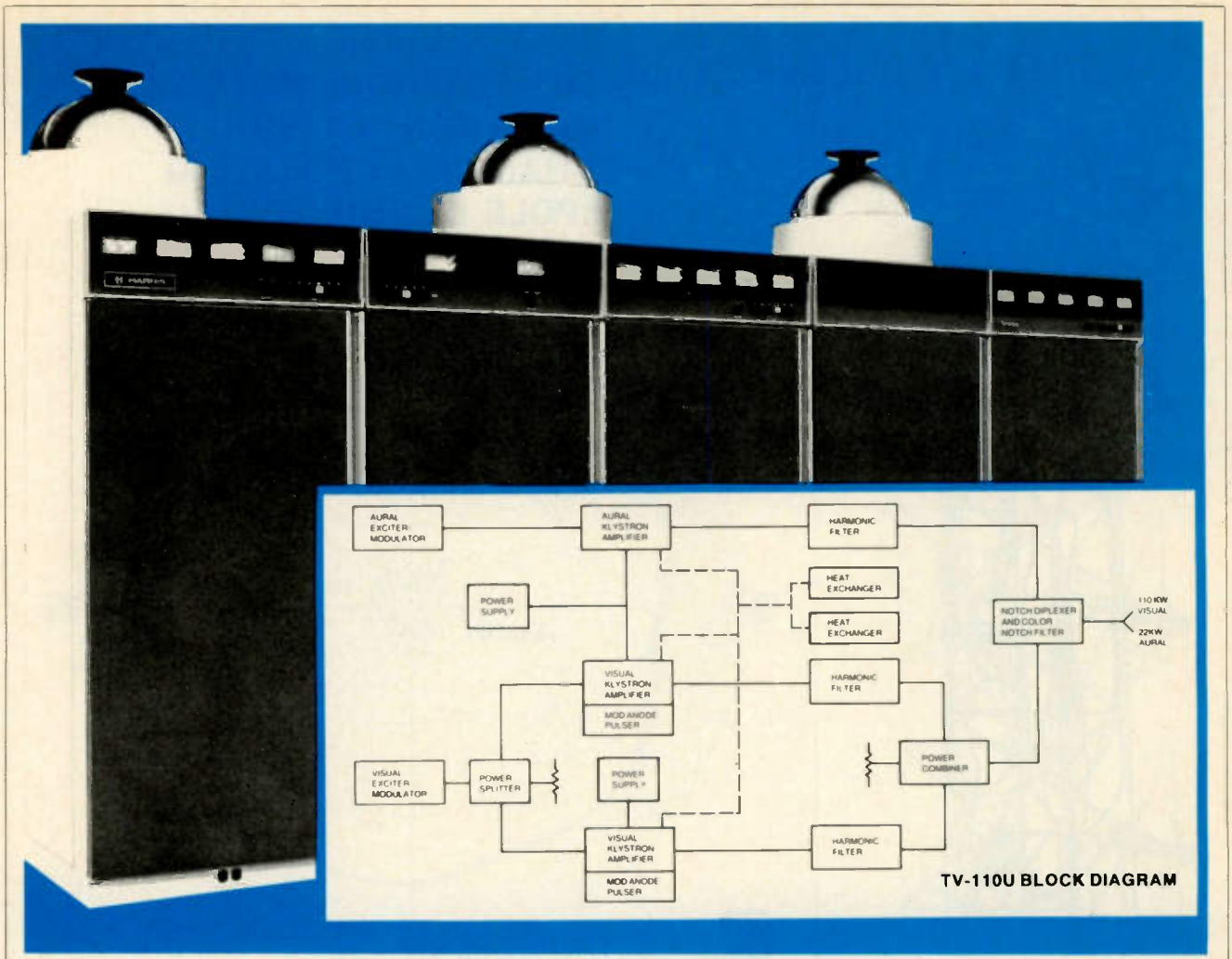

Fig. 4. HARRIS' 110 KW, TV-110V, UHF color TV transmitter, designed for unattended operation. (Courtesy HARRIS Corp.)

nas, multipath interference, intermittent field strength coverage, and the usual problems associated with whips and rabbit ears.

Is it any wonder that North Carolina, New York, and Takoma, Washington are making haste to have highly useful CP transmissions on the air before much of the remainder of the U.S.? Other cities and communities, obviously, will certainly come around in time.

CP receiving antennas

CP consumer antennas have already been designed for experimental use by JFD, Channel Master, and Blonder Tongue, but have not in the past been offered to the general public. We do know, however, that crossed Yagi and log periodic types are now being engineered, and an indoor (Fig. 6) CP 4-element crossed dipole array has been patented by Harris' Jeff Steinkamp, Quincy, Ill., and is being tested by nine different CP broadcasters at this writing. Production was scheduled for early 1981, with the promise of a reasonable retail price not yet announced. Mr.

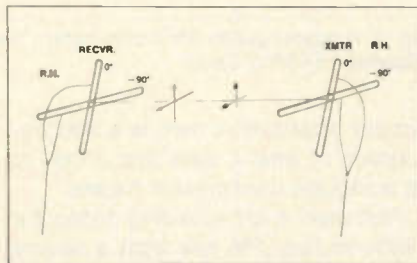

Fig. 5. CP between transmitter and receiver. Note right hand polarized antenna connections.

Steinkamp claims gain over standard rabbit ears of 3dB, ghost reduction of 78%, and 300-ohm input connections. The only catch is that separate antennas will be required for channels 2-6 and FM, 7 through 13, and 14 through 83. We have also just learned that 150 Channel Master 3-element Yagi CP antennas cut for channels 7 through 13 have been shipped to KSTW, Tacoma, Washington, for CP reception there. So the race is really on, both indoors and out.

For now, however, be patient, for just like the first hi-low, folded separate vhf receptors for black and white, CP man-

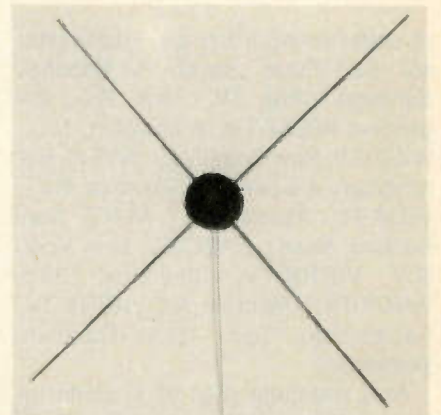

Fig. 6. A newly patented CP indoor antenna has 2.15 dB gain plus 13 dB ghost rejection.

ufacturers will have to matriculate through the various learning curves until a combined u/v circularly polarized antenna can be structured to serve all 82 FCC assigned channels. That could take a while, naturally, but in the meantime, all those with CP stations in their areas would do well to climb on the video bandwagon immediately for considerably better pictures. You'll be glad you did!



Fig. 7. An amplified indoor antenna that works.

Whips and Rabbit Ears

All sorts of radiator/receptors have been designed for outdoor use in TV antenna applications, as well as indoor, but few originals have actually survived over the years except corner reflectors, bow ties, Yagis, and the familiar indoor circular elements—most of which are for uhf applications and not vhf.

With wavelengths much longer and antenna dimensions considerably larger for vhf, any similarity between indoor and outdoor 54 to 216MHz signal transducers has really not been possible except among some ill-fated window ledge units that were both narrowband and rigged for black and white reception; hence, the ubiquitous rabbit ears, which are nothing more than a pair of telescoping metal rods some 40 inches long, and fastened to a hank of twin lead that connects to vhf terminals on the TV set. It's not an especially scientific way to go since simple dipoles for channel 2, as example, should be cut for 102 inches, and those for channel 13, 27 inches—all without reflectors, directors, tuned elements, coupling harnesses, or anything else that affects the precise receptor characteristics of the antenna. Then top this off with a generalized Vee rather than a pure horizontal receiving dipole, and you have the usually enormous problems surrounding any type of indoor antenna.

Even the newer multi-element indoor rigs with various capacitance switches, used for minor tuning and to minimize extraneous signals, only aid a little rather than a lot. You just can't pull in a signal without adequate receiving equipment, even with gimmicks. One must also remember that an inert metal

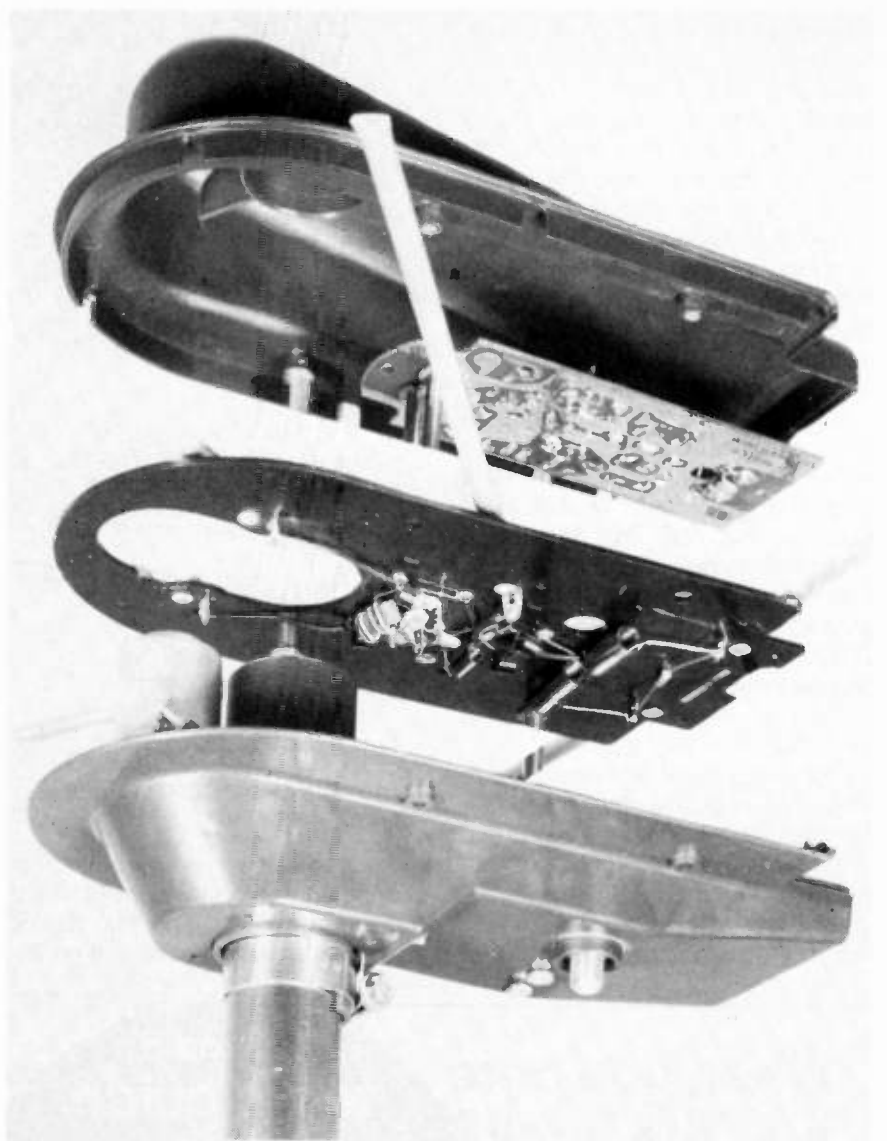

Fig. 8. The inside of Winegard's AT Thousand amplified antenna series for both indoor and outdoor use.

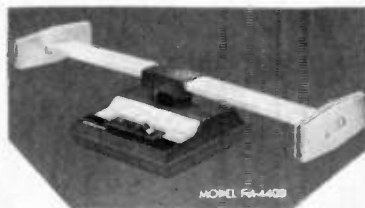

Fig. 9. Another amplified indoor antenna from Winegard. It works quite well on FM.

antenna has absolutely no real "gain" (increase in received signal strength) unless actually amplified; and that, of course, is the subject of our next topic.

Amplified indoor antennas

At one time or another various manufacturers have tried to install amplifiers among the indoor offerings, but without notable success. There have been round ones, rectangular ones, Yagis, plain rabbit ears and many more. But the only antennas we've seen recently that work

satisfactorily—either in or out of doors—are directional arrays with sufficient active elements and amplifying electronics to attract enough electromagnetic energy to put an adequate picture on television screens. Otherwise, few, if any, of the other designs really work. And for this you have to have signals between a minimum of 100 microvolts (best tuners) to 1,000 microvolts for overall good set performance of every variety.

The Winegard Co., of Burlington, Iowa, fortunately has recently introduced such an antenna (fig. 7) for TV that we have had under continuous test for 6 months. Three additional uhf stations are now received where no signal existed previously, and vhf stations as far away as 30 plus miles are usable, although not perfect. All this takes place in a walkup steel and brick apartment building on the second floor.

The assembly looks like a 4-way clamshell (Fig. 8) with baluns and the

necessary transistorized electronics mounted on two printed circuit boards in between. Noise figure for vhf is only 3dB and for uhf 6dB, while gain amounts to 16dB for vhf and 8dB for uhf. Front-to-back ratios are 16 and 10dB, respectively. There is also diode protection for the transistors and, of course, a 12-volt transformer isolated power supply for rotor and set. Turning radius amounts to 30 inches. Winegard says this is the same preamplifier (with FM rejection circuitry) that's been used in the Gold Star line for the past five years.

Actually, the unit is available for both attic and outside installations, but you're really better off with a standard, first line chimney mount receptor under outside conditions than with this specialized equipment. Models are AT-5000 ant. and mast, AT-4000 with rotator and signal amplifier, AT-3000 with amplifier, AT-2000 with rotator only, and AT-1000 for basic antenna without either rotor or amplifier. Suggested retail prices range from \$36.75 to \$127.75.

For FM and stereo, Winegard is also offering a pair of 19-inch amplified FM-4400 and FM-2400 table top walnut and gold tone antennas with good to excellent performance (Fig. 9.). They're attractive, and the amplified version may be plugged into the switched outlet of

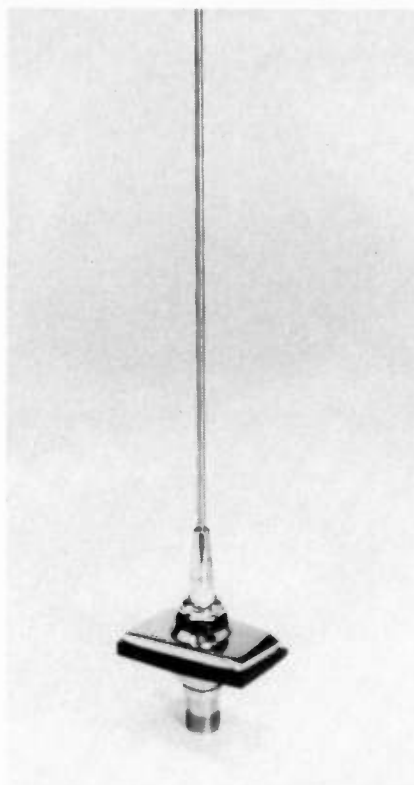

Fig. 10. A concealed CB/AM/FM antenna. This is the Ford version.

your stereo so it will be turned off whenever the set is. In out tests, the FM-4400 outperformed TV input (for f-m) coming down from an outside antenna on 75-

ohm coax. Suggested retail: \$39.95 and \$71.95.

CB is still here, too

And for the little ladies and boys, young or old, who still have the highway spirit of adventure lingering, why not a concealed AM-FM-CB antenna?

Useful in all sorts of emergencies such as flat tires and accidents, get-acquainted sessions, or smokey talk, a vertical steel whip of modest proportions can only help, not hinder. Antenna Specialists, of Cleveland, Ohio, has a very special series of MS or M cowl mount disguised antennas of 17-7 PH tapered stainless steel built especially for Ford, Chrysler, GM, etc., that can do wonders (Fig. 10).

Forty eight inches high, with an electronic tri-band coupler, this series features a voltage standing wave ratio (VSWR) of better than 2:1 on all channels, good road range, and a tunable core for maximum a-m, sideband output and minimum loss. Installation is simple and cables fit nicely through existing body holes—at least on Ford and Mercury Cougar, anyway. You'll enjoy good AM-FM radio, too, as the truckers' call of "a super trooper northbound at the 42-mile marker" comes crackling down the superslab. **ETD**

When you price by "The Book" everyone benefits!

Eliminates undercharging...controls overpricing...treats both customer and shop owner fairly!

The Parts Pricing Book

200 pages of fast moving parts...with a selection of mark-up you feel is correct for your shop...computerized with automatic up-dating service...\$69.50

The Labor Pricing Book

Tech's Guide to Pricing will not only change your customer's attitude and perception...It will change yours as well...\$29.50

CALL TOLL FREE: 800-228-4338

8/5 C.S.T. MONDAY/FRIDAY

sperry tech inc. P.O. Box 5234 Lincoln, Nebraska 68505

tv & radio tech's guide to pricing

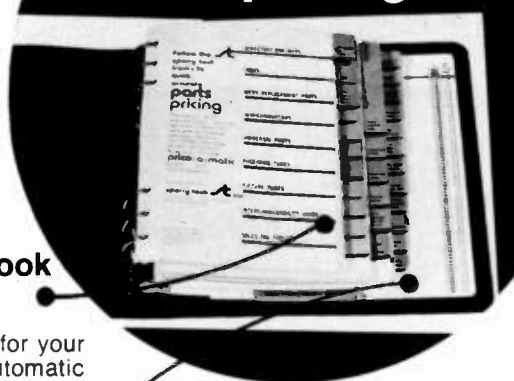

When you appear on the job with organized pricing material...you create an image of both technical and business skills!

Circle No. 122 on Reader Inquiry Card

FREE CATALOG OF Burglar/Fire Alarms

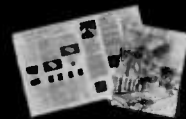

With over 1600 hard to get security products for home, business and industry, Mountain West is a one-stop supermarket for professional alarm installers as well as do-it-yourselfers. Systems and parts range from simple, quickly installed units to the most sophisticated electronic equipment. 68 pages are filled with pictures, diagrams and instructions.

Mail to: Mountain West
4215 N. 16th St.
Box 10780 Dept ET-11
Phoenix, Az. 85064

Circle No. 114 on Reader Inquiry Card

Alarm system service, II

More Troubleshooting

Here we examine some of the problems various intrusion sensors can cause and some ways to avoid them and look at dialer and direct wire system troubleshooting.

By Joe Lanier*

This article is a continuation of *Alarm System Service* which appeared in October ET/D. It also presents a number of factors to be considered in the application of various intrusion detectors.

Study the motion detection check lists for possible false alarm causes (or mis-applications). It is possible for the unit itself to be defective since anything electronic is subject to failure, but generally this is not the case if good, name brand equipment is employed. Most false alarms are the result of something happening within the detection field range. In some instances you may not be able to cure this condition with the existing form of detector used, and you may have to replace it with some other type of detector, not affected by the same conditions.

Should the alarm be only a very rare random condition, with no apparent explanation, a so-called "pulse counter" might be considered as a last resort. These devices are inserted in the protective circuit between the control and motion detection unit. They may be adjusted time-wise for number of trips required, before the master itself would see an open on the circuit, for example, two trips within 10 seconds. This should serve to cancel out any one-time random alarms, yet alarm on continued movement within the protected area.

Motion detector malfunctions

These units are quite complex, rendering field service difficult. Most manufac-

Microwave application check list

Microwave motion detectors use very high frequency radio signals in the vicinity of 10GHz. Air motion will not affect their operation. Antennas transmit the coverage in a controlled pattern (various patterns are available), which will penetrate most non-metallic surfaces, especially head on.

(1) A large loading door can be as large as 90-200 sq ft and due to its size can produce an alarm with as little as ¼ in. movement. It is advisable to parallel such doors, keeping the pattern off the doors.

(2) Microwaves can penetrate non-metallic walls and glass, mount the unit accordingly to avoid signal detection in unwanted areas, and adjust its range as required. Note: Just because the signal does not catch a man-size target, does not mean it will not see a larger object. Walk-test outside of the building, including a vehicle drive-around.

(3) Microwave energy can be reflected by large metal objects placed or parked within range, into areas where coverage is not desired, resulting in false alarms.

(4) Fluorescent lighting is an ionized gas column that is reflective to microwaves, and can appear as a moving target. It is recommended that such lighting can be turned off during protected hours, or that the unit look over or under such lighting.

(5) Movement of pets, moving signs, blowing curtains, machinery in operation (such as moving fan blades), as well as water flow in plastic pipes (or pipes shaking) can produce alarms. A ¼ in. wire mesh grill may be placed over fan blades to make them appear as a solid object to the microwaves.

(6) Make sure areas where protection is desired are not hidden by metal racks, bins, machinery, etc., which would block and reflect signals.

(7) Unit must be mounted on a firm, vibration-free surface.

(8) In event of RF problems, the unit chassis should be grounded, although this would be an extremely rare condition.

(9) Some manufacturers offer dummy load devices, which have impedance characteristics of an antenna. It will permit testing of the unit at full gain without sensing external disturbances or interferences, thus determining the status of the problem as to application or malfunction.

turers would definitely prefer that you return the unit direct to the factory for repair. Be sure unit is properly used in the application, and that it is changing over to the standby battery provisions upon power failure. Most of these devices contain small gel cells or ni-cads, the average life span of which is approximately five years, and which may easily be field replaced.

Make sure the unit is plugged into (normally by a transformer) a live 24 hour 120vac outlet (master control as well), and is not being cut off at night by a breaker. This would result in a false

alarm after standby power has been exhausted, and is a very, very common cause of false alarms. Also, avoid use of house circuits containing unusual items, which could create spikes on the line, such as time clocks, etc. If you suspect a recent lightning strike line surge, change the transformer. It could be damaged, yet this is nearly impossible to tell with a VOM.

Dialers

Most dialers (tape) have a test position that tests most of the dialer's functions. This pre-programmed taped message

*President, Defensive Security, Jasper, TX.

Passive infrared application check list

Infrared detectors are optical and passive devices that monitor or receive infrared energy heat. They do not transmit. Thus, by not radiating energy they are somewhat less susceptible to false alarms than devices that transmit energy, but are generally higher in cost. The more expensive models generally provide range fingers (more than one such finger must be entered to provide alarm) along with logic circuitry. The devices are optical in that patterns are precisely defined (no range adjustment). They sense a change in IR radiation, such as caused by an intruder entering protected pattern.

(1) The target area should be temperature stable. Do not locate the unit in a direct draft of heating/cooling vents. Normal operating temperature for IR's is -20 degrees F to 140 degrees F. The unit will compensate for gradual changes in temperature, but a rapid change (such as 10 degrees within 4 seconds) can false activate.

(A) Mount unit at least 10 ft away from air outlet vents.

(B) Unit must not see an open flame, such as a fireplace.

(C) Avoid mountings where direct car headlights or sunlight would strike the optical viewer on the unit, through a window.

(D) An uncovered incandescent light bulb that burns out (or an ac power failure) will have an immediate temperature change that could create a false alarm.

(E) The unit should not view any subject to rapid temperature change.

(F) Small pets can emit through IR difference to false activate.

However, often the unit can be located with high mounting to allow pets to pass under the viewing area.

(G) Sensitivity is greatest for motion across the field of view, and is least for movement toward or away from the sensor. Performance is also determined in part, by background temperature and clothing type worn by the intruder, as well as high speed.

(2) Mount the unit on a firm, vibration-free surface.

(3) In the event of RF problems, ground the chassis of the unit.

Special note: In the remote event that outside RF signals appear to be false activating ANY TYPE of MOTION DETECTION unit (such as Ultrasonic, Microwave, Passive InfraRed) CONTACT FACTORY INVOLVED for recommended solutions. Test for outside RF activation by having police, etc., key their mikes near the building, etc.

a spare tape programmed with your numbers, for testing purposes). Should the dialer itself be defective, replacement rather than attempting field service would generally be called for. Dialers are fairly complex in operation and most manufacturers would prefer them to be returned for factory repair.

For digital dialers, special testers are available, with LED type digital read-out of the number being called, account numbers and violation code. Tip and Ring polarity must be observed if touch-tone phones are in use.

Direct wire receiver systems

Most problems with direct wire systems (via leased telephone lines) are caused by the telephone lines themselves; opens, shorts, and grounds. Unfortunately, you usually have to literally prove to the telephone company that these conditions exist, before obtaining repair. The special "B.A. Circuit" is a dedicated private-pair, with nothing on the line but the voltage (normally 6-12vdc) from your master control, via a reversing relay. This voltage is terminated at the receiver, into the receiver itself. Voltage present, will be indicated by a normal meter reading. Very low, or no voltage or current would indicate trouble, whereas a reversal of polarity of the normal voltage would produce an alarm reading. A trouble reading will remain until the trouble is corrected, and an alarm reading will remain until the system is reset. In the latter instance, voltage polarity would revert to a normal, non-alarm state. The voltage itself is on the line 24 hours per day, regardless of when the master control is armed or off.

If a trouble condition is present, check for the line dc input voltage (and current) at the receiver location. Although rare, it is possible to have a proper voltage reading, yet no current reading, due to poor connections on the phone line itself. At least 10ma should be present to properly operate the receiver. Also, check the voltage and current output at your master control prior to calling the phone company for service, to make sure your equipment is operational. At the receiver location be sure to unplug the receiver from the cabinet before taking the voltage and current readings directly from the phone line, so you don't read through the receiver under load. When calling the phone company for service, it would help to have the test board (frame room) telephone number for the exchange you are in, and call them direct. State the B.A. Circuit Num-

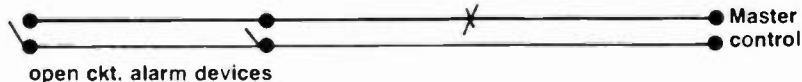

Fig. 10: A break in wiring to normally open sensors can render them inoperative.

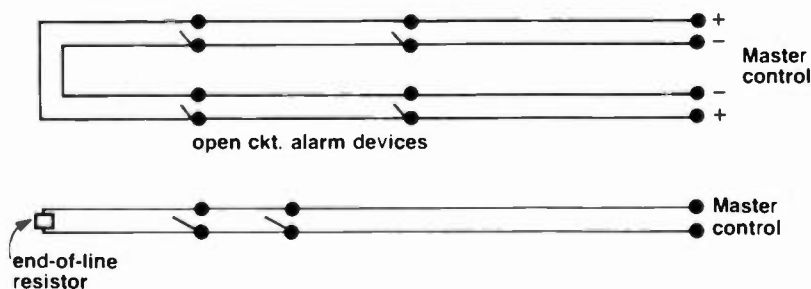

Fig. 11: Typical supervised fire alarm circuits.

may be heard through a speaker in the unit, without actually dialing out. Test units also are available, which allow you to connect across the dialer phone line output, hear the ringing and the phone being answered at the programmed numbers (or a busy signal, etc.). In servicing this equipment, such a device (or headset) is almost required, to make

sure you are obtaining a dial tone on the phone line you are connected to.

Make sure the dialer is actually being tripped (started), by your tripping device (such as bell output voltage or dry contact closure), with dial tone present. Tape contact head should be clean (spray cleaners are available). Should malfunctions exist, try a new tape (keep

ber if known, and the problem, such as, "My equipment is putting 6vdc on line at (premises location), and we have no voltage at (receiver termination location)." The receiver meter power comes from the voltage you apply on the phone line from the protected premises. Power for the lamp and buzzer on the receiver is provided by an accessory 6vdc power pack (or batteries) at the receiver.

Special line amplification add-on modules are available to boost line voltage where needed for extremely long phone lines. Also, leased line monitors are available that parallel phone lines at the protected premises with a status LED type-light. This device will glow green as long as voltage is on the phone line, change to red for alarm, and be out in event of no voltage. It is inexpensive and can save service time, as you can call the subscriber to check its status, rather than have to go to the location and check for phone line voltage.

Fire circuits & panic (hold-up) circuits

Fire circuits are generally Normally Open in design, and employ normally open detection devices that short (or close) the circuit to activate the control. Therefore, the devices used are installed parallel (across) the circuit. This holds true with the 24 hour Panic or Hold-Up circuit, which may either require a latching type device or momentary device to activate. A broken wire could defeat or render inactive the circuit, or at least a portion of it (figure 10).

Supervised fire circuits

These circuits are either 2-wire with an E-O-L (end-of-line) resistor used to provide supervision, or 4-wire (2 wires out and 2 back to control) (Figure 11). In the case of 2-wire circuits, the control could see an open circuit, such as a broken wire, because it couldn't see the resistance provided by the end-of-line resistor. The 4-wire would also see an open, due to a loss of voltage. A short on either system would provide an alarm condition. Four wire is known as "Class A," and 2-wire as "Class B" wiring. Troubleshooting would consist of using a VOM to trace an open (no continuity) or short (causing a constant alarm condition) when the system is armed. Tracing shorts was covered earlier. Just keep in mind that Fire and Hold-Up circuits operate open circuit, with alarm devices that close the circuit to activate. Burglary circuits are generally closed circuit, with alarm devices that open the circuit, requiring for series wiring, rather than parallel wiring. **ETD**

Ultrasonic application check list

Ultrasonic is "silent sound," inaudible high frequency sound waves. Any movement within the protected area changes the pattern of the waves. Flood coverage is generally provided within adjusted range, but it does not penetrate walls, etc. Maximum range listed by the manufacturer is often based on a temperature of 75 degrees F, with 40% relative humidity, with satisfactory operation normally rendered between 50-90 degrees. Lower temperatures will reduce the range up to 20% at 20 degrees, but humidity will generally affect range only about 10%. average range of most mini-sonics is 20 ft x 25 ft maximum. Larger multi-head systems may be used to provide trap zone coverage in additional areas with various protection patterns offered. Hard, reflective surfaces allow for greater coverage per area than soft absorbent areas with carpet, drapes, etc.

- (1) Ultrasonic signals are blocked by merchandise, cartons, etc., stacked too near transceivers. This can result in false alarms due to excessive wave reflection (unit too hot), as well as blocking the area coverage is desired in. Units generally should not be mounted over 12 ft from the floor.
- (2) Setting the range control too high (unit super sensitive) can result in false alarms. Adjust sensitivity no higher than required to provide coverage desired in protected area.
- (3) Excessive air turbulence can false activate the system. Mount unit(s) at least 10 ft away from outlet vents, loose fitting, drafty doors, etc.
- (4) Harmonics within the frequency range of the system can cause activation. This can be caused by mounting too near telephones, TV or Hi-Fi equipment, and any equipment powered under air or gas pressure, such as leaking compressors. Also, excessively strong outside RF signals (unit chassis should be grounded) can cause trouble. Harmonic problems also can result from rain on an uninsulated metal roof.
- (5) Movement in the protected area by pets as well as air movement of signs, curtains, etc., can cause unwanted alarms.
- (6) Unit must be mounted on a firm, vibration free surface, not subject to vibration from passing trains, traffic, etc.
- (7) Remote slave units generally require shielded cable to avoid inductive pickup. This wiring should be kept away from existing ac premises wiring at least 1 ft and should cross at right angles only.
- (8) If more than one, single stand alone mini-sonic is installed at the same location, they must be of the crystal controlled type to avoid cross talk (inter-reaction false alarms).
- (9) Doppler Meters (testers) are available, and should be used on the large systems to check over all stability and system balance.

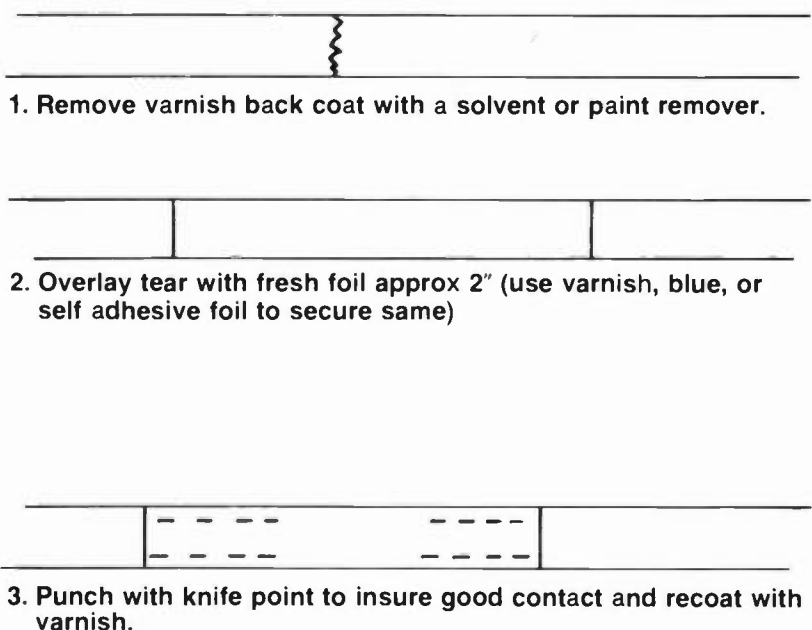

Fig. 12: How to repair window foil.

OP Amps, V

Practical active filters and troubleshooting

This is the final installment of ET/D's series on operational amplifiers. Here we conclude our description of active filters and offer some cautions and troubleshooting tips.

By now you should have a good basic understanding of the significance and use of operational amplifiers and should have the background upon which to build further expertise. You cannot afford to stop learning!

By Bernard B. Daien

There are several types of circuits which are able to simulate inductance. Known by a variety of unusual names, such as "Gyrators", "Impedance Converters", etc., these circuits are able to make a capacitor/resistor combination look like an inductor. . . (or, conversely, they can make an inductor/resistor combination look like a capacitor). We are primarily interested in simulating an inductor, in active filter applications.

To understand the basic principle of these circuits, study Figure 1, which is a review of basic parallel resonance. Note that we have an AC generator with a perfect AC ammeter of zero impedance reading the generator's output current. There are two loads connected in parallel with the generator, one an inductor, and the other a capacitor. We assume the inductor and capacitor are

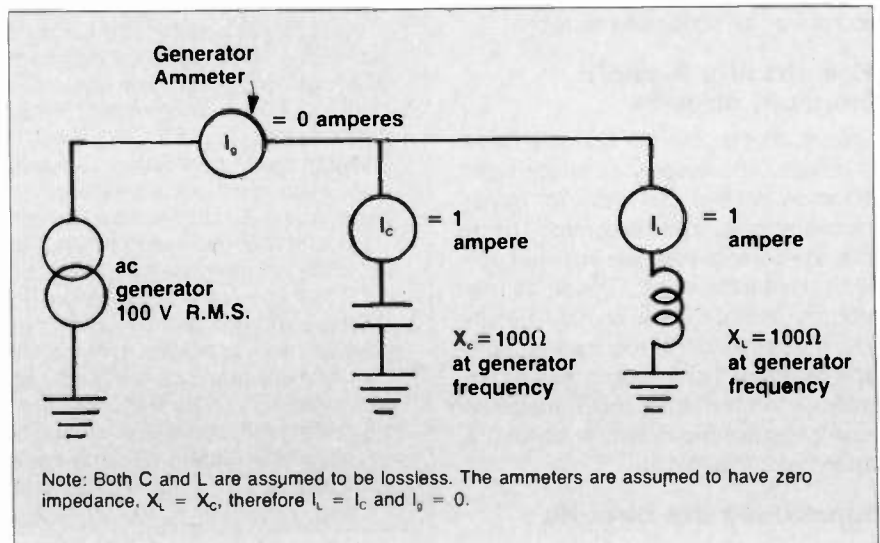

Fig. 1. Parallel resonance

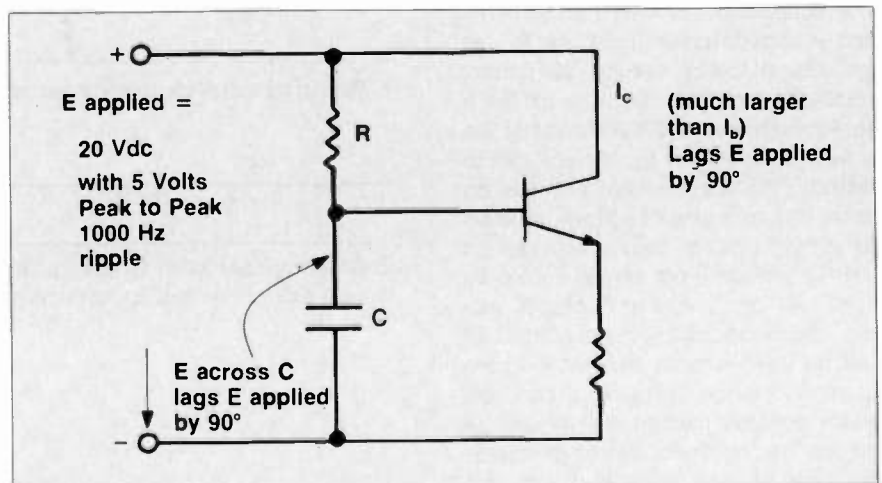

Fig. 2. A power supply active ripple filter.

lossless, in which case the current through the inductor will lag the generator voltage by 90 degrees, and the current through the capacitor will lead

the generator voltage by 90 degrees. The currents I_L and I_C are read on zero impedance perfect ammeters.

When X_L equals X_C , then I_L will equal

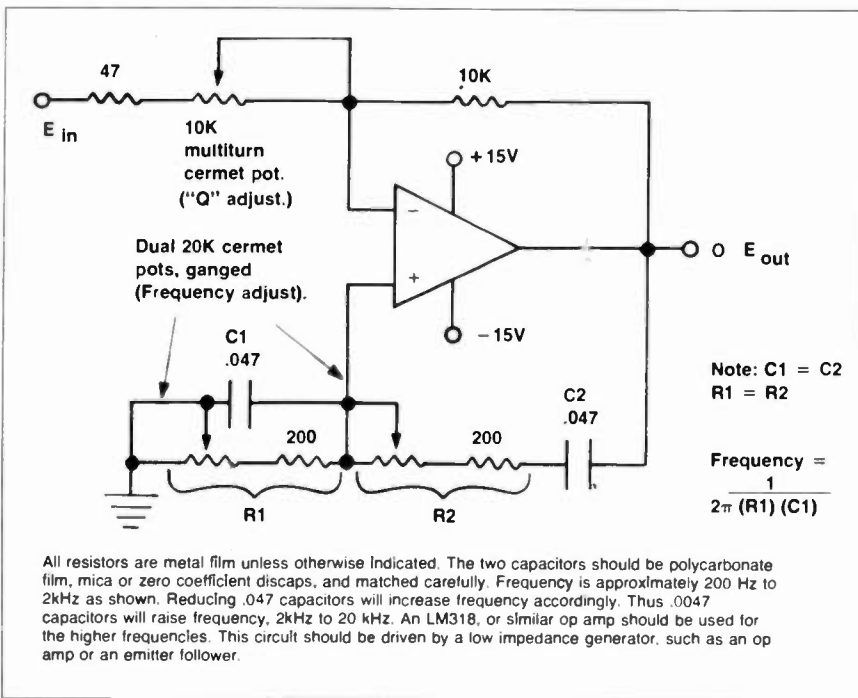

Fig. 3. A practical active bandpass filter.

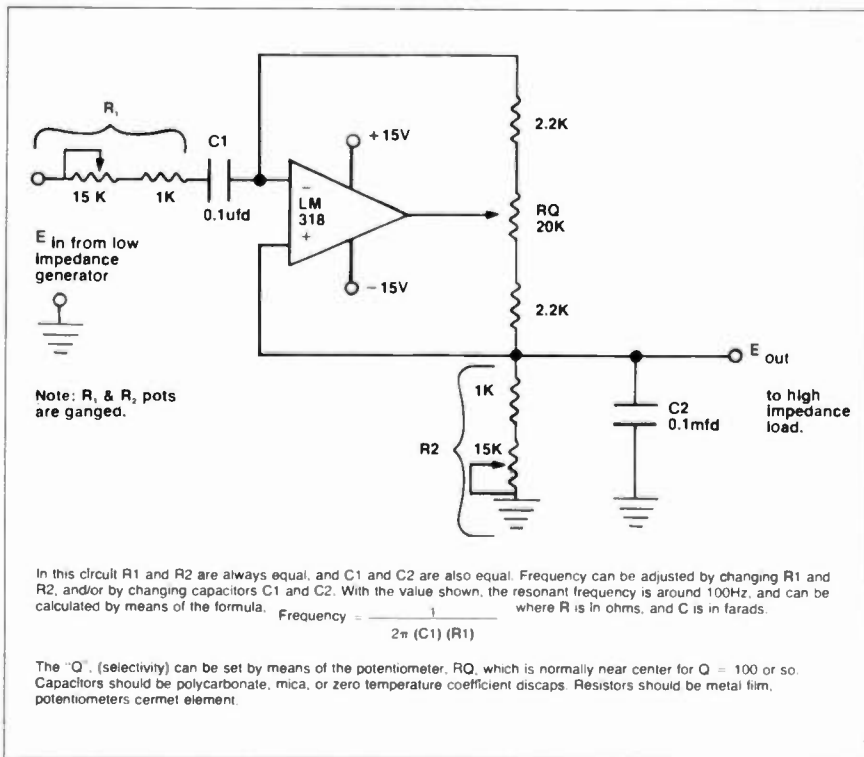

Fig. 4. An adjustable selectivity bandpass active filter.

I_c . Since the two currents are equal, and 180 degrees out of phase, they will "cancel", and the net output current read on the generator output ammeter will be zero. Of course zero current indicates an infinitely high load impedance therefore the parallel resonant circuit looks like an open circuit so far as the generator is concerned.

Now then, if we can generate a current 180 degrees out of phase with the capacitive current, when the same voltage is applied to both loads, then the

non-capacitive load will "look like" an inductor. Stated another way, if I covered up the inductor in Figure 1, but you were given the facts that the currents I_L and I_c were equal and out of phase, you would assume that the concealed component was an inductor. Further, looking at the generator current, and noting that it was zero, you would also assume that the circuit was parallel resonant. And, according to accepted theory, your assumptions would be correct.

However, you could be wrong . . . if

there was an active filter in place of the inductor. With the aid of Figure 2, we can demonstrate how an amplifying element (active element) can be used along with an RC network, to simulate many of the properties of an inductor. In Figure 2, the ac ripple component is applied to the transistor's base, but the voltage across the capacitor lags the line voltage by 90 degrees. Since there is a resistor in the emitter of the transistor, the transistor base input resistance is very high, and does not load the capacitor down. The base input voltage therefore follows the voltage across the capacitor. The input current of the transistor follows the base input voltage variations. The collector current follows the base current variations, but AMPLIFIED. Therefore the collector current is quite large compared with the current flowing into the R/C network, and the base. Now remember, the base current was shifted, to lag the applied voltage by 90 degrees, therefore the collector current lags the applied voltage by 90 degrees. The net current drawn from the supply line is therefore inductive . . . i.e., this circuit looks like a parallel inductor.

In actual practice we would implement such a circuit with separate dc and ac inputs, and use an op amp instead of a simple one-transistor amplifier. But Figure 2 suffices to illustrate how an amplifier and an R/C network can simulate the performance of an inductor in many ways. It must be pointed out that active filters do NOT have the ability to store energy, thus an "inductor" made of an active filter cannot be successfully used for the inductor in a spark coil (ignition system). On the other hand, series and parallel tuned circuits show normal Q and selectivity, proper phase shift characteristics and energy transfer . . . (but not energy storage), when constructed with simulated inductances.

Some practical circuits

The following active filters have been chosen for ease of construction. (It is possible to change frequency with simple component value changes only, while some are adjustable by means of a potentiometer, for example). They are all practical circuits that can be constructed by the average technician. Although there is much literature available about theoretical active filters, very little is directly useable for constructing practical filters (and usually requires matching of components to one tenth of one percent!) Figure 3 is the schematic of an adjustable narrow-band bandpass filter. Not only is the frequency adjustable, but also the bandwidth ("Q"). This

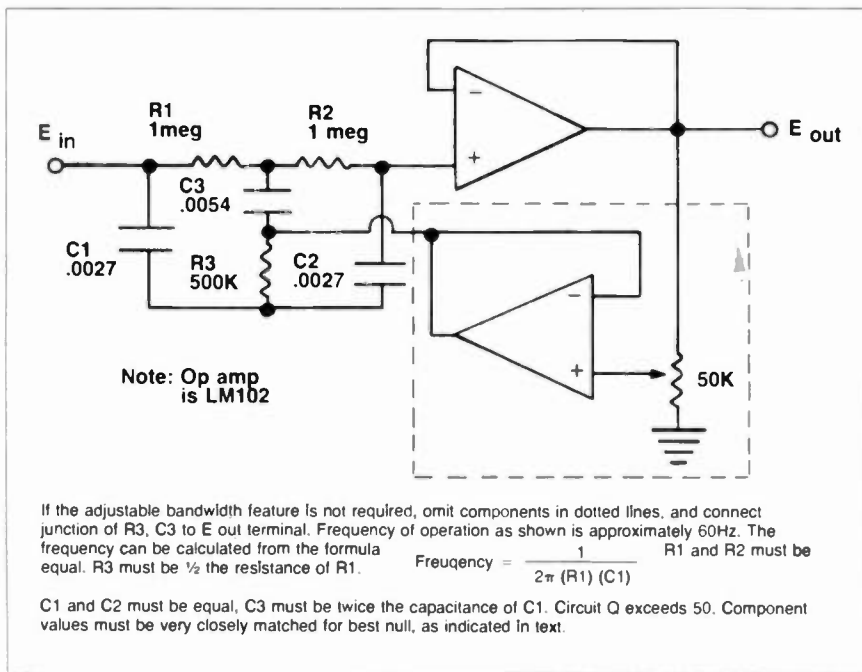

Fig. 5. An adjustable bandwidth notch filter (Twin T configuration).

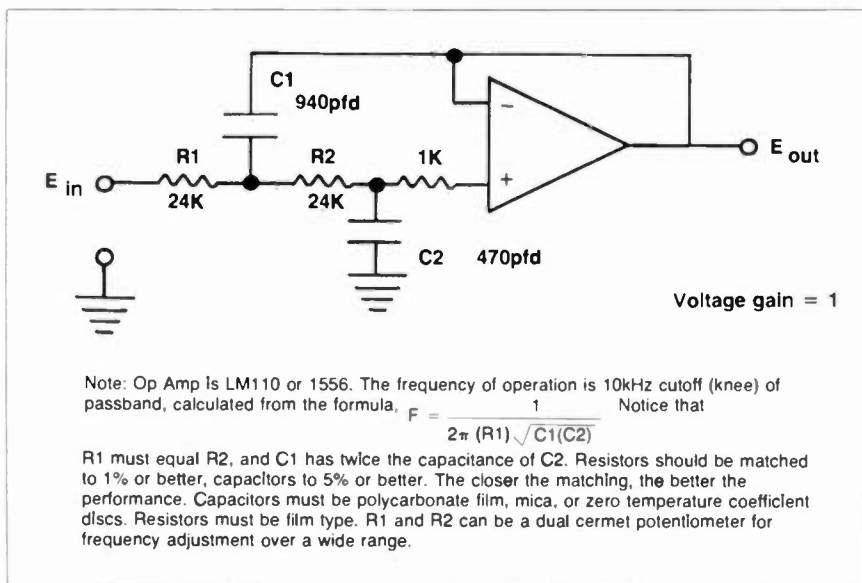

Fig. 6. A low pass filter.

circuit offers a Q up to 1000 or more, and gain in the hundreds of times. (The higher Q settings yield the higher gains.) Unlike most configurations which use more components, and are more difficult to adjust, this circuit is based on the "Wien Bridge", and offers ease of adjustment. For better high frequency performance, try an LM318 op amp in this circuit. Stability depends upon the quality of components used, with polycarbonate film capacitors preferred in the larger sizes, and mica or zero temperature coefficient ceramics used for the smaller values. All resistors should be metal film, while the potentiometers are "cermet" element, multiturn preferred. Changing the value of BOTH capacitors changes the range of operation, the smaller capacitors providing the higher

frequencies.

Figure 4 is the schematic of another bandpass filter with adjustable frequency and bandwidth. This one uses both positive and negative feedback, has high gain, high Q, and the frequency can be readily calculated for your own designs. Large changes in frequency can be made by changing the values of C1 and C2, which must always be equal. Changes in frequency over a ten to one range can be made by means of the potentiometer, which should be a good quality unit, in which the sections track each other closely. As is the case with Figure 3, the input should be driven from a low impedance such as an op amp or an emitter follower. The output of Figure 4 should drive a high impedance, such as the non inverting input of

an op amp or the input of an emitter follower. The 1000 ohm resistors are used to limit the range of the pots and are considered to be, with them, single resistors (part of the potentiometer resistances) for frequency calculation.

Figure 5 illustrates a high Q notch filter (band reject filter). By adding the components in the dotted area, adjustable Q can be provided. It is best to stay with resistor values between 10,000 ohms and 1 megohm, . . . (we chose the larger value resistors in order to use small capacitors at the low frequency involved). The closer the components are matched to the ratios described in the illustration, the better the null will be. Figure 6 illustrates a very handy low pass active filter with 40 db per octave roll off after the knee of the curve is reached.

This circuit can be made adjustable by ganging R1 and R2. This circuit is a voltage follower, with unity gain, due to the fact that the output is directly connected back into the inverting input. The output impedance is very low, and will drive most normal loads without problems. The input should be from a low impedance source.

Figure 7 is the same circuit as Figure 6, with the components reversed in order to provide high pass filter action. It is difficult to provide adjustment of frequency, since the two resistors, R1 and R2 are not equal, and therefore tracking becomes a severe problem. (When ganged pots are used in these active filters, they MUST be high grade units in order to provide the stability, and the close tracking required).

"Poles", "orders", and decibels . .

As you read about active filters in other literature you will find references to "filter poles", "filter order", and "db per octave" . . . plus a lot of other terminology that tends to be very confusing. In a general way, here is how to make some sense of this for practical applications. A "pole" is usually an "RC element" in active filters, thus a filter circuit with one element would have one pole. The "order" of the filter is directly related to the number of poles . . . it can be said that a two pole filter is a "second order filter", a three pole filter is a "third order filter", etc. The attenuation, or roll off, of a filter is directly related to the number of poles, having 6 db per octave, per pole. Therefore a second order filter would roll off at the rate of 12 db per octave, while a third order filter would roll off at 18 db per octave, and so forth.

As you can readily see, the resistors

and capacitors used determine the performance of the active filter . . . and often must be very closely matched. When CDA's are used, the required biasing networks and current limiting resistors pose a problem since they offer parallel resistance networks, effectively upsetting resistor matching, etc. I strongly recommend that you read the "Linear Applications Handbook", available from the National Semiconductor Corporation, at the cost of a few dollars. It provides thorough coverage of a wide variety of op amp applications, including CDA's and active filters.

Op amp destruction modes

It is helpful to know the things that can cause an op to fail. Of course the usual things apply, overvoltage on the supply bus, excessive current due to improper load, etc. However, the op amp is very vulnerable at its input, in two ways. First, the differential voltage between the two inputs cannot exceed the rated value, and second, the input voltage usually cannot be driven higher than the positive supply voltage nor lower than the negative supply voltage. In the case of a single power supply, the input cannot be driven below ground.

Some trouble shooting notes . . .

As noted in Part I of this series, the input to the op amp is reduced to close to zero when the feedback loop is closed. The gain of the op amp IC itself is not reduced at all. For example, if we are using an op amp with an open loop gain of 100,000 and a closed loop gain of 100, with a supply voltage of 20 volts, the output signal swing cannot exceed 20 volts and the input cannot exceed 100 microvolts! (20 volts divided by the gain of 100,000.) With the feedback loop closed, the gain will drop to 100, and we can not apply a signal of 200,000 microvolts (200 millivolts) to the input because the feedback loop reduces the input signal to 200 microvolts! The signal source resistance must have a fairly high internal impedance, or else we must add a resistor in series with the op amp input, as shown in the schematic of the inverting op amp in Figure 8, in order to prevent short circuiting the signal source by the low input impedance of the op amp. (in the inverting mode only). What happens is that the signal of 200 millivolts is reduced to 200 microvolts at the op amp end of the input resistor, due to the negative feedback. This reduction of the signal to an extremely low level has led to such statements as, "The inverting input is a virtual ground", implying that any signal fed into it will be reduced to zero. Actually, the signal is reduced to an extremely low level, but not to zero. Many oscilloscopes do not have sufficient gain to see signals below one millivolt, and this can lead the service technician to erroneous conclusions . . . like assuming that there is no input to the op amp, when, in fact, the circuit is operating exactly as it should! Even worse, the distortion products fed back into the input via the feedback loop will now be very large in comparison with the reduced input signal, and the input, if it can be seen at all, will appear to be a bunch of spikes, noise, and odd waveforms!

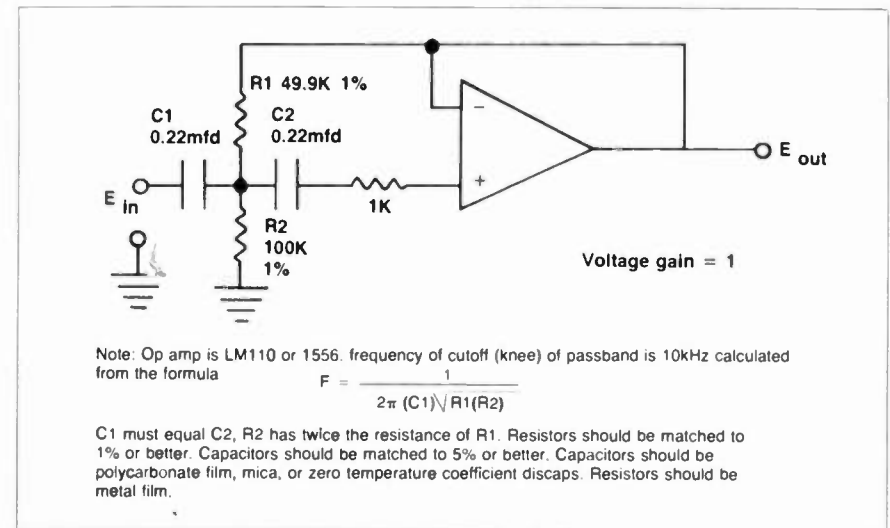

Fig. 7. A high pass filter.

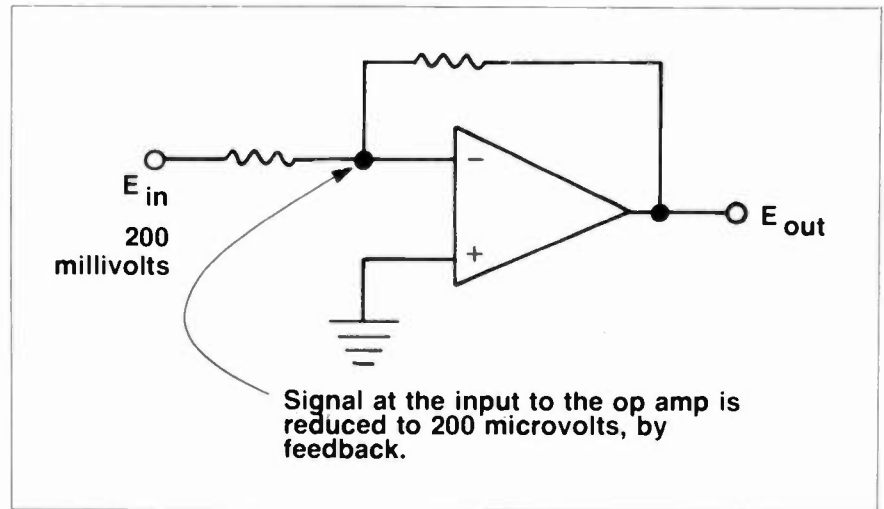

Fig. 8. An inverting op amp.

In normal use, the op amp has close to zero differential input voltage, due to the action of the inverse feedback. If you open the feedback loop, or ground it out somehow, the differential input can rise in some circuits and exceed the input rating. *Shorting and opening the feedback loop are no-no's in troubleshooting op amps!*

Well, for the perservering reader who

has come through all five parts of this series . . . five months is a long time. All things must end . . . and it is time to end our discussion of op amps. But let me hasten to state that we have only scratched the surface of this vast subject of op amps. Many ingenious circuits exist, and we have only explored a few of the most basic. Hopefully the reader will use this introduction to follow the subject a little further. Most of the op amp manufacturers offer literature, either free, or at very reasonable charge. They are a very good starting point for a basic library about op amps.

Remember, op amps are finding new uses every day, and your study of the subject will certainly find good use both in your work and your personal life. Where can you buy four versatile amplifiers for around a buck? That has to be the best buy around, and you can bet the electronics industry people aren't losing sight of that fact! Skill in applying op amps can be a very saleable commodity . . . so, sharpen up your op-amp skills. **ETD**

CET quiz IX

Radio & TV

This entire quiz is on radio and television fundamentals. It should be a good review to help you get ready for the CET tests. Why not take the test soon and surprise yourself with how much electronics knowledge you really have and didn't realize? See if you can get more than 75% on this quiz.

By Frank Egner

Questions 1 through 15 refer to figure 1.

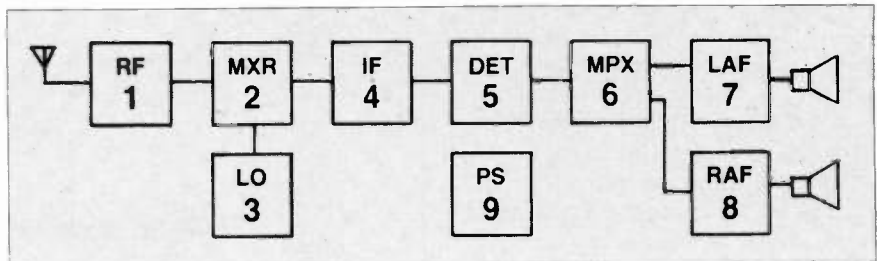

Figure 1 used for questions 1 through 15.

1. The block diagram indicates this is
 - a. AM stereo receiver.
 - b. FM stereo receiver.
 - c. Shortwave receiver.
 - d. May be any of these.
2. Block 1 will accept frequencies of:
 - a. 540 to 1610 KHz.
 - b. 30 to 50 MHz.
 - c. 88 to 108 MHz.
 - d. 1540 to 2610 KHz.
3. If an SCA signal is being received, it could be recovered at the output of block:
 - a. 6
 - b. 4
 - c. 2
 - d. 5
4. A complementary-symmetry amplifier circuit might be used in:
 - a. Blocks 7 and 8.
 - b. Block 6.
 - c. Block 4
 - d. Blocks 2 and 3.
5. The signals present at the output of block 5 during a stereo broadcast are:
 - a. The monaural and pilot signals.
 - b. L + R and L - R sidebands.
 - c. L - R sidebands and monaural signals.
 - d. L + R, pilot, and L - R sidebands.
6. The range of frequencies that may appear at blocks 7 and 8 area:
 - a. 50 Hz to 15 KHz.
 - b. 60 Hz to 5 KHz.
 - c. 50 Hz to 20 KHz.
 - d. 60 Hz to 7.5 KHz.
7. Some receivers stabilize the local oscillator by using _____
 - a. AGC.
 - b. AFC.
 - c. ACC.
 - d. AFT.
8. To decode the stereo signal, a carrier of _____ must be developed.
 - a. 19 KHz.
 - b. 10.7MHz.
 - c. 455 KHz.
 - d. 38 KHz.
9. If present, the SCA signal must be filtered out. The SCA filter must respond to:
 - a. 4.5 MHz.
 - b. 10.7 MHz.
 - c. 67 KHz.
 - d. 38 KHz.
10. Good quality receivers include block 1. An advantage of block 1 is:
 - a. Broadcast band image rejection.
 - b. Improved signal to noise ratio.
 - c. Broader selectivity.
 - d. More than one but not all above.
11. There is no receiver output. The first test should be made at:
 - a. Block 9.
 - b. Blocks 7 and 8.
 - c. Block 5.
 - d. Block 3.
12. The bandwidth authorized by FCC for this type transmission is:
 - a. 75 KHz.
 - b. 150 KHz.
 - c. 200 KHz.
 - d. 20 KHz.
13. The circuit within block 5 could be a:
 - a. Grid or base leak detector.
 - b. Slope detector.
 - c. Ratio detector.
 - d. Infinite impedance detector.
14. The block *least* likely to use a unipolar device is:
 - a. Block 1.
 - b. Block 2.
 - c. Block 4.
 - d. Blocks 7 and 8.
15. Block 3 must be operational over the range of:
 - a. 98.7 to 118.7 MHz.
 - b. 995 to 2065 KHz.
 - c. 88.7 to 108.7 MHz.
 - d. 40.7 to 60.7 MHz.
16. Which of the following are compatible by FCC regulation?
 - a. Monaural and multiplex FM receivers.
 - b. Monochrome and color TV receivers.
 - c. Both a and b.
 - d. Neither a nor b.
17. In the 6 MHz TV channel at the transmitter, the sound carrier is lo-

cated exactly:

- a. 250 MHz below the channel upper frequency.
 - b. 250 KHz above the channel lower frequency.
 - c. 4.5 MHz below the picture carrier frequency.
 - d. 920 KHz below the color subcarrier.
18. In the TV IF passband, the color subcarrier is located:
- a. 3.58 MHz above the picture carrier.
 - b. 920 KHz above the sound carrier.
 - c. 1.5 MHz below the picture carrier.
 - d. 600 KHz below the sound carrier.
19. To develop linear sweeps in vacuum tube TV receivers, the yoke must be driven by:
- a. Sawtooth voltages.
 - b. Trapezoidal currents.
 - c. Sawtooth currents.
 - d. Trapezoidal voltages.
20. Coaxial cables may be connected to TV receivers using a balun. This device is:
- a. An impedance matching device.
 - b. An attenuator network.
 - c. An RC time constant network.
 - d. A circuit to attenuate ghosts.
21. The vertical sync pulse is used to initiate:
- a. The vertical blanking period.
 - b. The start of the vertical trace.
 - c. The horizontal blanking period.
 - d. The vertical retrace cycle.
22. The vertical sync pulse is serrated into six pulses. This is necessary to:
- a. Properly charge the integrator.
 - b. Prevent overcharging the differentiator.
 - c. Maintain horizontal stability.
 - d. Prevent vertical retrace lines.
23. Maximum conduction of the video diode detector:
- a. Can be during sync or video time.
 - b. Occurs during video signal time.
 - c. Always occurs during sync pulse time.
 - d. Occurs during brightest picture peaks.
24. A TV receiver is tuned to channel 10 (192-198 MHz). The L/O operates at 239.25 MHz. The sound and video IFs at the mixer output are:
- a. S: 41.25 MHz, V: 45.75 MHz.
 - b. S: 47.25 MHz, V: 51.75 MHz.
 - c. S: 41.5 MHz, V: 46.0 MHz.
 - d. S: 31.5 MHz, V: 36.0 MHz.
25. Video amplifiers use peaking coils to compensate for attenuation of:
- a. Audio frequencies.
 - b. Mid-range frequencies.
 - c. Low frequencies.
 - d. High frequencies.

Answers on page 49

Would you pay \$20 a month for a highly skilled technician?

Here's your opportunity!

Computech is solving problems across the country and overseas!



Our exclusive COMPUTECH manual is an organized, easily accessible source of solutions to those frustrating "tough-dog" service problems. Most importantly, this manual is expanded and updated each month to keep you in step with the rapidly changing television industry.

COMPUTECH can save hours of frustrating and unprofitable diagnostic time!

It's the largest collection of symptoms and solutions to "tough-dog" problems yet compiled.

The manual now contains approximately 10,000 symptoms and cures.

- indexed numerically by SAMS number
- symptoms listed alphabetically for faster access
- monthly updating provided
- contains step-by-step procedures to locate the most difficult problems.
- standardizes your trouble shooting techniques.
- excellent training aid.
- at a cost of less than 2¢ per solution — you can't afford not to!

Over the past two years "COMPUTECH" has combined hundreds of hours of experience by professional technicians with the unique advantage of a computer to produce an attractive, easy to read, 8½"x11" binder that contains the type of information needed to make TV servicing faster, easier, and more profitable.

COMPUTECH — AT TODAY'S PRICES... YOU CAN'T AFFORD NOT TO!

COPYRIGHT © 1980

Call us direct (801) 277-2655 or mail this coupon today.

COMPUTECH	ETD
4685 Holladay Blvd. Salt Lake City, Utah 84117 Phone (801) 277-2655	
Please send my COMPUTECH manual on the following basis:	
<input type="checkbox"/> A trial issue for \$29.95 plus postage and C.O.D. charges.	
<input type="checkbox"/> My yearly subscription updated monthly on the basis of \$20.00 per month plus postage and C.O.D. charges.	
<input type="checkbox"/> Or, my yearly subscription for \$240.00 which includes all monthly updating and postage.	
Name _____	
Service Company _____	
Phone _____	
Address _____	
City _____ State _____ Zip _____	



4685 Holladay Blvd.
Salt Lake City,
Utah 84117
Phone (801) 277-2655

Circle No. 101 on Reader Inquiry Card

TEST INSTRUMENT REPORT

This month we are going to discuss two quite unrelated products, both of which are, however, very useful.

Micro Design recently sent us a portable microfiche reader. With more and more service data available on microfiche—often less costly than standard printed copy, and an obvious choice for outside service—the Micro Forty-Four is very logical for field service or when a compact unit is needed on the bench. The Micro Forty-Four's screen is about 4 inches square, which seems a small

By Walter H. Schwartz

area on which to project a standard $8\frac{1}{2} \times 11$ inch page. I had no trouble reading any of the text or schematics viewed, however. Focus and brightness are good.

The Micro Forty-Four measures about $3 \times 5 \times 12$ inches, and is obviously very portable; it has as accessories a soft carrying case, an ac adapter, a cigarette lighter adapter, and a battery holder. A hard carrying case also is available. Lenses are available for various magnifications.

We also received, some time ago, a circuit board prototype kit from Electronic Trend Products. This kit, ETP-II, contains all the equipment and supplies necessary to produce circuit boards and panel labels of up to 6×9 inches. Major components of the kit are an ultraviolet exposure unit, a high speed drill, trays, developer, etc., and a timer. A variety of glass laminate board and label material also is included.

I have worked with various circuit board

processes off and on for a long time, but certainly am not expert in any way. The kit processes required a little learning; our first try didn't look very good. With a little practice, very acceptable boards resulted. To produce a board, the pattern is laid out with drafting aids on transparent drafting film using a 0.1 inch grid behind it for accuracy. The pattern is placed on the resist coated board and exposed, developed and etched—a straightforward process.

We used—copied—a circuit board layout from *Weekend Projects For the Radio Amateur*. The circuit selected was a power supply regulator board measuring about 2×4 inches. Our first attempt did not etch properly; streaks of copper were left on the board. We looked things over and carefully tried again. This time we produced an acceptable board. A little experience and experimentation is very useful.



Electronic Trend Products ETP-11 prototype kit. For more information Circle 151 on the Reader Service Card.

Schematics and circuit boards



Micro Design's Micro Forty-Four. For more information Circle 150 on the Reader Service Card.

A microfiche reader and a prototype kit.

SECURITY PRODUCTS



Control System

Circle No. 136 on Reader Inquiry Card
Vicon Industries, Inc. has recently introduced the VPS1200 microprocessor-based command control center. Featuring continuous signal polling and restoration, the VPS1200 Control incorporates non-volatile EAROM computer memory, alarm processing, and status reporting. Through an integrated software library, the VPS1200 Control processing unit permits operation of up to 256 remote receivers and 48 remote operator consoles. Designed for system expansion, additional interfaced remote operator consoles offer optional time/date display, variable speed, and audio switching functions. The VPS1200 Microprocessor-based control system automatically adjusts voice-grade compatibility and operates at distances of up to five miles between video stations in the most demanding security environments.

Radio Monitoring System

Circle No. 137 on Reader Inquiry Card
Seaboard Electronics Company manufactures three levels of Long Range Radio Alarm Monitoring Systems. The Model M-1A System has the capacity to monitor up to 16 zones of information at each of up to 10,000 remote locations. The system is 100 percent solid state and microprocessor based. Alarm transmissions are sent over UHF and 21VHF radio frequencies. The use of telemetry encoding assures reliable performance. This is a one-way system. The Model M-2 System adds the ability for a central station to supervise or poll

each of the remote locations via radio transmissions. At the top of the line, the Model M-3 System has the ability to



control, from the central station, electrical relays located at the remote locations through a computer. With the cost of telephone lines skyrocketing, Radio Alarm Systems for security can be considered as an alternative to conventional digital communications which rely on the services of the Bell Telephone System.

Alarm System

Circle No. 138 on Reader Inquiry Card
 The *Aritech* 230 alarm system can be installed with up to 15 of a wide variety

of intrusion detection sensors: ultrasonic or passive infrared, wall ceiling corner shelf mount, transceivers or range expanders, surface or flush mount, white or brown, long range or wide angle. One system with one power supply, one relay output, one quad cable; with the most appropriate sensor for each pro-

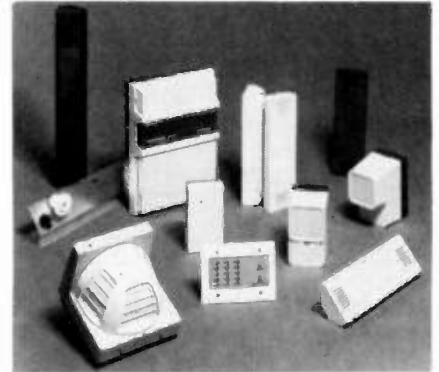

tected area being selected. Each 230 sensor has independent signal processing. Background disturbances in one room reportedly do not affect detection in another room. This permits high sensitivity, minimizes false alarms, and allows daytime walktesting. An LED light on each sensor and on an optional remote annunciator indicates which sensor is in alarm. This permits walktesting and allows for troubleshooting.

PUBLIC NOTICE

Do you understand the new

RCA

Start-up and shut-down circuits?

We at METS are willing to bet that you haven't even seen a schematic that shows how **this** circuit is wired . . . much less how it works! *†£*
(Yet you will soon be required to work on them)!

FURTHERMORE,

unless you are using METS literature you will **never** know just how easy it is to troubleshoot the start-up/shut-down circuits in RCAs CTC 85-86-88-89-90-91-92-93-96-97-99-107-108-109.

PROVE IT TO YOURSELF

Send us \$3.95 and we will send you the above procedures. Then you will know once and for all who writes the best service literature.

Our exclusive Time-Lapse® Schematic Pictorials all but eliminate reading (just follow the pictures) — We explain in detail how it works, how it is wired, and how to fix it —

METS, Box 8228, Amarillo, TX 79109

(Don't forget to include your name, address, city, state & zip)

Circle No. 111 on Reader Inquiry Card

Glass Break Detector

Circle No. 139 on Reader Inquiry Card

A new sound discriminator is now available from *Unisec, Inc.* This model uses the Unisec "Audio Force" detection technique which permits adjustment of both volumetric and frequency discrimination of sounds of breaking and en-

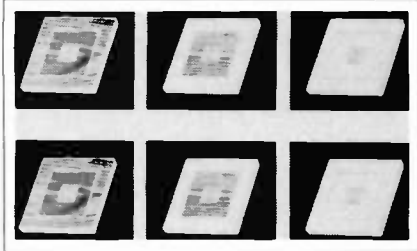

tering, either through glass, wood or other surfaces. Based on the principle that shock waves produced by breaking sounds disperse in a different manner depending upon the total space into which they dissipate, the AFD-5000 provides a range of adjustments to accommodate areas up to 1200 sq. ft. and will detect glass breaking up to 15 feet. Adjustments through the use of digitally coded dip switch permits finite steps of adjustment which may be recorded and repeated. Power requirements of each self-contained AFD-5000 is 11 to 14 vdc

at 20 ma. Output is a pair of normally closed contacts. Detectors may be paralleled on a four conductor telephone type cable or, when using the audio listen-in feature, a four conductor shielded cable should be used. The AFD-5000 Audio Force Detector is designed with choice of decorative decal for both residential and commercial applications and eliminates the need for individual glass break sensors in areas with several windows and doors.

Infrared Sensor

Circle No. 140 on Reader Inquiry Card

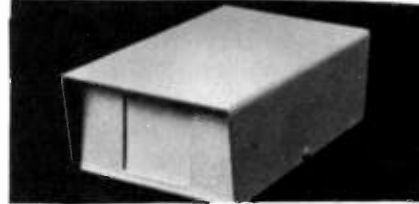

Salco recently announced a new micro-power passive infrared system called The Infra Sensor 455[®]. The unit has a range of up to sixty feet, requires no external power, and has the unique feature of connecting to a loop without having to observe polarity. An installer can now increase coverage in new or existing systems, by merely splicing anywhere into a protective loop and is ideal

with wireless systems. Infra Sensor 455[®] comes in an all metal enclosure to increase RFI immunity.

Digital Key Package

Circle No. 141 on Reader Inquiry Card



SenDEC Corporation has packaged a 5 digit code digital keypad with an electric door strike and a power transformer. The Push Button Keying Package, suitable for counter display, contains the necessary components to secure a wooden door with field programmable access control. The SenDEC Push Button Key can be used in controlling access to areas such as computer rooms, file rooms and stock areas.

SEE WORKMAN'S NEW ASSORTMENT OF SWITCHES

Appearance and function are offered in a wide selection of types. For use in Alarms, Communication Equipment, Data Processing, Electronic, Medical, Office and Computer Applications.



- Slide Switches
- Rotary Lock Switches
- Subminiature Toggle Switches
- General Purpose Toggle Switches
- Miniature Snap-In Paddle Switches
- Miniature Snap-In Rocker Switches

WEP

Workman Electronic Products, Inc.
75 Packinghouse Rd. • P.O. Box 3828
Sarasota, Florida 33578
Phone 813 371 4242 • TWX 810 864 0401

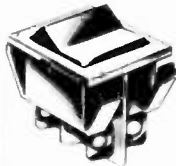

Circle No. 109 on Reader Inquiry Card

STOP LOOKING



WE ALREADY HAVE AN
EASY WAY
TO UNDERSTAND ELECTRONICS

WHAT MAKES DIGITAL THINKING
SO EASY?

All other manuals teach you to understand a **working** circuit.

DIGITAL-THINKING

teaches you **how** to understand **any** circuit that is **not** working!

D-T is an actual ten-hour self-study course on troubleshooting. It comes complete with three test sections.

ONLY \$89⁰⁰

METS, Box 8228, Amarillo, TX 79109

(Don't forget to include your name, address, city, state & zip)

ATTENTION SKEPTICS: Digital Thinking is an entirely new approach to explaining electronics. The **DT** approach is so **new**, so **simplified**, and so **effective** that we don't even expect you to believe it until you have seen it with your own eyes. For this reason, we are extending this special offer. Send us \$3.00 for postage and handling, and we will mail you four pages from the D-T manual that will show you just how simplified electronics can be. After reading the samples you will be delighted with the \$89.00 price tag.

Circle No. 112 on Reader Inquiry Card

BULLETIN BOARD

A new data book detailing the specifications of discrete semiconductor components for hybrid circuit manufacture has recently been published by *Motorola*. The new Discrete Hybrid Components Data Book covers 10 different discrete-product categories, including a variety of transistor, diode, thyristor and optoelectronic lines, and includes five different packaging methods: standard chips (dice), flip-chips, Micro-T[®], SOT-23 and SOT-89. The book includes an easy-to-use cross reference between standard discrete packaged devices and equivalent unencapsulated chips, and provides both electrical and physical data for each of the chips. All Hybrid components described in the Data Book are available from Motorola or through authorized Motorola Hybrid Components distributors.

Circle No. 125 on Reader Inquiry Card

Simpson Electric Company is offering their **new 64-page four-color catalog** 5100 listing their complete line of stock analog and digital panel meters, meter relays, controllers, sound level meters and test instruments. New products in the catalog include Simpson's compact Model 467 Digital Multimeter with Digalog[™] Display and the new 3300 Series Meter Relays. For a free copy of the Simpson Catalog 5100, write to Simpson at 853 Dundee Ave., Elgin, IL 60120.

Circle No. 126 on Reader Inquiry Card

A new catalog from *Exact Electronics* covers over 30 models of Function Generators, Combination Pulse/Function Generators, Materials Test Generators, Arbitrary Waveform Generators, IEEE-488 Programmable Generators and Precision Current and Voltage sources. A convenient instrument selection chart is included along with worldwide sales and service offices.

Circle No. 127 on Reader Inquiry Card

A new application note from *Hewlett-Packard*, AN 222-4, "Guidelines For Signature Analysis" assists designers and engineers in designing or retrofitting microprocessor-based products for signature analysis testability and serviceability. The note's guidelines

answer questions commonly asked, and help the user understand signature measurement. Some of the topics covered in this comprehensive 34-page note include: How signature measurements are made by Hewlett-Packard signature analyzers, guidelines for controlling the rate through the start, stop and clock inputs, how measurements of three-state nodes are treated, getting correct, repeatable and stable signatures, and when noise can and cannot affect the signatures. Special emphasis is placed upon creating stable and repeatable signatures so that correct signatures can be documented in a troubleshooting procedure. When that goal is met, then incorrect signatures obtained during troubleshooting will accurately indicate incorrect or intermittent circuit behavior. Application Note 222-4, "Guidelines for Signature Analysis" is available without charge from Hewlett-Packard.

Circle No. 128 on Reader Inquiry Card

Full line of desoldering equipment for the removal and replacement of printed circuit board components is detailed in **two-section full color catalog** from *Air-Vac Engineering Company, Inc.* Section one details vacuum desoldering stations, desoldering tools, tips and accessories which utilize a tubular tip to transfer heat to individual solder joints and high vacuum to completely remove solder, leaving leads and plated-through holes totally clean. Section two details Reflow Modules which flow molten solder against complete lead pattern of any size multi-lead pattern for desoldering, resoldering, a selective soldering.

Circle No. 129 on Reader Inquiry Card

A 16 page reference brochure from *Data Precision* describes a broad range of digital instrumentation including: 5½ digit and 4½ digit lab and systems multimeters; 4½ digit portable/bench DMM's; 3½ digit hand held portable DMM's; DC Voltage/Current Standards; Analog Multiplexer; 488 Interface; Frequency Counters; Capacitance Meter and Thermometer. Also included is a complete range of options and accessories.

Circle No. 130 on Reader Inquiry Card

The 64-page **1981 Power Source Engineering Guide** from *Semiconductor Circuits* features 20-pages of test and applications techniques, circuit and terminology definitions and performance criteria. The reader is then invited to select the "best supply" for his needs from among the 20 families of industry-standard ac/dc, dc/dc and off-line

switch-mode power sources described in the remainder of the guide. Complete electrical and mechanical specifications, and available options are presented for each product family, ranging from ultra-miniature 24-DIP dc/dc converters to 125 watt off-line switch-mode power supplies and uninterruptible power systems. In-depth discussions of thermal management, power routing, input line transient suppression techniques and much more appear in the Applications Section.

Circle No. 131 on Reader Inquiry Card

A new illustrated instruction booklet that describes how to thread holes, rods, or pipes is being introduced by *Henry L. Hanson, Inc.* The Ace Hanson Tap & Die Instruction Booklet provides a step-by-step outline of how to thread a hole with a tap, or thread a rod or pipe with a die. In addition to explaining tap and die nomenclature and types of threads, it shows how to properly measure external and internal threads. Illustrated with photos and diagrams, the 6-page Ace Hanson Tap & Die Instruction Booklet contains a handy tap-drill sizing chart. It also lists many of Hanson's home and industrial cutting tools, tap wrenches, and die stocks. The Ace Hanson Tap & Die Instruction Booklet is enclosed with all Hanson Tap & Die Sets, or offered free from Henry L. Hanson, Inc. of 200 Brooks St., Worcester, MA 01606.

Circle No. 132 on Reader Inquiry Card

A newly revised 24 page catalogue of CCTV lenses, lens accessories, video access control, portable surveillance systems and convert or overt CCTV housings is now available from *Visual Methods Incorporated*. The updated catalogue not only comprehensively encapsulated VMI's unusual line, but also provides useful charts and tables to aid in CCTV system design. For a free copy contact: Visual Methods Inc., 35 Charles St., Westwood, NJ 07675.

Circle No. 133 on Reader Inquiry Card

A new, 144 page catalog has recently been issued free by *Electronic Tool Co., Inc.* The catalog is a buyer's guide illustrating thousands of electronic tools, tool kits, test equipment and related products. Included in the newly updated ETCO catalog is an extensive and expanded section on quality tool kits of interest to those engaged in repairing, maintaining and servicing electronic and electro-mechanical equipment. Name brand hand tools, as well as an extensive coverage of test equipment are also fully illustrated and

described in detail. All products shown in the ETCO catalog are in-stock and available for immediate shipment. The catalog can be obtained by contacting Electronic Tool Co., Inc, 101 Castleton St., Pleasantville, NY 10570.

Circle No. 134 on Reader Inquiry Card

Semitronics has recently issued a special **60-page catalog and specifications guide**. This Semitronics Guide contains specifications for over 7,000 types of the most popular semiconductors, including silicon and germanium transistors,

SCR's, Triacs, Diacs, rectifiers, diodes, zeners, transient suppressors, special assemblies and packages. Units have operating voltages to 1,000 volts and current to 300 amps. Of special interest is the Semitron Economy line of small signal bipolar transistors, EIA, MPS, PN and European types in T05, T072, T092, T0105, and T0106 mountings. It reportedly features many semiconductors which have been discontinued by other manufacturers. Semitronics can reportedly provide many hard to obtain semiconductors.

Circle No. 135 on Reader Inquiry Card

24 good reasons why you'll enjoy this *free* gift from TCG.



The top two dozen replacement semiconductors at your fingertips...packaged for convenience...identified for accuracy...priced for profit. And now organized for faster servicing in this TCG 304A Kit.

A total of 50 pieces—all fast movers—inventoried according to known service demand. **Each piece is individually boxed and shows the device type, rating limits, package diagrams and replacement equivalents for easy cross-reference.**

Yours free...with purchase of a TCG 304A Organizer...this 40-pc. Socket/Ratchet Set • Combination 1/4" and 3/8" drive • Metric and Inches • Heavy chrome plated.

For sparkling benefits, look for the green diamond at your TCG Distributor—your source for quality semiconductors.

New-Tone Electronics, 44 Farrand St., Bloomfield, NJ 07002
(201) 748-5089 • (212) 732-1376.

TECHNICIAN COMPONENTS GROUP 

Circle No. 115 on Reader Inquiry Card

BOOK REVIEWS

ET/D has not had a book review column for some years now; this reintroduces what will be a regular department, since good books for the service industry are continually being published. To begin the column again, we have just received from McGraw-Hill/Byte Books and from McGraw-Hill Book Company, *Build Your Own Z80 Computer* by Steve Ciarcia and *Intuitive IC Electronics* by Thomas M. Frederiksen. *Build Your Own Z80 Computer* is the first such book I have read that does a reasonably good job of telling the non-digital technician how to build a microcomputer, how to program an EPROM, build a CRT terminal and interface a microcomputer to the real world. I recommend it for anyone wanting to build a microcomputer from scratch.

Do you like to know how electronic devices really work? Not just the mathematical expression for what goes on? *Intuitive IC Electronics* presents a very good picture, non-mathematically, of what happens inside a diode, a transistor, an IC. Well illustrated, it shows exactly how those electrons behave in a diode or a junction or field-effect transistor. Even if you are fairly comfortable with mathematics as an explanation this will make things clearer. Covered are diodes including Zener action and varactors, high conduction diodes, tunnel diodes and Schottky diodes and LED's and light detecting diodes; bipolar transistors including a brief account of processing; IC's and field-effect transistors of several types. Some mathematics is used but it is explained well. This book is highly recommended for the technician who wishes to know how semiconductor devices really work.

I have recently come across a book that has been out for a year or so, but does deserve notice, even now. *The Theory and Servicing of AM, FM, and FM Stereo Receivers*, by Clarence R. Green and Robert M. Bourque, published by Prentice-Hall, is by far the best book on the general principles and servicing of radio broadcast receivers I have seen for quite a while. The theoretical background material presented is up to date and the coverage is thorough. It does an excellent job, for example, of explaining FM and FM-stereo demodulator systems includ-

continued on page 47

NEW PRODUCTS



Signature Analyzer

Circle No. 143 on Reader Inquiry Card

The *B&K-Precision* product group of Dynascan Corporation has recently announced its new model SA-1010 Signature Analyzer. The new instrument is designed to simplify and reduce the cost of troubleshooting complex digital and microprocessor-based products. The SA-1010 reportedly allows semi-skilled technicians to troubleshoot microprocessor-based products down to the component level, by making simple comparisons of "digital signatures." And, instead of the common practice of swapping boards in the field to locate a suspected problem, the field engineer can use the SA-1010 to localize the problem and replace only the board or components found to be defective. When the data probe of the SA-1010 is applied to a circuit node, the instrument converts the lengthy bit stream present into a unique four-digit hexadecimal type display. To locate a problem, the field engineer traces through the circuit comparing the observed signatures to those identified on a schematic diagram or service manual of the product under test. When a node is reached that has a correct input signature and incorrect output signature, the problem has been isolated. For a fast field check of the board only, signatures can be observed at the board interconnection points and compared with data in a simplified field test procedure. The SA-1010 is a multi-family instrument, usable with TTL, MOS and CMOS logic circuits. For user convenience, a 1MHz TTL clock synchronizing output is featured on the rear panel. The instrument is supplied with detachable

probe assembly, control and data pods, and vinyl pouch for storage of probes and manual.

Digital Power Source

Circle No. 144 on Reader Inquiry Card

A new digitally programmable power source for use with automatic test equipment, exercisers, measurement systems and diagnostic equipment is available from *Kikusui International Corporation*, a subsidiary of Kikusui Electronics Corporation. Called the



Model DPSV 20-1, this new instrument provides a bi-polar, constant voltage output of -20v to $+20\text{v}$ at 0.05a to 1a . It features an accuracy of 0.05% and a response time of $500\mu\text{s}$ from minus to plus full scale. The 20-1 incorporates a

unique design that includes the DAC, high accuracy power supply and binary interface circuitry in a single integral package. This is in contrast to most manufacturers who treat DPSs as hybrid systems with the problems of mixing and matching two or more "black boxes." This multiple black box design of a DAC and standard off-the-shelf power supply requires multiple "power on" circuits that can introduce spikes and incremental startup time lag. It also requires interconnect cabling that contributes to EMI, copper loss and noise. The 20-1 can be programmed to respond to a wide range of control signals such as polarity, strobe, data clear, range, direct zero, address, standby, set, direct standby and output voltage. It will also provide status signals including address valid, data accepted, overdata, range incorrect, thermal down, ready and current limit. For IEEE bus applications, Kikusui offers an interface device that will control up to fifteen power sources. A fully programmable read/write controller and a manual controller/exerciser also are available. In addition to the 20-1, there are fourteen other models in the line including current programmable and voltage programmable series in voltage ranges from 0 to 100v and

COMPUTED STEP-BY-STEP

UNIVERSAL

TROUBLESHOOTING PROCEDURES

(as described by ET/D Editor Walter Schwartz in July 81 issue)

that cover 41 different circuits from AGC, SCR horiz sweep, color, video, vertical and IF, to the new RCA auto start-up/shut-down circuits... and more. The METS Dog-Catcher Series is the easiest to follow, most innovative, yet universal troubleshooting system ever published—everything is written in **plain** English. Over 9,000 TV shops now use it on a daily basis. The Dog-Catcher Series is so extremely effective that it all but eliminates the necessity to take the same voltage or resistance reading more than once. Furthermore, it requires nothing more than a volt meter (no other test equipment). The entire system is ONLY \$121⁹⁵.

METS, Box 8228, Amarillo, TX 79109

(Don't forget to include your name, address, city, state & zip)

Circle No. 113 on Reader Inquiry Card

with current capacities from 0.02 to 5 amps.

Logic Probe Tester

Circle No. 145 on Reader Inquiry Card

The new Model 205 "Catch-A-Pulse" hand-held logic probe and Model 205-K kit, recently introduced by the *Triplet Corporation*, provides a means of analyzing and troubleshooting logic gates and sequential circuits such as flip-flops, counters, registers and microprocessors. The probe is similar in size to a felt-tip marker pen and has a shirt pocket clip. It provides a visual (LED) display of Hi, Lo, pulsing or open circuit logic probes, which are referred to on the probe's Truth table. The "Catch-A-Pulse" logic probe automatically adjusts



to the proper DTL, TTL, MOS, CMOS or Microprocessor circuit thresholds when its leads are connected to the IC circuit power supply. Power supply reverse polarity protection is also provided. The input impedance of the probe's tip becomes a slave to the circuit under test, causing it to react to whatever signal or logic condition is present. The probe's memory automatically resets every 50 microseconds to observe and display another pulse. The Triplet "Catch-A-Pulse" logic probe circuitry has built-in current limiting for intermittent or low duty cycle over-voltages. The Model 205 "Catch-A-Pulse" comes complete with one year warranty, detachable 6 ft. coiled cord with mini-alligator clips, instruction manual and clear plastic carrying case.

Digital Multimeter Probe

Circle No. 146 on Reader Inquiry Card

The Digi-Check from *Energy Electronic Products Corp.*, is a 3½ digit hand-held multimeter consisting of two probe tips connected by a lead. The hand units are

basically the same size as conventional probe tips. They contain the instrument with digital display, a power supply with IC battery charger, and the test lead.



Specifications include a dc voltage range of 0.1mv to 500v, an ac voltage range of 10mv to 500v, resistance measurement from 0.1 Ω to 20 meg, automatic polarity indication and auto zero.

Hand Held Power Meter

Circle No. 147 on Reader Inquiry Card



F.W. Bell, Inc., has recently introduced a new Hall effect power meter that reads real power on circuits from dc to 1kHz to 199.9kw and to 150 a (to 300 a with slightly reduced accuracy), and with a range to 480vac and 600vdc. Fully portable, the new meter, Model PC200D, has a three-and-a-half-digit LCD and automatic decimal shift. The PG200D may be used on conductors up to ¾-in. in diameter. It utilizes the pistol shape of Bell's hand-held current meters, and weighs 1 lb.

Power Line Noise Detector

Circle No. 148 on Reader Inquiry Card

A portable test instrument, formerly manufactured by Millen, for detecting power line noise interference and verifying when the problem has been corrected has recently been introduced by *Caywood Electronics, Inc.* The Millen Type 71001 Power Line Noise Interference Detector is a passive, portable test instrument that helps determine if EMI/RFI noise problems are coming in on the ac or dc power line, or being generated by some device on the line. Used with an oscilloscope or panel-meter-equipped radio receiver, it can also be used to confirm that the noise problem has been corrected. Sensitive only to

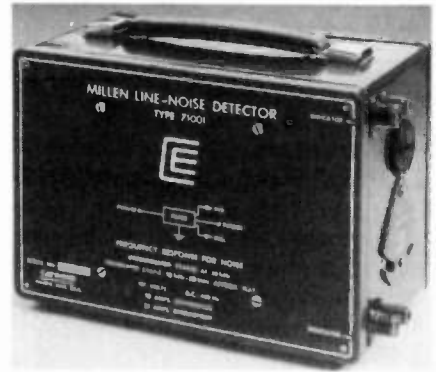

EMI/RFI noise on power lines, the 8 in. H \times 6 in. W \times 11 in. L, 11 lb. Millen Type 71001 Power Line Noise Interference Detector incorporates a damped filter that rings slightly allowing pulses to show up on a narrow band oscilloscope. The sensing elements in the filter are not traversed directly by line current, and are immune to saturation effects that could distort results.

Miniature Soldering Station

Circle No. 149 on Reader Inquiry Card

A new miniature soldering station from *Wahl Clipper Corporation* operates on 6w (ac), allowing for safe soldering on miniature circuits and instruments as well as on heat-sensitive components. The model 7230 is suited for production line operations, or anywhere where fine, close work is required. Principal performance features of the 7230 station include a double-insulated transformer, a tip-cleaning sponge, sponge well, spring holder, indicator lamp and internal safety fuse. Fourteen tips from 1/25

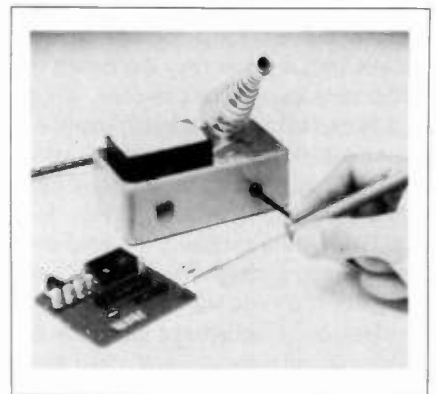

to 5/32 in. are available, and can be interchanged quickly without special tools. Tips cool down fast from 360°C, and resist seizure. A 6w iron similar to the 7230's is offered separately. The model 7240 iron has a 4-ft pigtail which connects to a transformer on an ac or dc power source. With a variable power source, the 360°C temperature can be lowered for special applications. A 3/32-in. tip is standard, but many shapes and sizes are available.

True RMS Analog Voltmeter

Circle No. 152 on Reader Inquiry Card

The Model MV-800 Analog Voltmeter from IET Labs, Inc. is a true RMS instrument and will therefore accurately present the effective power of waveforms which depart from a true sine wave. Fifteen ranges are provided from 30 μ v full scale to 300v, and from -90 dB full scale to +50dB in decades. Readings as low as -105dB are therefore accomplished. A front panel bandwidth switch permits a choice of wide band measurements, standard first order audio bandpass (20-20kHz) or "External Filter." A group of standard cus-

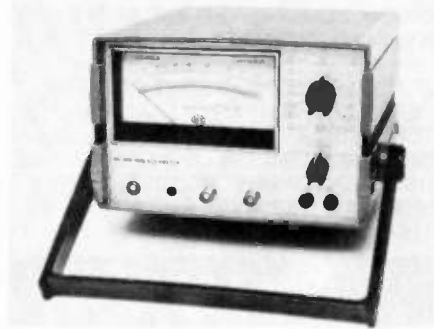

tom plug-in filter modules are available from IET. The Model MV-800 can be used as an oscilloscope preamplifier through the use of its front panel BNC output jack. A chart recorder, DVM, X-Y plotter, etc. may be connected to the rear BNC connector for permanent records of readings or "under-over limits" observations. This terminal provides a linear dc output of 0-1 volt proportional to meter deflection. Due to its internal Nicad battery pack, the Model MV-800 may be totally isolated from the power line and external grounds. Ground loop problems are therefore minimized, and measurements can be made at or near the power line frequency without "beating" when using sensitive scales. The unit may be used on the ac line during battery recharging and a "BATTERY TEST" position on the range switch reads battery condition. An LED indicates the requirement to recharge batteries before they have become discharged to a point which causes erratic readings.

Tool Case

Circle No. 153 on Reader Inquiry Card

Vaco Products Company's new Tool Bvx Super Case No. 70470, has recently been introduced. This new tool case contains a selection of 29 professional hand tools in a vinyl zipper case with retractable handles for easy carrying. The assortment of tools includes a variety

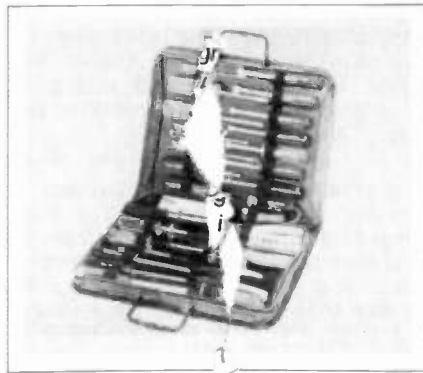

of screwdriver styles, AT follow shaft nut drivers, wiring and crimping tools, electrical testers, and special problem solving tools such as a magnetic screwdriver, spring tool, adjustable plier, hex key wrench set, and convertible snap ring plier. Each tool is held by a heavy duty elastic band which makes it easy to remove the tools, yet holds them in place. The combination of a broad representation of the Vaco tool line and a lightweight case makes the Tool Bvx Super Case useful as a distributor salesman's sample case, as a serviceman's case, or for use around the home.

TV Bar/Dot Mixer

Circle No. 154 on Reader Inquiry Card

The Signal Source 1207 from Visual Information Institute superimposes precise patterns (Bar, Dot, H Bars and V Bars) on a composite video signal for complete TV service and setup. The BAR pattern is useful in setting up proper deflection size and linearity of monitors or other display devices. Control of BAR width and spacing permits pattern to be used as a reference grid overlay for exacting measurements. The DOT pattern is used universally with the EIA Linearity Chart 1961 to set and check camera tube linearity. This pattern may also be used as a reference overlay on the normally televised image. The 1207 is designed for portable laboratory or field use with carrying handle. It is also available in a rack-mount cabinet for inclusion into TV equipment installations.

BOOK REVIEWS

continued from page 44

ing phase-locked-loops. Six of the book's twenty chapters cover troubleshooting thoroughly, from analyzing voltage readings to replacing the defective part, on both solid state equipment and older tube type units. This book is an excellent reference for any technicians library. W.H.S

SIMPLE SIMON KITS

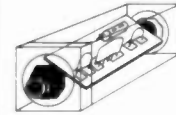

ZYZX
VHF-UHF WIDEBAND
ANTENNA AMPLIFIER
MODEL ALL-1
50 MHz — 900 MHz
12 dB GAIN \pm 0.5dB

SIMPLE SIMON ELECTRONICS
INTRODUCES

**A REVOLUTIONARY NEW ONE STAGE
HYBRID IC BROADBAND AMPLIFIER**

This unit is not available anywhere else in the world. One unit serves many purposes and is available in Kit or Assembled form. Ideal for outdoor or indoor use. Input-output impedance is 75 ohms. Amplifier includes separate co-ax feed power supply. Easily assembled in 25 minutes. No coils, capacitors etc. to tune or adjust.

ALL-1 Complete Kit plus Power Supply \$24.95
ALL-1 Assembled / Tested plus Power Supply \$34.95

7 + 11 PARTS KITS

MITSUMI VARACTOR

UHF TUNER
Model UES-A56F

\$34.95

Freq. Range UHF470 — 889MHz
Antenna Input 75 ohms
Channels 14-83 Output Channel 3

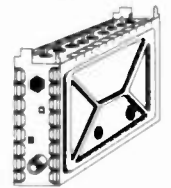

KIT NO.	PART NO.	DESCRIPTION	PRICE
1	VT1-SW	Varactor UHF Tuner, Model UES-A56F	\$34.95
2	CB1-SW	Printed Circuit Board, Pre-Drilled	18.95
3	TP7-SW	P.C.B. Potentiometers, 1-20K, 1-1K, and 5-10K ohms, 7-pieces	5.95
4	FR35-SW	Resistor Kit, 1/4 Watt, 5% Carbon Film, 32-pieces	4.95
5	PT1-SW	Power Transformer, PRI-117VAC, SEC-24VAC, 250ma	6.95
6	PP2-SW	Panel Mount Potentiometers and Knobs, 1-1KBT and 1-5KAT w/Switch	5.95
7	SS14-SW	IC's 7-pcs, Diodes 4-pcs, Regulators 2-pcs Heat Sink 1-piece	29.95
8	CE9-SW	Electrolytic Capacitor Kit, 9-pieces	7.95
9	CC33-SW	Ceramic Disk Capacitor Kit, 50 W.V., 33-pieces	5.95
10	CT-SW	Variable Ceramic Trimmer Capacitor Kit, 5-65pfd, 8-pieces	5.95
11	L4-SW	Coil Kit, 18mhs 2-pieces, 22 μ hs 1-piece (prewound inductors) and 1 T37-12 Ferrite Toroid Core with 3 ft of #26 wire	5.00
12	ICS-SW	I.C. Sockets, Tin Inlay, 8-pin 5-pieces and 14-pin 2-pieces	1.95
13	SR-SW	Speaker, 4x6" Dual and Prepunched Wood Enclosure	14.95
14	MISC-SW	Misc. Parts Kit Includes Hardware (6/32, 8/32 Nuts, & Bolts), Hookup Wire, Ant. Terms, DPDT Ant. Switch, Fuse, Fuseholder, etc.	9.95
When Ordering All Items, (1 thru 14), Total Price			139.95

ANTENNAS & ACCESSORIES

STVA-1STV	Yagi Antenna, 13.5 dB, 75 ohm Chan. 42-54	\$9.95
STVA-2STV	Yagi Antenna, 13.5 dB, 75 ohm Chan. 20-28	9.95
	CX-75 Coaxial 75 ohm Low Loss Ant. Cable	\$.12 P/FT.
	F-59 Coaxial Connectors ea	\$.39
	MT-1 Special UHF 75-300 OHM Matching Transformer ea	\$1.45
	ALL-1 Indoor/Outdoor HYBRID IC Wideband VHF-UHF-FM 75 OHM Antenna Amplifier Kit	\$24.95
	Assembled	\$34.95

Mail Order Only — Send Check or Money Order To:

SIMPLE SIMON ELECTRONIC KITS

Calif. Orders:
3871 S. Valley View, Suite 12, Las Vegas, Nevada 89103
Tel: (702) 322-5273

All Other Orders:

11850 S. Hawthorne Blvd., Hawthorne, Calif. 90250
Tel: (213) 675-3347

Minimum Order: \$19.95. Add 10% Shipping and Handling.
For Orders over \$40.00, Add 5% Catalog \$1.00.
— VISA and Mastercard Acceptable —

Circle No. 121 on Reader Inquiry Card

CLASSIFIED

RATES: 60 cents per word (minimum charge, \$20). Bold face word or words in all capital letters charged at 85 cents per word. Boxed or display ads charged at \$75 per column inch (one inch minimum). Agency commissions will be given only when camera-ready art is provided by agency. For ads using blind box number, add \$5 to total cost of ad. Send ad copy with payment to Dawn Anderson, ELECTRONIC TECHNICIAN/DEALER, 1 East First Street, Duluth, MN 55802.

BOX NUMBER REPLIES: Mail box number replies to: ELECTRONIC TECHNICIAN/DEALER, Classified Ad Department, 120 W. 2nd St., Duluth, MN 55802. Please include box number in address.

HELP WANTED

Fort Lauderdale area. Wanted inside Service Tech. for well established TV Sales and Service store. Full time job, good benefits and working conditions. Contact Service Mgr. 2750 E. Atlantic Blvd, Pompano Beach, FL 33062. (305) 941-1441 12/81

FOR RENT

SCHEMATICS - LIBRARY SERVICE. One month rental fee \$2.25. Membership card \$10.00. **ALL RIDERS** manuals and **SAMS** available for your use. **THE TV SHOP**, 530 Minnesota Ave., Fallbrook, California 92028. (Telephone 1-714-723-1302). 1/82

WANTED

MIRROR-IN-THE-LID, SPINNING DISK, AND OTHER PRE-1946 TELEVISION SETS, parts, literature wanted for substantial cash. Also need 12AP4, 9AP4, MW-31-3 picture tubes, and any information on projection sets made by **TELICON CORP.** of N.Y. in 1947. Arnold Chase, 9 Rushleigh Rd., West Hartford, CT 06117. (203) 521-5280. 3/82

WANTED: PICTURE TUBE REBUILDING EQUIPMENT working or not. Write or call Atoll Television, 6425 Irving Park, Chicago, Illinois 60634. Phone 312-545-6667. 11/81

BUSINESS OPPORTUNITIES

T.V. TECH'S

EXPAND YOUR EARNING POTENTIAL

Microprocessor technology is the way. New repair horizons open up to you when you know how to work on micro's, such as coin operated video games, pinball machines and many others. At E.I.B. we offer courses in microprocessor repairs at all levels. We can open up new earning potentials for you or your shop. Our courses are complete and comprehensive and will give you the practical know-how to get started. It will also provide a solid background to enable you to keep up with this fast changing business. Day and evening courses are available. For further information and an application Call 212-377-0369 (call collect). Write: **Electronic Institute of Brooklyn**, 4823 Ave. N., Brooklyn, N.Y. 11234.

PACIFIC BEACH, SAN DIEGO 17 years established TV rental and repair business. Main street shopping center, \$16,500. For details call 1-714-274-1161 or write shop owner **TELSTAR TV**, 16 Garnet Ave., San Diego, CA 92109. 11/81

Long established T.V. service business in excellent central Oregon Coast location. Complete tools and equipment for 2 techs. Long lease available. \$50,000 inventory and equipment at wholesale. Owner retiring. Ideal husband and wife operation. Price set to sell at \$35,000. **OREGON REALTY ASSOCIATES**, Box 28, Depoe Bay, OR. 97341 (503)765-2131. 11/81

Established TV & Stereo repair shop for sale So. West Mo. in Ozark hills, equipment and inventory plus 3 bedroom home in town on main highway. Details call 417-628-3840 or write Merle's TV, Box 178, Stella, MO. 64867.

TV Business in Central City, NE. COMPLETE! Small town, agricultural community. Great Potential. Inventory, building, truck and records \$45,000. Central Farm Development Co., 308-946-3263, Box 275, Central City, NE 68826. 11/81

FOR SALE

BAR graph voltmeter 10 element LED display. Smoked glass front, ready for panel mounting. 3 input ranges, requires 4 to 15-VDC supply. Send \$14.95. **FARTHEST FRINGE S.A.**, 101 Highway Blvd., N. Pekin, IL 61554.

NOVEMBER SPECIALS, Cable-Speaker Wire, 18 Ga.6c/ft. 24 Ga.Mini,3c/ft., Zip Cord, 18 Ga.Brown,6c/ft. COAX-RG-59/U, Black Or White Jacket,7c/ft. RG-58/U,8c/ft., RG-8/U,30c/ft., Micro 8/U,17c/ft., RG-62/AU, 10c/ft., UHF Connectors, PL-259-60c/ea. PL-258-99c/ea., UG-175 or 176, 19c/ea., M-358-2.50/ea. M-359-1.99/ea., SO-239-49c/ea., CZ Labs, 55 Railroad Ave, Gamerville, N.Y. 10923 (914)947-1554. 10/81

SATELLITE TELEVISION: Information on building or buying your own earth station. Six pages of what's needed, where to get it, costs, etc. \$4.00 to Satellite Television, RD #3, Box 140, Oxford, NY 13830. TF

TUBES—Receiving, Industrial and Semiconductors, factory boxed. Free price list. Low, low prices. **TRANSELETRONIC INC.**, 1365-39th Street, Brooklyn, N.Y. 11218E 800-221-5802, 212-633-2800.

25C1172B HORIZONTAL OUTPUT EQUIV-ECG 238, 20 LOT \$1.75, ECG 165 BULK 20 LOT \$1.75, 25C1308K BULK 20 LOT \$1.75, MICRO-WAVE KIT COMPLETE \$149 (3 LOT-\$300) WITH CABLES, CLAMPS CONVERTER FULL WARRANTY. RED-COAT ELECTRONICS, 66-15 THORNTON PLACE, FOREST HILLS, NY 11374. 212-261-9479. 11/81

Automobile radio and tape replacement parts: Delco, Chrysler, Philco-Ford, Motorola, Panasonic and many others. Large inventory. **Laran Electronics Inc.** 3768 Boston Road, Bronx, NY 10469 (212) 881-9600 out of New York state (800) 223-8314 TF

FOR SALE: Electronic test instruments in excellent condition; Hickok 532 30mhz oscilloscope; Hickok 257 rf. gen; Triplett 630NS VOM; Triplett 801 TVOM; Data Precision 175 DVM; Data Precision 5740 timer/counter; Heath 3121 curvetracer; much more! Call: 607-871-2451 or write: **RANDALL CON-SULTANTS, R.D. #1, Box 47, Arkport, New York 14807.** 11/81

SCRAMBLED-TV WHAT IT IS-HOW IT WORKS. New publication explains how the two encoding/decoding systems used today work. Theory, circuits, etc. Send \$9.95 to: Workshop, Box 393ETP Bethpage NY 11714. TF

Lowcost MATV/CATV equipments, needles, antennas, audio cables, speaker wires, tools, batteries, fuses, tapes, power cords, modular telephone accessories, transistors, connectors, switches, free catalog. 212-897-0509. D & W, 66-19 Booth, Rego Park, NY 11374. 11/81

SONY-PANASONIC-RCA-ZENITH-EXACT REPLACEMENT PARTS-LARGE INVENTORIES-SEND PART OR MODEL NUMBERS-WILL UPS OR COD-GREEN TELE RADIO DISTRIBUTORS, 172 SUNRISE HIGHWAY, ROCKVILLE CENTRE, N.Y. 11570. TF

SIMPLE SIMON 7 + 11 PART KITS

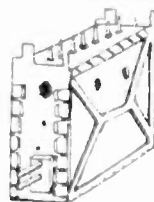

**MITSUMI
UHF
TUNER**

**PRICE
\$34.95**

Freq. Range UHF 470-889 MHz
Channels 14-83 Output Chan 3

- | | | |
|--|---|----------|
| 1 VT1-SW | Varactor UHF Tuner Model UES-A55F | \$34.95 |
| 2 CB1-SW | Printed Circuit Board Pre-Drilled | \$18.95 |
| 3 TP7-SW | P.C.B. Potentiometers 1-20K 1-1K & 5-10K OHMS. 7 pieces | \$5.95 |
| 4 FR35-SW | Resistor Kit 1/4 W. 5% Carbon Film. 32 pieces | \$4.95 |
| 5 PT1-SW | Power Transformer PRI-117VAC. SEC-24VAC. 250MA | \$6.95 |
| 6 PP2-SW | Panel Mount Potentiometers & Knobs 1-1KBT & 1-5KAT W/SW | \$5.95 |
| 7 SS14-SW | IC's: 7 ea. Diodes 4 ea. Regulators 2 ea. Heat Sink 1 ea. | \$29.95 |
| 8 CE9-SW | Electrolytic Capacitor Kit 9 ea. | \$5.95 |
| 9 CC33-SW | Ceramic Disk Capacitor Kit 50 W.V. 33 ea. | \$7.95 |
| 10 CT-SW | Variable Ceramic Trimmer Capacitors 5-65PFO 6 ea. | \$5.95 |
| 11 L4-SW | Coil Kit 2 ea. 18 MHS. 1 ea. 22 MHS inductances: prewound and 1 ea. T37-12 Ferrite Toroid Core with 3 ft. of #26 Wire | \$5.00 |
| 12 ICS-SW | I.C. Sockets Tin Inlay 5 ea. 8 Pin. 2 ea. 14 Pin. | \$1.95 |
| 13 SR-SW | Speaker Oval 4x6" & Prewound Wood Enclosure | \$14.95 |
| 14 MISC-SW | Misc. Parts Kit Includes Hardware, 6/32 & 8/32 Nuts & Bolts, H.U. Wire, Ant. Terms, DPOT ANT. SW., Fuse Fuseholder etc. | \$9.95 |
| *When Ordering All Items 1 Thru 14 Total Price | | \$139.95 |

ANTENNA & ACCESSORIES

- | | | |
|--|--|-------------|
| STVA-1-STV | Yagi Antenna 13 5 DB. 75 OHM. CHN 42 Thru 54 | \$9.95 |
| STVA-2-STV | Yagi Antenna 13 5 DB. 75 OHM. CHN 20 Thru 28 | \$9.95 |
| CX-75 Coaxial 75 OHMS Low Loss | | \$.12 P/FT |
| F-59 Coaxial Connectors ea. | | \$.39 |
| MT-1 Special UHF 75-300 OHM Matching Transformer ea. | | \$1.45 |
| A-1 Indoor VHF-UHF Antenna Amplifier with Power Supply 300 OHM IN & Out. APT 130c gain | | \$19.95 |

Min. Order Amount is \$19.95. Add 10% Shipping and Handling Over \$40.00 Add 5% Catalog \$1.00 Mail Orders Only

SIMPLE SIMON ELECTRONIC KITS

Calif. orders mail to
3871 S. Valley View, Suite 12
Las Vegas, NV 89103
(702) 322-5273

Other orders mail to:
11850 S. Hawthorne Blvd., Hawthorne
California 90250. Tel: (213) 675-3347

VISA — MASTERCHARGE ACCEPTABLE

PRINTED CIRCUIT BOARDS

- We manufacture PC Boards from your artwork.
- We can handle any size order
- only 35¢ per. sq. in. single side-45¢ double side
- drilling and tin plating at no charge
- S15 minimum order
- send check or money order to

International Circuit Company

903 Tyler Ave., Dyer, Ind. 46311 (219) 865-9925

FREE speaker catalog! Woofers, mids, tweeters, hardware, crossovers, grille cloth, plans, kits, information, much more. Discount prices. **UNIVERSAL SOUND**, Dept. ET, 2253 Ringling Blvd., Sarasota, FL 33577, (813) 953-5363. 1/82

"QUALITY ELECTRONIC PARTS AT WHOLESALE PRICES." ELECTRONIC DEALERS AND HOBBYISTS! Send your name and address for "free catalog" and be placed on mailing list for monthly specials. Free technical assistance available with order! R.L. Miller, Box 391 Bay Station, Dept. EDT 5 Brooklyn, NY 11235. TF

MECHANICALLY INCLINED INDIVIDUALS Assemble electronic devices in your home. Knowledge or experience not necessary. Get started in spare time. Turn your spare or full time into cash. No investment-Write for free details. **ELECTRONIC DEVELOPMENT LAB**, Box 1560B, Pinellas Park, FL 33565. TF

TV AND RADIO TUBES 49¢ EA!! Send for free color parts catalog. Your order free if not shipped in 24 hours. **Cornell Electronics** 4215-17 University San Diego California 92105. TF

OSCILLOSCOPES SPECIAL SALE-HP & TEK, 50MHZ DUAL TRACE, \$595. reg. \$695. Limited Quantities. Reconditioned, Calibrated, Guaranteed. Free Catalog. **A-OK ELECTRONICS**, 1445 NW. 9th St., Homestead, FL. 33030. (305)247-6349. 11/81

Collect your over-due bills for a nominal service charge. NO collection fees. Satisfaction guaranteed. Free information. **Charles S. Johnson**, Box 78, Colo City, Ariz. 86021.

SENCORE CB-42 automatic CB analyzer \$595.00; never used. In factory carton with warranty card. **Heinz TV**, 730 N. 81, Lincoln, NE 68505. 402-464-0197. 11/81

FOR SALE: TV Repair eqpt. and inventory. List of inventory and eqpt. available on request. Closing out a shop. Contact **Don** at **The Silencer Shoppe**, 3022 Sycamore Ave., Kingman, AZ 86401. Tel: 602-757-4744.

2 SC1172B's, 20 lot, \$1.79. 2 SC1308K's, 20 lot, \$1.79. Full size BSR changes, fully automatic, \$29.95. **Redcoat Electronics**, 66-15 Thornton Place, Forest Hills, NY 11374. 212-261-9479. 11/81

NEED A 470 MFD AT 75 WV (RCA #134179)? Norfolk got a replacement 470 mfd at 80 wv, pc at the right price—\$2.00 each/10 for \$19.00—f.o.b. **Garnerville, NY** 10923, **Norfolk Electronics**, P.O. Box 91. 1/82

PICTURE TUBE REBUILDING EQUIPMENT capable of producing four high quality tubes per day (**WILL TRAIN TO OPERATE**) Call or Write **Atoll Television**, 6425 Irving Park, Chicago, Illinois 60634, ph. 312-545-6667. 11/81

FOR SALE—PS29 Pushbutton Oscilloscope 2 probe. All leads included. Used only 10 hrs. \$500. **Arthur Annucci**—2122 West Saug Rd., Saugerties, NY 12477.

NEED A 4700 MFI 50 WV? NORFOLK'S got it at the right price—\$3.95 each—f.o.b. **Garnerville, NY** 10923. 1/82

SAMS Complete set 1-2039 plus 7 heavy duty 4 drawer cabinets excellent condition \$3,250.00 Also used test equipment. 5480 S. Waco, Aurora, CO 80015 (303) 690-3393. 11/81

SYSTEM 21



\$289.95
\$5.00 shipping

MICROWAVE TV SYSTEM

- Precision 25" Parabolic Antenna
- Prebuilt Converter and Preamp
- Assembled Power Supply
- Low-loss Coaxial Cables
- One Year Warranty
- Completely Built and Tested

DATA SERVICE CO.
3110 Evelyn Street
Roseville, MN 55113
612-636-9469

SATELLITE TV antenna, 10 ft. fiberglass, complete, polar mount, \$1,950.00, electronics at cost also. **KROMA ELECTRONICS**, 5344 Jackman Road, Toledo, OH 43613. 419-476-9131.

ELECTRONICS MAGAZINES Free subscriptions. List of 24, complete with instructions on how to qualify, Send \$4.50 for printing and handling. **EEL**, Box 165, LaPorte, IN 46350.

Answers to Electronic Quiz

- | | | | | |
|-----|------|------|------|------|
| 1.b | 6.a | 11.a | 16.c | 21.d |
| 2.c | 7.b | 12.b | 17.a | 22.c |
| 3.d | 8.d | 13.c | 18.b | 23.c |
| 4.a | 9.c | 14.d | 19.d | 24.c |
| 5.d | 10.b | 15.a | 20.a | 25.d |

Bring home the bacon.

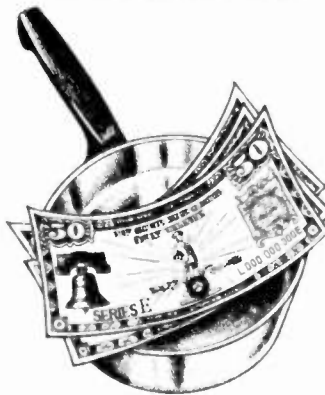

**Take stock in America.
Buy U.S. Savings Bonds.**

STATEMENT OF OWNERSHIP, MANAGEMENT AND CIRCULATION

Statement required by the Act of October 23, 1962, Section 4369, Title 39, United States Code, showing the ownership, management, and circulation of **ELECTRONIC TECHNICIAN DEALER**, published monthly at One East First Street, Duluth, MN 55802 as filed September 22, 1981.

The name and address of the Publisher is **Tom Greney**, 111 East Wacker Dr., Chicago, Illinois 60601.

The owners are: **Barclays Nominees Branches Limited**, 4 George Yard, Lombard Street, London E.C. 3, England; **Cede & Co.**, c/o The Depository Trust Co., Box 7547, Church Street Station, New York, New York 10249; **Mrs. Katherine Brace Cummings**, c/o Ernst, Cane, Berner & Gitlin, 7 West 51st Street, New York, New York 10019; **Ellen Knowles Harcourt**, William I. Jovanovich & Peter J. Ryan as Trustees U-T-A Dtd 5/23/66, c/o First National City Bank A-C, P.O. Box 2781, Grand Central Station, New York, New York 10043; **Mrs. Thekla E. Johnson**, 19 Hewitt Avenue, Bronxville, New York 10708; **Mr. Walter J. Johnson**, 19 Hewitt Avenue, Bronxville, New York 10708; **Mr. William Jovanovich**, P.O. Box 490, Briarcliff Manor, New York 10510; **Mr. Martin Revson**, 19th Floor, 445 Park Avenue, New York, New York 10022; **Rice & Co.**, c/o Agency The Toronto Dominion Bank, 42 Wall Street, New York, New York 10005; **Shaw & Co.**, c/o Morgan Guaranty Trust Company of New York, P.O. Box 491, Church Street Station, New York, New York 10008; **Mr. Joseph C. Sindelar**, 794 Park Boulevard, Glen Ellyn, Illinois 60137; **Mr. Robert J. Sindelar**, 80 Colonia Miramonte, Scottsdale, Arizona 85253; **Kray & Co.**, P.O. Box 10645, Newark, New Jersey 07101; **Pacific & Co.**, P.O. Box 7014, Church Street Station, New York, New York 10249.

The known bondholders, mortgages, and other security holders owning or holding 1 percent or more of total amount of bonds, mortgages or other securities are: None.

Names and addresses of individuals who are stockholders of the corporation which itself is a stockholder of the publishing corporation have been included in the two paragraphs above when the interests of such individuals are equivalent to 1 percent or more of the total amount of the stock or securities of the publishing corporation.

Average number of copies of each issue during preceding 12 months, and of single issue nearest to filing date, respectively, are as follows: Total number of copies printed (Net press run) 45,555-42,675; paid circulation (1) sales through dealers and carriers, street vendors and counter sales 0-0; (2) mail subscriptions 43,582-41,154; total paid distribution by mail carrier, or other means (1) samples, complimentary, and other free copies 870-567; (2) copies distributed to news agents, but not sold 0-0; total distribution 44,452-41,721; office use, left-over, unaccounted, spoiled after printing 1,100-954; total 45,552-42,675.

I certify that the statements made by me above are correct and complete.
(signed) **Joe Bilderbach**, VP/Circulation

Vital protection for PC Boards

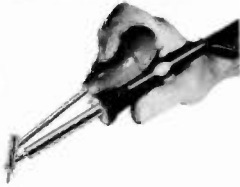

Be safe. Desolder PC components with Endeco irons. Get *proper* HEAT TO MELT and *strong* VACUUM ACTION TO LIFT solder and *cool* both PC board and component without damage.

These PC components replaced fast with Endeco desoldering or soldering tools.



Endeco professional features include safety light that denotes *high*, low and *off* on switch models, SS construction for long life, light weight and balance for easy use.

Contact your distributor for Endeco desoldering and soldering irons, kits and equipment—or write us today.

Enterprise Development Corp.

5127 East 65th Street
Indianapolis, IN 46220
Phone: (317) 251-1231

Circle No. 105 on Reader Inquiry Card

NATIONAL ELECTRONIC

NESDA

SERVICE DEALERS ASSOCIATION, INC.

Your KEY to SUCCESS

NESDA OFFERS

- A National Certification Program
- National Recognition
- Government Representation
- Business Contacts
- Purchase Discounts
- Low Bankcard Rates
- Educational Materials
- Industry and Business Information

PLUS

- A Subscription to "ServiceShop" Magazine and Yearbook

Please send more information about:

NESDA, 2708 West Berry St.
Ft. Worth, TX 76129

name _____

address _____

city _____ state _____ zip _____

business _____

AD INDEX

Circle No.	Page No.
101 Computech	39
103 Digitron Electro Corp.	9
104 Edtron Instruments	14
105 Enterprise Development Corp.	50
106 Electronic Book Club	15
107 Leader Instruments Corp.	Cov. 4
108 MCM Audio	Cov. 2
110 Mets System	9
111 Mets System	41
112 Mets System	42
113 Mets System	45
114 Mountain West	22
115 Newtone Electronics	44
116 Omnitron	6
117 Optima Electronics	14
118 PTS Electronics	13
RCA Distributor & Special Products Div.	8
119 RNJ Electronics	10
120 Sentrol Inc.	5
121 Simple Simon Electronics	47
122 Sperry Tech Inc.	22
123 Sprague Products Company	Cov. 3
124 Tele-Teck	11
109 Workman Electronics	42

SECURITY PROD.

Circle No.	Page No.
136 Vicon Industries, Inc.	41
137 Seaboard Electronics Company	41
138 Aritech 230	41
139 Unisec, Inc.	42
140 Salco	42
141 Sendec Corporation	42

BULLETIN BOARD

Circle No.	Page No.
125 Motorola	43
126 Simpson Electric Company	43
127 Exact Electronics	43
128 Hewlett-Packard	43
129 Air-Vac Engineering Company, Inc.	43
130 Data Precision	43
131 Semiconductor Circuits	43
132 Henry L. Hanson, Inc.	44
133 Visual Methods Incorporated	44
134 Electronic Tool Co., Inc.	44

135 Semitronics 44

NEW PRODUCTS

Circle No.	Page No.
143 B & K Precision	45
144 Kikusui International Corporation	45
145 Triplett Corporation	46
146 Energy Electronic Products Corp.	46
147 F.W. Bell, Inc.	46
148 Caywood Electronics, Inc.	46
149 Wahl Clipper Corporation	46
152 IET Labs, Inc.	47
153 Vaco Products Company	47
154 Visual Information Institute	47

TEST INSTR. RPT.

Circle No.	Page No.
150 Micro Design Micro Forty-Four	40
151 Electronic Trend Products ETP-11	40

This index is furnished for the readers' convenience. However, the publisher can not guarantee its accuracy due to circumstances beyond our control.



The Seal of Approval for the 47 million children and adults who suffer from lung disease. Use it. Don't let a single card or letter leave your house during the holidays without a people-helping Christmas Seal.

AMERICAN LUNG ASSOCIATION
The Christmas Seal People®

Space contributed by the publisher as a public service

You'll find **MORE** in wiring components at a Sprague Q-LINE™ Distributor

The next time you visit your Sprague distributor, look for the Q-LINE wiring component display. Here, you'll find it's easy to select exactly what you want in solderless terminals and wiring component accessories . . . shrink tubing, cable ties, cable clamps, terminal blocks, butt connectors, bullet connectors, quick-splices, end-caps, soldering aids, wiring tools, and component assortments. Everything is logically arranged for quick location.

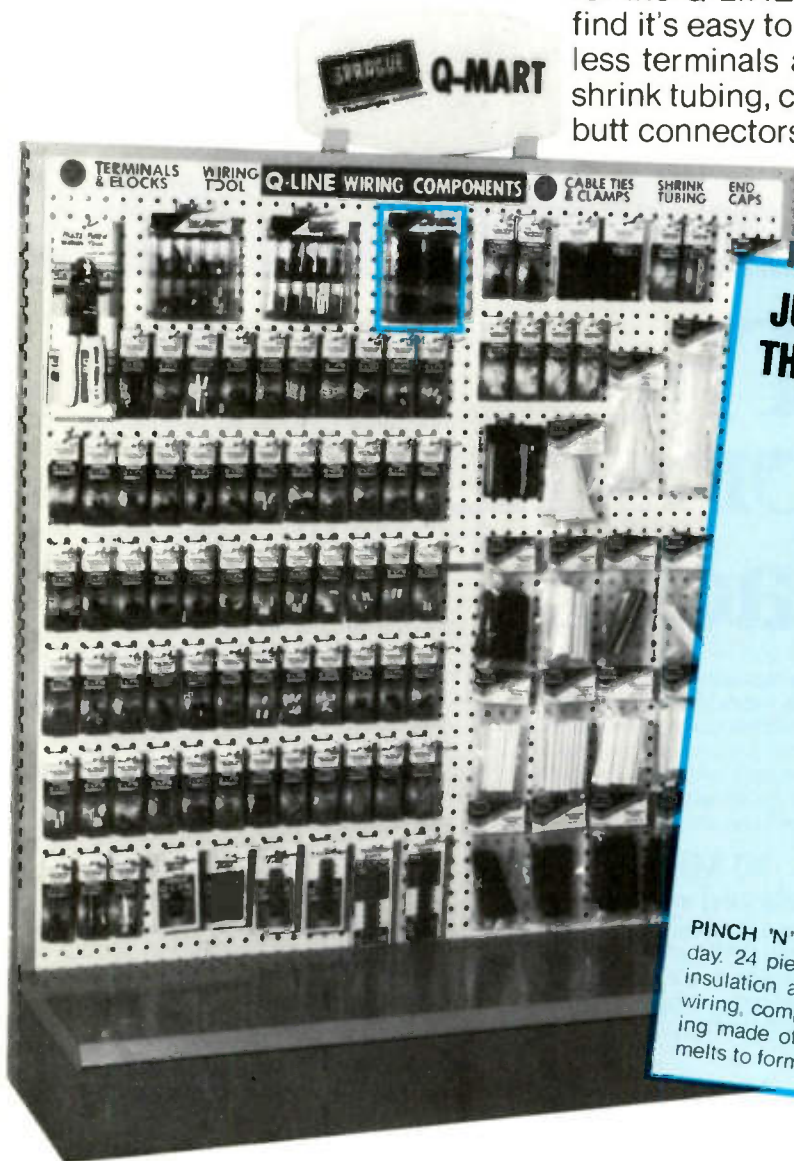

**JUST ONE OF DOZENS OF PRODUCTS
THAT CAN SAVE YOU TIME EVERY DAY.**



PINCH 'N' SEAL™ TUBING ASSORTMENT: Useful every day. 24 pieces in 4 frequently-needed sizes. Provide ideal insulation and strain relief for end cap terminations, worn wiring, component breakouts, fragile components, etc. Tubing made of dual-wall polyolefin. When heated, inner wall melts to form seal while outer wall shrinks to skin tight fit.

For detailed information on all Q-LINE products (capacitors, switches, chassis boxes, optoelectronic devices, DIP/SIP components, resistors, wiring components, etc.) write for 40-page Catalog C-652 to Sprague Products Co., Distributors' Division of the Sprague Electric Co., 65 Marshall St., North Adams, Mass. 01247.

Where MORE is more than a promise.



a subsidiary of **GK Technologies**
incorporated

Circle No. 123 on Reader Inquiry Card

10 to 50 MHz oscilloscopes with more performance and reliability than you ever thought possible.



It's easy to see why LEADER oscilloscopes are now specified more than ever. More performance and quality for less cost. And the best two-year warranty in the industry ... backed by efficient factory service depots on the East and West coasts.

A full-range of reliable, medium bandwidth oscilloscopes.

LEADER's oscilloscope line includes 12 single and dual trace models for bench and field use. All offer comprehensive triggering controls, TTL compatible Z-axis inputs, front panel trace alignment control and convenient, color-keyed front panel layout. Probes are furnished with every oscilloscope and options include probe pouches, carrying cases, front panel covers and rack mounting adapters.

50 MHz alternate time base.

LBO-517 gives you complex analysis capability with composite triggering

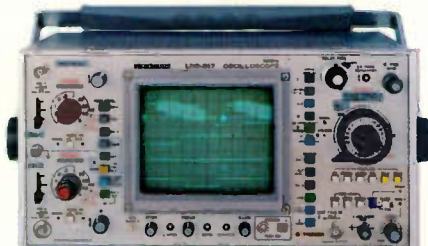

The LEADER LBO-517 with dome-mesh CRT displays bright, clearly defined traces at all sweep speeds and repetition rates.

The surprising leader.

and simultaneous main/delayed time base display on its dome-mesh CRT with 20 kV accelerating potential. Has 7 ns rise time, 5 mV/cm sensitivity with X5 multiplier for 1 mV/cm up to 10 MHz, 5 ns sweep speed with X10 magnifier, and 2 trigger view channels.

30 MHz delayed sweep.

LBO-515B is a dual trace oscilloscope using a 4-inch CRT with parallax-free internal graticule, 5 mV sensitivity, 120 ns signal delay, trigger hold-off, delayed sweep and x-y operation at full sensitivity.

35 MHz with signal delay.

The dual trace LBO-520A combines 10 ns rise time with 5 mV sensitivity and 120 ns signal delay lines. Has 5.6 kV PDA CRT with internal graticule.

20 MHz dual and single trace.

LBO-508A and LBO-507A have 17.5 ns rise time, X5 sweep magnifier, 10 mV/cm sensitivity and add/subtract modes.

10 MHz with 1 mV sensitivity.

LBO-514 features both vertical and horizontal X5 magnifiers, 1 mV/cm sensitivity and sweep speeds to 0.1 μ s/cm. (Single trace version, LBO-513.)

20 MHz battery/ac portable.

LBO-308S provides lab performance in field service applications. Dual trace, 2 mV sensitivity, 18 sweep divisions to 0.1 μ s/div with X5 magnifier, and 3-inch rectangular, internal graticule CRT. Optional battery pack recharges during ac operation.

LBO-308PL high performance version includes high intensity 10 kV CRT and signal delay lines.

Two-year warranty. Evaluation units.

Proven reliability lets us give a generous 2-year warranty ... backed by factory service on both coasts. Free, trial use of LEADER instruments is available to qualified companies.

Call toll-free (800) 645-5104 to request:

- an evaluation unit
- our 40-page catalog
- the name of your nearest "Select" distributor
- additional information.

When Quality Counts



380 Oser Avenue
Happauge, N.Y. 11787 (516) 231-6900
Regional Offices:
Cincinnati, Los Angeles, Dallas