

MARCH 1977 • 75 CENTS



A HARCOURT BRACE JOVANOVIICH PUBLICATION

ELECTRONIC TECHNICIAN/DEALER

WORLD'S LARGEST TV-RADIO SERVICE & SALES CIRCULATION



FR1W8262905-P2-
1
WILLIAM W FRISE
7176 GALE RD
ATLAS

AW -8783AL
AS

MI 48411

Servicers' Test Instrument Source Guide

Twenty Uses For Field-Strength Meters

Luminance-Related Faults In Modular Color

Scope Facts For Techs

THE BEST OF EVERYTHING HAS ITS PRICE ...EVEN TUNER SERVICE!

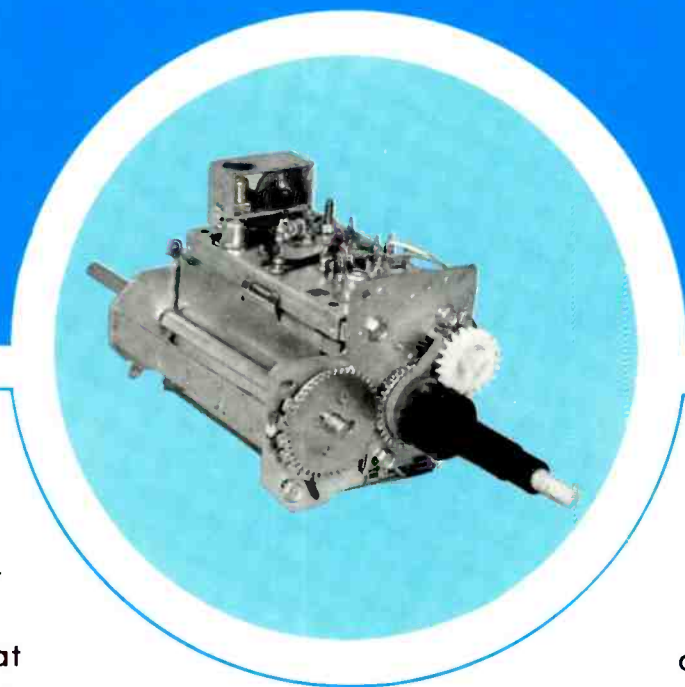

From the beginning, our goal has been to provide the best tuner service—never the cheapest. You get what you pay for in business and tuner service is no exception. The extra dollar you might pay at PTS is peanuts when you consider the added

reliability and the standards of excellence we apply to every job. Thousands of PTS customers must agree or we wouldn't be the world's largest tuner service company. When you are comparing tuner service companies, price alone doesn't tell the story.

SAME DAY SERVICE • ORIGINAL PARTS • ONE YEAR WARRANTY

**WE REPAIR THEM ALL . . . COLOR, BLACK & WHITE, TUBE,
TRANSISTOR OR ELECTRONIC/VARACTOR . . . ANY MAKE OR MODEL.**

VHF or UHF. . . \$11.95 UV-Comb. . . \$18.95

(MAJOR PARTS AND SHIPPING EXTRA — DEALER NET)



PTS ELECTRONICS, INC.

PRECISION TUNER SERVICE

General Headquarters: P.O. Box 272, Bloomington, IN 47401

THE COMPLETE LIST OF ALL PTS SERVICE CENTERS APPEARS ON THE NEXT PAGE.

...for more details circle 102 on Reader Service Card

LETTERS

AN OVERLOOKED ADVANTAGE OF WARRANTY SERVICING

I've read your editorial and the article about TV warranty servicing in the January 1977 issue of ET/D (What Servicers Say About TV Warranty Servicing) and want to congratulate the ET/D editorial staff for throwing some badly needed light on a subject which for a long time has needed this type of exposure.

However, there is one advantage of warranty servicing which was not mentioned in the article: the 'you scratch my back and I'll scratch yours' relationship which can and frequently does evolve between the warranty servicer and distributor and factory service people.

The resultant exchange of technical information helps all parties involved, and has proven more valuable to me than the gross income I've received from in-warranty servicing.

Consequently, I'll knowingly undertake a money-losing in-warranty service problem for any of my distributor service manager friends because I know that they in turn will help me with any difficult-to-diagnose servicing problem which I might encounter—regardless of whether it is an in- or out-of-warranty situation.

*Bob Baker, CET
Bob's TV Service
Billings, Montana*

BEFORE TACKLING DEFIBRILLATOR SERVICING

I would like to point out that servicing defibrillators is not as simple as Mr. Carr would have us believe ('Intro To Defibrillator Servicing, by Joseph J. Carr, December 1976 ET/D).

The simplified schematics in the article do provide a basic understanding of how a defibrillator operates, but will be virtually useless to a repairman confronted with an actual unit. The designs of defibrillators vary from one manufacturer to another....

Schematics and service manuals help alleviate this problem, but few hospitals have this type of information, and most defibrillator manufacturers are hesitant about sending such information to 'just anyone.'

Another point that should be brought out is the legal aspect of repairing medical electronic equipment...the technician who repairs any piece of medical equipment in most cases is then legally liable for the performance of that equipment.

The technician must keep in mind that: 1) he is dealing with emergency

resuscitation equipment, 2) people's lives depend on the equipment to operate properly and efficiently, 3) he may not be able to obtain the information necessary to repair such equipment, and 4) he can be held legally responsible for the operation of the equipment.

I suggest to any technician who is interested in entering the medical electronics field that he first obtain the necessary training before offering his services to any health care institution. After all, he'll not only be dealing with sophisticated equipment, he'll also be dealing with human lives.

*Jerry L. Painter, President
Central Iowa Biomedical Electronics Society
Iowa Lutheran Hospital
Des Moines, Iowa*

EXTENDED PARTS WARRANTIES FURTHER DECREASE SERVICERS' DWINDLING PARTS INCOME

In the article about TV servicers' attitudes toward warranty servicing in the January 1977 issue, you forgot to ask the surveyed servicers how they feel about the long warranty periods manufacturers have applied to parts such as CRTs and modules...

Most TV parts warranties are so long that by the time the warranty expires it is time for the owner to buy a new set...

Two manufacturers for whom I have done warranty servicing recently sent me the 'good news' that they now provide 'lifetime' warranties on their products. (Does this mean that I will have to wait until the customer dies before I can service his or her set on an out-of-warranty basis? If so, how do I contact them in heaven or hell to offer out-of-warranty service on their sets?)

I have given up all in-warranty servicing because, for example, I can't afford to repair a stereo for a service labor charge of \$9.50-\$12.50, including removing the defective parts and mailing them back to the manufacturer, who hopefully will send me a 'genuine replacement part' in return.

*Jim Covoserio
Rainbow TV Service
Richmond Hill, NY*

WANTED: YOUR COMMENTS & OPINIONS..

We at ET/D invite you to share with other ET/D readers your comments and opinions about controversial issues and/or business-related problems confronting the electronic service industry. Send them to: LETTERS TO THE EDITOR, ET/D, 1 East First St., Duluth, MN 55802. (Only signed letters will be considered for publication.)

YOU'VE GOT US WHERE YOU WANT US!

THE WORLD'S LARGEST TUNER SERVICE IS CLOSE TO YOU!

MIDWEST

Home Office
BOOMINGTON, IN 47401
5233 S. Hwy. 37, P.O. 272
812-824-9331

CLEVELAND, OH 44134
5682 State Road
216-845-4480

KANSAS CITY, KS 66106
3116 Merrifarm Lane, P.O. 6149
913-831-1222

MINNEAPOLIS, MN 55408
815-W. Lake St., P.O. 8458
612-824-2333

ST. LOUIS, MO 63130
6456 Page Blvd., P.O. 24256
314-428-1299

TROIT, MI 48235
13707 W. 8-Mile Rd.
313-962-1783

GRAND RAPIDS, MI 49501
1134 Walker Northwest
P.O. 1435
616-454-2754

CINCINNATI, OH 45216
8172 Vine St., P.O. 15491
513-821-2298

MILWAUKEE, WI 53218
7211 Fond du Lac
414-464-0789

COLUMBUS, OH 43227
4005 A.E. Livingston
614-237-3820

INDIANAPOLIS, IN 46202
28 E. 14th St.
317-631-1551

DAVENPORT, IA 52805
2024 E. River Dr., P.O. 187
319-323-3975

OMAHA, NE 68132
500B Dodge Street
402-558-1800

CHICAGO
Berkeley, IL 60163
1756 S. Tatt Street
312-449-2082

NORTHEAST

SPRINGFIELD, MA 01103
191 Chestnut St., P.O. 3189
413-734-2737

PHILADELPHIA
Upper Darby, PA 19082
1742-44 State Road
215-352-6609

PITTSBURGH, PA 15202
257 Riverview Ave., P.O. 4130
412-761-7648

E. PATERSON, NJ 07407
158 Market St., P.O. 357
201-791-6380

BUFFALO, NY 14212
993 Sycamore St., P.O. 1241
716-891-4935

BOSTON
Somerville, MA 02144
52 Holland St., Davis Sq., P.O. 187
617-666-4770

SYRACUSE, NY 13204
418 Solor St., P.O. 207, Solina St.
315-475-2330

BALTIMORE, MD 21215
5505 Reisterstown Rd.
301-358-1186

PACIFIC

SACRAMENTO, CA 95841
4611 Auburn Blvd., P.O. 41354
916-482-6220

SAN DIEGO, CA 92105
5111 University Ave., P.O. 5794
714-280-7070

LOS ANGELES, CA 90023
4184 Pacific Way
213-266-3728

PORTLAND, OR 97213
5220 N.E. Sandy Blvd.
P.O. 13096
503-282-9636

SEATTLE, WA 98109
432 Yale Ave. N., P.O. 9225
206-623-2320

MOUNTAIN

DENVER
Arvada, CO 80001
4958 Allison St., P.O. 672
303-423-7080

SALT LAKE CITY, UT 84106
1233 Wilmington Ave.
P.O. 6218
801-484-1451

PHOENIX, AZ 85061
2412 W. Indian School Rd.,
P.O. 27248
602-266-0582

SOUTHWEST

LONGVIEW, TX 75601
Mopac Rd., P.O. 7332
214-753-4334

OKLAHOMA CITY, OK 73106
3007 N. May, P.O. 60566
405-947-2013

HOUSTON, TX 77207
4326 Telephone Rd., P.O. 26616
713-644-6793

CANADA

MONTREAL, QUEBEC H2 P2 M4
8400 St. Laurence Blvd., Room 205
514-381-5838



PTS ELECTRONICS, INC.
PRECISION TUNER SERVICE

...for more details circle 102 on Reader Service Card

J.W. PHIPPS
Editor
1 East First Street
Duluth, Minn. 55802
(218) 727-8511

ALFRED A. MENEGUS
Publisher
757 Third Avenue
New York, N.Y. 10017
(212) 754-4382

TOM GRENEY
Publishing Director

DONALD W. MASON
Managing Editor

JOHN PASZAK
Graphic Design

DEBI HARMER
Production Manager

BERNICE GEISERT
Production Supervisor

LILLIE PEARSON
Circulation Fulfillment

GENE BAILEY
Manager, Reader Services

SUSAN HELLERMAN
Classified Ad Manager

DISTRICT MANAGERS

DAVE HAGELIN
43 East Ohio Street
Chicago, Ill. 60611
(312) 467-0670

CHUCK CUMMINGS
Ad Space South/West
613 North O'Connor
Irving, Texas 75061
(214) 253-8678

ROBERT UPTON
Tokyo, Japan
C.P.O., Box 1717

ELECTRONIC TECHNICIAN/DEALER

MARCH 1977 • VOLUME 99 NUMBER 3

THE COVER: The photo is of a typical electronic servicer using a field-strength meter to check TV antenna system performance. Twenty ways to use an FSM are described in the article which begins on Page 20.

16 Luminance Circuits And Problems In Modular Color TV

We trace the circuitry of the luminance sections of one of today's color TV chassis to see how it works—and offer troubleshooting methods for problems affecting brightness and video quality. By Don W. Mason.

20 Twenty TV-Related Uses For a Field-Strength Meter

Here are 20 useful applications for a field-strength meter in the testing and troubleshooting of the performance of a TV antenna system. By James E. Kluge.

27 Test Instrument Source Guide—For Entertainment/Two-Way Communications Electronics Servicers



A listing of test instrument manufacturers and the generic types of test instruments which are available from each for servicing consumer and communications electronic products.

36 Scope Facts For Techs

A review of specs and features which servicers should consider when selecting an oscilloscope. A TAB BOOK condensation, by Charles M. Gilmore.

DEPARTMENTS

1 LETTERS	48 NEW PRODUCTS
4 NEWS OF THE INDUSTRY	56 CLASSIFIED ADS
10 TECHNICAL LITERATURE	58 ADVERTISING INDEX
13 DEALER SHOWCASE	67 READERS SERVICE
46 TEST INSTRUMENT REPORT	69 TEKFAK

HBJ A HARCOURT BRACE JOVANOVICH PUBLICATION  

HARCOURT BRACE JOVANOVICH PUBLICATIONS: Robert L. Edgell, President, Lars Fladmark, Senior Vice President, Richard Moeller, Vice President/Treasurer, Thomas Greney, Vice President, Ezra Pincus, Vice President, James Gherna, Vice President, Lois Sanders, Vice President, George Glenn, Editorial Director.

ELECTRONIC TECHNICIAN/DEALER is published monthly by Harcourt Brace Jovanovich Publications. Corporate offices: 757 Third Avenue, New York, New York 10017. Advertising offices: 43 East Ohio Street, Chicago, Illinois 60611 and 757 Third Avenue, New York, New York 10017. Editorial, Accounting, Advertising Production and Circulation offices: 1 East First Street, Duluth, Minnesota 55802. Subscription rate: one year, \$8; two years, \$14; three years, \$18 in the United States and Canada. Other countries: one year, \$15; two years, \$24; three years, \$30. Single copies: 75¢ in the U.S. and Canada; all other countries: \$2. Second Class postage paid at Duluth, Minnesota 55802 and at additional mailing offices. Copyright © 1977 by Harcourt Brace Jovanovich, Inc. All rights reserved. No part of this publication may be reproduced or transmitted in any form or by any means, electronic or mechanical, including photocopy, recording, or any information storage and retrieval system, without permission in writing from the publisher.

POSTMASTER: Send Form 3579 to ELECTRONIC TECHNICIAN/DEALER, P.O. Box 6016, Duluth, Minnesota 55806.

Suddenly, you're the most versatile shop in town.

With this little 25-pound test jig, you can adapt to over 10,000 color sets, 59 different brands. Delta 70° and 90° tube, hybrid, transistor, SCR sweep. Anode voltages to 30kV and more. Regular 4.5kV and 7.1kV focus voltages.

And our new optional In-Line Test Kit lets you handle more than 100

precision in-line chassis, including RCA, Magnavox, Admiral and Sears. (We're the first test-jig manufacturer to offer a kit like this.)

CK3000 comes to you fully assembled, pretested and ready to use. Just plug it in, and you're in business. See it now, at your Sylvania distributor.

GTE Sylvania, Electronic Components Group, 100 First Avenue, Waltham, Massachusetts 02154.

The Sylvania CK3000



Simply the most versatile test jig you can buy.

GTE SYLVANIA

NEWS OF THE INDUSTRY

Punctuality On TV Repairs Is Major Goal of New RCA Consumer Program

The RCA Service Company has launched a nationwide program to make certain that TV repair service is provided on the day agreed to with the customer. The new consumer program was announced by Sigmund Schotz, vice president, consumer affairs, of RCA. "When we make a date to visit a customer's home, we'll keep that date," Schotz said. "If we fail to keep it, the customer will pay no labor charge."

"We know there are few things more frustrating than waiting around for a repairman who never shows up," he added. "We decided that the surest way to keep this from happening would be to penalize ourselves by not making a labor charge if we miss an appointment."

The campaign involves over 2,500 technicians at 164 RCA branches nationwide, and includes service on RCA television sets and other home entertainment products, as well as Whirlpool appliances.

RCA Enters the Video Game Field

National distribution of a home TV programmer, called "Studio II", by RCA will begin about the middle of 1977. The new product can be programmed to reproduce games and instructional material on the screen of any size black-and-white or color TV set.

The new RCA unit has five games built into its control console and includes a provision for add-on cartridges. The five programs built into the console are: bowling, freeway, patterns, doodles and a competitive math game. The first cartridges offered will be in three series: TV School House, TV Arcade and TV Casino.

Admiral To Drop Out As U.S. TV Manufacturer

According to *TV Digest*, Admiral TV will "rely on the Taiwan plant for the manufacture of their portable and color console chassis in 1977," and will restrict "operations at their Harvard, Ill. plant to the mating of imported chassis with U.S.-made cabinets and picture tubes."

FCC To Allow Eased Radiation Standards For Remanufactured 23-channel CB

The 23-channel CB radios turned in to manufacturers for conversion to 40-channel models during 1977 will be permitted chassis radiation as high as 50 mv, instead of the standard emission limit of 5 mv. The easing of radiation standards was a partial answer to a petition from the Electronic Industries Association (EIA) for action to prevent the dumping of 23-channel models this spring.

The relaxing of radiation standards, however, does not apply to new 40-channel units to come onto the market during the year, or 23-channel models not capable of remanufacture to 40-channel operation.

NEDA Electronic Distributor Firms Show 90 % Sales Growth

In an analysis report for the membership of the National Electronic Distributors Association (NEDA), member firms showed a 90% growth over the past four-year period and an increase of 11.23% during the last fiscal year.

Gene Chaiken, chairman of NEDA's report committee, pointed out that "NEDA firms showed the 90% growth versus 82% for all electronic parts and equipment wholesalers as reported by the Bureau of the Census."

In the NEDA report, firms are classified by size, location and product category emphasis (General line/industrial, OEM/MRO, dealer service). "The 82 firms submitting data for the report represent a good cross section of all classifications," according to Chaiken.

Switchcraft Is Bought By Raytheon

The acquisition of Switchcraft, Inc., Chicago, has been completed by the Raytheon Company. Switchcraft, whose sales were \$27 million in 1976, will be operated as a wholly-owned subsidiary of Raytheon. It is the manufacturer of switches, jacks, plugs, audio connectors and related equipment.

NESDA Service Management Schools Will Coincide With CB Training Workshops

An agreement has been reached between the National Electronic Service Dealers Association (NESDA) and Forest Belt, sponsor of the CB Training Workshops program, to offer NESDA's Profitable Service Management Schools immediately preceding each of the 12 week-long CB service training workshops to be held around the country. (See 'The CB School Bells Are Ringing'; News of Industry, Jan. ET/D.)

Cost of the 1-day PSM School, to be conducted on Sundays, will be \$20 to CB Training



"There is no excuse for discourteous service to a customer. They are the only reason for us to be in business."



"A lot of people in the service industry visit our place. I like sharing ideas; it makes the industry stronger as a whole."



"The flexibility of our routing system means we can handle two or three extra calls a day per man. We increase gross revenue and save mileage."

"We don't just have a repair shop; we have a service system."

John Sperry, Sperry TV, Lincoln, Nebraska.

"We don't view our relationship with customers as 'us' vs. 'them'; we both want the same thing. Their satisfaction with our work. We want them to remember us if they need service again." That philosophy has contributed a lot to the growth of Sperry TV in Lincoln, Nebraska. Management is so progressive that they've become a model for others in the industry.

Sperry TV is a large operation with 35 employees, 25 of whom are technicians, operating in facilities that cover 8,400 square feet. Eleven radio equipped trucks carry the Sperry logo in and around Lincoln. A good first impression is created when carry-in customers are met by skilled, concerned personnel.

Organization is the key to Sperry's success. He has worked out a detailed and highly efficient routing system. It is very flexible to meet changing schedule demands. At the heart of the system is the Job Control Center which



Operations Manager Norman Foreman (standing right) oversees the Work Control Center with rotating board which gives each member of the call duty crew ready access to the Job cards.

handles incoming calls, radio traffic, counter traffic, routing and dispatching service orders to the trucks in their zoned areas.

All service requests begin as information on a special service tag bearing the customer's name, address, make of set and service request. Each card is processed in the customer history file for warranty information, service of a repetitious nature and credit information.

The card is then routed to the dispatch board by area and time specified when the call is to be made. Field techs can check their next-day work schedule at a glance. Shop repairs are made on a pre-date system. The customer is given a completion date and called if the date can't be met for any reason. Once repairs are completed an invoice is filled out and the work order is scheduled for delivery or recorded alphabetically for over-the-counter pickup. Rotary-file trays place service history records at the fingertips of technicians and scheduling people.

The television service area is divided into five work areas including an overhead test console, up and out of the way. The idea is to move the equipment to the set rather than the set to the equipment. It's a real time saver. In addition, there are three individual radio service sections.

Sperry's trucks have been carefully organized for efficiency, neatness, and each carries a complete range of parts and test equipment.

Training includes technical matters, customer relations, personal dress, attitude, truck preparedness and paperwork.

Sperry developed a standardized pricing system and has published a book including flat rate schedules covering each step of a repair on a hourly charge basis. His technicians have been using the system for five years and agree that it makes their

job easier. For your copy write: Sperry Tech, Inc., P.O. Box 5234, Lincoln, NE 68505.

Sperry travels extensively to promote his system and discuss it with other servicers. "I don't believe that by helping someone else I'll be creating competition. In fact, anything I can do to improve the industry will make business better for me as well as my competition," he stated. "I conduct perpetual studies about my business; every bit of information I collect is used to make my business more efficient and profitable."

"Our plans for the future include expanded facilities, computerized



Service Manager Robert Tigeris (left) telephones to order a part while Technician Norval Huff checks a TV chassis at one of their specially-designed moveable service consoles.

recording of service data and a video readout system linked to the computer downtown." The key to Sperry's success is his attitude. His mind is always working on new concepts, new methods, new equipment—all geared to making the service industry better.

RCA

Consumer Electronics Division
600 N. Sherman Drive
Indianapolis, IN 46201

Better Service Through Better Communications

...for more details circle 125 on Reader Service Card

MARCH 1977, ELECTRONIC TECHNICIAN/DEALER / 5

Workshop attendees, and \$30 to others.

The announcement was made by Dick Glass, NESDA executive vice president, who said, "Hundreds of good servicers have failed in business because of their lack of management ability. The PSM Schools have helped thousands of service dealers gain the necessary management skills to operate a successful business."

For further information contact: NESDA, 1715 Expo Lane, Indianapolis, Indiana 46224

TV Set Sales—Color & B&W—Expected To Improve Very, Very Slightly

Two forecasts of what 1977 will produce in TV set sales—both close to each other—indicate that there won't be much difference between 1976 and 1977. The first forecast is one from the TV industry itself. It calls for color sales to dealer in 1977 of 8.05 million and black & white sales of 5 million. (See EIA figures for the end of 1976 below)

The second forecast is one made by *TV Digest*, calling for 8.25 million new color sets and 5.2 million black & whites. Other parts of the *TV Digest* 1977 forecast include: "Color TV prices will rise slightly as cost pressures continue"; "It seems more likely than not that Sony will buy former Westinghouse picture tube plant"; and "At least one more TV maker will follow GE into VIR-controlled color, and there'll be more emphasis on digital tuning."

The Second Sony Plant At Dothan, Alabama Is To Be Added

Sony Corporation of America has announced the addition of a second manufacturing facility at Dothan, Alabama, bringing the total plant investment in that city to \$21 million. The second plant, to be constructed for \$4 million, will occupy about 26,000 square feet will manufacture plastic shells for Betamax videocassettes. The plant will be completed by next October.

Research Firm Predicts 30 Per Cent Growth In CB Sales By 1980

A major U.S. research firm, Arthur D. Little, Inc., is looking beyond 1977 and is predicting that factory sales of citizens band radio will extend into the \$1.3 to 1.8 billion range by 1980, up from the \$1 billion estimated for 1976. "The existing CB ownership base is now so large that growth percentages won't be as spectacular as the seven-fold increase the industry experienced between 1973 and 1975, or the doubling expected for

Be a SuperTech... Get RCA's new Module Kit for the 1977 "XtendedLife" chassis series.



the current year," Clifford Bean, study director, observes.

Bean said that he "believes the principal factor which could limit future growth of the CB industry is the number of frequencies available." He said "this situation was only partially alleviated by the FCC's decision last summer to expand to 40 channels."

The research report indicates that all of the forces that contributed to past growth are still operating in the marketplace—simplified licensing procedures, wider availability in general merchandise retail outlets, aggressive merchandising, and CB radio clubs.

According to Bean, "CB's usefulness in public safety, stressed by law enforcement officials as well as CB safety organizations, has really lifted CB out of the realm of gadgetry."

NESDA To Hold 1977 National Convention In Orlando, Florida In August

Over 700 dealers, technicians and family members are expected to attend the 1977 NESDA convention at the Sheraton Twin Towers in Orlando, Florida, from August 16 through August 20. Some of the events will include: 'A College of Service Knowledge', 'The Wonderful World Of Service', 'The Magic Kingdom of Electronics,' and a Manufacturers/Dealers golf tournament sponsored again by Electronic Technician/Dealer magazine and hosted by ET/D publisher Al Menegus.

The Game's The Same But The Name Has Changed

In reorganizing Part 95 of the CB Rules and Regs, the FCC has changed the name of the Citizens Radio Service division of the FCC to Personal Radio Services. Likewise, the Class A Citizens Radio Service has been changed to the General Mobile Radio Service; the Class C Citizens Radio Service to the Radio Control (R/C) Service; and the Class D Citizens Radio Service to the Citizens Band (CB) Radio Service. Also revised are the rules for keeping Rule Part 95 in possession. Now CB'ers need only have in possession the subparts of Rule 95 that apply to them.

GTE Sylvania Announces New Five-Year Warranty Program On Color Picture Tubes

A 5-year warranty program for one series of color picture tubes has just been announced by the Replacement Markets operation of the Electronic Components Group of GTE Sylvania. The new, longer warranty program covers everything but installation for the firm's Colorbrite 85 series of replacement color picture tubes. ■



Be prepared to make service calls faster than a speeding bullet. The new RCA 199045 Module Kit, available for a limited time at a special introductory price, contains 8 modules for quick and easy servicing of the new 1977 color TV sets. This new kit, plus your ColorTrak and XL-100 Module Kits, lets you fix most RCA sets right in the customer's home. You'll save time, make more service calls per day, and earn more profit.

Be an RCA SuperTech — carry these 3 RCA Module Kits and meet almost all RCA color-module needs. All 3 kits contain RCA replacement modules which include the

latest design improvements. And don't forget the RCA Module Caddy — makes it easy to carry all three kits on home service calls.

See your authorized RCA Parts Distributor, or contact RCA Distributor and Special Products Division, 2000 Clements Bridge Road, Deptford, NJ 08096, for additional information.

RCA Distributor and
Special Products Division

...for more details circle 128 on Reader Service Card

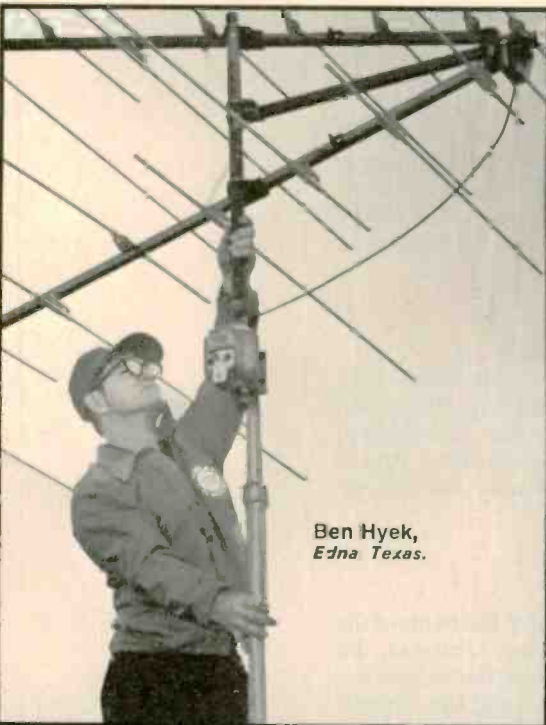

Ben Hyek,
Edna, Texas.



Dean Johnson and Pete Childers,
Joliet, Ill.

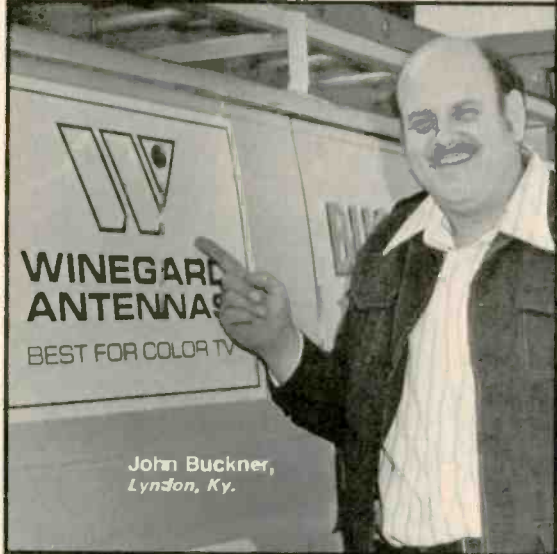

John Buckner,
Lyndon, Ky.



Vic Hyek,
Nada, Texas.



Bill Hughes,
Niceville, Florida.

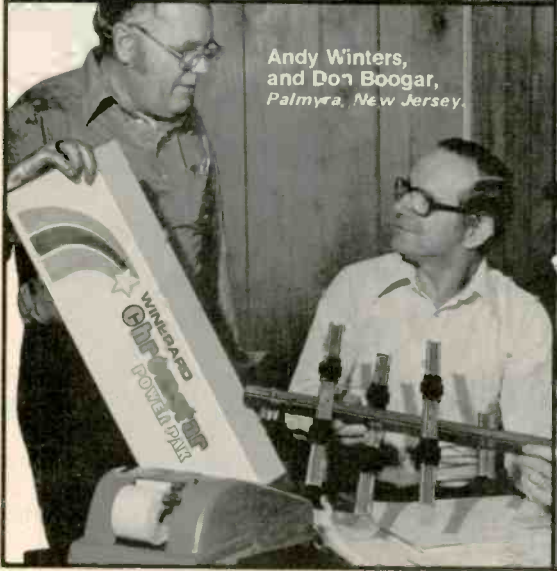

**Andy Winters,
and Don Boogar,**
Palmyra, New Jersey.



WINEGARD WORKS...For Me!

Here are 10 of the reasons why
WINEGARD WORKS...For ME!

- 1. Winegard PRODUCTS work for me.** Variety as well as quality in the complete line of TV reception products is important to me. I can take care of my customers, with confidence. Winegard engineering research innovates new products to solve problems, or improve TV reception, as I found with the new low noise UHF preamp-antenna combination.
- 2. The Winegard NAME works for me.** It gives me the top national brand name in my business, to sell, install, and recommend. When you are in your own business, you have to have a manufacturer back of you that you can depend on.
- 3. The Winegard REPUTATION works for me.** Most all my customers and prospects know the Winegard name, and know their products are excellent. This consumer acceptance makes my selling job easier than it would be with an unknown or lesser known brand.
- 4. Winegard's MARKETING works for me.** Their advertising, publicity and promotions reach customer prospects and create sales opportunities for me. Winegard helps build my business.
- 5. Winegard INFORMATION works for me.** Winegard communicates with me, through distributor meetings, trade advertisements, product announcements, technical articles by their engineers, and with their Dealer Newsletter.
- 6. Winegard DISTRIBUTION works for me.** My local distributor carries Winegard products in stock so I can always get what I need, fast.
- 7. Winegard PROFITABILITY works for me.** Winegard has stayed in business for over 20 years because they make the finest products, and because they make a profit. They expect me to make a profit, too. With the right products, and my experience, I *do* make a good profit.
- 8. Winegard SALES HELPS work for me.** Literature, sales tools, ad materials and displays are available to me, to promote and secure new business. My store, truck, and uniform also identify me as a Winegard antenna dealer. This all helps me cash in on Winegard advertising.
- 9. Winegard RELIABILITY works for me.** Winegard's manufacturing facilities, research capabilities, product testing, quality control, and delivery via their own truck fleet are aimed at getting to me the kind of reception products I need to satisfy my customers. They count on me. I count on Winegard.
- 10. Winegard INSTALLATIONS work for me, too.** Whenever I install Winegard products, I can count on the customer being satisfied. I also expect to get additional business from that customer's neighbors and friends. And that's the best part . . . when your customers recommend you.

Winegard works . . . for professional installers all over the country. Just call your Winegard distributor, or write to us. Let us work for you.



WINEGARD

The Winegard Company • 3000 Kirkwood • Burlington, Iowa 52601

...for more details circle 137 on Reader Service Card

ARROW AUTOMATIC STAPLE GUNS

CUT WIRE & CABLE INSTALLATION COSTS

... without cutting into insulation!

SAFE! Grooved Guide positions wire for proper staple envelopment! Grooved Driving Blade stops staple at right depth of penetration to prevent cutting into wire or cable insulation!

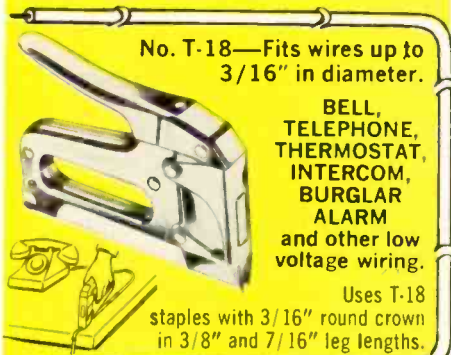

No. T-18—Fits wires up to 3/16" in diameter.

BELL, TELEPHONE, THERMOSTAT, INTERCOM, BURGLAR ALARM and other low voltage wiring.

Uses T-18 staples with 3/16" round crown in 3/8" and 7/16" leg lengths.

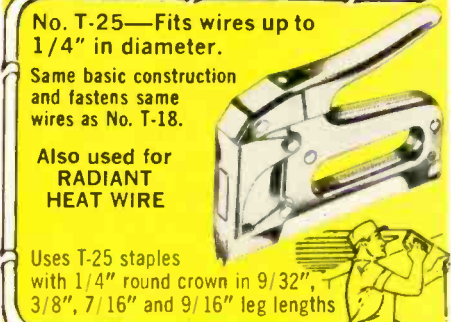

No. T-25—Fits wires up to 1/4" in diameter.

Same basic construction and fastens same wires as No. T-18.

Also used for RADIANT HEAT WIRE

Uses T-25 staples with 1/4" round crown in 9/32", 3/8", 7/16" and 9/16" leg lengths



NEW! Intermediate No. T-37—Fits wires and cables up to 5/16" in diameter.

Same basic construction as Nos. T-18 & T-25.

Also used for CATV and DRIVE RINGS in stringing wires.

Uses T-37 staples with 5/16" round crown in 3/8", 1/2" and 9/16" leg lengths.

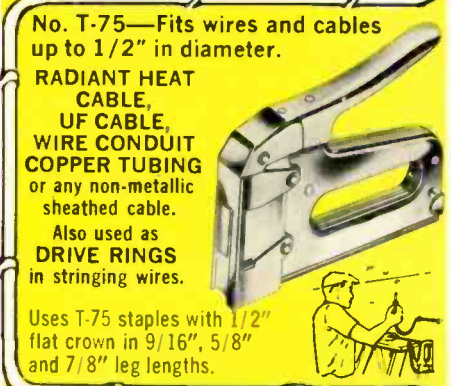

No. T-75—Fits wires and cables up to 1/2" in diameter.

RADIANT HEAT CABLE, UF CABLE, WIRE CONDUIT COPPER TUBING or any non-metallic sheathed cable.

Also used as DRIVE RINGS in stringing wires.

Uses T-75 staples with 1/2" flat crown in 9/16", 5/8" and 7/8" leg lengths.

ARROW FASTENER COMPANY, INC.

271 Mayhill Street, Saddle Brook, N. J. 07663

...for more details circle 106 on Reader Service Card

TECHNICAL LITERATURE

Discrete Semiconductor Test Instruments are highlighted in a new six-page, full-color brochure available now from B&K-Precision. The new literature describes the firm's complete line of semiconductor test instruments, including the Model 530 lab-quality tester that features a unity-gain frequency measurement capability up to 1500 MHz and non-destructive semiconductor breakdown voltage testing. Three other B&K Precision semiconductor testers are described, along with a detailed analysis of the Dynapeak digital-pulse testing technique. The new brochure, B&K-500, is available free from B&K-Precision, 6460 W. Cortland Avenue, Chicago, Illinois 60635.

An ECG Semiconductor Replacement Guide Supplement, listing over 3,000 devices used in 139 brands of consumer electronic equipment, is now available from GTE Sylvania. The line includes both encapsulated thick film integrated circuits (modules) as well as the more popular monolithic integrated circuits. The new supplement lists all part numbers in alphanumeric order and is cross-referenced to equivalent Sylvania ECG replacements. Part numbers are also indexed by equipment brand name. Copies of the supplement, as well as the master guide, are available at GTE Sylvania distributors.

Exact Replacement Products for CB and TV Equipment are cross-referenced in a new replacement guide from Thordarson Meissner, Inc. The guides list 44 flame retardant flybacks and 14 yokes for the TV replacement market, of which 7 yokes and 19 flybacks are designed for imported TV sets. Also included is information on CB replacement parts, including 19 chokes, 16 driver transformers and 34 output/modulation transformers. The cross reference guides—for TV, TVPG 9, and for CB, CBRG 2—are available free at Thordarson distributors.

Equipment For MATV Systems is illustrated and described in the new 1977 Systems catalog from Channel Master. The new literature covers the products in line with the firm's new Total Systems Concept. Included is information and specifications for antennas, balun-antenna joiners-traps, the Join-tenna system, antenna amplifiers, signal processing equipment, distribution amplifiers, power supplies and accessories. The new catalog also covers coaxial cable tools, cable connectors, test equipment, and coax-

ial cable. Available free from Channel Master, Ellenville, New York 12428.

Loudspeakers For Public Address, background music and general sound systems are described in a new specification sheet from Quam-Nichols. The new literature provides specifications on the firm's line of eight-inch speakers such as single cone PA speakers, single and dual cone background music speakers, flame retardant models and standard variants for intercom and outdoor use. The new spec sheet, Form 77-1, is available free from Quam-Nichols Company, 234 East Marquette Road, Chicago, Illinois 60637.

Do-it-yourself Electronic Kits are described in the latest 96-page catalog from the Heath Company. New products introduced in the new literature include: a 3-way bookshelf speaker system, a battery monitor device for radio control modelers, 40-channel CB radios, a two-way freezer alarm and a mount-anywhere touch control light switch. The new catalog, No. 814, is available free from Heath Company, Benton Harbor, Michigan, 49022.

Communications Test Instruments and Test Instruments are covered fully in two new catalogs available now from Leader Instruments. The folder on communications instruments describes the firm's line of antenna couplers, SWR wattmeters, RF power meters, dip meters, antenna impedance meters, and the CB harmonic meter. The 1976-77 catalog covers specifications and prices for the firm's complete line of test instruments including oscilloscopes, multimeters, color bar and pattern generators, signal generators and accessories. Both catalogs are available now from Leader Instruments Corp., 151 Dupont Street, Plainview, N.Y. 11803.

Citizens Band Radio Accessories are described in a new catalog from Siltronix. The 12-page catalog features meters, antennas and antenna accessories, speakers and accessories such as a desk microphone and mobile mounting kit. Prices are included. Available free from Siltronix, 330 Via El Centro Avenue, Oceanside, CA 92054.

The New Electronics Catalog from Mouser Electronics is now available. The 64-page catalog features a wide variety of electronic components, transformers, electronic tools, test equipment, hardware and related items. Capacitors, resistors, potentiometers, and switches are featured in a range of sizes from sub-miniature to full size. Complete with prices.

Available free from *Mouser Electronics*, 11511 Woodside Avenue, Lakeside, CA 92040.

CB Antennas, in full color, are described in the latest catalog from Avanti. Included are antennas that utilized the Avanti principle of co-induction, including the omnidirectional Astroplane and the direction Astrobeam, PDL-II, and Moonraker. Facts about CB mobile and base antennas, the principle of coinduction, and full specifications are included. Free from *Avanti Research & Development*, 340 Steward Avenue, Addison, Ill. 60101.

RF Semiconductors for linear applications are described in a new 12-page booklet from TRW. The booklet contains complete data for hybrids and discretes for RF linear applications from microwatts to kilowatts of output from 1 MHz to 4 GHz. It includes specifications, application block diagrams and reliability notes. Available free from *TRW RF Semiconductors*, 14520 Aviation Blvd., Lawndale, Calif. 90260.

A Guide to CB and Scanner Semiconductor Replacements is now available from General Electric. This first edition of the guide is designed for the technician now entering CB and scanner work. The guide covers the parts and devices contained in GE's new CB scanner semiconductor kits. Cross-referenced between original brand part numbers and GE replacement parts. Free from GE distributors, or Tube Products Dept., *General Electric Co.*, Owensboro, Ky. 42301.

Microphones, Antennas, Test Equipment and Accessories for CB are listed and pictured in the latest booklet from Mura Corp. Included are variable gain power microphones, three-level gain power microphones and base-station power microphones. A selection of mobile and base station CB antennas and test equipment such as meters, impedance matchers, and multitesters is also included. Free from *Mura Corporation*, 177 Cantiague Rock Road, Westbury, N.Y. 11490.

CB Antennas And Accessories are described completely in a new 16-page catalog from Antenna Incorporated. Complete specifications on the firm's line of mobile and base station CB antennas, replacement parts and accessories, along with an easy-to-read format, are included in the new literature, Form SP-17. Available free from Randall J. Friedberg, *Antenna Incorporated*, 23850 Commerce Park Road, Cleveland, Ohio 44122. ■

MEET OUR family of High VOLTAGE TEST PROBES

In 1967 we introduced the first high voltage test probe with a built-in meter. It became so popular that we have been adding new models ever since. Now there are five different versions to satisfy the demands of radio, television, appliance, audio, and electrical repair men in a wide variety of high voltage testing applications.

The five models are briefly described below. Our general catalog contains complete applications information, illustrations, specifications, and prices. Write for your free copy.

MODEL 4242—42,000 volts DC.
Negative ground.

MODEL 3157—15,000 volts DC.
Negative ground.

MODEL 4312—15,000 volts DC.
Positive ground.

MODEL 3163—6,000 volts DC.
Negative ground.

MODEL 3200—10,000 volts AC.

AVAILABLE THROUGH YOUR
FAVORITE ELECTRONIC PARTS DISTRIBUTOR

ITT POMONA ELECTRONICS

1500 East Ninth St., Pomona, Calif. 91766
Telephone (714) 623-3463, TWX: 910-581-3822

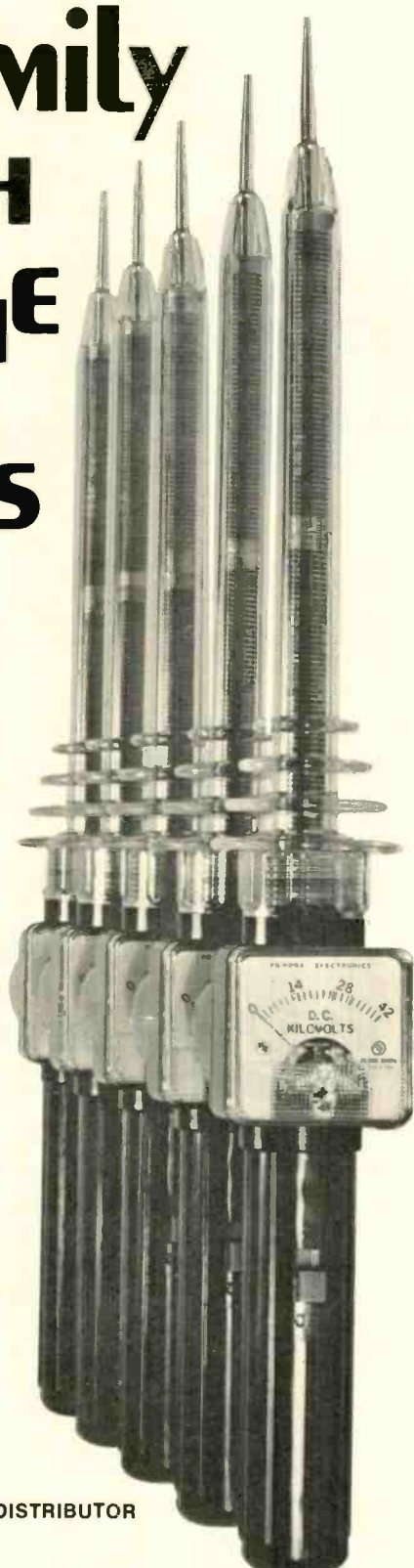

...for more details circle 124 on Reader Service Card

BE COMPETITIVE



40 CHANNEL CAPABILITY
with exclusive
Percent Off Channel
direct readout
(Patent Pending)

\$975

All cables included

With Everything You Need for Fast CB Service in One Lower Priced, Compact Instrument . . .

AVOID TIME-WASTING MULTIPLE INSTRUMENTS AND CONFUSING CABLE SYSTEMS. GET AT THE PROBLEM IN A JIFFY WITH THE

SENCORE CB42 AUTOMATIC CB ANALYZER

It's a CB Profit Center All in One Handsome Instrument

The CB service market is growing and more "on the ball" technicians are getting into the act every day. Competition for the CB business is getting tougher and you'll want to be sure you can compete. Knowledge alone won't be enough. You'll want to get ahead by simplifying your work to get the most jobs out with the least effort. You'll want to concentrate on your troubleshooting and not fiddle with 15 cable connections and 28 knobs on different instruments. So you will want to get an instrument that takes you from antenna input to speaker, and from mike to antenna load in one neat package.

To top that off, the complete CB42 is hundreds of dollars below the nearest competition, and thousands below most. We've got our competition beat, and you'll beat your competition, too, by saving these six ways with this CB42 Profit Center.

\$AVE ON REPAIR TIME:

One simplified tester in a single case saves time on every test on any CB that comes in your door, including Single Sideband sets; you won't even need a scope.

\$AVE ON READOUT TIME:

One direct-reading digital readout saves interpretation time and reading errors. You'll know the CB's frequency, generator frequency, Percent Off-Channel, positive/negative modulation and distortion, RF output, and audio output with a simple flick of a switch. Only the CB42 is this simple and complete.

\$AVE ON CHANNEL CHECKING:

Simply rotate the CB42 and CB selectors through all 40 channels and read "percent off center frequency" on the direct-reading digital meter (.005% FCC maximum deviation) in less than two minutes for all 40 channels.

\$AVE ON TIME CONSUMING CONNECTIONS:

Three cables, provided with your CB42, do the entire job; audio cable, transmitter cable, and receiver cable.

\$AVE ON ANNOYING HOWL:

Why get a screwdriver in the back from the guy next to you, when you can substitute for that annoying speaker howl? Just plug the built-in, non-grounded speaker sub cable into the transceiver and quietly monitor the audio output on the meter.

\$AVE ON BENCH SPACE:

The CB42 takes less than one-third the bench space of other equipment. You can even take it to the field with you, for on-the-spot mobile checks, since it is also 12 Volt battery powered.



SENCORE

3200 Sencore Drive, Sioux Falls, South Dakota 57107
Phone (605)339-0100

VALUE LEADERS IN RADIO-TV, 2 WAY AND MRO INSTRUMENTS

...for more details circle 130 on Reader Service Card

DEALER SHOWCASE

Noteworthy new resale products and merchandising aids and programs available to independent electronic retailers

Jerrold's Universal All-Channel TV Remote Control System

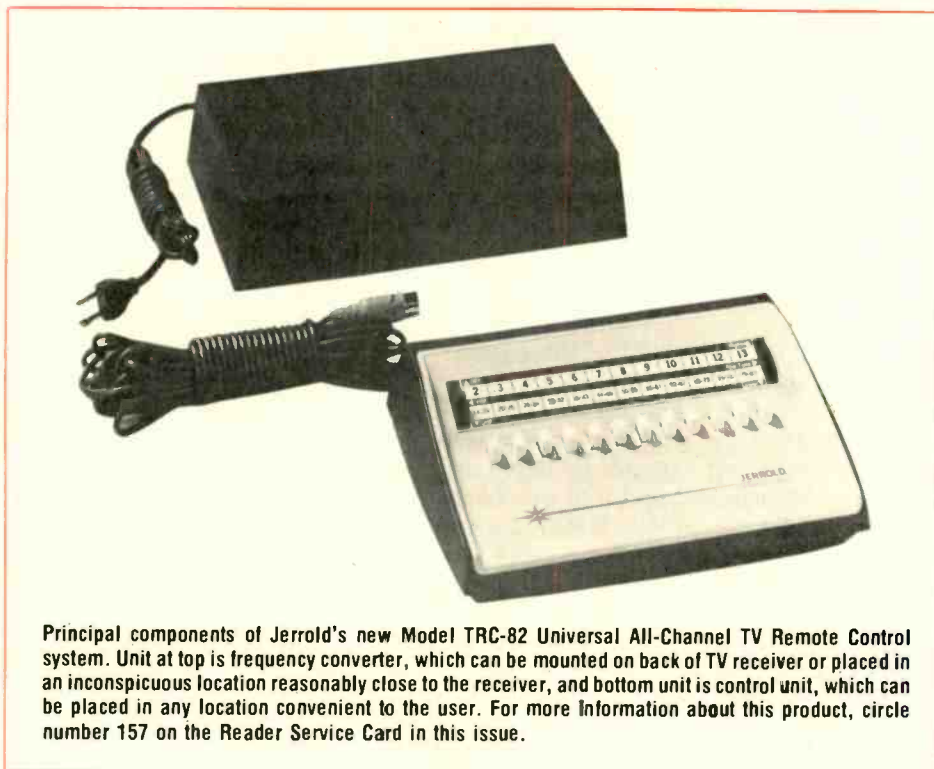

Principal components of Jerrold's new Model TRC-82 Universal All-Channel TV Remote Control system. Unit at top is frequency converter, which can be mounted on back of TV receiver or placed in an inconspicuous location reasonably close to the receiver, and bottom unit is control unit, which can be placed in any location convenient to the user. For more information about this product, circle number 157 on the Reader Service Card in this issue.

■ Jerrold Electronics recently introduced the first TV 'wired' remote-control system capable of providing remote pushbutton selection of all VHF and all active UHF TV channels, plus remote turn-on and turn-off of the receiver.

Designed for use with any TV receiver—b/w or color—and any antenna system—75 or 300 ohm—Jerrold's new Model TRC-82 All-Channel TV Remote Control system consists of two units: a frequency converter unit and a remote-control unit, which are interconnected by an easily concealed, 25-foot, plug-in control cord. (A 5-foot length of 75-ohm coax with connectors and a 75-to-300 ohm matching transformer also are supplied with the TRC-82.)

Two versions of the TRC-82 are available: one for use with the TV receiver tuner in the Channel 3

position (TRC-82-3) and one for use with the receiver tuned to Channel 4 (TRC-82-4).

Installation of the TRC-82 is simple and, as evident from the following description of the installation procedure, can be performed either by the selling dealer or by the purchaser:

1) Tune the receiver tuner to the channel on which the particular TRC-82 is factory tuned to operate (either Channel 3 or 4)

2) Plug the receiver's power cord into the AC receptacle on the back of the TRC-82 converter unit

3) Connect the coax or twin-lead from the antenna or MATV system to the appropriate antenna input plug or terminals on the back of the TRC-82 converter unit. (For operation from a 75-ohm antenna system, the external coaxial jumper on the back of the converter is unplugged from the converter's 75-ohm antenna input jack

and the coaxial connector from the antenna or MATV system is plugged directly into this jack. For operation from a 300-ohm antenna system, the converter's external coaxial jumper is left plugged into the 75-ohm antenna input jack and the 300-ohm antenna lead-ins are connected to the screw-type VHF and UHF connections on the back of the converter.

4) The 75-ohm output of the converter unit is then connected to the antenna input jack or terminals of the receiver via the 5-foot coaxial cable supplied with the TRC-82. (If the receiver is equipped with only 300-ohm antenna inputs, the 75-to-300 ohm matching transformer supplied with the TRC-82 is employed between the 75-ohm coax and the 300-ohm terminals of the receiver.)

5) The 25-foot line from the control unit is plugged into the control input jack on the back panel of the

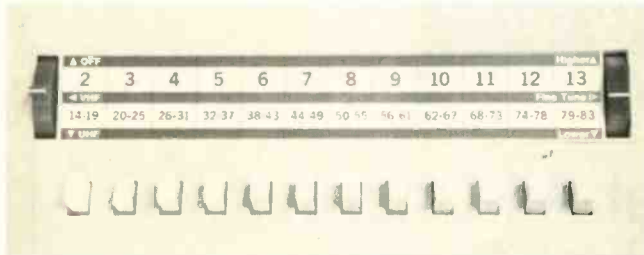

Close-up of the TRC-82 control unit. Three-position switch on left turns on receiver and selects either VHF or UHF reception. Thumbwheel on right functions as fine tuning control. Although control unit comes from factory with pushbuttons programmed to select segments of the UHF TV band in the UHF mode, it can be easily re-programmed by the dealer or purchaser so that the pushbuttons select specific UHF stations. Only a small screwdriver is required for UHF re-programming.



Close-up of the rear panel of the TRC-82 converter unit. Built-in 75- and 300-ohm antenna inputs and matching transformer permit use of TRC-82 with any TV antenna or MATV system.

converter unit.

6) The final step is to plug the AC power cord of the converter unit into a convenient AC receptacle—channel selection and turn-on and turn-off of the receiver are now controlled from the TRC-82 control unit.

As shown in the accompanying close-up photo of the front panel of the TRC-82 control unit, a three-position switch on the left of the panel controls the receiver on/off function and determines whether the twelve pushbuttons select corresponding VHF channels or cor-

responding segments of the UHF band.

In the 'VHF' (middle) position of the OFF/VHF/UHF switch, the receiver is turned on and the pushbuttons select VHF Channels 2-13, with fine tuning provided by the thumbwheel control on the right of the panel.

In the 'UHF' (lower) position of the OFF/VHF/UHF switch, the twelve pushbuttons select corresponding segments of the UHF band and precise tuning to a specific UHF channel within the selected portion of the band is pro-

vided by the 'FINE TUNING' thumbwheel on the right of the panel.

Alternatively, the UHF tuning portion of the control unit can be easily re-programmed by the dealer or the purchaser so that in the UHF tuning mode the pushbuttons can be used to select specific locally active UHF channels, not just segments of the UHF band. (Peel-off, self-stick UHF channel numbers are furnished with the TRC-82 for application to the UHF portion of the channel indicator panel when the control unit is re-programmed to provide pushbutton selection of specific UHF channels.)

In addition to the obvious conveniences inherent in remote turn-on and turn-off of the receiver and instant, pushbutton selection of a desired channel without the need to 'cycle through' a number of undesired channels, the TRC-82 remote system also provides a minimum 6dBs of signal amplification—which, along with no degradation of the noise figure of the receiver, in many reception areas can mean the difference between unstable, snowy pictures and clean, clear, stable reception. And, because use of the TRC-82 permits the tuner of the receiver to be operated on an inactive channel, any ghosting and other picture degradation caused by direct-pickup or co-channel interference are eliminated.

The suggested list price of the TRC-82 is \$124.50. (Optionally available for resale at a suggested list of \$8.95 is a 25-foot extension control cord, complete with male and female connectors, for extending the 'control range' of the TRC-82 beyond the 25 feet provided by the control cord supplied with the remote system.) ■

SpaceSaver: New RCA Flameproof Film Resistor Kit

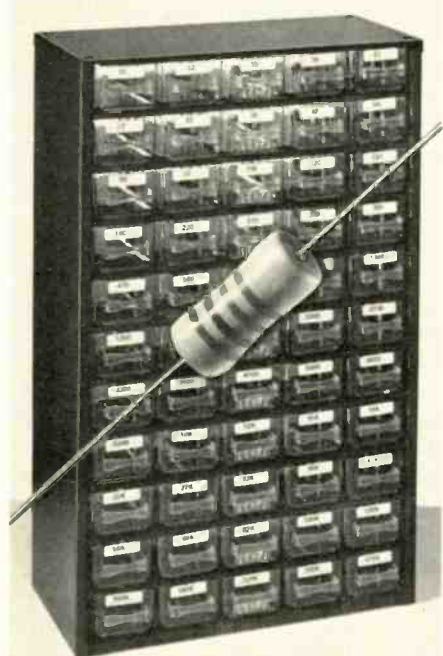

Introducing RCA's convenient, preloaded and pre-labeled Flameproof Resistor Kit containing a wide range of the most-needed, standard value resistors in 1/2, 1 and 2 watt ratings. Two of each rating for a total of 330 resistors; all ±2% tolerance. Packed in a sturdy metal-frame cabinet for easy availability.

Service Technicians prefer RCA Flameproof Film Resistors because of their inherent safety characteristics. Design Engineers prefer them because they won't flame or short even under severe conditions. Look to RCA — your best single source for a complete line of flameproof film resistors.

Contact your authorized RCA Parts Distributor for all the details, or write to RCA Distributor and Special Products Division, 2000 Clements Bridge Road, Deptford, NJ 08096.

RCA Flameproof Film Resistors

...for more details circle 127 on Reader Service Card

the only prime time test pattern.

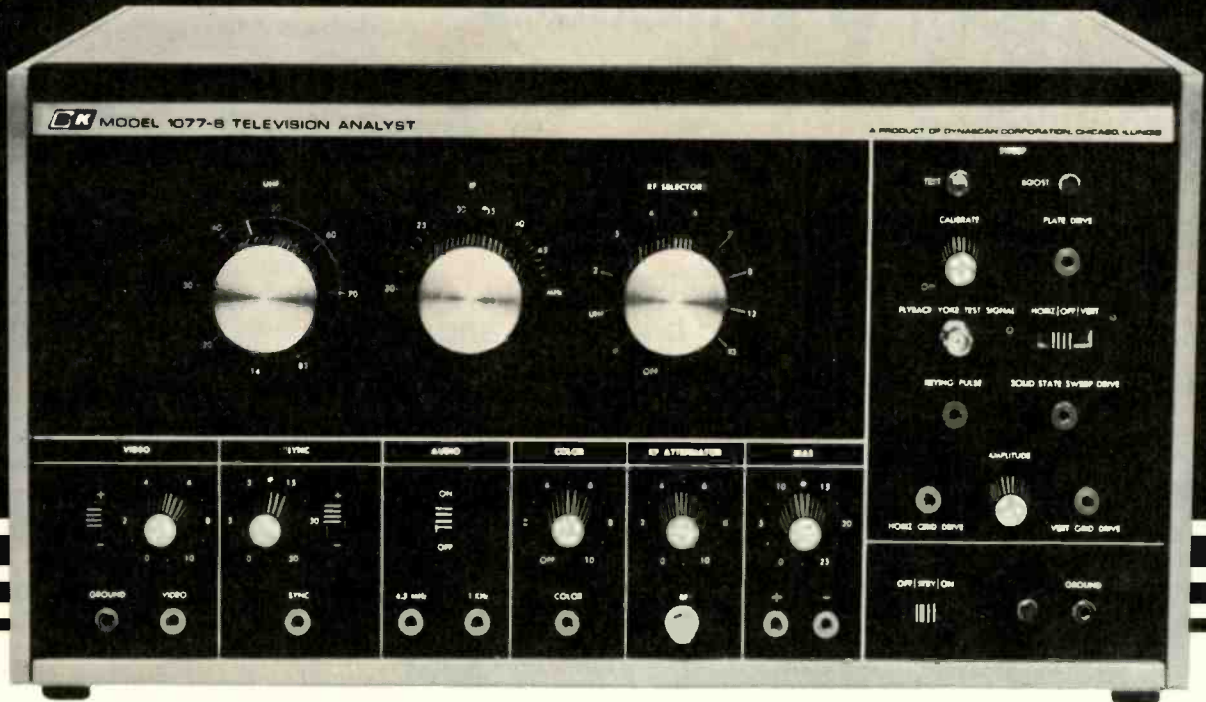

Model 1077B
\$530

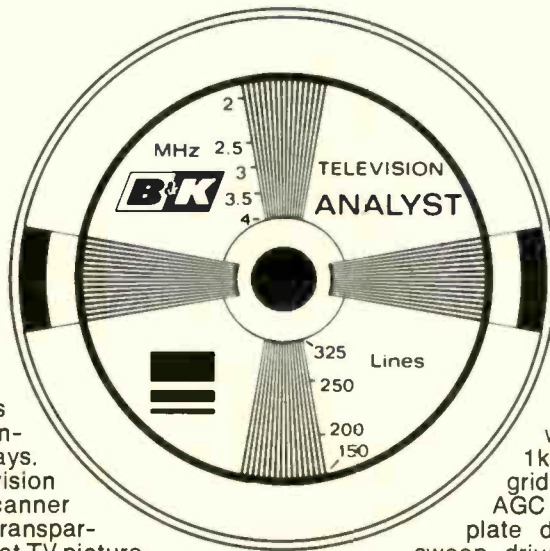

Remember the test pattern? Here's how to use that old standby to cut your troubleshooting time in half.

Broadcast test patterns are available only at very inconvenient times these days. So our Model 1077B Television Analyst has a flying-spot scanner that transforms any 3"x4" transparency into a broadcast-format TV picture. We even supply you with a test pattern slide.

A test pattern provides valuable information about picture size, linearity, focus, resolution, ringing (overshoot), low-frequency phase shift (smear) and frequency response. Unless the TV receiver isn't working, of course.

That's why the 1077B provides signal-substitution outputs to let you inject the test pattern anywhere in the chain from the flyback all the way back to the antenna terminals. You can pinpoint the problem in minutes instead of hours, check-

ing the quality of each stage as you go.

Outputs include: IF, 8 VHF channels, all UHF channels, video, sync, 4.5MHz sound subcarrier with 1kHz FM modulation, 1kHz audio, chroma, vertical grid drive, horizontal grid drive, AGC keying pulse, horizontal plate drive, horizontal solid-state sweep drive, vertical plate drive and vertical solid state sweep drive.

There's also a built-in dot/bar/crosshatch generator for color TV chroma and convergence adjustments. Plus positive or negative bias supply and B+ boost indication. All level controls are conveniently located on the front panel.

There's nothing else like it.

Ask your distributor for Model 1077B, the latest in over 25 years of television analysts—in stock now or write Dynascan.

B&K PRECISION
PRODUCTS OF DYNASCAN

6460 W. Cortland Avenue
Chicago, Illinois 60635 • 312/889-9087
In Canada: Atlas Electronics, Ontario

Complete Line of Analog and Digital Multimeters, Oscilloscopes, Signal Generators, Semiconductor Testers, Power Supplies, Probes, Tube Testers and Substitution Boxes.

...for more details circle 108 on Reader Service Card

Luminance Circuits And Problems In Modular Color TV

By Don W. Mason

How the luminance circuitry of a typical modular color TV chassis functions—and manufacturer-recommended techniques for troubleshooting problems affecting brightness and video quality.

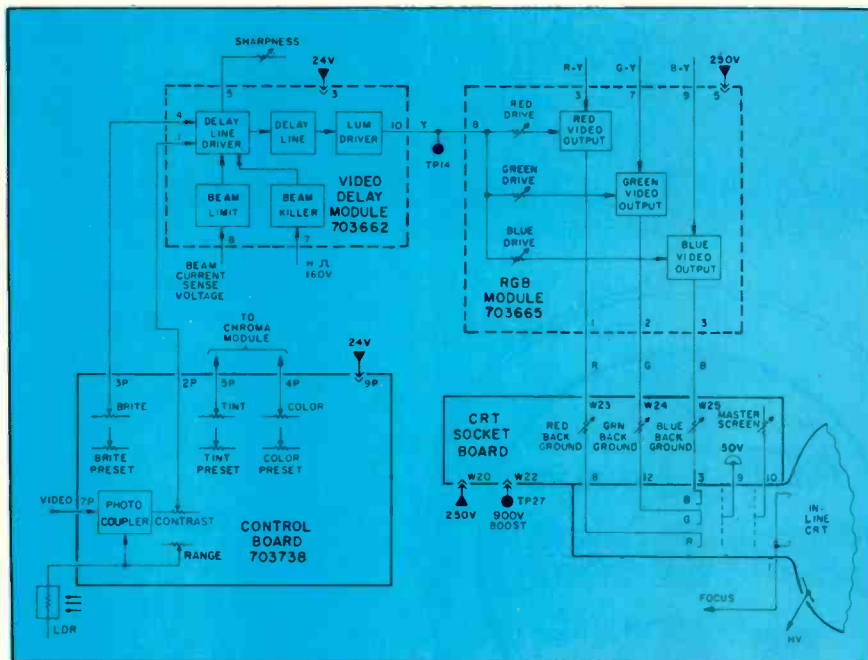

Fig. 1—A block diagram of modular luminance circuitry used in Magnavox color TV chassis T991.

The luminance circuitry that produces the black and white portion of a color TV picture has been modularized in most of today's color TV chassis. Because it is somewhat typical of the luminance circuits used by a number of different manufacturers, we'll take a look in this article at the modular luminance circuitry used in the Magnavox T991 chassis—how it works, what kind of problems can appear, and how to troubleshoot those problems.

PROCESSING THE LUMINANCE SIGNAL

The simplified block diagram in Fig. 1 shows the path of the signal

through the luminance circuitry. The model used for our article includes the Magnavox *Videomatic* feature, which uses a photo-coupler on control board 703738 to increase or decrease the amplitude of the video signal to compensate for changes in room lighting as sensed by the light dependent resistor (LDR).

Control Board Circuitry

The circuits of the control board are shown in Fig. 2. The main operating controls are for contrast, brightness, color and tint. Preset controls for brightness, color, tint and the Videomatic range are accessible through the hollow shafts

of the main operating controls. The LDR is located on the front of the set. The Videomatic switch is located off the control board and is connected to it through a plug-in cable.

The luminance signal, or composite signal, is DC coupled from the video detector on the IF module to a voltage divider network on the control board. Included as part of the input circuit on the control board is the photo-coupler, which we've already mentioned. The photo-coupler consists of the LDR and a Light Emitting Diode (LED), which is connected to the LDR through resistor R432. The LDR is in series with the Contrast control. The resistance of the LDR decreases when room lighting increases and in turn applies more voltage to the LED. As the light from the LED increases, it causes the resistance of the LDR to decrease and thus, apply more video signal to the contrast control and the picture tube. And since DC coupling is used throughout the luminance channel, brightness is also increased.

The Brightness, Color and Tint controls, along with the Preset controls, are simply voltage dividers connected between a DC source and ground. The output voltages at the 'arms' of the controls connect through the Videomatic switch to their respective modules. When the Videomatic switch is in the ON position, the Preset controls become the primary adjustments, while the main operating controls act as vernier adjustments.

Video Delay Circuits

The luminance signal coming from the Contrast control on the control board is coupled to the Delay Line Driver stage, Q1, which is on the Video Delay module 703662, as seen in Fig. 3. After amplification, the luminance signal is delayed approximately 1 microsecond by delay line TD1 so that the signal arrives at the video output stages in time with the color signal. The Video Driver stage, Q2, is operated as an emitter-follower and its output drives the Video Output stages.

The Beam Limiter, Q4, which is

normally biased to cut-off, performs the job of limiting beam current in the picture tube to prevent blooming, poor focus, high voltage loading and other effects that would result from excessive beam current. Whenever the beam current exceeds about 1.5 ma, the voltage from the Tripler ground return circuit become less positive and Q4 starts to conduct. This makes the emitter of Q1, the Delay Line Driver, and the picture tube cathodes, go more positive—and this in turn opposes, or limits, further increases in beam current. If the Beam Limiter, Q4, were to become leaky, it would cause a reduction in brightness.

A Beam Killer stage, Q5, is also included in the luminance channel to protect the picture tube from phosphor damage that may result from the loss of horizontal sweep voltage.

The RGB Module and CRT Socket Board

The T991 chassis, which uses an in-line CRT, uses the RGB method of matrixing the luminance and color difference signals prior to application to the CRT. The circuits of the RGB module and the CRT Socket Board are shown in Fig. 4.

The luminance signal coming from the Video Delay module is coupled to the emitter of each output stage. The three detected color-difference signals from the Chroma module are then applied to the base of their respective amplifiers. These input signals combine then to produce the red, green and blue drive signals for the picture tube cathodes.

The CRT Socket Board is mounted onto the base of the picture tube. The DC voltages needed to set up white balance are provided by three Background controls and a Master Screen located on the socket board.

When the Service switch is placed in the Service position, a fixed bias is applied to the emitters of the Video Output stages and then the cathodes of the picture tube. The set up adjustment is simplified by D1, which switches out the Drive controls while the Background controls are adjusted for low lights. At high brightness

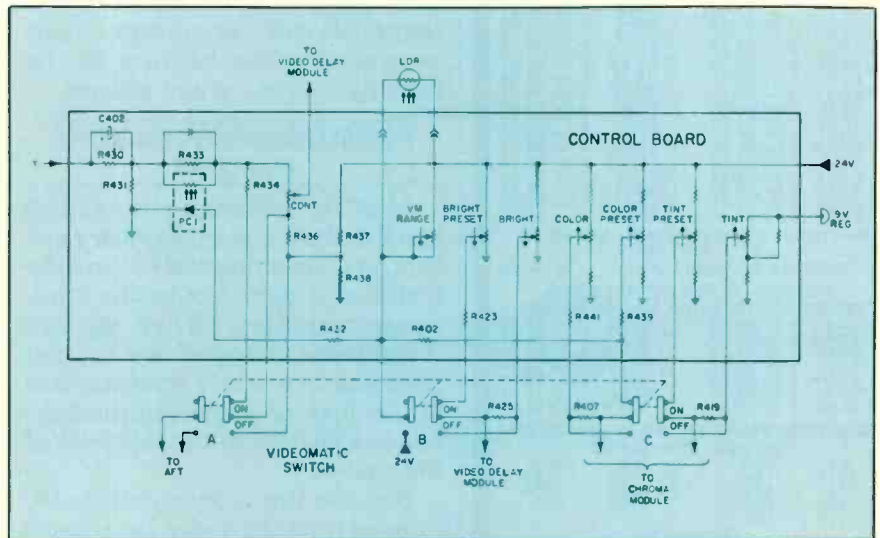

Fig. 2—Control Board circuitry in the T991 chassis.

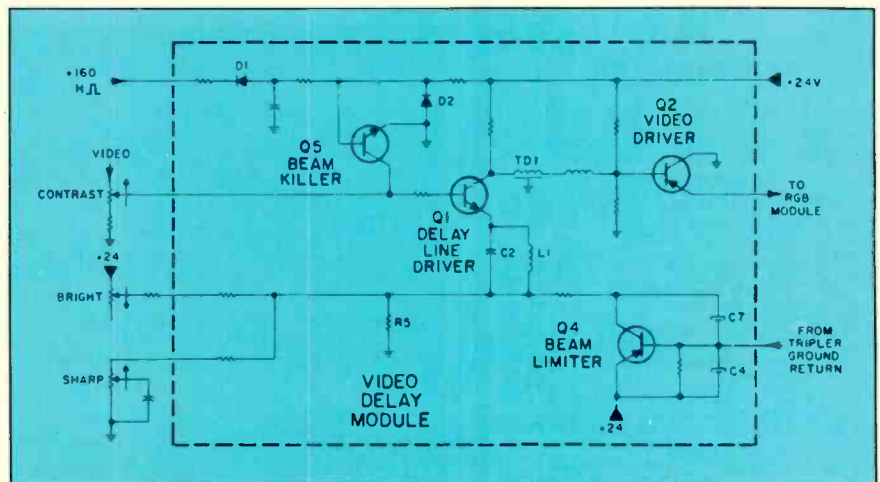

Fig. 3—Diagram of circuitry used on the Video Delay Module of the T991 chassis.

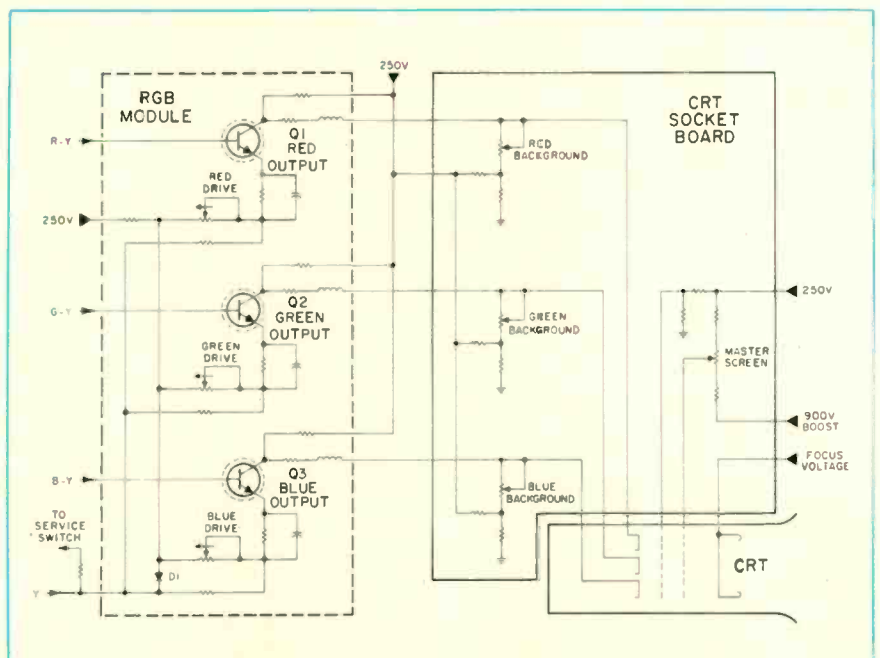

Fig. 4—Circuit diagram of the RGB module and the CRT Socket Board.

T & T VALUE SALE

SYLVANIA, G.E.

FAMOUS MAKE NEW JOBBER-BOXED TUBES

80% OFF LIST

3A3 5 for \$6.22	6JC6 5 for \$6.88
3AT2 5 for \$6.05	6JE6 5 for 12.87
6GH8 5 for \$7.26	6J86 5 for 11.44
6BK4 5 for 11.50	6J88 5 for \$9.82
6CG3 5 for \$9.05	6KA8 5 for \$7.48
6CJ3 5 for \$5.78	6KE8 5 for \$9.41
6DW4 5 for \$5.78	6KZ8 5 for \$8.36
6EM7 5 for \$5.89	6KZ8 5 for \$6.27
6EJ7 5 for \$5.50	6L86 5 for 12.38
6FQ7 5 for \$4.68	6LQ6 5 for 12.87
6F77 5 for \$8.20	8F07 5 for \$4.08
6GH8 5 for \$4.84	12GN7 5 for \$8.58
6GJ7 5 for \$4.07	17JZ8 5 for \$8.38
6GU7 5 for \$6.44	23Z9 5 for \$7.87
6HA5 5 for \$5.89	33GY7 5 for \$9.96
6HQ5 5 for \$7.81	38HE7 5 for 11.20
6HV5 5 for 13.84	38HK7 5 for 11.00

WRITE IN UNADVERTISED TUBES AT 80% OFF LIST.

* SPECIAL 100 6GH8 Tubes \$ 79.00

SYLVANIA - GE NEW FACTORY BOXED

70% OFF LIST ON ENTIRE LINE IN SLEEVES

3A3 5 for \$8.48	6LQ8 5 for 17.55
6BK4 5 for 15.88	6LR6 5 for 16.13
6CJ3 5 for \$7.88	17JZ8 5 for \$8.70
6FQ7 5 for \$6.38	21LU8 5 for 10.20
6GH8 5 for \$6.80	23Z9 5 for 10.73
6HA5 5 for \$8.03	35LRA 5 for 16.13
6LB6 5 for 16.88	42KN6 5 for 14.40

TRANSISTORS EQUIVALENT UP TO 95% OFF LIST

30¢ each—Minimum 20

8K	ECG	SK	ECG
3018	108	3122	123A
3024	128	3124	123A
3025	129	3132	161
3114	159		

Minimum 5

SK	ECG	ea. 60¢
3021	124	ea. 90¢
3027	130	ea. 70¢
3054	184	ea. 80¢
3103	157	ea. 70¢
3041	152	ea. \$2.50
3079	162	ea. \$2.75
3115	165	

IC'S EQUIVALENT TO ECG

\$1.50 each—Minimum 5

703	708	709	710	712
713	714	718	719	720
722	723	725	731	740
743	748	780	793	788
790	791	793	812	

CB HARDWARE WIRE

PL259 10 for \$3.90	PL258 10 for \$4.90
3 ft. RG58U Cable 2PL259	ea. \$1.25
20 ft. RG58U Cable 2PL259	ea. \$2.00
20 ft. RG58U Cable PL259	
spade lugs	\$1.70
50 ft. RG58U 2PL259	ea. \$2.95
50 ft. RG8U 2PL259	ea. \$7.95
100 ft. RG58U Cable 2PL259	\$3.95
CB Lightning Arrestors	\$1.25
75 ft. 59U Cable	\$1.95
100 ft. 59U incl. "F con"	\$2.95
500 ft. 59U coax. cable Mill ends	\$10.00
500 ft. Asst. Hook-up Wire	\$2.95
20 Cheater Cords	\$6.00
20 ft. RG8U 2PL259	\$4.95
50' \$7.95	75' \$9.95
100' \$11.95	
RCA—RCA Audio Cables	
8 ft. 10/\$4.90	20 ft. 10/\$5.90

YOKES

Y-88	Y130	Y94	Y105
95-2779	ea. \$5.95	5 for \$29.95	
Y153			
DY92C	Y162/Y132		ea. \$12.95

DIODES, RECTIFIERS, EQUIVALENT

6500 PIV Color Focus Rect.	10 for \$8.00
2.5a 1000 PIV LR170	20 for \$3.50
Syl.—Zenith Tripler	ea. \$8.95

GENERAL

20 Asst. Belts (Reg. \$70.00)	\$7.00
Your cost	
72 ohm to 300 ohm matching	
trans.	10 for \$8.95
300 ohm signal splitters	10 for \$7.90
500 ft. Speaker Wire	\$5.00
BSR Deluxe Changer	\$24.95
S300 Surprise Package	\$10.00
50 Asst. Caps Pop	\$4.00

AUDIO-CARTRIDGES-NEEDLES EQUIV.

Astastic 133	ea. \$1.90
Ast. 142	ea. \$1.47
BSR SC7	ea. \$1.59
BSR SC7m	ea. \$1.95
Paterson EPC 42	ea. \$2.45
EV 28 ea. \$1.49	5015 ea. \$1.95
GE 850	ea. \$2.50
GE 860	ea. \$1.95
TETRAD—All Numbers	ea. \$1.95
ZEN.—142-187	142-188 ea. \$1.95
N44, N75, N91	ea. \$2.45
N3	ea. 89¢
Tetrad Univ. Needle	10 for \$8.90

Letters of credit & all checks placed on deposit with Manufacturers Manover Trust Bank, N.Y.C. Master Charge—Min. \$100—C.O.D.'s 50% Dep. Minimum Order \$80 FOB Brooklyn, N.Y. Catalogs, \$2 Refundable Upon Your Order. SEND CHECK OR MONEY ORDER TO:

T & T SALES CO.

4802 AVENUE K

BROOKLYN, N. Y. 11234

Phone: (212) 241-5940

settings, the Drive controls are re-connected with the emitter circuit to control white balance in the high light areas of the picture.

TROUBLESHOOTING LUMINANCE CIRCUITRY

Most brightness changes—a black or dark screen, a smeary picture, or a blooming raster—are the result of some defect in the luminance circuitry. When we say "brightness changes" we are not referring to a white screen which is the lack of video information, but to a change in the intensity of the raster.

Because the video circuit is DC coupled from the Video Detector to the CRT (see Fig. 1), any DC voltage change along the circuit will

cause a DC voltage change at the CRT cathodes and this will cause the raster to be darker or brighter. A more positive voltage anywhere from the Brightness control to the CRT cathodes will increase the bias between the cathodes and the grid and this will produce a darker raster. On the other hand, if this voltage becomes less positive, the cathodes also become less positive, the CRT bias voltage is lowered and the raster gets brighter.

With the grid, however, the opposite is true. When grid voltage increases, bias is reduced and the screen gets brighter—and when grid voltage decreases, the raster gets darker.

Although a defect in the lumi-
continued on page 54

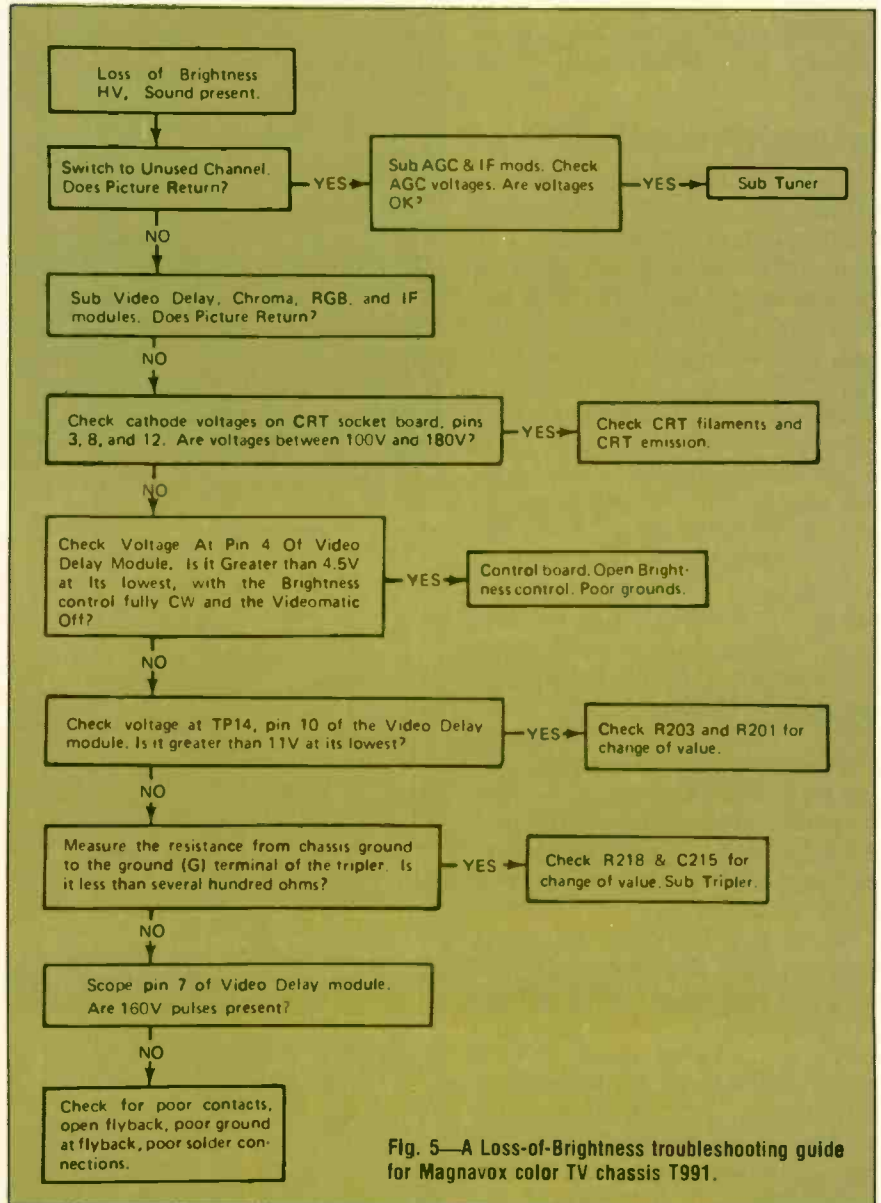

Fig. 5—A Loss-of-Brightness troubleshooting guide for Magnavox color TV chassis T991.

TUNER SERVICE CORPORATION

SUBSTITUNER



JUST
\$49.95
U.S.A. ONLY
WITH CABLES

ONE YEAR
GUARANTEE



STILL ONLY
\$10.95
U.S.A. ONLY
MAJOR PARTS
AND SHIPPING
CHARGED
AT COST

FEATURES

- A UHF Tuner with 70 channels which are detented and indicated just like VHF channels.
- A VHF Hi Gain Solid-State Tuner
- AC Powered
- 90-Day Warranty

Demonstrate the **SUBSTITUNER** to your customers and show improved reception with their TV sets.

You may place your order through any of the Centers listed below.

PROVIDES YOU WITH A COMPLETE SERVICE FOR ALL YOUR TELEVISION TUNER REQUIREMENTS.

REPAIR

VHF OR UHF ANY TYPE (U.S.A. ONLY) **\$10.95**
UHF/VHF COMBINATION (U.S.A. ONLY) **\$17.95**

Major Parts and Shipping Charged at Cost.

- Fast, efficient service at our conveniently located Service Centers.
- All tuners are ultrasonically cleaned, repaired, realigned, and air tested.

REPLACE

UNIVERSAL REPLACEMENT TUNER **\$13.95** (U.S.A. only)

- This price buys you a complete new tuner built specifically by Sarkes Tarzian Inc. for this purpose.
- All shafts have a maximum length of 10½" which can be cut to 1½".
- Specify heater type parallel and series 450 mA. or 600 mA.

CUSTOMIZE

- Customized tuners are available at a cost of \$14.95 and up (U.S.A. only).
- Send in your original tuner for comparison purposes to any of the centers listed below.

**F
L
A
S
H**

NOW AVAILABLE—TUNER SERVICE PARTS CATALOG OF ALL SARKES TARZIAN VHF AND UHF TUNERS, INCLUDING EXPLODED VIEW DRAWINGS. OVER 200 PAGES. ORDER YOUR COPY TODAY. SEND \$2.50 WITH ORDER TO BLOOMINGTON HEAD OFFICE.

SAME DAY SERVICE—ONLY ORIGINAL FACTORY PARTS USED



HEADQUARTERS	BLOOMINGTON, INDIANA 47401	537 South Walnut Street	Tel. 812-334-0411
ALABAMA	BIRMINGHAM, ALABAMA 35212	5623 1st Ave., N.	Tel. 205-592-9150
CALIFORNIA	NORTH HOLLYWOOD, CALIF. 91601	10654 Magnolia Boulevard	Tel. 213-769-2720
	MODESTO, CALIF. 95351	123 Phoenix Avenue	Tel. 209-521-8051
	SAN MATEO, CALIF. 94402	600 S. Amphlett Blvd.	Tel. 415-348-3292
FLORIDA	TAMPA, FLORIDA 33606	1505 Cypress Street	Tel. 813-253-0324
	FT. LAUDERDALE, FLA. 33309	3516 N.W. 10th Avenue	Tel. 305-566-4882
GEORGIA	ATLANTA, GEORGIA 30310	646 Evans Street S.W.	Tel. 404-758-2232
ILLINOIS	SKOKIE, ILLINOIS 60076	5110 West Brown Street	Tel. 312-676-0230
	URBANA, ILLINOIS 61801	708 E. Main St.	Tel. 217-384-2052
INDIANA	INDIANAPOLIS, INDIANA 46204	112 West St. Clair Street	Tel. 317-632-3493
KENTUCKY	LOUISVILLE, KENTUCKY 40205	2244 Taylorsville Rd.	Tel. 502-452-1191
LOUISIANA	SHREVEPORT, LOUISIANA 71104	2423 Southern Avenue	Tel. 318-221-3027
MASSACHUSETTS	SPRINGFIELD, MASSACHUSETTS 01108	405 Dickinson Street	Tel. 413-788-8206
MISSOURI	ST. LOUIS, MISSOURI 63132	9577 Page Avenue	Tel. 314-429-0633
NEVADA	LAS VEGAS, NEVADA 89102	1412 Western Avenue	Tel. 702-384-4235
NEW JERSEY	TRENTON, NEW JERSEY 08638	1139 Pennsylvania Avenue	Tel. 609-393-0999
	JERSEY CITY, NEW JERSEY 07307	454 Central Avenue	Tel. 201-792-3730
	ROCHESTER, NEW YORK 14615	37 Putman Ave.	Tel. 716-647-9180
NEW YORK	GREENSBORO, NO. CAROLINA 27405	2914 E. Market St.	Tel. 919-327-6276
NO. CAROLINA	CLEVELAND, OHIO 44109	4525 Pearl Road	Tel. 216-741-2314
OHIO	PORTLAND, OREGON 97210	1732 N.W. 25th Ave., P.O. Box 10141	Tel. 503-222-9059
OREGON	PITTSBURGH, PA. 15209	515 Grant Avenue	Tel. 412-821-4004
PENNSYLVANIA	MEMPHIS, TENNESSEE 38111	3158 Barton Avenue	Tel. 901-458-2355
TENNESSEE	DALLAS, TEXAS 75218	11540 Garland Road	Tel. 214-327-8413
TEXAS	ST. LAURENT, QUEBEC H4N-2-7	305 Decarie Boulevard	Tel. 514-748-8803
CANADA	CALGARY, ALBERTA T2H-1Y3	P.O. Box 5823, Stn. "A"	Tel. 403-243-0971

**WATCH US
GROW**

IF YOU WANT TO BRANCH OUT INTO THE TV TUNER REPAIR BUSINESS, WRITE TO THE BLOOMINGTON HEADQUARTERS ABOUT A FRANCHISE.

...for more details circle 134 on Reader Service Card

Twenty TV-Related Uses For A Field-Strength Meter

How to use the field-strength meter in TV antenna system performance testing and troubleshooting.

By James E. Kluge*



Fig. 1—A typical signal-level/field-strength meter, Winograd Model FS-780B, that provides measurements of all VHF (± 1 dB), UHF and FM carriers in the 10-microvolt to 2-volt range.

■ The field-strength meter (FSM) could probably be called more correctly a signal-level meter (SLM) (Fig. 1). It is basically a tuned-RF voltmeter with a scale that is calibrated in *microvolts* or in *decibels referred to 1 millivolt* in 75 ohms (dBmV).

A signal-level meter does *not* indicate the field strength of radiated electromagnetic energy expressed in *microvolts per meter*. Only a field-strength meter does that. However, it is fair to say

that there is a relationship between signal strength and field strength when the instrument is matched to a calibrated dipole antenna and properly oriented. Because the instrument is seldom, if ever, used that way, we will for the purposes of this article refer to it as a signal-level meter (SLM).

WHAT IS AN SLM?

Basically, the SLM simply measures the *voltage level* across a

75-ohm impedance at the frequency to which it is tuned. When the meter is connected to a 75-ohm coaxial cable, tap, or amplifier, its 75-ohm input impedance properly terminates the device to which it is connected.

TWENTY WAYS TO USE AN SLM

Common applications for the SLM include orienting antennas and measuring relative signal levels at various locations in an MATV system. The other eighteen applications presented in this article should also make your instrument far more useful and valuable to you in terms of saving time and effort when making measurements and adjustments.

Number One—Orienting An Antenna

For antenna orientation, connect the SLM to the antenna or download through a suitable matching transformer, as the SLM "wants to see" 75 ohms. Tune the SLM to the picture carrier of the weakest channel received and turn or move the antenna to achieve maximum signal.

Number Two—Measuring Relative Signal Levels

With the SLM still connected to the antenna, tune the SLM to the picture carrier of each channel to be received, and note the signal level indicated.

Number Three—Balancing Channels Out Of Headends

Connect the SLM to the output of each single-channel amplifier or channel separator panel in turn and note the relative signal levels. Plug in the appropriate

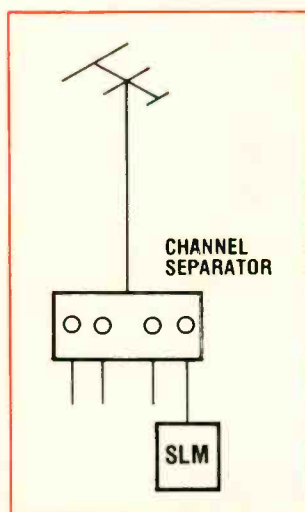

Fig. 2—A diagram of the set-up for balancing channels.

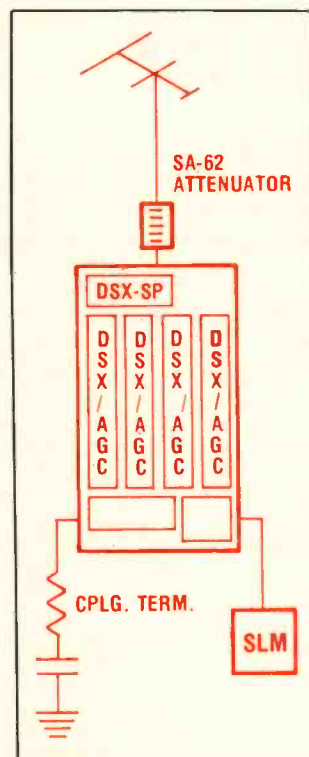

Fig. 3—The set-up for the measurement and adjustment of AGC amplifiers.

Astatic cuts your inventory.

with the world's finest and most complete
Tetrad replacement kits and **UNATET™** needles.

ONE **UNATET™** NEEDLE DOES IT ALL! Replaces all Tetrad
type needles. Ends the need to stock hundreds of
different Tetrad needles. And you never compromise
performance with **UNATET™**

But that's not all...
ASTATIC REPLACES ALL Tetrad two screw and snap-in
type cartridges with no compromising of capacities or
performance. Covers over 60% of your Tetrad
cartridge needs!

Pin down the details on **UNATET™** needles and Tetrad
replacement kits. Contact your Astatic dealer or distributor.
Or write Astatic today.



THE ASTATIC CORPORATION

CONNEAUT, OHIO 44030 (216) 593-4411

IN CANADA: Canadian Astatic Ltd., 1820 Ellesmere Road, Scarborough, Ontario M1H 2V5, (416) 438-6384



...for more details circle 107 on Reader Service Card

MARCH 1977, ELECTRONIC TECHNICIAN/DEALER / 21

pads in each channel to bring all channel levels within 2 to 3 dB of each other. (Fig. 2).

Number Four—AGC Settings And Measurements

When the AGC strip amps must be adjusted to compensate for varying input levels, the SLM may be used to measure the upper and lower levels of AGC effectiveness. (Fig. 3)

Connect the SLM to the headend output test jack and tune to the interested channel. Insert external attenuation ahead of the AGC-amplifier input until the SLM reading drops ½ dB. Note the attenuation. It will equal the amount that the input signal level can drop before losing AGC. Now take out attenuation until the SLM reading increases ½ dB and then note the attenuation. (In case there is insufficient input signal to cause the ½ dB increase, add a small amount of amplifier gain ahead of the input.)

Remember, the difference in attenuation equals the total AGC

range. In other words, attenuation *added* equals the amount the input-signal level may decrease before losing control; and attenuation *removed* equals the amount the input-signal level may increase before losing control. Procedures for making the AGC adjustments vary with the different models and manufacturers, but the SLM can be used to monitor the input and/or output levels while making any adjustments.

Number Five—Setting Tap Isolation

Line taps come in 3 varieties—fixed, selectable and variable isolation. Connecting an SLM to the tap (Fig. 4) will indicate the signal level. By clipping out fixed resistors (selectable) or turning the screwdriver adjustment shaft (variable) the isolation can be

varied to provide the desired level. Fixed-isolation taps must be interchanged to adjust the level.

Number Six—Measuring Insertion Loss

Connect the SLM to the cable entering a device such as a tap or a filter and measure the input level (Fig. 5). Then connect the SLM to the output of the device and reconnect the cable to the device input. The difference in level between the input and output is the insertion loss.

Number Seven—Measuring Gain Of Amplifier

Connect the SLM to the amplifier output, and note the level. (Fig. 5) Transfer the SLM to the cable previously connected to the amplifier input. The difference in readings gives the amplifier gain.

Number Eight—Determining the Tilt-Compensator And Line-Amp Location

An SLM aids in properly locating tilt compensators and line amplifiers in a trunkline. By

connecting the SLM to the output jack (Fig. 6) of various drop-line taps, the level can be measured until it falls below a level considered inadequate for tap isolation. Then, ahead of this tap, locate a tilt compensator followed by a line amplifier and then, the drop-line tap.

To determine the amount of tilt compensation, measure the level at the lowest and highest channels. The difference equals the tilt compensation required. VHF tilt compensators have a linear slope between channels 2 and 13; UHF models slope between channels 14 and 83. With the aid of a simple graph the correct tilt compensator can be selected for the channels actually used. The tilt of other channels added at a future date will be automatically and correctly

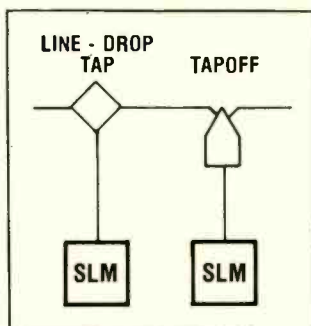

Fig. 4—The set-up for the adjustment of variable isolation on taps.

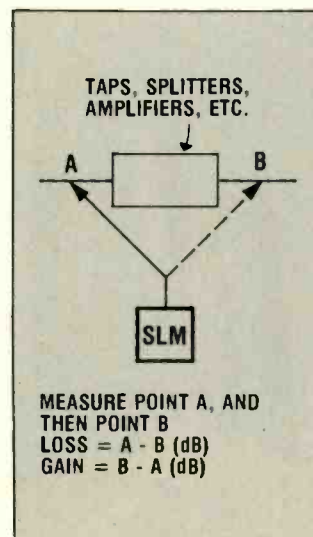

Fig. 5—The set-up and method for measuring insertion loss and amplifier gain.

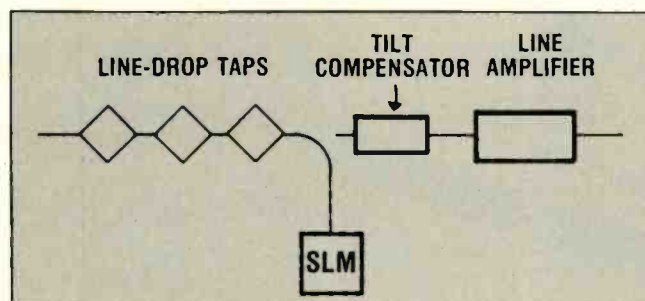

Fig. 6—Set-up for determining tilt-compensator and line-amp location.

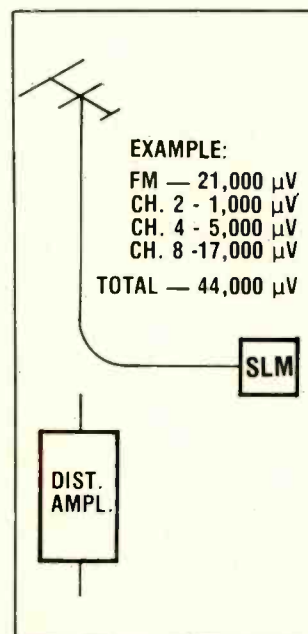

Fig. 7—Arrangement for measurement of total signal input to prevent overload or crossmodulation.

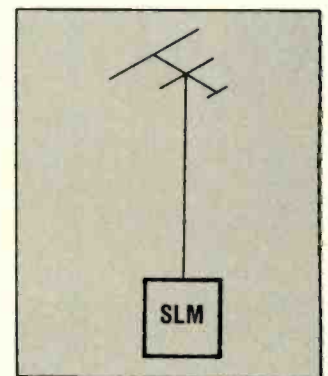

Fig. 8—The set-up for identification of interfering signals prior to purchase of factory-tuned traps.

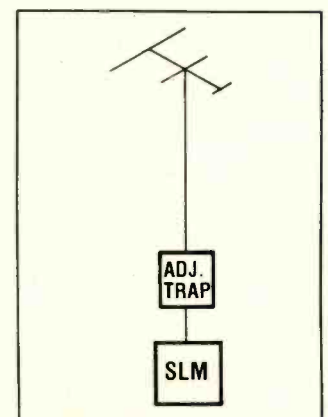

Fig. 9—Diagram of arrangement for field adjustment of tunable traps.

compensated.

Number Nine—Measuring Total Signal Input To Prevent Overload Or Crossmodulation

SLM's permit the reading of individual channel levels so that by totaling the individual *voltages*, the total voltage level applied to a distribution amplifier, or such, can be determined and, thus, avoid overload and consequent crossmodulation problems (Fig. 7).

Number Ten—Identifying Interfering Signals

Interfering signals can be located, frequency-wise, by tuning the SLM until a signal is indicated at a frequency where no signal should be (Fig. 8). Diagnosing the picture or listening with the SLM earphone while tuning will usually help an experienced technician to identify or deter-

mine the approximate frequency of an interfering signal. Verifying the frequency with an SLM then allows one to select a trap, an antenna configuration, or an orientation to minimize the interference.

Number Eleven—Tuning Taps In The Field

SLM's permit coarse- and fine-tuning adjustments of the picture-carrier or aural-carrier traps in the field (Fig. 9). By tuning the SLM to the carrier or interfering signal to be tapped out, the trap may then be inserted and tuning adjustments may be made to null the interfering signal level as indicated on the SLM.

Number Twelve—Monitoring Relative Field Strength

An SLM connected at any point in the MATV

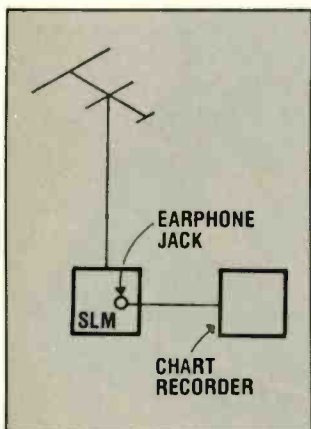

Fig. 10—Set-up for the monitoring of relative field strengths.

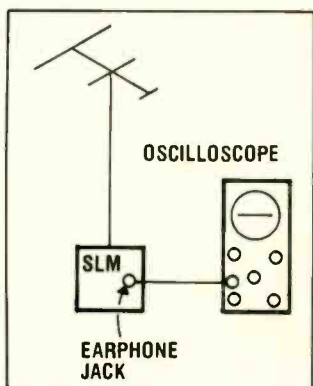

Fig. 11—Method of performing visual observation of carrier modulation.

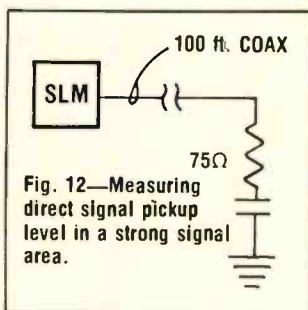
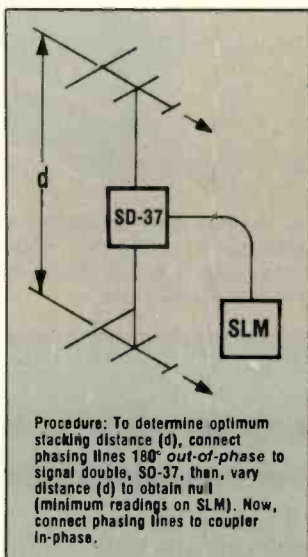
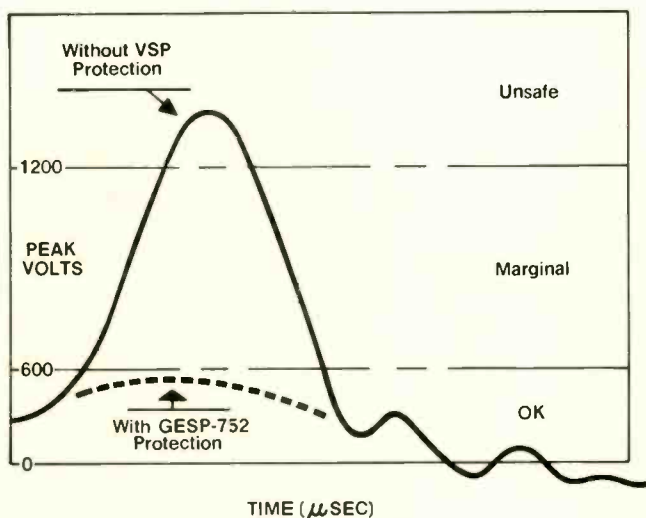

Fig. 12—Measuring direct signal pickup level in a strong signal area.



Procedure: To determine optimum stacking distance (*d*), connect phasing lines 180° out-of-phase to signal doubler, SD-37, then, vary distance (*d*) to obtain null (minimum readings on SLM). Now, connect phasing lines to coupler in-phase.

Fig. 13—Procedure for determining optimum stacking distance, phase and alignment.



GE Introduces Spike Protection

Protects TV's, Stereos and other sensitive electronics from brief high voltage surges from lightning strikes near power lines or switching Off and On of major appliances.



Insurance research has shown that TV sets are more susceptible to lightning caused voltage spike damage than other kinds of electronic equipment. Tube-type sets are less susceptible than solid-state circuitry. Some manufacturers offer built-in spike-protection circuits; others don't. Why take a chance? Especially when spike protection is made so easy.

Just plug the GE Voltage Spike Protector into any 15 amp, 125 volt wall outlet, then plug in the TV set.

Every service technician should carry several GE Voltage Spike Protectors in his service kit. Every service call means a sales opportunity. See your GE Authorized Tube Products Distributor; ask for Part No. GESP-752.

Tube Products Department
General Electric Company
Owensboro, Kentucky 42301

GENERAL  ELECTRIC

system (AGC circuits must be disabled) permits monitoring of relative field strength by monitoring the actual signal levels at that point (Fig. 10). Since the field strength, as seen by the antenna, is proportional to the voltage level at the antenna terminals, the voltage levels anywhere in the system are also proportional to field strength at the antenna. Thus, any variation in field strength at the antenna (in dB) causes a corresponding voltage-level change (in dB) anywhere in the system. Unattended monitoring of relative field strength is accomplished by connecting a suitable chart

recorder to the earphone jack on the SLM.

Number Thirteen—Visual Observation of Carrier Modulation

Most SLM's have a jack to which both an oscilloscope and an earphone can be connected (Fig. 11). By connecting the oscilloscope input to this jack, the picture or sound carrier modulation can be observed, and with an earphone or audio-amplifier/speaker, the modulation can be heard.

Number Fourteen—Measuring Direct Signal Pickup

In areas where the signals are strong enough to be picked up directly in

the coaxial cable, the SLM can be used to measure the level (Fig. 12). Connect a 100-foot length of cable to the SLM and terminate the free end of the cable. Tune the SLM to channels of interest and note the direct-pickup levels for the 100 feet of cable. Like any antenna, the distance from the signal source, orientation and positioning will affect the pickup level.

Number Fifteen—Stacking and Phasing Antennas

The spacing and alignment of vertical stacked antennas to achieve maximum gain is generally a "cut and try" situation except when one

uses an SLM. To easily find the optimum spacing, purposely connect the antennas out-of-phase (Fig. 13). Then, by observing the SLM connected to the coupler, vary the spacing or alignment to get a null on the SLM. Then, reconnect the antennas in phase. You could also seek a maximum reading with the antennas in phase, but it would only be a 2 or 3 dB increase, compared to a 20 or 30 dB sharp null with the antennas out-of-phase. To determine the correct phasing of two antennas, observe the SLM for the highest of two readings (in-phase versus out-of-phase connections).

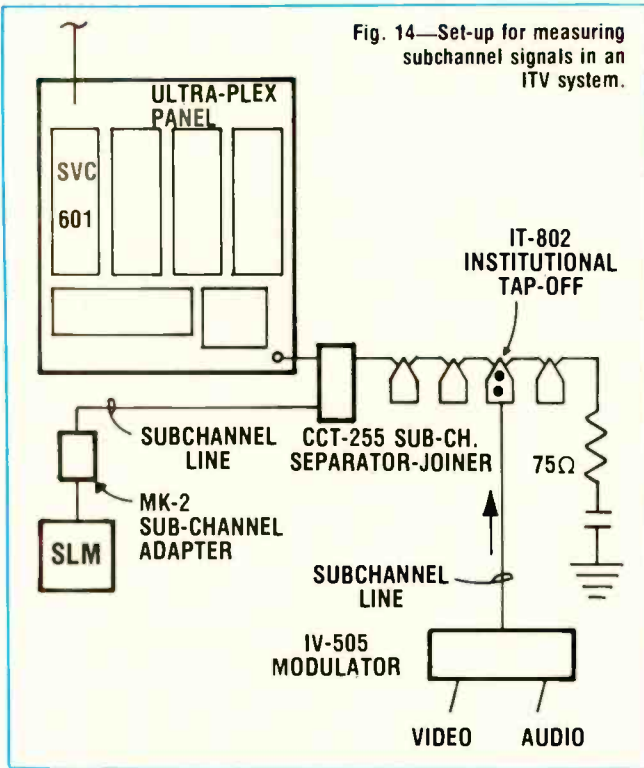

Fig. 15—A typical low-frequency adaptor, MK-2, that converts incoming 4.5 to 54 MHz frequencies to 115 to 164 MHz, which are then read on the SLM's midband scale. Battery powered, the unit slips into the accessory compartment of the FS-780B SLM.



Fig. 16—This Spectrum Analyser, Model 260A, emits a continuous, flat signal from 4.5 to 300 MHz, uniform to within ± 1 dB throughout its frequency range. A built-in 75-ohm comparison bridge permits direct measurements of return loss.

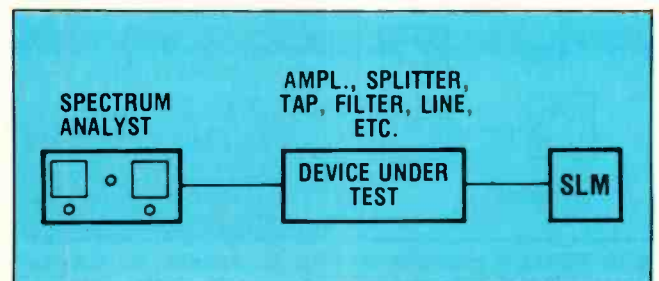

Fig. 17—Diagram of the set-up for measuring frequency response.

Number Sixteen—Measuring Subchannel Signals In ITV Systems

Institutional TV, as used in schools, hospitals and office buildings, employs subchannel signals from 17 to 48 MHz to distribute music, announcements, CCTV, and other special program material throughout the facility via MATV cable. To measure these signal levels with an SLM, a separator-joiner (CCT-255) is required to tap into the ITV system at some point, preferably at a cable connection (Fig. 14). Some SLM's may also require a low-frequency adapter (Fig. 15) if they cannot be tuned down to

subchannels.

Number Seventeen—Measuring Frequency Response

By connecting an SLM to the output of a device such as an amplifier, filter or tilt compensator, and supplying the device input from a flat, broadband signal source such as a Spectrum Analyst (Fig. 16), you can measure the frequency response of the device (Fig. 17). When you tune the SLM over the bandpass of the device you'll get voltage-versus-frequency data from which you can construct a VHF frequency-response curve. This curve will be within the accuracy limitations of the SLM and the flat-



Fig. 18—This is a Porta-Bridge, Model PB-1, a portable 75-ohm comparison bridge that also generates a continuously flat signal ($\pm 1.5\text{dB}$) to permit direct measurements of return-loss and VSWR.

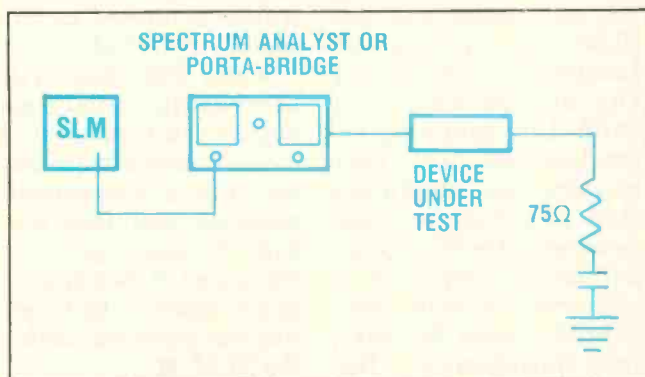

Fig. 19—This is the equipment set-up for the measurement return loss and VSWR for individual components of a trunk of a system.

Quality, Convenience, Capability And Price Make HP's Low-Cost DMM's The Right Decision.

\$225*—The HP 3476A—3½ Digits—Autoranging, automatic polarity and automatic zero. \$225* for the "A" version with AC line operation or \$275* for the portable "B" version with batteries and recharging circuit.

\$375*—The HP 970A—3½ Digits—Handheld, autoranging, automatic polarity and zero. Readout can be inverted with a flick of your thumb for easy reading in any position.

\$400*—The HP 3435A—3½ Digits—Autoranging or manual operation and wide-range operation, plus built-in batteries and recharging circuits. Option 001 gives you line operation only for \$335*.

\$500*—The HP 3465B—4½ Digits—1 μV sensitivity gives you performance you'd normally expect from 5½-digit's. Fully portable with Nickel-Cadmium batteries and recharging circuit. Dry-cell operation and rack-mount are available in the 3465A for as low as \$425*.

Confidence in low-cost DMM's comes from knowing you've made the right decision. HP's quality and service let you rest assured. Contact your local HP field sales engineer or write today for more information. *Domestic U.S.A. price only.

HP DMM's... the right decision.

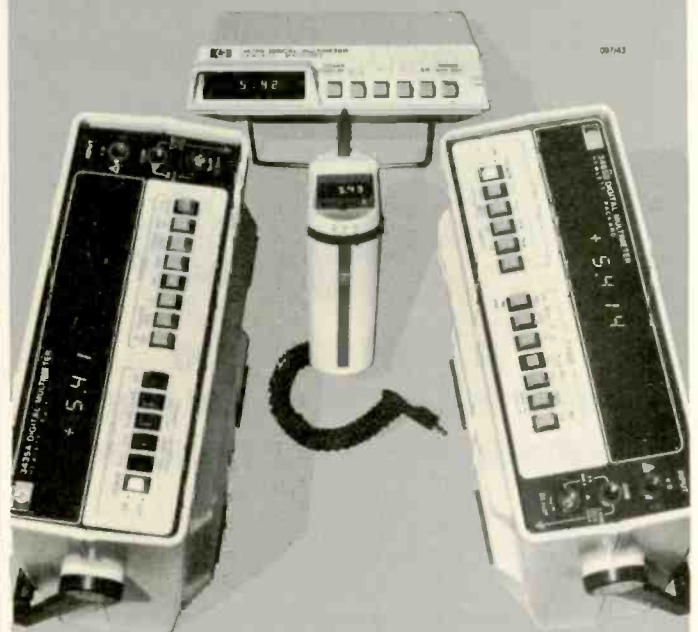

HEWLETT  PACKARD

1507 Page Mill Road, Palo Alto, California 94304

For assistance call: Washington (301) 546-6370, Chicago (312) 255-9800, Atlanta (404) 955-1500, Los Angeles (213) 877-1282

...for more details circle 158 on Reader Service Card

MARCH 1977. ELECTRONIC TECHNICIAN/DEALER / 25

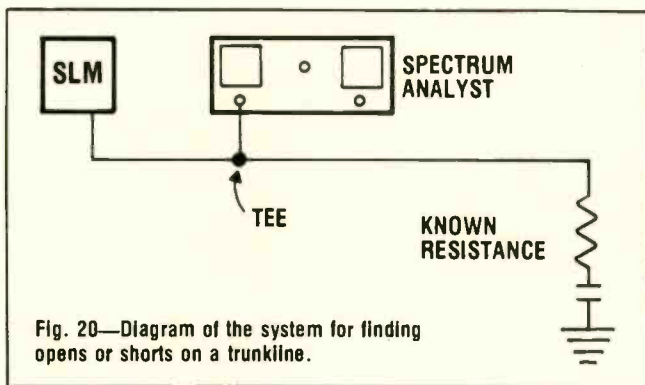

ness of the source voltage.

Number Eighteen—Measuring the Return Loss Or SWR

When used with a Spectrum Analyst or a Porta-Bridge (Fig. 18), the SLM allows you to measure the standing wave ratio (SWR) of an individual device such as an amplifier, cable, or tap filter, or an entire system. By connecting the SLM to the Porta-Bridge or Spectrum

Analyst (Fig. 19) and setting the output to 1000 μ V, the SWR of the device or system can be read directly off the meter scale. Using the chart of *Return Loss vs. VSWR*, shown in Table 1, SWR can be converted to return loss.

Number Nineteen—Locating Cable Faults

Again, using a Spectrum Analyst or a Porta-Bridge in combination with an SLM,

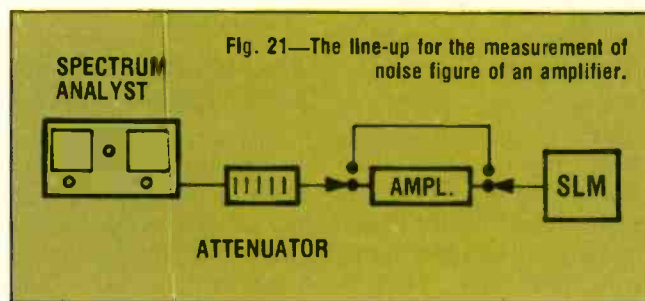

shorts or opens in coaxial cable can be located up to 500 feet away from the test point. (Fig. 20). Using a simple tee, inject the wideband output from the Spectrum Analyst or Porta-Bridge into the cable where the SLM is connected. Starting at the low-frequency end of the band, tune the SLM until a null is located, and note the frequency. Then, increase the tuning frequency until another null is located and note that frequency. The difference between these two frequencies will tell you at which frequency the cable distance to the fault is an electrical half-wavelength. The distance to the short or open can be calculated from a chart or graph prepared by the instrument manufacturer.

Number Twenty—Measuring Noise Figure

The noise figure of amplifiers can be measured with an SLM, (Fig. 21) with certain limitations. Because the bandwidth of the SLM is, in nearly all cases, narrower than the unit under test, the SLM will determine the bandwidth over which the measurement is valid. Low-gain amplifiers (less than 35 dB) may require post amplification to obtain a noise reading on the SLM. If an additional amplifier is required, its noise contribution must be taken into consideration. De-

termining the noise figure consists of three steps:

- With the SLM connected to the output of the amplifier, or post amplifier, terminate the amplifier input with its characteristic impedance (usually 75 ohms) and read the SLM in dBmV.

- Compute the theoretical noise level (in dBmV) at the input termination and add to it the gain (in dB) of the amplifier. i.e.,

$$EN = KT^{\circ}R\Delta f, \text{ where:}$$

EN = Noise level in volts rms

K = Boltzmann's constant = 1.38×10^{-23}

T[°] = Temperature in Kelvins

R = Characteristic impedance = 75 ohms

Δf = Bandwidth in hertz (Use a Spectrum Analyst or Porta-Bridge as a broadband signal source to measure the gain of the amplifier.) The result is the noise output if the theoretical input noise figure of the amplifier were amplified without any noise contribution by the amplifier itself. Remember, the computed input-noise level is a function of bandwidth which is limited in this case by the SLM

• The difference in dB between the actual noise output (as measured in step 1) and the noise output from a theoretically noiseless amplifier having the same gain (as measured in step 2) is the noise figure of the amplifier over the bandwidth of the SLM. ■

*The author is a technical editor for the Winegard Company



A Platt tool case won't fall apart at the seams because there are no seams.

Unlike other tool cases, the pockets on a Platt Pallet are molded without any seams, stitches or rivets to form a one-piece unit. It's practically indestructible.

The case itself has that same rugged construction. It comes in either tough, lightweight ABS Thermoplastic, rich looking expanded vinyl or a combination of both.

Platt also has rugged hardware. Like an aluminum rim for extra strength. Steel core handles. And tough brass locks.

Inside there are compartments for larger tools, parts boxes and testing equipment. And multiple lid pockets for paper and order books.

Besides having a tough case Platt has a tough 5-year guarantee on both the case and pallet.

• Pat. No. 3,880,285

Cases for business and industry.

2301 S. Prairie Ave., Chicago, Ill. 60616 (312) 225-6670

platt

...for more details circle 123 on Reader Service Card

Test Instrument Source Guide

For Entertainment/Two-Way Communication Electronics Servicers

A list of the most common generic types of electronic test instruments typically employed in the servicing of entertainment and/or two-way communications electronic products and the most prominent* manufacturers and/or marketers of such test instruments.

American Technology Corp.

225 Main St.
Canon City, CO 81212
303-275-8991

Antenna Specialists

12435 Euclid Ave.
Cleveland, OH 44106
216-791-7878

Ballantine Labs, Inc.

P.O. Box 97
Boonton, NJ 07005
201-335-0900

B&K Precision

6460 W. Cortland
Chicago, Ill. 60635
312-889-9087

Bird Electronic Corp.

30303 Auroro Rd.
Cleveland, OH 44139
216-248-1200

Blonder Tongue Labs

One Jake Brown Rd.
Old Bridge, NJ 08857
201-679-4000

Channel Master

Consumer Products
Group
Ellenville, NY 12428
914-647-5000

Colonial Merchandising

This directory consists of two sections: 1) A test instrument-to-manufacturer/marketer cross reference in which the generic types of instruments are grouped according to the general categories of entertainment and/or two-way communication electronic product servicing for which they are designed and/or in which they typically are employed. (Those types listed under 'GENERAL APPLICATIONS' are applicable to the servicing of most types of entertainment and two-way communication electronic products.) 2) An alphabetized listing of the names, addresses and phone numbers of the most prominent* manufacturers and/or marketers of electronic test instruments specifically designed for or typically used in the servicing of entertainment and/or two-way communications electronic products.

Div. of GTE Sylvania

7555 S. 10th St.
Oak Creek, WI 53154
414-762-0100

Commando Communication Corp.

P.O. Box 11071
Chattanooga, TN 37401
615-837-8681

Cushman Electronics, Inc.

830 Stewart Drive
Sunnyvale, Calif. 94086
408-739-6760

Dana Laboratories Inc.

2401 Campus Dr.
Irvine, CA 92715
714-833-1234

Data Precision Corp.

Audubon Rd.
Wakefield, MA 01880
617-246-1600

Data Tech

2700 S. Fairview
Santa Ana, CA 92704
714-546-7160

Edison Electronics Div.,

McGraw-Edison Co.
Grenier Field Munic
Airport
Manchester, NH 03103
603-669-0940

Eico Electronic Instr.

283 Malta St.

Brooklyn, NY 11207
212-272-1100

Elenco Electronics

1940 Raymond Dr.
Northbrook, IL 60062
312-564-0919

Exact Electronics Inc.

455 SE 2nd Ave.
Hillsboro, OR 97123
503-648-6661

The Finney Co.

34 W. Interstate St.
Bedford, OH 44146
216-232-6161

GC Electronics

400 S. Wyman
Rockford, IL 61101
815-968-9661

Heath Co.

Benton Harbor, MI
49022
616-982-3207

Hewlett-Packard

1820 Embarcadero Rd.,
Blg. 9B
Palo Alto, CA 94303
415-493-1501

Hickok Electrical Instr.

10514 Dupont Ave.
Cleveland, OH 44108

216-541-8060

Instant Instr.
306 River St.
Haverhill, MA 01830
617-373-9260

James G. Biddle Co.
Plymouth Meeting, PA
19462
215-646-9200

Jerrold Electronics Corp.
200 Witmer Rd.
Horsham, PA 19044
215-674-4800

John Fluke Mfg. Co., Inc.
P.O. Box 43210
Mount Lake Terrace,
WA 98043
206-774-2211

Keithley Instruments, Inc.
28775 Aurora Rd.
Cleveland, OH 44139

Lapp Co., Inc.
33 W. Water St.
Wakefield, MA 01880
617-245-4640

Leader Instrument Corp.
151 Dupont St.
Plainview, NY 11803
516-822-9300

Lampkin Labs, Inc.
P.O. Box 9048
Bradenton, FL 33506
813-792-5566

Letrotech, Inc.
5810 North Western
Ave.
Chicago, IL 60659
312-769-6262

Logimetrics, Inc.
121-03 Dupont St.
Plainview, NY 11803
516-681-4700

Mura Corp.
177 Cantiaque Rock Rd.

TELEVISION APPLICATIONS	AGC BIAS BOXES	ALIGNMENT GENERATORS	WITHOUT NUMBER GEN	W/NUMBER GEN	COLOR BAR	TESTING PATTERN GENERATORS	TUNER SUBSTITUTERS	COLOR TV TEST JIG	SWEEP CIRCUIT ANALYZER
	AMERICAN TECHNOLOGY								
B&K PRECISION									
COLONIAL MERCHANDISING									
DANA LABS									
DATA PRECISION									
DATA TECHNOLOGY									
EICO									
ELENCO									
HEATH									
HEWLETT-PACKARD									
HICKOK									
JERROLD									
JOHN FLUKE									
LEADER									
LECTROTECH									
NON-LINEAR									
PHILIPS									
POMONA									
PTS ELECTRONICS									
RCA									
SENCORE									
SIMPSON									
TEKTRONIX									
TELEMATIC/POLARIS									
TRIPLETT									
TUNER SERVICE									
VIZ									
WAVETEK									

RCA'S FREE & EASY '77 Dealer Awards

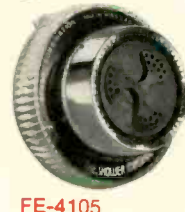

AUDIO APPLICATIONS

	DISTORTION METERS	DUMMY LOADS	SPECTRUM ANALYZERS	SINE WAVE ONLY	WAVE SQUAREWAVE	WATTMETERS	AUDIO ANALYZERS	FLUTTER METERS	SIG GENS
B&K PRECISION									
COMMANDO									
DATA TECHNOLOGY									
EDISON									
EICO									
EXACT									
GC									
HEATH									
HEWLETT-PACKARD									
HICKOK									
JERROLD									
JOHN FLUKE									
LAMPKIN LABS									
LEADER									
LOGIMETRICS									
PHILIPS									
SENCORE									
SIMPSON									
SYSTRON-DONNER									
TEKTRONIX									
TRIPLETT									
VIZ									
WAVETEK									
WESTON									

RADIO APPLICATIONS
(Broadcast Receivers, Home & Auto)

	AM	FM	STEREO FM ANALYZERS	SIG GENS (RF)	FM ANALYZERS
B&K PRECISION					
DATA TECHNOLOGY					
EDISON					
EICO					
ELENCO					
GC					
HEATH					
HEWLETT-PACKARD					
JOHN FLUKE					
LAMPKIN LABS					
LEADER					
LECTROTECH					
LOGIMETRICS					
PHILIPS					
SENCORE					
SIMPSON					
SOLITRON					
SYSTRON-DONNER					
VIZ					
WAVETEK					

Westbury, NY 11590
516-935-3640

Noble Electronics
P.O. Box 2536
El Cajon, CA 92021
714-449-6650

Non-Linear Systems, Inc.
533 Stevens Ave.
Solana Beach, CA 92075
714-755-1134

Philips Test & Measuring Co., Inc.
85 McKee Dr.
Mahwah, NJ 07430
516-921-8880

Phipps & Bird, Inc.
P.O. Box 27324
Richmond, VA 23261
804-264-2858

Pomona Electronics
1500 E. 9th St.
Pomona, CA 91766
714-623-3463

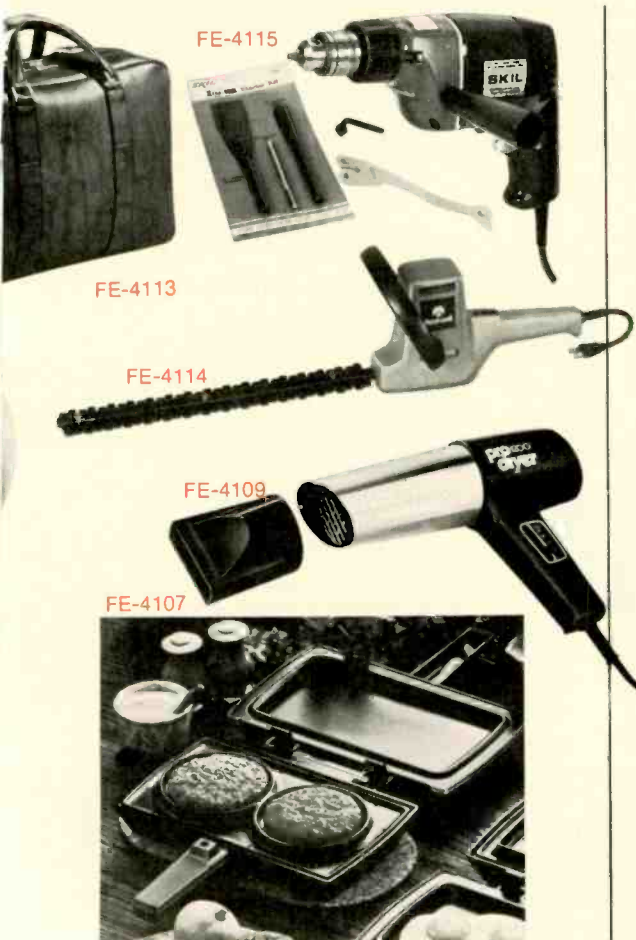

When you think of receiving tubes, think RCA! When you think of dealer awards, think RCA "Free and Easy '77." Then get both from your local participating RCA tube distributor. Quality tubes and quality awards go hand in hand from RCA.

Free with your purchase of RCA Entertainment Receiving Tubes

Check out these 17 values; select the award you want; then visit your participating RCA distributor and find out how easily you can take home that award when you place your tube order.

- SPALDING "DRIBBLER" BASKETBALL — FE-4102 — Value: \$12.00 (Not Illustrated)
- SPALDING TENNIS CARRY-ALL — FE-4103 — Value: \$15.40 (Not Illustrated)
- WILSON PRO STAFF GOLF BALLS — FE-4118 — Value: \$15.75
- SPALDING REBEL FOOTBALL — FE-4104 — Value: \$17.00
- WATER PIK SHOWER MASSAGE — FE-4105 — Value: \$24.95
- SPALDING PANTO GONZALES SIGNATURE RACKET — FE-4106 — Value: \$22.60
- PRESTO BURGER/2 — FE-4107 — Value: \$35.90
- GARCIA MITCHELL SPINNING COMBO - FE-4108 - Value - \$39.95
- SCHICK PRO JET-1200 STYLING DRYER - FE-4109 - Value: \$39.00
- SKIL DOUBLE INSULATED 2-SPEED JIG SAW — FE-4110 — Value: \$40.95 (Not Illustrated)
- TAYLOR AMERICAN EAGLE BINOCULARS — FE-4111 — Value: \$56.95
- SHEPHERD BALL-B-Q FAMILY SIZE GRILL — FE-4112 — Value: \$54.95
- HAZEL SAXONY 21" DUFFEL BAG — FE-4113 — Value: \$50.00
- ROCKWELL 16" HEDGE AND SHRUB TRIMMER — FE-4114 — Value: \$34.95
- SKIL MULTI-PURPOSE X-TRA TOOL — FE-4115 — Value: \$67.95
- OLIVETTI UNDERWOOD PORTABLE TYPEWRITER — FE-4116 — Value: \$79.50
- OLIVETTI "DIVISUMMA 32" ELECTRONIC PRINTING CALCULATOR — FE-4117 — Value: \$109.00

RCA Distributor & Special Products Division, Deptford, N.J. 08096

RCA Receiving Tubes

3 things that TV servicemen want most in a Color Bar Generator

PORTABILITY • PERFORMANCE • PRICE

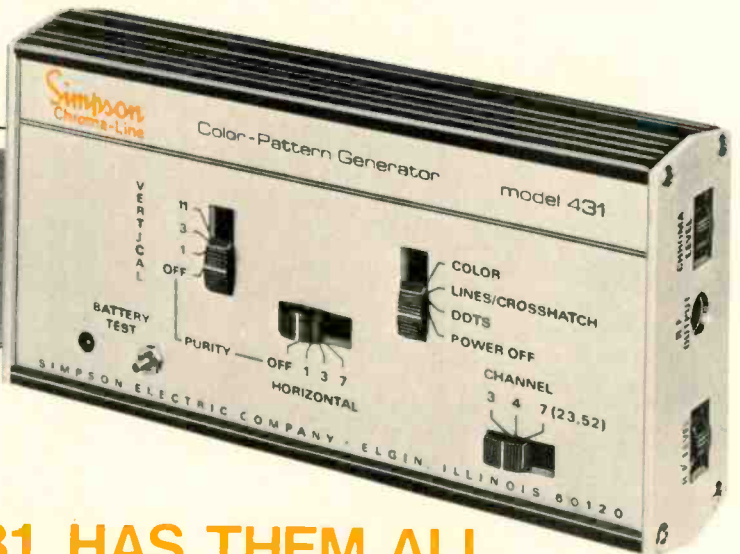
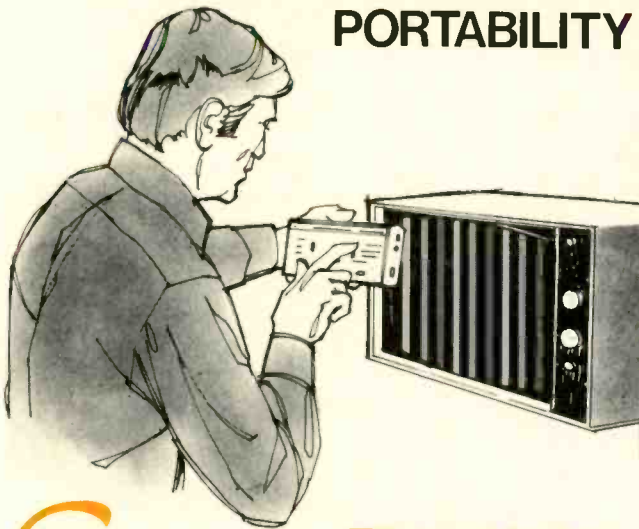

THE NEW Simpson® MODEL 431 HAS THEM ALL

- Fits in the hand. Weighs 13 oz.
- 28 Patterns. 13 Tests.
- Easy, Accurate Adjustment of Color and Black-and-White Sets.
- More Performance for the Price than Any Other Small Size Unit.
- One 9-V Battery Gives about 80 Hours of Continuous Use.
- Digital IC Logic Countdown Chains.
- Crystal-Controlled Master Oscillator and Chroma Subcarrier Oscillator for Stability.
- 3 VHF and 2 UHF Channel Outputs.
- Adjustable Chroma and RF Output.
- External Access Battery Compartment.

MODEL 431 complete with battery, cable assembly and operator's manual ... **\$95.00**
Carrying case, catalog No. 00817 \$7.50

GENERATES THESE MOST USEFUL PATTERNS PLUS MANY MORE ... 28 PATTERNS IN ALL

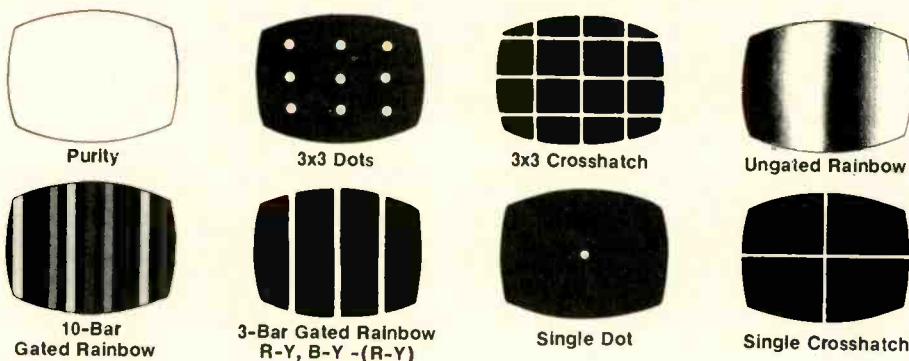

ORDER FROM YOUR DISTRIBUTOR

PERFORMS THESE TESTS:

1. Purity (Whiteness)
2. Static Convergence
3. Gray Scale Tracking
4. Dynamic Convergence
5. Overscan Adjustments
6. Horizontal Linearity
7. Vertical Linearity
8. Centering
9. Pincushion
10. Automatic Gain Control
11. Automatic Frequency/Phase Control
12. Color Sync Lock
13. Color Killer Adjustment



SIMPSON ELECTRIC COMPANY

853 Dundee Avenue, Elgin, Illinois 60120
(312) 697-2260 • Cable: SIMELCO • Telex: 72-2422
IN CANADA: Bach-Simpson, Ltd., London, Ontario
IN ENGLAND: Bach-Simpson (U.K.) Limited, Wadebridge, Cornwall
IN INDIA: Ruttonsha-Simpson Private, Ltd., Vikhroll, Bombay

KATY INDUSTRIES



INDUSTRIAL EQUIPMENT GROUP

COMMUNICATION (Two-Way) APPLICATIONS	COMMUNICATIONS ANALYZERS				SIGNAL GENERATORS (RF)				SWR METERS				
	CB	LANDMOBILE	MARINE	AVIATION	FREQ. COUNTERS (DIGITAL)	POWER SUPPLIES (ANALOG)	RF DUMMY LOADS	RF WATTMETERS		LANDMOBILE	MARINE	AVIATION	SPECTRUM ANALYZERS
ANTENNA SPECIALISTS													
B&K PRECISION	•												
BIRD ELECTRONICS					•	•						•	•
COMMANDO													
CUSHMAN	•	•	•	•									
DANA LABS													
DATA TECHNOLOGY	•	•	•										
EDISON													
EICO	•												
ELENCO													
GC													
HEATH													
HEWLETT-PACKARD	•	•	•	•									
HICKOK	•												
JERROLD													
JOHN FLUKE													
KEITHLEY													
LAPP													
LAMPKIN LABS	•	•	•	•									
LEADER													
LECTROTECH	•	•											
LOGIMETRICS													
MURA	•												
NON-LINEAR													
PHILIPS													
SENCORE	•												
SIMPSON	•	•	•	•									
SOLITRON													
SYSTRON-DONNER	•												
TEKTRONIX													
VIZ													
WAVETEK													
WESTON													

GENERAL APPLICATIONS	RC SUB BOX		CAPACITOR TESTER		DIGITAL MULTIMETERS		RECURRENT TRIGGERED		BETA RADIATION		CURIE TRACER		SOLID STATE TUBE STATE		VTVMs		VOHMs (analog)		FIELD STRENGTH		MEGOhmmeter		RF NOISE DETECTOR		
	SCOPES	SEMI-CONDUCTOR TESTERS																							
BALLANTINE LABS																									
B&K PRECISION	•																								
CHANNEL MASTER																									
COMMANDO																									
DANA LABS																									
DATA PRECISION	•																								
DATA TECHNOLOGY	•																								
EDISON																									
EICO	•	•	•	•	•	•	•	•	•	•	•	•	•	•	•	•	•	•	•	•	•	•	•	•	•
FINNEY																									
GC																									
HEATH	•	•	•	•	•	•	•	•	•	•	•	•	•	•	•	•	•	•	•	•	•	•	•	•	•
HEWLETT-PACKARD	•	•	•	•	•	•	•	•	•	•	•	•	•	•	•	•	•	•	•	•	•	•	•	•	•
HICKOK	•																								
JAMES G. BIDDLE																									
JERROLD																									
JOHN FLUKE																									
KEITHLEY																									
LEADER	•	•	•	•	•	•	•	•	•	•	•	•	•	•	•	•	•	•	•	•	•	•	•	•	•
LECTROTECH																									
MURA																									
NOBLE																									
NON-LINEAR																									
PHILIPS																									
PHIPPS & BIRD	•																								
PTS ELECTRONICS																									
SENCORE	•	•	•	•	•	•	•	•	•	•	•	•	•	•	•	•	•	•	•	•	•	•	•	•	•
SIMPSON																									
SPRAGUE																									
SYSTRON-DONNER																									
TEKTRONIX																									
TELEMATIC/POLARIS																									
TRIPLETT	•	•	•	•	•	•	•	•	•	•	•	•	•	•	•	•	•	•	•	•	•	•	•	•	•
VIZ	•	•	•	•	•	•	•	•	•	•	•	•	•	•	•	•	•	•	•	•	•	•	•	•	•
VU-DATA																									
WESTON																									
WINEGARD																									

PTS Electronics, Inc.
5233 S. Highway 37
Bloomington, IN 47401
812-824-9331

Systron-Donner
10 Systron Dr.
Concord, CA 94518
415-676-5000

Vaco Products Co.
510 N. Dearborn St.
Chicago, IL 60610
312-467-0123

Wavetek Indiana, Inc.
66 N. First Ave.
Beech Grove, IN 46107
317-783-3221

Sencore, Inc.
3200 Sencore Dr.
Sioux Falls, SD 57107
605-339-0100

Tektronix, Inc.
P.O. Box 500
Beaverton, OR 97005
503-644-0161

VIZ
335 E. Price St.
Philadelphia, PA 19144
215-844-2626

Weston Instruments
614 Frelinghuysen Ave.
Newark, NJ 07114
201-242-2600

Simpson Electric Co.
853 Dundee Ave.
Elgin, IL 60120
312-697-2260

Telematic
2245 Pitkin Ave.
Brooklyn, NY 11207
212-827-1500

VU Data
7170 Convoy Court
San Diego, CA 92111
714-279-6572

Winegard Co.
3000 Kirkwood
Burlington, IA 52601
319-753-0121 ■

Solitron Devices
256 Oak Tree Rd.
Tappan, NY 10983
914-359-5050

Triplett Corp.
286 Harmon Rd.
Bluffton, OH 45817
419-358-5015

Sprague Products Co.
87 Marshall St.
North Adams, MA 01247
413-664-4481

Tuner Service Corp.
537 S. Walnut St.
Bloomington, IN 47401
812-334-0411

**The word 'prominent' as used in this directory is intended only to indicate those manufacturers and marketers whom the editors of ET/D have been able to source out and survey via phone within the time available for the preparation of this directory. Any test instrument manufacturer or marketer who currently markets test instruments directly applicable to the servicing of entertainment and/or two-way communications electronic products but who is not included in this directory is invited to furnish relevant information to the editor of ET/D for inclusion in a future update of this directory.*

An Extraordinary Offer

to introduce you to the benefits of Membership in

ELECTRONICS BOOK CLUB

for a limited time only you can obtain

ANY 3 OF THESE UNIQUE BOOKS . . . yours for only **99¢** each
(Combined List Price \$43.85) Club Membership . . . with Trial

May we send you these helpful new books as described on the facing page as part of an unusual offer of a Trial Membership in Electronics Book Club?

These are quality hardbound volumes, especially designed to help you increase your know-how, earning power, and enjoyment of electronics.

These handsome, hardbound books are indicative of the many other fine offerings made to Members . . . important books to read and keep . . . volumes with *your* specialized interests in mind.

Whatever your interest in electronics—radio and TV servicing, audio and hi-fi, industrial electronics, communications, engineering—you will find Electronics Book Club will help you.

With the Club providing you with top quality books, you may broaden your knowledge and skills to build your income and increase your understanding of electronics, too.

How You Profit from Club Membership

This special offer is just a sample of the help and generous savings the Club offers you. For here is a Club devoted exclusively to seeking out only those titles of direct interest to you. Membership in the Club offers you several advantages.

1. Charter Bonus: Take any three of the books shown (values to \$43.85) for only 99¢ each with your Trial Membership.

2. Guaranteed Savings: The Club guarantees to save you 15% to 75% on all books offered. All books are offered at low Member prices (plus a small shipping charge).

3. Continuing Bonus: If you continue after this trial Membership, you will earn a Dividend Certificate for every book you purchase. Three Certificates, plus payment of the nominal sum of \$1.99, will entitle you to a valuable Book Dividend which you may choose from a special list provided members.

4. Wide Selection: Members are annually offered over 50 authoritative, new books on all phases of electronics.

5. Bonus Books: If you continue in the Club after fulfilling your Trial Membership, you will receive a Bonus Dividend Certificate with each additional Club Selection you purchase. For the small charge of only \$1.99, plus three (3) Certificates, you may select a book of your choice from a special list of quality books periodically sent to Members.

6. Prevents You from Missing New Books: The Club's FREE *News* gives you advance notice of important new books . . . books vital to your continued advancement.

This extraordinary offer is intended to prove to you, through your own experience, that these very real advantages can be yours . . . that it is possible to keep up with the literature published in your areas of interest . . . and to save substantially while so doing.

How the Club Works

Forthcoming selections are described in the FREE *Club News*, published thirteen times a year. Thus, you are among the first to know about, and to own if you desire, significant new books. You choose only the main or alternate selection you want (or advise if you wish no book at all) by means of a handy form and return envelope enclosed with the *News*. As part of your Trial Membership, you need purchase as few as four books during the coming 12 months. You would probably buy at least this many anyway . . . without the substantial savings offered through Club Membership.

Limited Time Offer!

Here, then, is an interesting opportunity to enroll on a trial basis . . . to prove to yourself, in a short time, the advantages of belonging to Electronics Book Club. We urge you, if this unique offer is appealing, to act promptly, for we've reserved only a limited number of books for new Members.

To start your Membership on these attractive terms, simply fill out and mail the postage-paid airmail card to-

day. You will receive the books of your choice for 10-day inspection.

SEND NO MONEY! If you are not delighted, return it within 10 days and your Trial Membership will be cancelled without cost or obligation. Electronics Book Club, P.O. Box 10, Blue Ridge Summit, Pa. 17214.

Typical Savings Offered Club Members on Recent Selections

Understanding/Using Mod. Elect. Svc. Test Equip. & Sig. Gen. (dual selection)	List Price \$18.90; Club Price \$9.95
CB Radio Schematic/Service Manual—Vol. 1	List Price \$8.95; Club Price \$5.95
CB Radio Schematic/Service Manual—Vol. 2	List Price \$8.95; Club Price \$5.95
CB Radio Schematic/Service Manual—Vol. 3	List Price \$8.95; Club Price \$5.95
Master Transist./IC Substitution Handbk.	List Price \$11.95; Club Price \$5.95
Gen. Electric Color TV Service Manual—Vol. 3	List Price \$8.95; Club Price \$4.95
Broadcast Engineering & Maint. Handbk.	List Price \$19.95; Club Price \$12.95
Practical Solid-State DC Power Supplies	List Price \$9.95; Club Price \$6.95
How to Repair Home Kitchen Appliances	List Price \$8.95; Club Price \$4.95
Transistor Ignition Systems	List Price \$8.95; Club Price \$5.95
Service Medical & Bioelectronic Equip.	List Price \$10.95; Club Price \$6.95
Optoelectronics Guidebk./w Tested Proj.	List Price \$8.95; Club Price \$4.95
Master Handbook of Digital Logic Applications	List Price \$11.95; Club Price \$7.95
Fire & Theft Security Systems—2nd Ed.	List Price \$8.95; Club Price \$4.95
Impedance	List Price \$8.95; Club Price \$5.95
CBer's Handbook of Simple Hobby Proj.	List Price \$6.95; Club Price \$3.95
Build Your Own Working Robot	List Price \$8.95; Club Price \$5.95
Switching Regulators & Power Supplies	List Price \$9.95; Club Price \$5.95
106 Easy Elec. Proj.—Beyond the Transistor	List Price \$8.95; Club Price \$5.95
Linear IC Applications Handbk.	List Price \$9.95; Club Price \$5.95
Math. Unraveled/New Commonsense Ap.	List Price \$9.95; Club Price \$6.95
Mod. Guide to Digital Logic: Processors, Memories & Interfaces	List Price \$9.95; Club Price \$5.95
Electronic Conversions, Symbols/Formulas	List Price \$8.95; Club Price \$4.95
Electronic Music Circuit Guidebook	List Price \$9.95; Club Price \$5.95
Digital/Logic Electronics Handbk.	List Price \$9.95; Club Price \$6.95
Handbook of Multichannel Recording	List Price \$10.95; Club Price \$7.95

SEND NO MONEY! Simply fill in and mail postage-paid Airmail card today!

Troubleshooting with the Dual-Trace Scope

For fast, effective color TV troubleshooting, no instrument compares with the dual-trace triggered-sweep scope. It does in minutes what takes hours with the old-fashioned recurrent-sweep scope. Veteran servicer Goodman tells about the dual-trace scope and its features; how to use the triggered- and automatic sweep modes, dual-alternate and dual-chopped sweep modes, and other features of these instruments. He takes you through a variety of specific color TV modules to show how each troubleshooting step is performed. Apply his procedure to any make, any model! Over 125 photos of actual scope traces illustrate defective and normal waveforms. 224 pps., 252 illus. Hardbound.

List Price \$8.95 • Order No. 772

Practical CB Radio Troubleshooting and Repair

Here's complete info on antennas, system design, installation, servicing—PLUS 21 programmed troubleshooting charts and complete schematics for 18 popular transceivers! Contains more practical info on troubleshooting and installing CB transceivers than any book in print—no nonsense, stage-by-stage service data for all types of CB gear, plus down-to-earth advice on getting to the source of trouble and making repairs fast—in the field or on the bench. For the first time ever, it brings all aspects of CB operation and maintenance together; it's chock-full of hundreds of shortcuts, hints and kinks the author has gained from servicing thousands of CB units. 238 pps., 108 illus. Hardbound.

List Price \$8.95 • Order No. 754

Master Tube Substitution Handbook

A 3-section handbook covers 99% of tube replacement needs. Lists best substitutes for receiving, transmitting (both ham and 2-way), commercial, industrial, and foreign tubes. Only readily available substitutes listed—no need to search lists of tubes you'll rarely see in use. Section 1 contains a cross-reference of all popular vacuum tubes and their variations, listing substitutes which have similar or superior characteristics. 2 illustrates 576 basic diagrams in alphanumeric order. 3 contains a complete listing of B&W and color TV picture tubes and substitutions, notes on how to fit tube to chassis, how to make necessary wiring changes, chassis alterations, cabinet modifications, etc. 322 pps., 576 illus. Leatherette.

List Price \$8.95 • Order No. 870

Electronic Circuit Design Handbook

New Fourth Edition—A brand-new, enlarged edition of the ever popular circuit designer's "cook-book," now containing over 600 proven circuits, for all types of functions, selected from thousands on the basis of originality and practical application. Now you can have, at your fingertips, this carefully planned reference source of tried and tested circuits. Selected on the basis of their usefulness, this detailed compilation of practical design data is the answer to the need for an organized gathering of proved circuits... both basic and advanced designs that can easily serve as stepping stones to almost any kind of circuit you might want to build. 418 pps., 19 big sections, over 600 illus., 3 1/4" x 11".

List Price \$17.95 • Order No. T-101

Photo/Symptom Guide to Solid-State Color TV Troubles

The book to reach for when the going gets tough! Now you can get to the trouble fast by letting the TV itself tell what's wrong, by using picture symptoms to zero in on the fault. Contains 150 photos, carefully organized by symptoms, that illustrate actual circuit faults—you can really see what happens when different video and color stages fail. You'll learn how to recognize the characteristic symptoms produced by each TV stage. Each page contains a clear photo of symptom, plus an easy-to-understand description of the problem and its solution. There are also 20 schematics of typical solid-state circuits. Helps anyone in TV servicing to take the trouble out of troubleshooting. 224 pps., 169 illus. Hardbound.

List Price \$8.95 • Order No. 809

C.E.T. License Handbook, 2nd Edition

This completely revised guide to the C.E.T. exam features the first coverage of medical, communications, and MATV systems exams, and covers all you need to know to pass all 6 available exams, including circuit explanations, basic circuit math, signals, and waveforms. B&W and color TV, antennas and transmission lines, test equipment, waveform analysis and its use in TV troubleshooting, etc. Info is priceless for day-to-day reference—you'll refer to it again and again. Separate Chapters cover 5 options with info needed to pass the specialized exams. Each Chapter includes questions and answers for self-testing, and a replica test is included to help you know when you're ready! 448 pps., 381 illus. Hardbound.

List Price \$12.95 • Order No. 901

Microprocessor/Microprogramming Handbook

A practical, authoritative guide to the construction, operation, programming and applications of perhaps the most significant new technological achievement of our time. Tells what microprocessors are, how they work, where they're used, how you can use them in your applications! Shows how to write the necessary programs (called microprograms) to allow microprocessor to process and manipulate information, simulate control processes, and emulate other machines. Covers every aspect of microprocessors—inside and out, and illustrates basic microprogramming techniques to build up program loops, subroutines, and handle interrupts from other peripheral devices. 294 pps., 176 illus. Hardbound.

List Price \$9.95 • Order No. 785

Master Handbook of 1001 Practical Electronic Circuits

The ideal schematic sourcebook of IC and transistor circuits for practically anything and everything—with ALL data needed to put them to work. Each circuit diagram has every component carefully labeled, and every schematic is accompanied by all the info you need to construct the circuit for use in your own individual application. The circuits included are completely up-to-date, and have been designed, built, tested, reworked as necessary, and perfected. You'll find any circuit you're ever likely to need in the pages of this volume. Includes an ultra-complete, 2-page Index, plus an Appendix of IC substitutions. 602 pps., over 1250 illus. Hardbound.

List Price \$12.95 • Order No. 800

Modern Electronics Math

This giant, 686-page living math course is packed with absolutely everything you'll ever need to know about electronics math! It's a shortcut course for technicians and hobbyists, and a refresher "boonup" for engineers. The text is extremely easy to read and understand— you learn without a tutor at the pace you select for yourself! Thoroughly covers basic arithmetic, theory of numbers, AC and DC circuits, Ohm's law, algebra, logarithms, binary numbers, Boolean algebra, graphs, scales, and nomograms, and integral calculus... plus math tables and formulas so that within one handy volume, you have a complete electronics math course. 686 pps., 424 illus. Hardbound.

List Price \$12.95 • Order No. 655

Basic Electronic Test Procedures

A mammoth step-by-step guide to all types of basic electronics measurements, using simple, inexpensive test instruments. In this new book, mysteries usually associated with electronics tests are unveiled—many for the first time. The author shows how to get accurate, meaningful measurements with ordinary VOMs, electronic meters, oscilloscopes, etc., by taking into consideration the errors inherent in most test instruments. The important thing is knowing, and understanding, the true nature of what is to be measured and how to measure it; with VOMs, VTVMs or EVMs, digital meters, oscilloscopes, curve tracers, signal generators, tube and transistor testers, etc. 416 pps., 178 illus. Hardbound.

List Price \$9.95 • Order No. 627

Airline (Montgomery Ward), Volume 1

AIRLINE (Montgomery Ward), Vol. 1. Covers modular chassis 3M20, 20M-20, and M25; hybrids 3K19, 20K19, 21K19, 20K17, 22K18, 23K18, 24K18, 27K10, T11K10, T20K10, T21K10, T22K10, T23K10, T24K10, T25K10, GEN-12743 and GEN-12973. Includes service notes and parts lists, 196 pps., incl. 36-page foldout with 12 schematics.

List Price \$8.95 • Order No. 741

Build-It Book of Miniature Test & Measurement Instruments

The most comprehensive "how-to-do-it" book on low-cost, precision test equipment construction and use—complete with circuits, photos, full-size PC-board layouts, and complete instructions on operation and calibration. Includes panel layouts (with photos and templates), suggestions on knob and meter placement, plenty of tips and notes. Construction as easy as building a professional kit! Instruments give an almost unlimited range of measurement capability. They include RC(L) bridge, audio oscillator, function generator, amplifiers, tone-burst generators, Q-meter, digital frequency, period meter, sound level meter, logic probe, filters, etc., tips and circuits for updating oscilloscope. 238 pps., 151 illus. Hardbound.

List Price \$7.95 • Order No. 792

Color TV Trouble Factbook—Problems & Solutions: 3rd Ed.

The most comprehensive single all-in-one guide to color TV troubles and solutions ever, revised and enlarged by over 30%, the book can save hours of troubleshooting time! It's a fully indexed all-in-one reference guide to over 1,000 color-set troubles and recommended solutions, manufacturers' service notes, and production change data—all alpha-numerically arranged by make and model. Contains service tips, repetitive troubles, field-factory changes, new and unusual circuits and descriptions of how they work, special adjustment procedures, troubleshooting data and special problem-solving aids for popular U.S. and Canadian color TVs from A to Z. 434 pps., 100's of schematics and diagrams. Hardbound.

List Price \$9.95 • Order No. 919

VHF/UHF Fire, Police, Ham Scanners—Schem./Serv. Man.

Contains all data you need to begin complete and professional scanning monitor service for these important brands: Becey, Heathkit, Midland, E. F. Johnson and Unimetrics. You get topflight advice on how to select the right receiver, the proper antenna, and useful accessories—plus a review course on antenna and receiver theory, including a rundown of how the scanner scans! Shows how to order crystals (including complete specs and easy-to-use alignment tables). Contains parts lists with factory parts numbers, breakdown of receiver alignment instructions, printed circuit board parts layout drawings, voltage data that gives factory-type info for effective troubleshooting. 250 pps., 107 illus., 7" x 10". Leatherette.

List Price \$9.95 • Order No. 835

How to Repair Home Laundry Appliances

A complete and modern guide to washer/dryer service teaches how to confidently install, troubleshoot, and repair every modern-day system—top loaders, front loaders, suds-return machines, and gas and electric dryers. You will learn what to do when anything goes wrong with multicontact timers, motors, switches, automatic control thermostats, valves, pumps, relays, glow-coil igniters, and filters... how to "fix" rather than "replace" any component—including electric motors! Includes home wiring, water systems and hookups, water-treatment systems, ventilation, plus 100's of shortcuts and tricks of the trade. You'll learn as much about washer/dryer repair as any pro in the business. 280 pps., 37 illus. Hardbound.

List Price \$8.95 • Order No. 855

Small-Screen TV Servicing Manual

A 2-part supermanual that give all the service info you need to repair any small-screen TV, plus alignment/adjustment procedures for 30 best-selling models made by Admiral, Broadmoor, Gambles, GE, Hitachi, JVC, Magnavox, Airline, Panasonic, RCA, Sanyo, Sharp, Sony, and GTE-Sylvania. Describes methods for adjustment of deflection yoke, focus, horizontal circuits, AGC, etc. Discusses all kinds of typical circuits, circuits for battery, and power-line operation and battery charging are fully explained, along with troubleshooting and servicing info for these systems that simply cannot be found anywhere else! Contains over 100 actual case histories. 240 pps., 367 illus. Leatherette.

List Price \$9.95 • Order No. 778

AN EXTRAORDINARY OFFER...

...for more details circle 116 on Reader Service Card

TECH BOOK DIGEST

Condensed from a single chapter of a recently introduced TAB book, by permission of TAB BOOKS, Blue Ridge Summit, Pa. 17214

Scope Facts For Techs

Specs, characteristics and features which a service tech should consider during the selection of a scope

■ As a result of continuing advances in solid-state technology, the prices of medium- and high-performance oscilloscopes have been decreasing dramatically, making available to service technicians scopes with specs and operating features which heretofore were found only in the most sophisticated, high-cost 'lab' scopes.

Today, for slightly over \$200, a service technician can purchase a 10-MHz triggered scope equipped with a calibrated vertical input attenuator and time base. Thus, service technicians today are suddenly face to face with operating features such as 'dual-trace', 'sweep magnifiers', 'auto' and 'normal' triggering, and a host of other features and operating controls which, although they increase the ease and accuracy of measurements and make the scope a much more versatile test instrument, nevertheless also make its selection and operation more complex.

For these reasons, to insure that he selects a scope which is suited for his needs and budget, it is more important than ever that a technician be thoroughly familiar with the specs and operating features available in modern scopes.

The following review of scope fundamentals and related specs, features and general characteristics is intended only as a 'refresher!'

(From Chapter 4, "Understanding & Using Modern Electronic Servicing Test Equipment," by Charles M. Gilmore, TAB BOOKS, Copyright 1976. A review of the complete book follows this article.)

SCOPE FUNDAMENTALS

Fig. 1 is a block diagram of a basic oscilloscope. The oscilloscope consists of a cathode-ray tube (CRT), a vertical amplifier, a horizontal amplifier, and sweep circuits.

Amplifiers

Vertical and horizontal amplifiers increase small electrical signals sufficiently to deflect the electron beam vertically and horizontally over the CRT screen. Typically a CRT will require a voltage between its vertical plates of 100V to deflect the beam across the tube. Oscilloscope input levels will be more like 100 mV, thus requiring a gain of 1000 in the amplifier.

Sweep Circuits

A sweep circuit is used to cause a horizontal displacement of the beam on the face of the CRT that is proportional to time. The sweep circuit generates a waveform (Fig. 2) which rises linearly with respect to time and then suddenly drops to zero; it waits for some definite time, then begins to rise linearly again. This signal is commonly called a sawtooth, or ramp.

Time Base

The ramp signal is used to drive the horizontal amplifier. The initial beam position will be at the left edge of the CRT. As the sweep circuit's output voltage increases,

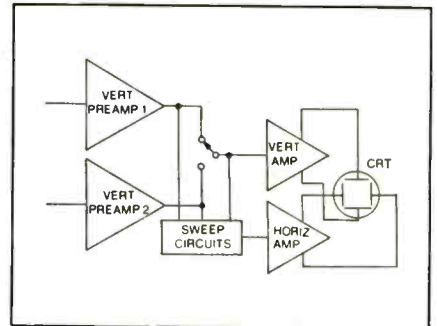

Fig. 1—Simplified block diagram of a recurrent, single-trace scope.

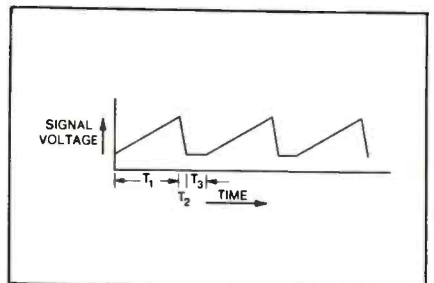

Fig. 2—Three cycles of the waveform generated by the sweep circuits of an oscilloscope. The duration indicated by t_1 is the highly linear ramp which deflects the beam across the face of the CRT, creating the time axis of a graph. The duration indicated by t_2 is the retrace time, when the beam is being moved back to its starting point. The duration indicated by t_3 is the holdoff time. Holdoff time is zero on a recurrent sweep oscilloscope and a fixed value dependent on sweep speed, plus a random variable time for triggered oscilloscopes.

the beam is driven to the right; when the peak of the ramp is reached, the beam is at the right edge of the CRT. The beam then rapidly returns to the initial point as the sweep voltage returns to zero. When the horizontal amplifier is driven with such a linear sweep signal, the horizontal displacement of the beam may be equated to time. This gives the oscilloscope a time base. For example, the center of the CRT represents 0.5 sec of elapsed time with respect to the left edge of the CRT if the period of the ramp is 1 sec.

The ramp must be synchronized to the vertical signal. In other words, it must start at the same point every time on the input waveform. If this did not happen, the displayed waveform would start randomly, and a jumbled display would result. Synchronization, or triggering circuits are employed to prevent this.

Recurrent Sweep

In the simplest oscilloscopes the

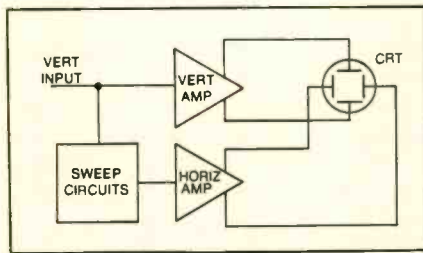

Fig. 3—A simplified block diagram of the dual-trace oscilloscope. Note that a standard CRT with a single set of horizontal- and vertical-deflection plates is used. Signals to operate the vertical switch are derived from an oscillator in the chopped mode and from the sweep signals in the alternate mode.

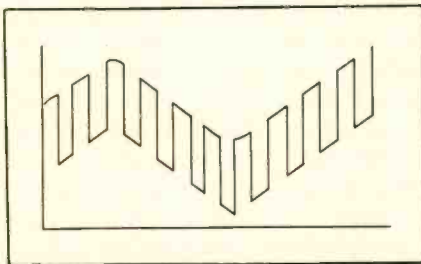

Fig. 4—An expanded illustration of the chopping technique for displaying two separate signals (a sine wave and a triangle wave) on a dual-trace oscilloscope. This technique is used when the writing rate using alternate modes will allow one trace to fade before the other has been completed. The chop rate is usually sufficiently high. There are at least 100 samples of each waveform per sweep. The vertical transitions between traces will either be blanked or made at such a high speed that the beam cannot write.

sweep generator consists of a free-running oscillator which generates the ramp waveform. The free-running oscillator is synchronized to the vertical signal by adjusting the sweep generator until its frequency is identical to, or a submultiple of, the frequency of the vertical signal. With the oscillator and vertical-amplifier signals at approximately the same frequency, a small amount of the vertical signal is injected into the sweep oscillator. The sweep generator will lock or synchronize, tending to assume the frequency and phase of the vertical signal. Obviously this method of synchronization is somewhat crude; however, until recently it has provided the lowest cost method for deriving a synchronized horizontal time base. For some forms of work this is entirely satisfactory. This elementary time base, called *recurrent sweep*, has some rather severe limitations: It can only synchronize an integral number of vertical cycles; it is virtually im-

possible to change the point at which the triggering starts; and unless some separate form of time measurement is available, the period of the sweep signal is unknown.

Triggered Sweep

All of these problems may be solved through the use of a calibrated triggered sweep. With triggered sweep, the sweep generator is converted from a free-running oscillator to a single-shot generator; that is, the oscillator will produce one single ramp of a known period when the appropriate trigger signal is applied. With this time base the user may select the exact period of sweep and, through various amplification and comparing circuits, the exact point on the input wave at which he desires the sweep to start. Given a time base of this sophistication, there are many applications for the oscilloscope which were simply not available with recurrent sweep.

Blanking

The rapid retrace of the beam from the right side of the CRT to the left can cause undesirable traces on the display. To eliminate this effect a special signal is developed just before the end of each sweep signal. This signal *blanks*, or turns off, the beam in CRT. The blanking signal prevents the undesirable retrace signals from appearing on the face of the CRT. Normally the trace is blank until a new sweep is under way. This permits the ramp to become fully linear, which it may not be in the first few percent of its rise.

Some oscilloscopes have provisions for external input to the blanking circuits so that the blanking may be controlled externally for special applications.

Dual-Trace

On the simple oscilloscope of Fig. 1, the vertical movement of the beam is governed by the signal in the vertical amplifier. Such an oscilloscope is called a single-trace oscilloscope. This simply means that all vertical deflection is a function of one input to the scope.

Frequently, when working with

an electronic circuit, it is desirable to determine cause and effect—that is, to compare the input and output signals of the circuit. This may be done with a single-trace oscilloscope by first observing the input signal, then moving the probe to the output and observing the output signal. Obviously this process is difficult. As neither trace remains on the screen permanently, one has to remember each small variation of each waveform to compare them.

This problem has been more popularly solved with the dual-trace oscilloscope (Fig. 3). This oscilloscope is similar to the single-trace oscilloscope; however, two vertical preamplifiers are employed, and a switch connects the main vertical amplifier to either input 1 or input 2. This switch is controlled by the time base circuitry or an internal oscillator. The switch operates in one of two modes.

In the *alternate mode* the switch is changed from one input to the other following each horizontal sweep. On the first sweep, input 1 is displayed; on the second sweep, input 2 is displayed. On the third sweep, input 1 is again displayed, and so on. The alteration is rapid enough to keep the trace presented by one input from fading during the time the other input is writing.

At sweep rates of sufficiently long duration to cause a flickering problem, a different mode of dual-trace display is used. In this, the *chopped mode*, the switch is no longer operated by successive cycles of the time base, but is alternated by a high-frequency oscillator, generally in the 50-200 kHz region. This produces a trace as demonstrated in Fig. 4. The time intervals in the figure are considerably exaggerated. In actuality, even at quite short time base periods, one must carefully scrutinize the trace to observe the chopping effect.

Trigger Selection

With the dual-trace oscilloscope a question presents itself: Where should the trigger signal be taken from? Most oscilloscopes using dual vertical channels have a switch permitting the user to

select either input 1 or input 2. In some products the user is offered a third option: that of triggering on the combined signal available after the switch.

Delay Lines

If the triggered oscilloscope is used with very short periods of horizontal sweep (generally under 10 μ sec or so) and the user desires to observe either the leading or trailing edge of a pulse in some detail, there is a new problem. Most trigger circuits are incapable of producing any sweep before the first few hundred nanoseconds of the vertical signal has actually arrived at the vertical-deflection plates. Therefore the signal that caused the triggering—say, the leading edge of a fast pulse—generally reaches the deflection plates a few hundred nanoseconds before the sweep actually starts. When this occurs the initial part of the signal is completely lost. To avoid this the signal in the vertical amplifier must be delayed. The most common technique is to use some form of transmission line to slow the signal. The signal in the vertical amplifier must be delayed enough to permit the trigger and then the sweep circuits to respond. To achieve these considerably long delays without limiting the frequency response of the vertical amplifier, rather specialized transmission lines are employed. Delay lines certainly add to the oscilloscope's performance and obviously add to its cost.

XY Oscilloscopes

Occasionally it is desirable to make certain measurements by comparing two external signals, one of them on the Y or vertical axis and the other on the X or horizontal axis. When the oscilloscope is used in this mode, the internal sweep circuits are no longer employed. With the simple oscilloscope, X Y operation is achieved by applying one signal to the vertical input and the other signal to the external-input connection of the horizontal amplifier. Horizontal amplifiers do not usually have calibrated attenuators, nor will they accept a wide range of input

signal levels. When the oscilloscope is either a dual-trace or dual-beam type, two identical vertical amplifiers are available. Such oscilloscopes often have an XY mode, in which one of the vertical-input amplifiers remains connected to the vertical-deflection plates, and the other vertical-input amplifier is connected to the horizontal plates. This provides the user two wide-range inputs with calibrated attenuators.

VERTICAL AMP SPECS

Vertical Bandwidth

Vertical bandwidth is one of the most fundamental specifications of an oscilloscope. This specification, more than any other, will determine the suitability of a particular oscilloscope for the job at hand. Oscilloscope manufacturers try to create a vertical amplifier whose frequency response is constant until an upper frequency limit is reached, where a controlled rolloff (decrease in gain) starts. The bandwidth of the oscilloscope is defined as the point at which the displayed vertical signal has been reduced by 3 dB with respect to some low-frequency reference point. As vertical signals continue higher in frequency, the oscilloscope response should continue to roll off at a rate slightly greater than 6 dB per octave. This controlled rolloff is necessary to provide proper vertical-amplifier response to complex signals.

Oscilloscopes having a vertical-frequency response which rolls off at a rate considerably greater than 6 dB per octave will not faithfully reproduce the high-frequency components of complex waveforms. On the other hand, oscilloscopes with insufficient high-frequency attenuation will tend to create *overshoot*, or excessive high-frequency response on pulse signals.

Note that a signal reduced by 3 dB is at its half-power point, not its half-voltage point. At -3 dB the voltage is 70.7% of the reference value. Furthermore, a signal reduced in amplitude by 3 dB because of an increase in frequency has a large phase shift with re-

spect to the reference point, normally in the area of 45°.

Occasionally the vertical bandwidth of an oscilloscope is specified with a deflection limitation. Such a specification might read: 10 MHz at 4 cm deflection, 8 MHz at full deflection. This specification indicates that the oscilloscope may not be used at its full bandwidth if full deflection must be utilized. This specification is popular with some solid-state oscilloscopes, which may have a limited vertical-plate driving capability. Generally speaking, most higher cost modern oscilloscopes are not specified in this manner. However, one should watch out for a deflection limitation when purchasing a unit if this would result in application limitations.

Oscilloscopes come with vertical amplifiers that are only AC coupled and with vertical amplifiers having both AC and DC coupling, usually switch selectable. The AC—DC coupling is the more versatile, but AC-only is generally lower in cost. When an oscilloscope is operated in AC-coupled mode, it will have an upper -3 dB limit set by the vertical-amplifier high-frequency rolloff and a lower -3 dB limit set by the low-frequency reactance of the AC input coupling capacitor. The 3 dB lower frequency limit is usually 2—10 Hz. With AC coupling, the highest potential that may be applied across the input coupling capacitor must be specified. This is usually 400V—600V. This specification is peak AC plus DC, *not* just DC.

The input mode selector may also have a third position in addition to the AC and DC positions described above (Fig. 4). This third position, usually described as GROUND, disconnects the input connector from the input amplifier; the input to the vertical amplifier is grounded. This feature is frequently used to note the 0V height of the CRT trace.

Rise Time

Closely related to vertical bandwidth is vertical rise time. Rise time is defined as the time required for the signal to increase in amplitude from 10% of its total

value to 90% of its total value (Fig. 5). The rise-time of an oscilloscope is important in determining the limits of rise-time measurements that may be made by the oscilloscope. Rise-time t_r (in microseconds) is directly related to bandwidth f_{MHz} by the formula

$$t_r = 0.35/f_{MHz}$$

An oscilloscope which meets a given rise-time requirement will have proper high-frequency roll-off.

Rise time is especially important if the oscilloscope is to be used for pulse analysis. Then the oscilloscope should ideally have a rise time that is 20% of the value of the pulse to be measured.

Deflection Sensitivity

Vertical-deflection sensitivity ranks equally with vertical bandwidth as an important oscilloscope specification. Both of these limitations can prevent a measurement from being made.

The deflection or input sensitivity specification indicates the smallest voltage that will produce a standard deflection, usually one vertical division on the CRT. Stated in another way, deflection sensitivity indicates the maximum vertical amplification available. As a typical example, an oscilloscope might have a sensitivity of 10 mV. This oscilloscope would display a 10 mV peak-to-peak specification, not RMS. A 10 mV RMS sine wave would cover approximately 2.82 divisions, as a 10 mV RMS sine-wave signal is a 2.82 mV peak-to-peak signal. Sensitivity obviously costs money; therefore, the amount of sensitivity required must be weighed against the cost of the oscilloscope.

Often the oscilloscope is used with an accessory probe which acts as a voltage divider, reducing the input signal by a factor of 10 or more. If this is the case, one must remember that the oscilloscope sensitivity is effectively reduced

by the same factor.

To obtain maximum sensitivity, some models offer increased sensitivity at a reduced bandwidth. Oscilloscopes offering this feature typically give an additional gain of 10 with a bandwidth reduced by a factor of 4. For example, a 10 MHz oscilloscope might maintain 10 MHz bandwidth at 10 mV per centimeter, however, the input attenuator may be adjustable to 1 mV per centimeter, but with a bandwidth of only 2.5 MHz. Often this bandwidth is quite different, as high-frequency signals may not be of interest at high-sensitivity levels.

Input Attenuator

The maximum sensitivity of an oscilloscope cannot be utilized on all measurements. For example, in a 10 mV per centimeter oscilloscope with 6 cm of total vertical display, the electron beam will go off the screen for signals in excess of 60 mV. To overcome this prob-

You get MORE from the RCA 10J106 Test Jig

MORE ease in changing yoke impedances. Tapped horizontal and vertical transformers with front-panel switches eliminate plug-in impedance adapters.

MORE sets can be serviced ... almost all makes — standard focus tube, hybrid or solid state, including PIL types.

MORE screen area. Bigger, shielded 19" picture tube gives large raster area.

MORE high-voltage capability. No expensive "extras" needed to service 33kV sets.

MORE ease in troubleshooting with Set-Up Index, extension cables, and a range of optional adapters.

MORE savings in time and labor. Quick to hook up, easy to use.

MORE dollar savings because the need for external impedance-matching devices is minimized.

MORE convenience. Simple adapters and no transformers mean less clutter in your shop.

MORE safety. Designed to handle chassis up to 33kV without danger from X-ray radiation.

MORE years of dependable service thanks to RCA high-quality design and construction.

Contact your RCA Test Jig Distributor or write RCA Distributor & Special Products Division, P.O. Box 100, Deptford, N.J. 08096, Attn: Sales Promotion Services.



RCA Color TV Test Jig

...for more details circle 129 on Reader Service Card

lem, an input attenuator is provided. This is usually one of two types. On the simplest oscilloscopes it may be nothing more than a variable control, or at best, a 3-position switch labeled $\times 1$, $\times 10$, $\times 100$. In such oscilloscopes the amount of attenuation and the vertical sensitivity are generally uncalibrated. The more sophisticated oscilloscopes have an attenuator with steps calibrated in the resultant vertical deflection sensitivity. This is usually in a 1—2—5 sequence, although occasionally a 1—3—10 sequence is used.

Because of high impedances and stray capacitances, a simple resistance divider will not maintain the same attenuation at high frequencies as at DC. To correct this, the input attenuator must be capacitively compensated. With compensated attenuators the attenuation is constant at all frequencies.

The step attenuator has a disadvantage in that it will not allow signals of any arbitrary amplitude to be made exactly full scale or some other desired size. To permit such operation, most oscilloscopes include a variable control that adjusts the effective attenuation between the indicated value and its next highest position. For example, an oscilloscope used at 500 mV per division can be adjusted continuously between 500 mV per division and 1V (1000 mV) per division by this control. This variable control will have a CALIBRATED position (normally extreme clockwise). In the CALIBRATED position, the deflection factors indicated on the attenuator positions fall within the accuracy limits set for the oscilloscope. Accuracy of attenuation is normally +3% to +5%. Vertical-accuracy specifications also include any inaccuracies found in the vertical amplifier. Accuracies are frequently not specified at the high-frequency limits, at temperature extremes, nor on extremely low cost instruments.

Input Impedance

For most servicing applications a high input impedance is desirable. One megohm has been cho-

sen as a standard. As was noted, there is compensating capacitance involved with attenuators. Therefore, the input impedance of an oscilloscope includes the value of capacitance found in parallel with the IM resistance. This capacitance usually lies in the area of 20-40 pF if the oscilloscope is designed to be used with a divider probe. Obviously, the lower the capacitance the better. Other impedances have been used. Some of the older, very low cost oscilloscopes have inputs ranging from 100K to 10M. Some of the very sophisticated high-frequency oscilloscopes built today have a non-reactive input.

Vertical-Delay Lines

To allow for trigger and sweep startup, a delay line is inserted in the vertical-amplifier circuit. The object of the delay line is to uniformly delay signals of all frequencies by an amount slightly greater than the time required to permit triggering, startup of the sweep circuits, and an unblanking of the tube before the triggering signal is presented to the CRT. Specifications will indicate the amount (number of nanoseconds) of pretriggered waveform which will be displayed.

Delay lines are essential for good pulse analysis. They are especially important with digital circuitry, in which the measurement of pulse rise times may be critical to proper operation.

TIME BASE SPECS

As noted earlier, recurrent sweep is the simplest form of time base available. The recurrent sweep time base offers no way to make calibrated time measurements except by comparison. The recurrent-sweep-generator specifications indicate the upper and lower frequencies of the sweep oscillator. The frequency can be changed with a variable control within a decade range, and over multiple decades in switched steps. Sweep oscillator frequency range from 5 Hz to 500 kHz is typical. Converted to time per division, assuming 10 horizontal divisions, this gives an equivalent range of 20 msec per division to

200 nsec per division. A few oscilloscopes have provisions to lower the sweep oscillator frequency by use of an external capacitor.

The recurrent sweep time base may also have a control to adjust the amplitude of the synchronizing signal injected into the sweep oscillator from the vertical amplifier. Switch selection of a positive- or negative-going synchronizing signal is frequently made available. Often this same switch will permit positive or negative synchronization by an external signal or a sample of the power-line frequency.

Calibrated Sweep

Calibrated sweep yields a time measurement device. The period of the time base is selected as a time per division. (The majority of oscilloscopes use the centimeter as the basic horizontal and vertical division. There are some oscilloscopes with vertical divisions slightly longer or shorter than a centimeter. For this reason the general term *division* will be used.) The switching is either in decades (on lower cost oscilloscopes) or a 1-2-5 sequence.

Slowest sweep speeds vary with the manufacturer and the price of the oscilloscope, but usually they are in the vicinity of 200 msec per division to 2 sec per division.

The fastest sweep speed is dependent upon the bandwidth limit of the oscilloscope. A rule of thumb is that the fastest sweep speed should present no less than three complete cycles of a waveform whose frequency is identical to the vertical bandwidth of the oscilloscope. For example, a 10 MHz oscilloscope would require an upper sweep speed $3 \times 1/(10 \times 10^6) \text{ sec} = 300 \text{ nsec}$ for the full horizontal span, or 30 nsec per division. This requirement would be met by an oscilloscope time base having a maximum speed of 200 nsec per division and a $\times 10$ magnifier yielding to 20 nsec per division display.

For low-bandwidth oscilloscopes (3-5 MHz), fastest sweep speeds in the area of 0.5-1 μsec are typical. Sweep speeds of 0.05-0.2 μsec per division are common on 50 MHz oscilloscopes.



Dodge makes vans with a sense of value.

Here are some great reasons why Dodge is the number one maker of compact van-type vehicles.

1. Value for the money.

Every Dodge Tradesman is designed to give you what you want for your money. That's why Tradesman offers you two wheelbases, three overall lengths, and a variety of power plants. Not to mention standard equipment like front disc brakes and Electronic Ignition. Plus options like overdrive transmission,* power steering, and automatic transmission with a new low-slip torque converter. And we didn't leave out comfort, either. Tradesman gives you a good-looking interior. You can even equip it with optional high-back Command seats for on-the-job comfort.

2. Large cargo capacity.

Tradesman's a trim compact size with an engine that is far forward. So you can carry king-sized loads. Even our 109-inch-wheelbase model, the shortest in the business, has more than nine feet of loadspace behind the engine.

3. Better maneuverability.

Curb to curb, Tradesman's turning circle is tighter than either Chevy's or Ford's. And since Tradesman is shorter overall than

Chevy and Ford, you can load and unload in even the tightest spots.



4. Maxivan: Biggest van there is.

For extra-big jobs, there's Max van, the biggest van in the business... with 17 extra inches of load length over the standard Tradesman.

5. Good gas mileage.

In EPA estimates, Dodge B100 Tradesman with a standard 225 Six and manual transmission* got 24 MPG, highway; 18 MPG, city. Your actual mileage may differ depending on your driving habits, condition of your van, and optional equipment. But Tradesman offers a Fuel Pacer option that can help you get maximum mileage.

Dodge Tradesman: A whole lot more.

The reasons for buying a Dodge Tradesman van don't stop there.

They're as numerous as Tradesman's other great features: small Six and V8 engines. Big 22-gallon gas tank. Or an optional 36-gallon tank. Options like a sliding side door (127-inch-wheelbase models only) for easy loading. Automatic speed control. Air conditioning that's available as an option on every eight-cylinder model Tradesman. A KaryVan model that gives you the maneuverability and convenience of a Tradesman van... plus the loadspace of a bigger truck.

See for yourself at your Dodge Dealer's. There are a lot of great reasons to buy or lease from America's number one maker of compact van-type vehicles.

*Not available in California or with High altitude certification. Available on B100 only.

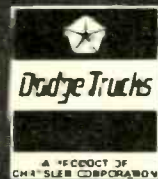

...for more details circle 1-2 on Reader Service Card

Although the time per division may be stepped in either a 1-2-5 or 1-10-100 sequence by the time base switch, there is usually provision to vary the time per division continuously between steps with an uncalibrated control. Accuracy of the time base is usually +5% to +3%. Time base speeds are often affected by temperature, line voltage variations, and age, so they should not be used as ultimate standards of time comparison.

Triggering Controls

The triggered oscilloscope gains much of its flexibility from the various modes of operation which may be selected for the trigger circuits. The trigger signal, taken from the vertical amplifier, is used to start the sweep generator. Variations of triggering include selection of positive or negative triggering, level of triggering, AC or DC coupling, high- or low-frequency filtering, and selection of trigger source (including an external source, the power line, and the vertical-amplifier channels). Each of these features adds to the ability to observe complex waveforms.

Older oscilloscope designs also incorporate a STABILITY control which assists in proper operation of the trigger circuits. The STABILITY control is adjusted prior to using the TRIGGER LEVEL control. Generally speaking, STABILITY controls are not found on modern oscilloscopes.

The methods of defining trigger sensitivity and triggering bandwidth are not consistent. The following are Heath Company standards for such measurements. *Trigger sensitivity* indicates the smallest deflection (or external input level) that will permit a stable trace on the face of the CRT. Sensitivity of one division or less is desirable. An oscilloscope requiring more than one division of vertical deflection for a stable display does not have sufficient trigger sensitivity for many applications.

Trigger bandwidth can be defined as the highest frequency at which a stable trace can be maintained with some nominal deflection (often one division). Trigger bandwidth determines the ease with which the oscilloscope will

trigger on complex waveforms and what the stability of high-frequency signals will be. An oscilloscope with a trigger bandwidth twice the vertical bandwidth provides exceptional triggering performance, while one with a triggering bandwidth of less than its own vertical bandwidth creates difficulties when high-frequency or complex waveforms are being observed.

Time Base Modes

The time base generator usually has two modes of operation. In the *normal* mode the sweep generator is cycled by a trigger pulse, which follows the sweep and holdoff periods. In the *automatic (auto)* mode the oscilloscope automatically generates trigger pulses in the absence of a signal in the vertical amplifier. This provides baseline (trace) in the absence of a vertical signal rather than the blank CRT seen in the *normal* mode.

Some oscilloscopes provide a time base mode called *single sweep*. This permits the operator to select a set of conditions that will trigger the sweep and then to "arm" the sweep. When the set of conditions occurs, the time base will be activated for one sweep and then will remain locked out until rearmed. This mode is especially useful when attempting to observe fast events occurring randomly and at widespread intervals.

HORIZONTAL AMP SPECS

Although the primary source of horizontal signals is the sweep circuit of the oscilloscope, there are occasions requiring the horizontal deflection signal to be derived from an external source.

Horizontal Bandwidth

As the only requirement of the horizontal amplifier is to pass the sweep signals with reasonable fidelity, the bandwidth of this amplifier is generally not great. Bandwidths of the order of 1-3 MHz are quite common. Occasionally a high-frequency signal must be handled, and at such times the horizontal bandwidth of the oscilloscope must be considered.

One should also remember that when specifying a limit of horizontal bandwidth, such as -3 dB at 3 MHz, the manufacturer is also specifying a phase shift. In certain measurements (especially phase measurement), phase shift in the horizontal amplifier can cause measurement errors.

External Horizontal Input

The input impedance of a horizontal amplifier varies from oscilloscope to oscilloscope. However, for most oscilloscopes it is specified as 100K or 1M with some shunt capacitance. On more elaborate oscilloscopes, the horizontal-sensitivity specification may also include specifications for a horizontal attenuator and a variable gain control. The most limited oscilloscopes have only a fixed amplitude specified for horizontal sensitivity. External horizontal-input connectors will normally be the same as those for the vertical input.

CRT SPECS & CHARACTERISTICS

A limitation on the high-frequency capability of the oscilloscope, above that of the bandwidth of the vertical amplifier, is the ability of the CRT to write (produce traces) at high speeds. That is, the phosphor must be sufficiently sensitive and the electron beam sufficiently intense to cause the phosphors to emit light in the time the beam strikes them. At higher and higher rates of trace deflection, this becomes more and more difficult, until a point is reached where the CRT is unable to display the signals in the vertical amplifier.

Another situation causing this same condition is a moderate to fast sweep speed, with infrequent sweep triggering caused by the low rate of the desired waveform. An example of this is a 60 Hz waveform being observed at a 10 μ sec/cm setting. In such a case the phosphors are being refreshed only infrequently (once every 16 msec), and unless the oscilloscope CRT has good writing speed, the trace will be very faint. Unfortu-

nately, the writing speed of an oscilloscope is not easily specified. Generally speaking, the higher the accelerating potential, the better the writing speed.

Acceleration

Two different types of CRTs are available. The simplest is what is known as a *monoaccelerated* tube, in which all the electron beam acceleration takes place within the gun assembly before the deflection plates, usually with voltages of 2kV or less. The most common circuits use 1.4 kV acceleration.

Postdeflection Accelerator

In more sophisticated oscilloscopes, a more expensive tube with *postdeflection acceleration* (PDA) is used. Tubes with PDA will generally exhibit much better writing characteristics as much higher voltages are used, generally between 4 and 20 kV. Generally speaking, oscilloscopes with a vertical bandwidth exceeding 10 MHz

should use a PDA tube for optimum results.

Rectangular and Flat Tubes

The original oscilloscope tube looks somewhat like a wine bottle. This tube has served for many years, despite the generally preferred viewing area being a rectangle. With the round-face tube, a portion of the corner display area is lost (see Fig. 6), and there is a large unused portion of the screen. While many oscilloscopes today still have round tubes, they are frequently masked off to show a rectangular viewing area. Generally speaking, this is of no detriment to the oscilloscope user. The rectangular tube also makes more efficient use of the front-panel space.

A rectangular tube requires a control for trace rotation. This control—which is not needed on the round tube, as it may be simply rotated to produce a horizontal trace—rotates the electron beam

with a magnetic field produced by a DC current in a coil wrapped around the tube. True rectangular tubes are generally of the PDA type and represent a significant increase in construction cost.

The original oscilloscope tube had a slightly convex display area. This was necessary so the beam would remain focused on the face of the CRT at any position. A convex tube face leads to errors due to parallax. So this CRT has been replaced by the flat-face tube. The flat-face tube has its focusing problems corrected by the internal mechanics of the CRT and eliminates the parallax error.

Viewing Area

The viewing area of the CRT is generally divided into squares, with the most common being 8 x 10 or 6 x 10 cm. However, some oscilloscopes use smaller units of measurements, sometimes as small as 0.6 or 0.8 cm per division; and some oscilloscopes use larger divi-

Big little DMM.

You get bench-size accuracy, and long-term stability and performance, with our new, hand-held, 3½-digit VOM. It's in a class by itself.

- Highly readable, field-effect LCD
- Semi-autoranging
- Fast, accurate response
- Small size, battery operated (ac optional)
- Low power consumption
- Built-in overload protection

See it at your VIZ distributor.

**VIZ Test
Instruments Group**

of VIZ Mfg. Co.

335 E. Price St., Phila., PA 19144

© VIZ
6826

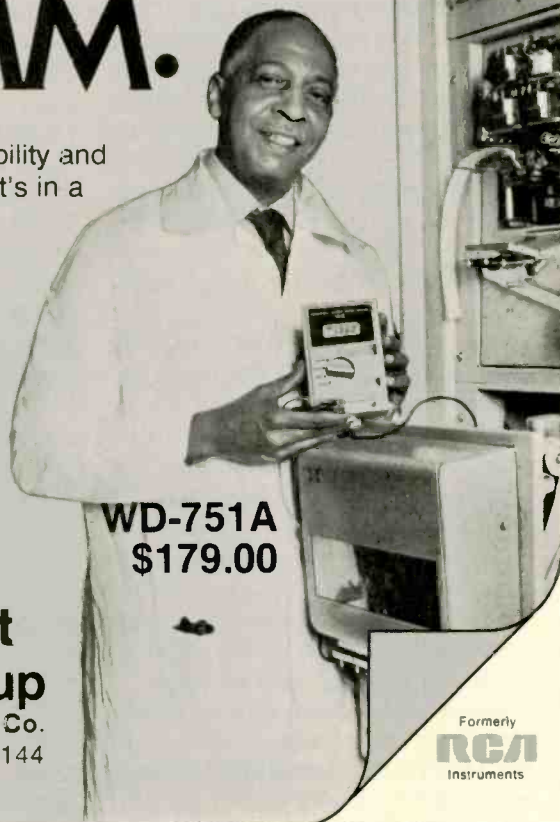

**WD-751A
\$179.00**

Formerly
RCA
Instruments

...for more details circle 135 on Reader Service Card

sions, such as 1.2 cm per division. Generally speaking, the larger the screen size, the more easily the oscilloscope is read.

The extremely small tubes, those using 0.6 and 0.8 cm per division, were popular with some of the early portable solid-state oscilloscopes, in which it was difficult to obtain large deflection voltages. The 8 x 10 cm screen is by far the most popular today, although the 6 x 10 screen is also common. Generally speaking, the 8 x 10 screen with 1.2 cm per division is only available on high-priced oscilloscopes. On some low-priced oscilloscopes the diameter of the tube is given. This is usually 5 in. or 3 in. A 3 in. tube will give a small display and should be considered only when small size of portability is a necessity. A 5 in. diameter tube will give an 8 x 10 cm rectangular display (see Fig. 6).

Graticules

The graticule is a thin window placed over the face of the CRT. It bears the lines defining the rectangular divisions. The oscilloscope manufacturer constructs the oscilloscope so the graticule lies as close as possible to the face of the CRT. This is required to minimize the parallax error between the trace and graticule. This problem can be absolutely minimized by etching the lines on the inside of the faceplate of the CRT. Such internal graticule tubes are expensive, and thus this feature is found only on higher priced oscilloscopes.

To make the lines of the graticule stand out, the more expensive oscilloscopes have an illuminated graticule. This can be achieved by simply flooding the graticule with the light generated by a lamp similar to a pilot lamp, or it may be accomplished by grinding the edge of the graticule (or the faceplate of the CRT on an internal-graticule tube) and illuminating this ground edge. If the lines have been scribed in the graticule rather than painted on, extremely uniform illumination of each of the marks and lines will result. If scale illumination is

available, a control is normally provided to vary the intensity.

Phosphors

The phosphor on the inside of the CRT face turns the electron beam into a visible trace. There are three different types of phosphors common to oscilloscopes. Type P1 is the most common phosphor on the low-cost, round CRTs. The P1 phosphor emits a yellow-green light, has a moderate resistance to burns, and has a decay to 0.1% of maximum light output in 95 msec. Wherever possible, the P1 phosphor is being replaced with a newer phosphor, the P31. The P31 phosphor emits a yellow-green light similar to that of the P1 but at nearly twice the intensity. The burn resistance of P31 is considerably better than that of P1, an important consideration as this is a frequent cause of damage. The P31 phosphor will appear to flicker at a much faster sweep repetition rate than will the P1, though, as it has only a 32 msec life of 0.1% output.

The P7 phosphor appears in a few special-purpose oscilloscopes where long persistence is required. Decay to 0.1% output is nearly 1.5 sec, and under low-level lighting conditions, a trace can be seen over a full minute. The P7 phosphor fluoresces with a blue light when excited and then emits a yellow phosphorescent glow. Light output of the P7 is the lowest of all the phosphors, and it can be easily burned.

All phosphors can be damaged by permitting a high-intensity trace to remain in one spot too long. Make a habit of turning down the intensity or of defocusing an oscilloscope when it's left on for long periods of time. A single small spot left on the face of the CRT will damage the phosphor very rapidly, especially if the P7 or P1 type is used.

OPERATING FEATURES

Most of the previously described scope characteristics, or specifications, can be defined, and therefore evaluated, in terms of specific numerical quantities. However,

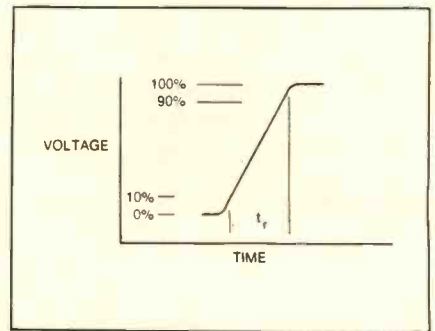

Fig 5—A drawing depicting the definition of rise time. Fall time is defined in a similar manner.

other equally important scope characteristics cannot be defined and evaluated in such specific, easy-to-compare terms but, instead, must be evaluated on the basis of their contributions to ease of operation and display interpretation and to what degree they expand or enhance the versatility of the scope. The more important of these characteristics, which usually are referred to as 'operating features', are described in the following paragraphs.

Calibrators

Voltage calibrators are generally found on all high-priced oscilloscopes, and to varying degrees and with varying quality, they are found on low-priced oscilloscopes.

A voltage calibrator which provides a square wave of reasonable rise time (at least a microsecond or two) and a calibrated voltage waveform serves a number of purposes. It permits the user to check the amplitude accuracy of the vertical amplifier he desires. It permits him to establish a gain level using a variable vertical-gain control. And it permits compensation of oscilloscope probes to insure the frequency response of the probe is matched to the particular oscilloscope input.

On the simpler oscilloscopes, the only waveform made available may be a sinusoidal waveform with known vertical amplitude. In extremely simple oscilloscopes that only have a simple vertical attenuator and an uncalibrated amplifier, this may be used to establish the amplitude of the measured waveform by relative measurements. Outside voltage sources may be used to calibrate

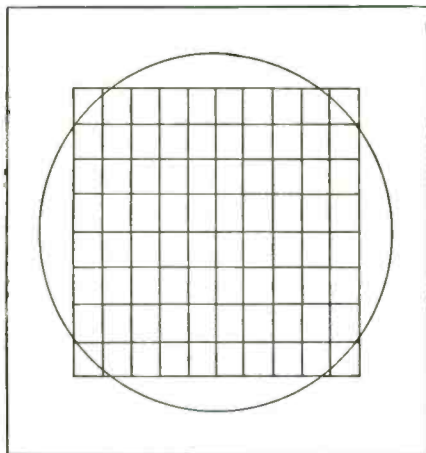

Fig. 6—A maximum-sized rectangular graticule placed on a round-faced CRT. Note that the outermost squares at each corner are lost due to the round edge on the tube. A 5 in. round tube will give an 8 x 10 cm graticule. Although some squares are lost, these are rarely needed to make a usable display.

the oscilloscope; however, the vertical calibrator signal is always a desirable feature when it can be obtained.

Magnifiers

Often it is desirable to observe a signal in more detail. With a triggered oscilloscope this generally is accomplished by increasing the sweep speed. However, there are occasions when a magnifier is used instead. Most magnifiers have magnification factors of 5 or 10, although sometimes a factor of 2 is used. There are two forms of magnifiers, horizontal and sweep.

A horizontal magnifier, by far the more common, extends the length of the sweep by the magnification factor. Thus, a $\times 10$ magnifier effectively makes a 10-division trace 100 divisions long. Using the HORIZONTAL POSITION control, different 10-division sections of the 100-division waveform can be observed. Effectively, the time per division is shortened by a factor of 10, so a 10 μ sec per division sweep speed is effectively made 1 μ sec per division with a $\times 10$ horizontal magnifier. The trade will tend to dim when a horizontal magnifier is in use, as the beam is on the screen on the CRT only one-tenth as often as it would have been without the use of the magnifier. A sweep magnifier multiplies the repetition rate of the sweep circuit

by the magnification factor, and the trace does not dim. The effect, in terms of sweep speed per division, is still the same. As noted before, sweep magnifiers are rather uncommon. Frequently magnifiers contribute additional error, often as much as +2-3%.

XY Mode

An XY mode is a feature occasionally found on single-trace scopes and more frequently found on dual-trace models. Accompanying the XY feature is a specification indicating the degree of differential phase shift between the X and Y channels. This may be something like 3° at 100 kHz. The XY mode is frequently used for making phase measurements. Therefore, with an oscilloscope that has 3° differential phase shift at 100kHz, a measurement indicating a 45° phase shift at 100 kHz between the signal supplied to the X and Y inputs could be in error by 3° , or 7%. Oscilloscopes with vertical-delay lines present an additional problem, as the delay line itself creates an effective added phase shift and must be compensated for in the horizontal amplifier, or the user must tolerate the added phase shift contributed by the delay line.

Regulated Supplies

The accuracy and stability of the oscilloscope are directly related to the stability of its power supplies. The deflection sensitivity of the CRT is directly dependent upon the accelerating potentials supplied to it, and the accuracy of the vertical deflection is directly proportional to the stability of the deflection sensitivity. The accuracy of the oscilloscope thus becomes dependent upon the stability of the high-voltage power supplies. Regulated high-voltage power supplies tend to be expensive, and some manufacturers forego regulation to produce lower cost oscilloscopes. As a result, traces bounce or jump and reductions in horizontal and vertical accuracy occur with power line variations. A good specification to look for is one indicating the range(s) of

power line voltages over which the oscilloscope may be operated. Generally, the wider the range, the better the regulation.

TECH BOOK REVIEW

Title: *Understanding & Using Modern Electronic Servicing Test Equipment* (TAB BOOK No. 777)

Author: Charles M. Gilmore

Publisher: TAB BOOKS, Blue Ridge Summit, Pa. 17214

Size: 252 pages, 125 illustrations.

Price: \$5.95 paperback; \$8.95 hardbound

This is not a textbook. It is designed, rather, as a reference book for the technician to consult whenever a question arises as to the theory behind, or application of, a particular test instrument. Each of six chapters is devoted to a different group of instruments. Each chapter starts with a review of the fundamentals behind the instrument, then discusses in detail specifications of each instrument group, and finally takes a thorough look at the applications of each instrument.

The book approaches the application of the instruments in two ways—first, the useful applications of each instrument, and secondly, the errors which creep into a measurement made by the instrument. Errors are divided into operator errors and instrument errors.

The book is well-supplied with schematic drawings and photographs of the test instruments covered, and a 42-page appendix contains front-panel photographs of a number of instruments and their specifications. All of the instruments covered in this book are available for under \$1000.

CONTENTS: Electronic Analog Multimeters,—Voltmeters—Digital Frequency Counters—Oscilloscopes—Curve Tracers—Test Leads and Probes—Appendix A, Decibel Ratios—Appendix B, Characteristics of Commonly Used Coaxial Cables—Appendix C, Specifications of Low-cost Instruments. ■

Weston Model 6000 Autoranging Digital Multimeter

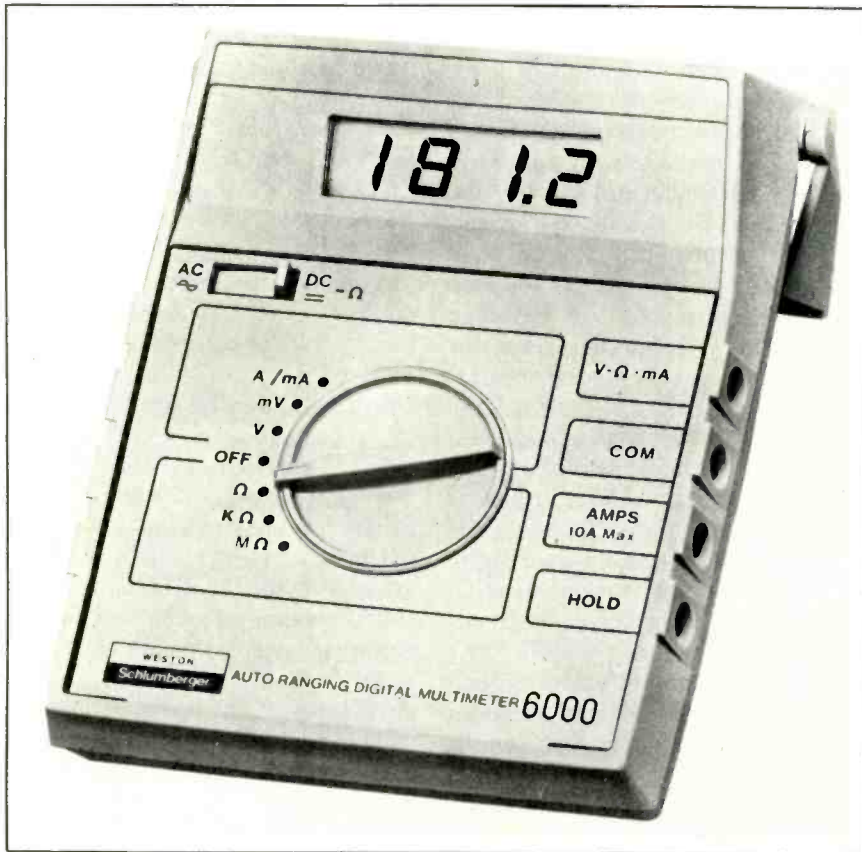

Fig. 1—The new Weston Model 6000 Autoranging Digital Multimeter, that features a 3½ digit liquid crystal display, and covers voltage, current and resistance in 26 ranges. Circle Number 156.

■ The new auto-ranging and auto-zeroing digital multimeter, Model 6000, from Weston, is a portable, self-contained instrument with a liquid crystal 3½ digit readout. Designed for use on the bench or in the field, the Model 6000 combines the convenience and accuracy of automatic digital measurements with the economy and broad-range coverage of analog VOMs.

Five AC and DC voltage ranges, five AC and DC current ranges and six resistance ranges—a total of 26 ranges—are provided by the Model 6000's auto-ranging circuitry and its six switch-selectable measurement functions: volts, millivolts, milliamperes, amperes, ohms, kilohms and megohms. The 0-200 mV and 0-200 ohms ranges are selected by separate positions

on the function switch, while selection of either AC or DC measurements is accomplished by a two-position slide-type switch.

The Model 6000 also offers a 'Display Hold' feature that allows a given reading to be retained indefinitely after the probe is removed from the circuit. With the use of an optional 'Hold Probe,' or a user-furnished SPST switch, the technician can concentrate on the placement of the test probe in crowded or hazardous circuitry and still be able to read the display after the probe is withdrawn.

A reflective, field-effect liquid crystal display provides readability over a wide range of ambient light levels. The height of the display numerals is 0.5 inch.

A single pair of banana-type

continued on page 54

SPECIFICATIONS

WESTON MODEL 6000 AUTORANGING DIGITAL MULTIMETER

DC VOLTAGE

Ranges: +199.9 mV, +1.999V, +1000V
Accuracy: (90 days, 23°C +5°C) 0.35% Rdg. +2d
Input Impedance: 10 MΩ, all ranges
Resolution: 100 μV
Overload Rating: 1500 V peak

AC VOLTAGE

Ranges: 199.9mV, 1.999V, 1000V
Accuracy: (90 days, 23°C+5°C) 0.5% Rdg. +5d, 40 to 400 Hz, + (2% Rdg. +5d) for 1000 VAC range.
Input Impedance: 9 MΩ /39pF
Resolution: 100μV
Overload Rating: 1000 V (1500V peak)

DC CURRENT

Ranges: +1.99 mA, +19.99 mA, +199.9mA, +1.999 A, +19.99 A
Accuracy: (90 days, 23° C+5° C) 0.75% Rdg. +3d
Input Impedance: 10Ω, except 0-2A/10A ranges: 0.01 ohm input, 15A maximum
Resolution: 1 μA
Overload Rating: 1/4 A/250 V fuse, except 0-2A/10A ranges: 0.01 ohm input, 15A maximum

AC CURRENT

Ranges: 1.999 mA, 19.99 mA, 199.9 mA, 1.999 A, 19.99 A
Accuracy: (90 days, 23°C+5°C) 1.5% Rdg. +5d, 40 to 400 Hz, +2% Rdg. 5d for 0 to 1000 VAC range
Input Impedance: 10 Ω, except 0-2A/10A ranges; 0.01 ohm input, 15A maximum
Resolution: 1 μA
Overload Rating: 1/4 A/250V fuse, except 0-2A/10A ranges: 0.01 ohm input, 15A maximum

RESISTANCE

Ranges: 199.9Ω, 1.999 KΩ, 19.99 KΩ, 199.9 KΩ, 1.999 MΩ, 19.99 MΩ
Accuracy: 0.5% Rdg. +1d, +1% Rdg. +2d and 2000 ppm/°C for 200 Ω range
Resolution: 0.1Ω
Overload Rating: 250V (350V peak)

GENERAL

Operating Power: Two 9V "transistor" batteries
Battery Life: 200 operating hours (350 hours with alkaline batteries)
Size: 7" x 5.75" x 2.25"
Weight: 22 oz., incl. batteries
Price: \$195



ROOF PROOF:

Up where it counts, Channel Master Antennas outnumber every other brand!

And for a very good reason. Channel Master has been manufacturing outdoor UHF, VHF and FM antennas for more than a quarter century. We have the widest selection of antennas, covering every TV region in America....from metropolitan, suburban, fringe, deep fringe to you-name-it. Channel Master makes antennas that pull the picture in! Clear, customer-pleasing reception that can't be beat.

The right combination for every location

Antennas plus rotors, boosters, masting, wire and every accessory you can think of....that's what makes Channel Master **Antenna Headquarters** for dealers and installers throughout

the country. Quantum, Crossfire, Ultra-Hi Crossfire, Channel King, Coloray, Magnadyne..... names to remember when it comes to antennas. All from Channel Master...the best name in reception. Proven on more roof tops than any other brand.

Channel Master

DIVISION OF AVNET, INC., ETD377, ELLENVILLE, N.Y. 12428

...for more details circle 109 on Reader Service Card

MARCH 1977, ELECTRONIC TECHNICIAN/DEALER / 47

no strings attached



NEW Weller[®] CORDLESS SOLDERING IRON... GOES ANYWHERE

Weller's WC-100... the professional quality, feather-light cordless. Lets you make connections anywhere. Without AC cord and outlet.

Fingertip touch on exclusive sliding safety switch activates long-life, nickel-cadmium battery. Heats tip to over 700°F in 6 sec. Locks in "off" position to prevent accidental discharge in use or while restoring energy with fast-power recharger (UL listed).

Simple, instant change to any of 4 tips... for any job. Built-in light focuses on tip and work area.

Get this! It's at your dealer or distributor now... waiting for you. Need more info first? Request literature.

**Weller-Xcelite
Electronics Division**



The Cooper Group

P. O. BOX 728,
APEX, NORTH CAROLINA 27502

...for more details circle 136 on Reader Service Card

NEW PRODUCTS

Descriptions and specifications of the products included in this department are provided by the manufacturers. For additional information, circle the corresponding numbers on the Reader Service Card in this issue.

LOGIC PROBE

138

A new logic probe that tests both TTL/DTL and CMOS logic systems has been introduced by *Control and Information Systems*. Called the Probit, the device detects pulses down to 35 nano-seconds and accurately checks for valid and abnormal logic levels. No loading is added to the circuit under test because of a high input impedance, and protection against over-voltage inputs is provided along

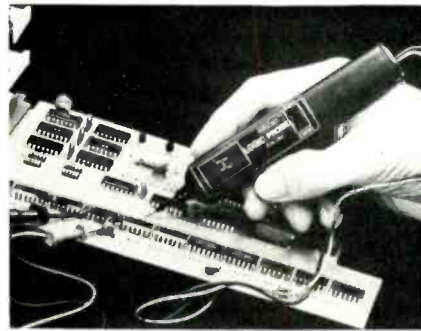

with reverse voltage protection to 100V. A seven segment display indicates "H" for logic high, "L" for logic low and a period for pulse detection. Display is blank for abnormal logic levels. Micro-hooks are used for test connection and the probe tip is detachable. Priced at \$34.95.

CEILING LOUDSPEAKERS

139

Decorator-styled ceiling loudspeakers, pre-packaged to look and install like recessed lighting, are being introduced by *Atlas Sound*. The new DC-10 series loudspeakers are completely factory-assembled including backbox, an installation frame that acts as template for acoustic ceiling tile, a



5-inch loudspeaker, and decorative diffuser ring. Recessed torsion-spring mounting eliminates visible hardware. The finish of the assembly is brushed aluminum with circular diffuser in matte black. Power handling capacity of the speaker is 10 watts and frequency range extends from 225 to 12,000 Hz.

SHIELDED POWER CORDS

140

Two versions of new, UL-listed shielded power cords and cord set, designed to minimize electronic interference in power supplies of business machines and test equipment, have been introduced by *Belden*. The new cords reduce the need for filtering devices on sensitive electronic test equipment and office machines, such as microprocessors. Two types of shielding are available—Beldfoil with a drain wire, or copper serve shielding. Beldfoil consists of aluminum/polyester film wrapped around the conductors. Copper serve shielding is



formed by spiralling copper wire around the conductors. Cords are SJT-type, 14 to 18 gage, with three stranded copper conductors. Heavy-duty vinyl plugs are molded onto the cords.

WIRELESS RADIO LINK ALARM SYSTEM

141

A new wireless radio link alarm system that utilizes frequency shift keying (FSK) to eliminate interference-caused false alarms has been introduced by *Mountain West Alarm*. The brains of the system, the L4 receiver/control, can accept alarm signals from any number of L4 panic or alarm transmitters. The control contains a loud siren and has terminals to connect an external 12V standby battery and a 12 VDC bell. Features include: on/off power switch, delayed instant mode switch, entry time delay, reset button, and entry and exit time delays. Designed for use in small homes,

FORDHAM

BEST BUYS

SENCORE TEST EQUIPMENT

Sencore TF40 Pocket Cricket Portable Transistor & FET Tester

One simplified, safe test for all transistors and FETs. 99.9% reliable with complete leakage test on meter. And the Pocket Portable is the only one that has it. No set-up information is needed. Total test takes seconds. Identifies transistor polarity, FET or bipolar transistor. Identifies all 3 leads everytime. Includes test tone indicator.



CB41 Portable CB Performance Tester

Tests SWR, RF power and % modulation. Tells if a CB rig is getting out as far as possible . . . if it needs servicing.



CB42 Total CB Automatic Analyzer

The complete CB service bench, simplified for quick troubleshooting and performance testing. Performs 12 receiver tests; 12 transmitter tests. Single digital readout for all tests. Combines five units in one: 1) Frequency Counter; 2) RF-IF Generator; 3) Audio Generator; 4) Digital RF Wattmeter; and 5) special CB Tester.



PS43 Port-A-Pak Power Supply/Battery Eliminator

Combines advantages of rechargeable batteries with an AC operated supply for any 12 volt service need.

FOR PRICING AND TO PLACE YOUR ORDER:

Call collect for Mr. Louis (516) 752-0050
Master Charge, BankAmericard and C.O.D.'s accepted

FORDHAM RADIO SUPPLY CO., INC.
855R Conklin St.
Farmingdale, N.Y. 11735

YOUR ONE STOP DISCOUNT CENTER



FREE

148 page catalog of over 3000 items . . . test equipment, CB, tools, tubes, components and a full line of electronic supplies



apartments and office, the new system is priced at \$335.

CB POWER LINE FILTER 142

A new CB power line filter has been introduced by *Electronic Specialists*. The new filter has been designed for use where CB interference enters TV, FM or stereo equipment through the power line. This 100 watt unit can bring the filter as close to the equipment as needed, and is also useful in



some CB base installation where interference enters the power line directly from the CB equipment. The 2-conductor model is priced at \$10.50 and the 3-conductor model at \$13.50.

TWIN BIDIRECTIONAL LOUDSPEAKER 143

A new 30 watt bi-directional loudspeaker with individual volume selectability of up to 15 watts in each direction is being introduced by *Atlas*

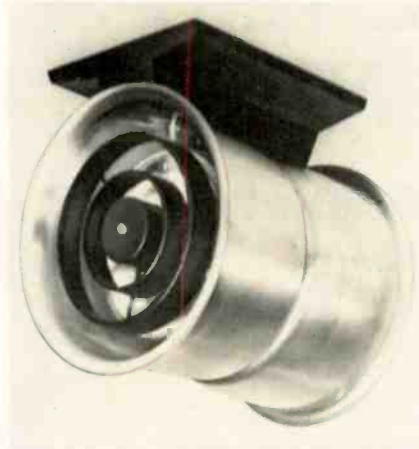

Sound. The all-metal loudspeaker, model APT-15, is designed for both indoor and outdoor installation in large open spaces, hallways, or corridors.

Each speaker includes two complete compression-drivers and re-entrant assemblies and provides up to 15 watts of individually adjustable power output in each direction. Housing is of heavy gauge brushed aluminum with black diffusers. Includes mounting base and subplate.

CRT RECOVERY/TEST SET 144

A new CRT Recovery/Test Set for testing and rejuvenating TV picture tubes is being introduced by *SYT Electronics*. The new unit, Model 84-1/A, is said to use lower filament voltages,

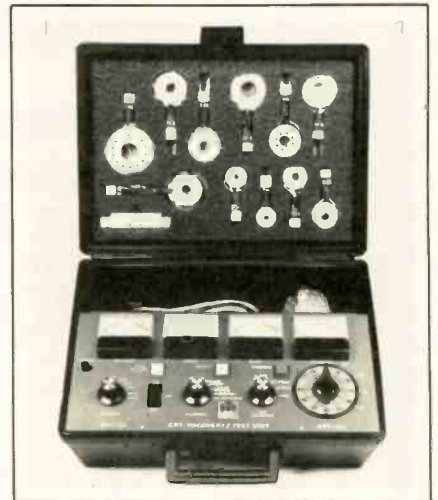

A "bestseller" you'll never put down.

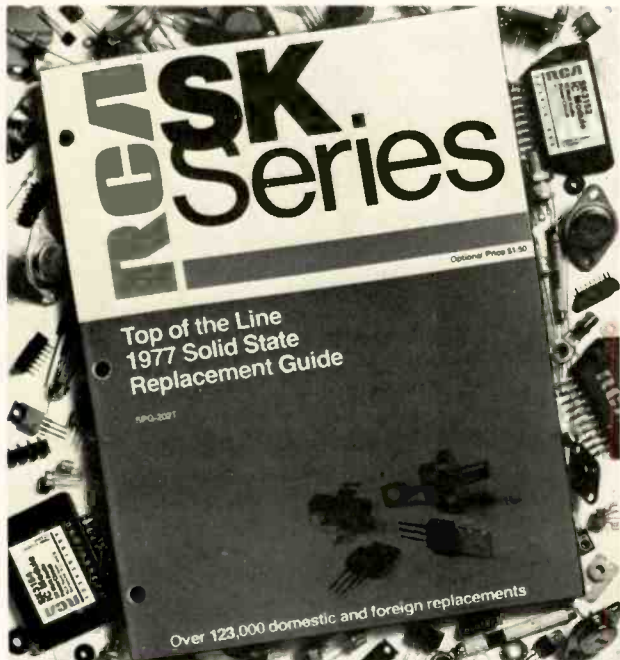

It's RCA's all new 1977 "Top of the Line" SK Series Replacement Guide. The most comprehensive list to date of transistors, rectifiers, thyristors and integrated circuits — 381 RCA types, including 68 brand new, that will replace 123,000 domestic or foreign semiconductors in entertainment and industrial equipment. The 68 new types have enabled us to increase our replacement capability by over 11,000 additional industry devices.

You can't afford to be without it. The 1977 Replacement Guide is a complete, accurate information source for your Solid State replacement needs. The book represents thousands of hours of engineering know-how. Keep in mind, too, that RCA SK replacement semiconductors measure up to strict AQL standards.

Get yours now. RCA's SK Replacement Guide. Contact your RCA Distributor. Or send \$1.50 (check or money order) to RCA Distributor and Special Products Division, PO Box 85, Runnemede, NJ 08078.

RCA SK Replacement Semiconductors

...for more details circle 126 on Reader Service Card

lower restoration currents, and a longer restoration cycle to restore gun structures in color and black and white TV. Model 84-1/A, in the test function, checks the color guns simultaneously; with emission characteristics displayed on separate meters. The unit includes a Life Test Function, and comes complete with 13 separate test adapters. A self-test adapter is also included for checking the unit's performance.

PULSE-SWEEP FUNCTION GENERATOR 145

A new function generator that offers sine, triangle, and square wave outputs is being introduced by *Helectronix*. Designated Model L-15, the unit is also a pulse generator offering a variable duty cycle pulse. All outputs are short circuit proof and capable of



being swept. The voltage controlled sweep input at the back of the instrument allows a precise sweeping of all three outputs. Frequencies of lower than 1Hz and greater than 100 KHz are obtainable with minor adjustments. Priced at \$75.

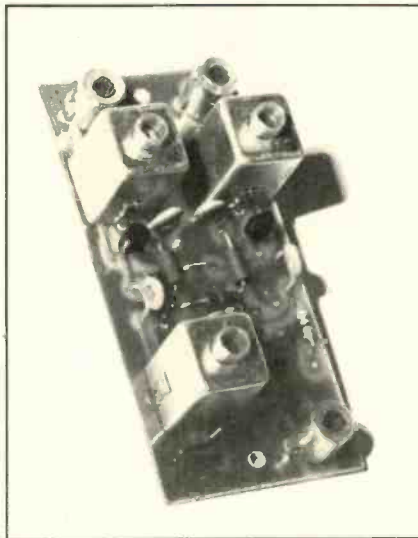

RECEIVE MULTICOUPLER 146

A new dual output FET preamplifier which provides low noise gain and power splitting to drive two receiver inputs from one antenna has been introduced by *Hamtronics Inc.* The new

unit, called the P13 Receive Multicoupler Unit, gives about 15 dB of gain in each of the two channels. If desired, outputs can be on somewhat different parts of the band with some reduction in gain. Standard models are available for any segment of the 26-230MHz vhf range. Prices are: \$12.95 for the P13 Receive Multicoupler kit; \$24.95 for the P24 wired and tested model; and \$49.95 for the P50 model, housed in a die-cast box with BNC connectors.

WIRE CUTTER-CRIMPER TOOL 147

A new wire cutter-crimper tool that performs seven different tasks for professional and home use is now available from *Clauss Cutlery Company*. Called the Model CS-8 cutter/crimper, the new tool features a compact design to allow work in cramped quarters. The features include: scissors action and stripping ability; bolt cutter for sizes 4-40 and 10-24; crimp stations for non-insulated electrical wire sizes

FREE ALARM CATALOG

Huge selection of burglar & fire systems, supplies. Motion detectors, infrared beams, controls, door switches, bells, sirens. 900 items, 64 pp. packed with technical details, notes.

Phone (602) 263-8831



mountain west alarm

4215 n. 16th st., phoenix, az. 85016

...for more details circle 121 on Reader Service Card

FOR HOME AND INDUSTRY
WORLD'S MOST PRACTICAL SOLDER HANDLING TOOLS
SOLDERING + DESOLDERING + RESOLDERING =
SOLDER Ability ELEMENTARY TO ELITE

- LONG
- MED
- SHORT



ADJUSTABLE VACUUM STROKE

US140

UNIVERSAL SOLDAPULL®
 DESOLDERING TOOL

Compact tool for convenient tool box storage. Precision molded plastic barrel and low-mass plunger creates rapid vacuum impulse with negligible recoil. Three position plunger adjusts loading span to fit large or small hands. Ample vacuum for most circuit board desoldering requirements.

contact your local **DISTRIBUTOR** inquiries invited

Covered by U.S. and Foreign Patents and Pending Applications

ESPECIALLY DESIGNED FOR YOU!

EDSYN® 144 PAGE TRAINING MANUAL
 1590 ARMINA ST., VAN NUYS, CALIF. 91411
 24 HR. PHONES Local (213) 980-2324 L.A. (213) 873-5115
 CABLE: EDSYNES VAN TELE 63-1466

NEW! OVER 1,000 ILLUSTRATIONS

FANOVISION TM

...for more details circle 115 on Reader Service Card

GO DIGITAL, GO DANAMETER®

(The New VOM For Today's Needs.)

- 0.25% Accuracy
- Full Overload Protection
- Really Drop-Proof
- Full One Year Battery Life

DANA®

Dana Laboratories, Inc.

2401 Campus Dr, Irvine, Ca 92715, (714) 833-1234

...for demonstration circle 114 on Reader Service Card

...for more details circle 113 on Reader Service Card

MARCH 1977, ELECTRONIC TECHNICIAN/DEALER / 51

FOR FAST TROUBLE-SHOOTING

"FERRET"

TV MINI-ANALYZER



SG-785 \$99.95

- VHF/UHF Subber
- I.F. - Video Troubleshooter
- Convergence Generator
- Dots and Cross-Hatch Patterns

The "FERRET" is a multi-functional instrument for fast, efficient trouble-shooting and adjustment of all Color and B & W tvs. It is ideal for both shop and field work. (Cables included.)

TeleMatic 2849 Fulton St.
Brooklyn, N.Y. 11207

Please send more information.

NAME _____
ADDRESS _____
CITY _____ STATE _____

SOLD THROUGH DISTRIBUTORS ONLY

...for more details circle 133 on Reader Service Card

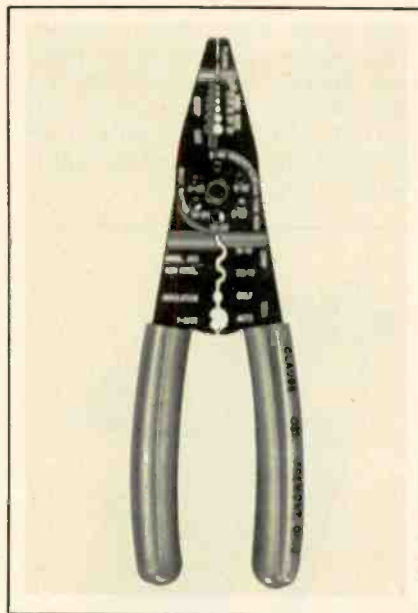

7mm to 12-x0 and insulated wire size 2w-20 to 12-10. The CS-8 also has a serrated jaw needle-nose plier and an "up front" wire cutter for tight spaces, and a hardened pivot bushing for easy, precise adjustment.

DIGITAL MULTIMETERS 148

Two new five-function digital multimeters that offer a 30,000 count display, large half-inch digits, automatic

or manual range selection, high/low ohms, and 2 or 4-terminal resistance measurements have been introduced by *Keithley Instruments*. Both of the units—models 172 and 173—measure DC voltages from 10 μ V per digit to 1200 volts, AC voltages from 10 μ V to 1000 volts rms and resistance from 10

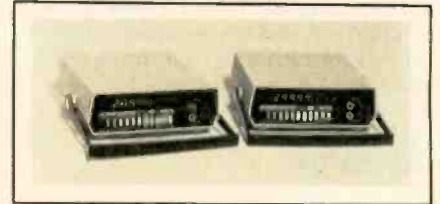

milliohms per digit to 300 megohms. The units differ only in their current measuring capability. The 172 handles AC and DC currents from 10 μ A/digit to 2 amps while the 173 offers a broader span of 10 nanoamps/digit to 3 amps. Both are fully overload protected. Model 172 sells for \$499 and Model 173 sells for \$625.

CB BASE STATION ANTENNA 149

A new CB base station antenna, based on the .64 wavelength principle used in commercial broadcast practice, has been introduced by *Newtronics Corporation*. The new design of the Hustler "Super Swamper" Model 27-TD is in line with FCC rules

Precision, Versatility, Value. Lampkin 109 Monitor. CB to 500 MHz. \$1,550.

- Measure / Generate better than 0001%
- Optional eight 12 MHz bands to 512 MHz
- Eight-digit display to 512 MHz
- Calibrated output 50 mv to 0.1 mv
- Measure / Generate 0-100% AM, metered
- Internal Mod 50 Hz to 6000 Hz
- Optional full FM function, 1 MHz sweep, frequency error meter.
- \$1,550. Options extra.



Manufacturers of Precision Communications Test Equipment Since 1932
LAMPKIN LABORATORIES INC. P.O. Box 9048 • Bradenton, Fla. 33506 • Ph. 813-792-5566

©1976 Lampkin Laboratories Inc.

...for more details circle 120 on Reader Service Card

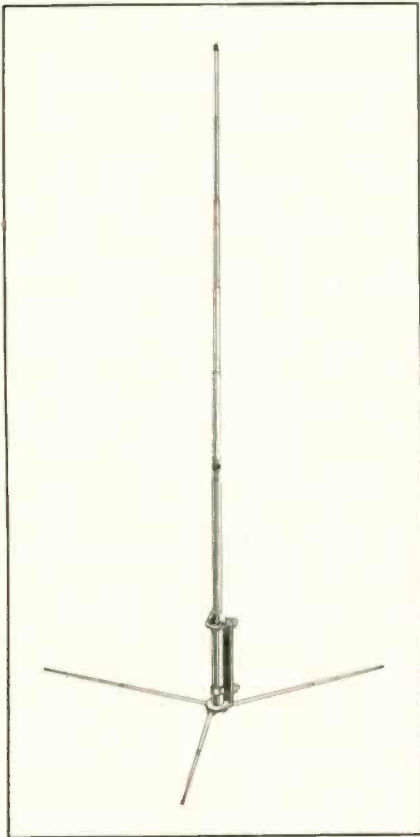

changes that permit greater antenna heights for CB Radio. The .64 wavelength, 22 ft. radiating element of the antenna is said to substantially improve performance to extend AM and SSB two-way, all directional radio communications over greater distances. The "Super Swamper" also has extremely low SWR for total coverage of existing and proposed CB channel expansion operation. Price is \$52.95.

ANTENNA COUPLER 150

A new antenna coupler, designed to combine signals from separate 300 ohm VHF and UHF antennas into a single 75 ohm output, is introduced by the *Winegard Company*. The input connections on the new coupler, Model CA-2830, are 300 ohm no-strip screw type and the output is a standard 75 ohm F-type connector. Model CA-2830

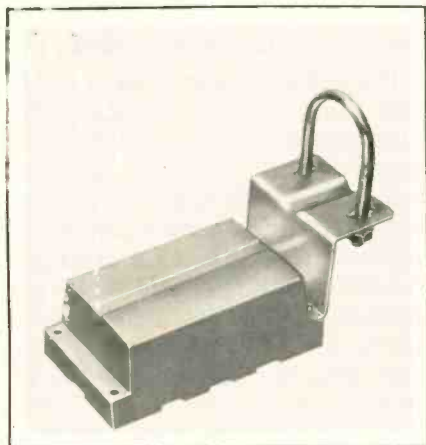

features a low insertion loss. On VHF, it averages $-.6\text{dB}$ and on UHF it averages -1.5dB . The coupler also has an excellent match, 1.2:1 at VHF and 1.3:1 at UHF. Isolation is high, 30dB or greater on both VHF and UHF. It is AC/DC passive on the VHF side. Model CA-2830 lists at \$13.75.

FUNCTION GENERATOR 151

A new low-price function generator, available in kit form, or wired, is offered now by the *A E Corp.* Designated Model 12, the new unit features simultaneous sine, triangle and squarewave outputs, with 0 to 20 Vpp amplitude. The selectable output has continuously adjustable dc offset and will drive 5 Vpp into 50 ohms. The frequency range covers 1 Hz to 1 MHz with 200 PPM/ $^{\circ}\text{C}$ frequency stability. The sine wave distortion is less than



2% from 1 Hz to 100 KHz. External frequency sweeping permits FM control of all waveforms. The kit price is \$79.95, and wired, it is priced at \$124.95.

DUAL-CHANNEL OSCILLOSCOPE 152

A new dual-channel oscilloscope with a vernier on the two vertical amplifier range switches has been introduced by *Ballantine Laboratories*. Designated the Model 1010A, the new scope has a 10 MHz bandwidth and 2 mV/cm sensitivity. It fulfills field



service, maintenance and production test requirements for industrial, commercial and government applications. Model 1010A has a maximum sweep speed of 1 us/cm, expandable to 100 ns/cm with a X100 magnifier.

CUTTERS WITH THE DURABLE CUTTING EDGE.

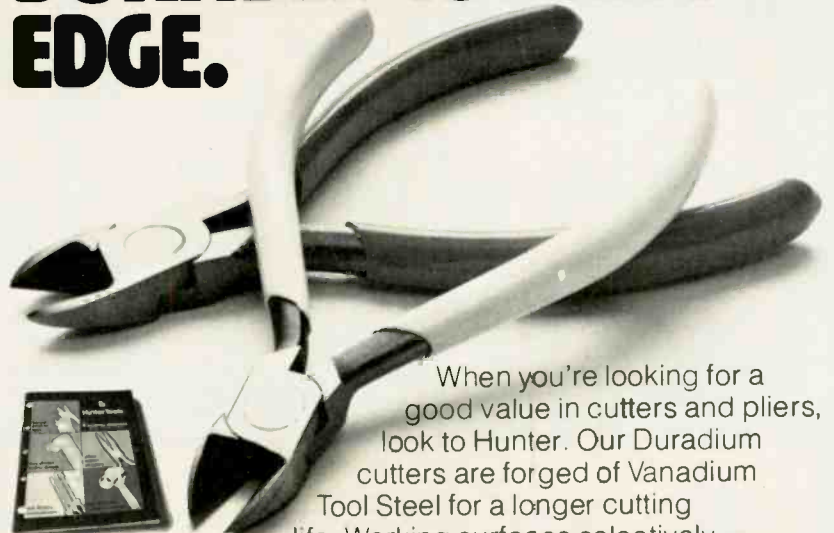

FREE CATALOG

Free Catalog of our cutters and other hand tools, write to Hunter Tools, 9674 Telstar Ave., El Monte, Ca. 91731.

When you're looking for a good value in cutters and pliers, look to Hunter. Our Duradium cutters are forged of Vanadium Tool Steel for a longer cutting life. Working surfaces selectively hardened for 1000's of wear-free cuts.

Hunter Tools
From the Group Called Marshall

...for more details circle 119 on Reader Service Card

Trigger coupling is ac, ac fast (low frequency reject) and TV frame. The triggering source can be internal or external. It is capable of X-Y operation and its passband in this mode is dc to 500 kHz. Priced at \$595.



TEST LEAD RACKS

TEST LEAD BENCH RACKS 153

A new series of bench racks to hold test leads, cords, co-ax cables, BNC plugs and adapters, as well as round chassis punch sets, are now available from *Herman Smith, Inc.* The new racks have been designed for laboratory, test station and service bench. Included are three racks for test leads, patch cords, jumpers and co-ax cables with cable diameters up to 7/32 in., in

7-slot, 14-slot and 21-slot models. The racks can be mounted side by side in mixed lengths to suit any space requirement. Width is 3-3/4 in.

AC LINE FILTER FOR CB 154

A new AC line filter, designed to overcome television interference caused by CB transmission through AC power lines, has been introduced



by *Avanti Research*. The new filter, AV-820, is installed at the CB transmitter or at the TV set. The unit plugs into a wall receptacle and has a recep-

tacle for the TV or CB plug-in.

TEST INSTRUMENT REPORT

continued from page 46

input jacks on the right-hand side of the Model 6000 handle all functions except the current-measuring ranges, which are provided through a separate jack.

Two disposable, 9-volt zinc carbon batteries provide more than 200 hours of operation, and circuitry is included that gives a "low battery" warning during the final 10 hours of battery life.

Model 6000 is housed in a tough polycarbonate plastic case which features a carrying handle that folds forward to provide protective cover for the display window and, in addition, can be folded backward to serve as a stand for bench-top viewing. A color-coded range plate is easily removed for battery replacement and access to the input fuse.

The price of the Weston Model 6000 is \$195.00. A high-voltage probe is also available on an optional basis. ■

LUMINANCE CIRCUITS

continued from page 18

nance circuitry is usually the cause of brightness problems, it should be remembered that troubles in other circuits can sometimes cause the same kind of symptoms. For example, a severe AGC overload could cause the screen to "black out" completely—or a power supply failure could produce excessive or low brightness—or low emission, an internal short, or open filaments in the CRT could cause brightness changes.

Checking the Luminance Circuit

If the AGC is operating properly and there is high voltage, the luminance circuits should be checked out. Modular circuitry makes this task relatively simple because it mainly is a matter of module substitution. For example, substituting the Video Delay module replaces most of the luminance circuit components. The next step is to substitute the IF module which contains the Video Detector and the Video Output

SUBBER®

MARK IV-CUVB

A TIMESAIVING INSTRUMENT BY CASTLE

UHF-VHF TV tuner and i-f signal analyst
Incorporates these important features:

- Tunes all UHF & VHF Channels
- Electronic Fine Tuning
- Dual 40 MHz IF Output Jacks
- Battery Condition Indicator

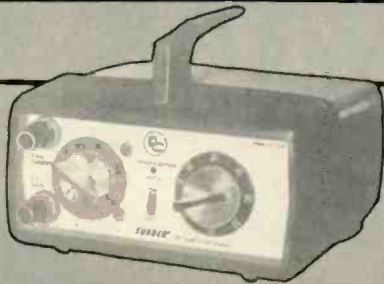

MARK IV-CUVB
(BATTERY POWERED ONLY)

Net \$64.95



CASTLE ELECTRONICS

5233 Old South Highway 37 Bloomington, Indiana 47401

For More Details and Specifications Contact Your Nearest Distributor
In Canada: Len Finkler Ltd; Ontario

...for more details circle 122 on Reader Service Card

VIBRA-JET®

Turns Tun-O-Wash into a



patent pending

PULSATING...VIBRATING... "CLEANING MACHINE"

You have never seen anything like Vibra-Jet, our new patent pending aerosol pulsating device. Just plug it into a can of Tun-O-Wash and you get strong vibrational solvent impacts that instantly penetrate heavy grease, gunk and baked-on contaminants. Vibra-Jet action even washes away dirt on horizontal surfaces . . . makes Tun-O-Wash more effective, leaving tuner parts and controls "vibrantly clean."

Vibra-Jet is made of strong durable polyurethane construction. Works in all positions and comes complete with 26 in. hose and 12 in. probe for hard-to-reach parts.

FREE! FREE! FREE!

FOR A LIMITED TIME ONLY, Vibra-Jet will be offered free with the purchase of 2 cans of Tun-O-Wash or Super Tun-O-Wash.

Pick up our "Cleaning Machine" . . . it will be the best time saving investment you've ever made.

Available at participating Chemtronics distributors.

CHEMTRONICS
INCORPORATED
45 HOFFMAN AVE. HAUPPAUGE, N.Y. 11787 • (516) 382-3322



Our business is improving yours!

...for more details circle 111 on Reader Service Card

transistor. If the trouble is not corrected, the RGB module should be substituted, and finally, the last of the four possible modules is the Chroma module. This contains the Blanker and related components which can cause brightness problems when defective.

If substitution of these four modules does not solve the problem, the trouble is with either the main PC board components or the power supplies. This usually can be determined with a few voltage checks.

CRT Voltages

All voltages on the CRT socket board, which is mounted directly to the base of the picture tube, can be measured directly on the socket pins, except for the anode voltage. With the negative lead of the meter grounded to the chassis, the CRT grid should read 50V. This is a fixed voltage and should remain constant. The CRT cathodes, pins 3, 8 and 12 (Fig. 4), should read between 115V and 170V, depending on the setting of the Brightness control and the background controls. Other voltage checks are included in the Brightness Troubleshooting Guide in Fig. 5.

Intermittent Problems

Troublesome intermittent problems with the T991 chassis can usually be localized by wiggling, tapping, and pulling wire bundles, boards, modules and sockets until a sensitive area is located. Intermittents will usually be caused by one or more of the following: broken or crystalized solder connections, loose plug and socket connections, broken wires, or corroded module or switch contacts. Problems that can't be visually observed will probably require the cleaning or replacement of a switch, or the tightening of all pins on a plug.

Because so many circuits are involved, brightness problems represent a good percentage of TV problems. In modular construction, such as with the T991 chassis, troubleshooting boils down to just a couple of steps—module substitution and systematic DC voltage checks of the luminance and CRT circuits—plus one more important ingredient—a thorough understanding of how the circuits work. ■

CLASSIFIED

RATES: 40¢ per word; 50¢ per word Bold Face Type. Add \$3.00 if you wish Box Number. Minimum \$10.00 charge. Classified Display Rate billed \$43.00 per inch, 1 inch minimum. Remittance must accompany order. Mail ad copy to: Susan Hellerman, ET/D, 757 3rd Ave., N.Y., N.Y. 10017

Business Opportunities

TV SALES AND SERVICE. FLORIDA EAST COAST. BUSY SHOP. GOOD REPUTATION. EXPERIENCED TECHNICIAN CAN NET \$20,000/YEAR. FULL PRICE \$9,500. TERMS IF REQUIRED. TITUSVILLE TV, 2957 GARDEN ST., TITUSVILLE, FL 32780. 4/77

FOR SALE: In Sunny Florida. TV Sales and Service, Retiring, Excellent Location. Reasonable Rent. Established 15 years. \$25,000.-Reasonable Down Payment With Terms. Year Round Business. 1-(305) 723-6161. 4/77

SELLING, FLORIDA—ZENITH T.V. SALES & SERVICE: 16 YEARS SAME LOCATION—PARTS, FIXTURES, EQUIPMENT & CUSTOMERS—\$7000.00. BILL ELLIS, 5688 OAKHURST DR., ST. PETERSBURG, FL. 33542. 3/77

TV Sales & Service in same location 15 years. Nets over \$25,000. Includes truck, equipment and inventory. \$25,000 with \$13,000 down. Arnold's TV, 3533 Adams, San Diego, CA 92116. Phone 714-282-2522. TF

TIRED OF CUSTOMER ABUSE? EXPAND INTO LUCRATIVE PATENTED MATV. PRELIMINARIES \$3.00. BOX 809, BOYNTON BEACH, FLA. 33435.

ELECTRONICS/AVIONICS EMPLOYMENT OPPORTUNITIES. Report on jobs now open. Details FREE. Aviation Employment Information Service, Box 240 Y, Northport, New York 11768. 6/77

BUILD ELECTRONIC DEVICES IN YOUR HOME. GET STARTED IN YOUR SPARE TIME. BIG PROFITS - EXPERIENCE NOT NECESSARY. WRITE FOR FREE LITERATURE TELLING HOW. ELECTRONIC DEVELOP LAB. DEPT. B, BOX 1535, PINELLAS PARK, FL 33565. 5/77

Established 30 years. Radio and TV Sales and Service. Reasonable terms. Retiring. Will help part-time. Write 44 N. Spencer, Mesa, AZ 85203. 4/77

MOVING? BE SURE TO LET US KNOW YOUR NEW ADDRESS

Alarm Systems

ALARM EQUIPMENT FOR SALE: High Quality Professional Equipment at Low Prices. Industrial, Commercial, Residential and Auto. Write for Free Literature. B. Johnson Alarm Co., 180 Prospect St., East Orange, NJ 07017. 4/77

CALL THE POLICE (or anyone else) AUTOMATICALLY. Model 672 dailing unit \$29.95. Send today for your free catalog of high quality burglar and fire alarm equipment at low prices. S&S Systems, 5619 E St. John, Kansas City, MO 64123. 3/77

Construction Plans

REPAIR TV TUNERS—High earnings, Complete Course Details, 12 Repair Tricks, Many Plans, Two Lessons, all for \$2. Refundable. Frank Bocek, Box 3236, Ent., Redding, CA 96001. TF

For Sale

For Sale. Lampkin 107C signal generator-frequency meter. Complete. Mint. \$2000.00. Cashier's check only. Will deliver UPS. Richard Matassa. 225 E. Irving Park. Roselle, IL 60172. 3/77

**send a message...
...write here.**

1. Number of insertions: (circle) 1 2 3 6 12
2. Start with (month) _____ issue (Copy must be in by 1st of month preceding)
3. Amount enclosed: \$ _____

PAYMENT MUST ACCOMPANY ORDER WE'LL BILL RATED FIRMS NO AGENCY COMMISSION

NAME _____ COMPANY _____

STREET _____

CITY _____ STATE _____ ZIP _____

MAIL COPY FOR AD(S) TO SUSAN HELLERMAN, Electronic Technician/Dealer, 757 Third Ave., New York, N.Y. 10017

RATES: 40¢ per word; 50¢ per word Bold Face Type. Add \$3.00 if you wish Box Number. Minimum \$10.00 charge. Classified Display Rate billed \$43.00 per inch, 1 inch minimum.

**ELECTRONIC
TECHNICIAN/DEALER CLASSIFIED**

ELECTRONIC TECHNICIAN/DEALER

is not responsible for any of the items, plans, courses or quality of products offered through our classified section.

SONY PARTS—Tuners, Cabinets, Antennas, Knobs, Speakers, Earphones, Switches, Pots, Components and Cheater Cords available at 50%-75% savings. All parts have been removed from new Trinitron color sets. Parts available for every Trinitron ever produced. Price list available. World Video, Inc., Box 117, Boyertown, Pa. 19512. 5/77

TRANSISTOR TESTER. Convert Transistor Radio Into In-circuit Transistor Tester. Tone Indicates Good Transistor. Plans \$2.00. SZA Electronics Systems Inc., 3 Bayberry Lane, Levittown, NY 11756.

TRANSISTOR REPLACEMENTS. PHYLTRON ELECTRONICS LX REPLACEMENT LINE REPLACES THE MOST POPULAR REPLACEMENT TYPES AT OR BELOW DISTRIBUTOR COST. One year unconditional guarantee. Buy direct and save. Write for free catalog. Phyltron Electronics, 487 Springfield Ave., Summit, N.J. 07901. 3/77

Color-Bar Generator, 16 Patterns, Pocket Size. **CMOS-LSI** Chip, One Transistor. Complete Plans \$5.00. P.C. Boards, Kits Or Wired Units Also Available. Science Workshop, Box 393-ET, Bethpage, New York 11714. 4/77

REPLACEMENT COLOR YOKES-DEALERS ONLY. Zenith 95-2501-2532-2638-2667-S89633 etc. \$14.95. Magnavox 361380-1 \$18.95 etc. *Sylvania, G.E. etc.* \$14.95 to \$19.95. Request for price list on your letterhead. David Sims Enterprises, Inc., 665 Jerricho Turnpike, Huntington Station, N.Y. 11746. TF

Fully depreciated test instruments we no longer need. Write or call for list and prices. Frazier Electronics, 105 Church St., Fredericktown, MO 63645. 314-783-5732. 4/77

LINEAR AMPLIFIER for C.B., 2-meter, walkie-talkie. Tiny Solid-State Portable Unit produces 100 Watt PEP from Milliwatts and can be inserted inside existing unit. Build for about \$20. Send \$5.00 for plans to: J. Martin Peter, P. O. Box 07071, Milwaukee, WI 53207. 7/77

RF Sig. Gen. Knight 83Y145 \$18.00; Audio Gen. Knight 83Y137 \$18.00; Audio Voltmeter RCA WV-73A \$18.00; Freq. Meter LM-13 \$30.00; Freq. Meter TS-175/U \$40.00; Heath TV Align. Gen./SWP TS-4A \$25.00; Heath TV Post Marker/SWP Gen. IG-57A \$80.00, all postpaid. Rubarts, Route 2, Box 104-B, Blountsville, AL 35031. 3/77

CB ENGINE NOISE AND TV INTERFERENCE STOPS HERE: Free brochure describes nine **EMI-LINE** filters providing complete coverage of mobile engine noise and base TV interference problems. Easy do-it-yourself installation. Dealers wanted. Marine Technology, ET. 2780 Temple Ave., Long Beach, CA 90806. (213) 427-6443. 3/77

TV & RADIO TUBES .36¢ EA!! Send for free color parts catalog. Your order free if not shipped in 24 hours. Cornell Electronics 4215-17 University San Diego California 92105. TF

TEN FIXES for b/w, color TV's. Send \$1.00 and SASE to: **TERRY**, Box 209A, Park Ridge, Illinois 60068 (Out-of-state residents only). 3/77

OFFICIAL IRS TAX AUDIT GUIDE BOOKS I AND II, \$11.55. Order from J. Fowler 145 N. Douglas, Los Angeles, California 90026. 4/77

RCA EXACT REPLACEMENT PARTS. Largest stock. Green Tele-Radio Distributors, 172 Sunrise Highway, Rockville Centre, NY 11570. UPS, C.O.D. 4/77



AMAZING OFFER RADIO/TV SERVICE DATA

Your best, complete source for all needed early Radio and TV diagrams and helpful servicing data from 1970 back. Old prices; amazing values. Sets sold at 30% discount. Cover all important makes and models. Use this ad as your *no-risk* order form.

NO-RISK ORDER COUPON

TELEVISION SERVICE MANUALS

Supreme TV manuals are still best for faster, easier TV repairs. Accurate factory data at bargain prices. Complete circuits, all needed alignment facts, printed circuit views, waveforms, voltages and double-page schematics. Issued in large annual manuals. Sold in sets at 30% off, or at \$4 per volume. Send entire ad as your order form.

- Between 1965 and 1970, in 7 large vols., B-W & color, value \$28, only \$19.60
- Between 1957 and 1964, in 7 handy volumes, regular price \$28, now only \$19.60
- 3 early of 1950's TV manuals, \$9.95

RADIO DIAGRAM MANUALS

These low-priced radio manuals simplify all repairs. Cover everything you may need from recent radios to antiques; all makes radios, stereos, transistor portables, FM-AM, and auto sets. Large schematics, all needed alignment facts, printed boards, voltage data, dial stringing. Volumes are big, 8½ x 11", most have 192 pages. Only \$4 each.

- 1960 through 1969, in 8 volumes, cover all makes, value \$32, only \$22.40
- Between 1951 and 1959, in 7 large vols., data you need, value \$28, only \$19.60
- 1950, 1948, 1942, 1941, each \$4
- 1926-1938 Antique Radio data, only \$7
- Auto Radio Repair Manual, \$2.50

SUPREME PUBLICATIONS

1760 Balsam Road, Highland Park, IL 60035

Rush TV and Radio manuals checked in no-risk order form above. I am enclosing full price plus \$1 for postage and handling. Satisfaction guaranteed.

Name:

Address:

City: Zip:

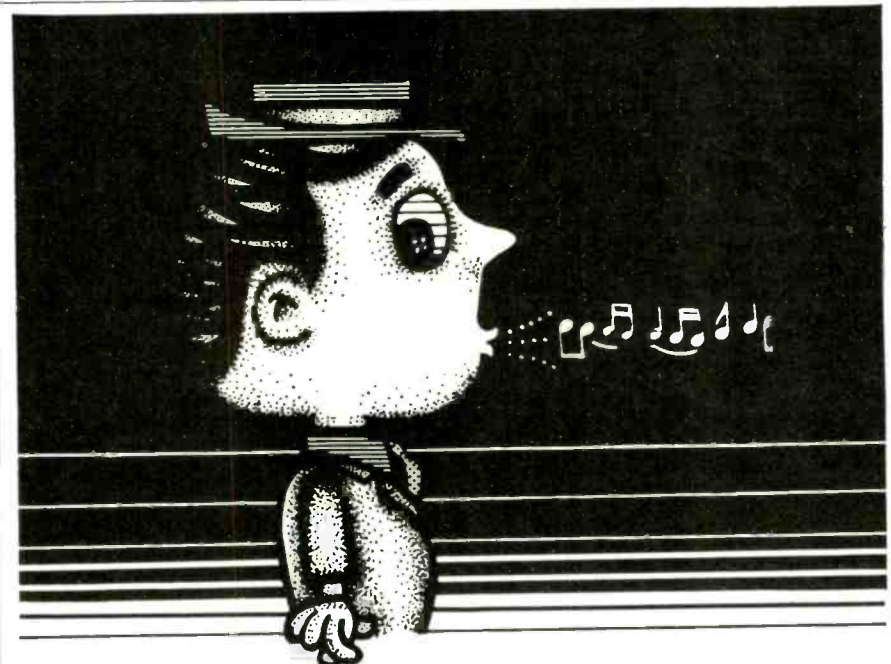

you're whistling in the dark.

If you think that heart attack and stroke hit only the other fellow's family.

Help your Heart... Help your Heart Fund 

American Heart Association

Contributed by the Publisher

APPLIANCE REPAIR BOOKS

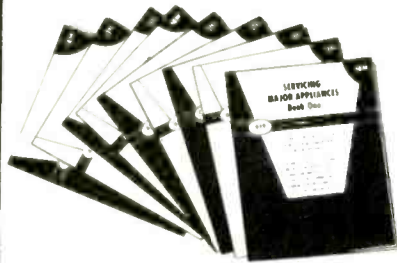

Thirteen Handbooks written in easy-to-understand language by experts in the service field with illustrations and diagrams! Acclaimed by instructors and professionals alike! How to diagnose and repair air conditioners, refrigerators, washers, dryers, ranges, microwave ovens, dishwashers, vacuum cleaners, electrostatic air cleaners, RV gas appliances, hair dryers, motors, water heaters, coffeemakers, can openers, floor polishers, steam irons, food mixers, lawn care appliances, electric knives, electric and digital clocks and many others. Also fundamentals of solid state, setting up a shop, using test instruments and more. Only \$2.65 to \$4.90 ea.

SEND FOR FREE PRICE LIST

C & N, Dept. ET
5841 W. Montrose Avenue
Chicago, Illinois 60634

...for more details circle 110 on Reader Service Card



endeco soldering & desoldering equipment

SOLDERING IRONS

Pencil style. Safety light. Two heats — 20w and 40w. 6 tips. Unbreakable handle. 2 and 3 wire neoprene cords.

DESOLDERING IRONS

Pencil style. Safety light. Some operate at 40w, idle at 20w. 8 tip sizes. 2 and 3 wire neoprene cords.

SOLDERING & DESOLDERING KITS

Everything needed to solder or desolder or both. All in a handy lifetime metal box with hasp.

See your distributor or write

Enterprise Development Corp.

5127 E. 65th St. • Indianapolis IN 46220
PHONE (317) 251-1231

...for more details circle 117 on Reader Service Card

READER SERVICE INDEX

ADVERTISER'S INDEX

101 American Technology Corp.	58
106 Arrow Fastener Co., Inc.	10
107 Astatic Corp.	21
108 B & K Div., Dynascan Corp.	15
109 Channel Master	47
110 Charous & Niebergall, Inc.	58
111 Chemtronics, Inc.	55
112 Chrysler Corp.	41
113 Dana Labs, Inc. (for info.)	51
114 Dana Labs, Inc. (for demo.)	51
115 Edsyn, Inc.	51
116 Electronic Book Club	32-35
117 Enterprise Development Corp.	58
118 Fordham Radio Supply Co., Inc.	49
GTE Sylvania Consumer Renewal	3
General Electric Co., Tube Div.	23
158 Hewlett Packard/Loveland Instr.	25
119 Hunter Tools	53
120 Lampkin Labs, Inc.	52
103 Leader Instruments Corp.	Cover 3
121 Mountain West Alarm Supply Co.	51
102 PTS Electronics	Cover 2, 1
122 PTS Electronics	54
123 Platt Luggage	26
124 Pomona Electronics	11
125 RCA Corporation	5
129 RCA—Outdoor Antennas	39
128 RCA—QT Parts	6, 7
RCA—Receiving Tubes	28, 29
127 RCA—Resistors	14
126 RCA—SK's	50
130 Sencore, Inc.	12
131 Simpson Electric Co.	30
132 T & T Sales Co.	18
133 Telematic Div., UXL Corp.	52
104 Triplet Corp. (for info.)	Cover 4
105 Triplet Corp. (for demo.)	Cover 4
134 Tuner Service Corp.	19
135 VIZ Manufacturing Co.	43
136 Weller-Xcelite Electronics Div.	48
137 Winegard Co.	8, 9

This Index is furnished for the readers' convenience. However, the publisher can not guarantee its accuracy due to circumstances beyond our control.

THE GENERAL TELEVISION SERVICER



Patents Pending covering 13 unique features.

YOUR PORTABLE, COST EFFECTIVE SOURCE OF A CONVENTIONAL COLOR BAR PATTERN GENERATOR, A SUBSTITUTE TUNER AND MOST USED FUNCTIONS OF AN ANALYST, PLUS:

- Extra wide range RF/IF attenuator for testing receiver sensitivity.
- **GRAY QUAD** pattern for gray scale tracking checks/adjustments.
- **COLOR BARS** pattern for oscillator frequency checks with no need to short the AFPC test point.
- **RED RASTER** pattern for checking and adjusting purity at the flip of a switch.
- **HATCHDOTS** - versatile composite pattern for dynamic & static convergence plus other checks.
- High level, 75 ohm video output.

ALL THIS FOR ONLY \$299.95!

Write for more information on the ATC-10 General Television Servicer, or try it at our risk. — **30 DAY SHOP TRIAL** — (If not 100% satisfied in every way, return for instant refund in full.)

American Technology Corporation

225 Main Street, Dept. 3B,
Canon City, CO 81212

For your convenience, we accept Master Charge, BankAmericard and COD phone orders.

Same day shipment!
(303) 275-8991

...for more details circle 101 on Reader Service Card

GROUP
295

SCHEMATIC NO.

SCHEMATIC NO.

ADMIRAL1683
Color TV Chassis 9M50

GTE SYLVANIA1685
Color TV Chassis E42-3

GENERAL ELECTRIC1684
Color TV Chassis CD/LB

GTE SYLVANIA1686
B/W TV Chassis A12-6, -11, -13

TUNER/CONTROL ASSEMBLY

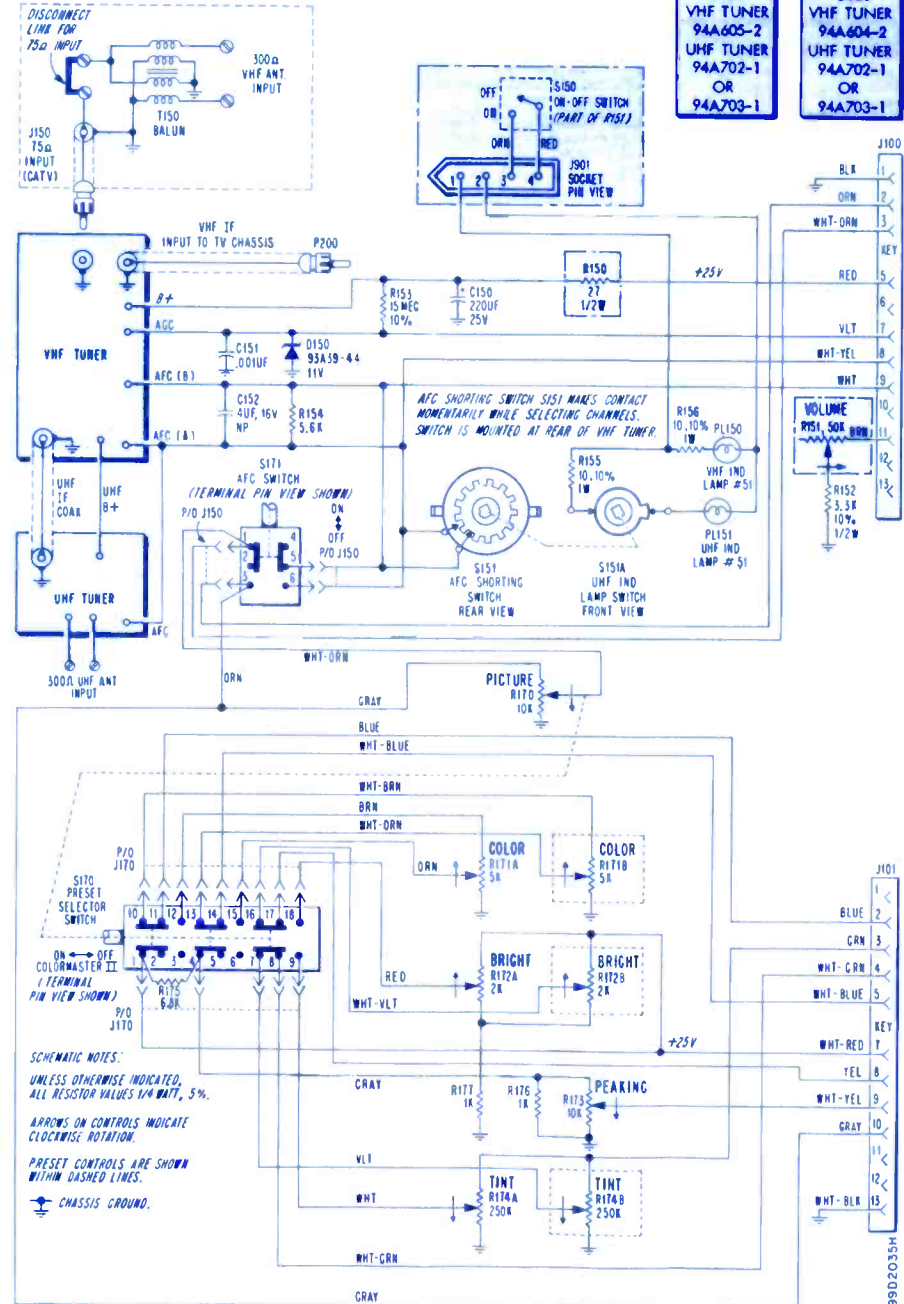

9M50 CHASSIS LAYOUT

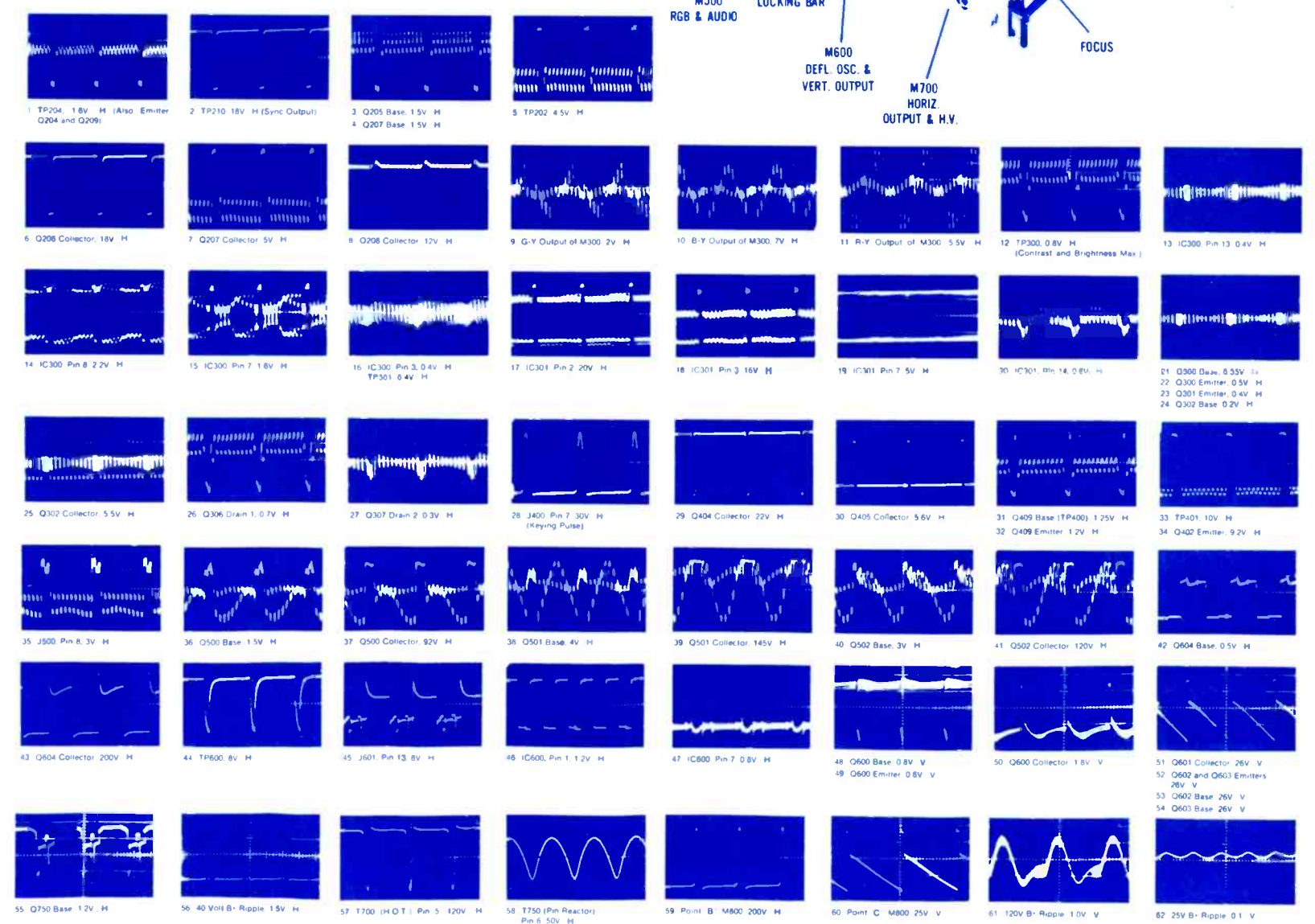
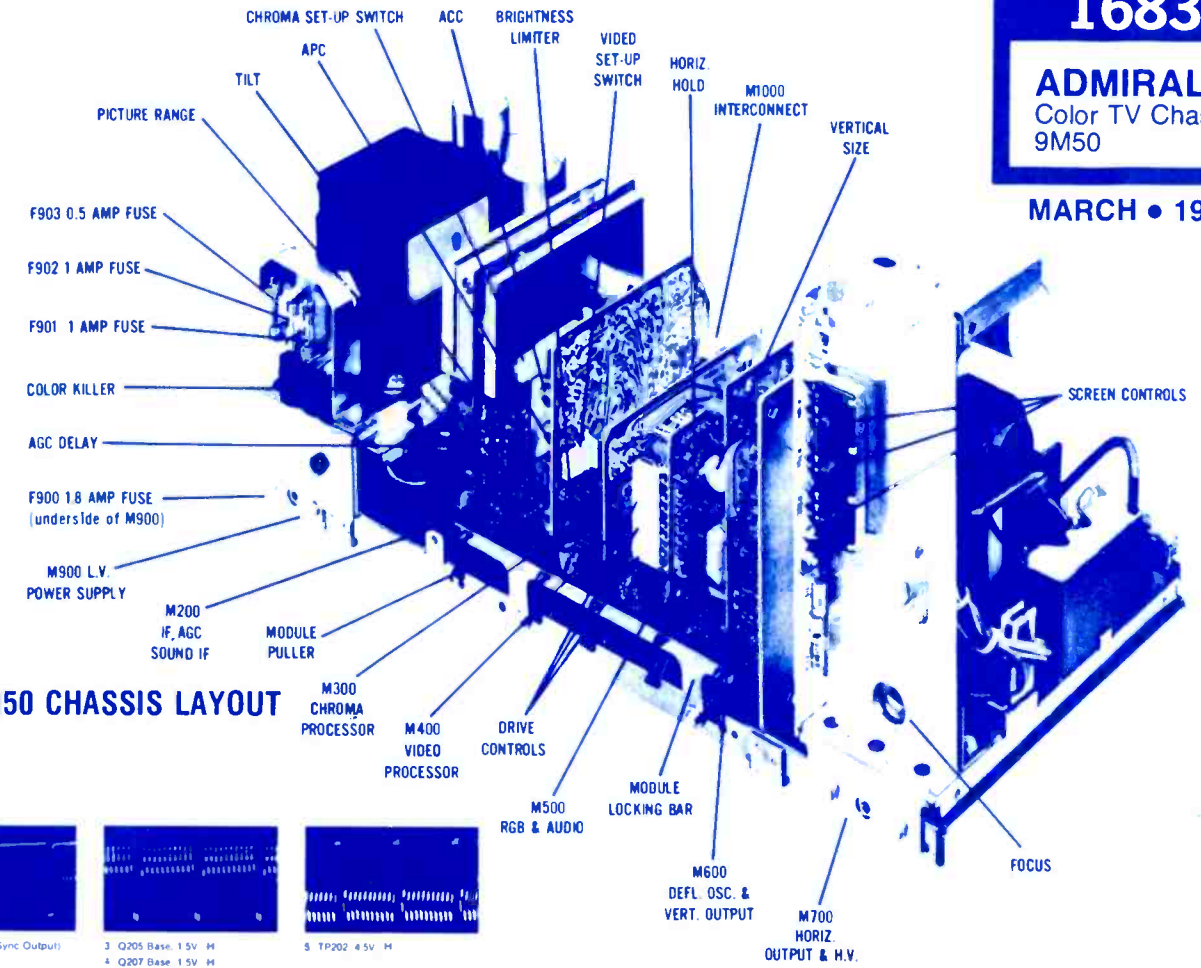

ADMIRAL
Color TV Chassis
9M50

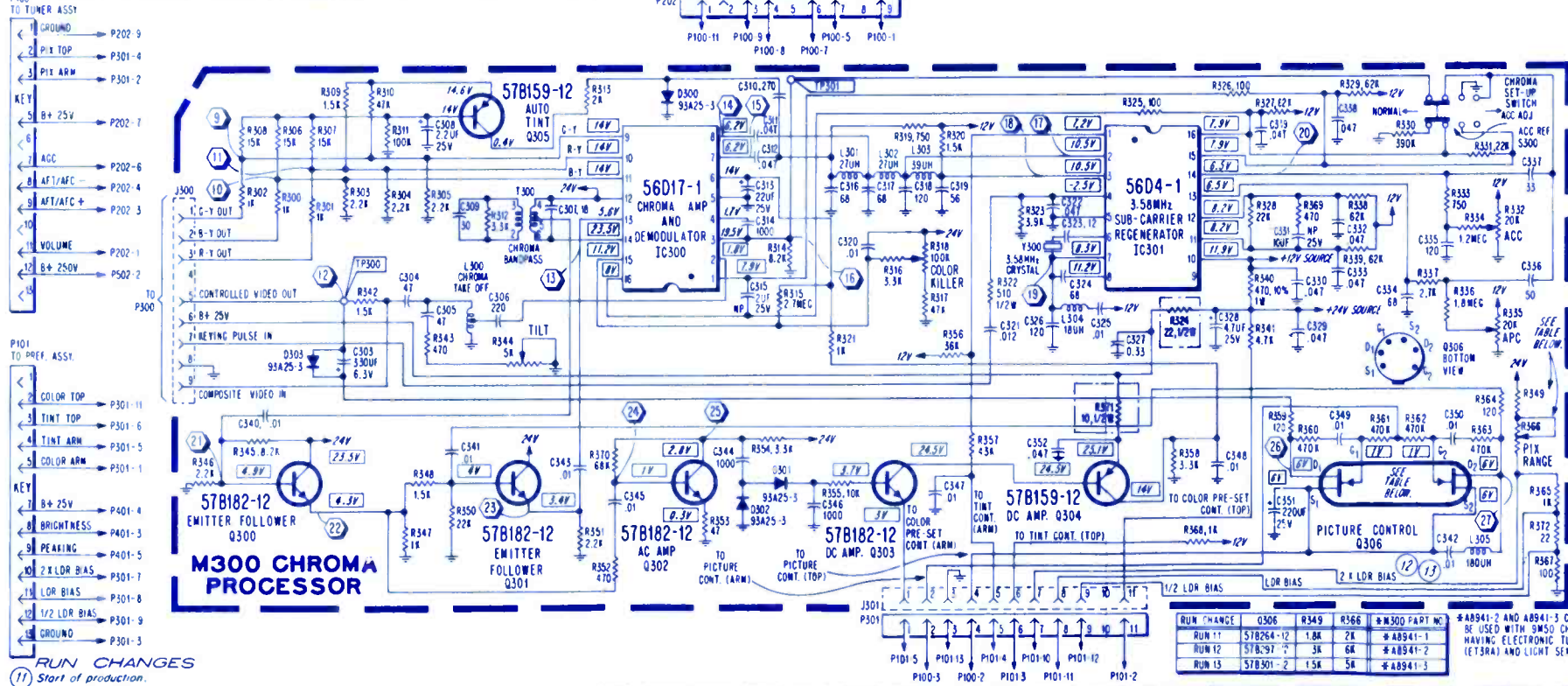
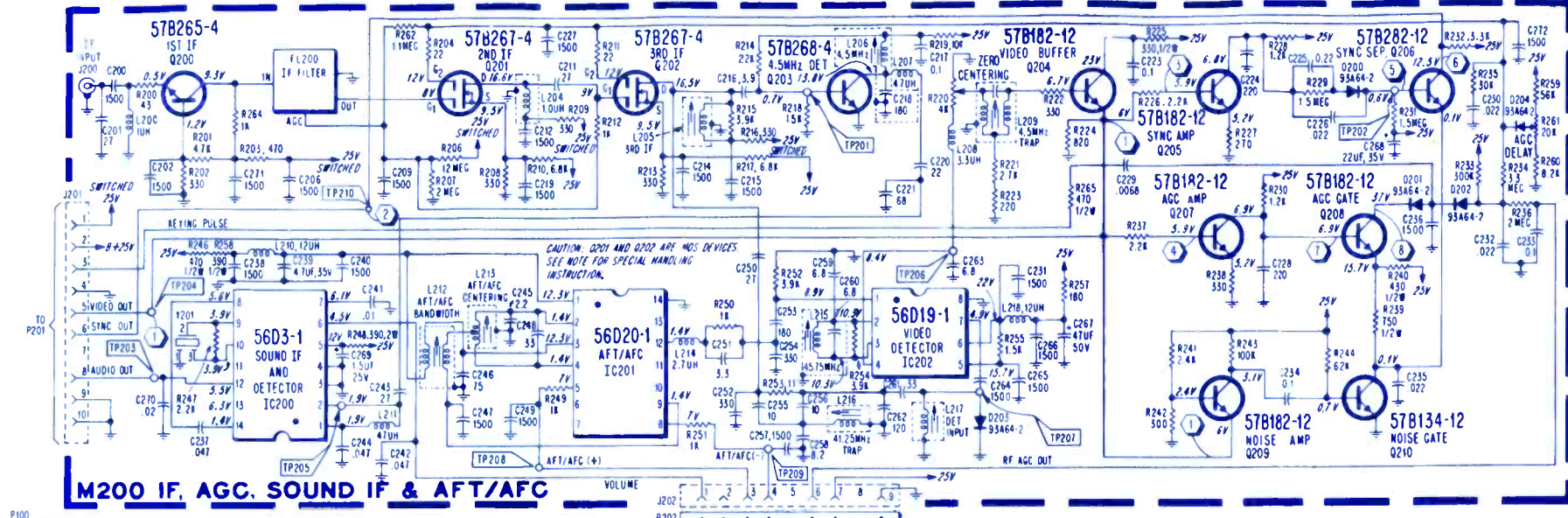

- RUN CHANGES**
- 11 Start of production.
 - 12 M300 Chroma Processor Board changed from A8941-1 to A8941-2.
 - 13 M300 Chroma Processor Board changed from A8941-2 to A8941-3.

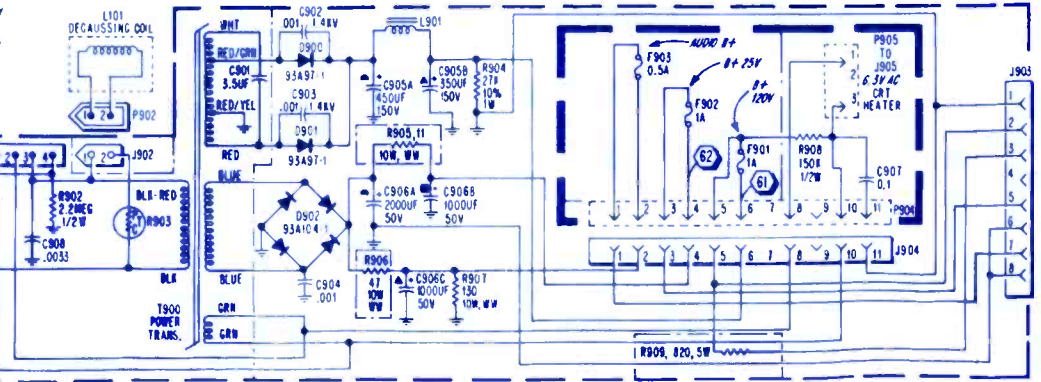
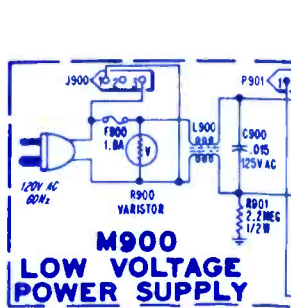

RUN CHANGE	Q306	R349	R366	*M300 PART NO.	*A8941-2 AND A8941-3 CANNOT BE USED WITH 9M50 CHASSIS HAVING ELECTRONIC TUNING (ETBRA) AND LIGHT SENSOR
RUN 11	57B264-12	1.8K	2K	*A8941-1	
RUN 12	57B267-4	5K	6K	*A8941-2	
RUN 13	57B301-2	1.5K	5K	*A8941-3	

- SCHEMATIC NOTES**
- (UNLESS OTHERWISE INDICATED):
- RESISTOR** values in Ohms, $\pm 5\%$, 1/4W.
 - CAPACITOR** values 1 or higher in PF, less than 1 in UF, $\pm 20\%$.
 - COIL** resistance values less than 1 Ohm, not shown.
 - \perp Common ground (B-)
 - ∇ Component not mounted on printed circuit board.
 - \bigcirc Run number indicates change(s) incorporated as given under that run number, as well as all lower run changes.
 - \square Symbol indicates test point connections.
 - \curvearrowright Arrows on controls indicate clockwise rotation.

WARNINGS

Use Isolation Transformer when servicing chassis.

When servicing, use EXACT REPLACEMENT PARTS. See "SAFETY CRITICAL COMPONENTS" notice. Also perform all safety checks specified under "IMPORTANT PRODUCT SAFETY INFORMATION" in Service Manual.

SEMICONDUCTOR CAUTIONS

To avoid damage to semiconductor devices, do not arc 2nd anode lead or picture tube anode to ground. Discharge only to picture tube dag or dag ground. Do not turn set on with transistors removed, or picture tube or other leads removed or unsoldered. Use caution to prevent accidental shorts between component leads or to chassis ground. Make continuity and resistance measurements with VTVM, Field Effect Meter, or other high input impedance meter. Do not use a volt-ohmmeter having less than 100K Ohms/Volt for resistance measurements.

VOLTAGE & WAVEFORM INFORMATION

DC voltages are measured with respect to common ground (B-) using a VTVM, line voltage set at 120VAC and all controls set for normal picture. Voltage readings taken without signal and tuner set to unused channel.

\square Voltages in box taken with set tuned to a color signal.

\hexagon Hexagons identify waveform observation points. All waveforms taken with wide band oscilloscope. See waveform pages for other information.

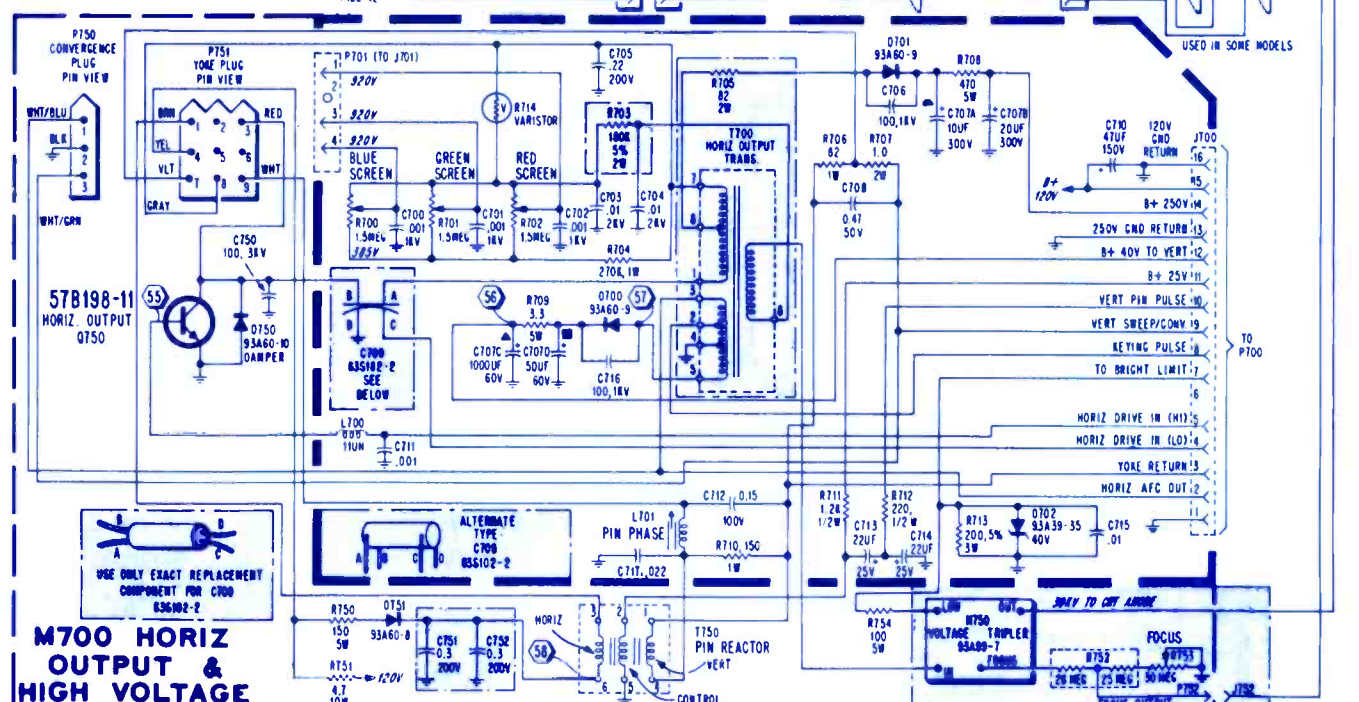
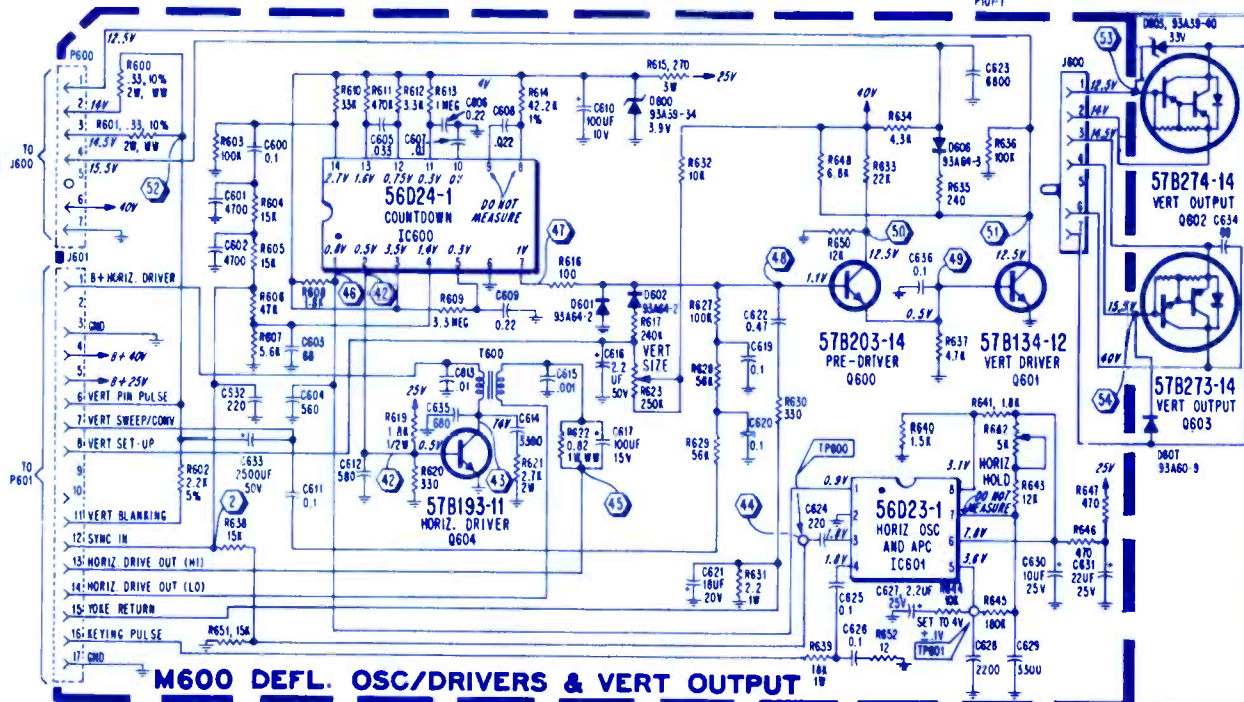
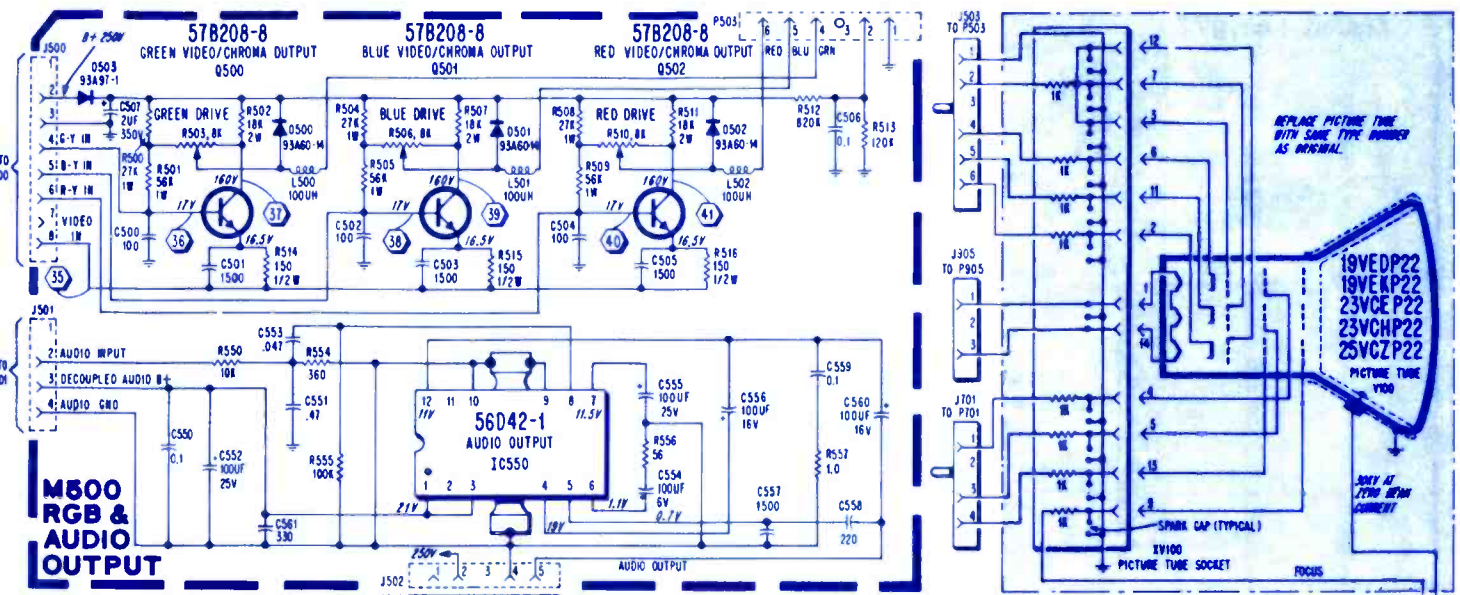
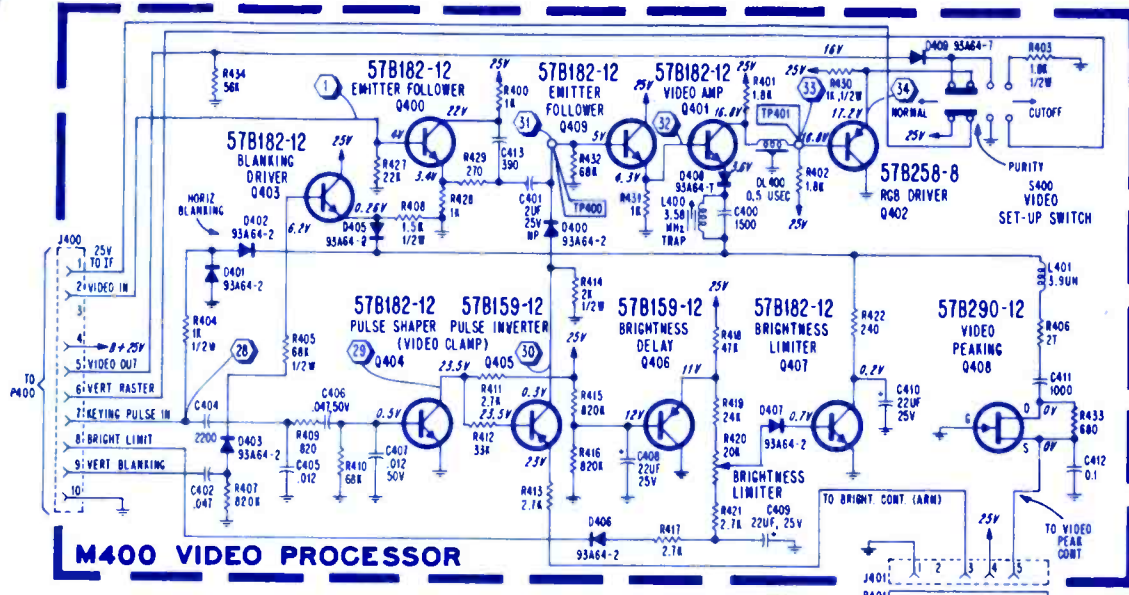

SAFETY CRITICAL COMPONENTS

THE DESIGN OF THIS RECEIVER CONTAINS MANY CIRCUITS AND COMPONENTS INCLUDED SPECIFICALLY FOR SAFETY PURPOSES. FOR CONTINUED PROTECTION, NO CHANGES SHOULD BE MADE TO THE ORIGINAL DESIGN AND COMPONENTS SHOWN IN SHADED AREAS ON THE SCHEMATIC SHOULD BE REPLACED WITH EXACT FACTORY REPLACEMENT PARTS. THE USE OF UNAUTHORIZED SUBSTITUTE PARTS MAY CREATE A SHOCK, FIRE, X-RADIATION, OR OTHER HAZARD. SERVICE SHOULD BE PERFORMED BY QUALIFIED PERSONNEL ONLY.

RELIABILITY AND PERFORMANCE

FOR CONTINUED RELIABILITY AND PERFORMANCE, EXACT FACTORY REPLACEMENTS ARE RECOMMENDED FOR ALL OTHER PARTS REPLACED. IF A SUBSTITUTE MUST BE USED, BE SURE ITS QUALITY AND SPECIFICATIONS ARE IDENTICAL TO THE ORIGINAL PART.

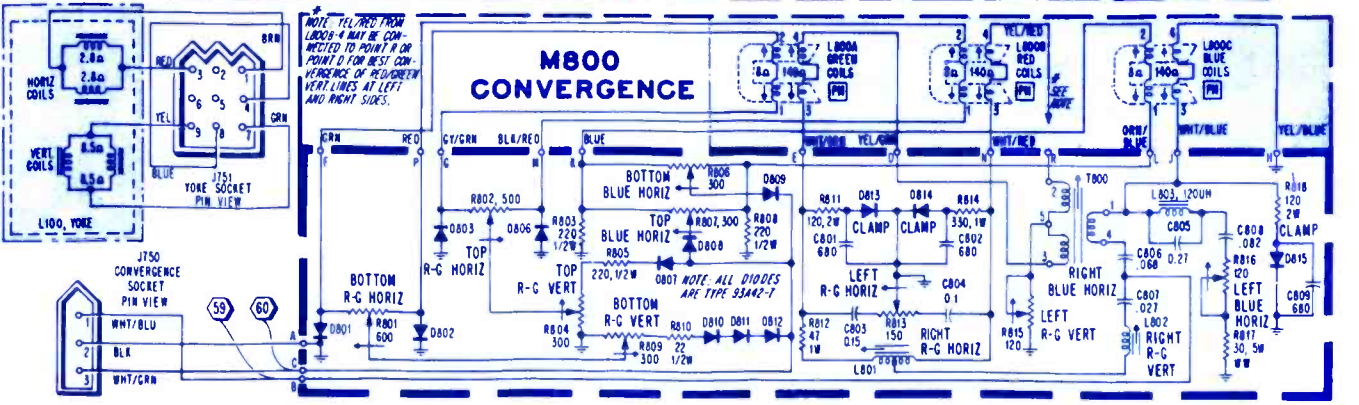

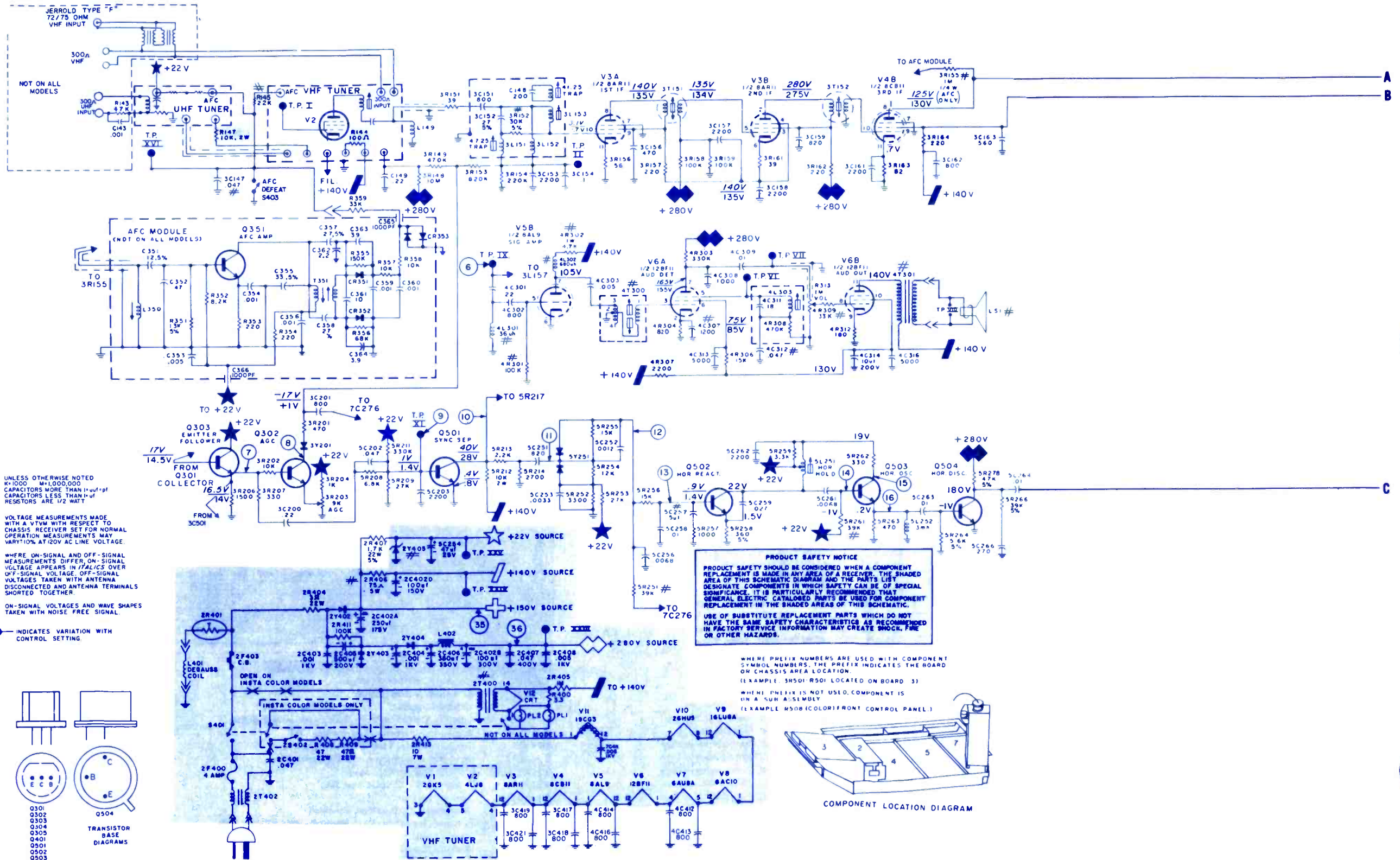

UNLESS OTHERWISE NOTED
 K=1000 M=1,000,000
 CAPACITORS MORE THAN 1µF OF
 CAPACITORS LESS THAN 1µF
 RESISTORS ARE 1/2 WATT

VOLTAGE MEASUREMENTS MADE
 WITH A VTVM WITH RESPECT TO
 CHASSIS RECEIVER SET FOR NORMAL
 OPERATION MEASUREMENTS MAY
 VARY 10% AT 120V AC LINE VOLTAGE

WHERE ON-SIGNAL AND OFF-SIGNAL
 MEASUREMENTS DIFFER, ON-SIGNAL
 VOLTAGE APPEARS IN *ITALICS* OVER
 OFF-SIGNAL VOLTAGE. OFF-SIGNAL
 VOLTAGES TAKEN WITH ANTENNA
 DISCONNECTED AND ANTENNA TERMINALS
 SHORTED TOGETHER.

ON-SIGNAL VOLTAGES AND WAVE SHAPES
 TAKEN WITH NOISE FREE SIGNAL

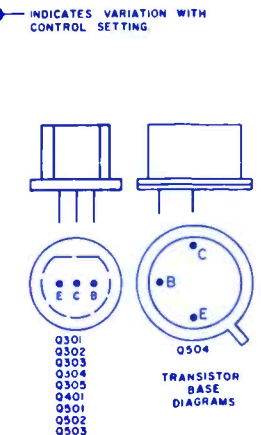

PRODUCT SAFETY NOTICE

PRODUCT SAFETY SHOULD BE CONSIDERED WHEN A COMPONENT
 REPLACEMENT IS MADE IN ANY AREA OF A RECEIVER. THE SHADED
 AREA OF THIS SCHEMATIC DIAGRAM AND THE PARTS LIST
 DESIGNATE COMPONENTS IN WHICH SAFETY CAN BE OF SPECIAL
 SIGNIFICANCE. IT IS PARTICULARLY RECOMMENDED THAT
 GENERAL ELECTRIC CATALOGED PARTS BE USED FOR COMPONENT
 REPLACEMENT IN THE SHADED AREAS OF THIS SCHEMATIC.

USE OF SUBSTITUTE REPLACEMENT PARTS WHICH DO NOT
 HAVE THE SAME SAFETY CHARACTERISTICS AS RECOMMENDED
 IN FACTORY SERVICE INFORMATION MAY CREATE SHOCK, FIRE
 OR OTHER HAZARDS.

WHERE PREFIX NUMBERS ARE USED WITH COMPONENT
 SYMBOL NUMBERS, THE PREFIX INDICATES THE BOARD
 OR CHASSIS AREA LOCATION.
 (EXAMPLE: 3R151 R501 LOCATED ON BOARD 3)

WHERE PREFIX IS NOT USED, COMPONENT IS
 IN A SUB-ASSEMBLY
 (EXAMPLE: W508 COLOR FRONT CONTROL PANEL)

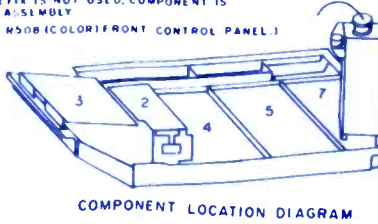

GENERAL ELECTRIC
Color TV Chassis
CD/LB

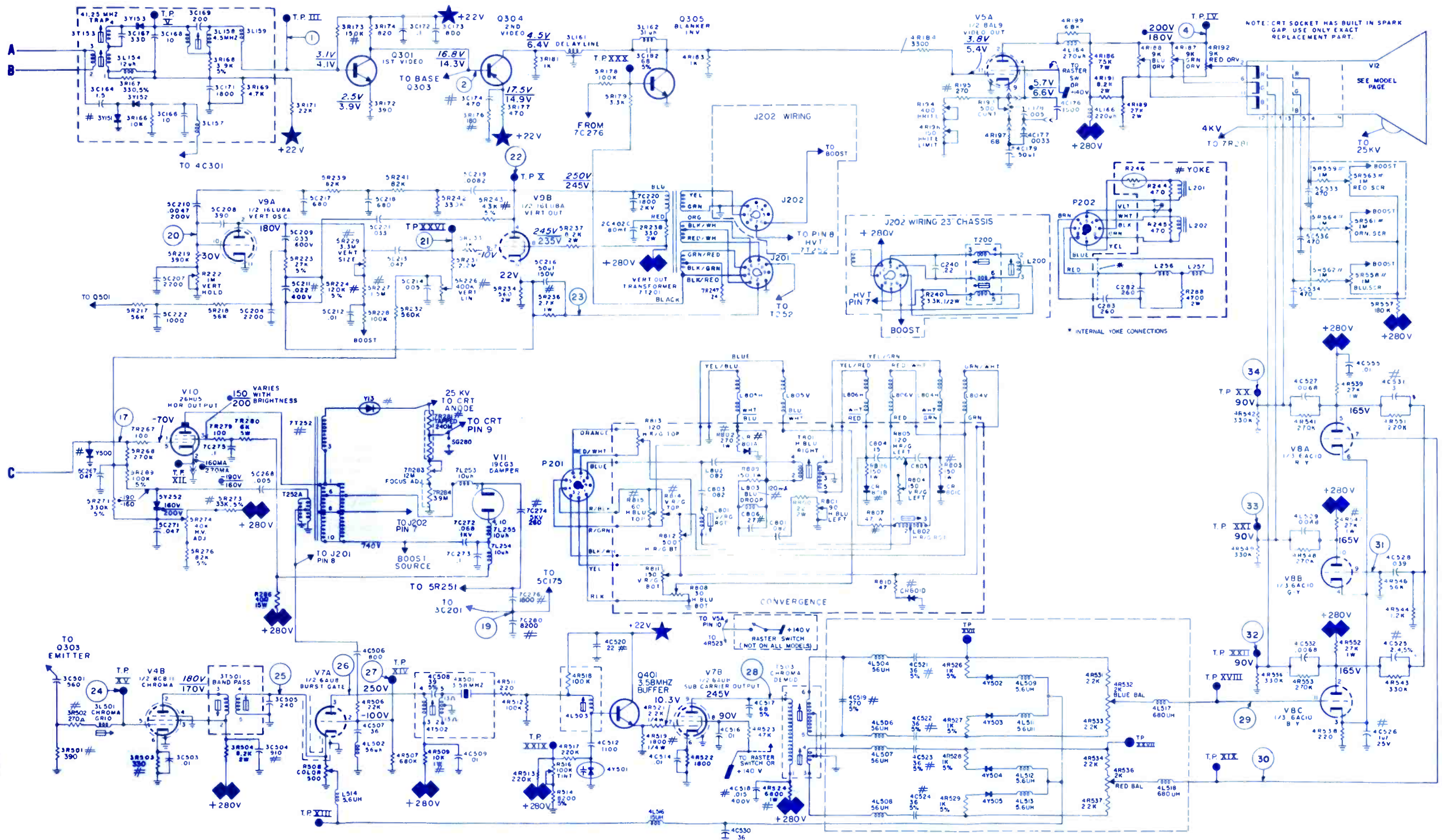

ELECTRONIC TECHNICIAN/DEALER **TEKFAK**

MARCH • 1977

COMPLETE MANUFACTURERS' CIRCUIT DIAGRAMS AND TECHNICAL INFORMATION FOR 4 NEW SETS

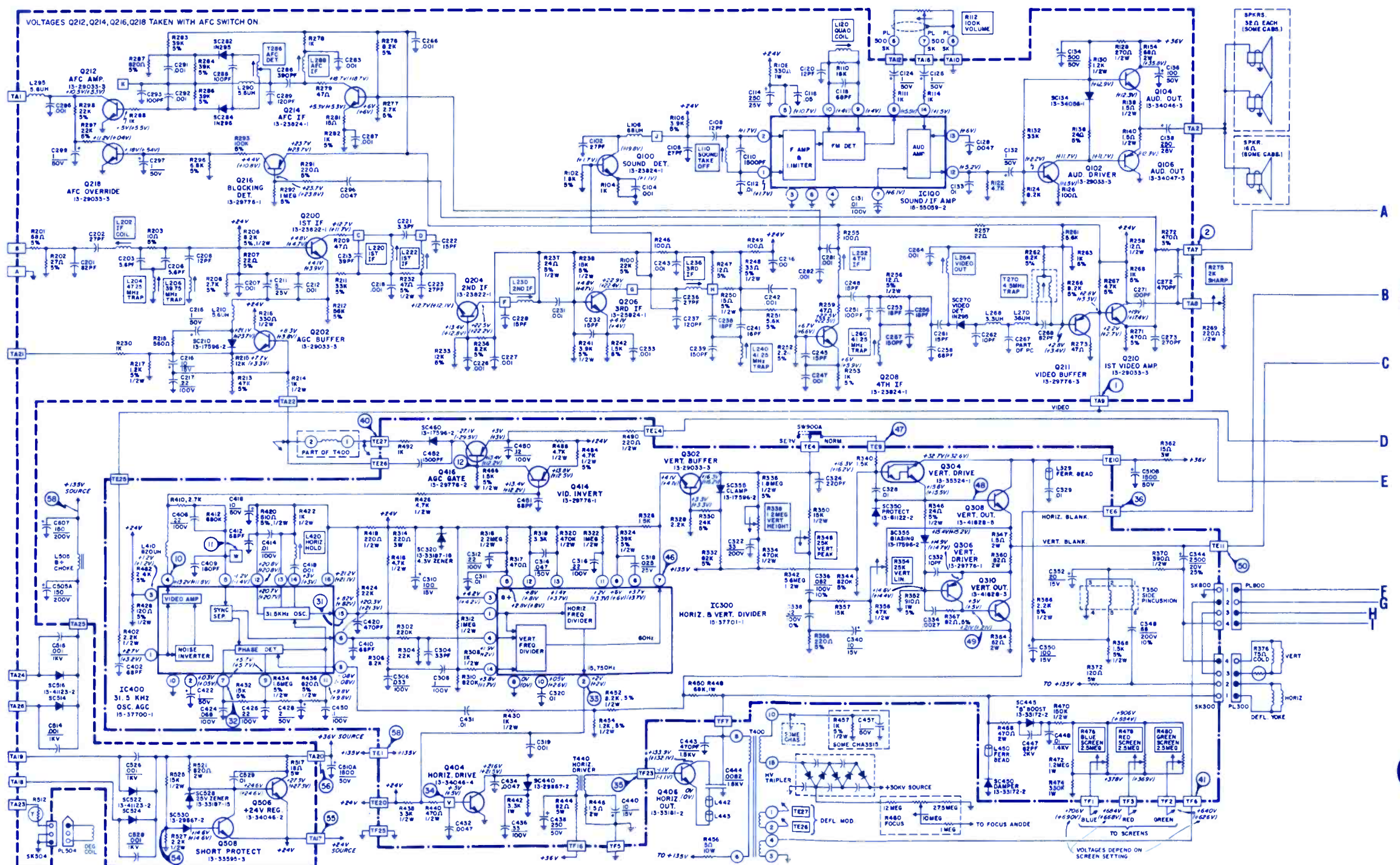
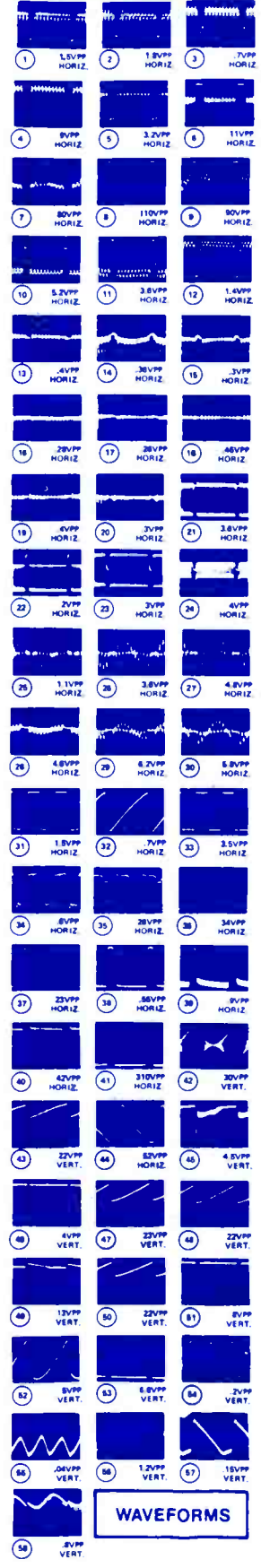

TRANSISTOR LAYOUT

NOTE: DUE TO NORMAL PRODUCTION CHANGES, GENERAL LAYOUT AND ORIENTATION MAY CHANGE SLIGHTLY.

TRANSISTOR ELEMENT LEADS:
B-BASE
E-EMITTER
C-COLLECTOR
S-SHIELD (GROUND)
A-ANODE
K-CATHODE
G-GATE
REPLACE ALL TRANSISTORS WITH ORIGINAL TYPE ONLY.

CHASSIS TRANSISTOR LAYOUT
*13-29033-3

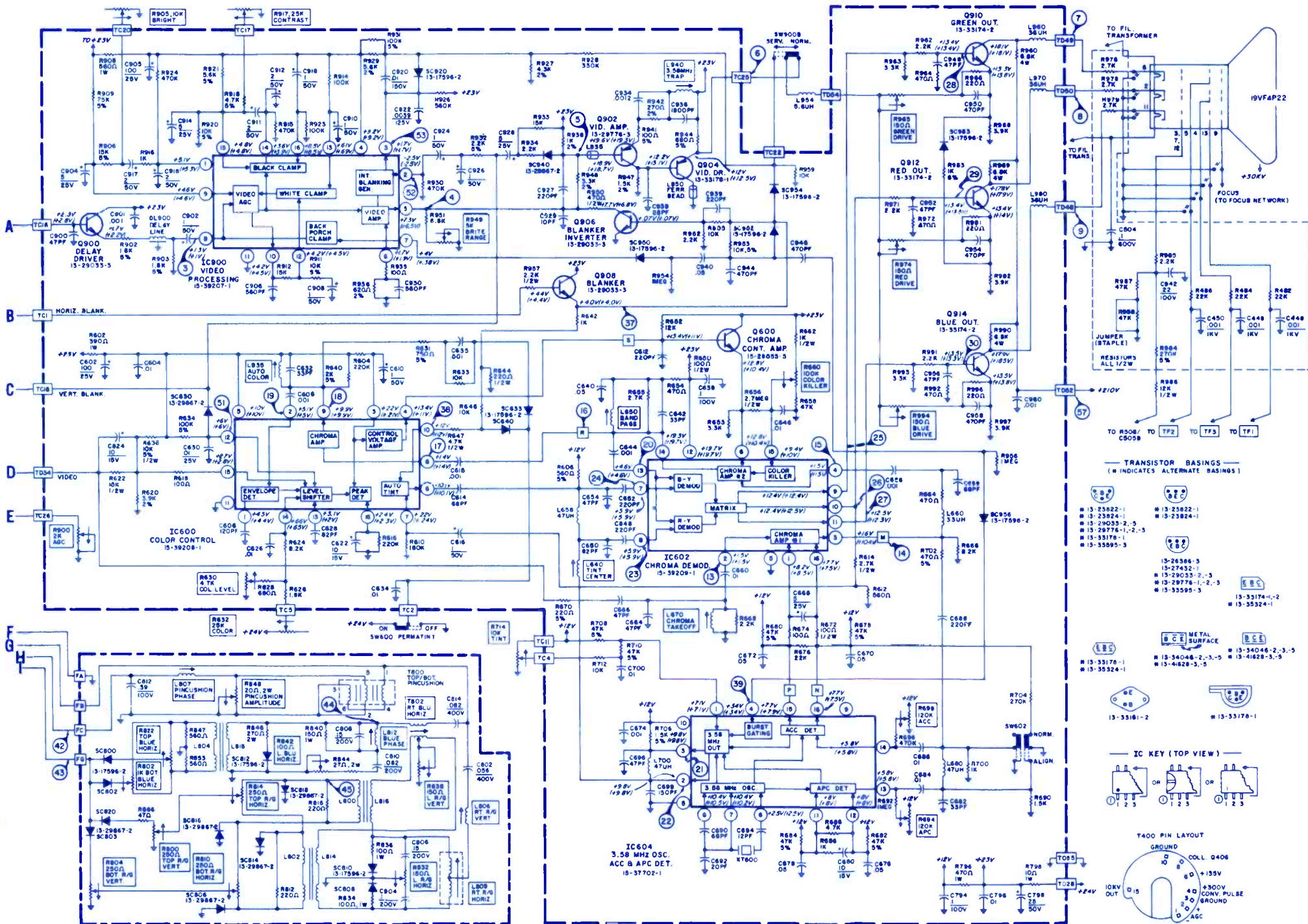
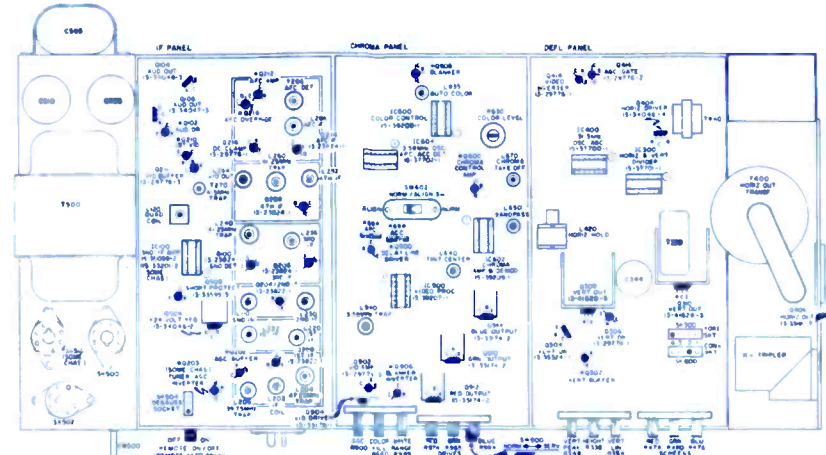
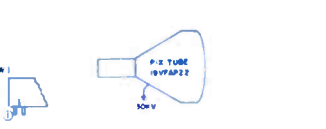
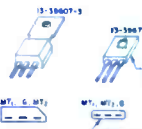
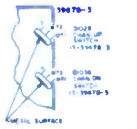
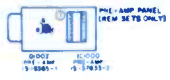

TUNER/CONTROL ASSEMBLY

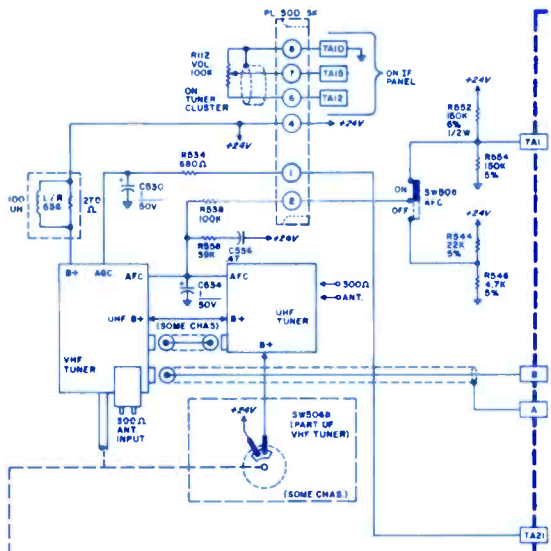

TRANSISTOR BASINGS
(# INDICATES ALTERNATE BASINGS)

- # 13-23822-1
- # 13-23824-1
- # 13-29033-2, -3
- # 13-29776-1, -2, -3
- # 13-33176-1
- # 13-35593-3
- # 13-26586-3
- # 13-27432-1
- # 13-29033-2, -3
- # 13-29776-1, -2, -3
- # 13-35593-3
- # 13-33174-2
- # 13-35524-1

METAL SURFACE

- # 13-33176-1
- # 13-35524-1
- # 13-34046-2, -3, -5
- # 13-41628-3, -5

IC KEY (TOP VIEW)

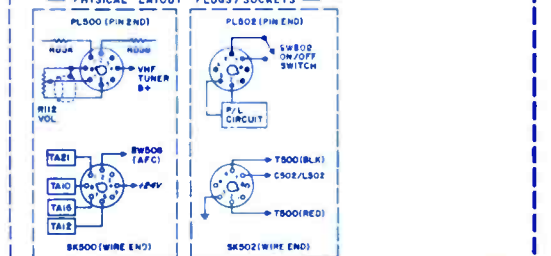
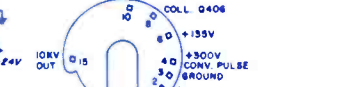

NOTE: ARROWS DESIGNATING POINTS NOT CONNECTED - POINT IN THE DIRECTION OF THE COMPONENT OR THE POINT WHERE THEY ARE TO BE CONNECTED.
EXAMPLE: TO C...

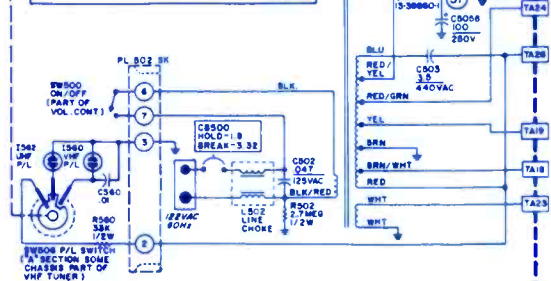

1686
GTE SYLVANIA
 B/W TV Chassis
 A12-6, -11, -13

ELECTRONIC TECHNICIAN/DEALER
TEKFAX
 MARCH • 1977
 COMPLETE MANUFACTURERS' CIRCUIT DIAGRAMS
 AND TECHNICAL INFORMATION FOR NEW SETS

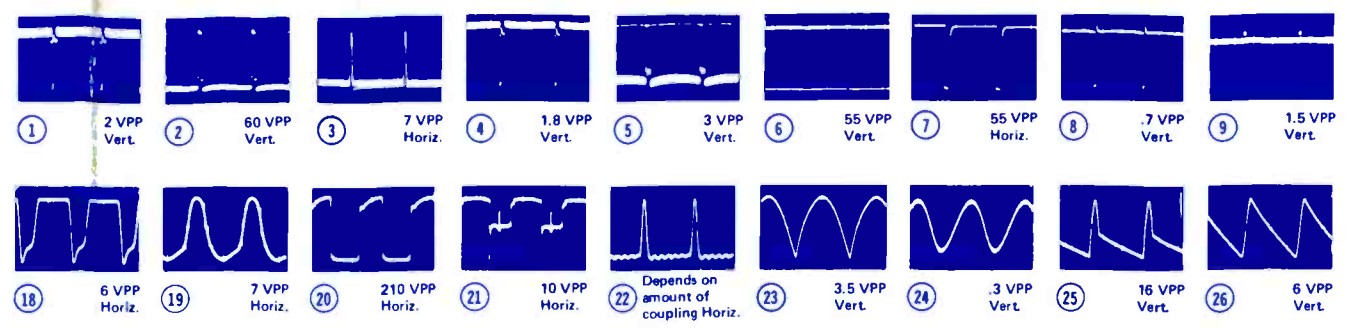

IC100 VOLTAGE CHART

PIN NO.	1	2	3	4	5	6	7	8	9	10	11	12	13	14
IC CHIP INSERTED	+2V	+2V	0V	+12V	+12V	0V	+8.8V	+8.2V	+4.2V	+4.2V	N.C.	+3.4V	N.C.	+1.8V
IC CHIP REMOVED	0V	0V	0V	+27V	0V	0V	0V	0V	0V	0V	N.C.	0V	N.C.	0V

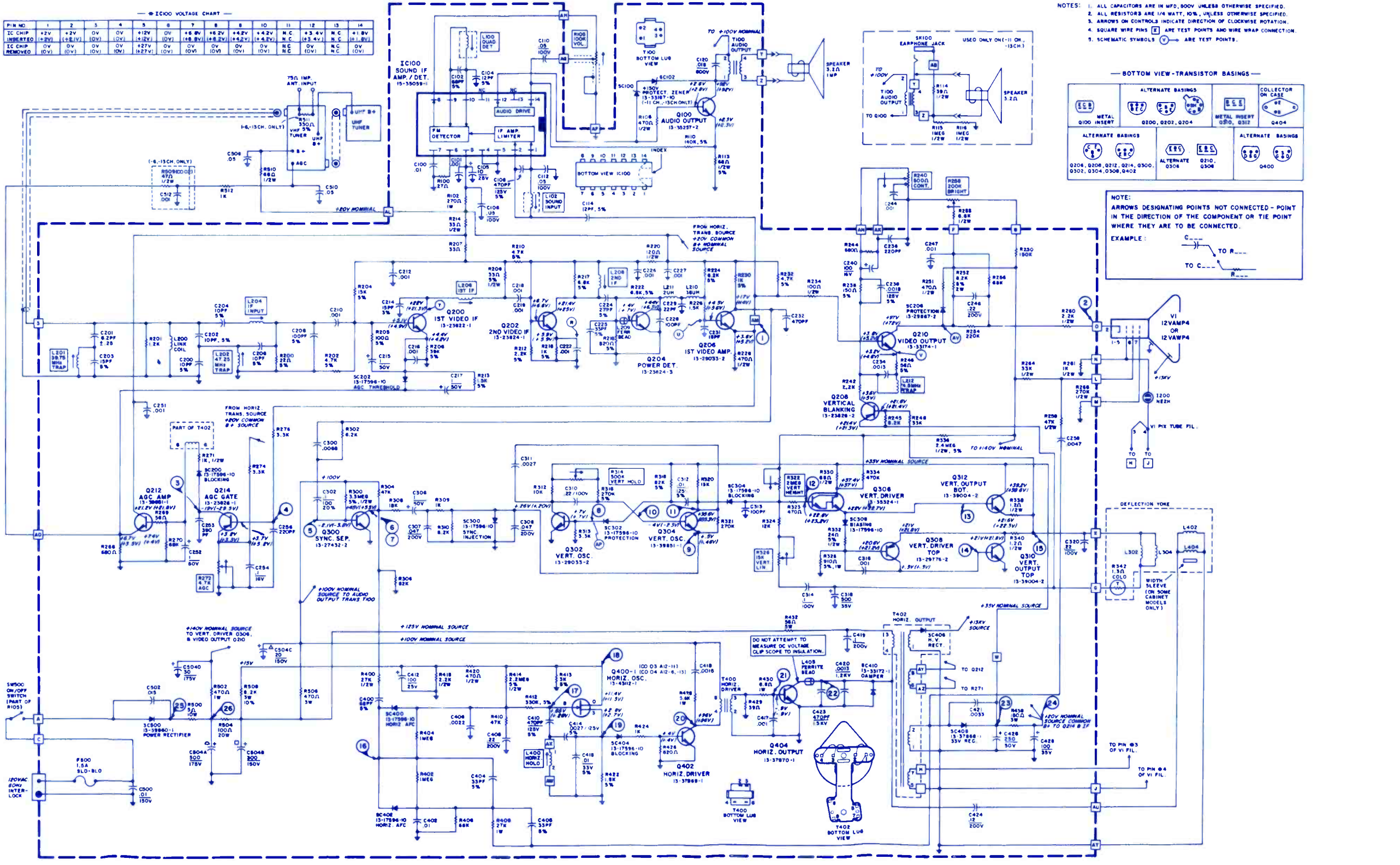

- NOTES:
- ALL CAPACITORS ARE IN MFD. 500V UNLESS OTHERWISE SPECIFIED.
 - ALL RESISTORS ARE 1/4 WATT, 10%, UNLESS OTHERWISE SPECIFIED.
 - ARROWS ON CONTROLS INDICATE DIRECTION OF CLOCKWISE ROTATION.
 - SQUARE WIRE PINS ARE TEST POINTS AND WIRE WRAP CONNECTION.
 - SCHEMATIC SYMBOLS ARE TEST POINTS.

BOTTOM VIEW-TRANSISTOR BASINGS

ALTERNATE BASINGS	ALTERNATE BASINGS	COLLECTOR ON CASE
METAL Q100 INSERT	Q200, Q202, Q204	METAL INSERT Q310, Q312
Q208, Q208, Q212, Q214, Q300, Q302, Q304, Q308, Q402	ALTERNATE Q308	Q400

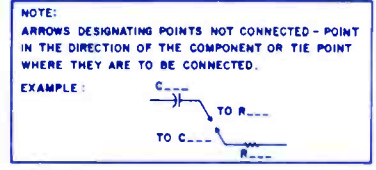

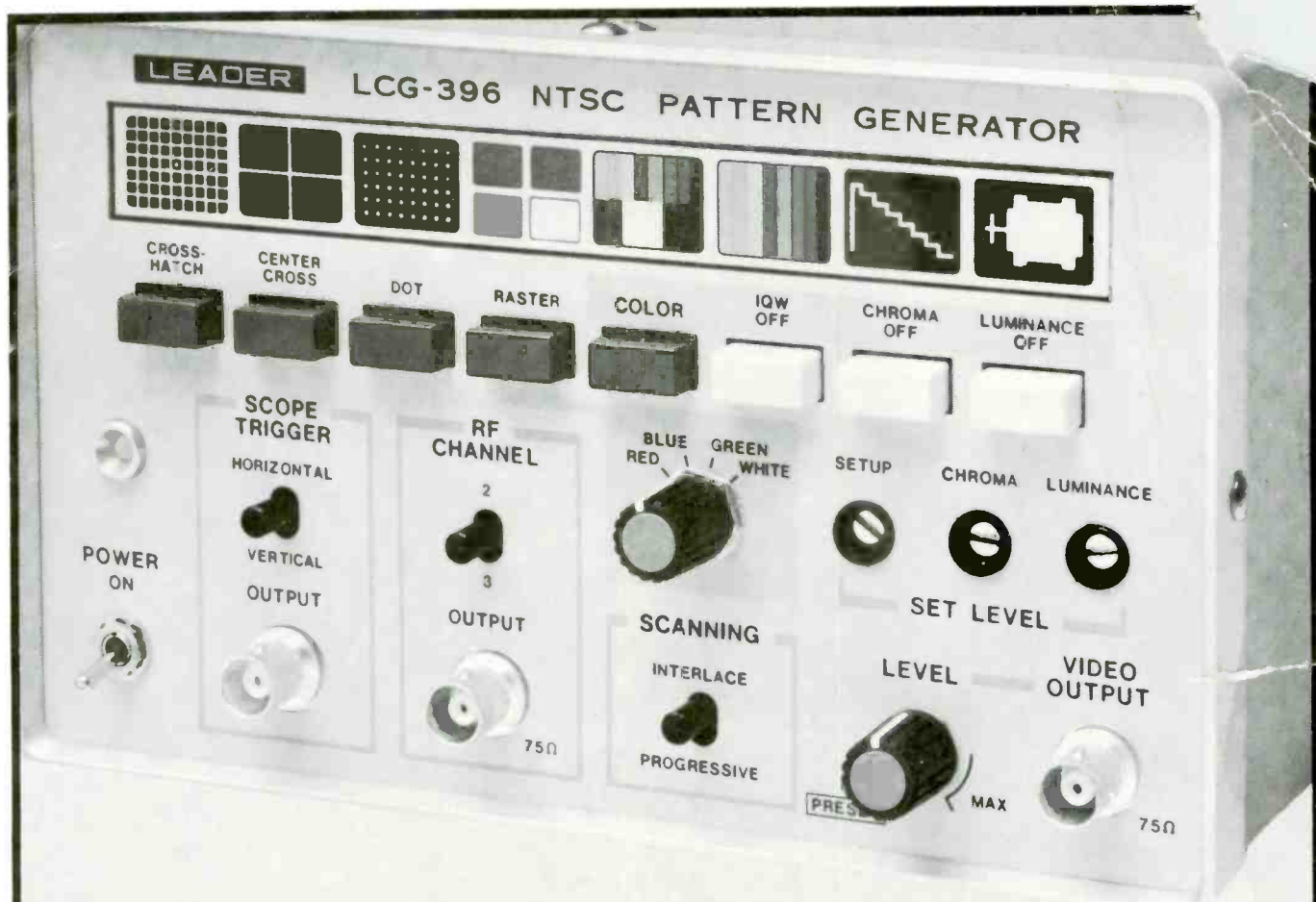

LEADER LCG-396

VTR PROBLEM SOLVER

**The New NTSC Color Bar Pattern Generator
Designed For The Newest VTR Systems!**

- Provides all signals necessary to precisely time, test, evaluate and judge all standard NTSC, MATV, CATV, color and b&w video.
- Synchronization intensity and chroma signals variable by 20% to extend use into R&D and broadcast areas.
- Generates 8 fixed color bars, dot, crosshatch, centerline signal, white raster and red raster.
- Adjustable scanning control permits progressive and interlaced scanning checks.
- Utilizes digital integrated circuitry and includes composite video output with 2 switch selectable channels.
- Particularly useful for testing, servicing and maintaining the newest VTR systems.

At under \$900 it's far less than competitive testers.

Tests More . . . Tests Better . . . for Less!

LEADER
Instruments Corp.

151 Dupont Street, Plainview, N.Y. 11803 (516) 822-9300
West Coast: 7733 Densmore Ave., Van Nuys, Calif. 91406 (213) 989-2760 · In Canada: Omnifitronix Ltd., Montreal, Quebec

...for more details circle 193 on Reader Service Card

The NEW POCKET SIZE DVOM for all occasions. \$140

Triplet's New 3000 DVOM goes everywhere . . .

At the bench . . . away from the bench . . . This super-compact five function, 22 range DVOM has all the features you'd expect from Triplet. Like 3½ digit hi-intensity LED display, rechargeable snap-in Ni Cad Battery Pac™ with an AC charger. And, you get all the "automatics" that make life a lot simpler: Auto-zeroing, auto-polarity and auto low-battery warning. The red and gray probe includes a switch with momentary "ON" and lock "ON" and "OFF" positions for convenient operation.

- 1 HAND-SIZE, 3½ DIGIT—Easy operation with 22 ranges and Hi/Low Power Ohms. Auto-zeroing and Auto-polarity.
- 2 OVERLOAD PROTECTION—Protected up to 600 volts on all ranges with special 2A/600V fuse arrangement.
- 3 BATTERY PAC™—Easily removed, snap-in Battery-Pac™ provides convenient field exchange for fully charged Pac. Battery Pac™ rechargeable in tester or externally.

Price does include Ni Cad batteries and AC Charger.

Ask your Triplet distributor to demonstrate the rugged little Model 3000 DVOM and show you our complete line of handy accessories, too.

TTT TRIPLETT
BLUFFTON, OHIO 45817

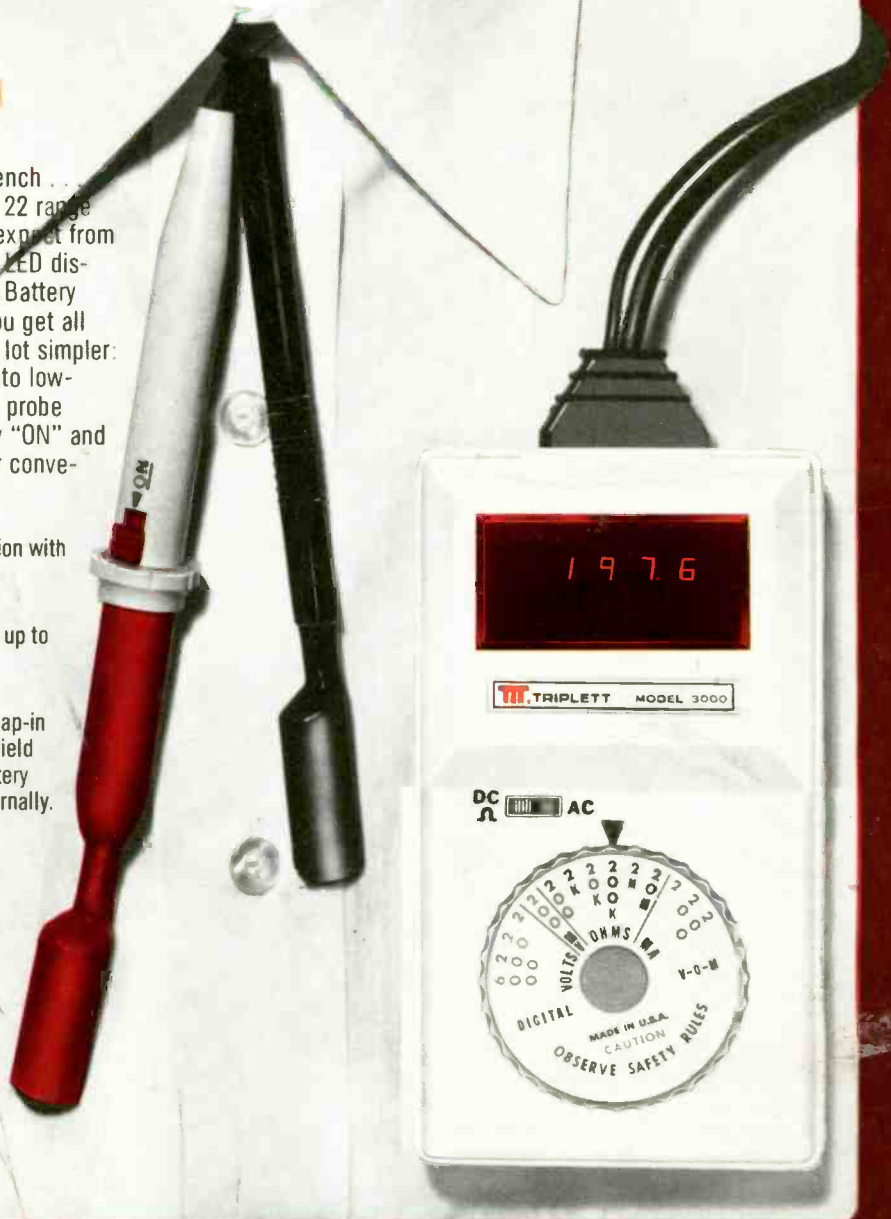

...for more details circle 104 on Reader Service Card
...for FREE demonstration circle 105 on Reader Service Card