

NOVEMBER 1970  A HARCOURT BRACE JOVANOVIĆ PUBLICATION

ELECTRONIC TECHNICIAN/DEALER

WORLD'S LARGEST TV-RADIO SERVICE & SALES CIRCULATION

FRIM3347465M2AZ 8722693AJ1
WILLIAM W FRISSE AS
7176 GALE RD
ATLAS MI 48411
XX

Solid-State TV Antennas

Moving TV Sets

1971 TV Circuit Review

Why get caught with your pants down because of false shorts? The new B & K Model 607 Dyna-Jet is the first reasonably priced tube tester to give you nothing but positive short indications in every tube you'll ever test.

Why? Because 10 lockout buttons let you create any combination of live pin connections you want. How? By locking out the pin connections you *don't* want.

It's so easy to use too. A shape-coded chart does practically all the thinking for you. And the B & K multiple socket design means you need only 3 or 4 settings to complete a quality check.

Consider all the advantages:

- Exclusive multiple-pin lockout switches mean *all* tubes now can be tested for shorts. You never get false short indications regardless of pin connections. Reset button clears all lockouts.

- Tube testing speed doubled by (1) exclusive shape-coded symbols that match controls to chart, and (2) minimum number of settings—maximum of 4, and sometimes only 3.
- Checks tubes the accurate way—under simulated load conditions.
- Exclusive grid leakage and gas tests.
- Simplified heater voltage setting.
- Power 'ON' indicator.
- Superior load and plate voltage capability.
- Attractive, attache-type case for professional appearance.

Ask your distributor about the new solid state Model 607 Dyna-Jet from B & K. It's the most modern portable tube tester yet. And you'll never be left in the cold with false shorts. And that's the naked truth!

Put an end to false shorts that leave you naked

...with the new 607 portable tube tester from B&K

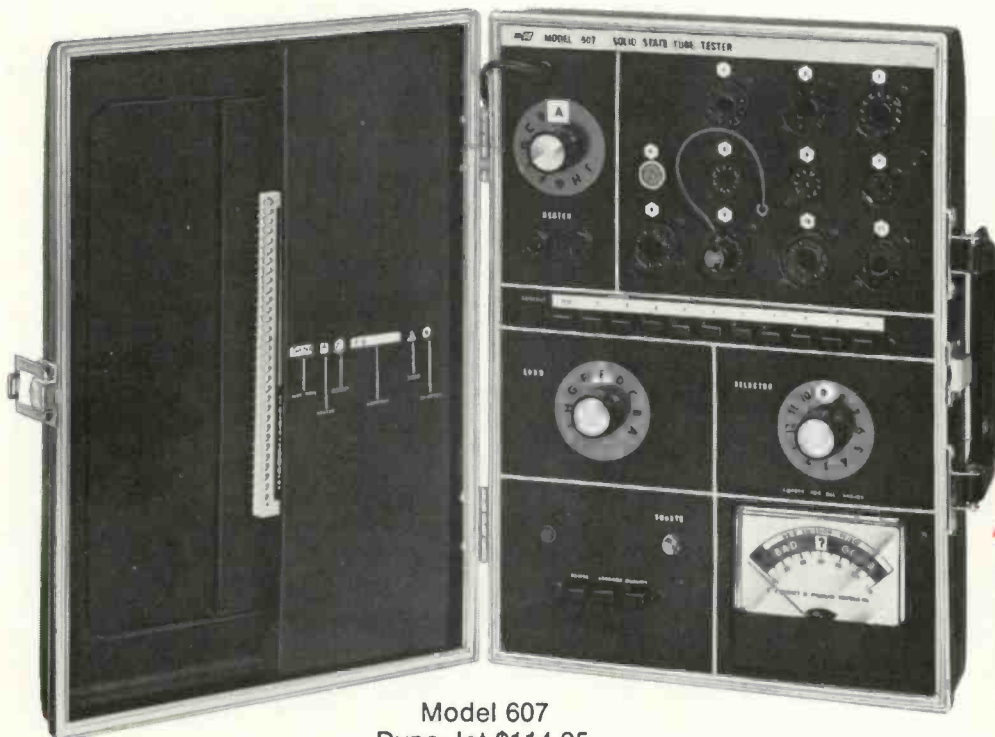

Model 607
Dyna-Jet \$114.95

B&K

Product of
DYNASCAN CORPORATION
1801 W. Belle Plaine
Chicago, Illinois 60613

**The professional
test equipment.**

1327

DUMONT

Color TV Chassis
120926, 928,
957, 958

ELECTRONIC TECHNICIAN / DEALER **TEKFAAX**

COMPLETE MANUFACTURERS' CIRCUIT DIAGRAMS
AND TECHNICAL INFORMATION FOR 5 NEW SETS

NOVEMBER • 1970

| SYMBOL | DESCRIPTION | DUMONT PART NO. |
|--------|----------------------------|-----------------|
| C-102A | 80uf, 450v elect capacitor | 925686 |
| C-102B | 30uf, 450v elect capacitor | 925686 |
| C-102C | 20uf, 450v elect capacitor | 925686 |
| C-102D | 40uf, 150v elect capacitor | 925686 |
| C-103A | 80uf, 450v elect capacitor | 925586 |
| C-103B | 50uf, 450v elect capacitor | 925586 |
| C-103C | 20uf, 250v elect capacitor | 925586 |
| C-103D | 50uf, 50v elect capacitor | 925586 |
| C-104A | 80uf, 450v elect capacitor | 925650 |
| C-104B | 2uf, 350v elect capacitor | 925650 |

| | | |
|--------|--|--------|
| C-104C | 25uf, 25v elect capacitor | 925650 |
| R-101 | volume control w/switch (ch. 120926, 120957) | 391035 |
| R-101 | volume control w/switch (ch. 120928, 120958) | 391036 |
| R-102 | tone control, 2.5M | 390970 |
| R-106 | bright control, 250K | 390970 |
| R-107 | contrast control, 368 | 390963 |
| R-108 | hnt control-1.2K | 390965 |
| R-109 | color control-500Ω | 390966 |
| R-111 | vert hold control-750K | 390962 |
| R-113 | vert size-3.4M | 390785 |

| | | |
|------------|--|---------|
| R-114 | vert lin-100K | 390908 |
| R-126 | horiz hold control-35K | 390962 |
| R-140 | video peaking control-50K | 390963 |
| R-212 | adjacent sound control-15K | 390934 |
| R-231 | self sound reject control-750Ω | 390883 |
| R-264 | AGC control-6K, 2w | 390882 |
| R-364A,B,C | triple control-blue, green, red screen adj-1.5M each | 390879 |
| RV-103 | voltage dependent resistor | 397186 |
| RV-104 | voltage dependent resistor | 397191 |
| RV-301 | varistor | 397171 |
| L-105 | deflection yoke | 708539 |
| L-107 | filter choke | 737057 |
| L-205 | sound trap-47.25MHZ | 708427 |
| L-221 | AFT take-off coil | 720576 |
| L-301 | chroma take-off coil | 708438 |
| L-307 | reactance coil | 708439 |
| L-309 | horiz efficiency coil | 708462 |
| L-310 | A,B-horiz frequency & sine wave coil | 708434 |
| T-101 | audio output transformer | 734223 |
| T-102 | horiz output transformer | 738222M |
| T-103 | focus adi transformer | 708461 |
| T-104 | vert output transformer | 738207 |
| T-105 | power transformer | 730169 |
| T-201 | sound take-off transformer | 720558 |
| T-203 | sound det transformer | 720472 |
| T-301 | band pass transformer | 720515 |
| T-302 | burst transformer | 720516 |
| T-304 | 3.58MHZ oscillator transformer | 720579 |
| SE-101 | boost rectifier | 817124 |
| SE-102 | focus rectifier | 817123 |
| CB-101 | circuit breaker | 808252 |
| IC-201 | integrated circuit-AFT | 815215 |

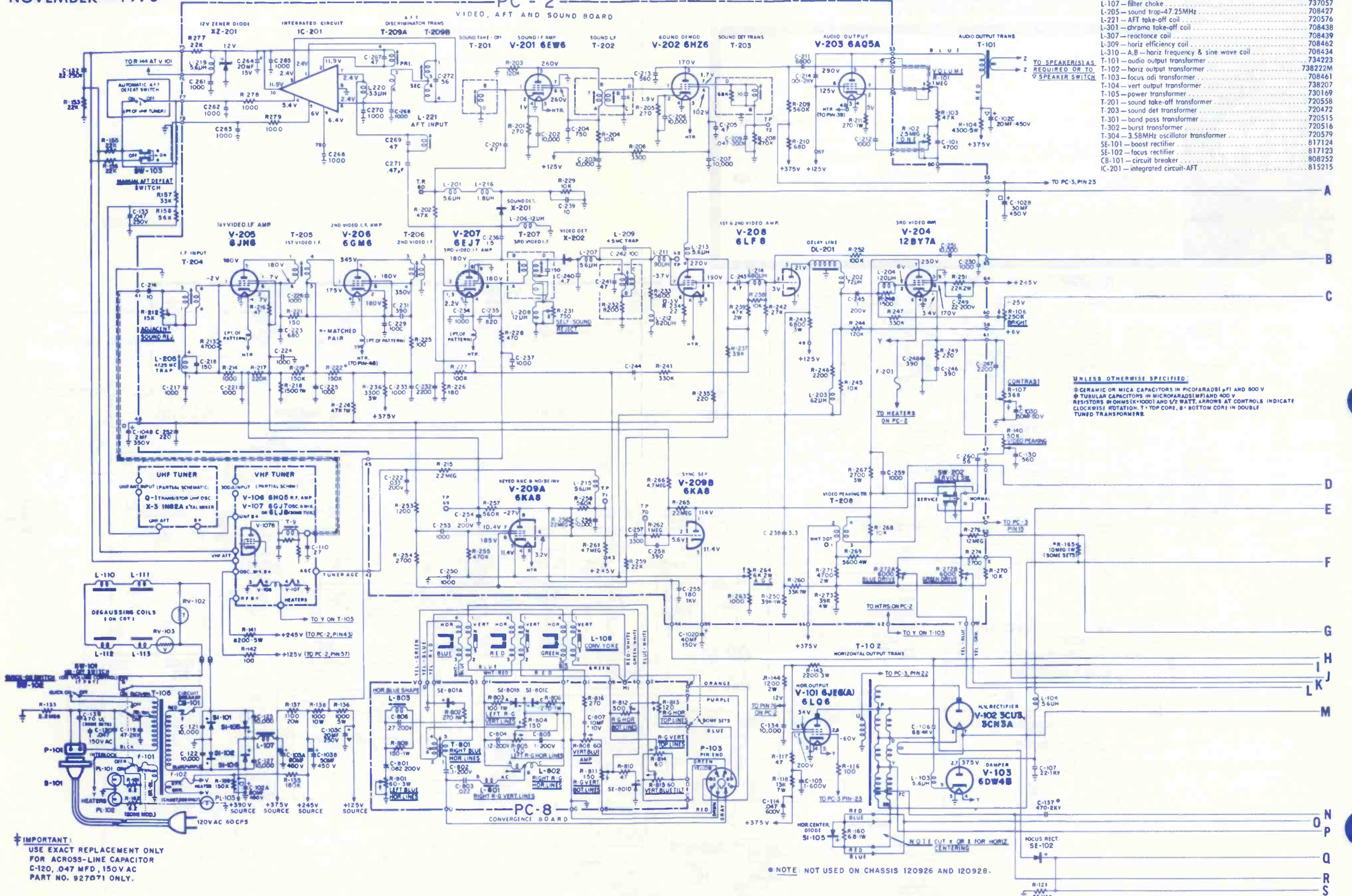

UNLESS OTHERWISE SPECIFIED:
 * CERAMIC OR MICA CAPACITORS IN MICROFARADS (μF) AND 500V
 * TUBULAR CAPACITORS IN MICROFARADS (μF) AND 400V
 * RESISTORS IN OHMS (R), K (K), AND W (W). ARROWS AT CONTROLS INDICATE CLOCKWISE ROTATION. T = TOP CORE, B = BOTTOM CORE IN DOUBLE TUNED TRANSFORMERS.

† IMPORTANT!
 USE EXACT REPLACEMENT ONLY
 FOR ACROSS-LINE CAPACITOR
 C-120, 0.47 MFD, 150V AC
 PART NO. 927071 ONLY.

NOTE: NOT USED ON CHASSIS 120926 AND 120928.

| | |
|--|-----------|
| R102B - 50K, AGC (T950-06, 07) | 220208-55 |
| R103A - 1M, color killer (T950-01, 03, 04, 06-08, 10-13) | 220208-45 |
| R103A - 1M, color killer (T950-02, 05, 09) | 220248-7 |
| R115B - 600, sharpness (T950-01-05, 8-10) | 220248-6 |
| R115B - 600, sharpness (T950-06, 07, 11-13) | 220208-57 |
| R118 - 600, contrast (T950-01, 02, 03, 06, 07, 13) | 220146-29 |
| R120 - 200K, CRT bias | 220208-44 |
| R122 - 250K, bright (T950-01, 02, 03, 13) | 220146-49 |
| R123 - 250K, preference (T950-01, 02) | 220146-78 |
| R215 - 750, sound rejection | 220166-4 |

| | |
|--|-----------|
| R404 - 250K, bright (T950-04, 05, 08, 09, 10, 11) | 220146-49 |
| R404 - 250K, bright (T950-06, 07, 12) | 220232-19 |
| R406 - 750K, V. Hold (T950-04, 05, 08, 09, 10, 11) | 220146-50 |
| R406 - 750K, V. Hold (T950-12) | 220232-23 |
| R407 - 600, contrast (T950-04, 05, 08, 09, 10, 11) | 220146-29 |
| R407 - 600, contrast (T950-12) | 220232-24 |
| R602 - 150K, V. Lin. | 220166-21 |
| R605 - 5M, height | 220166-22 |
| R632 - 50K, high voltage adj. | 220193-25 |
| R737 - 750, chroma tilt | 220217-10 |
| CR101 - focus rectifier | 530132-1 |
| CB1 - circuit breaker, 3.1a | 180723-2 |

| | |
|---------------------------------|-------------|
| F1 - fuse, .5a, 125v, slow blow | 180157-17 |
| F2 - fuse, .6a, 125v, slow blow | 180948-5060 |
| RV301 - thermistor, 120 (cold) | 230170-3 |
| VDR101 - varistor | 230173-3 |
| VDR301 - varistor | 230175-2 |

| SYMBOL | DESCRIPTION | MAGNAVOX PART NO. |
|--------|--------------------------------------|-------------------|
| L1 | -discriminator coil | 361384-1 |
| L101 | -filter choke | 320124-1008 |
| L501 | -horiz frequency coil | 361269-1 |
| L701 | -4.5MHz sound take-off coil | 360845-2 |
| L702 | -sound lf coil | 360846-3 |
| L703 | -quadrature coil | 360847-2 |
| L717 | -chroma take-off coil | 360959-4 |
| L101 | -filament xformer | 320359-4 |
| T102 | -high voltage (horiz output) xformer | 361383-2 |
| T103 | -focus coil | 361306-1 |

| | | |
|-------|--|-----------|
| T104 | -vert output xformer | 320374-4 |
| T301 | -audio output xformer | 320130-16 |
| T701 | -bandpass xformer | 361192-1 |
| T702 | -burst xformer | 361296-1 |
| T702 | -burst xformer (ATC chassis) | 361296-2 |
| T703 | -3.58MHz Osc xformer | 361198-1 |
| C305 | -elect, 160/100/60µf, 350v | 270071-22 |
| C306 | -elect, 180µf, 350v, 150/100/100µf, 250v | 270071-20 |
| R3 | -5K, AFT bias | 220217-13 |
| R102A | -1200, M Hold (T950-01-05, 08-13) | 220248-5 |
| R102A | -1200, M Hold (T950-06, 07) | 220146-71 |
| R102B | -50K, AGC (T950-01-05, 08-13) | 220248-5 |

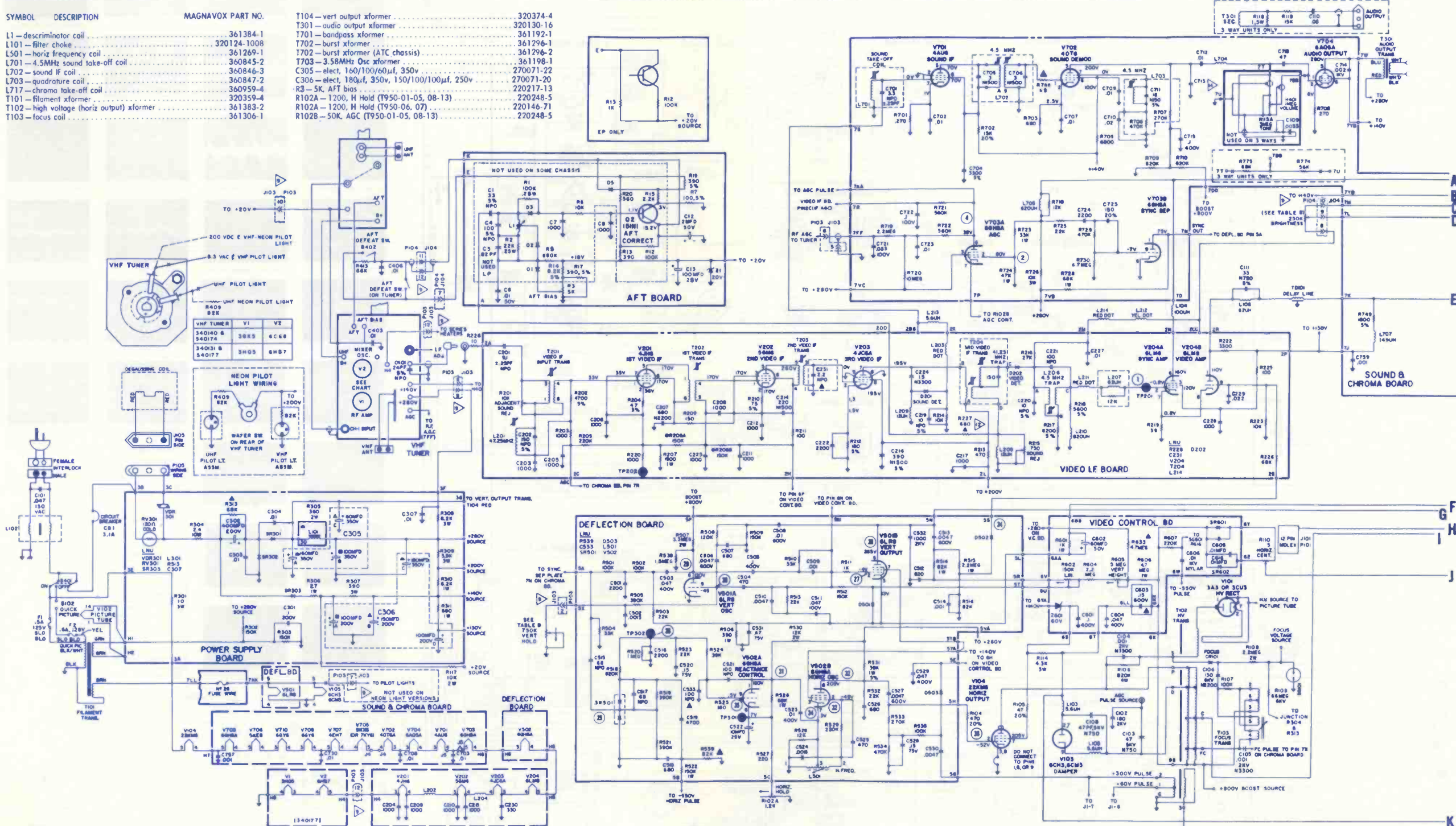

- NOTES
- UNLESS OTHERWISE SPECIFIED:
 - INDICATES RESISTOR VALUE MATCHED WITHIN 2%.
 - ARROW INDICATES CLOCKWISE ROTATION WHEN CONTROL IS VIEWED FROM ACTUATOR END.
 - OFF BOARD.
 - UNDER SIDE OF P.C. BOARD (COPPER SIDE).
 - CAPACITANCE VALUES GREATER THAN 1µF ARE IN MICROFARADS.
 - CAPACITANCE VALUES OF 1µF OR LESS ARE IN MICROFARADS.
 - ALL VOLTAGES MEASURED WITH NO SIGNAL, EXCEPT THAT IDENTIFIED WITH AN asterisk (*).
 - SOURCE VOLTAGE IS MEASURED WITH SIGNAL.
 - 3-WAY UNITS ONLY.
 - SELECT 10A OR 22A FOR BEST BLUE CONVERGENCE.
 - RESISTORS ARE 10%, 5WATT.
 - AFT UNITS ONLY.
 - CAPACITORS ARE 10%, 500V.
 - NON-3 WAY UNITS, USE 220PF.
 - 3-WAY UNITS, USE 1500PF.
 - EP = EARLY PRODUCTION.

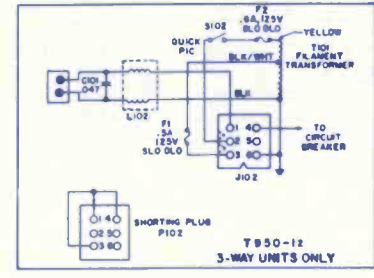

WAVEFORMS

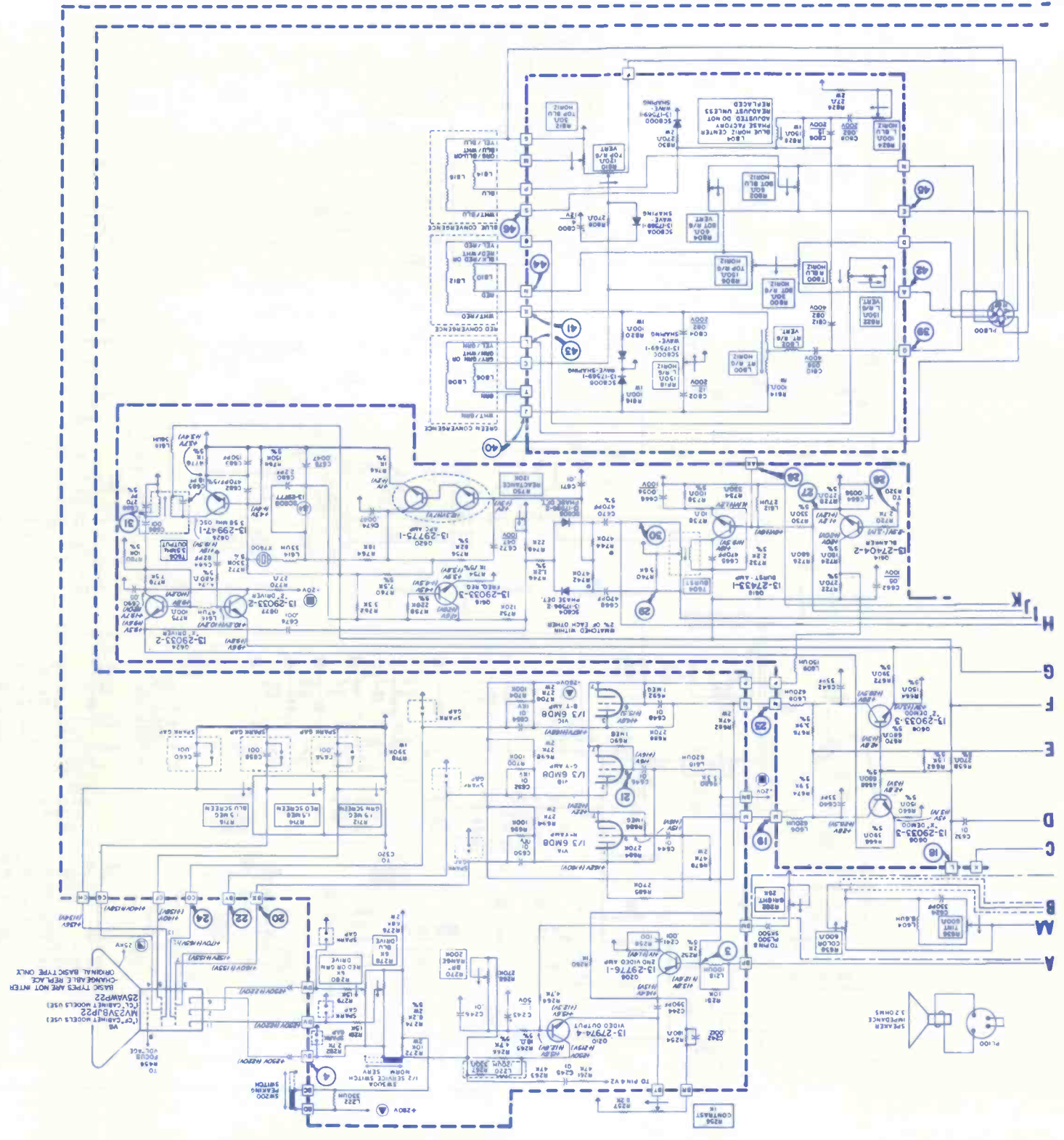
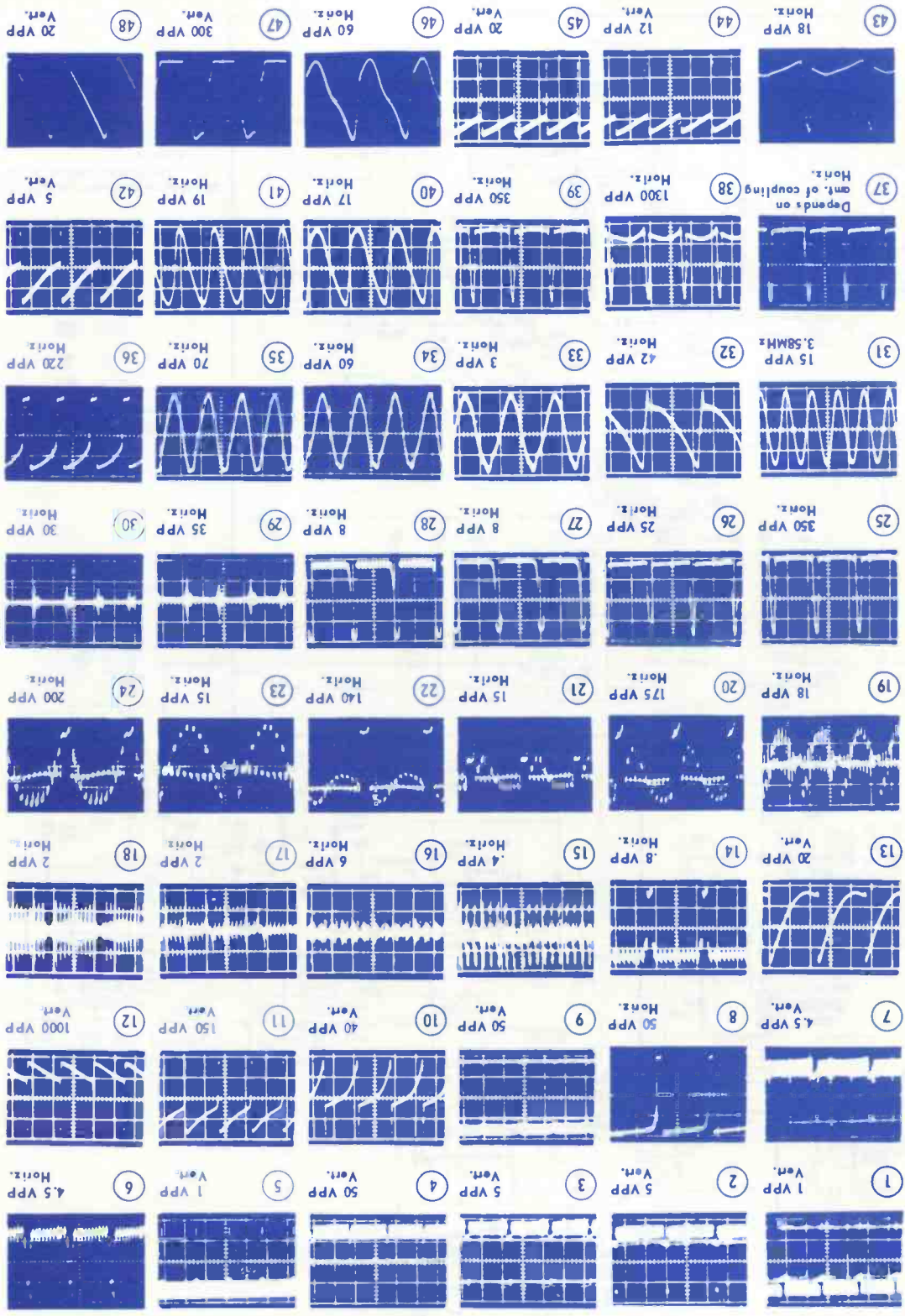

| SYMBOL | DESCRIPTION | AIRLINE PART NO. |
|--------|---------------------------------|------------------|
| R219 | —500K, pot. AGC (9V-120) | TV 25234 |
| R315 | —1M, pot. volume | TV 25408 |
| R316 | —1M, pot. tone (9V-149) | TV 25235 |
| R517 | —1M, pot. vert hold (9V-117) | TV 25237 |
| R518 | —1M, pot. vert size (9V-119) | TV 25238 |
| R519 | —1M, pot. vert lin (9V-119) | TV 25238 |
| R626 | —50K, pot. horiz hold (9V-182) | TV 25314 |
| R718 | —20K, pot. contrast (8V-0072) | TV 25409 |
| R719 | —250K, pot. bright (9V-118) | TV 25239 |
| L201 | —coil, 47.25MHz trap (21F-487) | TV 62248 |
| L302 | —coil, sound detector (11F-544) | TV 62254 |
| L601 | —coil, horiz hold (TL-23) | TV 61174 |

| | | |
|--------|--|----------|
| T301 | —transformer, sound IF (11F-378) | TV 62364 |
| T302 | —transformer, audio output (7T-194) | TV 11255 |
| T501 | —transformer, vert output (8T-192) | TV 11216 |
| T601 | —transformer, horiz output (8T-670) | TV 11263 |
| T701 | —transformer, sound IF & 4.5MHz trap (21F-491) | TV 62252 |
| T702 | —transformer, power (9T-204) | TV 11218 |
| M501 | —capacitor (PRC-302) | TV 3455 |
| M701 | —capacitor (PRC-306) | TV 3465 |
| D601 | —dual diode (SELEN-26) | TV 24226 |
| SR701 | —rectifier (SI-RECT-102) | TV 24298 |
| | tuner, UHF (UT-2-20) | TV 53551 |
| | tuner, VHF (PT6-JU2G) | TV 53186 |
| DC-601 | —yoke deflection (assembly) | TV 61477 |

ELECTRONIC TECHNICIAN/DEALER is published monthly by Harbrace Publications, Inc., Harbrace Building, Duluth, Minnesota 55802, a subsidiary of Harcourt, Brace & World, Inc. Subscription rates: One year \$5, two years \$8, three years \$10, in the United States and Canada. Other countries: One year \$9, two years \$14, three years \$18. Single copies 60¢. Second class postage paid at Dansville, New York and at additional mailing offices. Copyright 1970 by Harbrace Publications, Inc. POSTMASTER: Send Form 3579 to ELECTRONIC TECHNICIAN/DEALER, Harbrace Building, Duluth, Minnesota 55802.

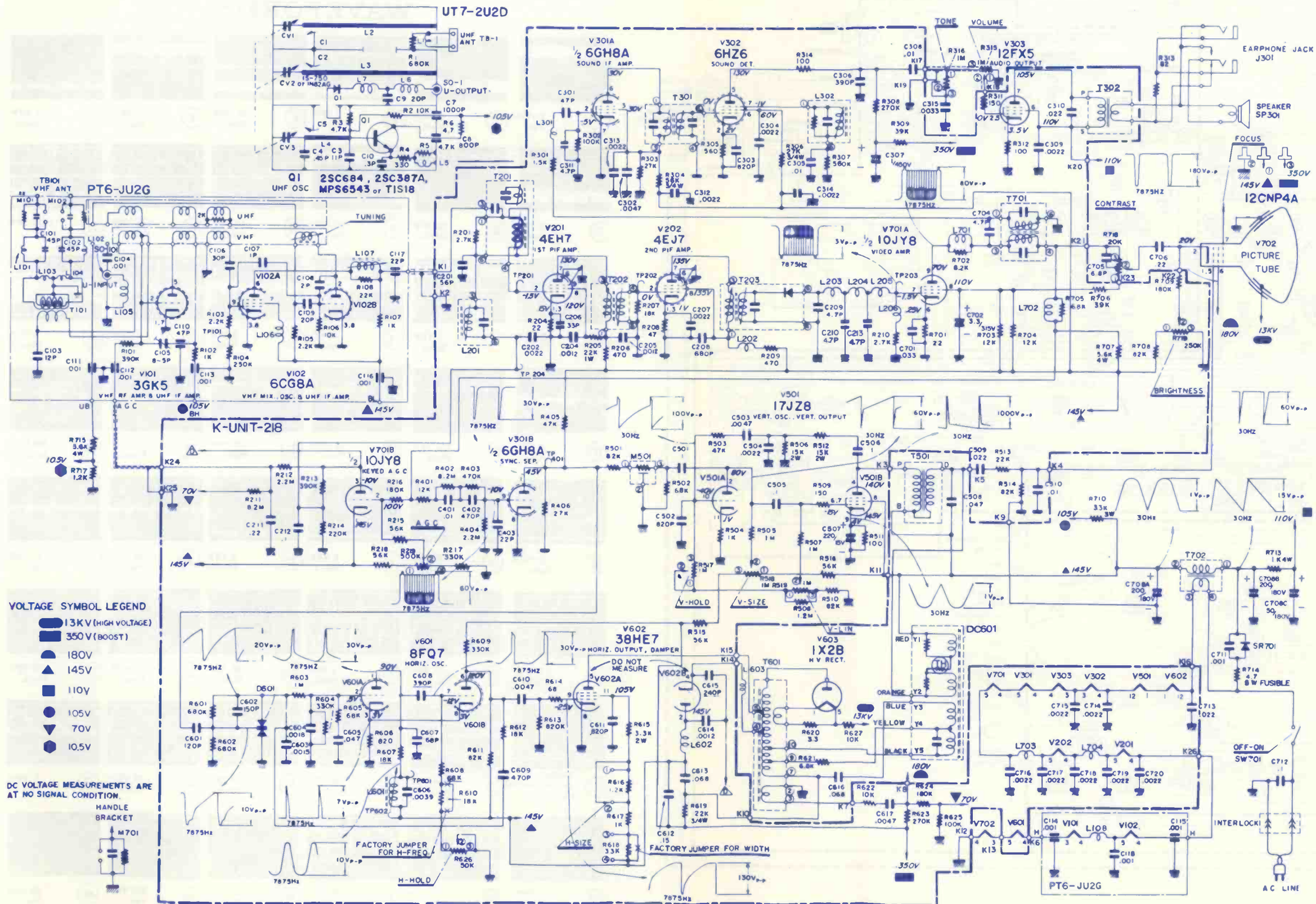

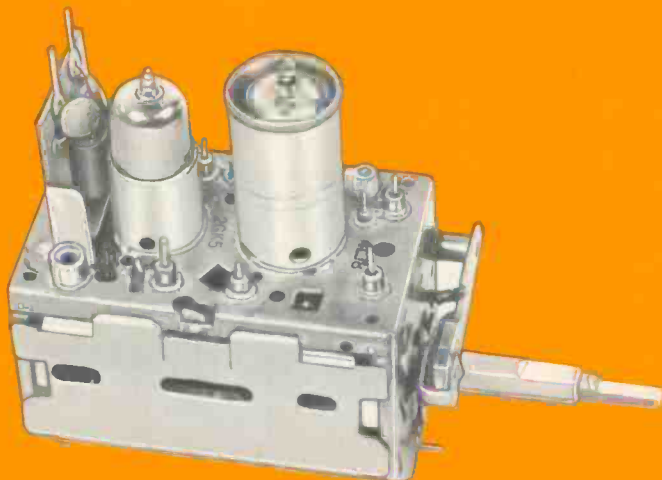

\$975

TUNER SERVICE CORPORATION

PROVIDES YOU WITH A COMPLETE SERVICE FOR ALL YOUR TELEVISION TUNER REQUIREMENTS AT ONE PRICE.

TUNER REPAIR

VHF Or UHF Any Type \$9.75.
UHF/VHF Combo \$15.00.

In this price all parts are included. Tubes, transistors, diodes, and nuvistors are charged at cost.

Fast efficient service at our four conveniently located service centers.

1 year guarantee backed up by the largest tuner manufacturer in the U.S.—SARKES TARZIAN, INC.

All tuners are cleaned inside and out, repaired, realigned and air tested.

TUNER REPLACEMENT

Replacement Tuner \$9.75.

This price buys you a complete new tuner built specifically by SARKES TARZIAN INC. for this purpose.

The price is the same for every type of universal replacement tuner.

Specify heater type

Parallel 6.3V
Series 450 mA
Series 600 mA

All shafts have the same length of 12".

Characteristics are:

Memory Fine Tuning
UHF Plug In
Universal Mounting
Hi-Gain Lo-Noise

If you prefer we'll customize this tuner for you. The price will be \$18.25. Send in original tuner for comparison purposes to our office in INDIANAPOLIS, INDIANA.



TUNER SERVICE CORPORATION

FACTORY-SUPERVISED TUNER SERVICE

MIDWEST 817 N. PENNSYLVANIA ST., Indianapolis, Indiana TEL: 317-632-3493
(Home Office)

EAST 547-49 TONNELE AVE., Jersey City, New Jersey TEL: 201-792-3730

SOUTH-EAST 938 GORDON ST., S. W., Atlanta, Georgia TEL: 404-758-2232

WEST SARKES TARZIAN, Inc. TUNER SERVICE DIVISION
10654 MAGNOLIA BLVD., North Hollywood, California TEL: 213-769-2720

. . . for more details circle 132 on Reader Service Card

Instant inventory.

Keep electronic components handy with Mallobin® Benchtop Organizers. Each Mallobin contains a popular assortment of electronic components in a stackable, interlocking plastic case. Fifteen partitioned drawers keep parts neat. And each drawer is color coded and labeled for quick location of the part you want.

Mallobins come with selected components including all types of fixed capacitors, MOL and wire-wound resistors, carbon and wire-wound controls. In addition to regular Mallobins, custom assortments are available.

Ask your Mallory distributor for Mallobin prices and details today.

MALLORY

MALLORY DISTRIBUTOR PRODUCTS COMPANY

a division of P. R. MALLORY & CO., INC.
Box 1558, Indianapolis, Indiana 46206 Telephone: 317-630-5353

Batteries **Capacitors** Cassette Tapes **Controls** **Resistors** Semiconductors • Sonalert® • Switches • Timers • Vibrators

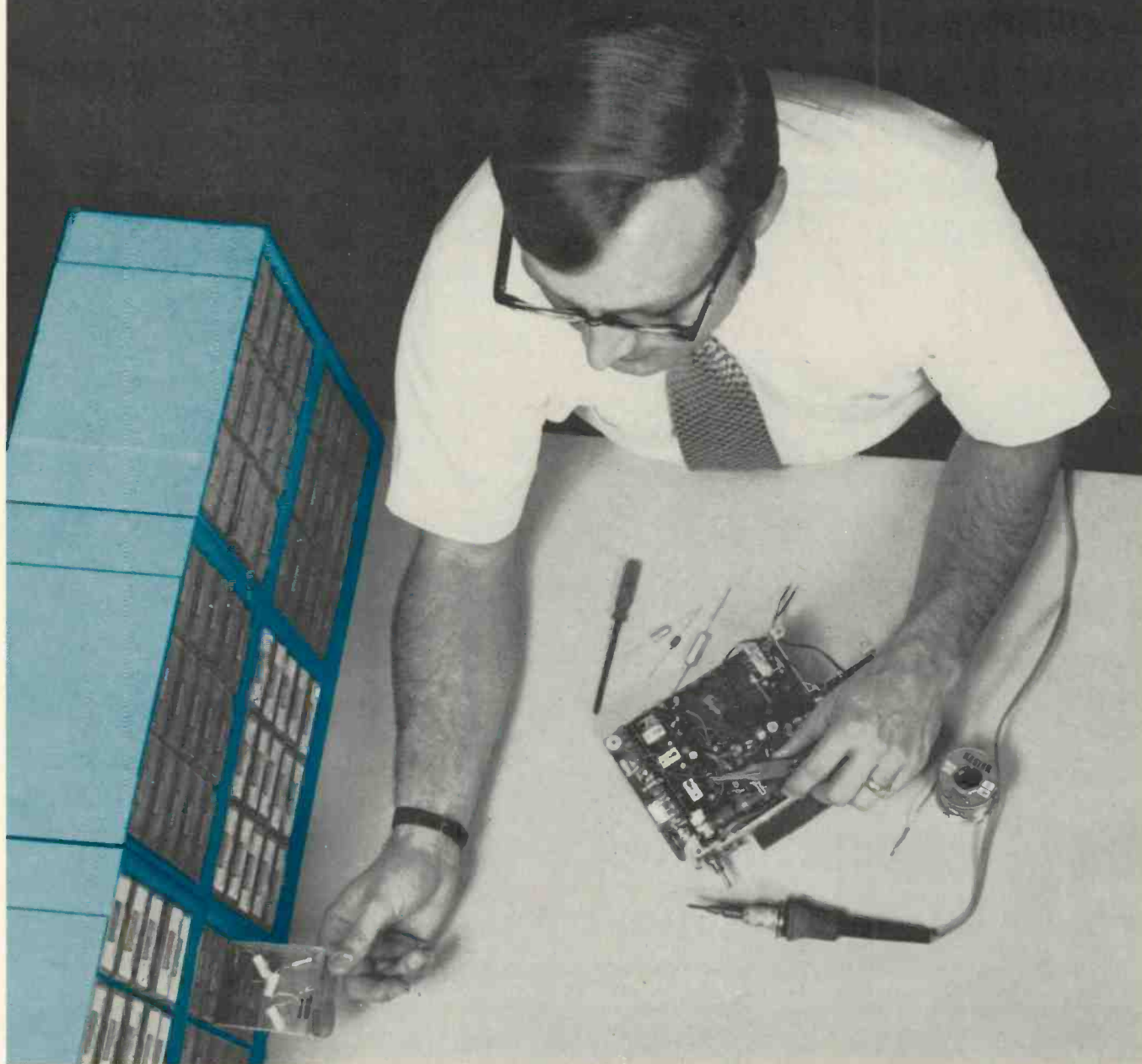

... for more details circle 119 on Reader Service Card

ELECTRONIC TECHNICIAN/DEALER

NOVEMBER 1970 • VOLUME 92 NUMBER 5

HUGH "SCOTTY" WALLACE

Publisher
43 East Ohio Street
Chicago, Ill. 60611
(312) 467-0670

PHILLIP DAHLEN

Editor
1 East First Street
Duluth, Minn. 55802
(218) 727-8511

JOSEPH ZAUHAR

Managing Editor

EMILY WILSON

Associate Editor

DEBBIE GOLDBERG

Production Editor

BOB ANDRESEN

Graphic Design

LILLIE PEARSON

Circulation Fulfillment

JOHN KESSLER

Manager, Reader Services

BERNICE GEISERT

Advertising Production

MANAGERS

ALFRED A. MENEGUS

757 Third Avenue
New York: (212) 572-4829

DEAN GREENER

43 East Ohio Street
Chicago: (312) 467-0670

DONALD D. HOUSTON

1901 West 8th Street
Los Angeles: (213) 483-8530

CHARLES S. HARRISON

CY JOBSON

57 Post Street
San Francisco
(415) 392-6794

ROBERT UPTON

Tokyo, Japan
I.P.O., Box 5056

PUBLISHING DIRECTOR

TOM GRENEY

The unique characteristics of the antenna shown being installed on this month's cover, are described in the article, "New Approach to Antennas."

-
- 3 TEKFAQ: Servicing is easier when you've got the right schematic.
 - 23 EDITORIAL: Any job worth doing should be done right.
 - 24 LETTERS: More about what you think and need.
 - 31 NEWS: Events of interest to our industry.
 - 33 NEW AND NOTEWORTHY: Products that may be of special value.
-

FEATURES

39 TELEVISION CIRCUIT REVIEW FOR 1971

Part II—More information on the TV sets that you may encounter next year.

45 NEW APPROACH TO ANTENNAS

Solid-state circuits improve TV signals obtained from recently developed Sensor.

46 MOVING TV SETS

Our experience with a hand truck designed specifically for bringing in TV sets.

50 QUICK-TESTING TRANSISTORS

Simple in-circuit procedures for checking transistors—by Forest Belt.

54 PORTABLE HOME SERVICE LAB

Reader tells of a unit he has designed for making service calls faster and easier—by Robert Sickels.

56 PICKING THAT NEW SHOP LOCATION

Things to look for so that the next move will be successful—by Ernest W. Fair.

57 TEST PROBE LEAVES ONE HAND FREE IN THREE-HANDED JOB

The use of a helpful tool for making simultaneous contact with printed-circuit emitter, base and collector terminals—by Chuck Dotson.

58 GUEST AUTHOR: BAIT YOUR MOUSETRAP FOR PROFITS

Andy Baker tells how your business can become more profitable by making your customers aware of any product or service that you offer that will benefit them and make your business more valuable to them.

59 TEST INSTRUMENT REPORT

A review of specifications for Hickok's 3300 Digital Multimeter.

65 TECHNICAL DIGEST: Hints and shortcuts for more effective servicing.

69 COLORFAQ: Tips for easier color TV servicing.

71 NEW PRODUCTS: More helpful tools of the trade.

81 DEALER SHOWCASE: Better products for easier sales.

84 TECHNICAL LITERATURE: More information on useful equipment and supplies.

85 BOOK REVIEWS: Other publications that may prove helpful.

86 ADVERTISERS' INDEX: The companies that feel their products are worth mentioning.

87 READER SERVICE: A source of additional information.



A HARCOURT BRACE JOVANOVIH PUBLICATION



ELECTRONIC TECHNICIAN/DEALER is published monthly by Harcourt Brace Jovanovich Publications. Corporate Offices: 757 Third Avenue, New York, New York 10017. Advertising Offices: 43 East Ohio Street, Chicago, Illinois 60611 and 757 Third Avenue, New York, New York 10017. Editorial, Accounting and Circulation Offices: 1 East First Street, Duluth, Minnesota 55802. Subscription rates: One year \$5, two years \$8, three years \$10, in the United States and Canada. Other countries: one year \$9, two years \$14, three years \$18. Single copies: 75¢ in the U.S. and Canada; all other countries \$2. Second class postage paid at Dansville, New York 14437 and at additional mailing offices. Copyright 1970 by Harcourt Brace Jovanovich Publications.

POSTMASTER: Send form 3579 to ELECTRONIC TECHNICIAN/DEALER, 1 East First Street, Duluth, Minnesota 55802.

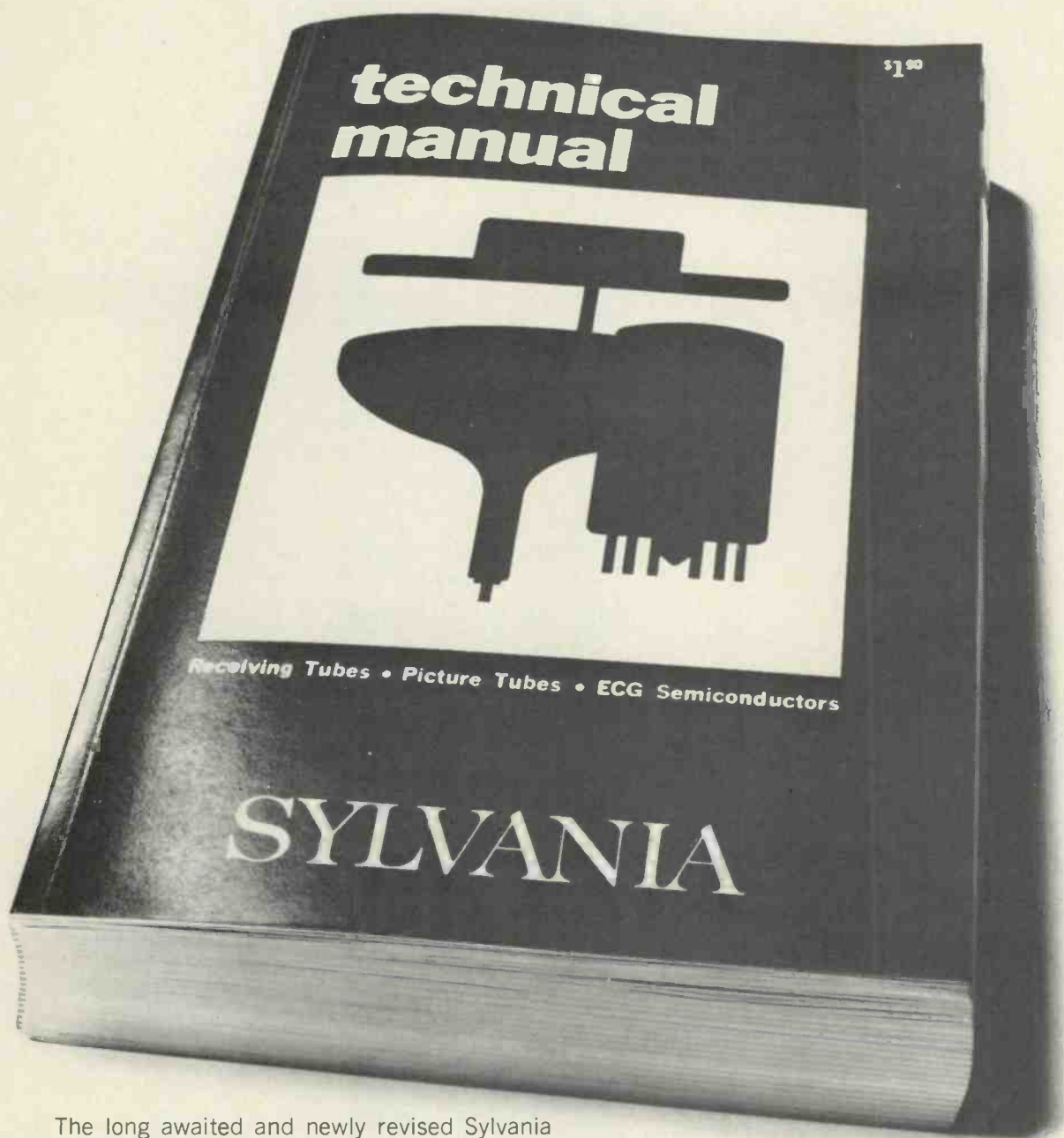

The long awaited and newly revised Sylvania Technical Manual is out. Complete and unexpurgated. The fantasy of every Independent Service Technician. Written anonymously by an agile team of Sylvania engineers. 32,000 components described in breathtaking detail. Including thousands of unretouched diagrams and illustrations. Discover the unspeakable thrill of new color TV Tubes, listed as never before. The ecstasy of 28,000 ECG Semiconductors.

From exotic Deflection Oscillators to a lurid account of Transistors and Rectifiers.

This book has what you want. Components for the man who knows what to do with them.

The 14th Edition of the Sylvania Technical Manual is not available in any bookstore. Your Sylvania Distributor is discreet. Speak to him.

“Electrifying”

SYLVANIA
GENERAL TELEPHONE & ELECTRONICS

EDITORIAL

What's Your Life Worth?



Previous memos have stressed the importance of getting out there and selling like crazy so that the shop might prosper despite unfavorable economic conditions. We have stressed the importance of effective advertising, good customer relations, and prompt and effective servicing to increase revenue. We tear our hair out frantically attempting to keep on top of the heap while unwashed, long-haired hippies stand on the street corners feeling sorry for us for having "blown our minds" for material things.

From the adjacent photo you can see that I have not quite reached the stage of pulling all my hair out and I am too "square" to let it grow. And Scotty Wallace would be the first to acknowledge that I am as much a capitalist as anyone. Yet at times I feel that it is all a race to see who can beat who to the grave.

When a close relative dies of a heart attack (as my father did but a few years ago) it is easy to conclude that it was partly the result of medical incompetency and add that to the burden of grief. But when a prominent statesman—such as Egypt's President Nasser—is unable to secure the necessary resources to extend his life, then it becomes apparent that under such circumstances the possession of power is to no avail.

Don't get me wrong, money is important. I have yet to turn down a raise. And people have died in American hospitals for want of adequate financial resources. But, as the old saying goes, "You can't take it with you."

With all due respect to the minister of the church that I attend (I think he's terrific), the one man that has recently had the greatest impact on our church has been the organ repairman. It wasn't that he was so religious a man that he inspired us all. Instead, it was the result of the fact that once he had collected his \$2000 fee he left town—having torn the pipe organ apart. Now the congregation, which was accustomed to generously donating money but letting the other fellow do the work, is faced with the task of pitching in and rebuilding the organ itself. The fellowship that is developing is revitalizing the church. (By the way, does anyone happen to have any diagrams for a hydraulically coupled pipe organ built around the turn of the century? It will be a great organ once we get the miles of tubing straightened out.)

The value of our lives cannot be nearly as well expressed in dollars and cents as it can in the way we spend the time that God has given us. I personally feel that if I am to spend my time editing this magazine, then I had better do as good a job as I am able. And I feel personally hurt unless the final printed version adequately reflects this effort. As you well know, this same feeling of pride can be expressed in the quality of workmanship that goes into the repair of consumer electronic products. Although out of necessity you must of course charge for your services, there is the satisfaction of helping your fellow man by doing a first-class job.

Whenever one friend of mine made a house call, he would ask the family if they were new in the community. If they were, he made them feel welcome and took a little time to tell them about the town. If they had no religious affiliation and were interested, he would use their phone to call the local pastor.

One TV shop where I once worked provided the public address system for school baseball games. Although the name of the shop was boldly printed across the speaker horns, the shop owner was still performing a community service, a little something to help others.

Our primary reason for being at our jobs is to comfortably support ourselves and our families. But at the same time, if our lives are to be of any value, we must take time to demonstrate a personal interest in our co-workers, customers and community.

Phillip Waller

LETTERS

Readers' Aid

I am appealing to you and my fellow readers for a schematic and possibly tuning instructions for a CB radio manufactured by Texas Comm., Inc. (now out of business). The model no. is R1, serial no. 1234. It goes by the name of "Ranger."

G. BUIGE

3302 Ryerson Cir.
Baltimore, Md. 21227

I would like to know the address of a radio manufacturer called Avia Products Co. The only information I have so far is that it is located in Los Angeles, Calif.

JOSEPH J. CALICCHIO

226 Hutton St.
Jersey City, N.J. 07307

I am a new reader of your magazine, and I enjoy the features. I am an electronics student and can pay \$2 each for "Supreme Publication TV Information Manuals," No. 26, 27 and 28; and 50¢ each for Supreme TV manuals 6, 7, 8, 9, 10, 11, 13, 14 and 15. I also need a good 110° universal test picture tube.

S. TANLEY

4624 N. Marvine St.
Philadelphia, Pa. 19140

I have an L M frequency meter, vintage unknown. It has 6A7, 76 and 77 tubes. The VFO and audio sections are working, but the 1Hz oscillator isn't. It had been modified by some earlier owner. I would like to rewire it per the original.

I have a schematic from a conversion manual, but component values are not listed. I would like to know if some of the readers could give me the component values of the following: R-107, R-109, R-110, R-115, C-105, C-106 and X-105.

CHARLES L. SLANE

Route 3, Box 156
Rochester, Ind. 46975

I have been a subscriber for a few years, and I have gained a vast amount of service knowledge. I would like some information, and thought maybe you or a reader might be able to help me.

I have a Model 622A Hycon Oscilloscope with no operating manual or schematic. The calibration circuit is

not functioning, and I have been unable to locate the trouble.

The scope was manufactured by Moletronics Corp. of South El Monte, Calif., and later the manufacturing rights were sold to Robertson Instrument Co. of Azusa, Calif. I have written to that company several times, but have received no reply to date.

If any one of your readers can furnish me with a manual or schematic, I will pay all costs for the loan or photostats, whichever is more convenient.

GEORGE E. MARAK

2031 W. Houston Ave.
Fullerton, Calif. 92633

I am in need of a schematic for a geiger counter, Model 521, Serial No. 8653, manufactured by Raytomic Atomic Research Corp. I have written to their address but have been informed that they have moved. Their old address is Colorado Springs, Colo.

HAROLD E. JONES

c/o Skating Rink
Moab, Utah 84532

I'm interested in going into business for myself in the Pacific northwest (Oregon to be exact). I would appreciate it if some of the readers could help in locating a TV sales and service shop for sale. Also, I would be interested in employment in that area.

G. A. HEISTER, JR.

6138 Coldwater Canyon
North Hollywood, Calif. 91606

Comments

Your article "Why A Trigger-Sweep Scope" in the September issue merely confirmed what most of us already suspected—that a \$100 scope is inferior to a \$340 scope. Not one photo showed any advantage of the triggered sweep, merely of better response and of higher top speed. My own B & K 1450, in common with most scopes of over \$200, can draw the waveforms equally well and at less cost with conventional sync. I don't doubt that triggered sweep has its advantages, but they were apparent neither in the article nor in the photos.

It would have been more instructive to your readers to have made two separate articles:

- To take two scopes of similar cost and attempt to show the advantages of triggered sweep;
- To demonstrate that a 5MHz bandwidth is not necessary to service color TV.

Most people are dazzled by wonderful specs—bandwidth to 100MHz, etc.

That makes their present equipment look almost pre-war, but gear doesn't repair anything. It's the man who interprets the readings who does that, which is where you often repeated advice comes in: "Get to know your equipment." There are plenty of technicians around who fix color TV with a 20-year-old scope and do it just as well as the next guy with his \$500 chromium-plated, super-duper, because he first knows exactly the limitations of his instrument. Further, why pay for more accuracy than necessary? How often do you read exactly where the needle points on the VOM? I know what I do—the schematic says 154v, a quick dab with the probe, and if the 5 percent accurate needle swings to somewhere around 150v, I'm happy. So why bother with a mirror scale and 1 percent accuracy if it's not needed? Most young technicians seem to worry too much about slightly wrong voltages and small differences in resistance from those published in schematics, and I think that you would be doing them a service by running an article on tolerances, possibly with the schematic of some simple radio showing published voltages and the acceptable variations from the norm.

P. M. LEYDEN

I've subscribed to your publication for many years—I find it very informative. But your last editorial (September 1970) forced me to chuckle.

I've been doing TV, radio and other repairs for 22 years—it started as a hobby in 1937. You brought up the old cliché put forth by RCA: "What else is there to fix." The big point is not what is to be fixed, but what will you get paid for!

The reason I've existed so long as a small, one-man operation is because I like my work. At the same time, and most importantly, I make sure I get paid. Getting paid for your work is more important than any other factor. All the people I know would like all their equipment repaired, except that they never have the money to pay.

As for a substitution, all TV technicians know parallel-series hook-ups on resistors or capacitors, or else 20 to 50 percent deviations in either.

Parts of your editorial make sense when you refer to wasted time, but there are times when we want to break away. At the distributors' there are other guys we like to chew the fat with and cry on each other's shoulders.

Remember that old song: "No one knows what Charley does until he wears shoes that Charley wore." That's part of life.

My old dear father always said,

Do you judge capacitors
on the same basis
Bill Dickerson does?

Then you'll use
Sprague Twist-Lok[®] Capacitors when
you need twist-prong electrolytics.



To be successful, a TV service dealer has to be fussy about a lot of things. No one knows it better than Bill Dickerson of Central Radio and Television, Santa Barbara, California. He's building on his 17 years' servicing experience every day in a spot where being fussy counts a lot. Central Radio is 14 people strong and has 4 service trucks on the go. It's easy to see why Bill prefers Sprague Twist-Lok Capacitors. They can be used as exact replacements to avoid call-backs. It pays to be fussy.

Ask your Sprague distributor for a copy of Sprague's Electrolytic Capacitor Replacement Manual K-109 or write to:
Sprague Products Company, 65 Marshall St., North Adams, Mass. 01247

P.S. You can increase your business 7½% by participating in EIA's "What else needs fixing?" program. Ask your distributor or write to us for details.

... for more details circle 130 on Reader Service Card

SPRAGUE[®]
THE MARK OF RELIABILITY

how to get a \$400 frequency counter for \$199^{95*}



...build the new Heathkit® IB-101

- Accurate counting, 1 Hz to over 15 MHz
- Automatic trigger level for wide range input without adjustment
- Five digit readout with Hz/kHz ranges & overrange indicators give eight digit capability
- High Z input
- Computer-type integrated circuitry eliminates divider chain adjustment

The latest Heath breakthrough in low cost, high quality instrumentation. New IB-101 counts from 1 Hz to over 15 MHz; advanced integrated circuitry eliminates blinking readout & divider chain adjustment.

Overrange indicator & Hz/kHz switch give the IB-101 8-digit capability. Set the range switch to kHz & the display reads out to the nearest kHz . . . push the range switch to Hz and read down to the last Hz. Overrange & Hz/kHz indicators light up to give error-free measurement & correct range at all times. Automatic decimal locator eliminates interpolation & figuring.

Exclusive Heath-designed input circuit uses a dual-gate, diode-protected MOSFET . . . provides proper triggering without adjustment from less than 100 mV to over 200 V. Input Z is 1 megohm shunted by less than 20 pF to minimize circuit loading & error. Other features include sockets for all 26 IC's & 5 display tubes . . . 120/240 V AC operation & convenient handle/tilt stand.

Compare the new Heathkit IB-101 . . . then order yours. Kit IB-101, 7 lbs. . . \$199.95*

IB-101 SPECIFICATIONS: Frequency Range: 1 Hz to greater than 15 MHz. Accuracy: ± 1 count \pm time base stability. Gate Times: 1 millisecond or 1 second with automatic reset. **INPUT CHARACTERISTICS** — Sensitivity: 1 Hz to 1 MHz, less than 100 mV rms. 1 MHz to 15 MHz, less than 250 mV rms, after 30 minutes warmup. Trigger Level: Automatic. Impedance: 1 Megohm shunted by less than 20 pF. Maximum Input: 200 V rms, DC — 1 kHz. Derate at 48 V per frequency decade. **TIME BASE:** Frequency: 1 MHz, crystal controlled. Aging Rate: Less than 1 PPM/month after 30 days. Temperature: Less than ± 2 parts in 10^7 /degree C. 20 to 35 degrees C after 30 minutes warmup. $\pm .002\%$ from 0 to 50 degrees C. **GENERAL:** Readout: 5 digits plus overrange. Temperature Range: Storage: —55 to 80 degrees C. Operating: 0 to 50 degrees C. Power Requirements: 105-125 or 210-250 V AC, 50/60 Hz, 8 watts. Cabinet Dimensions: 8 1/4" W x 3 1/2" H x 9" D not including handle. Net Weight: 4 1/2 lbs.

HEATH COMPANY, Dept. 24-11
Benton Harbor, Michigan 49022

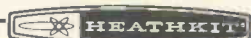

a Schlumberger company

Enclosed is \$ _____, plus shipping.

Please send model (s) _____

Please send FREE Heathkit Catalog. Please send Credit Application.

Name _____

Address _____

City _____ State _____ Zip _____

*Mail order prices; F.O.B. factory. Prices & specifications subject to change without notice. TE-232

. . . for more details circle 114 on Reader Service Card

LETTERS

"Editors are like teachers. They think that they are the only smart people because they only know what they read-need."

ORLANDO MUCCIARONE

As Scotty Wallace indicated in his August Publisher's Memo, both Joe and I have had experience "in Charley's shoes." But this doesn't mean that we feel that we know all that we need to know as editors. Not all of our readers have had the benefit of 22 years of experience, and for that reason we are offering tips that may seem "old hat" to others. It is through your letters that we learn more of your needs. These letters are appreciated and we hope to hear from more of you. Ed.

For some time I have wanted to let you know how much our technicians enjoy your magazine. We are very much in the servicing business and your publication, above all others, is very appropriate. I especially appreciated the article (August 1970) on MATV systems since we are in the process of building one.

We hope that a "clearing house of information" such as yours might be of assistance to us in the following areas.

- Some sound and proven guidelines for operating a service department to make a reasonable profit. We presently service stereo component equipment, automobile sound equipment and TV. Having been in business only two years, we still have a lot to learn.
- Some tips on solving stubborn electrical noise in automobile radios and tape players. This seems to be a field of its own. Does anyone build a noise "sniffer" or locator?
- Does any business that you know of still rebuild large speaker cones? If so, we would like their address.

Any assistance on any of these matters will be greatly appreciated.

H. D. WRIGHT

B-W Electronics
414 Glover Ave.
Enterprise, Ala. 36330

For Sale

For the past eleven years, I have operated a one-man TV servicing business.

continued on page 28

To the planners
of those companies
who will build new
offices totalling
\$11,500,000,000
in 1970.



MASTERCOM™ M100
World's most
efficient intercom...
easiest to install!

When you call in your architect, it's time to consider the Norelco Mastercom M100. This new intercom system now sets the standard for modern internal communications. It offers instant hands-free operation . . . assured privacy of conversations . . . and superb voice reproduction. Matching handset also available.

Installation is simplified, using a single 8-pair cable and noiseless all-electronic control pack, only 3.1 cubic feet *small*. The handsome rosewood stations can be easily relocated without rewiring. And the system allows for *unlimited* expansion.

A Norelco specialist will gladly survey your intercom needs and supply facts on costs and savings. Call him today. See the yellow pages under "Intercommunication Equipment" or mail coupon today.

No elco®
PHILIPS BUSINESS SYSTEMS, INC.
A NORTH AMERICAN PHILIPS COMPANY
100 East 42nd Street, New York, N. Y. 10017

Gentlemen:
Please send full details on the
Norelco Mastercom M100

Company Name _____

My Name _____

Street Address _____

City, State _____ Zip _____

EFD-1170

DICTATION EQUIPMENT • MASTERCOM SYSTEMS • ELECTRONIC PRINTING CALCULATORS • OFFICE COMPUTERS

... for more details circle 124 on Reader Service Card

cash in on a GROWING NEW business...

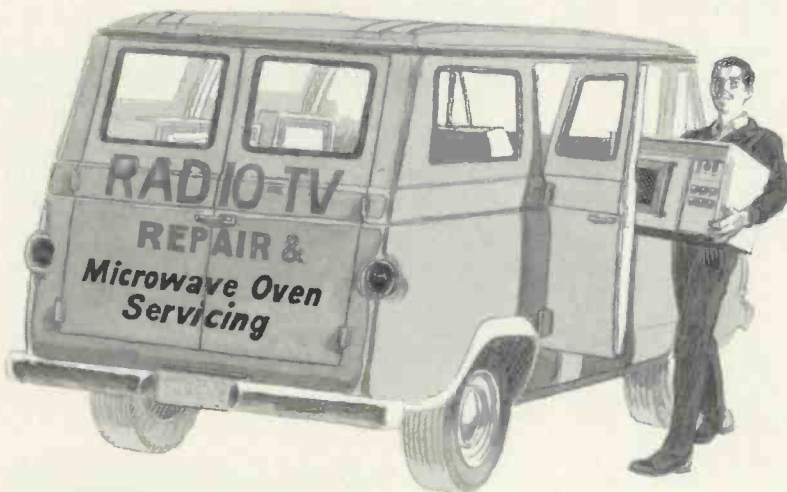

SERVICE MICROWAVE OVENS

Thousands of new microwave ovens are sold each year for commercial or home use. As oven sales continue to climb a brand new opportunity opens for those presently engaged in radio and television servicing. It's an opportunity to supplement your present income . . . or start an entirely new servicing business.

A majority of the franchised "fast food" eating establishments are using microwave ovens. Hundreds of restaurants are discovering the oven that will bake a potato in five minutes, heat precooked frozen food in minutes. Homeowners everywhere are becoming aware of the electronic oven which cuts cooking time from hours to minutes . . . even seconds. Prepare yourself now for this new servicing and maintenance business.

International Crystal Mfg. Co., a pioneer manufacturer of microwave ovens, has information regarding this space-age opportunity for skilled technicians. Write today for complete details.

ADDRESS INQUIRIES TO:
SERVICING INTERNATIONAL CRYSTAL MFG. CO., INC.
10 North Lee Oklahoma City, Okla. 73102

. . . for more details circle 115 on Reader Service Card

LETTERS

continued from page 26

I'll be 69 years old next February and I feel it's time to retire. Since I have had to limit my business during the past three years because of Social Security, I feel this is a worthwhile opportunity for someone who wishes to step into an established business with excellent growth potential.

Because I've always been a careful buyer, my inventory is not excessive. The price I'm asking (excluding truck) would be returned to the owner in less than one year even if business is maintained only at present limitations.

JO-CA TV

468 Northwest 79th St.
Miami, Fla. 33150

I have the following TV test equipment for sale: RCA—Oscilloscope WO-91B; Jackson—Sweep & Marker Generator, Model TVG-2; and Sen-core—DeLuxe Color Bar Generator, Model CG-141. The above includes all leads, probes and instruction manuals.

W. D. SHEVCHUK

1 Lois Avenue
Clifton, N.J. 07014

I have several old receiver/transmitter tubes I would like to sell. 807, 6Q7, 41, 76, 78, 6D6, 6A7/ 39/44, 57, 24, and 75 are just some of the tubes. I have at least one or more of each.

DUANE E. WOLD

745 Le Brun Drive
Jacksonville, Fla. 32205

Tube Rebuilding

I just read the article by R. L. Warner in the August issue. I am so disgusted I just had to write.

I have been rebuilding tubes for years and I know there is no way to rebuild one for \$1.50, unless the labor, rent, gas, electricity, bases, glass, tubing, paint, epoxy, etc., are free. The average price for the electron gun is \$1.75. It takes \$2.00 worth of epoxy to laminate one 23-in. tube. We average about \$10 to \$12 in costs on black-and-white tubes.

Stating that it costs \$1.50 for black-and-white and \$5.50 for color is causing a lot of innocent people trouble and money. When a technician reads that and then comes in here and pays \$15 to \$20 for a tube, he thinks we are skinning him.

K. N. ROBESON

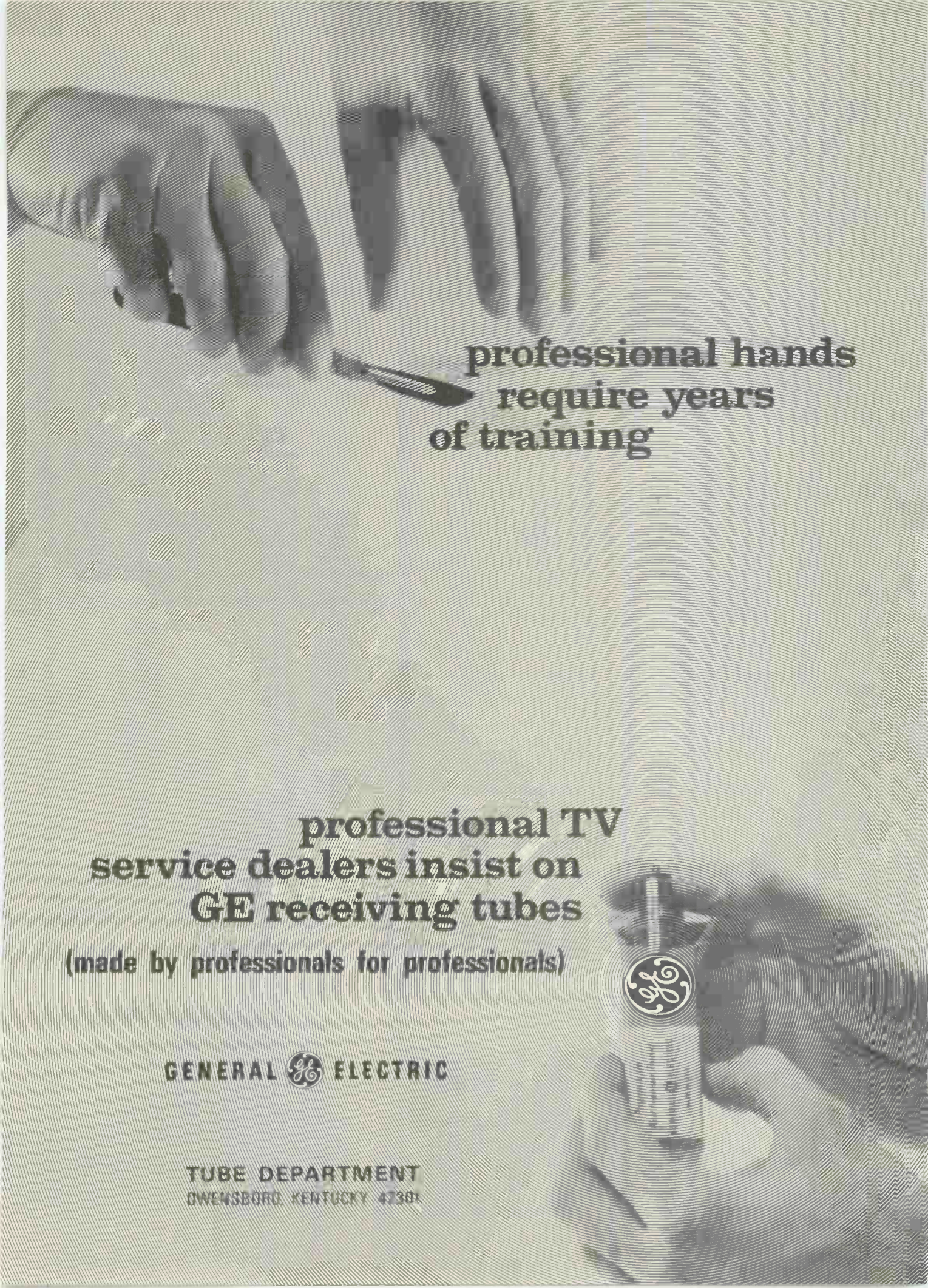

**professional hands
require years
of training**

**professional TV
service dealers insist on
GE receiving tubes**
(made by professionals for professionals)

GENERAL  ELECTRIC

**TUBE DEPARTMENT
OWENSBORO, KENTUCKY 47301**

NOW... ONE man can do what TWO used to

Mighty Mover^{T.M.} can be the most valuable tool you own

Remember the last time you carried a heavy TV or stereo console down a flight of stairs? One slip, and . . . disaster!

Mighty Mover was designed especially for you. It uses the principles of the hand truck and tilting cradle to not only carry the heaviest objects . . . console TVs, stereos and table models . . . even up and down steps, but to load them onto a van.

Field testing and research proves the Mighty Mover can save you time, lower your risk and raise your profits at the same time!

INTERESTED?
SEE YOUR LOCAL TV
DISTRIBUTOR OR WRITE FOR
MORE INFORMATION.

GRIFFITHS
electronics, inc.

National Handling Equipment Sales Office
2875 Westside Blvd. / Jacksonville, Florida 32209

Phone: (904) 355-9006

. . . for more details circle 113 on Reader Service Card

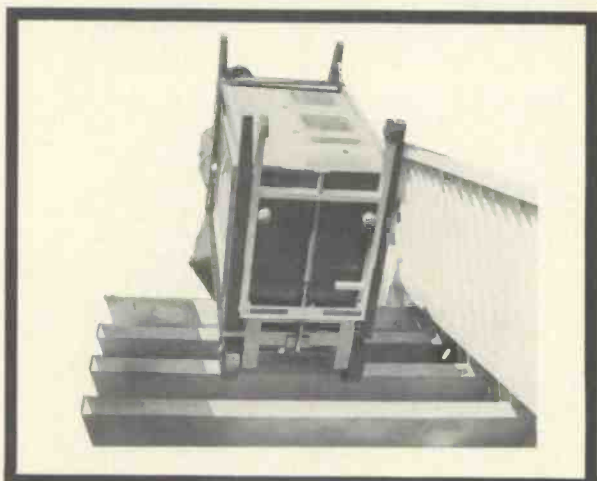
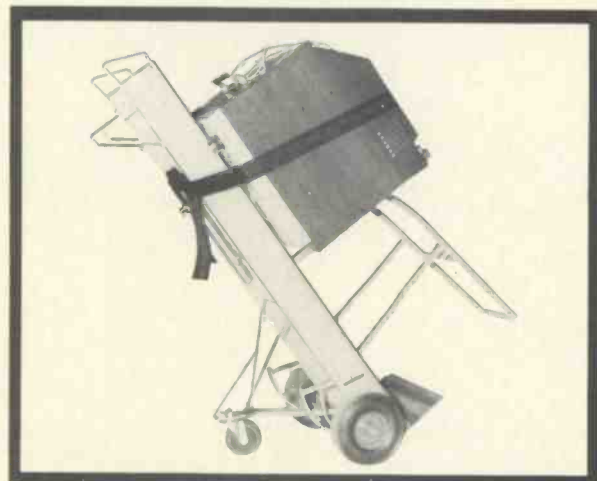

NEWS OF THE INDUSTRY

Audiovisual Information Programs Offered by RCA

Three new audiovisual informational programs designed to furnish practical guidelines and solutions to technicians in everyday servicing of TV receivers and other electronic equipment are now available from RCA distributors.

Prepared by RCA Commercial Engineering, Harrison, N.J., the new technical service aids cover critical areas in specific detail to save service technicians time and trouble. Each program consists of a series of color slide presentations containing professional graphics and illustrations, an audibly-synchronized cassette tape recording and a brochure recapping the salient points necessary to achieve maximum effectiveness. A Kodak "Carousel" 35mm projector and a standard cassette tape recorder are required for group or individual presentation.

A valuable "building block" for distributor-sponsored dealer meetings, the first tape-cassette/slide-film presentation is entitled "Color TV Picture Tube Installation and Associated Receiver Adjustments" (1D1441). It offers specifics on color picture tube replacement; outlines safety precautions; indicates short cuts on tube removal and replacement; and provides a step-by-step guideline covering convergence, purity and tracking—intermixed with electronic theory for greater understanding of TV electronics. Optional list price for this 43-minute presentation is \$65.95 each.

The second audiovisual aid—keyed to RCA's SK line of replacement solid-state devices—covers "Part I—Basic Techniques for Transistor Checking" (1L1337). It explores the use of basic test equipment, provides simple techniques for transistor checking, reveals quick ways to identify unknown transistor leads and types, and offers cost-saving information on good servicing practices, techniques and short cuts. Optional list price for this 23-minute presentation is \$39.95 each.

The third service aid deals directly with a no-raster problem and is entitled "Television Servicing—Part I: No Raster Condition" (1A1853). This audiovisual presentation is keyed to an RCA tube replacement Road Chart and provides a preliminary checklist and a diagrammatic procedure recommended by RCA TV specialists. Both "no raster—no sound" and "no raster—sound present" conditions are discussed in detail. Servicing techniques are presented that will save the technician's most important commodity—his time. Optional list price for this 18-minute presentation is \$39.95 each.

Total U.S. Sales of Consumer Electronics Released for First Six Months of 1970

Total U.S. sales of consumer electronic products, including domestic and foreign label imports for the first six months of 1970 showed decreases in TV, radio and phonograph categories and sizable increases in magnetic tape recorders and players over the same period in 1969, reported EIA.

Total U.S. color TV sales during the first half of 1970 were 27.2 percent behind the same period in 1969. Monochrome total U.S. sales of 2,965,131 sets were off 10.2 percent from the 3,302,365 sets sold during the first six months of last year.

Total U.S. radio sales were down 6.9 percent in the first six months of 1970 as compared to the same period last year. Table radio was the only radio category to show an

increase in this time period: 3,621,390 sets sold vs. 2,169,645—a sizable 66.9 percent increase.

FM radios' share of home radio sales increased to 56.0 percent, from 48.2 percent during the first half of 1969, continuing its steady upward climb.

Phonograph sales declined with 2,147,618 sets sold in the first six months compared to 2,687,550 sets sold in the same period last year.

Total U.S. sales of magnetic tape recorders, consumer electronic's fastest growing category, showed a 26.7 percent increase over the same period last year. Total U.S. sales of tape players are incomplete, although tape player imports showed increases in both automobile and home categories, over the same period in 1969.

Admiral Color TV Sets Sold to Hilton Chain

The commercial products division of Admiral Corporation has received an order for 10,000 color TV receivers from the Hotel Equipment Corp., which is the purchasing subsidiary of the Hilton Hotels Corp.

The customized 18 in. color TV sets will carry the Hilton logotype and will be installed in Hilton-owned and operated hotels and inns, and franchised hotels throughout the country over the next 12 months.

The special Admiral color receivers will have a heavy-duty chassis combining solid-state components with copper bonded and etched circuits. They will be manufactured at the company's electronics center in Harvard, Ill.

Combination Horizontal Output-Damper Tube for Color TV

The Y-2014 Compactron tube—the first combination of a horizontal output and damper in one envelope rated for color-TV service—is announced by the General Electric Tube Dept.

According to L. G. Mumford, Manager of Product and Sales Planning, the Y-2014 combines two high performance tubes—the 6KD6 horizontal output tube and 6CJ3 damper tube—into one T-14 envelope, and offers ratings highly compatible with requirements for horizontal service in 18-in. 90° color-TV receivers.

"GE-designed horizontal output and damper tubes in the same envelope have been available for B/W TV service for some time, but now both functions are available in one envelope for color TV," Mumford noted.

The Compactron contains a high-perveance diode and a beam-powered pentode. The diode is intended for service as the damping diode and the pentode as the horizontal-deflection amplifier.

The new Compactron operates at heater voltage of 45v and a heater current of 0.600a. Average heater warm-up time is 11 sec.

The tube reportedly may be used in any operating position and is available in the following dimensions: maximum diameter—1.813 in.; minimum diameter—1.687 in.; maximum over-all length—4.875 in.; maximum seated height—4.500 in.; and minimum seated height—4.250 in.

The tube joins over 170 different GE Compactron types for color and monochrome TV and other applications. Since the Tube Dept. introduced the Compactron in 1960, close to 200 million of these multifunction tubes have been produced for the TV industry.

The replacement picture tube no other color tube can replace!



Simulated TV picture

ZENITH
CHROMACOLOR

Now you can install the revolutionary Chromacolor picture tube in almost any brand of 23" (diag.) color TV. And let your customer see the difference: a new, sharper Chromacolor picture with greater brilliance, contrast and color definition.

Zenith pioneered, developed and patented (U.S. Patent No. 3146368) the Chromacolor picture tube. And only Zenith has Chromacolor.

Chromacolor is an easy sale because people already know of Chromacolor's superiority. (Last year, after the revolutionary new Chromacolor system was

introduced, Zenith giant-screen color TV sets became the No. 1 best-seller!)

Full two-year warranty.

Here's your sales clincher: Chromacolor replacement color tubes are warranted for two full years. Exactly double the warranty period for most other replacement color picture tubes.

Give your customers the best — Chromacolor replacement color tubes. Only your Zenith Distributor has them.

TWO-YEAR WARRANTY

Zenith Radio Corporation warrants the replacement CHROMACOLOR picture tube to be free from defects in material arising from normal usage for two years from date of original consumer purchase. Warranty covers replacement or repair of picture tube, through any authorized Zenith dealer; transportation, labor and service charges are the obligation of the owner.

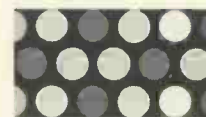

Zenith Chromacolor picture tube pinpoints the color dots on a jet black background and for the first time fully illuminates every dot.

ZENITH
The quality goes in
before the name goes on

NEW AND NOTEWORTHY

For additional information on products described in this section, circle the numbers on Reader Service Card. Requests will be handled promptly.

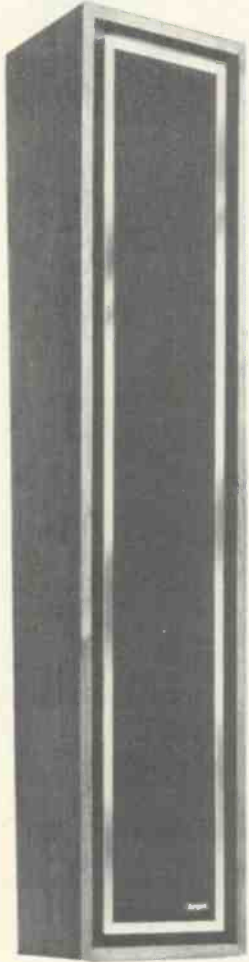

SOUND COLUMN 700

*Tunes to match
room acoustics*

A model ASD 1091 AdjustaCoustic sound column is designed with a built-in variable equalization filter that allows the installer to tune the system to match room acoustics, minimizing low frequency resonance. This filter reportedly minimizes acoustical problems while permitting maximum frequency response sound to be utilized. The filter control is recessed into the top of the column to provide easy adjustment by the installer, and requires no instruments. If desired, the column can also be remotely controlled to operate in both modes—full range for music or room equalized for maximum voice intelligibility. Specifications indicate that the projection pattern is wide horizontally (120°) and narrow vertically (25°). Sound energy can be beamed so that little or none is misdirected to bounce off walls or ceilings. Frequency response is said to be variable between 50 to 15,000Hz and 400 to 15,000Hz. Base roll-off equalization is reportedly variable from 0dB to 12dB per octave beginning at

approximately 400Hz. Power is rated at 75w EIA sinewave, 150w program material. The column utilizes nine special design 5½ in. speakers with a total magnet weight of 5 lb, 10 oz. Measuring 50½ in. high, by 10¾ in. wide by 8¼ in. deep, the unit weighs 61 lb, and is finished in oiled walnut. Argos.

**FOR MORE NEW
PRODUCTS SEE
PAGES 71 AND 81**



SOCKET WRENCH SET 701

*Can be assembled in
seven different combinations*

A 14-piece, ¼-in. square drive socket wrench, set No. 1001, contains components that can reportedly be combined in seven different ways to drive both hex and square fasteners. The reach of the assembled components varies from 1½ in. to 9¼ in. Specifications indicate that the set includes a precision-made, reversible ratcheting handle with a short swing for close-quarter work. Xcelite.

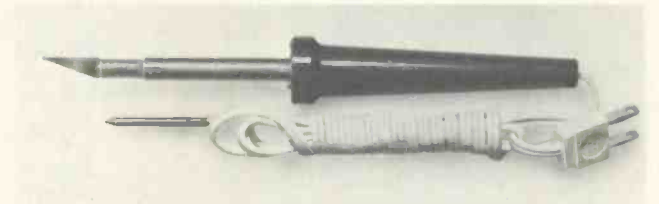

HOT KNIFE/SOLDER IRON 702

*Removable adapter chuck holds
knife blade or soldering tip*

A model SP23HK hot knife and soldering iron is manufactured with applications for hobbyists, electronic technicians, model builders and homeowners. The dual purpose tool has a removable adapter chuck, holding a standard type knife blade. With chuck removed, the soldering tip, which is supplied, may be screwed in. When used as a hot knife, the 25w tool will cut most light plastics and epoxies, strip insulation from wires, carve foam plastics, cut and seal ends of plastic rope and woven plastics. Kit price is \$4.98. Weller.

An Extraordinary Offer

to introduce you to the benefits of Membership in ELECTRONICS BOOK CLUB

for a limited time only you can obtain

ANY 3 OF THESE UNIQUE BOOKS (Combined List Price \$33.85) ... yours for only **99¢** each ... with Trial Club Membership

May we send you your choice of many three books on the facing page as part of an unusual offer of a Trial Membership in Electronics Book Club?

Here are quality hardbound volumes, each especially designed to help you increase your know-how, earning power, and enjoyment of electronics.

These handsome, hardbound books are indicative of the many other fine offerings made to Members... important books to read and keep... volumes with your specialized interests in mind.

Whatever your interest in electronics—radio and TV servicing, audio and hi-fi, industrial electronics, communications, engineering—you will find that Electronics Book Club will help you.

With the Club providing you with top quality books, you may broaden your knowledge and skills to build your income and increase your understanding of electronics, too.

How You Profit From Club Membership

This special offer is just a sample of the help and generous savings the Club offers you. For here is a Club devoted exclusively to seeking out only those titles of direct interest to you. Membership in the Club offers you several advantages.

1. Charter Bonus: Take any three of the books shown (combined values up to \$33.85) for only 99¢ each with your Trial Membership.

2. Guaranteed Savings: The Club guarantees to save you 15% to 75% on all books offered.

3. Continuing Bonus: If you continue after this trial Membership, you will earn a Dividend Certificate for every book you purchase. Three Certificates, plus payment of the nominal sum of \$1.99, will entitle you to a valuable Book Dividend which you may choose from a special list provided members.

4. Wide Selection: Members are annually offered over 50 authoritative books on all phases of electronics.

5. Prevents You From Missing New Books: The Club's FREE monthly *News* gives you advance notice of important new books... books vital to your continued advancement.

This extraordinary offer is intended to prove to you, through your own experience, that these very real advantages can be yours... that it is possible to keep up with the literature published in your areas of interest... and to save substantially while so doing.

How the Club Works

Forthcoming selections are described in the FREE monthly *Club News*. Thus, you are among the first to know about, and to own if you desire, significant new books. You choose only the main or alternate selection you want (or advise if you wish no book at all) by means of a handy form and return envelope enclosed with the *News*. As part of your Trial Membership, you need purchase as few as four books during the coming 12 months. You would probably buy at least this many anyway... without the substantial savings offered through Club Membership.

Limited Time Offer!

Here, then, is an interesting opportunity to enroll on a trial basis... to prove to yourself, in a short time, the advantages of belonging to Electronics Book Club. We urge you, if this unique offer is appealing, to act promptly, for we've reserved only a limited number of books for new Members.

To start your Membership on these attractive terms, simply fill out and mail the postage-paid airmail card today. You will receive the three books of your choice for 10-day inspection. SEND NO MONEY! If you are not delighted, return them within 10 days

and your Trial Membership will be cancelled without cost or obligation. Electronics Book Club, Blue Ridge Summit, Pa. 17214.

Typical Savings Offered Club Members on Recent Selections

| | |
|---|---------------------------------------|
| How to Repair Solid-State Imports | List Price \$7.95; Club Price \$4.95 |
| Dictionary of Electronics | List Price \$6.95; Club Price \$5.50 |
| TV Trouble Diagnosis Made Easy | List Price \$7.95; Club Price \$4.95 |
| Computer Circuits & How They Work | List Price \$7.95; Club Price \$4.95 |
| Commercial Radio Operator's License Study Guide | List Price \$7.50; Club Price \$5.95 |
| Home-Call TV Repair Guide | List Price \$6.95; Club Price \$2.95 |
| FET Applications Handbook-2nd Edition | List Price \$14.95; Club Price \$9.95 |
| RCA Monochrome TV Service Manual | List Price \$7.95; Club Price \$4.95 |
| Computer Architecture | List Price \$12.50; Club Price \$8.95 |
| Understanding Solid-State Circuits | List Price \$7.95; Club Price \$4.95 |
| Electronic Test & Measurement Handbook | List Price \$7.95; Club Price \$4.95 |
| Pulse & Switching Circuits | List Price \$7.95; Club Price \$4.95 |
| How to Use Test Instruments in Electronics Servicing | List Price \$7.95; Club Price \$4.95 |
| Circuit Consultant's Casebook | List Price \$9.95; Club Price \$5.95 |
| Amateur Radio Extra Class License Study Guide | List Price \$7.95; Club Price \$4.95 |
| Small Appliance Repair Guide | List Price \$7.95; Club Price \$4.95 |
| G. E. Color TV Service Manual | List Price \$7.95; Club Price \$4.95 |
| Basic Electronics Problems Solved | List Price \$7.95; Club Price \$4.95 |
| Handbook of Magnetic Recording | List Price \$7.95; Club Price \$4.95 |
| 125 One-Transistor Projects | List Price \$7.95; Club Price \$4.95 |
| Integrated Circuits & Systems | List Price \$12.95; Club Price \$8.95 |
| Practical Semiconductor Databook for Electronic Engineers and Technicians | List Price \$10.95; Club Price \$8.75 |
| Servicing Modern Hi-Fi Stereo Systems | List Price \$7.95; Club Price \$4.95 |
| Understanding & Troubleshooting Solid-State Electronic Equipment | List Price \$7.95; Club Price \$5.95 |
| 104 Easy Projects for the Electronics Gadgeteer | List Price \$6.95; Club Price \$3.95 |

AN EXTRAORDINARY OFFER...

Philco Color TV Service Manual



An all-in-one service guide for Philco color sets, with 12 complete schematic diagrams for chassis 15M90/91 to 20QT88. Here in one manual is complete service data for all the color models produced by Philco and Philco Ford (thru 1970), from the all-tube to the latest hybrid solid-state chassis, including the small-screen portable

Model T5062WA. The unique 36-page foldout section contains 12 complete schematic diagrams, representing all the chassis covered. The profusely illustrated text delves into each section (video, chroma, vertical, horizontal, etc.), and points out specific problems based on the author's extensive experience. Included are complete alignment and setup instructions, detailed in step-by-step form. 160 pps., plus 36-page schematic foldout section. Long-life vinyl cover.

List Price \$7.95

Order No. 522

1970 Popular Tube/Transistor Substitution Guide

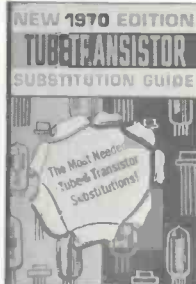

Now, a brand-new updated edition of this famous guide, containing 40% more material, including the newest popular tube and transistor types. Lists 99% of the tubes and transistors you'll ever need to replace. Moreover, only readily-available and comparably-priced substitutes are listed—no need for you to search through lists of tubes and transistors you'll rarely see in use to find a substitute. Contains 8 BIG sections: Popular Receiving Tubes, Industrial and Commercial Tubes, American Substitutes for Foreign Tubes, Tube Circuit and Base Diagrams, Popular Transistor Substitutes, American/Foreign Transistor Cross-Reference, General Purpose Transistor Substitutes, Transistor Base Diagrams and Manufacturer Abbreviations. 224 pps. Long-life vinyl cover.

List Price \$4.95

Order No. 525

How To Repair Home & Auto Air Conditioners



You don't have to be a refrigeration expert to get started—it's all here, from the basics on refrigeration to electrical controls and wiring, how to determine what size air conditioner is needed for a given room, how to compute BTU or tonnage needed, and the wiring required to handle the load. The last two

chapters deal with auto air conditioners—how they work, and how they are connected both mechanically and electrically in the car. What's more, the book contains over 100 close-up photos to show you, physically, just what all the parts look like and how they go together. Strategically located in appropriate chapters are cause-and-cure tables listing the most common troubles. When confronted with any defect, you simply refer to a table to find out what is most likely the trouble. 208 pps., over 100 illustrations. Hardbound. List Price \$7.95

Order No. 520

Modern Electronic Troubleshooting

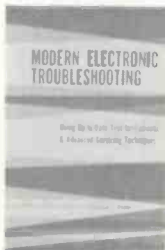

A down-to-earth handbook that deals with today's electronic servicing problems on a practical level, using modern test instruments and advanced troubleshooting procedures to cope with the special problems created by printed boards and solid-state circuitry. It is hard to conceive of a book that encompasses monochrome and color

TV, multiband radio receivers, hi-fi equipment, tape recorders, two-way communications equipment, and test instruments for servicing all this equipment. Yet this book does! By getting right to the subject of how to service the equipment without the usual wordy theoretical discussions of how the circuits work. An all-inclusive servicing guidebook service technicians have been asking for. 256 pps., over 100 illus., 5 big sections, 24 chapters.

List Price \$7.95

Order No. 474

Digital Computer Theory

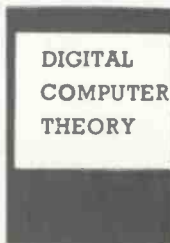

Whether you are a technician or engineer who needs comprehensive knowledge of computer operation, or simply a hobbyist with a passing interest in the subject, this outstanding text is for you. In the first section you are acquainted with basic computer technology, including computer codes and language programming. The second

section presents a detailed study of modern computer logic circuits, such as AND, OR, NAND, and NOR gates. In addition, thorough explanations of basic circuit blocks are discussed—bistable, monostable, and astable multivibrators, Schmitt trigger circuits, etc. Finally, the third section covers memory, control, arithmetic, and input-output units. 320 pps. Hardbound.

List Price \$7.95

Order No. 276

Electronic Circuit Design Handbook



New Third Edition—A brand-new, enlarged edition of the ever popular circuit designer's "cookbook," now containing over 600 proven circuits, for all types of functions, selected from thousands on the basis of originality and practical application. Now you can have, at your fingertips, this carefully-planned reference

source of tried and tested circuits. Selected from thousands submitted by distinguished engineers, these "thought-starters" are a collection of original circuits selected on the basis of their usefulness. This detailed compilation of practical design data is the answer to the need for an organized gathering of proved circuits... both basic and advanced designs that can easily serve as stepping stones to almost any kind of circuit you might want to build. 384 pps., 19 big sections, over 600 illus., 8 1/2" x 11". List Price \$17.95

Order No. T-101

Electronic Hobbyists' Handbook

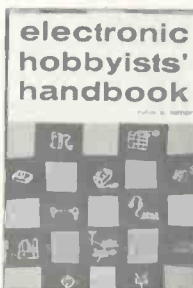

Nearly 100 tested and debugged circuits for technicians, engineers, experimenters, and hobbyists. If you are an avid project builder, or like to dabble around developing circuits to perform special functions, this book is for you. As a matter of fact, it is THE time-honored classic on the subject, having served many thousands of

readers through its many printings. Some 100 different practical circuits are included, all tried-and-proven by the author. Projects range from amplifiers and oscillators for scores of applications (signal tracers, hearing aids, PA amps, grid-dip and code-practice oscillators, etc.) to transmitters, receivers, photo-electric devices, Geiger counters, metal locators, and field strength meters. 160 pps., 118 illus. 9 chapters. Hardbound.

List Price \$6.95

Order No. 69

Color TV Trouble Factbook



Here's a complete guide to color TV troubles and solutions, arranged by make and model, a low-cost, all-in-one reference handbook every TV service technician should own. The information it contains may easily save you hours of time repairing a "tough-dog" color TV. Included are details concerning repetitive troubles, field-factory

changes, new and unusual circuits and descriptions of how they work, special adjustment procedures and other such pertinent service information. The content is arranged by brand names, covering every major make of color TV receiver produced in the past several years. Models and chassis covered are arranged in alpha-numerical order. 176-pps. Hardbound.

List Price \$6.95

Order No. 519

Electric Motor Test & Repair



A guide to maintenance practices for all types of small horsepower motors. While many of the larger motor repair shops find it more expedient to replace low horsepower units, re-winding of small electric motors is still a wide-spread and profitable practice. This practical guide contains a wealth of information on testing and re-winding small motors of every type, including fan, starter, polyphase, capacitor, induction, synchronous, etc. Early chapters tell you how to set up a motor test panel, make general tests and measurements, and advise you about the tools and equipment necessary (such as an armature winder, wedge driver, cutting and gauging board, coil taper, puller plate, etc.). 160 pps., 102 illus. Comb-bound with soft cover.

List Price \$6.95

Order No. T-97

SEND NO MONEY!

Simply fill in and mail postage-paid Airmail card today!

... for more details circle 104 on Reader Service Card



Panasonic parts for Panasonic products. It makes sense.

Any other part means less than Panasonic quality. And we couldn't have that. Because we couldn't let our Panasonic family down.

A family made of Panasonic people. Standing behind every Panasonic part we make. Specialists at what they do. Designers. Engineers. Technicians. Testers. Inspectors. All concerned with doing their job the best way, and the most advanced way. Even the kind of package design and proper packing is carefully considered. Ensuring the best possible care in handling.

And our quality control and inspection doesn't end when a part is made. Products from the production line are tested. And re-tested. And tested again before they're put on shelves. And

sometimes even after they've been on the shelves for a while. It's a job that's continual. The only way we know how to do it. Because quality is our "thing" at Panasonic. We owe this allegiance to our family. To you who sell and service our products. And to our customers. So they'll be happy they bought Panasonic. And so they'll continue to buy Panasonic.

That's why we have Factory Servicenters, five Regional Parts Depots and a Central Parts Depot. To stock over 20,000 kinds of parts. There to back up each and every Panasonic sale.

Think about it, Panasonic parts for Panasonic products does make sense.

PANASONIC®

just slightly ahead of our time.

Matsushita Electric Corporation of America
National Headquarters, Service and Parts Division
10-16 44th Drive, Long Island City, N. Y. 11101

... for more details circle 123 on Reader Service Card

TEKLAB REPORT

Most of the color-TV receivers reviewed have new circuits to simplify the most annoying adjustment, correcting the fleshtones viewed on the TV screen

Television Circuit Review for 1971

Part II

by Joseph Zauhar

■ A majority of the color-TV sets for 1971 have made some efforts towards chassis serviceability, simplifying component removal and new circuits making customer color adjustments easier.

General Electric has introduced a new clamp circuit for improved gray scale stability.

Philco-Ford's large-screen color-TV chassis employs diodes for red-to-green matrixing to help adjust for differences in signal variations for improvements in flesh tones.

RCA features a slide-out chassis and a split-cascode mixer circuit, permitting individual prealignment of the VHF tuners and IF link circuit so that the tuners may be interchanged in the field without realigning the link circuit.

We will describe the functions of some of the new circuits, but a more detailed Teklab Report will follow as the new color-TV sets are introduced.

ADMIRAL

Admiral has introduced its first color Cartrivision console, which incorporates a video tape recording/playback deck and a color-TV receiver. This system has the dual capability of recording programs directly off the air in B/W or color, and playing back prerecorded cartridges containing tapes of full length movies, which will be available on a purchase or rental basis for only \$3.00.

An 18-in. color-TV receiver with solid-state components, slide TINT and COLOR controls, and solid-state automatic fine tuning has been added to the 1971 line.

Admiral's 23-in. Solarcolor-TV consoles feature slide lever COLOR and TINT controls and a Color Monitor circuit.

The color monitor is of completely solid-state design with the circuit panel components located directly in front of and beneath the pulse regulator tube. The purpose of the monitor is to automatically adjust the color signal so that a correct flesh color is maintained when switching stations or during change of programs, cameras or scenes.

The color monitor switch has three positions allowing FULL, PARTIAL or NO correction to the color. The preference control is adjusted for the fleshtone most pleasing to the user. The chassis also has automatic frequency control to keep the station correctly fine tuned and automatic chroma control to hold the chroma at a constant level.

All of the chroma signal passes through the color monitor on its way from the first bandpass to the second bandpass amplifier (see Fig. 1). The color signal is then

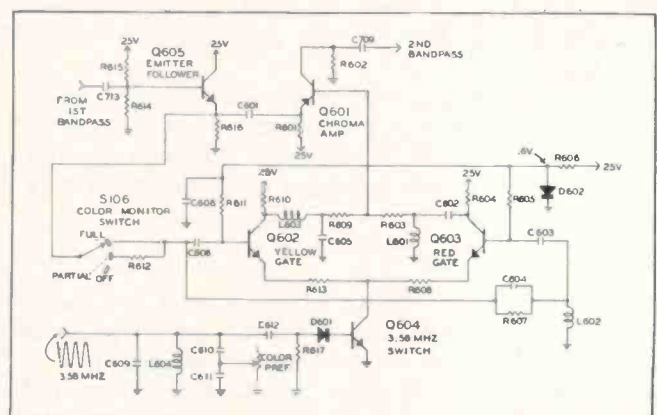

Fig. 1—Admiral's solid-state Color Monitor automatically adjusts the color signal for a satisfactory flesh color.

fed to the emitter follower transistor (Q605). The signal from the emitter is split; one circuit going through capacitor C601 to the emitter of the chroma amplifier transistor (Q601) and the other going to the three-position color monitor switch. With the color monitor switch in the OFF position, there is no amplification of phase change by transistor Q601 and the color signal returns to the second bandpass amplifier without phase correction. In the FULL position, the color signal is fed to the base of the yellow-gate transistor (Q602) through capacitor C606 and to the base of the red-gate transistor (Q603) through resistor R607 and capacitor C603. In the PARTIAL position, the signal is attenuated by resistor R612 before going to the bases. Both gates may be operating at the same instant with different signal levels, or one may be completely shut off while the other is operating. The emitters of both the yellow and red gates are joined together and complete their conducting paths through the collector-emitter of transistor Q604 to ground. The collector of both gates is connected to phase correction networks then to resistors R609 and R603. The two signals mix with the original color signal in transistor Q601 and return to the second bandpass amplifier.

There are two phase shifting networks associated with the red-gate transistor. The first shift network is in the input circuit, consisting of coil L602 and capacitor C604, and it shifts the signal in a 90° leading direction. The second shift network is in the output circuit, consisting of coil L601 and capacitor C602, and it shifts the signal in a 30° leading direction. There is also one phase shifting network associated with the yellow-gate transistor. This network is located in the output circuit, consisting of coil L603 and capacitor C605, and it shifts the signal 90° in a lagging direction.

The 3.58MHz color oscillator signal passes through the phase adjusting network (C609-L604) causing it to be in the proper phase relationship with the burst signal. The preference control (R149) is connected at this same point. It will vary the phase angle $\pm 30^\circ$. The signal passes through capacitor C612 and switching diode D601 to the 3.58MHz switching transistor (Q604). Diode D601 allows positive pulses to pass to the base of transistor Q604 and only the very peaks of these pulses control the transistor and create the low resistance path to ground in the collector circuit. Diode D602 is used as a voltage regulator to provide a constant bias for the base of each gate transistor (Q602 and Q603).

There are several causes for flesh colors to be wrong but the common one is that the color signal is out of proper phase with the burst signal. The color monitor will compensate for this condition and make satisfactory flesh color corrections.

CHANNEL MASTER

The new line of Channel Master color-TV consoles includes a black screen and bright rare earth phosphors for a truer color picture. The screen of the tube is a jet black base, surrounding the minute green, blue and red rare earth phosphor dots. The tube will carry the full three-year warranty with one year labor charges—Channel Master being reportedly the first to offer the

black face tube with a full three-year warranty.

Seven color consoles are offered with the following features: new black screen picture tube, instant-on, automatic fine tuning, keyed automatic gain control, automatic degaussing and three-year warranty on the CRT.

The color consoles also feature a Color-Trac circuit, shown in Fig. 2, for providing dynamic chroma gain

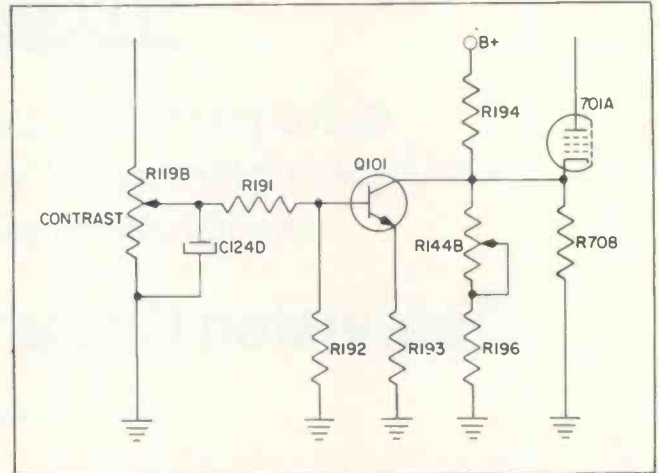

Fig. 2—Diagram of the Color-Trac circuit employed in the Channel Master's color-TV consoles.

dependent on the setting of the contrast control. Dynamic control is achieved because transistor Q101 is connected in parallel with the cathode resistor R708 of the chroma bandpass amplifier, V701A. This circuit decreases the total cathode resistance, thereby increasing chroma gain. Total cathode resistance becomes smaller as the transistor collector current increases and the effective collector-to-emitter resistance of the transistor decreases.

The color trac transistor base bias voltage is obtained from the voltage divider network, resistors R191 and R192. This voltage varies with the voltage across capacitor C124D which, in turn, varies with the setting of the contrast control, R119B. Through transistor action, the collector current of transistor Q101 increases and decreases in step with the setting of the contrast control. Since increasing contrast causes greater conduction of the transistor and increasing transistor conduction causes the chroma gain to increase, the color output then tracks with the contrast control setting. Color trac can also be varied by adjusting the color trac control R144B. As the resistance of control R144B is increased, the voltage divider network (resistors R194, R144B and R196) supplies more collector voltage to transistor Q101. The transistor gain is thus increased and color trac action becomes more effective.

Color portable TV receivers are also available in 12-in. diagonal (75 sq in.), 15-in. diagonal (117 sq in.), and 18-in. diagonal (180 sq in.) screen sizes.

GENERAL ELECTRIC

The new KE-II color television chassis introduced for 1971 is a continuance of the KE chassis line of large screen receivers.

The main difference between the basic KE-II and the

KE chassis is the copper pattern configuration of the main etched circuit board. The copper pattern has been changed to accommodate the addition of two new circuits used in the deluxe KE-II chassis models.

Six deluxe KE-II models feature picture tube type 25VAKP22 with a 25-in. diagonal measurement picture. The secondary controls are mounted on a tilt-out control panel assembly. The BRIGHTNESS, CONTRAST, COLOR and TINT controls are operated by sliding the knobs rather than rotating them.

In addition to the Customatic Tint Lock circuit, the deluxe models also have a clamp circuit which controls the CRT No. 1 grid voltages for improved gray-scale stability. The clamp circuit components are assembled on an etched circuit board which is mounted vertically on the metal channel directly above the main circuit board.

In most color-TV receivers, long term gray scale shift may occur due to the common practice of dc coupling the color difference amplifiers to their respective number one grids in the CRT to maintain the dc component of the chroma signal.

With this circuit, gray scale can be maintained only as long as the dc voltage remains constant on each of the CRT No. 1 grids. Because of the dc coupling, however, the voltage on any one of the CRT No. 1 grids can change if its respective color difference amplifier plate voltage changes. A plate voltage change could occur because of a circuit malfunction or aging of tubes or components.

The new clamp circuit maintains a constant voltage on each CRT No. 1 grid that is unaffected by any changes that might occur in the plate circuits of the color difference amplifiers. The clamp circuit is shown in Fig. 3 as a black box for one CRT No. 1 grid.

The color difference amplifier plate is ac coupled to

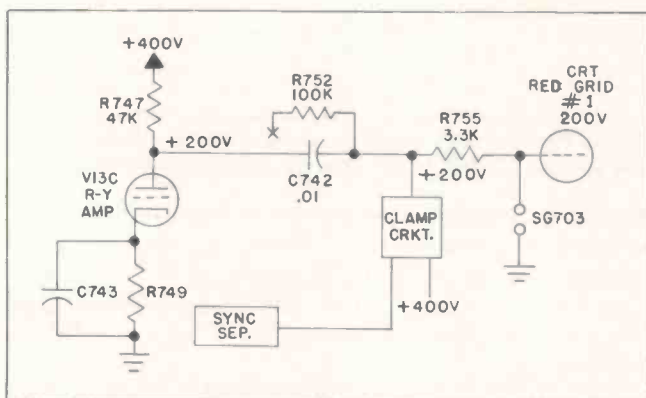

Fig. 3—General Electric's clamp circuit maintains a constant voltage on each CRT No. 1 grid to produce a stable gray scale.

the CRT No. 1 grid (the 100K resistor has been disconnected) with a coupling capacitor blocking its dc plate voltage from the CRT grid.

The clamp circuit supplies a voltage to the CRT No. 1 grids, which remain constant because they are clamped each time a horizontal sync pulse is present. This constant grid voltage serves to maintain a stable gray scale and provides restoration of the dc component of the color signal since the CRT grid voltage has the

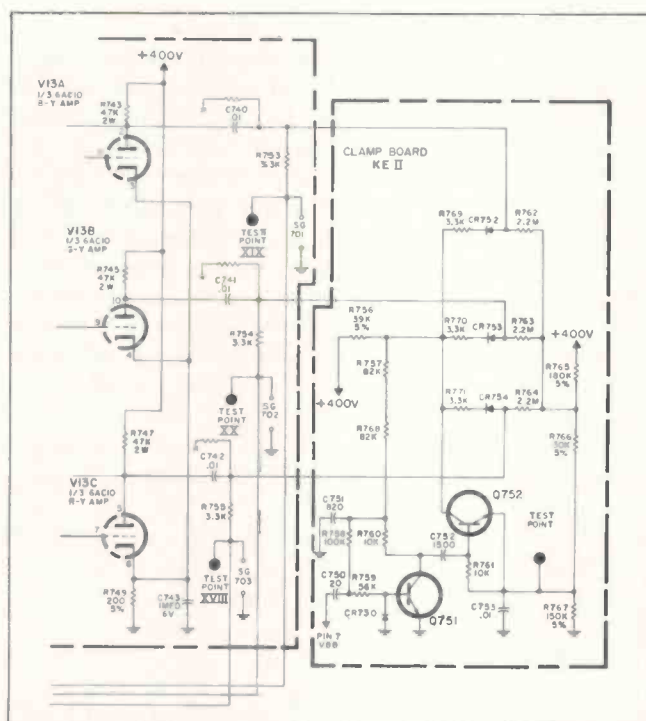

Fig. 4—Shown in this schematic are the simple connections made from the clamp circuit board to the main circuit board in General Electric's KE-II chassis.

same value as the amplifier plate voltage.

Several simple connections are made (Fig. 4) from the clamp circuit board to the main circuit board: Three connections to the coupling capacitors C740, C741, C742; one connection to B+ 400v; one connection to ground; and one connection to the plate of the sync separator tube, V8B Pin 7.

The clamp circuit is connected to the color difference amplifier coupling capacitors and the CRT No. 1 grids. The circuit is unique in its ability to supply a constant voltage to the CRT No. 1 grids either without signal or with signal at the antenna terminals.

In short, the circuit operates in the following manner: during the 3.5μs pulse duration the three color difference amplifier coupling capacitors C740, C741 and C742 are discharged from 0.06v and clamped to zero volts while capacitor C753 is charged to +190v. During the 60μs trace interval, the coupling capacitors are charged to 0.06v from the +225v bleeder supply which was elevated from +200v by the +190v charge on capacitor C753.

Thus a stable voltage is provided for the CRT No. 1 grids (with dc restoration on the chroma signal) which is entirely independent from the plates of the three color difference amplifiers.

The Customatic Tint Lock Circuit is basically designed so that good skin tones become available over a wider range of the tint control, and the tint changes which are normally seen on the screen, due to camera or program changes at the station, are greatly minimized or not seen at all when the tint lock is used.

In the KE Chassis and KE-II 23-in. chassis, the demodulation phase angle is set at 110°.

In the deluxe 25-in. KE-II chassis models, the same

method is used to set the demodulation at 110° but, in addition, a switch is used for setting the demodulation angle at 130° and 150° . This phase angle between the demodulators can be increased by either of two methods.

The KE-II Customatic Tint Lock circuit changes the phase of the chroma information to the two demodulators in a manner that would be comparable to increasing the demodulation angle by changing the phase of the subcarrier. This required a change in the demodulator circuit. The first change is to remove the connection between the cathode of diode CR703 and the anode of diode CR704. This circuit is then added between the arm of the color control (R101) and the demodulators, as shown in Fig. 5.

A three position switch (SW110) is used to switch

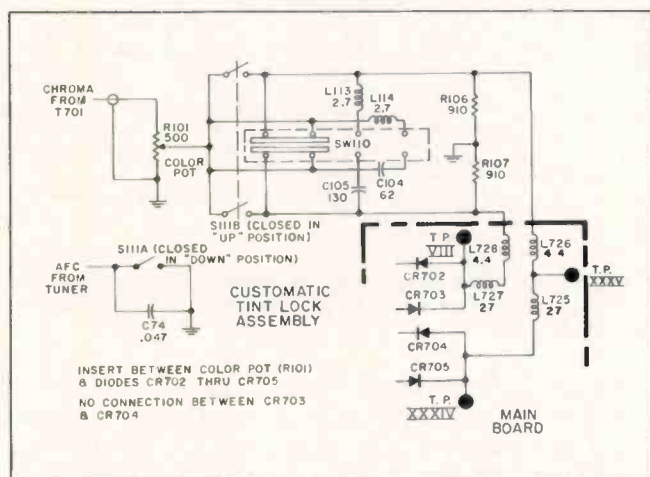

Fig. 5—The Customatic Tint Lock circuit in General Electric's KE-II chassis is added between the color control and the color demodulators.

in the three demodulation angles: Position 0 = 110° , Position 1 = 130° , and Position 2 = 150° .

The switch is shown in Position 0. Tracing the chroma signal from the color control (R101) to the demodulators, through both sides of the switch, reveals that both demodulators are receiving chroma information at the same amplitude and phase so the demodulation angle is 110° . Since there is a separate line for chroma to each demodulator, coil L728 has been added to match coil L726 and coils L725 and L727 have been added for additional tweet suppression. Then there are resistors R106 and R107. They are needed in Positions 1 and 2, but in Position 0 they only serve to attenuate the chroma signal since they are balanced to ground.

With SW110 in Position 1, the basic tint lock circuit is in place. The chroma signal for the B-Y demodulators (diodes CR702 and CR703) is fed from the color control R101, through switch SW110 and capacitor C104. The R-C circuit (resistor R107 and capacitor C105) is called a differentiator and it causes a phase lead in the chroma information to the B-Y demodulator, which rotates the B-Y chroma information counterclockwise (CCW) on a vector—the equivalent of moving the B-Y subcarrier in a clockwise (CW) direction. Stray capacitance, plus demodulator impedance, account for the difference between the measured and calculated values.

The chroma signal for the R-Y demodulators (diodes

CR704 and CR705) is fed from the color control R101, through switch SW110 and choke L113. The RL circuit (resistor R106 and choke L113) is called an integrator; and it causes a phase lag in the chroma information to the R-Y demodulator, which rotates the R-Y chroma information CW on a vector—the equivalent of moving the R-Y subcarrier in a CCW direction.

The results of the chroma phase shifts for switch Position 1 are shown in Fig. 6 in the form of subcarrier phase shifts. The B-Y subcarrier has shifted 15° CW and the R-Y subcarrier has shifted 5° CCW. The demodulation angle for Switch Position 1, therefore, is: $5^\circ + 15^\circ + \text{original } 110^\circ = 130^\circ$ total.

The circuit for switch Position 2 is the same as Position 1, except that the capacity in the differentiator has been reduced to 42pf due to the addition of capacitor C104 in series with capacitor C105. Calculating 0 in the same manner as for Position 1, produces an equivalent CW change of 30° in the B-Y subcarrier phase an-

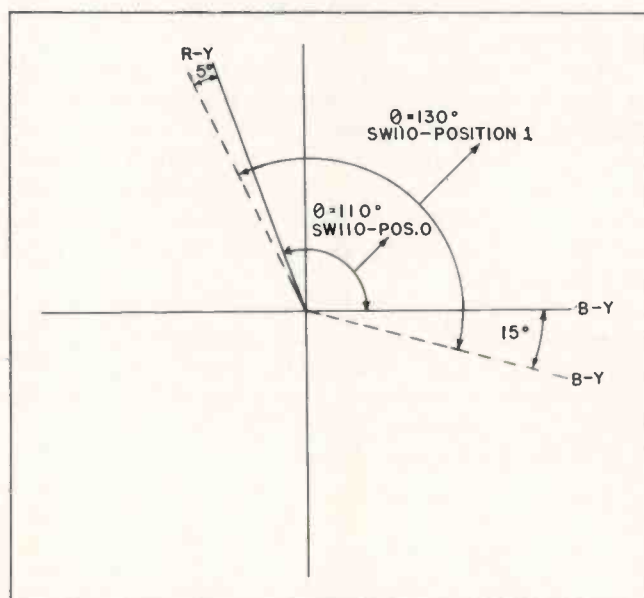

Fig. 6—Vectors indicate the results of the chroma phase shifts in General Electric's tint lock circuit when the switch is in position one.

gle. In the integrator, choke L114 has been added in series with choke L113 to double the inductance resulting in an equivalent CCW change of 10° in the R-Y subcarrier phase angle. The demodulation phase angle for switch Position 2 is then: $30^\circ + 10^\circ + 110^\circ = 150^\circ$ total.

The result of all this is that with the switch in Position 0, the tint control range and colors are the same as in the KE Chassis. In switch Position 1, with a demodulation angle of 130° , there is a slight loss of green and the chroma response is moved slightly towards the orange-cyan axis of the chromaticity diagram. In Position 2, with a demodulation angle of 150° , there is a moderate loss of green and the chroma response is operating near the orange-cyan axis.

PHILCO-FORD

Among the features built into Philco-Ford's new sets are two innovations in UHF tuning, including an elec-

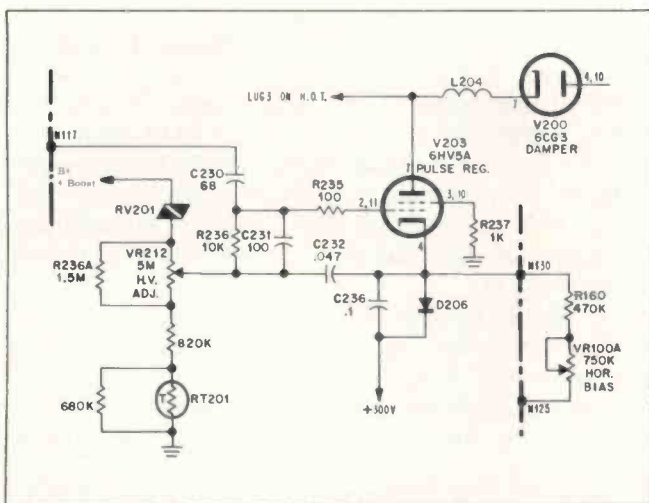

Fig. 7—Partial schematic of the high-voltage pulse regulator now employed in Philco-Ford's 25-in. color-TV chassis.

tronic touch-button system. Also included are a new 25-in. picture tube, plus other tube and chassis changes providing brighter pictures and truer color reproduction.

The Hi-Brite Magicolor CRT has been extended to all 1971 models and screen sizes in the current line range from 10 in. to 25 in. (measured diagonally). The company's Cosmetic Color circuit is now in all receivers with 16-in. and larger screens.

The silent, electronic tuner for UHF channels 14 through 83 is offered in the 25-in. console models C7380UWA and C7382UDK at the top of the line. Another change incorporated in the 25-in. receiver provides better control of the high voltage.

The high-voltage pulse regulator now employed in the 25-in. color chassis, as shown in partial schematic Fig. 7, is entirely different from the shunt-regulator system used in the early 16M91 chassis. The shunt regulator was a dc control system whereas the pulse regulator is a pulse-controlled system.

When the shunt regulator was replaced by a varistor controlled feedback circuit in the 16QT85 hybrid color chassis, this system operated by pulse action to develop the necessary dc to maintain a regulated high-voltage system.

In the 21ST90 series chassis, the use of a varistor feedback circuit and the advantage of a pulse-regulator system are combined to give the chassis a double controlled high-voltage system.

The operation of the pulse-regulator system is based on the loading and unloading of the H_{OT} primary winding, this change being reflected in the tertiary winding (secondary winding). All of this occurs during retrace time. As a result, the tuning of the primary and secondary pulses are changed.

Conduction of the regulator tube is controlled by two parameters:

- A variable dc voltage obtained from the B boost voltage to vary the conduction of the regulator tube.
- Narrow timing pulses of constant width and amplitude obtained from the horizontal oscillator to allow the regulator to conduct only during retrace time.

The CRT anode and B boost voltages vary in the same direction and are both inversely dependent on pic-

ture brightness variation. If the picture brightness increases, the CRT anode and B boost voltage decreases and vice versa. For this reason the B boost voltage is used to control the conduction of the regulator tube.

The timing pulses stay on top of the dc voltage derived from the B boost voltage, and the amount of conduction of the regulator tube is controlled by how far the timing pulses surpass a predetermined level of grid voltage. If the dc level set by the high voltage control adjustment (VR212) is too low, the regulator tube may become cut off. The variation of the B boost voltage in conjunction with the timing pulses varies the current through the regulator tube. As the current varies, the regulator tube presents a varying load to the primary of the transformer in such a way that the overall tuning is changed.

The new VVC UHF tuner utilized in the 21ST91 chassis incorporates four varactors as a control for UHF channel selection.

The tuner can be pretuned to select up to six UHF

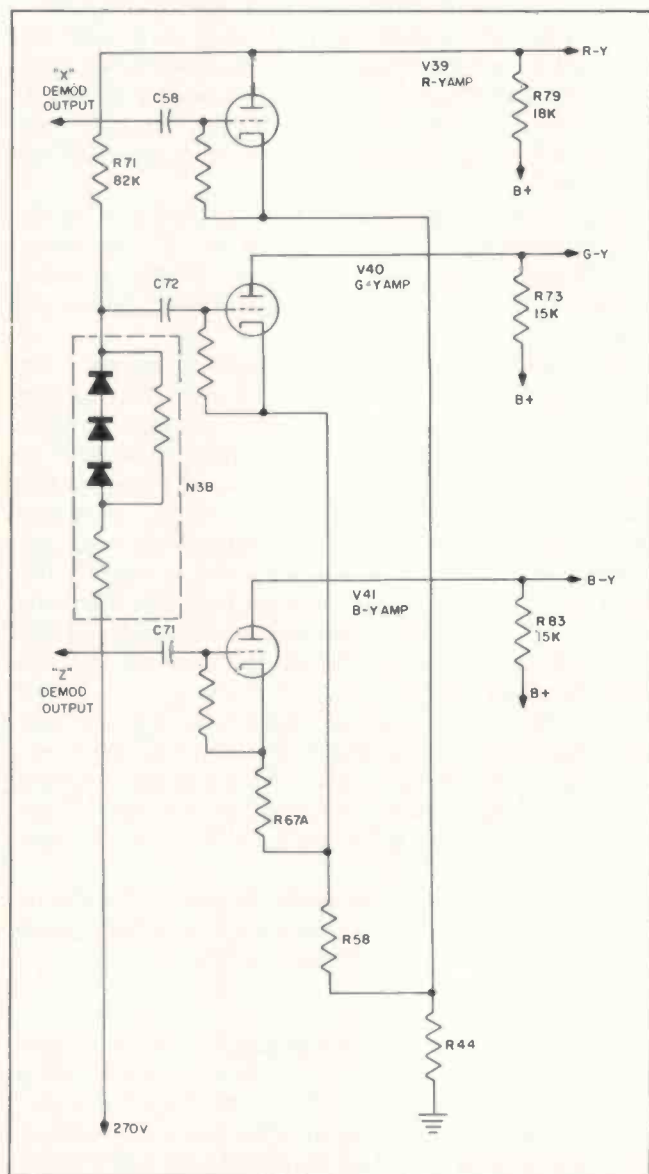

Fig. 8—Philco-Ford's new color matrixing circuitry employs diodes for red-to-green matrixing to help adjust for color transmission variations.

channels by the adjustment of six front mounted thumb controls and the individual selection of up to six channels by the touch of a button adjacent to the thumb control. Automatic channel selection control of the six channels is developed by use of channel selection circuit stages mounted on a separate VVC control panel.

The variable voltage capacitance (VVC) UHF tuner is tuned to a desired frequency by varying the voltage impressed upon varactor diodes (found inside the UHF tuner). The varactor is a diode employed as a variable capacitor. The application utilizes the junction capacitance and the characteristics of a P-N junction. The junction capacitance of a varactor varies with the reverse bias voltage impressed upon it.

When a reverse bias voltage is impressed upon a P-N junction the depletion region is widened. This is the same as separating the plates in an ordinary capacitor, and since capacitance is inversely proportional to the distance between plates of a capacitor, the junction capacitance is decreased.

The VVC UHF tuner incorporates four varactors, two to tune the transistorized RF amp stage and the other two to tune the transistorized local oscillator stage.

The 1971 Philco-Ford color-TV chassis for the larger screen sets also utilize diodes for red-to-green matrixing to help adjust for differences in color camera set up at the studio.

Fig. 8 shows this circuit with a matrix network (N38) replacing resistor R78, used in "T" line color TV receivers. And resistor R71 was changed in value to provide the desired amount of quiescent diode current.

When the "X" Demodulator output is negative, the R-Y amplifier plate voltage is high and the voltage across N38 is low, making the diode impedance high. This causes a little green contamination of the reds as more R-Y signal is fed to the G-Y amplifier and the red vector moves towards orange. When the "X" demodulator output is positive, the R-Y amplifier plate voltage is below quiescent value and the color is cyan if the green and blue guns are at quiescent bias. The low voltage at the R-Y amplifier plate means high diode current and nearly constant diode impedance, producing no appreciable distortion.

Since the red vector shifted towards orange, the face tones will shift towards green. The tint control is adjusted to rotate the face vector to the proper position and, in so doing, rotates all vectors in the same direction. Thus, the greens are greener and the cyans are less bluish and more correct.

The resistor shunting the diode prevents color distortion due to diode cutoff by providing a path for current to flow when the diodes are reverse biased.

RCA SALES CORP.

The 1971 color television line features two new chassis, including the hybrid CTC39, 39X chassis which is similar in many respects to the CTC38. TransVista color television instruments features the new CTC44 chassis, which is much like last year's CTC40 and CTC47 chassis.

Both chassis feature slide-out chassis serviceability

by simply loosening two screws on the rear apron of the chassis and sliding them back to expose the bottom for servicing.

Both chassis feature a split-cascode mixer circuit that permits individual prealignment of the VHF tuner and IF link circuit so that the tuners may be interchanged in the field without the necessity of realigning the link circuit. Also featured are dual 75/300Ω antenna inputs that allow the receiver to be connected to a 75Ω antenna system.

The chassis features Accu-Tint, a customer feature that optimizes color reception under differing transmission conditions. This system improves the color picture by modifying the color reproduction to minimize the change in tint of fleshtones when a burst phase error exists.

Considering the phase angles of reproduced colors, in reference to the burst at 0°, it is found that the desirable fleshtone orange lies very close to (or on) the phase angle of 57°. The vector diagram of Fig. 9 reveals that the desirable fleshtone is composed mostly of

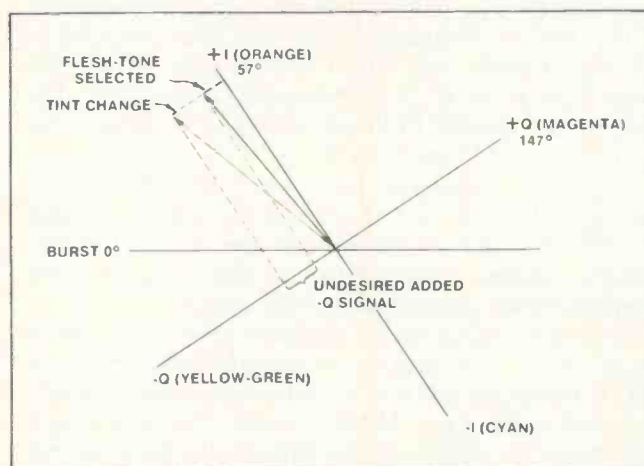

Fig. 9—The vector diagram reveals that the desirable fleshtone is composed mostly of the $\pm I$ signal plus a relatively small amount of $\pm Q$. Shown are the fleshtones produced without the RCA Accu-Tint circuit.

the $\pm I$ signal plus a relatively small amount of $\pm Q$.

Assume now that the burst phase has shifted so that "greenish" fleshtones are produced. "Greenish" fleshtones result from the addition of more $-Q$, as illustrated in Fig. 9. If the burst phase error should be in the other direction, or where $+Q$ is added to $+I$, the fleshtone vector rotates to a phase angle producing "purplish" fleshtones. Thus, the addition of undesired amounts of $\pm Q$ produces undesirable fleshtone changes.

Accu-Tint reduces the fleshtone tint change by reducing the amount of $\pm Q$ added to the I signal. This minimizes the change in the fleshtone coloration as a result of burst phase errors. Engineering and viewing tests revealed that the Q signal could be reduced 50 percent without adversely affecting the color picture quality. The reduction of Q is possible because the narrow bandwidth Q signal contains substantially less color information than the I signal. Also, colors produced by large amounts of $\pm Q$ are those to which the eye is relatively insensitive.

continued on page 60

New Approach to Antennas

by Phillip Dahlen

Wing-like elements are designed to replace the many tubular elements found on standard antennas of comparable power

■ A 2½-lb, solid-state TV antenna has just recently been unveiled which is only 46 in. long and measures only 6 in. at its widest point. Yet, according to John R. Winegard, president of Winegard Co., it performs as well or better than much larger antennas, satisfactorily picking up stations 40 or more miles from TV transmitters.

Called the Sensar Model SR-20, the antenna has two flat "wing-like" anodized elements and solid-state, modular circuitry enclosed in a high-impact polystyrene housing. Like the elements, the antenna is said to be

totally waterproof. Connections from the antenna to the power coupler is accomplished through 75Ω shielded coaxial cable. Dual mounting clamps are designed to fit 1- to 1½-in. o.d. masts.

Additional specifications indicate that the antenna has a 54 to 88MHz and a 174 to 218MHz VHF bandpass and a 470 to 890MHz UHF bandpass. It is said to have bi-directional sensitivity with approximately a 90° optimum capture angle from each direction and excellent side-signal rejection. A pilot light at the bottom of the antenna housing is de-

signed to indicate when all connections are tight and the circuitry is functioning properly. The lamp also serves as a voltage-surge regulator.

The antenna output signal is fed from a 75Ω coaxial "F"-type jack and is unbalanced to match standard coaxial cable. This cable is fed to a power coupler where it is terminated with the same type of jack.

The power coupler is housed in a 6- by 3 3/16- by 1¾-in. zinc-plated steel chassis having a clear irridite finish. It requires 110 to 125vac, 60Hz power and has two 300Ω TV-signal outputs. A signal control switch is provided to offer 0db and -20dB signal attenuation.

Because of the uniqueness of the Sensar's size and overall design, antenna company engineers have created three new antenna mounts. These include the SRM, which is a universal tripod roof mount measuring only 30-in. high; the SWM, which is a combination wall, window and chimney mount; and the STM, which has been designed to meet the growing need for a travel trailer and mobile home mount. ■



Unique design reduces antenna size while increasing its signal output.

Moving TV Sets

by Phillip Dahlen

Combination hand truck and tilting cradle helps ease job of bringing defective equipment back to the shop

■ Hernias are unfortunately an affliction not too uncommon for those engaged in electronics servicing. When a technician goes out alone (as he must if house calls are to be economically feasible) he is faced with the problem of bringing in any TV sets requiring benchwork. Fortunately there are several solutions . . . he can disassemble the TV set and lug it piece by piece to the truck for reassembly in the shop and maintenance—a task that must be repeated when the set is returned to the home . . . he can coax the frail housewife into helping him lift one end and run the risk of a lawsuit as she trips down the front stairs . . . he can tell the customer that movers will pick the set up for repair the first of next week . . . he can simply drag the console out of the house, ruining his back and scraping the cabinet against the doorway . . . or he can use some sort of cart to assist him in moving the TV set to his truck.

We are currently aware of only one hand truck on the market that is designed specifically for moving TV sets—the Mighty Mover manufactured by Griffiths Electronics, Inc. After reviewing the company's literature, it was felt that this helpful tool warranted a first-hand evaluation that could be passed on to other technicians in the industry.

The basic hand truck (Fig. 1) is lined with sponge rubber to prevent any cabinet damage and contains a fold-down platform for supporting table-model TV sets, as well as a clamp for tightening the security belt. Also included is a retractable third wheel (Fig. 2) for making the hand truck self-supporting and a swivel breaking system designed for easing the hand truck up and down flights of stairs.

After placing a new Zenith table-model TV set on the platform and securing it in place with a security belt, we found the load quite stable and easy to roll from place to place. The third wheel even proved capable of supporting the hand truck without outside assistance (Fig. 3).

Becoming a little more adventuresome, the loaded hand truck was then rolled down a flight of stairs (Fig. 4). Although the elevator was used to bring the load back up, the stairs had been maneuvered without any difficulty.



Fig. 1—Basic hand truck used for transporting TV sets.

The foam-rubber lined tilting cradle (Fig. 5) adds even greater versatility to the hand truck in that it permits the truck to transport console-model TV sets. The central portion of this cradle contains a large clamp, which when tightened can be used to exert an adequate force between the bottom of a console TV set and the hand truck. A locking collar prevents the clamp from loosening. Two rubber handles (which appear in the photo as though they were small black wheels) are used for locking extendable legs at the desired length. Fig. 6 shows this tilting cradle being supported by the hand truck prior to transporting a console TV set. Note that the fold-down platform has been folded out of the way.

For transporting TV consoles, the hand truck is first layed across the top of the console (Fig. 7), the foam rubber protecting the wood. One end of the cradle clamp is then placed beneath the TV set while the other is placed over the edge of the hand truck—the clamp being tightened until the hand truck just begins to lift off the top of the console. It is then locked into position against the hand truck. (Note the two flanges on the cradle, shown in Fig. 8, which are used to help secure it against the hand truck.)

Once the tilting cradle has been tightened, a security belt is passed under and around the TV console and then overlapped through the clamp slot. Fig. 9 shows that there are two clamp slots—one for long consoles and one for short ones. The belt-tightening handle is swung to secure the hand truck more tightly to the con-



Fig. 2—Third wheel and swivel breaking system are extra features included on the hand truck.



Fig. 3—The third wheel is capable of making the loaded hand truck self-supporting.



Fig. 4—Little difficulty was encountered in taking the loaded hand truck down a flight of stairs.

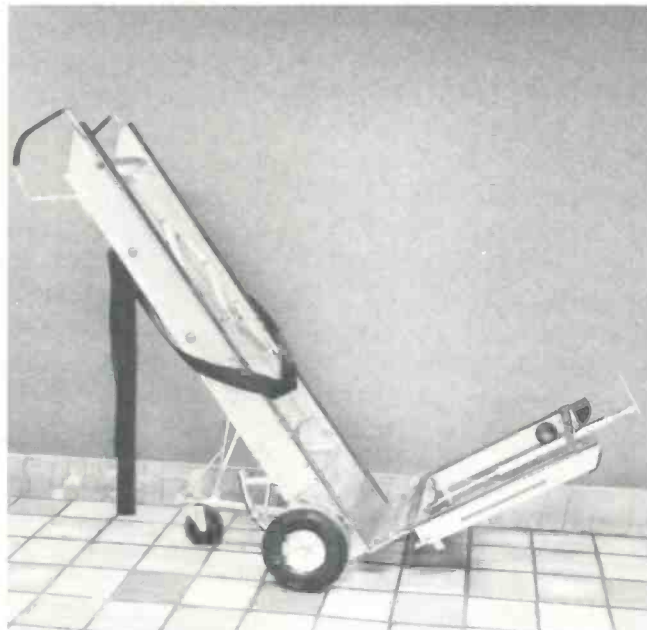

Fig. 6—Even without carrying a TV set, the hand truck and tilting cradle can be moved about as a single unit.



Fig. 5—The tilting cradle increases the versatility of the hand truck.

MOVING TV SETS . . .

sole and then locked in place.

After both the top and bottom portions of the hand truck are secured to the TV console, the legs of the tilting cradle are extended until they reach the floor (Fig. 10) and then locked in place. These cradle legs bear the weight of the console as it is lifted (Fig. 11) and turned over for transporting (Fig. 12).

Virtually no difficulty was experienced when transporting a new Sylvania console-model TV set with this hand truck. In fact, the hand truck was used to bring the new set in from the doorway of our Duluth building, where the shippers had left it, up to the ELECTRONIC TECHNICIAN/DEALER lab for a future report. ■

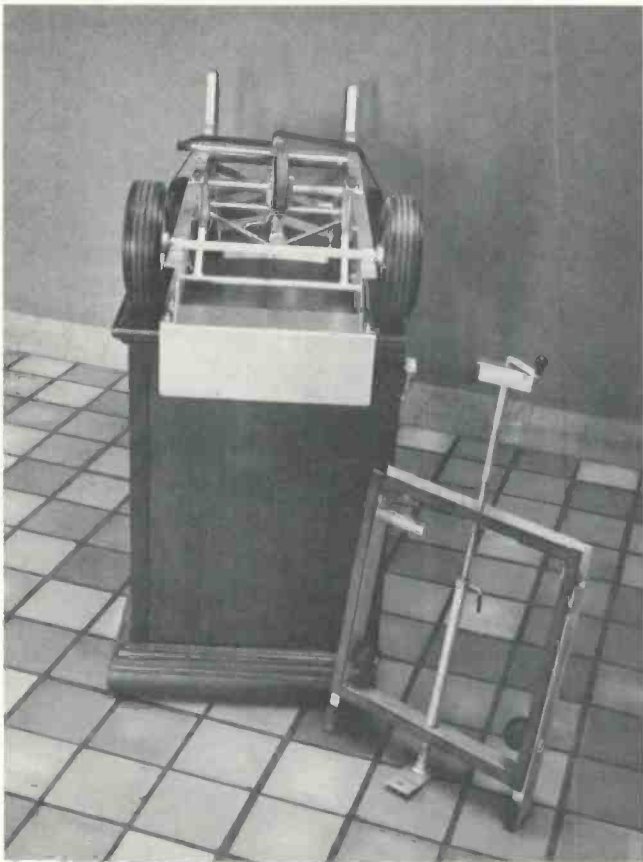

Fig. 7—The hand truck is layed across the top of the console-model TV set as the first step in securing the two together.

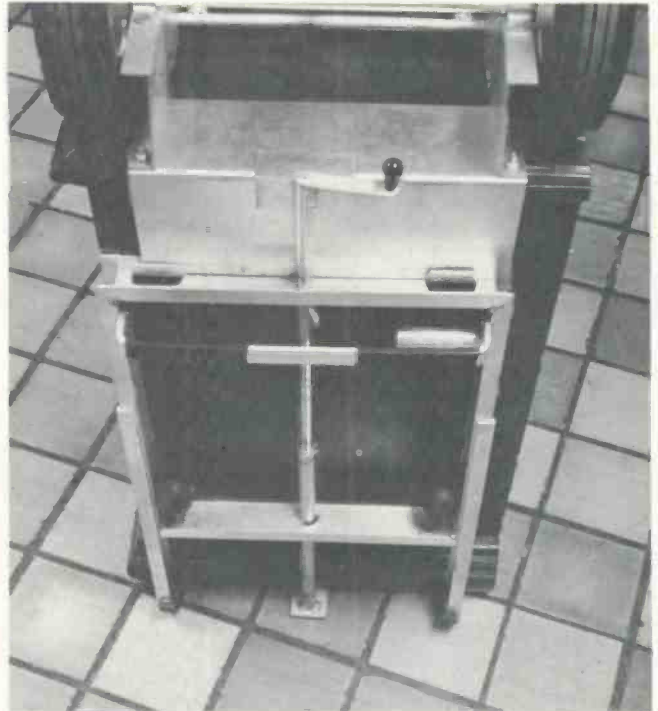

Fig. 8—Cradle flanges mesh with the hand truck to offer greater mechanical stability.



Fig. 9—Swinging a clamp at the top of the hand truck tightens a security belt around the console TV set and truck.

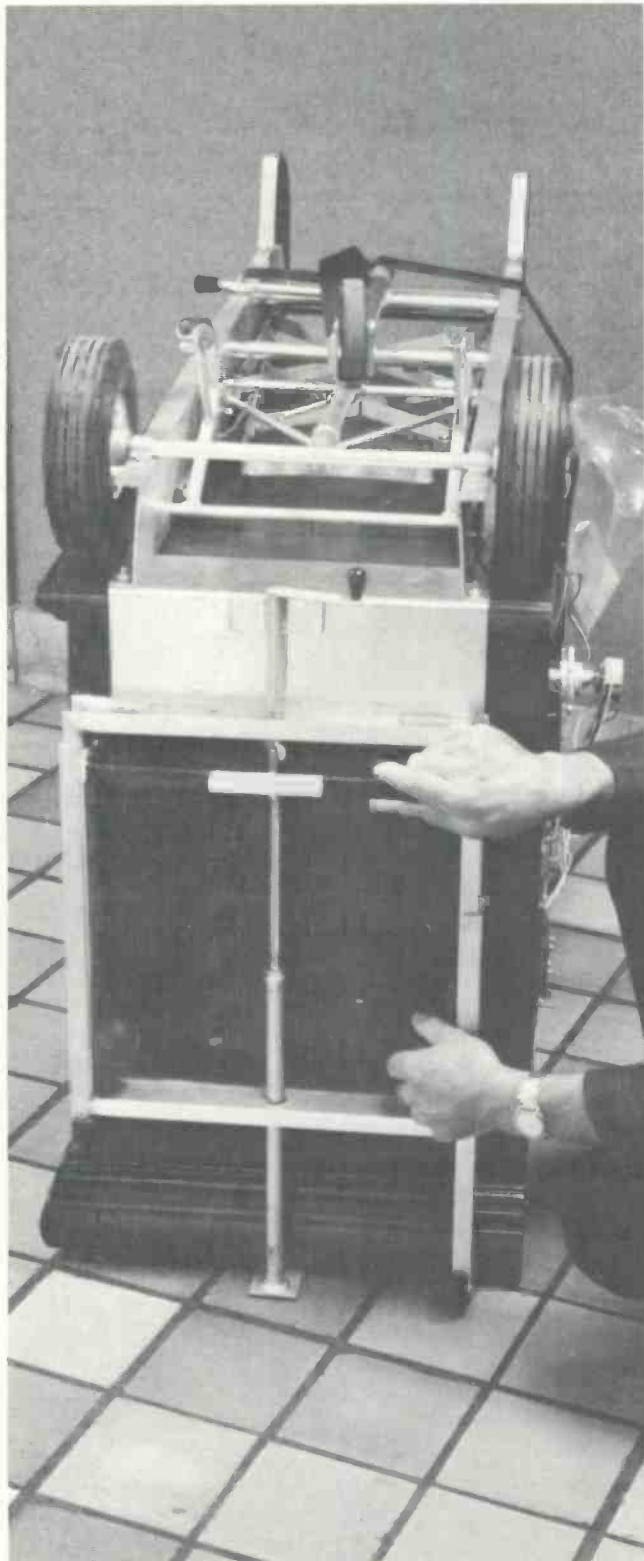

Fig. 10—The cradle legs are extended to the floor and then locked in place to bear the weight of the TV set when it is turned over to transport.

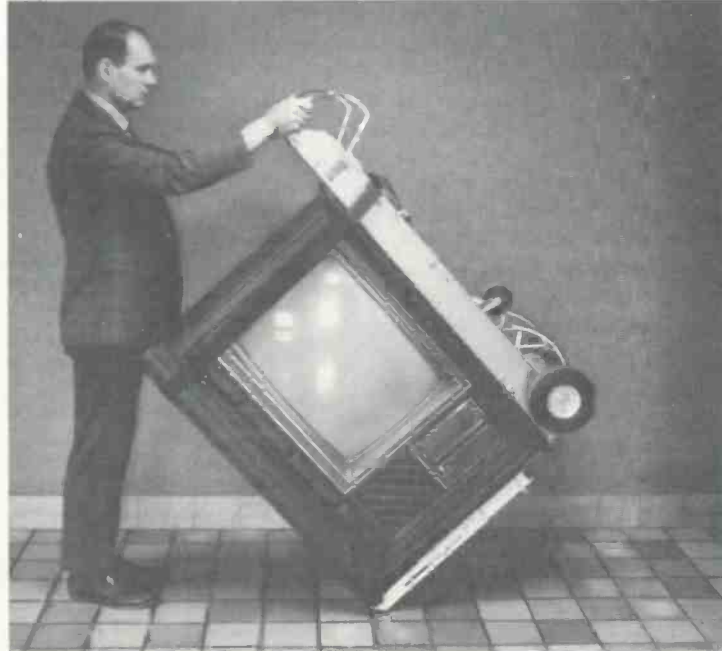

Fig. 11—The cradle supports the TV set as it is turned over.

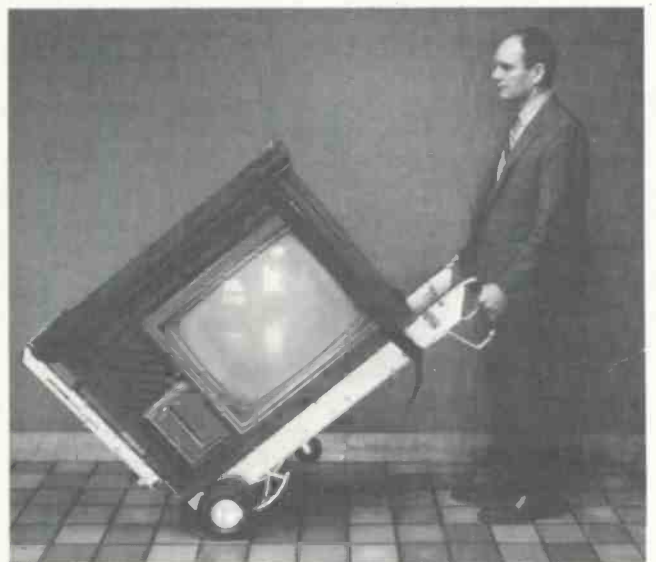

Fig. 12—Once in position, the hand truck bears the weight as the console TV set is moved to another location.

Quick-Testing Transistors

by Forest Belt

For some technicians, transistors are easy.

That is because they know these simple checks.

■ Despite the dependability of transistors, they are still the component most likely to be at fault in a solid-state set. So, if you can find bad transistors easily and promptly, you can lick most problems in a hurry.

If you have a transistor tester, especially an in-circuit type, by all means use it. It is the fastest and usually the surest way to make a test. But if you do not have a regular tester handy, do not let that stop you. There are other ways to test a transistor.

What Tests Are Needed?

In servicing, you are usually concerned with a stage that has somehow stopped functioning properly. You need to know right away if the transistor is at fault. If you can do that without having to take the transistor out of its circuit board, so much the better. Unsoldering and resoldering is messy, and offers the danger of heat-damaging an otherwise good transistor.

There are three basic ways to check a transistor. Which one you choose depends on your preference, how well you understand transistor operation, and what equipment you have on hand. Any one of the following three methods will give you a fairly good evaluation.

- You can deliberately change the bias on a transistor stage and measure the result across a collector or emitter resistor.
- You can open certain lead connections to the transistor and test for junction leakage.
- You can remove the transistor from its circuit board (or socket) and check it with your ohmmeter.

Changing the Bias

The thing you need most to know about any transistor in a TV set, radio or stereo system is whether it

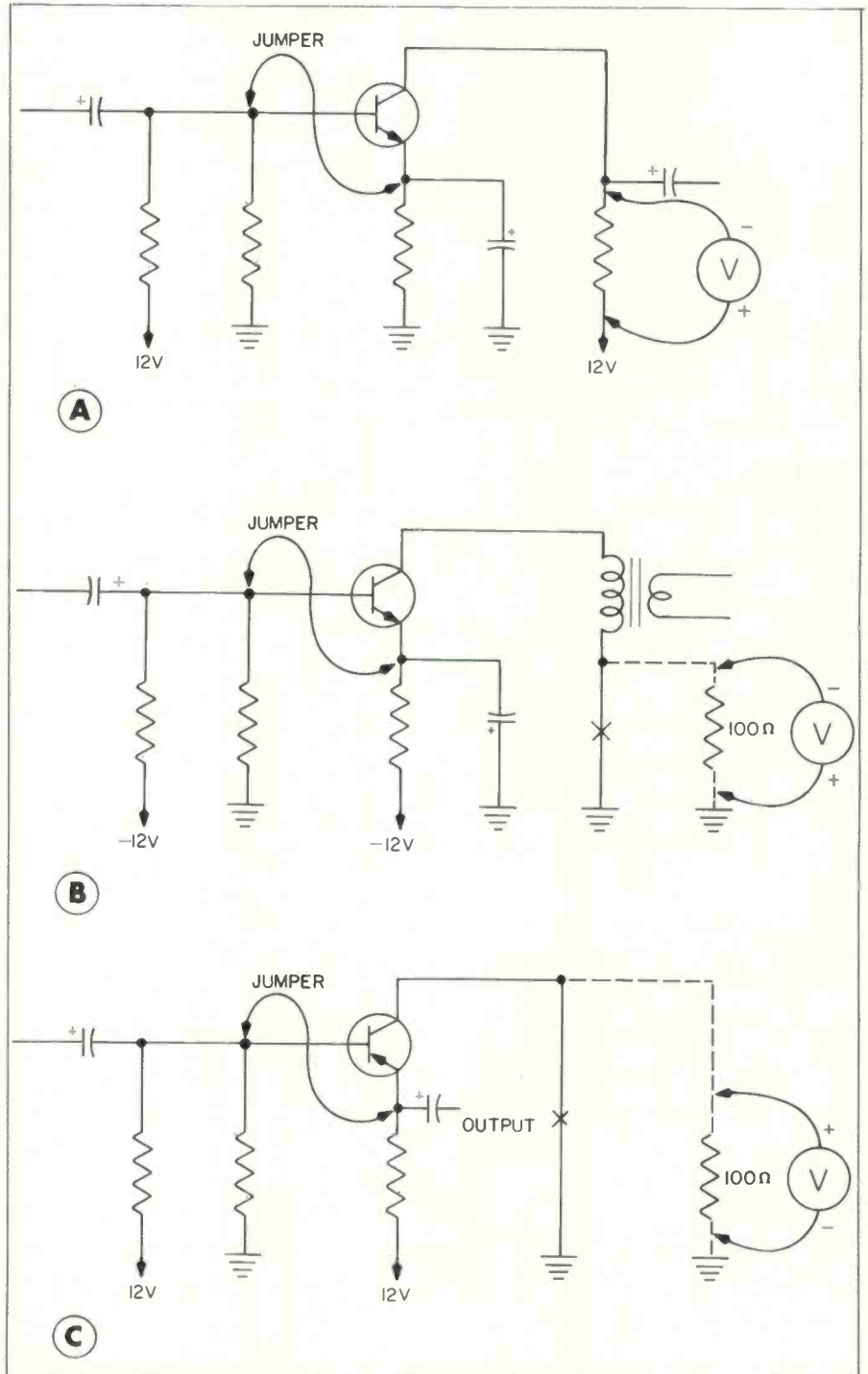

Fig. 1—Changes in circuit voltages, as a result of shorting the base of a transistor to its emitter, can indicate whether or not the transistor functions properly.

Transistor Ups and Downs

Don't laugh. The "ups" and "downs" are the most difficult barrier to understanding transistor troubleshooting.

Take the amplifier circuit shown below, for example. Suppose the emitter voltage has gone "down." What they mean is that its 0.3v emitter-to-ground voltage is lower than the normal 0.6v figure indicated in the diagram.

But the *bias* hasn't gone down. Bias is the voltage *between* the emitter and base. [*Editor's Note: It can also be the voltage between the emitter and collector.*] The schematic shows a 0.1v difference between these two voltages. That's the bias.

Notice, however, that the base is less negative than the emitter. For a PNP-type transistor, *forward* bias has the base *more* negative. So, the normal average bias in this particular stage is a reverse bias.

To say that the bias has gone down implies only that it has become less. Even greater confusion may result from the fact that the normal bias is 0.1v, but the new bias (with the emitter

at 0.3v) is 0.2v. Though it might seem as though the bias went up, it didn't. This is due to polarity. With the emitter-to-ground voltage reduced to 0.3v, the *base* has become more negative than the *emitter*. As a result of these voltage changes the base is now forward biased, rather than reverse biased as originally intended. This condition would upset any transistor circuit.

So, what is the answer to this dilemma in transistor voltages? [*Editor's Note: By the way, the same basic problem also occurs in tube circuits since tubes are actually regulated by their cathode-to-grid voltages.*] The answer is to quit using the words "up" and "down." Instead voltage measurements should be described as "more negative" or "less negative," and "more positive" or "less positive." Bias is described as "more reverse biased" or "less reverse biased," and "more forward biased" or "less forward biased." Or it could be said that the bias polarity has changed, as in this example.

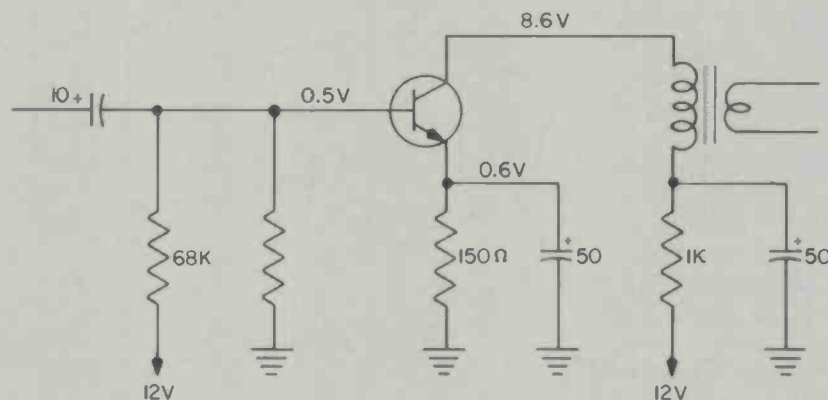

The transistor voltages indicated in this schematic are NOT transistor bias voltages.

can amplify. Even if it is an oscillator, the transistor's main purpose is to amplify a signal applied between its base and emitter. The amplified signal shows up across the output load, usually in the collector circuit.

Keep in mind that a signal is merely a voltage that changes value (and sometimes polarity) very rapidly, many times every second. Any voltage change that alters transistor bias is a half cycle of signal voltage. So, if you alter the dc bias some way and measure the change it causes in dc voltage across the output load, you are testing the ability of the transistor to respond to input-voltage changes.

Surprisingly enough, you can do this whole operation with a sensitive voltmeter, a jumper lead and sometimes a 100Ω resistor. Sound simple? It is.

Several possible connections for the voltmeter are shown in Fig. 1. Use the 100Ω resistor if there is no collector load or if its dc resistance is too low to develop much dc voltage. The 100Ω value will not bother the stage much, it is too low. By measuring voltage across it, you are indirectly measuring collector current.

The first test is for stages in which forward bias is used. In a PNP-transistor stage, this means that the transistor base is more negative (or less positive) than its emitter. Forward bias of an NPN-transistor stage means that the transistor base is more positive (or less negative) than its emitter.

Connect your voltmeter as shown in Fig. 1, and then watch its reading. Then clip a shorting jumper between the transistor's base and its emitter. The voltmeter reading should drop to almost nothing. If it does not, the base is not controlling the collector current the way it should.

There is a different way to test stages where zero or reverse bias is normal. The transistor, under these conditions, may conduct only during a small portion of each signal cycle, leaving an average or dc bias that is zero or of reverse polarity.

For testing transistors biased in this manner, the voltmeter connections are the same as those shown in Fig. 1; but instead of a shorting bias,

a definite forward bias is supplied to the base of the transistor (Fig. 2). If the transistor is working, the voltmeter readings become higher. This is because the forward bias has increased the collector current on the transistor.

How do you forward bias the transistor? Take the NPN-transistor stage shown in Fig. 2A as an example. The forward bias for NPN tran-

sistors demands that the base be more positive than the emitter. To provide this voltage, use a resistor substitution or decade box, starting with a high value (10K or more). Clip the box in parallel with the supply resistor, thus lowering its value. You could instead apply a positive voltage from any source through the resistor test box, but be sure the voltage applied to the base is ini-

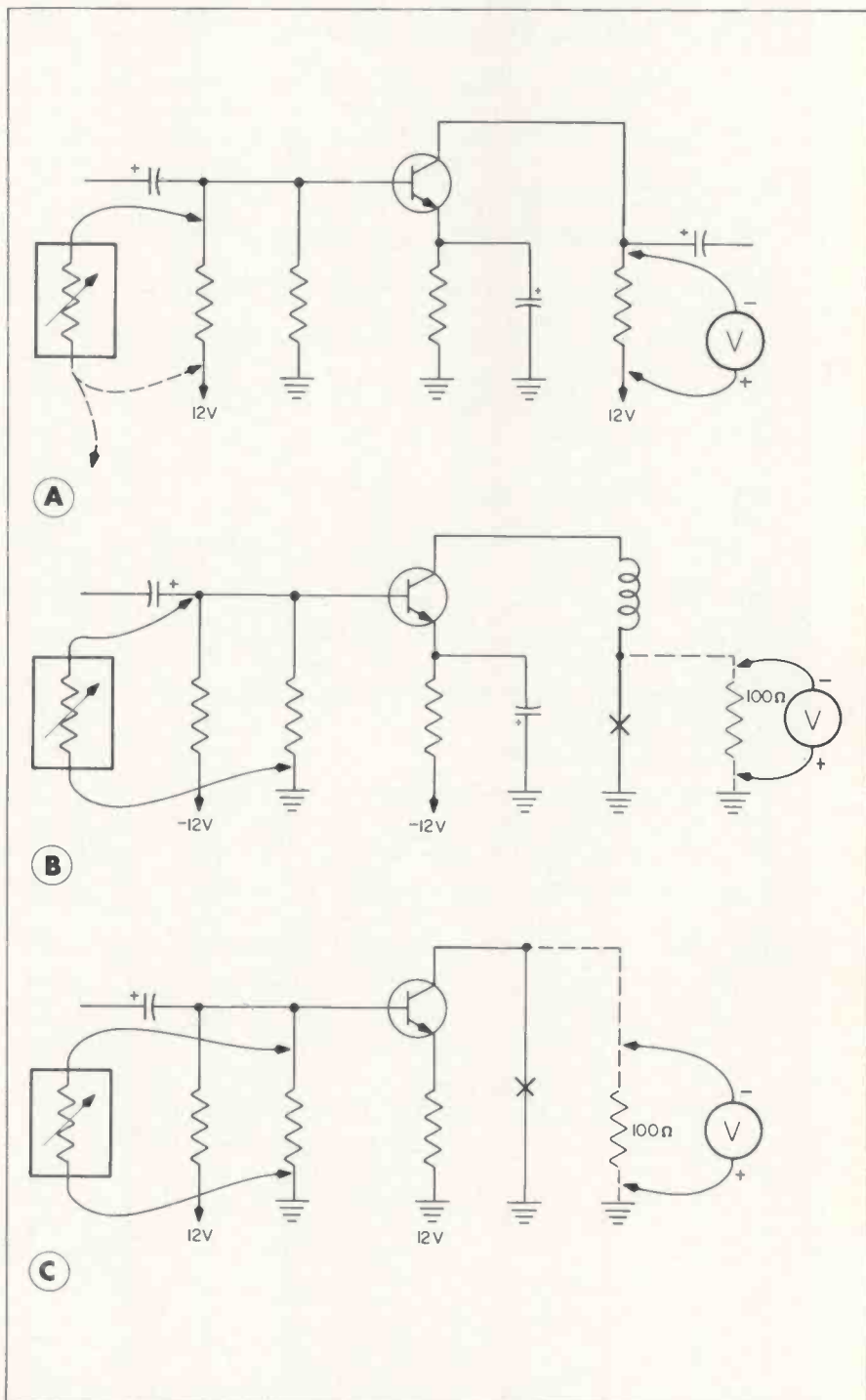

Fig. 2.—Changes in circuit voltages, as a result of modifying the transistor base-bias voltage, can also indicate whether or not the transistor functions properly.

tially so small that you do not blow the transistor.

It is not quite that simple with a transistor stage like the one shown in Fig. 2B. This circuit also contains an NPN transistor, which must be biased more positive than its emitter. That is the same as having a smaller negative voltage, so the object is to lower the transistor's negative base voltage. This can be done by bridging the base of the transistor under test to ground through a resistor-substitution or decade box. Again, start with a fairly high resistance value and gradually reduce it until the resulting voltage is right for forward biasing the transistor.

The voltmeter reading should be much higher with the additional forward bias than without it. If this is not the case, the transistor is not being controlled by its base and is faulty.

The PNP transistor shown in Fig. 2C needs a base more negative (less positive) than its emitter if it is to be forward biased. When the test resistor is connected as shown, the collector current reading should increase.

Testing for Leakage

Leakage can occur across the junctions of a transistor. There are two kinds of leakage. The kind that causes the most trouble in the stages of a solid-state consumer electronic product is collector-to-base leakage. It can seriously impair amplification.

To test for this leakage, set the voltage range of your voltmeter as if you were going to measure collector voltage. Leaving it set on that range, disconnect the base lead of the transistor. Then connect the voltmeter between the emitter and the free end of the base lead. The meter should detect almost no voltage as a result of transistor leakage.

Outside the Circuit

Your ohmmeter can be used for testing transistors once they have been removed from a circuit. It will tell you if a junction is open or if the collector-to-base junction is leaky. This is often enough to identify a defective transistor.

When making these measurements, use an ohmmeter that has a very low battery voltage (1.5v or

less) or you might damage the transistor. The polarity of the voltage at the ohmmeter test leads is not important unless you have to identify whether it is an NPN- or PNP-type transistor under test.

Start testing by clipping the ohmmeter to any two transistor wires. Connect them first in one direction and then in the other. If there is no reading either way, try a different pair of transistor wires.

Sooner or later you will get a reading below 150Ω . If you do not, the transistor is open and should be replaced. When you do, one of the leads is connected to the transistor's base. This is almost always the wire in the middle.

Leave one ohmmeter lead clipped to the wire you think is the base.

Move the other lead to the other transistor wire. If your guess was right, the reading should be low again. If it is high, you were wrong. Try the other lead.

Having identified all the leads, measure between the collector and emitter wires. The reading should be above $10K$ in both directions. If not, the transistor has internal leakage and should be replaced.

Conclusion

You should get low base-to-collector and base-to-emitter readings in only one direction, and readings above $10K$ in the other direction. Collector-to-emitter readings should never measure less than $10K$. The chart in Fig. 3 should help you remember that fact. ■

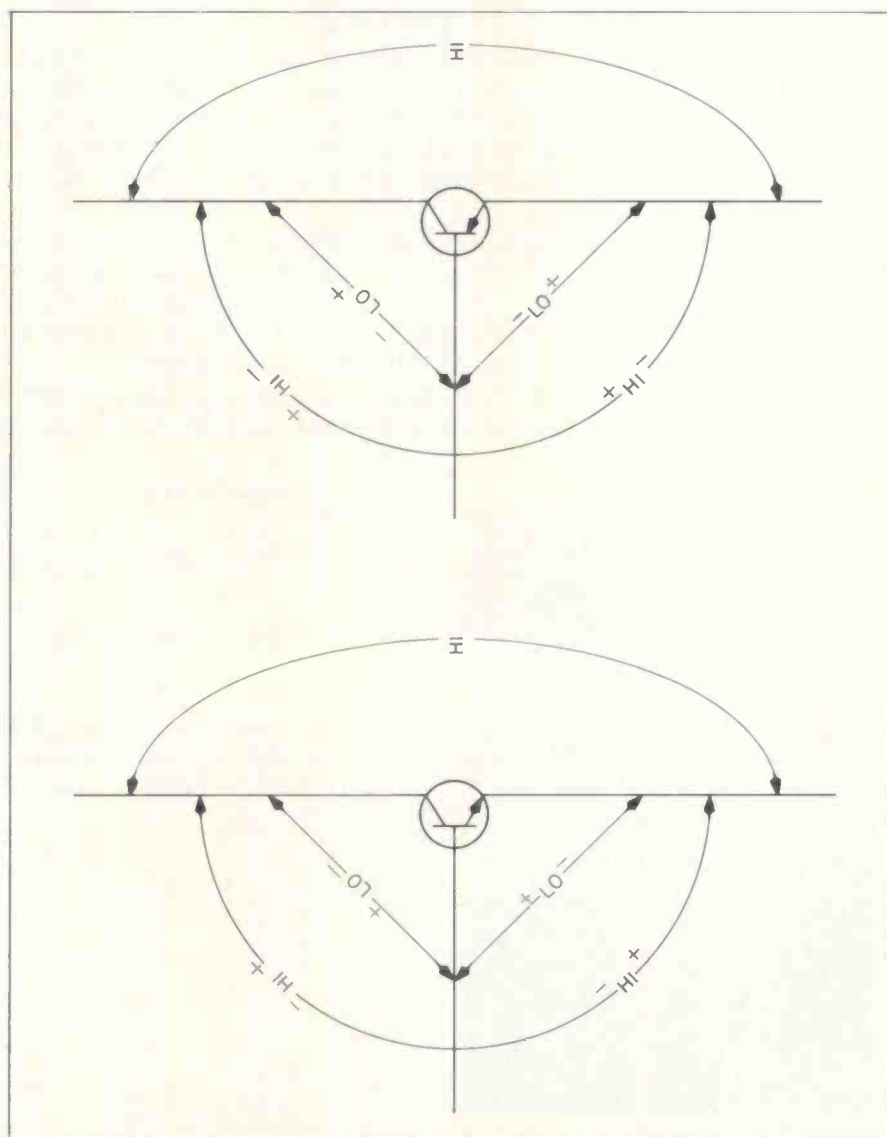

Fig. 3—Typical resistance measurements across PNP- and NPN-type transistors.

Portable Home Service Lab

by Robert Sickels

Custom made case contains assortment of instruments and tools selected for easier, more efficient servicing

■ I have never visited another man's service business without spotting some useful wrinkle he uses to do a more efficient job. Moreover, most technicians are patient, friendly fellows who are cooperative in dispensing hard-won knowledge to any other technician intent upon improving his techniques. It is in this spirit that I offer the results of 30 years of

In response to your invitation for readers to submit items of useful service information [Our July 1970 Editor's Memo] I am enclosing photos and description of a portable service-call rig I use. Perhaps some of its features will be of interest to your readers.

By way of introduction, I am 49, started in electronic servicing at 19 and have now completed 30 years in this field. I formerly operated a successful six-man operation in Indianapolis for 20 years but now make my home in Florida and operate a one-man business by preference.

I find that my net profit is about the same as it was with the larger business—and I have much more leisure time for fishing, boating, oriental gardening and even amateur astronomy. My wife and I live comfortably—without the harassment of a large business—and little efficient "wrinkles" that I have adopted over the years enable me to complete a day's work in about six or seven hours and get on with living.

I am a former president of the Indiana Electronic Service Assn. and was among the prime movers in its founding. I also served for a time as Co-Editor of the HOOSIER TEST PROBE, its trade publication which had on its mast head "Service to the Service Industry." IESA is still a very active trade association and was the nucleus of a successful national group.

I certainly enjoy your publication and its useful articles. These 30 years of servicing have not dulled my interest nor my urge to improve.

Keep up the good work.

Sincerely,

Robert M. Sickels

Robert M. Sickels

Bob's Electronic Service
817 North Andrews Ave.
Fort Lauderdale Fla. 33311



Robert Sickels

groping for more efficiency on service calls, rolled up into a single, lightweight, completely portable "service lab."

This unit is shown in Fig. 1 as it appears when ready for transporting. The tube tester list lashed to the top is kept current every 90 days or so through a service offered by the instrument's manufacturer. On the left end of the cabinet are secured a capacitance decade and 15M potentiometer, which are each calibrated for rapid capacitance and resistance substitution. These units are wired to a jack patch panel inside the unit. I service electronic organs in addition to TV sets and home stereo equipment, and find this decade arrangement useful for that application.

With this outfit I can enter a home, greet a customer and make only one connection to his house current while asking him a few searching questions about the nature of his service problem. In about five minutes I can remove the back of his set and be well on my way to diagnosing his difficulty. This 22-lb unit is all that I carry into a customer's home since current inventories are so voluminous and heavy. I leave my "store" in the service truck unless I am pretty certain from the nature of the complaint that I will need some specific part or two.

If a home repair is possible, it can be readily dispatched on the spot. If the trouble indicates necessary removal to the shop—by this time a suitable enough diagnosis has been made of the problem to quote

the customer a reasonably accurate estimate. I find that the customer pays the fees any good technician must charge today—with much better grace—if he first knows what he is spending and approves of it. I find that there is no better time to discuss shop fees than before the set leaves the home. Secondly, most householders are by now sufficiently informed in electronics that they are inclined to look askance at the technician who indulges in head scratching, fumbling and tube switching. To be blunt—he wants complete control of any judgment concerning his finances—and he wants to see some useful, efficient action performed for his money. (As a customer he has a perfect right to expect this.)

Fig. 2 shows the unit open for service. The protective front cover serves a dual purpose in that it also contains a bottom bay which holds such service items as cement, hot-tube pullers, a pair of channel lock pliers for wrestling a stubborn outside antenna into proper azimuth, and a sort of "clothes line" arrangement to store jumper cables.

A B & K tube tester is located in the upper left portion of the unit's instrument section, and below it is a B & K transistorized dot-bar generator. Both of these instruments have been found to be light, dependable and rugged.

Beneath these instruments is a jack patch panel. Only one cable and set of test prods are used to connect the electronic equipment under test to any of the instruments wired to the patch panel. This eliminates a maze

of cables in a generally constricted work area.

A miniature but highly accurate VOM multimeter is located in the upper right portion of the unit's instrument section and wired to the patch panel. Directly below the VOM are two meters—a 0 to 150vac voltmeter and a 0 to 15 amp ac ammeter. These meters are wired in such a way that they will immediately register line voltage and current conditions at the convenient outlet below.

This arrangement serves a multitude of purposes. The voltmeter monitors the line voltage, eliminating any possibility of wasting diagnostic time if the culprit proves to be a low-line-voltage situation, which can occur many times if an air conditioner or other high-current product is operated on the same circuit. And the ammeter arrangement gives an immediate power readout on the appliance under test. If the power consumption turns out to be too high, the equipment can be shut down by simply striking a switch on the top right of the panel.

A small transistorized AM/FM radio is mounted between the line monitoring meters and the convenience outlet. This radio is operated from an internal, isolated power supply to avoid the nuisance of batteries. The FM detector output is brought down to a jack on the patch panel and serves as a clean audio source for checking distortion in tape recorders, amplifiers, etc. The output amplifier driver stage is also

continued on page 60

Fig. 1—Packed and ready to go, this portable home service lab contains the basic equipment required for servicing in the field, yet it weighs only 22 lb.



Fig. 2—Once opened in the home, this service lab simplifies the task of preparing to work on a defective electronic consumer product.

Picking That New Shop Location

by Ernest W. Fair

A checklist to help prevent a mistake that may cost you your business

■ With today's shifting population centers even the long established electronics shop owners are faced with the problem of making certain that their shop is located where maximum profit can be realized.

For those repeating a task once done many years ago and the new technicians just in the planning stages for opening a new shop, this checklist is recommended to make certain that important factors are not overlooked.

☑ What is the probable volume of business that can be done at the proposed location? Buying power within the area, buying habits as they affect electronic services, size of families, and other data should all be used in answering this check point.

☑ What are the transportation and parking facilities? Is the area easily accessible from all directions? Are there ample existing facilities or a suitable area where these can be provided? The latter is a point of utmost importance today.

☑ What is the nature of the surroundings? Is it a new and developing business district or an old and deteriorating one? Are there geographical factors that might retard growth around the area?

☑ What is the nature of the competition in the locality immediate to the proposed site? Assuming competition does not matter may overlook a most vital factor. Often a desirable location in all other aspects can be made undesirable by well entrenched shops already located within the area. The cost of overcoming the good hold they have on customers may be prohibitive.

☑ The availability of the site should be checked thoroughly.

☑ What are the types of customers in the shopping and visiting area,

and are they not only possible profitable customers but those whose regular needs will be large enough to justify our shop being located at the spot?

☑ Is the proposed spot the most or least desirable in the area? Often we can overlook something more advantageous to our plans by being too greatly sold on one particular building or spot for a building.

☑ Is a permit for a shop obtainable and is there the possibility of any objection to the shop being raised by existing businessmen or residents in the area?

☑ Does the size of the building or lot offer plenty of opportunity for future expansion? If our decision is a good one, the business may grow more rapidly than expected and justify an even larger building than presently exists.

☑ Was an electronics shop ever located in the area in the past and if so why is it not still in business?

☑ Why is the building or site under consideration not in use today by some other business?

☑ Are there any visibility obstructions nearby to reduce the view of the shop sign when it is erected or to impair the efficiency of the shop's front windows?

☑ Is the district one that is definitely improving or one that is on the decline? Often this is a compelling factor in reasons why a location may or may not be available today.

☑ What changes in traffic are possible or probable in the future? Many a business has suffered drastically though such changes are not always easily foreseen when the shop site is first selected.

☑ Are competitors in the district price cutters? If other electronic servicing shops are noted as price cutters we may be sure that our first

year in the new location will be a rough one financially.

☑ Is the rental or lease figure asked reasonable? Paying even a small premium in rent to obtain a given location is seldom wise. The reasonableness of the rental figure asked should be stacked not only against the overhead cost of doing business but also against rentals asked by landlords of other firms in the area.

☑ What rent is being paid for a similar property in the vicinity and do the rental conditions set down in the proposed lease match those of other leases in the area or are they more demanding?

☑ How sound a lease can be obtained? A bad lease can make the most desirable locations profitless spots in which to do business. Figuring on a lot of new business to take care of such extra charges seldom proves out for any service-shop owner.

☑ What possibility is there for a future increase in population for the area?

☑ Are there primary and secondary schools in the area? Such schools can mean the presence of families making more use of their TV sets. Their absence may mean an area devoid of such families.

☑ What is the nearest existing or projected shopping center? These can have a decided affect on every type of business located in the general area and should be investigated very closely during preliminary planning.

☑ How large is the percentage of home ownership in the area? Established home ownership generally means that there will be continual contact with customers once they have been introduced to the business; while a low percentage of home ownership may mean considerable customer turnover and a greater cost of doing business.

☑ Are the renewal specifications of the lease good ones or are they so vague that exorbitant rental demands may develop once the business has been solidly established? Thought should always be given to the possibility of losing a very good location to some other firm unless some degree of protection is granted in the lease. ■

Test Probe Leaves One Hand Free in Three-Handed Job

by Chuck Dotson

In-circuit transistor testing can be made easier with the use of specialized equipment

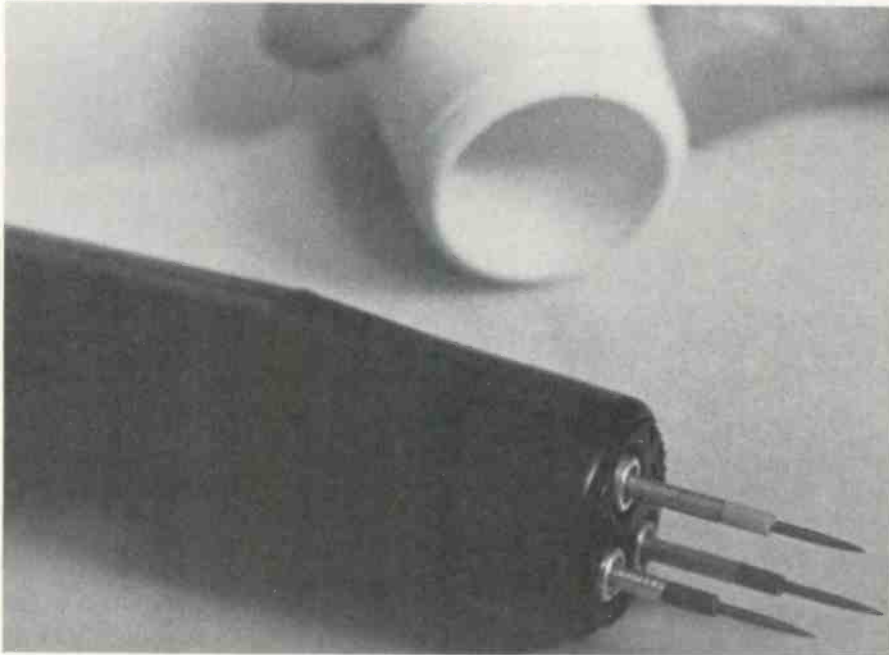

Fig. 1—Sharply pointed tips of different lengths make it easy to make contact with the transistor emitter, collector and base terminals, one at a time.

■ There are occasions when it can be quite difficult to simultaneously connect three test points to appropriate transistor leads in the limited space available on most printed-circuit boards. In order to simplify this problem, one manufacturer has developed the Dyna-Flex three-point probe.

Normally protected by a white cap (Fig. 1), the probe tips are color coded yellow for emitter, green for base and blue for collector. Uneven in length, the blue tip is the longer, while the green one is the shortest. Each probe tip is spring loaded and a slight pressure can force them back into their ball sockets.

When using the probe, the blue tip is first positioned against the collector terminal of the transistor under test (Fig. 2). Its sharp point can

easily penetrate the solder for a good electrical connection. The yellow tip is then placed against the emitter connection (Fig. 3), while the spring-and-ball socket keeps the first tip in place against the collector terminal. After these two tips are in place, the green tip is pressed against the base connection (Fig. 4).

This sequence of connecting probe tips, required by the design of the probe, is good in that then transistors cannot be damaged as a result of a test signal being applied to the base before being applied to the collector or emitter. The rigidity of each spring-loaded contact is designed to make it possible to maintain all three test points in their proper position while holding the probe with but one hand—leaving the other hand free for changing test instrument functions. ■



Fig. 2—The blue tip is pressed down first against the collector connection. Pushing lightly on the probe barrel causes the point to penetrate to the solder.



Fig. 3—The yellow tip is applied to the emitter connection next. A spring-and-ball socket keeps the blue tip in place while positioning the yellow tip.



Fig. 4—The green tip makes the base connection after the collector and emitter have already been positioned.

GUEST AUTHOR

Bait Your Mousetrap for Profits

by Andrew E. Baker

Remember the old proverb, "If a man builds a better mousetrap than his neighbor the world will beat a pathway to his door, even if he lives in the depths of some wilderness"? Now, think about your business as the mousetrap and consider the quotation again.

■ As a TV serviceman and businessman you know that the quotation about the mousetrap is not true. You are a specialist, highly competent and keenly aware of the need for exposure of your capabilities if your business is to grow and prosper. You did not get that exposure by sitting back in some wilderness! You got it by word of mouth recognition from your satisfied customers—from local advertising—from civic organizations and from donating your services to charitable causes. In short, you used various sales promotion methods to gain attention and acceptance of your skills by the people in your community. Unfortunately, this is where many TV technicians stop their promotional effort.

By using these promotional meth-



Andy Baker is advertising and sales promotion manager of Mallory Distributor Products Co. and Mallory Capacitor Co., divisions of P. R. Mallory & Co., Inc. He is a graduate of the University of Illinois and has spent more than 10 years in the electronics industry.

ods you are in effect merchandising your mousetrap. Once the mousetrap has been established, why not make it work more effectively by selling the bait too? The bait in this instance is any product or service that you offer that will benefit your customer and make your business—the mousetrap—more valuable to him.

Do not use excuses such as: *I am not a salesman or I don't have time or my customers are not interested in what I have.* You are in an enviable position to increase your sales and profits because you already command their confidence. You are the expert that your customers have selected to repair one of their most expensive possessions. Your customers already believe in you; consequently, they will be receptive to your suggestions that may benefit them.

Review the merchandising techniques that are described in the following paragraphs and see how many you use to bait your mousetrap.

"Remind them to ask—what else needs fixing," is the slogan that was developed by the Distributor Products Div. of the Electronics Industry Assn. Only you can ask that question. Sure, the TV set might be of prime importance but what about radio, stereo and other electronic products your customers own. By asking "what else needs fixing?" you will not only save an extra call but gain the added respect of your customer which results from rendering this extra service.

Make your service truck a "convenience wagon" by carrying with

you those products you handle that every homeowner needs. In fact, develop a full service concept by carrying as many samples as possible wherever you go. Batteries, flashlights, lanterns, cassette and reel-to-reel recording tape, etc. Here you will remind them about the supplies and accessories they need to continue to enjoy equipment they already own. And you will have added samples available to show when the situation arises.

Use the flyers and brochures that manufacturers supply describing products you handle. Put them in a three-ring binder. Index the binder and carry it with you on house calls. Suggest that your customers look through it while you check their TV set. You will be surprised at the number of customers you have who never knew you handled certain products.

When you have a new product that requires a demonstration, be sure you carry it with you in your "convenience wagon." After the customer has read the descriptive brochure and shows interest, suggest a demonstration to him. This is the best way to gain the conviction necessary to close the sale and to properly apply the product.

Use a little showmanship in your billing. Tell your customer in legible writing what you have done for him to improve the performance of his set. Say this in layman language and add that this is a special service unique with your organization. Substantiate your service charges and be sure to leave with your customer all the service parts you have replaced. This gives the customer added confidence in you.

Enclose mailers that are available from manufacturers whenever you send out those bills. This is an extra reminder to your customers that you carry a variety of products which are useful to him.

Whether your operation is small or large, periodically go through your list of accounts and contact those you have not heard from for a while. Ask if their TV set is operating satisfactorily, mention a new product that you can offer them and always ask "what other electronic equipment needs adjustment or repair." ■

TEST INSTRUMENT REPORT

Although designed for simplicity and portability, this instrument covers 27 ranges for ac and dc voltage, ac and dc current and resistance measurements

Hickok's 3300 Digital Multimeter

by Phillip Dahlen

■ With recent developments in electronics, many test instrument manufacturers are turning from galvanometer movements to digital meter design. These instruments first appeared in sophisticated laboratories, but units are now beginning to appear on the market that are in the price range of the average electronic technician. This instrument is priced at \$395.00.

This digital multimeter is designed to operate from either its internal, rechargeable battery pack or a 115/230v, 50 to 400Hz ac power source. Specifications indicate that when the batteries are charged the instrument can operate up to 24 hours, whether operated continuously or intermittently. The recharging time is said to be 16 hours or less, depending on the state of the batteries.

The front panel is color coded for ease of operation. The battery check is blue, the voltage settings are red, resistances are green and the current settings are yellow.

The probes are also color coded to eliminate the need to trace the leads to the front panel to distinguish them. The black alligator clip is the common lead, the red probe is for dc voltages, and the black probe is for all other measurements. High dc voltage measurements, over 1500v, must be made through the 10kv jack, and must be made with a special high-voltage probe. No measurements over 1000vac RMS may be taken.

Specifications indicate that ac measurements should be limited to those at frequencies between 22Hz and 100kHz. They also indicate that the instrument is designed to accept large ac voltages across its input terminals and still give an accurate

indication of dc voltages present—for example, a 60dB rejection of 60Hz interference.

Other manufacturer specifications are as follows:

AC and DC Volts:

| Range | Reading | Resolution |
|---------------|--------------|------------|
| 100mv | 0 to 199.9mv | 100µv |
| 1v | 0 to 1.999v | 1mv |
| 10v | 0 to 19.99v | 10mv |
| 100v | 0 to 199.9v | 100mv |
| 1kv | 0 to 1.500kv | 1v |
| 10kv dc probe | 0 to 15.00kv | 10v |

AC and DC Current:

| Range | Reading | Resolution |
|-------|--------------|------------|
| 1ma | 0 to 1.999ma | 1µa |
| 10ma | 0 to 19.99ma | 10µa |
| 100ma | 0 to 199.9ma | 100µa |
| 1a | 0 to 1.999a | 1ma |

Resistance:

| Range | Reading | Resolution | Polarity | | Current |
|-------|-------------|------------|----------|-------|---------|
| | | | Common | Probe | |
| 100Ω | 0 to 110.0Ω | 0.1Ω | — | + | 250µa |
| 1K | 0 to 1.100K | 1.0Ω | — | + | 25µa |
| 10K | 0 to 11.00K | 10Ω | — | + | 2.5µa |
| 100K | 0 to 110.0K | 100Ω | — | + | 0.25µa |
| 1M | 0 to 1.999M | 1K | + | — | 250µa |
| 10M | 0 to 19.99M | 10K | + | — | 25µa |
| 100M | 0 to 199.9M | 100K | + | — | 2.5µa |

Maximum open circuit voltage: 2.5v.

Overload Protection:

AC Volts
250v on 100mv range
1000v on all other ranges

DC Volts
1000v on 100mv range
150v on all other ranges

Resistance
100v on 100mv range
250v on all other ranges

Current
10 times full scale on all ranges

Operating Temperature Range: 32° to 122°F

Input Impedance at Probe Tip
DC: 11M/5pf, including 1M isolation resistor
AC: Infinite/200pf

Dimensions: 8 in. by 5½ in. by 4 in.
Weight: 6 lb. ■

Hickok's
Model 3300
Digital Multimeter.
For more details
circle 900 on
Reader's Service Card.



CIRCUITS...

continued from page 44

With reduced Q, the vectors shown in Fig. 10 result, illustrating the Q error reduced by 50 percent. The fleshtone vector produced by adding I and $\frac{1}{2}$ Q is

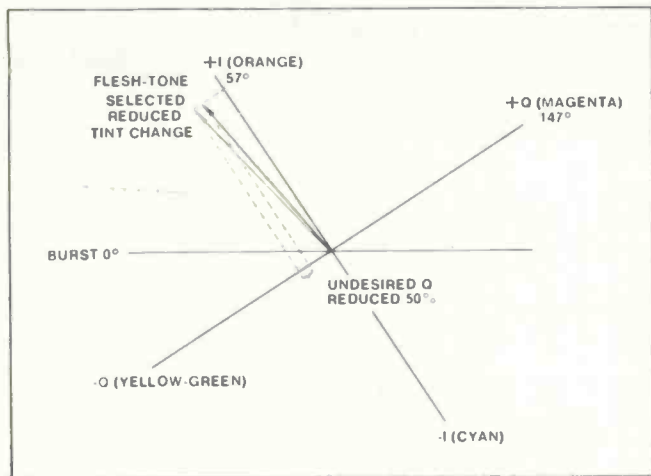

Fig. 10—With reduced Q the vectors shown illustrates the Q error reduced by 50%. The fleshtone vector produced by adding I and $\frac{1}{2}$ Q is much closer to the ideal fleshtone than that produced by the same error in a receiver without RCA Accu-Tint.

much closer to the ideal fleshtone than that produced by the same error in a receiver without Accu-Tint.

Up to now Accu-Tint has been described in terms of I and Q. Modern color receivers demodulate color differentiate signals directly. This means our thinking must be modified somewhat to consider the Accu-Tint equipped R-Y and B-Y receiver. These receivers recover red and blue chrominance information by choosing demodulation axes that recover the R-Y and B-Y signals. R-Y demodulation occurs on an axis shifted from burst by approximately 90° . B-Y is demodulated at a phase angle of approximately 180° from the 0° burst reference. The vector diagram of Fig. 11 illustrates

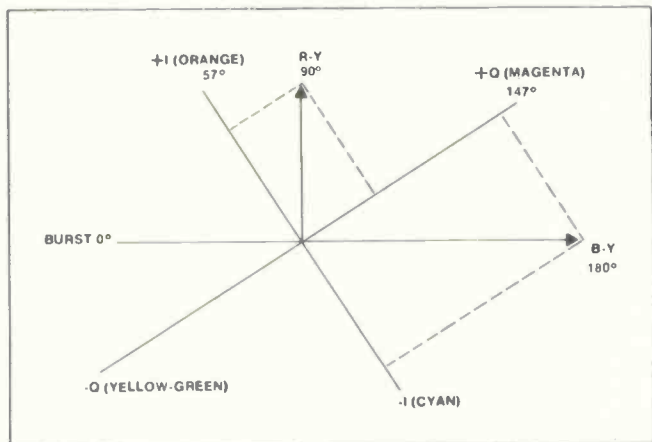

Fig. 11—The R-Y and B-Y signals are composed of specific amounts of $\pm I$ and $\pm Q$. The vector additions of I and Q shown yields a 90° R-Y signal and a 180° B-Y signal.

that the R-Y and B-Y signals are actually composed of specific amounts of $\pm I$ and $\pm Q$. The vector additions of I and Q that yields a 90° R-Y signal and a 180°

B-Y signal are shown in this illustration.

When Accu-Tint is used in an R-Y/B-Y receiver, the 50 percent amplitude reduction is accomplished by altering the R-Y/B-Y demodulation angles and reducing the B-Y channel gain. The R-Y signal is shifted slightly toward the $+I$ axis and the B-Y signal is shifted towards the $-I$ axis. The result is a set of three color signals which are identical to those produced by an I-Q demodulation system with a 50 percent reduction in Q demodulator gain. Thus, by a suitable choice of demodulation angles and color difference signal amplitudes, the effects of burst phase error on fleshtones are minimized. The Accu-Tint R-Y and B-Y vectors are illustrated in Fig. 12.

The Accu-Tint system carries flesh-tone optimization

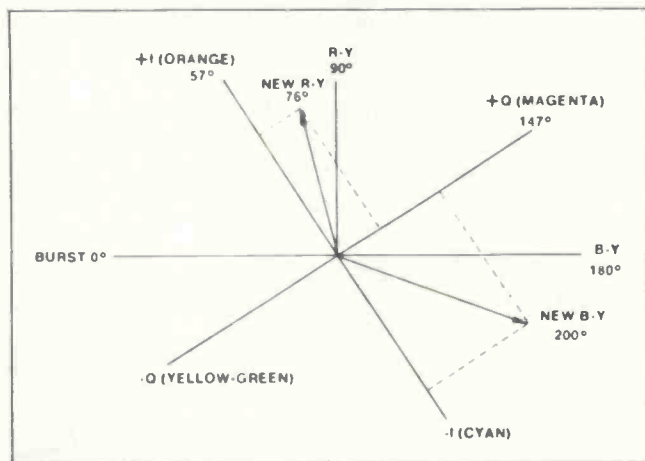

Fig. 12—RCA's Accu-Tint R-Y and B-Y vectors.

one step further by shifting the picture tube screen temperature from the normal 9300°K to a lower (more sepia) 6800°K . This warmer picture has proven to be subjectively more pleasing and allows fleshtone correction with less reduction of the Q signal. In addition, the green in the picture is enhanced due to the reduced amount of blue in the white reference background. ■

HOME SERVICE LAB...

continued from page 55

brought down to the patch panel so that it may be used as a signal tracer. In this way, reasonably good signal injection and signal tracing equipment can be purchased for around \$9.00. Although cost was not a significant factor, weight and functionality certainly are for any equipment that is going to be lugged about daily.

A rotary switch, mounted below the center of the patch panel, allows the radio to be restored to its normal operation. This permits me to listen to late breaking news or weather casts. Since I live and work in Florida, this function can be of some importance.

A compartment on the right of the cabinet, shown with its door open, houses such useful items as a dual cheater cord, a complete set of Xcelite tools, a mirror, miniature high-intensity lamp, lightweight Wen soldering gun with extra tip, a 30kv metered probe for accurate

continued on page 79

More than 5 million two-way transmitters have skyrocketed the demand for service men and field, system, and R & D engineers. Topnotch licensed experts can earn \$12,000 a year or more. You can be your own boss, build your own company. And you don't need a college education to break in.

HOW WOULD YOU LIKE to earn \$5 to \$7 an hour... \$200 to \$300 a week ... \$10,000 to \$15,000 a year? One of your best chances today, especially if you don't have a college education, is in the field of two-way radio.

Two-way radio is booming. Today there are more than *five million* two-way transmitters for police cars, fire trucks, taxis, planes, etc. and Citizen's Band uses—and the number is growing at the rate of 80,000 per month.

This wildfire boom presents a solid gold opportunity for trained two-way radio service experts. Most of them are earning between \$5,000 and \$10,000 a year *more* than the average radio-TV repair man.

Why You'll Earn Top Pay

The reason is that the U.S. doesn't permit anyone to service two-way radio systems unless he is *licensed* by the FCC (Federal Communications Commission). And there aren't enough licensed experts to go around.

This means that the available licensed expert can "write his own ticket" when it comes to earnings. Some work by the hour and usually charge at least \$5.00 per hour, \$7.50 on evenings and Sundays, plus travel expenses. Others charge each customer a monthly retainer fee, such as \$20 a month for a base station and \$7.50 for each mobile station. A survey showed that one man can easily

maintain at least 15 base stations and 85 mobiles. This would add up to at least \$12,000 a year.

How to Get Started

How do you break into the ranks of the big-money earners in two-way radio? This is probably the best way:

1. Without quitting your present job, learn enough about electronics fundamentals to pass the Government FCC License. Then get a job in a two-way radio service shop and "learn the ropes" of the business.

2. As soon as you've earned a reputation as an expert, there are several ways you can go. You can move out, and start signing up your own customers. You might become a franchised service representative of a big manufacturer and then start getting into two-way radio sales, where one sales contract might net you \$5,000. Or you may be invited to move up into a high-prestige salaried job with one of the same manufacturers.

The first step—mastering the fundamentals of Electronics in your spare time and getting your FCC License—can be easier than you think.

Cleveland Institute of Electronics has been successfully teaching Electronics by mail for over thirty years. Right at home, in your spare time, you learn Electronics step by step. Our AUTO-PROGRAMMED® lessons and coaching by expert instructors make everything clear and easy, even for men who thought they were "poor learners."

Your FCC License... or Your Money Back!

By the time you've finished your CIE course, you'll be able to pass the FCC License Exam with ease. Better than nine out of ten CIE graduates are able to pass the FCC Exam, even though two out of three non-CIE men fail. This startling record of achievement makes possible our famous FCC License Warranty: you'll pass the FCC Exam upon completion of your course or your tuition will be refunded in full.

Find out more. Mail the bound-in post-paid card for two FREE books, "How To Succeed In Electronics" and "How To Get A Commercial FCC License." If card has been detached, use coupon below.

ENROLL UNDER NEW G.I. BILL

All CIE courses are available under the new G.I. Bill. If you served on active duty since January 31, 1955, or are in service now, check box on card for G.I. Bill information.

CIE Cleveland Institute of Electronics
1776 East 17th Street, Cleveland, Ohio 44114

Please send me without cost or obligation:

1. Your 44-page book "How To Succeed In Electronics" describing the job opportunities in Electronics today, and how your courses can prepare me for them.
2. Your book on "How To Get A Commercial FCC License."

Name _____ Age _____
(PLEASE PRINT)

Address _____

City _____ State _____ Zip _____

Accredited Member National Home Study Council ET-58

How to get into one of today's hottest money-making fields—servicing 2-way radios!



He's flying high. Before he got his CIE training and FCC License, Ed Dulaney's only professional skill was as a commercial pilot engaged in crop dusting. Today he has his own two-way radio company, with seven full-time employees. "I am much better off financially, and really enjoy my work," he says. "I found my electronics lessons thorough and easy to understand. The CIE course was the best investment I ever made."



Business is booming. August Gibbemeyer was in radio-TV repair work before studying with CIE. Now, he says, "we are in the marine and two-way radio business. Our trade has grown by leaps and bounds."

... for more details circle 108 on Reader Service Card

NOW you can measure resistors accurately **IN CIRCUIT!**

in solid state devices



FE20 HI-LO
with hi-voltage probe and large
six-inch meter **\$129.50**



FE21 HI-LO
with 4 1/2-inch
meter **\$99.50**

WITH THE NEW HI-LO FIELD EFFECT MULTIMETERS

USES ONLY .08 VOLTS TO POWER OHMMETER TO PREVENT TRANSISTORS FROM CONDUCTING AND UPSETTING READINGS

Look at these extra features to see why the Hi-Lo meter belongs on your want list:

- Unbelievable specifications of 15 megohm input impedance on DC and 12 megohms on AC
- Laboratory accuracy of 1.5 percent on DC and 3 percent on AC
- 9 DC voltage ranges from as low as .1 volts full scale to 1000 volts
- 3 hi-voltage ranges of 3 KV, 10 KV and 30 KV
- 9 DC zero center ranges from .05 volts to 500 volts . . . a must for delicate transistor bias measurements
- 7 resistance ranges from 1000 ohms full scale to 1000 megohms
- 9 DC current ranges from 100 microamps to 1 amp
- Automatic built-in battery test . . . never a worry about rundown batteries, just push the switches under the meter and read.
- Standard .6 amp fuse to protect the ohms and milliamps scales if voltage or overload is accidentally applied. No more need to return the meter to factory for repair . . . just replace the fuse.
- Special probe with 100K isolation resistor in probe to prevent AC pickup or to prevent loading oscillator circuits. Leave in normal position for most tests.

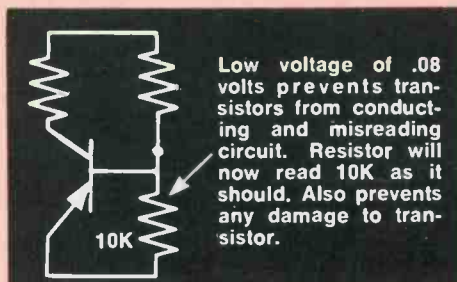

Here is why you should have both Hi and Lo battery voltages for correct in-circuit resistance measurements in solid state circuits:

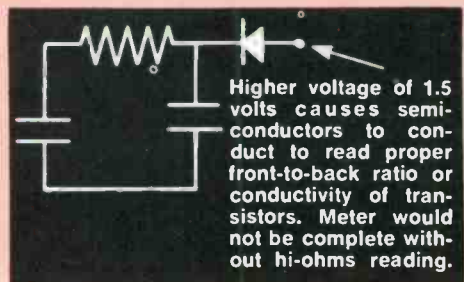

SENCORE INC. 3200 Sencore Drive • Sioux Falls, South Dakota 57107

... for more details circle 128 on Reader Service Card

TECHNICAL DIGEST

The material used in this section is selected from information supplied through the cooperation of the respective manufacturers or their agencies.

ADMIRAL

UHF-VHF Crossover Network

When installing a TV set in a location that has a single antenna lead from the UHF and VHF antennas or from a combination UHF/VHF antenna, the connections to the antenna terminal board on the cabinet back can be made with the device shown if a standard UHF/VHF antenna coupler is not available.

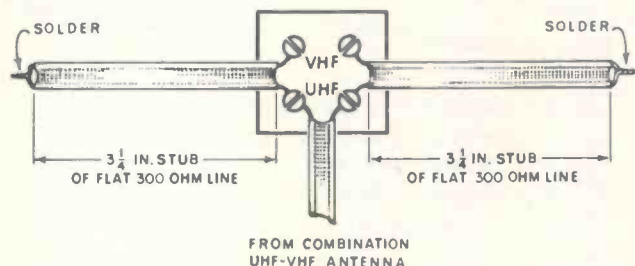

RCA SALES CORPORATION

Speaker Magnets "Ceramic-Ferrite"

Many RCA products use speakers having a ceramic (ferrite) magnet structure rather than the customary Alnico V. Since the term "ceramic" suggests something made from potter's clay, and "ferrite" is the material used to make deflection yokes and high-voltage transformers, the reader may wonder how a combination of these materials could become a permanent magnet.

"Ferrite" is a special ceramic containing enough iron to exhibit magnetic properties. This magnetic ceramic (ferrite) can be compounded to be either magnetically "soft" or "hard"—these terms referring to the behavior of the magnetic material when subjected to a magnetizing field. If two pieces of ferrite, one "soft" and one "hard," are

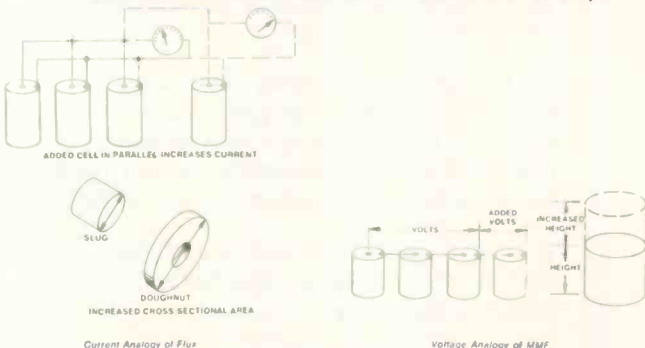

placed in a strong magnetic field and then removed from that field, the "soft" material will retain very little magnetism. The magnetically "hard" material, by contrast, remains strongly magnetized and may be used as the permanent magnet in a loudspeaker. Since "hard" ferrite and Alnico V are both good permanent magnets, either can be used in a loudspeaker if their basic differences are considered.

A magnet is somewhat like a battery in its ability to produce a magnetic field. A battery will produce a certain

terminal voltage, and a magnet will have a certain Magneto-Motive-Force (MMF). To increase the voltage from batteries, it is necessary to use several connected in series. To increase the MMF of a magnetic material, it is necessary to increase its height.

Also, batteries have definite current capabilities. To increase current, several batteries may be connected in parallel. The magnetic analogy of current is "flux," and to increase the cross-sectional area.

Although both Alnico V and ferrite are commonly used for speakers, the different properties of the two magnetic materials result in different physical dimensions for equivalent magnets. The magnetic properties of Alnico V allows a magnet design having a height dimension about equal to the cross-sectional diameter. In contrast to this, the ceramic-ferrite magnet has a smaller height and the cross-sectional area is much larger. Thus where a "slug" of Alnico V was used, the magnetically equivalent ferrite magnet requires a "washer" or "doughnut" of ceramic material. In short, the ceramic magnet has a flatter but wider structure than the Alnico V equivalent.

So much for the differences—which is better? Alnico V is made from costly materials (Aluminum, Nickel and Cobalt) by a rather inexpensive process. The ceramic magnet, in contrast, is manufactured from inexpensive materials (iron-oxide and barium) by a rather costly process. Thus, small magnets are less costly when manufactured from Alnico V and large magnets are less expensive when ferrite material is used.

FM Radio Models RHC17, 19, 21, 25, RHS33, 35, 37, 41—FM Antenna Revisions

Should the three-wire cable connecting the FM antenna terminal to point "A" on the board become disconnected

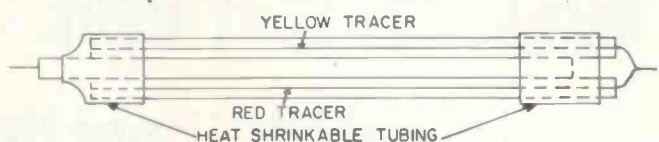

or removed, it should be reinstalled as follows. The center conductor should be connected to point "A" on the board, and the two outer conductors connected together at the opposite end and to the FM antenna terminal. After connection is completed, a check should be made from point "A" on the board to the antenna terminal to ascertain that there is no continuity between the FM antenna terminal and the board.

Safety in Servicing—Protective Devices and Special-Rated Components

Exhaustive tests are conducted on RCA instruments to insure adequate protection against faults that could cause fires or excessive damage. The Underwriters Laboratories require certain fire prevention protective devices to obtain UL listing. Basically, these devices consist of fuses (quick-blow, slow-blow, fuse wire) and circuit breakers. In addition, any component that is connected across the power line is very likely to be a special part requiring UL approval.

UL approval for an instrument is obtained with specific

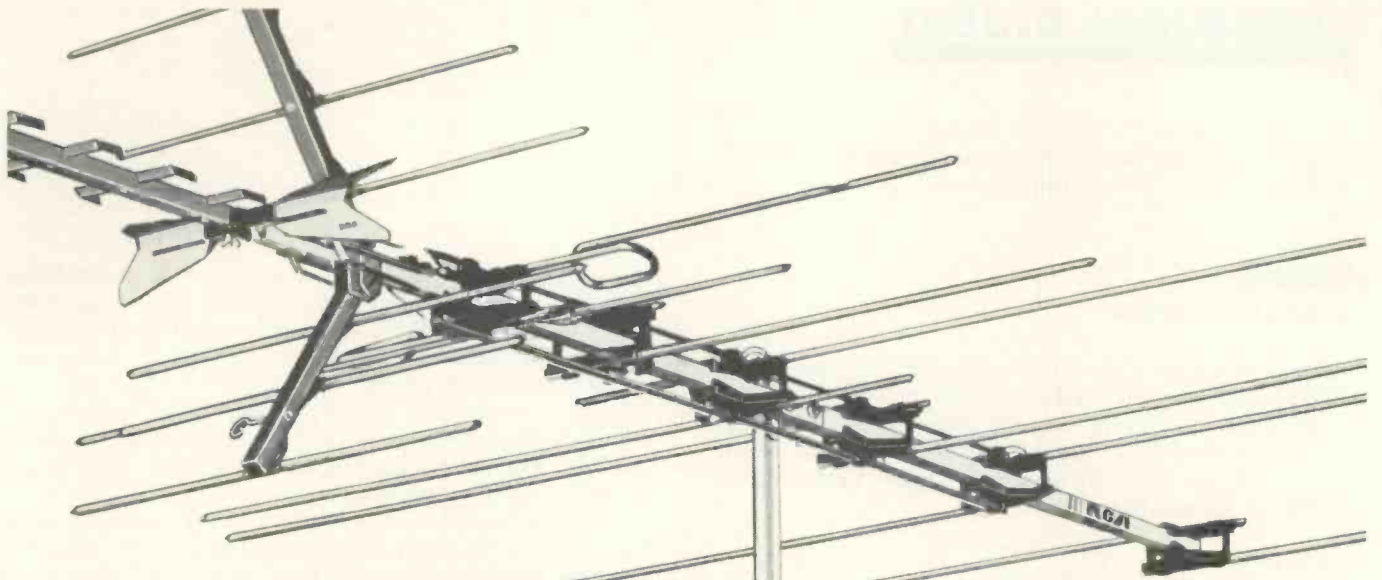

The new Permacolor antenna from RCA has:

“Long-lasting” element/feed line connections.

Waterproof, polypropylene insulators that pivot.

Integrated UHF bow tie.

Rigid, square boom.

Tough vinyl finish.

That ought to prove RCA is serious about the antenna business.

So serious we've set up a new production facility at our Memphis plant. But before we manufactured a single antenna, our engineers literally started designing from scratch. The result? Permacolor.

Here are just a few reasons why RCA Permacolor antennas are different, and are an improvement over what you're now selling.

1. Durable connections/Perma-tuned circuits. All active elements (many perform more than one function) are solidly connected to a symmetrical aluminum feed line by riveted straps. This reduces reception failure due to flimsy or intermittent connections.
2. “Single unit” insulator/element. Insulators are polypropylene. Elements extend 5½ inches into the insulators. Elements and insulators pivot as a unit—lock in place—have no loose connections. No high stress points.
3. Bow tie and 110° corner reflector UHF Section integrated into a single downlead for better UHF reception.
4. Easy installation. Simply unfold and install. Permacolor antennas go up in one piece. No bag of bolts. Nothing to take apart and reassemble. Snap-off elements let you quickly tailor the antenna to reception requirements.
5. Tough, handsome blue and gold vinyl coating protects against weather and airborne chemicals.

The new RCA Permacolor Antenna is the antenna you can put up for good. See it now at your RCA Parts and Accessories distributor.

Parts and Accessories, Deptford, N.J.

RCA

TECHNICAL DIGEST

parts that provide the proper safety measures for that instrument. Substitute parts provide a measure of safety; however, only those parts which were submitted, tested, and approved are exact duplicate replacement parts. For example, the ac line capacitors are special parts; therefore, an unapproved capacitor of the same value and voltage rating might not be acceptable. Another instance pertains to isolation networks (capristors). As an example, an IRC capristor may be required to protect certain parts in the event of arcing. In other instances, a common carbon resistor may provide the desired isolation.

UL approval is obtained on specific protective devices (fuses and circuit breakers) installed in the instrument. The service technician should never defeat the purpose of these safety devices by jumpers, oversize fuses, or incorrect circuit breakers. When a protective device fails, the correct servicing procedure is to troubleshoot the instrument to determine the cause of failure before replacing the device. Never substitute a clip lead for the protective device when troubleshooting, since this can result in extensive damage to the instrument as well as possible serious bodily injury.

Fuses are rated from a few milliamperes to several amperes. Also, other ratings are important; for instance, a specific time delay, before failure, may be specified. Therefore, the correct replacement fuse may be either the "quick-blow" or "slow-blow" type. Obviously, replacing a quick-blow fuse with a slow-blow fuse may not provide adequate protection.

Another fuse type is the small wire fuse that opens on

overload. Ordinary quick-blow fuses may be used to replace this type of fuse wire. Referring to the chart below, it can be seen that a number 34 fuse wire could be replaced with a five-amp quick-blow fuse. However, never replace fuses with fuse wire.

| Copper Wire Size Number | Approximate Ampere Fusing Current |
|----------------------------|--------------------------------------|
| 36 | 3.6 |
| 34 | 5 |
| 32 | 7 |
| 30 | 10 |
| 28 | 14 |

In summary, a fuse should be replaced with one having the same specific ratings originally called for by the manufacturer.

The same rules apply to circuit breakers. Circuit breakers also have different break currents and characteristics just as fuses do. Replacements should have the same ratings as the original circuit breaker and should be connected into the circuit in exactly the same configuration as the original.

The safety devices and special-rated components serve several purposes in electronic instruments. Among these are:

- Protecting the customer and his property;
- Preventing damage to the instrument;
- Guarding the safety of the serviceman.

When a protective device fails, never defeat its intended purpose.

no other
heat gun...
**offers
all these
attachments!**

Attachments to speed your job ...
attachments that tailor Master heat
gun airflow precisely to your needs
... attachments that fit any existing
Master flameless heat gun. No other
line offers so many choices ...
including the exclusive patented
cone for 1/4" concentrated heat, optional
adjustable base, convenient carrying
case, and *the only U.L. listed gun*
available. Send for free 12 page catalog.



for shrinking
thermoplastic
tubing and film,
curing, forming,
melting, drying,
soldering.

MASTER >> HEAT GUNS

Racine, WI 53403

... for more details circle 120 on Reader Service Card

Don't sell a color picture tube unless its been on a test ride.

Down at the bottom of the page, you have a major advance in space-age homeliness.

And a major advance in color tube testing as well.

That machine squatting down there is our beloved Iron Horse, the fully-automated, revolving carousel we use to test our color bright 85® tubes for emission, gas leakage, shorts, arcing and screen uniformity prior to shipment.

Now we don't intend to go into a song and dance on how total automation reduces testing error.

But we will tell you one thing.

Our Iron Horse test ride, combined with our life testing and 100% set testing, makes it almost impossible for you to get a defective color tube from us.

Which in turn makes it almost impossible for you to get chewed out by a customer.

Next time you need a color replacement tube, remember the great thing about the color bright 85. We don't send it to you till it's been around.

SYLVANIA
GENERAL TELEPHONE & ELECTRONICS

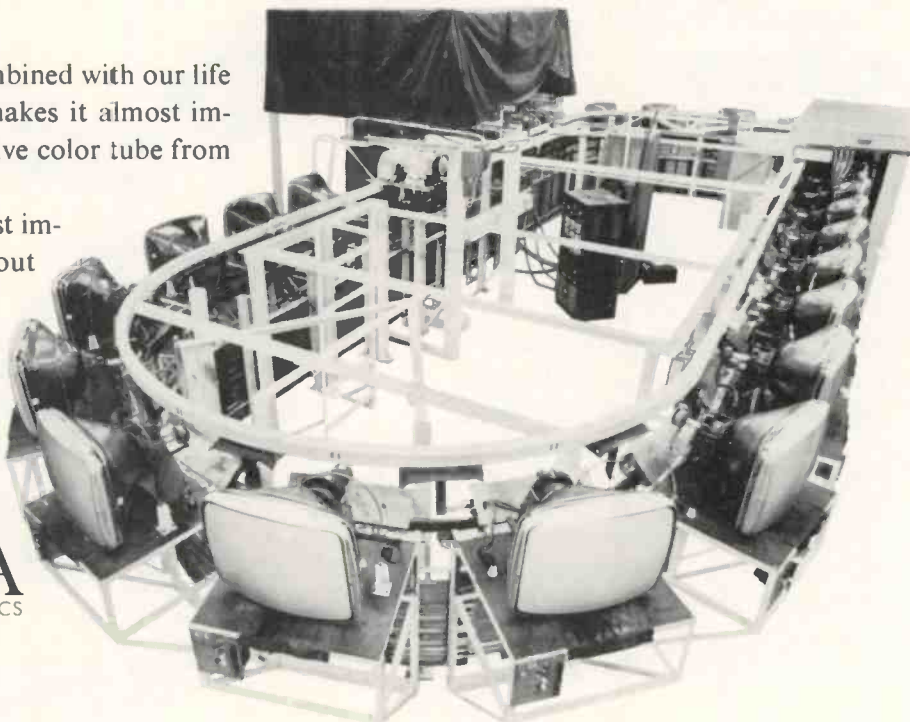

COLORFAX

The material used in this section is selected from information supplied through the cooperation of the respective manufacturers or their agencies.

GENERAL ELECTRIC

Color TV Chassis N-1—Vertical Sweep Circuit

Modern sweep circuit design is becoming increasingly more sophisticated. New circuits have been developed to meet the more critical performance requirements of color television. Linearity must be better, efficiency must be better, and satisfactory performance must be delivered throughout the usable life of the components without re-adjustments.

The N-1 chassis incorporates one of these advanced design concepts in its vertical deflection system. In effect, the circuit is said to automatically correct for the aging characteristics expected in vacuum tube amplifiers, maintaining satisfactory deflection throughout the life of the tube. The vertical circuit is oscillatory but more precisely, it is a Ramp (sawtooth) generator system.

The vertical output stage is a conventional pentode power amplifier, class A operated, obtaining its bias from a standard RC cathode network. The output is taken through a transformer that matches the impedance of the output tube to the impedance of the yoke. The control grid receives three signals: A degenerative feedback signal is coupled from the plate to the grid through a low-pass filter made up of resistor R261, capacitor C269 and the other components in the grid system. Another signal, the generator ramp voltage, is coupled from tube V10A. The third signal applied to the grid is the vertical sync pulse from the sync separator.

To simplify the explanation, let's assume a dormant situation immediately prior to the arrival of a sync pulse. The pentode power amplifier (a high-gain device) is ready to react to whatever arrives on the control grid. Along comes the negative-going sync pulse, a comparatively high-frequency component; it is amplified and appears at the plate as a positive-going pulse. The amplified, positive-going sync pulse is coupled into the triode section of the vertical tube. Since the pulse is applied to the grid of this tube, the triode turns ON causing both grid current to flow. Current flowing in the grid circuit charged capacitor C252 while the plate current discharges capacitor C268. As the sync pulse passes, capacitor C252 begins to discharge through the Vertical Hold control and resistor R251. The resulting voltage drop across the Hold control switches the triode OFF. The time constant of the Hold control and capacitor C252 is such that the triode will remain cut off for at least 1/60 of a second. The instant the triode was switched OFF, capacitor C268 started to charge through the Height control. The voltage across capacitor C268 is coupled to the power amplifier control grid and becomes the sweep-drive signal. The voltage on the vertical output tube grid is a modified sawtooth having a rounded bottom. The sweep current delivered to the yoke is sawtooth because of the transformer design.

The three signals are applied to the control grid of the

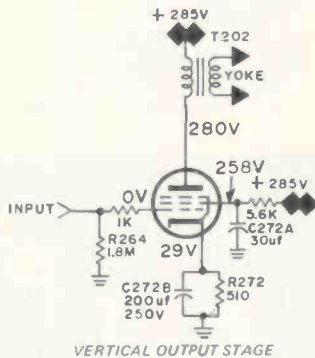

vertical output stage. The sync pulse and the generated ramp (sawtooth) voltage were just described. The third signal is the degenerative feedback signal from the plate circuit. Included in this feedback loop is the Linearity control and the automatic correction for the aging tube feature mentioned previously. By degenerative, it is meant that the signal is out of phase and tends to oppose the original signal appearing at the grid. A significant point about this signal is that it must be substantially attenuated or else the feedback signal would completely nullify the drive signal going to the amplifier. In addition to being attenuated, the feedback signal is altered by virtue of the low-pass nature of the feedback loop. The automatic correction feature results from the fact that as the feedback signal diminishes the ramp generator signal experiences less opposition; consequently, the amplifier is driven harder. The end result of all this is that a constant raster size is maintained throughout the life of the vertical output tube.

Vertical linearity control is included in this degenerative feedback signal. The technique of control may not be readily apparent. In effect, the Linearity control is a signal shunt and produces the desired results by shunting a portion of the feedback signal to ground.

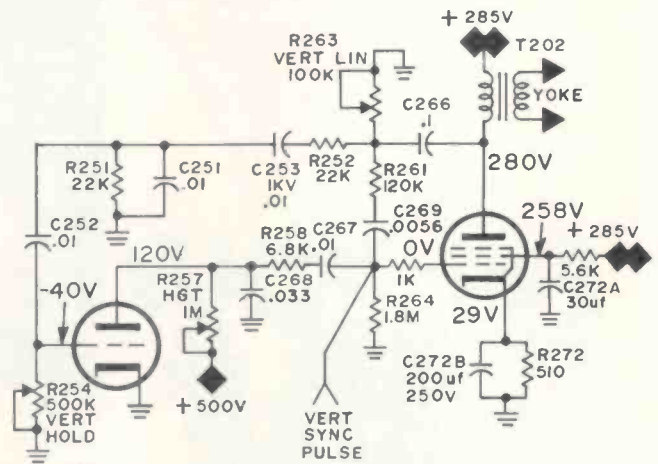

ETCH-O-MATIC

MARKS MOST ANYTHING



Electrochemical process puts your name, number, or mark on any metal surface. System includes marker for 115 V., ground plate, electrolyte solution, and special stencils. Kit marks up to 2000 items.

ETCH-O-MATIC
KIT
58B100 - \$19.95

Free Catalog — ELECTRONIC ASSEMBLY TOOLS

JENSEN TOOLS and ALLOYS
4117 N. 44th Street, Phoenix, Arizona 85018

Precision Tuner Service

gives you **profit power**

..with even finer, faster, Service!

WE HAD JUST REPRINTED OUR LITERATURE . . .
 ADDING OUR THIRD NEW PLANT . . .
 WHEN WE DID IT AGAIN . . . PRECISION TUNER SERVICE

ADDS

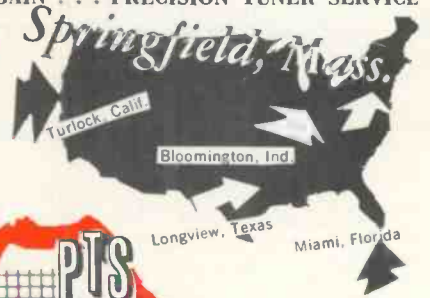

PRECISION TUNER SERVICE

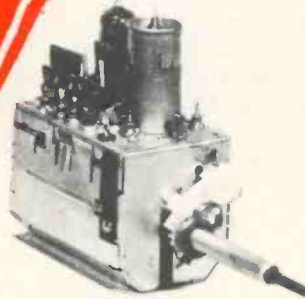

does its thing



..again!

YOU can offer this specialized, expert service. Quality Tuner Service is our bag, man! Experienced, conscientious PTS craftsmen with sophisticated, precision (and expensive) tools and equipment mean faster PROFIT for you with PTS 8-hour service. . . .

**For YOU:
 MORE &
 FASTER
 PROFIT**

TURN OVER

. . . . No doubt about it! PTS mails your tuner back the SAME DAY it is received! Now less in-transit time, too!

**Precision
 Tuner Service**

FREE JOB CARDS FREE SHIPPING LABELS

**8 Hr.
 Service**

..and now with even shorter in-transit time!

VHF or UHF

\$8.95

UV Combo's

\$14.95

Major Parts, Tubes, Transistors charged at Net Price

CUSTOMIZED REPLACEMENTS AVAILABLE FOR \$12.95 UP (NEW OR REBUILT)

FIRST TO OFFER 365-DAY GUARANTEE!

COLOR — BLACK & WHITE — TRANSISTOR TUNERS — ALL MAKES GUARANTEED COLOR ALIGNMENT — NO ADDITIONAL CHARGE

For fastest service, send faulty tuner with tubes, shields and all broken parts to:

| | | |
|--------------|--|-------------------|
| HOME OFFICE— | Box 272—Bloomington, Ind. 47401 | Tel. 812/824-9331 |
| EAST— | Box 334—W. Springfield, Ma. 01089 | Tel. 413/734-2737 |
| SOUTHEAST— | 4451 N.W. 37th Ave., Miami, Fla. 33142 | Tel. 305/633-0002 |
| SOUTHWEST— | Box 7332—Longview, Tex. 75601 | Tel. 214/753-4334 |
| WEST— | Box 1431—Turlock, Calif. 95380 | Tel. 209/632-2928 |

. . . for more details circle 125 on Reader Service Card

ELECTRONIC TECHNICIAN/DEALER

NEW PRODUCTS

For additional information on products described in this section, circle the numbers on Reader Service Card. Requests will be handled promptly.

DIGITAL MULTIMETER 703

Designed for measuring in 25 ranges

The Model 262A digital multimeter is designed for measuring dc voltage and current, ac voltage and current, and ohms. The multimeter reportedly has a basic dc accuracy of 0.1%. The dc ranges are said to feature automatic polarity indication and automatic zero correction circuitry. Price \$375. United Systems.



MINIATURE RELAYS 704

Designed for limited space and long life

Two-, four- and six-pole miniature relays have been designed for limited space and long life, reportedly requiring less than 1 cu in. of space. Their magnetic structure reportedly enables them to operate on voltages as low as 35mw for a single pole double throw relay. The plug-in base is said to be made with a filled polycarbonate. Deutsch.

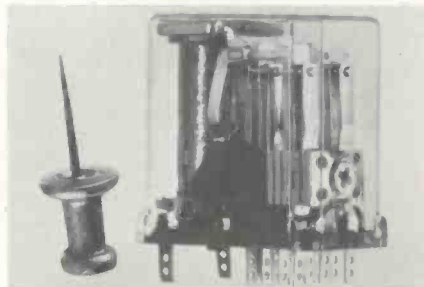

RESISTOR ASSORTMENT 705

Comes in free, factory-packed plastic storage cabinets

Four assortments of axial-lead wire-wound resistors reportedly come in free, factory-packed plastic storage

cabinets. The assortments are said to include 1½, 3¼, 5 and 11w sizes ranging from 1 to 50K. The manufac-

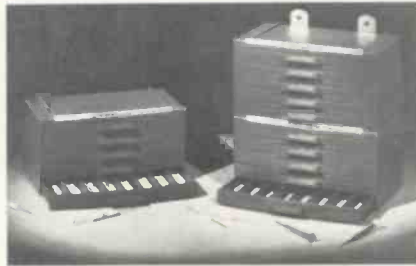

turer reports that the vitreous enamel coating guarantees a 1000vac insulating rating which can withstand 1500° F, high humidity and immersion in salt solution without distortion. The resistors are said to have a ±5% tolerance. Ohmite.

WIRE MARKER 706

120 markers in a pocket-size book

A "GROUNDED" wire marker has been added to the manufacturer's wire marker book line. The markers are reportedly packaged in quantities of 120 in a pocket-size book, and mea-



sure 1 3/16 in. by 1¼ in. Specifications indicate that the markers feature black lettering on white cloth tape which resists moisture, fungus, oil and abrasion over a temperature range of -65° to +300°F. Thomas & Betts.

DC DIGITAL VOLTMETER 707

Measures dc voltage to 1000v in 4 ranges

A portable DVM is reportedly capable of measuring dc voltages up to 1000v in 4 ranges of 1.5, 15, 150 and 1000v with 3½ digits. It is said to feature a direct-reading neon display, and is designed to give warning by a

neon light when the input has exceeded the full scale value of the selected range. When the input data is in the wrong polarity, the digital readouts will reportedly indicate zero. Specifications indicate that input impedance is approximately 2M for the 1.5v range and 10M for all other ranges. The unit measures 3 by 5¾ in. and weighs 4½ lb. Price \$189.50. Alco.



RADIOTELEPHONE 708

Comes with crystals for four channels

A VHF marine radiotelephone reportedly features push-button channel selection and a 6w voice transmitter-receiver operated from a 12vdc power source. The unit is said to include a mounting cradle for installation in various positions as well as crystals for four channels, fiberglass antenna, carbon microphone and coil cord. Price \$229.95. Simpson.



TV CAMERA 709

Designed for CCTV and CATV systems

An expandable TV camera has been designed for educational CCTV and CATV systems. Specifications indicate that the camera produces pictures under widely varying light conditions and that a view finder can be added to the camera without additional wiring.

NEW PRODUCTS

The camera reportedly employs a 1-in. vidicon pickup tube designed to main-



tain constant beam current throughout the life of the tube. Nasco.

AGC AMPLIFIER

710

Maintains constant signal levels

An AGC amplifier has been developed to maintain constant signal levels for reception over telephone lines. Specifications indicate that the unit will control input signals from -40dBm to $+10\text{dBm}$ and provide an output signal of $0\text{dBm} \pm 3\text{dB}$. Input impedance is said to be 600Ω to match

telephone lines, and output impedance is said to be 100Ω . The manufacturer reports that the signal frequency range is 100Hz to 20kHz, attack time is 250ms, release time is 500ms and operating temperature range is -40° to $+65^\circ\text{C}$. The unit requires a 24vdc nominal power supply and reportedly draws 0.015a. The amplifier is contained in a plug-in module 2 in. square by $3\frac{1}{8}$ in. high. Douglas Randall.

SOLDER DISPLAY

711

Solders, fluxes, solder pastes and creams

A self-service solder display includes a selection of packaged solders, fluxes, solder pastes and creams that can reportedly be used with most metals. Specifications indicate that the products are color-coded and come with instructions. Alpha Metals.



CHANNELLOCK

Gives You More In Hand Tools Including

"Look Before You Buy"

PATENTED FEATURES

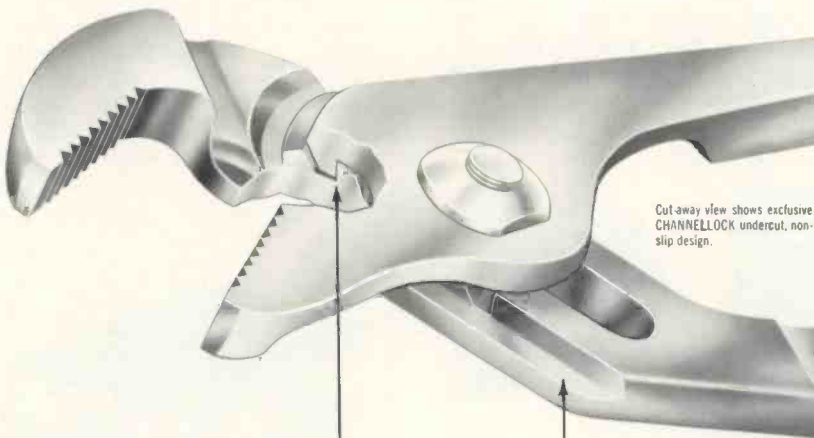

Cut-away view shows exclusive CHANNELLOCK undercut, non-slip design.

Smooth working, machined UNDERCUT mating parts. The greater your grip, the greater the lock-action. A patented CHANNELLOCK exclusive.

Reinforcing flange practically eliminates stress breakage. Another patented CHANNELLOCK exclusive.

And here you see only two of many reasons why CHANNELLOCK, the original tongue-'n-groover, outsells them all. It's better designed, better made, better working. How to distinguish CHANNELLOCK from its imitators? Look for the CHANNELLOCK trade mark on the handle. Not there? Go elsewhere. You'll be glad you did.

YOURS FOR THE ASKING. Our tool-guide catalog. Write us.

TOOLS BY
CHAN NEL LOCK

MEADVILLE, PA. 16335

... for more details circle 105 on Reader Service Card

VARACTOR DIODES

712

High Q, linear response and 5:1 spread at 3 to 30v

A series of varactor diodes has been developed for use in solid-state TV tuners, instrumentation, remote frequency controls and microwave circuits. The diodes are said to have high Q, linear response and a spread of 5:1 at 3 to 30v. Standard Kollsman.

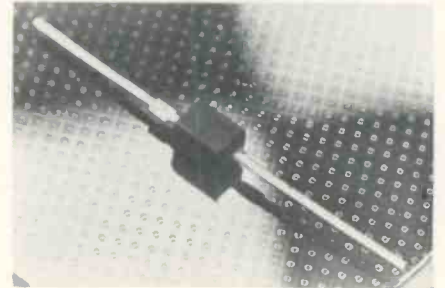

BRAZING ROD KIT

713

Ideal for home workshop and service shops

A brazing rod kit is reportedly equipped with silver and aluminum

CUT TV ALIGNMENT TIME

IN HALF!

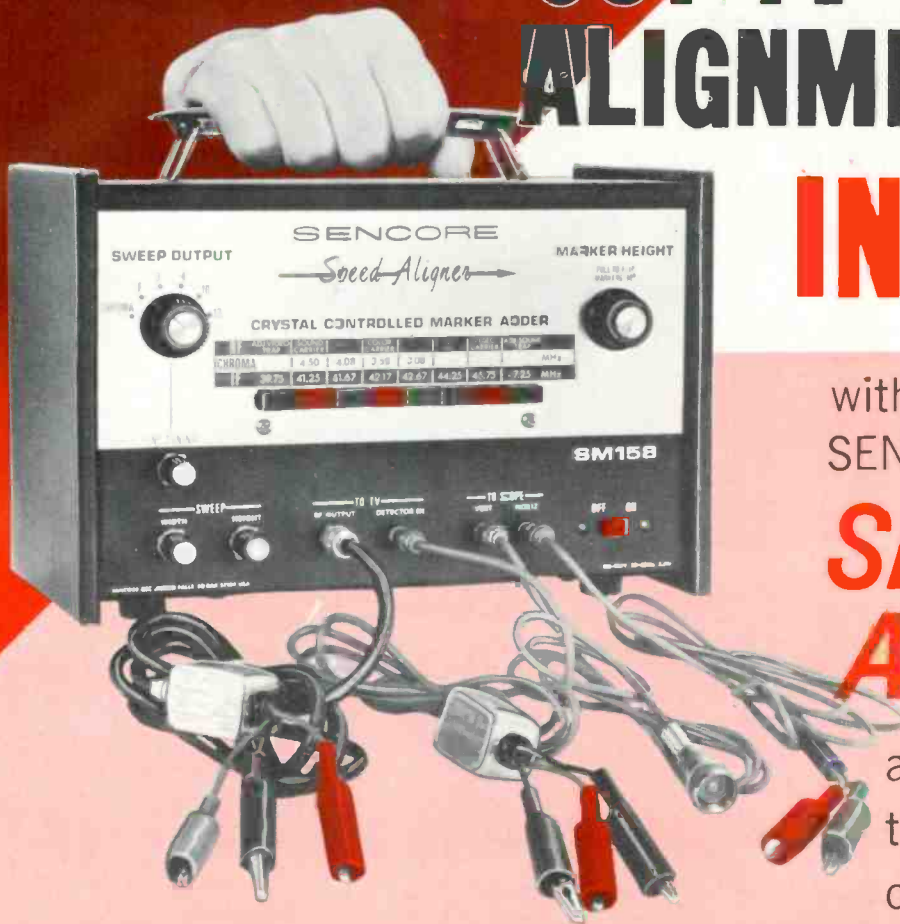

with the all new
SENCORE SM158

SPEED ALIGNER

and at \$120.00 less
than competition!
only \$275.00

Here are 7 Reasons why we call the SM158 the Speed Aligner

AUTOMATIC ALL CRYSTAL CONTROLLED MARKERS: You will never spend any more time looking up marker frequencies or interpreting them when you own an SM158; they are automatic. For example, want the chroma carrier on any RF curve, IF curve, or chroma curve, simply push the chroma carrier marker button. Want the sound, video, adjacent carrier markers or any other marker on any curve, just push the button as directed on the panel. The SM158 is fast and saves you time . . . that's why we call it the speed aligner.

UNLIMITED MARKER AMPLITUDE: The marker height control is like a powerhouse; crank it up as far as you want, even to the point where the markers are larger than the scope screen, without upsetting the response curve. Each marker is crystal controlled on fundamental frequencies and post-injected so that you may place all markers on the curve at unbelievable heights without affecting the curve in the least. That's why we call the SM158 the speed aligner.

EASY TO CONNECT: Just four connecting cables clearly marked TO TV and TO SCOPE. It takes just seconds to connect . . . that's why we call the SM158 the speed aligner.

RF
CHROMA
IF

JUST
PUSH
THE
BUTTON

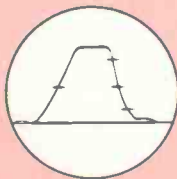
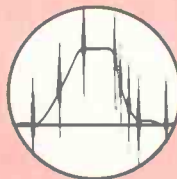

TWO EXTRA VHF CHANNELS: Competition has only two VHF channels; the SM158 has an extra high channel and an extra low frequency channel to prevent any co-channel interference. The SM158 is interference-free . . . that's why we call it the speed aligner.

PLENTY OF SWEEP WIDTH: A full 15 megahertz sweep signal, constant on all IF, chroma and RF curves, provides adequate sweep width to cover new solid state IF amplifiers. Competition covers only 12 megahertz. The SM158 gives you the full picture the first time . . . that's why we call it the speed aligner.

GENERATES A ZERO REFERENCE BASE LINE: You know where zero is with the SM158. All alignment instructions show a base line, yet some competitors do not generate a base line. You can follow TV manufacturers' instructions to the "T", easier and faster with the SM158 . . . that's why we call it the speed aligner.

SWITCHABLE HORIZONTAL OR VERTICAL MARKERS: want to tilt markers 90 degrees so you can view markers better in traps or for leveling? Merely pull the MARKER HEIGHT control out and markers appear horizontally — a real plus feature.

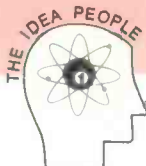

SENCORE

3200 Sencore Drive
Sioux Falls, South Dakota 57107

SAVE MONEY

WITH THE

Telematic

COLOR ECONO JIG

KIT



Use your 19" color tube easily assembled metal cabinet for portable, bench, or hanging operation all components — less picture tube.

SERVICE ALL MAKES

OF COLOR SETS WITH THE ECONO-JIG OR ANY COLOR TEST JIG. SEND FOR FREE CROSS-REFERENCE

TELEMATIC DIV., U.X.I. CORP.
2245 PITKIN AVE.
BROOKLYN, N.Y. 11207

... for more details circle 131 on Reader Service Card

NEW PRODUCTS

solder rods, silver and aluminum solder flux, sandpaper and an instruction manual. It is intended to be used with the manufacturer's gas torch. Microflame.



POWER LIMITER

714

Burn-out protection for microwave components

The Model MIC 3151 coaxial power limiter has been designed to provide burn-out protection for microwave components operating in a frequency range of from 225 to 400MHz. Operating in the passive mode, these units reportedly require no external bias or dc return path. Specifications

indicate that a limiter can be installed at any point in a 50Ω system to provide protection of down-line components. \$75 each in quantities over 1000. AEL.



TOOLS

715

Reversible screwdrivers reduce tool supply

A new unit has been added to a line of 4-in-1 reversible screwdrivers. The assortment comes packed with four combinations, each of the four types of screwdrivers: MX-41, with mixed, slotted and Phillips blades; RC-41, with Phillips point Nos. 0, 1, 2 and 3; FB-41, with slotted blades from 1/8 in. to 9/32 in.; and CH-41, with clutch heads from 5/32 in. to 5/16 in. Special combinations are also available to include Scrulox Nos. 0, 1, 2 and 3. Upson.



READOUT DEVICE

716

Can be ganged, built-in filter for viewing under ambient lighting

A complete readout and plug-in decoder-driver display package can reportedly be ganged for multiple use. The readout is said to use standard incandescent lamps and to be removable by unplugging it from the mated decoder/driver module. Characters from 0 to 9 are said to be displayed on a flat plane, and the built-in filter reportedly allows excellent viewing under all ambient lighting conditions. The seven segments are said to be illuminated separately. The plug-in

NEW

from the originators of "NO NOISE"

You've tried others, now try the best!

3 years of constant research and testing have put us way ahead!

NO NOISE has been an innovative force in the development and production of cleaners and lubricants for 25 years. Our technical people, who made us No. 1, were turned loose to create a new line that would out-perform anything on the market. Three years of experimentation and testing developed these 2 new products. Approved by leading service organizations.

SUPER-LUBE

A miracle concentrated formulation for heavy duty jobs. Its clinging action foams away corrosion, dirt and oxidation—and polishes all tuners continuously without drift or detuning. SUPER-LUBE's built-in lubricating quality makes channel selecting smooth and easy. For color and black & white.



8 oz.
\$2.35

Introductory Offer! BUY 4 CANS OF SUPER-LUBE AND GET 2 EXTRA CANS FREE FROM YOUR JOBBERS! MONEY BACK GUARANTEE!

SUPER SPRAY BATH dissolves and flushes away grease, dirt, oil and oxidation. Simply spray tuners, its penetrative action cleans and restores tuners inside and out.

All NO NOISE products are non-toxic - non-flammable - no carbon tet - safe for all plastics.



24 oz.
\$3.25

ecc

Often imitated but never duplicated

813 Communipaw Avenue
Jersey City, N. J. 07304

ELECTRONIC CHEMICAL CORP.

... for more details circle 109 on Reader Service Card

The compleat angler

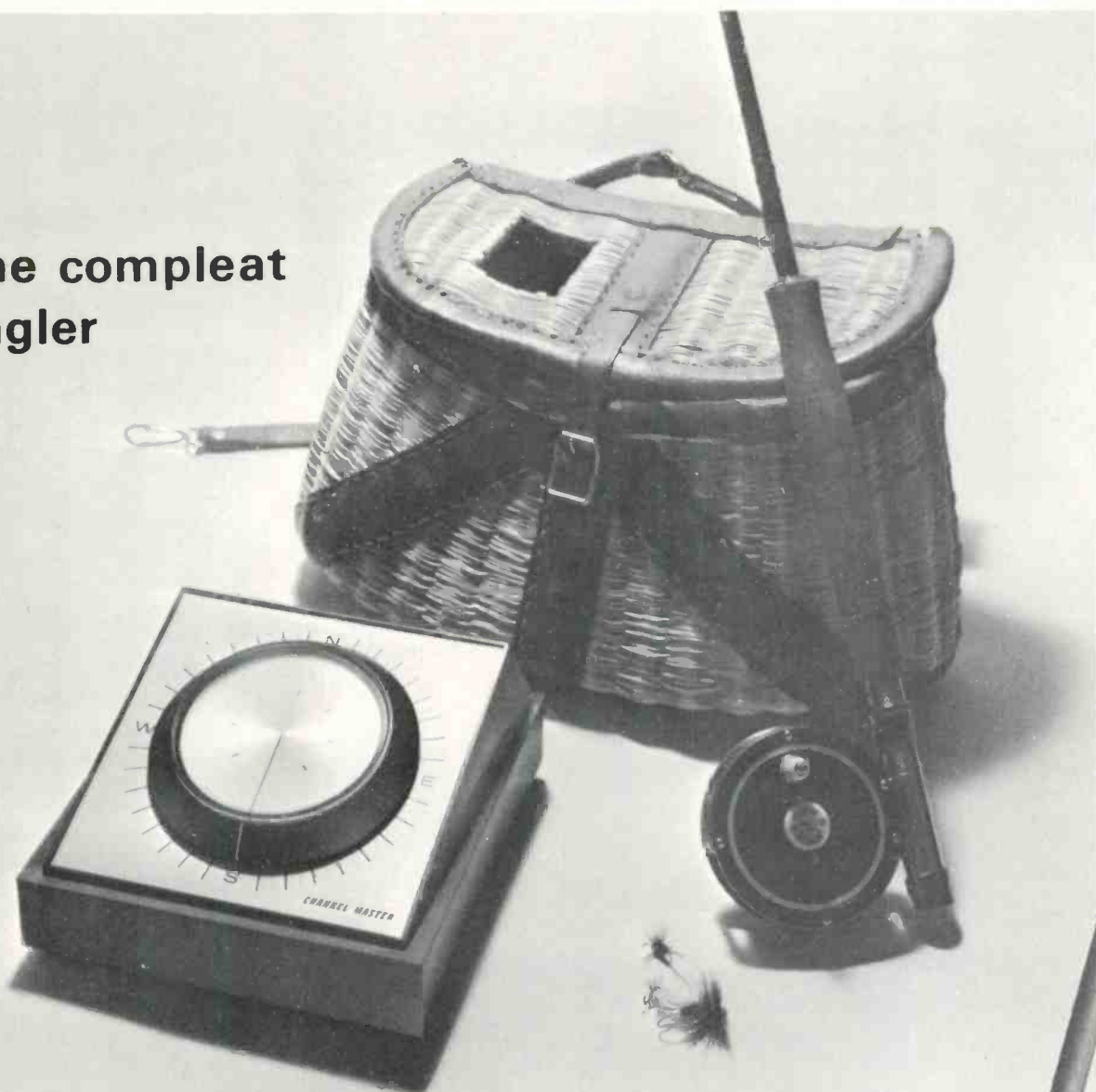

At Channel Master we make rotators that angle to 360 exact degrees, and no fooling about it!

We use two motors in synchronization, and built-in thrust bearing to move the heaviest duty antennas...under the heaviest loads...to any angle required for perfect color reception. Oversized brake pads keep them there at winds up to 70 mph.

We've trimmed the hidden wiring costs by using 3 instead of 4 or 5 strand conductor cable, and thrown in a 90 day free replacement and four year pro-rated guarantee.

Now here's the angle...TV installers from coast to coast have made our Automatic Rotator the nation's number 1 seller...and there's nothing fishy about that!

The Automatic Antenna Rotator from Channel Master!

CHANNEL MASTER
Div. of Avnet, Inc., Ellenville, N.Y.

NEW PRODUCTS

module reportedly has an 80ma output capability. Combination price for both display device and decoder-driver \$22.09 in 100 lots. Single lot price \$29.45. Alco.

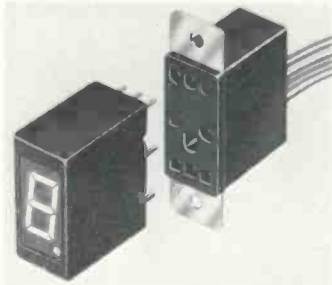

PRE-SCALER

717

Can drive digital frequency counters

A pre-scaler with a maximum measuring range of 280MHz has been designed to drive any digital frequency counter. Specifications indicate that the pre-scaler comes in a bench-top enclosure or a nuclear instrument modular enclosure without power supply. For direct combination into the

existing counter, it can reportedly be obtained as an integrated circuit board alone. High Frequency Engineering.



PLASTIC KNOBS

718

Numbers from 0 to 10 or arrowhead indicator

A plastic knob (.937 in. in diameter) reportedly features an aluminum dial skirt which is marked counterclockwise with numbers from 0 to 10. The



same type skirt reportedly comes with an arrowhead indicator rather than numbers. Price 55¢ each. Alco.

DECADE BOXES

719

Life rated for more than 50,000 operations

A line of decade boxes has been produced to cover a resistance range from 1 through 1M with a $\pm 0.1\%$



precision. Each unit reportedly provides direct numeric readout. Specifications indicate that maximum contact and circuit resistance per decade is 0.01Ω . Switches are life rated to exceed 50,000 operations. The operating temperature range is said to be 15° through 35°C . Ohmite.

COLOR TV CONTROLS

- Audio Controls
- Convergence Controls
- A.G.C. Delay Controls
- Vertical Linearity Controls
- Horizontal Linearity Controls

EXACT REPLACEMENTS FOR

RCA • SILVERTONE
ADMIRAL • ZENITH
GENERAL ELECTRIC

COLOR CODED KNOBS SAME AS MANUFACTURER'S SPECS.

NOW AVAILABLE FROM

WORKMAN Electronic PRODUCTS, INC.
P.O. BOX 3828 SARASOTA, FLORIDA 33578

TRANSISTOR

720

Delivers 80w across a 100 to 160MHz band

A transistor designed for broadband application reportedly delivers 80w power output across the 100 to 160MHz band with a minimum of 7dB gain. Source voltage is said to be 28v. Price \$72. TRW Semiconductors Div.

ATTENUATOR

721

82.5dB attenuation, low return loss

Specifications indicate that a high-precision attenuator provides a maxi-

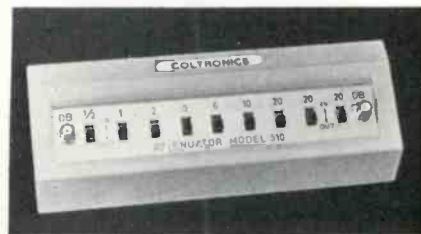

imum of 82.5dB attenuation from dc up to 900MHz with very low return loss. The unit reportedly features double-shielded die cast housing,

... for more details circle 133 on Reader Service Card

FREE! YOUR FIRST CAN OF TUN-O-BRITE IS ON US!



We say TUN-O-BRITE is head and shoulders above any other tuner spray you've ever tried. You say you've heard that song before.

It's time for us to put our money where our claims are. Tell you what we're gonna do. Buy a can of TUN-O-BRITE from your favorite distributor — at the regular price.

When you've used the TUN-O-BRITE up, send the empty can to us. We'll send you a new can *OF YOUR FAVORITE TUNER SPRAY FREE!*

There are no strings attached to this offer. If you ask for TUN-O-BRITE, we'll be delighted to send you another can absolutely free. If you ask for a competitive brand, we'll be disappointed, but we'll send it to you anyhow. Either way, you can't lose. You get to try TUN-O-BRITE at our expense because you can swap the empty can for a free can of your favorite tuner spray.

Of course, we're betting that once you try TUN-O-BRITE, you simply won't settle for any other product, no matter how cheap you can buy it. After all, you can tell a professional TV technician by the tools he uses.

ONLY ONE
FREE CAN
TO A
TECHNICIAN.

This offer expires
February 1, 1971

CHEMTRONICS INC.
 1260 RALPH AVE.
BKLYN., N.Y. 11236

... for more details circle 107 on Reader Service Card

popular paks



- GE-504A
- GE-509
- 6GC1
- GEGR-1

rectifiers and diodes for the replacement market

GE-504A—1-amp, 600-volt PIV universal silicon rectifier with a 60-amp surge current rating.

GE-509—1-amp, 1000-volt PIV universal silicon rectifier with a 60-amp surge current rating.

6GC1—VAC-U-SEL® dual diode primarily used as a discriminator or phase detector in TV receivers.

GEGR-1—Focus rectifier designed as a heavy-duty replacement for the focus diode in color television.

ask for
General Electric
Popular Paks at
your GE distributor

TUBE DEPARTMENT
OWENSBORO, KENTUCKY

GENERAL  ELECTRIC

NEW PRODUCTS

nine slide switches, "F" type connectors and resistors having 1% tolerances. Input/output impedance is reportedly 75Ω. Coltronics.

METAL DETECTOR KIT 722

For both ferrous and non-ferrous metals

A solid-state metal detector kit has been designed to detect both ferrous and non-ferrous metals to a depth of 6 in. The pressure of metals reportedly heightens the pitch of the audio-frequency beat note heard through the built-in speaker. Price \$29.95. EICO.



CHOKES 723

With resonant frequencies from 240MHz to 680MHz

A line of epoxy roll-coated chokes is being produced. Specifications indicate that the chokes have an inductance range from 0.10μh to 1.00μh with ±10% tolerance. Self-resonant frequencies are said to range from 680MHz on the 0.10μh model to

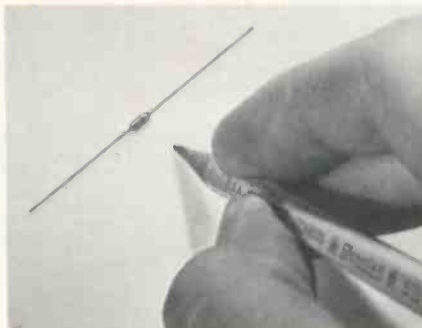

Why not export?

It could double your business.* And we'll help you get started.

What's in it for us? Only that the more this country exports, the better we'll be able to reduce our balance-of-payments deficit. For really helpful information on world markets and how to break into them, just pick up the phone and call your local office of the U.S. Department of Commerce.

*It happened to one of America's largest chemical companies. And there are dozens of others—large and small—that have been just as successful abroad. Case histories on request from U.S. Dept. of Commerce, Washington, D.C.



Published as a public service in co-operation with The Advertising Council and the Department of Commerce.

240MHz on the 1.00μh model. Standard dimensions of the choke body are 0.350 in. maximum length, 0.135 in. maximum diameter, and 2.955 in. minimum overall length, including the leads. Dale Electronics.

CRT TESTER/REJUVENATOR 724

Heater, G-1 and G-2 voltages are continuously variable and metered

A tester/rejuvenator, Model 466, for B/W and color picture tubes reportedly tests for opens, shorts or leakage between elements, rejuvenates guns and repairs shorted or leaky tubes. A "monitored rejuvenation" is designed to permit reading relative cathode emission improvement directly. This is not only a time saver, but provides accurate rejuvenation for maximum CRT life. Specifications indicate that there is a separate G-2 control for each color gun and sufficient

G-2 voltage range to check color guns to cut-off at recommended voltage setting. CRTs are reportedly tested in accordance with the manufacturer's rec-

ommended procedures and in all test modes. The unit measures 13¼ by 9½ by 5¼ in. and weighs 8 lb. Price \$129.95. B & K.

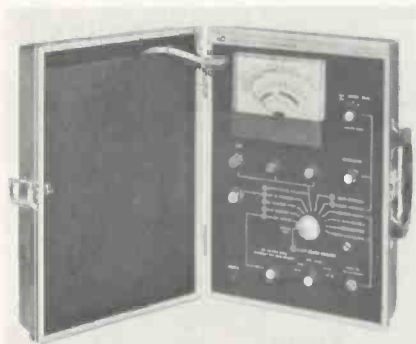

MOVING?

Be sure to let us know
your new address.

Please enclose a complete
address label from one
of your recent issues.

SERVICE LAB...

continued from page 60

color-TV second anode voltage measurements and a can of tuner cleaner.

The entire unit represents an investment of less than \$500.00. The cabinet was constructed of ¼-in. plywood over a frame of what carpenters call "screen door stock." It was put together with glue and screws to absorb the constant buffeting it gets in the service truck. For the same reason, the finish is but a simple walnut stain. The tube checker and dot bar generator were removed from their cabinets to reduce weight, but were installed in such a way as to be easily accessible for maintenance.

Many technicians have their own favorite systems for service, and for this reason I am sure that many of them would not care to "buy" my idea in its entirety. However, some feature or other might serve to stimulate thinking along the lines of greater efficiency. I personally have found this unit to be a great boom and labor saver for a very hard-pressed and busy one-man service business.

Although the unit was not constructed with an eye to impress the customer—but rather to get on with making a living—it nevertheless has favorably impressed quite a few customers as evidenced by their comments. ■

DEPENDABLE ANTENNAS AND ACCESSORIES FOR PROFITABLE INSTALLATIONS...

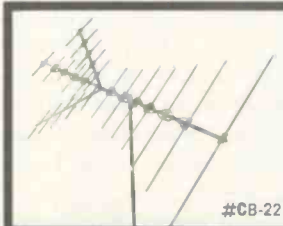

#CB-22

RMS COLOR-BOOSTER UHF/VHF SINGLE DOWN-LEAD ANTENNAS...

#CB-22: 22 elements, #CB-28: 28 elements, #CB-34: 34 elements. Adds mileage to UHF/VHF TV reception. Features Reynolds Aluminum Colorweld weather-proof Gold finish.

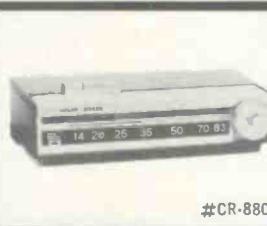

#CR-880

RMS MODEL CR-880 SOLID-STATE UHF CONVERTER...

Powerful amplifier and Local/Distant Switch provides 30 db gain! Brings in clearest Color and Black and White UHF reception even in areas where other Converters fail to!

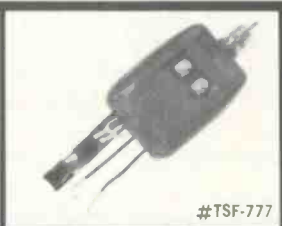

#TSF-777

RMS HAS THE MOST COMPLETE LINE OF UHF/VHF/FM SPLITTERS AND MATCHING TRANSFORMERS

For all multi-set home installations, master antennas, and closed circuit TV systems. All configurations for every requirement.

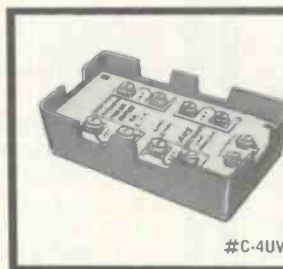

#C-4UV

RMS UHF/VHF/FM HIGH GAIN 4-SET COUPLER

Couple 4 TV and/or FM Sets to a single antenna with low signal loss—minimum interference between sets. Or couple 2 antennas, (VHF, UHF or FM), to a single down-lead.



#HS-20U
2-Way

#HS-40U
4-Way

UHF/VHF 2-WAY AND 4-WAY HYBRID SPLITTERS

For multi-set home and master antenna installations. Unbeatable specifications. Also top performing UHF/VHF Tap-Offs.



#CTB-70

DEPENDABLE ALL-PLASTIC COLOR-TUBE BRIGHTENERS

Reusable. Simple installation. Plugs in between color tube and color tube socket. #CTB-70 for 70° button base tubes. #CTB-90 for 90° button base picture tubes.

Couplers, Splitters, Matching Transformers, Hybrid Splitters, Tap-Offs, and Color-Tube Brighteners are individually blister sealed on attractive Peg-Hang Cards. Write for latest Catalog—

RMS ELECTRONICS, INC.

50 Antin Place, Bronx, N.Y. 10462 • Tel. (212) 892-6700



... for more details circle 127 on Reader Service Card

STATEMENT REQUIRED BY THE ACT OF OCTOBER 23, 1962 (39 U.S. Code, 4369) SHOWING THE OWNERSHIP, MANAGEMENT AND CIRCULATION OF ELECTRONIC TECHNICIAN/DEALER published monthly at 757 Third Avenue, New York, New York 10017 for November 1969.

1. The names and addresses of the publisher, editor and managing editor are: Publisher, Hugh Wallace, 43 East Ohio Street, Chicago, Illinois 60611; Editor, Phillip Dahlen, 1 East First Street, Duluth, Minnesota 55802; Managing Editor, Joseph Zauhar, 1 East First Street, Duluth, Minnesota 55802.

2. The owner is: Harcourt Brace Jovanovich, Inc., 757 Third Avenue, New York, New York 10017. Stockholders owning 1 percent or more of stock: (Holders of One Per Cent (1.0%) or more of the outstanding shares of Harcourt Brace Jovanovich, Inc., as of August 21, 1970) Donald H. Harcourt, 2444 Brinkerhoff Avenue, Santa Ynez, California 93460; Ellen Knowles Harcourt, William I. Jovanovich & Peter J. Ryan as Trustees u/t/a dated 5/23/66, c/o First National City Bank, 20 Exchange Place,

New York, New York 10015; Hastings Harcourt, 835 Laguna Street, Santa Barbara, California 93101; William Jovanovich, 92 Birch Road, Briarcliff Manor, New York 10510; S. Spencer Scott, 5 Quaker Center, Scarsdale, New York 10583; Barnett & Co., c/o Bankers Trust Company, P.O. Box 704, Church Street Station, New York, New York 10008; King & Co., 22 William Street, New York, New York 10005; Shaw & Co., P.O. Box 1426, Church Street Station, New York, New York 10015; Sigler & Co., c/o Manufacturer's Hanover Trust Company, New York, New York 10015; Emp & Co., Harris Trust and Savings Bank, 111 West Monroe Street, Chicago, Illinois 60603; Harwood & Co., c/o State Street Bank and Trust Company, Boston, Massachusetts; Cede & Co., Box 20, Bowling Green Station, New York, New York 10004; Leslie & Co., Irving Trust Company, 1 Wall Street, New York, New York 10005; State of Wisconsin, Investment Board, 16 North Carroll Street, Madison, Wisconsin 53703; Cudd & Co., P.O. Box 1508, New York, New York; Kane & Co., c/o Chase Manhattan Bank, 1 Chase Manhattan Plaza, New York,

New York 10005; Stuart & Co., c/o First National City Bank, Pension Trust Department, 20 Exchange Place, New York, New York 10005; Hastings Harcourt Trustee u/t/a dtd. 6/27/56 F/B/O Magdelene Brooks Huber, P.O. Box 238, Church Street Station, New York, New York; Katherine Brace Cummings, c/o Ernest Cane Berner & Gitlin, 4 West 45th Street, New York, New York; Walter J. Johnson, 19 Hewitt Avenue, Bronxville, New York 10708; Henry M. Stratton, 118 E. 60th Street, New York, New York 10022; Thekla Johnson, 19 Hewitt Avenue, Bronxville, New York 10708; Finabob Co., c/o First National Bank, P.O. Box 1061, Bradenton, Florida 33505.

3. The known bondholders, mortgages and other security holders owning or holding 1 percent or more of total amount of bonds, mortgages or other securities are: None.

4. The average number of copies of each issue of this publication sold or distributed, through the mails or otherwise, to paid subscribers during the 12 months preceding the date shown was 77,383. Free distribution by mail, carrier or other media: 1,797.

(signature) Richard Moeller
Treasurer

You need both! VECTORSCOPE/ COLOR BAR GENERATOR



Made in U.S.A.

One Year Warranty

MODEL V-7

Unique all-in-one unit

- Checks, aligns demodulators to any angle
- Checks, aligns bandpass-amplifier circuit
- Pinpoints troubles to a specific color circuit
- Portable for field or shop

Exclusive Features: Self-Calibrating—adjust timing circuit without external test equipment. Plus: All Crosshatch, Dots, and Color Patterns; Voltage Regulated. Free copy, Wayne Lemon's "Color TV Servicing Simplified with Vectorscope".

\$199⁵⁰
NET



See your distributor or write Dept. ET-10
LECTROTECH, INC.

4529 N. Kedzie Ave., Chicago, Illinois 60625

... for more details circle 135 on Reader Service Card

FOR COLOR AND BLACK & WHITE PICTURE TUBE ANALYZER

MODEL CRT-100

- Critical Grid-to-Cathode Leakage read on meter for greater accuracy.
- Line voltage adjustment (insures all test voltages are correct).
- Tests each color gun to a standard set of test conditions. Method used by tube manufacturers to simulate performance in TV receiver.
- Tests each color gun separately.
- Rejuvenates and removes shorts for increased brightness and life.



Surpasses higher priced CRT Testers in accuracy and performance.

One Year Warranty
Made in U. S. A.

89⁵⁰
NET



See your distributor or write Dept. ET-11
LECTROTECH, INC.

4529 N. Kedzie Ave., Chicago, Illinois 60625

... for more details circle 118 on Reader Service Card

DEALER SHOWCASE

For additional information on products described in this section, circle the numbers on Reader Service Card. Requests will be handled promptly.

POWER AMPLIFIER 725

Voltage sensitivity selector for 0.5, 1 and 2v

A power amplifier has been designed to deliver 120w of music power. Its frequency response reportedly extends from 15Hz to 60kHz within a 5dB range. The unit is said to feature silicon transistors and a voltage sensitivity selector switch on its front panel for 0.5, 1 and 2v. The signal-to-noise ratio is said to be 100dB. The amplifier can reportedly power two pairs of speaker systems. The unit measures 11 13/16 in. by 4 5/8 in. by 10 in. Price \$129.95. Pioneer.



STEREO SPEAKERS 726

Ultra-slim enclosure for limited space

A 2-way, 5-speaker system reportedly features an ultra-slim enclosure for limited space. Specifications indicate that the speaker system has a 20w power capacity and a frequency response of 60 to 20,000Hz. Price \$39.50. Weltron.

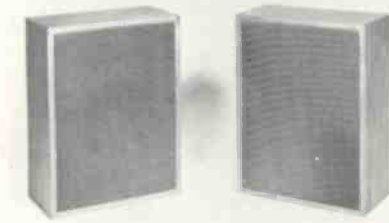

UNDER-CABINET RADIO 727

Conveniently out of the way for kitchen use

An AM/FM cordless 10-transistor radio has been developed for mounting on the underside of any kitchen cabinet. The radio is said to be provided with a mounting template and an adhesive-backed mounting bracket that sticks to wood or metal. The unit reportedly features automatic frequency control, FM antenna, built-in

rod antenna for AM and a 3 1/2-in. speaker. The solid-state radio is said to be able to operate on house current with an optional ac adapter. The radio is 2 3/8 in. high. Price \$40. Sears.

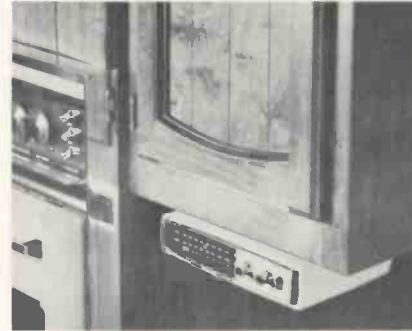

MEGAPHONE 728

Weights only 4 1/2 lb and gives 4 hr of continuous use

A 6w electronic megaphone, designed to be effective at distances up to 1/4 mile, has a reported frequency response of 500 to 5000Hz. The unit is said to provide approximately 4



hours of continued operation. It reportedly weighs 4 1/2 lb with batteries in place. Price \$69.95. Chamberlain.

AM/FM STEREO RECEIVER 729

A light indicates optimum reception and lowest distortion

An AM/FM stereo receiver reportedly features an indicator which shows when the receiver is tuned for optimum reception and lowest distortion. Specifications indicate that the receiver



A NEW AND IMPORTANT DEVELOPMENT FOR TV SERVICING

12 MODELS

SANS-A-FUSE®

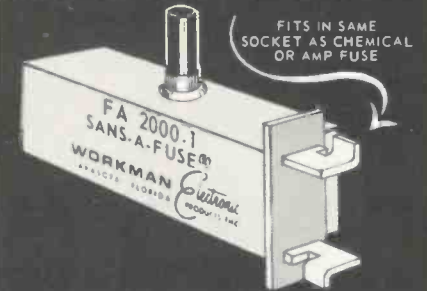

FITS IN SAME SOCKET AS CHEMICAL OR AMP FUSE

COLOR CODED CIRCUIT BREAKER REPLACEMENT FOR CHEMICAL OR AMP FUSE

SAVES TIME AND FUSES WHEN LOCATING SHORTS IN TELEVISION CIRCUITS

DEVELOPED AND MANUFACTURED BY

WORKMAN Electronic PRODUCTS, INC.
BOX 3878 SARASOTA, FLA. 33578
TELEPHONE: Area Code 813 955-4242

... for more details circle 134 on Reader Service Card

NEW ENDECO Desoldering Kits

MODEL 300-K KIT SHOWN



All you need to handle almost any desoldering and resoldering job!

Kit 300K includes the famous Endeco pencil desoldering iron Model 300, six different size tips (.038 to .090) for any job, tip cleaning tool, and metal stand for iron . . . all in a handy lifetime steel storage box. \$19.90 net. Model 300K-3 with a 3-wire cord \$20.90. Also a similar kit for military users. Kit 100K with large Endeco iron (Model 100A) is \$27.40, and 3-wire Kit 100AD-3 \$28.40.

SEE YOUR DISTRIBUTOR OR WRITE



ENTERPRISE DEVELOPMENT CORPORATION

5127 E. 65th St., INDIANAPOLIS, IND. 46220

... for more details circle 110 on Reader Service Card

DEALER SHOWCASE

features modular construction, an electrical connection which takes the place of most solder joints, and a muting circuit that cuts out noise between FM stations. Scott.

MICROPHONE

730

Has a dual impedance of 600K and 50K

A cardioid microphone reportedly features a mikeholder, shielded cable and built-in ON/OFF switch. Specifications indicate that the hand-held



model has a dual impedance of 600K and 50K. Price \$29.95. Weltron.

UHF CONVERTERS

731

Low silhouette polystyrene cabinets in mahogany or beige

Two 10w silhouette UHF converters have been developed. A major advantage of the converters is that they employ transistor inputs with very low noise figures. This assures a maximum signal-to-noise ratio, reportedly resulting in snow-free pictures, even under difficult reception conditions. The Model 6715 shown includes a built-in UHF preamplifier and an illuminated dial. Recommended for fringe areas, the converter is said to boost incoming UHF TV signals to four times the signal voltage received by the antenna. A convenient outlet is provided to accommodate a lamp or clock. The Model 6714 is similar to the 6715, but includes no amplifier and is recommended for metropolitan and suburban areas. To connect, the user simply places the unit on the TV set and

hooks them up between the antennas and the TV set terminals. A VHF bypass circuit is included so that only a single lead-in wire is connected to the TV set antenna terminals. A twin lead and UHF loop antenna are packed with each unit. Model 6715 lists for \$25.95 and Model 6714 lists for \$19.95. Channel Master.



POCKET PAGING SYSTEM

732

Automatically switched ON when clipped into the user's pocket

A pocket paging system is described by the manufacturer as a personal paging unit which connects employees with the operator at a control panel. Specifications indicate that the control panel operator contacts an individual on the system by sending a call signal to a 3½ oz receiver worn in the user's breast pocket. The unit is said to be automatically switched ON when clipped into the pocket and switched OFF when removed. The receiving unit is battery powered. Philips.



STEREO TAPE DECK

733

Automatic program scanner for preselected listening

The Model 850 stereo tape deck reportedly features an automatic program scanner. Specifications indicate that the unit is designed for three tape speeds: 15, 7½ and 3¾ ips. Each head block is said to contain one

HOPPING ALL OVER TOWN FOR REPLACEMENT PARTS . . .

Just hop to

STANCOR...

for all your exact monochrome and color TV replacement needs.

Stancor Products offer a complete line of flybacks, yokes, vertical outputs, audio outputs, power width and linearity controls for all major manufacturers.

Stocked by over 1,000 Service Part Distributors. Back up stock—Chicago, Dallas, Los Angeles, Hackensack and Atlanta.

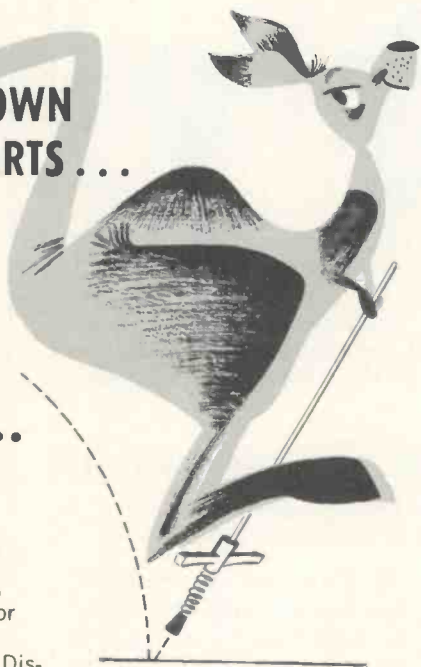

ESSEX
WIRE CORPORATION

ESSEX CONTROLS DIVISION • STANCOR PRODUCTS • 3501 W. ADDISON ST. • CHICAGO, ILL. 60618

. . . for more details circle 111 on Reader Service Card

erase, one record and two play-back heads for playing back half-track, two-track and quarter-track tapes. Price \$775. Superscope.



STEREO TAPE PLAYER 734

*Solid-state,
battery or ac*

A portable AM/FM stereo amplifier has been developed for use in combination with an 8-track cartridge player and removable speakers. The unit reportedly features controls for balance, volume, bass and treble. Specifications indicate that the amplifier is of solid-state design and able to operate on battery or ac power. Price \$149.95. Westbury.



TWO-WAY RADIO 735

*Noise-cancelling microphone
and adjustable squelch*

A 30w, AM, single-channel transceiver reportedly features a noise-cancelling microphone and adjustable squelch. The entire unit can reportedly be installed under the dashboard. Specifications indicate that the unit



comes equipped with one pair of transmit and receive crystals, coil cord and hanger, power cable and fuse block and mounting bracket. Price \$339.95. Pearce-Simpson.

FREE CASSETTE 736

*Obtained with
purchase of three others*

Display packs containing three cassettes plus a complimentary 60-min. cassette are being offered to dealers. Customers will be able to obtain the free cassette with the purchase of



three other cassettes—all are of the same length. 3M.

ACA
ANTENNA CORPORATION of AMERICA
HARRY E. RHEINSCHMIDT
P. O. Box 865 • Burlington, Iowa 52601 • Tel. 319/753-1625

CLIP and SAVE!

ANNOUNCING...

a new line of patented TV antennas
from a most reliable source

The new ACA antenna line offers a complete selection of VHF, UHF, FM reception in color and black/white. Priced for today's market, with all of the top quality features you expect, including gold-anodized, high tensile aluminum elements, die cut impedance correlators, dual action director/reflector screen and tetrapole collector element. Also, available from ACA — antenna preamplifiers, booster couplers, matching transformers. Line up today with ACA!

For complete details, write or call:

ACA ANTENNA CORPORATION of AMERICA
P. O. Box 865 • Burlington, Iowa 52601 • Tel. 319/753-1625

simplest
top
quality
modular
amplifier
system



NEWCOMB
TOP QUALITY CUSTOM **K**



Newcomb's finest, the Custom K Series is the climax of 30 years devoted to developing and producing the very best public address amplifiers. You quickly and simply get the combination of channels and power you need. A power output module is dropped into either a front-end or booster chassis. Two electrical plug-in connections; no soldering. Put a cover over the top or insert the chassis in a rack mount. You can plug in a transistorized VU meter accessory which has a sensitivity control and monitor jack for crystal headphones. The 4-channel models have provisions for a remote control accessory. There are 3 power amplifier modules: 40, 60, and 125 watts, and a power supply when you want to use a front end as a mixer-preamplifier only. There are three preamplifier modules: 3, 4, and 5 channels, and a chassis for making a booster amplifier out of any of the output modules. All in all, only 14 components permit 70 combinations. Performance is superb. Frequency response is ± 1 db 20-20,000 cps; distortion is extremely low. Custom K amplifiers run remarkably cool. Easy-to-trace, easy-to-service vacuum tube construction is used throughout. Colors are soft shades of gray-green. Write for Catalog K-15.

NEWCOMB AUDIO PRODUCTS CO., Dept. ET-11
12881 Bradley Ave.
Sylmar, California 91342

TECHNICAL LITERATURE

For additional information on products described in this section, circle the numbers on Reader Service Card. Requests will be handled promptly.

Tools 400

A 40-page, 4-color catalog describes the manufacturer's comprehensive line of hand tools. Each of the tools is fully illustrated and described together with a color-keyed application and user's guide for correct tool selection and use. Products illustrated include a variety of "unique" tools each specifically designed to solve a particular tool usage problem faster and more safely. A special section is devoted to displays for distributors and retail store operators. All of the tools described in the catalog are said to carry an unconditional guarantee of complete satisfaction. Vaco.

Semiconductor Replacement 401

An interchangeability guide lists more than 100 basic types of semiconductors that can be used as substitutes for over 12,000 other types of semiconductors. The guide provides replacement data for semiconductors used in AM/FM portable transistor radios, automobile radios, transistorized TV sets, solid-state Hi-Fi amplifiers and tuners, power converters, auto ignition systems, CB and marine electronic equipment. Semitron.

Power Transistors 402

A 96-page manual has been written to provide a basic understanding of the theory and application of medium-frequency power transistors. It covers physical theory, structures, geometries, packaging, critical application-limiting factors, and the operation and requirements of power transistors in amplifier, switching and control applications. Typical circuits illustrate the use of these transistors in series voltage regulators, linear amplifiers, switching regulators, inverters and converters, and the application of complementary transistor pairs. Selection charts are included to facilitate choice of the optimum type of power transistor for a variety of military, industrial and commercial applications. RCA.

Parts and Equipment 403

A 522-page catalog describes a highly comprehensive selection of electronic parts and equipment cur-

rently on the market, with 125 companies listed in an "Index to Manufacturers." Product descriptions and illustrations are said to be included along with thumb tabs and up-to-date prices. The catalog is divided by product categories. Kann-Ellert.

Frequency Monitor Radios 404

A four-page, two-color catalog has been published which contains the manufacturer's complete line of special frequency monitor radios, lightweight pocket portable and table models. Full frequency specifications for each AM and FM model are included along with illustrations. Hallicrafters.

Index 405

An index of over 300 articles and letters that have appeared in the Signalite Application News has been issued. The index reportedly lists each item by title, volume, and number of the issue in which it appeared, as well as by consecutive page number. Signalite.

Digital VOM 406

A two-page data sheet has been compiled which describes two of the manufacturer's digital VOM's—Models 8000 and 8000-A. The data sheet provides complete electrical ranges and mechanical specifications for both digital VOM's as well as suggested user net prices. Triplett.

Two Revised Catalogs 407

Two revised catalogs have been issued, the first of which, in addition to updating, describes a new microminiature printed circuit connector and a series that offers EMI shielding. The second is an audio catalog which reportedly includes an XLR cross-reference mating selection guide. ITT.

Consumer Electronics Annual

The 1970 Golden Anniversary edition of CONSUMER ELECTRONICS ANNUAL outlines the industry's first 50 years and contains a year-by-year statistical review of the products through 1969: TV, radios, phonographs and magnetic tape equipment. The special edition also contains a listing of the industry's contributions to the national economy, a chronology of important industry events, a glossary of terms used in the industry, and a list of the names and addresses of the major industry allied trade associations. Copies are available at 50 cents a copy, postpaid, from the Electronic Industries Assn., Consumer Products Div., 2001 I St., N.W., Washington, D.C. 20006. 25-99 copies are 25 cents each, 100 or more copies are 15 cents each.

BOOK REVIEWS

ELECTRONIC CIRCUITS FOR TECHNICIANS by Lloyd Temes. Published by McGraw-Hill, 444 pages, hard cover, \$8.95.

The preface to this book indicates that it has been, "written for use in two-year technical programs found in junior and community colleges and technical institutes. . . . All mathematical explanations are presented with simple algebra and a bit of geometry. At no point in this text is calculus used."

The author was really too conservative in his description of this book—the best that we have yet to encounter in this field—in that its subjects are so beautifully illustrated and simply explained that the book should be of value to anyone in the electronics industry interested in either reviewing what he has learned or expanding his knowledge with recent developments in electronics.

Beginning with simple half-wave rectifier circuits and an easy-to-understand explanation of peak, RMS and average values, the book progresses to capacitor characteristics in filter circuits, SCR diode circuitry, transistor parameters, the response of a capacitance-coupled vacuum-tube amplifier, negative-feedback amplifier circuits and signal differentiation. Described are such components as vacuum tubes, transistors, diodes, SCR diodes, MOS-FETS, and integrated circuits.

It is a joy to review a book that has been printed with more apparent concern for quality than production costs. Although it has been published in but one color, the book beautifully illustrates the circuits described and includes very clearly drawn and reproduced curves to indicate waveforms and circuit characteristics.

BASIC MATHEMATICS FOR ELECTRONICS by Nelson Cooke and Herbert Adams. Published by McGraw-Hill, 690 pages, hard cover, \$9.95.

This is the third edition of a book originally entitled, "Mathematics for Electricians and Radiomen." It deals specifically with the type of mathematics encountered when servicing electronic products, and includes electronic schematics and drawings to illustrate mathematical problems. Many of the pages contain a second color to add interest and emphasis.

Beginning with simple arithmetic and then progressing to higher forms of high school and trade school level mathematics, the book demonstrates the use of mathematics in solving such problems as those involved when de-

termining the length of a folded dipole antenna, the capacitive reactance of a circuit, the maximum power applied to a component in a circuit containing varying load conditions, the resistance of a transmission wire, inductive current and resonant frequencies.

Since mathematics is required for effective servicing, this book would be of value to any electronic technician that wishes to brush up on his mathematics as it relates to his job. It is also a good resource for students preparing to enter this industry.

MOTOROLA COLOR TV SERVICE MANUAL by Forest H. Belt. Published by Tab Books, 160 pages, soft cover, \$7.95.

There are not too many books on color TV servicing that go into as much detail as this one. Although the technician should first have some background in servicing, some relatively sophisticated test instruments and a thorough understanding of their operation; he can then use this book as a guide for servicing even TV components generally "jobbed out" by most shops—VHF and UHF tuners.

Being 160 pages in length, with a number of fold-out diagrams, the book

is unable to go into precise detail on every conceivable component failure. But by concentrating exclusively on one brand of TV set, it can offer maximum value for servicing their receivers, while still supplying information that would be of value when servicing other brand receivers.

AM/FM BROADCAST STATION PLANNING GUIDE by Harry A. Etkin. Published by Tab Books, 192 pages, soft cover, \$12.95.

This book offers those interested in starting a commercial AM or FM broadcast station a good introduction in station design. Beginning with the history of broadcast radio, the book gives general coverage to the problem of determining available frequencies, interference from other stations, making FCC applications, designing studio and transmitter floor plans, FM signal polarization, AM directional antennas, selecting a transmitter and studio equipment, and automatic programming equipment now available.

Although not intended as a source of all necessary information for such a formidable project, the book does a good job in indicating the general problems that will be encountered and recommends sources of additional help.

TV TECHNICIANS

If you are a qualified, experienced electronic technician who can repair television sets...if you have the desire to make maximum use of your working time and earn an annual net income in excess of \$20,000...if you want the respect your profession deserves...then we're prepared to offer you a unique opportunity.

Our totally new Full Service Franchise gives you corporate benefits and services, plus the pride and profits of owning your own business.

We're building the largest, finest, and most reliable television repair network in Southern California. We hope you will look into joining us. Initial cash requirement \$4,500 (partial financing available), for a complete and ready-to-go Mobile TV MAN franchise.

For information contact Ronnie Simon, C.E.T., Vice President of Technical Services, Mobile TV MAN, 2040 Cotner Ave., Los Angeles 90025.

(213) 477-3057

... for more details circle 121 on Reader Service Card

ARROW AUTOMATIC STAPLE GUNS

CUT WIRE & CABLE INSTALLATION COSTS

... without cutting into insulation!

SAFE! Grooved Guide positions wire for proper staple envelopment! Grooved Driving Blade stops staple at right depth of penetration to prevent cutting into wire or cable insulation!

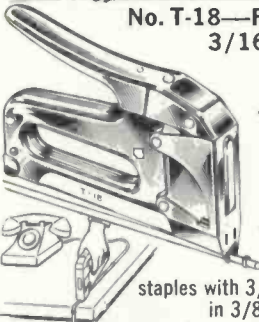

No. T-18—Fits wires up to 3/16" in diameter.

BELL, TELEPHONE, THERMOSTAT, INTERCOM, BURGLAR ALARM and other low voltage wiring.

Uses T-18 staples with 3/16" round crown in 3/8" leg length only.



No. T-25—Fits wires up to 1/4" in diameter.

Same basic construction and fastens same wires as No. T-18.

Also used for **RADIANT HEAT WIRE**

Uses T-25 staples with 1/4" round crown in 9/32", 3/8", 7/16" and 9/16" leg lengths.

T-18 and T-25 staples also available in Monel and with beige, brown and ivory finish at extra cost.

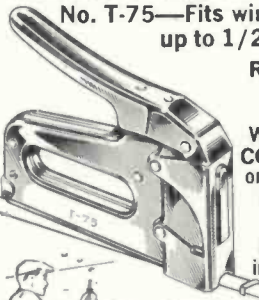

No. T-75—Fits wires and cables up to 1/2" in diameter.

RADIANT HEAT CABLE, UF CABLE, WIRE CONDUIT COPPER TUBING or any non-metallic sheathed cable.

Also used as **DRIVE RINGS** in stringing wires.

Uses T-75 staples with 1/2" flat crown in 9/16", 5/8" and 7/8" leg lengths.

Arrow Automatic Staple Guns save 70% in time and effort on every type of wire or cable fastening job. Arrow staples are specially designed with divergent-pointed legs for easier driving and rosin-coated for greater holding power! All-steel construction and high-carbon hardened steel working parts are your assurance of maximum long-life service and trouble-free performance.

Ask your Electrical Supply Dealer or write for further details.

ARROW FASTENER COMPANY INC
Saddle Brook, New Jersey 07683
"Pioneers and Pacesetters For Almost A Half Century"

... for more details circle 102 on Reader Service Card

READERS SERVICE INDEX

ADVERTISER'S INDEX

| | | |
|-----|--|-----------|
| 101 | Antenna Corporation of America | 83 |
| 102 | Arrow Fastener Co., Inc. | 86 |
| 103 | B & K Division Dynascan Corporation | 2nd Cover |
| 104 | Book Club—Tab Books | 34-37 |
| 105 | Channellock, Inc. | 72 |
| 106 | Channel Master, Division of Avnet, Inc. | 75 |
| 107 | Chemtronics, Inc. | 77 |
| 108 | Cleveland Institute of Electronics | 61-63 |
| 109 | Electronic Chemical Corp. | 74 |
| 110 | Enterprise Development Corp. | 81 |
| 111 | Essex International, Inc.—Stancor Division | 82 |
| | General Electric Co. | 29 |
| | General Electric Co. | 78 |
| 112 | Grantham School of Engineering | 86 |
| 113 | Griffiths Electronic Inc. | 30 |
| 114 | The Heath Company | 26 |
| 115 | International Crystal Mfg. Co. | 28 |
| 116 | Jensen Tools & Alloys | 69 |
| 117 | Jerrold Electronics Corp. | 3rd Cover |
| 118 | Lectrotech, Inc. | 80 |
| 119 | Mallory Distributor Products Co. | 20 |
| 120 | Master Appliance Corporation | 67 |
| 121 | Mobile TV Man | 85 |
| 122 | Newcomb Audio Products Co. | 84 |
| 123 | Panasonic | 38 |
| 124 | Philips Business Systems, Inc. | 27 |
| 125 | Precision Tuner Service | 70 |
| | RCA Entertainment Tubes | 4th Cover |
| 126 | RCA Parts and Accessories | 66 |
| 127 | RMS Electronics, Inc. | 79 |
| 128 | Sencore, Inc. | 64 |
| 129 | Sencore, Inc. | 73 |
| 130 | Sprague Products Company | 25 |
| | Sylvania Electric Products | 22 |
| | Sylvania Electric Products | 68 |
| 131 | Telematic UXL Corp. | 74 |
| 132 | Tuner Service Corporation | 19 |
| 133 | Workman Electronic Products, Inc. | 76 |
| 134 | Workman Electronic Products, Inc. | 81 |
| | Zenith Radio Corporation | 32 |
| 135 | Lectrotech, Inc. | 80 |

TECHNICAL LITERATURE

| | | |
|-----|---------------------------|----|
| 400 | Tools | 84 |
| 401 | Semiconductor Replacement | 84 |
| 402 | Power Transistors | 84 |
| 403 | Parts and Equipment | 84 |

| | | |
|-----|--------------------------|----|
| 404 | Frequency Monitor Radios | 84 |
| 405 | Index | 84 |
| 406 | Digital VOM | 84 |
| 407 | Two Revised Catalogs | 84 |

NEW PRODUCTS

| | | |
|-----|------------------------|----|
| 700 | Sound Column | 33 |
| 701 | Socket Wrench Set | 33 |
| 702 | Hot Knife/Solder Iron | 33 |
| 703 | Digital Multimeter | 71 |
| 704 | Miniature Relays | 71 |
| 705 | Resistor Assortment | 71 |
| 706 | Wire Marker | 71 |
| 707 | DC Digital Voltmeter | 71 |
| 708 | Radiotelephone | 71 |
| 709 | TV Camera | 71 |
| 710 | AGC Amplifier | 72 |
| 711 | Solder Display | 72 |
| 712 | Varactor Diodes | 72 |
| 713 | Brazing Rod Kit | 72 |
| 714 | Power Limiter | 74 |
| 715 | Tools | 74 |
| 716 | Readout Device | 74 |
| 717 | Pre-scaler | 76 |
| 718 | Plastic Knobs | 76 |
| 719 | Decade Boxes | 76 |
| 720 | Transistor | 76 |
| 721 | Attenuator | 76 |
| 722 | Metal Detector Kit | 78 |
| 723 | Chokes | 78 |
| 724 | CRT Tester/Rejuvenator | 79 |
| 725 | Power Amplifier | 81 |
| 726 | Stereo Speakers | 81 |
| 727 | Under-Cabinet Radio | 81 |
| 728 | Megaphone | 81 |
| 729 | AM/FM Stereo Receiver | 81 |
| 730 | Microphone | 82 |
| 731 | UHF Converters | 82 |
| 732 | Pocket Paging System | 82 |
| 733 | Stereo Tape Deck | 82 |
| 734 | Stereo Tape Player | 83 |
| 735 | Two-Way Radio | 83 |
| 736 | Free Cassette | 83 |

TEST INSTRUMENT

| | | |
|-----|--|----|
| 900 | Hickok's Model 3300 Digital Multimeter | 59 |
|-----|--|----|

Technicians, Earn Your Associate DEGREE

mostly by correspondence
Accredited by the Acctd. Comm. of National Home Study Council. G.I. Bill Approved. Free catalog. Write: **Dept. T**
Grantham School of Engineering
1505 N. Western, Hollywood, Calif. 90027

... for more details circle 112 on Reader Service Card

ELECTRONIC TECHNICIAN/DEALER

**GET
MORE
FACTS**
NO POSTAGE
NECESSARY

Circle
the
Reader
Service
numbers
of those
items of
interest
to you.

OK

FOR MORE INFORMATION fill out and mail today!

Please send more information on items circled.

ADVERTISED PRODUCTS

| | | | | | | | | |
|-----|-----|-----|-----|-----|-----|-----|-----|-----|
| 101 | 102 | 103 | 104 | 105 | 106 | 107 | 108 | 109 |
| 110 | 111 | 112 | 113 | 114 | 115 | 116 | 117 | 118 |
| 119 | 120 | 121 | 122 | 123 | 124 | 125 | 126 | 127 |
| 128 | 129 | 130 | 131 | 132 | 133 | 134 | 135 | 136 |
| 137 | 138 | 139 | 140 | 141 | 142 | 143 | 144 | 145 |
| 146 | 147 | 148 | 149 | 150 | 151 | 152 | 153 | 154 |

TEST INSTRUMENTS

| | | | | | | | | |
|-----|-----|-----|-----|-----|-----|-----|-----|-----|
| 900 | 901 | 902 | 903 | 904 | 905 | 906 | 907 | 908 |
|-----|-----|-----|-----|-----|-----|-----|-----|-----|

NEW PRODUCTS

| | | | | | | | | |
|-----|-----|-----|-----|-----|-----|-----|-----|-----|
| 700 | 701 | 702 | 703 | 704 | 705 | 706 | 707 | 708 |
| 709 | 710 | 711 | 712 | 713 | 714 | 715 | 716 | 717 |
| 718 | 719 | 720 | 721 | 722 | 723 | 724 | 725 | 726 |
| 727 | 728 | 729 | 730 | 731 | 732 | 733 | 734 | 735 |

CATALOGS & BULLETINS

| | | | | | | | | |
|-----|-----|-----|-----|-----|-----|-----|-----|-----|
| 400 | 401 | 402 | 403 | 404 | 405 | 406 | 407 | 408 |
| 409 | 410 | 411 | 412 | 413 | 414 | 415 | 416 | 417 |

Note: Inquiries serviced until February 5, 1971.

(Please type or print)

11/70

Name

Position

Company

Street

City

State Zip Code

Please describe your type of business.
.....

FOR MORE INFORMATION fill out and mail today!

Please send more information on items circled.

ADVERTISED PRODUCTS

| | | | | | | | | |
|-----|-----|-----|-----|-----|-----|-----|-----|-----|
| 101 | 102 | 103 | 104 | 105 | 106 | 107 | 108 | 109 |
| 110 | 111 | 112 | 113 | 114 | 115 | 116 | 117 | 118 |
| 119 | 120 | 121 | 122 | 123 | 124 | 125 | 126 | 127 |
| 128 | 129 | 130 | 131 | 132 | 133 | 134 | 135 | 136 |
| 137 | 138 | 139 | 140 | 141 | 142 | 143 | 144 | 145 |
| 146 | 147 | 148 | 149 | 150 | 151 | 152 | 153 | 154 |

TEST INSTRUMENTS

| | | | | | | | | |
|-----|-----|-----|-----|-----|-----|-----|-----|-----|
| 900 | 901 | 902 | 903 | 904 | 905 | 906 | 907 | 908 |
|-----|-----|-----|-----|-----|-----|-----|-----|-----|

NEW PRODUCTS

| | | | | | | | | |
|-----|-----|-----|-----|-----|-----|-----|-----|-----|
| 700 | 701 | 702 | 703 | 704 | 705 | 706 | 707 | 708 |
| 709 | 710 | 711 | 712 | 713 | 714 | 715 | 716 | 717 |
| 718 | 719 | 720 | 721 | 722 | 723 | 724 | 725 | 726 |
| 727 | 728 | 729 | 730 | 731 | 732 | 733 | 734 | 735 |

CATALOGS & BULLETINS

| | | | | | | | | |
|-----|-----|-----|-----|-----|-----|-----|-----|-----|
| 400 | 401 | 402 | 403 | 404 | 405 | 406 | 407 | 408 |
| 409 | 410 | 411 | 412 | 413 | 414 | 415 | 416 | 417 |

Note: Inquiries serviced until February 5, 1971.

(Please type or print)

11/70

Name

Position

Company

Street

City

State Zip Code

Please describe your type of business.
.....



GET THIS FREE BONUS WITH YOUR PERSONAL SUBSCRIPTION TO ELECTRONIC TECHNICIAN/DEALER!

Enter your subscription for a two- or three-year term and we'll send you the new TEKFAX 109 Book of Schematics—FREE!

- \$10 for 3 Years \$8 for 2 Years \$5 for 1 Year
 Payment Enclosed Bill Me Later

PLEASE CHECK BELOW:

1. In the TV, Radio and other consumer products fields, is your firm **PRIMARILY a:** (check most descriptive item)

- Retailer with service department
 Service/repair firm with some retail
 Industrial electronics service firm
 Manufacturer
 Other (please describe)

2. Title: (please check one)

- Owner, manager, buyer, other executive
 Service manager
 Service repairman or other employee

Name

Title

Firm

Street

City

State Zip

If you are renewing your subscription, check here and attach your address label. If you renew your subscription for 2 to 3 years, you are still eligible to receive the TEKFAX 109 as your free bonus.

BUSINESS REPLY MAIL

NO POSTAGE STAMP NECESSARY IF MAILED IN THE UNITED STATES

POSTAGE WILL BE PAID BY

Reader Service Department

**ELECTRONIC
TECHNICIAN / DEALER**

1 EAST FIRST STREET, DULUTH, MINNESOTA 55802

FIRST CLASS

PERMIT NO. 665

DULUTH, MINNESOTA

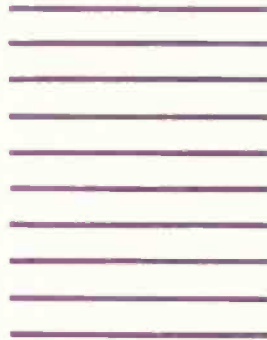

**GET
MORE
FACTS**

NO POSTAGE
NECESSARY

BUSINESS REPLY MAIL

NO POSTAGE STAMP NECESSARY IF MAILED IN THE UNITED STATES

POSTAGE WILL BE PAID BY

Reader Service Department

**ELECTRONIC
TECHNICIAN / DEALER**

1 EAST FIRST STREET, DULUTH, MINNESOTA 55802

FIRST CLASS

PERMIT NO. 665

DULUTH, MINNESOTA

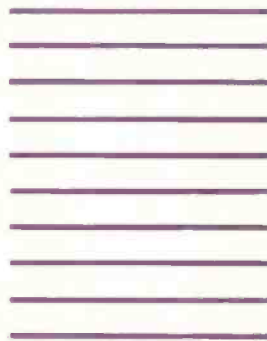

**GET
MORE
FACTS**

NO POSTAGE
NECESSARY

BUSINESS REPLY MAIL

NO POSTAGE STAMP NECESSARY IF MAILED IN THE UNITED STATES

POSTAGE WILL BE PAID BY

Circulation Department

**ELECTRONIC
TECHNICIAN / DEALER**

1 EAST FIRST STREET, DULUTH, MINNESOTA 55802

FIRST CLASS

PERMIT NO. 665

DULUTH, MINNESOTA



**FOR
ONLY
PENNIES
PER
MONTH—
YOUR
OWN
PERSONAL
COPIES**

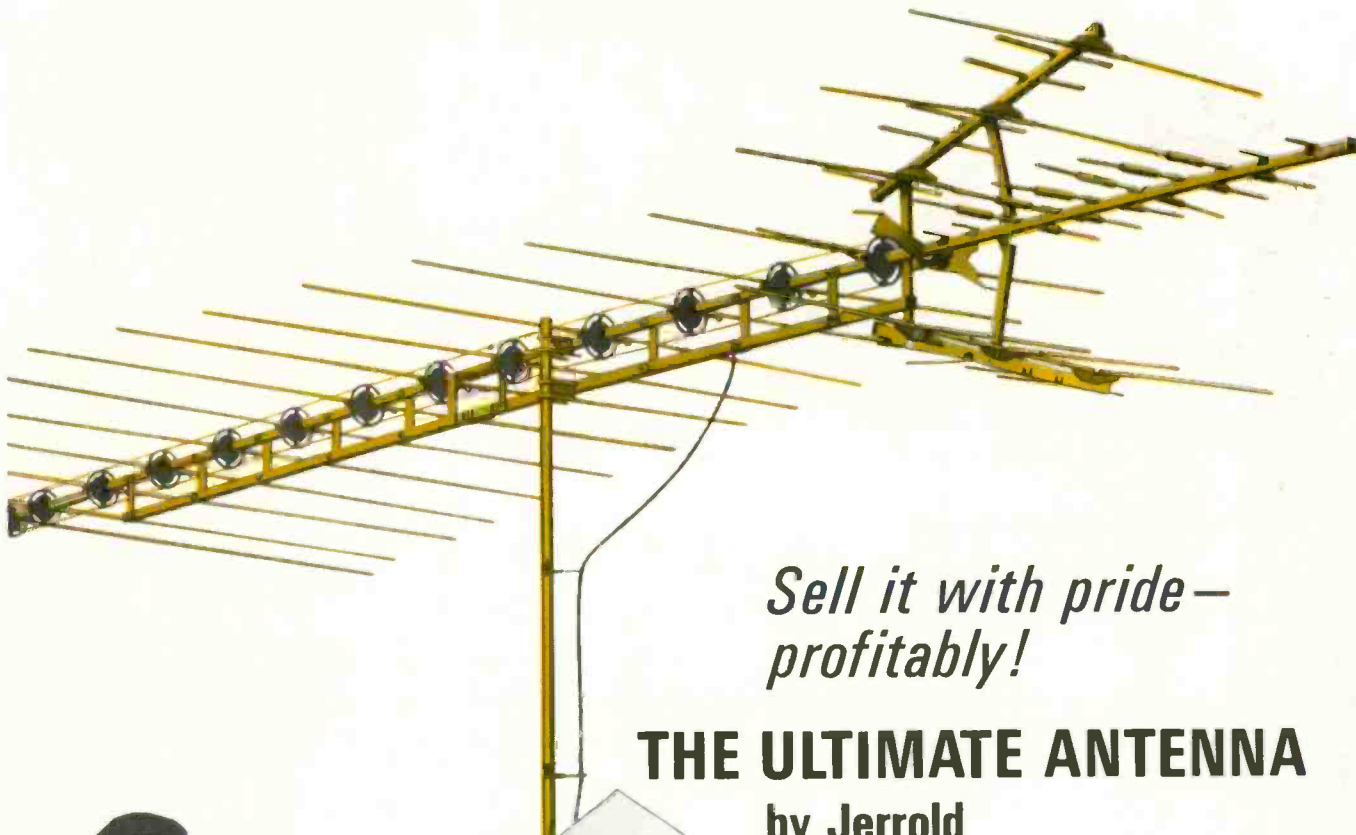

*Sell it with pride—
profitably!*

THE ULTIMATE ANTENNA by Jerrold



The new Jerrold VU 937—THE ULTIMATE ANTENNA—is one deep fringe antenna that needs no apologies. For the performance. For the construction. For the price. VU 937 beats all the really tough fringe area reception problems without creating any new ones:

- Picks up Color, UHF, VHF, and Stereo FM loud and clear
- No ghosts, interference, smears, or snow
- 16-foot boom features preassembled snap-lock construction and *goes up all in one piece*
- Snap-on transformer converts antenna from 300-ohm to 75-ohm Coloraxial cable use
- Double square boom construction stays ramrod rigid

The Jerrold VU 937 has performance that you've got to see to believe. For total reception power, see your Jerrold Distributor about full data on THE ULTIMATE ANTENNA today. Or write Jerrold Electronics Corporation, Distributor Sales Division, 401 Walnut St., Philadelphia, Pa. 19105.



*Focusing on one thing...
better reception*

BRING ON THE GIFTS WITH RCA

All these attractive gifts are available with your purchases of RCA entertainment receiving tubes from your local participating RCA tube distributor. See your participating RCA tube distributor for complete details... and bring on the gifts at holiday time!



Westchester by Gorham Silverplated 4 Piece Coffee Server (1A1877) This elegantly styled set includes coffee server with 9 cup capacity, a sugar server, a 6 ounce creamer with cap, and a beautiful oval tray.



Oster Deluxe Beauty Salon Hair Dryer (1A1874) Ladies can enjoy professional hair drying right in the home. Gentle filtered air, adjusts to cool, warm, medium or hot, provides quiet, fast drying.

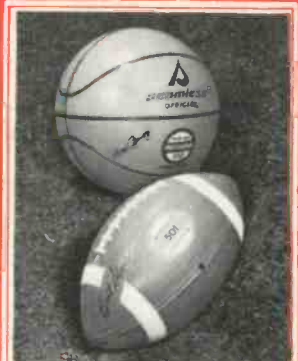

Bob Cousy Professional Basketball (1A1880) The players in your family will appreciate the basketball endorsed by Mr. Basketball himself. Hightoned, official in size and weight.

Bart Starr Official Size Football (1A1879) Boys will get a charge out of playing with the football endorsed and approved by the great Green Bay Packer quarterback, Bart Starr.



Mickey Mouse Folding Alarm Clock (1A1875) Kids will love this one. Mickey Mouse points out the time with his animated hands in this unique 40 hour folding-case alarm clock.

"Spartan" Wrist Watch (1A1878) For boys or girls, the "Spartan" by Vantage is a "this-minute" watch with wide band, heavy link styling that is very much part of the contemporary youth scene.



The New Kodak Instamatic X-15 Self Powered Flash Camera Kit (1A1876) The Magicube Type X is the newest, easiest way to take great flash pictures every time. No flash batteries are required in this new breed of camera.

Electronic Components, Harrison, N.J.

RCA