

# ELECTRONIC TECHNICIAN / DEALER

WORLD'S LARGEST ELECTRONIC TRADE CIRCULATION

PICTURE TUBE HEADQUARTERS

Colorama

Colorama

TO HOME OR  
GO WITH 2-W  
YOUR BEST  
BATE WE



POULIT 108556072X368812A17466B  
THOMAS POULIN  
5899 LONDON ROAD  
DULUTH MN  
55894

HOME AUDIO EQUIPMENT ROUNDUP  
REPORT ON THE ZENITH COLOR PORTABLE  
THIRTY-EIGHT YEARS OF TWO-WAY RADIO

AN OUTWAY PUBLICATION  
JUNE 1968



# breakthrough

Breakthrough

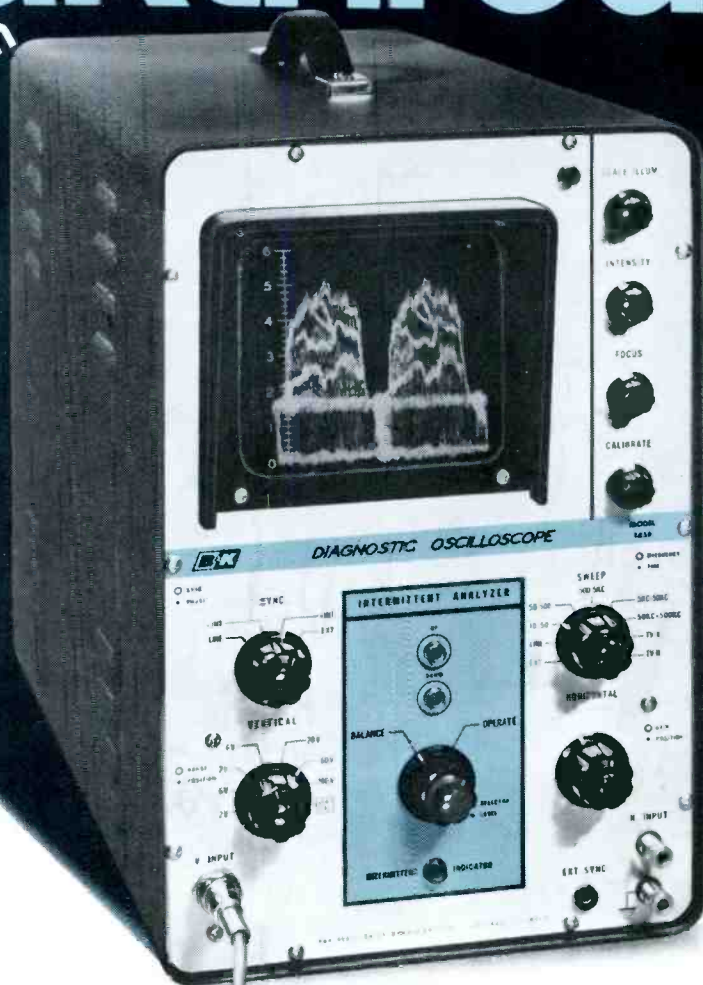

## B&K Model 1450 first and only service-designed oscilloscope with "intermittent analyzer" and "electronic memory"

That elusive intermittent . . . how many hours have you spent trying to locate the source of the problem—how much time was wasted testing each circuit when you could have been doing more productive work? Now, B&K know-how and engineering genius have come through for you.

Result . . . the intermittent analyzer in the Model 1450 Diagnostic Oscilloscope. It will tell you *if* and *where* an intermittent occurs—even without your being there! The electronic memory will keep the intermittent indicator "on" until you return. Think of the time and money it saves.

The easiest to use 'scope ever built, its unique screen gives error-free direct readings of peak-to-peak voltages—it syncs automatically at any signal level—easily displays color reference signal. Convenient for use as a vectorscope too, all inputs and controls are on the front panel.

Deluxe in every respect, the 1450 is another B&K innovation that will make your time more profitable in solid state and color TV service. Years-ahead planning for present and future use . . . the best-value all-around 'scope you can buy. With probe. Net, \$279.95

INTERMITTENT MONITOR. Designed to supplement the indicators on the 1450, this plug-in monitor can be placed anywhere in your shop. It flashes and buzzes when an intermittent occurs . . . and projects a professional image to your customer. Net, \$24.95



B&K Division of Dynascan Corporation

1801 W. Belle Plaine Avenue • Chicago, Illinois 60613



Where Electronic Innovation Is A Way Of Life

. . . for more details circle 101 on postcard



# \$975

EFFECTIVE 8/1/67

## GUARANTEED

*Nine-seventy-five* buys you a complete tuner overhaul—including parts (except tubes or transistors)—and absolutely no hidden charges. All makes, color or black and white. UV combos only \$15.

*Guaranteed* means a full 12-month warranty against defective workmanship and parts failure due to normal usage. That's 9 months to a year better than others. And it's backed up by the only tuner repair service authorized and supervised by the world's largest tuner manufacturer—Sarkes Tarzian, Inc.

Four conveniently located service centers assure speedy in-and-out service. All tuners thoroughly cleaned, inside and out . . . needed repairs made . . . all channels aligned to factory specs, then rushed back to you. They look—and perform—like new.

*"Prefer a replacement? Sarkes Tarzian universal replacements are only \$10.45, customized replacements \$18.25. Universal replacements shipped same day order received. On customized, we must have original tuners for comparison purposes, also TV make, chassis, and model number. Send orders for universal and customized replacements to Indianapolis."*

Part #	Intermediate Frequency	AF Amp Tube	Osc. Mixer Tube	Heater
MFT-1	41.25 mc Sound 45.75 mc Video	6GK5	6LJ8	Parallel 6.3V
MFT-2	41.25 mc Sound 45.75 mc Video	3GK5	5LJ8	Series 450 MA
MFT-3	41.25 mc Sound 45.75 mc Video	2GK5	5CG8	Series 600 MA

*Genuine Sarkes Tarzian universal replacement tuners with Memory Fine Tuning—UHF Plug in for 82-channel sets—Pre-set fine tuning—13-position detent—HI gain—Lo noise—Universal mounting*

**FOR FASTEST SERVICE, SEND FAULTY TUNER WITH TV MAKE, CHASSIS, AND MODEL NUMBER, TO TUNER SERVICE CENTER NEAREST YOU**



**TUNER SERVICE CORPORATION FACTORY-SUPERVISED TUNER SERVICE**

HOME OFFICE, MIDWEST . . . . . 817 N. PENNSYLVANIA ST., Indianapolis, Indiana . . . . . TEL: 317-632-3493  
 UNDER NEW MANAGEMENT, EAST 547-49 TONNELE AVE., Jersey City, New Jersey . . . . . TEL: 201-792-3730  
 SOUTH-EAST . . . . . 938 GORDON ST., S. W. Atlanta, Georgia . . . . . TEL: 404-758-2232  
 WEST . . . . . SARKES TARZIAN, Inc. TUNER SERVICE DIVISION  
 10654 MAGNOLIA BLVD., North Hollywood, California . . . . . TEL: 213-769-2720



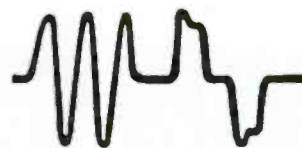

## Tips on selling batteries



Just about every customer who walks into your shop, or whom you see on a service call, is a prospect for batteries. You can get yourself more sales and profits from battery business, by recommending Mercury Duracell® and Alkaline Duracell batteries—the *different* high energy batteries made by Mallory.

Here are some facts about batteries that can help you trade customers up to today's best values in portable power.

*Which batteries are best for transistor radios?* At the relatively low drain service in most radios, Mercury Duracell batteries are generally the best buy. They actually cost about 15% less per hour of service than ordinary zinc-carbon types. And they give you better listening; their output voltage stays constant throughout life, so you don't drop into the high distortion part of the transistor characteristic. Next best are Alkaline Duracell batteries. Both Duracell types have the further advantage of extremely long shelf life—no appreciable drop in power even after two years. So they can sit idle in a radio instead of dying even when not used, like ordinary batteries.

*How about cameras?* For the electric eye devices which automatically adjust exposure, there's nothing like Mercury Duracell batteries. They last over a year, and produce highly accurate voltage required for this job. For built-in flash and for electric drive of movie cameras, Alkaline Duracell batteries are far superior to ordinary types. They drive 4 to 5 times more movie footage, and fire about three times more flashes.

*What's good for tape recorders?* Motor drive is a fairly heavy drain job . . . ideal for Alkaline Duracell batteries. These outlast zinc-carbon by 2 to 5 times in portable recorders.

*Flashlights? Toys?* For ordinary flashlight duty, the old zinc-carbon is hard to beat. But if you're apt to use a light continuously for long periods, Alkaline Duracell batteries can give steady lighting for up to 10 times longer than zinc-carbon. And they're much safer for emergency use, because they don't die in a few months on the shelf. Toys are real high drain duty; here Alkaline Duracell batteries are a real bargain, for they outlast zinc-carbon types by 5 to 8 times.

Sell your customer on the greater value of Duracell batteries, and you'll make twice as much profit per sale. Get the story on the new Mallory battery merchandise displays from your nearby Mallory distributor. Or write Mallory Distributor Products Company, a division of P. R. Mallory & Co. Inc., Indianapolis, Indiana 46206.

©DURACELL is a registered trademark of P. R. Mallory & Co. Inc.

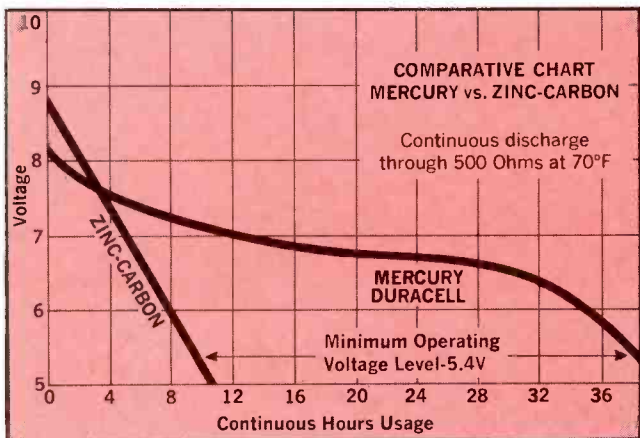
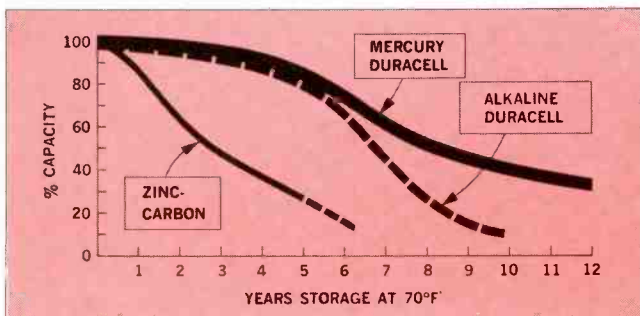

DON'T FORGET TO ASK 'EM "What else needs fixing?"

... for more details circle 121 on postcard

# ELECTRONIC TECHNICIAN / DEALER

WORLDS LARGEST ELECTRONIC TRADE CIRCULATION  
JUNE 1968 • VOL. 87 No. 6

**HUGH "SCOTTY" WALLACE**  
Publisher

**PAUL DORWEILER**  
Editor

**JACK HOBBS**  
Managing Editor

**JOSEPH ZAUHAR**  
Technical Editor

**PHILLIP DAHLEN**  
Associate Editor

**RICHARD CLAYTON**  
Field Editor

**MARTIN PADLEY**  
Field Editor

**BARBARA BURNSON**  
Production Editor

**ROBERT ANDRESEN**  
Art Editor

**RUTH GELINEAU**  
Circulation Manager

**JOHN KESSLER**  
Manager, Reader Services

**MAGGIE KANE**  
Advertising Production

## GENERAL OFFICES

Ojibway Building  
Duluth, Minn. 55802  
Phone: (218) 727-8511  
Telex: 029-4417

**DEAN MYHRAN**  
President

**RICHARD MOELLER**  
Treasurer

**JOE WOLKING**  
Vice President, Marketing

**BEN MARSH**  
Vice President, Editorial

**HARRY RAMALEY**  
Vice President, Production

**LARS FLADMARK**  
Circulation Director

**JAMES GHERNA**  
Art Director

**WARREN BODIN**  
Ad Production Supervisor

**NEW YORK OFFICES**  
71 Vanderbilt Ave.  
New York, N.Y. 10017  
Phone: (212) 686-2200

**ROBERT EDGELL**  
Senior Vice President

**RICHARD C. REINHARDT**  
Vice President

**DON GENOAR**  
Manager, New York Office

**CHICAGO OFFICES**  
43 East Ohio Street  
Chicago, Illinois 60611  
Phone: (312) 467-0670  
Telex: 02-53549

**TOM GRENEY**  
Vice President

**DOROTHY BOLAN**  
Manager, Chicago Office

## MARKETING REPRESENTATIVES

New York: (212) 686-2200  
**HUGH "SCOTTY" WALLACE**

Chicago: (312) 467-0670  
**DEAN GREENER**

## 37 THE GROWING HOME ENTERTAINMENT MARKET

A look at the latest in stereo, AM/FM and tape recorders shows consumer trend for a higher order of listening pleasure

## 40 EXPLORING ZENITH'S SMALL SCREEN COLOR PORTABLE

A Teklab report on Zenith's first hybrid portable color TV includes chassis layout and circuit description

## 44 SELLING AND INSTALLING MATV SYSTEMS

Part three of this series discusses amplifiers, preamps, mixers, splitters and traps and their use in the system

## 47 SEMICONDUCTORS FROM A TO Z

The twenty-second article in this series describes the new breed of power supply and regulation devices

## 51 HOW TO MAKE MORE MONEY AND LIVE BETTER

This is part one of a two part series defining marketing programs directed at increased profit for you as a TV-radio service-dealer

## 53 THIRTY-EIGHT YEARS OF TWO-WAY RADIO

An Oklahoman tells us what the two-way business was in the 1930s and what it is today

22 LETTERS TO THE EDITOR  
26 EDITOR'S MEMO  
28 TECHNICAL DIGEST  
51 DEALER FAX  
58 DEALER SHOWCASE  
62 COLORFAX

66 NEW PRODUCTS  
70 ET/D 1968 DIRECTORY  
77 NEWS OF THE INDUSTRY  
82 ADVERTISERS' INDEX  
83 READER SERVICE CARD

## COVER

Electronic components and test instruments play a vital role in the economic lives of our nation's service-dealers. These and other items of interest to the service-dealer are on display at the National Electronics Week (NEW) Show in New York this month.

## TEKFAX • 16 PAGES OF THE LATEST SCHEMATICS • Group 190

GENERAL ELECTRIC: Color TV Chassis G-1  
MAGNAVOX: TV Chassis T927 Series  
RCA VICTOR: TV Chassis KCS136ML Series  
SILVERTONE: Color TV Chassis 528.72500  
WESTINGHOUSE: TV Chassis V-2660  
ZENITH: TV Chassis 14Y33

## OJIBWAY PRESS, INC.

A Subsidiary of Harcourt, Brace & World, Inc.

ELECTRONIC TECHNICIAN/DEALER is published monthly by Ojibway Press, Inc. Subscription Rates: One year \$5.00, two years \$8.00, three years \$10.00 in United States and Canada Other Countries: One Year \$9.00, two years \$14.00, three years \$18.00. Single Copies: 60 cents. Copyright 1968 by Ojibway Press, Inc.  
"SECOND CLASS POSTAGE PAID AT WASECA, MINN. AND AT ADDITIONAL MAILING OFFICES." Postmaster: Send form 3579 to ELECTRONIC TECHNICIAN/DEALER, Ojibway Building, Duluth, Minnesota 55802.



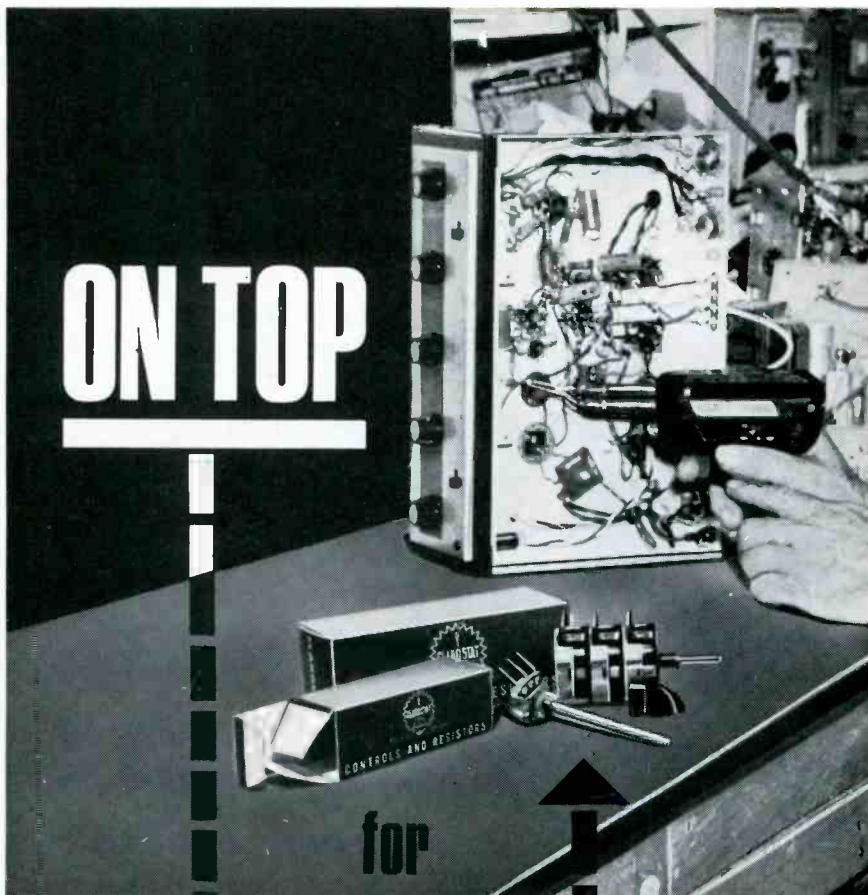

**ON TOP**

for

**quality and  
performance**

**CLAROSTAT REPLACEMENT  
POTENTIOMETERS, RESISTORS & SWITCHES  
... GUARANTEED TOPS IN PERFORMANCE**

... A complete line, immediately available from your local distributor. Whatever your replacement needs — radio and television — sound systems — industrial — hi-fi — all the top performers are on tap at your local Clarostat distributor. Every Clarostat component including composition element, wire wound and trimming potentiometers, sound system controls, field assembled uni-tite controls, power rheostats, adjustable power and wire-wound resistors, switches, decade boxes — all manufactured to maintain a reputation for engineering accuracy. If the job calls for a pot, resistor or switch, call your Clarostat distributor. You'll get components built to maintain your reputation as well as ours.

**CLAROSTAT**

CLAROSTAT MFG. CO., INC., DOVER, NEW HAMPSHIRE 03820

110

... for more details circle 111 on postcard

#### **ILL — Will Sell**

After 20 years of TV servicing I was unexpectedly laid low by a heart attack. I am forced to retire and would like to hear from a good technician interested in obtaining a reputable name. I have a new color bar generator and other test instruments, plus a complete stock of tubes which I will sell very reasonably.

PHILLIP CHEUSE  
Perth Amboy, N. J.

#### **Needs Back Issue of ET/D**

I would like to obtain a copy of Bob Middleton's article which appeared in the August 1957 issue of ET/D. I enjoyed the article "Unique Test Instruments for Color TV Servicing" in the October 1967 issue. Our shop has been using the B&K analyst for several years.

T. M. KIMBALL  
Savannah, Ga.

• The article Mr. Kimball refers to is "Vectorscope Technique To Service Color TV" on page 34 of the August 1957 issue.—Ed.

#### **Help for Old Scott**

I have a 1934 Scott receiver and I need a schematic and tuning instructions. Can anyone help me? The only information I have on it is that it is serial number P-392, according to the chassis layout. I have no model or chassis numbers.

J. DOMBKOWSKI  
Floral Park, N. J.

#### **Whoops**

I have written and asked you for the address of the company that makes the Tonfunk W199K. I need a schematic for this unit and I received no answer from you. I also need a number 92 tube for a German WW2 short wave receiver. Possibly an ET/D reader can help me.

FRANCIS J. REES  
2 Greebrook Dr.  
Levittown, Pa.  
19055

• Sorry we goofed on not answering your letter, Frank, but we bat very close to 1000 around here when it comes to answering letters and requests from our readers. In fact, we spend a great deal of time looking up old schematics on everything from TVs to tube testers. If we can't find an item we generally let the reader know



# YOU DON'T NEED TO MAKE MORE SERVICE CALLS TO DO MORE BUSINESS

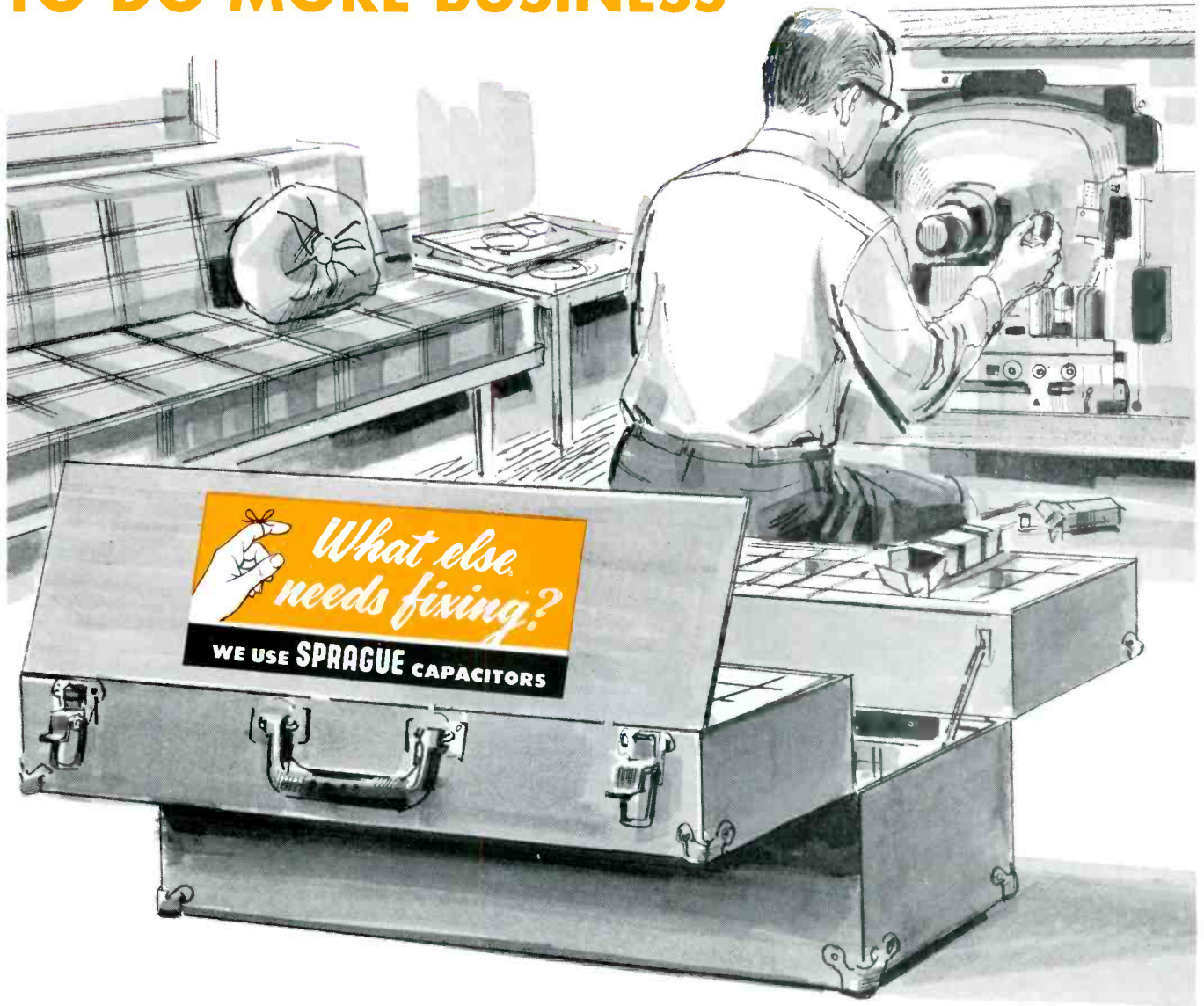

## JUST ASK, "WHAT ELSE NEEDS FIXING?" ON EVERY SERVICE CALL YOU MAKE

A test program initiated by the Electronic Industries Association in a large mid-west area proved the point. Participating service dealers enjoyed a 7½% bounce in business. There's magic in asking!

**You can do it too!** Put the question to your customers visually as well as verbally. Apply "What else needs fixing?" stickers on your caddy and in your store. Request sticker D-200 from your Sprague distributor, or write: Sprague Products Co., 65 Marshall St., North Adams, Mass. 01247.



WORLD'S LARGEST MANUFACTURER OF CAPACITORS

... for more details circle 134 on postcard

# LETTERS

## TO THE EDITOR

it. However, once in a while we slip and miss one. It helps us a great deal if the reader requesting assistance, types or prints the material on letter-size paper rather than hand written copy on a postcard. Some of the requests we receive are very difficult to decipher and lack sufficient information to enable us to locate the requested schematic or part. Many times the hand written letters we receive are so

illegible that it is hard to even read the name or address. For that reason we strongly urge that any reader sending letters to us include the address label from their copy of ET/D — Ed.

### Female Technician Speaks

This is my first year as a subscriber to ET/D — I want to tell you that it has been more help to me than all my other technical magazines put together. It's what the doctor ordered for technicians who want to keep up with new improvements and improve him — or herself. I never see letters

or articles by female technicians. Are you prejudiced or is it a lack of such contributors? I can't believe I am the only woman who chose electronics as a career. I have a TV-radio service business which I operate part time because I have a husband and three children to look after. I don't do any advertising, but I have more service business than I can handle. I find customers are considerably more interested in good service than in the "sex" of the service technician. However, I'll bet we have problems you men never thought of! I'd sure like to see letters from other service gals. You might get a few chuckles if we service gals started airing our gripes!

Seriously, I am treated with courtesy by the men in this business. But it does take a while for people to get used to a woman appearing on the doorstep, tube caddy in hand. Acceptance comes fast, however, if the service is good.

Laura Lassiter

Evanston, Wyo.

We enjoy receiving letters from technicians in the field — especially ones with different views of the business as Mrs. Lassiter's must surely be. Sorry to say, we do not often hear from technicians of the opposite sex, although we know there are a few around. Come to think of it, it would be rather different to find a woman standing at your door with a tube caddy in hand — Ed.

### Manual for Visual Generator

ET/D has been very helpful to me for a number of years and possibly one of your readers can help me with a problem.

I have a Precision Visual alignment generator for TV and FM, Model 7008 made by Philco. The instrument works fine as far as I can tell. But it is an early unit, possibly WWII, and I need an instruction manual for it. I would appreciate a letter from an ET/D reader who might have one I could borrow or buy. As it is, the generator is useless to me without the manual. Keep up the excellent work in your fine publication.

Howard W. Jenkins

536 Lyding Lane  
Sebastopol, Calif. 95472

### Life-Long Friend

I was surprised and relieved to find a business company that was fulfilling its prime responsibility of "service to its patrons." You are in a minority group I'm sorry to say. Your policies have made me a life-long friend of ET/D.

SSGT. Douglas G. Corbett  
Glasgow AFB, Mont.

## Now — Compare CRT Color Guns AUTOMATICALLY!

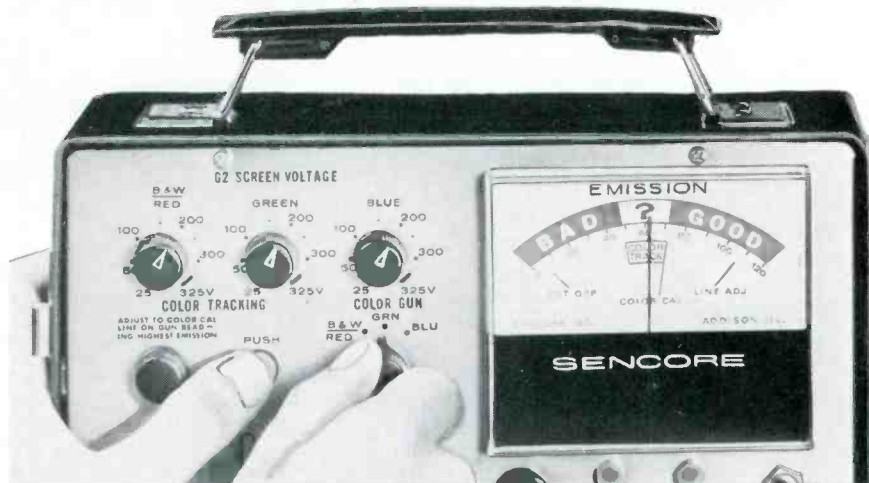

- Simplifies Color CRT Tracking Test
- Tests Each Gun in Color or B&W CRT's Completely

Now, for the first time, you can test CRT color guns for color tracking automatically; and exactly according to industry standards. No more time-consuming logging of each color gun reading at every setting of the G2 control like other testers.

Only the Sencore CRT CHAMPION has three separate G2 screen grid controls just like the color TV itself. A color tracking scale right on the meter makes the all-important tracking test easy, fast, and accurate. This is most important when claiming credit for a defective color CRT.

The CHAMPION also makes all the standard color and black and white CRT tests — short, emission, and life tests. Line Adjust control assures exceptional accuracy. An exclusive three step Automatic Rejuvenation Circuit lets you save many a faulty black and white tube or equalize gun currents in color tubes. Plug-in sockets are provided for fast testing and easy updating. Rugged vinyl-clad steel case has spacious lead compartment.

CRT manufacturers, set manufacturers, distributors, technicians all recommend the CR143 CRT tester as the only tester that does a complete job. Why not check with them before you buy.

Sencore CR143 — CRT CHAMPION ... \$99.50



**SENCORE**

NO. 1 MANUFACTURER OF ELECTRONIC MAINTENANCE EQUIPMENT

426 SOUTH WESTGATE DRIVE, ADDISON, ILLINOIS 60101



... for more details circle 128 on postcard



How to get into

# One of today's hottest money-making fields —servicing 2-way radios!

More than 5 million two-way transmitters have skyrocketed the demand for service men and field, system, and R&D engineers. Topnotch licensed experts can earn \$12,000 a year or more. You can be your own boss, build your own company. And you don't need a college education to break in.

HOW WOULD YOU LIKE to start collecting your share of the big money being made in electronics today? To start earning \$5 to \$7 an hour... \$200 to \$300 a week... \$10,000 to \$15,000 a year?

Your best bet today, especially if you don't have a college education, is probably in the field of two-way radio.

Two-way radio is booming. Today there are more than five million two-way transmitters for police cars, fire trucks, taxis, planes, etc. and Citizen's Band uses—and the number is growing at the rate of 80,000 new transmitters per month.

This wildfire boom presents a solid gold opportunity for trained two-way radio service experts. Many of them are earning \$5,000 to \$10,000 a year more than the average radio-TV repair man.

## Why You'll Earn Top Pay

One reason is that the U.S. Government doesn't permit anyone to service two-way radio systems unless he is licensed by the FCC (Federal Communications Commission). And there simply aren't enough licensed electronics experts to go around.

Another reason two-way radio men earn so much more than radio-TV service men is that they are needed more often and more desperately. A two-way radio user *must* keep those transmitters operating at all times, and *must* have them checked at regular intervals by licensed personnel to meet FCC requirements.

This means that the licensed experts can "write their own ticket" when it comes to earnings. Some work by the hour and usually charge at least \$5.00 per hour, \$7.50 on evenings and Sundays, plus travel expenses. Others charge each customer a monthly retainer fee, such as \$20 a month for a base station and \$7.50 for each mobile station. A survey showed that one man can easily maintain at least 15 base stations and 85 mobiles. This would add up to at least \$12,000 a year.

## Be Your Own Boss

There are other advantages too. You can become your own boss—work by yourself or gradually build your own fully staffed service company. Instead of being chained to a workbench, machine or desk, you'll move around, see lots of action, rub shoulders with important police and fire officials and business executives who depend on two-way radio for their daily operations.

## How to Get Started

How do you break into the ranks of the big-money earners in two-way radio? This is probably the best way:



He's flying high. Before he got his CIE training and FCC License, Ed Dulaney's only professional skill was as a commercial pilot engaged in crop dusting. Today he has his own two-way radio company, with seven full-time employees. "I am much better off financially, and really enjoy my work," he says. "I found my electronics lessons thorough and easy to understand. The CIE course was the best investment I ever made."

1. Without quitting your present job, learn enough about electronics fundamentals to pass the Government FCC Exam and get your FCC License.
2. Then get a job in a two-way radio service shop and "learn the ropes" of the business. All CIE students can use our free employment service.
3. As soon as you've earned a reputation as an expert, there are several ways you can go. You can move *out* and start signing up and servicing your own customers. You might become a franchised service representative of a big manufacturer and then start getting into two-way radio sales, where one sales contract might net you \$5,000. Or you may be invited to move *up* into a high-prestige salaried job with one of the major manufacturers.

The first step—mastering the fundamentals of electronics in your spare time and getting an FCC License—can be easier than you think.

Cleveland Institute of Electronics has been successfully teaching electronics by mail for over thirty years. Right at home, in your spare time, you learn electronics step by step. Our AUTO-PROGRAMMED™ lessons and coaching by expert instructors make everything clear and easy, even for men who thought they were "poor learners." You'll learn not only the fundamentals that apply to all electronics design and servicing, but also the specific procedures for installing, troubleshooting, and maintaining two-way mobile equipment.

## Get Your FCC License... or Your Money Back!

By the time you've finished your CIE course, you'll be able to pass the FCC License Exam with ease. Better than nine out of ten CIE-

trained men pass the FCC Exam, even though two out of three non-CIE men fail. This startling record of achievement makes possible our famous FCC Warranty: you'll be able to pass the FCC Exam upon completion of your course or your tuition will be refunded in full.

Find out more about how to get ahead in all fields of electronics, including two-way radio. Mail coupon below for two FREE books, "How To Succeed In Electronics" and "How To Get A Commercial FCC License."

### ENROLL UNDER NEW G.I. BILL

All CIE courses are available under the new G.I. Bill. If you served on active duty since January 31, 1955, or are in service now, check box in coupon for G.I. Bill information.

### Cleveland Institute of Electronics

1776 E. 17th St., Cleveland, Ohio 44114

Please send me without cost or obligation:

1. Your 40-page book "How To Succeed In Electronics" describing the job opportunities in Electronics today, and how your courses can prepare me for them.
2. Your book on "How To Get A Commercial FCC License."

Name \_\_\_\_\_  
(Please Print)

Address \_\_\_\_\_

City \_\_\_\_\_

State \_\_\_\_\_ Zip \_\_\_\_\_

Occupation \_\_\_\_\_ Age \_\_\_\_\_

Check here for G.I. Bill information

 Accredited Member National Home Study Council

ET-41

... for more details circle 112 on postcard

 CIE

Cleveland Institute of Electronics

1776 E. 17th St., Dept. ET-41, Cleveland, Ohio 44114

# 2

## ALIGNMENT OSCILLATORS

DESIGNED TO MAKE SERVICING EASIER  
BOTH NEW FROM INTERNATIONAL



### MODEL 812 (70 KHz — 20 MHz)

The Model 812 is a crystal controlled oscillator for generating standard signals in the alignment of IF and RF circuits. The portable design is ideal for servicing two-way radios, TV color sets, etc. This model can be zeroed and certified for frequency comparison on special order. Individual trimmers are provided for each crystal. Tolerance .001%. Output attenuators provided. Battery operated. Bench mount available.

Complete (less crystals) \$125.00

### MODEL 814 (70 KHz — 20 MHz)

The Model 814 is identical in size to the 812. It does not have individual trimmers for crystals. Tolerance is .01%. Battery operated. Bench mount available.

Complete (less crystals) \$95.00

*Both the Model 812 and Model 814 have positions for 12 crystals and the entire frequency range is covered in four steps.*

Write for catalog



**CRYSTAL MFG. CO., INC.**  
10 NO. LEE • OKLA. CITY, OKLA. 73102

... for more details circle 115 on postcard

## EDITOR'S MEMO

### Deadly Eliminator

It's a comfort to know we have some alert electrical inspectors in our country. Especially when they discover that a harmless-looking device used as a battery eliminator in transistor radios is actually a potentially lethal killer.

The device was recently discovered by an inspector in Ohio, and the results published by the International Ass'n. of Electrical Inspectors (IAEI).

The unit is manufactured and patented in Japan and sold all over the United States. It can be purchased by any unsuspecting customer to replace the 9v battery in his transistor radio. It looks like an ordinary 9v battery with an ac line cord attached, but the instruction sheet packed with the unit indicates its "special features." We quote: "This eliminator can be used as a substitute for 9v batteries, model 006P, Eveready 216, RCA VS312 or any other equivalent. It is identical in size with 006P battery and can be set in any transistor radio operated with 9v battery, 006P, or the equivalent. It operates far better than a 9v battery and always retains its good condition as to sensitivity, tonal volume, etc.

Used as a battery charger, the eliminator prolongs the life of the battery five times as much. The eliminator is made by a complete shuttered system and remains in good condition at all times."

What the manufacturer fails to mention is that the product can cause a radio to explode when — and if — it comes in contact with any grounded object. And worse — any person using the eliminator while coming in contact with a grounded object can be *electrocuted*.

A product of this type available to millions of transistor radio owners is a grave threat, as IAEI points out. It indicates a lack of proper testing on the manufacturer's part. One ponders how it could ever have been accepted into this country.

We should have, and need, more stringent control regulations on imported consumer goods.

This particular device was not approved by the Underwriters Laboratories, Inc. If electrical equipment manufactured in our own country must undergo exacting safety requirements — why not that of foreign manufacturers?



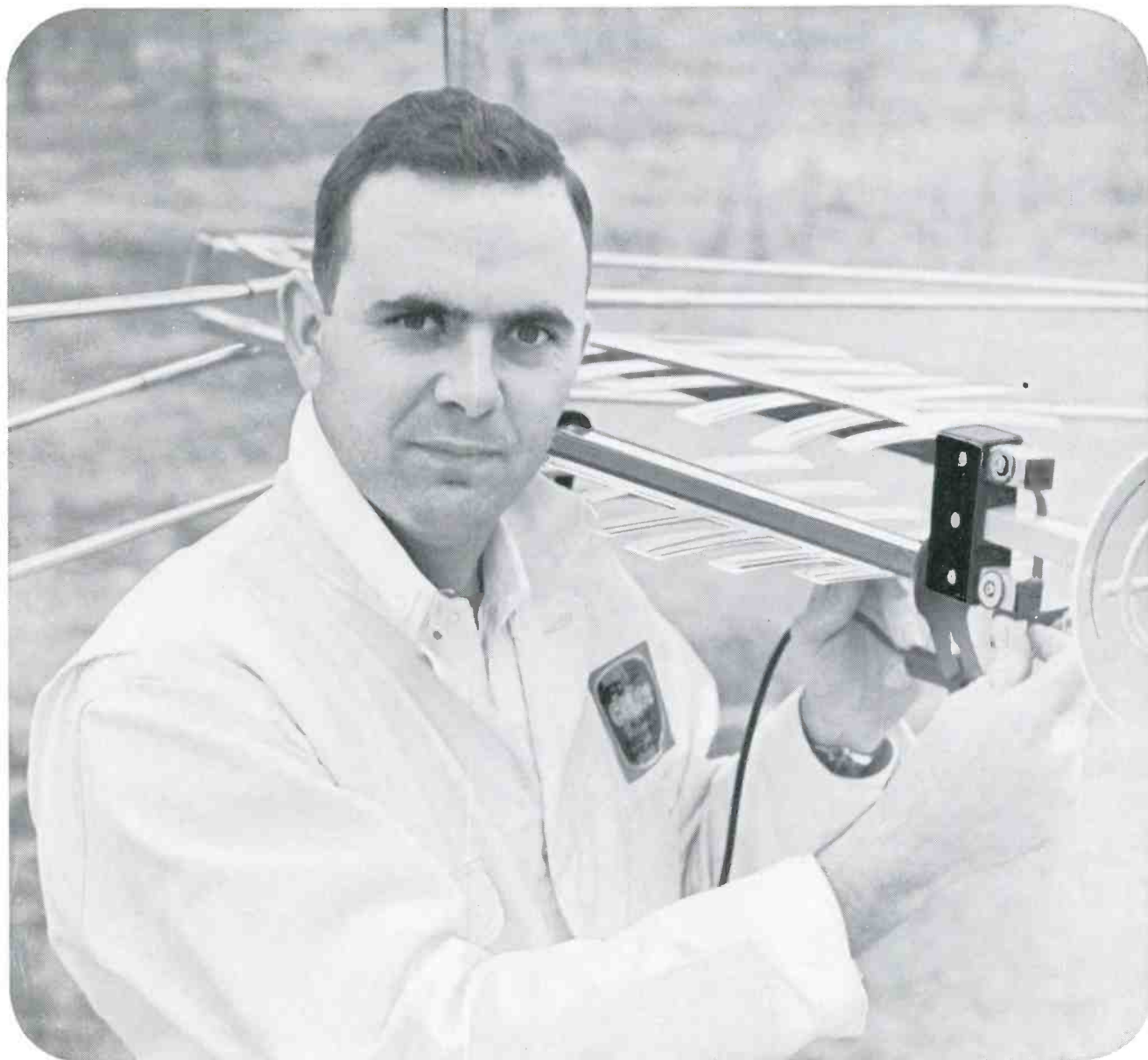

**“Good bandwidth... good gain...  
good directivity:... on VHF, UHF and FM.**

— with a single lead-in, are the reasons why we buy JFD Color Lasers,” says Phillip Van Winkle of Van Winkle TV Service, Joplin, Missouri.

“We install Color Lasers in all kinds of locations: fringe, suburban, and local — and use JFD Color Shield 82 Coaxial Cable on about 95 per cent of them. That’s why we can guarantee our customers top-notch color performance.”

“We also like the way the Color Laser construction stands up against the high winds, ice and snow we’ve got to cope with.”

Installing antennas? Take the advice of professional installers such as Phillip Van Winkle. If you’re selling TV — there isn’t a *better* way to make hay during (or between) set sales, than with JFD Color Lasers.

Interested? See your JFD distributor, or write direct to JFD for form 6828.

Remember... PROFESSIONAL ANTENNA INSTALLERS KNOW — the Best Antenna for Color TV is The Color Laser by

**JFD®**

LICENSED UNDER ONE OR MORE OF U.S. PATENTS 2,958,081, 2,985,879; 3,011,168; 3,109,280; 3,150,376; 3,210,767; RE. 25,740 AND ADDITIONAL PATENTS PENDING IN U.S.A. AND CANADA. PRODUCED BY JFD ELECTRONICS CO. UNDER EXCLUSIVE LICENSE FROM THE UNIVERSITY OF ILLINOIS FOUNDATION.

LICENSED UNDER ONE OR MORE OF U.S. PATENTS 2,955,287 AND 3,015,821 AND ADDITIONAL PATENTS PENDING.

**JFD ELECTRONICS CO.** 15 Avenue at 62 Street, Brooklyn, N.Y. 11219

JFD International, 64-14 Woodside Ave., Woodside, N.Y. 11377 JFD Canada, Ltd., Ontario, Canada  
JFD de Venezuela, S.A., Avenida Los Haticos 125-97, Maracaibo, Venezuela

... for more details circle 117 on postcard

# TECHNICAL DIGEST

## PEARCE-SIMPSON

### Citizens Band Radio Companion IV — Circuit Descriptions

This two-way radio is a fully transistorized, 10 channel 5w transmitter/receiver for mobile use and operates in the 26.965 to 27.255MHz citizens band.

Of interest is the rocker type channel switch which allows "touch-tap tuning." Slight pressure on the right hand button advances the switch to the next channel with each "tap" while pressure on the left hand button moves the switch in the opposite direction one channel for each tap.

Other features include: Push-pull Class B audio output stage; electronic transmit-receive switching; two RF stages in the receiver; a filter type IF amplifier mounted on a printed circuit board; the inclusion of a public address feature and using a highly reliable transmitter circuit with a TL filter output circuit.

Of the 13 transistors used, 7 are in the receiver circuit, 3 in the transmitter circuit and 3 used in the common audio circuit.

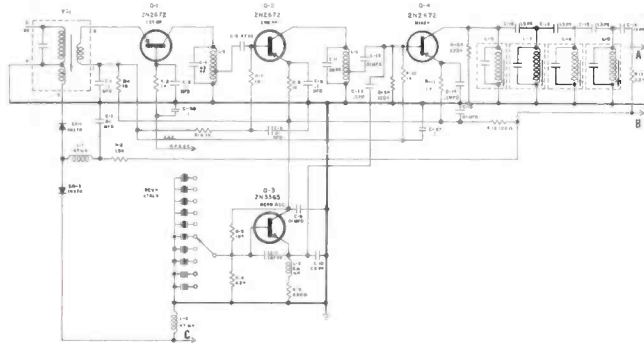

A type 2N2672 germanium transistor connected in a common base configuration is used as both the 1st RF amplifier and AGC amplifier. The high gain and low noise characteristic of this transistor makes it ideally suited for this stage. In addition, its AGC characteristic is excellent, providing good RF AGC gain control in this stage and at the same time delivers AGC for the other stages. The incoming signal is applied to the emitter and AGC voltage is applied to the base. The amplified signal appears at the collector and AGC voltage for other controlled stages results from the drop across R1 in the emitter circuit. This voltage drop will vary with change in base bias resulting from variations in the RF AGC voltage applied at the base.

A 2nd 2N2672 transistor is used in the conventional manner as the 2nd RF amplifier stage. AGC voltage is applied to the base of this transistor and its AGC characteristic is again used in this stage.

The 2N2672 transistor mixer has both the 27MHz incoming signal and the signal from the local oscillator applied to its base while the collector feeds directly into the 455kHz LC IF filter circuit. AGC voltage provides base bias.

A 2N3565 silicon transistor is used as the receiver local oscillator. The circuit is tuned to the crystal frequency by choice components and requires no service adjustments.

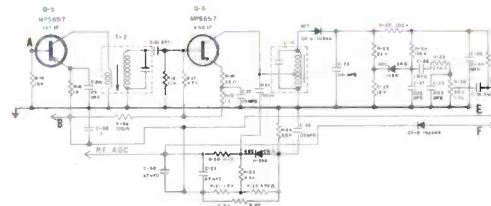

Two MPS6517 silicon transistors are employed as conventional IF amplifier stages. No AGC is needed in these stages as a result of effective control obtained in earlier stages.

Since the detector, noise limiter and AGC detector circuits are conventional in every respect, a description of these circuits will not be required.

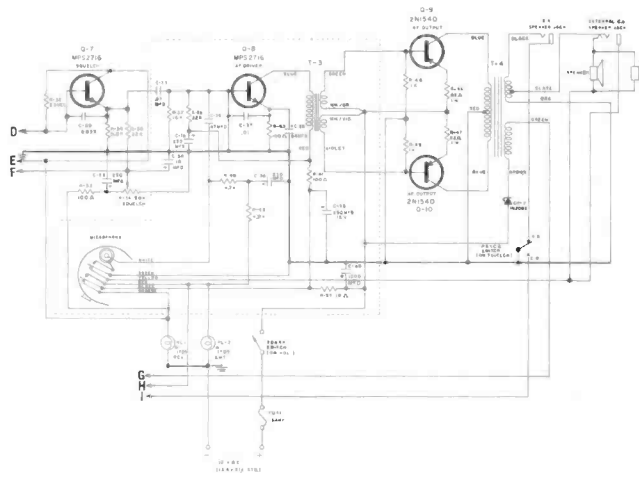

Squelch action is obtained in Q7, an MPS2716 silicon transistor in the following manner: The squelch control (R36) adjusts the emitter bias of the transistor and the squelch threshold. When a signal is received, dc voltage is developed across R31, biasing the transistor into conduction. During no signal periods, R32 provides a slight amount of bias making it possible to completely unsquelch the radio. To provide better squelch control, the gain of AGC controlled stages is adjusted slightly (by the squelch control) by B+ voltage passing through squelch gate CR6 and into the AGC line. When a signal is received and AGC voltage builds up above the level of this voltage, the squelch gate closes and AGC takes control.

A second MPS2716 silicon transistor functions as the audio frequency driver. Audio from the receiver is coupled to the base of this transistor through C33 while the microphone output is coupled through C36. During transmit periods, the receiver is switched off and only audio from the microphone will reach this stage. Conversely, during receive periods, a microphone switch opens the microphone circuit and only receive audio will be present. Output from Q8 is transformer coupled to the audio output stage.



# Zenith Tubes...

life-tested for greater dependability!



**ZENITH TV PICTURE TUBES** are rigorously tested at elevated line voltages for lengthy periods. Just one reason you can be sure of Zenith's great reliability and long life that better satisfies your customers. More than 200 Zenith quality tubes—for color TV, black-and-white TV, or special purposes—are in the complete line.

**ZENITH "ROYAL CREST" CIRCUIT TUBES** undergo over 1½ million hours of life-testing every month. Under actual operating conditions, they must meet the same quality standards as Zenith original parts—to perform with unrivaled dependability. Choose from a full line of more than 900 top-quality Zenith tubes.

*Order all genuine Zenith replacement parts and accessories from your Zenith distributor*

Zenith B&W replacement picture tubes are made only from new parts and materials except for the glass envelope in some tubes which, prior to reuse, is inspected and tested to the same high standard as a new envelope. Some color picture tubes contain used material which, prior to reuse, is carefully inspected to meet Zenith's high quality standards.

Exciting Surprises  
for You—  
and Your Family!  
Fun for all!  
Get the details  
at your Zenith  
Distributor's  
Parts Department.

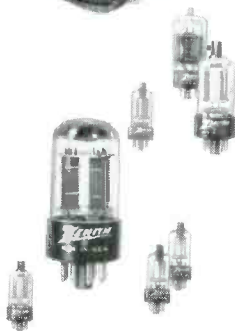

BEST YEAR YET TO SELL THE BEST



# ZENITH

*The quality goes in  
before the name goes on*

... for more details circle 140 on postcard

# New Dual Purpose OSCILLOSCOPE / VECTORSCOPE



PS148

NOW — YOU CAN HAVE BOTH IN ONE INSTRUMENT:

- A CONVENTIONAL WIDE BAND OSCILLOSCOPE
- A PROFESSIONAL 5-INCH VECTORSCOPE

The PS148 wide band scope is identical in features and specifications to the popular Sencore PS127. In addition, it provides a vectorscope for complete simplified trouble-shooting and alignment of color TV chroma circuits. Now, you can view the vector patterns as recommended by Zenith or display the standard "S" pattern as recommended by RCA. Both methods are at your fingertips with the PS148. Now, for only \$20.00 more than the Sencore PS127, and even less than other wide band scopes, you can view vectors and still own a deluxe wide band scope for all other work. Why pay many times more?

- Converts at the flick of a switch on rear panel from a professional wide band scope to a large 5-inch vectorscope. All vectorscope connections and controls are located on rear for ease of operation and to prevent color demodulator circuit loading.
- Simplified instructions for using the vectorscope in color TV chroma circuits and for troubleshooting and alignment are packed with each instrument.
- Comes with special vectorgraph screen which shows exact degree of chroma demodulation; also includes viewing hood.
- Use with any standard 10 bar color generator, such as all Sencore, RCA, etc. Use your present color generator and save money.
- Vectorscope connections on PS148 rear also speeds up other work where direct connections to the CRT deflection plates are required; such as, modulation checks and lissajous patterns for communications or lab work.

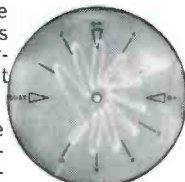

Typical Vector pattern

**ONLY**  
**\$219<sup>50</sup>**

NO. 1 MANUFACTURER OF ELECTRONIC MAINTENANCE EQUIPMENT



**SENCORE**

426 SOUTH WESTGATE DRIVE, ADDISON, ILLINOIS 60101

... for more details circle 129 on postcard

## TECHNICAL DIGEST

Two 2N1540 germanium power transistors are used in the audio output circuit in a class B configuration to provide audio output signal. Using class B in this stage allows the no signal resting current to be quite low, while in the presence of signal, the current required will increase with demand.

Choice of impedances involved in the output transformer makes it possible to have the full 3w power capability available for modulation and public address operation. For receive operation, this capability is reduced to 1w, preventing damage to the smaller receive speaker. Modulator gate diode CR7 and diode action of the transmitter output transistor Q13 open the modulation winding of the transformer during receive operation. During transmit operation, a microphone contact opens, thus opening the speaker winding.

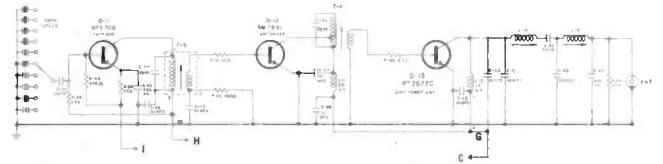

The crystal controlled transmitter oscillator circuit uses a MPS706 silicon transistor coupled to the driver stage through transformer T5. A microphone contact applies B+ voltage to this stage during transmit periods.

Another silicon transistor, a type S19386, operating in class C, functions as the transmit driver stage, delivering a signal to the power amplifier base, through transformer T6.

The type PT2677C silicon power transistor, also operating in class C, builds this signal up to provide a substantial output signal, which is coupled to the antenna through a TL network output filter.

Class C operation of the driver and output stages allows the transmitter to be cut off by switching off the oscillator. These stages do not function unless driven.

Antenna switching between transmitter and receiver is accomplished by two back-to-back type 1N270 diodes in series with the signal path from antenna to receiver. During receive operation, these diodes are biased in conduction by plus voltage through R2.

This allows the signal to pass through these diode switches. When the microphone button is pressed to transmit, this voltage is removed along with the receiver B+ voltage and these diode switches open, preventing the transmitted signal from reaching the receiver.

Switching between transmit operation and public address function employs a single pole, double throw switch ganged to the squelch control. In the CB position, one pole opens the PA speaker circuit while the other pole closes the B- circuit to the transmit oscillator. When switched to PA operation, this condition is reversed allowing the PA speaker to function and by disabling the transmitter oscillator preventing the transmitter from functioning.

### WESTINGHOUSE

Transistor TV Chassis V-2483-1 — Vertical Jitter, Vertical Instability

Vertical jitter can be caused by combined overloading and/or critical AGC setting. This condition may vary with signal levels and may occur intermittently.



# FREE.



**It tells you  
how 12 Delco  
transistors replace  
over 7,500 other types.**

In radios, television sets, stereo systems, tape recorders.  
In cars. In industry. In the home.  
Delco DS transistors are actually designed for both original  
equipment and replacement use in General Motors car  
radios (which gives you an idea of their quality). But they're  
capable of replacing over 7,500 other type transistors. And we  
don't have to tell you what that means to inventory.  
Want the new Delco replacement guide? Drop us a line. We'll  
send it right out with a free directory of United Delco  
electronic parts suppliers. They have our DS transistors  
in inventory, ready to go.  
Send for it soon though.  
The best things  
in life may be free,  
but they don't last forever.



MARK OF EXCELLENCE



# Weller®

**makes first class  
soldering the easiest  
part of any job**



The original Dual Heat Soldering Guns

Preferred by technicians for their fast heating copper tips, exclusive trigger-controlled dual heat, and high soldering efficiency. Available in 3 watt-age sizes, each with spotlight.

100/140-watt Model 8200, 145/210-watt Model D-440, and 240/325-watt Model D-550. Also in complete kits:

## Dependable MARKSMAN Irons in a size for every job



Ideal for deep chassis work and continuous-duty soldering, Marksman irons outperform others of comparable size and weight. All five feature long-reach stainless steel barrels and replaceable tips.

- 25-watt, 1¾-oz. Model SP-23 with 1/8" tip (In kit with extra tips, soldering aid, solder—Model SP-23K)
- 40-watt, 2-oz. Model SP-40 with 1/4" tip
- 80-watt, 4-oz. Model SP-80 with 3/8" tip
- 120-watt, 10-oz. Model SP-120 with 1/2" tip
- 175-watt, 16-oz. Model SP-175 with 5/8" tip

## 25-watt Technician's Iron for intricate circuit work



Industrial rated pencil iron weighs only 1¾ ounces, yet delivers tip temperatures to 860°F. Cool, impact-resistant handle. All parts readily replaceable. Model W-PS with 1/8-inch tapered tip.

Also available: A new Battery Operated Iron for use with 12 volt battery or 12-24 volt AC/DC source. Complete with 12 ft. cord and battery clips. Model TCP-12.

Complete Weller Line at your Electronic Parts Distributor.

**WELLER ELECTRIC CORPORATION, Easton, Pa.**

WORLD LEADER IN SOLDERING TOOLS

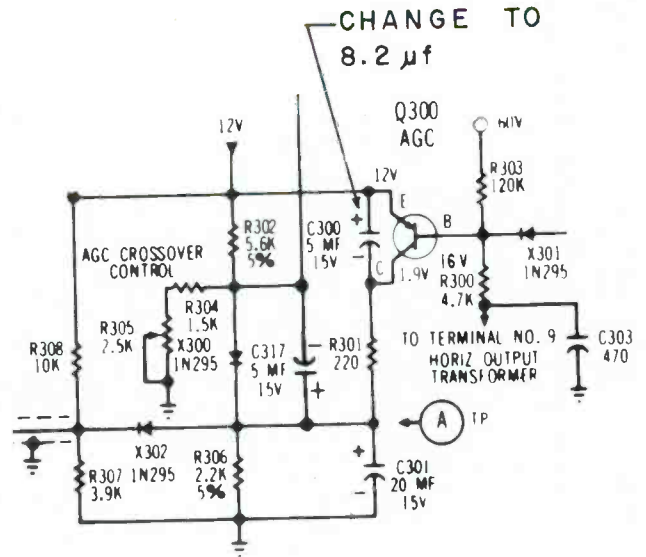

To correct this problem, change the 5 µf electrolytic capacitor, C300, connected collector-to-emitter of the AGC transistor, Q300, to an 8.2 µf capacitor as used in C420 application in the same chassis. In other words, substitute a new capacitor, C420, 218V063B01 in place of C300, 218V060H04. Use only C420, 218V063B01 as the replacement since it has special internal resistance characteristics.

If you encounter vertical hold instability, which may act as one-way vertical roll or the vertical hold may not lock near center range of the control, add a 0.022 µf capacitor, 5%, in parallel with capacitor, C310. This will extend the vertical lock-in range. If difficulty continues, you should check the vertical oscillator transistor, Q303.

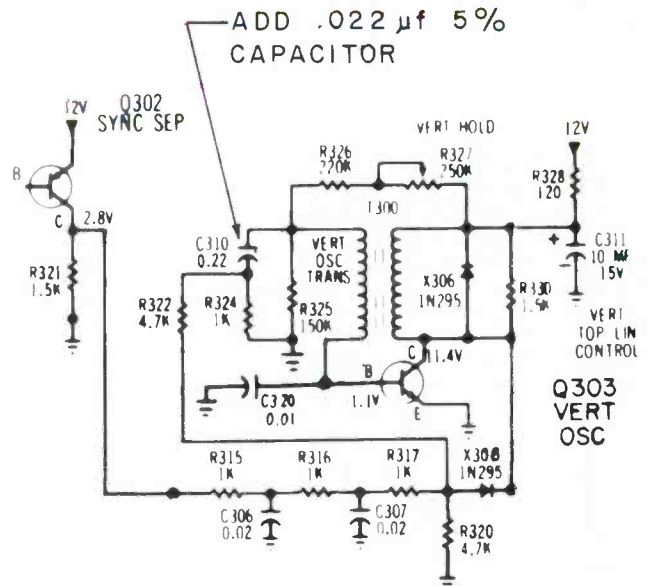



# NOW...a full-sized **VOM** in a palm sized "package"

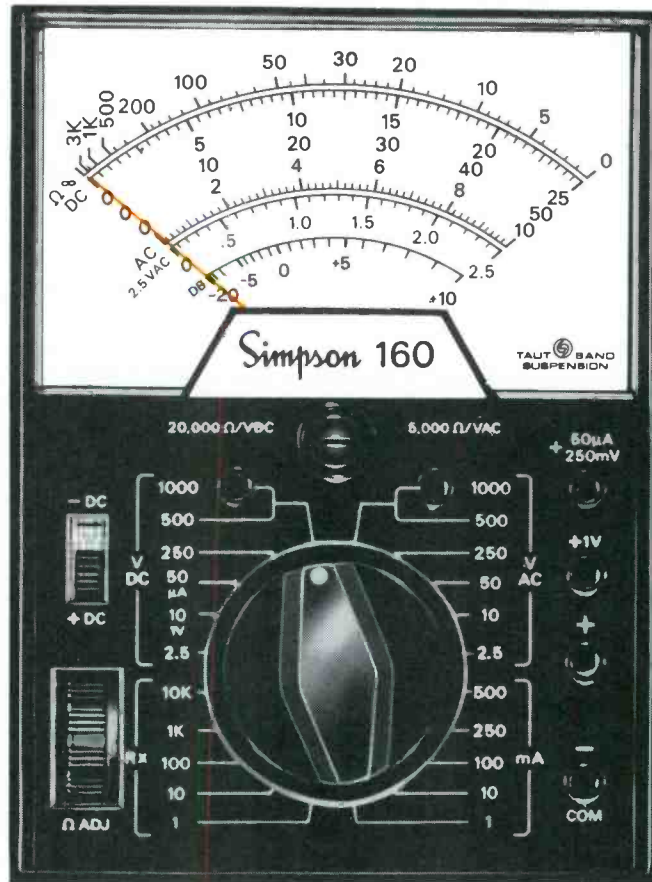
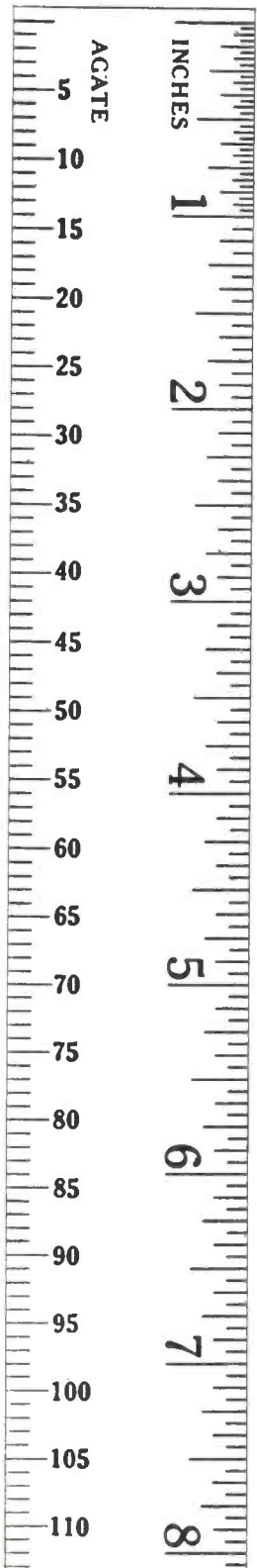

160 Volt-Ohm-Milliammeter  
Complete with alligator clip  
leads and operator's manual.

.....\$53.00



Carrying Case—  
Cat. No. 2225.....\$10.00

Accessory Leads—  
Probe Tip Lead—  
Cat. No. 2055.....\$3.00

## Simpson 160 Handi-VOM<sup>®</sup>

Simpson Handi-VOM gives you the ranges, the time-saving conveniences and the sensitivity of a full-sized volt-ohm-milliammeter—yet it's only 3-5/16" wide, weighs a mere 12 ounces. Recessed range-selector switch never gets in the way . . . polarity-reversing switch saves fuss and fumble. Self-shielded taut band movement assures high repeatability and freedom from external magnetic fields. Diode overload protection prevents burn-out—permits safe operation by inexperienced employees and students. The demand is BIG, so get your order in to your electronic distributor, TODAY!

### RANGES

**ACCURACY:**  $\pm 3\%$  FS DC,  $\pm 4\%$  FS AC  
**DC VOLTS:** 0-0.25, 1.0, 2.5, 10, 50, 250, 500, 1000 @ 20,000  $\Omega/v$   
**AC VOLTS:** 0-2.5, 10, 50, 250, 500, 1000 @ 5000  $\Omega/v$   
**DC MICROAMPERES:** 0-50  
**DC MILLIAMPERES:** 0-1, 10, 100, 500  
**DB:** -20 to +10, -8 to +22, +6 to +36, +20 to +50  
**"O" REFERENCE:** 1 MW into 600 $\Omega$   
**RESISTANCE:** Rx1, Rx10, Rx100, Rx1K, Rx10K (30  $\Omega$  center)



DIVISION

**Simpson**  
INSTRUMENTS THAT STAY ACCURATE

**SIMPSON ELECTRIC COMPANY**

5200 W. Kinzie Street, Chicago, Illinois 60644 • Phone: (312) 379-1121  
 Export Dept: 400 W. Madison Street, Chicago, Illinois 60606, Cable, Simelco

IN CANADA: Bach-Simpson Ltd., London, Ontario

IN INDIA: Ruttonsha-Simpson Private Ltd., International House, Bombay-Agra Road, Vikhroli, Bombay

**WORLD'S LARGEST MANUFACTURER OF ELECTRONIC TEST EQUIPMENT**  
 ... for more details circle 132 on postcard



mystery: where  
did all  
the color  
GO?

## here's the missing link in color

Belden's Color Twins deliver full color power all the way to the set. Eliminate many causes of lead-in signal loss. Deliver a ghost-free picture. ■ Belden's COLOR TWINS are: 8290† Shielded Permohm with Beldfoil\* for congested or high interference areas; and 8285† Unshielded Permohm for rural, low-signal-strength areas. ■ 8290 with patented Beldfoil shielding prevents line pick up of interference signals that produce ghosts and electrical interference. 8285 Permohm's conductors are encapsulated in low-loss cellular polyethylene to maintain a strong signal in all weather conditions, especially in fringe reception areas. ■ 8290 Shielded Permohm is designed so that you can install it to a mast or run it through a rain gutter. ■ With Permohm lead-ins, the set gets the full color power of the signal (full power for UHF or VHF, too.) Now owners can get the kind of picture they bought a color set for. You get the laurels.

**BELDEN CORPORATION**  
P.O. Box 5070-A • Chicago, Illinois 60660



reception!

8285<sup>†</sup>

Belden  
Unshielded Permohm  
for rural areas.

Call your Belden distributor about the  
Color Twins—



**BELDEN**

PERMOHM

8285

CHANNEL TV

8290<sup>††</sup>

Belden  
Shielded Permohm  
with Beldfoil  
for congested areas.

don't forget  
to ask them  
what else needs  
fixing?

\*Belden Trademark Reg. U.S. Patent Office †Belden Patent No. 2,782,251 ††Belden Patent No. 2,782,251 and Pat. Pending

... for more details circle 108 on postcard

# Alliance Tenna-Rotor®

## REDUCES COLOR SET RETURNS

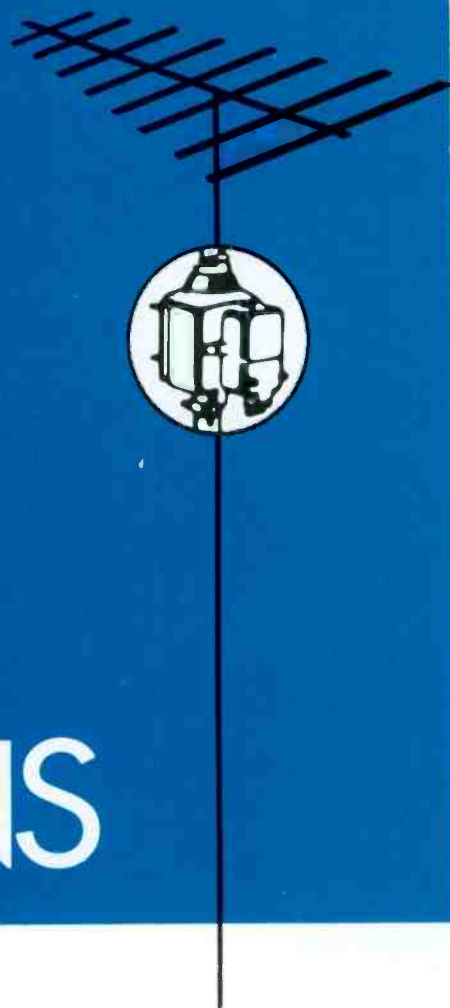

- CUT COSTLY CALL BACKS
- KEEP CUSTOMERS SATISFIED
- EARN MORE PROFITS

Since color reception is so critical, it is important to have an Alliance Tenna-Rotor and proper antenna to eliminate color ghosts, snow, and other interference. With an Alliance Tenna-Rotor, your customers will enjoy improved Color TV reception, and you'll be backed by the nationwide Alliance Service, Advertising and Merchandising Program. There are four attractive models to choose from. Let us tell you how to take advantage of this program.



*"TV's better Color-Getter"*



the **ALLIANCE** Manufacturing Company Inc.

(Subsidiary of Consolidated Electronics Industries Corp.) **ALLIANCE, OHIO**

**Maker of famous Alliance Genie® Automatic Garage Door Opener System**

ET-6

... for more details circle 103 on postcard



---

# The Growing Home-Entertainment Audio Equipment Market

---

Expand your 'acreage' and increase your cultivating efforts in this steadily advancing area of the electronics field

■ Last year an affluent American public bought over 40 million radios, phonographs and tape recorders for home use. This does not count radios and tape players used in autos nor phonos, radios and tape recorders included in TV combos.

We do not have figures to show how much this represents in retail

dollars, but it has been conservatively estimated — based on figures supplied by the Electronics Industries Assn. (EIA) — to be well beyond \$1 billion. The total retail value of all kinds of consumer electronics equipment sold last year, including TVs, came close to \$6.5 billion. Under continuing favorable

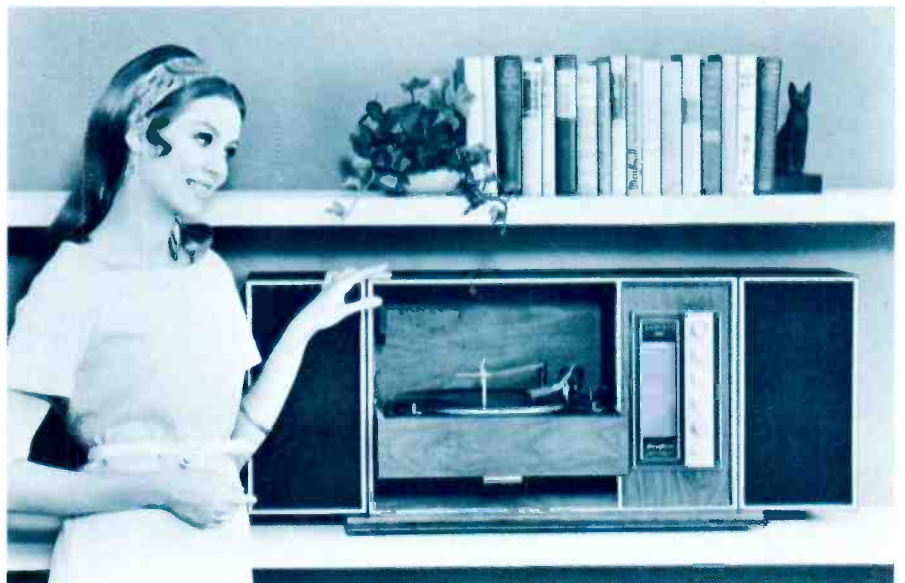

Admiral's YF1361SA stereo phono is portable, solid-state and has AM/FM-stereo radio.

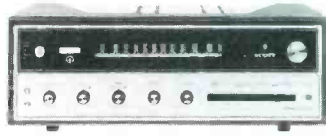

Scott's 348B AM/FM-stereo receiver uses three FETs in the front end and IC IFs. It is said to have a  $1.7\mu\text{v}$  sensitivity and 40db stereo separation.

Allied AM/FM-stereo receiver employs 65 semiconductors and is said to have FM IHF sensitivity of  $2\mu\text{v}$  with 35db separation at 1kHz and 40db separation at 400Hz.



Philco-Ford solid-state AM/FM table radio.

economic conditions, this figure is expected to increase yearly at a rate of about 7 percent.

The market for home-entertainment audio equipment is a big slice of the over-all consumer electronics pie (perhaps 16 percent or more).

But what seems equally important to service-dealers and technicians who sell and service this equipment, is the accumulating supply of total radios, phonos, tape recorders and tape players in U.S. homes.

It is estimated that close to 400 million radios, phonos, tape recorders, tape players and other home-entertainment audio equipment (excluding TVs) are now in U.S. homes. No matter how you slice it, this seems to represent another big pie, labeled "service revenue." And, as reported in ELECTRONIC TECHNICIAN/DEALER every month under the DEALERFAX section, it is a pie which many alert and aggressive service-dealers are now profitably slicing among themselves.

### Some Growth Factors

Much of the recent growth in

home-entertainment audio equipment sales has been fertilized by increases in the number of FM broadcast stations, both monophonic and stereo, plus a substantial increase in programming and higher quality programs.

Developments in solid-state technology are other factors which have contributed to this growth. New circuit innovations have come about, easier-to-operate, lighter-weight, more convenient equipment has been designed. High-style, home-decor-oriented "package-type" equipment has come back in style after more than three decades. This equipment carries more substantial markups. And, of course, sales have been spurred onward by an exponentially increasing population and a Gross National Product (GNP) which results in a more affluent public.

But this affluent, younger-than-ever public, has grown more discriminating, too. It is looking for even better equipment — demanding a higher order of "listening pleasure." By and large, the R & D,

the design and manufacturing departments have kept tuned-in on the "message" and seem thoroughly convinced of its urgent nature. A few, however, are still locked-in on the dead voices of yester-year. But most service-dealers, especially those located in interurban, suburban and rural areas, have caught on fast and have been capitalizing on the highly favorable objective conditions which have existed for some years now. Many have learned that it is a lot easier to "sell-up" on home-entertainment audio equipment today than it was a few years ago — especially since a wide selection of upgraded equipment is now available.

### Some Equipment Developments

In addition to the strides made in developing more compact component-type, one-piece AM/FM/stereo tuner/preamp/amplifier entertainment systems, other audio equipment — from small battery-powered phonos to elaborate "theaters" to computerized-type "automated" record-player music cen-

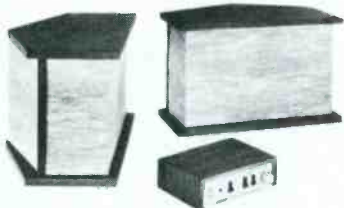

Bose 901 direct/reflecting stereo speaker and solid-state equalizer.

Keystone 800 CR cassette tape recorder operates on 5 "C" cells.



Sherwood's S330 all solid-state FM/stereo tuner has microcircuits and FETs.



Uher 7000 tape deck.



Harman-Kardon's TD3 three-head stereo deck.





Norelco 2500 stereo cassette player deck for use with an existing Hi Fi system.



Jensen's PR400A speaker is rated at 40w. Uses three speakers in enclosure.

SJB's ST120G stereo tape player. Types are available for home, auto or boat.



ters that automatically play both sides of up to 50 LP (33 1/3) records — has been developed.

Although the field-effect (FET) transistor concept is older than the common junction type transistor which is now widely used in home-entertainment audio equipment, FETs have been developed in the past year or so which have contributed greatly to improving FM tuners, IF circuits and preamps. Additionally, we can look forward to smaller and smaller equipment having attending improvements as integrated circuits (ICs) are used more extensively. ICs are now being employed in a considerable amount of home-entertainment audio equipment.

A number of improvements have been made in record-player, tape recorder, tape player and speaker design. Equipment power supplies have been upgraded and refined. Much equipment, considered "professional" only a few years ago, has become "common fare" in many homes. Of course, it goes without mention, that a lot of "kid-oriented" equipment is being made which pro-

vides little service-potential to service-dealers because most of the equipment, like \$5 transistor radios, falls in the "breakdown-to-ashcan" category.

### Unique Approach to Stereo Reproduction

One manufacturer, primarily concerned with government and industrial R & D, has recently come up with what appears to be a unique approach to home stereo reproduction. A speaker is designed which operates on a direct/reflecting principle. An arrowhead-shaped enclosure houses nine high-compliance, long-excursion speakers. Eight speakers, mounted on two rear baffles, supply the reflected audio and one off-center-mounted speaker on the front baffle supplies the direct audio. It is said that 89 percent of the audio is reflected from a rear wall and 11 percent of the total audio is radiated directly. (For stereo, two speaker housings are placed 1 ft in front of the wall.)

The system employs a solid-state equalizer which contains over 100

components. It is used to precisely control the frequency response over the audible range. This unit has front panel controls which enable the listener to satisfy his personal taste in compensating for recording techniques and room characteristics. It is said that the system solves the long-existing, "hole-in-the-middle" effect problem. In addition to equalization that produces the flat frequency response of the radiated audio, the active equalizer system is said to provide the listener with a choice of 19 additional equalization contours that can be selected from the unit's front panel.

Although the tape-recording and tape-player segment of the home-entertainment audio equipment area is suffering some growing pains, it seems certain — whether reel-to-reel, ordinary cartridge, cassette or whatever — this segment of the business appears to be steadily growing and presents one more potential opportunity to service-dealers and technicians who take the home-entertainment audio equipment business seriously. ■



Seeburg's "audio-mated" system allows up to 40 hours of continuous listening.

LEL's tape cartridge background music reproducer provides 10 hours of music on a single cartridge.



Concord's STA12 AM/FM-stereo receiver with matching speakers.



Altec Lansing's high-style furniture cabinet is designed for housing receivers, tuners, amplifiers, record changers and tape recorders.

# Exploring Zenith's Small Screen Color Portable

Understand circuits used in color portables — sales hit a new high and more transistors being employed

■ We were eager to unpack Zenith's first small screen portable color TV. When placing the set on the bench for inspection it was far from a lightweight unit, but after reading the article, you will likely agree no corners were cut in quality.

The 15Y6C15 chassis has most of the features employed in previous big sets: power transformer, parallel tube filaments, automatic degaussing, three stages of IF employing transistors, keyed AGC circuit and hand-wired chassis.

Some of the new features not used in previous circuits are: HV regulation accomplished by a pulse controlling the bias voltage on the grid of the horizontal output tube eliminating the HV regulator tube, two AGC controls, AGC LEVEL and the AGC DELAY control, an additional adjustment in the color oscillator circuit, low-level color demodulation and a new HUE control location.

All customer controls are in the front panel, including the AGC DELAY, VERTICAL SIZE and LINEARITY control. These controls are hidden by a drop-down panel with magnetic catches. By having the picture adjustments up front, reaching around or using a mirror to adjust the picture is eliminated.

The 15Y6C15 chassis has a 14in. (diagonal measurement) or 102sq in. screen and contains hybrid circuitry, 18 tubes including CRT, 6 transistors and a number of diodes.

If chassis work is needed, all components can be exposed by removing the back cover, the four screws holding the bottom panel and laying the set on its side. This eliminates the need to pull the chassis for shop work (see illustration Fig. 1).

We will now go into several important circuit features which are quite different from previous chassis.

## IF Amplifier

The transistorized IF section consists of a separate chassis contained in a shielded metal case to minimize radiation effects and provide isolation between stages. The IF chassis is secured within the metal case by four screws (see illustration Fig. 2). The metal case, which measures approximately 6 x 2½ x 1½ in., is held vertically in place by three screws. Electrical connections consist of plug-on leads.

The IF amplifier system consists of three transistorized stages (see schematic Fig. 3), TR1, TR2 and TR3. All three stages are NPN types, with the 1st stage AGC

controlled using "forward" AGC voltage applied to its base. An increase in positive voltage at its base will increase the collector current and decrease the collector-to-emitter voltage, reducing stage gain.

The input circuitry consists of a double-tuned circuit formed by the 1st IF transformer and the mixer plate coil in the VHF tuner coupled through the IF cable. The 1st IF transformer is a step-down coil providing a low impedance input to TR1. Variations in electrical characteristics of the tuner and IF cable are controlled by the bottom winding adjustment of L1A and L1B trap coil (winding L1B is the 39.75MHz trap).

A full complement of traps is provided: the 39.75-MHz adjacent video, 47.25MHz adjacent sound, and two (input and output) 41.25MHz traps.

The 41.25MHz input trap (L3) and the 47.25MHz trap coil (L4) form a bridge type circuit which has minimum band pass effect. Two cores are provided in all trap coils providing adjustment for proper rejection level.

The first IF transistor (TR1) is biased through the two 470  $\Omega$ , series resistors, R2 and R3. Capacitors, C14 and C15, provide filtering.

Capacitor C12 provides dc blocking, preventing the AGC voltage applied to the TR1 base from being grounded through L2. "Maximum gain" bias is approximately 4.5v and is applied to the base of TR1 under a very weak signal condition. "Minimum gain" bias is ap-



Zenith's Model Z3508W color portable.



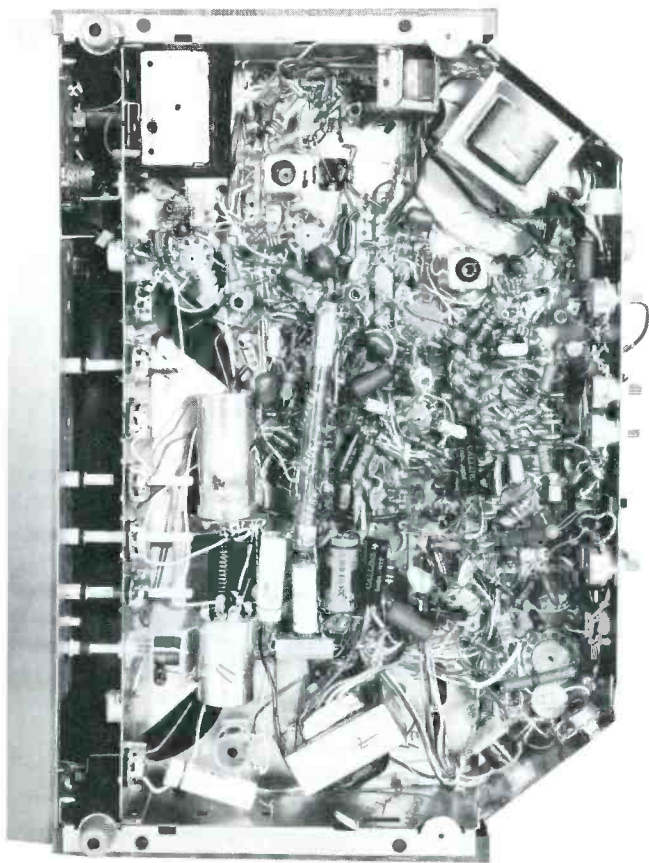

Fig. 1 — All components are exposed for servicing, by removing the back cover and four screws on the bottom panel.

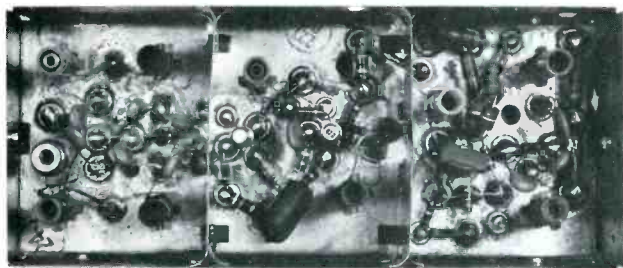

Fig. 2 — The transistorized IF section consists of a separate chassis contained in a shielded metal case.

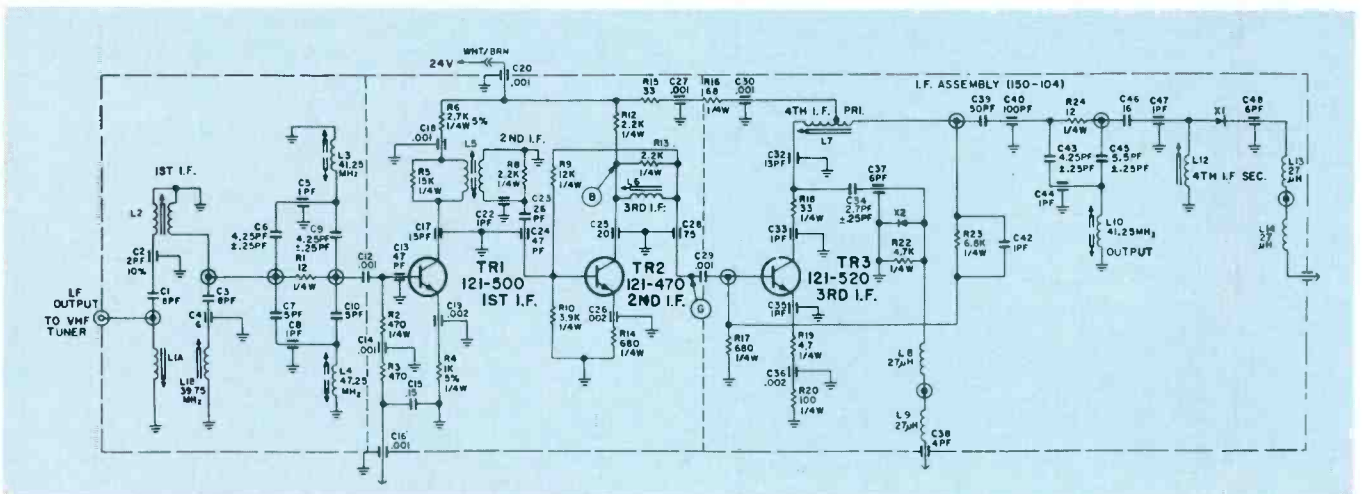

Fig. 3 — Schematic of the transistorized IF amplifier system.

proximately 7v and would be present at the base of TR1 under a very strong signal condition. This minimum voltage (4.5v) is then held constant by a clamp network including the AGC transistor TR5.

Transistor TR1 is coupled to TR2 by the double-tuned interstage transformer (L5) in the TR1 collector circuit. This circuit also has a unique design providing a "boost" of the sound carrier on weak signals. TR2 is coupled to TR3 through a pi-coupling network (L6, C25 and C28) providing the necessary "Q" combined with a low pass characteristic.

Coils L7 (4th IF primary) and L12 (4th IF secondary) form a slightly overcoupled, double-tuned circuit with a 41.25MHz output trap in the coupling network between L7 and L12. Resistor R23 and capacitor C42 form a partial neutralizing and dc stabilizing circuit for the TR3 base. Detectors X1, X2, provide detection for Y amplifier and sync-sound amplification. Approximately 4v peak appears at test point C1 and approximately 2v peak at test point C2. Capacitors C39 and C40 provide a three to one capacity divider which lowers the impedance coupling to the 41.25MHz trap, while capacitors C46 and C47 provide an increase in impedance for proper detection.

### High Voltage Regulation

The horizontal oscillator circuit is very similar to previous chassis designs. The high voltage circuit of the

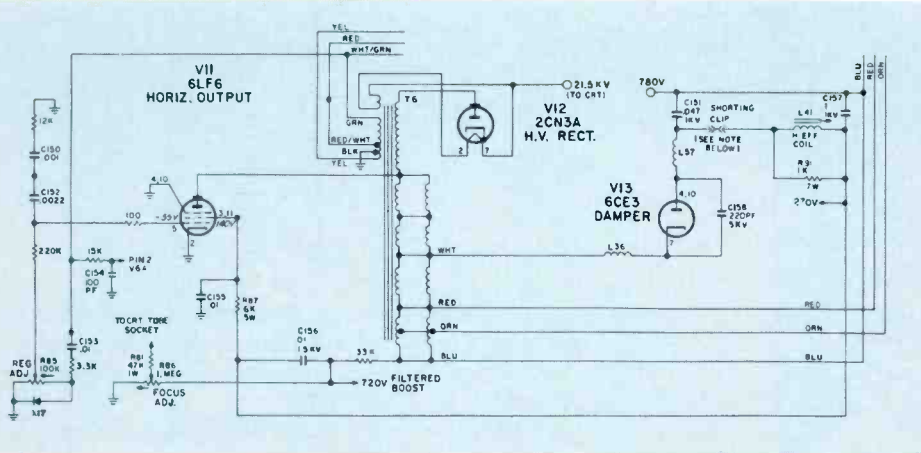
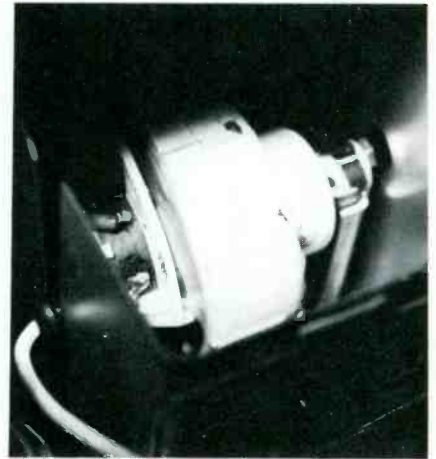

Fig. 4 — Schematic of the HV circuit with HV regulation accomplished by a pulse controlling the bias voltage on the horizontal output tube grid.



The HV sweep transformer is shielded by a metal cage and sealed in polyester resin which is protected against moisture and corona discharge.

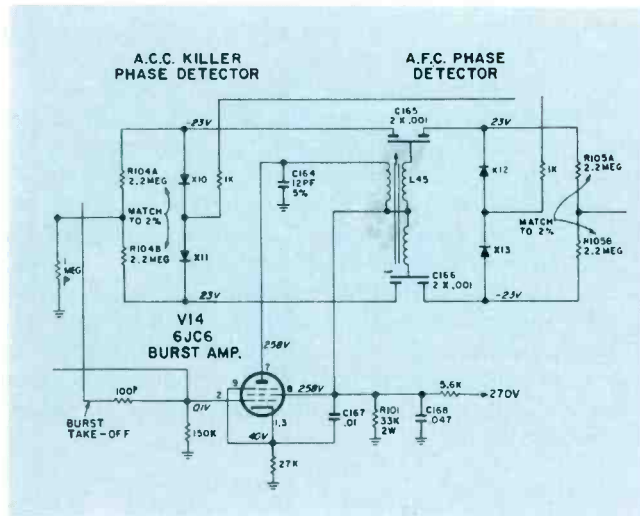
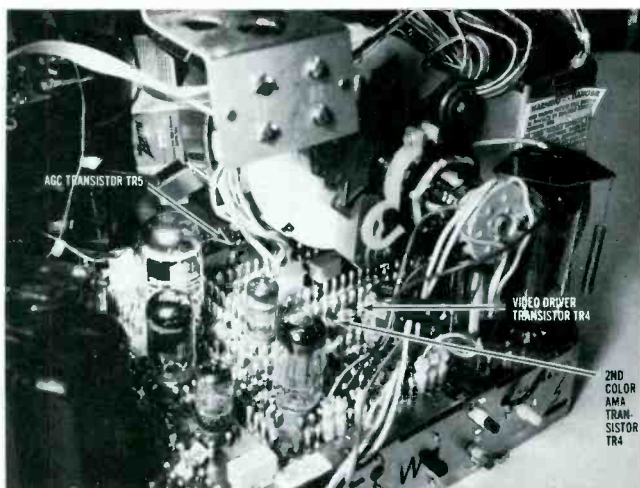

Fig. 5 — Schematic showing burst amplifier and phase detectors.



Top view of chassis showing transistors employed, except IF transistors.

15Y6C15 chassis differs considerably from previous designs. HV regulation (see schematic Fig. 4) is accomplished by a pulse controlling the bias (drive) voltage on the horizontal output tube grid. For example, if the CRT beam current increases to cause an increase in load on the sweep transformer, the HV pulse will decrease, causing a decrease in high voltage. This decrease in pulse amplitude causes a decrease in the 200v pulse coupled to a REGULATOR ADJUST control (R85) through C153. This causes a decrease in the horizontal output tube grid bias which results in a greater output tube conduction thus increasing the HV pulse and the high voltage. The REGULATOR ADJUST control is normally set for 21.5kv. A voltage regulator is not used in this chassis.

#### Noise Gate-AGC-Sound-Sync Amp

With transistorized IF stages, a slightly smaller output signal amplitude is obtained from the video detector (approximately 4v peak as compared to tube IFs that produce about 6v peak). Because of this, the signal fed to the sync-AGC tube input grid (V4) is taken from cathode follower tube plate (V1A) employing the extra gain of that stage.

Noise pulses of relatively large amplitude will cut off V4, which could cause the IF amplifiers to be at full gain (lack of AGC action) and could cause "lock-up," a sustained overload condition. Under such a large signal condition, however, the video coupled to the sound-sync amplifier, V3A, will also be sufficient to cause cut-off and thereby increase the screen voltage. This sudden, momentary increase in screen voltage is coupled through C67 as a positive pulse which allows V4 to conduct and prevent "lock-up".

The negative (or positive) AGC voltage developed at the plate (pin 3) of V4 is applied to the tuner RF stage through a 2.2M resistor and to the TR5 base through a 680K resistor. The AGC voltage for the 1st



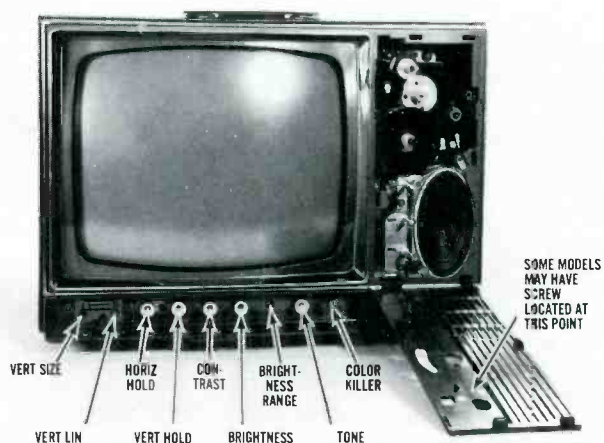

Front view showing controls and front panel removed for servicing, by simply removing knobs and prying panel off.

IF, however, must be a positive voltage since it is an NPN type. To decrease the gain of an NPN transistor amplifier, the base voltage (positive) must be increased. Thus, the AGC voltage produced by V4 must be employed in a manner that it will control a positive 1st IF amplifier AGC voltage. Under a "no" signal condition, the AGC tube (V4) is cut off. Thus, the base of TR5 is approximately 5 to 6v positive formed by a voltage divider consisting of a 2.2M resistor (from 270v, V4 plate), in series with a 680K and a 120K resistor to ground. The voltage at the tuner under this condition is approximately 1.0v positive. The 5 $\mu$ f capacitor (C59) located in the TR5 base circuit is a non-polarized type since the base voltage of TR5 may be positive or negative depending upon signal strength.

Transistor TR5 is also across part of another voltage divider consisting of a 1.8K and a 560 $\Omega$  resistor in series with a 250 $\Omega$  AGC DELAY control. The positive base voltage of TR1 is approximately 4v depending upon the setting of R44 (AGC DELAY). Under a given weak signal condition V4 will conduct and the voltage at TR5 base will decrease (less positive) to approximately .5v or only slightly positive. Transistor TR5 will conduct less and the voltage at the base of TR1 will increase slightly, thus reducing its gain accordingly.

Under a given strong signal condition, the tuner AGC voltage may become highly negative, driving the TR5 base voltage negative causing it to cut off and resulting in a positive voltage of approximately 7v at test point E and at the TR1 base. With 7v positive at the base of TR1, its gain is substantially reduced. (The "range" of AGC control on TR1 is adjustable by the setting of R44, AGC DELAY control).

### Burst Amplifier-Phase Detectors

The burst amplifier (V14) separates burst information and couples this signal to the ACC and AFC

phase detector stages. The circuitry of V14 (see schematic Fig. 5) is also similar to previous chassis designs with the exception of the new HUE control location. The phase detector coil (L45) approaches a coarse hue adjustment providing a tolerance of  $-30\text{deg}$  and  $+45\text{deg}$  on the total tuning range. The V14 suppressor grid is returned to the cathode rather than to ground for additional stability.

The ACC phase detector employs two silicon diodes with the color oscillator phase injection voltage "in phase" with burst. The 1K resistor in series with the sample voltage injection path filters out any 3.58MHz radiation which might otherwise be caused by diode switching transients.

The AFC phase detector also employs two silicon diodes in a similar circuit with the injection (sample) voltage coupled to the diodes through a 1K resistor for 3.58MHz radiation suppression.

### Color Amplifiers

Chroma (color) information is coupled to the grid of the 1st color amplifier (V1B) through a 12pf capacitor from the 4.5MHz trap (test point C1). The color signal is amplified and coil L25, 1st color amplifier plate coil is adjusted for minimum transient response. The output of V1B is also coupled to the burst amplifier, V14, for burst separation.

The chroma output of V1B is coupled to the HUE and COLOR LEVEL control circuitry, and to the base of the 2nd color amplifier, an NPN transistor. Coil L25 is tapped in the output circuit to provide impedance matching for the transistor input.

The circuitry of the HUE control provides nearly 90-deg phase shift of color throughout its range. The HUE control has a linear taper and the COLOR LEVEL control a non-linear taper. Thus, the action of the COLOR LEVEL control provides a smooth increase and decrease of color level without excessive overload or saturation at maximum color level control setting.

The 2nd color amplifier (transistor TR6) is properly biased from a regulated (Zener controlled) 24v source in the power supply.

The output of TR6 is coupled to the grid of V6B (3rd color amplifier). Input tuning is fixed by L26, C107 and capacities of TR6 and input capacity of V6B. The cathode of V6B also accepts the positive horizontal pulse from the blanker stage to cut off V6B during this period providing zero color output during horizontal blanking.

Color killer action is similar to previous chassis designs with killer voltage being applied to the grid of the 3rd color amplifier.

### Color Oscillators

The color oscillator, although similar in circuitry to previous design, contains an additional adjustment (L48) which is tuned for maximum oscillator output. The tuning range is very broad and not critical. ■



**Blonder-Tongue broadband amplifier.** These amplifiers are generally easier to use than single channel strips.

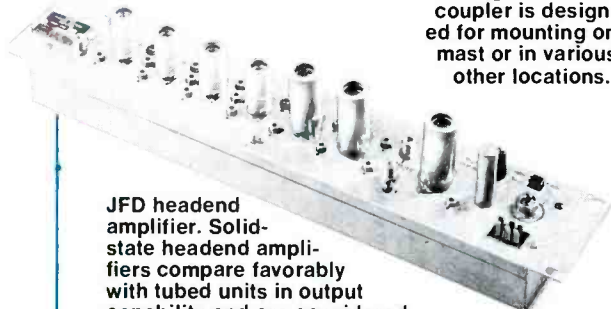

**Winegard two-set coupler** is designed for mounting on mast or in various other locations.



**Jerrold single channel amplifier.** These units provide high output capability and may include AGC.



**UHF converter** may be plugged directly into single channel headend strip. *Courtesy Winegard.*

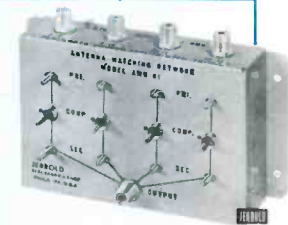

**Jerrold antenna matching network.**

**JFD headend amplifier.** Solid-state headend amplifiers compare favorably with tubed units in output capability and are considered more maintenance-free.

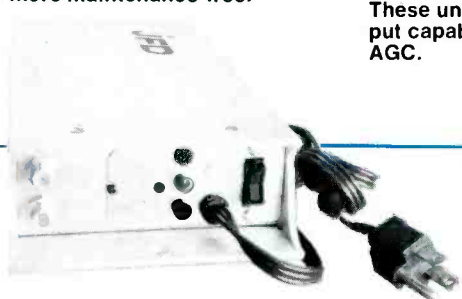

**JFD mast-mounted preamp.**



**Blonder-Tongue transistorized UHF converter/amplifier.**



# Selling and Installing MATV Systems

Understand the essentials of headend design

Part three of a series

■ Part two of this series (ELECTRONIC TECHNICIAN/DEALER, April 1968), explained how to design and lay out MATV distribution systems. We will now discuss MATV headend equipment — amplifiers, preamps, mixers, splitters, filters, traps, attenuators and provide a word about antennas.

Until recently, equipment was not available for distributing UHF signals through a large master TV system. In the past the practice has been to convert UHF into VHF before distribution. This article will deal only with VHF systems. A forthcoming article will cover 82-channel systems having on-channel UHF distribution.

## MATV Amplifiers

MATV amplifiers are classified into two groups: 1) single channel and 2) broadband.

Broadband amplifiers are generally easier to use, especially with broadband antennas. Single channel

amplifiers, however, can provide more output per channel and simplify signal equalization.

Until recently, tubed amplifiers outperformed solid-state units. But the state-of-the-art has now advanced significantly. Solid-state amplifiers not only provide very high gain, they are more reliable.

The two main criteria for selecting an MATV amplifier are *gain* and *output capability*. Gain is easy to understand. Suppose, for example, that you put  $100 \mu v$  into an amplifier and measure  $10k \mu v$  at the output. Obviously, the signal has been amplified 100 times. According to the chart shown in part one of this series (ET/D, page 45, February 1968), 100 times voltage is 40db. This amplifier would then provide 40db gain. To express this mathematically, we can say:  $G$  (gain) =  $V_o$  (output voltage) /  $V_i$  (input voltage).

Now, suppose we have a distribution system which has a 50db loss.



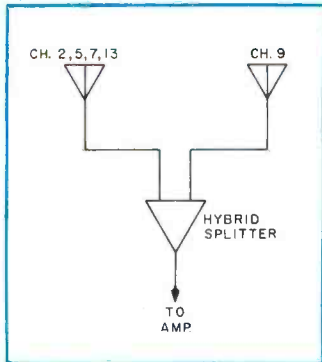

Fig. 1 — Single channel antenna combined with a broadband antenna.

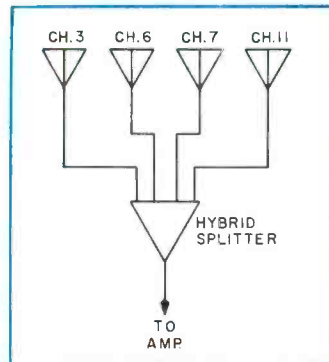

Fig. 2 — Hybrid splitter used to mix four single-channel antenna outputs.

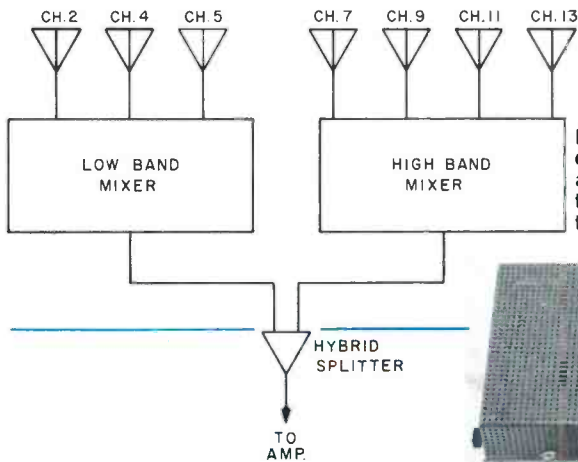
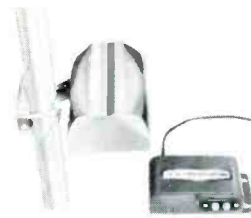

Fig. 3 — Mixing four high-band channels into a single lead-in and combining a low-band unit to produce a seven-channel system.



Blonder-Tongue mast-mounted transistorized VHF/UHF preamp.

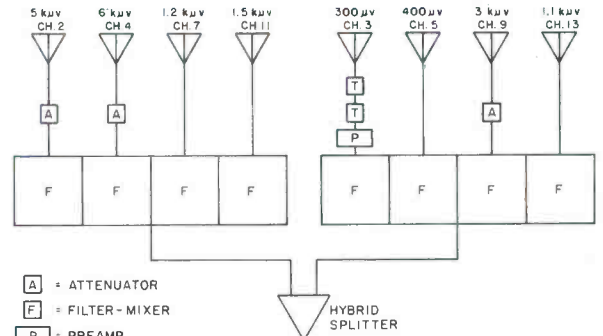

Fig. 4 — A complex head end uses mixers, filters, traps and attenuators.

Winegard's transistorized VHF/FM booster/coupler/amplifier.

Will an amplifier that provides 50db gain handle this system?

Unfortunately, it's not quite that easy. To choose an MATV amplifier, we have to consider the *output factor*. For example, if we have an input to the amplifier of only  $500 \mu v$ , or  $-6dbmv$ , the output will be only  $44dbmv$  — not enough to provide good signals throughout the system.

Even if we do have an input of  $1k \mu v$  (Odb) and a gain of 50db, this amplifier may not work. This brings us to the concept of *output capability*. Try to get too much signal from a given amplifier and it will overload. If a broadband amplifier overloads, you get intermodulation (between channels) and if a single channel amplifier overloads, you get sync compression. Overloads show up on a TV screen as poor sync, beats or "windshield-wiper-effect."

Manufacturers invariably specify the output capability of their ampli-

fiers, but these specs can be confusing. Some manufacturers give you total voltage output of all channels combined. Others give you output per channel. Some give it to you in dbmv and others in microvolts. It's confusing to say the least. Today, many manufacturers give you specifications in dbmv per channel, assuming seven channel operation (three low and four high bands) and these are easiest to use.

In choosing an amplifier, make sure that it has enough gain and output capability to give you at least as much output as the distribution system loses. For example, if your system loses 54db at channel 13, you need an output of at least  $54dbmv$  at channel 13.

### Preamps

The ability of a TV signal to produce top-quality color reception depends on several factors:

1) The signal amplitude at the antenna's output.

2) The signal-to-noise ratio.

3) The amount of interference present.

Preamplifiers not only increase the signal amplitude, but they can improve the system's s/n ratio. Every antenna picks up a certain amount of noise — along with the signal. In a strong signal area, the signal is considerably stronger than the noise and you have no problem. In a weak signal area, however, the s/n ratio may be poor and the noise may be almost as strong as the signal.

It is generally agreed that a 28db s/n ratio is required for good TV reception. If the ratio falls much below 28db, you get a snowy picture. And here's an important point to remember: If the headend has a low s/n ratio, no amount of amplification directly at the distribution system input will improve it. Because the noise is in the same passband as the signal, it is amplified along with the signal.

The output of the antenna system determines the s/n ratio. But a long lead-in, or one having excessive loss, can cause signal attenuation. Unfortunately, since the noise covers a broad frequency range, it is not attenuated as much by the lead-in as the signal is. The result is a low signal-to-noise ratio.

Preamps are designed to overcome this problem. They are properly mounted on the mast directly at the antenna output. Thus the signals are amplified before they can be attenuated by the lead-in — maintaining the best possible s/n ratio. Most preamps are remotely powered — an indoor power supply sends power up to the preamp through the same lead-in that pipes the signals down.

### Mixers and Splitters

You don't always have to use a broadband amplifier with a broadband antenna or single channel amplifiers with single channel antennas. There are often good reasons for mixing and splitting signals. Suppose, for example, that you have four channels coming from one direction and one channel coming from another direction. You might use a single channel antenna mixed with a broadband antenna as shown in Fig. 1. Similarly, to mix four single channel antennas into a broadband amplifier, you can use a hybrid splitter as shown in Fig. 2. A unit designed to mix four high band channels into a single lead-in, is shown in Fig. 3. It is easily combined with a similar low band unit, to produce a seven channel system as shown.

### Filters, Traps And Attenuators

So far, we've assumed that all channels are received at about the same strength. This is seldom the case. In an MATV system, it is easy for one channel to interfere with another, especially if adjacent channels are included. To eliminate or minimize interference from one channel to another, we use filters, traps and attenuators.

Filters are relatively broadband. Their passbands are about 6MHz and they attenuate frequencies above and below this passband. Unfortunately, they are not too selective. For example, a channel 3 filter

will generally pass channel 2 and channel 4, attenuating them only about 6db. And mixers can actually act as filters as well as mixers.

To eliminate adjacent channel interference, traps are required. Traps give you sharp attenuation, only a few kHz wide. You can buy traps for any VHF sound or video carrier frequency.

Attenuators are not frequency sensitive. Their job is to reduce strong signals.

A rather complex headend, using mixers, filters, traps and attenuators is shown in Fig. 4. The adjacent channels are 2, 3 and 4. Because it is so weak (only 300  $\mu$ v), channel 3 will cause no problems to 2 and 4. However, 2 and 4 can cause severe interference on 3. To eliminate this interference, we trap out the two carriers closest to channel 3 (two sound and four video) using two traps in series as indicated. Next, we use a single channel preamp to build up channel 3. Notice that the traps precede the preamp. This is because neither the single channel antenna nor the preamp are selective enough to reject channels 2 and 4. The traps attenuate the offending carriers by 50 or 60db before they are amplified by the preamp.

The attenuators on channels 2, 4 and 9 are used to bring these signals as close as possible to the level of the other channels. For best results, the inputs to a broadband amplifier should be equalized in this way.

**Automatic gain control.** Many modern single channel amplifiers are equipped with AGC (automatic gain control). AGC is used to insure that output signals remain constant in spite of fluctuations in input signals. AGC is especially important for large MATV systems in metropolitan areas where signal fluctuation may be severe.

**UHF converters.** Earlier, we mentioned that UHF channels can be converted to unused VHF frequencies for easy distribution. There is a danger in this, however. Conversion requires an oscillator with fundamentals and harmonics that can cause interference in a given system. Choose your converter frequencies with care. It's a good idea

to rely on your manufacturer's recommendation and to use no more than two UHF channels in any single MATV system. UHF converters are available that plug directly into a single channel headend panel.

Any of the headends shown here can be combined with the distribution systems covered in part two of this series to make a complete VHF MATV system. The trend, however, is to 82 channel systems — distributing UHF without conversion.

### Antennas

We already know that antennas are essential and critical components in any communications system. The antenna determines the amount of incoming signal available at the headend and MATV-type antennas differ considerably from the typical home-type TV antennas with which we are most familiar.

But it must be admitted that ordinary home-type TV antennas will work in MATV systems. In fact, some antennas are specifically designed and recommended for home and various other small MATV systems.

The real difference between home-type TV antennas and those used for large MATV systems involves time and money. You can afford, for example, to spend more time and money on the antenna used for 200 sets than for one used on a single set. (For detailed information on antennas, see the article series, "Antennas — Sans 'Bafflegab' and 'Bushwa'" which began in the September 1967 issue. The second and third parts appeared in the March and May 1968 issues.)

A typical MATV antenna is usually more ruggedly constructed than home-type antennas. Large MATV systems use a separate, high gain antenna for each channel. Smaller systems can often use an all-channel broad-banded antenna. Single channel antennas are more costly and usually more difficult to install. They frequently are necessary, however, when TV signals do not all come from the same direction. Remember, you can't use a rotor in an MATV system!

Part four of this series will cover 82 channel MATV, both headends and distribution systems. ■





The 22nd article in a continuing series

# Semiconductors from A to Z

Technicians must understand a new breed of semiconductors to effectively service modern power supplies and power regulating circuits

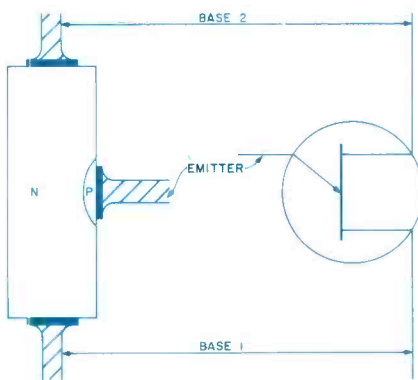

Fig. 1 — The structure of a unijunction transistor.

■ All of the semiconductor circuits described in the previous articles have required dc bias supplies. Most of these circuits can function in a fairly satisfactory manner with batteries, but greater stability, and frequently greater convenience, results when they receive their bias from ac-driven power supplies.

Many of the newer power supplies and power regulating circuits require semiconductors that have not yet been described in this series. These semiconductors must be understood if new power circuits are to be effectively serviced.

## Unijunction Transistors

Although the basic structure of a unijunction transistor (Fig. 1) may appear somewhat similar to that of a field-effect transistor, this semiconductor operates on an entirely different principle, somewhat resembling that of a tunnel diode.

When the two bases ( $B_1$  and  $B_2$ ) of a unijunction transistor are connected in a circuit (Fig. 2), current flows through the transistor from base-one to base-two and the resulting voltage drop between the two bases ( $V_{B_2B_1}$ ) is dependent on the amount of current through the channel of N-type material ( $I_{B_2}$ ) and the

total resistance of that channel ( $r_{BB}$ ). Just as the voltage drop at a potentiometer tap is less than the total voltage drop across the potentiometer, the voltage drop at the P-N junction (the voltage drop in the N-type material at the junction, not the voltage drop across the junction) within the semiconductor channel is less than the total voltage drop across the channel. The junction is, therefore, more positive than base-one, while less positive than base-two.

When a capacitor ( $C_E$ ) connected to the transistor's emitter (Fig. 2) is discharged (both plates at the same potential), the emitter (constructed of P-type material) is less positive than the conductive channel (constructed of N-type material), and virtually no current flows between the conductive channel and the emitter (the diode formed by the P-N junction is reverse biased, and virtually no current flows through the diode).

As a small current flows through resistor  $R_E$ , the voltage across the capacitor increases (resistor-capacitor time constants for increasing or reducing the voltage across a capacitor are described with Fig. 2 in the September 1967 article), and once the charge across the capacitor be-

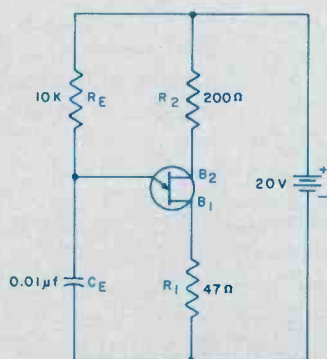

Fig. 2 — A simple unijunction transistor switching circuit.

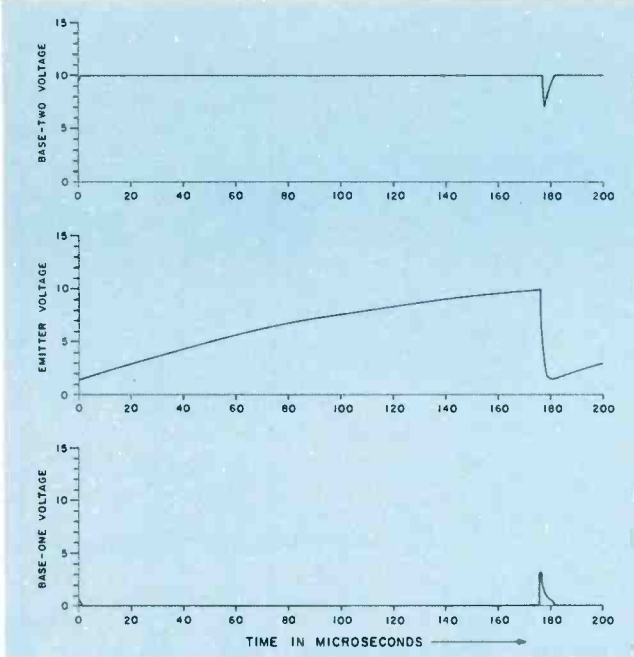

Fig. 3 — Emitter, base-one and base-two voltages present in the switching circuit.

comes so great that the P-type material is more positive than the N-type material, the diode formed is forward biased and current will flow from base-one to the emitter. (The emitter is still less positive than base-two, so the current must flow from the more negative base-one to the emitter.)

Once a current flows between base-one and the emitter, the semiconductor material between base-one and the emitter behaves like the material in a tunnel diode. The flow of current between base-one and the emitter reduces the resistance of this semiconductor material. The reduction in resistance reduces the voltage drop between base-one and the emitter, which in turn further reduces the material's resistance. (This condition is indicated by the negative resistance slope of a tunnel diode characteristic curve shown in Fig. 1 and 2 of the February 1967 article.) The current flowing between base-one and the emitter reduces the potential drop across the capacitor ( $C_E$ ) to zero. When the emitter is no longer more positive than base-one, the current ceases to flow through the emitter, and the capacitor again becomes charged by resistor  $R_E$ .

While current was flowing from base-one to the emitter, the resistance of N-type material near base-one was reduced. As a result of this reduced resistance, more current flowed not only to the emitter but to base-two as well. The base-one to

emitter current increased the base-one to base-two current.

The entire channel of N-type material conducts more current when the emitter voltage exceeds a peak-point voltage ( $V_p$ ). The emitter, base-one and base-two voltages that result are shown in Fig. 3.

### Field-Effect Diodes

Field-effect, or current-regulating diodes (Fig. 4), are very similar to the field-effect transistors described with Fig. 1 in the December 1966 article of this series. The basic difference is that the diodes are only double-lead components and the gate material in field-effect diodes is connected to the same lead as the end of the conductive channel designated the source. (Another difference between the two particular examples shown is that in the transistor the gates are shown as being made of N-type material, while in the diode they are shown as being made of P-type material—the type of material for the conductive channel having also been changed.)

If the diode gates were not connected to the source lead and the P-type material was made more negative than the N-type conductive channel, the P-N junctions would be reverse biased. The greater the reverse bias, the greater the effective junction size and the smaller the remaining N-type channel for conducting current. The opposite condition would occur if we were to re-

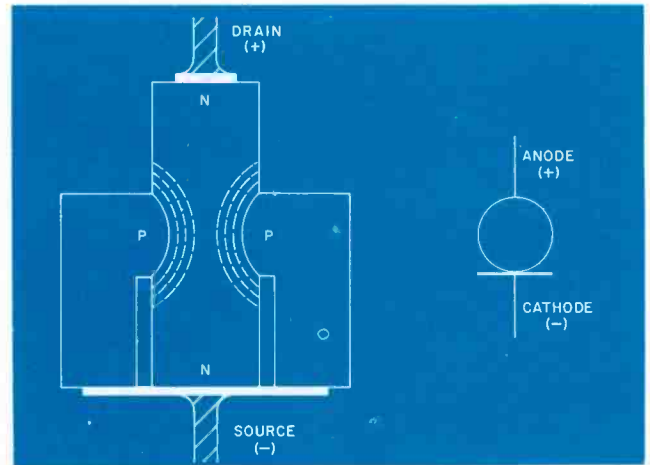

Fig. 4 — Structure of a reverse-biased field-effect diode.

verse the polarity of the applied bias voltage.

The December 1966 article (Fig. 2) shows the characteristic curve of a junction FET. With the gate and source connected to a common lead, there is no gate-to-source voltage ( $V_G = 0$ ); and from the " $V_G = 0$ " curve we see that as the drain-to-source voltage varies between 8.5v and 25v, the drain current remains a virtually constant 5.8ma. (The polarity of the voltages and currents for the diode are opposite those for the transistor since the arrangement of P- and N-type material has been reversed.) The current regulating diode maintains a nearly constant current as the applied voltage changes.

As indicated in the December 1966 article, the source is where current enters a FET's conductive channel, while the drain is where the current leaves the channel. The source and drain can be interchanged by reversing the applied voltage and the resulting current through the channel.

By reversing the voltage across the field-effect diode shown in Fig. 4, we are in effect changing the diode so that the gates are connected to the drain rather than the source (Fig. 5). The P-type gate then becomes positive with respect to the source and N-type channel. The P-N junctions are then forward biased, reducing the effective size of these junctions and increasing the effective



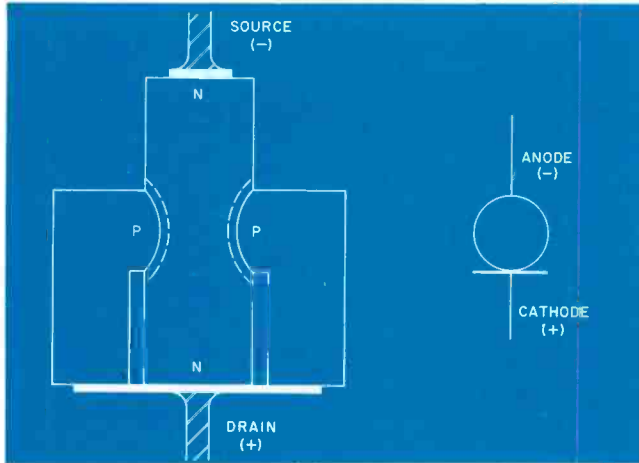

Fig. 5 — Structure of a forward-biased field-effect diode.

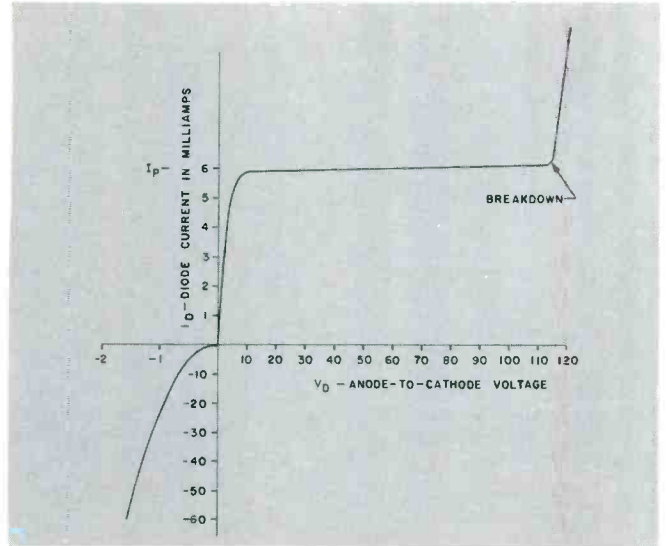

Fig. 6 — The characteristic curve of a field-effect diode.

size of the N-type channel—permitting it to conduct more current.

The curve in Fig. 6 indicates the characteristics of the field-effect diode just described. When the anode is more positive than the cathode, moderate changes in anode-to-cathode voltage results in nearly insignificant changes in diode current. When the polarity of the applied voltage is reversed, much greater changes in diode current result from changes in diode voltage.

### Zener Diodes

The physical structure of a zener diode (Fig. 7) is basically the same as the structure of a conventional diode. In fact, when forward biased, both types of diodes conduct current in the same manner — both then having the same general forward-

bias characteristic curve.

Within certain limits, zener diodes and conventional diodes also conduct current in the same manner when reverse biased—both again having the same general characteristic curve.

As indicated in earlier articles, when a P-N junction is reverse biased, a barrier is formed between the P- and N-type material and only a nearly insignificant amount of leakage current is permitted through the barrier and the component. If this reverse bias becomes too great, however, the barrier breaks down and the current becomes considerably greater in both zener and conventional diodes. The basic difference between these two types of diodes is the stability of this barrier breakdown voltage.

The resistance of P- and N-type material in regular diodes is not as great as that of the material used in zener diodes (there is a slight chemical difference), and the resulting junction barriers formed are not as thin in regular diodes as they are in zener diodes. The electric field developed across a thin junction (zener junction) is greater than that developed across a wider junction (regular diode junction). It is the intensity of this electric field in zener diodes that is the primary cause of its junction breakdown, while in the wider junction of less resistive semiconductor material (regular diodes) the electric field is not as great and the temperature of the semiconductor material has a direct effect on the junction breakdown. (The strength of an electrical field developed across a P-N junction is the strength of the mutual attraction of positive and negative charges across the diode barrier. This condition is explained in the September and October 1967 articles.)

Zener diodes are used (instead of regular diodes) for voltage regulation since their breakdown voltage remains nearly constant—heat having very little effect on the breakdown voltage.

Many zener diodes generate noise when their reverse bias current nearly equals the current encountered during junction-barrier breakdown—the “knee” region of the zener diode characteristic curve

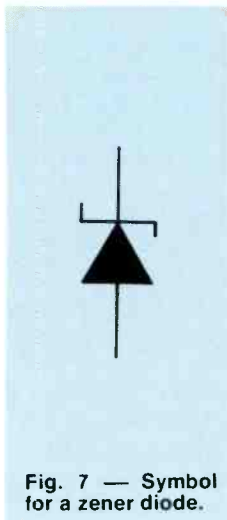

Fig. 7 — Symbol for a zener diode.

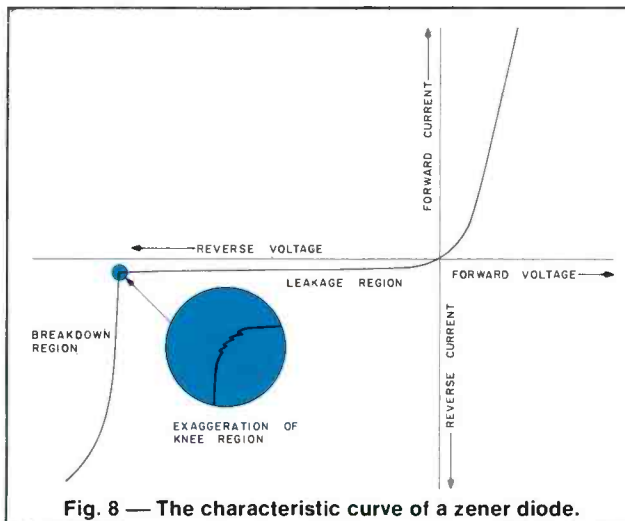

Fig. 8 — The characteristic curve of a zener diode.

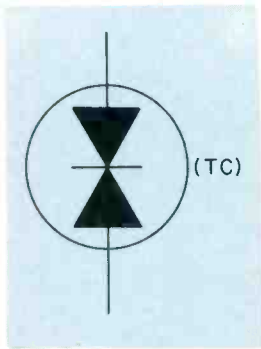

Fig. 9 — Symbol for a temperature-compensating diode (with letters TC) or a thyrector (without those letters).

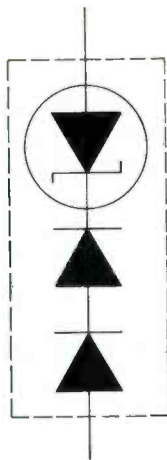

Fig. 10 — Equivalent structure of a temperature-compensating diode.

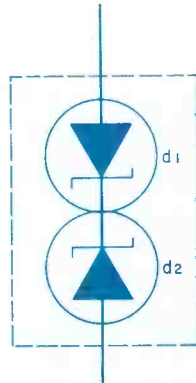

Fig. 12 — Equivalent structure of a thyrector.

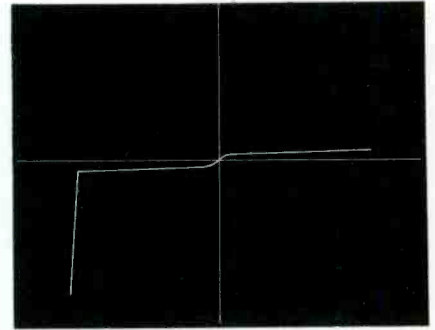

Fig. 11 — The characteristic curve of a temperature-compensating diode.

(Fig. 8). This is true because the breakdown current does not increase suddenly, but increases in increments as the breakdown voltage is reached. To reduce zener diode noise, the resistance in a zener diode circuit should be low enough to permit a zener diode current greater than the current encountered at breakdown.

### Complex Diodes

Just as there is no limit to the possible assortment of designs for integrated circuits, there is no limit to the assortment of stacked P-N junctions that can be fabricated to produce different types of complex diodes. Rather than attempt to describe every possible variation, the balance of this article and the following article in this series is restricted to six complex diodes most frequently encountered in power-supply and power-regulating circuits.

The characteristics of these complex diodes can be more readily understood by studying their more simple diode and/or transistor equivalent circuits. It would, therefore, be merely repetitious to also discuss the arrangement of junctions within these complex diodes.

### TC Diodes and Thyrectors

Unfortunately, both temperature-compensating diodes and thyrectors are occasionally identified by the same symbol (Fig. 9). Unless the letters "TC" are shown to the right of the symbol (Fig. 9) to indicate that a temperature-compensating diode is being used, technicians must identify the component by checking

the function of the circuit or a parts list.

Temperature-compensating diodes, sometimes called reference diodes, are an improved and more complex version of zener diodes. Earlier in this article it had been indicated that, compared to regular diodes, heat had very little effect on zener diode breakdown voltages. Measurements, however, do indicate that the breakdown voltage of a reverse-biased zener diode actually increases slightly as the diode's temperature increases. Similar measurements also indicate that the small voltage drop across a forward-biased regular diode decreases slightly as the temperature increases. These two opposing characteristics can be combined, and a temperature-compensating diode is formed by connecting one or more forward-biased regular diodes in series with a reverse-biased zener diode (Fig. 10). As the temperature increases, a reduction in the voltage drop across the regular diodes equals a corresponding increase in the voltage drop across the zener diode, and the total voltage drop remains nearly unchanged.

When the voltage across the temperature-compensating diode forward biases the regular diode (it then being capable of conducting current) and reverse biases the zener diode, both the regular diode and zener diode will conduct current once the zener breakdown voltage has been reached. Under these conditions the temperature compensating diode will function as though it was merely a zener diode—except for greater temperature stability (the

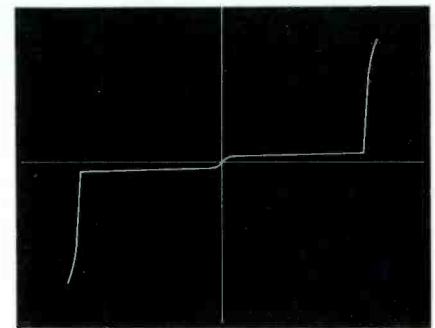

Fig. 13 — The characteristic curve of a thyrector.

left portion of the characteristic curve shown in Fig. 11).

When the polarity of the voltage across the temperature compensating diode is reversed, the zener diode will be forward biased (it then being capable of conducting current as indicated by the right portion of the characteristic curve shown in Fig. 8) and the regular diode will be reverse biased (it then being incapable of conducting any significant current). Under these conditions, only a very small current flows through the temperature-compensating diode (the right portion of the characteristic curve shown in Fig. 11).

Thyrectors, sometimes called surge protectors or trigger diodes, contain the equivalent of two zener diodes (Fig. 12) connected so that one is reverse biased when the other is forward biased.

When the top lead (Fig. 12) is more positive than the bottom lead, one zener diode ( $d_1$ ) is forward biased while the other ( $d_2$ ) is reverse

*Continued on page 82*





## DEALERFAX

ADVERTISING/MERCHANDISING/SALES/BUSINESS MANAGEMENT

# How To Make More Money and Live Better

Design a 'road-map' to better money management and increased profits

Part one of a two-part series

■ As a TV-radio service-dealer, you have probably never paid much attention to "marketing programs." The fact is, most of you already *have* a program, but you don't call it marketing. You merely consider it "running a business." But effective business management requires a detailed and clearly defined total basic program — written on paper.

### What's a Marketing Program?

For a variety of reasons, most businessmen think of the word "marketing" as a term reserved for a production-type business. It is high time that we all realize that *any* business, regardless of its nature, must have a set of clearly defined goals and a profitable operating plan. To leave these factors to chance is to invite trouble. Far too many businesses today are not businesses at all — in the true sense — but are simply refuges for those who would otherwise be completely without work. If this statement seems strong and sharp, it is meant to be. Only one justifiable reason can exist for being in business — and that is to make money.

Of course, we all know that business provides employment, produces a useful product or provides a necessary service, and helps to distribute wealth — the basis of our economy. But a business is first and foremost a profit-making institution. To forget or ignore this fact is, indeed, to court disaster.

So, a business must make money. This, we are sure, comes as no great

surprise. But, what is more important — a point you may not be conscious of — it is entirely possible that you are not moving in this direction effectively. Additionally, things being what they are in today's business world, just making a profit is not enough. Business is full of uncertainties, variables, unpredictables. Hence, we have to conduct a business to make as much profit as possible — within the framework of approved ethical practices.

Even though a business continues from one year to the next and even shows a profit, it may not be making as much profit as it should. When you get down to brass tacks, it is almost as bad to settle for a small or minimum profit as it is to settle for no profit. A businessman must do *more* than just show a net gain at the end of the year. He must continually strive for *maximum possible* gains. In short, he must seek to obtain maximum profits in every conceivable way. This is what a marketing program is for.

Marketing can be considered the science of running a business. It includes every aspect of the business and every person within the business. Because it is fundamentally a science, marketing can take a lot of guesswork out of running any enterprise. It can provide management with answers to previously unanswerable questions. It can eliminate costly errors, reduce worry, sooth the pains of many headaches. And a marketing program doesn't cost you a dime. It can be set up within the

existing framework of a business and not disrupt anything. How then can a program of this type be adapted to a TV-radio sales-service business?

The answer will depend largely on the degree of confidence you have in a marketing program. If you are willing to try a few innovations and make a few changes, you can look forward to corresponding improvements in your business. Basically, what we want to do is take some of the hit-and-miss out of the sales-service business and replace it with proven, scientific — and often exacting — methods.

In a nutshell, a service-dealer marketing program should:

1. Set realistic goals for the business.
2. Establish a budget and determine the firm's break-even point.
3. Improve operational organization.
4. Provide a "service-mix" analysis.
5. Provide a cost and pricing analysis.
6. Re-evaluate the advertising and sales promotion role.

### Realistic Goals

Essentially, what we want here is an outline of basic directions and objectives. This should be done in the short run, on a monthly and yearly basis. In the long run, it should be a master plan for future growth and expansion in the years to come. Every businessman should have a marketing plan and should stick to it

## More Money . . .

as closely as possible. Allowances must be made, of course, for innovations and changes in the industry and in national and local economies — but the plan must be there and it must be used.

### Budgeting and the Break-Even Point

Once the ultimate goals of the business have been set down, the next job is to establish the framework for carrying out and pursuing these goals. This framework should properly be called a budget and it should be *written down* — not merely recorded mentally. This budget should set forth a schedule of expected expenses, both operating and sales, including fixed labor expenses, rent, trucks, insurance and taxes (assessments, water tax, real estate taxes, etc.).

Although a budget may seem to be unnecessary in a sales-service business, this is not so. Any business must *know* what it expects to spend in a given period, so it will be able to gage its break-even point — the point at which a business takes in enough money to cover its expenditures. Once this point has been reached, all additional money taken in can properly be considered profit.

In attempting to set up an operating budget for a TV-radio service-dealer, we are immediately confronted with a difficulty: There's no such thing as an "average operation." Variations are extremely wide, and include: Sales and service of electronic home-entertainment equipment; service only; contract service; diversified service; diversified service and sales — commercial audio, two-way radio, audio-visual. The cost, income, manpower, all vary greatly.

To come up with a significant budget example for this article, ET/D decided, considering the absence of specific facts, to confine itself to a basic budget for a service-dealer operation employing 3½ persons. (For this information, we are indebted to Mr. Frank J. Moch, executive di-

rector of the National Alliance of Television & Electronic Service Assns. (NATESA). Mr. Moch cautions that there's no such thing as a "typical" service-dealer and that variations in operation exceed by far the famed "57 varieties.")

ANNUAL BUDGET — 3½-Man Operation	
Salaries (Owner)	9,160
Technicians (2)	12,480
Part-Time Office (½)	4,160
Rent	1,500
Office Supplies, Forms, etc.	360
Utilities	840
Phone	480
Vehicle Expense	2,160
Insurance	960
Taxes	460
Repairs and Maintenance (Plant)	300
Accounting and Legal	450
Depreciation	600
Advertising and Promotion	480
	<b>\$34,390</b>

Although it is possible for a business to make money without an established budget, it seems much wiser to spend a little time and find out at what point a profit occurs. Why take a chance when you can be sure by investing a small amount of your time? This point becomes especially clear when you want to analyze why your business is *not* showing a profit. If you have a written budget, you can use it as a valuable tool to determine the cause of your problem. It can be an invaluable tool to the profit- and marketing-conscious service-dealer.

For example, suppose your operation fits this 3½-man organization and its budget; let's see what you'll have to do if you barely remain in business.

Assume that you have kept careful books on your operation, profit on TV set sales, radio sales, batteries, profit on service, etc., and you find that you are operating on an average markup of 28 percent.

What must your gross yearly intake be to break even? It seems simple: You must take in \$122,821.43. This is your break-even point. Twenty-eight percent of \$122,821.43 is \$34,390 — your total operating expenses. If your annual gross rises to \$150,000 and your operating costs remain the same, you end up the year with a gross profit (before taxes) of \$7610.12 on your capital investment, including what you have spent for technical education and keeping up with the technological explosion.

### Operational Organization

The next step in a service-dealer marketing program should be the proper organization of everyday business activities. This includes proper delegation of responsibilities, a simple and efficient routing scheme, a schedule of the work for the day and a simple system of recording and categorizing customer service calls.

Work should be planned so little or no overlap occurs. Two men working on the same chassis, for example, put a drain on your labor price. Only *one* man is productive. Of course, consultation should take place on sticky problems, but this should only be advisory. If a technician is "stuck" on a set, it would be better for him to turn it over to another technician and go on to some other job. If two men spend half an hour each on two different sets, you get a total of one hour's worth of productivity. If two men spend half an hour on the same set together, however, you only get a half hour's productivity. You, as a businessman, should be able to take it from here. Basically, what you are striving for is maximum daily efficiency. This leads, ultimately, to maximum daily productivity.

(The second and concluding part of this article will appear in a forthcoming issue of ELECTRONIC TECHNICIAN/DEALER and will cover service-mix analysis, cost and pricing, and the role of advertising and sales promotion.) ■



■ Cherry's Radio Communications Service is one of the busiest and most modern two-way radio service shops in Oklahoma City. And it is the oldest. Cherry's Radio has been in the same block of downtown Oklahoma City since 1935, but R. B. Cherry's interesting career dates back to the days of oatmeal box coils in the 1920s.

"I started my two-way radio service business in October 1935 by renting 400sq ft of floor space in an old garage," says "RB" Cherry, owner.

Our reporter, not yet born when Mr. Cherry first started in the radio business, was impressed and wanted to hear about the "old days."

### In the Beginning

"Well," "RB" chuckles reminiscently, "let me tell you how I got started in the two-way radio business.

"It really began back in the spring of 1940. I did some two-way radio work for a pair of revenue agents who had long been on the trail of some moonshiners. When I had their gear all rigged, I remember how the agents 'bellied' their way up a sloppy, muddy hillside overlooking a small valley. The moonshiners were meeting in the valley and the agents planned to surprise and capture the entire group.

"Each agent had a walkie-talkie, a rather uncommon luxury in 1940. They had planned to go up opposite sides of the hill. And when they got into position they were to radio each other to rush down and surprise the moonshiners.

"Dragging the bulky radios with them through the mud was catastrophic. By the time they had sloshed their way to the hill top, the microphones were so clogged with mud they wouldn't key the transmitters. The only thing left to do was stand up and shout to each other to close in — which they did. Moonshiners ran off in every direction.

"Early the next morning when I

## 38 Years of Two-Way Radio

Successful service business began in 1935 with \$2000 annual gross

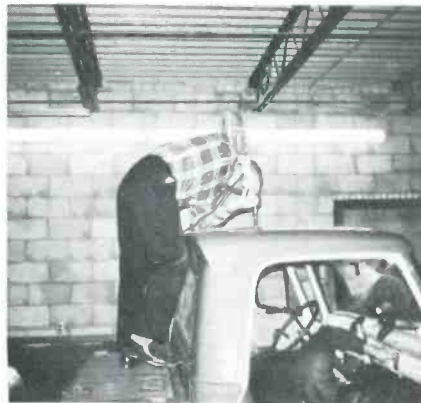

Mobile installation of two-way radio takes team work.



Installation technician mounts transceiver bracket to dash panel.



Technician checks out mobile transceiver in shop equipped van.

arrived at work, I found two very muddy and disgusted revenue agents sitting on the curb in front of my radio shop. They looked like a couple of soldiers who had just gone through an obstacle course after a four-day rain. The outcome of my first two-way radio venture was rather disheartening."

### Early Years

"But we've come a long way since those days," "RB" continues. Two-way radios were big then — bulky, low frequency, battery-operated tube units. They were as heavy and rugged as tanks."

"RB" was also one of the first in his area to work on TV sets when they were introduced in the late 1940s. He moved his shop to a larger building at 410 N.W. 4th in 1938 when auto radios became popular. The new place had 950sq ft of floor space.

"And I used every square inch of it," Mr. Cherry says. "In fact, before long I had to add a balcony for storage because I couldn't expand any other way."

At that time Cherry's radio had one technician and an office girl. When WWII broke out, Mr. Cherry was asked to train armed forces personnel in aircraft radio for nearby Tinker field. He worked in his radio shop during the day and taught classes from 4 to midnight for about a year. Then he was called to the East Coast as a civilian to train Army officers in the fundamentals of radar service. During his absence from the shop a local engineer took care of his business. For the duration of the war "RB" taught and serviced radar equipment. Ten days before "D" day he was sent to Eng-

land to service radar for Doolittle's 8th Air Force group. He returned to his radio business in 1946, and in 1947 became an authorized Motorola service station.

### **Strictly Two-Way Service**

Oklahoma City got its first TV station, WKY-TV, in 1950 and Mr. Cherry took on the installation and service of TV sets because he was about the only man in the area who could do it at the time. His two-way and TV-radio business grew until 1959 when he decided TV and two-way were too much of a load. He sold the TV service business. His first love was two-way radio, so in 1959 he moved to his present location a few doors away from the old shop and concentrated on service and installation.

Cherry's Radio Communications Service grossed \$30,000 the first year in its new location. He had two technicians for service and installation, and his wife took care of the office. The new location had 3800sq ft of floor space and has since been expanded by an additional 460sq ft which is used for mobile installations. The service shop area takes up about 1000sq ft with the remaining space devoted to storage and offices.

"We have parking space in the rear to accommodate 13 cars," "RB" adds. "We also have three vehicles of our own equipped with two-way radio. One is a van loaded with test instruments which we use for field service."

Besides "RB" and Mrs. Cherry, the shop has four technicians and a building maintenance man. One technician specializes in installation work. "We average about 80 to 100 service calls a month," "RB" continues. "But it's hard to really determine how many calls we get in a month because they sometimes come in batches. We also make a number of routine calls each month that are simple frequency checks as required each year by the FCC. I'd say about one-third of all our service is on contract. We maintain equipment for

some local government agencies, including several FAA radio systems, the Air Force station and the Internal Revenue Service. All the government service is on contract."

### **Inventory and Installation**

Cherry's Radio stocks enough small parts to handle the bulk of the service jobs that the shop is called on to do.

"We stock very few new system components," Mr. Cherry smiles. "Since we are not in the selling business, we only inventory the items we need for service plus a few things like mobile antennas, speakers and cabling. When a Motorola salesman sells a system, it generally includes the antennas and other necessary parts to complete the installation. The salesman also know what we charge for a given standard installation and this is figured in the system selling price. They usually send the entire system package to us when we are to do the installation job. If the system is to be something other than a standard one, if it is to have a remote transmitter, paging system or other additional units, the salesman contacts us and we give them an estimate of installation costs.

"Towers are normally put up on a contract or bid basis," Mr. Cherry continues. "We farm out tower installations over 170ft. A normal tower installation consists of the tower, antenna and cable connected to the transmitter. If there is to be a multiple antenna system on the tower, as many of the towers over 100ft have, there is obviously an extra charge. I guess one of the reasons many businesses put their antennas on someone else's tower is because of the paper work involved in authorizing a certain antenna location and height.

"The FAA has to authorize tower installations, and because of the nearby airfields, many of the towers are required to have marker lights. For these reasons, businesses will often rent antenna space at a cost of 20 to 30 cents per foot of tower height per month. A renter will pay

at least \$100 per month for space on top of a 500ft tower. (20 cents times 500)). Sometimes as many as eight or nine antenna systems are installed on a single tower and connected to transmitters operated by remote control over leased telephone lines. Two local TV towers have such antenna systems now."

Cherry's has performed many mobile and base station installations over the years. "RB" tells our ET/D reporter that "we did mobile radio installations as far back as 1938 — before they even had base stations. Then they could only communicate mobile to mobile. In those days the only ones who had mobile two-way radios were the government agencies. We installed a number of mobile radios in cars for the FBI at that time and what a job it was. We couldn't mount the antenna on the outside of the car because it would be too conspicuous. So, we made a snap-on connector on the body of the car to which the antenna could be quickly connected. When the antenna was not being used it was hidden inside the car by clips that held it in place in a horseshoe loop next to the upholstery on the roof. Remember, they had long antennas then because of the low frequency they operated on. Every time they wanted to transmit to another car they had to un-clip the antenna and rush outside to connect it.

"In those days our radio service charge was \$1.50 per hour and a technician had to know a lot more than just radios." Cherry's Radio Communication Service has grown over the years to an \$85,000 business in 1967, with an even better outlook for 1968.

### **Service, Design and Training**

"RB" says "our actual range of service work covers as much as a 120-mile radius from Oklahoma City, but there's hardly a county in the state that we haven't done some service in." As a service shop, Cherry's not only has some of the most modern test instruments available, but even a number of special test



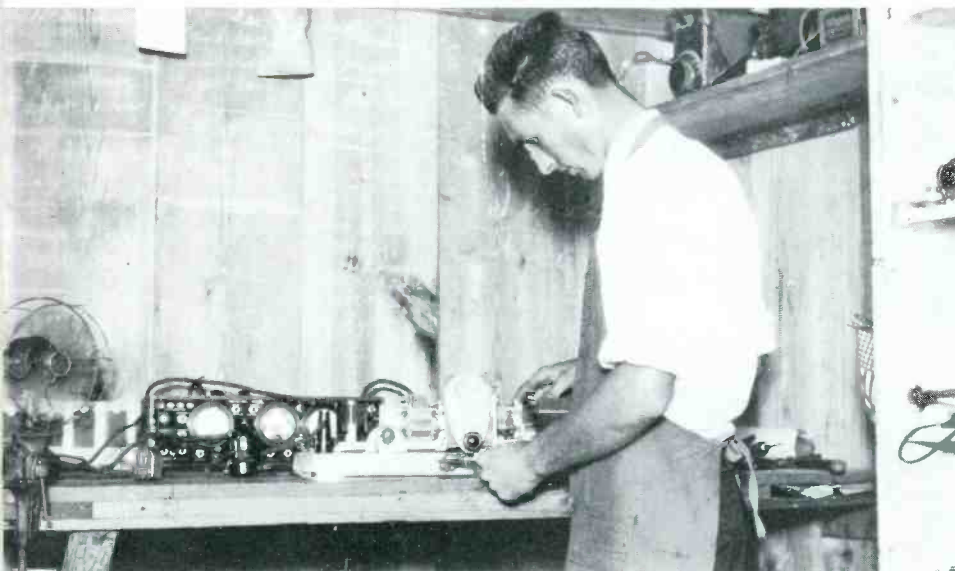

Service shop bench in 1928.

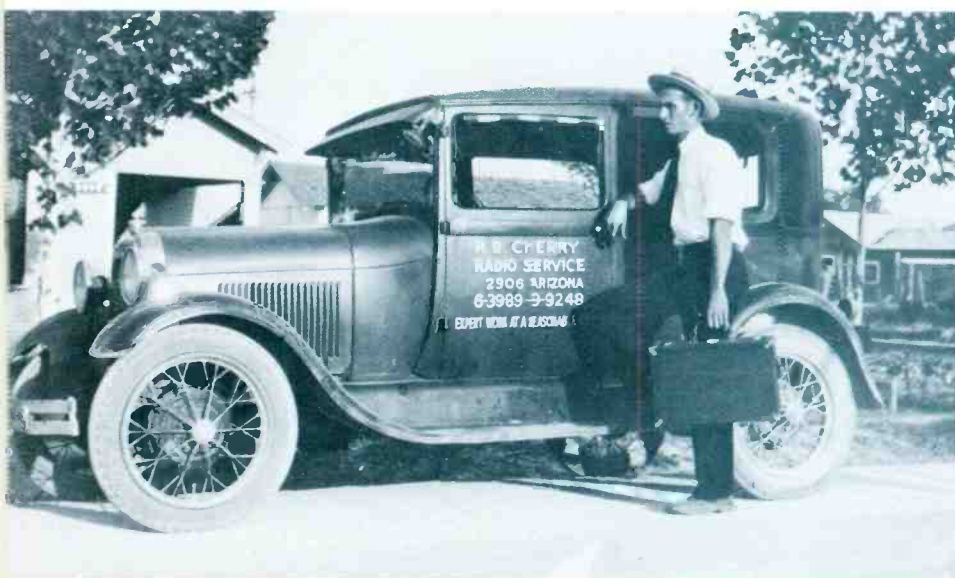

First service vehicle for Cherry's Radio Service — 1929.



R.B. Cherry, owner of Cherry's Radio, figures antenna matching system.

jigs he built himself. "RB" is well known for his ability to design special systems for special jobs. He was called upon to design a remote monitoring system which would tell a maintenance engineer miles away if a pipeline valve at a petroleum pumping station was opening and closing properly. He designed the system using a single transistor-battery-operated transmitter with a relay to light an alarm lamp on the maintenance control panel. At that time transistors were still in their infancy.

"It was quite a challenge" Mr. Cherry states, "and it's still working."

He has built other units for similar applications and still gets calls for special designs from local government agencies as well as petroleum companies.

He once built a remote transmitter for the Secret Service which was used to round up a gang of counterfeiters. "That one wasn't used in the mud, however," he smiles.

Mr. Cherry is also well known for his willingness to share his knowledge of electronics. He gave up his business during the war years to train many good technicians for the armed forces, and in 1965 he was asked by the FCC in Washington to train a man from the Republic of Samali in two-way radio. Mr. Cherry readily accepted. Hassan Ali Abdislam arrived at Oklahoma City in February 1966. He was sponsored by the Agency for International Development (AID) who paid his transportation, medical care and living expenses during the seven months he was at Cherry's Radio. "RB" taught Hassan everything he could about two-way radio from installation to service. Hassan was a Lieutenant in his country's police system when he came to the United States. When he returned to Samali he was promoted to Captain. Of all the technicians Mr. Cherry has helped to train, Hassan Ali Abdislam will probably be his most memorable. ■

# introducing the hundred dollar antenna





# plus a not so short story about why Winegard's new SC-1000 is worth every penny...why it's the most powerful 82-channel antenna ever created for civilian use...and how it can change your antenna business.

Every once in a while a new antenna comes along that's more than just "new" and "different looking" and "bigger" and "better" and "more powerful". Once in a while, maybe once in a lifetime, an antenna is created that makes all the "usual claims" and then supports every one of the claims with *performance*. That's our hundred dollar antenna. The SC-1000. The top of our Super Colortron line. The top of any antenna line ever created.

This VHF-UHF-FM super fringe antenna has undergone exhaustive testing and tuning refinements—and proved that it delivers performance worthy of its name, and it's price. Take, for example, an installation in Houston—41-feet above ground, equipped with rotor and 75 ohm download (no preamplifier.) The owner\* writes that with the SC-1000 he is now receiving superior reception on stations ranging from 60 miles away (Bryan, Texas) to 200 miles away (Alexandria, La. and Lafayette, La.) Now that's what we call results. And it's why the SC-1000 is already being called "the long distance antenna." Because it pulls in the farthest away, toughest channels—and always better than ever before.

Yes, feature for feature and dollar for dollar (even a hundred dollars) there has never been an antenna like the SC-1000. Let's take a look at the features.

\*Name supplied upon request.

**Exclusive New Compact "Wedge" Design . . . Plus New Vertical Beam Phasing On Each VHF Channel.** Vertical Beam Phasing on all VHF channels means there is no signal pickup from above or below the antenna. It means interference from such sources as airplanes, cars and diathermy machines are shut out. And it means that ghost signals are highly rejected. And that's not all. The VHF capture area is doubled and power gain over a conventional single bay is doubled. The vertical beam is flattened and elongated and spurious vertical lobes are eliminated. All that, and the SC-1000, with its unique "Wedge" design, is

still vastly shorter and more mechanically stable than any other configurations would have to be to come close to the gain of the SC-1000.

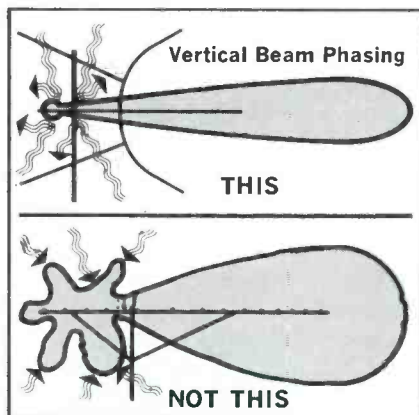

**New "Constant Focus" UHF Screen.** Concentrates all signal on Tetrapole collector element, provides as much signal capture area as an 8-foot parabolic, and at a fraction of a parabolic's size and weight.

**New "Interlaced UHF Resonant Reflectors".** Form a high density magnetic screen with all current fields in phase and working together for a new high in parabolic reflector efficiency.

**Exclusive Patented\* VHF Director System.** Absorbs VHF signal and focuses it onto the collector elements. Helps give the SC-1000 pinpoint directivity to knock-out ghosts, smear and snow. \*U.S. Patent No. 2700105, Canada No. 511984.

**New "Tetrapole" UHF Collector Element.** Has larger signal absorption area than standard UHF dipole. Maintains constant 300 ohm impedance and allows *no loss* coupling between the VHF and UHF operations.

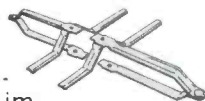

**Exclusive "Impedance Correlators".** Provide perfect 300 ohm VHF impedance match and produce more signal gathering power per inch of antenna—and also contribute to

making the SC-1000 extremely compact.

**Exclusive Ellipsoidal Boom.** Strongest boom ever used on a tv antenna. All elements of antenna are special aluminum alloy 40% stronger than used on most antennas.

**Long Distance FM & FM Stereo Reception Bonus.** Comparable to the results you get with a 10 element FM yagi.

**Genuine Gold Anodized Finish.** The only permanent gold finish on any antenna. Sunfast. Protects against corrosion and fading. Lasts years longer.

**Exclusive Built-In Cartridge Housing.** Integral part of the antenna



keeps download connection weathertight. Accepts Winegard's solid state cartridge preamplifiers, color spectrum filter, etc. A truly great Winegard innovation.

**Exclusive Winegard Gold Bond Performance Guarantee, Plus A New 2-Year Replacement Warranty.**

**The SC-1000 Will Change Your Entire Antenna Business.** We created the SC-1000 simply because there was a glaring need for a modern 82-channel super powerful, super fringe antenna. And performance figures show that it has far surpassed even our most optimistic goals. So whenever you want to get the last ounce of clean, brilliant reception from a new color set—whenever you have a tough reception problem, install the new Winegard SC-1000. You'll have the most satisfied customers in town. And you'll have the best antenna profits in town!

**Find Out For Yourself.** We want you to see for yourself that "the hundred dollar antenna" is everything we say it is, and more. So try one first chance you get. Ask your Winegard distributor for details now. And write for Fact-Finder #261.



## Winegard

ANTENNA SYSTEMS

WINEGARD COMPANY • 3000 Kirkwood Street • Burlington, Iowa 52601

© Copyright 1968, Winegard Company, Burlington, Iowa  
... for more details circle 138 on postcard

# DEALER SHOWCASE

For additional information on products described in this section, circle the numbers on Reader Service Card. Requests will be handled promptly

## Mobile PA System 700

Introduced is a 30w mobile public address system for sports events, parades, political campaigns, civil defense, traffic safety, for general fire and police duty, outdoor promotions



and special events. The system consists of an amplifier, microphone, twin speakers and quick-fastening car-top mounting assembly. It is said to fit any hard-top car, station wagon or truck and necessitates no modifications to the vehicle. An attachment on the power supply cord leading to the dash-mounted amplifier plugs into the cigaret lighter or the cord may be fastened to the automobile's 12v battery for permanent installation. Bell.

## FM Two-Way Radios 701

Built to operate in the VHF 150-174MHz range, a line of two-way FM radios employs a building-block approach to transceiver design. The basic 7w radio can be adapted to mobile or base station use or boosted in power to 60w. The basic transceiver is transistorized throughout and measures 2½ x 8 x 11in. and weighs 8 lb.



It is said to be designed in accordance with FCC regulations parts 21, 89, 91 and 93. The basic receiver is a super-heterodyne dual conversion unit. It has four stages of IF, four audio stages and uses a series type coil which requires no transformer in the speaker output circuit. E. F. Johnson.

## Portable Tape Recorder 702

Announced is a portable cassette tape recorder that provides convenient on-the-go recording in the classroom, office, home or car. It may be plugged into any standard ac outlet or operates from 5 C batteries. It is said the snap-



on ac adapter looks like part of the recorder when in use. The unit records up to two hours of monophonic audio on two tracks of the tape. Cassettes, sold in mailing boxes, are available for 60, 90, and 120 minute recording. Features include keyboard-type push-button operation, fast forward and rewind, level/battery meter and extension speaker jack. Unit is light weight and compact, 12 x 6 x 4. Price \$59.95 with ac adapter, remote control start/stop dynamic microphone, a cassette, earphone and carrying case. Allied.

## Orchestra Bells 703

An orchestra bell has been introduced which consists of 30 tuned bars which are electrically operated from any organ keyboard through additional key contacts. Ranging from G above



middle C to top C they are said to add sparkle and rhythm to all kinds of music. The attractive 12½ x 26½ x 5in. oiled walnut case can be located up to 20ft from the console. All necessary cable, contacts and installation instructions are included. Price, \$197.50. Artisan.

## Two-Way Radio 704

A 30w two-way radio, FCC Type Accepted and powered for AM business operation, is introduced. It is said



to provide more usable channels and greater power input with increased range in the frequency range of 25-45MHz. Radio is completely self-contained and no separate remote head or separate power source is required. Price \$259. Courier.

## Six-Band Radio 705

A six-band ac/dc portable radio features AM/FM, marine, shortwave aircraft and police bands. Push but-





# We've rectified high-voltage rectifiers.

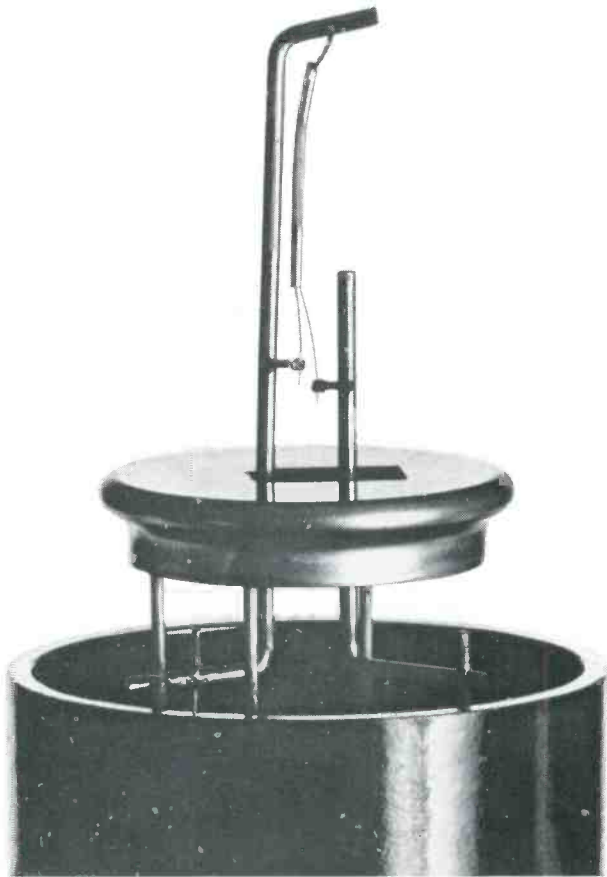

How it used to be.

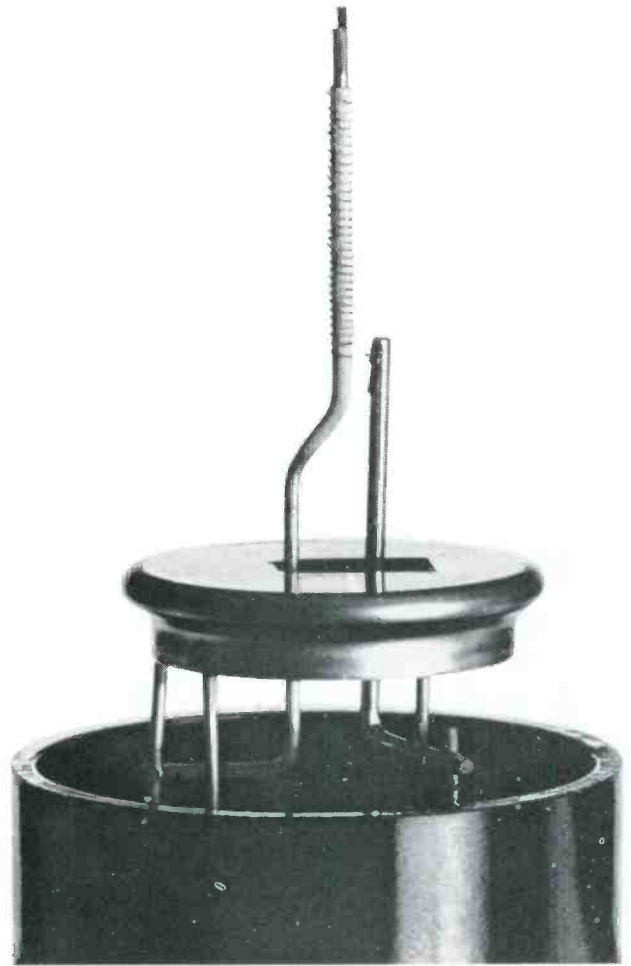

Our new 3CU3

Take a look at our new "Posted filament" design. There's no delicately suspended heater-cathode system. There's no need to heat up a metal sleeve and then an oxide coating.

It takes less than a second for the 3CU3 to start rectifying full swing.

In case of a break, there's no way for the 3CU3's filament to fall against the anode, creating a short and knocking out other components in the circuit.

The 3CU3's filament is always perfectly centered. It emits electrons uniformly in every direction. From a much larger surface than in the old design. There's no suspension post in the way to create an "electron shadow" that cuts down the plate current.

The uniform electric field around the rigid support reduces high voltage stresses. Arcing and its resulting troubles are eliminated.

The 3CU3 is interchangeable with 3A3 and 3A3A

high voltage rectifiers. And it's made exclusively by Sylvania.

The 3CU3 is just one of a new "posted filament" family which includes the new 3BL2 and 3BM2. They're designed for use in new color TV sets. These tubes are especially good for transistorized TV where their fast warm-up fits in with the "instant on" feature of solid state circuitry.

The new construction has higher reliability and longer life and should give you fewer and less troublesome callbacks.



From the outside you can hardly tell it's changed.

**SYLVANIA**  
A SUBSIDIARY OF  
GENERAL TELEPHONE & ELECTRONICS

tons at the top help make channel selection easy. Has 14-transistor circuitry and 5in. speaker. Complete with built-in ac line cord, batteries and earphone, the radio weighs 4 lb. Retail \$69.95. Aiwa.

### Two-Way Radio 706

Announced is a fully transistorized two-way radio designed for small businesses. The system uses FM (frequen-

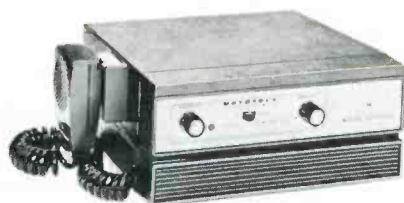

cy modulation), which reduces interference from vehicle ignitions and power lines. These and many other noise sources make messages hard to understand on ordinary AM (amplitude modulation) radios. Audio output is said to be a full 3w to override background noise; messages come through clearly. Transmitter power — 10w in-

put, 5w output. Units are available on frequencies from 25 to 50MHz. Motorola.

### Portable Speaker 707

A solid-state portable speaker and public address system is said to be engineered for extra powerful voice projection — to be heard up to a mile away. The 30w transistorized unit does not require warmup. It uses standard flashlight batteries or may be



operated from a 12v auto battery or 117vac. The unit is light weight and compact, ruggedly built of steel and injection-molded plastic to resist impact and all outdoor weather conditions. Size is 13 x 11 x 12in. List price \$129.95. Hamilton.

### Microphone 708

Announced is a cardioid microphone that reportedly features a satin chrome finish, ON/OFF switch



and internal foam pop and blast filter. It is designed to offer a choice of high- or low-impedance output. List Price \$92. Turner.

# NO MORE GUESSWORK!

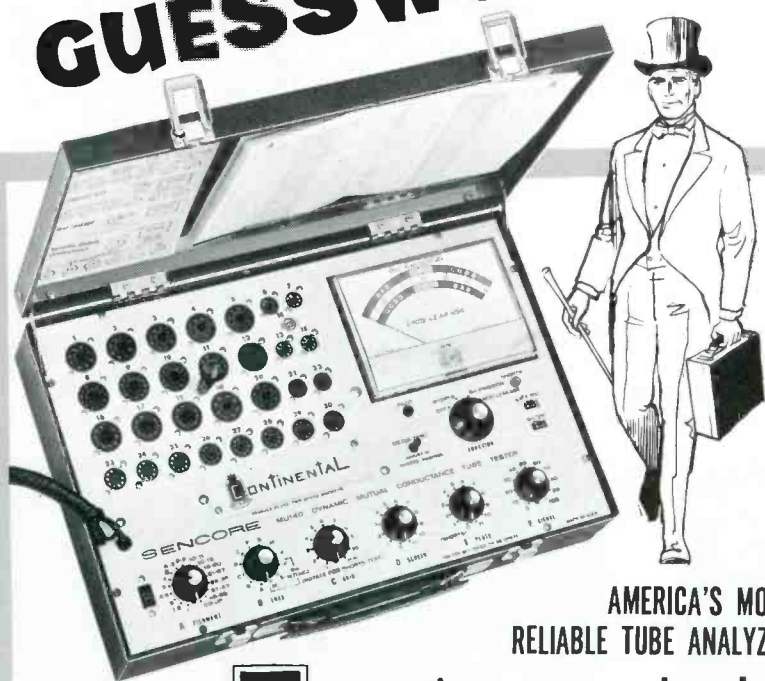

AMERICA'S MOST RELIABLE TUBE ANALYZER

## CONTINENTAL

You don't need three guesses to tell if a tube is bad — or why. With the new Sencore MU140 Continental, you **know**. Right now. And you simply can't go wrong. Because it's a complete tube analyzer for 4-way testing — true mutual conductance (using exclusive 5000 hertz square wave), full cathode emission, 100 megohm grid leakage, and internal shorts. Tests all tubes, including foreign — over 3000 in all. Obsolete-proof, too — with "new socket" panel, and controls so standard the switch numbers correspond to the pin numbers in any tube manual.

If it's reliability you want — for years to come — you need the Continental. It's the best way to be sure —

See America's most complete line of professional test instruments — at your Distributor now.

for only  
**\$179<sup>50</sup>**



## SENCORE

NO. 1 MANUFACTURER OF ELECTRONIC MAINTENANCE EQUIPMENT  
426 SOUTH WESTGATE DRIVE, ADDISON, ILLINOIS 60101

... for more details circle 130 on postcard

For more information on  
DEALER SHOWCASE  
See pages 83 & 84  
READERS SERVICE



# Gavin gives you more gain per dollar!

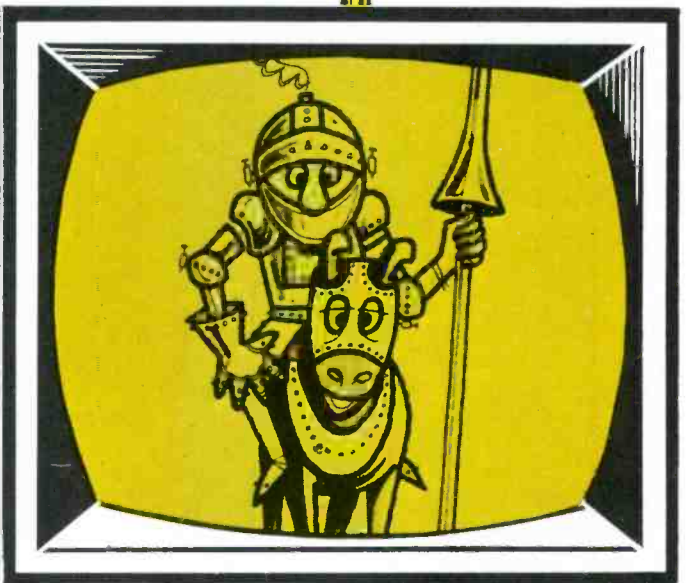
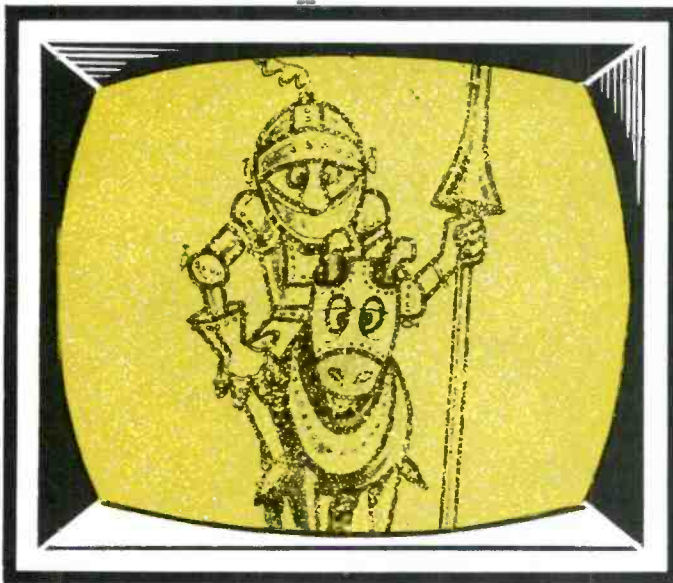
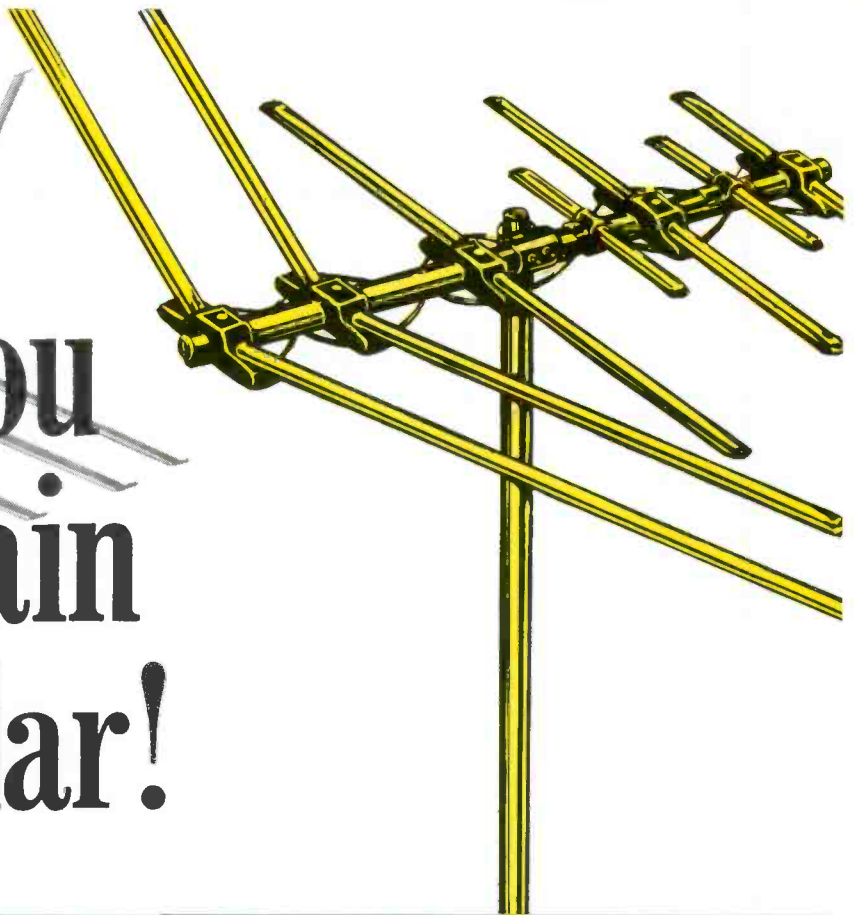

## Side By Side Tests Prove . . .

...that model for model, dollar for dollar, the new Gavin V-Yagi design outperforms any other type of antenna you can buy.

Here's how the test works: We hoist your favorite antenna up on our specially equipped van. We check the signal pick-up on a field strength meter and a color receiver simultaneously. Then, we replace your antenna with a Gavin antenna costing the same or less. The results are eye opening.

Ask us to set up a side-by-side test for you. Invite a representative of the antennas you now handle to observe the demonstration—or set it up himself if he likes. The field strength meter tells the truth no matter who's asking the questions.

Once you see this test, you'll probably switch to Gavin. What are you waiting for?

**SEE US IN BOOTH 1023 AT THE NEW SHOW**



**GAVIN INSTRUMENTS, INC.**

Subsidiary of ADVANCE ROSS CORP.  
Somerville, N. J. 08876 U. S. A.

... for more details circle 114 on postcard



# COLORFAX

## SYLVANIA

### Color TV Chassis D06/D07/D09/D10 — Convergence Problems

If two parallel light beams swing back and forth at a point of rotation and scan a screen horizontally, the problem of dynamic misconvergence

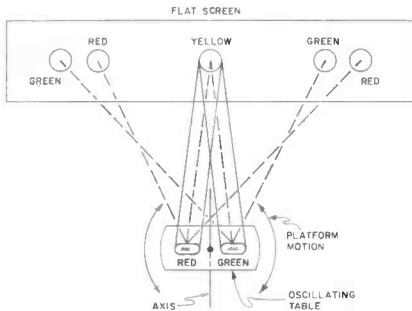

can be illustrated. In the illustration, note the red and green beams coincide at the screen center and form a yellow circle of light. However, when the beams swing right or left an equal amount, the beams no longer coincide, then separate red and green light circles are formed. The farther the beams move away from the center position, the worse this condition becomes.

To correct this condition, keeping a yellow spot of light in all positions of the oscillating platform, it can be seen the most remote lamp from the point being scanned must be reduced in its swing, or the nearest lamp swing, or a combination of both of these correc-

tive measures. If the beams are scanning a vertical screen with a vertical oscillating table, a similar type correction is required.

In the color CRT the three scanning beams must receive a similar corrective deflecting field from the convergence yoke. They can first be made to converge mechanically and statically at the center of the screen by static and purity adjustments. But as soon as they move horizontally or vertically, an increasing amount of correction is required. It is the function of the dynamic convergence waveforms and the convergence yoke to provide this correction. Correction waveforms, taken as part of the output from the horizontal and vertical deflection systems, are used to provide both vertical and horizontal beam scanning correction. The horizontal and vertical convergence voltage circuits are shown in illustrations. The typical input waveforms to these circuits are also shown. It should be noted that R/G convergence waveforms interact with the blue waveforms; these circuits are also shown. It should be noted that the R/G convergence waveforms interact with the blue waveforms through T800 (RT Blue Horiz.). Therefore, in this circuit the blue convergence should be approximately adjusted before proceeding with R/G convergence.

Horizontal and vertical convergence errors can be separated for ease of viewing while making adjustments. For example, all vertical conver-

gence adjustments should be made on a vertical line through the screen center. Any errors appearing on left or right during this adjustment should be ignored. The only misconvergence that can occur along this vertical line is because of the horizontal parabolic waveform causing the beam to move faster or slower across the screen to cause bending of a center vertical line.

Center horizontal convergence in a vertical line is a function of the vertical sweep waveform.

The best convergence is obtained when all raster positioning controls including center and linearities have already been made. Rough setup should be made preliminary to setting purity. Then go back and make final adjustments of static and dynamic convergence. Any further adjustment of the raster positioning should not be made unless touch-up of all controls is intended.

The following notes apply chiefly to Sylvania D06, D07, D09, and D10 chassis (see illustration):

1. Left red horizontal droop may be brought up to match the green by breaking connection between the .082  $\mu$ f capacitor and the RT R/G horizontal coil and inserting a 100  $\Omega$ , 1/2w resistor. (For less correction, less resistance may be used.)

2. A high red, left, horizontal line may be corrected (opposite problem of No. 1) by moving the yellow/green wire on convergence board from pin "L" (RT-Blue horizontal) to ground connection "G," or reverse leads from T700 primary at "B" and "L."

3. If red is high on RT horizontal, replace the .082  $\mu$ f capacitor with a .056  $\mu$ f capacitor.

If you make any of these changes, the convergence board should be so tagged. A touch-up of both static and dynamic controls is nearly always necessary after any of these changes.

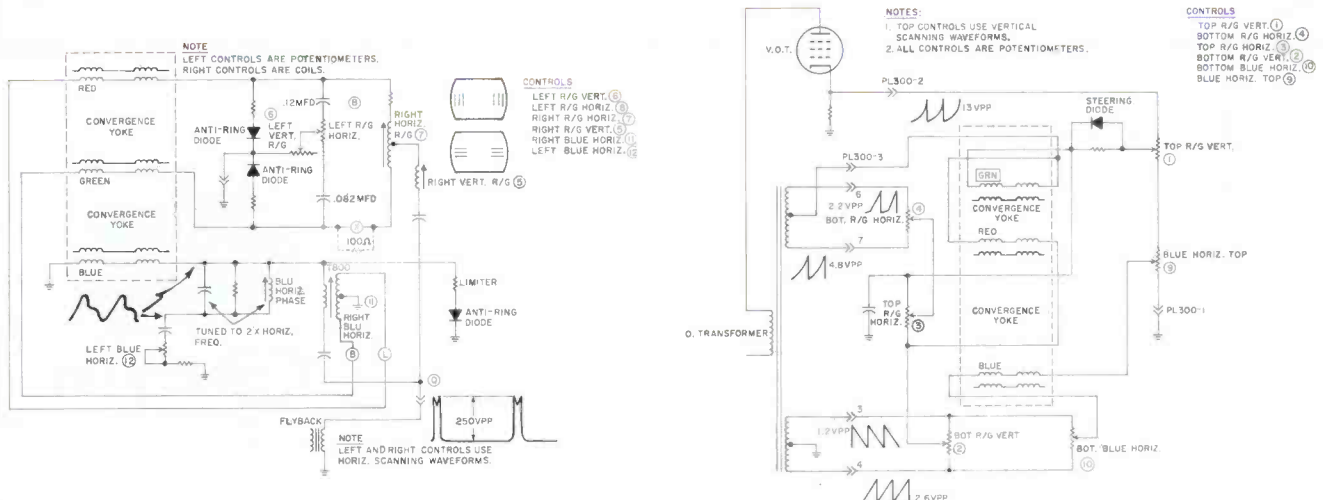



## The 1968 Krylon Giveaway

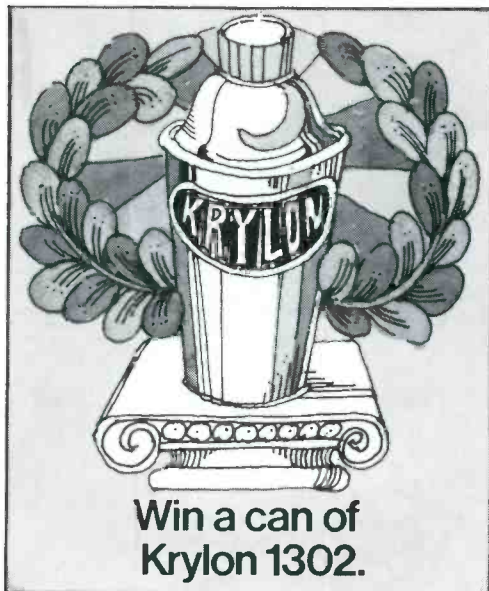

Or  
**\$100.**

Simply fill in the coupon below.

If you become our lucky winner, we have a pretty good idea what prize you'll choose. But we figure it this way: If you win \$100 on us, chances are you'll spend \$1.95 on us — for Krylon.®

(That way, you'll be a two-time winner.)

And while we've got you thinking about Krylon, think about our whole line of sprays. They're standard equipment for all TV/Radio installation and repair work.

### Entry rules:

1. No purchase necessary. Print your name and address on entry coupon and mail to: Krylon Contest—Dept. 300 St. Clair Associates, 435 Madison Ave., New York, N.Y. 10022.
2. Entries must be postmarked no later than July 31, 1968.
3. Winner will be selected in random drawing by St. Clair Associates, whose decision will be final.
4. 1968 Krylon Giveaway is open to anyone in the U.S. except in Wisconsin and where prohibited or restricted by law. Employees (and their families) of Borden Inc, its affiliates and advertising agencies, or St. Clair Associates are not eligible.



Krylon Contest—Dept. 300  
 St. Clair Associates  
 435 Madison Avenue  
 New York, New York 10022

If I win, I'd prefer:

The Krylon     The Cash

Name \_\_\_\_\_

Street \_\_\_\_\_

City \_\_\_\_\_

State \_\_\_\_\_ Zip \_\_\_\_\_

The number on the bottom of my Krylon can is \_\_\_\_\_

I don't use Krylon.



... for more details circle 109 on postcard



# COLORFAX

## GENERAL ELECTRIC

Color TV Chassis KC — Service Hints

**Correcting Horizontal Foldover.** Change R512 from 82K to 62K. This is most easily done by shunting a 240K 1/2w across the existing 82K

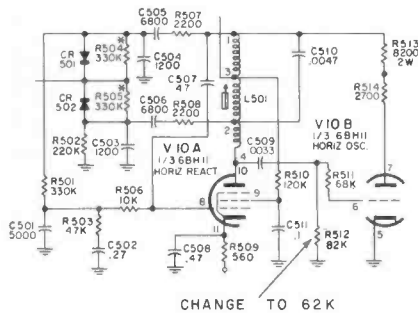

resistor. The extra resistor may be added to the underside of the circuit board. Following this change, the horizontal oscillator should be re-adjusted for proper operation. This is not intended as an instruction to re-work sets, but is used as a correction if this complaint is encountered.

**B-Fuse F101.** Some early production receivers, used a slo-blo fuse in the B-line. This was found to be unnecessary and deleted in early production. If a fuse failure occurs, it should be bridged with a plain buss wire. This will avoid callbacks resulting from fuse failure.

**Filament Fuse F103.** If a failure of filament fuse F103 should occur, it is important that it be replaced properly. Use either an ET10X33 fuse or a length of No. 22 bare copper wire. The most important point is to be sure it is run inside the 3in. fiber-glass tubing. This fuse is intended to burn off in the event of a filament circuit short in the chassis. The fiber-glass tubing contains

the heat of burnoff and prevents other receiver damage. Therefore it is important that the proper gage of wire is used and run inside the tubing.

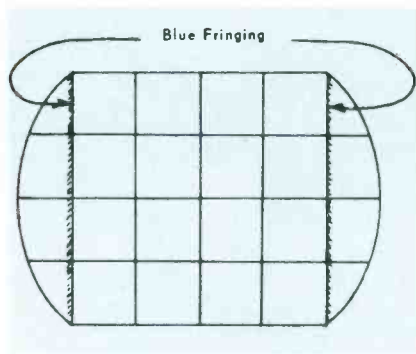

**Using the Wide Blue Convergence Corrector (ET42X59).** If a wide blue raster exists, we now have available a unit to correct this condition.

Before any correctors are installed, it should be determined that a wide blue problem actually exists. This is identified as follows:

1. Adjust for proper center convergence.
2. Observe the vertical lines of a cross-hatch pattern. If blue fringing shows mainly on the outside as illustrated in drawing, this is defined as a wide blue raster.

Blue fringing may be corrected as follows:

1. This condition may be caused by improper vertical positioning of the yoke, which must be corrected by tipping up the front of the yoke, to obtain a coaxial relationship with the tube neck. This may be done by loosening the wing nuts on the yoke clamp and tilting the yoke upward at the front. If this does not result in a coaxial condition with the tube neck, it may be necessary to raise the yoke retaining ring slightly on the bell of the tube.
2. If wide blue condition still exists, install corrector ET42X59 as follows: (a) Slide the corrector down vertically over the rear face of the deflection

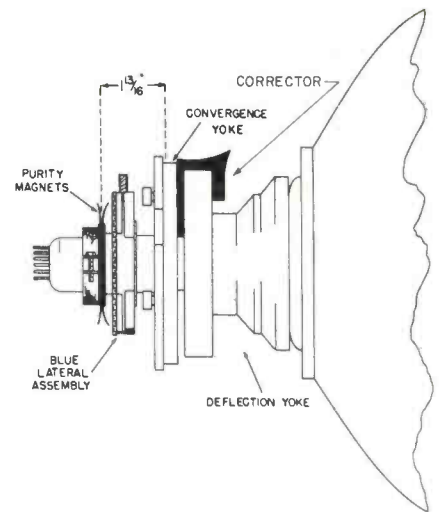

yoke as shown in illustration. This is to be positioned directly above the blue gun and the top clip is to be pressed down firmly on the yoke body for the entire length of the clip. (b) If excessive correction is encountered (narrow blue), the clip should be raised slightly above the yoke body.

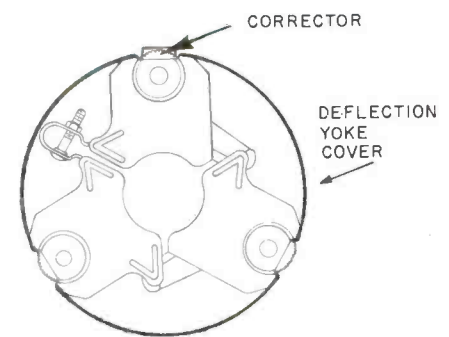

If the final position of the corrector is loose on the yoke, which might permit it to fall off and thus create a short hazard, the degree of correction required is not sufficient to warrant using the corrector. Therefore, it should not be used.

The corrector must not be used in any other position, or for any other purpose than that outlined above.

GET A BETTER PICTURE FROM ANY SET WITH A...

colorphase  
COMBINATION ANTENNA

UHF-VHF-FM

CPC-33G  
WITH FREE  
BAND SPLITTER

# KAY-TOWNES

## ANTENNA

SEE IT AT  
BOOTH 1030  
JUNE - N.Y.  
ELECTRONICS SHOW

KAY-TOWNES ANTENNA CO.  
P.O. Box 593, Rome, Georgia 30162

... for more details circle 118 on postcard  
ELECTRONIC TECHNICIAN/DEALER



ELECTRONIC TECHNICIAN'S BOOK CLUB INVITES YOU AS PART OF TRIAL MEMBERSHIP TO  
**Take This Brand-New Book for only \$1.99!**

Publisher's List Price  
**\$7.95**

**YOURS  
 for only  
 \$1.99**

with Trial Member-  
 ship in Electronic  
 Technician's Book  
 Club.

PARTIAL LIST OF CONTENTS

**HANDBOOK OF SEMICONDUCTOR CIRCUITS** is a GIANT collection of 124 transistor circuits. It contains literally hundreds of diagrams, schematics, and illustrations, complete with operational data for amplifiers, oscillators, logic and switching circuits, power supplies, etc. These are *practical* circuits which have wide application.

<p><b>DIRECT-COUPLED AMPLIFIERS</b>                  Single Unbalanced Stages                  Balanced Configurations                  Balanced Difference Amplifiers                  Modulation                  List of Selected Circuits</p>	<p><b>OSCILLATORS</b>                  Frequency Stability                  Types of Oscillators                  List of Selected Circuits</p>	<p><b>AC TO DC POWER SUPPLIES</b>                  Unregulated Power Supplies                  Regulated Power Supplies                  List of Selected Circuits</p>
<p><b>LOW-FREQUENCY AMPLIFIERS</b>                  Transistor Characteristics                  Circuit Considerations                  Thermal Considerations                  Distortion                  Negative Feedback                  Basic Amplifiers                  List of Selected Circuits</p>	<p><b>SWITCHING CIRCUITS</b>                  Basic Flip-Flop Designs                  Symmetrical Circuits                  Triggering Methods                  Blocking Oscillator Designs                  Direct-Coupled Transistor Methods                  Negative Resistance Circuit Methods                  Other Circuit Methods                  List of Selected Circuits</p>	<p><b>POWER CONVERTERS</b>                  Basic Transistor Oscillator                  Other Connections for Basic Circuits                  Starting Circuits                  Basic Power Converter Designs                  De-Spiking Networks                  Transistor Selection                  Transformer Selection and Design                  Modified and Improved Circuits                  Regulators and Protective Circuitry                  Thermal Considerations                  List of Selected Circuits</p>
<p><b>HIGH-FREQUENCY AMPLIFIERS</b>                  Equivalent Circuits                  Power Gain and Stability                  Neutralization                  Noise                  Automatic Gain Controls                  Tuned Amplifier Interstages                  Video Amplifiers                  List of Selected Circuits</p>	<p><b>LOGIC CIRCUITS</b>                  Basic AND-OR Gates                  Counters and Shift Registers                  High Speed Gating                  List of Selected Circuits</p>	<p><b>SMALL-SIGNAL NONLINEAR CIRCUITS</b>                  Modulators                  Mixers and Converters                  Detectors                  Frequency Multipliers                  Frequency Dividers                  List of Selected Circuits</p>

May we send you this unique new book as part of an unusual offer of a Trial Membership in Electronic Technician's Book Club?

Now you can have, at your finger tips, this GIANT 448-page working guidebook on practical semiconductor circuits of all types.

This handsome, hardbound book is indicative of the many other fine offerings made to Members . . . important books to read and keep . . . volumes with your specialized interests in mind.

**How the Club Works**

Forthcoming selections are described in the FREE monthly *Club News*. Thus, you are among the first to know about, and to own if you desire, significant books. You choose only the main or alternate selection you wish (or advise if you want no book at all) by means of a handy form enclosed with the *News*. As part of your Trial Membership, you need purchase as few as four books during the coming 12 months. You would probably buy at least this many anyway . . . without the substantial savings offered through Club Membership.

**How You Profit From Club Membership**

This is just a sample of the help and generous savings the Club offers you. For here is a Club devoted *exclusively* to seeking out only those titles of interest to you as an electronic technician. Membership in the Club offers you several advantages:

- 1. Charter Savings:** *Handbook of Semiconductor Circuits* carries a retail price of \$7.95. But it can be yours for only \$1.99 with your Trial Membership.
- 2. Continuous Savings:** The Club guarantees to save you 15% to 75% on all books offered through the *Club News*.
- 3. Wide Selection:** Members are annually offered well over 50 of the new and authoritative books on electronic servicing.

**Limited Time Offer!**

Here, then is an interesting opportunity to enroll on a trial basis . . . to prove to yourself, in a short time, the advantages of belonging to Electronic Technician's Book Club.

To start your Membership on these attractive terms, simply fill out and mail the Postpaid Trial Membership Coupon today. **SEND NO MONEY!** If you are not delighted with the book, return it within 10 days and your Trial Membership will be cancelled without cost or obligation. We take all the risk.

FIRST  
 CLASS  
 Permit No. 9  
 Blue Ridge Summit, Pa.

**BUSINESS REPLY MAIL**  
 No Postage Stamp Necessary If Mailed in The United States

Postage Will be Paid By

**ELECTRONIC TECHNICIAN'S BOOK CLUB**

Monterey & Pinola Ave's.

Blue Ridge Summit, Pa. 17214

DO NOT CUT HERE ▲ JUST FOLD OVER, SEAL AND MAIL—NO STAMP OR ENVELOPE NECESSARY

**Send No Money! Simply fill in and mail Trial Membership Coupon Today!**

**ELECTRONIC TECHNICIAN'S BOOK CLUB, Blue Ridge Summit, Pa. 17214**

Please open my Trial Membership in Electronic Technician's Book Club and send me a copy of *Handbook of Semiconductor Circuits*, (billing me only \$1.99 plus a few cents postage and mailing expense.) If not delighted, I may return the book within 10 days and owe nothing. Otherwise, to complete my Trial Membership, I agree to purchase at least four additional monthly selections or alternates during the next 12 months. I have the right to cancel my membership anytime after purchasing these four books.

Name \_\_\_\_\_ Phone No. \_\_\_\_\_  
 Address \_\_\_\_\_  
 City \_\_\_\_\_ State \_\_\_\_\_ Zip \_\_\_\_\_  
 Company \_\_\_\_\_

NOTE: check if  home or  business address

(The Club assumes postage on all prepaid orders)

T-68

**THIS ENTIRE FOLD-OVER COUPON FORMS A NO-POSTAGE-REQUIRED BUSINESS REPLY ENVELOPE**

... for more details circle 141 on postcard

# NEW PRODUCTS

For additional information on products described in this section, circle the numbers on Reader Service Card. Requests will be handled promptly

## Voltage Regulators 709

A line of gas discharge voltage regulator and voltage reference tubes is said to hold reference voltages to  $\pm 3\%$ . These units, designated in the "V" series, have a temperature co-

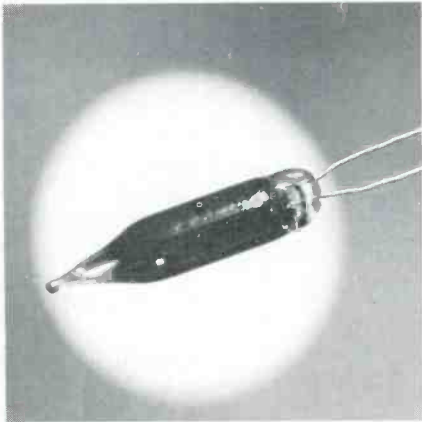

efficient of less than  $15\text{mv}/^\circ\text{C}$ , less than  $.01\%/^\circ\text{C}$ . Operating currents are extremely low, from a minimum of 0.1ma to a maximum of 4.0ma. Designed for typical commercial applications in reference voltage sources, regulated power supplies, timing circuits, oscilloscope calibrators, photo multipliers, digital voltmeters, and many others, these tubes cover a range of voltages from 83vdc to 143vdc. For potentials over 143v two or more tubes may be stacked to provide higher voltage regulation. Operating lifetimes are said to be in excess of 20,000 hours. Signalite.

## Color Alignment Generator 710

A lightweight, solid-state TV alignment generator is capable of generating the familiar 10-bar gated rainbow — plus all new single-bar and three-bar test patterns. It is said the addition-



al patterns minimize the time a technician must spend on the job making adjustments. Known as the Model 865 "Deluxe Color Commander," the generator combines extensive convergence and centering display capability with a variety of popular color-bar patterns. As a protection against obsolescence, the instrument is equipped with a unique single color-bar pattern capability. The pattern can be adjusted for any present — or future — demodulator phase angle. Another feature is the unit's three-bar color pattern provision. Serving to eliminate all but the three bars used for color demodulator alignment, it is said a scope is not necessary. The first bar, red (R-Y), is at  $90^\circ$ ; the second bar, blue (B-Y), at  $180^\circ$  and the third bar, green (R-Y), at  $270^\circ$ . A single-dot pattern can be moved vertically or horizontally to the exact center of the screen for accurate alignment of static convergence. A movable single-cross pattern for constant reference during purity adjustments is included. This feature can also be used for making center vertical and horizontal top-bottom-center dynamic and right-left-center dynamic convergence checks. The calibrated cross-hatch display provision affords a pattern with a 3:4 aspect ratio: 15 horizontal and 20 vertical lines. Other patterns featured in the generator are 10-bar gated rainbow (each bar spaced at 30 electrical degrees, for complete range of spectrum color), 300-dot multiple, multiple vertical bar and multiple horizontal bar. The generator measures  $4\frac{7}{8} \times 9\frac{1}{2} \times 5\frac{1}{4}$  in. Fully equipped with a carry-about handle, the Model 865 weighs less than 4 lb. Price \$189.95. Amphenol.

## Mobile CB Antenna 711

A dual mounting CB antenna system for either permanent or "shiftable" mobile use is one of several original features of this Model M178 "Stick-Shift" 27MHz antenna. Designed for temporary mounting on trunk or rooftop, the user may employ a powerful built-in magnet, identical to that used in the A/S "Grip-Stick" antenna. A firm, permanent mount may be achieved alternatively by applying an accessory ring of double-

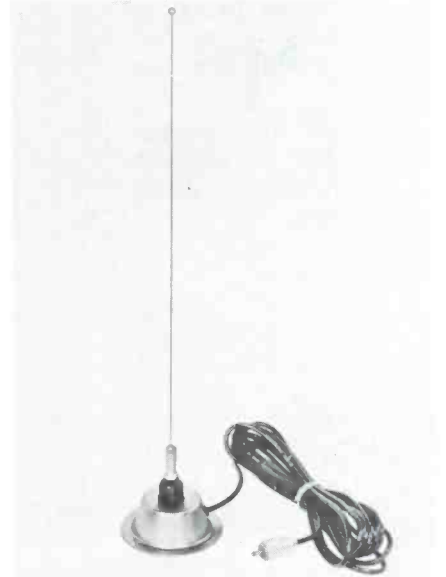

faced adhesive to the bottom of the base and then to the auto surface. The adhesive material is currently being used by several auto manufacturers in mounting accessories. In the permanent configuration, the cable may be fully concealed by feeding it into the bottom of the base through a small hole drilled in the roof or trunk. Antenna Specialists.

## Tester/Rejuvenator 712

A tester/rejuvenator features measurement of high-voltage internal leakage. The unit can be used with almost all B/W and color CRTs. The instrument is said to permit service technicians to tell customers whether a CRT needs replacement. The unit also permits technicians to rejuvenate CRTs that are considered "beyond hope." In addition to the HV-leak feature and rejuvenating aspects, several new circuit improvements are said to have been incorporated into the instrument for maximum versatility on the job. These include a heater-adjust control, allowing for variations in line voltage and variable G1 and G2 voltages. All heater voltages are monitored on a voltmeter. A built-in pilot light alerts the user when the unit is switched on. For hookup purposes, three different socket assemblies are provided, permitting direct mating with more than 90 percent of all CRT types.



# NEW 82-CHANNEL



# POWERMATE®

**Now! An antenna-mounted preamplifier that more than triples every VHF and UHF signal**

**New Jerrold All-Channel Powermate Model ACP-105-L** provides "far-out viewers" with "close-in" reception of *all* available TV channels from Channel 2 to Channel 83—plus FM. And it's built by the people who pioneered and perfected TV/FM antenna preamplifiers.

**Model ACP-105-L features:** • Flat to  $\pm 0.5$  dB on any given channel • Strong resistance to overload from nearby stations • 300-ohm input • 75-ohm Coloraxial output for single all-channel, interference-free down-lead • Built-in shielding and circuit protection against lightning surges • And all solid-state construction.

**Suggested list price of \$49.95** for the new Jerrold All-Channel Powermate Model ACP-105-L is a real value. People need it. They want it. They'll buy it. And you stand to make a respectable profit on it. The ACP-105-L will be backed up by advertising and sales tools from Jerrold.

**Stock up now** with the perfect complement to Jerrold's complete line of VHF and UHF Powermates for every reception need. Order Model ACP-105-L from your Jerrold Distributor today. Or write Jerrold Electronics Corporation, Distributor Sales Division, P.O. Box B, Philadelphia, Pa. 19105.

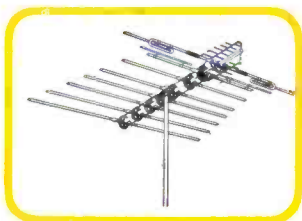

Outdoor Antennas



Home Distribution Systems

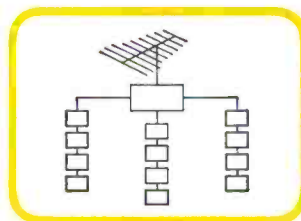

MATV Systems



*Focusing on one thing...  
better reception*

a GENERAL INSTRUMENT company  
... for more details circle 116 on postcard



## LOOKING FOR MINIATURE ELECTROLYTIC CAPACITORS

CALL

# AEROVOX

### CRE - MINIATURE ALUMINUM CASED ELECTROLYTICS

The modern replacement for a wide range of low-voltage, compact devices like transistor radios, hearing aids and tape recorders. Values from 1 mfd to 500 mfd, rated from 3 to 150 volts.



### BCD - UPRIGHT MOUNTING BAKELITE CASE ELECTROLYTICS

The natural choice for solid-state equipment where printed wiring and tightly-cramped circuits make space a premium. BCD uprights are available in all popular capacities and working voltages from 3 volts to 50 volts.

### PTT - AXIAL LEAD PLASTIC CASED ELECTROLYTICS

Small in size - Big in performance! Second only to metal cans in "no leak" reliability. Voltage ratings and capacities to suit any replacement need. "Polycap" cases permit reliable operation from -30°C to +65°C.



### NEW AEROVOX AK530 ELECTROLYTIC CAPACITOR KIT



20 popular Type EKA upright mounting, plastic-cased miniature electrolytics in values from 1 to 500 mfd and voltages from 3 to 50 VDC. Perfect for those transistorized circuits in radios, recorders, musical instruments, etc. Packaged in compact, plastic box that fits in tube caddy. Assortment contains \$28.00 worth of capacitors and dealer cost is only \$7.95.

Available from your local  
Aerovox Distributors



## AEROVOX CORPORATION

DISTRIBUTOR SALES, New Bedford, Mass. 02741

... for more details circle 102 on postcard

## NEW PRODUCTS



Other adapters are available optionally for future types; these are continually updated. Additionally, a large storage area is included for housing cables and probes when the instrument is not in use. Amphenol.

### RF Test Probe 713

A miniature RF test probe that permits dc measurements of RF signals, extending the frequency response for ac voltage measurements to 250MHz. is designed to be used with the manufacturer's 11M input impedance model 600 transistorized volt-ohmmeter (TVO). The RF probe and TVO serve as a signal tracer and gain analyzer as well as an RF voltage measuring device. The probe can also be used with an oscilloscope to observe detected modulated RF signals. The probe has a safe insulated red colored plastic body 5in. long and a 1-in.-long nickel plated metal probe tip. It is said the probe can be connected to dc high po-

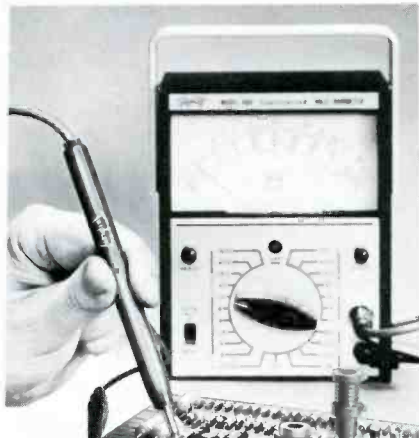

tentials up to 500v safely as long as the superimposed RF voltage does not exceed the 20v limit. A spare alligator clip to place on the probe tip for monitoring purposes is provided. The probe is also connected with a 4ft long shielded connecting cable with phono plug connector and ground lead. User net price \$9. Triplett.

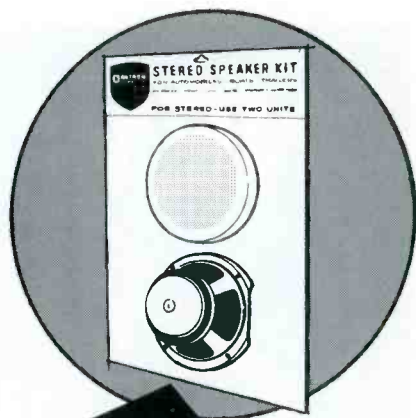

### STEREO SPEAKER KIT

A new auto, boat, and trailer stereo kit that's skin packed for greater eye-appeal. Available in 4 different models with heavy-duty snap-on grill for fast installation. Unit includes speaker, grill, hardware, wiring, and instruction sheet.

## NEW FROM AKTRON INDUSTRIES, INC.

For complete information, write or call—  
Oaktron Industries, Inc.  
930 Thirtieth Street  
Monroe, Wisconsin 53566  
Phone - 608/325-2121

### PVS-800

The hottest new idea for speaker baffle combinations in 20 years. Use the PVS-800 indoors or outdoors. Provides greater sound dispersion and better full range fidelity than any other combo in its price range.

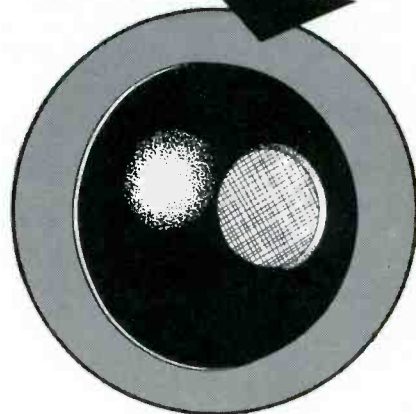

... for more details circle 124 on postcard  
ELECTRONIC TECHNICIAN/DEALER





# QUIETROLE



The Original Control  
and  
Switch Lubri-Cleaner

The oldest, most  
reliable and efficient  
product obtainable for  
positive lubrication and  
cleaning of TV Tuners,  
Controls and Switches.  
Harmless to plastics  
and metals. Zero effects  
on resistance and  
capacity. **Non-inflam-  
mable—non-conductive—  
non-corrosive.**

The Choice of Better  
Servicemen, Everywhere.

For Color and  
Black and White

Available in Aerosol or Bottle

Product of

## QUIETROLE

COMPANY

Spartanburg, South Carolina



... for more details circle 126 on postcard

## WAVE FORM ANALYSIS & PEAK FM MODULATION



### all for LESS MONEY!

The Lampkin 205A FM Modulation Meter accurately indicates PEAK modulation on mobile transmitters. To shoot trouble visually, use your own general-purpose oscilloscope at the 205A rear jack output. This makes a low-cost, highly effective test combo — and a well-rounded shop — all for less money.

Lampkin pioneered the PEAK voltmeter for FM modulation indication.

Like to see the complete specs? Mail coupon today!

Use this coupon for FREE booklet "How To Make Money in Mobile-Radio Maintenance" and information on Lampkin meters.

Name \_\_\_\_\_  
Address \_\_\_\_\_  
City \_\_\_\_\_ State \_\_\_\_\_ Zip \_\_\_\_\_

**LAMPKIN LABORATORIES, INC.**  
Div. II, Bradenton, Fla. 33505

... for more details circle 120 on postcard

# 1968

## ELECTRONIC TECHNICIAN / DEALER

### DIRECTORY

#### A

- AC Electronics Div. GMC, 1925 E. Kenilworth, Milwaukee, Wis. 53202
- ATR Electronics 300 E. 4th St, St. Paul, Minn. 55101
- Acme Electric Corp., 31 Water St., Cuba, N.Y. 14727
- Acme Lite Products Co., Congers, N.Y. 10920
- Acoustic Research, 24 Thorndike St., Cambridge, Mass. 02138
- Acro Products, 369 Shurs Lane, Philadelphia, Pa. 19127
- ADC, Inc., 2833 13th Ave. S., Minneapolis, Minn. 55407
- Adler TV Specialties, PO Box 2005, Atlantic City, N.J. 08406
- Admiral Corp., 903 Morrissey Drive, Box 845, Bloomington, Ill. 61701
- Advance Relay, 2435 N. Naomi St., Burbank, Calif. 91504
- Aerovox Corp., 740 Belleville Ave., New Bedford, Mass. 02745
- Akro-Mills, 820 Market St., Akron, Ohio
- Allen-Bradley, 136 W. Greenfield Ave., Milwaukee, Wis. 53204
- Alliance Mfg. Co., Alliance, Ohio 44601
- Allied Radio, 100 N. Western Ave., Chicago, Ill. 60680
- Almo Industrial Electronics, Inc., 412 N. 6th St., Philadelphia, Pa. 19123
- Alpha Wire Corp., 180 Varick St., New York, N.Y. 10013
- Altec-Lansing, 1515 S. Manchester, Anaheim, Calif. 92802
- American Concertone, 9449 W. Jefferson Blvd., Culver City, Calif. 90230
- American Electronic Labs, Inc., Colmar, Pa. 18915
- American Geloso Electronics, 251 Park Ave., New York, N.Y. 10010
- American Microphone Div., see Electro Voice
- American Telephone & Telegraph, 195 Bdw., New York, N.Y. 10007
- American Trading Co., Blaustine Bldg., Baltimore, Md. 21201
- Amp Inc., 3822 Eisenhower Blvd., Harrisburg, Pa. 17111
- Amperex Electronic, 230 Duffy Ave., Hicksville, L.I., N.Y. 11802
- Ampex Audio, Inc., 934 Charter St., Redwood City, Calif. 94063
- Ampex Corp., 25564 Willow Pond Lane, Los Altos Hills, Calif. 94022
- Amphenol Distributor Div., 2875 S. 25th Ave., Broadview, Ill. 60153
- Amprobe Instrument, 630 Merrick Rd., Lynbrook, N.Y. 11563
- Analab Instrument, 30 Canfield Rd., Cedar Grove, N.J. 07009
- Anasphone Corp., 10912 La Cienega Blvd., Inglewood, Calif. 90304
- Andrea Radio, 27-01 Bridge Plaza N., Long Island City, N.Y. 11101
- Antennacraft, 1215 Agency St., Burlington, Iowa 52601
- Antenna Designs, Inc., 802 Washington St., Burlington, Iowa 52601
- Antenna Products Co., Box 110, Mineral Wells, Tex. 76067
- Antenna Specialists, 12435 Euclid Ave., Cleveland, Ohio 44115
- Antronic Corp., 4942 W. Div. St., Chicago, Ill. 60651
- Arco Electronics, Community Drive, Great Neck, N.Y. 11021
- Arcturus Electronics, 420 Kearny Ave., Kearny, N.Y. 07032
- Argos Products, 600 S. Sycamore, Genoa, Ill. 60135
- Arkay Int'l, 88-06 Van Wyck Expressway, Richmond Hill, N.Y. 11418
- Armco Steel Corp., 703 Curtis St., Middletown, Ohio 45042
- Arrow Fastener Co., 201 Mayhill St., Saddle Brook, N.J. 07662
- Arrow-Hart & Hegerman, 103 Hawthorn St., Hartford, Conn. 06105
- Artisan Organs, 2475 N. Lake Ave., Altadena, Calif. 91001
- Arvin Industries, Columbus, Ind. 47201
- Astatic Corp, Jackson & Harbor Sts., Conneaut, Ohio 44030
- Astron Corp., 255 Grant Ave. E., Newark, N.J.
- Atlas Sound Corp., 10 Pomeroy Rd., Parsippany, N.J. 07054
- Audax, Inc. 109-01 37th Ave., Corona, N.Y. 11368
- Audio Devices, 444 Madison Ave., New York, N.Y. 10022
- Audio Dynamics, 1677 Cody Ave., Ridgewood, N.J.
- Audio Empire Div. Dyna Empire, 1075 Steward Ave., Garden City, L.I., New York 11530
- Audio Corp., 514 Bdw., New York, N.Y. 10012
- Audio-Master Corp., 17 E. 45th St., New York, N.Y. 10017
- Audio Wave, Inc., 4541 Furman Ave., Bronx, N.Y. 10470
- Audiotex Mfg., 400 S. Wyman St., Rockford, Ill. 61101
- Audiotex Mfg. 3225 Exposition Pl., Los Angeles, Calif. 90018



# FINCO<sup>®</sup>

the company that brought you the famous Color Spectrum Antennas<sup>T.M.</sup>

now brings you a complete line of VHF & 82 channel MATV equipment

## Over 200 items including:

- Preamplifiers
- Amplifiers
- Passive Networks
- Wall Taps
- Test Equipment
- MATV Heavy Duty Antennas

Finco will work with you to plan your MATV installations *at no charge*.  
Send for FINCO's 45-page illustrated catalog and layout information forms.

*Mail this coupon today*



**THE FINNEY  
COMPANY**

34 W. Interstate St., Dept. 110 Bedford, Ohio 44146

Send FREE 45-page illustrated catalog of MATV Equipment and FINCO layout information forms.

Name \_\_\_\_\_

Company \_\_\_\_\_

Address \_\_\_\_\_

City \_\_\_\_\_ State \_\_\_\_\_ Zip \_\_\_\_\_

... for more details circle 113 on postcard

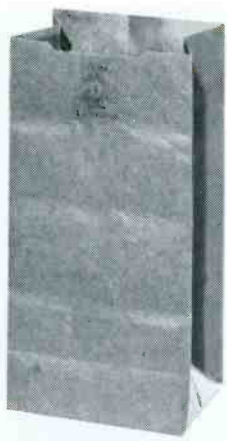

## THEIR BULK PACK



## OURS!

 Pick up this handful of best-selling needles from your Electro-Voice distributor, and you get a handsome display carton free.

And if you want more, ask about our permanent phono needle/cartridge merchandiser, wall banners, literature, and the best cross-reference catalog in the industry.

We don't just make the most complete line of needles and cartridges, we also help you sell... help you profit. Insist on Electro-Voice. From the parts distributor with more than parts to offer!

**ELECTRO-VOICE, INC.**, Dept. 687T  
663 Cecil Street, Buchanan, Michigan 49107

**Electro-Voice**<sup>®</sup>

A SUBSIDIARY OF GULTON INDUSTRIES, INC.

Auricord Corp., 34-43 56th St.,  
Woodside, N.Y. 11377  
Automatic Electric Co.,  
Northlake, Ill. 60164

### B

B & B Electronic Products, 2120 S. Platte  
River Dr., Denver, Colo. 80223  
B&K Instruments (Bruel & Kjaer), 3006 W.  
106 St., Cleveland, Ohio 44111  
B&K Mfg. Co., 1801 W. Belle Plaine,  
Chicago, Ill. 60613  
BSR (Birmingham Sound Reproducers),  
Ltd., College Point, L.I., N.Y. 11356  
Ballantine Labs, Boonton, N.J. 07005  
Barber-Colman Co., Rockford, Ill.  
Barker & Williamson, Bristol, Pa. 19007  
Barry Electronics, 512 Bdwy.,  
New York, N.Y. 10012  
Bauchaine Sales Corp., 584 Union Ave.,  
Laconia, N.H. 03246  
Beckman Instruments Berkeley Div., 220  
Wright Ave., Richmond, Calif. 94804  
Belden Corp., 415 S. Kilpatrick,  
Chicago, Ill. 60644  
Bell & Howell, 7100 McCormick Rd.,  
Chicago, Ill.  
Bell PA Products, 1209 N. 5th St.,  
Columbus, Ohio 43212  
Bell Telephone Labs, 463 West St.,  
New York, N.Y. 10014  
Benco TV Assoc., 27 Taber Rd., Rexdale,  
Ont., Canada  
Bendix Radio Div., Industrial Electronic  
Prods., Baltimore, Md.  
Berns Mfg., 9853 Chalmers,  
Detroit, Mich. 48213  
Bird Electronics Corp., 30303 Aurora Rd.,  
Solon, Ohio 44139  
Birnbach Radio, 435 Hudson,  
New York, N.Y. 10014  
Bliley Electric, Union Station Bldg., Erie, Pa.  
Blonder-Tongue Labs, 9 Alling St.,  
Newark, N.J. 07102  
Bogen-Presto, PO Box 500,  
Paramus, N.J. 07652  
Boonton Radio, Boonton, N.J. 07005  
Bosco Elec. Inc., Don Littell Rd.,  
Hanover, N.J. 07936  
Bourns Labs, Box 2112,  
Riverside, Calif. 92506  
Bozak Co., Rt. Box 1166,  
Darien, Conn. 06820  
Brach Mfg. Corp., 899 Main,  
Sayreville, N.J. 08872  
Bright Star, Ind., Clifton N.J.  
British Ind.,  
Port Washington, L.I., N.Y. 11050  
Browning Labs, 100 Union Ave.,  
Laconia, N.H. 03246  
Brush Instruments, 37 St. & Perkins,  
Cleveland, Ohio  
BSR (USA), Ltd., Route 303,  
Blauvelt, N.Y. 10913  
Bud Radio, 4605 E. 355 St.,  
Willoughby, Ohio 44094  
Burgess Battery, Exchange St.,  
Freeport, Ill. 61032  
Burroughs Corp., 6072 2nd Ave.,  
Detroit, Mich. 48202  
Bussman Mfg., W. University St.,  
St. Louis, Mo. 63107

### C

Cabinart Inc., 35 Geyer St., Haledon, N.J.  
Cadre Ind., Box 150, Endicott, N.Y. 13760  
Calbest Electronics, 4801 Exposition Bldg.,  
Los Angeles, Calif.

Cannon Electric, 3208 Humbolt St.,  
Los Angeles, Calif. 90031  
Castle TV Tuner Service, 5710 N. Western  
Ave., Chicago, Ill. 60645  
Castle TV Tuner Service, 41-92 Vernon,  
Long Island City, N.Y. 13476  
Centralab, 900 E. Keefe Ave.,  
Milwaukee, Wis. 53212  
Channellock Inc., S. Main St.,  
Meadville, Pa. 16335  
Channel Master Corp., Ellenville, N.Y. 12428  
Charles Engineering, Inc., 3421 N. Kroll  
Drive, Los Angeles, Calif.  
Chem Spray Corp., 67-27 Cadillac St.,  
Houston, Tex. 77021  
Chemical Electronic Engineering, Jackson  
& Ravine Drive, Matawan, N. J. 07747  
Chemtronic, Inc., 1260 Ralph,  
Brooklyn, N.Y. 11236  
Cinch Jones Div., Cinch Mfg., 1026 Homan  
Ave., Chicago, Ill.  
Cisin Co., Harry G., Amagansett, N.Y. 11930  
Clairex Corp., 19 W. 26th St.,  
New York, N.Y. 10010  
Clarostat Mfg., Dover, N.H. 03820  
Clear Beam Antenna Corp., 9754 Deering  
St., Chatsworth, Calif. 91311  
Cletron, Inc. 1974 E. 61 St.,  
Cleveland, Ohio 44103  
Cleveland Institute of Electronics, 1776 E.  
17th St., Cleveland, Ohio 44114  
Cohu Electronics Massa Div., 5725 Kearny  
Villa Rd., San Diego, Calif. 92123  
Cole Inst. Div., 2034 Placenta,  
Costa Mesa, Calif.  
Colman Tool & Electric Products, PO Box  
2965, Amarillo, Tex. 79105  
Colson Corp., 395 LaSalle,  
Chicago, Ill. 60603  
Colorgrams, Inc., 58 Old Steward Ave.,  
New Hyde Park, L.I., N.Y. 11040  
Columbia Products Co., Rt. 3,  
Columbia, S.C. 29206  
Columbia Wire & Supply Co., 2850 Irving  
Park Rd., Chicago, Ill. 60618  
Communications Co., 300 Greco Ave.,  
Coral Gables, Fla. 33146  
Communications Electronics, PO Box 1272,  
Scottsdale, Ariz. 85252  
Communications Prod. Co., Rt. 79,  
Marlboro, N. J. 07746  
Components Specialties, Inc., 101 Buffalo  
Ave., Freeport, N. Y. 11520  
Conar Instrument, 3939 Wisconsin Ave.,  
Washington D.C. 20016  
Conrac, Inc., 19217 Foothill Blvd.,  
Glendora, Calif. 91740  
Continental Electronics, 1050 N. Central  
Expressway, Dallas, Tex. 75201  
Courier Communications, Inc., 56 Hamilton  
Ave., White Plains, N.Y. 10601  
Cornell-Dubilier Electronics, 50 Paris St.,  
Newark, N.J. 07105  
Creative Products, Inc., 8120 Blue Ash Rd.,  
Cincinnati, Ohio 45236  
Crescent Enterprises, 7301 Mission Rd.,  
Prairie Village, Kan. 66208  
Crown Int'l, Box 261 Elkhart, Ind. 46514  
Cush Craft, 621 Hayward St.,  
Manchester, N.H. 03103  
Cutler-Hammer, 436 N. 12th St.,  
Milwaukee, Wis. 53233

### D

Dale Electronics, 1378 28th Ave.,  
Columbus, Neb. 68601  
Davies Molding Co., Harry, 1428 N. Wells  
St., Chicago, Ill. 60610



Daystrom, Inc., Archbald, Pa. 18403  
 DeJur-Amsco, 45-01 Northern Blvd.,  
 Long Island City, N.Y. 11101  
 Delco Radio Div., GMC, Kokomo, Ind. 46901  
 Delmonico Int'l., 120-20 Roosevelt,  
 Corona, Ill.  
 DeWald Radio, 35-15 37 Ave.,  
 Long Island City, N.Y. 11103  
 Dialight Corp., 60 Steward Ave.,  
 Brooklyn, N.Y. 11237  
 Diamond Tool, 4602 Grand Ave., W.,  
 Duluth, Minn. 55807  
 Dickey, Inc., D.F., 4863 Rivoli Dr.,  
 Macon, Ga. 31204  
 Drake Mfg., 4826 N. Olcott,  
 Chicago, Ill. 60656  
 DuKane Corp., St. Charles, Ill. 60174  
 DuMont Labs, Allen B., 750 Bloomfield,  
 Clifton, N.J. 14431  
 Du Pont de Nemours,  
 Wilmington, Del. 19801  
 Doutone Co., Locust St.,  
 Keyport, N.J. 07735  
 Dutch Brand Div., Johns-Manville, 78 S.  
 Woodlawn Ave., Chicago, Ill.  
 Dymo Ind., 2725 10th St.,  
 Berkeley, Calif. 94710  
 Dynaco, Inc., 3912 Powelton Ave.,  
 Philadelphia, Pa. 19104  
 Dyna-Empire, 1075 Steward Ave.,  
 Garden City, L.I., N.Y. 11530

E

ECI Electronics Communications, 56  
 Hamilton Ave., Mount Vernon, N.Y. 10552  
 ELPA Ind. Ortofon Div., New Hyde Park, Ill.  
 E-Z Hook Products, 1536 Woodborn Ave.,  
 Covington, Ky.  
 E-Z Way Towers, Inc., P.O. Box 5797,  
 Tampa, Fla. 33605  
 Eby Sales, 148-05 Archer Ave.,  
 Jamaica, L.I., N.Y. 11435  
 Eitel-McCullough, 301 Industrial Way,  
 San Carlos, Calif. 94070  
 Eico Corp., M St. below Erie,  
 Philadelphia, Pa.  
 Eico Electronic Instrument Co.,  
 283 Malta St., Brooklyn, N.Y. 11207  
 Electric Auto Lite, 3529 24 St.,  
 Port Huron, Mich. 48060  
 Electric Storage Battery, 1717 E. 9 St.,  
 Cleveland, Ohio 44114  
 Electro Acoustic Prods., 2135 Bueter Rd.,  
 Fort Wayne, Ind.  
 Electro Products Labs, 6125 W. Howard St.,  
 Chicago, Ill. 60648  
 Electronic Chemical Corp., 813 Communi-  
 paw Ave., Jersey City, N.J. 07304  
 Electronic Communications, Inc., 56 Ham-  
 iltion Ave., White Plains, N.Y. 10601  
 Electronic Measurements, Lewis St. &  
 Maple Ave., Eatontown, N.J. 07724  
 Electronic-Missiles & Communications,  
 Inc., 262 3rd St., Mount Vernon, N.Y.  
 Electronic Organ Arts, 4949 York Blvd.,  
 Los Angeles, Calif. 90042  
 Electronic Prods. Div., Victoreen Instru-  
 ment, 111 E. 3 St., Mount Vernon, N.Y.  
 10550  
 Electronic Publishing, 133 N. Jefferson St.,  
 Chicago, Ill. 60606  
 Electronic Technician, Ojibway Bldg.,  
 Duluth, Minn. 55802  
 Electrovert, Inc., 86 Hartford Ave.,  
 Mount Vernon, N.J. 10553  
 Electro-Voice, Inc., 629 St.,  
 Buchanan, Mich. 49107  
 Elgin Advance Relays, 2435 W. Naomi St.,  
 Burbank, Calif.  
 Elpha Marketing-Thorens, Atlantic &  
 Steward Ave., New Hyde Park, N.Y. 11040

**FAR  
 SUPERIOR  
 TO  
 ANY  
 VTVM  
 OR  
 VOM**

**--and  
 for  
 less  
 money**



## NEW FIELD EFFECT MULTIMETER

Here is the revolutionary new approach to circuit testing, the solid state Sencore FIELD EFFECT METER. This FE14 combines the advantages of a VTVM and the portability and versatility of a VOM into a single low-cost instrument. This is all made possible by the use of the new space age field effect transistor that is instant in action but operates like a vacuum tube in loading characteristics. Compare the features of the FIELD EFFECT METER to your VTVM or VOM.

**Minimum circuit loading** — 15 megohm input impedance on DC is better than a VTVM and up to 750 times better than a 20,000 ohm per volt VOM — 10 megohm input impedance on AC is 20 times better than a standard VTVM. The FIELD EFFECT METER is constant on all ranges, not like a VOM that changes loading with each range.

**Seven AC peak-to-peak ranges** with frequency response to 10MHz. Seven zero center scales down to 0.5 volt. Five ohmmeter ranges to 1000 megohms. DC current measurements to 1 ampere. Full meter and circuit protection. Mirrored scale. Low current drain on batteries — less than 2 milliamps. Built-in battery check. Unbreakable all-steel vinyl clad case. Optional Hi-Voltage probe adds 3KV, 10KV and 30KV ranges with minimum circuit loading for greatest accuracy in the industry... \$9.95.

**Only Sencore offers the FIELD EFFECT METER.  
 Ask for it by name at your distributor.**

**only \$69.95 (less batteries)**



**SENCORE**

NO. 1 MANUFACTURER OF ELECTRONIC MAINTENANCE EQUIPMENT

426 SOUTH WESTGATE DRIVE, ADDISON, ILLINOIS 60101

... for more details circle 131 on postcard



Eltec, 14 Alsop Ave.,  
 Middletown, Conn. 06457  
 EMC, 625 Bdwy., New York, N.Y. 10012  
 Emerson Radio & Phono, 14 & Coles,  
 Jersey City, N.J. 07302  
 Empire Scientific, 1075 Steward Ave.,  
 Garden City, L.I., N.Y. 11530  
 Enterprise Development Corp., 5123 E.  
 65th, Indianapolis, Ind. 46220  
 Entron, 2141 Industrial Pkwy.,  
 Silver Spring, Md. 20904  
 Ercona Corp., 16 W. 46 St.,  
 New York, N.Y. 10036  
 Essex Wire, 1601 Wall St.,  
 Indianapolis, Ind.  
 Euphonics Corp., P.O. Box 2746 Rio  
 Piedras, Puerto Rico, USA 00926  
 Eveready Batteries (see Union Carbide Co.)  
 Exide Ind. Div., Electric Storage Battery,  
 52 S. 15 St., Philadelphia, Pa. 19102

**F**

Fanon-Masco, 439 Frelinghuysen Ave.,  
 Newark, N.J. 07114  
 Fidelitone, Inc., 6415 Ravenswood Ave.,  
 Chicago, Ill. 60626  
 Finney Co., 34 W. Interstate St.,  
 Bedford, Ohio 44146  
 Fischer Special Mfg. Co., 446 Morgan St.,  
 Cincinnati, Ohio 45206  
 Fisher Radio, 21-2444 Dr.,  
 Long Island City, N.Y. 11101  
 Foxboro Co., New Ponset Ave.,  
 Foxboro, Mass. 02035  
 Freed Transformer, 1718 Weirfield St.,  
 Brooklyn, N.Y. 11227

**G**

GAM Electronics, 138 Lincoln St.,  
 Manchester, N.H. 03103

G & W Electric Specialty Co., 3500 W. 127  
 St., Blue Island, Ill. 60406  
 Gator Probe Corp., 2751 San Juan Rd.,  
 Hollister, Calif. 95023  
 GC Electronics, 400 S. Wyman St.,  
 Rockford, Ill. 61101  
 Garrard Sales, 80 Shore Rd.,  
 Port Washington, N.Y. 11050  
 Gavin Instruments, Depot Sq. & Division St.,  
 Somerville, N.J. 08876  
 General Dynamics/Electronics, 1407 N.  
 Goodman St., Rochester, N.Y. 14609  
 General Electric Audio Products Div.,  
 Decatur, Ill.  
 General Electric Communications Products  
 Div., Lynchburg, Va.  
 General Electric Receiving Tube Dept.,  
 Owensboro, Ky. 42301  
 General Electric Receiver Div., Utica, N.Y.  
 General Instrument, 65 Gouveneur St.,  
 Newark, N.J. 07104  
 General Precision GPL Div.,  
 Mount Kisco, N.Y. 10549  
 General Radio, West Concord, Mass. 01742  
 General Radiotelephone Co., 3501 W.  
 Burbank Blvd., Burbank, Calif. 91505  
 Gertsch Products, 3211 S. La Cienega Blvd.,  
 Los Angeles, Calif. 90016  
 Greyhound Package Express, 140 S. Dear-  
 born 10 S. Riverside Plaza, Chicago,  
 Ill. 60606  
 Griffiths Electronics, 1301 E. Linden,  
 Linden, N.J. 07036

**H**

H & H Equipment Co., Laotto, Ind. 46763  
 Hallamore Electronics, 714 N. Brookhurst  
 St., Anaheim, Calif. 92801

Hallicrafters Co., 4401 W. 5 Ave.,  
 Chicago, Ill. 60624  
 Hallmark Electronics, 436 N. 31 St.,  
 Philadelphia, Pa. 19104  
 Hallmark Instruments, 2620 Freewood Dr.,  
 Dallas, Tex. 75220  
 Hammarlund Mfg., 53 W. 23 St.,  
 New York, N.Y. 10010  
 Harman-Kardon Inc., 55 Ames Crt.,  
 Plainville, N.Y. 11803  
 Hartley Products, 521 E. 162 St.,  
 Bronx, N.Y. 10451  
 Hathaway Instrument, 5800 E. Jewell Ave.,  
 Denver, Colo. 80222  
 Heath Co., 305 Territorial Rd.,  
 Benton Harbor, Mich. 49022  
 Heintz & Kaufman Ltd., 3650 Hayden Ave.,  
 Culver City, Calif. 90230  
 Hewlett-Packard, 1501 Page Mill Rd.,  
 Palo Alto, Calif. 94304  
 Hickok Electrical Instrument, 10523 Dupont  
 Ave., Cleveland, Ohio 44108  
 Hi-Lo Mfg., 1122 Newport St., Chicago, Ill.  
 Hitachi (see Sampson Co.)  
 Hoffman Electronics Consumer Prods. Div.,  
 3761 S. Hill St., Los Angeles, Calif.  
 90007  
 Hollywood Television Wuerth Surgitron Div.,  
 1949 Moffett St., Hollywood, Fla.  
 Holub Industries Inc., Sycamore, Ill.  
 Honeywell Commercial Residential Div.,  
 2753 4 Ave., Minneapolis, Minn.  
 Hunter Sales R.N., 9851 Alburton Ave.,  
 Santa Fe Springs, Calif. 90670  
 Hycon Electronics, 1030 Arroyo Pkwy.,  
 Pasadena, Calif. 91105  
 Hy-Gain Electronics, 8473 N.E. Highway 6,  
 Lincoln, Neb.  
 Hysol Co., 322 Houghton, Olean, N.Y. 14760

**Discriminate Between  
 Desired Signal and  
 Unwanted Noise**

*with the*

**FREE SPACE  
 STANDING WAVE  
 MAGNETIC ANTENNA  
 UHF-VHF-FM-COLOR**

*Investigate now!*

**S&A Electronics Inc.**

*Manufacturers of the TARGET ANTENNA*

**Phone 419-693-0528**

**204 West Florence Street Toledo, Ohio 43605**

**SPEEDY  
 T.V.  
 COLOR  
 SPECIALISTS**

*“Wow! There's a color you don't see very often!”*

... for more details circle 127 on postcard



I  
 I E H Manufacturing Co., 102 Prince St.,  
 New York, N.Y. 10012  
 IERC Div., Box 271, Burbank, Calif. 91503  
 Illumitronic Engineering, 680 E. Taylor St.,  
 Sunnyvale, Calif.  
 Injectorall Co., 4 N. Great Neck N.Y. 11024  
 Institute of Electrical & Electronic  
 Engineers (IEEE), 72 W. 45th St.,  
 New York, N.Y. 10036  
 Int'l. Business Machines, 590 Madison Ave.,  
 New York, N.Y. 10022  
 Int'l. Correspondence Schools,  
 Scranton, Pa. 18515  
 Int'l. Crystal Mfg., 18 N. Lee,  
 Oklahoma City, Okla. 73102  
 Int'l. Electronics, 316 S. Service Rd.,  
 Melville, L.I., N.Y. 11746  
 Int'l. Rectifier, 233 Kansas St.,  
 El Segundo, Calif. 90245  
 IRC Inc., 401 N. Broad,  
 Philadelphia, Pa. 19108  
 I-T-E Circuit Breaker, 601 E. Erie Ave.,  
 Philadelphia, Pa. 19134  
 IT&T, 320 Park Ave., New York, N.Y. 10022  
 IT&T Components, 100 Kingsland Rd.,  
 Clifton, N.J. 07013  
 IT&T Distributor Products, 250 Broadway,  
 New York, N.Y. 10007

J  
 Jackson Electrical Instrument, 124  
 McDonough St., Dayton, Ohio 45402  
 J-B-T Instruments, 61 Hamilton,  
 New Haven, Conn. 06511  
 Jensen Industries Div. Electrovoice,  
 633 Cecil St., Buchanan, Mich. 49107  
 Jensen Mfg., 6601 S. Laramie,  
 Chicago, Ill. 60638  
 Jensen Tools, 3630 E. Indian School Rd.,  
 Phoenix, Ariz. 85018  
 Jerrold Electronics, 401 Walnut St.,  
 Philadelphia, Pa. 19132  
 Jersey Specialty Co., Box 576,  
 Mountain View, N.J.  
 Jetronic Industries, 4312 Main St.,  
 Philadelphia, Pa. 19127  
 JFD Electronics, 1462 62 St., Brooklyn, N.Y.  
 Johnson Co. E.F., 6516 10th Ave. S.W.,  
 Waseca, Minn. 56093  
 Jonard Industries Corp., 3047 Tibbett Ave.,  
 Bronx, N.Y. 10463  
 Jones & Laughlin, 401 Liberty,  
 Pittsburgh, Pa. 15222  
 Jones Div. Cinch Mfg., 1026 S. Homan,  
 Chicago, Ill. 60624  
 J W Electronics, 1538 W. Jarvis,  
 Chicago, Ill. 60626  
 JW Electronics, PO Box 51,  
 Bloomington, Ind. 47401

K  
 KLH Research & Devel, 30 Cross St.,  
 Cambridge, Mass. 02138  
 KTV Tower & Com. Equip. Co., PO Box 294,  
 Sullivan, Ill. 61951  
 Karr Engineering Co., 2998 Middlefield Rd.,  
 Palo Alto, Calif. 94306  
 Karg Laboratories, 162 Ely Ave. S.,  
 Norwalk, Conn. 06854  
 Karlson Assoc., 1610 Neck Rd.,  
 Brooklyn, N.Y. 11229  
 Kay Electric, 14 Maple,  
 Pine Brook, N.J. 07058  
 Kay-Townes Antenna Co., PO Box 593,  
 Rome, Ga. 30162  
 Kenwood Electronics, 3700 S. Broadway Pl.,  
 Los Angeles, Calif. 90007

THE BEST ANTENNA INSTALLATIONS START WITH . . .

## South River QUALITY MOUNTING ACCESSORIES

THE MOST COMPLETE LINE IN THE INDUSTRY

*South River* QUALITY BUILT, ANTENNA  
**PARAPET MOUNT**

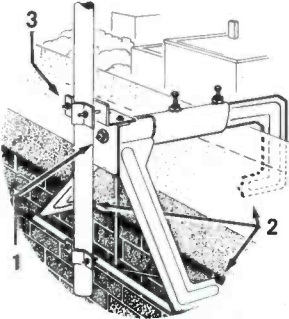

1. Mounts quickly, safely and securely by tightening one clamping bolt.
2. Three point contact insures uniform, positive, non-rocking grip.
3. Adjustable upper mast holder for vertical mast positioning.

■ Made of heavy gauge embossed steel, arc welded for extra strength and rigidity; hot-dip galvanized. ■ Adjustable for walls 4" to 13" thick. ■ Ideal for apartment house installations.

SEND FOR COMPLETE DATA SHEET

AT SOUTH RIVER QUALITY IS OUR MOST IMPORTANT PRODUCT

SOLD THROUGH DISTRIBUTORS

SOUTH RIVER METAL PRODUCTS CO., INC. / SOUTH RIVER, N. J. 08882

... for more details circle 133 on postcard

## MID-STATE TUNER SERVICE

Satisfied with second best? Mid-State offers absolute satisfaction and 24-hour service a necessity.



UHF VHF COLOR  
**\$950**

Mid-State is as close as your nearest post-office or United Parcel Service outlet. All units tracked and aligned to factory spec's, with crystal controlled equipment. Ninety day warranty. Mutilated or damaged tuners may take slightly longer if major parts are not in stock. Send complete with model and serial numbers and all damaged parts.

Put your confidence in Mid-State to take care of your tuner problems. "Remember" there is only one "Mid-State Tuner Service."

**COMBO'S — \$17.50**

Major Parts, Tubes, Transistors  
charged at Net Price

Distributors-Wholesalers  
Write for Price Sheet

**MID-STATE  
TUNER SERVICE**

Mid-State Tuner Service T-8  
1504 So. College, Box 1141  
Bloomington, Ind. 47401  
Tel: (812) 336-6003

... for more details circle 122 on postcard

Kepeco Inc., 131-38 Sanford Ave.,  
Flushing, N.Y. 11355  
Kester Solder, 4201 Wrightwood,  
Chicago, Ill. 60639  
Klipsch & Assoc., PO Box 96,  
Hope, Ark. 71801  
Kinematix Inc., 2040 W. Washington,  
Chicago, Ill. 60612  
Knob Corp. of America, 469 Jericho Tpk.,  
Mineola, N.Y. 11501  
Koss Inc., 2227 N. 31 St.,  
Milwaukee, Wis. 53208  
Krauter Tools, 332 South Michigan Ave.,  
Chicago, Ill. 60604  
Krylon Inc., Ford & Washington St.,  
Norristown, Pa.  
Kwikheat Mfg., 3731 San Fernando Rd.,  
Glendale, Calif. 91204

LA Turner Exchange, 4611 W. Jefferson,  
Los Angeles, Calif. 90016  
Lafayette Radio Electronic, 111 Jerico Tpk.,  
Syosset, L.I., N.Y. 11791  
Lakeside Industries, 5234 N. Clark St.,  
Chicago, Ill. 60640  
Lambda Electronics, 515 Broad Hallow,  
Huntington, N.Y. 11743  
Lampkin Labs, Bradenton, Fla. 33505  
Lance Antenna, 1730 1st St.,  
San Fernando, Calif. 91340  
Lansing Sound James B., 3249 Casitas Ave.,  
Los Angeles, Calif. 90039  
Larsen Electronics Inc., 11611 N.E. 50th  
Ave., Vancouver, Wash. 98665  
Lavoie Labs, Morganville, N.J. 07751  
Leach Corp., 18435 Susana Rd.,  
Compton, Calif. 90221

Lectrotech Inc., 1221 W. Devon Ave.,  
Chicago, Ill. 60626  
Ledex Inc., 123 Webster,  
Dayton, Ohio 45402  
Leeds & Northrup, 4907 Stenton,  
Philadelphia, Pa. 19144  
Lesaf America, 11 W. 42 St.,  
New York, N.Y. 10036  
Littelfuse Inc., Des Plaines, Ill.  
Litton Industries, 336 N. Foothill,  
Beverly Hills, Calif. 90210  
Los Angeles Turner Exchange, 4611 W.  
Jefferson, Los Angeles, Calif. 90016

M  
3M, 2501 Hudson Rd.,  
St. Paul, Minn. 55119  
Macdonald & Co., 213 So. Brand Blvd.,  
Glendale, Calif. 91204  
McIntosh Labs, 2 Chambers St.,  
Binghamton, N.Y. 13903  
Magnavox Co., 2131 Bueter Rd.,  
Ft. Wayne, Ind.  
Magnecord Div. Midwestern Instrument,  
PO Box 7186, Tulsa, Okla. 74105  
Magnettrack Box, 147 Caroline,  
Puerto Rico, U.S.A.  
Majestic Int'l., 743 LaSalle St.,  
Chicago, Ill. 60605  
Mallory & Co. P.R., PO Box 1558,  
Indianapolis, Ind. 46206  
Marantz, 25-14 Bdw.,  
Long Island City, N.Y. 11106  
Marconi Instruments, 111 Cedar Lane,  
Englewood, N.J. 07631  
Mark Products, 5439 W. Fargo,  
Skokie, Ill. 60076  
Master Mobile Mounts, 4125 W. Jefferson  
Blvd., Los Angeles, Calif. 90016  
Matsushita Electric Co., 200 Park Ave.,  
New York, N.Y. 10017  
Mercury Electronics, 315 Roslyn Rd.,  
Mineola, N.Y. 11501  
Mercury TV Tuner Service, 890 River,  
Bronx, N.Y.  
Merit Coil & Transformer, Merit Plaza,  
Hollywood, Fla.  
Metex Corp., 970 Durham Rd.,  
Edison, N.J. 08817  
Methode Mfg., 7447 W. Wilson Ave.,  
Chicago, Ill. 60656  
Metrex (UXL Corp.), 819 Blake Ave.,  
Brooklyn, N.Y. 11207  
Metritape Controls, 33 Sudbury Rd.,  
Concord, Mass. 01742  
Michigan Magnetics,  
Vermontville, Mich. 49096  
Microflame Inc., 7800 Computer Ave.,  
Minneapolis, Minn. 55424  
Midland Int. Corp., 1519-21 Atlantic N.,  
Kansas City, Mo. 64116  
Midland Industries Inc., 8219 W. Irving  
Blvd., Wichita, Kansas 67209  
Milgray/N.Y., 136 Liberty St.,  
New York, N.Y. 10006  
Millen Mfg. James, 150 Exchange,  
Malden, Mass. 02148  
Miller Co. J.W., 5917 S. Main,  
Los Angeles, Calif. 90003  
Milo Electronics, 530 Canal,  
New York, N.Y. 10013  
Monarch Elec. Int'l. Inc., 7035 Laurel  
Canyon Blvd. N., Hollywood, Calif.  
90028  
Monitorradio Div. Idea, 7900 Pendleton  
Pike, Indianapolis, Ind. 46226  
Mosley Electronics, 4610 N. Lindberg,  
Bridgeton, Mo. 63044  
Moss Electronics, 2435 White Plains Rd.,  
Bronx, N.Y. 10467

If you think you've already  
heard the last word  
in sound columns...



*You may be in for a little shock at  
Argos Booth #1207 at the NEW Show*

Argos engineers are constantly seeking new ways to revolutionize sound reproduction. For more than a decade, Argos has pioneered the sound column principle. Today, Argos manufactures the finest, most complete line of sound columns—the Sound Directors!

To put more profit in the sound business, Argos has condensed its years of field experience into a 12 page system planning booklet with an accurate, easy-to-use sound column selection chart. Unique features like "speedy mounting" clips and the exclusive built-in focus gauge make Sound Directors quick to install and aim with the turn of a screw.

More pioneering is on the way from Argos—extreme miniaturization, for example. And so, for sound profits without question, anytime, ask for the Argos Sound Column Story.

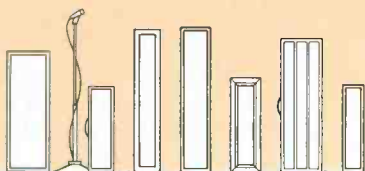

**Argos**  
PRODUCTS COMPANY

600 So. Sycamore, Genoa, Illinois 60135

... for more details circle 107 on postcard

*continued on page 78*



## Awards Recognize NBS WWV Radio

Transmissions from the National Bureau of Standards radio station, WWV, are used not only in the laboratories of industry, governments and educational institutions, but also by amateur radio operators around the world to calibrate their receivers and keep transmissions on-



frequency. WWV was recently honored by two awards, the WAS — "Worked All States" — given by the American Radio Relay League and the WAC — "Worked All Continents" — given by the International Amateur Radio Union. Both awards are prizes coveted by "hams" — amateur radio operators. Here David Andrews (right), recently retired chief of NBS Radio Broadcast Services, hangs the WAC award for Peter Viezbicke, Jr. (left), his successor, while Leo Honea, engineer-in-charge of WWV, positions the WAS award. Displayed in the left background of the photo are some of the QSL cards — verifications of reception — sent to WWV by hams of many countries. WWV transmits on 2.5, 5, 10, 15, 20, and 25MHz.

## Distributor TV-Radio Sales Up

February distributor sales of TVs and radios moved strongly upward, the Electronic Industries Assn.'s Marketing Services Dept. reports.

Color TV sales to dealers totaled 465,236 for the month, 30.3 percent above the February 1967 sales figure. The year-to-date total thus rises to 870,989 color TV sets distributed, 29.9 percent over the figure attained at the end of February 1967.

February sales to dealers of B/W TVs rose to 459,914 units, 7.2 percent over the same month in 1967. This strong showing pulls B/W year-to-date figures up over 1967 — 837,565 through February 1968 vs 827,236 for the same 1967 period.

Home radio sales to dealers in February reached 971,321 units, 12 percent over the February 1967 performance. Year-to-date home radio sales, totaling 1,642,867, were 7.5 percent over sales for the comparable period in 1967.

Auto radio distributor sales surged 17.6 percent over February 1967 — 760,418 units compared with 646,575 in 1967. Auto radio sales for the year through February thus showed 10.4 percent greater in 1968 than in 1967 — 1,518,921 compared with 1,376,241 in the former year.

Distributor sales of phonographs were more mixed. While portable and table models showed a February rise of 7.4 percent over the same 1967 month, console models were down by almost the same percentage. Likewise, a total phonograph rise in February of 2.5 percent was paralleled by a year-to-date performance showing a drop of 2.7 percent from 1967.

**MOST  
VERSATILE**

**TRIPLET**



**MODEL  
850  
\$93.00**

## MODEL 850 ELECTRONIC VOLT-OHMMETER IS BEST FOR YOU

### FACTS MAKE FEATURES:

- 1** Long 7" easy-to-read scale.
- 2** .5 D.C. volt range for transistor circuits.
- 3** HIGH STABILITY. Meter connected in cathode circuit of 12AU7.

High Input Impedance (11 MEGOHMS) and wide Frequency Ranges give this extremely versatile Electronic Volt-Ohmmeter considerable advantage in the measurement of DC voltages, AC RMS and Peak-to-Peak voltages. It measures directly the Peak-to-Peak values of high-frequency complex wave forms and RMS values of sine waves on separate scales.

**ADDED PROTECTION.** Meter is shorted out in OFF position for greater damping, meter safety during transit, electrically protected against accidental overload. ZERO CENTER mark for FM discriminator alignment, plus other galvanometer measurements.

New pencil thin test probe used for all functions: DC, AC, and ohms. No need to change cables. Beautifully styled case for professional appearance and functional utility, 7 $\frac{1}{8}$ " x 6 $\frac{1}{16}$ " x 3 $\frac{3}{4}$ ".

Carrying handle can be used as a tester stand to place the tester at 25° angle for ease in reading.

Frequencies to 250 MC may be measured with auxiliary Diode Probe, \$9.00 extra. DC voltages to 50 KV may be measured with auxiliary High Voltage Probe. \$25.20 extra.

**TRIPLET ELECTRICAL INSTRUMENT COMPANY, BLUEFTON, OHIO**

... for more details circle 136 on postcard

# now there are 3 time & tool-saving double duty sets

New PS88 all-screwdriver set rounds out Xcelite's popular, compact convertible tool set line. Handy midgets do double duty when slipped into remarkable hollow "piggyback" torque amplifier handle which provides the grip, reach and power of standard drivers. Each set in a slim, trim, see-thru plastic pocket case, also usable as bench stand.



PS88

5 slot tip,  
3 Phillips screwdrivers

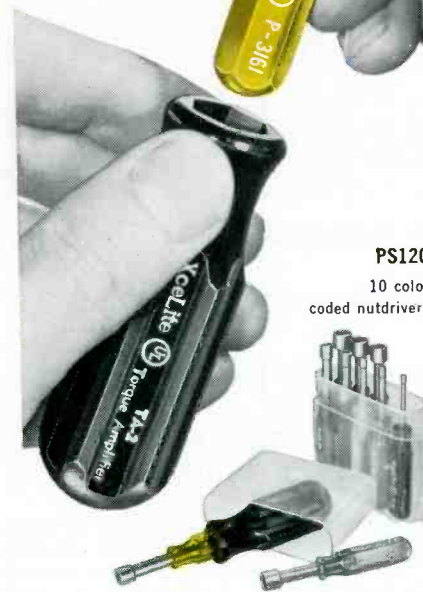

PS120

10 color  
coded nutdrivers



PS7

2 slot tip,  
2 Phillips screwdrivers,  
2 nutdrivers

WRITE FOR CATALOG SHEET N563



XCELITE, INC. 14 Bank St., Orchard Park, N.Y., U.S.A.  
Canada: Charles W. Pointon, Ltd., Toronto, Ont.

... for more details circle 141 on postcard

continued from page 76

Motorola Communications Div., 4501 W. Augusta, Chicago, Ill. 60651  
Motorola Consumer Prods., 9401 W. Grand Ave., Franklin Park, Ill. 60131  
Motorola Semiconductor Products, PO Box 955, Phoenix, Ariz. 85001  
Motorola Training Int., 4545 W. Augusta, Chicago, Ill. 60651  
Mueller Electric, 1583 E. 31 St., Cleveland, Ohio 44114 Mullard (see Int'l. Electronics, New York, N.Y.)  
Multicore Sales Corp., Westbury, N.Y. 11590  
Multitron Corp., 309 Queen Ann Rd., Teaneck, N.J. 07666  
Mura Corp., 380 Great Neck Rd., Great Neck, N.Y. 11021  
Muzak Co., 220 4 Ave., New York, N.Y. 10003

## N

National Radio Institute, 3939 Wisconsin Ave., Washington, D.C. 20016  
Neshaminy Electronics, Neshaminy, Pa.  
Newark Electronic, 223 W. Madison, Chicago, Ill. 60606  
Newcomb Audio Products Co., 12881 Bradley Ave., Sylmar, Calif. 91342  
Newtronics Corp., 3455 Vega Ave., Cleveland, Ohio 44113  
North American Philips (Norelco), 100 E. 42 St., New York, N.Y. 10017  
Nortronics Co., 8133 10th Ave. N., Minneapolis, Minn. 55427  
Nutone Inc., Cincinnati, Ohio

## O

Oak Mfg. Co., Crystal Lake, Ill. 60014  
Oaktron Industries, Monroe, Wis. 53566  
Oelrich Publications, 4308 Milwaukee Ave., Chicago, Ill. 60641  
Ohmite Mfg., 3673 Howard St., Skokie, Ill. 60076  
Olson Electronics, 464 S. Forge, Akron, Ohio 44308  
Olympic Radio & TV, 34-01 38 Ave., Long Island City, N.Y. 11101  
Ortron Electronics, 29 Lincoln Ave., Orange, N.Y.  
Oxford Transducers, 3911 S. Mich. Ave., Chicago, Ill. 60653

## P

Packard Bell Electronics, 12333 W. Olympic Blvd., Los Angeles, Calif. 90064  
Pace Communications Corp., 24049 Frampton Ave., Harbor City, Calif. 90710  
Palmer Electronics Laboratories, Lowell Rd., Carlisle, Mass. 01741  
Parker Metal Goods Co., 85 Prescott St., Wooster, Mass.  
Parts Unlimited Inc., 1 State St., Bloomfield, N.J. 07003  
Pearce-Simpson, PO Box 800 Biscayne Annex, Miami, Fla. 33152  
Perma-Power Co., 5740 N. Tripp Ave., Chicago, Ill. 60646  
Phaostro Instruments & Electronics, 151 Pasadena Ave. S., Pasadena, Calif. 91105  
Phelps Dodge Communications Products Div., Route 79, Marlboro, N.J. 07746  
Philco Corp., "C" and Tioga Sts., Philadelphia, Pa. 19134  
Philharmonic Radio & TV, 235 Jersey Ave., New Brunswick, N.J. 08901  
Pickering & Co., Sunnyside Blvd., Plainview, N.Y. 11803  
Pilot Radio, 100 Electra Lane, Yonkers, N.Y.  
Pioneer Electric & Research, Forest Park, Ill. 60130

## impedance mismatch problems?

When most voice coil impedances were either 3.2 ohms or 8 ohms, speaker replacement was relatively simple. Then came transistor sets, and equip-

ment without output transformers, and now voice coil impedances range all over the map.

It's important to remember that a mismatched impedance in a speaker replacement will almost surely create problems... from a loss of volume to a blown transistor.

## Quam... and only Quam... helps you avoid these problems these three ways:

**1. WIDE CHOICE**—As Photofacts/Counterfacts participants, we know in advance what voice coil impedance the new equipment will require, so we generally have the right speaker in our comprehensive line *when you need it.*

**2. VERSATILE SPEAKERS**—Quam *multi-tap speakers* offer a choice of impedances in a single unit. Available in all the sizes you need for automotive replacement, Quam multi-taps handle 10, 20, or 40 ohm applications.

**3. SPECIAL SERVICE**—Just in case you run across an oddball, we offer this convenient exclusive: *any Quam speaker can be supplied with any voice coil impedance, only \$1.00 extra, list price.*



**QUAM**

THE QUALITY LINE  
FOR EVERY SPEAKER NEED

**QUAM-NICHOLS COMPANY**  
234 East Marquette Road • Chicago, Illinois 60637

... for more details circle 125 on postcard  
ELECTRONIC TECHNICIAN/DEALER



## CRT Rebuilder



Rebuild your own CRT's. Average cost B/W \$1.50—Color \$8.50. Easy to operate. Requires only 4x8 feet of space.

Supplies for your first 50 picture tubes free!

Color — black and white. Rebuilt while you are here. See the results for yourself.

Terms Available

Lakeside Industries - Div. Associated Ind.  
5234 N. Clark St.  
Chicago, Ill. 60640  
Phone: 312-465-2881

- Free demonstration appointment  
 Send me more information

Name \_\_\_\_\_  
Address \_\_\_\_\_  
City \_\_\_\_\_ State \_\_\_\_\_

... for more details circle 119 on postcard

## BLUE STUFF... FOR THE PROFESSIONAL TECHNICIAN

First New Development in Tuner Care Since 1957  
**REVOLUTIONARY**



BLUE STUFF is NOT a liquid cleaner... It is a thick coating that gently cleans, polishes and re-lubricates each time the channel is changed. No drift, no oscillation, no callbacks. Nothing else like it.

### TECH SPRAY

2112 West Third Amarillo, Texas 79106

(Successors to the Chemical Division of Colman Electronic Products)

... for more details circle 135 on postcard

Planet Mfg. Corp., 225 Belleville Ave., Bloomfield, N.J. 07003

Pocket Socket Inc., 17415 Ecorse, Allen Park, Mich. 48101

Polytronics Laboratories Inc., 900 Burlington Ave., Silver Spring, Md.

Pamona Electronics Co., 1500 E. 9th St., Pomona, Calif. 91766

Potter & Brumfield, 107 N. 10th St., Princeton, Ind. 46017

Precise Electronics, 76 E. 2 St., Mineola L.I., N.Y. 11501

Precision Apparatus Div. of Dynascan, 1801 W. Belle Plaine Ave., Chicago, Ill. 60613

Precision Electronics Inc., 9101 King Ave., Franklin Park, Ill. 60131

Precision Tuner Service, PO Box 272, Bloomington, Ind. 47401

Pyramid Electronic Co., Darlington, S.C. 29532

### Q

Qualitone Industries, 102 Columbus Ave., Tuckahoe, N.Y. 10707

Quam-Nichols, 234 E. Marquette Rd., Chicago, Ill. 60637

Quan-Tech Labs, 60 Parsippany Blvd., Boonton, N.J. 07005

Quietrole Co., 395 St. John St., Spartanburg, S.C. 29302

### R

Radar Devices Mfg. Corp., 22003 Harper Ave., St. Clair Shores, Mich. 48080

R C A Components and Devices Div., 415 S. 5 St., Harrison, N.J. 07029

RCA Semiconductor Dist. Prod. Div., 415 S. 5 St., Harrison, N.J. 07029

RCA Parts and Accessories, 2000 Clements Bridge Rd., Deptford, N.J. 08096

RCA Set Div., 600 N. Sherman Dr., Indianapolis, Ind. 46201

RFS Industries, 102 Harbor Rd., Port Washington, N.Y. 11050

RMS Electronics Inc., 2016 Bdwy., New York, N.Y. 10023

Radiart Co., 2900 Columbia, Indianapolis, Ind. 46205

Radio Receptor, 240 Wythe, Brooklyn, N.Y. 11211

Radio Shack, 730 Commonwealth, Boston, Mass.

Rauland Corp., 4245 N. Knox, Chicago, Ill. 60630

Rawn Co., Spooner, Wis. 54801

Ray-O-Vac Co., 212 E. Washington St., Madison, Wis. 53703

Raytheon Communications Prod., 213 Grand St., San Francisco, Calif.

Raytheon Distributor Products, Div. 55 Chapel, Newton, Miss. 39345

R-Columbia Products, 305 Waukegan Ave., Highland, Ill. 60040

Recoton Corp., 52-35 Barnett, Long Island, N.Y. 11104

Record-O-Phone Div., ElectroSpace Corp., 408 Concord Ave., N.Y. 10451

Reeves Soundcraft, Great Pasture Rd., Danbury, Conn. 06810

Regency Electronics, 7900 Pendleton Pike, Indianapolis, Ind. 46226

Rego Insulated Wire, 830 Monroe, Hoboken, N.J. 07030

Rek-O-Kut Co., 38-19 108 St., Corona, N.Y. 11368

Robert Electronics, 829 N. Highland Ave., Hollywood, Calif. 90028

Robert Bosh Corp. Blaupunkt Car Radio Div., 40-25 Crescent, Long Island City, N.Y. 11101

Robins Industries, 1558 127 St., College Pt., N.Y. 11356

## New Amphenol Transistor Analyzer with easy-to-read GOOD/BAD meter scale eliminates manual reference time.



This is the Model 830 "Transistor Commander." Easy and quick tests can now be made thanks to the exclusive Good/Bad meter scale. No more lengthy cross-references from manuals or transistor specifications. You know immediately the condition of the transistor. Other features of this unique instrument include the ability to check high and low power NPN and PNP power transistors for in-circuit dc beta characteristics; check high and low power NPN and PNP transistors out-of-circuit for dc beta, ICBO and ICEO leakage; check diodes and rectifiers for in-circuit open conditions, shorts and the ability to rectify; and check diodes out-of-circuit for forward and reverse currents.

The new 830 TRANSISTOR COMMANDER combines semiconductor checks with the ability to measure supply voltages to 100 v d-c using the same probes the operator uses in other checks.

Only 9 1/4" wide, 5 3/4" high and 6 3/8" deep, the Model 830 comes complete with built-in 117 v a-c power supply.

Dealer net..... \$79.95

For complete specifications on the Model 830 or any of Amphenol's professional test equipment write Amphenol Distributor Division, Dept. ET4 68, 2875 S. 25th Ave., Broadview, Ill. 60153.



## AMPHENOL

Don't forget to ask what else needs fixing

... for more details circle 104 on postcard

Give your CB mobile antenna sales this **PROFESSIONAL "SPRING" TUNE-UP!**

Antenna Specialists does it again—with the newest, slickest "Hot Rod" in mobile CB antennas! All the high-performance, high-reliability features of the famous M-67... now with a beautiful and functional stainless steel shock spring. Get up and go for more sales!

**M-124**  
for 3/4" hole

**M-125**  
3/4" hole,  
snap-in mount

**M-123**  
Like M-125  
less spring

**M-126**  
Shock  
Spring Kit—  
converts M-67,  
M-73, M-74

Only 46" short  
equally suitable  
for deck, cowl or  
roof mount.

**"SUPER  
MAGGIE  
MOBILE"**

(every high-powered  
combination you can think of)

**the  
antenna  
specialists co.**

12435 Euclid Ave., Cleveland, Ohio 44106  
see your A/S rep for details!



T.M. "Stripes of Quality"

Rockbar Corp., 650 Halstead,  
Mamaroneck, N.Y. 10543  
Rohm Mfg., 116 Limestone St.,  
Peoria, Ill.  
Rustrak Instrument, 130 Silver,  
Manchester, N.H. 03103

**S**

S&A Electronics, 204 W. Florence St.,  
Toledo, Ohio 43605  
Sadelco Inc., 601 W. 26th St.,  
New York, N.Y. 10001  
Salch & Co. Herbert Marketing Div.,  
Tompkins Radio Prod., Woodsboro,  
Texas, 78393  
SECO Electronics Corp., 1205D S. Clover,  
Minneapolis, Minn. 55420  
Sampson Co., 2244 S. Western Ave.,  
Chicago, Ill. 60608  
Sangamo Electric, 1301 N. 11st.,  
Springfield, Ill. 62702  
Sansui Electronics Corp., 34-43 56th St.,  
Woodside, N.Y. 11377  
Sargent Gerkhe Co., 323 W. 15th St.,  
Indianapolis, Ind. 46202  
Sarkes Tarzian Tuner Service,  
537 S. Walnut, Bloomington, Ind. 47401  
Sarkes Tarzian Tuner Service,  
547-49 Tonnele, Jersey City, N.J. 07307  
Sarkes Tarzian Tuner Service,  
10654 Magnolia N., Hollywood, Calif.  
90028  
Schematic Library, 809 N. 7th St.,  
Phoenix, Ariz. 85006  
Schober Organ, 43 W. 61,  
New York, N.Y. 10023  
Scott Inc., HH 111 Powdermill Rd.,  
Maynard, Mass. 01754  
Seco Electronics, 1201 W. Clover Dr.,  
Minneapolis, Minn.  
Semitronics Corp., 265 Canal St.,  
New York, N.Y. 10013  
Sencore Inc., 426 S. Westgate Rd.,  
Addison, Ill. 60101  
Sentry Electronics Inc., 707 S. Okfuskee,  
Wewoka, Okla. 74884  
Setchell-Carlson, New Brighton,  
St. Paul, Minn. 55112  
Sherwood Electronic Labs,  
4300 N. California Ave., Chicago, Ill.  
60618  
Shure Brothers, 22 Hartrey Ave.,  
Evanston, Ill. 60202  
Signalite, Inc., Neptune, N.J.  
Simpson Electric, 5200 W. Kinzie St.,  
Chicago, Ill. 60644  
Singer Co., 3211 So. LaCienega Blvd.,  
Los Angeles, Calif. 90016  
Slep Electronic Co., Automotive Div.,  
PO Box 178, Ellenton, Fla. 33532  
Smith Inc., Herman H., 2326 Norstrand,  
Brooklyn, N.Y. 11210  
Snyder Mfg., 22 & Ontario,  
Philadelphia, Pa.  
Sola Electric, 1717 Busse Rd.,  
Elk Grove Village, Ill.  
Sonar Radio, 73 Wertman Ave.,  
Brooklyn, N.Y.  
Sonotone Corp., Elmsford, N.Y. 10523  
Sony Corp of America 580 5 Ave.,  
New York, N.Y. 10036  
Sorensen Prods Div., Raytheon S.,  
Norwalk, Conn.  
Soundolier Inc., PO Box 3848,  
St. Louis, Mo.  
South River Metal Products, 377 Tpk. Rd.,  
South River, N.J. 08882  
Sprague Products, 65 Marshall St. N.,  
Adams, Mass. 01247

Sprayon Products Inc., Bedford Heights,  
Ohio. 44146  
Stockpole Carbon Electronics Div.,  
St. Marys, Pa.  
Stancor Electronics, 3501 W. Addison,  
Chicago, Ill. 60618  
Standard Instrument Corp., 657 Broadway,  
New York, N.Y. 10012  
Standard Kollsman Industries,  
2085 N. Hawthorne, Melrose Park, Ill.  
60160  
Stromberg-Carlson Div., General Dynamics,  
1400 N. Goodman St., Rochester N.Y.  
14609  
Sturtevant Co., PA, Addison, Ill. 60101  
Superelex Electronics Corp., 4 Radford Place,  
Yonkers, New York  
Superior Electronics, 208-212 Piaget Ave.,  
Clifton, N.J. 07011  
Swing O Lite Inc., 13 Moonachie Rd.,  
Hackensack, N.J.  
Switchcraft Inc., 5555 N. Elston,  
Chicago, Ill. 60603  
Sylvania Electronic Products, 730 3 Ave.,  
N.Y., N.Y. 10017  
Sylvania Electronic Tube Div.,  
Seneca Falls, N.Y. 13148  
Symphonic Radio & Electronic,  
10 Columbus Circle N., New York, N.Y.  
10023

**T**

Tab Books, Monterey & Pinola Ave.,  
Blue Ridge Summit, Pa. 17214  
TACO, Sherburne, N.Y. 13460  
TRX Electronic Corp., 200 Park Ave. S.,  
New York, N.Y. 10003  
TV Tuner Service, 2103 W. 3 St.,  
Bloomington, Ind. 47401  
TV Tuner Service, 118 3rd St., W.,  
Twin Falls, Idaho 83301  
Talk A Phone Co., 5013 N. Kedzie Ave.,  
Chicago, Ill. 60625  
Tandberg of America, 83 Ave., Pelham, N.Y.  
10803  
Tap A Line Mfg., PO Box 563,  
Pompano Beach, Fla. 33061  
Tech-Master, 75 Front St., Brooklyn, N.Y.  
11201  
Techni-Parts Corp., 156 Hempstead Tpk.,  
W. Hempstead, L.I., N.Y. 11552  
Techpress Inc., Brownsburg, Ind. 46112  
Tektronix Inc., PO Box 500, Beaverton, Ore.  
97005  
Telerad Div. Lionel Corp., Route 69-202,  
Flemington, N.J. 08822  
Telex Inc., 3054 Excelsior, Minneapolis,  
Minn. 55416  
Telex/Aemco Div., Telex Inc.,  
Mankato, Minn. 56001  
Teleonic Industries, 60 N. 1 Ave.,  
Beech Grove, Ind. 46107  
Telvac Instrument Co., 18531 Ventura Blvd.,  
Tarzana, Calif. 91356  
Tenatronics Ltd., 1011 Power Ave.,  
Cleveland, Ohio 44114  
Tenna Mfg., 19201 Cranbrook Pkwy.,  
Cleveland, Ohio  
Tennalab, 10 & State St.,  
Quincy, Ill. 62301  
Terado Co., 1068 Raymond Ave.,  
St. Paul, Minn. 55108  
Texas Crystals, 1000 Crystal Dr.,  
Ft. Myers, Fla. 33901  
Thomas & Betts Co., Inc., 36 Butler St.,  
Elizabeth, N.J. 07207  
Thomas Electronic Organs,  
8345 Hayvenhurst Ave.,  
Sepulveda, Calif. 91343

... for more details circle 106 on postcard



Thordarson-Meissner, 7 & Belmont, Mt. Carmel, Ill. 62863

Thorens Div., Atlantic & Steward Aves., ELPA Mktg., Ind., New Hyde Park, N.Y. 11040

Toshiba Mitsui & Co., 530 5 Ave., New York, N.Y. 10036

Tram Electronics, Lower Bay Road, PO Box 187, Winnisquam, N.H. 03289

Trav Ler Radio, 571 W. Jackson, Chicago, Ill. 60606

Triad Transformer, 4055 Redwood Ave., Venice, Calif. 90291

Trio Mfg., Griggsville, Ill. 62340

Triplett Electrical Instrument, 286 Harmon Rd., Bluffton, Ohio 45817

Tung-Sol Electric, 1 Summer Ave., Newark, N.J. 07104

Turner Co., 918 17 St. N.E., Cedar Rapids, Iowa 52401

## U

Ullman Devices, Ridgefield, Conn. 06877

Ungar Co., Sid, 1880 Rayford Dr., Los Angeles, Calif. 90045

Ungar Electric Tools, 2701 W. El Segundo Blvd., Hawthorne, Calif. 90250

Union Carbide, 270 Park Ave., New York, N.Y. 10017

Useco Div., Litton Industries Inc., 13536 Saticoy St., Van Nuys, Calif. 91402

Utah Electronics, 1123 E. Franklin St., Huntington, Ind. 46750

U Test M Mfg., 4325 W. Lincoln, Milwaukee, Wis. 53219

United Transformer, 150 Varick St., New York, N.Y. 10013

University Loudspeakers Div., Ling Temco Vought, 9500 W. Reno St., Oklahoma City.

Up Right Towers, 1013 Pardee St., Berkeley, Calif. 94710

Utah Radio & Electric Corp., 1123 E. Franklin St., Huntington, Ind. 46750

Utica Drop Forge & Tool, 2415 Whitesboro, Utica, N.Y. 13502

Utica Electronic Communications, 2714 W. Irving Pk., Chicago, Ill. 60618

V.M. Corp., 4 & Park Sts.,

Benton Harbor, Mich. 49022

Vaco Products, 510 N. Dearborn, Chicago, Ill. 60610

Valley TV Tuner Service, 5641 Cahuenga Blvd. N., Hollywood Calif. 90028

Vector Electronic, 1100 Fowler St., Glendale, Calif.

Victoreen Instrument, 5806 Hough Ave., Cleveland, Ohio 44103

Vidair Electronics, 365 Babylon Tpk. Roosevelt, L.I., N.Y. 11575

Video Industries Co., 242 Madison Ave., Port Chester, N.Y. 10573

Viking Cable Co., 400 9th St., Hoboken, N.J. 07030

Viking of Minnesota, 9600 Aldrich St., Minneapolis, Minn.

Viking Electronics, 830 Monroe, Hoboken, N.J. 07030

Vitramon Inc., Box 544, Bridgeport, Conn. 06601

Vocaline Co. of America, 133 Colter St., Old Saybrook, Conn. 06475

Volkswagen of America, 476 Hudson, Terrace Englewood Cliffs, N.J. 07632

## W

Waber Electronics, 200 N. 2nd St., Philadelphia, Pa. 19106

Walco Electronics, 60 Franklin St., East Orange, N.J. 07017

Waldom Electronics, 4625 W. 53 St., Chicago, Ill. 60623

Wall Mfg. Co., P, Grove City, Pa. 16127

Waller Corp., Crystal Lake, Ill. 60014

Wallin-Knight Industries, 3321 McKinley St. NE., Minneapolis, Minn. 55108

Walsco Electronics, S. Wyman St., Rockford, Ill. 61101

Ward Leonard Electric, 115 McQueston Pkwy, Mt. Vernon, N.Y.

Ward Products, Edsom St., Amsterdam, N.Y. 12010

Weathers Industries, 66 E. Gloucester Pike, Barrington, N.Y. 08007

Webcor Inc., 5626 Bloomingdale Ave., Chicago, Ill. 60639

Weller Electric, 601 Stone Crossing Rd., Easton, Pa.

Wells-Gardner, 2701 N. Kildare Ave., Chicago, Ill. 60639

Wen Products, 5810 Northwest Hwy, Chicago, Ill. 60631

Western Electric Co., Inc., 195 Broadway, New York, N.Y. 10007

Western Tuner Rebuilders, 1140 N. Vermont Ave., Los Angeles, Calif. 90029

Westinghouse Electric Radio TV Dept., Metuchen, N.J. 08840

Westinghouse Electric Corp., Tube Div., PO Box 284, Elmira, N.Y. 14902

Wilco Co., 4425 Bandini Blvd., Los Angeles, Calif. 90023

Windsor Electronics, 999 N. Main St., Glen Ellyn, Ill. 60137

Winegard Co., 3019 Kirkwood, Burlington, Iowa 52601

Wire Products Co., 1215 South Ave., Syracuse 7, N.Y.

Workman Electronic Products, Box 5297, Sarasota, Fla. 33579

Worner Electronic, Rankin, Ill. 60960

Wuerth Tube Saver Corp., PO Box 66, Hollandale, Fla.

Wurlitzer Co., N. Tonawanda, N.Y. 14150

# NOW... a complete color bar generator for the pro's.



Amphenol's NEW Deluxe Color Commander, Model 865, incorporates advanced features for your protection against obsolescence . . . and to save you time!

Three color patterns: (1) exclusive single-bar, (2) exclusive three-bar, (3) familiar ten-bar gated rainbow. Plus, six line and dot patterns. To top it all off—instant pattern stability from 0° to +125°F without using old-fashioned heaters. True AC/DC operation.

The simplified controls on the Color Commander reduce the time you must spend working on the customer's set and increase the number of set repairs you can complete. *That means more profit for you!*

Other features that separate the Amphenol Deluxe Color Commander from other color alignment equipment: color coded control panel. Two preset channels. Built-in gun killers with lead piercing clips. Laminated gloss-epoxy circuit boards. Storage space for leads and tools. Automatic shut-off. Luggage-type case measures 8¾" wide, 7⅞" high, 5½" deep and the whole unit weighs only 4¼ pounds. Runs on AC line or batteries.

There's a lot more you'll like about the Deluxe Color Commander. Only \$189.95. Stop at your nearest Amphenol distributor and ask to see it. Don't know who your Amphenol distributor is? Write Dept ET3-68 Amphenol Distributor Division, 2875 S. 25th Avenue, Broadview, Ill. 60153. We'll give you his name.



**AMPHENOL**

... for more details circle 105 on postcard

## FIELD ENGINEERS Medical Electronics

Our Medical X-Ray division needs qualified technicians at various locations to install, service and repair sophisticated Medical X-Ray/CCTV systems.

Requirements include electronic schooling, experience in installing and maintaining electronic apparatus plus a knowledge of medical x-ray equipment or a willingness to be trained.

- LIBERAL SALARIES
- MANY COMPANY BENEFITS
- A GROWTH INDUSTRY
- MAJOR METROPOLITAN LOCATIONS

Write indicating current salary to:

MARTIN G. WOLFERT

NORTH AMERICAN PHILIPS CO., Inc.  
100 E. 42 St., New York, N.Y. 10017

**Norelco**®

An Equal Opportunity Employer

... for more details circle 123 on postcard

# THERMAL INTERMITTENT COMPONENT LOCATOR



**COOLS FASTER!**  
**LEAVES NO LIQUID  
RESIDUE!**

SUPER FROST-AID is the latest in Chemtronics' contribution to improving servicing chemicals. SUPER FROST-AID is a faster, higher concentrated freezing action with **NO LIQUID RESIDUE**. Makes locating those "tough" intermittents much faster and more positive. CHEMTRONICS leads in research for the **DISCRIMINATING SERVICE-MAN!**

15 OZ. SPRAY CAN  
**\$279**  
No. 1550



**COLOR LUBE**  
**NON-DRIFT COLOR TV  
TUNER CLEANER**

A tuner cleaner specially formulated with TC-5 to safely clean and lubricate all color T.V. tuners.

- Will not detune tuners
- Safe for all plastics
- Non-flammable

No. CL 8



BROOKLYN N. Y. 11236  
... for more details circle 110 on postcard

**X**  
Xacto Inc., 48-41 Van Dam St.,  
Long Island City, N.Y. 11101  
Xcelite Inc., 12 Bank St.,  
Orchard Park, N.Y. 14127

**Y**  
Yeats Appliance Dolly Sales Co.,  
2124 N. 12th St., Milwaukee, Wis.  
53205

**Z**  
Zenith Sales Corp., 6001 W. Dickens,  
Chicago, Ill. 60639

## SEMICONDUCTORS . . .

*continued from page 50*

biased. Under these conditions, diode  $d_1$  is capable of conducting a significant current at any reasonable voltage and diode  $d_2$  is capable of conducting a significant current when the applied voltage exceeds its breakdown voltage.

When the polarity of the applied voltage is reversed (the bottom lead now more positive than the top lead), the conditions in the two zener diodes are reversed. Diode  $d_2$  is now forward biased and capable of conducting a significant current at any reasonable voltage, while diode  $d_1$  is now reverse biased and capable of conducting a significant current only when the applied voltage exceeds its breakdown voltage.

Because of the characteristics described, the polarity of the voltage applied to the thyrector is insignificant. The thyrector has a relatively high internal resistance that breaks down only when the applied ac voltage or dc voltage of either polarity exceeds its zener breakdown voltage (Fig. 13).

The next article in this series will complete the description of semiconductors most commonly used in power supplies and power regulating circuits. The semiconductors covered will include four-layer diodes, SCR diodes, diacs and triacs.

### Erratum

The patent number referred to in Fig. 9 of the April 1968 Semiconductors From A to Z article was in error. The published French Patent, "Appareil Phonographique," is no. 1,502,481.

## ADVERTISERS' INDEX

Aerovox Corp. ....	68
Alliance Mfg. Co. ....	36
Amperex Electronic Corp. ....	3rd Cover
Amphenol Distributor Products ....	79, 81
Antenna Specialists Co. ....	80
Argos Products Co. ....	76
B & K Div., Dynascan Corp. ....	2nd Cover
Belden Corp. ....	34-35
Borden Chemical, Krylon Div. ....	63
Chemtronics, Inc. ....	82
Clarostat Mfg. Co. ....	22
Cleveland Institute of Electronics ....	25
Delco Radio Division ....	31
Electro-Voice, Inc. ....	72
ET/D Book Club ....	65
Finney Co. ....	71
Gavin Instruments, Inc. ....	61
General Electric Co. ....	69
International Crystal Mfg. Co. ....	26
Jerrold Electronics Co. ....	67
JFD Electronics Co. ....	27
Kay-Townes Antenna Co. ....	64
Lakeside Industries ....	79
Lampkin Laboratories ....	70
Mallory Distributor Products ....	20
Mid-State Tuner Service ....	75
Norelco ....	81
Oaktron Industries ....	68
Quam-Nichols Co. ....	78
Quietrol Co. ....	70
Radio Corp. of America RCA Electronic Compents ....	4th Cover
S & A Electronics, Inc. ....	74
Sencore, Inc. ....	24, 30, 60, 73
Simpson Electric Co. ....	33
South River Metal Products Co. ....	75
Sprague Products Co. ....	23
Sylvania Electric Products, Inc. ....	59
Tech Spray ....	79
Triplett Electrical Instrument Co. ....	77
Tuner Service Corp. ....	19
Weller Electric Corp. ....	32
Winegard Co. ....	56-57
Xcelite, Inc. ....	78
Zenith Sales Corp. ....	29





# RCA HI-LITE... the replacement picture tube with “new set” quality

Offer your customers a replacement color picture tube that truly meets OEM specs! RCA HI-LITE picture tubes are RCA's best...the same quality...the same tubes...that go into original equipment sets...with **all new glass, gun, the works**. And because they incorporate the latest technological advances of the world's leading color picture tube manufacturer, they offer picture brightness and color fidelity at its finest. Serving your needs with the broadest line of types in the industry, including 15-inch, 19-inch, 22-inch and 25-inch rectangular and 21-inch round tube types. RCA Electronic Components, Harrison, N. J.

## RCA

