

ELECTRONIC TECHNICIAN

WORLD'S LARGEST ELECTRONIC TRADE CONFERENCE

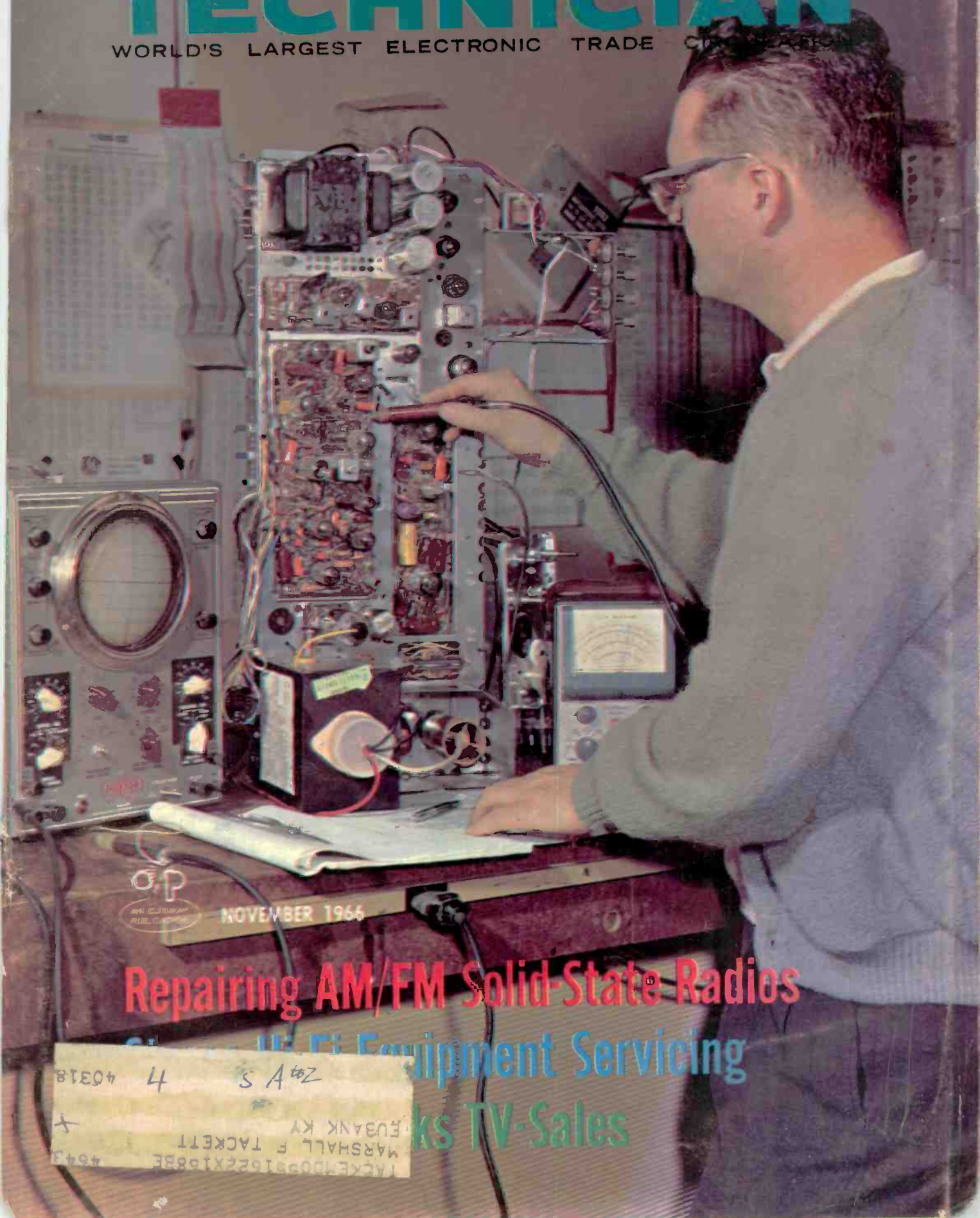

NOVEMBER 1966

Repairing AM/FM Solid-State Radios

Hi-Fi Equipment Servicing

TV-Sales

4643 TACKER00991622X1588E
MARSHALL F TACKETT
EVANSVILLE KY
46018 4 S A to Z

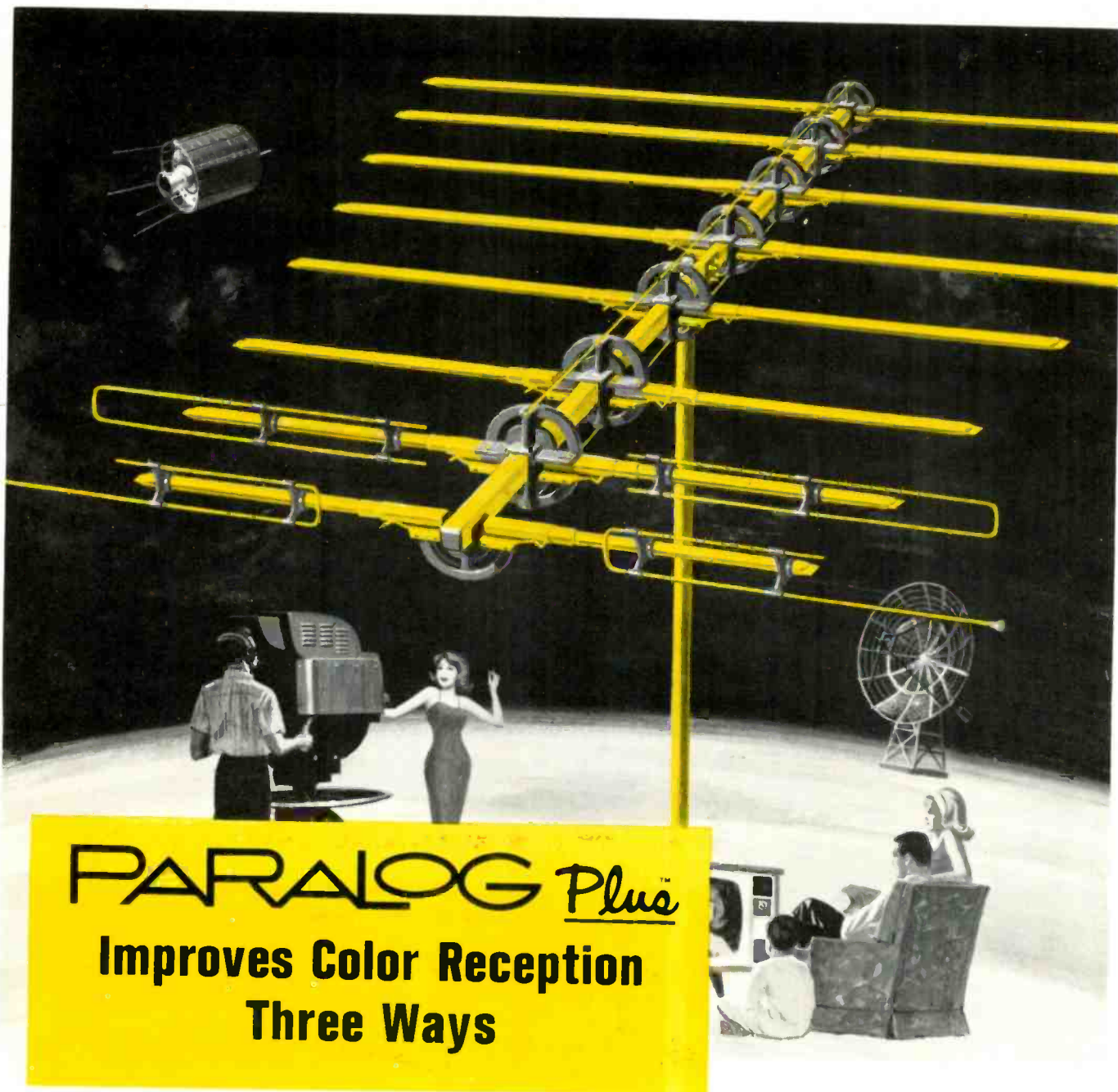

PARALOG *Plus*TM

Improves Color Reception Three Ways

1. Plus GAIN—to provide sharper directivity to eliminate multipath reception.

2. Plus FLATNESS—to eliminate tilts which cause incorrect colors on the TV screen. Industry experts say that color antennas must be flat within ± 2 db. Paralog-Plus antennas are flat within ± 1 db per channel.

3. Plus MATCH—to prevent color-distorting phase shifts.

The unique feature of the Paralog-Plus is a BI MODAL DIRECTOR system. Its parasitic elements combine two hi-band directors into a single director covering all lo-band channels, plus the entire FM band. Thus, more of the elements work to bring in any given channel.

Plus—300 and 75 ohm outputs for match to *either* twinlead or coax. And full, flat gain over the entire FM band.

Plus these quality mechanical features: Self-cleaning wedge-snap locks that tighten with vibration, Cyclocac insulators to eliminate cumbersome cross feed points, Golden Armor coating, Square boom construction, One-piece antenna array—and more.

Check on how these plus features can help make plus profits for you. See your Jerrold distributor, or write:

DISTRIBUTOR SALES DIVISION
401 Walnut St., Phila., Pa. 19105

JERROLD

... for more details circle 128 on postcard

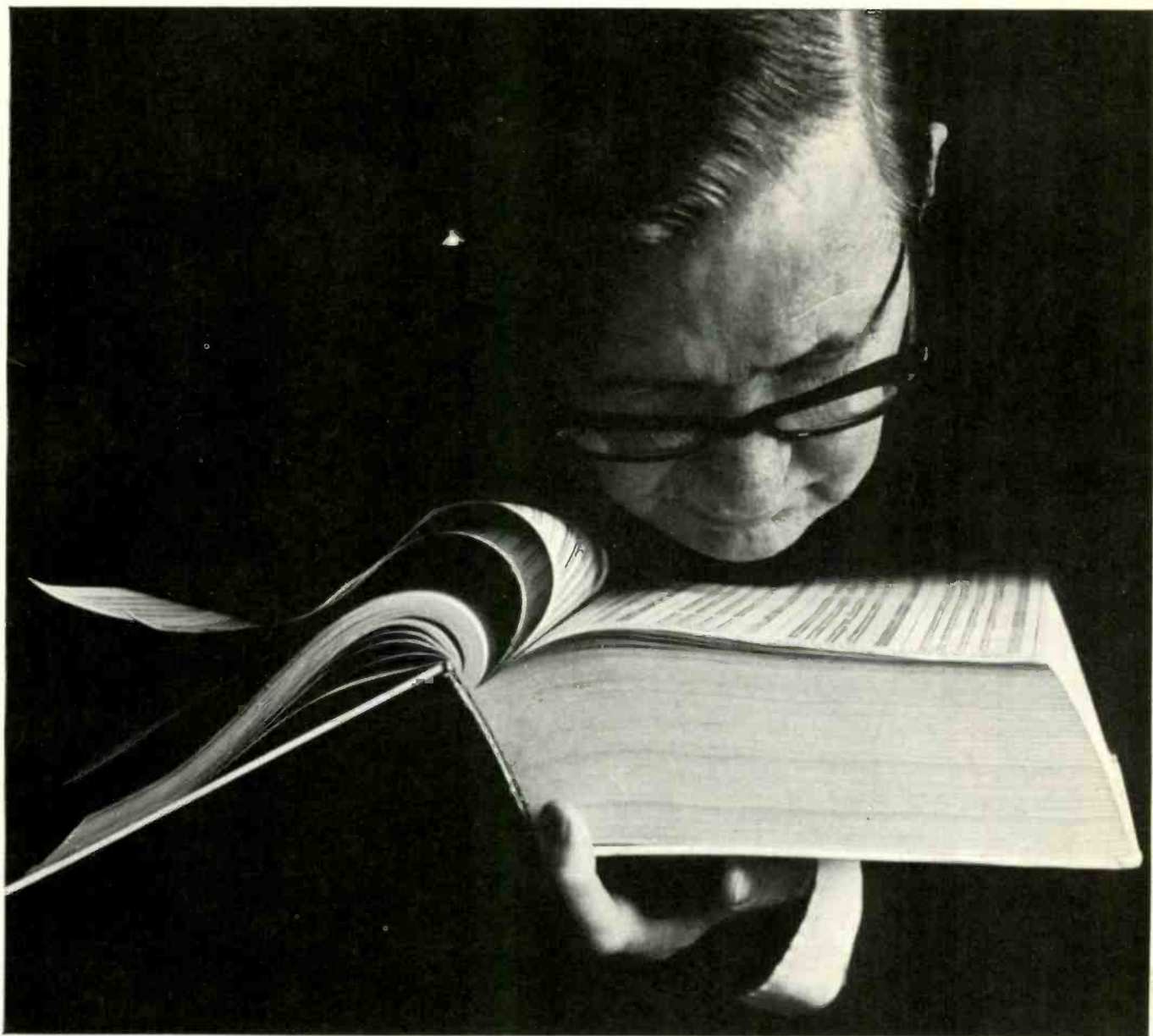

Listen!

Service dealers... stop playing the numbers game

If you're in the service business you're selling time. And tracking down loudspeaker numbers can be a real waste of it.

Get out of the speaker numbers game and turn wasted time into profit by remembering this: Jensen has every replacement speaker in the book. You tell the Jensen distributor the type of speaker you

need and he'll take one right off the shelf. That's fast.

Another nice thing about Jensen speakers is that they make the set sound better than new.

So when it comes to loudspeakers, the only number you need to remember is the telephone number of your Jensen distributor. You name it—radio, television, automo-

tive, intercom, electronic musical instrument or hi-fi—he's got a loudspeaker for everything.

Call him now. If you don't have the name of your Jensen distributor we'll send it to you.

Write to us: Jensen Manufacturing Division, The Muter Company, 6601 South Laramie Avenue, Chicago, Illinois 60638.

jensen

Get this \$65 RCA color TV course

FREE



RCA INSTITUTES, INC.
A SERVICE OF RADIO CORPORATION OF AMERICA
HOME STUDY SCHOOL
48 West 48th Street, New York 18, New York
Approved for Enrollment
Through the
RADIO CORPORATION OF AMERICA
Electronic Test Equipment, Harrison, New Jersey

I hereby apply for enrollment in the following RCA Institution course in accordance with the terms and conditions on both sides of this paper.

Color Television Course 3-T **FEE PAID**

Name: _____
 Home Address: _____
 City: _____ State: _____
 Zip: _____
 General Education (circle number of years completed):
 0 1 2 3 4 5 6 7 8 9 10 11 12
 Name and address of last school: _____
 Technical or advanced education: _____
 Accepted by RCA Institutes, Inc., at New York, N. Y., _____
 Registrar Date: _____

When this form is completely filled out and returned, the course is enrolled to the candidate RCA Institutes Color TV Course. Enrollments further subject to free examinations, examining services and a Certificate of Graduation in accordance with terms listed on the reverse side.

Student Number: _____

when
you buy
this



WR-64B RCA Color Bar/DoV/Crosshatch Generator

or this



WR-69A RCA TV-FM Sweep Generator

or this



WR-99A RCA Marker Generator

or this



WO-91B RCA 5" Scope

That's right! RCA Institutes famous Home Study Color TV Servicing Course FREE, when you buy ANY ONE of the instruments shown here. Buy all four...get four courses. Enroll all your technicians while you equip your shop with the instruments you'll need for color TV servicing anyway.

Here's how it works: Simply buy one, or all, of the four instruments shown, the WR-64B, WR-69A, WR-99A, or WO-91B—ALL essential color TV test instruments—from your Authorized RCA Test Equipment Distributor between now and November 15, 1966. Fill out your warranty registration card and attach the white identification label on the carton. Send them to RCA, Test Equipment Headquarters, Bldg. 17-2, Harrison, New Jersey. We will send you the enrollment form and a binder

containing the first two lessons. When you complete the lessons and forward them to RCA Institutes for grading, the next lessons will be supplied to you directly from RCA Institutes, all without charge to you.

But do it now. This offer is good only for equipment purchased between September 1, and November 15, 1966. To allow for postal delay, we will honor cards received up until December 1, 1966. Here's your chance to equip your shop for color servicing while we train your people for FREE!

Electronic Components and Devices, Harrison, N.J.



The Most Trusted Name in Electronics

NOVEMBER 1966

VOL. 84 NO. 5

ELECTRONIC TECHNICIAN

WORLD'S LARGEST ELECTRONIC TRADE CIRCULATION

RON KIPP Publisher
 JACK HOBBS Managing Editor
 JOSEPH ZAUHAR Technical Editor
 PHILLIP DAHLEN Associate Editor
 DONALD GRANT Assistant Editor
 RICHARD CLAYTON Field Editor
 JUDITH BERINI Editorial Production
 MAGGIE KANE Advertising Production
 RUTH GELINEAU Circulation Fulfillment



AN OJIBWAY
PUBLICATION

OJIBWAY PRESS, Inc.

Ojibway Building, Duluth, Minn. 55802

AREA CODE 218 727-8511

PUBLICATIONS DIVISION:

ROBERT EDGELL President
 ANGUS STONE Marketing Manager
 BEN MARSH Editorial Director
 HARRY RAMALEY Production Director
 JIM GHERNA Art Director
 JOE WOLKING Circulation Director
 WARREN BODIN Ad Production Supervisor

Sales Offices:

NEW YORK: Ron Kipp, 25 W. 45 St.
 New York, N.Y. 10036
 AREA CODE 212 583-4200

CHICAGO: Jack Daniels, 43 E. Ohio St.
 Chicago, Ill. 60611
 AREA CODE 312 467-0670



Copyright 1966 by Ojibway Press, Inc., Duluth, Minn. 55802. Reproduction and reprinting prohibited except by written authorization of the publication. Subscription price: \$5 for 1 year, \$8 for 2 years, \$10 for 3 years. Pan American and Foreign, \$9 for 1 year, \$14 for 2 years, and \$18 for 3 years. If you have a change of address or a question about your subscription, write: ELECTRONIC TECHNICIAN, Circulation Department, Ojibway Building, Duluth, Minnesota 55802. BE SURE TO SEND ALONG THE ADDRESS LABEL FROM YOUR MOST RECENT ISSUE. Second class postage at Waseca, Minnesota and at additional mailing offices.

POSTMASTER: Send notification form 3579 to ELECTRONIC TECHNICIAN, Ojibway Building, Duluth, Minnesota 55802.

Cover

More technicians are servicing color TV sets today than ever before. Turn to page 56 and learn about the new innovations coming up in 1967 sets.

FEATURES

- Repairing Solid-State AM/FM Radios 41
An expert radio technician tells how he troubleshoots and repairs these dual-band home and auto radios
- Semiconductors from A to Z 48
This continuing article series is a complete course in semiconductor technology
- Service Bedrocks Sales 52
The oldest service-dealer in Portland, Ore., tells how he's grossing a quarter-million in 1966
- Review of 1967 TV Sets 56
Part two of a review that covers important innovations noted in 1967 color and B/W TV sets
- Stereo Hi Fi Tone-Arms, Cartridges and Styli 60
Part one of an article that covers some critical areas in Hi Fi stereo equipment
- Another Opportunity For Alert Technicians 62
A glimpse of things-to-come in medical electronic equipment
- Communications and Control Equipment 64

DEPARTMENTS

- | | | | |
|-----------------------------|----|------------------------------|-----|
| Editor's Memo | 22 | New Products | 70 |
| Letters to the Editor | 24 | Catalogs and Bulletins | 92 |
| Technical Digest | 28 | News of the Industry | 98 |
| Colorfax | 66 | Advertiser's Index | 104 |

TEKFAQ - 16 PAGES OF THE LATEST SCHEMATICS

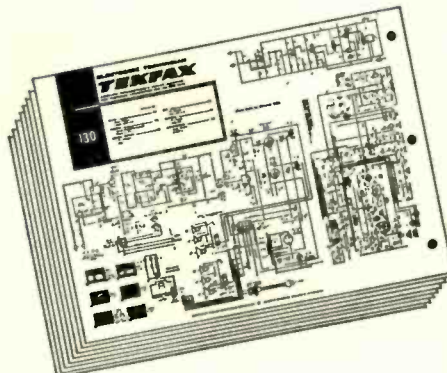

- Group 171 November • 1966
- ADMIRAL: Color TV Chassis H12 & IH12
- AIRLINE: TV Model GHJ-3067A, GHJ-3367A
- EMERSON: TV Chassis 120804, 805, 806, 807, 823
- GENERAL ELECTRIC: TV Chassis ETV
- MOTOROLA: TV Chassis TS-461
- SYLVANIA: Color Chassis DO1, -1,2,8

How "saving" 50¢ can ruin a \$700 color TV system!

The coupler is probably the least expensive item in a home TV system . . . yet the wrong coupler can send the investment in a top-quality distribution system and TV set right down the drain.

At Blonder-Tongue, the same engineering skill and meticulous quality control goes into couplers that goes into our professional MATV products. The result: high isolation between sets, extremely low insertion loss and sharp pictures (they're backmatched).

Blonder-Tongue gives you variety, too . . . the widest variety of color-approved, all-channel coupler models in the industry:

A-102U/V—deluxe 300-ohm model connects 2 sets to one download.

A-104/UV—similar to A-102U/V except for 4 sets.

MDC-2VU—connects two coax (75-ohm) cables from TV sets to a single coax download.

TV-2—economy indoor model. Connects two sets to a single 300-ohm twin-lead. Not recommended for weak signal areas.

Quality combiners and splitters are also essential to a good all-channel color TV system. When you specify Blonder-Tongue, you get high quality, low loss and high isolation.

UVF-1—deluxe 300-ohm weatherproof model. Provides separate UHF, VHF and FM outlets from download carrying all three signals or feeds a single download from separate UHF, VHF and FM antennas.

UVF-C/S—a lower priced version of the UVF-1.

A-107—deluxe, weatherproof unit combines UHF and VHF antennas to one 300-ohm download or provides separate UHF and VHF output at set.

UV-C/S—indoor unit provides separate UHF and VHF outputs from a single 300-ohm cable carrying both signals, for connection to converter or TV set with separate UHF and VHF inputs.

Write for free catalog #74.

Blonder-Tongue Laboratories, Inc., 9 Alling Street, Newark, N.J.

Blonder-Tongue, the name to remember, for TV reception you'll never forget

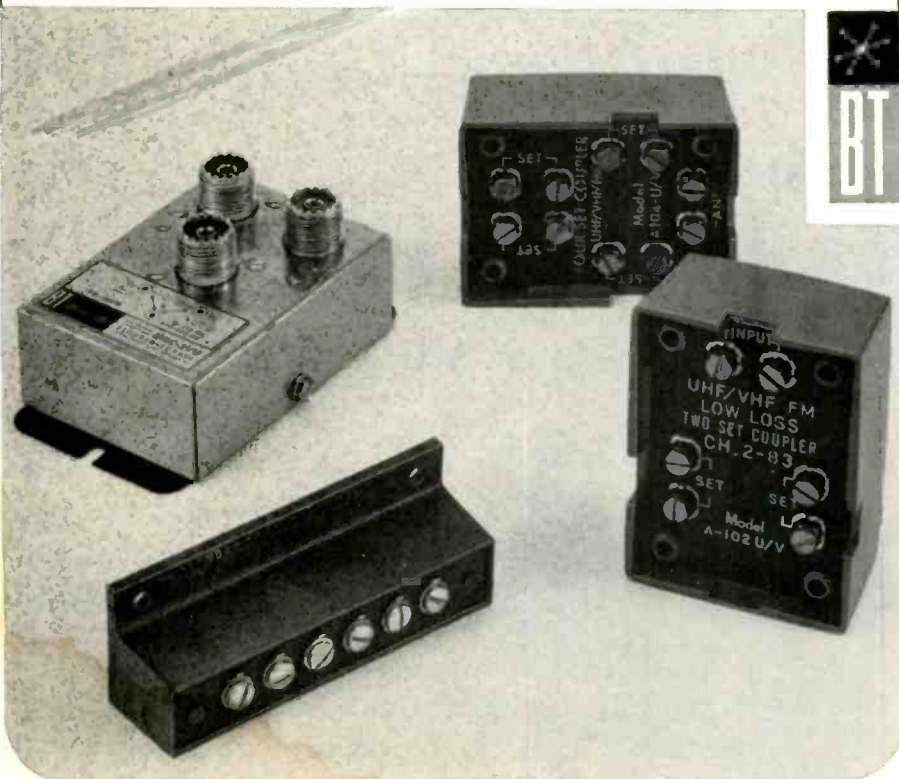

. . . for more details circle 107 on postcard

EDITOR'S MEMO

Tighten Your Business Belt

Once again we're thumping on an old tom-tom we've been beating for almost two decades: and the message is the same. If you haven't heard it before or have forgotten the sounds, turn to page 52 of this issue and read about it in detail. Thousands of old-timers in this business have heard the sounds echoing through the business forest for years and they have listened, learned and prospered.

About this time every year some so-called trade magazines will start telling you how "tough" competition will be in the coming year. In a sense, this is true. But what they fail to tell you is a lot more important. The business man who *really* knows what he's doing and where he's going—knows his business thoroughly—makes his job look easy. And so it is with the successful service-dealers and technicians whom we have been telling you about in every issue of *ELECTRONIC TECHNICIAN* since March of this year.

Sure, competition is getting tougher. But when was it not tough? People in general have always wanted as much service and quality as they can get for a buck. They've always wanted to be "catered" to—to be treated fairly and squarely. These are some of the simple fundamental psychological factors of ordinary human relations which almost every child in grammar school is aware of.

Yes, competition will be keener in 1967—like we said it would be in 1963 and 1964 and 1965 and 1966—and for many years before that. So what?

The people you do business with will spend more money in 1967 for products and services than they did in 1966. This assumes, of course, that no major "cracks" develop in our over-all national economy. And it assumes, too, that you run your business like our successful service-dealers are doing and have been doing for years.

So, if you are not hep to what is going on in the Space Age world, especially in the area of home entertainment equipment, you'd better tighten your business belt—give your customers top service and recommend only quality equipment and accessories—and you'll breeze right through the "competition" bugaboo.

Ed Leahy doesn't work for us. We work for him.

Ed Leahy believes in being his own boss. Which is what Ed likes about running his own Philco Qualified Service Center. It means that, with no strings attached, he gets better training, better service and more benefits than any other manufacturer offers.

When he needs a part, he gets it fast. His Philco Parts Distributor has what Ed needs right on hand. But even if Ed gets a job like fixing a 1947 model, he knows the oddball part he needs will be shipped in 24 hours or less through Philco's Lifeline Emergency Service.

Ed keeps up on new products with Philco Tech Data Service. He tried other services and found out that he gets the facts sooner, better and at lower cost from Philco.

Ed likes Philco's "fringe benefits," too. A complete accident insurance program for himself and his men. Advice on business management, found in Philco's popular "Service Businessman" magazine. He gets extra business, too, when his name appears under a Philco listing in the Yellow Pages.

Ed Leahy has it good. You can, too. Talk to your Philco Parts Distributor or contact Parts & Service Department, Philco Corporation, Tioga and "C" Streets, Philadelphia, Pa. 19134.



FAMOUS FOR QUALITY THE WORLD OVER

... for more details circle 139 on postcard

**IF YOU PRIZE IT...
KRYLON-IZE IT!**

Goes on in seconds—
dries in minutes!
The spray that
pays off
in better, faster
electrical work!

Krylon...
America's No. 1 spray coatings



**BORDEN
CHEMICAL**



... for more details circle 108 on postcard

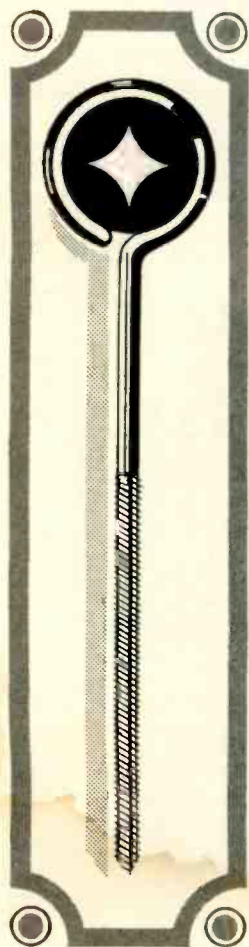

SEE THE ANTIQUE!



Columbia Wire Products Company's new shielded ultra-low loss Permafoam transmission cable has made standoff insulators a thing of the past. Hookup to the antenna (with terminals already fitted to the cable for your convenience), then run the cable to the set by the easiest route. **Easily terminated at TV set.** You can tape new shielded Permafoam cable to the antenna mast . . . run it down gutters . . . **anywhere!** Yet, there is no pickup interference. It gets the job done faster . . . to make you more of a good, old-fashioned profit.

You can get full specifications on new shielded Permafoam from your distributor.



Columbia 

WIRE PRODUCTS COMPANY
2850 Irving Park Rd., Chicago, Ill. 60618

Available in 50', 75' and 100' coils - 500' spools and 1000' reels.

... for more details circle 115 on postcard

LETTERS

TO THE EDITOR

Deluged With Help

This is in reference to my recent request for help in locating some old tubes (3E6 and 1LA6). This request appeared in the September "Letters to the Editor." Did I receive help?

To date I have received 18 letters, two telephone calls and two cartons of tubes plus two notices from the Post Office regarding postage due.

Shortly after my request for help I did locate these tubes and repaired the radio.

Thanks to everyone who so kindly wrote and offered help in locating these tubes. In the future I will surely know where to find help. Thank you very much.

GEORGE ROBERTS

Maywood, N.J.

• We also received dozens of letters here offering you help. — Ed.

Needs Schematic

I have a Hawthorne Eldorado stereo amplifier and preamp unit distributed by Electronics Transmission Corp., 103 E. Hawthorne Ave., Valley Stream, L.I., N.Y. A letter to them requesting a schematic received no reply. They must be out of business. I wonder if anyone has taken over the responsibility of supplying parts? I need a power transformer in addition to the schematic.

Can any ET reader furnish information or help in contacting this company or furnish information regarding a schematic or replacement transformer?

DAN CRYSTAL
Crystal TV Service

Brighton, Mass. 02135

No Competitors

I am well pleased, as in the past, with ELECTRONIC TECHNICIAN and can find no real competitors to it in existence. It is the only magazine which serves the purpose for which it is intended — to aid those employed in the professional repair of TV, radio and two-way communications equipment. The TV schematics alone are more valuable than the subscription cost. The articles are well written in a manner easily understood. Words are not used (or wasted) on technical "jargon," petty quips and boring disputes between writers wish-

continued on page 90

WHY risk your reputation with "just-as-good" capacitors?

When you pay little or no attention to quality in tubular replacement capacitors, you leave yourself wide open for criticism of your work . . . you risk your reputation . . . you stand to lose customers. It just doesn't pay to take a chance on capacitors with unknown or debatable performance records when it's so easy to get guaranteed dependable tubulars from your Sprague distributor!

There's no "maybe" with these 2 great SPRAGUE DIFILM[®] TUBULARS!

The ultimate in tubular capacitor construction. Dual dielectric . . . polyester film and special capacitor tissue . . . combines the best features of both. Impregnated with HCX[®], an exclusive Sprague synthetic hydrocarbon material which fills every void in the paper, every pinhole in the plastic film *before it solidifies*, resulting in a rock-hard capacitor section . . . there's no oil to leak, no wax to drip. Designed for 105°C (220°F) operation without voltage derating.



DIFILM[®] BLACK BEAUTY[®]
Molded Tubular Capacitors

The world's most humidity-resistant molded capacitors. Tough, protective outer case of non-flammable molded phenolic . . . cannot be damaged in handling or installation. Black Beauty Capacitors will withstand the hottest temperatures to be found in any TV or radio set, even in the most humid climates.



DIFILM[®] ORANGE DROP[®]
Dipped Tubular Capacitors

A "must" for applications where only radial-lead capacitors will fit . . . the perfect replacement for dipped capacitors now used in many leading TV sets. Double-dipped in rugged epoxy resin for positive protection against extreme heat and humidity. No other dipped tubular capacitor can match Sprague Orange Drops!

For complete listings, get your copy of Catalog C-616 from your Sprague distributor, or write to Sprague Products Company, 65 Marshall Street, North Adams, Massachusetts 01247



WORLD'S LARGEST MANUFACTURER OF CAPACITORS

. . . for more details circle 147 on postcard

assault on

perfect

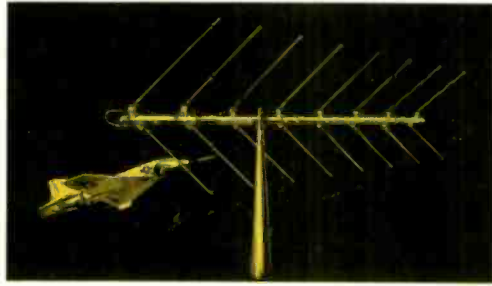

Back in 1962, we invented a new kind of TV antenna.

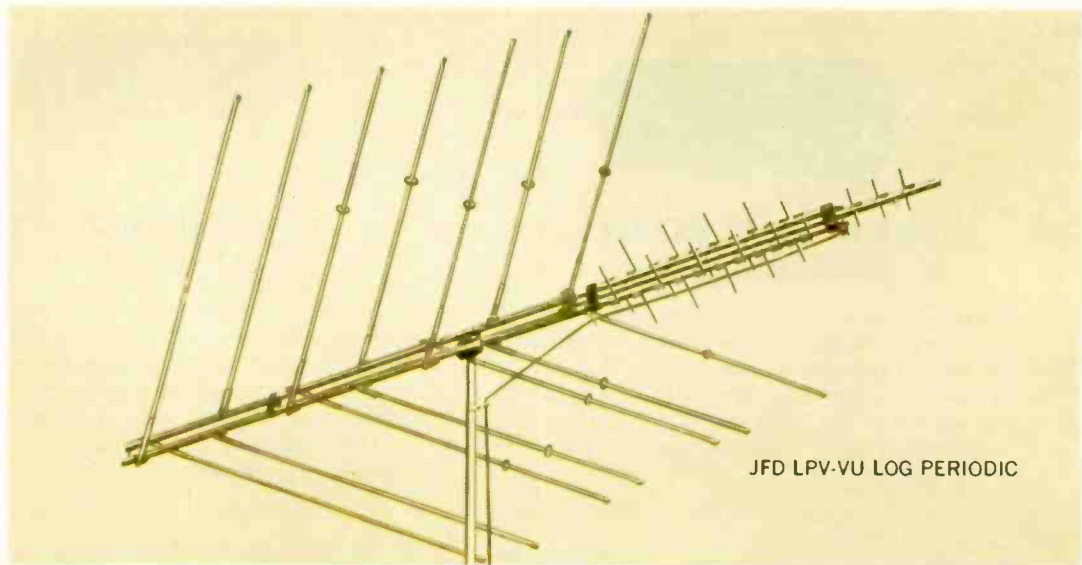

Licensed under one or more of U.S. patents 2,958,081; 2,985,879; 3,011,168; 3,108,280; 3,150,376; 3,210,767; RE. 25,740 and additional patents pending in U.S.A. and Canada. Produced by JFD Electronics Co. under exclusive license from the University of Illinois Foundation.

tion: PERFECTION CONQUERED

We did not improve on an old antenna. We started from scratch to design a new one. *Really new.*

It wasn't easy. And it wasn't cheap. But it worked like mad.

We called it the LPV Log Periodic. Its performance caught our competitors with their charts down. But it wasn't long before they came up with LPV copies in every way—except in performance.

Meanwhile back at the JFD labs in Champaign, Illinois, our scientists and engineers continued their "assault on perfection." In 1963, they again shattered antenna precedent by coming up with the *first* combination VHF/UHF/FM log periodic antenna, the LPV-VU. Instead of three different antennas, installers now needed only *one* LPV-VU and *one* download.

Our competitors scoffed at the idea. They said it couldn't be done. Until the "eyepopping" results started to roll in. Then there was a mad scramble for the LPV-VU bandwagon.

These "me-too" antennas looked like the LPV-VU Log Periodic. Sounded like it, too. But their charms were skin-deep.

Only the JFD LPV-VU delivered deluxe 82-channel log periodic performance. Because only the JFD LPV-VU followed the genuine patented log periodic concept of the University of Illinois Antenna Research Laboratories. Thanks to the protection of eleven different LPV-VU U.S. patents issued and pending—more than those of any other antenna.

You would think by now our Research and Development people in Champaign would leave well enough alone. But no. These "Young Turks" have gone and done it again. This time it's a new all-band log periodic design—the LPV-CL Color Laser. (Must be that "assault on perfection" bug they've still got up their polinear recorder.)

Why did we call it the Color Laser?

Well, engineers tell us that laser light beams with their tremendous bandwidth capacity are the communications carrier of the future. And we believe that our new VHF/UHF/FM Color Laser with its extreme bandwidth, among other unique characteristics, is the antenna of the future—only it's available to you *now*. How does the Color Laser deliver unsurpassed natural color, black and white across 82 channels, and FM, too?

Three reasons: (1) *Patented* *VHF "cap-electronic" Log Periodic V Design, (2) a new

broad band UHF "zoned" trapezoid driver, (3) a new disc-on-rod UHF director system. And there are patents issued and pending on all three.

We've also spun off the LPV "cap-electronic" Log Periodic section of the Color Laser. It forms the heart of a great new VHF antenna series we've named the LPV-TV.

This "assault on perfection" of ours involved a complete new mechanical design, as well. Results: "fast-lok" element brackets, "hot" twin booms (no lossy harnesses or transformers), new super-strength double U-bolt profiles, high reliability cylindrical capacitors, plus our electrically conductive gold alodized aluminum.

If you're the breed of professional contract installer or self-servicing appliance dealer who *never* settles for less than the best, we have a suggestion. Use a JFD LPV-CL Color Laser or LPV-TV Color Log Periodic on your next installation. See what it feels like to install the *best* of all in performance and customer satisfaction.

You will also see why our research and development people have now changed their watchword from "assault on perfection" to "perfection conquered".

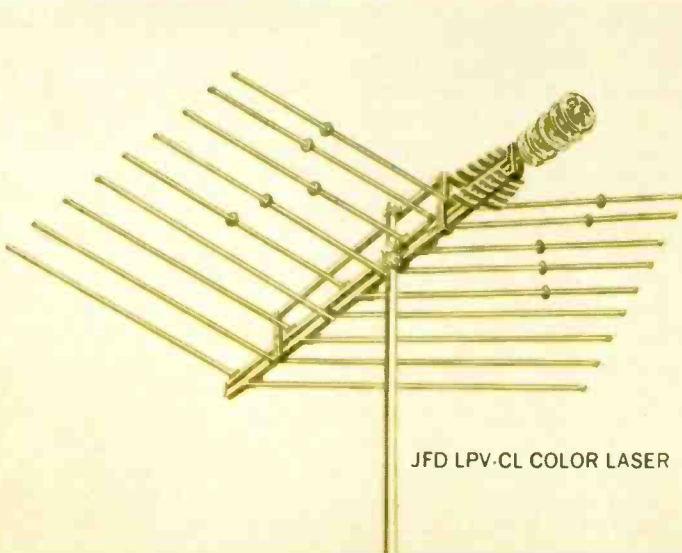

JFD LPV-CL COLOR LASER

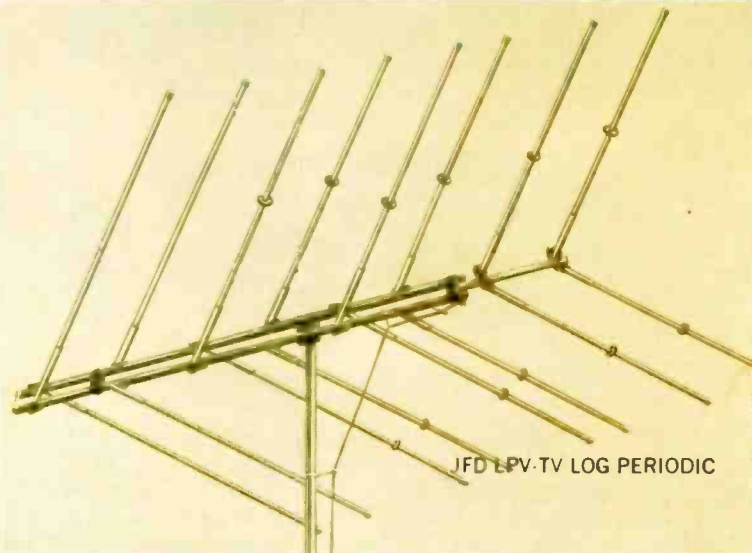

JFD LPV-TV LOG PERIODIC

Licensed under one or more of U.S. Patents 2,955,287 and 3,015,821 and additional patents pending.

JFD®

JFD ELECTRONICS CO.

15th Avenue at 62nd Street, Brooklyn, N.Y. 11219

JFD International, 64-14 Woodside Ave., Woodside, N.Y. 11377 JFD Canada, Ltd., Canada

JFD de Venezuela, S.A., Avenida Los Haticos 125-97, Maracaibo, Venezuela

... for more details circle 130 on postcard

PEARCE-SIMPSON'S

WINNING TWO-WAY RADIO COMBINATION

FOR MOBILE OPERATION

The 23 channel DIRECTOR
OR The 11 channel ESCORT II

AND FOR BASE STATION

The 23 channel GUARDIAN

Performance matched for peak efficiency, the All Solid State Director or Escort II in car, truck or tractor teams with the Guardian 23 base station command unit to give the finest two-way radio communications network in the nation!

SEE IT! HEAR IT! SELL IT!

ALL
SOLID
STATE
CB'S



DIRECTOR —

23 Channel CB \$269.90
(complete with crystals for 23 channels)

ESCORT II — 11 Channel CB \$219.90
(complete with crystals for six channels)



GUARDIAN 23 — 23 Channel CB \$269.90
(complete with crystals for 23 channels)

FREE! Send for profit-packed dealer kit



PEARCE-SIMPSON, INC.

P.O. Box 800 - Biscayne Annex, Miami, Florida 33152
Please send me FREE dealer kit and profit-making details on the complete Pearce-Simpson CB line.

Name _____

Company _____

Address _____

City _____ State _____



PEARCE-SIMPSON, INC.
MIAMI, FLORIDA

... for more details circle 137 on postcard

TECHNICAL DIGEST

MAGNAVOX

Radio Chassis R212—FM Stereo Translator Circuit

A new stereo translator circuit was introduced last year in the R211 radio and it has been incorporated in all new radio chassis developed since that time. Three transistors are used in translators which include a stereo indicator lamp circuit—otherwise, only two transistors are needed. In most radio chassis the translator components are contained on a single printed circuit board; but in some chassis, such as the R212, the translator components share the same board with most of the other receiver components.

The stereo signal at the output of the FM detector contains three parts—an audio signal, a 19kHz CW signal and stereo sidebands. The audio signal, or monophonic signal, contains frequencies up to 15kHz. The 19kHz CW signal, called the pilot signal, is present when a stereo signal is transmitted. The stereo sidebands contain still higher frequencies which are positioned above and below a 38kHz center frequency. All three of these signal components combine to form the composite stereo signal.

THE MAGNAVOX FM STEREO TRANSLATOR

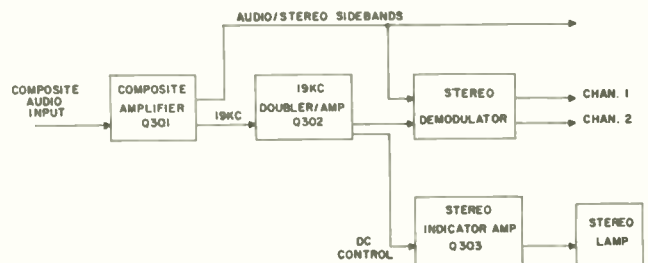

A block diagram of the stereo translator circuits is shown here. The composite signal from the FM detector is amplified by Q301. Q301 is a broadband stage which amplified all frequencies from the lowest audio frequency to the highest stereo sideband frequency at 53kHz. At the collector of the composite amplifier the 19kHz pilot signal is separated from the audio signal and the stereo sidebands. This is accomplished by a transformer tuned to 19kHz which acts as a high impedance trap at 19kHz and also couples the pilot signal through the secondary winding to the 19kHz amplifier and doubler, Q302. The pilot signal, when doubled in frequency, serves to reproduce the 38kHz carrier which was suppressed at the transmitter. This carrier must be regenerated in the receiver to demodulate the high frequency stereo sidebands. Doubling the pilot signal takes place at the output of Q302 and results from a transformer tuned to 38kHz. The 38kHz CW signal is then combined with the audio signal and stereo sidebands in the demodulator circuit to produce right and left channel audio output signals.

A separate monophonic audio output is provided in cases where extremely weak stereo signals may produce excessive noise. Better audio quality and improved signal-to-noise ratio may be obtained by operating the receiver in the monophonic position of the bandswitch.

A transistor, Q303, acts as a switch to turn on a stereo indicator lamp in those chassis which have this feature.

Complete TUNER REPAIR for only

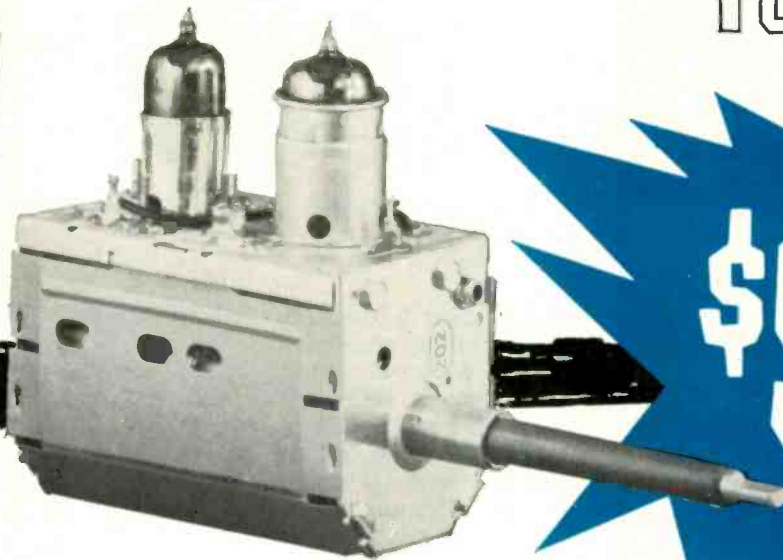

\$9.50

Sarkes Tarzian, Inc., largest manufacturer of TV and FM tuners, offers unexcelled tuner overhaul and factory-supervised repair service. Completely-equipped and conveniently-located Service Centers offer fast, dependable and factory-supervised repair service on all makes and models. Centers are staffed by well-trained technicians, assisted by engineering personnel.

Tarzian-made tuners received one day will be repaired and shipped out the next. More time may be required on other makes. Every channel—not just the channels existing in any given area—is checked and re-aligned per orig-

inal specifications. Exclusive cleaning method makes the tuner look—as well as operate—like new.

Cost, including ALL labor and parts (except tubes) is only \$9.50 and \$15 for UV combinations. No additional charge. No hidden costs. Too, you get a full, 12-month warranty against defective workmanship and parts failure due to normal usage.

Always send TV make, chassis and Model number with faulty tuner. Check with your local distributor for Sarkes Tarzian replacement tuners, parts or repair service. Or, use the address nearest you for fast, factory-supervised repair service.



TUNER SERVICE CORPORATION

(Factory-supervised tuner service authorized by Sarkes Tarzian)

MIDWEST — 817 N. Pennsylvania St.
Indianapolis, Ind., Box 1642
Tel: 317-632-3493

EAST — 547-49 Tonnele Ave., Jersey City, N. J.
Tel: 201-792-3730

SOUTH-EAST — 938 Gordon St., S. W.
Atlanta, Georgia
Tel: 404-758-2232

WEST—

SARKES TARZIAN, Inc.
Tuner Service Division

10654 Magnolia Blvd.,
N. Hollywood, Calif.
Tel: 213-769-2720



4 ways to increase your income

RCA Institutes, Inc. offers these four comprehensive home study courses especially designed to help build your income immediately!

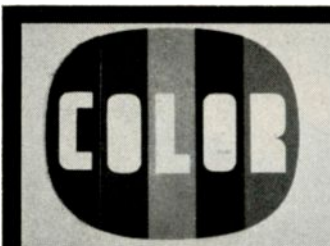

COLOR TV Add Color TV Servicing to your skills with this up-to-the-minute home training course and take advantage of the growing profit potential in this area! Train under the direction of RCA... experts in Color TV.

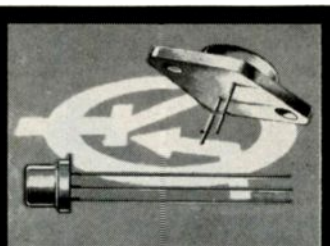

TRANSISTORS You get the necessary background for semiconductor technology including characteristics of tunnel diodes, rectifiers and other solid state devices. Transistor trainer also available.



AUTOMATION ELECTRONICS Trains you for the many applications of automation electronics in industry and government including Photoelectronics, Digital Computer Techniques, Synchros and Servomechanisms, Automatic Control Systems, and many more!



MOBILE COMMUNICATIONS Trains you to service and maintain 2-way radio communications on land, sea, and air! Gives you the technical foundation for space communications!

Take advantage of RCA's Liberal Tuition Plan. You only pay for lessons you order; and have no long-term obligations. Licensed by New York State Education Department. Approved for Veterans.

RCA INSTITUTES, INC.
A Service of Radio Corporation of America



The Most Trusted Name in Electronics

SEND THIS COUPON NOW FOR COMPLETE FREE INFORMATION

RCA INSTITUTES, INC. Home Study School, Dept. ET-N6
350 West Fourth Street, N. Y., N. Y. 10014
Without obligation, rush me free information on the following RCA Home Training Course: COLOR TV TRANSISTORS MOBILE COMMUNICATIONS AUTOMATION ELECTRONICS

Name _____ Age _____
Address _____

CANADIANS—Take advantage of these same RCA courses at no additional cost. No postage. No customs. No delay. Send coupon to: RCA Victor Company, Ltd., 5581 Royalmount Ave., Montreal 9, Quebec.

TECHNICAL DIGEST

The switch is turned on when the 19kHz amplifier conducts. The 19kHz amplifier conducts when a pilot signal is applied to its base.

A schematic of the composite amplifier is shown here.

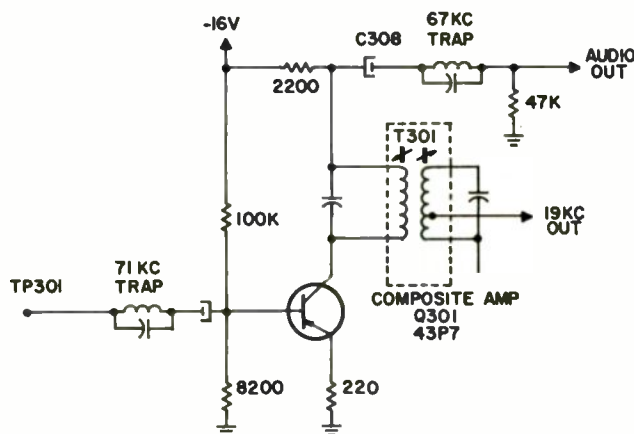

A lowpass filter is located in the base circuit of this stage which effectively removes extraneous noise that may be present in the detected signal above 71kHz. The amplifier is a conventional RC coupled stage and all three components of the composite signal appear amplified at the collector. Here, at the collector, the pilot signal is separated from the composite signal. The transformer, T301, is tuned to 19kHz and couples the pilot signal through the secondary winding to the frequency-doubler stage. At the same time, the transformer acts as a 19kHz trap and prevents the pilot signal from appearing across the 2.2k collector load resistor. The low frequency audio component and the high frequency stereo sidebands see the primary winding as a low impedance and are coupled through C308 and a second trap circuit.

Some FM stations are authorized to transmit background music service for hotels, offices, retail stores, etc. Such broadcasts are referred to as SCA (Subsidiary Communications Authorization). These special transmissions use a 67kHz subcarrier frequency to convey the music information. It is possible for the SCA signal to mix with the stereo sidebands and produce beats and whistles in the

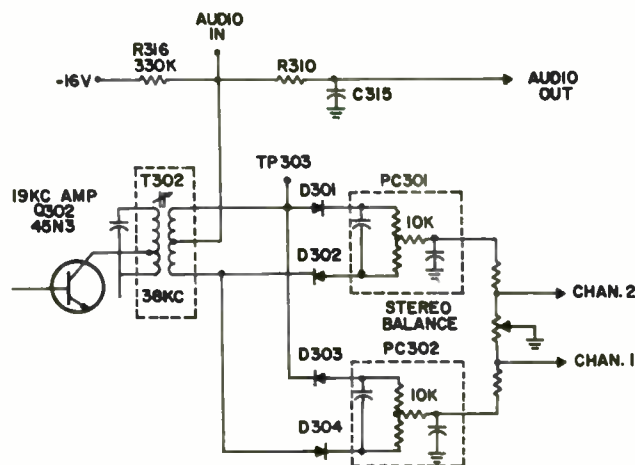

Operates like a manual. *Aims like an automatic!*



The *Semi-Automatic* Colorotor!

If you're selling manual rotators, step up your sales with Channel Master's totally new concept in rotator controls that gives your customers pinpoint precision at an economy price!

For the first time in the design of rotator controls, Channel Master has put a motor instead of a meter into a non-automatic control unit. The new Semi-Automatic uses a second motor in the control unit which works together with the drive unit motor as a synchronized team. Up until now only automatic models have offered this quality feature, yet the semi-automatic is priced midway between a manual and an automatic.

MUCH GREATER ACCURACY! Exclusive new Semi-Automatic control unit provides almost 6 times more indicator travel than the compass control—more precise aiming—

more accurate relocation of stations. Simple two-button control. Right button for clockwise rotation—left button for counterclockwise rotation. Antenna stops instantly when button is released.

BEAUTIFULLY STYLED. The control console has been beautifully styled by a top industrial designer to a sleek, contemporary look. These handsome new units have the grace and elegance to blend tastefully with the styling of the contemporary television sets in modern homes.

FAST, SIMPLE INSTALLATION. Uses economical, dependable 3-

conductor rotator wire. No need to calibrate or compensate for different cable lengths. "Cut 'n Strip" Guide molded into bottom. Barrier terminal board prevents shorts. Built-in wire strain-reliever insures permanently tight connections.

Channel Master has the most complete antenna rotator Step-up line in the industry—choose from manual, Semi-Automatic, Automatic or Deluxe Automatic models.

CHANNEL MASTER

ELLENVILLE, N. Y.

... for more details circle 111 on postcard

Poll shows appliance dealers prefer Channel Master color antennas by tremendous margin. We're not surprised. Read why.

When it comes to color antennas, we know our place. That it happens to be **first** place—and that Channel Master has been up there a long time—is a sweet thing to know. (Just try and budge us.)

But—once in a while—isn't it nice to have somebody else confirm what you've always known?

What happened was this: One of the nation's top three publications in the radio-TV-appliance merchandising field—(name on request)—made an independent survey of color set appliance dealers. Result? The lopsided box-score, in case you haven't noticed,

is down below. Please observe that the opposition isn't even close.

Now as long as Channel Master Crossfires are up there we wanted to know why they're up there. So we requested the same publication to take a second poll. And just as we thought: Any specific brand of antenna may be preferred on many counts. But one reason leads all the rest. Performance! That's why the Crossfires are No. 1. They work better! (With color sets or black-and-white, naturally). This includes our VHF/FM series for suburbs-to-fringes, our Coloray ghost-killer series, and our

Ultradyned Crossfire 82-channel FM or Ultradyned UHF only series.

To what do we owe our success? Our principles. (Unique engineering ones, of course. All of them patented or with patents pending.) They make the Crossfires the mightiest antennas ever developed. With remarkably high gain and up to 30-to-1 front-to-back ratios. (Maybe the competition's principles just aren't as powerful as ours.)

So call your nearest Channel Master distributor, join the rest of the gang, and come on up. The installation's fine and the profit's high.

High Man
On The
Totem Poll!



OF THE 5 TOP-SELLING
ANTENNA BRANDS DEALERS
PREFER CHANNEL MASTER:

2 to 1 over Brand **B**
3 to 1 over Brand **C**
3½ to 1 over Brand **D**
5½ to 1 over Brand **E**

CHANNEL MASTER

new

Color Crossfire

TV/FM ANTENNA



The best selling
antenna series
in TV history

... for more details circle 112 on postcard

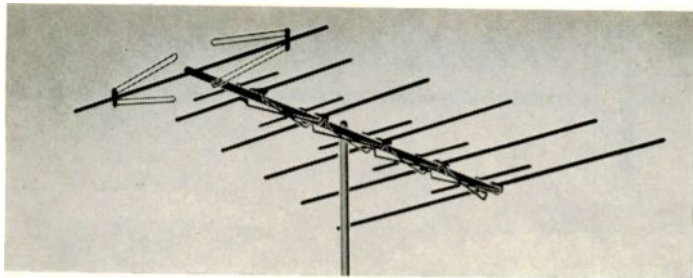

COLOR CROSSFIRE, Model 3614-G

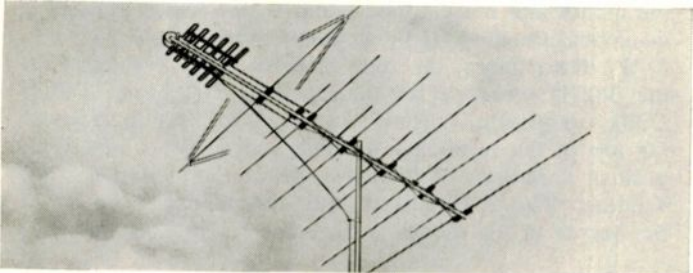

ULTRADYNE CROSSFIRE, Model 3638-G

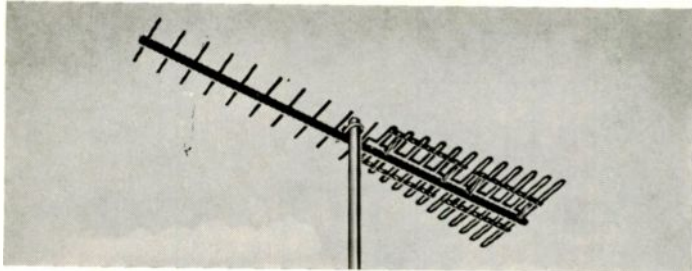

ULTRADYNE, Model 4314-G

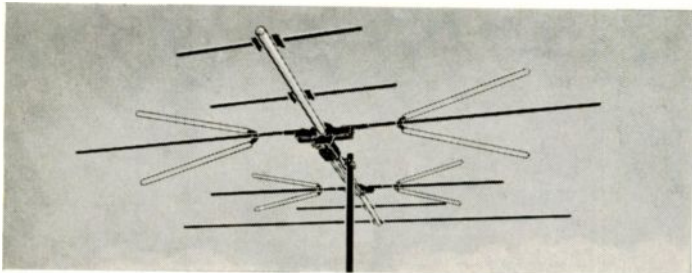

CROSSFIRE COLORAY, Model 3618-G

The Winners!

All COLOR-ENGINEERED by Channel Master

COLOR CROSSFIRE SERIES Seven models for VHF/FM/FM Stereo from near suburban to deepest fringe areas.

ULTRADYNE CROSSFIRE SERIES Revolutionary 82-channel plus FM and FM Stereo antennas. Six models for suburban to near fringe reception.

ULTRADYNE SERIES Unique no-coupler-required design in three UHF only models for metropolitan to near fringe areas.

COLORAY SERIES Amazing electronic ghost-killers in two VHF/FM/FM Stereo models and one 82-channel plus FM/FM Stereo model.

CHANNEL MASTER Ellenville, New York

... for more details circle 113 on postcard

demodulated audio output. For this reason, a 67kHz trap is used to attenuate the SCA signal so that interference is avoided.

The stereo demodulator circuits are shown here. The 19kHz pilot signal is amplified by Q302 and the frequency is doubled by T302 which is resonant at 38kHz. The 38kHz signal is always separated 180deg across the ends of the secondary winding. The audio signal and the high-frequency stereo sidebands from the composite amplifier are connected to the center-tap of the secondary winding. The combined signal is then applied to the four demodulator diodes. The waveform at TP303 is a 38kHz envelope with left channel audio variations along the positive peaks and right channel audio variations along the negative peaks. At the opposite end of the secondary winding the waveform is inverted and the right and left channel audio variations reverse their positions on the envelope.

38KC WAVEFORM AT TP303

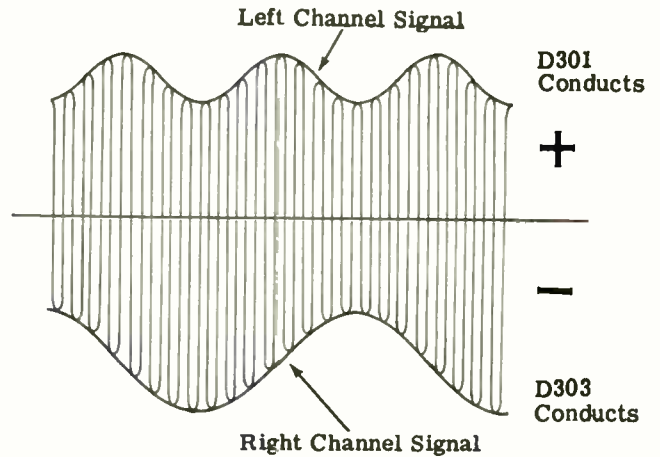

38KC WAVEFORM AT OPPOSITE END OF T302 SECONDARY WINDING

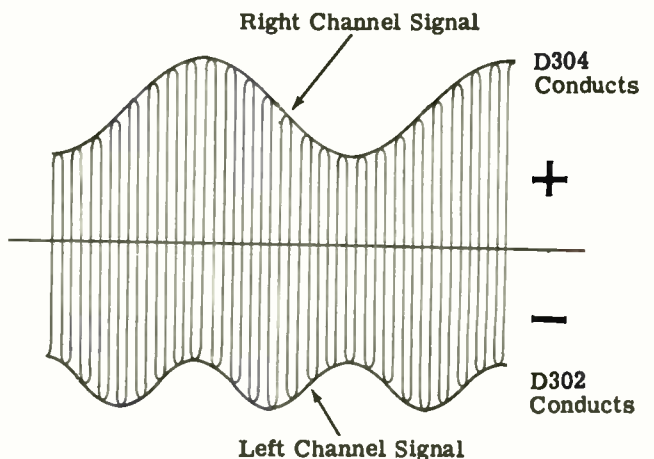

Audio variations in the positive peaks of the 38kHz envelope at TP303 forward bias D301 in the left channel demodulator. At the same instant the audio variations in the negative peaks of the bottom envelope forward bias D302 which is also on the left channel. The 38kHz sub-

Experience for Sale.....45¢

Sure seems we started something!

Yes; over ten years ago, when we started overhauling tuners (all makes and models), we set a price of \$9.95 for this service.

Apparently there are those who would like to imitate our achievement—and for 45¢ less.

Maybe the special skills, special equipment and downright old fashioned experience we built up during these past years are worth that little extra.—You be the judge.

Remember; 45¢ buys you more than a quarter of a million man/hours of experience, plus true devotion to our business . . . our only business . . . overhauling your television tuners the best way we know how. And in over ten years we sure know how!

Castle — The Pioneer of TV tuner overhauling
Not the cheapest — just the best.

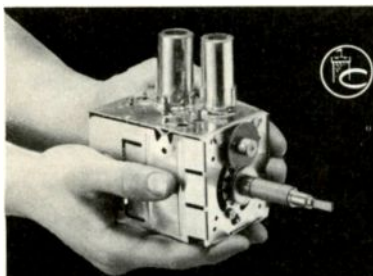

For complete tuner overhaul we still charge only \$9.95. This includes all labor and parts; except tubes and transistors, which are charged extra at low net prices.

Simply send us the defective tuner complete; include tubes, shield cover and any damaged parts with model number and complaint. Your tuner will be expertly overhauled and returned promptly, performance restored, aligned to original standards and warranted for 90 days.

UV combination tuner must be single chassis type; dismantle tandem UHF and VHF tuners and send in the defective unit only.

Exact Replacements are available for tuners unfit for overhaul. As low as \$12.95 exchange. (Replacements are new or rebuilt.)

CASTLE

TV TUNER SERVICE, INC.

MAIN PLANT: 5713 N. Western Ave., Chicago 45, Illinois
EAST: 41-92 Vernon Blvd., Long Island City 1, N. Y.

CANADA: Castle TV Services, Ltd. . . . Nation-wide service.
For service in Canada write to Chicago or use reader service card in this magazine.

*Major parts are charged extra in Canada.

... for more details circle 110 on postcard

TECHNICAL DIGEST

carrier is filtered out by the capacitor connected between the diodes and the detected audio signal passes through a de-emphasis network to the audio preamp.

In like manner, the right channel audio variations on the 38kHz envelope are detected by D303 and D304. D303 conducts on negative variations of the envelope at the top of the secondary winding and D304 conducts on positive variations of the envelope at the bottom of the winding. The 38kHz filter and de-emphasis network at the output of the diodes is the same for both channels.

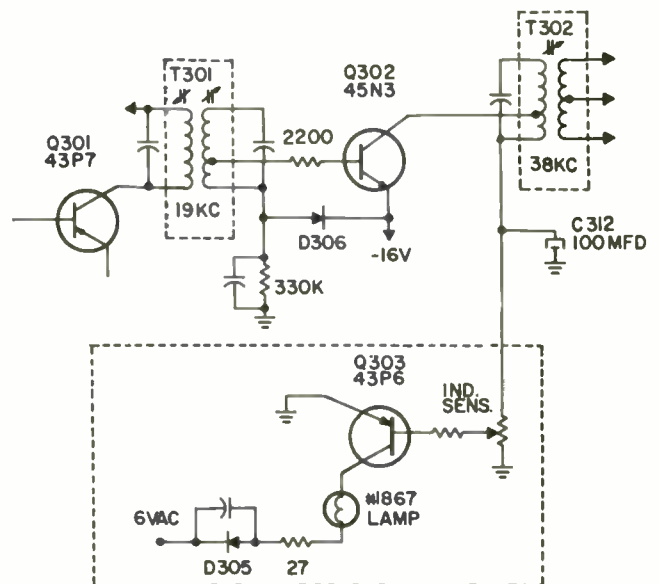

The stereo indicator lamp circuit is also shown here. The operation of the lamp is dependent upon the conduction of the 19kHz amplifier. During no-signal conditions or when a monophonic program is received, Q302 is forward biased by a very small amount so that collector current barely flows. The low forward bias voltage is obtained by using a large value resistance, 330K, in the base circuit to ground. To stabilize the base-emitter voltage for variations in power supply voltages and temperature changes, diode D306 is effectively connected across the base-emitter junction.

When a stereo signal is received the 19kHz pulses on the base of Q302 cause full collector current to flow. After passing through the primary winding of the 38kHz transformer, the pulses are filtered by C312 and a negative dc voltage is developed across the indicator sensitivity control. A portion of this voltage is applied to the base of Q303 and causes it to conduct. Q303 acts as a switch which effectively grounds one side of the indicator lamp. Power for the lamp is obtained from the 6vac winding on the power transformer. The ac voltage is rectified by D305 which drives the lamp with negative-going pulses. A 27Ω resistor is connected in series with the lamp to limit current flow.

Under no-signal conditions, or when a monophonic program is received, Q302 is biased to near cutoff. Since very little collector current flows, there is practically no voltage drop across the indicator sensitivity control and

Brand **NEW** FROM **HICKOK**

MODEL GC-660—COLOR BAR GENERATOR

A
GENERATOR
THAT
“STAYS PUT”

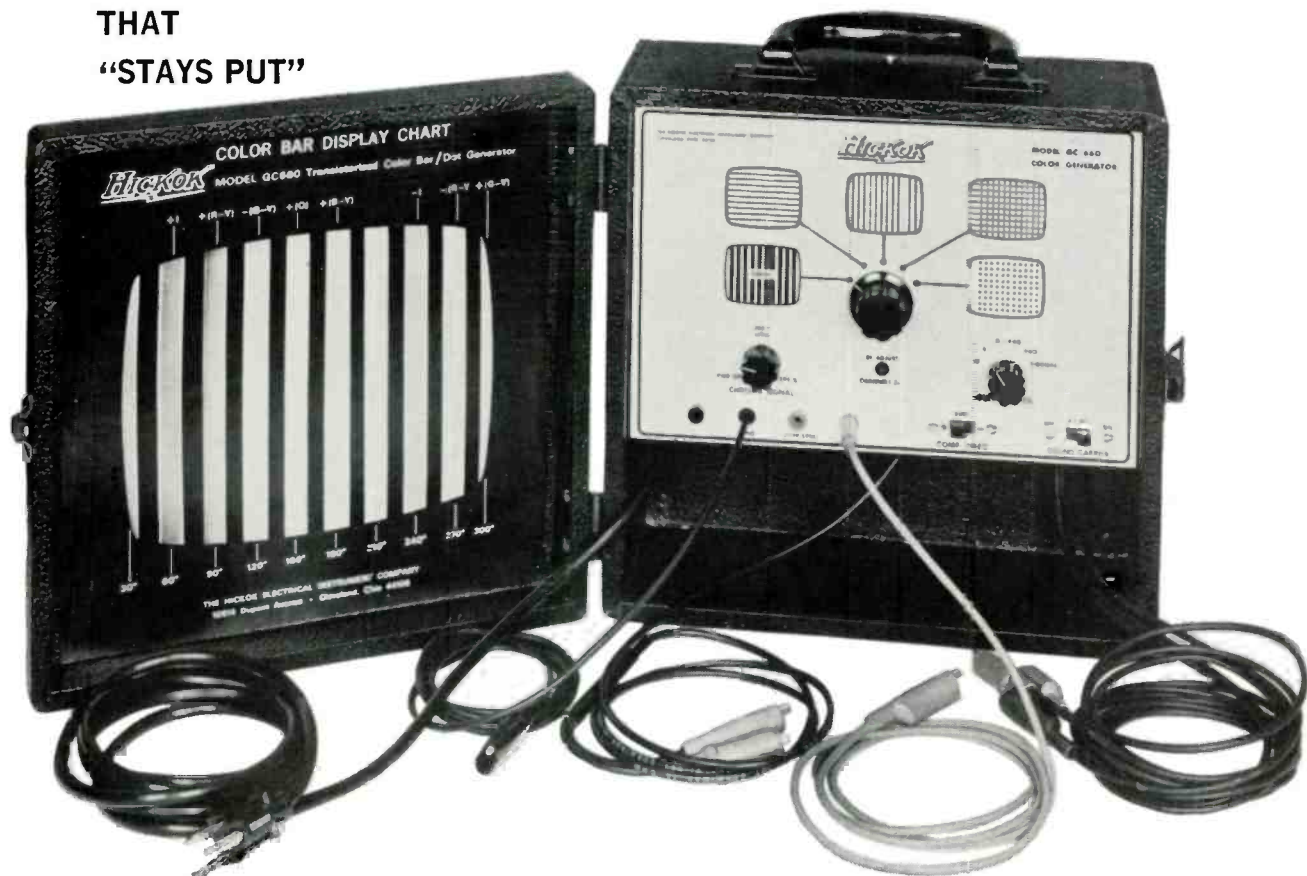

Price
\$159.50

■ A proven, field-tested design ■ “Stays put”—designed for Alaskan cold and Florida heat and humidity* ■ 0.1 μ sec dots—plus a crosshatch pattern that doesn’t “flicker” ■ Standard gated color bars at zero reference level—for *correct* color phasing adjustments.

Let’s face it, the biggest problem you’ve had in using *anybody’s* color generator has been having it work right every time you turn it on—you can’t get much use out of a generator that wastes your time while you wait for it to settle down, lock in, and *stay put*. *Hickok’s new Model GC-660 has actually been tested for its ability to “stay put” not only in field tests but in a Military Standard Environmental Chamber. It’s not *perfect* but we think it beats anybody else’s. Why not ask your Hickok distributor for a demonstration and prove it to yourself?

THE HICKOK ELECTRICAL INSTRUMENT CO. • 10523 Dupont Avenue • Cleveland, Ohio 44108

NOVEMBER 1966

... for more details circle 126 on postcard
... for more details circle 123 on postcard →



A Family Fun-for-all from the Family of G-E Tubes

If you're all for fun, then get set for a real treat! Exciting G-E gifts (the premiums the whole family wants) can be yours with purchases from G. E.'s family of receiving tubes. Earn long-lasting G-E home and business products for your family and yourself... and at the same time stock up on G-E entertainment receiving tubes... the line you can count on for top quality. See your G-E Distributor* today and get the full picture on how you can earn your share of G-E premiums. Distributor Sales, Owensboro, Kentucky.

288-03

*Premiums available at the option of your G-E Tube Distributor

Where There's More
in Store for You...



GENERAL  ELECTRIC

- A. **Slicing Knife** A real sharp performer! Perfect for slicing everything from tomatoes to roasts. Handy wall rack permits blades and unit to be stored ready for immediate use. Has 9" stainless steel slicing blades and detachable cord. Order ETR-4484.
- B. **Trip Mate Travel Clock (Electric)** A great traveling companion! When the sun goes down, the dial lights up for easy reading at any hour. Compact, with rich vinyl case. Cord is stored in handy compartment. Order ETR-4483.
- C. **Miniature Transistor Radio** Trim, compact and a great performer! Includes 6 transistors and features a 2" magnetic-type speaker in an acoustically designed case. Comes complete with matching carrying case, battery and earphone. Order ETR-4474.
- D. **Flashbulb Kit (Pack of 12)** A flashbulb to fit every camera! The AG1B bulb is used with most modern low-end cameras. The M2B is used with older models of standard cameras. The M3 is for Polaroid Cameras and for taking color photographs indoors.
AG1B Order ETR-4478 ■ M2B Order ETR-4479 ■ M3 Order ETR-4480
- E. **Electric Can Opener** A great timesaver! Opens any shape can: large, small, round or square. Magnet lifts the lid and prevents it from dropping into food. Easy to clean. Includes a storage area for cord. Order ETR-4485.
- F. **Walkie Talkie (Set of 2)** Calling all families! Includes 4 transistors and will carry a voice as far as 3/4 of a mile. Features a telescopic whip antenna, push button talking switch and on-off volume control button. Order ETR-4475.
- G. **Rechargeable Flashlight** Lets you see the brighter side! Provides a constant strong beam of light for two hours when fully charged. Handsomely styled charger base keeps batteries fully charged. Order ETR-4481.
- H. **Portable Transistor Radio** The sweet sounds of music and news! Has 8 transistors and features a powerful 3" Dynamic speaker. Operates on 4 "AA" penlite batteries for 150 hours of listening pleasure. Includes a separate earphone and attractive carrying case. Order ETR-4477.

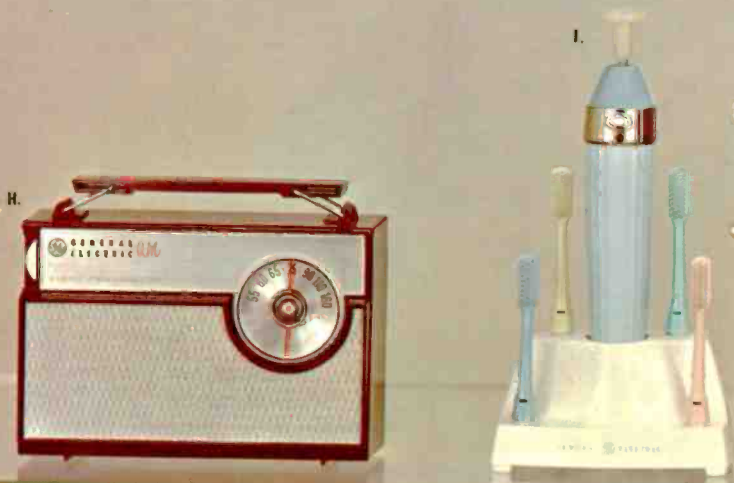
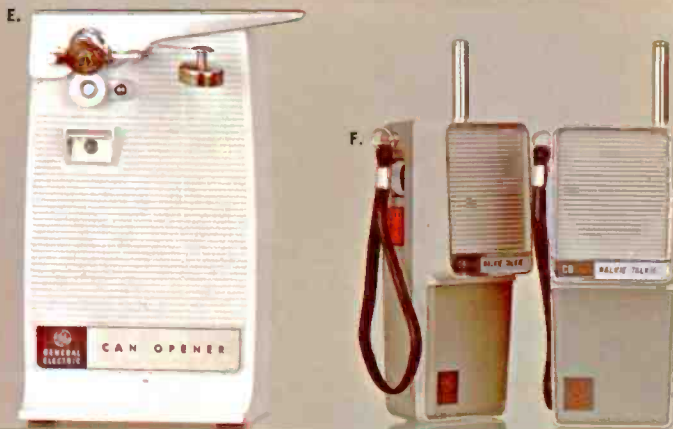



- I. **Cordless Electric Toothbrush** Get radiant smiles from the family! Brush has a safe controlled up and down motion. Power handle has a convenient push button switch for on-off action. Complete with attractive charger base and brushes. Order ETR-4486.
- J. **Rechargeable Cigarette Lighter** The perfect match! Elegantly styled, windproof lighter. Will light up to three packs of cigarettes, without recharging. Features a double coil lighting element for fast even lights. Complete with charger unit. Order ETR-4482.
- K. **Show 'N Tell** A masterpiece in showmanship! Projects colorful film slide stories on the simulated television screen in time to words and music. Unit can be used separately as a 4-speed record player. Plays all 16, 33 $\frac{1}{3}$, 45 and 78 rpm records. Order ETR-4476.

B.



C.



D.



G.



K.



J.

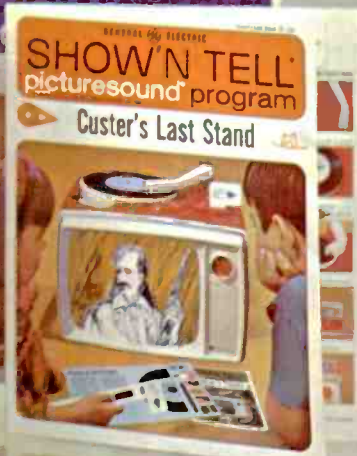

*before you buy any
color generator...
get all the facts*



only one has all
these features and
it's only 99⁵⁰*

LECTROTECH V6

Any comparison will prove that the Lectrotech V6 truly stands alone. Provides all of the time-tested standard features plus many Lectrotech exclusives for the fastest, most reliable color installation and servicing. The V6 gives you: Crystal-controlled keyed rainbow color display • All cross hatch, dots, vertical lines only, horizontal lines only • Red-blue-green gun killer (usually extra or not available on other color bar generators) • Exclusive Dial-A-Line feature (Horizontal adjustable 1 to 4 lines wide) • Exclusive solid state reliability • Exclusive voltage-regulated transistor and timer circuits • Exclusive simplified rapid calibration • Off-On Standby Switch • Adjustable dot size • Color level control • Connects to antenna terminals (no connections needed inside of set) • Power transformer-line isolated, to prevent shock hazard • Lightweight and portable, only 4½" H. x 7½" W. x 10¾" D. Weight, 7½ lbs.

*Except our own V7



V7 Sensational new Lectrotech V7 — the only complete Color TV Test Instrument.

Has all the features and performance of the V6 PLUS Lectrotech's exclusive built-in Color Vectorscope for simplified visual color servicing.

Complete.....only **18950**



ONE YEAR WARRANTY

See your distributor or write for details before you buy any color generator.

LECTROTECH, INC.

Dept. ET-11, 1221 Devon Avenue • Chicago, Illinois 60626

... for more details circle 155 on postcard

TECHNICAL DIGEST

Q303 is zero biased. Under these conditions Q303 acts as an open switch so the indicator does not light.

The stereo indicator sensitivity control should be adjusted while receiving a stereo program. A VTVM is connected to the collector of the indicator amplifier (Q303) and the sensitivity control is adjusted for a reading of $-1v$. Operation of the lamp should then be checked on all stereo stations normally received in the area. If the lamp fails to light on a particular station, and that station is *known* to be transmitting a stereo program and is received with almost full quieting, alter the setting of the control slightly until the indicator just lights. Sensitivity is increased by turning the control in the CCW direction.

During monophonic reception the audio signal passes through the demodulator diodes and is amplified equally in each channel. To prevent the diodes from partially rectifying the audio signal and producing distortion, a dc voltage is applied to the diodes. R316 couples a small amount of negative voltage through the center tap of the 38kHz transformer to all four diodes. Diodes D302 and D303 become forward biased so that a direct signal path into each channel is established and distortion is avoided.

The stereo translator used in the new R216 and R217 radio tuners contains the same circuits as those described here. A variation does exist to the extent that the AM audio signal also passes through the composite amplifier. This point should be remembered when servicing the AM circuits of these tuners.

MOTOROLA

Color TV Chassis TS-914—Low Brightness

Check the value of R224 connected from arm to ground of master G1 control. If the value of this resistor is 47K, change it to 150K and readjust background and master G1 control.

Low brightness can also be caused by low emission of the 1st video amplifier tube V6 (6DX8) or the 2nd video amplifier tube V7 (6LY8). Conduction of these tubes affects the plate voltage of the video output tube and thus the voltage of the cathodes of the CRT.

Check the value of the contrast control. It should be 200Ω. A higher resistance will also reduce brightness.

IF YOU

CHANGE YOUR ADDRESS

NOTIFY: ELECTRONIC TECHNICIAN

Ojibway Building

Duluth, Minnesota 55802

Please include the address label from a recent issue and allow six weeks for the change.

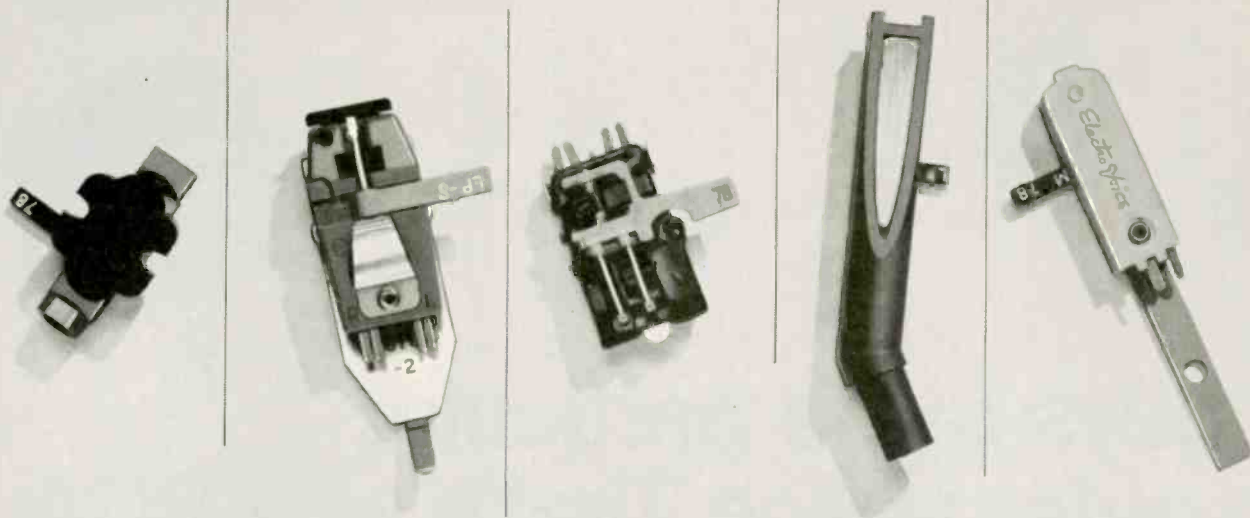

How long was your distributor out of stock after these new cartridges were introduced?

It isn't easy to keep up with the many new phono cartridges being introduced these days.

And if your distributor doesn't order until you ask for them — you're in trouble.

After all, a delay of more than 24 hours can cost you plenty in customer goodwill — perhaps even a sale.

But that problem is eliminated when you deal with an Electro-Voice distributor.

Here's how. He can place a standing order with us. We ship every new model to him *automatically*, as soon as it comes out. He doesn't wait for an order, and neither do we.

This way, the new models are waiting for you *before* you need them. It's good business to see your E-V distributor — he's first with everything in needles and cartridges.

Electro-Voice®

The modern complete line of replacement phono cartridges

ELECTRO-VOICE, INC., Dept. 1167T, 663 Cecil St., Buchanan, Michigan 49107

... for more details circle 119 on postcard

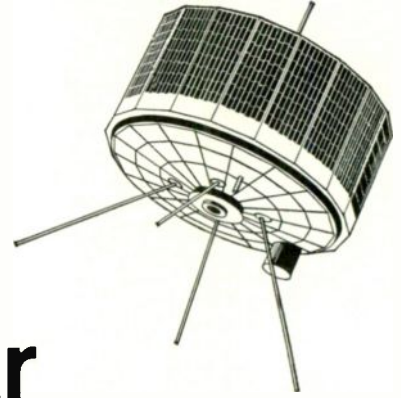

It pays to be particular in outer space. That's why RCA builds weather satellites for NASA using solid integrated circuits—the most reliable kind of circuitry ever made. And it pays to be particular about performance. That's why RCA Victor was the first to adapt this kind of circuitry for use in the sound system of some of its newest color and black-and-white TV sets – the most reliable TV on the market.

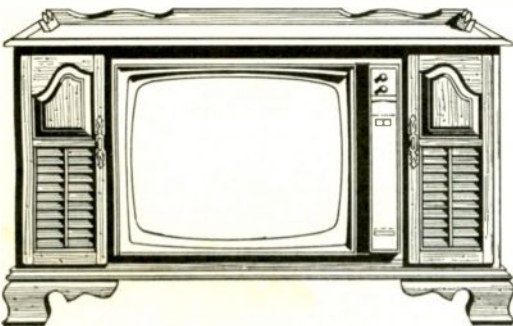

The Most Trusted Name
in Electronics

Tmk(s)®

Service technician checks an RCA solid-state amplifier.

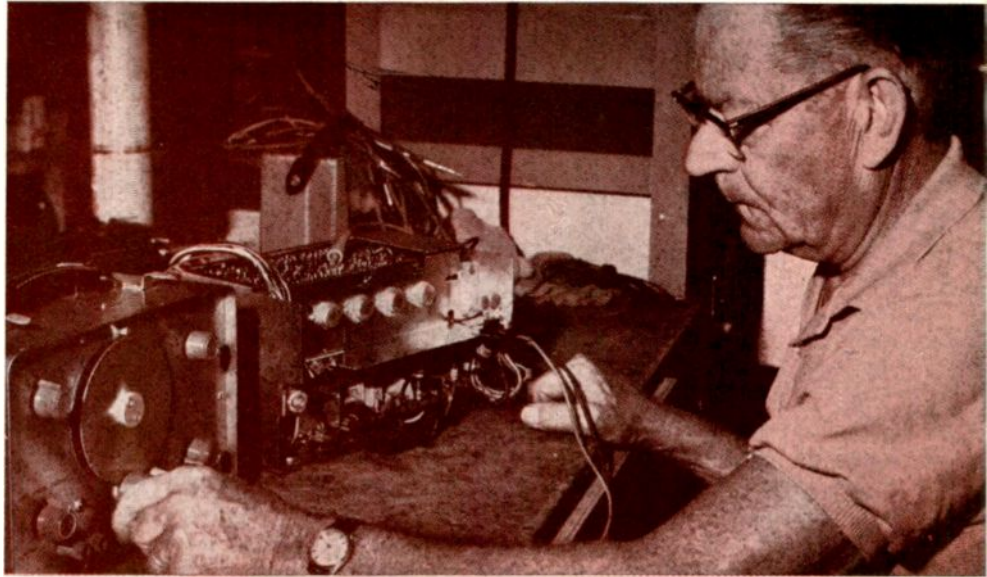

REPAIRING SOLID-STATE AM/FM RADIOS

Learn how to speed
troubleshooting procedures
and make more money
servicing this equipment

■ Most AM/FM radios made today contain solid-state circuitry having a variety of transistors and diodes, the radios are made in several sizes. The smallest units are pocket-type receivers and they increase in size to table models, auto radios and AM/FM console home types.

All solid-state AM/FM receivers eventually require the attention of good technicians. But many shops are neither technically prepared nor properly instrumented to efficiently service this equipment.

Large and Small AM/FM Radios

Small AM/FM pocket radios are not much different than console models, except they have fewer transistors and other components — generally from eight to ten transistors. As we already know, the AM band tunes from 550 to 1600kHz and the FM band tunes from 88 to 108MHz.

Pocket radios usually have three IF stages preceded by an FM RF amplifier and FM converter circuit. The first FM IF transistor amplifier also serves as the AM converter. The following two FM IF stages also serve as the AM IF amplifiers. Crystal diodes are used in both AM and FM detector stages.

The audio section may have a separate 1st audio stage feeding the transistor driver stage. Two transistors are generally used pushpull in the audio output circuit. These small pocket radios are battery operated.

Most circuits in small AM/FM portables and table model radios are identical. In some larger models a separate FM converter stage and FM AFC circuit may be added. The larger AM/FM radios are ac operated and have a silicon diode and transistorized power supply.

Although solid-state AM/FM portable radios are very small and compact, don't be afraid to tackle them when repairs are needed. They are only smaller versions of AM/FM table or console varieties and defective components are isolated in the same way.

SOLID-STATE AM/FM RADIOS

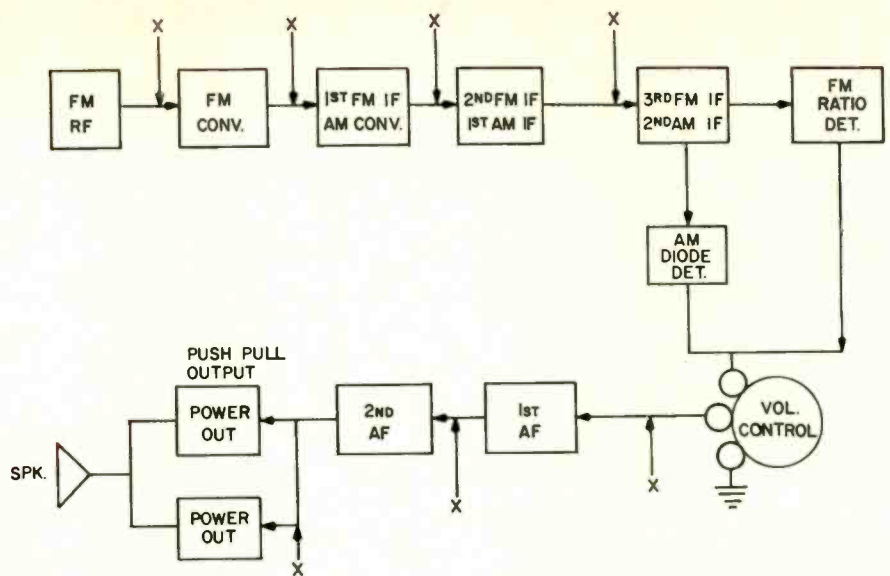

Fig. 2—Block diagram of a typical AM/FM radio.

Auto and Console Types

Auto and console type AM/FM solid-state radios are somewhat more complicated in circuit design and have several added stages. You may also find a separate AM converter and FM oscillator stage in these models. The AM converter stage may combine the mixer and oscillator or have a separate solid-state mixer circuit. A separate mixer stage is employed on the FM band.

Some console models may have an AM RF amplifier ahead of the converter stage. Most large console models have a separate FM IF amplifier stage ahead of the first AM IF amplifier and 2nd FM IF amplifier stages. And most console models have four FM IF amplifier stages.

Console AM/FM radios include FM/stereo with a stereo phono amplifier section. The FM multiplex circuit has a multiplex amplifier, a 38kHz amplifier, stereo indicator or two 19kHz amplifier stages preceding the 38 kHz amplifier.

Two dual high gain solid-state amplifier channels are switched into the FM multiplex or phono circuit. Generally, the two audio channels have two AM amplifiers ahead of a driver stage. Two or more power transistors are used in the final push-pull output stages.

Solid-state AM/FM auto radio circuits have a high gain output and compacted components. Most FM front-end tuning units are well shielded and are difficult to repair without unsoldering a lot of circuit connections. The FM RF amplifier,

FM oscillator and FM mixer transistor are frequently sandwiched between the circuit board and the tuning unit.

Test Instruments You'll Need

A VTVM is a valuable test instrument you'll need for making low voltage measurements in transistor circuits. Also, a good VOM, having low voltage and current scales, is required. An AM/FM signal generator or a small noise generator will also prove helpful in locating defective RF, IF or audio stages. The AM/FM generator is also used in frequency alignment. A straight AM signal generator can be used to align the FM stages but a sweep generator and scope are more accurate for discriminator alignment.

A regular output meter or VTVM can be used to measure gain in frequency alignment. A scope and audio squarewave generator is useful when checking for loss of signal or distortion in the stereo audio circuits.

You can use your old AM signal generator to trace and isolate faults in the RF, IF and converter stages of solid-state AM/FM radios.

Test instruments required for effective AM/FM radio servicing are found in a large number of shops today but a few relatively new instruments are still missing from many shops. These include quick-action "analyst" type radio troubleshooting instruments, in-circuit ac beta transistor testers and stereo multiplex generators. The latter is

a much-needed instrument for FM/stereo multiplex servicing. Last, but not least, are manufacturers exact-type schematics which are a great help in locating defective components.

Rapid Troubleshooting

As most expert bench technicians already know, the first step in troubleshooting is to isolate the section where the defective component is located. In other words, isolate the fault to one of the specific functional sections of the receiver. If the radio performs on the AM band, for example, but is dead on the FM band, then you know immediately that you have to go directly to the FM oscillator and FM RF amplifier stages. In most AM/FM receivers, if the trouble is in the AM section, it must be ahead of the 3rd transistor (see schematic in Fig. 1). Remember, the 3rd transistor is the AM converter and 1st IF amplifier stage. Generally, if this stage is defective, the FM section will also be inoperative. It is possible, in some cases, for the AM converter transistor to be weak enough not to oscillate on the AM band but a strong local FM station can still be heard.

If you have a dead receiver, begin at the volume control. Inject a signal from a noise generator into the center terminal of the volume control. If the audio stages are working, a loud tone will be heard from the speaker.

If the audio stages appear to be working, inject a signal into the

Model RGM19

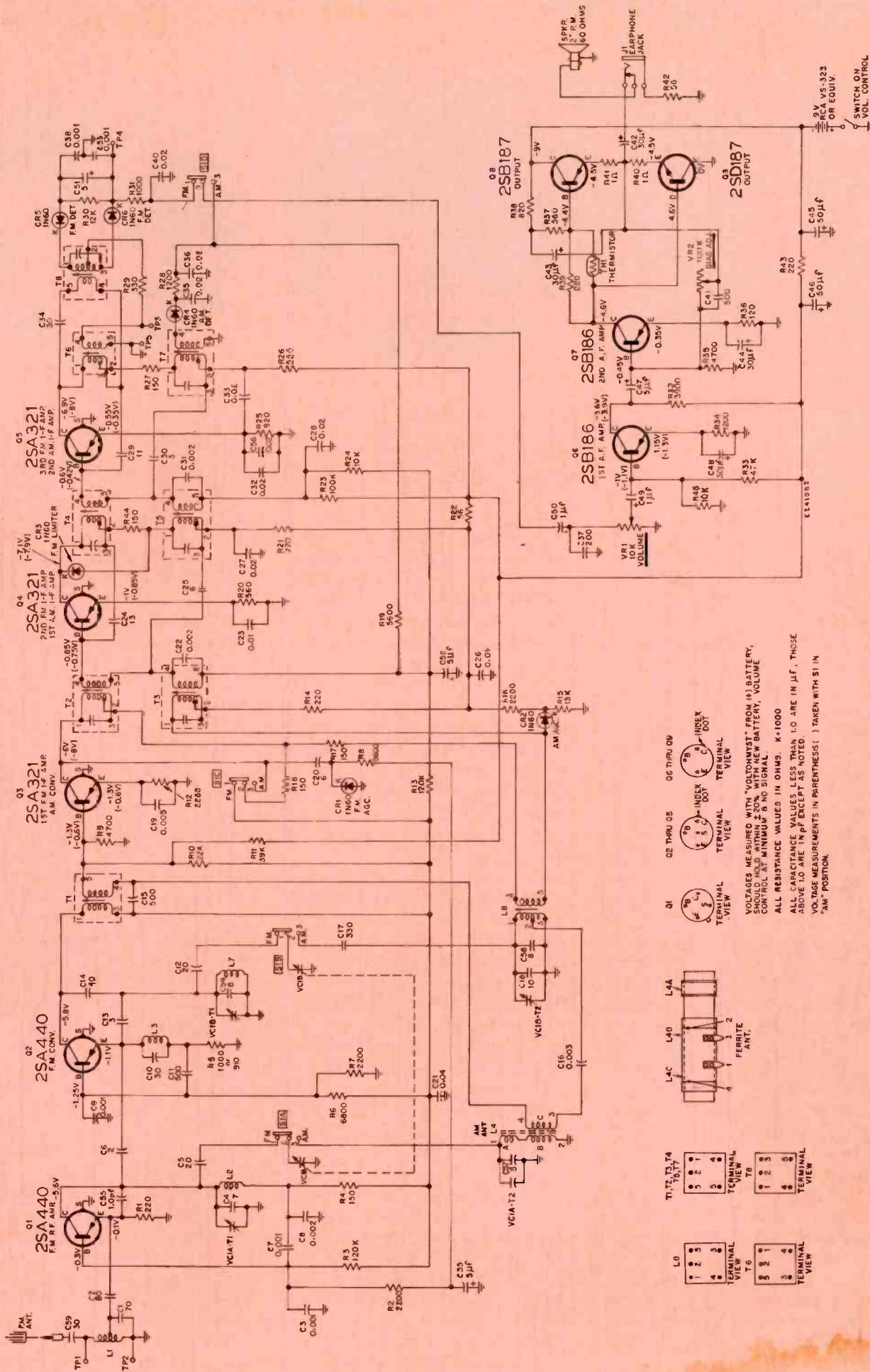

Q1 Q2 THRU Q5 Q6 THRU Q9
 TERMINAL VIEW INDEX DOT
 TERMINAL VIEW INDEX DOT
 TERMINAL VIEW INDEX DOT

L0 L40 L44
 TERMINAL VIEW FERRITE ANT.
 TERMINAL VIEW

T1, T2, T3, T4 T5, T7
 TERMINAL VIEW T6
 TERMINAL VIEW

VOLAGES MEASURED WITH "VOLTOHMIST" FROM (+) BATTERY, SHOULD HOLD WITHIN ±20% WITH NEW BATTERY, VOLUME CONTROL AT MINIMUM & NO SIGNAL.
 ALL CAPACITANCE VALUES LESS THAN 1.0 ARE IN μF. THOSE ABOVE 1.0 ARE IN pF EXCEPT AS NOTED.
 VOLTAGE MEASUREMENTS IN PARENTHESES () TAKEN WITH S1 IN "AM" POSITION.

Fig. 1—Schematic of RCA RGM19 AM/FM radio.

SOLID-STATE AM/FM RADIOS

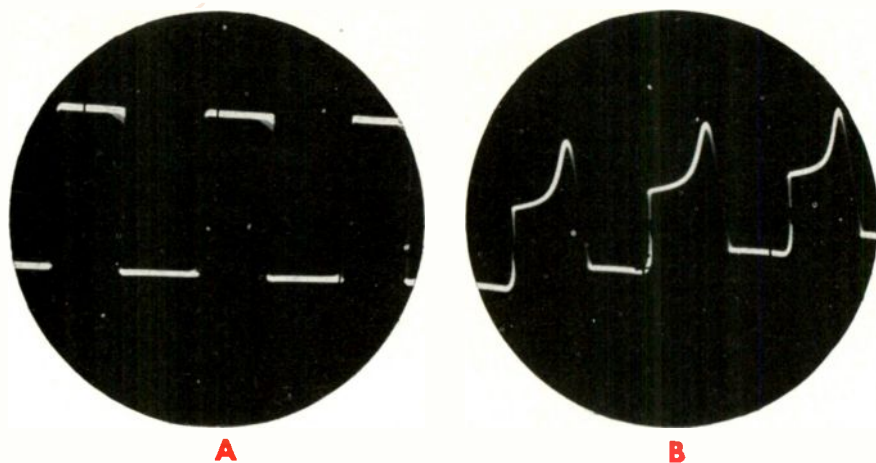

Fig. 3, 4 and 5. (A)—Scope trace shows a perfect output from a solid-state amplifier using a 1kHz squarewave at the input. (B)—A 1kHz squarewave applied to the phono input shows low frequency boost at the amplifier output. (C)—A 1kHz signal injected at the volume control of an RCA model VGP83 amplifier shows a loss of gain and distortion at the amplifier's output. The trouble was caused by a shorted 100 μ f 6v coupling capacitor.

base of the 3rd IF amplifier stage. Proceed toward the front-end of the AM/FM circuit. If you do not have a noise-type injection signal generator, use an AM/FM signal generator to check the RF and IF sections. Leave the volume control turned full on and keep the signal generator's gain control as low as possible (see Fig. 2).

When you locate a point of low signal or no signal, as indicated by the radio's speaker, the trouble is near at hand. If, for instance, the signal is low at a transistor's collector terminal and high on the base terminal, you have probably located a defective transistor. Take voltage and resistance measurements at this point.

A quick way to prove if the transistor is leaking or not amplifying properly (before removing it from the circuit), is to shunt a silicon diode across the base-to-collector terminals. If the gain is about the same, reverse the diode connections and notice if the volume increases. If it does, the transistor is defective. This simple check will work on defective RF, IF or audio transistors when they are still in-circuit. There is no danger of damaging the transistor being checked if the silicon diode is placed in the circuit momentarily.

If the transistor is defective, unsolder it and install a new one after making certain that supply voltages, capacitors and resistors are normal.

To check the AM IF stages, inject a 455kHz AM generator signal into the base of the AM converter transistor and go through each IF stage *toward* the AM detector stage. In checking the FM IF stages, set the AM signal generator to 10.7-MHz and proceed in the same manner.

The RF stages of the AM section can be checked by loosely coupling a signal loop to the AM antenna coil with the signal generator set at 1600kHz. Feed a 90MHz modulated signal into the antenna terminal connections to check the FM RF stage.

Manufacturers' instructions should be followed in all solid-state AM/FM receiver alignments. This applies especially to alignment of stereo multiplex sections.

Quick Audio Circuit Check

A quick check of the audio section can be made as follows: First determine if the complaint is weak audio, distortion or no volume. Low volume and distortion can usually be traced to the audio output stages. Begin at the volume control and inject a signal from the noise generator into the base of each audio transistor. A good audio signal generator can also be used to inject a signal at this point. If the transistor amplifier's volume is very weak, notice if the signal decreases as you proceed through the audio circuit.

For example, if the collector ter-

minal of the driver transistor indicates the presence of a signal and we apply the audio signal generator probe to the base of the same transistor and the signal is very weak, we have found a defective audio stage. Most causes of audio distortion can be located in the audio amplifier stages. Distortion can be caused by leaky output transistors, leaky coupling capacitors and changed-value bias resistors. A very good instrument for locating audio amplifier distortion is a squarewave generator and a scope. Various scope patterns are shown in Fig. 3, 4 and 5. Use a 47 to 60 Ω resistor across the speaker terminals on the output transformer. Remove the speaker from the circuit.

A squarewave generator may also be used to locate weak or low-gain audio stages. Each stage can be checked for gain and distortion with the output meter or scope. If the audio stage happens to be a stereo amplifier section, each stage can be compared with the good audio channel.

For instance, if one stereo channel is weak and will not balance, check the signal out and compare each stage with the good channel until the stage is located where the volume is lost. The balance control may be off only to one side but by using an audio signal generator and checking from the phono cartridge output through the amplifier, the small signal loss can be easily located. Compare and check each

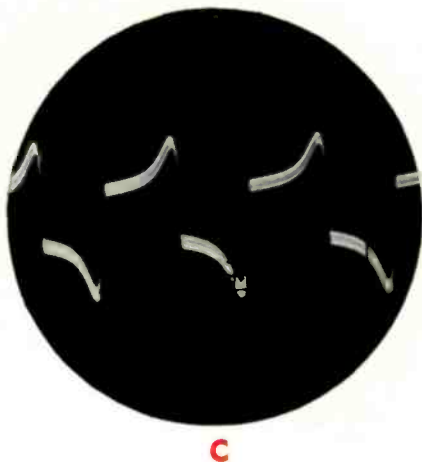

AM FM Solid-State Radio Trouble Chart

Symptoms	AM	FM
Weak Stations—poor selectivity	Check AM RF amplifier, oscillator, 1st and 2nd IF stages.	Check FM RF amplifier. Check alignment of FM IF stages.
Noisy Reception	Check both IF stages capacitors in IF transformer will short out — see if same voltage on both windings.	Check transistors in front end of tuning unit. Check capacitors in emitter legs of each IF transistor.
Stations Fade Out	Check RF and convertor transistor. May be weak and oscillate only on one portion of the dial. After awhile will fade out.	Check RF, Oscillator, and mixer transistors.
Loud Tuneable Hum or Buzz	Check IN34 or AM detector	Check ratio detector diodes. Check filter across both diodes.
No FM Multiplex indicator light		Check bulb. Check transistor in multiplex circuit. Check indicator transistor. Check multiplex alignment.
Poor AM reception Good FM reception	Check AM antenna and RF, convertor transistors if the receiver has separate stages.	
Poor FM reception Good AM reception		Check FM RF Amp. FM oscillator, FM mixer transistors. Take voltage measurements.
Weak Audio on phono output	Check and see if right or left channel. Compare the signal with each stage as progress through circuit — use an audio signal generator and scope for gain or loss of signal.	
Intermittent audio	Check if on phono, see what channel and first check the crystal cartridge. See which channel is intermittent. Use scope to trace intermittent signal of each stage — isolate defective stage. Check large electrolytic capacitors in transistor output stages. Check coupling electrolytic capacitors.	
Audio Distortion	Check driver and output transistors. Check for burned transistors, or changed bias resistors. Take critical voltage checks. Check for leaky coupling capacitors. Use a scope with 1 kHz tone from audio signal generator and go from stage to stage.	

individual stage with the good stereo channel.

As the FM receiver section becomes older, the stereo balance control will become more difficult to balance. You may also notice on stereo multiplex that the balance control will not be perfectly balanced when the receiver is new.

Actual AM/FM Trouble Cases

A weak FM station within the FM band can easily be caused by a weak RF amplifier transistor. Other stations can come in good. When this condition exists, you will notice that the FM “hissing” noise is usually low on the FM band.

This trouble actually happened in a 1966 Dodge model 364 AM/FM auto radio which came to the shop. The local FM station was operating as it should, but a station thirty miles away could not be heard. When the auto was new, this station was received regularly.

Isolating the trouble with the help of a schematic, the trouble was indicated in either the FM mixer, oscillator or the RF amplifier stages. These three transistors are sandwiched between the FM etched board and the tuning assembly. To pull the FM board out is a lot of work so the FM transistors were removed and checked. Since the local FM station came in good, we decided to begin with the RF transistor. Removing these transistors from the etched board requires extreme care and patience.

SOLID-STATE AM/FM RADIOS

Pencil points to a cracked printed circuit board on a G-E portable. Note the crack is around a heavy component—a pm speaker.

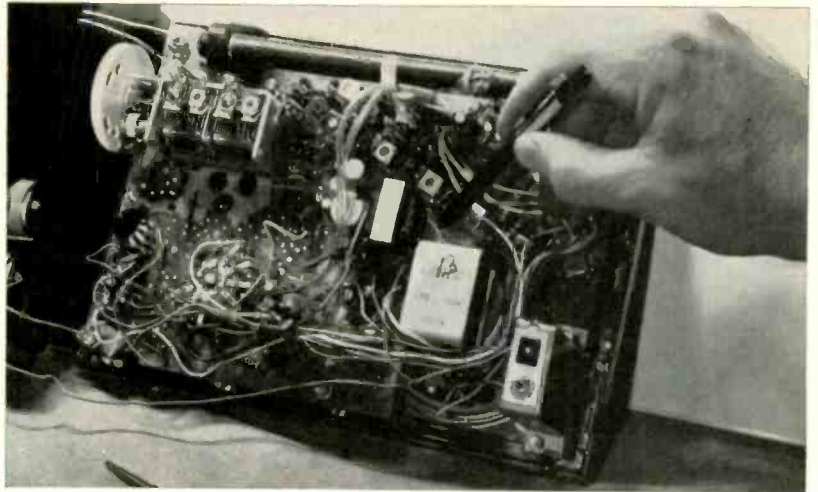

We quickly discovered a very weak RF transistor and replaced it.

Always make sure that FM trouble is first investigated beyond this FM unit. These FM tuning units are generally well shielded and wedged tightly together. When removing or bending any components or wires in these circuits, be sure to replace them in their original position.

Intermittent FM reception is usually caused by loose coils, capacitors and a cracked printed board.

Coil L2, for example, in a pocket-sized RCA model R6M19, is soldered into the printed circuit board.

A local FM station faded in and out. One of the ends of the small coil became loose and intermittent reception resulted. Intermittent AM/FM reception can also be caused by a weak RF, oscillator or IF transistor. A weak oscillating transistor in any one of these stages will cause an intermittent squeal or muffled audio.

Another RCA model R6M39, AM/FM radio had only FM hissing noise on the entire FM band. This was caused by a leaky IN34 diode (see Fig. 6).

Another AM/FM receiver with the same model number had only

weak local AM reception. A broken yellow lead to the ferrite AM antenna caused this trouble. Only the two local stations could be heard, along with a lot of hum.

The next trouble was in a VM model 962-1 radio chassis with weak local AM stations and no FM reception. The trouble was first traced to the 2nd FM IF amplifier and first AM IF transistor, X7. This transistor was removed from the circuit but it checked good. The trouble was caused by C50, a 0.05 capacitor in the emitter circuit of the transistor (see Fig. 7).

A leaky 2nd AM/FM IF tran-

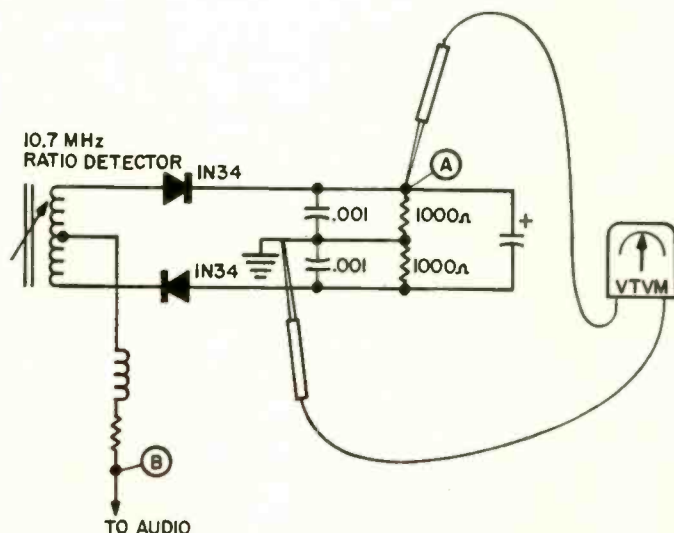

Typical alignment set-up for FM.

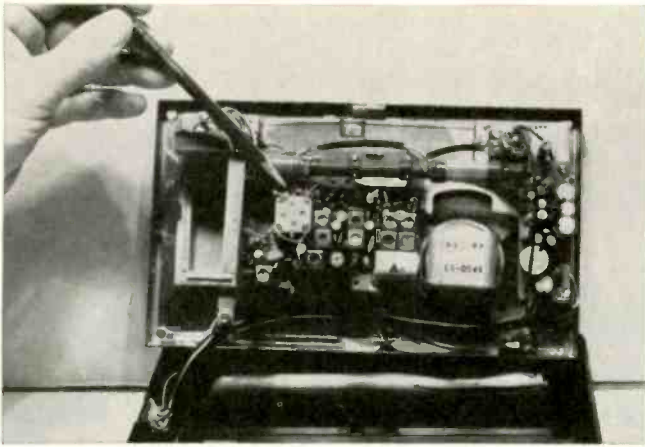

The pencil points to a broken antenna coil in an RCA model RGM39 receiver.

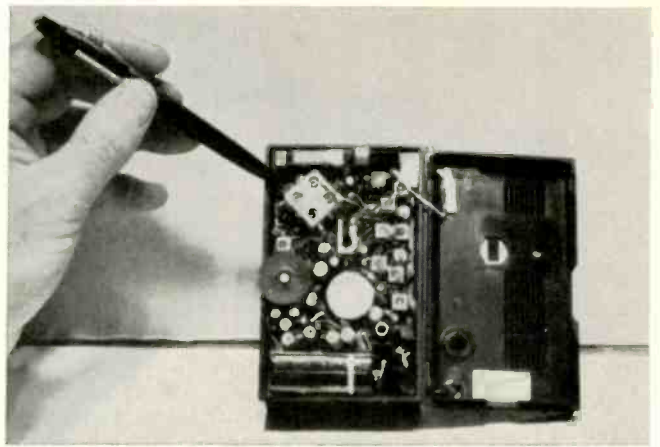

The pencil points out a loose FM coil in an RCA RGM19 receiver which caused intermittent FM reception.

sistor in a Magnavox R205-01-00 chassis caused low volume and a lot of distortion.

A loud hum and rushing noise on the FM band of an Admiral 12A2 chassis was caused by a shorted diode, CR4, in the FM ratio detector circuit. Only a local FM station was heard and it was covered by heavy hum and distortion.

Another Admiral model Y8519 solid-state console came into the shop with a dead right stereo channel. The customer said a loud pop and cracking noise was heard before the right channel went completely

dead. A 1kHz audio generator signal was injected into the base of each transistor and the trouble was quickly traced to a defective AF emitter-driver stage. No signal came from transistor 57C6-1. Simply by shunting a silicon diode across the base and collector terminals, the 1kHz audio tone was heard through the right channel speaker.

Intermittent audio may be caused by defective electrolytic coupling capacitors, transistors and a cracked board.

A G-E model p1905B came in with the board cracked around the

output transformer and speaker. Most breaks on etched boards take place around heavy mounted components.

Hum and motorboating are usually caused by filter capacitors in the ac power supply or battery input circuits. An RCA model RGM19 AM/FM receiver was motorboating. The trouble was caused by a 50 μ f filter capacitor, C50, following R43 in the battery circuit.

High impedance hum may be caused by ungrounded circuits in the phono or transistor base inputs of audio amplifier stages, also a poor ground on shielded leads. ■

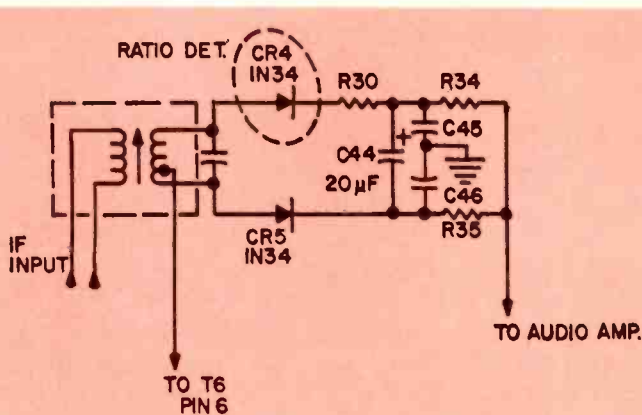

Fig. 6—A leaky 1N34 in the detector section of an RCA RGM39 caused hissing noise on the FM band.

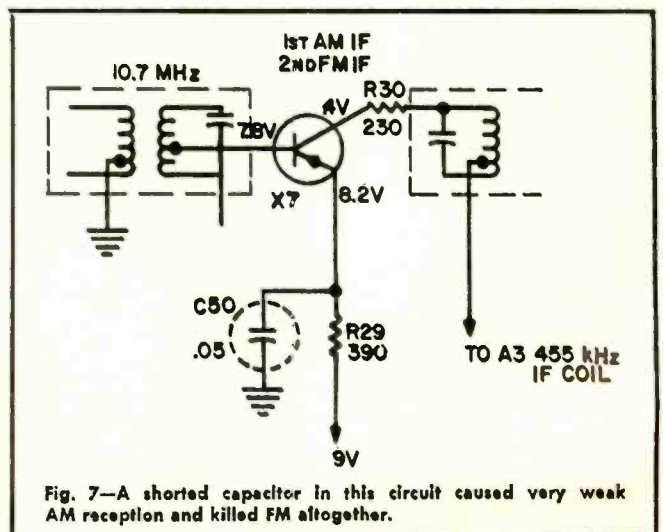

Fig. 7—A shorted capacitor in this circuit caused very weak AM reception and killed FM altogether.

Semiconductors

Know what affects their frequency response and you'll find it

■ A previous article discussed voltage and current gains in transistor circuits without making reference to the frequency of the signal amplified. Measurements show that a transistor's ability to amplify decreases as the signal frequency increases. The frequency at which the gain drops to 0.707 ($\frac{1}{2}\sqrt{2}$) its value at 1kHz is called the cutoff frequency. This is equivalent to a signal drop of 3db.

As previously indicated, the signal gain in a common-base circuit (h_{rb}) is the ratio of the emitter and collector current signals $\frac{(\Delta I_C)}{\Delta I_E}$. The cutoff frequency for this circuit is expressed as f_α or f_{rb} .

The signal gain in a common emitter circuit (h_{re}) is the ratio of the base and collector current signals $\frac{(\Delta I_C)}{\Delta I_B}$. In this circuit the cutoff frequency at which the gain has dropped 3db is expressed as f_{beta} or f_{re} .

The effect a signal's frequency has on a transistor's gain is shown in Fig. 1. The common-base cutoff

frequency (f_{rb}) is higher than the common-emitter cutoff frequency (f_{re}) and is more often used to describe the characteristics of a transistor.

The gain-bandwidth product is the most commonly used measure of a transistor's frequency response. It is the frequency (f_T) at which the common-emitter signal gain (h_{re}) equals one. This frequency is usually determined by measuring the current gain near f_{re} and extrapolating at -6db per octave. When logarithmic scales are used in a graph as shown in Fig. 1 to represent gain and frequency, a -6db per octave slope is represented by a 45deg. angle. A line was drawn from the value of h_{re} at f_{re} at a 45deg. angle to extrapolate the value of f_T .

Today's transistors have an f_{re} , f_T and f_{rb} frequency response ranging from 0.12, 12 and 18MHz, respectively, for germanium alloy transistors to 50MHz, through 1.7 and 2.5GHz for silicon diffused transistors.

Two Factors Limit High Frequency Response

The base in an NPN transistor circuit (Fig. 2) is more positive than

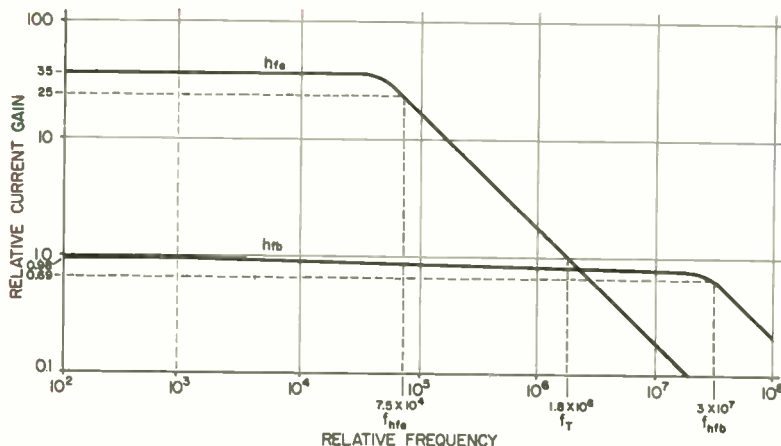

Fig. 1—Transistor gain is reduced at higher frequencies.

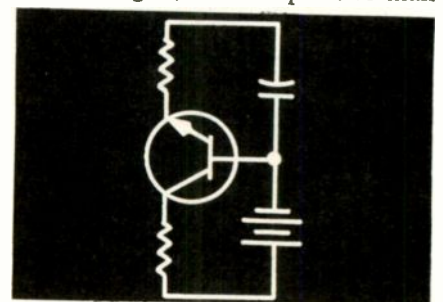
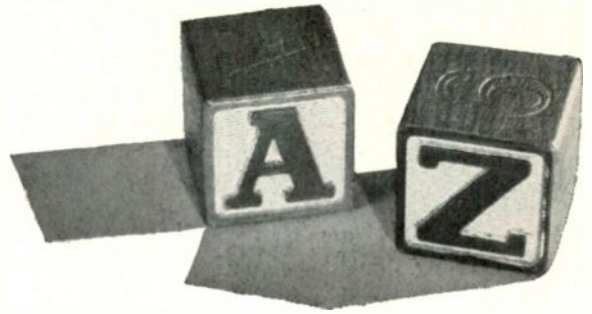

Fig. 2—Base-to-emitter junctions are forward biased while base-to-collector junctions are reverse biased.

the emitter and, therefore, the base-to-emitter junction is forward biased. In this circuit the base is

from A to Z



easier to service transistor circuits

less positive than the collector and, therefore, the base-to-collector junction is reverse biased. (The same bias conditions occur in a PNP transistor circuit containing voltages of opposite polarity.) Reverse biased semiconductor junctions develop a "diffusion capacity" that is directly proportional to the area of the junction and inversely proportional to the square root or cube root of the voltage applied.

Since only the base-to-collector junction is reverse biased, it is this junction that contains a noticeable capacitance. This capacitance is represented by C_{bc} and generally ranges from 1 to 50pf.

The base-to-collector capacitance has an adverse effect on the frequency response of the transistor circuit shown in Fig. 3. As indicated

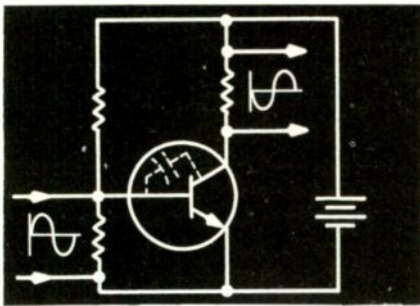

Fig. 3—Transistor gain is reduced by the transistor's internal capacitance.

in a previous article, the input in a common emitter circuit is normally inverted at the output. The capacitance (C_{bc}) couples this output with the input. Since the output signal is the inverse of the input signal, it reduces the input signal (negative feedback), reducing the circuit's gain.

Capacitor (C_{bc}) provides a signal opposing the input signal and more base current (I_B) is required to provide an output signal of the same amplitude. This condition has the

effect of decreasing the transistor's base-to-emitter impedance.

The feedback resulting from the transistor's internal capacitance (C_{bc}) is called the "Miller Effect." This effect can be reduced by lowering the circuit's input impedance to match the lower impedance of the transistor's base.

The circuit in Fig. 4 is designed

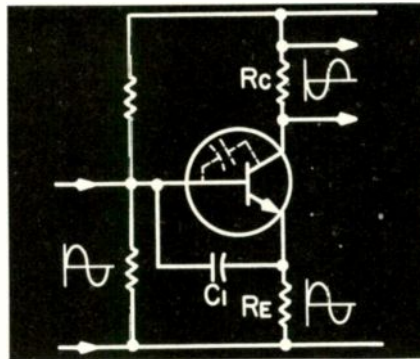

Fig. 4—Transistor internal capacitance can be neutralized by the circuit.

to "neutralize" the effect of the transistor's internal capacitance (C_{bc}) by providing an equal amount of positive feedback. The output signal present in the emitter resistor (R_E) is in phase with the input signal and can be a source of positive feedback. This signal is fed to the base by capacitor C_1 .

It has been indicated that the base-to-collector capacitance affects the transistor's frequency response, and that the amount of this capacitance (C_{bc}) is dependent on the reverse bias of the base-to-collector junction. For this reason, the transistor's gain bandwidth varies with the collector-to-emitter voltage (V_{CE}) and collector current (I_C). The curves shown in Fig. 5 indicate how voltage and current combinations increase or decrease a transistor's frequency response.

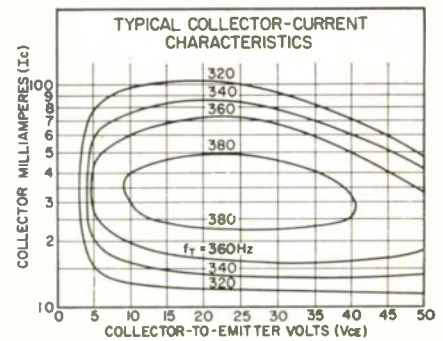

Fig. 5—Voltage and current combinations can affect a transistor's frequency response.

Transistors require a finite time for the current to pass across the base from the emitter to the collector. This "transit time" is dependent on the thickness of the base region. A typical germanium alloy transistor has a 0.001 in. base, a 0.002sec transit time and a 3MHz f_{β} cutoff frequency. A silicon diffused transistor may have a 0.0001in. base thickness and a f_{β} cutoff frequency of 150MHz.

The delay that a signal experiences when passing through the base results in a phase shift. The higher the signal's frequency, the greater the phase shift resulting from this delay. Slight variations in the distance that signals must

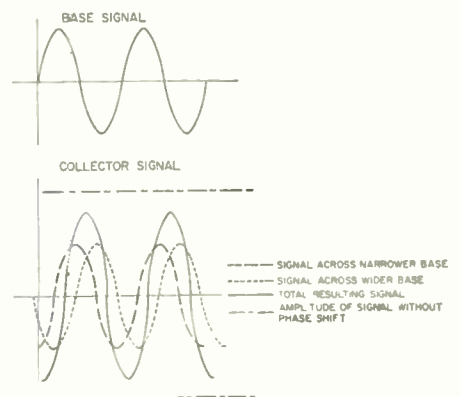

Fig. 6—Varying phase shifts can reduce the collector signal.

SERVICE BEDROCKS SALES

An Oregon service-dealer tells how he's doing a quarter-million gross business this year

■ The more things change, the more they remain the same when it comes to sales and service, says Vern L. Wenger, Portland, Oregon.

Mr. Wenger proudly advertises "Serving Portland Folks Since 1908." That makes him the dean of Portland service-dealers and one of the nation's oldest purveyors of home entertainment sales and service still active in the business.

"The buying public doesn't know now and never did know what's involved in producing home entertainment," Mr. Wenger declares. "It *does* know when the performance is satisfactory—and the public also wants top service.

"Basically, from the customer's view, there's no fundamental difference between today's servicing concepts and those of fifty to sixty years ago in the days of mechanical sound reproduction. Service is the foundation on which sales rest for small and medium-sized dealers."

Personal Attention

Basing sales on personal attention to service, Vern L. Wenger Co. will top \$250,000 in gross sales this year, comments Mr. Wenger's son, Bob, who is active in the business carrying on the traditions established by his father during the past 58 years. The gross will break down to approximately 70 percent sales and 30 percent service.

Mr. Wenger, Sr., was a journeyman machinist when he went to work for a Portland phonograph company in the days of cylinder (Edison-type) records. He started his own business in 1918 and in 1920 introduced crystal detector radios to the Portland area. With the upsurge in radio listening which came with the introduction of dynamic speakers, Mr. Wenger put a big horn right out on the sidewalk where it could be heard for blocks around.

"We can't get away with this to-

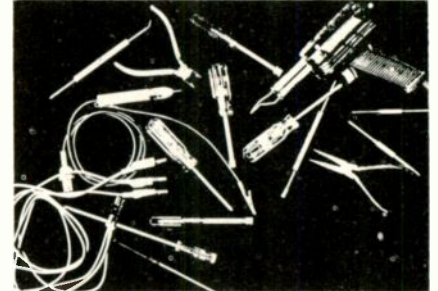

day," he smiles, "but good use of point-of-sale methods is still an important way to attract attention.

"When we went into color TV eight years ago, we put the word 'color' all over the windows. We had a large sign running across the entire top of the windows, moving signs bouncing up and down in the windows, and so on, to attract attention. Color today is more of a shot in the arm to dealers than superheterodyne was in its day, but we're using just about the same methods as we did then to cultivate markets."

Direct Mail Promotion

The father and son team base their market cultivation on direct mail.

Says Bob Wenger: "We're not out to do the biggest volume in Portland and, consequently, are not big users of newspaper advertising. It's our conviction gained through years of experience in merchandising phonographs, radios, and TVs that direct mail is the best advertising method for service-dealers to build sales and service."

No yearly direct-mail schedule is set up although the heaviest sales advertising is done in the fall and service is promoted in the summer.

A mid-September mailing piece and another in November calls attention to new merchandise and new developments in TV and stereo.

"Autumn is the time when potential customers are settling in for



Bob Wenger tunes in a set for a demonstration. He reports that 'training' customers to get the most out of their sets is the decisive follow-up on sales-satisfied customers.

Vern L. Wenger with Mrs. Vivienne Cromwell who handles the bookkeeping and office details.



A well-signed downtown location helps build traffic for Portland's oldest service-dealer.

the winter months," Bob Wenger points out. "You can't hypo the market when people aren't ready to buy. You get the best results when they're thinking about buying."

The best time for us to send out a direct mailer on service is early summer, and the approach that gets the best response for us is a "Summer TV Service Special."

Last summer's special, offered at "Only \$5.95," covered: "tube checks, tuner cleaning, CRT cleaning (if protection glass can be removed), adjust entire set (B/W) for best picture and sound."

The mailer concluded: "We are also specialists on color TV service. Call us for prompt service you will like."

Generally, on both sales and service, a direct mailing will run around 1500 and 2000 names per mailing, rather than flooding the trading area all at one time. This method, Bob Wenger points out, enables the dealer to pace his sales and service.

"Our winter sales letters first point out that we've just received the latest color TV models then explains that we have them on display. We always go on to say that if it's hard for the reader to get to the store we'll be happy to go to his home to show him new models and explain new features.

"In all such general sales letters, we always mention that we have skilled technicians to see that the set works perfectly."

Pinpointing Markets

In addition to general letters on both sales and service, the company finds that direct mail slanted to specific markets brings good results. As an example of this type of mailing, Bob Wenger cites a mailing of 100 letters sent to tenants of Terwilliger Plaza, a retirement center. Names were selected at random from the list of tenants.

The letter read in part: "Here for a limited time is a special offer to the folks at the Terwilliger Plaza—a two-day free trial of a color TV, in your own apartment.

"Here is a chance to see how color looks in your own home—there is no obligation—all you do

SERVICE BEDROCKS SALES

Wenger's service technicians have their own customers because management has found that many people like to have the same technician on every call. And management buys everything the service technicians say they need to do top work.

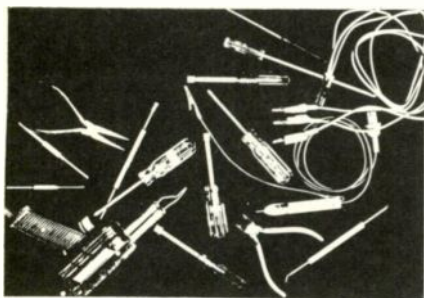

is phone us and on two days of your choosing we will see that you have color."

The letter points out that Wenger's is the oldest service-dealer in the city and requests recipients to "tell your friends that live in the Plaza about this because our list of names is not complete."

This direct appeal to the "folks" in the retirement center brought the best results per letter ever received, indicating that direct mail to retired people of above-average income offers considerable possibilities for color sales. As a consequence, the dealer is now building up a mailing list of these people to develop a broader program of mailings pinpointed toward retired senior citizens.

Youth Market

The youth market, Bob Wenger continues, is another market area that can be effectively cultivated by direct mail pinpointed toward newlyweds.

"According to our early experience, newlyweds are going for stereo," he says. "A good stereo, a nice TV set or a combination home entertainment center, is one of the first things they want when they begin housekeeping.

"We're working with a specialist who gets up a list of newlyweds. We've just started our mailings and it will take awhile to determine just how prolific this market is, but early indications are that special efforts to reach the newlyweds will pay off for us."

One problem the company is en-

countering in reaching special markets is in connection with its downtown location. For this reason, the father and son team is now considering the possibility of moving the store to one of Portland's outlying areas where major expansion of new homes and apartments is under way.

The downtown location — and the company has been in the same block ever since 1939 — has some traffic advantages, however. One advantage is that used merchandise can be turned over rapidly. Some sets taken on trade-in are repaired before being offered for sale, others are sold "as is."

Used Set Sales

"We wait until we get about six to ten used sets on hand," Bob Wenger says. "Then we put them all in the window at one time with a big sale sign on the window. Since we are in a heavy-traffic location, the word gets around fast and we move them right out without having to spend any money on advertising."

More and more families are becoming two- and three-TV owners, the Wengers find. The new color set goes into the living room and the B/W goes into the children's room.

Often, the family wants a good used set for the recreation room, and so there is a substantial market for trade-ins.

The ability to sell trade-ins easily, with little or no selling costs, means the dealer can stay competitive by going a little higher on his trade-in allowances. Most people realize that the \$400 they paid for a B/W set several years ago is not worth very much now and they don't expect a big trade-in allowance, Bob Wenger reports. But many expect more than is usually offered them.

"We've tried the flat trade-in allowance generally used by the department and furniture stores, that is, ten dollars or twenty dollars on any set, but people don't like that very much," Bob Wenger explains. "They like to wheel and deal with you on the trade-in.

"We set up each deal on an individual basis and are able to make a few dollars on the trade-in by staging our used TV sales. We've also found that the traffic from running used-set sales naturally feeds into sales of new color sets and into the service business."

The downtown location also brings in considerable radio repair work. Sets are personally brought in



Service technician Bob Salvus at work. Wenger's technicians are oldtimers in the business.



Bev Bronson checks out a portable-type TV in Wenger's well-instrumented shop.

from all over the trading area, and Wenger's probably repairs more small radios than anyone in the city.

The dealer carries a \$5000 stock of tubes, including tubes for older sets and on up through the latest models, to be able to handle everything in radio. Vern Wenger himself does a good deal of repairing on kitchen radios as well as on record players, which he can handle in his spare time between working the sales floor. He has a little shop for the purpose in one corner of the sales floor. Radio repair, it has been found, is also a lead into new business.

Service Shop Efficiency

A service shop, Bob Wenger says, is no more efficient than the men who do the work. Wenger's has two service technicians on a year-around basis, adds an apprentice in the summer who is always accompanied by a journeyman when he goes out on any outside calls.

"We make a big point that all our service is handled by fully qualified electronic technicians," Bob Wenger says. "When it comes to the service shop, we don't tell the men what to do—we let them tell us what to do. A good man likes to work effici-

ently. We have all the latest test instruments and buy anything the service technicians say we need."

Both journeymen have been with the company for more than seven years, are paid the union scale, and are given the opportunity to make a little extra money by turning in sales leads.

The dealer's prices on service calls are \$6.95 on B/W, \$7.50 on color—a flat charge.

"We make it a point to note on our copy of the service ticket which technician handles a call," Bob Wenger says. "Some customers always want the same man to handle their service calls and our customer becomes his customer, so to speak."

This customized service approach enables service technicians to get to know their customers and puts them in a good position to discuss a new set. When a customer is ready to buy a new set, the service technician reports it to the office and Bob Wenger goes to the home and talks with the customer. When the sale is made, the service technician receives a commission on the sale.

After-sale Follow-up

Young people are not so much of a "training problem" when it comes

to showing them how to use their new set—they've grown up with TV. But some training is often necessary with the older folks and, in many instances, some psychological selling is required after the set goes in, particularly on color.

"Often, the older folks are a little afraid of the color set and have to be shown a number of times how to operate it properly," Bob Wenger smiles. "We always make a strong point of insisting that they call us if they have any questions. Then we go out and go over it with them again.

"This isn't time wasted. It's a good business practice which makes satisfied customers. In one instance recently, we had to spend several hours in showing a man and his wife how to operate the set, then had to go back again for further instruction. But they were so enthusiastic about us that they sent in their father-in-law who bought a \$550 set from us."

A generous use of Bob Wenger's time in working with those who have purchased sets gives Wenger's a strong service identity and leaves service technicians free to concentrate on repair work. Bob also goes

continued on page 94

Manufacturers say raw material prices result in

Review of

HOFFMAN

■ There will be close to 100 percent color on the three major TV networks this fall. Last year NBC offered almost all its programs in color, this is the first season that ABC and CBS are competing with NBC, although NBC will telecast 1000 more hours of color than the two combined. As a result, retailers can expect even more sales in color this year.

Most companies are hiking their prices on new color sets, mainly on the middle and upper end of 25in. color lines, the increase comes about primarily because of higher prices for basic raw materials like copper, steel, cabinetry and plastic, according to manufacturers. But it is felt that the increase will not affect sales.

Some major CRT manufacturers have announced discontinued production on B/W TV tubes to concentrate full production facilities on color CRTs. Smaller, lighter portables seem to be the trend for the fall and Christmas season.

Admiral has introduced a new 9in. portable, selling for \$69.95. The TV weighs only 12lb, has a "precision crafted chassis," front speaker, monopole antenna and carrying handle. Known as the PN904, it will be featured in 85 major markets.

Industry officials estimate that less than one percent of Canada's 5.3 million television sets can receive color programs and forecast color sales this year of 65,000 sets. Industry expects to sell 1.3 million color sets by the end of 1970.

With the increase of color sets it will mean more service work for Canadian TV technicians.

Hoffman's color chassis 913-000366 is used in all 23 and 25in. sets, basically the same as last year. Employing the Standard Kollsman VHF tuner and three stage video IF, UHF tuning is simplified from last year's two control, two speed tuner to a one control and one speed transistorized tuner. A new 19in. color portable is planned this fall.

Chroma bandpass amplifier. The basic color circuits remain the same. A 6GH8 is used as a bandpass amplifier and the plate of this circuit incorporates the "Colorcaster" indicator lights. These are fired by two transistors, connected in a GO/NO/GO circuit (Fig. 1). when the bandpass amp is conducting. A bias control is used for "Colorcaster" sensitivity adjusting. Three lights illuminate the color controls: INTENSITY, TINT and CINEMA, during color transmission. The CINEMA varies the gray setting to customer preference. A color defeat switch, to kill extraneous color during black and white transmission, is located in the secondary of the bandpass amplifier transformer.

Power supply. This year's chassis has a four-way

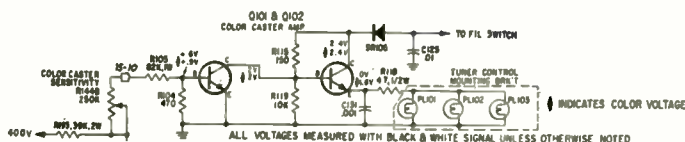
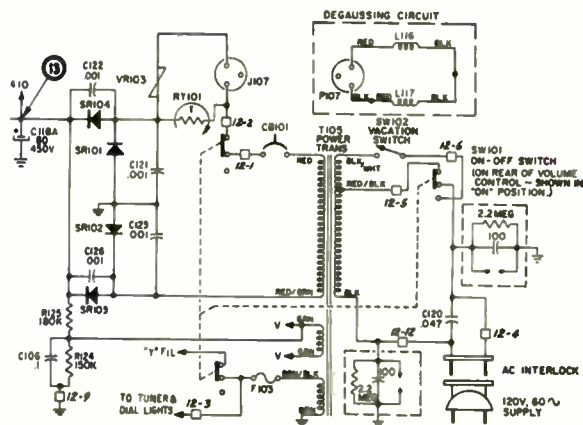

Fig. 1 — Hoffman's "color caster" circuit.



CHASSIS NO. 913-000366

Fig. 2—Hoffman's power supply circuit.

color set price increases

1967 TV Sets

bridge instead of two silicon rectifiers as in last year's (Fig. 2). A circuit breaker is in the power transformer secondary and a fuse has been placed in the B+ line to the HV circuit.

The new chassis employs a circuit called "Instavision" which keeps the tube filaments at a low voltage level for instant sound. The picture follows within eight seconds. More reactance is injected and obtained, from a tap on the power transformer primary. (Last year's chassis used a separate reactor.) When the set is off, B+ and the dial light circuits are open and only the secondary to the tube heaters is in the circuit. A manual "vacation" switch is on the back apron if the customer desires to use the set in a normal mode.

Provisions are made for adding a three function wireless remote control having a transistorized receiver. Being a sonic type control, installation is accomplished in approximately 15min. The remote has ON/OFF, three volume steps and channel change and comes in a packaged kit.

A plug-in tuner and control panel assembly for easy removal, are incorporated in the new line. Two connectors (one a 12-pin the other a 15-pin) plus the video cable are used to connect this unit to the main chassis.

MOTOROLA

Motorola's TS918 color chassis, for the most part, is identical electrically to the TSA914 which has been in the field for some time. The chassis is an improved version, employing the same basic circuitry and the same receiving tube types.

The 1967 color line consists of 46 models and includes three CRT sizes. The 46 models include 13 in the premier series carried over from last year. The 21in. models use a newly developed CRT.

Some of the new features added to the line are: All CRTs use rare earth phosphor, sets have horizontal pincushion corrector circuits, four CRKT switch type VHF tuners and numbered color controls for customer convenience.

Service features added to the new line are: Up front convergence on all models, serviceable convergence panel without removing chassis, two slide switches added to replace jumper wires, removable front escutcheon on 21in. models for easy dial light replacement and alignment stud on bezel for easy control panel alignment.

Horizontal pincushion corrector circuit. A portion

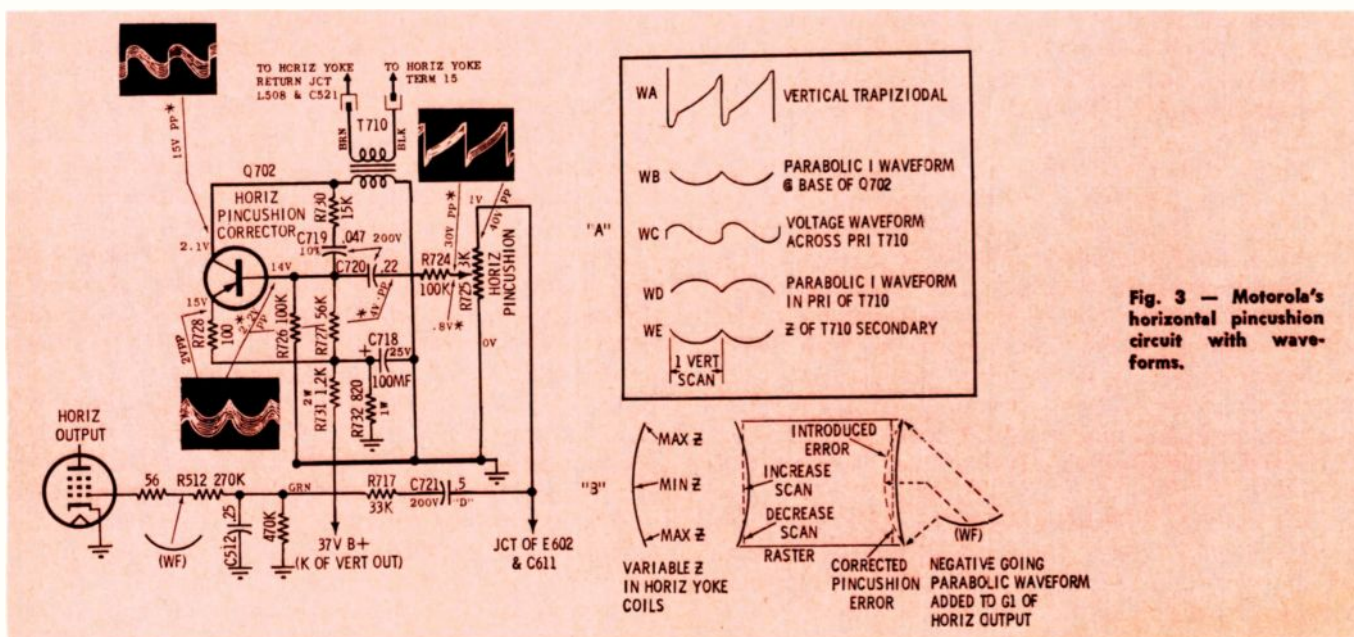

Fig. 3 — Motorola's horizontal pincushion circuit with waveforms.

1967 TV SETS

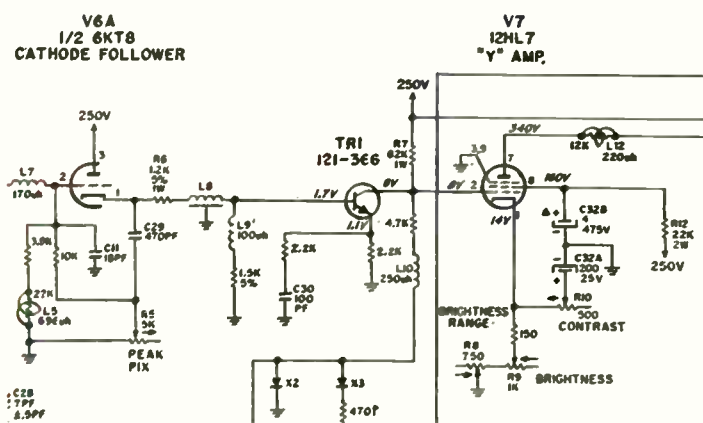

Fig. 4—Zenith's Y amplifier drive circuit.

of the vertical trapezoidal waveform (WA — Fig. 3) is integrated by R717 (33K), C512 (.25 μ f) and C721 (.5 μ f) into a negative going parabolic waveform (WF) as shown in Fig. 3. The parabolic waveform is fed to the control grid of the horizontal output tube through R512 (270K). Since this waveform is at a vertical rate and negative going, no effect is noted at the top and bottom of raster (Fig. 3). As the negative portion of the parabolic waveform progresses through its excursion, it is applied to the control grid of the horizontal output tube and progressively decreases the horizontal scan. This introduces sufficient pincushion error to be equal to the left side of the raster.

Transistor Q702 is a silicon PNP type and is forward biased for class A operation.

A trapezoidal waveform (WA) is fed to the top of horizontal pincushion corrector control R725 and is coupled into Q702 base through C720 (.22 μ f).

C179 (.047 μ f) and R730 (15K) wired between base and collector of Q702 integrates the trapezoidal waveform into negative going parabolic waveform (WB) and is fed into the base of Q702.

The amplified parabolic current is positive going in the primary of T710 which is the collector load for Q702.

The secondary impedance of the saturable reactor (T710) varies inversely as shown in curve WE.

In Fig. 3, the impedance curve (WE) is related to the raster. Since the impedance varies as shown at a vertical rate, it can be seen that at the top of the raster, the impedance presented in series with the horizontal coils is maximum which reduces horizontal scan shown by the dotted line. In the center of vertical sweep, the impedance of the saturable reactor secondary is minimum, thereby increasing scan. Likewise, at the bottom of the raster, the impedance is maximum and decreases scan.

The variable impedance applied in series with the horizontal yoke coils is symmetrical, thereby correcting the pincushion error on both sides of raster as indicated by the straight dotted lines in Fig. 3.

Motorola's 1967 B/W television line consists of

20 models using five chassis. Fifteen are new models and five are models which were introduced last December. Included in the line are two 12in., two 16in., three 19in., three 21in. and ten 23in. receivers.

The new chassis being presented for the first time are the TS461 being used in 12in. receivers; the TS-594, used in 21in. receivers.

The TS594 is a transformer powered hybrid chassis, employing transistors in the small signal circuits and tubes in the VHF tuner and all output circuits. Transistor circuitry is on an etched board mounted in the center of a conventional chassis. This chassis is being introduced in thirteen receivers.

Some improvements are being employed in present sets. These include addition of an optimizer control and an improved method of adjusting the video amplifier bias control.

Optimizer control. The purpose of the optimizer is to reduce the effects of high frequency noise in the picture. In previous tube type receivers, the optimizer control varied the 2nd detector load which effected a change in video high frequency response. The TS594 2nd detector circuit is closely related to the bias for the video amplifier stages, a different method of effecting a video high frequency roll off is employed. The optimizer control is a 750 Ω pot installed in series with the base of the 2nd video amplifier stage.

The optimizer control effects a gain reduction for high video frequencies by causing a reduction of high frequency information applied to the base emitter junction of the 2nd video amplifier stage. This is due to the effective base to ground capacity which represents a frequency sensitive impedance (input capacity) across the input to the 2nd video amplifier stage. As long as the resistance in series with this input capacity is low, most of the input signal will be developed across the input capacity. However, if the series resistance is increased, some of the applied voltage will be developed across the series resistance as well as the input capacity. The ratio of the voltage developed across the series resistance and the input capacity will be a function of

their respective impedances. At low frequencies, the input capacity will be the largest impedance so most of the low frequency information will be developed across the input capacity. However, at high frequencies, the input capacity represents a smaller impedance so more of the high frequency information will be developed across the series resistance.

ZENITH

Zenith's new 23X36 chassis has many circuit modifications over the previous model, plus a transistor for more video drive to the cathodes of the CRT. New tubes are used and alignment procedures for the color amplifier and demodulator circuits has been modified. A pulse-controlled high voltage regulator system is used.

Additional Y amplifier driver (transistor). Additional video drive to the cathodes of the CRT is provided by a transistor driver stage between the output of the cathode follower and Y amplifier tube. (See Fig. 4). This transistor provides a signal gain of approximately three. The video output at test point C1 is approximately 6v P-P and is coupled to the cathode follower stage. Since the gain of a cathode follower is always less than one, approximately 3v P-P is coupled to the transistor driver. With a voltage gain of three through the driver, approximately 9v P-P is fed to the 12HL7 Y amplifier.

Color receivers prior to this series chassis fed about 3v P-P to the Y amplifier (6v P-P at test point C1).

The transistor used in this application is part No. 121-366. To have the proper video polarity to the CRT, the picture detector diode is reversed in comparison to previous chassis.

12HL7 amplifier. A new 12HL7 tube is used, similar to a 12GN7A but with only half (approximately) the transconductance, providing excellent gain and stability. To provide the additional video drive to the cathodes of the CRT, plate voltage to the 12HL7 is increased. This is accomplished by the "extra" power supply between the 350v B+ bus and the 12HL7 plate. In this manner, approximately 80 to 100v additional is added to the 350v B+ bus and the 12HL7 plate.

Video Peaking. Additional video peaking coils are used throughout the "Y" circuitry (from the video detector to the CRT cathodes). Improved peaking with the PEAK PIX control is accomplished in part by the addition of a peaking coil in series with the B and G gain controls.

Increased screen (G2) voltages. The G2 voltages (CRT screens) have been increased. To accomplish this, a "Boost-Boost" voltage rectifier is incorporated in the horizontal sweep section. Boost voltage is coupled to a selenium rectifier providing 1200v of "boost-boost."

This is applied to the G2 controls. To limit the voltage across the controls, they are returned through a 120K, 1w resistor to the 350v B+ bus.

Color alignment and circuitry. Alignment of the color amplifier and demodulator circuits has been modified for the 23XC36, 23XC38, and 23XC38Z series chassis. Dc coupling has been improved, and two new 6ME8 demodulator tubes replace the previously used 6JH8 tubes. The internal plate construction of the 6ME8 tube gently reduces secondary emission. The 6ME8, although similar to the 6JH8, is not interchangeable because of differences in operating characteristics.

The G-Y matrix (output circuit of the R-Y and B-Y demodulators) has been modified to produce improved flesh tone reproduction. Also, the demodulator alignment (injection coil, quadrature adjustment) is aligned to approximately 100-105deg. Earlier chassis prior to this series were aligned for 90deg.

Demodulator alignment data has been modified for the 100-105deg injection separation.

Pulse-controlled high voltage regulation. A new pulse-controlled high voltage regulator system is used in the 23XC36, 23XC38, and 23XC38Z series chassis. As in any high voltage regulator system, its purpose is to maintain (regulate) the high voltage for the CRT at a constant value during brightness (beam current) changes. In this circuit (6HS5) regulation is accomplished by maintaining the pulse applied to the HV rectifier (3A3A or 3AT2) at a constant amplitude during brightness changes and thus, maintaining a constant high voltage. Circuit operation is as follows:

For a given brightness condition, the HV sweep transformer (primary and tertiary windings) are loaded to a given power value. For this particular condition, we will assume high voltage to be 25kv. The primary winding is loaded by the regulator tube and the tertiary (HV) winding by the HV rectifier and CRT.

As brightness increases, the tertiary winding load increases. By transformer action, this load is reflected to the primary winding resulting in less primary ringing. Since conduction of the damper tube is dependent upon the primary ringing (directly proportional), its conduction decreases. This results in decreased boost voltage. This decrease in boost voltage is coupled to the grid of the regulator tube causing a decrease in regulator tube conduction and increasing its plate voltage. This decreases the loading of the primary winding and thus, tends to increase (or maintain constant) the pulse amplitude to the HV rectifier. As brightness increases, this pulse would normally (under unregulated conditions) decrease and cause a decrease in high voltage. As brightness decreases the opposite action occurs.

Positive pulses occurring during retract time are also coupled from the horizontal oscillator to the grid of the regulator tube. These pulses "gate" the regulator tube "on" during retract time only. Thus, with the regulator tube conducting only during the retrace interval, it operates at higher efficiency, lengthens tube life, and virtually has no effect upon raster width. ■

Know these components and increase your annual income by replacing and repairing them

PART I OF A TWO-PART SERIES

STEREO HI FI TONE-ARMS CARTRIDGES AND STYLI

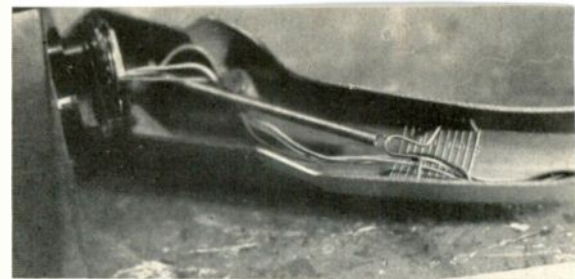

Double pressure verification is necessary in this type of tone arm adjustment, having a spring tension scale.

A stereo tone-arm that accepts a variety of pickups is always advantageous.

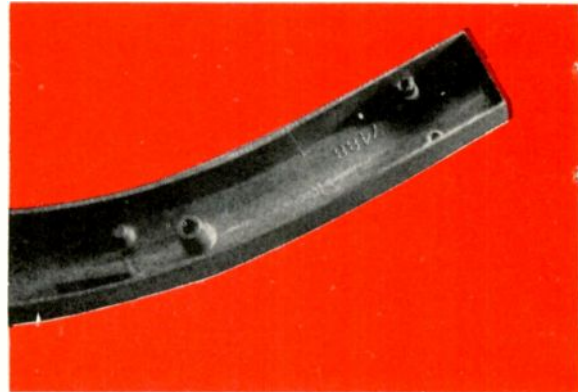

■ The audio quality from Hi Fi speakers is only as good as the weakest link in the entire system—no better than the poorest component in the system. The quality of the stereo cartridge, stylus or record can be completely cancelled by noise, distortion or hum contributed by an inadequate turntable, amplifier or speaker—not to mention problems created by poor workmanship in repairs, adjustments and alignments.

Careful attention must be given to manufacturers' service instructions as never before. There are several reasons for this. Stereo cartridges, as one example, are not as interchangeable as in the past. Color wiring codes, as another example, not only change from model to model, but in some instances, from changer to changer with the same type cartridge. Additionally, installation and adjustment of new stereo units are more critical and sensitive. The problems that occur are not difficult to understand but require a greater amount of patience and care.

Stereo Tone Arms

Almost any stereo record changer will produce higher quality performance and improved audio if

given a better tone arm. A better tone arm provides lighter tracking force and longer stylus, cartridge and record life.

A good tone arm has several requirements. It must move freely over the surface of the modulated groove. It must allow the stylus to sit down easily on the record and to be easily removed from the cartridge. And it must be designed to accurately track each groove tangentially as it moves inward on the record.

Not all stereo changer arms reach the high quality of the "professional" types but, in recent times, they are certainly coming closer.

The floating arm on the new automatic changers must not be confused with the true floating tone arm. This arm literally floats in the record grooves. The floating quality of this arm insures against careless handling or accidents. The arm will not drop on the record. Instead, it floats slowly and gently, making damage to the record or the stylus almost impossible. Few automatic stereo record changers use this type arm when employed in self-contained, or package-type stereo units.

The basic function of the tone arm is simply to permit the trans-

ducer to track the modulated groove as unobtrusively as possible. This means that the combination of the stylus, cartridge and arm must move with maximum friction. New stereo tone arms are meeting these requirements.

Service Problems

Critical areas for tone arms are pivot points, tracking, cartridge mounting and counterbalance. A tone arm that does not track in the modulated groove may have a broken or worn stylus, improper tracking or stylus force or the tone arm may not be vertically correct. One exception may be if the rejection slide is sticking or sluggish.

In those instances where the complaint is noisy reproduction, accompanied by frequent replacements of styli or cartridges, the vertical plane of the tone arm should be checked. The tone arm may not be perfectly vertical because of alignment bending at the pivot point. This defect will not only cause distortion and noise but excessive record wear will damage one side of the modulated groove wall.

Since the stylus is well concealed when playing the record it is difficult to ascertain its angle by vis-



The plastic at the pivot point can be broken if too much upward pressure is applied.

ual examination. Visual inspection can be accomplished by placing a small mirror on the turntable, then place the tone arm gently on the mirror. The stylus and its reflection should be perfectly in line when viewed from any angle. If the stylus is off slightly, grasp the tone arm near the pivot and twist gently in the proper direction. This may have to be done several times to achieve perfection. This problem usually occurs because the arm is grasped while it is traveling inward to the record.

Although maximum performance is obtained by excellent counterbalancing and retractable cartridges, these have created some adverse problems. The most common is proper tracking after the unit has been delivered to the home. It must be admitted that most will track excellently at manufacturers' specifications, but only under ideal conditions. Conditions in the average home are far from ideal.

The light weight tone arms are more susceptible to skipping because of extraneous vibrations. In some instances, walking in front of the unit will cause the stylus to leave the modulated groove. This is not caused by a fault in the stereo unit, but by weak subflooring in

the home. Greater isolation between the changer and other portions of the system does not always solve the problem. In most cases it is found that increasing the stylus force by one or two grams above manufacturers' specifications minimized the problem. This is not normally recommended, however.

Not all tone arms can be raised high enough to connect, repair or install the stereo cartridge. This is caused primarily because most automatic changers in self-contained units are "well" mounted. It is much easier to perform repairs by removing the changer from the cabinet. Attempting to install a cartridge or repair cartridge terminals in a well-mounted unit may result in too much pressure being applied in the upward direction and thereby putting a strain on the tone arm's pivot action. This can cause imperfection in the vertical plane or even snap the pivot point. Most of these pivot areas are made of plastic and are easily damaged.

Low mass stereo arms and retractable cartridges are said to be fail-safe—dropping them on a record will not damage the stylus, cartridge or record. Experience has proven that this should not be demonstrated with any great zeal or confidence. In several instances, the stylus did break. And any impact to a record is bound to cause some damage even if microscopic.

A stereo tone arm that accepts a variety of pickups is always advantageous. Installing a more modern cartridge than the original may improve over-all reproduction quality.

An example of an early stereo cartridge that used grease damping can be used here. The damping agent flowed onto the stylus after a short period of time and caused lint to accumulate on the stylus. In every instance a different style pickup was installed with improvement in quality and a lengthening of cartridge life.

Stereo tone arms, with their pencil-like shapes, are very slowly bringing to a halt the possibility of improving performance by the aforementioned method. At the present time exact replacement must be made in most stereo automatic changers.

Stereo Cartridges

A stereo pickup is the heart of a stereo Hi Fi unit. The transducer employs the same kind of electrical generation as a monophonic unit, except the stereo cartridge must have two generating mechanisms driven by a single stylus. Separate signals are generated within the cartridge for right and left channels by having two separate voltage generators arranged at an angle within the pickup to distinguish the lateral and vertical stylus movements.

Only a pickup with a very high compliance whose stylus can be displaced with very little force can afford to operate under conditions of very low stylus pressure. The new sensitive counterbalances and retractable cartridges are meeting these requirements.

The new retractable cartridges are not always easy to install. The small springs for the floating mechanism are frequently a hindrance to rapid repair. But most cartridges are accessible by various methods. Some cartridges can be pulled directly off the arm. These are called plug-ins. Others are easily removed by releasing the spring clip and some by either removing a small screw under the tone arm and turning the complete arm, or pick-up head.

Despite the rugged nature of these stereo cartridges, replacements are usually required because of physical shock. This occurs when the tone arm is dropped accidentally or is jarred in some other manner. Although many of the cartridges have a retractable mechanism and a small bumper at the end of the tone arm, this does not make them entirely fool-proof — eliminating physical damage.

The retractable mechanism is simple. Any time the tone arm or stylus force is excessive, the pickup retracts into the tone arm and the rubber or plastic bumper at the end of the tone arm absorbs the shock or impact. There are various types of mechanisms but they are all basically the same regardless of the name used. Technicians should not attempt to demonstrate a stylus' or cartridge's indestructibility in the home—for reasons that now seem obvious. ■



Prompt diagnosis of a patient's suspected heart condition will shortly be available to rural physicians, hospitals and clinics using Bell System's Data-Phone medical sets. Here, in his office in a small town in Iowa, Dr. Martin Deakins reads a patient's electrocardiogram while it is being sent over telephone lines to Creighton University's cardiac laboratory in Omaha, Neb., for interpretation.



Dr. Anthony Carazzo monitors an electrocardiogram coming over Data-Phone medical sets installed at Creighton University cardiac lab. Technician Ingrid Peters speaks directly with the sending person and obtains the patient's personal data.

ANOTHER OPPORTUNITY FOR ALERT TECHNICIANS

Medical electronic equipment booms as Data-Phone brings medical-center services only minutes away from rural areas

■ A significant number of medium sized TV-radio service-dealer operations — amply organized, staffed and instrumented—are engaged in servicing industrial and medical electronic equipment. This type diversification, of course, requires additional capital investments, careful planning and a management who is not afraid of burning some “mid-night oil.” And some electronics technicians are specializing in servicing medical electronic equipment.

Since Data-Phone services have become available, many rural doctors have installed electrocardiographs for obtaining heart-condition information direct from medical-centers in a number of areas. This service is expected to expand across the country in the not too distant future. Additionally, doctors throughout the country are showing interest in applications of an increasing variety of electronic instruments already being manufactured or now under development.

‘Heartline’

The electrocardiograph is one medical instrument just now coming into its own. The dramatic story of its use is briefly outlined here.

A person living in a rural area complains to his doctor of chest pain. Is it heart trouble? If so, how

serious? What should be the medical treatment? Often, the decision can only be made after a heart specialist studies an electrocardiogram (ECG, or visual reproduction of heart action). But, for the patient's physician—far from a medical center and not a cardiologist himself—mail consultation or trips to a distant city could delay diagnosis and treatment for days. But now doctors can transmit ECGs over telephone lines to specialists almost anywhere. This service is already being used in a number of places around the nation today. It works this way:

A doctor prepares a patient for an ECG. Before beginning the examination a call is dialed to a heart specialist or a medical center which is set up to handle the service. When the call is answered, the electrocardiograph is connected to Data-Phone service with the specialist's ECG instrument. During the examination, zigzag squiggles appear on paper tape from electrocardiographs at both ends of the link. This tape can then be analyzed and discussed with the sender.

The Bell Telephone Co. has announced that electrocardiograph service will be available nation-wide shortly. This service will also be made available to community hospitals and clinics who do not have staff cardiologists available. ■

Sencore has done it again—introduced the right instrument at the right time at the right price. FM-Stereo Multiplex is here, now, and growing as fast as Color TV. This new field is just waiting for qualified men. All you need to start “channelizing” profits your way is the new Sencore Econoline MX11 Channelizer Multiplex Generator. So light and compact you take it with you on your TV service calls, and when in the home suggest an alignment on that FM-Stereo hi-fi in the corner.

So simple to operate, you need no other instrument. Just hook up the RF output cable to the receiver antenna terminals; connect the two speaker leads in place of the speakers; then read the channel separation directly on the meters. Two meters with built-in loads substitute directly in place of speakers. When you flick on the left channel switch you have left channel output; now flip on the right channel switch and you have both. That's all there is to it.

All solid state circuitry—battery operated. Feature for feature, dollar for dollar, the Sencore MX11 Channelizer is your No. 1 buy in multiplex generators. Sencore has paved the way—so take the quickest road to your distributor. In stock now for only

\$99⁵⁰

(Less than the price of a kit.)

CHANNELIZER

PAVES THE WAY TO ADDED PROFITS

With Simplified FM-Multiplex Servicing

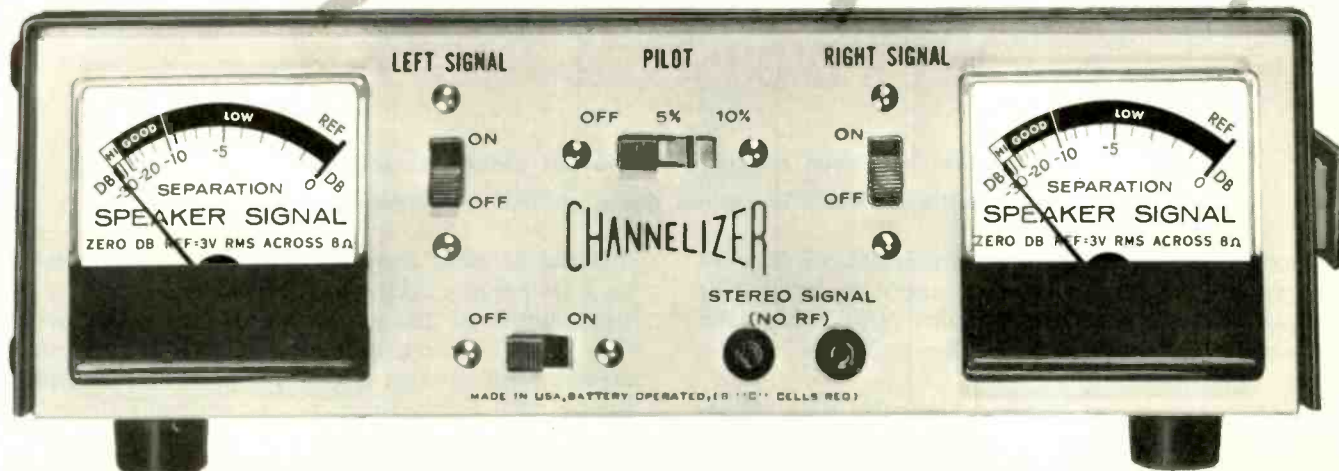

SENCORE MX129 FM STEREO MULTIPLEX GENERATOR AND ANALYZER

A Complete FM Stereo Service Center

The ultimate in multiplex generators for this field that's growing as fast as color TV. Like having your own FM stereo transmitter on your bench or service truck.

The MX129 produces all signals needed for trouble-shooting and aligning the stereo portion of the FM multiplex receiver. It is a complete trouble-shooting analyzer with a sensitive transistorized AC voltmeter calibrated in peak to peak volts and decibels. It can be used as a stereo demonstrator even when no stereo program is being broadcast. With the MX129 you can use external sources to modulate the carrier, re-balance the system at any time, and adjust the crystal controlled pilot signal to any level. Instantaneous warm-up—all solid state, A.C. powered.

The Sencore MX129 gives you features comparable to equipment costing up to \$350.00, yet its priced at only

\$169⁵⁰

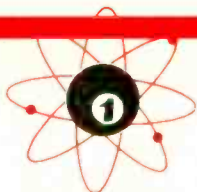

SENCORE

NO. 1 MANUFACTURER OF ELECTRONIC MAINTENANCE EQUIPMENT

426 SOUTH WESTGATE DRIVE, ADDISON, ILLINOIS 60101

... for more details circle 142 on postcard

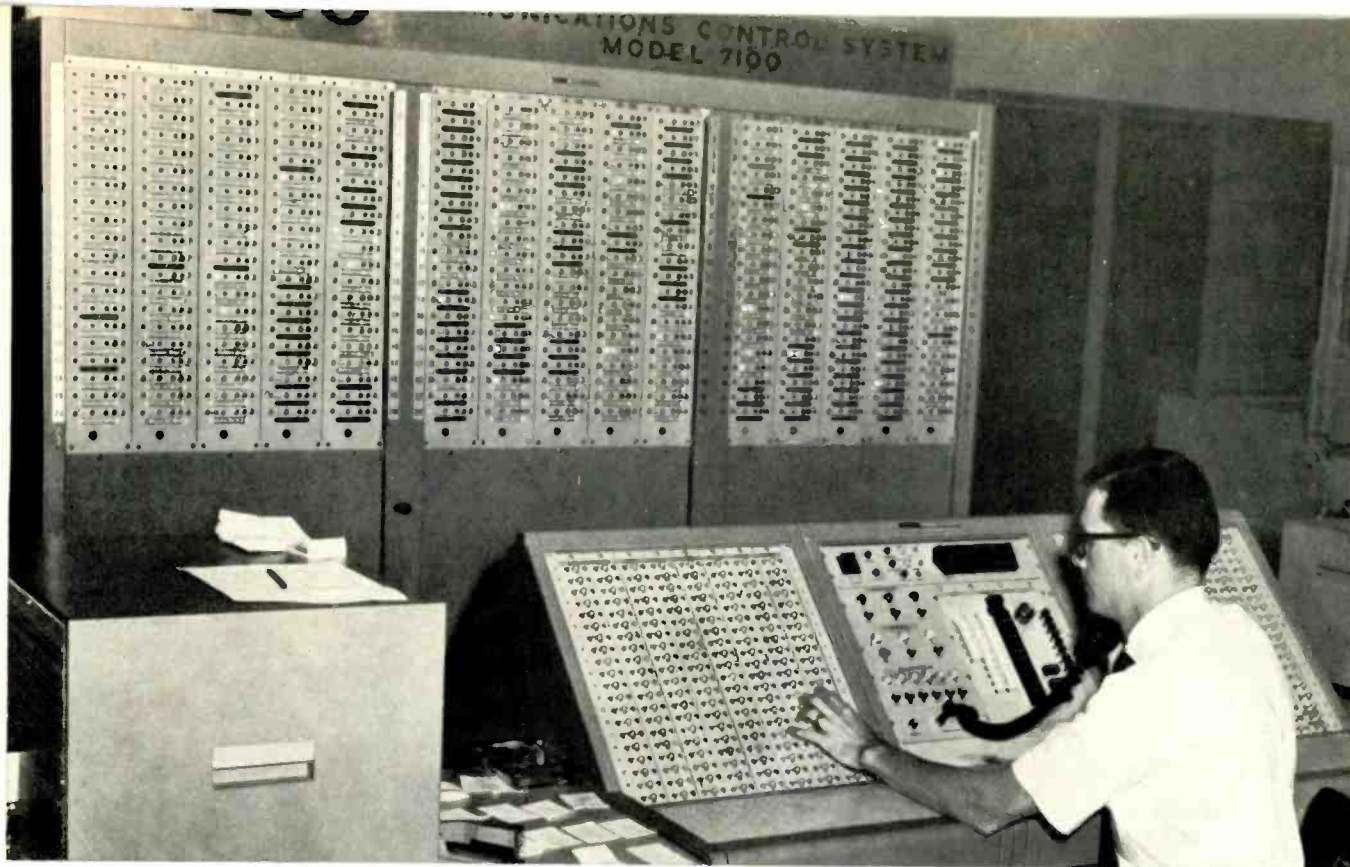

This communications and control system provides complete electronic data collection and memory storage from machines and equipment throughout the plant.

COMMUNICATIONS AND CONTROL EQUIPMENT FOR INDUSTRIAL PLANTS

A system has been designed to provide plant foremen with additional flexibility when doing routine assignments.

■ Ford Motor Co.'s Philco Electronics Group has developed a communications and control system (CCS) for industrial plants called the Philco 7100. It has been installed in the Ford steering gear and cold heading plant at Indianapolis, Ind.

The system offers complete electronic data collection and memory storage from machines and equipment throughout the plant. It provides direct-line communications between production areas and the central control room, and includes a paging and public address network.

The heart of the 7100 system is a control and display center where information may be gathered from up to 600 machines connected to the equipment. An illuminated display board provides a visual indication of each machine's operational status, while a memory device records and stores this vital information on magnetic tape. The stored information includes production counts and service requests, providing accurate real-time data on the status and history of equipment.

When a machine or a piece of equipment malfunctions, it is automatically detected by the 7100 and the control room operator can immediately take remedial action. When a machine operator desires assistance,

material or other service, he can, by turning a switch on a station monitoring box, automatically inform central control of the service request. Central control then pages a foreman, material handler or maintenance crew, informing them of the type of service required in the troubled area according to an automatically-printed report provided by the communications system.

The system is particularly helpful to plant foremen, since it allows them more time for pressing problems by providing flexibility in accomplishing assignments.

In addition to machine counts, production counts and trouble spotting, the 7100 system automatically detects idle time, provides automatic interim reporting and shift summary reporting on production—automatically sounding alarms for off-standard conditions. It can also be used in conjunction with other data handling systems.

More than 387,000 ft of wiring and 48,000 connections were implemented in installing the system.

Other Ford installations scheduled to receive the 7100 system include four General Parts Div. plants at Rawsonville, Ypsilanti and Saline, Mich. and Sandusky, Ohio; and the Transmission and Chassis Div.'s plant in Sterling, Mich. ■



CG138



CG10

It's time you too switched to Sencore and saved \$100 in the bargain. The new LO-BOY is a solid Sencore value — already selling at the rate of one every 8 minutes.

Small wonder. The LO-BOY outperforms the highest priced unit on the market . . . and gives you all this: • Ten standard RCA licensed color bars; NTSC phased colors. • All the patterns found on more expensive generators—crosshatch, individual vertical and horizontal lines, and adjustable white dots . . . all at the flick of a switch. No lines missing on crosshatch—14 horizontal and 10 vertical, same as our more expensive models. • Interlace control—a Sencore "first." Stops dot bounce that varies from set to set. • Rugged all steel construction with tough scuff-resistant vinyl finish. • LO in silhouette—not much bigger than a cigar box. • LO in warm-up time. All solid state design. • LO in troubles. All new **patent pending** counting circuits using new silicon transistors. Crystal controlled timers for the utmost in stability.

Timer controls brought right out on the front panel as simple operators controls. Adjusted as easily as the horizontal and vertical hold controls on a TV set, if they should ever jump. Absolutely eliminates timer instability.

Compare these features and you'll decide in less than 8 minutes that you need a new Sencore Lo-Boy.

SENCORE CG10. All solid state. New zener regulated battery power supply with long life "C" cells. The 12 volt battery supply can wear down to nearly 9 volts before the circuits are affected. New leakproof battery holders permit easy battery replacement without dismantling the unit. You don't have to hunt for a place to plug it in. Priced at less than the cost of a kit.Only **\$89⁵⁰**

SENCORE CG138. A performance giant just like the CG10 except AC operated with a zener regulated power supply for added stability even with line voltage variations. Has 4.5 mc crystal controlled signal for fine tuning as recommended by color set manufacturers.Only **\$109⁵⁰**

Every 8 Minutes of Every Business Day

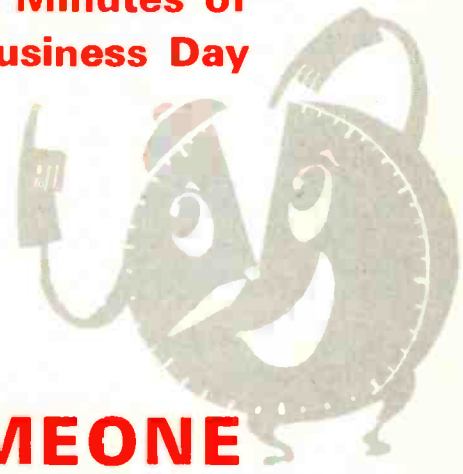

SOMEONE BUYS A NEW SENCORE LO-BOY STANDARD COLOR BAR GENERATOR

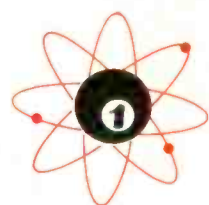

See America's most complete line of professional test instruments — at your Distributor's now.

SENCORE

NO. 1 MANUFACTURER OF ELECTRONIC MAINTENANCE EQUIPMENT

426 SOUTH WESTGATE DRIVE, ADDISON, ILLINOIS 60101

. . . for more details circle 143 on postcard

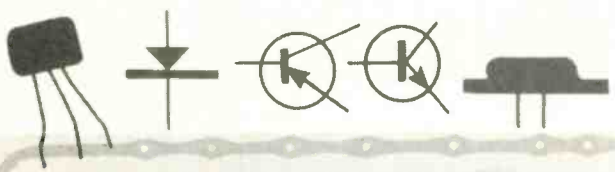

TEST TRANSISTORS IN SECONDS in circuit

TR139
89⁵⁰



Also check all transistors, diodes, and rectifiers out of circuit for true AC beta and Icbo leakage.

Your best answer for solid state servicing, production line testing, quality control and design.

Sencore has developed a new, dynamic in-circuit transistor tester that really works—the TR139—that lets you check any transistor or diode in-circuit without disconnecting a single lead. Nothing could be simpler, quicker or more accurate. Also checks all transistors, diodes and rectifiers out of circuit.

BETA MEASUREMENTS—Beta is the all-important gain factor of a transistor; compares to the gm of a tube. The Sencore TR139 actually measures the ratio of signal on the base to that on the collector. This ratio of signal in to signal out is true AC beta.

ICBO MEASUREMENTS—The TR139 also gives you the leakage current (Icbo) of any transistor in microamps directly on the meter.

DIODE TESTS—Checks both rectifiers and diodes either in or out of the circuit. Measures the actual front to back conduction in micro-amps.

COMPLETE PROTECTION—A special circuit protects even the most delicate transistors and diodes, even if the leads are accidentally hooked up to the wrong terminals.

NO SET-UP BOOK—Just hook up any unknown transistor to the TR139 and it will read true AC beta and Icbo leakage. Determines PNP or NPN types at the flick of a switch.

Compare to laboratory testers costing much more. . . . \$89.50

See America's Most Complete Line of Professional Test Instruments — At Your Distributor Now.



. . . for more details circle 145 on postcard

PA For Quarterbacks

■ The New York Jets may have solved the problem of crowd noise that often drowns out the signals their quarterbacks call at the line of scrimmage.

A specially designed helmet seems to be the answer. The helmet contains a transistorized public address system that boosts the quarterback's voice to about three times the volume of a TV set turned on full blast. The Jets now have four of these helmets ready for use.

Six transistorized speakers solved the problem raised by an American Football League ruling that prohibited the Jets from using an earlier design that had used radio-type speakers mounted in outboard pods on the helmet.

Jensen Manufacturing was contracted by Technical Materials to design a speaker system that would fit inside the helmet, and thus conform to League rules. They restricted the range of the speakers to voice frequencies (900-3000Hz) and boosted the power to about 50 times normal ratings.

Three speakers over each of the quarterback's ears,

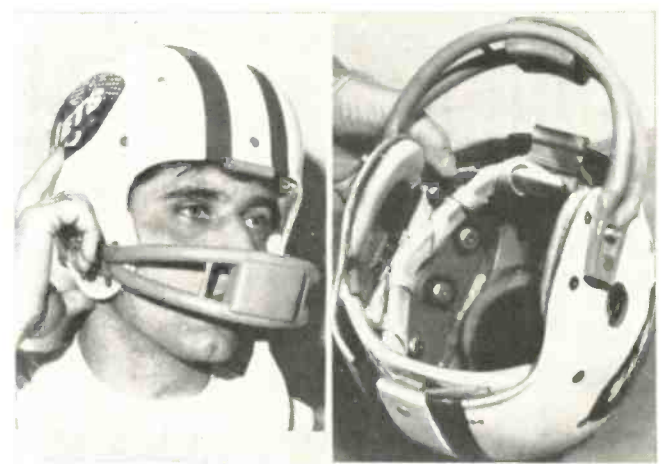

A public address system, contained in the quarterback's helmet, is designed to overcome the noise of the crowd.

plus small vents, permit the amplified voice to issue freely from the helmet. Padded enclosures far from the helmet webbing protect the quarterback's head from bumping against the speakers or amplifier. All parts of the system, including the speakers, are completely waterproofed.

When he chooses to call an "audible," at the line of scrimmage, the quarterback speaks into a small microphone fastened firmly to the inside of his face guard. A switch turns off the speakers while signals are called in the huddle.

More than the lungs of professional football quarterbacks will be saved by the new helmet—countless yards lost each year when confused linemen jump off sides will be added to the offensive might of the Jets and other teams which adopt the helmet. ■



A typical scene in the training department of Triplett when a large group of technical specialists met for a two-day workshop program.

Training Workshop Held for Instrument Technicians

Independent instrument specialists are taught meter design and modification to handle needs of distributors and local OEMs

■ The Triplett Electrical Instrument Co. of Bluffton, Ohio, recently held a two-day workshop and training program for a large group of technical specialists from its 30 instrument modification centers across the United States and Canada.

The instrument specialists were instructed in the intricate assembly and repair of the firm's top quality suspension meter movement. New meter designs and constructions were also discussed. One of the main aims of the workshop sessions was to provide the specialists with the precision tools and data they needed to work on the many types of instruments in the field. The company's appointed modification centers are not merely service stations for the firm's products—though they do provide repair service. They are often described as small manufacturing facilities that can provide a specially modified meter, a non-stock item with unusual performance characteristics or a standard meter with a dial designed solely for an individual customer. Each center, though independently owned, serves as a low-volume, custom-production extension of the manufacturing plant.

In addition to providing repair services, calibration and modification, the centers carry large instrument and parts inventories for immediate delivery. They perform a variety of local area services quicker for industrial distributors and original equipment manufacturers. ■

PINPOINT COLOR TV TROUBLES IN SECONDS...

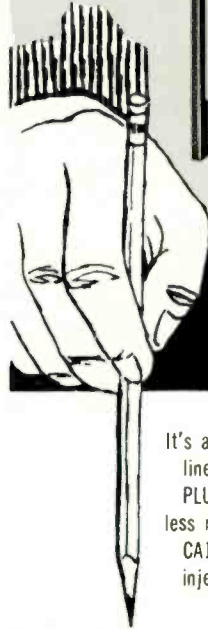

WITH THE NEW IMPROVED SENCORE CA122 COLOR CIRCUIT ANALYZER

It's a standard ten color bar generator; produces vertical lines, horizontal lines, crosshatch, and adjustable dots, PLUS a complete TV analyzer for color and B&W—at less money than color generators only. Here is what the CA122(B) will do for you by tried and proven signal injection into these stages.

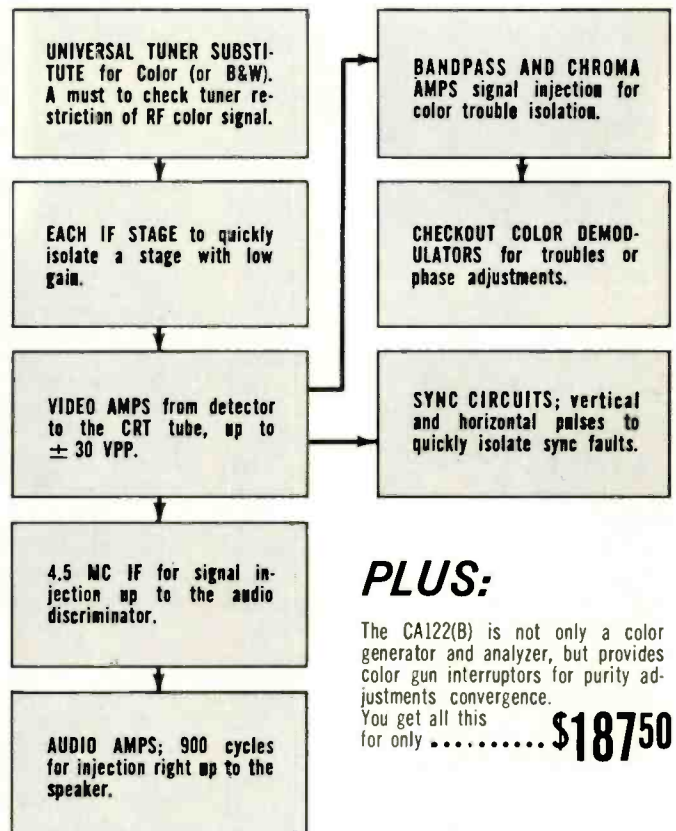

PLUS:

The CA122(B) is not only a color generator and analyzer, but provides color gun interruptors for purity adjustments convergence. You get all this for only **\$18750**

See your distributor today. He has the CA122(B) in stock now.

SENCORE

426 SOUTH WESTGATE DRIVE • ADDISON, ILLINOIS

... for more details circle 146 on postcard

NEW PRODUCTS

FOR MORE INFORMATION CIRCLE NEW PRODUCT NUMBERS ON POSTCARD INSIDE LAST COVER.

Two-Channel Transceiver 700

Announced is a portable CB transceiver featuring a standby position for



low battery drain, sensitive to an alert tone signal. The 10 transistor circuit is powered by 6 penlight batteries. Price \$24.95. Lafayette.

Turntable 701

Announced is an automatic turntable with a low-mass pickup reportedly so well counter-balanced, both vertically and horizontally, that the entire turntable can be turned on a bias while playing, without interrupting the record. The stylus pres-



sure is controlled by a micrometer-like pressure setting permitting $\frac{1}{3}g$ adjustments from 0 to 6g. The pickup arm is supported on horizontal ball bearing pivots for minimal vertical friction. The turntable accepts either monophonic or stereo cartridges and has an automatic lock to secure the arm to its rest whenever the machine switches off. Retail price \$49.50. BSR Limited.

Tape and Head Spray 702



A tape and head spray designed to clean and lubricate tape recorders, is announced. According to the release, the spray contains a silicone that forms a microscopic protective film to prevent excessive tape wear. It is reportedly safe for all tapes, plastics or other materials used on tape recorders. Codman Electric Products.

FM Stereo Tuner 703

An FM stereo tuner is announced which features a silver-plated, 3-field effect transistor front end and an all-

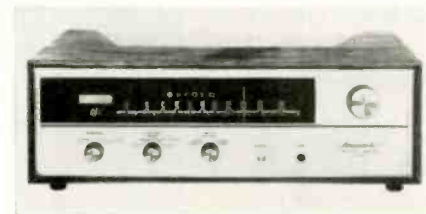

silicon IF section. The tuner is designed for a 1.7 to 1.8 μv sensitivity with 90db cross modulation rejection, 45db selectivity and 40db stereo separation. Price for kit \$189.95, assembled \$294.95. Scott.

All Glass Rectifiers 704

A series of silicon double diffused all glass rectifiers is announced that reportedly is capable of delivering currents of up to 1.0a at 100°C and can withstand 1kv reverse working voltages. The rectifiers feature low operating reverse leakage currents at elevated temperatures in addition to controlled avalanche characteristics that enables them to withstand in-

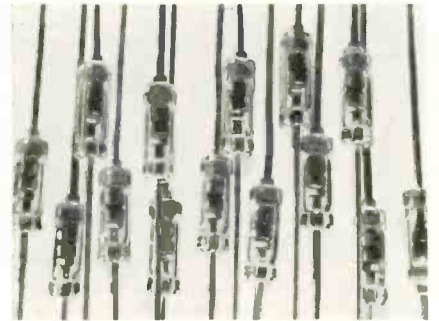

stantaneous reverse transient power surges far in excess of their normal ratings, the announcement said. Price 48 cents. Sylvania.

Mobile CB Antennas 705

A spiral-shaped, printed-circuit coil, waterproofed and suspended inside a wing-shaped ornamental base,

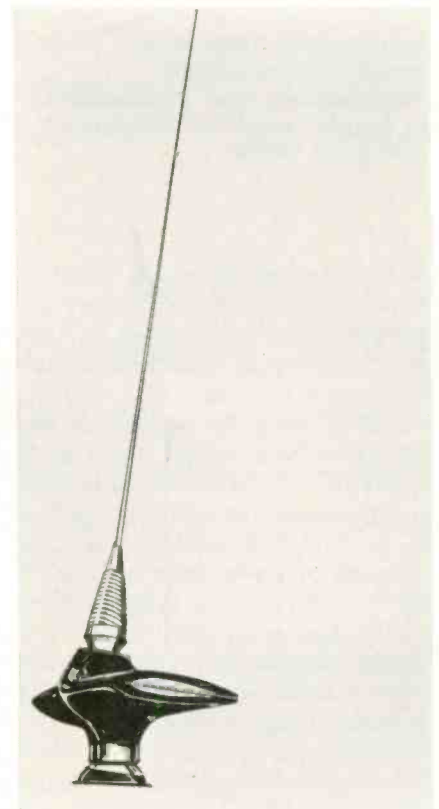

is a feature of this CB mobile antenna. The quarter-wave antennas are dc grounded to improve their VSWR. Net prices range from \$12 to \$25. Antenna Specialists.

CB Transceiver 706

A 1½ lb 100mw CB transceiver is announced that operates on 6 pen-

Gold Brand tubes live so long they hurt our business.



*See the
Sylvania
man around
the corner.*

They can last 10,000 hours. They survive 10-g's vibration or 500-g's impact shock. And withstand extreme temperatures, high altitudes.

Every Gold Brand tube in Sylvania's complete line is this dependable. So even though customers don't reorder them frequently, they always reorder.

We use our new gold-plating process to make grids for these tubes. It forms a strong bond and eliminates flaking and peeling. Eliminates shorts from these causes.

Rhenium-tungsten heater wire increases ductility and mechanical strength, thus improving heater life.

A heavy insulating coating guards against heater-to-cathode leakage. Bends are coated individually to prevent hot spots and shorts.

Cathodes are formed from powdered metals. This way we can control properties and minimize contaminants.

In fact, we sometimes wonder if we've done too much to our Gold Brand tubes. Sylvania Electronic Tube Division, Electronic Components Group, Seneca Falls, N. Y. 13148.

SYLVANIA
SUBSIDIARY OF
GENERAL TELEPHONE & ELECTRONICS **GTE**

NEW PRODUCTS

lite batteries and has a separate microphone and speaker for telephone-like operation. The superhet-



erodyne receiver includes an RF amplifier stage. Housed in a metal case with chrome grills, the transceiver has a switch-controlled squelch, 60in. antenna and 115v adapter jack. Claricon.

Record Changer 707

Announced is a record changer with a direct reading tracking force dial designed to permit cartridge tracking at forces ranging from 1/2 to 6g. The stylus and cartridge are adjusted by using a leadscrew located at the front of the cartridge unit. Also included is



an illuminated speed indicator for all four speeds. Price less base and cartridge \$149.50. Benjamin.

Regulated Power Supply 708

A transistorized zener reference regulated power supply is available in factory assembled or kit form. It reportedly delivers a continuously var-



iable output from 0-15vdc with useable currents to 250ma, and regulation better than $\pm 2v$. The ac ripple is less than 5mv for outputs to 100ma, the report said. Price for kit \$13.95, assembled, \$19.95. Viking.

Display-Storage Racks 709

A rack designed specifically for displaying radios, TV sets or portable appliances for a maximum visual advantage within a limited space, is an-



nounced. The unit reportedly enables dealers to double their display area and thereby effectively increase their potential visual exposure. According to the announcement each section is 8ft long and 6ft high with 30in. arms, and can support 1100 lb. The rack is assembled from bolted steel sections, and is finished in "safety white" baked enamel. Palmer-Shile.

Helps stop ghosts!

Zenith Quality Wavemagnet® Indoor TV Antenna

Designed for finest all-channel (2 to 83) reception in color or B&W. Special network provides stepped-up basic dipole impedance, resulting in lower voltage standing wave ratio than ordinary VHF indoor antennas . . . cuts down snow, reflections and ghosts. Two full-size UHF loops, one behind the other, develop an unusually high front-to-back ratio (equal to that in many outdoor antennas), remarkably reducing ghosts and man-made interference. Order as Part Number 973-56 from your Zenith distributor.

Built to the quality standards of Zenith original parts

ZENITH

The quality goes in before the name goes on

EICO 380's color signals (3 primaries, 3 complementaries) cover fully 60% of the screen: thus tell you MORE about the set's response — enable EXACT alignment.

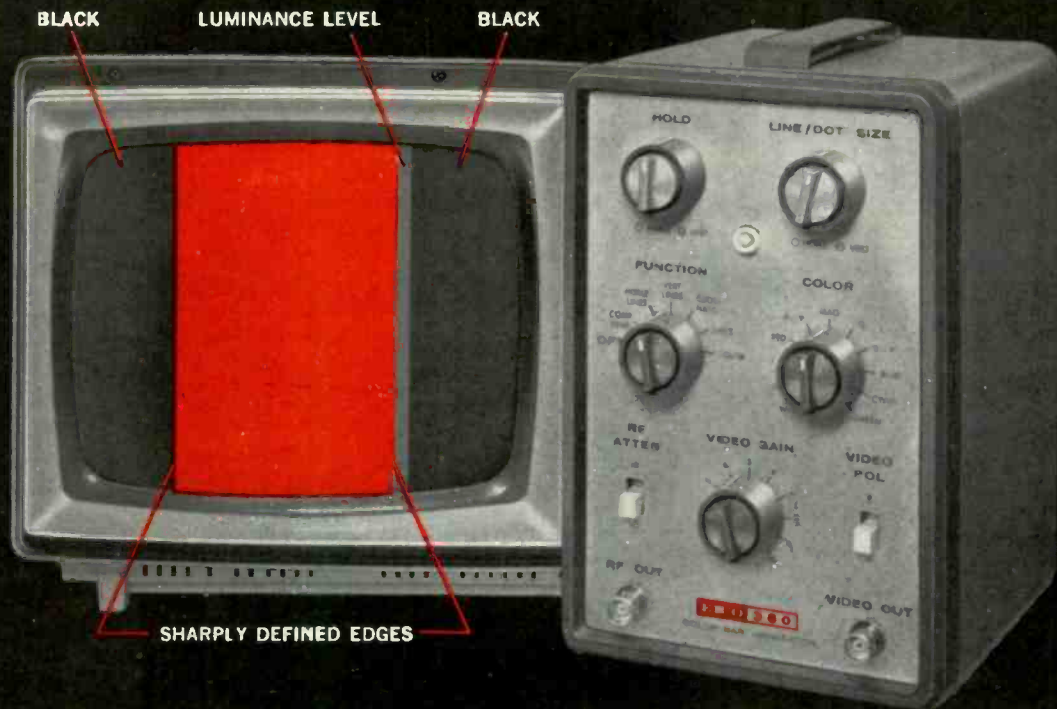

Now you can afford a True NTSC* Color Generator (NEW EICO ALL SOLID STATE 380 IS ONLY \$169.)

Every pro knows

that the best generator to use to do the *best, fastest, most accurate* color servicing is the NTSC type. EICO is first to bring it to you at a serviceman price.

The 380 takes the risky guesswork out of color servicing — because it gives you all test signals *exactly* like the Color TV station. So now you can be *certain* of exact results — faster, easier, for more profits per day. You'll also quickly become known as the pro who makes sets "*come alive*" with brilliant *correct* color response!

Only EICO provides you with all these advanced engineering features at so low a cost: ■ **100% true NTSC* full-field color signals**, including both chrominance and luminance exactly as specified for a Color TV station transmission. ■ **No "Gun Killers"** — Faster, easier use by feeding to the RF stage. You don't need to go inside the TV set to feed the color signal. ■ **Each true NTSC* color signal covers fully 60% of the entire TV screen** (as compared to 1-inch from a rainbow generator) — this tells you a full, true picture of what's going on inside the set — all the way from the RF to the screen. ■ **100% solid state** (33 transistors). ■ **5 Individual switch-selected alignment patterns** for monochrome and color, ■ **Individual, switch-selected full-field color display**. ■ **Generates I, Q, R-Y, and B-Y signals** for demodulator adjustment, plus 7 standard color signals (3 primaries, 3 complementaries, plus black and white). ■ **Adjustable bar width and dot size** down to just visible for exact convergence. ■ **3 crystal-controlled oscillators** for true 3.58 MC color signal generation, pattern timing, and RF output. ■ **Drift-free RF output** (crystal-controlled Channel 3) and video output. ■ Conveniently compact: 8" high x 5" wide x 6" long. ■ Portable and light weight (only 4 lbs.) for easier field use. ■ Instant-on operation: time-saving, accurate, drift-free. ■ Excellent for field or shop. And *will not* become obsolete!

Why buy an old-fashioned semi-accurate non-NTSC rainbow generator when you can get all the extra benefits of a 100% TRUE NTSC COLOR GENERATOR for the same money,

See your EICO dealer today for a free demonstration.

Unbeatable Value COMPLETE COLOR / BW TV LAB

With the 380 — plus just the 369 & 435 — you're ready for *anything* in Color/BW servicing: EICO 369 Sweep/Marker Generator gives easiest, fastest visual alignment of color or B&W TV and FM RF and IF circuits. Five sweep ranges from 3-220mc. Four marker ranges from 2-225 mc. Crystal marker oscillator. Post injection of markers. \$99.95 kit, \$149.95 wired.

EICO 435 Direct-Coupled Wideband Scope. DC-4.5mc with 3" flat-face CRT. Zener calibrator. Outperforms 5" scopes three times its price. \$109.95 kit, \$159.95 wired.

How about FM-MX Stereo?

Just add EICO 342 FM-MX Signal Generator: Gives both composite audio and FM RF outputs. Inputs for stereo audio, critical A/B tests. \$149.95 wired.

*The NTSC (National Television Systems Committee) color signal is based on the fact that each transmitted color is produced by an NTSC-defined relationship between a 3.58 MC reference and a 3.58 MC chroma modulated subcarrier, with each color having a standard NTSC brightness component. This is the basis upon which all color-TV broadcasters must operate. There are no separate rules for color-TV reception, or color test sets.

EICO EICO Electronic Instrument Co., Inc.
131-01 39th Ave., Flushing, N.Y. 11352 ET-11

Send me FREE:

- "Definitive Comparison of NTSC and rainbow generators FROM THE SERVICEMAN'S VIEWPOINT."
- 32-page catalog on 200 EICO best buys.
- Name of nearest dealer.

NAME.....
ADDRESS.....
CITY.....STATE.....ZIP.....

... for more details circle 118 on postcard

NEW PRODUCTS

to make
"AS GOOD AS
NEW"

you've got
to put in
a little

"OLD"

for instance

... when installing replacement speakers, it makes sense to replace with a speaker identical to the original equipment ... the speaker for which the unit was designed. This is the one sure way to maintain proper balance in a sound system.

Oxford Transducer Company manufactures the most complete line of standard replacement speakers to O.E.M. specifications, for phonographs, TV, tape recorders, and conventional and transistor radios. Oxford speakers are used by most manufacturers of consumer electronic equipment, so you are guaranteed O.E.M. standards.

All speakers are available from stock, right now. You benefit two ways: from reduced inventories, and from assured customer satisfaction.

Write today for your technical bulletin on Oxford's line of standard replacement speakers.



Full Range
of Replacement
and Commercial
Sound Speakers

OXFORD TRANSDUCER
COMPANY
A Division of
Oxford Electric Corporation

3911 S. Michigan Ave.
Chicago, Ill. 60653

... for more details circle 136 on postcard



Three-Channel Transceiver 710

A 1w "walkie talkie" with a 12-transistor, 2-diode superheterodyne circuit and temperature compensating components (thermistors), is announced. Equipped with earphone



jack, external antenna jack and telescopic antenna, the transceiver operates on 8 type "Z" penlight batteries. It is designed to operate on 3 CB channels but is available on special order modified for the government frequency 27.575MHz or on CAP frequency 26.62MHz. Price \$47.95. Lafayette.

Crimping Tool 711

An adjustable microcrimp tool is introduced, designed to facilitate crimping even the smallest contacts.

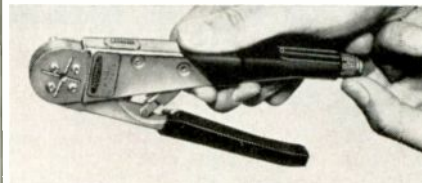

The tool allows the user to select the precise crimp-depth setting that suits the need. The setting is easily determined on a direct reading indicator located on the handle of the tool.

Elliptical Cartridge 712

A stereo-mono cartridge is introduced, that is designed for record playing systems that require a somewhat higher tracking force, 3/4 to 6 grams, than is recommended for the

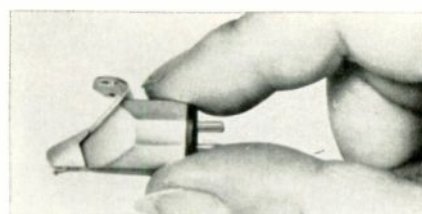

standard 0.2 x 0.9 mil stylus. The cartridge's 0.4 x 0.9 mil diamond stylus provides the advantage of an elliptical stylus for this type of record playing system. The frequency response is said to be 10Hz to 30kHz with an 8.0mv output voltage and 30db channel separation. List price \$34.95. Empire Scientific.

Inverter 713

An all-transistorized inverter is announced that converts 12 or 24v battery power to 60Hz 120v ac with

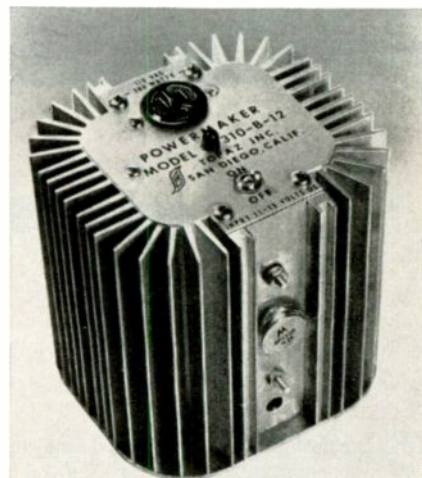

300w continuous power. The inverter weighs 11 1/2 lb, and measures 5 1/2 x 6 1/8 x 6 13/16 in. Prices start at \$59.95. A remote control unit and 400Hz model are also available. Topaz,

Test Socket Adapters 714



A 10-pin decal base adapter, used with the new 6Y9, 6X9 and 6U9 tubes, is introduced. It is designed to facilitate voltage and resistance measurements from tube sockets protected by captive or telescoping tube shields. The test adapter is tall enough to rise above the top of a captive tube shield, hence measurements may be taken without removing the shield. A technician can insert the adapter into a concealed socket, plug the tube into the adapter and take measurements from the exposed test tabs. Other models fit 7-pin, 9-pin and 10-pin miniature bases. Pomona Electronics.

What do you do for an encore after introducing the most exciting solid-state CB line in the business?



Tag it with a 10 year guarantee!

Start with typical Courier pricing. The 23-channel TR-23S at \$169. The 12-channel TR-12 at \$139. Solid-state. Feature packed.

Then add the biggest guarantee in the business—*10 full years!* The kind of guarantee that sales are built on.

Want more? Courier's sold through limited dealerships. Protected territories. Protected mark-ups. Courier CB is no football.

If you're interested in a CB line with profit, with a sales-clinching manufacturer's guarantee, quality and features, find out about a Courier CB dealership. The coupon brings you all the facts.

 **e.c.i. electronics communications inc.**
56 Hamilton Avenue, White Plains, N. Y.

Yes. I'd like to know all about the Courier CB line with the 10-year guarantee—and dealership opportunities.

Name _____

Firm _____

Address _____

City _____ State _____ Zip _____

... for more details circle 117 on postcard

NEW PRODUCTS

Flat Cable 715

A flat cable for telephone and intercom applications, is announced. It features a thin layer of vinyl foam which is coated with a pressure sensitive adhesive that reportedly adheres to nearly any clean, relatively smooth surface; tile, metal, wood, stone, etc. The cable and accessories are simply pressed into place. Accessories are



connected to the cable by laying the cable in place in the accessory and

screwing the top of the accessory into place. 3M.

Four-In-One Screwdriver 716

Announced is a four-in-one screwdriver which is four screwdrivers in one compact tool. It is designed to eliminate the frustration of finding the right size or type tool for the job on hand. There are two inter-

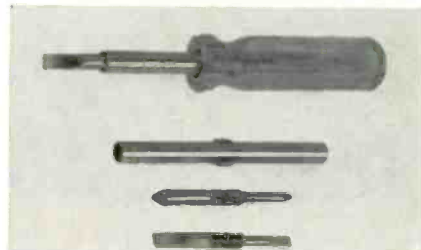

changeable bits — one for slotted type screws, in two sizes, and one for Phillips type, in two sizes. The bits are made of tool steel while the handle is Tentite plastic. Price \$3.49. Habny Products.

Dual Purpose Gift from Perma-Power

FREE!
WITH EITHER
BRITENER PACK

The gals call them
SCONCES

You can get one free from your Perma-Power distributor, with your next purchase of Vu-Brites or Tu-Brites.

VU-BRITES—the world's best-seller for brightening faded TV pictures. Series or parallel. \$9.95 per dozen during this special promotion, and the scone is free!



TU-BRITES—If the base is right, the boost is right! No other britener gives you this assurance of the right voltage. 4 Tu-Brites of any base type for \$8.95, and the scone is your extra bonus!

and they love the way they

BRITEN UP

any wall • with plants or candlelight



THE BRITE LINE
for brighter TV pictures and brighter customer smiles... from

PERMA-POWER COMPANY

5740 N. Tripp Avenue • Chicago, Illinois 60646 • Phone (312) 539-7171

... for more details circle 138 on postcard

CB Transceiver 717

An eight-channel, crystal-controlled, CB transceiver containing 15 silicon transistors and 5 diodes, is announced. The manufacturer has rated the trans-

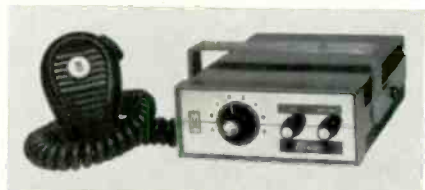

mitter output at 3¼ w minimum output, with 0.005% frequency stability when modulated at -90%, +100%. Specifications indicate the receiver has a sensitivity of 1µv or less. The unit comes with carbon microphone, coil cord and a mounting bracket. The dimensions are 2-5/16 x 5½ x 8¼ in. Price \$89.95. Regency.

Guy Wire Tightener 718

A guy wire tightener is introduced for use anywhere wire or line needs



tightening. A hook eye is slipped through the lip hole, and the wire is run through the eye and wrapped or knotted around the spindle. North Central Plastics.

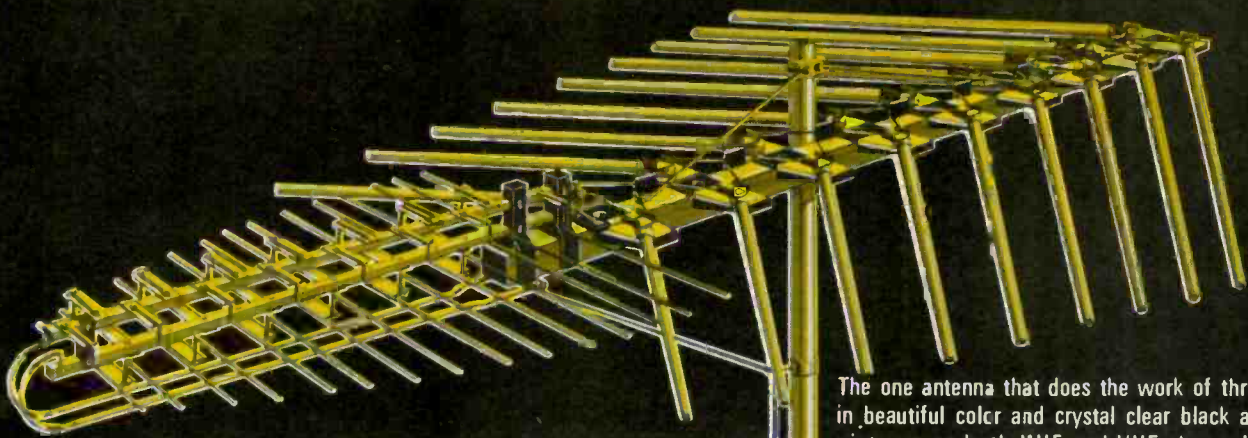

FINCO ALL-BAND UHF-VHF-FM ANTENNA
75 OHM Model CX-UVF-24 \$72.10 List

FINCO ALL-BAND UHF-VHF-FM ANTENNA
300 OHM Model UVF-24 \$59.95 List

The one antenna that does the work of three! Pulls in beautiful color and crystal clear black and white pictures on both UHF and VHF channels... plus the finest stereophonic and monophonic FM sound reproduction.

300-ohm models for normal reception areas from \$18.50 to \$59.95

75-ohm models for poor reception areas from \$42.65 to \$72.10

FINCO

introduces / 75-ohm COLOR VE-LOG ANTENNAS
FOR UHF-VHF-FM RECEPTION

Finco's Swept-Element Antenna challenges all competition. Its unique design assures the finest color and black and white TV reception—plus superb FM and FM Stereo tone quality.

300-ohm models for normal reception areas from \$16.95 to \$54.50

75-ohm models for poor reception areas from \$18.55 to \$62.80

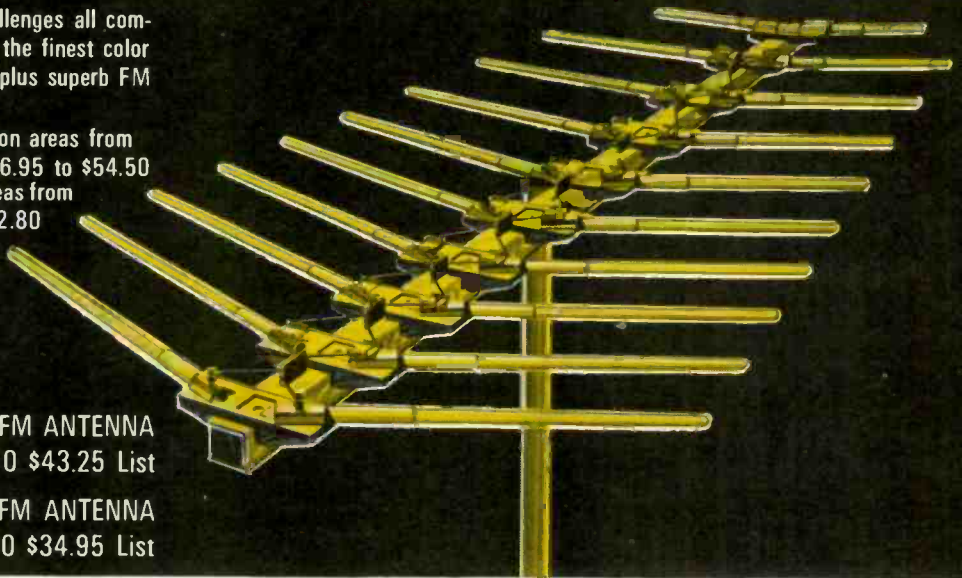

FINCO SWEPT-ELEMENT VHF-FM ANTENNA
75 OHM Model CXVL-10 \$43.25 List

FINCO SWEPT-ELEMENT VHF-FM ANTENNA
300 OHM Model VL-10 \$34.95 List

FREE! ALL FINCO CX-VL, CX-UVF AND UVF ANTENNAS COME WITH A FREE INDOOR SET-MOUNTED TRANSFORMER, VHF-UHF TRANSFORMER SPLITTER OR VHF-UHF SPLITTER.



THE FINNEY COMPANY

34 WEST INTERSTATE STREET, DEPT. 110 BEDFORD, OHIO

NEW PRODUCTS

Screwdriver Kits 719

Two "Plastic View" screwdriver kits, each containing a regular size handle and a selection of interchangeable, single-end, screwdriver blades

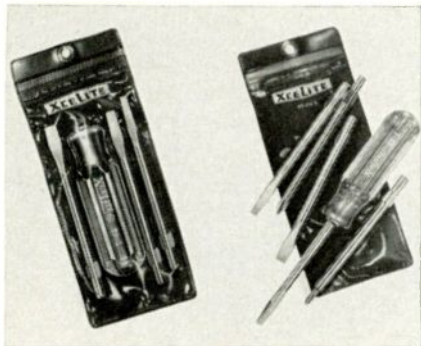

are introduced. A spring device is designed to hold the blades firmly and yet allow quick, easy insertion and removal. The handles will accept any of the interchangeable screwdriver, nutdriver or other blades in the manufacturer's line. Xcelite.

Solid-State Kits 720

Solid-state kits to be sold by service-



dealers to do-it-yourselfers are designed to offer beginners an introduction to electronics. The kit builder learns printed circuit soldering techniques, components and terms while constructing the kits. Among the kits offered are an electronic siren, burglar and fire alarm, intercom, audio power amplifier, metronome, tremolo, light flasher, photo cell nite lite, power supply and code oscillator. Retail prices range from \$2.50 to \$9.95. EICO.

Ignition Filter Kits 721

Announced are kits designed to reduce interference caused by ignition pulses. These kits consist of RL filters that snap in place between spark



plugs and leads, plus a coil-to-distributor high tension lead. They reportedly fit all standard gasoline engines and will not affect the engine's mechanical or electrical operation. List price, \$12.95. Hallett.

ZENITH QUALITY LOUDSPEAKERS AND BATTERIES

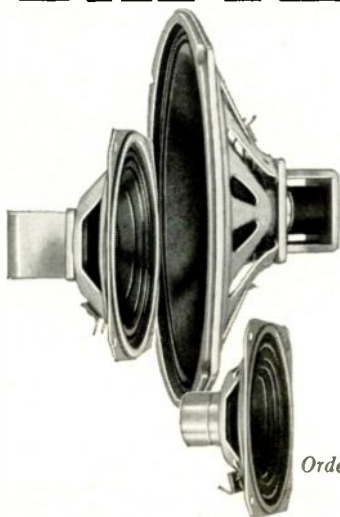

Looking for the finest replacement loudspeaker you can find? It's Zenith . . . for practically any purpose: stereo, TV, radio or car radio. Zenith has sold quality speakers for over 45 years. Today you can choose from a full line, with each speaker offering exceptional power and frequency response.

Zenith Quality Long Life batteries with "Transistor Blend" electrolyte are designed for superior performance in transistor radios. Zenith's high standards and constant Positive Quality Control help Zenith batteries deliver more power and longer service for radios and flashlights.



Order all genuine Zenith replacement parts and accessories from your Zenith distributor.

BUILT TO THE QUALITY STANDARDS OF ZENITH ORIGINAL PARTS

ZENITH

The quality goes in before the name goes on

. . . for more details circle 152 on postcard
ELECTRONIC TECHNICIAN



B&K MODEL 970 TRANSISTOR EQUIPMENT ANALYST

SERVICE AM & FM AUTO & TRANSISTOR EQUIPMENT AT A PROFIT!

NEW!

Jobs that used to be unprofitable now go so quickly that you can make good money handling them! There are millions of auto radios and transistor radios in the field—portables, auto and table models, plus hi-fi and communications equipment. Instead of turning them away, you can turn them into money-makers with the B&K Model 970 Radio Analyst.

The 970 is effective because it's *accurate and complete*. Using the famous B&K signal injection technique, this all-in-one instrument provides the required dc power, lets you test power and signal transistors in and out of circuit; generates RF and audio signals, and includes a rugged, accurate VOM. Four functions in one compact package—with solid state reliability, B&K professional quality.

LOW INVESTMENT—QUICK RETURN

See your B&K Distributor or write for Catalog AP22-R

Net \$199⁹⁵



B & K DIVISION OF DYNASCAN

1801 W. BELLE PLAINE AVE. • CHICAGO, ILL. 60613

Canada: Atlas Radio Corp., 50 Wingold, Toronto 19, Ont.
Export: Empire Exporters, 123 Grand St., New York 13, U.S.A.

FEATURES:

BUILT-IN POWER SUPPLY

Auto Radios—High current, low-ripple, for transistor, hybrid, and vibrator types.

Transistor Portables—1½ to 12 volts for battery substitution—plus separately variable voltage tap for bias.

QUICK AND ACCURATE TESTING OF POWER AND SIGNAL TRANSISTORS

In-Circuit—stage by stage DC signal injection and sensitive metering of power supply current.

Out-of-Circuit—Direct Beta and Leakage meter scale readings. Easy balancing or matching.

VERSATILE SIGNAL GENERATORS

RF Generators—provide broadcast and IF frequencies for both AM and FM bands.

Audio Generator—for AM or FM modulation of the RF signals, and for trouble-shooting audio circuits.

RUGGED VOM

Volt-OHM-Milliammeter—with rugged, taut band meter—provides correct ranges for easy, fast servicing of all home and auto radios, as well as transistor portables.

... for more details circle 105 on postcard

TWO NEW "plastic view" screwdriver kits

EASY TO USE, CARRY & STORE

These neat, extremely compact kits fit hip pocket, tool box, boat kit, glove compartment . . . can also be hung on a wall. Durable "Plastic View" zipper case permits instant identification of tools.

Amber plastic (UL) Service Master handles are shockproof, breakproof, have patented spring holding device that accepts all Xcelite Series 99 blades — lets you add tools as needed at minimum cost.

Space saving, single-ended interchangeable blades . . . can be used with Xcelite extensions for extra reach.



99PV-6

Handle and 3 slotted screwdriver blades ($\frac{3}{16}$ ", $\frac{1}{4}$ ", $\frac{5}{16}$ " tips), 2 Phillips (#1, #2)

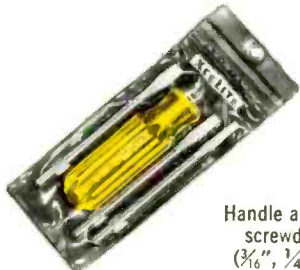

99PV-4

Handle and 3 slotted screwdriver blades ($\frac{3}{16}$ ", $\frac{1}{4}$ ", $\frac{5}{16}$ " tips)

WRITE FOR CATALOG 166

XCELITE

XCELITE, INC., 14 Bank St., Orchard Park, N. Y. 14127
In Canada contact Charles W. Pointon, Ltd.

. . . for more details circle 150 on postcard

NEW PRODUCTS

Junction Insulators 722

A heat-shrinkable, rounded-end cap for insulating wire terminations, splices and junctions is announced. The end caps are designed to form a quick, permanent insulating bond and

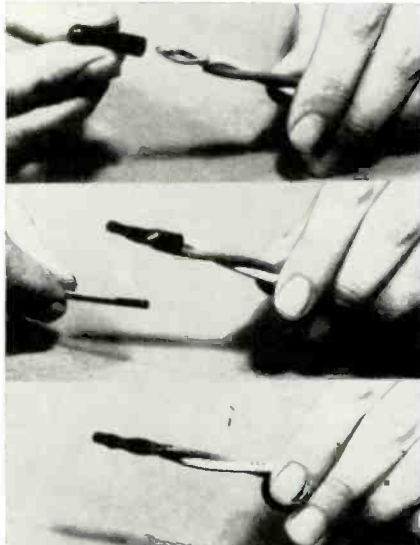

have no sharp edges to cause abrasion to nearby wires. Available in $\frac{1}{16}$, $\frac{1}{8}$, $\frac{1}{4}$, $\frac{3}{8}$, and $\frac{1}{2}$ in. expanded ID sizes. When subjected to temperatures in excess of 275°F they will shrink more than 50%. Electronized Chemicals Corp.

TV Camera 723

A solid-state, vidicon tube, TV camera is announced which reportedly has a 550 line resolution. It is designed



to be connected to either a video monitor or the RF section of a standard TV set. The camera comes with an F1.4, 25mm lens, a built-in microphone-speaker and an automatic light compensator. Tele-Guard.

20kv VOM 724

A VOM kit having a total of 57 ranges, starting as low as 0.8vdc is announced. It contains a range-doubler switch that doubles the effective



number of ranges. Price with test leads, batteries and instructions, \$39.95 in kit form, \$59.95 fully assembled. Allied.

Mobile Speaker 725

A 75w speaker designed for high power mobile applications, is announced. The speaker mounting bracket is reportedly aircraft aluminum — cast in one rigid piece for secure, failsafe mounting under severe mobile



service conditions. The bracket has space for concealed wire connections. It is designed for the noise-cutting reproduction of siren and foghorn signals, or attention-commanding communications systems having mobile amplifiers. List price, \$83.75. Atlas Sound.

Hot Blade Iron 726

Announced is a hot blade iron designed for connector rework, removal of components on printed circuit boards, epoxy coated module rework



and to clear surfaces of end products that may have epoxy or flash on spoilage. The razor-like blade reportedly cuts nylon and plastic fabrics. Price with one angle blade, one curved blade and a gram of high temperature lubricant, \$9.25. MacDonald.



No color?



Use this procedure to narrow down the trouble area...

If the receiver produces a normal black-and-white picture but no color during a color broadcast, try the following steps, in order:

1. Tune to a channel broadcasting color, or feed an rf color-bar signal into the antenna terminals.
2. See that the fine-tuning and color (saturation) controls are correctly set.
3. Rotate the color-killer threshold adjustment in the direction which disables the color-killer stage. If locked-in (in sync) color appears, reset this control as recommended by the set manufacturer.
4. If color appears out of sync, look for trouble in the automatic frequency and phase control (AFPC) circuits. Use a color-bar generator, and follow the AFPC adjustment procedures described in the manufacturer's service notes.
5. If no color appears, determine whether the color is lost in the circuits which handle the composite signal (antenna to bandpass amplifier) or in circuits that handle the separated color signal, as follows:
6. Feed a color-bar signal into the antenna terminals

and use a scope to check the composite signal at the video detector.

7. If color-bar waveforms are absent or badly distorted, check for trouble, including poor bandpass, between the antenna terminals and video detector.
8. If color-bar signals are present at the video detector, check the burst keyer or separator, bandpass amplifier, color-killer, and the 3.58 MHz oscillator stages and their associated circuits.
9. Once the inoperative stage is found, use voltage and resistance measurements to pinpoint the circuit defect.

This ad is still another in a series of color TV service hints from RCA. To keep your customers satisfied, always replace with RCA receiving tubes. Your local RCA Distributor is your best source for top quality receiving tubes for color TV.

RCA ELECTRONIC COMPONENTS AND DEVICES, HARRISON, N. J.



The Most Trusted Name in Electronics

Plywood Pallets Cut Freight and Fabrication Costs

Shock-proof design eliminates in-transit damage to electronic equipment

■ Texas Instruments, Inc., of Dallas, Tex., has cut shipping costs and eliminated in-transit damage to its delicate equipment by using shock-proof plywood and foam rubber floating pallets.

The complex electronic systems shipped on the pallets include radar, infrared and space component equipment—used primarily by the military.

No pallet failure or shipping damage has occurred during a two-year period, the announcement said.

The plywood-foam pallet has also cut fabrication costs substantially. The pallets also result in lower transportation costs.

The floating pallet is a sandwich unit consisting of two $\frac{3}{8}$ or $\frac{3}{4}$ in. exterior plywood decks (depending on weight of the electronic equipment being shipped) with a cushion-

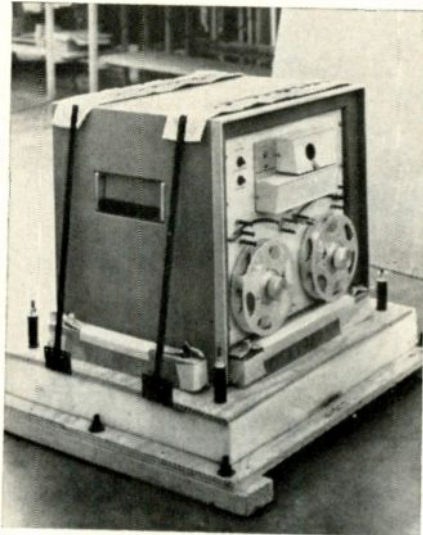

Tape deck mounted on a pallet for trans-continental shipment.

ing middle layer of polyurethane, polyethylene foam or hair latex. The cushioning material is selected

according to the weight, size, bearing area and equipment fragility.

The whole pallet is bolted together with compression springs on the bolts to ease the rebound shock of the pallet if it is dropped. Steel straps slipped under the top deck of the pallet secure the part during shipment. Loosening the bolts that hold the top layer of plywood facilitates sliding the steel strapping into place under the top panel.

To keep equipment from shifting on the pallet, lumber blocking is bolted to the top deck of the pallet around the base of the equipment. Corrugated scuff liners are inserted between the blocking and the equipment to prevent abrasion.

A typical pallet is made up of a 36 x 36 in. bottom and 30 x 30 in. top plywood deck with cushioning placed between both decks.

New! Deluxe 107C Tester!

Only tester with "eye" tube to spot momentary shorts; constant voltage transformer for greatest stability and accuracy!

Now, Seco brings you a compact, portable tube tester unmatched in speed, sensitivity and reliability! "Eye" tube spots momentary shorts missed by normal meter lag—constant voltage transformer eliminates need for "line-adjust", provides proper filament and test voltages for superior accuracy. Patented Grid Circuit Test; Dynamic Mutual Conductance and Cathode Emission Tests. 38-socket, pre-wired panel accepts 80 base arrangements to test more than 1000 tubes without setup. Replaceable, 10-socket plug-in panel for complete test on all modern TV, Radio, Hi-Fi, Industrial and Foreign tubes. Model 107C

\$198.50
NET

NEW! thyristor (SCR) analyzer



Checks SCR's, TRIAC's, Breakdown Diodes, Gate Controlled Switches. Rapid information on: Gate Firing Voltage and Current; Peak Forward Voltage and Current; Peak Reverse Voltage and Current. Model 240 **\$144.50** net

NEW! transistor analyzer



Safe, fast, accurate—no setup required. Analyzes Power and Signal transistors. Dynamic "in-circuit" check; thorough DC analysis "out-of-circuit". Identify NPN and PNP types as well as lead connections. Beta test measures DC gain—Iceo and Icbo Tests read leakage. Model 260 **\$69.50** net

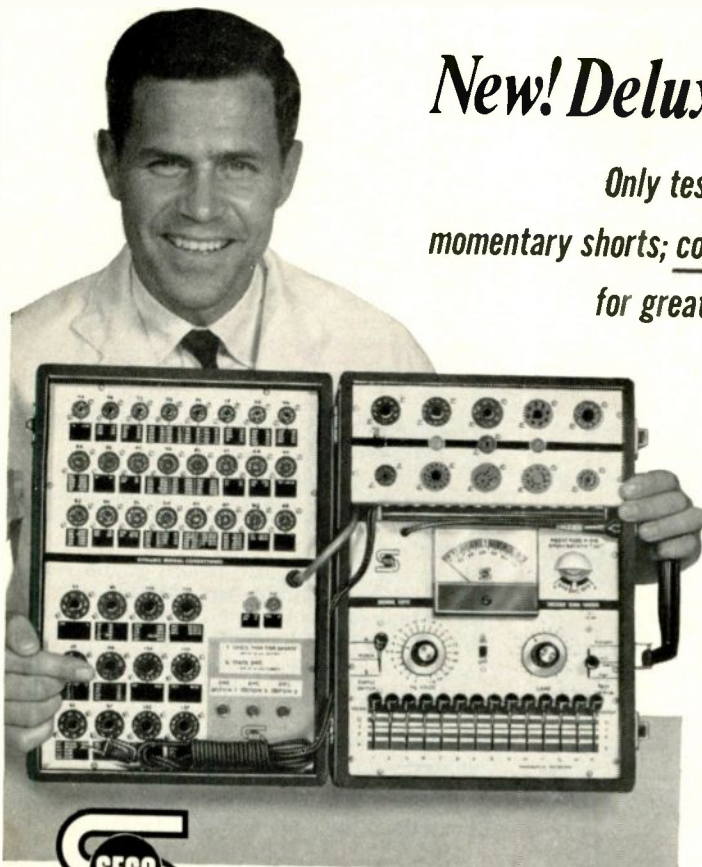

SECO ELECTRONICS CORP. 1205 South Clover Drive • Minneapolis, Minn. 55420

... for more details circle 141 on postcard
ELECTRONIC TECHNICIAN

Even if you've never had a slide rule in your hands before

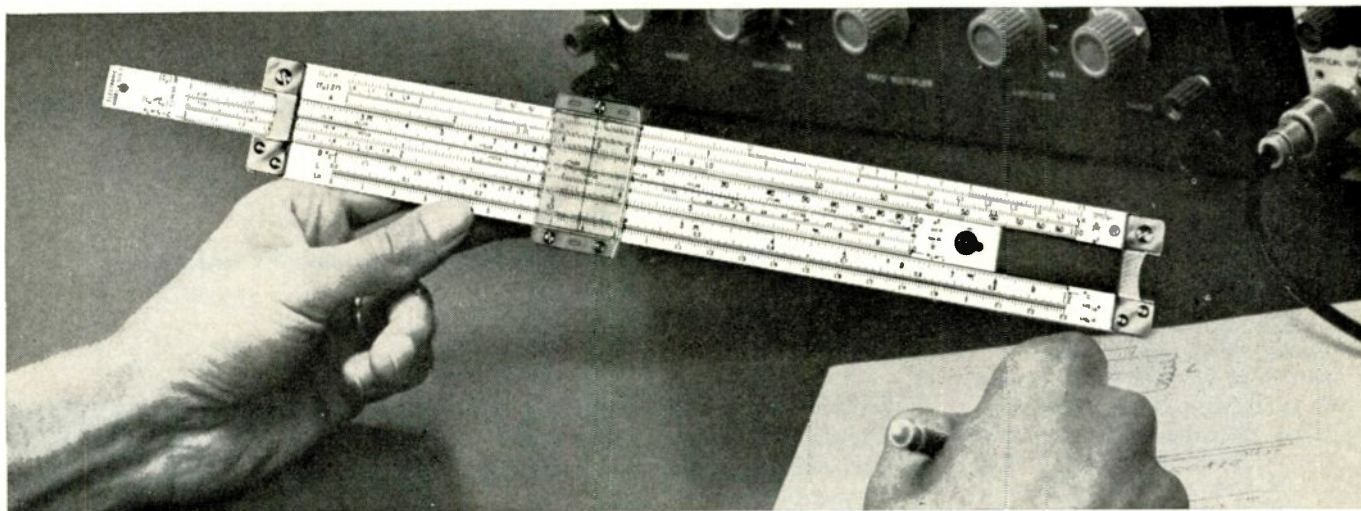

...you can now start solving electronics problems fast with this new electronics slide rule and course

HAVE YOU EVER ENVIED the way some fellows whip out a "slip stick" and whiz through a problem in multiplication, division, square root, logs, etc., instead of struggling through it with pad and pencil?

Now you can "outshine" them—even if you've never used a slide rule before. (If you're already using a conventional slide rule, you'll learn new tricks with this one.)

You can do, in just a few seconds, not only common mathematical calculations but also special electronics problems in resonance and reactance that even a conventional slide rule can't directly answer.

The secret is in this new Electronics Slide Rule and a complete how-to-do-it Course developed especially for men in electronics by the Cleveland Institute of Electronics.

This is a professional slide rule in every detail, made exclusively for us by Pickett, Inc. It can do everything a regular slide rule can—and more. It has two special scales for solving resonant frequency problems and inductive or capacitive reactance problems or any problem involving the factor 2π . On the other side... a unique decimal point locator plus useful electronics formulas and conversion factors. Also included is a handsome leather carrying case with a heavy-duty plastic liner, removable belt-loop, and flip-open cover.

The Course gives you not just printed instruction but *personal tutoring* in the use of this lightning-quick calculator. You get four full-length AUTO-PROGRAMMED™ lessons which "start from scratch" and teach you with actual examples everything you need to know. These lessons have been carefully designed to meet the same high educational standards as the electronics career courses for which our school is famous. Each lesson you do may be sent in to CIE, where it will be personally graded by one of our expert instructors the same day he receives it and returned to you with his comments.

To make friends with career-minded electronics men around the country, we have deliberately underpriced the CIE Slide Rule and Course. The low cost will really surprise you.

Find out more about this remarkable new Slide Rule and Course and what they can do for you. We have prepared a Free Booklet explaining them in detail. Send for it today. No obligation, of course—just an opportunity to get in on the best offer ever made to people in electronics. Mail coupon, or write Cleveland Institute of Electronics, Dept. ET-113, 1776 East 17th St., Cleveland, Ohio 44114.

CIE Cleveland Institute of Electronics
1776 East 17th Street, Cleveland, Ohio 44114

Acclaimed by Electronics Experts

"It opens a whole new era of quick calculations. Even if you never had a slide rule in your hands before, the four-lesson instruction course that is included takes you by the hand and leads you from simple calculations right through resonance and reactance problems with hardly a hitch. If you already use a slide rule, you'll find the lessons a first rate refresher course. And they explain in detail the shortcuts built into this new rule."
—WAYNE LEMONS, *Radio-Electronics*

"Why didn't someone think of this before?...the slide rule saved me time the very first day. The 'refresher' course is a marvel of clarity. I couldn't help being amazed at how many standard formula functions I was performing the hard way."
—OLIVER P. FERRELL, Editor, *Popular Electronics*

"I was very intrigued by the 'quickie' electronics problem solutions. It is an ingenious technique. The special scales should be of decided value to any technician or engineer. Your slide rule is a natural."
—JOSEPH J. DeFRANCE, Head of Electrical Technology Dept., New York City Community College.

Mail this coupon for
FREE BOOKLET



Cleveland Institute of Electronics
1776 East 17th Street, Cleveland, Ohio 44114

Please send me without charge or obligation your booklet describing the CIE Electronics Slide Rule and Instruction Course. **ALSO FREE** if I act at once: a handy pocket-size Electronics Data Guide.

Name _____
(please print)

Address _____

City _____ State _____ Zip _____

Accredited Member National Home Study Council
A Leader in Electronics Training... Since 1934.

ET-113

... for more details circle 114 on postcard

UHF DEALERS RING UP with



Gavin puts LIFE in your sales. You get more . . . net more. Get your name in Life Magazine, free. Get Life selling aids by the truckload, free. Get a full UHF line at full profits: 3 new converters, new zone-centered antennas, boosters, couplers and splitters. Ask about a special Gavin Life Deal. Call up. Ring up with Gavin!

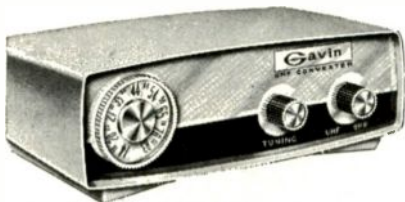

GAVIN INSTRUMENTS, INC.
Somerville, N. J.

(201) 356-3500



. . . for more details circle 122 on postcard

TV Series Shows Space-Age Advances

Program explains developments in scientific knowledge

■ Television's Don Herbert is before the TV cameras with an adult-level science program called "Experiment."

Aimed directly at the general public as well as scientists and engineers, the series includes a program on the laser.

In the televised animation of a laser, a rotating drum memory switch controls the symbolic interaction of electrons and photons by programming 324 lamps representing photons on a demonstration board. It also controls three cork balls, each representing an electron. As the aluminum drum of the programer rotates on its axis, actuators located about the perimeter of the drum, trigger 32 switch contacts. The contacts are mounted in a bank next to the drum and open or close circuits as required.

The laser demonstration board has 27 strips of 12 lamps apiece with 27 of the 38 contacts on the programer selecting the strip of lights to be illuminated at any given time. Stepping relays, placed between the programer and the lamps, are used to light the 12 lamps on any strip in sequence.

Two contacts on the programer also serve to trigger three levers activated by solenoids to control the motion of the cork "electrons" in the televised animation. Three other contacts control the motion of the "photons" as they move from left to right, right to left or diagonally while a 24v solenoid drives the rotating programer in predetermined steps.

Each program in the series deals with the work of an individual scientist and his search for new

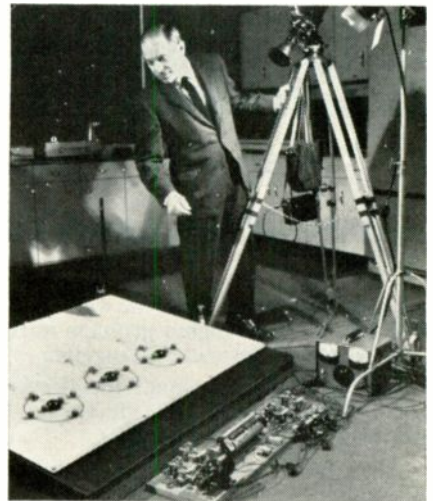

TV's Don Herbert prepares to film an animated demonstration to describe laser operation.

knowledge. Facts and visual material supplementing them are presented simply and clearly.

The drama of each experiment and its result unfolds step by step, involving the viewer directly. The viewer becomes more and more intellectually involved as these steps become increasingly sophisticated. By the end of the program, the viewer has a clearer understanding of the subject and how it may have an affect on both him and his environment.

Other subjects in the series include the science and engineering behind Mariner IV and its successful quest for pictures of the planet Mars, computerized weather prediction, discovery of the invisible planet Barnard's Star B, attack patterns of sharks, white blood cells, social behavior of chimpanzees and the Kilauea Volcano. ■

OK, Watch Watchers!

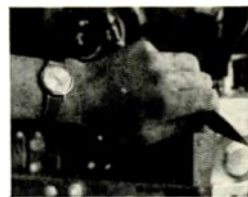

We want you to time your

next service call

with our watch!

Buy our Color Commander color bar generator. If it doesn't save you time, return the Color Commander within 10 days and keep the \$10.95 Timex.



What makes us so sure you'll save time? Amphenol's exclusive technique of color alignment. Only Amphenol gives you a:

1. Single cross bar that immediately centers the raster.
2. Single dot for fast, constantly accurate static convergence.
3. Three-bar color array that isolates your working bars—the 3rd, 6th and 9th.

Your Time is Money

If you're spending 45 minutes on a color alignment job, the Color Commander technique can cut that to as little as 27 minutes. That could mean two or three more calls a day—\$24-\$36 more income. Result: The Color Commander could pay for itself in two to three weeks.

Become an Amphenol Watch Watcher

Take advantage of this limited time offer. Cut out this coupon and beat the Watch Watcher rush. For the name of your nearest Amphenol distributor, write Dan O'Connell, Head Watch Watcher, Amphenol, Box 134, Broadview, Illinois 60153.



Watch Watcher Special

Count me in on the Watch Watcher Special. I understand I will get a lightweight, compact, completely solid state Amphenol Model 860* Color Commander along with a Timex watch to time my savings all for **\$169⁹⁵**

Model 860AC \$20.00 higher*
*Suggested resale prices



AMPHENOL

... for more details circle 103 on postcard

Language Laboratory

■ A specially equipped, electronically controlled laboratory for teaching foreign languages has been installed at Brookline, Mass., High School. It contains 63 student positions: 54 in the language laboratory, 8 in the library, and 1 in the foreign language office. All are interconnected by a dial telephone system to offer students up to 60 different language programs.

Each student records his foreign-

language narration on an individual remotely-located cartridge recorder. The instructor can play back the student's recording at the teacher's console or can remove the cartridge and play it back for evaluation at his convenience on a portable tape recorder.

Dr. Ferdy J. Tagle, Jr., assistant superintendent of schools for Brookline, says the new system provides growth capabilities for possible in-

terconnection in the future with other schools in the Brookline system. He said the Raytheon system is also compatible with video distribution systems and could be extended to include picture as well as voice transmissions.

Three teachers will be able to instruct subdivisions within a group of 54 students in the lab. A dual instructor's console at the front of the classroom permits two teachers to monitor and instruct individual students or the entire group while another control station at the rear of the room interconnects a third instructor with a portion of the class. Complete student testing facilities are incorporated in the system.

The eight stations installed in the library are particularly significant. Just as a student can currently go to the library after class hours and consult a book, this system permits the student to dial the appropriate lesson for make-up work or extra drills in a particular facet of the course. A student can draw on a wide range of prerecorded language instruction materials in a central program library and thereby progress at his own speed.

Programs are in French, German, Spanish and Russian.

STATEMENT REQUIRED BY THE ACT OF OCTOBER 23, 1962, (39 U. S. Code, 4369) SHOWING THE OWNERSHIP, MANAGEMENT AND CIRCULATION OF ELECTRONIC TECHNICIAN published monthly at Duluth, Minnesota for November 1966.

1. The names and addresses of the publisher, editor and managing editor are: Publisher, Ron Kipp, Ojibway Press, Inc., 25 West 45th Street, New York, N.Y. 10036, Editor, None, Managing Editor, Jack Hobbs, Ojibway Press, Inc., Ojibway Building, Duluth, Minn. 55802.

2. The owner is: OJIBWAY PRESS, INC., Ojibway Building, Duluth, Minn. Royal D. Alworth, Jr., 1605 Alworth Building, Duluth, Minn.; Robert L. Edgell, 5 Indian Point Lane, Westport, Conn.; Albert J. Forman, Woodbrook Drive, Springdale, Conn.; Herschel B. Fryberger, 712 Lonsdale Building, Duluth, Minn.; William B. Fryberger, 712 Lonsdale Building, Duluth, Minn.; C. E. Fuller, Jr., 711 Alworth Building, Duluth, Minn.; Orrin Henry & Company, Irving Trust Co., 1 Wall St., New York, N.Y.; Verne D. Johnson, Jr., 302 East Superior Street, Duluth, Minn.; S. R. Mason, 212 Medical Arts Building, Duluth, Minn.; Dean Myhran, 1 East First Street, Duluth, Minn.; Jeno F. Paulucci, 200 N. 50th Ave. West, Duluth, Minn.; Howard A. Reed, 174 Waverly Road, Scarsdale, N.Y.; Anita Reinig, 1 East First Street, Duluth, Minn.; Marshall Reinig, 1 East First Street, Duluth, Minn.; Marshall Reinig, as custodian for Janet Reinig, 1 East First Street, Duluth, Minn.; Mary Anne Reinig, 4514 Connecticut Ave. N.W., Washington, D.C.; L. M. Rosenthal, 330 East 49th Street, New York, N.Y.; Martin Wold Company, 7 East First Street, Duluth, Minn.

3. The known bondholders, mortgagees and other security holders owning or holding 1 percent or more of total amount of bonds, mortgages, or other securities are: None.

4. The average number of copies of each issue of this publication sold or distributed, through the mails or otherwise, to paid subscribers during the 12 months preceding the date shown above was: 82,840. Free distribution by mail, carrier or other media: 649. Total distribution: 83489.

(Signature) Dean Myhran
Vice President-Operations

Brand New and Exclusive!

Discriminates Between Desired Signal and Unwanted Noise!



**3-Way Combination
FREE SPACE
STANDING WAVE
MAGNETIC
ANTENNA**
(UHF-VHF-FM-COLOR)

Here for the first time, is an antenna with the unique ability to discriminate between the desired signal and unwanted noise! A complete absence of minor lobes and an extremely high front to back ratio are characteristics of these antennas. This is made possible by the development of the Free Space Standing Wave Magnetic Drive Antenna system (F.S.M.). The outstanding electrical qualities, combined with the simplified mechanical construction of this system yields a total performance package unparalleled in today's market. 4 models, 60-inch to 180-inch boom, all modestly priced.

There's a Quality Built S & A Antenna to Meet Every Need!

S&A Electronics Inc.
Manufacturers of the TARGET ANTENNA
204 West Florence St. • Phone (419) 693-0528 • Toledo, Ohio 43605

... for more details circle 140 on postcard

This part speaks for the whole radio.

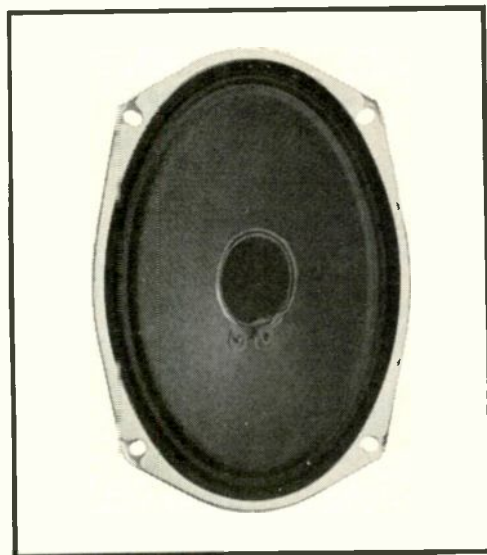

This box speaks well of you.

To the listener, the speaker is the most important part of the radio. Reason enough that it be of the highest quality and reliability. And when it says Delco on the box you can be certain you've got it: genuine OEM quality.

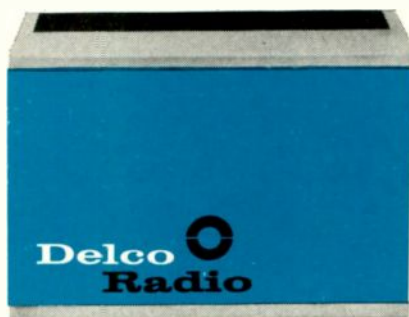

Delco Radio Parts are designed by engineers who specialize in automotive radios. Delco Radio speakers, for example, provide greater efficiency and sensitivity per ounce of magnet than any other speakers built. And since nearly half the cars on the road

have Delco Radios as original equipment, you are assured of a vast pre-sold market.

Doesn't it make sense to stock the best for your customers?

They know Delco's reputation. So, the next time you reorder, remember your United Delco Supplier. He handles the most widely advertised, merchandised and recognized name in the parts business.

Why not let Delco Radio speakers say something nice about you?

Delco Radio, Division of General Motors, Kokomo, Indiana.

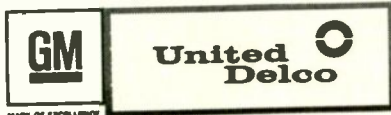

JERROLD FREE HANDBOOK

**HELPS
YOU
EARN
BIG
MONEY
IN
SMALL
SYSTEMS**



Here's a book that'll help you cash in on the growing market in master antenna systems for TV showrooms, small motels, hotels, and apartment houses.

You're the logical one to install—and profit from—these small systems, and this all-new *Jerrold Split-Page Handbook* gives you help for easy, top-quality installation. This 76-page book, regularly priced at \$1.25, provides over a hundred system layouts and describes the equipment needed for each. Jerrold solid-state systems equipment, including the famous "Gibraltar" series, assures high reliability and customer satisfaction.

Clip and hand this coupon to your Jerrold distributor for a free copy of the *Handbook*. Start now to earn the BIG profits waiting for you in the small-systems market! *Jerrold Electronics, Systems Products, Distributor Sales Division, 4th & Walnut Sts., Philadelphia, Pa. 19105.*

GIVE THIS COUPON TO YOUR DISTRIBUTOR

Mr. Distributor:
Please give me my free copy of the *Jerrold Split-Page Handbook of TV Distribution Systems*, which normally sells for \$1.25. I understand there is no obligation.

Name _____
Company _____
Street Address _____
City _____ State _____ Zip Code _____



... the most experienced name
in TV signal distribution



LETTERS TO THE EDITOR

continued from page 24

ing to fling their weight or "intelligence" around. Neither does its policy encourage diversification to the point that technicians end up as plumbers helpers. Indeed, your so-called competitors are *for* something one month and *against* it next month. They have become so diversified in their coverage that the titles become misleading and have little reference to the article material they publish.

Yours is the best publication with meaning and purpose to the service trade. May you continue as in the past. Thank you.

GEORGE STRONG
Strong's TV & Radio

Chardon, Ohio.

More Help

For those needing schematics of "Rider Chanalyst," model 11, we can furnish schematic and parts list as follows: One page schematic (with resistor and capacitor values included); 3 pages parts lists, 78 pages entire manual. Can reproduce for 50¢ a page.

SCOTT INSTRUMENT LAB.
2222 Broadway

San Diego, Calif. 92102

... Tell Paul Christie to write Grundig-Triumph, Adler Sales Corp., 75 Sedgwick St., Brooklyn 31, N.Y. They may be able to furnish him with a schematic for the Grundig tape recorder.

MARIO ALBA

Brooklyn, N.Y.

... Regarding Mr. R. Cooper Bailey's request for a schematic on the Scribe Dictaphone, tell him to try Permaflex Scribe, 333 N. Michigan, Chicago 39, Ill. Phone FI 6-8582.

HARRIS GREENBERG

Westmont, Ill.

A Thank You

... Because of a mix-up in the postal system, I did not receive (or have forwarded) three issues of ET — along with six other magazines I subscribe to. Of the seven magazines, only ET acknowledged receipt of my letter requesting the copies — and only ET offered to replace the three issues I had missed. Yesterday I received the three issues of ET, all in perfect condition . . . Thank you.

PETER WIKOFF

Wilmington, Ohio



Zowie! Here's big news for "Mister Right"—the independent service dealer who carries Sylvania tubes.

Every time you order Sylvania picture or receiving tubes from a participating distributor, you receive Sylvania Means Business (SMB)-Mister Right dealer certificates. They're redeemable for an exciting selection of gifts. For yourself, your family, your home.

You get certificates for your purchases of receiving tubes and every SILVER SCREEN 85®, color bright 85™ or COLOR SCREEN 85 picture tube.

So you're a winner in two ways: big profits and top-quality prizes. Sylvania Means Business.

See your participating Sylvania Distributor for all the details. Sylvania Electronic Tube Division, Electronic Components Group, Seneca Falls, New York 13148.

SYLVANIA
SUBSIDIARY OF
 GENERAL TELEPHONE & ELECTRONICS **GTE**

CATALOGS AND BULLETINS

CB Transceivers 400

Two-color specification sheets give information on features and accessories for a regular 5w CB transceiver and a 1.5w hand-held type. Amphenol.

Test Instruments 401

Three two-color specification sheets cover features, accessories and applications of a color generator, field strength meter and CRT rejuvenator. Amphenol.

Antennas 402

Fixed and mobile antennas designed for magnetic mounting and covering frequencies from 27MHz to 1GHz are described in a catalog. Versa Tronics.

Showroom Antenna System 403

Solid-state, all-channel antenna distribution systems designed for demonstrating color TV are described. Jerrold.

Console Decorating Handbook 404

A full-color 20-page brochure contains articles on high fidelity, the role

of music in the home, choosing the correct console to match individual room decor and explanations of the more technical aspects of stereo consoles. Scott.

Paging Amplifier 405

A 15w solid-state amplifier designed for paging is described in an 8-page folder. The amplifier will operate on 12v external or internal batteries or with an ac adapter. American Geloso.

Transistor Cross Reference 406

A transistor cross reference sheet lists over 2900 transistors which it indicates can be replaced by but five transistors. Workman.

Motors and Controls 407

Motors, speed controls, synchronous motors, translators, variable reducers, torque controls, impulse counters, timers and tachometers are discussed in a 64-page catalog. B & B Motor and Control.

Switches 408

An eight-page, two-color catalog describes a line of rotary, pushbutton, lever and slide switches. Complete specifications — from finishes to insulation materials — for each type of switch are listed. Oak.

Soldering Tool 409

A four-page bulletin describes a soldering tool that grips as it solders. The tool is designed to solder special parts frequently inaccessible to ordinary soldering irons. Triton.

Slide Switches 410

An eight-page catalog describes a versatile line of double-wipe slide switches. In addition to specifications, the catalog contains an easy-to-use guide for specifying special variations of standard switches. Switchcraft.



by [signature]
"We couldn't fix the interference, so we made it neater."

SUBMINIATURE TOGGLE SWITCHES

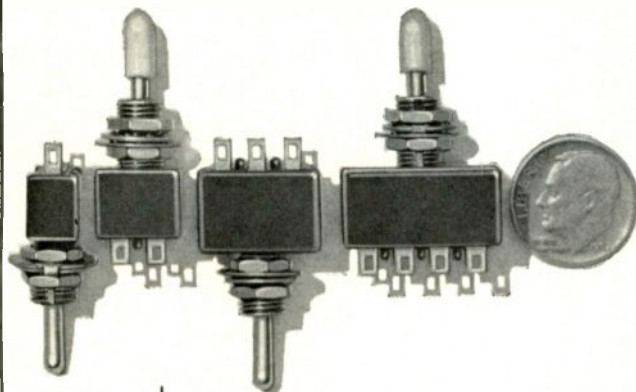

SPDT Designed to meet the highest standards of reliability, C&K's quality subminiature toggle switches combine maximum performance with small size! They feature rugged construction, simple mounting, excellent appearance, and long, trouble-free operation!

DPDT

3PDT

4PDT

A competitively-priced, made-in-America product. Write for literature today!

C&K quality electro-mechanical products
103 Morse Street, Watertown, Massachusetts 02172
Telephone: 617 926-0800
COMPONENTS, INC.



NOW . . .

a convenient, sturdy binder for your ELECTRONIC TECHNICIAN Schematics!

Here's a sturdy book binder designed specifically for technicians who want to file away the ELECTRONIC TECHNICIAN Tekfax schematics for easy reference.

KING-SIZED 11" x 15". Your schematics lay flat, no folding necessary.

EASY TO USE Just press back the special spring clamp and slip your new schematics into place. No holes to punch.

STURDY Handsome, reinforced binding. Tough duty fabric cover.

ORDER TODAY — USE THIS CONVENIENT FORM

ELECTRONIC TECHNICIAN

DEPT. B-B OJIBWAY BUILDING, DULUTH 2, MINNESOTA

Please Rush Me.....Schematic Binders at \$4.95 each

I am enclosing \$.....

Name

Company Name

Street Address

City Zone..... State

Dollar for dollar, feature for feature...

knight-kits® ARE YOUR BEST BUYS



NEW! KG-640 20,000 OHMS/VOLT VOM KIT WITH TAUT-BAND METER

- Dependable, Taut-Band Movement Assures Repeatability of Readings
- 57 ranges. Starts as low as 0.8 VDC Full Scale for Accurate Transistor Work
- Mirrored Scale and Knife-Edge Pointer Eliminate Parallax Errors for Accuracy

This 20,000 ohms-per-volt VOM is easy-to-build, low-priced. 57 ranges for reading AC, DC, Output volts, resistance, DC current, decibels. Perfect for testing radio and TV sets, hi-fi components, appliances, motors, house wiring, etc. Complete with batteries, test leads, assembly manual for only **\$39⁹⁵**

Available factory assembled \$59.95

Read the unique money-back guarantee below . . . exclusive in the industry . . . then rush the coupon at right for full details and Special Introductory Offer.



NEW! KG-685 PORTABLE SOLID-STATE COLOR BAR/PATTERN GENERATOR KIT

The perfect choice for both on-the-bench and in-the-home color TV servicing. Gives you seven accurate, stable, crystal-controlled patterns—all displays needed for complete color set adjustments. Special minus 2-volt output for Zenith color sets. All parts, cables, service light and mirror, instructions and 32-page operator's manual for just **\$89⁹⁵** Available factory assembled \$129.95

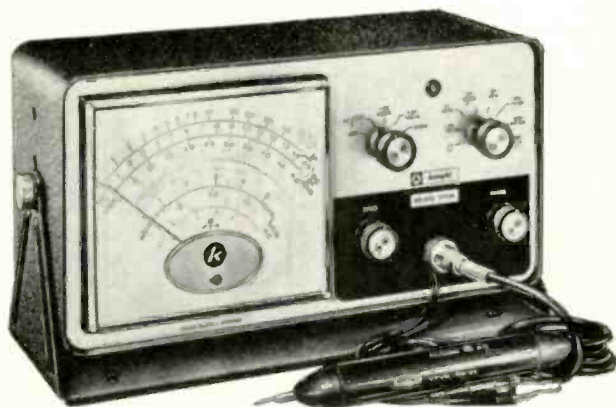

KG-625 Deluxe 6" Vacuum Tube Voltmeter Kit

Knight-Kit's best VTVM features ½-volt full-scale DC range; a pre-aged bridge tube with matched triode sections for easy calibration; single, switchable AC-Ohms/DC test probe; inverted chassis for quick, easy assembly; 200-microamp movement with fluorescent knife-edge pointer. With all parts, battery, test probe and instructions. **\$39⁹⁵** Available factory assembled \$59.95

KNIGHT-KIT GUARANTEE

Build a Knight-Kit in accordance with our easy-to-follow instructions. When you have completely assembled the kit, you must be satisfied or we will return your money, less transportation charges, under the Allied guarantee of satisfaction.

ALLIED RADIO

ALLIED RADIO, Knight-Kit Div.

Dept. 28-LL, P.O. Box 8528
Chicago, Illinois 60680

Please rush—FREE and without obligation—full details and Special Introductory Offer on Knight-Kit Test Equipment.

Name _____ PLEASE PRINT

Address _____

City _____ State _____ Zip _____

... for more details circle 102 on postcard

VOM and Pannel Meters 411

One 12-page catalog describes a complete line of VOM meters while another describes pannel meters. Tube testers, plus a transistor analyzer, transistor tester, signal generator and laboratory quality meter are also described. Triplett.

SEMICONDUCTORS . . .

continued from page 51

feedback can be used to improve the high frequency response of a transistor circuit. It can also be used to improve a circuit's low frequency response. One method for obtaining such feedback is shown in Fig. 13. Here a portion of the output signal passes through a capacitor (C_4) and resistor (R_3) and is returned to the input. Since a signal is normally inverted when it is amplified in a common emitter cir-

cuit, the returned output signal reduces the amplitude of the input signal. The circuit is designed so the input signal has a greater amplitude than the feedback signal, and the portion of the input signal fed back is neutralized by the input signal.

A portion of the output signal is the result of internal transistor noise and distortion. (Transistor signal distortion was discussed in a previous article.) This portion of the signal fed back is not the inverse of the input signal and is not neutralized by it. This distortion and noise remains to be fed into the base of the transistor and amplified. When amplified, the noise and distortion signals are inverted and serve to partly neutralize the original noise and distortion in the circuit's output.

Negative feedback can also be produced in the circuit shown in Fig. 10 by removing capacitor C_1 . The signal voltage ($\Delta I_E R_E$) developed across the emitter resistor (R_E) is the inverse of the base input signal voltage. It provides negative feedback by reducing the total emitter-to-base voltage (V_{EB}) developed by the input signal.

A forthcoming article will discuss field-effect transistors and their related circuits. ■

SERVICE BEDROCKS . . .

continued from page 55

out on repair estimates. This not only relieves service technicians of the responsibility, but has the advantage of keeping the boss in touch with customers.

Handling Repair Estimates

Wenger's won't bring in or take in an older set unless the owner OK's repair work up to \$25, but they never surprise anyone with a bill, always phoning back before proceeding with repairs.

"We make it clear that there will be a \$3.50 charge for an estimate, whether we repair the set or not," Bob Wenger says. "What we do is list on the back of a service ticket what the set needs. If the owner wants to get an estimate elsewhere, we advise him that he should do so. Since the \$3.50 charge for the esti-

**ZENITH
LOG PERIODIC
ANTENNAS**
offer high
signal gain and
ghost rejection

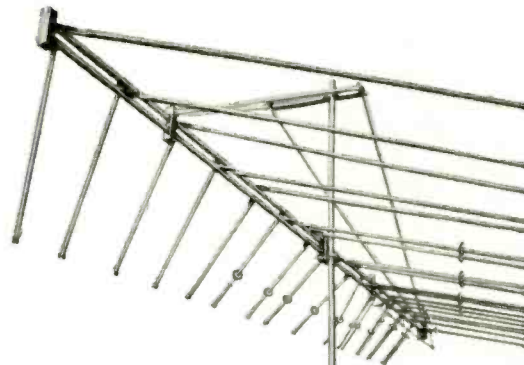

All-channel VHF/UHF/FM and FM Stereo

Developed by the University of Illinois antenna research laboratories, each Zenith log periodic antenna works like a powerful multi-element Yagi . . . not on just one or a few channels, but across the entire band it's designed for.

Order Zenith antennas and all genuine Zenith replacement parts and accessories from your Zenith distributor.

BUILT TO THE QUALITY STANDARDS OF ZENITH ORIGINAL PARTS

**Also Zenith
periodic
antennas for**

- UHF • VHF
- FM AND FM STEREO
- PLANAR HELICAL UHF



*The quality goes in
before the name goes on*

. . . for more details circle 153 on postcard
ELECTRONIC TECHNICIAN

Less than 15¢ per schematic!

A Full Year's Information For Under \$20!

Hayden's new TV TECH/MATICS gives you a full year's TV schematics and servicing data for only \$19.90! Compare that with the well over \$100 you are paying now for comparable information. Just your first two years of TV TECH/MATICS will save you an incredible \$200 or more!

No doubt about it, this is the ideal information "package" for the active TV Technician. It provides complete schematics and vital servicing data for a full year's models of every TV receiver produced by the leading American manufacturers. All the diagrams and data are based on the original manufacturers specifications—compiled and organized by the expert editorial staff of **Electronic Technician** magazine. They are permanently bound into volumes opening flat to 29½" x 11", ready to travel with you into the home or give you instant information at the bench.

First of all, you get a clearly detailed and annotated circuit diagram of the specific model. You also get the following: a replacement parts list, alignment instructions, tube and critical parts locations, and important waveforms and voltage

readings. In other words, all the information you really need!

In addition, TV TECH/MATICS '65, the first in the annual series, includes, at no extra cost, complete servicing data and schematics for all color sets 1960-1965! TV TECH/MATICS '66 will be out this month. TV TECH/MATICS '67 is due early next year. So, save time, cut costs! Kick the "separate schematics habit" for good!



See your Electronic Parts Distributor today!

Hayden Book Company, Inc. • 116 W. 14th St. • New York, N. Y. • 10011

... for more details circle 124 on postcard

mate is deducted from the bill when we do the repairing, the owner can seldom find a price that beats ours.

"In any case, this program protects the owners and protects the shop. The owner knows exactly what he's paying for and why, he can get all the other estimates he wants, using the information we've written on the back of the shop ticket. At the same time, the \$3.50 charge at least covers our cost of making the estimate.

"We've built a lot of customer confidence as a result of this pro-

cedure. There is no mystery about what we're charging for and why. This is fundamental to the continued growth of our service business, we believe."

Low Carrying Charges

A sales feature that helps Wenger's expand its market is the company's self-financing system.

"Our customers are 'fussy' on credit," Bob Wenger says, "but a low interest rate is a big talking point when it comes to selling, particularly to the shopper whose B/W set is still good but who wants color. Combined with the customized trade-in program made possible by the firm's ability to move out the trade-ins, our company credit program becomes a powerful lever for the sale."

Wenger's charges one-half of one percent flat on the unpaid balance, carrying the paper for the first ninety days without charge.

"It's often argued by dealers that the general public doesn't care what the total cost is. All they want to know is what are the monthly payments," Bob Wenger says. "We're finding this situation is changing rapidly—perhaps because there has been so much publicity, including some Congressional investigations, about credit charges.

"We thoroughly explain our charges and the fact that we carry our own paper. Most people are sharp enough to figure out the difference.

"Older folks, particularly, are very conscious about interest. We always suggest to the shopper who wants to look elsewhere before buying that he ask 'What's your interest charge? We're getting many returnees as a result of this sales tool and are closing the sales.'"

Following up all sales with lots of personal attention, putting the emphasis on the shop's service and on management's concern that the buyer get maximum satisfaction from his set, is a merchandising package that brings results for Wenger's.

This package, the senior Wenger concludes, is the same today as it was yesterday and will undoubtedly be the same tomorrow because it's the package that produces satisfied customers and satisfactory profits for the independent dealer. ■

Save Time on PC Board Repairs!



MODEL 100A

Melted solder disappears up hollow tip into tube

The ENDECO Desoldering Iron Removes Soldered Components in seconds... without damage!

Endeco melts solder, then removes it by vacuum • Leaves terminals and mounting holes clean • Resolders too • One-hand operation • Temperature controlled for continuous use • Ideal for use with shrinkable tubing • 4 tip sizes • Quickly pays for itself in time saved • Only \$18.75 net.

SMALLER SIZE AVAILABLE. SEE YOUR DISTRIBUTOR OR WRITE:



ENTERPRISE DEVELOPMENT CORPORATION

5123 E. 65th • INDIANAPOLIS, IND. 46220
IN CANADA: A. C. Simmonds & Sons, Ltd.
100 Merton St., Toronto 7

... for more details circle 120 on postcard

"TORQUE WRENCH" MANUAL

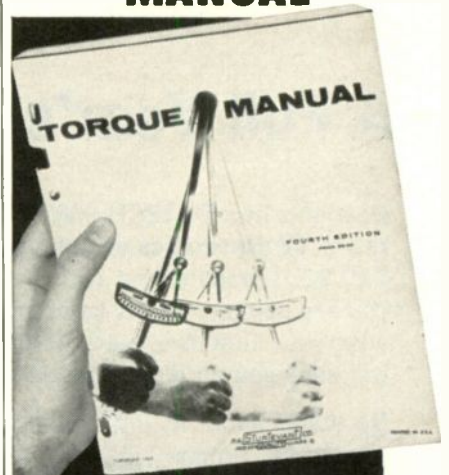

SENT UPON REQUEST
Formulas Applications
Engineering Data
Strew Torque Data
Adapter Problems
General Principles

P.A. **STURTEVANT CO.**
ADDISON QUALITY ILLINOIS

Manufacturers of over 85% of the torque wrenches used in industry

... for more details circle 148 on postcard

KAY-TOWNES

UHF-VHF-FM antennas



ORIGINATORS and DESIGNERS of the WORLD FAMOUS

CROSS PHASE CIRCUIT

Now Used By Most All Modern-Day Antennas

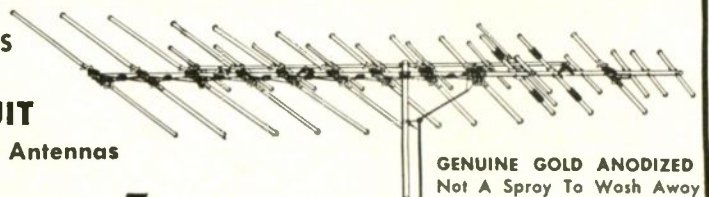

GENUINE GOLD ANODIZED
Not A Spray To Wash Away

KAY-TOWNES ANTENNA CO.

1511 DEAN AVE., ROME, GA. 30162

colorphase

CP-7, 11, 15, 19, 23, 28

... for more details circle 131 on postcard
ELECTRONIC TECHNICIAN

Compare Color Generators

look at the rest... and you'll buy the best, new B&K model 1245

The all solid-state B&K Model 1245 Color Generator duplicates the waveforms transmitted by a color TV station.

Adherence to these waveforms makes it easy to converge the color tube, check sync and make other raster adjustments... and the color generator with station quality signal will be able to sync next year's sets. Generators with compromise waveforms do not give you this obsolescence protection.

Here are oscilloscope photographs from the outputs of two typical competitive color generators, one transistorized and one tube type, and the B&K Model 1245. The detailed analysis with each photograph shows a few of the reasons why you'll save time and effort with B&K.

COLOR

CROSSHATCH

STANDARD STATION SIGNAL



One horizontal sync pulse with its color burst.

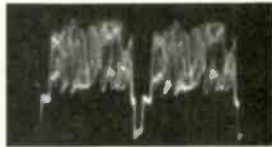

Two lines showing horizontal sync pulse with black and white TV signal.

TRANSISTORIZED B&K MODEL 1245

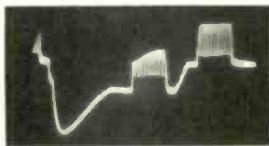

Good duplication of station signal including back porch. If the set won't sync, the set is defective.

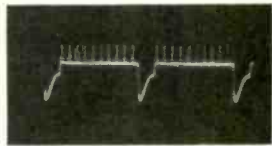

Well defined back porch on horizontal sync pulse permits accurately setting color killer and almost eliminates need to adjust brightness and contrast.

TRANSISTORIZED GENERATOR A

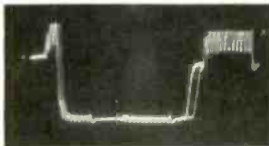

No back porch causes unstable color sync. Burst amplitude compression may permit sync on wrong color bar.

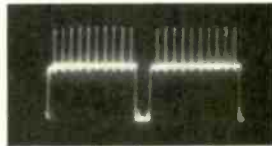

Square wave horizontal sync pulse with no back porch and poor dc coupling forces adjustments of brightness, contrast & fine tuning to obtain usable pattern.

GENERATOR B



No back porch; color information on top of sync-pulse makes sync difficult on some sets.

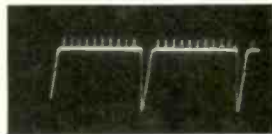

Complete absence of any back porch necessitates readjustment of brightness, contrast and fine tuning to obtain a usable pattern.

See your B&K Distributor for a demonstration or write for Catalog AP22.

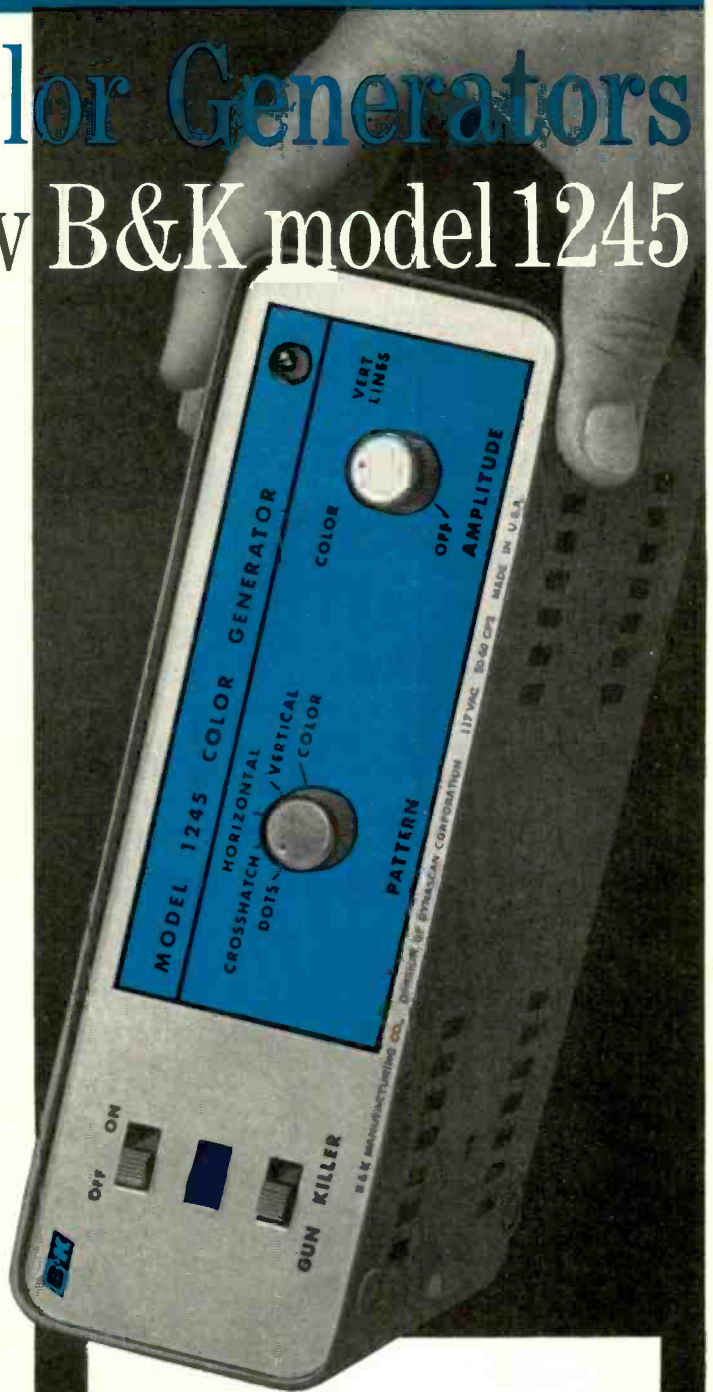

For the first time, with the no-compromise waveforms from the B&K Model 1245, it is possible to accurately set the color killer threshold control with a color generator.

The miniature size and convenience of the Model 1245 match its performance. It provides crystal-controlled keyed rainbow color bar display, and dot, crosshatch, horizontal line and vertical line patterns as well as gun killer controls that will work with any picture tube. Size only 2 7/8 x 8 1/2 x 8 7/8". Net \$134⁹⁵.

B & K MANUFACTURING CO.

DIVISION OF DYNASCAN CORPORATION
1801 W. BELLE PLAIN AVE. • CHICAGO, ILL. 60613

Canada: Atlas Radio Corp., 50 Wingfield, Toronto 19, Ont.
Export: Empire Exporters, 123 Grand St., New York 13, U.S.A.



You earn your FCC First Class License

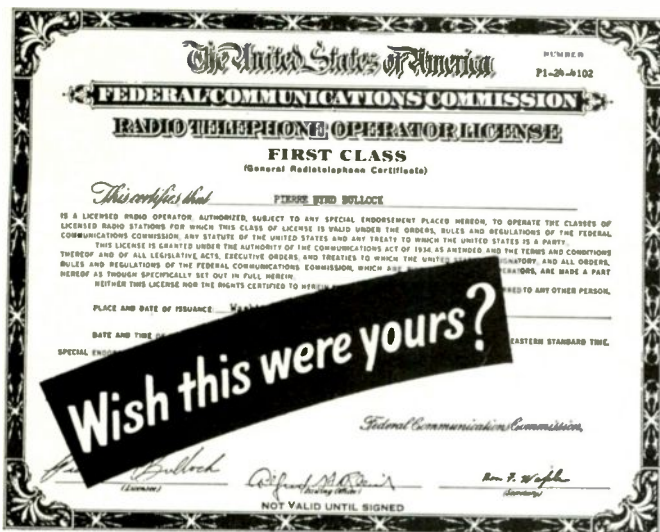

or your money back

THERE'S A WORLD OF OPPORTUNITY FOR THE MAN WITH AN FCC LICENSE

All it takes is a few spare hours a week and NRI's FCC License Course to open the way to increased opportunities in Communications. With an FCC License, you're ready to operate, service and install transmitting equipment used in aviation, broadcasting, marine, mobile and Citizens-Band communications.

What does it take? Men with absolutely no training or experience in Electronics complete the course in 10 months. A Technician or man with some background can easily cut that time in half. And because NRI has a greater enrollment than any other school of its type, training costs you less than comparable courses offered by other schools. Further, YOU MUST PASS your FCC exams or NRI refunds your tuition in full.

Get full details about NRI FCC License Course plus other home-study plans offered by NRI, oldest and largest school of its kind. Mail coupon. No obligation. No salesman will call. NATIONAL RADIO INSTITUTE, Washington, D. C.

Available Under NEW GI BILL. If you served since January 31, 1955, or are in service, check GI line in coupon.

MAIL for FREE CATALOG



NATIONAL RADIO INSTITUTE
Electronics Division
Washington, D. C. 20016 14-116

Please send me complete information on FCC License Training and other NRI courses, as checked below. (No salesman will call.)

- | | |
|--|---|
| <input type="checkbox"/> FCC License | <input type="checkbox"/> Radio-TV Servicing |
| <input type="checkbox"/> Complete Communications | <input type="checkbox"/> Industrial Electronics |
| <input type="checkbox"/> Aviation Communications | <input type="checkbox"/> Electronics for Automation |
| <input type="checkbox"/> Marine Communications | <input type="checkbox"/> Basic Electronics |
| <input type="checkbox"/> Mobile Communications | <input type="checkbox"/> Math for Electronics |
| <input type="checkbox"/> Check for facts on new GI Bill. | |

Name _____ Age _____
PLEASE PRINT

Address _____

City _____ State _____ Zip _____
Code _____

ACCREDITED MEMBER NATIONAL HOME STUDY COUNCIL

... for more details circle 134 on postcard

NEWS OF THE INDUSTRY

New Hampshire's Educational TV Network

A web of microwave paths fanning out from the University of New Hampshire will soon bring educational TV programs to all residents of the State.

Raytheon Co. has been awarded a contract to link Saddleback Mountain in the state's southeast corner, with Walpole in the southwest, Hanover in the west central area and Littleton in the north.

This equipment will make it possible for educational and cultural programs of the nationwide educational tv network, or those originating at Durham, to be carried across the state where three new UHF transmitters can broadcast them simultaneously.

From Saddleback, near the TV station, pictures and sound will be beamed 35 miles to Mt. Kearsarge. There they will be split three ways for simultaneous relay to Walpole (35 miles), Hanover (30 miles) and to Cannon Mountain and Littleton (65 miles). A spur from Saddle-

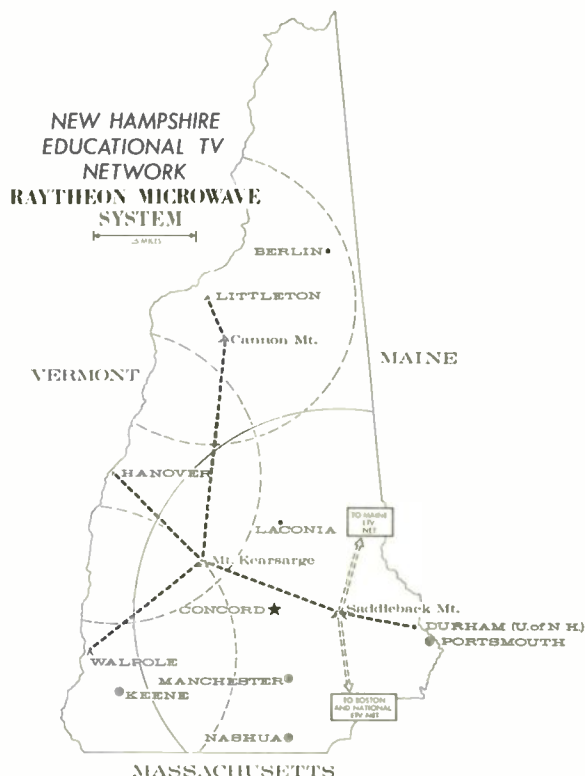

back to the university studios at Durham will enable programmers to monitor educational network programs coming from Boston, record them on tape and broadcast them at another time. Network programs are now received only at the transmitter on Saddleback Mountain where there are no recording facilities. Consequently, these programs must be broadcast "live" or be lost.

The system will employ two transmitters, four receivers, and two transmitter/receivers. The latter will be installed atop Mt. Kearsarge and Cannon Mountain to relay the combined picture and sound to the three satellite transmitters, designed for unmanned operation.

Cost of the project is being shared equally between the state and federal governments through grants from the Dept of Health, Education and Welfare.



Tips on replacing circuit breakers

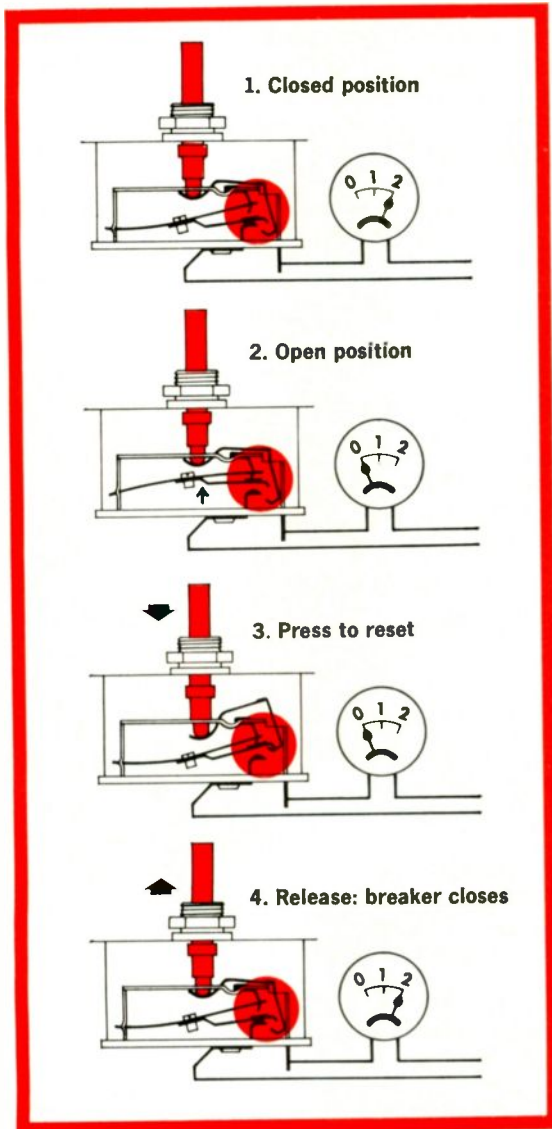

That little red "breaker reset" button that sticks out of the back of nearly every television chassis can be a time-saver or a trouble-maker, depending on what's wrong inside the set, and who's pushing the button. As you well know, when a transient fault has popped the breaker, you can get the set back in business just by pressing the reset. But if there has been a short-circuit failure and some uninformed tinkerer presses the button and *keeps* it pressed, there's a good chance that more power keeps flowing into the fault. Result: a minor trouble becomes a calamity.

This is why Underwriters' Laboratories require that breakers should be "cheat-proof"—that is, they should not allow current to pass when the reset button is held depressed. Some of the replacement breakers you'll find on the market *aren't* cheat-proof. We have one that *is*. It has features that you'll find valuable any time you need to install a new breaker, or when you're working on a breadboard circuit that needs over-current protection.

Take a look at how this breaker works, and you'll see what we mean.

At top (Picture 1) is the way the breaker mechanism looks when it's in the "on" position.

Along comes an overload (Picture 2). The bi-metal strip heats, snaps into the "break" position, opening the current carrying contacts.

Now you press the button to reset (Picture 3). As long as you hold the button down, the contacts at the right remain open. Release the button and the contacts go back to closed (Picture 4). If the overload is still there, the breaker will open again. You can't keep it closed on a short circuit!

No wonder this particular breaker is used as original equipment on the majority of all television sets. They're made for Mallory by Mel-Rain Corp. to the same specifications as for original equipment, and they're available from a Mallory distributor near you. Off-the-shelf ratings go all the way from 0.5 to 7 amperes break current, and include all the values you'll need for service replacement or for industrial equipment maintenance. And as an extra convenience, you can get them with either a twist-tab or bushing mount. For your copy of our new 24-page cross-reference guide to circuit breaker replacement in all popular TV sets, see your Mallory distributor, or write to Mallory Distributor Products Company, a division of P. R. Mallory & Co. Inc., P. O. Box 1558, Indianapolis, Indiana 46206.

50th
ANNIVERSARY

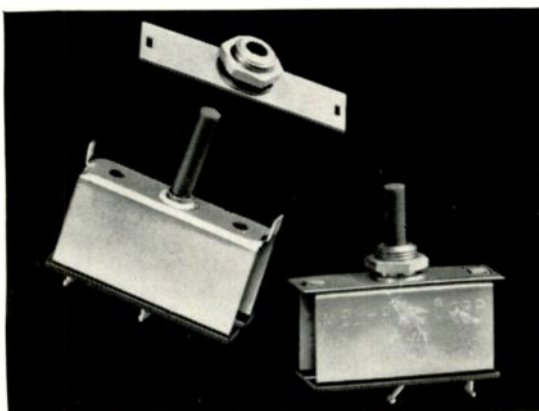

... for more details circle 132 on postcard

HEATHKIT® Lab Power Supplies

... First in Sales For Service, Production, Design

Solid-State 0.5 to 50 Volt /Regulated DC Power Supply

The IP-20 features a solid-state circuit that delivers up to 1.5 amperes with better than ± 15 millivolts load regulation and less than 150 microvolts ripple and noise. It boasts an adjustable current limiter to protect your equipment (50 ma to 1.5 amps. in 5 ranges). Regulation & limiting transient response is better than 25 micro-seconds. 0.1 ohms impedance. Here is a tremendous value in a DC supply.

Kit IP-20, 13 lbs. \$72.95
Wired IPW-20, 16 lbs. \$114.95



0-400 Volt Regulated DC Supply With Bias & Filament Voltages

Furnishes high voltage at 100 ma. max., bias of 0 to -100 volts at 1 ma., and 6.3 VAC filament at 4 amps. max. Load regulation is better than 1%. Ripple, jitter, and noise less than 10 millivolts. Separate voltage & current metering.

Kit IP-32, 17 lbs. \$56.95
Wired IPW-32, 18 lbs. \$84.95



0 to 6 And 0 to 12 Volts DC @ 5 amps. ... A 6 Or 12 Volt Battery Eliminator

Features switch selection of 6 or 12 volt power. Separate metering of current and voltage. High-power unfiltered DC output for battery charge or industrial use — 6 volts @ 10 amperes and 12 volts @ 5 amperes.

Kit IP-12, 18 lbs. \$47.50



0 to 25 Volts at 200 ma.

A handy power source for a multitude of uses ... excellent for low-power transistor circuits. Output resistance is less than 50 ohms. Ripple less than 0.1%. Includes 3-wire line cord.

Wired EUW-17, 3 lbs. \$20.00



FREE! World's Largest Electronic Kit Catalog

Includes these and over 250 other items for the service technician, engineer, ham, teacher, and hobbyist.

HEATH COMPANY, Dept. 24-11
Benton Harbor, Mich. 49022
In Canada, Daystrom Ltd.

Please send my FREE Heathkit Catalog.

Enclosed is \$ _____, plus postage.

Please send model(s) _____

Name _____

Address _____

Ci _____ State _____ Zip _____

Prices & Specifications subject to change without notice. TE-153



... for more details circle 125 on postcard

NEWS OF THE INDUSTRY

Color TV Still Booming

Color TV and FM radios were distributor sales product leaders for July 1966 despite erratic vacation plant shutdowns. Although total TV sales declined about 9 percent in July, year-to-date sales were ahead by 18.5 percent.

B/W TV sales in July decreased 18.7 percent from the total for July 1965, while Color TV sales increased 31.3 percent, increasing the January-to-July period total sales to a figure 99.1 percent above that for the comparable 1965 period.

FM sales in July increased 11.4 percent over July 1965, giving the sets sold in the first seven months of 1966 a 42.0 percent edge over the comparable period of 1965.

The year-to-date figures on January-to-July unit sales are as follows:

	1965	1966
B/W TV Sets	4,045,842	3,935,766
Color TV Sets	1,061,649	2,114,250
Home Table, Clock and Portable Radios	6,272,819	6,919,688
Home FM Radios	1,333,916	1,893,564
Auto Radios	5,755,569	5,023,063
Portable & Table Phonographs	1,513,957	1,420,044
Console Phonographs	739,643	905,453

Three-Day Master TV Antenna Seminar

Architects, engineers, technicians, educators and sales personnel from six Middle Atlantic and Southern states gathered in Atlanta, Ga., to participate in a three-day TV master antenna seminar conducted by Blonder-Tongue Laboratories, Newark, N.J.

Under the direction of Nick Young, the electronics firm's national training program director, representatives from more than a dozen companies, as well as from the Georgia State Dept. of Education and the Georgia State Educational TV Network, discussed a variety of subjects relating to MATV and educational TV equipment, installation and servicing techniques.

Topics discussed during the seminar sessions included TV-fundamentals, TV-signal origination and distribution systems for MATV and ETV.

"These training sessions," according to Mr. Young, "are designed to provide an outline of the basic requirements of MATV and ETV systems, and the reasons for selecting certain electronic components and equipment instead of others."

Station WWV Relocated

Effective midnight Nov. 30th, all of the services presently provided by the National Bureau of Standards broadcast station WWV, Greenbelt, Md., will be continued by WWV, Fort Collins, Colo. Unavoidable delays in equipment procurement and building construction delayed the original target date of July 1, 1966.

All six carrier frequencies — 2.5, 5, 10, 15, 20, and 25MHz — will be transmitted by omnidirectional vertical half-wave dipoles.

install ALLIANCE Tenna-Rotor®...now

*Profit now with world-famous
Tenna-Rotors.®*

**You'll sell more than ever before.
And they're twice as easy to sell!**



In-store demonstrations sell on sight! Hook up a Tenna-Rotor . . . Every color set needs one . . . Then, watch their faces light up when you turn the dial and they see a beautiful color picture. Switch to black & white or FM Stereo. Same result: Tenna-Rotor pulls 'em in sharp, clear, bright and strong! Use the color-TV delivery lag to sweeten up profits with Tenna-Rotor sales, antenna and lead-in wiring jobs. Then, you'll be all set for fast, easy deliveries and installations.



Install the world famous Alliance Tenna-Rotor®

"TV's Better Color Getter"



The **ALLIANCE** Manufacturing Company, Inc.

(Subsidiary of Consolidated Electronics Industries Corp.) **ALLIANCE, OHIO**

Maker of **GENIE®** Garage Door Openers

AN EXTRAORDINARY OFFER...

introducing the benefits of Membership in Electronic Technician's Book Club



- 192 pages
- Special Color Sections
- Permanent, Hardbound Volume
- Over 350 solutions to "tough dog" problems
- Over 125 schematic diagrams & illustrations

PARTIAL LIST OF CONTENTS

TV TROUBLESHOOTER'S HANDBOOK contains over 350 proven servicing items describing "tough dog" problems and their solutions. For ease of use, these helpful trouble cures are arranged by manufacturer & model number. And, a special section concentrates on color set servicing.

These tried and tested troubleshooting aids constitute a vital reference source of servicing techniques will help make your own work easier and more effective.

Circuit faults and solutions are included for these manufacturers:

B&W SETS

RCA Victor
General Electric
Philco
Sylvania
Westinghouse
Magnavox
Motorola
Zenith
Admiral
Emerson
Curtis-Mathes
Hallicrafters
Truetone
Coronado
Symphonic

Silvertone
Emerson-
Dumont
Gamble-Skogmo
COLOR SETS
RCA Victor
Sylvania
General Electric
Zenith
Philco
Magnavox
Motorola
Olympic
Setchell-Carlson
Westinghouse
Admiral

May we send you this unique time-saver as part of an unusual offer of a Trial Membership in Electronic Technician's Book Club?

A Massive, Authoritative Compilation

Now you can have, at your fingertips, this carefully-planned reference source of over 350 different, tried and tested solutions to "tough-dog" TV servicing problems.

Selected by the Editorial Staff of "Electronic Technician" from thousands, these helpful techniques are a complete digest of late-model TV receiver troubles and cures, compiled strictly on the basis of their usefulness to you!

This detailed compilation of practical help is the answer to the need for an organized gathering of proven troubles and cures, new and unusual circuits and descriptions of how they work, field and factory changes, recurring defects, etc., that will help you locate and correct the most elusive TV circuit faults. This practical information will help you solve your daily servicing problems . . . will save you hours of time and effort. These accurate and clear servicing descriptions are supplemented by over 125 easy-to-follow schematic diagrams and illustrations. For ease of use, all data has been logically organized by manufacturer and model number.

Special Sections on color TV describes recurring defects and cures, and includes service hints for troubleshooting chroma circuits, short cuts for making convergence adjustments, descriptions of new circuits, etc.

Assembled for the first time in book form, *TV Troubleshooter's Handbook* is the one volume "Electronic Technician" readers have literally demanded as the answer to simplifying their own work. This handsome, hardbound book is indicative of the many other fine offerings made to Members . . . important books to read and keep . . . volumes with your specialized interests in mind.

How You Profit From Club Membership

This is just a sample of the help and generous savings the Club offers you. For here is a Club devoted exclusively to seeking out only those titles of interest to you as an electronic technician (no hobby or "fringe" books are offered). Membership in the Club offers you several advantages:

for a limited time only you can obtain this invaluable **NEW**

TV TROUBLESHOOTER'S HANDBOOK

for only **99c**... with Trial Membership in the Club

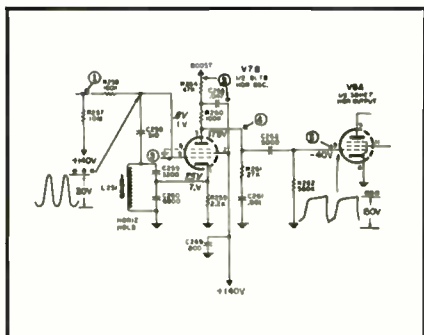

Literally scores of easy-to-use schematic diagrams are contained in "TV Troubleshooter's Handbook." (Example shown greatly reduced in size)

1. Charter Bonus: *TV Troubleshooter's Handbook* carries a retail price of \$6.95. But it can be yours for only 99¢ with your Trial Membership.

2. Continuous Savings: The Club guarantees to save you 15% to 75% on the books you need.

3. Editorial Advisory Services: The Club's Editorial Advisory Board selects *only* the important books of direct interest to you.

4. Wide Selection: Members are annually offered over 50 of the authoritative books on all phases of electronic servicing. The Club makes it a point to offer new books, along with standard classics... lists books from *all* publishers — not just one or two.

5. Prevents You From Missing New Books: The Club's **FREE** monthly *News* gives you advance notice of important new books... books vital to your continued professional advancement.

This extraordinary offer is intended to prove to you, through your own experience, that these very real advantages can be yours... that it is possible to keep up with the professional literature published in your specific area of interest... and to save substantially while so doing.

How the Club Works

Forthcoming selections are described in the **FREE** monthly *Club News*. Thus, you are among the first to know about, and to own if you desire, significant books. You choose only the main or alternate selection you want (or advise if you wish no book at all) by means

CUT OUT ENTIRE POSTPAID ORDER FORM AT RIGHT — Fill in, paste, staple or tape, and mail

of a handy form and return envelope enclosed with the *News*. As part of your Trial Membership, you need purchase as few as four books during the coming 12 months. You would probably buy at least this many anyway... without the substantial savings offered through Club Membership.

Limited Time Offer!

Here, then, is an interesting opportunity to enroll on a trial basis... to prove to yourself, in a short time, the advantages of belonging to the only Book Club devoted *exclusively* to electronic

servicing. We urge you, if this unique offer is appealing, to act promptly, for we've reserved only a limited number of Handbooks for new Members.

To start your Membership on these attractive terms, simply fill out and mail the postage-paid reply form today. You will receive *TV Troubleshooter's Handbook* for 10-day inspection. **SEND NO MONEY!** If you are not delighted with the Handbook, return it within 10 days and your Trial Membership will be cancelled without cost or obligation. Electronic Technician's Book Club, Drawer D, Thurmont, Md. 21788.

FIRST CLASS
Permit No. 30
Thurmont, Md.

BUSINESS REPLY MAIL

No Postage Stamp Necessary If Mailed In The United States

Postage Will Be Paid By

ELECTRONIC TECHNICIAN'S
BOOK CLUB
DRAWER D
THURMONT, MARYLAND 21788

DO NOT CUT HERE ▲ JUST FOLD OVER, SEAL AND MAIL—NO STAMP OR ENVELOPE NECESSARY

Send No Money! Simply fill in and mail Trial Membership Coupon Today!

Please open my Trial Membership in the Electronic Technician's Book Club and send me a copy of your 192-page *TV Troubleshooter's Handbook*, billing me for only 99¢ plus a few cents postage and mailing expense. If not delighted, I may return the book within 10 days and owe nothing. Otherwise, to complete my Trial Membership, I agree to purchase at least 4 additional monthly selections or alternates during the next 12 months. I have the right to cancel my membership anytime after purchasing these four books.

Name _____ Phone No. _____

Address _____

(NOTE: check if home or business address)

City _____ State _____ Zip _____

Company _____ Title _____ 116
(The Club assumes postage on all prepaid orders. Foreign and Canadian prices 10% higher.)

THIS ENTIRE FOLD-OVER COUPON FORMS A NO-POSTAGE-REQUIRED BUSINESS REPLY ENVELOPE

**WORLD'S
FINEST
5-CORE
SOLDER**



**ERSIN
MULTICORE
NEW EASY
DISPENSER
PAK ONLY 69¢**

BUY IT AT RADIO-TV PARTS STORES
MULTICORE SALES CORP. WESTBURY, N.Y. 11591
... for more details circle 133 on postcard

ADVERTISERS INDEX

Alliance Mfg. Co.	101
Allied Radio Corp.	93
Amphenol Distributor Div.	87
Arrow Fastener Co.	104
B & K Mfg. Div.	81, 97
Blonder-Tongue Laboratories, Inc.	22
Borden Chemical, Krylon Div.	24
C & K Components, Inc.	92
Castle TV Tuner Service	34
Channel Master Corp.	31, 32, 33
Cleveland Institute of Electronics	85
Columbia Wire Products Co.	24
Cornell-Dubilier	
Delco Radio Div.	89
E. C. I. Electronics Communications, Inc.	77
EICO Electronic Instrument Co.	75
Electro-Voice	39
ELECTRONIC TECHNICIAN Book Club	102-103
Enterprise Development Corp.	96
Finney Co.	79
Gavin Instruments, Inc.	86
General Electric Co.	36-37
Hayden Book Co.	95
Heath Co.	100
Hickok Electrical Instrument Co.	35
Jensen Mfg. Co.	19
Jerrold Electronics Corp.	2nd Cover, 90
JFD Electronic Corp.	26-27
Kay-Townes Antenna Co.	96
Lechtrotech, Inc.	38
Mallory Distributor Products Co.	99
Multicore Sales Corp.	104
National Radio Institute	98
Olson Electronics, Inc.	104
Oxford Transducer Co.	76
Pearce-Simpson, Inc.	28
Perma-Power Co.	78
Philco Corp.	23
Radio Corp. of America RCA Electronic Components & Devices	4th Cover, 20, 83
RCA Institutes, Inc.	30
RCA Sales Corp.	40
S & A Electronics	88
Sarkes Tarzian Tuner Service Div.	29
Seco Electronics Corp.	84
Sençore, Inc.	63, 65, 67, 68, 69
Sprague Products Co.	25
Sturtevant Co.	96
Sylvania Electric Products, Inc.	73, 91
Viking Electronics	104
Xcelite, Inc.	82
Zenith Sales Corp.	74, 80, 94

new from Viking

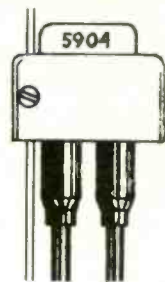

**FEED-THROUGH
LIGHTNING
ARRESTOR**

Model #5904 - just \$3.00

Now install practical, efficient protection against lightning damage to your CATV system. Viking Model #5904 protects against power surges caused by electrical fields in the atmosphere, lightning hits, short circuits, and direct contact with power lines. Features discharge gap sealed in with rare gas atmosphere. Compactly packaged, (1½" h x 2" w x 7/8" d), the die-cast zinc housing is Vik-O-Processed against damage by the elements. More information? Write or call (collect of course):



viking

830 Monroe St., Hoboken, N. J. 07030
(201) 656-2020 ■ (212) 943-5793
... for more details circle 149 on postcard

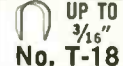

**AUTOMATIC
STAPLE GUNS**

**For Fastening Any
Inside or Outside
Wire Up to 1/2" in Diameter**

-  UP TO 3/16"
No. T-18
-  UP TO 1/4"
No. T-25
-  UP TO 1/2"
No. T-75

- Telephone wire
 - Intercom wire
 - Bell wire
 - Thermostat wire
 - Radiant heating wire
 - Hi-Fi, Radio & TV wires
- Tapered striking edge gets into close corners!

Available in:
Brown, Ivory, Beige,
Monel, Bronze, Natural

ARROW FASTENER COMPANY, INC.
1 JUNIUS STREET - BROOKLYN 12, N. Y.

... for more details circle 104 on postcard
ELECTRONIC TECHNICIAN

Olson



*** FREE**

Fill in coupon for a **FREE** One Year Subscription to **OLSON ELECTRONICS'** Fantastic Value Packed Catalog—Unheard of **LOW, LOW PRICES** on Brand Name Speakers, Changers, Tubes, Tools, Stereo Amps, Tuners, CB, Hi-Fi's, and thousands of other Electronic Values. Credit plan available.

NAME _____
ADDRESS _____
CITY _____ STATE _____ ZIP _____

If you have a friend interested in electronics send his name and address for a **FREE** subscription also.

OLSON ELECTRONICS, INC.
535 S. Forge Street Akron, Ohio 44308

... for more details circle 135 on postcard

The Magnificent 12



Here's your inventory of over 100 exact replacements!

It's a fact: This CDE twist-prong capacitor assortment will satisfy almost all your replacement requirements. Instead of carrying 100 or more capacitors, now you carry just 12! And with the addition of a BR, your flexibility is increased to over 200 capacitors!

Are these "exact" replacements? As exact as they can be! Don't be fooled by the "numbers game." The EIA has published capacitor rating values that are standard for the industry. Hiding behind the labels of over 1,800 of our competitor's "exact" replacements are only a few hundred different capacitors!

The convenient CDE kit. The Magnificent 12 represent your money-saving minimum working inventory. Backing them up is the rest of CDE's twist-prong line... a line developed after five years of research. Your CDE distributor guarantees instant availability on all of them. That's right: you get over-the-counter service on all 200 wide application range twist-prongs... as opposed to ordering from over 1,800 "exact" replacements.

Investigate the practicality and convenience of CDE twist-prong capacitors today! Free! Ask your distributor for CDE's 96-page Twist-Prong Electrolytic Reference, plus details on the 100+ replacements this kit covers.

CDE CORNELL-DUBILIER

Are you offering *today's color?*



RCA Hi-Lite color picture tubes bring OEM quality to your replacement tube customers

Odds are that when you're called to replace a customer's color picture tube and you replace it with an RCA Hi-Lite, you're giving him a better product than he had when his set was new.

That's because RCA Hi-Lite picture tubes are RCA's best... the same quality... the same tubes... that go into today's original equipment sets. RCA Hi-Lites are all-new... glass, gun, the works! And incorporate the continued advancements in picture tube technology achieved by the world's leading color picture tube manufacturer. So you literally "up-date" your customer's color set when you install one.

Here's picture brightness and color fidelity at its finest, available for the service trade in 19-inch and 25-inch rectangular and 21-inch round tube types.

How about you? Are you offering your customers today's color?

RCA Electronic Components and Devices, Harrison, N. J.



The Most Trusted Name in Electronics