

# ELECTRONIC TECHNICIAN

WORLD'S LARGEST ELECTRONIC TRADE CIRCULATION

UHF Converter Boom / Tuner Techniques / UHF Antennas



JUNE 1965

# TUNER REPAIRS

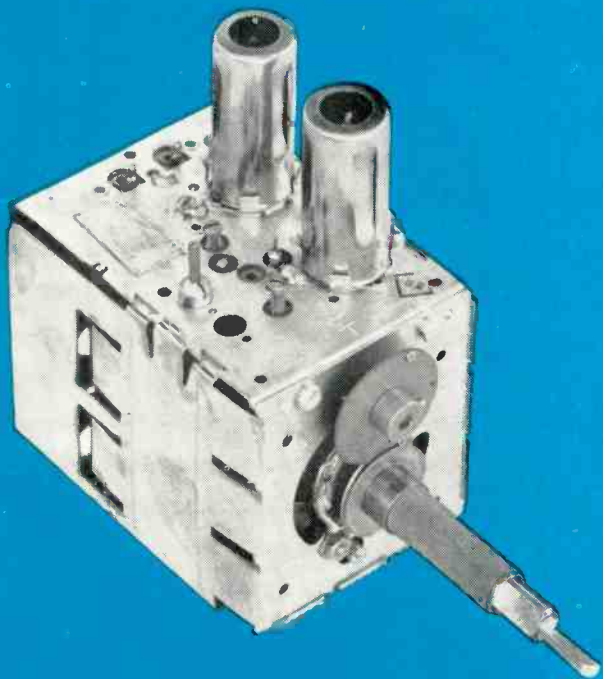

# \$9.50

**FOR COMPLETE OVERHAUL**

**Includes ALL parts (except tubes)  
ALL labor on ALL makes**

**24-HOUR SERVICE with  
FULL YEAR WARRANTY**

Sarkes Tarzian, Inc., largest manufacturer of TV and FM tuners, maintains two completely-equipped Service Centers to serve YOU. Both centers are staffed by well-trained technicians in this specialized field and are assisted by engineering personnel to assure you of FAST, DEPENDABLE service.

Ⓢ Tarzian-made tuners—identified by this stamping—received one day will be repaired and shipped out the next. A little more time may be required on other makes. Every channel is checked and re-aligned per manufacturer's specifications, not just the channels which might exist in any given area.

You get a 12-month guarantee against defective workmanship and parts failure due to normal usage. Cost to you is only \$9.50 and \$15 for UV combinations, including all labor and parts except tubes. No additional costs. No hidden charges. All tuners repaired on approved, open accounts. You pay shipping. Replacements on tuners beyond practical repair are available at low cost.

When inquiring about service on other than Tarzian-made tuners, always send TV make, chassis and Model number. Check with your local distributor for Sarkes Tarzian replacement tuners, parts, or repair service. Or, use the address nearest you for fast factory repair service.



**SARKES TARZIAN, INC.**  
TUNER SERVICE DIVISION

*See your distributor, or use the address nearest you*

537 South Walnut St.,  
Bloomington, Indiana  
Tel: 332-6055

10654 Magnolia Blvd.,  
North Hollywood, Calif.  
Tel: 769-2720

# ELECTRONIC TECHNICIAN TEKFAX

COMPLETE MANUFACTURERS' CIRCUIT DIAGRAMS  
AND TECHNICAL INFORMATION FOR EIGHT NEW SETS

GROUP  
**154**

Schematic No.	
ADMIRAL	928
TV Chassis D761-1, 1D761-1 and 1D760-1	
EMERSON	929
TV Chassis 120758, 759, 760	
GENERAL ELECTRIC	930
TV Chassis DB	
MOTOROLA	931
TV Chassis TS-454	
PHILCO	932
TV Chassis N1200 and N1204	
RCA VICTOR	927
TV Chassis KCS 148	
SYLVANIA	933
TV Chassis 584-1 through 7	
ZENITH	934
TV Chassis 14M32	

ELECTRONIC TECHNICIAN and TEKFAX are published monthly by Electronic Technician, Inc., a subsidiary of Ojibway Press, Inc., Ojibway Building, Duluth, Minnesota 55802. Single copies, 60c. Subscription rates: U. S. and Canada, \$5 for 1 year; \$8 for 2 yrs.; \$10 for 3 yrs. Pan American and foreign countries, \$9 for 1 year; \$14 for 2 yrs.; \$18 for 3 yrs. Second class postage paid at Waseca, Minn. and at additional mailing offices. POSTMASTER: Send notification form 3579 to ELECTRONIC TECHNICIAN, Ojibway Building, Duluth, Minnesota 55802.

Symbol	Description	RCA Part No.
R103	Resistor-control, on-off-volume	114174
R122	Resistor-control, volume limiter	114173
S10	Switch-UHF tuner, TMA66B	112192
C101	ceramic-0.0039 $\mu$ f, $\pm$ 10%, 1000v	109060
C103	ceramic-0.01 $\mu$ f, $\pm$ 10% - 0%, 1000v	113639
C109	ceramic-150 $\mu$ f, $\pm$ 10%, 4000v, N2200	109955
C111	electrolytic-150 $\mu$ f, 200v	107472
C112	electrolytic-150/5/100 $\mu$ f, 350/350/50v	113167
C113	electrolytic-100/10/5/20 $\mu$ f, 350/350/150/25 v	109689
C551	ceramic-82 $\mu$ f, $\pm$ 10%, 500v, N750	104214
C560	ceramic-1000 $\mu$ f, $\pm$ 10%, 100v	105778
CB101	Breaker-circuit	113950
CR201	Diode-crystal detector	112524
L104	Reactor-B+ filter choke	113256
L207	Coil-peaking 330 $\mu$ h	113280
L209	Coil-peaking 47 $\mu$ h	113281
L501	Coil-horizontal oscillator	109947
PC502	Circuit-printed component (includes C531, R532)	112628
PC503	Circuit-printed component (includes C538, R539)	109325
PW200	Circuit-printed IF and video circuit less tubes	114083
PW500	Circuit-printed deflection circuit (less tubes)	114082
R102	fixed film-2000 $\Omega$ , $\pm$ 10%, 4 w	113948
R104	Control-contrast	114081
R112	wirewound-0.47 $\Omega$ , $\pm$ 5%, 2w	113152
R121	180,000 $\Omega$ , $\pm$ 10%, 1/2 w	502418
R125	wirewound-8200 $\Omega$ , $\pm$ 5%, 7w	113150
R501	control-A.G.C.	113156
R510	fixed film-4700 $\Omega$ , $\pm$ 10%, 4w	112850
R534	control-height	113162
R536	control-vertical hold	113158
R543	wirewound-820,000 $\Omega$ , $\pm$ 10%, 1/2w	109384
R544	control-vertical linearity	113163
R560	control-horizontal hold	113157
R561	fixed film-73,000 $\Omega$ , $\pm$ 5%, 1/2w	113945
SR101, SR102	Rectifier-silicon	106379
SR501	Rectifier-selenium	109474
T101	Transformer-output	113100
T102	Transformer-hi-voltage	113599
T103	Transformer-vertical output	113096
T104	Transformer-power	114343
T201	Transformer-sound take-off and 4.5 Mc trap	109949
T202	Transformer-sound detector grid (includes C206, C207)	109951
T203	Transformer-sound detector 3rd grid (includes C210, R205)	109948
T204	Transformer-1st pix IF grid trap	113425
T205	Transformer-1st pix IF grid	113097
T207	Transformer-2nd pix IF	109158
T208	Transformer-3rd pix IF	113099
	Yoke-deflection	109532A

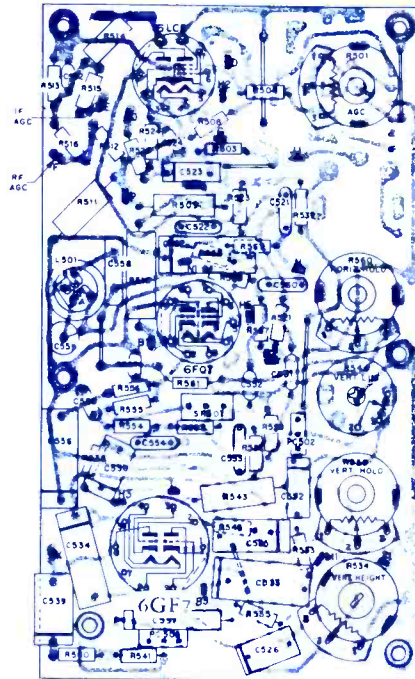

KRK114C VHF Tuner  
5GK5 R-F Amplifier  
6KE8 R-F Oscillator and Mixer

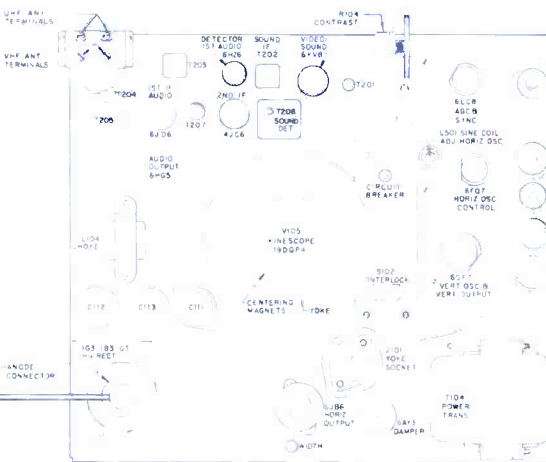

COPYRIGHT 1965 BY ELECTRONIC TECHNICIAN • OJIBWAY BUILDING, DULUTH, MINNESOTA 55802

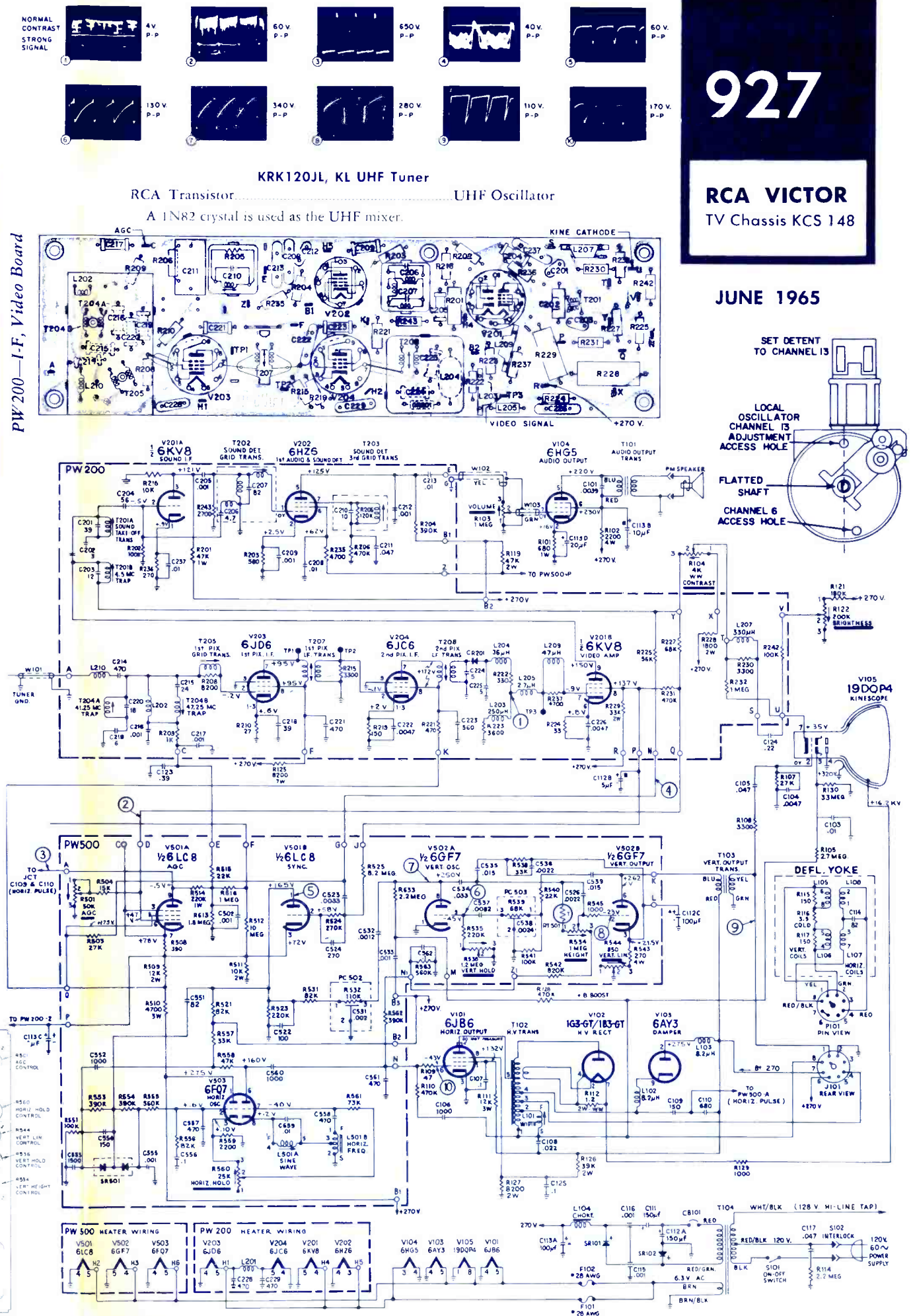

PW200—I-F, Video Board

PW500 Deflection Board

**927**  
RCA VICTOR  
TV Chassis KCS 148

JUNE 1965

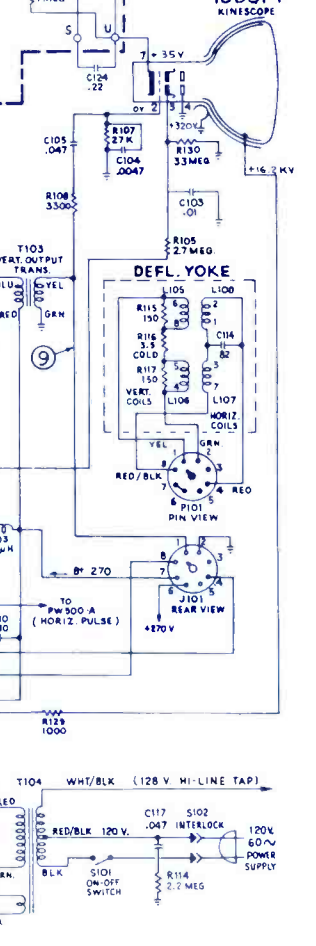
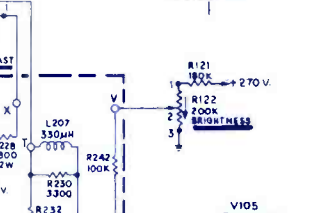
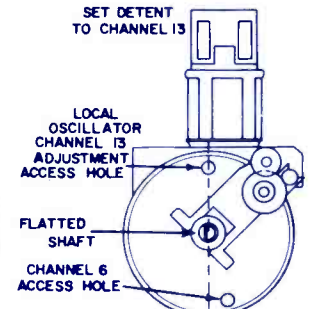



# ELECTRONIC TECHNICIAN TEKFAX

COMPLETE MANUFACTURERS' CIRCUIT DIAGRAMS  
AND TECHNICAL INFORMATION FOR EIGHT NEW SETS

# 929

**EMERSON**  
TV Chassis 120758,  
759, 760

JUNE 1965

- T-1 Sound Interstage Transformer 720486
- T-2 Audio Output Transformer 734221
- T-6 Sound Take-off coil & 4.5 Mc Trap 720447
- T-7 Horizontal Output Transformer 738191
- T-8 Vertical Output Transformer 738189
- T-10 Power Transformer 730114

Q-1 TRANSISTOR UHF OSC.  
X-2 1N82A MIXER XTAL

V-15 6HQ5 R.F.A.M.P.  
V-16 6HB7 OSC. & MIXER

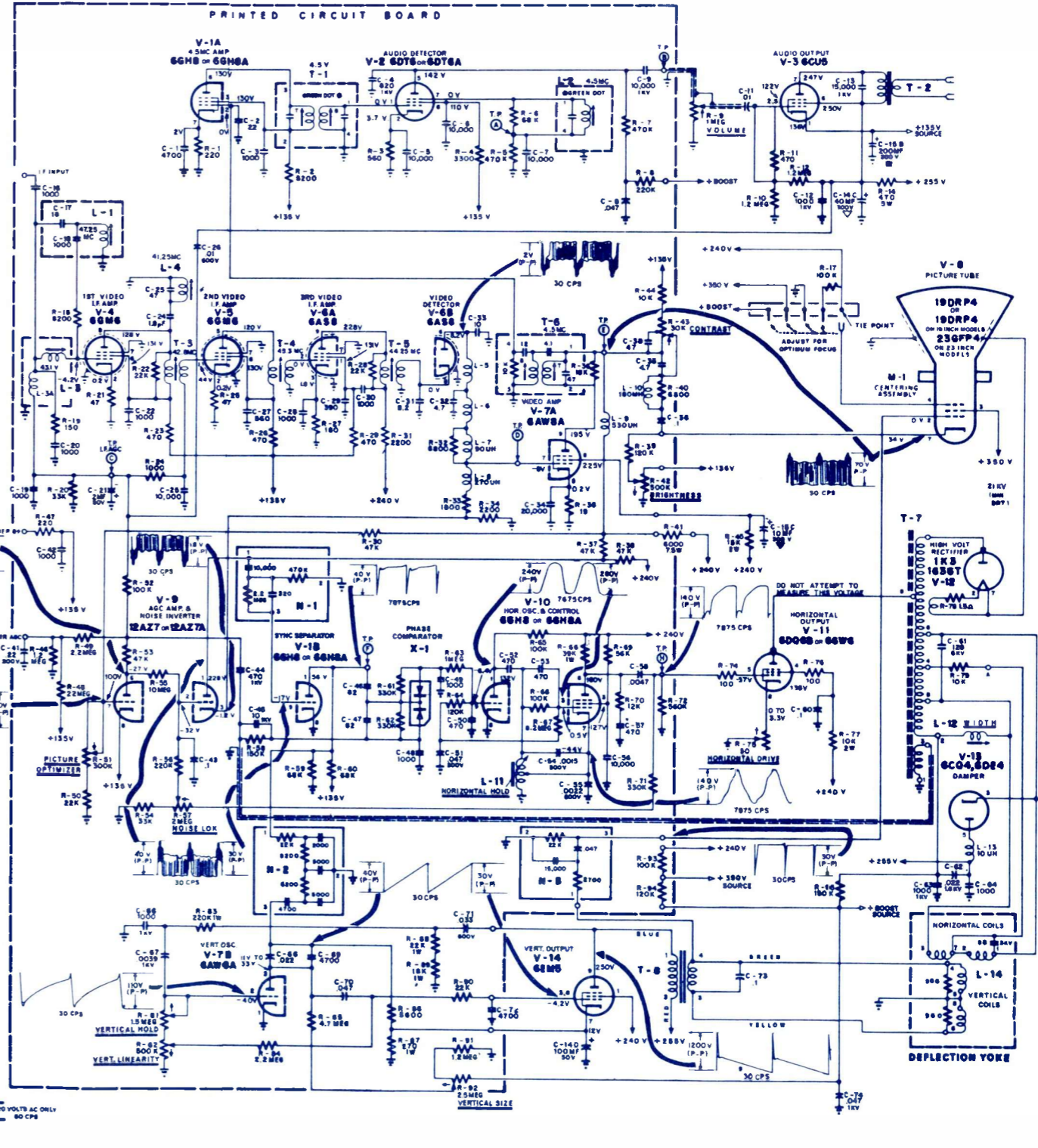
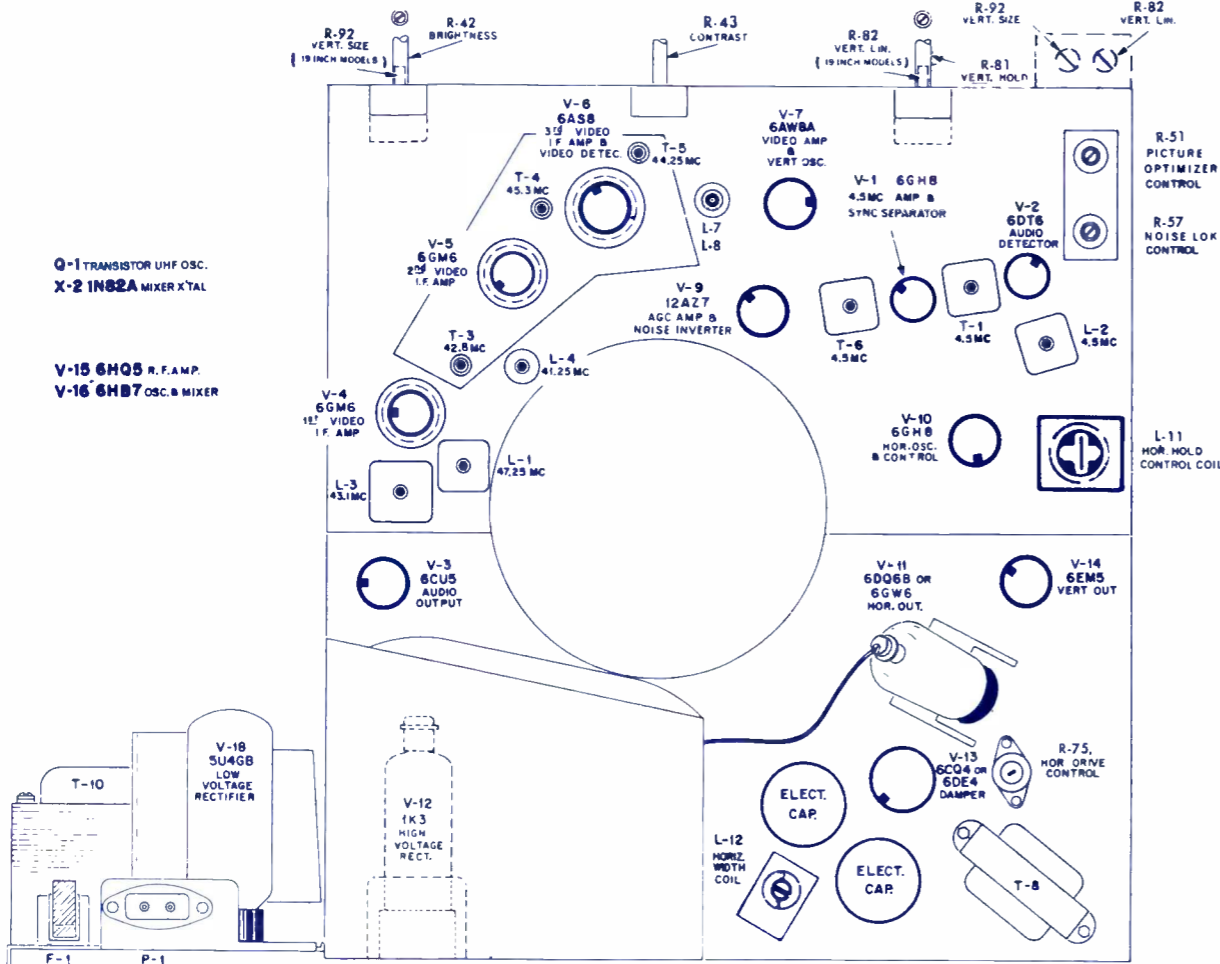

Symbol	Description	Emerson Part No.
R-14	Resistor-470 Ω 10% 5w	397149
R-41	Resistor-6,000 Ω 10% 7 1/2w	394243
R-97	Resistor-220 Ω 10% 7w	394234
R-9	Control-Vol-1 MΩ with Sw (Ch. 120758, 759)	390804
R-9	Control-Vol-1 MΩ less Sw (Ch 120760)	390802
R-42, 92	Control-Dual Brgt. & Vert. Size (19" Sets)	390628
R-42	Control-Brgt. (23" Sets)	390837
R-43	Control-Contrast (19" Sets)	390706
R-43	Control-Contrast-30,000 Ω (23" Sets)	390840
R-51, 57	Control-Dual Picture Optimizer Noise-Lok	390740
R-75	Control-Horizontal Drive- 30 Ω 2w	390625
R-81, 82	Control-Dual-Vert. Hold & Lin. Control-Vert. Hold (23" Sets) (19" Sets)	390629
R-82, 92	Control-Dual-Vert. Lin. & Size (23" Sets)	390838
C-T	Capacitor-Ceramic-39 pf 500v	928931
C-4	Capacitor-Ceramic-820 pf 1Kv	92905 1K
C-9	Capacitor-Ceramic-10,000 pf 1Kv	929023K
C-12	Capacitor-Ceramic-1,000 pf 1Kv	929000
C-13	Capacitor-Ceramic-15,000 pf 1 Kv	929028
C-14	Capacitor-Electro. -80+40+40 μf @ 300 v, plus 100 uf @ 50 v	925513
C-15	Capacitor-Electro. -80+10 μf @ 300v plus 200 @ 200 v	925514
N-1	Couplate-Sync Separator	923175
N-2	Couplate-Vertical Intergrator	923159
N-3	Couplate-Vertical Retrace Suppression	923174
L-3A	RF Choke - 45 Mc (IF Input)	705042
L-7	Peaking Coil - 90 μh	708406
L-8	Peaking Coil - 270 μh	708405
L-9	Peaking Coil - 530 μh	708404
L-11	Horizontal Oscillator Coil	716148
L-12	Width Coil	708416
L-14	Deflection Yoke Assembly (19" Sets)	708403
L-14	Deflection Yoke Assembly (23" Sets)	708402
L-15	Filter Choke - B+ Rectifier	737047
L-16, 17	RF Choke - Filament	705031

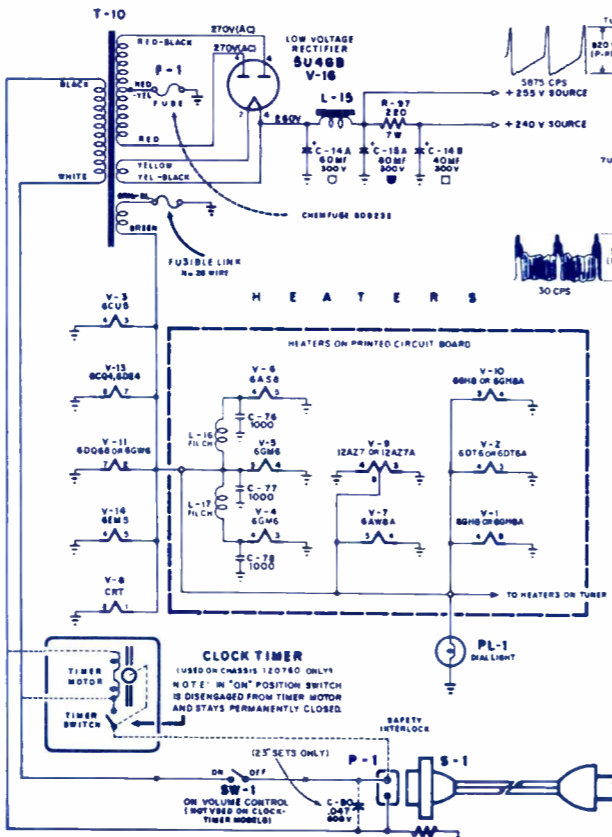

# 930

## GENERAL ELECTRIC TV Chassis DB

JUNE 1965

# ELECTRONIC TECHNICIAN TEKFAX

COMPLETE MANUFACTURERS' CIRCUIT DIAGRAMS  
AND TECHNICAL INFORMATION FOR EIGHT NEW SETS

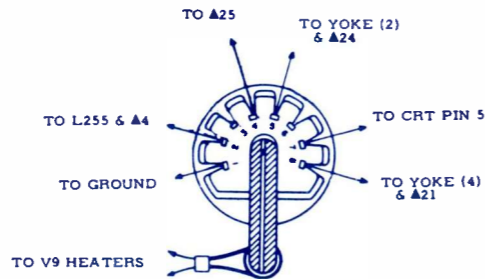

T251 WIRING

Symbol	Description
R263	560 Ω, 10%, 2w, Wire Wound
R269	125K, 25%, 25°C Thermistor
R401	3.6Ω, 10%, 7w, Wire Wound
R403	810Ω, 5%, 18w
R410	12K, 10%, 2w Glass
R167	25KΩ, Contrast, w/Stop at 22K
R170	300KΩ, 30%, Brightness
R205	1.5 MΩ, 30%, Vert. Hold
R207	2 MΩ, 30%, Vert. Lin.
R214	500K Ω, 20%, Vert. Size
R307/	2 MΩ, 30%, Volume, w/ac
S401	Rotary Switch
C402A	250 μf, +100/-10%, 200v
C402B	200 μf, +100/-10%, 200v
C402C	10 μf, +100/-10%, 200v
C402D	10 μf, +100/-10%, 200v
C1-C3	470 pf, GMV, 1400v
C152	6 pf, 10%, 500v, N220
C160	910 pf, 10%, 500v
C207	1000 pf, 20%, 1Kv, SSHK
C210	1800 pf, 20%, 2Kv
C258	510 pf, 5%, 500v, Char. D
C265	250 pf, 10%, 4500 v, N1500
C268	800 pf
C304	2.4 pf, 5%, 500v, Comp.

GE Part No.	Common
ET14X197	
ET14X183	
ET14X189	
ET14X104	
ET49X502	
ET49X501	
ET49X503	
ET49X499	
ET49X500	
ET49X454	
ET31X231	
ET22X151	
ET18X530	
ET22X87	
ET18X188	
ET22X161	
ET19X86	
ET18X412	
ET22X80	
ET21X12	

L153	COIL-Video Det., Primary w/Core
L154	COIL-Video Det., Sec., w/Core
L156	COIL-Choke 390 μh, 7%, Single Pi
L157	COIL-Choke, 300 μh, 7%, Single Pi
L158	COIL-Choke, 10 μh
L159	COIL-Choke, 36.2 μh, 44Mc
L160	COIL-41.25 Mc Link Trap Assy
L201	YOKE-To roidal, Deflection, Less
L254	Centering Ring, Retainer, and Spacer, with Magnets
L251	COIL-Horizontal Oscillator
L252	COIL-Choke, 10 μh, 10%
L255	COIL-Width Control
L301	COIL-4.5 Mc Interstage w/Core
L302	COIL-Quadrature w/Core
L401	Reactor-B+ Filter Choke
L402	COIL-Line Filter Choke
T151	Transformer-1st IF w/Core
T154	Transformer-Sound Take-off, 4.5 Mc Trap with Core
T201	Transformer-Vertical Output
T251	COIL-Horizontal Output XFMR w/Cap and Lead Assembly
T301	Transformer-Audio Output

ET36X536	
ET36X587	
ET36X264	
ET36X718	
ET36X420	
ET36X583	
ET36X770	
ET76X39	
ET35X51	
ET36X105	
ET36X774	
ET36X695	
ET36X732	
ET63X65	
ET36X729	
ET61X162	
ET36X731	
ET64X106	
ET77X86	
ET64X105	

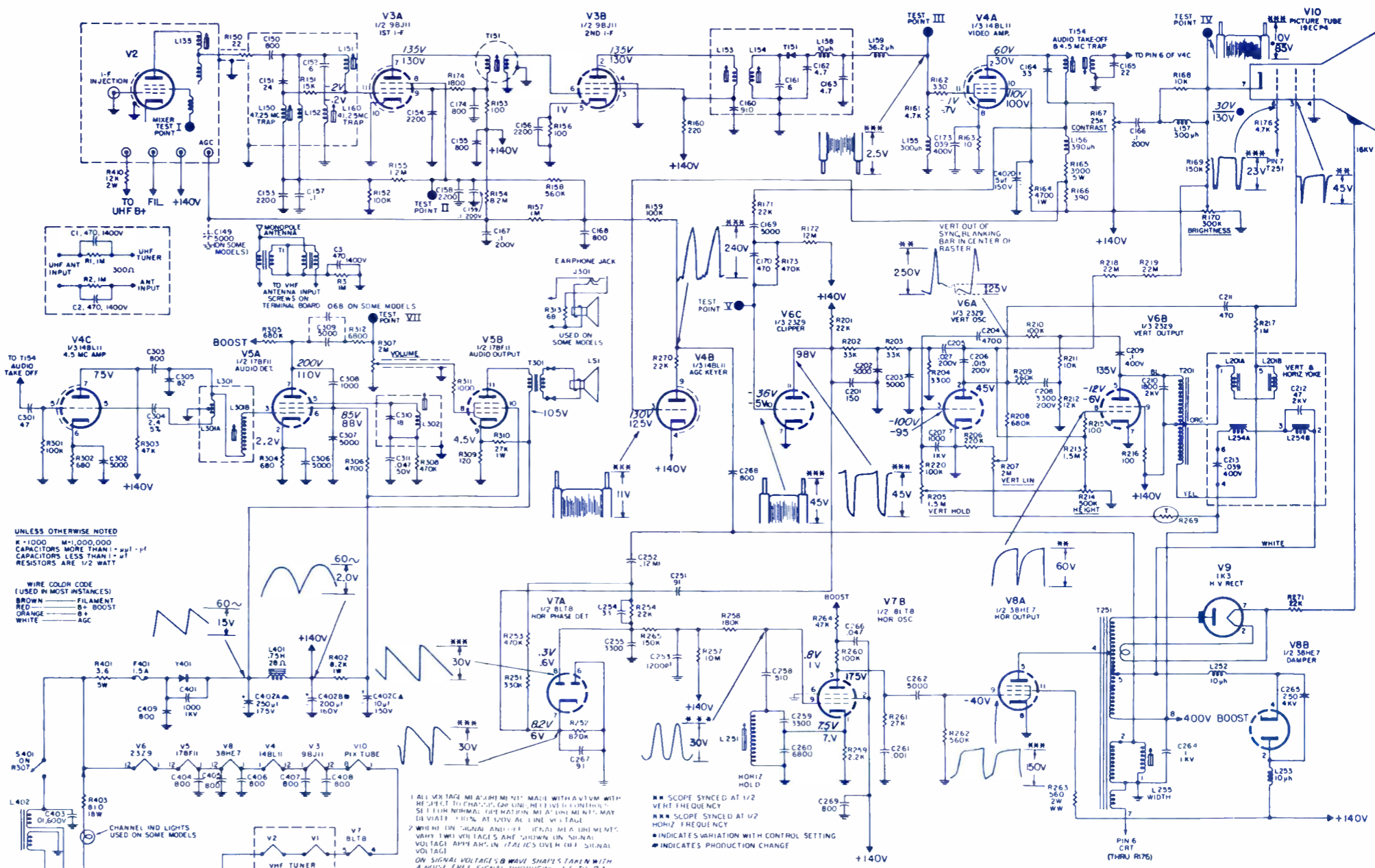
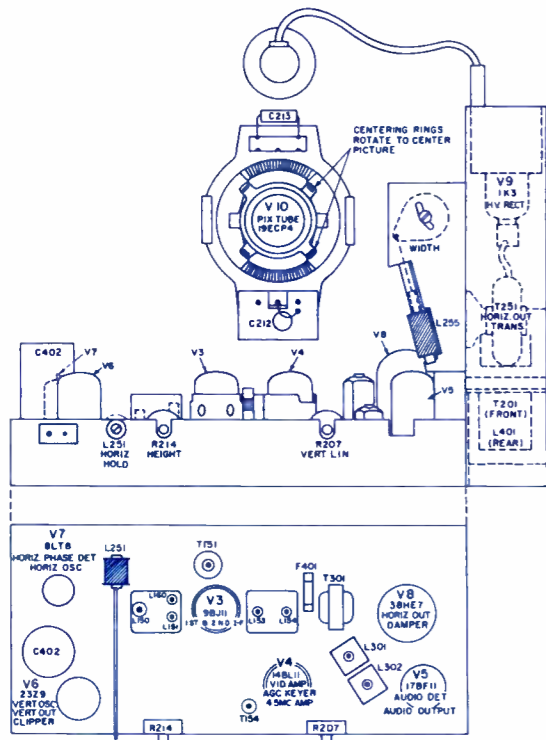

UNLESS OTHERWISE NOTED  
R = 1000 M = 1,000,000  
CAPACITORS MORE THAN 1 μf - pf  
CAPACITORS LESS THAN 1 μf  
RESISTORS ARE 1/2 WATT

WIRE COLOR CODE  
(USED IN MOST INSTANCES)  
BROWN FILAMENT  
RED - B+ BOOST  
ORANGE - B+  
WHITE - AGC

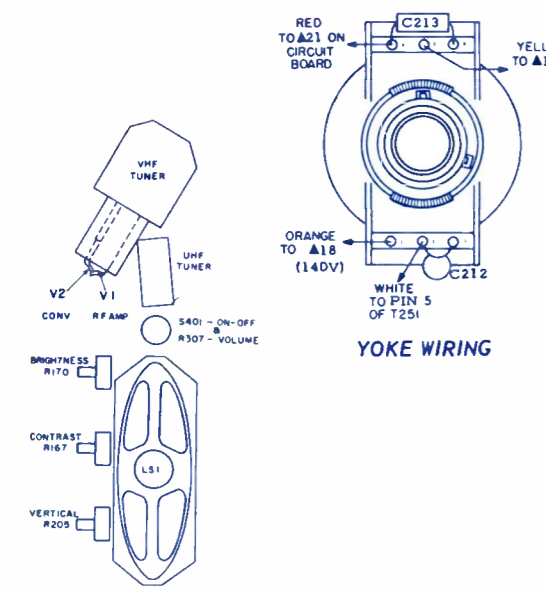

1 ALL VOLTAGE MEASUREMENTS MADE WITH VTVM WITH REFERENCE TO CHASSIS GROUND. MEASUREMENTS SHOULD BE MADE WITH SET IN NORMAL OPERATION. MEASUREMENTS MAY DEVIATE ±10% AT 120V AC LINE VOLTAGE.

2 WHEN IN SIGNAL AND LINE TEST MODE MEASUREMENTS SHOULD BE MADE IN THESE MODES. SIGNAL VOLTAGE APPLIED IN TEST MODES OVER THE SIGNAL VOLTAGE.

ON SIGNAL VOLTAGE SHAPES TAKEN WITH A WIDE-BAND SIGNAL GENERATOR 1.5 TO 2.5 VOLTS AGC AT VHI TUNE.

OFF SIGNAL VOLTAGE TAKEN WITH ANTENNA DISCONNECTED & ANTENNA TERMINALS SHORTEC TOGETHER ON UNIPOLAR CHANNEL.

ALL OTHER CONTROLS ARE ADJUSTED FOR NORMAL OPERATION.

\*\*\* SCOPE SYNCED AT 1/2 VERT. FREQ. \*\*\*  
\*\*\* SCOPE SYNCED AT 1/2 HORIZ. FREQ. \*\*\*  
• INDICATES VARIATION WITH CONTROL SETTING  
• INDICATES PRODUCTION CHANGE

Symbol	Description
E-2	Earphone: 12BP71 series
E-101	Diode, crystal: video det
E-301	Res-Cap: audio det plate
E-304	Speaker, 3 PM: 8Ω VC
E-401	Res-Cap: AGC
E-402	Res-Cap: clipper grid
E-501	Diode, low power: blue-horiz phase det
E-502	Diode, low power, blue-horiz phase det
E-801	Diode, silicon: power rect
L-100	47.25 Mc trap
L-108	Audio Take-Off & 4.5 Trap: incl cap & res
L-500	Horiz Osc: incl mtg nut
L-501	Choke, horiz suppressor
L-701	Yoke, defl: 114 deg
L-801	Line Choke: ac
L-802	Filter Choke
R-110	4700K 10% 3w glass
R-153	820 10% 2w glass
R-617	Varistor: vert trans

Motorola Part No.	Symbol	Description
50D6773A01	R-618	Thermistor .4 Ω Hot ±10% 2.6Ω cold (on yoke)
48C65837A02	R-800	33 5% 10w ww
51D67701A01	R-801	5 10w ww fusing
50D67688A02	R-801	Contrast: 25.5K with 4.5K stop
51D67748A01	R-111	Contrast: 25.5K without stop (in A-04 & later)
51D67701A02	R-111	
48D67120A02	R-200	Brightness: 100K
48D67120A02	R-308	On-Off & Vol: 2 meg
48C66037A12	R-604	Vertical Lin. Size & Hold: 2 meg
24D67754A01	R-604	2 meg & 1.2 meg
1V66539A40	T-102	1st IF
24D65853A08	T-103	2nd IF & Video Det: incl cap, E101 & L104
24C66772A06	T-301	Audio IF, 4.5 MC: incl cap & cores
24D67621A01	T-302	Audio Output
24C67534A02	T-501	Horiz Output Trans
25D67554A02	T-601	Vertical Output
17K751479		
17S10130A18		
6C66263A01		

6C65884A05
17S1350A60
17C67673A01
18D67502A03
18D67502A04
18D67559A10
18D67559A11
18D67678A01
24D67754A02
1V66539A39
1V66539A41
25D67552A04
24D67602A02
25D67749A01

# ELECTRONIC TECHNICIAN TEKFAX

COMPLETE MANUFACTURERS' CIRCUIT DIAGRAMS  
AND TECHNICAL INFORMATION FOR EIGHT NEW SETS

# 931

MOTOROLA  
TV Chassis TS-454

JUNE 1965

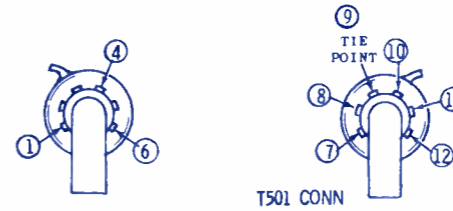

- NOTES:**
- VOLTAGE MEASUREMENTS**
- TAKEN FROM POINT INDICATED TO CHASSIS WITH A VTVM, ±20%
  - LINE VOLTAGE MAINTAINED AT 120V AC.
  - TAKEN WITH CONTRAST CONTROL AT MINIMUM AND ALL OTHER CONTROLS IN NORMAL OPERATING POSITION WITH NO SIGNAL INPUT.
  - TUNER ON CHANNEL 13 OR CHANNEL OF LEAST NOISE WITH ANTENNA TERMINALS SHORTED.
- WAVEFORM MEASUREMENTS**
- TAKEN FROM POINT INDICATED TO CHASSIS WITH A WIDE-BAND OSCILLOSCOPE.
  - OSCILLOSCOPE SYNC'D NEAR SWEEP RATE INDICATED.
  - TAKEN WITH STRONG SIGNAL, CONTRAST CONTROL AT MAXIMUM: ALL OTHER CONTROLS IN NORMAL OPERATING POSITION.
- \* INDICATES VOLTAGE VARIES WITH CONTROL SETTINGS.
- \*\* INDICATES SPECIAL COMPONENTS, SEE REPLACEMENT PARTS LIST FOR PROPER REPLACEMENT PART NUMBER.

UNLESS OTHERWISE SPECIFIED: CAPACITORS ARE DISC CERAMIC 500V DC, TOLERANCE & CHARACTERISTIC AS NOTED; IF TOLERANCE IS NOT GIVEN CAPACITORS ARE GMV (GUARANTEED MIN. VALUE) TYPE. TUBULAR CAPACITORS ARE 20% 400V DC. DECIMAL VALUES IN MF ALL OTHERS IN PF. RESISTORS ARE ALL 10% 1/2 WATT UNLESS SPECIFIED.

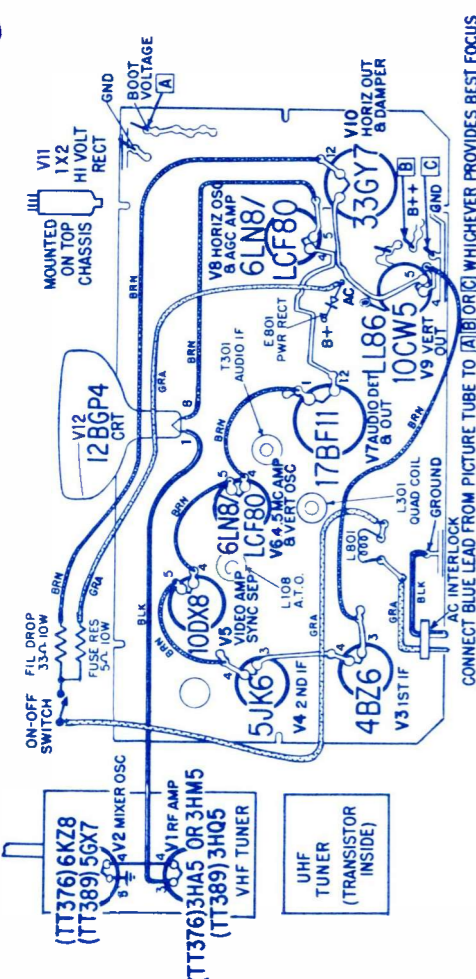
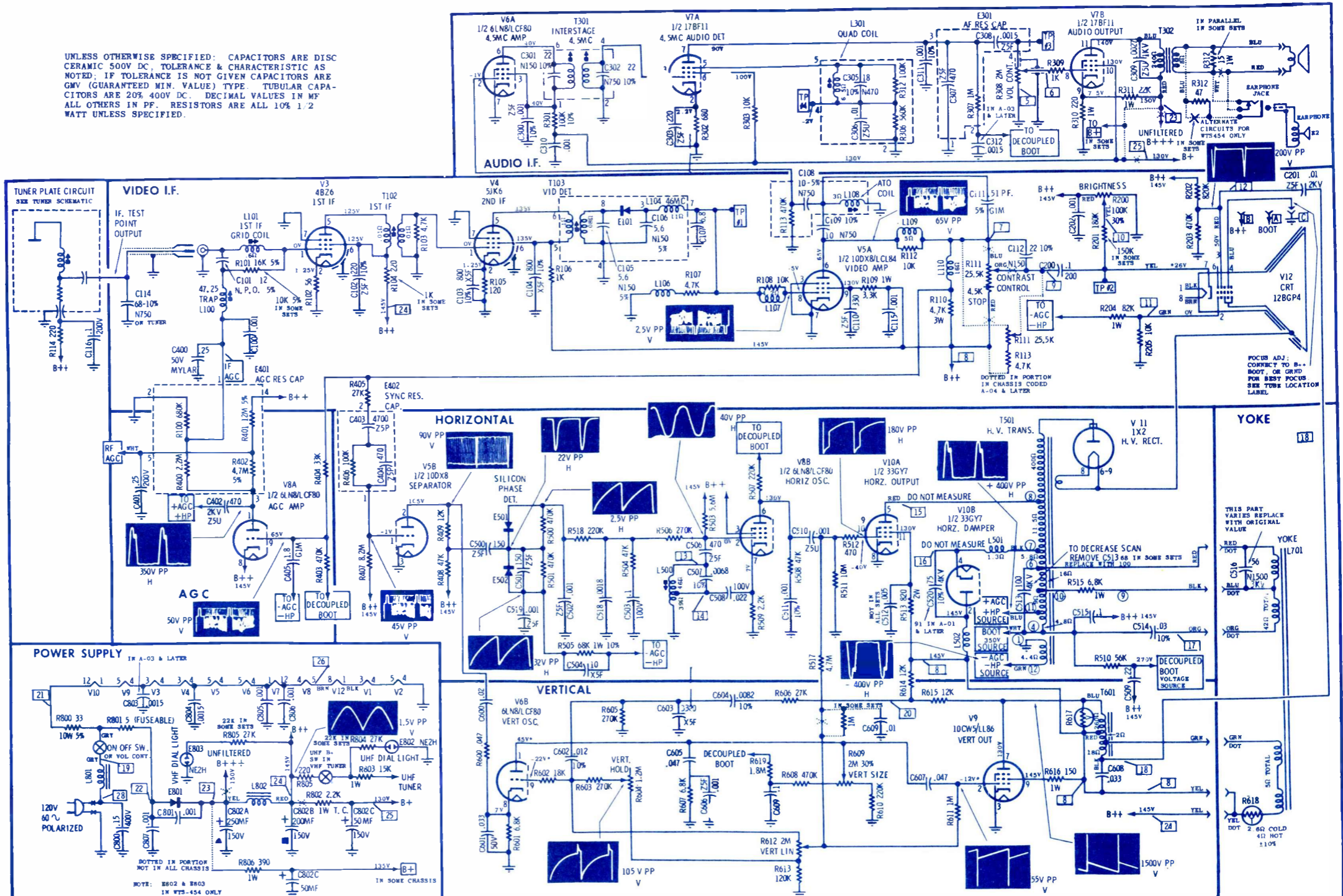

# 932

**PHILCO**  
TV Chassis N1200  
and N1204

JUNE 1965

N1200 RESISTANCE CHART

		PIN NUMBERS									
SYMBOL	TUBE	1	2	3	4	5	6	7	8	9	
V3	6EH7	1ST VIF	33Ω	2.5MΩ	33Ω	FIL	FIL	0Ω	17KΩ	40KΩ	0Ω
V4	6EJ7	2ND VIF	82Ω	0Ω	82Ω	FIL	FIL	0Ω	13KΩ	13KΩ	0Ω
V5	15CW5	VID. OUT.		820KΩ	47Ω	FIL	FIL	INF.	20KΩ	INF.	125KΩ
V6	8AB	1ST IF AND SYNC. SEP.	18KΩ	39KΩ	15KΩ	FIL	FIL	12.5KΩ	270Ω	0Ω	1.2MΩ
V7	6DT6	SND. DET.	1.5Ω	560Ω	FIL	FIL	900KΩ	38KΩ	600KΩ		

		PIN NUMBERS									
SYMBOL	TUBE	1	2	3	4	5	6	7	8	9	
V8	16AB	AUD. OUT & SYNC. SEP.	350KΩ	170Ω	1.2KΩ	FIL	FIL	16.5KΩ	18KΩ	0Ω	30KΩ
V9	18GV8	VERT. OSC. & OUT.	4.2MΩ	1MΩ	0Ω	FIL	FIL	12KΩ	12KΩ	100Ω	1.4MΩ
V10	17AB	HORIZ. OSC. & AFC	45KΩ	302KΩ	15.5KΩ	FIL	FIL	15.5KΩ	220KΩ	0Ω	280KΩ
V11	50JY6	HOR. OUT.	FIL	24KΩ	15KΩ	680KΩ	FIL	0Ω	0Ω		
V12	34R3	DAMPER		FIL	FIL			15.5KΩ	15.5KΩ		

Symbol	Description	Philco part no.
C116	4pf/500v	ECC-D5040D
C118	.015 μf/100v	ECQ-M4153M
C154	3 μf/150v	ECE-B150V3
C210	200pf/500v	ECC-D5201K
C252	20 μf/25v	ECE-B25V20
C302	250pf/500v	ECC-D5251K
C410	2000pf/500v	ECK-S202PU
C414	.0062 μf/1000v	ECN-D10622K
C415	.0062 μf/1000v	ECN-D10622K
C416	.068 μf/600v	ECN-D6683K
C417	3 μf/500v	ECE-C500V3
C510	470pf/2000v	ECK-D0471PW
C511	470pf/2000v	ECK-D20471PW
L153	Peaking, Shunt	TLB-351-999
L154	Peaking, Series	TLB-750-272
L155	Peaking, Shunt	TLB-301-999
L401	Hor. Osc.	TLH-303-1
L403	Hor. Stabilizer	TLH-210
L404	Choke, Damper Plate	TLM-080-999
L405	Choke, Damper Cathode	TLM-080-999
L406	Hor. Width	TLH-719
L501	Choke, RF	TLP-8501
L503	Choke, Power	TLP-452-1
L155	4.7K Ω 8w	ERM-9PT472
R417	560 Ω	Part of T401
R501	4.7 Ω 10w	ERM-10H4R7

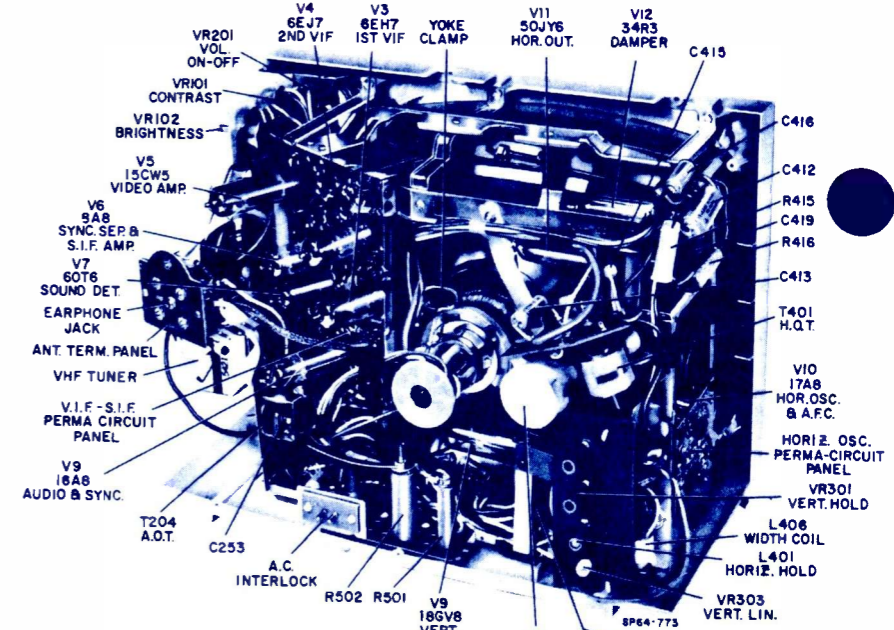

TNT-86713 Tuner, UHF  
 INR-5611U Tuner, VHF  
 V2T 7GS7 OSC. - MIXER  
 V1T 4GK5 RF AMP

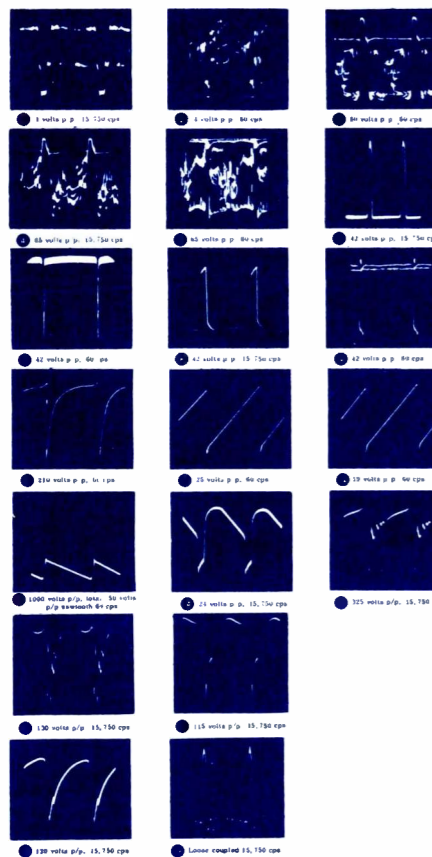
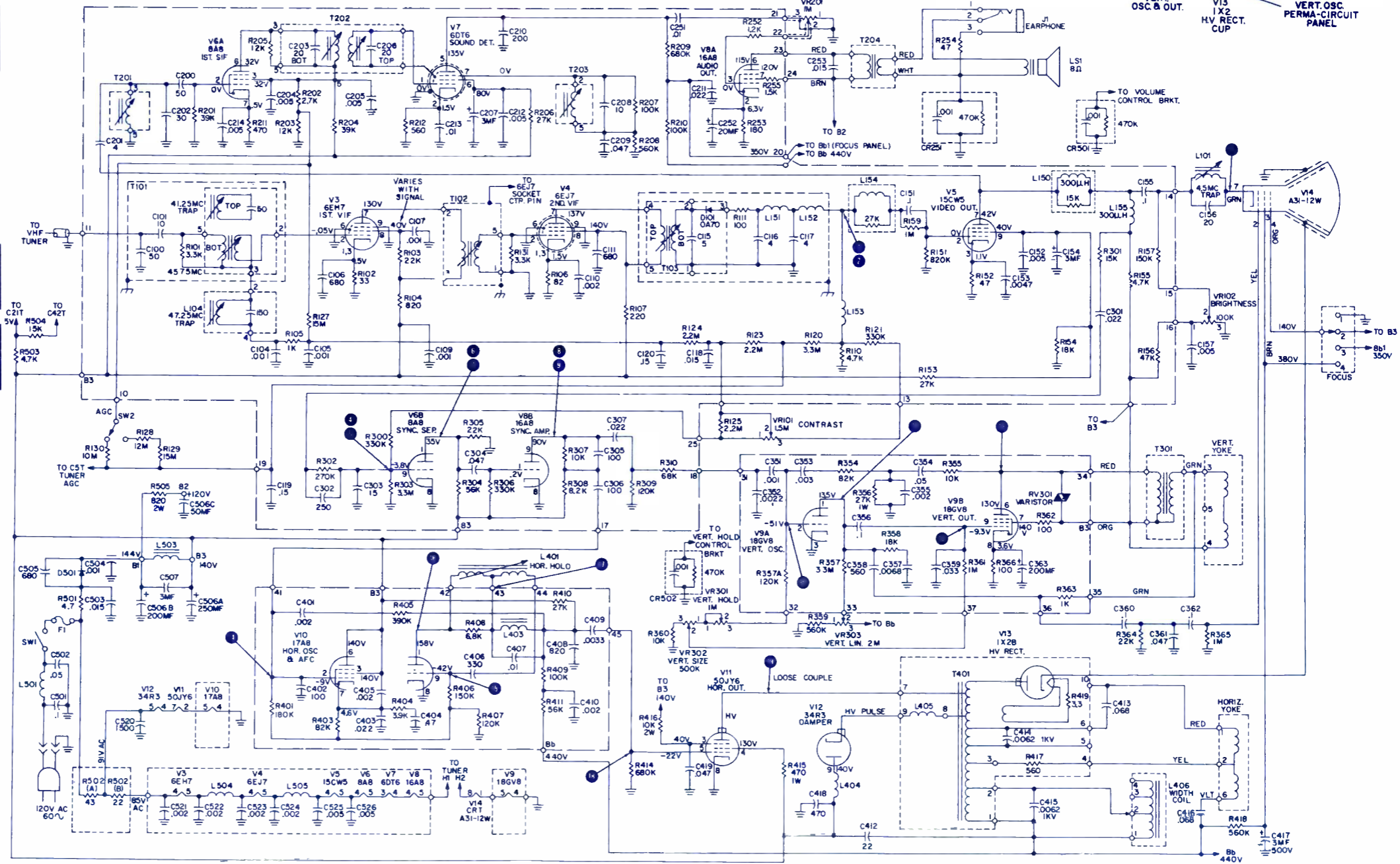

- R502A (A) 43-10w
  - B (B) 22-5w
  - RV301 Varistor vert. out.
  - SW1 Switch, On-Off
  - SW2 Switch, AGC
  - T101 1st VIF
  - T102 2nd VIF
  - T103 Video Det.
  - T201 1st SIF
  - T202 2nd SIF
  - T203 Quadrature
  - T204 Audie Output
  - T301 Vert. Output
  - T401 Horiz. Output
  - VR101 1.5 Meg. Contrast
  - VR102 100K Brightness
  - VR201 1 Meg. volume-On-Off
  - VR301 1 Meg. Vert. Hold
  - VR302 500K vert. size
  - VR303 2 Meg. Vert. Lin.
  - Yoke Yoke, Hor. - Vert.
- ERE-20G650
  - 229-1200-8 Part of VR201
  - ESR-E112L26A
  - TLI-1153
  - TLI-1152
  - TLI-5152
  - TL5-1106
  - TL5-2102
  - TL5-1507
  - ETA-28A14A
  - TLV-227
  - TLF-413
  - 229-1200-3
  - 229-1200-4
  - 229-1200-2
  - 229-1200-5
  - 229-1200-11
  - 229-1200-6
  - TLY-462-1



Symbol	Description	SYLVANIA Part No.
C316	.0022 mfd. - GMV	43-15009-1
C412	.0047 mfd - Polystyrene	40-10285-4
C508	150 mfd - 200v - electrolytic	41-11635-1
C514	4 Section Electrolytic	41-15466-1
A	150 mfd - 350v	
B	100 mfd - 350v	
C	5 mfd - 350v	
D	60 mfd - 75v	
R248	7,000 Ω - 7w	189-0088
R328	390,000 Ω - Thermistor	
L100	Coil - 4.5 Mc	57-11602-1
L200	Coil - Link	50-11609-1
L202	Coil - IF Input	57-11611-2
L204	Coil - IF Trap	57-11637-1
L205	Coil - Video Detector	57-11616-2
L206	Coil - Filter	50-11634-1
L207	Coil - Video Detector	57-11652-1
L208	Coil - Peaking - 220 UH	50-15318-12
L210	Coil - Peaking - 100 UH	50-15318-8
L212	Coil - Peaking - 220 UH	50-15318-12
L300	Coil - Vert. Deflection	Part of Yoke
L302	Coil - Vert. Deflection	Part of Yoke
L400	Coil - Horiz. Frequency	50-11603-2
L404	Coil - Filter	50-92043-3
L406	Coil - Horiz. Lin.	50-15019-1
L408	Coil - Horiz. Deflection	Part of Yoke
R224	220,000 Ω - AGC	Part of R338
R256	1 MΩ - Brightness	37-15064-2
R258	25,000 Ω - Contrast	37-15065-1
R332	5 MΩ - Vert. Height	Part of R338
R334	3 MΩ - Vert. Hold.	37-15065-2
R338	100,000 Ω - Vert. Lin.	
	(-1, -2, -3 CH)	37-11632-1
R338	3 MΩ - Vert. Lin.	
	(-5, -6, -7 CH)	37-11632-2
R414	50,000 Ω - Horiz. Hold	153-0319
R430	50,000 Ω - Width	153-0236
L409	Coil - Horiz. Deflection	Part of Yoke
L500	Coil - Choke	56-11651-1
L502	Coil - Filament	50-85963-2
L504	Coil - Filament	50-85963-2
L508	Coil - Choke	50-15023-1
L510	Coil - Choke	50-15023-1
T100	Transformer - Sound Interstage	57-11606-1
T102	Transformer - Audio Output	143-9995
T200	Transformer - IF Interstage	57-11612-2
T204	Transformer - Sound Take-Off	57-11604-1
T300	Transformer - Vert. Output	
	(-5, -6, -7 CH)	56-15476-1
T300	Transformer - Vert. Output	
	(-5, -6, -7 CH)	56-11607-1
T400	Transformer - HV	50-11605-2
CB500	Circuit Breaker	191-0026
SC200	Diode - Video Detector	1N295
SC400	Diode - AFC	1N4092
SC402	Diode - AFC	1N4092
SC500	Rectifier - Silicon	13-10102-1
SC502	Rectifier - Silicon	13-10102-1
SK400	Socket - Yoke	72-11785-2
SK500	Socket - Tuner	412-0016
SW500	Switch-On/Off	
	Yoke	51-15473-1
R117	1.5 MΩ - Tone	Part of R118
	(-2, -3, -6, -7 CH)	
R118	1 MΩ - Volume/On/Off/Tone	37-15230-1
R118	1 MΩ - Volume/On/Off	37-11959-6
	(-1, -5 CH)	

**VOLTAGE MEASUREMENT CONDITIONS UNLESS OTHERWISE SPECIFIED.**

1. Voltages measured to chassis using VTVM.
2. AC power source 120 volt 60 cycle line.
3. Voltage readings in brackets taken with no input; channel selector set to a free channel, antenna disconnected, antenna terminals shorted together and grounded to chassis.
4. Voltage readings not in brackets taken with a strong signal input; tuner set to a strong local station developing approximately -7 volt on AGC Buss. NOTE: AGC VOLTAGE AT TEST POINT (B) WILL VARY FROM -7 VOLT ON A VERY STRONG SIGNAL TO A +20 VOLT ON A VERY WEAK SIGNAL.

5. Contrast control set to maximum. Brightness control set to minimum.
6. Voltage values shown are average readings. Variations may be observed due to normal production tolerances.

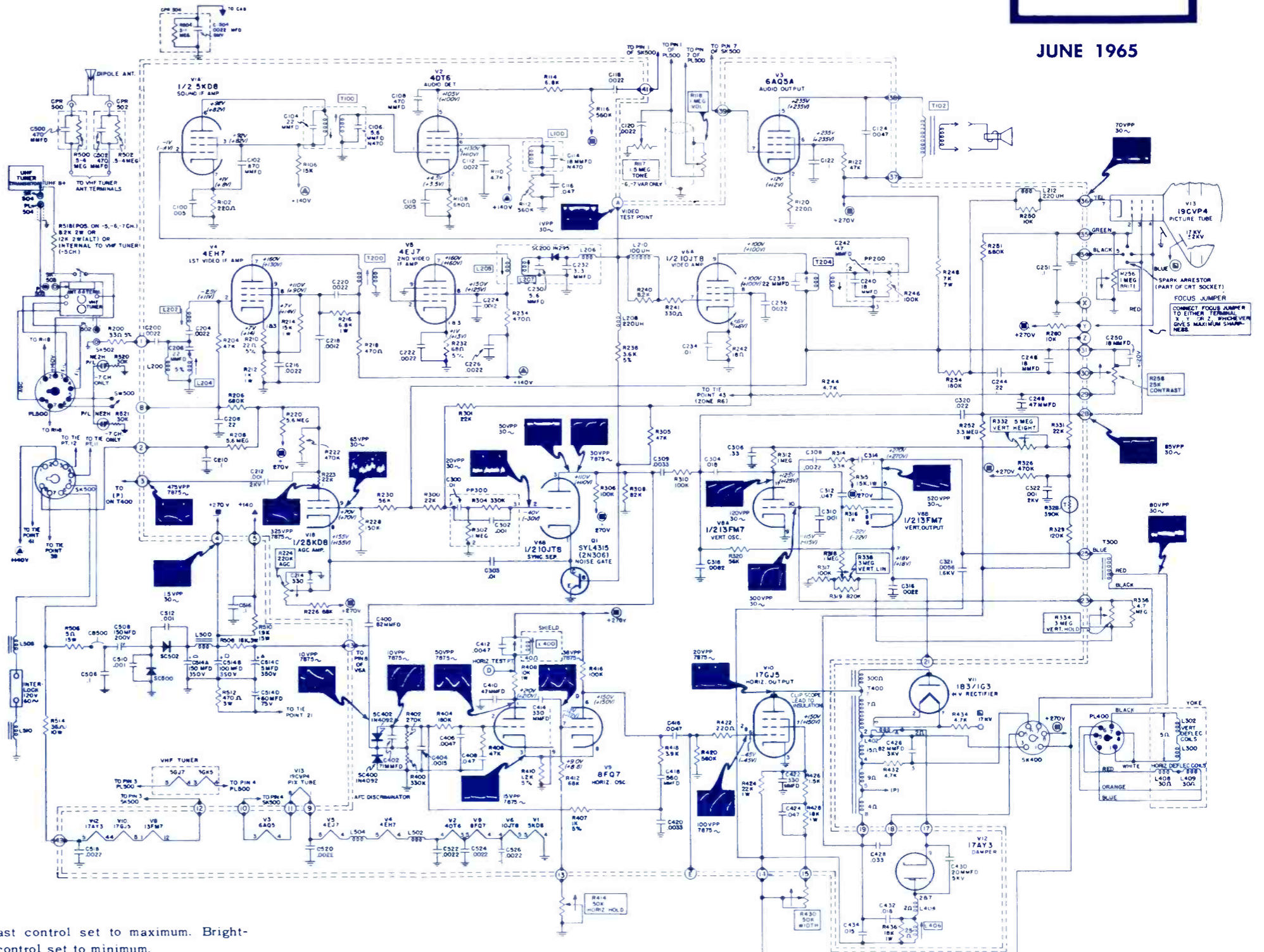
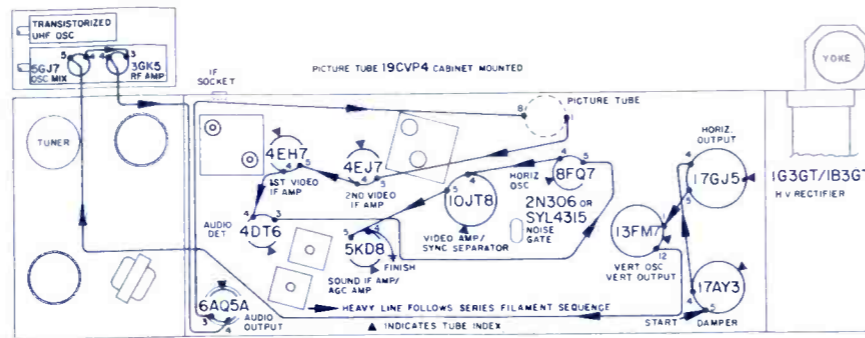

**ELECTRONIC TECHNICIAN**  
**TEKFAX**

COMPLETE MANUFACTURERS' CIRCUIT DIAGRAMS  
AND TECHNICAL INFORMATION FOR EIGHT NEW SETS

**933**

**SYLVANIA**  
TV Chassis 584-1  
through 7

JUNE 1965

# ELECTRONIC TECHNICIAN TEK FAX

COMPLETE MANUFACTURERS' CIRCUIT DIAGRAMS  
AND TECHNICAL INFORMATION FOR EIGHT NEW SETS

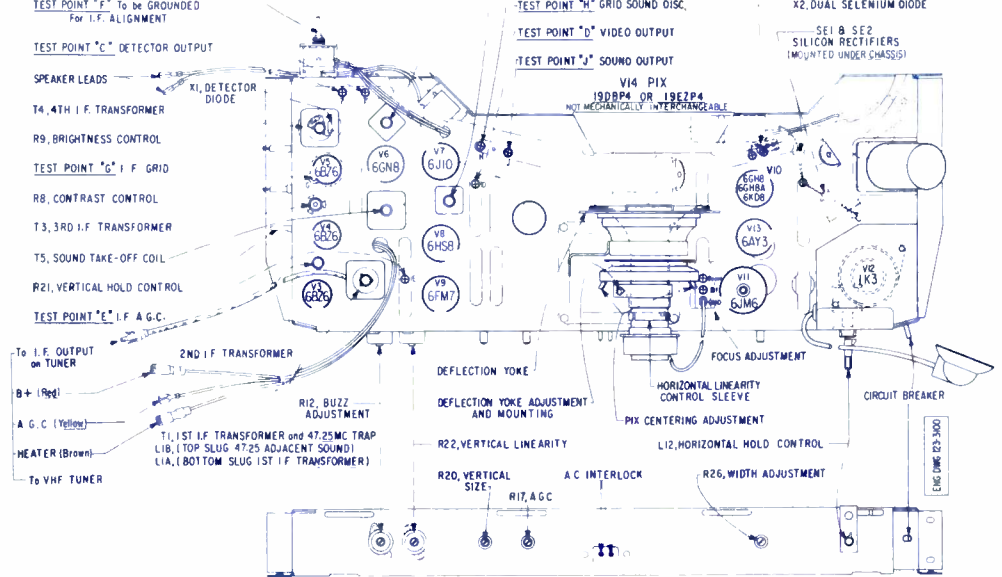
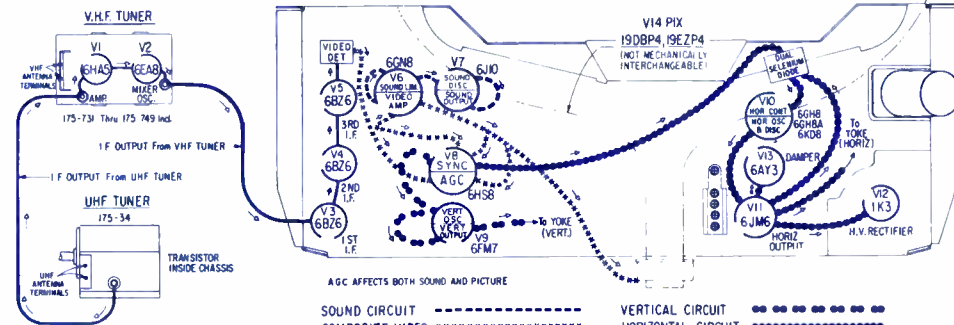

Symbol	Description	Zenith Part No.
C7	.001 Mfd disc 10% 1000v	22-17
C8	.001 Mfd disc 10% 1000v	22-17
C12	.001 Mfd disc 10% 1000v	22-17
C17A	4 Mfd electrolytic 350v	22-2744
C17B	20 Mfd electrolytic 25v	22-6
C17C	10 Mfd electrolytic 400v	22-3748
C22	470 PF disc 1000v	22-17
C27	.001 Mfd disc 10% 1000v	22-17
C30	.001 Mfd disc 10% 1000v	22-5021
C32	.001 Mfd disc 10% 1000v	22-3040
C33	.0068 Mfd disc 10% 1000v	22-3863
C42	.015 Mfd Molded 1000v	22-3965
C43A	200 Mfd electrolytic 25v	22-21
C43B	80 Mfd electrolytic 200v	63-2845
C43C	80 Mfd electrolytic 400v	63-5384
C45	80 Mfd electrolytic 200v	63-4997
C48	2X.001 Mfd disc 10% 500v	63-5380
C50	.470 PF disc 1000v	63-3284
R1	12KΩ A.B. only 10% 1/2w	63-5395
R2	3.3KΩ A.B. only 10% 1/2w	63-4833
R7	30KΩ contrast contr.	63-5314
R8	250KΩ B right. contr.	
R10	750Ω buzz contr.	
R12	1 meg. vol. contr. (acsw.)	
R14	1 meg. Ω A.G.C. contr.	
R15	voltage dependent res.	
R18	5 meg vert. size contr.	63-5030
R19	750K vert. Hold contr.	63-5379
R20	2.5K Ω vert. Lin. contr.	63-4815
R24	3K width contr.	63-5031
R26	2.7 Ω W.W. 1/2w	63-3631
R28	Thermal Res. supplied w/yoke	63-5187
L4	Choke coil	20-2004
L6	sound take off coil assem.	S-54785
L10	quadrature coil assem.	S-45229
L11	Filter choke	95-1805
L12	horiz. osc. coil assem.	S-56876
L13	spook choke coil	20-2005
T7	quadrature coil assem.	S-45831
T8	sound output trans.	95-2185
T9	vert. output trans.	95-2186
T10	yoke	95-2290
T11	power trans.	95-2311
T12	horiz. sweep trans.	S-65092
X1	diode crystal	103-23
X2	dual selenium diode	103-20
A1	integrator	87-8
A2	integrator	87-7
SE1	silicon rectifier	212-27
SE2	silicon rectifier	212-27
S1	circuit breaker	85-763
S2	part of R14 vol. contr.	
SP1	speaker	

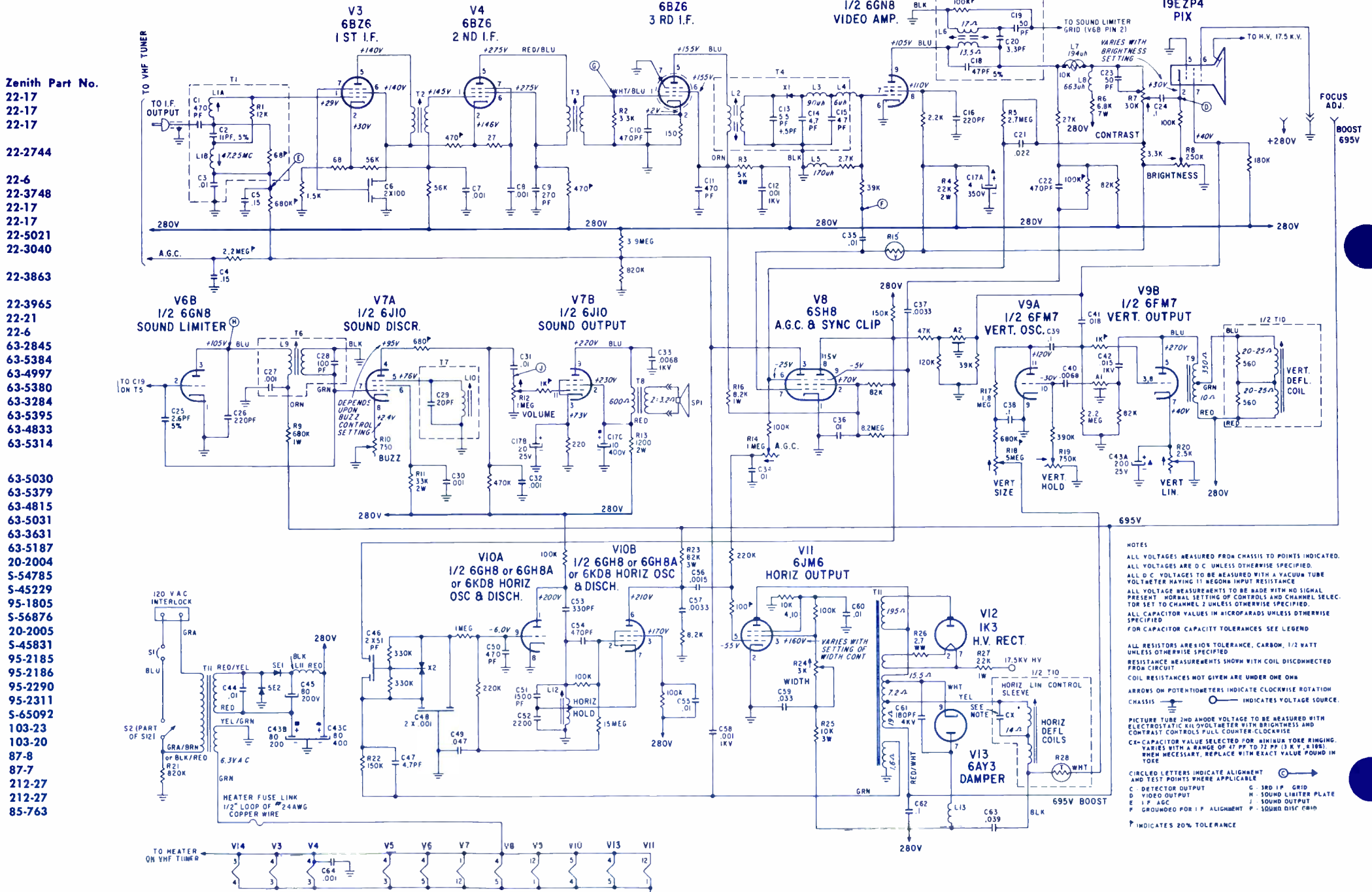

NOTES  
ALL VOLTAGES MEASURED FROM CHASSIS TO POINTS INDICATED.  
ALL VOLTAGES ARE D.C. UNLESS OTHERWISE SPECIFIED.  
ALL D.C. VOLTAGES TO BE MEASURED WITH A VACUUM TUBE VOLTMETER HAVING 11 MEGOHM INPUT RESISTANCE.  
ALL VOLTAGE MEASUREMENTS TO BE MADE WITH NO SIGNAL PRESENT. NORMAL SETTING OF CONTROLS AND CHANNEL SELECTOR SET TO CHANNEL 2 UNLESS OTHERWISE SPECIFIED.  
ALL CAPACITOR VALUES IN MICROFARADS UNLESS OTHERWISE SPECIFIED.  
FOR CAPACITOR CAPACITY TOLERANCES SEE LEGEND.  
ALL RESISTORS ARE 10% TOLERANCE, CARBON, 1/2 WATT UNLESS OTHERWISE SPECIFIED.  
RESISTANCE MEASUREMENTS SHOWN WITH COIL DISCONNECTED FROM CIRCUIT.  
COIL RESISTANCES NOT GIVEN ARE UNDER ONE OHM.  
ARROWS ON POTENTIOMETERS INDICATE CLOCKWISE ROTATION.  
CHASSIS IS INDICATED VOLTAGE SOURCE.  
PICTURE TUBE 2ND ANODE VOLTAGE TO BE MEASURED WITH ELECTROSTATIC SILVOLT METER WITH BRIGHTNESS AND CONTRAST CONTROLS FULL COUNTER-CLOCKWISE.  
C=CAPACITOR VALUE SELECTED FOR MINIMUM TUBE RINGING. VARIES WITH A RANGE OF 47 PF TO 22 PF (3 K.V., 2.188). WHEN NECESSARY, REPLACE WITH EXACT VALUE FOUND IN TUBE.  
CIRCLED LETTERS INDICATE ALIGNMENT AND TEST POINTS WHERE APPLICABLE.  
C= DETECTOR OUTPUT  
D= VIDEO OUTPUT  
E= I.F. AGC  
F= GROUND FOR I.F. ALIGNMENT  
P= SOUND DISC. CHRD.  
P INDICATES 20% TOLERANCE

# A New Electronic Slide Rule with Instruction Course

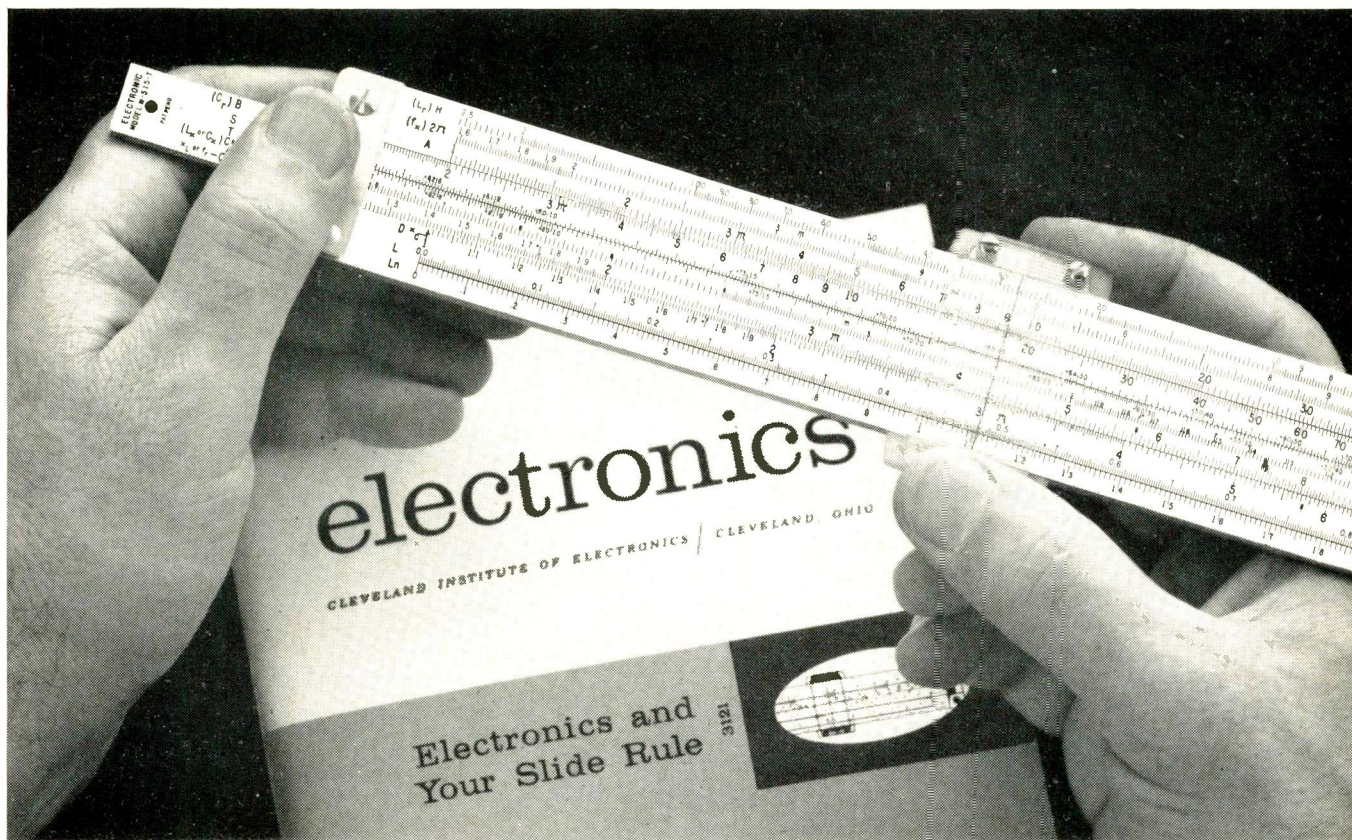

## Why didn't someone think of this before?

Here's a great *new* way to solve electronic problems accurately . . . easily. The Cleveland Institute Electronics Slide Rule is the only rule designed specifically for the exacting requirements of electronics computation. It comes complete with an illustrated Instruction Course consisting of four AUTO-PROGRAMMED lessons . . . each with a short quiz you can send in for grading and consultation by CIE's expert instructors. With this personal guidance, you'll soon be solving complex electronics problems in seconds while others still struggle along with pad and pencil.

Here's what Mr. Joseph J. DeFrance, Head of the Electrical Technology Dept., New York City Community College, has to say about it:

"I was very intrigued by the 'quickie' electronics problem solutions. It is an ingenious technique. The special scales should be of decided value to any technician, engineer, or student. The CIE slide rule is a natural."

See for yourself. Learn how to whip through all kinds of reactance, resonance, inductance, AC and DC circuitry problems in seconds . . . become a whiz at conventional computations too!

This all-metal 10" rule is made to our tough specs by Pickett, Inc. . . . comes complete with top grain leather carrying case *and* Instruction Course. A \$50 value for less than \$20. Send coupon for FREE illustrated booklet *and* FREE heavy vinyl Pocket Electronics Data Guide. Cleveland Institute of Electronics, 1776 E. 17th St., Dept. ET-103, Cleveland, O. 44114.

**GET BOTH FREE!**

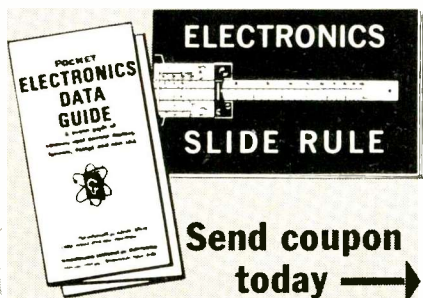

## Cleveland Institute of Electronics

1776 E. 17th St., Dept. ET-103 • Cleveland, Ohio 44114

Please send FREE Electronics Slide Rule Booklet.  
SPECIAL BONUS: Mail coupon promptly . . . get FREE Pocket Electronics Data Guide too!

Name \_\_\_\_\_ (Please Print)

Address \_\_\_\_\_ County \_\_\_\_\_

City \_\_\_\_\_ State \_\_\_\_\_ Zip \_\_\_\_\_

A leader in Electronics Training . . . since 1934

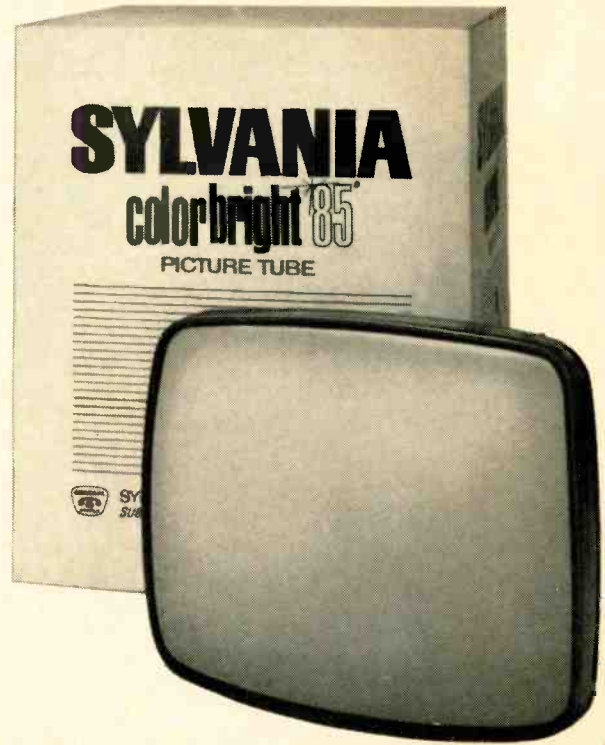

# CONSUMERS' CHOICE

## Here's how.

	BRIGHTEST COLOR PICTURE	BEST OVERALL COLOR PERFORMANCE	CLEAREST COLOR PICTURE TO WATCH	BRIGHTEST BLACK AND WHITE PICTURES
Sylvania color bright 85 picture tube	76.1%	66.6%	68.0%	77.7%
Picture Tube A	6.9	9.8	8.9	7.4
Picture Tube B	9.5	13.7	13.4	7.1
Picture Tube C	7.5	9.9	9.7	7.8

Test made under supervision of John J. Henderson and Associates, N. Y. Note: Not all people answered all questions—votes tabulated for 100% of answers to each.

In six major cities from coast to coast, 9,789 consumers compared the new *color bright 85*<sup>TM</sup> picture tube to ordinary non-rare-earth color tubes in three leading brands of TV sets. Sylvania's new tube, the first with rare-earth phosphors, was the overwhelming choice.

## Here's why.

The vivid colors, derived from europium rare-earth compounds, are unexcelled for true color fidelity. In monochrome, the picture is noticeably brighter; there's better contrast too. And today this extraordinary tube is still the performance leader. Sylvania's new air-spun screening process gives *color bright 85* picture tubes the competitive difference in the sharpest images ever displayed.

The *color bright 85* tube is available to you now for today's growing color TV market. It is a product of Sylvania Electronic Tube Division, Electronic Components Group, Seneca Falls, N. Y.

**SYLVANIA**  
SUBSIDIARY OF  
GENERAL TELEPHONE & ELECTRONICS **GTE**

JUNE 1965  
VOL. 81 No. 6

# ELECTRONIC TECHNICIAN

WORLD'S LARGEST ELECTRONIC TRADE CIRCULATION

## Cover

See page 82 for details on our cover this month.

## FEATURES

<b>The Explosion In UHF and FM/Stereo</b> .....	45
<i>Service-dealers and technicians are hard pressed in some areas to keep up with the demand</i>	
<b>Converting VHF Sets to UHF</b> .....	48
<i>You'll be converting old sets for years to come</i>	
<b>Tuner Techniques</b> .....	50
<i>Joe Hayes brings us another in-shop tale about 'Bob' and 'Scoot'</i>	
<b>You and Color TV</b> .....	53
<i>A continuing series on the practical and theoretical aspects of color servicing</i>	
<b>Replacement Speakers</b> .....	56
<i>An industry expert answers the questions you have asked about this subject</i>	
<b>More About Replacement Controls</b> .....	58
<i>A follow-up article that's full of tips on control problems</i>	
<b>Additional Uses for an R/C Bridge</b> .....	61
<i>Article tells you more ways to use your bridge</i>	
<b>Measuring Milliwatt Midget Modulation</b> .....	63
<i>How to tune up these unlicensed two-way transceivers</i>	

## DEPARTMENTS

Letters to the Editor .....	24	Colorfax .....	68
Editor's Memo .....	30	New Products .....	70
Technical Digest .....	34	News of the Industry .....	84
Sync on Business .....	40	Advertisers Index .....	90
Tough Dogs .....	66		

## TEKFAX

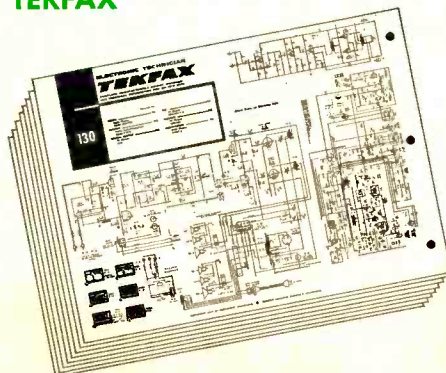

ADMIRAL: TV Chassis D761-1, 1D761-1 and 1D760-1  
EMERSON: TV Chassis 120758, 759, 760  
GENERAL ELECTRIC: TV Chassis DB  
MOTOROLA: TV Chassis TS-454  
PHILCO: TV Chassis N1200 and N1204  
RCA VICTOR: TV Chassis KCS 148  
SYLVANIA: TV Chassis 584-1 through 7  
ZENITH: TV Chassis 14M32

RON KIPP Publisher  
JACK HOBBS Managing Editor  
QUINTO BOCCI Technical Editor  
DOUGLAS HEDIN Industrial Editor  
JOHN BAILEY Assistant Editor  
THOMAS MURN Assistant Editor  
MARY CONNORS Production Manager  
MAGGIE KANE Advertising Production  
JIM GHERNA Art Director  
RUTH GELINEAU Circulation Fulfillment



AN OJIBWAY  
PUBLICATION

## OJIBWAY PRESS, Inc.

Ojibway Building, Duluth, Minn. 55802  
AREA CODE 218 727-8511

### ADMINISTRATION:

MARSHALL REINIG President  
ROBERT EDGELL Executive Vice President  
DEAN MYHRAN Vice President  
GREGORY BLODGETT Treasurer  
BEN MARSH Editorial Director  
HARRY RAMALEY Production Director  
JOE WOLKING Circulation Director

### Sales Offices:

NEW YORK: Ron Kipp, 25 W. 45 St.  
New York, N.Y. 10036  
AREA CODE 212 581-4200

CHICAGO: Jack Daniels, 221 N. LaSalle  
St., Chicago, Ill. 60601  
AREA CODE 312 CE 6-1600



Copyright 1965 by Ojibway Press, Inc., Duluth, Minn. 55802. Reproduction and re-printing prohibited except by written authorization of the publication. Subscription price: \$5 for 1 year, \$8 for 2 years, \$10 for 3 years. Foreign, \$9 for 1 year, \$14 for 2 years, and \$18 for 3 years. If you have a change of address or a question about your subscription, write: ELECTRONIC TECHNICIAN, Circulation Department, Ojibway Building, Duluth, Minnesota 55802. BE SURE TO SEND ALONG THE ADDRESS LABEL FROM YOUR MOST RECENT ISSUE.

# The new Amphenol 860 Color Commander cuts alignment time in half!

Ever finish a convergence job to find the raster off center. Lose convergence when you re-centered? Can't happen with the new Amphenol Color Commander, battery-powered, solid-state color generator. A special, single-crossbar pattern consists of one horizontal and one vertical line, crossing just where the center of the raster should be. No need to guess when centering the raster with this new pattern.

See dots before your eyes when you want only one to start static convergence? The 860 gives you that single dot, right at center screen. You'll be switching back to this important dot during dynamic adjustment to make sure you haven't gone off the track.

Even the old patterns offer something new. Line spacing in the crosshatch pattern is rigidly maintained for the 4:3 aspect ratio. You can rely on it for linearity, height, and width adjustments. The pattern gives you finely etched line width at normal brightness levels. What good is perfect convergence at reduced brightness if you lose it when the set's readjusted for normal viewing? This special crosshatch also eliminates receiver



fine-tuning error. Among the 860's nine useful patterns (most color generators have 5 or 6) are: multiple-dot, single vertical line, single horizontal line, vertical lines only, and horizontal lines only.

Finally, the Color Commander's unique color bar pattern (just three bars—R-Y, B-Y and—R-Y) simplify color adjustments. First you can get a rapid, overall check of color circuits. Then you can adjust color demodulator phase or pre-set the hue control and check its operating range. In each step, you know precisely how the color bars should look and how they should change during adjustment.

A new timing circuit eliminates instability and loss-of-sync problems. Silicon transistors maintain built-in precision and stability indefinitely. RF output is on channel 3 or 4, switch selected. An attenuator simulates weak-signal conditions. It has gun killer circuit. With 9 penlight cells, the Color Commander weighs 3½ lbs. In compact, leatherette carrying case, only \$149.95.

**The new solid-state Amphenol CRT Commander, Model 855**, checks all black-and-white or color CRT's with the same techniques used by tube

manufacturers. Variable G-2 voltage and choice of bias voltages permit you to simulate conditions found in TV receivers. Adjust electron guns to exact cut-off characteristics, check for emission, continuity, shorts, gas, and expected tube life. In color tubes, check for gun balance. The 855 rejuvenates CRTs where others fail. Features—AC operated, completely portable in matching leatherette case. Built-in burnout-proof voltmeter uses 50- $\mu$ a d'Arsonval movement. Screen and plate voltage and B+ distribution can be measured with direct probe on 1000-volt scale. Optional probe measures 2nd anode voltage to 50,000 volts. Filament voltage range, in 11 steps: 2.2 to 20 volts. Versatile 5-socket cable accommodates 7 different sockets, handles virtually every CRT without adapters. Complete with CRT Test Chart, \$89.95. See Color Commander test instruments at your Amphenol distributor.

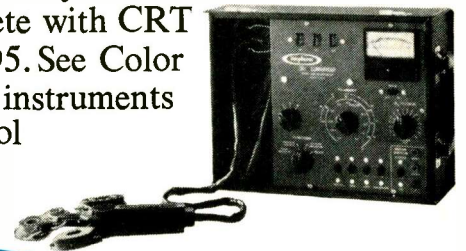

**DISTRIBUTOR DIVISION**  
amphenol • borg electronics corporation  
2875 S. 25th Ave., Broadview, Ill. 60155

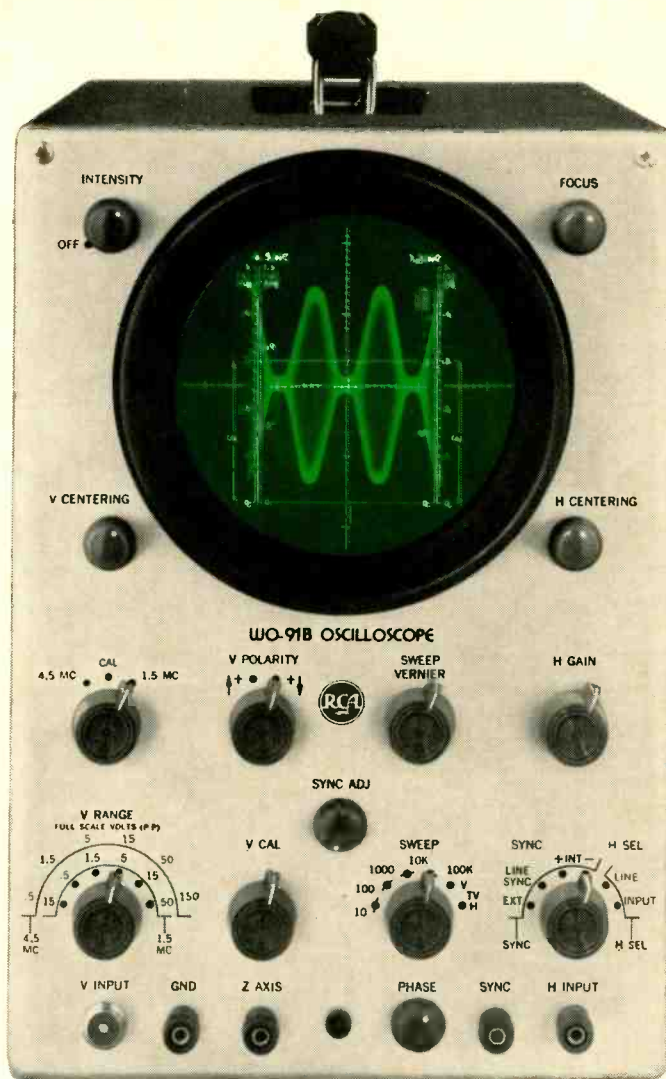

## The famous RCA 5-inch scope NOW WITH MORE FEATURES TO SIMPLIFY YOUR JOB

Here's the latest model of the famous RCA 5-inch scope: the NEW WO-91B

- Provision for connecting signals directly to the vertical deflection plates of the CRT. Permits observation of high frequency RF waveforms, such as trapezoidal and wave-envelope modulation patterns.
- Two-stage sync separator simplifies checking of TV horizontal and vertical sweep synchronization... provides exceptionally solid lock-in action on composite TV signals.
- Choice of wide-band or high-sensitivity, narrow-band display.
- Complete with RCA WG-300B Direct/Low Cap. Probe and Cable.

- Optional at slight extra cost: RCA WG-354A slip-on capacitance-type voltage-divider probe that extends the range of the scope to permit observation of signal pulse amplitudes up to 5000 volts. RCA WG-302A slip-on RF/IF/VF signal tracing probe for RF applications from 100 Kc to 250 Mc.

- WO-91B Scope: \$249.50\*
- WG-354A Probe: \$ 7.50\*
- WG-302A Probe: \$ 8.50\*

Ask to see it at your Authorized  
RCA Test Equipment Distributor.

\*Optional distributor resale price. All prices subject to change without notice. Prices may be slightly higher in Alaska, Hawaii and the West.

RCA Electronic Components and Devices, Harrison, N. J.



The Most Trusted Name in Electronics

## LETTERS TO THE EDITOR

### Radio City Products

For the info of Mr. Randy Acorman, Radio City Products was a little instrument firm that suffered from under capitalization and not too aggressive a sales policy and hence are no longer with us. Even so, for your readers who asked about instrument information, you may get service data and parts from the following firm: C. J. S. Electronics, Box 765, Easton, Pa.

J. H. BRUENING  
Scientific Lab. Equipment  
University, Miss.

• And regarding Shell Electronics, we have been informed that it also went bankrupt several years ago. — Ed.

### Needs TEKFAK

I am looking for TEKFAK volumes 101, 102 and 103 if any reader has copies they want to part with. I am a newcomer in the business and need all the info I can get.

THEODORE PLUMEAU  
Brentwood, N. Y.

• We inadvertently sent Guy Warren's letter to someone else and have misplaced his address. If he lets us have it again we will forward your letter to him. — Ed.

### Outranks Them All

... May I also say, as a rank beginner (3 years in TV service), I find your publication to be most consistent in the way of help, advice, new ideas and shop hints. In TV service, I find ELECTRONIC TECHNICIAN outranks all other magazines...

B. E. MEIKLE  
Verdun, Que., Canada

### More TEKFAK Available

I too have an almost complete set of TEKFAK available to interested readers. Your magazine has been well read through the entire publication period and *muchly* enjoyed.

C. S. ROADHOUSE  
Omaha, Neb.

### More on ETC

One can hardly realize it has been over 9 years since I subscribed to wonderful ELECTRONIC TECHNICIAN.



# WHY

## risk your reputation with "just-as-good" capacitors?

When you pay little or no attention to quality in tubular replacement capacitors, you leave yourself wide open for criticism of your work . . . you risk your reputation . . . you stand to lose customers. It just doesn't pay to take a chance on capacitors with unknown or debatable performance records when it's so easy to get guaranteed dependable tubulars from your Sprague distributor!

## There's no "maybe" with these 2 great SPRAGUE DIFILM<sup>®</sup> TUBULARS!

The ultimate in tubular capacitor construction. Dual dielectric . . . polyester film and special capacitor tissue . . . combines the best features of both. Impregnated with HCX<sup>®</sup>, an exclusive Sprague synthetic hydrocarbon material which fills every void in the paper, every pinhole in the plastic film *before it solidifies*, resulting in a rock-hard capacitor section . . . there's no oil to leak, no wax to drip. Designed for 105°C (220°F) operation without voltage derating.



**DIFILM<sup>®</sup> BLACK BEAUTY<sup>®</sup>**  
Molded Tubular Capacitors

The world's most humidity-resistant molded capacitors. Tough, protective outer case of non-flammable molded phenolic . . . cannot be damaged in handling or installation. Black Beauty Capacitors will withstand the hottest temperatures to be found in any TV or radio set, even in the most humid climates.

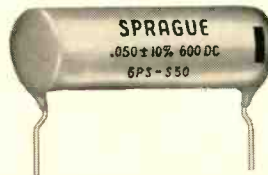

**DIFILM<sup>®</sup> ORANGE DROP<sup>®</sup>**  
Dipped Tubular Capacitors

A "must" for applications where only radial-lead capacitors will fit . . . the perfect replacement for dipped capacitors now used in many leading TV sets. Double-dipped in rugged epoxy resin for positive protection against extreme heat and humidity. No other dipped tubular capacitor can match Sprague Orange Drops!

For complete listings, get your copy of Catalog C-616 from your Sprague distributor, or write to Sprague Products Company, 65 Marshall Street, North Adams, Massachusetts.



WORLD'S LARGEST MANUFACTURER OF CAPACITORS

# NEW TV and FM distribution designed specially



**MODEL A-430**  
4-tube, 30 DB GAIN  
distribution amplifier  
\$84.95 list

Operates 1-50  
TV-FM outlets,  
100 with preamp.

**3** *New Winegard  
Distribution Amplifiers  
to Run 2 Sets, 200 or MORE*



**MODEL A-215**  
2-tube, 15 DB GAIN / general purpose TV-FM Amplifier  
\$44.95 list

■ Provides 15 DB gain for home systems, small motels or apartment buildings. Drives up to 20 TV-FM outlets or line tap-offs . . . up to 40 with preamp. 30 volts AC is available by preamp switch at input jack to operate Colortron or Stereotron antenna directly from A-215 without extra power supply.

**SPECIFICATIONS—Tubes:** two 6HA5. **Gain:** +15db. **Bandpass:** 50-110MC, 170-220MC. **Response:** flat, ±.25db per 6 MC channel. **Noise Figure:** 3.7db lo-band, 5db hi-band. **Max. Signal Input:** 350,000 microvolts. **Max. Signal Output:** 2V. **Input Impedance:** 75 or 300 ohm. **Output Impedance:** 75 or 300 ohm. VSWR input and output better than 1.5 to 1. Two C-59 75 ohm connectors supplied. Blue Baked enamel perforated steel cabinet, 2 1/8 x 9 1/4 x 3 3/8". AC cord. **Switches:** On-Off; power to pre-amplifier. AC fuse. 117V 60 CPS 14 watts.

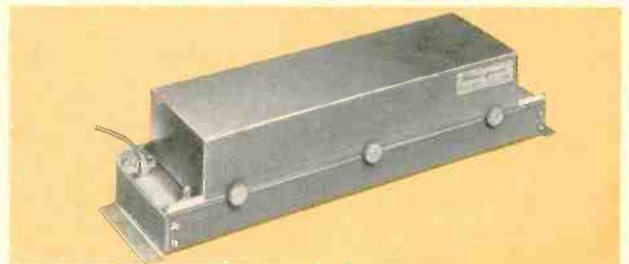

**MODEL A-845**  
8-Tube, 45 DB GAIN / Distribution Amplifier \$159.95 list

■ For large hotels, motels, hospitals, schools and apartments. Operates 1-150 TV outlets, 300 sets with preamp. 30 volts available by switch at input jack for operating Colortron or Stereotron preamplifier directly from A-845 without extra power supply.

**SPECIFICATIONS—Tubes:** Six 6HA5; two 6DJ8. **Gain:** +45db. **Bandpass:** 50-110MC, 170-220MC. **Response:** flat, ±.25db per 6 MC channel. **Noise Figure:** 3.7db lo-band, 5 db hi-band. **Max. Signal Input:** gain control at max., .008V per band; gain control at min., .025V. per band. **Max. Signal Output:** 3.2V. **Separate Hi and Lo Band Gain Controls:** 0-10db; Separate hi and lo band tilt controls 3-6db. **Input Impedance:** 75 ohm. **Output Impedance:** 75 ohm. VSWR input and output better than 1.5 to 1. Blue baked enamel perforated steel cabinet. 2 1/8 x 14 1/2 x 3 3/8". AC cord. **Off-On** switch. AC fuse. 117V. 60 CPS 48 watts.

## ANTENNAS

Colortron All-Channel Antennas  
GOLD ANODIZED 4 models  
\$24.95 to \$64.95  
Finest TV antennas made.

De Luxe Yagis  
GOLD ANODIZED  
Broadband and cut-to-channel.  
Amplified or non-amplified.  
High gain, rugged  
construction, channels 2 to 13,  
low band and hi band.

Stereotron FM  
Antenna  
Model SF-8  
\$23.65  
most powerful  
FM antenna,  
gold anodized.

## ANTENNA PREAMPLIFIERS

Colortrons—twin nuvistors  
300 ohm Model AP-220N,  
\$39.95. 75 ohm  
Model AP-275, \$44.95  
Drive 1-6 sets

Red Head RD-300 transistor  
preamplifier Drive  
1-6 sets \$29.95

Stereotron Preamplifier for  
FM. Twin Nuvistors Model  
AP-320, 300 ohm \$39.95  
Model AP-375, 75 ohm  
\$44.95

A COMPLETE LINE OF WINEGARD MATCHED DISTRIBUTION SYSTEMS

# system equipment by **WINEGARD** for the TV Service Technician

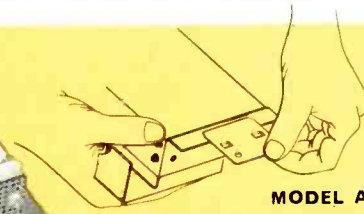
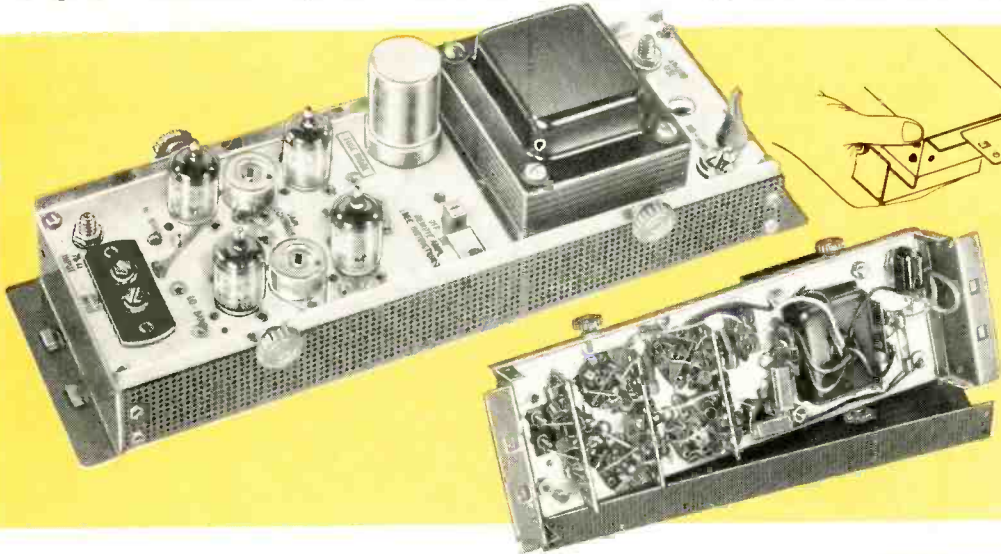

Exclusive wall hanger bracket for instant removal of amplifier.

**MODEL A-430**  
**SPECIFICATIONS**—Tubes: four 6HA5. Gain: +30db. Bandpass: 50-110MC, 170-220MC. Response: ±25db per 6 MC channel. Noise Figure: 3.7db lo-band, 5db hi-band. Max. Signal Input: gain control at max., .02V. per band; gain control at min., .1V per band. Max. Signal Output: 2V. Separate Hi and Lo Band Gain Controls: 0-10db. Input Impedance: 75 or 300 ohm. Output Impedance: 75 ohm. VSWR input and output better than 1.5 to 1. Two C-59 75 ohm connectors supplied. Blue baked enamel fully ventilated perforated steel cabinet, 2 1/4" x 11" x 3 3/4". AC cord. Switches: OFF-ON; power to preamplifier. AC fuse. 117V. 60CPS 25 watts.

## BEST DISTRIBUTION AMPLIFIERS MADE—HERE'S WHY

- **DESIGNED FOR COLOR AND FM STEREO**  
Flat frequency response, no phase distortion, full gain to top of FM band.
- **EASIEST TO SERVICE** —  
All jacks, controls, switches and connections accessible from top of chassis. Knurled thumb nuts for fast removal of dust cover.
- **LOWEST NOISE** —  
Only amplifiers made that use all high transconductance, low noise triodes—no pentodes.
- **EXTENDED BAND PASS** —  
Allows cascading without clipping in end channels.
- **FULLY VENTILATED TOP AND SIDES.**  
Perforated dust cover and chassis cover. Dissipate heat for extra long life.

## With Winegard Equipment, any Good TV Technician Can Get Perfect Results with the First Installation

Winegard equipment has been engineered for the busy technician who doesn't have the time to do a lot of pre-planning and experimental work on the job. If you have been installing distribution systems, you will appreciate the way the engineering has been done in the factory to eliminate time on the job. If you haven't installed distribution systems, now you can get into this interesting, exceptionally profitable work in your area.

Every component of a Winegard distribution system is designed to match perfectly, from the antenna to the set... for installations in homes, apartment buildings, schools, hospitals, motels, hotels, trailer courts.

Practically every new public building today has a TV/FM distribution system, and systems are becoming standard equipment in new homes. You should be getting your full share of this profitable, interesting work. Winegard offers you the best equipment and free layout service. If requested, our engineers will be glad to check over your system or lay out a system for you. Same day attention will be given to your problems.

### Example Winegard's Simplified System

For instance, an apartment house with 20 outlets; fringe area—stations 50 and 80 miles away—channels 3, 6 and 8 in 3 different directions.

Note the Winegard system uses only 4 major components to simplify the installation yet gives better performance as against other systems' use of 7 components.

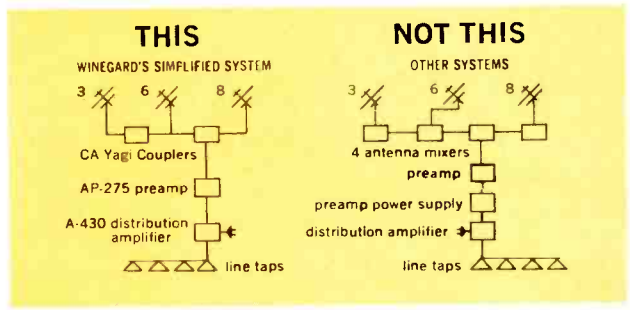

Write today for FREE Winegard layout guide and new book "How to Select and Use Master Antenna System Equipment".



3019-G Kirkwood, Burlington, Iowa  
World's most complete line of TV & FM reception equipment.

## ANTENNAS AND ACCESSORIES FOR EVERY INSTALLATION NEED

### ANTENNA COUPLERS

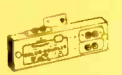

EC-230 Amplified 2 set Color Coupler Transistorized amplifies signal, \$17.95, 10 set, 6 set, 4 set and 2 set couplers for 2 to 10 TV or FM sets.



Yagi Couplers—Couple any combination of Winegard cut-to-channel or broadband yagis.



TV-FM Coupler — couples TV and FM antennas, also can be used to split TV-FM signals.

### LINE TAP-OFFS, TV/FM OUTLETS, LINE DROP TAPS, SPLITTERS



Flush or surface mount line tap-off, 75 and 300 ohm models.



TV-FM outlets for both flush and surface mount. Complete with outlet plugs—10 models.



Line Drop Taps—Drop branch lines from trunk lines. Split line 2 or 4 ways.

- Matching Transformers,
- Pressure Taps,
- Attenuation Pads,
- TV-FM channel Traps
- A complete line available for all purposes.

# DE-SOLDER 50% FASTER

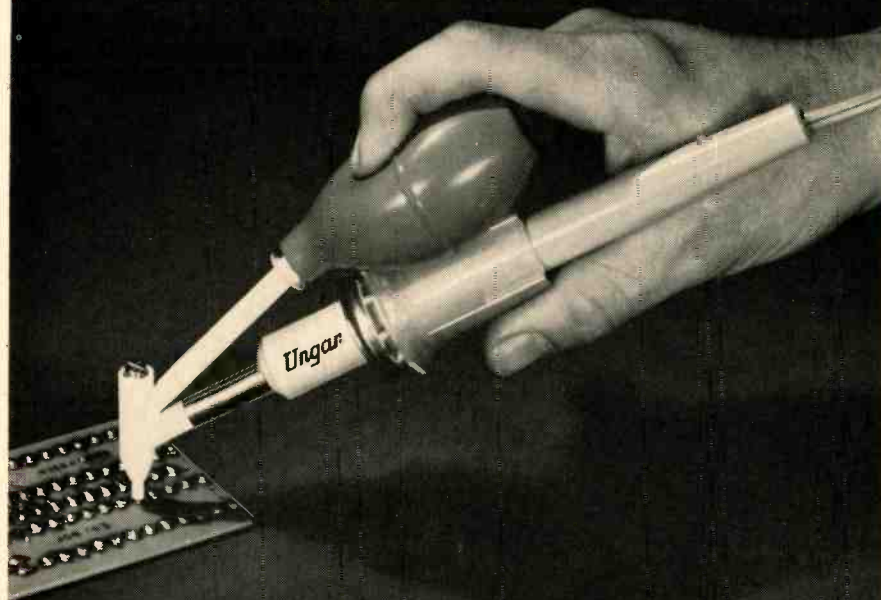

## NEW HOT-VAC DE-SOLDERING TOOL

... reduces your PC repair and rework time by half... proved faster in actual use.

- **One hand, one operation.** HOT-VAC melts and removes solder in one operation, other hand is free to lift components.
- **Ungarized coating** on tip and other metal components prevents solder from sticking and clogging.
- **HOT-VAC features the NEW #777 Clean Room Handle.** It's heat stabilized, non-slip, poly grip, won't dust or deteriorate.

Get the full story from your local authorized Ungar distributor or send this coupon.

PAT. PENDING

UNGAR ELECTRIC TOOLS, Hawthorne, California 90252 • Dept. ET.

Send full information on HOT-VAC

Name \_\_\_\_\_ Title \_\_\_\_\_  
Company \_\_\_\_\_  
Address \_\_\_\_\_  
City & State \_\_\_\_\_ Zip Code \_\_\_\_\_

## LETTERS TO THE EDITOR

I have been in the business for many years and ET has helped me most of all . . . I need more information on Engineering Technician Certification if you can help me.

JOE WAKAYAMA  
Oakland, Calif.

### Piracy Again

Please! The first 50 pages of my April ET was missing when the magazine was delivered . . .

J. W. SHEELY  
Martinsburg, W. Va.

### Help!

I have been a faithful reader of ELECTRONIC TECHNICIAN since it began and there's no better magazine around. I need a schematic for an "Accurate" VTVM, Model 152. I have no other information on the instrument. Since I do not know the name of the manufacturer, or where they are located, I am calling on your readers for possible help.

JOHN LIND  
Flushing, N. Y.

### Butoba Info

Please inform reader R. A. Pelletier (April letters) that Butoba is a German made machine presently being distributed in the U. S. by Stanford International, 1227 Laurel St., San Carlos, Calif. This brand has had several different exclusive importers in the past few years. Whether the aforementioned firm can help may depend on the age of the machine he has.

ROBERT E. GERSON  
Japan Light Machinery  
Information Center  
New York.

• We also received the same information from Mrs. Chris H. Leubner, of Leubner's Radio and TV, Killien, Texas.—Ed.

### Buck Passing

I tried without success to get a schematic of a scope, Philco Model 7021. I was referred to the Canadian counterpart and then referred back to the U. S. again. I hope you can help me.

G. MCINTOSH  
Vancouver, B. C., Canada

# ALL NEW FROM **HICKOK**

**100% G<sub>m</sub> TESTS . . .**  
*No Emission Tests,  
 No Compromise!*

**OBSOLESCENCE PROTECTION**  
*Realistic, Practical  
 No Compromise!*

**MULTI-SOCKET SPEED . . .**  
*No Compromise  
 In Accuracy!*

**MORE PROFIT**  
*Because You'll Sell  
 More Tubes . . .  
 Sell Them  
 Honestly!*

**NEW HIGH-SENSITIVITY  
 LEAKAGE AND  
 GAS TESTS!**

**MODEL 799**

**Mustang**

**\$199<sup>95</sup>**

From the laboratories of the world's leading tube tester manufacturer comes the model 799 "Mustang" — a completely new tube tester.

Multi-socket tube testers used to have two serious drawbacks: circuit limitations made them obsolete overnight and, at best, no more than 10% of their tests were actually mutual conductance. But the Hickok "Mustang" doesn't compromise; it delivers *honest* mutual conductance tests. And a unique circuit approach, together with an easily replaceable accessory socket panel, makes it "circuit ready" for

any possible new tube types.

A solid-state power supply gives increased accuracy and dependability. An all-transistorized gas and leakage test circuit sets a new standard of reliability for spotting "tricky" tube defects that can "chew up" your profit. You can actually read interelement leakage to 50 megohms; gas/grid leakage effects to 0.1  $\mu$ a!

We call it the "Mustang" because it uses fresh, new engineering ideas and because it gives you a real opportunity to break into new profits.

See it at your Hickok distributor or write for circular TT799.

# HICKOK

## THE HICKOK ELECTRICAL INSTRUMENT CO.

10566 Dupont Avenue, Cleveland, Ohio 44108

Represented in Canada by Stark Electronics, Ajax, Ontario  
 Internationally by Hughes International, Culver City, California

a new world of UHF performance



**"VENUS" DELUXE UHF CONVERTER**

World's finest, accented in elegant gold. High gain built-in amplifier, years-ahead circuitry assure peak all-channel reception. Exclusive Ultrascope® fine tuning. For all areas, even deepest fringe. Model 503.



**"SATURN" UHF CONVERTER**

In mellow walnut, yet only the look is expensive! Powerful new solid state circuit for metropolitan locations. Model 502.



**"JUPITER" ECONOMY CONVERTER**

Decorator designed in sleek, dramatic brass. Clear, all-channel reception. The price? New and nice. Model 501.

WRITE FOR FREE CATALOG showing world's most advanced UHF converters, antennas and VHF equipment.



GAVIN Instruments, Inc. General Offices: Somerville, N. J.

**EDITORS' MEMO**

**A Cure For Ulcers**

A land-office business has been done in books describing how "rugged individuals" have carved out empires single handed. The writers of these books seldom reveal that this was possible only in a developing society. Although the romantic overtones always make exciting reading — especially for the young — these stories have initiated many harmful concepts.

Actually, the "lone wolf" disappeared on the first day that two cave-men pooled their individual clubs and wits and chased edible meat together. After that came clans and societies and governments of the people.

In today's business jungle, as consumers become more intelligent and discriminating, as the "profit-squeeze" becomes tighter, the lone wolf finds it even more difficult to survive.

There's a story about three "loners" — three one-man TV-radio shops — whose owners came in out of the cold back in 1961 and joined forces. It happened in a small town in Iowa. They formed a corporation called A-C TV Electronic Clinic, Inc.

Now they work under one roof, keep their own individual service businesses and have incorporated the sales end. They can and do carry a large line of TVs, stereos and radios — and most important — the TV Clinic has become the largest service shop in their county.

Some of the details of the operation are interesting. The founders say it wasn't easy. But they first looked for, and found, a combination business manager and technician. Then they pooled some of their resources and began with one thing foremost in mind — *to get along together* — and forget about their lone-wolf instincts. The net result has been, according to a report published by the "Hoosier Test Probe," official publication of the Indiana Electronic Service Assn., that they eat better, dress better and sleep better at night than they ever did when they were going it alone. They can even take a week off without having to close the doors.

Oh, they made foolish mistakes for a while at first, they say, but they moved along smoother. They have four phone numbers — and one girl to answer them and keep books. Each technician buys parts from the Clinic — paying for them only *after* they are used.

They suggest that some of you "ulcer-ridden loners" try it.

**VOTE ROW "REGO-WRAP"**

ROW "REGO-WRAP"	HIGHER PROFITS FOR YOU	100% SHIELDING	EXCELLENT FLEXIBILITY	LIGHT WEIGHT AND SMALL O.D.	DRAIN INSIDE WRAP
	YES	YES	YES	YES	YES
	NO	NO	NO	NO	NO
	YES	YES	YES	YES	YES

What is REGO-WRAP? REGO-WRAP is a composite of polyester film and aluminum foil bonded together by a permanent adhesive resulting in a strong, highly conductive shield.

REGO-WRAP provides the practical solution to 100% shielding where small diameter, flexibility, and light weight prohibits the use of spiral or braided shields. The drain wire, inside the shield provides continuous contact along the entire length of the cable. REGO-WRAP serves as a positive means of carrying off any

accumulated static charges from the shield.

Costs are less with REGO-WRAP than with other standard type shields, enabling you to make higher profits. REGO-WRAP is lighter in weight and smaller in diameter making it much easier to work with in all installations.

REGO-WRAP reflects the creative and quality engineering applied in all phases of production at REGO. Why not write or CALL US COLLECT and ask for our new catalog illustrating all of REGO's quality wire?



**REGO**

Call Us Collect:

CABLE: JHB

830 Monroe St., Hoboken, N. J. ■ N. Y. (212) WH 3-5793, Hoboken: (201) OL 6-2020



## Why does Arco wind all its tv-replacement capacitors with computer-grade 99.99% pure aluminum foil?

### To help cure that pain in your neck.

Impurities in aluminum foil can lead to deterioration, premature failures, lost customer confidence—and call-back time you can't charge for. Big pains in the neck.

So we wind every Arcolytic® electrolytic capacitor with the purest aluminum foil available: 99.99% pure. It meets computer manufacturer standards. And exceeds those of radio-tv manufacturers.

Result: Arcolytic capacitors last longer in your customer's set. In fact, they won't deteriorate even at high operating temperatures of 85° C.

And while we wind them with computer-grade foil, we price them for home-entertainment service. You pay no premium.

You'll find whatever discrete capacitance value you need at your Arco Distributor's. And in your choice of single- and multiple-section tubular, or twist-mount designs. (You'll also find a complete line of equivalent-quality miniature ceramic disc capacitors up to 6000 VDCW.)

Start using Arcolytic capacitors. And the next call from your customer will be because he likes your kind of reliability, and wants more of your service.

#### **Arco Electronics**

A DIVISION OF LORAL CORPORATION

COMMUNITY DRIVE, GREAT NECK, N.Y. DALLAS, TEX. PASADENA, CALIF. WRITE FOR FREE CATALOG.

**5 Transistors  
No Tubes  
30 db Gain\***



**NEW JERROLD  
ALL-SOLID-STATE  
"DE-SNOWER" Model SPC-132**  
...the most powerful  
of all antenna amplifiers

Do you remember the original and famous Jerrold De-Snower? Thousands of De-Snower preamplifiers have served fringe-area antenna systems since 1950, amplifying weak television signals at the antenna before download loss. Now every benefit of the original De-Snower, and more, is offered by the new SPC-132 all-solid-state antenna amplifier.

Jerrold has combined the ultra-sensitive twin-transistor preamp, SPC, with a compact three-transistor postamp, 132, to give you the powerful double-punch performance of this unusual new antenna amplifier—with absolutely no tubes to replace.

**30 db high-band gain\* • 26 db low-band gain\*  
• Lowest input noise figure • Highest output capability  
(100,000 microvolts each of 7 channels)**

Use the SPC-132 on your next "tough-dog" antenna system—custom home or multi-set installation. Drive as many as 20 to 30 sets from one antenna system.

Only \$97.95 list. Ask your Jerrold distributor or write Jerrold Electronics, Distributor Sales Division, Philadelphia, Pa. 19132.

\*Measured average production unit

The nation's foremost manufacturer and supplier of television antenna systems and equipment



# Solid-State Color Generator

■ A solid-state color generator, called the "Color Commander," will help TV technicians cut receiver alignment time by 40 percent, according to the manufacturer.

Its outside dimensions, 9 x 5 x 4 inches brings it to a size capable of fitting into a tube caddy. Manufactured by the Amphenol Borg Corp., the instrument provides nine test patterns. These include single vertical and horizontal crossbars for accurately centering the raster before beginning convergence alignment.

A single center-screen dot pattern is also provided for static convergence. This system, it is said, makes it easier to reset static convergence because of interactions between adjustments.

The instrument provides three color bars; R-Y, B-Y and -R-Y, in 90, 180 and 270 degree color phases. It is said that an oscilloscope is not necessary for making some adjustments — reducing occasions when a set must be taken to the shop for alignment.

Other patterns available on the generator include: 1) Single horizontal and vertical line patterns; 2) 15 horizontal bars for dynamic convergence and linearity; 3) 20 vertical bars for dynamic convergence and linearity; 4) 300 multiple dots for critical inspection of convergence and 5) 20 x 15 crosshatch for dynamic convergence and proportioning adjustments. ■



Amphenol's compact, solid-state color generator fits into tube caddy.



## Where to use audio attenuators

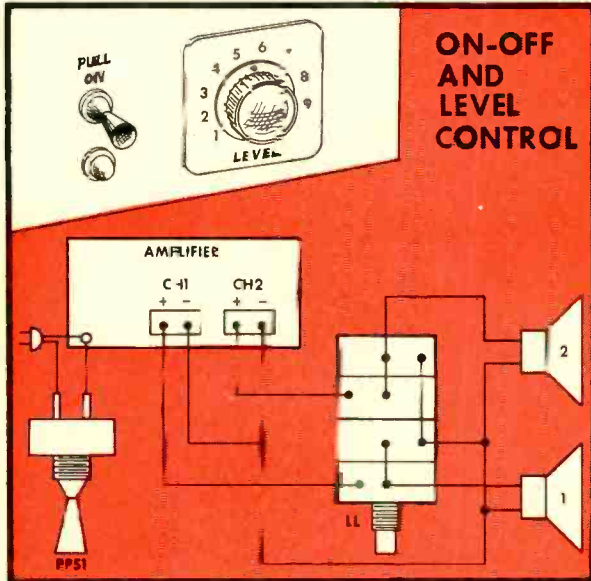

Are volume control "twidgers" upsetting the careful balance of your hi-fi rig? After you spend an hour or better setting "levels", "contour", "bass", and "treble" does your dear wife come along and goof the whole deal up because everything is too *LOUD*?

Why not maintain your balance, your temper, and your domestic tranquility by installing a simple on-off switch and an audio attenuator. In this way the dear girl can simply turn the music on at one place and control the sound with one knob. The drawing to the left shows a Mallory PPS1 push-pull switch and an LL pad controlling the whole works. It works great and looks fine. If you want to add a "Hands Off" sign on your amplifier, that's up to you.

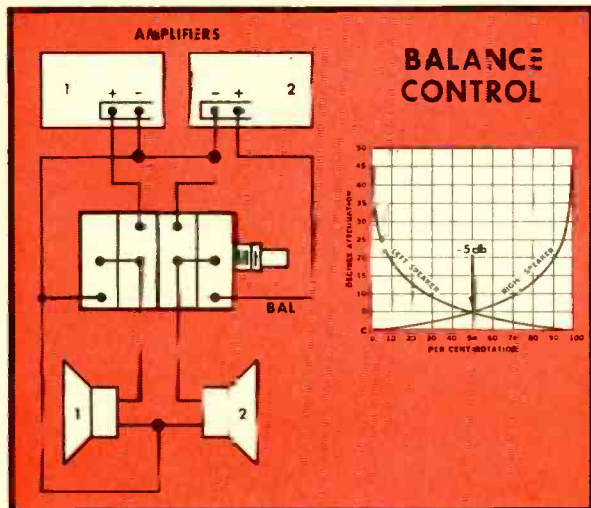

*Balance Control.* We have a brand new control you'll be interested in (BAL8 and BAL16). It's a true stereo balance control. Consists of two L pads connected back to back so that when one level goes up the other goes down. Dead center loss is a tiny 5 db which you'll never miss. Saves a lot of time and gives marvelous flexibility to your stereo sound system.

*Remote Speaker Control.* Why not install a set of stereo speakers in your family room or other remote location? Use an LL dual pad to control the level here, too. You can install the LL in one speaker enclosure and eliminate all those extra steps back to the main controls. Or you might want to check out the RR50 control (a dual rheostat) which is the perfect low-cost way to control inexpensive speakers in the basement or on the porch.

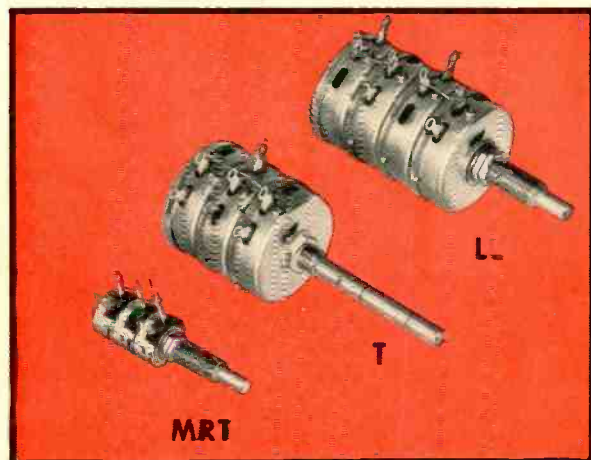

Your Mallory Distributor can help you select an audio attenuator exactly right for the job. Choose from the new miniature MRL, MRT and MRL pads . . . rugged Mallory RL, RT and RR . . . the 15-watt T, L, LL, and BAL pads, or the powerful 50-watt MGL and MGT series. You name it, he has it.

In case you'd like a complete list of Mallory audio controls and other precision electronic components, drop us a line. We'll send you the new 1965 Mallory Catalog. Write to MALLORY DISTRIBUTOR PRODUCTS COMPANY, a division of P. R. Mallory & Co. Inc., P.O. Box 1558, Indianapolis, Indiana 46206.

# TECHNICAL DIGEST

## EMERSON

### TV Chassis 120771—Tuner and Video IF Circuit Description

**Tuner:** The VHF tuner uses two germanium (RF and Mixer) and one silicon (oscillator) transistor. The UHF tuner utilizes a silicon diode (mixer) and a silicon transistor (oscillator). Tuning shafts are concentric with the inner shaft as the VHF selector and the UHF and VHF fine tuning as well as the UHF coarse tuning. The outer-

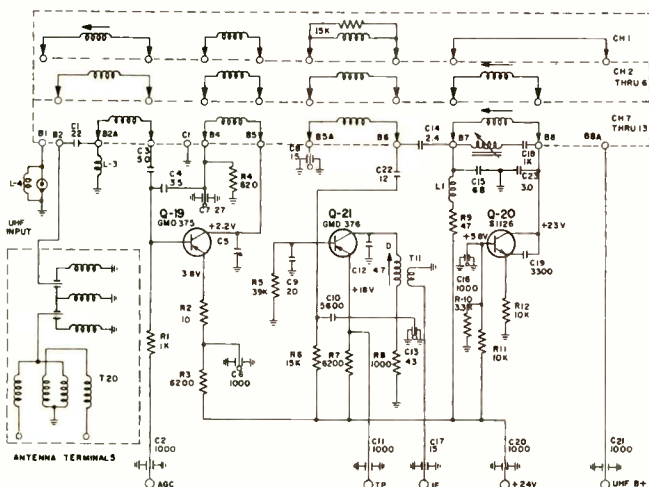

Schematic of VHF tuner used in Emerson TV Chassis 120771.

most shaft is for the UHF dial. The UHF is switched-on in the channel "1" position, in which case the VHF tuner acts as the first stage of IF amplification. The oscillators of both the VHF and UHF tuners are carefully designed to minimize drift. Tuner B+ is 22 v and normal AGC is +5 v with stronger signals resulting in lesser AGC voltages. This decreased voltage is applied to the base of the VHF RF amplifier (Q-19) and results in an increase of collector current, thereby reducing both

collector voltage and gain as the transistor approaches saturation. A LOCAL/DISTANCE switch (SW2) at the antenna input to the tuner places a 330  $\Omega$  resistor in series with each side of the 300  $\Omega$  balanced line, when switched to the LOCAL position.

**Video IF:** The video IF section consists of three synchronously tuned (44 Mc) transistor stages and one diode detector. The first two stages are gain controlled by the AGC amplifier. Normal AGC is 3 v which decreases as signal increases, resulting in forward gain control for the first stage. This action is similar to that in the VHF RF stage, ie: the resultant increased collector current reduces both the collector voltage and the gain of the stage. This stage is initially biased by the emitter bleeder resistors R32 and R31.

The second video IF stage is gain controlled by reverse AGC applied by the first stage. As the collector current in the 1st stage increases, the voltage developed across emitter resistor R33 is applied to the emitter of the 2nd stage through R37. This acts to decrease collector current resulting in the reduction of gain. There is no AGC applied to the 3rd IF stage.

The reason for using forward AGC in the 1st stage and reverse AGC in the 2nd stage is to achieve greater bandpass stability with changes in AGC voltage. The 3rd IF stage is not gain controlled and is biased by the bleeder resistors R43 and R42.

Each of the video IF stages is tuned by a single resonant circuit in the collector of each of the three transistors. The tuned coils are tapped to permit the application of neutralization. T4, T5 and T6 are all tuned to the center of the IF band (44 Mc). The tuner output coil (T11) and L3 form an overcoupled system and together with the traps (L2 and L4 shape the IF curve). L2 and L4 supply the proper amount of attenuation at the 41.25 and 47.25 Mc sound carrier frequencies.

The video detector produces a sync negative signal which is directly coupled to the base of the video amplifier.

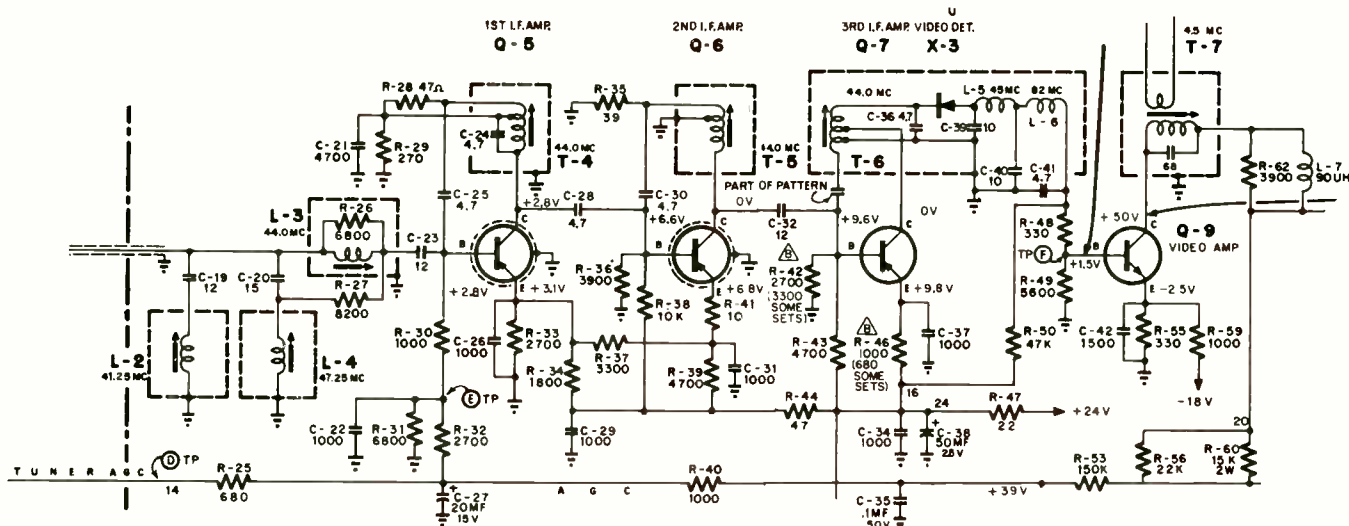

Video IF strip of Emerson transistorized TV.

**Don't just wait there.**

**Do something.**



Electronic products are your bread-and-butter.

Yet manufacturers seem to have forgotten that electronics is a service business. Because they're selling to you, the same products they sell to national mail order catalog houses; who, in turn, *advertise* these products—at approximately the same prices you *pay* for them.

No wonder you're waiting for a lot of customers who will never turn up. They're passing you by—thanks to the aforementioned manufacturers who, in effect, have been by-passing you.

No law says you have to take this lying down.

Channel Master never permits itself to forget that electronics is a service business. We recognize that our growth and

our whole future is closely tied to you, the service dealer.

Our entire operation is geared to this recognition.

**Take antennas**, for example. Over 35% of our business in this product is in fringe-areas, where big installations are a job *for a service dealer only*. The same holds true for Channel Master rotators, boosters, and other antenna accessories—all built to the service dealer's highest quality specifications.

**Replacement picture tubes?** The plant where Channel Master's superior tubes are made is the newest, largest, and most modern in the world; and it's equipped to meet your need for every kind of tube—including the hard-to-come-by types.

**Receiving tubes?** Channel Master Premium Quality Tubes show less than 1% call-back returns—lower than any major tube line.

It's against our policy, of course, to sell any of the above products to 1-step consumer outlets (or their captive discount chain stores)...that advertise at dealer prices.

Now that you know what side your bread is buttered on—what are you waiting for?

**CHANNEL  
MASTER**

ELLENVILLE, N.Y.

Makers of world-famous antennas, antenna accessories, picture tubes, and producer of outstanding transistor radios and tape recorders.

# 200,000 OHMS PER VOLT

## TRIPLET



**Model 630-NS  
VOLT-OHM-  
MICROAM-  
METER**

**\$99.50**

SUGGESTED U.S.A.—USER WET

**TRIPLET SUSPENSION MOVEMENT**  
no pivots . . . no hair springs  
no jewels . . . thus **NO FRICTION**

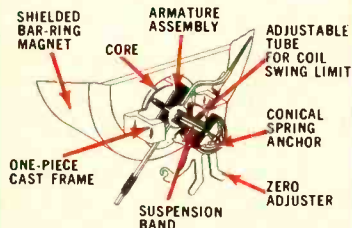

### FACTS MAKE FEATURES:

- 1** 200,000 OHMS PER VOLT D.C. for greater accuracy on high resistance circuits. 20,000 OHMS PER VOLT A.C.
- 2**  $5\mu\text{a}$  SUSPENSION METER MOVEMENT. No pivots, bearings, hair-springs, or rolling friction. Extremely RUGGED. Greater sensitivity and repeatability.
- 3** 62 Ranges, usable with frequencies through 100 Kc. Temperature compensated.  $1\frac{1}{2}\%$  D.C. ACCURACY, 3% A.C.

Low voltage ranges and high input impedance make the 630-NS especially useful in transistor circuit measurement and testing. Input impedance, at 55 volts D.C. and above, is higher than most vacuum tube voltmeters.

The unit is designed to withstand overloads and offers greater reading accuracy. Reads from  $0.1\mu\text{a}$  on  $5\mu\text{a}$  range. Special resistors are rigidly mounted and directly connected to the switch to form a simplified unit. Carrying cases with stands are priced from \$9.90.

**TRIPLET ELECTRICAL INSTRUMENT CO., BLUFFTON, OHIO**

### ADMIRAL

Color TV Chassis G11—3.58 Mc Reference Oscillator—Circuit Description

The 3.58 Mc reference oscillator is an injection lock type. The circuit utilizes a quartz crystal as used in the past, and the oscillator continues to operate whether or not a color transmission is being received.

The burst is coupled to the oscillator by the burst transformer and by this means the reference oscillator is synchronized with the 3.58 sub-carrier at the transmitter.

The color killer cut-off bias and the ACC (Automatic Color Control) voltage is developed by CR501 (ACC Det.) and its associated circuit. CR501 is connected in the 3.58 Mc reference oscillator circuit and rectifies the oscillator frequency. When burst is present, the rectified voltage ( $-\text{dc}$ ) increases and is sufficient to bias off the color killer. This voltage is also used to control the conduction of the 1st bandpass amplifier (V501A). The amplitude of the burst signal received determines the amount of  $-\text{dc}$  voltage produced; therefore, variations in burst levels are utilized to maintain a constant chroma level (ACC).

### MOTOROLA

Color TV Chassis T5-908—Service Experience Information

**Symptom:** Color indicator light burns all the time. No color. **Solution:** capacitor C912, .01 in T902 shorted.

**Symptom:** Overheating or burn up of resistor R802 in 275 v B+ line. **Solution:** Shorted capacitor C920 plate circuit of V21A, the blue demodulator.

**Symptom:** Picture smeared - low brightness. **Solution:** Green drive control R137A open.

**Symptom:** Left side of raster turns purple. Set appears out of convergence. **Solution:** C924,  $.1\mu\text{f}$  in plate circuit of V27B. G-Y amp open.

**Symptom:** No R-G vertical amplitude dynamic control action. **Solution:** Lead to red converge coil broken off.

**Symptom:** On color, can get only magenta. Hue control has little or no effect. **Solution:** Defective crystal oscillator tube or crystal.

**Symptom:** No channel 5. Other channels OK. **Solution:** Tuning slug not engaging drive gear because retaining spring on channel 5 strip missing.

**Symptom:** Poor blue horizontal dynamic convergence. **Solution:** Open or poor connection in plug P3 which supplies pulse.

**Symptom:** No color. **Solution:** Lead from color intensity control to main chassis not plugged in at chassis or making poor connection.

**Symptom:** Poor focus, brightness, lack of width. **Solution:** Capacitor, C522,  $.015\mu\text{f}$  in regulator circuit shorted.

**Symptom:** Uncontrollable, excess brightness. **Solution:** V10 — 6BH6 tube shorted.

**Symptom:** Insufficient range of blue lateral control. **Solution:** Be sure the blue lateral assembly is properly seated and positioned on CRT neck. Remove and discard the small metal clip from around blue lateral magnet if set has one.

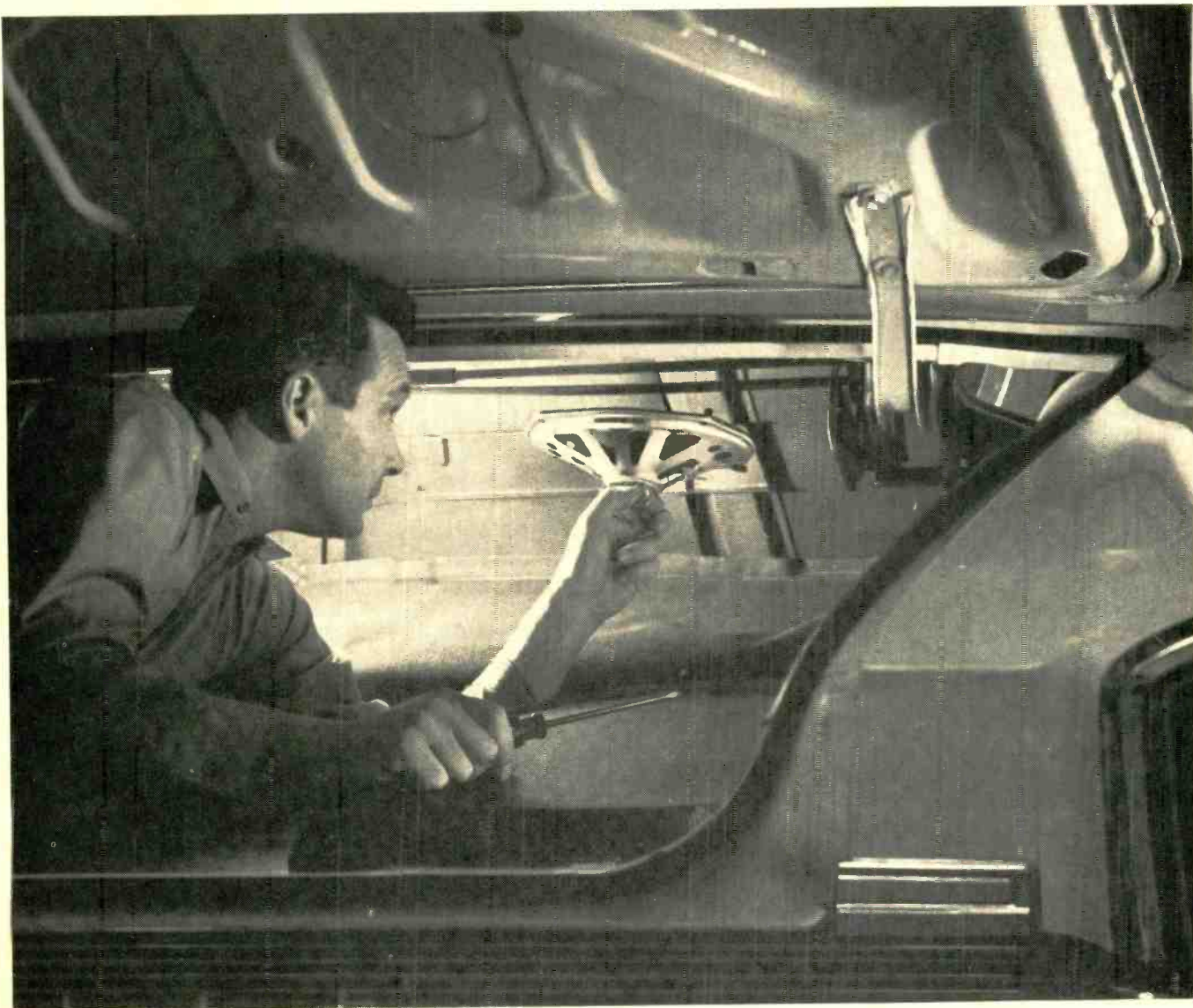

## How to make some sound money

Talk up rear-seat speakers! Here's a good profit item you can sell to your car-owning customers. And spring is the time when everyone wants one. If he doesn't have a rear-seat speaker now he's probably already half sold, just waiting for someone to ask him to buy.

The Delco Radio Universal 8-10-OHM 6"x9" Rear Speaker Package #6122 contains all material necessary for a quick, easy one-man installation. Will take "tip jack", "blade", or

solder connection. And you're sure of selling the "right kind" because these speakers are acoustically designed for use in cars.

This spring make some sound money on rear-seat speakers. For full information on the complete Delco Radio line of speaker packages and accessories, call your United Delco supplier.

DELCO RADIO, Division of General Motors, Kokomo, Indiana

# simply say **Delco**

**Delco Radio** Automotive Radio Service Parts and Electro-Mechanical Devices are distributed nationally through **United Delco**



# KIT OR ASSEMBLED!

Either Way, These HEATH Instruments Are Your Best Buy!



**A** Heathkit IM-21 Laboratory AC VTVM.  
 • 10 voltage ranges—0.01 to 300 volts RMS full scale • 10 megohm input Z  
 Kit IM-21, 5 lbs. .... \$33.95  
 Assembled IMW-21 ..... \$52.95

**B** Heathkit IM-11 VTVM ... Versatile!  
 • 7 AC, 7 DC, 7 Ohms ranges • Frequency response  $\pm 1$  db, 25 cps to 1 mc.  
 Kit IM-11, 5 lbs. .... \$24.95  
 Assembled IMW-11 ..... \$39.95

**C** Heathkit Wide-Band Oscilloscope  
 • 5 mc bandwidth • Sweep 10 cps to 500 kc • 5" screen with graticule  
 Kit IO-12, 24 lbs. .... \$76.95  
 Assembled IOW-12 ..... \$126.95

**D** Heathkit IM-13 "Service Bench" VTVM • 7 AC, 7 DC, 7 Ohms ranges • Extra-large 6" meter • Gimbal mounting  
 Kit IM-13, 7 lbs. .... \$32.95  
 Assembled IMW-13 ..... \$49.95

**E** Heathkit Variable-Voltage Regulated Power Supply • Furnishes B+, Bias, & Filament voltages • Fully metered  
 Kit IP-32, 16 lbs. .... \$56.95  
 Assembled IPW-32 ..... \$84.95

**F** Heathkit Audio Generator • Switch-selected output—10 cps to 100 kc • Near-perfect sine wave  
 Kit IG-72, 8 lbs. .... \$41.95  
 Assembled IGW-72 ..... \$64.95

**G** Heathkit "Solid-State" Regulated DC Power Supply • 0.5 to 50 v. • Up to 1.5 amp. • Less than 150 uv ripple  
 Kit IP-20, 13 lbs. .... \$72.95  
 Assembled IPW-20 ..... \$114.95

**H** Heathkit Battery Eliminator • Switch select 6 or 12 v. DC power • AC ripple less than .3%  
 Kit IP-12, 20 lbs. .... \$47.50  
 Assembled IPW-12 ..... \$59.95

**FREE CATALOG**  
 Fully describes these at over 200 other different and exciting Heathkits and savings of 50% or more! Fill out the coupon below and send for your FREE copy today!



HEATH COMPANY, Dept. 24-6  
 Benton Harbor, Mich. 49023

Please send my free 1965 Heathkit Catalog.  
 Enclosed is \$ \_\_\_\_\_, plus postage.  
 Please send model(s) \_\_\_\_\_

Name \_\_\_\_\_  
 (Please Print)

Address \_\_\_\_\_

City \_\_\_\_\_ State \_\_\_\_\_ Zip \_\_\_\_\_

Prices & Specifications subject to change without notice.

TE-134

## Canned

## Electron Tubes

Space-age scientists in San Carlos, Calif. are fairly sure they have achieved an unpredicted breakthrough over their Iron Curtain competitors.

The Californians are now turning out the world's first pack of electronic tubes — preserved in cans.

The fragile electronic components, used in radar and radio transmission systems on the ground and in missiles, are valued at \$10 to \$40 each.

Until now, the unsolved problem was to find a quick-opening package to protect each tube against corrosion and breakage.

Brooding over the problem while sipping their morning orange juice, engineers at Eitel-McCullough Inc., hit upon the answer: pack each tube in a can with an easy-open tab-top, just like the cans used for frozen citrus juice.

The American Can Co. turned out several thousand cans of the proper type and size. Tests showed that, when each tube is nestled in soft polyurethane foam and the can is sealed, the tubes remain unharmed even when test-dropped on a concrete surface from the height of a three-story building.

Hurried electronics technicians working at remote missile bases, radar installations or radio communications centers, no longer have to fumble for knives or can-openers to get at the tubes. The easy-open tops on the cans peel all the way off, at a pull of the metal tab, making removal of the tube a chore requiring only a few seconds.

Paper labels applied to the cans clearly identify the exact type tube inside, eliminating the possibility of selecting the incorrect component.

Cans used to pack the tubes are similar in size to the familiar cans used for fruits and vegetables. The bodies of the cans are made of tin-coated steel plate, while the easy-open tops are made of aluminum. ■



Space-age canned electron tubes.



The quality goes in before the name goes on

Choose from the complete line built to Zenith's high quality standards!

# ZENITH FAMOUS QUALITY TUBES

Zenith replacement picture tubes and receiving tubes meet the famous quality standards set for Zenith "original" parts—your assurance of the

world's finest performance! Wherever you are located, there's a Zenith Distributor near you, who can supply you quickly on a day-to-day basis.

## ZENITH QUALITY TELEVISION PICTURE TUBES

Complete line of more than 180 top-quality picture tubes . . . color, black-and-white, special purpose. These picture tubes have the same standard of quality that goes into Zenith television sets as original Zenith equipment.

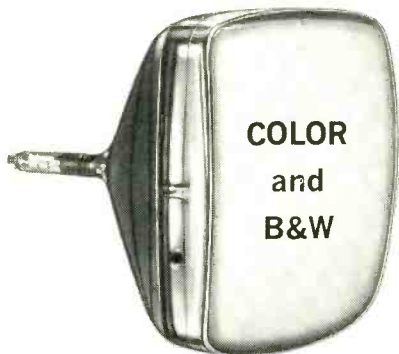

Zenith black-and-white replacement picture tubes are made only from new parts and material except for the envelope which, prior to re-use, is inspected to the same standards as a new envelope. In color tubes the screen, aperture mask assembly and envelope are inspected and tested to meet Zenith's high quality standards prior to re-use. All electron guns are new.

## ZENITH QUALITY "ROYALTY CREST" RECEIVING TUBES

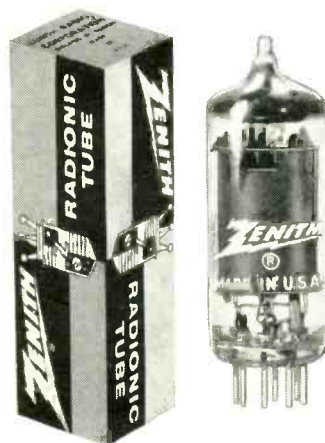

Complete line of more than 800 top-quality receiving tubes . . . made to the same quality standards as original equipment in Zenith products! More than 1,500,000 tube hours are accumulated every month by Zenith's life-testing under actual operating conditions. This insures that Zenith "Royalty Crest" tubes have greater reliability which reduces costly call-backs . . . and longer life which increases customer satisfaction!

Check the Yellow Pages for the Zenith Distributor nearest you. Or write to Zenith Sales Corporation, Parts & Accessories Division, 5801 West Dickens Avenue, Chicago, Illinois 60639, for Distributor name and information on Zenith quality replacement picture tubes and receiving tubes.

Specifications subject to change without notice.

# SYNC ON BUSINESS

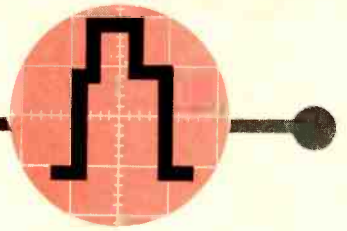

The electronic parts distributing business is on the brink of another revolution because of the impact of color TV, according to Gene K. Beare, president of Sylvania Electric Products. He advised distributors to . . . "help build up the strength of independent service organizations . . ."

• • •

Certified engineering technicians from every state in the Union will be in attendance at the first annual meeting of the American Society of Certified Engineering Technicians (ASCET), to be held June 18-19 at the Schroeder Hotel, Milwaukee, Wis., according to an announcement from the Society.

• • •

A TV replacement guide book — which may answer many of the questions you frequently ask — costs only \$1 (\$2 in a 3-ring hard cover binder). It covers practically every TV and radio set ever produced in the U.S. (and many foreign makes) for all transformers, coils, yokes and chokes. Available from Thordarson Meissner, Electronic Center, Mt. Carmel, Ill. 62863.

• • •

A free pocket alarm-timer worth \$3.95 goes with a capacitor promotion that costs you \$16.95. The capacitor kit contains 100 of the nine most used disc capacitors. At your Centralab Distributor.

• • •

A rugged tube caddy, capable of holding 365 tubes, is available from G-E. Has a rust-brown vinyl covering and a Bakelite handle guaranteed against breakage. See your authorized G-E distributor.

• • •

Undergraduate day and evening courses for 1965 and 1966 are detailed in a book available from the Newark College of Engineering, 323 High Street, Newark, N. J.

• • •

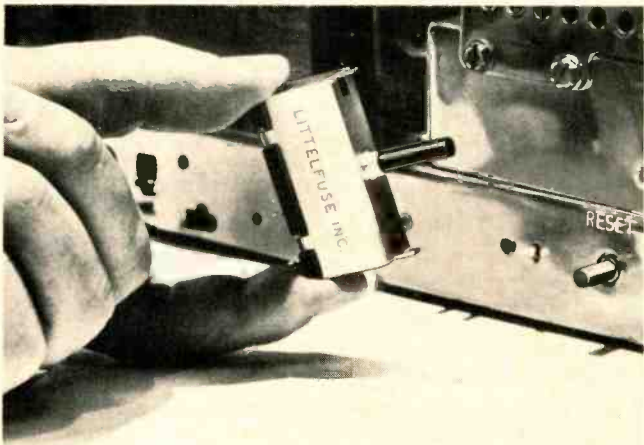

A manual reset circuit breaker, an exact replacement for all TV sets now using this type of circuit interrupter, is available through Littelfuse distributors.

A modern record player is being offered by Benjamin Electronic Sound Corp., 80 Swalm St., Westbury, L.I., N.Y., in exchange for acceptable ancient-vintage phonographs which are being collected and will eventually be made available to banks, schools and libraries as an educational service. Send a photo of the old phonograph, along with its description. *Don't ship the phonograph until you hear from them.*

• • •

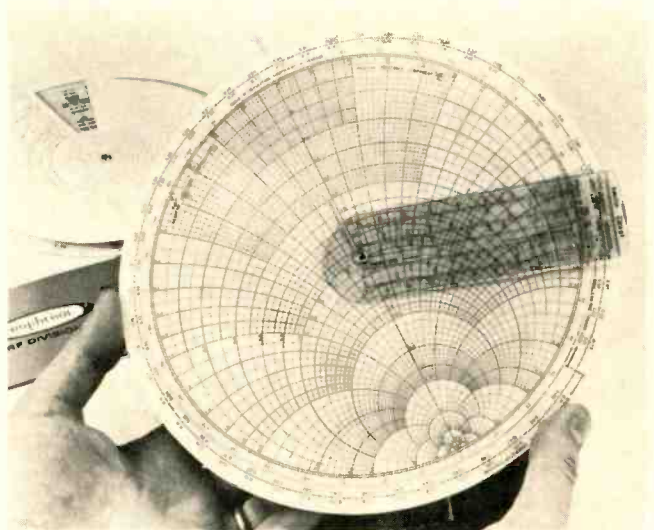

A transmission line calculator and circular slide rule is available from the Amphenol-Borg Electronic Corp. at a cost of \$3. The address is Business Services, Inc., Newton Road, P.O. Box 427, Danbury, Conn. Checks and MO's should be made out to "Business Services."

• • •

A free Xcelite nutdriver set comes with a special assortment kit of Elmenco capacitors. Known as Deal Number 150X, the kit contains 150 pieces of the ten most popular types of capacitors. The nutdriver set is PS120. At your distributor.

• • •

The "Seven Deadly Sins of Supervisors" is an interesting free leaflet available from the Society for Personnel Administration that may prove helpful to service-dealers. The address of the Society is 1221 Connecticut Avenue, N.W., Washing, D.C. 20036.

• • •

A transistorized inverter converts 12-vdc from auto or boat batteries to 117 v 60 cps ac at 125 w output. Bulletin is available from Electro Products Labs., 6123 Howard St., Chicago, Ill.

• • •

Selection and certification of proficient independent service outlets is now being carried out by Philco. If you are interested in the Philco Qualified Service Program, write to Philco Corp., Tioga & C Streets, Philadelphia, Pa. 19134.



# NOW! OVER 2700 REPLACEMENTS

with only 13 RCA Top-of-the-Line transistors

With RCA's "Top-of-the-Line" SK Replacement Series, you need only 13 transistors, including two matched pairs for ready replacement of more than 2700 types. In addition, RCA's two new SK-Series rectifiers—the SK3016 and SK3017—enable you to replace virtually any selenium or silicon rectifiers having comparable ratings.

Stock the complete SK-Series—13 transistors and 2 rectifiers. They will provide the answer to many of the replacement problems you face servicing auto radios, battery-operated portable radios, tape recorders, hi-fi equipment, phonographs, black-and-white and color TV, and other entertainment-type equipment using solid-state devices.

Accurate, comprehensive replacement information is given in the new 16-page RCA "Top-of-the-Line" Semiconductor Replacement Guide SPG-202. With it you have at your fingertips information on more than 2700 transistor types, including many of foreign manufacture—which the 13 RCA "Top-of-the-Line" types replace.

See your RCA Distributor about the RCA SK-Series, and be sure to ask for your copy of the RCA Semiconductor Replacement Guide.

RCA ELECTRONIC COMPONENTS AND DEVICES, HARRISON, N. J.



The Most Trusted Name in Electronics

## "Top-of-the-Line Replacement Transistors"

SK-3003	pn-p type, AF Driver and Output Stages (9 V Supply)	SK-3010	npn type, AF Driver and Output Stages of Broadcast Receivers
SK-3004	pn-p type, AF Driver and Output Stages (15 V Supply)	SK-3011	npn type, RF, IF, and Converter Stages of Broadcast Receivers
SK-3005	pn-p type, RF, IF, and Converter Stages of Broadcast Receivers	SK-3012	pn-p type, Audio Output Stages of Auto Radios
SK-3006	pn-p type, RF, IF, and Converter Stages of FM and AM/FM Receivers	SK-3013	Matched pair of SK-3009
SK-3007	pn-p type, RF, IF, and Converter Stages of All-Wave Receivers	SK-3014	Drift Field type for Output and Driver Stages of Hi-Fi equipment
SK-3008	pn-p type, RF, IF, and Converter Stages of Auto Radios	SK-3015	Matched pair of SK-3014
SK-3009	pn-p type, Audio Output Stages of Auto Radios	SK-3016	Silicon Rectifier for color, B/W TV, Radios, Phonographs
		SK-3017	Silicon Rectifier for color, B/W TV, Radios, Phonographs





# Don't Be 1/2 Set... With JFD LPV Log

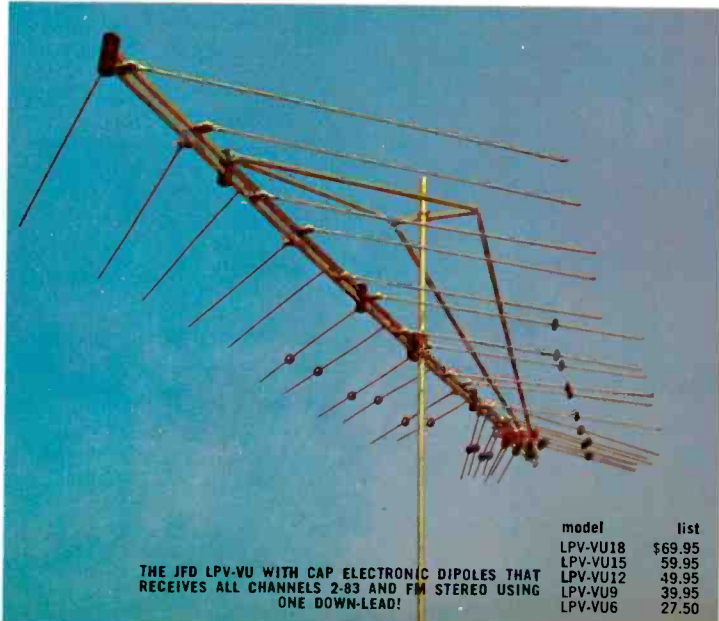

THE JFD LPV-VU WITH CAP ELECTRONIC DIPOLES THAT RECEIVES ALL CHANNELS 2-83 AND FM STEREO USING ONE DOWN-LEAD!

model	list
LPV-VU18	\$69.95
LPV-VU15	59.95
LPV-VU12	49.95
LPV-VU9	39.95
LPV-VU6	27.50

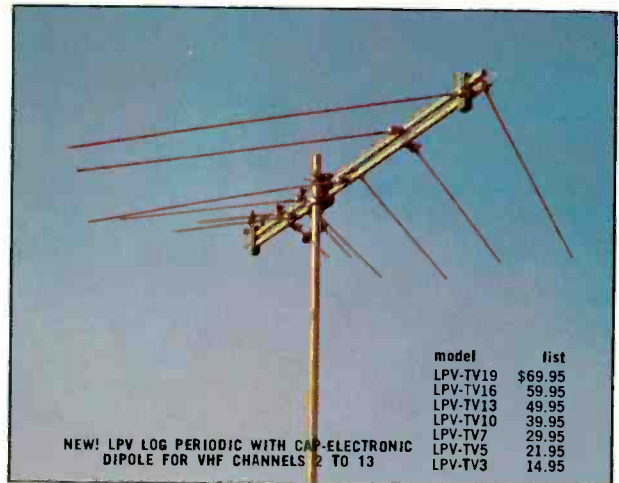

NEW! LPV LOG PERIODIC WITH CAP-ELECTRONIC DIPOLE FOR VHF CHANNELS 2 TO 13

model	list
LPV-TV19	\$69.95
LPV-TV16	59.95
LPV-TV13	49.95
LPV-TV10	39.95
LPV-TV7	29.95
LPV-TV5	21.95
LPV-TV3	14.95

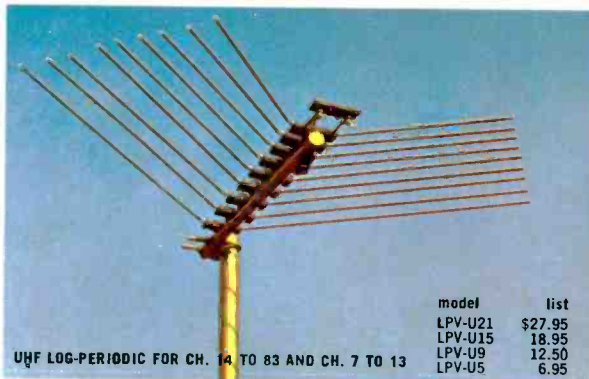

UHF LOG-PERIODIC FOR CH. 14 TO 83 AND CH. 7 TO 13

model	list
LPV-U21	\$27.95
LPV-U15	18.95
LPV-U9	12.50
LPV-U5	6.95

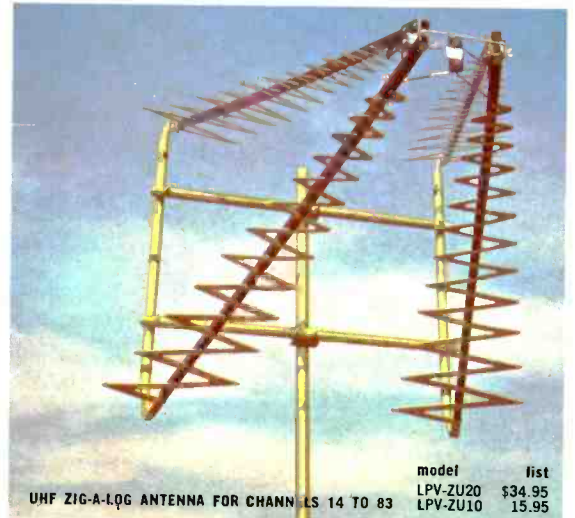

UHF ZIG-A-LOG ANTENNA FOR CHANNELS 14 TO 83

model	list
LPV-ZU20	\$34.95
LPV-ZU10	15.95

## Only JFD offers You LPV Log Periodics for VHF (Ch.2-13)...UHF

GET THE LION'S SHARE OF ANTENNA BUSINESS (FLATTEN CATV COMPETITION, TOO) BY FEATURING THE JFD LPV-VU LOG PERIODIC! THIS NEW GENERATION OF LOG PERIODIC ANTENNAS DELIVERS WHAT VIEWERS WANT—MANY MORE STATIONS...VHF CHANNELS 2 TO 13...UHF CHANNELS 14 TO 83...FM/STEREO. GIVES THE CLEAN, UNIFORM SIGNAL SETS NEED ESPECIALLY FOR VIVID COLOR RECEPTION.

Only the LPV follows the patented frequency independent Log Periodic antenna formula developed by the Antenna Research Laboratories of the University of Illinois. This new log periodic cellular concept provides you with a combination of gain, bandwidth, directivity and impedance match never before possible with conventional antenna designs.

You can actually see the difference in truer color purity, in greater contrast, in finer detail—not on just some of the channels but all of the channels! Small wonder more JFD Log Periodics were installed in the last 12 months than any other brand.

PREFERRED BY MORE N. Y. WORLD'S FAIR PAVILIONS... New York World's Fair exhibitors demand flawless color reception. That's why the House of Good Taste, Ma-

sonic Pavilion, Formica House, Eastman Kodak Exhibit, New York City Exhibit, House of Japan and other Fair showplaces chose the JFD LPV. This exclusive preference is pre-selling millions of Fairgoers—opening the door for more LPV sales by you.

WHY THE LOG PERIODIC IS THE MOST DRAMATIC BREAK WITH ANTENNA TRADITION SINCE DR. YAGI INVENTED THE YAGI... Up until the JFD Log Periodic, it was not possible to devise a truly broadband antenna except by "compromise" design that had to give up vital gain to get wider bandwidth... or had to degrade directivity for better impedance. Burdensome parasitics were piled on to try to compensate for gain "suck-outs", ghost-prone polar patterns, and inadequate bandwidth. This pyramided performance complications resulting in signal-sapping standing waves and impedance matches—and yet were only effective at the band edges.

Through the use of the revolutionary new logarithmic periodic formula, the entire frequency range is covered with dipole



# Be All Set— Periodic TV & FM Antennas

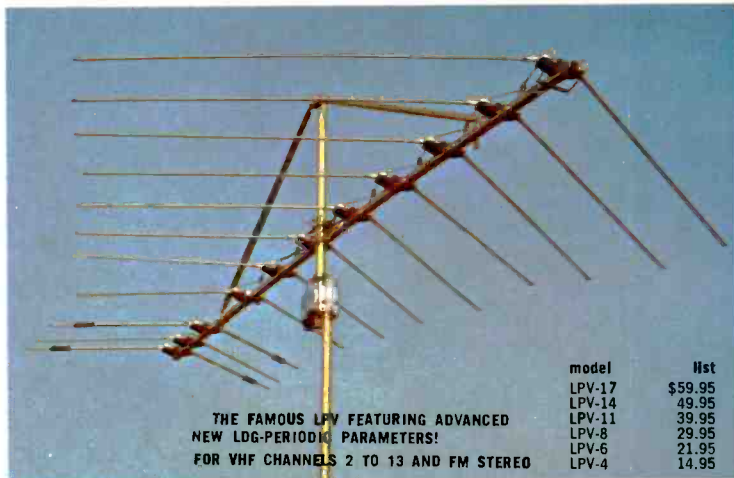

THE FAMOUS LPV FEATURING ADVANCED  
NEW LOG-PERIODIC PARAMETERS!  
FOR VHF CHANNELS 2 TO 13 AND FM STEREO

model	list
LPV-17	\$59.95
LPV-14	49.95
LPV-11	39.95
LPV-8	29.95
LPV-6	21.95
LPV-4	14.95

THE FIRST LOG PERIODIC TRAPEZOID INDOOR ANTENNA—  
FOR CHANNELS 2 TO 83  
ULTRA VU-VISTA VHF-UHF INDOOR ANTENNA



model	list
LPT283	\$12.50

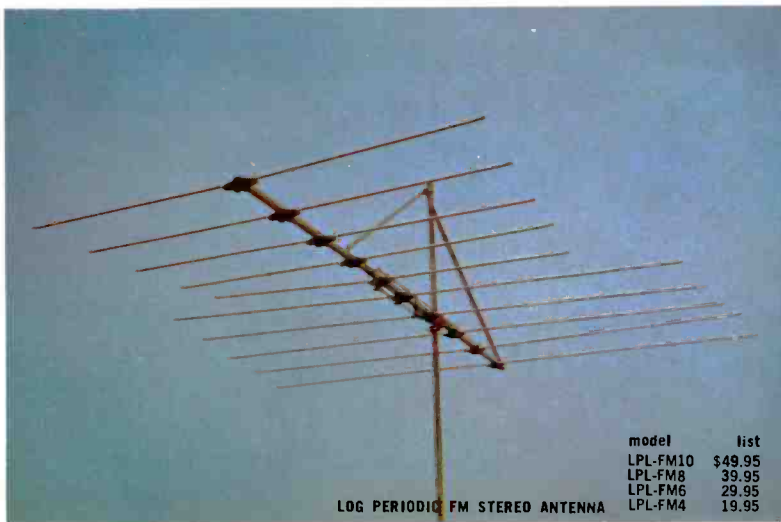

LOG PERIODIC FM STEREO ANTENNA

model	list
LPL-FM10	\$49.95
LPL-FM8	39.95
LPL-FM6	29.95
LPL-FM4	19.95



VU-VISTA UHF LOG-PERIODIC INDOOR ANTENNA—CHANNELS 14 TO 83

model	list
LPT-100	\$7.50

## (Ch. 14-83)...FM/Stereo...VHF/UHF/FM—**COLOR** & Black/White

groups (cells) of overlapping resonances. These harmonically resonant V-dipoles result in a frequency-independent performance. The LPV's inherently high gain, sharp directivity, 300 ohm impedance match and flat response are virtually constant across the entire band.

**AND ONLY THE JFD LPV HAS IT!** . . . The JFD LPV is the product of the world's largest and newest antenna laboratories. Here, in the JFD Champaign, Illinois R & D Research Center, a team of scientists and engineers, under the direction of Dr. Paul E. Mayes, are revolutionizing the state of the antenna art.

**MECHANICALLY SUPERIOR!** . . . **COMPARE CONSTRUCTION!** . . . Life-time stainless-steel take-off terminals that can never corrode, "tank-turret" element brackets, tough heavy-wall Implex A acrylic insulators, twin U-bolts with 6 inch mast grip span; supple, permanently riveted aluminum drive line rod; electrically conductive gold alodizing; plus a host of other exclusive mechanical improvements.

**FIGHT CATV WITH THE JFD LPV!** Keep CATV out of your area with JFD Log Periodics (such as the 82-channel LPV-VU) which provide viewers with more channels—sharper reception—richer color—plus FM stereo. Don't install inferior antennas that open the door to CATV. Install the best to get the best performance—the LPV!

**ADVERTISED IN LOOK, SUNSET . . . COMPARE ADVERTISING AND PROMOTION!** . . . A versatile selection of indoor and outdoor sales helps . . . advertisements in LOOK, SUNSET and other national and local consumer publications . . . in newspapers . . . on television . . . sell your best prospects.

Now is the time and your JFD distributor is the place to stock up and step up into big-league LPV Log Periodic profits.

**SEE WHY AT THE MOMENT OF TRUTH THE PICTURE IS THE PROOF THE JFD LPV LOG PERIODIC WORKS BEST!**

Licensed under one or more of U.S. Patents 2,958,081; 2,985,879; 3,011,168; 3,108,280; 3,150,376 and additional patents pending in U.S.A. and Canada. Produced by JFD Electronics Corporation under exclusive license from the University of Illinois Foundation.

**JFD** **JFD ELECTRONICS CORPORATION**  
15th Avenue at 62nd Street, Brooklyn, N. Y. 11219  
JFD Electronics-Southern Inc., Oxford, North Carolina  
JFD International, 64-14 Woodside Ave., Woodside 77, N. Y.  
JFD Canada, Ltd., 51 McCormack Street, Toronto, Ontario, Canada

copyright 1965, JFD Electronics Corp.



**Cathode-Ray Tubes.** Play it safe with known-for-quality Philco Star Bright 20/20 Picture Tubes.

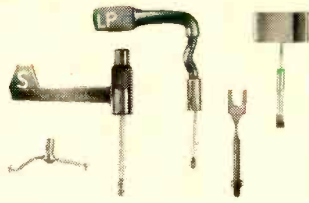

**Phonograph Needles.** Exact replacement for Philco Phonographs. Diamond, synthetic-sapphire or precious metal tips.



**Capacitors.** All values, sizes and shapes. Exact replacement for Philco plus all other makes and models.

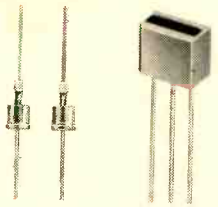

**Diodes and Rectifiers.** Complete variety for all makes and models. Precision-made to exacting Philco factory standards.



**4-Speed Record Changers.** Replacement record changers for all makes and models, for upgrading older sets or replacement.

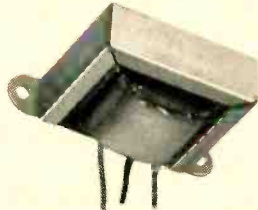

**Transformers.** For Philco and other makes. I.F.'s, outputs, yokes, power and all other transformers.

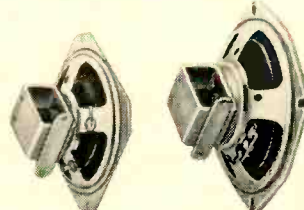

**Loudspeakers.** All sizes, shapes, magnet weights and impedances available for all makes and models.

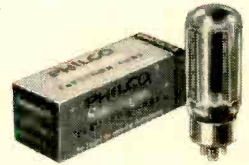

**Philco Receiving Tubes.** Made to rigid Philco standards. Thoroughly tested and inspected. For all electronic-circuit applications.

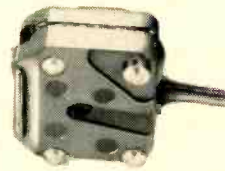

**Phono Cartridges.** Exact replacement for all Philco cartridges, plus models for all other phonographs.

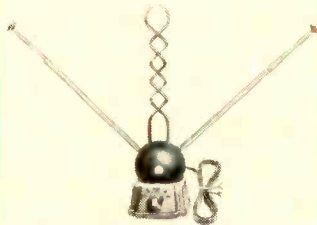

**Rotary Switch Indoor Antennas.** All types of indoor antennas available. Padded bases with or without selectivity switches.



**Remote Speakers.** For use with all radio and television sets and amplifiers. Connecting cables in assorted lengths also available.



**Controls.** For Philco and other makes, universal and exact replacement.

# All these quality parts...

## and more

# are at your Philco Distributor

Get all the parts you need in one quick stop at your Philco Parts Distributor. He has universal replacements for almost every radio and TV receiver made, a tremendous range of national-brand components and many profit-making accessories and extras. □ And your Philco Parts Distributor's services include valuable know-how and data on just about every Philco product ever made. □ When you're stuck, he's the man who can help you. □ If you're not getting this kind of fast, complete parts service, you should be. And you will when you start doing business with Philco.

PARTS & SERVICE DEPARTMENT  
**PHILCO**  
A SUBSIDIARY OF *Ford Motor Company*

# THE EXPLOSION IN UHF AND FM/STEREO

**Be prepared when a station opens in your vicinity — don't allow the vagaries to confuse and confound you**

■ A modest revolution in ultra high frequency TV telecasting and FM/stereo broadcasting has recently been superimposed on top of the knowledge, information and population explosions. And along with the general public-spending spurt which took place in the first three months of this year, UHF converters, antennas, preamplifiers, rotors, masts and new improved lead-in cable have been enjoying a brisk market. More income, in effect, has been finding its way into thousands of TV-radio service-dealer tills.

From coast-to-coast and from border-to-border — in cities where new UHF stations are opening and FM stations are switching to stereo multiplex — reports indicate that service-dealers and technicians were hard pressed to handle the business.

An outstanding and significant example, perhaps, was the planned opening of Channel 47, WNJU-TV, in Newark, N. J. Meetings co-sponsored by Channel 47 and UHF converter manufacturers were attended by almost 250 electronics dealers. The station plans to program New Jersey-oriented shows throughout the daytime hours, while devoting its primetime, nighttime schedule to Greater New York's minority ethnic audiences, including Spanish-speaking, Jewish, Negro, Italian, Polish, German and Irish viewers.

Channel 47's president, Edwin Cooperstein, announced a contest which provides free trips to Puerto Rico for consumers as well as for retailers. He also told the dealer meetings of promotional activity by manufacturers, including the distribution of in-store displays and window streamers in Spanish and English, to promote the sale of UHF converters, as well as advertising in the program guide and various newspapers. It was also pointed out that the station had purchased over \$1,000,000 worth of color and black-and-white telecasting equipment. With telecasting antennas atop the Empire State Building in midtown New York, it was estimated that close to 170,000 or more

UHF converters would eventually be sold as a result of the station's activities.

In Ann Arbor, Michigan, another report said that converters and UHF antennas had been moving at a rapid rate since Channel 50 and 56 had opened in that area. Extra technicians were being hired by some service-dealers. Many other similar reports from various sections of the country told the same gold-plated story. Manufacturers were kept busy dispatching trailerloads of converters, antennas and lead-in.

### **Special-Interest Programing**

Many of the new UHF stations in larger cities were programing heavily for "special-interest" and racial groups. It is too early to say if this approach for winning viewers from VHF stations will succeed. But some stations, on the air for a year or a little longer, are already beginning to move out of the red into the profit area. A large group of operators who already have building permits to establish UHF stations are planning to follow suit with similar programs for racial groups. In addition, college sports, horse racing, wrestling, golf and a variety of off-beat programs, not generally available on most VHF stations, are being planned. Some UHF stations have even gone in for bullfights and dramatic programs in Spanish. If these techniques succeed, it is believed that further expansion, over and above the increase in straight educational TV stations, will be assured.

### **Sour Notes**

One situation arose which some observers believed would "damper" UHF developments. A three-man FCC panel, fearing that UHF expansion in cities already having three VHF outlets, would result in financial failures among UHF stations, held that applicants for UHF stations in these areas must show that they have sufficient resources to remain on the air for at

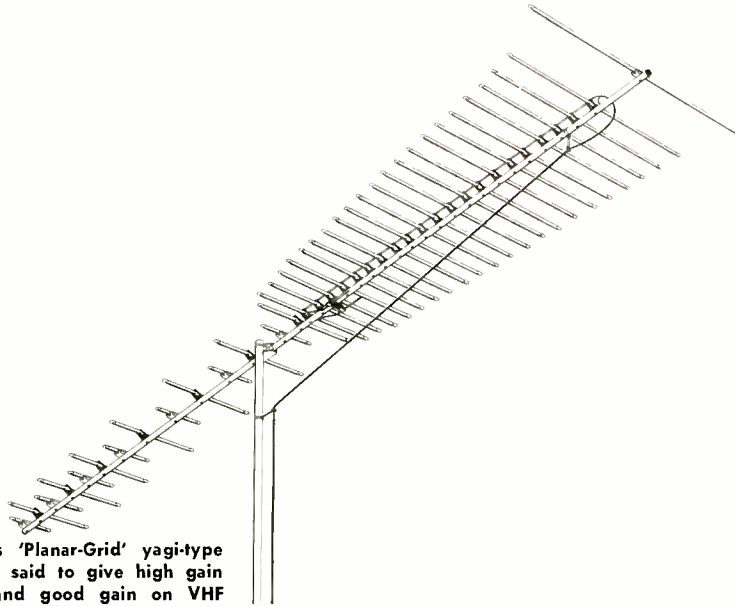

Winegard's 'Planar-Grid' yagi-type antenna is said to give high gain on UHF and good gain on VHF and FM with built-in coupler.

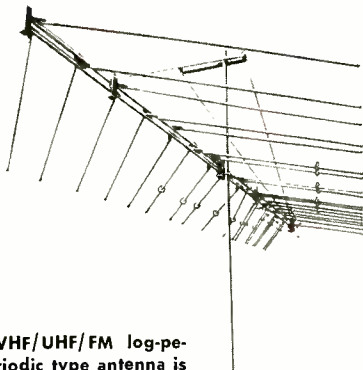

VHF/UHF/FM log-periodic type antenna is by JFD.

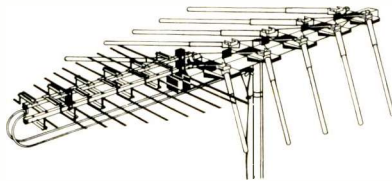

Finney's combination UHF/VHF/FM antenna.

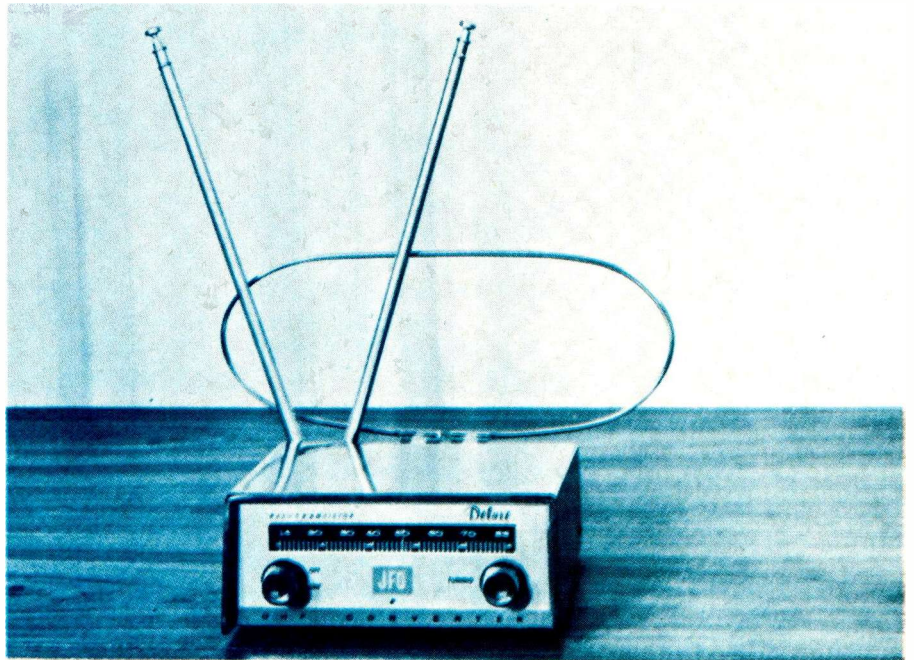

JFD UHF converter.

least three years. A final decision on this point is up to the full FCC membership.

Another discouraging note came from one city where a UHF converter manufacturer held one of a planned series of seminars, ostensibly designed to "provide the public with accurate information on UHF." Unfortunately, this effort was not directed entirely through TV-radio service dealers and technicians who are better prepared than any other group to accurately inform the public about UHF. In the case of the Detroit area seminar, at least, the main effort was directed toward educating salesmen in large department and other stores.

### Business and Technical Problems

Because of the hectic situation in some areas, together with the particular characteristics of UHF,

some service-dealers and technicians were running into problems.

Although the problems appeared to exist in two areas — both business and technical — a closer look indicated that they were primarily technical. Many technicians have not had experience with the peculiar characteristics of UHF: blocking and absorption of signals by mountains, hills, buildings and trees; lead-in losses and other problems.

In relation to FM/stereo, many technicians suddenly discovered that this broadcasting technique requires higher antenna gain for good reception.

Many found it difficult to reconcile manufacturers' equipment specifications and claims with results achieved under actual conditions. They began last minute "boning up" on UHF theory and requested further information from manufacturers on a variety of UHF

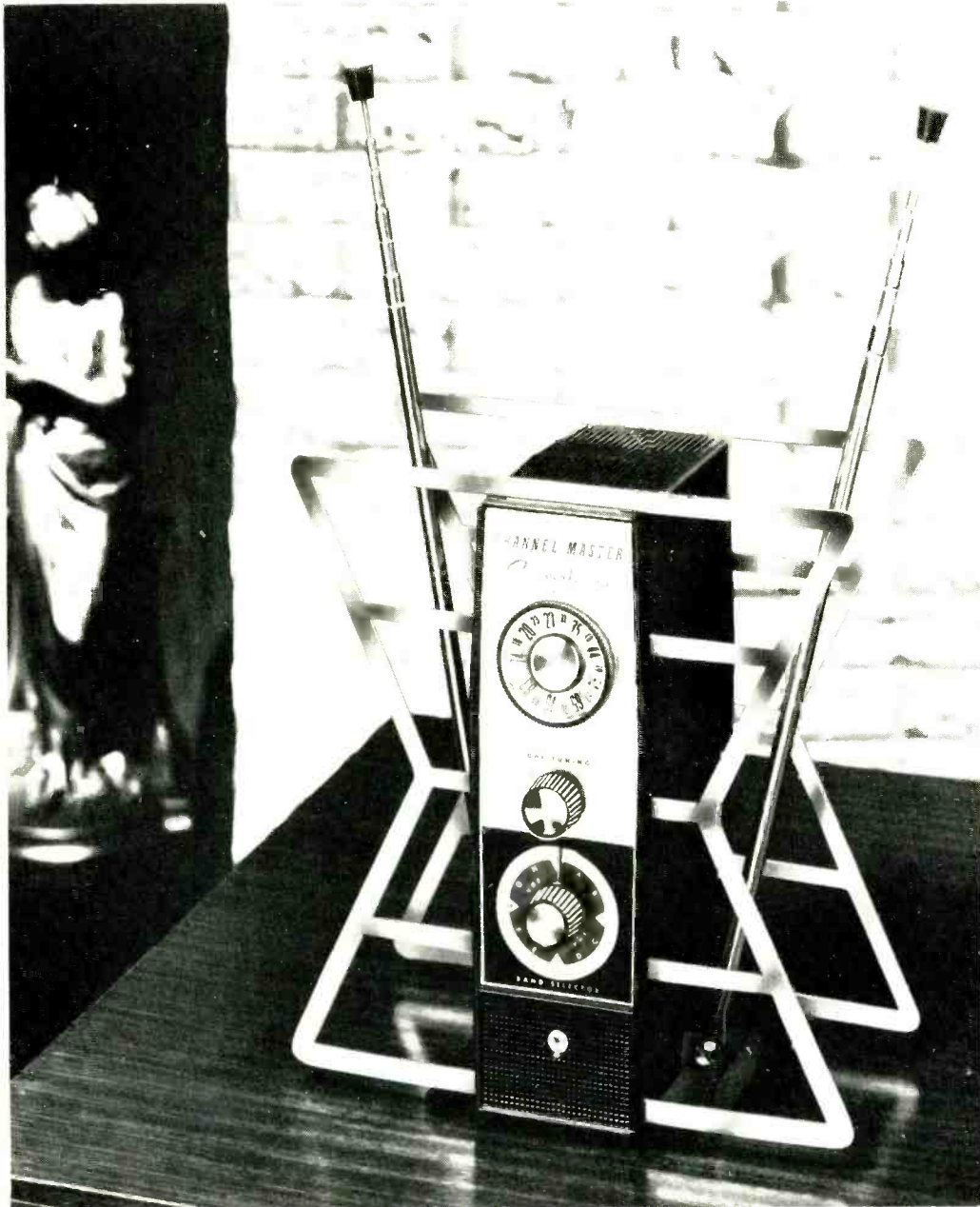

Channel Master's indoor UHF antenna has a transistorized UHF converter built in.

and FM/antennas, high-gain transistorized antenna boosters for fringe and far-fringe areas and UHF converters. Others were not sure whether they should recommend a UHF converter or put in channel strips to handle the UHF channel.

Still others were flabbergasted by certain events that appeared little short of "weird." For example, a number of installations — made in early spring — ceased to give satisfactory reception when foliage developed on trees.

Lead-in that worked reasonably good when installed, ceased to operate properly in spring rains.

Despite the problems, a consensus of opinion indicated that more business was coming in and that the possibility existed for continued expansion of UHF — with still more business for those who are thoroughly prepared to handle it. ■

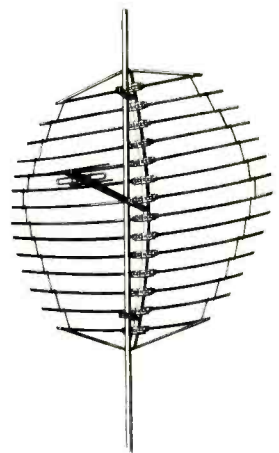

Parabolic UHF antenna by Finney.

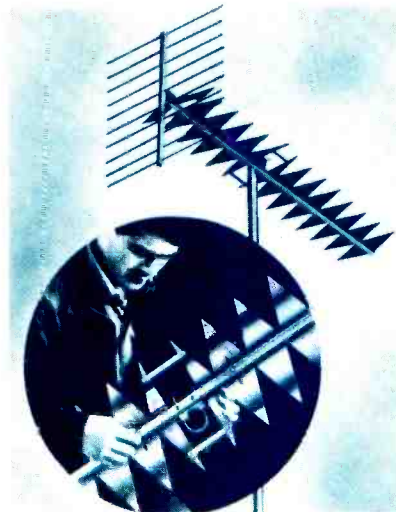

'Bandsaw' UHF antenna is adjustable to give narrow or broader coverage over a portion or all of the spectrum. By Channel Master.

# Converting VHF Sets

Provide your customers with the best possible solution to their  
ultra high frequency reception problems

by Jerome Balash

Blonder-Tongue Labs.

All-Transistor, All-Channel UHF converter/amplifier.

■ Until the new, all-channel TV sets are in wide use—which will probably take five or more years—you will be called upon to convert VHF-only TV sets to receive UHF stations in many localities. And any TV set that now receives channels 2 to 13 can be adapted to receive one or more UHF channels.

As we already know, there are a number of approaches to converting VHF receivers to UHF. Most TV set manufacturers provide UHF "dealer conversion kits" for this purpose. Other UHF television converter kits are also available for in-cabinet installation.

In some cases, one or more UHF channels can be received by substituting channel strips in turret-type VHF tuners. But this system may not function satisfactorily except in strong signal areas.

## Set-Top All-Channel Converters

It is generally understood that compact, set-top, all-channel UHF converters—somewhat smaller than most table-model radios—offer the best approach to UHF conversion. UHF converters of this type are quickly and easily installed and usually require minimum maintenance. They are available in both electron tube and transistorized types. The transistorized (solid state) converters are considered more reliable and provide longer life and lower noise ratios. Average life of solid state converters is con-

servatively estimated—under present state-of-the-art conditions—to be in the vicinity of 10 years. And, because they tune over the entire UHF spectrum, from channel 14 through 83, they provide full coverage at any time and in any locality. These converters are available with or without amplification. Amplified-type converters are generally recommended in many fringe and far-fringe areas when the UHF signals are weak and below normal requirements. This is particularly true where color programs are being telecast.

Some modern solid-state converters, designed for prime signal areas, operate on an ordinary flashlight battery which may last from six to nine months. Some use tunnel diodes for high reliability.

## Antenna and Lead-In

No matter what kind of converter you install for your customers, it is necessary to provide an adequate antenna. This may be a combination VHF/UHF or straight UHF type. In some localities, according to research done by the FCC, indoor antennas operate satisfactorily. But make sure the antenna is capable of providing satisfactory reception during all hours of the day and all seasons of the year. Except for indoor antennas, ordinary flat twin-lead should not be used. "Foam-filled" or open-line types should be used with outdoor anten-

nas to guarantee reliable reception under all weather conditions.

## Maintenance Problems

You should not encounter too many problems with well designed converters—especially the solid-state types. Tuner contacts may require occasional cleaning. A good aerosol-type contact cleaner should prove satisfactory for this.

Some converters are installed in sealed cabinets. If these units are not easily opened they should be returned directly to the factory for repair. If a converter begins to tune erratically or does not tune easily, it is best to return it directly to the manufacturer if you have not had wide experience in servicing UHF equipment. Manufacturers' warranty service is usually inexpensive and the factory can provide quick and efficient service because production line personnel and factory parts are readily available.

Some converters have been found to have what is known as "hot" numbers for certain UHF channels. These converters may pull in a very strong signal, or be "hot," for channels 72 through 80, for example, while giving weak reception on channels 14 through 56. It is almost impossible to predict the causes of this malfunction, but in general it is possible to compensate for this deficiency in certain sections of the UHF band by installing a higher gain antenna.



# To UHF

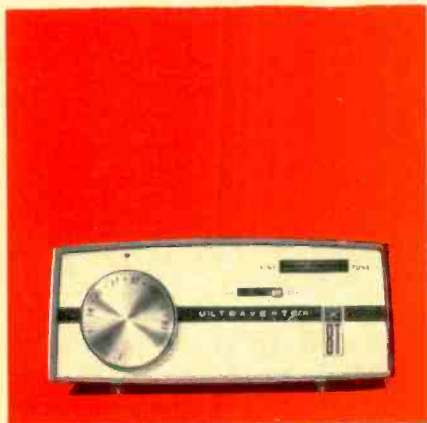

Costs of converters are approximately equal between the different brands currently on the market. And, it goes without saying, established manufacturers with brand-name products generally offer the most reliable converters.

## **Let Them Know**

Unfortunately, most technicians are not very good salesmen. But they can become much better salesmen with a very small amount of extra effort. For example, to sell UHF converters in areas where UHF stations are located, it is only necessary to inform prospective customers of the facts about UHF.

Besides the additional reception coverage, UHF is superior to VHF in a number of ways. Within its range, it produces a sharper picture because man-made electronic "noise" and atmospheric interference is much less on UHF than on VHF channels.

In addition, UHF is almost completely free from "airplane flutter," "ignition noise" and medical diathermy equipment.

In areas where UHF stations are now located or where stations are being planned, each home service call you make offers the ideal opportunity to inform your customers—and make more money for yourself by selling UHF converters and UHF antennas. ■

TV actress Zina Bethune ('The Doctors and Nurses,' CBS-TV) has added a converter to her set to receive UHF stations.



# TUNER TECHNIQUES

'Scoot' learns more about gassy and shorting tuner tubes

by Joe Hayes

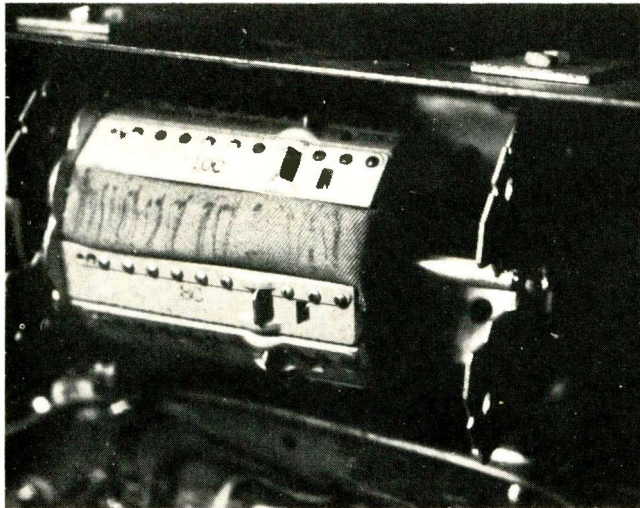

Fig. 1—Cloth sprayed with tuner cleaner and attached to spare channel strip keeps tuner fixed contacts clean.

■ "Hey Bob!" Scoot yelled. "Somebody stuffed an old rag in this tuner."

Bob walked to Scoot's bench and looked over his shoulder.

"That's one I put there, Scoot. It keeps the tuner contacts clean when the tuner is subjected to more than an average amount of dust. Isn't that Murphy's set?"

"Yeah."

"Well, after they had the set about two months they called me in to repair it. Nothing was wrong except dirty contacts. I cleaned it and forgot it until they called me about two months later. The same thing was wrong. This time I noticed the chassis was covered with dust.

"When I cleaned the tuner this time I wrapped a piece of cloth around one of the unused channel strips. Each time the channel selector is turned, the cloth wipes the stationary contacts." (See Fig. 1.)

"Well, why does Murphy's tuner get dirtier than anyone else's tuner?"

"Oh, come on, Scoot. They live out on Turkey Pen Road. Every car that goes by kicks up the gravel and lays dust for half a mile. I put that cloth there about a year ago. Is that what's wrong with it now?"

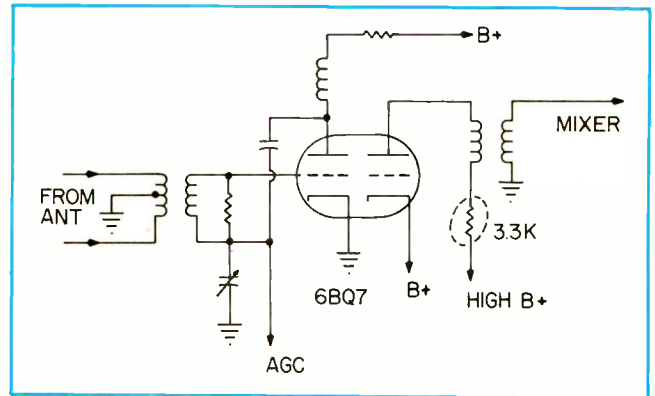

Fig. 2—The 3.3K resistor frequently overheats and changes value or burns open entirely.

"It doesn't act like it, Bob. To tell the truth I don't know what's wrong with it. It acts like dirt on the contacts or an intermittent connection."

"Did you check the tubes first?"

"Uhh—no. I thought . . ."

"I know. You thought you'd do something else first. Scoot, you just got your Journeyman Technician's certificate; I thought it might give you a little more incentive to do a better job but you still do the most difficult things first. What's so hard about checking a tube?"

"It's not that it's hard, Bob. But you've 'brain-washed' me to substitute tubes whenever in doubt and now that you've got me working on tuners you tell me that I have to test first and then substitute if necessary. I don't get it."

"It's really very simple, Scoot. Maybe I should have told you why instead of just 'do it.' You see, most tuner tubes on the sets that I've been giving you have a tendency to short or burn out because of a tuner malfunction. We can't afford to burn out a \$2 tube for the extra few seconds work-time.

"If a tube checks shorted or open, you should make a few resistance measurements before you substitute a new tube. It can save a lot of time and trouble."

"OK Bob. It just seemed kind of stupid without knowing why. I'll check 'em."

Scoot busied himself checking the tubes and Bob went back to a color alignment he was doing. The telephone jangled and Bob answered it since Saturday was his 'girl's' day off.

"Factory TV Service; Bob speaking. May I help you? Oh, Hi Screwy. What can I do for you? . . . Sure. Scoot is working on one now. By the time you get here he should be ready to start on another. OK. I'll see you then.

"Screwy, over at A-1 TV, is going to bring over a set that's giving him trouble. He thinks it may be the tuner and that maybe a fresh mind can do some good on it."

"You mean you're going to turn me loose on a 'tough dog' tuner when I can't even fix the easy ones yet?"

"Why not? Usually they aren't tough at all. Screwy probably has worked himself into a rut. You can fix it."

Scot wasn't delighted with Bob's confidence in his ability or enchanted with the idea that he would have to work on something that another technician had been 'playing' with. He finished checking tubes.

"There's a short in this 6BQ7 Bob. Now what?"

"Take resistance readings around the socket. If they're OK, put in another tube. If not, find out what's wrong."

A moment elapsed before Scot announced that he thought the plate resistance was 'off.' Bob looked surprised.

"That's unusual. You've probably got a high resistance plate resistor in there. Tube shorts open them up sometimes but more often just increases their value slightly."

"Well, why do you say it's unusual then?"

"Very simple, Scot. The total resistance for that circuit from plate to ground is about 100,000  $\Omega$  or so. If the plate resistor goes from 2700 to 5000  $\Omega$  it can rarely be detected. In this case it looks like the resistor has almost burned completely open." (See Fig. 2.)

"Hey, you can see this one! It's really burned. Guess I'll have to check the schematic to see what its value is . . ."

"Don't bother, Scot. That series uses a 3.3 K resistor and they burn out frequently. Later sets have 'em mounted outside the tuner, so it really helps."

Scot soldered in a new resistor, put in a new 6BQ7 and switched the set on. It looked good so he put it on one of the racks to cook.

Just then Screwy bounced into the shop struggling with a '56 vintage set with yoke and speaker dangling from the chassis.

"Ready for this one, Bob?"

"Sure. Let Scot have it. Show him where you want it Scot."

"I can't stay Bob," Screwy cut in. You'll have to tell me what you find later. I've got a couple of calls to make down the street. I'll pick up the set Monday if you have it ready then."

"Making calls in my territory huh?" Bob asked jokingly.

"Well, you know how it is Bob. We experts are in demand."

They both laughed and Screwy left. Scot was already connecting the rat's nest but not very enthusiastically.

"Hey—he didn't even say what was wrong with the set!"

"That's good Scot. It won't contaminate your thinking. You don't want *his* thinking anyway; if it were any good he would have located the trouble himself."

Scot switched the set on and a strong negative image showed on the screen.

"I give up," Scot said.

Bob was getting used to Scot's weird sense of humor and just laughed. A few months ago he would have flaired up, but Scot had been working for Bob about a year now; full time for about the last three months.

"Come on, Scot. You know where you're supposed to start. Check the tubes!"

"But Bob . . ."

"But nothing. Check those tubes. You have to start on a 'dog' like that just as if no one had touched it."

A few minutes later Scot found a tube that was a 'little gassy' (Fig. 3). Substituting a new tube cleared the trouble.

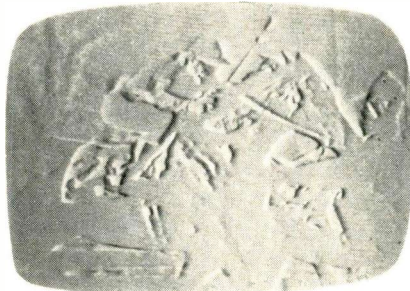

Fig. 3—Negative picture caused by gassy tube.



Fig. 5—Multiple images (ringing) caused by mis-match.

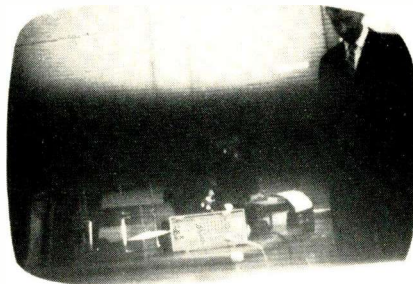

Fig. 4 (A)—A 60 cps bar in picture — usually caused by cathode-heater tube leakage.



Fig. 4 (B)—A 120 cps ac signal causes two bars in picture — usually because of filter leakage in full-wave power supply circuits.

"I don't get it Bob, how can a gassy tube cause a negative picture?"

"By delivering too much signal to the CRT. That's another unusual problem Scot. Most of the time a gassy tuner tube will drag the B+ down enough to kill the oscillator."

"I wonder why Screwy couldn't fix this one?"

"He probably checked the tubes in a tester which didn't have a good gas check. After they checked OK in his tester he probably thought it would be unnecessary to substitute."

"What's next, Bob. It looks like we've got everything fixed that we have parts for. Those two flybacks are supposed to be in Monday."

"Well, one of our loaners has a problem—interestingly enough it looks like a tuner problem too. Don't let it throw you though. It could be almost anything."

Scoot switched the set on and waited for it to warm up. The picture came on with one dark heavy bar through it. The bar moved slowly through the picture. (Fig. 4A.) He knew this was 60 cps hum since 120 cps hum would display two bars. A 120 cps hum is usually caused by a bad filter in the power supply (full wave) where 120 cps ripple is present.

Scoot went through the procedure Bob outlined and checked the tubes first. The mixer had a cathode-to-heater short. He replaced the tube with a good one and the bar disappeared.

Now that Scoot could see the picture more clearly he noted that the set had multiple images. (Fig. 5.)

"What do I have to do with this one, Bob, change the antenna or can I look at the set first?"

"I'll let you assume that the antenna is good on this one Scoot. I want you to take a good look at those images, though. They can tell you a lot about the problem."

"What do you mean?"

"The first thing you can do when you see ghosts is check some of the other channels. If the images are about the same on all the other channels, chances are it's a set fault. On the other hand, if it is different on each channel it's a real ghost, probably caused by signal reflections from high buildings or mismatch in the antenna system.

"Here, we know that the picture has the same type of ringing on all channels. This means then, that it is a set fault. Now, if you turn the fine tuning control you can isolate the trouble to one or another section of the set."

Scoot turned the fine tuning and watched.

"What do you see Scoot?"

"Well, the number of ghosts—reflections—change, their spacing changes and the first one turns negative."

"OK. That tells us that the trouble is not in the video amplifier. It would make it a lot easier if the images didn't change because we could pinpoint the trouble to the video amplifier. We've only narrowed it down slightly; we've got to narrow it still further but we do know that the trouble is in the tuner or the video IF."

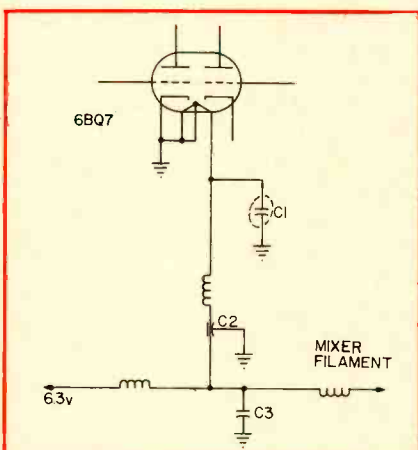

Fig. 6—'Scoot' wired in a bypass capacitor to ground and the ringing disappeared — but now the picture was a little snowy.

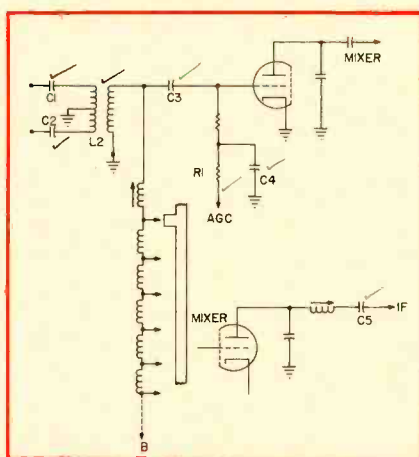

Fig. 7—Components in tuner checked off by Bob for Scoot to investigate.

"That doesn't seem like much help to me."

"In a way it isn't, Scoot. About the only thing you can do with these things is check the alignment to see what's wrong with the RF and video IF response. Poor neutralization in the tuner and poor coupling between the RF amplifier and the mixer present the biggest problems.

"A lot of times you can get around this though, by taking a small bypass capacitor and shunting all the filament leads in the tuner. Poor bypassing is sometimes the trouble. One caution though, Scoot: Anytime you have to go into the tuner don't 'monkey' with the lead dress. Changing one of the leads may make an alignment necessary."

Bob once again went back to the color set and Scoot started shunting the filament bypass capacitors in the tuner.

"Hey by gosh. I found it. That's the first time I've ever fixed a tuner's 'inards'!"

Not so fast, Scoot. Wire a new one in before you get carried away."

Scoot wired in a new bypass capacitor (Fig. 6) and the ringing was gone. He noticed that the picture was a little snowy though and he reported it to Bob.

"Check all the channels and make sure they are all that way. If they aren't, you know you have a problem that can be caused by a dirty contact or a misadjusted oscillator slug. If the trouble is apparent only on the low or high band channels, the mixer section may be at fault; it may possibly be an alignment job.

"If the trouble is in all channels, the AGC, RF amplifier or any number of components could be at fault."

"It looks about the same on all channels to me."

Scoot substituted all the IF tubes and both tuner tubes but the problem persisted.

"One thing you have to watch," Bob cautioned, "is component substitutions. Watch the lead length, dress and body capacity while you hold the capacitor in your hand.

"Well what do I do now?"

"Alignment is the best check. I've found there are a couple of easy checks which will help you spot the

trouble before you go that far though. First, of course, you'll want to make voltage measurements. Be particularly careful of AGC and B+ readings. These are critical. In fact, one way to check AGC is to connect a bias box on the tuner and IF AGC lines. If adjusting the bias on either of these lines makes the picture considerably better, you have AGC circuit troubles.

"In fringe areas some technicians tie the AGC connection in the tuner to ground. Where local and distant stations both have to be received they put a switch on the line to re-connect the AGC for local reception.

Continued on page 76

# You and Color TV

## Understand the burst signal as the key to proper color reproduction

by Don R. Borden

■ In a previous article of this series we described some of the important chroma circuits. We will now review color synchronization circuitry. Color sync circuits are an integral part of a color receiver and technicians should thoroughly study their operation and learn how to troubleshoot and align them. If these circuits are not functioning properly the set will not reproduce true color hues.

In B/W transmission the vertical and horizontal sections are synchronized with the transmitter by timing pulses which are transmitted at proper time intervals. In addition to the vertical and horizontal sync pulses, a color TV set requires further sync information to keep it in step with the transmitter. This information is transmitted as a burst of RF energy at the local 3.58 Mc oscillator frequency. A number of special circuits are required in the receiver to process this burst signal.

Customer satisfaction and a fair and reasonable profit are the goals of every TV shop. Achievement of these goals depends wholly on the technician himself. He must get the job done quickly, thoroughly and accurately. And especially in color TV, he must thoroughly understand circuitry and color principles.

### Burst Sync Signal

At the transmitter, the color signal modulates a 3.58 Mc subcarrier in quadrature (90 deg out of phase). This is done with a pair of balanced modulators. One modulator output contains sidebands of the 3.58 Mc subcarrier formed by modulating the subcarrier with the B-Y color signal. The output of the second modulator is also a series of sidebands which are the result of using the R-Y signal to modulate the same 3.58 Mc carrier after it passes through a 90 deg phase shift. Modulator outputs are then combined to form a *resultant* which modulates the main picture carrier.

Because the subcarrier is suppressed by balanced modulator action in the transmitter, a carrier must be reinserted at the receiver. This carrier must be locked in frequency and phase with the original transmitter signals. A local 3.58 Mc oscillator is used in the receiver to supply this carrier. Correct phase relationships are maintained by a synchronizing signal sent out by the transmitter. This signal consists of a burst of about 8 cycles of the 3.58 Mc color subcarrier frequency and is sent during each horizontal blanking interval. The burst is timed to appear on the "back porch" (following the horizontal sync pulse) of the horizontal blanking pulse (see Fig. 1).

These 8 cycles of the subcarrier frequency become a part of the composite video signal and are used as a reference signal to insure correct color reproduction in the demodulators. And the burst signal rides along on the video signal which is finally applied to the burst amplifier stage.

### Color Sync Block Diagram

As shown in Fig. 2, the composite video signal is routed to the burst amplifier. The amplifier is normally at cutoff and is keyed by a pulse from the horizontal section of the receiver and the stage is operative only during the horizontal retrace period. This coincides with the time the burst is received so only the burst signal is permitted to pass through this stage. It rejects

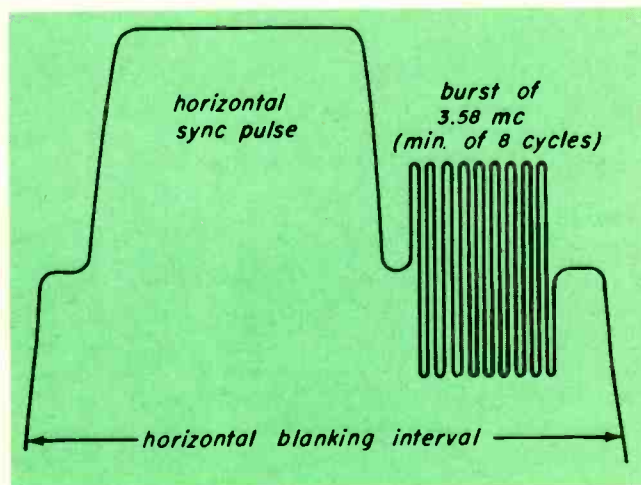

Fig. 1—The color burst is sent during the horizontal blanking interval following every horizontal sync pulse.

the remainder of the video signal. The burst amplifier, therefore, amplifies the burst signal and separates it from the composite signal.

The separated signal is then fed to a phase detector circuit together with a sample of the 3.58 Mc local oscillator signal. The phase detector circuit is very similar in operation to a horizontal AFC circuit employed in B/W sets. Here the two signals are compared and if a difference in phase or frequency exists, a correction voltage is developed. This correction voltage is applied to a reactance tube which acts as a variable capacitance with the varying correction voltage causing a capacity change in the stage. The reactance stage then varies the capacitance of the grid circuit of the local

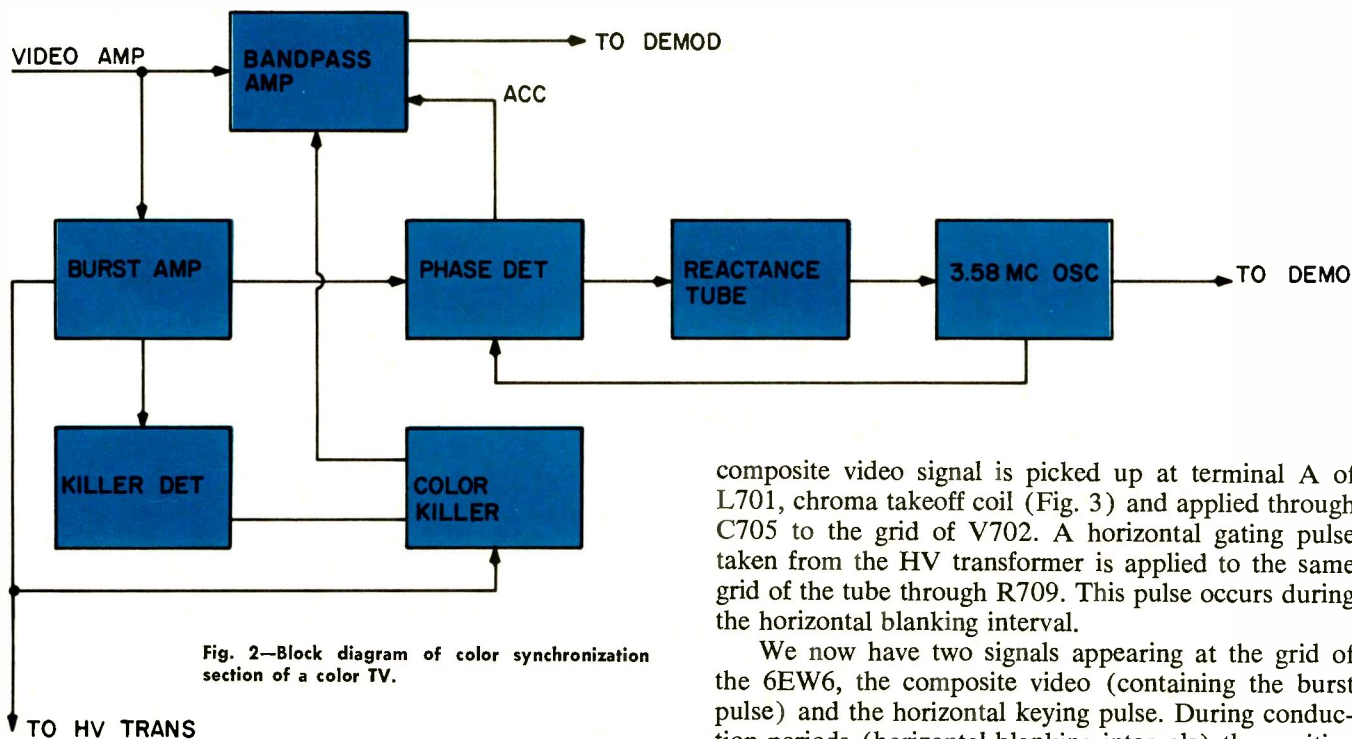

Fig. 2—Block diagram of color synchronization section of a color TV.

oscillator which controls the oscillator frequency. Any variation in phase or frequency of the local oscillator is reflected back through the reactance stage to the oscillator grid. In this manner the frequency and phase of the 3.58 Mc oscillator are kept within very stringent limits. The oscillator is invariably a highly stable crystal controlled type which maintains practically a zero phase error and drift-free signal. Extreme accuracy is necessary for proper color reproduction.

In some sets an automatic color control (ACC) voltage is taken from the phase detector stage; this dc voltage varies with the amplitude of the burst signal and forms the bias voltage of one of the bandpass amplifiers. The gain of the bandpass stage is then dependent on the strength of the signal. This prevents signal amplitude changes from affecting the hue and saturation of the colors on the CRT screen.

A color killer detector circuit is very similar to a phase detector. Both the burst and a 3.58 Mc sample are fed to this stage. The circuit is designed so that the burst signal causes a negative voltage to be developed when color is being transmitted. This negative voltage is then used to control the following stage—a color killer control tube. A description of these circuits will be given later. The function of the color killer stage is to turn a chroma amplifier off and on.

During B/W transmission the dc voltage developed by the color killer disables one of the chroma amplifiers, thereby preventing noise and other unwanted signals from reaching the CRT. When color signals are received the color killer tube is "turned off," removing the bias voltage from the chroma amplifier and allowing color information to pass.

#### Burst Amplifier

Burst amplifiers (separators) perform much in the same manner as a sync separator in a B/W set. The

composite video signal is picked up at terminal A of L701, chroma takeoff coil (Fig. 3) and applied through C705 to the grid of V702. A horizontal gating pulse taken from the HV transformer is applied to the same grid of the tube through R709. This pulse occurs during the horizontal blanking interval.

We now have two signals appearing at the grid of the 6EW6, the composite video (containing the burst pulse) and the horizontal keying pulse. During conduction periods (horizontal blanking intervals) the positive keying pulse causes the tube to conduct heavily. While the tube is conducting, C706 charges and between pulses it begins discharging through R706. The time constant of this circuit is long enough to maintain cutoff bias on the tube until the next horizontal pulse. As a result, the tube conducts only when the burst signal is being transmitted. The amplified burst then appears across the primary of T702.

When the front panel control, R143, in the secondary of T702, is varied, the effective capacitance of the tuned circuit changes. This change in capacitance alters the incoming burst signal phase. A change in burst phase at this point will appear as a change in hue or tint on the CRT.

#### Phase Detector

The phase detector compares the incoming burst signals with a sample of the local oscillator signal. As shown in Fig. 3, the burst signal is coupled through T702 to one diode plate of V705A and to the second diode cathode. With the center tap of T702 secondary at ground potential, the voltage appearing at terminal B of T702 is equal in amplitude but 180 deg out of phase with the voltage at terminal C. The local 3.58 Mc oscillator signal is fed through C722 to common connection, pin 2 of V705A. The local signal is applied in equal amounts to the first diode cathode and to the second diode plate.

When the local oscillator frequency is 90 deg out of phase with the incoming burst, leading in one diode and lagging in the other, the instantaneous voltages across the two diodes are equal. When this situation exists, no voltage will appear at the junction of R716A and 716B. If the phase or frequency of the local oscillator should change, one diode will conduct more than the other and a correction voltage will be developed at the junction of the two resistors.

Polarity of this correction voltage will depend on

whether the oscillator phase leads or lags the burst and is also dependent on whether the frequency of the oscillator is high or low. A lagging phase or a lower frequency will produce a negative correction voltage. A positive voltage will be generated by a leading phase relationship or by a higher local oscillator frequency. This correction voltage is then fed to the reactance tube (V703A) which corrects the frequency and phase of the local oscillator.

### Reactance Tube and 3.58 Mc Oscillator

V703A is employed as a reactance control tube in the circuit shown in Fig. 3 and the tube plate is coupled to the grid through C709. This 4 pf capacitor in series with R746, the 1500  $\Omega$  ac ground return, presents a high capacitive reactance to the 3.58 Mc feedback signal. This causes the current to lead the voltage by about 90 deg. The voltage across the grid resistor, R746, is in phase with the current. With the plate current in phase with the grid voltage, and the grid voltage leading the plate voltage by 90 deg, the plate current then leads the plate voltage by 90 deg. The tube supplies a leading current and therefore acts like a capacitor. The correction voltage applied to the tube grid changes the bias slightly and effectively changes the tube capacitance.

C717 and L702 are part of the frequency determining circuit of the oscillator (V703B). The reactance tube is in parallel with these components and when the capacitance of the tube is changed the frequency of the oscillator will be altered.

The screen grid of V703B acts as the plate of the oscillator. Coupling to the plate takes place in the electron stream. The reactance tube in parallel with C717 and L702 in series with crystal Y701, form the frequency determining portion of the circuit. With the variable reactance tube and the crystal we have a very stable oscillator whose frequency and phase can be controlled.

The oscillator output is taken from the plate of V703B and fed with the proper phase shift to the demodulators. A portion of the output is also applied through C722 to the phase detector circuit.

### Color Killer Circuits

In Fig. 3, the killer detector stage, V705B, is very similar in operation to the phase detector (V705A). One major difference is that the 3.58 Mc signal is fed in phase with the incoming burst. To accomplish this, the local 3.58 Mc signal is taken from the secondary of T703 and fed through a divider network and applied in phase (with the burst) to the common connection, pin 8 of V705B.

The burst signal is applied through C740 and C741 to the cathode of the lower diode and to the plate of the upper diode (V705B). A 180 deg phase difference exists between the burst signal applied to the upper diode and the portion applied to the lower one.

The circuit is designed so that when normal burst is present a high negative voltage is formed at the junction of R750A and R750B. This negative voltage

*Continued on page 80*

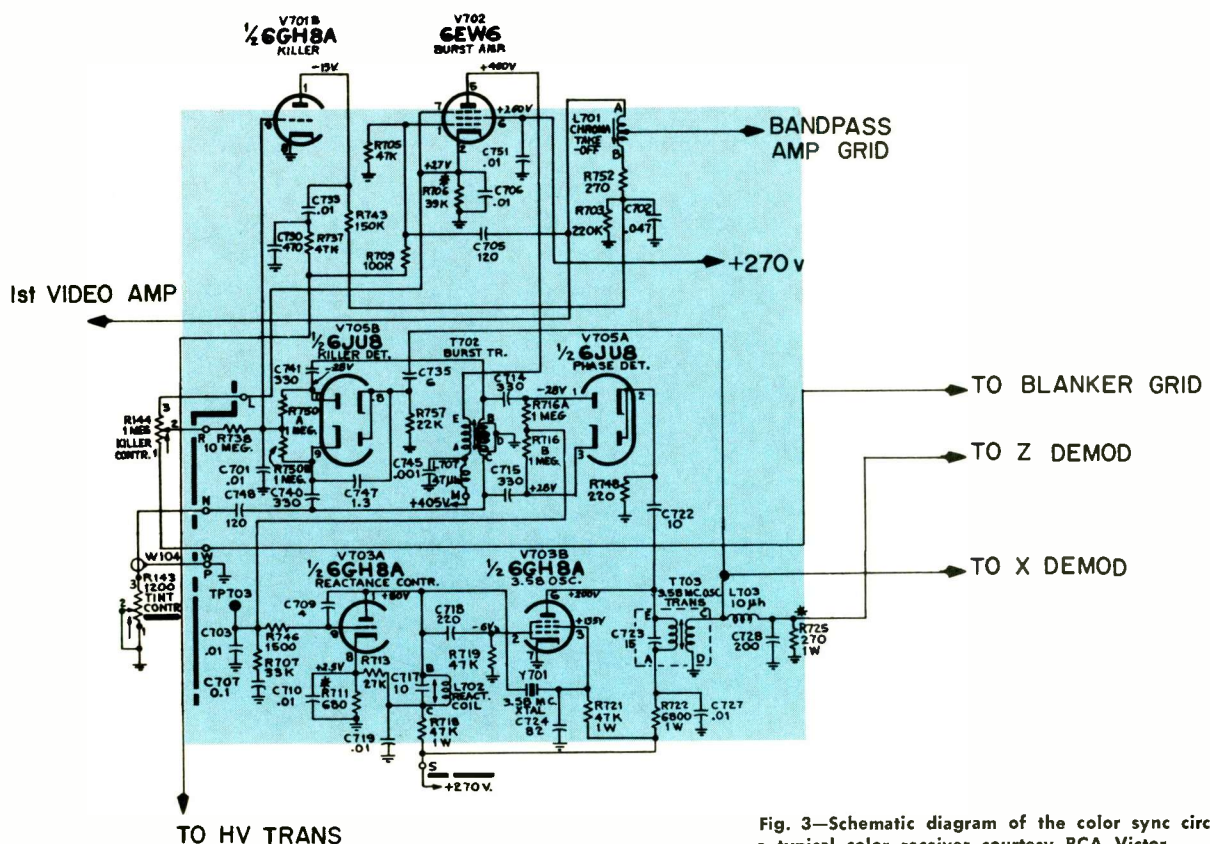

Fig. 3—Schematic diagram of the color sync circuits of a typical color receiver courtesy RCA Victor.

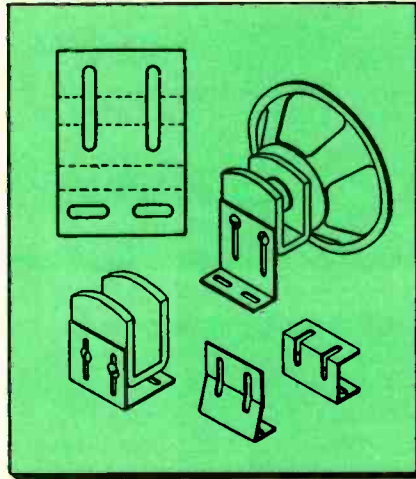

Fig. 1 — Universal type bracket can be bent to shape so it fits most installations.

by *Herbert F. Brett*

Quam-Nichols Co.

# Replacement Speakers

## Important facts about a

■ Loudspeaker replacement problems are quite different today than they were a number of years ago. The electro-dynamic speaker, with wire wound field coils, was then in common use. Some loudspeakers used in TV sets required field coils of low resistance (60 to  $90\Omega$ ) and high current rating, as much as one third amp. Very few speaker manufacturers made this type of speaker for the replacement market so technicians had difficulty obtaining exact replacements.

Many odd shaped brackets were used for standard mounting methods and most were not available for replacement. The most successful substitute was the universal bracket (Fig. 1) which was available from several manufacturers of replacement speakers.

Loudspeakers today are quite different, with the great number of speaker types creating the major replacement problem. The large variety of round, oval and foreign types makes exact replacements difficult to obtain. Special speakers of shallow design, inverted magnet structures or other custom designs complicate matters further.

### Oval Speaker

The oval speaker was originated by a speaker manufacturer for one

of the larger radio set manufacturers who wanted something different to advertise. Most claims made for the superiority of the oval speaker were questionable. Although the first oval speaker was designed as an advertising "gimmick" it soon became a much needed speaker for the design of radio and TV sets. Because of their shape, oval speakers permit a reduction in cabinet size.

The response of an oval speaker, although not as good as from a round speaker, is quite satisfactory for most TV and radio uses.

### Radio Speakers

Radio replacement speakers can be divided into several classifications: pocket size transistor type, larger transistor type, ac/dc, auto and Hi Fi types. In pocket transistor sets the major problem is the very small size. Since the parts in these sets are crowded together, the speaker diameter, depth and magnet dimensions become critical considerations. Foreign-made pocket sets use 2 in.,  $2\frac{1}{4}$  in. and  $2\frac{3}{4}$  in. types with voice coil impedances of 8 or  $12\Omega$ . American made sets use the same size speakers but voice coils vary from 8 to  $100\Omega$ .

Larger transistor sets may have 3 in.,  $3\frac{1}{2}$  and 4 in. speakers and some may have 3x5 or 4x6 size

ovals. Many of these sets have conventional mountings while others have slotted mounting holes. Speakers with slotted mounting holes are usually not available from replacement speaker suppliers. In many cases, technicians can carefully drill or ream out mounting holes to utilize the standard speaker. In larger transistor sets the necessary voice coil impedance may be difficult to obtain since it may run from 3.2 to  $130\Omega$ . Some replacement manufacturers will make up speakers with special voice coil impedances.

Speaker replacement problems are not quite as severe on ac/dc radios. We still have the slotted mounting hole problem which can be taken care of with a tapered reamer or by drilling. Voice coil difficulties are practically non-existent since these speakers all use 3.2  $\Omega$  voice coils, although an occasional 8  $\Omega$  voice coil may be found. Most sets are now using speakers with the smallest possible magnet, but if space allows it is advantageous to use a speaker with a larger magnet. Loudspeakers used for ac/dc type sets vary in size from 3 in. to a 4x6 in. oval.

### Auto Speakers

Just a few years ago auto radio speakers were either 4x7 or 6x9



types. Although these are still being used, more recent cars require either the 5x8, 6x10 or 4x10 with the 4x10 being the most popular. Practically all auto sets today are either hybrid or all-transistor with a rather wide range of voice coil impedances being used. For older sets we still need a 3.2  $\Omega$  voice coil speaker but the all transistor type uses 8, 10, 20, or 40  $\Omega$  impedances. Most manufacturers can supply exact replacement speakers for recent model automobiles.

An interesting development in auto replacement speakers has been

the introduction of the multi-tap speaker. This speaker is actually made with dual 20  $\Omega$  voice coils which, when connected in series, parallel or series parallel, provide voice coil impedances of 10, 20 or 40  $\Omega$ . This speaker appears to be replacing single impedance speakers on parts jobbers' shelves. Foreign auto radios require 4 in., 5 in. or 4x6 in. speaker sizes which are not usually listed in replacement catalogs but many technicians indicate that replacements can often be made from existing stock on distributors' shelves.

### Hi Fi Speakers

The replacement of speakers in Stereo/Hi Fi equipment may cause some unusual problems because of the large variety of speaker sizes and types now being used. The price and quality of the speaker varies almost directly with the price of the unit. Quality speakers are seldom used in small inexpensive record players. A manufacturer may test many combinations of cone, voice coil and magnet weights to select the speaker that sounds best in the small cabinet or enclosure used. Speakers of general replacement quality may be used in repairing most lower priced equipment.

Larger Stereo/Hi Fi sets can be classified under several groups. Less expensive sets are classified under Group "A" and Group "B" includes the more sophisticated units. In Group "A" usually one and sometimes two speakers per channel are used. In most cases a replacement quality speaker will work satisfactorily. Group "A" sets usually do not use an LC dividing network and the midrange speaker (if one is used), is connected in parallel with the woofer and the voice coil impedance might be several times that of the woofer so that its shunting effect on the woofer is lessened. In most instances this speaker can be removed from the circuit without injuring the performance of the set. Group "A" sets may also use tweeters which are either connected in parallel with the woofer or have a 2 to 5  $\mu\text{f}$  capacitor in one lead. Such tweeters are available on the replacement market in many sizes.

Group "B" Stereo/Hi Fi sets employ from three to six speakers per channel. In most Stereo/Hi Fi sets the speaker system is built around the larger speaker, which may be an excellent quality extended range speaker, a good quality speaker of standard range or a true woofer. Extended range speakers are readily available and a good quality standard range unit can also be found at most distributors.

Replacement of woofers presents more of a problem because of the large variety used. The better qual-

*Continued on page 74*

### sometimes difficult service problem



# More About

by Harry Abramson

International Resistance Co.



A typical dealer kit from which approximately 88 percent of all TV, radio and Hi Fi replacement controls can be selected.

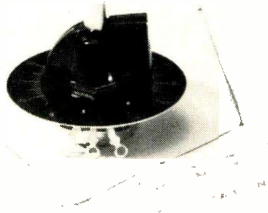

Fig. 1—Resistance element taper can be checked with a uniformly calibrated dial and knob.

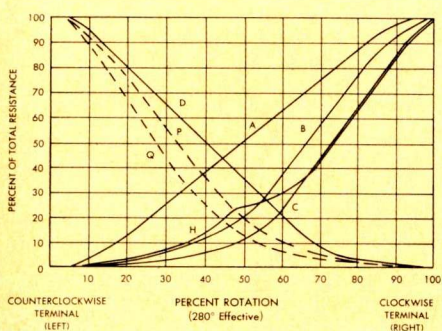

Fig. 2—The standard tapers are identified as: (A)—Linear taper for potentiometers or rheostats where uniform resistance change is required. (B)—Left-hand semi-logarithmic curve for tone control or audio circuit control. (C)—Left-hand logarithmic curve for audio circuit control. (D)—Right-hand semi-logarithmic taper used in contrast circuits in TV. (H)—Tapped left-hand logarithmic curve for audio level control for automatic bass compensation. (P&Q)—Right-hand semi-logarithmic curve—reverse taper used in contrast and picture control circuits in TV. (S)—Special taper—based on specific specifications.

■ Every service-dealer and technician knows by now that time is money! The faster you can handle control failures, the quicker you get on to your next job, and more jobs mean greater profits!

It's a sad moment when a technician doesn't have a replacement part. Running to a parts distributor every time a control is needed is just not practical; ordering from the original equipment manufacturer is usually too time-consuming!

To help you solve these problems, replacement control makers have developed kits from which high quality, economical controls can be readily assembled into duplicate units. These kits provide a broad, balanced assortment of front and rear resistance sections, mountings, shafts, switches and special accessories. They offer service technicians wide coverage and versatility at a modest price—not to mention on-the-spot replacements.

Complete information and instructions on how to assemble these replacements are provided in kits which are carried by most electronic parts distributors.

If you feel your replacement control volume does not justify a dealer kit, compromise! Stock the fastest moving universal controls. A good control inventory for the average-size shop is shown in Table I.

## Universal Control Requirements

Two features stand out in a versatile universal control. The shaft should be insulated as well as flatted, slotted, and knurled. This permits its use in receivers with hot chassis.

Terminals should be wire-wrap designed. This will double for the solder lug as well as the printed-circuit variety.

Occasionally, you may come across a control that has no part number for replacement information reference. Then you must go to the local parts distributor, or original equipment manufacturer, for a

replacement. A handy check list which enables you to call-out the pertinent control characteristics is shown in Table II.

Before buying a replacement control, it is a good idea to measure the maximum depth available and the point of closest obstruction on the sides of the control. This information will help you select the proper size control, one that's not too large to mount.

A control's taper requirements are also important—just as significant as the resistance value. But you do not need to worry about duplicating the taper exactly to achieve satisfactory circuit performance. It's enough to know whether it's a left-hand, right-hand, or linear taper.

Here's an example of what we mean. A volume control having a 10 percent left-hand log taper (10 percent resistance at 50 percent rotation) can be substituted for a 20 percent left-hand log taper (20 percent resistance at 50 percent rotation). Substituting a linear taper, however, would crowd the selectivity into a small segment of the rotation.

Likewise, a right-hand log taper, when connected as a rheostat, provides greater wattage dissipation for contrast controls than a linear or left-hand log taper.

Tapers can easily be determined by using a dial and pointer knob set-up (Fig. 1) and measuring the resistance and plotting the curve of the control at 25, 50, and 75 percent rotation. Resistance measurements should be made between the left and center terminals. After plotting the curve, identify it from the standard tapers, (Fig. 2).

Most controls need no special attention after installation; but the "bias" control in transistorized output stages demands a great deal of precaution. (Fig. 3).

This control adjusts collector current by varying the bias. It should be installed with the contactor in the full clock-wise position. If set

# Replacement Controls

Understand replacement controls, save hours, raise work output, and multiply profits

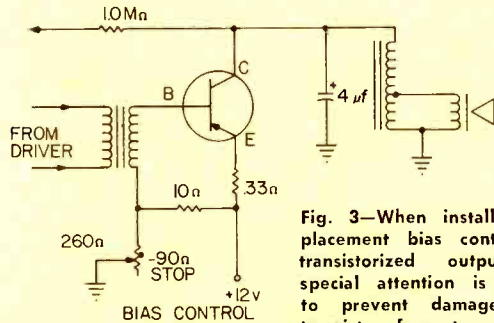

Fig. 3—When installing a replacement bias control on a transistorized output stage, special attention is necessary to prevent damage to the transistor from too much current.

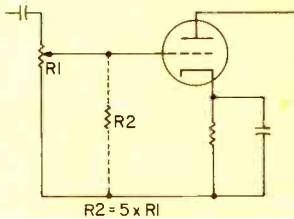

Fig. 4—When all other methods fail, a grid return circuit is a good way to reduce control noise.

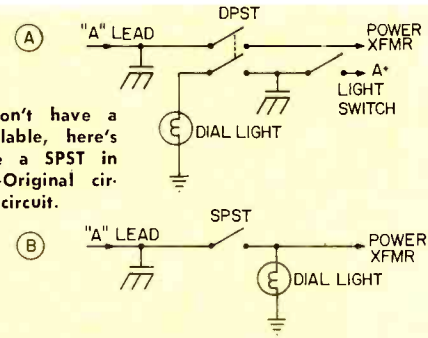
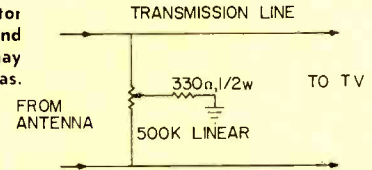

Fig. 5—If you don't have a DPST switch available, here's how to substitute a SPST in auto radios. (A)—Original circuit. (B)—Revised circuit.

Fig. 6—This simple attenuator will eliminate distortion and 'ghosts' which boosters may produce in strong signal areas.



at full counter-clock-wise or minimum resistance, a possibility exists that too much current will be drawn and the transistor damaged. For this reason, many bias controls have a fixed minimum resistance.

## Bias Setting Procedure

Here's how to set the bias on automobile radios:

1. Connect the set to power supply and adjust to *exactly* 12 v. Radio should be at normal volume.
2. Watch the power supply ammeter and turn bias adjustment to point of lowest current drain.
3. The output should now be distorted. Advance bias control just beyond the point where distortion disappears.
4. Check for distortion at different volume levels. If no distortion, bias is set at optimum point.
5. If distortion is noted at high volume, advance bias setting more. If no improvement, return to original setting.

This procedure should be followed whenever replacing an output transistor as well as a defective bias adjuster. Quite often, it is found better than the manufacturer's sug-

Table I SUGGESTED TECHNICIANS CONTROL STOCK							
EQUIP.	QUANTITY	FUNCTION	RESISTANCE VALUE	TAPER	MOUNTING	SWITCH	UNIVERSAL SHAFT (Knurled, flattened, and slotted)
R	2	Volume Control	500KΩ	L.H. Log	3/8"-32, 3/16" Bush.	SPST	1/8" Diameter
A	2	Volume or Tone	50KΩ	"	"	None	1/4" Diameter
D	2	Volume or Tone	100KΩ	"	"	None	"
I	4	Volume Control	500KΩ	"	"	SPST	"
O	3	Volume Control	1.0MΩ	"	"	SPST	"
T	1	Volume Control	500KΩ	L.H. Log	3/8"-32, 1/4" Bush.	SPST (Push-Pull)	1/4" Diameter
E	2	Volume Control	1.0MΩ	"	"	"	3/16" "
L	2	Volume Control	1.0MΩ	"	"	"	3/4" "
E	2	Volume Control	1.0MΩT @ 250 KΩ	"	"	"	3/16" "
V	2	Contrast	1000Ω	R.H. Log	"	None	1/4" "
I	2	Contrast	30KΩT @ 10KΩ	R.H. Log	"	"	1/4" "
S	2	Height or AGC	2.5MΩ	Linear	Tab Mount	"	Insulated, 1/4" Diameter
I	3	Height or AGC	5.0MΩ	"	"	"	"
O	1	Height or AGC	7.5MΩ	"	"	"	"
M	2	Linearity,	500	"	Flange Mount	"	Screwdriver Slot
	2	Hold, AGC,	1000	"	"	"	"
	2	Centering,	1500	"	"	"	"
	2	Locking and	3000	"	"	"	"
	2	many others	5000	"	"	"	"
	1	Focus	5000Ω, 4 watts	"	3/8"-32, 1/4" Bush.	"	1/4" Diameter
	2	Bias Pot.	5Ω	Linear	Tab Mount	"	Screwdriver Slot
	2	Bias Pot.	15Ω	"	"	"	"
	2	Bias Pot.	100Ω	"	"	"	"
	2	Bias Pot.	600Ω	"	"	"	"
	1	Sensitivity	1.0KΩ	"	"	"	"
	1	Sensitivity	3.0KΩ	"	"	"	"

Table II CHECK LIST OF CONTROL CHARACTERISTICS		
SPECIFICATIONS		DESCRIPTION
Type of Control	Carbon or wirewound	
Resistance	_____ Ω (give fixed minimum, if any)	
Taper	Linear, Left-Hand Log, Right-Hand Log. (See Fig. 2 for Tapers)	
Wattage	Carbon - 1/2 watt Wirewound - 2 to 5 watts	
Mounting	Bushing (give diameter and length) Tab Mount, Spring Clip, Dog House, Grasshopper, etc.	
Shaft	Give Diameter, Length (from mounting surface), and Trim	
Terminals	Solder lug or printed circuit	
Switch (if any)	SPST, SPDT, or DPST	

gested procedure of simply measuring the collector voltage to ground.

### Control Failures

Controls are replaced because they develop various defects—they open, short, ground, change value—but most often because they become noisy. This happens for various reasons: worn resistance strips, dirty collector rings, noisy contacts, or loss of contactor tension.

An easy way to determine noisy volume controls in transformer operated sets is to remove the sound IF tube and rotate the volume control while listening for noise. In series string sets, the RF section can be made inoperative by grounding the IF grid or the oscillator capacitor stator and again rotating the control while listening for noise.

In video circuits—contrast or brightness—turn control full counter-clockwise and rotate rapidly while watching picture. This action should produce no streaks, flashes, picture breaks, or jumps. If it does, the control is worn or dirty. In this event, clean or replace it.

Many noisy controls can be re-

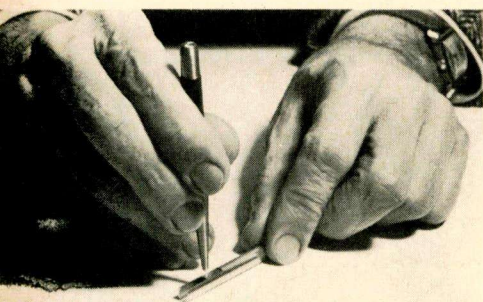

Fig. 9—More about dimple, center punch outer shaft, will provide the necessary drag for friction-clutch controls.

stored by liberal application of a control cleaner. Simply squirt the fluid around the three terminals and the shaft "C" ring. Work the control back and forth—but if there's no improvement, after two or three treatments, replace it.

### Switches

Many service technicians, seeking a higher current single-pole, single-throw switch with the two switch sections connected in parallel. This is a rather widespread misconception and frequently leads to callbacks.

The rating of a switch is dependent upon several factors, among which are the voltage and current surges on contact "make" or "break." The higher the current rating of a switch, the greater is the provision for these surges.

If the two sections of a double-pole switch would continuously "make" and "break" at exactly the same instant, the rating of the paralleled sections would be substantially increased. In practice, however, this does not occur. One section will "make" or "break" contact before the other, resulting in early failure of that section.

Do not parallel switch sections for higher current ratings—use a higher-rated, single-pole switch. This is especially important on heavy current auto radio volume control switches.

The more popular switch configurations and their nominal current ratings are listed in Table III.

### Control Tips

1. **Auto Controls.** To preserve

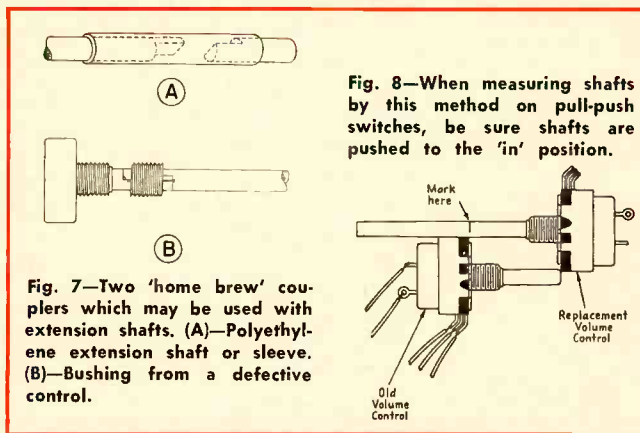

Fig. 7—Two 'home brew' couplers which may be used with extension shafts. (A)—Polyethylene extension shaft or sleeve. (B)—Bushing from a defective control.

Fig. 8—When measuring shafts by this method on pull-push switches, be sure shafts are pushed to the 'in' position.

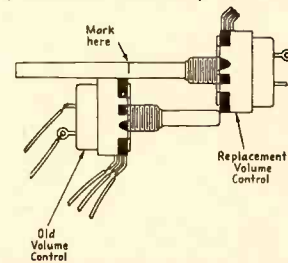

Table III		
TYPE	SYMBOL	RATING
SPST		5 amp at 125 v
DPST		3 amp at 125 v
SPDT		1 amp at 125 v
SPDT		1 amp at 125 v One pole open, One pole closed (4 Terminals)

\* Jumper Required

Table IV	
KIT FOR REPLACING VOLUME CONTROLS	
Control Cleaner with Extension Tube	
Hacksaw Blade or Jeweler's Saw	
Small Ruler	
Set of Small Files	
Epoxy Cement	
Center Punch	
Small Vise	
Open-End Wrench with 1/2 & 9/16 inch Ends	

the life of auto controls from dirt, especially in dusty country, it is advisable to cover the chassis plate ventilating holes beneath the control. The set may run a bit hotter, but it's better than frequent callbacks for control cleaning.

2. **Bias-Adjuster Emergency Imp-  
provision.** Because of component failures in the transistor output stage, the bias-adjuster frequently burns open. As an emergency im-

provision, a 2 w fixed resistor can

Continued on page 78

# Additional Uses For an R/C Bridge

Rapid transformer and diode checks can be made with this inexpensive instrument

by George Oberto

■ Our shop uses an inexpensive resistance/capacitance bridge for checking and troubleshooting various TV and radio circuits. The applications outlined here are in addition to those specified in the bridge manufacturer's instruction manual.

Small 455 kc IFs in ac/dc radios are often leaky because of a breakdown in the built-in capacitors shunting each winding. Sometimes a primary or secondary winding will fail because of insulation breakdown between turns within either windings.

Discriminator transformers can frequently result in a "tough dog" problem because of leakage in the capacitor connected from the plate side of the transformer primary winding to the secondary winding center tap (Fig. 1). Many intermittent or leaky transformers can be localized easily with the bridge. The procedures outlined here will apply to most bridges.

## IF and Discriminator Transformers

Set the range switch of your bridge on TEST VOLTAGE. The control is set at 500 v (or at 150 v when testing transistor or car radios). Disconnect the B+ primary lead from the IF transformer and connect the bridge voltage to the transformer as shown in Fig. 2. (The plus supply lead from the bridge is connected to the primary and the minus supply lead is connected to the secondary). Leakage between primary and secondary windings of an IF is indicated on our bridge by opening of a "magic eye" tube. Some bridges work in reverse.

If leaky capacitors are found in discriminator transformers, replace the capacitor rather than install a new transformer — if the capacitor is not molded-in the transformer.

## Other Transformers

Power, audio, modulation, vertical and horizontal TV sweep and other transformers and coils are also



EICO bridge

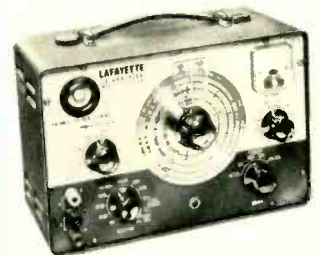

Bridge by Lafayette

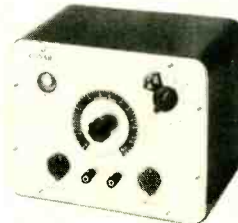

Conar bridge.



Knight bridge.

Heathkit lab-type bridge.



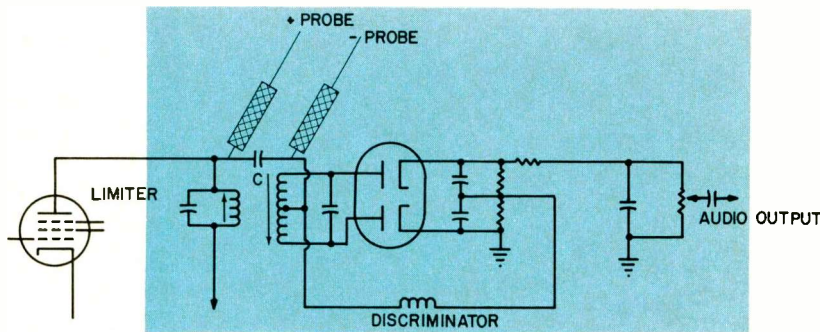

Fig. 1—Checking for leakage in discriminator transformer capacitor.

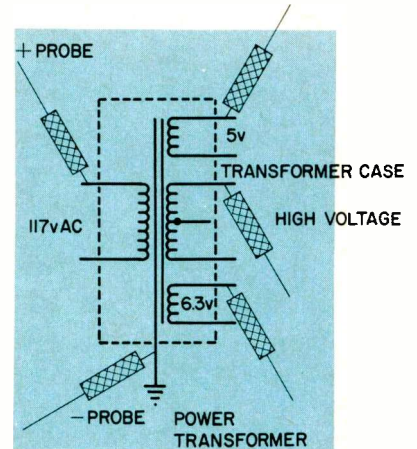

Fig. 3—Checking for leakage in iron-core transformers.

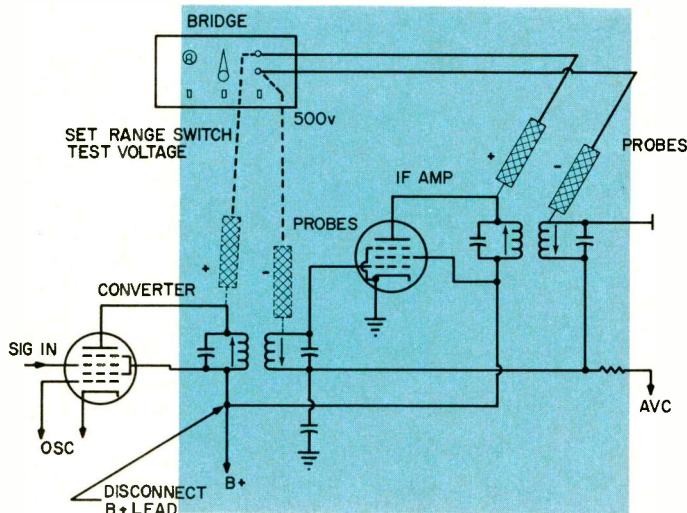

Fig. 2—Test set-up using R/C bridge.

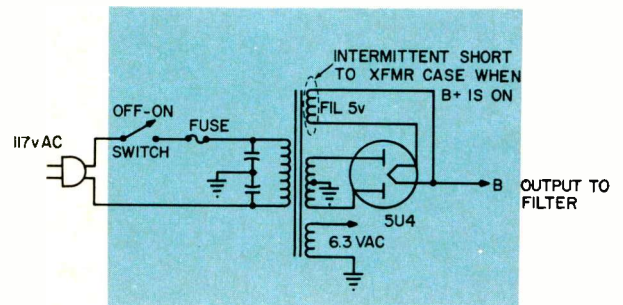

Fig. 4—Intermittent short of filament winding to transformer case was located with R/C bridge.

checked for primary to secondary leakage as shown in Fig. 2. The same procedure described for checking IF transformers is used and the bridge voltage is set to 500 v.

Leakage from a winding to case or chassis is checked with the negative lead of the bridge connected to case or chassis (Fig. 3), and the plus lead is connected to one side of each winding on the transformer. Our bridge operates as a "megger" up to 20 MΩ and any leakage indicated in this range means a defective unit.

Several radios and TVs have come into our shop with the complaint of "blowing fuses" intermittently in the power transformer primary winding. An ohmmeter check revealed all was OK. But, in all cases, when the bridge was applied as shown in Fig 2 and 3, the culprit was easily located as an intermittent short from rectifier filament to case (Fig. 4).

If power, audio or similar transformers have a shorted turn or turns, and since  $X_L = 2\pi FL$ , the in-

ductance and inductive reactance will be considerably lower than normal. Because the bridge power source is 60 cps, we can check this out by setting the bridge range switch to 0.5-500 Ω and the 50-50K range and measure the primary winding's ac resistance. If the transformer is bad, the resistance reading will be low.

Some transformers will indicate a reading on the bridge only when there's trouble with shorted turns. With experience, you'll have little trouble checking out a good or bad transformer.

### Rectifiers and Diodes

To check silicon diodes, selenium rectifiers and germanium diodes which have at least a 50 v PIV rating, the bridge range switch is set to ELECTROLYTIC LEAKAGE TEST. Connect the negative terminal to the cathode of the rectifier or diode and the positive terminal to anode of the rectifier. With the bridge volt-

*Continued on page 89*

How to view the envelope without making connections to the transceiver

# Measuring Milliwatt-Midget Modulation

by Elmer C. Carlson

■ Modulation measurements of handi-talkies is usually a problem. Small size, compact construction and low power output all combine to make measurements difficult.

At 27 Mc, power losses are possible in even the shortest lead length necessary for displaying a trapezoidal pattern on the scope (Fig. 1)—the usual method of measuring modulation.

The biggest problem is the low signal levels. These voltages are often too small to deflect the CRT beam directly. Scopes with 30 Mc bandwidth amplifiers are beyond technicians' budgets.

## Bench Set-up

Direct connections do not have to be made between the scope and the transceiver, however. Besides, it is too easy to upset RF circuits with test leads. They produce stray capacitances that detune the circuits and introduce unknown losses along their length.

Modern service type scopes, suitable for color-TV servicing, can display 455 kc signals and most communications receivers use an IF at or very near 455 kc.

Connecting the scope to the communications receiver IF amplifier output-stage plate (Fig. 2) or to the IF side of the detector makes it possible to see the complete modulation envelope.

Modulate the transceiver with a normal speaking voice and you can see just how much the carrier envelope is compressed and expanded. It is not easy to determine any exact modulation percentage.

If frequent modulation tests are to be made, a permanent connection to the IF strip can be brought out to a convenient point on the front panel (Fig. 3) or rear-chassis apron. If the top of a cabinet opens, a jack can be mounted on the chassis nearer to the IF amplifier output. A low-value capacitor ("C" Fig. 2) must be used to isolate the scope lead from the IF amplifier to reduce IF transformer detuning. For occasional tests a low-capacitance probe can be used with little, but some effect on the tuning of the IF amplifier.

## Tone Modulation Technique

Exact modulation measurements are easy to make by using tone modulation (Fig. 4). A steady tone can be made to stand still on the scope screen — voice patterns can't.

Feeding tone into a milliwatt transceiver can be just as difficult as trying to take signals out for measuring purposes. The best way to inject tone into the microphone circuit is through the microphone. Use an external speaker driven by a tone between 350 and 3500 cps. Higher frequencies are not needed

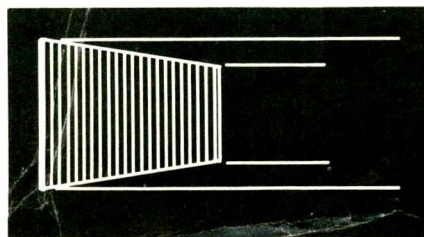

Fig. 1—Trapezoidal modulation scope pattern.

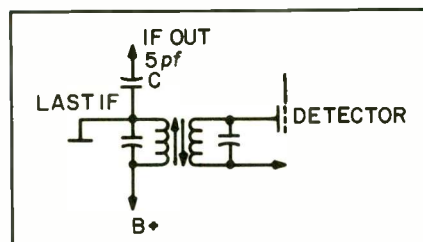

Fig. 2—Couple scope to communications receiver IF amplifier output-stage plate or to the IF side of the detector to see modulation envelope.

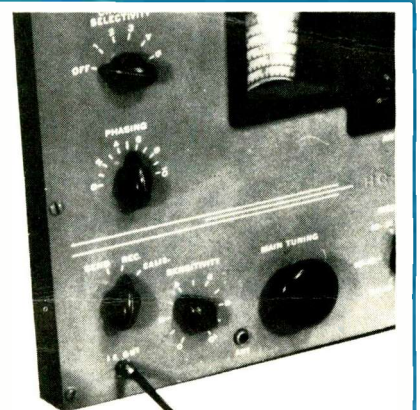

Fig. 3 — Permanent output jack wired to front panel of communications receiver.

but can be used in some special tests that are helpful in increasing the useful range of the unit.

Any audio generator can be used. If it has an output tap that will nearly match the speaker impedance it makes connections easier, otherwise a matching transformer must be used (Fig. 5) to get sufficient power into the speaker to drive the transceiver modulator.

The speaker is put face down over that in the transceiver and connected to the generator. The ground lead of the generator is also connected to the ground lead of the scope and the chassis of the monitor receiver (Fig. 6).

A second lead is connected from the high side of the generator output to the horizontal input. A short jumper goes from there (Fig. 7) to the scope's EXTERNAL SYNC input. A temporary lead from the external sync input to the vertical input is used to set up the scope for a stationary pattern using 1,000 cps. You are now ready to modulate the transceiver.

### Practical Work

With the receiver, scope, audio generator and transceiver connected as in Fig. 6, key the transceiver and tune the receiver until the tone signal is located — key the transceiver ON and OFF several times to make sure it is the proper signal.

Now, when the transceiver is keyed, the modulation envelope, at 455 kc, should be seen. Increase the audio-generator output until the envelope shows distortion (Fig. 8). If it is not possible to distort the modulation envelope, the generator does not have enough output or the transceiver circuit does not have enough gain.

Try a voice transmission. If it is possible to get a greater percentage of modulation by voice (loud talking or shouting) the output of the generator is not high enough for further testing. Should the modulation envelope be no greater (or even less) with voice, the trouble lies in the modulator circuit.

The speaker volume used to drive the microphone need not be ear-

splitting to match the lung power needed to give the same amount of modulation. For one reason, the sound level is concentrated in one frequency and second, the speaker is so closely coupled to the microphone that there is much nearer 100 percent transfer of sound energy between the generator driven speaker and that used as a microphone for the transceiver.

Once you are sure the modulation is too low, there are several possible methods of increasing it. But before any circuit changes are made a more complete analysis of the modulator should be made.

### Transmitter Interference

Transmitter testing should be done with the least interference to regular transmissions. Since the low power of the handi-talkie generally limits transmissions to less than one mile, the interference is low to begin with. You can reduce the possibility of generating interfering signals by using the transceiver (antenna too) in a horizontal posi-

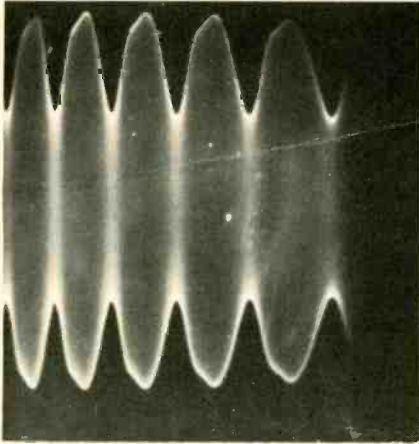

Fig. 4—Tone modulated scope pattern.

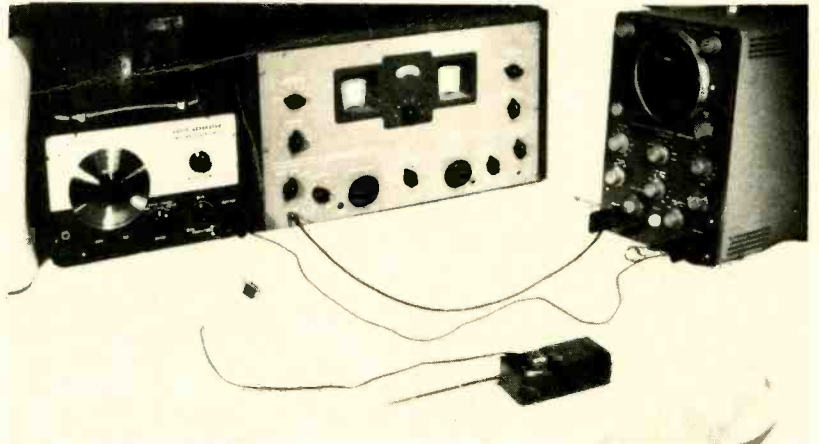

Fig. 6—Test hook-up using audio generator, communications receiver and scope. Milliwatt-midget with antenna extended is in the right foreground.



Fig. 5 — Matching transformer from audio generator to test speaker.



Fig. 7 — Closeup of scope connections.



tion as shown in Fig. 6. The antenna for the receiver must also be in a horizontal position.

With the transceiver antenna at a right angle to all other station antennas, your pickup of their signals is greatly reduced and interference to their transmissions is also greatly reduced. The communications receiver antenna should be 30 to 50 ft away from the transceiver to prevent overloading during modulation tests.

### Wasted Side-Band Power

A check of the actual bandwidth of the modulator should be the first step. Vary the input frequency from about 300 cps up to the cutoff frequency where the audio no longer has an effect on the envelope.

For communications purposes it is not necessary to modulate with frequencies above 3,500 cps. All the needed sound frequencies for intelligible voice communications are contained between 350 and 3,500 cps. Cutting off much below

3,500 will make speech less understandable and it becomes almost impossible to identify persons by voice characteristics. To allow higher frequencies to modulate the carrier wastes transmitter power in the side-bands which reduces the effective range and will interfere with units operating on adjacent channels. This affects units that can not be heard during the required listening period before transmitting. All efforts should be made to eliminate, or drastically reduce, frequencies above 3,500 cps. This will increase the range of the handi-talkie.

### Improving Modulation

It is possible to increase the modulation percentage by increasing either the gain of the audio amplifier in the modulator or by increasing the signal pickup for the modulator.

For proper efficiency, the speaker used as a microphone must match the input impedance into the first transistor. For economy, this is often neglected — the speak-

er is connected directly into the first transistor-base circuit and the mismatch gives too low a signal to drive the modulator to its full possible percentage of modulation. It is easy to wire a matching transformer into the circuit. Basically, all the transceiver circuits are the same (Fig. 9). For some circuits it may be necessary to wire a capacitor in series to prevent a dc path from upsetting either the transistor or transformer circuits.

Sound-powered magnetic units are a better impedance match than a 10  $\Omega$  speaker. These too are generally designed for communications. Being small ( $\frac{3}{4}$  x  $1\frac{1}{4}$  in.) they are easy to mount.

### Souping Up Equipment

It is possible to add a carbon microphone to the transceiver (Fig. 10). The carbon microphone is not the best all-around microphone but it has two features that makes it popular for communications work. It will give the highest output and generally has a cutoff frequency around 3,500 cps — the carbon microphone is designed for communications.

Sometimes the modulation can be increased by using higher gain transistors in the audio/modulator stage. This has a double effect — it increases modulation and increases the level of the received signals too.

The audio/modulator gain can be checked like an ordinary audio amplifier — as far as voltage is concerned. Current gain is the factor in transistor circuits. So unless you have a second transceiver of the same model (that has greater range), to be used as a standard for comparison, it is best to rely on the scope pattern of the modulation for indications of greater output.

Changing the modulation transformer is another way of increasing modulation. Some transceivers use a special transformer — don't change this type. For economy, an ordinary transformer may be used — (Fig. 11). This can be changed to a center-tapped type — then autotransformer action will feed a higher and lower value voltage to the collector of the RF transistor for increased modulation. ■

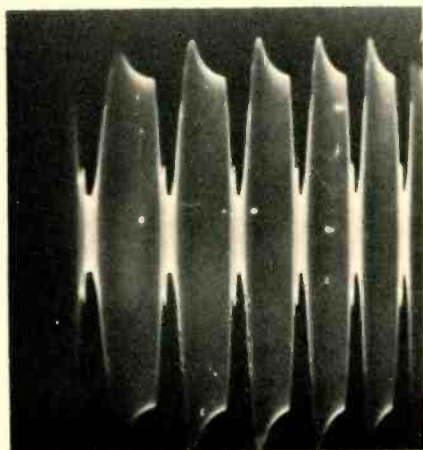

Fig. 8—Distorted envelope.

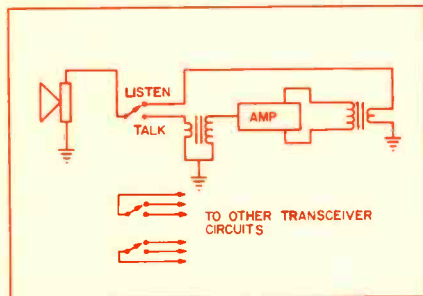

Fig. 9—Matching transformer may be wired into circuit for higher driving power.

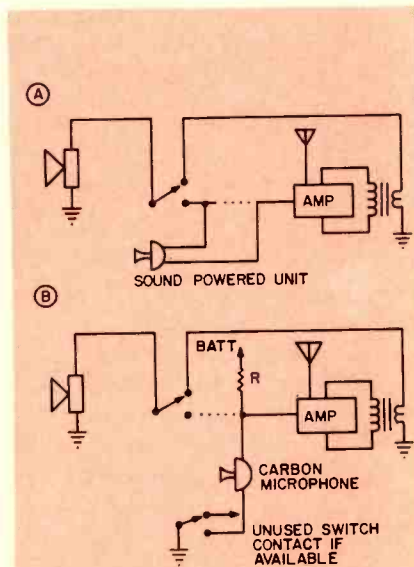

Fig. 10—Adding carbon microphone to transceiver.

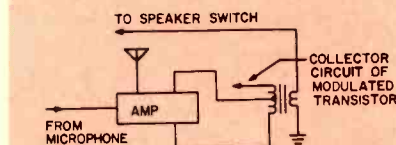
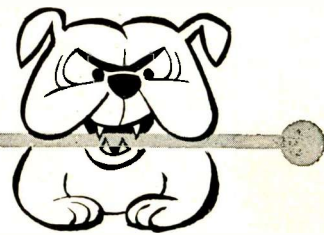

Fig. 11—Substituting modulation transformer to increase modulation.



## Difficult Service Jobs Described by Readers

### Faulty Bypass

A Curtis Mathes Chassis TV-17-1 had symptoms which seemed to indicate sync trouble. Vertical and hori-

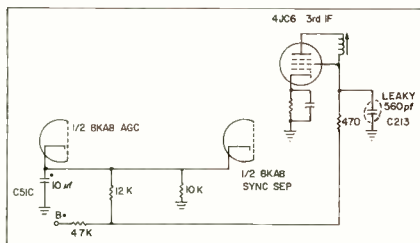

zontal sync were unstable with moderate to severe horizontal pulling. Clamping the AGC line with a bias box made no significant improvement. Connecting the scope to the sync separator plate showed sync coming through, but severely distorted with video information. Sync at the separator grid was practically non-existent. The composite video waveform at the plate of the video amplifier looked normal. This indicated that the trouble was probably in the sync separator stage. Voltage on the cathode of the separator was around 35 v when it should have been 80 v (on schematic). The resistance to ground also was somewhat low. After time was spent checking components in the separator I noticed that the AGC and separator cathodes were tied together and were connected through a 12K resistor to the B plus feedpoint for the 3rd IF screen. This led me to the 3rd IF stage. Resistance checks here disclosed that C213 was leaking.—*Glen H. Bryant, Hoisington, Kansas.*

### Intermittent Ground Connection Causes Hum and Poor Sync

A Hallicrafters TV, model 621-H-20, chassis 412M6, turned out to be more than a routine repair job. The complaint was poor horizontal sync.

After a few weak and gassy tubes were replaced and the tuner was cleaned, the set was put aside to cook. It worked fine for an hour or so, then the picture started to pull and bend horizontally. The symptom appeared like one caused by a gassy AFC or

horizontal oscillator tube. The picture would then go out of horizontal sync and adjusting the hold control demonstrated that it was critical and would not lock the picture in solid. The conditions were intermittent, sometimes just pulling and weaving, other times slipping out of sync.

Waveforms and voltage measurements indicated the signal was good up to the oscillator output. The drive signal feeding the grid of the horizontal output tube indicated fluctuations on the scope.

I then decided to adjust the drive trimmer to see the reaction. There was none. But when I moved it gently with an insulated tool the trouble would be corrected temporarily. I disconnected wires from one side of the trimmer and checked it for leakage but it showed none. Since this seemed the source of trouble, I then clipped a jumper wire from the trimmer ground side to the chassis. This immediately corrected all my troubles, locking the picture solidly in sync, with no pulling or bending.

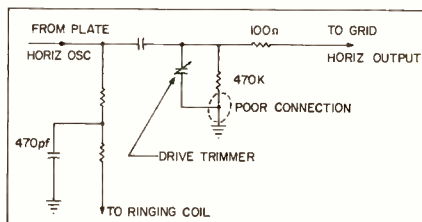

I then connected an ohmmeter in place of the jumper and a resistance reading of 15  $\Omega$ , sometimes varying as high as 25  $\Omega$  showed up when the trimmer was moved with the insulated tool. It was obviously not making proper contact to ground.

A short piece of wire soldered in place of the jumper cured the trouble for good.—*Danny St. Onge, Lethbridge, Alta. Canada.*

### Narrow Pix

Several weeks ago I had a call regarding a Motorola color chassis, TS908. This set has a 23 in. rectangular CRT. It lacked about 3 in. of width on the right side. The left side

was OK. I replaced both output tubes, the damper and the horizontal oscillator tubes. I even changed the high voltage rectifier for good measure. The problem still remained.

I then called the shop for another man and we turned the set on the side and removed the bottom plate. Without the set switched on, we made visual checks for possible bad solder joints and loose wires. Finding none, we then switched the set on. When the raster came on I was amazed to find that it almost filled the screen. I then turned the slug in the width coil and found that the coil worked fine but the width was still shy about a half in. I then noted that the coil was running hot. I shut the set off, removed the leads from the coil and checked its resistance. It was OK. At this point I decided to take the set to the shop. When the set was turned back to its normal position again and switched on, the width again decreased to the original 3 inches on the right side.

When the set arrived in the shop and was switched on it worked perfectly again! We again turned it on its side, and as we did so the width again decreased three in.

We now got a brain storm. By slowly turning the set from its upright position to its side we could make the picture shrink an in. to 3 in.

At this point the service manager remarked that, according to this, we should turn the set on its top side and it would work fine! We did just that. You can guess what happened. The set worked better than ever!

We then turned the set upright again, removed the chassis and mounted it on the jig. I also removed the high voltage shield. After probing for about ten minutes the trouble was located.

The black lead to the hi-voltage transformer had a rosin joint. After resoldering this and a few other places on the transformer to eliminate future possibilities, I switched the set on and had no further trouble. The lead in question connects to the Horiz. centering control, and this is also part of the width circuit.—*Elio J. Cavalet, Akron, Ohio.*

# MIRACLE WORKER

*in professional TV service shops*

*PINPOINTS ANY TV TROUBLE FAST! UPS YOUR PROFIT!*



**DELUXE B&K**

## MODEL 1076 B&W and COLOR TELEVISION ANALYST

*with Crystal-Controlled Keyed Rainbow Color Display  
and Highly-Stable Horizontal Oscillator Sync*

### **FLYING SPOT SCANNER**

*transmits B&K patterns or your own  
pictures onto TV screen*

It's like having your own TV station! You can inject your own TV signals at any time, at any point—and quickly solve tough dogs, intermittents, any TV trouble, as you watch the generated test pattern on the raster. Checks any and all circuits in any stage throughout the video, audio, r.f., i.f., sync and sweep sections of the TV set. No external scope or waveform interpretation is needed. And if you wish, you can transmit your own slide-pictures.

### **Makes Color TV Servicing Easy, Too.**

Generates white dot, crosshatch and color bar patterns for convergence. Generates crystal-controlled keyed rainbow color display to check color sync circuits, check range of hue control, align color demodulators. Demonstrates correct color values.

Saves time and work for the "pro." Makes servicing easier and faster for the beginner technician. Most valuable instrument in TV servicing.

Net, \$329.95

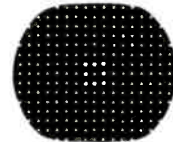
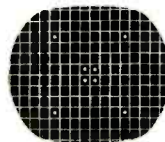
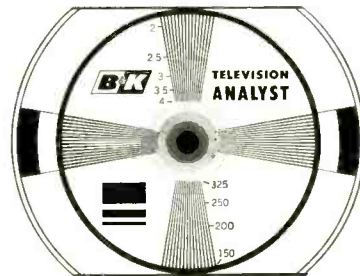

*Profit with a B&K Service Shop  
See your B&K Distributor  
or Write for Catalog AP21-T*

**B & K MANUFACTURING CO.**  
DIVISION OF **DYNASCAN CORPORATION**  
**1801 W. BELLE PLAINE AVE. • CHICAGO, ILL. 60613**  
Canada: Atlas Radio Corp., 50 Wingold, Toronto 19, Ont.  
Export: Empire Exporters, 123 Grand St., New York 13, U.S.A.

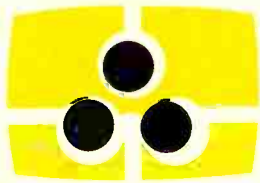

# COLORFAX

## RCA Color TV CRTs Employ "Rare Earth" Phosphor

RCA announces that all of its color television picture tubes are now being manufactured with improved phosphors, including a Europium red "rare earth" phosphor. Douglas Y. Smith, vice president, RCA Electronic Components and Devices, said the company has completed the conversion of facilities at plants in Lancaster, Pa.,



and Marion, Ind., for manufacturing all 25, 21 and 19 in. color tubes with the new phosphors. These phosphors are applied by an advanced slurry screening process. Mr. Smith pointed out that since January of this year, all 25-in. 90 deg rectangular color tubes shipped to set makers have utilized picture screens produced with the improved phosphors and process. He said the red Europium phosphor is being completely incorporated in the 21-in., 70 deg round color tube. These 21-in. "Hi-Lite" color tubes are currently being shipped to all customers. The 21-in. round tube is regarded as the present standard of the color TV industry, he added. RCA also employs the improved phosphors and screening process in making engineering samples of its new 19-in., 90-deg rectangular color tubes which are now being evaluated by manufacturers.

## Increased 1965-66 Color Programing

NBC-TV has disclosed that, during its 1965-66 season, almost all its network programing — statistically, more than 95 percent — would be color.

The 95 percent color decision means an increase of 35 percent over

current season's color prominent schedules. It also means that excepting occasional B/W movies and news programs, network evenings will be 100 percent color Monday through Thursday. All 14 of returning nighttime shows will be color (four for the first time) as will most of the new programs. The only two exceptions, both first-timers: *Convoy* (8:30-9:30 p.m. Fridays), a war drama strongly dependent on stock B/W naval footage, and *I Dream of Jeannie* (8-8:30 p.m. Saturdays).

Come fall, then NBC-TV will be coloring 34½ of its weekly 36 nighttime network hours, which accrues to a yearly volume of 3000 multi-hued hours. Annual total for NBC back in 1954, their first color year, was just 68 hours.

ABC TV, which so far hasn't emphasized its color equipment or programing, announced a step-up in its 1965-66 color season too. Its previously intermittent colorcasts will be converted to something like four and a half and six and a half hours of color per week. Expectedly multi-hued next season: *Big Valley*, *Gidget*, *Voyage to the Bottom of the Sea*, the animated *Flintstones* and most films on *Sunday Night at the Movies*.

CBS-TV, too, was riding the colorwagon. *Danny Kaye* and *Red Skelton* will be televised in color, as well as "most" Thursday evening movies, plus other programs.

## Motorola Introduces New 23 in. Models

Motorola has broadened its 23-in. rectangular picture tube color TV line by adding five basic models with manufacturer's suggested list prices (optional to dealer) of \$499.95 to \$599.95. The five new color models, along with the 15 receivers that have represented the 1965 Motorola rectangular color TV line, extend the company's suggested list price spread from \$499.95 to \$1650 in this product category. The color chassis used in this line is a horizontal, hand-wired unit with power transformer and two solid state rectifiers. The chassis has three IF stages, a four-circuit VHF color tuner and solid state UHF color tuner. A push button demagnetizer is included on all models.

## Admiral Shows 1966 Color TV Line

The 1966 Admiral color TV line includes 21, 23 and 25 in. screens. A. A. Medica, vice president-electronics division, said that the new color line is the most extensive introduced by the company. The line opens with a 21 in. table model priced at \$369.95. There are 18 21 in. models including three stereo theaters. Nine 23 in. and three 25 in. consoles are offered. Three 23 in. stereo theaters with solid-state amplifiers are also included.

## General Electric to Manufacture Color CRT

General Electric has begun pilot production of an improved type of color television picture tube. According to a statement made by William E. Davidson, general manager of the company's Television Receiver Department, the G-E CRT is an improved version of the industry's standard "three-gun" type, and incorporates the rare earth phosphors being almost universally used across the industry. Mr. Davidson noted that tube production will be limited in 1965 and that the company will continue purchasing tubes from outside sources for the next few years.

## Final Inspection Of Color Chassis

Color television chassis manufactured at the RCA Victor plant in Bloomington, Indiana, receive their final inspection before being placed in new color receivers. Approximately

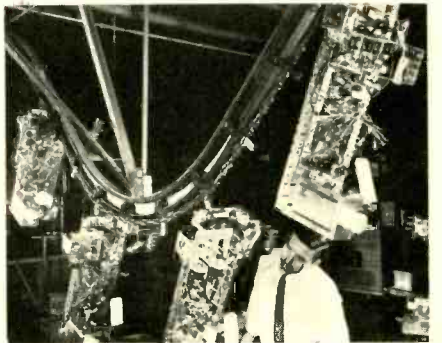

one out of every seven people working in the RCA plant make inspections, tests or checks of the work of the people who actually build the sets.

Now you can quickly locate defective capacitors affecting the performance of electronic circuits —and prevent costly call-backs!

## CAPACITOR TESTING IN-CIRCUIT/OUT-OF-CIRCUIT IS QUICK AND EASY



# NEW B & K CAPACITOR ANALYST

MODEL 801

for TV, Radio, Transistor Radio, Auto Radio, Hi-Fi, and other electronic equipment

Unique new B & K development puts the measurement of capacitors and electrolytics on a practical basis—picks up all defects that will affect performance—turns lost time into profit dollars.

Servicemen are aware that capacitors and electrolytics are second only to receiving tubes in creating the most servicing problems.

The new B & K Capacitor Analyst enables you more easily to measure capacitance and leakage resistance—detect both opens and shorts—both in-circuit and out-of-circuit. In-circuit leakage resistance test can be made on low-voltage circuits such as transistor radios, or on higher voltage circuits. Checks capacitor value from 25 pfd to 100 mfd.

Tests electrolytic capacitors by unique circuit (Pat. Pend.) which determines how well the electrolytic does the job of storing electrical energy and returning it back to the circuit. Detects marginal electrolytics that should be replaced. Also predicts life expectancy of any electrolytic capacitor rated 3 volts or more.

Model 801 Capacitor Analyst is attractive, rugged, and easy to use.

NET, \$99<sup>95</sup>

Ask Your B & K Distributor for Details,  
or Write for Bulletin No. 108-T



**B & K MANUFACTURING CO.**  
DIVISION OF DYNASCAN CORPORATION  
1801 W. BELLE PLAINE AVE. • CHICAGO, ILL. 60613  
Canada: Atlas Radio Corp., 50 Wingold, Toronto 19, Ont.  
Export: Empire Exporters, 123 Grand St., New York 13, U.S.A.

# NEW PRODUCTS

## Tweeters

Two cone tweeters have been added to a line of high fidelity speakers. The Model T 3C208 is 3-in. square

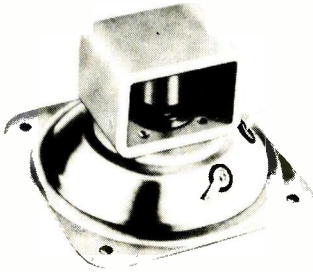

and has a frequency response of 1800 to 17,000 cps. Its power handling capacity is 6 w. Model T 5C208 is 5-in. square, with a frequency response of 1000 to 17,000 cps. It has a power handling capacity of 6 w. Oxford Transducer Corp., 2331 N. Washenaw Ave., Chicago, Ill. 60647.

## Fusible Resistors

A line of fusible resistors in sizes up to 15 w normal dissipation, are introduced. They have application in surge limiting, missile ignition, short duration controlled time fusing, small photographs, ac-dc radios, and TV. Resistance range available: 0.1  $\Omega$  to 30K  $\Omega$ . International Resistance Co.,

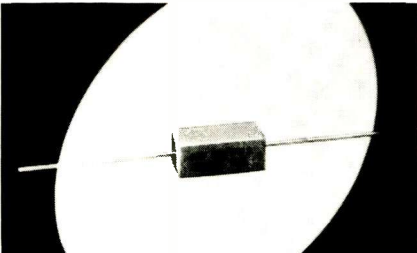

401 N. Broad St., Philadelphia, Pa. 19108.

## Compass Cutter

A cutter designed for cutting large diameter holes in thick wood, metal plate and plastic is announced. This

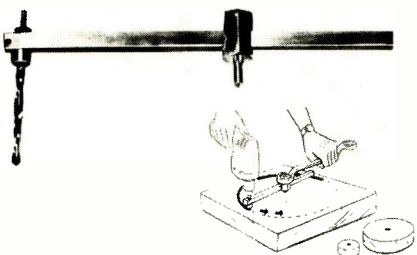

tool attaches to any electric drill and uses a hardened, tool steel bit with side-cutting action to make holes and circles from 1½ in. to 20 in. diameter. The bit, so hard it can cut steel plate, turns in a heavy-duty needle bearing for smooth, positive action. With this tool you can cut holes, discs, circles, etc. in two in. wood, ¼ in. aluminum, ⅝ in. cold rolled steel and in most plastics up to 1 in. thick. Nassau Shores H & G, Dept. 468, 5500 Merrick Rd., Massapequa, N. Y.

## Electrolytic Substitutor

An instrument for substituting electrolytic capacitors in transistor and

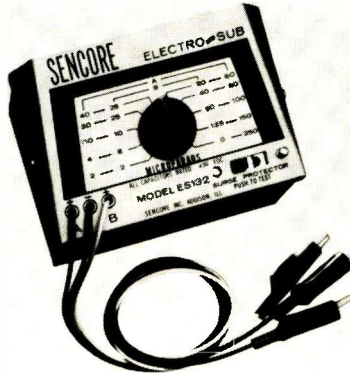

vacuum tube circuits is introduced. The ES132 provides 10 dual electrolytics with values from 2 to 250  $\mu$ f and with potentials from 2 to 450 vdc. The electrolytics can be used singly, as duals or paralleled. The instrument is housed in a steel case and has a "push to test switch." The switch also discharges the substituting electrolytics, to prevent shock. Sencore, Inc., 426 S. Westgate Dr., Addison, Ill. 60101.

## Emergency Fuse Kit

A kit containing fuses for most popular makes of English, German, French, and Swedish autos is announced. The kit, which can be stored in the car's glove compartment, contains both glass and ceramic fuses to replace "burn-outs" in all models of the Volkswagen, Mercedes-Benz, Porsche, MG, Austin, Renault, Opel, Volvo, Fiat, Jaguar, Morris, Sunbeam, Vauxhall, Hillman, Saab, Triumph and others. Included in the kit are two each of the following ceramic-body fuses: 8 amp, 16 amp, 25 amp short, and 25 amp long. There is also a 35



and a 50 amp glass fuse in the kit. Littelfuse, 800 E. Northwest Highway, Des Plaines, Ill.

## Replacement Cords

A line of coiled cords designed for replacement of most monaural headphone cords is announced. The coiled cords are available with either a two-conductor straight or right angle phone plug, with cable clamp, securely

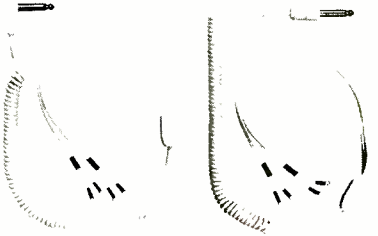

molded to one end of the cord. Switchcraft, 5555 N. Elston Ave., Chicago, Ill.

## Color Generator

A color generator containing a color vectorscope is announced. The unit provides crosshatch, dots, vertical lines only, horizontal lines only and keyed rainbow patterns. It has a vectorscope to check color phase angles. It is 8¼ x 7½ x 12⅞ in. and weighs 13 lb. Lectrotech, 1737 Devon Ave., Chicago, Ill. 60626.



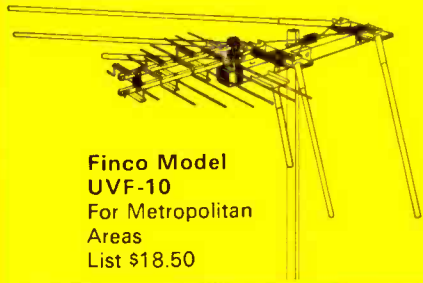

Finco Model  
UVF-10  
For Metropolitan  
Areas  
List \$18.50

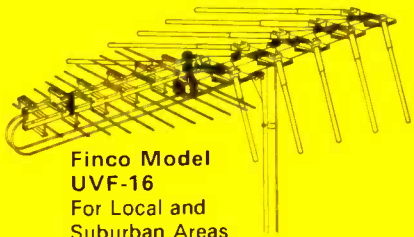

Finco Model  
UVF-16  
For Local and  
Suburban Areas  
List \$30.50

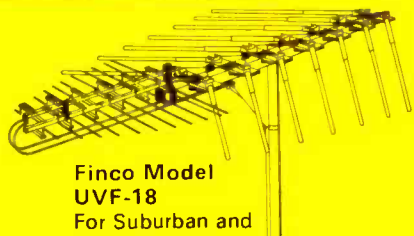

Finco Model  
UVF-18  
For Suburban and  
Near Fringe Areas  
List \$42.50

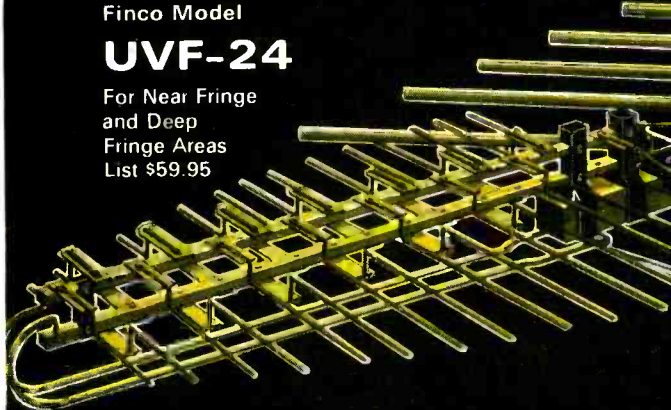

Finco Model  
**UVF-24**  
For Near Fringe  
and Deep  
Fringe Areas  
List \$59.95

*A major breakthrough  
in Antenna design!*

**FINCO**

**ALL BAND  
UHF•VHF•FM**

**“COLOR VE-LOG”**

Featuring Finco's Exclusive Gold Corodizing

**UVF Color  
Ve-Log Antennas . . .  
Engineered for  
the future!**

- Revolutionary new UHF Section
- Heavy Aluminum reinforced insulator insert cup and heavy duty rivet
- Back-up bracket and square boom
- Finco's exclusive triple thick sleeved elements
- Lock-tite no-tilt saddle bracket
- Finco's exclusive double contact to drive line
- Continuous one-piece drive line and exclusive air insulated polystyrene cross-over spacer

Finco's new All-Band Color Ve-Log Antenna does the work of three — gives startlingly clear black and white pictures and beautiful color on *both* UHF and VHF television channels. Its superlative design also assures the finest in stereophonic and monophonic FM sound reproduction. Comparison tests have proved the superiority of the All-Band UVF Series — superiority backed by Finco's guarantee of supremacy and unquestioned warranty.

Prices and specifications subject to change without notice.

**THE FINNEY COMPANY • 34 W. Interstate Street • Bedford, Ohio**

Write for beautiful color brochure Number 20-322, Dept. 110

## NEW PRODUCTS

### Portable Oscilloscope

An oscilloscope with solid state circuits, calibrated triggered sweeps, dc to 5 Mc bandwidth, line and battery powered, regulated power supplies and 5 in. CRT is announced. A low capacity (12 pf) probe is available as an accessory. The Model 055 is 9¼ x 7 x 16 in. and weighs 15 lb.



Aul Instruments Inc., 47-29 36th St., Long Island City, N. Y. 11101.

### Replacement Controls . . .

*Continued from page 60*

be substituted temporarily. Here's what to do:

(A) Connect resistance substitution box across the open bias-adjuster. Set it at the resistance value of the bias pot.

(B) Reduce the resistance in small increments to get a distortion-free output. Make sure the power supply is set at 12 v.

(C) After the proper value resistor is found and installed, step the power supply up to 15 v to see if the resistor overheats or discolors. If it does, use the next higher wattage available.

3. **Control Cleaning.** Sometimes injecting control cleaner between the concentric shafts cures the noise without having to remove chassis.

4. **Minimum Resistances.** When replacing a control with a fixed minimum resistance, be sure to install a fixed resistor of the same value in series with the left terminal.

5. **Noise.** A unique method of reducing volume control noise, if all else fails, and if a replacement is not available, is to add a grid return circuit (Fig. 4). Its value should be five times the control.

6. **Sensitivity Adjustments.** Besides peaking the antenna compensating screws to receive distant stations on auto sets, many tube type auto radios have sensitivity or gain adjustments in the IF stage cathode circuit. This control should be adjusted whenever the IF tube is replaced.

7. **Switches.** Rotary switch type volume controls can be replaced with controls having pull-push switches for longer life. Naturally, the resistance element will not wear out as fast.

8. **Switch Substitution.** An easy way to install a SPST switch in place of a DPST switch on auto radios is shown in Fig. 5.

9. **TV Attenuator.** Boosters in strong signal areas may produce overloading, causing smear, distortion, pulling, and ghosts. An easy solution is to insert an attenuator as shown in Fig. 6.

10. **Contrast Controls.** Because of its high wattage dissipation, the contrast control is one of the most often replaced units in TV servicing. Many of these controls have linear

*Continued on page 78*



# You Stock ONE Automotive Speaker But You Can Replace **THREE!**



Model AT69C

That's the big advantage of selling the new Oxford Multi-Impedance Automotive Speaker . . . it will replace original units with an impedance of 10, 20 or 30 ohms. This, of course, reduces your inventory and increases your profits!

And, when you install any Oxford automotive speaker, you can be confident of having used the finest product available. Oxford is the major manufacturer of the original equipment speakers used by Detroit's "Big three." The know-how gained through producing these OEM speakers, plus the latest design innovations go into every replacement unit bearing the name Oxford. So for the ultimate in quality and design . . . be sure it's an Oxford automotive speaker.

**OXFORD  
TRANSDUCER  
CORPORATION**

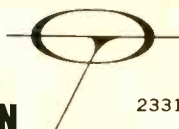

*A Subsidiary of Oxford Electric Corporation*

2331 North Washtenaw Avenue • Chicago 47, Illinois





# “Which microphone should I use?”

- for tape recording
- for broadcasting
- for CB and ham
- for public address
- for any application...

**Free Booklet—**  
Everything You  
Want To Know  
About Micro-  
phones! Send  
Coupon Today!



**LTV UNIVERSITY.**  
A DIVISION OF LING TEMCO-YOUGHT, INC.

Dept. 6, P. O. Box 1056, Oklahoma City, Okla.

Name \_\_\_\_\_

Address \_\_\_\_\_

City \_\_\_\_\_ State \_\_\_\_\_ Zip Code \_\_\_\_\_

## ... SPEAKERS

*Continued from page 57*

ity sets all use a true woofer. It may have a large diameter voice coil, wound with several layers of rather large wire or it may be of “long throw” design with these features plus a treated cloth cone edge. Technicians should examine the unit being replaced to determine from the voice coil diameter, magnet size and cone design just what type of replacement unit is required.

Midrange speakers on the Group “B” sets are very likely true midranges, that is, they are designed to cover the midrange band only. The low frequency response is eliminated on many by using a closed back cone housing (basket) and the high end can be controlled by using a cone of proper design. In addition, the response of the midrange is often controlled by using a proper dividing network. An open back speaker of the proper size and voice coil can often be used if stiff chipboard is cut to size and cemented over the basket openings.

Some of the best quality sets in

the Group “B” class have horn type midrange-tweeter combinations and since these are available in a wide range from your parts jobber, no problems should arise in finding a replacement. The tweeters in Group “B” sets are made the same as in Group “A” except that they usually have larger and more efficient magnets. Most distributors keep a good stock of tweeters on hand. Many of these sets will have true dividing networks comprised of the proper inductances and capacitors. It is very important that replacements used in this equipment have exactly the same voice coil impedance.

An additional group, Group “C”, contains component type equipment, usually high priced and well recognized. Little difficulty should arise in obtaining replacement speakers for units of this type.

Speakers for foreign made Stereo/Hi Fi sets, particularly of German make, are difficult to obtain because many are odd size ovals not made in the U.S. It may be necessary to substitute a larger oval or mask the baffle opening and use a smaller speaker. ■

# great profits



**that's about the size of it**

Microminiaturization has come to cartridge design in the new Sonotone Micro-Ceramic<sup>®</sup> Cartridge—a king-sized profit-maker in a tiny case. This remarkable new cartridge updates to 1965 performance almost any phonograph using a ceramic cartridge produced within the past 20 years.

The Sonotone Micro-Ceramic Cartridge embodies all the advantages of miniaturization and light weight. Designed for low mass, lightweight tonearms—it weighs less than 1 gram (without bracket). Superb stereo performance is assured by—high compliance; ability to track at the low forces required by today's modern record changers; excel-

lent separation and a smooth, clean response over the full audio range. To top it off, all Micro-Ceramic cartridges are equipped with the virtually indestructible Sono-Flex<sup>®</sup> stylus. For ease of installation, three different standard mounts are available.

Four Micro-Ceramic cartridges cover all of your replacement needs; the “27T,” a high capacitance model for transistorized phonographs; the high compliance “25T” for deluxe stereo units; the “26T” and “28T” for replacement in a wide range of popularly priced phonographs.

For comprehensive Cartridge Replacement Guide, write:

**SONOTONE**  
audio products

Sonotone Corp., Electronic Applications Div., Elmsford, N. Y.



YOUR SYLVANIA DISTRIBUTOR HAS A

# COMPLETE INVENTORY

From his full-line inventory of Sylvania industrial and commercial tube types, you get immediate off-the-shelf delivery. Electronic tubes for every application. Same-day service, wherever possible.

These are rugged, long-life electronic tubes,

proven by outstanding performance and characteristics over long periods of testing and in actual use.

Call your Authorized Sylvania Distributor,  
Electronic Tube Division, Sylvania Electronic  
Components Group.

**SYLVANIA**  
SUBSIDIARY OF  
GENERAL TELEPHONE & ELECTRONICS **GTE**

NEW CAPABILITIES IN: ELECTRONIC TUBES • SEMICONDUCTORS • MICROWAVE DEVICES • SPECIAL COMPONENTS • DISPLAY DEVICES

**READY . . . JUNE 1st!**



**NEW** *Brach*  
**UHF/VHF  
TV ANTENNAS  
FOR  
Black/White & Color**

6651 Chromate  
6652 Chrome

- **Ultimate in Design!**
- **Unequaled in Performance!**
- **Outstanding in Value!**

**BRACH MANUFACTURING CORP.**  
DIVISION OF GENERAL BRONZE CORPORATION  
200 CENTRAL AVE., NEWARK, N. J. 07103

**REPLACEMENT  
GUIDE**



**NEW  
COIL CATALOG  
AND  
REPLACEMENT  
DIRECTORY  
No. 165**

New 160-page catalog gives specifications and prices for the world's most complete line of RF and IF coils . . . comprehensive directory cross references exact replacements for all known TV sets, radios, car radios.

For your free copy, see your local distributor or write directly to:



**J. W. MILLER COMPANY**

5917 South Main Street • Los Angeles, California 90003

**. . . TUNER**

*Continued from page 52*

"After you're through with these checks, there're some components which fail more frequently that you can check. If all this fails, then I'd still suggest checking the set alignment."

Once again Scoot started on Bob's outline that had already rewarded him with two quick tuner repairs only an hour earlier. Nothing was turned up and he asked Bob for the component check list. Bob had already marked them on the schematic.

"Here, Scoot, I've marked the components that can be easily checked." (Fig. 7.) Be sure to include the solder joints in your continuity checks. They can be a big headache."

After 20 minutes of struggling Scoot announced that he had the problem 'corraled.'

Bob came over to look.

"Bad balun, huh? Did you 'mess up' that terminal strip?"

"No. It was already broken."

"Scoot. What am I going to do with you? You should have questioned that when you first looked this set over. The reason that balun lead is pulled from the antenna terminal strip."

"I know, I know. If I would just look a little closer I could solve half of my problems just by looking."

"Precisely, Scoot. Maybe there's some hope for you after all!" ■



"The picture's flopping! gets snow and the horizontal knob is broken and the antennas . . ."

# RCA Solid Copper Circuits

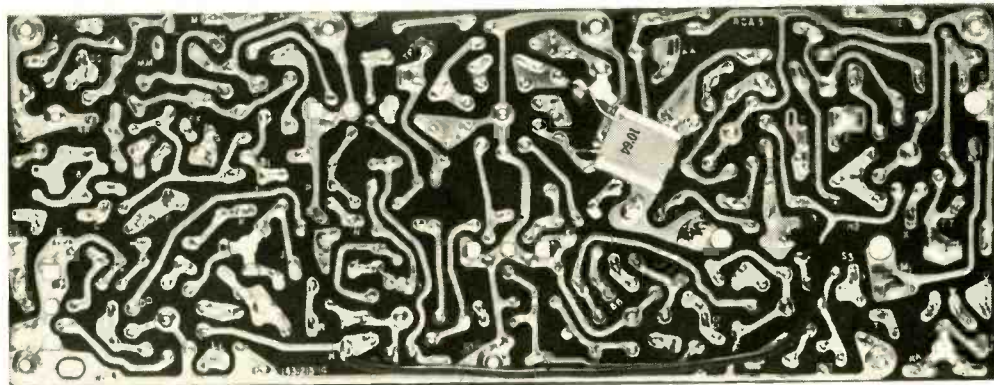

replace old-fashioned  
"hand wiring".. RCA Solid  
Copper Circuits are the  
circuits of the space age

RCA Solid Copper Circuits are made by methods as modern as tomorrow. They give greater dependability . . . better TV performance. It's typical of the advanced design you'll find throughout every RCA Victor home instrument. It all adds up to sets that are easier to service so that owners are more satisfied with results.

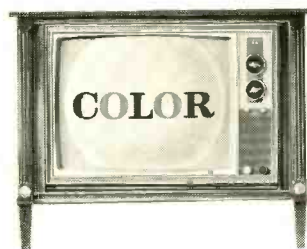

The Most Trusted Name  
in Electronics

Tmk(s)®

More TV servicemen own RCA Victor Color TV than all other leading makes combined



Mr. TV Service Dealer:

# You made a lot of dough

on Snyder  
3-D Directronic®  
TV Antennas.

## Now Invest ONE BUCK and Test Our Newest TV Product!



Patents  
Pending

# tenna-mate®

Not a TV antenna . . . but a 7-inch wonder that supplements built-in antennas—dials out TV picture interference! Every owner of a TV set with a built-in antenna is a natural prospect! Installs without tools!

Regular List  
\$4.95

Service  
Dealer  
Special \$1

POSTPAID

For test purposes only — not for resale! Just attach a dollar bill to your business card or letterhead, add name of your favorite jobber, mail to Snyder today. If it isn't all we say it is, your dollar refunded!



Westmoreland & Stokley Sts.  
Philadelphia, Pa. 19140

## Replacement Controls . . .

*Continued from page 72*

tapers, and are wired as rheostats. When this is the case, a more reliable replacement would be a control of the resistance value but having a right-hand log taper—a design which uses more of the resistance element area.

### Mechanical Considerations

**1. Couplers & Extension Shafts.** Extension shafts are useful when the original shaft is longer than the universal control shaft. These shafts are generally 4 inches long and are available in 3/16 and 1/4 inch diameters. They come complete with a coupler. Or, shaft couplers, which may be purchased separately, can be used with a portion of original shaft. Poly-extension shafts can also be used as couplers (Fig. 7A). Be sure to place epoxy on the ends of both shafts before inserting sleeve. This will prevent shafts from pulling apart. Bushings from defective controls make ideal couplers, too (Fig. 7B).

**2. Measuring and Cutting Shafts.** An easy and accurate way to measure the replacement control shaft length is shown in Fig. 8. When controls have a pull-push switch, make sure both shafts are in the "in" position. Metal shafts can be neatly cut with a jeweler's saw—especially after the control is installed.

**3. Friction-Clutch Controls.** On occasion, you may encounter a stereo control with friction coupled concentric shafts. This is a friction fit between the panel and rear shafts which enable both rotors to operate in tandem when either shaft is turned. Either section can also be adjusted independently by holding one shaft and rotating the other. Once set, turning either knob will maintain the preset relationship between the sections. The problem now, is how to duplicate this effect when replacing the control with standard replacement parts. Here's how! Form a small dimple with a hammer and center punch (Fig. 9) on the flat-milled portion at the rear of the outer shaft slot to provide drag (friction clutch effect) between shafts, then assemble control in normal manner.

Keep a copy of these tips handy. They'll help you solve more of your control problems—faster. ■

brand new  
...and very important...

# QUAM COLOR TV REPLACEMENT SPEAKERS PREVENT COLOR PICTURE DISTORTION

OFTEN CAUSED BY STRAY  
MAGNETIC FIELDS FROM  
ORDINARY LOUDSPEAKERS

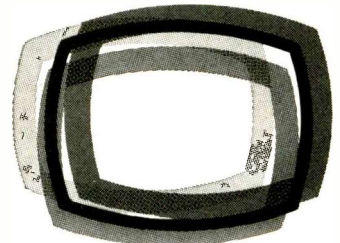

*When you use an ordinary loudspeaker in a color TV set, you're looking for trouble . . . picture trouble. The external magnetic fields from standard loudspeakers will deflect the primary color beams, causing poor registration and distorted pictures.*

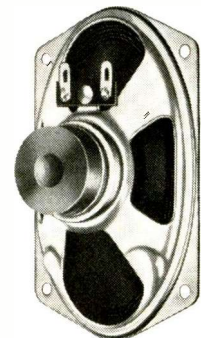

## QUAM RESEARCH SOLVES THIS PROBLEM

An entirely new construction technique, developed in the Quam laboratories, encases the magnet in steel, eliminating the possibility of stray magnetic fields and the problems they cause! These new Quam speakers have been eagerly adopted by leading color TV set manufacturers. Quam now takes pride in making them available for your replacement use. Five sizes (3" x 5", 4", 4" x 6", 5 1/4", 8") . . . in stock at your distributor.

# QUAM

QUAM-NICHOLS COMPANY

234 E. Marquette Rd. • Chicago, Ill. 60637

# The VHF-FM antenna that challenges all competition

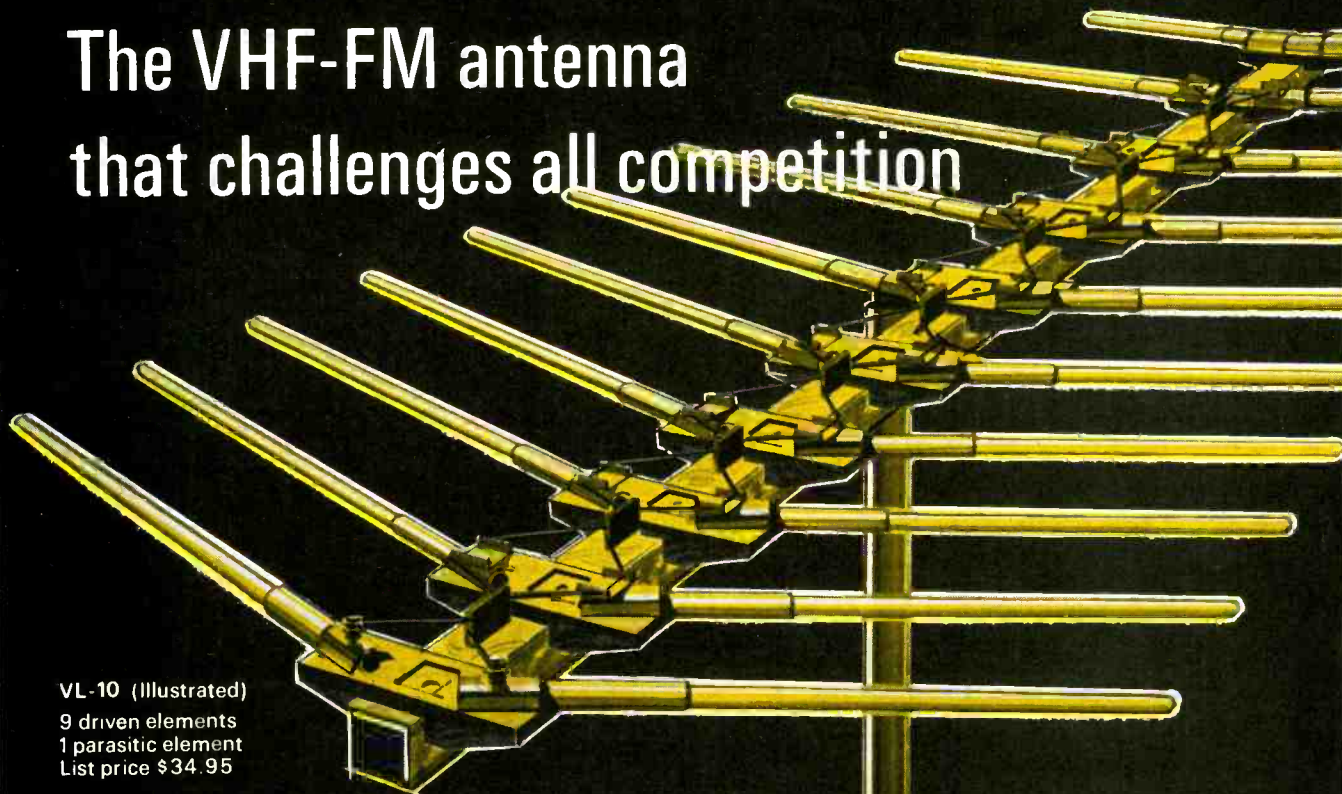

VL-10 (Illustrated)  
9 driven elements  
1 parasitic element  
List price \$34.95

## NEW **FINCO**® *Swept Element* "COLOR-VE-LOG" VHF-FM ANTENNA

Finco's Color Ve-Log challenges all competition on color or black and white reception and stands behind this challenge with a "Guarantee of Supremacy". The swept element design assures the finest in brilliant color and sharply defined black and white television reception – as well as superb FM monaural and stereo quality. FINCO precision-engineered features make these advanced-design antennas indispensable to good home sight-and-sound systems. And, of course, they carry the famous unconditional guarantee from the leading manufacturer in the field – FINCO. Promote the Color Ve-Log Antennas with pride, sell them with confidence, and profit handsomely.

Featuring Finco's Exclusive Gold Corodizing

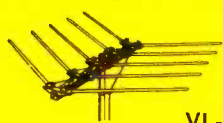

VL-5

5 element VHF-FM  
5 driven elements  
List price \$16.95

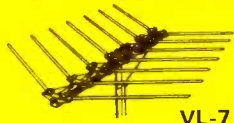

VL-7

7 element VHF-FM  
7 driven elements  
List price \$23.95

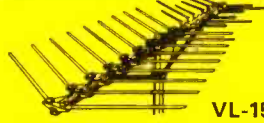

VL-15

15 element VHF-FM  
9 driven elements  
6 parasitic elements  
List price \$46.95

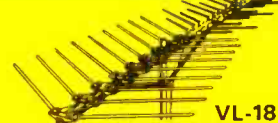

VL-18

18 element VHF-FM  
9 driven elements  
9 parasitic elements  
List price \$54.50

The FINNEY Company • 34 W. Interstate Street • Bedford, Ohio

Write for color brochure #20-307, Dept. 110



PICTURE  
TUBES, TOO

## SECO MODEL 88 TESTS ALL TUBES

Tests all receiving tubes including novars, nuvistors, 10 pin types, compactrons, magnovals—plus over 400 cathode ray picture tubes including 110° deflection types. Reveals cathode emission, leaks, shorts, grid emission, gas error, filament continuity and cathode-to-heater emission.

MODEL 88 TUBE TESTER \$74<sup>50</sup><sub>NET</sub>

### MODEL 98 HAS PLUG-IN CHASSIS

Plug-in socket chassis is easy to replace if it wears or if new tube types appear. Tests picture tubes and all receiving tubes (over 2500 types)—reveals same tube errors as Model 88 above.



PICTURE  
TUBES, TOO

MODEL 98  
TUBE TESTER \$99<sup>50</sup><sub>NET</sub>

PICTURE  
TUBE ADAPTOR  
INCLUDED

This picture tube adaptor with a 12-pin socket fits over 400 cathode ray picture tubes including 110° deflection types. Comes with Model 88 and Model 98 Seco Tube Testers!

### MODEL 107B FOR NO SET-UP TESTING

40 prewired sockets fit 63 tube bases—plus a plug-in 8 socket chassis wired to 14 lever type pin selectors. Gives three comprehensive tests—finds faults quickly.

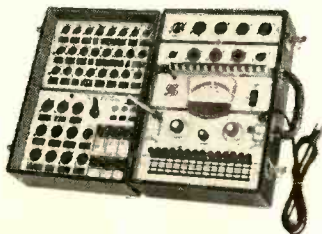

MODEL 107B TUBE TESTER \$189<sup>50</sup><sub>NET</sub>

Write for full information today

**SECO ELECTRONICS**

1211 S. Clover Drive • Minneapolis, Minn. 55420



## ... YOU AND COLOR

Continued from page 55

is the result of unequal conduction of the diodes. When the burst signal is absent both diodes conduct equally so no voltage appears at the junction of the resistors. The negative voltage developed when the burst is present is applied to the control grid of V701B, the color killer stage, biasing it at cutoff.

The operation of V701B, the killer stage, is like an AGC amplifier because it is keyed by a high positive pulse which is the only B plus applied to the tube. During B/W transmission, with the burst signal absent, the negative bias is removed from the grid of V701B. Conduction then takes place and a negative voltage is developed at pin 1, the plate. This negative voltage is applied to the grid of the bandpass amplifier, cutting it off and preventing any spurious and unwanted signals from reaching the CRT through the chroma channel.

When the burst is present (during color telecasts) a negative voltage appears at the grid of V701B, the killer, cutting it off. While this tube is at cutoff no plate current can flow and no negative voltage is developed at its plate. This action removes the cutoff bias from the bandpass amplifier—allowing it to pass color information.

R144, the 1 M  $\Omega$  potentiometer, allows the technician to set the bias of the color killer stage for optimum performance in any given area. ■

## TECHNICIANS ... Open the Door to Greater TV Profits

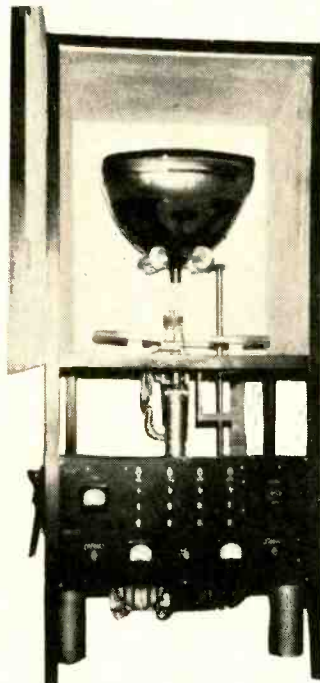

Rebuild Color — Black  
and White — Bonded Face  
Television Picture Tubes in  
**YOUR OWN SHOP**

Send today for 16 page brochure describing how you can capture the television picture tube rebuilding market in your area. Low investment of \$3,290.00 and up. Financing available. Training at our plant included in low price. Get started today toward greater profit tomorrow.

### VACATION BONUS

When on vacation, plan to stop by and see a complete demonstration. If purchase is made while you are here Windsor will pay equivalent to your tourist rate plane fare from your U. S. home and back with the exception of Alaska and Hawaii.

**WINDSOR ELECTRONICS, INC.**

Equipment Division

999 N. Main St., Glen Ellyn, Illinois





# Sales boom

**We've got a powerful, proved way to expand your sales.**

**We can tell you how many people use the Yellow Pages to find most products or services.**

**We can tell you how many took Action ...a visit, a call, or a letter...after looking in the Yellow Pages.**

**So, if you want to start a sales boom for your business...take a long look at the Yellow Pages National Usage Study.**

**Call your Yellow Pages man, today...for the details. You'll find him listed in the Yellow Pages, naturally, under Advertising — Directory & Guide.**

**Installing  
UHF converters  
can cost you money**

**OR**

**you can install  
Standard Kollsman**

Do you realize that a high percentage of converters being sold today **don't** meet minimum F.C.C. requirements? It's a fact.

It's also a fact that Standard Kollsman converters fall well within F.C.C. minimum requirements—and are among the few which do. This is one reason why we're the number one seller in Los Angeles, Chicago, Boston, or wherever UHF is on the air.

Here's how to convert 45 minutes into solid profit. Install a Standard Kollsman Transistor UHF Converter. That's all the time it takes. It's the built-in, all-channel converter that gives any set a sought after custom look. **And, only Standard Kollsman gives a full year warranty.**

Best performance. Fits all consoles, table models, and most portables. Compact size: 5½" long, 11¼" wide, 4½" high; weight: 1¼ lbs. Easy tuning high-ratio ball bearing drive. Service-free tuning element. For both series or parallel filament sets. Quick and easy way to make TV trade-in's saleable.

**ORDER YOUR UCT-051  
KITS TODAY**

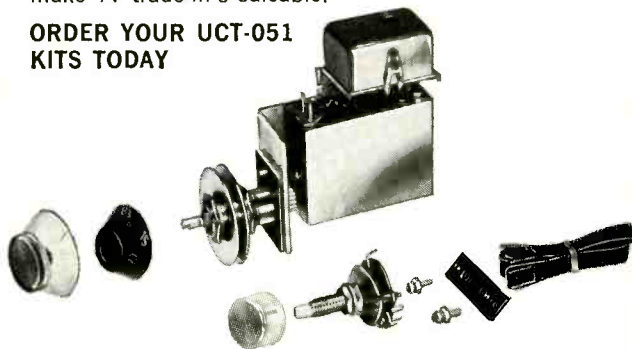

WORLD'S LARGEST MANUFACTURER OF TELEVISION TUNERS



**Standard Kollsman  
INDUSTRIES INC.**  
2085 NORTH HAWTHORNE AVE., MELROSE PARK, ILLINOIS

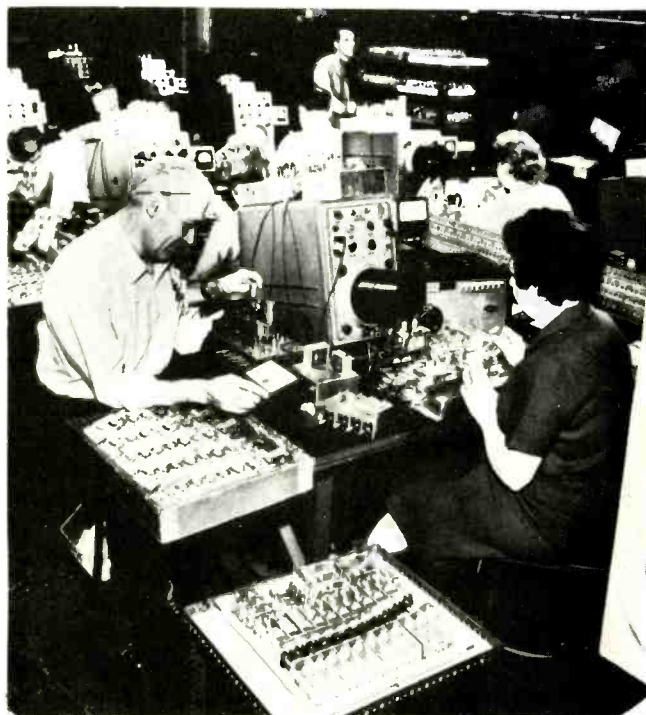

**Our Cover**

Our cover this month shows a production inspection station at the final UHF TV tuner alignment section of Standard Kollsman Industries' tuner division located in Melrose Park, Ill. The solid-state tuner is shown being checked. Thousands of tuners are checked each day by these production inspection stations. Test instruments used include UHF sweep generators, marker generators and scopes. RF bandpass, oscillator tracking and tuning range are some of the parameters checked. Tuners are fully checked for noise factor when they leave these stations.

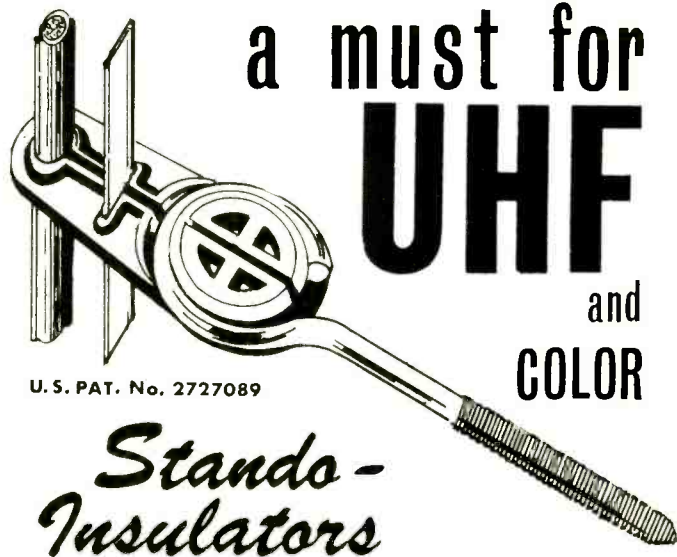

U. S. PAT. No. 2727089

*Stando-  
Insulators*

**COMPLETELY INSULATES LEAD-IN WIRE FROM METAL**

Available with all Standoff Insulators.

Also separately for use on any Standard Insulator.

Holds all types of UHF wire separately or in combination with flat wire.

Write for full information.

**PARKER METAL GOODS CO.**  
85 Prescott St., Worcester, Mass.

# "It's there in hours...and costs you less..."

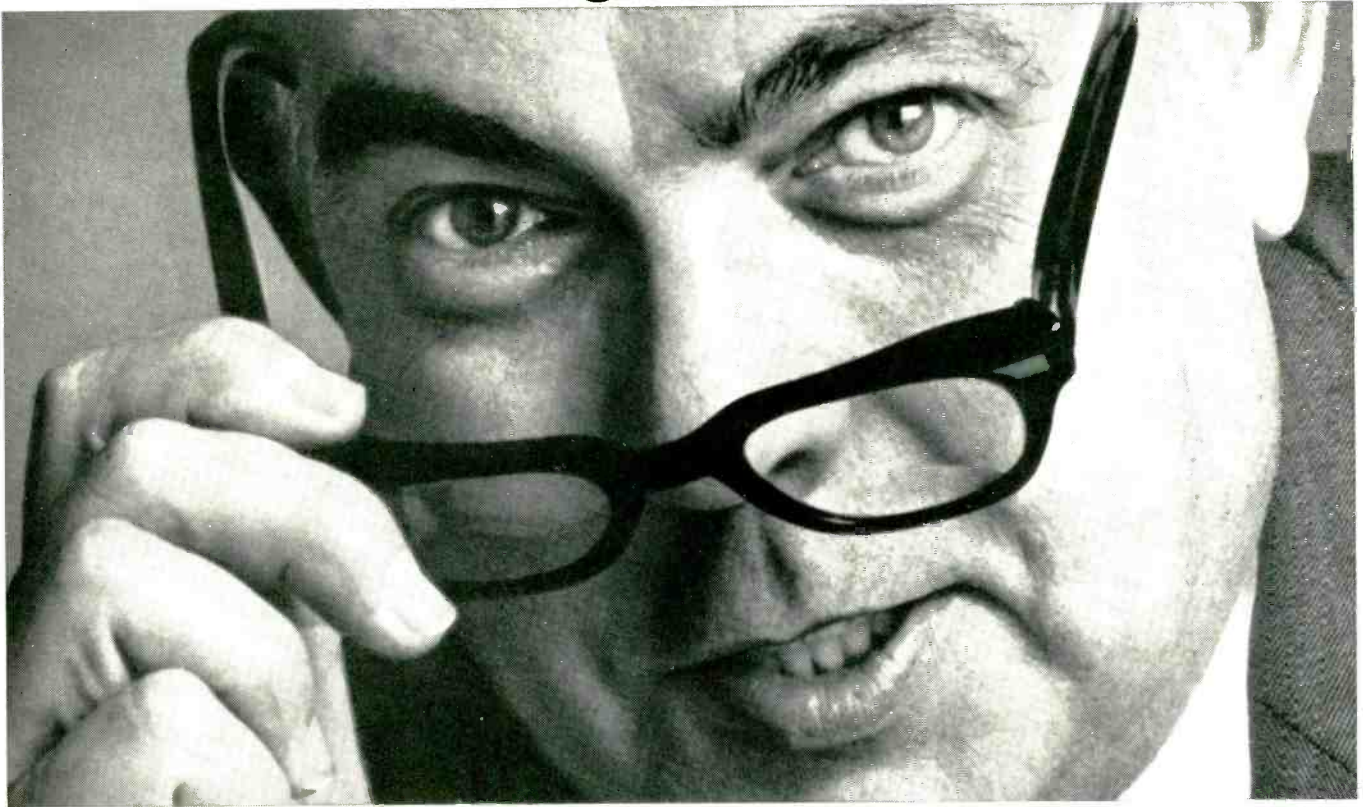

## that's why I always specify Greyhound Package Express!"

When you want something in a hurry (as you so often do)... specify Greyhound Package Express. Your shipments go anywhere Greyhound goes... on regular Greyhound buses... via fast, frequent Greyhound schedules. This means you can ship to thousands of communities not reached by any other form of public transportation. It means you can ship anytime—twenty-four hours a day, seven days a week,

week-ends and holidays. And it means your shipments get there *faster*, because they get moving *sooner*! Save time! Save money! Save trouble, too! Ship C.O.D., Collect, Prepaid or open a Greyhound Package Express Charge Account.

*For information on service, rates and routes, call Greyhound or write today: Greyhound Package Express, Dept. 53-B 140 S. Dearborn St., Chicago 3, Ill.*

### Save hours and minutes! Save dollars and cents!

For Example	Buses Daily	Running Time	20 lbs.	30 lbs.	40 lbs.*
BOSTON— NEW YORK	20	5 hrs. 0 min.	\$2.00	\$2.35	\$2.60
LOS ANGELES SAN FRANCISCO	28	9 hrs. 20 min.	2.10	2.45	2.80
PITTSBURGH— CLEVELAND	13	2 hrs. 55 min.	1.80	2.05	2.40
INDIANAPOLIS CHICAGO	10	4 hrs. 15 min.	1.90	2.20	2.55

\*Other low rates up to 100 lbs.



One of a series of messages depicting another growing service of The Greyhound Corporation.

# Recommend the TURNER 500 Cardioid

**DON'T GO WRONG  
... GO TURNER**

In your business, your reputation depends on your recommendation. Don't risk either — always recommend the high-performing, trouble-free Turner 500 Cardioid. Most problems in PA or sound applications — extraneous noises, poor acoustics, etc. — can be successfully solved by incorporating Turner 500's into the system. So before you make your next installation, check the Reader Service card for the complete Turner catalog. Get details on the Model 500 — list price \$84.00 — and the rest of the Turner line, including:



**MODEL 251**

Low cost, high performance paging microphone with Turner's unique lift-to-talk feature. List price \$49.50



**MODEL SR585D**

Fixed mounted microphone conveniently mounted on a flexible 16" gooseneck. List price \$40.



**MODEL 58**

A natural for any application requiring freedom and mobility ... does double-duty on desk stand. List price \$57.

**THE TURNER MICROPHONE COMPANY**  
918 17th Street N.E.  
Cedar Rapids, Iowa

In Canada: Tri-Tel Associates, Ltd., 81 Sheppard Avenue West, Willowdale, Ontario  
Export: Ad Auriema Inc., 85 Broad Street, New York 4, N.Y.

## NEWS OF THE INDUSTRY

### Blonder-Tongue Files Suit for Patent Infringement

Blonder-Tongue Electronics and Isaac S. Blonder, chairman of the board, filed suit against Channel Master Corp. of Ellenville, N.Y. and Gavin Instruments, Inc. of Somerville, N.J. for patent infringement on Blonder-Tongue's UHF converters. The suit charges Channel Master and Gavin with manufacturing and selling ultra high frequency converters using tunable electronic circuit elements covered by U.S. Patent No. 2,778,943, issued to Mr. Blonder. An additional action is filed against Channel Master for infringement of transmission line connectors covered by U.S. Patent No. 3,154,362. The complaints, filed in the Federal District Court of the Southern District of New York, asks the court for preliminary and final injunctions against further infringement. It also asks for, "... accounting of profits and damages, attorney fees and, in view of the wanton character of the infringement, three times the amount of actual damages."

### RCA Reports Record First Quarter Sales and Earnings

Sales and earnings of the Radio Corp. of America in the first quarter of 1965 set all-time records for the period, maintaining the upward profit trend that began four years ago, Chairman David Sarnoff and President Elmer W. Engstrom announced. Profits after taxes in the first three months this year amounted to \$25,000,000, a 16 percent increase over the previous first quarter high of \$21,600,000 established in 1964. This was the sixteenth consecutive quarter in which RCA profits ran above the comparable quarter of the preceding year. Sales of products and services rose 3 percent to a new first quarter peak of \$475,500,000 from last year's record \$461,400,000. Earnings per common share for the first quarter were 43 cents, an increase of 19 percent over the 36 cents per share in the comparable 1964 period, both figures adjusted for the 10 percent stock dividend declared in December, 1964, and paid February 1, 1965.

### Oxford Appoints Representative

Oxford Transducer Corp. of Chicago announces the appointment of AES, Inc. of Aurora, Colorado to represent them in the Rocky Mountain States. Territory includes Colorado, New Mexico, Utah, Wyoming, El Paso County, Texas and Eastern Montana.

### Olympic Appoints Four to New Sales Posts

Olympic Radio & Television Sales Corp. announces four new salesforce appointments. W. E. Dodson was promoted to regional manager and will cover a territory including Louisiana, Arkansas and the southern half of Mississippi. In addition, Olympic named three new district managers. They are: Edward H. Therrien of Tampa, Fla., who will cover most of Florida and three counties in Georgia; N. C. Matlock of Charlotte, N.C., whose territory will include 22 counties in the western part of North Carolina; and Charles L. Highfill of Greensboro, N.C., who will also handle parts of North Carolina. Olympic is a division of Lear Siegler, Inc.

# New, compact, beautiful, profitable

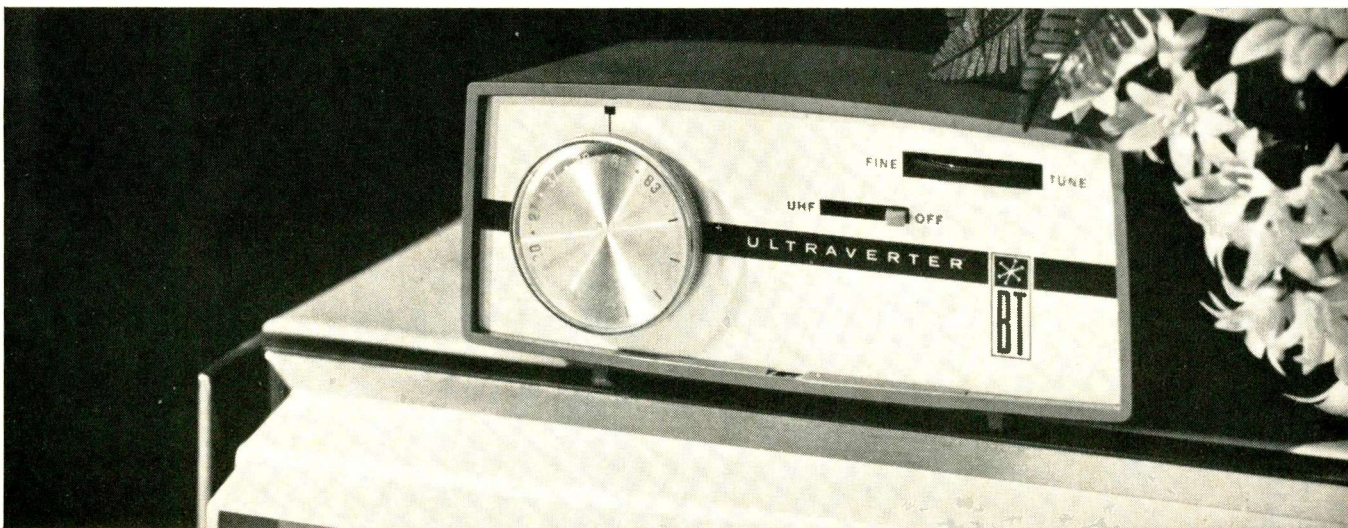

## Blonder-Tongue solid-state UHF converters

The only top-rated line... performance-proved in 4 million homes!

Now, Blonder-Tongue converters add solid-state circuitry and outstanding styling to match its performance record . . . make it the most wanted converter on the market today. Easier to sell because they are rated "tops" by leading independent consumer testing laboratories and technical magazines . . . backed by the experience of 4 million set owners in every UHF market . . . proved by the remarkably low  $\frac{1}{4}$  of 1% return for service. The new solid-state line retains many traditional Blonder-Tongue features including peak performance on all UHF channels, easy tuning and installation and reliable long-term operation. They add all the benefits of solid-state circuitry—improvements in noise figure, stability and in long-term reliability (no tubes to burn out).

**BLONDER-TONGUE BTX-99A** The ideal converter for prime signal areas. In many areas it will perform well using only

an indoor antenna. Meets the critical needs of superior color reception with a precise impedance match and a low noise all-transistor circuit. List \$27.95.

**BLONDER-TONGUE BTX-11A** Most powerful and stable UHF converter ever engineered for the home. The perfect selection anywhere within the range of a UHF signal, it excels in weak signal areas. This superior converter has a powerful low-noise signal amplifier that triples signal strength, assures reception in fringe and translator areas. Produces brilliant color TV, sharp, clear black-and-white reception. List \$44.50.

These two new solid-state models join the BTD-44, a tunnel-diode, cordless power, economy model, to give you a complete line to meet the needs of any area—any price—any reception condition. *Look to the leader in UHF.*

 **BLONDER-TONGUE**  
9 Alling Street, Newark, New Jersey 07102  
home TV accessories • closed circuit TV •  
community TV • UHF converters • master TV

## BLOCKS FOR BUSS FUSES



Single pole, multiple pole, small base, full base, molded base, laminated base, porcelain base for fuses from  $\frac{1}{4}$  x  $\frac{5}{8}$  inches up. Also signal type fuse blocks and special blocks of all types.

Tell us what you need or...

**Insist On  
BUSS  
QUALITY  
Fuse Blocks**

Write for  
BUSS  
Bulletin SFB

BUSSMANN MFG. DIVISION, McGraw-Edison Co., St. Louis, Mo. 63107

**BUSS: The Complete Line of Fuses and . . .**

## NEWS OF THE INDUSTRY

### IRC Reports Record Earnings

IRC reports the highest earnings in its history for the first 15 weeks of a year. For the period ended April 18, 1965, the company reports net profit of \$1,047,600 or 70 cents per share on sales of \$11,067,000. The profit was 94 percent above the \$543,400 or 36 cents per share for the 15 weeks ended April 12, 1964. The sales figure was 27 percent above the \$8,701,000 volume of last year's comparable period. Per share figures are based on 1,491,662 shares currently outstanding.

### FCC Assumes Control of CATV

The Federal Communications Commission has asserted control over the many present and proposed CATV systems. The FCC said that it is acting to protect local television stations from the mushrooming competition of Community Antenna Television (CATV). The FCC presented a number of unanswered questions to the general public and the broadcasting industry inviting suggestions and comments on which course it should take in the future.

What effect will CATV have on independent UHF stations in the large cities?

Should CATV be required to carry the programs of nearby stations rather than leap frog those stations with the programs of more distant stations?

Should CATV be allowed to originate programs? If so, should they be placed under such FCC regulation as the equal-time law in political campaigns?

Should local television station owners be allowed to own local CATV systems?

The agency has asked Congress for clarification of its role in regulating CATV.

### Golbus Joins Hallicrafters

Bernard J. Golbus has joined The Hallicrafters Co. as director of marketing and distribution, distributor products, it was announced by Ned S. Underhill, vice president and general manager of the commercial products division. In his assignment with Hallicrafters, Mr. Golbus will have over-all responsibility for all sales, distributor and marketing activities for that company's line of amateur, short wave listener and citizens band radio products.

### Three New York Transmitters Moving to Empire State Tower

Three New York City FM stations, in cooperation with the Empire State Building, have signed an agreement to transmit their FM signals next fall from the nation's first master FM antenna atop the world's tallest skyscraper. The stations are WQXR-FM, operating on 96.3 Mc; WHOM-

## TRON SUB-MINIATURE PIGTAIL FUSES

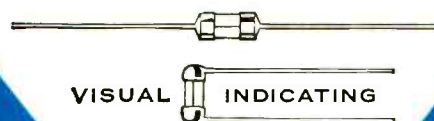

**BODY SIZE  
ONLY  
.145 x .300  
INCHES**

For use on miniaturized devices, or on gigantic space tight multi-circuit electronic devices.

Glass tube construction permits visual inspection of element.

Smallest fuses available with wide ampere range. Twenty-three ampere sizes from 1/100 thru 15 amps.

Hermetically sealed for potting without danger of sealing material affecting operation. Extremely high resistance to shock or vibration. Operate without exterior venting.

**Insist On  
BUSS  
QUALITY  
Fuses**

Write for  
BUSS  
Bulletin SFB

BUSSMANN MFG. DIVISION, McGraw-Edison Co., St. Louis, Mo. 63107

Made to  
Military  
Specifications

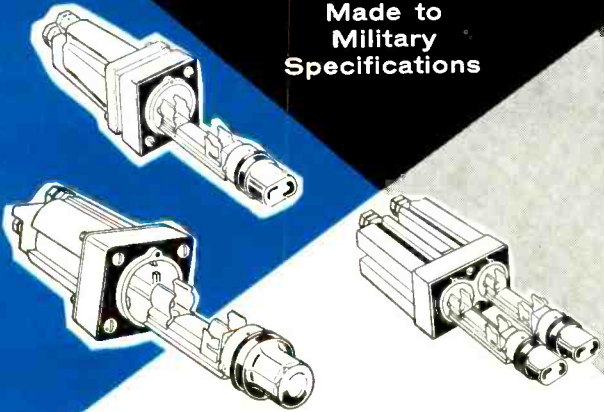

## BUSS FUSEHOLDERS

LAMP INDICATING SERIES HG

Made to MIL Specs.—FHL10U, FHL11U, FHL12U

Quick, positive, visual identification of faulted circuit. Transparent knob permits indicating light to be readily seen.

Fuses held in clips on fuse carrier which slides into holder and locks in place with bayonet type knob.

Holder designed for panels up to 1/8 inch thick.

Insist On  
**BUSS**  
**QUALITY**  
Fuseholders

Write for  
BUSS  
Bulletin SFB

BUSSMANN MFG. DIVISION, McGraw-Edison Co., St. Louis, Mo. 63107

were \$72,488,000, setting a record for any first quarter in the company's history. This compares with \$54,275,000 in the first quarter of last year. Speaking at a national sales convention attended by 700 distributor personnel, Barreca said that profits after taxes were \$1,543,000 or 63 cents per share compared with \$909,000 and per share earnings of 37 cents in the first quarter of last year. The Admiral official reported that March sales established a record high for any month, and added that the strong business momentum of the first three months has carried over into the second quarter. He said that while the outlook for the balance of the year appears favorable at this time, much depends upon a continued high level of the general economy and an easing of international tensions.

### NEDA Honors General Sarnoff as Industrial Statesman of the Year

David Sarnoff, board chairman of the Radio Corp. of America, received the first annual Industrial Statesman of the Year award from the National Electronics Distributors Assn. NEDA board chairman, Sam Poncher, Newark Electronics Corp., Chicago, presented a special plaque to General Sarnoff in ceremonies held in the industrialist's Rockefeller Center offices. The inscription on the plaque reads: "The National Electronic Distributors Assn. awards the distinguished service citation to David Sarnoff, industrial statesman, whose vision and leadership in electronics have contributed profoundly to the strength of our nation—in grateful recognition from America's independent electronic parts distributors."

## Fuseholders of Unquestioned High Quality

FM, 92.3 Mc and WLIB-FM, 107.5 Mc. The nation's first master FM antenna will provide potentially for the broadcasting of 17 FM stations simultaneously from the new antenna to be designed and built by the Alford Manufacturing Co. of Boston. It will be erected directly above the 102nd floor, known to millions as the observation floor, at the 1250 foot level of the structure. The new antenna will be omni-directional, providing a circular pattern with horizontal and vertical polarization. This optimum location will provide greater FM coverage and stronger signals throughout the New York area. Transmitter locations also are included in the project. The equipment will be installed on the 81st floor of the building and will feed the antenna 21 floors above through co-axial cables.

### Extended Warranty Survey

A National Electronics Assn. (NEA) committee recently conducted a survey among TV-sales and service-dealers. The dealers were queried on their attitude toward Admiral's full one year service color TV warranty in the Chicago and New York areas. The NEA member dealers were allowed to voice their opinion of the warranty program. Out of 238 replies to the nationally conducted survey, 230 oppose the plan, 7 expressed approval and 1 had no comment.

### First Quarter Sets Record for Admiral

Vincent Barreca, president of Admiral Corp., announced that consolidated sales for the first three months

# BUSS QUALITY

small  
dimension  
fuses



For protection of all types of electronic and electric devices

The complete line of BUSS and "TRON Family" fuses includes quick-acting, slow-blowing, signal or visual indicating fuses in sizes from 1/500 amperes up.

All standard items are easily obtained through your BUSS distributor, but if you don't find what you want get in touch with us.

Insist On  
**BUSS**  
**QUALITY**  
Fuses

Write for  
BUSS  
Bulletin SFB

BUSSMANN MFG. DIVISION, McGraw-Edison Co., St. Louis, Mo. 63107

**top money maker in  
the service business**



## NEW IMPROVED SENCORE CR133 CRT CHECKER & REJUVENATOR

The new, improved CR133 CRT Checker is designed to test all present picture tubes — and it's ready for future tubes too! Two plug-in replaceable cables contain all sockets required. The compact, 10 lb., CR133 checks CRT emission, inter-element shorts, control grid cut-off capabilities, gas and expected life. Checks all tubes: conventional B&W, new low drive B&W, round color tubes and new rectangular color picture tubes. Exclusive variable G2 Volts from 25 to 325 Volts insures non-obsolescence when testing newly announced "semi-low" G2 CRT tubes. New Line Voltage Adjustment insures the most accurate tests possible. Uses well-filtered DC for all checks to avoid tube damage and reading errors. Color guns are individually tested as recommended by manufacturers. Exclusive automatically controlled rejuvenator applies rejuvenation (ACR) voltage as required by individual tube condition; precisely timed to prevent over-rejuvenation or tube damage. The ACR feature is most useful for color tube current equalization to insure proper tracking. Hand-wired and steel-encased for protection of meter and panel in truck or shop, the new improved CR133 is only . . . **\$89<sup>95</sup>**

The famous CR128 CRT Checker and Rejuvenator is similar to above, but with a three position G2 slide switch and without Line Voltage Adjustment at \$69.95

*professional quality — that's the difference!*

# SENCORE

426 SOUTH WESTGATE DRIVE • ADDISON, ILLINOIS

## NEWS OF THE INDUSTRY

### Harris Introduces Bill on CATV Rulemaking

Rep. Oren Harris has jumped on the FCC for going ahead with its proposed CATV rule-making without first consulting with Congress. The House Commerce Committee chairman has introduced a bill to put the CATV problem in perspective of a whole new look at the "realities of television today." The Harris Bill, H.R. 7715, would authorize FCC to regulate all types of CATV systems—but the commission would have to wait 90 days before making any rules effective, to give Congress time to review them. The Commerce chairman bitingly informed his fellow congressmen last week that the 90-day enforced waiting period is something new in the relationship of Congress to its regulatory agencies. But Rep. Harris feels that in cases of very broad rulemaking, this waiting period is and will continue to be necessary to keep agencies from deciding large matters on, for example, a 4-3 or 3-2 vote. The Harris bill calls for Congress to newly evaluate "all aspects" of television's future in the United States. The FCC is advised to wait for the whole policy picture to be clarified, before taking piecemeal action on the CATV aspect of TV service to the public. However, the FCC is directed to make "full inquiry" into all aspects of CATV, using subpoena powers when necessary. Rep. Harris says his bill would "give frank recognition to some of the realities of television today." It would amend the "all too general" public interest yardstick used by the FCC. The statutory policy would be "to give the people of the United States access to the greatest practicable diversity of local, network, educational and other TV programs." On CATV, the Harris bill would establish FCC authority to regulate, but not license, all forms of CATV, wire or air-link, but never to consider them as common carriers. Federal control would preempt local control, but only where matters affecting national TV policy were concerned. The bill makes it clear that regulation of CATV is a necessary phase of national TV policy as part of interstate television. The Harris bill also knocks out the FCC's interim action requiring microwave-link CATV applicants to voluntarily put themselves under rule to carry local stations and not duplicate local programming 15 days before or after station showing. Rep. Harris says this is just one more example of FCC's "freeze" on broadcast industries. The bill calls for full rulemaking proceedings on the microwave CATV requirements. The NCTA president Frederick Ford says CATV "welcomes" the bill. It will give Congress a chance to review the proposed rules (CATV had held FCC needed congressional authority to regulate). NCTA is happy about the promised "reappraisal" of the best TV service possible to the American public, and the role of community antenna in it.

### LSI's Brooks Takes Chamber Seat

John G. Brooks, board chairman and president of Lear Siegler, Inc., and newly installed member of the board of the Chamber of Commerce of the United States, is the first representative of the electronics industry to be elected to that body. Mr. Brooks took his National Chamber seat during the organization's convention. He was elected to the 62 member board for a two-year term. The electronics executive was proposed to represent the nation's fifth largest manufacturing group by the Electronic Industries.



Assn., with support by a number of other trade associations and local Chambers of Commerce. He has served on the EIA board since 1958, representing the Consumer Products Div.

### Zenith Reports Record First Quarter Sales and Earnings

Record first quarter sales and earnings were announced by Zenith Radio Corp. Earnings during the three months ended March 31, 1965 amounted to \$6,682,000, or 72¢ per share, after estimated provision for Federal income taxes of \$6,410,000. This represents a 14 percent increase over the previous record first quarter earnings reported in 1964 of \$5,845,000, or 63¢ per share on the shares then outstanding. Sales of \$115,311,000 were at an all-time high for any quarter, up 12 percent from the record sales of \$102,663,000 in the first quarter of 1964 and 6 percent ahead of the previous all-time sales record established in the fourth quarter of 1964. This is the ninth consecutive quarter in which sales have increased from the preceding year.

### ... R/C BRIDGE

*Continued from page 62*

age control on zero, turn the control up until the magic eye closes (or opens, depending on your instrument). The control setting will be between 10 and 50 v. Reverse the connections to the rectifier. The eye should not close even when the voltage control is up to 50 v or a little higher with a good rectifier or diode. Closing (or opening) of the eye indicates a defective rectifier. Do not turn the voltage control so high that a good rectifier will be ruined, of course.

### Filter Choke Values

Occasionally we need to know the value of an unmarked filter choke. We keep a spare 5 hy choke on hand for a "standard." With a known-value choke we can then use the bridge to find the unknown value choke. This is done by setting the range switch to COMPARATOR and then connecting the known choke to the COMPARATOR, PROTOTYPE or STANDARD terminals of the bridge. The unknown choke is connected to the plus and minus terminals. Adjust the pointer until the magic eye shows maximum opening (or closing), and read the ratio of the two chokes on the ratio scale. Divide the 5-hy value by the readings on the ratio scale to obtain the unknown choke's value.

### Electrical Appliances

If you repair small electrical motor appliances — mixers, drills, etc. — set the bridge on test voltage range with the control at 500 v and check for leakage from each side of the 117 vac line to case. Leakage indicated by opening (or closing) of the magic eye indicates a breakdown somewhere within the appliance insulation. A leakage problem should be solved before returning the appliance to the customer to prevent possible electric shock or a major breakdown in the equipment.

We discover new uses for our bridge almost every day and it is paying off as a valuable time-saver. ■

at last...  
instant color patterns  
at your finger tips...  
zero warm-up time

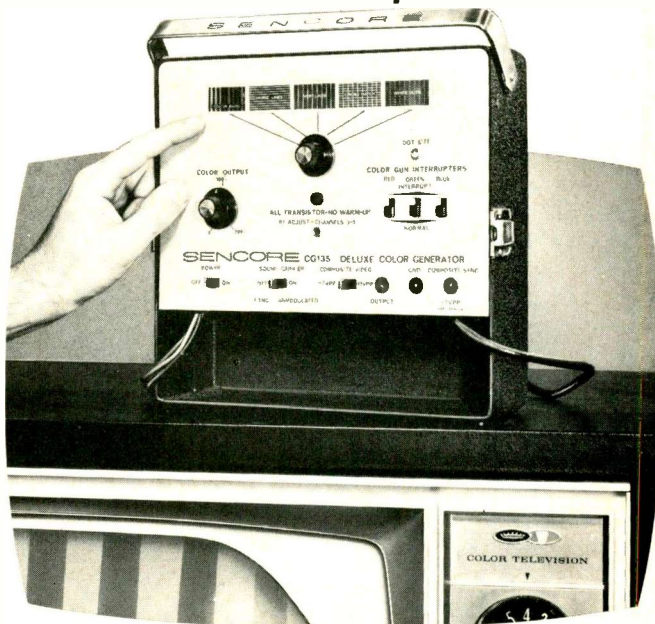

## THE ALL NEW SENCORE CG135 DELUXE TRANSISTORIZED COLOR GENERATOR

The big push is on in Color TV. Equip yourself now with the new, solid state Sencore CG135 and cash in on the zooming volume of new service business as Color-TV booms! Instant, service-ready RCA standard color bars, cross-hatch, white dots and individual vertical and horizontal bars enable you to set up or trouble-shoot more Color TV sets per day; earn top money in this fast growing service field. It's an analyzer too: Color gun interruptors, unmodulated video for chroma circuit trouble isolation and unmodulated sync pulses to keep Zenith receivers in sync for this test, make color trouble shooting a snap. Sturdy all-steel construction for rugged, heavy duty in the field or shop. Another Best Buy in profit-building service instruments from Sencore at **\$149<sup>95</sup>**

COMPARE THESE FEATURES: SEE WHY THE CG135 IS IN A CLASS BY ITSELF

- Solid state construction employs high priced GE "Unijunctions" to develop six "jump out proof counters" that guarantee stable patterns at all times with no warm-up
- Standard RCA licensed patterns as shown on schematics throughout the industry
- Handy universal color gun interruptors on front panel
- Lead piercing clips insure non-obsolescence
- CRT adaptors optional
- Crystal-Controlled 4.5mc Sound Carrier Analyzing Signal to insure correct setting of fine tuning control
- RF output on Channel 4 adjustable to Channel 3 or 5 from front of generator when Channel 4 is being used
- No batteries to run down; uses 115 V AC
- Less than one foot square, weighs only 8 lbs.

*professional quality — that's the difference!*

**SENCORE**  
426 SOUTH WESTGATE DRIVE • ADDISON, ILLINOIS

## ADVERTISERS INDEX

American Telephone & Telegraph Co. ....	81
Amperex Electronic Corp. ....	3rd Cover
Amphenol Distributor Division ....	22-23
Arco Electronics ....	31
Armco Steel Corp. ....	73
Arrow Fastener Co. ....	90
B & K Manufacturing Co. ....	67, 69
Blonder-Tongue ....	85
Brach Manufacturing Corp. ....	76
Bussmann Mfg. Division ....	86-87
Channel Master Corp. ....	35
Cleveland Institute of Electronics ....	19
Delco Radio Division ....	37
Finney Co. ....	71, 79
Gavin Instruments, Inc. ....	30
Greyhound Corp. ....	83
Heath Company ....	38
Hickok Electrical Instrument Co. ....	29
Jerrold Electronics ....	32
JFD Electronics Corp. ....	42-43
LTV University ....	74
Mallory & Co., P. R. ....	33
Miller Company, J. W. ....	76
Oxford Transducer Corp. ....	72
Parker Metal Goods Co. ....	80
Philco Corporation ....	44
Quam-Nichols Co. ....	78
Quietrole Co. ....	90
Radio Corp. of America RCA Electronic Components & Devices ....	41, 4th Cover
RCA Sales Corp. ....	77
Rego Electronics ....	30
Sarkes Tarzian Tuner Service Div. ....	2nd Cover
Seco Electronics ....	80
Sencore, Inc. ....	88-89
Snyder Manufacturing Co. ....	78
Sonotone Corp. ....	74
Sprague Products Co. ....	25
Standard Kollsman Industries, Inc. ....	82
Sylvania Electric Products, Inc. ....	20, 75
Triplett Electrical Instrument Co. ....	36
Turner Microphone Co. ....	84
Ungar Electric Tools ....	28
Viking Electronics ....	90
Windsor Electronics, Inc. ....	82
Winegard Co. ....	26-27
Zenith Sales Corp. ....	39

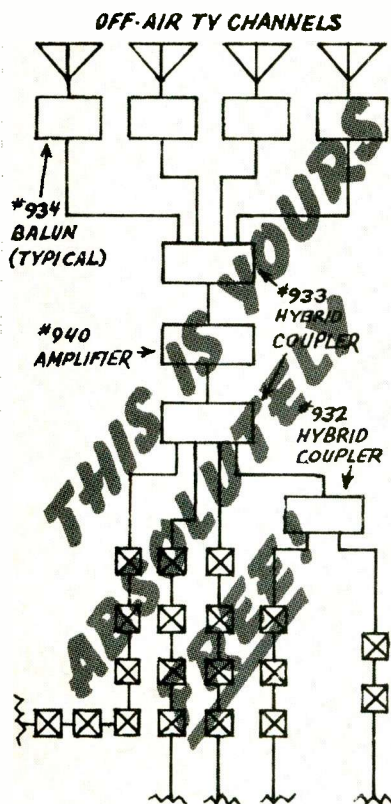

## LET VIKING DO ALL YOUR MATV LAYOUTS FREE!

### Master Antenna and Closed Circuit TV System

Viking is the only manufacturer of cable and equipment for all your MATV needs. Get completely free layouts for all size installations from the smallest to the most comprehensive and involved combination.

Let Viking's staff of trained technical engineers assist you in your layout work free of charge.

One source for all your needs.

Call Us Collect

**viking**

Manufacturers of Quality Coaxial Cables and Television System Products

830 Monroe Street, Hoboken, New Jersey  
New York: (212) WH 3-5793  
Hoboken: (201) OL 6-2020



## AUTOMATIC STAPLE GUNS



For Fastening Any Inside or Outside

Wire Up to 1/2" in Diameter

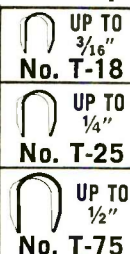

- Telephone wire
  - Intercom wire
  - Bell wire
  - Thermostat wire
  - Radiant heating wire
  - Hi-Fi, Radio & TV wires
- Tapered striking edge gets into close corners!
- Available in:  
Brown, Ivory, Beige, Monel, Bronze, Natural

ARROW FASTENER COMPANY, INC.

1 JUNIUS STREET - BROOKLYN 12, N. Y.

## NEW PRICES from QUIETROLE



the oldest, most widely proved and sold radio and TV lubricant



- |                                 |             |
|---------------------------------|-------------|
| 2 oz. bottle with dropper       | LIST \$1.49 |
| 4 oz. bottle                    | LIST 2.54   |
| 4 oz. bottle (brush-n-cap)      | LIST 2.64   |
| 8 oz. bottle                    | LIST 5.07   |
| 6 oz. spray can — with extender | LIST 2.79   |
| 3 oz. spray can — with extender | LIST 1.79   |

Quietrole is your guarantee of the most effective, quick silencer of noisy radio and TV controls — the quality product that is a top value.

Get Quietrole at quality jobbers. Some territories still available for experienced representation.



manufactured by **QUIETROLE Company**  
Spartanburg, South Carolina

# PICK ANY NUMBER FROM 1G3GT TO 19AU4 AND YOU'RE A WINNER!

1G3GT/1B3GT	4HA5	6BZ6	6GWB	8CW5
1X2B	5HG8	6CB6A	6HA5	9A8
3BZ6	5U8	6GG7	6HG8	10CW5
3CB6	6AL5	6DT6	6S4A	12AT7
3GK5	6AU4GTA	6EH7	6S47GTB	12AU7A
3HA5	6AU6A	6EJ7	6U8A	12AX4GTB
4BL8	6AV5	6GB5	6U9	12AX7A
4EH7	6AX4GTB	6GJ7	6X9	15CW5
4EJ7	6BA5	6GK5	6Y9	16A8
4GK5	6BL3	6GK6	8EQ5	19AU4

...AND ON AND ON. FOR THE COMPLETE LIST, WRITE  
AMPEREX ELECTRONIC CORPORATION, HICKSVILLE, L.I., NEW YORK 11802.



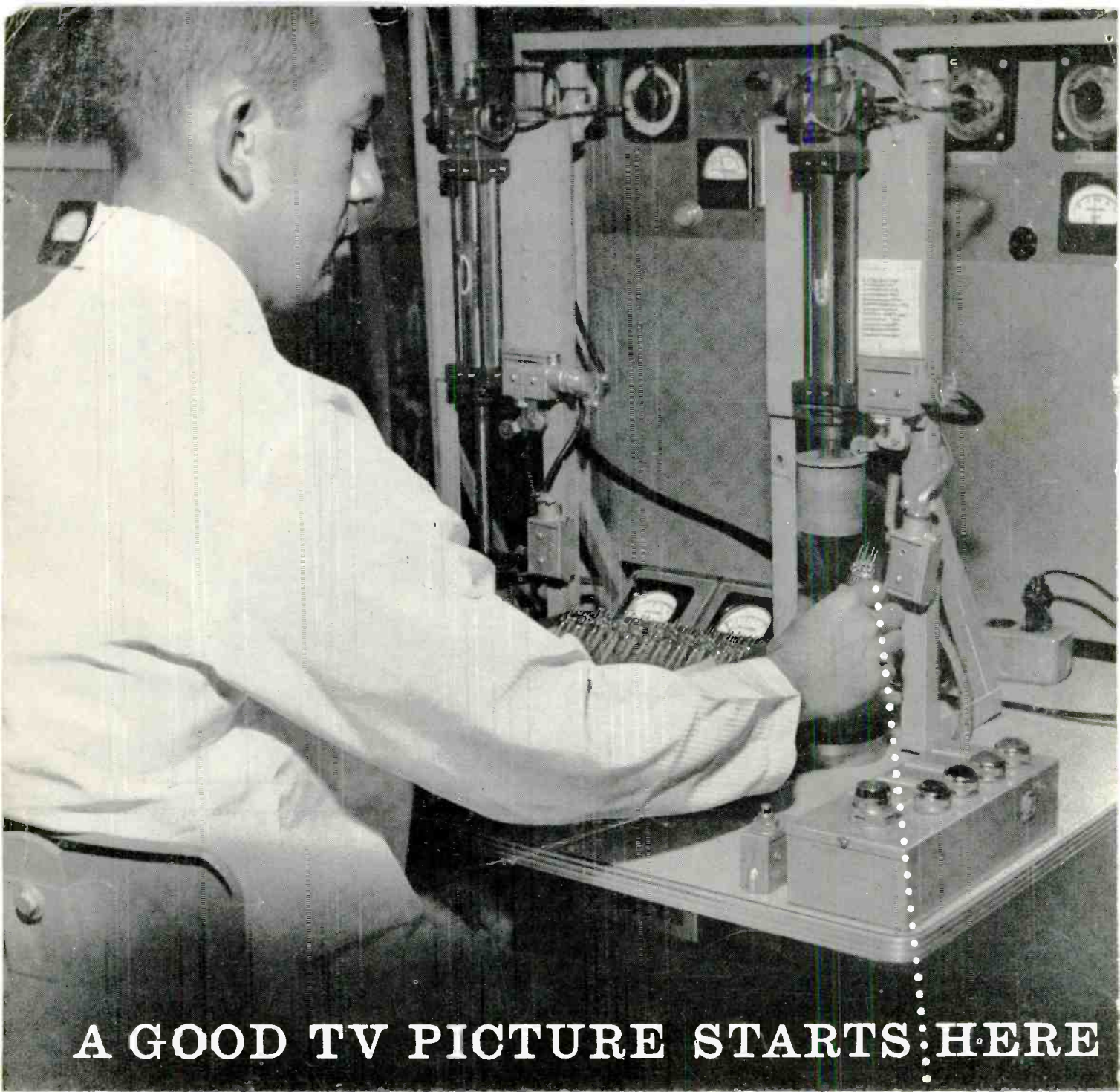

## A GOOD TV PICTURE STARTS HERE

### It Depends on a Leakproof Stem Seal

The slightest leakage of air weakens the high vacuum of a TV picture tube...resulting in a costly callback and a dissatisfied customer for you. This is why RCA takes extra precautions to maintain the vacuum in Silverama picture tubes.

Potential trouble spots are the glass-to-metal lead-wire seals in the electron-gun stem assembly (below). At RCA, stem assemblies are batch tested for leakage in a supersensitive leak detector *before* they go into electron guns.

So sensitive is this detector that it can pinpoint a leak that would not affect tube performance for years...a leak so tiny that no other inspection method could hope to find it.

*Yet the slightest sign of a leak is cause for rejection of a stem.* This extra precaution is one more example of the care that goes into every phase of Silverama manufacture...and one more reason why RCA Silverama should be your first choice in replacement picture tubes.

Silverama is made with an all-new electron gun, finest parts and materials, and a glass envelope that has been thoroughly cleaned and inspected prior to re-use.

RCA ELECTRONIC COMPONENTS AND DEVICES, HARRISON, N. J.

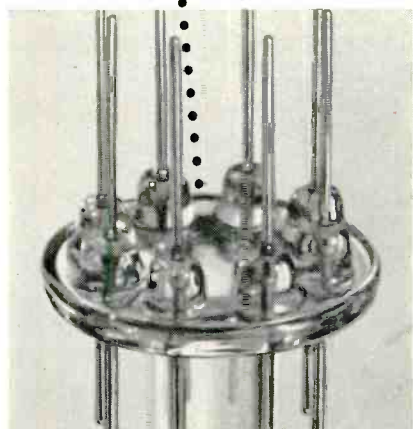

Stem assemblies are tested on a special high-vacuum leak detector. Detector is a helium mass-spectrometer, detecting passage of helium "tracer" gas through any of the glass-to-metal seals. A stem assembly passing this rigorous test is ready to become a vital part of an RCA Silverama® Picture Tube.



**The Most Trusted Name in Electronics**