

ELECTRONIC TECHNICIAN

APRIL 1963

REPAIRING TRANSISTOR AMPLIFIERS

JAPANESE TRANSISTOR RADIO GUIDE

SONY'S 5 INCH TV

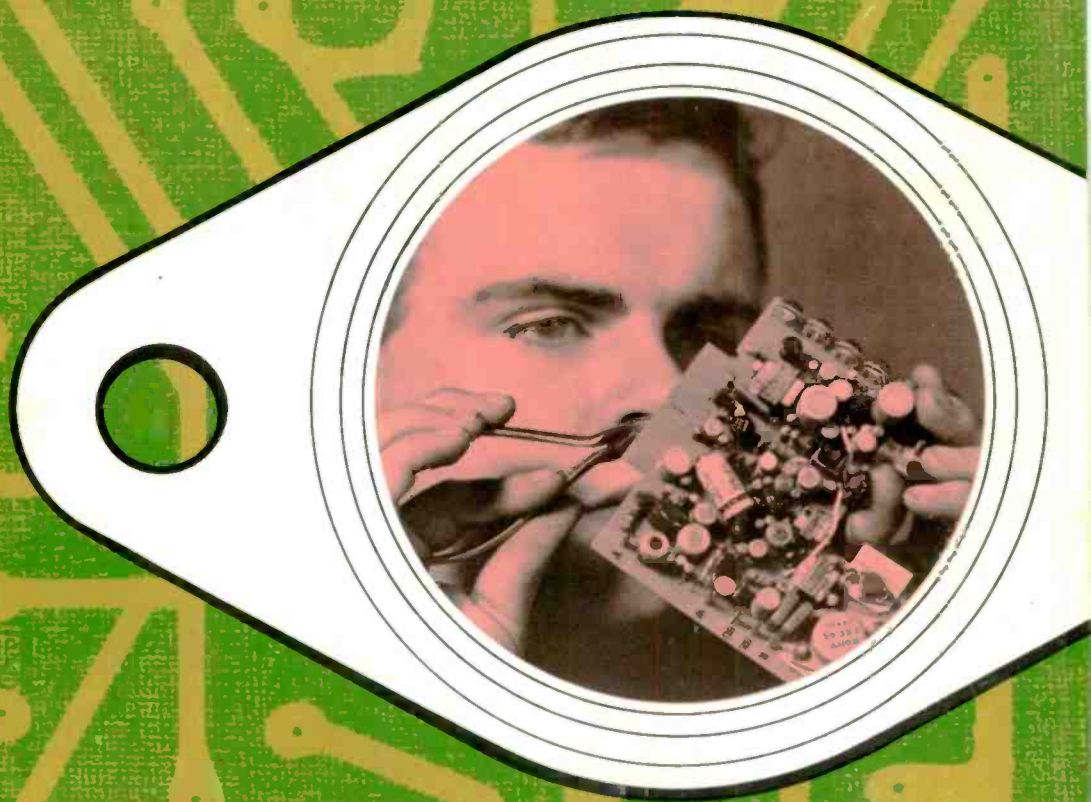

**Transistor Radio
Repair Techniques**

LIBRARY
TACKLE

SENCORE

SIMPLIFIES COLOR SERVICING

NEW! CA122

COLOR CIRCUIT ANALYZER

A simple approach to a complex problem

Here is an instrument that is designed to eliminate the guesswork in color TV servicing. A complete analyzer that provides all required test patterns and signals for testing from the tuner to the tri-color tube. Additional analyzing signals for injection at each stage including audio, video and sync, brings to life a truly portable and practical TV analyzer for on the spot service; virtually obsoleting other analyzers with the advent of color. Sencore's simplified approach requires no knowledge of I, Q, R-Y, B-Y, G-Y or other hard to remember formulas. The CA122 generates every signal normally received from the TV station plus convergence and color test patterns.

The CA122 offers more for less money:

TEN STANDARD COLOR BARS: The type and phase that is fast becoming the standard of the industry. Crystal controlled keyed bars, (RCA type) as explained in most service literature, offer a complete gamut of colors for every color circuit test.

WHITE DOTS: New stabilized dots, a must for convergence, are created by new Sencore counting circuits.

CROSS HATCH PATTERN: A basic requirement for fast CRT convergence.

VERTICAL AND HORIZONTAL BARS: An added feature to speed up convergence, not found on many other color generators.

SHADING BARS: Determines the ability of the video amplifier to produce shades (Y Signal) and to make color temperature adjustments. An important feature missing on other generators.

COLOR GUN INTERRUPTOR: For fast purity and convergence checks without upsetting color controls. Insures proper operation of tri-color guns, preventing wasted time in trouble shooting circuits when CRT is at fault.



A must for color . . .

a money maker for black and white TV servicing

ANALYZING SIGNALS: RF and IF signals modulated with any of the above patterns for injection into grid circuits from antenna to detector. IF attenuator is pre-set for minimum signal for each IF stage to produce pattern on CRT thus providing a check on individual stage gain. Sync and video, plus or minus from 0 to 30 volts peak to peak, have separate peak to peak calibrated controls for quick checks on all video and sync circuits. Crystal controlled 4.5 mc and 900 cycles audio simplify trouble shooting of audio circuits.

NEW ILLUMINATED PATTERN INDICATOR: A Sencore first, offering a rotating color film that exhibits the actual color patterns as they appear on color TV receivers. Locks in with pattern selector control.

You'll pay more for other color generators only.

Dealer Net 187.50

NEW! PS120 PROFESSIONAL WIDE BAND OSCILLOSCOPE

A portable wide band 3 inch oscilloscope for fast, on-the-spot testing. An all new simplified design brings new meaning to the word portability . . . it's as easy to operate and carry as a VTVM. Though compact in size, the PS120 is powerful in performance: Vertical amplifier frequency response of 4 MC flat, only 3 DB down at 7.5 MC and usable to 12 MC, equips the technician for every color servicing job and the engineer with a scope for field and production line testing. AC coupled, with a low frequency response of 20 cycles insure accurate low frequency measurements without vertical bounce. Sensitive single band vertical amplifier; sensitivity of .035 volts RMS for one inch deflection saves band switching and guessing. Horizontal sweep frequency range of 15 cycles to 150 KC and sync range from 15 cycles to 8 MC (usable to 12 MC) results in positive "locking" on all signals. New exclusive Sencore features are direct reading peak-to-peak volts — no interpretation; dual controls to simplify tuning; lead compartment to conceal test leads, jacks and seldom used switches. Rear tilt adjustment angles scope "just right" for easy viewing on bench or production line.

Size: 7" w x 9" h x 11 1/4" d. Weight: 12 lbs.

Dealer Net 124.50
(with low cap. probe)

Kit 74.50



A must for servicing color TV in the home . . . lowest priced broad band scope. All hand wired — all American made

SENCORE, ADDISON, ILLINOIS

--- for more details circle 29 on post card



NEW

JERROLD
TACO

COLOR GUARD



TV ANTENNA

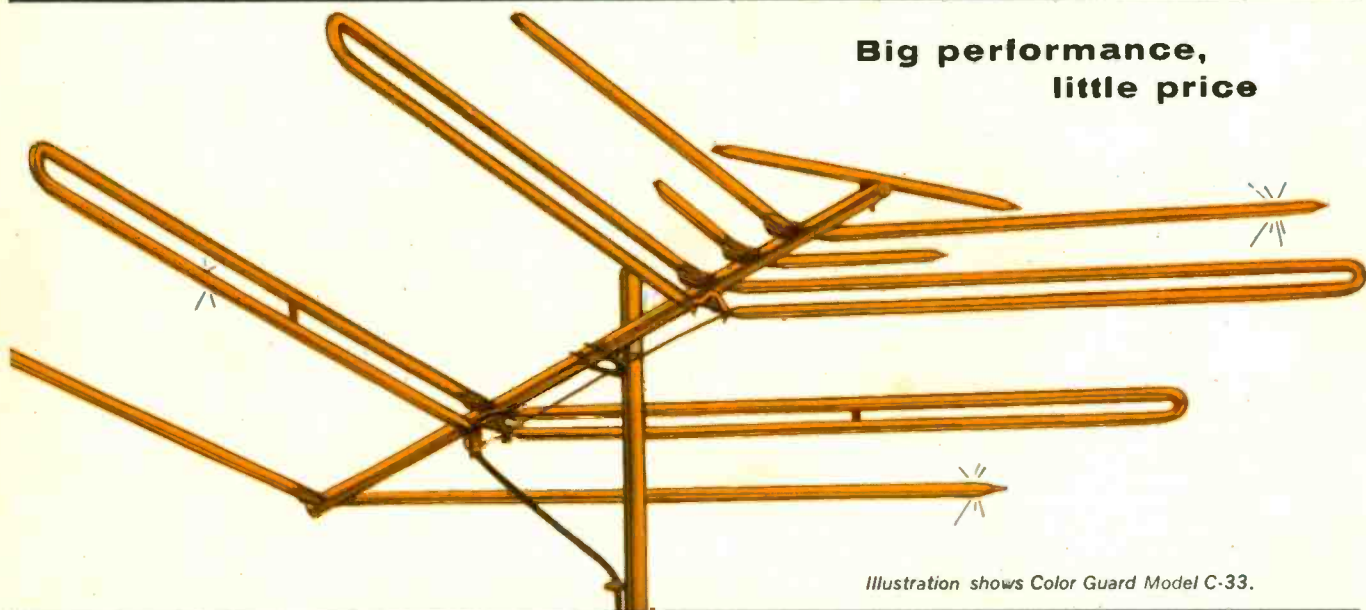

Big performance,
little price

Illustration shows Color Guard Model C-33.

Engineered for metropolitan and suburban areas, delivers sparkling color—superb black-and-white

The day of the old conical and V-cone antennas is definitely over. Today you need something better to pull in satisfactory pictures on modern big-screen sets.

The new Color Guard is just that — something better! It's patterned after the large, rugged fringe-area antennas; but it's compact, a top performer, and budget-priced for high volume throughout metropolitan and suburban reception areas.

Listing from \$7.95 (Model C-31) to \$17.95 (Model C-33), Color Guard antennas give you the flat response and gain to meet your customers' needs at modest prices. Get on the color bandwagon with the JERROLD-TACO Color Guard. See your Jerrold distributor today, or write:

JERROLD ELECTRONICS
Distributor Sales Division • Philadelphia 32, Pa.

A subsidiary of THE JERROLD CORPORATION 

... for more details circle 21 on post card

Prices effective January 1, 1963

Tarzian offers
**FAST, DEPENDABLE
TUNER REPAIR
SERVICE (ALL
MAKES)**

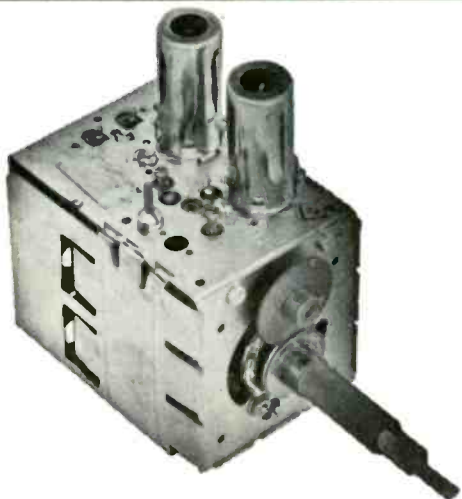

It just makes sense that a manufacturer of tuners should be better-qualified, better-equipped to offer the most dependable tuner repair and overhaul service.

Sarkes Tarzian, Inc. pioneer in the tuner business, maintains two complete, well-equipped Factory Service Centers—assisted by Engineering personnel—and staffed by specialized technicians who handle **ONLY** tuner repairs on **ALL** makes and models.

Tarzian-made tuners received one day will be repaired and shipped out the next. Allow a little more time for service on other than Tarzian-made tuners.

Tarzian offers a 12-month guarantee against defective workmanship and parts failure due to normal usage. And, compare our cost of \$9.50 and \$15 for UV combinations. There is absolutely no additional, hidden charge, for **ANY** parts except tubes. You pay shipping costs. Replacements on tuners beyond practical repair are available at low cost.

Ⓢ Tarzian-made tuners are identified by this stamping.

When inquiring about service on other tuners, always give TV make, chassis and Model number. All tuners repaired on approved, open accounts. Check with your local distributor for Sarkes Tarzian replacement tuners, replacement parts, or repair service.

 **SARKES TARZIAN, INC.**
Bloomington, Indiana

MANUFACTURERS OF TUNERS . . . SEMICONDUCTORS . . . AIR TRIMMERS . . . FM RADIOS . . . AM/FM RADIOS . . . AUDIO TAPE . . . BROADCAST EQUIPMENT

ONLY
\$9.50
INCLUDING

ALL PARTS
(except tubes)
and LABOR

24-HOUR SERVICE
1-YEAR WARRANTY

**TWO SERVICE CENTERS
TO SERVE YOU BETTER**

**See your distributor, or use the
address nearest you for fast fac-
tory repair service**

537 South Walnut St.
Bloomington, Indiana
Tel: 332-6055

10654 Magnolia Blvd.
North Hollywood, Calif.
Tel: 769-2720

**WORLD'S LARGEST
ELECTRONIC TRADE
CIRCULATION**

ELECTRONIC TECHNICIAN

RON KIPP Publisher
TOM COOPER Editorial Director
VICTOR L. BELL Editor
JACK HOBBS Managing Editor
WARREN CREWS Technical Editor
ALEX ORR Assistant Editor
JERROLD PATTERSON Assistant Editor
EARL HINTZ Production Manager
MAGGIE KANE Advertising Production
JIM GHERNA Art Director
JERRY WHITTLESEY Circulation Manager
ETHEL NASH Circulation Fulfillment

April • 1963

Vol. 77 • No. 4

CONTENTS

Letters to the Editor	22
Technical Digest	27
Test Instruments for Bench and Caddy	30
Editor's Viewpoint	35
Transistor Radio Repair Techniques	36
<i>by John N. Lane</i>	
Servicing Broadcast and Multiband Transistor Radios	39
<i>by Ben Allen</i>	
Repairing Transistor Amplifiers	42
<i>by Eino Niemi</i>	
Small Boat Radar	45
Japanese Transistor Radio Guide	46
Are You Selling Your Share of The Battery Market?	48
Fringe Area Antenna Installation	50
How To Collect Delinquent Accounts	53
<i>by Harold J. Ashe</i>	
Technicians Look at Sony's 5-inch TV	54
Improved Video Amplification Circuit	56
'Tough Dog' Corner	60
<i>by Leroy Snyder and Frank A. Salerno</i>	
Shop Hints	62
<i>by Joseph J. Schneider, Ivan White, Dennis Crisp, H. B. McCulley and John A. Krzywulak</i>	
New Products	64
Free Literature	71
New Books	72
Coming Events	76
News of the Industry	78
Advertisers Index	82



OJIBWAY PRESS, Inc.
 Ojibway Building
 Duluth 2, Minn.
 AREA CODE 218 727-8511

Sales Offices:
NEW YORK: Ron Kipp, 480 Lexington Ave., New York 17, N. Y. TN 7-0011
CHICAGO: William Klusack, 221 N. LaSalle St., Chicago 1, Ill. CE 6-1600
CLEVELAND: Arnold T. Suhart, 6207 Norman Lane, Cleveland, Ohio. YE 2-6666
LOS ANGELES: Boyd B. Garrigan, 1145 W. Sixth St., Los Angeles 17, Calif. HU 2-2838



Copyright 1963 by Ojibway Press, Inc., Duluth 2, Minn. Reproduction and reprinting prohibited except by written authorization of the publication.
 If you have a change of address or a question about your subscription, write: ELECTRONIC TECHNICIAN, Circulation Department, Ojibway Building, Duluth 2 Minnesota. BE SURE TO SEND ALONG THE ADDRESS LABEL FROM YOUR MOST RECENT ISSUE.

TEKFAX 16 PAGES OF LATEST SCHEMATICS

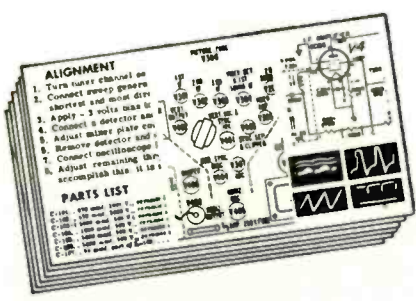

- AIRLINE:** AM/FM Console, Models WG-2313A, 43A, 73A, BB, 43B, and 73B
- DELCO:** Buick Radio, Model 980464
- EMERSON:** Transistor Radio Chassis 120664, 664L
- HEATH:** TV Chassis, Model GR-22
- WESTINGHOUSE:** CB Transceiver and Radio Chassis V-2451-2
- ZENITH:** Color TV Chassis 26KL20 and 20QS
- WESTERN AUTO:** Transistor Radio, Model DC3438



NEW VERSATILITY & COMPACTNESS in PROFESSIONAL TEST EQUIPMENT



AC VOLT-WATT METER #261

Formerly designated as #260
Kit \$49.95 Wired \$79.95



AC voltmeter and load-compensated audio-wattmeter of unique quality and accuracy. Measures AC voltage from 1 millivolt to 1000 volts in 11 ranges, and power from .015 milliwatt to 150 watts in 7 ranges, across standard loads from 4 to 600 ohms. The instrument incorporates a tapped power resistor load (4, 8, 16, and 600 ohms) to handle up to 80 watts of power on 8 ohms, and 40 watts on other taps. It may be switched to external load up to 150 watts. The meter is automatically compensated for any load selected, internal or external, to provide a single watt scale for all loads and ranges.

VOLTMETER: Ranges: .01, .03, .1, .3, 1, 3, 10, 30, 100, 300, 1000 RMS volts. Frequency Response: ± 0 db 10c to 150kc, -3 db at 500 kc. Input Impedance: 2 megohm shunted by 15mmf. Accuracy: $\pm 4\%$.

WATTMETER: Ranges: 15mw, 1.5mw, 15mw, 150mw, 1.5W, 15W, 150W. Frequency Response: ± 0 db 10c to 100kc. Accuracy: $\pm 5\%$. Internal Loads: 4 (40W), 8 (80W), 16 (40W), 600 (40W). External Loads: 4, 8, 16, 600 (all to 150W).

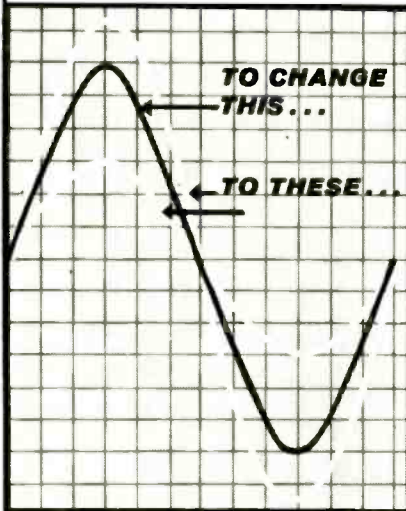

...USE THESE!



METERED VARIABLE AUTO-TRANSFORMER AC BENCH SUPPLIES

1073 (3-amp rating)
Kit \$35.95 Wired \$47.95
1078 (7 1/2-amp rating)
Kit \$42.95 Wired \$54.95

Connect to 60 cycle, 120 volt line and obtain any desired voltage between 0 and 140 volts. Highly efficient variable auto-transformer of toroidal core design gives you continuously variable output, linear versus rotation, with excellent regulation and negligible waveform distortion. Model 1078 permits either 50 or 60 cycle operation.

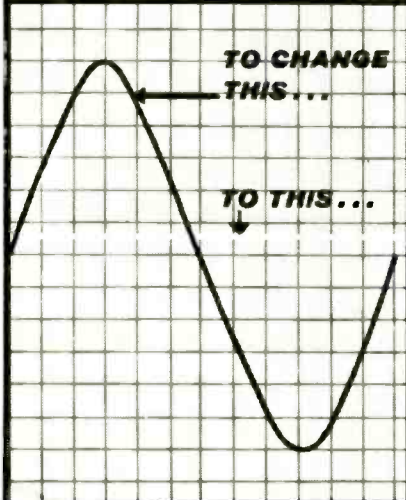

...USE THIS!



Extra-Low-Ripple 6- and 12-Volt BATTERY ELIMINATOR AND CHARGER #1064

Kit \$45.95 Wired \$54.95

Connect to 60 cycle, 120 volt line and obtain highly filtered low dc voltage continuously variable over two ranges 0-8, 0-16 VDC. Heavy-duty pi-type LC filter is rated to take the full rated current output continuously (10 amps on 8V range, 6 amps on 16V range), reduces ripple as low as 0.3% at 2 amps on the 16V range. An essential instrument for servicing battery-operated equipment, including transistor or hybrid types, and an excellent battery charger.

Also New From EICO:



AC VTVM &
AMPLIFIER
#250
Kit \$49.95
Wired \$79.95



TRANSISTOR
AND CIRCUIT
TESTER #680
Kit \$25.95
Wired \$39.95



IN-CIRCUIT
CAPACITOR
TESTER #955
Kit \$19.95
Wired \$39.95

For complete catalog of over 106 EICO kits and wired units—hi-fi. test equipment, citizens radio, ham gear—plus name of nearest distributor, write to dept. ET-4.



ELECTRONIC INSTRUMENT CO., INC.
3300 Northern Blvd., Long Island City 1, N. Y.

ADD 5% IN THE WEST Export Dept., Roburn Agencies Inc., 431 Greenwich St., New York 13, N. Y.

LETTERS TO THE EDITOR

Old Schematics in Demand

Will you please send me the address of "Supreme Publications" referenced at bottom of page 29, ELECTRONIC TECHNICIAN for Feb.

CARL F. BEALL
Cocoa Beach, Fla.

I read your article in Feb. '63 issue, Profits on Pre-War Radios Run High. It so happens that I have two such radios in for repair, a Crosley Model 124 and Truetone Model D724.

Would like to know where service literature and schematics can be obtained. I read every article in your magazine as soon as I receive it and to me ELECTRONIC TECHNICIAN magazine is the best.

GEORGE B. JAMES
Valley Park, Mo.

• The Answer to both questions is Supreme Publications, 1760 Balsam Road, Highland Park, Ill.—Ed.

Sound Business

This is just to inform you that I found myself in business with your CIRCUIT DIGEST (now TEK-FAX, ed.) issued monthly. I think your magazine is quite the thing.

HENRY P. CHAVONEL
New Orleans, La.

Static

Your method of suppressing the static interference caused by an oil burner worked. The capacitors in series across the input of the high voltage transformer with the junction of the two grounded did the trick. Thank you for your help on this problem.

HOWARD J. MEAD
Woodbury, N. J.

• We have received many letters from technicians plagued by interference problems. The solution we offered to Mr. Mead can be applied to many appliances which cause interference. Be sure to use capacitors rated at least 600 wvdc.—Ed.

--- for more details circle 16 on post card

The **HIDDEN 600*** wrote these **6 SUCCESS STORIES...**

Service Technicians supply the happy endings!

Capacitor success stories are no novelty at Sprague. The "Hidden 600", Sprague's behind-the-scenes staff of 600 experienced researchers, have authored scores of them! And customers add new chapters every day. But none has proved more popular than the 6 best sellers shown here. Developed by the largest research organization in the capacitor industry, these 6 assure happy endings to service technicians' problems.

1 **DIFILM® BLACK BEAUTY® MOLDED TUBULAR CAPACITORS**



The world's most humidity-resistant molded capacitors. Dual dielectric—polyester film and special capacitor tissue—combines best features of both. Exclusive ECX® solid impregnant produces rock-hard section—nothing to leak. Tough case of non-flammable phenolic—cannot be damaged in handling.

2 **DIFILM® ORANGE DROP® DIPPED TUBULAR CAPACITORS**



Especially made for exact, original replacement of radial-lead tubulars. Dual dielectric combines the best features of both polyester film and special capacitor tissue. Exclusive HCX® solid impregnant—no oil to leak, no wax to drip. Double dipped in bright orange epoxy resin to beat heat and humidity.

3 **TWIST-LOK® ELECTROLYTIC CAPACITORS**



The most dependable capacitors of their type. Built to "take it" under torrid 185°F (85°C) temperatures—in crowded TV chassis, sizzling auto radios, portable and ac-dc table radios, radio-phono combinations, etc. Hermetically sealed in aluminum cases for exceptionally long life. Withstand high surge voltages. Ideal for high ripple selenium rectifier circuits.

4 **ATOM® ELECTROLYTIC CAPACITORS**



The smallest dependable electrolytics designed for 85°C operation in voltages to 450 WVDC. Small enough to fit anywhere, work anywhere. Low leakage and long shelf life. Will withstand high temperatures, high ripple currents, high surge voltages. Metal case construction with Eraft insulating sleeve.

5 **LITTL-LYTIC® ELECTROLYTIC CAPACITORS**



Ultra-tiny size for use in transistorized equipment. High degree of reliability at reasonable price. All-welded construction—no pressure joints to cause "oper." circuits. Withstand temperatures to 85°C (185°F). Hermetically sealed. Extremely low leakage current. Designed for long shelf life—particularly important in sets used only part of the year.

6 **CERA-MITE® CERAMIC CAPACITORS**



Tiny, tough, dependable in practically every application. Low self-inductance of silvered flat-plate design gives improved by-pass action in TV r-f circuits. Higher self-resonant frequency than tubular ceramics or micas. Tough moisture-proof coating. Designed for 85°C operation.

*The "Hidden 600" are Sprague's 600 experienced researchers who staff the largest research organization in the electronic component industry and who back up the efforts of some 8,500 Sprague employees in 16 plants strategically located throughout the United States.

Handy Hanging Wall Catalog C-457 gives complete service part listings. Ask your Sprague Distributor for a copy, or write Sprague Products Company, 65 Marshall Street, North Adams, Massachusetts.

SPRAGUE
THE MARK OF RELIABILITY

powerful and portable

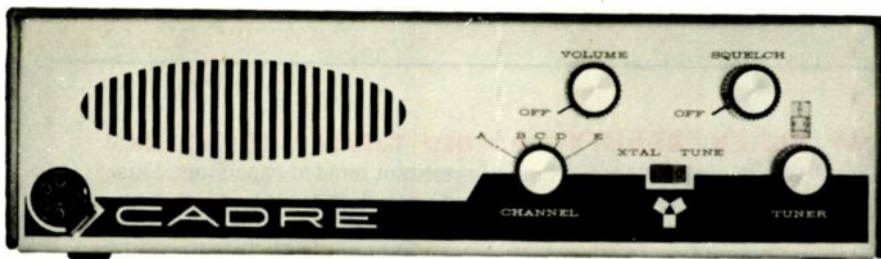

POWERFUL—5-watts, 5-channel crystal-controlled channels, 100% all-transistor, the Cadre series of transceivers can be used in any vehicle, boat or office. They deliver sharp, clear reception over the greatest transmission range possible in the 27 mc citizens band. Five fixed crystal-controlled channels spell accurate, fast communication contact. Sensitive dual superheterodyne circuit responds to weakest signals. Tuned ceramic filters increase selectivity. Reception is clear, free of noise—automatic noise limiter defeats ignition noise; adjustable squelch eliminates annoying background signals. Extended range AGC provides uniform audio output. Solid state circuitry throughout means no heat problems, no tubes to burn out, ability to withstand vibration and shock, negligible current drain, compact size.

Four Cadre 5 watt, 5-channel models—one is best for your CB application.

CADRE '515'—AC/DC transceiver can be used anywhere. \$194.50

CADRE '510'—AC/DC unit. Offers 23 channel manual tuning. \$209.95

NEW! CADRE '520'—DC only with DC power cord and mounting kit—ideal for mobile and portable use—operates from 12 volt auto battery or special battery pack. \$187.50

NEW! CADRE '525'—for complete field portability. Standard AC cord permits recharging of two built-in nickel-cadmium batteries, telescoping antenna, aluminum carrying handle. \$269.95

PORTABLE—Power is only a part of the story with Cadre transceivers. These units go anywhere—operate anywhere. An optional accessory, (Cadre 500-1 Portable Pack) adapts Cadre 510, 515 and 520 for field use. The Portable Pack is a lightweight case which contains rechargeable battery supply (two 500-2 nickel cadmium 6-volt batteries). These units can be used for base or mobile application as well as in the field. Cadre 5-watt models in the Portable Pack weigh less than 9 lbs. Cadre 500-1, \$29.95, Cadre 500-2, \$10.95.

For the finest CB transmission anywhere, rely on Cadre. For literature write:

4 CADRE 5-WATT, ALL TRANSISTOR CB RADIOS



CADRE INDUSTRIES CORP. □ COMMERCIAL PRODUCTS DIVISION □ ENDICOTT, NEW YORK □ AREA CODE 607, 748-3373
Canada: Tri-Tel Assoc., Ltd., 81 Sheppard Ave. West, Willowdale, Ont. Export: Morhan Exporting Corp., 485 Broadway, New York 13, N. Y.

... for more details circle 15 on post card

LETTERS TO THE EDITOR

Wants Ions

We are writing you with the thought that you may have advertisers that have the equipment we are looking for. We are seeking equipment that will produce "Ions." This equipment is being used in the medical field for relief of respiratory ailments, etc.

The equipment used in this field is known by several names, such as "Ion Controllers" and "Negative Ion Generators."

We would appreciate hearing from you as to the names of the sources we could contact to obtain these generators.

K. G. CONROY

President, Conroy Associates
Fall River, Mass.

● *Several units are available for air purification which could be used for this purpose, but we know of none strictly for ion generation. How about it, advertisers?—Ed.*

Needs Info on Ratioformer

I have recently been exposed to a test device called a (Ratioformer) it is connected to a transformer and the ratio arm on the test device is varied to obtain a balance and gives a direct turns ratio read-out. I would appreciate an article or some information concerning the theory and operation of this device as I cannot obtain any literature anywhere on it.

C. L. NICHOLS

Inglewood, Calif.

Shell Model 18 Tester

I have been unable to locate Shell Electronic Mfg. Corp., although I have two addresses. One at Westbury, N. Y. and Brooklyn, N. Y. I have a self testing tube tester Model 18 manufactured by them and am trying to get up-to-date testing charts from them. If you can help me in getting this information I would greatly appreciate it.

W. CRAIG

Milan, Mich.

It's time somebody challenged the misleading propoganda about "hand wiring" in TV sets

The simple truth is that the much touted and advertised "hand wiring" in some television sets is an outmoded type of construction, not to be compared for reliability and trouble-free performance with modern copper-engraved circuit boards.

Once upon a time there was only one way to connect the various components in a television circuit.

That was to run a wire from one to the other and solder the connections by hand. If you go back far enough, you'll find that all television sets were once made this way.

The trouble is that in just one such set there has to be hundreds of these soldered connections, each requiring a hand operation. There is always a good chance that one or more won't be perfect . . . and sooner or later cause trouble. Hand placement of components and connecting wires can cause harmful performance and quality variations.

A better method from space technology

With the development of space electronics, there is a need for both more compact construction and *absolute uniformity and reliability*. So another method of building electronic circuits had to be perfected.

It's called the circuit-board technique.

Circuit boards are not new. They have been known in various forms for more than a quarter of a century. However, it is only within the past decade that the efforts of U. S. industry, including those of PHILCO, have led to the development of special raw materials, components, production equipment and techniques which have resulted in the wide adoption of the use of circuit boards as a more satisfactory and reliable type of construction than hand wiring.

All the circuits and connections are engraved in copper on one solid piece of rigid material. No more tangle of wires and no clumsy individual component placement and soldering.

Progressive television manufacturers—including Philco—naturally adopted this new and far better construction. Others who were unable or unwilling to switch to modern engraved circuits stayed with hand wiring.

This they had a perfect right to do.

However, we challenge statements that hand wiring means finer performance, fewer service problems and greater operating dependability.

Ask any informed television serviceman

Informed, up-to-date television servicemen will confirm the fact that modern circuit boards are more reliable than old-fashioned hand wiring. What's more, when servicing is required, it is far easier to find and repair troubles in a set utilizing circuit boards, which carry a complete circuit and component placement chart right on the face to assist in locating a test point or component. Repairmen do not relish floundering around in a "rat's nest" of "hand wiring" to trace a circuit fault.

There is another extremely important reason why Philco eliminated old-fashioned hand wiring from chassis circuits.

Some years ago, scientists studied the effects of heat on television-set components. They found that the life of tubes, condensers, transformers and other vital parts could be increased *many times* by decreasing operating temperature.

To put it another way, they proved that poorly designed television sets didn't wear out—they burned out.

Key to the Philco "Cool Chassis"

One way to prevent the burning out of television parts was to properly ventilate all parts of the set. So the famous patented Philco Cool Chassis was developed. The accurate placement of components on the circuit board provides accurate control of operating temperatures of all parts.

Today, based on our actual experience, we can make this statement—and challenge anyone to prove otherwise: **Philco Cool Chassis sets with modern, copper-engraved circuit boards, will give better performance, more reliable service, will require fewer repairs and cost less to maintain.**

We hope you will remember this when you buy your next television set. "Hand wiring," because of its association with *hand made*, sounds very good . . . makes good propoganda . . . but it simply does not make the best television sets. Not when we can *prove* the reliability, the performance and the ease of servicing Philco Cool Chassis TV with modern engraved circuit boards.

PHILCO

A SUBSIDIARY OF *Ford Motor Company*

Reprinted from the Chicago Tribune—
Monday, January 7, 1963



© 1963 VOLKSWAGEN OF AMERICA, INC.

Changes in the '63 Volkswagen.

We've always had just one engine. But this year, we're a two-engine truck. (Which is a pretty revolutionary change for a VW.)

You can choose our old faithful, air-cooled, 24 miles-to-the-gallon job.

Or, for a little extra dough, our more powerful engine.

(It's still air-cooled, still goes 24 miles

on a gallon of regular.)

If you carry a heavy load or do a lot of driving over hilly terrain, then you'll probably want the extra power.

Another change: the new engine comes with bigger brakes.

What else is new?

The driver has his own adjustable seat. (The passenger seat comes out to

make more room for the cargo.)

The cab has more legroom.

There's a new fresh air heater.

And a new clutch.

The nice thing is, that after 13 years and 216 changes like these, you don't have to wonder what kind of shape our truck is in.



... for more details circle 38 on post card

ELECTRONIC TECHNICIAN

MANUFACTURERS TECHNICAL DIGEST

EMERSON

Stereo Multiplex—Clipper Circuit Addition

FM Stereo receivers of DuMont and Emerson current manufacture incorporate a diode noise-clipping circuit which results in an acceptable noise-free output during reception of FM programs in the stereo mode, even when the level of the input signal is below that which is normally required for stereo quieting.

An FM receiver which requires a 10-15 μV input signal for proper quieting during monophonic reception, would require a signal of about 150 μV , or over ten times as strong, to achieve the same amount of quieting during stereophonic reception. Assuming that a receiver with sensitivity figures similar to these was installed in such a manner that a station transmitting in FM stereo produced a signal of 100 μV at the antenna input terminals, reception of these transmissions in the stereo mode would normally be unacceptable due to the amount of noise present in the receiver's audio output. This same signal, however, would be adequately in excess of that required for proper quieting during reception of these same transmissions monaurally. Programs broadcast stereophonically would not be received in stereo without annoying noise, except by sacrificing the stereo feature. Switching the receiver to monaural operation would, of course, restore noise-free reception, but not stereo.

Without special stereo noise-clipping circuitry, a rather sharp transition between noise-free and noisy stereophonic reception occurs, depending upon the incoming signal.

Should the level of the incoming signal fall below a point where usable channel separation is no longer obtainable, the stereo indicator lamp on the control panel will either be extinguished entirely or flash intermittently, thereby indicating that the input signal has now fallen below a point where any acceptable form of stereo reception is practical. When this occurs, the receiver's function control should be switched to monaural operation. This provides better results than inadequate stereo reception without a worthwhile amount of channel separation.

The net result of this noise-clipping is that it approximates an automatic Stereo-Mono switching device. Under conditions of sufficient signal strength it has no effect upon the receiver, and maximum stereo channel separation is present in the audio output. It is only when the strength of the signal falls below the

normally usable level that a loss of stereo separation begins to occur, and it is not until channel separation has been reduced to an unusable level, that noise begins to appear in the output of the receiver.

GENERAL ELECTRIC

Chassis M579—Production Changes

"Y" Code: A ceramic capacitor C266 100 pf 10% 1000 v N1500 (Cat. # R743) is added between terminal 7 of the Horizontal Output Transformer T251 and the junction of C259/R263 and R264 (grid circuit of V13). **"X" Code:** R402 (in series with the pilot light) is deleted. The pilot light now connects directly to pin 3 of V5.

MOTOROLA

Stereo—Storecast Trap Alignment

The storecast traps provide attenuation in excess of 40 db at the 67 kc storecast sub-carrier frequency. Under normal conditions, they should require no service. They are carefully set at the factory and unless there is a specific complaint of storecast interference, it is best not to include these traps in a routine alignment procedure.

To align the storecast traps, proceed as follows:

1. Disconnect the 3.9 M resistor, R-18, from B+ to remove the 2 v bias from the detector.
2. Connect positive VTVM lead to pin 5 of the diodes, negative to ground.

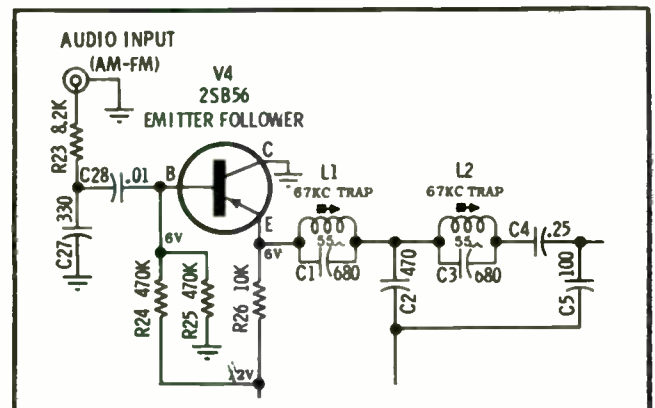

MANUFACTURERS TECHNICAL DIGEST

3. Apply a 67 kc signal to the input of the traps at the emitter of the emitter follower transistor.
4. Set traps L-1 and L-2 for minimum response at the VTVM.
5. Re-connect R-18 to B+.

RCA

Kelvin Color Temperature

The color temperature of the raster on a color picture tube refers to the TINT of white or gray produced by the raster and not to its brightness level. To reproduce transmitted pictures properly on a color TV receiver during both black and white and color programming, it is necessary that the raster be set up to a specific color temperature. This provides the background upon which the picture can be reproduced. The proper color temperature is described in degrees Kelvin (K).

Kelvin is a temperature scale used in reference to light, as a method of establishing certain characteristics in a light source, namely its hue. Most light is produced by thermal-radiation (matter being raised in temperature until it emits light). This temperature is a quality of light that can be readily measured.

The Kelvin scale simulates the centigrade scale but provides for a greater range in the degree of represented temperature without going below zero. The Kelvin scale uses absolute zero as its starting point, while the centigrade scale uses the freezing point of water as its zero — zero degrees centigrade being 273°K.

In using temperature to measure the color of light, black is the color that an absolute black body would emit at zero degrees K (absolute zero). As the black body temperature is increased, the color emitted from the body changes. When the body temperature reaches the range of 8000 to 9000 degrees K, the color of light emitted approaches the white that is seen in the raster of a CRT.

The light color emitted from several of the more common sources is shown in the color temperature Chart 1.

Color using the 21CYP22 color CRT normally

Chart 1	
LIGHT SOURCE	KELVIN TEMPERATURE
Ordinary Candle	1900-1950
Common Household Lamp	2750-2850
Moonlight	4100
Sunlight	5300-5800
Daylight (Sun & Clear Sky)	5800-6500
Daylight (Overcast Sky)	6300-7200
Clear Blue Sky	14000-50000

calls for a color temperature of 8200°K. It sets incorporating the 21FJP22 and 21FBP22 color CRT, the color temperature is set up to 9300°K which gives the slightly bluer tint viewers seem to prefer.

Knowing the meaning and value of the Kelvin temperature scale, technicians will realize the importance of adjusting the color receiver to produce the proper white raster.

When a color TV receiver is adjusted to an excessively high color temperature a loss of red in the picture detail will result, and the over-all picture will take on a metallic appearance. Too low a color temperature results in the loss of blue, green, or cyan colors in the picture, giving objects a generally red-dish-brown cast.

WESTINGHOUSE

Adapter And UHF Channel Strip

A circuit of the UHF Antenna input adapter (enclosed by a solid outline), a typical UHF channel strip (enclosed by long dashes), and a simplified representation of the basic VHF tuner (enclosed by short dashes) is shown here.

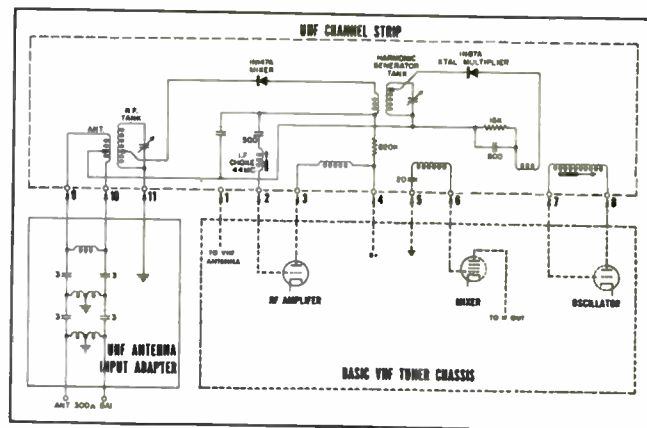

Westinghouse interconnecting circuitry for UHF channel strip to VHF tuner. Connections apply only when the channel selector is set on a UHF channel position.

resentation of the basic VHF tuner (enclosed by short dashes) is shown here. From left to right on the UHF channel strip contacts provide the following connections:

Contacts 9 and 10 connect to the antenna input adapter. A common ground between the strip and the VHF tuner body is provided by contact 11. Contacts 1 through 8 make connections with the wiper contacts that were part of the VHF tuner before the UHF antenna adapter was installed.

If we now skip over to contacts 7 and 8 on the strip (these correspond to the oscillator control grid contact and plate contact on the VHF tuner), we find a tuneable winding which is the primary of a transformer. This winding tunes the VHF oscillator to a frequency which, when passed through the tuned xtal multiplier, is 44 Mc higher than the center frequency of the input UHF signal.

The xtal multiplier output is transformer coupled to the incoming UHF signal tapped from the RF tank. The result of this mixing is an IF signal having a 44 Mc center frequency. This IF signal is fed through a 44 Mc coil and through contact 2 to the RF amplifier control grid. Strip contact 1 grounds the VHF antenna input.

ish
alone?

Belknap Steel
growth in
all companies

Techni-talk

COMPLETE ELECTRONIC SERVICING INFORMATION
radio • tv • hi-fi

Vol. 15, No. 1

Spring, 1963

How to Measure HV Rectifier Filament Voltage

A simple device employing two lamps has been devised to measure the voltage across the filament of a TV high voltage rectifier tube. By adjusting the intensity of one lamp to equal that of the other, the filament voltage can be read with the use of a D.C. voltmeter. The complete unit is shown in Fig. 1, and the circuit in Fig. 2.

This device can be easily con-



verted in the Vector Electronic Co., Inc., catalog number P3.

Resistor Increases Range
A 10 ohm resistor in parallel with a DPST switch (see Fig. 2) is put in series with lamp No. 1 in order to measure a wider range of filament voltages. With the switch in the low position (as indicated in Fig. 1) the 10 ohm resistor is shunted. Filament

DON'T MISS THIS ISSUE!

The rectifier plate lead is prevented from arcing between the plate lead and the T.V. chassis since the plate lead is in

distributor, or else, he has to order one. It is listed in the Radio-Electronic Master catalog. One manufac-

ture of the device was designed to measure. (Continued on page 5)

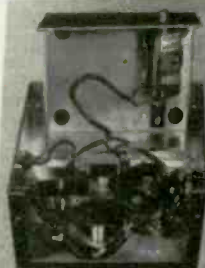
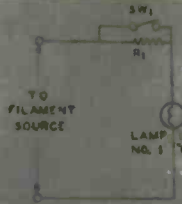
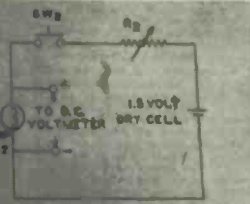

Fig. 1 Inside construction.



Lamps No. 1 and No. 2
Q10 10 115 1/2V 0.22A
Resistor 30 ohm 1/2W
2 Terminal 1/2W 100Ω
Voltmeter 100Ω - 2 Terminal 1/2W



R1 - 10 ohm 1/2W
S1 - DPST 1/2W
S2 - DPST 1/2W
S3 - DPST 1/2W
S4 - DPST 1/2W
S5 - DPST 1/2W
S6 - DPST 1/2W
S7 - DPST 1/2W
S8 - DPST 1/2W
S9 - DPST 1/2W
S10 - DPST 1/2W



READ HOW TO MEASURE HV RECTIFIER FILAMENT VOLTAGE

... complete information on how to build a measuring device at low cost; how to use it.

G-E HORIZONTAL PHASE DETECTOR discussed; BENCH NOTES ... helpful hints from your fellow Service Dealers; SERVICE NOTES on television and radio.

GET YOUR COPY FREE FROM YOUR G-E TUBE DISTRIBUTOR

Techni-talk is now available only from your General Electric tube Distributor. Techni-talk is loaded with electronic data, news of electronic developments, schematics and other information to make TV, radio, hi-fi servicing more profitable for you. Pick up a copy at his store and ask him to add your name to his mailing list to receive Techni-talk regularly.

ANOTHER ACCENT ON VALUE FROM G-E ELECTRONICS DISTRIBUTORS

Get a complete set of Techni-talk back issues in a handsome three-ring binder for only \$8.50 or send 10¢ in coin for this latest issue. Fill out coupon and mail to: GENERAL ELECTRIC COMPANY, Dept. B, 3800 N. Milwaukee Ave., Chicago 41, Illinois.

Progress Is Our Most Important Product

GENERAL ELECTRIC

ORDER COUPON

Please send:

_____ ETR-3560 Latest Issue of Techni-talk.
(Enclose 10¢ in coin.)

_____ ETR-3567 Complete set of Techni-talk
back issues in tabbed three-ring
binder. (Enclosed is check or money
order for \$8.50 payable to General
Electric Company.)

Name _____

Street and No. _____

City _____ Zone _____ State _____

... for more details circle 17 on post card

TEST INSTRUMENTS for Bench and Caddy

COLOR CIRCUIT ANALYZER

Sencore Model CA 122 Color Circuit Analyzer at \$187.50—TV set manufacturers haven't taken the color TV business as lightly as many TV technicians. Don't wait until color "really gets under way" to do anything about it. Several manufacturers are now producing or have plans to produce color sets in the very near future. Don't wait any longer — some dealers are actually selling more color sets than B/W sets. Obtain the proper equipment and solicit the business right now.

The Sencore CA 122 is one of the types of equipment you will need to service color sets. The unit has been designed with factors other than alignment in mind. The approximate gain of each IF stage can be checked, for example. IF signals are generated for this purpose in addition to RF signals for over-all performance checks.

Working with the manufacturers now engaged in the design of new color sets helped Sencore build this unit which can be successfully employed on any of the new color TVs. Sync take-off, for example, on some color sets does not allow troubleshooting in the chroma section without additional sync. The CA 122 provides this sync.

Deconverging for complete set alignment is not necessary. Gun interrupter switches make it simple to show the actual amount of convergence variation. Shading bars are provided for tracking adjustments.

Patterns which will be present on the CRT are shown on a small panel that changes with the display selec-

tor switch. Chroma amplitude is variable from 0 to 200 percent to check stability or to drive the signal "through" when troubleshooting weak or dead chroma sections. The video and sync outputs are also variable from 0 to ± 30 v.

A 4.5 Mc crystal oscillator is employed to assure optimum fine tuning adjustment and for sound channel troubleshooting.

No knowledge of demodulator systems is necessary to use the CA 122. All cables to operate the unit on any color set are in a compart-

ment located in the rear of the cabinet.

When it is desired to keep the unit ready for instant operation, a standby switch is provided just to keep the unit hot; at the flick of a switch it becomes operable.

The unit has many desirable features and shouldn't be looked at as if it were something that would only be used when that "once in a while" color set comes into the shop. Most of the functions used for color service work can also be employed to good advantage in B/W servicing.



For Manufacturer's brochure of this equipment circle 400 on post card.

SIGNAL GENERATOR

For Manufacturer's brochure of this equipment circle 401 on post card.

Lafayette Model TE-20 RF signal generator at \$27.95—The TE-20 is completely factory wired and calibrated. The unit is designed for IF/RF alignment, audio signal tracing, TV linearity checks etc. Fundamental frequencies are produced from 120 kc to 130 Mc in 6 bands plus a calibrated harmonic band of 130 to 260 Mc. A built in



Tips for Technicians

Mallory Distributor Products Company
P. O. Box 1558, Indianapolis 6, Indiana
a division of P. R. Mallory & Co. Inc.

The new generation of batteries ... how to use them

You may not realize it, but dry batteries used in modern electronic circuits are as different from old style dry cells as 1962 autos are from the Model T.

Of primary interest to you as a technician is the mercury battery. Instead of the ordinary combination of zinc, carbon, and electrolytic compounds, Mercury batteries use mercuric oxide and a zinc amalgam in combination with an alkaline electrolyte. This chemical system produces a dry battery uniquely matched to solid-state electronic circuits. For example, Mercury batteries have about four times the milliamper-hour capacity of ordinary batteries of the same physical size.

Not only do mercury batteries contain more actual power, they hold this power for long periods of time. Ordinary batteries start to lose power from the instant they are assembled *whether used or not*. On the other hand the storage life of a mercury battery is amazing. We've had some on storage test for more than nine years . . . **AND THEY'RE STILL ALIVE.**

Perhaps the best thing about mercury batteries is their steady output voltage. It stays nearly constant throughout the entire life of the battery (see chart). Ordinary battery voltage drops steadily. Constant voltage is important in solid state circuits . . . it means constant gain and linearity.

Terminal voltage on a mercury cell is 1.35 volts $\pm 1\frac{1}{2}\%$! This is so accurate there's a special multi-voltage reference battery (Pt. No. 303113) that's widely used as a secondary voltage standard. It's excellent for setting scopes, meters, etc., and all sorts of lab work. We'll be happy to send complete information. Just ask.

Mercury batteries are a Mallory development. We like to think we're experts on them. But we know there are jobs a mercury battery shouldn't do. Jobs where very high surge drains or continuous heavy drains are required . . . flash cameras, flashlights, movie cameras, etc. So we developed the Mallory Manganese Battery. It's the king of heavy drain batteries . . . with excellent storage life and moderate price.

There are literally dozens of other battery systems available from Mallory. We simply don't have space to go into them here. But if you're interested in rechargeable batteries, or ultra low temperature types, or extreme low or high voltage types, or other exotic types, write to Dept. 762. We'll send the information.

Meanwhile, when you need a battery for a grid bias circuit, or a portable instrument, or a transistor radio, use a Mallory Mercury Battery. For flashlights and similar applications use Mallory Manganese Batteries. You can get them from your Mallory Distributor. He's the man to see for Mallory capacitors, controls, switches, semiconductors, and vibrators . . . and for all your electronic requirements.

... for more details circle 23 on post card

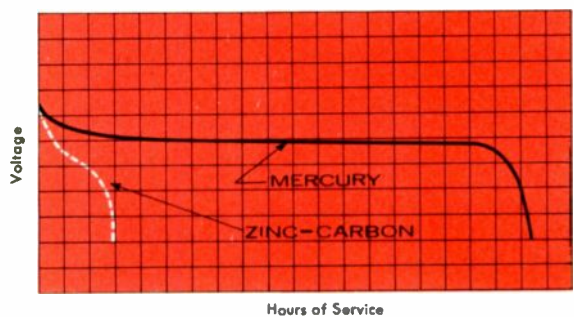
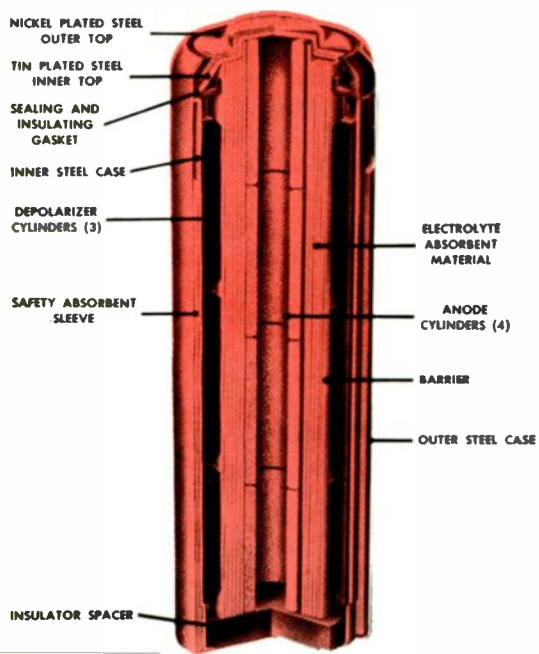

TEST INSTRUMENTS *Continued*

400 cps audio oscillator with adjustable output to 8 volts; continuously variable RF attenuator and "high-low" RF outputs for added flexibility. Accuracy is said to be 5 percent.

The generator performed well in our tests, and it was felt that such a low priced unit would be a good

second generator for technicians who have a radio bench. Like more and more of the equipment being imported from Japan, the design is good. Two tubes are employed, a 12BH7 and a 6AR5. A selenium unit is used for B+.

With suitable means for calibration, the TE-20 could be used as a

marker generator for sweep alignment or for alignment when not using a sweep generator.

Housed in attractive wrinkle steel case with leather carrying handle. Complete with instructions and test leads. The unit measures only 7 x 10½ x 5¾ in. and has a 4½ in. etched steel vernier dial.

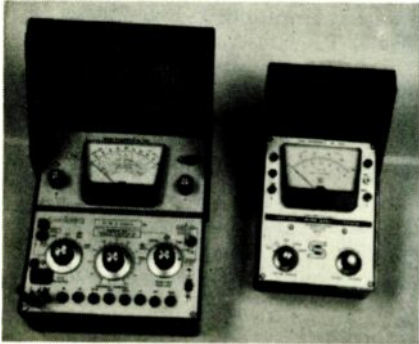

SECO Transistor and Tunnel Diode Analyzer model 250 at \$74.50 and Power Supply model RPS-5 at \$69.50—These units were checked together since they are companion pieces which can be used to repair and test most transistorized equipment.

The RPS-5 is a very stable power supply which will handle a wide range of service problems. The voltage output is variable from 0 to 30 v with additional "INT" bias output which is half the output at the — and + jacks. Special jacks

TRANSISTOR ANALYZER AND POWER SUPPLY

For Manufacturer's brochure of this equipment circle 402 on post card.

are provided for a low voltage 0 to 1.5 v output.

The unit employs transistor regulation referenced to a Zener diode to supply a constant voltage over a wide range of current demands. Connecting the supply to a short circuit will not cause damage to the instrument. The meter also reads current in two ranges: 0 to 30 ma and 0 to 150 ma.

The beauty of the transistor and tunnel diode analyzer is that no set up is required. An oscillator circuit built into the test set allows a quick go, no-go test which in many cases is all that is needed. This test also shows whether a transistor is an NPN or PNP type.

Icbo is read on a scale from 0 to 200µa; Icco from 0 to 1 ma; and dc beta gain is read directly on a 0 to 200 scale. In only a few minutes

anyone can check a transistor with no reference to charts or instructions. For slow learners, however, instructions are included in the lid.

All transistors up to 10 w dissipation can be checked. Higher power units can be checked if their Icbo leakage does not exceed 200µa. Signal, and power diodes can also be checked as well as tunnel diodes. All the knobs are clearly marked and in addition to a heavy duty socket three color coded leads are provided to connect to units that do not fit the socket or for in-circuit testing. In every case where we applied the unit for an in-circuit test, the tester showed the transistor's condition without fail.

Both units are very handsomely finished with brushed aluminum panels, black lettering and a flat black hood.

CHEK-TUBE CONVERTER

For Manufacturer's brochure of this equipment circle 403 on post card.

Antronic Corp. Chek-Tube Converter model TC-438 at \$11.95—Here's a little unit which, although not new, seems to have been overlooked by many technicians. Baffled about what to do when CRTs became non-standard a few years ago, most technicians just did the best they could with what they had.

Any shop with a regular check tube, however, would do well to invest in the TC-438. With this unit,

any B/W TV set can display a picture on a standard test tube (8JP4/8YP4 or 8XP4). Filament voltages are selected with a single knob on the unit and any combinations of four sockets can be selected between the TV and the test tube.

With the unit plugged into a power outlet in the shop, the cheater plug included on the unit can be used to supply voltage to the TV set.



***even the
transistors
are revolutionary!***



SONY MICRO-TV—THE TELEVISION OF THE FUTURE



Even the transistors in the remarkable SONY Micro-TV are revolutionary. For the first time in a home set, the new epitaxial power transistor is used, to permit a smaller and much more efficient power supply. Heretofore, epitaxials were used only in complex industrial and military systems. Service is no problem, either. Just snap out the board with the defective component and ship it to the nearest SONY service station. Only 8 lbs., Micro-TV operates on its own rechargeable battery, 12v power and AC. New low price is only **\$189.95**. Accessories extra.

SONY
RESEARCH MAKES THE DIFFERENCE

SONY CORPORATION OF AMERICA
580 Fifth Avenue, New York 36, N.Y.

Regional Offices

Western: 627 South Towne Ave., Los Angeles 21, Calif.

Central: 4959 W. Belmont Ave., Chicago 41, Ill.

Dear SONY:

Please send me further information on the Micro-TV, and especially, on how I can get SONY service.

Name _____

Firm _____

Address _____

City _____ Zone _____ State _____

SONY Corp. of America, Dept. E-4, 580 Fifth Ave., New York 36, N.Y.

*Every RCA Victor New Vista® TV uses
Space Age Sealed Circuitry...Circuits
that are dependable and...*

easy to service



Old-fashioned all hand-wired Circuitry



Precision Crafted RCA
Space Age Sealed Circuitry

Let your own TV
service records
prove the 
dependability
of RCA Victor
New Vista® TV

SEE WALT DISNEY'S "WONDERFUL WORLD OF COLOR" SUNDAYS, NBC-TV NETWORK



The Most Trusted Name in Electronics

TMK (a)®

EDITOR'S VIEWPOINT

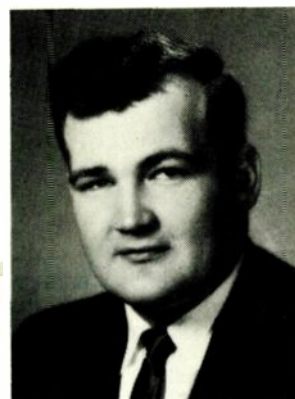

Please, No Sidelines!

In the past few weeks readers have written to us about the advisability of entering into the small appliance repair business as an adjunct to their normal TV business. Although each business is faced with a slightly different situation, in most cases we feel the electronic technician is better off promoting his regular business. Sidelines generally cause more grief than they are worth.

Take the small appliance business as an example: Does your present electronic distributor handle thermostats for electric irons? If not, it would be necessary to make many special trips for this and similar items. Certainly you could not afford to stock all the necessary parts.

Could you afford to devote enough time to appliance repair to put it on the same level as your TV business? The chances are pretty good that you'd need some of the time you now spend on TV business.

"Well," you say, "what should I do with my free time this summer; it's always the slack time of the year?" In most parts of the country this is true. But summertime doesn't have to be slow.

Before we take up what you can do, let's look at the sideline business from one more angle. When fall rolls around again, will you be able to continue with your sideline? Again, the chances are pretty slim. Of course, if the business has actually grown a great deal (which is unlikely in only three months) you could hire another man. But if you are this optimistic and energetic about appliances, think what you could do with all that energy if you put it in your TV business.

What do you think will run through your customers' minds if you service appliances for a short while and then turn them down later? Probably that you didn't really know how to run a business; that you failed in your "sideline" or "if he can't fix my toaster, how can he possibly fix my TV?"

You must also consider the feelings of your customers: Many people are easily embarrassed. If you get a call from a customer to repair a small appliance and have to confess that you only repair appliances in the summer, you'll probably never hear from them again.

Don't risk your TV service business for "greener pastures." You should know by now that often, though the grass is greener, there's not much of it.

This summer, instead of looking for something out of the ordinary to do, why not devote some time trying to increase your regular business. Instead of spending your hard earned cash on temperature measuring equipment, mending sleeves, etc. which will only be used a portion of the year, use it for an advertising campaign.

Advise your customers to take advantage of your slack season rates. Offer specials for a complete TV or audio check up and alignment. Make yourself headquarters for transistor radio repairs. Remember that every transistor radio customer is a potential TV or audio customer.

Finally, start a card file of your customers. On the card list their name, the make and models of their TV, Hi Fi, tape recorder, radios and other potential service items. It will take some time to accumulate all this information. When one of these sets is serviced, briefly list the date and what was wrong with the set. File these cards alphabetically, near the phone. When one of your "filed" customers call, you can quickly thumb through the file and remind the customer what was wrong with his set the last time.

Of course, the customer will probably remember—but you will gain his esteem by your interest in him. This is not trickery—it's good business practice.

Thumb through the cards every day. Sixty days or so after your last service call phone and inquire about the operation of the unit you repaired. Ask about their tape recorder, Hi Fi or "that little radio I fixed last year" while you're on the phone.

You'll be amazed at the business and good will you will generate from this system. And above all, don't give up the system when business picks up in the fall.

Vic Beale

TRANSISTOR Radio Repair



Technician and parts-changer essentially repair 75 transistor radios in an 8-hour day.

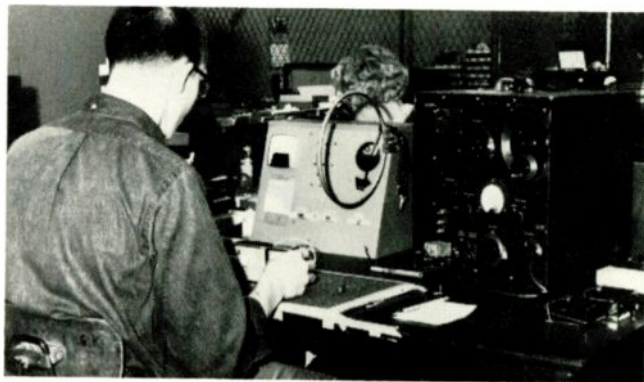

Repaired radios move on belt to another position where alignments are checked.

You can quickly
repair 90 percent
of all defective
transistor radios
by following
the procedures
outlined here

by John W. Lane

Service Manager
Channel Master Corp.

■ Many proven transistor radio repair techniques developed as a direct result of repairing thousands of sets under ideal conditions can be useful to all TV-radio technicians. The system has been used for some time. Definite repair procedures have been worked out which enable two persons to essentially repair an average of 75 radios daily. Modified production techniques are used to repair the transistor radios.

A highly skilled technician analyzes the defective radios, troubleshoots them and locates the source of trouble. The radio is then passed, assembly-line fashion, to the next person (normally a skilled woman parts-changer) who removes the defective parts and replaces them with new components.

Although the radios are repaired at this point they pass, via a moving conveyor, to another technician who is an alignment specialist. A complete IF and RF alignment check is made by this technician. The radio then proceeds via the conveyor to a final inspector who checks it for

sensitivity, S/N ratio and distortion. This test includes an "on the air" check to simulate results the radio's owner can expect to obtain.

The system has been refined over a period of several years and incorporates some distinctive service procedures that result in a highly efficient operation.

When a defective radio arrives, the first technician classifies it in one of six possible categories. These are as follows: (1) Low gain. (2) Dead. (3) Distorted. (4) Noisy. (5) Oscillating. (6) An intermittent state of one or more of the other five conditions.

Low Gain

Low gain is easy to correct. By far the greatest majority of radios in this category are repaired by simply changing an electrolytic capacitor. Because of low voltages and currents involved, capacitors usually open rather than short. The easiest and most practical way to troubleshoot an open electrolytic is by substitution. The suspected defective

Techniques



Sensitivity check is final test made before radios are boxed for shipment.

part can remain in the circuit during this check. The only thing to remember is correct polarity on the substitute capacitor. Wrong polarity will cause no damage but test results will be invalid.

After checking for open electrolytic capacitors by substitution, proceed with a complete IF and RF alignment check. Alignment is, of course, basic and most technicians are well versed in it. But one small point is often overlooked — RF tracking. Proper tracking can be obtained simply by correct placement of the radio's antenna coil on the ferrite rod. To make this check, a small piece of aluminum about $\frac{3}{8}$ in. in diameter and 2 or 3 in. long, and a piece of ferrite rod are needed. When the radio is tuned to 600 kc and signal is applied, both the aluminum and ferrite rods should be brought near the radio's antenna, one at a time. Both materials should cause a decrease in sensitivity. If this does not happen, loosen the antenna coil and shift it on the ferrite rod until the proper

reaction is obtained (See Fig. 1). This simple operation may make a difference of 10 db in the receiver's sensitivity.

Dead Radio

Dead radios are perhaps the most difficult to properly analyze primarily because of the time usually required to locate the defective component. Radios referred to as dead are those that pass no signal and have absolutely no background noise.

We use the following approach to repair dead radios:

A careful visual examination is made to detect physical damage or breaks. One place to look is the ground circuit which is often located around the chassis perimeter. The ground strip will frequently be cracked as a result of the receiver being dropped.

The trouble is next isolated to either the audio section or further back in the circuit. This can be done by touching the volume control center tap with a finger or screwdriver. Better results may be obtained, however, by jumping a 5-30 μ f electrolytic capacitor between the driver transistor's base and the audio amplifier transistors' emitters (See Fig. 2). If an audible buzz or click is heard, the audio section is good. If no reaction is obtained, we then proceed to check the on-off switch.

If the switch is OK then check the set's total current drain. If the drain is excessive, check for shorts between hot leg and ground. If no trouble here, check the input transformer for continuity. Check the output transformer for continuity. Check speaker's continuity. One leg of the speaker must be disconnected. Check voltages at emitter, base and collector of driver transistor. If the collector voltage is OK and emitter and base are low, check to see if voltage is proper at electrolytics and resistors in that portion of the circuit. If the voltages are good at electrolytic and resistors, the driver transistor is bad and should be replaced.

If the audio section is good then check continuity of all IF RF and oscillator coils. Check voltages of

the converter transistor's emitter, base and collector. If base and collector voltages are low, check antenna coil winding for continuity. If continuity is OK, then the converter transistor is bad.

If the converter's collector voltage is low, then check the oscillator coil's secondary winding for voltage at both points. If voltage is OK, then the converter is bad. If voltage is good on only one side, then the oscillator coil is bad. If the voltage is low on both points, then the IF transformer is bad.

Check voltages at the IF transistor's emitter, base, and collector next (See Fig. 3). If the first and second IF transistor emitters have low voltage, then check to see which transistor (either first or second IF) has lowest voltage and change that transistor.

Check voltages on the first IF transistor. If the collector voltage is low, check second IF transformer for an open. Check voltage on the second IF transistor collector; if low, check third IF transformer for an open.

If the radio has background noise but passes no signal, then check antenna coil's continuity. Check the oscillator coil's primary winding for continuity. Disconnect the tuning capacitor's ground leg and check it for shorts.

Distortion

Distortion in small radios is generally detected audibly. Although a small transistor radio is not a high fidelity instrument, sound reproduction should be reasonable and not unpleasant to the ear. Try substituting speakers first. This can usually be accomplished simply by substituting a good speaker into the earphone jack provided on most transistor radios. Speaker impedance is not too critical for this test.

Check all electrolytic capacitors by substitution. Check the input transformer secondary for a balanced resistance between both legs and the center tap. If resistance is unbalanced, replace the input transformer. Check the output transformer primary for a balanced resistance between center tap and both legs. If unbalanced, replace it.

Check current at the output transistor's base legs. This is done with the transistors in-circuit. Although an accurate measurement cannot be obtained in this manner, the error margin will apply equally to both transistors. Current readings obtained must be balanced on both transistors approximately 0.3 to 0.4 ma. The transistor which varies from this range should be replaced.

It should be mentioned here that low gain will sometimes give an indication of distortion and this can usually be corrected by simple realignment.

Noisy

If the radio generates noise when

tapped or jarred, check by lightly tapping the radio's components. When a section is located that generates the most noise when tapped, check that area for broken components, cold solder joints, or a broken circuit. Caution must be observed when resoldering suspected cold solder joints in the area of electrolytic capacitors. If the capacitor is faulty, the heat from the iron may heal the defect. This cures the fault only temporarily and the capacitor will quickly break down again. It is best to change the electrolytic capacitor involved to be safe. The cost of this part is not worth aggravation caused by having to re-service the radio. If the radio has a constant frying or hissing noise, check the printed circuit board for battery leakage. If the circuit is contaminated by leakage, a good quality contact cleaner will usually remove the corrosion.

Check for excessive voltage at the converter transistor's emitter. If the voltage is materially over 1 v, change the transistor. If C4 (see Fig. 1) shorts out intermittently under load, noise will also be present. Replace C4. IF alignment should also be checked.

Oscillation

Oscillation is usually caused by defective electrolytic capacitors. Use the substitution method and bridge all electrolytic capacitors. Check first IF transistor emitter voltage. If

voltage is excessive, replace the unit. Check between primary and secondary of the third IF transformer's windings for shorts. Check radio carefully for physically broken disc capacitors. Check IF and RF alignment. Motor boating, a form of oscillation, is usually caused by defective power supplies or batteries which have high internal resistance.

Intermittent Faults

Intermittent radios usually have broken or cracked components. A thorough physical check is necessary. A magnifying glass is helpful in locating small hairline cracks in printed wiring. Some difficult cases are solved only by playing the radio until the condition shows up and then analyzing the defect.

About 90 percent of the defective transistor radios you will be called upon to service can be repaired by using the techniques outlined here.

A pencil type soldering iron should be used when replacing parts in a transistor radio. The iron should not be more than 50 w. When properly used, this iron will not damage transistors when unsoldering or soldering them in radios.

If technicians remember that a transistor and vacuum tube have many similarities — the transistor base, collector and emitter corresponding to grid, plate and cathode respectively — troubleshooting becomes much easier

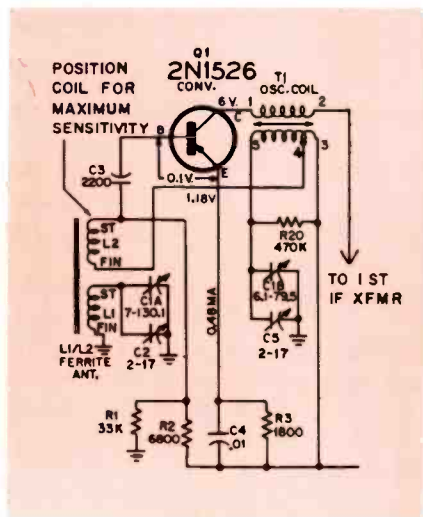

Fig. 1—Position antenna coil on ferrite rod for maximum sensitivity.

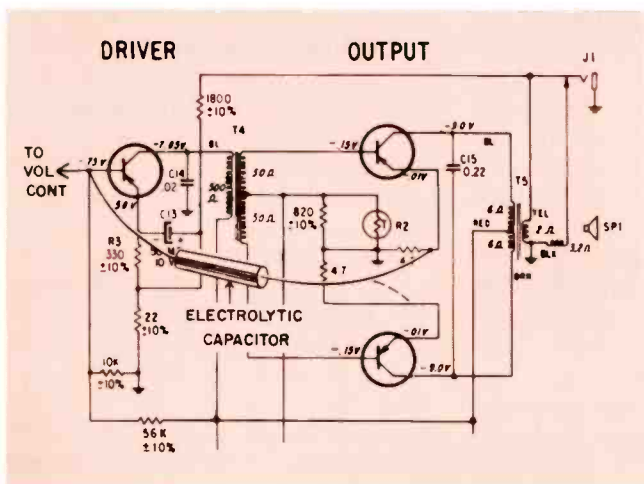

Fig. 2—Jump a 5 to 30 μ f electrolytic capacitor between the driver transistor's base and the audio amplifier transistors' emitters to isolate trouble.

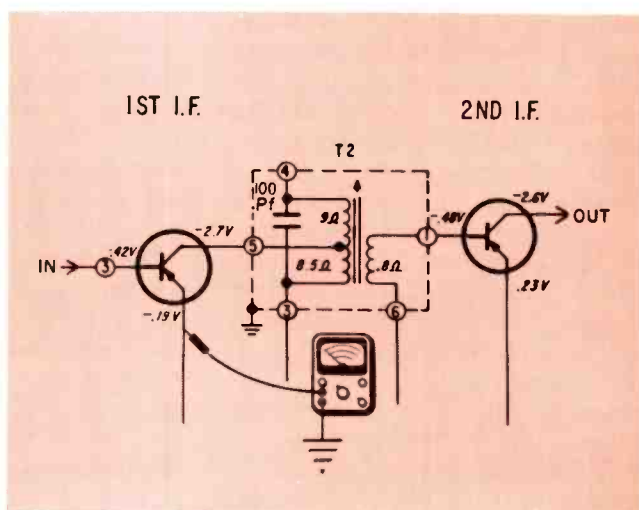

Fig. 3—Check voltages on all transistor emitters, bases and collectors to isolate defective transistor.

Servicing Broadcast

Typical circuits and tips on rapid repair to speed service

■ Transistor Multiband and AM/-FM receivers are appearing on the market with almost the frequency of standard broadcast units. It is simple to offer the consumer a much greater latitude of enjoyment in these units since little circuitry and almost no additional space is required.

Repairing the "little monsters" poses another problem to the technician, however. Component-crowded standard broadcast units are no comparison for the extra parts squeezed into the multi-function sets. Although the components are few in actual number, the additional inches of PC foil may be considerable. For the most part the extra parts are coils and some sort of a switching arrangement; usually a slide switch.

Understanding the underlying principles of two basic designs should help you lick 90 percent of the multi-band radios.

Converters and Oscillator-Mixers

The simplest way to change a standard broadcast receiver to receive short wave is by simply changing the tuned coils in the RF and converter stages. Many sets do just that. A circuit shown in Fig. 1 shows how this is done.

In some cases, the manufacturer uses both the standard converter for broadcast reception while an oscillator-mixer is employed for short wave reception. This type circuit is shown in Fig. 2.

Trouble in one band of the receiver almost always points toward a defect in the tuned circuits of the dead band. This can be easily proven with signal injection. Several instruments are available to help in rapidly locating transistor stage and component defects.

Unlike tube converters, the transistor bias will not indicate whether

or not the oscillator is functioning. Connecting a sensitive meter between the base and emitter of the converter stage and turning the tuning dial should give some bias fluctuation. This is usually an indication that the transistor is functioning.

One of the most common causes of oscillator failure is the transistor itself. Substitution is the best method to check for this. A good quality transistor should be used for replacement here, since the range of frequencies handled by the converter is the widest.

The second most likely component to fail in the converter stage is the antenna coil. In sets using an RF amplifier, of course, the coil is an oscillator coil. Frequently these units are not actually burned out but are victims of rough handling. Often the units are not well mounted, and a sharp blow breaks the hair-like wires.

Just remember when you're troubleshooting multi-band units to troubleshoot one section at a time.

Transistor IFs

Several basic differences can be found in common transistor IF circuits. Although most units are coupled by some form of transformer, several different methods of matching the stages and stabilizing them can be found.

Basic IF coupling is shown in Fig. 3. This is rarely used, however, since some sections of the band are almost deadened because the tuned circuit is paralleled to the collector. A more practical approach to the problem is shown in Fig. 4. Here, the load is effectively the power supply, since the output coil is center tapped.

Both capacitive and link coupling are shown in Fig. 5. These circuits offer better selectivity,

and Multiband Transistor Radios

by Ben Allen

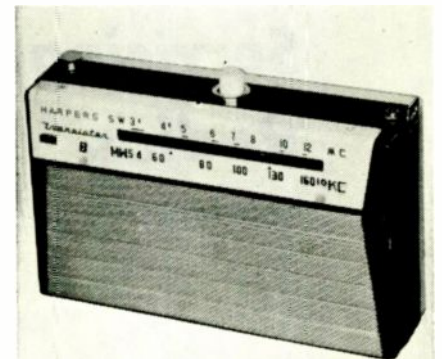

Harper's model GK-200. This set employs switched-coils for band change.

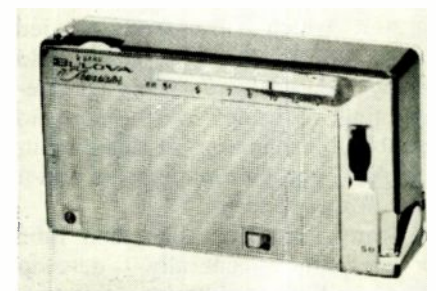

Buleva's model 782. Dial cord stringing for this and similar sets may present a problem unless manufacturer's literature is available.

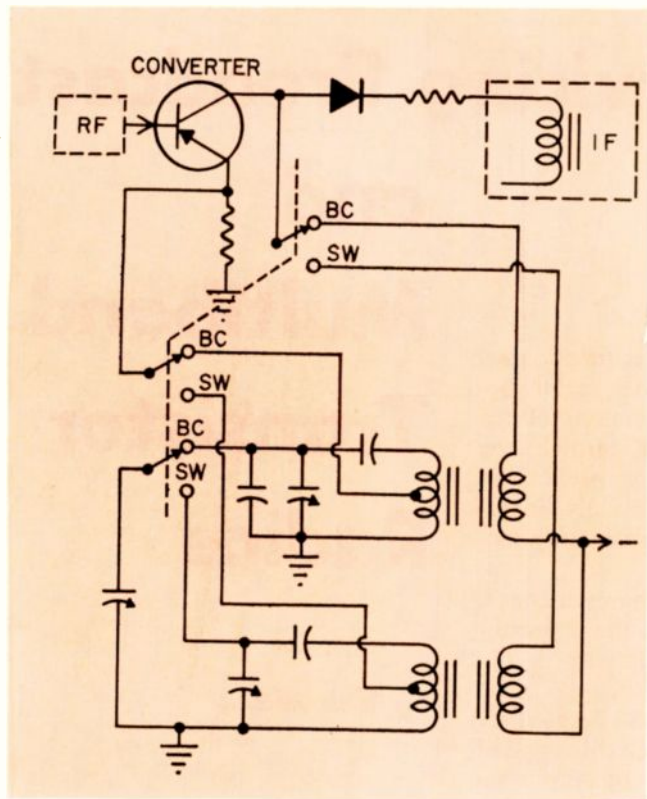

Fig. 1—Converter circuit found in inexpensive BC-SW radios employs simple coil switching circuit.

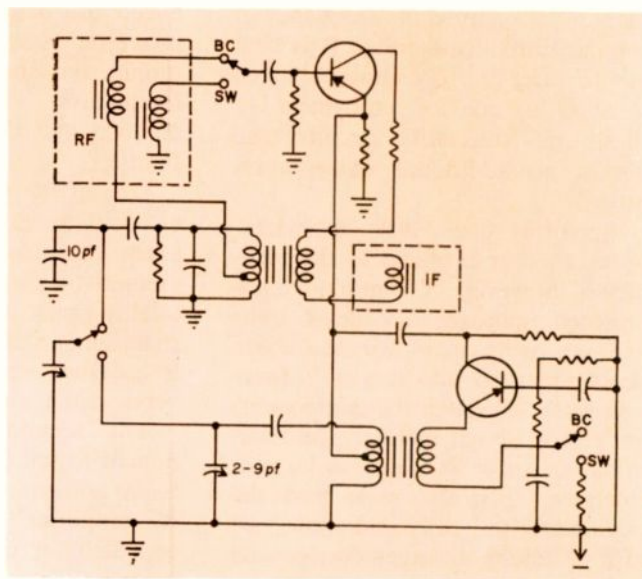

Fig. 2—Combination type uses converter for BC reception and oscillator-mixer circuit for SW.

Servicing Radios Continued

though they are more expensive and take up more room.

A compromise between the capacitive or link coupling and standard transformer coupling is usually made by tuning both the input and output transformer windings when better selectivity is desired.

AGC which is frequently applied to one or more IF stages should always be considered when troubleshooting in the IF. To be sure no trouble is originating in this circuit, the AGC can be disconnected and a bias box clipped in.

Transistor radios, like their tube counterparts generally develop AGC voltage by filtering a portion of the signal at the detector, filtering it and using it for bias on the IF.

Since transistors have relatively flat gains at a wide range of biases, the AGC voltage is quite critical.

Repair Tips

Never try to service a transistor radio without an adequately filtered power supply. Several units are on the market, most of them with both metered voltage and current. Some of the units also have several bias taps or a variable bias output.

A signal generator, a VOM and the normal complement of small hand tools should also be on hand.

The first thing to do is to connect the power supply to the radio—observing polarity. Never trust a battery brought in by the customer, no matter how new he says it is.

Turn the radio on and check the current drain. A drain in excess of about 25 ma should be investigated.

Higher current warrants turning the set off and checking it "cold." Double check the battery connections. Operating the set with reversed polarity may cause considerable damage.

If the current drain is normal, turn the on-off switch and the volume control to see if any noise comes from the speaker. No noise usually means the output or driver stage is dead. On the other hand, if noise is heard at the speaker, the stages before the volume control are probably at fault.

Poor alignment is the most troublesome of all the complaints.

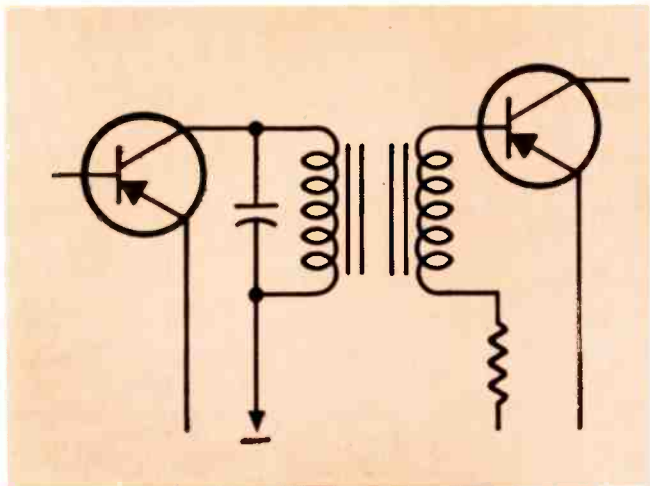

Fig. 3—Basic IF stage is rarely found in transistor amplifiers because tuned circuit across transistor "swamps" stage at some frequencies.

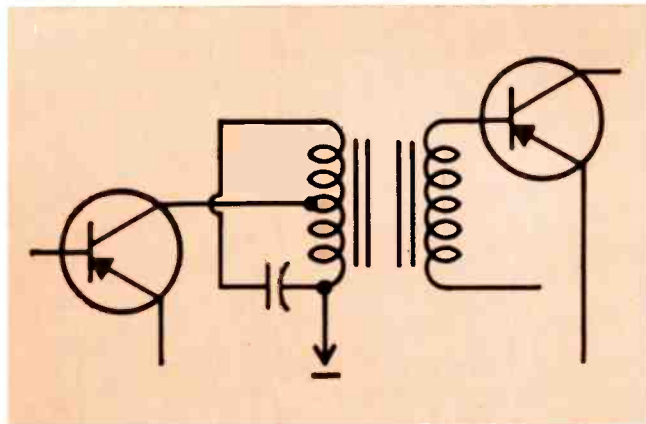
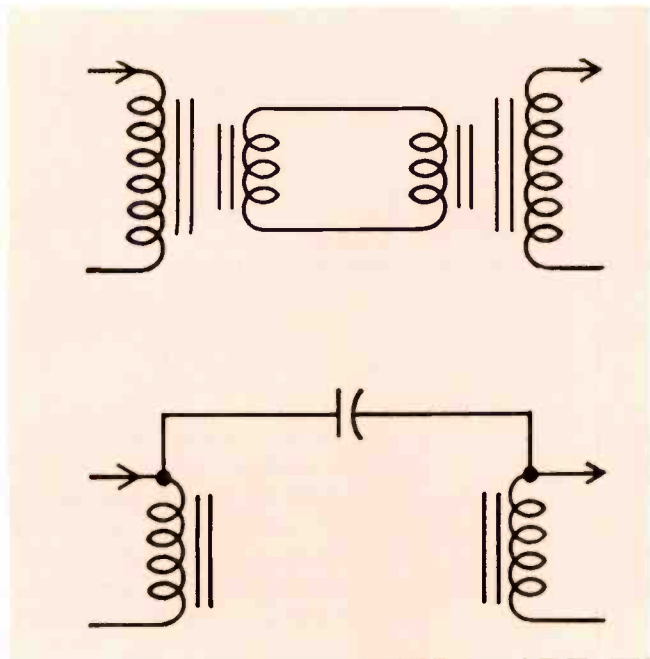

Fig. 4—A solution to "swamping" encountered with circuit in Fig. 3 is offered by center tap on transformer.

Fig. 5 (A)—Link coupling and (B)—capacitive coupling both offer great selectivity.

Usually the customer will complain of weak stations, poor separation or weak on one end of the band. A thorough alignment, including tracking adjustments usually cures the difficulty.

Removing components in transistor radios can be one of the most time consuming and tedious phases of transistor radio repair. Since most of the components in a transistor radio are mounted on the PC board, they can be easily substituted another way: Use a single edged razor blade and cut the PC foil near all points of component contact except one. The new component can then be substituted by pressing the leads or tack-soldering them to the circuit side of the cut. After the

substitution is completed, the board may be repaired by soldering the foils.

It is interesting to note that most components used in Japanese transistor radios are interchangeable. The only problem that will be encountered in replacing the components from one unit to another will be component mounting.

Barring a sudden breakthrough in some new area, transistors will soon be commonplace in TVs. Not only do you stand a good chance of losing your present TV trade, but when the transistor sets do reach the market in quantity, you will be faced with two problems: first, you won't be familiar with techniques for repair or principles employed in

transistor circuits. Remember how much time you've had to put in with tubes to get where you are. Things that you learn to speed up your work; things that no one can teach you. Transistor radios offer an excellent medium for training.

And second, almost everyone, it seems, has a transistor radio. And almost everyone's transistor radio fails at one time or another. Your customers know "that little transistor thing" is in there. And when your customer gets his transistor TV you can bet he'll take it to "the man that was so good with my transistor radio."

Don't leave yourself outside when this gets under full swing. And remember, it has already started. ■

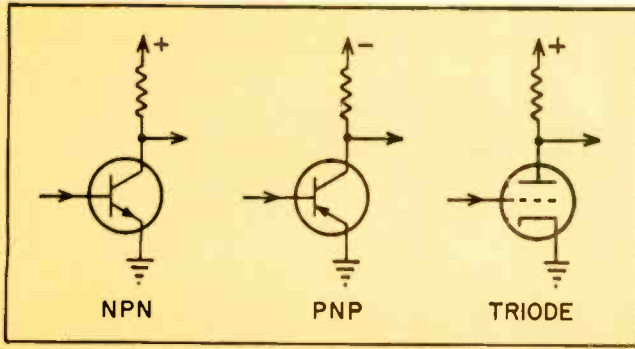
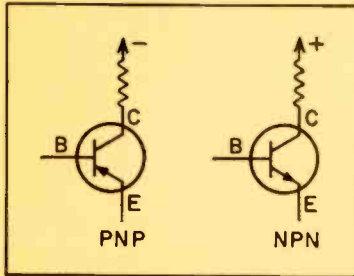
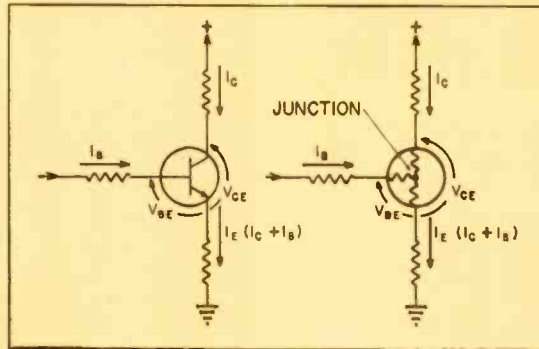

Fig. 1—Basic common amplifier transistor circuits compared to triode vacuum tube equivalent circuit.



Symbols for NPN and PNP transistors. The NPN type may be compared to the triode with the base equated to the grid; the emitter to the cathode and the collector to the plate. PNP types are the same except relative polarity on all elements is reversed.



Current flow through an NPN transistor and its equivalent "T" circuit.

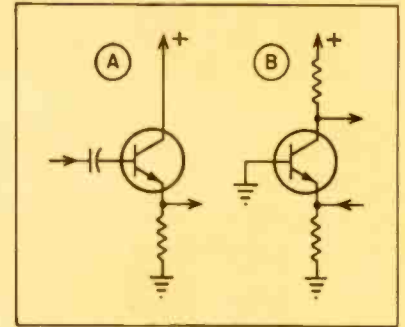

(A)—Emitter follower circuit and (B)—Grounded base transistor amplifier.

REPAIRING TRANSISTOR AMPLIFIERS

by Eino Nlemi

■ The amplifier is one of the first complex circuits taught in electronic fundamentals school. It is a basic part of almost every piece of electronic equipment found in the home and is the foundation of every oscillator circuit.

In spite of the amplifier's popularity and the transistor's characteristics making it an ideal amplifier component, many technicians are still "forgetting" about transistors. Transistors are becoming more popular at an increasing rate. It is

entirely possible that within the next few years the majority of home entertainment equipment will be transistorized.

TV, radio, Hi Fi, and PA manufacturers are all building transistorized equipment. Transistor antenna boosters are also popular. For the most part, prices are somewhat higher than tube counterparts but the smaller size and portability make transistorized equipment attractive to the consumer. All this points to one significant fact: Eith-

er you learn transistor repair techniques or another trade.

But don't be scared too easily; transistor equipment is easier to service than vacuum tube equipment. Each unit has only three leads and no filaments to cause burned fingers!

All You Need To Know

The circuits shown in Fig. 1 are, for the most part, self explanatory. The NPN and PNP transistor types may be confusing, at first, in that each type uses a different polarity supply voltage. The NPN type may be compared to the vacuum tube triode, while the PNP type uses opposite polarities.

A bias check is probably the most important test to help localize a transistor circuit malfunction. The base voltage will always be slightly higher than the emitter voltage. i.e., either more negative (for PNP transistors which have negative emitters) or more positive (for NPN transistors which have positive emitters). Usually the difference is only a fraction of a volt. A good low-range meter and accurate measurements

Develop troubleshooting techniques through better understanding of fundamental amplifiers

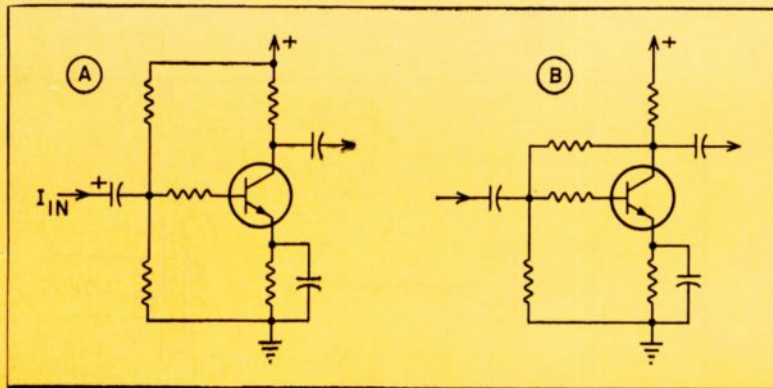

(A)—Voltage divider type bias circuit. (B)—Voltage divider circuit incorporating negative feedback.

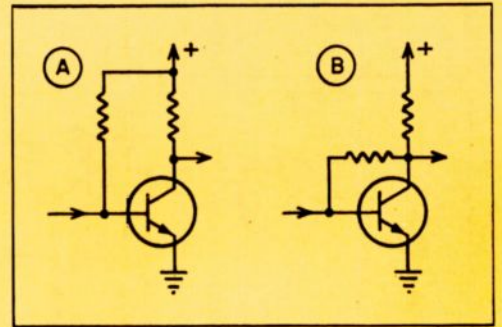

(A)—Circuit utilizing the emitter to base current flow for bias. (B)—The same principle is used here except negative feedback is used to increase stability.

are a "must" to make bias checks. Tolerances for these voltages are about the same as in tube type equipment, so a very small voltage may denote a malfunction.

Most of the malfunctions found in transistor circuitry will be capacitor failures and transistor failures. The small amount of current drawn through bias and load resistors limits resistor failures (with the exception of high power output stages) to a small percentage of over-all failures.

Finding the stage at fault is no more difficult than with tube circuits—and in many cases even easier. Signal injection seems to be favored by most technicians who are doing a lot of transistor repair, though signal tracing is also employed.

Typical Amplifier Circuits

Transistor amplifier circuits vary widely depending on the application. Hi Fi amplifiers, for example, are much more elaborate than amplifiers found in small portable radios. The same configurations, however, found in tube amplifiers will be found in transistor amplifiers.

The common grounded cathode amplifier is equivalent to the grounded emitter; the grounded grid is equivalent to the grounded base amplifier; and the cathode follower or grounded plate amplifier is equivalent to the emitter follower or grounded collector amplifier.

Push-pull circuits are also quite common in transistor amplifiers. The operation may be considered to be about the same as the tube counterpart. One circuit, however, is difficult to explain in terms of a vacuum tube equivalent. The complementary-symmetry amplifier. A typical complementary-symmetry amplifier is shown in Fig. 2. The main advantage of this circuit is that no coupling device is needed between the output and the load to prevent current from flowing in the load. Most manufacturers have not made use of this amplifier, however, because of the necessary matched complementary NPN and PNP transistors.

Since the output impedance of the transistor is a relatively low impedance, most amplifiers are coupled to the load through a large

electrolytic capacitor. The coupling capacitor may be as large as 2000 μf . In aged units, this capacitor may be weak and, therefore, should be checked on each amplifier.

Coupling in transistor amplifiers may take one or more of several different forms. Resistance or direct coupled, capacitor coupled, or transformer coupled. Each has its merits and each presents its own problems in troubleshooting. Capacitor coupling is perhaps the easiest to troubleshoot since this type of coupling is most frequently used in vacuum tube circuits. Further, malfunctions are easier to pinpoint to a single stage since dc is not coupled to succeeding stages.

Many direct coupled amplifiers alternate NPN and PNP type transistors so that excessive bias is not necessary on each succeeding stage. An example of this type circuit is shown in Fig. 3.

Before attempting to troubleshoot any transistor circuit you should be thoroughly familiar with its operation. If you understand the basic operation of the transistor, no difficulty should be encountered.

REPAIRING TRANSISTOR AMPLIFIERS

Continued

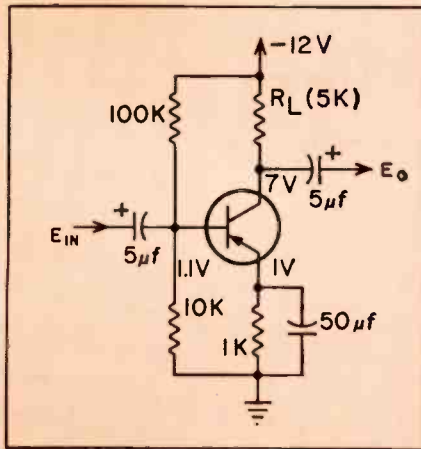

Practical single stage common or grounded emitter transistor amplifier using voltage divider type biasing. Note the small differential between the base and emitter. "Rough" voltage measurements are not acceptable in transistor repair.

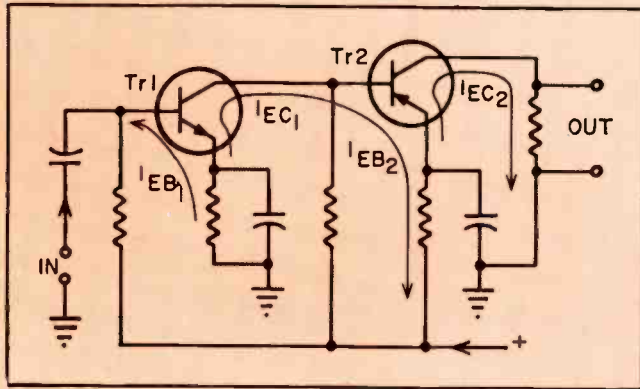
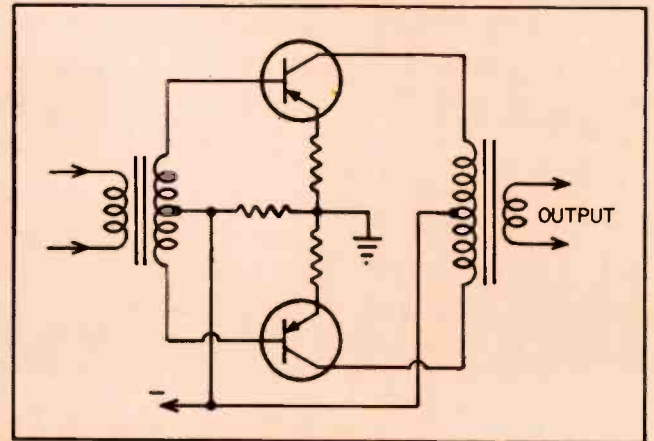

Fig. 3—Current flow in a direct coupled transistor amplifier. Alternate NPN and PNP transistors are used to reduce bias required on successive stages.



Class B push-pull output stage of the type found in portable radios.

Test Equipment

Since the initial cost of some transistor items is relatively small, the repair cost must be kept to an absolute minimum. A customer who pays \$20 for a transistor radio, for example, will think twice before giving you new business after being presented with a \$15 repair bill. The only way you can keep the repair cost down is to repair the sets quickly and efficiently.

Although it is possible to struggle with older types of test equipment, some of the newer equipment will greatly increase your speed. Several manufacturers are now marketing test equipment specially built for transistor radio repair. In most cases, they are designed around the injection philosophy. An RF signal is available to inject at the antenna or other parts of the RF circuit and a switch selects IF and audio voltages to check other portions of the receiver. The same equipment can be used for TV audio checks.

Anyone servicing transistor equipment needs a good transistor tester. Substituting transistors to check the old unit, as tubes are often checked, may lead to immediate failure of the substituted unit. When a bad transistor is uncovered, the associated parts should be checked to assure that the original transistor did not fail because of another faulty component. Resistance checks will usually uncover these malfunctions.

A good VOM or VTVM will prove itself invaluable, of course, to help isolate a faulty component.

Antenna Preamps

Antenna preamps will be coming into the shop for repair before too long—their repair should present no great difficulty. (ED. note: Readers interested in learning more details on these amplifiers should read "Know Your Transistorized Antenna Preamps" in Oct. '62 issue of ET). For the most part, these units can be repaired in short order by

simply checking the transistor and each of the components in the circuit. Since the components are few, little time is required. Time is not as important here, however, since some of the profit margin can be absorbed in the removal and installation of the preamp.

If you are now in an area where transistor preamps are used, be sure and obtain schematics of the units from the manufacturers. Your distributor should be able to supply you with addresses you might need.

This brings us to another important point: Schematics are most valuable as an aid in troubleshooting. Sometimes it may be difficult to obtain schematics on short notice. You should be prepared to explain to your customer that a wait of one, two or three weeks may be involved in the repair of some imported equipment.

Never degrade the customer's set, however. They bought it, and it's the best available, as far as the customer is concerned. ■

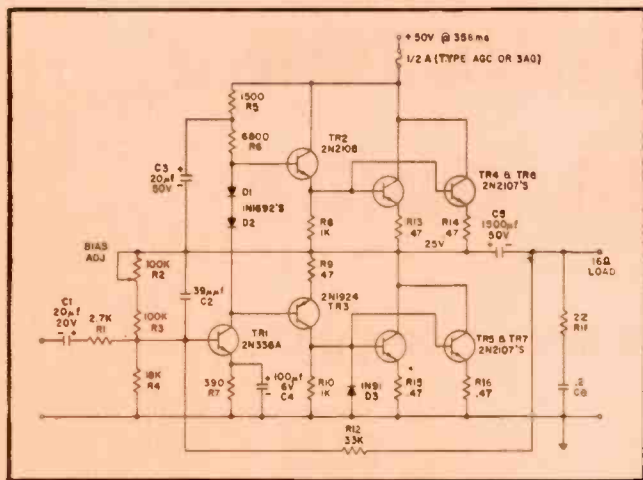

Capacitor outputs for Hi Fi amplifiers are common. This unit photo-type, designed by G-E, is capable of 12 w output.

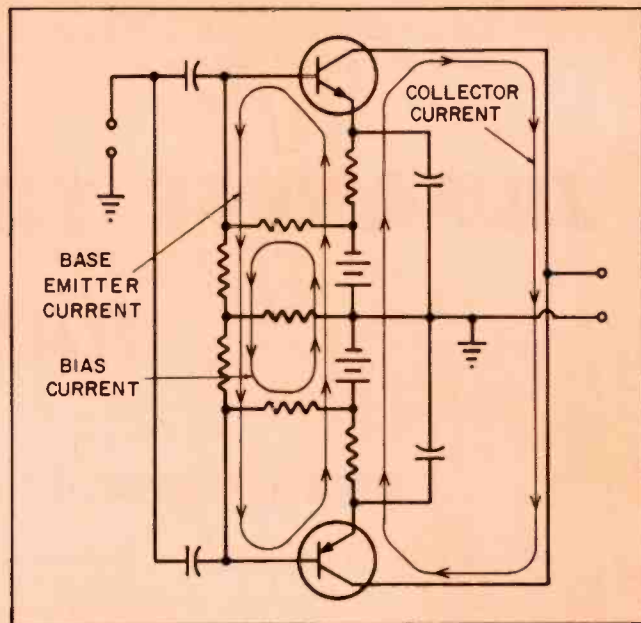

Fig. 2—Current flow in the complimentary-symmetry amplifier under static conditions.

Small Boat Radar

Design eliminates waveguide 'plumbing'



Weather-sealed, 30-in. plastic dome over pilot house contains the 43 lb. radar antenna.

■ A radar for commercial fishermen and pleasure boatmen, the model 1900, has been introduced by Raytheon Company's marine products operation.

Especially well adapted for close-in work in returning to port in fog, snow or heavy rain, the radar can distinguish targets as close as 30 yd and can discriminate between targets only 35 yd apart on the 1/2-mile scale.

Four range scales—1/2, 2, 6, and 12 miles—give the boatman a detailed electronic picture of landmarks, buoys, and other vessels over an area up to 450 sq miles around his position. Information is displayed on a 7-in. CRT.

Target definition is enhanced by an antenna beam width of only 3° made possible by a newly designed

30-in. parabolic antenna mounted in a weather-sealed plastic radome. Folded back on itself, the lightweight aluminum antenna has the transmitting and receiving slots mounted one above the other eliminating expensive duplexer tubes. The QK-798 magnetron tube that sends out the radar signal has been positioned to pump its 3500 w power directly into the transmitting parabola at the focal point simplifying construction and reducing antenna weight to only 43 lb.

Simplified construction does away with bulky waveguide. As the radar frequencies are contained entirely within the antenna, a single electrical cable, which is supplied with the radar, connects the two units. A third small cabinet with

Continued on page 61

Many of the troublesome problems encountered when servicing Japanese radios can be alleviated with this new compilation of importers and distributors. To find the address for schematics or parts, first locate the brand name in the list on this page. Check the code number with the brand name and find the importer or distributor's name and address which has the same number on the distributor list.

JAPANESE TRANSISTOR RADIO GUIDE

DISTRIBUTORS OF JAPANESE TRANSISTOR RADIOS

1. A & A Trading Co.
64-14 Woodside Ave.
Woodside, L.I.
2. Allied Purchasing Co.
401 Fifth Ave.
New York, N.Y.
3. Amerex Trading Co.
444 Fifth Ave.
New York, N.Y.
4. Arel Corp.
39-30th St.
Queens, N.Y.
5. Arrow Trading Co.
1133 Broadway
New York, N.Y.
6. Artic Import Co.
1024 W. Randolph St.
Chicago 7, Ill.
7. A & S Trading Co.
124 W. 30th St.
New York, N.Y.
8. Associated Importers
1168 Battery St.
San Francisco, Calif.
9. Audion Importers
18 W. 27th St.
New York, N.Y.
10. Azad International
1133 Broadway
New York, N.Y.
11. B&B Import Co.
157 Wyoming Ave.
Detroit 28, Michigan
12. Best Tone Electronics
295 Fifth Avenue
New York, N.Y.
13. Brothers International
36-50 38th St.
New York, N.Y.
14. Canton-Son Inc.
12 W. 27th St.
New York, N.Y.
15. Carolina Mfg. Co.
315 5th Ave.
New York, N.Y.
16. Channel Master
Ellenville, N.Y.
17. Charles Brown & Co.
1170 Broadway
New York, N.Y.
18. A Cohen & Sons, Inc.
27 W. 23rd St.
New York, N.Y.
19. Commodore Import Corp.
507 Flushing Ave.
Brooklyn, N.Y.
20. Consolidate Sewing Machine
1115 Broadway
New York, N.Y.
21. Continental Merch. Corp.
236 Fifth Avenue
New York, N.Y.
22. Craig Panorama
5290 Washington Blvd.
New York, N. Y.
23. Dalamal & Sons
1185 Broadway
New York, N.Y.
24. Delmonico International
120-20 Roosevelt Ave.
Corona, N.Y.
25. Eastern Associates, Inc.
40 Spear Street
San Francisco, Calif.
26. Eisenberg & Co.
52 Broadway
New York, N.Y.
27. Electra Industries Co.
1204 Broadway
New York, N.Y.
28. Federal Aides Corp.
875 Broadway
Brooklyn, N.Y.
29. Fen Tone Corp.
106 Fifth Avenue
New York, N.Y.
30. Fortune Star Products
1207 Broadway
New York, N.Y.
31. Fujiya Electric Corp.
45 W. 21 St.
New York, N.Y.
32. General Consolidated Ltd.
5 East 17th St.
New York, N.Y.
33. Golden Shield Corp.
Great Neck, N.Y.
34. Goshu Trading Co.
50 Broad St.
New York, N.Y.
35. Halen Associates
125 5th Ave.
New York, N.Y.
36. Harlie Transistor Prod.
393 Sagamore Ave.
Mineola, L.I.C., N.Y.
37. Harpers International
315 Fifth Avenue
New York, N.Y.
38. Inter-Mark Corp.
80-00 Cooper Ave.
Brooklyn, N.Y.
39. International Importers
2242 S. Western Ave.
Chicago, Ill.
40. Inter-Ocean Commerce Corp.
170 Broadway
New York, N.Y.
41. Kanematsu New York
1 Whitehall St.
New York, N.Y.
42. Ken Electronics
500 Fifth Ave.
New York, N.Y.
43. Kent Overseas Inc.
14 W. 23 St.
New York, N.Y.
44. Kinoshita & Co.
26 Broadway
New York, N.Y.
45. Kowa American Inc.
230 Fifth Avenue
New York, N.Y.
46. Lafayette Radio Co.
165-08 Liberty Ave.
Jamaica 33, N.Y.

47. Linmark International Corp.
276 Park Avenue S.
New York, N.Y.
48. Lissner Trading Co.
1111 N. Cherry St.
Chicago 2, Ill.
49. Lloyd Trading Co.
1147 S. Hope St.
Los Angeles, Calif.
50. Lucky International
1155 Broadway
New York, N.Y.
51. Manhattan Novelty Co.
263 Canal Street
New York, N. Y.
52. Marubeni Iida
39 Broadway
New York, N.Y.
53. Masuyama Int'l Corp.
214 W. 14th St.
New York, N.Y.
54. Matsushita Electric Co.
67 Irving Place
New York, N.Y.
55. Metropolitan Industries
216 W. Jackson
Chicago 6, Ill.
56. Nason Trading Co.
303 Fifth Ave.
New York, N.Y.
57. Nichimen Co.
60 Broad Street
New York, N. Y.
58. North American Foreign Trading
220 5th Ave.
New York, N.Y.
59. N Y Merchandise Co.
32 West 23rd St.
New York, N. Y.
60. NY Transistor Corp.
150 Fifth Avenue
New York, N.Y.
61. Omscolite Corporation
Stokley & Roberts Ave.
Phia., Pa.
62. Pacific Import Co.
149 Fifth Ave.
New York, N.Y.
63. Peerless Telerad, Inc.
15 W. 29th St.
New York 1, N.Y.
64. Petely Enterprises
300 Park Ave. S.
New York, N.Y.
65. Realtone Electronics
71 Fifth Ave.
New York, N.Y.
66. Reliance Intercontinental
1225 Broadway
New York, N.Y.
67. Ross Electronics
216 W. Jackson Blvd.
Chicago 6, Ill.
68. Sanyo Trading Co.
149 Broadway
New York, N.Y.
69. Sharp Electronics
1270 Sixth Ave.
New York, N.Y.
70. Shiro Trading Corp.
276 Park Ave. S.
New York, N.Y.
71. Sonic Electronics
2101 Jerrico Turnpike
New Hyde Park, N.Y.
72. Sony Corporation
514 Broadway
New York, N.Y.
73. Spera Electronics
3710 33rd St.
New York, N.Y.
74. Standard Radio Corp.
350 Broadway
New York, N.Y.
75. Starlite Electronics
37 W. 23rd St.
New York, N.Y.
76. Sterling Hi Fi Co.
20-20 40 Ave.
New York, N.Y.
77. Terra International
3 East 28th St.
New York, N.Y.
78. Tessler Industries Inc.
Cne Park Avenue
New York, N.Y.
79. Alfred Toepfer
1 Broadway
New York, N.Y.
80. Best of Tokyo
11 West 42nd St.
New York, N.Y.
81. Toyama & Co.
855 Ave. of Amer.
New York, N. Y.
82. Toyomenka Inc.
2 Broadway
New York, N.Y.
83. Trade Distributors
260 Fifth Ave.
New York, N.Y.
84. Trans America Import & Export
116 So. Michigan Blvd.
Chicago 3, Ill.
85. Transistor World Corp.
513 W. 24th
New York, N.Y.
86. Trans-Aire Electronics Corp.
393 Segamore Ave.
Mineola, N.Y.
87. Transworld Industrial Corp.
5404 Hudson Ave.
West, N.J.
88. Tussah Corp.
1412 Broadway
New York, N.Y.
89. Valiant Importers
1200 Sixth Avenue
New York, N.Y.
90. Windsor Pen Co.
88 3rd Ave.
Brooklyn, N.Y.
91. Yashica Inc.
5017 Queens Blvd.
Woodside 77, N.Y.

JAPANESE TRANSISTOR RADIO BRAND NAMES

NAME	CODE	NAME	CODE	NAME	CODE	NAME	CODE
Acme	51	Ebner	29	Kogyo	35	Realtone	65
Aiwa	44	Eldorado	18	Kowa	26, 45	Renown	59
Alaron	11	Electra	27	Lafayette	46	Ross	67
Alpha	79	Empire	83	Lic	50	Sampson	39
Ambassador	2	Family	5	Linmark	47, 70	Sansei	26
Amertone	3	Fen-tone	29	Little Pal	51	Satellite	80
Angel	5	Fleetwood	22	Lloyd's	49	Saxony	86
Arleigh	4	Fountain	37	Lucor	76	Sharp	69, 82
Arrow	5	Four Star	30	Mantone	51	Sheraton	13
Audlon	9	Fuji	26	Mark	79	Skymaster	59
Beniida	52	Fujitone	5	Marvel	51	Sony	72
Best Tone	12	Fujiya	31	Mayfair	6	Sovereign	13
Brenell	29	General	84	Matsushita	54	Spica	40
Brighton	1	Global	53	Mel Rose	28	Standard	74
Browni	17	Grand Prix	7	Mel Rose	28	Starlite	75
Candle	81	Hadson	15, 66	Mitsubishi	48, 55	Starlite	75
Canton-Son	14	Halco	35	Monarch	73	Tempest	10
Capri	56, 79	Harlie	36	National	54	Ten	68
Channel Master	16	Harpers	37	Nec	35, 41	Three Star	56
Commodore	19, 56	Hi-Delity	64	Nippon Columbia	36	Toptone	34, 79
Constant	14, 79	Hi-Delity	64	Nobility	59	Toshiba	85
Consul Deluxe	32	Hilton	78	Olympic	57	Tussah	88
Continental	21	Hitachi	39	Omega	58	Twii	87
Coronet	5, 56	Imperial	57	Omscoltte	61	United Royal	71
Craig	22	Intermark	38	Onkyo	68	Universal	57
Crest	79	International	3	Pacific	62	Valiant	89
Crestline	14	Invictor	82	Panasonic	54	Viscount	20
Crown	70	Ken	42	Peerless	63	Wilco	68
Daltone	23	Kent	43	Petite	76	Windsor	90
Delmonico	24	Kensington	77	Plata	57	Yaou	79
		Kobe	35	Realistic	1	Yashica	91
						Zephyr	25



Are You Selling

■ Transistor radios have re-made the radio market in the past few years and have developed steady customers for batteries. Transistor radios (and TV too) are far less demanding on batteries than their tube counterparts, but the manufacturer usually compensates for this by installing a smaller battery. As a result, there are literally millions of potential battery customers walking the streets in search of a replacement. Unless these people are firm customers of yours because of your TV business you must compete for their attention.

A set owner who knows that he needs a battery is going to be someone's customer now! He is not going to wait while you save up enough requests to place an order. If you don't make this sale, the drug store, discount house or competitor down the block will.

Off-the-street business is just good retailing. You must bring the prospect into your shop, show them a product they want in a pleasant atmosphere and quote them a reasonable price. Miss any of these points and you miss a sale.

Bringing them in

Getting the customer in the door is obviously your first step. You don't need a big, spacious shop in a high traffic area. And since you probably are not moving now, let's see what you can do with your present location.

First, how do people know that you sell batteries? In other words, do you tell them or do they have to guess? If you try to make the customer decide for himself he will be very apt to go elsewhere.

The very minimum way to tell people that you sell batteries is a window sign. An effective display or a stand out sign would, of course, be even better. If you are seriously after battery business, your distributor and the battery manufacturer will help.

The best window display or street sign while suitable for bringing in passers-by, needs to be supplemented by other advertising. If your shop is in a low traffic area, advertising is vital. (In this case, batteries are not the only thing you need to advertise.)

Clean Up Time

So the combination of advertising techniques, including an attractive window display brought a prospect in—now what? Do people ever come into your shop, look around uncomfortably, mumble an apology and rush out? It happens to every retailer sometime. The prospect was not paying attention and wandered into the wrong store. But if customers often walk out of your shop without a purchase, you had better examine its appearance.

Be honest now, is your shop clean? Somehow it is difficult to convince some people that dirty, neglected looking equipment is new, first line merchandise worth more than the discounters price. While most customers are repelled by unkept stock, the battery with a quarter inch of dust on it is particularly bad. Batteries do have limited shelf life. Many customers know this even if they don't know how long a battery does last on the shelf. The manufacturers date, if the unit is dated, won't really display the idea

of old stock if the customer ever sees the dirt.

So let's clean up the store and dust the stock. Look at some of the other merchants in your neighborhood. When they are not waiting on a customer, its a good bet that they are cleaning and arranging either the stock or the store itself. Sure, they don't have bench work to do, but they do know how to sell.

How about reasonable price? This does not mean a discount price. Rather it means a price that seems fair to the customer who is asked to pay it. To many people, especially those with brand new radios, the lowest discount price seems high for "that little thing." Manufacturers' displays with prices prominently attached go a long way toward indicating that what you are asking is *the* price. Of course, it is easier to ask list prices if your store is clean and attractive. Those few hardy souls that don't walk out of an unkempt shop are very prone to



By providing a handy, consumer package already marked with the suggested retail price, the manufacturer has helped protect you against overcharging complaints.

Your Share of the Battery Market?

Additional battery business can help you bridge the slow months

expect a reward for dealing with you. (Since your purpose in selling batteries is to make a profit, we assume you are asking list price. If you discount batteries, how can you ask full price for tubes or even for your services?)

Built in Business

So far, we have been talking about selling batteries to strangers—those people that have not used your repair services. (Some technicians seem to forget that this group includes more people. After all, not every one has a TV set and not every one who does has had you fix it.) These first time customers are important both for today's battery sale and the prospect of future business. But remember, there is a second—if smaller group—that has a built-in bias in your favor. These are the people that have utilized

your expert repair service. Now just because these people know you, don't treat them like unwanted relatives. Your established customers are perfect targets for special promotion mailings. These mailings can be general in nature or can be limited in scope and personalized. For example, send a short, but attractive note to everyone that you know has a battery using radio or TV. You should have this data from your service and sales business. If you don't have it, you can't start accumulating it any sooner than now.

When you repair a transistor set always check the battery. This should be your first check—not only because it may enable you to sell a battery, but also because a very high percentage of malfunctions are caused by defective batteries. Few transistor sets will tolerate a voltage drop of 30 percent. yet this

may be only 20 hours playing with some radio-battery combinations.

Even if the customer tells you he just bought a new battery, check it. He may have gotten a weak one or may not realize how old the battery really is.

Remember, there are millions of battery customers wandering the streets and most of them need batteries now or will for that so-called slack summer season. ■

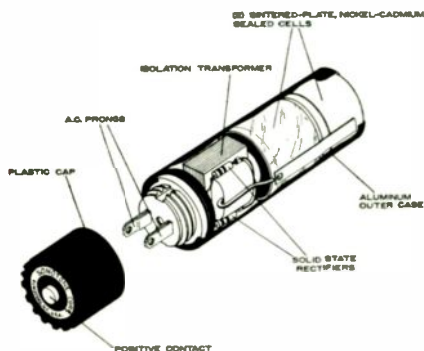

This rechargeable nickel cadmium unit replaces two D batteries and can be recharged hundreds of times by plugging into an ac outlet. Sonotone Corp.

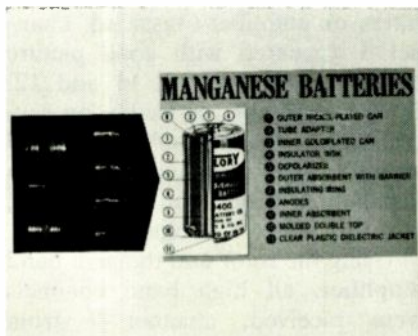

For heavy drain applications several firms are offering manganese alkaline cells that can outlast ordinary dry cells 10:1. P. R. Mallory & Co., Inc.



Specialized tools to help you sell batteries include display racks provided by individual battery manufacturers.

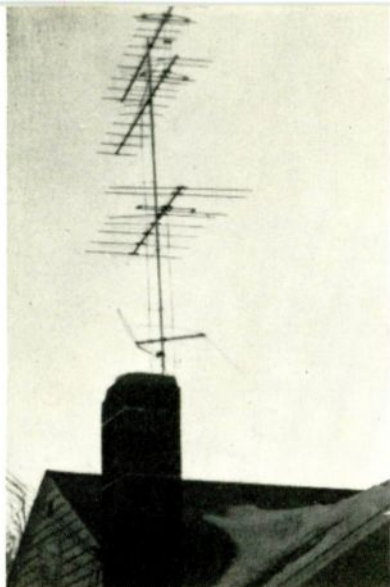

The Wineyard installation was installed several miles from the local stations on high ground. The top two units are for high band TV reception the next unit down is for FM; and the bottom antenna (shown not completely unfolded) for local TV. Two feed lines were used for FM and TV with a mixer to add local and fringe antenna signals.

Fig. 1 (left)—Simple mast mounted type filter is designed to reduce interference from local TV stations or FM. Units are made by TACO for any TV or FM interference. (Right)—JFD's preamplifier shown "piggy-backed" to the filter. Filters are designed to connect directly to the antenna. Units may be attached for almost any combination of interfering signals.

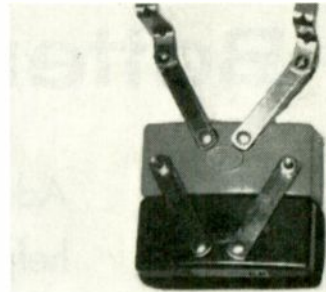
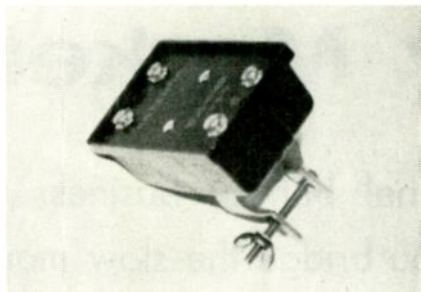

FRINGE AREA

Antenna Installation

Part II

■ Combined fringe-local TV reception is complicated many times over by local stations. When the local stations are confined either to the low or high band, however, and the fringe stations are on the remaining band, problems are minimized. Although extremely directive antennas are often effective, when the local and fringe stations are in the same general direction expensive filters will be required.

At one of our experimental test installations it was necessary to use high quality tandem filters to eliminate local interference. Unless the local interference is very mild, a simple or inexpensive filter will rarely be effective. In some instances not only adjacent channels cause interference, but set overload (even without a preamp) will occur

and cause normal reproduction of one local channel on several other channels.

Broadband Antennas with Rotor

Our Channel Master installation was a good example of this. Without filters or amplifiers installed, channel 3 appeared with good picture quality on channels 9, 11 and 12. It was detectable or usable on several other channels. A high band amplifier was installed first on this installation, without auxiliary filters, and this effect was eliminated.

Using the rotor and the high band amplifier, all high band channels were received; channel 7 from Alexandria, Minn., 165 mi. from Duluth, in the western part of the state; channel 8 from LaCrosse, Wisc. (160 mi.); channel 9 from

Minneapolis-St. Paul, (130 mi.); channel 10 from Rochester, Minn., (200 mi.); channel 11 from Minneapolis-St. Paul; channel 12 from Manakto, Minn., (200 mi.) and channel 13 from Eau Claire, Wisc., (140 mi.).

All the pictures were acceptable, though snowy with a tendency to fade. This installation was the lowest in Duluth.

Since all of the installations were experimental, no attempt was made to install the antennas at great heights. We feel that at this particular location a much better signal could be received by increasing the antenna height.

Though there are no obstructions to the south for several miles and tall hills to the immediate west, the signal strength was about the same in all directions. This is another case to point up the fact that pre-installations surveys are an absolute necessity.

With tandem filters in the feed line ahead of the amplifier, it was possible to receive channels 2, 4, and 5 from Minneapolis-St. Paul. Channel 2 from Port Arthur, Canada could not be picked up at all.

Special Cases

The most practical installation for this particular area seemed to be the high band antennas. In most

Fig. 2 (left)—Blonder-Tongue designed for high attenuation with sharp cutoff for strong local channels. The unit is tuneable throughout either the low or high band. Coaxial fittings are required. (Right)—tuneable filter made by Jerrold is designed for coaxial cable installation in areas with strong interfering signals.

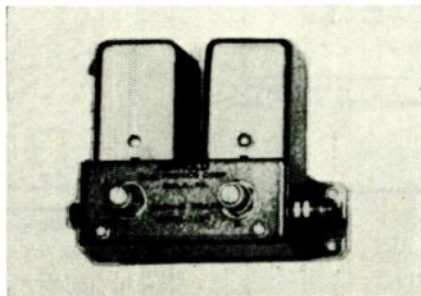
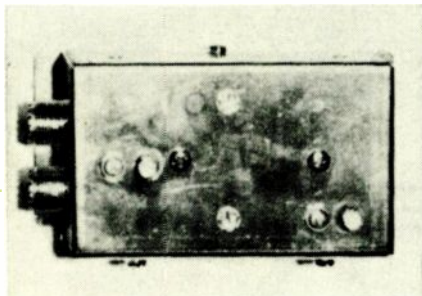

The Benco Filter Matic is designed for attenuation of two selected channels by lever switch. Each channel position is tuneable. The unit has an off position when it is not desirable to use it.

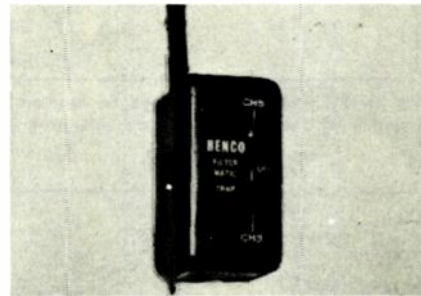

cases, although we did not measure the actual antenna gain, and since they were installed in different locations, we found the return was more in line with the cost. That is, little or no filtering was found necessary and high band reception was acceptable. Of course, low band or FM fringe reception is impossible with this type of installation.

If an amplifier is found to be necessary, however, the low or high band only is the best choice. If an all band amplifier is used, extensive filtering will definitely be required. And a signal less than 100 μv will require amplification for a more snow-free picture.

Selection of an antenna for your area may, of course, lead you to another conclusion. In any case, most of the antenna manufacturers make both types of antennas, and we found their antenna recommendations and specifications to be valid.

The same applies to areas where only high band channels are located. In this case a low band antenna would be used. The low band antenna is much larger, however, so the actual cost is not much less than an all-band unit. FM too can usually be received on a low-band only antenna.

If fringe and local TV stations are interspersed in the high and low

band, heavy filtering will be absolutely necessary regardless of station direction. Single channel filters with high attenuation and a very sharp cutoff cost from \$25 to \$100. You can therefore see that if you already have several local channels it could be quite expensive to add fringe channels to the list. Fig. 2 shows some typical filters for quality installations.

A simple filter for very weak interference is shown in Fig. 1. These filters usually cost less than \$10.

If the interference is from adjacent channels, coaxial cable will also be required since a very short piece of twin lead will pick up sufficient signals from an adjacent channel to cause interference with the weak incoming fringe signal. It is for this reason the Jerrold-Taco installation uses coaxial cable. Of course, the shielding also prevents noise from entering the feed line and interfering with very weak signals.

The two local FM stations do not seem to pose a problem to FM reception. The only exception to this is where an inexpensive tuner is employed and station images are found at several points on the dial.

For our tests, Sherwood AM/FM tuner was used. We found that four stations could be picked up reliably from Minneapolis plus a

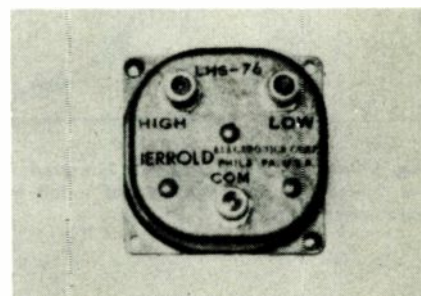

High-low mixer made by Jerrold for 75 ohm installations. High and low band antennas can be mixed into a common output with this unit.

Rice Lake, Wis. station and the two local stations. Certainly an improvement over the two part-time stations which normally broadcast in this area. Several other stations can be received spasmodically on all the broadband installations.

One of the highest installations made happened to be a poor signal area. Only channel 8 showed any promise from a preliminary ground survey (with about 20 μv signal) while the other channels were all between 5 and 10 μv . The final installation of this particular antenna proved the ground survey to be accurate. Channel 8 was received with some snow and the other channels faded and proved to be much too weak to be usable.

Additional Considerations

The familiar "airplane flutter" sometimes encountered with local signals is usually magnified many times in fringe area reception. There is no sure cure. Since airplanes do fly within 150 miles of most places almost all installations will be af-

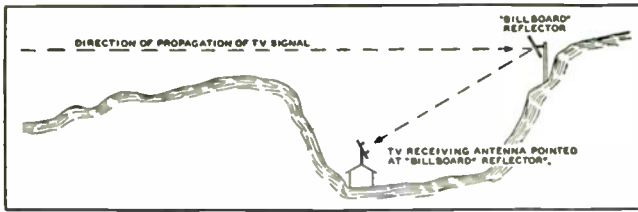

Fig. 3—TV reception in valleys or canyons can sometimes be made possible by the use of billboard reflectors.

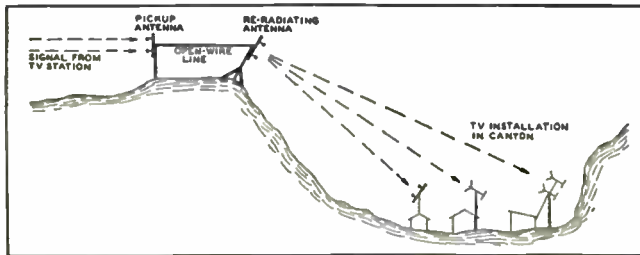

Fig. 5—When billboard reflection is not possible, the signal can often be "piped" to the other side of a hill by re-radiating the signal received at the top.

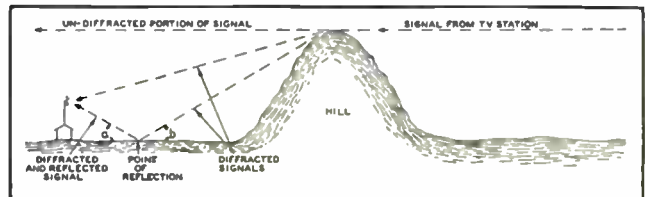
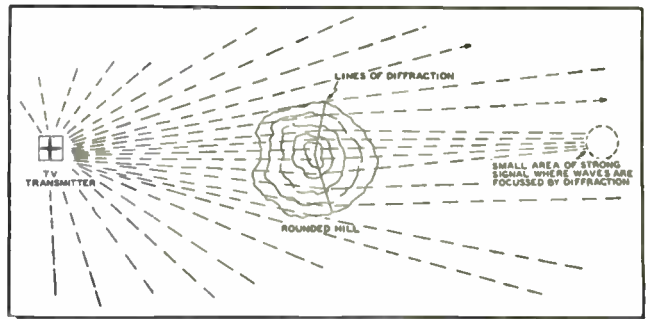
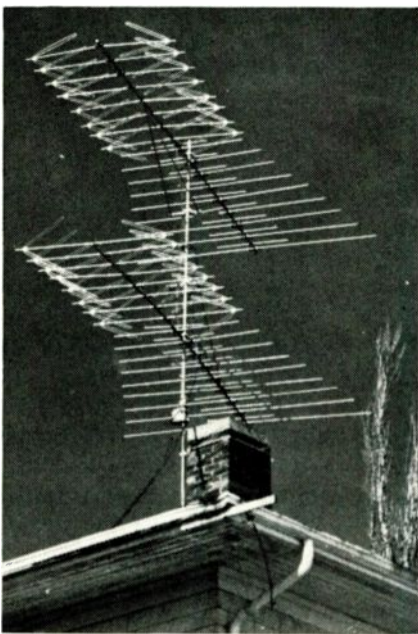

Fig. 4 (top)—Hotspots often occur behind a hill when diffraction causes the signal to focus at some point. (Bottom)—reflection and diffraction sometimes add to increase the normal signal strength. Space loops are sometimes formed in these areas caused by phase cancellation of the two signals. Changing the antenna heights slightly eliminates the cancellation.



Channel Master installation consisted of stacked Crossfire antennas and a rotator. All high band channels were received with this installation since direction was easily changed. Low band reception required heavy filtering but was possible.

The Finney high band antenna was installed with a Blonder-Tongue mast mounted preamp. Guy wires loosened a short time after installing them. The mast used for this particular installation were not keyed and in a high wind the antenna had a tendency to turn. Both 9 and 11 from Minneapolis were received with this installation. With some rotation, channel 13 could be received.

ected by this problem to some extent.

In some cases, the techniques used for a standard installation will be impractical. If an antenna is located in a canyon, such as that shown in Fig. 3, for example, direct fringe reception will be impossible. Sometimes the use of a "billboard" reflector or one of the other passive installations will be an effective remedy.

Minimum and maximum antenna height as well as lightning protection and the type of installation is usually specified by city building codes and fire ordinances.

To prevent hardships and unnecessary expenses, the installer

should check with the City Engineer and the fire inspector. A copy of the city building code can be obtained by writing to the city engineer's office.

In addition to the local laws and regulations which may affect the type of antenna installation you may make, National Electrical Codes and Civil Aeronautics rules also apply. If the installation is to be made near an airport, a check with the local CAA representative is in order. In some instances special lighting and paints may be necessary or possibly a restriction on the maximum height of the mast.

The National Electric code specifies lightning protection precautions to avoid invalidating fire insurance regulations and to comply with the National Code. Among the regulations affecting the installer is that the maximum voltage run on the mast (for lights or a preamp, for instance, 24 v) and grounding procedures.

Some "Rules of Thumb"

The installing technician should be particularly aware of the various ways fringe TV or FM signal are received so he can better evaluate and orient the antenna. Fig. 4 shows how a hill may affect a TV or FM signal. Proper orientation

Continued on page 75

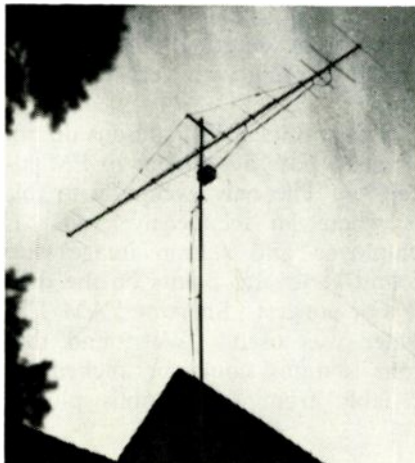

■ Every shop owner who extends credit eventually accumulates a group of dead-beats and slow payers. All orthodox collection devices are of no avail.

You can divide these customers roughly into three categories:

1. Deadbeats who have no intention of paying.
2. Slow-pay customers who have genuine difficulties in promptly honoring their obligations, but who eventually do.
3. Slow-pay customers well-able to pay bills promptly, but who take their time.

Many of the community's leading citizens may be found in the third category. They are "good for their obligations" and know it! Debt-wise, they consider themselves in a special class. Ordinary monthly billings leave them unmoved because someday — six months or a year later — they'll pay the bills, but not now.

There're likely to be a few odd-balls who never willingly close out their obligations, or pay in full. They always maintain at least a small unpaid balance. Some do so deliberately to obtain a substantial amount of money that their creditors would otherwise use as operating capital.

As time passes, some of these accounts will go bad because debtors' financial circumstances will change for the worse. Even if a shop feels that customers "are good for it" he should make serious efforts to collect. It's his money — not theirs.

To do so, there's one collection device that's calculated to liquidate the accounts. It should be used only as a last resort; and, it should be employed only on those customers who won't otherwise pay.

Up the Bill

In routinely sending out monthly statements to slow-paying customers, a shop owner should deliberately increase the balance due him. Except for outright deadbeats, this will bring negligent customers into the shop to protest indignantly. At this point, the shop owner or an employee looks up the account and cheerfully admits that an error was made. The customer is then asked to pay the true balance.

Although some customers may never again patronize the shop, collection may activate others who have postponed getting needed services because of the old balance owed. Many customers have been lost for this reason because some individuals don't like to "pay for dead horses." With the passage of time, and monthly reminders of their long-past-due obligations, some customers will even develop a "grievance" against those they owe.

In one instance, a shop owner sent out 15 bills indicating "blown-up" balances. The actual unpaid balances ranged from \$5 to \$50 each. This device brought in 11 irate customers. Nine of them either paid the full amount owed or a substantial amount on account. A total of \$181 was collected when all other efforts had failed. All bills were at least eight months old and some had run on for more than two years. Based on the length of the delinquencies, at least \$90 of the \$181 would eventually have be-

How to Collect DELINQUENT ACCOUNTS

by Harold J. Ashe



"Pretend Smith here's the customer who comes in and tells me he's broke after I spend a week fixing his set."

come bad debts beyond collection despite the fact that all were initially considered good risks.

When deliberately boosting a bill, care should be used. Inaccuracies should be plausible. If a bill is \$17, the incorrect figure can be \$37 or \$47, preserving the figure 7. Or, for a larger amount, the figures may be transposed: \$13 to \$31, or \$27 to \$72. A customer is easier mollified and the error easier explained than when an additional cipher is added—as \$100 for a \$10 bill. ■

Access to the two PC boards in the Sony transistor TV is easily gained by removing three phillips head screws from the rear of the set and the two screws located on the brushed aluminum around the front edge of the set.

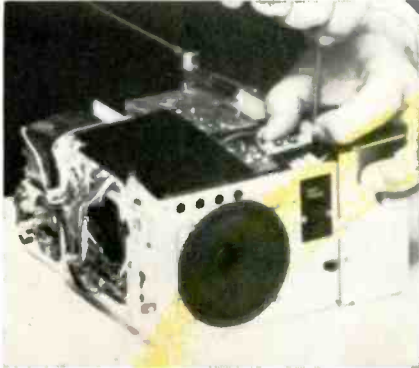

The top PC board is removed by unscrewing three flat-head phillips screws on the front edge of the PC board.

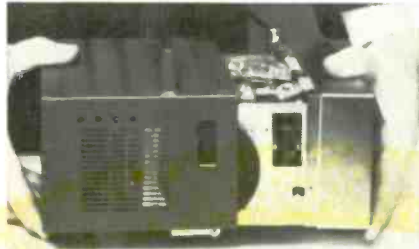

The cabinet slips off from the rear with no tugging. The speaker can be seen emerging just in front of the cabinet's edge. Small black terminal at upper right of set contains two earphone jacks; opposite side has terminals for external antenna.

Picture tube installed and parts gathered for reassembly. Controls, seen through front panel, are easily replaced by removing only the front panel. Slotted panel holes make no behind-the-panel work necessary.

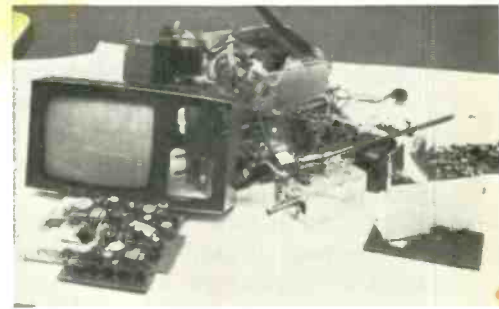

And unplugging it.



Small size and light weight allows easy manipulation of the set.

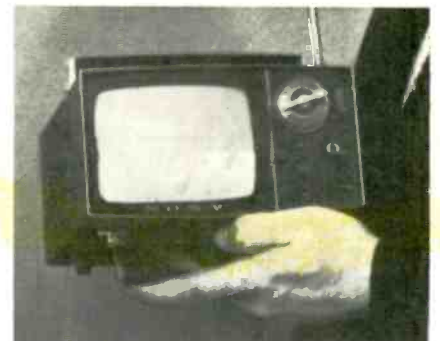

All done. Total time to disassemble and reassemble, 45 min. to 1 hour.

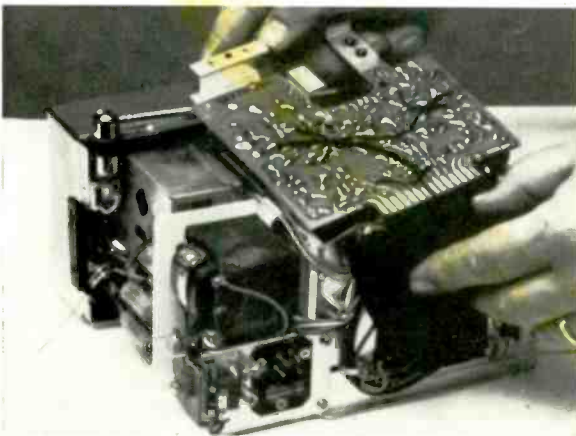

The PC board is then free except for the connecting wires. Power supply components can be seen at the left-rear corner of the chassis.

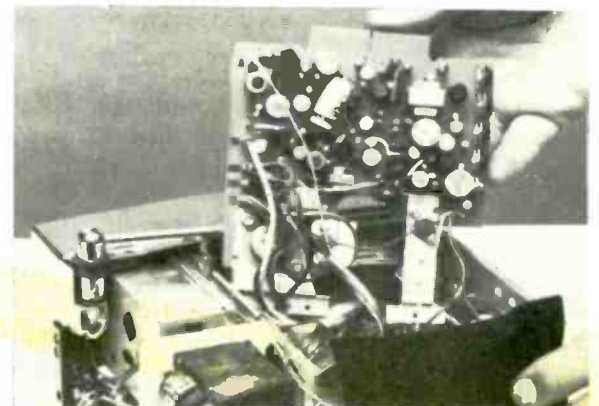

Connecting wires on the board are all color coded. Two wires which are yellow could be interchanged, however.

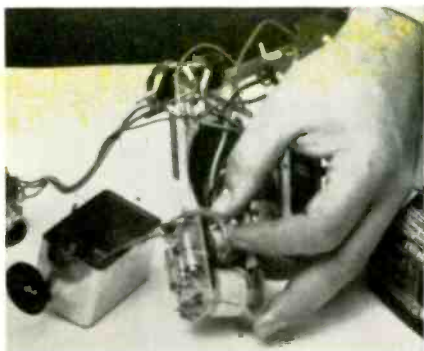

The flyback and high voltage subassembly is contained in a small plastic-lined can. Index finger points to silicon type rectifier. Three vacuum diodes on the left of the unit are for damping and high voltage.

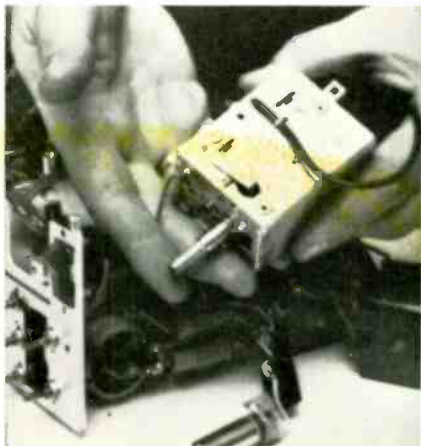

Only three wires are connected to the tuner. Loose wires permit some degree of servicing without complete removal.

TECHNICIANS LOOK AT SONY'S 5-INCH TV

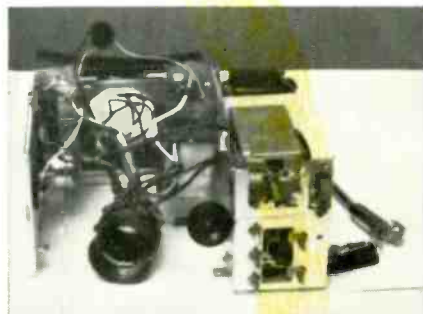

The "chassis" stripped of most subassemblies is hardly more than a piece of metal and bits of wire.



Miniature yoke contains positioning magnets similar to conventional yokes. A set screw on outside magnet prevents accidental misadjustment.

Removing the picture tube from the bezel requires removing three screws. The nuts are not captive and must be held from the inside. Band around picture tube has three slotted holes to accept mounting screws and assure a flush fit against mask. Note the braided ground strap across the picture tube.



The bottom PC board is removed in a similar manner. Two round-head Phillips screws secure it.



Both PC boards. The video board is shown on the left and the sweep board is on the right.

Improved Video Amplification Circuit

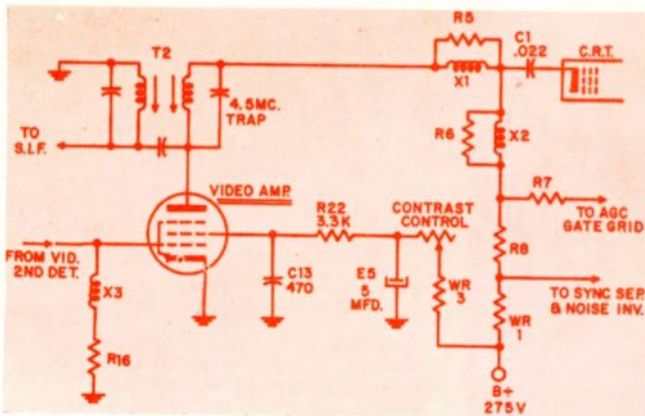

Fig. 1—Contrast control circuitry in Philco's "K" line TV receiver.

New feature in Philco's "K" line TV receiver

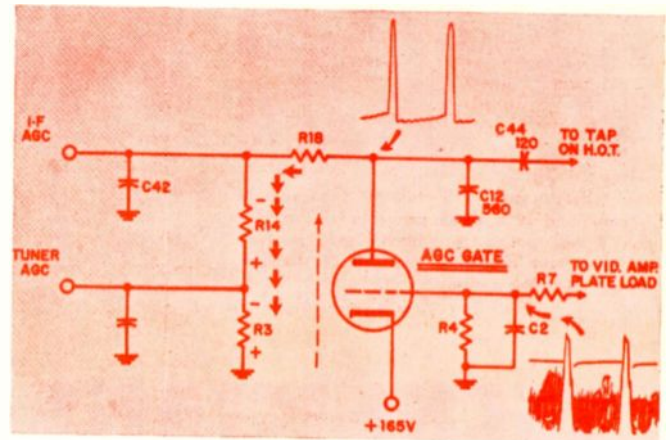

Fig. 2—AGC circuit of "K" line chassis.

■ The video amplifier used in Philco's new "K" Line television receivers has been designed to give greater video drive with low signal levels and less overload at high signal levels.

As shown in Fig. 1, the contrast control has been specially placed in the screen grid circuit to maintain good picture quality. With this "screen control," the amplifier's transient response is not altered by different control settings and, for this reason, the characteristics of the video signal remain unchanged. There is also an improved and increased contrast range. This is shown on the schematic.

Circuit and Components

Note that coil X3 and resistor R16 serve the combined purposes of detector load, amplifier grid peaking, and grid return. Note secondly that the cathode is grounded and that bias is developed by the signal conduction of the second detector through the grid return path. Note thirdly that the plate circuit is made up of T2, (the 4.5 Mc trap),

coil X1, and resistor R5 (for series peaking), C1, (the coupling capacitor to the CRT cathode), X2, resistor R6, (a second series peaking circuit), and resistors R8 and WR1 which go to 275 v B+. R7 is the isolating and coupling resistor connected to the AGC gate grid. Finally, note that the signal applied to the noise inverter, and sync-separator stages is taken from the junction of resistors WR1 and R8. The plate circuit, then, is quite conventional.

You will recall two facts about pentode amplifiers: (1) the average plate current will change over a rather wide range with only a small change in the stage's amplification, and (2) plate current is controlled to a considerable degree by the screen voltage. Hence, the contrast control located in the series screen circuit, by varying the video amplifier's conduction current, effectively controls the AGC gate stage bias.

Operation

Here is how this comes about—
(1) A decrease in screen resistance

causes screen voltage to rise. (2) Increased screen voltage causes the video amplifier plate current to increase and, as a result, its plate voltage to decrease. (3) Since the AGC gate tube grid is dc coupled to the video amplifier plate circuit, the positive grid voltage decreases, increasing bias (Fig. 1 and 2). (4) This increase in gate tube grid bias reduces gate tube conduction current. (5) Reduced gate tube conduction slows the charging of capacitor C12—thereby causing a lower AGC potential to be developed. (Fig. 2). (6) Under reduced AGC conditions, the "front-end" tuner and IF stages operate at a higher gain and furnish a larger video signal to the video amplifier control grid. This signal, once amplified, provides increased CRT drive.

The screen circuit resistor R22, contrast control, and resistor WR3 also perform a protective function. If for any reason, (a slightly gassy tube condition for example), the plate current increases, the screen current will also rise. This creates

Continued on page 61

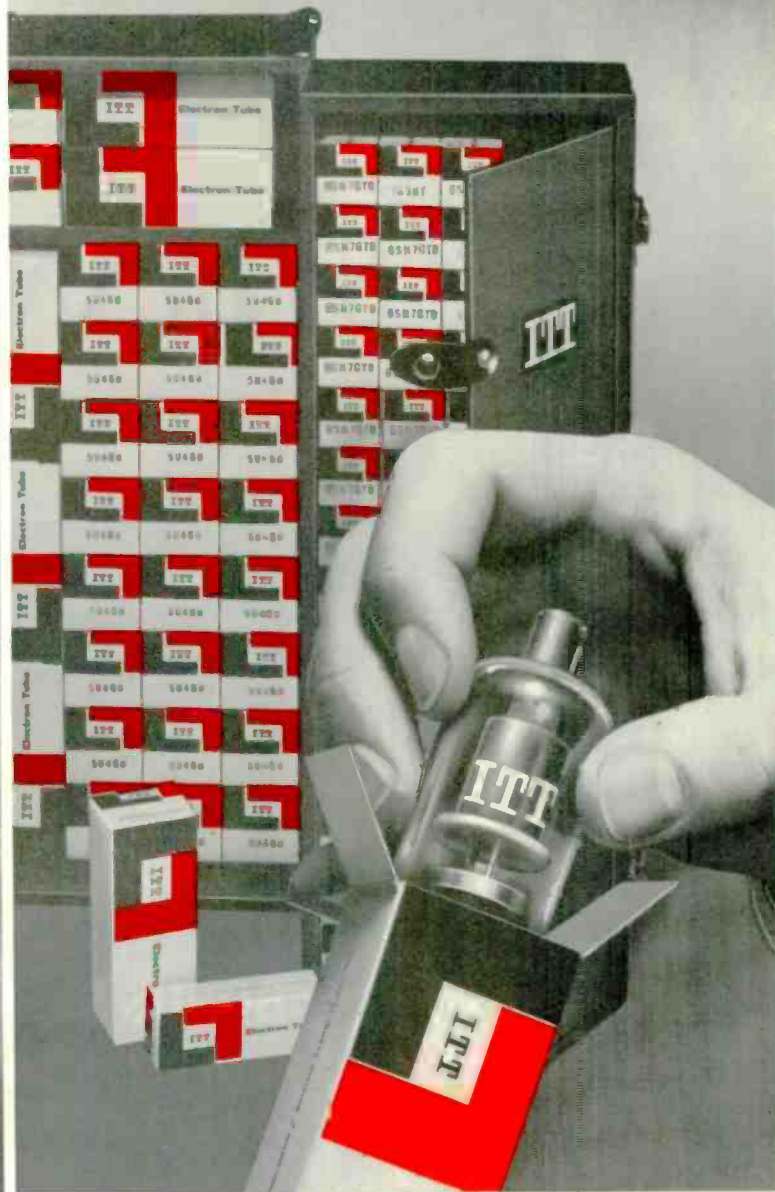

ITT batteries...and ITT tubes...give you first-line quality ...and extra profit margin

ITT batteries—penlites, C, D, and 9-volt miniatures — now offer the same “extra value” and acceptance already experienced with fast-moving ITT Receiving Tubes.

ITT can provide this “extra value” of finest quality at higher profit margins in each of its lines because ITT products are on call from 154 factories and laboratories in 24 countries. If you are selling ITT tubes and batteries, you can compete with anyone in the world

... on quality, on price, and on acceptance. Brands without these worldwide resources are finding it tougher than ever.

Make sure *you* have this *value* leadership in *your* service market. Stock ITT tubes and batteries—the only worldwide lines with such a world-famous name.

ITT Distributor Products Division, International Telephone and Telegraph Corporation, Box 99, Lodi, New Jersey.

... for more details circle 20 on post card

ITT



SYLVANIA DECLARES

through

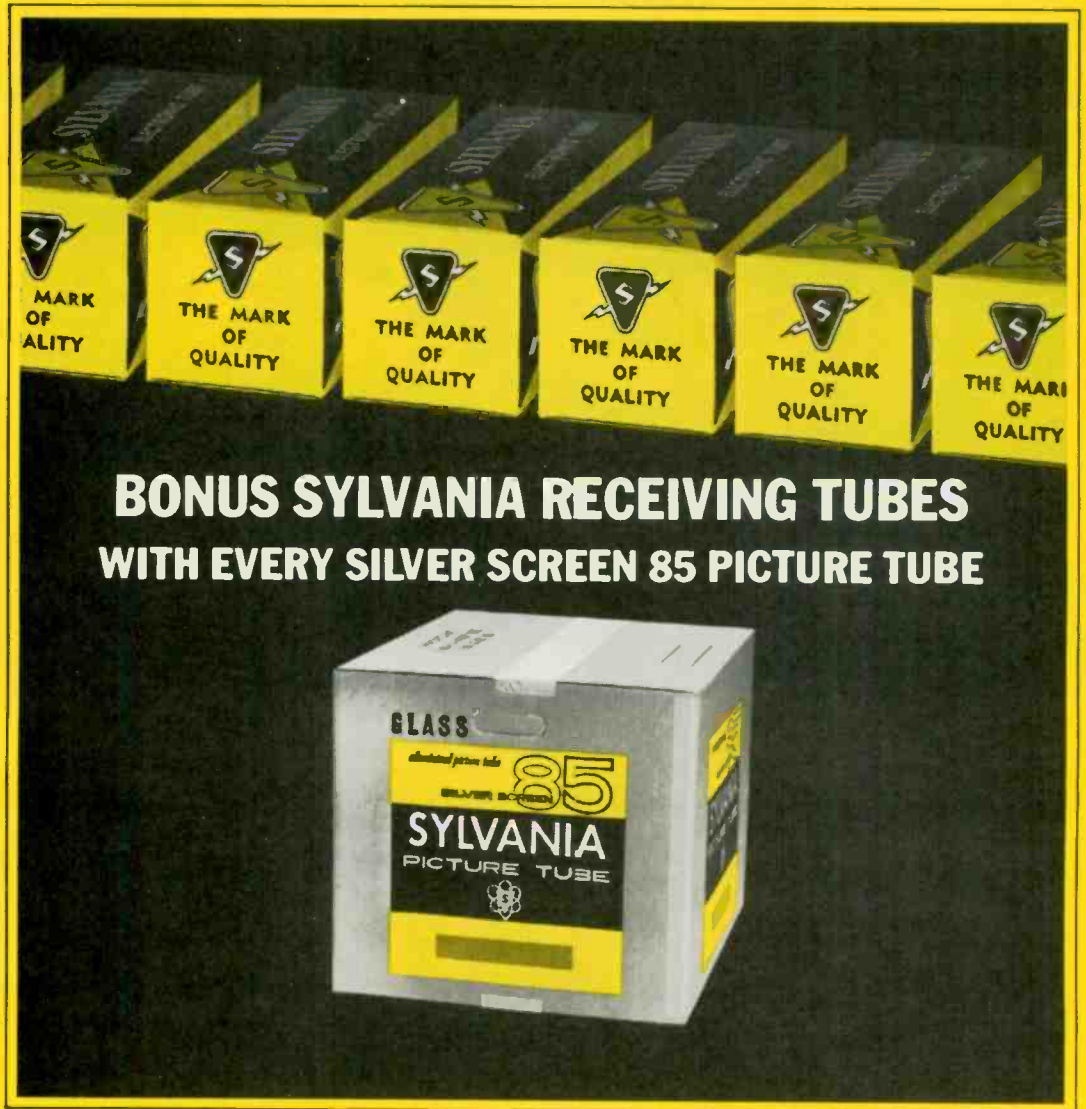

**BONUS SYLVANIA RECEIVING TUBES
WITH EVERY SILVER SCREEN 85 PICTURE TUBE**

SILVER SCREEN 85 Picture Tubes are made only from new parts and materials except for the envelopes which, prior to reuse, are inspected and tested to the same standards as new envelopes.



A DIVIDEND

Participating Distributors...

REWARD FOR DEALERS WHO RECOGNIZE VALUE: . . . popular, fast-moving Sylvania receiving tubes with every SILVER SCREEN 85® picture tube you buy—regardless of size—during Sylvania's Spring Savathon!

This is actually a *double* dividend. First, you get bonus tubes at no cost—which will move quickly in your servicing business. Then comes the even more valuable dividend of additional satisfied customers—because of the inherent quality of Sylvania picture tubes and receiving tubes. For you, this means fewer profit-stealing call-backs when you stay with Sylvania.

Dealers know: the only good business is dealing with quality. And Sylvania dealers know that only quality comes from Sylvania. We think it's the only way to do business, and this dividend is our way of thanking you for the confidence you have shown. But hurry, this is a limited-time offer, available only through Sylvania Distributors who are participating in the Spring Savathon promotion.

LOOK FOR THIS DISPLAY at your Distributor's—and get bonus quality receiving tubes with every quality Sylvania picture tube you buy during the Spring Savathon!



SYLVANIA

SUBSIDIARY OF

GENERAL TELEPHONE & ELECTRONICS





Difficult Service Jobs Described by Readers

Transformer Kills Battery

I recently encountered a rather unusual service job. A six transistor radio was brought into the shop, the complaint being local reception only, very weak and very short battery life.

I hooked a milliammeter in series with the battery and the radio came on faintly. The current drain was very high, around 250-300 ma. I turned the switch off, but the radio continued to draw the same high current. Checking the schematic didn't help. It showed the positive battery lead connected through the switch to ground, with no other connections to the ungrounded side of the switch. The switch was OK, so I checked the radio and found the positive battery lead was tied to the same place on the printed board as the audio output transformer mount, before going to the switch. Realizing the only way for current to flow with the switch off, is for the transformer to short to the mounting

case, I replaced the transformer and this corrected the problem.—*Leroy Thrower, Snyder, Tex.*

Tiny Problem

An old customer of mine with an MV411M Magnavox called me over to service his remote control unit. He warned me before hand that he had just come back from one of the large Appliance stores in the neighborhood where he tested the hand transmitter against several floor models similar to his and found it to be in perfect order.

Armed with that information I proceeded to change every tube in the remote receiver. I removed the remote chassis from the cabinet, gave it a cursory examination and then ran through it with the ohmmeter. Nothing out of the way.

I sat there a while contemplating my next move when the customer brought another fact out for my attention. It seemed that if he de-

pressed the transmitter key very hard and sharp he might be able to change a channel occasionally. The volume level was functioning normally. An easy depression of the key activated the relays.

This puzzled me. I brought the transmitter right up close to the receiver transducer and depressed the channel key. Nothing happened. I pressed it sharply and the channel changed. At the other end of the room I got the very same behavior.

If changing channels only by forcing the transmitter key indicated that the receiver was weak, this theory was immediately expelled by the fact that I could not change channels by depressing the key in a normal way even when I placed the transmitter transducer and the receiver transducer face to face. In spite of what my customer insisted I was forced to blame the hand transmitter for our trouble so I opened it.

By pressing the keys two things happened. First, a bellows filled with air would be squeezed and then a tiny needle valve freed a tiny hole through which the air was released. This gave off a supersonic whistle which the receiver would pick up. There were two holes, one for audio level changing and one for channel changing. As I depressed the channel key I swear that I saw a minute speck of dirt bobbing around in it's hole. With a sewing needle I searched into the hole being very careful not to scratch the metal in any way. Sure enough, out came a tiny speck of dirt.

I put the unit together again and all was well once more. Now the customer could change his channels by gently pressing the key at the other end of the room.

A short between the coil and transformer mount caused us to remain "on."

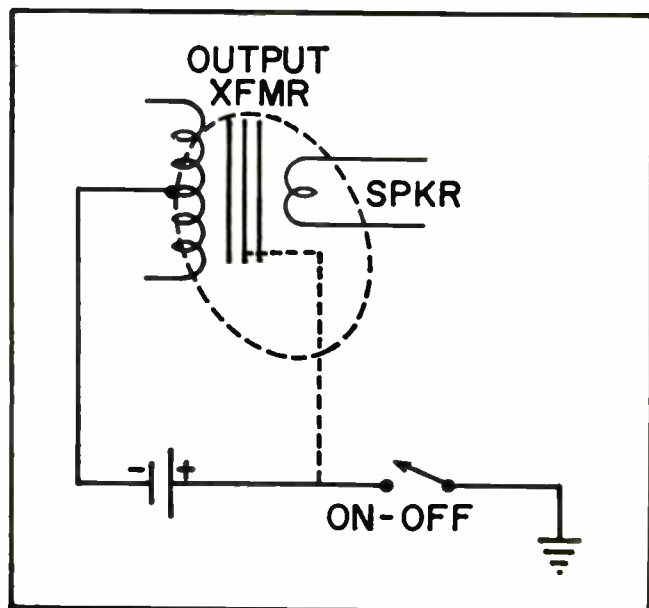

... SMALL BOAT RADAR

Continued from page 45

the appropriate power supply for 12, 24, 32, 110, or 220 dc, or 115 ac operation is also provided with the system and can be installed below decks where space is not at a premium. The system draws only 220 w for 115 vac operation.

The new radar is offered at a suggested retail price of \$2120 for 115 vac operation, or \$2290 for dc operation, complete with power supply.

A light-shielded hood is provided for daytime viewing. ■

... VIDEO AMPLIFIER

Continued from page 56

a greater screen voltage drop which counteracts the plate current rise.

In Fig. 1, resistor R22 and capacitor C13 form a high frequency compensation circuit. C13 acts as a bypass for the high video frequencies and thereby prevents high frequency degeneration while capacitor E5, the electrolytic, is included to bypass lower frequency signal components—preventing degeneration in this range also for maintenance of proper dc control.

Now consider one final aspect of the video amplifier used in the 12N50 series "K"-Line receivers—the new type 6JE8 tube (11JE8 in the portables). This tube has a higher plate (7 w) and double the screen rating of older types. It provides up to 150 v peak power video output without any increase in input, representing an efficiency increase of about 25 percent. Hence it follows that operating at last year's power input level with a tube of greater capability increases the over-all circuit reliability.

The new-improved video amplifier circuit has the following desirable features:

1. Approximately 25 percent more output.
2. An improved and increased contrast range.
3. Better contrast over the entire range of the control.
4. Ample use of series peaking circuits for greatest uniform response. ■

most RELIABLE TRANSISTOR antenna AMPLIFIER



WINEGARD'S RED HEAD

Red Head is one transistor amplifier that does what it's supposed to do . . . boosts those weak signals right out of the snow, gives brighter contrast to your pictures without trouble and call-backs.

Red Head has a lightning-protected circuit—no transistor burnout due to lightning flashes, static precipitation or power line surges. Built-in high pass filter rejects interference from Citizen's Band, hams, etc. Unlike other transistor amplifiers, it can't cause smear or graininess in picture from phase distortion . . . has linear frequency response, no suck-outs or roll-offs at end of bands. You get clear, bright picture detail on color and black and white.

OTHER ADVANTAGES OF WINEGARD'S RED HEAD—has newest type four-lead transistor . . . is AC powered, no corrosion at terminals, no polarity problems—has built-in 2-set coupler in power supply—mounts easily on antenna, mast or wall—powerful enough to drive 6 sets, can be remoted up to 1500 feet using 300 ohm twin lead or ladder line. New eye-catching bright red amplifier housing—gives lasting product identity.

Red Head is your *best* transistor antenna amplifier buy. Try a few and see for yourself. Write for technical data or ask your Winegard distributor.

There's a Winegard Quality Antenna for Every Reception Need

 COLORTRON AMPLIFIER \$39.95	 COLORTRON ANTENNA Model C-44—Gold Anodized \$64.95	 COLORTRON ANTENNA Model C-43—Gold Anodized \$51.90	 COLORTRON ANTENNA Model C-42—Gold Anodized \$34.95	 COLORTRON ANTENNA Model C-41—Gold Anodized \$24.95
--	---	--	---	---

YOU GET AN EXTRA BONUS OF QUALITY AND VALUE FROM WINEGARD



Winegard ANTENNA SYSTEMS

WINEGARD COMPANY • 3019-4B KIRKWOOD BLVD. • BURLINGTON, IOWA

... for more details circle 41 on post card

SHOP HINTS

TIPS FOR HOME AND BENCH SERVICE

Variable Voltage Supply

I use a variable voltage transformer for line isolation and a source of higher or lower voltage. I find it useful also to preheat my low-wattage soldering iron. By setting the control for about 130 v for several minutes and then maintaining it at 120 v, my iron is ready for instant use. When not in immediate use I turn the control to about 80 or 90 v to keep the iron in ready heat. With a greater non-usable time lapse, I turn the control to about 40 v this keeps the iron warm and when needed, I turn the voltage up to 130 for several seconds and back to 120 v and my iron is ready for instant use. — *Joseph J. Schneider, Allison Park, Pa.*

In-Circuit Transformer Test

When you remove the back from a TV set and find the rectifier tube burned out and the pungent odor of a hot transformer, the customer wants to know how much it will cost to repair. And you have to know if the transformer is shorted in order to make an estimate. You could stick in another 5U4 and turn on the set to see if it works. But if the original trouble was caused by a short in the B+ circuit, then your

customer would be in for another ordeal of smoke and odor. If the transformer is shorted, you may blow the house fuses. Use the following test procedure:

Wire an NE-2 neon bulb to pins 4 and 6 of an octal tube base as shown in the accompanying drawing. Plug this assembly into the rectifier tube socket. Unplug the receiver, replace the line fuse if blown, and turn on the ac switch. With your ohmmeter set to R X 1, touch the probes to the pins of the interlock receptacle. The ohmmeter will read some low value of resistance. Remove the probes; if the neon lamp flashes, the transformer is not shorted and likely will not. If your ohmmeter does not have a high enough voltage source to fire the bulb, you can substitute a 1.5 v flashlight cell in place of the ohmmeter. You should make the ohmmeter check first, however, to be sure that there is continuity in the primary circuit. — *Ivan White, Albuquerque, New Mexico.*

Preventing Fine Tuning Failures

I'd like to add a step to the hint sent in by H. L. Davidson regarding repair of fine tuning shafts on standard coil tuners. Before replacing the retaining bracket, flatten down the rotation stop lug on the bracket. The customer may then whirl the fine tuning knob to his hearts content. The damage is usually caused in the first place by the fiber being forced against the stop, stripping the indentation in the fiber loose from the shaft. — *Dennis Crisp, Howard Kansas.*

Emergency Rectifier Replacement

Save some defective 35W4, and 35Z5 tubes that have good filaments. By removing all but filament pins, installation of a silicon diode is all that's needed for an emergency repair when a filament opens. — *H. B. McCulley, La Liz, N. Mexico.*

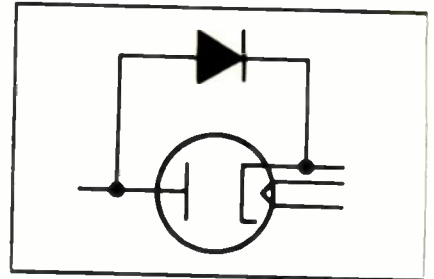

Emergency repair for series — string sets when rectifier fails.

Rubber Bands Secure Yoke for Test

I have a hint which has solved my problem of keeping the yoke from slipping when using a univer-

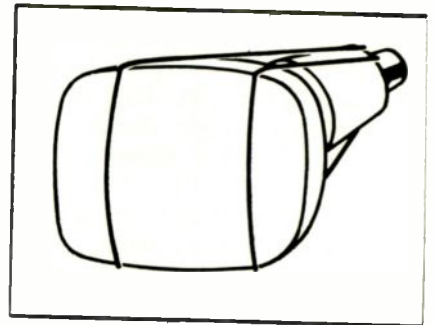

Rubber bands prevent yoke slippage on test CRT.

sal pix tube. Place two heavy rubber bands on each side of the yoke and around the front of the CRT in vertical position. This draws the yoke up close to the CRT bell and prevents the yoke from moving. This prevents the yoke from slipping back on the CRT neck when connecting socket extension cord and positioning test CRT. — *John A. Krzywulak, Trenton, N. J.*

SHOP HINTS WANTED!

\$3 to \$10 for acceptable items. Use drawings to illustrate whenever necessary. A rough sketch will do. Photos are desirable. Unacceptable items will be returned if accompanied by a stamped envelope. Send your entries to Shop Hints Editor, ELECTRONIC TECHNICIAN, 1 East First St., Duluth 2, Minnesota.

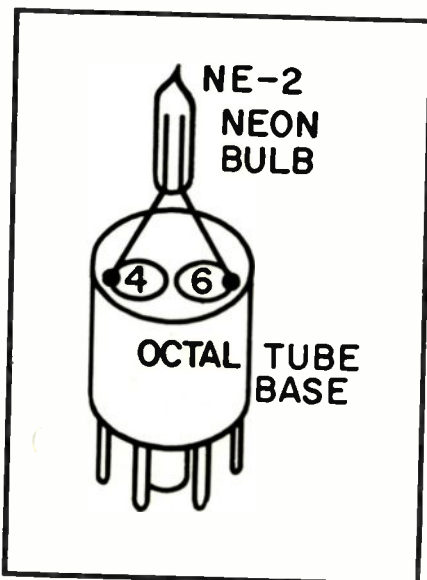

Test adapter for power transformers.

Find it and Fix it in 1/2 the time!

EASILY SOLVES "TOUGH DOGS"... INTERMITTENTS... ANY TV TROUBLE



B&K MODEL 1076 TELEVISION ANALYST BLACK & WHITE AND COLOR

By Easy Point-to-Point Signal Injection, You see the Trouble on the TV Screen and Correct it—Twice as Fast and Easy!

Simplified technique stops lost hours never recovered on "tough dogs", intermittents, and general TV troubleshooting. This one instrument, with its complete, accurate diagnosis, enables any serviceman to cut servicing time in half... service more TV sets in less time... satisfy more customers... and make more money.

With the Analyst, you inject your own TV signals at any time, at any point, while you watch the generated test pattern on the picture tube of the television set itself. This makes it quick and easy to isolate, pinpoint, and correct TV trouble in any stage throughout the video, audio, r.f., i.f., sync and sweep sections of black & white and color television sets—including intermittents. No external scope or waveform interpretation is needed. Checks any and all circuits—solves any performance problem. Gives you today's most valuable instrument in TV servicing—proved by thousands of professional servicemen everywhere.

Available on Budget Terms. As low as \$30.00 down.

Net, \$329.95

SIMPLIFIES COLOR TV SERVICING, TOO

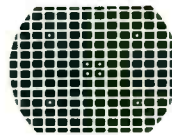

Enables you to troubleshoot and signal trace color circuits in color TV sets, or facilitate installation.

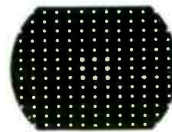

Generates white dot, crosshatch and color bar patterns on the TV screen for color TV convergence adjustments.

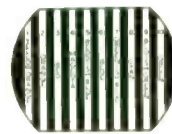

Generates full color rainbow display and color bar pattern to test color sync circuits, check range of hue control, align color demodulators. Demonstrates to customers correct color values.

Time-Saving, Money-Making Instruments Used by Professional Servicemen Everywhere



Model 960 Transistor Radio Analyst



Model 360 V O Matic Automatic VOM



Model 375 Dynamatic Automatic VTVM



Model 700 Dyna-Quik Tube Tester



Model 440 CRT Rejuvenator Tester

See Your B&K Distributor or Write for Catalog AP 20-T



B & K MANUFACTURING CO.

Division of DYNASCAN CORPORATION

1801 W. BELLE PLAINE AVE. • CHICAGO 13, ILL.
Canada: Atlas Radio Corp., 50 Wingold, Toronto 19, Ont.
Export: Empire Exporters, 253 Broadway, New York 7, U.S.A.

... for more details circle 43 on post card

NEW PRODUCTS

FOR MORE INFORMATION CIRCLE PRODUCT NUMBERS ON POST CARD FOLLOWING PAGE 82

MUSIC SYSTEM 200

A versatile background music system complete in one package, the SCA Channel-matic 4 is a 4



track system which requires no special installation. Just plug in the Channel-matic play back unit and the twin speakers (20 ft of wire included), insert tape cartridge. The SCA Channel-matic delivers music automatically, continuously. This compact package, 14 sq. in. is finished in hand rubbed walnut with gold and black trim for use in home, office or business. Sound Corp. of America.

VTVM 201

The horizontal design of the IM-13, with gimbal mounting bracket, permits neat, permanent



mounting under a shelf, on the wall or bench top, wherever most convenient to the operator. The meter tilts to any desired angle to eliminate light reflections and provide for best reading position. Thumbwheel nuts on the side of the case hold the meter firmly in any position. The IM-13 features a proven circuit design, oversize 6 in. 200 μ a meter movement, multi-colored meter scales and high contrast panel screening, to show at a glance the correct scale and range in use for fast, easy reading of all measurements. New features include vernier driven Zero and

Ohms adjust controls for settings and a new single ac-Ohms-dc probe for operating convenience. Specifications—Meters scales dc and ac rms: 0-1.5, 5, 15, 50, 150, 500, 1500 v full scale (1.5 and 5 v ac ranges read on separate scales). Ohmmeter: Scale with 10 ohm center x1, x10, x100, x1000, x10K, x100K x1 meg. Measures 1 ohm to 1000 megohms with internal battery. Kit price is \$32.95. Heath Co.

ANTENNA AMPLIFIER 202

The "Red Head" transistor antenna amplifier has been designed "to improve performance of transis-

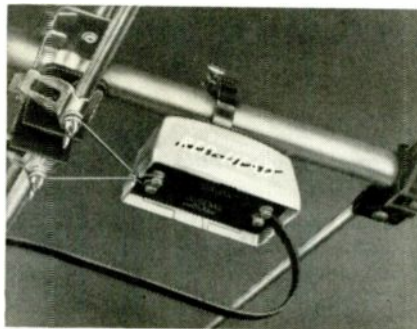

torized antenna amplifiers and to increase reliability. Transistor 'pop-out' due to lightning flashes, precipitation static and power line surges, is eliminated. The Red Head is designed to give trouble-free service and avoid 'call backs' which are expensive to TV technicians." The model RD-300 has a high pass interference filter, built-in 2 set coupler and is fully ac with no polarity problems. It is recommended by the manufacturer for areas where all signals are less than 20,000 μ v. It uses MADT transistor and has a bright red amplifier housing for lasting product identification. Winegard Co.

HUMIDITY PROTECTION 203

HumiSeal protective compounds, available in self-contained pressurized cans, bring new convenience and ease of application to the bene-



fits of single component protective coatings for electronic assemblies. Type 1B15, packaged in 16 oz aerosol containers, is a plastic formulation providing insulation and protection against extreme environmental conditions. The easy to spray, solderable coating contains a combination of highly desirable electrical, thermal and chemical properties. The absence of exotherm during cure prevents damage to temperature sensitive components. The solderable coating permits component replacement or repair without chemically or mechanically removing the coating. Because it is transparent, components, color or marking, are easily identifiable. HumiSeal IB15 spray is also waterproof and fungus-proof. Columbia Technical Corp.

THIN LINE SPEAKER 204

The KN-2250 system, only 6 7/8 in. deep assembled, combines a 12-in. thin-type woofer, a 6 in. closed-back mid-range unit and a dome lens compression tweeter. The woofer has a high compliance thick foam-type cone and 1 lb. ceramic magnet. The enclosure is of 3/4 in. hardwood construction

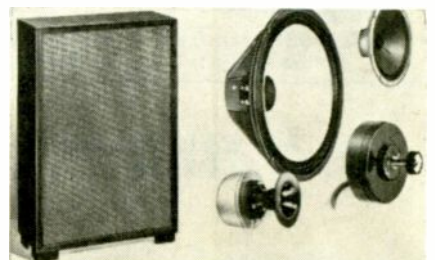

with oiled walnut furniture veneer. Four "feet" may be attached for either vertical or horizontal placement. Frequency response is 35-19,000 cps; power capacity of 45 w, crossover is a capacitor-type at 5,000 cps; impedance is 8 ohms. Sold in kit form, factory assembled or with speaker components only, less enclosure. Kit price is \$59.95 each and the assembled version is priced at \$69.95. Speaker components only, less enclosure but complete with crossover, level control, and wiring harness, for built-in wall installation, each \$42.50 Allied Radio Corp.

BATTERY SHOWCASE 205

The 1963 "Eveready" Radio Battery Program offers dealers five in-store merchandisers. One is the Security Showcase, a complete battery center for all popular transistor battery types, the handcrafted hard-



wood displayer measures 15 in. high, 24½ in. wide and 10½ in. deep. It is dustproof and pilferproof, yet the clear view cover invites customers to see and buy. A precision-calibrated radio battery tester is attached to the unit. Easy-serve channels quickly refilled with batteries, operate with gravity-feed action and there's extra storage space behind sliding doors in the back of the cabinet. The Security Showcase is now available to dealers ordering the No. 84 battery assortment. Union Carbide, Div. of Union Carbide Corp.

SELENIUM RECTIFIERS 206

This 65 ma rectifier is primarily intended for rectification of line voltage. The device is only 0.375 in. thick and less than an inch long and wide, including mounting. The rectifier, known as type G165C, incorporates a mounting bracket for easy bolting or riveting to the chassis. It meets all the requirements of

\$13.50 plus enclosure: a speaker system that sounds like a million



NEW SONOTONE 8" COAX

Put the new 8-inch Sonotone "WR8-BH" into a good stiff infinite baffle or bass reflex cabinet, and hear sound that'll make you think someone misplaced the decimal point in the price.

It looks just like any other 8" speaker. The Alnico V magnet is about the same weight as you'd expect to find in a good 8" speaker — the cone and suspension material appears to be the same. The difference? The design. The material used is not half as important as *how* it is used.

One difference you're bound to see. That's the unique high frequency cone radiator, instead of the usual spherical tweeter. Just that little element extends the range clear out to 20,000 cycles. And with a properly matched enclosure, she'll go down to 50, 40 and even 30 cycles, under ideal conditions.

Sound incredible for \$13.50? Wait until you hear how smooth and clean the response is over the entire frequency range. If there is any distortion, you'd have to measure it — you can't hear it. Further, there's no perceptible dip in the vicinity of the 6 KC crossover frequency. The result: A very satisfying sense of "presence" in the mid-range — lacking in so many coaxial speakers.

The WR8-BH handles 20 watts average program material and peaks to 40 watts. Highly efficient, it requires less power input for a given acoustical output, which makes it very desirable for use in low-efficiency bookshelf enclosures. Terminals of the WR8-BH are color coded to simplify correct phasing in multiple speaker and stereo systems. Nominal impedance is 8 ohms. The magnetic structure is completely enclosed, eliminating dust.

The same combination of quality at a sensible price, embodied in the new Sonotone "WR8-BH," is evident in the rest of the Sonotone speaker line. The "CA-12A" coaxial provides clean, smooth response 35 to 20,000 cycles. List \$31.00. The "W-12" woofer produces natural bass for 3-speaker stereo systems or multi-speaker mono systems. List \$19.00. And the elliptically shaped "T-64" tweeter reaches from 2000 to 20,000 cycles. List \$12.00.

Sonotone speakers can put new life into your high fidelity music system. Hear them today.

SONOTONE® CORPORATION

ELECTRONIC APPLICATIONS DIVISION • ELMSFORD, N. Y.
In Canada: Atlas Radio Corp., Ltd., Toronto • Cartridges • Speakers • Tape
Heads • Microphones • Electron Tubes • Batteries • Hearing Aids • Headphones

... for more details circle 30 on post card



NEW PRODUCTS

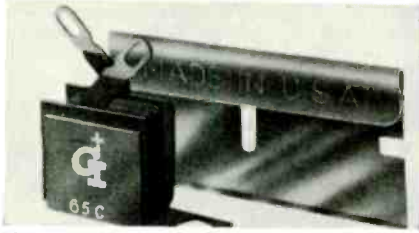

the older type 8J1 (and has been tested and approved by UL) but was designed for production by automatic manufacturing methods. Maximum PRV of the device is 380 v and maximum input voltage is 130 v. Rectifier Div., General Instrument Corp.

MINIATURE CIRCUIT BREAKER 207

A low-cost, snap-action miniature circuit breaker can be used for regulating temperature and current flow in electric motors and electronic circuitry. Called the Thermo-Snap, it provides fast, positive thermal response and long contact

life. The glass-encapsulated, hermetically sealed breaker contains an inert gas that provides faster heat conduction and prolongs the life of the contacts by reducing oxidation. The breaker operates on a thermal-mechanical principle. The key component is a bi-metal blade which expands with heat and snaps the silver contacts open. This action is caused by the different coefficients of expansion of the bi-metal acting in conjunction with a mechanical stress built into the blade dur-

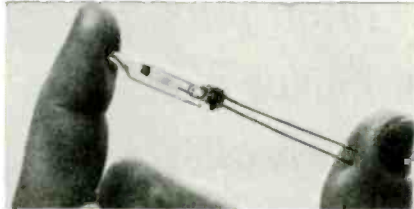

ing fabrication. When the contacts open, the metal cools and reverses the procedure, snapping the contacts closed. It is rated for 5 amp, 115/240 v continuous duty. The breakers (series type SB-600) cover a temperature range from 80 to 180°C. Sylvania Electric Products, Inc.

TRANSISTOR POWER SUPPLY 208

This transistorized power supply delivers constant voltage over wide fluctuations. Called the RPS-2, it



provides adjustable output from 0 to 25 v and up to 100 ma. A separate on-off switch controls the bias tap output which is 0 to 12½ v. Any 105-130 v/ac, 60 cps source will operate the unit. Price is \$26.95. Seco Electronics, Inc.

WIDE RANGE SPEAKER 209

Just released, the Model "WR8-BH" is a wide range, 8 in. speaker designed to perform at peak efficiency no matter how it is used — in bookshelf enclosures, as an extra stereo speaker, mono use or in communications. The speaker has

NEW! Winegard TV-FM Signal Outlets!

Look better, offer greater convenience and versatility—Easy to install!

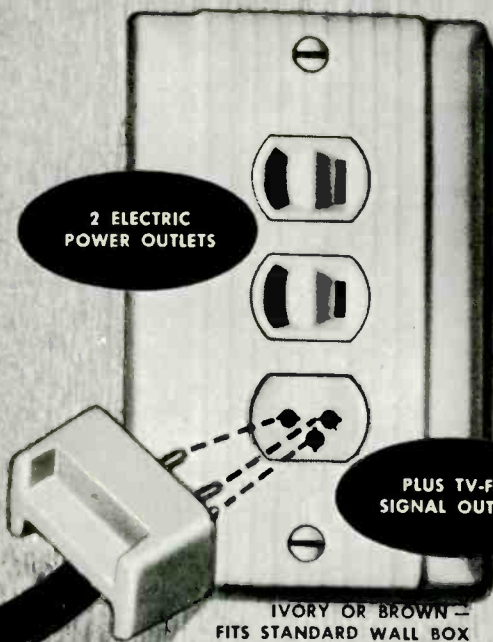

SINGLE TV-FM SIGNAL OUTLET



TV-FM SIGNAL OUTLET WITH ROTOR CONNECTION



Nylon plug has no-strip wire connection — loosen screws, insert twin-lead and tighten. Can't pull out. Prongs are spaced so it is impossible to plug into AC outlets by mistake.

Winegard now offers a complete line of TV-FM wall outlets with plug. They are available with 117V AC electric power connections plus a TV-FM signal connection in various combinations. Or they can be bought as single TV-FM outlets, with or without rotor con-

nection. All Winegard TV-FM outlets are "fast connect", require no wire stripping—are available for both 75 and 300 ohm hook-up. Provides isolation between sets preventing set interaction.

On your next home TV-FM system, try Winegard signal outlets.

There's an extra bonus of quality and performance in every Winegard product.



At your distributor or write for spec. sheets and prices.

Winegard

ANTENNA SYSTEMS

3019-4A Kirkwood • Burlington, Iowa

for more details circle 42 on post card

ELECTRONIC TECHNICIAN

a controlled frequency response that is smooth over the entire frequency range of 45 to 20,000 cps. Its extended range is made possible through a unique high frequency cone radiator. Instead of the usual spherical tweeter, it has a built-in cone radiator designed to complement and match the main cone, giving smooth listening response with no perceptible dip in the vicinity of the 6 kc crossover frequency. The "WR8-BH" handles 20 w average program material and peaks



to 40 w. The speaker has a list price of \$13.50. Electronic Applications Div., Sonotone Corp.

PLASTIC BOX 210

Known as No. P924, this box has 24 compartments, each measuring 1-11/16 x 2 x 1-9/16 in. Over-all

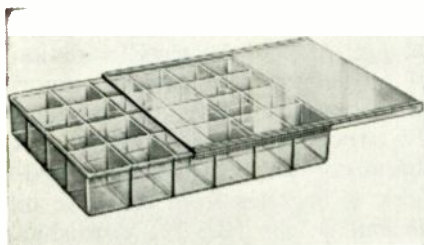

size is 10 3/4 x 8 7/8 x 1-13/16 in. The box is molded of clear, transparent polystyrene. It is recommended for storage of small items. Boxes are available either with or without tops. Vichek Plastics Co.

FM TUNER 211

A stereo FM tuner is designed to meet the requirements for professional usage in FM radio broadcasting stations as both a monitor and network relay, as well as, application for home mono or stereo music systems. The 315A "Emperor Royale" Tuner provides front panel

*she's
listening
to the
specifications
of the*



NEW SONOTONE SONO/COM[®]

This pretty lass is no engineer, but she does know what her ears tell her about the new Sonotone Sono/Com[®] Headphone/Microphone. She hears every word sharply, clearly. (Engineering specs say: Frequency response of headphone, flat from 50 to 10,000 cps.) When listening to a recording of the way she pronounces a foreign language, she can easily recognize if her accent is correct — (specs say: boom mike is famed Sonotone Ceramike with high sensitivity, -53db and wide frequency response, 80 to 9,500 cps.)

They're comfortable, too — her hair is never mussed or fussed. Even when she wears glasses, the Sonotone Sono/Com[®] is comfortable (Specs read: Only 13 ounces; polyurethane foam ear cushions that snap out for easy cleaning.)

By accident, she has also discovered they're rugged. She dropped them and they still continued to perform perfectly (specs say: Ceramic transducer in boom mike will withstand shock, moisture.) She knows, too, that the instructor can listen in to her recording on the spot (swivel permits either earphone to rotate 90°.)

Finally, she feels like learning, because she feels important and modern. Spec sheet says these attractive headsets are available in attractive suntan, spruce green, coral and black). Small wonder, the Sono/Com is the Student's Favorite—Teacher's Pet.

What our pretty friend doesn't know is that the high impedance output of the Sono/Com makes it easily adaptable for installation in any system. (Specs say 50K ohm impedance.)

The Sono/Com[®] is available three ways: Model SHM-1000, headphone/boom mike combination. SH-2000, headset only. Model SB-3000, the Ceramike boom microphone, which fits not only the Sono/Com but other headphones, is available separately. A magnetic microphone will be available shortly. Other Sonotone products for language lab applications include Sonotone "CERAMIKES," a group of top-quality, sensibly-priced microphones.

On your next A-V installation — specify Sonotone Sono/Com headphones and Sonotone Ceramikes.

SONOTONE[®] CORPORATION

ELECTRONIC APPLICATIONS DIVISION • ELMSFORD, N. Y.
In Canada: Atlas Radio Corp., Ltd., Toronto • Cartridges • Speakers • Tape
Heads • Microphones • Electron Tubes • Batteries • Hearing Aids • Headphones

... for more details circle 31 on post card



NEW PRODUCTS

switching controls for automatic frequency control, interstation squelch, multiplex, noise filter and an ac power switch. It also incorporates a horizontal tuning indicator for "on frequency" tuning and signal strength indication. The 314A has a monophonic audio output jack which permits all program material, regardless of nature, to be supplied



to a separate monophonic amplifier for remote locations. It has sensitivity of 1.2 μ v for 20 db quieting with 300 ohm antenna and built-in multiplex, time division type: 30 db separation 50-15,000 cps. With

dimensions of 5½ x 15 x 10 in., the 12¼ lb component, complete with cabinet, will sell for \$359 including tax. Altec Lansing Corp.

TRANSISTOR TV

212

This 9 in. portable is said to be the result of research to develop a small size screen that would cause absolutely no eye-strain. The portable incorporates an extra-thin,



square-corner picture tube. It utilizes the high-power DB-type transistor and the highly sensitive AD-type transistor found in the firm's 14 in. transistorized TV sets. The unit uses a stabilizing circuit-system — called the "Super-Synchronizing System." This specialized circuit provides the stabilized image by automatically adapting to any change in field intensity, variation of power source, exterior noises or vibrations. The set employs 27 transistors; 20 diodes; 1 thermistor and 3 high-voltage rectifiers. It operates from either ac or dc and weighs 10.5 lb. Matsushita Electric Industries.

RECORD SPRAY

213

A record cleaner in an aerosol spray can is offered by a manufac-



the big difference...
a Quam Whizzer

WORKS



When you choose a dual cone high fidelity speaker, you naturally want a whizzer that works.

That's the kind that Quam makes. A Quam whizzer cone is not just a decoration, and not just a part that looks impressive but has no functional value. The Quam whizzer cone is responsible for extending the speaker's frequency response an extra 3,000 cycles, and is guaranteed to operate for the life of the speaker.

There are four extended range dual cone speakers in the Quam high fidelity line . . . a 12", 10", 6½", and 6" x 9" size. They provide audible proof that a good high fidelity speaker need not be expensive. Write for your free copy of Quam's new High Fidelity Catalog, containing detailed specifications.

QUAM

QUAM-NICHOLS COMPANY

226D East Marquette Road • Chicago 37, Illinois

... for more details circle 25 on post card

turer of phonograph needles and accessories. With the new formula, one spray application will clean and protect records, and leave them static free for months. It also lubricates record grooves which adds longer life to both records and needles. The cleaner which retails for approximately \$1.50, comes complete with cleaning cloth conveniently tucked into the cover. Duotone Co.

NYLON GROMMET 214

The "Pipcat" nylon caterpillar grommet combines electrical insulation with versatility. With three sizes available from stock, grommets can be supplied to fit 10 gauge to 24 gauge steel or aluminum sheets. As the standard length is 10 in., the user need only cut to whichever length he requires. The "Pipcat" is used for insulating holes up to 3 in. in dia and may be used in combination to fit any size hole. For square or round holes of over 6 in. dia, commercial sol-

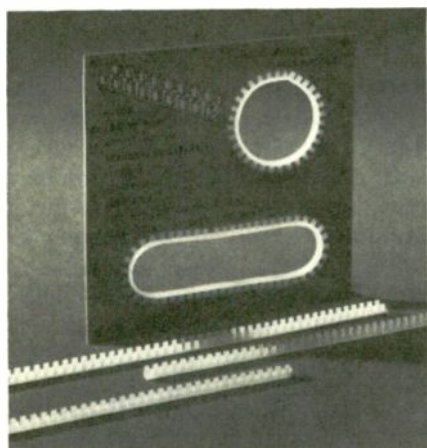

vents may be required to hold it to metal. However, for smaller sizes, the tension is adequate to hold any surface. Plastiglide Manufacturing Corp.

LIGHT ACTIVATED SWITCH 215

Designed specifically for light-controlled power applications, this series of 250 mw rated silicon PNP switches may be triggered by from 100 to 900 footcandles of light. The 4-layer devices feature complete electrical isolation of input from output, possess blocking voltages from 25 to 250 v, and currents up to 100 ma (ratings dependent on degree of light sensitivity required). Designated Types

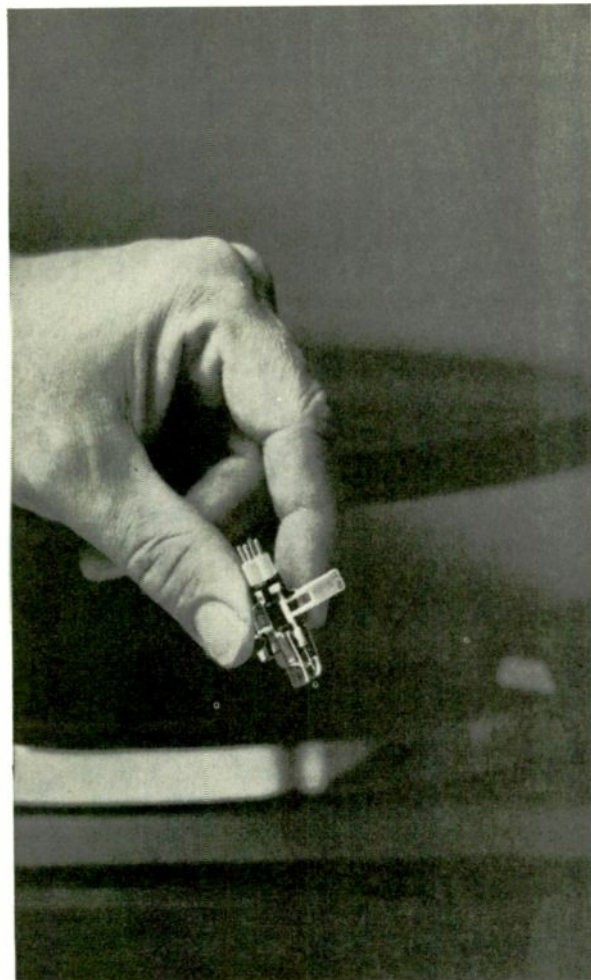

*ask the
music lover
who owns one*

VELOCITONE CARTRIDGES

While the famed Velocitone series has received acclaim from leading high fidelity critics and editors, we're sure the comments by owners of Sonotone Velocitone cartridges are of greater significance to you. To wit:

- "... without doubt the best cartridge buy for the money—excellent. Am well pleased."
- "Bass response better than (present cartridge). Has crisp, clear sound. I like it."
- "Sonotone cartridge produces very noticeable improvement . . . certainly worth the price."
- "Bravo!"
- "Sounds smoother than my old cartridge, which had irritating peaks . . . main advantage seems to be its ability to track at 2 grams and still be an inexpensive cartridge."
- "Am very pleased with the reproduction . . ."
- "Separation is unbelievable . . ."
- "I am very pleased with this cartridge—it has very clear response."
- "I am well satisfied with it . . . your separate equalizers are a very good idea."
- "As soon as I plugged in my Velocitone, I noticed an instantaneous and vast superiority to (present cartridge)."



The Mark III is the newest in the Velocitone series. It represents the latest advance in cartridge design. Try it yourself and become a satisfied music lover—Velocitone Mark III, dual diamond styli, \$22.25; diamond sapphire, \$19.25; dual sapphire, \$14.75.

SONOTONE® CORPORATION

ELECTRONIC APPLICATIONS DIVISION • ELMSFORD, N. Y.

In Canada: Atlas Radio Corp., Ltd., Toronto • Cartridges • Speakers • Tape Heads • Microphones • Electron Tubes • Batteries • Hearing Aids • Headphones

. . . for more details circle 32 on post card

STANCOR PRESENTS

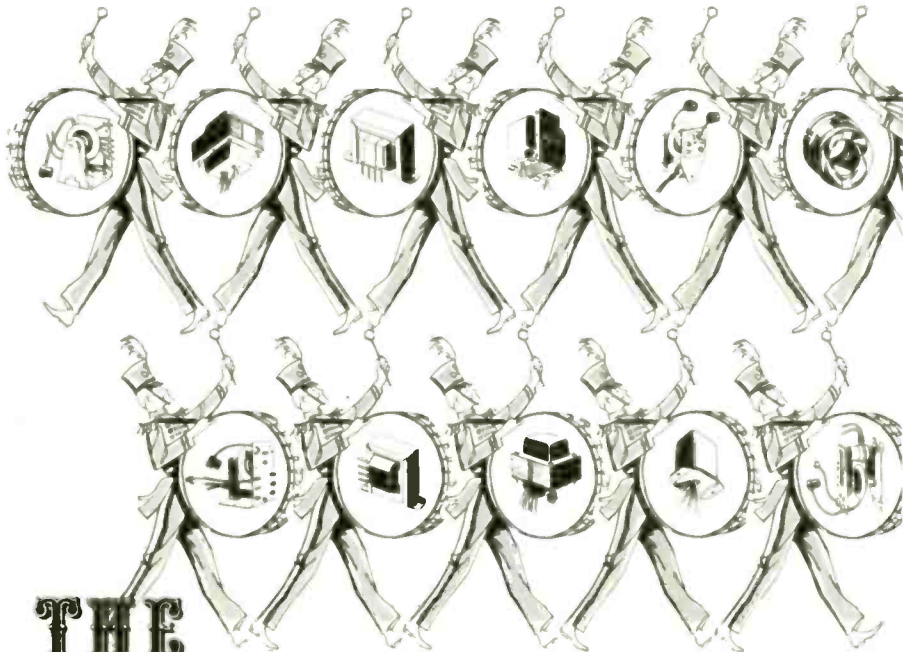

THE PARADE OF PARTS

Over 40 new yokes, flybacks, powers, and vertical output transformers have been added to the Stancor line *so far in 1963* — and that's just the beginning. We're continually marching toward our goal of complete replacement coverage of all major manufacturers' TV sets.

The 1963 Stancor Parade of Parts assures you that there's an *exact replacement* transformer available for your needs through your electronic parts distributor.

You can rely on him . . . and on

STANCOR
ELECTRONICS, INC.
3501 W. ADDISON • CHICAGO 18, ILL.

TV TUNERS * REBUILT OR EXCHANGED

ALL TYPES

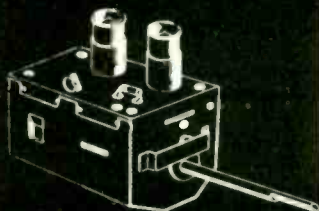

\$9.95 including parts and labor
(broken parts at our cost)

- Normally shipped same day received
- 90 day full guarantee
- U/V combinations \$17.95

FREE—If Mailing carton sent to you on request

Phone Republic 3-9189

L. A. TUNER EXCHANGE

4611 West Jefferson Blvd.
Los Angeles 16, California

... for more details circle 22 on post card

NEW PRODUCTS

QLS2-QLS25, these switches have an operating temperature range of -20 to $+150^{\circ}\text{C}$. On-off control is limited to junction temperatures of 75°C and below; at higher temperatures the units may be activated thermally. In latching applications, where unit is turned off by de-energizing, junction temperatures up to 150°C are permissible, once unit

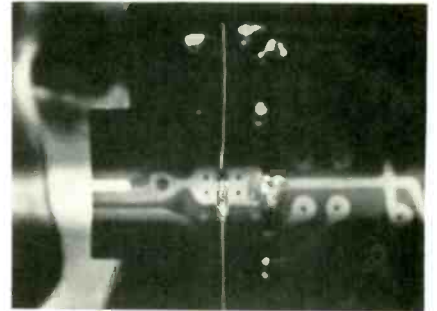

is turned on. Spectral response makes an ordinary tungsten lamp or sunlight a suitable light source. International Rectifier Corp.

PANEL JACK

216

The Dual Jack Blocks, Series 2300, were designed to be used with either telephone or military type, long frame jacks. The jacks are mounted on $\frac{5}{8}$ in. centers to the block. The blocks can be rack panel mounted singly or in multiples. Complete jack circuit cover-

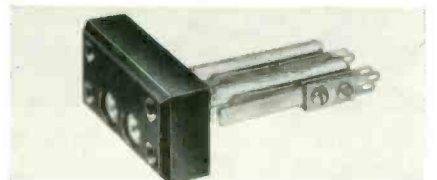

age is available in 2 or 3 conductors; single "Break" or "Make" to "Make-Make," "Break-Break" circuits. Switchcraft, Inc.



ELECTRONIC TECHNICIAN

TUBE MANUAL 300

This manual details the characteristics of 10 new strap frame grid receiving tubes. The first section contains a brief description of each type, circuits for a number of basic building block applications and performance data. The second section is comprised of data sheets, which define each type in terms of mechanical and electrical ratings, average characteristics, basing connections and other pertinent details. Characteristic curves also are provided to facilitate circuit design and evaluation. Sylvania Electric Products Inc.

SERVICE BOOKS 301

Separate course-books covering Radio and Television servicing are described in a circular. A listing of other service manuals also included. Supreme Publications.

HEAT SINKS 302

This catalog includes a concise summary of information necessary for applying each heat sink—dimensional cutaway drawings, performance curves, weight of devices and other specifications. The complete line includes heat sinks for all TO-5, TO-8, TO-9, TO-18 and all popular power transistor case types. These devices feature two piece threaded construction which tightens firmly to the transistor weld flange where case temperature is maximum, providing the shortest thermal path from transistor to heat sink. Thermalloy Co.

COLUMNAR SPEAKER 303

This technical bulletin describes the Model CM-109-6 Columnar Speaker System, a professional unit for high-quality sound reinforcement over wide and deep indoor and outdoor areas. It employs six weatherproof M-109 loudspeakers in a close-coupled vertical array in a weathertight housing for its broad horizontal dispersion, wide frequency range, low distortions and high power-handling capacity. R. T. Bozak, Mfg. Co.

TOUCH SWITCH 304

This technical brochure describes

*the key to
over 1,200
profitable
cartridge
replacements*

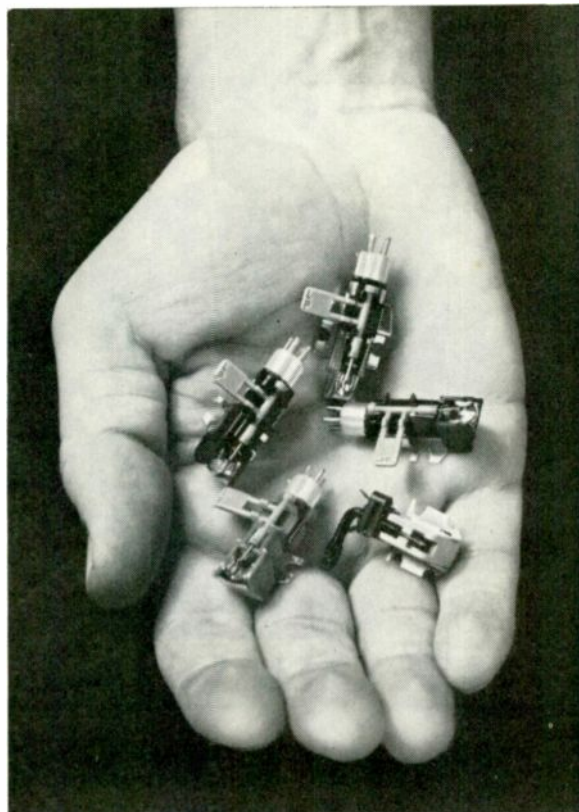

SONOTONE CARTRIDGES

When you rely on Sonotone cartridges, you're always in the best position to increase your replacement profits.

1. You tie up less capital in inventory, because fewer cartridges replace more models.
2. You always have the right replacement. Sonotone cartridges have been specified as original equipment in more than 14,000,000 phonographs — that's the number of genuine direct replacements you can make with Sonotone.
3. You have more satisfied customers. Replace with Sonotone and the improvement in performance is dramatic. Sonotone cartridges feature ceramic transducers—no problem from magnetically induced hum. They're designed to track at the optimum tracking forces for record changers. Needles can be replaced with ease thanks to unbreakable nylon, snap-in-snap-out type needle assembly.

5 new Sonotone cartridges—excellent replacements for more than 1,200 phonograph models

Model "2TA." Ceramic mono cartridge, an improved version of the famous Sonotone "2T Series." New needle assembly, plus increased compliance and lower tracking force, make it ideal for both stereo and mono records.

MODEL "916-TA." This low cost stereo ceramic cartridge employs some of the basic design features of the audiophile-accepted Velocitone Series. New universal tonearm terminal plug for easy replacement in quality models.

MODEL "9TA." Ceramic stereo/mono cartridge features low stylus mass and high compliance. New universal tonearm terminal plug for fast easy replacement. For deluxe models.

MODELS "16T-A" AND "18T-A." Two budget priced stereo cartridges with wide channel separation and smooth flat response over the high fidelity range. New universal terminal plug for fast replacements.

Your most profitable cartridge replacement is Sonotone. Call your distributor today.

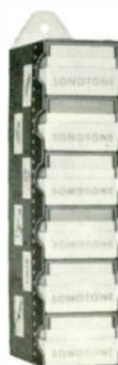

SONOTONE CORPORATION

ELECTRONIC APPLICATIONS DIVISION • ELMSFORD, N. Y.

In Canada: Atlas Radio Corp., Ltd., Toronto • Cartridges • Speakers • Tape Heads • Microphones • Electron Tubes • Batteries • Hearing Aids • Headphones
- - - for more details circle 33 on post card



KIT OR WIRED

NOW YOU CAN ENJOY FAMOUS HEATHKIT TEST INSTRUMENT QUALITY & ECONOMY EITHER WAY!

Now, whether you choose to "do-it-yourself" or want your equipment factory assembled and tested, you save more, receive more for your money, with Heathkit. We now offer a selected group of Heathkit test and lab. instruments in factory assembled form, ready for you to put to work in your business . . . VTVM's, Power Supplies, 'Scopes, Probes, Generators, Testers, and Decades all at traditionally low Heathkit prices. Write for information.



Heathkit Test Instruments Save Money, Make Money, For You!

NEW HEATHKIT SERVICE-BENCH VTVM



The most versatile vacuum tube voltmeter ever designed! Mount it under a shelf, on a shelf, on the bench; tilt it for best vision with its "gimbal" bracket. Has 6" 200 ua meter, single-probe system, 7 voltage-ohm ranges. Kit IM-13, only \$32.95

FREE HEATHKIT CATALOG

World's biggest kit catalog, over 250 kits for every interest at savings up to 50%. Send for your free copy.



HEATHKIT

a subsidiary of Daystrom

HEATH COMPANY

Benton Harbor 24, Michigan

Please send my FREE Heathkit Catalog

Name _____

Address _____

City _____ Zone _____ State _____

... for more details circle 18 on post card

FREE LITERATURE

the "Touch Control Switch" a capacity operated device that can be turned on and off with the touch of a finger. The six page brochure includes an illustration of the assembled module, which is completely self contained in a small plastic package with six leads. A block diagram of the switch is used to explain the circuit operation. All electrical and physical specifications are included for the switch and also for six types of Dynaquads having different operating characteristics. Tung-Sol Electric, Inc.

NEW BOOKS

TELEVISION SIMPLIFIED 6th Edition. By Milton S. Kiver. Published by D. Van Nostrand Co., Inc. 630 pages, hard cover, \$9.95.

In this sixth edition of his popular text, Kiver has included new television material on service and design. In addition to up-dating the information found in previous editions, a new chapter on remote control systems and added information on agc and special circuits are included. The book leaves nothing assumed for the reader except a basic knowledge of radio and sound systems. New pictures and more than 250 line drawings have been added or changed in the over 500 illustrations of this edition. To help the self-study student, progress—questions are included at the end of each chapter. Theory and general servicing procedures are presented in a step-by-step easy-to-follow manner. Schematics are used freely, including large foldout prints

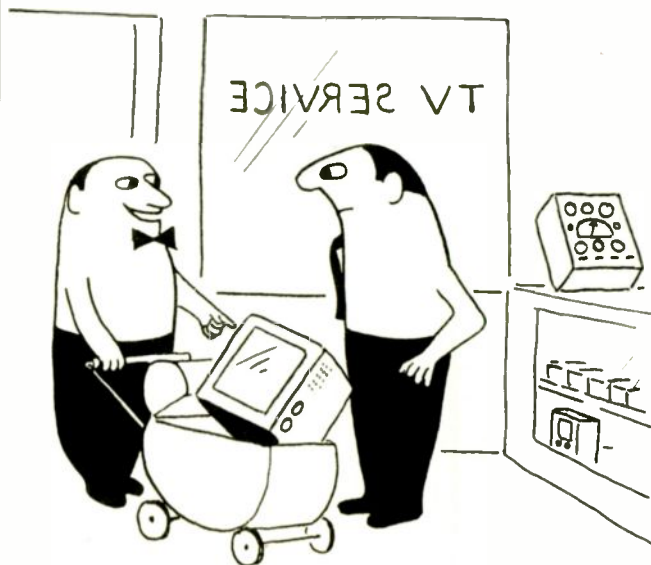

Lyons

"This baby needs something changed."

of entire receivers. Typical chapters include Video IF Amplifiers, D-C Reinsertion, Deflection Systems, Servicing Television Receivers and Color Television. In all there are 19 chapters and a glossary. The volume is virtually a television library of theory and practice for the technician or student.

RCA TRANSISTOR MANUAL. Published by Semiconductor and Materials Division, Radio Corporation of America. 304 pages, soft cover, \$1.50.

Technical data for 373 RCA transistors, tunnel diodes and silicon rectifiers are included in this manual. The manual has the familiar RCA tube manual's format with a text section covering basic transistor, diode and semiconductor theory, installation and applications, each in a different chapter. Selection charts are included in the manual which categorize each semiconductor by its function and performance. Over 30 representative circuits with complete part lists are also included. The circuits include amplifiers, shortwave, AM and FM radios, and CB equipment.

TECHNICAL TELEVISION. By A. V. J. Martin. Published by Prentice-Hall, Inc. 557 pages, hard cover. \$14.65.

This book assumes a knowledge of dc and ac electricity and radio fundamentals. It is aimed at a point between the engineer and technician — "striking a happy medium between books written for engineers and for technicians." The text's major area is devoted to the theory of TV — transmitting and reception. Two chapters cover color TV. Black-and-white circuits and components are detailed in the 21 remaining chapters. A variety of antennas are described — including the rhombic. Math requirements are normal for the fundamentals covered. Although primarily designed "as a text for a specialized course in television offered by electrical engineering departments of schools, colleges and technical institutes," the book may prove helpful as a reference for those technicians who like to bone-up on theory from time to time. The text displays the normal amount of ambiguity and redundancy characteristic of "formal" technological writ-

*that
something
extra that
makes a big
difference in
performance*

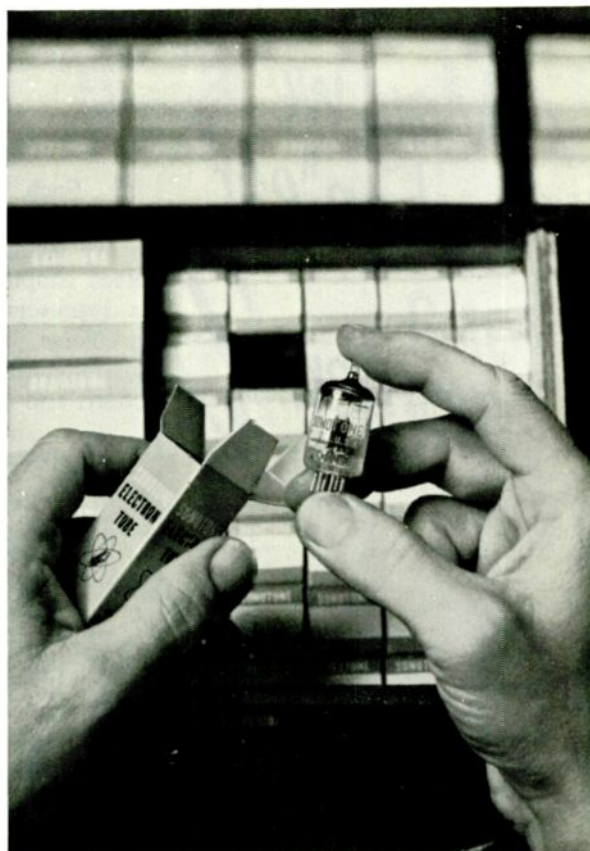

SONOTONE TUBES

When tube deterioration causes fuzzy TV pictures, mars the beauty of the music in a hi-fi system, robs communication gear of crisp, clear reception of transmission — the choice of the right tube replacement can make a world of difference. Let's take a look at some Sonotone tubes and see why they offer that something extra that contributes to better performance.

Take the 12AX7A. Its unique damper mica and coiled heater assure low hum and low microphonics. While we're discussing audio tubes, the Sonotone EL34 and EL84, available in custom matched pairs for push-pull applications, have been chosen to protect the quality of amplifiers made by leading hi-fi manufacturers. If they are good enough for selection by quality conscious hi-fi manufacturers, they certainly will make excellent replacements.

Then there's the bread-and-butter TV tube types — 1B3GT, 1G3GT, 1X2B, 3BZ6, 5U4GB, 6AL5, 6AQ5A, 6AU6, 6BZ6, 6CB6A, 6DQ6, 12AU7, to name a few. Each is 100% tested — short and continuity, heater current, noise. No noisy or gassy tubes, just sparkling TV pictures and crisp clear sound when you replace with Sonotone.

In critical UHF — the Sonotone 6AF4A and 6DZ4 employs a coiled heater rather than the less expensive folded heater found in other tubes. This means lower hum or hum modulation, lower microphonics.

For every replacement, Sonotone tubes offer extra performance. Replace with Sonotone!

For complete list of tubes, write

SONOTONE® CORPORATION

ELECTRONIC APPLICATIONS DIVISION • ELMFORD, N. Y.

In Canada: Atlas Radio Corp., Ltd., Toronto • Cartridges • Speakers • Tape Heads • Microphones • Electron Tubes • Batteries • Hearing Aids • Headphones

- - - for more details circle 34 on post card





There's much to be said for the slim, inconspicuous, yet professional appearance of the "MAGGIE-MOBILES". Still more for their clean, crisp signal and unbelievably low noise level.

But the real point of this message is a hidden virtue you can't see or hear. It's called, "17-7 stainless steel", one of the most resilient alloys ever made. We use nothing else in our MAGGIE-MOBILES, even though it costs considerably more than the stainless steels used in run-of-the-mill whips. Here's why:

You can bend it full circle, from tip to butt; let go and it snaps back to a perfect vertical. (Don't try this with other brands). It slips around obstructions like an eel. No breakage . . . no "water shorts".

One more reason why Antenna Specialists' brand antennas are preferred by more citizens banders than any other kind.

Switch to a
"MAGGIE-MOBILE"
 Base-loaded CB 27Mc
ANTENNA

MOUNTING'S A SNAP, TOO!

Available in three simple and attractive mounts . . . 20 ft. cable with connectors attached . . . take your choice!

MODEL M-67

Roof mounted entirely from outside. Ideal omni signal pattern. Only \$15.68 (net)



MODEL M-74

Cowl or deck. Ingenious swivel base adjustable up to 35° angle. Only \$19.32 (net)

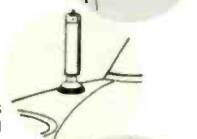

MODEL M-73

Trunk groove mount. No holes in body! Fits all makes and models. Only \$17.06 (net)

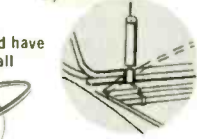

P.S. Your CB base station should have the famous big-gain, easy-to-install Magnum 27. It won't bend.



Reg. T.M. "Stripes of Quality" write for specifications to:

the antenna specialists co.

12435 Euclid Avenue, Cleveland 6, Ohio
 Export Div., 15 Moore St., New York 4, N.Y.

--- for more details circle 12 on post card

NEW BOOKS

ing. Each chapter heading has a brief summary which cannot but prove stimulating to the student. Each chapter ending is followed by a representative selection of test problems. The material is well illustrated with schematics, drawings, charts and graphs.

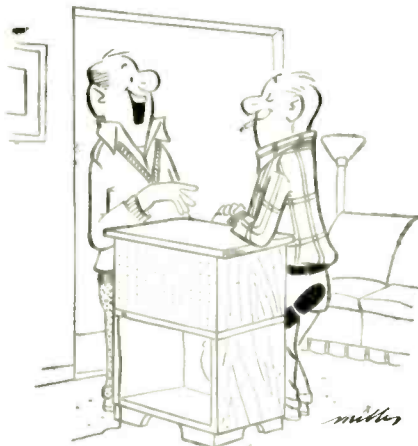

"Boy! You really told off that TV technician. What did he say when you bent over and told him how to repair the set?"

from Scott...
**FREE STEREO
 KIT CATALOG**

Have fun . . . save money . . . build the best! Now world-famous Scott stereo components come in easy-to-build kit form. You can build an FM Multiplex tuner, your choice of an 80 watt or 48 watt stereo amplifier, a preamp, power amplifier, and a speaker. Write for complete details.



SCOTT DEPT. 140-4
 H. H. Scott, Inc. 111 Powdermill Road, Maynard, Mass.

Rush me your new Kit Guide and your Free 20 page "Guide to FM Stereo."

Name.....
 Address.....
 City..... State.....

Export: Morhan Exporting Corp., 458 Broadway, N. Y. 6.
 Canada: Atlas Radio Corp., 50 Winbold Ave., Toronto

--- for more details circle 27 on post card

TRANSCEPTOR



**THE ONLY INDUCTIVE
 SET COUPLER**

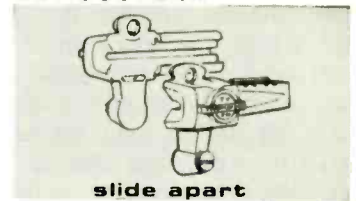

slide apart

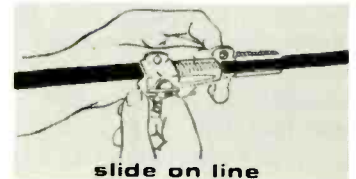

slide on line

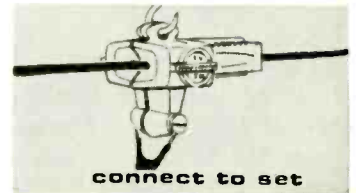

connect to set

**ANYONE CAN
 INSTALL IN
 SECONDS**

Any number and combination of TV and FM sets can be run off one antenna with foolproof, simple, rugged TRANSCEPTOR. Because it uses electromagnetic pickup, TRANSCEPTOR simply snaps on main antenna line without tools, stripping, splicing or soldering. Line is not cut, signal loss is minimized, set-to-set isolation is improved (12 db).

Impedance is matched automatically. Uses standard 300-ohm flat line. Operates up to 20 sets without amplification in normal signal areas. Easy to sell, easy for customer to use, TRANSCEPTOR is guaranteed for life of the set.

As an inexpensive impulse purchase, accessory sales builder, or give-away on larger purchases—you'll build sales and profits with TRANSCEPTOR.

AEROGAP CORPORATION
 1880 VINE STREET HO 6-7385
 LOS ANGELES 28, CALIFORNIA

\$2.98
 RETAIL

--- for more details circle 10 on post card

ELECTRONIC TECHNICIAN

. . . FRINGE AREA

Continued from page 52

in such cases may even negate the requirement of a booster even in very remote areas. In such cases, a low antenna may supply a stronger



A ground survey using JFD's LPV antenna. This unit proved to be quite effective, though the area where it was installed was a weak signal area.

signal to the set by in-phase addition of more than one signal path.

Fig. 5 shows two methods which may be used to "pipe" a signal into similar areas where refraction or diffraction does not occur.

Generally, as was mentioned in Part I, the higher the antenna, the better. A good rule of thumb, however, is not to use more feed line (to increase height) than will attenuate the signal by 3 db. The ac-



Connecting TACO's low band antenna sections together. Two high band units can be seen to the left. Spring loaded detents on the high band unit allows quick assembly and dis-assembly of the unit.

a selection
of 7 quality
microphones
for natural,
life-like
tape
recordings



SONOTONE CERAMIKES

Whether you're a professional or a home recordist, there's a Sonotone "Ceramide"® to bring out the best in your tape recording equipment. So sensitive they pick up all the beauty of the original performance — so selective they screen out unwelcome intrusions — so rugged they withstand almost any abuse, even accidental dropping, and continue to provide topflight performance. The heart of every Ceramide is a rugged rubber-encased ceramic transducer — immune to extremes of temperature and humidity.

7 sonotone ceramikes for tape recording

SONOTONE CERAMIK "CMT-10A" MATCHED TWINS. Ideal for stereo applications. Each set is a selected matched pair exhibiting similar coloration, frequency response and output characteristics to within ± 2 db. Frequency response: 50 to 11,000 cps. Sensitivity: -56 db ± 2 db. 7' shielded cable and phone plug. List \$35.50 per pair.

SONOTONE CERAMIK "CMT-11A" MATCHED TWINS. Where greater sensitivity is desired. Same specifications as CMT-10A except—Frequency response: 80 to 9000 cps. Sensitivity: -53 db ± 2 db. List \$35.50 per pair.

SONOTONE CERAMIK "CM-10A." Natural clean reproduction over the full audible range—50 to 11,000 cps. Sensitivity: -56 db ± 2 db. 7' shielded cable with phone plug. List \$17.50.

SONOTONE CERAMIK "CM-11A." Where greater sensitivity is desired. Same specifications as CM-10A except—Frequency response: 80 to 9000 cps. Sensitivity: 53 db ± 2 db. List \$17.50.

MATCHING TABLE STANDS. Available with $\frac{5}{8}$ " No. 27 thread for floor stand mounting. List \$5.00.

SONOTONE CERAMIK "CM-32." Ideal low cost microphone for tape recording. Frequency response: 80 to 9500 cps. Sensitivity: -53 db ± 2 db. Standard plug and phone jack. List \$12.50.

SONOTONE CERAMIKES "CM-40" & "CM-41." Low price ceramic mikes in high impact plastic case. Unique swing type stand sits upright for table use. Response: 40 to 8000 cps. Sensitivity -50 db for both models. Model CM-41 has push-to-talk switch. CM-40 List \$9.90; CM-41 List \$11.90.

Next time you're ready for a tape recording session, think of Sonotone Ceramikes and select the one that will bring greater pleasure to you.



SONOTONE® CORPORATION

ELECTRONIC APPLICATIONS DIVISION • ELMSFORD, N. Y.

In Canada: Atlas Radio Corp., Ltd., Toronto • Cartridges • Speakers • Tape Heads • Microphones • Electron Tubes • Batteries • Hearing Aids • Headphones

. . . for more details circle 35 on post card

IT PAYS TO USE AEROVOX!

First-rate quality just doesn't happen by chance... you have to work at it. This is just as true in the manufacture of capacitors as it is in radio-TV-electronics servicing. You know that you cannot expect repeat business unless you have built a reputation for dependability and honest service. If you're particular about your service and your profits... be particular about the capacitors you use. Take ceramic capacitors, for example. Aerovox offers you a complete line of rugged, dependable and proven top-quality ceramic capacitors in every case style for your every replacement need. See your Aerovox Distributor for a wide selection of disk types for by-pass coupling, general purpose, hi-voltage and temperature compensating applications. Yes, he stocks cartwheels, standoffs and feedthrus, too. And for real "plus" profits ask about kits AK-200 and AK-201HS. Remember, it pays to use Aerovox!

PROTECT YOUR REPUTATION FOR QUALITY SERVICE... USE AEROVOX CERAMIC CAPACITORS

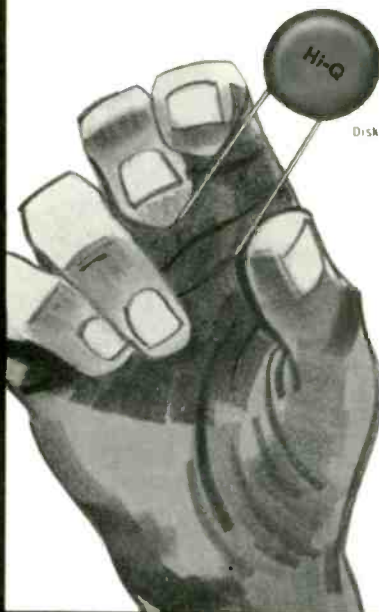
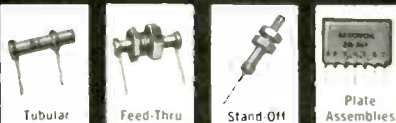

AEROVOX CORPORATION
 DISTRIBUTOR DIVISION, NEW BEDFORD, MASS.
 Technical Leadership—Manufacturing Excellence

- - - for more details circle 11 on post card

tual length of lead in used under these circumstances will depend on its quality and type. Certain grades of twin lead for example may limit the height of the antenna to 50 ft or less. Higher grades may double that distance. On the other hand, some open wire leads may be run in excess of 500 ft with less than a 3db loss.

In one case, this rule of thumb may be broken: If fading is a problem, the increase in height may reduce the fading sufficiently to more than tolerate the average signal loss. Fading is usually overcome easily if the antenna can be raised to a higher position.

Drawings courtesy of Editors and Engineers Ltd.

COMING EVENTS

Apr. 1-3: Third Alabama Electrical and Electronics Exposition, Birmingham City Auditorium, Birmingham, Ala.

Apr. 17-19: SWIRECO (Southwestern IRE Conference & Electronic Show) Dallas Memorial Auditorium, Dallas, Tex.

Apr. 23-25: Eleventh National Conference on Electromagnetic Relays, Student Union Building, Oklahoma State University, Stillwater, Okla.

May 20-22: Electronics Parts Distributors Show, Conrad Hilton Hotel, Chicago, Ill.

June 4-5: Fifth National RFI Symposium, Bellevue-Stratford, Philadelphia, Pa.

IF YOU CHANGE YOUR ADDRESS

- ☆ Notify us at Ojibway Building, Duluth 2, Minn.
- ☆ Try to let us know in advance — (because 6 weeks should be allowed for the change to get into effect).
- ☆ Notify us in writing — and include the address label from one of your recent issues, showing your old address and code line.



INJECTORALL

THE NEEDLE DOES THE JOB!

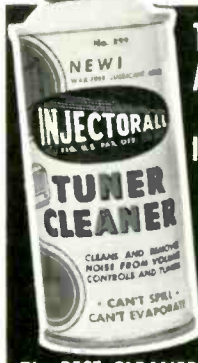

TUNER CLEANER AND LUBRICANT with... INJECTOR NEEDLE

The leak-proof steel Injectorall Needle lubricates where you need it... you can reach hard-to-get at Wafers without pulling Tuners apart, or even removing Chassis.

The BEST CLEANER on the market today!

INJECTORALL CO. Brooklyn 14, New York

- - - for more details circle 19 on post card

PROFESSIONAL technicians

use *Dave Rice's* **OFFICIAL ORDER BOOKS** for every **TV-RADIO** service call

This is the businesslike approach to service record keeping. Triplicate forms serve as order form, invoice and office record, with spaces for complete information on every job. Separate listings for receiving tubes, pix tube, parts, serial numbers, labor and tax charges, signatures, etc. 75c a book, \$6.50 for dust-proof box of 10. In stock at your distributor.

FREE

Write for your free folder describing Dave Rice's OFFICIAL ORDER BOOKS, including an actual size sample copy of the handy order form.



ELECTRONIC PUBLISHING CO., INC. 133 N. JEFFERSON ST. CHICAGO 6, ILLINOIS

ELECTRONIC TECHNICIAN

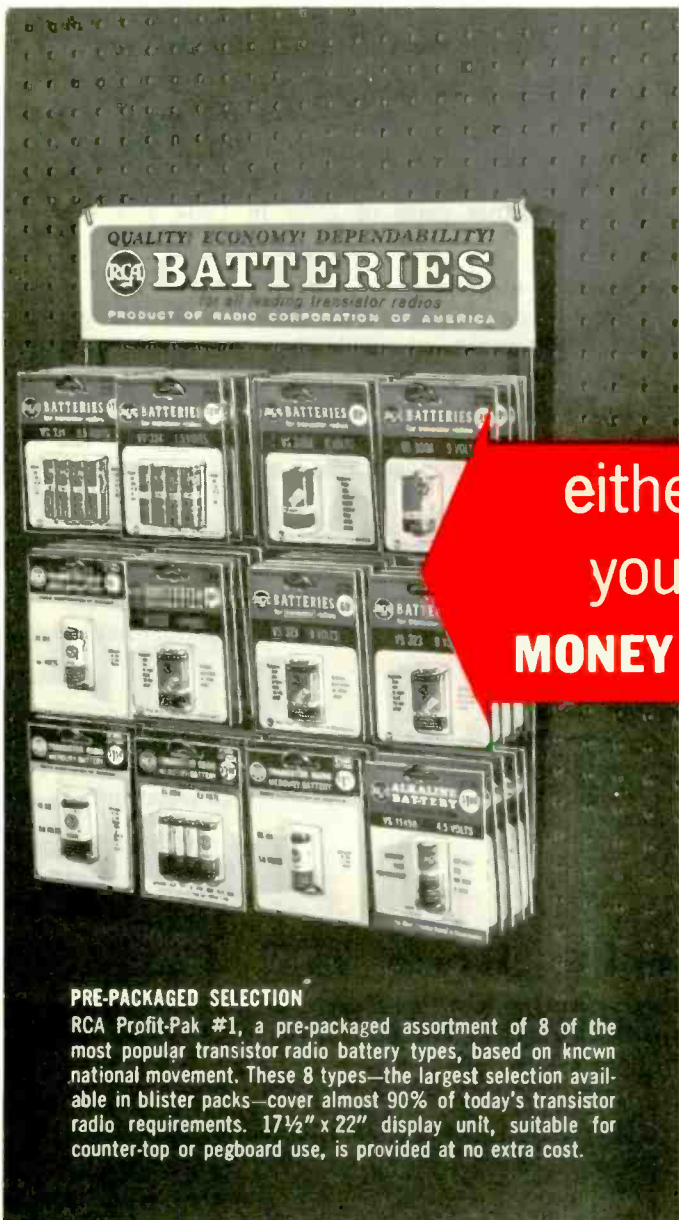

PRE-PACKAGED SELECTION

RCA Profit-Pak #1, a pre-packaged assortment of 8 of the most popular transistor radio battery types, based on known national movement. These 8 types—the largest selection available in blister packs—cover almost 90% of today's transistor radio requirements. 17½" x 22" display unit, suitable for counter-top or pegboard use, is provided at no extra cost.



OPEN-STOCK SELECTION

A 15" x 12" 6-prong wire-rack display provided free with minimum order quantities of any RCA blistered battery types you select. For counter-top or pegboard use. Enables you to feature the types you feel will be most in demand in your area.

either way
you'll be
MONEY AHEAD...

RCA TRANSISTOR RADIO BATTERIES

Now Blister-Packed for greater Sales Appeal

The efficiency and sales appeal of modern packaging techniques can now put new life into your transistor radio battery sales. For the first time, RCA transistor batteries are blister-packed and supplied with self-displaying wire racks for use on your counter-top or wall pegboard. Profit-making advantages include:

- Smart, appealing product display. Blister-packs protect batteries from dust and dirt, keep them looking fresh.
- Strong sales reminder to stimulate impulse buying is provided by blister-pack display units.
- Savings in in-store time and work. Batteries arrive ready for display, with all pertinent information (type, size, voltage, replacements) clearly spelled out on each card.

- Reduced pilfering. Card-size makes profit-draining pilfering difficult.
- Prominent RCA identification, the brand name that sells itself in electronics.

Put one of these sales-making displays to work for you. For details, see your participating Authorized RCA Distributor, or write: Battery Department, RCA Electron Tube Division, Harrison, N. J.



The Most Trusted Name in Electronics

BLOCKS for BUSS FUSES

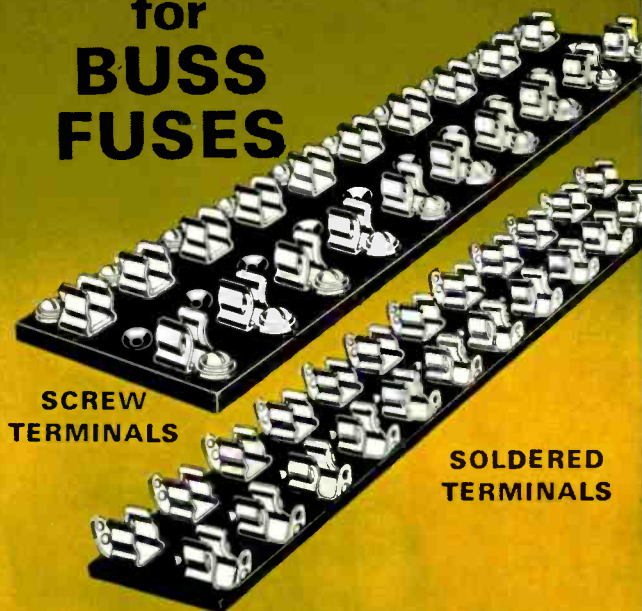

Standard type — 1 to 12 pole.

BUSS

Write for BUSS
Bulletin SFB.

BUSSMANN MFG. DIVISION, McGraw-Edison Co., St. Louis 7, Mo.

--- for more details circle 14 on post card

to manufacture some 20,000 this year, according to a company announcement. Sylvania predicts the total color television receiving tube market this year will be 900,000 as compared to half that figure for 1962.

100% Increase in Color

Robert S. Bell, president of Packard Bell Electronics predicts the market for color television receivers this year will increase 100% over 1962. He predicts further gains of 25% in 1964 and 43% in 1965.

Japanese Imports Soar

Japanese manufacturers imported to this country 7,785,000 radio sets with three or more transistors during 1962, according to the U. S. Government figures.

This was a 48% increase over 1961. The total value of these imports amounted to \$48 million.

16-in. Color Tube

Tokyo Shibaura Electric Co. of Japan showed a 16-in. rectangular tube in its new color television set at the IEEE show in New York in late March. The set was powered by 27 tubes, five germanium diodes and two silicon rectifiers.

FM Stereo

Nearly 46% of all radio-television and radio-phonograph combinations produced in 1962 were capable of receiving FM stereo broadcasts, according to the EIA.

BUSS : the complete line of fuses . . .

NEWS OF THE INDUSTRY

Patent Infringement

Shure Brothers, Inc. has sent patent infringement notices to several major manufacturers of moving magnet stereo phonograph cartridges, and also to several phonograph needle manufacturers, according to a company announcement. In the notices, Shure called upon these companies to cease and desist immediately from further infringing activities.

Two patents were recently issued to Shure covering its Dynetic moving-magnet stereo phonograph cartridges and needles. Other patents covering the moving-magnet cartridges were previously awarded Shure.

Admiral in Color

Admiral's entire production of color television receivers this year will come from its Harvard, Ill. plant which has a capacity to produce 100,000 sets this year.

Monthly production capacities of Admiral black and white television receivers has been set at 85,000.

Sylvania Color Tubes

Sylvania Electric Products, Inc. is now in production of color television picture tubes and expects

BUSS FUSEHOLDERS ● LAMP INDICATING SERIES HG

*Made To
Military
Specifications*

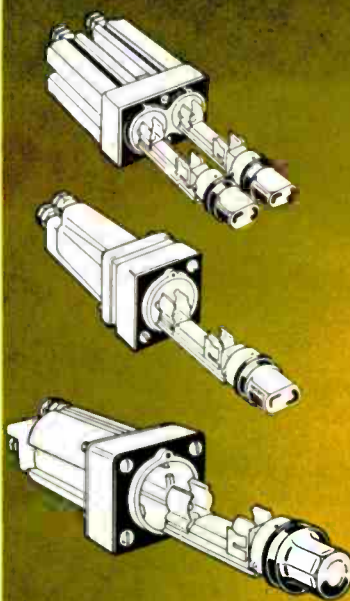

Provides quick, positive, visual identification of faulted circuit. Transparent knob permits indicating light to be readily seen.

Fuses are held in clips on a fuse carrier.

Fuse carrier slides into holder and is locked in place with bayonet type knob.

Holder designed for panels up to 1/8 inch thick.

Holder is inserted in panel from rear. Mounting screws can be conveniently tightened from front of panel.

BUSS

Write for BUSS
Bulletin SFB.

BUSSMANN MFG. DIVISION, McGraw-Edison Co., St. Louis 7, Mo.

--- for more details circle 14 on post card

ELECTRONIC TECHNICIAN

BUSS FUSEHOLDERS



- LAMP INDICATING
- SIGNAL ACTIVATING
- SERIES HKA

For $\frac{1}{4}$ x $\frac{1}{4}$ inch BUSS GLD Fuses, $\frac{1}{4}$ to 5 amps.

Where a visible or audible signal or both is desired to indicate trouble on a circuit, the BUSS HKA fuseholder with BUSS GLD fuses presents a practical answer.

When fuse opens, an indicating pin completes a circuit that lights knob indicating lamp and makes electrical contact on external signal circuit. The external signal can be an audible alarm, or another lamp mounted at a distance, or it can operate a relay.

BUSS

Write for BUSS
Bulletin SFB.

BUSSMANN MFG. DIVISION, McGraw-Edison Co., St. Louis 7, Mo.

... for more details circle 14 on post card

service, are now available through approximately 200 distributors in 26 states and the District of Columbia. "Service Pak" sets are being distributed for the following makes: RCA, GE, Motorola, Admiral, Emerson, Philco, Westinghouse and Magnavox.

Low Price Transistor Radios

Motorola has come out with new low prices on its line of transistor radios. The different models were shown to distributors with the X54 model coming in at a \$14.95 suggested retail price.

200 Million Radios

The Radio Advertising Bureau reports a total of 200 million radios in use in this country in 1962. In all, some 24 million sets were sold during the year. At this rate, according to the RAB, a radio set was sold every 1.3 sec, battering the U.S. birth rate of one baby born every 7.5 sec.

Raytheon Files Suit

Raytheon recently filed suit against Accuracy Reytron Electronics, Inc. of Chelmsford, Mass. alleging unfair competition by wrongful use of the word "Reytron" in its corporate name and as a trademark.

Raytheon is seeking damages and costs in the suit.

The suit was filed to enjoin Accuracy Reytron Electronics from further use of the notation "Reytron" or any similar notation which might cause confusion or deception as to the source or origin of products, according to a Raytheon announcement.

... of unquestioned high quality

In all, 767,539 contained the FM stereo capability out of the total production of 1,677,000.

Miscellany

Tung-Sol Electric, Inc. and subsidiaries had declines of 44% in earnings and a 2% in sales during 1962. Net profit during the year was \$842,139.

RCA chalked up record increases in earnings amounting to 45% and a 13% increase in sales during 1962. Corporate officials said sales of color television receivers accounted for \$200 million in 1962 and predicted color sales of \$400 million this year. Total sales for RCA during 1962 were \$1,751,646,000, a new record.

Profitable Color

Said David Sarnoff, chairman of the board for RCA, "Color sets and tubes were the largest profit contributors of any products sold by RCA in 1962."

For Licensing

Between 120 and 150 electronic technicians attended a public hearing at the Indiana State Capitol recently on the question of licensing TV service technicians. Of the 60 who testified, all spoke in favor of the proposed legislation.

Colorgrams Moving Fast

Colorgrams, the new color coded TV schematic

Let BUSS Fuses Help Protect Your PROFITS

To make sure BUSS fuses will operate as intended under all service conditions, each and every BUSS fuse is individually tested in a sensitive electronic device.

This is your assurance that when you sell or install BUSS fuses, you are safeguarded against complaints, call-backs and adjustments that might result from faulty fuses and eat away your profit.

It is just good business
to sell fuses the BUSS way.

BUSS

Write for BUSS
Bulletin SFB.

BUSSMANN MFG. DIVISION, McGraw-Edison Co., St. Louis 7, Mo.

... for more details circle 14 on post card

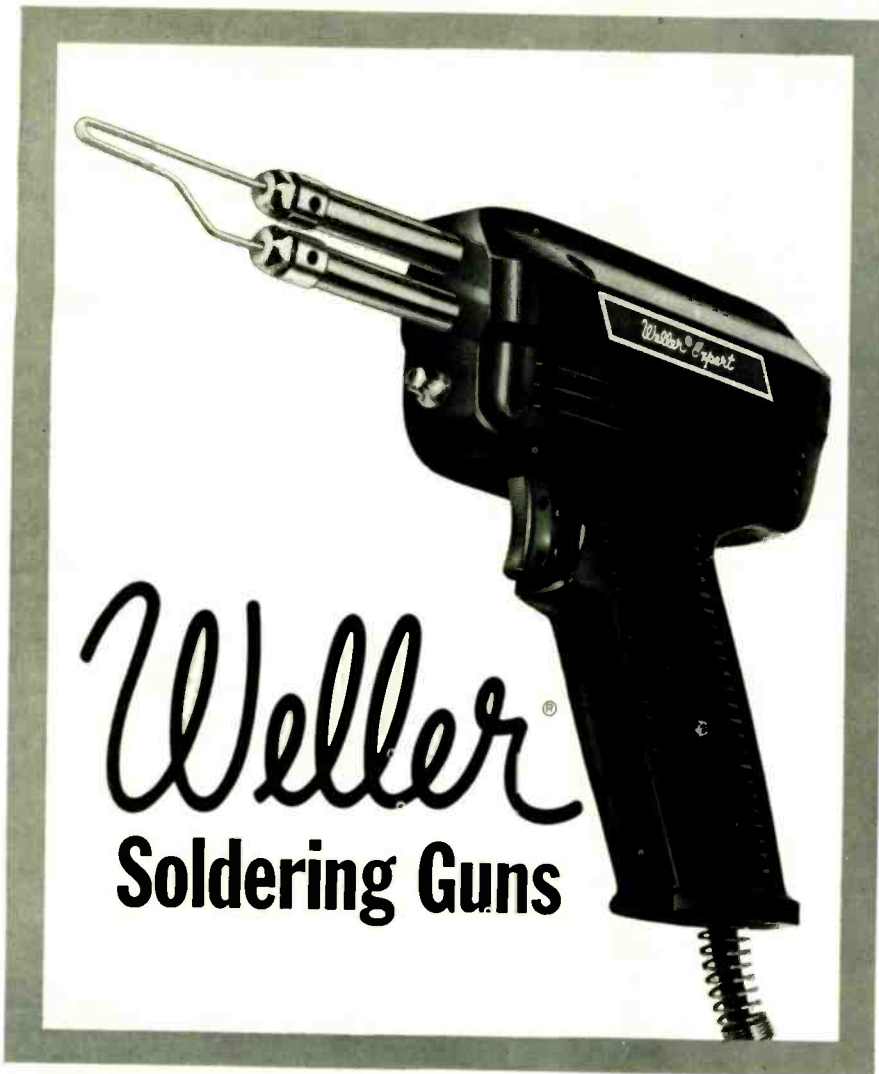

OVER
5 MILLION
SOLD

ALL MODELS
DUAL HEAT

YOUR
BEST BUY

2 soldering temperatures. An original Weller feature that provides 2 trigger positions, lets you switch instantly to high or low heat to suit the job.

Prevents damage to critical components. You use low heat when working with heat-sensitive components.

Tip lasts longer. Dual Heat enables you to prolong tip life by using high heat only when necessary.

Weller Dual Heat Soldering Guns are available in many models with ratings from 100/140 to 240/325 watts. Also supplied in plastic-case kits with accessories. All Weller Guns are guaranteed 1 year.

At your Electronic Parts Distributor

WELLER ELECTRIC CORP., 601 STONE'S CROSSING RD., EASTON, PA.

... for more details circle 39 on post card

... TINY PROBLEM

Continued from page 60

As a matter of fact we were even able to identify the dirt. It was white and square, very very small. During the last Christmas time the family had set up a miniature artificial Christmas tree atop the TV receiver and had sprinkled the tree with artificial snow and a powdery glitter. It was one bit of the glittery material that had somehow made it's way into the hand unit and then gotten sucked into the hole.—*Frank A. Salerno, L.I.C., N.Y.*

Theater TV Net

■ The nation's first full-scale theater TV network, based on development of a unique color television projector is established by National General Corp. and the General Electric Company.

The projector permits display on full-size theater screens of high quality color TV pictures with a brightness equal to current movie color films. System paves the way for nationwide viewing—in color—of live Broadway shows, and major sports, entertainment and cultural events.

A unique programming schedule developed by National General will start televising to theaters, probably in early 1964. Live full-color telecasts of top Broadway shows, major sports events, specially produced programs of educational and entertainment value are being planned. Transmission will be by telephone company facilities.

The system can also be used for medical and other instruction, military briefings, long distance business meetings and political conventions.

Similar to a standard movie projector, the system uses a high-power light source and a system of lenses to direct the light beam through the film and produce a picture on the screen.

An electron gun operating as it does in a TV picture tube scans the surface of the control layer. Instead of producing a picture directly on the layer as it does on the phosphor face of a TV picture tube, the electron beam causes the fluid layer to control the light so that the picture is projected onto the screen. ■

NEW



FEWER CONTROLS

VERSATILE

CONTROLLED REJUVENATION



PORTABLE

Designed by
VYTANT ALEKS

Easy to Use!

GC-CRT TESTER and REJUVENATOR

FOR COLOR and Black and White!

Just off the GC Production lines . . . designed for the serviceman to answer his specific need, simply and practically. The GC CRT Tester and Rejuvenator brings you, in addition to conventional testing, a unique **DYNAMIC EMISSION** test together with an effective **CONTROLLED SHOT REACTIVATION** circuit.

CATHODE EMISSION TEST is a GC first. A high voltage pulse applied to the 2nd anode of the CRT provides more accurate tube condition. Provisions for bias cut-off test.

LIFE TEST to predict the remaining useful life of the picture tube. **CONTROLLED DC shot REACTIVATION** cleans cathode surface for normal emission provided by 3 levels of reactivation intensity. Indicator light safeguards against overdose and tube damage.

ADAPTABLE TO ALL 110" PICTURE TUBES with special filament voltage, as well as the newest 19" and 23" Tubes (23EP4).

CHECKS SHORTS, FILAMENT CONTINUITY, GRID LEAKAGE with "E-Z View" neon window indicator. Easy . . . positive.

TESTS, REACTIVATES ALL COLOR CRT TUBES, each gun separately including the newest "small button" Diheptal RCA unit.

100% SELF CONTAINED in handsome, protective carrying case. **ACCESSORY COMPARTMENT** contains power cord . . . a single combination socket cable to accommodate ANY CRT.

PLUS easy to read wide angle, calibrated meter and selector control indicator lights clearly indicate test functioning.

No. 36-616 CRT TESTER AND REJUVENATOR Net 69.95

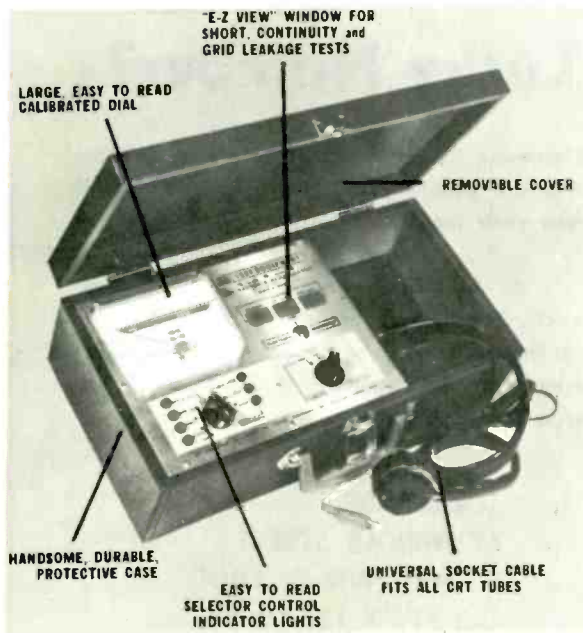

FREE Send for new catalog of complete line of GC Test Equipment. Write Dept. 44, GC Electronics, 400 S. Wyman, Rockford, Ill.

Name _____
Address _____
City _____ State _____



GC ELECTRONICS CO.

DIVISION OF TEXTRON ELECTRONICS, INC., 400 So. WYMAN STREET, ROCKFORD, ILLINOIS, USA

... for more details circle 13 on post card

ADVERTISERS INDEX

Aerogap Corporation74	GC Electronics 81	Philco Corporation 25
Aerovox Corporation76	General Electric Company 29	Quam-Nichols Company 68
Antenna Specialists Company 74	Heath Company 72	R C A Battery Div. 77
B&K Manufacturing Company 63	Injectorall Company 76	R C A Entertainment Rec. Tube Div.4th cover
Bussmann Manufacturing Company78-79	ITT Distributor Products Div. 57	R C A Sales Corporation 34
Cadre Industries Corporation 24	Jerrold Electronics Corp. 19	Sarkes Tarzian, Tuner Service Div. 20
EICO Electronic Instrument Co., Inc. 22	L. A. Tuner Exchange 70	Scope Aid 82
Electronic Publishing Co., Inc. 76	P. R. Mallory & Company, Inc. 31	H. H. Scott, Inc. 74

Western T.V. Tuner Rebuilders

VHF or UHF ALL MAKES

\$9.95 Including all parts and labor

major parts extra at (low) net price.

UHF-VHF COMB. \$17.00

90 Days Guarantee — 24 Hour Service

All tuners are thoroughly cleaned, mechanically and electrically overhauled, aligned with crystal-controlled equipment, and finally given air check for sensitivity with TV transmitters.



WESTERN TUNER REBUILDERS

1140 N. Vermont Ave.
Los Angeles 29, Calif.
NO 2-1397

4130 El Cajon Blvd.
San Diego 5, Calif.
AT 4-2733

- - - for more details circle 40 on post card

Seco Electronics, Inc. 3rd cover
Sencore, Inc. 2nd cover
Sonotone Corporation..... 65, 67, 69, 71, 73, 75
Sony Corporation of America 33
Sprague Products Company 23
Stancor Electronics, Inc. 70
Sylvania Electric Products 58-59
TACO—(See Jerrold Electronics Corp.) 19
Volkswagen of America 26
Weller Electric Corporation 80
Western Tuner Rebuilders 82
Winegard Company 61
Winegard Company 66

Find the *frequency* Faster



Scope Aid makes short work of converting all repetitive waveforms, as read from an oscilloscope, into frequency. Usable on any standard time/div. range. Read from any 10-division graticule. Determines frequency or repetition rate of any recurring symmetrical or non-symmetrical waveform, pulse, time mark signal. A nifty, accurate converter for bench, desk, or pocket that quickly pays for itself in time saved. 5" diameter. Durable non-smudge plastic finish. Full instructions.

NO RISK TRIAL. \$2.00 postpaid in U.S.A. (Check or money order, no c.o.d.'s, please.) Return in 5 days for full refund if not fully satisfied.

Manufactured and sold exclusively by:

SCOPE AID, Box 3831, Portland 8, Oregon

- - - for more details circle 26 on post card

What's Your Lucky Number?

Whenever you write us about your subscription, please enclose the address label from your latest copy . . .

. . . or **AT LEAST** give us your address exactly as it appears on the label, including the code number. The code is your lucky number because it enables us to serve you promptly.

JOHN DOE

67 MIDDLE STREET

HOMETOWN 3, OHIO

132-116-X-12XX9-14

ELECTRONIC TECHNICIAN

Ojibway Building, Duluth 2, Minnesota



TUBE TESTER 88, \$69.50 NET—locates all tube faults quickly, accurately with patented Seco grid circuit test that checks tubes 11 ways—also cathode emission test.

DELUXE POWER SUPPLY RPS-5, \$69.50 NET—transistorized zener-regulated circuit maintains constant voltage over wide load fluctuation without overshoot—up to 30 V DC and 150 ma.

REGULATED TRANSISTORIZED SUPPLY RPS-2, \$26.95 NET—constant voltage—adjustable 0-25 V. Bias tap—0-100 ma.

TRANSMITTER TESTER 510B, \$46.95 NET—reads both positive and negative modulation peaks on 0-120% scale—also RF output in 0-5 watts and 0-400 ma. For Handy-Talkies tool.

REGULATED TRANSISTORIZED SUPPLY RPS-4, \$36.95 NET—constant voltage—meter ranges 0-1.5, 0-15, and 0-30 V DC—reads load in 0-30 and 0-150 ma. Taps for simultaneous biasing.

TRANSISTOR AND TUNNEL DIODE ANALYZER 250, \$74.50 NET—complete transistor lab in one compact unit—even has VOM! Analyzes semi-conductors in or out of circuit—no set-up data needed.

ANTENNA TESTER 520A, \$49.95 NET—reads Forward Power and Reflected Power directly in watts! Antenna efficiency reads in: SWR from 1:1 to 8:1, per cent, or GOOD-POOR. For 50 ohm coax.

New Look in Test Equipment



The look is bold, professional, functional. Handsome black cases, lustrous brushed aluminum panels, wide easy-to-read meters—"matched set" appearance and quality. It comes to you now from Seco. See the "New Look" display of Seco test equipment at your electronic distributor's and at the May Parts Show in Chicago. Look for the red velvet!

SECO ELECTRONICS, INC. 1211 South Clover Drive,
Minneapolis 20, Minnesota
Subsidiary of Di-Acro Corporation,
Lake City, Minnesota

- - - for more details circle 28 on post card

LET RCA PUT YOU IN THE COLOR PICTURE

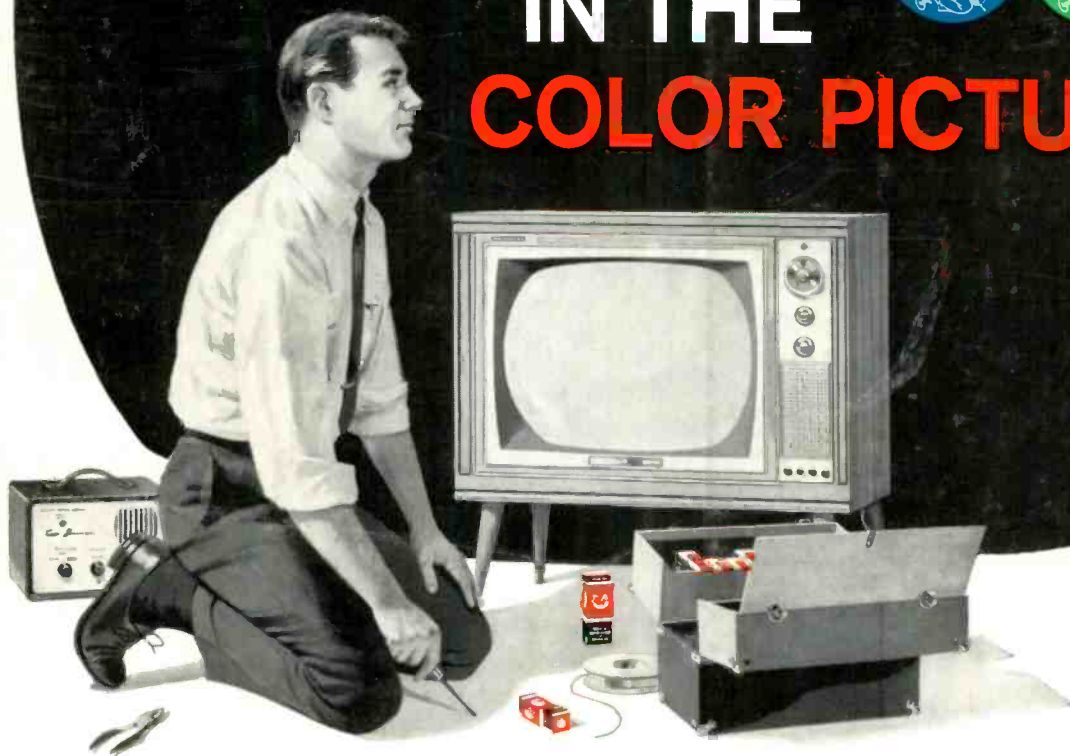
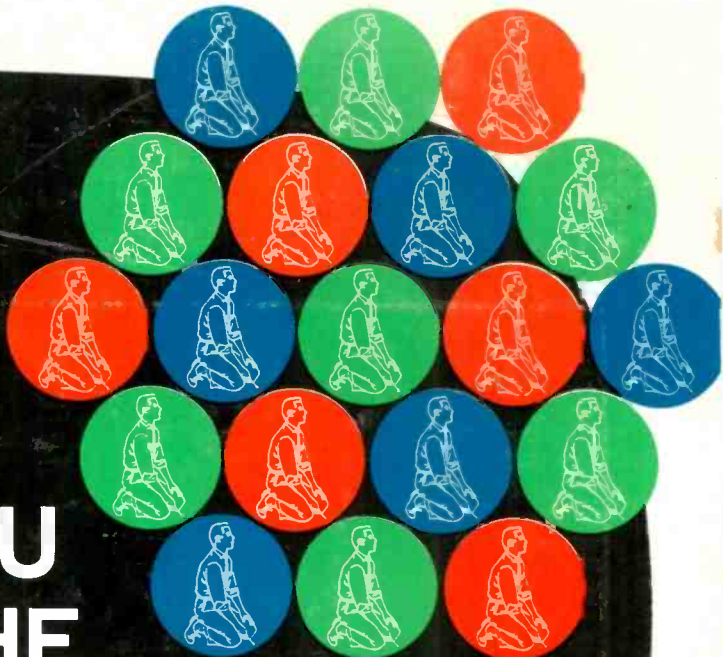

Get the All-New RCA Institutes Color TV Home Study Course **FREE** with Your Purchases of Dependable RCA Receiving Tubes

Make no mistake about it: the future of electronic servicing is in Color TV! ... And here's how RCA—pioneer of the compatible Color TV system in use today—can put you in the color picture.

The RCA Electron Tube Division offers you the RCA Institutes brand-new, completely up-dated Color TV Home Study Course FREE with your purchases of RCA entertainment receiving tubes. This practical course, filled with the latest up-to-the-minute information, will help equip you to troubleshoot and repair all modern color receivers regardless of brand.

Because Color TV is already such big business (approaching \$300 million a year), this course can start making money for you as soon as you complete it—and for many years to come. Don't miss this major opportunity for a more profitable future. Ask your participating Authorized RCA Tube Distributor for full details right away.

WHAT YOU GET

4 Study Groups, 8 Graded Lessons. This is an all-new course, never before offered. Covers the most modern Color TV circuits. Even if you've taken a previous color course you'll still benefit from this one.

Handsome, durable 3-ring binder to keep all lessons and examinations in a permanent reference file.

RCA Institutes Color TV Graduation Certificate on completion of course—plus all regular RCA Institutes educational services to students. Graded examinations on every lesson.



The Most Trusted Name in Television

RCA ELECTRON TUBE DIVISION, HARRISON, N. J.