

# ELECTRONIC TECHNICIAN

Including  
**SERVICE**  
Magazine

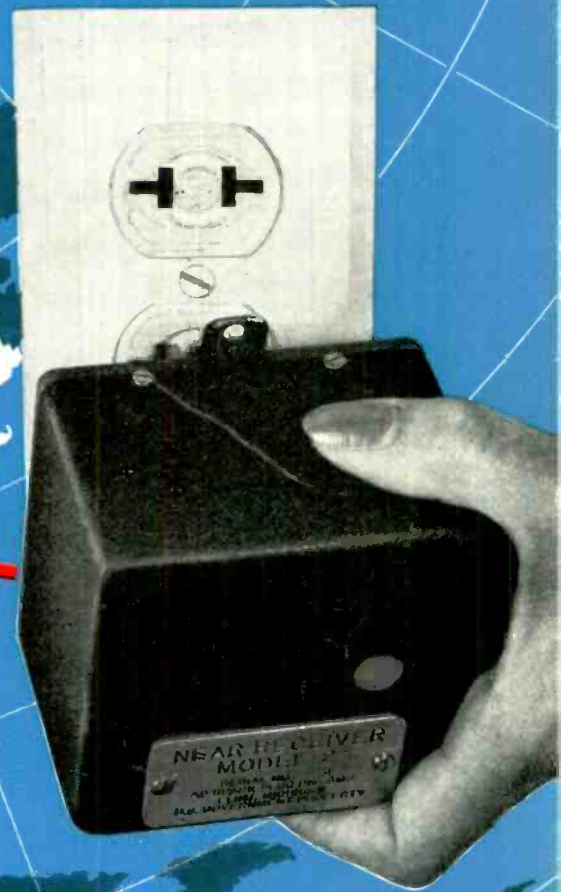

**N**ational  
**E**mergency  
**A**larm  
**R**epeater

50¢  
December • 1960



# PUZZLED

*...no need to be*

## look to this sign of assurance!

The Distributor displaying this sign will solve your tuner problems at a profit to you.

He has available the New Standard Tuner Replacement Guide, including replacement parts listings. This is the only Guide of its kind in the world. Covers all Standard tuners produced through 1959. Includes replacements for many tuners not produced by Standard. He handles our 48-hour Factory Guaranteed Repair Service and Trade-In Allowance on unrepairable Standard tuners.

*See This Authorized Distributor Today*



### **standard kollman**

INDUSTRIES INC. Formerly Standard Coil Products Co., Inc.  
2085 N. HAWTHORNE AVENUE, MELROSE PARK, ILLINOIS

For more data, circle 12-C2-1 on coupon, p. 48

# ELECTRONIC TECHNICIAN

Including  
**SERVICE**  
Magazine

World's Largest Electronic Trade Circulation

ALBERT J. FORMAN *Editor*  
ARTHUR P. SALSBERG *Managing Editor*  
JACK HOBBS *Technical Editor*  
B. V. SPINETTA *Assistant Editor*  
HARVEY WETZLER *Assistant Editor*  
ROBERT TALL *Washington Editor*  
HENRY SCHWARTZ *Contributing Editor*  
C. F. DREYER *Consultant Art Director*  
M. FARRIS *Editorial Assistant*



Address all mail to  
480 Lexington Ave., New York 17, N. Y.  
Telephone YUkon 6-4242

HOWARD A. REED *Publisher*

## BUSINESS DEPARTMENT

C. HENNESSY *Regional Manager*  
R. L. KIPP *Regional Manager*  
N. McALLISTER *Production Manager*  
M. RUBIN *Circulation Manager*  
J. PREVET *Asst. Circulation Manager*  
M. KANE *Accounting Manager*  
A. MOYLAN *Accounting Supervisor*

P. H. DEMPERS JR. *Regional Manager*  
10 E. Huron St., Chicago 11, Ill.  
Telephone Mlchigan 2-4245

CHRIS DUNKLE & ASSOCIATES  
California Representative  
740 S. Western Ave., Los Angeles 5, Calif.  
Telephone DUnkirk 7-6149  
420 Market St., San Francisco 11, Calif.  
Telephone SUtter 1-8854

BERNIE EDSTROM *Regional Manager*  
15605 Madisan Ave., Cleveland 7, Ohio  
Telephone LAKewood 1-7900

JOHN R. KIMBALL & CO.  
Mauntain States  
420 Market St., San Francisco 11, Calif.  
Telephone DOuglas 2-9183



ELECTRONIC TECHNICIAN & Circuit Digests, including Service, December, 1960. Vol. 72, No. 6. \$5.00 a copy. Published monthly by Electronic Technician, Inc. Publication Office, Concord, N. H. Editorial, advertising and executive offices, 480 Lexington Avenue, New York 17. Telephone YUkon 6-4242.

Entered as Second-class matter at the post-office at Concord, N. H., October 19, 1960. Subscription rates: United States and Canada, \$4.00 for one year; \$6.00 for two years; \$8.00 for three years. Pan American and foreign countries: \$7.00 for one year; \$10.00 for two years; \$14.00 for three years. Copyright 1960 by Electronic Technician, Inc., New York. H. Reed, President, A. Forman, Executive Vice-President. Title registered in U. S. Patent Office. Reproduction or reprinting prohibited except by written authorization of publisher. Printed in U.S.A. by Rumford Press, Concord, N. H.

December, 1960

**FRONT COVER** The National Emergency Alarm Repeater System (NEAR) developed by the Office of Civil and Defense Mobilization will, when operational, provide indoor disaster warning to the populace. A three-inch receiver that plugs into a standard wall outlet is activated by a NEAR signal generated at the power station. The receiver automatically responds to the signal by issuing a loud alarm. See article starting on page 32.



## FEATURES and ARTICLES

"Tuning in the Picture" .....	12
Something New Added; Licensing Survey; Season's Greetings (Editorials) .....	29
TV Manufacturers Technical Digest .....	30
NEAR—The National Emergency Alarm Repeater System .....	32
Troubleshooting TV Hi-Voltage Rectifier Circuits .....	Perry Sheneman 34
Understanding Audio VU Meters .....	Herman Burstein 36
The Communications Receiver as a Service Instrument .....	L. E. Garner, Jr. 38
The BBB's Candid View of Service Problems .....	K. B. Willson 40
New Products .....	42
"Tough Dog" Corner .....	G. J. Rupp, F. J. Will 46
Free Literature .....	48
Cumulative Article Index. Jan. 1960 through Dec. 1960 .....	50
Shop Hints .....	J. H. Larry, G. F. Stillwell 54

## DEPARTMENTS

Editor's Memo .....	4	Reps. & Dists. ....	20
News of the Industry .....	8	Catalogs & Bulletins .....	24
Calendar of Coming Events ....	13	Audio Newsletter .....	59
Letters to the Editor .....	14	New Books .....	68
Association News .....	69		

## CIRCUIT DIGESTS

..... Preceding Back Cover

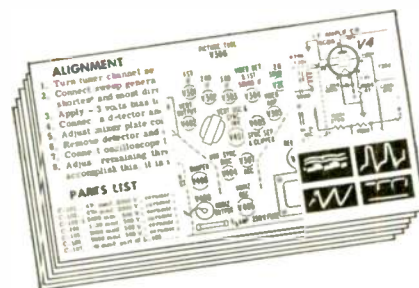

## IN THIS ISSUE

- (16 pp. latest schematics & data)
- DELCO: GMC Truck Radio Model 2233850
  - DU MONT: TV Chassis 120530-C, 531-D
  - GENERAL ELECTRIC: Transistorized Intercom Model W300A
  - PHILCO: AM-FM Radio Models J-996, J-997
  - RCA: TV Chassis KCS133 Series
  - SYLVANIA: TV Chassis 546-1,2
  - WESTINGHOUSE: TV Chassis V-2412-1, 2

For more data, circle 12-2-1 on coupon, p. 48 →

# Why are more Service-Dealers Switching to **JFD** EXACT REPLACEMENT TV ANTENNAS?

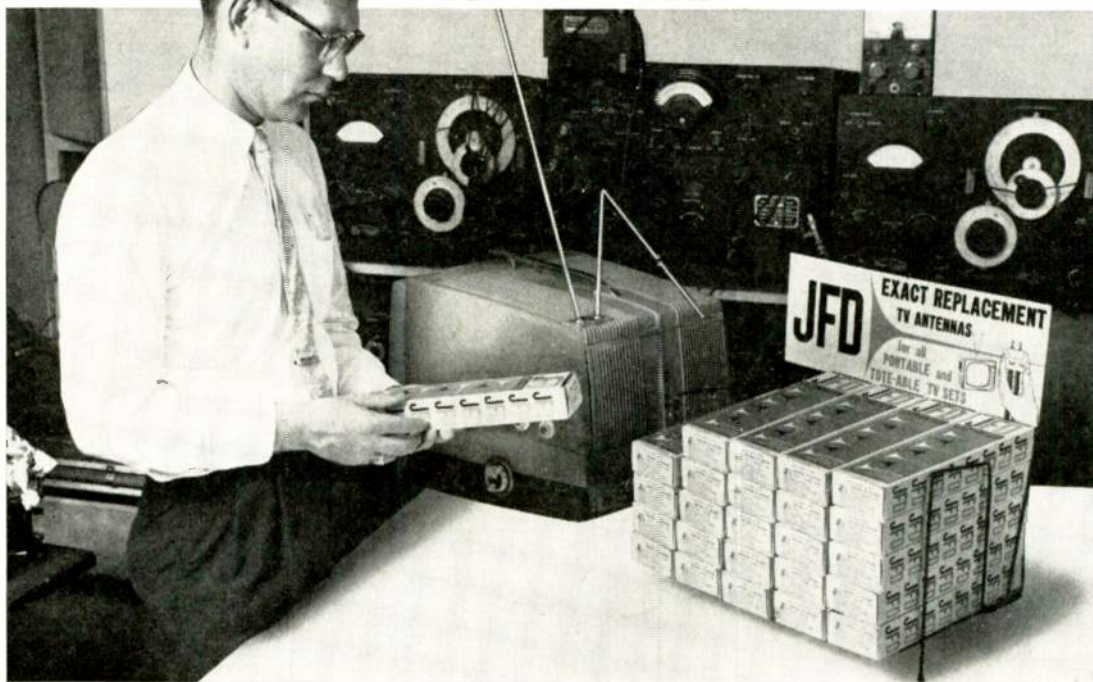

## because

50 per cent of all TV sets made in the last 4 years are portables—sending *more* antenna replacement business to service-dealers every day.

## because

with the JFD PA500 and PA515 Exact Replacement Kits, dealers are ready and able to service *90%* of antenna replacements for portables and tote-ables.

## because

as JFD Exact Replacement Specialists, service-dealers can get out of the unprofitable “rabbit-ear” business—earn a *profit* on the antenna *sale* (at full mark-up) *and* on the *installation*.

## because

with JFD guides, streamers, and sales helps, service-dealers get the merchandising *know-how* that nets them a bigger slice of the *3,500,000* dollar portable antenna replacement market.

***NOW IS THE TIME TO WRITE JFD OR ASK YOUR JFD DISTRIBUTOR FOR YOUR EXACT REPLACEMENT PROFIT PLAN PORTFOLIO!***



Only JFD keeps you up-dated with the 1960 Portable TV Antenna Guide covering every portable TV set made since 1956 (compiled and edited by Howard W. Sams & Co., Inc.)

**CHECK SAMS PHOTOFACT FOLDERS**  
For JFD Exact Replacement Antenna Information



THE BRAND THAT PUTS YOU

# JFD

JFD ELECTRONICS CORPORATION BROOKLYN 4, NEW YORK

JFD International, 15 Moore Street, New York, New York • JFD Canada, Ltd., 51 McCormack Street, Toronto, Ont., Canada **IN COMMAND OF THE MARKET**

# Why are more Service-Dealers Switching to **JFD HI-FI TV ANTENNAS?**



The Businessman in the Service-Dealer just knows five million TV antennas are in need of replacement. For his installation, he relies on the superior performance and quality of JFD HI-FI Antennas to guarantee complete customer satisfaction and guard his reputation.

**JFD**

HI-FI HELIX HI-FI BANSHEE HI-FI FIREBALL



## because

they know 5 million antennas need replacement—that JFD HI-FI TV antennas assure them a bigger share of this profitable market.

## because

JFD is the *total* antenna line with the *right* model, at the *right* price for every location—does the *most* for them in mile-shrinking *performance* and customer *confidence*.

## because

JFD all-out advertising *sells* for them in powerful national mass media—such as Look, TV Guide, Successful Farming, Farm Journal, Progressive Farmer.

## because

JFD sales stimulators such as cloth patches, decals, mobiles, banners, displays and direct mail give them the *complete* package to *sell* new customers.

**HOW MUCH INSTALLATION BUSINESS ARE YOU LOSING BY NOT SWITCHING TO JFD? THE TV ANTENNA LINE AMERICA KNOWS BEST!**

HI-FI HELIX  
Silver or Gold Anodized



HI-FI BANSHEE  
Silver or Gold Anodized

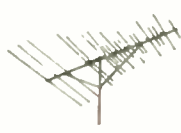

HI-FI FIREBALL  
Silver or Gold Anodized



THE BRAND THAT PUTS YOU

**JFD**

IN COMMAND OF THE MARKET

# SAVE TIME ON THE JOB!

## BUY *Walsco's* NEW **KOIL-PIK Exact Replacement TRANSFORMERS AND COILS**

45 MOST USED RADIO & TV REPLACEMENTS

Look for this Package

★ CROSS REFERENCE

★ ACTUAL PRODUCT

★ WALSCO PART NO. VALUE MFRS. PART NO.

★ LIST PRICE

★ YOUR COST IN CODE

At your distributor's, on the bench, out on the job—Walsco's *EXACT* Replacements save you time. Forget about part modifications—these are *EXACTS*. Forget about thumbing through manuals. The manufacturer's original part number, model numbers in which part is used, values—all you need to buy, to use, to reorder is right on the card. *You See The Part*—these are skin packed. See them today at your distributor's!



### WALSCO ELECTRONICS MFG. CO.

Division of Textron Electronics, Inc.  
West Plant: Los Angeles 18, California Main Plant: Rockford, Illinois, U.S.A.  
Canada: Atlas Radio Ltd., Toronto

Mail This  
Coupon  
TODAY...  
Get FREE  
CATALOG!

WALSCO ELECTRONICS MFG. CO., Rockford, Illinois

Please send your new free KOIL-PIK Transformer Catalog.

NAME \_\_\_\_\_

FIRM \_\_\_\_\_

ADDRESS \_\_\_\_\_

CITY \_\_\_\_\_ ZONE \_\_\_\_\_ STATE \_\_\_\_\_

For more data, circle 12-4-1 on coupon, p. 48

## Editor's Memo



I have been encouraging readers for a long time to broaden their income base by getting into business activities allied to TV-electronic service.

Such diversification smoothes out abrupt peaks and valleys in earnings, as well as opening up new growth fields.

Whenever information has been developed on new fields such as communications, public address, garage door operators, and the like, the facts have been presented in these pages.

Now I would like to recommend that service dealers outside of the very large cities consider the extraordinary earning potential of background music systems.

I am so very enthusiastic about it because it offers substantial profits not only on the initial sale, but also on the music service. The recorded music must be replaced regularly at a charge. It's like being in the razor blade business—the major profits come from the blades and not from the razors.

If you are interested in investing your know-how plus a couple of hundred dollars with the excellent prospects of earning a few thousand dollars per year, spending only a minimum amount of time, write to me immediately on your letterhead. I will put you in touch with a manufacturer who has a special plan worked out for service dealers.

Diversification of your activities may sound crazy to some, but it makes good sense to growth-minded dealers. Think of the story of the man driving his car past a mental institution when a wheel fell off. He could find only one bolt, so how was he to remount the wheel? He was stumped. Suddenly, a face appeared from behind the barred windows shouting, "Why don't you take one bolt from each of the three mounted wheels to hold the wheel that fell off?"

The driver looked at him and said, "That's a pretty clever idea. It's strange coming from someone in an asylum. How did you ever figure it out?"

"Listen," said the face behind the bars, "I may be crazy, but I'm not stupid!"

*Al Forman*

## CBS 6AX4GTB CAN

POSITIVELY CUT YOUR CALL-BACKS

let me  
prove it...  
try me... **FREE!**

You'll get no fireworks and costly call-backs from me. I've been arc-proofed from heater . . . to cathode . . . to plate. And I'm "blast-tested" to guarantee it. That goes for my whole family of CBS damper diodes. We've been completely redesigned to give you CBS total reliability that can positively cut your call-backs.

Get one CBS 6AX4GTB FREE with your purchase of nine from your distributor of CBS Electronics products. Let me *prove* to you, at my expense, CBS TOTAL RELIABILITY . . . proved in performance, year in year out, by leading TV and radio set manufacturers. Act now . . . offer ends December 31.

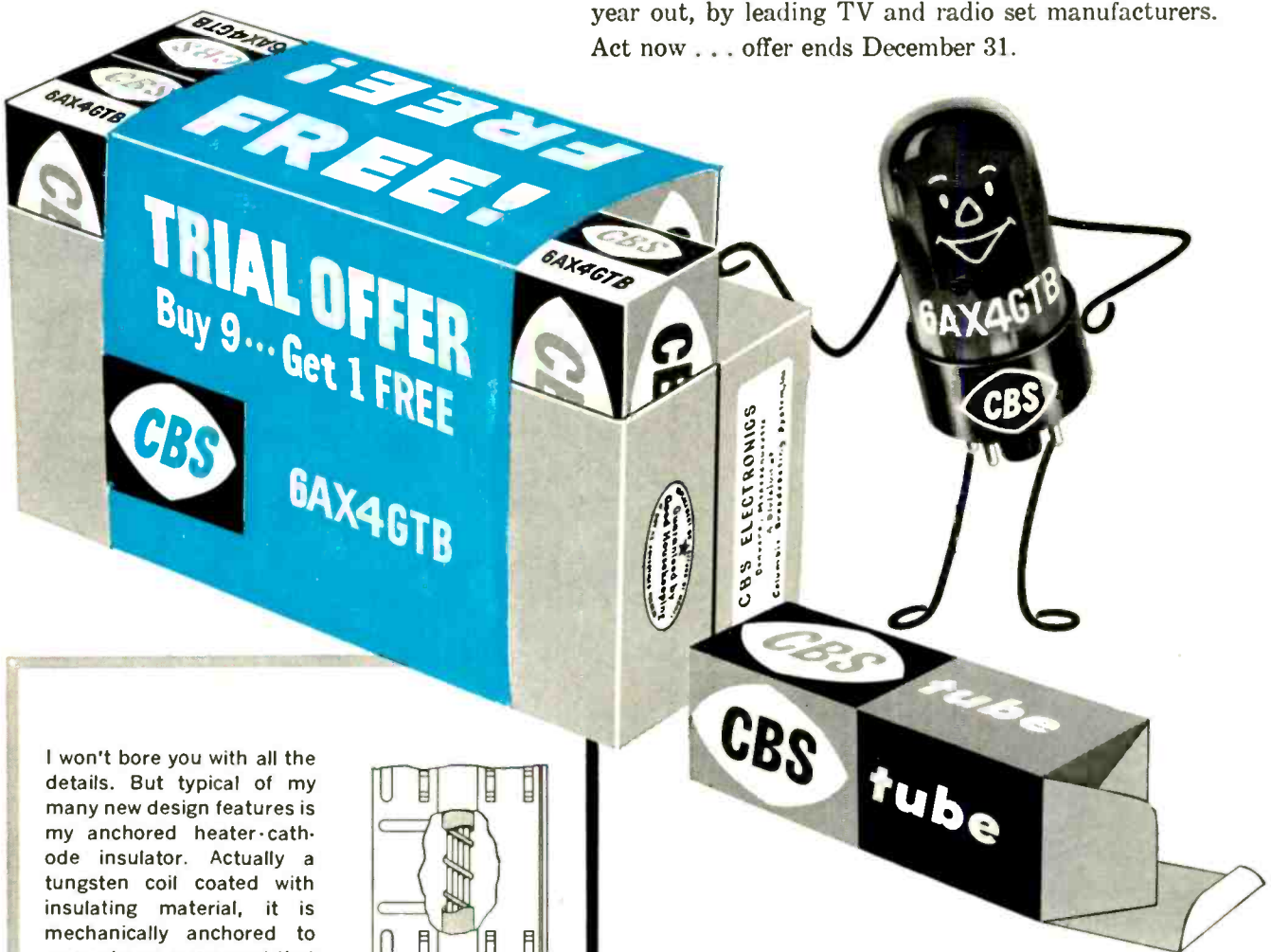

I won't bore you with all the details. But typical of my many new design features is my anchored heater-cathode insulator. Actually a tungsten coil coated with insulating material, it is mechanically anchored to prevent any movement that might cause me heater-cathode shorts. This coil also has fewer turns to minimize cathode-to-insulator contact . . . yet keep my heater-cathode spacing perfect.

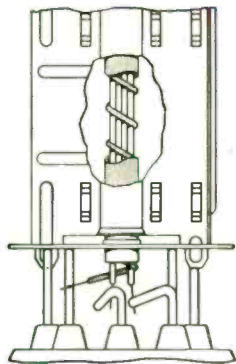

## CBS ELECTRONICS

Danvers, Massachusetts

A Division of Columbia Broadcasting System, Inc.

Receiving, industrial and picture tubes • transistors and diodes • audio components • and phonographs

For more data, circle 12-5-1 on coupon, p. 48

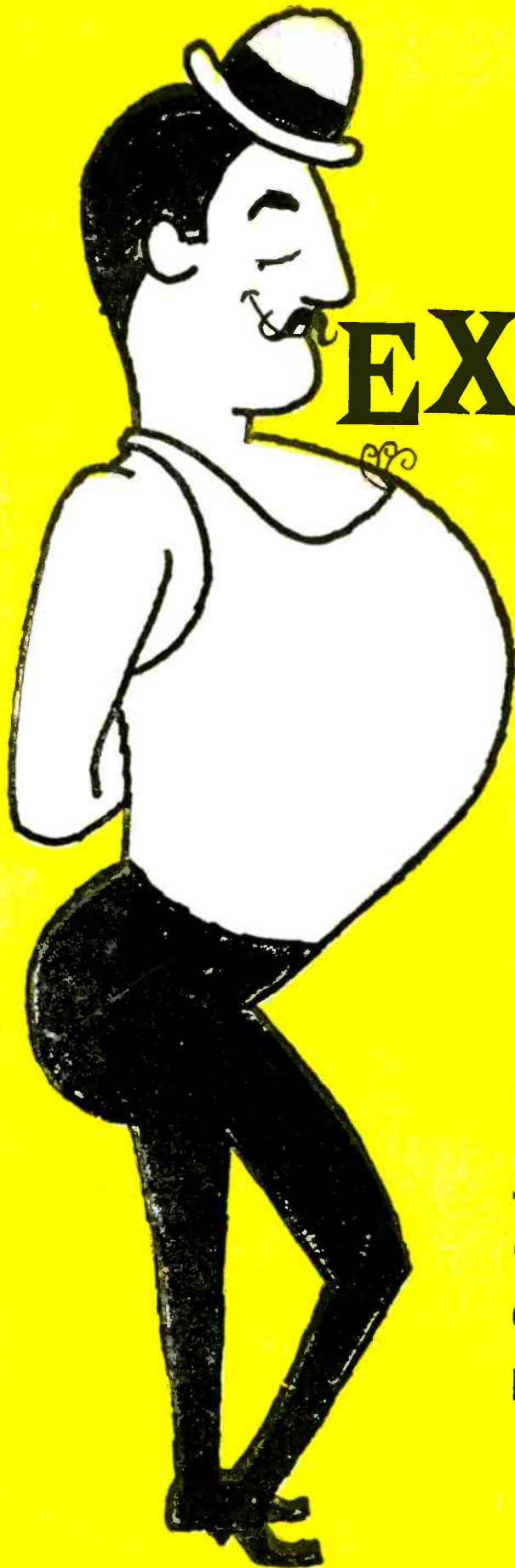

# START EXPANDING, MISTER!

you make more with

***CHANNEL  
MASTER***

because  
Channel Master  
builds in more  
of what your  
customers  
need and want!



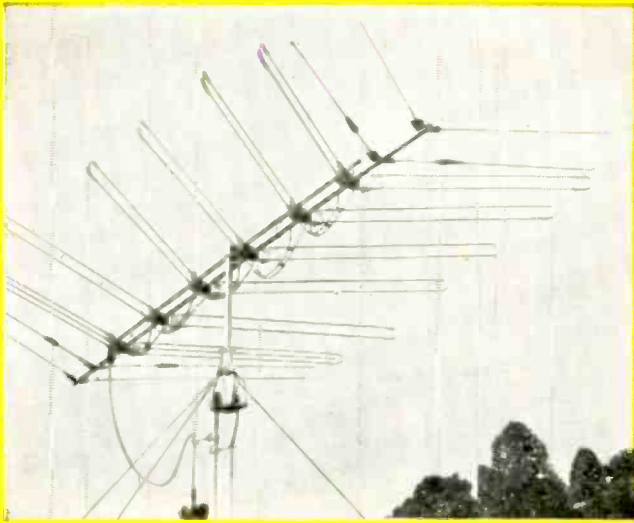

## 78% more Picture-Power in CHANNEL MASTER

**T-W ANTENNAS!** The unique Traveling Wave principle—already fully proved and approved in deep-fringe areas—is now further improved! The new Super 10, with 10 elements, pushes the fringes back even farther—provides unsurpassed super-fringe performance for “picture-poor” homes. Up to 78% more gain than the famous 7-element T-W. Greater front-to-back ratio, exceptional mechanical strength. Another fringe-area powerhouse is the new Super 8—with 4 driven elements, 4 parasitic elements.

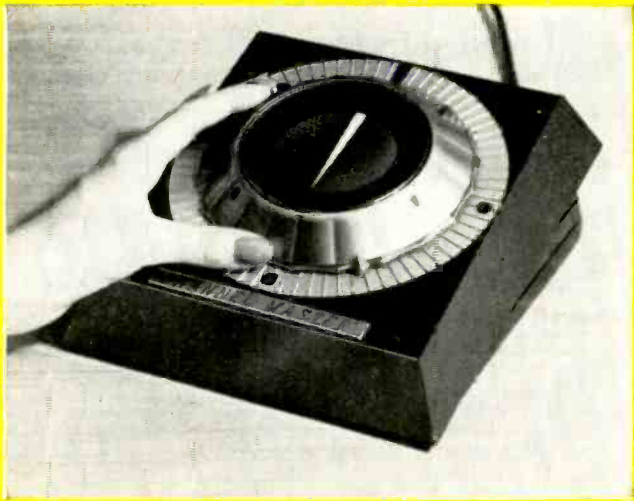

## More accuracy in CHANNEL MASTER

**AUTOMATIC ROTATORS!** For best reception, an antenna must be aimed accurately—not in jumps of 10 or 15 degrees. The Channel Master Tenn-A-Liner is the only automatic rotator that can be aimed within ONE DEGREE of the required direction. And is so easy to operate even a child can do it! Greater turning power, fool-proof control box, elimination of solenoids means quieter operation. No other rotator compares with this one!

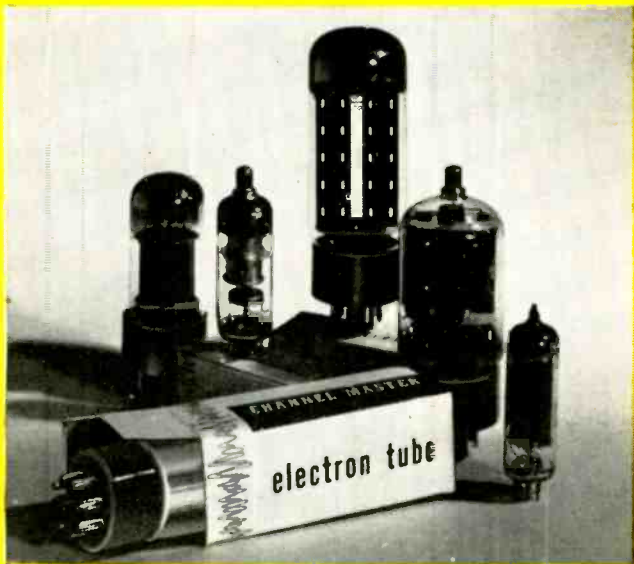

## Extra Dependability in CHANNEL MASTER PREMIUM QUALITY TUBES!

Longer life, un failing uniformity, completely dependable performance—are what your customers expect of their tubes. And Channel Master Premium Quality Tubes give them all three of these qualities to spare! The Channel Master tube line also takes care of over 75% of your service calls. America's fastest-growing line?...You bet!

**CHANNEL MASTER**

works wonders in sight and sound

Ellenville, New York

For more data, circle 12-7-1 on coupon, p. 48

## News of the Industry

RAYTHEON Distributor Products Div. announces the appointment of ARTHUR W. RANDALL as Chicago Dist. Mgr.

WALL Mfg. is in the process of establishing field engineering services throughout the U.S. to give Wall customer free services on any soldering problems.

CBS ELECTRONICS has announced the appointment of CLARENCE H. HOPPER as Pres., succeeding ARTHUR L. CHAPMAN, who will join the headquarters staff of CBS in New York.

SENCORE reports a "Sencore Time Saving Clinic" was sponsored in Indianapolis by BROWN DISTRIBUTING. The company reports more than 20,000 servicemen have attended clinics in the last eight months.

ARCO ELECTRONICS reports signing a long term lease on 46,000 sq. ft. of space at Lake Success Business & Professional Park in Lake Success, L.I., New York. The projected move will double their space.

VIDAIRE ELECTRONICS announces the removal of its plant and offices to larger quarters at 365 Babylon Turnpike, Roosevelt, N.Y. With this move double the space has been added, totaling 6000 sq. ft.

HICKOK ELECTRICAL INSTRUMENT reports opening a new 14,000 sq. ft. electronics research center located at 1348 E. 133rd St., East Cleveland, O., devoted to research and development for the company's line of electronic test instruments as well as special development work on government contracts.

RCA Sales Corp. announces the following appointments: JAMES M. TONEY, Vice Pres., to the staff of Chairman of the Bd. W. WALTER WATTS, to be responsible for special projects; and C. RICHARD JOHNSTON, as Mgr., Product Planning & Development. The Electron Tube Div. announces the appointments of JOSEPH T. CIMORELLI as Mgr., Engineering, Receiving Tube Operations and KENNETH G. BUCKLIN to the newly created position of Mgr., New Products Engineering. Details of the new sales promotion program, "Front Page Program," were disclosed. Seventeen premiums will be offered to dealers and service technicians through RCA distributors.

(Continued on page 10)

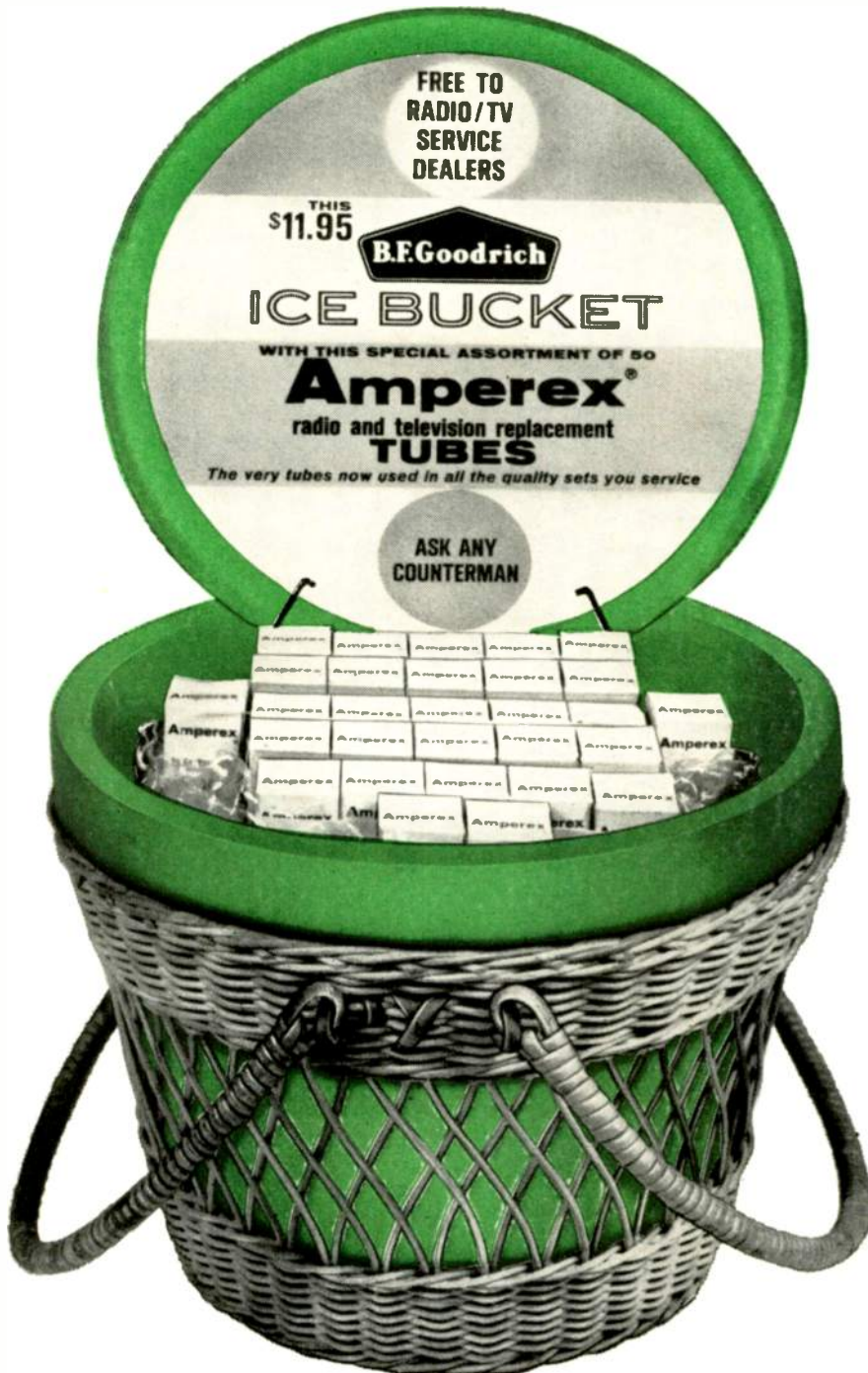

The very tubes now used in all the quality sets you service, *plus*... the famous B. F. Goodrich NICER BUCKET... *both* yours for the price of the tubes alone! The 'Nicer Bucket', made of miracle PVC won't rust, scratch or break. From the night before to the morning after, it keeps hot food hot or cold beer cold. Smart, simple design... no fragile liner to break... in fact for food—hot or cold... for ice... there's no other bucket like it at any price! Pick up this 2-for-1 offer today. You'll service your customers with the best, pocket the profits, take home the bucket! Act today, supplies are limited.



GET YOUR FREE GOODRICH 'Nicer Bucket' from any Amperex replacement tube distributor. Ask Amperex for the name of the franchised distributor in your neighborhood.

**AMPEREX ELECTRONIC CORPORATION**  
230 Duffy Avenue, Hicksville, Long Island, New York

For more data, circle 12-8-1 on coupon, p. 48



*universal  
acceptance!*

miniaturized  
**ELMENCO**

The exclusive Elmenco dip-coated Mylar-Paper capacitors (Arco type dp) represent a double breakthrough in capacitor design. They combine missile and computer quality and compare favorably in price with commercial general purpose units. The "dp" series is designed for universal use, from TV by-pass to critical industrial applications requiring stringent electrical and environmental characteristics. New high levels of ruggedness, stability and reliability have been achieved in a miniaturized body.

**54,745,000 SOLD  
IN LESS THAN 2 YEARS**

\* DuPont Reg. Trademark

Write for catalog dp 110.



**ARCO** *electronics inc.*

64 White Street, New York 13, N. Y. • Branches: Dallas 19, Los Angeles 35

For more data, circle 12-9-1 on coupon, p. 48

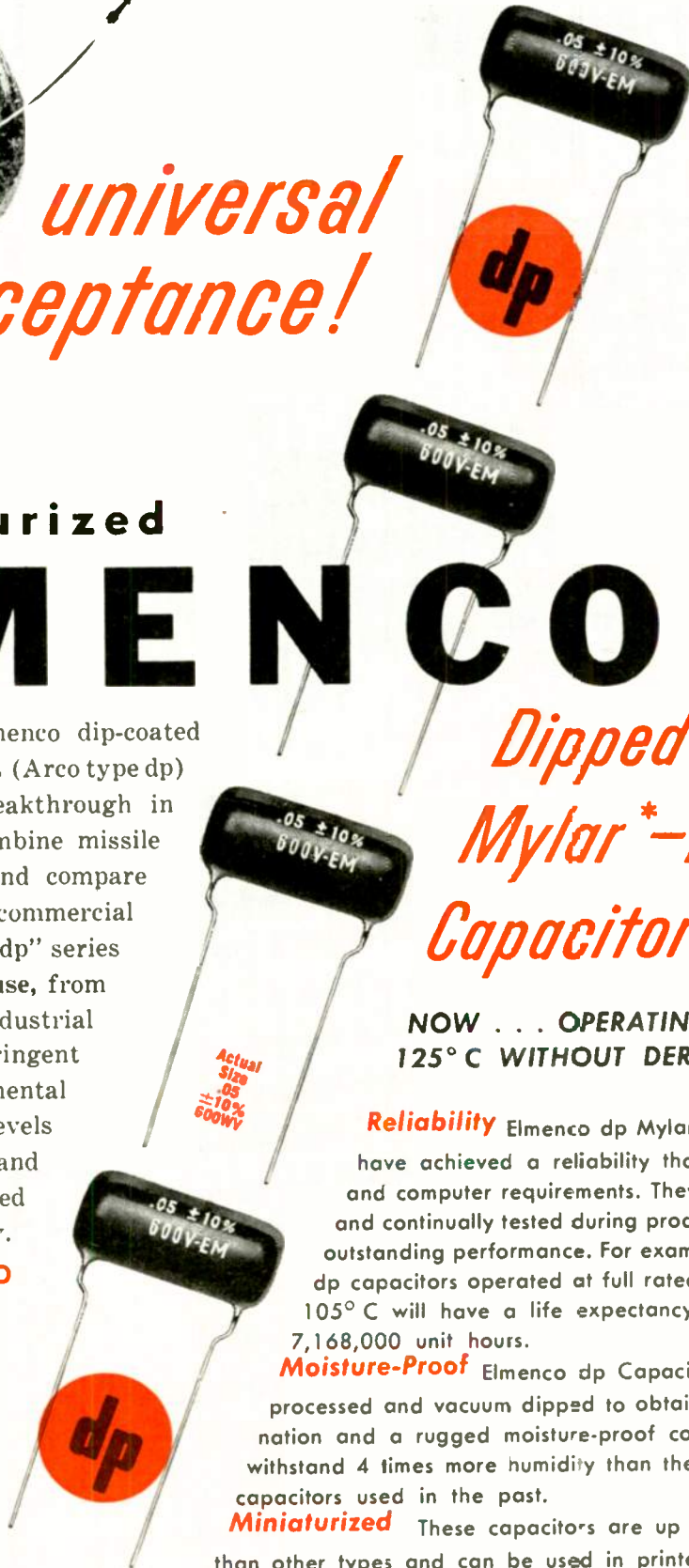

*Dipped  
Mylar\*—Paper  
Capacitors*

**NOW . . . OPERATING AT  
125° C WITHOUT DERATING**

**Reliability** Elmenco dp Mylar-Paper Capacitors have achieved a reliability that meet missile and computer requirements. They are thoroughly and continually tested during production to insure outstanding performance. For example a 0.1 mfd. dp capacitors operated at full rated voltage and at 105° C will have a life expectancy of more than 7,168,000 unit hours.

**Moisture-Proof** Elmenco dp Capacitors are specially processed and vacuum dipped to obtain solid impregnation and a rugged moisture-proof coat designed to withstand 4 times more humidity than the best molded capacitors used in the past.

**Miniaturized** These capacitors are up to 50% smaller than other types and can be used in printed circuit and transistor applications.

**±10% Standard Tolerance**

# UNMATCHED FOR CONVENIENCE...

# DUAL

# HEAT SOLDERING GUN

FOR ONLY  
**\$7.95**  
LIST  
Model 8200K



...and best of all, it's a

# Weller®

Here from Weller, long time leader in the soldering field, is the most practical convenience feature ever offered in a soldering tool.

**WELLER DUAL HEAT FEATURE** saves time, gives greater convenience and greatly increases tip life. A touch of your finger on the Triggematic control switches heat to high (125 watts) or low (90 watts) as your job requires. It adapts instantly to varying needs, and you use high heat only when necessary.

**HIGH EFFICIENCY WELLERTIP** utilizes copper for superior heat transfer and soldering efficiency, plus iron plating for durability. Flat cross-section design gives added strength and rigidity.

**MODERN DESIGN** with sturdy plastic housing that resists hard knocks. Compact "feel" and comfortable balance aid precision soldering. Like all other Weller guns, this new model features instant heat, and a spotlight illuminates your work.



## KIT INCLUDED

In addition to the Dual Heat Soldering Gun you get:

- Nylon Flux Brush
- Soldering Aid for opening old joints, twisting wires
- All-purpose Solder

Other dual heat models available—\$12.95 and \$16.25—up to 275 watts.

WELLER ELECTRIC CORP. • 601 Stone's Crossing Rd., Easton, Pa.

For more data, circle 12-10-1 on coupon, p. 48

(Continued from page 8)

AMPEREX announces the promotion of TOM O'CONNOR to the position of Distributor Sales Specialist.

MIDWESTERN INSTRUMENTS has named PAUL R. BUNKER Sales Mgr. for Magnecord products.

SYLVANIA Home Electronics Corp. has named RAYMOND J. STEINER as South Bend, Ind. District Sales Mgr.

B & K announces "New Tube Information Service" covering data on new tube types as they are announced by the manufacturers. Available to owners of B & K tube testers on annual subscription of four issues at \$2.50 per year, or \$1.50 each year for individual copies.

VOCALINE announces formation of a network of warranty repair stations for their line of CB radios and wireless intercoms, totaling 31 stations. Names and addresses of warranty service stations in an area can be secured by contacting Service Manager of Vocaline.

GENERAL ELECTRIC announces nominations are open for the 1960 Edison Award which honors the licensed radio amateur who has performed the most outstanding public service during the year. Deadline for nominations is Jan. 2, 1961. The Receiving Tube Dept. reports the appointment of LYNN E. GREELEY as Dist. Mgr. in Charlotte, N.C. for replacement sales of electronic components.

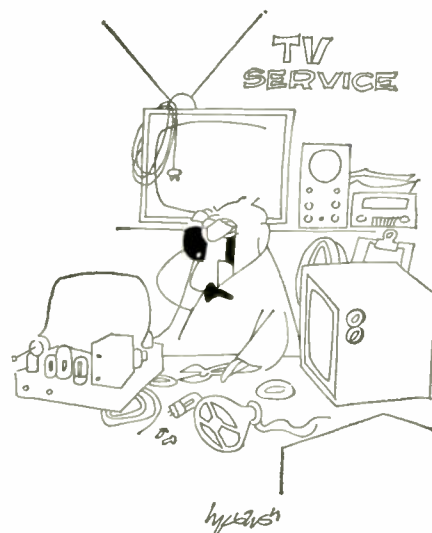

"You've got snow on your set and it's Christmas eve, what more could you want?"

**Hold that line  
against callbacks**



Just one callback throws your profits for a loss on the next three service calls. But you can tackle any service job and make big gains in profit territory, when you back your line with Tung-Sol Blue Chip quality. Made to industry's top standards, Tung-Sol tubes are best for every replacement — radio, tv or hi-fi. Tung-Sol Electric Inc., Newark 4, N. J.

*Tell your jobber you'd rather have*

**ts TUNG-SOL®**

*Blue Chip Quality*

**TUBES • TRANSISTORS • DIODES**

For more data, circle 12-11-1 on coupon, p. 48

# Tuning In the

**HAPPIER BABIES** are in the offing with Sonotone Corp.'s development of an electro-mechanical device that simulates the sound of "mother's heartbeat." Infants exposed to this sound (72 double pulses per minute) gained weight, slept better, and cried less. The unit, invented by Dr. Lee Salk (brother of the Salk vaccine discoverer), operates on household current with a small noiseless motor that can be switched on or off. Called "Securitone," it is expected to sell for "under \$30" through major retail outlets.

*JAPANESE EXPORTS of electronic products to the U. S. for the first six months of 1960 totaled \$38.7 million, compared with \$22.1 million during the same 1959 period, according to the U. S. Dep't. of Commerce. This accounts for one-half of Japan's electronic product exports to all countries during this period.*

**SEARS, ROEBUCK** is forming Allstate Enterprises as a forerunner to its entry into the service industries. The new corporation is not an additional organization to service Sears' goods. It is implied that the new services will be different from the various types of insurance now offered by its subsidiary, Allstate Insurance Co. The giant firm's chairman said retailers may expand their market by branching out into the field of services.

## SATELLITE COMMUNICATIONS

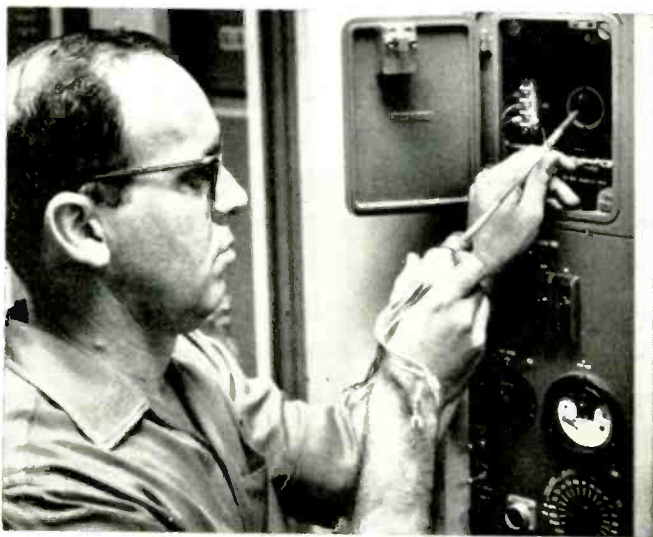

The traveling-wave tube in the technician's hand is the amplifying device planned for the Bell System's proposed satellite communication relay station. The high-frequency device can amplify radio signals from earth 10,000 times. This boosted signal will be relayed to ground stations in the U.S., United Kingdom, and W. Europe.



**AUTOMATED SUPERMARKET** demonstrated by Solartron-John Brown Ltd. has electronic clerks dispensing products. Shoppers made their choices by inserting cards into slots above display items. The card is then fed into a processing machine which activates automatic dispensing equipment from a warehouse.

*PHOTOEMISSIVE MATERIAL* which permits "electronic eyes" to operate at high temperatures is announced by Westinghouse. The chief advantage is its capability of functioning efficiently for long periods at temperatures twice the range of current photoemitters. Also, its high sensitivity allows it to operate at low light levels. Tests on the new material show excellent stability when operated as long as 140 hours at 1200° C which is well above the boiling point of water. This compares with other photoemissive surfaces which begin deteriorating at about 60° C, suffering a large loss in sensitivity after 100 hours at the 120° level. The new photoemitter uses a semi-transparent combination of antimony, potassium, and sodium deposited as a thin semi-transparent layer on glass.

**NUCLEAR-POWERED ELECTRONIC "SENTRY"** which is being developed by the AEC, is capable of recording data and transmitting it from a remote ground location for at least two years without servicing or refueling. The automatic unit will be used with weather instruments to measure wind speed and direction, temperature, and barometric pressure but may also be modified to detect seismic disturbances or continuously record other data in a remote location. Energy for the "sentry" will be provided by a 5-watt generator which converts heat from safety-enclosed pellets containing strontium-90 directly into a continuous flow of electricity.

# Picture .....



LOS ANGELES "SMOG" is finally being used beneficially. A Hughes Aircraft electronics engineer, John T. Chambers, learned that VHF signals can be transmitted over much greater distances than limited line-of-sight transmission due to L.A.'s inversion layer acting as a waveguide. The signals are trapped by the smog and "bent" around the earth's surface. Chambers was awarded the ARRL 1960 Award of Merit for his 2540 mile transmission to Hawaii, beating the previous record of 1700 miles. Chambers' discovery may lead to practical VHF communication over the Pacific at far lower power levels than currently required.

ELECTRONIC TRAIN DISPATCHER was demonstrated on a New York City subway shuttle line. The 24 relay system, eliminating the need for a motorman and conductors, automatically set the train in motion to a speed of 35 miles-per-hour, braking to five mph when nearing the station; stopped the train, and opened and closed doors before repeating the cycle. It is expected to be placed in operation within the next six months. A telephone system will maintain voice communication between trains and human dispatchers.

TV CHANNEL reallocation has been discussed for some time. There is mixed sentiment in the Federal Communications Commission. One view is that more stations will be able to serve the public if all channels are moved to UHF. Another view is that the FCC should swap the UHF channels for a part of the VHF spectrum now occupied by the military. It seems probable that in view of UHF's failure to compete favorably with VHF in many sections of the country, more VHF drop-in channels will be approved. That is, by a proper arrangement of transmitter power and antenna pattern, additional VHF stations will be able to operate closer to existing stations without substantial interference. The National Association of Broadcasters has officially gone on record as opposing any reallocation which will remove channels 2 through 13 from TV service.

FM RADIO meters patients' hearts while on an operating table. The technique, developed by the North Carolina School of Medicine, Chapel Hill, employs a palm-sized FM transmitter that broadcasts electrical signals from a surgery patient's heart to conventional electrocardiogram display equipment. Advantages of the radiotelemetry system are: less subject to interference, convenience, and reduction of electrical wires from patient to nearby apparatus.

## CALENDAR OF COMING EVENTS

- Dec. 12-14: URSI-IRE Fall Meeting, Radio Bldg., Boulder Labs., National Bureau of Standards, Boulder, Colo.
- Dec. 12-15: Industrial Building Exposition & Congress, The Coliseum, New York, N. Y.
- Dec. 13-15: 10th Annual Eastern Joint Computer Conference, Hotel New Yorker, New York, N. Y.
- Jan. 8-12: Symposium on Thermo-electro Energy Conversion, Statler Hotel, Dallas, Texas.
- Jan. 9-11: 7th National Symposium on Reliability and Quality Control in Electronics, Bellevue-Stratford Hotel, Philadelphia, Pa.
- Jan. 22-26: 1961 Southwestern Electronic Conference, Fort Clark Guest Ranch, Brackettville, Texas.
- Jan. 23-26: 12th Annual Plant Maintenance & Engineering Show, Palmer House, Chicago, Ill.
- Feb. 1-3: IRE 1961 Winter Convention on Military Electronics, Biltmore Hotel, Los Angeles, Calif.

REBUILT CRT's installed by dealers in N. Y. must be accompanied by written disclosure to the consumer advising that the tube utilizes used components. General Electric Co. offers replacement picture tube "stickers" through their franchised distributors to help conform with this law. The "stickers" declare that all parts are new except for the envelope, which has been inspected and tested to the same standards as new envelopes.

## ELECTRONIC TIMEPIECE



A 1.3-volt mercury cell (shown on finger) powers Bulova's new electronic watch, called "Accutron." The timepiece's cell can be replaced by unscrewing a cap on the back of its case. Replacement cells cost about \$1.50. The timepiece's electronic circuitry (insert) contains a transistor, resistor, and two coils, among other components.

from **EICO**... a completely new  
CITIZENS BAND TRANSCEIVER

that meets  
FCC regulations\*



Model 760: 117 VAC  
Kit \$59.95 Wired \$89.95  
Model 761: 117 VAC & 6 VDC { Kit \$69.95  
Model 762: 117 VAC & 12 VDC { Wired \$99.95  
incl. mtg. bracket (Pat. Pend.)

\*EICO premounts, prewires, pretunes, and seals the ENTIRE transmitter oscillator circuit to conform with FCC regulations (Section 19.71 subdivision d). EICO thus gives you the transceiver in kit form that you can build and put on the air without the supervision of a Commercial Radio-Telephone Licensee!

Highly sensitive, selective SUPERHET (not regenerative) receiver with 5½ dual function tubes and RF stage. Continuous tuning over all 23 bands. Exclusive Super-Hush® noise limiter. AVC-3" x 5" PM speaker. Detachable ceramic mike. 5-Watt crystal-controlled transmitter. Variable "pi" network matches most popular antennas. 12-position Posi-Lock® mounting bracket. 7 tubes and 1 crystal (extra xtals \$3.95 each). Covers up to 20 miles. License available to any citizen over 18—no exams or special skills required, application form supplied free. Antennas optional.

## YOU PROFIT WITH EICO

Everything in top-quality  
TEST EQUIPMENT for Shop  
and Field—at savings of 50%.



COLOR & Mono DC-5MC  
Lab & TV 5" Oscilloscope #460  
Kit \$79.95, Wired \$129.50  
5" Push-Pull Oscilloscope #425  
Kit \$44.95, Wired \$79.95



Peak-to-Peak VTVM #232 & \*UNI-PROBE®  
Kit \$29.95, Wired \$49.95  
\*U. S. Pat. No. 2,790,051  
Vacuum Tube Voltmeter #221  
Kit \$25.95, Wired \$39.95

More typical EICO values: Signal Generators from \$19.95, Tube Testers from \$34.95, Sweep Generators from \$34.95, Power Supplies from \$19.95, VOMs from \$12.90.

Everything in CUSTOM HI-FI:  
finest quality at ½ the cost.



FM Tuner HFT90  
Kit \$39.95, Wired \$65.95  
Cover \$3.95. Includes FET.  
AM Tuner HFT94  
Kit \$39.95, Wired \$65.95  
Includes Metal Cover and FET.  
FM/AM Tuner HFT92  
Kit \$59.95, Wired \$94.95  
Includes Metal Cover and FET.



Stereo Dual Amplifier-Preamp HF81  
Kit \$69.95, Wired \$109.95  
Includes Metal Cover.  
Stereo Dual Amplifier AF4  
Kit \$38.95, Wired \$64.95  
Includes Metal Cover.

Write for free catalog ET 12 and name of nearest distributor.  
Most EICO distributors offer budget terms.

**EICO**

3300 N. Blvd., L.I.C. 1, N. Y.  
Add 5% in the West

# LETTERS To the Editor

## Scope Improvement

Editor, ELECTRONIC TECHNICIAN:

Many thanks to you and to Mr. West for his tip on Eico scope improvement in Sept. Shop Hints. I applied his tip to my Heath scope, which I almost wanted to junk. Even factory suggestions had not helped. I used 100 K control since sweep vernier in mine is only 2 meg. This actually saved me the price of another scope. My scope is fine now! Thanks a lot.

A. G. HESMATI

Carmel TV & Radio Service  
Carmel, Calif.

## Troubleshooting Chart

Editor, ELECTRONIC TECHNICIAN:

I have received an advertisement from National Technical Research Laboratories of Whittier, Calif. This ad describes a TV repair system called Tele-Vue Trouble-Shooter. It apparently consists of 50 charts relating symptoms and faulty components, and is priced at \$8.50. As a subscriber to your magazine, I wonder if you can tell me if it is worthwhile.

JOSEPH OBIECUNAS

Pittsburgh, Pa.

• Readers who have used the Tele-Vue Trouble-Shooter charts are invited to write in and describe their experiences.

—Ed.

## Speed Reader

Editor, ELECTRONIC TECHNICIAN:

The only reason I'm renewing my subscription is your Circuit Digests. After 10 years in this business, I know almost everything there is to know. I can finish reading your magazine in about 15 minutes. How about more human interest articles—like interviews of individual shopowners in various sections of the country.

R. M. THORSON

R. M. Thorson TV-Radio  
Palo Alto, Calif.

## Experienced Reader

Editor, ELECTRONIC TECHNICIAN:

Enclosed is my check for a 3-year subscription renewal to the finest technical magazine I have ever seen. I've been in business for myself 30 years.

JOHN H. HILDRETH

Johnnie's Radio Shop  
Phelps, N. Y.

## "Industry Dilemma"

Editor, ELECTRONIC TECHNICIAN:

Have just read the article "Industry Dilemma—Distributor Retail Sales." In it one of the distributors whom I have had occasion to deal with over the past five years openly denies having sold to the public at wholesale prices. I know of two cases in my small town of 900 population that bought from this distributor at wholesale prices and they have no connection whatsoever with the electronic trade. I have heard of several other instances with this same distributor. Naturally, those who are guilty will lie through their teeth to retain their relationship with legitimate dealers. There is only one salvation in solving this problem, and that is the proper legislation to deal with it and then the proper amount of enforcing to keep it under control. Enjoy your magazine and admire the spirit with which you are endeavoring to further our case.

BRUCE KING

King's TV  
Frederic, Wisc.

(Continued on page 16)

For more data, circle 12-14-1 on coupon, p. 48



# DEAD ANTENNAS! DRAIN THROUGH!

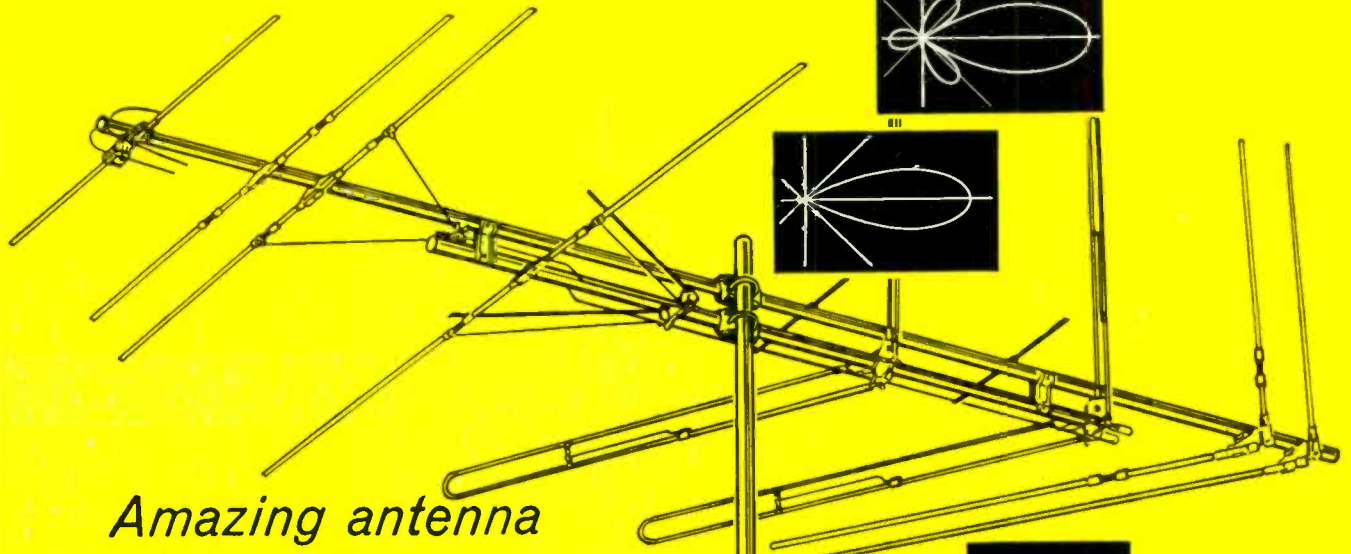

*Amazing antenna  
developments  
now make possible...*

## PEAK POWER ON EVERY CHANNEL

with the **T-A-C-C-O**



Now—for the first time—Peakpower on every channel plus a directivity pattern clean as a whistle! Advanced antenna engineering on a specially-built test range by the most competent group of antenna engineers in the country now brings you the first high-gain, broad-band antenna with a single lobe—no side lobes—producing the sharpest pictures possible on any TV receiver . . .

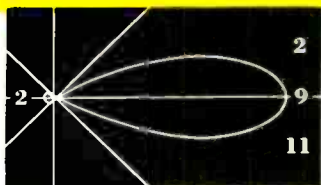

A difference you can see on every TV screen! Elimination of side lobes ends displaced image (ghosts) to sharpen every channel. For the crispest, brightest pictures you ever sold—go T-Bird!

*Ask your distributor  
or write for complete details . . .*

**TECHNICAL APPLIANCE CORPORATION, SHERBURNE, NEW YORK.**

### PACKED WITH PROMOTION







The T-Bird is pre-sold by the most powerful promotion ever, spearheaded by Allie Scollon and her Injun Puppets on TV and radio. Point-of-sale, direct-mail, magazine and newspaper ads, giveaways, bus cards, and everything else to make everyone ask for a T-Bird . . .

For more data, circle 12-15-1 on coupon, p. 48



1600 pages



- 
**IT'S NEW.** Covers all the latest products for servicing radio-TV-hi-fi and industrial equipment: • miniature and sub-miniature components • printed circuit components • silicon rectifiers • stereo equipment • automatic test equipment • citizens band, SSB and mobile ham gear, etc.
- 
**IT'S THE WORLD'S BIGGEST ELECTRONIC CATALOG.** 1600 pages—more than 175,000 items—with specifications, illustrations and prices. Contains hundreds of items not found in smaller catalogs.
- 
**IT'S THE EASIEST TO USE.** Quickest way to get current catalog data on the products of more than 330 manufacturers. Systematically organized in 32 product sections for rapid reference.
- 
**SAVES TIME AND MONEY FOR SERVICE TECHNICIANS.** Whether you're servicing radio, TV, audio or industrial electronic equipment, you find the right part to do the job best in The MASTER. The reason: you're shopping in the electronic supermarket. The MASTER is easy to sell from because it contains list prices. It's easy to buy from because your distributor has it and all you need do is select the item you want and order by part number. No matter what product or component you require, you'll find it faster in the 1961 MASTER.

AND IT'S NOW AVAILABLE AT  
YOUR LOCAL DISTRIBUTOR

# 1961 MASTER

**\$3.95** at parts distributors  
\$4.95 in Canada

FREE from your distributor: New Foreign Tube Interchangeability Guide, or write direct, enclosing 25c.

RADIO-ELECTRONIC MASTER — 60A MADISON AVE., HEMPSTEAD, N. Y.

(Continued from page 14)

... We in Pennsylvania also have the same problem—distributors sell to anyone. Penna. has a sales and use tax, the service man and retailer are issued a license and a number. The distributors could eliminate the chiseler very easily if he would insist to see the License for Sales and Use Tax. Here in Penna. the serviceman must charge tax for parts and also for labor to repair any appliance.

PIERCE M. DISSINGER

Dissinger's Radio & Television  
Lebanon, Pa.

... Why waste valuable space in your excellent publication by the printing of the "brilliant masterpiece" sent to you by some member of National Electronic Distributors Association in Chicago. He states that it is beyond his intelligent comprehension where his industry would benefit by rehashing its problems in print. In other words, the operation was a success but the patient (the legitimate serviceman) died. We have a member of the Electronics Assoc. in this city. If that writer feels that back-stabbing and double-dealing is a mark of harmonious mutual relationship between serviceman and dealer, I suggest he consult his dictionary again. It is high time that such worthy publications as yours be read and re-read by the independent service personnel of this country. The only code of ethics which the writer of the National Electronic Distributors Association understands is the all-mighty dollar. Please keep up the good work.

BOB MILLIGAN

Bartlesville Electronics  
Bartlesville, Okla.

... According to some of the articles in almost every ET issue, some servicemen blame the distributor for selling parts to customers because they are lagging in business. Has anyone ever tried to find out why the business has been lagging, besides blaming the distributors? I think someone should go out and ask some of the customers why they would rather have a dead receiver sitting around instead of calling a serviceman to repair it. In my opinion it's "some" of the servicemen who are to blame instead of the distributors. Why? Because some of the servicemen are not capable of doing any service work except to change tubes. Secondly, they are out to rob the customers all they can get. Please understand I said "some servicemen." I speak from personal experience on this subject. There should be a law compelling servicemen to take an examination on skill and honesty, then issue a license if qualified.

Name Withheld

Springfield, Mass.

### N. F. I. B.

Editor, ELECTRONIC TECHNICIAN:

Distributor sales have been a great concern of mine, and I have been looking for some method or means of voicing my concern. Since most of the servicemen's organizations of this area can't seem to accomplish much, I have joined, and am a voting member of the National Federation of Independent Business, which is a non-profit organization representing small business so that we may have a voice in government. Through this medium, I have written to both my congressman and state representative concerning the unfairness of the price advantage of distributors selling to retail customers, my customers. Although I realize the National Federation of Independent Business possibly has many of these questionable distributors as members, it is also an organization in which the thoughts and desires of many are collected and analyzed, and I am sure that are far more retailers than wholesalers—I think! Although big business represents an impressive influence in our government, I believe small business, if brought together in a common voice so that it can be heard in government, can also be an impressive influence on our lawmakers.

JAMES S. SMITH, JR.

Art's TV & Radio Service  
Hartford City, Ind.

READY TO SERVE YOU!

OVER  
1500

CLAROSTAT  
DISTRIBUTORS

with

**CLAROSTAT**  
"Right Replacements"

### RTV CONTROLS

Completely factory-made and assembled — ready for use right from the carton — eliminates all fuss, bother and cussing because they fit right and work right just as you get them.



### GREENOHM RESISTORS

King of them all — for price and dependability. Available in all popular values. Ideal for replacement purposes especially where overloading burns out less rugged resistors.



### PICK-A-SHAFT CONTROLS

Pick the one you need — wire-wound or carbon — from the many popular values available. Then choose your shaft — snap it in. Need a switch? Ad-a-Switch attaches to control in seconds — no sweat, no bother . . .



WRITE FOR COMPLETE CATALOG, OR ASK YOUR DISTRIBUTOR

**CLAROSTAT MFG. CO., INC.**  
DOVER, NEW HAMPSHIRE

In Canada: CANADIAN MARCONI CO., LTD., Toronto 17, Ont.

For more data, circle 12-17-1 on coupon, p. 48



LEARN

**SUBJECTS OFFERED AT NO COST TO YOU:**

- ① TRANSISTOR FUNDAMENTALS—complete coverage of transistor theory without the use of mathematics.
- ② GUIDE-MATIC POWER HEADLIGHT CONTROL (Autronic Eye)—lecture and lab.
- ③ TWILIGHT SENTINEL ELECTRIC HEADLIGHT SWITCH—lecture and lab.
- ④ TROUBLE-SHOOTING PROCEDURES for dead or weak low voltage auto radio tuners and trigger circuits.
- ⑤ LECTURE AND LAB. PRACTICE ON "SIGNAL SEEKER" AND "WONDER BAR" auto radio tuners and trigger circuits.
- ⑥ TRANSISTOR CIRCUIT TROUBLE-SHOOTING—lecture and lab. work analyzing defects in transistor circuits.
- ⑦ HYBRID-TYPE AUTOMOBILE RADIOS—low voltage tube and output transistor circuits. Lecture and lab.
- ⑧ DELCO-MATIC ALL-TRANSISTOR GARAGE DOOR OPERATORS—lecture and lab.
- ⑨ AUTO PORTABLE RADIOS—lectures and lab. practice on all-transistor portable radios. Get prepared for the all-transistor auto radio that will appear in the next few years.

**THE LATEST ON TRANSISTORS AND AUTOMOTIVE ELECTRONICS** 9 SUBJECTS AVAILABLE TO YOU AT THE FREE DELCO RADIO-GUIDE LAMP ADVANCED TRAINING SCHOOL. One week of instruction. No lab. fees. No tuition charge. Textbooks supplied.

In 1960 over 900 electronics technicians completed our one-week course. You, too, can receive this same valuable training in 1961. Bring yourself up to date on transistors and automotive electronics with personalized instruction at the General Motors Training Center near you. (See schedule below.)

Classes will be conducted by graduate engineers with special training in your field. Diplomas, awarded only to those who successfully complete the courses, will mean a great deal to you—and to your customers.

Register now through your local Delco Electronics Parts Distributor or write directly to Delco Radio Division, General Motors Corporation, Kokomo, Indiana, Attention: Service Manager.

**GUIDE LAMP DIVISION**

GENERAL MOTORS CORP.  
ANDERSON, INDIANA



DELCO ELECTRONICS TRAINING SCHOOL SCHEDULE						
DATE	REGION 1	REGION 2	REGION 3	REGION 4	REGION 5	REGION 6
1-16	Philadelphia		Detroit			
1-23		Charlotte	Detroit		Dallas	
2-6	Washington			St. Louis		
2-13	Washington	Atlanta			Houston	
2-20			Cincinnati		Houston	Los Angeles
2-27						Los Angeles
3-6	Tarrytown	Memphis		Omaha		
3-13	Tarrytown					
3-20		Jacksonville	Cleveland			San Francisco
4-10	Boston		Cincinnati			Portland
4-17	Boston	Atlanta		Kansas City	El Paso	
5-1		New Orleans	Pittsburgh	Kansas City	El Paso	
5-8	Union		Pittsburgh	Minneapolis		Los Angeles
5-15					Oklahoma City	
5-22		Memphis		Milwaukee		
6-5	Philadelphia		Buffalo			San Francisco
6-12		Charlotte		Chicago	Denver	
6-19				Chicago		Portland
6-26	Union	Atlanta	Cleveland			
				Minneapolis	Dallas	Salt Lake City

For more data, circle 12-18-1 on coupon, p. 48



**“People tell us they found us through the Yellow Pages!”** says M. N. Fairman, co-owner, Jay’s, Peoria, Ill. “95% of our service business comes in by phone, so it’s easy to see why the Yellow Pages is important to us. Newcomers in our area often say they found us in the Yellow Pages. That’s why we run 14 different Yellow Pages ads under TELEVISION DEALERS & SERVICE and other headings.”



Display this emblem. It builds your business!

Display ad shown reduced at right runs under TELEVISION DEALERS & SERVICE. Call the Yellow Pages man at your Bell Telephone business office to plan your program.

**T.V.** SALES QUICK SERVICE QUICK INSTALLATION

\* LARGE MEDIUM DISPLAY ROOMS \*  
Visit Our Shop at 3-Block South

• Hi-Fi and STEREO	• RCA VICTOR
• RADIOS	• ZENITH
• PHOTOGRAPHS	• PHILCO
• ORGANS	• TELEVISIONS
• REFRIGERATORS	• Sylvania
• FREEZERS	• J&J CRUISE
• WASHERS	• HOOVER
• DRYERS	• HECLA
• STAINERS	• SANYO
• AIR CONDITIONERS	• COLUMBIA

IT'S ONE OF THE LARGEST RECORD DEPARTMENTS IN CENTRAL ILLINOIS

**37**

YEAR PHONE SERVICE INSTALLATION

**JAY'S**

3-Block South Peoria, Ill.

For more data, circle 12-19-1 on coupon, p. 48

# How do you rope 5 watts of Power in a 2-watt sized Wirewound?



it's easy with  
**Centralab's**  
"Thermo-Pass"  
Insulation

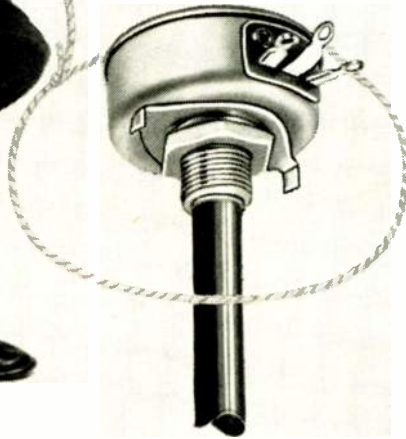

Nowadays all kinds of critters have Texas capacity with Rhode Island size. Tubes, relays, and many other components have gotten smaller without any sacrifice in performance.

Now it's true with wirewounds, too! CENTRALAB has corralled 5 watts of power in a 2-watt size wirewound . . . by using "Thermo-Pass" insulation. A control's rating and size depend on the speed with which heat can be transferred from the resistance element to the atmosphere. CENTRALAB "Thermo-Pass" insulation combines exceptional heat transfer with a dielectric strength of 4500 volts per mil at 25° C. Result: a conservatively rated 5 watt Radiohm control measuring only 1 1/2" in diameter and 9/16" in depth. They are available in values from 1 ohm to 100 K ohms.

Meanwhile, back at the ranch, you'll find this one small size taking care of your 2, 3, 4 and 5 watt replacements in tv, hi-fi, home and auto radio sets. Just make sure you use the wirewounds—short (Model WN) or long (Model WW) shaft style—that carry the  brand.

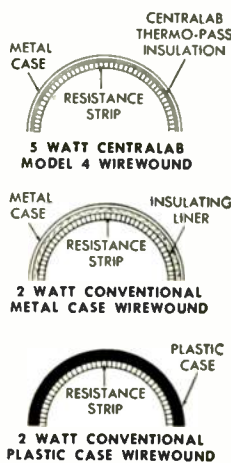

## Reps & Distributors

ERA announces the second annual convention will be held in the Ambassador Hotel, Los Angeles, Calif., February 1-4, 1961.

LOUIS A. GARTEN & ASSOC. has announced a move from West Orange into their own newly constructed building, 375 Passaic Ave., Caldwell, N. J.

LAND-C-AIR SALES CO. announces the opening of their new field office at 610 Washington St., Reading, Pa. with WALTER ULLRICH heading all activities at that office.

LAFAYETTE announces creation of a nation-wide chain of associated, franchised stores to distribute electronic parts, high fidelity components, and allied products, marking the first time distribution through associate stores has been undertaken in this field. Two new officers have been elected as follows: ROBERT LAUB, Vice Pres.-Sales; and JACK BREAK-IRON, Vice Pres.-Mail Order Operation.

SYLVANIA reports the opening of a sales office at 718 Bugbee St., Jacksonville, Fla. for Sylvania Home Electronics Corp., with BRUCE H. GARDNER as resident Sales Mgr. Other appointments include ROBERT J. PERRY as Sales Coordinator and RICHARD L. BERRY as Sales Mgr. Also announced is the appointment of the following franchised distributors for TV sets, radios, and stereo hi-fi phonos: REED RADIO & SUPPLY CO., southern Mo.; and HOUGH WYLIE CO., western N. C. and northern S. C.

(Continued on page 22)



"A condition like that could cause a lot of damage. Notice what happens when I touch it with my screwdriver."

# Centralab

B-6001 

Electronics Division of Globe-Union, Inc.  
902 M. E. KEEFE AVE. • MILWAUKEE 1, WIS.  
IN CANADA: 669 Bayview Avenue • Toronto 17, Ont.

CONTROLS • ROTARY SWITCHES • CERAMIC CAPACITORS  
PACKAGED ELECTRONIC CIRCUITS • ENGINEERED CERAMICS

For more data, circle 12-20-1 on coupon, p. 48

*"Here's the slickest reminder board I've ever used!"*

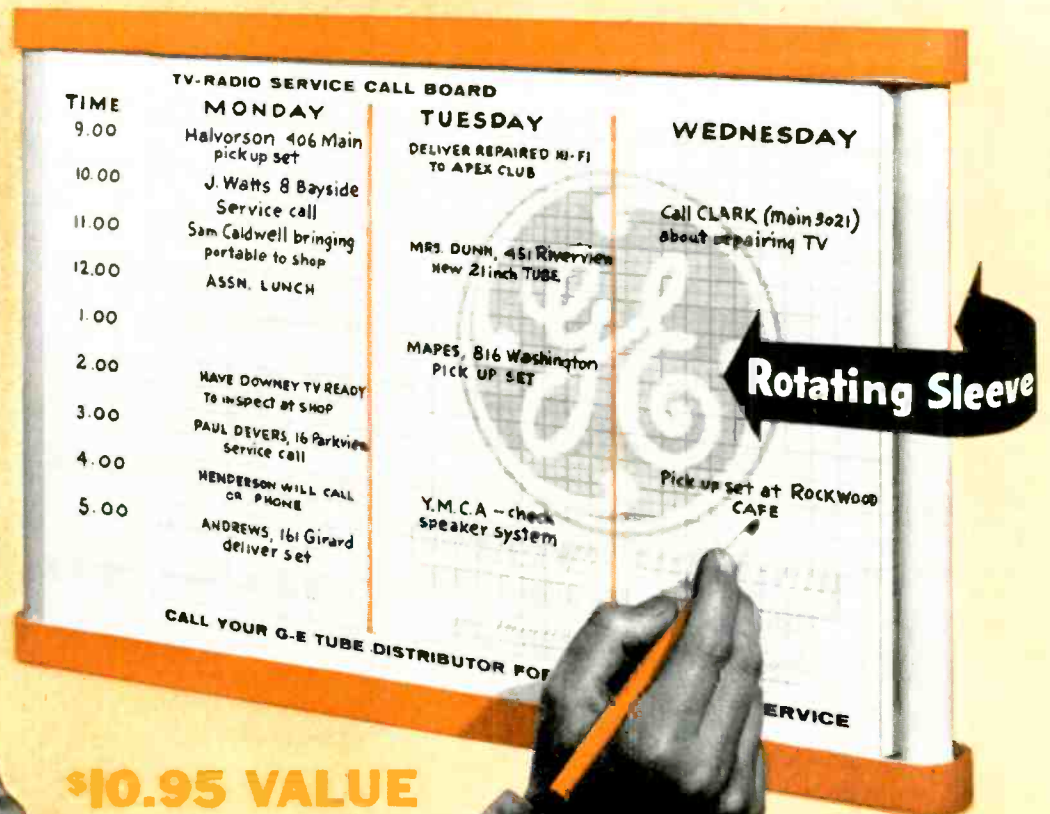

**\$10.95 VALUE**

**SHOWS WHAT'S HAPPENING—AT A GLANCE!**

This G-E Service Call Board makes it easy to keep track of jobs. You see at once what calls, pick-ups, and deliveries are to be made—when and where.

**BIG (21½" by 14")...EASY TO SEE AND USE!**

Entries are written on a rotating plastic sleeve with a marking pencil, and erased or changed quickly with the wipe of a cloth.

**ALWAYS UP-TO-DATE. HANDSOME, MODERN!**

The rotating sleeve is the real feature. As you turn it each day, all deadlines move up. No job is overlooked. See your General Electric tube distributor about your Service Call Board, or mail coupon at right to the Chicago warehouse address given. *Distributor Sales, Electronic Components Division, General Electric Company, Owensboro, Kentucky.*

*Progress Is Our Most Important Product*

**GENERAL  ELECTRIC**

311-405

- **ONLY \$5!** Schedules your service calls... pick-ups... deliveries... back orders... inventories... work assignments... sales. You'll want more than one Service Call Board. Order today!

General Electric Company, Dept. B  
3800 North Milwaukee Avenue  
Chicago 41, Illinois

Kindly ship me prepaid:

\_\_\_\_\_ Service Call Boards (ETR-2144) at \$5.00 each.

My check or money order is enclosed for the required amount plus any sales or use tax applicable in my area.

NAME \_\_\_\_\_

STREET ADDRESS \_\_\_\_\_

CITY \_\_\_\_\_ ZONE \_\_\_\_\_ STATE \_\_\_\_\_

# STEREO QUALITY SOARS TO NEW HEIGHTS...



Presenting the  
finest ceramic stereo cartridge  
ever perfected by Sonotone

## THE "PROFESSIONAL QUALITY" 9T!

Now, the ceramic cartridge proved in independent A-B listening tests to perform as well as the highest-priced "professional" types. It's Sonotone's revolutionary new 9T. So superior, you can expect faithful reproduction from the most robust musical passages to the most subtle overtones. Sonotone's new 9T series stereo cartridge:

**GUARANTEES** performance equal to cartridges costing up to 3 times as much—as proven in A-B listening tests.

**GUARANTEES** highest compliance—allows major reduction of tracking force.

**GUARANTEES** more than adequate channel separation.

**GUARANTEES** crisp definition.

**GUARANTEES** superior, more compact mechanical design—including revolu-

tionary new needle design with instant "snap-in, snap-out" replacement needle feature and built-in jewel tip protector.

**ELIMINATES** distortion—incredibly flat response of  $\pm 1$  db from 20 to 17,000 cps—cuts listening fatigue.

**ELIMINATES** dust pile-up—at recent trade show the 9T ran 4 straight hours, collected no dust.

**ELIMINATES** most record groove noise or hiss—no "needle talk".

Imagine, the 9T boasts all these "professional" features...yet sells for less than half the price of the least expensive "professional" cartridge. Simplify your inventory...cut call-backs—increase sales and profits—with Sonotone's great new 9T cartridge...unsurpassed for performance—and for value.

LIST PRICE:	9T-S...\$16.50 (0.7-mil and 3-mil sapphires)	9T-S77...\$16.50 (Two 0.7-mil sapphires)	9T-SD...\$19.50 (Sapphire-Diamond)
-------------	---	---	---------------------------------------

# Sonotone

ELECTRONIC APPLICATIONS DIVISION, ELMSFORD, N. Y. DEPT. C9-120  
IN CANADA, CONTACT ATLAS RADIO CORP., LTD., TORONTO

LEADING MAKERS OF



BATTERIES • CARTRIDGES • SPEAKERS • TAPE HEADS • MIKES • ELECTRONIC TUBES

For more data, circle 12-22-1 on coupon, p. 48

(Continued from page 20)

**HUTMACHER ASSOC.** reports W. H. "BILL" ELLINGER, JR. has joined the staff.

**GORDON MOSS ELECTRONICS** reports the opening of a new branch office at 1502 Preston St., P.O. Box 22, Foothills Sta., Salt Lake City 8, Utah. LEROY G. MOSS will serve as Branch Mgr.

**TERMINAL ELECTRONICS** and **HUDSON RADIO & TELEVISION CORP.** announce a merger to form **TERMINAL-HUDSON ELECTRONICS, INC.**, 236 W. 17th St., N. Y. C., with the following officers: WM. FILLER, Pres. and Chairman of the Board; SOL BAXT, Vice Pres. and a director; ROBERT CORENTHAL, Vice Pres.

**PACIFIC ELECTRONIC TRADE SHOW**, to be held next Feb. 26-March 1 at Los Angeles' Great Western Exhibit Center, has disclosed plans for an "Exhibitor Council for Show Development." The Council will be formed following the 1961 show, "for the purpose of expressing the manufacturers' needs and wishes with respect to the future development of the Pacific Electronic Trade Show."

## Check the MODERN STYLING you get in the RCA V-O-M with the Extras



- Big attractive 5 1/4" meter for better readability and visibility.
- Non-breakable plastic case and meter faceplate; no glass to crack or shatter.
- Orderly location of jacks below the switches keeps test leads out of the way.

See page 55 for the full story on this superlative value at only \$43.95\* \*User Price (Optional)



RCA Electron Tube Division, Harrison, N.J.

The Most Trusted Name  
in Electronics

RADIO CORPORATION OF AMERICA



Another outstanding product by the HIDDEN

**500\***

who plan for your future:



## TYPE TE LITTL-LYTIC® CAPACITORS



Transistors revolutionized the industry. And to make the most of their inherent advantages, they called for an entirely new group of components. Here, Sprague Research was the first to answer the call with the smallest truly reliable dry electrolytic made for transistor circuits—the Littl-Lytic. This reasonably priced capacitor is the most reliable subminiature you can buy for transistorized radios, hearing aids, wireless microphones, pocket wire recorders, and other miniature electronic equipment.

The remarkable reliability of Littl-Lytic is the result of a new manufacturing technique in which *all the terminal connections are welded*. Units are hermetically sealed and metal encased . . . *with no pressure joints . . . there are no "open circuits" with the passage of time*. Leakage current is extremely low as the result of the use of high purity foil and ultra-stable formation techniques. Sprague's catalog replacement ratings are the most comprehensive in the industry. They assure you of exact replacements to meet your day-to-day service requirements.

Littl-Lytic is a typical example of how Sprague Research keeps its products up-to-the-minute. Reliable components mean reliable service work—your business keeps pace with the electronic industry when you use Sprague.

\*The "Hidden 500" are Sprague's 500 experienced researchers who staff the **largest research organization in the electronic component industry** and who back up the efforts of some 6,000 Sprague employees working in 14 manufacturing operations—four at North Adams, Mass.; Bennington and Barre, Vt.; Concord and Nashua, N.H.; Lansing, N.C.; Grafton, Wis.; Visalia, Calif.; two at Ponce, Puerto Rico; and Milan, Italy.

don't be vague . . . insist on

**SPRAGUE®**

*world's largest capacitor manufacturer*

For more data, circle 12-23-1 on coupon, p. 48

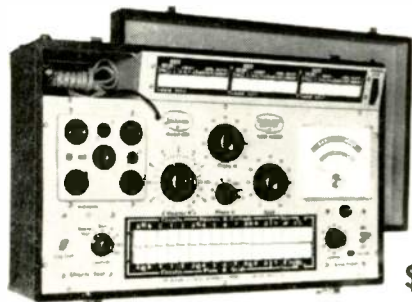

## TUBE TESTER

Model 658 Dynamic® Output Type  
Faster, more versatile, more accurate.  
Makes more tests than any other tube  
tester. Meets the needs of every engi-  
neer, lab technician and serviceman.

\$189.95 Net

## OSCILLOSCOPE

Model 600 Laboratory type, wide  
band/high sensitivity operation . . .  
for every industrial, scientific and  
service application. Has every per-  
formance feature of higher priced  
scopes.

\$335.00 Net



**ALL-NEW  
JACKSON INSTRUMENTS FOR  
PROTOTYPE DEVELOPMENT  
INDUSTRIAL MAINTENANCE  
COMPONENT TESTING**



## SINE/SQUARE WAVE OSCILLATOR

Model 605 Precision unit gives both  
sine and square wave output for ac-  
curate amplifier circuit checks in hi-fi,  
stereo, video and industrial lab appli-  
cations. 20 to 200,000 cycle range.

\$129.95 Net

## POWER SUPPLY

Model 607 Laboratory unit provides  
heater, Negative and regulated vari-  
able B voltages in one compact  
package.



\$79.95 Net

*Investigate these new Jackson instruments. See your  
electronic distributor . . . or write for literature.*



**ELECTRICAL INSTRUMENT COMPANY**

124 McDonough St., Dayton, Ohio

In Canada: The Canadian Marconi Co.

For more data, circle 12-24-1 on coupon, p. 48

## Catalogs & Bulletins

**AUTO RADIOS:** Literature covers na-  
tional service and distribution facili-  
ties for two new all-transistor au-  
tomobile radios. Vitrex, Inc., P. O.  
Box #10, North Miami Beach 62, Fla.  
For more data, circle 12-24-2 on coupon, p. 48

**TRANSISTORS:** STC Bulletin II-109 gives  
technical data, specifications and illus-  
trations for types 2N389 and 2N424 high  
power silicon transistors. Silicon Tran-  
sistor Corp., Carle Place, L.I., N.Y.  
For more data, circle 12-24-3 on coupon, p. 48

**RESISTORS:** Literature covers a new  
line of fixed composition resistors  
in ½, 1 and 2 watts. Range, from  
10 ohms to 22 megohms in all stand-  
ard E.I.A. values. U.S.A. made.  
Hamilton-Hall Electronic Specialties,  
227 N. Water St., Milwaukee 2, Wis.  
For more data, circle 12-24-4 on coupon, p. 48

**WIRE:** A colorful display card shows a  
complete line of UHF-VHF 300 ohm  
transmission wire. Actual samples of  
the various transmission lines are at-  
tached to the card, alongside a descrip-  
tion of the wire. Saxton Products, Inc.,  
4320 Park Ave., New York, N.Y.  
For more data, circle 12-24-5 on coupon, p. 48

**RECORD ACCESSORIES:** A new 16-page, 2-  
color, illustrated catalog, #15, shows  
a line of over 300 record and tape care  
accessories. Also covered: tape spli-  
cers and other accessories for indus-  
trial use; and a number of new prod-  
ucts such as the Syl-A-Scope for  
checking stylus wear. Applications,  
specifications and prices included. Ro-  
bins Industries Corp., 36-27 Prince St.,  
Flushing 54, N. Y.  
For more data, circle 12-24-6 on coupon, p. 48

**STEREO:** The booklet, "Guide to Custom  
Stereo," includes: room arrangements  
and decorating tips; an article on  
stereo components, what they are and  
how to select them; a section on kit  
building; and a section explaining how  
to read technical specifications, and  
how to rate one component against  
another. H. H. Scott, Inc., 111 Powder-  
mill Rd., Maynard, Mass.  
For more data, circle 12-24-7 on coupon, p. 48

**MICROPHONES:** A new 28-page general  
catalog, #60A, covers: more than 30  
microphone models; microphone acces-  
sories; hi-fi components; magnetic re-  
cording heads; and replacement phono  
cartridges. Also: the Dynetic line of  
cartridges, tone arms, broadcast equal-  
izer, and line pre-amplifier; and a  
separate section listing 21 models of  
ceramic and crystal pickup cartridges,  
20 pickup needle models, 3 cartridge  
replacement kits, and 16 magnetic re-  
cording head models. Shure Brothers,  
Inc., 222 Hartrey Ave., Evanston, Ill.  
For more data, circle 12-24-8 on coupon, p. 48

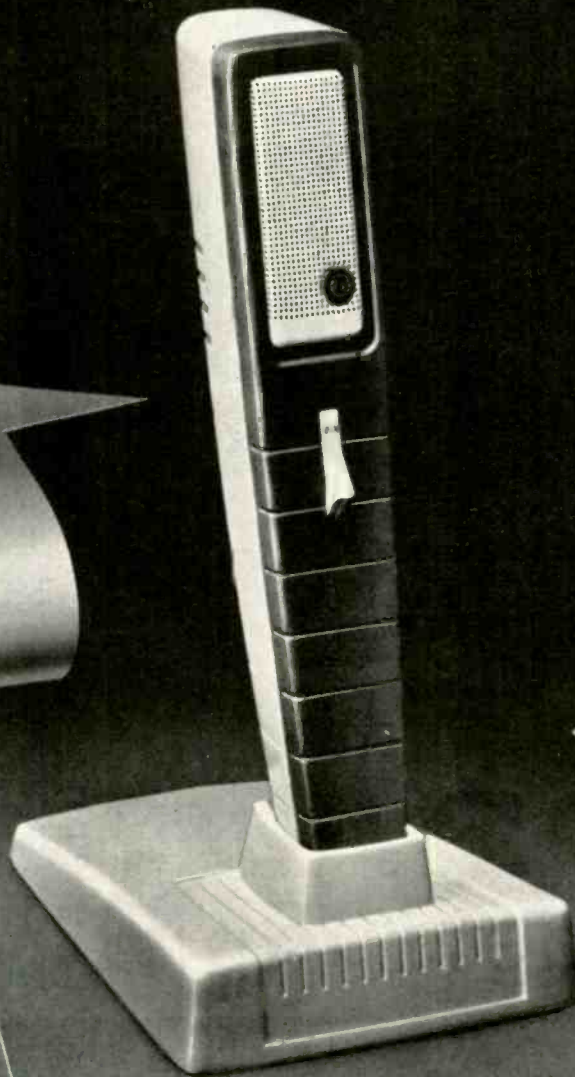

# SELECTIVE

**ELECTRO-VOICE'S MODEL 729 MICROPHONE reduces random room noise and reverberation by as much as 67%**

The Electro-Voice 729 cardioid microphone is the first low-cost microphone to offer the enormous advantages of a directional microphone and a virtually indestructible ceramic generating element. The ability to reject unwanted sound from the rear of the microphone permits better sound pickup and superior performance of associated equipment.

You get all this, and more, in the new E-V 729 at a list price of only \$24.50 with all trade discounts applying. The cardioid pickup pattern of the 729 dramatically reveals the greatly increased distance at which you can work from the microphone. It is virtually dead from any sound pickup from the rear, removes annoying room reverberation, and assures excellent microphone pickup even in the hands of inexperienced users. Response is peak-free, and the high output is ample for use with all

preamplifiers, tape recorders, public address microphones, communications equipment and similar equipment.

The generating element is indestructible ceramic, guaranteeing years of efficient operation in any climate and under wide variations of temperature and humidity. The 729 feels good in the hand; instantly lifts out of desk stand (supplied with microphone) without any hardware adjustment. A plug-in floor stand adapter is supplied also with each microphone. Built with E-V's traditional quality, the 729 is guaranteed satisfactory or your money back.

***Electro-Voice***<sup>®</sup>  
Commercial Products Division  
ELECTRO-VOICE, INC.  
Dept. 12T Buchanan, Michigan

For more data, circle 12-25-1 on coupon, p. 48

# RECTIFIER PERFORMANCE THAT PLEASURES CUSTOMERS



## TARZIAN TUBE REPLACEMENT SILICON RECTIFIERS

Tarzian's 9 standard models of tube replacement rectifiers are directly interchangeable with over 95% of all popular vacuum tube rectifiers. An added plus is the new Sarkes Tarzian Full Wave Silicon Rectifier (S5347), replacing 6BW4 or 12BW4 in Citizen's Band radios where maximum performance in reception quality and range is desired.

## TARZIAN SILICON RECTIFIERS (PLUS CONVERSION KITS)

Sarkes Tarzian silicon rectifiers are made in production quantities by a special Tarzian process that provides optimum forward to reverse ratios, extremely low voltage drop, high reliability and long useful life. Compact conversion kits are available for both the M-150 and M-500 units.

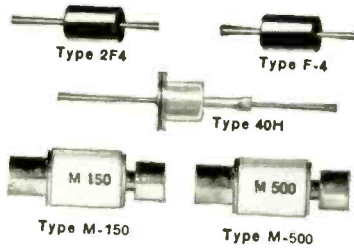

## TARZIAN "CONDENSED-STACK" SELENIUM RECTIFIERS

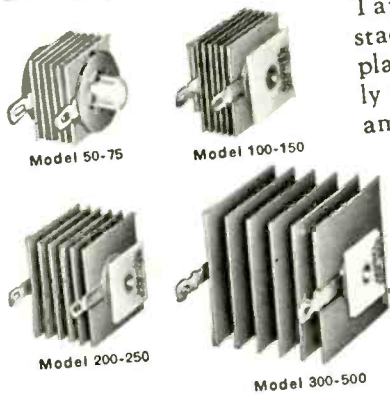

Tarzian's four "condensed-stack" selenium rectifiers—replacing the 20 types that formerly made up the 50 to 500-milli-ampere line—not only cover your selenium rectifier needs, but their small size eases both your application and inventory problems. Improved production processes have substantially reduced watt losses by as much as 50%.

### Tarzian "Distributor Line" Rectifier Catalog

• The new "Distributor Line" Rectifier Catalog is now available on request. It contains complete details on ratings, dimensions, electrical specifications. For additional information write Section 554C.



### SARKES TARZIAN, INC.

World's Leading Manufacturers of TV and FM Tuners • Closed Circuit TV Systems • Broadcast Equipment • Air Trimmers • FM Radios • Magnetic Recording Tape • Semiconductor Devices  
**SEMICONDUCTOR DIVISION • BLOOMINGTON, INDIANA**  
 In Canada: 700 Weston Rd., Toronto 9 • Export: Ad Aurlema, Inc., New York  
 For more data, circle 12-26-1 on coupon, p. 48

(Continued from page 24)

**TOOLS:** A 72-page, full-color catalog lists almost 800 tool items, from acid core solder to wrenches. Includes combination tool sets, bubble-packed carded items, promotional tool deals, etc. Hi-Test Premier Products, Inc., 361 Broadway, New York 13, N. Y. For more data, circle 12-26-2 on coupon, p. 48

**TUBES:** Announced is a "New Tube Information Service" covering data on new tube types as they are announced by the tube manufacturers. Issued every 3 months, this service includes complete tube charts in January and July; supplemental data in April and October. Annual subscription of four issues, \$2.50 per year, or \$1.50 for individual copies. Send your order direct to B&K Mfg. Co., 1801 W. Belle Plaine, Chicago 13, Ill.

**SEMICONDUCTORS:** Over 800 semiconductor devices are covered in a 24-page short form catalog. Ratings, characteristics and descriptive data are provided on silicon glass diodes; silicon small power, medium power and high power rectifier cells; high voltage cartridge rectifiers, zener diodes and others. Also a comprehensive listing of JEDEC rectifier types. Write, on your letterhead, direct to International Rectifier Corp., 1521 E. Grand Ave., El Segundo, Calif.

## Check the TECHNICAL ADVANTAGES you get in the RCA V-O-M with the Extras

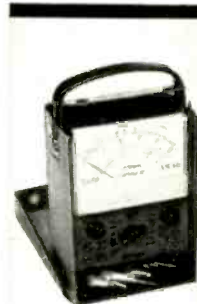

- 20,000 ohms-per-volt meter movement
- Clearly marked db scales; no squinting to read results
- Special 1-volt and 0.25 volt (full-scale) ranges dc
- 3% accuracy on dc
- 5% accuracy on ac

See page 55 for the full story on this superlative value at only \$43.95\* \*User Price (Optional)



RCA Electron Tube Division, Harrison, N.J.

The Most Trusted Name in Electronics

RADIO CORPORATION OF AMERICA

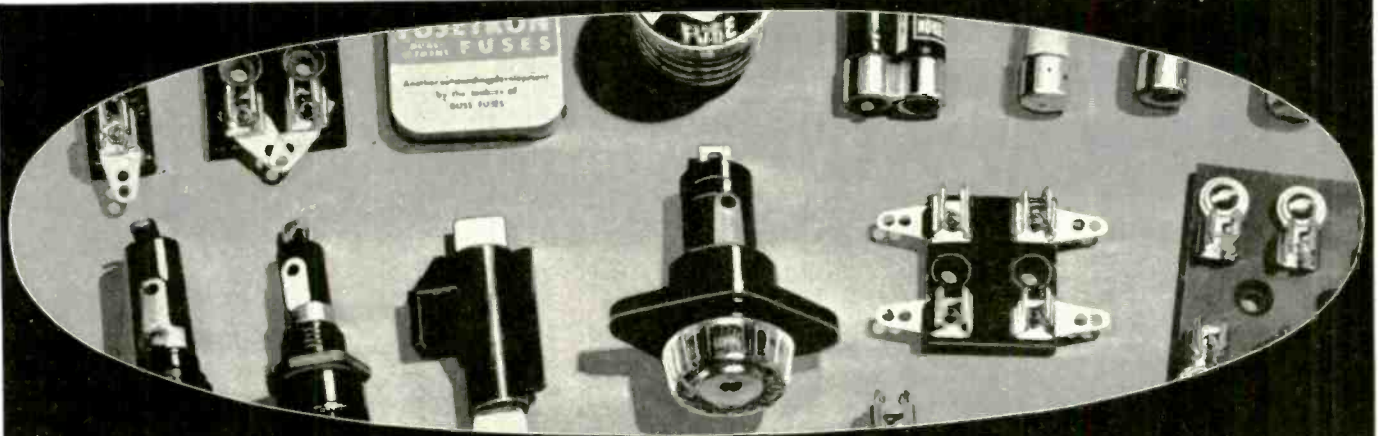

**You'll save time, trouble..**

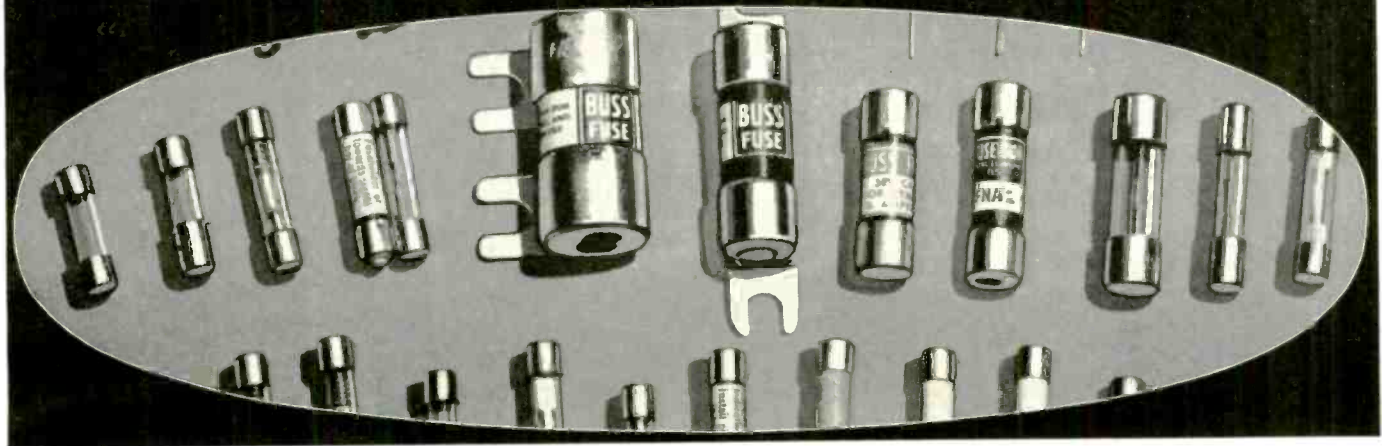

*... by turning **FIRST** to **BUSS** for fuses of unquestioned high quality*

By relying on BUSS as your source for fuses, you can quickly and easily find the type and size fuse you need. The complete BUSS line of fuses includes: dual-element "slow-blowing", single-element "quick-acting" and signal or visual indicating types . . . in sizes from 1/500 amp. up — plus a companion line of fuse clips, blocks and holders.

**BUSS fuses are made to protect —not to blow needlessly**

When you install BUSS fuses — you are sure your customers receive maximum protection against

damage due to electrical faults. And just as important, your customers are safeguarded against irritating, useless shutdowns caused by faulty fuses blowing needlessly.

It pays to rely on dependable BUSS fuses because there are no 'kicks' or complaints from users about their operation . . . and you avoid costly, unnecessary call-backs.

**Capitalize on the BUSS trademark**

The universal trade and consumer acceptance of BUSS fuses

is based on the millions upon millions of BUSS fuses used in homes, on farms and in industry over the past 46 years. Handling BUSS fuses — and other KNOWN items — helps safeguard your reputation for service and quality.

*For more information on BUSS and Fusetron small dimension fuses and fuseholders . . . Write for bulletin SFB.*

BUSSMANN MFG. DIVISION,  
McGraw-Edison Co.  
University at Jefferson, St. Louis 7, Mo.

1260

**BUSS fuses are made to protect - not to blow, needlessly.**

*BUSS makes a complete line of fuses for home, farm, commercial, electronic, electrical, automotive and industrial use.*



For more data, circle 12-27-1 on coupon, p. 48

# *silhouette of satisfaction*



## ALL-NEW HIGH-FIDELITY CUSTOM TURNTABLE

The dramatic shadow of the V-M extra-long, dynamically-balanced, feather-light Tone Arm signifies impending thrilling performance. Structural perfection and superb musical reproduction are here embodied in a fine High-Fidelity Turntable at a reasonable price. Here, truly, is the silhouette of a sparkling symphony in customer satisfaction . . . in greater profits for you.

*these many "customer-benefit" features benefit YOU!*

- DIAMOND NEEDLE • STEREO CARTRIDGE • MICRO-PRECISION TURNTABLE BEARING SYSTEM WITH TEFLON THRUST BEARING • REMARKABLE V-M IDLER RETRACTION FEATURE • QUIET OPERATION • PLAYS ALL FOUR SPEEDS • SPECIAL V-M 45 RPM INSERT SPINDLE

V-M/Model 1580 in Beautiful Two-Tone Brown with Gold Trim — AMAZINGLY PRICED AT JUST . . . . . \$35.00 List\*

\*Slightly Higher West

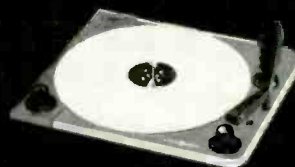

**CALL YOUR V-M REPRESENTATIVE NOW!**

the **V**oice  of **M**usic<sup>®</sup>

V-M CORPORATION • BENTON HARBOR, MICHIGAN



# ELECTRONIC TECHNICIAN

Including  
**SERVICE**  
Magazine

## *Something New Added*

Readers who have developed the habit of turning this page to find the "Tuning In the Picture" section are in for a bit of a surprise. You will find a new feature, one which should prove of great value to service technicians—"Television Manufacturers Technical Digest." It will bring you the latest revisions, circuit modifications, and service data right from the horse's mouth, the manufacturer of TV and radio receivers. This new monthly section will complement the basic schematic data published in Circuit Digests.

For faithful readers of Tuning In, we are happy to report that it is still with us, moved forward to page 12.

## *Licensing Survey*

Next month we will publish the results of the licensing "Election," based on the pro and con ballots cast by ELECTRONIC TECHNICIAN readers.

This study is most important because there has been so much contention within the industry over the licensing attitude of service technicians and dealers. Furthermore, the study will break down licensing attitudes according to the locations and situations of those replying. Watch for it next month.

## *Season's Greetings*

This has been a most hectic year for us, and no doubt for you too. The entire ELECTRONIC TECHNICIAN staff wishes to express its appreciation for your continued interest, and to wish you and yours a happy holiday and good health and success for the coming year.

← For more data, circle 12-28-1 on coupon, p. 48

# TV MANUFACTURERS

## DELCO RADIO

### 1960 Auto Radios—Intermittently Weak, Stations Drift

Some early production 1960 auto radios used square, green-colored compensating capacitors which, in some instances, were intermittent. In addition to causing intermittently weak stations, stations also shift frequency towards the low end of the band. The  $0.000220 \mu\text{f}$  capacitor is located under the small metal shield which mounts on top of the dual trimmer. It can be reached by removing the

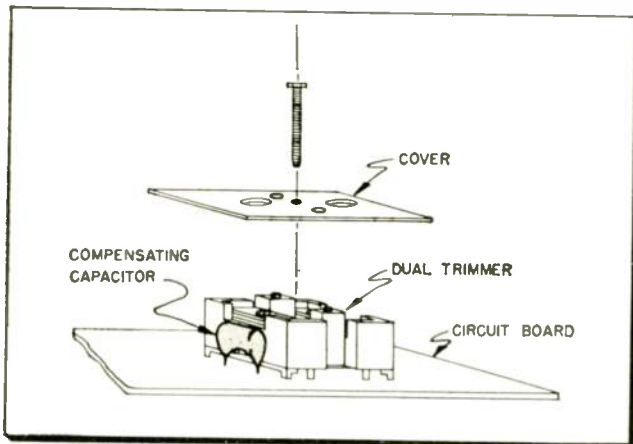

Physical location of Delco  $220 \mu\text{f}$  compensating capacitor which may cause intermittently weak and shifting stations.

plate over the trimmer (see drawing).

This defect is an elusive one; even heat from a soldering iron will not break down the capacitor, in most cases. It just seems to break down by itself. When it is out, though, shunting another one across it will restore operation. Delco advises: if a 1960 intermittent complaint has a history of intermittent weak condition with oscillator drift and the radio has a green compensating capacitor (a dark brown-colored one which didn't exhibit any defects was also used), better change it.

## GENERAL ELECTRIC

### Chassis M575—Replacement Yoke Adjustment

Two pin-cushion correction magnets are assembled to the replacement yoke flange in easily removable plastic holders. Proper placement of these mag-

nets will provide several degrees of correction:  
*For maximum correction*—mount magnets on front side of flange.  
*For no correction*—remove and discard magnets and holders.  
*For moderate correction*—mount magnets on rear side of flange.

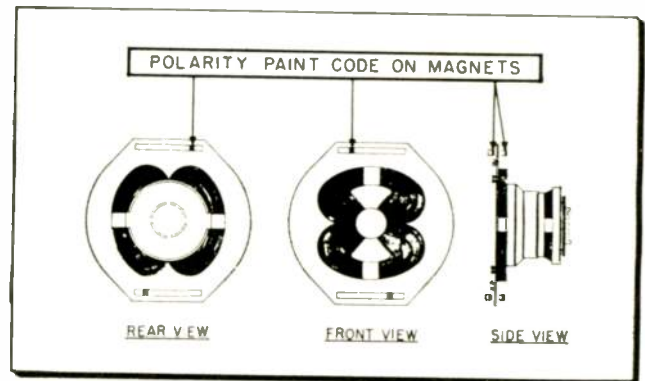

G-E pin-cushion correction magnets mounted on a replacement yoke must be mounted in their plastic holders with correct polarity, as indicated by red paint at one end.

The degree of correction needed can be determined by viewing the top and bottom of the raster with the vertical size reduced inside the mask opening. It is important that the magnets be mounted with correct polarity as indicated by the red paint at one end (see illustration).

## MAGNAVOX

### 19 & 27 Series Chassis—Vertical Shrinkage

A possible source of vertical shrinkage is the change of capacity in C502 ( $0.15 \mu\text{f}$ ) because of heat from the nearby 12R5 tube. To correct this condition, a heat shield made of asbestos may be placed between the tube and capacitor or wrapped around the body of the capacitor.

## PACKARD BELL

### Chassis V8-2, -4, -5—Silicon Rectifier Failure

Because of voltage surges, some silicon rectifiers have failed in these chassis. New silicon rectifiers



# TECHNICAL DIGEST

of the solder-in variety now replace the snap-in rectifiers. If replacement is necessary, *both* rectifiers should be changed to the new type. Be sure to

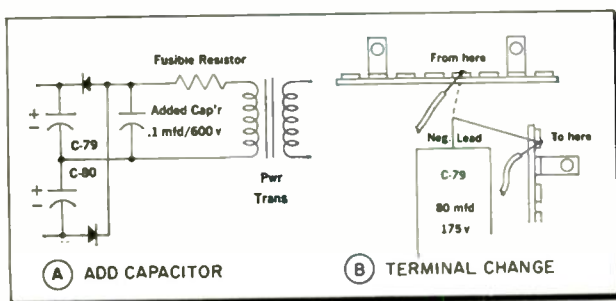

Some Packard Bell silicon rectifiers have failed due to voltage surges. Use the new solder-in types when replacing. Other changes for rectifier protection are shown in (A) and (B).

observe proper polarity. The following changes are also necessary: (A) Add a 0.1  $\mu\text{f}/600\text{ v.}$  capacitor across the power transformer's secondary, on the output side of the fusible resistor (see illustration). This will protect rectifiers from any high transient voltages. (B) To prevent possible arcing from the yoke lead back through the rectifiers, the negative lead of C-79 (80  $\mu\text{f}/175\text{ v.}$ ) and the lead it connects to should be moved as shown.

## PHILCO

### Chassis 11N51—Bad Connection Causes Ringing

A distributor service manager reported a perplexing case of an 11N51 receiver exhibiting excessive horizontal ringing. The ringing was due to a 1000 ohm resistor, located on the rear of the yoke socket, changing in value due to excessive current. This was caused by a bad pin connection of the yoke plug with the yoke socket.

The horizontal yoke is wired into pins P3, PX, and P8, as the schematic indicates. In this case, pin 8 was not making good contact. To eliminate a future problem, Philco suggests that all three socket pin connections be checked and adjusted. This can be done by inserting a soldering aid or any sharp pointed instrument between the metal connector and the outside shell of the hole in the yoke socket and pushing the metal towards the center of the hole. In other words, making the metal loop smaller to insure good contact with the male plug.

If the 1000 ohm resistor is damaged, it should be replaced. Since this component is located on the rear of the yoke socket, the chassis must be removed and the high voltage cage's four drive screws removed. Two screws holding the HV cage to the HV transformer bracket are then removed. Bend the cage towards the front of the chassis and replace the defective resistor on the yoke socket.



Horizontal ringing in a Philco 11N51 chassis was due to a changed-value 1000 ohm yoke resistor shown in the insert. The resistor is physically located on the rear of the yoke socket, which is secured to the high voltage cage. Chassis must be removed to change it. The resistor could change value because of bad yoke female contacts P3, PX, or P8.

## WESTINGHOUSE

### Chassis V-2374, 5, & 7 Series—5CL8A Tube

If trouble occurs in the "sound" or "vertical" circuit of these chassis, and a 5CL8A tube replacement is necessary, *do not substitute* a 5CL8. The replacement should either be a 5CL8A or 5FV8 tube.

A 5CL8, when used in place of a 5CL8A in these chassis, can cause severe hum in the sound and/or vertical foldover.

# NEAR— The National Emergency Alarm Repeater System



Fig. 1—The NEAR system receiver plugs into a standard double wall outlet just like a lamp. Manufactured at the AC Spark Plug Div. plant in Flint, Mich., it emits a loud warning buzz when activated.

*Home Electro-  
Mechanical Alarm,  
Triggered By Signal  
On A-C Power Line,  
Gives Disaster  
Warning*

## Introduction To NEAR

**Q. What is NEAR?**

A. The National Emergency Alarm Repeater system developed to alert as many people as possible to a danger within one minute.

**Q. Will this system supplant sirens?**

A. No. Sirens provide outdoor alert coverage in many areas. NEAR provides indoor coverage, especially needed in suburban and rural areas.

**Q. How does it operate?**

A. A three-inch box, plugged into a standard wall outlet, emits an alarm when activated by a 240-cycle voltage transmitted over the regular 60-cycle power lines.

**Q. What will it cost?**

A. In mass produced quantities—between \$5.00 and \$10.00. Average power consumption cost is \$0.50 per year.

**Q. Is it ready for production?**

A. Yes, though a certain amount of tool-up time is required. Installed nationwide, with a "crash" program, the system could be operative in two years.

**Q. Who will control its operation?**

A. The Federal Government through the Office of Civil and Defense Mobilization.

• It's just a little black box that plugs into any standard electrical outlet—yet it holds the solution to a serious national defense problem: how to issue an alert warning *inside* millions of American homes, schools, factories, and offices, as a supplement to outdoor sirens. Many outdoor sirens don't reach suburban and rural areas.

The "little box" shown in Fig. 1 is one of the basic components in the NEAR system (abbreviated title for the National Emergency Alarm Repeater system recently developed). It is the receiver or alerting device that warns listeners of an enemy attack. The device is activated by a special signal carried through the regular community power system.

The search for such a system started in 1952. The final choice had some stringent goals: (1) Absolute reliability. (2) Available to everyone, 24 hours a day. (3) Economical. The NEAR system, of course, closely fulfills these requirements. In addition, the system can conceivably be used for local warnings, such as tornadoes, floods, or any other type of disaster.

### Operation

Different transmission methods were explored, including: telephone lines, radio, and power lines. The latter method, power lines, was selected. Investigation revealed that electric power lines reach 96% of the population (99% in critical defense areas), while telephones cover only 73% of the population. Although millions of families own radios, only a small percentage (8%) have it on at a given moment.

Saturable reactors at power stations are used to generate a fourth harmonic of the regular 60 cps current. The ensuing 240-cycle signal can be transmitted over regular power lines without interfering with the flow of commercial power.

To send a signal throughout the nation a master station and a network of repeaters must be used. Between 400 and 600 signal-generating stations, strategically placed, can cover the United States. This cost is approximated at 50 million dollars.

Following the coded signal, each

generator will produce the necessary signal to activate home receivers. The "little box" receiver responds to the 240 cps signal by emitting an audible alarm loud enough to be heard throughout a typical two or three bedroom home.

### NEAR Receiver

A NEAR receiver simply plugs into a standard wall outlet in the same manner as an electric iron or toaster. An orange glow from a neon lamp indicates that the a-c line voltage is being applied and is normal. Mechanical support of the receiver, insuring that it doesn't fall out of the outlet, is accomplished by securing the unit to the outlet's cover plate with a screw.

The receiver, shown in Fig. 2 with its cover removed, must have adequate sensitivity to detect a one-volt, 240-cycle signal for more than ten seconds. To compensate for some loss of sensitivity due to aging of components, the receiver is made to function on 0.6 to 0.8 volts. The one-volt threshold signal represents a signal-to-ambient noise ratio of about 5 to 1, thereby aiding in the prevention of false triggering. (A time-delay of 10 seconds between detection of the 240-cycle signal and actuation of the alarm is sufficient to detect false spasmodic signals, such as lightning and other similar transients.)

The 240-cycle NEAR signal is

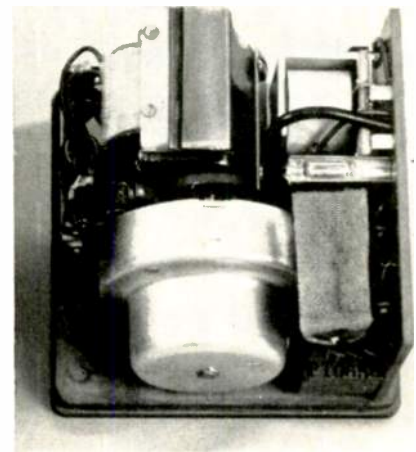

Fig. 2—NEAR receiver with cover removed.

partially detected by the L-C series-resonant circuit connected across the a-c line (see Fig. 3). This circuit draws approximately 2.5 watts when on stand-by. It is estimated that operation of the receiver will only cost the average family \$.50 per year (less than an electric clock's cost).

When a signal voltage appears, the magnetic flux of the inductor causes a mechanically-resonant reed to vibrate. The vibrating reed intermittently closes a contact. Power is taken from the 60-cycle line through the reed contact, is rectified by a diode, causing a sensitive d-c relay to close. The closed

(Continued on page 65)

Fig. 3—Schematic of a NEAR receiver. The capacitor-inductor across the line resonates to 240 cps.

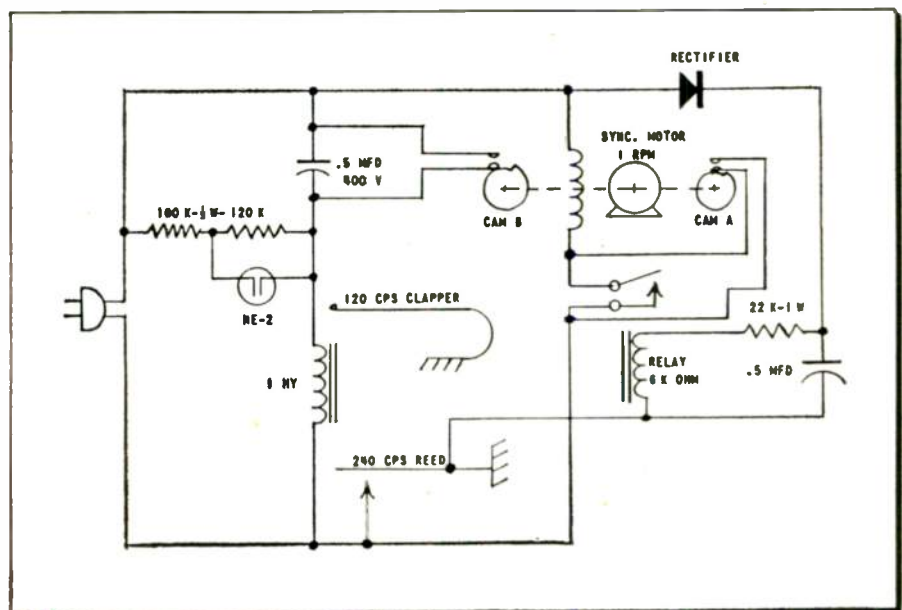

# Troubleshooting TV Hi-Voltage Rectifier Circuits

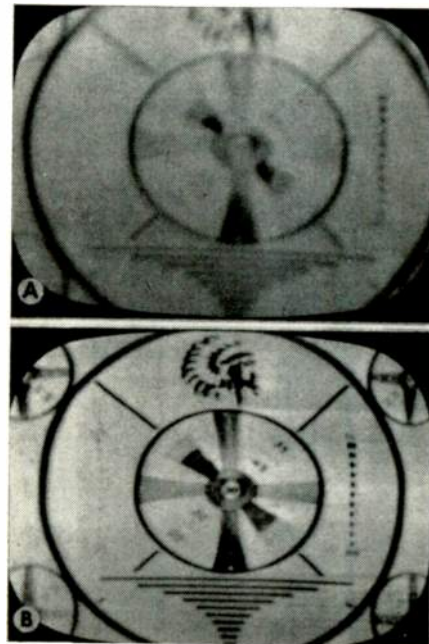

Fig. 1 (A)—Out-of-focus "blooming" picture caused by fault in HV rectifier circuit. (B)—Normal picture after fault is corrected.

## Techniques For Locating & Correcting "Blooming," Decreased Brightness, Unstable Picture, And Other Rectifier Faults.

PERRY SHENEMAN

• High voltage rectifier faults are frequently the direct cause of decreased brightness, blooming, poor focus, excessive size, poor picture quality, in addition to a complete loss of raster. Furthermore, an occasional "tough dog", poor sync, unstable picture, or "noisy" sound problem can arise directly from HV rectifier circuit faults. A "blooming", expanded, out-of-focus picture caused by a HV rectifier defect is shown in Fig. 1A, compared to a normal picture shown in Fig. 1B.

High voltage appearing in the rectifier circuit employed in TV sets is a combined chain-result of various preceding and associated circuits. Failure or below average operation in any of these circuits can naturally be reflected in a decrease or complete loss of high voltage. Hi-voltage rectifier circuits, however, have their own par-

ticular problems, distinct from those arising in preceding or associated circuits.

Disregarding infrequently used voltage doubler and tripler circuits, most TV sets manufactured today employ a simple half-wave hi-voltage rectifier circuit, basically similar to that shown in Fig. 2. Rectifier tube types used may be the 1B3, 1G3, 1J3, 1K3, 1X2, or 1AX2. Color sets generally have a 3A3 rectifier with some form of voltage regulator.

In addition to a special hi-voltage tube socket and well insulated 2nd anode cable, other components may include a tube heater current-limiting resistor (R-1 Fig. 2), filter capacitor (C-1 Fig. 2), and a filter resistor in series with the 2nd anode lead (R-2 Fig. 2). Current limiting resistors may vary from approximately  $\frac{1}{2}$  to 8 ohms, rated from 1 to 2 watts. Depending upon circuit design, the filter resistor can be from 1k to 2 megohms, with similar or higher wattage rating. Hi-voltage filters are usually 500

$\mu\text{f}$  capacity, rated to withstand 20kv or higher. When no filter capacitor is provided in the rectifier circuit, or when additional filtering is desired, the inside and outside CRT colloidal graphite aquadag coatings may provide filtering. In this case it is important for the CRT's outside dag coating to be well grounded.

Preceding and associated hi-voltage circuits provide from 12,000 to more than 20,000 a-c volts to the hi-voltage rectifier plate. As we already know, frequency of this pulsed voltage is the same as the horizontal sweep rate—15,750 cps.

### Preliminary Tests

Recognizing that CRT brightness varies with electron beam velocity, and that this speed is primarily determined by the amount of voltage applied to the CRT's 2nd anode (inner dag coating), we are well on the way to solving our rectifier problems. Obviously, the symptoms previously mentioned are all

related—or varying in degree. Thus, a simple, systematic, straight-forward approach is easily possible.

When servicing sets in the home, some technicians use a neon lamp attached to a length of plastic rod for a rapid check to determine the presence or absence of high-voltage. The gas within a low wattage neon lamp (NE-2, NE-51, etc.) will light up in close proximity with r-f. If the high voltage circuit is operating, the lamp will glow at the damper tube's high side, plate cap of the horizontal amplifier, high voltage rectifier, and anywhere around the output and rectifier tubes, and along leads connected to these points.

After making this test with the neon lamp, however, the technician has only proven the *presence* or *absence* of r-f in the circuit. Actual voltage being applied to the CRT 2nd anode is still unknown.

Another practice is to draw an arc from the high voltage rectifier cap and CRT 2nd anode. This, like the neon lamp test, provides no precise information concerning actual anode potential. Furthermore, if a spark is jumped to chassis from the 2nd anode lead, abnormal stresses are placed on the high voltage circuit and may cause breakdown of good components. In addition, this is a dangerous procedure.

When carried out with caution, however, considerable information can be obtained by drawing an arc from various points with a screw driver having a well insulated plas-

tic handle. For example, suppose rapid checks indicate that some r-f exists at the fly-back output—but no raster appears on the CRT screen after the brightness control is turned up. A screw driver tip is placed very near the HV rectifier plate cap. If only a small arc jumps to the screw driver, or no arc jumps, and only a small spark appears at the cap when it is touched momentarily with the screw driver tip, the next step is to remove the fly-back lead clip from the rectifier plate cap.

The screw driver tip is now placed near the metal fly-back lead clip. If a husky arc can now be drawn, the rectifier tube should be changed. If no arc and very little spark appears with the lead removed, the trouble is not in the HV rectifier section.

If the raster still does not appear after the rectifier tube is replaced, the tube should be removed and if it feels at all warm the filter capacitor can be defective. The 2nd anode cable can be leaking to ground, especially around any spring-wire dressing support or at a metal feed-thru point. Metal CRT's sometime leak to ground. Leakage can also occur between inner and outer dag coatings by (a) heavy carbonized dust accumulation at the CRT 2nd anode connection, or through contaminated rubber cup, and (b) in rare cases through glass impurity flaws. If the rectifier tube is not defective the set would generally be taken to the shop where it can be given ade-

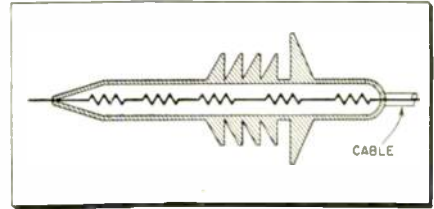

Fig. 3—Simplified cut-away view of a d-c multiplier probe for HV rectifier output measurements. Probes may be designed with a ratio ranging from 5 to 100-to-1 for VOM's, and 30 to 100-to-1 for VTVM's.

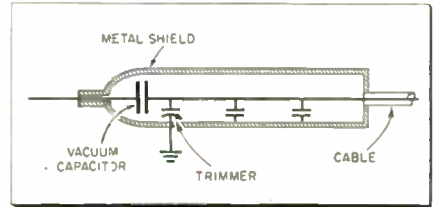

Fig. 4—An a-c HV probe can be used to measure input voltage to a HV rectifier and for observing a-c HV waveforms on scope. Usually designed with a 100 to 1 ratio, series capacitors divide voltage between them. Probe is not suitable for accurate voltage measurements at low a-c frequencies.

quate attention with equipment not normally carried into the home.

### Advanced Techniques

Capacitive-divider a-c probes are available for voltage measurements at the HV rectifier plate (or flyback output), or for observing HV waveforms on a scope. A simplified schematic of an a-c probe is shown in Fig. 4. These probes are generally constructed with a ratio of 100 to 1, or higher. The low input capacitance employed in the probe is a HV vacuum type. A trimmer capacitance is included for calibration purposes.

D-c potential across the output side of the filament of the high voltage rectifier tube and B minus or ground, will vary from approximately 10kv for small screen portables to beyond 20kv for color sets. To quickly locate the cause of HV-rectifier faults it is absolutely essential to measure the anode voltage if valid and useful information is to be obtained. Measurements must be made under load, with the 2nd anode lead from the rectifier circuit connected to a CRT. If not, adequate equivalent load must be provided. Voltage information can

(Continued on page 56)

Fig. 2—A d-c high voltage probe is used with a VTVM or VOM for measuring voltage at the HV rectifier output. 2nd anode voltage should be measured with connector attached to CRT.

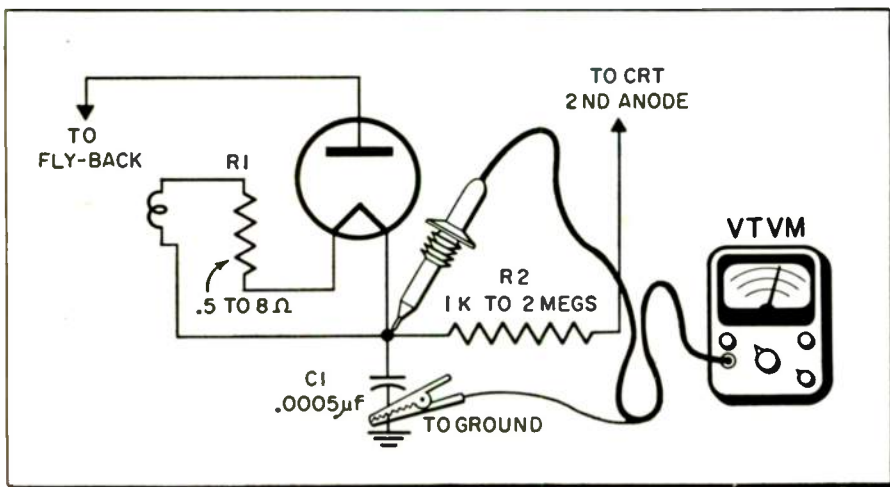

# Understanding Audio VU Meters

*How They Work, Applications,  
And Interpreting Meter Readings*

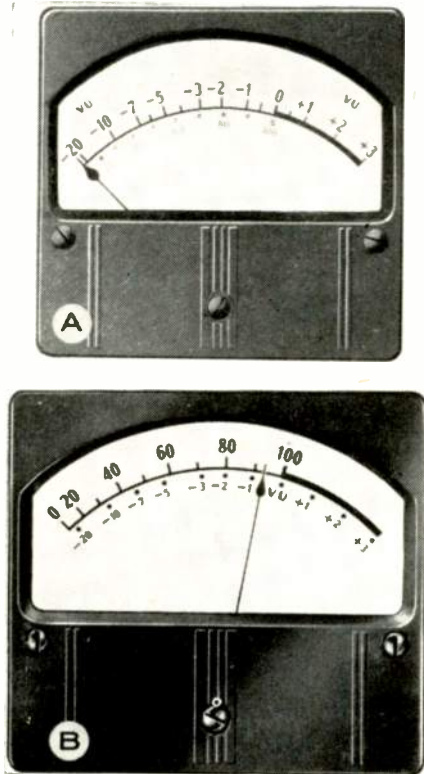

Fig. 1 (A)—Type "A" VU meter has an enlarged volume units scale. (B)—Percentage scale is emphasized on the type "B" VU meter.

HERMAN BURSTEIN

• Audio level indicating meters in tape recorders were almost entirely confined to professional instruments until recent years. Now they are being employed in an increasing number of semi-professional instruments as well as in quality "home" types suited to high fidelity applications.

Two types of audio indicating meters are generally used in tape recorders, as shown in Fig. 1. The type A scale (Fig. 1A) features a VU (volume units) or db scale above, and percentage of modulation scale below. The type B scale (Fig. 1B) is marked with the percentage scale above and VU or db unit scale below. The meter contains a 50 microampere d-c movement and a full wave copper oxide rectifier.

The "0" point on a VU meter scale is an arbitrary reference level. One milliwatt of power through a 600 ohm resistance will cause a VU meter connected directly across the resistance to read "0" VU. However, the VU meter is intended to be used in series with a 3,600 ohm resistor, as shown in Fig. 2. An addi-

tional 3,900 ohms is represented by the meter movement, the rectifier, and a resistor within the meter housing. Thus, total load presented by the meter circuit is 7,500 ohms. When used in series with a 3,600 ohm resistor, 2.5 milliwatts of pow-

er in a 600 ohm line are needed to drive the meter to "0" VU. This translates into a driving requirement of 1.23 volts.

## Advantages

Audio level indicating meters have a number of distinct advantages over visual indicators. For example, the meter can accurately indicate, plus or minus, the recording level producing maximum permissible distortion. It allows proper adjustment of recording level from a particular sound source to obtain the best combination of high signal-to-noise ratio and low distortion. The meter also provides a means of riding the gain constantly, if desired.

The VU meter is a relatively uniform product, and if replaced the new meter provides essentially the same indications. It remains stable over operating time; is highly sensitive and therefore has low driving requirements.

In addition to serving as a record level indicator, it can also be used to check the record head a-c bias level. This is a decided advantage since excessive bias reduces distor-

Fig. 2—Standard method for connecting a VU meter level indicator is across a 600 ohm line with 3,600 ohms in series.

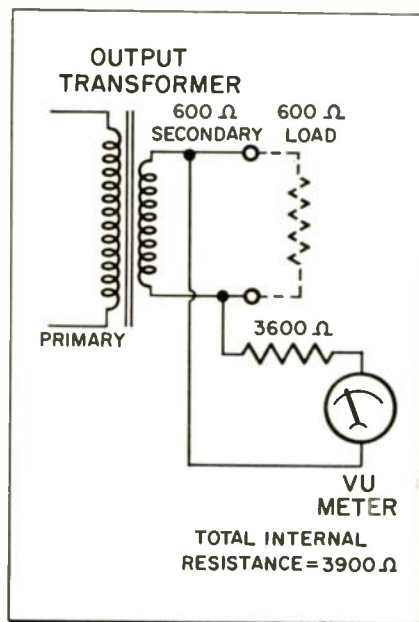

tion but attenuates treble response, while too little bias has the opposite effect. Optimum bias value is fairly critical, especially at speeds below 15 ips. When a switching arrangement is used (see Fig. 3), the VU meter can measure bias through the record head. Voltage is measured across a resistor in series with the record head, and a calibrating resistor is employed so that optimum bias corresponds to a specific point on the meter, usually "0" VU. The meter can also be switched, as in some professional tape instruments, to measure oscillator current through the erase head.

Playback levels, often important in professional applications, can also be measured with the VU meter. As we already know, if the output level is too low in these applications, there may be interference from adjacent audio lines carrying higher level signals. A high level playback may also produce crosstalk on other audio lines, or cause distortion or unnecessary compression in associated line amplifiers.

When connected as shown in Fig. 2, the VU meter exhibits certain characteristics which enables the practiced operator to properly interpret and rely upon its readings. For example, when a sine wave of 2.5 milliwatts is suddenly introduced in the line, overshoot would normally be between 1 and 1.5%. The pointer should read 99 on the percentage scale within 0.3 seconds. Frequency response will generally be within  $\pm 0.2$  db, between 35 and 16,000 cps. Harmonic loading distortion should not exceed 0.2%. The meter can normally withstand 10 times normal voltage overload for half a second, and 5 times normal overload continuously.

High sensitivity of the VU meter is obtained by using a special magnetic alloy. If the meter is mounted in a steel or iron panel, some of the magnetic flux of this alloy is shunted, upsetting the calibration of the meter. When mounted on a steel or iron panel, a VU meter must be specially calibrated by the manufacturer on the basis of panel thickness.

### Applications

When the VU meter is driven as it was meant to be—across a 600

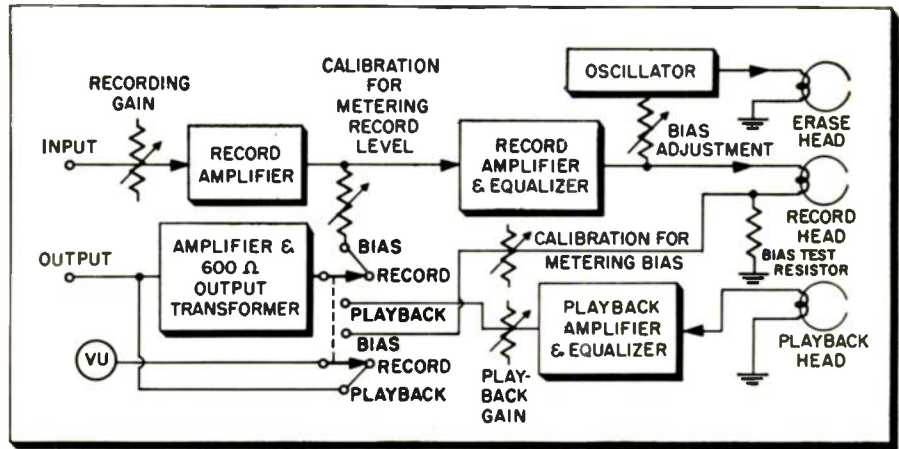

Fig. 3—Switching arrangement in a tape recorder having separate record and playback heads provides a method for measuring record head bias, and record and playback levels. Some switching arrangements allow erase head bias measurements.

ohm line in series with a 3,600 ohm resistor—its dynamic characteristics (overshoot and response time) are preserved. This is of particular importance to the recordist.

In some tape recorders the VU meter is employed as shown in Fig. 3. It can be switched to a 600 ohm output transformer for measuring either recording level or playback level, or it can be switched to measure bias current through the record head. With a stage of amplification, the 600 ohm transformer can be connected to the record amplifier through a calibrating resistor. The VU meter then serves as a level indicator. It can also be connected to the playback amplifier to measure output level.

In another arrangement a separate A-B switch is used to connect the output jack to either the incoming or the playback signal. Thus the meter can be employed to measure recording level while the playback signal is available for monitoring.

Fig. 4—VU meter in a single record-playback head type recorder is driven by its own cathode follower. Meter does not load signal.

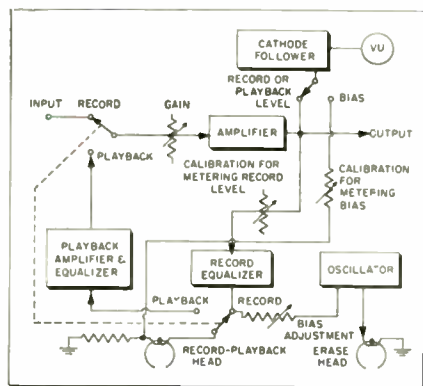

A number of other arrangements are used. In some circuits the VU meter is not placed directly across the output, as in Figs. 3. Instead, it is driven by its own cathode follower, as shown in Fig. 4. The advantage here is that the meter does not load the signal.

If the VU meter plus the 3,600 ohm external resistor are placed across a circuit having appreciably more than 600 ohms output impedance, excessive loading distortion will result. Although the external resistor could be increased, more driving signal would be required.

It should be noted at this point that the copper oxide rectifier used in the VU meter (and other comparable movements) displays a certain non-linear characteristic: Its impedance varies with polarity and instantaneous signal voltage. The resulting fluctuation in load impedance can have a significant effect on the signal voltage unless this impedance is more than ten times that of the signal source. Otherwise, distortion and signal attenuation can result. By isolating the VU meter from the circuit with a cathode follower providing required drive, minimum loading can be obtained.

When serving as a record level indicator, in most cases the VU meter is connected to the audio signal at a stage prior to record equalization, as illustrated in Fig. 3, rather than after equalization. In most quality instruments, equalization conforms to NAB standards—involving a large amount of treble boost and little or no bass boost.

(Continued on page 66)

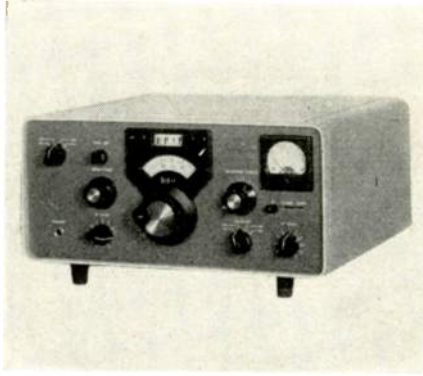

Collins Model 51S-1



Gonset Model G-63



Hallicrafters Model SX-110

# The Communications Receiver As A Service Instrument

LOUIS E. GARNER, JR.

• It is surprising to learn that the multiband communications receiver, used extensively by laboratory engineers, factory technicians, ad-

vanced hobbyists and hams, is seldom found in the radio-TV service shop. Properly used, the communications set is a versatile test instrument. What's more, the unit can be invaluable in keeping more conventional instruments "up-to-snuff."

Fig. 1 (A)—General purpose r-f probe employed with communications receiver for stage-by-stage signal tracing. (B)—Pick-up loop probe used for multi-band location of interference. This unit is also ideal for probing radio transmitters for spurious and harmonic radiations. (C)—Special probe for checking high level r-f circuits. Invaluable for making stage-by-stage checks in two-way mobile and other type transmitters.

Like most electronic equipment, the communications receiver is manufactured in a variety of shapes, sizes, styles and price ranges. Sometimes, the name "communications receiver" is tagged to receivers which are not much more than ac-dc broadcast-band sets with a few extra tuning bands, a mechanical "bandspread" control, earphone jacks, and a built-in beat frequency oscillator (B.F.O.). The true communications set is a much more sophisticated instrument.

For maximum service shop utility, the set should have certain basic specifications. A suitable receiver probably will cost about \$140.00 to over \$300.00 if purchased new as a factory-built instrument, and between \$100.00 to \$200.00 in "kit" form. Used receivers, if in good condition, are frequently quite satisfactory and sell from about 30% to 50% less.

## Receiver Specifications

The set chosen should be a superhet, of course, and while its i-f value

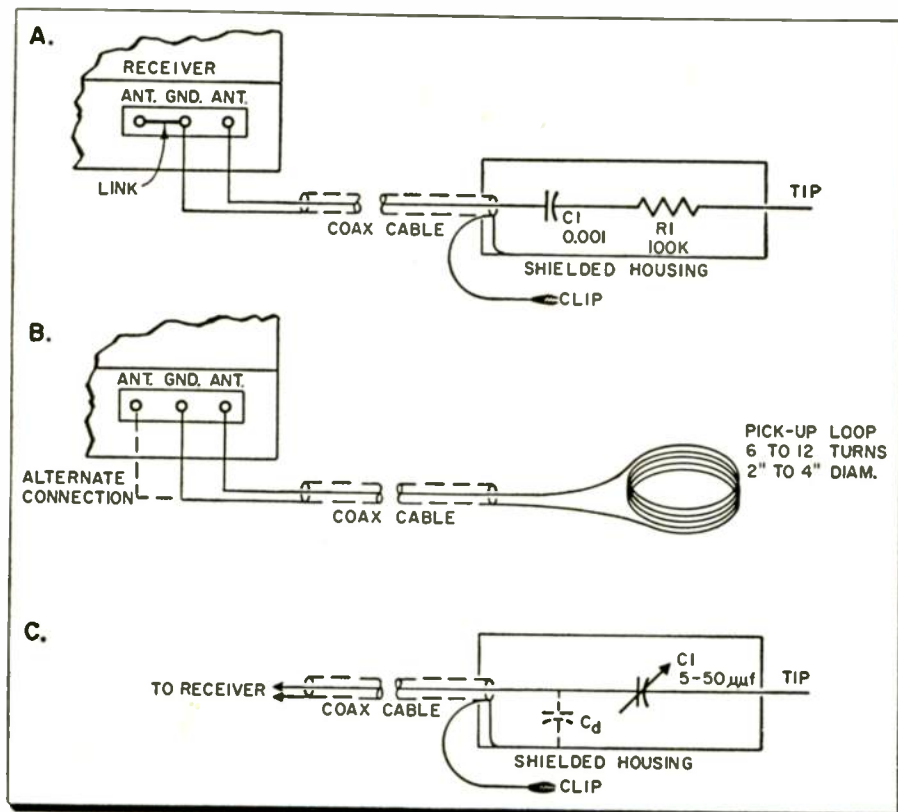





Hammarlund Model HQ180



Heath "Mohican" Model



National Model NC-270

## Unit Can Serve As A Frequency Standard, Interference Locator, And Signal Tracer

is not too critical, its tuning range should extend from the lower end of the AM broadcast-band (540 Kc) to (at least) 28 or 30 mc. Coverage should be continuous in three to five overlapping bands.

Good sensitivity and selectivity are important features. A good "rule of thumb" is about 2 microvolts (or better) for a 10 db s/n ratio on the short-wave bands, although somewhat less sensitivity may be tolerated on the broadcast-band (540 to 1620 Kc). An image rejection of at least 20 db is desirable. In most cases, the set's sensitivity and selectivity specifications will vary over its tuning range . . . the values given should be considered as minimums.

Circuit-wise, a tuned r-f stage ahead of the mixer should be considered a must. The majority of better receivers will have at least two i-f stages, followed by a diode detector and a two or three stage audio section. A separate BFO should be provided. Since good stability is an essential requirement, the set will probably be equipped with a separate temperature compensated local oscillator, and possibly, a voltage-regulated B supply.

A built-in S-meter and a crystal-controlled calibrator (100 Kc) are extremely worthwhile optional features. Useful from an operational viewpoint, but not too necessary in bench work, such features as variable selectivity i-f's, Q-multiplier, calibrated bandspread, crystal i-f

filter, and an automatic noise limiter (ANL) will be found in some receivers.

If the technician is unfamiliar with communications receiver operation, he'll find that an hour or two spent studying the set's instruction manual and familiarizing himself with the purpose and function of each control will pay rich dividends in future work. With as many controls as a typical oscilloscope, the better receivers are capable of superior, poor, or indifferent performance, depending on the skill of the operator.

The more common controls include the power switch (OFF, ON, STANDBY), function switch (PHONE, CW, CAL., SSB), BFO Pitch (or Tone), Bandswitch, main, tuning, bandspread tuning, r-f gain, a-f gain, and antenna tuning (or trimmer). The use of these controls should be obvious from their titles, although the "STANDBY" position of the power switch may be new to workers unfamiliar with communications practice. When on "standby," the receiver's filaments are kept on, but plate and screen voltages are not applied to the tubes. This offers two advantages . . . (a) the set is ready for instant operation without additional "warm-up" and (b) component temperatures are kept constant, assuring stable operation and minimum drift.

A variety of additional controls will be found on some receivers. The type and number will depend

on special circuit features (such as a "Q" multiplier, an ANL circuit, etc.) included in the set's design. These special controls will vary considerably from one set to another and, therefore, cannot be covered conveniently in a general discussion. However, the function and use will be discussed in detail in the set's instruction manual.

In most service work, the set will be kept on standby during working  
(Continued on page 60)

Fig. 2 (A)—Sound take-off adaptor for signal transfer from receiver's phone jack can be used in hi-fi and other audio applications. (B)—Similar sound take-off adaptor for use at set's speaker terminals.

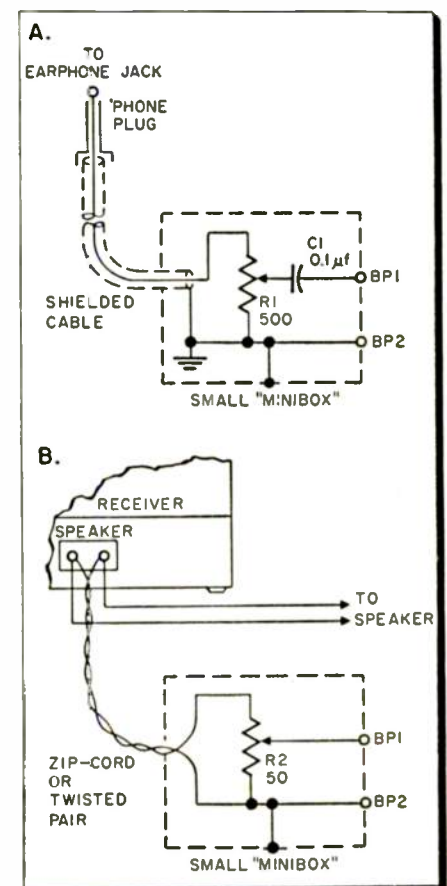

# The BBB's Candid View

## The National Better Business Bureau's President

KENNETH B. WILLSON  
President

National Better Business Bureau

• The Better Business Bureaus keep national statistics of the complaints and inquiries which they receive, breaking them down into categories such as apparel, food, jewelry, etc. In 1959, the third largest volume of complaints involved sales and service of major electronics consumer products. (The home improvement field—storm windows, roofing, etc.—had the largest volume of public complaints; second largest concerned household appliances.) Approximately one out of every ten complaints registered with the Bureau in 1959 was against electronic consumer products.

Considering the enormous volume of radios, TV receivers, phonographs, tape recorders, auto radios in use today, the complexity of these products and the inevitability of the need for servicing, the poor rating in our complaint pic-

ture is understandably related to the nature of these products.

### Consumer Complaints

The criticisms and complaints received cover a wide range of factors; many overlap. They may be organized into three divisions: (1) consumer complaints, (2) service dealer complaints against manufacturers, (3) . . . against parts distributors. Consumer complaints are as follows:

**Misunderstanding of Warranties:** A great many consumers simply do not comprehend why they are obligated to pay a serviceman to tell them why an in-warranty set or product has broken down. They comprehend even less why they must pay him to repair it. People feel if their new product has some factory built-in defect they should not be penalized by being asked to pay for it. This is the primary cause of all home electronics and appliance complaints received.

What this amounts to is manufacturers failing somewhere along the line to communicate to their customers that a warranty is not an unconditional guarantee. Even though the terms of warranties may be specifically stated in advertising and sales literature, many complain about any costs involved—largely, I believe, because they do not understand or remember those terms.

**Excessive Charges:** Reports and stories from consumers of having been "robbed" by servicemen are far from infrequent, and servicemen themselves complain in volume about their unethical minority. On a number of occasions, Better Business Bureaus have made investigations of the integrity of cer-

tain dealers after receiving a multiplicity of public complaints charging dishonesty. Such investigations invariably have confirmed that the servicemen complained against in volume were over-charging or loading the bill with extensive repairs and replacement parts.

The honest serviceman is also subject to complaints of over-charging by consumers who do not understand the economies of running a service business, and the complexity of electronic equipment.

Thus, such complaints of excessive charging, whether justified or not, are often accompanied by the charge of dishonesty. This is an albatross which accompanies the serviceman on every service call.

**Inefficient Service:** The Better Business Bureau has many complaints about the inefficiency and/or incompetence concerning servicemen who call at homes. Consumers report, after extensive probing these men can't figure out what's wrong with a set, and insist it has to go to the shop for repairs. Often, even the qualified serviceman who cannot properly diagnose or correct a fault without using his bench equipment, is complained against by a public which does not understand the difficulty encountered in servicing.

When failure to diagnose and fix a fault in the home is followed by an extensive list of repairs and replacements in the shop, public complaint of inefficiency is joined by that of excessive charging.

**Other Complaints:** There are a few other scattered causes of public complaint to Better Business Bureaus against the servicing of home electronics products, such as: the use of defective parts and re-



"Look who's complaining about a repair bill!"

# Of Service Problems

## Discusses Complaints Of Consumers & Service Dealers

placement tubes in TV; failure to perform on promised adjustment of unsatisfactory service; failure to fulfill guarantees, or contracts; insistence upon continually attempting to repair a "lemon;" oral misrepresentation as to what's wrong, often made in connection with a "free" estimate followed by a final price much higher than the estimate; rates for servicing are too high; "brush-off" by manufacturer on complaints made directly to him; failure to live up to "24 hour" and similar service claims.

### Service Dealers vs Mfrs.

Hundreds of dealers and servicemen throughout the country have given the National Better Business Bureau their current views as to why the public complains so bitterly about the servicing of electronics consumer products. Their consensus constitutes a seriously disturbing indictment of the policies and practices which, permissively or not, have developed and now flourish in this business.

**Servicemen's Public Image:** The public's image of the electronics serviceman is something that, to put it mildly, leaves a great deal to be desired.

Many servicemen complain to us that manufacturers have not done enough to help create public acceptance of the servicing of their products. Instead, it is argued, manufacturers soft-pedal the service needs of their products, thereby failing to create public acceptance of the inevitability of having to repair and replace worn-out parts, and for the costs incident thereto.

Servicemen tell us the push-button magic of home electronics

products is largely taken for granted by a public which has little conception of the problem of diagnosing failure and correcting it.

**Extended Warranties:** Many dealers and servicemen complain that offering one year warranties on electronics products places an undue economic burden upon them, considering the number of calls required and the profit margins under which they operate. This leads to stalling, inadequate service, and resort to outside servicing facilities with resulting complaint and loss of public good will.

**Inadequate Testing:** A more complete inspection job at the factory should materially reduce the cause of customer complaints. Inadequate inspection may result in equipment arriving in the field inoperative, or in breaking down prematurely. Servicemen who see the industry's products as a whole feel adequate field testing is bypassed too often in the competitive rush to get new models on the market.

We are informed that failure of manufacturers to get repair information to the service industry concurrent with the introduction of new products contributes unnecessarily to the delay in servicing, and loss of public confidence in the competence of the servicemen.

The discontinuance of electronics consumer products by numerous firms has left servicemen without some replacement parts for keeping such orphan items in operation and results, they say, in complaints against them if they cannot come up with substitute or scavenger parts.

**Serviceability:** Much of the trouble now laid at the doorstep of the serviceman, they report to the Better Business Bureaus, could be

prevented right at the drawing board. Many believe components that may need servicing should be located in conveniently accessible spots. Having to pull a whole chassis to change a tube or make a repair only adds unnecessarily to the service costs—and the dissatisfied customer list.

Some servicemen report the high cost of labor in servicing some printed circuits, because of the difficulty of isolating trouble, gives rise to unwarranted protests of excessive charges against them.

**Inadequate Training Facilities:** Many servicemen tell us that public complaints involving incompetence and inefficiency are due in large part, to the poor quality of public and vocational training, not to mention the hit-or-miss training of the self-taught. Some also believe that manufacturers have far too few service clinics, and this handicaps them in servicing some products.

Other complaints cited against  
(Continued on page 58)

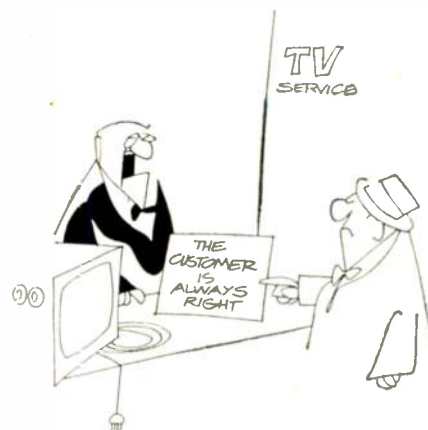

"Never mind that, I'm telling you it's a condenser and a weak 6AS5."

# New Products

## Triplet VTVM

Model 850 features superior voltage measuring capabilities plus resistance range to 1000 megohms; 5v full scale range on d-c; meter connected in cathode circuit of 12AU7 for stability; scales, 7" long at top arc for easy reading; frequency range, 15 cps to 3 megacycles; separate scale for peak-to-peak readings; single unit probe with built-in switch for a-c/d-c/ohms; 11 megohm input resistance on all d-c voltage ranges; a-c impedance, minimum .83 megohm. Triplet Electrical Instrument Co., Bluffton, Ohio.

For more data, circle 12-42-1 on coupon, p. 48



## Centralab CONTROLS

Models A/U-1, A/U-2 and A/U-3 exact replacement auto radio controls are announced. The three units are exact replacements for Automatic Universal radios, dating from 1942 to the present time. Models A/U-1 and A/U-2 are exact replacements in the Automatic Universal radios used in 31 lines of foreign automobiles now being used in the United States. Model A/U-3 covers applications in 1957, 1958 and 1959 Fords. Centralab, 900 E. Keefe Ave., Milwaukee 1, Wis.

For more data, circle 12-42-2 on coupon, p. 48

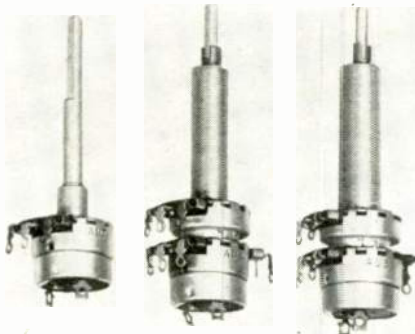

## Clarostat SWITCH/CONTROL

C47S push-pull switch/control, with Pick-A-Shaft shafts, is a standard Clarostat series 47 with a push-pull switch rear unit. It permits preset volume settings independent of on/off function. The replacement of this type assembly has long presented a problem as each manufacturer employed a shaft of different length or configuration. The new unit permits the selection of the appropriate electrical assembly, and then that of the proper shaft. Assembly of unit and shaft can be made in seconds. Clarostat Mfg. Co., Dover, N. H.

For more data, circle 12-42-3 on coupon, p. 48

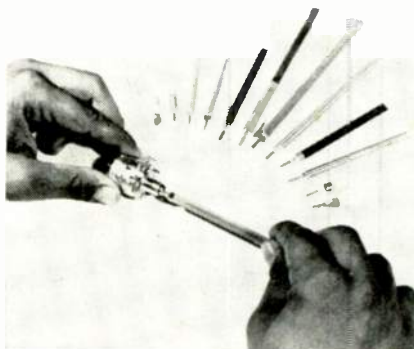

## Mercury RECTIFIER TESTER

Model 600 in-circuit rectifier tester checks all power rectifiers (selenium, germanium, silicon, copper oxide, etc.), without disconnecting the rectifier from the circuit. Also checks all rectifiers out-of-circuit as effectively as in-circuit for quality, shorts, fading, opens, arcing and life expectancy. For in-circuit testing, the test leads are simply clipped across the rectifier right in the circuit, and the test switch is depressed for an instant reading. \$27.50. Mercury Electronics Corp., 77 Searing Ave., Mineola, N. Y.

For more data, circle 12-42-4 on coupon, p. 48



## G-E TUBE

Type 6EA7, a new low-high plate dissipation double triode tube, is designed for vertical-deflection oscillator and amplifier applications in TV receivers. It is an octal "GT" type and contains both a high-mu triode (section 1) and a low-mu, high-perveance triode (section 2). Section 1 has

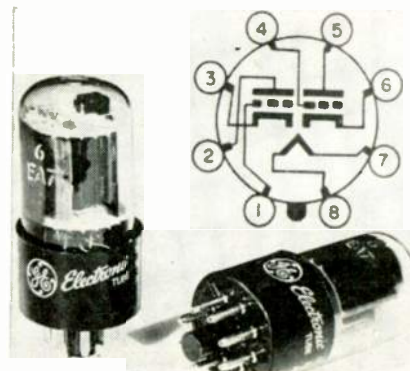

a design maximum rating of 350 plate volts with peak negative grid voltage of 400 and plate dissipation of 1.0 watt. Section 2, design maximum plate voltage rating, 550v d-c, rated at 10 watts plate dissipation and 175 milliamperes of peak cathode current. General Electric Co., Receiving Tube Dept., Owensboro, Ky.

For more data, circle 12-42-5 on coupon, p. 48

## B&K TUBE TESTER

New model 685 dynamic mutual conductance tube tester features the speed of multiple-socket testing for existing tube types, plus punch-card testing for new tubes. Checks all tubes most widely used in TV receivers, plus popular home and portable radio

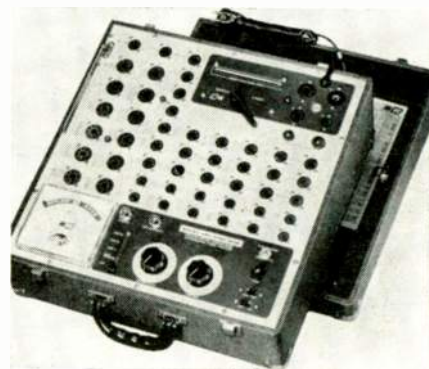

tubes, including the nuvistor, also many industrial tubes and two-way radio tubes. It is compact and easily portable 17" x 17" x 7½". Includes 25 blank Dyna-cards, hand punch and tube card information service. \$199.95. B&K Mfg. Co., 1801 W. Belle Plaine, Chicago 13, Ill.

For more data, circle 12-42-6 on coupon, p. 48

# DOUBLES YOUR EFFECTIVE MANPOWER



Fix "Tough Dogs" Fast!

Save Half Your Time!

Step Up Your Profit!

**B&K** NEW  
MODEL 1076

## TELEVISION ANALYST

for Black & White and Color



Check all circuits—Pinpoint any TV trouble...in minutes

**By Easy Point-to-Point Signal Injection,  
You See the Trouble on the TV Screen and  
Correct it—Twice as Fast and Easy!**

There's no longer any need to "lose your shirt" (and customers)—and worry about the lost hours you never recover—on "tough dogs" or even intermittents. The remarkable B&K Analyst enables you to inject your own TV signal at any point and watch the resulting test pattern on the picture tube itself. Makes it quick and easy to isolate, pinpoint, and correct TV trouble in any stage throughout the video, audio, r.f., i.f., sync, and sweep sections of black & white and color television sets—including intermittents. Makes external scope or wave-form interpretation unnecessary. Most useful instrument in TV servicing! Its basic technique has been proved by thousands of successful servicemen the world over.

The Analyst enables any serviceman to cut servicing time in half, service more TV sets in less time, really satisfy more customers, and make more money.

Model 1076. Net, \$29995

Available on Budget Terms. As low as \$30.00 down.

Combines all the features of both  
the Model 1075 and Model A107

COMPLETE R.F. and I.F.	HI-VOLT INDICATOR
VIDEO TEST PATTERN	YOKE and HI-VOLTAGE TRANSFORMER TEST
COMPOSITE SYNC	<b>Also Now Provides:</b>
FM MODULATED AUDIO	SWITCH-TYPE TUNER
COLOR PATTERNS	NEGATIVE BIAS SUPPLY
HORIZONTAL and VERTICAL PLATE and GRID DRIVE	AGC KEYING PULSE
B+ BOOST INDICATOR	PICTURE TUBE MODULATION

**B&K**

**B & K MANUFACTURING CO.**

1801 W. BELLE PLAINE AVE • CHICAGO 13, ILL.

Canada: Atlas Radio Corp., 50 Wingold, Toronto 19, Ont.

Export: Empire Exporters, 277 Broadway, New York 7, U.S.A.

See Your B&K Distributor or Write for Bulletin API6-T

For more data, circle 12-43-1 on coupon, p. 48

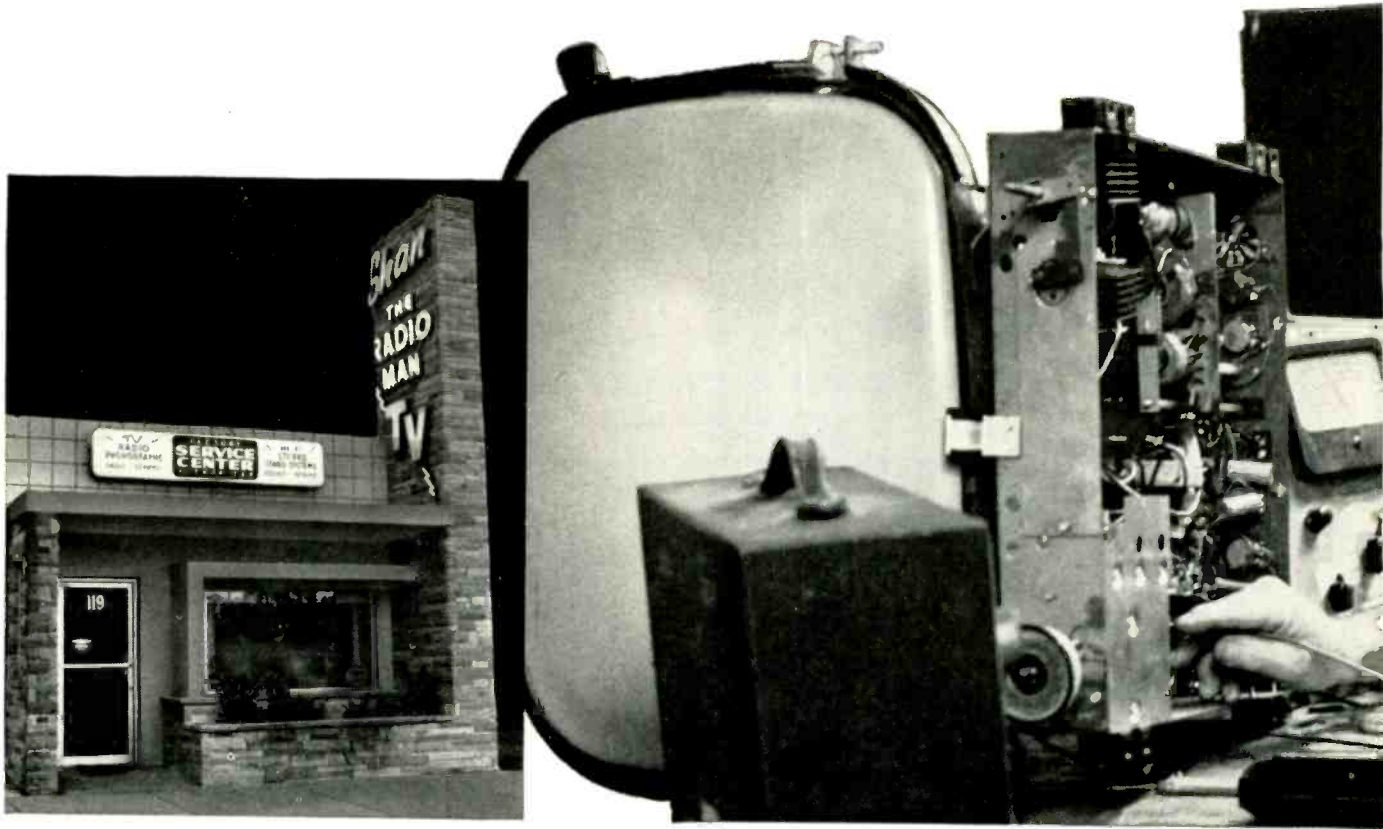

*Shan the Radio Man says:*

**“100 years’ experience**  
*has proved we can depend on Mallory components.”*



“To be successful, you must make a profit, hire competent technicians, pay a fair salary, give prompt, dependable service and use the best quality components,” states Shan Des Jardins, discussing the growth of his business.

“I’ve used Mallory components since I first started my shop. My shop people and I have a total of a century of experience and we know we can depend on Mallory for top quality components.”

Shan runs an exceptional shop . . . the first in Miami to have a complete transistor radio service department, and among the first to service color TV. In all

his operations, he relies on quality Mallory components. When electrolytics need replacement, for instance, he knows—as do thousands of other service technicians—that Mallory FP’s give extra service in the smaller, hotter cabinets now common for TV and hi-fi . . . or when mounted next to a hot rectifier or output tube, where ordinary replacement filters wilt. They’re the original 85°C capacitor. Leak-proof seal and etched cathode construction—available without premium price only in Mallory FP’s—assure long life and hum-free performance.

Whatever your component needs, see your Mallory distributor. He carries the widest line of quality Mallory products . . . at sensible Mallory prices.



Shan Des Jardins is owner and manager of Shan the Radio Man Inc. in Miami. A charter member of TESA and Miami Service Association, he also is zone governor of NATESA. In 1928, Shan opened a one-man service shop for battery-powered radios. He now has five technicians and three trucks, handling 20 to 25 calls a day, servicing radio, TV, stereo and hi-fi.

*Distributor Division*

P. R. MALLORY & CO. Inc.

# MALLORY

P. R. MALLORY & CO. Inc., INDIANAPOLIS 6, INDIANA

THESE QUALITY MALLORY PRODUCTS PUT AN END TO CALL-BACKS



**GEMS**  
Handy five-pack dispenser of rugged, moistureproof Mallory "Gem" tubular capacitors . . . keeps stock fresh, clean, easy to find . . . prevents kinks in lead wires. Unequalled for service in buffer, by-pass or coupling applications.



**PTC DISCAPS\***  
Made by the world's largest producer of ceramic disc capacitors. Long the original equipment standard, they are available for replacement in a handy 3 x 5" file card five-pack package.

\*Reg. Trademark of Radio Materials Company, A Division of P. R. Mallory & Co. Inc.



**GOLD LABEL® VIBRATORS**  
For the best in auto radio servicing, use Mallory Gold Label vibrators every time. The quietest vibrator ever made, Exclusive buttonless contact design gives longest life, sure starts.

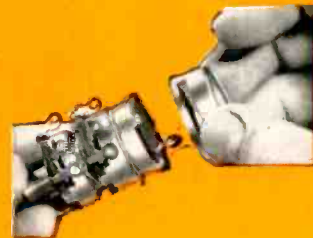

**STA-LOC® CONTROLS**  
No waiting for out-of-stock controls. In just 30 seconds, your distributor can custom-build any of over 38,000 single or dual controls. You can replace the line switch by itself, without unsoldering control connections.



**TC TUBULAR ELECTROLYTICS**  
Twin-pack of economically priced filter capacitors with a reputation for top performance. Proved in service and backed by years of Mallory experience. Also special Type TCX capacitor available for -55°C.



**MERCURY BATTERIES**  
Unequalled for transistor radios. They give steady power several times longer . . . stay live for years when idle. Chosen as the "power package" in U. S. satellites. Made by the world's largest manufacturer of mercury batteries.

For more data, circle 12-45-1 on coupon, p. 48

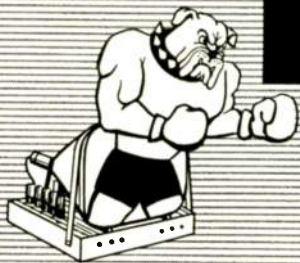

# "Tough Dog"

## Corner



### Difficult Service Jobs Described by Readers

#### Jumped Ballast Pops Rectifier

When this Emerson TV model 650D was turned on, the 200  $\mu$ fd input filter would become very hot, boil out electrolyte, and a selenium rectifier CR-2 (see Fig. 1) would pop. This was naturally followed by

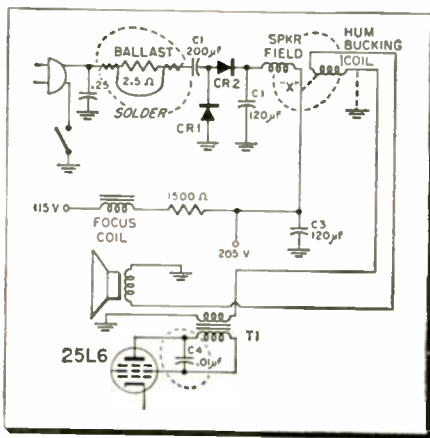

Fig. 1—Solder jumper across ballast tube caused damage to selenium rectifier and filter capacitor when dynamic speaker shorted.

a loud hum in the sound. To complicate matters, this was a case where voltage measurements were impractical, an ohmmeter being the only practical tool.

After checking resistances at different points along the power (this set uses a ballast tube) and B+ lines, I discovered the hum-bucking coil (in conjunction with the speaker field) was shorting to ground—but only when the set was on. This placed a direct ground at point "X," as shown in Fig. 1. Note that the secondary of T-1, the output transformer, and the hum-bucking coil in series are grounded. This short

placed C-1 and CR-2 directly across the line, causing high current to be drawn. Careful investigation revealed why the ballast tube didn't blow. A piece of wire solder was twisted across the ballast tube terminals. In effect, there was no ballast!

After replacing the ballast tube, input filter, and speaker, I still had no audio. Further checks showed that C-4 across the primary of T-1 was shorting. Replacing this capacitor restored the sound.—George J. Rupp, Baltimore, Md.

#### Motorboating Radio

A Philco portable radio, model E676, recently came into my shop with a defective selenium rectifier. Replacing this part corrected the difficulty. Thinking the repair was completed, I turned the set on for a final check. At low volume the sound was normal. But after advancing the control, "motor-boating" became apparent in the sound. After considerable troubleshooting—checking bypass capacitors and filters, nothing proved defective. Attempting to eliminate this new problem, I found that installing a jumper wire between the low end of the volume control and the control mounting bracket, as shown in Fig.

2, stopped the motor-boating. The radio now sounded good. While re-assembling the set, I noticed the

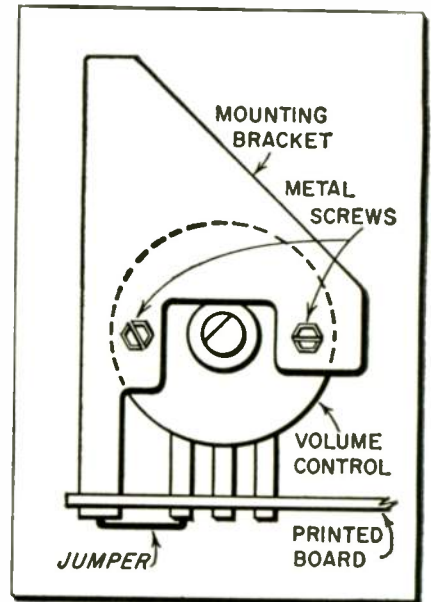

Fig. 2—Motorboating in PC radio is caused by open ground-return on volume control when bottom plate is removed to service set.

metal plate covering the printed board underside completes the volume control ground return circuit. Naturally, with the metal plate removed for servicing, there was no ground return; hence the unwanted condition. When a technician runs into a set of this type a jumper should be placed between the volume control and the mounting bracket to avoid a self-made dog.—Fred J. Will, East St. Louis, Ill.

#### TOUGH DOGS WANTED

\$10 for acceptable items. Use drawings to illustrate whenever necessary. A rough sketch will do. Photos are desirable. Unacceptable items will be returned if accompanied by a stamped envelope. Send your choice entries to "Tough Dogs" Editor, ELECTRONIC TECHNICIAN, 480 Lexington Ave., New York 17, N. Y.





# SYLVANIA-6AU4-GTA

WITH

# SARONG CATHODE

HELPS YOU

# "WRAP-UP" PROFITS!

**N**ew life-giving, profit-building features are built into every SYLVANIA-6AU4-GTA TV-damper tube. Consider, for one feature, the SYLVANIA SARONG CATHODE and how it adds dependability to tube life. SARONG provides uniform spacing between cathode and plate—reduces possibility of plate-to-cathode arc-over. SARONG prevents the build-up of “whiskers” inside the cathode sleeve that can develop during other types of coating processes—reduces possibilities of cathode-to-heater arc-over.

Consider, too, the “pigtail” heater in SYLVANIA-6AU4-GTA. Welded securely to the stem-lead, it reduces heater “hot spots” and the possibilities of heater burnout. More . . . rectangular top and bottom miccas with exceptionally wide slots increase the resistance of dc leakage paths, further reduce the possibilities of internal arc-over and breakdown.

There's extra profit assurance, too, with SYLVANIA-6AU4-GTA. Every one of them is tested for shorts, emission and the ability to withstand arc-over at 5000-volts peak inverse on the anode.

So, “wrap up” the profits you make by putting a “damper” on call-backs. When you ask your distributor for 6AU4-GTA's, always specify SYLVANIA.

Electronic Tubes Division, Sylvania Electric Products Inc., 1740 Broadway, New York 19, New York.



# SYLVANIA

Subsidiary of **GENERAL TELEPHONE & ELECTRONICS** 

# FREE LITERATURE

To receive the literature below without charge, simply circle the numbers on the coupon.  
Cut out and mail to ELECTRONIC TECHNICIAN, 480 Lexington Ave., New York 17, N. Y.

**1** **Picture-Tube Repair Tool:** Literature covers a pin-crimper to notch pins and element leads for solid electrical connections, and for use as a channel selector wrench and screwdriver. Berns Mfg. Co.

For more data, circle 12-48-1 on coupon

**2** **Packaged Circuits:** 31 new PEC's, with part numbers from PC-371 through PC-404, are described in current literature. Included in these new units are vertical integrators, tone control networks, etc. Centralab.

For more data, circle 12-48-2 on coupon

**3** **Transistors:** A new interchangeability chart lists all Japanese-made radio transistors and the firm's American counterparts. Over 100 different transistor types covered. Electronic Transistors Corp.

For more data, circle 12-48-3 on coupon

**4** **Transformers:** Top-tuned miniature i-f transformers and top-tuned printed circuit i-f transformers are included in the firm's general catalog and TV replacement guide. J. W. Miller Co.

For more data, circle 12-48-4 on coupon

**5** **Tube Briteners:** "Guide to Proper Britener Selection," a new leaflet, covers the firm's line of TV tube briteners. Includes a "Quick Selector Chart." Perma-Power Co.

For more data, circle 12-48-5 on coupon

**6** **Transistor Home Study Course:** Booklet describes a new 10-lesson home study course titled "Transistors." Course includes: review of solid stage physics fundamentals; and such subjects as transistor ratings and parameters, equivalent circuits, impedance matching, etc. RCA Institutes.

For more data, circle 12-48-6 on coupon

**7** **Transistor Checker:** Model TR110 Transi Master, described in current literature, is a new unit designed to quickly test all transistors in circuit with a new a-c gain check without the use of set-up charts. Sencore.

For more data, circle 12-48-7 on coupon

**8** **Mylar Polyester Film:** Rainy weather or long periods of high humidity will not affect capacitors made with Mylar polyester film. A new booklet contains test data that detail the basic properties of Mylar. E. I. du Pont de Nemours & Co.

For more data, circle 12-48-8 on coupon

**9** **Microphone:** Literature is available covering model 729 cardioid microphone reported to reduce random room noise and reverberation by as much as 67%. Electro-Voice.

For more data, circle 12-48-9 on coupon

CUT HERE

Use this coupon, or your letterhead, before January 20, 1961

Please send me literature of companies whose code numbers I have circled below (includes editorial and advertised items):

Note: Code 12-2-1 means December issue, Page 2, 1st item on page.

12-2-1	12-18-1	12-24-7	12-42-5	12-48-8	12-53-4	12-63-2	12-68-2
12-4-1	12-19-1	12-24-8	12-42-6	12-48-9	12-56-1	12-64-1	12-69-1
12-5-1	12-20-1	12-25-1	12-43-1	12-49-1	12-57-1	12-64-2	12-69-2
12-7-1	12-22-1	12-26-1	12-45-1	12-50-1	12-58-1	12-64-3	12-70-1
12-8-1	12-23-1	12-26-2	12-48-1	12-52-1	12-59-1	12-64-4	12-70-2
12-9-1	12-24-1	12-27-1	12-48-2	12-52-2	12-59-2	12-65-1	12-70-3
12-10-1	12-24-2	12-28-1	12-48-3	12-52-3	12-60-1	12-66-1	12-70-4
12-11-1	12-24-3	12-42-1	12-48-4	12-52-4	12-60-2	12-67-1	12-71-1
12-14-1	12-24-4	12-42-2	12-48-5	12-53-1	12-61-1	12-67-2	12-71-2
12-15-1	12-24-5	12-42-3	12-48-6	12-53-2	12-62-1	12-67-3	12-C2-1
12-17-1	12-24-6	12-42-4	12-48-7	12-53-3	12-63-1	12-68-1	

Name ..... Position .....

Firm ..... Address .....

City ..... Zone ..... State .....

# TUBES GET THERE FASTER



Shipping parts or entire sound units? Remember, speedy shipment of delicate goods is a specialty of Greyhound Package Express. Shipments going hundreds of miles can arrive *the same day they're sent!*

Whatever the destination of your shipment, chances are, a Greyhound is going there anyway... *right to the center of town.* Greyhound travels *over a million miles a day!* No other public transportation goes to so many places—so often.

You can ship anytime. Your packages go on regular Greyhound passenger buses. Greyhound Package Express operates twenty-four hours a day...seven days a week... *including weekends and holidays.* What's more, you can send C.O.D., Collect, Prepaid...or open a charge account.

**SEND THIS COUPON NOW! IT CAN SAVE YOU TIME AND MONEY!**

GREYHOUND PACKAGE EXPRESS  
DEPT. 17L, 140 S. DEARBORN ST., CHICAGO 3, ILLINOIS

Gentlemen: Please send us complete information on Greyhound Package Express service...including rates and routes. We understand that our company assumes no cost or obligation.

NAME \_\_\_\_\_ TITLE \_\_\_\_\_

COMPANY \_\_\_\_\_

ADDRESS \_\_\_\_\_

CITY \_\_\_\_\_ ZONE \_\_\_\_\_ STATE \_\_\_\_\_

**IT'S THERE IN HOURS...AND COSTS YOU LESS!**

For more data, circle 12-49-1 on coupon, p. 48

*More Signal  
Power with Winegard  
TV Amplifiers and  
Booster Couplers!*

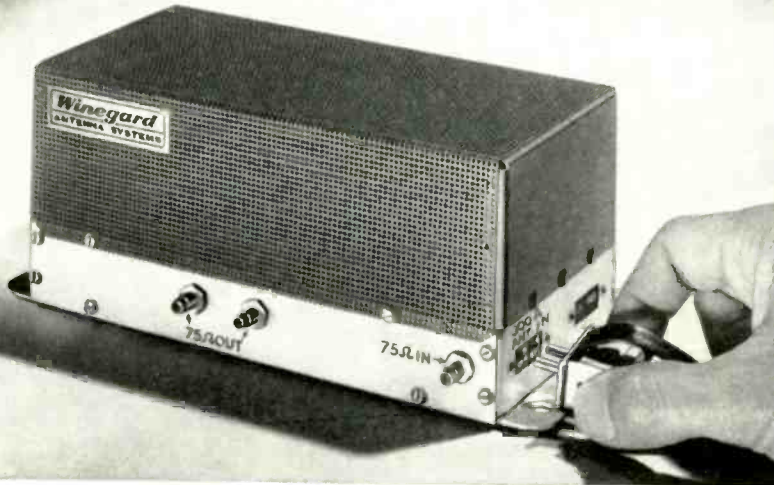

**New Precision Amplifier A-400** drives 1 to 30 TV sets. You get up to 26db gain on TV and FM bands with the Winegard A-400. Has four 6FY5 neutroelectrode tubes with extremely low noise characteristics. Dual 75 ohm outputs—300 ohm balanced input with no-strip disconnect plug and 75 ohm coaxial input. Unit completely fused. Finest amplifier in its class—\$79.95.

**Booster Coupler WBC4**—operates 1 to 4 TV and FM sets. Delivers up to 12.5 db gain all channels on one set. Operates 2, 3 or 4 sets with up to 6 db gain for each set. Powerful 6DJ8 tube, shielded and protected. 4 sets of no-strip lead-in terminals—quick disconnect plug for antenna lead-in—\$27.50.

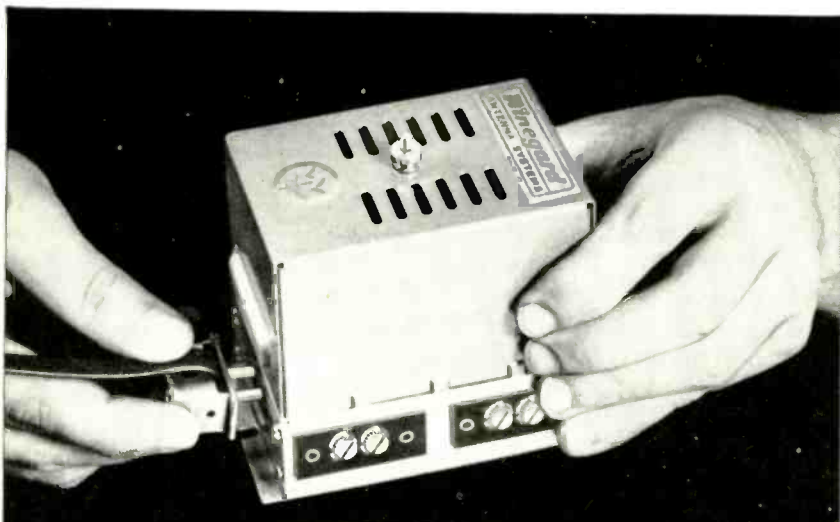

*Write today for full information  
on Winegard TV distribution systems  
and famous Winegard TV antennas.*



**Winegard Co.**

3019-12 Scotten Blvd. Burlington, Iowa  
Antenna Systems

*Everything from the  
antenna to the set*

# Cumulative Article Index

*All feature articles  
appearing in  
ELECTRONIC TECHNICIAN  
From January  
through December 1960*

## AUDIO, HI-FI, PA

How to Assure Dependable Audio Measurements	N. H. Crowhurst	1/60-40
1/4 Track Tape		1/60-81
How to Change a Needle	Charles Weigand	2/60-40
Service That Audio Amplifier	Mannie Horowitz	3/60-38
Checking Tape Recorder Frequency Response	Herman Burstein	4/60-34
Adjusting Tape Recorders	Herman Burstein	5/60-36
Analyzing Hi-Fi Power Supplies	Mannie Horowitz	6/60-35
Solving Audio Matching Problems	N. H. Crowhurst	7/60-42
Time-Delay System Creates Reverberant Acoustics		7/60-65
Optical Sound Servicing	L. B. Hoffman	8/60-26
Starting a Sound & Intercom Business	M. S. Sumberg	8/60-50
Adjusting Stereo To The Room Environment		9/60-85
Solving The Stereo Disc Puzzle		9/60-88
The Stereo Cartridge/Stylus Partnership		9/60-90
Loudspeaker Installation Problems		9/60-92
Status of Stereo Broadcasting		9/60-98
Stereo Changers, Players & Turntables		9/60-102
Analyzing Stereo Tape Equipment		9/60-104
Evaluating Stereo Packages		9/60-106
Stereo Sales Set-Up For Dealers		9/60-108
Manufacturer & Product Stereo Directory		9/60-111
Hi-Fi Power Ratings	Fred Bergman	10/60-38
Hi-Fi Warranty & Service Practices		10/60-65
Single-Stage Audio Amplifier Troubleshooting Methods	Mannie Horowitz	11/60-38
Stereo Tape Glossary	Magnetic Recording Industry Assn.	11/60-62
Understanding Audio VU Meters	Herman Burstein	12/60-36

## BUSINESS

Eliminating Set Loaners Ups Service Income	C. Thomas	1/60-38
Measure Your Service Operations, Part I	A. E. Kimball	2/60-61
Computer Services for Small Business	I. J. Seligsohn	2/60-90
Measure Your Service Operations, Part II	A. E. Kimball	3/60-41
Stop Shipping and Billing Errors	H. J. Ashe	3/60-64
Collection Letter Precautions	E. W. Fair	4/60-48
Starting a Sound & Intercom Business	M. S. Sumberg	8/60-50
Industry Dilemma-Distributor Retail Sales	A. J. Forman	9/60-38
What To Do When a New Competitor Appears	E. W. Fair	10/60-82
The BBB's Candid View of Service Problems	K. B. Willson	12/60-40

## COMPONENTS—TUBES—TRANSISTORS

Electronic Components Preview of 1960	L. B. Davis	2/60-47
Practical Desoldering Methods	George Kravitz	4/60-38
TV Tube Inventory Guide		4/60-77
Boosters for Ailing CRT's	Bob Jarmolow	7/60-32
New Thermoelectric Semiconductors Heat & Cool Efficiently		7/60-45
Transistors Boom Battery Sales	Neal Fossage	7/60-52
"Compactron" Multi-function Tubes		8/60-61
TV Deflection Yoke Defects	Harold West	11/60-36
Component & Transmission Characteristics at UHF	Allan Lytel	11/60-42

## EDITORIALS

Let's Practice What We Preach		1/60-25
He Profits Most Who Serves Best		2/60-31
The Three Faces of Industry		3/60-31

← For more data, circle 12-50-1 on coupon, p. 48

Abusing Citizens Band	4/60-29
Showdown at Distributor Gulch	5/60-31
Death of a License Bill	6/60-27
Postscript to "Showdown at Distributor Gulch"	7/60-29
The Meaning of the Census	8/60-23
"STEREO 1961"	9/60-33
Industry Dilemma	9/60-33
Vote	10/60-29
The Day Electronic Service Stopped	11/60-31
Something New Added	12/60-29
Licensing Survey	12/60-29
Season's Greetings	12/60-29

### GENERAL

Electronic Statistics	1/60-32
New York Bill Regulates Tube Sales	1/60-66
Do Newspapermen Take Payola?	2/60-68
FCC Radio Statistics	3/60-60
Cases from the Files of the "Kilocycle Kops"	3/60-72
1960 Parts Show Preview	5/60-44
1960 ELECTRONIC TECHNICIAN DIRECTORY,	
Alphabetical Listing of Mfrs.	5/60-48
Technician Associations—1960 Roster	5/60-46
Electronic Schools	5/60-47
Technical Societies & Industry Associations	5/60-47
The Winners—Shop Hint & Tough Dog Contest	5/60-92
Manufacturer & Product Stereo Directory	9/60-111
Vote in the Licensing "Election"	10/60-50
TV Ownership in U.S. & Canada	11/60-55
NEAR—The National Emergency Alarm Repeater System	12/60-32
Cumulative Article Index, Jan. 1960 through Dec. 1960	12/60-50

### INDUSTRIAL ELECTRONICS & COMMUNICATIONS

Using Solar Energy	Herb Allen	1/60-28
Precautions for Installing Marine Radios	Al Lynch	1/60-36
Automatic Document Retriever	National Bureau of Standards	1/60-60
Preventive Maintenance for Mobile Radio	Allan Lytel	2/60-48
Computer Service for Small Business	I. J. Seligsahn	2/60-90
Uses for Closed-Circuit TV		3/60-40
Working with Electronic Depth Finders	Allan Lytel	4/60-44
Guide to Citizens Band Radio	Allan Lytel	5/60-38
Mobile Radio Accessories	L. G. Sands	5/60-40
Service Citizens Band Radios Part I	Allan Lytel	6/60-38
Service Citizens Band Radios Part II	Allan Lytel	7/60-35
Technicians Check Missile Early Warning System		7/60-47
Radar—How it Works	Allan Lytel	8/60-38
How Technical Security Equipment Functions	L. E. Garner, Jr.	9/60-42
Radar for Pleasure Boats	Ernest Wilson	10/60-32
Servicing Electronic Bowling Alleys	Walter Blair	11/60-34
Using the Communications Receiver as a Service Instrument	L. E. Garner, Jr.	12/60-38

### SHOP HINTS

Auto Radio Short Checks	Delco Radio Div., GMC	1/60-37
Yoke Clamp	A. J. Krukowski	1/60-37
Checking Magnetized Tape Heads	RCA Victor Co., Ltd.	1/60-37
Handy Retriever	G. F. Stillwell	1/60-37
Magnetic Soldering Iron (Contest)	P. R. Foster	2/60-44
Determining Open Resistor Values (Contest)	A. J. Krukowski	2/60-44
Control Replacement (Contest)	R. E. Maroney	2/60-44
Splicing Aid (Contest)	J. J. Mameno	2/60-44
Tube Socket Repair (Contest)	M. E. West	2/60-44
CRT Heater Repair	C. B. Bailey	3/60-45
Versatile Jig	H. Leeper	3/60-45
Lang Handle Tweezers	G. F. Stillwell	3/60-45
Case History File	F. M. Dickinsan	4/60-41
CRT Warning	A. J. Krukowski	4/60-41
Solder Feeder	G. F. Stillwell	4/60-41
Scope Graticule Retainer	Bob Cornthwaite	5/60-45
Shaft Repair	R. I. Martel	5/60-45
PC Desoldering	Wilbur Pier	5/60-45
Tape Head Cleaner	G. F. Stillwell	5/60-45
Winners—Feb. 1960 Contest		5/60-92
Antenna Attachment Jig	E. J. Comeau	6/60-51
Faster Tube Tester Set-Up	Wm. Dews	6/60-51
Testing PC Components	L. C. Maly	6/60-51
Iron Cord Halder	Ralph Rinaldi	6/60-51
Antenna Helper	Dennis Crisp	7/60-49
Damper Kills Sound	A. J. Krukowski	7/60-49
Flag That Tool	G. F. Stillwell	7/60-49
Sync Instability	General Electric Co., Radio & TV Div.	8/60-37
Eliminating Vertical Jitter	M. G. Goldberg	8/60-37
Solder Dispenser	G. R. Lince	8/60-37
Repairing Arcing Fly-Backs	Stanley Block	9/60-62
Speaker Needs Ground Return	Delco Radio Div., GMC	9/60-62
Substitute TV Control Shaft Covers	F. M. Dickinsan	9/60-62
Eico Scope Improvement	M. E. West	9/60-62

Life Saver	A. J. Krukowski	10/60-42
CRT Heater Resistor	RCA Service Co.	10/60-42
PM Tape Eraser	P. S. Segars, Jr.	10/60-42
Rapid Diode Check	A. J. Krukowski	11/60-65
Self-Holding Templates	H. J. Miller	11/60-65
Solder Gun Repair	G. F. Stillwell	11/60-65
Rapid Battery Tester Attachment	J. H. Larry	12/60-54
Thermistors in TV Yokes	RCA Service Co.	12/60-54
Base Template	G. F. Stillwell	12/60-54

### TELEVISION—RADIO, Consumer Products

How to Troubleshoot TV Power Supplies	Jerry Wells	1/60-34
Install TV Vertical Blanking Circuits	E. C. Kiley	2/60-34
Checking-Out Color TV Rainbows	R. G. Middleton	2/60-38
Install Antenna Lightning Protection	L. G. Sands	3/60-34
Stop TV-Radio Interference	Jerry Wells	3/60-42
Servicing Automatic Toasters	Harald Katz	3/60-48
Sophisticated Approach to AFC TV Problems	Stuart Haberman	4/60-32
TV Troubleshooters—This Could Happen to You!		
A. Kinckiner, J. Darr		5/60-42
Repairing Transistor Portables	L. G. Sands	6/60-30
How to Install TV Roof Antennas	Dan George	6/60-42
Exterminate Those Video Bugs	Harold West	6/60-44
19" Transistor TV		6/60-60
Boosters for Ailing CRT's	Bob Jaromolow	7/60-32
TV Vertical Circuit Stumbling Blocks	Harold West	7/60-38
Optical Sound Servicing	L. B. Hoffman	8/60-26
Benchman's View of Damper Circuits	Harold West	8/60-28
How to Correct Manufacturers' Printed Wiring Defects		
Jack Kalterackus		9/60-36
Improve TV Performance with Trap Adjustments	Harold West	9/60-40
Servicing Transistor Radio Midsets	L. E. Garner, Jr.	10/60-34
"Vitamins" For Aging TV's	Harold West	10/60-40
TV Deflection Yoke Defects	Harold West	11/60-36
Erecting Fringe-Area TV Antennas	Dan George	11/60-48
TV Ownership in U.S. & Canada		11/60-55
TV Manufacturers Technical Digest		12/60-30
Troubleshooting TV Hi-Voltage Rectifier Circuits	Perry Sheneman	12/60-34

### TEST EQUIPMENT, Measurements

How to Assure Dependable Audio Measurements		
N. H. Crawhurst		1/60-40
Exploring Dynamic Transistor Testers	Jack Helmi	2/60-36
Ringin' & Overshoot in Scopes	R. G. Middleton	5/60-34
Becoming Acquainted with your VOM	John Haskell	8/60-30
Using the Communications Receiver as a Service Instrument	L. E. Garner, Jr.	12/60-38

### "TOUGH DOG" CORNER

"Soft" Ground Makes A Hard Dog	C. B. Bailey	1/60-31
TV Prefers Test Pattern	Peter Fehr	1/60-31
Over-Heating Flyback (Contest)	H. E. Chace	2/60-44
Unstable Sync (Contest)	F. A. Salerna	2/60-44
Dynamic Voltage Divider (Contest)	Robert Samadell	2/60-44
TV Antenna Completes Circuit	D. A. Daleske	3/60-37
Heaters Too Cool	L. C. Kisor	3/60-37
Cross Modulation	Leonard Cox, Jr.	4/60-37
Tuner Trouble	H. S. Johnson	4/60-37
Sound Buzz	W. C. Sappington	5/60-39
Shorting Width Shim	I. C. Tilman	5/60-39
Winners—Feb. 1960 Contest		6/50-92
Intermittent Horizontal Pulling	Felix Grumann	6/60-41
Vertical Drift	W. A. Pisciotto, Jr.	6/60-41
Intermittent Vertical Stretch	G. F. Georges	7/60-41
AFC Resistors Kill High Voltage	Edward Tromanhauser	7/60-41
Stretched Heads & Poor Vertical Sync	R. E. Cox	8/60-33
Volume Control Varies Video	C. M. Fuqua	8/60-33
Misaligned Switch Wafer Weakens Reception	A. J. Krukowski	9/60-55
Cable Contamination Causes Snow	C. B. Randall	9/60-55
Sound Normal, Intermittent Video	M. R. Albert	10/60-37
Runaway Horizontal Oscillator	L. C. Huneault	11/60-46
Poor Width, Sound Buzz	Jim Uterback	11/60-46
Jumped Ballast Pops Rectifier	G. J. Rupp	12/60-46
Motorboating Radio	F. J. Will	12/60-46

### NOTE:

Cumulative index of all Circuit Digests to date is published in every May issue. An interim 6-month index was published in last month's November 1960 issue.



**J-Tran**  
top-tuned  
miniature  
IF  
transformer

by **MILLER**

You can align *both* tuned circuits from the top of the shield. Unit is designed with tuning cores which have hex holes extending the length of the core. This construction permits aligning tool to pass through one core and engage the other.

The J-Tran comes complete with a new style mounting clip which is part of the shield can.

### TOP-TUNED MINIATURE IF TRANSFORMERS

Cat. No.	Item
14-H1	262 kc Input I.F.
14-H2	262 kc Output I.F.
14-H6	262 kc Output I.F. <sup>o</sup>
14-C1	455 kc Input I.F.
14-C2	455 kc Output I.F.
14-C6	455 kc Output I.F. <sup>o</sup>
14-C7	455 kc Input I.F. - battery radios
14-C8	455 kc Output I.F. - battery radios
14-C9	455 kc Input I.F. - AC-DC radios
14-C10	455 kc Output I.F. - AC-DC radios
6270	4.5 Mc Input or Interstage
6271	4.5 Mc Ratio Detector

<sup>o</sup>with diode filter capacitors

Size: 3/4" square x 2" high

### TOP-TUNED PRINTED CIRCUIT IF TRANSFORMERS

Cat. No.	Item
16-PH1	262 kc Input I.F.
16-PH2	262 kc Output I.F.
16-PH6	262 kc Output I.F. <sup>o</sup>
16-PC1	455 kc Input I.F.
16-PC2	455 kc Output I.F.
16-PC6	455 kc Output I.F. <sup>o</sup>
16-PC7	455 kc Input - battery radios
16-PC8	455 kc Output I.F. - battery radios
16-PC9	455 kc Input I.F. - AC-DC radios
16-PC10	455 kc Output I.F. - AC-DC radios
6270-PC	4.5 Mc Input or Interstage
6271-PC	4.5 Mc Ratio Detector

<sup>o</sup>with diode filter capacitors

Size: 3/4" square x 2" high

Write for Miller general catalog, and the TV Replacement Guide, or ask for them at your distributor.



**J. W. MILLER CO.**

5917 S. Main Street  
Los Angeles 3, California

EXPORT REPRESENTATIVE:  
Roburn Agencies, Inc., N.Y. 13, N.Y.

CANADIAN REPRESENTATIVE:  
Atlas Radio Corp., Ltd., Toronto 19, Ont.

For more data, circle 12-52-1 on coupon, p. 48

52

### Stanton CALIBRATION STANDARD

Announced as now available for general use, model 381 ultra-linear pickup originally developed for the professional level of the recording and broadcasting industry. In addition to the standard high impedance model (47,000-100,000 ohms), low impedance models of 250 or 500/600 ohms are

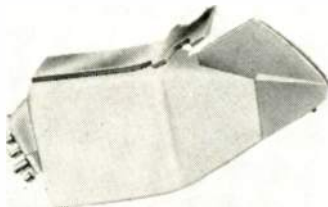

available. Response, flat within 1 db from 20 to 10,000 cycles and within 2 db from 10 kc to 17 kc. Output, 5 millivolts per channel. Separation, 35 db. Tracking force, 2 to 3 grams. Model 381A, complete with calibration test report, 0.7 mil diamond V-Guard stylus, \$48.00. Pickering & Co., Plainview, N. Y.

For more data, circle 12-52-3 on coupon, p. 48

### Scott STEREO AMPLIFIER

Announced is the completely new stereophonic power amplifier, model 290. Dual channel. 50/watts channel, by IHFM standards. Harmonic distortion, at maximum output, 0.5%. First order intermodulation distortion, 0.1%. Output circuits, meter-monitored. Built on an aluminum chassis. The attractive case matches almost any decor. It has no wires on the front and the functional controls and meter are designed for good looks. The unit is designed to operate with a high-quality stereo preamplifier such as the firm's models 122 and 130. H. H. Scott, Inc., 111 Powdermill Rd., Maynard, Mass.

For more data, circle 12-52-4 on coupon, p. 48

### CORRECTION

On page 20 of the Oct. 1960 issue, a description of Jerrold Electronics' new Model DSA-202 mast-mounted preamplifier for TV and FM contains a typographical error. It was incorrectly stated that the unit covers the UHF channels. The correct statement is that the DSA-202 provides 20 db gain for all VHF (very high frequency channels 2 to 13) TV channels.

## BERNS PERFECT PIN-CRIMPER

### Picture-Tube Repair Tool

Eliminates that hard soldering job.

only \$1.25

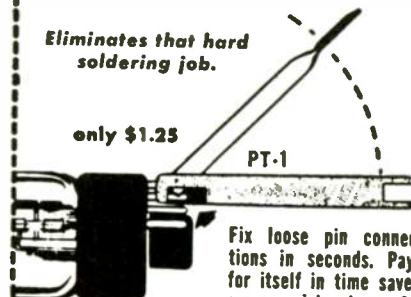

Fix loose pin connections in seconds. Pays for itself in time saved on one job alone. 3" long.

U. S. Pat. 2,878,698  
Canadian Pat. 592,702

Intermittent operation of picture tubes due to defective solder connections at socket pins is easily corrected through the use of the Berns Perfect Pin Crimper. Actually a 3-in-1 tool that can also be used as a channel-selector wrench and screwdriver, it serves to notch pins and element leads to provide solid electrical connections. Pin keeps its original form.

3 models: PT-1 for 3/32" pin diameter; AU-2 for 1/8" pin diameter and installing C rings; LC-3 for 5/32" pin diameter.

Available at your parts distributor.

Another fine product from:

**BERNS** Mfg. Co.  
9849 Chalmers,  
Detroit 13, Mich

For more data, circle 12-52-2 on coupon, p. 48

## Check the EXTRA CONVENIENCE you get in the RCA V-O-M with the Extras



- Rugged, scuff-proof, stain-resistant laminated vinyl carrying case: only \$4.95 extra. Special receptacle for test leads!
- Spring clips on handle hold leads when instrument is not in carrying case.
- Red test probe supplied with slip-on alligator clip for added versatility.

See page 55 for the full story on this superlative value at only \$43.95\* \*User Price (Optional)

RCA Electron Tube Division, Harrison, N.J.



The Most Trusted Name in Electronics

RADIO CORPORATION OF AMERICA

**Mullard TUBE**

Model EFC86/6HG8 frame grid triode pentode, for use in TV tuners as a frequency changer at frequencies up to 220 mc, features high gain, tube-to-tube uniformity and low intermodulation distortion. Heater current, .34



amp. Heater voltage, 6.3v. Pentode and triode section respectively: transconductance, 1200  $\mu$ mhos, 6000  $\mu$ mhos; amplification, 60, 17; plate voltage, 150v, 100v. International Electronics Corp., 81 Spring St., New York 12, N. Y.

For more data, circle 12-53-3 on coupon, p. 48

**Robins SYL-A-SCOPE**

Model SG-66 Syl-A-Scope magnifies the contours of a stylus and reflects the image on a 2 1/4" x 2 1/4" illuminated screen. It is reported to be the first truly reliable method for checking stylus wear. Can be used without re-

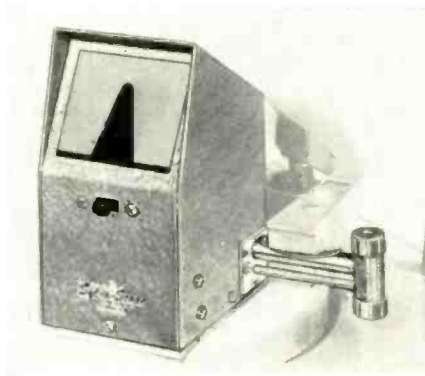

moving the stylus or the cartridge from the tone arm. Its operation is based on the same principles as optical comparison equipment. Plugs into any 110-120v a-c outlet. \$19.95. Robins Industries, 36-27 Prince St., Flushing, N. Y.

For more data, circle 12-53-4 on coupon, p. 48

**BUY WHAT YOU NEED!**

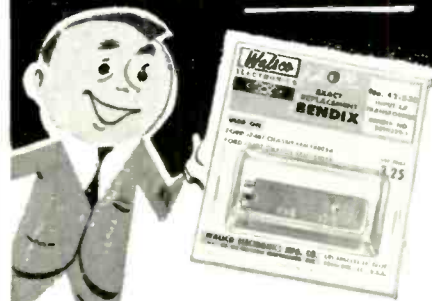

**NEW Walsco KOIL-PIK**

**EXACT REPLACEMENT TRANSFORMERS**  
SAVE TIME IN SELECTION

NEW WALSCO KOIL-PIK TRANSFORMERS save you time and money because they're so easy to select—44 exact replacements that are clearly identified and protectively packaged.

**EXACT REPLACEMENTS FOR**

- IF & RF Coils & Transformers
- TV Sound Discriminators
- Miniature IF Transformers
- Portable Radio & Auto Capacitors
- Printed Circuit Capacitors

SEND FOR FREE CATALOG!



**WALSCO ELECTRONICS MFG. CO.**

Division of Textron Electronics, Inc.  
West Plant: Los Angeles 18, California  
Main Plant: Rockford, Illinois, U.S.A.

For more data, circle 12-53-1 on coupon, p. 48

**NEW YORK • WORLD CENTER FOR RADIO-ELECTRONICS • 1961**

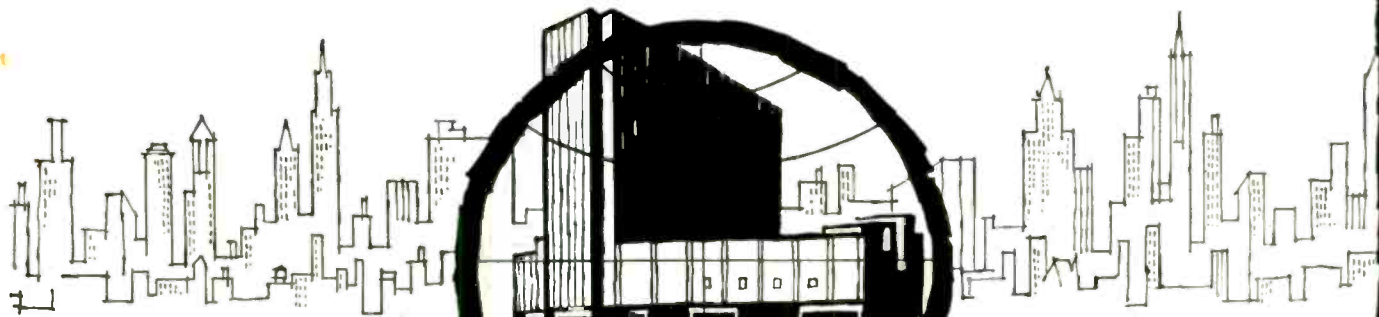

**INTERNATIONAL IRE SHOW CONVENTION**

Visitors from all over the world will converge on the Coliseum, March 20-23, for IRE's big Show and International Convention. Join the more than 65,000 radio-electronics engineers who will attend! On the Coliseum's 4 gigantic floors you'll see the latest production items, systems, instruments and components in radio-electronics; in radar; in complex air traffic control; in space communications—in any and

every field of radio-engineering you care to name. At the convention, you'll trade ideas with brilliant delegates from the world of radio-electronics, and choose from amongst scores of papers to be read by experts in their field. Like the IRE show, the convention is both a summing-up and a look into the future! Remember the occasion, the time, the place.

Registration: IRE members \$1.00—non-members \$3.00



**MARCH 20-23 1961**

**INTERNATIONAL CONVENTION and IRE SHOW**

**The Institute of Radio Engineers**  
1 East 79th St., New York 21, N. Y.

**WALDORF-ASTORIA HOTEL COLISEUM • NEW YORK**  
No one under 18 years of age will be admitted.

For more data, circle 12-53-2 on coupon, p. 48

# SHOP HINTS



## Tips for Home and Bench Service

### Rapid Battery Tester Attachment

"Snap cap" type batteries can be quickly tested by placing a battery bottom-side-up on this gadget, as shown in Fig. 1. The rig eliminates fumbling with the battery and two leads.

It can be easily made by attach-

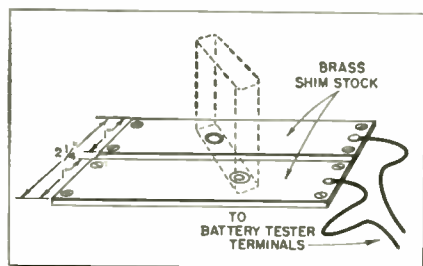

Fig. 1—Two strips of brass shim stock attached to board provides a test adaptor for rapidly checking clip-type batteries.

outline of the working mechanism, as shown in Fig. 2.



Fig. 2—Chalk marks on record player mounting pins can be transferred to a brown paper or cardboard template to be used for accurately cutting equipment mounting bases.

Hold the paper against the chalked outline and the markings will be transferred to the paper accurately. Permanently mark pin locations then cut out the paper as outlined. It will then prove an exact template for making an accurate baseboard—*Glen F. Stillwell, Manhattan Beach, Calif.*

### SHOP HINTS WANTED!

\$3 to \$10 for acceptable items. Use drawings to illustrate whenever necessary. A rough sketch will do. Photos are desirable. Unacceptable items will be returned if accompanied by a stamped envelope. Send your entries to "Shop Hints" Editor, ELECTRONIC TECHNICIAN, 480 Lexington Ave., New York 17, N. Y.

### Base Template

It is frequently necessary to make a base for a record player or comparable electronic unit, and difficulty is encountered with cut-outs. This trouble can be easily overcome by first making a template from stiff brown paper or cardboard. Make the cut-outs roughly in the sheet of brown paper. Next, chalk the unit's mounting pins and the

outline of the working mechanism, as shown in Fig. 2. (tor) is placed in series with the vertical windings to prevent an increase in winding resistance with a rise in temperature. Compensation for this temperature increase is necessary to maintain a stable vertical height and linearity.

Thermistors, having a negative coefficient of resistance, decrease in resistance with an increase in ambient temperature. It is placed in series with the vertical windings, as shown in Fig. 3, and positioned in proximity with the vertical coils. As these windings heat, resistance of the thermistor and the yoke's vertical coils oppose one another and the effective overall resistance naturally remains relatively constant.

Although few thermistors fail, an improperly functioning thermistor can affect vertical height and linearity. Consequently, technicians

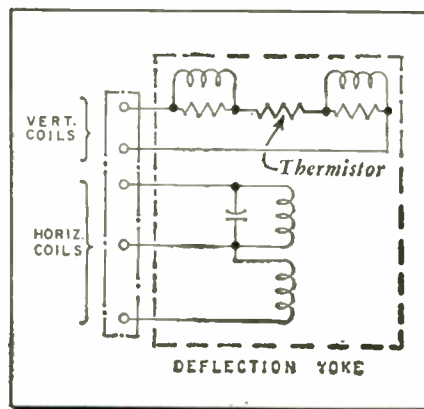

Fig. 3—A thermistor has been installed in series with the vertical windings of an RCA deflection yoke to stabilize vertical height and linearity. If it becomes defective it can affect vertical height and linearity.

### Thermistors in TV Yokes

Deflection yoke vertical windings in RCA TV receivers employ a thermistor in addition to regular damping resistors. The thermistor (a temperature compensating resis-

should not forget to check the thermistor when encountering poor height and linearity symptoms in RCA sets.—*RCA Service Co., Camden, N. J.*



# RCA ELECTRONIC INSTRUMENTS

"PREFERRED BY PROFESSIONALS"

## METERS and TUBE TESTERS



### WV-38A VOLT-OHM-MILLIAMMETER THE V-O-M WITH THE EXTRAS!

Compare this superlative RCA V-O-M against the model you may have been thinking of buying. See if it doesn't check out better in these extra features:

- EXTRA! 1.0 volt and 0.25 volt ranges DC!
- EXTRA! Big easy-to-read 5 1/4" meter!
- EXTRA! Non-breakable plastic case; no glass to crack or shatter!
- EXTRA! Smart attractive modern styling—the V-O-M of the future!
- EXTRA! Red test lead has probe and slip-on alligator clip for added versatility!
- EXTRA! Orderly location of jacks below switches keeps leads out of the way!
- EXTRA! Spring clips on handle to hold test leads!

- EXTRA! DB scales clearly marked: no squinting!
- EXTRA! Rugged, scuff-proof, stain-resistant laminated vinyl carrying case, only \$4.95\* extra!

Only \$43.95\* complete with batteries, instruction book and all probes, clips and cables. (RCA V-O-M Kit only \$29.95\*).



### NEW! WV-77E VOLTOHMYST®

Measures AC and DC voltages to 1500 volts; resistance from 0.2 ohm to 1,000 megohms. Separate scales, 1 1/2 volts rms and 4 volts peak-to-peak for low AC measurements.

Only \$43.95\* complete with probes, leads, instructions. (RCA VoltOhmyst Kit only \$29.95\*).



### NEW! WV-98B SENIOR VOLTOHMYST®

Measures AC and DC voltages (3% accuracy); resistance from 0 to 1,000 megohms. Measures peak-to-peak values of complex waveforms. Rugged cast aluminum case, field-tested printed circuits. Big 6 1/2" meter.

Only \$79.50\* with leads, clips, instructions.

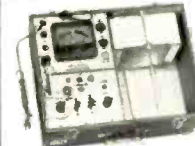

### WT-110A AUTOMATIC ELECTRON TUBE TESTER

Especially designed for testing of electron tubes. Uses automatic punched-card selection of correct test conditions on wide variety of tubes. Checks vacuum-tube rectifiers under high-current conditions.

\$199.50\* complete with 263 punched cards, 24 blank cards, card punch; instruction book.

## SCOPES



### WO-91A 5-INCH COLOR-TV OSCILLOSCOPE

High-performance, wide-band oscilloscope ideally suited for color-TV, black-and-white TV, and other electronic applications. Dual bandwidth (4.5 Mc, 0.053 volts rms/in. and 1.5 Mc, 0.018 volts rms/in.). Internal calibrating voltage and calibrated graph screen. Includes special direct/low-cap shielded probe and cable.

Only \$239.50\* complete with ground cable, insulated clip, instruction book.



### NEW! WO-33A SUPER-PORTABLE OSCILLOSCOPE

A low-cost all-purpose scope you can carry anywhere—only 14 pounds—ideal for in-the-home servicing of black-and-white and color-TV, audio and ultrasonic equipment. High gain and wide bandwidth to handle the tough jobs! Rugged and compact—scaled 3" graph screen.

Only \$129.95\* complete with low-cap direct input probe, cable, power cord, cord-carrying brackets, instructions. (RCA Super-Portable Oscilloscope Kit, only \$79.95\*).

## GENERATORS



### NEW! WA-44C AUDIO GENERATOR

Generates sine and square wave signals for testing audio systems. Frequency range: 20 cps to 200 Kc. Used to measure intermodulation distortion, frequency response, input and output impedances, speaker resonance, speed of recording and playback mechanisms, transient response and phase shift. Only \$98.50\* with cable and instructions.

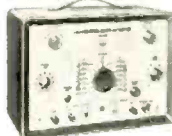

### WR-69A TELEVISION/FM SWEEP GENERATOR

For visual alignment and troubleshooting of TV rf/lf/vf circuits and other electronic equipment. IF/video frequency ranges 50 Kc to 50 Mc, TV channels 2 to 13, plus FM range—88-108 Mc. Sweep width continuously adjustable to 12 Mc or more. Only \$295.00\* with cables, instruction book.



### WR-99A CRYSTAL-CALIBRATED MARKER GENERATOR

To supply a fundamental frequency rf carrier of crystal accuracy for aligning and troubleshooting color-TV, black-and-white TV, FM receivers and other electronic equipment operating in 19 Kc to 260 Mc range. Only \$242.50\* complete with output cable, two phone tips, instruction book.



### WR-49B SIGNAL GENERATOR

For alignment and signal tracing of AM/FM receivers, low-frequency signal tracing and alignment of TV vt/lf amplifiers. Six ranges—85 Kc to 30 Mc. Internal 400 cps modulation. Low rf signal leakage!

Only \$79.50\* complete with shielded cable for rf and af output, instruction book.



### WR-70A RF/IF/VF MARKER ADDER

To be used with WR-69A or similar electronic equipment. Eliminates waveform distortion due to receiver overloading during visual alignment by adding markers after the rf signal is demodulated.

Only \$74.50\* with cables, instruction book.

There's an RCA test instrument to help you do every job better, and easier—and to save you valuable time. A comprehensive line of test accessories: video multi-markers, TV isotaps and bias supplies, probes and cables. See your Authorized RCA Electronic Instrument Distributor for complete information.

RCA Electron Tube Division, Harrison, N.J.

\*User Price (Optional)



The Most Trusted Name in Electronics  
RADIO CORPORATION OF AMERICA

## High Voltage Rectifier Circuits

(Continued from page 35)

be obtained accurately and safely with a VTVM or high resistance d-c voltmeter fitted with a d-c multiplier probe, as shown in Fig. 3.

Commercial high voltage probes both a-c and d-c types, are standard accessories for most VTVM's, VOM's, etc. If a high voltage probe is not available, however, the re-

sistance needed to increase an instrument's range can be easily computed. Probe resistance for any d-c meter, either a VTVM or moving coil voltmeter, may be computed when the internal resistance of the meter, the volts range to be used, and the maximum volts to be measured is known. The meter current is first determined in microamperes at full scale:

$$\text{Meter current in } \mu\text{amps} = \frac{\text{meter range (full-scale v.)}}{\text{meter resistance (megohms)}}$$

VTVM's usually draw 40 to 90 microamperes at full scale, whereas moving coil type d-c voltmeters draw from 10 to 50 microamperes at full scale. D-c input resistance of service VTVM's generally range from 10 to 20 megohms, and the VOM's range varies from a few thousand ohms to beyond 150 megohms—depending upon the voltage scale being used.

Total required resistance is determined as follows:

$$\text{In megohms resistance} = \frac{\text{maximum voltage to be measured}}{\text{meter current } (\mu\text{amps})}$$

Probe resistance equals total resistance minus the meter resistance.

A probe may be checked by setting the brightness at a low level and connecting the probe to the 2nd anode. If the brightness increase is negligible, resistance of the probe is probably satisfactory. However, if brightness increases during the test, the probe resistance is probably too low. If the brightness decreases, of course, resistance of the probe is too high. The probe should have little effect on lowering the anode voltage. Because of the inherently poor high voltage regulation of monochrome television sets, however, indicated voltage may read somewhat lower than that obtained under no-load conditions. It should be pointed out here that all probes employed in HV measurements should be adequately insulated for the technician's protection.

### Voltage Measurements

If voltage at the CRT 2nd anode measures normal, the trouble is not in the high voltage rectifier circuit. If the voltage is low at the CRT 2nd anode connection, the next point of measurement should be at the HV rectifier tube's heater. If the voltage is normal here, this indicates an open or defective anode series resistor. Some sets do not include this resistor. If it is employed in the circuit it can overheat, go very high in resistance, and result in a large voltage drop.

Of course, another approach is possible here. After measuring the 2nd anode voltage under load, it can be measured under no-load conditions by removing the lead

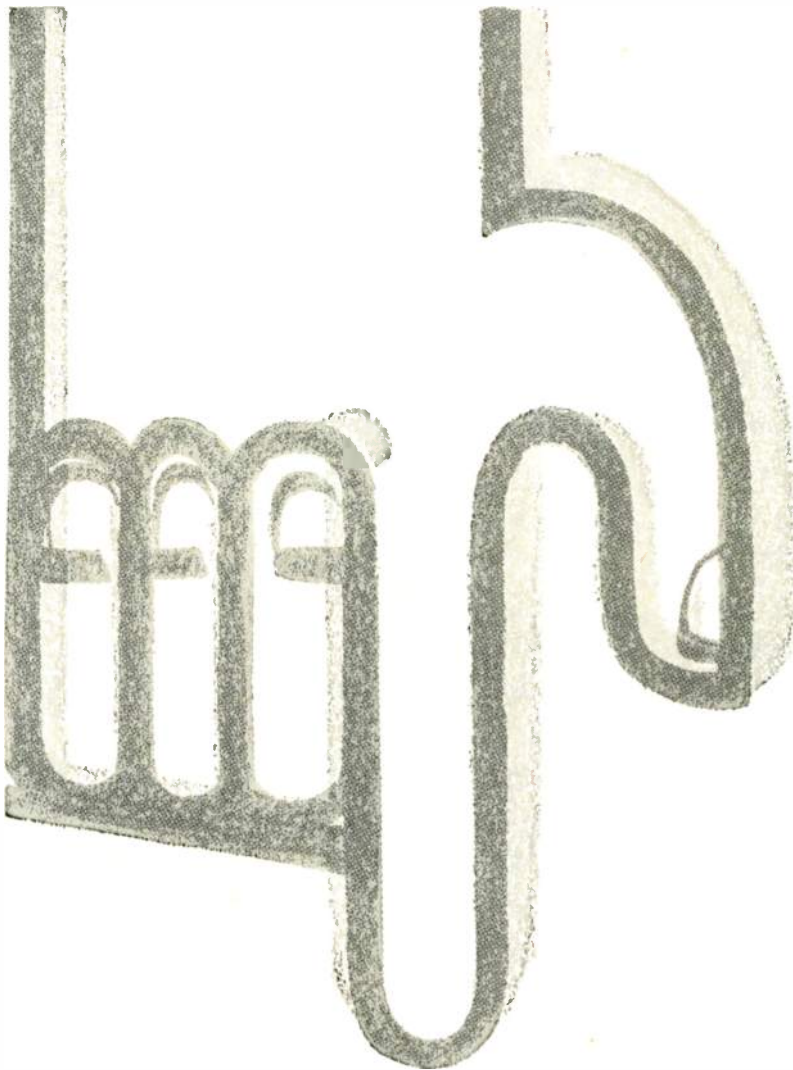

exact replacement **STANCOR TRANSFORMERS**  
that do the job...and do it better  
FLYBACKS • YOKES • POWER TRANSFORMERS

Your distributor has them in stock—along with many other types and the complete line of Stancor Coils. Complete replacement listings in PHOTOFACTS and COUNTERFACTS.

**CHICAGO STANDARD TRANSFORMER CORPORATION**  
3501 WEST ADDISON STREET • CHICAGO 18, ILLINOIS

For more data, circle 12-56-1 on coupon, p. 48

from the CRT. If the voltage at the anode connector rises appreciably from load conditions, somewhat similar conclusions can be drawn except (assuming rectifier tube is good) the current limiting resistor in the tube's heater can be defective. Likewise, conditions previously outlined for CRT and 2nd anode cable leakage could also be the cause.

If a current limiting resistor is used in the set it will usually be located beneath the HV-rectifier tube socket and will normally be soldered across two socket contacts. When this resistor is replaced the same tie points should always be used. Because of its position the resistor is often overlooked by technicians. The resistor is critical and should be replaced with the exact value specified by the manufacturer.

When several high voltage rectifier tubes burn out within a short period of time the cause is generally excessive filament voltage. This sometimes occurs when a "nearly exact" flyback transformer is substituted. It is not practical to measure rectifier filament voltage without special equipment, and attempting to judge proper temperature of a high voltage rectifier heater by the amount or color of light it gives off can be misleading. A better way is to disconnect the heater wires at the socket and wire in a 1.5 volt dry cell. Operation of the circuit should then be observed under these conditions to determine if the tube heater again burns out. Since the dry cell is at high d-c potential, it naturally must be well insulated. Filament voltage may be reduced by separating the filament winding (if more than one turn is used) or placing heater turns in a weaker field of the fly-back—depending upon design. If a heater winding is replaced on a fly-back because of age, etc., make certain the original position and amount of wire is duplicated.

Defective HV filter capacitors, variously called "hy-caps," "cart-wheels," "door-knobs," etc., are in a special class—perhaps because shops are seldom equipped with an instrument capable of providing a precise test of the capacitor's condition. When leaking under load the capacitor can cause interference to picture, sound, and disrupt

sync stability, in addition to normal HV failures. The only sure test is a substitution.

### Component Replacement

Many highly qualified technicians seldom realize how critical the HV "cage" can be. Tolerances are narrow in most respects—including lead dress, parts placement, solder joints, etc. Sloppy replacement of a fly-back, filter capacitor, rectifier tube socket, etc., can result

in unnecessary call-backs. Parts placement should conform precisely with that of original components. All leads should be short and run as direct as practical. HV leads should be dressed away from lower potential points whenever possible. Ties should contain one full turn of pre-tinned wire with no surplus bare wire extending away from the tie point—insulation snug to the tie. Solder should cover all strands of the wrap—being built up in a slightly curved

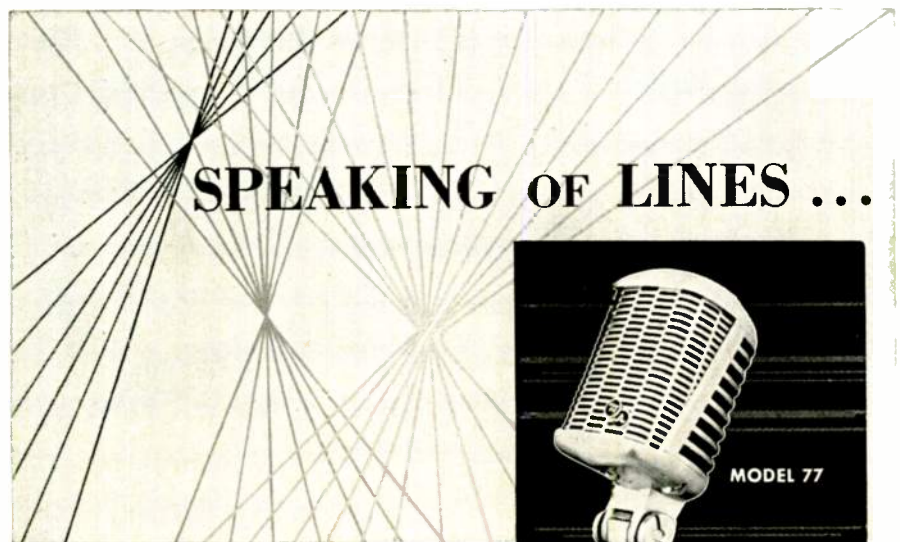

... The complete line of Astatic microphones includes types and styles to meet all communication and amplification needs. Astatic offers a full range of models . . . every one superbly engineered with many advanced features found in no other line. There is an Astatic microphone to meet all demands for finest fidelity . . . to resist wear and tear of the most abusive service, extremes of temperature and the elements . . . to fill the bill whatever is required. This is why Astatic microphones are preferred by sound engineers and installers the world over. Astatic has been manufacturing quality microphones for more than a quarter century . . . and none which carries the Astatic label is ever unworthy of the name. Illustrated are a few popular Astatic models.

**Model 77**—highest fidelity with most positive anti-feedback characteristics of any cardioid.

**Vogue 988**—utmost professional instrument quality.

**Three-Thirty Series** — small, compact, classically simple in design with professional performance.

**Model DN-50**—famous for performance with famous traditional microphone design.

WORLD'S MOST FAMOUS NAME IN PHONO CARTRIDGES AND NEEDLES, MICROPHONES

THE **Astatic** CORPORATION,  
CONNEAUT, OHIO

In Canada: Canadian Astatic Limited, Toronto, Ont.  
Export Sales: Roburn Agencies, Inc.,  
431 Greenwich St., N. Y. 13, N. Y., U.S.A.

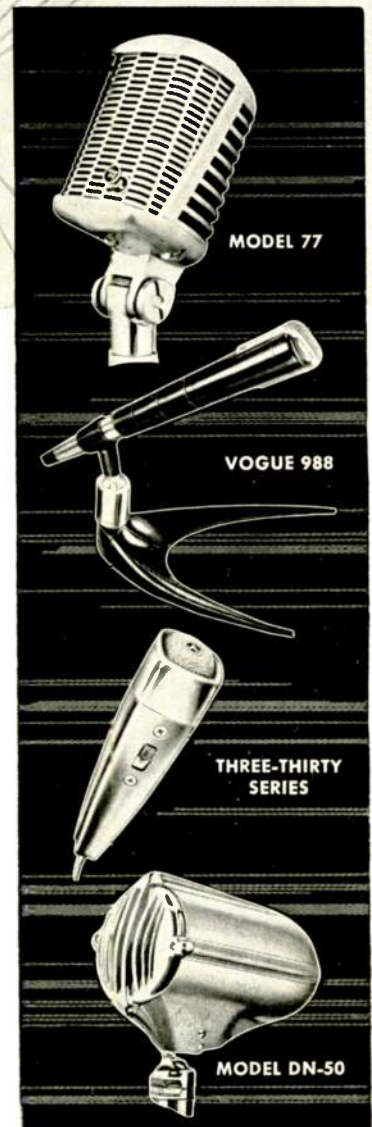

For more data, circle 12-57-1 on coupon, p. 48

flattened mound, and perfectly smooth. Sharp turns and edges should be avoided.

With the exception of the CRT, the high voltage cage will probably accumulate more dust than any other section of a TV. When parts are replaced the entire area should be thoroughly cleaned; a compressed air blower is useful here. After replacements are made the area should be sprayed with an appropriate insulating plastic. Cleaning and spraying will discourage corona and arc-over.

Before working on the HV-rectifier section the CRT 2nd anode and filter capacitors should always be discharged to ground. Many technicians carry a 2 or 3 foot length of well-insulated grounding clip-lead in the tube caddy for this purpose. On series string sets make sure the discharge is made to main chassis or a true ground point—not just to any metal part of the chassis. This rule should also be observed when grounding a meter's common lead. If not, components or test instruments may be damaged.

A TV set should never be returned to a customer with the cage or housing removed from the HV section. In addition to being a hazard, considerable interference can be picked up by other sections of the set from an improperly shielded HV section.

*Illustration Credit: John F. Rider Publishers, Inc., New York, N. Y.*

## BBB's View

*(Continued from page 41)*

manufacturers included a cordial dislike for "captive" service organizations.

### Service Dealers vs Distributors

**Unavailability of Replacement Parts:** A cause of both public and service industry complaint to the Better Business Bureaus is the unavailability of replacement parts, and the inordinate delay often occasioned in getting them. Considering the variety of products and models produced and the many parts they contain, it is understandable that a problem may exist. But this doesn't satisfy an irate customer or a frustrated serviceman.

**Distributor Sales Practices:** Many servicemen complain bitterly about the willingness of some distributors to sell to anyone who comes in the door at the same prices charged to established dealers and servicemen. According to the complainers, this also leads to public belief it is being gouged by the marked-up prices necessarily charged by the established trade. This practice is a sore point with servicemen. They feel the industry whose products they service should not tolerate a system of parts distribution which tends to pull the rug out from under their economic feet.

Servicemen complain from coast to-coast their industry is plagued by too many ill-trained, ill-equipped, part-time servicemen who operate from their garages, attics, basements or hats. They siphon off a lot of business with lower charges, due to lower overhead, allegedly abetted in some cases by their failure to report income to local and federal tax authorities. •

## An open letter to George W. Riggle

**QUAM-NICHOLS Co**  
MANUFACTURERS OF  
LOUDSPEAKERS AND TELEVISION  
MARQUETTE ROAD AND PRAIRIE  
CHICAGO 37, ILLINOIS

Mr. George W. Riggle  
Ace Radio & Television  
Service  
Jacksonville, Florida

Dear Mr. Riggle:

I have just received a report from our laboratory on the Quam speaker you recently sent back to us.

You are absolutely right; this speaker, which you installed more than 25 years ago, is still in perfect operating condition.

As proud as we are to have this evidence of the quality of materials and workmanship of Quam speakers, we are prouder still that you took the time and trouble to tell us about it.

It's nice to know we have such good friends in the service profession—men like yourself, dedicated to quality, dedicated to thirty year, not thirty day, installations. It affirms our policy of manufacturing only the finest possible product.

Very Cordially,  
QUAM-NICHOLS COMPANY

*Helen S. Quam*  
Helen S. Quam

P.S. We, also, agree with you that an ad with a picture of this unit would speak "loud" for Quam.

226 East Marquette Road  
Chicago, Illinois

UNRETOUCHED  
PHOTOGRAPH



**QUAM-NICHOLS COMPANY**

For more data, circle 12-58-1 on coupon, p. 48



# Audio NEWS LETTER

SARKES TARZIAN announces a new magnetic recording tape div. to produce high fidelity tape. Fred Lucas is div.'s new sales mgr.

JENSEN MANUFACTURING appoints Severson & Assoc. sales reps for loudspeakers in Ill., Wisc., and Porter & Lake counties in Ind.

GARRARD'S Type A changer-turntable with dynamically balanced arm is priced at \$69.50 less cartridge. Table weighs six pounds.

ROBINS INDUSTRIES publishes 4-page illustrated brochure describing their complete line of record and tape-care accessories.

H. H. SCOTT introduces the Model 310D Broadcast Monitor FM Tuner with new electro-relay interstation quieting circuit. Sensitivity is 2  $\mu$ v, IHFM.

ASTATIC "Asta-Stock" system simplifies maintaining a balanced stock of needles. System includes stock cabinets with cross-reference information on index tabs and on package for each needle.

A. BERNARD SMITH LABS., 2969 Ludlow Rd., Cleveland 20, Ohio, announces a new type of phono cartridge, the "photoSonic 120," priced @ \$47.50. Power supply and preamp cost is not included. Limited production is set for year end. Unit uses photocells and a light beam modulated by the record groove to pick up sound. Stylus, for tracking only, requires 0.5-0.9 gram. Ratings are d-c to 100 kc flat response, V&H compliance 20, output 4 mv @ 5 cm/sec, claimed to be completely non-inductive.

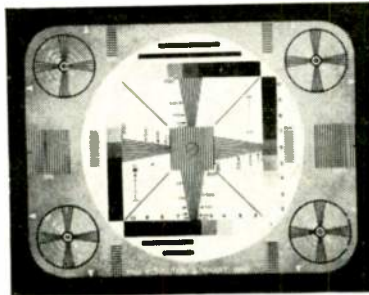

## TV TIPS FROM TRIAD

NO. 10 IN A SERIES

"What gives with the schnorkel?," asked Bill as he examined the receiver on the bench. A four inch line of vent tubing angled up crazily and appeared to originate in the lower portion of the cabinet. A slight whirring sound suggested some kind of motor operating in the nether recesses.

"You are looking at the second power transformer I've installed in that set," answered Joe. "With everything normal it still smells after running for a couple of hours with the cabinet buttoned up. I thought the little fan on the phono motor might move enough air if I had the vent to direct it out of the cabinet. Well, it seems to help, but I can't put the back on, and you can hear the motor when the room is quiet. Looks like I need a power transformer that will give more watts without being one iota larger."

Neither Bill nor Joe had noticed Al, the parts salesman, enter, which was unusual, because Al was usually very noticeable, and today he was still exhibiting effects of the weekly sales meeting brainwashing.

"Just happen to have exactly what you want," said Al, "I looked over the shipment of new Triad power transformers with Triple X Steel," — he shifted smoothly into high gear — "and these transformers use the same size iron, so they fit, but because they're made of fine grade audio steel, we can design them to operate at a higher flux density and in many cases do not need heat dissipating fins to maintain safe temperatures—"

"Send me one," said Joe.

"—and since the efficiency of the steel is higher we do not require as large a stack, so our copper losses are lower—"

"I'm sold," said Joe.

"—and by utilizing a simple type of mounting bracket you can adapt the new series, even where the original had an unusual configuration — Oh, you'll take one? So soon? What's the matter? Don't want to learn anything?"

\* \* \*

MORAL: Sometimes a little "extra" in a replacement part will help make up for the effects of ageing in the receivers you service. If you would like to see for yourself how "Triple X" differs from the old "one grade better than stovepipe iron" drop us a line and we will be pleased to send you a sample. We will also include information on the new "Triple X" units. Write to **Triad Transformer Corporation**, 4055 Redwood Ave., Venice, California.

For more data, circle 12-59-1 on coupon, p. 48

**PHONE**  
ED 9-9653



**\$7.50**  
plus parts,  
C.O.D. and postage charges

**90 DAY**  
**WARRANTY**

### Precision Tuner Service

ALL TYPES T.V. TUNERS REPAIRED AND ALIGNED TO FACTORY SPECIFICATIONS ON CRYSTAL-CONTROLLED SWEEP GENERATORS  
24-HOUR SERVICE ON MOST TUNERS  
**UHF - VHF COMBINATIONS — \$13.50**

See your local distributor or send to:

**P.O. Box 272, 601 N. College**  
**BLOOMINGTON, INDIANA**

**State make and model. Send**  
**all parts, tubes and shields.**

For more data, circle 12-59-2 on coupon, p. 48

# ATLAS "Job Rated" P. A. SPEAKERS



## There is an Atlas Speaker Ideally Suited for Every Job

All Atlas P. A. speakers are highly efficient, especially in the voice frequency range, providing the extra "punch" needed to override high level background noise. Most are 100% weatherproof; aluminum and diecast parts are treated with corrosion inhibitors, then finished in "stone hard" baked enamel. The CJ Cobra-Jector horns are constructed of nonresonant, indestructible fiberglass, and HU and TP speaker horns of aluminum, finished in gun-metal grey. The HU and TP speakers are particularly designed for efficient talkback operations. The peaked characteristics within the voice frequencies increase the sensitivity of these speakers as pickup devices.

All HU and CJ speakers are equipped with versatile "Versalock" . . . This rugged, reliable mounting bracket, completely adjustable both horizontally and vertically, provides positive locking in any position.

The DU-12 and DC-5, Atlas' renowned DeCor projectors, are styled to harmonize with any decor, modern or traditional.

Send for free catalog to Dept. ET-12

Model	HU-12N	HU-15N	HU-24N	CJ-14N	CJ-30N	CJ-44	TP-15N	TP-24N	DU-12	DC-5
POWER*	7.5 w	25 w	25 w	7.5 w	25 w	60 w	25 w	25 w	7.5 w	6 w
IMPEDANCE**	8 ohm	8 ohm	8 ohm	8 ohm	8 ohm	16 ohms	8 ohm	8 ohm	8 ohm	8 ohm
FREQUENCY	350-	250-	200-	400-	250-	150-	250-	200-	400-	120-
C.P.S.	10,000	10,000	10,000	10,000	10,000	9000	10,000	10,000	10,000	7000
LENGTH OVERALL	7 1/4 in.	8 3/4 in.	12 in.	8 in.	1 1/4 in.	23" x 13"	16 1/2 in.	23 in.	14 in.	14 in.
BELL DIAMETER	7 1/2 in.	9 3/4 in.	11 1/4 in.	9 1/2" x 5 1/2"	14" x 6"	19 in.	9 3/4 in.	11 1/4 in.	7 in.	7 in.
NET PRICE	\$16.20	\$20.10	\$22.35	\$18.00	\$24.60	\$43.50	\$31.20	\$34.50	\$19.80	\$13.20

\*Input range limited to frequencies above horn cutoff \*\*All models available in 45 ohms at slightly higher prices

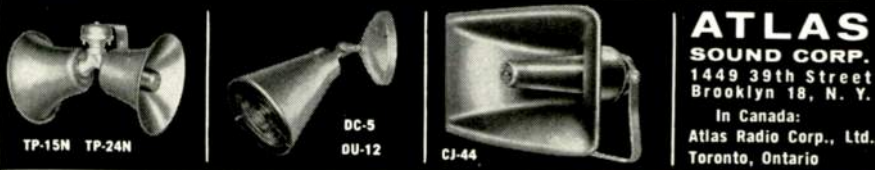

**ATLAS**  
SOUND CORP.  
1449 39th Street  
Brooklyn 18, N. Y.  
In Canada:  
Atlas Radio Corp., Ltd.,  
Toronto, Ontario

For more data, circle 12-60-1 on coupon, p. 48

## Communications Receiver

(Continued from page 39)

hours, and turned on only when actually needed for tests. For the majority of jobs, the receiver's controls are first set up for normal "phone" reception. Special circuit features, such as the BFO or crystal calibrator, are used only for certain test procedures, as we shall see later. Tuning is accomplished with the main tuning dial with the bandswitch set to an appropriate range. The r-f gain control is turned full up, and the a-f gain control set for a comfortable listening level. Where several technicians share the same shop area, earphone rather than speaker operation may be preferred.

### Service Applications

The communications set's potential as a service instrument comes into focus if we think of the unit as a highly selective, very sensitive, tuned r-f detector. Depending on control settings and circuit connections, then, the receiver can serve variously as a signal comparator, a tuned signal tracer, or as a signal source. Used in the first capacity, it is suitable for comparing two r-f signals over a wide range of frequencies and thus can serve for checking and recalibrating other test equipment, such as the shop's signal generator. As a high-gain signal tracer, the receiver can be used to check signals in the r-f and i-f stages of standard sets as well as the output of another set's local oscillator, indicating frequency as well as relative signal levels. In addition, it is useful for tracking down and isolating sources of interference. Finally, as a signal source, it can provide a known i-f signal and tone, pulse, or voice (music) signals for checking audio equipment or the audio sections of other receivers. In a pinch, it can provide substitute filament and B plus voltages for circuit tests.

### Accessories

A few inexpensive probes and other accessories are necessary for use with the basic receiver. Several

Superior's New Model 85—a DYNAMIC type

## TRANS-CONDUCTANCE TUBE TESTER

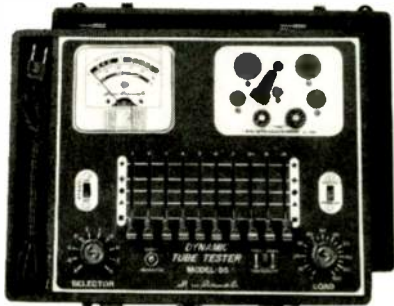

• THE "FREE-POINT" LEVER TYPE ELEMENT SWITCH ASSEMBLY marked according to RETMA basing, permits application of test voltages to any of the elements of a tube.

• NEW IMPROVED TYPE METER with sealed air-damping chamber provides accurate, vibration-less readings.

• FREE FIVE (5) YEAR CHART DATA SERVICE. The chart provided with Model 85 includes easy-to-read listings for over 1,000 modern tube types. Revised up-to-date subsequent charts will be mailed to all Model 85 purchasers at no charge for a period of five years after date of purchase.

• Employs latest improved TRANS-CONDUCTANCE circuit. Tests tubes under "dynamic" (simulated) operating conditions. An in-phase signal is impressed on the input section of a tube and the resultant plate current change is measured as a function of tube quality. This provides the most suitable method of simulating the manner in which tubes actually operate in radio, TV receivers, amplifiers and other circuits. Amplification factor, plate resistance and cathode emission are all correlated in one meter reading.

• SYMBOL REFERENCES: For the first time ever in a trans-conductance tube tester, Model 85 employs time-saving symbols (★, †, ♣, ▲, ■) in place of difficult-to-remember letters previously used. Repeated time studies proved to us that use of these scientifically selected symbols speeded up the element switching step. As the tube manufacturers increase the release of new tube types, this time-saving feature becomes more necessary and advantageous.

• SPRING RETURN SAFETY SWITCH guards Model 85 against burn-out if tube under test is "shorted."

• AN ULTRA-SENSITIVE CIRCUIT is used to test for shorts and leakages up to 5 megohms between all tube elements.

Model 85 comes complete, housed in a handsome portable cabinet with slip-on cover. Only.....

**\$52.50**

**SHIPPED ON APPROVAL  
NO MONEY WITH ORDER — NO C. O. D.**

Try it for 10 days before you buy. If completely satisfied send \$12.50 and pay balance at rate of \$8.00 per month for 5 months. — **No Interest or Finance Charges Added.** If not completely satisfied, return to us, no explanation necessary.

MOSS ELECTRONIC, INC.  
Dept. D-839, 3849 Tenth Ave., New York 34, N. Y.  
Please rush one Model 85. I agree to pay \$12.50 within 10 days after receipt and \$8.00 per month thereafter. Otherwise I may return, cancelling all further obligation.

NAME \_\_\_\_\_  
ADDRESS \_\_\_\_\_  
CITY \_\_\_\_\_ ZONE \_\_\_\_\_ STATE \_\_\_\_\_  
All prices net, F.O.B., N.Y.C.

r-f probes are illustrated in Fig. 1, and two sound take-off adaptors are shown in Fig. 2. Standard, readily available components are used and circuitry employed is not critical if standard wiring practices are observed. A few hours free time is ample for assembly of all the units.

The general purpose probe shown in Fig. 1A is made from a 24 to 36" length of coaxial cable, with a  $0.001 \mu\text{f}$  paper, mica or ceramic capacitor and a  $100\text{k}, \frac{1}{2}\text{w}$  isolating resistor assembled in a small shielded housing. A short length of aluminum tubing may be used for the probe body. This probe is used for stage-by-stage signal tracing in other receivers. The series resistor prevents undue circuit loading when checking across tuned circuits.

The probe shown in Fig. 1B is used primarily for tracking down sources of interference. A small coil, wound from enameled magnet or standard hook-up wire, is attached to the free end of a length of coax cable. Wire size, number of

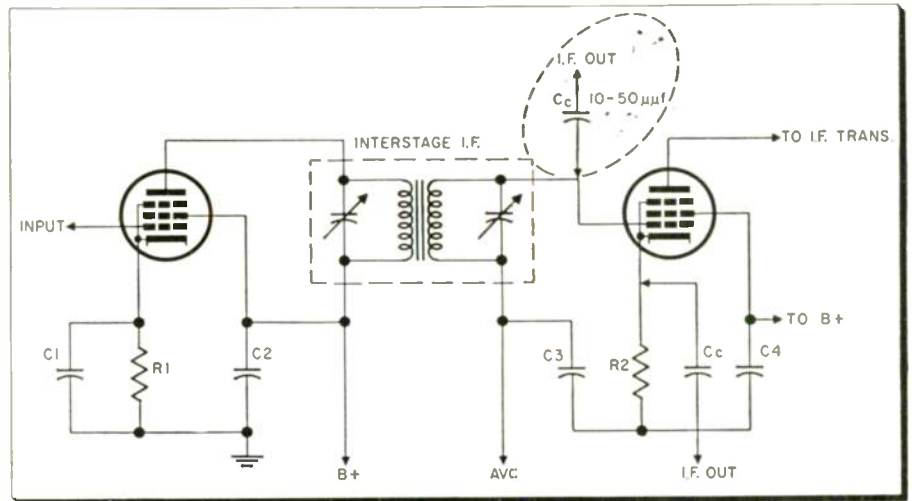

Fig. 3—A signal for injection and alignment purposes can be obtained from the communication receiver's 2nd i-f grid by employing a small capacitor as shown in dotted circle.

turns, and coil diameter are not critical.

The unit shown in Fig. 1C is an r-f probe for checking high level circuits. Basically, it is a capacitive voltage-divider to reduce input signal levels to prevent overloading the receiver's first stage. The probe is valuable for stage-by-stage

checks of small transmitters, CB transceivers, and two-way mobile radio gear. Components include a small padding capacitor, C-1, a shielded housing, and a length of coaxial cable. The instrument's attenuation characteristics are determined by the ratio of C-1 and the set's input impedance in paral-

Look beyond the price tag and you'll see why

POWERS

**Service-Master<sup>®</sup>**

**OUTSELLS ALL OTHER MAKES OF SERVICE BODIES COMBINED**

Precision-crafted by expert workmen who grind welds marble-smooth and finish off all dangerously sharp tray and shelf edges.

Compare doors! Open and slam ours... then competitors'. Note our "solid" sound, balanced "feel", superior construction, and "can't-bind", nylon bushings.

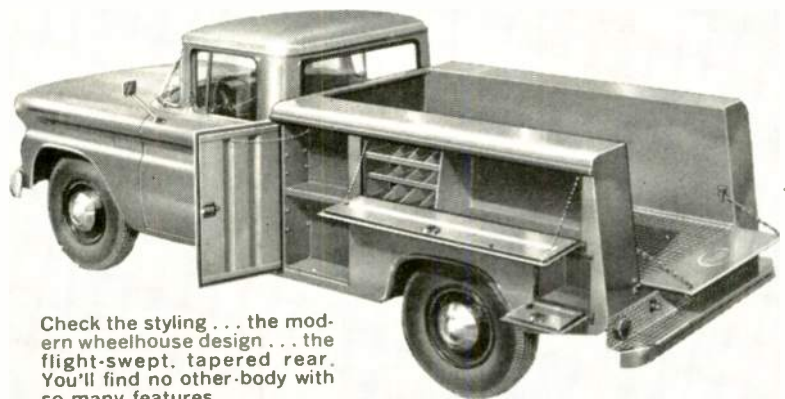

Check the styling... the modern wheelhouse design... the flight-swept, tapered rear. You'll find no other body with so many features.

Finest recessed latches on the market. Fool-proof, safety catches make it impossible for doors to fly open in travel.

Concealed fenders with built-in "lastability" assure at least 10 years of rugged service... truly your best body buy.

**IMMEDIATE DELIVERY!** WRITE FOR BULLETIN AND NAME OF DEALER.



Optional Canopy Top, at left, has 53" floor-to-roof height. Body is also available with compartment-high telescopic roof.

**McCABE-POWERS BODY COMPANY**  
5900 N. BROADWAY • ST. LOUIS 15, MO.

For more data, circle 12-61-1 on coupon, p. 48

lel with cable and wiring distributed capacities ( $C_d$ ). Attenuation may be increased by reducing C-1's capacity and vice-versa.

Each of the sound take-off adaptors shown in Fig. 2 are made with a length of connecting cable, an appropriate potentiometer, a small minibox, and a pair of binding posts (BP-1, BP-2). The circuit arrangement shown in Fig. 2A is used for sound take-off through the set's 'phone jack. The circuit at 2B is preferred when the signal is to

be taken from speaker terminals. C-1 is desirable when the signal is coupled into "hot" circuits—for example, a tube's plate.

### Equipment Calibrator

As a shop test equipment calibrator the communications receiver is highly valuable. This is especially true if CB and mobile type transmitters are checked and repaired. For example, a signal generator or frequency standard can be checked by coupling it to

the receiver's antenna post through a small "gimmick" capacitor (2 to 10  $\mu$ f). A regular antenna is connected to the set. The receiver is tuned to a known station and the signal generator or frequency standard is tuned until a zero beat is obtained, as heard in the set's loudspeaker (or 'phones). Broadcast stations may be used for checking lower frequency ranges, WWV for the higher bands. Frequencies below the broadcast band may be checked by using harmonics.

As a typical instance, suppose there are local stations at 600 and 900kc. The 600kc station is tuned in. The signal generator's calibration can then be checked by zero beating the 4th harmonic of 150kc, the 3rd of 200kc, the 2nd of 300kc and, of course the fundamental at 600kc. In a similar fashion, the 900kc station may be used for checking the signal generator's accuracy at 225kc, 300kc, 450kc, and 900kc. With several local stations, it is no trick at all to obtain a large number of check points.

When the receiver has a built-in crystal calibrator, this can be adjusted to zero beat with WWV, say at 5mc, and then harmonics of these highly accurate check points can be used to check equipment well into 30mc or higher every 100kc. By employing the sound take-off adaptors, WWV can also be used with the receiver as a source of tone or pulse signals for checking audio equipment. The pulses are especially valuable for checking the transient response of audio amplifiers and for adjusting resonant speaker baffles in hi-fi work.

### Signal Tracer

The communications receiver is an excellent high-gain tuned signal tracer and can be used both for stage-by-stage checks in other receivers and for tracking down r-f interference.

The probe shown in Fig. 1A should be used for signal tracing. The communications receiver is tuned to the fundamental or harmonic frequency of the signal to be traced. For example, if a 455kc signal is being injected into the receiver being tested, the communications receiver is tuned to 910kc.

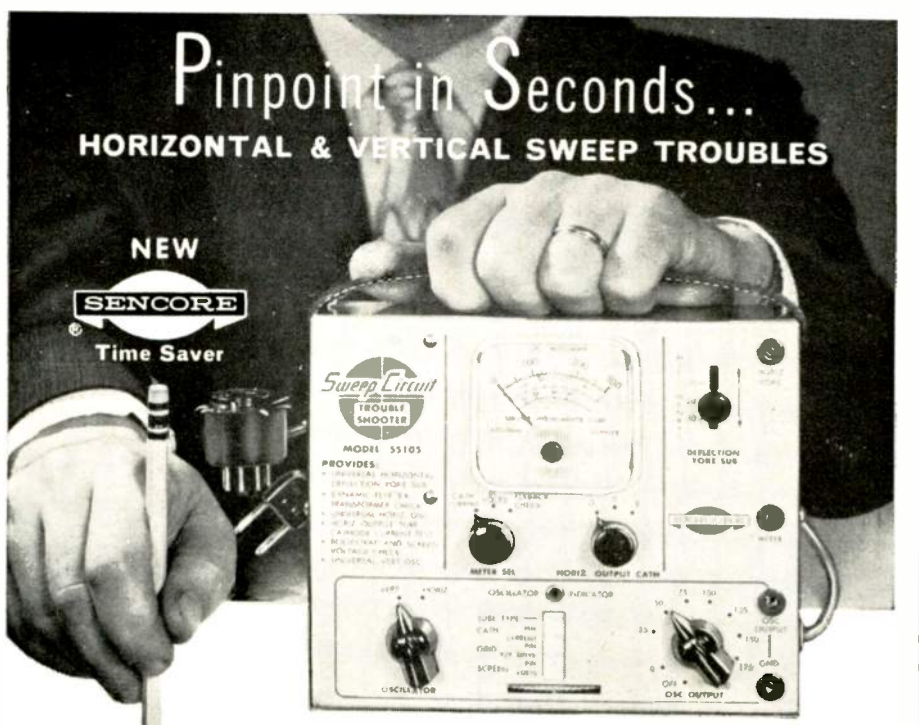

The missing link in TV service . . .

## SENCORE SS105 SWEEP CIRCUIT TROUBLE SHOOTER

**IT'S A . . . UNIVERSAL HORIZONTAL OSCILLATOR.** For direct substitution. No wires to disconnect in most cases. Traces trouble right down to the defective component. Variable output from 0-200 volts, peak-to-peak. Oscillator will sync to TV sync signal giving check on sync circuits.

**HORIZONTAL OUTPUT CATHODE CURRENT CHECKER.** A proven method that quickly checks the condition of the horizontal output tube and associated components. Adaptor socket prevents breaking wires. Easily replaceable Roll Chart gives all necessary pin, current and voltage data. New Roll Charts are Free.

**UNIVERSAL DEFLECTION YOKE.** A new, simple way to determine yoke failure accurately—without removing yoke from picture tube. Merely disconnect one yoke lead and substitute. If high voltage (also bright vertical line) is restored, TV yoke is defective.

**DYNAMIC FLYBACK TRANSFORMER CHECKER.** Merely flip switch to "Flyback Check" and meter will indicate condition of flyback transformer, in degrees of horizontal deflection. Extremely sensitive and accurate; even shows up one shorted turn on flyback.

**VOLTMETER.** For testing bootstrap, screen and other voltages. Direct-reading voltmeter, 0-1000 volts.

**UNIVERSAL VERTICAL OSCILLATOR.** Checks oscillator, output transformer and yoke. Merely touch lead to component and check picture on screen.

**SS105 is completely self-contained, nothing else is needed. New Improved Circuit . . . DEALER NET 42<sup>95</sup>**



HORIZ. OSC.	VERT. OSC.
HORIZ. O.P. STAGE	VERT. O.P. STAGE
HORIZ. FLYBACK XFORMER	VERT. O.P. XFORMER
HORIZ. DEFLEC. YOKE	VERT. DEFLEC. YOKE

ALL PARTS  
  
 MADE IN AMERICA

# SENCORE

ADDISON 2, ILLINOIS

For more data, circle 12-62-1 on coupon, p. 48



Relative signal levels can be determined by noting the S-meter reading or the setting of the r-f gain control. The meter can also be used to peak i-f's in the receiver under test.

Multi-stage transmitters can be checked out and adjusted by using the probe shown in Fig. 1C. Adjust C-1 to avoid overloading the receiver. If adjustments are made without modulation, use the receiver's BFO to provide an audible signal.

R-F interference from motors, household appliances, or other sources can be tracked down using the inductive probe shown in Fig. 1B. Once the source is located, line filters, shielding, or similar techniques may be used to eliminate the trouble. Frequency of any radio station causing interference, either at its fundamental or on harmonics, can easily be identified with the communications receiver.

In an emergency, for example, if the shop's signal generator breaks down, the communications receiver may be used as a source of r-f signals at its i-f value by "tapping" off a signal from its second i-f stage, as shown in Fig. 3. A small coupling capacitor, C<sub>1</sub>, minimizes loading and prevents d-c shorts.

Audio signals for checking hi-fi gear, pa systems, intercoms, record players, and similar equipment, may be obtained by tuning in an appropriate station and using one of the sound take-off adaptors shown in Fig. 2. Voice or music signals may be obtained by tuning in local broadcast stations—tone and pulse signals by tuning to WWV.

A variable frequency audio signal is obtained quite easily. Set the signal generator to deliver an unmodulated r-f signal and couple it to the receiver's antenna post. Adjust the receiver and signal generator to a spot on the dial where no station is operating. Turn on the set's BFO. The desired audio frequency is obtained by adjusting the set's BFO pitch control. With most receivers the control can be set for frequencies from zero to beyond audibility.

As the technician works with the receiver, he'll soon discover for himself that its versatility is limited only by his own skill and imagination. •

## ATR TUBE PROTECTORS

Designed to protect all electronic tubes in TV or hi-fi sets, amplifiers, and similar electrical equipment, these protectors are reported to double or triple normal tube life. Wall model, for use where the instrument can be plugged directly into a wall outlet, \$3.95. Floor model, for use where the instrument is located at a distance from the wall outlet, with 6 feet of cord, \$4.95. Both types are fuse protected and can be used with equipment having an input wattage of 100 to 300 watts. American Television & Radio Co., 300 E. 4th St., St. Paul 1, Minn.



For more data, circle 12-63-2 on coupon, p. 48

# FIND TUBE TROUBLES OTHERS MISS!

**A New Dynamic Approach**

Check over 1300 tubes for

- Cathode Emission
- Grid Emission
- Leakage
- Shorts
- Gas

## SENCORE "MIGHTY MITE" TUBE CHECKER

Answers the needs of the fast moving, profit minded serviceman who hates time consuming call backs. A "mite" to carry but a whale of a performer that spots bad tubes missed by large mutual conductance testers.

New unique "stethoscope" approach tests for grid emission and leakage as high as 100 megohms, yet checks cathode current at operating levels. Special short test checks for shorts between all elements. The MIGHTY MITE will test every radio and TV tube that you encounter (over 1300!) plus picture tubes, foreign, five star and auto radio tubes (without damage). As easy to set up as a "speedy tester" from easy to follow tube booklet. New tube charts free of charge.

AND check these added Sencore servicing features: • Meter glows in dark for easy reading behind TV set • Stainless steel mirror in cover for TV adjustments • Rugged, all steel carrying case and easy grip handle • Smallest complete tester made.

Model TC109.....DEALER NET **5950**

Ask your distributor for the "MIGHTY MITE" with the mirror in the cover

ALL PARTS

MADE IN AMERICA

# SENCORE

ADDISON 2, ILLINOIS

For more data, circle 12-63-1 on coupon, p. 48

Eliminate call backs...  
use dependable,  
industry-preferred...



**3 WATT SIZE**  
5/16" x 1/4"

**5 WATT SIZE**  
1 1/16" x 1 1/32"

**AXIAL-LEAD RESISTORS**

Vitreous-enameled, power-type, axial-lead units designed to withstand high temperatures.

**LITTLE DEVIL®**  
COMPOSITION RESISTORS

Meet all MIL-R-11A requirements. Available in 1/10, 1/4, 1/2, 1, and 2-watt sizes in all standard EIA values.

**BROWN DEVIL®**  
RESISTORS

Vitreous-enameled. In 5, 10, and 20-watt sizes.

**TYPE AB**  
POTENTIOMETERS

Resistance material is solid-molded, noise-free. Rated at 2 watts.

**FR-7.5 FUSE**  
RESISTOR

For easy replacement in many television receivers. 1 1/2" Tinned wire leads.

WRITE FOR STOCK CATALOG



OHMITE MANUFACTURING COMPANY  
3687 Howard St. • Skokie, Illinois

For more data, circle 12-64-1 on coupon, p. 48

**Channel Master RADIO**

Model 6515, 8-transistor radio, serves equally well as a table radio or as a personal portable. Features include: 8 transistors plus diode and thermistor; r-f amplification stage; extra-long built-in antenna; 3-gang condenser; 3 1/2" speaker; vernier tuning; and large dial face. Operates on 4 standard "C" batteries. Accessories included with the model are: cowhide carrying case; shoulder strap; magnetic earphone with its own leather case; and a plug-in extension antenna. \$59.95. Channel Master Corp., Elenville, N. Y.

For more data, circle 12-64-3 on coupon, p. 48

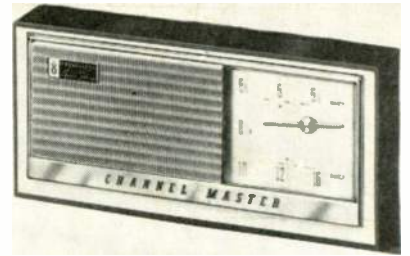

**Sonotone MICROPHONE**

Model CM-12 low impedance, ceramic, microphone is designed for public address systems or any installation that requires long leads. Features: easy-to-reach interrupter button; finely controlled acoustic port between the microphone chamber and sealed chamber in the handle; built-in, finely wound miniature transformer; and ceramic transducer. Frequency response, extends to 8,000 cps. Impedance, 150 ohms. Output, -63.5 db. \$29.50. Chrome-finished stand, \$4.00. Sonotone Corp., Elmsford, N. Y.

For more data, circle 12-64-4 on coupon, p. 48



# TRU-VAC 1-YEAR GUARANTEED RADIO and TV TUBES

Factory Used or Factory Second Tubes! TRU-VAC will replace FREE any tube that becomes defective in use within 1 year from date of purchase!

**ALL TUBES INDIVIDUALLY BOXED, CODE DATED & BRANDED "TRU-VAC"**

Partial Listing Only... Thousands More Tubes in Stock!

**SPECIAL!**

65N7GT.....30¢ 6W4GT.....30¢

0Z4	5T8	6BE6	6SF5	12AT7	
1A7GT	5U4	6BF5	6SQ7	12AU6	
1B1GT	5Y8	6CG6G	6SN7	12AV6	
1MSGT	5V4G	6BM6	6SJ7	12AV7	
1R5	5V6GT	6BJ6	6SK7	12AX1GT	
1S5	5X8	6BM5	6SL7	12AX7	
1T4	5Y3	6BQ7	6SQ7	12AZ7	
1U4	6AB4	6BL7GT	6SR7	12B4	
1U5	6AF4	6BN6	6T4	12BA6	
1V2	6AH4GT	6BQ6GT	6T8	12B7	
1X2	6AM5	6BQ7	6U5	12BD6	
2AF4	6AK5	6BR8	6U8	12BE6	
30C5	6AQ5	6AL5	6V6GT	12B9T	
30N6	6A8	6AM8	6RY5G	12BQ6	
30S5	6A9S	6AN8	6RZ6	6X4	12BR7
30M6	6AQ6	6AQS	6RZ7	6X5GT	12BY7
3BZ6	6AQ7	6CA8	6Y6G	6X8	12CA5
3CB6	6AR5	6CB6	7A4/XXL	12D4	12D5
3S4	6A55	6CD6G	7A5	12K5	12K6
3V4	6AT6	6CF6	7A6	12K7	12L6
4B07A	6AU6GT	6CG8	7B4	12L5	12L6
4B88	6AUSGT	6CM6	7B7	12M7	12N7
4BZ7	6AU8	6CL6	7B8	12R5	12R6
4C85	6AV5GT	6CM8	7B5	12R7	12S7
5AM8	6AV6	6CM7	7B8	12S7J	12S7K
5AN8	6AW8	6CN7	7C5	12S7GT	12S7GT
5AT8	6AX5GT	6CG8	7C6	12S7GT	12S7GT
5AV8	6B8	6CR6	7C7	12S7GT	12S7GT
5AZ4	6BC5	6CS7	7E5	12V6GT	12W6GT
5CG8	6BC9	6CU5	7E6	12W6GT	12W6GT
5R4	6BD6	6CU6	7E7	12X4	12Y4
		6D6	7F7	12AU4GT	12B06GT
		6DE6	7F8	12B06GT	12B06GT
		6DQ6GT	7O7	12T8	12T8
		6DQ6	7H7	25Z6GT	25Z6GT
		6F6	7Q7	35A5	35A5
		6H6	7S7	35B5	35B5
		6J5	7X6	35C5	35W4
		6J5	7X7	35Z5	35Z5
		6K6	7Y4	50A5	50A5
		6K7	7Z4	50A5	50A5
		6N7	12A8	50B5	50B5
		6Q7	12A8S	50C5	50C5
		6S8GT	12AQ5	50L6	50L6
		6S8GT	12AT6	117Z3	117Z3
		6SD7GT			

**SPECIAL!**  
TO READERS OF ELECTRONIC NEWS  
1c SALE ON TRU-VAC  
9 YR. GUAR. TUBES IN 8c-10c LOW LIST ONLY  
\*2 TUBES FOR PRICE OF 1 PLUS 1c  
\*35c EACH PER 100 TUBES  
Buy all you want for 35c each get extra tubes for 1c each, Buy 100 tubes for \$33, get 100 extra tubes for \$1.

Pick Any Types Mix If You Wish!

6AG7	6SA7
6AG5	7A7
6AU6	7C4
6AX4GT	7H7
6BA6	12AU7
6CG7	12BF6
6GGT	12CN5

**TRU-VAC**  
Harrison Avenue • Box 107 • Harrison, N. J. Humboldt 4-9770

Dept. No. T12

For more data, circle 12-64-2 on coupon, p. 48

## NEAR

(Continued from page 33)

contacts of the relay completes the synchronous motor circuit and the timing motor starts.

If the signal stops in less than 10 seconds, the relay contacts open and the timing motor is reset to the starting point by a return spring. If the signal duration is longer than 10 seconds, cam A on the motor closes contacts, permitting the motor to control the alarm cycle. The alarm is actuated by the action of cam B, which periodically shorts the 0.5 capacitor, applying full line voltage across the inductor. This causes the clapper to sound the alarm, which is presently a loud, distinctive buzzing. The total alarm period is 50 seconds. After this time has elapsed, cam A opens, returning the receiver to stand-by operation. An alarm having an 85

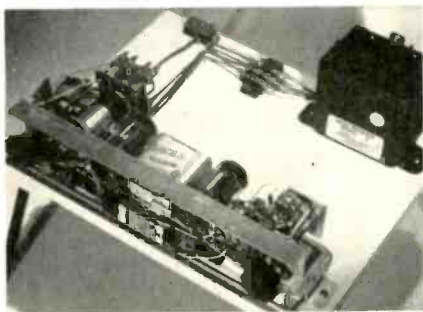

Fig. 4—A breadboard hook-up of a G-E compactron radio with a NEAR receiver illustrates how the civil defense-sponsored device can turn on a home radio.

db loudness at 10 feet, with silent periods at irregular intervals, is being established. A special receiver with a visible alarm can be designed for the deaf.

### Other Applications

Simple modifications can be made to enable the NEAR receiver to activate a radio or lamp. A prototype NEAR-radio hookup for a civil defense alarm that would automatically turn on a home radio is shown in Fig. 4.

Another device operating on the NEAR 240-cycle signal can be selectively coded for 40 separate functions through various combinations of signals. Many utility applications are apparent: control of street lights, selected warning of

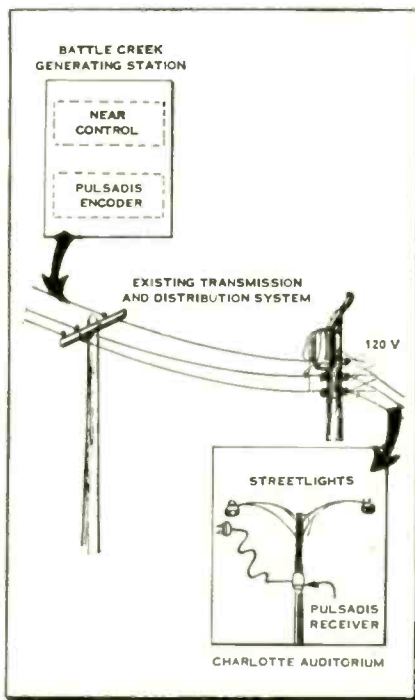
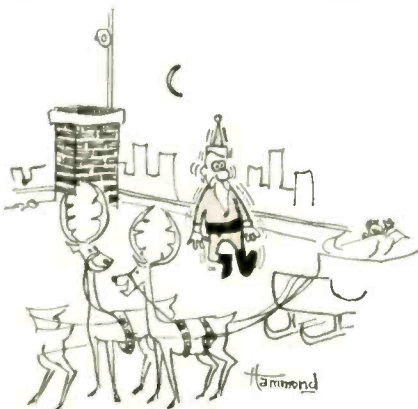

Fig. 5—Sangamo Electric Co.'s coded receiver can be employed for selective warning and utility application, such as controlling street lighting.

various echelons of government and military personnel, etc. (See Fig. 5.) A timing motor drives coded discs with attached pointers through a timed cycle. The coded discs are keyed according to the desired signal.

The NEAR system was demonstrated in Charlotte, Michigan, October 11, 1960 by the Office of Civil and Defense Mobilization. The system, though not presently operational, is undergoing tests similar to the Charlotte one. When it does become operational, the listener, upon hearing the alarm, should tune a radio to the CONELRAD frequency—640 or 1240—for official directions. •



"That makes the third hot antenna he's run into that wasn't grounded."

# SUPERIOR SERVICE

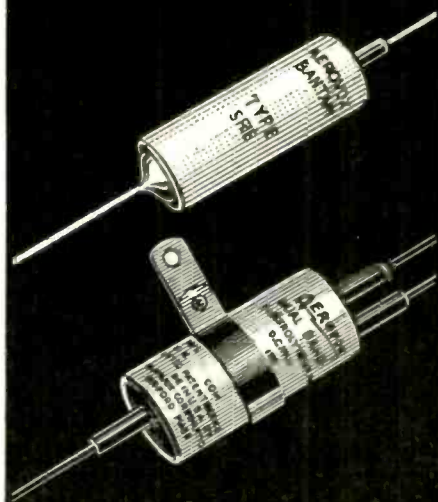

## AEROVOX TUBULAR ELECTROLYTICS

The most popular 'lytics used in TV and radio service. Long established favorites with all service-technicians, Aerovox electrolytic capacitors can be counted on for dependable performance.

**PRS DANDEES** . . . compact tubular units in aluminum cans with cardboard insulating sleeves. Available in singles, duals, triples and quads as well as AC rated and non-polarized units. Multiple units are furnished with insulated stranded wire leads 5" long. Available in a wide range of capacity and voltage combinations.

**SRE BANTAMS** . . . smaller than the PRS type but perfectly capable of handling full size loads. Hermetically-sealed in aluminum cans and furnished with cardboard insulating sleeve. Available in voltages of 3, 6, 12, 15, 25, 50, 70 and 150 VDCW in all popular capacities. For "Off-the-shelf" delivery on these and other Aerovox capacitors see your local Aerovox Distributor.

**AEROVOX CORPORATION**  
DISTRIBUTOR DIVISION  
NEW BEDFORD, MASS.

For more data, circle 12-65-1 on coupon, p. 48

## Audio VU Meters

(Continued from page 37)

The post-equalization connection has the advantage of indicating the actual amount of signal applied to the tape at all frequencies, so that the meter warns of possible distortion throughout the audio range. In view of the large amount of treble boost employed, usually exceeding 20 db at 15,000 cycles (7.5 ips),

treble distortion is not unlikely.

The pre-equalization connection creates the following conditions: (1) Isolating the VU meter from the record head helps prevent bias current leaking to the meter—producing misleading indications. (2) High frequencies of excessive amplitude can damage the VU meter if recording level is accidentally set too high after pronounced treble boost. Transients are particularly dangerous. (3) Incoming signal metering should precede equalization to be properly compared with the playback signals.

Can the pre-equalization connection satisfactorily warn against distortion? It can essentially. Record treble boost operates largely above 3,000 cycles. Treble boost in this region is primarily compensated by audio energy decline with frequency increase. Moreover, for a given amount of distortion, more signal can be applied to the tape at high frequencies than at mid-range and bass. Hence an unequalized signal reading tends to accurately indicate the safe amount of signal being applied to the tape.

The VU meter's chief disadvantage is its greater cost and its mechanical lag. The pointer does not indicate true peak magnitudes. Furthermore, the meter is subject to damage by heavy magnetic fields. For example, if a bulk eraser is brought near it.

As shown in Fig. 3, a variable calibrating resistor is employed so that the meter will read "O" VU at the proper recording level.

Meter calibration is usually based on a recording level that produces 2% harmonic distortion. 3% is probably the most frequent reference. As previously indicated, the VU meter reads average rather than peak level because mechanical inertia prevents its pointer from following sharp transients. These transients may exceed the average level by as much as 10 to 20 db, although 6 to 8 db is probably more typical. Transients cause very severe, though brief distortion.

When calibrating a VU meter it is desirable to make allowance for its mechanical lag. Ordinarily, 6 to 10 db allowance is provided by setting the meter ahead this amount. This is done by adjusting the calibrating resistor. A sine wave signal (usually between 250 and 1,000 cycles), and between 6 and 10 db below the signal producing 3% harmonic distortion, is employed. The meter's reading is adjusted to "O" VU under these conditions. To illustrate further, a manufacturer may set the meter to read "O" VU for a recording level producing 1% harmonic distortion. Since a level about 6 db higher produces 3% distortion, there is a 6 db allowance for mechanical lag with reference to 3% distortion.

### 3 REASONS WHY YOU SHOULD

## RECOMMEND H. H. SCOTT STEREO COMPONENTS

1. H. H. Scott specifications are always accurate. Only H. H. Scott of all manufacturers, performs all measurements according to strict IHFM standards. Only H. H. Scott guarantees that every component will meet or exceed its published specifications.
2. H. H. Scott uses many exclusive circuit features: copper-bonded-to-aluminum chassis, stand-up resistors, spacious chassis layout . . . all contribute to longer component life, easier servicing.
3. H. H. Scott amplifiers and tuners are designed to the highest standards. Only H. H. Scott, of all manufacturers, silver-plates critical FM front ends . . . only H. H. Scott uses extra-heavy, specially wound transformers to assure wattage as specified throughout the entire audio range.

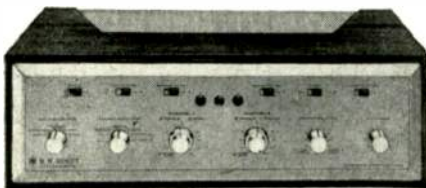

299B 50 WATT STEREO AMPLIFIER

**H. H. SCOTT**  
H. H. Scott Inc., Dept. ET-12,  
111 Powdermill Rd., Maynard, Mass.

Yes . . . I want advance technical information on new H. H. Scott products. Please send me your new technical bulletins and your latest catalog.

Name

Address

City  State

Export:  
Telesco International, 36 W. 40th St., NYC

For more data, circle 12-66-1 on coupon, p. 48

## BINDERS FOR YOUR ELECTRONIC TECHNICIAN

. . . to keep your copies for convenient  
reference . . . **\$3.75** each—postpaid  
(Canada and Foreign—please add  
50¢ for additional mailing costs)



(Holds 24 monthly issues)

### ELECTRONIC TECHNICIAN

480 Lexington Ave., New York 17, N. Y.

Please ship . . . . . "ELECTRONIC TECHNICIAN Magazine  
Binders." I enclose \$ . . . . . (please print)

Name

Street & No.

City  Zone  State

## Interpreting Readings

Although the VU meter calibration allows for mechanical lag, the recordist must exercise judgment and rely on his experience in set-

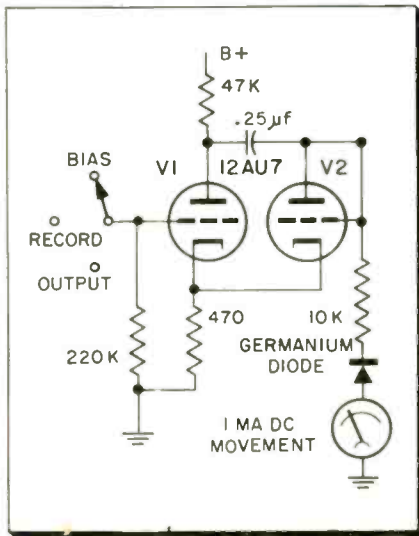

Fig. 5—Some meters with VU type scales have 1 ma basic movements—essentially VTVM's.

ting record level. Various types of speech and music have different relationships between peak and average level. Allowing the pointer to hit "0" VU may result in over-recording in one case but not in another. Furthermore, a given amount of distortion is less objectionable in some kinds of sound than in others, and this factor must also be taken into account in setting recording gain.

When the meter is used as a record level indicator, precautions must be taken to prevent bias current from reaching it and producing false readings. One measure for preventing this has already been suggested: by connecting the meter circuit prior to the equalization stage. Filter traps can also be used. A low-pass filter permits audio frequencies to reach the VU meter but substantially attenuates the much higher bias frequency—generally from 50,000 to 75,000 cycles. A parallel resonant trap also presents very high impedance at the bias frequency but allows audio frequencies to pass easily.

Not every tape recorder with a VU scale is a true VU meter. These types may or may not prove satisfactory. They are frequently a less sensitive 1 ma movement driven by a voltage amplifier, as shown in Fig. 5. In effect, this is a VTVM. •

Professional Technicians Use CASTLE'S Complete

# TV TUNER OVERHAUL

ALL MAKES ONE PRICE

\$9<sup>95</sup>

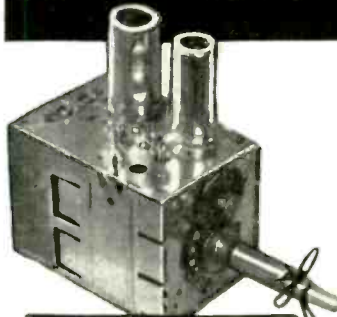

**SAME DAY SERVICE!**  
on Popular Types  
48 Hours most Others

VHF TUNERS • UHF TUNERS • UV Combinations\*

Castle overhaul charge includes all labor and minor parts and written 90 day warranty. Tubes and major parts are extra at net prices. Tuner to be overhauled should be shipped complete; include tubes, shield cover and any damaged parts. Write down model number and state complaint. Pack well and insure.

Castle pioneered TV Tuner Service almost a decade ago. Overhauling TV Tuners is our only business and all specifications are met exactly.

\* UV combination tuner must be of one piece construction. Separate UHF and VHF tuners with cord or gear drives must be dismantled and the defective unit only sent in.

## Castle TV TUNER SERVICE, INC.

5710 North Western Avenue  
In Canada: 136 Main Street

Chicago 45, Illinois  
Toronto 13, Ontario

For more data, circle 12-67-1 on coupon, p. 48

## E-Z-HOOKS

MAKE TESTING EASIER... FASTER...  
MORE PROFITABLE!

Now you can save hours of testing time with E-Z-HOOK TEST CONNECTORS. And time is money!



The exclusive E-Z-HOOK design assures you of positive grip. NO slip connections... made as easily as you'd push a button.

Self-adjusting E-Z-HOOKS make positive connections practically anywhere. The stainless steel hook and the nylon insulator grip firmly, leaving your hands free.

Intermittents and adjacent shorts are eliminated. You make ALL tests quickly... surely... safely with E-Z-HOOKS.

With E-Z-HOOKS you'll service more equipment in less time... satisfy more customers... make more money.

- No. 61-1 E-Z-HOOK CLIP® For jumper and equipment leads, etc. \$ .49 net
  - No. 71-1 E-Z-HOOK SUB For substituting parts without soldering. .69 net
  - No. 59-4 E-Z-HOOK TIP Adapter for Banana test prods. .69 net
  - No. 56-1 E-Z-HOOK TIP Adapter for Standard (.000") test prods. .89 net
  - No. 55-0 E-Z-HOOK TIP Adapter for Needlepoint (.000") test prods. .89 net
  - No. 54-1 E-Z-HOOK CUSTOM PROBE® For special probe assemblies and replacements. 1.39 net
- \*Also available with gold plated hook-wire for Guided Missile work and other special projects.

All feature 6, enables for easy lead identification.  
ORDER THE COMPLETE LINE TODAY  
FROM YOUR FAVORITE PARTS  
DISTRIBUTOR



E-Z-HOOK TEST PRODUCTS  
1536 Woodburn Avenue Covington, Ky.  
Canadian Representative:  
Len Finkler, Ltd. Toronto 12, Ontario

For more data, circle 12-67-2 on coupon, p. 48

all new edition

up-to-date  
component prices

PLUS

the quick easy way  
to figure service charges

EQUALS



Pure Price's

## OFFICIAL PRICING DIGEST

VOL. 4, NO. 1



Flat rate and hourly service charges, based on and showing regional and national averages, plus up-to-date list or resale prices on over 63,000 components. Arranged alphabetically by manufacturers and products, numerically by part number. Compact, convenient size fits in tube caddy, toolbox or pocket. \$2.50 per copy from your distributor.

ELECTRONIC PUBLISHING COMPANY, INC.  
180 N. WACKER DRIVE, CHICAGO 6, ILL.

For more data, circle 12-67-3 on coupon, p. 48

Mr. Service Technician:

Want to service transistor radios rapidly  
—accurately? You can with

## REPAIRING TRANSISTOR RADIOS

by S. Libes (Director Technical  
Publications, Bogen-Presto)

The man who wrote this book knows his subject well and provides practical procedures that you can apply to faster troubleshooting and to finding those elusive 'dog troubles'.

Basic theory is presented in a way that you will understand easily, quickly. Operation and service of the latest transistorized circuit designs are covered. All new ideas about transistors as used in current transistor radios are explained. Also included are the latest design practices in transistor portable AM, multi-band, imported, all-transistor, auto-hybrid and FM radio receivers. High power transistorized public address power amplifiers and current high fidelity applications are covered.

Servicing is explained on a step-by-step basis including trouble check points and charts, instruction of handy-to-use test equipment (e.g. signal source, power supply). And, there's another feature—*transistor and diode substitution charts*. Also included is information on how to select test equipment and tools for repairing transistor radios. #270, \$3.50

### TV SERVICING

**MASTER RECEIVING — PICTURE TUBE SUBSTITUTION GUIDEBOOK, H. A. Middleton, \$7.45**  
**RECEIVING TUBE SUBSTITUTION GUIDEBOOK 4th suppl., H. A. Middleton, \$1.35**  
**TUBE CADDY-TUBE SUBSTITUTION GUIDEBOOK, H. A. Middleton, 90c**  
**HOW TO TROUBLESHOOT TV SYNC CIRCUITS, I. Remer, \$2.90**  
**REPAIRING TELEVISION RECEIVERS, C. Gluckstein, \$4.40**

### AUDIO & HIGH-FIDELITY SERVICING

**HOW TO INSTALL & SERVICE INTERCOMMUNICATION SYSTEMS, J. Darr, \$3.60**  
**HOW TO SERVICE TAPE RECORDERS, C. A. Tuttle, \$2.90**  
**REPAIRING HI-FI SYSTEMS, David Fidelman, \$3.90**

### TEST EQUIPMENT

**HOW TO USE METERS (2nd ed.), J. F. Rider & S. Prensky, \$3.50**  
**HOW TO USE TEST PROBES, A. Ghirardi & R. Middleton, \$2.90**  
**OBTAINING INTERPRETING TEST SCOPE TRACES, J. F. Rider, \$3.00**  
**HOW TO USE SIGNAL & SWEEP GENERATORS, J. Richard Johnson, \$2.40**  
**HOW TO USE GRID-DIP OSCILLATORS, R. P. Turner P. E., KeAl, \$2.50**

### RADIO SERVICING

**RADIO RECEIVER LABORATORY MANUAL, A. W. Levey, M. S., \$2.00**  
**RADIO TROUBLESHOOTING GUIDEBOOK, VOL. 1, Rider & Johnson, \$2.40**  
**HOW TO INSTALL & SERVICE AUTO RADIOS (2nd ed.), J. Darr, \$3.25**  
**REPAIRING PORTABLE & CLOCK RADIOS, B. Crisess & D. Gnessin, \$2.75**

### PROFITABLE SERVICING AREAS

**HOME AIR CONDITIONING, Installation & Repair, J. Derman, M.S., F. Makstein, II. Seaman, \$3.50**  
**BASICS OF FRACTIONAL HORSEPOWER MOTORS & REPAIR, Gerald Schweitzer, soft cover \$3.90; cloth \$4.90**  
**INDUSTRIAL CONTROL CIRCUITS, Sidney Platt, \$3.90**

Prices subject to revision.

At distributors or order direct!  
Write for new catalog. ET-12



JOHN F. RIDER, PUBLISHER, INC.  
116 West 14th Street, New York 11, N.Y.  
Canada: Chas. W. Pointon, Ltd.,  
66 Racine Rd., Rexdale, Ont.

For more data, circle 12-68-1 on coupon, p. 48  
68

## New Books

**SUCCESSFUL PREPARATION FOR F.C.C. RADIO OPERATORS LICENSE EXAMINATIONS.** By Darrell L. Geiger. Published by Prentice-Hall. 692 pages, hard cover. \$9.25.

This book may be added to the list of available reference guides for anyone interested in obtaining an FCC license. Information is presented in the FCC test question style, with the helpful addition of answers following each one. The text is divided into eight segments corresponding to the eight elements used by the FCC. Basic law, basic operating practice, basic radio-telephony, advanced radio telephony, radiotelegraph operating practice, ship radar techniques, etc., are among the various elements presented.

**101 KEY TROUBLESHOOTING WAVEFORMS.** By Robert G. Middleton. Published by Howard W. Sams & Co., Inc. 128 pages, soft cover. \$2.00.

This latest book on servicing with an oscilloscope is probably the best recent effort by the author. This comment is, no doubt, prompted by its concentrated practical TV service approach. It offers bench troubleshooting information, while the author's two previous books presented an introduction to scope work. The text revolves around three basic horizontal afc-oscillator circuits: (1) Multivibrator With Pulse-Width AFC, (2) Blocking Oscillator With Pulse-Width AFC, (3) Multivibrator With Duo-Diode AFC. Each circuit's operation is briefly examined with the aid of its respective schematic. Following the explanation is a series of *abnormal* waveforms with the defective component and cause noted next to the photo. Each waveform is analyzed by symptoms, tests accomplished, and evaluation of results. 101 waveforms are thus analyzed, presenting technicians with sufficient TV receiver faults analyzed by a scope to lay an excellent cornerstone for using this neglected instrument.

**PRACTICAL RADIO AND ELECTRONICS COURSE.** By M. N. Beitman. Published by Supreme Publications, 1760 Balsam Rd., Highland Park, Ill. 216 pages, soft cover. \$3.95.

This is the fifth edition of a former three-volume set prepared for home-study use. The book is divided into 35 lessons, from elementary radio principles through superhets and transmitters. Industrial electronics lessons are also included, covering, among other subjects, electron microscopes, strain gages, photocells, high frequency heating, and direction finders. Adequately illustrated and written in a simple manner, the text may be quite helpful to an individual unacquainted with radio theory.

**BASIC MATHEMATICS FOR ELECTRONICS.** By Nelson M. Cooke. Published by McGraw-Hill Book Co. 702 pages, hard cover. \$10.75.

The older edition of this new book was first published in 1942 as "Mathematics for Electricians and Radiomen." The book was favorably received due to its format of relating abstract math to practical electrical and electronic problems. Reprinted 32 times, it is only natural that a second edition, expanded and up-dated, is now available. The approach to mathematics (arithmetic to logarithms) is as stimulating today as it was 18 years ago. Correlating algebra, trigonometry, vectors, and logs to working problems in electronics makes a rather dreary subject unusually agreeable. A completely new chapter, "Meter Circuits," examines the circuitry of various meters through Ohm's Law. The addition of a second color, red, is unusual for a math book. It is used to emphasize important formulas, solutions, and circuit sections being discussed. Answers to problems are included. Highly recommended for self-study or reference.

**TAP-A-LINE**  
TRADE MARK U.S. PAT. 2,819,878

THE HANDIEST THING  
SINCE  
ELECTRICITY

FROM 6 INCHES  
TO 10 FEET LONG

Tap-A-Line —  
mounted on or  
behind work benches,  
in the lab, on test tables,  
in lamp or appliance stores —  
provides multiple taps from a single  
power source. Safe — concealed conductors —  
tight positive contacts — easy to install in any position.

Sold by Electrical, Electronic and  
Hardware Jobbers and Dealers

Tap-A-Line Mfg. Co.

P. O. Box 563  
Pompano Beach, Fla.



For more data, circle 12-68-2 on coupon, p. 48

ELECTRONIC TECHNICIAN • December, 1960

# ASSOCIATION NEWS

## California

CSEA, Fresno, reports the first state journeyman's certificate has been presented to George Tauchimoto, after completing apprenticeship training in the program sponsored by Santa Clara valley and Santa Cruz chapters. The Association also announced circulation of a labor pricing "blue book" to all service and sales shops in the area. It was noted that the list suggests an additional labor charge of \$5.75 on open-type printed circuit chassis and an additional \$10.00 labor charge on concealed types.

## Florida

TSDA, St. Petersburg, has become a NATESA affiliate. This is the third Florida association to join the national association.

## Illinois

NATESA, Chicago, announced that the more appropriate words "your dealer" will be substituted for "any drug or hardware store" in a customer instruction sheet furnished by Admiral for their transistor radio battery replacement suggestion. The association had previously called this matter to the manufacturer's attention.

## Missouri

TESA, St. Louis, advises that Fred Richman has been elected as a director of NATESA. The association also reported their invitation to distributors for a joint meeting to discuss mutual problems has not been accepted after a period of months.

## License Forum

TEAM, St. Louis, is sponsoring a Certificate and Bonding program for television service dealers and technicians. The plan is jointly supported by the St. Louis Better Business Bureau, and the St. Louis University's adult education department. The TV-radio service dealer and/or his technician employees must furnish proof of over 2,000 hours service experience in order to qualify. A service technician must be employed by a bonded dealer to be certified. Surety bond of \$500.00 must be obtained by the service dealer and is renewable annually if

not revoked by prior violations. The voluntary program is designed to up-grade public confidence in the independent television service technician's business integrity and technical proficiency, and establish higher standards in the industry.

## New York

TESA, Jamestown, has elected the following officers: Pres., Richard Hiller; V. P., Harold Cline; Sec., Howard M. Moore; Treas., Philip Pilato.

## Voluntary Bonding Program

ESFETA, Albany, recently held the second and final open forum on licensing. Prior to this meeting, twenty-four letters were sent to distributors, throughout the state, who oppose licensing. Only five replies were received. Two replies, from Brooklyn, N. Y. distributors, stated they had erroneously been listed as opposed to licensing. Of the three that returned letters stating they opposed licensing, one was from the national president of NEDA and the other from NEDA's Empire State chapter president. No response was received from the remaining nineteen distributors.



**GC  
ELECTRONICS**

—STACKPOLE  
**CARBON  
RESISTORS**

**NEW Coldite 70<sup>®</sup>**

A New Series Of Cold Molded Resistors Designed  
For The Most Stringent Requirements

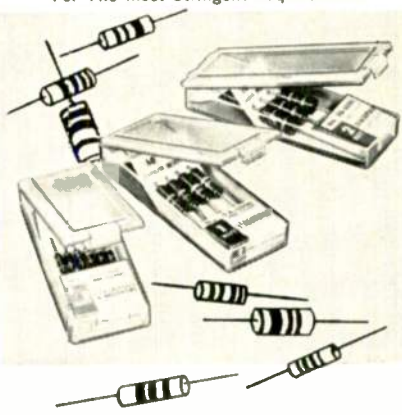

Now you can get carbon resistors scientifically packaged to prevent damage. All values are clearly indicated in these handy re-usable boxes. Buy several now . . . then you'll always have what you need. Packed 3 or 4 to box . . . only 72c net each.

**GC ELECTRONICS CO.**

Division of Testron Electronics, Inc.

West Plant: Los Angeles 18, Calif., Main Plant: Rockford, Ill., U.S.A.

**ASK YOUR JOBBER**

**FREE CATALOG . . . send postcard today!**

For more data, circle 12-69-1 on coupon, p. 48

TRUST YOUR TV TUNER  
REPAIR and ALIGN to



**24 HR SERVICE**

VHF or UHF—ALL MAKES

- VHF Tuners . . . . . **\$950**  
net
- UHF Tuners . . . . .
- UHF Converters . . . . .
- UHF-VHF  
Combinations . . . . . **\$17.95**



Prices are for service and unutilized units. Missing, broken and damaged parts, defective tubes charged extra at LOW net prices. We ship C.O.D.

### 10 STEPS IN OUR GUARANTEED SERVICE

1. All tuners mechanically and electronically inspected.
2. All necessary parts replaced.
3. Contact surfaces correctly cleaned and lubricated.
4. First test run for intermittents and drift indication.
5. Fine tuning range checked on all channels.
6. Local osc aligned to correct frequency all channels—XTAL controlled.
7. RF alignment—all channels—XTAL controlled.
8. AGC check, all channels—cut off of RF amp checked.
9. Overall response all channels, shield covers in position.
10. Quality control FINAL CHECK ALL UNITS, UHF-VHF.

IMPORTANT: Ship complete. Include all broken parts. State model and complaint. Package well to avoid transit damage.

**JW ELECTRONICS** 1540 W. Jarvis Avenue  
CHICAGO 26, ILLINOIS Broadway 4-9757

For more data, circle 12-69-2 on coupon, p. 48

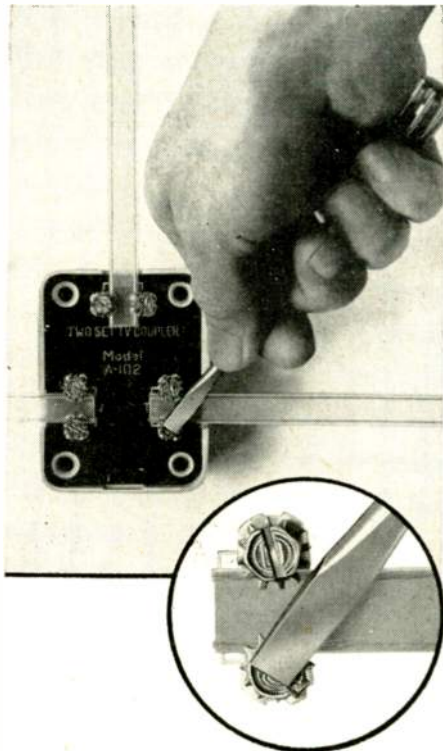

**MAXIMUM INTER-SET  
ISOLATION WITH  
MINIMUM SIGNAL LOSS  
BLONDER-TONGUE  
COUPLERS**

In just a matter of seconds, new quality engineered B-T couplers featuring 'stripless' terminals provide a low loss, matched installation for superior multi-set performance.

**2-SET COUPLER — maximum inter-set isolation — minimum signal loss**

Model A-102 Two-Set Coupler delivers more signal to each TV or FM set, with greater inter-set isolation than other couplers. A new original B-T circuit with phase cancellation feature automatically defeats interfering signals. No ghosts, no smears, ideal for color TV and FM.

List 3.50.

**NEW B-T COUPLERS-4-SET, HI-LO & UHF-VHF A-104 FOUR SET COUPLER.** Low loss 300 ohm directional coupler only 7 db insertion loss and 12-20 db inter-set isolation. Flat response 50 to 220 mc.

List 4.95

**A-105 HI-LO ANTENNA COUPLER.** Combines low band and high band VHF antennas or provides separate low and high outputs from a common line or antenna.

List 3.95

**A-107 UHF-VHF ANTENNA COUPLER.** Combines VHF and UHF antennas, or provides separate VHF and UHF outputs from a common line or antenna.

List 3.95

**A-100 OUTDOOR MOUNTING KIT.** Bracket and strap assembly for fast, easy mast mounting of models A-102, A-104, A-105, A-107.

List 1.10

Available at parts distributors.

For further information write Dept. ET-12

engineered and manufactured by  
**BLONDER-TONGUE**  
9 Alling St., Newark, N. J.

Canadian Div.: Benco Television Assoc., Ltd., Toronto, Ont.  
Export: Morhan Export Corp., New York 13, N. Y.

For more data, circle 12-70-1 on coupon, p. 48  
70

**Raytheon TUBES**

Ten new entertainment-type receiving tubes are: type 2FH5, 7 pin miniature triode tube for use in grounded r-f amplifiers; 4EW6, 7 pin miniature pentode featuring controlled heater warm-up time and for use as an i-f amplifier in TV receivers, 5GH8, miniature 9 pin containing a sharp-cutoff pentode and a medium-mu triode in one envelope, designed as an oscillator in the horizontal deflection system of TV receivers; 6EM7, octal double triode with dissimilar sections, used as a vertical deflection oscillator from section 1 and as a vertical deflection amplifier from section two; 7EY6, octal beam-power pentode designed as a vertical deflection amplifier in TV receivers, has controlled

heater warm-up time; 8ET7, 9 pin duo-diode sharp-cutoff pentode, with pentode unit designed as a video amplifier and the diodes as a horizontal phase detector in TV receivers; 22DE4, octal half-wave rectifier used as a damping diode in TV receivers, except for different heater ratings it is identical to the 6DE4; 6EZ5, octal beam-power pentode, a vertical deflection amplifier for TV receivers employing 110° deflection picture tubes; 6GM6, 7 pin miniature semi-remote-cutoff pentode for gain-controlled picture i-f stages of TV receivers; and 35EH5, 7 pin miniature pentode for use in radio and phonograph audio output circuits. Raytheon Co., Distributor Products Div., Westwood, Mass. For more data, circle 12-70-3 on coupon, p. 48

**Utah REVERBERATION UNIT**

Model RVB-1 add-on reverberation unit, for monaural or stereo systems, is completely self-contained with its own amplifier and speaker. It connects easily to any speaker line and can be added to any console, portable, or component system. Features an acousti-control knob that allows any proportion of reverberation to original source material. Blonde, mahogany, or walnut. 20"x10"x10 1/4". Complete, with all necessary inter-connecting cables, \$109.90. Utah Radio & Electronic Corp., 1124 E. Franklin St., Huntington, Ind.

For more data, circle 12-70-4 on coupon, p. 48

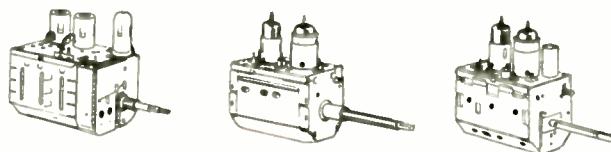
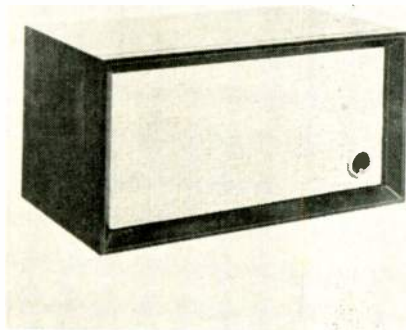

**TUNERS REPAIRED \$8.50**  
**24-Hour Service 6-Month Warranty**  
**Repair Charge includes**  
**ALL Replacement Parts**

SARKES TARZIAN, INC., pioneer in the Tuner Manufacturing business, offers fast, dependable, factory repair service on all makes and models. Cost—\$8.50 per unit. \$15 for UV combinations. Now offering 6-month warranty against defective workmanship and parts failure due to normal usage. Tuners repaired on approved, open accounts. Replacements available at low cost on tuners beyond practical repair.



Tarzian-made tuners easily identified by this stamping. When inquiring about service or replacements for other than Tarzian-made tuners, always give tube complement . . . shaft length . . . filament voltage . . . series or shunt heater . . . IF frequency, chassis identification. And, allow a little more time for service on these tuners. Use this address for fast, factory repair service:

SERVICE MANAGER • TUNER DIVISION  
Dept. B



**SARKES TARZIAN INC**

east hillside drive • bloomington, indiana  
edison 2-7251

Mfrs. of Tuners, Semiconductors, Air Trimmers, FM Radios, Audio Tape, and Broadcast Equipment

For more data, circle 12-70-2 on coupon, p. 48



# INDEX TO ADVERTISERS

December 1960

Aerovox Corp. . . . .	65	Mallory & Co., Inc., P. R. . . . .	44, 45
American Telephone and Telegraph Co. . . . .	19	McCabe-Powers Body Co. . . . .	61
American Television and Radio Co. . . . .	71	J. W. Miller Co. . . . .	52
Amperex Electronic Corp. . . . .	8	Moss Electronic, Inc. . . . .	60
Arco Electronics, Inc. . . . .	9	Ohmite Manufacturing Co. . . . .	64
Astatic Corp. . . . .	57	Precision Tuner Service . . . . .	59
Atlas Sound Corp. . . . .	60	Quam Nichols Co. . . . .	58
B & K Manufacturing Co. . . . .	43	Quietrole Co. . . . .	71
Belden Manufacturing Co. . . . .	Cover III	Radio Corporation of America 22, 26, 52, 55, 72, Cover IV	
Berns Manufacturing Co. . . . .	52	Rider Publisher, Inc., John F. . . . .	68
Blonder-Tongue Laboratories, Inc. . . . .	70	Sarkes Tarzian, Inc., Semiconductor Division . . . . .	26
Bussmann Manufacturing Co. . . . .	27	Sarkes Tarzian, Inc., Tuner Division . . . . .	70
Castle Television Tuner Service . . . . .	67	Scott, Inc., H. H. . . . .	66
CBS Electronics . . . . .	5	Sencore . . . . .	62, 63
Centralab Division, Globe-Union Inc. . . . .	20	Sonotone Corp. . . . .	22
Chonnel Mosler Corp. . . . .	6, 7	Sprague Products Co. . . . .	23
Chicago Standard Transformer Corp. . . . .	56	Standard Kollsman Industries, Inc. . . . .	Cover II
Clarostat Manufacturing Co. . . . .	17	Sylvania Div., General Telephone & Electronics . . . . .	47
Delco Radio Division . . . . .	18	Tap-A-Line Manufacturing Co. . . . .	68
EICO . . . . .	14	Technical Appliance Corp. . . . .	15
Electronic Publishing Co., Inc. . . . .	67	Triad Transformer Corp. . . . .	59
Electronic Technician . . . . .	66	Tru-Vac . . . . .	64
Electro-Voice, Inc. . . . .	25	Tung-Sol Electric Inc. . . . .	11
E.Z. Hook Test Products . . . . .	67	United Catalog Publishers, Inc. . . . .	16
G C Electronics Company . . . . .	69	V-M Corporation . . . . .	28
General Electric Co. . . . .	21	Walsco Electronics Corp. . . . .	4, 53
Greyhound Corp. . . . .	49	Weller Electric Co. . . . .	10
Institute of Radio Engineers . . . . .	53	Winegard Company . . . . .	50
Jackson Electrical Instrument Co. . . . .	24		
JFD Electronics Corp. . . . .	2, 3		
JW Electronics . . . . .	69		

While every precaution is taken to insure accuracy, we cannot guarantee against the possibility of an occasional change or omission in the preparation of this index.



## QUIETROLE LUBRI-CLEANER

The first of its kind and still best for silencing noisy controls and switches in TV, Radio & all Electronic Equipment.

### Spray it or Drop it

Just Press and whoosh . . . aerosol QUIETROLE quickly and easily cleans as it lubricates.

Or, if you prefer, use this handy eye-dropper and just a drop or two of quality QUIETROLE does the job perfectly.

Either way, make sure it's QUIETROLE

## QUIETROLE Company, Inc.

Spartanburg, South Carolina



In Canada:  
CROSS CANADA ELECTRONICS  
67 Ontario St., S., Kitchener, Ont.

For more data, circle 12-71-1 on coupon, p. 48

# ATR PRODUCTS FOR MODERN LIVING



## ATR PLUG-IN TYPE PORTABLE INVERTERS\*

A.C. HOUSEHOLD ELECTRICITY Anywhere . . . in your own car!

- Operates Standard A.C.
- Record Players
- Dictating Machines
- Small Radios
- Electric Shavers
- Heating Pads, etc.

In your own car or boat!

MODELS  
6-RMF (6 volts) 60 to 80 watts. Shipping weight 12 lbs. DEALER NET PRICE . . . \$33.00  
12T-RME (12 volts) 90 to 125 watts. Shipping weight 12 lbs. DEALER NET PRICE . . . \$33.00  
\*Additional Models Available



## ATR "A" Battery ELIMINATOR

For Demonstrating and Testing Auto Radios—TRANSISTOR or VIBRATOR OPERATED!

Designed for testing D.C. Electrical Apparatus on Regular A.C. Lines—Equipped with Full-Wave Dry Disc-Type Rectifier, assuring noiseless, interference-free operation and extreme long life and reliability.

MAY ALSO BE USED AS A BATTERY CHARGER  
MODEL 610C-ELIF . . . 6 volts at 10 amps. or 12 volts at 6 amps. Shipping weight 22 lbs. DEALER NET PRICE . . . \$49.95  
MODEL 620C-ELIT . . . 6 volts at 20 amps. or 12 volts at 10 amps. Shipping weight 33 lbs. DEALER NET PRICE . . . \$66.95

## ATR AUTO-RADIO VIBRATORS



By every test ATR Auto-Radio Vibrators are best! . . . and feature Ceramic Stack Spacers, Instant Starting, Large Oversized Tungsten Contacts, Perforated Reed, plus Highest Precision Construction and Workmanship and Quiet Operation!

There is an ATR VIBRATOR for every make of car!

Ask your distributor for ATR's Low Priced type 1400, 6 volt 4-prong Vibrator; and 1843, 12 volt 3-prong; or 184Q, 12 volt 4-prong Vibrator. THE WORLD'S FINEST!

## ATR CUSTOMIZED KARADIO

### KARADIO



Vibrator-Operated with Tone Control

ATR KARADIO . . . is ideal for small import cars or compact American cars! Unit

is completely self-contained—extremely compact! Powerful 8-tube performance provides remarkable freedom from engine, static, and road noises. The ATR Customized Karadio comes complete with speaker and ready to install. Can be mounted in-dash or under-dash—wherever space permits! No polarity problem. Neutral Gray-tan baked enamel finish. Overall size, 7" deep, 4" high, and 6 1/2" wide. Shipping weight, radio set, 7 lbs. Model K-1279—12 for 12V Dealer Net Price. . . \$33.57 Model K-1279—6 for 6V Dealer Net Price. . . \$33.57

Airplane Style Overhead Mounting under Cab Roof

NO PRINTED CIRCUITRY

## ATR TRUCK KARADIO



Excellent Tone, Volume, and Sensitivity!

Compact, yet powerful. Fits all trucks, station wagons, most cars and boats. Just drill a 3/8 inch hole in roof and s us send the one-piece unit (aerial, chassis and speaker) in 15 minutes. Watertight mounting assembly holds antenna upright. Yoke-type bracket lets you tilt radio to any angle.

Extra-sensitive radio has 6 tubes (2 double-purpose), over-size Alnico 5 PM speaker for full, rich tone. Big, easy-to-read illuminated dial. Fingertip tuning control. Volume and tone controls, 33-in. stainless steel antenna. Neutral gray-tan enameled metal cabinet, 7 x 6 1/2 x 4 in. high over-all. Shipping weight 10 1/2 lbs.  
Model TR-1279—12A for 12V Dealer Net Price \$41.96  
Model TR-1279—6A for 6V Dealer Net Price \$41.96

SEE YOUR ELECTRONIC PARTS DISTRIBUTOR WRITE FACTORY FOR FREE LITERATURE . . .



AMERICAN TELEVISION & RADIO CO. Quality Products Since 1931 SAINT PAUL 1, MINNESOTA—U. S. A.

For more data, circle 12-71-2 on coupon, p. 48

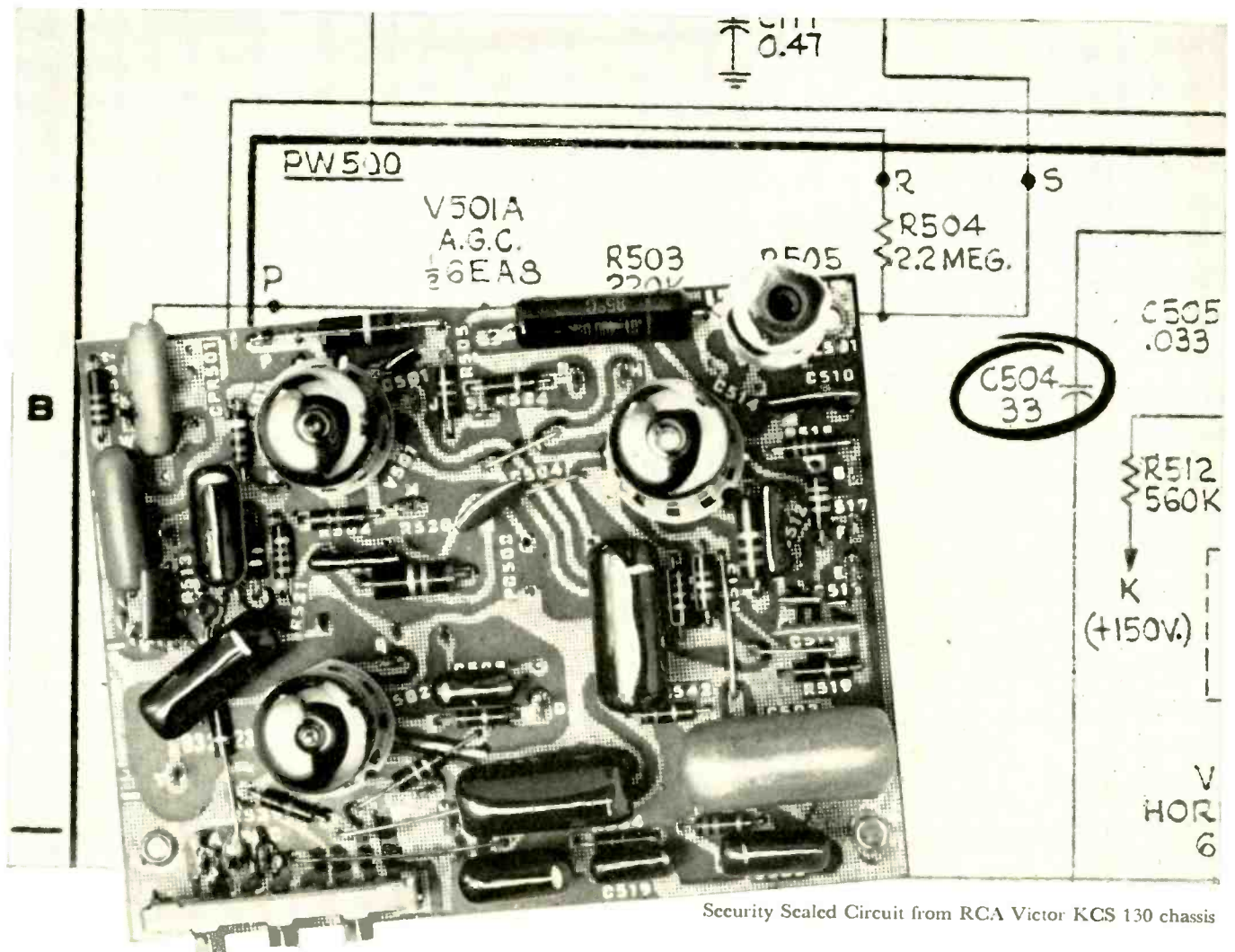

Security Sealed Circuit from RCA Victor KCS 130 chassis

## How fast can you find C 504? (Average time—10 seconds)

You know how valuable minutes are in TV servicing! Every one you save means money in your pocket.

With this all-important fact in mind, take a good look at the RCA Security Sealed Circuit in the picture above. All components are plainly marked. So are meter and scope take-off points and signal injection points. RCA Security Sealed Circuits take the *guesswork* out of servicing. That's for sure!

Now compare the RCA Security Sealed Circuit with any old-fashioned point-to-point wired chassis you have on your bench. Which do you vote for as a timesaver and error eliminator? If you vote for the printed circuit, you

are voting along with the nation's top missile, satellite and computer engineers! *Long ago, they chose printed circuits because printed circuits alone offer the maximum dependability.*

But, you may be thinking, how about parts replacement? Do printed circuits make this easier or tougher? The answer is—*easier!* All you need is a light, low wattage iron or gun, which is a good thing to have around the shop anyway. No special techniques are needed . . . just plain common-sense methods.

Next time a customer asks, explain that printed circuitry is the mark of modern, dependable, easy-to-service home entertainment equipment—such as RCA Victor!

TMK'S®



The Most Trusted Name in Television

RADIO CORPORATION OF AMERICA

Transmission Line Cables



8225



8226



8230



8285



8235

Microphone and Shielded Power Supply Cables



8410

RUBBER



8411



8413

PLASTIC



8420

# Mr. Service Technician:

Ask your Belden jobber about this complete wire and cable line

What types of wire and cable do you need? Ask your Belden electronics jobber for complete specifications on types, sizes, insulations, and convenient spooled lengths. Available from stock.

Hi-Fi, Stereo, and Phonograph Cables



8421



8430



8419

Power Supply Cords



17106

Rubber-Vinyl Multiconductor Portable Cordage



8462

8888

Antenna Rotor Cables



8464

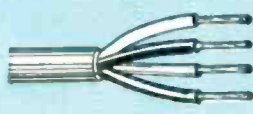

8484

Hook-Up Wire



8800

TV and Cheater Cords

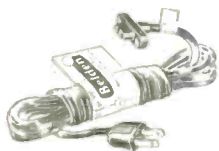

8874

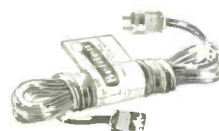

8875

Aluminum Ground Wire



8018



- power supply cords • cord sets and portable cordage • electrical household cords • magnet wire • lead wire • automotive wire and cable • aircraft wires • welding cable



# FRONT PAGE NEWS

## NOW FOR A LIMITED TIME, GET VALUABLE SERVICE AIDS AND GIFTS WHEN YOU BUY RCA TUBES!

RIGHT NOW'S the best time to stock up on the RCA receiving tubes you'll need through the coming season. Shown here are *just a few* of the exciting gifts and premiums you get FREE with RCA tubes purchased from participating RCA distributors.

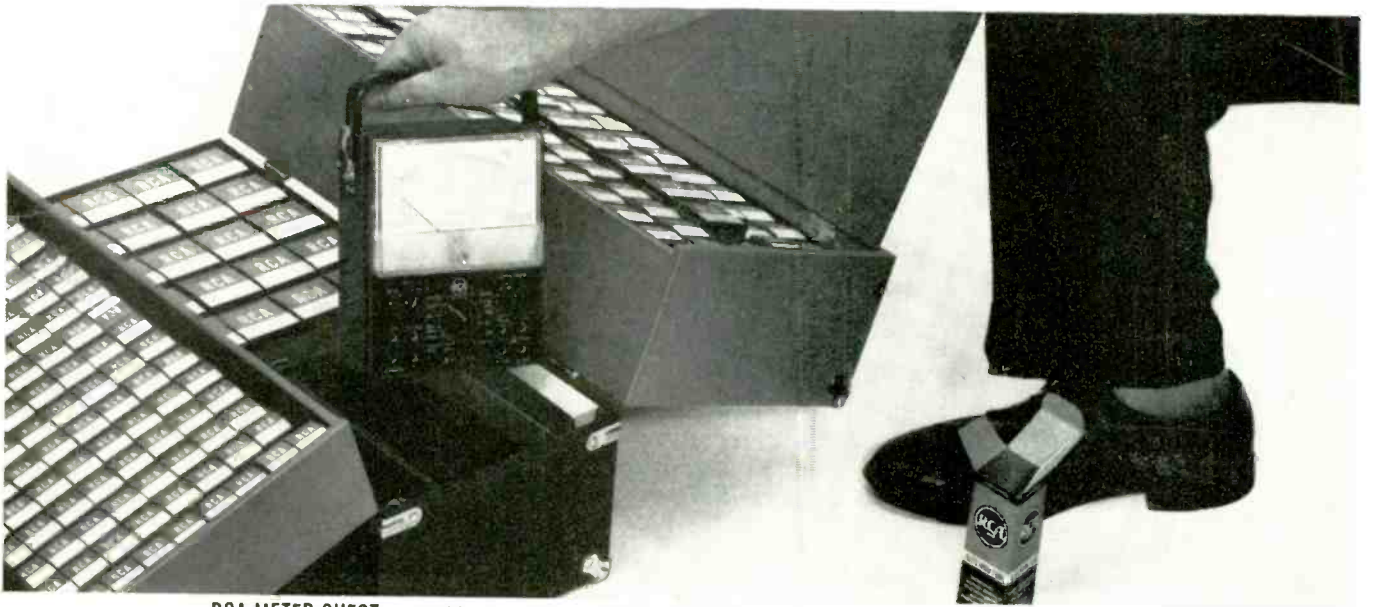

**RCA METER-CHEST**—a combination of famous RCA WV-38 VOM and "Treasure Chest" Tube Caddy. 750 tubes!\*



**TV TOTER TABLE**—simplifies moving heavy chassis. 350 tubes.\*

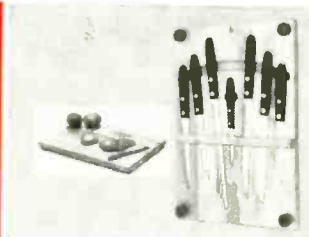

**CUTLERY SET**—7 utensils and cutting board. 325 tubes.\*



**KODAK BROWNIE PHOTO OUT-FIT**—550 tubes.\*



**BROWNIE 8 MOVIE CAMERA**—575 tubes.\*

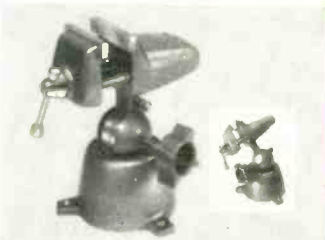

**PANAVISE**—for easier bench work. 300 tubes.\*

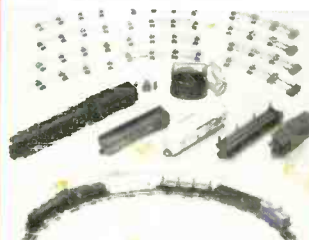

**ELECTRIC TRAIN SET**—350 tubes.\*



**MAN'S WATCH**—precision swiss movement. 475 tubes.\*



**LADY'S WATCH**—precision swiss movement. 475 tubes.\*

For complete selection of gifts and full details, check with your participating RCA distributor.

\*Suggested Value



The Most Trusted Name in Electronics  
RADIO CORPORATION OF AMERICA