

# ELECTRONIC TECHNICIAN / DEALER

WORLD'S LARGEST ELECTRONIC TRADE CIRCULATION

FRISEW10812392N869AD3A117966B  
WILLIAM W FRISE  
7176 GALE RD  
ATLAS MI  
48411

**TRIGSWEEP YOUR OLD SCOPE**

**WHAT ABOUT AUDIO COMMUNICATIONS**

**SMALL-BOAT ELECTRONICS**



MARCH 1968

# successful service shop beats rising costs with **B&K** television analyst

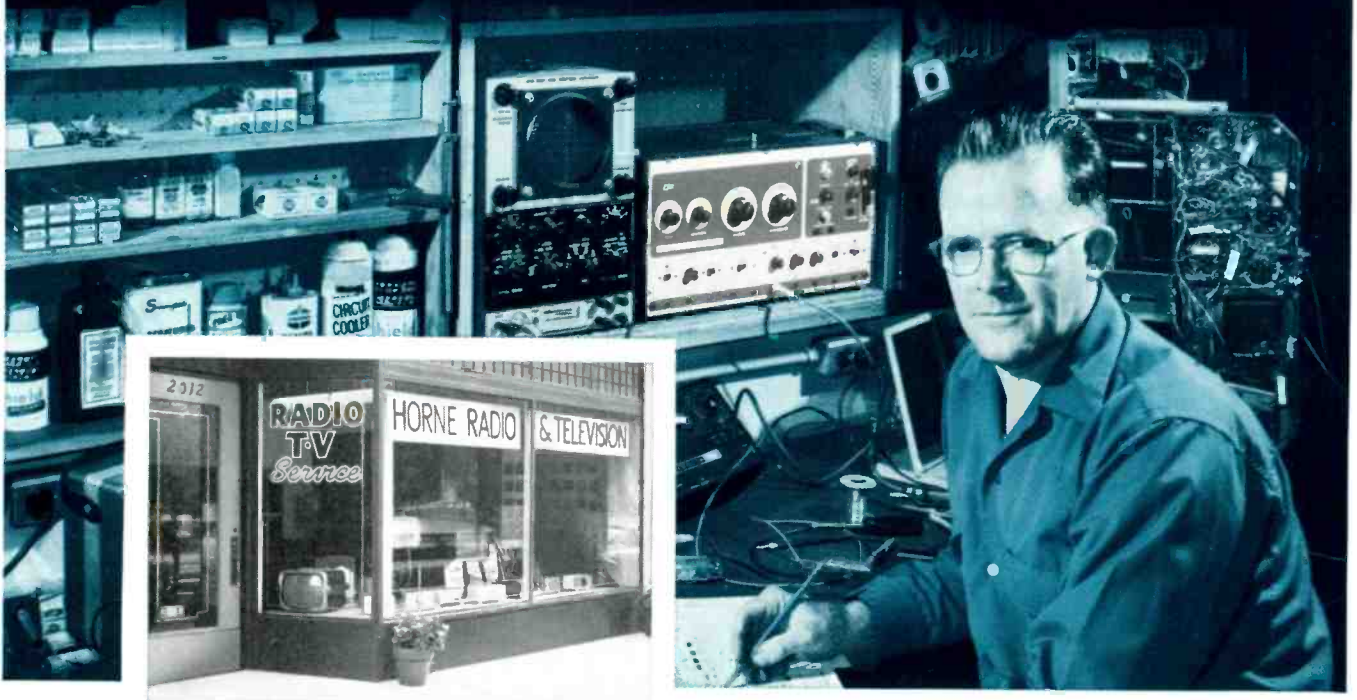

*"As every serviceman knows, major TV repairs represent an increasingly large part of the service business and the average time per repair has increased"...*

says Willard Horne of Horne Radio and Television in Evanston, Illinois.

After more than 25 successful years in the service business, twenty of them in the same location, Mr. Horne can be considered an authority on how to keep a business profitable. Mr. Horne says, "In order to be successful, our 3-man shop has to be competitive on the large jobs as well as the small ones. With the increase in bench time that we were experiencing and the limitations on what we could charge, there was a reduction of profit that had to be stopped. Then we bought a B&K Model 1076 Television Analyst."

"Now our customers get the same extra-value service on the big repairs and the small ones," said Mr. Horne. "We use the Television Analyst for troubleshooting a wide variety of complaints, particularly for those that require touch-up align-

ment, location of IF overloads and color convergence. We are more competitive now that we use the B&K Television Analyst because we spend far less time on the jobs that used to be dogs, with benefits both to the shop and our customers."

★ B&K Model 1076 Television Analyst checks every stage in a black and white or color TV receiver. Nine VHF RF channels, 20 to 45 MC IF, audio, video, sync, bias voltage and AGC keying pulse are available. The model 1076 provides its own standard test pattern, white dot, white line crosshatch, and color bar pattern slide transparencies. It includes a blank slide which can be used for closed-circuit-TV display floor promotion. Its net price is \$329.95.

*Find out how you will increase your TV service profits with a B&K Model 1076. See your distributor or write for Catalog AP 22.*



**A DIVISION OF DYNASCAN CORPORATION**

1801 W. Belle Plaine, Chicago, Illinois 60613

WHERE ELECTRONIC INNOVATION IS A WAY OF LIFE

Canada: Atlas Radio Corp. Ltd. 50 Wingold Avenue, Toronto 19, Ontario  
Export: Empire Exporters, Inc., 123 Grand Street, New York, N.Y. 10013

Made in U.S.A.

... for more details circle 101 on postcard

# TEKFAX

COMPLETE MANUFACTURERS' CIRCUIT DIAGRAMS  
AND TECHNICAL INFORMATION FOR 6 NEW SETS

GROUP  
**187**

MANUFACTURER	SCHEMATIC NO.	MANUFACTURER	SCHEMATIC NO.
GENERAL ELECTRIC Color TV Chassis KD	1141	RCA VICTOR Color TV Chassis CTC31 Series	1144
MAGNAVOX TV Chassis T916 Series	1140	WESTINGHOUSE TV Chassis V2659 Series	1143
MOTOROLA Color TV Chassis TS-921 Series	1142	ZENITH TV Chassis 8Y4B36	1145

SYMBOL	DESCRIPTION	MAGNAVOX PART NO.
<b>XFORMERS &amp; COILS</b>		
L1	IF input coil	360848-3
L2	47.25MHz trap	360842-1
L4	2nd IF xformer	360951-7
L5	3rd IF xformer	361161-2
L7	tweet coil	361157-1
L8	peaking coil	360853-1
L10	4.5MHz trap	360851-2
L11	sound take-off coil	360845-3
L12	sound interstage xformer	361251-1
L13	quad coil	360847-3
L14	ringing coil horiz hold	361171-2
L15	tweet coil	360783-4
L17	filter reactor	320335-1
L18	line coil	361075-3
T1	vert output xformer	320119-4
T2	audio output xformer	320334-1
T3	horiz output xformer	361265-2
	deflection yoke	361264-1

CAPACITORS: 20%, 500v  
unless noted otherwise

C22	1kpf, 2kv cer	250569-8
C43	0.027μf, 10% 1kv special paper	250290-13
C56	150pf, 10% 4kv cer	250475-35
C57	200μf, 200v, 300μf, 40μf, 150v, elect	270099-1
C70	39-pf, 5%, polystyrene	250525-3912

RESISTORS: 10%, 1/2w  
unless noted otherwise

R38	270Ω, 3w	
R66	4.712 WW fuseable	240098-1

CONTROLS

R18	25K, contrast	220231-1
R23	200K, bright	220231-1
R36	500K, vol w/oc switch	220231-1
R39	5M, vert lin	220233-1
R43	1M, vert hold	220233-1
R46	2M, height	220233-1

MISCELLANEOUS

PC1	printed pac	250526-2
VDR1	VDR	230167-2
	VHF tuner	340106-3
	UHF tuner	340122-1

**SPECIFICATIONS**

Power Source Rating	IF System	
Frequency	Picture IF	45.75MC
Voltage	Sound IF	41.25MC
Wattage	Intercarrier Sound IF	4.5MC
Tuning Range	Audio System	
Antenna Input Impedance	Output Impedance	3.2 Ohms
	Power Output	1 Watt

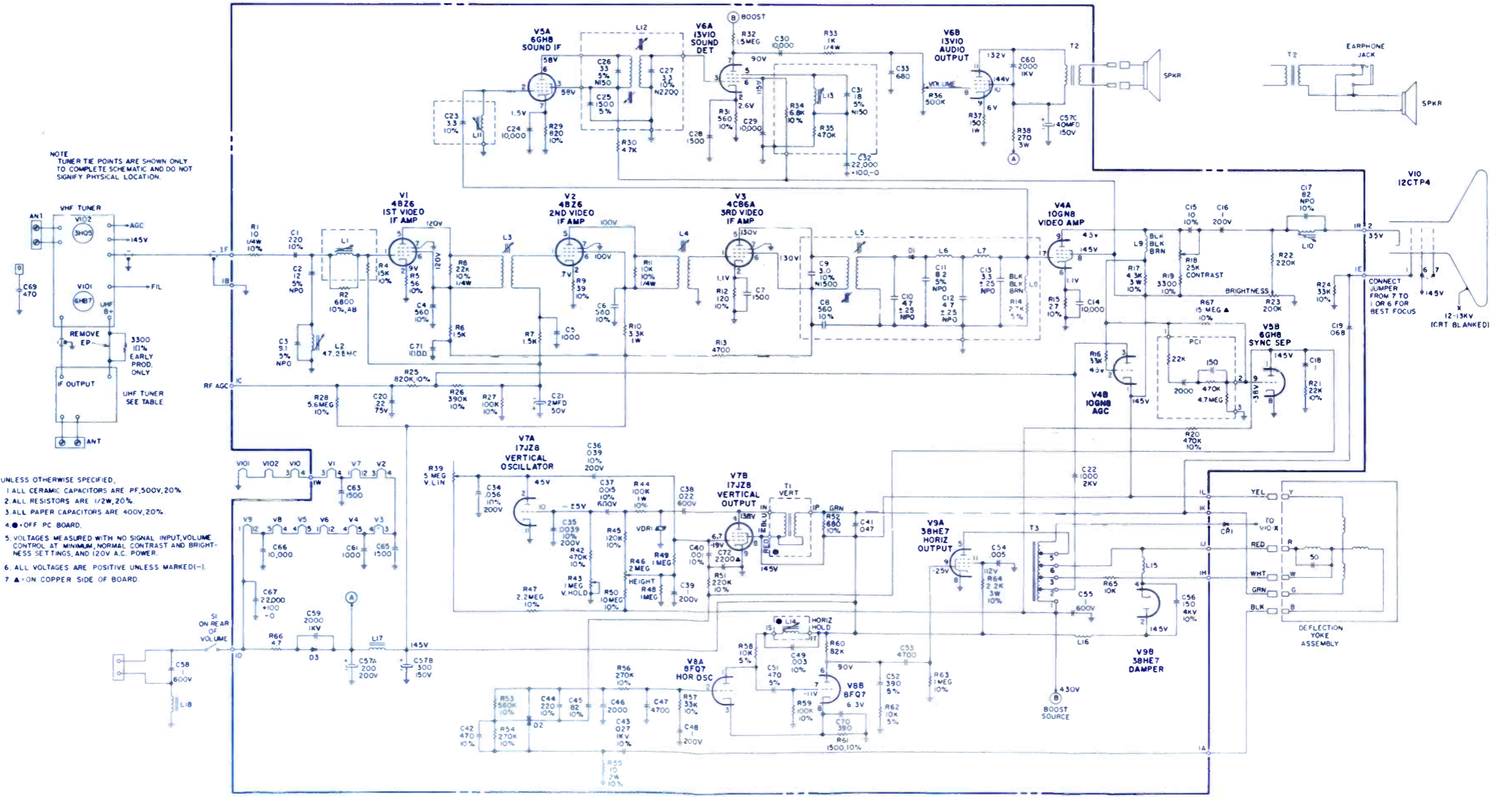

NOTE: TUNER TIE POINTS ARE SHOWN ONLY TO COMPLETE SCHEMATIC AND DO NOT SIGNIFY PHYSICAL LOCATION.

- UNLESS OTHERWISE SPECIFIED:
1. ALL CERAMIC CAPACITORS ARE PF, 500V, 20%.
  2. ALL RESISTORS ARE 1/2W, 20%.
  3. ALL PAPER CAPACITORS ARE 400V, 20%.
  4. ● OFF PC BOARD.
  5. VOLTAGES MEASURED WITH NO SIGNAL INPUT, VOLUME CONTROL AT MINIMUM, NORMAL CONTRAST AND BRIGHTNESS SETTINGS, AND 120V A.C. POWER.
  6. ALL VOLTAGES ARE POSITIVE UNLESS MARKED (-).
  7. ▲ ON COPPER SIDE OF BOARD.

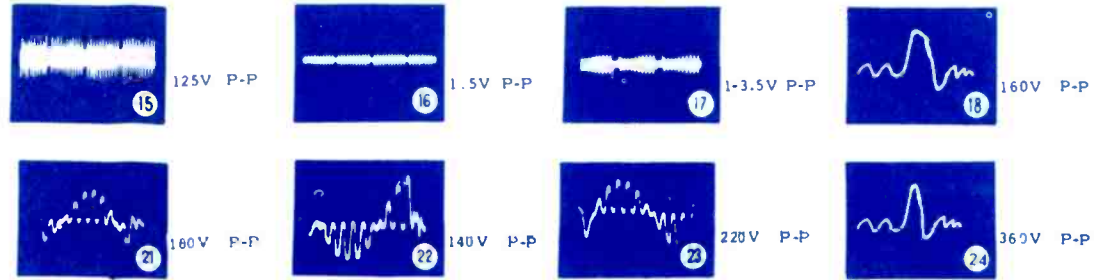

CHROMA WAVEFORMS

NOTE: CHROMA WAVEFORM TESTS PERFORMED WITH STRONG COLOR BAR PATTERN AND R115 AT 25% OF RANGE. USE LOW CAPACITY PROBE (2 $\mu$ f.) AND WIDE BAND SCOPE TO OBSERVE WAVEFORMS AND VOLTAGES

MISCELLANEOUS WAVEFORMS

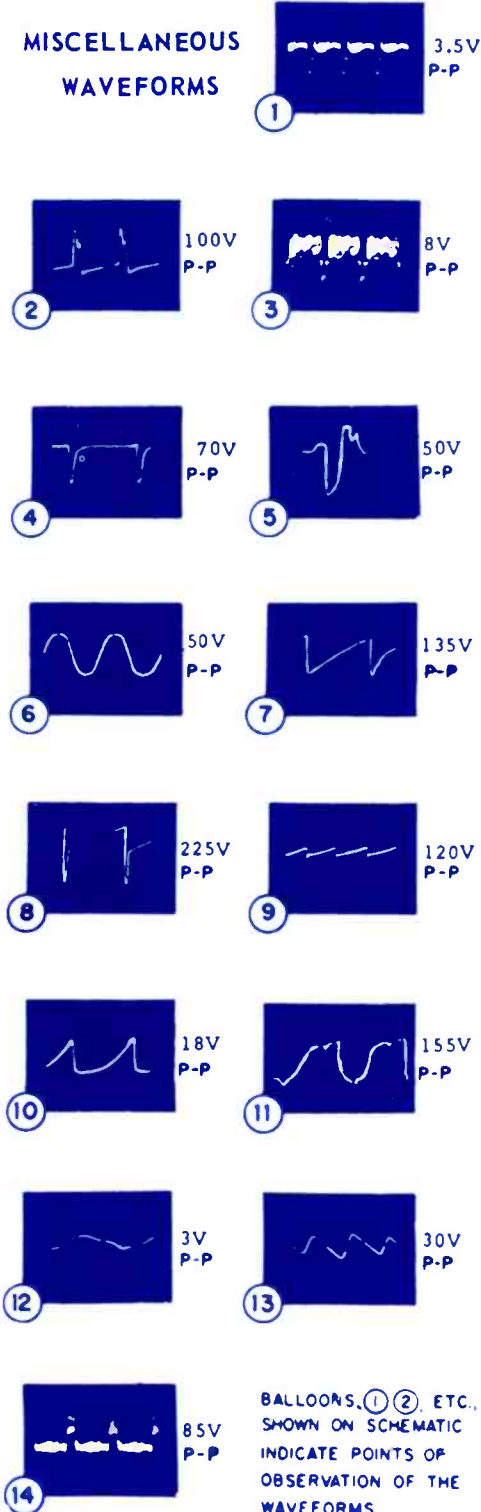

BALLOONS, ①, ②, ETC., SHOWN ON SCHEMATIC INDICATE POINTS OF OBSERVATION OF THE WAVEFORMS

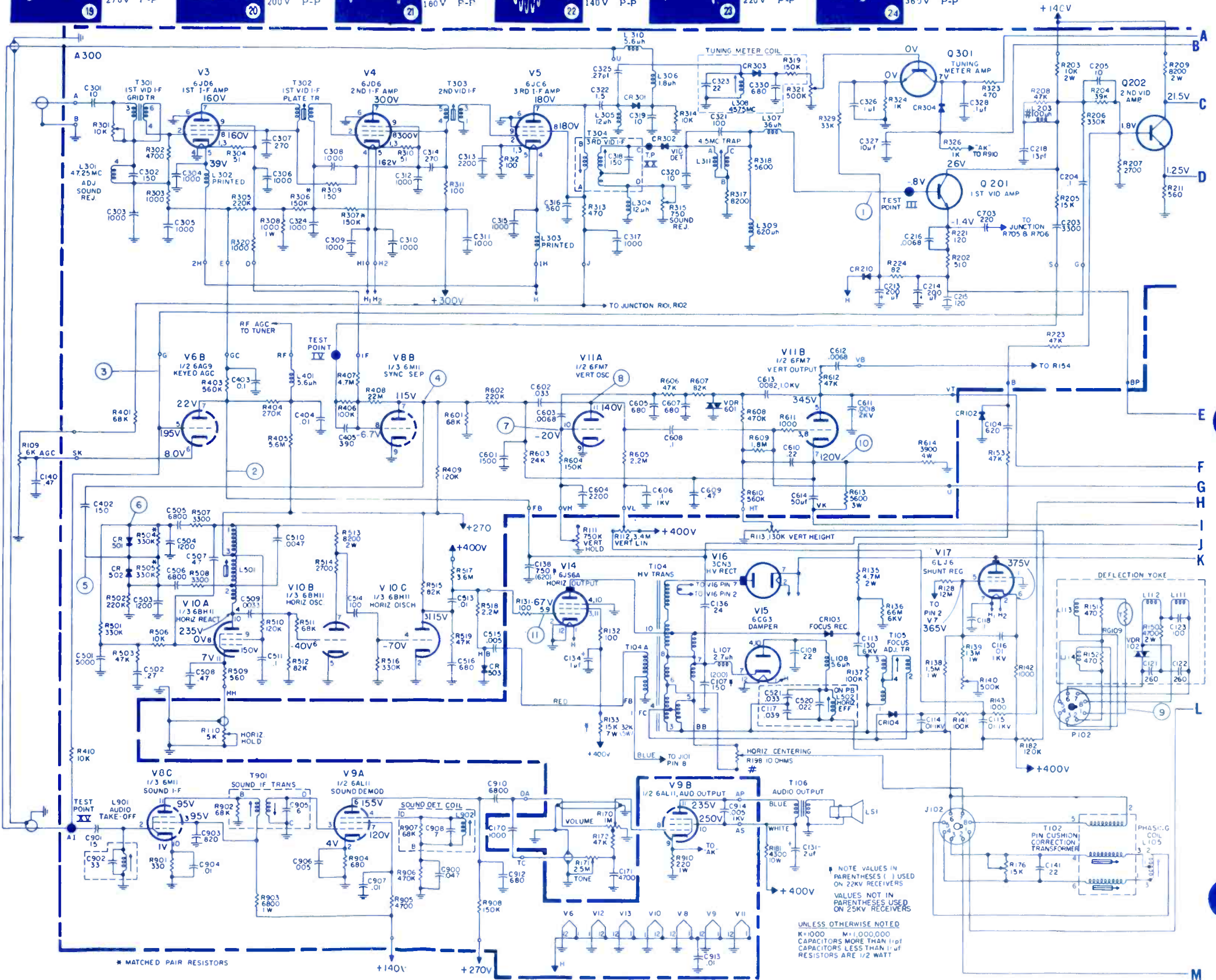

NOTE VALUES IN PARENTHESES ( ) USED ON 22KV RECEIVERS  
VALUES NOT IN PARENTHESES USED ON 25KV RECEIVERS  
UNLESS OTHERWISE NOTED  
K=1000 M=1,000,000  
CAPACITORS MORE THAN 1 $\mu$ f  
CAPACITORS LESS THAN 1 $\mu$ f  
RESISTORS ARE 1/2 WATT

**GENERAL ELECTRIC**  
Color TV Chassis KD

**RESISTORS**

RG101	— 120Ω cold, thermistor	ET14X221
VDR101	— varistor	ET14X196
R101	— 1K, 10%, 3w, metal film	ET14X176
VDR102	— 1mo, 175v, ±15%, varistor	ET14X215
R102	— 1.46K 10% 10w metal film	ET14X210
R103	— 250Ω 10% 10w WW	common
R104	— 800Ω 10% 20w WW 23" chassis only	common
RG109	— 3.8Ω @25°C 424Ω @104°C thermistor	ET14X147
R124	— .08Ω 10% 3w WW	ET14X209
R130	— 680Ω 10% 5w WW	common
R136	— 66M 20% 6kw	ET14X186
R181	— 4.3K 10% 10w WW (Allied 26U123C)	common
R203	— 10K, 10% w2, carbon	common

R209	— 8.2K 10% 5w WW	common
R218	— 5.6K 10% 7w metal film	ET14X116
R220	— 39K, 10% 5w WW	common
VDR601	— 1.48kV 15% 10ma, varistor	ET14X179

**CONTROLS**

R106	— 250K 20% bright	ET49X577
R107	— 35Ω 20% contrast	ET49X598
R109	— 6K 10% 2w AGC	ET49X435
R110	— 5K 30% horiz hold	ET49X576
R111	— 750K 30% vert hold	ET49X606
R113	— 130K 30% height	ET49X598
R114	— 500Ω 20% color	ET49X614
R117	— 1.5M blue screen	ET49X606
R120	— 130K 30% CRT bias	ET49X617
R122	— 6K 20% grn drive	ET49X437
R140	— 500K 30% HV adjust	ET49X648
R170	— 1M vol, w/push-push SPDT	ET49X646
S102	— AC switch, for lista-view sets	ET49X486
R170	— 1M vol w/push-push SPST	ET49X557
S102	— AC switch, for non-ista view sets	ET49X611
R171	— 2.5M 30% tone (tone not wired on some models)	ET49X486
R198	— 10Ω 10% horiz centering	ET49X354
R301	— 10K, sound rejection	ET49X557
R315	— 750Ω sound rejection	ET49X611
R321	— 500K 30% tuning meter amplitude	ET49X607
R731	— 1.5K 30% chroma balance	ET49X571
R801	— 120Ω horiz blue left	ET49X360
R804	— 150Ω vert red/grn left	ET49X359
R808	— 30Ω vert blue amplitude	ET49X605
R812	— 500Ω vert red/grn differential amplitude	ET49X358
R814	— 60Ω vert red/grn master tilt	ET22X50

**CAPACITORS**

C101	— 1000pf, GMV, 1.4kv, HiK	ET22X58
C107	— 160pf 10% 6kv N1500 23" sets	ET18X601
C107	— 200pf 10% 5kv N1500 for 18" and 20" chassis	ET18X614
C113	— 130pf 20% 6kv N2200	ET18X458
C121, C122	— 260pf 10% 2.5kv N3300	ET18X595
C123	— 100pf 10% 4kv N1600	ET18X600
C136	— 24pf, 10% 4kv N750	ET18X586
C208	— 5000pf, 20% 1.4kv HiK	ET22X110
C404	— .01μf 10% 500v stab HiK	ET22X50

**CAPACITORS-ELECT**

C131	— +80μf, -10+50% 450v	ET31X238
	□ 50μf -10+50% 450v	
	Δ 80μf -10+50% 450v	
	-2μf -10+100% 450v	
C132	— +80μf, -10+50% 450v	
	□ 20μf -10+100% 450v	
	Δ 50μf -10+100% 50v	
	-20μf, -10+150% 50v	
C327	— 10μf +10+100% 6v	E131X270
	ET31X238	

**RECTIFIERS-SOLID STATE**

CR102	— silicon blanking rectifier	ET57X30
CR103	— selenium, 3ma focus rectifier	ET57X32
CR104	— selenium, 2ma boost rectifier	ET57X31
CR210	— silicon, bias, rectifier	ET57X35
CR301, CR302	— silicon, sound & video det diodes, rectifier	ET16X1
CR303	— silicon, 45.75MHz tuning meter det rectifier	ET16X20
CR304	— silicon, damper, rectifier	ET16X21
CR501, CR502	— silicon, horiz, rectifier phase det	ET16X11
CR701	— chroma det, rectifier	ET16X19
CR710	— varactor-tint	ET30X87
CR801	— selenium 40ma, rectifier	ET57X38
L102, L103	— dual line filter, coil	ET36X856
L105	— pin cushion phasing, coil	ET36X836
L107	— peaking, 2.7μh 10%	ET36X804
L108	— peaking, 5.6μh, 10%	ET36X536
L111, L112, L113, L114	— deflection, yoke	ET76X47
LD201	— delay line	ET36X556
L203	— choke, 180μh, 7% EP, coil	ET36X826
L203	— choke, 100μh, 7%, LP, coil	ET36X433
L301	— 47.25MHz trap, coil	ET36X540
L305	— peaking, 12μh, coil	ET36X546
L306	— peaking, 1.8μh, 7%, coil	ET36X541
L308	— 45.75MHz, tuning meter bandpass	ET36X847
L501	— horiz osc, coil	ET36X727
L502	— horiz efficiency, coil	ET36X640
L701	— chroma input, 100μh, coil	ET36X795
L702	— choke, 4.3μh, coil	ET36X796
L703	— choke, 1500μh, 7%, coil	ET36X797
L705	— crystal tuning, coil	ET36X798
L734, L735, L736	— peaking, 2600μh, coil	ET36X799
L801	— right vert red/grn, coil	ET36X787
L802	— right horiz, red/grn coil	ET36X820
L803	— blue phasing (blue droop) coil	ET36X789
L901	— sound take-off, coil	ET36X793
L902	— sound det, coil	ET56X61
T101	— power, xformer	ET88X104
T102	— pin cushion correction-xformer	ET51X29
T103	— vert output, xformer	ET64X116
T104	— horiz output w/horiz centering for 23" chassis, xformer coil	ET77X106
T104	— horiz output late production without/horiz centering for 23" chassis, xformer coil	ET77X102
T104	— horiz output without horiz centering for 18" & 20" chassis, xformer coil	ET77X110
T104	— horiz output w/horiz centering for 18" & 20" chassis xformer coil	ET77X111
T105	— focus, coil	ET36X710
T106	— audio output	ET64X97
T301	— 1st IF grid, xformer	ET61X125
T302	— 1st IF plate, xformer	ET61X179
T303	— 2nd IF plate, xformer	ET61X180
T304	— 3rd IF plate, xformer	ET61X142
T701	— chroma bandpass, xformer	ET61X140
T703	— xformer-R-Y	ET61X176
T901	— 4.5MHz sound IF, xformer	ET61X164

**MISCELLANEOUS**

	neon glow type bulb, NE-83/5ah, N701	ET41X6
	1.2a CB101 circuit breaker	ET10X54
	tuning indicator, meter	ET41X48
	NPN silicon, 1st video amp Q201 transistor	ET15X34
	NPN silicon, 2nd video amp Q202, transistor	ET15X27
	NPN silicon, tuning meter Q301, transistor	ET15X10
	VHF, tuner, 13-position triode	ET86X263
	UHF, tuner, solid state	ET85X54

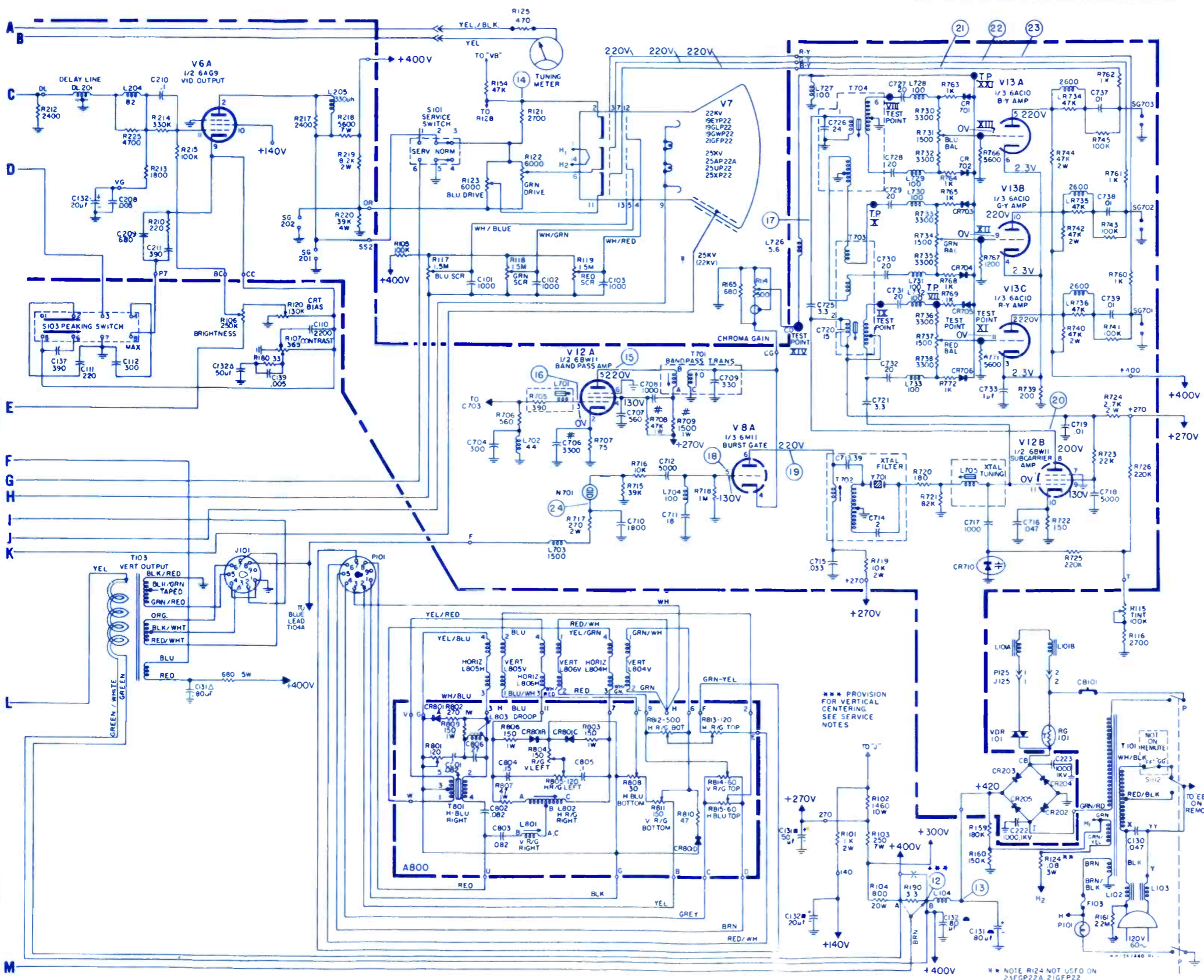

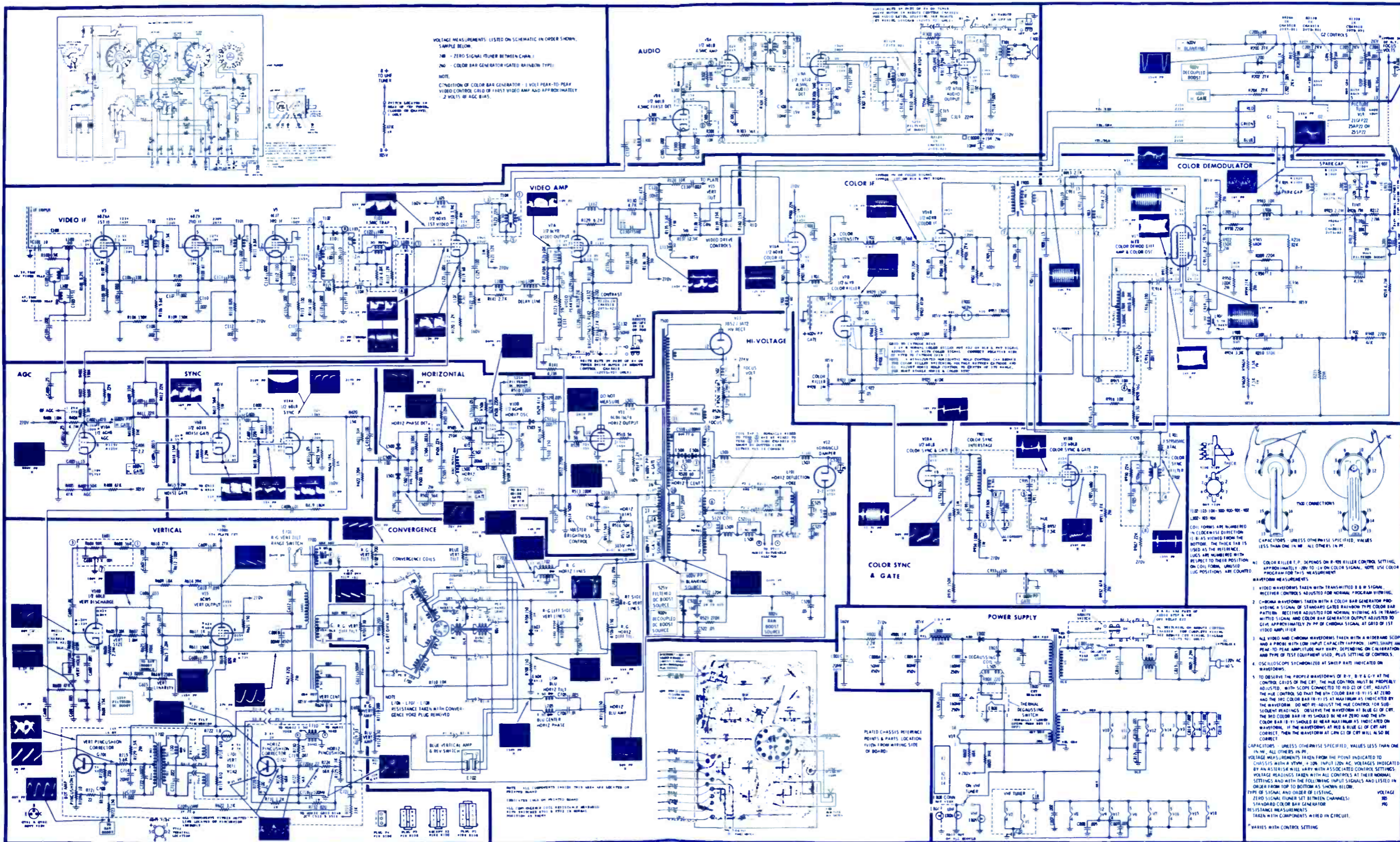

SYMBOL	DESCRIPTION	WESTINGHOUSE PART NO.
<b>CAPACITORS</b>		
C203	—43pf 500v cer NPO, 5%	215V134A30
C205	—2.7pf 500v cer NPO	215V122A79
C214	—3.9pf 500v fixed composition	217V013A99
C402A	—200uf 175v elect	
C403A	—30uf 175v elect	
C404A	—200uf 175v elect	218V054H30
C405A	—200uf 175v elect	
C416	—150pf 3kv cer	215V300H85
C418	—100pf 4kv cer	215V318H11
C419	—15pf 2kv cer	215V431A50
C420	—3.25pf AGC trimmer	217V511H02
C421	—0.39pf 400v mylar	210V116H25
C424	—75pf 3kv part of yoke	215V300H91
C429	—120pf 500v poly	210V290H11
<b>RESISTORS</b>		
R216	—6k, 4w WW	251V014H54
R400	—2k 5w 10% WW	251V033H14

R401	—680Ω 4w 10% WW	251V020H78	L206	—300μh, coil	230V141H08
R402	—47Ω 4w 10% WW	251V020H79	L207	—600μh, coil	230V141H02
R412	—910Ω 5w 5% carbon	250V219A11	L400	—375ma choke 4h, 10Ω reactor	430V161B01
R416	—3.3k 2w 10% carbon	250V423A32	L401	—horiz hold, less shaft, adjustable coil	230V144H01
R418	—5.6k 1w 10% WW	251V005A69	L403	—55μh, coil	230V125H01
SW400	—switch, on-off, incl: R108&R219	270V166H04	T100	—4.5MHz, sound limiter adjustable, xformer	235V046H01
R108	—500k vol control incl: SW400 & R219	270V166H04	T101	—audio output, xformer	430V150H02
R217	—15k contrast control incl: 400&R108	270V159H12	T200	—IF input 44.25MHz, xformer	235V049H02
R219	—300k, bright control incl: 400&R108	270V166H04	T201	—43.25MHz 1st IF xformer	235V048H04
R309	—5M, height control incl: R316, R413	270V155H05	T202	—44.65MHz 2nd IF xformer	235V094H06
R310	—2M, vert hold control	270V159H10	T203	—4.5MHz trap & sound xformer	235V076H04
R316	—500k, vert lin control incl: R309, R413	270V155H05	T300	—vert output, xformer	430V039H11
R413	—350k, horiz range control R309, R316	270V155H05	T400	—horiz output, xformer	493V020H03
<b>XFORMERS &amp; COILS</b>			Z401	—yoke 114° deflection	490V017C01
L100	—4.5MHz, quad, adjustable, coil	230V031H01	F400	—2A, slo-blo, fuse	758V001H09
L200	—24μh, IF link, coil	230V065H06	X401	—AF, dual sel, diode	296V004H01
L201	—47.25MHz, adjustable coil	230V076H01	X402	—silicon, instant on, diode	295V006H03
L202	—14μh, coil	230V130H01	Z400	—resistor-capacitor package circuit	219V004H03
L203	—4.7μh, coil	230V130H01	VHF tuner		470V177D01
			UHF tuner		472V060D01

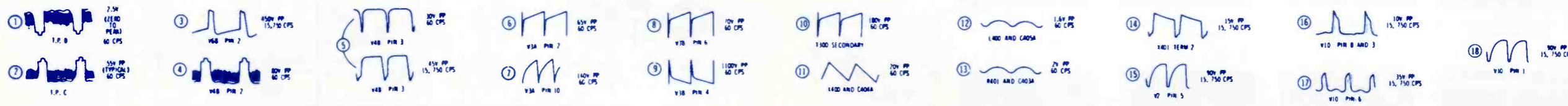

NOTE:  
 1. ALL CAPACITOR VALUES LESS THAN 1 ARE IN PF, AND VALUES GREATER THAN 1 ARE IN μF (MICROFARADS). ALL RESISTANCE VALUES ARE IN OHMS, 0.5 WATT UNLESS OTHERWISE INDICATED.  
 2. DC VOLTAGES ARE MEASURED FROM POINT INDICATED TO CIRCUIT GROUND WITH A VTVM. LINE VOLTAGE AT 120 V.A.C., NO SIGNAL APPLIED.  
 3. WAVEFORMS WERE TAKEN WITH CONTROLS SET FOR A NORMAL PICTURE.

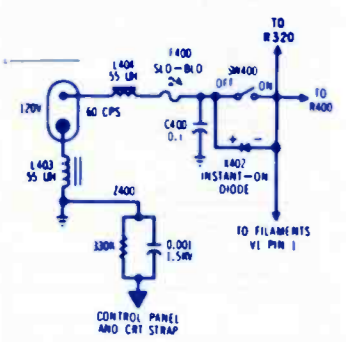
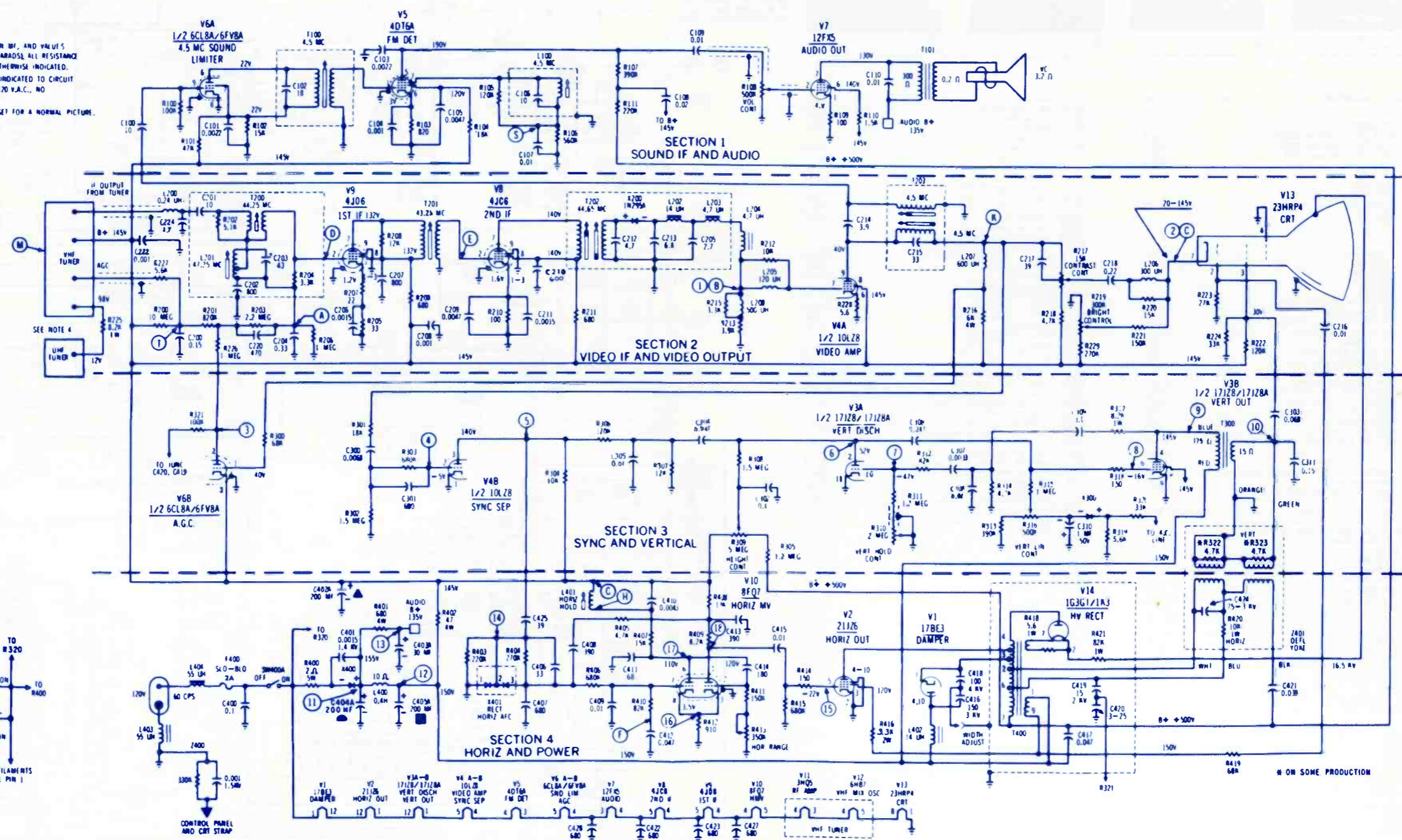

MARCH • 1968

NOTE: Voltage Waveforms taken with a wideband oscilloscope using a low capacitance probe. Color Bars from the WR64B Color Bar/Dot/Crosshatch Generator used for the chroma circuit voltage waveforms.

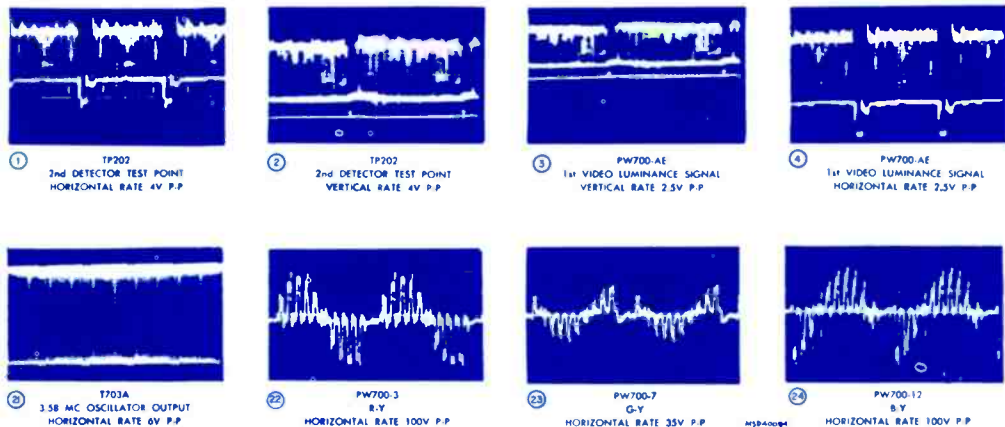
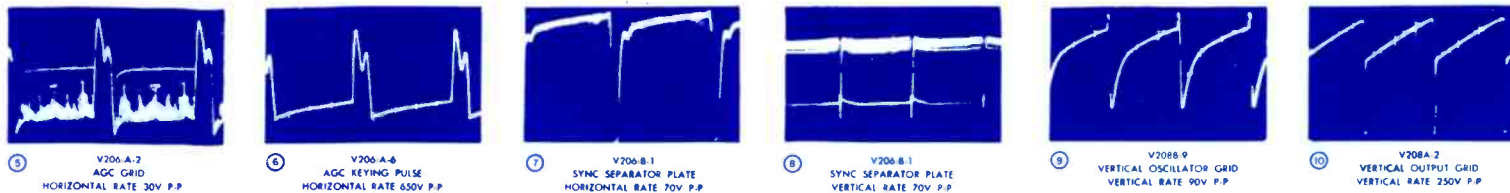

SYMBOL DESCRIPTION RCA VICTOR PART NO.

CAPACITORS  
C101 - 470pf ±10% 2.5kv cer N2200 114602  
C107 - 130pf ±20% 0kv cer, N2200 109229  
C113 - 68pf ±10% 4kv cer N1500 112847  
C118 - 3 section elect 115869  
A - 80µf, 450v  
B - 30µf, 450v  
C - 20µf, 450v  
C119 - 3 section elect 115869  
A - 80µf, 450v  
B - 2µf 450v  
C - 25µf 450v  
D -  
C124 - 4 section elect 112827  
A - 80µf 450v  
B - 50µf 450v  
C - 20µf 250v  
D - 50µf 50v

C128 - 0.0047µf ±10% 1.6kv paper 119827  
C131 - 5µf 10vac elect NP 115868  
C203 - 820µf ±5% 500v cer N2200 121569  
C206 - 15pf ±5% 500v cer NPO 109316  
C216 - 3-15pf trimmer 116502  
C217 - 91pf ±5% 500v cer NPO 121570  
C221 - 0.068µf ±20% 100v mylar 119378  
C234 - 240pf ±5% 500v mica 115652  
C235 - 0.1µf ±20% 100v mylar 77252  
C242 - 1000pf ±100 -0%, 500v cer 109818  
C276 - 0.0082µf ±20% 1kv paper 116500  
C723 - 0.82pf ±5% 500v headed lead 116501  
C724 - 2-10pf trimmer 116501  
C737 - 620pf ±5% 500v mica 107594  
C742 - 8pf ±1pf 500v cer NPO 105320  
C746 - 0.001µf ±10% 2kv paper 115652  
C755 - 0.1µf ±20%, 100v, mylar 121576  
C756B - 0.033µf +100 -0%, 600v (matched pair) 122207  
CB101 - breaker-circuit 1.75v 115436  
CPR101 - capristor 100pf and 2.2M

DIODES  
CR102 - 400piv at 500amp diode 113998  
CR204 - 500piv at 500amp diode 113998  
CR801A - selenium rectifier, diode 118244  
DL101 - line delay, diode 121554  
COILS  
L105 - 5.6µh coils 109171  
L107 - pin phase coil 114594  
L109 - choke-filter coil 112829  
L111 - filter choke coil 117526  
L201 - 47.25MHz coil 115844  
L202 - 41.25MHz coil 121564  
L205 - 4.5MHz coil 121446  
L206 - 1.8µh coil 109248  
L207 - peaking 36µh coil 101819  
L208 - horiz sine wave 116506  
L211 - 1.8µh coil 109248  
L213 - 3.9µh coil 116507  
L202 - 1500µh coil 121561  
L704 - 68µh coil 121591  
L705 - 4.7µh coil 121562  
L708 - horiz efficiency 122918

L710 - peaking 170µh 121563  
L801 - right vertical lines red/grn 114597  
L802 - right horiz lines red/grn 114598  
L803 - 120µh 118245  
L804 - right horiz blue lines 116580  
CONNECTORS  
PW200 - circuit-printed-pix, complete (less tubes) 121516  
PW700 - circuit-printed-chroma, complete (less tubes) 121517  
Q701 - transistor-color killer 2N4250  
Q702 - transistor-ACC, 2N3565  
RESISTORS: ±10%, 1/2w, composition unless otherwise noted

R111 - 66M, 6kv 114651  
R114 - 15K ±5%, 7w, film 121492  
R121 - 15K 5w, film 116515  
R133 - 6.8K, 4w 107541  
R136 - 15K, 10w, film 116644  
R150 - 680Ω, 15w 121552  
R151 - 750Ω, 7w, film 121551  
R156 - 3.9K, 7w, film 522322  
R743 - 22K, 2w  
RT101 - thermistor, part of yoke  
RV101 - varistor, 175v at 1 ma 114707  
RV102 - varistor, 870v at 1 ma 112876  
RV202 - varistor, 110v at 1 ma 114862  
SG101 - capacitor, spark gap, 0.75pf, 1kv 116636  
SG102 - capacitor, spark gap, 10.000pf, 1kv 117139  
SG702 - capacitor, spark gap, 0.5pf 1kv 120819  
SG704 - capacitor spark gap, 10.000pf 1kv 117139  
R117 - control, color killer 112841  
R119 - control, AGC 116556  
R120 - control, volume (on TMA) 122176  
R124 - control-vertical height 121586  
R126A - control-contrast, vert hold 121586  
R126B - control-contrast, vert hold 121586  
R127 - control-bright 112842  
R140 - control-bright (on TMA) 122355  
R143 - control-tint, CTC31B,J,R 121667  
R143 - control-tint, CTC31A,H,P 121669  
R145 - control-color, CTC31A,H,P 122354  
R145 - control-color, CTC31B,J,R 121587  
R149A,R149B - control-tone, horiz hold 114020  
R158 - control-vert linearity 116558  
R162 - control-top and bottom pin amp 116457  
R216 - control-adj sound rej 121575  
R782A - control, blue, grn, red drive 121588  
R783A - control-video peak, kinescope bias 121574  
R784A - control-blue, grn, red screen 120949  
R801 - control, left blue horiz lines 109472  
R804 - control-left vert lines red/grn 106320  
R805 - control-left horiz lines red/grn 109472  
R808 - control-bottom blue horiz lines 109472  
R811 - control-top red/grn vert lines 114623  
R812 - control-bottom red/grn vert lines 106320  
R813 - control-top red/grn horiz lines 105059  
R814 - control-bottom red/grn vert lines 113999  
T101 - focus adj 119834  
T102 - HV 119170  
T103 - audio 119828  
T104 - vert output 119830  
T105 - power 121560  
T107 - top and bottom pin 119835  
T108 - side pin 117382  
T201 - input sound IF 117384  
T202 - input sound demod 117383  
T203 - output sound demod 121555  
T204 - input 1st pix IF 116544  
T205 - input 2nd pix 121558  
T206 - output 2nd pix 121557  
T701 - 1st chroma band pass 121559  
T702 - burst amp 121589  
T703 - 3.58MHz oscillator 121562  
T704 - 2nd video output 121556  
T705 - 2nd chroma band pass 114742  
Y101 - thermistor, temperature compensating 5Ω cold (part of yoke) 114742  
yoke, deflection, FJ573E; FJ575M,W, MR, WR; FJ583WK; GJ615M,W,MR,WR; GJ619M,W,WR; GJ621W; GJ627L,LR; GJ631F,W; GJ635F,W; GJ673MK,WK,WRK; GJ675WK; GJ677LK; GJ679WK; GJ681FK; GJ683SK yoke-deflection, FJ593E; FJ595M,W,WR; FJ603MK,WK; GJ693M,W; GJ697M,W,MR,WR; GJ787MK,WK,WRK 114741  
VHF, tuner assembly KRK 128U,W UHF, tuner assembly KRK 120MA, NA, PA

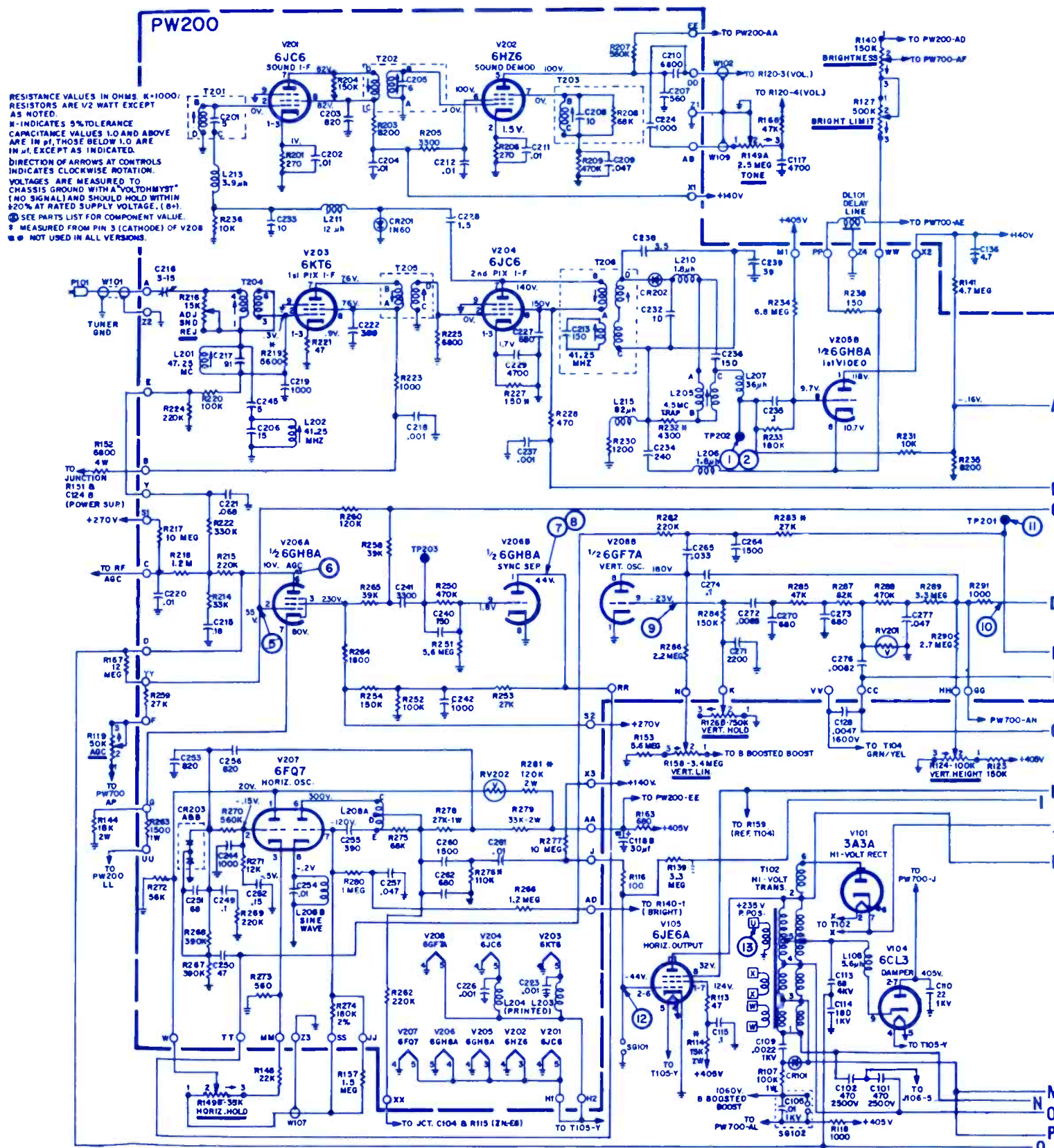



RCA VICTOR  
Color TV Chassis CTC31 Series

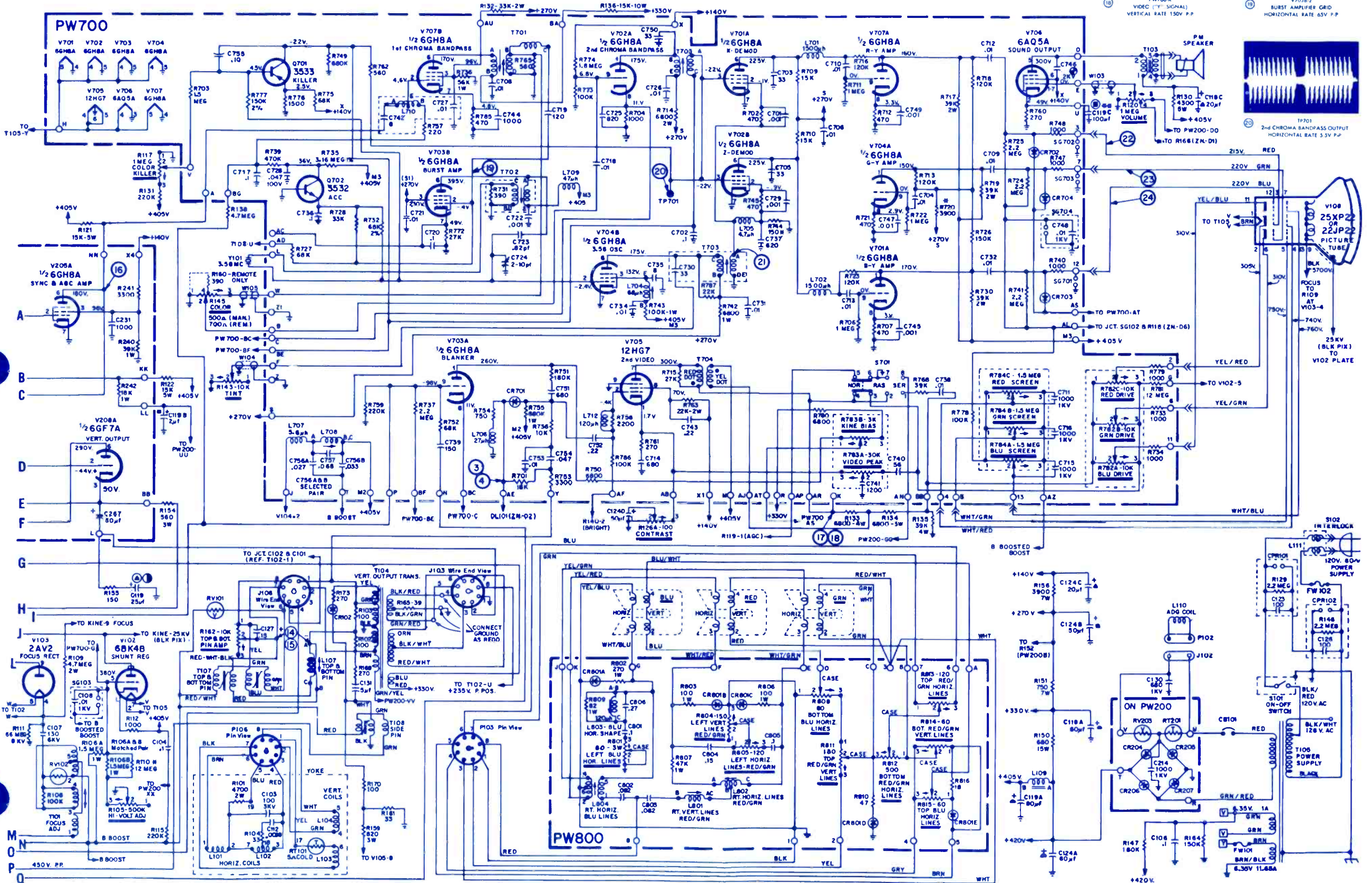
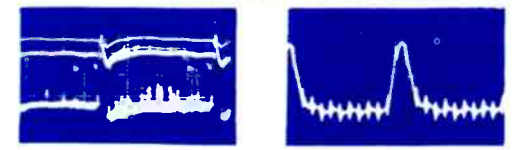
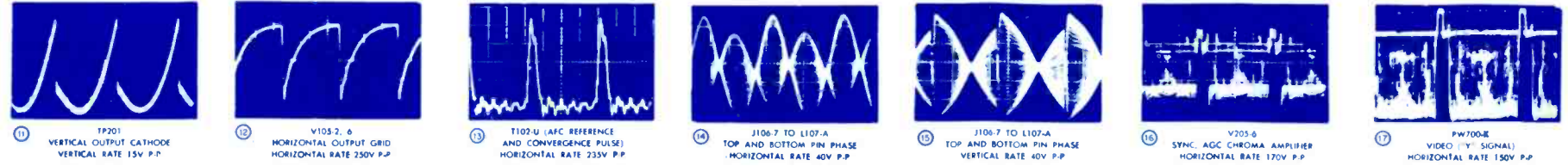

MARCH • 1968

COMPLETE MANUFACTURERS' CIRCUIT DIAGRAMS AND TECHNICAL INFORMATION FOR 6 NEW SETS

SYMBOL DESCRIPTION

C19 - 26pf disc cap 5% 25v	22-3939
C33A - 4uf elect cap 350v	22-2744
C33B - 20uf elect cap 25v	22-2744
C33C - 10uf elect cap 400v	22-2744
C43 - 220pf mica cap 10% 500v	22-2926
C45 - .001uf disc cap 10% 1kv	22-3748

ZENITH PART NO.

C46 - 100pf mica cap 10% 500v	22-5106
C67A - 200uf elect cap 25v	22-3863
C67B - 80uf elect cap 200v	22-3863
C67C - 80uf elect cap 400v	22-3863
C70 - 80uf elect cap 200v	22-3965
C73 - 2 times .001uf disc cap 10% 500v	22-21
C75 - 470pf disc cap 20% 1kv	22-6

C77 - 1500pf poly cap 10% 500v	22-3916
C79 - 330pf mica cap 10% 500v	22-3667
C89 - 75pf disc cap 10% 4kv	22-2954
R1 - 12Ω resistor 10% A-B only 1/4w	63-7102
R2 - 27Ω resistor 10% A-B only 1/4w	63-7103
R5 - 10k resistor 10% A-B only 1/4w	63-7106
R17 - VDR	63-6970
R18 - 15K resistor 10% 3w	63-4458
R19 - 6.8K resistor 10% 7w	63-5338
R35 - 7.5K resistor 10% 3w	63-4904
R41 - thermal resistor mounted in yoke	63-5187
R42 - 4.4K resistor 10% 20w	63-1783
R44 - VDR	63-6455
T1 - 1st IF xformer	20-1459
T2 - 4th IF xformer	20-1460
T3 - sound take-off coil assembly	5-65529
T4 - intercarrier coil assembly	5-67031
T5 - quad coil assembly	5-75410

T6 - audio output xformer	95-2185
T7 - vert output xformer	95-2523
T8 - yoke	95-2450
T9 - power xformer	95-2495
T10 - horiz sweep xformer	5-76741
T11 - 2nd IF xformer	20-1515
L2 - 41.25MHz trap coil	20-1591
L3 - 39.75MHz trap coil	20-1590
L4 - 47.25MHz trap coil	20-1516
L6 - 3rd IF coil	20-1458
L8 - peaking coil	20-2013
L9 - peaking coil	20-2707
L10 - shunt peaking coil	20-2014
L11 - shunt peaking coil	20-2028
L13 - series peaking coil	20-2524
L15 - quad coil	5-66699
L16 - filter choke	95-2189
L17 - horiz osc coil	5-56876

L18 - spook coil	20-2005
X6 - dual selenium diode	103-20
X7 - zener diode	103-105
A1 - integrator	87-4
F1 - bellfuse (2a)	136-66
FL1 - neon bulb	100-397
R20 - 15K contrast control	63-6356
R22 - 250K bright control	63-5380
R24 - 3M focus control	63-6467
R25 - 750Ω buzz control	63-3284
R27 - volume control (space command sets only) 2w	63-6422
R28 - volume control & switch	63-5126
R31 - 1M AGC control	63-4833
R32 - 7M vert size control	63-6433
R34 - 750K vert hold control	63-7185
R35 - 600Ω vert linearity control	63-5312
R38 - 3K width control	63-5031
R47 - IF AGC control	63-7181

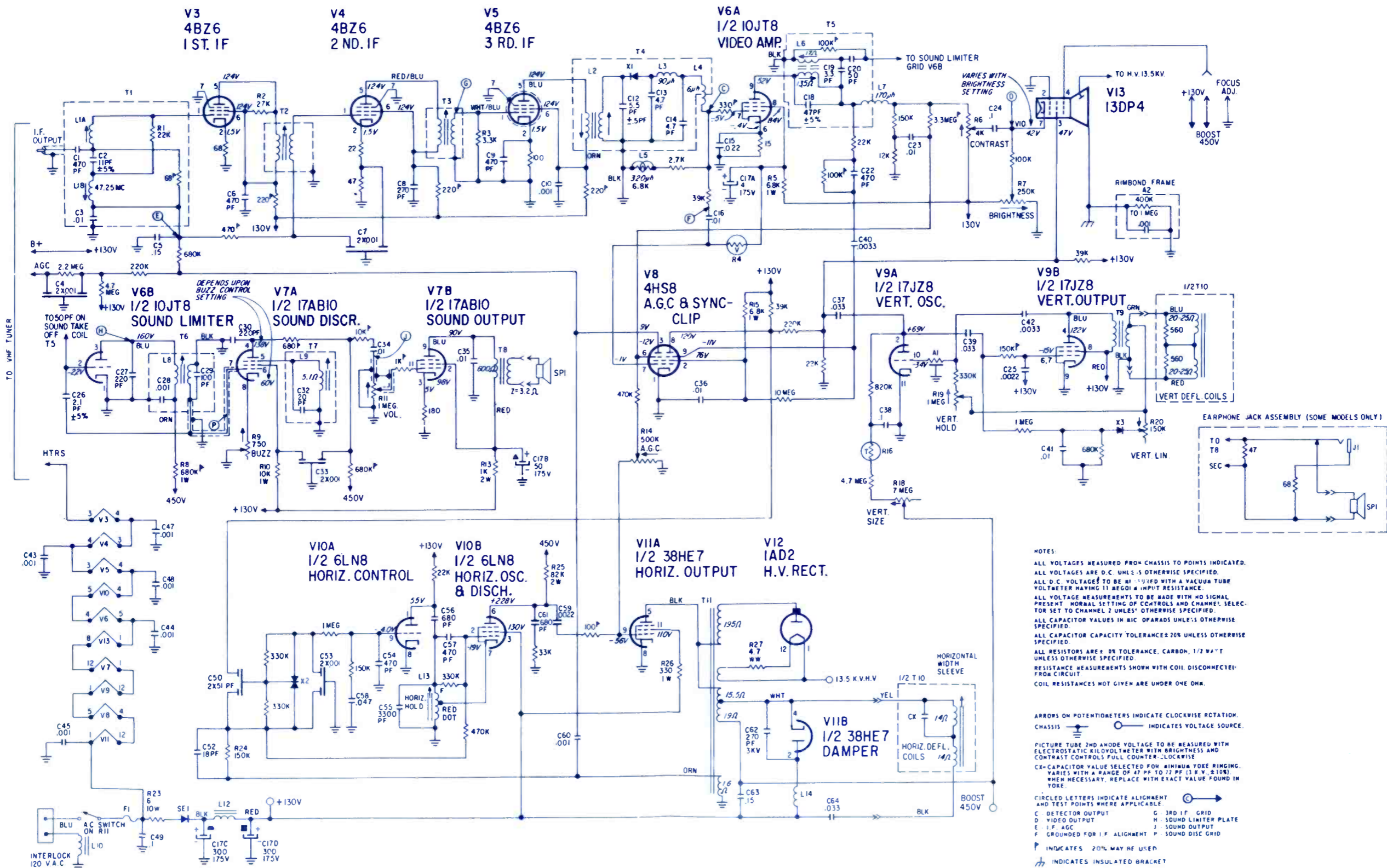

NOTES:  
 ALL VOLTAGES MEASURED FROM CHASSIS TO POINTS INDICATED.  
 ALL VOLTAGES ARE D.C. UNLESS OTHERWISE SPECIFIED.  
 ALL D.C. VOLTAGES TO BE MEASURED WITH A VACUUM TUBE VOLTMETER HAVING 11 MEGOHM INPUT RESISTANCE.  
 ALL VOLTAGE MEASUREMENTS TO BE MADE WITH NO SIGNAL PRESENT. NORMAL SETTING OF CONTROLS AND CHANNEL SELECTOR SET TO CHANNEL 2 UNLESS OTHERWISE SPECIFIED.  
 ALL CAPACITOR VALUES IN MIC. FARADS UNLESS OTHERWISE SPECIFIED.  
 ALL CAPACITOR CAPACITY TOLERANCES 20% UNLESS OTHERWISE SPECIFIED.  
 ALL RESISTORS ARE ± 5% TOLERANCE, CARBON, 1/2 WATT UNLESS OTHERWISE SPECIFIED.  
 RESISTANCE MEASUREMENTS SHOWN WITH COIL DISCONNECTED FROM CIRCUIT.  
 COIL RESISTANCES NOT GIVEN ARE UNDER ONE OHM.

ARROWS ON POTENTIOMETERS INDICATE CLOCKWISE ROTATION.  
 CHASSIS  $\perp$  INDICATES VOLTAGE SOURCE.

PICTURE TUBE 2ND ANODE VOLTAGE TO BE MEASURED WITH ELECTROSTATIC KILOVOLT METER WITH BRIGHTNESS AND CONTRAST CONTROLS FULL COUNTER-CLOCKWISE.  
 CX - CAPACITOR VALUE SELECTED FOR MINIMUM YOKE RINGING. VARIES WITH A RANGE OF 47 PF TO 12 PF (3 P.V. & 10K) WHEN NECESSARY, REPLACE WITH EXACT VALUE FOUND IN YOKE.

CIRCLED LETTERS INDICATE ALIGNMENT AND TEST POINTS WHERE APPLICABLE  
 C - DETECTOR OUTPUT  
 D - VIDEO OUTPUT  
 E - I.F. AGC  
 F - GROUNDED FOR I.F. ALIGNMENT  
 G - 3RD IF GRID  
 H - SOUND LIMITER PLATE  
 J - SOUND OUTPUT  
 K - SOUND DISC GRID  
 P - INDICATES 20% MAY BE USED  
 I - INDICATES INSULATED BRACKET



# \$975

EFFECTIVE 8/1/67

## GUARANTEED

*Nine-seventy-five* buys you a complete tuner overhaul—including parts (except tubes or transistors)—and absolutely no hidden charges. All makes, color or black and white. UV combos only \$15.

*Guaranteed* means a full 12-month warranty against defective workmanship and parts failure due to normal usage. That's 9 months to a year better than others. And it's backed up by the only tuner repair service authorized and supervised by the world's largest tuner manufacturer—Sarkes Tarzian, Inc.

Four conveniently located service centers assure speedy in-and-out service. All tuners thoroughly cleaned, inside and out . . . needed repairs made . . . all channels aligned to factory specs, then rushed back to you. They look—and perform—like new.

*"Prefer a replacement? Sarkes Tarzian universal replacements are only \$10.45, customized replacements \$18.25. Universal replacements shipped same day order received. On customized, we must have original tuners for comparison purposes, also TV make, chassis, and model number. Send orders for universal and customized replacements to Indianapolis."*

Part #	Intermediate Frequency	AF Amp Tube	Osc. Mixer Tube	Heater
MFT-1	41.25 mc Sound 45.75 mc Video	6GK5	6LJ8	Parallel 6.3V
MFT-2	41.25 mc Sound 45.75 mc Video	3GK5	5LJ8	Series 450 MA
MFT-3	41.25 mc Sound 45.75 mc Video	2GK5	5CG8	Series 600 MA

*Genuine Sarkes Tarzian universal replacement tuners with Memory Fine Tuning—UHF Plug In for 82-channel sets—Pre-set fine tuning—13-position detent—HI gain—Lo noise—Universal mounting*

**FOR FASTEST SERVICE, SEND FAULTY TUNER WITH TV MAKE, CHASSIS, AND MODEL NUMBER, TO TUNER SERVICE CENTER NEAREST YOU**



**TUNER SERVICE CORPORATION FACTORY-SUPERVISED TUNER SERVICE**

HOME OFFICE, MIDWEST . . . . . 817 N. PENNSYLVANIA ST., Indianapolis, Indiana . . . . . TEL: 317-632-3493  
 UNDER NEW MANAGEMENT, EAST 547-49 TONNELE AVE., Jersey City, New Jersey . . . . . TEL: 201-792-3730  
 SOUTH-EAST . . . . . 938 GORDON ST., S. W. Atlanta, Georgia . . . . . TEL: 404-758-2232  
 WEST . . . . . SARKES TARZIAN, Inc. TUNER SERVICE DIVISION  
 10654 MAGNOLIA BLVD., North Hollywood, California . . . . . TEL: 213-769-2720

# NOW...a full-sized **VOM** in a palm sized "package"

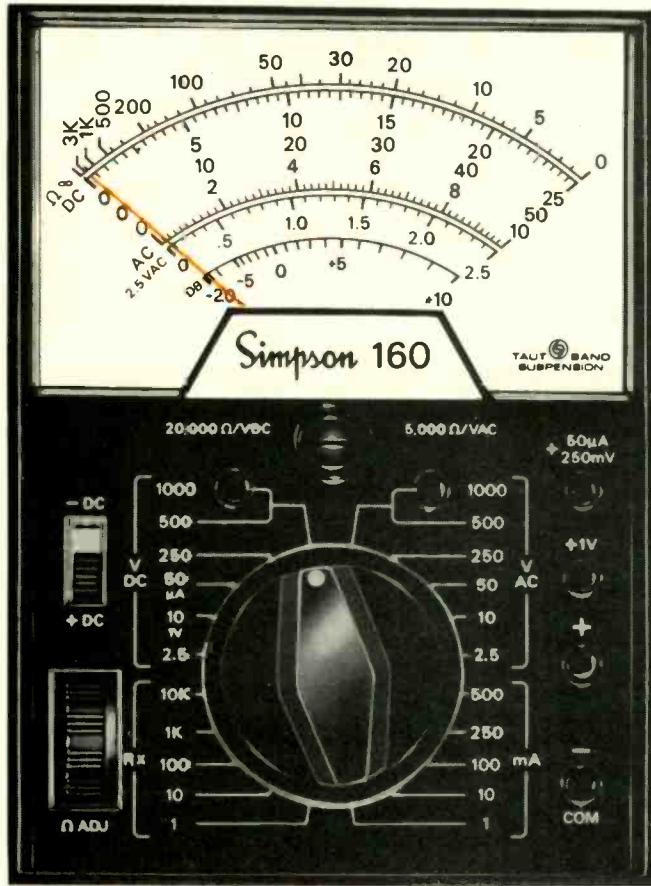
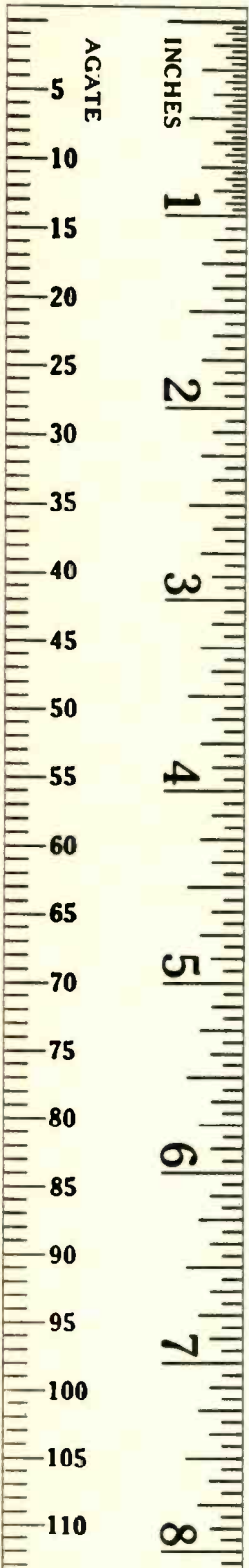

160 Volt-Ohm-Milliammeter  
Complete with alligator clip  
leads and operator's manual.  
.....\$53.00



Carrying Case—  
Cat. No. 2225.....\$10.00  
Accessory Leads—  
Probe Tip Lead—  
Cat. No. 2055.....\$3.00

## Simpson 160 Handi-VOM<sup>®</sup>

Simpson Handi-VOM gives you the ranges, the time-saving conveniences and the sensitivity of a full-sized volt-ohm-milliammeter—yet it's only 3-5/16" wide, weighs a mere 12 ounces. Recessed range-selector switch never gets in the way . . . polarity-reversing switch saves fuss and fumble. Self-shielded taut band movement assures high repeatability and freedom from external magnetic fields. Diode overload protection prevents burn-out—permits safe operation by inexperienced employees and students. The demand is BIG, so get your order in to your electronic distributor, TODAY!

### RANGES

**ACCURACY:**  $\pm 3\%$  FS DC,  $\pm 4\%$  FS AC  
**DC VOLTS:** 0-0.25, 1.0, 2.5, 10, 50, 250, 500, 1000 @ 20,000  $\Omega/v$   
**AC VOLTS:** 0-2.5, 10, 50, 250, 500, 1000 @ 5000  $\Omega/v$   
**DC MICROAMPERES:** 0-50  
**DC MILLIAMPERES:** 0-1, 10, 100, 500  
**DB:** -20 to +10, -8 to +22, +6 to +36, +20 to +50  
**"O" REFERENCE:** 1 MW into 600 $\Omega$   
**RESISTANCE:** Rx1, Rx10, Rx 100, Rx1K, Rx10K (30  $\Omega$  center)



DIVISION



**SIMPSON ELECTRIC COMPANY**

5200 W. Kinzie Street, Chicago, Illinois 60644

Phone: (312) 379-1121

Export Dept: 400 W. Madison Street, Chicago, Illinois 60606, Cable, Simelco

IN CANADA: Bach-Simpson Ltd., London, Ontario

IN INDIA: Ruttonsha-Simpson Private Ltd., International House, Bombay-Agra Road, Vikhroli, Bombay

Representatives in Principal Cities  
... See Telephone Yellow Pages

**WORLD'S LARGEST MANUFACTURER OF ELECTRONIC TEST EQUIPMENT**  
... for more details circle 141 on postcard

# ELECTRONIC TECHNICIAN / DEALER

WORLDS LARGEST ELECTRONIC TRADE CIRCULATION

MARCH 1968 • VOL. 87 No. 3

**HUGH "SCOTTY" WALLACE**  
Publisher  
**PAUL DORWEILER**  
Editor  
**JACK HOBBS**  
Managing Editor  
**JOSEPH ZAUHAR**  
Technical Editor  
**PHILLIP DAHLEN**  
Associate Editor  
**RICHARD CLAYTON**  
Field Editor  
**MARTIN PADLEY**  
Field Editor  
**BARBARA BURNSON**  
Production Editor  
**MADLINE SAMUELS**  
Art Editor  
**RUTH GELINEAU**  
Circulation Manager  
**JOHN KESSLER**  
Manager, Reader Services  
**MAGGIE KANE**  
Advertising Production

**GENERAL OFFICES**  
OJIBWAY PRESS, INC.  
Ojibway Building  
Duluth, Minn. 55802  
Phone: (218) 727-8511  
Telex: 029-4417

**MARSHALL REINIG**  
President

**GREG BLODGETT**  
Treasurer

**DEAN MYHRAN**  
Executive Vice President

**JOE WOLKING**  
Vice President, Marketing

**BEN MARSH**  
Vice President, Editorial

**HARRY RAMALEY**  
Vice President, Production

**LARS FLADMARK**  
Circulation Director

**JAMES GHERNA**  
Art Director

**WARREN BODIN**  
Ad Production Supervisor

**NEW YORK OFFICES**  
71 Vanderbilt Ave.  
New York, N.Y. 10017  
Phone: (212) 686-2200

**ROBERT EDGELL**  
Senior Vice President

**RICHARD C. REINHARDT**  
Vice President

**DON GENOAR**  
Manager, New York Office

**CHICAGO OFFICES**  
43 East Ohio Street  
Chicago, Illinois 60611  
Phone: (312) 467-0670  
Telex: 02-53549

**TOM GRENEY**  
Vice President

**DOROTHY BOLAN**  
Manager, Chicago Office

## MARKETING REPRESENTATIVES

New York: (212) 686-2200  
**HUGH "SCOTTY" WALLACE**

Chicago: (312) 467-0670  
**DEAN GREENER**

## 41 MARINE ELECTRONICS SALES AND SERVICE

This article raises some important points involved in running a pleasure-boat electronic equipment business

## 45 TRIGSWEEP YOUR OLD SCOPE

How to upgrade the EICO 460 and other scopes by using printed circuit boards

## 49 ANTENNAS — SANS BAFFLEGAB AND BUSHWA

Part two of this in-depth series continues with some important technical and business principles involved in selling and installing TV/FM antennas

## 52 WHAT ABOUT THE AUDIO COMMUNICATIONS EQUIPMENT BUSINESS?

Part one of an article that covers basic installation and maintenance procedures necessary in conducting an audio communications equipment business

## 54 SEMICONDUCTORS FROM A TO Z

The twentieth article in this elaborate, in-depth series covers photosensitive and photoemissive semiconductor applications in test instruments and consumer products — especially when used with lenses and fiber optics

## 59 THREE DOWN . . .

Bob and Scoot are back with a story which uncovers some "tough-dog" type color TV problems

## 62 LIGHT-HEARTED APPROACH WINS SALES

A report on a small service-dealer operation which does \$180,000 annual gross business

## 65 NO SECRETS TO MERCHANDISING

The story of a modest-sized, family-owned operation having a half-million yearly gross from TV, radio and Hi Fi sales

22 EDITOR'S MEMO

24 LETTERS TO THE EDITOR

32 TECHNICAL DIGEST

62 DEALER FAX

66 DEALER SHOWCASE

80 COLORFAX

86 NEW PRODUCTS

94 NEWS OF THE INDUSTRY

99 BOOK REVIEWS

101 CATALOGS & BULLETINS

104 ADVERTISERS' INDEX

105 READER SERVICE CARD

## COVER

Don't be surprised if a portable TV comes in for bench work and a "snow" problem turns out to be something other than the type you are normally used to.

## TEKFAX • 16 PAGES OF THE LATEST SCHEMATICS • Group 187

GENERAL ELECTRIC: Color TV Chassis KD

MAGNAVOX: TV Chassis T916 Series

MOTOROLA: Color TV Chassis TS-921 Series

RCA VICTOR: Color TV Chassis CTC31 Series

WESTINGHOUSE: TV Chassis V2659 Series

ZENITH: TV Chassis 8Y4B36

**OJIBWAY PRESS, INC.**

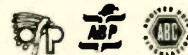

ELECTRONIC TECHNICIAN/DEALER is published monthly by Ojibway Press, Inc.. Subscription Rates: One year \$5.00, two years \$8.00, three years \$10.00 in United States and Canada Other Countries: One year \$9.00, two years \$14.00, three years \$18.00. Single Copies, 60 cents. Copyright 1968 by Ojibway Press, Inc.

POSTMASTER: Send form 3579 to ELECTRONIC TECHNICIAN/DEALER, Ojibway Building, Duluth, Minnesota 55802.

# PHONO DRIVE KIT

For all leading  
record players



Catalog No. 1408-03  
Suggested Net . . . \$34.95

Here's a brand new kit consisting of twenty-four Walsco phono drives, providing a profit-building assortment of the most-commonly needed replacement drives for servicing all popular record players. Made from selected materials, these Walsco "Exact Replacement Drives" conform precisely to the rigid specifications established by the original equipment manufacturer, assure you and your customer of "like-new" performance whenever used. Packed in a reusable, partitioned plastic box complete with a handy cross-referenced part number list, this kit is a must for every dealer and serviceman. Order yours today . . . it could be the key to faster, easier service calls, more profits for you.

Always insist on **GC** **Walsco** . . .  
you'll get more for your money, every time!

**GC ELECTRONICS**  
A DIVISION OF HYDROMETALS, INC.  
MAIN PLANT: ROCKFORD, ILL. U.S.A.



Giant FREE Catalog . . .

Only GC gives you everything in electronics . . . has for almost 40 years. Match every part and service need from over 10,000 quality items. Write for your copy today!

. . . for more details circle 117 on postcard

# GC

has  
everything  
in  
**PHONO  
DRIVES**



**CHASSIS PUNCH KIT**  
by GREENLEE  
For making clean  
holes with minimum  
effort. Punch sizes from  
 $\frac{1}{2}$ " to  $\frac{3}{8}$ ".  
Catalog No. 3005  
Suggested Net . . . \$5.85



**METAL STROBE DISC**  
For accurately  
checking all turntable  
speeds.  
Catalog No. 1405  
Suggested Net . . . \$7.50



**CHASSIS REPAIR  
CRADLE**  
All-metal construction,  
locks chassis securely  
in place.  
Catalog No. 5212  
Suggested Net . . . \$7.95



## EDITOR'S MEMO

### So What?

Every one who has studied a little history already knows that the industrial developments of this country have been punctuated by a series of little revolutions.

The steam engine, the cotton gin, the telegraph, telephone, automobile, wireless, radio, TV, computers and so on — not to mention wide-spread mechanization and automation of everything from berry-picking to making nuts and bolts. All these little revolutions have been accompanied by dire predictions that everyone involved would soon be out of work. Yet, there are more people working in this country today than ever before. But the scare-mongers are still with us.

When transistors' were first used, for example, we heard that TV-radio technicians would soon be out of work because transistors don't wear out. But right now the country is short at least 30,000 technicians. And forty-thousand TV-radio shops are piled high with transistorized equipment waiting to be repaired.

Some months ago we heard about the "tele-quick," automated diagnosing system for TVs, Hi Fi and other equipment. It seems the system is being used by a franchising company in a number of Midwestern areas. "Probably a scheme to take advantage of the technician shortage," some one said. Whatever it is, we think it would be a mistake to waste time worrying about it. We doubt if it will put any technicians out of work within the foreseeable future. Automation needs a lot of fodder to feed on to make a profit. And people don't walk, ride or fly very far to get their TV, radio or Hi Fi sets repaired — even at cut-rate prices.

A recent issue of BUSINESS WEEK gave three lines to the subject of automated electronic diagnosing. We didn't even mention it when the story broke a few months ago. And to the scare-mongers, we can only say, so what?

## MOVING?

Be sure to let us know your new address. Please enclose a complete address label from one of your recent issues.

ELECTRONIC TECHNICIAN/DEALER

# COLOR GENERATORS

# FOR EVERY NEED

**4 reasons why Sencore is your best buy  
in professional test instruments**

# 1

## LOBOY CG10

America's lowest priced professional quality standard color bar generator. All solid state. Battery powered for maximum portability.

**\$89.95**



# 2

## LOBOY CG12

AC operated version of the CG10. Also has 4.5 MHz crystal controlled signal for fine tuning adjustment.

**\$109.95**



# 3

## COLOR KING CG141

Absolute stability assured by exclusive "Temp Control" and new timer circuitry. All standard patterns, plus new movable single dot and single cross. Analyzing features too.

**\$149.95**



# 4

## COLOR ANALYZER CA122B

The complete analyzer for color and B&W—far more than just a color generator. Has variable RF and IF outputs, composite video, chroma, and horizontal and vertical sync pulses.

**\$187.50**



Whatever the need, Sencore has the color generator that is just right for you. Each has the built-in quality you expect from Sencore. Each has standard RCA licensed color bar patterns.

Each is triple tested for guaranteed accuracy. Each is steel encased with chrome panel. See your distributor for more reasons why Sencore is your best buy, always.



# SENCORE

NO. 1 MANUFACTURER OF ELECTRONIC MAINTENANCE EQUIPMENT  
426 SOUTH WESTGATE DRIVE ADDISON, ILLINOIS 60101

... for more details circle 138 on postcard

# The Transistor Testers that really work in circuit



TR139

NEW TR15A

Locate defective transistors in circuit in seconds with a true AC signal gain test (BETA) . . . without disconnecting a single lead . . . what a time saver. Also measure AC beta and  $I_{cbo}$  leakage out of circuit for complete analysis of the transistor. It's easy, fast and accurate. Also checks diodes and rectifiers in and out of circuit.

**TRUE BETA MEASUREMENTS:** the transistor's AC gain factor. Set the CAL knob, press the beta test button and read the actual AC gain on the meter. This is the ratio of AC signal on the base of the transistor to that obtained on the collector and is a standard of measurement in the industry.

**$I_{cbo}$  LEAKAGE MEASUREMENTS.** An important check since many transistors have good beta but don't work because the leakage current has become too high. Both instruments show the leakage current ( $I_{cbo}$ ) in microamps right on the meter.

**OUT-OF-CIRCUIT TESTS.** Test procedure is the same for in or out-of-circuit testing. Out of circuit, transistors may be sorted, selected and matched for specified values of beta and  $I_{cbo}$ .

**COMPLETE PROTECTION.** Special circuitry protects even the most delicate transistors and diodes, even if the leads are connected incorrectly. No possibility of damage to the transistor, circuit or instrument. Zener regulated power supply.

**NO SET-UP BOOK.** No need for a set-up book or manual. Just refer to the handy transistor checking guide on the back of the instrument. Even unknown transistors can be checked. PNP and NPN types can be determined at the flick of a switch.

**ALL STEEL CASE.** Vinyl covered, with brushed chrome panel. Beta range, 2 to infinity;  $I_{cbo}$ , 0 to 5000 microamps.

**DELUXE TR139.** "Howard W. Sams" transistor manual included for beta and  $I_{cbo}$  reference. 9" x 7½" x 6", with large 6" meter, 8 lbs. ----- **\$89<sup>50</sup>**

**COMPACT TR15A.** Only 5" x 7-3/16" x 3-1/16"—just right for easy handling. Easy-to-read 4½" meter. 4½ lbs. ----- **\$64<sup>50</sup>**



## SENCORE

NO. 1 MANUFACTURER OF ELECTRONIC MAINTENANCE EQUIPMENT

426 SOUTH WESTGATE DRIVE, ADDISON, ILLINOIS 60101

... for more details circle 139 on postcard

## LETTERS TO THE EDITOR

### Schematic for Signal Tracer

I have a complete manual for the Silver Spark Signal Tracer, Model 905. I also have a near-new Model 905 signal tracer which I will sell.

BEN MOSCA

Fair Lawn, N. J.

### Old Tubes Anyone?

I note in your "Letters to the Editor" column that now and then someone is looking for an old tube. Having been in radio and TV for many years, I still have a few unused tubes of the "way back" variety. If any ET/D readers are interested, they can contact me and enclose a self-addressed and stamped envelope.

R. CONOVER

Box 96  
Stone Ridge, N. Y.  
12484

### Back Issues of ET

I am now retired from the TV business as I am too old to go on. I have all the issues of your magazine from October 1961 to November 1967 which I will sell to anyone who is interested.

E. W. ULRICH

1247 N. Thorne  
Fresno, Calif.

### Thanks

As a long time subscriber to ELECTRONIC TECHNICIAN/DEALER, I would like to commend you for the excellent way in which my change of address was handled by your circulation department. Of all the magazines I get, yours was the only one that did not require a magnitude of mail to change my address. Again my profound thanks for efficient and prompt service.

A. DELECARIS

Salida, Colo.

### Tube Tester Roll Charts

I have been trying to obtain a roll chart for a Model TW11 tube tester, manufactured by the Superior Instruments Co. Can any ET/D reader help me?

MAX J. LENKE

Aurora, Ill.

... I would like to hear from any reader who could help me obtain a roll chart for a Supreme Tube Tester, Model 589A. I have been a reader of



# BRAND NEW...TO KEEP YOU OUT OF CALL-BACK TROUBLE!

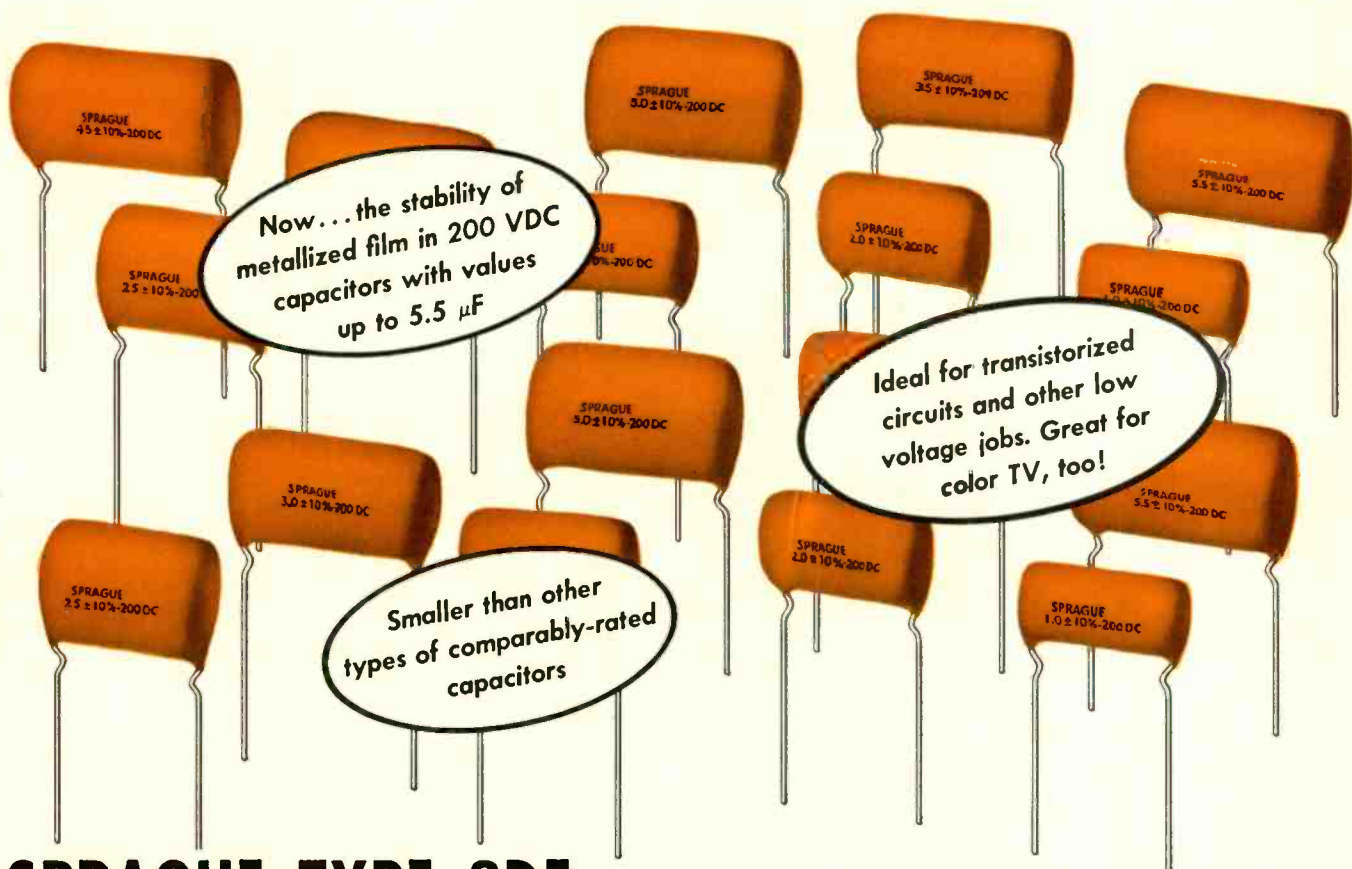



## SPRAGUE TYPE 2DF METALLIZED FILM ORANGE DROP® CAPACITORS

For the first time, the capacitance stability of metallized film is provided in 200 VDC service-type capacitors with values that start at .15  $\mu$ F and include the higher 1 to 5.5  $\mu$ F range, generally available only in electrolytics.

These new Sprague Type 2DF Orange Drops offer you many other advantages, too!  They have an

extremely high insulation resistance to insure peak performance at temperatures up to +85 C (185 F).

 Double-dipped in orange epoxy resin, they're amply protected against heat and humidity.

 Radial leads are not only extra long for point-to-point wiring but also crimped for printed boards.

 They're easier to fit into tight spots.

*For trouble-free service, start using Type 2DF capacitors now. They're available at your Sprague distributor. Or write for Bulletin M-877 to Sprague Products Co., 65 Marshall St., North Adams, Mass. 01247.*

**DON'T FORGET TO ASK YOUR CUSTOMERS  
"WHAT ELSE NEEDS FIXING?"**



... for more details circle 143 on postcard

# LETTERS TO THE EDITOR

ET/D for about six years. Enjoy and look forward to each issue, keep up the good work.

CLARENCE ENGLAND

Rose Hill, Va.

## Antennas

I read with great interest your antenna article which appeared in the September issue. I am eagerly await-

ing a continuation of the articles. But, if I may engage in some mild criticism. I think you are talking to the wrong people.

For one thing, I do not believe many antenna manufacturers supply accurate gain figures for their products. Uncalibrated polar graphs seem to be designed to create maximum sales enthusiasm and provide a minimum of useful information. Let's have our polar graphs drawn and calibrated by an impartial certified testing laboratory. And, while we're at it, let's publish the ones for the bad channels as well as the good ones and throw in a set of vertical graphs for

good measure. Then let's make up a set to cover the most-used stacked arrangements. Some antennas do funny things when stacked. In other words, let the lab do the research — not the man holding on to the tower.

I still treasure a nice color brochure from one company which concerns a "turnstile" type antenna with a 4-wire lead-in and a tricky switching arrangement. The gain figures (given to the nearest tenth of a db!) were comparable to those which I measured on a five-wavelength rhombic carefully designed and oriented for channel 2 — but my fieldstrength meter wouldn't measure to a tenth of a db! The material reminded me of the old Alaskan definition of a gold mine: "A hole in the ground owned by a damn liar."

We still have some horrible examples of flimsy construction, elements that break easily, joints that never make a good electrical connection, hardware that rusts and corrodes in the first rain. Are we so short of noncorrosive metals that we can't spare them to make a decent antenna?

There are, of course, some good antennas — but few that could not stand improvement — and you can't get adequate specifications on them without considerable personal correspondence. Performance data should be given in the brochures. I realize that price enters the picture and that many antenna faults actually arise because of manufacturing economies. But is it really economy when the product is downgraded?

FRANCIS C. WOLVEN  
Saugerties, N.Y.

• The article "Antennas — Sans Bafflegab and Bushwa," which appeared in the September 1967 issue of ET/D, has now become only an introduction to the subject. Beginning with this (March 1968) issue, we will publish the second article in this series, to be followed with at least three more articles covering the technical and merchandising aspects of antennas — including MATV systems which will be run as separate articles. —Ed.

## What Standards?

I would like to comment on a recent editorial, which has been answered by some of your readers in Letters to the Editor, regarding standardization in the TV industry.

You indicate in your comment to Mr. Neuman (ET, December 1967), that production changes are usually only schematic changes, but there are a lot more things to a TV set than a schematic. I am referring to the physical layout, and that's where we end up "low man on the totem pole."

# Knuckle-Saver.



Putting a sleeve on a connection can be frustrating. (If your hand slips, it can also be rough on the knuckles.)

Why not use Krylon Crystal Clear Spray Coating instead?

Krylon forms a hard, waterproof coating that stops many of the causes of high-voltage section loss and picture

fading. It doesn't dry out or crack. It prevents rusting.

Try it. All you have to lose are a few skinned knuckles.

*Krylon Crystal Clear...standard equipment for all TV/Radio installation and repair work.*

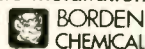

... for more details circle 107 on postcard

**RCA**

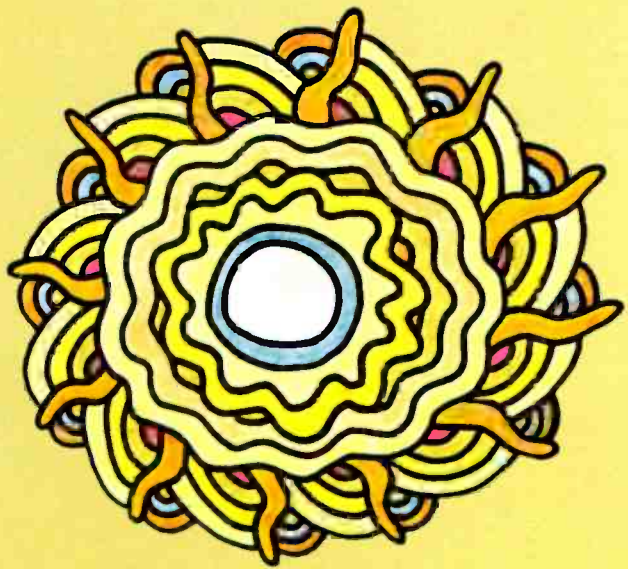

RCA helps you

**make way  
for spring!**

with a great array of

colorful  
outdoor  
furniture

quality  
garden  
tools

popular  
outdoor  
barbecues

Available  
with your purchases of  
RCA Entertainment  
Receiving Tubes from  
your participating  
RCA tube distributor.





make way  
for spring with  
folding  
outdoor  
furniture  
from  
Telescope!

In three different models, all in a very attractive Tango Green Floral Pattern with Vinyl Cushions.

Individually, and as a group, these chairs add comfort and charm to any outdoor setting.

**MWS-381**  
Poly Varnish Folding Armchair, (Overall width 23").

**MWS-361**  
Poly Varnish Folding High Back Rocker, (Overall width 23"; height of back from seat 22").

**MWS-391**  
Poly Varnish Folding Chaise, (Overall length 74", Overall width 25", back adjusts to 4 positions, has 2" built-in head pillow).

**All three models feature:**  
High strength frame of 1-inch polished special alloy aluminum.

Removable 1½" cushion covered with colorful vinyl floral pattern filled with urethane foam.

Reinforced seat and back of vinyl-nylon construction.

Natural weatherized poly-varnished hardwood parts.

Hardware of non-rusting aluminum and corrosion-resistant zinc or cadmium plated steel.

**MWS-167**  
Drape Style Umbrella Tango Pat. 67 Green.

The inner side of this beautiful umbrella matches the pattern of the folding chairs. The outer side is an attractive Olive Green.

Sun resistant fabric of triple laminated nylon and vinyl.

Silver anodized aluminum pole.

Frame of rust-resistant spring steel.

4" heavy corded bullion fringe on valance. Size: 7½' diameter with 8 ribs.

Heavy duty crank opens and closes umbrella mechanically, not by friction. Overall height approx. 8'.

Touch button tilting device tilts both ways.

**MWS-291**  
Umbrella Table.

42" diameter; 27" high.

Aluminum top finished in bright White.

Silver colored aluminum base.

Center hole for umbrella pole.

Aluminum top is weatherfast and highly resistant to marring and scratching.

make way  
for spring with  
Royal Chef  
covered  
cooking grills!

When you cover cook, even heat is maintained all around the food, automatically basting the food in its own natural juices.

You use less charcoal when you cover cook. You also eliminate flare-ups and burning of meat.

Each of these units is expertly engineered to provide maximum air intake through the bottom and expel smoke out the top or hood of the grill.

**Model MWS-ROS37E**  
Gleaming stainless steel barrel with nickel chrome-plated legs and handle.

Heat indicator; removable fire pans.

Two nickel chrome plated grids which give as much overall grilling area as an 18" round brazier.

Spit and U.L. approved electric motor.

Diameter 10"; length 15".

**Model MWS-ROS28**  
Baked-on enamel finish over bonderized steel.

Single nickel chrome-plated grid with removable fire pan.

Cooking area 8½" x 13½".

Top handle and latch for easy carrying.

Diameter 10", length 15".

got the urge  
to get at  
your garden?  
make way for  
spring with  
Ames  
garden tools!

Put it in shape with quality garden tools from Ames. Trimming, lopping and pruning garden gear plus convenient wall mount for garden hose put you in condition for shipshape gardening.

**MWS-23-010**  
Ames De Luxe Hedge Shear (\*Teflon coated blades.)

**MWS-23-021**  
Ames Standard Lopping Shears.

**MWS-23-085**  
Ames 3 Piece Pruning Set. (Includes hedge shears with \*Teflon coated blades, grass shears, and pruner with \*Teflon coated blade.)

**MWS-23-807**  
Ames Wall Mount Hose Reel. (Attaches to wall for convenient hose handling.)

\*Teflon is a DuPont approved finish



**RCA**

all the attractive  
**make way for spring**  
premiums are available  
with your purchases  
of RCA Entertainment  
Receiving Tubes from  
your participating  
RCA tube distributor!

See your local participating  
RCA tube distributor  
and make way for spring!

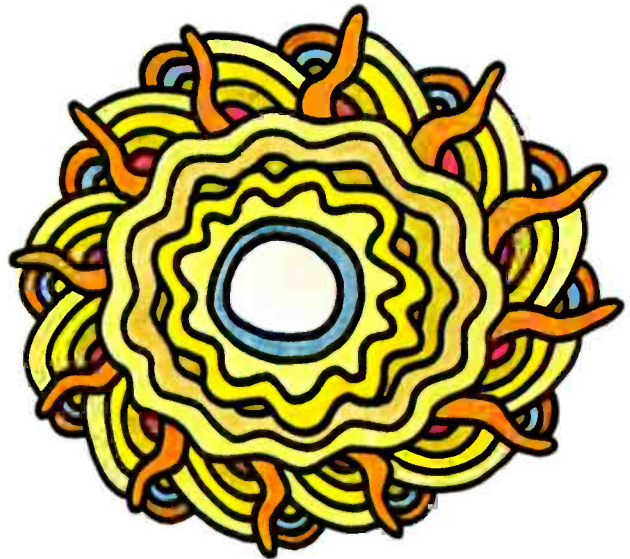

Electronic Components, Harrison, N. J.

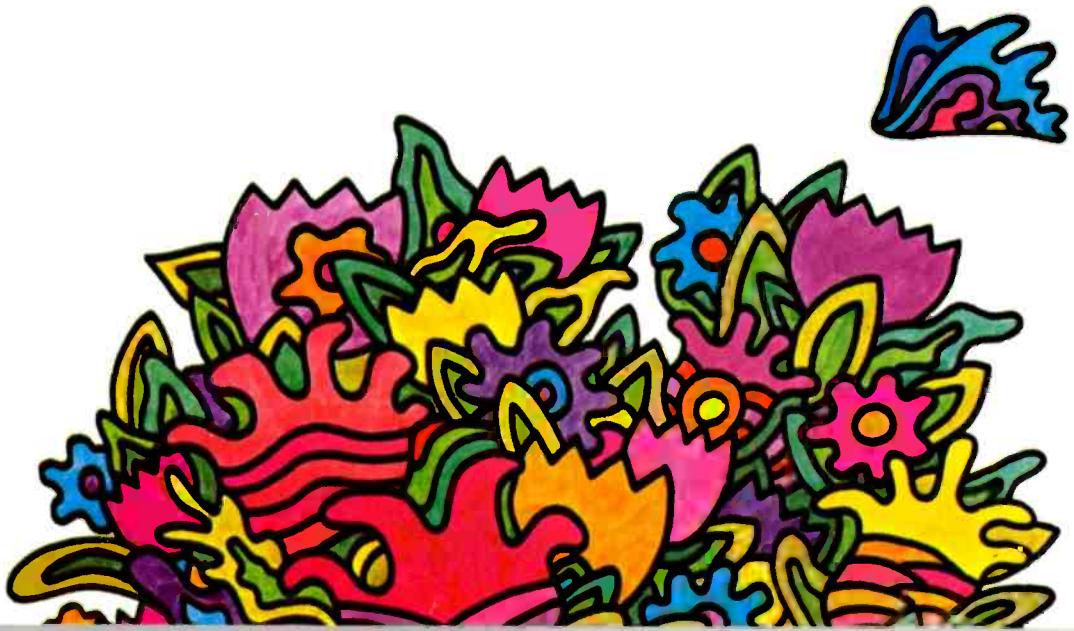

# LETTERS TO THE EDITOR

Many times the values of the capacitors are face down so you have to twist them around to read them without breaking the leads. Values on filter capacitors are almost always on the side that is hidden and markings on controls are likewise covered up.

And much time is wasted trying to find parts in the double and triple numbering systems used by some of the manufacturers who do not even supply catalogs referencing these controls. Ever since TV manufacturers started expanding their engineering staffs, they have had to expand their product lines to keep these engineers busy. The expanded product line has resulted in a multiplication of new parts which local distributors can't keep up with and they end up being nothing more than back-order-takers.

If we didn't have enough problems with American-made sets, we now have all the foreign ones with their own peculiar methods of layout and rare tubes. I can see why a number of technicians simply throw up their hands and look for greener pastures. Your entire magazine is permeated with how easy it is to fix these "monsters," when in real life it just isn't so.

One foreign TV-radio combination I worked on had the radio chassis in a very inconvenient spot. But they did provide a cutout on the bottom of the console which, incidentally, was covered with screen from the inside. I managed to push through the screen and had barely enough room to put my hand in to solder the replacement parts. When I finished the job, my neck was stiff and my hands scraped raw in places. Of course, I should be grateful for the hole, but why couldn't they make it "American size?"

Standardization is the enemy of the new-parts engineers. And their over-use of these parts wants to make me call them just a bunch of "featherbedders" and rival government bureaucrats pyramiding when it comes to wasteful activities.

HARRY GOLDMAN

Harry's Television Service  
Detroit, Mich.

## Import Radio Parts

I have been a reader of ELECTRONIC TECHNICIAN/DEALER for some years now, and I think it is the best. In fact, I've cancelled several other publications to concentrate on ET/D.

I've noticed in Letters to the Editor that some readers offer their assistance in certain matters. If any ET/D read-

er is interested, I have thousands of spare parts for imported transistor radios. These are parts I have received from the manufacturer and would be willing to supply at my cost.

HUBERT E. SPIEKER, JR.  
Pennsauken, N.J.

## Honest Comparison

Your magazine is really tops in all the areas it covers, and with subscriptions to seven others, I feel qualified to make an honest comparison. Along with this, I wonder if an ET/D reader can help me obtain a schematic and operating information on a Ca-

paciTester, Model CT355, which was manufactured by the Teletest Instrument Corp., N. Y.

HUGH G. STACEY  
Natick, Mass.

## MOVING?

Be sure to let us know your new address. Please enclose a complete address label from one of your recent issues.

# Now, for men in electronics —“a whole new era of quick calculation”

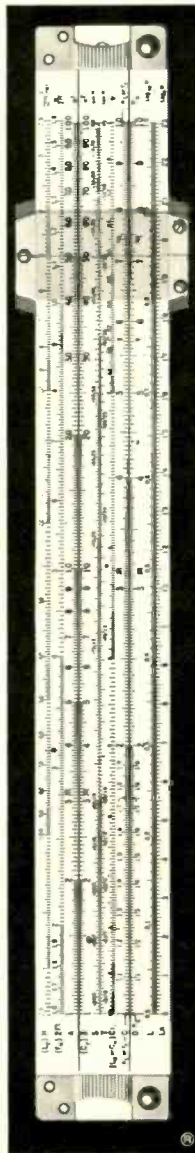

**T**HERE MUST BE THOUSANDS OF PEOPLE in electronics who have never had the marvelous adventure of calculating problems with a single slide rule; other thousands have had to content themselves with a slide rule not specifically designed for electronics. For both groups, the new slide rule designed and marketed by Cleveland Institute of Electronics and built for them by Pickett will open a whole new era of quick calculations.

“Even if you have never had a slide rule in your hands before, the four-lesson instruction course that is included takes you by the hand and leads you from simple calculations right through resonance and reactance problems with hardly a hitch. If you already use a slide rule, you'll find the lessons a first-rate refresher course. And it explains in detail the shortcuts built into this new rule.”

From an article in  
**Radio Electronics Magazine**

Want complete details about this time-saving new Electronics Slide Rule? Just mail coupon below... or write Cleveland Institute of Electronics, Dept. ET-122 1776 East 17th St., Cleveland, Ohio 44114.

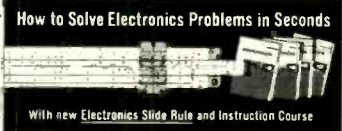

Mail this coupon for  
**FREE BOOKLET**

**CIE** Cleveland Institute of Electronics  
1776 E. 17th St., Cleveland, Ohio 44114

Please send me without charge or obligation your booklet describing the CIE Electronics Slide Rule and Instruction Course. Also FREE if I act at once: a handy pocket-size Electronics Data Guide.

Name \_\_\_\_\_  
(please print)

Address \_\_\_\_\_

City \_\_\_\_\_ State \_\_\_\_\_ Zip \_\_\_\_\_

Accredited Member National Home Study Council  
A Leader in Electronics Training... Since 1934

ET-122

... for more details circle 110 on postcard

## CANADIAN GENERAL ELECTRIC

### Amplifier Chassis M683—Pulse-Noise Radiation from the Power Supply

Tests showed that the power diodes were radiating an excessive amount of RF. Because of cabinet limitations, the AM loops had been placed close enough to the power

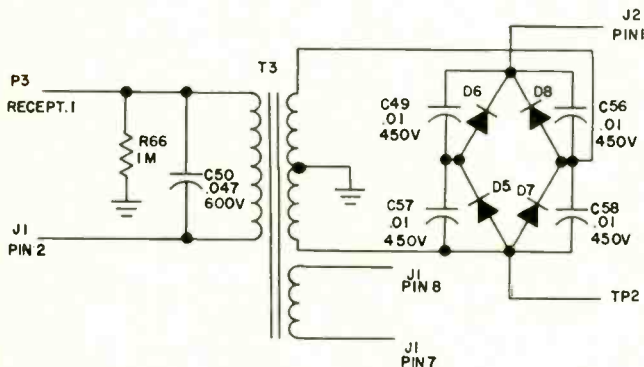

supply to pick up this radiation. The intent of C49 was to suppress residual radiation, but it could not handle this excess amount satisfactorily.

In future runs of the M683 chassis, bypass capacitors will be added across each power diode. These chassis will then be coded: "Chassis Code Z."

## MAGNAVOX

### Instant Automatic Remote Control—Receiver Circuit Description

The remote receiver chassis is constructed in two sections. The circuits which amplify the transmitted signal and actuate each of the eight functions are located on a circuit board inside the metal enclosure. Additional relays, terminal strips and the search board are mounted on the top cover of the receiver enclosure.

The receiver circuit board contains a power supply, four amplifier stages, eight tuned circuits, eight driver transistors and eight relays. Molex connectors are used to connect the receiver to the TV chassis, tuner and the radio chassis.

The receiver microphone (transducer) is identical to the one used in the transmitter. It is mounted on an opening in the front of the cabinet and plugs into the receiver chassis. The purpose of the transducer is to change the received sound signal to an electrical signal. This is accomplished by applying a dc bias voltage to the mike. As the plates are moved by the sound signal, the capacity is changed and

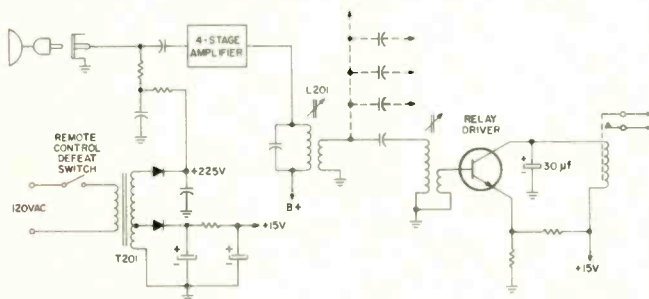

causes the dc voltage to become modulated. The signal is then amplified by four broad-band amplifier stages.

L201 resonates at the center of the pass-band, approximately 40kHz from a signal which is link-coupled to eight series-resonant circuits. Each resonant circuit is highly selective and will respond only to the frequency to which it is tuned while rejecting all other frequencies. The highest frequency to which a resonant circuit is tuned is 46.0kHz and the lowest frequency is 35.5kHz. The remaining six circuits are resonant to frequencies within this range and are spaced at 1.5kHz intervals.

The signal is passed through one of the resonant circuits and coupled to the base of an NPN driver transistor. The driver is normally cutoff by placing a small positive voltage on the emitter to reverse-bias the base-emitter junction. This arrangement reduces the possibility of random noise pulses turning on the driver. With a signal applied to the base, the transistor is switched on during the positive half-cycle and switched off during the negative half-cycle. During conduction time, the transistor acts as a closed switch and allows current to flow through the relay coil. Also during conduction time, the 30µf capacitor discharges through the transistor. When the transistor is cutoff by the negative half-cycle of the applied signal, current continues to flow through the relay coil as the capacitor charges toward the supply voltage. The relay contacts will be held closed as long as a signal is received from the transmitter. The contacts connect 120vac to a motor or relay coil depending upon the function selected.

The power supply contains two half-wave rectifier circuits. A ±15vdc output operates the transistor stages while the 225vdc supply is used to bias the microphone through a voltage divider. A switch is included in the primary winding of the power transformer so the remote control system can be switched off.

## RCA VICTOR

### Amplifier Chassis RS238—Circuit Descriptions

#### Predriver/Driver Stages





















Because of higher driver power requirements of the output stages, a predriver/driver circuit is used in the RS238. The predriver is a PNP transistor which acts as a voltage amplifier. The stage has an input impedance of about 1.5K to match properly the requirements of the preamplifier in the RC1218 tuner. The direct coupled driver stage employs an NPN power transistor. The base is directly coupled to the collector of the voltage amplifier transistor. Signal from the predriver stage appears across the 470Ω predriver collector load resistor. It is evident that signal from the predriver stage is applied between the base and emitter of the NPN driver transistor and is amplified by the driver transistor.

The class "A" driver stage operates from a -30v source and supplies approximately .3w at very low distortion to the bases of the output transistors.

#### Output Stages

The output stages employ specially selected high beta alloy junction power transistors. These devices were selected because of their excellent beta linearity and because



 CAPACITOR	 CAPACITOR	 CAPACITOR	 CAPACITOR
XCI-8	XCI-18	XCI-19	XCI-19.2
 CAPACITOR	 CAPACITOR	 CAPACITOR	 CAPACITOR
XCI-21	XC2-1.1	XC2-26	XC2-36.1
 CAPACITOR	 CAPACITOR	 CAPACITOR	 CAPACITOR
XC3-45	XC4-4.2	XC4-5.1	XC4-6.1
 CAPACITOR	 CAPACITOR	 CAPACITOR	 CAPACITOR
XC4-9.1	XC4-10.2	XC4-55.1	XC4-63.1
 CAPACITOR	 CAPACITOR	 CAPACITOR	 CAPACITOR
XC4-68.1	XC4-68.2	XC4-70.1	XC4-80

# 20 ways to break the exact replacement capacitor habit:

## Stock only 20 General Electric Service-Designed replacement capacitors and meet over 70% of your replacement needs.

Use General Electric extended-range replacement capacitors. Just 20 General Electric Service-Designed replacement units will meet over 70% of all TV can style needs!

"Extended-range" means that fewer General Electric types are needed to meet your requirements. Every GE aluminum capacitor meets not just one, but a range of capacitance and voltage requirements. And, to make selection easier, the application range of every General Electric capacitor is shown clearly on the unit, and on the carton.

You can quickly see, for example, that the GE capacitor rated 50-60 mfd up to 450 VDC will replace any unit between







50 and 60 mfd at any voltage up to 450 VDC. You save time and money in making replacements because General Electric capacitors are Service-Designed with you in mind!

Your local GE electronics distributor carries a complete line of replacement capacitors from General Electric, a leader in supplying capacitors to the radio and television industry. Call him today for full details.

430-31A

**GENERAL  ELECTRIC**

### Application ranges for 20 General Electric capacitors that meet over 70% of your replacement needs.

		<b>XC1-8</b> 60 to 80MF up to 450V.	<b>XC2-36.1</b> 60 to 80MF up to 475V. 90 to 160MF up to 250V.	<b>XC4-6.1</b> 60 to 80MF up to 475V. 2 to 4MF up to 450V. 2 to 4MF up to 450V. 90 to 200MF up to 25V.	<b>XC4-55.1</b> 30 to 40MF up to 450V. 15 to 20MF up to 450V. 15 to 20MF up to 450V. 60 to 80MF up to 450V.	<b>XC4-68.2</b> 15 to 20MF up to 450V. 90 to 160MF up to 250V. 20 to 50MF up to 75V. 20 to 50MF up to 50V.
		<b>XC1-18</b> 100 to 150MF up to 350V.	<b>XC3-45</b> 40 to 60MF up to 350V. 40 to 60MF up to 350V. 50 to 80MF up to 350V.	<b>XC4-9.1</b> 35 to 50MF up to 475V. 30 to 40MF up to 475V. 2 to 4MF up to 150V. 20 to 40MF up to 25V.	<b>XC4-63.1</b> 20 to 30MF up to 450V. 15 to 20MF up to 450V. 90 to 160MF up to 250V. 20 to 40MF up to 150V.	<b>XC4-70.1</b> 15 to 20MF up to 450V. 60 to 100MF up to 350V. 50 to 100MF up to 50V. 80 to 150MF up to 350V.
		<b>XC1-19</b> 88 to 160MF up to 250V.	<b>XC4-4.2</b> 75 to 100MF up to 475V. 3 to 4MF up to 475V. 3 to 4MF up to 475V. 90 to 200MF up to 25V.	<b>XC4-10.2</b> 1 to 2MF up to 350V. 10 to 25MF up to 25V. 45 to 80MF up to 250V. 50 to 100MF up to 25V.	<b>XC4-68.1</b> 10 to 20MF up to 250V. 25 to 50MF up to 50V. 40 to 50MF up to 450V. 60 to 80MF up to 450V.	<b>XC4-80</b> 30 to 40MF up to 450V. 30 to 40MF up to 450V. 30 to 40MF up to 450V. 30 to 40MF up to 450V.
<b>A FEW WILL DO!</b>		<b>XC1-19.2</b> 100 to 160MF up to 250V.	<b>XC4-5.1</b> 60 to 80MF up to 475V. 2 to 4MF up to 450V. 2 to 4MF up to 450V. 2 to 4MF up to 450V.			
		<b>XC2-21</b> 110 to 200MF up to 300V.				
		<b>XC2-1.1</b> 60 to 80MF up to 450V. 1 to 2MF up to 350V.				
		<b>XC2-26</b> 30 to 40MF up to 500V. 35 to 45MF up to 500V.				

***Introducing the finest Color TV***

# New Zenith Super 50

***Designed better for easiest servicing!***  
***Handcrafted for unrivaled dependability!***

The new Zenith Super 50 Handcrafted chassis is in forty-three of Zenith's forty-six color TV models—including 20" and 23" (diag. picture) Zenith Color TV.

The new Super 50 chassis is designed for better performance and greater reliability. Installation in the home and adjustment of alignment is easier. And if the necessity for service ever arises, you'll find the Super 50 chassis has been specially planned in many ways for fast, easy and efficient servicing.

Circuitry is simplified, clutter has been eliminated. Heat critical components are isolated in the coolest area of the chassis, for longer life. Important servicing test points are clearly identified by chassis stampings or by "flags." All parts are more accessible. And all separated assemblies (tuner, convergence assembly, deflection yoke, speakers, etc.) have a "plug in" connection.

Now the best color TV chassis is made even better!

BEST YEAR YET



TO SELL THE BEST

**ZENITH**  
The quality goes in  
before the name goes on

# chassis ever!

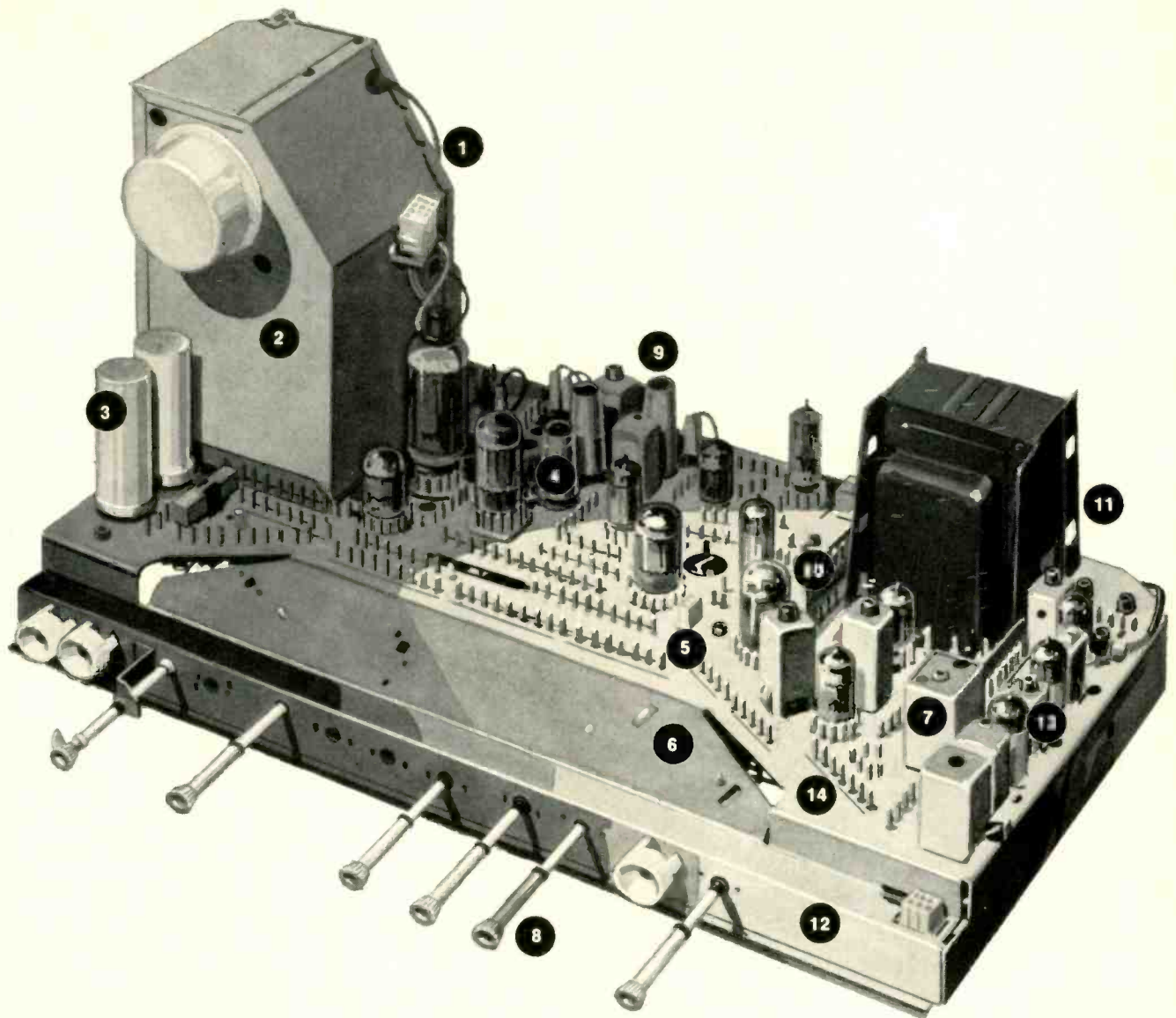

## 1. Exclusive Zenith High Voltage Regulator Circuitry

Zenith's regulator tube keeps a constant 25,000 volts of picture power while itself operating at 5,000 volts or less — one-fifth the operating voltage of a conventional shunt regulator tube when maintaining the same picture power.

## 2. High Voltage Sweep Transformer

Zenith's new sweep transformer is shielded within a metal cage. And it's sealed in polyester resin virtually impervious to moisture and protected against corona discharge.

## 3. Heat Critical Components Isolated

The electrolytics, relocated to the chassis's coolest corner, are isolated from heat producing components for longer life.

## 4. Automatic Color Level

Keeps colors constant—station to station, channel to channel. Helps compensate for variations in signal transmission.

## 5. Plug-In Assemblies

All assemblies not mounted on the rugged metal chassis have "plug-in" electrical connectors for easy removal without breaking soldered connections.

## 6. Automatic Degaussing Circuit

Automatically demagnetizes the color tube each time the set is turned on from a cold start.

## 7. Zenith AFC (Automatic Fine-tuning Control)

Electronically fine-tunes Zenith Color TV at the flick of a finger. Assures the sharpest color picture. Most of the 23" diagonal models are equipped with this feature.

## 8. Pull-Out Secondary Control Knobs

Now all secondary control knobs pull out one full inch for easier access and adjustment.

## 9. Advanced Color Demodulator Circuit

Zenith patented circuit extracts color from the incoming

signal and sends it to the picture-tube with peak precision for natural, life-like colors.

## 10. Solid-State Video Amplifier

This transistor amplifies the picture information and assures excellent highlight brightness and picture detail.

## 11. Fin-Cooled Power Transformer

With excellent heat-dissipating characteristics, it assures constant, full voltage.

## 12. Exclusive Horizontal Handcrafted Chassis

No printed circuits. No production shortcuts. Rugged 16-gauge steel base provides up to 200% greater heat conduction ability than phenolic material used in ordinary plastic printed boards.

## 13. 3 Stage I.F. Amplifier

All three stages—each with its own frame grid tube and interstage transformer—have been relocated to reduce possible interaction with other circuits for greater stability.

## 14. Metal Cone Check Points

Easy-to-read numbers and "flags" identify the metal cone check points, help to make diagnosis easy and accurate.

## NOT SHOWN ABOVE

### Easy Access Front Convergence

In most 20" and 23" (diag.) models simply remove the grille and speaker assembly for easy access to the entire convergence panel assembly, saving you time and trouble.

### Removable "Easy-Service" Plate

The bottom of the cabinet is cut out and covered with a perforated metal plate. Alignment tools may be inserted through slots in this plate. Or the plate can be removed for easy access to up to 90 per cent of the circuitry.

... for more details circle 148 on postcard

# ALL NEW!

NRI learn-by-doing training in

## ADVANCED COLOR TV





- Build your own custom color set in 5 training stages
- 50 designed-for-learning color circuit experiments
- Programmed with 18 "bite-size" lesson texts

A comprehensive training plan for the man who already has a knowledge of monochrome circuits and wants to quickly add Color TV servicing to his skills. DEFINITELY NOT FOR BEGINNERS. It picks up where most other courses leave off—giving you "hands on" experience as you build the only custom Color TV set engineered for training. You gain a professional understanding of all color circuits through logical demonstrations never before presented. The end product is your own quality receiver.

### TRAIN WITH THE LEADER

This NRI course—like all NRI training—is an outgrowth of more than 50 years experience training men for Electronics. NRI has simplified, organized and dramatized home-study training to make it easy, practical, entertaining. You train with your hands as well as your head, acquiring the equivalent of months of on-the-job experience. Demand for Color TV Service Technicians is great and growing. Cash in on the color boom. Train with NRI—oldest and largest school of its kind. Mail coupon. No obligation. No salesman will call. NATIONAL RADIO INSTITUTE, Color TV Div., Washington, D.C. 20016.

### MAIL FOR FREE CATALOG

	<b>NATIONAL RADIO INSTITUTE</b> Color TV Division Washington, D.C. 20016		14-038
	Send me complete information on NRI new Advanced Color TV Training. (No salesman will call)		
Name _____		Age _____	
Address _____			
City _____		State _____	Zip _____
ACCREDITED MEMBER NATIONAL HOME STUDY COUNCIL 			

... for more details circle 133 on postcard

## TECHNICAL DIGEST

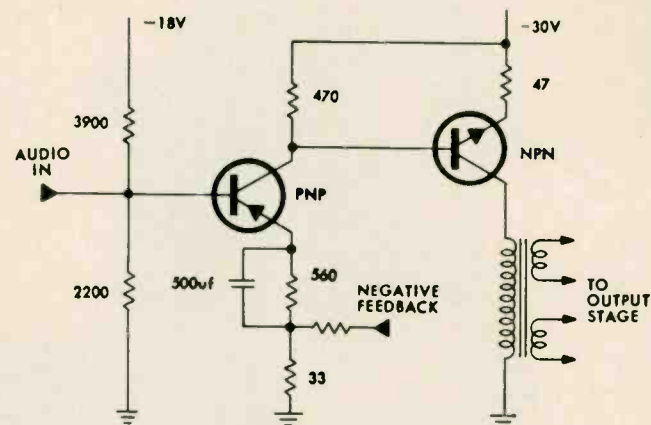

they yield low distortion at high power levels. Two power transistors are used in each channel in a familiar stacked class "B" arrangement employing a positive and negative 36v supply with about 25db of power gain when driving the 4 sealed speaker system used in the VJT70 series instruments.

Low distortion and excellent stability result from using negative feedback (in excess of 20db) to reduce the internal amplifier impedance to about  $1/3\Omega$  over the entire audio range.

### Power Supply

Two independent rectifier/filter systems are used in the RS238 power supply. The output stages are powered by a center-tapped bridge that produces  $\pm 36v$ . A 36v supply

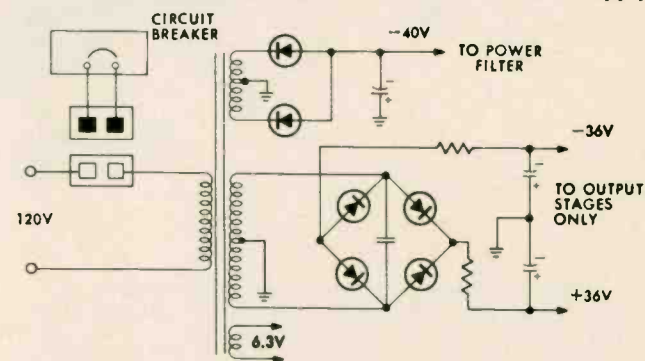

can be used at these high power levels because the speaker voice coil impedance has been reduced to  $4\Omega$  in instruments using the RS238 amplifier.

An auxiliary power supply operates from another secondary on the power transformer to furnish power for the remaining amplifier circuits and the RC1218 tuner. This full

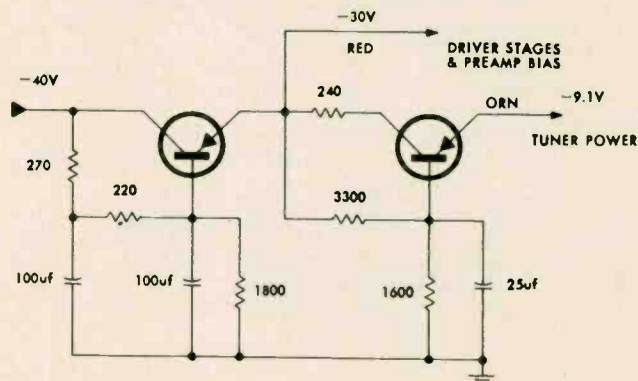

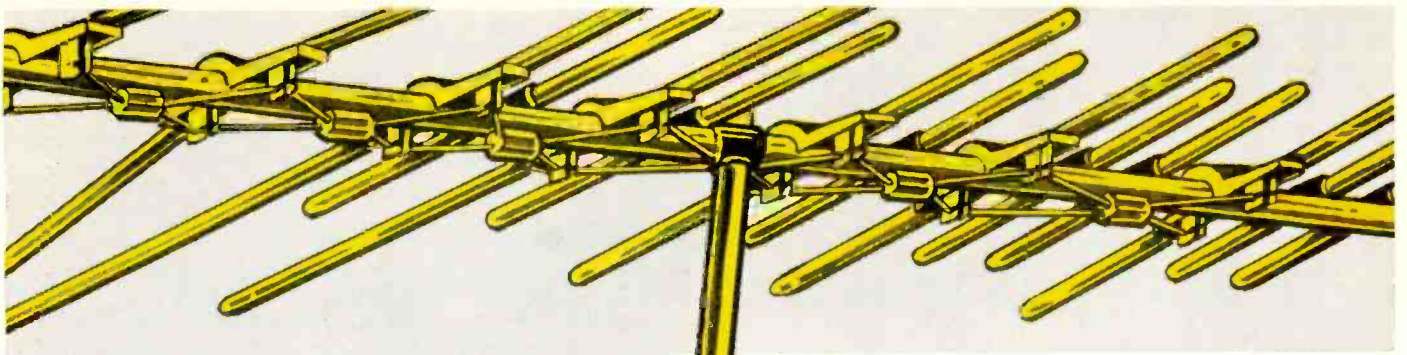

# Gavin Throws Down The Gauntlet!

We hereby challenge the entire antenna industry to side-by-side comparison tests. We claim that GAVIN antennas outperform all others. Our new V-Yagi design delivers stronger signals, better pictures than any other type antenna on the market.

But anybody can make claims. We're ready to back ours with objective proof, anytime, anywhere. The proof is simple. Using our specially equipped vans, we check your favorite antenna on a field strength meter and a color receiver simultaneously. Then, we replace your antenna with a GAVIN antenna, about the same size and costing the same or less. So far, we've never lost.

If you'd like to see a side-by-side comparison test, contact your local GAVIN representative or write us a note. We'll drive the van to your door — let you make all the adjustments and set up the test yourself, if you like.

This challenge applies to all distributors, installers, and antenna manufacturers. Any takers?



**GAVIN INSTRUMENTS, INC.**

Subsidiary of ADVANCE ROSS CORP.

Somerville, N. J. 08876 U. S. A.



... for more details circle 116 on postcard

Introducing the world's first 5-channel, solid state, Citizens Band Radio with a Class B push-pull audio amplifier, super-sensitive receiver, and full-powered transmitter, that comes with either palm microphone or telephone handset at no extra cost.

**Total weight: 3 pounds. Total price: \$99.90.**

How can anyone put so much into one radio, for so little, without cutting corners?

Anyone can't. Pearce-Simpson can.

In simple, unvarnished terms, Pearce-Simpson makes more marine radio telephones than anyone in the world.

Period.

Which means that Pearce-Simpson buys more components for marine radio telephones than anyone in the world.

In other words, because we buy in such quantity, we save money when we buy our CB components.

You save money when you buy our CB Radios.

And because we have our own plastics factory and make our own telephone handsets, our own cabinets and many of our own parts, we know we start out with quality.

You know you end up with quality.

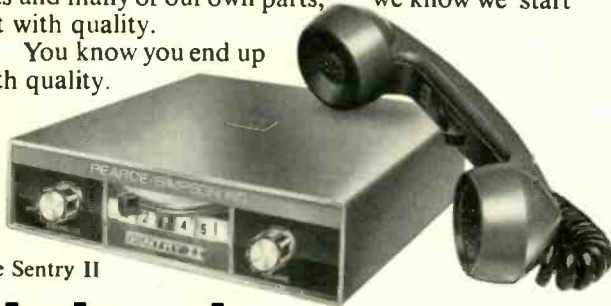

The Sentry II

**Nobody can make a better radio for \$99.90. Not even Pearce-Simpson.**

Important: Full year warranty.  4.0-watt power output  0.5 uv opens squelch  adjacent channel 50 db down  cross modulation 80 db down  no close range blocking  noise limiting circuit virtually eliminates ignition and alternator noise.

Pearce-Simpson, Inc.  
P.O. Box 800, Biscayne Annex,  
Miami, Fla. 33152

ET-368

Gentlemen:  
Please send free dealer kit and complete details on your new CB Radio Profit Line.

Name

Address

City

State

Zip

... for more details circle 135 on postcard

## TECHNICAL DIGEST

wave circuit serves as a -40v source. After filtering, the -40v is applied to the collector of a power filter transistor.

Output from the power filter is a well filtered -30v. This -30v source furnishes emitter voltage to the NPN driver transistors. The predriver transistor bases are supplied from -18v that is obtained by a dropping resistor from the -30v supply.

A second power filter transistor is used to obtain voltage (-9.1v) for the AM/FM and MPX circuits in the RC1218 tuner. The voltage at this point is very stable and no zener diode regulation is required.

### Tape Recorder Models YJC22, MJC28, YJG42/52, YJH32/36/38, MJG66/26 — Isolating/decoupling Circuits

Field reports mention the need for technical information concerning the matching of tape recorders, modules/players to external stereo instruments.

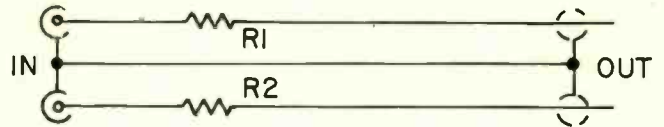

Simple isolating/decoupling circuit

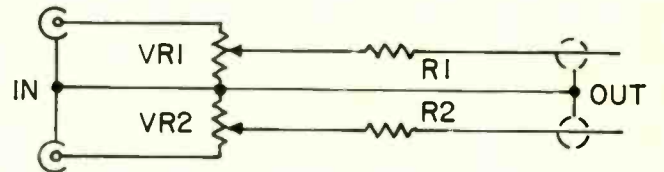

Isolating-decoupling/level set circuit

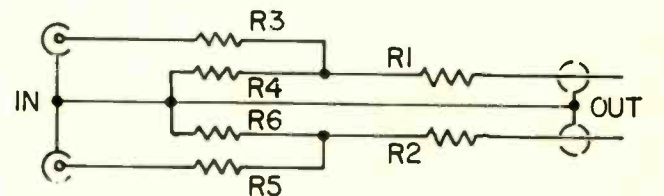

Isolating-decoupling/1:2 attenuator circuit

Any models causing an objectionable disturbance in volume or tone quality when connected to external stereo instruments should be corrected by the following methods:

Install a 47K to 68K, 1/4w, composition resistor in series with each center lead of the left and right channel cables.

This isolating/decoupling resistor eliminates the disturb-

*Continued on page 100*

### MOVING?

Be sure to let us know your new address. Please enclose a complete address label from one of your recent issues.

# Compare Color Generators

The rest... by the best, new B&K model 1245

B&K Model 1245 Color Generator  
 forms transmitted by a color TV

waveforms makes it easy to con-  
 check sync and make other raster  
 the color generator with station  
 able to sync next year's sets.  
 compromise waveforms do not give you  
 section.

scope photographs from the outputs  
 competitive color generators, one tran-  
 and one tube type, and the B&K Model 1245.  
 ed analysis with each photograph shows a few  
 reasons why you'll save time and effort with B&K.

## COLOR

## CROSSHATCH

### STANDARD STATION SIGNAL

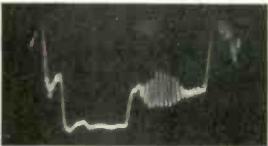

One horizontal sync pulse with its color burst.

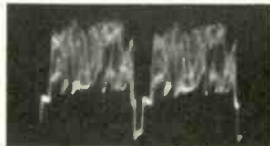

Two lines showing horizontal sync pulse with black and white tv signal.

### TRANSISTORIZED B&K MODEL 1245

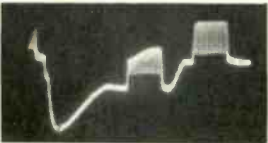

Good duplication of station signal including back porch. If the set won't sync, the set is defective.

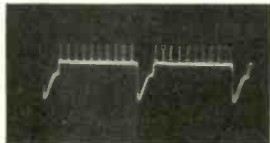

Well defined back porch on horizontal sync pulse permits accurately setting color killer and almost eliminates need to adjust brightness and contrast.

### TRANSISTORIZED GENERATOR A

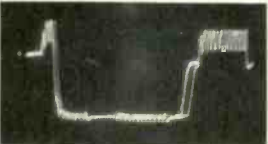

No back porch causes unstable color sync. Burst amplitude compression may permit sync on wrong color bar.

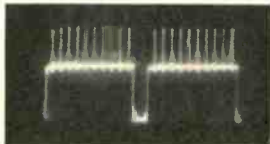

Square wave horizontal sync pulse with no back porch and poor dc coupling forces adjustments of brightness, contrast & fine tuning to obtain usable pattern.

### GENERATOR B

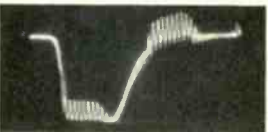

No back porch; color information on top of sync-pulse makes sync difficult on some sets.

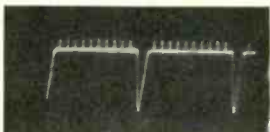

Complete absence of any back porch necessitates readjustment of brightness, contrast and fine tuning to obtain a usable pattern.

See your B&K Distributor for a demonstration  
 or write for Catalog AP22.

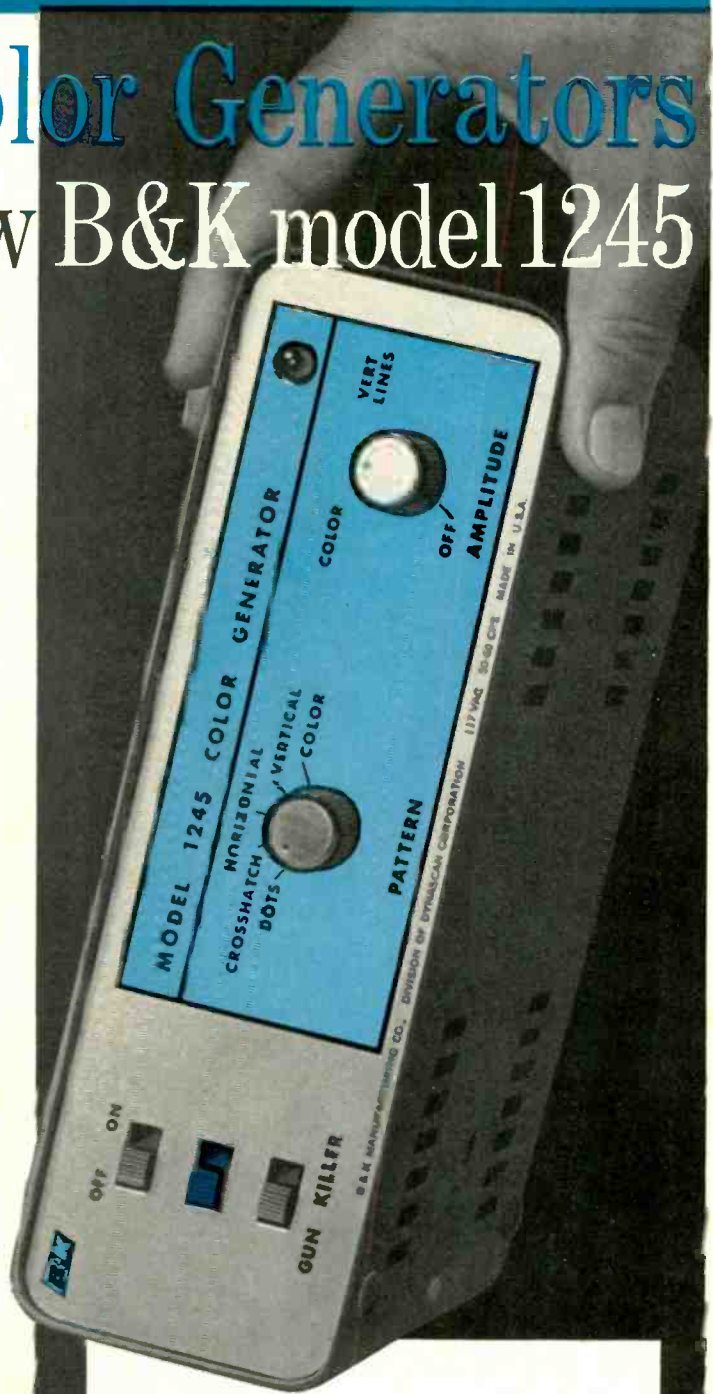

For the first time, with the no-compromise waveforms from the B&K Model 1245, it is possible to accurately set the color killer threshold control with a color generator.

The miniature size and convenience of the Model 1245 match its performance. It provides crystal-controlled keyed rainbow color bar display, and dot, crosshatch, horizontal line and vertical line patterns as well as gun killer controls that will work with any picture tube. Size only 2 7/8 x 8 1/2 x 8 1/8". Net \$234.95.



**B & K MANUFACTURING CO.**

DIVISION OF DYNASCAN CORPORATION

1801 W. BELLE PLAINE AVE., CHICAGO, ILL. 60613

Canada: Atlas Radio Corp., 50 Wingold, Toronto 19, Ont.  
 Export: Empire Exporters, 123 Grand St., New York 13, U.S.A.

... for more details circle 106 on postcard

# The people puller

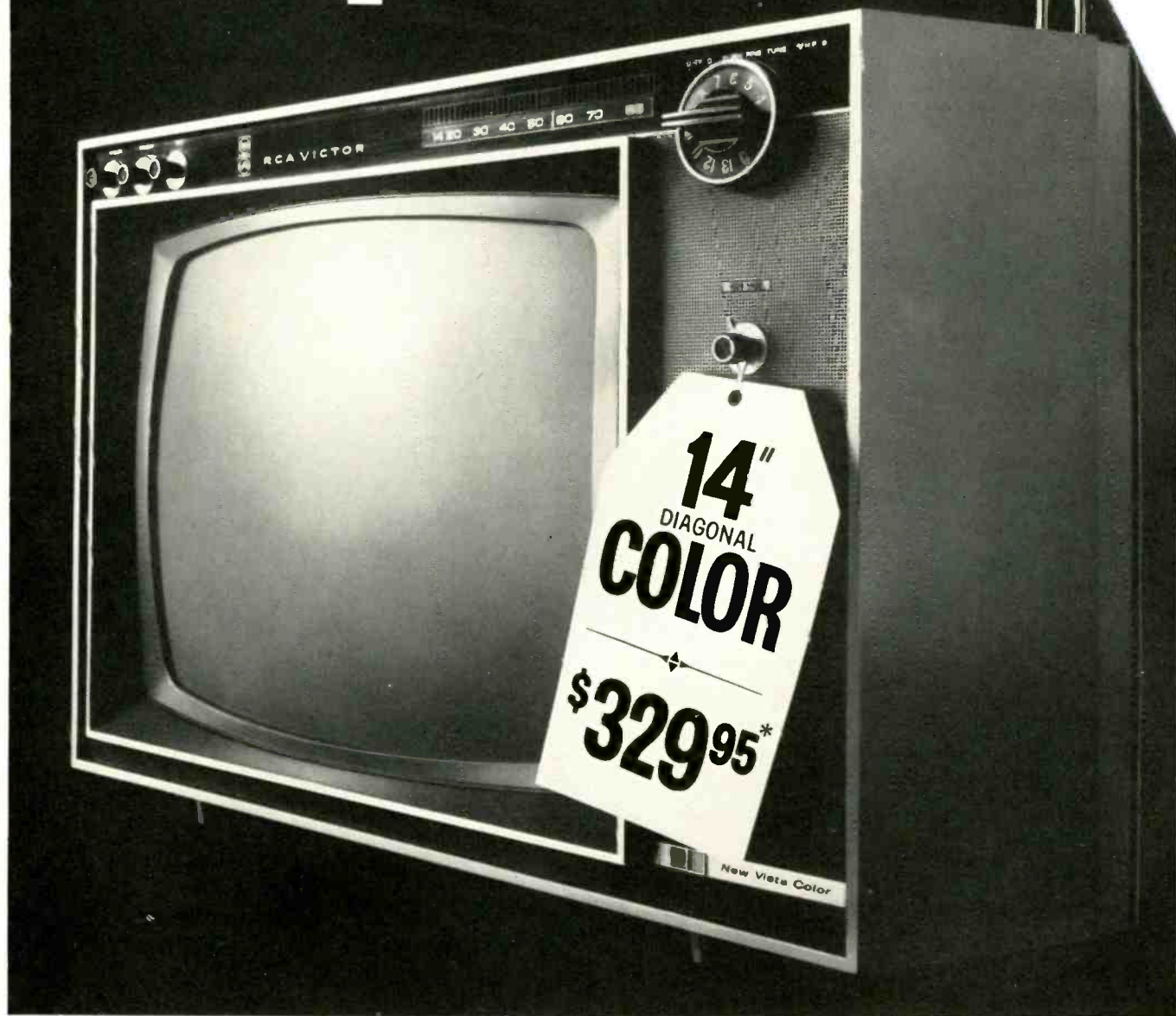

\*Optional with dealer

## RCA's Headliner: first and finest of the 14-inch portable color TVs.

First because it's pulled the most sales of any 14-inch diagonal color set made. Finest because it's got the big features. Like advanced circuitry that won't go haywire. Like true room-to-room portability. And a 102 sq. in. picture that's true to life—and true to the reputation of the pioneer name it bears. Sell the first and finest, the Headliner. It's one reason we say: When you're the first name in home entertainment there's got to be a reason.

# RCA

ELECTRONIC TECHNICIAN/DEALER



# Marine Electronics—Sales and Service

Add a profitable and challenging side-line to your TV-radio business



Heath marine 150w radio-telephone-Model MWW-15



Heath radio direction finder-Model MR-21



Heath electronic foghorn/hailer-Model MD-24

■ It wasn't too many years ago that the average citizen thought of two-way radio as a gadget used only in police cars and taxicabs. Then came citizens band radio. Suddenly, every housewife, farmer, sportsman, trucker and teenager became owners of their own radio stations. People started buying CB radios and accessories by the millions for their homes, cars, trucks, tractors — and boats.

## The Need Is Evident

In 1966, there were about 2.5 million licensed stations in the United States. The figure goes up a quarter of a million every year! An even greater number of people participate in boating every year. And, almost every one asks, "What could be more logical than having a two-way radio in your boat?" Just as citizens band radio provided an inexpensive means of communication between home and auto, it has helped fill the need for communications for the small boat owner. Marine electronic equipment is no longer a luxury enjoyed only by yacht owners. The boating industry has geared itself to meet this growing demand for marine electronics in the pleasure craft type of boat. It is providing electrical systems, outboard motors with generators and other accessories to allow the use of electronic equipment.

The popularity of boating and the associated need for communication is startling. In January of 1967, there were an estimated 8 million recreational outboard motor boats in use in the United States. More than 43 million people participated in boating activities on a more than casual basis, and — they spent more than 3 billion dollars on equipment, accessories and insurance. That means that roughly one out of every five people in the United States has participated in some boating activity at the cost of \$70 each! This is an increase over 1966 of 200,000 boats and \$200,000. With 8 million outboard pleasure boats and 43 million people active in the sport, it's no wonder that many of the electronic manufacturers are building two-way radios, depth sounders and other equipment for marine use.



Heath fuel vapor detector-  
Model MI-25

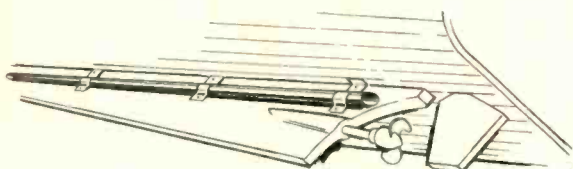

Heath radiotelephone ground system kit-  
Model MD-14



Zenith Super-Navigator, portable radio  
direction finder-Royal 97



Motorola VHF-FM trans-  
ceiver system-Model T-1141

The sale of marine electronic equipment could range from CB transceivers to complete radar systems. However, the pleasure craft boating enthusiast will probably have an interest only in two-way radio (either CB or marine), depth sounders, direction finders, tachometers, electronic foghorns and other accessory items.

Chart I lists some of the companies which manufacture electronic equipment for marine application. Many of these same manufacturers also make two-way radio and other equipment for use in the industrial and home entertainment areas.

### Getting Started

The easiest way to get started is to have an existing two-way radio repair shop or a TV and radio service-dealer operation in an area of boating activity.

Being in an active boating area is naturally a prime consideration if you plan to sell, service and install marine radio equipment. Make your own survey of the potential marine market in the area. You can check with local boating clubs, boat dealers, resorts, water safety organizations and the conservation department. Many areas even have water safety patrols and volunteer rescue services.

### Service and Installation

Now that we know we need potential customers, here is what we need to service them. As we said before, if you already have a two-way radio repair or TV service shop, starting in marine radio service should be relatively inexpensive. The basic test instruments include a VOM, VTVM, tube tester, scope, signal generator and, of course, test leads, tools and other accessories found in the normal shop. In servicing marine radio, as in any two-way radio service, adjustments of the transmitter frequency require First or Second Class (Radio-telephone or Telegraph) FCC license and some accurate means of checking the frequency. Other than these basic requirements no major test instruments are necessary for basic marine electronics service. However, there are some special techniques and considerations involved which we will get into a little later.

Marine radio equipment includes CB units, HF transceivers, VHF radiotelephones, and any of them could be AM, SSB, or both! This should be no problem as the basic theory is much like that of the two-way radio equipment used in mobile application. In fact, many of the same manufacturers make units for both marine and mobile use. The only other marine equipment which might be somewhat new to you in theory will be depth sounders and radio direction finders (RDF). Radio direction finders, however, are nothing more than radio receivers with rotating loop antennas usually coupled to some type of meter and compass card for visual reference. A little time spent with technical books and marine electronics manuals will probably clear away some of the cobwebs.

There is one major difference between servicing and installing marine equipment as compared to two-way radio and TV. You can usually bring the defective TV set or mobile unit to the shop for service—in marine service you must usually bring the shop to the boat —

### CHART I

Company	Marine Electronic Products
Heath Co. Benton Harbor, Mich.	radiotelephones, depth sounders, direction finders, power converters, ground systems, marine antennas and other accessories
Motorola Communications and Electronics, Inc. 4501 Augusta Blvd. Chicago, Ill. 60651	Maritime FM two-way radio equipment for use in VHF marine bands, systems of transceivers and additional receivers
Pearce Simpson Marine Electronic Div. 4701 N.W. 77th Ave. Miami, Fla.	radiotelephones, depth sounders, radio direction finders, gas fume detectors, marine band converters and antennas
Decca Radar Inc. 386 Park Ave. S. New York 16, N.Y.	marine radar navigational and automatic steering systems
Zenith Radio Corp. 1900 N. Austin Ave. Chicago, Ill. 60639	portable radio direction finders
Raytheon Co. Lexington, Mass.	VHF-FM radiotelephones and Fathometer depth sounder



Pearce-Simpson Catalina 85, 8 channel, 85w marine radiotelephone



Pearce Neptune 60 depth sounder



Pearce Simpson radio direction finder-Model DF-765



Pearce Simpson marine band converter

especially for installation work. Don't let this scare you. It just means that you must learn to take what you need along with you to the job. Remember, boats operate from battery power, so a portable battery supply should be included in your equipment. If the boat is near a dock with ac outlets, you might want to take along a converter which simply changes 117 vac to 6 or 12 vdc. If you are doing a radio installation, or work requiring ac operated tools and equipment, an inverter can be used which operates from a dc source. This inverter could be mounted in your car or truck and operated from the battery to provide the ac power necessary for test instruments and power tools. Many test instruments, such as the VOM and portable RF field strength meter, require no power and some instruments including frequency meters will operate from either ac or dc. If you have to drill holes, consider a hand- or battery-operated drill — a little more work but just as effective. You don't need a 20ft trailer full of test instruments to service marine equipment. A few of the right tools and in-

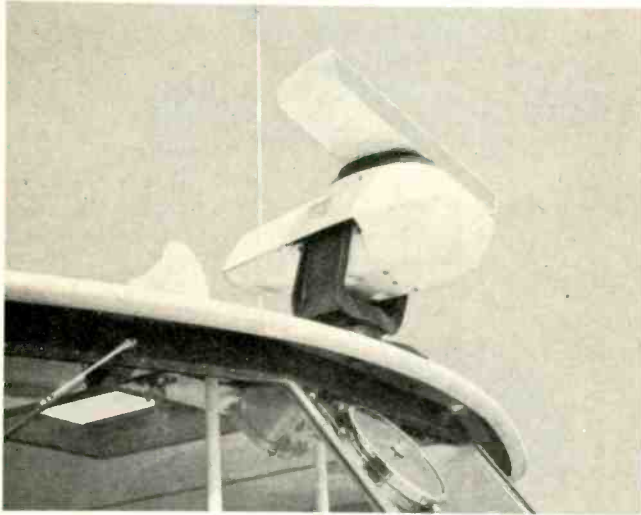

Decca Model 101 radar for small boats



Raytheon VHF radiotelephone-RAY-40



Raytheon Fathometer depth sounder-Model DE728



Heath electronic tachometer-Model MI-31A

struments along with a little brain work will often get the job done.

The installation of marine radio equipment should follow the same rules you use for mobile work. Mount the radio where it is convenient to the operator with consideration for the safe operation of the boat; observe proper polarity, fusing, short leads, clean and secure connections and proper routing for power and antenna leads. The techniques we mentioned at the beginning are those peculiar to marine radio installations, and ones you should be aware of. Some of these techniques fall into a general class, others depend on the size of the boat and whether it is used in fresh or salt water. This article is not directed at marine electronics as applied to large yachts or sea-going vessels, but some outboard motor boats do operate in some of our coastal waters.

As previously indicated, ac tools and instruments could be operated on a boat from a nearby ac outlet on the dock. One caution here — don't ground the ac equipment on the boat because of the danger of corrosion. Wiring should be well insulated and tied or clamped to prevent vibration and chaffing on corners. Cable connections and terminals should be taped. Another consideration in marine radio installation is the need for proper grounding of the antenna and transmitter. If the boat is metal, a copper strap should be connected between the transmitter and the closest point on the hull. If the boat is wooden or fiber glass, a copper plate should be secured to the hull as close to the radio as possible. You can probably obtain information from your local boat dealer for installing the copper plate, but new designs in antennas for marine use have eliminated this procedure somewhat. Also, some boat accessory suppliers have made available grounding kits for use in marine radio installations.

The actual servicing of marine electronic equipment is much like any other communications equipment with the exception of depth sounders. If you plan to service marine radio, contact the various manufacturers for manuals. You might also inquire about warranty and field service policies. Manufacturers are always on the lookout for good service shops as warranty repair centers. ■

# 'Trigsweeping' Your Old Scope

Update your service oscilloscope and it'll do more things for you — faster

■ You can easily install a triggered-sweep circuit in your standard service scope. Using transistor circuits, you can put the entire unit inside your present scope cabinet. A converted EICO 460 scope is shown in Fig. 1.

A number of extra features can also be provided: trigger selection, ac/dc input to allow triggering on dc level change, MANUAL/AUTO control for adjustments when there's no signal input and a TIMES-5 multiplier to slow the sweep half-way between the TIMES-10 steps.

The sweep selector switch is labeled from 0.01sec to 1 micro-second ( $1 \mu s$ ) rather than the old

frequency range (dial markings not visible in photo).

Triggered sweep and the extra facilities may not appear, at first glance, to be worthwhile. But wait a minute! A triggered-sweep scope will run rings around the repetitive-type oscillator-sweep scope if you *know why and know how* to apply it properly in your daily troubleshooting work.

## What's Triggered Sweep?

Simply and briefly, a triggered-sweep scope is one which has an additional sawtooth voltage applied to the sweep output amplifier. The sawtooth generator is a non-

repetitive (not free-running) type multivibrator which may be called a "single-shot," or triggered generator. The regular time-base sawtooth-deflection signal is generated only when a sync signal (trigger signal) is applied. When there's no trigger pulse, the scope screen is blank.

The horizontal deflection in a triggered-sweep scope can be set to any value and no overlapping display occurs. Additionally, a small portion of a waveform can be easily expanded. The color burst signal, for example, in a color set can be more easily and accurately observed with a triggered-sweep scope. Other

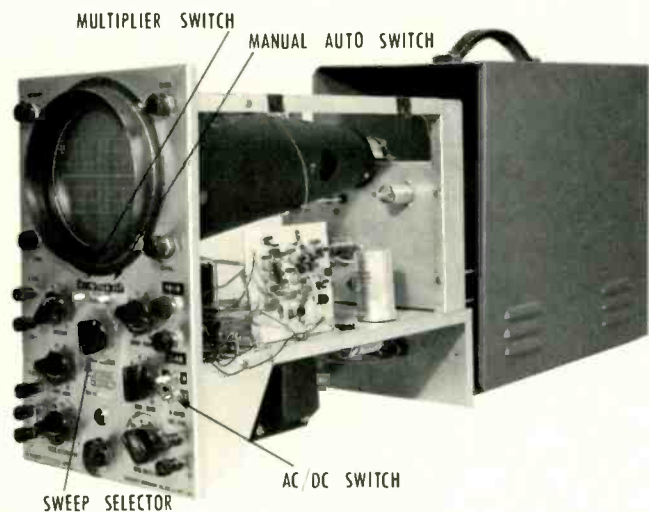

Fig. 1 — Converted EICO model 460 scope.

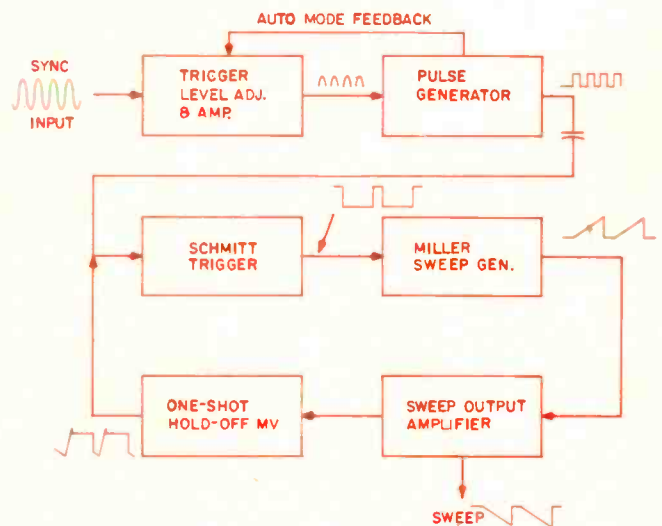

Fig. 2 — Block diagram of basic trigger sweep circuits.

rapid pulse forms, whether they appear at regular or irregular intervals, can be observed on a triggered-sweep scope. A triggered-sweep can be started at any point along the signal-input time-base so the leading edge, lagging edge or any portion of the signal-cycle may be observed.

What else can we do with a triggered-sweep scope? Let's set the triggered-scope sweep selector switch at  $2 \mu\text{s/in.}$  speed, for example, and look at the horizontal TV pulse which has a  $4.8 \mu\text{s}$  duration. The pulse will cover 2.4 in. on the screen (sync the trigger on the TV's flyback pulse if you like). And, when you flick the switch to the  $20 \mu\text{s/in.}$  speed, you'll see a complete horizontal line. Switch to  $200 \mu\text{s/in.}$  and TIMES-5 multiplier, synced to 60Hz, and you will see two-thirds of a frame (adjust 60Hz phasing to move the segment being viewed around). And the scope display will be rock-steady — with no sync control to "diddle." In the same way, you can observe TV vertical integration and horizontal differentiation circuit operation.

An audio or video amplifier's bandwidth can be measured by using pulse techniques — considering the limiting bandwidth of the scope's vertical amplifier. Bandwidth is approximately  $0.35/\text{pulse-rise-time}$  measured. With 5 percent or more overshoot (in the case of the EICO 460), the equation becomes  $0.45/\text{pulse-rise-time}$ . The scope and generator should have a rise-time 5 percent faster than the measured time to be accurate without calculations. In cases where rise-times are faster than an instrument's capability, use the equation  $t_o = \sqrt{t_1^2 + t_2^2}$  where  $t_o$  is the true rise time,  $t_1$  is the scope rise-time and  $t_2$  is the measured rise-time.

You can measure RC time of a network, too, by pulsing the network at a slow rate (to allow discharge). RC time is the time required to charge 0.63 percent of the total voltage or 0.86 percent for two RC times.

### Trigger-Sweep Circuits

The block diagram in Fig. 2 shows a group of basic circuits used in triggered-sweeping the EICO 460

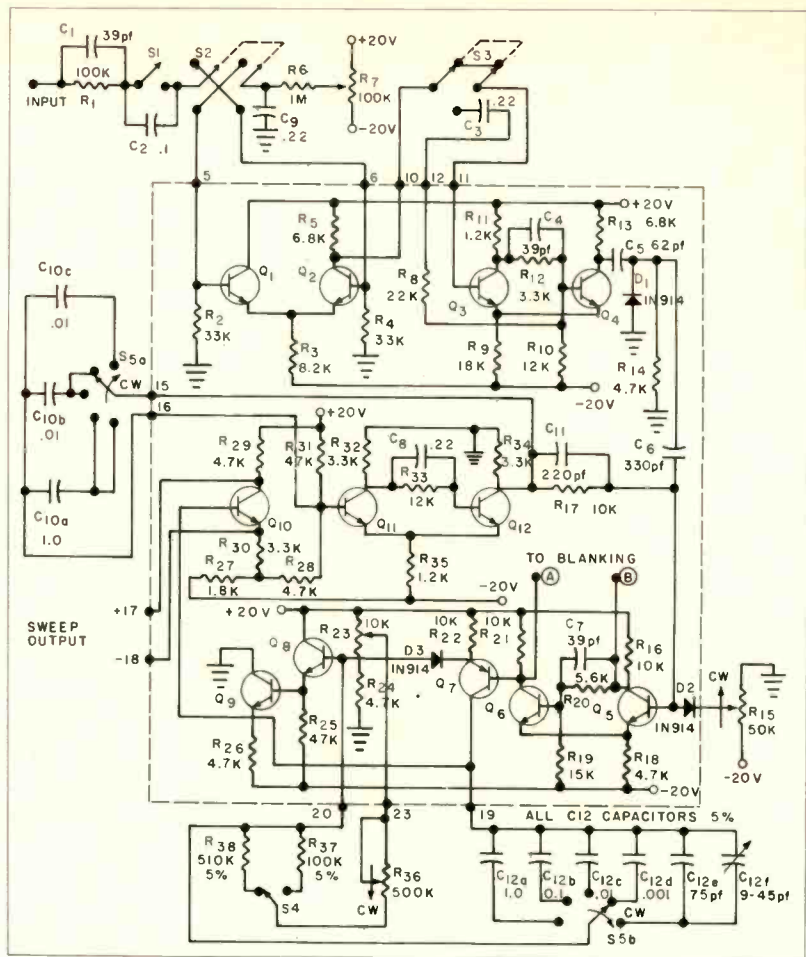

Fig. 3— Schematic of trigger-sweep circuits used in EICO scope.

scope. When built into a scope, the front panel controls and switches associated with the horizontal sweep are rewired or replaced so the same functions are available. A few other controls and switches are added for trigger adjustments and sweep-speed multiplication.

Operation of these circuits (see Fig. 3, 4 and 6) is typical for lab or professional-type scope sweeps. The first two stages condition the signal and the second stage output is a squarewave with a repetition rate equal to that of the input signal. The squarewave is differentiated and clamped so that fast positive spikes drive the start/stop generator — a Schmitt trigger circuit.

When triggered, the start/stop generator changes state and switches the Miller sweep generator on. The Schmitt trigger is a flip-flop which must be reset by a strong negative pulse before it will operate again. In the Miller sweep circuit, the capacitors charge at an exponential rate

through a resistor capacitor network. The amplified ramp (linear) voltage thus generated is the output.

At the end-of-sweep the hold-off flip-flop (another one-shot multivibrator) changes state and resets the Schmitt start/stop flip-flop. The hold-off RC time constant holds it off for about 10 percent of the sweep time to allow the Miller sweep circuit to discharge.

Action in the start/stop generator drives an unblanking circuit to switch the CRT on during sweep and off between sweeps. This circuit schematic is shown in Fig. 4.

The triggered-sweep circuit board (Fig. 5) is  $4\frac{1}{4} \times 3\frac{3}{4}$  in. and is placed above the chassis. The power supply board  $4 \times 3\frac{1}{2}$  in., is placed under the chassis. The power supply schematic is shown in Fig. 6 and its location in the underchassis is shown in Fig. 7.

The steps for converting an EICO 460 or comparable-type scope follow:

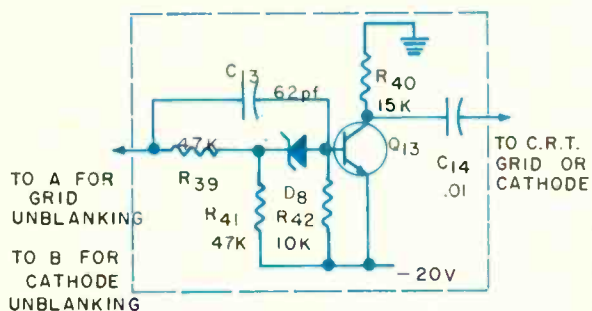

Fig. 4 — Schematic of unblanking amplifier. It may be necessary to vary R39 to allow Q13 to switch properly.

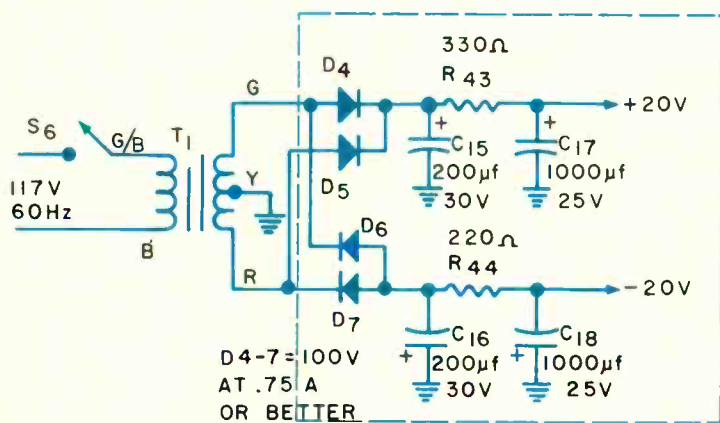

Fig. 6 — Power supply schematic.

(1) Remove the CRT from the scope chassis. (2) Remove the sweep selector switch and capacitors connected to it. (3) Remove EXT CAP jack and its wire. (4) Remove SAWTOOTH jack and its wire. (5) Remove tubes V5 (12AU7) and V6 (6J6) located on right front of the chassis. (6) Remove the 10K HORIZONTAL GAIN control and substitute a 50K control. (7) Remove the SWEEP VERNIER pot, EICO R54, and replace with R36, the 500K pot shown in Fig. 3.

Drill the following holes ( $\frac{1}{2}$  in. dia for miniature Alco switches): two straddling center panel over SELECTOR switch and two aligned vertically on right edge of panel over the H-INPUT jack (see Fig. 1). Obtain or make four "L" brackets and drill for 6-32 machine screws for mounting the PC boards.

Wire circuit boards, using schematics shown in Fig. 3, 4 and 6. Parts inside dotted line are on boards and parts outside are mount-

ed on the switches and controls.

Wire off-board components to switches and controls. Interconnect terminals on S1 and S2 before mounting since they are difficult to solder in cramped space after mounting. Mount S1 in the hole over H-INPUT jack and S2 in the second vertical hole.

Place the STABILITY control (50K) and TRIGGER control (100K) in the next two vertical holes, respectively. In the two horizontally placed upper center holes of the panel, mount S4 (multiplier) to the left and S3 (MANUAL/AUTO) to the right. Mount the SPEED SELECTOR switch, S5, in the lower center hole just below S3 and S4, where the previous FREQUENCY SELECTOR was located. Mount the circuit board along the right front of the chassis as shown in Fig. 1. Mount the power and blanking board under the chassis near the back where the ac power cord enters as shown in Fig. 7. Mount the power transformer next to it.

Now wire controls to circuit board. Run plus and minus power leads from underchassis to circuit board. Rewire horizontal selector switch. Terminals read clockwise looking from the back (terminal 1 connected to fine frequency control, EICO R54, which was removed). Remove and reconnect wires as necessary so switch terminals read as follows: No. 1, no connection; No. 2, no connection; No. 3 and No. 4, tie together and attach 33K,  $\frac{1}{2}$ w resistor (use blank terminal 2 as tie point if desired); No. 5, horizontal input (no change); No. 6, 60Hz sync (no change); No. 7, connect trigger sweep input R1 and C1 going to S1; No. 8, connect to top of horizontal gain control (this was replaced by a 50K value); No. 9, connect to sweep output of trigger-sweep.

Final connections before applying ac power to the scope: Connect blanking stage input from under the chassis board to collector of Q5 on trigger-sweep board. Connect blanking stage output to  $0.5 \mu$  f, 1kv capacitor (EICO C23) after disconnecting it from V6. horizontal output tube. Go to vertical rear panel of scope and find the 820K resistor (EICO R32) which is connected to the terminal strip on top where the twin lead sync cable terminates. Replace this resistor with a  $0.2 \mu$  f, 1KV ceramic capacitor. Connect other end of the twin-lead sync cable to the 33K resistor which goes to terminals 3 and 4 of the horizontal selector switch. Reverse leads to CRT socket, pins 9 and 10, so the sweep will go from left to right.

### Check-Out and Calibration

Check your wiring and reinstall the CRT. Switch the scope on and become familiar with the controls. You are now ready to calibrate the sweep with a standard signal source. Calibration on one speed automatically calibrates all the others. Speeds are shown in Table I.

Operation is slightly different from the conventional oscillator sweep. Switch to X1 on the multiplier, switch MANUAL/AUTO to AUTO position. Adjust the STABILITY control until you see a trace on the screen and turn TRIGGER LEVEL to where it locks in steady. Trigger

Fig. 5 — Components mounted on trigsweep board.

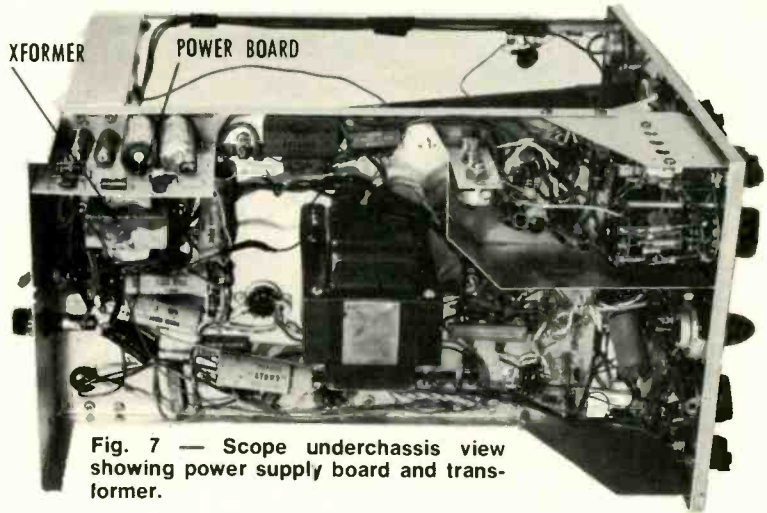
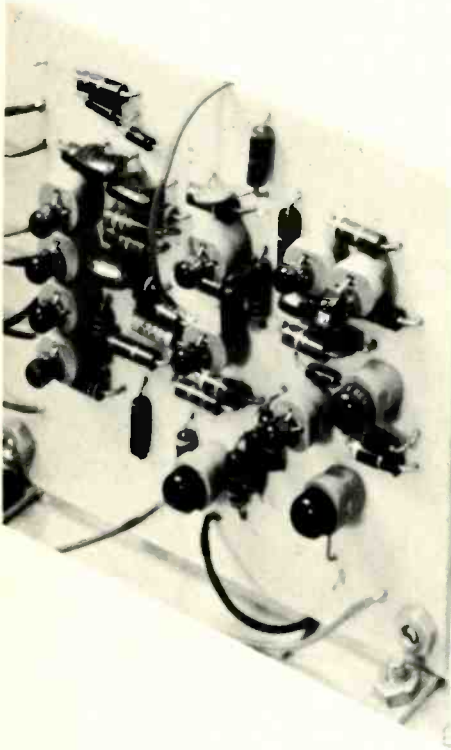

Fig. 7 — Scope underchassis view showing power supply board and transformer.

TABLE I  
SWEEP SPEEDS

Switch Pos.	Inch Div.		Cm. Div.	
	X1	X5	X1	X5
1	0.02 sec/in	0.1sec/in	.01sec/cm	.05sec/cm
2	2msec/in	10msec/in	1msec/in	5msec/cm
3	200 sec/in	1msec/in	100 sec/cm	0.5msec/cm
4	20 sec/in	100 sec/in	10 sec/cm	50 sec/cm
5	2 sec/in	10 sec/in	1 sec/cm	5 sec/cm

level adjustments vary for different input signal amplitudes. With internal sync, the signal level is fairly high so the trigger level control will be toward the extremes of rotation — one way is for positive and the other negative trigger polarity. The center area of the control is more sensitive for weaker signals.

MANUAL ON the AUTO/MANUAL switch blanks the screen — except when an input signal is present. Adjustment in this position is more critical. The STABILITY control is advanced until the sweep is triggered — but no further.

Attach a signal generator to the scope's vertical input; switch to internal sync, AUTO mode, adjust

vertical gain so waveform is several inches P-P and calibrate according to Table I using the calibration pot located on circuit board.

For example, using a 100kHz oscillator signal (which is 10  $\mu$ s per cycle) the calibration pot, R23, is adjusted when speed selector switch is in position 4 so that two cycles cover 1 in. on the screen (or one cycle for 1cm on cm scales). To check results, switch to position 5 and speed multiplier to X5. Now one cycle covers 1 in. (or 2cm on cm scales). A similar procedure is followed for a 1kHz oscillator input at 1ms (millisecond) per cycle. But begin with switch in position 2 for two cycles per inch.

A centimeter scale has been mentioned. This is normal for lab-type scopes. If you can find a suitable cm graticule you may wish to replace your inch/division graticule furnished on most service-type scopes. Centimeters are generally more satisfactory for measuring waveform time.

The partial conversion kit used by ET/D, consisting of two circuit boards both with drilled holes), 13 silicon planar type transistors, 3 diodes and 1 zener diode, plus instructions, is available from Solid-State Devices, 1720 Kimberly Drive, Sunnyvale, Calif. 94087. Other similar units may also be commercially available. ■



# Antennas—Sans Bafflegab and Bushwa

Learn what characteristics are essential for better TV/FM reception

■ The first article of this series appeared in the September 1967 issue of *ELECTRONIC TECHNICIAN*. The article briefly discussed some important questions regarding the technical and business principles involved in selecting, installing and merchandising TV and FM antennas. For the most part, these questions have been raised by ET readers during recent times. And some technical aspects discussed had been checked previously by ET editors in the field — in actual practice.

Two viewpoints prevail today concerning the over-all business of TV and FM antennas. Both viewpoints were briefly outlined in the introductory article. The first view, held by a significant number of service-dealers and technicians, is characterized by a considerable amount of frank criticism regarding the allegedly "skimpy" technical information provided by antenna manufacturers generally; and the "bafflegab" used to promote sales — no small amount of which is allegedly directed to the general public and the do-it-yourselfer.

Because TV-radio service-dealers and technicians know that the general public does not "buy" antennas, the antenna type invariably being specified and installed by service-dealers and technicians themselves, the criticism regarding general promotional material was exceptionally severe. It was admitted, however, that an occasional do-it-yourselfer, probably influenced by

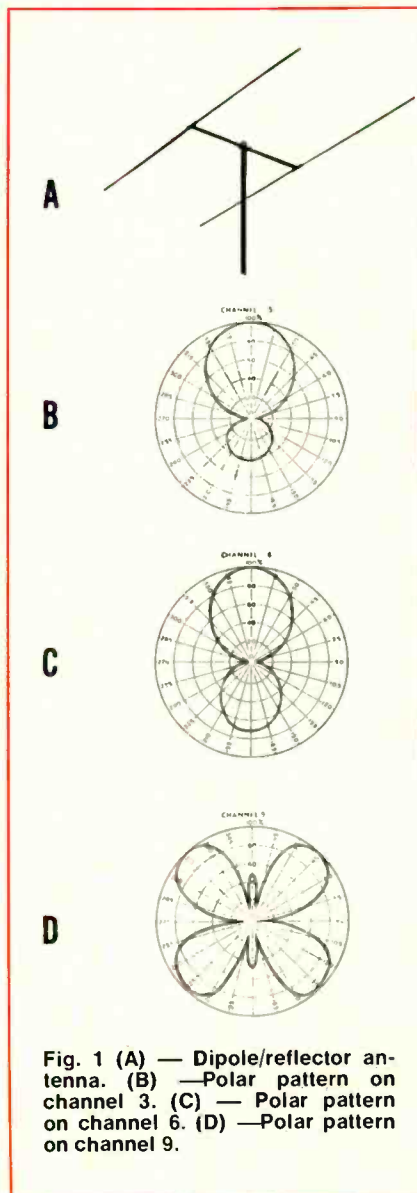

Fig. 1 (A) — Dipole/reflector antenna. (B) — Polar pattern on channel 3. (C) — Polar pattern on channel 6. (D) — Polar pattern on channel 9.

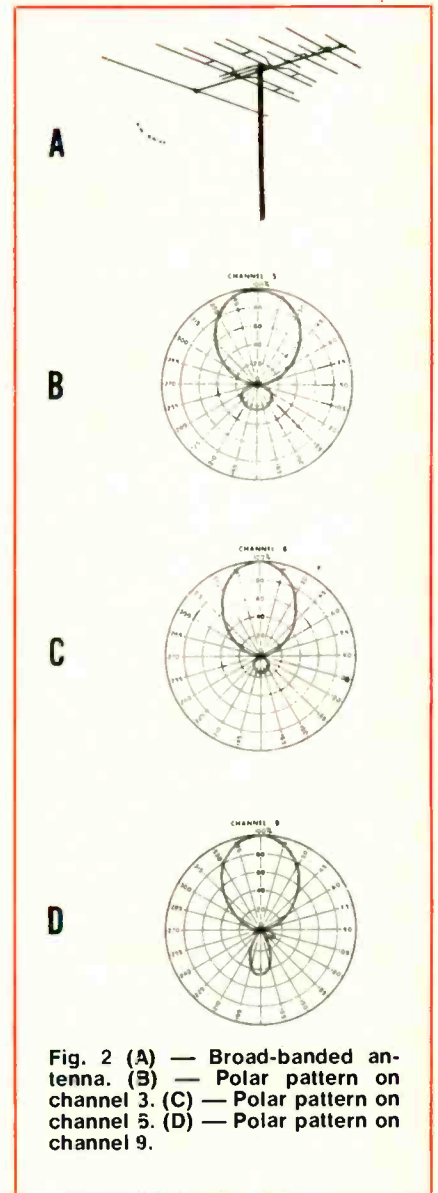

Fig. 2 (A) — Broad-banded antenna. (B) — Polar pattern on channel 3. (C) — Polar pattern on channel 5. (D) — Polar pattern on channel 9.

this material, does drop in and ask for a "TV" or "FM" antenna — although seldom specifying the brand name.

The other viewpoint holds, while agreeing with the validity of some criticisms concerning lack of essential technical information, general "gobbledygook" — including the rash of meaningless buzzwords used by manufacturers — that antennas have been much improved by research and development during the past two decades. And the point was made that many service-dealers have not taken advantage of these improvements to increase sales and, hence, increase their over-all profits.

This viewpoint also held that adequate technical information is available from most manufacturers — although it must again be admitted that considerable effort is required in some cases to obtain this

information and to sort the "meat" from the "bones," the "rice" from the "straw."

Every alert and reasonably informed TV-radio service-dealer and technician already knows that the demand for better color TV and FM reception has been increasing, continues to increase and will continue to increase for quite some time to come. But many are not taking advantage of this situation to augment their incomes by selling and installing more and better antennas. We will not, however, go into this particular phase of the subject at the moment. It will be covered in greater detail in a forthcoming article of this series.

Likewise, every alert and reasonably informed service-dealer and technician knows how important an adequate antenna system is in providing good TV and FM reception. They know that the antenna is the

most important part of a receiving installation and the entire antenna system must be in good condition and the antenna properly oriented if optimum results are obtained. But in many cases very little consideration is given to a particular antenna's characteristics in relation to the equipment to which it is attached, the area in which the equipment is located. It is a fact, discovered and confirmed by those who have had years of experience installing various types of antennas in different locations, that antenna characteristics cause some antennas to work better in one area and other types to give better results in another area.

Now let's shovel down and examine some of the bed-rock technical basics involved with antenna characteristics — spade up a little information that we are primarily concerned with in this business.

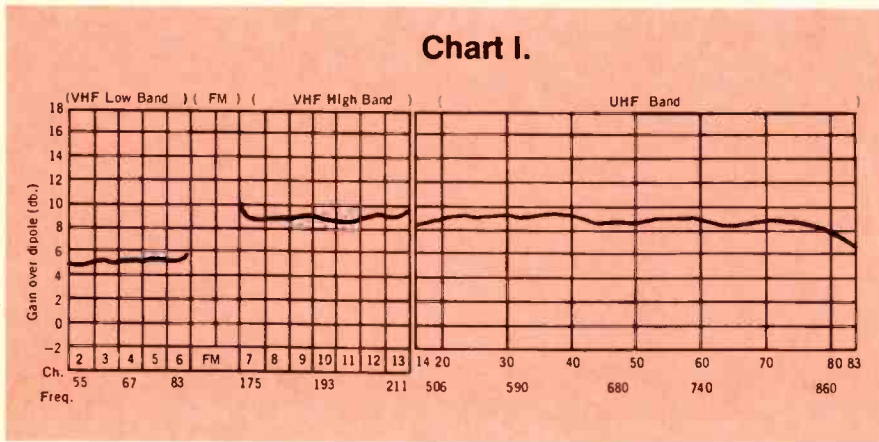

### Chart II

Power Gain	Voltage Gain	Gain in db
1	1	0
2	1.41	3
3	1.73	4.8
4	2	6
5	2.24	7
6	2.45	7.8
7	2.65	8.5
8	2.82	9
9	3	9.5
10	3.16	10
20	4.47	13
50	7.07	17
100	10	20
400	20	26
1000	31.6	30
10,000	100	40

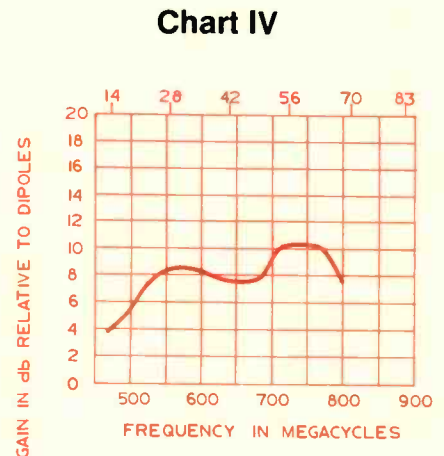
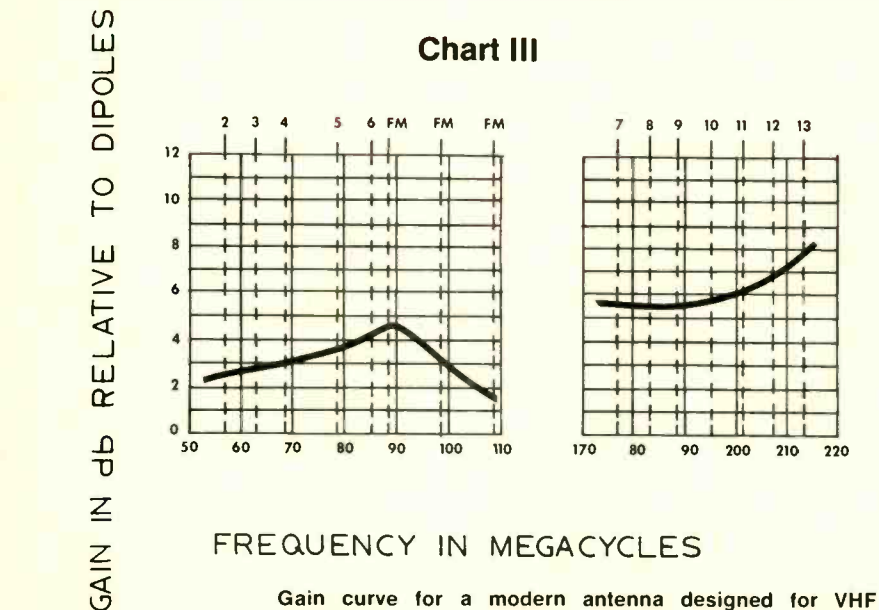

Gain curve for a modern antenna designed for VHF and UHF bands.

## Antenna Characteristics

We do not intend to become involved here in the semantic sport of word-juggling and phrase-twisting which appears to have become so popular in certain areas where technical writing abounds. But we would like to suggest that you ignore the meaningless buzzwords and phrase constructions (the baffle-gab) found today in much of the technical literature concerning antennas.

We are primarily concerned here with two electrical characteristics. These are revealed in *polar patterns* and *gain charts*. You must obtain these from the manufacturer for the various antennas made, and compare them with polar patterns derived from a variety of other antennas before you can intelligently select and install antennas calculated to provide optimum TV and FM reception for your customers. If you don't, then other alert and aggressive

service-dealers will, and you'll soon "pass away" — like old soldiers do.

Properly prepared polar patterns will indicate the signal pickup response of a particular antenna in all directions. It is important that these polar patterns be obtained for every TV channel involved in your operating area. No antenna designed for broadband reception has similar polar patterns for every channel.

Look at the three polar patterns for VHF TV channels 3, 4 and 9, taken from the low-gain, dipole/reflector antenna shown in Fig. 1. Although considerably less variation occurs from channel-to-channel in the higher-gain antenna shown in Fig. 2, the patterns do vary on the same three channels. They will show similar variations, in some cases considerably more variation, on the other four VHF channels.

Knowing the precise polar patterns for a given antenna is essential

under certain conditions — including problems which arise in areas where multipath signals are received and in areas where co-channel, adjacent channel and other interference exist. Polar patterns are essential as guides to effective antenna orientation under the aforementioned conditions. And the patterns are necessary when selecting the best antenna for a particular application, location, terrain.

Gain charts are also essential aids to selecting the best antenna for specific locations. And it should be realized at the outset — no broadbanded VHF or UHF antenna has yet been designed which has a perfectly flat response. The relationship between the VHF low- and high-bands and the UHF channels, plus a number of other factors, make this an insurmountable problem for antenna design engineers.

Whether the antenna design is based on this principle or that principle — all are forced to trade off one advantage for another, and all are compromises.

Antenna gain curves show us the relative sensitivity of antennas compared to a standard half-wave dipole type antenna at a given frequency. In TV work we normally use a 300  $\Omega$  folded, adjustable dipole as the reference — rather than a 72  $\Omega$  straight dipole.

Look at the gain curve shown in Chart I. This curve is developed from a modern antenna designed to give optimum reception on the VHF low- and high-bands and the UHF band. Polar patterns for some channels are shown in Fig. 3. Patterns cover five VHF and four UHF channels, together with VSWR and gain in db for these channels. Note that gain curves are referenced to db, rather than voltage or power gain. If you want to convert, use the data shown in Chart II.

The gain data shown in Chart III, covers VHF channels 2 to 6, the FM spectrum and the high-band area, channels 7 to 13, of the VHF band. Chart IV shows the frequency response of the same multi-band antenna across the UHF spectrum up to 800MHz.

Once again, let's remind ourselves, unless the antenna system

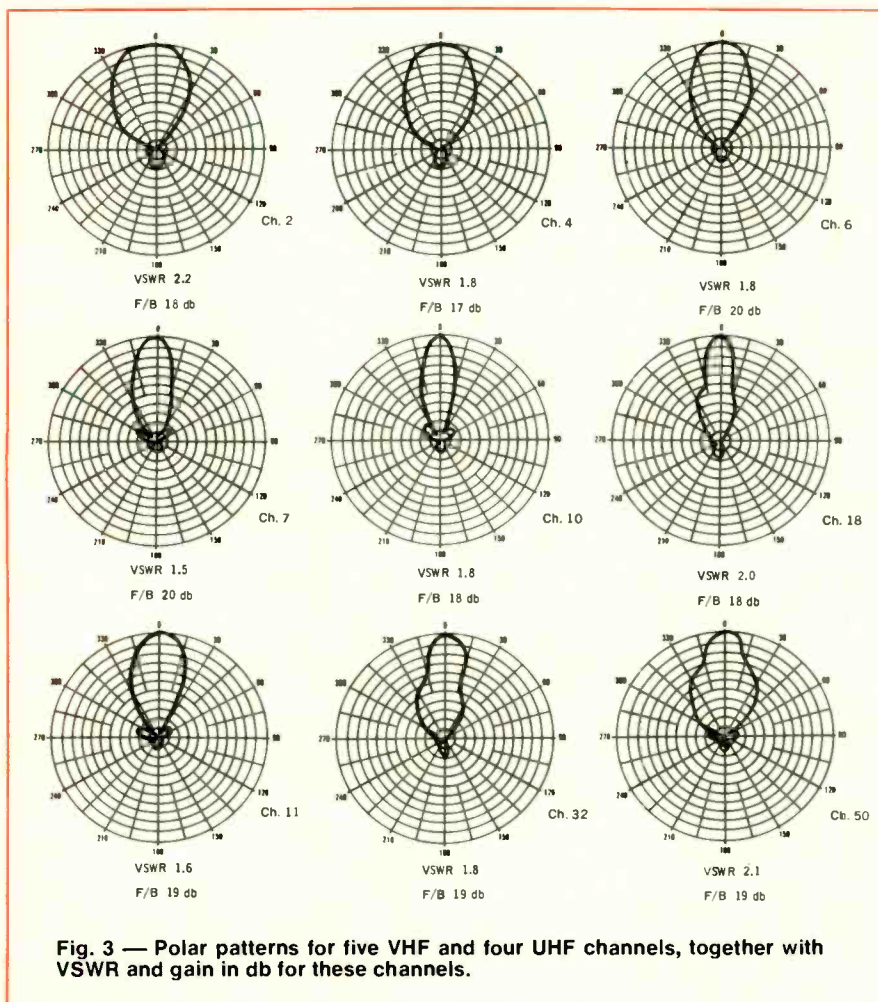
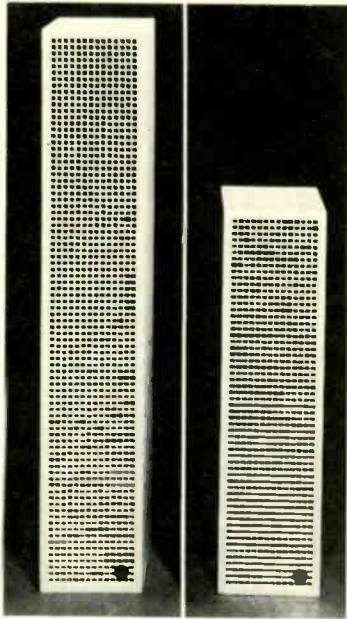

Fig. 3 — Polar patterns for five VHF and four UHF channels, together with VSWR and gain in db for these channels.

Continued on page 103



Columnar speakers by LTV University.

Part one of a series

# What about the Audio

Learn how to operate in this



Altec Lansing solid-state power amplifier.

■ Some important people (who should know better) are still talking about "sound equipment" (whatever they mean by that). But the business we are discussing here is audio communications.

What was once a narrow, thin market called "sound equipment" (primarily public address), has long since evolved into something that deserves more definite, more scientific and clearly defining nomenclature. The expression "sound equipment," when used to define audio communications equipment, has always been and still is too indefinite, ambiguous, confusing and communicates no specific intelligence.

The audio communications equipment sector of the electronics field encompasses public address systems (fixed and mobile), various other audio communications systems — including intercoms — paging systems, background music and teaching-lab equipment employed in business, industry, education, religion, the home, etc.

But even the definition "audio communications" is obsolescent. Much audio communications equipment used today is combined with visual communications equipment, particularly CCTV. Hence, "audio-visual communications equipment" would probably be a space-age definition more accurately defining this area of the electronics field.

It seems paradoxical that some people talk out of one side of their mouths about the inevitability of

change, of progress. At the same time from the other side (which appears inflexibly frozen) emerges the obsolete and already decayed *sounds* of yesterday, the past, the status quo. One thing is certain: There is no such thing as a "sound equipment market" — unless you include in the equipment catalog all of the sound instruments employed in the research labs of industry, education, medical science and the National Bureau of Standards.

## Getting into the Business

You can graduate, little by little, into the audio communications equipment business as a specialist or you can go into it in a limited way as a sideline. It depends on your particular business setup, how you plan it and carry it out. You can get quite a bit of help from a number of equipment manufacturers merely by writing and asking for the information.

You will need adequate, specialized technical knowledge in the areas of design and installation of audio systems, a knowledge of troubleshooting and repair techniques and a few specialized test instruments for properly maintaining the equipment you sell and install. The alternative, if you have the capital and sufficient business, is to employ a properly trained, experienced audio technician. Confidence in either your own knowledge or that of an experienced technician, the quality of workmanship and capability of your test in-

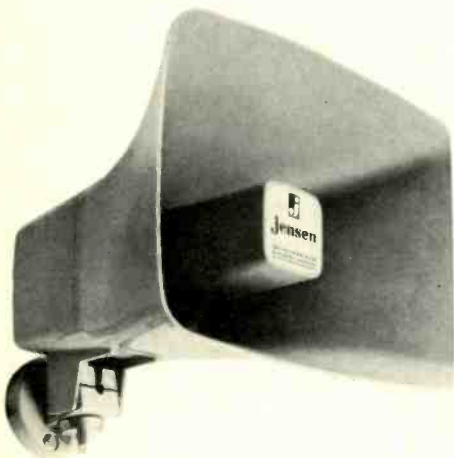

Jensen's VH100 compression-driver speaker.

# Communications Equipment Business?

fast-growing area of the electronics field

struments are important prerequisites to a successful and profitable business.

But you do not have to begin by investing a large amount of money in test instruments. Use what you now have to begin and buy the instruments, piece by piece, as you progress. If you don't know your business, the best test instruments in the world will not repair the audio equipment for you.

You will need a separate, uncluttered bench for servicing audio equipment that needs shop repair. When you can afford it, the bench would eventually have a good audio voltmeter, sine/squarewave generator having modulation provisions, a flip-flop (electronic switch), a separate scope and perhaps a distortion analyzer.

In the meantime, you can do some modestly accurate work with test instruments you probably already have by adding one or two reasonably good instruments. We will tell you how to go about this in a forthcoming article on servicing.

## Design and Installation

Out in the field, when you're asked to give an estimate on a background music system, PA system, paging system or a variety of other audio systems, you will need a background noise level indicator. The noise levels in a church, restaurant, department store, factory — or what have you — vary widely. And you'll need an instrument to measure it with. Then you'll need pre-

viously prepared special speaker/amplifier power selection charts to save time and to decide intelligently what equipment is required to deliver the goods under specific ambient noise conditions.

You will need to know how to select wire and cable for given applications and how to prevent mismatch when long speaker runs are necessary. On long speaker runs, for example, the size of the wire used becomes important. If not properly calculated, mismatch will result in loss of power and lack of balance between speakers.

You will need nomographs for reading audio levels, charts for calculating acceptable limits for reverberation, information on absorption co-efficients of various acoustical materials used inside buildings. You will learn about constant voltage distribution systems, impedance matching, line matching transformers.

You will learn about speaker "dispersion" characteristics, sound pressure level ratings and other relevant data about speakers.

And you will learn all about specialized speakers designed for every conceivable application, including columnar, paging/talk-back, explosion-proof, weather-proof and even underwater speakers for swimming pools and other aquatic uses.

## Tomorrow — your Future

We mentioned audio-visual communications equipment. You know

*Continued on page 103*



Synchro-Mite's audio-visual equipment used for industrial training and sales presentations.



Fasco Model 8000 intercom in apartment house.

# Semiconductors from

**Technicians must have a general understanding of optics service new optically coupled semiconductor instruments and**

■ The January and February 1968 articles in this series have described the operation of photovoltaic cells, photoconductive cells, photodiodes, photosensitive transistors, photofets, photomos' and light-emitting diodes. Next month we plan also to describe the application of many of these semiconductors in instruments and consumer products that the technician may have already encountered or may soon encounter. We plan to include an optically coupled integrated circuit; contactless meter relays; optical-electronic insulators for a floating ground on electronic scope switches, remotely tuning the radio described in the December 1967 article and a stereo amplifier balance meter; plus a solid-state phonograph designed to play optically the standard stereo and monophonic records in current use without using a needle.

Nearly all of these photosemiconductor applications require a general understanding of lenses or fiber optics for effective servicing.

## Lenses

An in-depth understanding of lenses, including the complex mathematics for determining lens curvature for minimum distortion and the compounding of lenses to reduce shape and color distortion, is not required for the successful servicing of photosemiconductor applications normally encountered. Unless a technician is repairing TV cameras, it is fairly safe to say that none of the lenses that he will encounter are color corrected (achromatic) since there is generally no need for having the photosensitive semiconductors respond to more than one color of light. Generally, an understanding of lens focal lengths and the images formed by lens optical systems is all that is required for servicing them in new optical-electronic products.

The image (Fig. 1) used to demonstrate the function of lenses on an optical bench is merely a black silhouette of a leaf on a clear cellulose film, mounted in a supporting rectangle. When light from some relatively distant source passes around this silhouette, a fuzzy shadow of the leaf (Fig. 2) is formed on the screen without the aid of a lens.

An even less distinct image of the leaf is formed (Fig. 3) when only a lens is placed near the screen. The pattern then seen is a white ring surrounding a white disc. The outer edge of the ring is the same as the outer edge of the projected disc shown in Fig. 2, while the inner edge of the ring is the shadow cast by the lens.

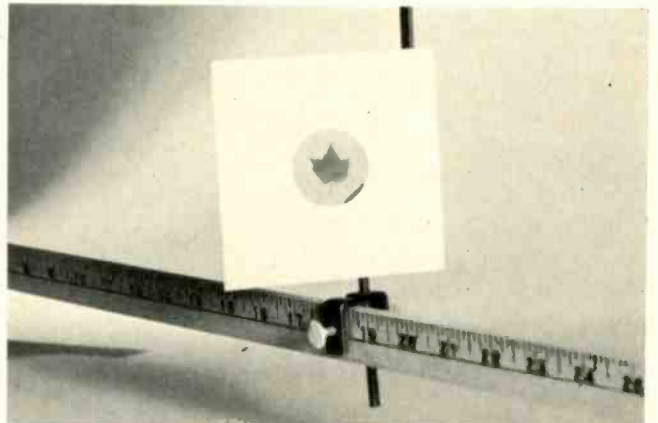

Fig. 1 — A black silhouette of a leaf on a clear cellulose film is the image used to demonstrate the function of lenses on an optical bench.

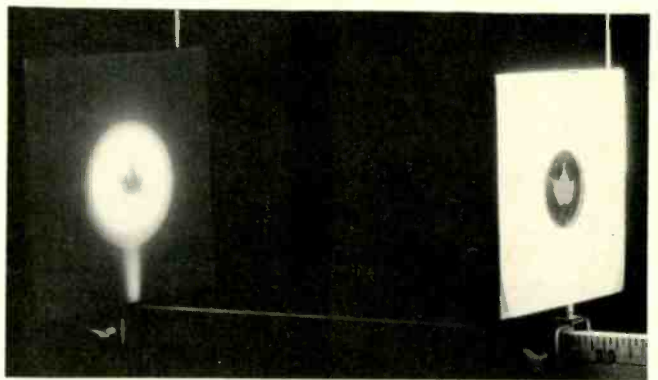
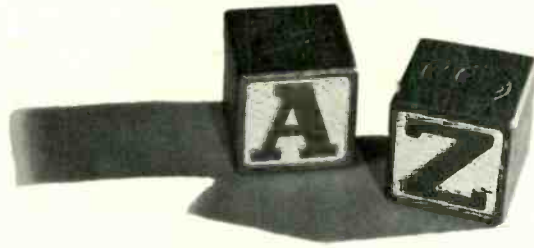

Fig. 2 — A distant light can be used to cast the shadow of the leaf on a screen without using a lens.

# A to Z



## before they can effectively consumer products

(The shadow of the lens holder can also be seen on the screen.) The leaf image formed in the central disc is not in sharp enough focus to be seen in Fig. 3. This demonstrates a problem common to many lenses. There is no sharp focal point for the entire lens. The outer edge of the lens tends to focus the image differently than the inner portion of the lens, and as a result, when light passes through the entire lens, it fails to focus sharply enough to be seen in the picture.

Without moving the lens, screen or mounted leaf pattern, the problems shown in Fig. 3 can be corrected (Fig. 4) by a mask which permits light to pass only through the central portion of the lens before striking the screen. The image of the leaf now appears in sharp focus on the screen.

Since the lens shown in Fig. 4 is nearer the screen than the cellulose film, the image on the screen is smaller than the design on the film. If a photosensitive semiconductor is substituted for the screen, the entire image of the leaf could be projected on the semiconductor despite the mounted leaf's design being considerably larger. This semiconductor is not capable of identifying the shape of the leaf's stationary image since it contains merely a single photosensitive surface which indicates

only the average amount of light exposed to it. It can, however, be used to determine whether or not the entire image of the leaf design is projected on its photosensitive surface, since this image is black and reduces the total amount of light exposed to the semiconductor.

By placing the lens nearer the cellulose film than the screen (Fig. 5), the projected image becomes larger than before. The image shown (Fig. 5) is not satisfactory, however, since we again (as in Fig. 3) failed to use a mask. The white circle in the central portion of the projected image is formed by light passing around the edge of the lens. The shadow of the lens can be seen within that circle.

This problem can be corrected by again using a mask (Fig. 6) which blocks the light passing around the lens or through its outer circumference. Only light passing through the central portion of the lens is used to form the image seen. The projected image is now complete (Fig. 6) and in better focus than before (Fig. 5).

Since the lens in Fig. 6 is nearer the cellulose film than the screen, the image on the screen is larger than the design on the film. In some rare instance, a photosensitive semiconductor might be secured to the upper portion of the screen and used in an electronic circuit for

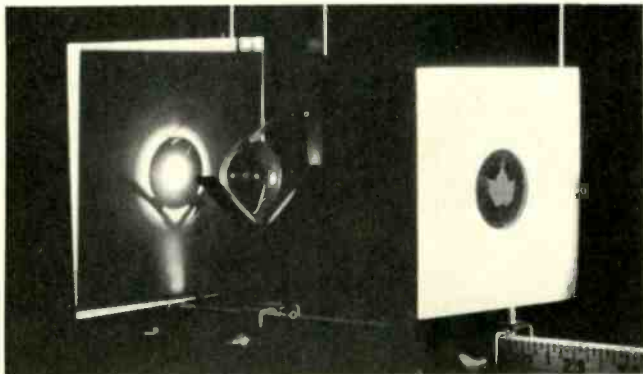

Fig. 3 — An unshielded lens usually fails to project a satisfactory image.

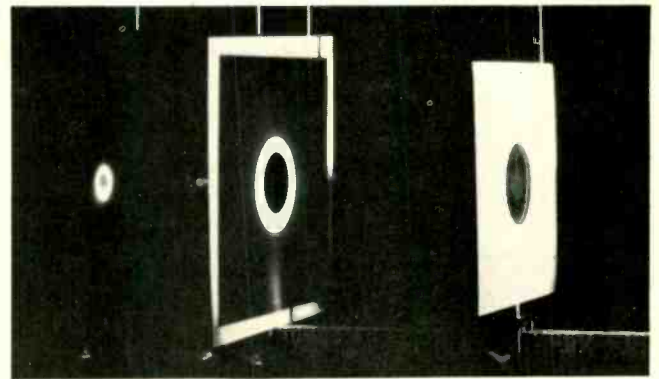

Fig. 4 — When the lens is nearer the focused image than the film, the image on the screen is smaller than the design on the film.

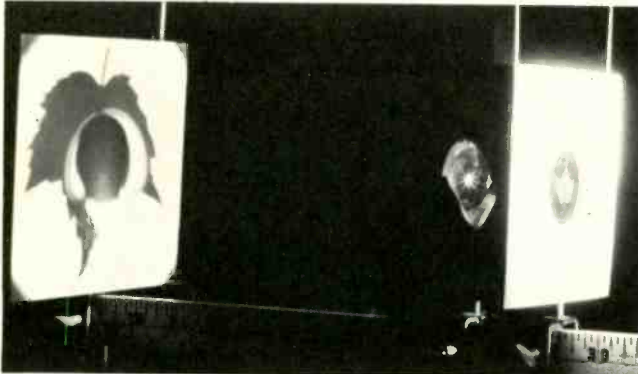

Fig. 5 — A lens usually fails to form a satisfactory image when there is no shield to block light passing around the sides of the lens or through its outer circumference.

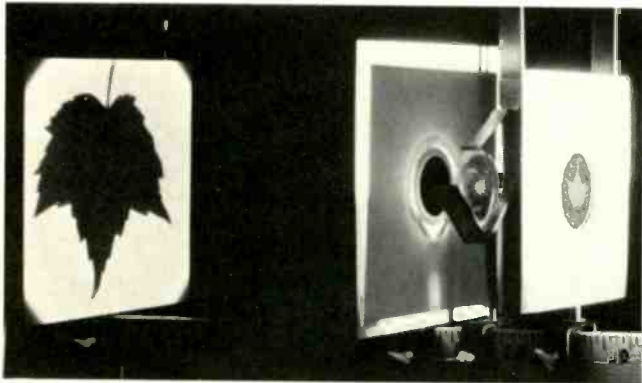

Fig. 6 — When the lens is nearer the film than the focused image, the image on the screen is larger than the design on the film.

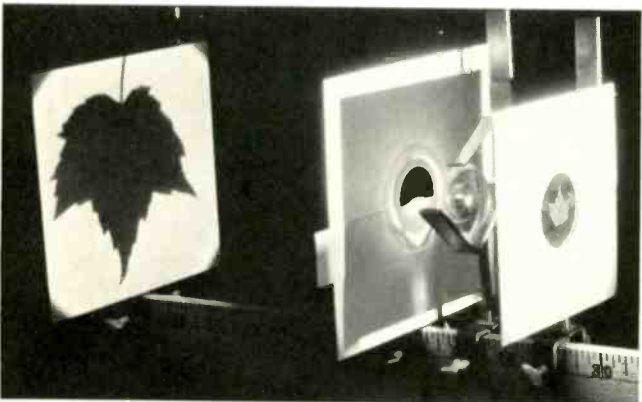

Fig. 7 — Nearly half the light normally passing through a lens can be blocked without affecting the quality of the image formed.

counting the stems of passing leaves — the image has been magnified so that the photocell can detect it.

It is interesting to note that we can block nearly half the light passing through the lens to form the image shown in Fig. 6 without reducing the quality of the projected image (Fig. 7). (This fact is important for one of the products that we expect to describe next month.)

When light from a relatively distant source is brought to focus on a screen (Fig. 8) through the central portion of a lens, the distance between the screen and the lens

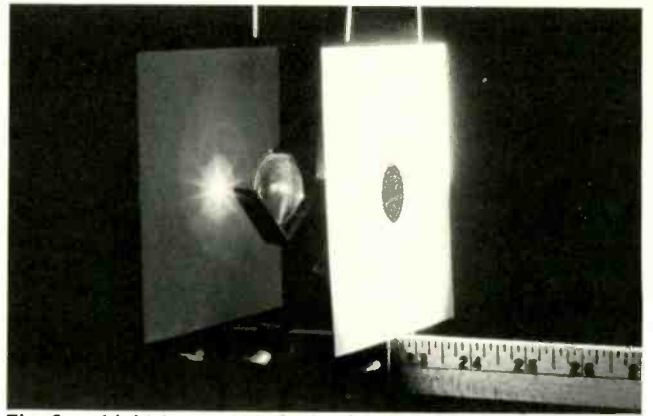

Fig. 8 — Light from a relatively distant source can be focused on a screen at virtually the focal length of the lens.

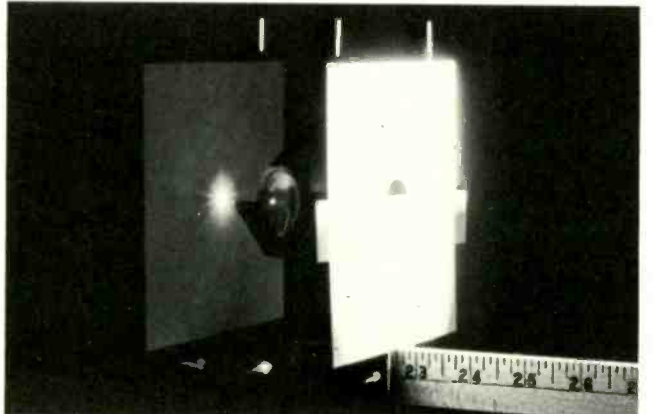

Fig. 9 — The shape of an image formed at the lens' focal length is not affected by reducing to less than half the portion of the lens used to focus it.

is virtually the focal length of the lens. Even when light is permitted to pass through less than half the portion of the lens used to focus it in Fig. 8, the remaining light is still focused as before — the image formed (Fig. 9) is merely a little less intense. This fact is also important.

The lens must be a certain distance between the object and its projected image (Fig. 10) to form the images shown in Fig. 4 and 6. The focal length of the lens ( $f$ ), the distance between the object and the lens ( $d_1$ ) and the distance between the focused image and the lens ( $d_2$ ) can be applied to the equation:

$$\frac{1}{f} = \frac{1}{d_1} + \frac{1}{d_2}$$

If we know that a lens has a 5-in. focal length and that the object is 20in. away, we can calculate the distance from the lens where the image can be focused on the screen.

$$\frac{1}{5\text{in.}} = \frac{1}{20\text{in.}} + \frac{1}{d_2}$$

$$\frac{1}{d_2} = \frac{1}{5\text{in.}} - \frac{1}{20\text{in.}} = 0.20/\text{in.} - 0.05/\text{in.}$$

$$= 0.15/\text{in.} \quad d_2 = \frac{1}{0.15/\text{in.}} = 6\frac{2}{3}\text{in.}$$



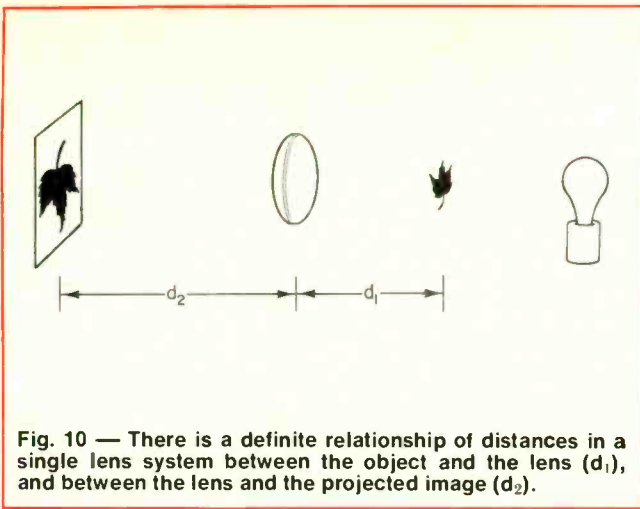

Fig. 10 — There is a definite relationship of distances in a single lens system between the object and the lens ( $d_1$ ), and between the lens and the projected image ( $d_2$ ).

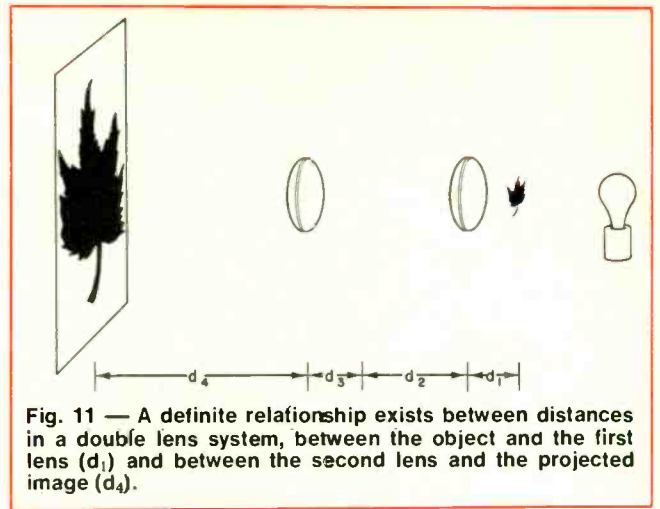

Fig. 11 — A definite relationship exists between distances in a double lens system, between the object and the first lens ( $d_1$ ) and between the second lens and the projected image ( $d_4$ ).

These calculations indicate that when an object is 20in. from the 5-in. focal length lens, its image is formed 6 $\frac{2}{3}$ in. from the other side of the lens.

We know from Fig. 4 that since the image in our example is nearer the lens than the object is, the image is smaller than the object. If the image and object distances are interchanged (Fig. 6), the image would be larger than the object.

The same equation can be used to show that when the object is 10in. from the 5-in. focal length lens, its image is formed on a screen 10in. from the other side of the lens. In this instance the image and object are the same distance from the lens and are the same size.

The equation can also be used to show that a 5-in. focal length lens will focus the light from a source 1000 in. away onto a screen 5.025in. from the lens. As indicated for Fig. 8, the lens is focusing light at virtually its focal point. If the light had been from an even more distant source, its image would have been focused even nearer the lens' focal length.

There are occasions when a greater magnification or reduction in image size requires more than a single lens. When two lenses are used (Fig. 11),  $d_1$  represents the distance of the object from the first lens,  $d_2$  represents

the distance of the imaginary image (the image that the first lens could have formed had there been a screen) from the first lens,  $d_3$  represents the distance of that imaginary image from the second lens and  $d_4$  represents the distance of the final focused image from the second lens. These distances can be applied to the equations:

$$\frac{1}{f_1} = \frac{1}{d_1} + \frac{1}{d_2} \text{ and } \frac{1}{f_2} = \frac{1}{d_3} + \frac{1}{d_4}$$

Since the distance between the two lenses ( $d_1$ ) in this optical system must equal the distance of the imaginary image from the first lens ( $d_2$ ) plus the distance of the imaginary image from the second lens ( $d_3$ ), ( $d_1 = d_2 + d_3$ ), we can combine the two preceding equations and arrange them in a more convenient form.

$$\begin{aligned} \frac{1}{f_1} + \frac{1}{f_2} &= \frac{1}{d_1} + \frac{1}{d_2} + \frac{1}{d_3} + \frac{1}{d_4} \\ &= \frac{1}{d_1} + \frac{1}{d_L} + \frac{1}{d_4} \end{aligned}$$

$$\frac{1}{d_4} = \frac{1}{f_1} + \frac{1}{f_2} - \frac{1}{d_L} - \frac{1}{d_1}$$

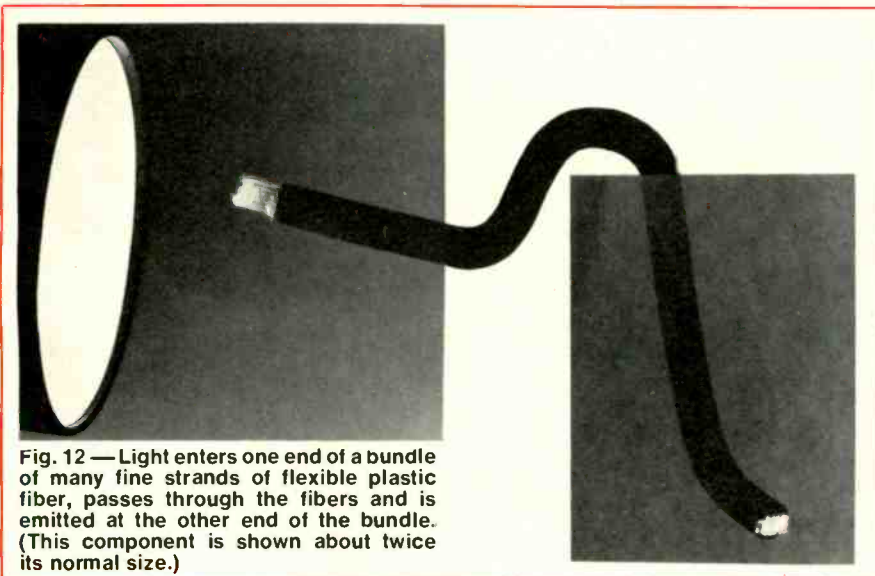

Fig. 12 — Light enters one end of a bundle of many fine strands of flexible plastic fiber, passes through the fibers and is emitted at the other end of the bundle. (This component is shown about twice its normal size.)

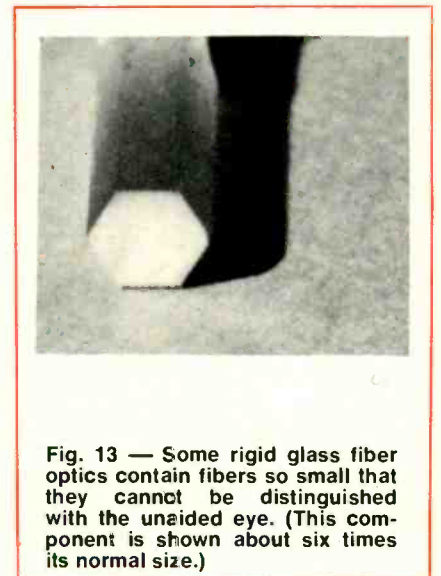

Fig. 13 — Some rigid glass fiber optics contain fibers so small that they cannot be distinguished with the unaided eye. (This component is shown about six times its normal size.)

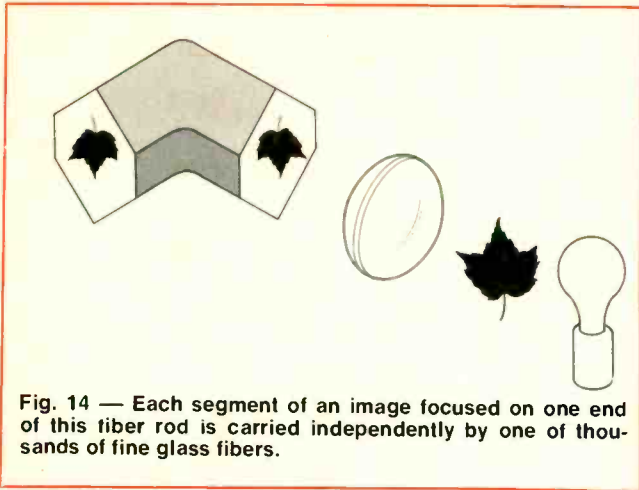

Fig. 14 — Each segment of an image focused on one end of this fiber rod is carried independently by one of thousands of fine glass fibers.

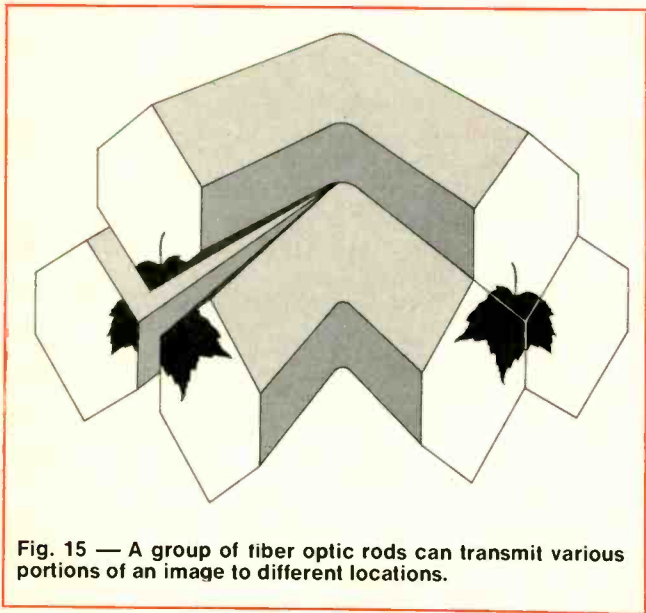

Fig. 15 — A group of fiber optic rods can transmit various portions of an image to different locations.

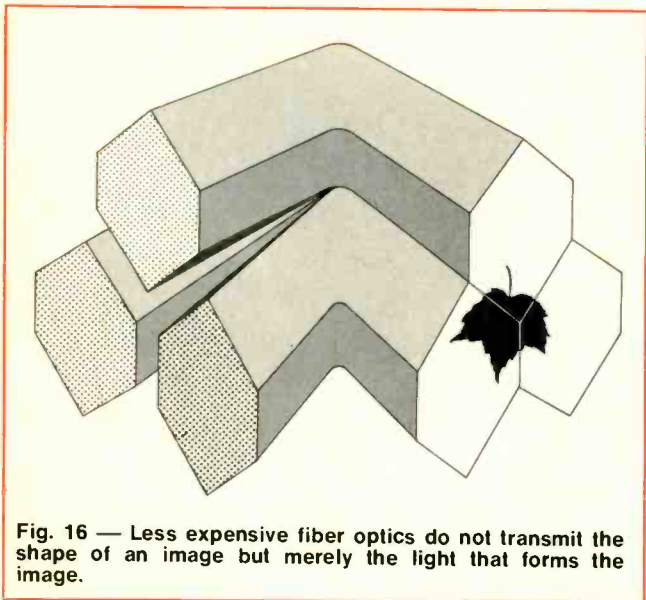

Fig. 16 — Less expensive fiber optics do not transmit the shape of an image but merely the light that forms the image.

In a double lens system the focal lengths of the lenses used ( $f_1$  and  $f_2$ ) remain constant while the object and focused image distances ( $d_1$  and  $d_4$ ) can vary and are mutually dependent — like the object and focused image distances ( $d_1$  and  $d_2$ ) in a single lens system. Since a change in the distance between the two lenses ( $d_L$ ) can vary the relationship between the object and focused image distances ( $d_1$  and  $d_4$ ), changes in this distance ( $d_L$ ) have the effect of changing the total effective focal length ( $f_T$ ) of the double lens system

$$\left(\frac{1}{f_T} = \frac{1}{f_1} + \frac{1}{f_2} - \frac{1}{d_L}\right).$$

### Fiber Optics

Light can also be “piped” to perform many desired functions. When light is applied to one end of a bundle of glass or plastic fibers (Fig. 12), it travels through the fibers and appears at the other end of the bundle.

There are many types of fiber optics on the market, ranging from the flexible, relatively coarse plastic fibers shown in Fig. 12 to rigid glass fibers that are so fine that one fiber can not be distinguished from another with the unaided eye (Fig. 13).

When an image is focused on one end of a fiber optic rod, like the one shown in Fig. 13, each fiber independently transmits a minute segment of the image from one end of the rod to the other (Fig. 14). In some rods the grain is so fine that an unaided eye can not detect it in the transmitted image.

Earlier in this article it was indicated that a single photosensitive semiconductor is unable to identify the shape of a stationary image, although it is able to determine the portion of the object’s image focused on it. (It can only tell if it sees half of an object, a quarter of an object, etc.) It can not be designed to center an object on its photosensitive surface. However, by splitting an image with three fiber rods (Fig. 15), three photosensitive semiconductors can be used to center the image on the common fiber rod surface. The image is centered when the three photosensitive semiconductors receive the same amount of light.

Fiber optics that transmit light in a coherent manner (maintaining the image’s shape) are more expensive to produce than fiber optics with twisted fibers that break the picture up in a random manner. Since the photosensitive semiconductors are unable to distinguish the shape of a stationary image and respond to only the light intensity corresponding to the segment of the image focused on their photosensitive surface, there is no need to use more expensive coherent fiber optics in the products that we plan to describe.

Three photosensitive semiconductors connected to the fiber rods shown in Fig. 16 can be used to center the image on the common fiber rod surface as effectively as three photosensitive semiconductors connected to the fiber rods shown in Fig. 15.

Next month we will cover several practical applications for photosensitive and photoemissive semiconductors, while the following month we expect to begin a study of solid-state power supplies. ■

# THREE DOWN ...

## Bob shows 'Scoot' how to lick three common problems in record time

■ "Hey Bob," Scoot said to his boss, "this color chassis Tommy brought in has a keystoneed raster but a new yoke doesn't fix it. What do you make of it?"

"Let's see, Scoot — hmmm. It doesn't look keystoneed too much, kind of pinched at the bottom. I'll have to admit, though, it does look like a yoke problem. Did you use the proper yoke for it?"

"Of course I did. I have just one problem. What do I do to find out what's wrong?"

"It's a job for the scope, Scoot. Wheel the scope over and we'll have a look at it. Set it up. What frequency do you want to look at?"

Scoot moved the scope as Bob spoke but stared blankly at it.

"Well, the raster is smaller at the bottom than at the top which means

that the horizontal scan lines are shorter at the bottom of the screen. I guess that means we need to look at the 15.75kHz waveform."

"Almost right, Scoot. We need to look at the horizontal waveform all right, but at a vertical rate. Remember, the horizontal scan lines are becoming shorter as the sweep progresses toward the bottom of the screen so we will need to see these waveforms at the vertical rate. Now, where do we start?"

"At the risk of being wrong again, I'll say at the grid of the horizontal output tube."

"Very good, Scoot. Hook the scope probe on to the grid."

Both men studied the waveform. The pattern was straight-edged on top and bottom (Fig. 1).

"It looks OK to me, Bob. Or

Fig. 1 — With the scope connected to the grid of the horizontal output tube the waveform was flat on both top and bottom.

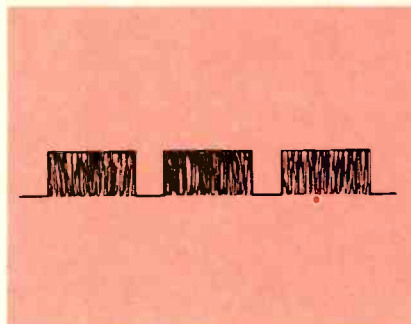
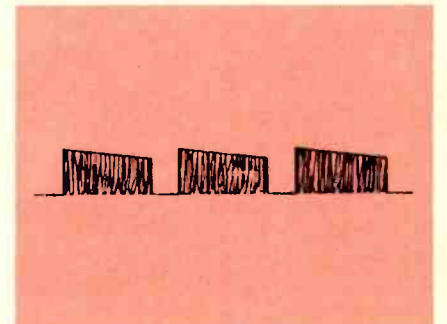

Fig. 2 — Both the plate and cathode signal showed a taper to the waveform although the signals were 180deg out of phase.



## THREE DOWN . . .

don't I know what I'm looking for?"

"It looks good all right, but don't make me answer your question. Let's move the scope probe to the output plate."

"Wait a minute, service instructions say not to observe or measure the output plate waveform. As I recall, it's a 5kv pulse and it can damage test instruments."

"That's partly true, Scoot. But if you want to look at the waveform, you can — by clipping the scope probe onto the insulation of the plate cap lead. You won't be able to measure the waveform amplitude but you can look at the waveform shape. And more important, in this case, the shape of an entire field of horizontal waveforms."

"Now clip the scope probe on the lead and we'll have a look."

"Hey! By jinkies it does have a taper to it (see Fig. 2). But what's that mean? The grid signal was good. Trouble in the plate circuit?"

"Not hardly, Scoot. This set has a resistor in the cathode circuit. Take a look at the waveform there."

Scoot hooked the scope on the cathode and reset the gain of the scope to read the pattern.

"I'll be darned. The waveform is tapered there, too (Fig. 2)."

"Right. Now what could cause the waveform on the plate and the cathode to be different from that on the grid: How about the screen?"

Scoot grabbed a meter and was about to measure the voltage.

"Wait just a minute. You've got a scope in your hand, what do you want that meter for?"

"Well, there's nothing on the screen except dc. A scope won't see anything."

"You mean there's not supposed to be anything on the screen but dc. Put the scope probe to it."

"Looks sort of like a sawtooth (Fig. 3). You mean to say that's what's modulating the output?"

"That's it all right. Now all that's left is to find the bad filter and you've got it licked. There's a couple

in that line — try jumping them to locate the bad one. Seems almost too easy to have asked for help, doesn't it?"

Scoot looked perplexed at Bob's last statement and went for the 'lytic sub box.

"This is it, Bob, this two-section job up in the power supply. But I don't see why you're acting so smug. I'll bet you couldn't have found that yourself when you had no more experience than I have."

"Undoubtedly, Scoot. When I had that little experience, the color set hadn't been invented!"

### Almost Focused

"OK, OK. Don't rub it in. Say, I've got another one over on the 23in. jig that's giving me trouble. How about having a look at it?"

Bob nodded his head and Scoot went on.

"I can't quite get it focused. The slug is all the way in and the focus voltage is just about what the book calls for."

"With the focus voltage 'just about' what the book calls for, the slug should be about in the middle. Do you have any other symptoms? I mean, like narrow picture or low high voltage?"

Scoot looked up at the high voltage meter built into the jig. It read 24kv. The line meter read 115v so Bob and Scoot concluded that all was well there.

"With the high voltage and the width normal, we can assume that everything at the plate of the horizontal output is normal. And since that's where the waveform for the focus circuit is picked up, the trouble must be in the focus circuit."

Bob pulled the plug on the set and reached into the high voltage cage.

"There's the trouble, Scoot. A bad focus rectifier. Here, feel this."

Bob guided Scoot's hand into the cage and moved Scoot's fingers along the focus rectifier stack on the side of the flyback.

"It's got little bumps on it. What's that mean?"

"It probably means that there are several shorted selenium cells in the rectifier. Go ahead and change it and your problems should be solved."

"You can't always spot a bad rectifier by feeling for bumps on it but it's a sure sign that it is bad if there are bumps on it. Even if it feels good, I'd advise changing it. That's what usually goes wrong in this particular circuit."

Scoot began to change the rectifier while Bob went back to the 21 in. jig to hook up another chassis.

"Here's one you should have, Scoot. You brought it in. Let's see. It belongs to the Gordens."

"Oh, yeah. That one had absolutely no color. And don't say it's probably the killer. I tried it in the house."

### B/W Rainbows

Bob had the set hooked up and switched it on. He connected the antenna to a coax jack on the front of the bench marked generator and set the generator under the bench to "color." A B/W "rainbow" pat-

Fig. 3 — Power supply ripple modulated the horizontal output signal through the tube screen.

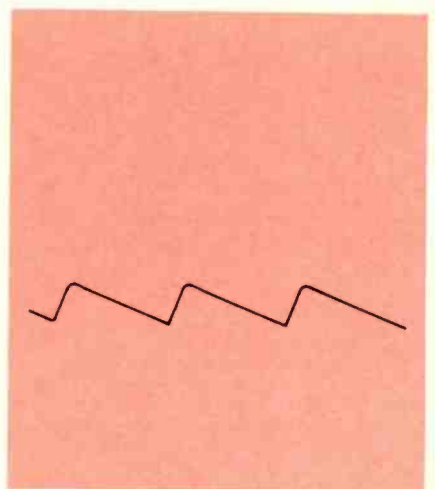

tern came on the screen. He switched the color killer on the set to OPEN and adjusted the color control fully clockwise. He adjusted the fine tuning but with no results. He walked for the scope.

"Stuck, huh Bob? You should be able to put your finger on that without the scope."

"I'm sure I could, Scoot, but the scope will make it quicker. Why don't you come here and watch. You might learn something."

Scoot walked over to watch the master.

"One thing that can cause this is no burst getting through to the phase detector, killer and so on. We can find that out if we go first to the plate of the chroma amplifier. But since we haven't any idea of where the color signal has been lost, we might as well start right in the middle at the most convenient spot. Right? Now where do you suppose that would be?"

"It seems like you told me that one of the controls was the best place. I guess it was the color control."

"You're batting about 750 today, Scoot. That's it."

Bob walked to the file nearest his bench and pulled out a schematic (see block diagram, Fig. 4.).

"Now we'll connect the scope probe on here (point 1). So, there's the answer — nothing. That means the trouble is ahead of the demodulators and the color difference amplifiers. So, we'll have to look at the schematic closer and find out where to go.

"We might just as well start in the middle of this circuit, too. Here's the plate of the first chroma amplifier (point 2). The signal is good there. The next stage is the bandpass amplifier."

Bob moved the scope probe to the bandpass plate (point 3).

"Looks like there's plenty of signal there, too, Bob," Scoot said. "And that's just ahead of the color control."

"Not quite. The bandpass transformer and a lot of wire goes between. The fact that the signal is normal on the plate of the tube is a good indication that the primary of the bandpass is OK, so let's check showed the secondary open.

Bob picked up the "solder-sucker" iron and removed the solder

from the terminals of the bandpass transformer. An ohmmeter check proved Bob's suspicion that the secondary was open.

"Now what are you doing? It's open. Why don't you just replace it?" Scoot asked.

"It's a standard part, Scoot, and I used the last one yesterday. Farber goofed up on our stock and we're out of them. I've fixed a lot of these. It's usually a broken wire right at one of the lugs or a cold solder joint."

Bob had the case of the transformer now and was examining the connections.

"Here it is. See, this wire is barely touching the lug. We're lucky this wasn't an intermittent."

Bob bent the lug slightly and soldered it back. In a minute the can was back in the set.

"Won't the set need a color alignment now?" Scoot asked.

"No, they're not that critical. You'd have to hang quite a blob of solder on the terminals before it would make much difference here. Somewhere along the line a lot of technicians got the idea that the color section was more critical than any other part of the set but if they'd stop and think, they'd realize that 3 or 4MHz could not be nearly so critical as the 44MHz IF components. Now there's where a blob of solder can make quite a difference.

"There's your color, Scoot. Learn anything?"

"I think so, Bob. But I never realized how hungry I could get listening to you talk. Let's go get something to eat. My wife yells at me every night because I don't eat and it's all because we never get to Pete's until 2:30."

"All right, I get the idea. I can't afford to get in trouble with your wife, too. I've got enough trouble with my own.

"When we get back, I'd like you to get those two other color sets out. I've got a couple of two-way jobs to finish." ■

Fig. 4 — The arm of the color control is a convenient starting place to trace color trouble. Points one, two and three show how Bob progressed to find the broken lead in the bandpass amplifier.

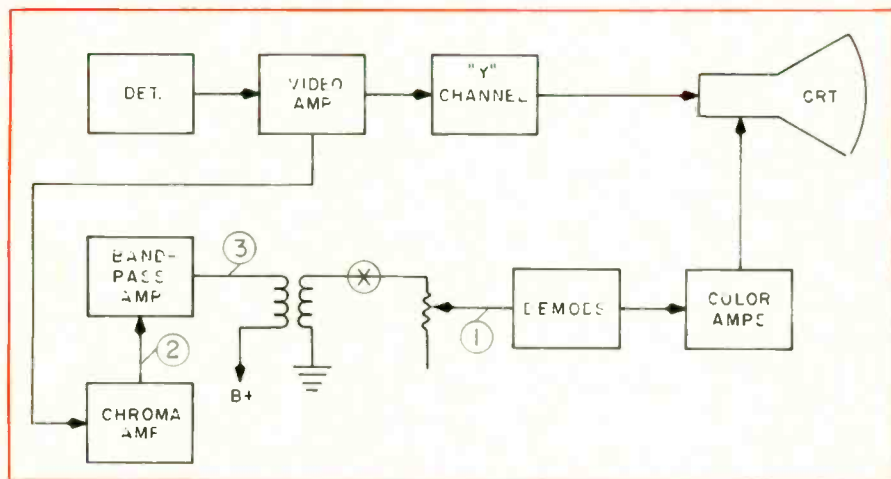



## DEALERFAX

ADVERTISING/MERCHANDISING/SALES/BUSINESS MANAGEMENT

# 'LIGHT-HEARTED

'We never get serious about spending

■ It wouldn't be fair to say that any one service-dealer has cornered the market on unique sale approaches, but ET/D recently visited a very interesting man with some very interesting sales techniques. His name is Richard Bischke, owner of Richard's TV in Miracle Mile, a shopping center in Rochester, Minn.

Mr. Bischke grew up in a family-owned radio-appliance sales and service store in Harvey, N. D. He spent 14 years in the store repairing radios. In 1952, he went in business for himself selling and servicing radios and phonographs. His store was a \$25-per-month rental area in the basement of a department store. By 1958 he outgrew the basement and built his own store, a block structure 25 by 50ft. The main floor was devoted to sales and the basement divided half for service and half for stock. At this time he had two technicians and grossed about \$60,000 a year. In 1960 he sold the store to one of his men and struck out for greener pastures.

Mr. Bischke and his family decided on the Rochester, Minn., area and purchased an existing TV-radio and appliance store. A short time later they sold out the appliances to become strictly a TV-radio service-dealer operation. For the past eight years Richard's TV has been a vital part of the Miracle Mile business community.

Richard's TV has a staff of two full-time technicians and one salesman. Besides Mr. Bischke, his wife

and daughter are very active in the business. Mr. Bischke takes part of the sales load and schedules shop service repair and home service calls with his technicians. His wife and daughter keep the book work in order, which is a big job in any business. The store does an annual gross business of \$180,000 and carries an inventory of about \$35,000. About 3 percent of the annual gross business is spent on advertising, which is done in the local newspaper. Mr. Bischke writes all of his advertising material and estimates about 50 percent of his business is from customers who recommend the store to their friends. As he puts it, "We have a close working relationship. We aren't trying to get rich, but we have a good business, a fine location and we're happy — and best of all, our customers are happy."

### 18-Month Warranty on TV?

Typical of Mr. Bischke's sales initiative is an 18-month warranty on new TV sets, which he once instigated to compete with some other local stores offering one-year warranties. The program worked like this, Mr. Bischke explained: "Each customer purchasing a new TV was given three coupons. For every service call made after the set was installed, the customer surrendered a coupon. The warranty lasted for 18 months or until the three coupons were used, whichever came first.

We did this for two reasons. It

allowed us to offer the customer more than the one-year warranty, and it kept the 'nuisance' calls to a minimum. In fact, the nuisance calls were so few that I found we were providing service on many of the sets which had been in operation for almost 18 months. People used their coupons only when the set had a real problem. Consequently, many customers had coupons left right up to the end of the warranty! But it proved to be a good way for us to get around the year warranty offered by our competitors." He even has a little gimmick for collecting accounts. "I have a magic sentence at the bottom of each monthly statement," he smiles. "It says '\$1 service charge per month on the unpaid balance.'" This is typical of the many ideas Mr. Bischke has put into action to make his business a success.

### Keep Em Smiling

Mr. Bischke has a very unique sales tool — a winning personality. And he knows how to use it!

"The first thing I do when a customer comes in," he smiles, "is get *him* smiling. Selling is like a sport — like boxing. You have to get in step with the customer and punch accordingly. There can be a million reasons for a person to be unhappy, but get a man to smile and you have opened a big door. When people are happy they generally like to do things that will keep them that way. We sell merchandise to give people pleasure.

# APPROACH WINS SALES'

money — the customer's money,' says Rochester, Minn., service dealer

"I usually approach a customer coming into the store by asking him if I can be of service in some way — only I do it in a manner that immediately throws him off guard. I use a light-hearted approach. I *never* get serious. For instance, when a customer comes in I say 'Can I help you?' The customer might then say he is only looking, to which I answer, 'Fine, we are happy to have you in our store, some of our best customers started by looking.'

"We have about six stock questions we normally ask a customer to qualify him — to feel him out as to which set fits his needs. We try to act as though the customer is going to buy, it's just a matter of which set will make him happy. One ingredient we feel essential in sales is enthusiasm. You have to believe in what you are trying to sell. It rubs off on the customer.

"As I said, I never get serious, especially about the business of spending money. Spending money is the worst part of buying in the customer's eyes, so why emphasize it? Even when I get to the point of closing a sale on a contract for example, a customer isn't signing a big monthly installment plan, he's signing our 'guest book.'"

## We Sell Happiness

Richard Bischke feels that people come to the store to buy something which will give the family enjoyment.

"We don't sell nuts and bolts,"



Richard's TV in Miracle Mile Shopping Center.



Main floor display area — well lighted with large selection of TV and stereo equipment.



Technicians mount a color TV on portable table for servicing. Table is innovation of technicians and consists of cloth covered bench with legs and casters.



Richard Bischke uses two-way radio to maintain contact with his service trucks.

says Mr. Bischke. "Customers want to be happy with what they buy, and they have their own ideas of what they want. When a man and wife come into the store to buy a TV or stereo, they usually size the item up for its style and color — in other words, they want a compatible, good-looking piece of furniture. So I give them what they want in terms of a fine piece of furniture, then it's easy to sell them on the features.

"We take trade-ins, too, but I use a little different approach when selling used TVs," says Mr. Bischke as he leads ET/D's reporter to a row of assorted cabinets along the wall. "Take a look at the tags on these TVs and you'll see what I mean," he smiles. On each of the sets there is a tag with a little poem and the price. Every one is different and normally has something to do with the appearance of the set. On one set was written "Take me home — I'm priced right. An extra TV can prevent a fight — \$50." Every used TV in the store had some little ditty attached to brighten it up.

We asked Mr. Bischke about his color TV sales in particular, and whether he had a problem with other stores in the area which offered free home demonstrations. Mr. Bischke grinned and said, "Well, I have an answer for that, too. We don't give free home demonstrations

and the reasons we don't are very simple. First, when a customer comes in for a color set we offer what's being looked for — something to give the family pleasure. The customer has a choice of furniture, sees the set in operation and knows we will make sure it stays in top shape. What more could a customer want? If we sold TV on home demonstrations, there would always be the possibility that the customer would want to argue price once the set is installed. We avoid this problem. When we sell a set, the customer gets it at a fair price and it's finalized before the set goes into the home. For that reason we don't end up haggling price with the customer and we don't end up with a bunch of used color TV sets. Our customers know what they are getting, how much it is costing and that we will stand behind it.

#### Service and Rental TV

"We carry our light-hearted approach right on through to our service department," continues Mr. Bischke. "Service makes up about 15 percent of our business, and a lot of our service customers come back to the store to buy."

Richard's TV has two service trucks and the technicians normally spend mornings in the shop and afternoons in the trucks making

house calls. The trucks are equipped with two-way radios which, Mr. Bischke feels, help him make more efficient use of the vehicles, especially if a rush service call is necessary. Mr. Bischke also has a rental TV service which is kept fairly active because of the large number of transients in town who visit the world-famous Mayo Clinic.

"We have to keep in touch when the trucks are out on calls to service our customers and rental accounts properly," asserts Mr. Bischke. The technicians schedule service calls for the following day which normally amounts to about 25 calls for the two trucks. When a tough problem is encountered during a service call and the set has to come into the shop, the technician will call the store on the two-way radio and schedule the set for pickup later that day. Two part-time men are used for pickup and delivery.

The technicians at Richard's TV work on a variety of items and labor charges are made accordingly. Bench charges are \$7 per hour for color TV work. A \$4 per hour flat rate is charged for transistor radios brought into the shop, \$2 per hour for tube type radios and \$3.50 for portable TVs. House calls are \$7.50 per hour for color TV, \$5.50 per hour for B/W and \$5 for pickup and delivery (or \$2.50 one way). ■



# No Secrets To Merchandising

Modest-sized family-owned operation shows steadily increasing sales

■ "There are no secrets to successful merchandising," says Earl Saathoff, president of Saathoff's, a two-store, family-owned operation in San Antonio, Tex.

"We think the two most important things are adequate floor space and a good service department," Mr. Saathoff emphasizes.

The Saathoffs have sufficient space to display about 50 color sets in each store. In addition to the special rooms for demonstrating color, another room in each store displays B/W sets.

The volume of business at Saathoff's has increased 20 percent every year for the past four years. Gross sales of TVs, radios and stereo equipment were about \$500,000 during the past year.

Earl Saathoff feels that this steady increase in business has come about primarily because of his merchandising policies which can be briefly summed up in his own words: "We give people value for their money and personal attention to service problems."

"Ninety-eight percent of our prospective customers want color TVs," Mr. Saathoff says. "And we started selling color here 12 years ago, before any other dealer would touch them," he smiles.

Generous parking space in front of each store is another important factor in merchandising, the Saathoffs believe.

"When a customer does not have to worry about a parking meter, he

can spend more time deciding to buy that TV set you want to sell him," Earl Saathoff says.

This generous parking space brings in more customer traffic to both stores, one located at 1134 W. Hildebrand and the other at 2340 E. Southcross.

"One store serves the South side of the city and the other serves the North side," Mr. Saathoff explains.

The Saathoffs now have four of their sons working in the business. Three salesmen are employed full time in each store.

## The Service Stance

Earl Saathoff believes in a well-managed and capable service department. "Customers feel more confident when a member of our family takes care of their problems," he declares.

Cliff Saathoff, one of the sons, gives personal attention to all service problems that arise. He is assisted by four technicians, two at each store.

"One technician has been specially trained to handle the shop work," Cliff Saathoff explains. "The other three have been trained for installation and in-home service work," he concludes. ■

And many times the youngsters will return with their fathers who frequently wind up buying a color TV set.



Comfortable chairs around a B/W TV facing the front door brings in the "little tries."



# DEALER SHOWCASE

For additional information on products described in this section, circle the numbers on Reader Service Card. Requests will be handled promptly

## Tape Deck 700

Announced is a playback-only solid-state four-track stereo tape deck designed for installation into an existing



stereophonic playback of four-track prerecorded stereo tapes. The TC155 operates at 7½, 3¾ and 1⅞ips. It also has a retractomatic pinch roller for threading ease as well as a stereo headphone jack. Sony.

## Columnar Speaker 701

A Columnar speaker has been added to a line of audio communications equipment. Specifications indicate that it contains six transducers arranged in a frequency tapered array designed to produce audio at the same level for people located in both the back row and up front. Its rated frequency response is 150 to 8000Hz ±5db with a sensitivity greater than 48db. The manufacturer indicates

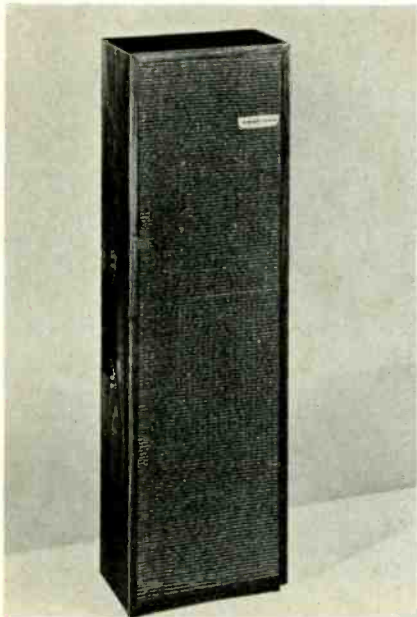

that it is included in a 30in. high, walnut-veneer case with brown grille cloth and a carrying handle on the side. Manufacturer's suggested net price \$59.95. Perma-Power.

## Two-Way Remote Controller 702

A line of low cost wall-type and desk-top remote control consoles — called "Deskon" — for FM two-way radio systems is announced. All solid-state and designed to control remotely placed two-way radio base stations over a telephone line, the unit comes



in the familiar telephone style with many features found only in larger consoles, it is said. All models are equipped with intercom as a standard feature, which enables up to five consoles, connected in parallel, to be used like an office intercom system without tying up the air frequency. An optional supervisory control feature permits the supervisor at that control console to monitor and cut off, if necessary, transmission from other consoles to mobiles. G-E.

## Indoor Antenna 703

Announced is a "rabbit ears" antenna which features a tall slim silhouette, fold-away dipoles and a synchronized rotating scanner making it unnecessary to rotate the antenna base. The Monitor 1000 works on UHF (channels 14-83), VHF (channels 2-13) and FM. Other features of the antenna include a dual UHF loop, rugged, highly conductive brass dipoles plated with satin finish chrome. The antenna is said to have a virtually unbreakable, static repellent plastic case. A UHF/VHF function switch, a multiposition phasing switch and separate leads for UHF and VHF with

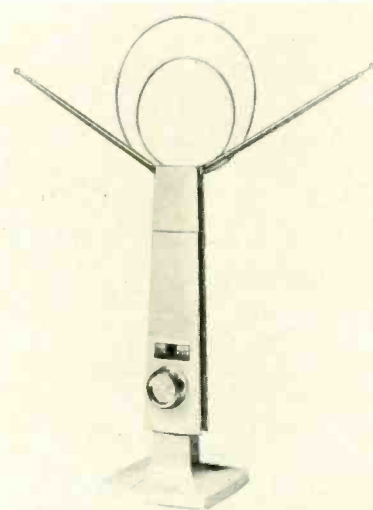

GAVIN MONITOR 1000 INDOOR ANTENNA

heavy-duty terminal lugs are also provided. Gavin.

## Earphones 704

Announced is a set of earphones that reportedly use a dynamic woofer and a ceramic tweeter interconnected



by a crossover network. Specifications indicate that a soft, tight ear seal is provided by removable vinyl cushions filled with urethane foam. A spring steel headband is designed for all head sizes. Net price \$50. Superex.

## Stereo 8-Track Cartridge Recorder 705

An 8-track cartridge recorder is designed for those who are building a library of stereo 8-track cartridges for automobile or home enjoyment. The cartridge tape recorder provides an economical means to record and duplicate 8-track stereo cartridge

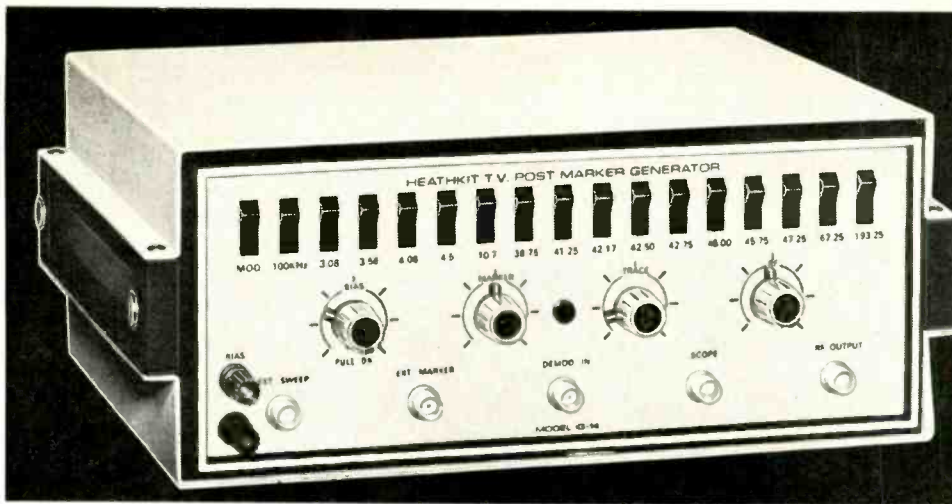

**new**  
**HEATHKIT®**  
**solid-state**  
**crystal-controlled**  
**POST-MARKER**  
**GENERATOR**  
**only \$99.95**

**the most important instrument you can own for Color TV and FM alignment now costs a lot less...the Heathkit IG-14**

• 15 crystal-controlled marker frequencies • Switch-select picture and sound IF frequencies, color bandpass and trap frequencies, 6 dB points, plus FM IF center frequency and 100 kHz points • Use up to six markers simultaneously for faster TV alignment • Birdie-type markers • Trace and Marker amplifiers and size controls • 400 Hz modulator • Variable bias supply • All solid-state, 22 transistors, 4 diodes • Circuit boards

**Fast, Accurate Color Alignment.** Speed and accuracy are important in today's service work . . . important to your customers, important to your profits. Speed and accuracy are what the new Heathkit IG-14 gives you . . . plus features usually costing five to ten times as much.

**Just Push A Button.** That's all it takes to set a frequency . . . no dial to twiddle, no searching, no resetting problems. Fifteen switch selected crystal-controlled markers. Nothing could be easier or more accurate. The IG-14 has input and output connections so that it can be used with any sweep generator and scope. Also an external marker input. BNC connectors are used throughout.

**No Trace Distortion.** One of the big values to using a post marker generator like the IG-14 is that markers are injected after the sweep signal passes through the set being tested, thereby eliminating the 'scope trace distortion usually found when injection or absorption type marker generators are used.

**Crystal-Controlled Markers For Any TV Alignment Task.** Four marker frequencies are provided for setting color bandpass, one marker for TV sound, eight at the IF frequencies between 39.75 and 47.25 MHz, and markers for channel 4 and channel 10 picture and sound carriers for checking tuner RF response. With the ability to use up to six markers at once, such as picture and color carriers at 6 dB points, corner marker and trap frequencies, alignment is fast and precise. Trap alignment is just a matter of selecting the appropriate trap frequency, applying the 400 Hz modulation, and tuning the trap for minimum audio on a scope or meter.

**Easy FM IF and Discriminator Alignment.** The IG-14 provides *visible* markers at the 10.7 MHz center frequency plus 100 kHz markers on each side . . . visible because they are applied to the trace after detection and so are not attenuated by the discriminator. Use of harmonics, fully explained in the manual, provide tracking markers as well.

**Trace and Marker Amplitude Controls . . .** on the front panel permit using a regular service type 'scope instead of a wide-band, ultra-sensitive model . . . and stage by stage alignment is easier.

**Variable Bias Supply . . .** 0 to 15 VDC @ 10 milliamps is isolated from chassis so you can use positive or negative bias.

**New Look . . .** Circuit Board Construction. Handsome low profile, "stackable" cabinets in the new look of Heath instruments . . . finished in beige and black. Easy-to-build layout with two circuit boards.

**Save Hundreds of Dollars.** Until now, an instrument with these features cost much more. Order the IG-14 now . . . it's the best investment in alignment facilities you can make.

Kit IG-14, 8 lbs., no money dn., \$10 mo. . . . . **\$99.95**

**IG-14 SPECIFICATIONS**—Crystal Marker Frequencies: 3.08, 3.58, 4.08, 4.5, and 10.7 MHz @ .01%; 39.750, 41.250, 42.170, 42.500, 42.750, 45.000, 45.750, 47.250, 67.250, and 193.250 MHz @ .005%. **FM Bandwidth Marker:** 100 kHz. **Modulation:** 400 Hz. **Input Impedance:** External sweep, 75 ohm; External marker, 75 ohm; Demodulation input, 220K ohm. **Output Impedance:** RF output, 75 ohm; Scope output, 22K ohm. **Bias Output Voltage:** Variable from 0 to 15 VDC @ 10 MA. Isolated from chassis for either negative or positive bias. **Type of Marker:** "Birdie." **Controls:** Bias voltage with AC on/off; Trace size; Marker amplitude; RF output; Modulation on/off; Markers, individual switches for each frequency. **Semiconductors:** Transistors: (16) 2N3692; (6) 2N3395; (3) Silicon diodes; (1) Zener diode, 13.6-V. **Power requirements:** 105-125 volts, 50/60 Hz AC @ 7.5 watts. **Net weight:** 8 lbs.

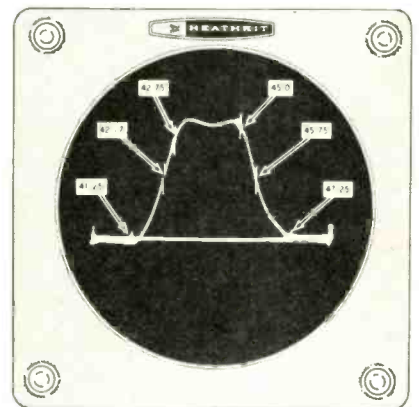

**SIX MARKERS SIMULTANEOUSLY.** The scope trace above shows how six markers can appear at the same time. Note the trap markers, 6 dB points, and picture and sound carriers . . . all on one trace with the IG-14.

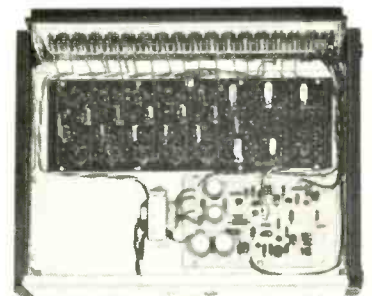

**EASY TO BUILD.** Note how everything except the front panel switches and controls mount on two circuit boards . . . even the crystals.



**FREE 1968 CATALOG!**

Now with more kits, more color. Fully describes these along with over 300 kits for stereo/hi-fi, color TV, electronic organs, electric guitar & amplifier, amateur radio, marine, educational, CB, home & hobby. Mail coupon or write Heath Company, Benton Harbor, Michigan 49022.

**HEATH COMPANY, Dept. 24-3**  
 Benton Harbor, Michigan 49022

Enclosed is \$ \_\_\_\_\_ plus shipping costs.  
 Please send \_\_\_\_\_ Heathkit IG-14 Post Marker Generator(s).  
 (quantity)

Please send FREE Heathkit Catalog.  
 Name \_\_\_\_\_  
 Address \_\_\_\_\_  
 City \_\_\_\_\_ State \_\_\_\_\_ Zip \_\_\_\_\_

Prices & specifications subject to change without notice.

TE-174

... for more details circle 121 on postcard

# To be in touch with solid-state servicing keep in touch with your RCA Distributor

This means having and using the best tools—products and servicing aids—available. Your RCA Distributor can provide these important tools... important to you if you're serious about closing the product and information gaps in solid-state servicing.

First, you'll want RCA "Top-Of-The-Line" universal SK-Series replacement transistors, rectifiers, and integrated circuits—the industry's finest. With just 31 SK types, now including six new silicon power transistors and four new 1 amp rectifiers covering PRV from 200 to 1,000 volts, you can replace approximately 10,000 solid-state devices.

You will also want the RCA Solid-State Replacement Guide—SPG-202-E. This new 48-page booklet gives a complete cross-reference of RCA SK-Series types against both domestic and international solid-state units with replacement information on approximately 10,000 types.

Hand-in-hand with the SK-Series is RCA's new Transistor Servicing Guide—1A1673—which is yours FREE with your purchase of SK-Series replacements from your participating RCA Distributor. Containing more than 200 pages, this guide includes sections on solid-state amplifier principles and radio circuits. It brings you up-to-date on the latest TV circuits, covering RF, IF, and video amplifiers. Much more, too. Get your copy at your participating RCA Distributor, and ask him about these other servicing aids:

- RCA Transistor Manual—SC-13. This book contains over 500 pages with technical data on more than 600 RCA solid-state devices.
- RCA Transistor Tester—WT-501A. The WT-501A requires no external power source, is completely portable, and tests both in-and out-of-circuit transistors. Compare it with any transistor tester you can buy... at any price!
- Storage Cabinet. Cartons of RCA SK-Series Semiconductors fit neatly into this four-drawer cabinet for visible, easily accessible storage and inventory.

RCA Electronic Components, Harrison, N. J.

# RCA

RCA SK-Series Storage Cabinet

RCA Transistor Manual



RCA Solid-State Replacement Guide

RCA Transistor Servicing Guide

SUGGESTED PRICE 26 CENTS

**RCA**  
**solid state** "TOP-OF-THE-LINE"  
**catalog & replacement guide**  
including experimenter kits

The advertisement features several RCA semiconductor products: a SK 3009 Silicon Rectifier, a SK 3008 Silicon Rectifier, a SK 3023 Integrated Circuit, and an Experimenter Kit (SK 3021). It also shows individual transistors and diodes. The background is a light-colored grid.

RCA SK-Series  
Semiconductors

Two SK-Series semiconductor packages are shown. The top one is a SK 3012 Silicon Rectifier, labeled as "TOP-OF-THE-LINE" and "OP-OF-THE-LINE". The bottom one is a SK 3011 Silicon Rectifier, also labeled as "TOP-OF-THE-LINE" and "OP-OF-THE-LINE". Both packages are red and black.

\$3.50

**RCA**  
**TRANSISTOR**  
**SERVICING**  
**GUIDE**

The cover of the RCA Transistor Servicing Guide features a circuit diagram and the RCA logo. At the bottom, it reads "RCA ELECTRONIC COMPONENTS AND DEVICES - HARRISON, N. J. The Most Trusted Name in Electronics".

For more details circle 137 on postcard

# Reward

for the recovery of each of these shunt regulator tubes



In early 1967, General Electric started a modification program to eliminate the possibility of soft downward x-radiation emission from some of its large screen color television receivers. This modification program, which involved replacement of the obsolete regulator tubes pictured above, is now complete except for a very few receivers which have not yet been located.

A second program is under way to encourage service technicians to replace the obsolete tubes in other models where they are present, even though the possibility of downward emission does not exist in these models. This program, which offers a \$5 reward plus a new replacement tube, can add to your earnings. To participate, you should be on the lookout for these three tube types whenever you service any large screen General Electric color receivers. Return the recovered tubes with the customer's name and address to any General Electric television distributor, or mail to:

**General Electric Product Service Section  
Northern Concourse Building  
N. Syracuse, New York 13212**

To promptly receive your free tubes and the reward, be sure to include your name and address.

A third program to recall all of these obsolete tubes from the replacement tube market is nearing completion. Should you still have unused tubes bearing these numbers in your shop or truck, send them to:

**General Electric Company  
P.O. Box 1008  
Owensboro, Ky. 42301**

You will receive a check in the amount of 50% of the list price plus transportation expense for each tube returned.

**GENERAL  ELECTRIC**

... for more details circle 119 on postcard

ET/D

DEALER SHOWCASE



tapes, the manufacturer says. The unit is capable of recording from a number of audio sources: home tape recorders, phonographs or FM receivers. It is simply plugged into the recording outputs of any stereo system or the line outputs of any other stereo tape recorder. Sony.

## Radio Call Box 706

A single-channel, solid-state radio call box is announced for either CB or business band frequencies. Specifici-

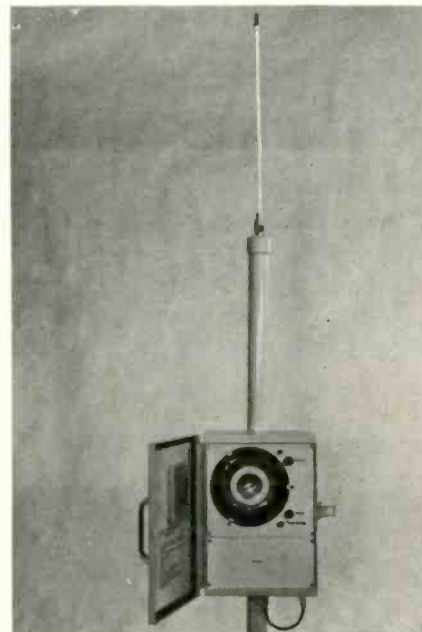

cations indicate that it is powered by rechargeable batteries and comes complete with utility pole and antenna. Price \$243.95. Polytronics.

## Home Stereo 707

Announced is a record playing mechanism that holds fifty 12-in. 33 rpm LP records vertically, together with a scanning device and a computerized memory bank geared to a dialing apparatus. The owner merely dials

# Now! Cash in on the big boom in TV distribution systems

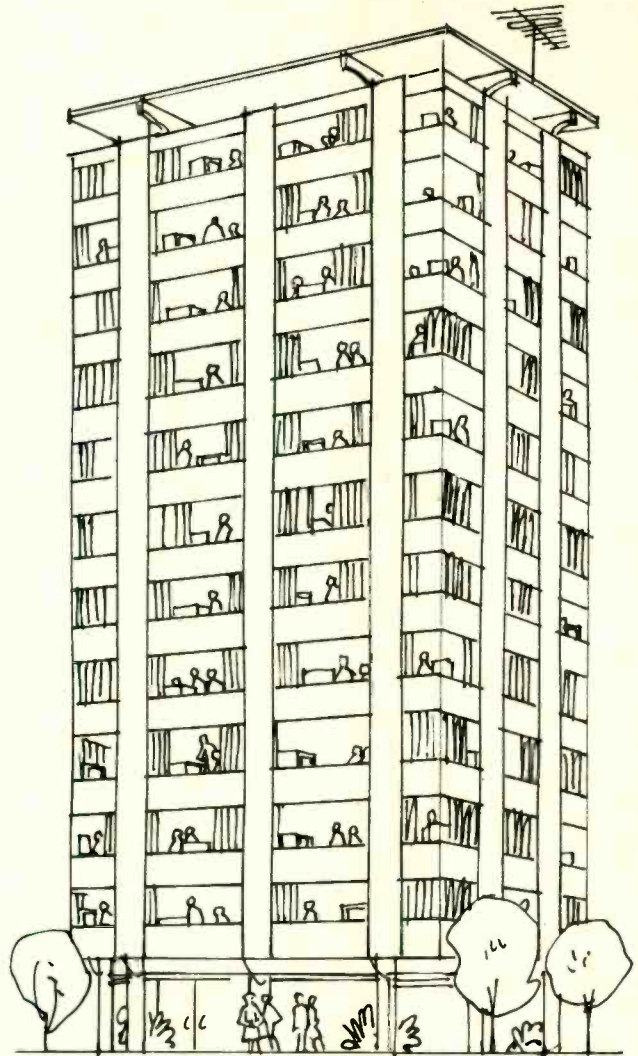
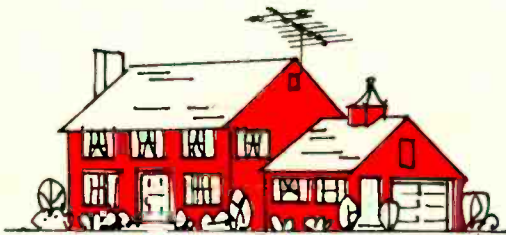

for two sets . . . to two hundred

Right now, a golden opportunity to make big money is staring you right in the face. TV reception distribution systems. For homes. For motels. For hotels. For industry. And with Color TV, it's important to get the best. Jerrold's home and system amplifiers.

Jerrold pioneered TV distribution systems more than 15 years ago. We've harnessed our experience in space-age technology to solve down-to-earth reception distribution problems. The result is the most complete, up-to-date line in the business—and the know-how

to help you build your reputation in the TV distribution system business.

Free *Jerrold Handbook of TV Distribution Systems*. Features 100 typical systems layouts and all the information you'll need. Just fill out and mail the coupon.



*Focusing on one thing  
... better reception*  
a General Instrument company

Jerrold Electronics Corporation  
Distributor Sales Division  
401 Walnut Street  
Philadelphia, Pa. 19105

Please send free Jerrold Handbook of TV Distribution Systems.

Name \_\_\_\_\_ Title \_\_\_\_\_

Company \_\_\_\_\_

Street \_\_\_\_\_

City \_\_\_\_\_ State \_\_\_\_\_ ZIP \_\_\_\_\_

... for more details circle 126 on postcard

# GENUINE BEL FUSES

UL Approved



Maroon  
Catalog No. 25-995-S  
Suggested Net....45c

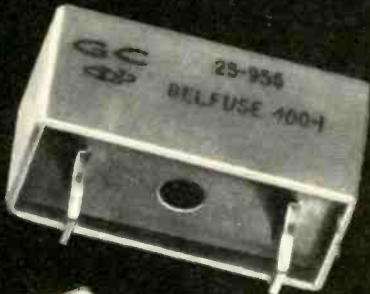

Blue  
Catalog No. 25-956-S  
Suggested Net....45c



White  
Catalog No. 25-976-S  
Suggested Net. .45c

Don't Accept Substitutes... Insist On  
Genuine BEL FUSES from **GC**

To get like-new performance, replace blown chemical fuses with GC Exact Replacement Types, all precisely engineered and made to the same rigid specifications set forth by the country's leading original equipment manufacturers. Match your needs from a variety of types, there's a selection to meet any need or application. Handy cross-referenced part numbers, clearly indicated on each package, together with its special color coding, will help assure you of using the correct fuse at all times. All are scientifically blister-packed to reach you factory fresh for peak performance. Remember too, all GC fuses are UL Approved, your assurance of top quality, maximum protection.

Always insist on **GC**...

you'll get more for your money, every time!



**GC ELECTRONICS**  
A DIVISION OF HYDROMETALS, INC.  
MAIN PLANT ROCKFORD, ILL. U.S.A.



Giant FREE Catalog...

Only GC gives you everything in electronics... has for almost 40 years. Match every part and service need from over 10,000 quality items. Write for your copy today!

... for more details circle 118 on postcard



has  
everything  
in  
**RESISTIVE  
DEVICES**



FUSE RESISTOR  
7.5 ohm, standard,  
Type F-80  
Catalog No. 25-988-1  
Suggested Net .32c



FUSE RESISTOR  
7.5 ohm, 5 watt,  
ceramic, universal  
replacement fuse  
Catalog No. 25-330-1  
Suggested Net .56c



FUSE RESISTOR  
7.5 ohm, 15 watt,  
giant heavy-duty fuse  
Catalog No. 25-308-1  
Suggested Net .59c



ET/D

DEALER SHOWCASE

the records he wants to hear — whether 1, 2, 10 or all 50 records and the unit provides up to 40 hours of

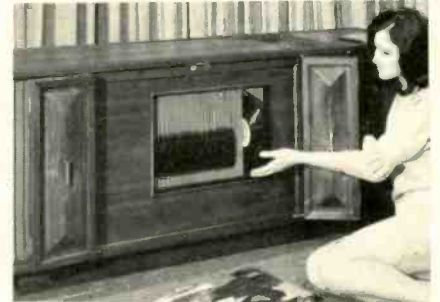

music. Other controls include push buttons — to switch the phonograph on or off, reject a record, erase the memory bank of previously made selection and play automatically all 100 sides of the 50 records. Seeburg.

## HI FI Accessories 708

Announced is a display rack designed to create impulse sales of Hi Fi accessories. Specifications indicate that the rack is enameled steel and contains a line of telephone pick up



coils, demagnetizers and matching transformers. All items are reportedly supplied in blister display cards or individual packaging complete with instructions for their use and applications. Microtran.

## Page Alarm Call Decoder 709

A "page alarm" call decoder can be used in any two-way radio system, the maker claims. Model 2PIQ is a call indicator for installation in a mobile two-way receiver. It responds (when selected) to a two-tone-sequence signal



Industry Demanded - only Sencore delivered

# AN ALL NEW IMPROVED COLOR CRT TEST



**Simple - Fast - Accurate • Automatic Color Tracking!  
No Time-Wasting Logging and Computing!**

CRT manufacturers, set manufacturers, distributors, technicians — all demanded a better CRT tester than any available. This is it — the new Sencore CHAMPION — a winner on every count.

Separate G2 screen grid controls, just like the color circuit itself, enable you to set up each color gun, then automatically compare it with the others for tracking — exactly according to industry standards. This check is important when claiming credit for a defective color CRT. No time consuming logging of each color gun reading at every setting of the G2 control like competitive models. It's automatic with the CR143 Champion.

The CHAMPION also makes all the standard color and black and white CRT tests — shorts, emission, and life tests. Its Line Adjust control assures exceptional accuracy. Its exclusive three step Automatic Rejuvenation Circuit lets you save many a faulty black and white tube or equalize gun currents in color tubes.

The all-new CHAMPION is equipped with plug-in sockets for fast testing and easy updating. Rugged vinyl-clad steel case has spacious lead compartment.

For a sure thing, put your money on the champion — the Sencore CR143 CHAMPION.



**CR143  
CHAMPION**

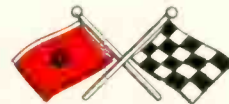

**\$99.50**



**SENCORE**

NO. 1 MANUFACTURER OF ELECTRONIC MAINTENANCE EQUIPMENT

426 SOUTH WESTGATE DRIVE, ADDISON, ILLINOIS 60101

... for more details circle 140 on postcard

sent from an encoder installed at the base station transmitter. The particular selection to which a unit responds depends on the wiring in the connecting plug. Patented circuitry provides complete built-in decoding for any of 200 different code (two-tone signal) combinations. This means that in a selective calling system using up to 200 mobile units, any spare can serve to replace any unit in the system. On an encoder connected to the transmitter, the base station dispatcher selects the vehicle desired. If the ve-

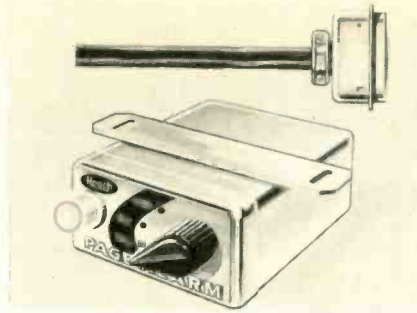

hicle selected has its "page alarm" decoder in HORN position, the horn will give a short "beep" when called, and the lighted push switch will come on and stay on until reset. Alternately, if the decoder is switched to CALL position, the radio speaker will be silenced until called, and then it and

the panel light will come on and stay on until reset. Reach.

### Stereo Headphones 710

Stereo headphones having separate tone and volume controls in each ear-piece are said to have both a comfortable and an airtight fit. The adjustable stainless steel headband is cushioned and earseals are fashioned of soft polyvinyl chloride that is kind to the ears



and locks out all distracting room noises, the manufacturer claims. The headset is designed with moving-coil dynamic transducers to give a frequency range of 15Hz to 20kHz. Impedance is 8  $\Omega$ . Phones are equipped with an 8ft cord and standard 1/4in. plug. Suggested retail price \$34.50. Allied.

### Microphone 711

A microphone is announced that reportedly has a volume control mounted on its case. Specifications



indicate that this control enables anyone using the microphone to change the loudness of the audio system to which the microphone is connected. List price \$72.50. Shure.

## CHANNEL LOCK

### No. 910 GripLock

The Portable Vise  
You Can Carry In Your Pocket  
....And Operate with ONE HAND

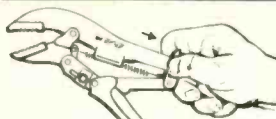

1 OPEN IT!



2 LET GO!



3 LOCK IT!

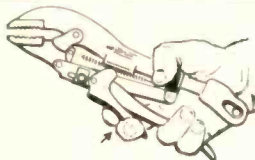

4 E-Z RELEASE!

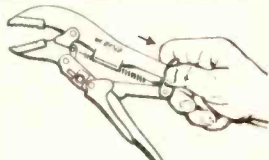

5 OPEN IT!

Easy, Fast,  
Efficient .....  
And All with ONE HAND

Let us send you a copy of our  
catalog, no charge.

TOOLS BY  
**CHANNEL LOCK**

MEADVILLE, PA.

... for more details circle 108 on postcard

## First twist-prong electrolytic to identify itself.

Add up the time you've lost waiting for counter men to look up part numbers for twist-prong electrolytic capacitors.

That's how much time you'll save—when your Distributor stocks new RCA "P" type and "R" type twist-prong electrolytics. The reason: new RCA twist-prong capacitors have self-identifying stock numbers . . . the first in the industry. Your counter man can forget his catalogs and go right to the shelf . . . because RCA stock numbers enable him to stock his inventory in voltage rating and capacitance value sequence. His shelves are his RCA catalog.

These twist-prong electrolytics are the beginning of a complete capacitor line from RCA.

Other General Purpose Electronic Parts, with RCA quality assurance, will be available from your RCA Distributor in the near future. Insist on RCA parts. Your customers will appreciate it.

RCA PARTS AND ACCESSORIES, Deptford, N.J.

**Type: R = Regular Solder Terminals**

**P = Printed Circuit Board Terminals**

**Number of Sections in Can**

**W.V.D.C.**

**Capacitor Can Size**

**Capacitance Code for Shelf Location**

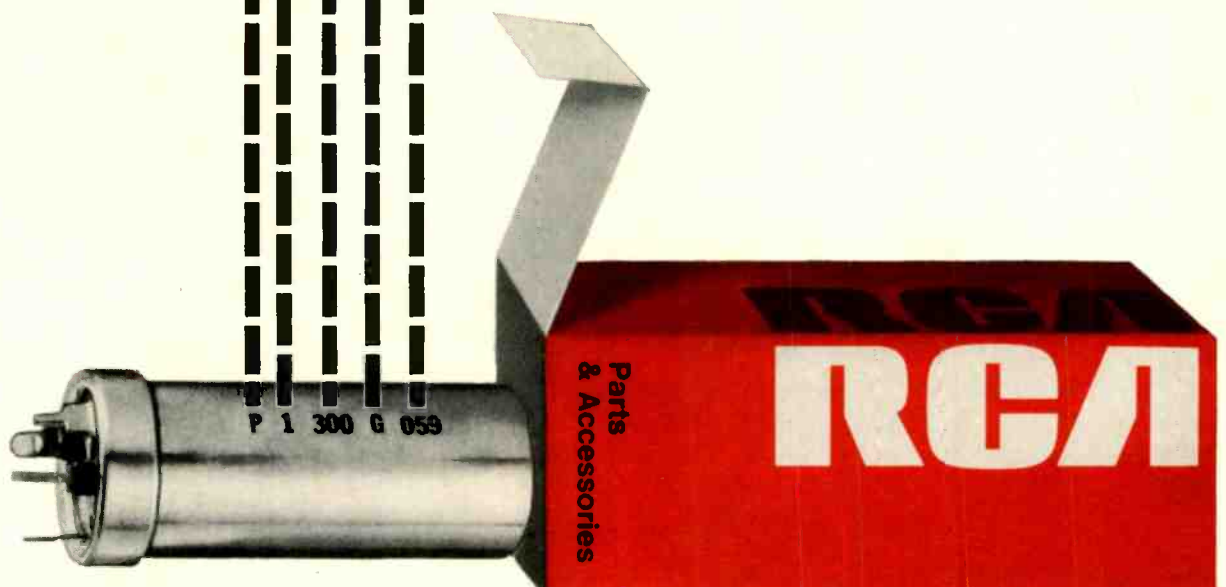

# When it comes to 82-channel,

# ONLY EVERY to install any

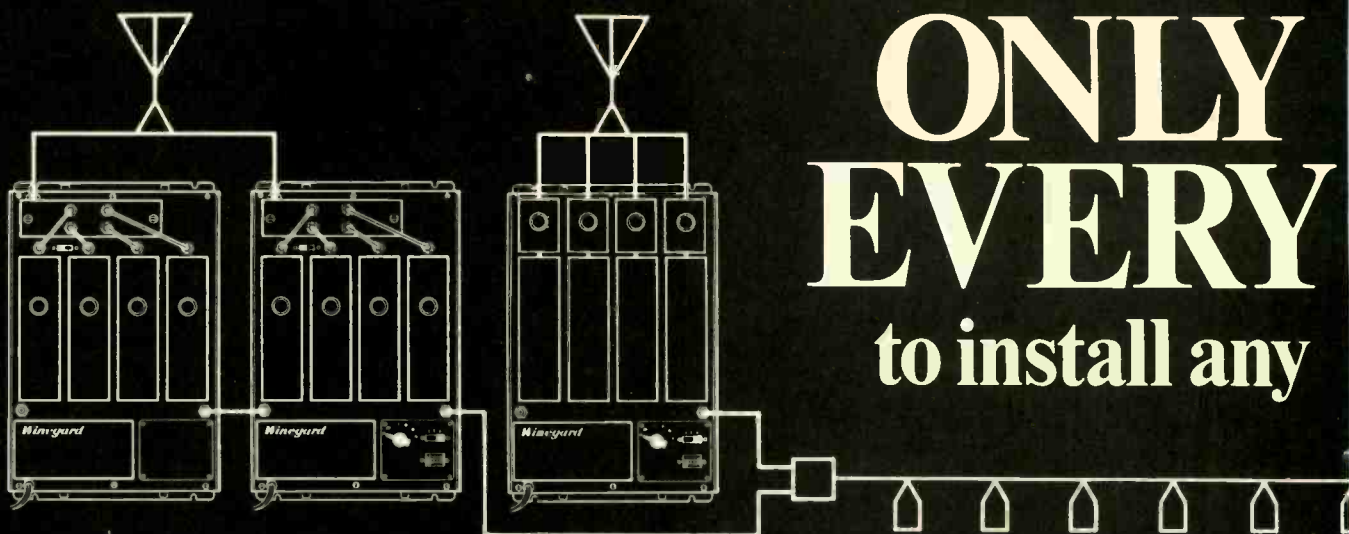

Doesn't make any difference how big or how small the system, or where you plan to install it (apartment building, hotel, motel, school, home, etc.) Winegard has all the products you need from antenna to outlet.

And we're not just talking about quantity. Winegard MATV products, all of them, are the finest quality commercial equipment available. They feature printed circuitry utilizing the newest, best performing temperature stable hi-input transistors.

Winegard not only gives you more products to choose from, but more professional assistance, too. That's right! Our staff of MATV engineers is ready to give you all the system layout service you need. And, of course, the service costs you nothing.

Yes, Winegard gives you everything you need to guarantee the best possible reception on each and every set in the system—on all channels—and in color as well as black & white.

You get maximum reliability with minimum maintenance. You get easy installation using standard fittings. You get attractive design and complete customer satisfaction. And, just as important, you get that feeling of personal satisfaction that comes from a job well done.

What more could you ask for except the highest profits in the new and skyrocketing MATV industry. And that's exactly what you get from Winegard!

(You can see here just a very few of our many MATV products.) Get all the facts today, and start making more money faster with Winegard. Send for MATV kit No. DMS.

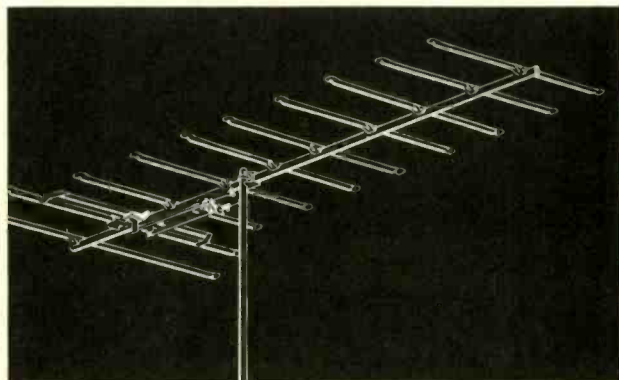

#### Transcoupler Yagis

Whether you're planning a master antenna system for a single set in a home, or several hundred sets in an apartment complex, it's essential that you provide the strongest, cleanest signal possible on all channels. And especially in color. It takes the best performing, longest lasting antenna available. And Winegard has them; 25 five and ten element Transcoupler yagis plus a full line of Super Colortron VHF-FM, VHF-UHF-FM, UHF and FM antennas.

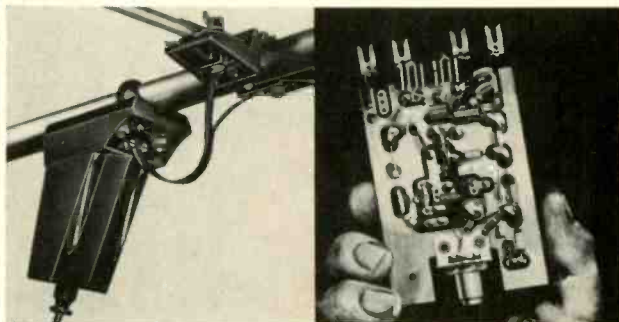

#### Antenna Pre-Amplifiers

Winegard's exclusive solid-state, printed circuit cartridge pre-amplifiers slip into the built-in, weatherproof housing of Super Colortron antennas, or into the Model ACH-1 Universal Cartridge Housing that mounts easily on any antenna. Downlead connection is internal, with 100% protection from the weather. Eight different cartridge pre-amplifiers are available, enabling you to customize each antenna installation for perfect color and black & white reception on all channels. All models utilize the newest silicon overlay transistors with an unequalled input of 500,000 microvolts (1/2 volt). Totally eliminates overload problems regardless of location.



Winegard Company • 3000 Kirkwood Street • Burlington, Iowa 52601  
... for more details circle 146 on postcard

solid state, color MATV systems,

# WINEGARD HAS THING YOU NEED size system easily and profitably!

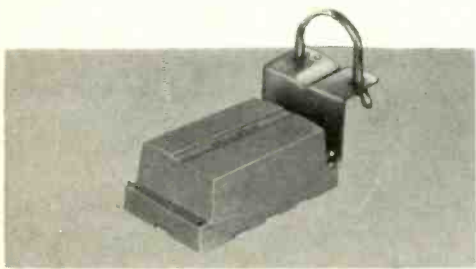

### Channel Control Couplers

Allow you to couple any number of VHF-FM antennas, equalize the signals to a predetermined level and match the 300 ohm antennas to a 75 ohm coaxial download. Any coupled antenna can be attenuated from 0 to -20 db with special plug-in attenuator pads.

### Ultra-Plex Distribution System

Ultra-Plex is a unique, solid state, 82-channel modular plug-in MATV distribution system. Components of the Ultra-Plex system are designed to match and work perfectly with each other. Ultra-Plex equipment will never become obsolete—new VHF stations, UHF stations and FM bands may be added at any time with negligible expense to the owner. Ultra-Plex gives the installer an unprecedented flexibility and complete signal control, regardless of system size. It works equally well in small or large systems—in apartment buildings, motels, hotels, hospitals, schools, etc.

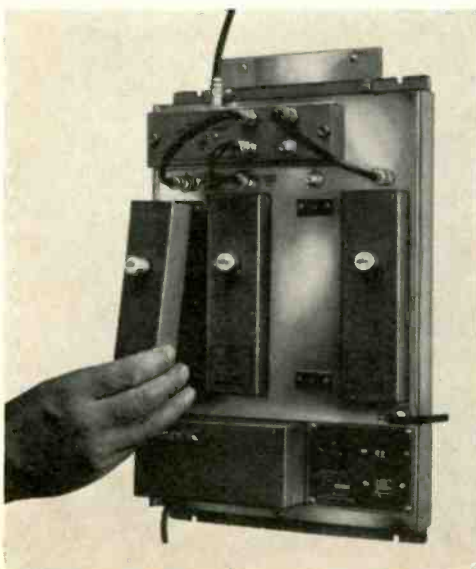

### Solid State Distribution Amplifiers

Winegard tv system amplifiers are designed to highest commercial standards with models and accessories available to provide optimum color and black & white reception to any number of sets. Each amplifier incorporates the most recent developments in solid state circuitry with the advantages of increased life expectancy, reliability and less power consumption. Higher gain, greater band-width, lower noise figures and improved VSWR are other advantages of Winegard's high performance amplifiers.

### 82-Channel Line Splitters



Line splitters divide the tv signals on a trunk line into equal parts and, when properly used, greatly increase the number of taps in a tv distribution system. Winegard line splitters have very low insertion loss, low VSWR and high isolation between outputs to insure perfect transmission of color tv signals.

### TV Signal Equalizers

Broad band distribution amplifiers operate most efficiently when input signals are equal and total picture carrier signals are the specified level. Winegard makes equalizers that can couple and equalize up to four low band or FM single channel antennas—or couple and equalize up to four high band single channel antennas.

### Variable Isolation 82-Channel Line Drop Taps

Drop taps allow the system designer to layout trunk lines in a straight line and operate outlet devices in remote locations with feeder lines. Variable isolation control from 10 to 25 db, with fast, easy adjustment, makes it unnecessary to specify and order several fixed values of tap to best utilize signals at the end of each trunk line.



### Variable Isolation 82-Channel Line Tap Offs

All Winegard line taps have 82-channel capability, and can be used for VHF, UHF or FM or any combination of the three. The variable isolation feature enables the installer to independently vary the VHF and UHF isolation values from 10 to 25 db through simple adjustment of "wiper arms" located at front of tap. Use of 82-channel line taps insures that a system cannot become obsolete regardless of what channels are later added to the system. Flush and surface mounts.

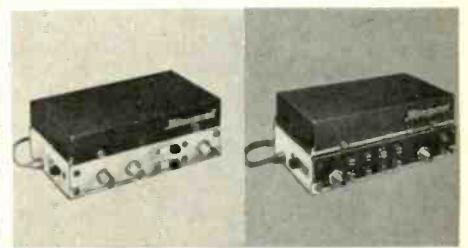

### Solid State Booster-Couplers

Winegard offers several transistorized booster-couplers which will handle up to 4 TV/FM outlets or sets from a single antenna—up to 16 sets using 75 ohm outlets. Seven different models: some for channels 2-13 plus FM, some for channels 2-83 plus FM. Built to finest commercial quality standards. Available in both 300 and 75 ohm models. Extremely high (500,000 microvolt) input eliminates overload problems.

### 82-Channel + 25 db Amplifier

New "color system" amplifier is ideal for home and smaller systems. Solid state, printed circuitry with excellent stability. Can't become obsolete when new channels come on the air. By adding Winegard's unique line amplifiers, you can lay out and install most systems without calculations of any kind. Separate VHF and UHF inputs and power for VHF and UHF preamplifiers. Easy to customize each installation to exact signal conditions.

Plus... UHF single channel converters, antenna and back-of-set matching transformers, band separators, interference rejection filters, etc.

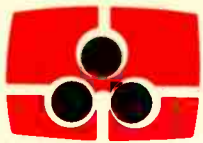

# COLORFAX

## CANADIAN GENERAL ELECTRIC

### Color TV Chassis M663—Vertical Green and Purple Stripes

Failure of C268 (.1 $\mu$ f 1kv - open) causes the appearance of a vertical green line approximately 1/4 in. wide

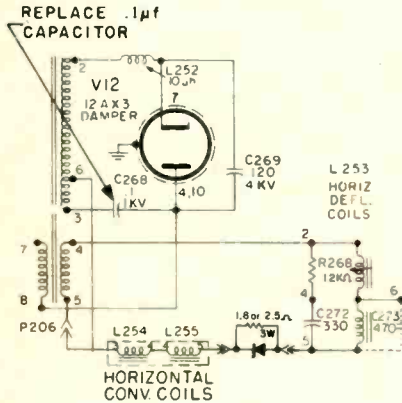

displaced from the left edge of the screen by roughly 1 1/2 in. Approximately in the center of the screen a faint purple line will also be seen.

This effect is more readily noticeable on a blank channel with the color control fully clockwise. This fault will also cause poor color rendition because of an improperly shaped flyback pulse appearing at the grid of the burst gate tube.

### Color TV Chassis M678/M679 — Poor Color

Colorfax November 1967 covered checking the color demodulator and pointed out that the demodulation angle should be checked to insure that skin tones would be correct.

The importance of this has been minimized by some technicians and there are a number of complaints from dealers, customers and technicians regarding color quality.

1. If the demodulation is less than 90deg or more than 110deg, not only skin tones are affected but the entire color reproduction of the televised scene will be drastically changed from the original.

2. If the angle is less than 90deg, the tint control will be very critical in adjusting for skin tones and they will change from one camera to another.

If the angle is too wide (over 110deg), the skin tone range will be fairly broad but probably appear brownish.

A more important factor, however, is that color reproduction of light blues, pinks and greens, etc., will be very poor. Therefore, if a customer or dealer complains of poor color, the first logical step is to determine if the demodulation is correct.

4. When examining a 10-bar color pattern on the screen for a demodulation check, do not try to evaluate it with all three guns at the CRT switched on. To do so will invite confusion and inaccurate results. The reason for this is that the eye is too easily misled in determining the correct color of each bar. If the receiver's color control is set too high, overload of the receiver color circuit will occur causing misleading results.

For the technician who uses a three color bar type of generator, the following method may be employed:

1. Connect gun killer to CRT.
2. Switch off the blue and green gun.
3. Adjust tint control so that the middle bar blends into the red background.
4. Turn all guns on and adjust the B-Y coil until the third bar starts going very slightly bluish (cyan).
5. If more than slight adjustment (1/8 turn) was required, go back to step 2, and repeat if necessary.

Before aligning any color set be sure the set has operated one hour to minimize drift. It is strongly recommended that if the set is new, the customer should be advised running the set at least one day before set up, to compensate for any aging process.

## MAGNAVOX

### Color TV Chassis T919/T920 — Horizontal Centering

These chassis employ a diode (SR104) paralleled by a 4.7 $\Omega$  resistor (R171) which is series connected with the horizontal deflection coils. This diode/resistor combination is connected between pin 8 on the deflection yoke plug (blue lead) and terminal BB on the horizontal output transformer. This circuit is used to provide

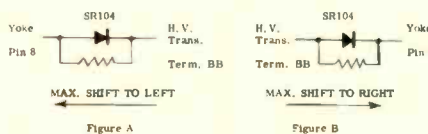

horizontal centering of the picture which can be shifted either to the left or right. In some chassis you will find a jumper wire connected across the diode resistor combination.

In cases when horizontal centering adjustment is needed, check the wiring of SR104. The illustrations indicate the direction of picture movement provided in each case.

If the circuit is connected as shown in Fig. A, placing a jumper across the diode will shift the picture to the right approximately 1/2 in. If additional shift to the right is needed, remove the jumper and reverse the connections to the diode as shown in illustration B.

To be sure of the direction and amount of picture movement, it is suggested that you use a crosshatch generator and mark the center vertical line on the tube face with a piece of masking tape.

### Color TV Chassis T924 — Horizontal output Circuit

The modified sawtooth signal, developed by the horizontal oscillator, is capacitively coupled to the horizon-

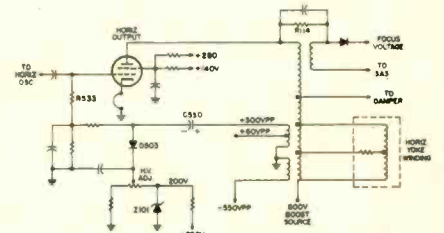

tal output grid (see illustration). The horizontal output tube conducts during approximately 50% of scan time and is responsible for scanning only the right hand side of the screen. When the beam reaches the right hand side of the screen, the horizontal output is driven to cut-off. At that time the field which has been developed in the flyback collapses causing a reversal in the voltage across it. The voltage across the yoke is suddenly reversed and the beam is moved from the right side of the screen to the extreme left side. This means yoke current has decreased from maximum in one direction to zero and then to maximum in the opposite direction. After this current reversal, yoke current ceases to flow and its field collapses causing a reversal in voltage which forward biases the

# NEW TRANSISTORIZED INVERTER by ELECTRO



**100%  
REVERSE  
POLARITY  
PROTECTION**

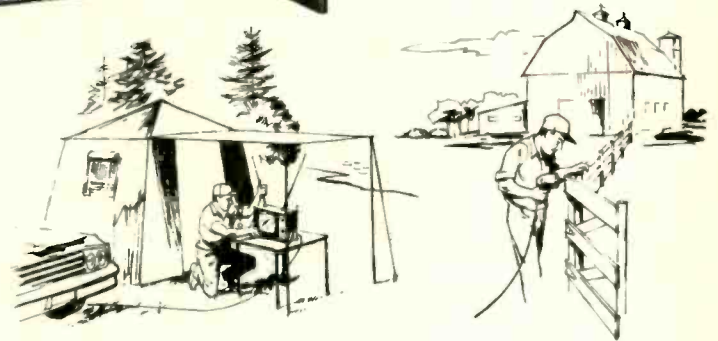

## TYPICAL PERFORMANCE CHARACTERISTICS AT FULL BATTERY CHARGE POWER OUTPUT—VA

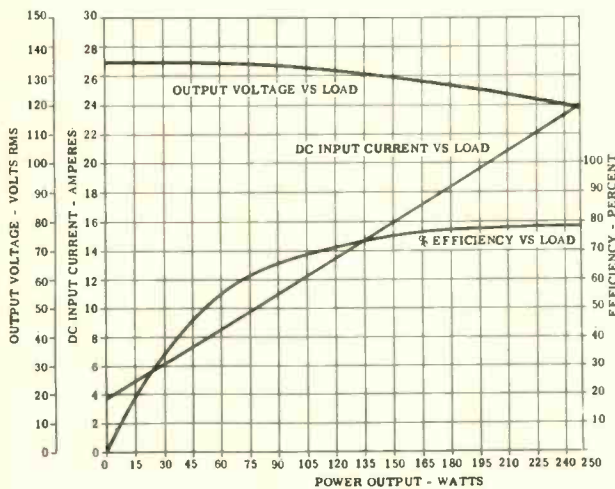

TYPICAL EFFICIENCIES at various power outputs are shown by this curve. The curve indicates the amount of input power required from a battery for a given amount of output power delivered by the inverter. Model TI-250A is designed for greatest efficiency at higher output loads to reduce battery drain.

## OUTPUT—250 VA 60 HERTZ FROM 12 VOLT DC to 117 VOLT AC

A dependable source of power to operate standard 117V, 60 Hertz AC equipment. Its 250 VA output is efficient for use with portable TV sets, radios, soldering irons, portable electric tools, CB equipment, PA systems and many other appliances.

## EXCLUSIVE DESIGN/CONSTRUCTION FEATURES

- Automatic electronic overload protection. When output is accidentally shorted or overloaded, inverter turns off instantly; turns back on when short is removed. No damage to inverter or appliance.
- Relay in circuit assures 100% reverse polarity protection.
- "Start" switch permits rapid starting for motors, light bulbs, etc.
- Indicator light shows condition of battery; gives low charge warning; warns when output is shorted or overloaded.
- Remote control.
- Mounting brackets supplied with unit for ease of installation.

Here is real brute power in a compact inverter. Measures 10" wide x 4 1/2" high x 7 1/2" deep. Weighs only 9 pounds. Other models available with outputs of 125 VA. Write for detailed specifications.

## CONVENIENT REMOTE CONTROL AVAILABLE

### Model RC-2 Remote Control

A remote control console, duplicating inverter's front panel controls, is available for the model TI-250A for operation from remote location. Size: 2 1/8" x 4 1/8" x 2 1/8". An 8 ft. cord is provided.

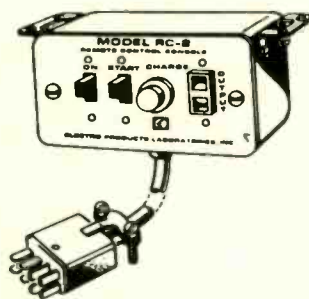

**ELECTRO**  
TRANSISTORIZED INVERTERS

**ELECTRO PRODUCTS LABORATORIES, INC.**  
6125-V Howard Street, Chicago, Illinois 60648 • 312/647-8744  
... for more details circle 114 on postcard

THE BEST ANTENNA INSTALLATIONS START WITH . . .

# South River QUALITY MOUNTING ACCESSORIES

THE MOST COMPLETE LINE IN THE INDUSTRY

South River

SINGLE STRAP

## CHIMNEY MOUNTS

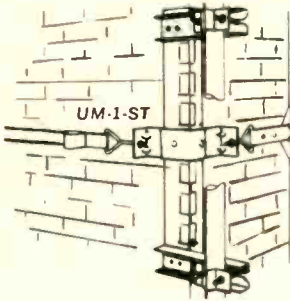

- One piece, completely preassembled.
- Heavily embossed riveted steel construction.
- Generous 18" mast holder spread.
- Extra heavy stainless steel strap.
- Furnished with aluminum chimney corner protectors, stainless steel eye bolts and stainless steel fold-over banding fastener.

SEND FOR COMPLETE CATALOG

AT SOUTH RIVER QUALITY IS OUR MOST IMPORTANT PRODUCT

SOLD THROUGH DISTRIBUTORS

SOUTH RIVER METAL PRODUCTS CO., INC. / SOUTH RIVER, N. J. 08882

for more details circle 142 on postcard



COLORFAX

damper tube. The yoke now discharges its energy through the damper to move the beam from the left side of the screen to the center. As the beam reaches the center, the horizontal output tube is again "switched on" and the cycle repeats.

The pulse, developed across the fly-back transformer as a result of the collapsing field, measures about 5kv at the plate of the horizontal output. This pulse is stepped up through the HV winding and rectified by a 3A3 to provide 24kv for the CRT anode.

This pulse is rectified directly by a solid-state rectifier to provide approximately 5kv of voltage for the focus electrode. This voltage is made variable by using a transformer to couple opposite phase voltages to the cathode of the focus rectifier. This is the same procedure used on previous Magnavox chassis.

The dc return for both the focus rectifier and HV rectifier is through R114 and the horizontal output tube to ground. The reason for this arrangement is that the focus voltage will "track" the high voltage.

This is required for proper focusing of the beams with different values of anode voltage. The anode voltage can vary slightly from one scene to another or as the brightness control setting is changed. If the focus voltage did not change accordingly, defocusing of the beams would occur at all levels of brightness except for the point where the two voltages were exactly equal.

The basic idea is to make the focus voltage go up as high voltage goes up, or down as the high voltage goes down.

To see how this is accomplished, assume the brightness control was advanced. This would cause the CRT anode to draw more current and since its dc return to ground is through R114 and the horizontal output tube, a voltage drop is developed across R114 making the anode side of the focus rectifier become more negative. The focus rectifier, therefore, cannot rectify as much of the 5kv pulse as before so the resultant dc focus voltage will be lower.

The HV shunt regulator system is not employed in this chassis. Instead a feedback regulation system is used, whereas a sample of horizontal signal is rectified, filtered and fed back as an automatic bias control for the horizontal output tube.

To establish a reference voltage, a 200v Zener diode (Z101) is connected in series with a resistor between the 280v supply and ground. This provides

NEW FROM INJECTORALL



# HERE'S PROOF!

PROOF that "SUPER 100" tuner cleaner is BETTER!

Tested by a leading independent laboratory against competitive products!

	SUPER 100	A	B	C
CLEANING	Excellent	Good	Fair	Fair
LUBRICATION	Good	Fair	Fair	Poor
PLASTIC ATTACK	None	None	None	None
FLAMMABILITY	None	None	None	None
CONDUCTIVITY	None	None	Slight	Slight
ANTI-STATIC PROTECTION	Excellent	Fair	Poor	Poor
DRIFT	None	Slight	Yes	Yes



SUPER 100 TUNER CLEANER . . . for COLOR and Black and White TV tuners  
6 oz. spray can with INJECTORALL steel needle  
CAT. NO. 100-6 net \$1.95

Buy it at your Electronic Parts Dealer.  
For free catalog on the complete line, write to:

INJECTORALL ELECTRONICS CORP. • Great Neck, N. Y. 11024

for more details circle 122 on postcard



# Precision Apparatus

introduces 5 new models; now a complete line of quality test equipment for service technicians

For over 30 years, professionals in industry, service, laboratory and educational fields have relied on Precision Apparatus Test Equipment. Today, through the experience and marketing know-how of Dynascan Corporation, Precision Apparatus offers even greater reliability and performance—maximum versatility—in all applications. By every standard, they are the hallmark of quality in test equipment.

## NEW! A MUST FOR COLOR TV ALIGNMENT

### MODEL E-410C—SWEEP GENERATOR AND MARKER ADDER

Wide range, frequency modulated signal source combined with Marker Adder circuitry designed for the alignment of color TV, FM and other high frequency wide-band receivers and circuits. Solves marker visibility and overloading problems. Furnished with a 4.5 mc crystal and 5 output cables. \$189.95



## NEW! MODEL B-12—REGULATED POWER SUPPLY

A reliable source of variable, regulated DC plate voltages, and bias plus AC filament voltages . . . with exclusive 6.3 VAC and 12.6 VAC supply. Perfect for service bench and circuit development, it offers regulated DC voltages from 0 to 400 volts, and a bias supply from 0 to -150 volts. Each output is variable throughout its range. Rugged, double-jewelled, D'Arsonval meters mounted on the front panel. \$99.95



## NEW! MODEL B-10—BATTERY ELIMINATOR & CHARGER

Twice the filtering provides .15% ripple! Designed to meet rigid, low-ripple output requirements of modern transistorized automobile radios and other electronic equipment of 6 and 12 volt ratings. Does not require additional investment for external filter adapters. Functions as an efficient, reliable battery charger with special high-current output at separately labeled terminals. \$69.95



efficient, reliable battery charger with special high-current output at separately labeled terminals. \$69.95



## NEW!

### MODEL V-95 PROFESSIONAL VTVM

More accurate readings on huge 7" mirrored scale. Special 0.5 VDC scale for precise transistor circuit analysis. Zener controlled internal power supply obsoletes ohmmeter batteries. Two-way protection: transit switch position and anti-burnout shunts prevent meter damage on the job or on the road. Single test probe eliminates cable tangles and lead shuffling. Rugged walnut-grain metal case; name-personalized handle stops "borrowing." \$79.95

MODEL V-75 with 4 1/2" meter. \$59.95



## NEW!

### MODEL S-55A PUSH-PULL OSCILLOSCOPE

Wide band amplification, DC coupled, zero to 5 MC. High vertical sensitivity and large CRT screen give more than 6" undistorted deflection. Automatic horizontal synchronization includes 60 Hz sinusoidal sweep for TV and FM alignment. Special 500 KHz sweep makes it easy to see complete 3.58 MKz burst signals; ideal for color TV. Exceptionally low distortion. \$199.95



## ES-550B WIDE-BAND OSCILLOSCOPE

Deluxe scope; extra brightness; extra high sensitivity. Unique calibration voltage makes measurement easy. \$289.95

## E-200C MULTI-BAND SIGNAL GENERATOR

Unique AVC substitution system for total accuracy. 88 KHz to 400 MHz, hand-calibrated. \$149.95



## 120M VOM

1 1/2% DC accuracy. Exclusive extra-low R x 1/10 scale reads to 0.1 ohm. Transit and burnout protection. Mirrored scale. \$69.50

## ALSO: MODEL 120 with 2% DC. \$59.50

## E-310 SINE & SQUARE WAVE GENERATOR

Only moderate-cost, low-distortion, 5 Hz to 600 KHz wide band generator. \$199.95



The Complete Line That Sets Industry Standards



**PRECISION APPARATUS**

hallmark of quality in test equipment

Tube supplement information now available for all Precision and Paco Tube Testers. . . for more details circle 136 on postcard

Division of Dynascan Corporation  
1801 W. Belle Plaine Avenue  
Chicago, Illinois 60613

Where Electronic Innovation Is A Way Of Life

# MID-STATE TUNER SERVICE

Satisfied with second best? Mid-State offers absolute satisfaction and 24-hour service a necessity.



Mid-State is as close as your nearest post-office or United Parcel Service outlet. All units tracked and aligned to factory spec's, with crystal controlled equipment. Ninety day warranty. Mutilated or damaged tuners may take slightly longer if major parts are not in stock. Send complete with model and serial numbers and all damaged parts.

Put your confidence in Mid-State to take care of your tuner problems. "Remember" there is only one "Mid-State Tuner Service."

## COMBO'S — \$17.50

Major Parts, Tubes, Transistors charged at Net Price

Distributors-Wholesalers  
Write for Price Sheet

## MID-STATE TUNER SERVICE

Mid-State Tuner Service T-8  
1504 So. College, Box 1141  
Bloomington, Ind. 47401  
Tel: (812) 336-6003

... for more details circle 129 on postcard



## COLORFAX

a voltage source which does not change with supply voltage variations. From this 200v source the HV adjust control is connected in series with a fixed resistor to ground. The wiper arm of the HV control is connected to the cathode of a small silicon diode (D503). Since the HV control and the fixed resistor to ground are approximately the same value, the cathode of D503 can be varied from 200 to 100 volts.

A positive going 300v pulse is coupled through C530 to the anode of D503 causing C530 to become charged to the polarity indicated. Assuming the HV control was set to midrange, C530 would charge up to approximately 150v. This voltage is filtered to remove the ac component and then connected to the horizontal output tube grid through R533.

To understand how this circuit regulates the HV, assume the video scene suddenly became brighter. The HV would drop because of increased loading on the output system.

The increased loading causes the amplitude of the pulse coupled through C530 to decrease; therefore the negative voltage developed at the anode of D503 becomes less. The grid voltage of the horizontal output becomes less negative (or more positive) and the stage conducts harder, thereby compensating for the additional load.

The opposite would occur should the loading on the output system decrease. As in the vertical circuit, this system also compensates for slight variations in ac line voltage.

In this circuit the horizontal output cathode current varies depending upon the brightness of the video scene as well as the brightness control setting. The average cathode current (at normal brightness) runs approximately 200ma but will vary from 160ma at minimum brightness to 220ma at high brightness.

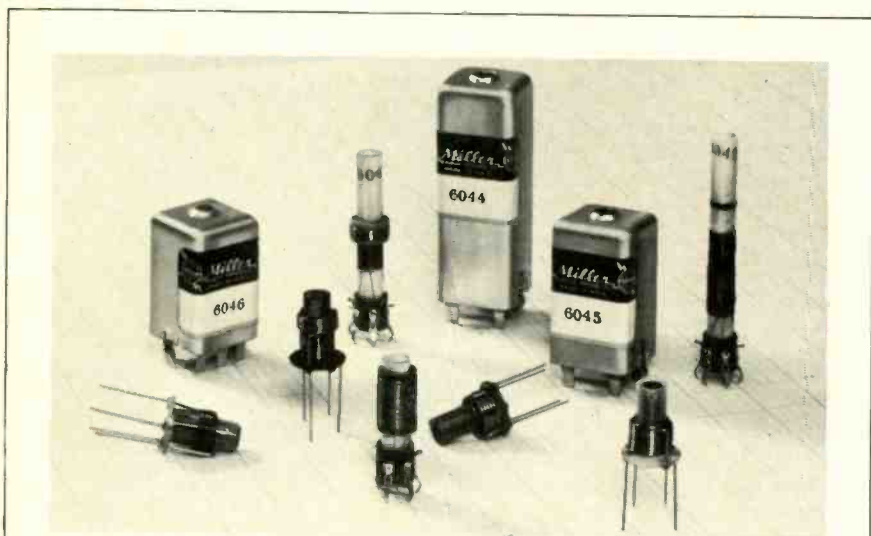

## Video and Chroma Coil Exact Replacements for More than 25 Color TV Manufacturers

Ten Color TV coils replace more than 550 video and chroma coils for sets made by manufacturers such as RCA • GE • MOTOROLA • PHILCO • MUNTZ. Installation instructions and diagrams are included.



Write today for latest Color TV Coil Cross Reference Guide

## J.W. MILLER COMPANY

5917 South Main Street • Los Angeles, California 90003

SEE YOUR LOCAL DISTRIBUTOR FOR THE FULL LINE OF RF AND IF COILS, CHOKES, FILTERS AND TRANSFORMERS

... for more details circle 130 on postcard

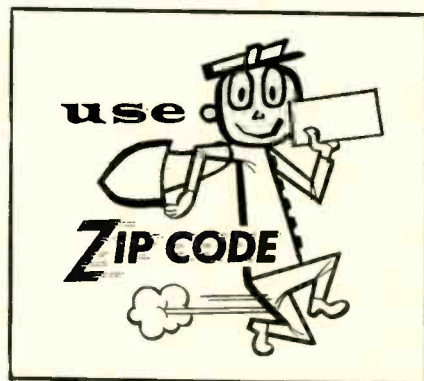

# We've rectified high-voltage rectifiers.

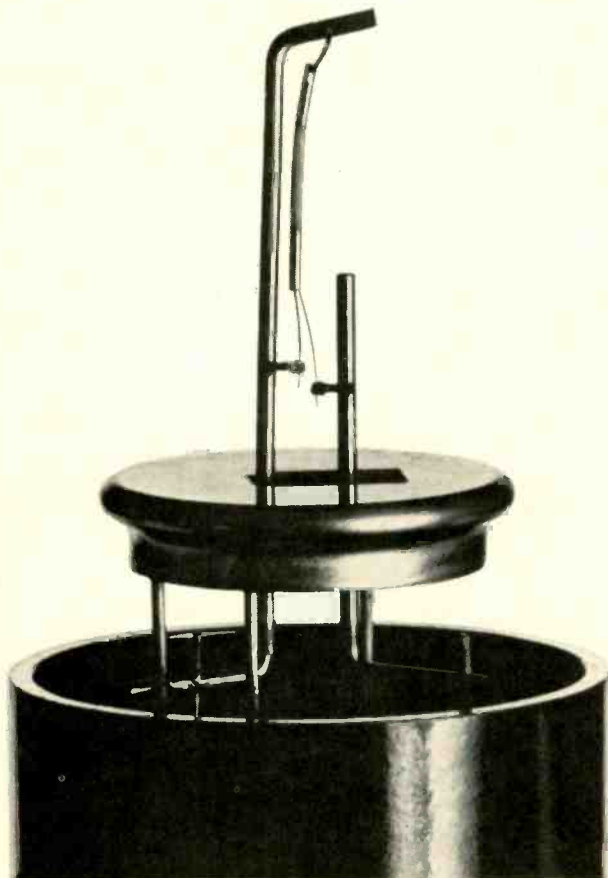

How it used to be.

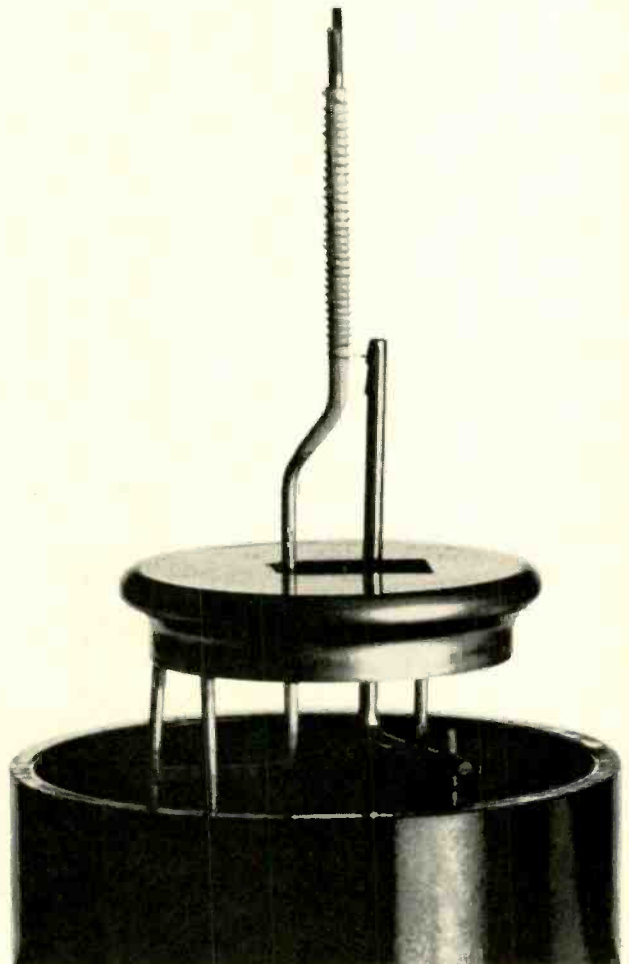

Our new 3CU3

Take a look at our new "Posted filament" design. There's no delicately suspended heater-cathode system. There's no need to heat up a metal sleeve and then an oxide coating.

It takes less than a second for the 3CU3 to start rectifying full swing.

In case of a break, there's no way for the 3CU3's filament to fall against the anode, creating a short and knocking out other components in the circuit.

The 3CU3's filament is always perfectly centered. It emits electrons uniformly in every direction. From a much larger surface than in the old design. There's no suspension post in the way to create an "electron shadow" that cuts down the plate current.

The uniform electric field around the rigid support reduces high voltage stresses. Arcing and its resulting troubles are eliminated.

The 3CU3 is interchangeable with 3A3 and 3A3A

high voltage rectifiers. And it's made exclusively by Sylvania.

The 3CU3 is just one of a new "posted filament" family which includes the new 3BL2 and 3BM2. They're designed for use in new color TV sets. These tubes are especially good for transistorized TV where their fast warm-up fits in with the "instant on" feature of solid state circuitry.

The new construction has higher reliability and longer life and should give you fewer and less troublesome callbacks.

**SYLVANIA**  
A DIVISION OF  
GENERAL TELEPHONE & ELECTRONICS



From the outside you can hardly tell it's changed.

# NEW PRODUCTS

For additional information on products described in this section, circle the numbers on Reader Service Card. Requests will be handled promptly

## Two-Way Radios 712

A dual line of all solid-state FM two-way radios — a "Royal Professional Series" and a "Royal Executive



Series" has been added to mobile communications equipment for cars and trucks. Fully transistorized — both transmitter and receiver — the models are available in 25 to 50MHz and 132 to 174MHz. Fifty-watt models are available for low band and 35w units for high band. A new protective circuit in the equipment — first to be engineered into solid-state equipment — is said to provide computer-like protection for power transistors. G-E.

## Liquid Sprayer 713

A self-powered sprayer suitable for pushbutton dispensing of a wide range of industrial liquids is introduced. The



sprayer is said to have a broad spectrum of uses in production and servicing electrical and electronic gear. It is said the sprayer will dispense contact cleaners, fluxes, lacquers and masking liquids, insulating and waterproofing compounds and even two-part epoxy systems of sufficiently low viscosity to be sprayed by a commercial gun. Precision.

## Antennas 714

Announced is a line of rugged LPV-type antennas for MATV use. The antennas are made of heavy gold anodized aircraft aluminum. Heavy-duty

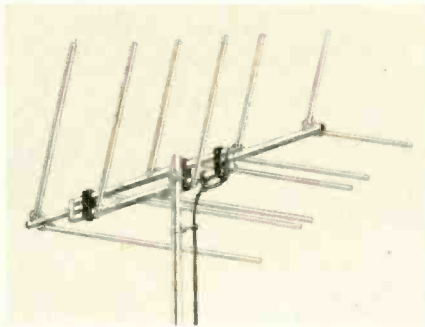

elements and double-boom construction add to their ability to withstand the most severe weather conditions, specifications indicate. Output is matched to 75  $\Omega$  coaxial cable, eliminating the need for a matching transformer. All units are shipped complete with an F59 coaxial connector and a weather boot. JFD.

## High Voltage Probe 715

Announced is a 40kvdc high voltage portable test probe specially designed to operate with the manufacturer's 11M input impedance, battery-operated transistorized volt-ohmmeter, model 600. The test probe, model 72-265, permits technicians to perform accurate and safe high voltage checks on all color as well as B/W TV receivers prior to making color alignment adjustments on the CRT. Three ranges can be checked with the probe, 40kvdc, 16kvdc and 4kvdc. To obtain proper readout, the model 600's selector range switch is simply set to the 40vdc, 16vdc or 4vdc range and multiplied by 1000, correspondingly. A spring-loaded cap in the well-insulated

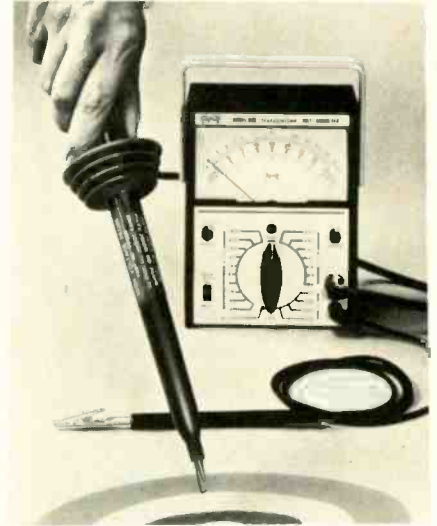

handle of the probe permits easy removal of an internal resistor making the probe flexible and functional for other test instruments like the volt-ohmmeter. A large circular-shaped corona guard located at the front of the fluted black plastic handle is said to prevent the hand from slipping during checks. The tip of the probe is nickel plated to insure better conductivity and longer life. The lightweight probe weighs approximately 7 $\frac{1}{2}$ oz., is 12 $\frac{1}{2}$ in. long and has a  $\frac{7}{8}$ in. diameter. Suggested user net is \$25.20, complete with heavy-duty ground lead. Triplett.

## Cable Clip 716

A "J" configuration for a complete line of adhesive-backed cable clips is announced. Clips look neater, it is said, because they can be installed closer to moldings, door jams and interior edges and take up less equip-



# The package carrier that never sleeps

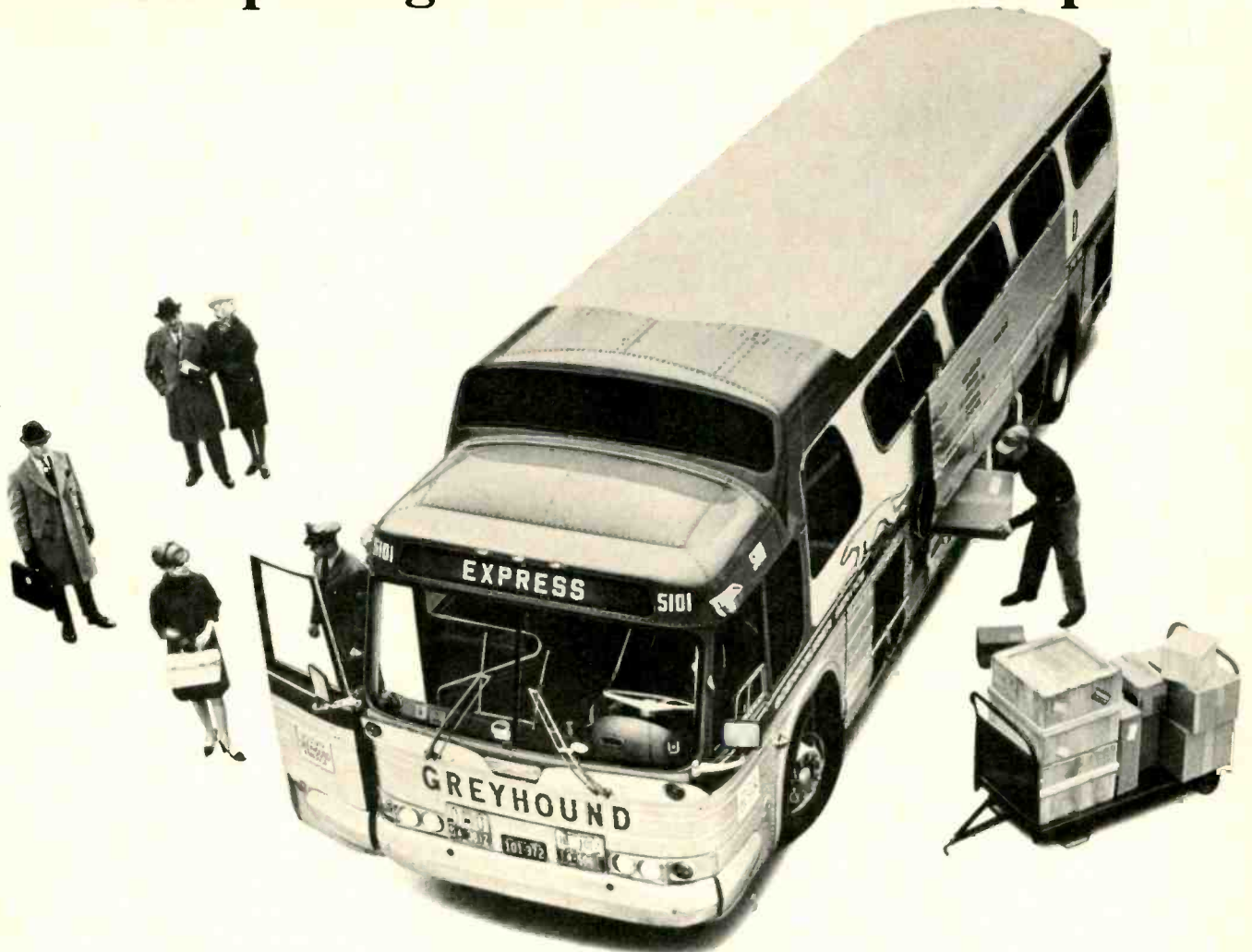

## Your packages go 24 hours a day, 365 days a year, by Greyhound Package Express

Greyhound Package Express is the wide-awake way to get your packages *where* you want them. Ship anytime 'round the clock, days, nights, weekends, and holidays, too! Your packages can go wherever Greyhound goes, and Greyhound goes just about everywhere in the U.S.A. When you ship by GPX,

your packages travel on fast, frequent "people" schedules, aboard regular Greyhound buses, serving more than 25,000 cities, towns and villages. Very often, packages shipped by GPX get where you want them in a matter of hours. Sometimes even faster than if you shipped them by air. Before you

make your next shipment, remember GPX. Ship C.O.D., Collect, Prepaid, or open a Charge Account. Extra savings on lot shipments also available. For information on service, rates and routes, call Greyhound or write: Greyhound Package Express, Dept. 53-C, 10 South Riverside Plaza, Chicago, Ill. 60606.

### It's there in hours and costs you less

For Example	Buses Daily	Running Time	20 lbs.	30 lbs.	40 lbs.*
BOSTON NEW YORK	28	4 hrs. 15 min.	2.20	2.60	2.90
LOS ANGELES SAN FRANCISCO	22	9 hrs. 15 min.	2.10	2.45	2.80
PITTSBURGH CLEVELAND	12	2 hrs. 45 min.	2.00	2.25	2.65
INDIANAPOLIS CHICAGO	10	4 hrs.	2.10	2.45	2.85

Rates subject to change. \*Other low rates up to 100 lbs. Lot shipments, too.



One of a series of messages depicting another growing service of The Greyhound Corporation.

... for more details circle 120 on postcard

## NEW PRODUCTS

ment space. According to the manufacturer, the new "J" style is more efficient because of increased holding power provided by the new design. Five sizes are available to hold wire bundle sizes ranging from 1/8 to 3/8 in. nominal od. Lengths vary from 1 to 2 in. depending on clip size; 48-in. lengths of all sizes are also available. 3M.

### Hook-Up Wire 717

Announced is hook-up wire having a 1/64 in. wall and stranded tinned copper conductor. The insulation is said to be temperature resistant from -10°C to +80°C with a maximum



load capacity up to 300v. Known as series 7230-7235, the wire is available in AWG sizes No. 24, 22, 20, 18 and 16. The od range is 0.057 in. through 0.095 in. Standard colors No. 1 through No. 10 and stripes are available. Birnbach.

### CB Transceiver 718

Announced is a 23-channel CB transceiver which features a cascode front-end with nuvistor mixer and is



said to include every known feature to dampen and filter noise. The unit has dual conversion, transistor power supply, illuminated S-RF meter, illuminated channel selector, PA system, auxiliary speaker jack, single-knob tuning, modulation indicator and built-in range-expander circuit. The unit comes complete with crystals for all 23 channels, mounting brackets, power cords and microphone. according to the announcement. Net \$199. Courier.

### RF Mini-Monitors 719

Announced are three palm-sized RF directional wattmeters for servicing communications equipment in the 2-175 MHz range. They weigh one lb and are said to be built to high quality

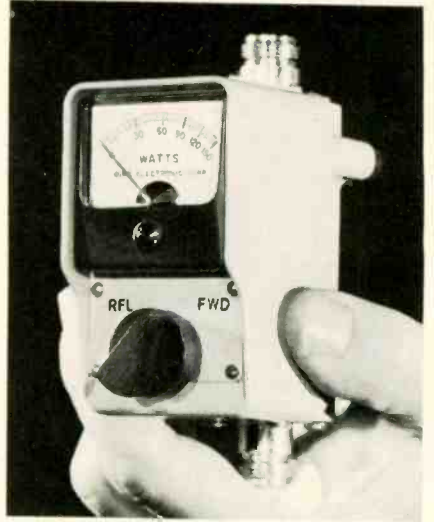

specifications and contain 1 to 2% tolerance components. Over-all accuracy is  $\pm 5\%$ . The wattmeters, only 2 x 3 x 4 1/2 in. can be switched from forward to reflected power on the blow-protected front panel. The 50  $\Omega$  instruments are completely self-sufficient without batteries, line power, charts or plug-ins. Bird.

## NEW COAX WALL TAPS

### for Color TV



Designed for ease of installation... Mosley provides the new MC Series of solderless Wall Taps to meet all your 75 ohm coax lead-in requirements - from the single lead-in outlet to the more complex multi-unit distribution system.



Write Dept. 158 for FREE detailed brochure.

**Mosley Electronics, Inc.** 4610 N. Lindbergh Blvd.,  
Bridgeton Missouri 63042

... for more details circle 131 on postcard

## NEW COLOR



### CONAR All-Channel COLOR TV KIT \$366.00

Model 600UK

- Easier to build because it's designed for learning
- Complete with cabinet—nothing else to buy!

Tops for quality, simplicity of design, ease of building, the new CONAR 600 gives you the latest advances in the art of color TV receiver construction. In addition to 21 tubes, this all-channel receiver incorporates a transistor UHF tuner, transistor noise cancellation circuit and 16 solid-state diodes. Separate gun killer switches and a cross hatch generator are built in. All hardware is engineered for accessibility. Attractive bronze-tone steel cabinet with durable wood-grained vinyl covering.

For information write Dept. CS8C

### CONAR instruments

DIVISION OF NATIONAL RADIO INSTITUTE  
3939 Wisconsin Ave., Washington, D.C. 20016

WRITE FOR FREE CONAR CATALOG

... for more details circle 113 on postcard  
ELECTRONIC TECHNICIAN/DEALER

# NEW PRODUCTS

## Test Adapter Holder

720

A test adapter holder is designed to keep tube test socket adapters and alignment tools organized and readily accessible for TV-radio service technicians.



Holder supplies storage space for seven socket adapters of  $\frac{7}{8}$  in. dia or less, and six adapters of  $1 \frac{9}{32}$  in. dia or less, plus room for 12 alignment rods, screw drivers or other small service tools. Mounting holes are provided for easy installation on any vertical surface. The unit is fabricated from cold rolled steel with baked enamel finish and is available only through electronic parts distributors. Price \$2.50 for model 2898. Pomona.

## Convergence Rectifiers

721

A series of color-TV convergence rectifiers are reportedly adaptable to any color set currently on the market. A cross reference part numbering guide is provided for correlating the 3, 4 or 5-cell part with that used as original equipment. GC Electronics.

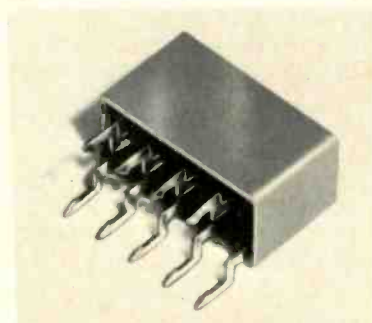

## Flexible Cable Tie

722

Announced is a cable tie, the TY409, a general purpose, heavy-duty tie and lashing strap. The strap has a wide application for lashing cables to messenger wires, a practice widely used by telephone companies, electric utilities and contractors. The one-piece strap exceeds a 200 lb loading. Its 19in. length will accommodate bundle diameters from  $1\frac{3}{4}$  to  $4\frac{3}{4}$  in. Width of the tie is  $\frac{1}{2}$  in., which provides good bearing surfaces on conductors. This plastic strap, unlike metal bands, cannot injure installers hands it is said. Thomas & Betts.

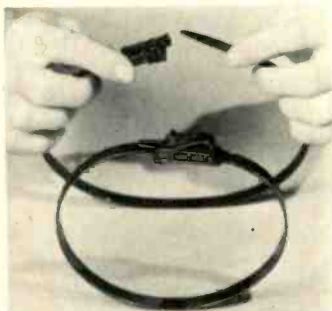

## Oscilloscope

723

A low cost, general purpose scope having an extended frequency range to 7MHz is introduced. The Model 555 is designed for both laboratory and field use and contains performance and construction features normally found only in larger expensive units. Its CRT is a 5 in. flat-faced, Braun tube, divided into a viewing area of 8 x 10cm by a removable edge lit graticule. All amplifiers are multi-



# HIDDEN QUALITY

## MODEL 630 V-O-M



Standard of the Industry

PRICE† \$61.00

### FACTS MAKE FEATURES:

- 1 One selector switch minimizes chance of incorrect settings and burnouts.
- 2 4.4 ohm center scale, reads from 0.1 ohm up to 100 megohms resistance in 4 ranges.
- 3 20,000 ohms per volt DC sensitivity; 5,000 AC.

Attention to detail makes the Triplet Model 630 V-O-M a life-time investment. It has an outstanding ohm scale; four ranges—low readings .1 ohm, high 100 megs. Fuse affords extra protection to the resistors in the ohmmeter circuit, especially the X1 setting, should too high a voltage be applied. Accuracy 2% DC to 1200V. Heavy molded case.

†630A same as 630 plus 1½% accuracy and mirror scale only \$71.00

TRIPLET ELECTRICAL INSTRUMENT COMPANY, BLUFFTON, OHIO

THE WORLD'S MOST COMPLETE LINE OF V-O-M'S.  
AVAILABLE FROM YOUR TRIPLET DISTRIBUTOR'S STOCK.

... for more details circle 144 on postcard

# 4 ways to increase your income

RCA Institutes, Inc. offers these four comprehensive home study courses especially designed to help build your income immediately!



**COLOR TV** Add profitable color TV to your skills with this home training course, newly revised to include information on the latest techniques, receiver circuitry and equipment. Train under the direction of RCA Institutes... experts in Color TV home study training.



**TRANSISTORS** You get the necessary background for semiconductor technology including characteristics of tunnel diodes, rectifiers and other solid state devices. Transistor trainer also available.



**AUTOMATION ELECTRONICS** Trains you for the many applications of automation electronics in industry and government including Photoelectronics, Digital Computer Techniques, Synchros and Servomechanisms, Automatic Control Systems, and many more!

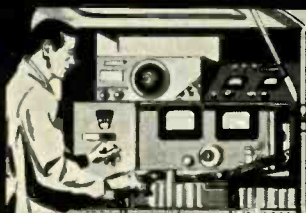

**MOBILE COMMUNICATIONS** Trains you to service and maintain 2-way radio communications on land, sea, and air! Gives you the technical foundation for space communications!

Take advantage of RCA's Liberal Tuition Plan. You only pay for lessons you order; and have no long-term obligations. Licensed by New York State Education Department. Approved for Veterans.

# RCA

SEND THIS COUPON NOW FOR COMPLETE FREE INFORMATION

RCA INSTITUTES, INC. Home Study School, Dept. ET-38  
320 West 31st Street, New York, N.Y. 10001

Without obligation, rush me free information on the following RCA Home Training Course: COLOR TV TRANSISTORS MOBILE COMMUNICATIONS AUTOMATION ELECTRONICS

Name \_\_\_\_\_ Age \_\_\_\_\_

Address \_\_\_\_\_

City \_\_\_\_\_ Zone \_\_\_\_\_ State \_\_\_\_\_

## NEW PRODUCTS



stage dc coupled, and solid-state with full compensation for optimum response. The nine step attenuator has a variable trimmer for each step, to provide frequency compensation. An extremely linear time base using a miller circuit is said to provide accurate and precise sweep speeds with variable controls in 19 calibrat-

ed ranges. The horizontal amplifier contains a 5X expansion which effectively increases the sensitivity by 5, and permits positioning of the expanded trace. To standardize time and voltage, a 3% calibration is built into the instrument. Specifications are: Vertical amplifier bandwidth: dc to 7MHz within 3db, dc coupled; 2Hz to 7MHz within 3db, ac coupled. Rise time: 0.05  $\mu$ s. Sensitivity: 0.02 v/cm to 10v/cm in nine ranges. Input Impedance:  $1\Omega$  parallel capacitance 33pf. Sweep speeds: 1  $\mu$ s/cm to 1sec/cm in 19 ranges. Accuracy:  $\pm 5\%$ . Size: 8 x 10 $\frac{1}{2}$  x 16in. Weight: 22 lb. A full year warranty for parts and service is provided. Data Instruments.

### Safety Belt

A safety belt which is said to provide built-in safety against the fall hazard is announced. A small light capsule attached out of the



way on the side of the belt contains a shock absorber which pulls loose from the belt and starts to work instantly should a fall occur. When force is applied to the shock absorber, the sewn-in threads start breaking row-by-row to absorb the damaging forces that would otherwise be transferred to the person wearing the belt. Exhaustive tests indicate that only 600lb pressure would be transferred to a person's body, well within the body's tolerances. Two models are available — the No. 2189 and 2190, with adjustable lanyard sewn in. Rose.

### MOVING?

Be sure to let us know your new address. Please enclose a complete address label from one of your recent issues.



**Illuminated Magnifier 725**

Announced is a magnifier that reportedly has a built-in light to illuminate

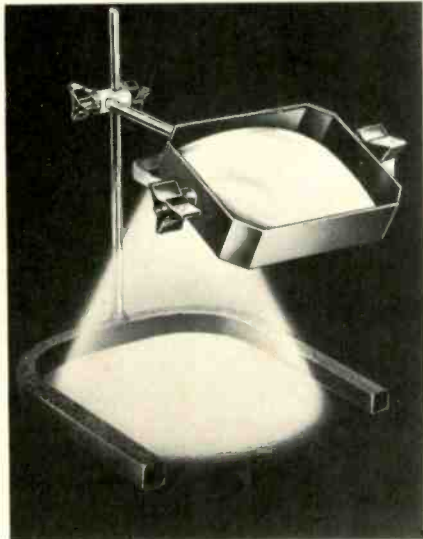

nate a 48-sq-in. work-viewing area. Specifications indicate that it provides 3X and 2.5X magnification. Edroy.

**Proximity Switches 726**

Announced is a proximity switch featuring the inherent simplicity of the basic dry reed switch for long life (18 million operations @ 48v). An enclosed permanent magnet provides the

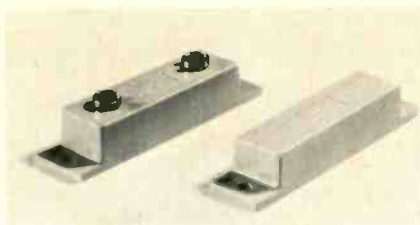

force to actuate the reed switch within distances of lin. apart (center to center), it is said. The current rating is 0.5a (break) and 1.0a (carry), with a potential breakdown of 300vdc. Alco.

**Alignment Tool Kit 727**

Introduced is a special alignment tool kit containing six alignment tools for any make or model TV set, whether monochrome or color. The kit includes two double-ended 0.100 in. hex wrenches, 5 and 11in. long for standard IF transformers and coils; a 5in. long alignment tool with both hex and screwdriver tips; a pair of tuner alignment tools 7in. long and 12in. long; and double-ended 0.075in hex wrench, 5in. long for miniature transformers and coils. All the tools are made of nylon and are said to flex without breaking. Because no metal is used, and because of the choice of convenient lengths, all problems encountered through improper tools and

**CRT Rebuilder**



Rebuild your own CRT's. Average cost B/W \$1.50—Color \$8.50 Easy to operate. Requires only 4x8 feet of space.

*Increase your income by \$1,000 or more, per month.*

*Supplies for your first 50 picture tubes free!*

Write or call

**LAKESIDE INDUSTRIES**

5234 N. Clark St. Chicago, Ill. 60640  
Phone 312-465-2881

... for more details circle 127 on postcard



**SNAP PAK**  
revolutionary new  
resistor package from



Snap Paks save time and eliminate loose parts and clutter in the shop or on the job. Handy five-card strip fits shelves, bins, or racks. Belongs in every tool kit or tube caddy.

The next time you need resistors, order IRC Snap Pak packages. They're available now at all IRC distributors.

... for more details circle 123 on postcard

# Save Time on PC Board Repairs!



MODEL 100A

Melted solder disappears up hollow tip into tube

## The ENDECO Desoldering Iron Removes Soldered Components in seconds... without damage!

Endeco melts solder, then removes it by vacuum • Leaves terminals and mounting holes clean • Resolders too • One-hand operation • Temperature controlled for continuous use • Ideal for use with shrinkable tubing • 4 tip sizes • Quickly pays for itself in time saved • Only \$18.75 net.

SMALLER SIZE AVAILABLE. SEE YOUR DISTRIBUTOR OR WRITE:



ENTERPRISE DEVELOPMENT CORPORATION

5123 E. 65th • INDIANAPOLIS, IND. 46220  
IN CANADA: A. C. Simmonds & Sons, Ltd.  
100 Merton St., Toronto 7

... for more details circle 115 on postcard

## NEW PRODUCTS

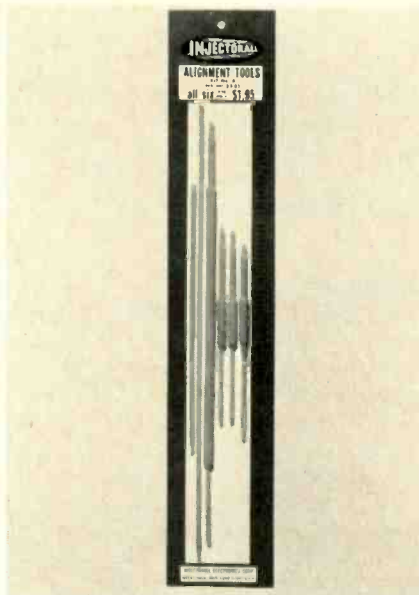

screwdriver use are said to be eliminated. Each tool is double ended, facilitating alignment of cores having either slotted or hex ends. Tools are said to be nonmagnetic. Price \$1.95. Injectoral.

## Power Riveter 728

Introduced is a power riveter of which it is said a squeeze of the hand will fasten anything up to 1/2 in. thick from one side. Specifications indicate that the riveter expands up to its own head-diameter for use in wide-tolerance holes; one length fits all



thicknesses within the grip range; clamp-up action assures a snug fit, eliminating the possibility of loose assembly and other features. The bubble-packed riveter includes a free supply of assorted rivets and instructions. \$4.95. Vaco.

## Grid Dip Meter 729

Announced is the No. 90651-A grid dip meter having transistor dc amplifier and taut band meter. It provides full scale meter readings at all frequencies from 1.7 to 300MHz. The

2.7 Ω 10%  
1/2 WATT  
MIL-R-11 STYLE RC20  
CARBON COMPOSITION RESISTOR

10 UNITS

**SNAP PAK**

Original Equipment Part

# SNAP PAK

## takes the guesswork out of resistor identification

Complete product identification —no reading of color code

Resistors stay put —won't fall out even if one is removed

Confidence in original parts—no "make do" substitutes

Exposed leads for easy in-package testing

Indexed scale for accurate in-package lead cutting

Technical data or helpful replacement information

674

IRC, Inc., Philadelphia, Pa.

PERFORMANCE ADVANTAGES YOU GET ONLY FROM IRC

- Greater moisture protection
- Stronger lead assembly
- Lower operating temperature
- Superior high frequency characteristics

REPLACES

GBT 1/2 SR 1/2 EB  
RC20 RC20GF

Snap Down and Tear Back

... for more details circle 124 on postcard  
ELECTRONIC TECHNICIAN/DEALER



meter is supplied complete in a convenient polypropylene carrying case which keeps the coil/probes with the grid dip meter and protects both. Five additional coils are available for extending the range to 165kHz. Millen.

### Diode and Transistor Tester 730

A diode and transistor tester, model DT100, a low-current instrument for checking diodes and transistors is announced. The unit is a "go," "no-go" tester. Diodes are checked by touching the leads to the binding posts on the tester in either direction. If the diode is good, the light on the panel will glow. No indication of light means that the diode is either open or shorted. Transistors may be checked by clipping one of the test leads sup-

plied with the tester to the base of the transistor and attaching the other lead to the emitter and then to the collector. If the transistor is good, the lamp will glow on both connections. If the lamp does not light in one or both positions, the transistor is bad. Texscan.

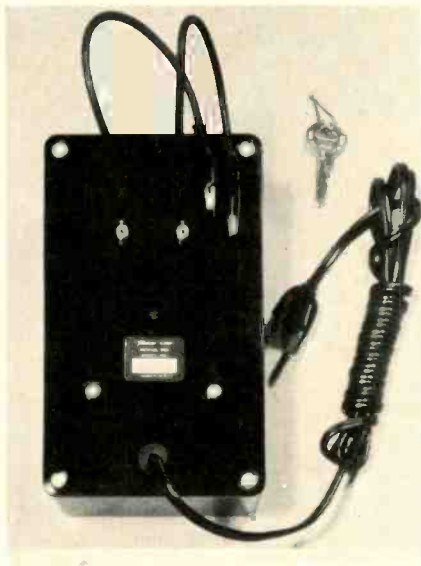

For more information on these  
NEW PRODUCTS  
See pages 105 and 106  
READERS SERVICE

# BUZIT TRANSISTORIZED SIGNAL TRACER

FOR ONLY \$9.57 DEALER NET  
WITH BATTERIES



NO CLIPS  
NO WIRES

MADE IN  
U.S.A.

USED FOR TROUBLE SHOOTING

- A.F. CIRCUITS • I.F. CIRCUITS
- R.F. CIRCUITS • CONTINUITY CHECKS • SPEAKERS, ETC.

EXCELLENT FOR TRANSISTOR  
RADIOS BECAUSE BUZIT USES  
ONLY A 3 VOLT POWER SUPPLY

ASK YOUR ELECTRONIC  
PARTS DISTRIBUTOR FOR

WEP MODEL NO. BZ-1

MANUFACTURED BY  
**WORKMAN** Electronic  
SARASOTA, FLORIDA PRODUCTS, INC.

... for more details circle 147 on postcard

# SNAP PAK

for all your service needs  
now at IRC distributors

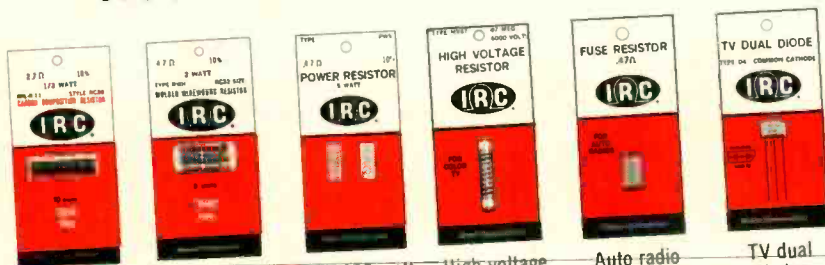

1/4-, 1/2-, 1-  
and 2-watt  
carbon comps

Wirewound  
Type BWH

5- and 10-watt  
power units

High voltage  
units for  
color TV

Auto radio  
fuse resistors

TV dual  
diodes



Look for this handy self-service rack at your distributor, or write IRC for name of nearest Snap Pak distributor.



414 N. 13th St., Phila., Pa. 19108

... for more details circle 125 on postcard

# only picture tube analyzer that tests all color tubes as they should be tested!

(THE WAY TUBE MANUFACTURERS DO)



## NEW LECTROTECH CRT-100 PICTURE TUBE ANALYZER FOR COLOR AND BLACK AND WHITE

Does everything . . . you would need all three units of the leading competitive brands to equal the performance of the Lectrotech CRT-100. No other brand has all the features . . .

- Line voltage adjustment (to insure all tube voltages are correct regardless of line voltage).
- Critical Grid-to-Cathode Leakage is read on sensitive meter for greatest accuracy.
- Leakages in all other elements are indicated on neon lamp.
- Tests all black and white and all color tubes for leakage, shorts and emissions.
- Tests each color gun separately.
- Tests each color gun to a standard set of test conditions. With variable G-2 voltage, each grid is normalized to a reference cut-off voltage. This method is used by tube manufacturers and simulates tube performance in color receiver.
- Rejuvenates and removes shorts on both color and black and white tubes for increased brightness.
- Life expectancy test, predicts remaining useful life of both color and black and white picture tubes.
- Continuously variable G-2 voltage for all tubes, present and future, including new 15 inch color tubes.
- Complete plug-in cables for easy replacement.
- Complete self-contained black and white socket assembly. No adapters to lose or cables to break.
- Including Pilot Light.

Only **89<sup>50</sup>** net

ONE YEAR WARRANTY

See your distributor or write DEPT. ET-3

**LECTROTECH, INC.**

1221 W. Devon Ave., Chicago, Illinois 60626

... for more details circle 128 on postcard

## NEWS OF THE INDUSTRY

### CB Industry Moves To Promote Solid Image

TV, radio and magazine messages carrying the story of CB two-way radio to the mass consumer marketplace in 1968 will spearhead the citizens band, industry's first concerted, cooperative advertising and publicity program, enthusiastically approved by the Citizens Radio Section of the Electronic Industries Assn.

Recognizing a need for a united educated effort at all potential user levels, the group is launching a market development program to expand public awareness of the value and simplicity of CB radio through consumer-oriented literature, highway signs, feature articles and store displays.

A separate campaign has been developed to promote better, more sympathetic understanding of the role and potential of CB in public service and safety among officials of government organizations such as highway, civil defense, law enforcement and fire protection. One prime objective is to assist the Federal Communications Commission in promoting more effective and mature use of CB.

### Commerce Department Communications Questionnaire

Firms producing TV-radio communications equipment, electronic components and accessories are among the various types of manufacturing firms which will help provide an over-all picture of the nation's economy by taking part in the 1967 Census of Manufacturers, according to the U.S. Dept. of Commerce's Census Bureau.

Firms being canvassed in the census will receive forms by mail early in 1968. Completion of these questionnaires is required under terms of an Act of Congress (12 U. S. Code). All answers on census questionnaires are confidential and are used only to produce statistical totals.

### Norelco Introduces New 'Car-Mount'

A new Norelco "Car-Mount," cassette tape audio system for automobiles, having a variety of special performance features, is introduced by North American Philips Co.

The "Car-Mount" consists of a sliding tray which holds the Norelco "Carry-Corder," a miniature cordless tape recorder using compact cassettes with up to 90 minutes of playing/recording time. The unit, which is attached below the car dashboard, provides for playback through the car radio.

### RCA Institutes Moves

RCA Institutes announces a 20-block move to larger quarters—without interruption of classes.

Expansion of the 59-year-old school will help meet the serious shortage of trained electronics personnel in all areas of the industry, including computer programmers, TV and nuclear instrumentation technicians, according to President A. L. Baker.

As the 4000 resident students left classes Friday afternoon and evening at the old school at 350 W. 4th St.—near 13th St. and Eighth Avenue in Greenwich Village—a small

army of professional movers began loading more than 150 van loads of classroom and laboratory gear. The equipment ranged from tiny transistors to huge electronic test instruments.

Some 30 hours later each numbered piece was in its proper place in what only a little more than a year ago was a warehouse for Franklin Stores, a few steps away from the new Madison Square Garden at Penn Station.

### Toshiba America Moves

Toshiba America will move to new and larger headquarters at 477 Madison Ave., New York City.

The new offices will be more than twice as large as the previous space at 530 Fifth Ave.

Noboru Takamiya, president, said the move was necessitated by a growing volume of business requiring a substantial number of new staff members.

### U. S. Hi-Fi Manufacturers Go After Scandinavian Market

Scandinavian businessmen will hear the sound of music from the newest in American high-fidelity components when U. S. firms feature their latest lines in a special show at the U. S. Trade Center in Stockholm, Sweden, Feb. 15 to 21.

The Trade Center show comes at a time of strong consumer demand for all types of high-quality convenience and luxury items. Sweden's economy is flourishing, giving its people one of the highest standards of living in the world.

U. S. makers of high-fidelity components have been successful at selling abroad through past commerce export promotions. For example, the 32 U.S. firms at a show of high-fidelity and stereo components at the U. S. Trade Center, London, in April, 1966, report doing more than \$1 million worth of business abroad in the year following the show. They also report signing 32 agents and distributors to handle their products on a long-term basis.

### Atomic Second Adopted as International Unit of Time

A new definition of the international unit of time, the second, was adopted in Paris by the 13th General Conference on Weights and Measures. The second has now been defined as the duration of 9,192,631,770 periods of radiation corresponding to the transition between the two hyperfine levels of the fundamental state of the atom of cesium 133.

The frequency (9,192,631,770 Hz) that the definition assigns to the cesium radiation was carefully chosen to make it impossible, by any existing experimental evidence, to distinguish the new second from the "ephemeris second" based on the earth's motion.

### EIA Service Technician Development Program

The Electronic Industries Assn.'s Consumer Products Div. announces implementation of the first phase of its Service Technician Development Program (STDP) an intensive "win friends and influence people" effort at the American Vocational Assn. (AVA) annual convention at the Sheraton-Cleveland Hotel. The AVA represents some 45,000 vocational education teachers and counsellors and is considered a major factor in that field.

The STDP is the EIA Consumer Products Div's long-range effort aimed at increasing the number of qualified service technicians for consumer electronic products. Over half a million dollars has been ear-marked for



## "My shop's been loaded... since I got my FCC License."

"And I could kick myself for not getting it sooner. I'm pulling in all kinds of mobile, marine and CB business that I couldn't touch before; have even had some calls to work on closed-circuit television. I've hired two new men to help out and even with them, I'm two weeks behind."

And so it goes. Once you have that FCC ticket, you open the door to all kinds of new business. And that's not all. The knowledge you need to pass the FCC exam gives you a fundamental understanding of *all* electronics. You'll find you can do more work in less time...work on almost any kind of electronics gear.

What's the best way to get a Commercial FCC License... and still keep up with your work? Thousands of men will tell you "Cleveland Institute of Electronics." CIE has been preparing men for FCC License exams since 1934. What's more, they back their Home Study Licensing Programs with this remarkable money-back offer:

**A CIE FCC License course will quickly prepare you for a Commercial FCC License. If you fail to pass the FCC examination...on the very first try...after completing your course, CIE will refund all your tuition. You get an FCC License...or your money back!**

And only CIE offers you new, up-to-the-minute lessons in all these subjects: Logical Troubleshooting, Laser Theory and Application, Micro-miniaturization, Single Sideband Technique, Pulse Theory and Application, Boolean Algebra, and many more.

Send coupon today for CIE's FREE informative book "HOW TO GET A COMMERCIAL FCC LICENSE." Cleveland Institute of Electronics, Dept. ET-38 1776 East 17th Street, Cleveland, Ohio 44114.

**ENROLL UNDER NEW G.I. BILL.** All CIE courses are available under the new G.I. Bill. If you served en active duty since January 31, 1955, OR are in service now, check box in coupon for G.I. Bill information.

**MAIL COUPON TODAY FOR FREE BOOK**

**CIE** Cleveland Institute of Electronics  
1776 East 17th Street, Cleveland, Ohio 44114

Please send FREE book, "How To Get A Commercial FCC License."

Name \_\_\_\_\_ (please print)

Address \_\_\_\_\_

City \_\_\_\_\_ State \_\_\_\_\_ Zip \_\_\_\_\_

Occupation \_\_\_\_\_ Age \_\_\_\_\_

**Check here for G.I. Bill information**

Accredited Member National Home Study Council  
A Leader in Electronics Training... Since 1934 ET-38



... for more details circle 111 on postcard

this manufacturer-sponsored effort over the next five years. One thrust of the program will seek to work closely with vocational educators and counsellors at the secondary school level.

The STDP eventually intends to influence and improve electronics teaching at the classroom level all over the country through teacher training seminars and institutes, curriculum upgrading programs and consultation services. In conjunction with a public relations and career guidance program, these activities are intended to gradually bring more and more well-trained and well-motivated young people into consumer electronics servicing as a career.

### Philco-Ford Corp. Opens New District Sales Office

A district sales office has been established in Atlanta, Ga., for the sale, distribution and servicing of Philco-Ford Corp.'s consumer products.

The new district office, located at 700 Forrest Road, N. E., Atlanta,

and operated as Philco Distributors, Inc., by the Sales and Distribution Div., will serve dealers in most of Georgia, eight counties in South Carolina and two counties in Alabama. (The Savannah, Ga., area is in Philco-Ford's Miami sales district.)

### Tuner Div. Will Change Name To Standard Components Div.

The Tuner Div. of Standard Kollsman Industries has been renamed and is now called the Standard Components Div. of Standard Kollsman Industries. TV tuners will remain the division's principal product line.

### Philco-Ford Appoints District Service Manager

Michael Viall has been appointed Philadelphia district service manager for Philco-Ford Corp.'s Parts and Service Office. In his new position he will serve Philadelphia, Baltimore and Washington, D.C.

### RCA Distributor For Hartford Area

Eastco, Inc., a wholly owned subsidiary of the Eastern Co., Cambridge, Mass., will assume responsibility im-

mediately for the distribution of RCA Victor products in the Hartford, Conn., marketing area. Martin F. Bennett, vice president, distributor and commercial relations, announces.

Mr. Bennett said the Eastern Co., which distributes RCA Victor products in the Boston and Providence marketing areas, has acquired Radio & Appliance Dist., 95 Leggett St., East Hartford, Conn., and will serve home instruments and record dealers from that address.

### Belden Corp. Constructs New Wire and Cable Plant

Belden Corp. plans to build a 150,000-sq-ft plant on a 43-acre site in central Louisiana's LaSalle Parish. The plant will be constructed during 1968. Approximately 200 employees will initially staff the new facility, which will produce insulated copper wire and cable.

### Integrated Circuit Sales Continue Their Rapid Climb

U. S. factory sales of semiconductor integrated circuits totaled \$162 million during the first nine months of 1967, climbing 57 percent above the sales figure for the same period in 1966, the Electronic Industries

## ZENITH TUBES built to the quality standards of Zenith original parts

### "Royal Crest" Circuit Tubes

More than 875 tubes—a full line with the same quality as original Zenith equipment. Get Zenith tubes for greater dependability and finer performance.

Order all genuine Zenith replacement parts and accessories from your Zenith distributor.

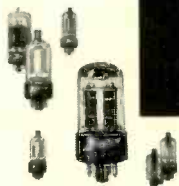

### TV Picture Tubes

For color TV, B&W TV or special purposes. A complete Zenith line of more than 200 tubes built for greater reliability, longer life.

Zenith B&W replacement picture tubes are made only from new parts and materials except for the glass envelope in some tubes which, prior to reuse, is inspected and tested to the same high standard as a new envelope. Some color picture tubes contain used material which, prior to reuse, is carefully inspected to meet Zenith's high quality standards.

BEST YEAR YET



TO SELL THE BEST

# ZENITH

The quality goes in before the name goes on

Assn.'s Marketing Services Dept. reports.

With a 33 percent decline in average value, the total unit sales rose 133 percent to reach 45 million during the January to September 1967 period.

#### **Vidaire Electronics Appoints New Sales Representative**

J. B. Parent Co. has been appointed sales representative for Vidaire Electronics. It will represent Vidaire in Ohio.

#### **Electronic Industry Show Elects New President**

Arthur Rabb, president of United Technical Publications, was elected President of Electronic Industry Show Corp.'s Board of Directors for the 1968 Electronics Show to be held June 14 to 16 at the New York Hilton Hotel in New York City.

#### **Littelfuse Appoints Sales Rep.**

The Mel Foster Co., 228 S. Cedar Lake Road, Minneapolis, Minn., has been appointed the sales representatives for distributor and OEM product sales for Littelfuse, Des Plaines, Ill., it is announced by Walter A. Clements, vice president of sales and marketing. The new appointment was effective Dec. 15, 1967.

The sales organization will represent Littelfuse in Minnesota, North and South Dakota and western Wisconsin.

#### **Fred Jones Named Director Of Sentry Manufacturing**

Fred Jones, an Oklahoma City industrialist and former chairman of the board of Braniff International, has been named a director of Sentry Manufacturing Co., producers of quartz crystals and electronic components for the communications industry.

#### **Curtis Mathes Names Sales Manager**

Curtis Mathes Manufacturing Co. (AMEX), Dallas, has named William D. Goldberg Northeastern regional manager for sales. His appointment is part of the company's continuing program to market Curtis Mathes color television and home entertainment centers in the Eastern United States, Horace B. Kelton, executive vice president, said. Mr. Goldberg will be responsible for all sales and marketing in the metropolitan New York, New Jersey and lower Connecticut areas. His address will be 414 Elizabeth Ave., Newark, N. J.

# Here's a remarkably stable, completely portable, all solid-state, battery operated voltmeter. **Naturally it's an RCA VoltOhmyst®**

Eliminate warm-up time! Eliminate zero-shift that can occur in tube-operated voltmeters! RCA's new **WV-500A** VoltOhmyst is an all solid-state, battery operated, completely portable voltmeter that is ideal for service, industrial, and lab applications. Seven overlapping resistance ranges measure from 0.2 ohm to 1000 megohms. Eight overlapping dc-voltage ranges measure from 0.02 volt to 1500 volts (including special 0.5 dc volt range), ac peak-to-peak voltages of complex waveforms from 0.5 volts to 4200 volts, and ac (rms) voltages from 0.1 to 1500 volts. Input impedance of all dc ranges is 11 megohms.

All measurements are made with a sturdy, wired-in, single-unit probe with fully shielded input cable. The probe is quickly adapted to either dc measurement or ac and resistance measurement by a convenient built-in switch. And an accessory slip-on high-voltage probe is also available to make possible measurements up to 50,000 dc volts.

See your Authorized RCA Test Equipment Distributor, or write RCA Electronic Components, Commercial Engineering Department, Section C-46-WA, 415 South Fifth Street, Harrison, New Jersey.

Solid-state reliability and convenience for only \$75.00\*.

\*Optional distributor resale price. Prices may be slightly higher in Alaska, Hawaii, and the West.

# RCA



... for more details circle 150 on postcard

## Old Tubes to Smithsonian

Historical TV tubes, among the world's first, are donated to the Smithsonian Institution by Dr. Philo T. Farnsworth, noted scientist of ITT. Five 40-year-old camera and picture tubes, plus all of his documents and laboratory notebooks of the time, were given upon invitation by the Smithsonian. Dr. Farnsworth earned the sobriquet "Father of Electronic Television" for his inventions in his late 'teens and early twenties, which tri-



umphed in the patent courts. The tubes, dating from 1927, include, left to right on the table, the first image dissector, first projection oscilloscope, a primitive image orthicon with electron multiplier and the first oscilloscope tube with a flat screen. Victoria Lynch of ITT holds the world's first oscilloscope with internal deflection plates.

## FTC Hits TV Sales Company

The Federal Trade Commission has issued a complaint charging violations of law by Lawrence TV Corp., 5832 Georgia Ave., N. W., Washington, D. C., and George Harris, the concern's manager.

The FTC's complaint states that, "Respondents are now, and for some time past have been, engaged in the advertising, offering for sale, sale and distribution of television sets, and television, radio and phonograph combinations to the public."

The complaint charges that, contrary to representations made in newspaper advertisements for the purpose of inducing the purchase of their products:

"1. The offers set forth in said advertisements were not bonafide offers to sell the advertised products at the

prices and on the terms and conditions stated. Respondents' salesmen, who called upon persons responding to the advertisements, did not display the advertised product. Instead, respondents' salesmen disparaged the advertised product and attempted to sell a higher priced product. By these and other tactics, purchase of the advertised product was discouraged and respondents frequently sold a higher priced product.

"2. In a number of instances, the respondents did not give a free home demonstration of the products advertised.

"3. In a number of instances, the respondents advertised a product when they did not have sufficient quantities on hand to make it available for purchase.

"4. Purchasers of the advertised television, radio and stereo combination did not receive free record albums."

The complaint further alleges that illustrated advertisements placed in newspapers by respondents represent that the cabinets of TV sets are wood, when "In truth and in fact, the cabinets of the advertised television sets were not wood, but were metal."

The respondents have 30 days within which to file answer to the complaint.

## We're looking for a few more warranty service stations (who aren't looking for very much business.)

Frankly, our present warranty service stations aren't doing as much business with Dual as they'd like. There just isn't that much to do. But once in a while, a Dual owner needs some servicing, or thinks he does, and we'd like to shorten his trip. If this is just what you've been looking for, drop a line to Phil Dubson, service manager. Or call him at (212) 478-5959.

**United Audio**, 535 Madison Ave.,  
New York, N.Y. 10022



"Your woofer and tweeter's giving you trouble out here, too."

... for more details circle 145 on postcard



**HOW TO USE SIGNAL GENERATORS IN COLOR TV SERVICING.**  
By John Lenk. Published by John Rider Publisher, Inc., 108 pages, soft cover. \$3.25.

Slightly more than half the book is devoted to basic color-signal generator operating principles, controls and procedures, and color-signal generator testing and calibrating. Some technicians may find that the manufacturer's manual for the test instruments that they already own provides them with all of this type of information that they need. This material may, however, be of some value to technicians confronted with the task of selecting new test instruments best designed to serve their purposes. The remainder of the book describes purity, convergence and linearity adjustments, and testing color sync characteristics, chroma demodulation characteristics and matrix circuit characteristics, plus some miscellaneous applications. Where practical, many simple test circuits are included. We feel that a few of the scope tracings drawn for the book may mislead new apprentice technician readers. This book should however, be of some value to technicians just learning about a few of the intricate problems they will eventually face in color TV servicing.

**HOW TO USE SIGNAL GENERATORS IN RADIO/TV/HI-FI SERVICING.** By John Lenk. Published by John Rider Publisher, Inc., 128 pages, soft cover. \$3.25.

More than a third of the book is devoted to basic signal generator operating principles, controls and procedures, and signal generator checking and calibrating. The remainder of the book describes procedures for checking TV antenna systems, AM receivers, FM receivers, TV sets and audio amplifiers. The many testing procedures included are illustrated and briefly described. The book may help the experienced technician expanding his checking techniques, and some of these checks may help the apprentice technician learn more about impedances and tuned circuits in antennas, leads and electronic circuits. We feel, however, that the book would have been more useful if it contained fewer circuits — described in more detail. The descriptions with a few diagrams stated that a variable resistor should be adjusted, while no variable resistors were shown in these diagrams.

Test this signal transistor at 1mA collector current... and this power transistor at 1Amp collector current... or any collector current you select, from 20  $\mu$ A to 1 Amp with the

## WT-501A in-circuit/out-of-circuit transistor tester

Battery operated, completely portable, RCA's new WT-501A tests transistors both in-circuit and out-of-circuit, tests both low- and high-power transistors, and has both NPN and PNP sockets to allow convenient transistor matching for complementary symmetry applications. The instrument tests out-of-circuit transistors for dc beta from 1 to 1000, collector-to-base leakage as low as 2 microamperes, and collector-to-emitter leakage from 20 microamperes to 1 ampere.

Collector current is adjustable from 20 microamperes to 1 ampere in four ranges, permitting most transistors to be tested at rated current level. A complete DC Forward Current Transfer Ratio Curve can be plotted. Three color-coded test leads are provided for in-circuit testing, and for out-of-circuit testing of those transistors that will not fit into the panel socket.

See your Authorized RCA Test Equipment Distributor, or write RCA Electronic Components, Commercial Engineering Department C-46-WB, 415 South Fifth Street, Harrison, New Jersey.

Extra features... RCA reliability... for only \$66.75\*.

\*Optional distributor resale price. Prices may be slightly higher in Alaska, Hawaii, and the West.

**RCA**



... for more details circle 151 on postcard

**TV Chassis KCS158 Series—Apparent 'Hum bar'**  
 Field reports mention an apparent "hum bar" on some KCS158 chassis. Investigation reveals that L110 positioning

Continued from page 38

ance and permits tape unit to be used with all types of external stereo instruments.

The illustrations show a series of networks that may be used, ranging from a simple 2 resistor type to a manual level-set type.

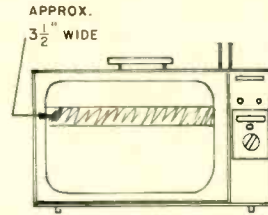

**IF YOU  
 CHANGE YOUR ADDRESS**

**NOTIFY: ELECTRONIC TECHNICIAN**  
 Ojibway Building  
 Duluth, Minnesota 55802

Please include the address label from a recent issue and allow six weeks for the change.

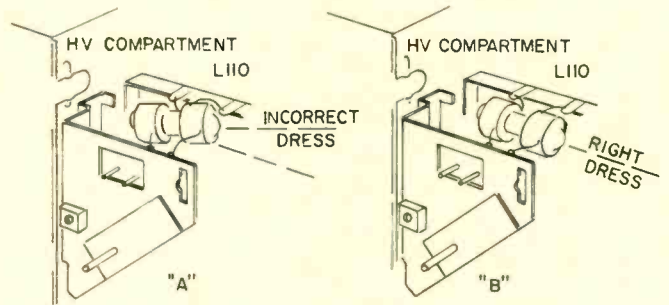

can be critical with respect to the yoke position. Where this "hum bar" is evident, L110 should be redressed as illustrated in "B."

**"IT'S GOOD BUSINESS  
 TO HIRE THE HANDICAPPED."  
 ISN'T THAT A GREAT IDEA, SNOOPY?**

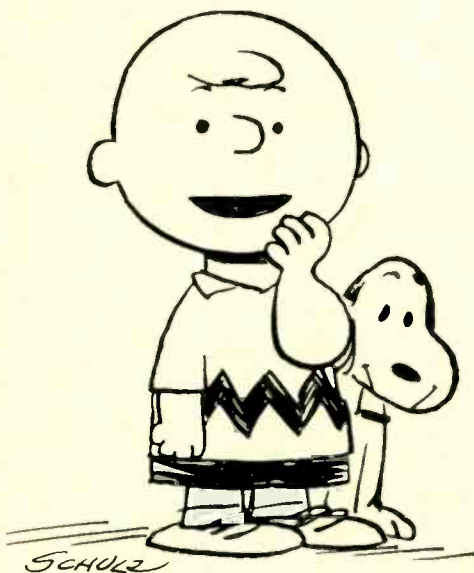

THE PRESIDENT'S COMMITTEE ON EMPLOYMENT  
 OF THE HANDICAPPED, WASHINGTON, D. C.



"Poor fellow, up on a ladder fixing a monitor and fell into a vat of beer."

# DURA-FOAM<sup>®</sup>

the vital link in your customer's TV Enjoyment

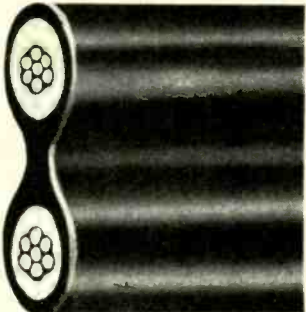

UHF, VHF... Color or Black and White; be sure your customer gets ALL the TV pleasure and enjoyment that's coming his way with DURAFOAM transmission cable. Easy to install... easy to terminate!

The unique superiority of DURAFOAM is protected by U.S. patent number 3219752 and backed up by over 18 million feet already in use.

DURAFOAM is unconditionally warranted 15 years and features two carefully spaced tubes of yellow foam polyethylene for lowest signal loss.

The outer protective jacket, separating the conductors, is 115 mils of specially compounded, high molecular weight, black polyethylene that provides maximum protection against moisture, chemical fumes, salt air, ultra-violet rays of sunlight and other hazards.

DURAFOAM impedance is 290 ohms and nominal capacitance is 4.9. Attenuation per 100 feet is 1.04 DB at 100 MC, 3.5 DB at 500 MC and 4.5 DB at 900 MC. Cable size is .410 wide, .150 over foam polyethylene tubes. DURAFOAM is available in 500 and 1,000 foot spools plus 50, 75 and 100 foot coils with attached terminals at one end. Order from your distributor. Write today for complete information.

*Columbia*

**WIRE PRODUCTS COMPANY**  
2850 Irving Park Road Chicago 60618  
... for more details circle 112 on postcard

## CATALOGS AND BULLETINS

### Photoelectric Controls 400

A 36-page catalog is loaded with practical application data and contains 51 application sketches. Included are specifications and prices of 130 pre-engineered control packages; a large selection of controls, photo sensors and light sources including retro-reflective, fiber optic and miniature; dual filament, adjustable focus and high intensity light sources with optional safety relay; electronic timer; bin and liquid level controls; also extremely sharp overload and underload controls. Autotron.

### Precision Instruments 401

This catalog covers over 5000 instruments which measure voltage from 1mv to 100kv and 1.5 $\mu$ a to 1kva. Included is information on electrostatic voltmeters, precision panel meters and automatic ac/dc transfer standard. Singer.

### Components and Tools 402

The products of more than 80 electronics manufacturers are listed in this 328-page catalog which includes a MIL specs guide, MIL/EIA standard resistance value table, quick reference capacitor and resistor code data chart and industrial tube cross reference. Pyttronic.

### Miniature Lamps 403

A miniature lamp catalog describes over 100 different styles of low-voltage lamps. Lamp sizes range from tiny grain-of-wheat size to 1 $\frac{3}{4}$  in. ultra-thin "long lines." Styles include fuse type, pig tails, neons, self-leads and complete lamp assemblies with colored lens caps and 6in. leads. Various currents and bases are offered. Mura.

### Television Systems 404

Three instructor-controlled television systems are shown in an eight-page brochure. Techniques for using the systems to increase teaching effectiveness in single classrooms, team teaching and instructional telecasting are also described. RCA.

### RFI Filters 405

A four-page bulletin contains specifications and performance characteristics of RFI filters for power lines. Features described include availability of filters at three noise rejection levels to supply desired attenuation in single, dual or triple circuit configurations and in 45 standard models with ratings from 20 through 100a. San Fernando Electric.

## New sensitivity for transistor servicing

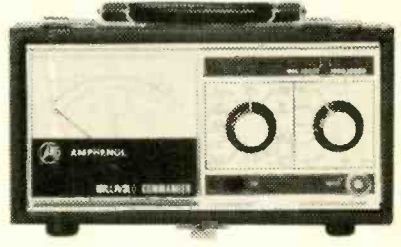

The new Model 870 Millivolt Commander from Amphenol is a low-cost, field-effect transistor instrument; it's designed with the needed low ranges for servicing transistorized equipment. Never before have such sensitive measuring capabilities been available in an instrument under \$100.

With the portability of a VOM and the accuracy and input impedance of a VTVM, the Millivolt Commander offers extreme versatility, with a price that will fit almost any budget.

The Model 870 Millivolt Commander's measuring capabilities are:

- 1/10 to 1000 volts DC, full scale, in 9 overlapping ranges, within  $\pm 2\%$  accuracy.
- 1/100 to 300 volts RMS AC, full scale, in 10 overlapping ranges, within  $\pm 3\%$  accuracy.
- -40 to +50 db in 10 steps of 10 db. Resistance from 10 ohms center scale to 10 megohms center scale within  $\pm 3$  degrees of arc in 7 overlapping ranges.

Other features include: battery life equal to shelf life; elimination of warm-up time; automatic shut-off when lid is closed; and a sturdy, single-unit probe with a built-in DC/AC-OHMS switch and shielded cable.

The Amphenol Millivolt Commander is 9 $\frac{1}{4}$  inches wide, 5 $\frac{3}{4}$  inches high and 6 $\frac{3}{8}$  inches deep and weighs only five lbs with batteries.

Suggested list price of Model 870 Millivolt Commander is only \$99.95.

Amphenol Corporation, Department ET2-38, 2875 South 25th Avenue, Broadview, Illinois 60153.



**AMPHENOL**

... for more details circle 103 on postcard

# Don't you read before you buy ?



FURNITURE BY PEERLESS STEEL EQUIPMENT CO.

Businessmen do. They have to. How else can they stay abreast of new ideas, new methods, new products? There's no better way to keep pace with progress than through the printed pages of your favorite magazine. To keep your products and services in a strong competitive position, make sure you tell your story regularly—in print. It's where businessmen look for facts on what to buy and where to buy it. Print makes sense, because print makes sales.

## PRINT ADVERTISING ASSOCIATION

638 SOUTH FEDERAL STREET, CHICAGO 60605

CHICAGO • NEW YORK • PHILADELPHIA • DETROIT • ST. LOUIS

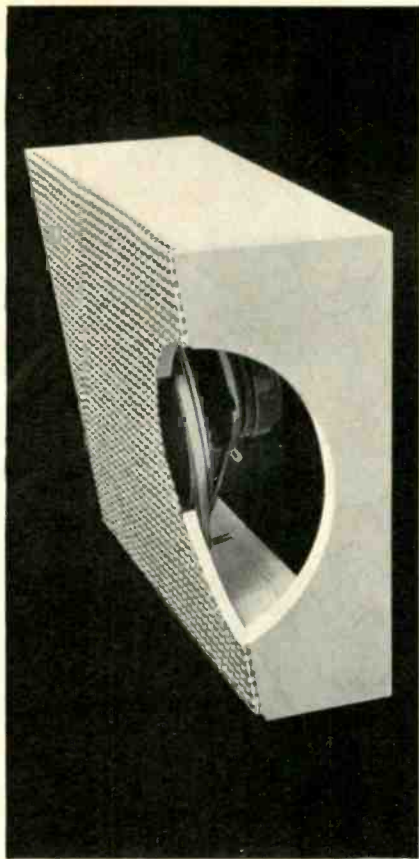

# GET PLUS PERFORMANCE FROM OAKTRON SPEAKERS

All Oaktron speakers feature the exclusive Aluminum Voice Coil. This tempered, all aluminum form eliminates warpage from humidity changes and from severe overload. The unique aluminum Voice Coil also provides increased sensitivity and longer speaker life.

A complete range of sizes and styles are available in Oaktron Baffles. Styled in smart furniture finish, Oaktron Baffles feature 1/2" hardwood, double strength interlocking corners, and solid glued and stapled grills.

For complete information, write today for your FREE Catalog.



OAKTRON INDUSTRIES, INC., MONROE, WIS.

... for more details circle 134 on postcard

## Calculators 406

This 24-page catalog covers special purpose slide rules, calculators, kits, books and other calculation and information aids to save engineering and management time. Info.

## Antennas . . .

*Continued from page 51*

provides an undistorted station signal to the receiver antenna terminals — especially on color installations — weak sync, poor picture definition, distorted audio, ghost reflections and interference may result.

Other important antenna characteristics to be considered, especially in selecting modern all-band antennas which cover VHF, FM and UHF frequencies, include the VSWR and the front-to-back ratios for each individual channel to be received. The VSWR, at a given frequency, affects the signal-to-noise ratio. And a high VSWR at a given channel can cause color-smear, for example.

The next article will cover other important points to be considered in selecting antennas and installation techniques involved in immediate, secondary, fringe and deep-fringe areas. ■

## Audio Communications . . .

*Continued from page 53*

that the video section of a TV receiver isn't much use without the audio section. And it follows that the future of audio communications is tied inexorably with CCTV, video tape recording and other visual communications methods. For this reason, we believe that your efforts in commercial audio should be synchronized with at least some effort in the direction of CCTV and VTR. These areas are expanding but are little cultivated today. They are wide open to all alert, aggressive service-dealers and technicians who would like to divert some or all of their efforts toward new, more fertile, more profitable frontiers.

Forthcoming articles in this series will elaborate on the technical and business aspects of audio and audio-visual communications equipment. ■

## 7 stereo instruments in one low-cost package



The Model 880 Stereo Commander from Amphenol provides a complete testing laboratory for audio FM and multiplex at a fraction of the cost of the seven individual instruments it replaces.

Four signal sources and three measuring instruments are contained in the package which includes:

- An audio generator that supplies either sine or square wave signals.
- A multiplex simulator that generates all signals necessary for alignment of an FM multiplex receiver.
- An RF/sweep oscillator that may be used as an FM source modulated by the signal present at the composite jack or as a sweep generator with 60 Hz sweep rate for FM tuner alignment.
- An oscillator that generates a crystal-controlled 10.7 MHz signal for use in aligning FM receivers.
- An intermodulation distortion analyzer which measures distortion to 100% using SMPTE standard signal.
- An impedance bridge capable of measuring largely resistive unknowns from 1 ohm to 20,000 ohms.
- A high-impedance AC voltmeter with a sensitivity of 100 millivolts full scale. The unit measures from 0.1 volt full scale to 1000 volts.

The Amphenol Stereo Commander is 11 1/2 inches wide, 9 3/4 inches high and 6 inches deep and weighs slightly over eight lbs.

Suggested list price of the seven-in-one unit is only \$329.95.

Amphenol Corporation, Department ET1-38, 2875 South 25th Avenue, Broadview, Illinois 60153.



**AMPHENOL**

... for more details circle 104 on postcard



The NEW  
NO. 800  
**TUN-O-LUBE  
TUNER CLEANER**  
*Specially*  
**FORMULATED  
FOR TV-TUNERS**  
USING NUVISTORS &  
TRANSISTORS  
**NO TUNER DRIFT**

Nuvistors and Transistors are highly sensitive to drift from ingredients in most ordinary TV tuner cleaners. Drift has been found to cause call backs and expensive tuner repairs. For over 18 months CHEMTRONICS has been formulating and testing this new cleaner in both the lab and field. Under the most critical test, there has been NO DRIFT on scope patterns. We invite you to try this test yourself.

**AMAZING  
HIGH VOLTAGE  
INSULATOR  
NO-ARC**  
20,000 VOLTS  
DIELECTRIC STRENGTH  
CHEMTRONICS' highly effective NO-ARC provides a tough and protective insulating coating for hi-voltage transformers, yokes, chassis and leads in high voltage sections.

No. 830



BROOKLYN N. Y. 11236  
... for more details circle 109 on postcard

**ADVERTISER' INDEX**

Amphenol Distributor Div. .... 101, 103  
Arrow Fastener Co. .... 104  
B & K Div., Dynascan Corp. ..2nd Cover, 39  
Borden Chemical Co., Krylon Div. .... 26  
Chanellock, Inc. .... 76  
Chemtronics, Inc. .... 104  
Cleveland Institute of Electronics .... 31, 95  
Columbia Wire Products Co. .... 101  
Conar Instruments ..... 88  
Cornell-Dubilier ..... 3rd Cover  
Electro Products Laboratories ..... 81  
Enterprise Development Corp. .... 92  
Gavin Instruments, Inc. .... 37  
GC Electronics Co. .... 22, 74  
General Electric Co. .... 33, 70  
Greyhound Lines, Inc. .... 87  
Heath Co. .... 67  
Injectorall Electronics Corp. .... 82  
IRC, Inc. .... 91, 92, 93  
Jerrold Electronics Corp. .... 73  
Lakeside Industries ..... 91  
Lectrotech, Inc. .... 94  
Mid-State Tuner Service ..... 84  
Miller Co., J.W. .... 84  
Mosley Electronics, Inc. .... 88  
Multicore Sales Corp. .... 104  
National Radio Institute ..... 36  
Oaktron Industries ..... 103  
Pearce-Simpson, Inc. .... 38  
Precision Apparatus Div., Dynascan Corp. .. 83  
Radio Corp. of America  
RCA Electronic Components &  
Devices. 4th Cover, 27-30, 68-69, 97, 99  
RCA Institutes, Inc. .... 90  
RCA Parts & Accessories ..... 77  
RCA Sales Corp. .... 40  
Sencore, Inc. .... 23, 24, 75  
Simpson Electric Co. .... 20  
South River Metal Products Co. .... 82  
Sprague Products Co. .... 25  
Sylvania Electric Products, Inc. .... 85  
Triplett Electrical Instrument Co. .... 89  
Tuner Service Corp. .... 19  
United Audio Products, Inc. .... 98  
Winegard Co. .... 78-79  
Workman Electronic Products, Inc. .... 93  
Zenith Sales Corp. .... 34-35, 96

**WORLD'S  
FINEST  
5-CORE  
SOLDER**

**ERSIN  
MULTICORE  
NEW EASY  
DISPENSER  
PAK ONLY 69¢**

BUY IT AT RADIO-TV PARTS STORES  
MULTICORE SALES CORP., WESTBURY, N.Y. 11591  
... for more details circle 132 on postcard

**ARROW**

**EFFICIENT!  
SAFE!  
FAST!**

**AUTOMATIC  
STAPLE GUNS**

For Fastening Any  
Inside or Outside  
Wire Up to 1/2" in Diameter

	UP TO 3/16" No. T-18	• Telephone wire • Intercom wire • Bell wire
	UP TO 1/4" No. T-25	• Thermostat wire • Radiant heating wire • Hi-Fi, Radio & TV wires
	UP TO 1/2" No. T-75	• Tapered striking edge gets into close corners!

Available in:  
Brown, Ivory, Beige,  
Monel, Bronze, Natural

**ARROW FASTENER COMPANY, INC.**

Saddle Brook, N.J. 07663  
... for more details circle 105 on postcard

ELECTRONIC TECHNICIAN/DEALER

**ELECTROLYTICS ARE DIFFERENT THE WAY A WET BATTERY DIFFERS FROM A DRY CELL.**



- A wet battery rated at 100 amp hours versus a dry cell rated at .01 to 1 amp hour.
- An electrolytic rated at 1 to 10,000 mfd versus a tubular or wrap or film at .000001 to 1 mfd.
- Wide tolerance (-10 to +150%) versus close tolerance (+2%).

**ELECTROLYTICS ARE USED AS FILTER CAPACITORS FOR POWER SUPPLIES — IN CIRCUITS WHERE CLOSE TOLERANCES ARE NOT NEEDED.**

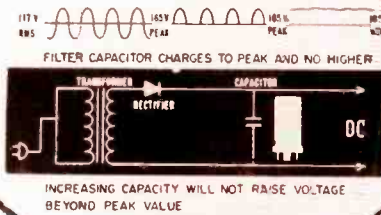

**ONE CAN REPLACE MANY; NO NEED FOR EXACTITUDE.**

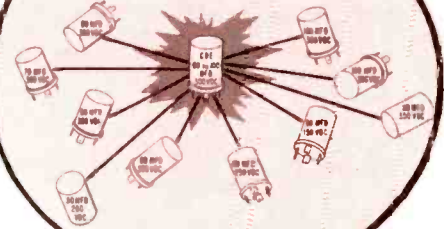

**EIA TOLERANCES PROVE THIS.**

3.4.5 The tolerance from nominal rated capacitance shall be:

Rated DC Voltage	Capacitance Tolerance
From 3 to 50 volts, inclusive	-10% to +150%
From 51 to 350 volts, inclusive	-10% to +100%
From 351 to 450 volts, inclusive	-10% to +50%

**NEW RATINGS ARE USUALLY COVERED BY WIDE RANGE COLOR-LYTICS.®**

No waiting for new "exact" replacements; wide range lytics will replace many cans in chassis now being designed.



**MAKE MORE MONEY!**



- Faster turnover
- More dollars earned
- Less dollars invested
- Less obsolescence
- Better customer service
- Fewer lost sales
- Less back orders
- Quicker inventory
- Less shelf space
- Better and wider coverage

**Six straight shots from the Wide Ranger.**

For TV replacement electrolytics there are many advantages with Wide Range Color-Lytics.® Most important for you, it means more profit. The Wide Ranger represents CDE's wide range electrolytic program. His 200-plus replacement electrolytics do the job of over 2000 so-called "exact" replacements. Since each of CDE's units are suitable for a number of different ratings, you can serve your customers better and faster with reduced inventories at greater profit. CDE Wide Range Color-Lytics—they should make everyone in the business happy except the Exact Kid.



## We can't leave well-enough alone...

*...so we decided to redesign the RCA-6GF7A vertical deflection tube to practically eliminate low-line top-picture compression, high-line top picture stretch in color TV receivers.*

We developed a cathode material that improves the tube's ability to provide uniform and consistent performance as a high-perveance, low-mu triode unit for vertical-deflection amplifier applications. A better grid-wire plating technique virtually eliminates cathode poisoning and grid emission problems. Linearity is 100% controlled. And for vertical-

deflection-oscillator applications, we test for grid leakage at higher plate and grid voltages than would normally be found in TV applications so the picture won't creep up the screen as the vertical deflection tube warms up.

Innovations and improvements that make your service operation more reliable, efficient, and profitable are our constant aim. See your Authorized RCA Tube Distributor for quality RCA receiving tubes.

RCA Electronic Components and Devices,  
Harrison, New Jersey.

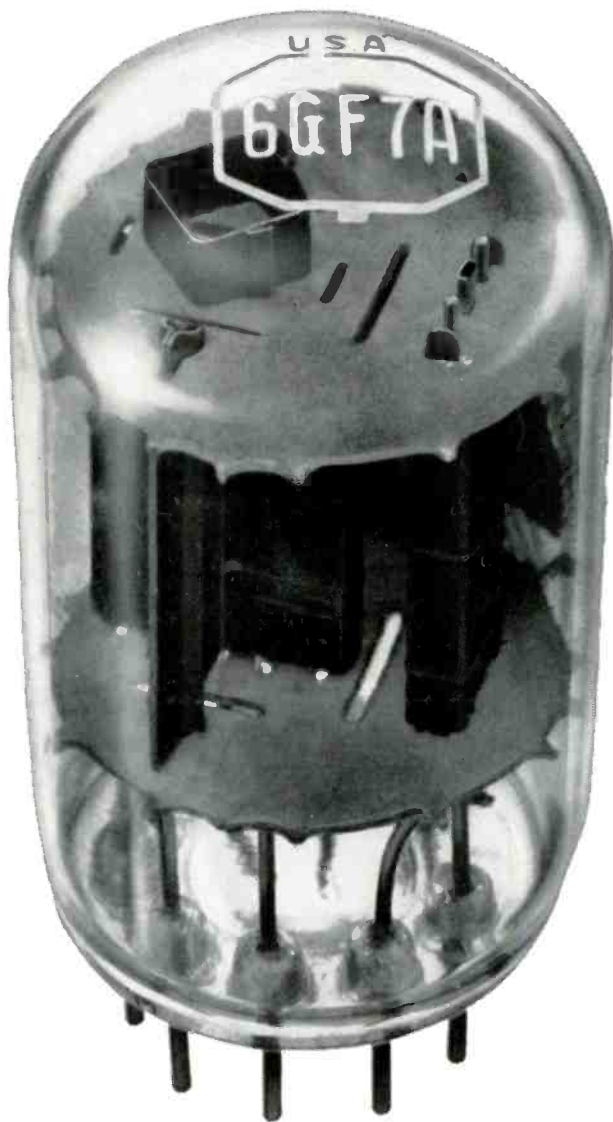

# RCA