

ELECTRONIC TECHNICIAN

WORLD'S LARGEST ELECTRONIC TRADE CIRCULATION



FEBRUARY 1967



CHANNELIZER

OPERATION

STEREO TUNER

100 102 104 106 108

MODE
MONO • STEREO

APC

REVERSE

OFF

628
829
558

Two-Way Test Instruments | Understanding Stereo Multiplex

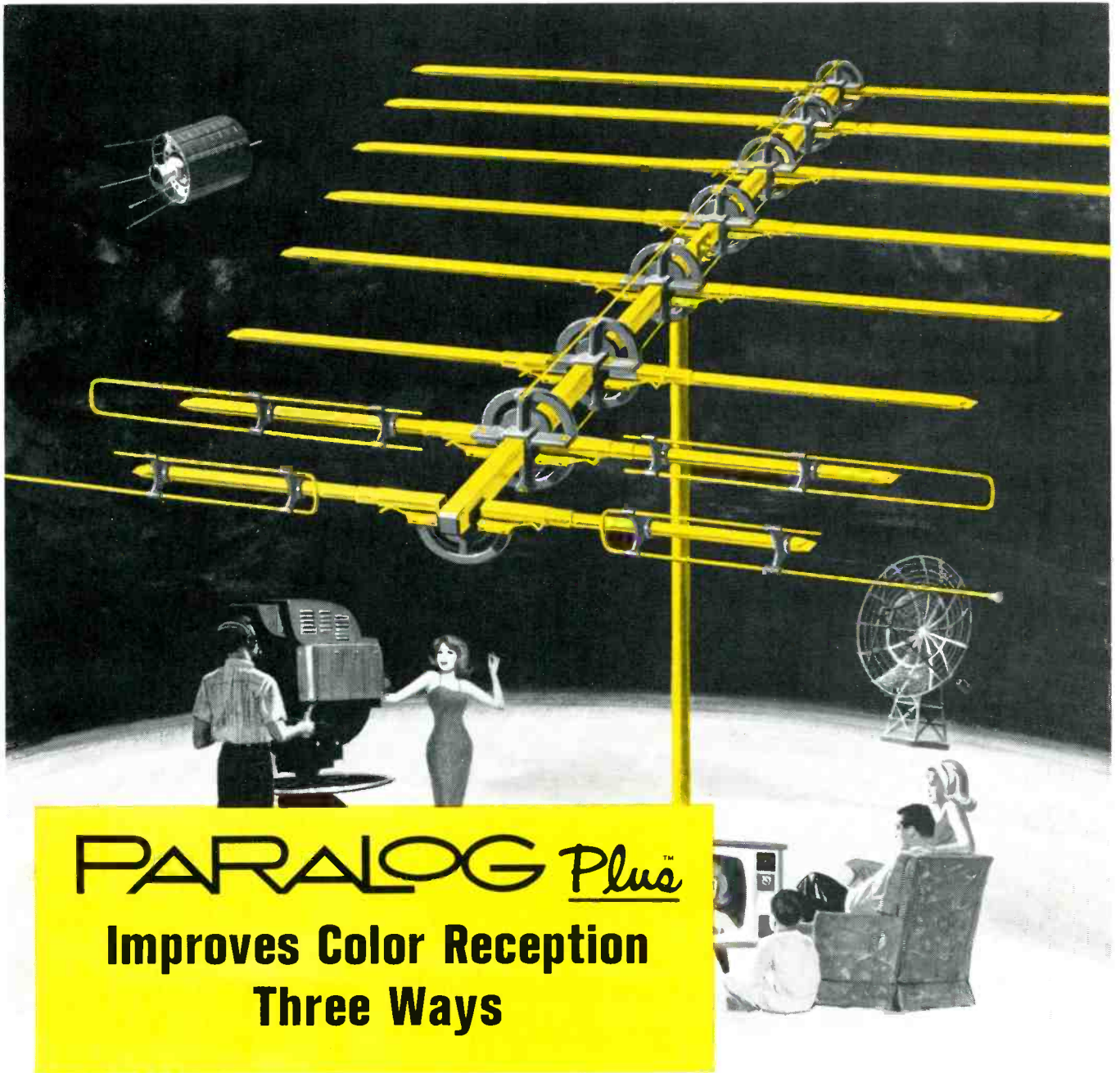

PARALOG *Plus*TM

Improves Color Reception Three Ways

1. Plus GAIN—to provide sharper directivity to eliminate multipath reception.

2. Plus FLATNESS—to eliminate tilts which cause incorrect colors on the TV screen. Industry experts say that color antennas must be flat within ± 2 db. Paralog-Plus antennas are flat within ± 1 db per channel.

3. Plus MATCH—to prevent color-distorting phase shifts.

The unique feature of the Paralog-Plus is a BI MODAL DIRECTOR system. Its parasitic elements combine two hi-band directors into a single director covering all lo-band channels, plus the entire FM band. Thus, more of the elements work to bring in any given channel.

Plus—300 and 75 ohm outputs for match to *either* twinlead or coax. And full, flat gain over the entire FM band.

Plus these quality mechanical features: Self-cleaning wedge-snap locks that tighten with vibration, Cyclocac insulators to eliminate cumbersome cross feed points, Golden Armor coating, Square boom construction, One-piece antenna array—and more.

Check on how these plus features can help make plus profits for you. See your Jerrold distributor, or write:

DISTRIBUTOR SALES DIVISION
401 Walnut St., Phila., Pa. 19105

JERROLD

... for more details circle 101 on postcard

Ed Leahy doesn't work for us. We work for him.

Ed Leahy believes in being his own boss. Which is what Ed likes about running his own Philco Qualified Service Center. It means that, with no strings attached, he gets better training, better service and more benefits than any other manufacturer offers.

When he needs a part, he gets it fast. His Philco Parts Distributor has what Ed needs right on hand. But even if Ed gets a job like fixing a 1947 model, he knows the oddball part he needs will be shipped in 24 hours or less through Philco's Lifeline Emergency Service.

Ed keeps up on new products with Philco Tech Data Service. He tried other services and found out that he gets the facts sooner, better and at lower cost from Philco.

Ed likes Philco's "fringe benefits," too. A complete accident insurance program for himself and his men. Advice on business management, found in Philco's popular "Service Businessman" magazine. He gets extra business, too, when his name appears under a Philco listing in the Yellow Pages.

Ed Leahy has it good. You can, too. Talk to your Philco Parts Distributor or contact Parts & Service Department, Philco-Ford Corporation, "C" and Tioga Streets, Philadelphia, Pa. 19134.

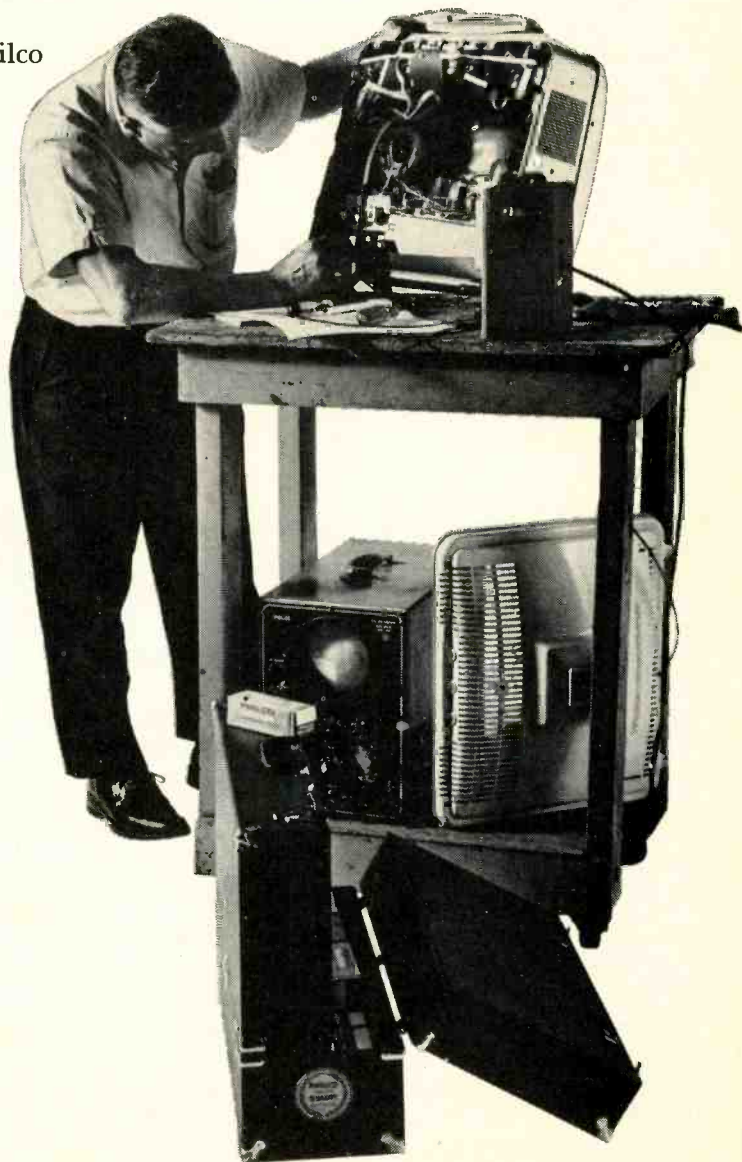

FAMOUS FOR QUALITY THE WORLD OVER

... for more details circle 123 on postcard

Precision Apparatus

hallmark of quality in test equipment

For over three decades, knowledgeable professionals in industry, service, laboratory and educational fields have relied on Precision Apparatus Test Equipment. Today, through the experience and marketing know-how of Dynascan Corporation, Precision Apparatus offers greater reliability and performance—maximum versatility—in all applications. Today, the Precision Apparatus line represents the industry's outstanding values in test equipment.

Each Precision Apparatus instrument is designed, engineered and built to meet your most critical needs of accuracy, versatility, reliability. By every standard, they are the hallmark of quality in test equipment.



ES-550B WIDE BAND OSCILLOSCOPE

Rugged, dependable performance. Automatic horizontal sweep synchronization. Wide-band 5 MHz vertical amplifier. Extra-high 10 Mv RMS/inch sensitivity allows measurement as low as 2 Mv. Wide-band vertical amplifier. **\$279.95**



120 VOLT-OHM-MILLIAMMETER

2% DC accuracy. Exclusive extra-low ohm scale for accurate readings to 0.1 ohm, extremely important for solid state measurements. Mirrored scale. Solid state protected meter movement. Transit meter movement protection. **\$51.95**



E-310 SINE & SQUARE WAVE GENERATOR

Only moderate cost, low distortion generator with both sine and square-wave coverage from 5 Hz to 600 KHz. Pre-aged tubes provide long-term stability. Over 7' of logarithmic scales for more accurate settings. **\$199.95**



V75 VACUUM TUBE VOLTMETER

Special built-in battery eliminator assures ohm-meter accuracy. Rugged uni-probe speeds operation. Special calibration on 1.5 VAC and 5 VAC scales assures maximum accuracy. **\$59.95**



E-200C MULTI-BAND SIGNAL GENERATOR

Unique! AVC substitution voltage system permits accurate alignment. Over 7' of etched dial scale from 88 KHz to 440 mHz with FM and TV band channels indicated. Each unit individually hand-calibrated on all bands. **\$119.95**



120M VOLT-OHM-MILLIAMMETER

Offers all of the convenience features of the 120 plus the extremely high accuracy of 1½% on DC and 3% on AC. **\$61.95**

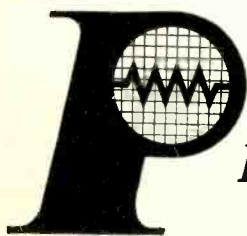

PRECISION APPARATUS

Tube supplement information now available for all Precision and Paco Tube Testers.

Division of Dynascan Corporation
1801 W. Belle Plaine Avenue
Chicago, Illinois 60613

Where Electronic Innovation Is A Way Of Life

... for more details circle 125 on postcard

ELECTRONIC TECHNICIAN

FEBRUARY 1967

VOL. 85, NO. 2

ELECTRONIC TECHNICIAN

WORLD'S LARGEST ELECTRONIC TRADE CIRCULATION

RON KIPP Publisher
 JACK HOBBS Managing Editor
 JOSEPH ZAUHAR Technical Editor
 PHILLIP DAHLEN Associate Editor
 DONALD GRANT Assistant Editor
 RICHARD CLAYTON Field Editor
 JUDITH BERINI Editorial Production
 KEN McSHANE Artist
 MAGGIE KANE Advertising Production
 RUTH GELINEAU Circulation Fulfillment

OJIBWAY PRESS, Inc.

Ojibway Building, Duluth, Minn. 55802

AREA CODE 218 727-8511

PUBLICATIONS DIVISION:

ROBERT EDGELL President
 ANGUS STONE Marketing Manager
 BEN MARSH Editorial Director
 HARRY RAMALEY Production Director
 JIM GHERNA Art Director
 JOE WOLKING Circulation Director
 WARREN BODIN Ad Production Supervisor

Sales Offices:

NEW YORK: Ron Kipp, 25 W. 45 St.
 New York, N.Y. 10036
 AREA CODE 212 581-4200

CHICAGO: Jack Daniels, 43 E. Ohio St.
 Chicago, Ill. 60601
 AREA CODE 312 467-0670



Copyright 1967 by Ojibway Press, Inc., Duluth, Minn. 55802. Reproduction and reprinting prohibited except by written authorization of the publication. Subscription price: \$5 for 1 year, \$8 for 2 years, \$10 for 3 years. Pan American and Foreign, \$5 for 1 year, \$14 for 2 years, and \$18 for 3 years. If you have a change of address or a question about your subscription, write: ELECTRONIC TECHNICIAN, Circulation Department, Ojibway Building, Duluth, Minnesota 55802. BE SURE TO SEND ALONG THE ADDRESS LABEL FROM YOUR MOST RECENT ISSUE. Second class postage at Waseca, Minnesota and at additional mailing offices.

POSTMASTER: Send notification form 3579 to ELECTRONIC TECHNICIAN, Ojibway Building, Duluth, Minnesota 55802.

FEBRUARY 1967

Cover

The "facts" of life are difficult to tie down. And so are the major problems facing the service-dealers and technicians of this industry. But ET's TEKLAB is a well-instrumented workshop where we follow a few old ideas, experiment with and develop new ideas—modern servicing and troubleshooting techniques. And our photographers are experimenters too. Our cover this month shows what they got when they sneaked up on a TECHLAB technician using a stereo multiplex generator to check out an AM/FM/Stereo receiver.

FEATURES

- Using Advanced Troubleshooting Techniques in Tricky AGC and Sync Circuits 37
An expert bench technician lets you in on some modern servicing techniques that eliminate so-called "tough dogs"
- Semiconductors from A to Z 41
Part 7 of a continuing series on solid-state components
- Understanding Stereo Multiplex 46
Bob and Scoot are back with an in-shop explanation of how stereo multiplex works
- Servicing Solid-State Multi-Band Home Receivers 50
Here's the story a lot of you have asked for
- Sophisticated Test Instruments for 2-Way Servicing 54
This one was worked up special for those of you who work in or plan to work in this area
- Stereo Hi-Fi Tone-Arms, Cartridges and Styli 57
The second part of a story that many technicians have asked for recently

DEPARTMENTS

- | | | | |
|-----------------------------|----|----------------------------|----|
| Letters to the Editor | 22 | Catalogs & Bulletins | 78 |
| Editor's Memo | 26 | Book Reviews | 80 |
| Technical Digest | 28 | News of the Industry | 82 |
| Colorfax | 60 | Advertisers Index | 84 |
| New Products | 66 | Reader Service | 85 |

TEKFAX — 16 PAGES OF THE LATEST SCHEMATICS

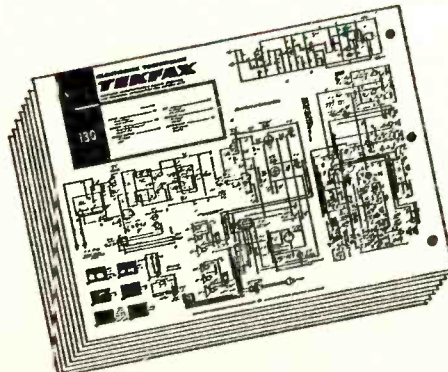

Group 174 February • 1967

- CORONADO: TV Model TV2-9552A, 53A
 MAGNAVOX: TV Chassis 47 Series
 OLYMPIC: Color TV Model CT-910
 PHILCO: TV Chassis 17J27, 27A
 RCA VICTOR: TV Chassis KCS 163 Series
 SETCHELL-CARLSON: TV Chassis 401
 ZENITH: TV Chassis 14N29Z

ALL-CHANNEL

MASTER ANTENNA SYSTEMS

... a profitable new market for TV servicemen



Installation of a Jerrold economy small-store TAC-4 system.

Install JERROLD "All-Channel" MATV systems in TV dealer showrooms, motels, homes, garden apartments

Capitalize on the 82-channel TV set market! Sell new Jerrold all-channel master antenna systems. Only Jerrold offers a complete line of all-solid-state all-channel equipment to make installation easy, permanent, and *profitable*.

Jerrold solid-state "Gibraltar" amplifiers for both VHF and UHF bands give you a reliable head end for systems of 40 or more sets, while the remarkable new TAC-4 is an economy system with four outlets. Jerrold all-channel antennas, all-channel mixing networks, all-channel combiners and splitters, all-channel room outlets, and low-loss all-channel coaxial cable complete the package.

All-channel systems are here—*now*. Profit from installing them—if UHF isn't yet in your area, it soon will be. Talk with your Jerrold distributor or write *Jerrold Electronics, Systems Products, Distributor Sales Division, 4th & Walnut Sts., Philadelphia, Pa. 19105.*

JERROLD

... the most experienced name in TV signal distribution

... for more details circle 118 on postcard

LETTERS TO THE EDITOR

Candle TV

I need a schematic for a Model MT510A Candle TV distributed by the Tokyo Transistor Ind. Co. which is said to be out of business. Can anyone help me?

RAYMOND KUHN

Detroit, Mich.

Old Timer Wants to Quit

From time to time I have noted in your Letters-to-the-Editor columns that various "old timers" have decided to retire. Some were at it up to age 75. Having reached the so-called magic age of 65, after 43 years in this business, I am on the lookout for an above-average technician who wants to take over an unusual electronics service business. I say "unusual," because I have given up all outside calls, auto radio work and in-the-shop TV work to concentrate on small industrial electronic repairs. These include timers, metal detectors, electronic flash units and similar equipment. Since no outside calls are made, all truck expense is eliminated, saving about \$1500 a year. About 90 percent of the work requires no estimate—getting the job out for the customer is the main objective. There are usually no transistor repairs. Very few elaborate test instruments are required. Most of the work is done with a VOM or VTVM and an inexpensive scope. All work is brought to the shop. And a steady trickle of jobs is shipped in from five states. One of the secrets of this steady business is a good supply of replacement parts chosen for reasonable turnover. I am official repair station for half a dozen large electronic flash manufacturers. Collections are about 99 percent. Nightwork means overtime charges when many customers want their work out fast at any cost. It sounds like a dream to many technicians trying to get out of the rat race — but to the right man it is a real opportunity if he is honest and reliable. My record of 43 years without a customer instituting a lawsuit speaks for itself. I'd like to see some competent man carry on this important work which has an unlimited future.

M. G. GOLDBERG

Beacon Electronic Service
611 University, Near Dale
St. Paul, Minn. 55103

• Mr. Goldberg has been a subscriber to ET for many years and has written technical articles which appeared in its pages from time to time. — Ed.

WHY

risk your reputation with "just-as-good" capacitors?

When you pay little or no attention to quality in tubular replacement capacitors, you leave yourself wide open for criticism of your work . . . you risk your reputation . . . you stand to lose customers. It just doesn't pay to take a chance on capacitors with unknown or debatable performance records when it's so easy to get guaranteed dependable tubulars from your Sprague distributor!

There's no "maybe" with these 2 great **SPRAGUE DIFILM[®] TUBULARS!**

The ultimate in tubular capacitor construction. Dual dielectric . . . polyester film and special capacitor tissue . . . combines the best features of both. Impregnated with H₂CX[®], an exclusive Sprague synthetic hydrocarbon material which fills every void in the paper, every pinhole in the plastic film *before it solidifies*, resulting in a rock-hard capacitor section . . . there's no oil to leak, no wax to drip. Designed for 105°C (220°F) operation without voltage derating.



DIFILM[®] BLACK BEAUTY[®]
Molded Tubular Capacitors

The world's most humidity-resistant molded capacitors. Tough, protective outer case of non-flammable molded phenolic . . . cannot be damaged in handling or installation. Black Beauty Capacitors will withstand the hottest temperatures to be found in any TV or radio set, even in the most humid climates.

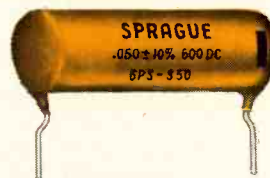

DIFILM[®] ORANGE DROP[®]
Dipped Tubular Capacitors

A "must" for applications where only radial-lead capacitors will fit . . . the perfect replacement for dipped capacitors now used in many leading TV sets. Double-dipped in rugged epoxy resin for positive protection against extreme heat and humidity. No other dipped tubular capacitor can match Sprague Orange Drops!

For complete listings, get your copy of Catalog C-617 from your Sprague distributor, or write to Sprague Products Company, 65 Marshall Street, North Adams, Massachusetts 01247



WORLD'S LARGEST MANUFACTURER OF CAPACITORS

How "saving" 50¢ can ruin a \$700 color TV system!

The coupler is probably the least expensive item in a home TV system . . . yet the wrong coupler can send the investment in a top-quality distribution system and TV set right down the drain.

At Blonder-Tongue, the same engineering skill and meticulous quality control goes into couplers that goes into our professional MATV products. The result: high isolation between sets, extremely low insertion loss and sharp pictures (they're backmatched).

Blonder-Tongue gives you variety, too . . . the widest variety of color-approved, all-channel coupler models in the industry:

A-102U/V—deluxe 300-ohm model connects 2 sets to one downlead.

A-104/UV—similar to A-102U/V except for 4 sets.

MDC-2VU—connects two coax (75-ohm) cables from TV sets to a single coax downlead.

TV-2—economy indoor model. Connects two sets to a single 300-ohm twin-lead. Not recommended for weak signal areas.

Quality combiners and splitters are also essential to a good all-channel color TV system. When you specify Blonder-Tongue, you get high quality, low loss and high isolation.

UVF-1—deluxe 300-ohm weatherproof model. Provides separate UHF, VHF and FM outlets from downlead carrying all three signals or feeds a single downlead from separate UHF, VHF and FM antennas.

UVF-C/S—a lower priced version of the UVF-1.

A-107—deluxe, weatherproof unit combines UHF and VHF antennas to one 300-ohm downlead or provides separate UHF and VHF output at set.

UV-C/S—indoor unit provides separate UHF and VHF outputs from a single 300-ohm cable carrying both signals, for connection to converter or TV set with separate UHF and VHF inputs.

Write for free catalog #74.

Blonder-Tongue Laboratories, Inc., 9 Alling Street, Newark, N.J.

Blonder-Tongue, the name to remember, for TV reception you'll never forget

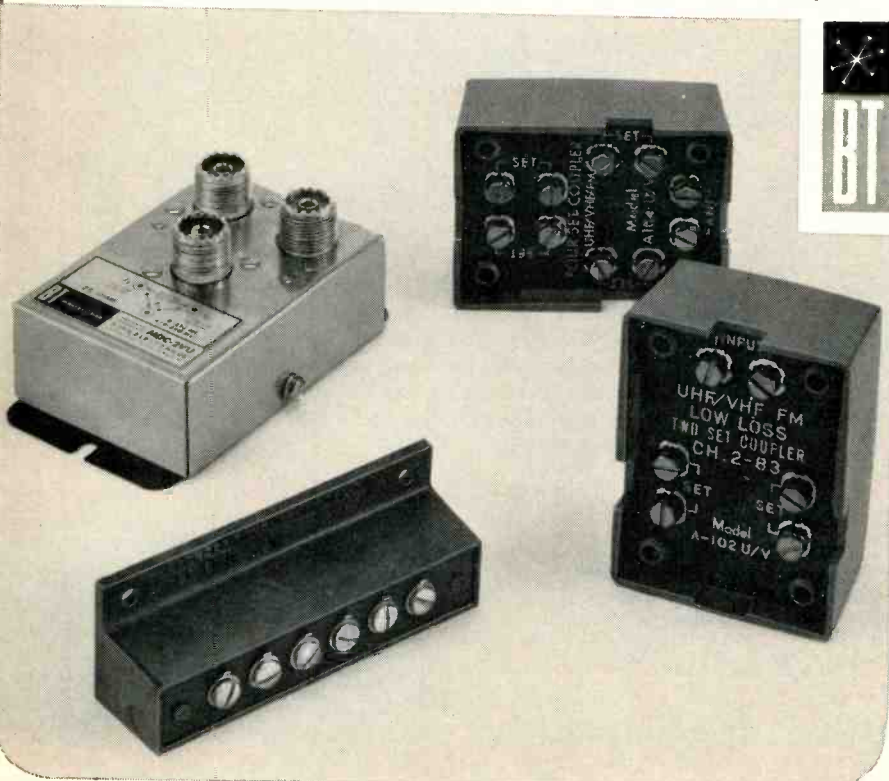

. . . for more details circle 107 on postcard

LETTERS TO THE EDITOR

Solar Equipment

I need operating manuals for a Solar type CC 1-60 and a model CE type 1-60 capacitor analyzer. Can any ET reader help me?

K. HALPIN

Douglaston, L.I., N.Y.

Medical Electronics

I am a subscriber to your fine magazine and would like to commend your editors for the excellent coverage given to our field. I am interested in medical electronics but need more information in this area.

LEO J. HEINZ, 3rd

Skokie, Ill.

• *Many ET readers maintain medical electronics equipment. Users of this equipment, doctors, clinics and hospitals, generally have service manuals which come with the equipment. A thorough knowledge of basic electronics is generally sufficient for keeping this equipment in repair. —Ed.*

Suggestion on Color

I have noted that a lot of older color sets show nearly correct voltages, resistances and waveforms and still do not work properly. This is generally caused by original design faults. The only way to handle these problems is to obtain manufacturers data on design changes for the particular receiver.

ROBERT APPEL

Newark, N.J.

• *This is true. Keep a sharp look-out for manufacturers' design changes in ET's TechDigest and Colorfax departments. Many design changes are published in these columns. —Ed.*

Needs 6P7 Tube

I need a 6P7 electron tube for an old Hallicrafters SW set. Can any reader tell me where I can find one?

GERALD FOUSE

Lakewood, Ohio

Reiner Scope

I need a schematic and parts list for a Reiner Model 550 scope. Can any ET reader give me information about this. ET is a fine magazine. Your articles on solid-state servicing have helped me. Keep up the good work.

LEONARD HANSON

Enumclow, Wash.

This **Remington** PREMIER PORTABLE TYPEWRITER

FREE



**WHEN YOU BUY THIS RCA WR-64B
COLOR BAR/DOT/CROSSHATCH
GENERATOR...THE ESSENTIAL
COLOR TV TEST INSTRUMENT**

Here's a deal you can't afford to miss! A FREE Remington portable typewriter—yours when you purchase the most essential color-TV test instrument—the RCA WR-64B!

Just imagine how handy your new typewriter will be—in the shop or at home. You'll use it almost as much as you use the RCA WR-64B—standard of the color TV servicing industry.

Here's how to get your FREE Remington Typewriter. Mail in the warranty card plus the gold label from the shipping carton of your new RCA color bar generator to RCA Test Equipment Headquarters, Bldg. 17-2, Harrison, N.J. We will ship your new Remington portable typewriter to you direct, freight prepaid. But remember—this offer covers only equipment purchased between February 1, 1967 and May 15th, 1967. To allow for postal delay, we will honor cards postmarked up to May 31st.

Plan NOW to take advantage of this BIG offer—a FREE Remington portable typewriter with your purchase of an RCA WR-64B color bar/dot/crosshatch generator.



The standard of the Color-TV Servicing Industry. Generates all necessary test patterns—color bars, crosshatch, dots plus sound-carrier.

Only \$189.50*

*Optional Distributor resale price. All prices subject to change without notice. Price may be slightly higher in Alaska, Hawaii, and the West.

Ask to see it at Your Authorized
RCA Test Equipment Distributor

RCA Electronic Components and Devices, Harrison, N.J.



The Most Trusted Name in Electronics

SEE YOUR ELECTRONICS PARTS DISTRIBUTOR:

Weller® for every soldering job

Pencil Soldering Irons by Weller



"Marksman" Kit with pencil soldering iron; screwdriver, cone and chisel tips; handy soldering aid and a supply of solder. \$444 list Model SP-23K.



"Marksman" Iron at popular price. Stainless-steel long-reach barrel, 1/8" replaceable tip. Maximum tip temperature, 750°F. \$298 list Model SP-23.



Weller Iron is industrial rated, highly efficient. Does work of bigger irons. Only 7 7/8" long including the tip. 25 watts. 115 volts. \$520 list Model WP-S.

Temperature Controlled Soldering Unit

For universal hobby soldering, including heavy-duty metal work. Temperature control is in the tip. Interchangeable tips give a choice of 500°F, 600°F, 700°F and 800°F controlled temperatures. Operates on 24 volts. Complete with 3/16" 700°F tip and 60 watt, 120 volt, 50/60 cycle power unit with soldering pencil stand and tip cleaning sponge attached. Model W-TCP. \$2600 list



Dual Heat Soldering Guns

100/140 Watts. Two trigger positions let you switch instantly to high or low heat to suit the job. Tip heats instantly and spotlight comes on when trigger is pulled. Tip has exceptionally long reach. Model 8200. \$695 list

145/210 Watts. A professional model with all Weller gun features: instant heat, dual heat, spotlights. Model D-440. \$995 list

240/325 Watts. Heavy-duty model with all Weller gun features: instant heat, dual heat, spotlights. Model D-550. \$1095 list



Dual Heat Soldering Gun Kit

Includes Weller 100/140 watt dual heat gun, 3 soldering tips, tip-changing wrench, soldering aid, flux brush, supply of solder . . . all in a colorful utility case of break-proof plastic. Model 8200PK. \$895 list



Heavy-Duty Soldering Gun Kit

Features Weller 240/325 watt dual heat gun; tips for soldering, cutting and smoothing; tip-changing wrench; solder; metal-tone utility case of break-proof plastic. Model D-550PK. \$1295 list



Utility Grade Solder On Hang Cards 5 feet of 40/60 alloy solder in each pack. Acid core, AC-40. Rosin core, RC-40. 39¢ list



Superior Grade Solder In Dispenser Tubes 10 feet of 60/40 alloy rosin-core solder in each tube. Number RC-60. 59¢ list

EDITOR'S MEMO

We're Not 'Hobbyists' Nor Amateurs

At this late date there are still too many TV-radio service dealers and technicians in this business who began as technical hobbyists. And most of these have never learned how to become businessmen. For that matter, some have not learned how to make a decent living as technicians.

The TV-radio sales and service business is not a place for hobbyists and amateur technicians. The faster everyone learns this, the better off the industry will be.

Everyone in this business should have adequate theoretical and practical training. A prospective service-dealer or technician goes to technical school or covers the equivalent through a correspondence school. He learns the technical end and then he does the same for the business know-how. And after this, he gets a job as an apprentice for a few years. Finally, if he learns the business well, he can begin to think about going into business for himself.

As never before, the greatest need in our industry today is well-trained technicians and hard-headed businessmen with vision. Technicians who make it a point to keep up with technological change. Well-trained technicians who can troubleshoot and properly repair or adjust five instead of two color TV sets in a day.

We need service managers who can provide better and faster service by employing modern service techniques to increase labor productivity.

Boosting service charges, although they have generally been in a sad state, is not necessarily a cure-all for our profit ills.

A few outstanding sales and service organizations around the country have been improving their profit pictures by more efficient servicing. And they have done it while giving their technicians increasingly higher pay and other benefits.

In this connection, we would like to call your attention to the article, "Using Advanced Trouble-shooting Techniques in Tricky AGC and Sync Circuits," on page 37 of this issue. It was written by a technician who knows his business and earns his daily salt.

No, we are neither hobbyists nor amateurs. We are professionals in a professional business. And it's about time that everyone knows it.

WELLER ELECTRIC CORPORATION, Easton, Pa.

WORLD LEADER IN SOLDERING TECHNOLOGY

... for more details circle 134 on postcard

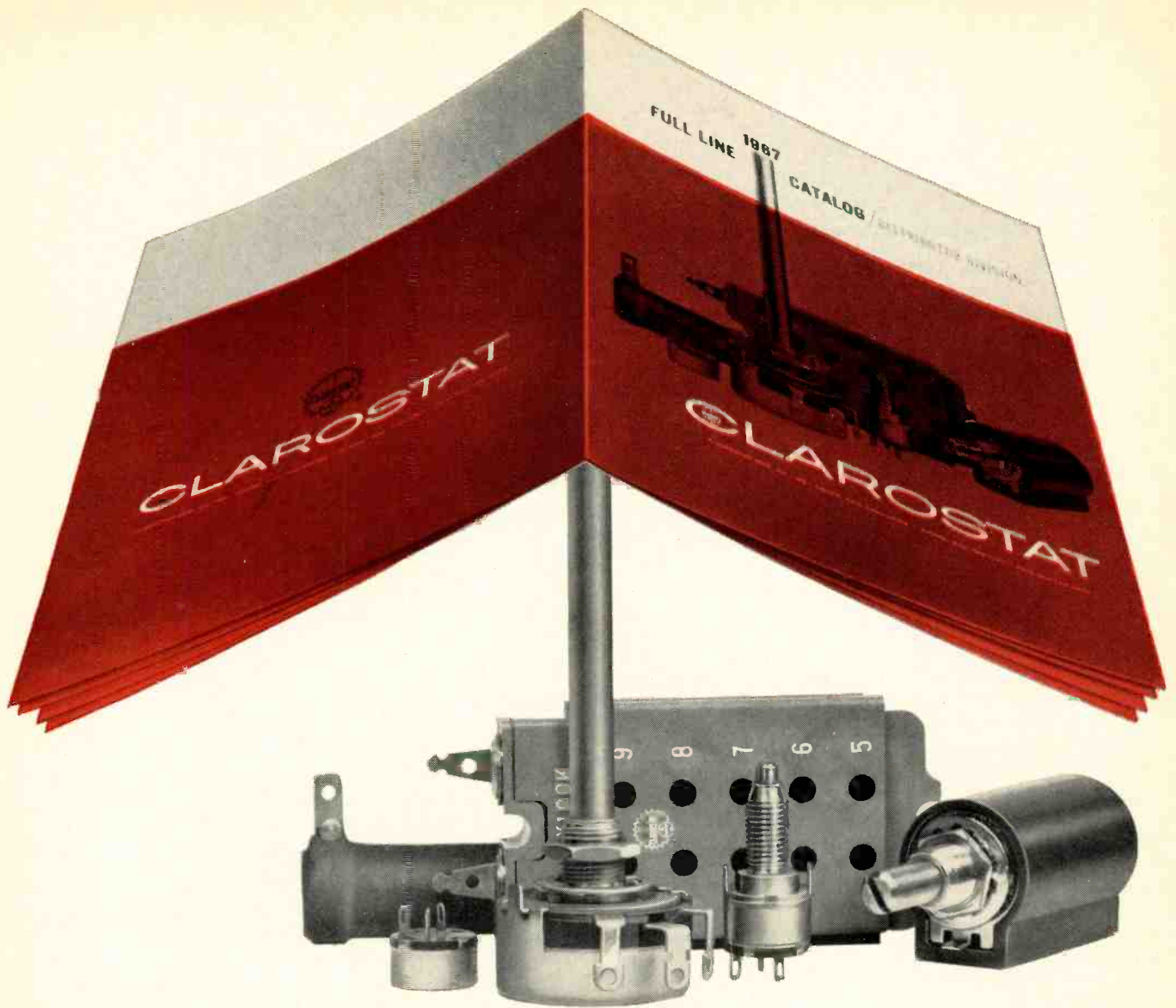

COVERING ALL YOUR INDUSTRIAL / SERVICE REPLACEMENT REQUIREMENTS IN ONE CATALOG

Here is your own private warehouse in print—the new 1967 FULL LINE CLAROSTAT CATALOG of distributor products. Between its pages, you'll find everything you need to meet replacement and original equipment requirements with appropriate technical and application data.

At a glance, you can quickly select quality resistors, potentiometers and switches to meet every customer need. The full line of industrial, service and military components is available to you on an off-the-shelf, immediate delivery program through your local Clarostat distributor.

Ask him for a free copy of the new 1967 FULL LINE CLAROSTAT CATALOG, or write directly to

CLAROSTAT

CLAROSTAT MFG. CO., INC., DOVER, NEW HAMPSHIRE, U.S.A.

... for more details circle 110 on postcard

TECHNICAL DIGEST

MOTOROLA

1967 Chevelle Model CE67A—Antenna Template

A single antenna installation sheet is provided with Motorola 1967 Chevrolet and Chevelle car radios. The wording on the Chevelle antenna template is not too clear

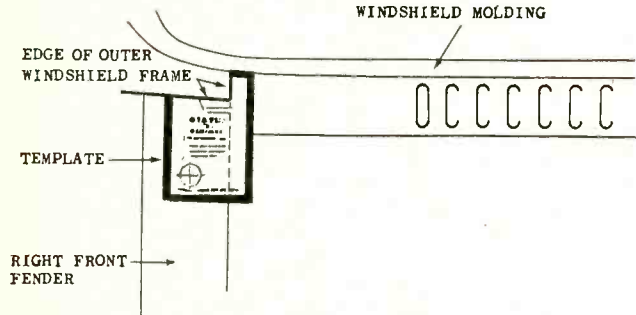

and if misused the antenna hole can be drilled over a fender brace. The template for the Chevrolet is correct.

Radios currently produced have different wording on the Chevelle template packed with the radio.

The correct location of the template on the 1967 Chevelle is shown in the sketch.

PHILCO-FORD

Color Chassis Models 16NT82, 16QT85A and 17KT50—Intensity Ringing

The following lead dress procedure should be performed to minimize any vertical bars that may appear on the left side of the screen, so they are not objectionable at the normal viewing level.

The blue and white wires coming from the contrast control should be dressed and prevented from overlapping

the IF panel. They should be squared to follow the sides of the panel. The blue wire goes to lug M2 (A) on the IF panel and the white wire goes to lug M103 (B) on the deflection-sound panel.

The series of leads coming from the secondary controls, running along the front apron of the chassis, should be secured to the front apron by using a tie lug mounted to the 1/4-in. self-tapping screw next to the vertical output transformer (C), if it is not already secured.

The proper dressing of the orange lead coming from terminal strip B6 lug 5 (D) and going past the IF panel along the front chassis apron, terminating on terminal strip B4 lug 5 (E), should be checked. This lead should be dressed away from the IF panel toward the front apron and down as close as possible to the chassis base and secured by the two tie lugs which are part of the front apron.

When the chassis is replaced in the cabinet, it should be securely bolted so the cabinet ground strip is properly grounded to the chassis.

GENERAL ELECTRIC

CB Chassis—Horizontal Output Circuit

A new procedure has been developed for replacing the horizontal output transformer T101 and for making efficiency coil and high voltage adjustments in the CB chassis. These new procedures and adjustments are to supersede service manual instructions.

A coat of No. 641 silicone heat compound should be spread between the chassis and the base of the replacement transformer. This compound will soon be available from G-E distributors under catalog No. ET90X23.

The replacement transformer must be securely mounted to the chassis, thoroughly tightening all screws.

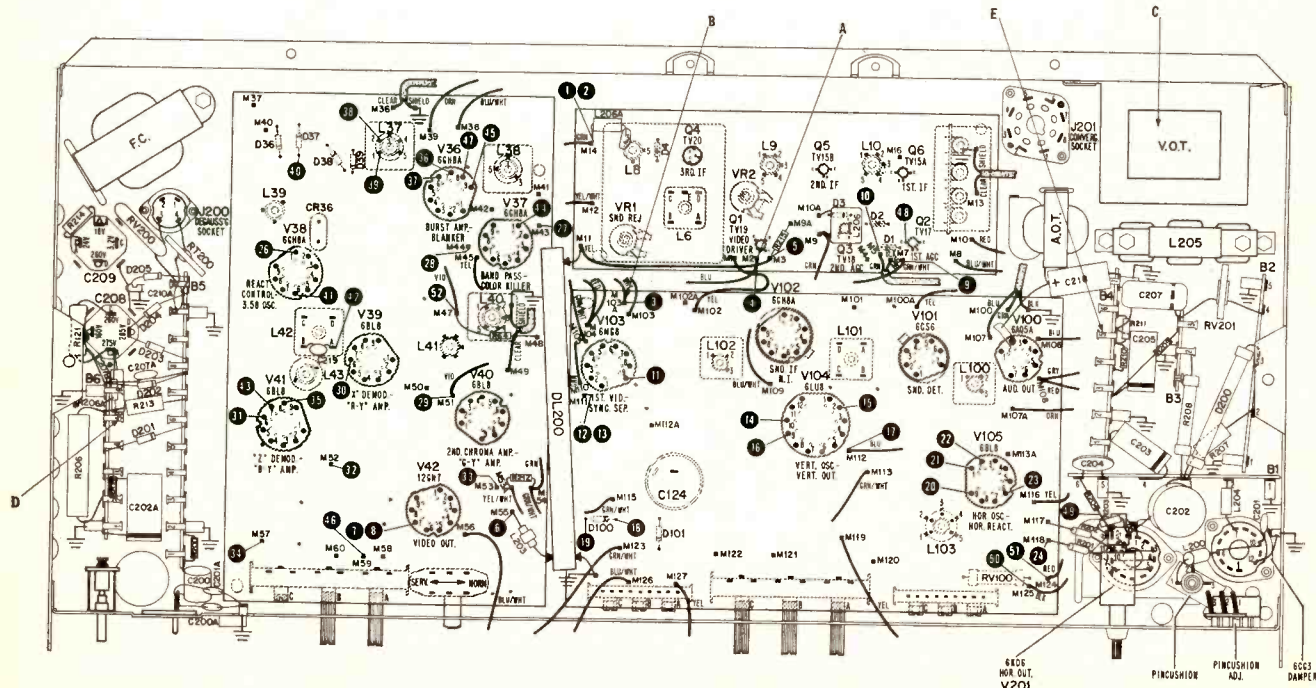

**STEP UP
TO THE
NEW**



CONTINENTAL

**AMERICA'S FINEST,
MOST RELIABLE
TUBE
ANALYZER**

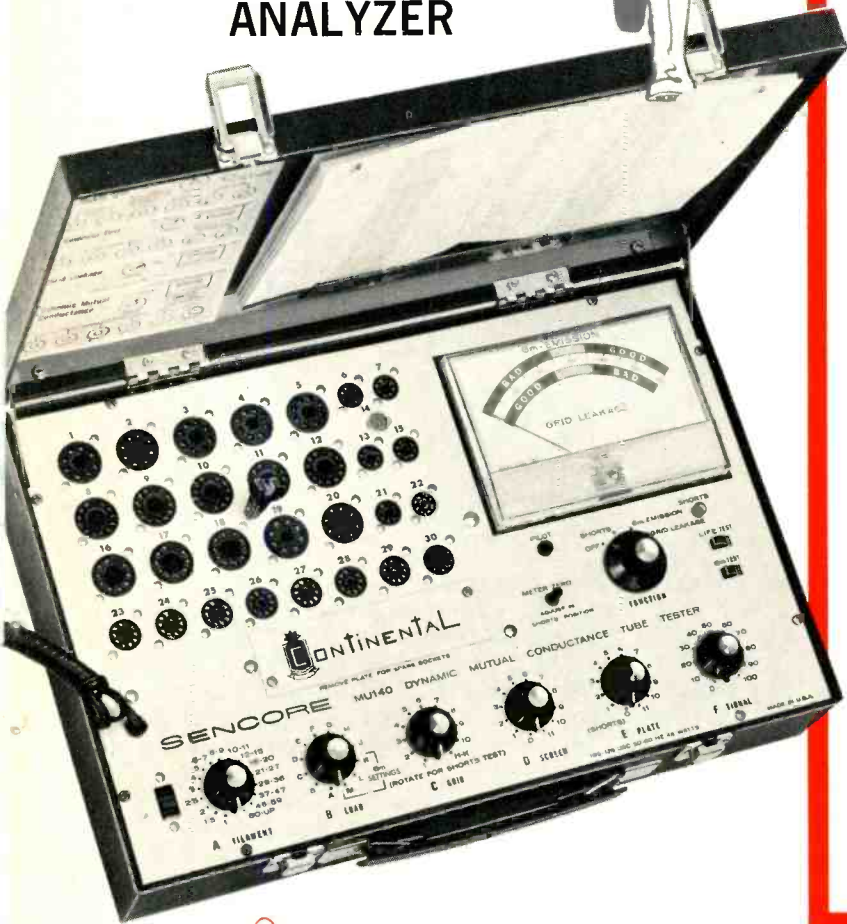
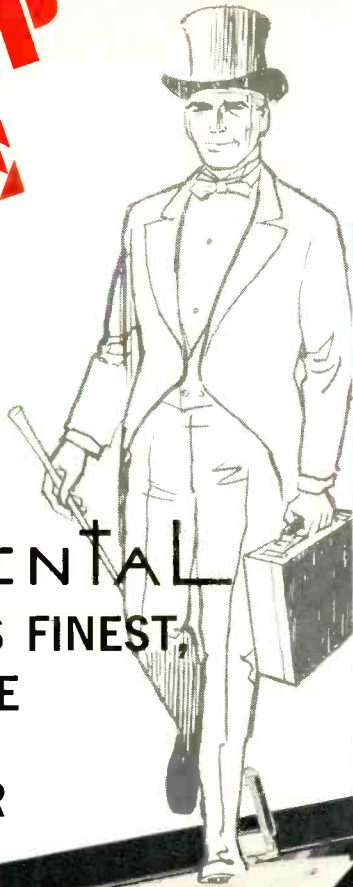

**A "MUST" FOR MODERN SERVICING
... PRODUCTION LINE TESTING ...
QUALITY CONTROL ... LABORATORY.**

A True Gm Tester

- 5000 Cycle Gm Test
- Full Cathode Emission Check
- 100 Megohm Grid Leakage Test
and Still the Speediest Tester in Town

In a nut shell . . . here is how Sencore does it. Using only the first three controls, the MU140 becomes a speedy "Mighty Mite" cathode emission tester with grid leakage sensitivity checks up to 100 megohm . . . for fast on the spot service. Flip the last three switches into operation from the set-up data and the MU140 becomes a true mutual conductance tube tester using 5000 cycle square wave to completely analyze any tube. You can't go wrong. No more need to mess around with time-consuming old fashioned tube testers with up to fourteen knobs and a rough 60 cycle sine wave test. The Continental tests them all including foreign tubes . . . over 3000 in all. And, it's guaranteed against obsolescence too with replaceable "new socket" panel and controls so standard that the switch numbers correspond to the pin numbers shown in any tube manual. You can actually set up the Continental without the set-up data in the cover if the need should arise. Here is everything that you could want. Its famous four way independent tests make you a master of the art of tube testing . . . internal shorts test; full cathode emission test; 100 megohm grid leakage test; and to back you up on critical tubes . . . a superb mutual conductance test. The beautiful Continental is housed in a vinyl-clad solid-steel attache case with lustrous all-chrome front panel. Yet at a price below all competition.

\$179.50

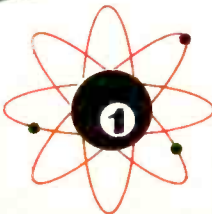

SENCORE

NO. 1 MANUFACTURER OF ELECTRONIC MAINTENANCE EQUIPMENT

426 SOUTH WESTGATE DRIVE, ADDISON, ILLINOIS 60101

. . . for more details circle 129 on postcard

TECHNICAL DIGEST



Here's the cardioid mike that delivers ALL the audio quality of the \$100-plus cardioids, but sells for at least \$40 less! (List price — \$59.50 everywhere.) The Turner 600 may be held by hand or stand . . . either way, you're assured of top performance, with no 'pop' and no feedback. Whether you're buying, selling, or simply recommending cardioid microphones that are ideal for any recording job (monaural or stereo) . . . try Turner 600's first. It's the best \$100-plus microphone that \$59.50 will ever buy.

THE TURNER MICROPHONE COMPANY
 946 17th Street N.E. Cedar Rapids, Iowa
 In Canada: Tri-Tel Associates, Ltd.
 Export: Ad Auriema Inc., 85 Broad Street, New York, N.Y. 10004

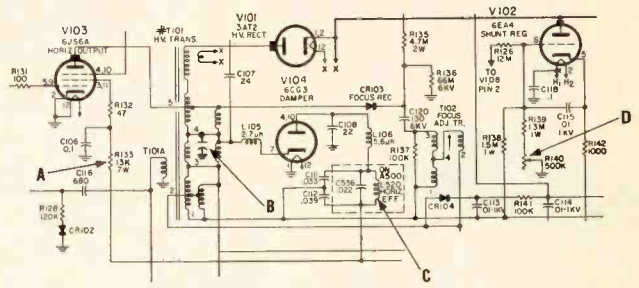

Defective or doubtful horizontal output, damper, high voltage rectifier or high voltage regulator tubes should be checked or replaced. The 6JS6A horizontal output tube screen resistor, R133 (A), a 13k resistor, should be replaced with a 17K resistor. On 23- and 25-in. chassis, an 82pf, 6kv capacitor, ET18X579 (B), should be connected from terminal 4

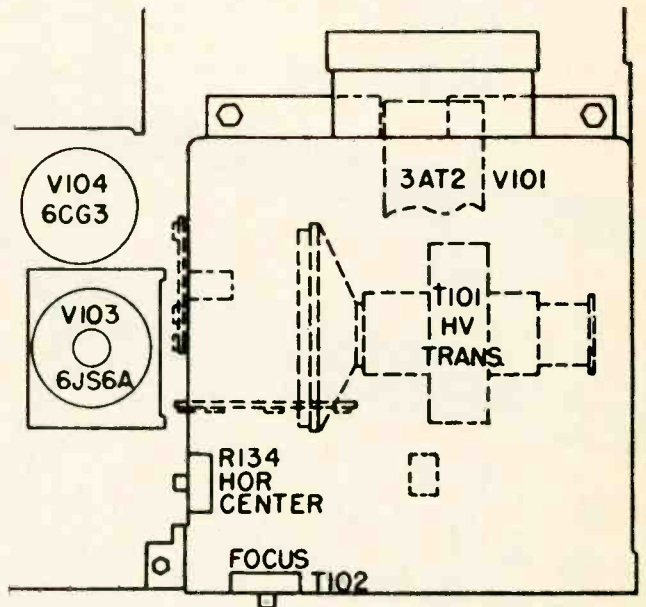

of the horizontal output transformer to the chassis ground. This 82pf capacitor will effectively increase picture width. After adjusting the line to 117v, the horizontal efficiency coil, L520 (C), should be adjusted for minimum cathode current dip in the 6JS6A horizontal output tube. It is not necessary to adjust for any particular current reading, but make sure that resonance occurs at a maximum dip point. The high voltage should be set by adjusting the 500K pot, R140 (D), to obtain 25kv. Use an accurate VTVM with HV probe. This pot should not be adjusted for any specific regulator current. The regulator circuit may be checked for proper operation by observing the meter reading as the brightness is adjusted from minimum to normal. The HV should not vary more than 300 to 400v over this range under any circumstances. The adjustments in the last three steps should also be made whenever it is necessary to service the HV circuits in any CB chassis for any reason whatever—whether the horizontal output transformer has been replaced or not.

... for more details circle 133 on postcard



With the time it^{*} saves in set-up, you can take a breather, make a few more calls and still have time to play with the kids.

*RCA's new Hi-Lite Color Tube with Perma-Chrome

If you've been waiting half an hour for the picture tube to warm up every time you repair or install a set, here's good news. RCA's new rectangular Hi-Lite Color Tubes with Perma-Chrome lock colors in place instantly, eliminate distorted color as the set warms up. Colors are true and unchanging

from turn-on to turn-off. Saves hours of set-up time. New Hi-Lite Color Tubes with Perma-Chrome now in RCA Victor consoles. **New service switch in all 1967 color chassis.** Three-position for Normal, Service and Raster. When Raster is selected, all video and noise is removed from

the color picture tube, leaving a noise-free Raster. Purity is adjustable without removing an IF tube or using other means to remove noise and/or interference from the screen.



The Most Trusted Name in Electronics

TM&©



Why is a Vectorscope essential for Color TV servicing?

- 1 Check and align demodulators to any angle . . . 90°, 105°, 115° . . . accurately and quickly. No guesswork. New color sets no longer demodulate at 90°. Only with a Vectorscope can these odd angles be determined for those hard-to-get skin tones.
- 2 Check and align bandpass-amplifier circuits. Eliminate weak color and smeared color with proper alignment. No other equipment required. Only a V7 Vectorscope does this.
- 3 Pinpoint troubles to a specific color circuit. Each stage in a TV set contributes a definite characteristic to the vector pattern. An improper vector pattern localizes the trouble to the particular circuit affecting either vector amplitude, vector angle or vector shape. Only a V7 Vectorscope does this.



EXCLUSIVE FEATURES:

Color Vectorscope: Until now, available only in \$1500 testers designed for broadcast use. Accurately measures color demodulation to check R-Y and B-Y, for color phase and amplitude. A must for total color and those hard-to-get skin tones. **Self-Calibrating.** Adjust timing circuit without external test equipment. **Dial-A-Line.** Adjust horizontal line to any width from 1-4 lines. **Solid State Reliability** in timer and signal circuits. **Plus:** All Crosshatch, Dots, Vertical only, Horizontal only and Keyed Rainbow Patterns. RF at channels 3, 4 or 5. Video Output (Pos. and Neg. adjustable) for signal injection trouble-shooting. **Red-Blue-Green Gun. Killer.** All transistor and timer circuits are voltage-regulated to operate under wide line voltage ranges. Lightweight, compact—only 8 1/4 x 7 1/2 x 12 1/2". **NET 189.50**

ONE YEAR WARRANTY

V6-B New, improved complete color bar generator with all the features of the V7 except the Vectorscope. Only **99.50**

For the full story, see your distributor or write for literature.

Dept. ET-2

LECTROTECH, INC.

1221 W. Devon Ave., Chicago, Ill. 60626

... for more details circle 120 on postcard

TECHNICAL DIGEST

RCA

CTC17, 17X, 21, 24, 25 and 25X Chassis Series—Extending Horizontal Output Tube Life

A close inspection and careful check should always be made of the horizontal efficiency coil adjustment if a "short life" is experienced for the 6JE6 horizontal output tube.

The usual horizontal deflection alignment procedure

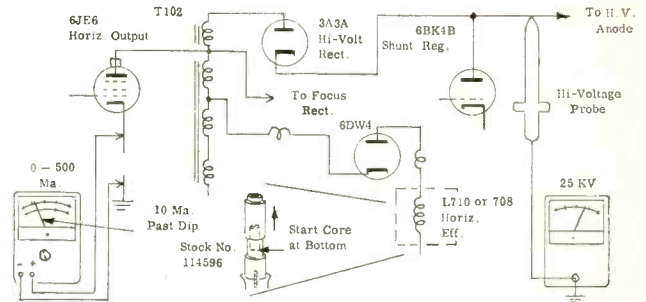

should be modified to include the following adjustments: Adjust the core of the horizontal efficiency coil (see illustration) until it is even with the bottom of the coil form and start from this point. Then adjust the core ccw to obtain a minimum dip of the 6JE6 cathode current. Continue to turn the core in the same direction until the cathode current is increased to 10ma, beyond the minimum dip reading.

After these adjustments have been made, set the brightness control for minimum brightness and readjust the HV to 25kv. An accurate VTVM and probe should be used here.

SYLVANIA

Color TV Chassis DO3—Screen Tracking Variation

Intermittent changes in the red or blue screen levels may occur in a semi-permanent fashion if the bias clamping diodes (A and B) in the R-Y and B-Y demodulators

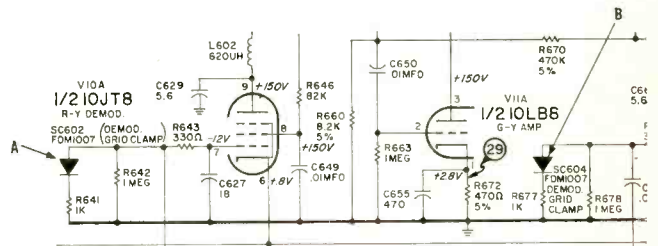

are defective. If a recurring need arises for screen re-balance on this chassis, check these diodes. A total diode short would cause a loss of color from the respective gun. Before seriously looking for trouble in the CRT or respective demodulator tube, check these bias diodes for a reasonable front to back ratio, using an accurate VTVM.

SYLVANIA

Color TV Chassis DO3—Failing Horizontal Oscillator

Intermittent failure of the horizontal oscillator may be caused by intermittent opening of a 0.5µf feedback

If it's **color** you want...
and you insist on the best of
everything...in color
replacement tubes...color
antennas...color rotators...
color transmission line...color
boosters...and colorful golden
masting...all with full profit
...there's only one place
you can go!

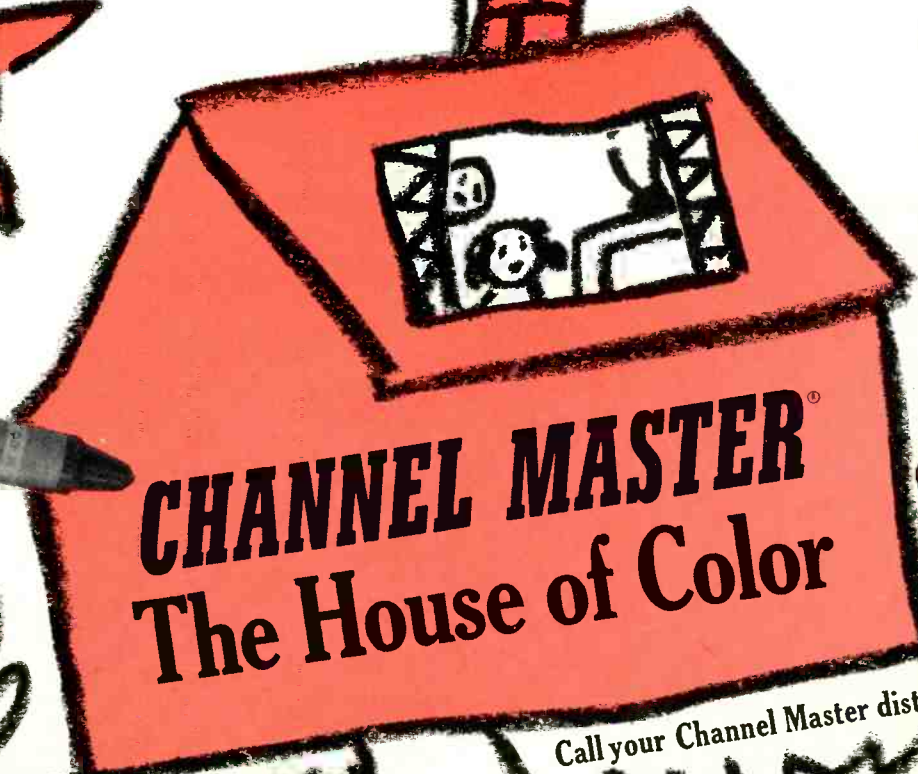
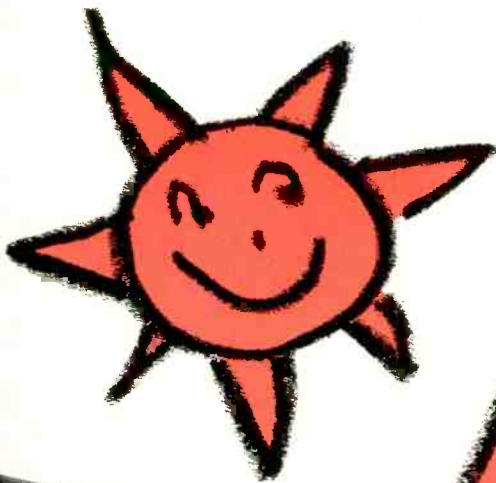

CHANNEL MASTER[®]
The House of Color

Call your Channel Master distributor.

4 ways to increase your income

RCA Institutes, Inc. offers these four comprehensive home study courses especially designed to help build your income immediately!



COLOR TV Add profitable color TV to your skills with this home training course, newly revised to include information on the latest techniques, receiver circuitry and equipment. Train under the direction of RCA Institutes... experts in Color TV home study training.



TRANSISTORS You get the necessary background for semiconductor technology including characteristics of tunnel diodes, rectifiers and other solid state devices. Transistor trainer also available.



AUTOMATION ELECTRONICS Trains you for the many applications of automation electronics in industry and government including Photoelectronics, Digital Computer Techniques, Synchros and Servomechanisms, Automatic Control Systems, and many more!



MOBILE COMMUNICATIONS Trains you to service and maintain 2-way radio communications on land, sea, and air! Gives you the technical foundation for space communications!

Take advantage of RCA's Liberal Tuition Plan. You only pay for lessons you order; and have no long-term obligations. Licensed by New York State Education Department. Approved for Veterans.

RCA INSTITUTES, INC.

A Service of Radio Corporation of America
350 West Fourth Street, New York, N. Y. 10014



The Most Trusted Name in Electronics

SEND THIS COUPON NOW FOR COMPLETE FREE INFORMATION

RCA INSTITUTES, INC. Home Study School, Dept. ET-27
350 West Fourth Street, N. Y., N. Y. 10014

Without obligation, rush me free information on the following RCA Home Training Course: COLOR TV TRANSISTORS MOBILE COMMUNICATIONS AUTOMATION ELECTRONICS

Name _____ Age _____

Address _____

City _____ Zone _____ State _____

TECHNICAL DIGEST

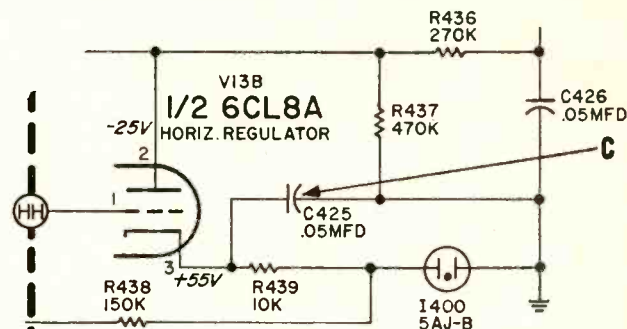

capacitor, C425 (C.) When this happens there is, of course, no horizontal drive and the circuit breaker will kick out. This trouble should be corrected by replacing the feedback capacitor.

SYLVANIA

Color TV Chassis DO5—Poor Video and Picture Flicker

If the picture flickers on and off intermittently and the quality of the picture is poor, the trouble may be

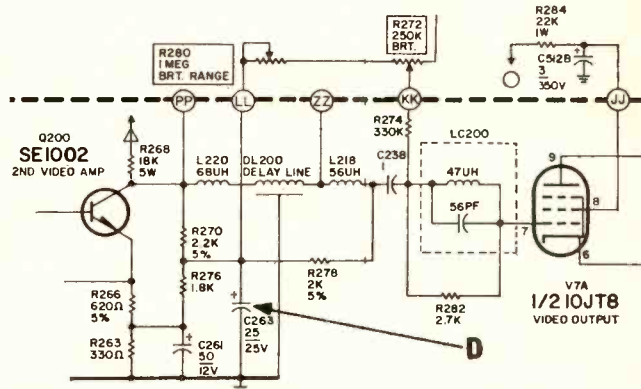

traced to the brightness control circuit. The difficulty could be caused by a leaky 25uF capacitor, C263 (D), connected to ground.

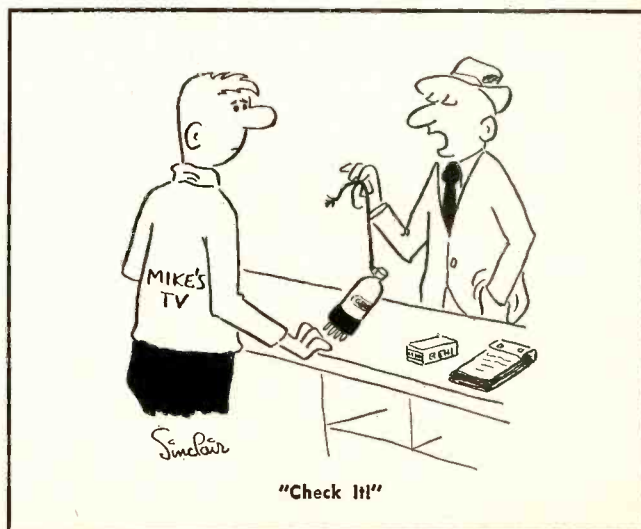

Packages that travel on "people" schedules!



Your packages go everywhere Greyhound goes. Same bus, same fast, frequent schedules, when you ship by Greyhound Package Express

"People" schedules *are* package schedules when you ship by Greyhound Package Express. Got a hurry-up shipment? Put it on a Greyhound...the same Greyhound bus that carries passengers. When the passengers arrive, your shipment arrives. Schedules are regular, fast and frequent. You can ship anytime

at your convenience... day or night. 7 days a week, 24 hours a day. Weekends and holidays, too. Greyhound travels the most direct routes, via the newest super highways, serving thousands of cities, towns and villages all over America. And GPX is a money-saver you can't afford to overlook. Next time

you've got a shipment ready to go, look into GPX. Take your choice of C.O.D., Collect, Prepaid, or open a GPX Charge Account. For complete information about service, rates and routes, call Greyhound, or write: Greyhound Package Express, Dept. 53-B, 10 South Riverside Plaza, Chicago, Ill. 60606.

It's there in hours and costs you less

For Example	Buses Daily	Running Time	20 lbs.	30 lbs.	40 lbs.*
LOS ANGELES— SAN FRANCISCO	25	9 hrs. 15 mins.	\$2.10	\$2.45	\$2.80
DALLAS— SAN ANTONIO	10	7 hrs. mins.	2.10	2.40	2.70
CINCINNATI— LOUISVILLE	13	2 hrs. 30 mins.	1.65	1.90	2.15
CLEVELAND— COLUMBUS	10	2 hrs. 55 mins.	1.80	2.05	2.40

*Other low rates up to 100 lbs. Lot shipments, too.



One of a series of messages depicting another growing service of The Greyhound Corporation.

... for more details circle 115 on postcard

Finally somebody is helping...
helping you prepare for

The growing crisis in service

Motorola takes the bull by the horns . . . introduces
“on-the-job” technical training
for your men—with a greatly expanded
staff of technical personnel.

Home entertainment products are changing—fast. There’s more transistorization . . . and of course more color every year. This means great opportunity for service organizations that keep abreast. Well-informed technicians will be in even greater demand than they are now.

Motorola can help your service department be well prepared.

We have recently increased our staff of field technical personnel. It is their job to help provide you with Technical information for your men and to give some of the training your men will need to cope with this rapidly changing industry.



Each of our technicians has had extensive, practical consumer experience. They know their business—from your side of the fence. The training will be done *right in your place of business*. It will provide a valuable adjunct to the large-scale training meetings held by Motorola Regional Managers & Distributors.

Two hours will be spent in formal training. The remainder of the day will be spent working with your men *on your work* to give information—and to help find ways to make more profitable and productive use of service time. Get full information on availability of this training for your shop. Just call your Motorola Distributor.

 **MOTOROLA®**

Using Advanced Troubleshooting Techniques In 'Tricky' AGC And Sync Circuits

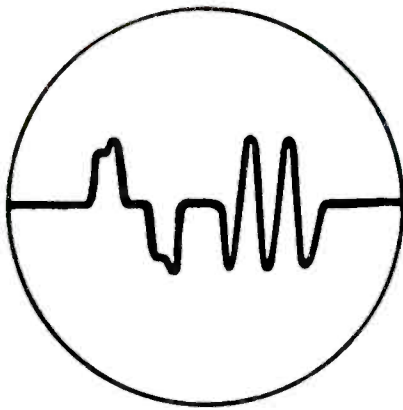

Try these sophisticated
methods to boost your
service-profit margin

■ Various competitive factors — including a more discriminating public — have combined to force many service-dealers and technicians to revise the old and develop new servicing techniques. This has meant, in addition to establishing a modern customer relations stance, instituting an upgraded test-gear program: the addition of “analyzer” and circuit-substituting type test instruments, electronic switches for dual CRO tracing, triggered-sweep scopes and even plug-in dual-trace-amplifier type scopes. These instruments become especially helpful in speeding repairs in stereo equipment and some tricky TV circuits — like 'BU8-type AGC and sync systems, for example.

Let's see how an expert goes about using some of this equipment to speed troubleshooting. But first, we'll remind ourselves briefly how a practical, typical 'BU8-type circuit functions. A description of circuit operation will be simplified.

Practical Circuit Functions

The schematic in Fig. 1 shows a section of a Zenith 15L32 chassis which uses a 6HS8 tube for keyed AGC and sync-clipping. A negative going composite video signal from the detector is coupled to the tube's element 7. This signal usually has low amplitude and, under noise-free conditions, has little effect on tube conduction. But when noise pulses do appear, a negative-going noise spike sends the tube deeper into cutoff — for the noise-pulse duration — preventing distortion of sync pulses at tube element 8.

The average conduction of the sync clipper, or separator, is controlled mainly by the screen grid, ele-

Troubleshooting Techniques...

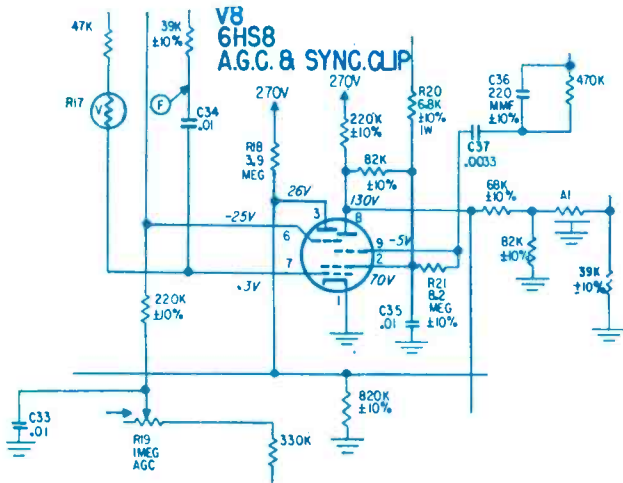

Fig. 2—AGC/sync circuit of Zenith 14L36 chassis.

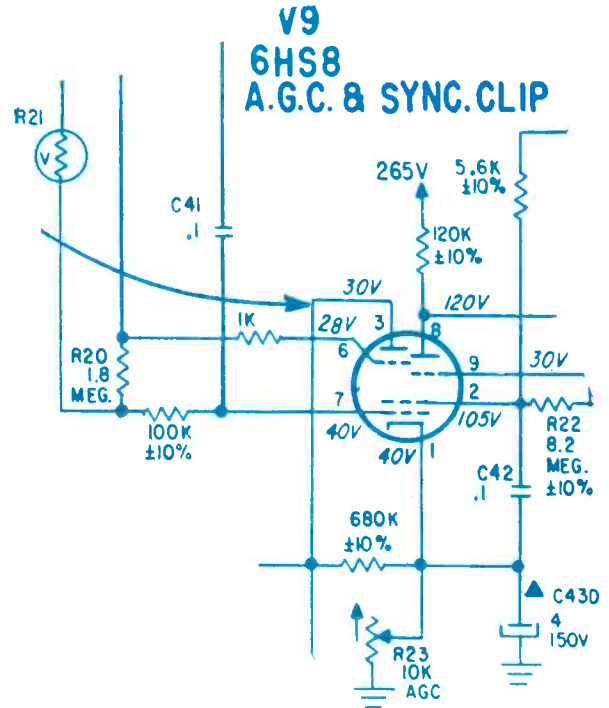

Fig. 1—AGC/sync circuit in Zenith 15L32 chassis.

ment 2. The operating point is set so only the upper 30 percent of the video signal brings the tube out of cutoff — permitting only sync pulses to appear at the tube's output (terminal 8). Tube elements 2, 7 and 1 are all common to the tube's AGC section.

When the 10K variable control in the cathode circuit is set for minimum resistance, the grid becomes more positive — with respect to the cathode — causing the tube to increase conduction. Thus, AGC voltage at terminal 3 (plate) goes more negative. This negative voltage increase is applied to the tuner RF and 1st video IF grids — decreasing conduction of these tubes and lowering the signal level.

When the 10K AGC control is rotated CW (clockwise), the cathode circuit resistance increases, the tube's grid becomes more negative with respect to the cathode and tube conduction decreases. This reduces negative AGC voltage on the tuner RF and the 1st video IF and, if the process is continued, video overloading results.

When the IF is cut off or when overloaded, video signals are blocked and do not reach sync-input grid (terminal 9) which will disrupt operation of the sync-clipper section.

These tubes and circuits are an engineering marvel, but because at least three actions are taking place in one tube envelope at the same time, this can pose a "triple threat" to TV technicians. Now let's see what the "old pro" has been up to lately while troubleshooting these circuits.

A lab-type, dual-trace amplifier scope sits on the bench of a well-instrumented shop located in a certain southern city. It never accumulates dust nor does any of its "innards" ever become atrophied from lack of use — it sweeps with two hands from shop-opening to shop-closing. It is thoroughly familiar with the several composite video signals, sync signals and a keying pulse which feed to the plates and grids of the 'BU8-type tube. And, as the old pro who uses the scope knows, all pulses must be correctly phased and have the proper amplitude — or this tube will not function properly.

When the dual-trace scope or an adequate electronic switch is used, any two of these waveforms can be monitored simultaneously for correct timing, phase, proper amplitude and shape.

While adjusting the AGC control and viewing these pulses on the scope, considerable information can be obtained at a glance. If the set you are working on, for example, does not have a picture or sound and AGC trouble is suspected, you are encouraged immediately to clamp the AGC line from an external bias source of the proper voltage — as called for by the manufacturer. If video comes in after applying external bias, you can then proceed in an orderly manner with further scope checks to isolate the trouble. If you are unable to observe a video signal at the CRT grid, there's also a good chance that no sync or video pulses will be observed at any point in the 'BU8 tube.

If a sync or video pulse is not present on one of the plates or grids, inject a pulse from a TV analyst. If

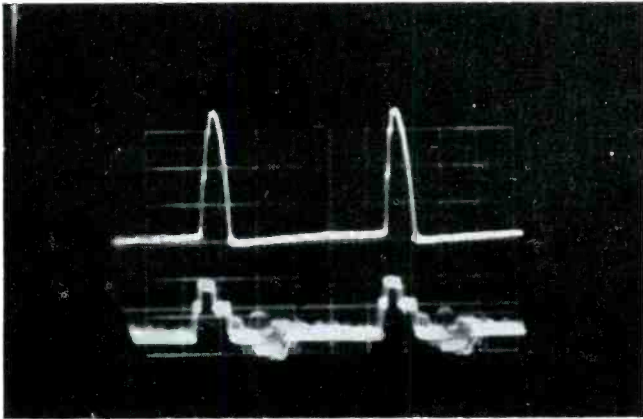

Fig. 3—Top: Normal waveform from tube element 3. Bottom: Normal waveform from tube element 6.



Fig. 5—Out-of-sync, washed-out picture from RCA CTC16 color chassis.

partial operation can be obtained, use the scope to pinpoint the fault. But now, let's get down to some actual bench cases.

A Dual-Trace Scope in Action

A portable Zenith TV, 14L36 chassis, came to the bench. The service tag indicated that the picture simply "faded away," like the proverbial "old soldier."

The set was switched on for an air test and in about 20 minutes the picture fell out of sync and faded out. With this information, the "old pro" naturally concluded that trouble existed in the AGC/sync section (see Fig. 2) and the set was switched off. He then connected one probe of the dual-trace scope to terminal 3 of the tube socket to pick up the flyback pulse and the other probe was connected to terminal 6 for the horizontal sync pulse from the composite video signal. The set was then switched on again and the two signals were viewed from a cold start. See Fig. 3, which shows normal waveforms for tube element 3 (top) and element 6 (bottom).

The set was left switched on to "cook" for a while and when the video faded out, a glance at the scope revealed an abnormal waveshape on element 6 (see bottom trace in Fig. 4). A few checks then revealed that capacitor C20, a $0.047\mu\text{f}$ coupling, (not shown) became leaky when it warmed up. Now wasn't that easy?

Flippity-Flop and Wishy-Washy Picture

This RCA CTC16 color chassis had very little vertical or horizontal lock, plus a wavy, washed-out picture

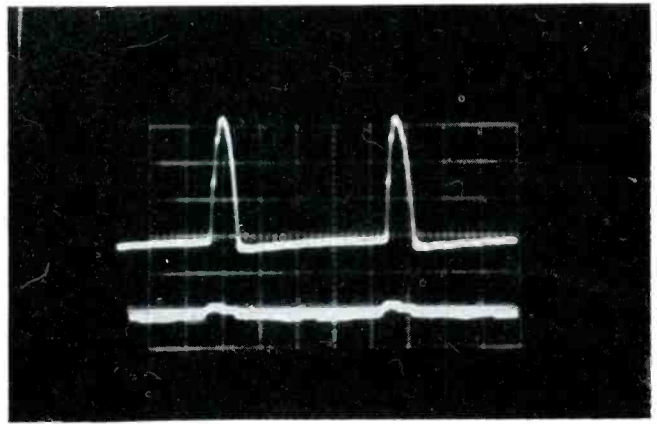

Fig. 4—When the video faded out, the waveform on tube element 6 (bottom) became abnormal.

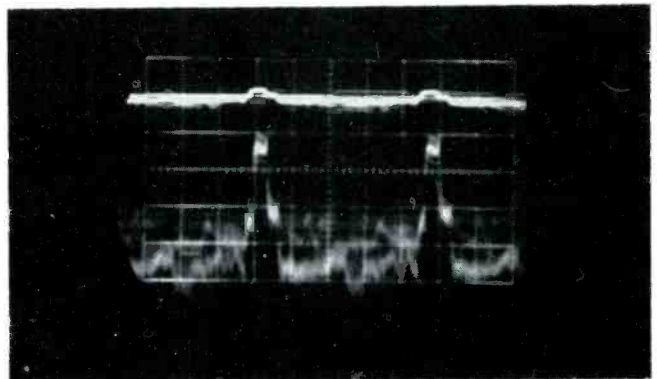

Fig. 6—Waveforms from 6KA8 tube showed only 4v P-P video signal (top trace) from terminal 6. Tube terminal 8 had a normal video signal (bottom trace).

(see Fig. 5). A 6KA8 tube is used in this chassis for keyed AGC, sync separation and noise inversion. A VTVM was used to check voltages on all tubes and all appeared normal.

A few important waveforms from the 6KA8 were observed with the dual-amplifier scope. Tube terminal 6 revealed only a 4v P-P video signal (Fig. 6 top) while terminal 8 had a normal video signal (Fig. 6 bottom trace). Jumping the probes back and forth, we obtained sufficient information to narrow the search down to an open $0.1\mu\text{f}$ coupling capacitor (C327) connected to the plate of the 6LF8 1st video amplifier.

In just a few minutes all waveforms at the terminals of this tube socket had been investigated and compared. A would-be "tough dog" proved to be very tame indeed — just a routine service job like most so-called tough-dogs are.

Beware of Shifty Disc-Ceramics

A very poor picture, unstable sync action and no background noise on the CRT screen when the tuner was switched to an inactive channel, characterized the faults of this Zenith 24NC31 color chassis.

Routine voltage and scope checks uncovered nothing significant. But we concluded that the trouble just had to be in the AGC section. The AGC line was clamped and a fair picture appeared on the screen. We guessed right for a change and thought that this would be a "snap."

This chassis uses $\frac{2}{3}$ of a 6BA11 tube (see schematic

Troubleshooting Techniques . .

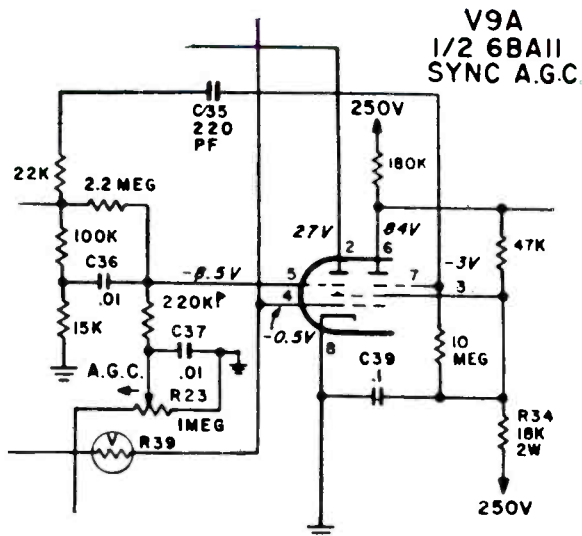

Fig. 7—Partial schematic of 6BA11 AGC/sync circuit from Zenith 24NC31 chassis.

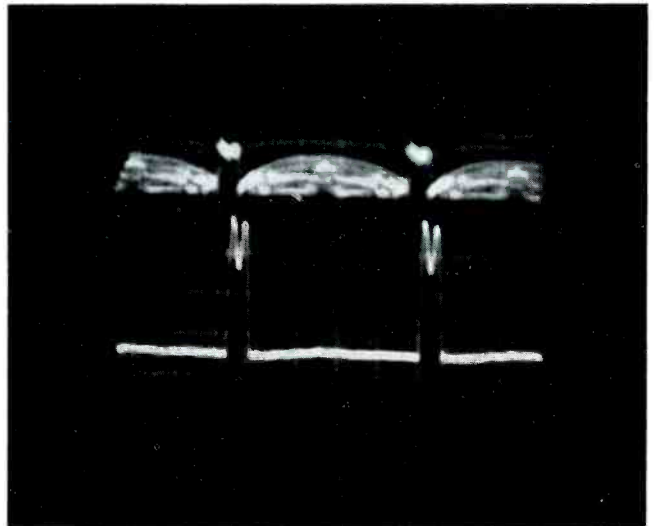

Fig. 8—Dual traces show that the keying pulse (bottom) lags the horizontal sync pulse (top) by $1\mu s$, causing improper tube conduction and poor AGC/sync action.

Fig. 7) which is actually a 6BU8, for sync and AGC functions. The only incorrect voltage noted was the AGC supplied to the tuner and video IF. All waveforms were scoped but nothing important showed up. The AGC line was completely disconnected but the abnormal voltage still persisted. What could cause this? A substitute keying pulse was injected from a TV analyst and the set operated perfectly!

One probe of the dual-trace scope was connected to terminal 2 (plate) of the 6BA11 tube. The other probe was attached to terminal 5 for a phase, or timing comparison, between the keying (flyback) and horizontal sync pulses. A very close look revealed the keying pulse (Fig. 8, bottom trace) was lagging the horizontal sync pulse (Fig. 8, top trace) by a microsecond and was also slightly distorted. This was causing improper tube conduction and thus, poor AGC and sync action.

The dual disc-ceramic which couples the keying pulse from the sweep oscillator coil was replaced and proper operation was restored. The characteristics of the ceramic capacitor had changed, causing the keying pulse to be delayed slightly.

When this trouble was resolved and the solution found, we naturally had to categorize this one as a rare bird.

The Sync 'Trouble' That Wasn't

Now this last case has nothing to do with using exotic-type test instruments. It is thrown in to show that the best instruments in the world will not "automa-

tically" locate faults. You'll need to use your head.

An RCA CTC16E color chassis came to the bench. It had a soft vertical hold and would roll frequently.

The vertical oscillator and output sections, using a 6EM7 tube, were checked out by all ordinary methods. The sync and AGC sections were scoped and checked but nothing appeared abnormal — except the soft sync condition.

But when the set was first switched on, the HV "crackle" seemed a bit too pronounced. The vertical height and linearity controls were next adjusted for a small vertical picture sweep. It was then noted, under these conditions, that the vertical lock was excellent! Now what?

HV to the CRT was checked with a VTVM and high voltage probe. A whopping 31kv showed up and the HV control had no effect when adjusted.

Our attention was now diverted to the 6BK4 shunt regulator tube. But that tube couldn't possibly cause vertical sync trouble! But, alas, dear fellow sufferers, it did!

Too much or too little HV can cause all kinds of problems in color TV sets. This is an amplified sync-pulse type vertical arrangement that contains plate and cathode feedback circuits. A high accelerating voltage, with a stiffer-than-normal electron beam, makes it impossible to obtain complete vertical sweep. Vertical roll and poor lock will result because the vertical height and linearity controls are adjusted for maximum vertical sweep. ■

Semiconductors from A to Z

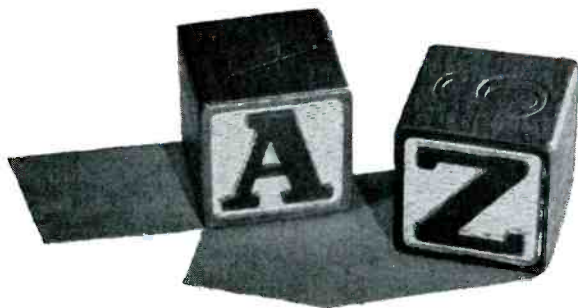

Tunnel diode characteristics must be understood before practical circuits can be serviced effectively

The Seventh Article in a Continuing Series

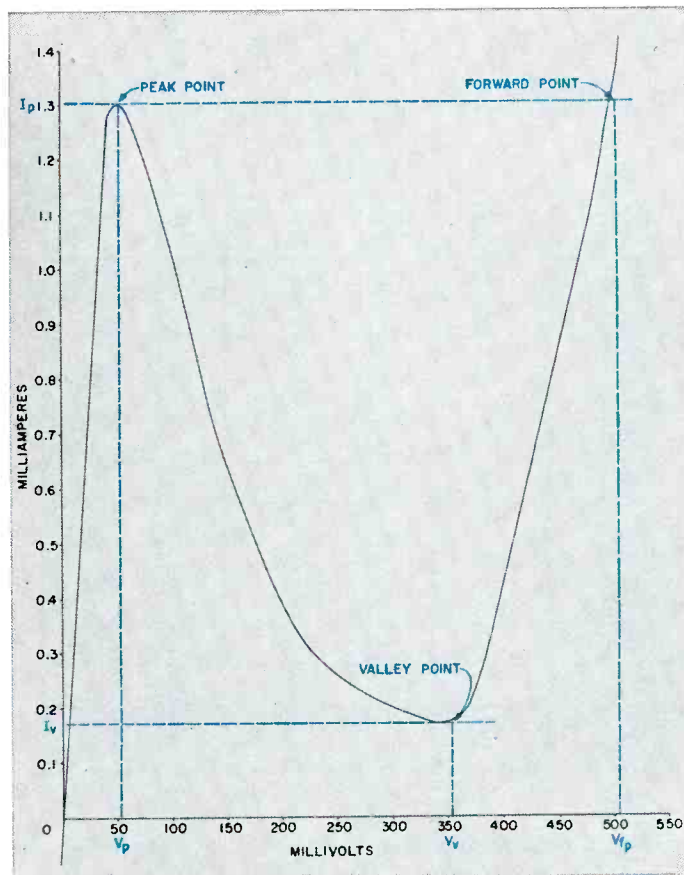

Fig. 2—A funnel diode characteristic curve.

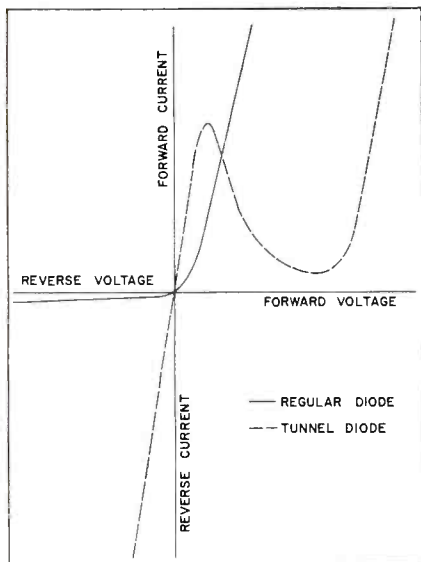

Fig. 1—Comparing a regular diode with a tunnel diode.

■ The structure of tunnel diodes differs considerably from those of regular transistors, FETS and MOS devices. These semiconductors contain only a single junction of P- and N-type material. They are called tunnel diodes since, according to the laws of quantum theory, electrons approaching their junction disappear — instantaneously reappearing on the other side of the junction. Because of this characteristic, tunnel diodes are available which have frequency capabilities of up to 2.5GHz (2.5×10^9 Hz) in the microwave region.

Tunnel Diode Characteristic Curves

The voltage-current characteristics of a tunnel diode differ considerably from those of a regular diode (fig. 1). The forward current of a tunnel diode, unlike that of a regular diode, is reduced as the forward bias voltage increases beyond a certain point. This reduction in current continues until a

higher voltage is reached beyond which the current increases in the same manner as that in a conventional diode.

The characteristic curve of a tunnel diode is shown in greater detail in fig. 2. The "peak point" represents the point on the curve where the diode's current reaches a maximum value before being reduced by a larger bias voltage. The corresponding current and voltage for this point are represented by I_p and V_p , respectively. As the bias voltage continues to increase, a "valley point" is reached on the curve where the increasing bias voltage has resulted in a minimum diode current. The corresponding current and voltage at this point are represented by I_v and V_v , respectively. With still larger forward bias voltages, the tunnel diode's current increases until it reaches the maximum current reached previously at the "peak point." The diode current and forward bias voltage corresponding

TABLE I

V_D (mv)	I_D (ma)	$V_2 = I_D R_2$ (mv)	ΔV_2 (mv)	$V_1 = V_D + V_2$ (mv)	ΔV_1 (mv)	$A_v = \frac{\Delta V_2}{\Delta V_1}$
50	1.3	119.6		169.6		
75	1.2	110.4	9.2	185.4	15.8	0.59
90	1.1	101.2	9.2	191.2	5.8	1.59
105	1.0	92.0	9.2	197.0	5.8	1.59
117	0.9	82.8	9.2	199.8	2.8	3.28
129	0.8	73.6	9.2	202.6	2.8	3.28
142	0.7	64.4	9.2	206.4	3.8	3.22
157	0.6	55.2	9.2	212.2	5.8	1.59
178	0.5	46.0	9.2	224.0	11.8	0.78
200	0.4	36.8	9.2	236.8	12.8	0.72
227	0.3	27.6	9.2	254.6	17.8	0.52
295	0.2	18.4	9.2	313.4	58.8	0.31

Voltage and current combinations present in a tunnel-diode amplifier.

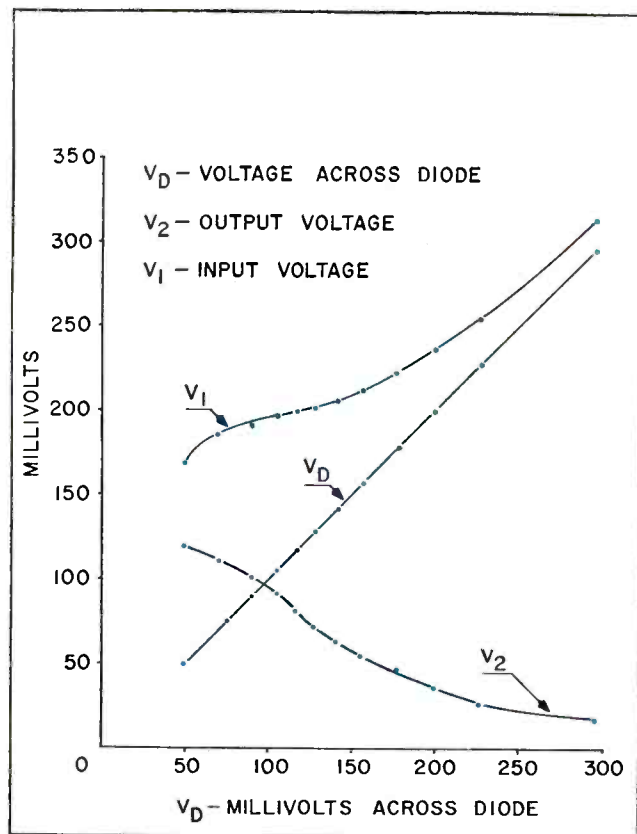

Fig. 4—Comparing voltage drops across components in a stable amplifier circuit.

to this third characteristic point on the graph, the "forward point," are represented by I_p and V_{fp} , respectively. At higher bias voltages, the diode's current continues to increase.

In the portion of the characteris-

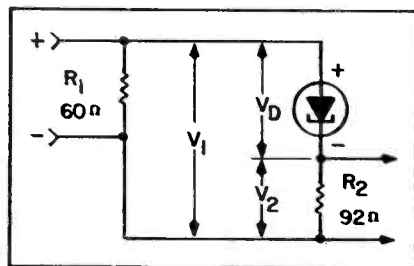

Fig. 3—Voltage drops in a simplified amplifier circuit.

tic curve between the peak point and valley point, the diode's current (I_D) decreases with increased voltage (V_D). This is unlike a regular resistor which permits a greater current flow as the voltage increases. Since the reverse condition occurs in the diode over this range of voltages, it is said to have a negative resistance. (See the article "Transistors — Diodes — and Negative Resistance," ELECTRONIC TECHNICIAN, May 1965).

A Simplified Amplifier Circuit

A simplified circuit (Fig. 3) was designed for the characteristic curve (Fig. 2) of the tunnel diode. For simplicity we will first consider various voltages (V_D) and currents (I_D) at the tunnel diode and then study the other circuit voltages and currents required for these conditions.

The current (I_D) flowing through the diode must also flow through the output resistor (R_2). This current will determine the circuit's output voltage ($V_2 = I_D R_2$). The voltage (V_1) across the input resistor (R_1) is equal to the sum of the other voltage drops within the circuit ($V_1 = V_D + V_2$). With this information the input voltages necessary for providing certain voltages across the tunnel diode can be calculated ($V_1 = V_D + V_2 = V_D + I_D R_2$). Since $R_2 = 92\Omega$, $V_2 = I_D \times 92\Omega$ and $V_1 = V_D + I_D \times 92\Omega$.

The first two columns of data in Table I contain the voltages (V_D) and currents (I_D) from the negative resistance portion of the tunnel diode's characteristic curve (Fig. 2).

When the tunnel diode has a 50mv forward bias (V_D), it conducts 1.3ma of current (I_D). Since the

current flowing through the tunnel diode also flows through the output resistor, the output voltage (V_2) can be calculated ($V_2 = I_D R_2 = 1.3\text{ma} \times 92\Omega = 119.6\text{mv}$). To develop 50mv across the tunnel diode and 119.6mv across the output resistor, the input voltage must equal the total of these two voltages ($V_1 = V_D + V_2 = 50\text{mv} + 119.6\text{mv} = 169.6\text{mv}$).

The same type of calculations can be made for a 75mv forward bias across the tunnel diode. Under these conditions the diode conducts 1.2-ma, develops a voltage drop of 110.4mv across the load resistor and the input voltage is 185.4mv.

With the calculated data in Table I, curves can be drawn (fig. 4) to show the relationship of the voltages present across the tunnel diode (V_D) at the circuit's input (V_1) and its output (V_2). Since the various output voltages are the sum of the diode voltages and the output voltages ($V_1 = V_D + V_2$), the curve representing the input voltages must equal the height of the other two curves combined. As seen from the curves, with a 92 Ω output resistor, the decrease in output voltage is smaller than the corresponding in-

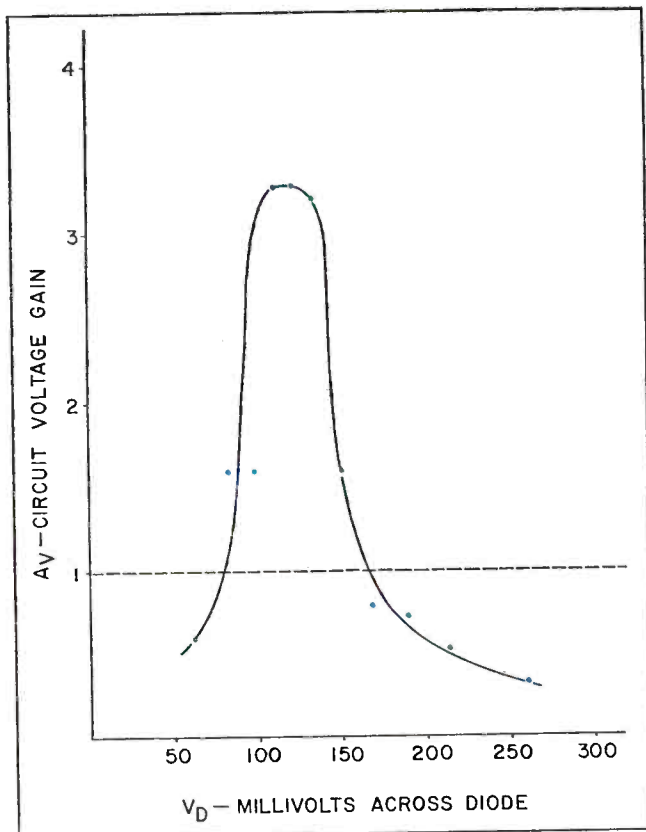

Fig. 6—Voltage gains in a tunnel diode amplifier.

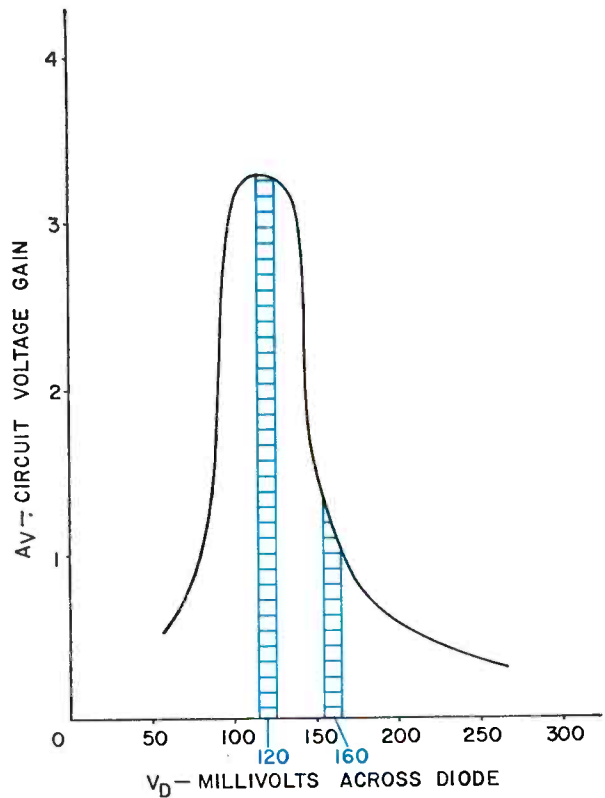

Fig. 7—The effect of diode biasing on a signal's gain.

crease in diode voltage. As a result, the input voltage always increases as the diode voltage increases. Or, with the 92Ω output resistor an increase in input voltage results in a corresponding increase in diode voltage. Under these conditions, the input voltage determines the diode voltage and the output voltage.

From the curves we can see that when the input voltage (V_1) is 200mv, very small input voltage fluctuations (ΔV_1) result in large output voltage fluctuations (ΔV_2). As the input voltage increases, the output voltage decreases, and any signal present at the input is inverted and amplified at the output.

The Amplifier's Output Resistance

As had been indicated, the diode current (I_D) passing through the output resistor (R_2) resulted in the output voltage (V_2), ($V_2 = I_D R_2$). The smaller the output resistor's value, the smaller the output voltage (V_2) and the resulting output signal. If the output resistor's value is too small, very little amplification results.

Another problem is encountered if the value of the output resistor (R_2) is too large. Suppose its value

is increased from 92Ω to 150Ω . The resulting output voltage curve (fig. 5) is not only higher, but steeper than before (Fig. 4). With the larger output resistor, the decrease in output voltage can be greater than the corresponding increase in diode voltage. As a result, the input voltage

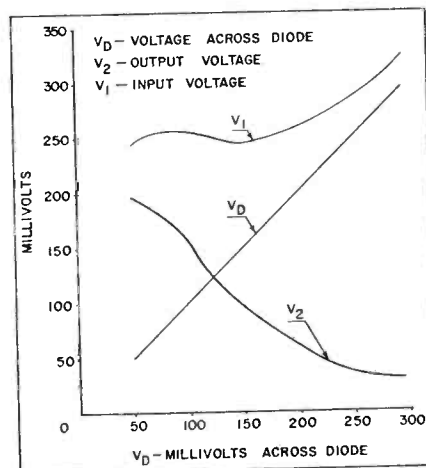

Fig. 5—Comparing voltage drops across components in an unstable amplifier circuit.

does not always increase as the diode voltage increases. We see from the resulting curves that when the diode voltage is between 95 and 150mv, the decrease in output voltage is greater than the increase in diode

voltage — resulting in a decreasing input voltage. At other diode voltages, increases in voltages across the output are smaller than those across the diode, and an increase in diode voltage results in an increase in input voltage. From these curves we see that when there is a 250mv input voltage there can be a diode voltage of 60mv, 125mv or 175mv, and an output voltage of 190mv, 122mv or 77mv. With the larger output resistor the input voltage cannot determine the output voltage and the circuit is unstable. The output resistor's value affects the stability and voltage gain of the circuit.

The Amplifier's Voltage Gain

When comparing the various sets of calculations in table I, using the smaller 92Ω output resistor, we note that although the increase in the input voltage (ΔV_1) was 15.8mv (185.4mv — 169.6mv), the corresponding increase in output voltage (ΔV_2) was only 9.2mv (119.6mv — 110.4mv).

The circuit's voltage gain (A_v) is equal to the change in output voltage (ΔV_2) divided by the change in input voltage (ΔV_1). ($A_v = \frac{\Delta V_2}{\Delta V_1}$).

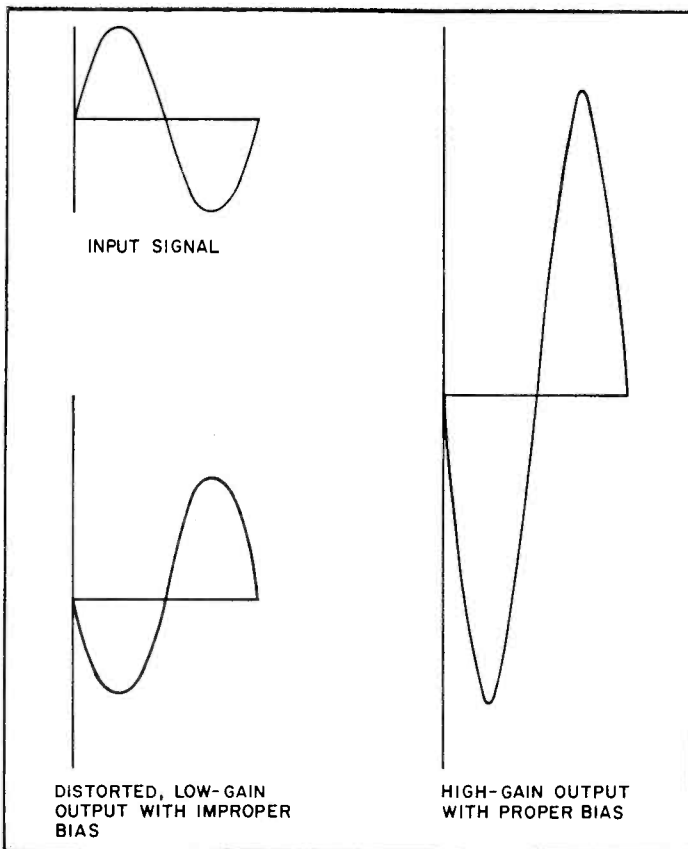

Fig. 8—Comparing input and output signals effected by the tunnel diode bias.

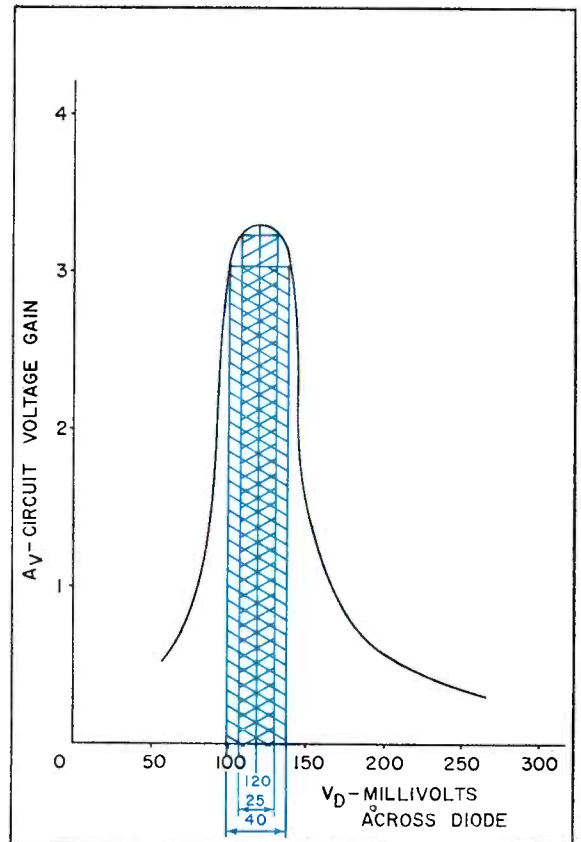

Fig. 9—The non-linear curve limits the gain of input signals.

This voltage gain can be determined from the change in voltages that have been calculated. ($A_v = \frac{\Delta V_2}{\Delta V_1} =$

$$\frac{9.2\text{mv}}{15.8\text{mv}} = 0.59).$$

Table I shows the voltages in the circuit that result when the input voltage is increased to provide various voltages across the tunnel diode. From the last column of the table we can see that over a certain range of input voltages, larger voltage gains are experienced in the tunnel diode circuit.

The circuit's voltage gains (A_v) can be more clearly visualized when plotted against some other variable. This has been done in Fig. 6 by plotting the voltage gain (A_v) against the bias voltage (V_D) across the diode. [Note, the curve does not follow exactly the points obtained from Table I. This discrepancy results from the fact that the tunnel diode's characteristic curve (Fig. 2) can not be read to as many significant figures as are required for a smoother curve.]

This curve (Fig. 6) should not be considered another characteristic curve of the tunnel diode. It is in-

stead a characteristic curve of an amplifier containing a tunnel diode of known characteristics.

Amplification occurs in the tunnel diode circuit when the change in output voltage exceeds the change in input voltage. Under these conditions the voltage gain is greater than one. (Circuit amplifies when $A_v > 1$.) From the curve in Fig. 6 we see that the circuit amplifies voltages when the diode voltage is between 80mv and 165mv.

The curve in Fig. 7 shows how the signals passing through the tunnel diode circuit are affected by various bias voltages across the tunnel diode. When the tunnel diode's bias voltage fluctuates about 120mv, the circuit's input signal experiences a maximum gain. Since both the positive and negative portion of the signal's wave have the same voltage gain (A_v) of 3.3, little distortion results in the output signal (Fig. 8).

Should the characteristics of the circuit be permitted to change and increase the tunnel diode bias voltage, causing it to fluctuate about 160mv, the voltage gain of the input signal is reduced. Since the posi-

tive portion of the signal's wave experiences a voltage gain of only one ($A_v = 1$) while the negative portion of the wave experiences a voltage gain of 1.3, the output signal is distorted.

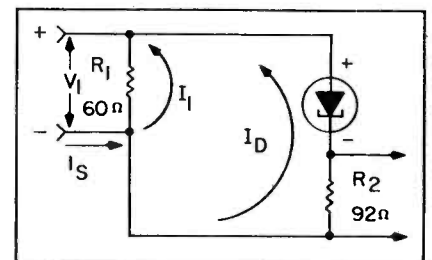

Fig. 10—Currents present in a simplified amplifier circuit.

The non-linear gain characteristic curve shown in Fig. 9 illustrates the circuit's possible use as an automatic volume control. When the diode bias voltage (V_D) contains a 120mVdc bias modified by a 25mV signal, the bias shifts from 107.5mV to 132.5mV, and the voltage gain (A_v) is 3.25. By increasing the signal's amplitude to 40mV, the diode's bias shifts from 100mV to 140mV, and the voltage gain is reduced to 3.05.

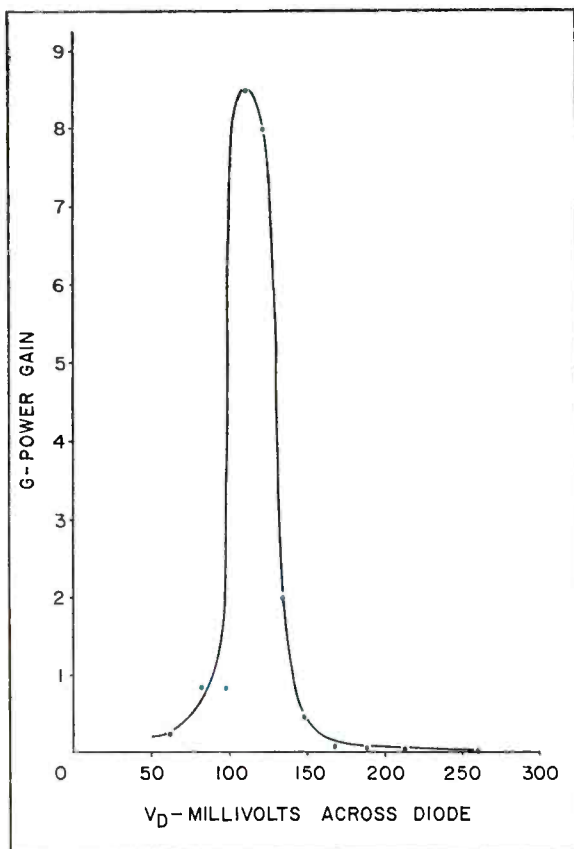

Fig. 11—Power gains in a tunnel diode amplifier.

TABLE II

V_1 (mv)	$I_1 = \frac{V_1}{R_1}$ (ma)	I_D (ma)	$I_S = I_1 + I_D$ (ma)	$P_{in} = V_1 I_S$ (mw)	ΔP_{in} (mw)	$P_{out} = I_D^2 R_2$ (mw)	ΔP_{out} (mw)	$G = \frac{\Delta P_{out}}{\Delta P_{in}}$
169.6	2.82	1.3	4.12	0.699	0.096	0.155	-0.023	0.24
185.4	3.09	1.2	4.29	0.795	0.025	0.132	-0.021	0.84
191.2	3.19	1.1	4.29	0.820	0.023	0.111	-0.019	0.83
197.0	3.28	1.0	4.28	0.843	0.002	0.092	-0.017	8.50
199.8	3.33	0.9	4.23	0.845	0.002	0.075	-0.016	8.00
202.6	3.38	0.8	4.18	0.847	0.007	0.059	-0.014	2.00
206.4	3.44	0.7	4.14	0.854	0.025	0.045	-0.012	0.48
212.2	3.54	0.6	4.14	0.879	0.068	0.033	-0.010	0.11
224.0	3.73	0.5	4.23	0.947	0.083	0.023	-0.008	0.10
236.8	3.95	0.4	4.35	1.030	0.126	0.015	-0.007	0.06
254.6	4.24	0.3	4.54	1.156	0.543	0.008	-0.004	0.01
313.4	5.22	0.2	5.42	1.699		0.004		

Comparing input and output power combinations present in a tunnel-diode amplifier.

The Amplifier's Power Gain

The power applied to the circuit (Fig. 10) is equal to the current (I_S) flowing from the voltage source, used to supply the input voltage (V_1), times that voltage ($P_{in} = V_1 I_S$). This current (I_S) is the sum of the currents flowing through the input resistor (R_1) and the diode ($I_S = I_1 + I_D$). The current (I_1) flowing through the input resistor (R_1) is equal to the applied voltage (V_1) divided by the value of that resistor ($I_1 = \frac{V_1}{R_1}$). These equations

can be combined to determine the applied power [$P_{in} = V_1 I_S = V_1 (I_1 + I_D) = V_1 (\frac{V_1}{R_1} + I_D)$]. The power at the circuit's output can also be calculated ($P_{out} = R_2 I_D^2$).

By using the voltage-current combinations listed in Table I, we can calculate (Table II) the amount of power present at the input and output of the tunnel diode circuit when the tunnel diode experiences various bias voltages.

When the input voltage (V_1) is 169.6mv, the current (I_1) flowing through the 60Ω input resistor (R_1)

can be calculated ($I_1 = \frac{V_1}{R_1} = \frac{169.6\text{mv}}{60\Omega} \approx 2.82\text{ma}$). From Table I we see that under these conditions the tunnel diode current (I_D) is 1.3ma. With this information the source current (I_S) can be determined ($I_S = I_1 + I_D = 2.82\text{ma} + 1.30\text{ma} = 4.12\text{ma}$). The power applied (P_{in}) can then be calculated ($P_{in} = V_1 I_S = 169.6\text{mv} \times 4.12\text{ma} = 698.752 \times 10^{-6} \approx 0.698 \times 10^{-3}\text{w} = 0.698\text{mw}$). Since we know that under these conditions the tunnel diode current (I_D) is 1.3ma, we can also calculate the output power (P_{out}) across the 92Ω output resistor (R_2). [$P_{out} = R_2 I_D^2 = 92\Omega \times (1.3\text{ma})^2 = 92\Omega \times 1.3 \times 10^{-3}\text{a} \times 1.3 \times 10^{-3}\text{a} = 155.48 \times 10^{-6}\text{w} \approx 0.155 \times 10^{-3}\text{w} = 0.155\text{mw}$]

In a similar manner we can calculate that when the input voltage (V_1) is 185.4mv, the power applied at the input (P_{in}) is 0.795mw and the power developed at the output (P_{out}) is 0.132mw.

From these calculations we see that when there is a 0.096mw increase (0.795mw — 0.699mw) in

power input (ΔP_{in}) there is also a 0.023mw decrease (0.155mw — 0.132mw) in power output (ΔP_{out}). By comparing these figures, we can determine the power gain (G) of the tunnel diode circuit ($G = \frac{\Delta P_{out}}{\Delta P_{in}} = \frac{0.023\text{mw}}{0.096\text{mw}} = 0.24$).

From the last column of Table II, we can see that over a certain range of input voltages larger power gains are experienced in the circuit. These power gains (G) can be more clearly visualized when plotted against some other variable. This has been done in Fig. 11 by plotting the power gain against the bias voltage (V_D) across the diode. Like the curve in Fig. 6, this curve (Fig. 11) should not be considered a characteristic curve of the tunnel diode. It is instead a characteristic curve of an amplifier containing a tunnel diode of known characteristics.

The next article in this series will discuss the input resistance of a tunnel diode amplifier, more common tunnel diode amplifier circuits, tunnel diode oscillators and tunnel diode switches. ■

UNDERSTANDING STEREO MULTIPLEX

'Bob' explains modern FM principles to 'Scoot' in a simple but unique way

■ "Hey Scoot," Bob called from across the shop, "haven't you got the Gibbons' FM/stereo fixed yet?"

"Yeah, sure Bob. But I don't really know what I'm doing. I can fix most troubles in these things and then align them but I don't really understand how they work."

"Let's take a coffee break and I'll go over FM/stereo with you."

Both men headed for the door and Bob told the office girl, Tilly, that they'd be back in a few minutes.

"One black and one half-cream, Freddie," Bob smiled at the waitress as he walked into the diner. And in the same breath, "Let's get into this multiplex thing, Scoot, we can't waste the entire morning." They slipped into a booth away from the door's cold blasts.

"We've got to get a coffee pot for the shop. We waste too much time over here," Bob remarked.

"Now let's see. You have to understand a little about audio and regular FM to comprehend the action in stereo multiplex, but since it's

just a little, I'm going to assume that you know enough."

"Gee chief, thanks for the confidence."

Bob ignored Scoot's remarks and pulled a napkin from the holder. He smoothed the napkin and began to sketch.

"One thing you need to understand, Scoot is that a portion of the audio material can be lost and the ear won't miss a bit of it. Take this sinewave; if we remove little pieces out of the sinewave like this (Fig.

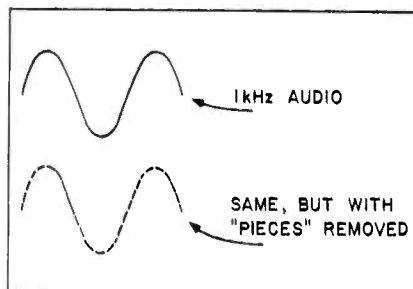

Fig. 1—". . . if we remove little pieces from the sinewave it will sound just like the original when it comes from the receiver's speaker."

1), it will sound just like the original when it comes from the receiver's speaker. Components in the audio portion of the receiver integrate the waveform back to its original state. Actually, if the amplifier and speakers didn't integrate the audio and cover up the missing portions, your ears would do a pretty good job of it anyway.

"Now, suppose I hook up a deal like this." Bob pulled a fresh napkin and started another sketch. He drew a pair of microphones connected to a commutator-type switch and connected a pair of speakers to a second commutator in the same way. Then he connected the commutators together with a conductive "flexible shaft" and the shaft, in turn, to a "motor" (Fig. 2).

"Let's assume that the speaker can be driven directly from a microphone, that the two microphones are located in Chicago the speakers in Milwaukee and the switches at both ends are connected by a long conductive shaft."

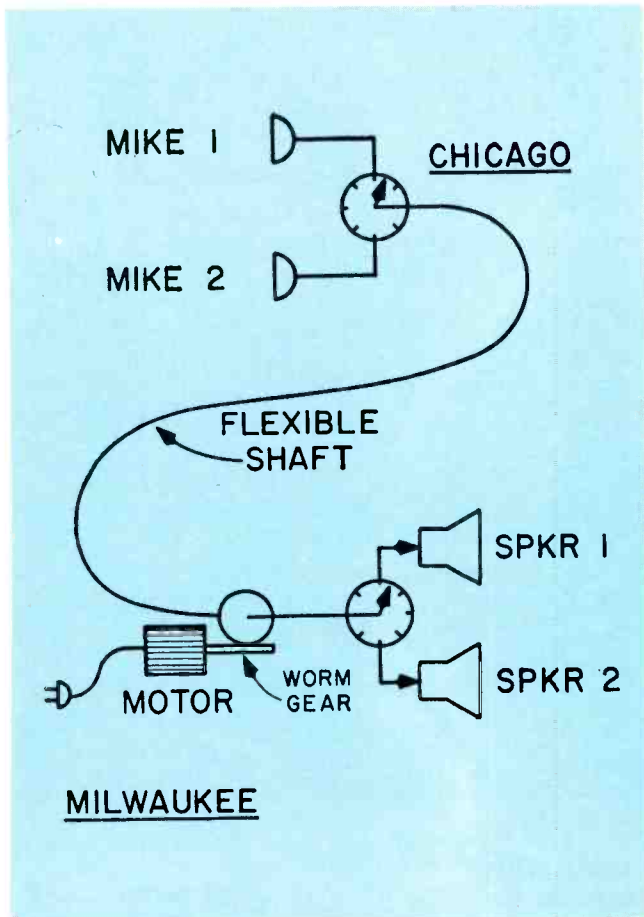

Fig. 2—"Then he connected the commutators together with a conductive 'flexible shaft' and the shaft, in turn, to a 'motor'."

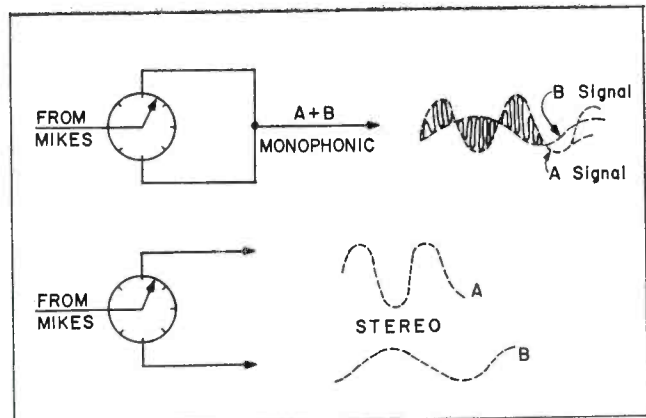

Fig. 3—"Actually, the signals through a monophonic system and a stereo system look like this."

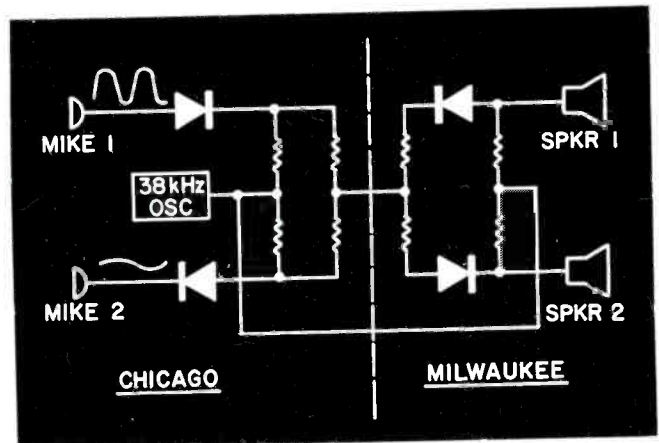

Fig. 4—"... the audio will pass through the diode only when it is biased on the 38kHz signal, right?"

"Are you kidding? A hundred-mile shaft for stereo?"

"Scoot, I'm not trying to develop a practical stereo system. I'm trying to explain how the system works.

"If we put a 400Hz signal into one mike and a 1kHz signal into the second mike and rotate the shaft at 38,000 rps, then we'd get the combined output going down the shaft and separate outputs from the speakers that matched the inputs to the respective mikes.

"If the outputs are tied together and into one speaker, we'd get the combined output just as it would sound through one mike and one speaker connected through a wire—a monophonic system.

"The important point is that the signal on the shaft is either from mike 'A' or mike 'B' at any given instant. There is no strange combination of signals on the 'line.' Actually, the signals through a monophonic system and a stereo system look like this." Bob drew the signal outputs on another napkin (Fig. 3).

"As you can see, the combined signals would look pretty weird on the average scope since the beam has to jump between one mike signal and another. Of course this shows the scope trace pretty much like I've drawn it."

"It looks confusing."

"I know it looks confusing, Scoot, but if you sit down and draw the waveforms like I have, it will come to you.

"Now what we have so far is a two channel audio system which is capable of splitting the audio equally and alternately between channels at 38,000 rps, or 38kHz. We also have a system of syncing the mike audio with the speaker outputs—the shaft.

"Now let's investigate an electrical system which does the same thing." Bob pulled another napkin and drew a diode.

"Even you know that a diode can be biased off with one signal and turned on with another."

"What-da-ya mean *even* me?"

"Skip it. Now if I put an audio signal into one end of a diode and a 38kHz signal on the other end, the audio will pass through the diode only when it is biased on by the 38kHz signal, right?" Bob continued to sketch (Fig. 4).

"And if I hook another diode up—opposite in polarity and connect them both to respective mikes, we can turn on each diode alternately." Bob filled the left side of his napkin.

"Now the resistors here prevent the bias signals for the respective diodes from triggering the wrong diode and adding the audio output. We can connect the audio output from the diodes to an identical system on the speaker side and can phase the speakers with the same 38kHz signal!" Bob drew another connecting line between the mikes and speakers.

"It all looks very impractical—even as simple as it is. There must be a better way."

"It's only impractical Scoot, because that's not the way it really

Fig. 5—"Here's the way it actually works." Bob started to draw on the table now. "Of course, this is a simplified version, but for all practical purposes it's close enough."

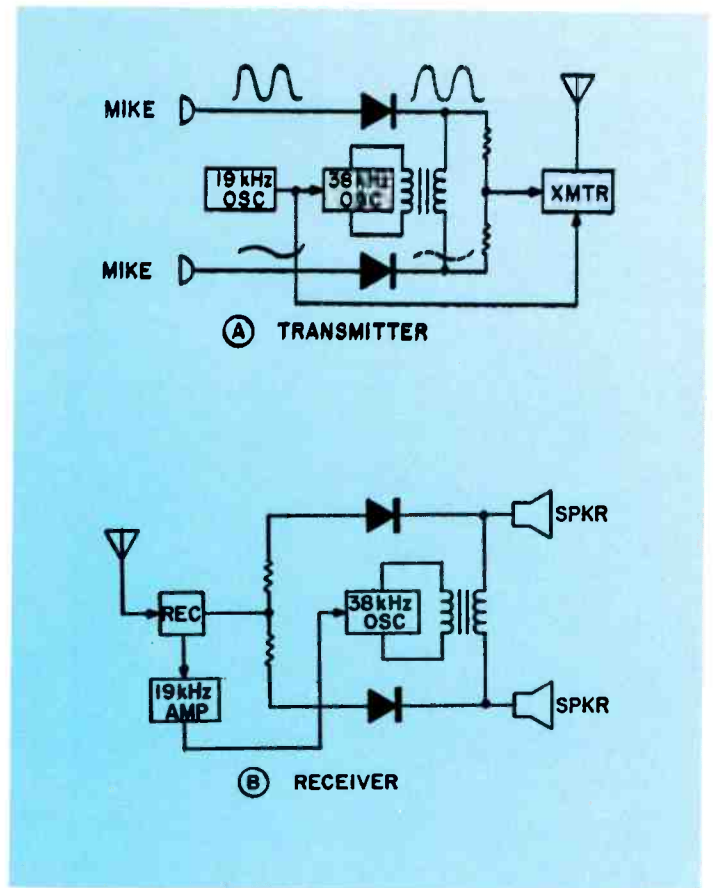

STEREO MULTIPLEX . . .

works. After all, there aren't a bunch of wires connecting the mikes and speakers in the average FM/stereo system.

"Here's the way it actually works." Bob started to draw on the table now. "Of course, this is a simplified version, but for all practical purposes it's close enough." Bob continued to draw without speaking (Fig. 5).

"Notice we still have the mike outputs feeding two diodes but that now the diodes are in phase, polarity-wise, and their added outputs are fed into a transmitter. Now, the reason the diodes are in phase is that they are being fed by a transformer and its outputs are already out-of-phase.

"Because of the way the FM signal is transmitted, the sync signal is really 19kHz instead of 38kHz, so that's the signal actually used to generate the 38kHz which gates the audio. Also, notice that 19kHz is transmitted with the left and right stereo signals.

"At the receiver end, the signals are naturally, integrated back together in a standard monophonic receiver but are treated a little differently in a stereo job. Basically,

the difference is that a circuit exists which traps out and amplifies the 19kHz sync; or pilot signal, from the received signal."

"Hey, Yeah. That's what operated the stereo ON light."

"Among other things, yes. Actually, the most important thing the 19kHz does is sync the 38kHz oscillator which gates the diodes in the receiver on and off in phase with the original. Really, that's all there is to it."

"Oh, that's all huh? Look, Bob. As an example of how you're all wet, I'm going to tell you that the set I was just working on had almost no diodes in it and one I worked on the other day had about a dozen. How come?"

"Well, Scoot, it's not as bad as it sounds. You know a transistor is actually a couple of diodes anyway. In some circuits, the transistors are used as diodes and amplifiers. What I've drawn here is actually not a working circuit. Practically, about twice that many diodes are used. At each junction of 38kHz and audio, one is used to prevent the audio, or 'switch' signal, from feeding back into the other circuit. Here's how a typical circuit might

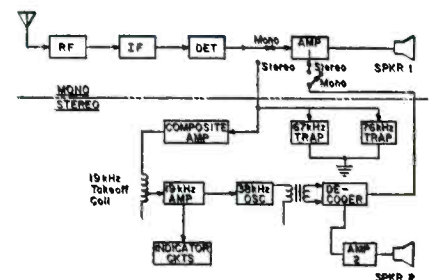

Fig. 7—"Fair question. Let's take a look at a block diagram for that."

look." Bob wiped away the table sketch and drew a new circuit (Fig. 6).

"How come when I align one of these things I find instructions to peak or dip about ten coils and transformers. How do they enter into the picture?"

"Fair question. Let's take a look at a block diagram for that." Bob had noticed Scoot's straining to see his table drawing so he drew the block diagram on another napkin (Fig. 7).

"In the first place, I think you've exaggerated the number of adjustments. Look. We've got one, two, three, four, five here and I don't think you'll find more than half a dozen in any multiplex equipment. you'll run into."

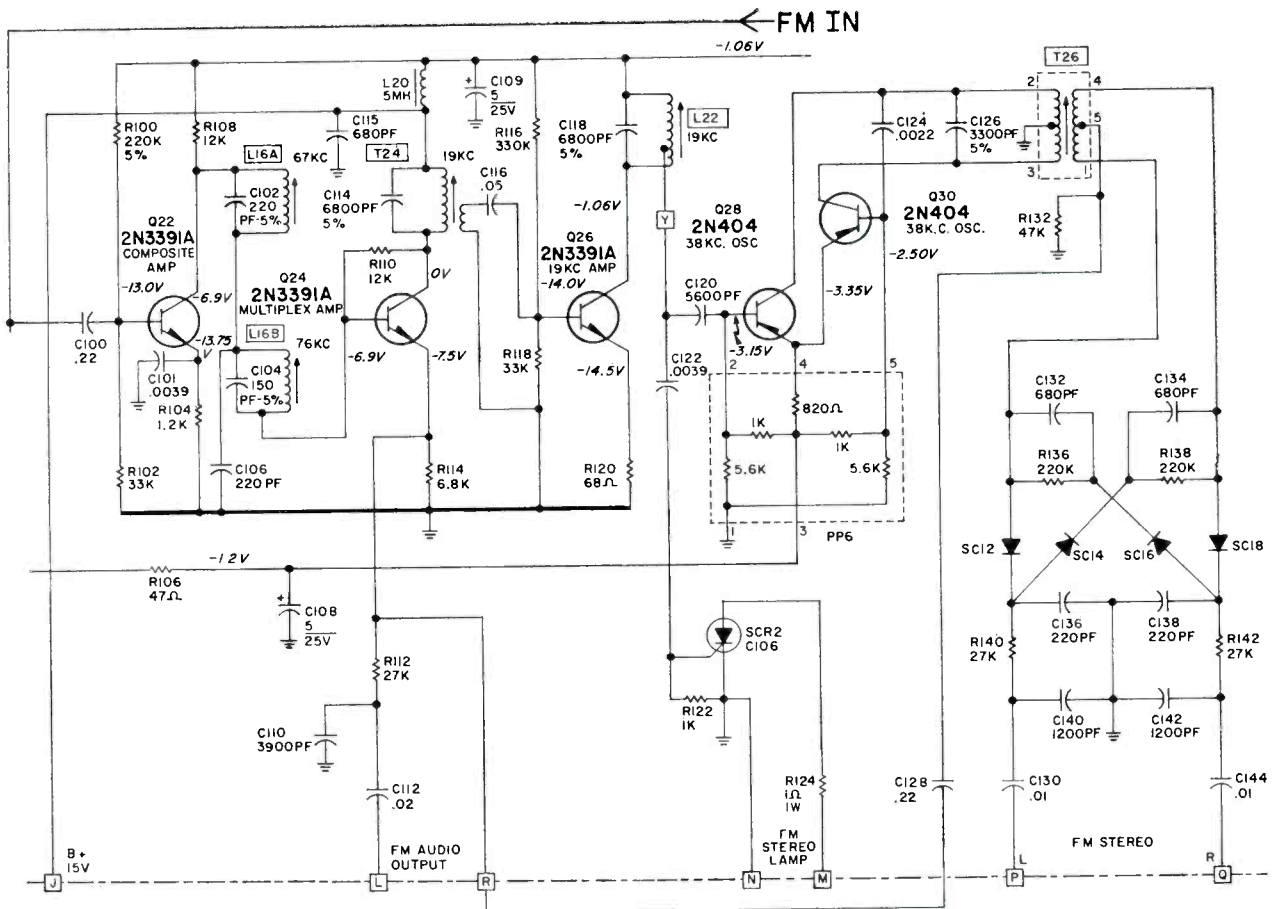

Fig. 6—"Here's how a typical circuit may look."

"If you really look at these adjustments, I don't see how you can go wrong in troubleshooting or in an alignment. The two boxes marked 67kHz and 76kHz are simply traps. You rarely have to adjust these unless someone has tampered with them. If you do have to adjust them, however, all you have to do is put in a signal at the trap frequency and monitor the output with a scope or volt meter. Adjust both traps for minimum signal output at their respective frequencies. The best place to monitor the trap output is on the output side of an amplifier so the trap won't be affected by test instruments.

"The traps are used to suppress signals which some stations send out at that subcarrier frequency. Most FM stations use this SCA frequency and lease the music or whatever they broadcast to stores, and so on.

"With all the stereo broadcasts right now, one good way to align a stereo set is with a broadcast signal. After the traps are dipped, put a scope on the output of the last 19kHz amplifier and peak all 19kHz coils. A meter can be used but it may be misleading at first but it can be used. In fact, after you get

used to the multiplex alignment you can use a stereo ON light. But then again, some neon indicator circuits can cause confusion.

"With the 19kHz peaked, you can zero-beat the 38kHz oscillator and you're almost done. You can generally get the 38kHz close enough by listening and adjusting it until it's in the middle of its zero-beat range. If this doesn't work, use a scope and connect the 19kHz to the other input. Then all you have to do is adjust the 38kHz for a figure-eight Lissajous.

"Very good, Bob, I'm learning,"

"Wait a minute. I said 'almost done,' remember? If you really want top-notch separation from the unit, you have to touch-up the 19kHz slugs. The best way to do that is with a stereo alignment generator.

"All you have to do is set the generator so the signal is being sent only to one channel. Then you measure the output from the unused channel and adjust the 19kHz slugs *slightly* for minimum output.

"Sometimes stereo stations broadcast news and other spoken programs on only one channel. When they do this you can turn the balance control to the dead channel and

adjust for minimum signal and achieve the same results."

"What else can you use the multiplex generator for?"

"Actually, Scoot, you can use the generator for all the alignments we talked about. Most generators put out a composite stereo signal which can be used in troubleshooting, a 19kHz signal, 67 and 76kHz signals and one channel signals as well. Most of the instrument instruction books have a wealth of good information in them. Did you ever think about reading the one we have?"

"The technical seminar," Scoot said, "sounds like it's turning into a lecture on morals or something. And at this point, even I'm ready to go back to work.

"Honestly, though, Bob, I think your talk straightened out quite a few things for me. I can probably use the instruction book now."

"It's true that many manufacturers make their instruction books difficult to use and understand, with too much technical jargon, confusing and ambiguous sentences. But we're not in a position to do much about it. When we need a test instrument for a job, we have to buy it and learn how to use it properly. ■

SERVICING SOLID-STATE MULTI-BAND HOME RECEIVERS

Learn how to
troubleshoot this
equipment efficiently

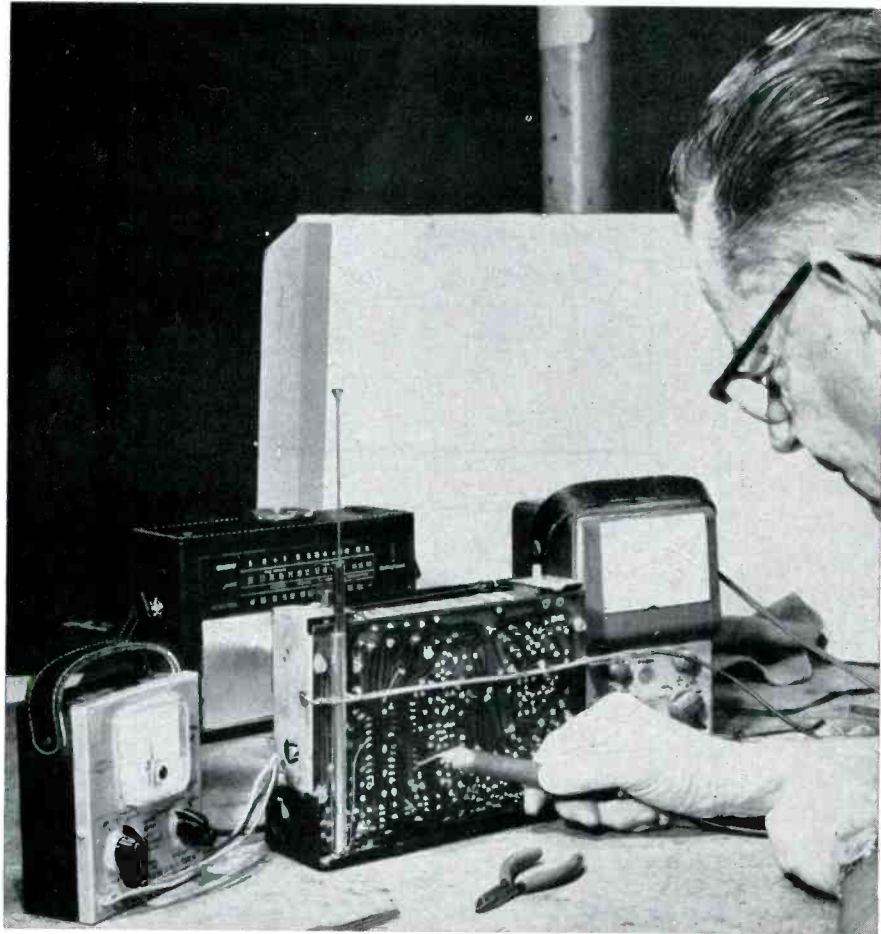

Fig. 1—Bench power supply connected to a Westinghouse multi-band receiver. The supply has a built-in voltage and current meter.

Band	Frequency Coverage	Band Name
1	150kHz to 400kHz	Long wave
2	535kHz to 1620kHz	Standard Broadcast
3	21MHz to 4MHz	Amateur
4	4MHz to 9MHz	SW Broadcast
5	9.4MHz to 10.1MHz	31 Meter
6	11.4MHz to 12.4MHz	25 Meter
7	14.6MHz to 16.0MHz	19 Meter
8	17.1MHz to 18.8MHz	16 Meter
9	20.6MHz to 23.0MHz	13 Meter

Chart I

■ Solid-state multi-band receivers are as easy to service as small pocket types or auto radios. Repair problems are similar in most solid-state receivers. But a glance at the coil switching arrangement in the schematic of a multi-band receiver makes the set look complicated. Hence, most technicians get an impression that the receivers are difficult to troubleshoot.

Don't let the added wires, a lot of coils and multiple switches create a "trouble-maze" for you. Take a look at a SW/BC schematic, for example. With a little practice you can easily break the various bands down into their switching circuits and check them out whenever necessary.

Typical Multi-Band Receiver

A typical solid-state multi-band receiver is a super-heterodyne type and it may have only two or three separate frequency bands—AM, FM and S/W. But some larger multi-band receivers may have up to 9 frequency bands covering the entire world of reception. See the frequency ranges shown in Chart I. Most multi-band receivers are carry-around portable types that may have two or three IF stages. The larger, around-the-globe receivers have an extra RF stage, a separate mixer stage, oscillator and several audio amplifier stages with pushpull solid-state output stages. The HF and AM frequency bands use the same transistors through-

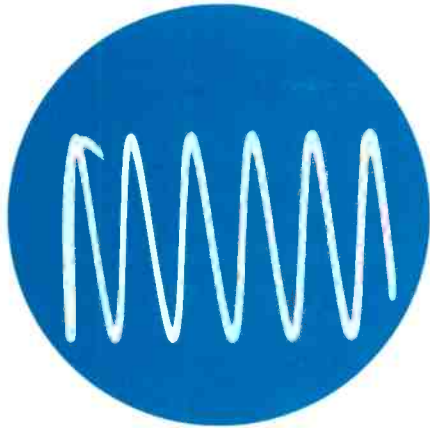

Fig. 2—Waveform taken from the variable tuning capacitor. Use a low-capacity probe to prevent oscillator circuit loading.

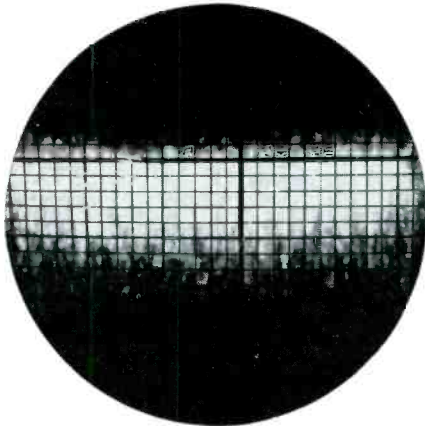

Fig. 3—Use a direct probe when checking the noise or audio of a receiver at the volume control. Turn the volume control full up.

After the batteries are checked, a quick current check is made. In many cases the customer has already checked the batteries but it is wise to recheck them to save precious servicing time. Connect a bench power supply to the receiver. The power supply we use has a voltage and current meter (see Fig. 1). Check to determine if the receiver is drawing the proper amount of current. Most three-band solid-state radios will draw from 5 to 20ma. Larger multi-band receivers may draw up to 30ma. If the receiver is drawing heavier-than-normal current, a leaky or shorted transistor or capacitor is likely. Compare the over-all current drain with that shown on the radio's schematic.

Use a signal-injection generator—like the small noise generator, for example—and inject a signal at the center point of the volume control. Be sure the volume control is turned full up. You can easily isolate the trouble to one section of the receiver at this first test point. If the audio channels are working, a loud audio tone will be heard. If not, proceed to the base of each audio transistor until a signal is heard. After the defective stage is isolated, make voltage and resistance measurements.

A current check in the emitter circuit will reveal a weak, open or leaky transistor. A voltage check across the emitter resistor will spell out the defective transistor. Of course, a very low VTVM voltage scale is needed here. A good schematic will indicate the correct voltages on all transistor elements.

Intermittent Reception

The intermittent solid-state radio can take up a lot of valuable servicing time.

It has been our experience that a *weak* intermittent reception trouble is much harder to locate than when the set goes *dead* intermittently. And many times when a VTVM or VOM is used to make voltage measurements at various points, the receiver will pop back into operation again. This can also happen when an injection signal generator is used.

But when the low-voltage capacitance probe of a scope is applied to these circuits, there is no loading of the intermittent circuits. It is wise to check the various stages of a working solid-state receiver with the scope before tackling an intermittent job. See the waveform shown in Fig. 2, taken from the oscillator variable capacitor section. The waveform taken from the volume control is shown in Fig. 3. Use a direct probe when checking the audio waveform across the volume control. When the scope probe is attached to the volume control, the receiver is automatically divided in half—isolating the RF and IF stages from the audio section.

Many intermittent troubles are caused by defective transistors, coupling capacitors, cracked resistors and broken etched board connections. Generally, you can see a cracked etched board. But a lamp placed behind the board makes it a lot easier to locate parts and defective wiring. Ask the customer, at the time when the job ticket is written, if the portable receiver has been dropped. When a cracked or broken board is suspected, simply twist or flex the board gently, to see

out the receiver. Only a method of switching different coils into the circuit is needed.

If an FM band is included in the same radio, a complete RF, converter, IF and discriminator stage is used in addition to those for the other bands. Most three band portables use the AM band (540 to 1600kHz), S/W band (2 to 10MHz and a second S/W band of frequencies (10 to 18MHz). Rarely do we see a "longwave" band on a portable receiver but we do find them—like the "Plata" model, 9TA370, for instance. Besides the American made multi-band receivers, many Japanese versions are on the market.

One advantage of solid-state receivers is that the customer can only replace batteries—and many times these are put in backward. There are no tubes to test and the receiver must come into the service shop for repair. These receiver types generally cost about three times as much as small transistor portables and the owner will consent to pay a reasonable price for repairing them.

Dead Receiver

A dead multi-band receiver is usually the easiest to repair. Generally, just solving the "dead" trouble puts the receiver back in normal working condition. Of course, an intermittently dead radio is a different story.

MULTI-BAND HOME RECEIVERS

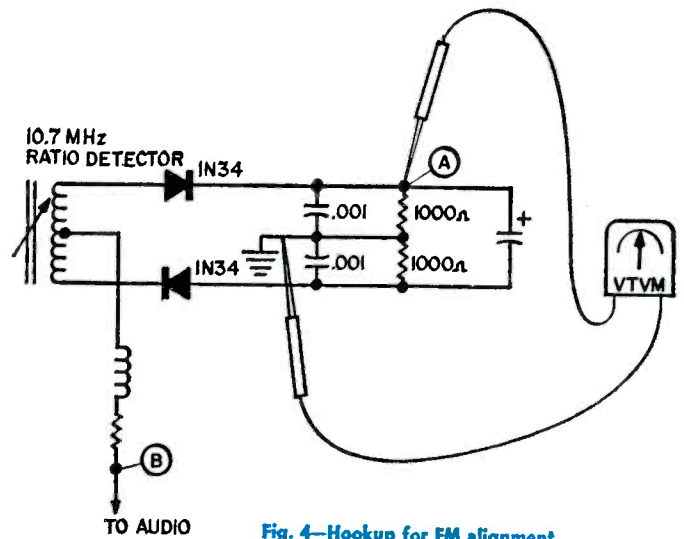

Fig. 4—Hookup for FM alignment.

Step	Signal Source	Set Signal to	SET Radio dial	Output Meter	Adjust
1	RF Signal Generator A standard radiating loop	1.7MHz	Gang closed	VTVM across voice coil	Osc. coil for Max.
2	or loop of wire placed near the AM antenna	5.5MHz	Gang open	Same	Osc. trimmer for Max.
3		5.2MHz	5.2MHz rock gang	Same	Ant. trimmer cap.

Chart II

Typical "SW" alignment Chart.

if the receiver goes off or on. If this happens, twist or flex the board so the receiver will stay off. Then take a test lead with sharp needle-type points and check from one end of the etched wiring to the other end. The receiver will come alive when the dead stretch of wiring is located. Another method is watching the current meter when twisting or flexing the etched board. If the current goes to practically zero you know the trouble must be in the B— or B+ supply circuits. Bad earphone jack connections will cause intermittent or a dead receiver. Broken, loose, dirty or corroded battery connections will also show up on the current meter.

AM Alignment

Trouble in a defective solid-state receiver can be isolated stage by stage with a signal generator. For accurate AM, FM, SW and IF frequency alignment a good reliable signal generator is needed. Let the generator warm up for a few minutes before attempting to align a solid-state receiver. Set the signal generator to 455kHz and couple its output to the mixer transistor base. Use a 0.1 μ f capacitor in series with the probe to the base of the transistor and fasten the shielded clip to common ground. Use a modulated IF signal and keep the output of the signal generator as low as possible to provide a stable indication on the output meter.

Place the output meter across the speaker voice coil or a VTVM across the volume control. Rotate the radio dial to the high end of the band—when the variable tuning capacitor is wide open. Adjust each IF section for maximum reading on the output meter.

If one of the IF slugs doesn't seem to make any difference when adjusted, there is a good chance that the IF transformer is defective. First rotate the IF slug out several turns and then slowly adjust the slug until the output on the meter changes. Do not rotate the slugs too far inward as powdered iron cores can be easily damaged. Also use a good flat alignment tool that is not too sharp or too thin, to avoid "chewing up" the powdered cores. Tune the IF coils to a sharp peak as shown on the output meter. When a multi-band receiver shows up with several chewed slugs in the IF transformer, it is best to replace the transformer.

To align the RF and oscillator stages, use several turns of hookup wire and form a loop and place it

near the antenna coil or loosely wrap three or four turns of wire around one end of the permeability rod of the antenna coil. Set the signal generator to 600kHz and leave the tuning capacitor fully open. Adjust the oscillator coil slug.

Then set the signal generator to 1.6MHz and adjust the oscillator padder capacitor for maximum reading. Now rock the variable tuning capacitor back and forth and at the same time tune the oscillator padder capacitor until the signal is strongest. Recheck the oscillator setting by tuning in a known station on the correct spot of the tuning dial and then rock the tuning capacitor back and forth while adjusting the oscillator padder capacitor. Maximum volume is obtained at the correct dial setting on the tuned station. Set the signal generator to 1.6MHz and adjust the RF trimmer capacitor for maximum reading. Now recheck the entire AM band to see if all stations are tracking correctly.

FM Alignment

Alignment of the FM band is not as difficult as it may seem. Use the same coupling loop to the FM antenna for a radiated signal. First align the IF transformers with a 10.7MHz unmodulated signal. Set the dial to the high end and place a VTVM as shown in Fig. 4. Adjust all IF slugs for maximum reading on the VTVM.

To align the ratio-detector transformer, leave the signal generator connected to the loop and the VTVM to point "B." Adjust the ratio-detector transformer for zero reading. A definite positive and negative reading will be obtained on either side of the correct reading.

For FM-RF alignment, set the signal generator to

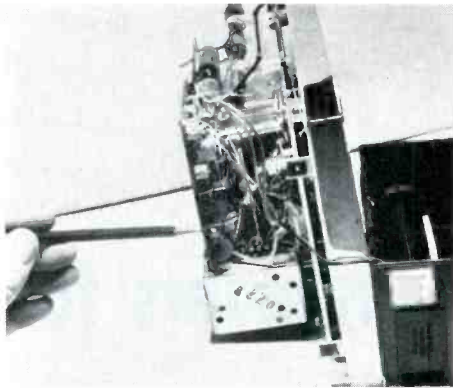
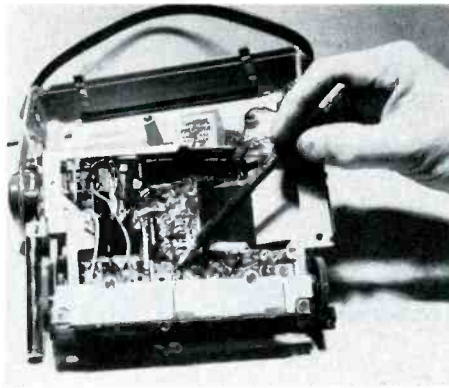
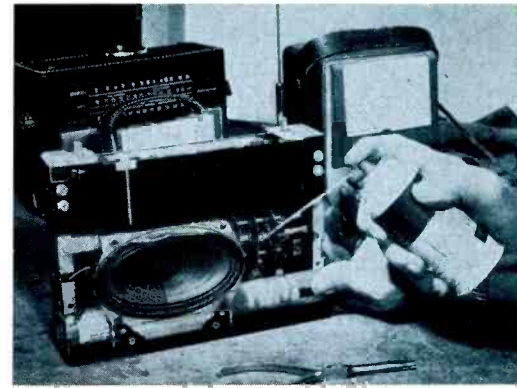

Fig. 5—A bad connection to etched board from FM coupling coil caused an intermittent in this RCA RGM55.



Cracked board on a multi-band receiver. Most breaks occur around heavy parts like tuning capacitors and speakers.



Cleaning and lubricating band switching coils on a multi-band Westinghouse portable. "Tuner lube" is good for this work.

108MHz and also set the radio dial at this reading. Place the dc probe of the VTVM to the original position "A" in Fig. 4. Adjust the RF trimmer for maximum reading. The slugs of the FM-RF tuning coil should be adjusted to 88MHz.

Alignment of the "shortwave" band is shown in Chart II. This chart shows typical alignment procedures for the various bands. Although these adjustments are quite typical, it is best to use the exact alignment procedures specified by the manufacturer.

The Tilted Philco

A Philco model INT815BK multi-band portable came in with an unusual trouble. When the portable was tilted from side to side or back and forth the radio would operate but only for a few minutes and then become completely dead.

A loose battery supply connection was suspected at first. But the batteries were removed and a transistor bench power supply attached. When the speaker would go dead the current remained the same and would vary with the music of the tuned local radio station. This made us believe that the trouble would have to be in the earphone circuit or the speaker itself.

Taking a closer look at the speaker wires revealed that the black common ground wire was cut into. When the radio was tilted or moved the wire touched the shortwave dipole antenna and played perfectly. The speaker wire was cut into when the extending dipole antenna was jammed down into the cabinet and the speaker wire just happened to be in the way.

Noisy Norelco

The complaint on this Norelco multi-band portable was "too much noise." Even when the volume control was completely turned down the radio was extremely noisy. Most noise in transistor receivers is caused by defective audio-stage transistors.

A small electrolytic capacitor was momentarily shunted across the volume control to see if the noise was coming from the front end of the receiver or the audio stage. The noise was isolated to the audio stages. The capacitor was then shunted from base to common ground and the trouble was further pinpointed to a defective second OC71 driver transistor. The noise disappeared when the capacitor was placed across the primary of the interstage transformer.

Intermittent FM

In an RCA RGM55 model AM/FM/SW portable receiver, the complaint was "intermittent FM reception." Sometimes when the table was jarred the portable radio would cut in and out. Even tapping the receiver lightly on top of the plastic case produced the same results.

We checked the S/W and AM bands and they were performing normally. When moving any part on the etched board the FM station would cut in and out. The trouble happened to be right on top of us when the intermittent component was located. An FM coupling coil at the edge of the etched board had a very poor soldered joint (see Fig. 5),

Fading Admiral

In an Admiral model 961B chassis the stations would fade out after the receiver operated for a short time. This happened on all nine receiving bands, thus eliminating the trouble from any particular band. The intermittent trouble was common to all bands.

The receiver operated as it should for one half hour and then would cut out. When the chassis was removed from the cabinet the radio was OK once again. The next time the radio faded out a 1kHz audio signal was applied to the center lug of the volume control and the audio section was checked out OK.

A 455kHz signal from the signal generator was then applied to the base of the mixer transistor, 2N372. Bingo, the radio played perfectly again. The trouble could be anywhere from the mixer through the two IF stages. We waited until the receiver faded out again.

This time a scope probe was applied to the base of the mixer stage, leaving the tuning dial set on the local station. The results were nil so the probe was applied to the emitter of the 2N371 oscillator stage. The oscillator stage was completely dead. A voltage check was made on the base and emitter terminals and the radio played once more.

The oscillator transistor was replaced with an RCA SK3007 type and the radio never faded again. Generally, a weak oscillator transistor will either fade out on the high or low end of the tuning dial. Then when the tuning dial is rotated back through once again the radio will operate again. In this particular oscillator stage the oscillator just faded out. ■

Sophisticated Test Instruments for



International Crystal FM 2400 frequency meter.

Some measurement 'gear' used by mobile communications technicians to provide customers with fast and accurate service

■ Users of two way communications equipment discovered long ago that its usefulness depends almost entirely on the availability of reliable service. And whether you specialize in the business or work at it as only one of a number of diversified services, you can't make money at it unless you are technically qualified and properly instrumented.

Let's take a brief look at some basic gear needed to successfully maintain modern two-way communications equipment.

Basic Test Instruments

A number of instruments for two-way communications equipment servicing, made by **International Crystal Mfg. Co.**, include the FM-5000 frequency meter which covers the spectrum from 25 to 470MHz. This is a beat-frequency measuring instrument said to have a stability of ± 0.00025 percent at temperatures ranging from 85 to 95°F. The unit has a transistor counter circuit and operates from batteries. It weighs about 17 lb. Other units available include frequency meters designed for marine band servicing with coverage from 2 to 15MHz, a

Fig. 1—Functional block diagram of Lampkin's 105-B micrometer frequency meter.

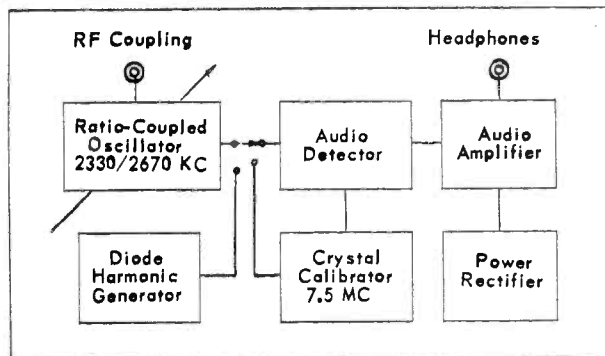

2-Way Servicing



Lampkin 105B micrometer frequency meter.



Lampkin type 205A FM modulation meter.

regular frequency meter for CB transceiver servicing, a frequency standard and alignment oscillator.

This company's FM-2400 frequency and deviation meter is a portable instrument designed for checking and adjusting mobile and base station equipment operating in the frequency spectrum from 25 to 470MHz.

The standard frequency of this instrument originates in a crystal-controlled oscillator. Up to 24 crystals may be used in the meter for selecting the various frequencies required.

The difference between the transmitter frequency and that of the frequency meter is read in kHz directly on a calibrated meter dial. Crystal oscillator stability is said to be ± 0.005 percent when the instrument is operated between 50 and 104°F. The meter is self-contained and is battery operated.

One of the oldest basic instruments used in two-way mobile servicing is the **Lampkin Laboratories** type 103-B micrometer frequency meter. The 105-B type is similar except for a built-in crystal calibrator. A functional block diagram of the 105-B is shown in Fig. 1.

This instrument is a heterodyne, or beat reception, type frequency meter. The fundamental frequency range, stamped on the nameplate, averages from 2330 to 2670kHz, or a spread of 1.14 to 1. By using harmonics and their combinations the instrument will measure frequencies of nearby transmitters from 100kHz to 175MHz. Accuracy of the instrument is guaranteed better than 0.0025 percent.

The instrument's frequency is varied by a 4-in. dial having 200 divisions around its circumference and a total travel of 40 turns. This amounts to 8000 divisions spread over 42ft of scale length and is said to yield a reset accuracy of better than 0.0005 percent. The dial reading is taken directly from the dial scale and a mechanical counter next to it. The instrument is 5 x 10 x 6in. and comes with operating instructions, a schematic and full details on making measurements. A 450MHz harmonic generator is available as an accessory. Custom "computer-type" center dial reading charts are also available.

This company also supplies what it calls a "PPM" package which in-

cludes the 105-B frequency meter and a Model 111 crystal calibrator designed by the **Measurements Corporation** of Boonton, N.J. and modified by Lampkin to indicate a calibrated PPM dial. With this package and a WWV Bureau of Standards receiver, any nearby transmitter frequency can be measured or the equipment adjusted when operating from 25 to 500MHz — with an accuracy said to be better than one part per million (PPM).

The primary purpose of the PPM package is to check the frequencies of base and mobile-radio transmitters which are used in the public-safety, land-transportation, industrial and other services, to conform to the "split-channel" regulations of the FCC. These regulations require mobile-radio installations operating above 50MHz to maintain transmitter frequency tolerance of 0.0005 percent — or five PPM.

Lampkin also supplies a model 205A FM modulation meter.

Another interesting instrument, the model 1163 deviation meter, is made by **Radio Specialty Mfg. Co.** It comes in a number of basic-unit packages having various frequency converters. Multipliers for tone

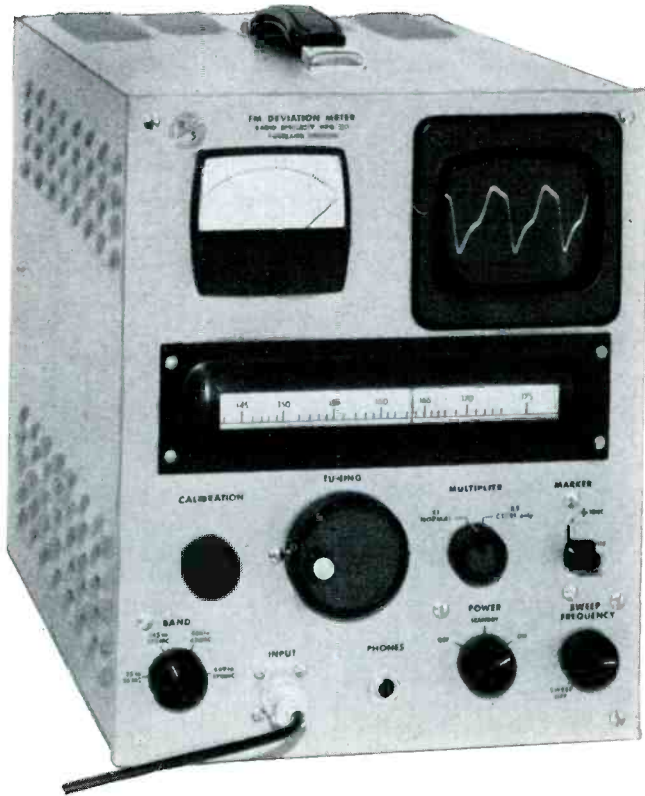

Radio Specialty FM deviation meter.

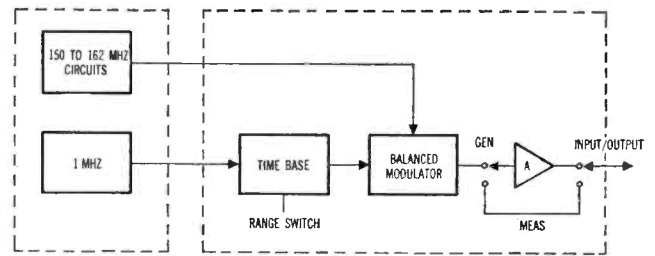

Fig. 2—Functional block diagram of the Gertsch FM9 frequency/deviation meter.



Gertsch FM9 frequency/modulation meter showing the FC3 converter attached at bottom.

squelch, tone deviation measurements and other accessories, including an amplifier for use with a distortion analyzer, are available. The basic unit covers frequency bands 25 to 55MHz and 145 to 175MHz. Converters cover frequency bands 405 to 435MHz and 440 to 470MHz.

The meter measures FM modulation of signal generators or mobile and base-station two-way communications transmitters. Instantaneous peak deviation is measured on the graticule scale in front of a 3in. CRT while at the same time the waveform may be observed. Measured deviation is independent of the modulation waveform.

Input sensitivity of this instrument is said to be better than 1mv. Calibration markers for plus or minus 10kHz are provided. Overall size is 9½ x 12 x 18 5/16in. and weight is approximately 33 lb. Each instrument comes with a full schematic, instruction manual covering operation, maintenance and replacement parts list.

Another group of sophisticated instruments for two-way communications equipment servicing is made by **The Singer Co. (Gertsch) Metrics Div.**

These include the FM-9 frequency/deviation meter and signal generator. "Snap-on" frequency converter, FC-3, covers the spectrum from 20 to 52MHz in three bands and converter, FC-4, covers the spectrum from 140 to 182-MHz, also in three bands. A functional block diagram of the instrument is shown in Fig. 2. This company manufactures a wide line of frequency measuring instruments. ■

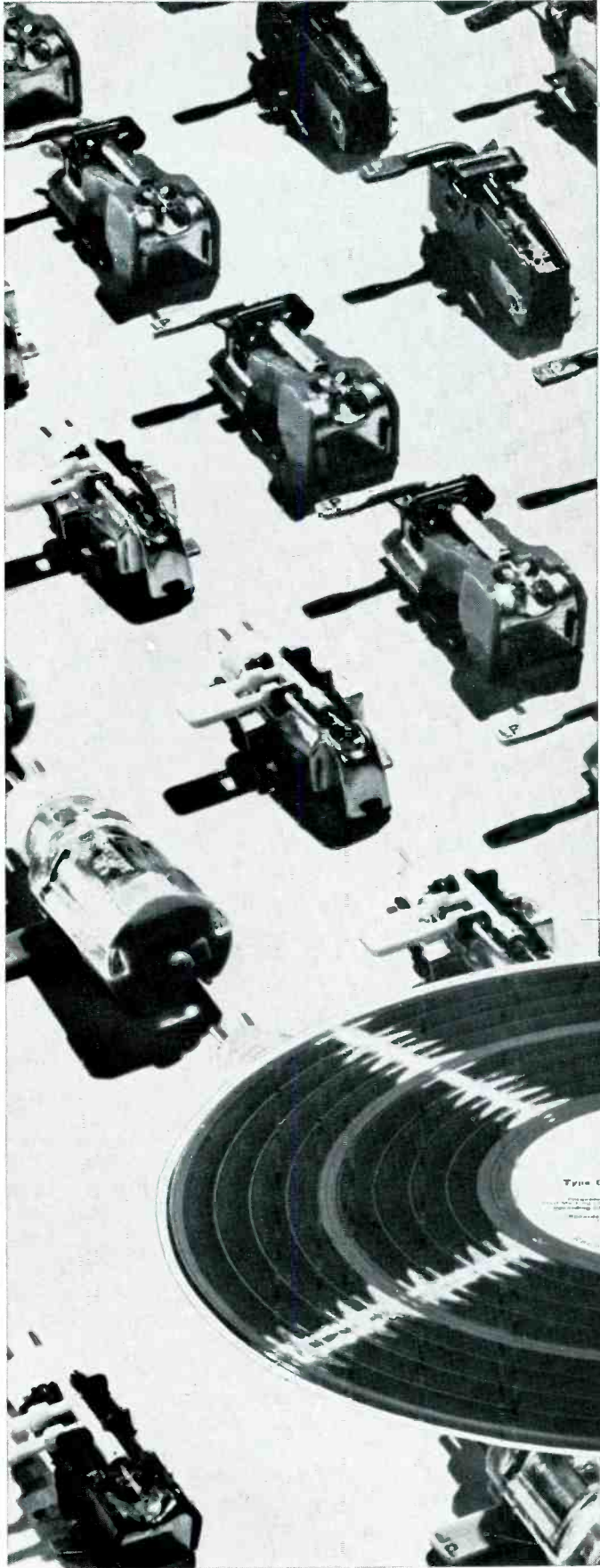

STEREO HI FI TONE ARMS, CARTRIDGES AND STYLI

(Conclusion of a Two-Part Series)

Stereo test record, model QR2009,
distributed by B & K Instruments.

Tone Arms...

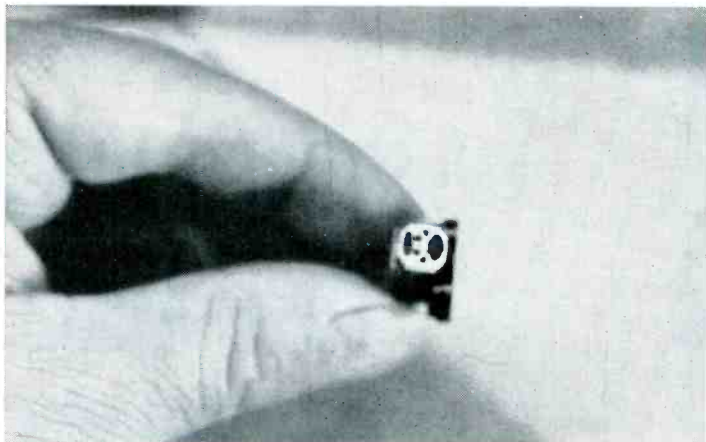

Be careful when installing plug-in cartridges.



Typical stereo cartridge by Audio Dynamics.

■ A previous article (ELECTRONIC TECHNICIAN November 1966, page 60) covered some major service problems in the area of Hi Fi tone-arms, cartridges and styli. Additional problems with cartridges and styli will be considered here.

Stereo Cartridge Problems

The most common problem encountered with stereo cartridge servicing will probably be poor balancing — weak or variable audio from one channel.

Most problems in this area are caused by owner-abuse of the equipment. Few cartridges are immune to the shock of rough handling. But you won't find most troubles in this area very difficult to diagnose. By touching the stylus tip with the end of a finger and rubbing the tip lightly — at the same time turning the balance control to one side and then to the other — it can be easily determined by listening to the speaker outputs, if one side of the crystal is dead or if one side is weaker than the other. Another approach employs the tip of a small screwdriver which is touched alternately to the pickup output terminals. In this case, if the noise heard from each channel is not similar in pitch or level, the pickup probably needs replacing.

Another method calls for playing a record on the changer while applying a slightly heavier-than-normal pressure to the end of the tone-arm and noting if the audio output undergoes any changes. A noticeable change will indicate a defective cartridge.

In those units that use a MONOPHONIC/STEREO switch (usually located on the bass control) a more rapid diagnosis may be made by simply moving the switch from STEREO to the MONO position. If audio is produced from each channel when the switch is in the MONO position but only comes from one channel when in the STEREO position, the cartridge is probably defective.

One important consideration arises in pickup replacement when the original is not quickly available: will the substitute cartridge fit the tone arm? This includes mounting centers, cartridge width and length, clearance of the top or front mountings and hole-size for knob type flip-overs. One other requirement is proper cartridge weight. This is a frequently-ignored consideration — until after the installation is completed.

Neglect of weight consideration, in several cases investigated, made it necessary to drastically alter the counterbalance to meet proper

tracking force requirements. This, of course, resulted in loss of time and reduction in profit margins on the jobs. Once the proper replacement pickup has been selected, the most difficult part of the job is finished — only the physical installation is necessary to complete the job.

Now let's consider a few pointers to remember if we are to avoid damaging new pickups during the installation procedure.

Heat is probably the greatest enemy of all cartridges. Do not apply solder to cartridge cable-lead connectors while they are attached to cartridge terminals. Remove the connectors from the cartridge terminals and then solder the cable-leads to each connector. Another point is to avoid applying too much pressure to the cartridge yoke during installation. Likewise, most cartridges have stylus guards installed when packaged. Leave this guard on until installation is completed. This will prevent damage to the stylus while a pickup is being installed.

You must employ more care today than in the past when removing or installing stereo pickups—particularly with plug-in types. Accidental damage can easily take place with plug-in cartridges if the male and female terminals do not match perfectly. Damage to either the male

or female areas are difficult to repair. In most instances, where the male terminals are bent, it is difficult to straighten them to provide good contact.

Styli Replacements

Knowing the cause and effect of record-wear and distortion, it is sheer folly to think that a stereo unit will maintain high-quality performance unless it contains a diamond stylus. A diamond will deliver many more satisfactory hours of reproduction than a sapphire—with the least record wear per-dollar invested by the user. It must be made clear to equipment owners, however, that sapphire needles will give similar-quality reproduction — but for a much shorter period of time.

Few styli are replaced because they are completely worn out. More often they are replaced after breaking or their tips are chipped as a result of accidental damage. And the alert technician will recommend styli replacements before they reach the point where they begin to wear or gouge valuable records.

Broken or chipped styli tips are usually detected by visual inspection. Inspection with a microscope is recommended.

You should also attempt to determine the reason for a defective stylus in an effort to prevent recurrence of the damage. Preventive maintenance should always be attempted in an effort to keep callbacks at a minimum and maintain good customer relations.

When making a visual inspection of a stylus with a microscope, view it from various angles—not only from the side, but straight down on the tip. Splits and cracks occur sometimes when the tone-arm has been dropped and they can be easily detected with this procedure.

All styli should be removed from stereo cartridges with great care. Many needles have been yanked from their mountings because of carelessness. If this should occur, do not attempt to re-install the needle into a rubber mounting. In most instances, the stylus will not be in a true vertical plane and will cause damage to the modulated groove wall.

You'll run into cases where a

needle falls out of its holder. This usually arises because of carelessness on the part of the owner — generally while cleaning the needle or when using a dust cloth inside the changer well.

Tracking Pressure

Because proper stylus-tracking pressure is one of the most essential considerations in high-quality stereo record reproduction — not to mention its importance in minimizing record wear, this should always be checked. This simple check should be made on all equipment brought to the shop for repair, for whatever reason, and on all equipment serviced in the home. This is a good business practice and it should be explained to the customer. The check is quickly made with a regular gram scale designed for record-changer work or a standard scale designed for measuring spring tensions.

The basic design of the tone-arm and its adjustments largely determine stylus force. Sliding counterweights or springs may be used for force adjustment. Present-day arms provide a force of only a few grams and a change of one or two grams can make a tremendous difference in tracking ability and the degree of record wear.

Some automatic stereo changers use a screwdriver adjustment to set stylus force. Others use a simple spring arrangement. Still more elaborate units use all three — counterweights, spring tension and bias compensators — to obtain efficient performance. Very little can go wrong with these mechanisms.

Incorrect stylus pressure is common in simple spring arrangements when you take correct spring tension for granted. This assumption is correct only if the original spring tension has not changed. The tension of this spring is rarely correct. Use a gram scale to check it.

The counterbalance spring, back of the pivot point, has various methods of adjustment on different machines — and some are not easy to adjust. A number of new units, for example, have no provision for screwdriver or spring-tension adjustment. These counterbalanced arms are factory adjusted to the re-

quired stylus force. If additional adjustments are required to increase or decrease stylus pressure, it is necessary to bend the mounting bracket to which the spring is attached. It is not recommended that you attempt to adjust this spring tension — you will usually end up by having to bend the mounting bracket anyway.

In the center spring and counterbalancing system (near the rear of the pivot point), the upward pull of the spring can make the arm “jumpy” and heavy footsteps or other vibrations in the home may cause the stylus to bounce out of the groove. Care must be taken to minimize these vibrations in the home. The return impact of the stylus on the record can cause permanent damage to the compliant stylus or pickup.

More elaborate stereo changers never use the center-arm spring and counterbalance system previously described. A system called “dynamic balancing” is used. This system has a counter-weight to render the tone arm practically weightless in respect to the cartridge. The arm is literally a true floating arm and the stylus pressure remains constant regardless of ambient vibration.

An additional adjustment in the more elaborate units, the bias compensator (sometimes called a side-thrust compensator, anti-skating, neutralizer or off-center counterweight adjustment) is necessary. The bias compensator balances the tone arm so the stylus pushes against both modulated walls with equal force. It actually equalizes the inward pull of the tone arm with equal force in the opposite direction. To keep the proper amount of force on the stylus during every moment of playing time, this adjustment must be made to balance the tone-arm in this special way.

The compensator arm carries an adjustable weight and the notches on this arm represent the position of the weight to correspond to stylus pressure. Each notch usually represents two to five grams.

Extreme care and strict adherence to manufacturers' instructions is the key to rapid servicing and providing your Hi Fi customers with peak performance from their equipment. ■



COLORFAX

Circuit Changes in Run 17 of Olympic's CTC20 Chassis

Several circuit changes have been made at the factory on the 17th run of the CTC20 chassis. These changes can also be made in the field without removing the chassis from the cabinet. It should not, however, be necessary to incorporate all of these changes on every set, and only those changes required to solve a specific problem should be made.

The color-TV receiver's sensitivity and picture quality can be improved in fringe areas by shunting the 470K

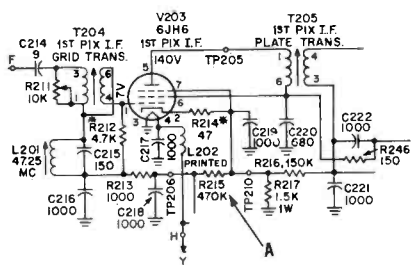

resistor, R215 (A), in the 1st picture IF section with a 220K, 1/2 w resistor. This will reduce the effective value of the resistor to 150K. After the resistor has been shunted, it will then be necessary to readjust the AGC control.

Additional beat or hash will probably develop as a result of having

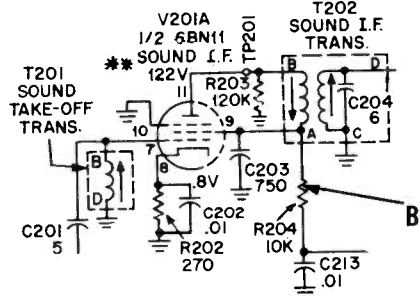

shunted the 470K resistor. This difficulty can be easily corrected by removing the 10K resistor, R204 (B), connected to the sound IF transformer and replacing it with a 22K, 1/2 w resistor.

The small hook or kink that may sometimes appear on vertical lines in the picture, where they are crossed by horizontal lines, can be easily eliminated by replacing the 6.8K resistor, R263 (C), in the horizontal reactance control circuit with a 470K, 1/2 w resistor.

The interlace can be improved by adding a 0.01µf, 1kv disc capacitor

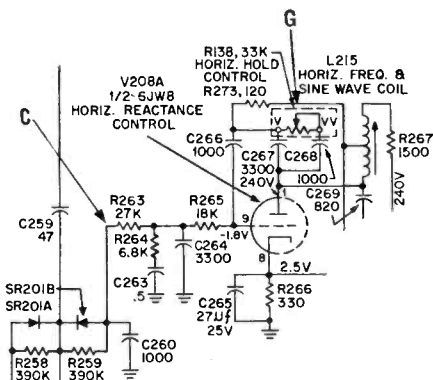

we looked into your future, then created the "little corporal," a most remarkable CRT tester.

B & K has done it again . . . put you a "jump ahead" by looking into your future . . . your problems, *your* needs. This is the "Little Corporal," the CRT Rejuvenator and Checker, designed to provide maximum obsolescence protection by providing continuously variable voltages for all CRT elements. You can make the most accurate possible tests, even on future CRT types, because the heater

voltage is metered and is continuously variable from 0 to 13 volts with any tube heater current. And, using the required adaptors, you can test and correct all tube, transistor or integrated circuit black and white and color picture TV tube troubles (including GE 11" color and imported color tubes) in a few minutes . . . in the home or on the bench . . . without removing tubes from the TV set.

You can give new life to weak or in-operative picture tubes—prove to your customers their need for new tubes.

The "Little Corporal," another product of B & K electronic innovation, carries the B & K Professional Servicing Equipment emblem, your assurance . . . your customers' assurance . . . that you use the finest equipment made.

Model #465, Net: \$89.95.



A Division of
Dynascan Corporation
1801 W. Belle Plaine
Chicago, Illinois 60613

Export: Empire Exporters, Inc.
123 Grand Street
New York, N.Y., 10013



A Division of Dynascan
Where Electronic Innovation
is A Way of Life

. . . for more details circle 105 on postcard



COLORFAX

control located on the front panel) has been added to the control grid of the 6LF8 tube. This control grid is also the insertion point for vertical blanking signals. Pulses, obtained from the vertical output plate circuit via an RC network (R321 and C328), are coupled to the control grid.

The 3rd video amplifier stage on the CTC21 series uses a 12BY7A tube. The only significant change in this circuit has been the removal of the video peaking switch from the cathode circuit.

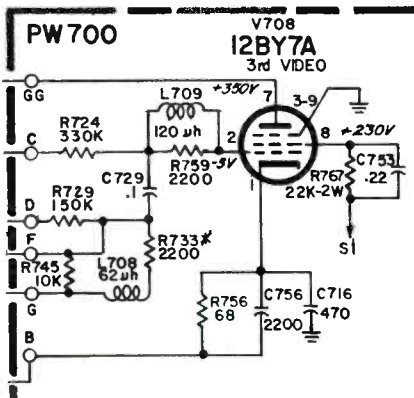

The AGC/sync separator and horizontal sweep stages (6KA8), the vertical oscillator and output stage

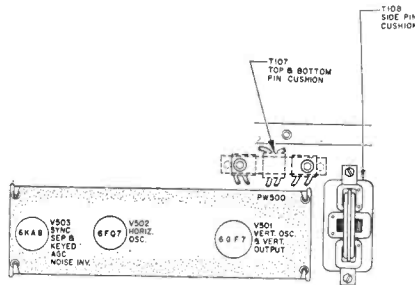

(6GF7), pincushioning circuits and

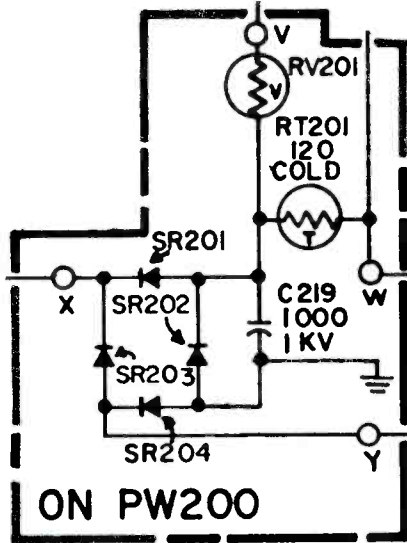

B+ supply (bridge circuit using silicon diodes) are all very similar to those in the CTC17X series.

A new high-voltage rectifier tube (3A3A) is designed for higher reliability in the high-voltage circuits. The new tube is slightly shorter than type 3A3, but they are directly interchangeable.

PW 700

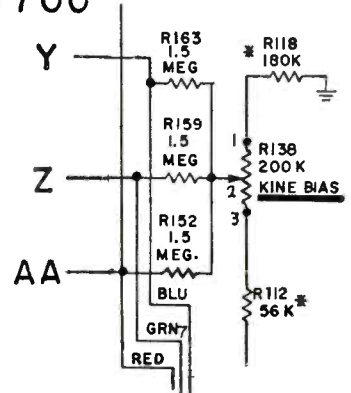

able. All new tubes of either type now have a circle of metallic paint on the bottom area of the glass envelope to help prevent HV radiation.

The KINE BIAS adjustment has been relocated, and in the CTC21 series the control (R138) is part of a voltage divider network across the 405V, B+ line. Adjusting the control changes the dc potential applied to the control grids of the color CRT. The red, green and blue grids are connected via 1.5M

the 4th FLOOR IS TOPS!

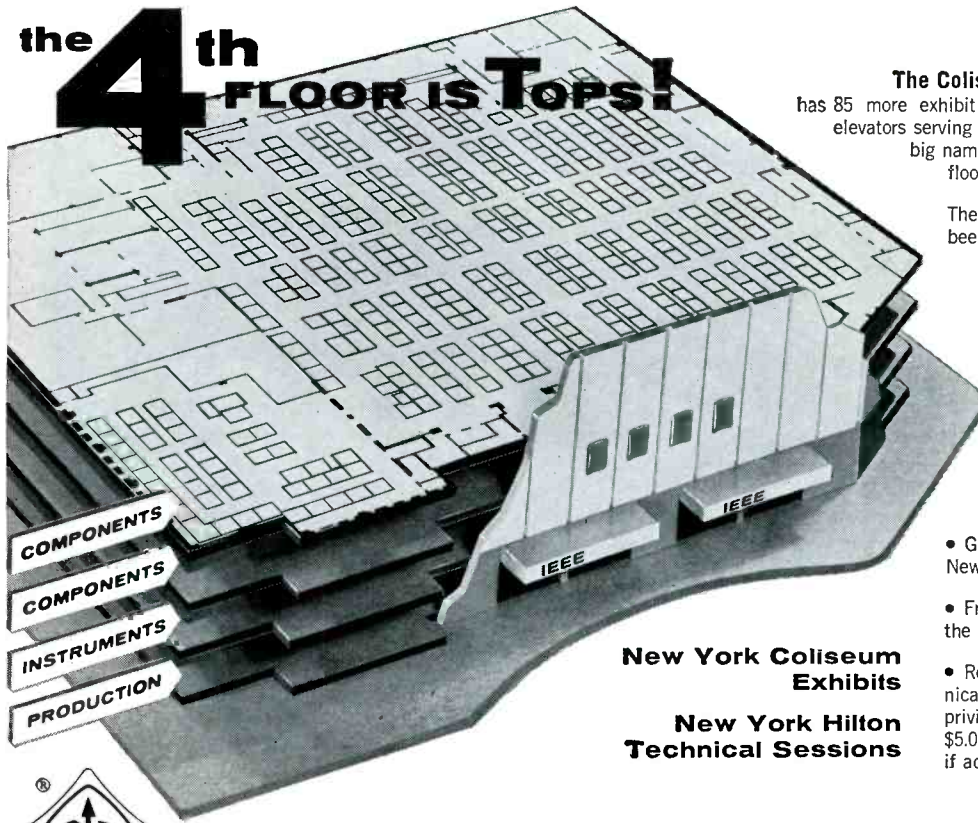

The Coliseum's newly constructed fourth floor has 85 more exhibit spaces and new escalators and express elevators serving it. Many engineers will go there first to see big name components firms who are exhibiting. This floor will really buzz!

The increased space finally gives firms who have been on the waiting list an opportunity to exhibit. It also helps to relieve crowding on the other floors. Any way you look at it, the fourth floor is tops and the IEEE EXHIBITION this year will be bigger and better than ever.

- 74 Technical Sessions at the New York Hilton
- FOUR COMPLETE FLOORS OF EXHIBITS (over 700 firms) at the New York Coliseum
- Gala Annual Banquet—Wednesday 7:15 p.m. New York Hilton Grand Ballroom—\$15.00
- Free shuttle busses every few minutes between the Hilton and the Coliseum
- Registration—Good for all four days—Technical sessions and exhibits, with in and out privileges. IEEE Members \$2.00 Non-members \$5.00 Ladies \$1.00 High School Students \$2.00 if accompanied by an adult.

New York Coliseum Exhibits
New York Hilton Technical Sessions

'67 International
IEEE CONVENTION / EXHIBITION

Monday thru Thursday
March 20 - 23

... for more details circle 116 on postcard
ELECTRONIC TECHNICIAN

As a sample of the important savings and significant books available from **Electronic Technician's Book Club**,

accept this helpful new book
for only **99¢**

... with Trial Membership in the Club

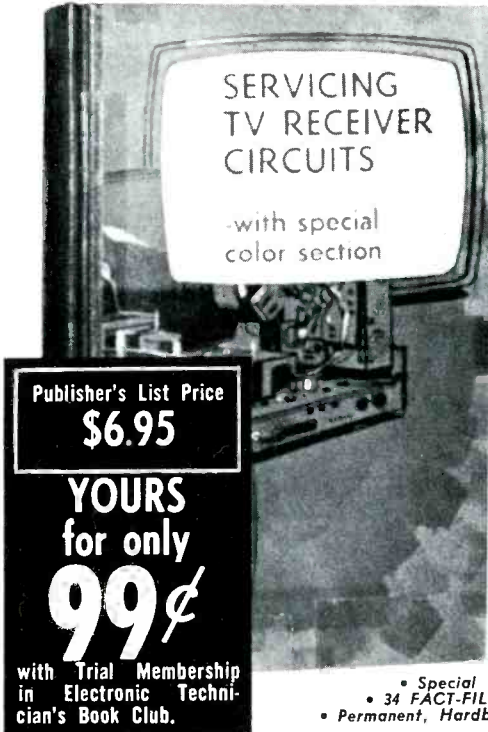

PARTIAL LIST OF CONTENTS	
SERVICING TV RECEIVER CIRCUITS — with Special Color Section, contains 224 pages — 34 BIG Chapters of the type of practical servicing data every TV service technician should have . . . expert troubleshooting techniques and solutions to the most complex circuit problems. Contains step-by-step approaches to locating and correcting defects in every section of the receiver — from tuner to picture tube, from power supply to audio output. Contains complete analyses of TV circuit troubles and solutions for sweep and sync problems, AGC malfunctions, RF and IF faults, sound and audio trouble, power supply defects, etc.	
Using Logic to Diagnose Troubles	Color Television Basics
Developing a Methodical Approach	Basic Color TV Circuitry
Troubleshooting Sync Circuits	Understanding Chroma Circuitry
Vertical Sweep Servicing Tips	Details of Color Sync Circuitry
Troubleshooting Noise Circuits	Blanking and Gating in Color Sets
Troubleshooting AFC Circuits	Color TV High-Voltage Circuits
Troubleshooting Synchroguide Circuits	Color TV Servicing Equipment
Troubleshooting Multivibrators	Chroma Circuit Servicing I
Troubleshooting Horizontal Sweep	Chroma Circuit Servicing II
Selecting Yoke Replacements	Color Sync and Demodulator Servicing
Solving HV Flyback Problems	Obtaining Proper Scope Waveforms
Troubleshooting B+ Circuits	Automatic Degaussing Circuitry
Servicing Sound and Audio Circuits	General Color Servicing Tips
Eliminating Unwanted Oscillations	Servicing the Horizontal Section
Understanding Transistor Circuits I	Servicing the Vertical Section
Understanding Transistor Circuits II	Adjusting Color Convergence
Servicing Transistor TV Circuits	

- 224 pages
- Special Color Section
- 34 FACT-FILLED Chapters
- Permanent, Hardbound Volume

May we send you this unique time-saver as part of an unusual offer of a Trial Membership in Electronic Technician's Book Club?

A Massive, Authoritative Compilation

Now you can have at your fingertips, this carefully-planned, comprehensive handbook which contains the TV service data most needed for troubleshooting both monochrome and color receivers.

Selected by the Editorial Staff of "Electronic Technician," this brand-new volume contains just the kind of practical, down-to-earth information you can use in your everyday service work . . . in home or at the service bench.

While no one book is a cure-all for TV troubles, *Servicing TV Receiver Circuits* comes about as close as you can get. Every chapter follows the time-proven method of experienced troubleshooters—analyzing circuit performance and applying logical and efficient test procedures. Numerous example troubles are cited to help you solve "tough-dog" problems.

More than half the content is devoted to color, and includes the practical background theory needed to troubleshoot and repair today's complex color TV receivers. A full 10 chapters are devoted to step-by-step color TV servicing techniques, complete with test procedures, waveform photos, and trouble-correction techniques. While experience is the best teacher, an occasional re-reading of a chapter or two when you're faced with a "tough-dog" set will make this book invaluable to you in servicing TV receivers.

How You Profit From Club Membership

This is just a sample of the help and generous savings the Club offers you.

For here is a Club devoted exclusively to seeking out only those titles of interest to you as an electronic technician. Membership in the Club offers you several advantages:

1. **Charter Bonus:** *Servicing TV Receiver Circuits* carries a retail price of \$6.95. But it can be yours for only 99¢ with your Trial Membership.
2. **Continuous Savings:** The Club saves you 15% to 75% on needed books.
3. **Editorial Advisory Services:** The Club's Editorial Advisory Board selects only the books of interest to you.
4. **Wide Selection:** Members are annually offered over 50 books on all phases of electronic servicing by means of the Club's FREE monthly *News*.

This extraordinary offer is intended to prove to you, through your own experience, that these very real advantages

can be yours . . . that it is possible to keep up with professional literature . . . and to save substantially while so doing.

Limited Time Offer!

Here, then, is an interesting opportunity to enroll on a trial basis . . . to prove to yourself, in a short time, the advantages of belonging to the only Book Club devoted exclusively to electronic servicing. We urge you, if this unique offer is appealing, to act promptly, for we've reserved only a limited number of Handbooks for new Members.

To start your Membership on these attractive terms, simply fill out and mail the Trial Membership coupon today. You will receive *Servicing TV Receiver Circuits* for 10-day inspection. **SEND NO MONEY!**

Send No Money! Simply fill in and mail Trial Membership Coupon Today!

ELECTRONIC TECHNICIAN'S BOOK CLUB, Thurmont, Maryland 21788

Please open my Trial Membership in the Electronic Technician's Book Club and send me a copy of your 224-page *Servicing TV Receiver Circuits* billing me for only 99¢ plus a few cents postage and mailing expense. If not delighted, I may return the book within 10 days and owe nothing. Otherwise, to complete my Trial Membership, I agree to purchase at least 4 additional monthly selections or alternates during the next 12 months. I have the right to cancel my membership anytime after purchasing these four books.

Name _____ Phone No. _____

Address _____

(NOTE: check if home or business address)

City _____ State _____ Zip _____

Company _____ Title _____

(The Club assumes postage on all prepaid orders. Foreign and Canadian prices 10% higher.)

T27

... for more details circle 138 on postcard

successful service shop beats rising costs with B&K television analyst



"As every serviceman knows, major TV repairs represent an increasingly large part of the service business and the average time per repair has increased"...

says Willard Horne of Horne Radio and Television in Evanston, Illinois.

After more than 25 successful years in the service business, twenty of them in the same location, Mr. Horne can be considered an authority on how to keep a business profitable. Mr. Horne says, "In order to be successful, our 3-man shop has to be competitive on the large jobs as well as the small ones. With the increase in bench time that we were experiencing and the limitations on what we could charge, there was a reduction of profit that had to be stopped. Then we bought a B&K Model 1076 Television Analyst."

"Now our customers get the same extra-value service on the big repairs and the small ones," said Mr. Horne. "We use the Television Analyst for troubleshooting a wide variety of complaints, particularly for those that require touch-up align-

ment, location of IF overloads and color convergence. We are more competitive now that we use the B&K Television Analyst because we spend far less time on the jobs that used to be dogs, with benefits both to the shop and our customers."

* B&K Model 1076 Television Analyst checks every stage in a black and white or color TV receiver. Nine VHF RF channels, 20 to 45 MC IF, audio, video, sync, bias voltage and AGC keying pulse are available. The model 1076 provides its own standard test pattern, white dot, white line crosshatch, and color bar pattern slide transparencies. It includes a blank slide which can be used for closed-circuit-TV display floor promotion. Its net price is \$329.95.

Find out how you will increase your TV service profits with a B&K Model 1076. See your distributor or write for Catalog AP 22.



A DIVISION OF DYNASCAN CORPORATION

1801 W. Belle Plaine, Chicago, Illinois 60613

WHERE ELECTRONIC INNOVATION IS A WAY OF LIFE

Canada: Atlas Radio Corp., Ltd. 50 Wingold Avenue, Toronto 19, Ontario
Export: Empire Exporters, Inc. 123 Grand Street, New York, N.Y. 10013

NEW PRODUCTS

For additional information on any products in this section, circle the numbers on Reader Service Card. Requests will be handled promptly.

Tape Recorder 700

Correction: The tape recorder (reader service number 718) shown at the bottom of page 78 in the December 1966 issue of *ELECTRONIC TECHNICIAN* was incorrectly described. Following is a correct description.

A tuner/tape recorder combination is designed to allow off-the-air recording in three-speed, four-track stereo. Inputs are provided for phono, micro-

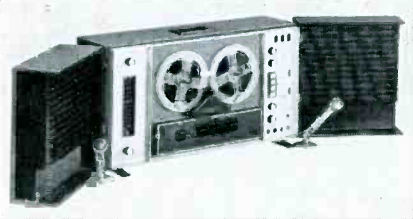

phone or auxiliary. Outputs are provided for external amplifier, speakers, headphones, and slide projector synchronizer. The speakers reportedly detach and can be placed up to 30 ft apart. Each speaker enclosure houses one 6-in. speaker and one 3½-in. speaker. Price with walnut veneer \$469.95, with black vinyl \$439.95. V-M.

Multimeter 701

A multimeter is now available with a reported dc sensitivity of 1M volt and ac sensitivity of 12.5K/volt. According to the manufacturer's spec-



ifications, the meter has 7 dc ranges from 500mv to 1kv full scale, 5 ac ranges from 2.5v to 1kv full scale, 5 dc current ranges from 10 μ a to 10a full scale, and four resistance ranges, plus 5 db ranges. Price \$34.95. EICO.

Polarization Diversity Antenna 702

A CB polar diversity antenna system is designed for switching between horizontally and vertically polarized

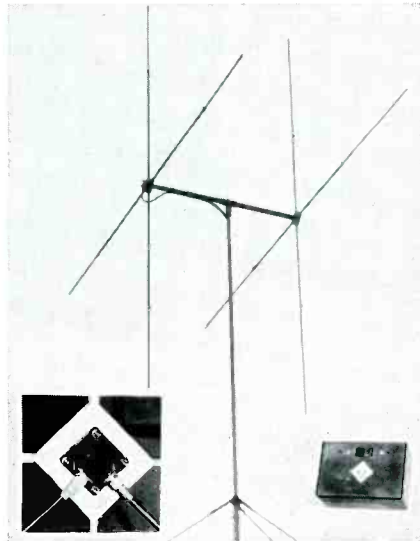

signals, using a common loop radiator and special cross-feed elements. All necessary parts, including boom, mount for attachment to a vertical pipe, and switch box for use near the operator's transceiver, are included with the array. The system can reportedly be used to communicate with another base station via the horizontal mode when channels are crowded with the presently used vertical polarizations or to maximize long distance reception by polar diversity. According to the report, the present array provides 23db isolation between polarities, a 8.12db forward gain over an isotropic radiator and a 30db front-to-back ratio. Price \$89. Avanti Research.

Stereo Headphones 703

A pair of stereo headphones now available features 2 x 3 x ¾-in. phone cavities; elliptical speaker cones; a single piece, padded headband; and vinyl earcushions. The dynamic driver



element is reportedly designed to match the characteristics of this headphone. Telex.

Condenser Microphone System 704

Announced is a solid state condenser microphone system, operable on either ac or dc, with optional cardioid or omnidirectional microphone characteristics. This system reportedly provides a flat frequency response from 20Hz to 20kHz with an output level of 53 dbm at 10 dynes/cm². The power supply is designed to run for up to a year on two self-



contained mercury batteries. Each system is provided with a microphone holder and a 25-ft. cable. Altec.

Identification Cable Strap 705

Announced are identification cable straps designed to serve the dual purpose of tying and identifying cable bundles. The nylon fabricated straps

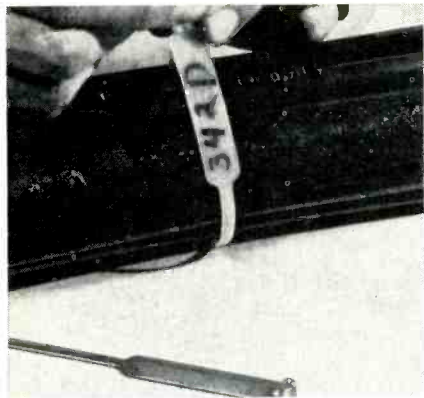

are available in self locking or twist locking types and are reportedly infinitely adjustable with a diameter range of $\frac{3}{4}$ to 4in. The straps provide a $2\frac{1}{4} \times \frac{1}{2}$ in. marking area. Thomas & Betts.

Tube Tester 706

A mutual conductance tube tester is announced that uses a 5kHz square-wave for checking tubes. Mutual conductance can reportedly be measured in actual μ mhos as the instrument provides the correct bias voltage at the



current selected for the plate circuit. This is designed to eliminate a set-up control, and reduces possible errors in set-up and readings. In checking amplifiers and rectifiers, the instrument reportedly pulls the actual rated cathode current from the tube being checked to measure its current emitting capabilities. According to the manufacturer, the new tube tester also provides high sensitivity grid leakage checks to spot leakages as small as 100M, plus short checks that find shorts of 180K between elements. Space is provided for additional sockets to accommodate future tubes. Price \$179.50. Sencore.

Power Amplifier 707

A 200w silicon-transistor amplifier has been developed to provide full output with 0.8v RMS input. According to the report, the amplifier contains a solid-state dissipation sensing component which provides protection for any load impedance, including short-circuits at any driving level. When the load is partially short-circuited, the driving signal is temporarily cut off if it reaches a level which endangers the output transistors. The amplifier recovers its normal function automatically as soon as the



output fault is removed. The amplifier can be powered by a 120v or 240vac source or a 28vdc source. The unit is rack mounted for installation in public address and commercial audio applications. Less than 4 percent third harmonic distortion is reported at 200w and 1KHz. Altec.

Helps stop ghosts!

Zenith Quality Wavemagnet® Indoor TV Antenna

Designed for finest all-channel (2 to 83) reception in color or B&W. Special network provides stepped-up basic dipole impedance, resulting in lower voltage standing wave ratio than ordinary VHF indoor antennas . . . cuts down snow, reflections and ghosts. Two full-size UHF loops, one behind the other, develop an unusually high front-to-back ratio (equal to that in many outdoor antennas), remarkably reducing ghosts and man-made interference. Order as Part Number 973-56 from your Zenith distributor.

*Built to the quality standards
of Zenith original parts*

ZENITH

The quality goes in before the name goes on

NEW PRODUCTS

Stripped Thread Replacement 708

Announced are machined screw-type inserts designed to replace stripped threads in all metals in sizes from #10 through 3/4 in. in both US (coarse) and SAE (fine). A 14mm size for sparkplug thread replacement

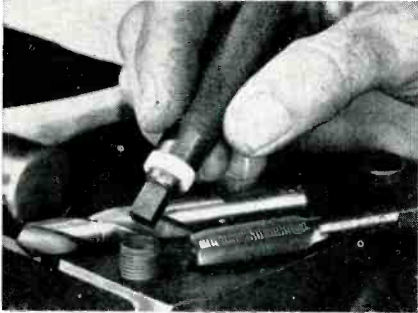

is also available. The replacement threads on the inserts duplicate the original threads they replace and are useful for thread replacement in iron, steel or aluminum and other lightweight aircraft metals. Proto Tool.

CB Transceiver 709

A 12-channel, solid-state CB transceiver now available features a crystal



filter in the receiver. This filter is designed to provide a reduction in adjacent channel interference. Other features include a multi-stage, noise-limiting circuit, speech compression in the transmitter, a plug for accommodating a selective calling system and a built-in PA amplifier. Price \$189.95. E. F. Johnson.

Cardioid Microphone 710

A dynamic microphone introduced, features a degree of directional con-



trol reportedly so effective that the frequency response is virtually independent of the sound source's angular location. According to the manufacturer, the microphone's directional pattern has its greatest sound rejection, up to 26db, at 150 deg. off-axis; while at other points, its pattern is a closely controlled classic cardioid. Frequency response of the microphone is listed at 60Hz to 15kHz, with a -55db output level. Net price \$153. Electro-Voice.

Color Bar Generator 711

A solid-state color bar generator reportedly features a gray scale pat-



tern that provides 6 discreet levels of brightness for gun tracking adjustments. A single control selects any one of seven crystal-controlled test patterns. This 4 5/8" x 9 5/8" x 12-in. generator is reportedly supplied with all parts, cables and detailed instructions. In kit form \$89.95. Fully assembled \$129.95. Allied.

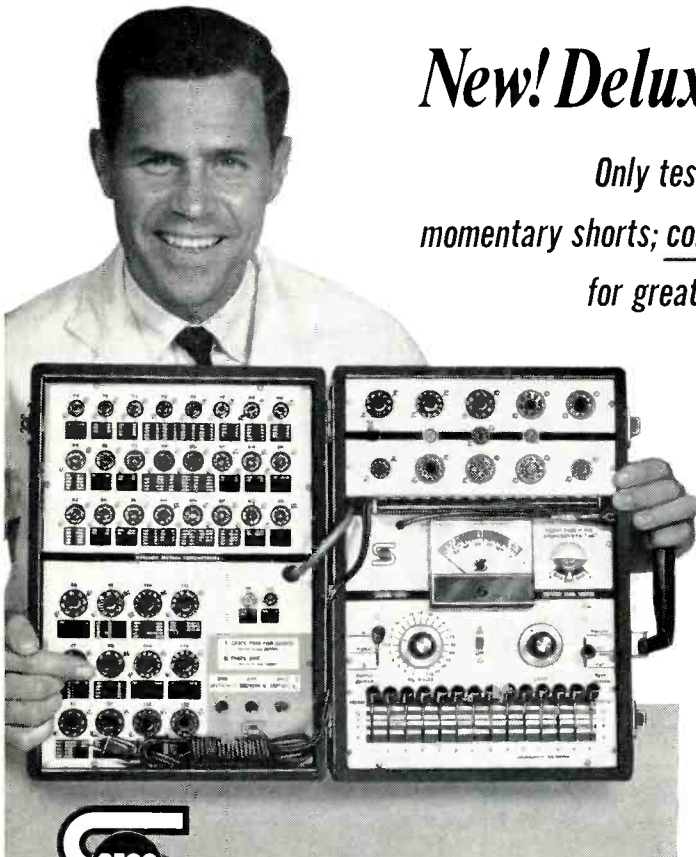

New! Deluxe 107C Tester!

Only tester with "eye" tube to spot momentary shorts; constant voltage transformer for greatest stability and accuracy!

Now, Seco brings you a compact, portable tube tester unmatched in speed, sensitivity and reliability! "Eye" tube spots momentary shorts missed by normal meter lag—constant voltage transformer eliminates need for "line-adjust", provides proper filament and test voltages for superior accuracy. Patented Grid Circuit Test; Dynamic Mutual Conductance and Cathode Emission Tests. 38-socket, pre-wired panel accepts 80 base arrangements to test more than 1000 tubes without setup. Replaceable, 10-socket plug-in panel for complete test on all modern TV, Radio, Hi-Fi, Industrial and Foreign tubes. Model 107C

\$198⁵⁰
NET

NEW! thyristor (SCR) analyzer



Checks SCR's, TRIAC's, Breakdown Diodes, Gate Controlled Switches. Rapid information on: Gate Firing Voltage and Current; Peak Forward Voltage and Current; Peak Reverse Voltage and Current. \$144⁵⁰
Model 240 NET

NEW! transistor analyzer



Safe, fast, accurate—no setup required. Analyzes Power and Signal transistors. Dynamic "in-circuit" check; thorough DC analysis "out-of-circuit". Identify NPN and PNP types as well as lead connections. Beta test measures DC gain—Iceo and Icbo Tests read leakage. \$69⁵⁰
Model 260 NET



SECO ELECTRONICS CORP.

... for more details circle 128 on postcard
ELECTRONIC TECHNICIAN

POWERED **NEW** POWER

FROM

FINCO

Model 65-3 VHF-TV ANTENNA AMPLIFIER

improves reception of WEAK VHF-TV signals in FRINGE AREAS even where strong local TV or FM signals are present. AMPLIFIES UP TO 7 TIMES for Better Color and B/W

A two-transistor—high and low band—amplifier in one compact weather-resistant housing. Engineered to provide the lowest noise and highest amplification with the most desirable overload characteristics. Designed for easy and convenient installation on antenna boom, mast, or under roof eave.

Amplifier used in conjunction with dual outlet power supply for one, two, or multiple set installations (with Finco 3003 coupler). 117 V 60 cycle input. AC power up to amplifier: 24 volts - 60 cycle. Metal enclosed with easy keyhole mounting. Amplifier and power supply provided complete with mounting hardware. Each unit tested and inspected prior to shipment.

Let Finco solve your Color and B & W reception problems. Write for complete information, schematics and specifications. Form #20-357.

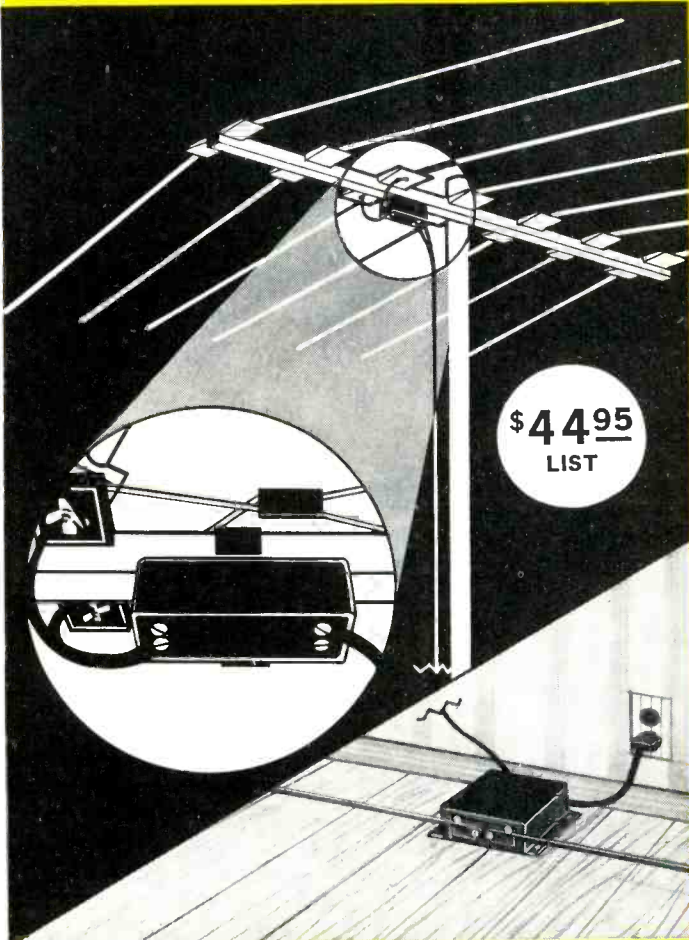

\$44⁹⁵
LIST

Model 65-3 VHF-TV ANTENNA AMPLIFIER



THE FINNEY COMPANY

34 West Interstate Street

• Bedford, Ohio 44014

• Dept. 110

349

PHONO CARTRIDGES!



459

PHONO NEEDLES!

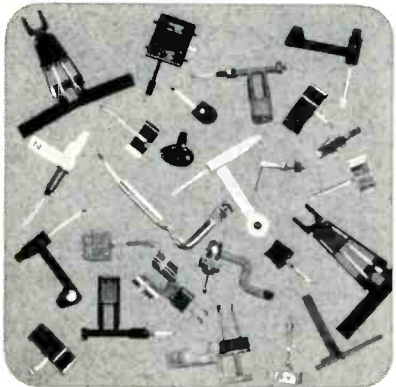

NEW! PHONO AND TAPE RECORDER WHEELS, DRIVES, BELTS!

(E-V) That's how many models are listed in the current Electro-Voice phono needle and cartridge catalogs. With more being added as you need them.

No other single source offers such variety—all built to the highest industry standards. All are exact replacements that install quickly, to give your customers "like new" performance—or better!

Electro-Voice models are listed in your Photofact files, or ask your E-V distributor for free copies of the E-V catalogs. It's your guarantee of complete customer satisfaction!

ELECTRO-VOICE, INC., Dept. 2771;
663 Cecil Street, Buchanan, Michigan 49107

Electro-Voice
SETTING NEW STANDARDS IN SOUND

... for more details circle 113 on postcard

NEW PRODUCTS

AM/FM Radio 712

A 13 transistor AM/FM radio is introduced. This model features slide-rule tuning, a tone switch, AFC and



external antenna. The radio reportedly comes in a leatherette saddlestitched carrying case. Price \$29.95. Admiral.

CB Frequency Meter 713

Announced is a meter designed to measure frequencies between 26.965-MHz and 27.255MHz with a reported stability of $\pm 0.0025\%$ between 32 and 125°F or $\pm 0.0015\%$ between 50 and 100°F. Specifications also indicate that the instrument can measure power from 0 to 5w with an accuracy of $\pm 1/4w$, AM modulation from 0 to 100% with 3% accuracy at 400Hz and 80% modulation, plus acting as a signal generator between 26.965MHz and 27.255MHz. The



manufacturer indicates that it is capable of holding 24 crystals and comes with 23 crystals installed. International Crystal.

Breadboarding Kits 714

A line of breadboarding kits is introduced for labs, the educational field and the electronics experimenter. Kit comes with a 3/32-in. thick punched phenolic deck, which mounts on an aluminum base with a slanting front. The base is provided with 1/4-, 3/8- and 1/2-in. holes on all four sides to mount switches, potentiometers, etc. Other items furnished with this line of kits reportedly include solder type feed-through terminals, a terminal insertion tool, universal deck mounting "Z" brackets, a positive retention switch and potentiometer brackets, right angle "L" brackets and small pieces of phenolic punched board. A multi-compartment plastic box is sup-

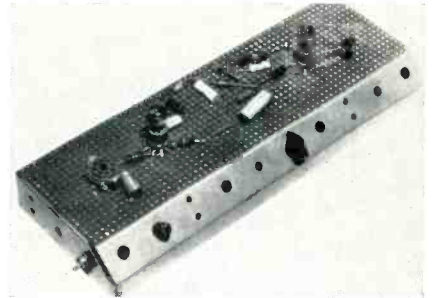

plied with each kit along with assembly nuts and bolts. Prices start at \$6.60. Aladin.

Acoustic Insulators 715

Announced is a kit of four insu-

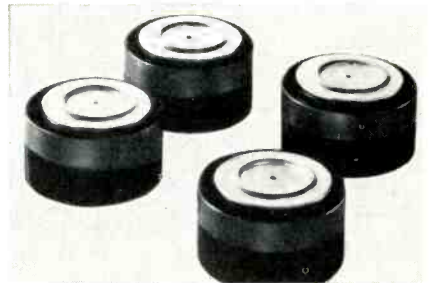

lators designed to fit under mounting feet of record changers, tape recorders, tuners, amplifiers, etc. The manufacturer indicates that these insulators are designed to absorb vibrations and, thereby, eliminate acoustic feedback. They contain felt pads to prevent furniture scratches. Dimensions: 2 x 1 1/2 in. Price \$3.49. Olson.

Alarm System 716

An automatic alarm system is able to electronically dial a preset telephone number during an emergency, according to the manufacturer. The system reportedly delivers a pre-re-



corded taped message to the police, fire department or other party dialed. Specifications indicate that up to four different numbers can be automatically dialed, the unit repeats the message twice as each number answers, and if a number dialed is busy or fails to answer after five rings, the unit automatically calls the next number. Ballistics Control.

UHF Converter 717

Announced is a two-stage, transistorized UHF converter which reportedly has a 15db average gain in the amplifier stage, 40db image re-



jection and a frequency drift of less than 200kHz. The unit is housed in a plastic case that measures 7 x 6 x 3½ in. GC Electronics.

Two-Way Radio 718

A two-way radio is designed for hands-free communications. The basic unit includes a shoulder harness which incorporates a speaker to aim sound directly at the ear, a small microphone on a goose neck and provision



for a variety of antennas. The model pictured is designed to be used with a safety-hard hat or helmet as the antenna. Another model is designed to permit two-way communications when wearing a gas mask. The unit reportedly weighs only five ounces. American Teletronics.

Multiple Socket Wrench 719

A multiple socket wrench contains a locking feature designed to fit any of nine different sized nuts from No. 2 to ¼ in. or hex-head screws from 3/16 in. to 7/16 in. The sockets are spring-loaded and the tips are aligned

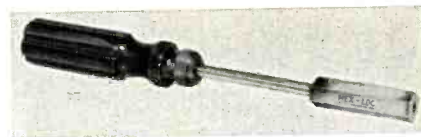

to present a flat surface. As the wrench is applied to a nut or hex-head screw, all sockets smaller than the one that fits are depressed to make room for the nut and any portion of the bolt that may be protruding. The locking mechanism reportedly permits the wrench to be locked in position for any size nut, eliminating the need to hold a steady pressure against the wrench while turning it. Price \$4.95. General Implements.

Now, for men in electronics —“a whole new era of quick calculation”

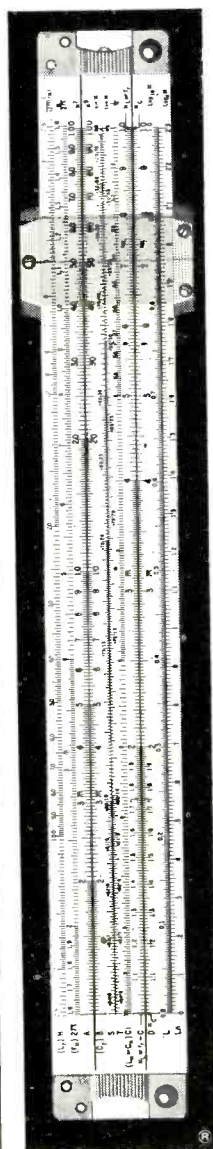

THERE MUST BE THOUSANDS OF PEOPLE in electronics who have never had the marvelous adventure of calculating problems with a single slide rule; other thousands have had to content themselves with a slide rule not specifically designed for electronics. For both groups, the new slide rule designed and marketed by Cleveland Institute of Electronics and built for them by Pickett will open a whole new era of quick calculations.

“Even if you have never had a slide rule in your hands before, the four-lesson instruction course that is included takes you by the hand and leads you from simple calculations right through resonance and reactance problems with hardly a hitch. If you already use a slide rule, you’ll find the lessons a first-rate refresher course. And it explains in detail the shortcuts built into this new rule.”

From an article in
Radio Electronics Magazine

Want complete details about this time-saving new Electronics Slide Rule? Just mail coupon below... or write Cleveland Institute of Electronics, Dept. ET-115, 1776 East 17th St., Cleveland, Ohio 44114.

Mail this coupon for
FREE BOOKLET

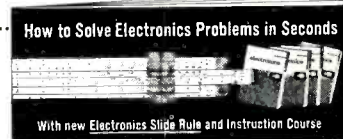

CIE Cleveland Institute of Electronics
1776 E. 17th St., Cleveland, Ohio 44114

Please send me without charge or obligation your booklet describing the CIE Electronics Slide Rule and Instruction Course. Also FREE if I act at once: a handy pocket-size Electronics Data Guide.

Name _____ (please print)

Address _____

City _____ State _____ Zip _____

Accredited Member National Home Study Council
A Leader in Electronics Training... Since 1934

ET-115

... for more details circle 111 on postcard

NEW PRODUCTS

Auto Tape Player 720

Announced is an automobile stereophonic tape player designed to play both 4- and 8-track cartridges. The player reportedly senses the type of



cartridge as it is being inserted, automatically engages the appropriate mechanism and switches the unit ON. It is designed to transfer channels electronically at the end of each program. A selector bar permits manual program selection. An optional foot-switch control is also available. Tenna Corp.

Motor/Light Control 721

A kit designed to control the speed of ac/dc motors, the brightness of lights and the heat of soldering irons (except transformer-type guns), is now available. Its solid-state circuit contains a silicon-controller rectifier and

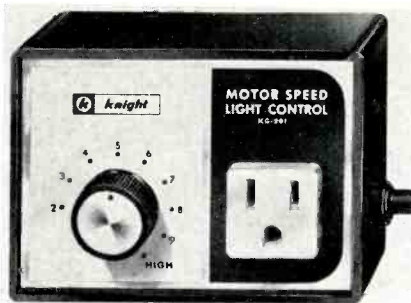

two diodes, and a calibrated control adjusts the output. The manufacturer's specifications indicate that the control can handle 7.5amp motor currents, 900w resistive loads and 500w incandescent lamps. A thermal circuit breaker is included in the kit. Price \$9.95. Allied.

AM & SB Transceiver 722

A 23-channel transceiver is reportedly compatible to both sidebands and conventional AM transmit and receive facilities. A front panel control enables the operator to select the upper sideband, lower sideband or conven-

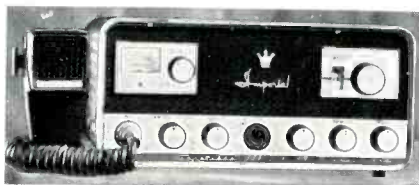

tional AM function on the receiver, while transmitting, the operator can use double sideband with reduced carrier facility for conventional AM signals or he can transmit on both sidebands simultaneously without carrier. This provides the ability to conduct two-way transmissions with receivers tuned to either the upper or lower sideband. The receiver is equipped with a R/VFO control for tuning to the exact channel frequency of the incoming signal, with a rated sensitivity of $0.5\mu\text{v}$ or less. The transmitter is reportedly capable of 30w P-P modulation and has a built-in network for matching 30 to 75- Ω antenna loads. The transceiver operates on 120vac or 12vdc. Price \$299.00. Regency.

Color CRT Pedestal 723

A CRT test pedestal is designed to secure a 21-in. color tube in a position that will enable it to be hooked up to a customer's chassis exactly as

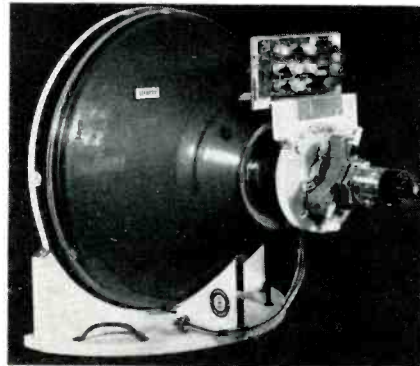

in the customer's cabinet. With this pedestal, technicians are reportedly able to provide bench service after having removed only the chassis from the customer's cabinet. According to the report, a test pedestal complete with color components weighs only 45 lb. Net price \$14.50. Eight Ball.

Flat Cables 724

A flat cable system has been developed for audio and low-voltage control systems. It is available with a pressure sensitive foam adhesive and

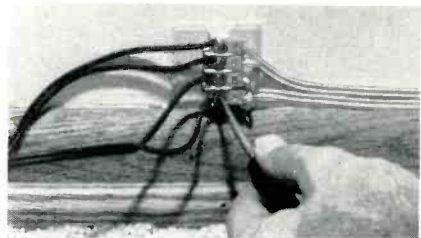

accessories for terminating and splicing. The flat 2- or 3-conductor cable consists of No. 22 AWG stranded wire embedded in a vinyl plastic strip, to which a layer of foam adhesive is applied; and the accessories are injection-molded plastic with foam adhesive backing. 3M.

EVERY 8 MINUTES...



SOMEONE BUYS A NEW SENCORE CG10 LO-BOY STANDARD COLOR BAR GENERATOR

It's time you too switched to Sencore and saved \$100.00 in the bargain. The new compact LO-BOY is a solid Sencore value that outperforms the highest priced generators—and is already selling at the rate of one every 8 minutes.

Compare these features:

- Ten standard RCA licensed color bars plus all patterns found on more expensive generators.
- New patent pending counting circuits using silicon transistors. Crystal controlled timers for the utmost in stability.
- New front mounted timer controls for quick adjustment if they should ever jump. Absolutely eliminates timer instability.
- All solid state. Battery powered by long life "C" cells.
- HI in performance — LO in price. . . . (Less than the cost of a kit.) . . . only \$89.50

SENCORE CG12 LO-BOY—Just like CG10 except AC operated, 4.5 mc crystal controlled signal; recommended for troubleshooting. . . . only \$109.50



SENCORE

NO. 1 MANUFACTURER OF ELECTRONIC MAINTENANCE EQUIPMENT

426 SOUTH WESTGATE DRIVE, ADDISON, ILLINOIS 60101

... for more details circle 130 on postcard

What are you doing in the Yellow Pages, Mr. Star?

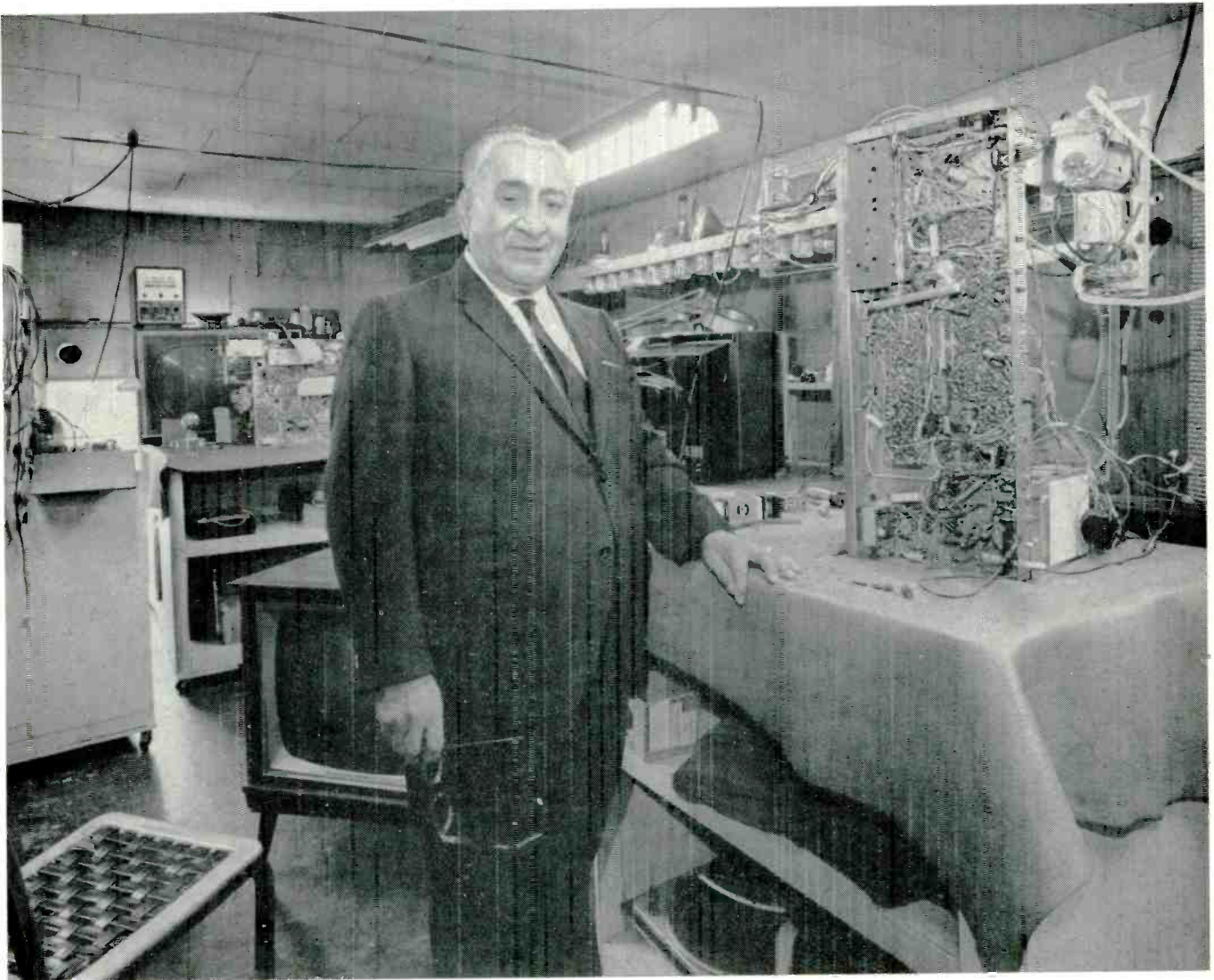

"We get lots of business through the Yellow Pages," says Mitchell Star, president, Star Super Service Inc., Battle Creek, Michigan. "We've got four ads in the Yellow Pages. We know they're working because we ask people how they happened to come in, and then mark it down on our tickets. Many customers look in the Yellow Pages even when they've seen our other advertising — even when they know us. This year we gave a separate ad to one line we carry, and gained thirty to thirty-five per cent more business on this alone."

Advertise for action...



Quality **ELECTRIC APPLIANCES**



**WE SERVICE
ALL MAKES
OF
ELECTRIC
APPLIANCES**

WATCH FOR OUR NEW ADDITION
WITH PARKING FOR OVER 100 CARS.

**COMPLETE SELECTION
OF**

- ★ REFRIGERATORS - FREEZERS
- ★ WASHERS
- ★ DRYERS (Gas or Electric)
- ★ RANGES (Gas or Electric)
- ★ DISHWASHERS

WITH SUCH FAMOUS NAMES AS:

MAYTAG RCA WH. REFRIG. HOTPOINT	WESTINGHOUSE TAPPAN KITCHENAID HOOVER
---------------------------------------	------------------------------------------------

OPEN DAILY 8 AM TO 9 PM - CLOSED SUNDAYS

CALL 963-5541

OVER 30 YEARS IN BUSINESS

STAR

"THE PLACE TO GO FOR THE NAMES YOU KNOW"
6 MAIN ST. AT THE MONUMENT

**Super Service
Inc.**
TELEVISION
APPLIANCES
FURNITURE

Display ad (shown reduced) runs under **ELECTRIC APPLIANCES — REPAIRING**. Call your Yellow Pages man to plan your program. Find him in the Yellow Pages under: **ADVERTISING — DIRECTORY & GUIDE**.

NEW PRODUCTS

Miniature Heater Buttons 725

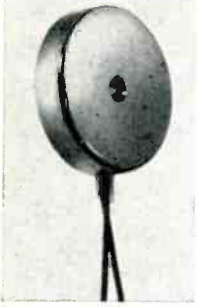

Announced are miniature heater buttons designed to provide concentrated, localized heat in a minimum of space. When used in conjunction with temperature controls, it can reportedly be used to maintain precise temperature levels for critical aero-space, laboratory and commercial applications. Three standard models in 5 power ratings (2, 5, 10, 15, 20w) and in both 28v and 115v versions, offer the user a choice of regular, low silhouette or environmentally sealed units. Prices range from \$6.70 to \$24.50. Minco.

Plastic Cable Tie 726

Two plastic cable ties are introduced for securing wire bundles in places where breakouts from the main bundle are made. Both cable ties are fabri-

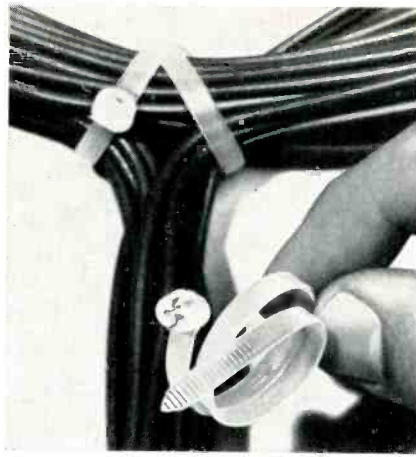

cated of nylon for a maximum wire bundle of 3/4 in. diameter. One tie is twist-locking — position the tie around the bundle, thread the tip through the eye, twist and cutoff — while the other is self-locking — a stainless steel tooth mounted in the eye reportedly locks the tie at any given diameter. Thomas & Betts.

Garage Door Opener 727

A radio controlled, garage door opener features a one-piece cover, reportedly removable by a single screw for faster, easier access to the interior and all circuit components are front-mounted for easier servicing. The unit



is designed to be actuated by either push-button or by a small remote control radio transmitter that may be carried in a car, purse, or pocket. By pressing a button on the transmitter, the garage door unlocks and opens or closes and locks, while the garage lights are turned on or off. Alliance.

Tube Tester 728

A mutual conductance tube tester is designed to check tubes under actual dynamic operating conditions, plus being able to check transistors, diodes and power rectifiers. A CRT adapter, available for an extra charge,



is designed to enable technicians to check color and B/W picture tubes as easily as receiving tubes. The instrument will check all tube types for gas and grid emission, with a reported sensitivity of over 150M in addition to checking for shorts and leakage between any tube elements. The circuitry has been designed with a lever switch principle to overcome obsolescence caused by new base pin arrangements or new internal jumpers in tubes. Price \$99.95. Adapter \$12.45. Mercury.

PLECTRON

PORTABLE FREQUENCY STANDARD

The PLECTRON SC-101 Portable Frequency Standard is a "lab" you can actually take to the field...anytime, any place...and, be confident of absolute alignment of two-way radio networks including transmitters, relay stations or transceivers.

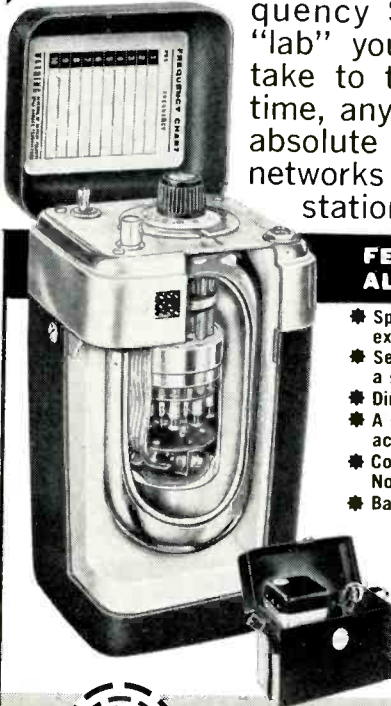

FEATURES FOUND ONLY IN THE ALL TRANSISTOR PLECTRON SC-101

- ★ Spot or fixed frequency measurements with accuracy exceeding FCC requirements from 10 to 480 MHz.
- ★ Selection of up to 10 frequencies by simply turning a selector knob.
- ★ Directly read frequencies — no bothersome charts.
- ★ A simple "zero beat" method is used to indicate accuracy of transmitter or receiver operation.
- ★ Constant temperature control with direct readings. No temperature compensation.
- ★ Battery powered, lightweight (2.6 lbs), 7 3/4" x 4" x 4 1/2".

The PLECTRON SC-101 comes with optional leather carrying case with battery compartment. Guaranteed by Plectron Corporation for 12 months.

Plectron also manufactures encoders decoders and a complete line of tone activated and monitoring FM communications receivers.



Manufactured by
PLECTRON CORPORATION
Overton, Nebraska 68863

Distributed in Canada by Wilson & Cousins, Ltd.

Electric Outlet Boxes 729

Announced is a line of portable extension electric outlet boxes. Each box contains from four to eight three-



wire grounding type outlets, and comes equipped with a self contained switch, pilot light and 10ft of three-wire appliance cord. If desired, the units can be supplied with either or both hot wires fused. Safcorde.

... for more details circle 124 on postcard

Color Bar Generator 730

Announced is a solid-state color generator that features two sets of color bar patterns in red, blue and green or yellow, magenta and cyan. This feature reportedly eliminates the



confusion of counting bars and is designed to enable technicians to concentrate only on the necessary bars. The RF output on channel 3 or 4 is controlled with a front panel switch and can be adjusted for channel 5 through an opening on the panel. Price \$149.95. Jackson.

Digital Voltmeter 731

A digital dv voltmeter, designed to measure voltages from 100mv to 1kv in five manually-selected ranges, is announced. The instrument can reportedly measure voltages accurately



60% above full scale in all but the 1kv range. Specifications indicate that the meter has a 0.1% plus 1 digit accuracy with a 10M input impedance on all ranges. Hewlett-Packard.

Speaker Systems 732

Designed to occupy only one cu ft of space, two speaker systems models X-40 and X-45, are announced, that reportedly have a frequency response of 30Hz to 16kHz and 30Hz to 18kHz, respectively.

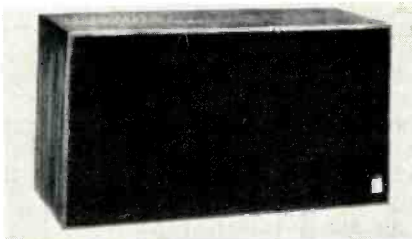

Specifications indicate that they both have a 25w power rating and controls that can be adjusted to attain optimum musical balance under various room conditions. Priced at \$57 and \$63. Technical Service Dept., Jensen Mfg.

Storage Bins 733

A line of 27 types of corrugated board, inventory-control bins are available. The line ranges from parts bins 2 x 9 in. to 12 x 24 in. Dividers,

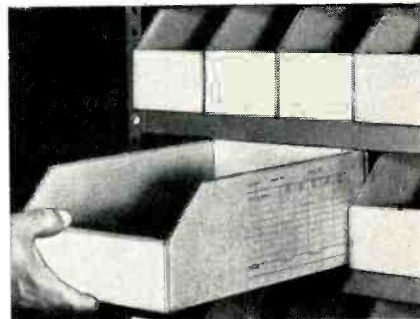

dust covers, bins with integral dust covers, legal or letter size record retention files and various types of steel shelving units are also said to be available. All of the units are shipped flat, and can reportedly be assembled with double-locked corners simply by easily folding the various units. Kole Enterprises.

ZENITH LOG PERIODIC ANTENNAS

offer high
signal gain and
ghost rejection



All-channel VHF/UHF/FM and FM Stereo

Developed by the University of Illinois antenna research laboratories, each Zenith log periodic antenna works like a powerful multi-element Yagi . . . not on just one or a few channels, but across the entire band it's designed for.

Order Zenith antennas and all genuine Zenith replacement parts and accessories from your Zenith distributor.

BUILT TO THE QUALITY STANDARDS OF ZENITH ORIGINAL PARTS

Also Zenith periodic antennas for

- UHF • VHF
- FM AND FM STEREO
- PLANAR HELICAL UHF

ZENITH
®

*The quality goes in
before the name goes on*

FIX'EM FAST! FIX'EM RIGHT!

WITH
JENSEN
EXACT REPLACEMENT
**PHONO
NEEDLES**
**PHONO
CARTRIDGES**

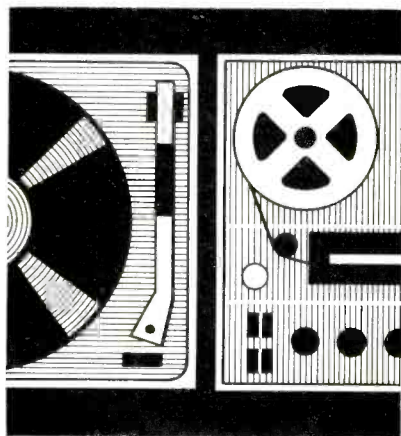

TAPE RECORDER AND PHONO DRIVE WHEELS, IDLERS, PULLEYS, BELTS, TIRES

Complete line, top quality,
all available at your
friendly Jensen
distributor's. Ask him
for your set of Jensen
catalogs, today!



JENSEN
INDUSTRIES DIVISION
ELECTRO-VOICE, INC., Dept. 278T,
663 Cecil Street, Buchanan, Michigan 49107

... for more details circle 117 on postcard

CATALOGS AND BULLETINS

Freq/Dev Meters 400

A 12-page catalog and a four-page bulletin describe a line of frequency measuring instruments. Included is a portable frequency meter, deviation meter and signal generator an instrument that reportedly acts as a signal generator in 1Hz increments from 5Hz to 50MHz and in 10Hz increments from 50MHz to 500MHz; plus VHF frequency meters and a HF standards receiver. Singer.

Frequency Meters/Oscillators 401

A single-page sheet describes frequency meters covering from 100kHz to 60MHz, 400kHz to 500kHz, 2MHz to 15MHz, 200kHz to 60MHz and each of the 23 CB channels plus a frequency standard for 10kHz, 100kHz and 1MHz. International Crystal.

Cable Connectors 402

A bulletin describes a line of portable cable connectors. Included in the literature are complete product descriptions, illustrations, schematics, ampere ratings, dimensions and cable size reference tables. Anderson.

Frequency Calibrator 403

A frequency calibration package is discussed in a bulletin now available. The bulletin describes the equipment contained in the package, a micrometer frequency meter and a modified crystal calibrator, which has an accuracy greater than 0.0001%, according to the manufacturer. Lampkin.

Tools 404

A 56-page catalog describes a wide range of tools including welding torches, reticles, torque screwdrivers, nut driver kits, pliers, tweezers, files, knives drills and grinders, chassis punches and soldering irons. Jensen Tools.

Vehicle Aids 405

A vehicle alarm system, rear view mirror, flare set and warning flasher system are described as accessories for the technician's service truck. Dealer Aids.

Circuit Breakers 406

A two-color data sheet describes a series of manual reset circuit breakers and adapter plates. The breakers are available in 17 models for 125vac application, with amperage hold ratings of 0.490 to 4.14 throughout the range of models. The dual-operating, bi-metallic units have application in

TV receivers, audio amplifiers, electronic business machines and other electronic systems. A multi-application circuit breaker adapter plate of glass-filled nylon, with a cadmium plated hex nut and lock washer, is also described. Littelfuse.

Sound Chart 407

A chart is available that compares the sound produced by footsteps, hand clapping, speech and 22 musical instruments with the limits of audibility, a musical scale and the frequency response of the manufacturer's microphone. Sonotone.

Micro Cleaners 408

An eight-page catalog graphically describes a product line of lint-free cloths, compressed gas and solvent used for precision cleaning of instruments, optics and electronic components — wherever "non-contamination is essential." Texwipe.

Ball-Bearing Dollies 409

Three sheets now available describe four lines of ball-bearing dollies ranging in size from 24 x 16in. to 36 x 24in. Durall.

Motors 410

A two-color, 16-page catalog of fractional horsepower motors includes dimensional details, operating information, and 10 engineering features incorporated in each line of motor. Emerson Electric.

Event Counter 411

A technical data sheet describes a plug-in event counter, which is used with the manufacturer's digital measuring system to provide an extension of the system's frequency measurement and event counting capability. Hickok.

Fiberglass Antennas 412

Two folders are available that describe a line of fiberglass antennas. One folder, containing 22 pages of data, describes base station and mobile unit antennas designed for commercial, amateur and CB use. The other folder describes marine antennas for radio-telephone use. Columbia Products.

Crystals and Filters 413

A 16-page catalog describes a complete line of quartz crystals, crystal filters and oscillators. Included are complete specifications on more than 100 different units of a wide variety of types and frequencies. The catalog also contains a frequency-band width guide for determining the feasibility and practicality of crystal filters. Midland-Wright.

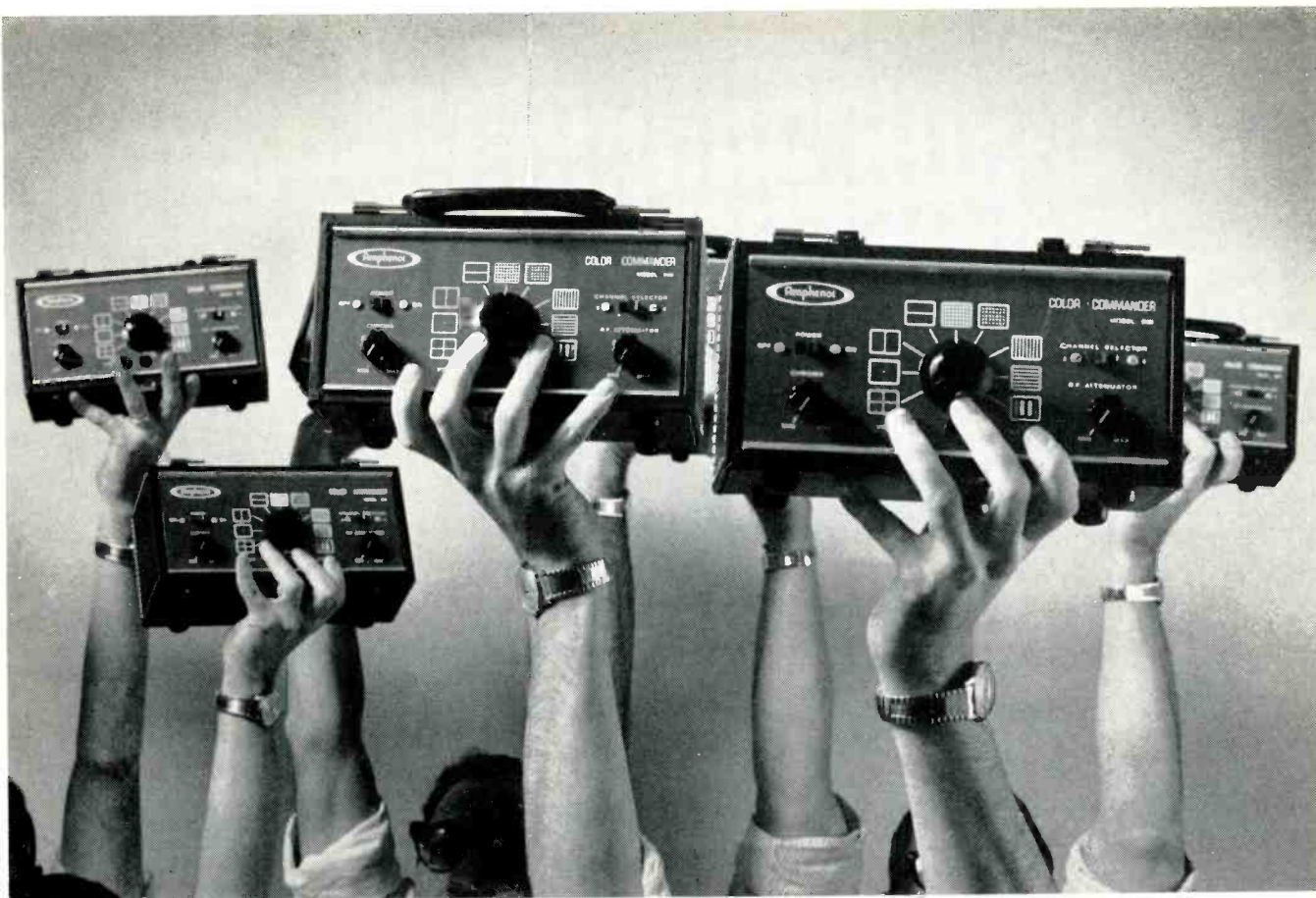

Suddenly, everyone's a Watch Watcher!

And for a good reason. Service dealers found out we were right when we said Amphenol's Color Commander color bar generator would save them enough time for two or three extra service calls a day.

What's it all about? We're so sure we can save you as much as 18 minutes a call, we're including a \$10.95 Timex watch with every Color Commander purchased—just so you can prove it yourself.

And if the Color Commander doesn't save as much time as we say, return it within 10 days and keep the Timex watch with our compliments.

What makes us so sure? Amphenol's exclusive technique of color alignment which features a:

1. Single crossbar to immediately center the raster.
2. Single dot for fast, consistently accurate static convergence.
3. Three-bar color array to isolate your working bars—the 3rd, 6th and 9th.

Join the Watch Watchers

If you take advantage of this limited-time offer today, your Color Commander can be paying for itself in extra income tomorrow. For the name of your nearest Amphenol distributor, contact your nearest Amphenol Sales Division office or write Dan O'Connell, Head Watch Watcher, Amphenol, Box 134, Broadview, Illinois 60153.

Watch Watcher Offer

With every lightweight, compact, completely solid-state Amphenol Model 860 Color Commander we'll include a \$10.95 Timex for you to time your savings. If the Color Commander doesn't save you time, return it within 10 days and keep the watch with our compliments. Act now. This offer is limited to available stock of your Amphenol Distributor.

\$169.95*

*Suggested resale prices

Model 860AC \$20.00 higher*



.TM



...and the public address system will use QUAM speakers!



MODEL 8C10PA

For top quality public address. This 8" speaker has a 10 oz. ceramic magnet, frequency response of 55-13000 Hz., easily handles 12 watts. One of 34 Quam speakers for sound system applications.

Men who specify loudspeakers in enormous volume have to be particular about quality and performance. That's why more and more sound system installers are developing the habit of specifying Quam.

It's a good habit to acquire, because Quam makes good speakers for public address, background music and other sound system needs, as well as for radio-tv-automotive replacements.

Whatever kind of speaker you need, look for Quam, the Quality line, in the red, white, and blue package at your distributor.

QUAM QUAM-NICHOLS COMPANY
234 E. Marquette Road—Chicago, Illinois 60637

... for more details circle 126 on postcard

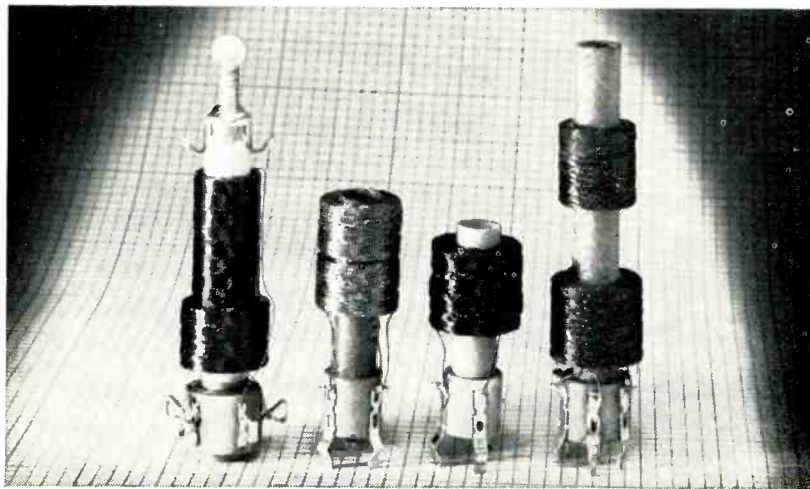

Exact Replacement Linearity Coils for More than 25 Color TV Manufacturers

Exact replacement Models 6347 and 6348 Red/Green Convergence... Model 6349 Horizontal Oscillator and Waveform... and Model 6350 Focus coils are for Color TV sets by manufacturers such as RCA • Admiral • GE • Silvertone • Emerson.

Write today for your Linearity Coil Cross Reference Guide.



J. W. MILLER COMPANY

5917 SO. MAIN STREET • LOS ANGELES, CALIFORNIA 90003

SEE YOUR LOCAL DISTRIBUTOR FOR FULL LINE OF RF & IF COILS, CHOKES, FILTERS & TRANSFORMERS.

... for more details circle 121 on postcard

ABCs OF CAPACITORS. By William F. Mullin. Published by Howard W. Sams and Co., 96 pages, soft cover. \$2.25.

Nearly all kinds of capacitors, except varactors, are discussed in detail in this book. When presenting this material, the author assumes that the reader has no prior knowledge of electronics and only a limited background in algebra. Considerable detail is given to the construction of various types of fixed and variable capacitors. Simple equations are presented with the description of capacitor operation. Although the book would at first appear to be of interest to only apprentice technicians, there are a few portions in the book that deserve the attention of experts.

101 QUESTIONS & ANSWERS ABOUT TRANSISTORS. By Leo G. Sands. Published by Howard W. Sams & Co. 112 pages, soft cover. \$2.50.

The author uses a question and answer technique to cover many aspects of transistors and transistor circuits. This may be of value to the apprentice technician who has just begun learning about semiconductors or to the more advanced technicians who may use the four-page table of contents as a technical dictionary to locate the meaning of unfamiliar terms that appear in the text. We do not feel, however, that the book delves deeply enough into the theory of semiconductors to be used as a text by advanced technicians or be of much help to the practicing professional.

Erratum

In the November article of the series "Semiconductors from A to Z," the circuit shown in Fig. 2 inadvertently contained a capacitor rather than a second bias battery. The circuit should have been printed as shown here.

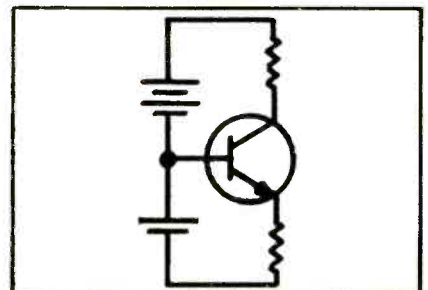



**SOME PEOPLE
KILL THEMSELVES
TRYING TO
GET TO WORK
ON TIME**

Getting your employees to and from work alive is a full-time job. *Yours*. And it's not just a matter of public welfare, either. Off-the-job traffic accidents cost American industry millions of dollars in lost time, training and production every year. Last year alone, more than twenty thousand workers were killed in off-job motor vehicle accidents. And more than 750,000 were injured. Motor vehicle accidents claimed more than 1½ times as many lives as on-the-job accidents. Can you do something about it? You really can't afford not to. Write now, to the National Safety Council for information on what you and your company can do. Address your letter to the Director of Public Information, National Safety Council, 425 N. Michigan Avenue, Chicago, Illinois 60611. *Published to save lives in cooperation with The Advertising Council and the National Safety Council.*



NEWS OF THE INDUSTRY

FM 'Transmitter' Reduced To Width of Eyelash

Dr. Leon Nergaard, director of the microwave research program at the RCA Laboratories reports the development of a solid-state FM "transmitter" that has successfully transmitted high quality music across a laboratory. Although the analysis is not complete, he noted,

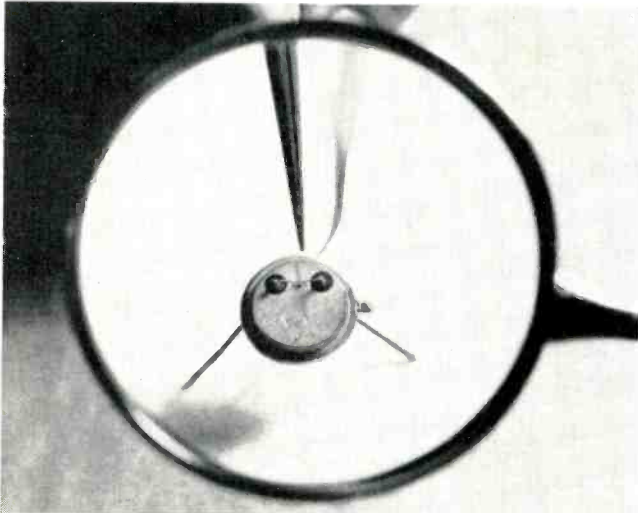

it appears the gallium arsenide unit derives its capability from the interaction of "Gunn effect" and "field effect" phenomena. "In essence," he stated, "we use the Gunn effect to cause the component to generate a microwave carrier and then the field effect to impress information such as voice or music onto the carrier for transmission to a standard FM receiver."

Manufacturers Describe 1967 Line

Admiral indicates that its color-TV line now includes 18 models that can be marketed for under \$500. Fourteen of their new models feature a wireless remote control that reportedly enables the viewer to adjust the tint and color intensities as well as provide the usual controls. Many of the B/W portable receivers will include a sun shield designed to permit the viewer to enjoy a good picture even in bright sunlight.

Olympic states that two 296-sq in. color TV consoles

and two 282-sq in. B/W consoles have been added to its 1967 line. The color console of contemporary styling is priced at less than \$500 while the prices for the other sets are open list.

Sylvania has introduced 15 color TV models, including 6 console models, to its 1967 line. The company indicates that a new family size series with 226-sq in. rectangular screens is expected to represent an ideal point of balance between its 180-sq in. portable color-TV set and its 295-sq in. consoles.

Zenith announces that its 1967 line includes 24 B/W TV models and 35 Color TV models. The announcement states that 21 of these color models are to contain a new automatic fine-tuning control circuit. A 227-sq in. family size is also among the new color models. Suggested retail prices for the company's color TV sets now range from \$399.95 for a table model to \$1125 for a console combination.

Dynascan Reports Earnings Up 61 Percent on Record Sales

Carl Korn, president of Dynascan, has announced that the sales for 1966 may have topped \$4,900,000, an 18 percent gain over 1965 sales of \$4,174,000. He indicated that earnings are estimated at about 42¢ per share, or about 61 percent higher than 1965 earnings of 26¢ per share.

RCA Reports Largest Single-Year Sales and Profit Increases

Subject to final confirmation, RCA's sales for 1966 will surpass \$2.5 billion and profits will exceed \$130 million. The comparable figures for 1965 were \$2,093,685,000 and \$102,541,000. The year will reportedly be the fifth in succession in which the company's sales and earnings have reached new peaks.

Symposium on Law Enforcement, Science and Technology

Scientists, engineers and law enforcement officials throughout the nation are being extended an open invitation to submit papers for presentation at a unique symposium scheduled for March 7, 8 and 9, 1967.

Called the First National Symposium on Law Enforcement, Science and Technology, the meeting is being sponsored by the U.S. Dept. of Justice's Office of Law Enforcement Assistance and the IIT Research Institute. The symposium will be held on the campus of Illinois Institute of Technology in Chicago.

According to symposium chairman, S. A. Yefsky, the symposium will be the first professional level meeting

KAY-TOWNES

UHF-VHF-FM antennas

ORIGINATORS and DESIGNERS
of the WORLD FAMOUS
CROSS PHASE CIRCUIT
Now Used By Most
All Modern-Day Antennas



colorphase

ANTENNA

CP 28, 23, 19, 15, 11, 7



KAY-TOWNES Antenna Co. 1511 Dean Ave., Rome, Ga. 30162

... for more details circle 119 on postcard
ELECTRONIC TECHNICIAN

designed to bring the law enforcement community together with the science and engineering communities, to exchange ideas and information on their latest research and development. The symposium will be held on an annual basis and proceedings will be published.

In issuing the call for papers, Mr. Yefsky said that persons engaged in all criminal justice activities are invited to submit papers describing problem areas to the technological community and to report research programs. Also, scientists and engineers from all disciplines are invited to submit papers on any aspects of science and technology associated with or relating to the problem area of criminal justice.

Sales Gains in Color TV Sets and Phonographs

October distributor sales of Color TV sets and phonographs registered the highest gains of all consumer electronic products. Color TV's rise continued with a 50 percent increase over the October 1965 figure—482,956 sets delivered to dealers compared with 321,919 in the comparable month a year ago, while in the portable/table phonograph category there was a 36.5 percent distributor sales jump in October—618,157 units vs. 452,779 in the 1965 month.

Motorola Sponsors 'Community Radio Watch'

A new, nationwide public service program designed to help communities of all sizes encourage residents to support the police in its effort to protect life and property has been announced by the communications division of Motorola. Part one of the program calls for residents to report suspicious acts and unusual occurrences to the police by telephone as soon as they see them, while part two calls for special cooperation from all personnel who drive vehicles equipped with two-way radios.

Contract Awarded For TV Station in Congo

RCA has been awarded a \$900,000 contract by the Government of the Democratic Republic of the Congo to establish the first TV station in the Central African nation.

The first shipments of TV equipment to the Congo were made in October and the UHF station in the capital of Kinshasa, formerly Leopoldville, is expected to be completed early in 1967.

The station will be operated by Congolese personnel under technical and management supervision, and programs will consist of news and documentary services at first. Later, live educational programs and other features of general interest will be added.

Kinshasa, together with the surrounding area, has a population of some 1,700,000 that will be served by the TV broadcasts. Brazzaville, with a population of 300,000 will also be in range of the Kinshasa transmissions.

According to plans of the Congolese Government TV service will be extended to five or six additional cities in the nation when adequate operating personnel can be trained. This is expected to be achieved shortly.

MOVING?

Be sure to let us know your new address. Please enclose a complete address label from one of your recent issues.

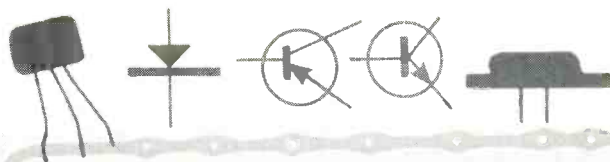

TEST TRANSISTORS IN SECONDS in circuit

TR139
89⁵⁰



Also check all
transistors, diodes,
and rectifiers out
of circuit for true AC beta
and Icbo leakage.

Your best answer for solid state servicing, production line testing, quality control and design.

Sencore has developed a new, dynamic in-circuit transistor tester that really works—the TR139—that lets you check any transistor or diode in-circuit without disconnecting a single lead. Nothing could be simpler, quicker or more accurate. Also checks all transistors, diodes and rectifiers out of circuit.

BETA MEASUREMENTS—Beta is the all-important gain factor of a transistor; compares to the gm of a tube. The Sencore TR139 actually measures the ratio of signal on the base to that on the collector. This ratio of signal in to signal out is true AC beta.

ICBO MEASUREMENTS—The TR139 also gives you the leakage current (Icbo) of any transistor in microamps directly on the meter.

DIODE TESTS—Checks both rectifiers and diodes either in or out of the circuit. Measures the actual front to back conduction in micro-amps.

COMPLETE PROTECTION—A special circuit protects even the most delicate transistors and diodes, even if the leads are accidentally hooked up to the wrong terminals.

NO SET-UP BOOK—Just hook up any unknown transistor to the TR139 and it will read true AC beta and Icbo leakage. Determines PNP or NPN types at the flick of a switch.

Compare to laboratory testers costing much more. . . . \$89.50

See America's Most Complete Line of Professional
Test Instruments — At Your Distributor Now.



NO. 1 MANUFACTURER OF ELECTRONIC MAINTENANCE EQUIPMENT

SENCORE

426 SOUTH WESTGATE DRIVE, ADDISON, ILLINOIS 60101

. . . for more details circle 131 on postcard

COMPLETE TUNER OVERHAUL

995

ALL LABOR AND PARTS (EXCEPT TUBES & TRANSISTORS)*

VHF UHF COLOR U-V TRANSISTOR

COLOR TUNERS GUARANTEED ALIGNMENT — NO ADDITIONAL CHARGE

Simply send us the defective tuner complete, include tubes, shield cover and any damaged parts with model number and complaint. Your tuner will be expertly overhauled and returned promptly, performance restored, aligned to original standards and warranted for 90 days.

UV combination tuner must be single chassis type; dismantle tandem UHF and VHF tuners and send in the defective unit only.

Exact Replacements are available for tuners unfit for overhaul. As low as \$12.95 exchange. (Replacements are new or rebuilt.)

And remember—for over a decade Castle has been the leader in this specialized field . . . your assurance of the best in TV tuner overhauling.

CASTLE
TV TUNER SERVICE, INC.

5713 N. Western Ave., Chicago 45, Illinois
41-92 Vernon Blvd., Long Island City 1, N. Y.

For service in Canada write to Chicago or use reader service card in this magazine.
*Major parts are charged extra in Canada.

. . . for more details circle 108 on postcard

ARROW

**EFFICIENT!
SAFE!
FAST!**

AUTOMATIC STAPLE GUNS

For Fastening Any Inside or Outside Wire Up to 1/2" in Diameter

UP TO 3/16" No. T-18	<ul style="list-style-type: none"> Telephone wire Intercom wire Bell wire Thermostat wire Radiant heating wire Hi-Fi, Radio & TV wires
UP TO 1/4" No. T-25	<ul style="list-style-type: none"> Tapered striking edge gets into close corners!
UP TO 1/2" No. T-75	Available in: Brown, Ivory, Beige, Monel, Bronze, Natural

ARROW FASTENER COMPANY, INC.
1 JUNIUS STREET · BROOKLYN 12, N. Y.

. . . for more details circle 104 on postcard

ADVERTISERS INDEX

American Telephone & Telegraph Co.75

Amperex Electronic Corp.3rd Cover

Amphenol Distributor Div.79

Arrow Fastener Co.84

B & K Div., Dynascan Corp.61, 65

Blonder-Tongue Laboratories, Inc.24

Castle TV Tuner Service, Inc.84

Channel Master Corp.33

Clarostat Mfg. Co.27

Cleveland Institute of Electronics73

Colson Corp.64

ELECTRONIC TECHNICIAN Book Club63

Electro-Voice, Inc.72

Finney Co.71

Greyhound Lines, Inc.35

IEEE62

Jensen Industries Div., Electro-Voice, Inc. 78

Jerrold Electronics2nd Cover, 22

Kay-Townes Antenna Co.82

Lectrotech, Inc.32

Miller Co., J. W.80

Motorola Parts & Service Dept.36

Philco Corp.19

Plectron Corp.76

Precision Apparatus Div., Dynascan Corp.20

Quam-Nichols Co.80

Quietrole Co.84

Radio Corp. of America
RCA Electronic Components
& Devices4th Cover, 25

RCA Institutes, Inc.34

RCA Sales Corp.31

Seco Electronics70

Sencore, Inc.29, 74, 83

Sprague Products Co.23

Turner Co.30

Weller Electric Corp.26

Yeats Appliance Dolly Sales Co.64

Zenith Sales Corp.69, 77

Color or Black & White TV respond to QUIETROLE like magic!

- Lubricates & Cleans
- Non-inflammable . . . Non-conductive . . . Non-corrosive
- Easy Spray or Dropper Application
- Nearly 20 Years of Outstanding Leadership
- Harmless to Plastics & Metal — Zero Effects on Capacity & Resistance

Acknowledged leadership by both manufacturers and servicemen. Silences noisy TV and radio controls with minimum attention. Mark-II for tuners . . . Spray-Pack for controls and switches . . . Silitron for general use.

Ask your distributor for Quietrole by name.

manufactured by **QUIETROLE CO.**
Spartanburg, South Carolina

. . . for more details circle 127 on postcard

MOVING?

Be sure to let us know your new address at least 6 weeks in advance. And please enclose a complete address label from one of your recent issues.

ELECTRONIC TECHNICIAN

Ojibway Bldg.
Duluth, Minn. 55802
727-8511

If you think
all replacement tubes are alike,
you've got a surprise coming

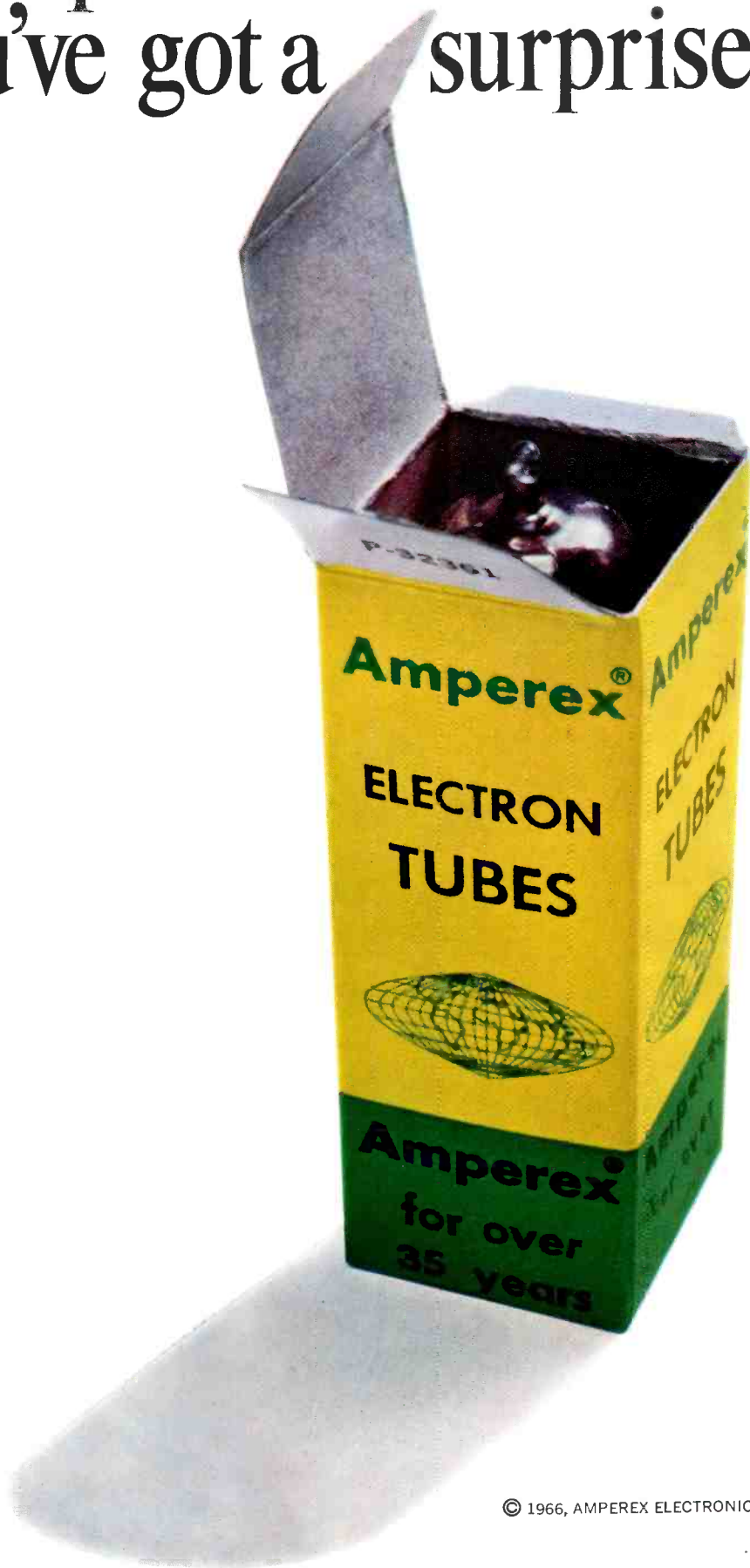



No color?

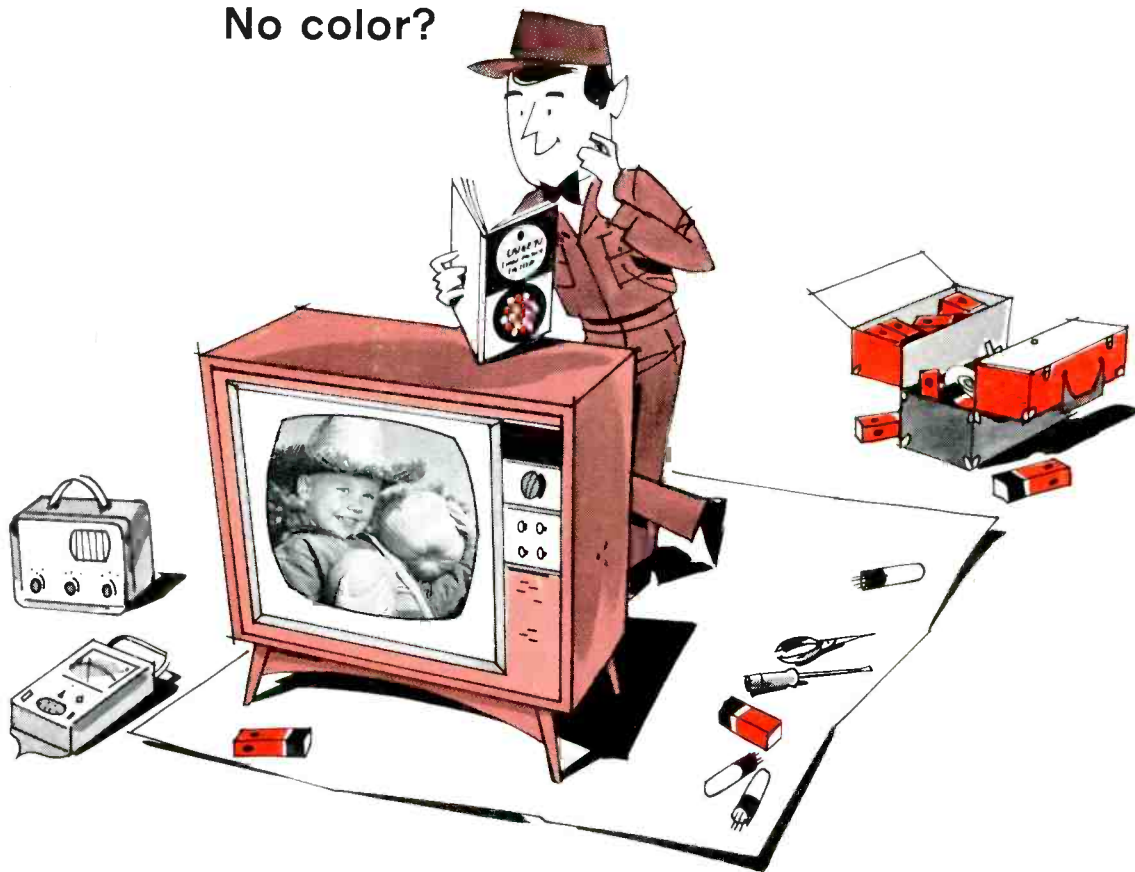

Use this procedure to narrow down the trouble area...

If the receiver produces a normal black-and-white picture but no color during a color broadcast, try the following steps, in order:

1. Tune to a channel broadcasting color, or feed an rf color-bar signal into the antenna terminals.
2. See that the fine-tuning and color (saturation) controls are correctly set.
3. Rotate the color-killer threshold adjustment in the direction which disables the color-killer stage. If *locked-in* (in sync) color appears, reset this control as recommended by the set manufacturer.
4. If color appears out of sync, look for trouble in the automatic frequency and phase control (AFPC) circuits. Use a color-bar generator, and follow the AFPC adjustment procedures described in the manufacturer's service notes.
5. If no color appears, determine whether the color is lost in the circuits which handle the composite signal (antenna to bandpass amplifier) or in circuits that handle the separated color signal, as follows:
6. Feed a color-bar signal into the antenna terminals

and use a scope to check the composite signal at the video detector.

7. If color-bar waveforms are absent or badly distorted, check for trouble, including poor bandpass, between the antenna terminals and video detector.
8. If color-bar signals are present at the video detector, check the burst keyer or separator, bandpass amplifier, color-killer, and the 3.58 MHz oscillator stages and their associated circuits.
9. Once the inoperative stage is found, use voltage and resistance measurements to pinpoint the circuit defect.

This ad is still another in a series of color TV service hints from RCA. To keep your customers satisfied, always replace with RCA receiving tubes. Your local RCA Distributor is your best source for top quality receiving tubes for color TV.

RCA ELECTRONIC COMPONENTS AND DEVICES, HARRISON, N. J.



The Most Trusted Name in Electronics