

# ELECTRONIC TECHNICIAN

CHROMINANCE VALUES

COLOR CONVERGENCE

CHROMA ALIGNMENT

December  
1962  
60¢



# are you replacing top quality tubes with identical top quality tubes?

You can, now! You can carry the identical tubes that you find in most of the quality TV sets you're servicing. Chances are, you were not aware that these sets were designed around special Frame Grid tubes originated by Amperex.

For some time now designers have been using many Amperex Frame Grid tubes in their quality TV receivers and we can tell you now that even more Amperex tubes are being designed into the sets you'll be handling in the future.

Compare, if you will, the performance of Amperex Frame Grid tubes with conventional IF tubes: they provide 55% higher gain-bandwidth, increase TV set reliability by simplifying circuits and they make your servicing easier, faster and more profitable because their extraordinary uniformity virtually eliminates time-consuming realignment when you replace tubes. Technicians are finding Amperex THE line to carry.

Tubes introduced by Amperex and currently being used by major TV set makers include:

<i>Frame Grid</i>				<i>Others</i>	
2GK5	4GK5	6GK5	6EH7	6AL3	9A8
2ER5	4EH7	6ES8	6EJ7	6BL8	15CW5
3GK5	4EJ7	6ER5	6HG8	6BQ5	16AQ3
3EH7	4ES8	6FY5	7HG8	12AX7	27GB5

For optimum customer satisfaction and maximum profit operation for yourself, make room in your caddy right now for the identical, matchless-quality tubes designed into the original sets. Next time you visit your distributor look for the green-and-yellow box and ask about Frame Grid tubes for TV and other entertainment replacement applications. Amperex Electronic Corporation, 230 Duffy Ave., Hicksville, L. I., N. Y. In Canada: Philips Electron Devices Ltd., 116 Vanderhoof Ave., Toronto 17.

# "OVER \$12,000 WORTH OF POWERMATES SOLD...AND IT'S JUST THE BEGINNING!"

**GEORGE MARKMILLER**

TV Sales and Service, 165 Ulster Avenue,  
Saugerties, New York

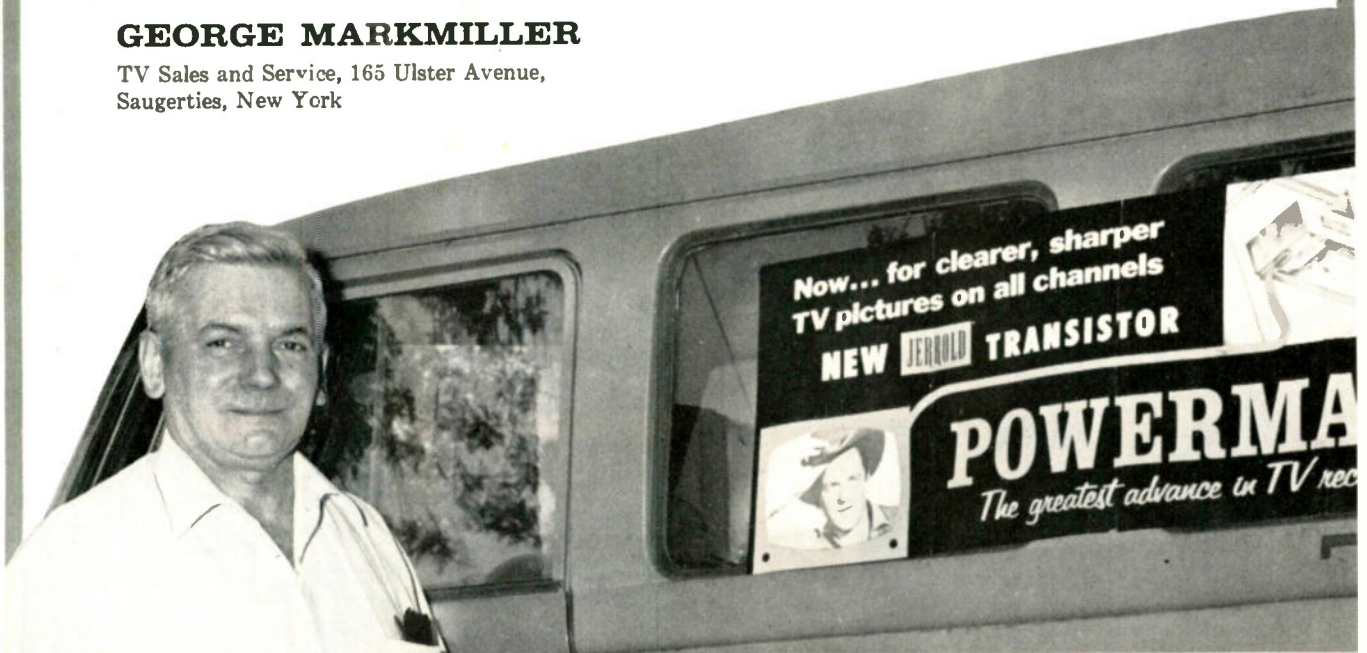

## POWERMATE sells itself through its performance

George Markmiller's customers "were from Missouri" where TV reception was concerned. The products they had tried, in spite of high claims, had not produced snow-free TV from the distant New York stations. With the help of his Jerrold distributor, George used the potent promotional kit to tell his customers the POWERMATE performance story. Newspaper ads, truck banners, stuffers and store displays presold

POWERMATE because the promotion was *custom-designed* for his area.

The real clincher came after the demonstration when one customer began to tell the other about POWERMATE's amazing reception. The Saugerties area had never seen such clarity in black and white *and in color*. As George says, "The performance of this unit has been the best advertising that has helped to sell it."

Jerrold's ready to set up a POWERMATE promotion designed for *your local area*. You can repeat George Markmiller's success story as hundreds are doing—all over the country. Write for the name of your nearest Jerrold distributor.

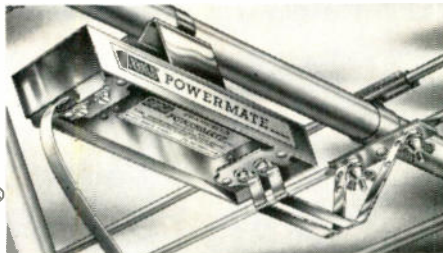

**JERROLD**®

TRANSISTOR

**POWERMATE**

ANTENNA AMPLIFIER

**\$3995**  
LIST

**JERROLD ELECTRONICS CORPORATION**  
A subsidiary of THE JERROLD CORPORATION  
Philadelphia 32, Pa.

Jerrold Electronics Corporation  
Distributor Sales Division, Dept. IDS-282  
Philadelphia 32, Pa.

I want Jerrold to promote the POWERMATE in my LOCAL area. Send me the name of my nearest distributor.

Name \_\_\_\_\_

Address \_\_\_\_\_

City \_\_\_\_\_ Zone \_\_\_\_\_ State \_\_\_\_\_

- - - for more details circle 32 on post card

Tarzian offers

# FAST, DEPENDABLE TUNER REPAIR SERVICE



ALL  
MAKES

It just makes sense that a manufacturer of tuners should be better-qualified, better-equipped to offer the most dependable tuner repair and overhaul service.

Sarkes Tarzian, Inc., pioneer in the tuner business, maintains a complete, well-equipped Factory Service Dept.—assisted by Engineering personnel—and staffed by specialized technicians who handle **ONLY** tuner repairs . . . on ALL makes and models.

Tarzian-made tuners received one day will be shipped out the next. There is a 12-month guarantee against defective workmanship and parts failure due to normal usage. And compare our cost of \$8.50 and \$15 for UV combinations. There is absolutely no additional, hidden charge for ANY parts except tubes. Replacements available at low cost on tuners beyond practical repair.

Tarzian-made tuners are identified by this stamping. When inquiring about service on other tuners, always give tube complement . . . shaft length . . . filament . . . voltage . . . series or shunt heater . . . IF frequency . . . chassis identification. All tuners repaired on approved, open accounts. Check with your local distributor for Sarkes Tarzian replacement tuners, replacement parts, or repair service.

SERVICE MANAGER • TUNER DIVISION • DEPT. 3A



**SARKES TARZIAN INC**

east hillside drive • bloomington, indiana  
edison 2-7251

MANUFACTURERS OF TUNERS . . . SEMICONDUCTORS . . . AIR  
TRIMMERS . . . FM RADIOS . . . AM-FM RADIOS . . . AUDIO TAPE  
. . . BROADCAST EQUIPMENT

ONLY  
**\$8.50**  
INCLUDING

**ALL PARTS**  
(EXCEPT TUBES)  
**and LABOR**

**24-HOUR SERVICE**  
**1-YEAR WARRANTY**

**Tuners Repaired on  
Approved, Open Accounts**

**See your distributor, or  
use this address for fast,  
factory repair service**

**WORLD'S LARGEST  
ELECTRONIC TRADE  
CIRCULATION**

# ELECTRONIC TECHNICIAN

**RON KIPP** Publisher  
**JACK HOBBS** Managing Editor  
**VICTOR L. BELL** Technical Editor  
**WARREN CREWS** Associate Editor  
**JACK O'CONNOR** Assistant Editor  
**JERROLD PATTERSON** Assistant Editor  
**EARL HINTZ** Production Manager  
**MAGGIE KANE** Advertising Production  
**HOWARD SIVERTSON** Art Director  
**JERRY WHITTLESEY** Circulation Manager



AN OJIBWAY  
PUBLICATION

**OJIBWAY PRESS, Inc.**

Ojibway Building  
Duluth 2, Minn.

Telephone: RA 7-8511

**Sales Offices:**

**NEW YORK:** Ron Kipp, 480 Lexington Ave., New York 17, N. Y. TN 7-0011

**CHICAGO:** William Klusack, 221 N. LaSalle St., Chicago 1, Ill. CE 6-1600

**CLEVELAND:** Arnold T. Suhart, 6207 Norman Lane, Cleveland, Ohio. YE 2-6666

**LOS ANGELES:** Boyd B. Garrigan, 1145 W. Sixth St., Los Angeles 17, Calif. HU 2-2838



**ELECTRONIC TECHNICIAN** and **Circuit Digests**, published monthly for Electronic Technician, Inc., Ojibway Building, Duluth 2, Minnesota, Marshall Reinig, president; Robert Edgell, vice president; Lawrence Rosenthal, vice president; H. B. Fryberger, Jr., secretary; E. A. Kuefner, treasurer. Single copies, 60c. Subscription rates: United States and Canada \$5 for one year; \$8 for two years; \$10 for three years. Pan American and Foreign countries, \$9 for one year; \$14 for two years; \$18 for three years. With subscription correspondence, include mailing label from most recent issue. Second-class postage paid at Waseca, Minn. and at additional mailing offices. Copyright 1962 by Ojibway Press, Inc., Duluth, Minn. Reproduction and reprinting prohibited except by written authorization of publisher.

**POSTMASTER: SEND NOTIFICATION** (Form 3579) to **ELECTRONIC TECHNICIAN**, 1 EAST FIRST STREET, DULUTH 2, MINNESOTA. If you have a change of address or a question about your subscription, write: **ELECTRONIC TECHNICIAN**, Circulation Department, Ojibway Building, Duluth 2 Minnesota. **BE SURE TO SEND ALONG THE ADDRESS LABEL FROM YOUR MOST RECENT ISSUE.**

December • 1962

Vol. 76 • No. 6

## FEATURES

Tuning In The Picture .....	14
Manufacturers Technical Digest .....	16
ET Viewpoint .....	21
Know Your Chrominance Values .....	22
<i>by Robert G. Middleton</i>	
Color TV Convergence .....	26
<i>by J. Futterman</i>	
Chroma Alignment .....	28
<i>by L. C. Powell</i>	
Repairing Tape Recorders .....	32
<i>by L. V. Winston</i>	
Servicing Remote Controlled TV Systems .....	36
<i>by Paul J. Walker</i>	
Test Instruments for Bench and Caddy .....	40
'Tough Dog' Corner .....	42
<i>by Kenneth F. Bangsberg and Homer L. Davidson</i>	
Shop Hints .....	44
<i>by Henry Mullen, H. L. Davidson, Jorge L. Gonzalez, Wesley Bazell and Henry Josephs, Sr.</i>	
1962 Article Index .....	71

## DEPARTMENTS

Editor's Memo .....	6	New Products .....	52
Letters to the Editor .....	8	Free Literature .....	68
Audio News Letter .....	18	Advertisers Index .....	74

## CIRCUIT DIGESTS

## PRECEDING BACK COVER

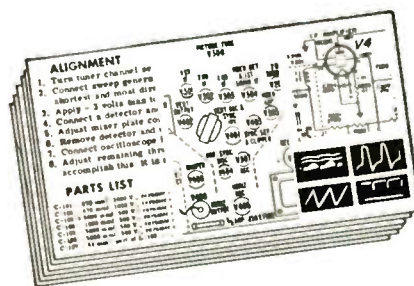

- AIRLINE:** Transistor Radio Model Gen 1225A
- EMERSON:** Transistor Radio Chassis 120655
- MOTOROLA:** TV Chassis TS-449 Series
- PHILCO:** TV Chassis 13N51, 52, 53
- RCA:** TV Chassis KCS 137 and 138
- SONY:** TV Chassis TV 5-303W

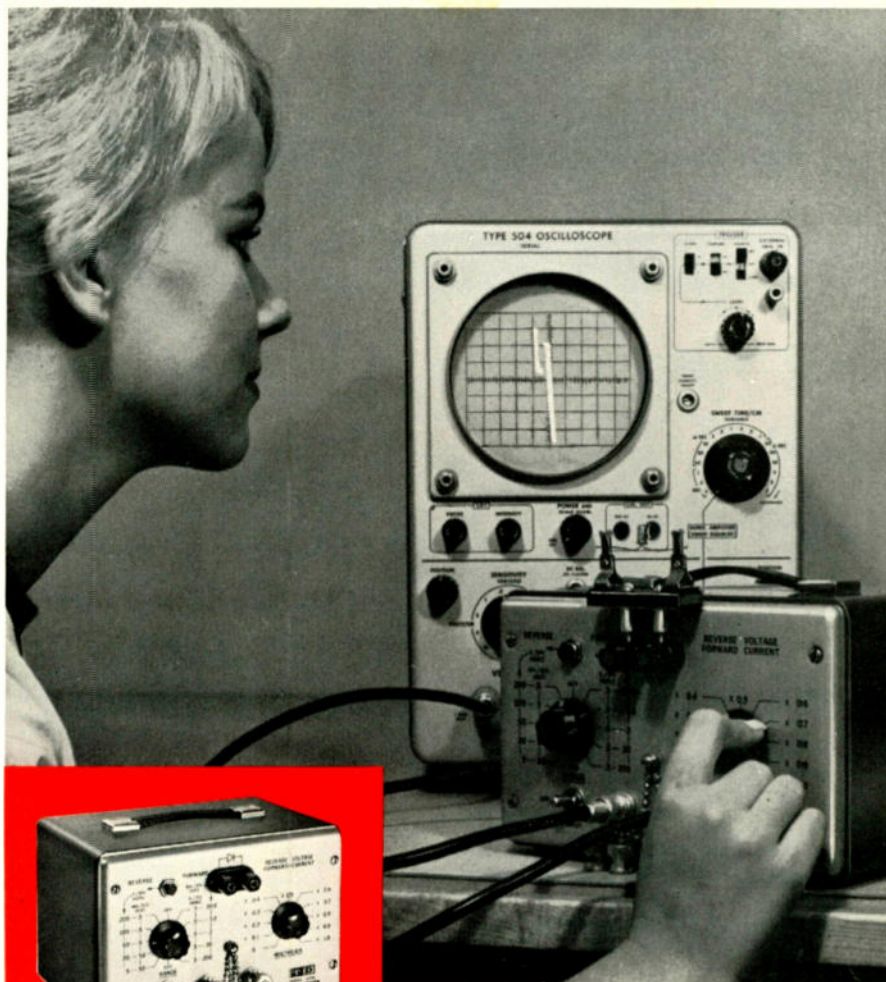

TYPICAL OSCILLOSCOPE TRACES OF DIODE CHARACTERISTICS USING MODEL 1050 TESTER

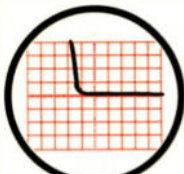

POWER DIODE FORWARD  
.5V./DIV. HORIZ.  
200 MA./DIV. VERT.

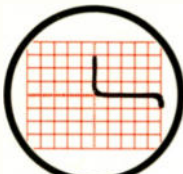

POWER DIODE REVERSE  
200 V./DIV. HORIZ.  
.5 MA./DIV. VERT.

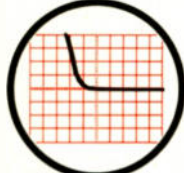

ZENER DIODE FORWARD  
.5V./DIV. HORIZ.  
20 MA./DIV. VERT.

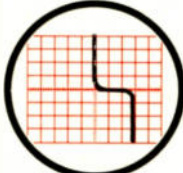

ZENER DIODE REVERSE  
5V./DIV. HORIZ.  
5 MA./DIV. VERT.

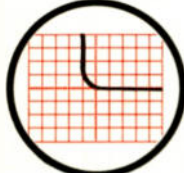

COMPUTER DIODE FORWARD  
.5V./DIV. HORIZ.  
20 MA./DIV. VERT.

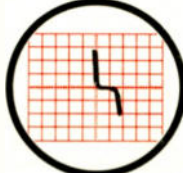

COMPUTER DIODE REVERSE  
50 V./DIV. HORIZ.  
.5 MA./DIV. VERT.

## NEW, LOW COST DIODE TESTER RAPIDLY CHECKS ZENER, POWER, COMPUTER AND TUNNEL DIODES

Checking diodes is quick and easy with this new tester. Accurate to 5%, it plugs into any standard DC oscilloscope. Just flip the five stage selector switch to the proper forward current range (0 to 1.5 amperes), and check the E-I trace on the scope. A touch of the push button rapidly switches to a display of the reverse voltage condition (0 to 1 KV). Release the button and the high voltage is automatically removed.

Priced at only \$135, here's a complete diode testing lab in one complete package. It's perfect for use as a portable "quick check" unit for incoming inspection departments, test labs and service areas. Shipping weight is 7 lbs., complete with two coaxial output cables and an auxiliary diode holder for top-hat devices.

Write for complete details.



**TEST DEVICES, INC.**

3014-B South Halladay Street, Santa Ana, California  
Formerly a subsidiary of Disc Instruments, Inc.

- - - for more details circle 50 on post card

We recently visited a 3-man TV repair shop in an Eastern city. It's a two-partner, one-hired-technician set-up. But this shop is a little unusual.

It is located on a quiet side street about three blocks from the nearest significant traffic. The one small show window displays nothing more than a few pieces of promotional material from a well-known TV manufacturer.

While we alternately listened and talked for two hours, not one inquiring customer entered the front door. We did note that the shop received 10 phone calls.

Most of the shop's interior wall and floor space was occupied by steel racks. A dozen TV chassis were on the racks. One set cooked on a 10-ft work bench while the technician "operated" on another. The rear wall was covered with shelves from floor to ceiling. Steel-drawer-cabinets housed small replacement parts—resistors, capacitors, coils—and other shelf space was stocked substantially with larger parts—including tubes, universal replacement controls, vertical and horizontal output transformers.

"In a sense," said one partner—explaining this off-beat operation—"B&G TV is a 'small-thinking' outfit." "But," he continued, "it has more business than it can handle. And it took years of hard work to arrive at this point. The management likes it that way."

We wanted to know more about how it got that way.

"This organization's customers have always been treated well," the other partner cut in. The shop sells no TVs, radios, or anything except service.

"Some antennas are installed but B&G charges more for antenna installations than any other shop in town. A Grade A job is given every customer and only top-quality material is used. The same goes for TV repairs." "You see," the first partner went on. "B&G doesn't need to advertise. Its customers do the honors by word-of-mouth. This all began about three years after the business was established. It kept growing—a 'snow-balling goodwill,'" the partner concluded.

We have been wondering about this "snow-balling" goodwill. It should be a universal trend.

Perhaps at this time of year, who knows, the voices of goodwill may even rise a few db above today's "missile rattling" din . . . .

The entire staff of ELECTRONIC TECHNICIAN offers seasons greetings to you and yours. We wish you a happy and prosperous 1963.

*The Editors*



The Sprague TCA-1 is specifically designed to safely test capacitors such as tantalum capacitors, low-leakage aluminum electrolytic miniatures, low voltage ceramics and low voltage paper and film capacitors used in transistor and other low voltage circuits. No industrial laboratory or modern electronic service shop can afford to be without one!

**MODEL TCA-1 TRANSFARAD 115 VAC/60 cy \$197.50 net**

**MODEL TCA-1RM FOR RACK MOUNTING**

Electrically identical with the standard instrument Model TCA-1RM has a standard 19" w. x 10½" h. panel so that it can be mounted in the conventional relay rack.

**MODEL TCA-1RM ..... \$207.50 net**  
\*Trademark

**TCA-1 TRANSFARAD\***  
**THE FIRST ANALYZER SPECIFICALLY DESIGNED TO SAFELY TEST TRANSISTOR CIRCUIT CAPACITORS**

- **CAPACITANCE BRIDGE** measures 1μF to 2000μF in five overlapping ranges. Only 0.5 volt is applied to the bridge from a continuously adjustable power supply. The voltage across the capacitor is less than this applied voltage, the amplitude depending on the capacitance being measured. No possibility of overheating or deforming any low voltage capacitor during measurements.
- **INSULATION RESISTANCE** directly read from 50 megohms to 20,000 megohms. Only 25v d-c is applied, permitting measurements on low voltage ceramic, mica, and film capacitors. IR of ceramics rated below 25v may be calculated from leakage current measurements at exact rated voltage.
- **LEAKAGE CURRENT** measured directly on meter at exact rated d-c voltage of capacitor. Sensitive circuit makes full scale measurements from 0.6 μa to 600μa in seven ranges.
- **POWER FACTOR** measured by Wien bridge from 0 to 50 per cent.
- **MAGIC EYE** null detector in high-gain amplifier has sensitivity control permitting accurate measurement of small capacitors.
- **SHORT-TIME STABILITY** is assured by dual regulation of the power supply. Specially processed etched circuits and complete encapsulation of the critical bridge-null amplifier insure long-time stability.
- **BINDING POSTS** are shielded against strays, assuring greater accuracy during low capacitance measurements.
- **FOR SAFETY** the capacitor under test is automatically discharged after testing. Three wire line cord grounds instrument case.
- **OPERATING PROCEDURES** are clearly shown on convenient pull-out slide.

**TO-5 TEL-OHMIKE® CAPACITOR ANALYZER**

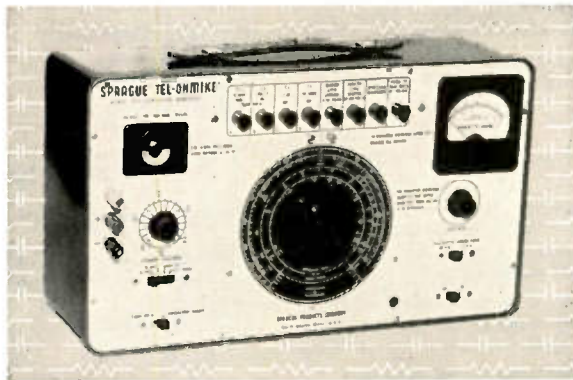

The TO-5 TEL-OHMIKE capacitor analyzer is a must for checking all capacitors except special low voltage transistor types. The TO-5 is a moderately priced instrument with laboratory quality and accuracy—the highest accuracy of any instrument of its type available to the service trade!

**MODEL TO-5RM FOR RACK MOUNTING**

Electrically identical with the standard instrument, Model TO-5RM has a standard 19" wide x 10½" high panel so that it can be mounted in standard relay racks.

**Model TO-5RM.....\$102.50**



- **CAPACITANCE BRIDGE** measures up to 2000 mf in five overlapping ranges. The special 1 mmf to 100 mmf range is exclusive with the Tel-Ohmike.
- **INSULATION RESISTANCE** directly read on large meter up to 20,000 megohms for papers, ceramics, and micas. No guessing with neon lamps.
- **LEAKAGE CURRENT** of electrolytics measured directly on meter, with exact rated voltage up to 600v. applied from continuously adjustable power supply. Two ranges: 0-6-60 ma. No guessing on eye-width or counting lamp blinks!
- **POWER FACTOR** of electrolytics measured by Wien Bridge up to 55% in three ranges.
- **TURNS RATIO SCALE** to measure turns ratio of power and audio transformers.
- **MAGIC-EYE TUBE** simplifies bridge balancing for capacitance and power factor measurements.
- **PUSH-BUTTONS** for instant range selection, also discharge capacitors for safety upon release.
- **MODERN CASE** finished in two-tone gray; measures 8 7/8" high, 14 3/8" wide, 6 1/8" deep. Weight only 12½ pounds.

**MODEL TO-5.....115 VAC/50-60 cy.....\$92.50 net**  
**Model TO-5X.....115-230 V/25-60 cy..... 98.75 net**

**SEE THEM AT YOUR SPRAGUE DISTRIBUTOR**



## LETTERS TO THE EDITOR

### Don't Hot Rod Your PR

Editor, ELECTRONIC TECHNICIAN:

If your editorial on accident statistics (ET, August 1962) causes only a few TV technicians to drive more carefully, it will have served a useful purpose. However, there's another important factor in safe driving that all TV servicemen should think about when driving to and from house calls. That is: public relations.

A driver who is forced to the curb, passed recklessly, or actually run into by a hot-rodding service truck is going to have an unfavorable outlook toward the TV repair business. Undoubtedly, his outlook will be so unfavorable as to make him take his repair business to another company, and even recommend other companies to friends.

Careful, safe driving is just as important to over-all business success as good telephone manners, courteous treatment of customers, and prompt, efficient service.

Perhaps the high mortality rate of small American businesses—especially such highly competitive businesses as TV repair—would be reduced if more attention were paid to the simple principles of good public relations.

R. E. WINTERMEYER

Advertising Department  
Armco Steel Corp.  
Middletown, Ohio

### More New Tubes?

Editor, ELECTRONIC TECHNICIAN:

Will some TV set manufacturer, designer, engineer or anyone else who is in a position to know, kindly explain to me why this never ending, ceaseless flood of new tubes? Years ago, when the panic began, I had a very efficient system going to keep up with the latest developments. Whenever I was called upon to service a set that had a couple of numbers as yet unknown to me, I would jot them down and stock up on the very next time out to the distributor. In this way I would be ready for that same set next time around. What has this five-year hoarding-spree netted me? A trunkload of oddball tubes that grew obsolete before I ever got to open their idle little boxes.

I've got over \$100 worth of tubes stashed away in a corner that may never see the light of day. Two weeks ago I was called in to service a six month old set that had an age overload. Out of all the tubes that I would normally check by substitution I had only one tube with me—just one. When this failed to help I had to decide which one of two courses I should follow. Either I rush down to

# CADRE HAS A PLAN FOR YOU

CB means big business—and many service-technicians—particularly those who sell and service auto radios or who install P.A.—are equipped to enter this lucrative new field of communications equipment.

Cadre, leader in CB, offers you a sensible approach to selling this market—the most powerful all-transistor CB radio, backed up by sales aids that pave the way to big Citizens Band 2-way radio profits.

## CADRE '510' ALL-TRANSISTOR 5-WATT CB 2-WAY RADIO

**POWERFUL**—Highest transmitter power authorized by FCC, 5-watts, provides maximum "talk" range—up to 20 miles (30 on water). Extra transmission punch through speech clipping. 5 crystal-controlled transmit/receive channels assure bull's-eye communications. Rugged microphone has "press-to-talk" switch and retractable cord. Audio power is a full 2.5 watts.

**SELECTIVE**—Dual-conversion superheterodyne receiver circuit with new tuned ceramic filters provides clear reception without adjacent channel interference. Automatic Noise Limiter suppresses external interferences. Adjustable squelch silences speaker for noise-free standby reception. Manually tunes in all 23 CB channels.

**VERSATILITY**—Built-in dual power supply, 12VDC/110-220VAC, for mobile or base station. Portable pack accessory with rechargeable batteries for field use.



**RELIABLE**—Negligible heat, no tubes to burn out because it's 100% transistorized—18 transistors, 8 diodes. Printed board, modular construction. Absorbs road shock without damage.

**COMPACT**—Slimmest, trimmest full-power unit takes up little leg room in car or truck. Fits conveniently on desk.

**ECONOMICAL**—Approximately 20% battery drain of a tube unit. Low current drain prolongs vehicle battery life. Also costs less to operate on AC.

## CADRE PROMOTION SUPPORTS YOU

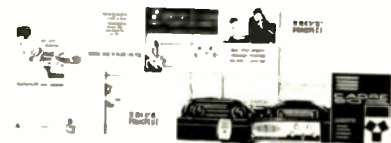

**ADVERTISING**—ads in all magazines reaching CB users, potential CB users—doctors, trucking companies, fleets, mariners.

**DISPLAY**—unique point-of-sale display '510' mounted on a simulated dashboard will attract customers to the Cadre display in your store, accommodates Cadre literature.

**MAILINGS**—Cadre supports you with an effective mailing program consisting of letters specially tailored to specific markets, imprinted on your letterhead if you wish.

**STUFFERS**—Cadre will supply you with descriptive, colorful line stuffers which you can give away or mail to your customers and prospects. Fit into point-of-sale display.

**BOOKLET**—Informative booklet of interest to everybody who owns CB equipment or is contemplating purchase of CB equipment will be featured in national advertising.

**AD MATS**—Effective ad mats for hard-hitting local newspaper advertising.

Wire . . . write today . . . phone for further information.

**CADRE**

INDUSTRIES CORP., COMMERCIAL PRODUCTS DIVISION, ENDICOTT, N.Y. AREA CODE 607. 748-3373

Canada: Tri-Tel Assoc., Ltd., 81 Sheppard Ave. West, Willowdale, Ont. Export: Morhan Exporting Corp., 458 Broadway, N.Y. 13, N.Y.

— for more details circle 19 on post card



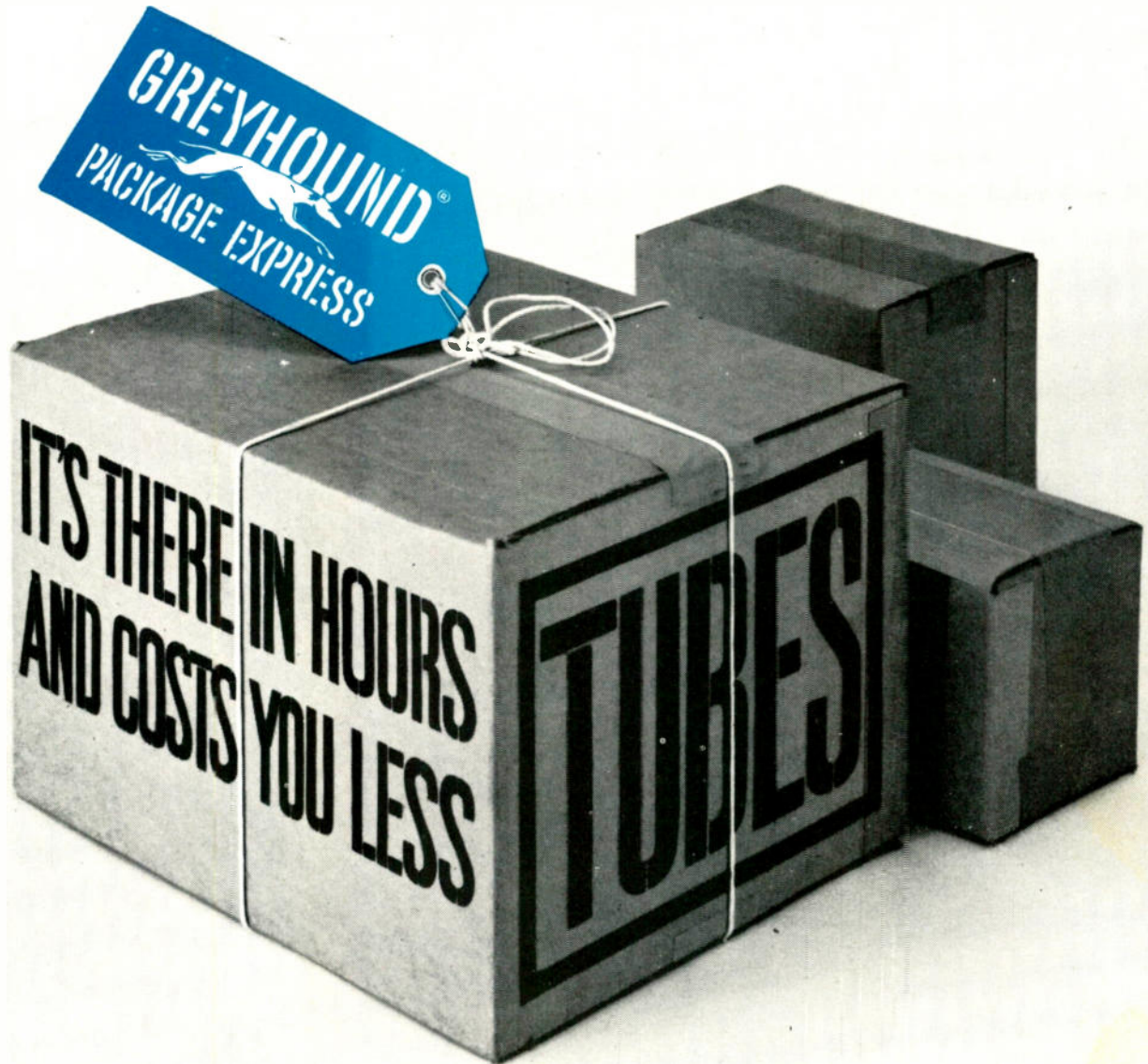

**SHIPMENTS LEAVE SOONER, GET THERE FASTER, COST LESS, TOO!**

	Buses Daily	Running Time	15 Lbs.	25 Lbs.	35 Lbs.
<b>BOSTON NEW YORK</b>	18	5 hrs. — min.	\$1.80	\$2.10	\$2.35
<b>PITTSBURGH CLEVELAND</b>	14	2 hrs., 55 min.	\$1.60	\$1.85	\$2.15
<b>CHICAGO ST. LOUIS</b>	8	6 hrs., 10 min.	\$1.90	\$2.15	\$2.45
<b>LOS ANGELES SAN DIEGO</b>	38	2 hrs., 30 min.	\$1.25	\$1.45	\$1.70
<b>CINCINNATI LOUISVILLE</b>	15	2 hrs., 40 min.	\$1.50	\$1.70	\$1.95

Greyhound Package Express not only saves you time and money, it could be the answer to your inventory control problems, too. Packages very often arrive the same day shipped. They travel in spacious compartments on regular Greyhound buses. That means you can ship any time...twenty-four hours a day, seven days a week, weekends and holidays. Ship C.O.D., Collect, Prepaid, or open a charge account. Be sure to specify Greyhound Package Express. **It's there in hours...and costs you less!**



**CALL YOUR LOCAL GREYHOUND BUS TERMINAL TODAY...OR MAIL THIS CONVENIENT COUPON TO:**

**GREYHOUND PACKAGE EXPRESS**

Dept. 17-M

**140 S. Dearborn St., Chicago 3, Illinois**

Gentlemen: Please send us complete information on Greyhound Package Express service...including rates and routes. We understand that our company assumes no cost or obligation.

NAME \_\_\_\_\_ TITLE \_\_\_\_\_

COMPANY \_\_\_\_\_

ADDRESS \_\_\_\_\_

CITY \_\_\_\_\_ STATE \_\_\_\_\_ PHONE \_\_\_\_\_

... for more details circle 28 on post card



## How 6½ sq. ft. can speed up your picture-tube service:

10 versatile "Universal" picture-tube types from Sylvania's SILVER SCREEN 85 line may be all you need to fill 52% of your renewal needs! This fact, verified by a recent industry survey, stems from a remarkable streamlining of the Sylvania line—making fewer, more versatile types that can be used as replacements for many others. Already 54 types can replace 217.

Think what the versatility of these "Universal" tubes

can mean. An in-shop inventory of a few popular types can help you quickly take care of most of your renewal calls. Ordering is simplified...and distributor calls for special tubes can be cut way down.

Start profiting now from Sylvania's SILVER SCREEN 85 picture tubes. Call your Distributor and put an inventory in your own shop—where it can enhance your reputation for fast service and quality replacements.

**SILVER SCREEN 85 Picture Tubes are made only from new parts and materials except for the envelopes which, prior to reuse, are inspected and tested to the same standards as new envelopes.**



use it for **SILVER SCREEN 85<sup>®</sup> tubes...**  
 (10 "Universal" types meet half of all renewal needs)



The "Big 10" Tubes that fill  
 52% of all renewal needs:

- 21CBP42
- 21ZP4B
- 21ACP4A
- 21YP4A
- 21AUP4A
- 24AEP4
- 21DEP4A
- 21DFP4
- 21EP4B
- 21FP4C



# SYLVANIA

SUBSIDIARY OF  
**GENERAL TELEPHONE & ELECTRONICS**



# Arcolytic<sup>®</sup>

Available from all authorized ARCO distributors



## 1401 Values... The largest selection of exact replacement twist-mount & tubular electrolytics

■ 99.99% high purity aluminum foil electrolytics at no extra cost! ■ Choose from stock any single, dual, triple or quadruple capacitance-voltage combination for replacement in television, radio, and other electronic equipment ■ Made to withstand high ripple and high surge voltages ■ Designed for 85°C high temperature operation ■ Greater shelf and operating life because only premium grade ingredients are used ■ Built and tested to meet EIA Specification RS-154 ■ Individually packaged with mounting plates for your convenience ■ Unconditionally Guaranteed.

Manufactured by  
**ARCO** ELECTROLYTIC DIVISION  
electronics inc.  
Community Drive, Great Neck, New York • HUinter 7-0500  
Branches:  
Dallas 7  
Los Angeles 35

## LETTERS TO THE EDITOR

the distributor and pick up a complete set of tubes at a cost to me of 15 to 20 dollars or abandon the job, and with it, the customer. I chose the latter course and couldn't even collect a service charge. Only yesterday I was called in on a four month old set that had no vertical sweep. I had never even heard of the tube type used as vertical oscillator and output, but since the possibilities were narrowed down to this one tube, I gambled on returning the next day with a new tube. The gamble didn't pay off. It wasn't the tube and the customer preferred to take it up with the store where she purchased the set. Another tube goes into my stockpile of obsolescence.

Granted, the TV art has seen some wonderful improvements since it came on the scene, but seriously now, is a 6DK6 really that much better than a 6DE6, or a 6CF6, or a 6CB6A, or a 6CB6? Please don't print my name. I wouldn't want it thought that I stand in the way of "progress."

(Name withheld)  
New York, New York

### Making Parts Available

Editor, ELECTRONIC TECHNICIAN:

Referring to Evangeline Electronics' "Letters to the Editor" comments on your very helpful listing of Japanese Radio Manufacturers in the September 1962 Edition of ELECTRONIC TECHNICIAN, I would like to submit the following information as a means of "completing" the listing and to pass along general information to the electronic service industry.

Matsushita Electric Industrial Co., Ltd., Japan, markets their electronic products, including radios and television receivers, in eighty seven (87) countries under the brand name of NATIONAL; except in the United States and Canada, where the products are marketed under the brand name of MATSUSHITA and/or PANASONIC. The executive and sales office of Matsushita Electric Corporation of America is presently located at: 41 East 42 St., New York 17, N. Y. The replacement parts and service sections of the office of technical services are located at: 67 Irving Place, New York 3, N. Y.

For dealer and consumer convenience, a national network of independent PANASONIC Service Centers are now being organized to service our products. Upon completion of this project, replacement parts for MATSUSHITA and PANASONIC brand products marketed in the United States will be made available to the entire service industry through our PANASONIC Service Centers.

SOI FIELDS  
Manager

... for more details circle 12 on post card

# BETTER THAN EVER IN 1963

## RENEW YOUR MEMBERSHIP NOW!

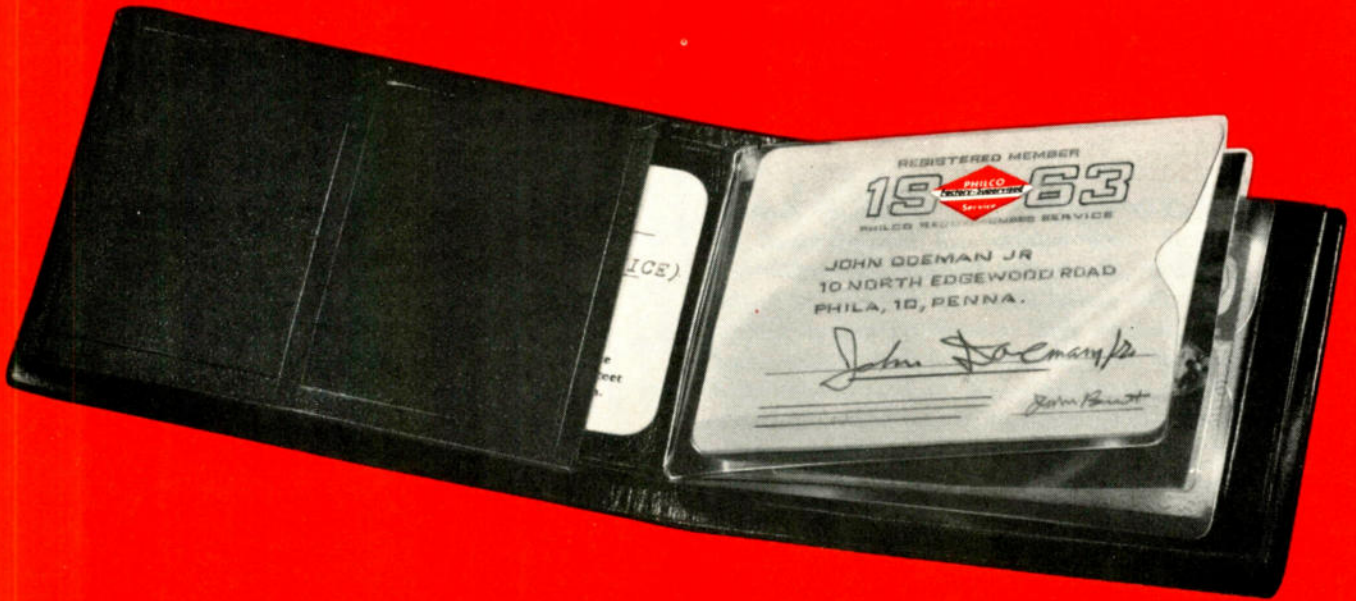

Join up now...for another helpful year with

# P. F. S. S.

(PHILCO FACTORY-SUPERVISED SERVICE ASSOCIATION)

...the most valuable business-building/service data "franchise"  
in the consumer product industry!

**Choose from three membership categories:** Electronics membership; Appliance membership; Laundry membership; or any combination.

**Complete Philco Product Service Information.** Direct to you each month by mail. You get them all: service manuals, model spec sheets; production bulletins, parts lists.

**Full-Year Subscription to Improved PHILCO SERVICE-BUSINESSMAN MAGAZINE.** You get all six issues. Technical articles and servicing short-cuts; articles on successful business management proved by reports from Philco's National Service Panel.

**Valuable Personal Identification as a Competent Professional**... and a Qualified Member of the PFSSA. Includes personalized Pocket ID Card, Wall Certificate, Counter Sign, Truck/Car and Window Decals, special direct mail material.

**Business and Technical Helps at Special PFSS Volume-Purchase Prices!** Shop Repair Tags, Service Work Orders, Business Stationery and many other items.

**PFSS Association Accidental Death Medical Expense Insurance at special group rates.**

**Opportunity to List under PFSS Trade Mark in "Yellow Pages" (where available).**

**Special Stencil on Back of Philco TV Sets Recommends Service by PFSS Members.** "Should this Product Require Service or Adjustment Call the Serviceman Who Displays This Registered PFSS Trademark"... on Philco sets means added business for PFSS members.

**User Instruction Booklets Recommend PFSS Member for Service.** Packed with every Philco product, the User Instruction Booklet includes added recommendation that the owner call a PFSS Service Shop.

**Local Service Training Meetings sponsored by your Philco Distributor.**

**Service Work Referrals by Philco Distributor.** Plus participation in Philco's Direct Pay Factory Service Programs (Philco paid over \$1,000,000 in direct-pay Service Payments to PFSS members in 1962 under Philco guarantee programs).

**YOUR MEMBERSHIP IN THE PHILCO FACTORY-SUPERVISED SERVICE ASSOCIATION MEANS:**

1. That you have qualified as a preferred service outlet.
2. That you are publicly identified through PFSS as a leading service business.
3. That you maintain a working partnership with Philco... the manufacturer who has demonstrated the greatest interest in the independent service businessman.



JOIN UP NOW FOR 1963... See your Philco Distributor Today



PARTS AND SERVICE OPERATIONS

# PHILCO

A SUBSIDIARY OF *Ford Motor Company*

... for more details circle 39 on post card



# TUNING IN

*A DIGITAL COMMAND SYSTEM for the Gemini two-man orbital space vehicle will be developed by Motorola's Military Electronics Division for McDonnell Aircraft Corp. The digital units will be installed in the space craft to receive and convert command signals from the ground for control of various space craft systems. Proven electronic items, such as a command receiver, successfully employed in the Mercury Space Capsule Program will be used to meet the very high reliability requirements.*

*INVISIBLE INFRARED BEAMS triggered from a bazooka, rifle or cannon can now help "war game" judges keep the score straight. Raytheon Co. has announced development of "TILT" infrared devices to replace live cartridges and shells during these experiences. As the electromagnetic beams bombard a tank, truck or other target, they set off a signal which tells orbiters of the hit and the extent of damage. At the same time, the beams "freeze" the target's weapons from further action. The rapid actions also enables judges to quickly determine effectiveness of a tactical maneuver.*

*AN ELECTRONIC REGISTER SYSTEM, which allows hospital personnel to centrally record their entering and leaving the building and which indicates if messages are waiting, is now available from Dictograph*

## UNDERWATER EARS

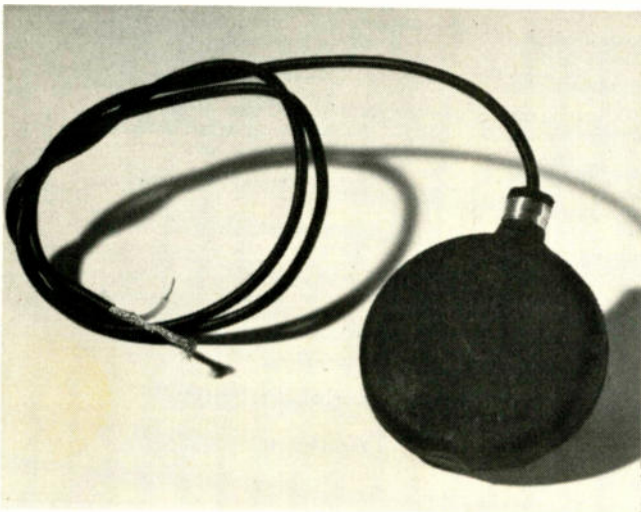

*New omnidirectional, high-sensitivity hydrophones for sensing underwater low-frequency signals have been developed by General Dynamics/Electronics — Rochester. Seen here is a lollipop-shaped hydrophone for applications where space is at a premium.*

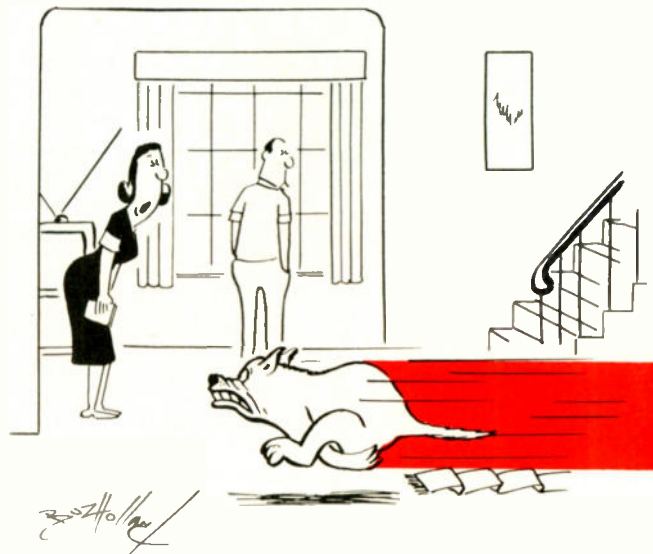

*"I think the TV repairman is at the door, George."*

*Products Inc. The system permits doctors and staff to register into a building by dialing an assigned code number. The registration station responds by displaying the number dialed; a check for accuracy. If there is a message for the individual registering, it will be indicated by a flashing light. To get the message, he picks up a handset located on the station and speaks directly to the operator. The same procedure is followed on leaving the building.*

*TRANSMITTING NEWS MATTER over telephone lines from New York to Los Angeles was recently started by the New York Times for its new western edition. Operating at a speed of 1000 words per minute, Digitronics Corporation's Dial-v-verter completed the transmission of 96,000 words in an hour and a half. Conventional facilities would require 15 hours of transmission time.*

*A TRANSISTORIZED COMPUTER that automatically records individual or team scores in bowling, provides each player with a printed record, and projects scoring to an overhead screen, has been developed by Brite-Lite Corp. of America. Heart of the system is a small, special purpose wired program digital computer. The miniaturized computer fits into a box which*

# THE PICTURE

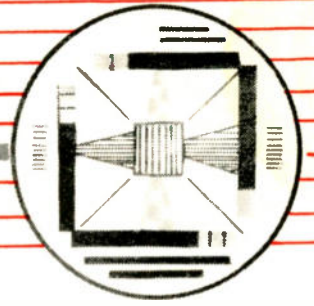

can be easily plugged into the console and easily replaced by the bowling lane operator should maintenance or servicing be required.

A COMPUTER TEST SET smaller than a shoe box is being built by RCA for the U. S. Navy Electronics Laboratory, San Diego, Calif., to monitor transmission within large data communications and processing systems. Through use of the tiny wafer circuits, or micro-modules the set's size will be kept to 4 x 4 x 8 in. and its weight to 9 lb. The device will accommodate one output and 32 input signals, with a total of five distinct operating functions. This capability is made possible by the use of 94 micromodules incorporating 143 digital circuits.

*WHITE-ROBED "DOCTORS" at General Dynamics/Electronics are using familiar medical instruments in an approach to improve reliability in electronic airborne radar systems. One of the key problem areas in manufacturing airborne radar antennas is to detect crippling air leaks around the edge of the antenna's vacuum chamber. Another is to permanently seal these tiny leaks. A technician, looking for a solution to these problems, came up with the idea of using a*

## TRANSISTORIZED TWO-WAY RADIO

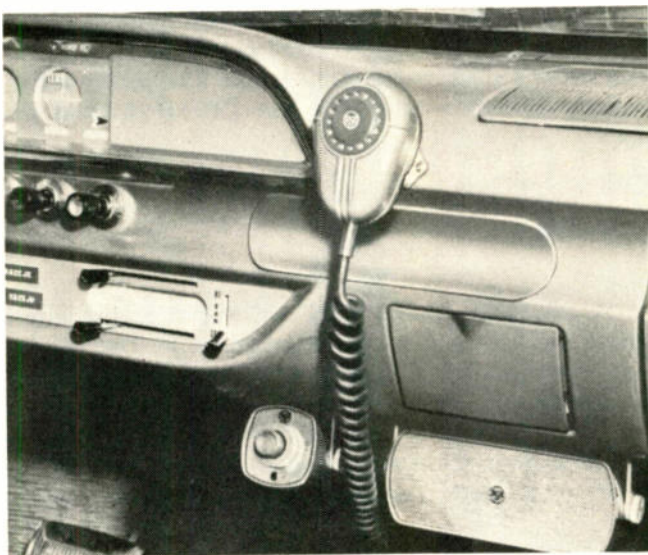

A new two-way radio has been announced by RCA's Mobile Communication Products division called "Super-Carfone," the new unit is available in 30 and 60 w models. It utilizes all-transistor receiver and power supply circuits, plus maximum transistorization in the transmitter. When the radio is turned on and volume adjusted, it goes on "gentle to the battery" standby. To transmit, the user removes the mike from the dash, pushes the mike button and is on-the-air immediately.

## CALENDAR OF EVENTS

- December 6-7: PGVC (PG on Vehicular Communications) conference, Mayfair Hotel, Los Angeles, Calif.
- January 21-24: 9th National Symposium on Reliability and Quality Control, Sheraton Palace Hotel, San Francisco, Calif.
- January 30 —  
February 1: 4th Winter Convention on Military Electronics, Ambassador Hotel Los Angeles, Calif.
- February 4-10: Western Electronic Week, Shrine Exposition Hall, Los Angeles, Calif.
- February 7-10: Pacific Electronic Trade Show, Shrine Exposition Hall, Los Angeles, Calif.
- February 18-20: American Standards Association, Biltmore Hotel, New York.

*medical stethoscope to isolate the sound of air entering the vacuum chamber between the front and back reflectors. The instrument has proved invaluable in locating fabrication defects. After the leak is pin-pointed, a hypodermic needle is used to inject resin along the edge of the plastic radar "dish" to seal any defective pin-holes in the coating.*

A NEW "FLASH" TECHNIQUE, which may revolutionize the printing of electronic circuits, has been announced by the Armour Research Foundation of Illinois Institute of Technology. Using a device similar in principles to the electronic flash lamps employed in photography, but considerably more powerful, extremely high temperatures are developed in a very short time. Using this flash technique, various metallic compounds, including compounds of copper, can be broken down. Copper oxide, for example, ground and used as a pigment in a paint, can be applied to a ceramic circuit board. A light-reflecting shield in which a circuit pattern is cut is superimposed on a copper coated board. The pattern to act as a conductor. The excess coating is then removed with a solvent.

*A WALKING STICK for self defense capable of sending a 4000 v charge through a human or animal has been produced by Freeman Electric Co., Freeman, Mo. Called a "Shock-Rod," the walking stick weighs 10 oz. and is 29 in. long. The stick operates on two photo flash batteries and features a transistorized circuit.*

THE TELSTAR COMMUNICATION SATELLITE can relay business-machine-type data across the Atlantic at the rate of 1,460,000 English words per minute—faster than 18,000 stenographers could simultaneously type the data. The "messages" for the experiment were generated in England by equipment supplied by Bell Telephone Laboratories in a 20-minute test, with reception accomplished at Bell's Andover, Me. station.

# MANUFACTURERS TECHNICAL DIGEST

## MOTOROLA

### Chassis TS-568A-06 — Reducing Busy Background

To reduce busy background in these chassis, change R104 (120K) to 220K; R105 (100K) to 180K; R121 (1.5 meg) to 2 meg and R122 (15 meg) to 12 meg; R130 (18K) should be added between the control grid of V4 (2nd IF) and the suppressor grid (pin 7) of V4.

## RCA

### CTC10, 11 and 12 Color TV — AGC Noise Stabilization

The inherent characteristics of a 6DT6A are used in CTC10 & CTC11 color receiver chassis to attain both keyed agc and automatic noise cancellation ac-

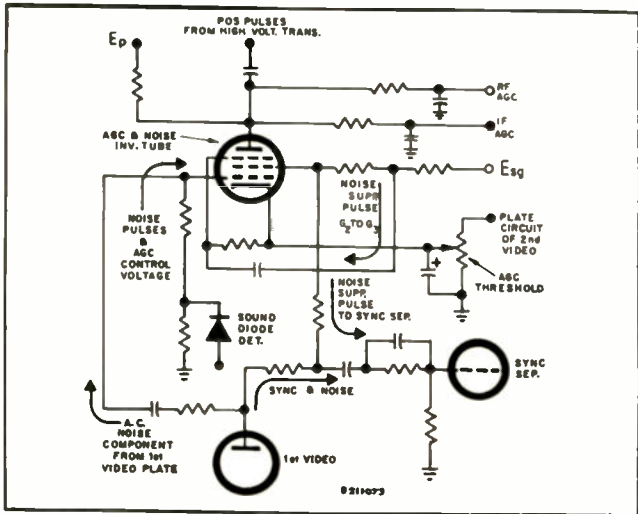

RCA color TV Noise stabilization and agc simplified circuit.

tion from the same tube. When the high-level positive pulses from the horizontal output transformer are applied to the plate of the 6DT6A, agc and Noise Inverter Tube, current within the 6DT6A tube provides keyed agc action from the plate circuit; current flowing through the 6DT6 screen circuit inverts the noise to provide for noise cancellation.

Noise cancellation is accomplished by applying the unlimited noise impulses (positive in polarity), obtained from the sound detector circuitry, to the 6DT6 grid. Once inverted and strengthened, the noise pulses on the 6DT6 screen become noise cancellation impulses which are fed into the sync separator grid

circuitry and used to cancel noise picked up with the sync information at the first video amplifier's plate. Coupling negative going noise pulses from the screen to the suppressor grid gives agc noise cancellation by cutting off the plate current during noise pulses. Strong continuous pulses rectified at the sound diode form a strong positive d-c component across the sound diode load resistor which, when applied to the 6DT6 grid tends to increase the agc voltage; this decreases the over-all i-f amplification. Therefore, to reinforce noise cancellation operations under these conditions, some a-c coupled noise pulse information is also applied to the 6DT6 grid from the first video amplifier's plate.

The noise cancellation circuitry is fully automatic in its operation; the formation of agc and the operation of the noise cancellation circuitry, in a sense, function independently. Inversion signals used to cancel noise are kept at the amplitude required for optimum sync stabilization by the operational characteristics of the 6DT6A tube and its associate circuit parameters. As the noise increases, the amplitude of the inverted noise pulses increases automatically.

The pentode section of the 6KA8 triode-pentode tube, is employed in the CTC12 color chassis to provide keyed agc and noise stabilization. The performance of these circuits is similar in the CTC10, 11 and 12 chassis.

## SYLVANIA

### Model 15T621 — Correcting Drift

A condition of FM drift, with possible oscillator failure may be encountered in model 621. The condition normally develops after the set is operated for an hour or more.

This condition is corrected by installing a .002 capacitor from the screen, (pin 6), of the FM driver, (V202) to ground. In addition, install a filament choke, (Part No. 360522-9) in series with the filament lead between P7 of the printed i-f board and pin 4 of the 6BE6.

The FM IF Section of the tuner must then be realigned to insure satisfactory instrument operation.

This condition may be noticed on other instruments using the 59 series (with agc) and in such cases the correction would be the same.



ALL YOU  
NEED FOR

# COLOR-TV SERVICING



## RCA Color-Bar/Dot/ Crosshatch Generator

Low-cost, lightweight, portable instrument that provides all essential Color-TV test patterns. Simple to operate: only 3 controls. RF output leads connect directly to antenna terminals of receiver; no external sync leads required. Crystal-controlled signals assure rock-steady patterns, free from "jitter" and "crawl." Extra-wide-range chroma control. Generates:

- **Color-bar pattern:** ten bars of color, including R-Y, B-Y, G-Y, I and Q signals spaced at 30° phase intervals for checking phase and matrixing, and for automatic frequency and phase alignment. Permits accurate alignment of the "X" and "Z" demodulators which are used extensively in RCA Victor and many other makes of color TV receivers
- **Crosshatch pattern:** a grid-like pattern of thin sharp lines for adjusting vertical and horizontal linearity, raster size, and overscan
- **Dot pattern:** a pattern of small sized dots facilitating accurate color convergence adjustments

\$189.50\* with output cables.

## RCA 5-Inch Oscilloscope for Color-TV

A wideband scope excellent for checking colorburst signals and general troubleshooting of wideband color circuits and other electronic equipment. Mult-scale calibrated graph screen makes measurement of peak-to-peak voltage as easy as with a VTVM.

- New 2-stage sync separator assures stable horizontal sweep lock-in on composite TV signals
- Dual bandwidth: 4.5 Mc at 0.053 volt rms/in. sensitivity. 1.5 Mc at 0.018 volt rms/in. sensitivity
- Continuously adjustable sweep frequency range: 10 cps to 100 Kc
- 3-to-1 voltage-calibrated, frequency-compensated step attenuator for "V" amplifier
- Simplified, semi-automatic voltage calibration for simultaneous voltage measurement and wave-shape display
- Vertical-polarity reversal switch for "upright" or "inverted" trace display

\$249.50\*, including direct/low capacitance probe and cable, ground cable, and insulated clip.

## RCA Television FM Sweep Generator

Specifically designed for visual alignment and troubleshooting of color and black-and-white TV receivers, and FM receivers. The RCA WR-69A has pre-set switch positions for all VHF TV channels, FM broadcast band, and TV frequencies. The WR-69A has these important features:

- IF/Video output frequency continuously tunable from 50 Kc to 50 Mc
- Sweep-frequency bandwidth continuously adjustable from 50 Kc to 20 Mc on IF/Video and FM; 12 Mc on TV channels
- Output level—0.1 volt or more
- Attenuation range: TV channels, 60 db IF/Video, 70 db FM, 60 db
- Return-trace blanking
- Two adjustable bias voltages on front panel

\$295.00\* including all necessary cables.

## RCA RF/VF/IF Marker Adder

Designed for use with a marker generator (such as RCA's WR-99A) and a sweep generator (such as RCA's WR-69A), this instrument is used for RF, IF, and VF sweep alignment in both color and black-and-white TV receivers. In visual alignment techniques, it eliminates distortion of sweep response pattern.

Important features:

- Choice of four different marker shapes provided by front panel switch for different types of sweep-response curves and for positive and negative sweep traces
- Provides very high-Q markers of high-amplitude and narrow bandwidth
- Complete front panel control of marker shape, marker amplitude, marker polarity, sweep amplitude, and sweep-trace polarity

\$74.50\* complete with cables.

## RCA Crystal-Calibrated Marker Generator

Supplies a fundamental frequency RF carrier of crystal accuracy for aligning and troubleshooting color and B&W TV receivers, FM receivers and other electronic equipment in the 19-260 Mc range. Combines functions of multiple-marker generator, re-broadcast transmitter, and heterodyne frequency meter.

- Highly stable output
- May be calibrated at 240 separate crystal check points—accurate calibration provided at 1-Mc and 10-Mc intervals
- Matched-impedance pad-type attenuator and double shielding of the oscillator provide effective attenuation of all frequencies
- Most-used IF and RF frequencies are specially indicated on the dial scale
- Sound and picture carrier markers available simultaneously

\$242.50\* complete with output cable and phone tip.

RCA ELECTRON TUBE DIVISION, Harrison, N. J.



The Most Trusted Name in Electronics

\*User Price (Optional)

# 4 ways to increase your income

RCA Institutes, Inc. offers these four comprehensive home study courses especially designed to help build your income immediately!

 <p><b>COLOR TV</b> Add Color TV Servicing to your skills with this up-to-the-minute home training course and take advantage of the growing profit potential in this area! Train under the direction of RCA... experts in Color TV.</p>	 <p><b>TRANSISTORS</b> You get the necessary background for semiconductor technology including characteristics of tunnel diodes, rectifiers and other solid state devices. Transistor trainer also available.</p>
 <p><b>AUTOMATION ELECTRONICS</b> Trains you for the many applications of automation electronics in industry and government including Photoelectronics, Digital Computer Techniques, Synchros and Servomechanisms, Automatic Control Systems, and many more!</p>	 <p><b>MOBILE COMMUNICATIONS</b> Trains you to service and maintain 2-way radio communications on land, sea, and air! Gives you the technical foundation for space communications!</p>

Take advantage of RCA's Liberal Tuition Plan. You only pay for lessons you order; and have no long-term obligations. Licensed by New York State Education Department. Approved for Veterans.

## RCA INSTITUTES, INC.

A Service of Radio Corporation of America  
350 West Fourth Street, New York 14, N. Y.



The Most Trusted Name in Electronics

SEND THIS COUPON NOW FOR COMPLETE FREE INFORMATION

RCA INSTITUTES, INC. Home Study School, Dept.  
350 West Fourth Street, N. Y. 14, N. Y.

Without obligation, rush me free information on the following RCA Home Training Course: COLOR TV TRANSISTORS MOBILE COMMUNICATIONS AUTOMATION ELECTRONICS

Name \_\_\_\_\_ Age \_\_\_\_\_

Address \_\_\_\_\_

City \_\_\_\_\_ Zone \_\_\_\_\_ State \_\_\_\_\_

CANADIANS—Take advantage of these same RCA courses at no additional cost. No postage. No customs. No delay. Send coupon to: RCA Victor Company, Ltd., 5581 Royalmount Ave., Montreal 9, Quebec.

## AUDIO NEWS LETTER

**GENERAL ELECTRIC CO.** announces a combination TV-radio-phono home entertainment center, designed to retail at less than \$900. The combination is "hutch" styled in genuine wood. It will be available in a choice of early American maple or Danish modern walnut. In addition to 21-in. color and monochrome television, GE's new combination offers high fidelity stereo record reproduction, monaural AM, FM, or FM Stereo radio. The combination will be available with and without a tuner.

**ALTEC LANSING CORP.** reports that "REVOCON," a new engineering concept for remote volume control for sound systems, is the subject of a patent allowed by the U. S. Patent Office. The device, said to represent one of the most significant advances in sound system development in over a decade, was invented by Alex Badmaieff, holder of 27 patents in the fields of electronics, acoustics, optics and mechanics, and is Chief Engineer of the firm's Acoustics-Transducers. The unit provides a means for controlling the gain of an amplifier from a point away from the amplifier's location.

**GENERAL ELECTRIC CO.** asks the Federal Communications Commission to take the necessary steps to adopt standards for compatible stereophonic sound transmission for television. At the same time, GE has proposed a system for TV stereo sound. The Company says the development program which resulted in its proposed TV Stereo sound system had three main objectives: (1) To develop a compatible system which could be used for stereo sound reception but which in no way would diminish or degrade the existing broadcast service to monophonic receivers; (2) To develop a system which would provide inexpensive stereo receivers at a price "which would put TV stereo within the reach of the entire public"; and (3) To develop a system which would not impose an unreasonable economic burden upon existing broadcast stations should they wish to add stereophonic service.

**SHERWOOD ELECTRONIC LABS, INC.,** is showing an experimental receiver, known as model XP-1 which features not only FM stereo multiplex and AM reception but also dual 100 w music-power output. Other features are in its timer-clock control, push-button triple speaker-system selector, dual tuning meters and self-contained, motorized fan to cool the output transistors and power supply.

**ROBINS INDUSTRIES CORP.** announces that 16 items in its line will be gift wrapped. According to Herman D. Post, president, the gift wrapping of these items is part of the company's program to make its customers aware of the sales possibilities offered by low cost, impulse-packaged audio accessories. Among the 16 items are: three "Stereo Four Tape Kare Kits"; two splicers; a bulk tape eraser; a head demagnetizer; the "Hi-Fi Stop-O-Matic"; the "Record Care Kit" and the "Instant Stereo Models" for Polaroid Land Cameras.

**JENSEN INDUSTRIES** is introducing a needle that will play stereo records monaurally on monaural phonographs. The needle reportedly was developed to allow hi-fi fans who have not yet converted to stereo to enjoy new stereo only records. The stereo needles have built-in "give" to prevent damage to records.

**FAIRCHILD RECORDING EQUIPMENT CORP.** introduces the "F-7" low mass, transistorized cartridge system. "This cartridge will now bring stereo disk reproducing on a parallel with the master stereo tape recording," according to the manufacturer. The cartridge generates an output voltage of only 0.5 mv and uses a transistorized preamp to increase this to 10 mv. Tracking force is 0.5 g to 2 g, separation is 20 db minimum over the reproduction range and frequency response is given as  $\pm 1$  db, 20-20,000 cps.

# NOW EVERYONE CAN QUICKLY Set up and Service Color TV



**1 PATTERN DISPLAY STANDARD**  
Shows correct pattern and color in window viewer for visual guide

**2 PATTERN SELECTOR**  
Produces each pattern individually for quick, easy convergence

**3 AUTOMATIC DECONVERGENCE**  
Simplifies static and dynamic convergence. No digging into set

**4 COLOR SELECTOR**  
Produces each color one at a time for accurate color set-up

**5 COLOR GUN KILLER**  
Automatically enables the technician to actuate any combination of the 3 guns

**6 DEMODULATOR ALIGNMENT**  
Makes alignment extremely simple, without going into the color set

## New! **B&K** Model 850 COLOR GENERATOR

*Most Complete, Most Versatile, Portable Instrument for Use in the Home and in the Shop  
Makes Color TV Set-up and Service Easier, Faster than ever!*

Now every service technician can be ready to set-up and service color TV with amazing new ease and speed! New advanced design simplifies the entire operation, saves time and work in every installation. Eliminates difficult steps in digging into the color TV set. Gives you new confidence in handling color.

**Produces Patterns, Burst, and Colors Individually**—Provides dot pattern, crosshatch, vertical lines, horizontal lines, burst signal, and individual colors—one at a time—on the instrument panel as well as on the TV color set—for fastest, easiest check. Unique window-viewer on front of the instrument panel shows you each pattern and color as it should be—gives you an exclusive display standard to use as a sure guide for quick, visual comparison.

**Provides Accurate, Individual Color Display**—Produces Green, Cyan, Blue, B—Y, Q, Magenta, R—Y, Red, I, Yellow, and Burst—one at a time. All colors are crystal-controlled and are produced by a precision delay-line for maximum accuracy. Each color is individually switch-selected—no chance of error.

**Provides Accurate NTSC-Type Signal**—Color phase angles are maintained in accordance with NTSC specifications.

**Makes Convergence and Linearity Adjustments Easy**—Highly stable crystal-controlled system with

vertical and horizontal sync pulses, assures the ultimate in line and dot stability.

**Simplifies Demodulator Alignment**—The type of color display produced by this instrument provides the ultimate in simplicity for precise demodulator alignment.

**Provides Automatic Deconvergence**—Eliminates the necessity for continual static convergence adjustments. The instrument automatically deconverges a white into a color dot trio without digging into the color set to mis-adjust the convergence magnets. It also deconverges a white horizontal or vertical line into red, green and blue parallel lines. This greatly simplifies dynamic convergence adjustments.

**Provides Exclusive Color Gun Killer**—Front-panel switch control makes it easy to disable any combination of the three color guns. Eliminates continuous adjustment of the background or screen controls, or connection of a shorting clip inside the receiver. The switch also selects the individual grids of the color tube and connects to a front-panel jack to simplify demodulator alignment.

**Provides Switch-Selected R.F. Signals**—Factory-tuned, for channels 3, 4, and 5—for open channel use in your area.

Model 850 also includes other features that make it invaluable for home and shop use. Net, **\$199<sup>95</sup>**

See Your B&K Distributor  
or Write for Catalog AP20-T



**B & K MANUFACTURING CO.**

Division of DYNASCAN CORPORATION

1801 W. BELLE PLAINE AVE. • CHICAGO 13, ILL.

Canada: Atlas Radio Corp., 50 Wingold, Toronto 19, Ont.

Export: Empire Exporters, 277 Broadway, New York 7, U.S.A.

... for more details circle 15 on post card

# Sarp\*

## SPELLS TROUBLE!

\*  
**Suburban Area Reception Problems are growing, but you can turn them to your advantage IF—you have the new answers.**

Once, a very, very short time ago—before SARP—it was the dealers in the far-out, weak-signal areas who had a virtual monopoly on TV reception complaints.

For dealers in suburbia (like you, maybe), life was relatively uncomplicated. Color programming, after all, was still in diapers—FM only a 2-letter word to most radio listeners. FM Stereo? It was still an experimental gleam in an engineer's eye.

And then, practically overnight—WHAM!—comes the big change! People suddenly buying COLOR TV like mad. FM coming of age. And with it, a rash of FM STEREO stations breaking out all over the compass. That's progress. That's good. But growth brought new complications. SARP!...Suburban Area Reception Problems.

### COLOR TV PROBLEMS

1. *Gain "suckouts" and dips.* A color antenna must have minimum variation on each channel. Extreme variations ("suckouts" and dips) which may hurt black-and-white performance to some degree—may positively ruin color reception—by knocking out one or all of the color signals. Critical impedance matching is vital since mismatch is the usual cause of excessive gain variation.

2. *Ghosts*—they're "murder" in color. Black-and-white ghosts are often tolerable—but in color TV ghosting affects each frequency differently. And that means *each* color. Some are strengthened, some weakened, some distorted, or lost altogether.

Ghosting occurs when the phase relationships between each color carrier are upset by unwanted reflected signals.

### FM STEREO PROBLEMS

1. *Loss of gain* due to the 20 DB signal loss inherent in the Multiplex circuit in FM Stereo receivers.

2. *Multi-path reception*—signal reflections which distort and even nullify the desired stereo effect.

3. *Directivity control.* Since, in most locations, FM programs come in from almost *every* direction, listeners need an economical, yet efficient way to get clear reception from all these directions.

### OLD ANSWERS WON'T DO!

Only new answers will do—and Channel Master gives them to you in today's best-performing antennas—every one featuring years-ahead design that assures top performance across the board—black-and-white, color TV, and FM Stereo.

### YES, CROSSFIRES IN THE SUBURBS, TOO

The Golden Crossfires—especially the largest versions—are recognized as the top fringe-area performers of them all. But, as many dealers now know, there are a number of smaller models, scaled to solve the problems

of *every* reception area—from the strongest to the weakest.

These Crossfires—particularly the 7, 11, and 15 element models—are today's most popular suburban antennas. Why? They offer more DB per dollar; more gain for their size; flat response (vital for good color); exceptional directivity; perfect impedance match; *plus* higher FM gain than any other TV/FM antenna. The Crossfire makes good sales sense for you. Because this line of 7 outstanding antennas will meet every reception challenge.

### ANOTHER NEW ANSWER—THE OMNI-RAY

Now you can have true directivity control in an outdoor antenna on *both* TV and FM—*without* a rotator. The Omni-Ray's figure-8 pattern can be electronically rotated in 22½ degree steps—with the indoor "Target Turner" switch. 10:1 rejection ratio means "Aim the beam" for top power—"aim the null" for ghost rejection. No color "suckouts" and dips. Impedance-matched. A beautifully styled antenna that does a big job at low cost.

**By featuring these "new-answer" antennas, you not only solve your suburban area reception problems; you turn them to your advantage—with more profitable installations than ever.**

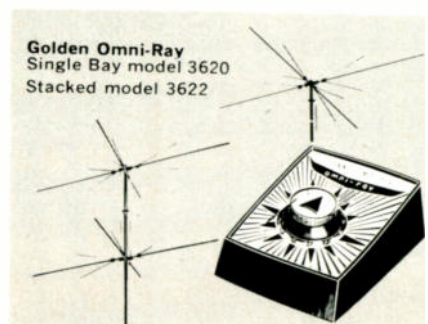
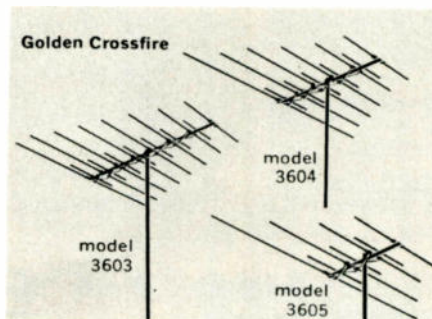

**CHANNEL MASTER CORP.** ELLENVILLE, NEW YORK

... for more details circle 21 on post card  
 ELECTRONIC TECHNICIAN

## Impressions of Audio Engineering Roundup

We attended a number of Audio Engineering Society technical sessions in New York recently. We have been showing up at these sessions for some years now, but something seemed different about the 14th annual meeting in October.

It's a little difficult to put a finger on the "change," if change there was. Maybe it was all our imagination. Perhaps it was the same in past years. But here's how we felt — sensing a quiet but potentially dynamic current flowing counter to traditional "ivory tower" tides.

In general, the technical presentations seemed to be more earthy. We wager that many Hi-Fi and sound technicians would have enjoyed hearing many of the speakers. And those same technicians can benefit by reading a number of the papers.

For example, one paper describes a "Stereo Phonograph Cartridge Evaluation Recording." Another tells about the "Stereo Operational Experience of WQXR-FM, New York." And "Management FM Stereo Problems" will up-grade every technician's knowledge of FM multiplexing. "Automatic Gain Switches for

Voice Intercoms," is another interesting subject. There are others, including one on a linear "1 kw Transistorized Audio Amplifier," driven by a 1 v rms signal.

Most papers appear better prepared than usual. They don't seem so stilted — overburdened with engineering "jargon" — and heavy with redundant words as in previous years. All appear more alive and crisp and capable of communicating information quickly to the busy reader.

We also got the impression that the individual presentations were more objective: with a minimum of "sales talk" and public relations "horse play." And we felt the sessions moved more smoothly through better organization. Only a few speakers, at the sessions we attended, took advantage and ran over allotted times.

Maybe we were skillfully brainwashed or "imagined" our way through the conferences. But we don't think so. We believe our impressions were stimulated by real and valid events. We suspect the Audio Society is growing upward — like everything normally grows if it wants to stay around awhile.

## Antenna 'Boom' Underway?

A modest boom in antenna sales was predicted some time ago. It was believed that increased demand would follow rising color TV sales, expanding FM stereo broadcasting, and implementation of Public Law 87-529 covering compulsory inclusion of VHF/UHF tuners on TV sets.

In those metropolitan areas offering a variety of TV channels, FM stereo stations, and generally strong signals, the "boom" may depend on you, however. A significant increase in sales beyond normal replacements may hinge entirely on your salesmanship.

Technicians and service-dealers in areas like New York City, Chicago, New Orleans, Los Angeles and other localities, may need to "educate and sell" customers on new and better antennas. Most prospects will have to be convinced that color and UHF TV viewing and stereo FM listening can be more pleasurable with better antennas.

Transistorized and tube type pre-amplifier "boosters" will become necessary in certain cities, even with substantial antenna arrays, if quality color and FM stereo reception is obtained. Demand for these items will probably tag along with antenna sales — but they will have to be "sold" too.

Brisk sales action will no doubt develop in UHF antennas in many localities. And because of the higher UHF frequencies, table top UHF antennas may prove popular in certain areas. Broad band stacked bow-tie-reflector types, for example, can be constructed in near-standard roof-type dimensions. Sizes will remain relatively small and appear unobtrusive on TV top or nearby table.

Research and development departments of many antenna manufacturers are turning out combination TV/FM arrays. Others are testing them on the range. These should help simplify some TV/FM reception problems in many areas.

Before installation, technicians may do well to study vital characteristics of all antennas in relation to local conditions. Depending on TV/FM station locations, you may end up having to sell the customer a rotor to go with the antenna if you do not plan the installation wisely. Study antennas' polar patterns for each channel to be received. And be certain the gain on dual TV/FM types is relatively flat across the FM band, from 88 to 108 Mc.

There's an expanding market here. With a little "push" you can get a substantial share.

# Understanding unadjusted and readjusted chrominance values simplifies troubleshooting

# Know Your

■ When servicing the chroma channels of a color-TV receiver, the technician often assumes that the gains of the three chroma channels should be the same. When he finds widely different gains he is sometimes puzzled, and feels that the receiver circuits must be faulty.

Actually, each chroma channel must have a different gain to obtain proper color reproduction. If all chroma channels had the same gain, color pictures would change blue to green and red to purple.

To understand the necessity for different chroma-channel gains, first recall pre-emphasis and de-emphasis, as used in FM broadcast transmission and reception. High audio

frequencies are accentuated (pre-emphasized) at the FM transmitter. This is done because there is normally less amplitude in the high audio frequency sidebands.

By pre-emphasizing high frequencies, the transmission is given a better signal-to-noise ratio and distant reception is improved. However, to obtain a uniform audio response from the system, the audio signal is de-emphasized at the receiver.

In de-emphasis, higher audio frequencies are attenuated so that a uniform response is obtained from the speaker. The pre-emphasis and de-emphasis curves are shown in Fig. 1.

Outputs from the color camera

at a color-TV transmitter have "naturally" proportionate values. The inputs to the color picture tube at the color receiver must have these same values. These are called *unadjusted* chrominance values.

Life would be simpler for the technician, if these unadjusted chrominance values were maintained throughout the system. But it would also be simpler if unchanged audio voltages were used throughout the FM broadcast system.

What is meant by *readjusted* chrominance values? The color cameras provide basic unadjusted color signal voltages. As shown in Fig. 2, the camera outputs are passed

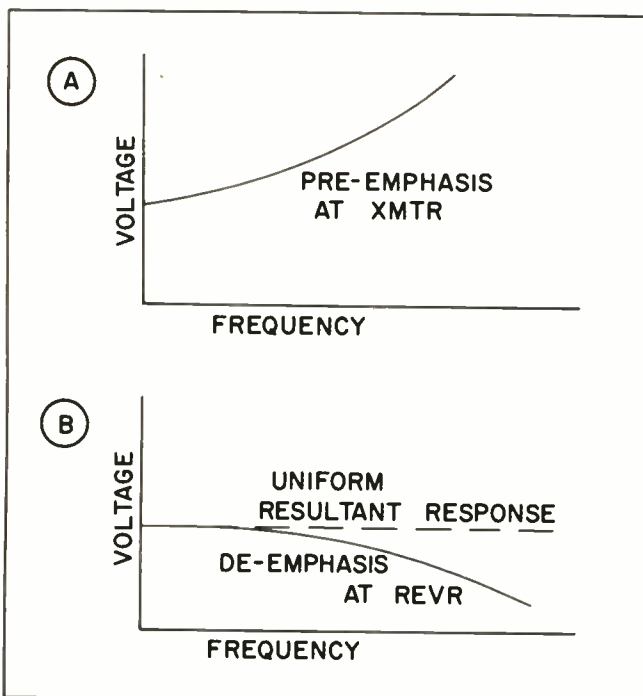

Fig. 1 (A)—Pre-emphasis of high audio frequencies improves signal-to-noise ratio of an FM transmission. (B)—Over-all gain of the receiver de-emphasizes the transmitter's boost in high frequencies.

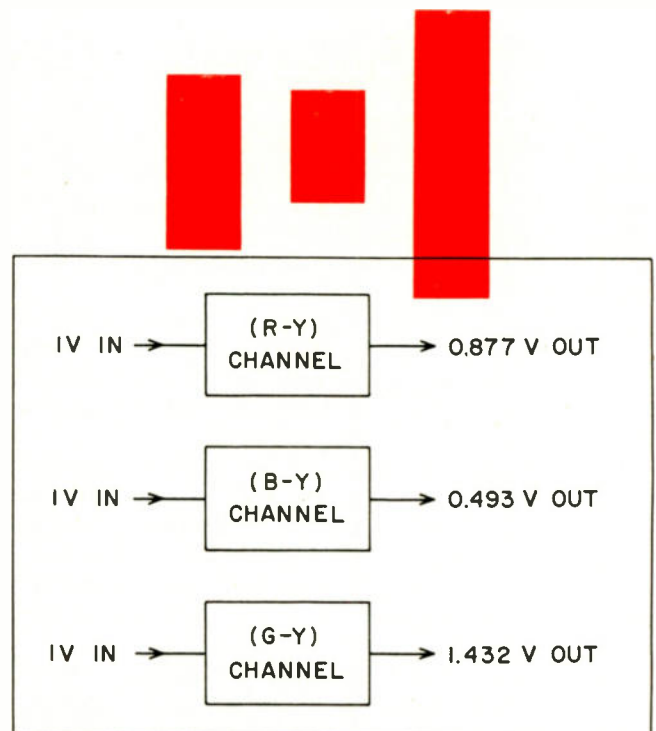
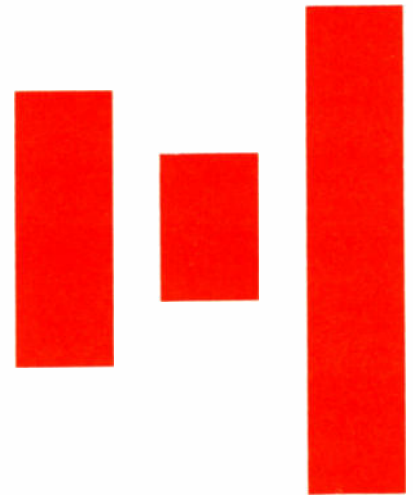

Fig. 2—Output voltages from the color cameras are given readjusted values at the transmitter.

# Chrominance Values



through circuits which change these voltages:

(R-Y) is reduced to 87.7 percent, (B-Y) is reduced to 49.3 percent, and (G-Y) is increased to 143.2 percent.

To obtain the original (unadjusted) relationship, chrominance values required by the color picture tube, corrective channel gains are used at the receiver, as illustrated in Fig 3.

Let (R-Y) be a reference value of 100 percent, then, (B-Y) must have a value of 176 percent, and (G-Y) must have a value of 61 percent.

This brings us back again to unadjusted values, as provided by the color cameras. The color picture

tube can then use these unadjusted chrominance values for proper color reproduction.

To obtain the correct outputs from the three chroma channels in the color receiver, the load values of the demodulator and amplifier tubes are chosen to give the required gains.

Summarizing the basic facts: The color picture tube uses *unadjusted*

by Robert G. Middleton

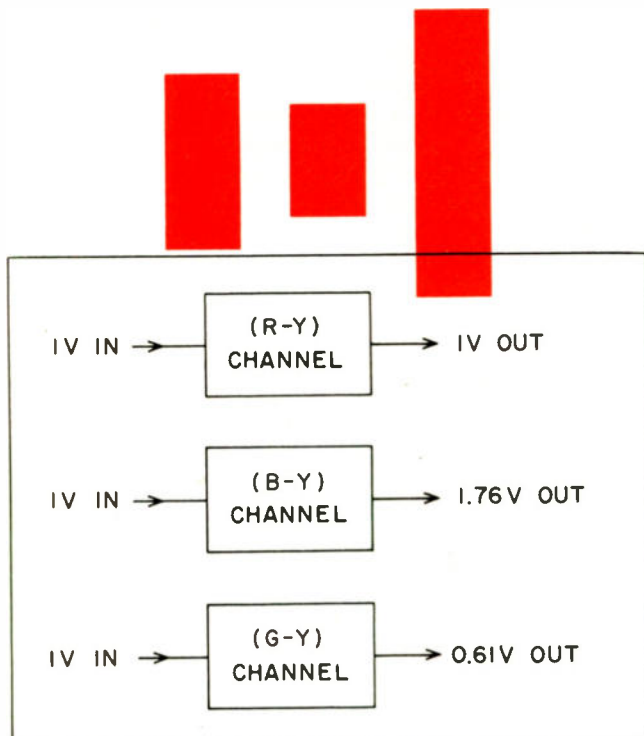

Fig. 3—Readjusted chrominance values are brought back to normal at the color receiver.

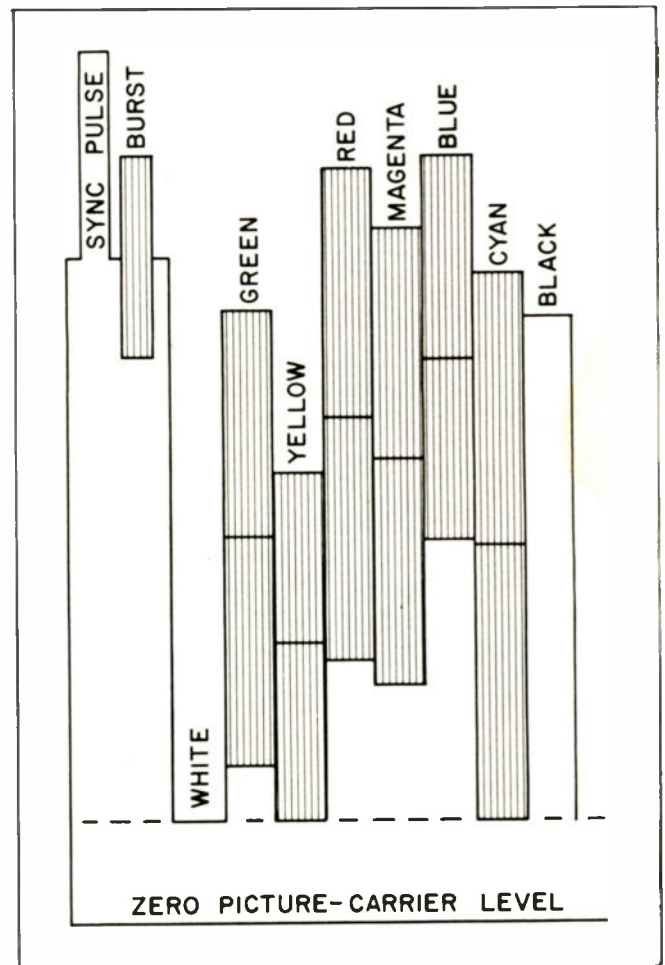

Fig. 4—The color-bar pattern from a TV transmitting station is held to 75 percent saturation, using readjusted chrominance values, so no colors overshoot the white level.

chrominance values in reproducing a picture. The color detectors use *re-adjusted* chrominance values. The

circuits between the color detectors and the picture tube convert readjusted chrominance values to unad-

justed chrominance values.

The color signal is transmitted from TV stations with readjusted chrominance values. This is done to avoid overmodulation, which would otherwise be inevitable. Overmodulation would mean badly distorted color reproduction.

### Requirement for Chrominance Values

Consider the color-bar signal illustrated in Fig. 4. This is the type of signal transmitted from a color-TV station; it represents a 75 percent saturated pattern. These are readjusted chrominance values.

If 100 percent saturated color bars were transmitted by the color-TV station — still using readjusted chrominance values, produces overshoots beyond white levels of 33 percent would occur. Engineers have concluded that this amount of overmodulation is tolerable. A 100 percent saturated signal is shown in Fig. 5.

If readjusted chrominance values were not used, a 100-percent saturated color-bar pattern using unadjusted chrominance values produces overshoots of 77 percent.

This is, of course, intolerable and is the reason why the NTSC signal utilizes readjusted chrominance values. The unadjusted color pattern is shown in Fig. 6.

### Methods of Readjusting Chrominance

Chrominance values are readjusted as shown in Figs. 5 and 6, by reducing the chroma signal voltage, but leaving the Y signal voltage the same. The Y signal cannot be readjusted, because the NTSC signal is compatible and must operate black-and-white receivers in the usual fashion.

Readjustment of chrominance values is made by reducing R-Y to 87.7 percent of its original value, and reducing B-Y to 49.3 percent of its original value. This means that the chrominance voltages for various colors are transmitted in an attenuated form.

Fig. 7 shows us that when chrominance values are readjusted, both voltages and phases are changed. The only phases that do not change are the reference phases, R-Y and B-Y. It is surprising for some tech-

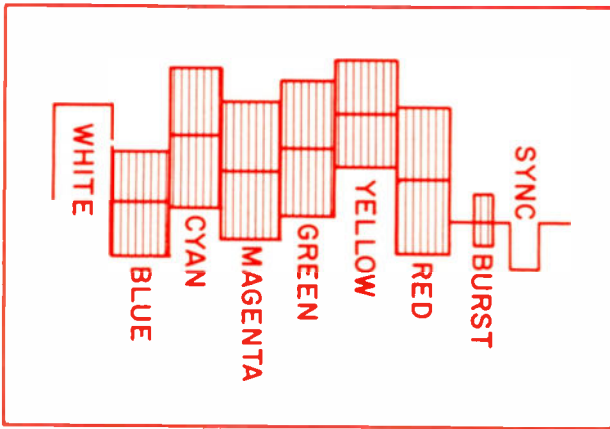

Fig. 5 — A 100-percent saturated color-bar pattern with readjusted chrominance values overshoots the white level by 33 percent. Since 100 percent saturated colors seldom occur in practice, the situation is regarded as tolerable.

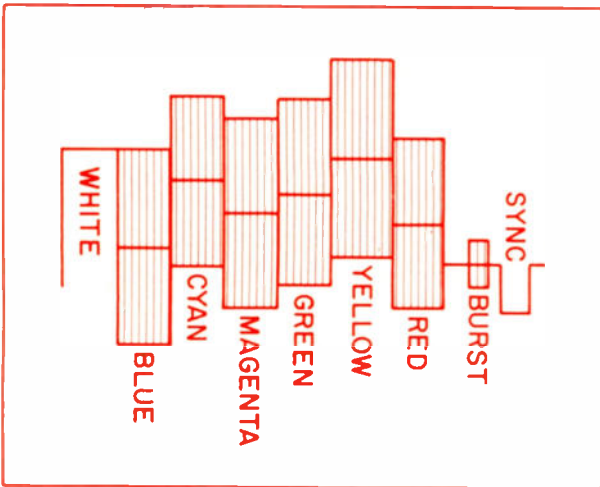

Fig. 6 — A 100-percent saturated color-bar pattern with unadjusted chrominance values overshoots the white level by 77 percent, and would produce intolerable overmodulation.

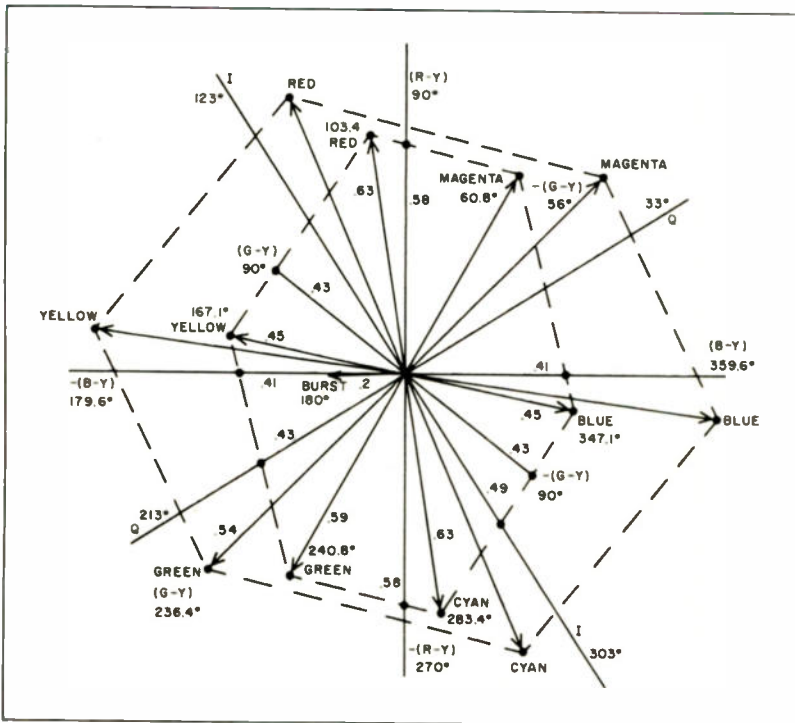

Fig. 7—The outer hexagon shows chrominance voltages applied to the color picture tube (unadjusted values). The inner hexagon shows the chrominance values applied to the color detectors in the receiver.



nicians to note that when R-Y is reduced to 0.877, and B-Y is reduced to 0.493, G-Y increases to 1.432.

This latter fact, it may be noted, provides G-Y with a better signal-to-noise ratio and motivated the trend to (R-Y)/(G-Y) detection rather than (R-Y)/(B-Y) detection employed in early sets.

### Working with Chrominance Values

It is easy to work with chrominance values once you get off to a good start. Consider the standard matrixing arrangement shown in Fig. 8. Start with the problem of producing a 100 percent saturated red field on the screen of the color picture tube. Of course, this is a consideration which deals with unadjusted chrominance values.

As shown in Fig. 9, the Y component of a red bar has a value of 30 percent. Hence, looking at Fig. 8, we know that this cathode drive will permit a 30 percent output from all three cathodes. Now, to produce a saturated red field, we require 100 percent output from the red gun.

An output of 100 percent can be obtained from the red gun by utilizing a 70 percent R-Y signal. We also see from Fig. 8 that a pure red field is not possible unless the blue and green guns are cut off. The blue and green guns can be cut off by utilizing a -30 percent B-Y

signal, and a -30 percent G-Y signal. Then, we will have full output from the red gun, and zero output from the blue and green guns.

The same considerations apply to other colors. Now, see what this means in regard to practical test work: Fig. 10 shows a series of crankshaft signals, for normal operation of a color receiver. These are the signal proportions which should be found when you apply a scope at the CRT signal-input terminals when the receiver is energized by a standard NTSC color-bar generator. The crankshafts shown in Fig. 10 correspond to the following test points:

R-Y crankshaft obtained at red grid. B-Y crankshaft obtained at blue grid. G-Y crankshaft obtained at green grid. Y crankshaft obtained at cathodes.

### Chroma Channel Gains

It is clear that these crankshaft signal proportions are based upon unadjusted chrominance values. Since the color detectors are energized by readjusted chroma values, the chroma channels must have unequal gains, to properly energize the color picture tube.

Here are the relative gains which are required in the chroma channels:

Let R-Y be the reference signal voltage, or 1, then, B-Y must deliver 1.76 times as much output, and, G-Y must deliver 0.61 as much output.

What is the best way to check chroma channel gains? It can be done by means of a standard NTSC color-bar generator; in this case, we look for the crankshaft proportions shown in Fig. 7.

Chroma channel gains can also be checked with a simple rainbow

*Continued on page 46*

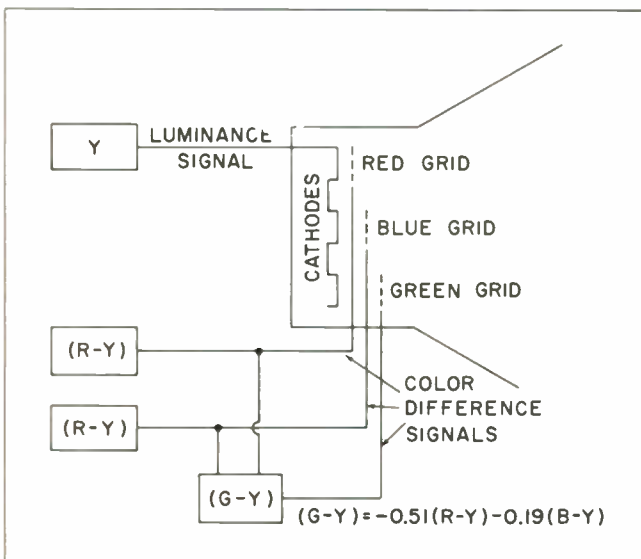

Fig. 8—A picture-tube matrixing system utilized in many color TV receivers.

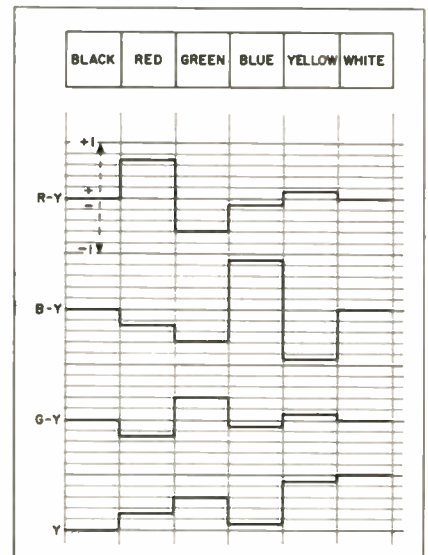

Fig. 10—Proportions of the crankshaft signals found when testing at signal input terminals of the color picture tube.

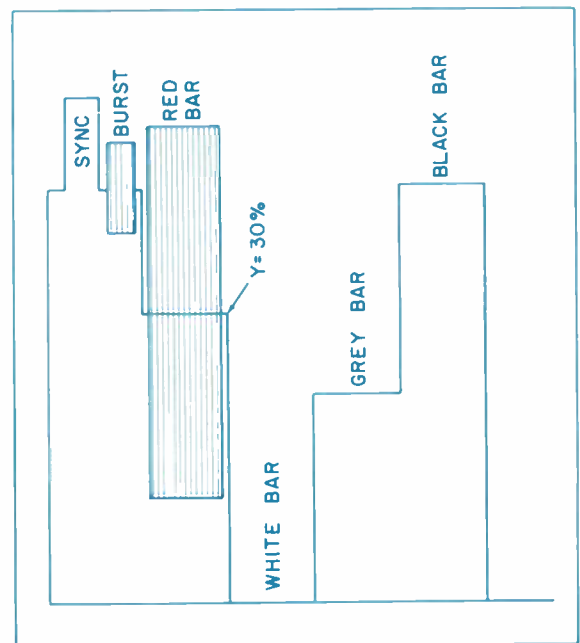

Fig. 9—The Y component of a red bar is 30 percent of white. This is a constant, irrespective of saturation or adjustment of chrominance values.

## Bar-dot generator is indispensable instrument for color TV convergence

■ Color TV servicing requires a relatively new piece of test equipment: the white-dot/color-bar generator. This instrument is as basic as the scope and signal generator for B/W TV service.

Although a white-dot/color-bar generator is an absolute requirement to properly install and service color TV, its ownership doesn't necessarily grant the technician the ability to use it. Successful convergence control adjustment is not an easy accomplishment. To understand dot generator application and the reasons for convergence adjustments, it would be worthwhile at this point to "look" into the color picture tube.

The tri-color picture tube has been developed to a high degree of perfection. The color tube's screen consists of thousands of phosphor dots arranged in groups of three. Each group has a red, blue, and green phosphor dot arranged to form an equilateral triangle. The shadow or aperture mask is located a short distance behind the screen, and for each group of three dots there is a hole in the mask. If the three electron beams (which originate from separate guns also spaced equilaterally) are made to converge at these holes as they are deflected horizontally and vertically, then each beam will strike only one phosphor dot in each group.

To illustrate convergence more clearly, punch a 1/4-inch hole in a sheet of paper and position it above the dots in Fig. 1. Sight directly through the hole, positioning it so that you can see approximately one third of each dot. Now incline your head so that you are sighting through the hole at an angle. When the angle is right, only one of the dots will be seen. In a similar manner two other angles will bring the other dots into view.



*by J. Futterman*

Applications Engineer, Precision Apparatus Co., Inc.

### Convergence Adjustments

It would be ideal if it were possible to align the guns so that they would converge perfectly at the holes in the shadow mask. However, manufacturing tolerances make it impossible to accomplish this on a practical basis. To deflect each beam individually for proper convergence, a small adjustable external magnet is mounted over each gun around the neck of the picture tube. Electromagnets using d-c current, take the place of permanent magnets in some sets. In either case, these are the beam positioning magnets used to deflect the beams toward a common point on the mask. In addition, a fourth magnet called the blue lateral positioning magnet, is mounted on the CRT's neck so that the blue beam can be deflected laterally to converge with the red and green

beams (Fig. 2). Positioning of these magnets (or the d-c current controls) constitutes the static convergence adjustments.

Because the length of the electron beam to the shadow mask is continually changing as it sweeps across the screen, it is necessary to supplement the four static convergence magnets with dynamic convergence magnets. These are electron magnets supplied with suitably-shaped current waveforms obtained from the horizontal and vertical sweep circuits. Control setup for proper phase and amplitude of these currents constitute the dynamic convergence adjustments.

A pattern of white dots will be produced on the screen of a properly converged picture tube when the set is connected to a white dot generator. If convergence is necessary, these dots will show groups

of red, green, and blue dots over portions of the screen. This can be understood by referring to the illustration used with Fig. 1.

It is not difficult to become acquainted with using the dot generator to converge a color TV receiver, however, it will require practice. And that practice will perfect your technique. An understanding of the principles involved is helpful, but is no substitute for experience. When working on a set, it is strongly advised that you have the service manual for the particular receiver you intend to converge.

Although all color sets, using the three gun CRT, employ the same basic methods for obtaining convergence, the manufacturer of each has found (usually through trial and error) the best method to use for his particular set and has incorporated it in his service manual.

#### An Actual Case

As a "live" example, we started with an RCA Model 21-CT-55 receiver and a White-Dot/Color-Bar Generator. In the shop, the set worked fine. Color was excellent and black-and-white good, although some color fringing was evident near the screen's edges. At home, color seemed ok, but black-and-white had

deteriorated badly. Assuming that transportation had jarred the convergence magnets, we hurried to the shop and returned with a dot generator and service manual. (One of the paradoxes in color TV is that non-convergence is more noticeable on a B/W picture than on one in color.) Turning the channel selector to three (unused in our area) we removed the antenna and connected the dot generator's r-f output to the receiver. We adjusted the generator controls for a dot pattern. Sure enough, there were more colored than white dots on the screen. In the shop, this check had shown some non-convergence, but only at the edges of the screen.

We took the back and top off the receiver to get at the convergence magnets. A mirror was set up on a stand in order to watch the screen. (The newest sets have all the convergence controls accessible from the front.)

Adjusting the magnets worked wonders. The colored dots merged into beautiful white dots. Critically, we appraised the scene and determined it was about the same as in the shop: There was non-convergence at the edges. With the top off, the dynamic convergence controls looked very inviting. We turned the

blue horizontal amplitude control, the effect was amazing. Now there weren't any white dots to be seen—only blue and yellow! Panicky, we turned back the control. Now we had red, green, and blue dots. Inadvertently, we had turned the red horizontal amplitude, which is concentric with the blue controls.

After a half-hour's work juggling the two controls and, in desperation, touching some of the others, we managed a reasonable state of convergence. At this time, the dot pattern had decided to jiggle and nothing we could do would quiet it down. Also, it was time for the wife's favorite program, so we packed up and called it a day.

The next day, we decided on a complete convergence set-up procedure. According to our service manual, the first step was to check the high voltage applied to the ultor of the kinescope. Using a VOM equipped with a high voltage probe, we measured 22,000 instead of 25,000 v. Locating the high voltage adjustment, we set it so as to obtain the required voltage. Next, we adjusted both vertical and horizontal linearity, and size of the raster as recommended in the service manual. For this, we used the horizontal

*Continued on page 48*

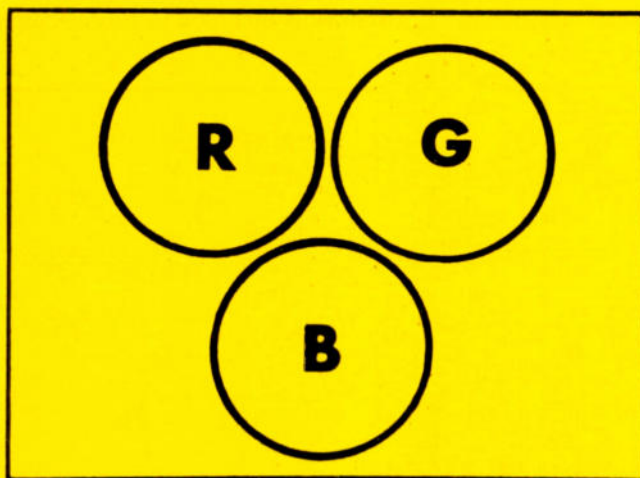

Fig. 1—Relative position of phosphor dots on the tri-color CRT. Each set of dots is backed by a hole in the aperture or shadow mask.

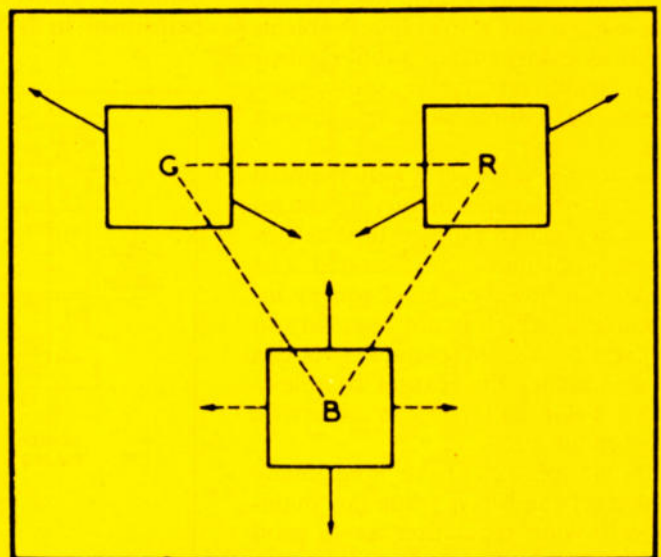

Fig. 2—Dot-pattern movements during convergence adjustments.

Bandpass amplifier, oscillator and demodulator alignment is a simple requirement on many ailing color sets



# CHROMA ALIGNMENT

by L. C. Powell

■ Many customers have become tolerant of B/W alignment defects because technicians have brushed them aside as "interference" or some other common excuse. Excuses have become a stock solution for some technicians' lack of time or understanding.

Color TV, on the other hand, poses problems which the average set owner won't tolerate. Problems such as colors that are too vivid or too weak; smeary or snowy pictures, or natural skies and brown grass.

Since the B/W set is only required to convey pictures in varying shades of grey, snow or other B/W alignment problems can be tolerated. The color set, however, must convey information which is not necessary in presenting a B/W picture. It is this added luxury that causes trouble—poor color can ruin an otherwise acceptable program.

Some of you have sold many color sets and have, thus far, maintained your reputation as a good dealer and service organization. People who put \$600 into a TV set will be more reluctant to trade for a new one than they were with B/W

sets. Thus, you will have to repair the color sets and put them in top condition or risk your business reputation.

Repairs of these aged color sets will almost invariably call for chroma alignment to put them into top shape.

Chroma alignment should not be confused with alignments normally performed in B/W sets. Alignment

of i-f and r-f sections are not included in this group even though their misalignment can cause a total loss or, at the least, extreme deterioration of color.

## Need for Alignment

Misalignment of the chroma section in a color receiver will not affect a B/W picture. Video amplifier circuitry is included in this circuitry,

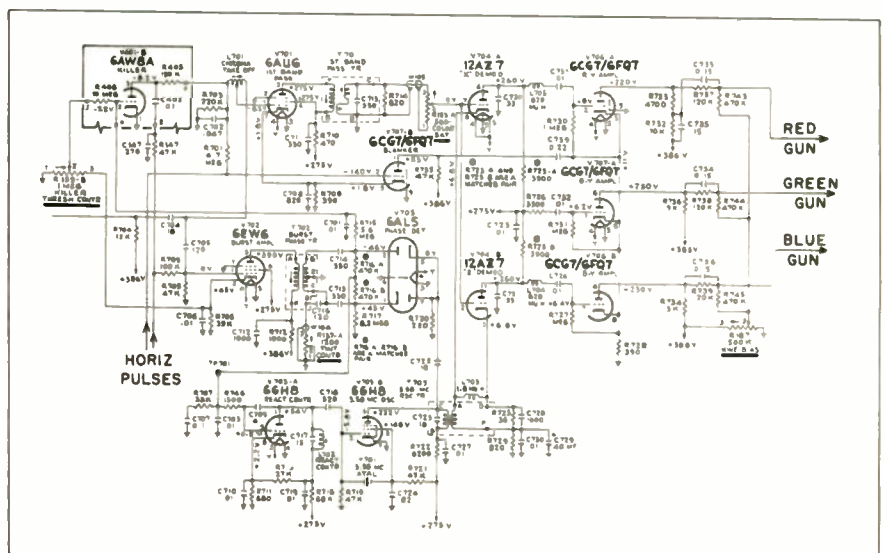

Fig. 1—Chroma circuitry employed in most recent RCA chassis.

however, and may cause poor B/W picture quality in case of malfunction. The same symptoms that apply to deterioration of picture quality in B/W sets apply to B/W pictures on color sets since the tuner and i-f strips are common.

Chroma misalignment will always be evidenced by a reduction in color quality. The fault may produce several effects—all of which will be readily noticeable in the picture: Confetti; smears; poor fitting (misplaced color); loss of, or poor color sync; and most noticeable, improper color tones. The last symptom may be all inclusive (inability to achieve proper hue) or only affect certain colors while others appear normal.

Prior to preparing for a complete chroma alignment, after seeing symptoms which might represent alignment problems, a series of checks should be made. The color TV receiver should be tested methodically as with other electronic devices: 1) Substitute tubes in the chroma portion of the receiver as well as other sections affecting color; 2) Make a thorough visual inspection; and 3) Check voltages. Make sure the conditions match those used by the manufacturer for this check.

If nothing has been found on

these preliminary tests, you are ready for alignment. It should be noted here that sets less than two years old rarely need alignment of any kind. Chroma alignment should only be necessary on old sets, sets that have been tampered with or those that have had parts in frequency sensitive circuits replaced, such as transformers or frequency determining capacitors.

Manufacturers' schematics of two chroma circuits now in common use are shown in Fig. 1 and Fig. 2. Although chroma circuitry varies somewhat, it is still common enough to apply rules of alignment to both. As with any alignment, however, the manufacturers' manuals should always be consulted for exact procedure.

### Chroma Circuitry

A block diagram of the circuitry involved in chroma alignment is shown in Fig. 3. Note that a Y channel amplifier is included, since the first video amplifier is used also to amplify the color signal. This explains why the Y channel is important to obtain proper color tones.

The 3.58 Mc color signal is extracted at some point beyond the first video amplifier and the Y information is delayed by a delay line.

Since the color signal must be processed through several stages, the Y information is delayed to arrive at the CRT at the same time as the color.

Color information is then amplified by the bandpass amplifier. This feeds the color demodulators and the burst keyer which, in turn, "syncs" the 3.58 Mc local oscillator through the burst amplifier. The output of the 3.58 Mc oscillator is fed to the color demodulators directly and out of phase. The amount of phase shift used depends on the type of demodulation employed.

Phase shift is variable about 45 degrees either side of the normal position (when properly aligned) by the hue control.

The oscillator is synced only during horizontal retrace when the color burst is available on the back porch of the horizontal sync pulse. This is accomplished by the burst keyer being driven into conduction with a pulse from the horizontal section of the receiver.

Some sets use a more elaborate system to sync the 3.58 Mc oscillator. This system can be compared to the feed-back afc system used with the horizontal oscillator in some sets. A sample voltage is compared with the oscillator frequency; a phase comparator then supplies a d-c voltage which controls a reactance tube, thus changing the frequency.

### Test Equipment

The Y channel video amplifier is an important part of the chroma system in a color receiver. In B/W sets, the video amplifier is rarely ever checked and the test equipment required to sweep in the video range is not usually on hand. The proper frequency range can be established, however, by mixing the outputs of a standard signal generator and a sweep generator through a chromatic probe. This setup is shown in Fig. 4.

The chromatic probe is actually a special mixing probe; its principle is shown in Fig. 5. In actual practice three diodes may be used in parallel so the generator's low impedance is more nearly matched. A smaller value resistor is not effective here,

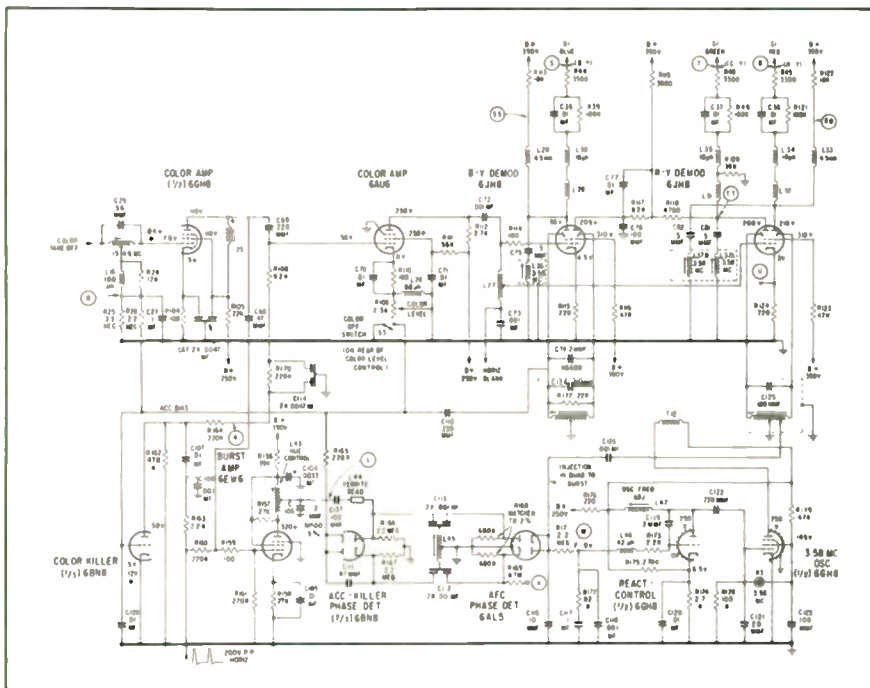

Fig. 2—Zenith's chroma circuitry uses less transformer coupling than other sets, relying on chokes and traps.

# Chroma Alignment

Continued

since the signal output will be decreased proportionately.

The chromatic amplifier shown in the test setup is an absolute necessity to check the test equipment. It may or may not be necessary in the actual test set up; largely depending on the gain of the stage being checked. In any case, the chrominance amplifier is an asset for chroma circuit servicing. The bandwidth of the chrominance amplifier is from 8 kc to 4.5 Mc, thus limiting its usefulness for purposes other than color applications.

A low capacity probe and a demodulator probe are also necessities. Failure to use a high impedance probe will attenuate the high frequencies to the point that the re-

sponse curve will be of no value. Checking the proportionate loss without the amplifier and trying to adjust the output for a flat response is also meaningless since the amplifier's loading effect is eliminated in the set up.

When the demodulator probe is used, a wide band oscilloscope is not essential because the sweep frequency will be only 60 cps. On the other hand, when the low capacity probe is used, the scope must be capable of handling the entire gamut of input frequencies (8 kc to 4.5 Mc). For a complete chroma alignment, however, a wide band scope is absolutely necessary. In addition, an accurate marker generator will be required.

## Alignment

Proper alignment of the chroma section will involve the first video amplifier, the bandpass amplifier, the oscillator and reactance circuitry, demodulators and several traps in the aforementioned circuitry.

The test setup shown in Fig. 4 should be used to check the video amplifier. Injection and take-off test points can be ascertained from service literature provided by the manufacturer for each particular set. The bandpass of this circuit should

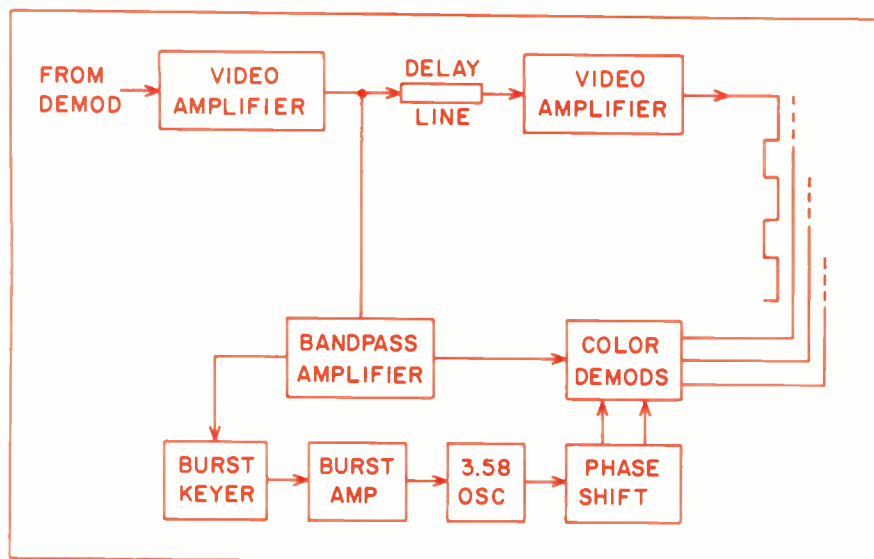

Fig. 3—Block diagram of chroma stages reveals simple process to extract chroma from composite signal.

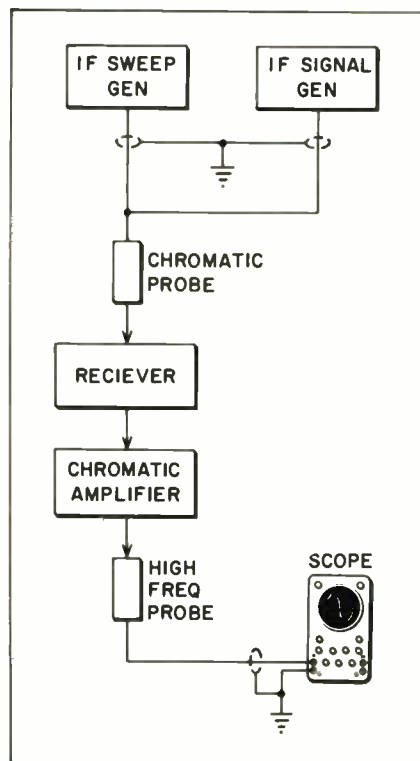

Fig. 4—Test setup for video amplifier check uses chrominance amplifier to build signal to usable amplitude.

be flat to beyond 4.2 Mc. Some sets will not be literally "flat" but will extend to 4.2 Mc at a prescribed rate of attenuation. Widely varying curves will be found in different models from the same manufacturer, so it is imperative that the available service literature be closely followed.

Bandpass amplifier circuitry varies even more widely. Early color receivers had bandpass amplifiers with broad responses. Later sets were built with highly peaked amplifiers. Once again the present trend is toward a broad response. Peaking is required, however, when the set's i-f response attenuates high frequencies

The bandpass amplifier's job is to pass the narrow band of frequencies around 3.58 Mc which contain the color information. The test setup for sweeping the bandpass amplifier is shown in Fig. 6. Again, test and injection points should be found in the service literature.

Trap alignment is very important in color sets. Poor trap alignment can cause weak or complete loss of color. Manufacturers' recommendations vary widely for trap alignment methods. Most common, however, is the sweep method using an accurate marker to determine the proper trap setting. If the trap has been properly designed, setting the center frequency of the trap should be all that is necessary.

Oscillator alignment is usually very simple. Since the oscillator is invariably crystal controlled, all that is necessary is peaking the tuned circuit for maximum plate current using a VTVM as a cathode voltage

indicator. In some cases, when the oscillator fails to operate, it may be necessary to adjust the oscillator plate coil.

After the oscillator is peaked, the reactance circuitry should be "zeroed." This is best accomplished with the aid of a color bar or rainbow generator. A short is placed on the input to the reactance tube and the reactance tube plate coil is adjusted for a slow drifting pattern on the CRT screen. A scope can be employed to view the pattern if the chassis is not connected to the CRT during alignment.

Several ingenious ways have been developed to check the demodulators for proper phasing. The simplest way is to use a NTSC color bar generator and observe the pattern at each CRT grid lead. The correct pattern for each grid is shown in Fig. 7. Variations should be no more than 15 percent

Another, and perhaps simpler method, also involves the use of a color bar generator. The tracking of brightness and contrast should first be adjusted by setting the screen

controls at a high brightness level and the background controls at a low brightness level.

With the color generator feeding the antenna terminals of the set, kill the blue and green CRT guns. This is accomplished with switches in some sets but can often be done with 100 kΩ resistors from the CRT grids to ground.

A red bar should appear on the screen with no shading evident. If the bar is shaded, the R-Y demodulator or quadrature transformer should be adjusted until a sharp red bar appears. Ground the red gun and remove the ground from the blue gun. Use the same procedure with its associated demodulator adjustment.

If the receiver being aligned uses a R-Y, G-Y demodulation system, the same procedure may be used except the green gun should be ungrounded in place of the blue for the second part of the check.

Once the test equipment is set up, and with a little practice, the alignment shouldn't take more than a few minutes to complete. ■

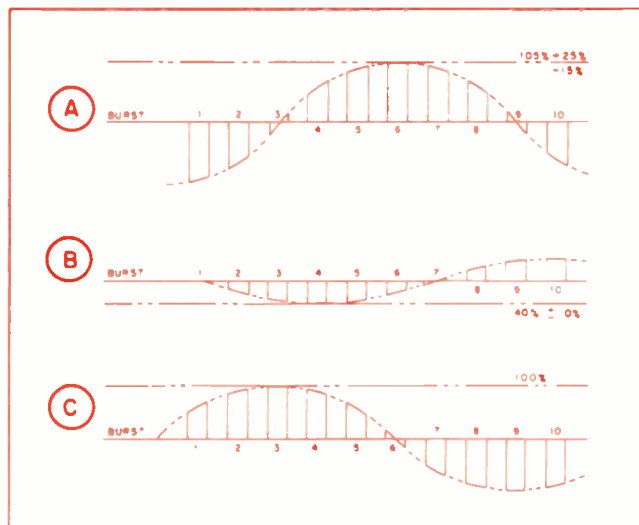

Fig. 7—Demodulator phase can be checked by viewing scope wave forms at CRT grids while feeding the set with a NTSC color generator. (A)—Signal at blue grid. (B)—Signal at green grid, and (C)—red grid.

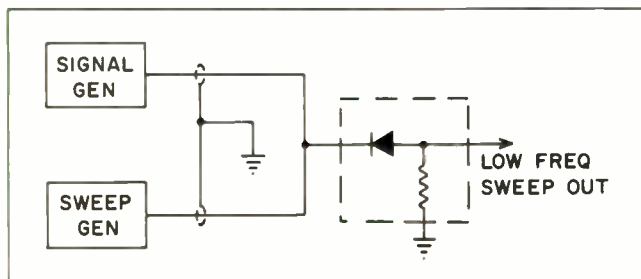

Fig. 5—The chromatic probe mixes two frequencies so standard alignment equipment can sweep at low frequencies. Actual probe (shown within dotted line) may contain three parallel diodes.

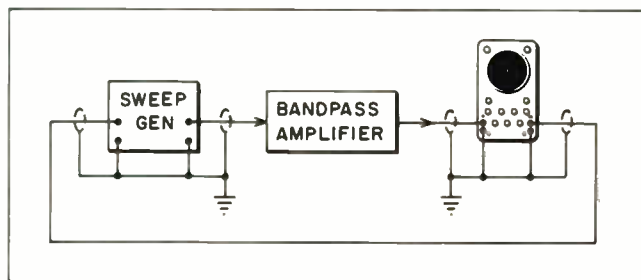

Fig. 6—Test setup for bandpass amplifier alignment is similar to i-f sweep test.

# REPAIRING TAPE RECORDERS

Understanding basic tape recorder systems simplifies trouble shooting

by L. V. Winston

■ What technician hasn't met his Waterloo in the form of a "dog" tape recorder? For some reason, many technicians unafraid of color TV or complex industrial electronic equipment shudder at the sight of a simple monophonic record-playback tape recorder. This fear may be well founded, but is generally unjustified.

Let's look at the basic sections found in a typical recorder. In one form or another an erase head, bias head, a record head and a playback head will be found on the *motor-board*. The heads may be unitized or may have common functions divided between two or three head coils.

A switching arrangement permits the preamp to be used for both record and playback, and a single oscillator to be used for *bias* and *erase* functions. An audio power amplifier is used for playback only to drive a speaker or speaker system.

Mechanically, the recorder is usually required to drive the tape from one spool to another at a given constant speed past the heads. Two or three motors may be employed for

these functions. The mechanical system may be slightly more sophisticated than indicated, since it may be required to shift to two or more speeds forward (during play) and one or more faster rewind speeds.

## Principles of Tape Recording

It may be easier to understand the principles of magnetic recording on

tapes if the earlier recorders are recalled. In place of plastic and paper tapes covered with a metallic oxide, early recordings were made on metal bands. The first of these recordings were produced with d-c bias.

Although d-c bias worked, noise and distortion were high. Several methods were devised to provide linear recordings using d-c bias but

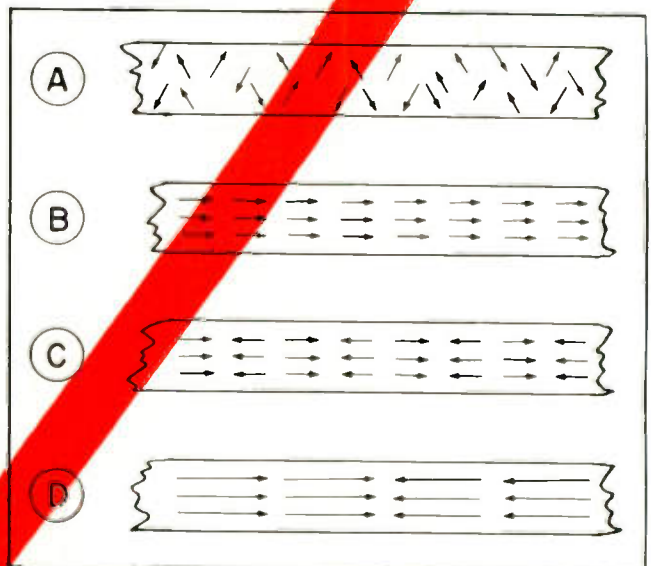

Fig. 1 (A)—Random North-South magnetic alignment. (B)—Pole alignment with d-c bias. (C)—Tape section showing pole alignment with a-c bias. (D)—Section of tape as it might appear with program material recorded on it.



all were less than desirable. The d-c bias system did not operate as the system we use today, but instead the metal strip to be recorded was magnetized — all in one direction. When the metal strip passed through the pickup head, audio voltages demagnetized it at the recorded audio rate.

An alternating bias is used, on all modern tape recorders to keep the audio in the linear portion of the magnetic core. The bias voltage may be as much as 10 times the signal voltage applied to the recording head. Tape sections in various states of magnetization are shown in Fig. 1.

B-H curves, shown in Fig. 2 illustrate how distortion takes place when various bias levels are em-

ployed to store audio magnetic materials.

Amplifiers are generally equalized according to tape manufacturers' standards. If they were not, tapes recorded on one machine would not be reproduced faithfully on another. Tone control circuits on most quality recorders are only used during playback.

The tape is driven past the record-bias head where an audio frequency magnetic flux is produced across a gap in the core of the record head. A detail of a record head and tape is shown in Fig. 3.

The varying intensity and direction of the magnetic flux across the gap causes the tape's metallic coating to become magnetized in "pole-pieces" whose lengths are propor-

tionate to frequency and intensity proportionate to signal amplitude.

During the playback, magnetic fields produced by the tape (moving past the playback head) produce voltages in the playback head coils. These voltages are amplified and fed to the speaker with the same frequency and intensity of the original signal. Construction of the playback head is similar to the record head.

### The Bias Oscillator

Bias oscillator principles are always the same; there are some circuit variations, however, which should be understood to ease troubleshooting. The most common simple configuration found in most medium-priced home recorders is the single-ended oscillator. This type

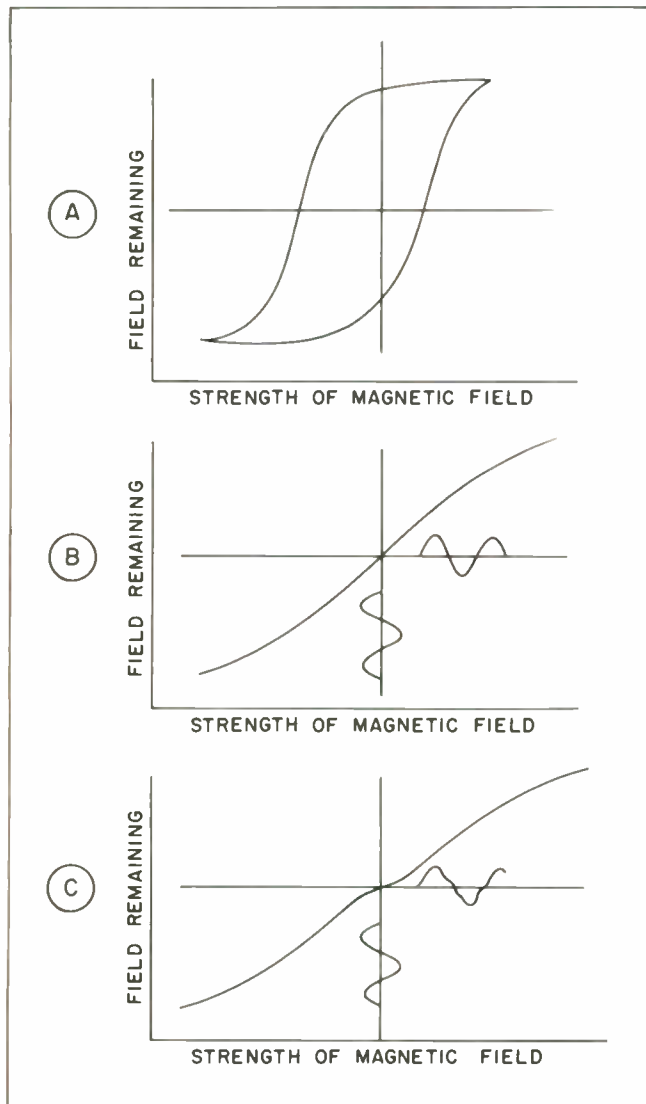

Fig. 2 (A)—B-H curve of a magnetic material. (B)—Normal response of tape with proper bias. (C)—B-H curve with a "twist" shows how improper bias creates distortion.

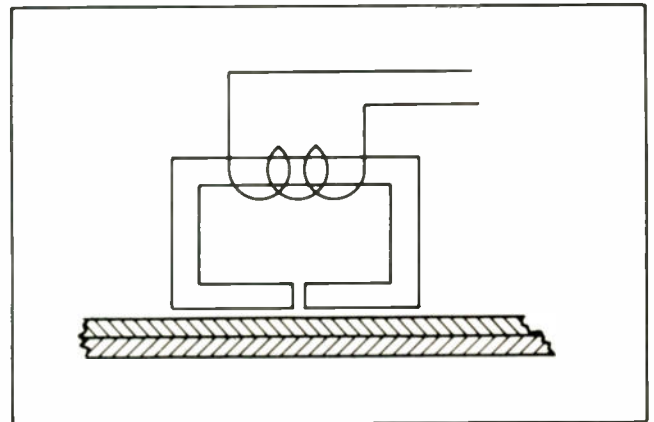

Fig. 3—Relative position of a tape recorder head and tape. Tape is enlarged out of proportion.

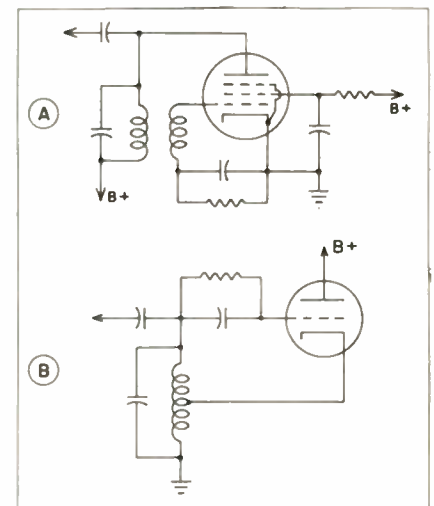

Fig. 4 (A)—Single-ended oscillator employing plate-to-grid feedback. (B)—Single-ended oscillator with cathode feedback.

oscillator type is shown in Fig. 4.

Most recorders use a single oscillator to feed both the record head and the erase head — the oscillator does not operate during playback. As much as 15 times the current used for record bias is often used for erase functions. This is accomplished from a single oscillator by using different methods of coupling. Typically, one ma is used for bias current. Low bias currents are used to preserve the high frequency component which decreases as bias is increased. The method of coupling the bias and audio to the record head and the erase current to the erase head is shown in Fig. 5.

In an effort to develop more erase power and to reduce second harmonic distortion, push-pull oscillators are sometimes used. A typical push-pull oscillator circuit is shown in Fig. 6.

Bias oscillator frequency should be determined from manufacturers' service literature. It may vary from 30 kc to over 70 kc.

It is noted here too, that in troubleshooting the oscillator loading plays an important part in oscillator operation; the oscillator's

load being the record and erase head. Removal of this load decreases the signal output of most oscillator types.

Generally speaking, if a tape recorder has a high noise level, or is distorted, the search can justifiably begin with the bias oscillator. Since the bias oscillator is not used for tape playback, however, a good quality tape can be played on the recorder to determine whether or not distortion is entering from the amplifier or some mechanical portion of the unit.

### Equalization Circuits

Equalization used in tape recorders for playback is fairly well standardized to NAB curves. This standard calls for no more than 1 db deviation from 100 to 7.5 kc and is attenuated at a rate of 3 db per octave above and below this range. The first 3 db increment being at 12 kc and 60 cps respectively. At 50 and 15,000 cps the signal should be down 4 db.

One may first ask why the extreme frequency ranges are cut rather than boosted — to increase the signal-to-noise ratio and com-

pensate for losses. The reason is quite simple. The over-all curve characteristic is a boost since the receiving head has a 6 db per octave boost.

Equalization circuitry employed in tape recorders is similar to equalization circuitry used in Hi-Fi control units for f-m and record compensation. Basically this consists of RC, RCL or CL networks using sufficient amplification to maintain the signal at a normal level or compensated feedback loops.

Care should be taken when installing new components in these circuits since indiscriminate replacements may alter normal system response.

The NAB curve was actually designed with the 15 ips broadcast standard in mind, but applies equally well to 7.5 ips high quality recorders. The curve is actually altered since increased tape speed also increases the frequency response within recorder limits.

The two general equalization circuit types are lossy and feedback. Typical circuit configurations of both types are shown in Fig. 7. The lossy type circuit can be considered

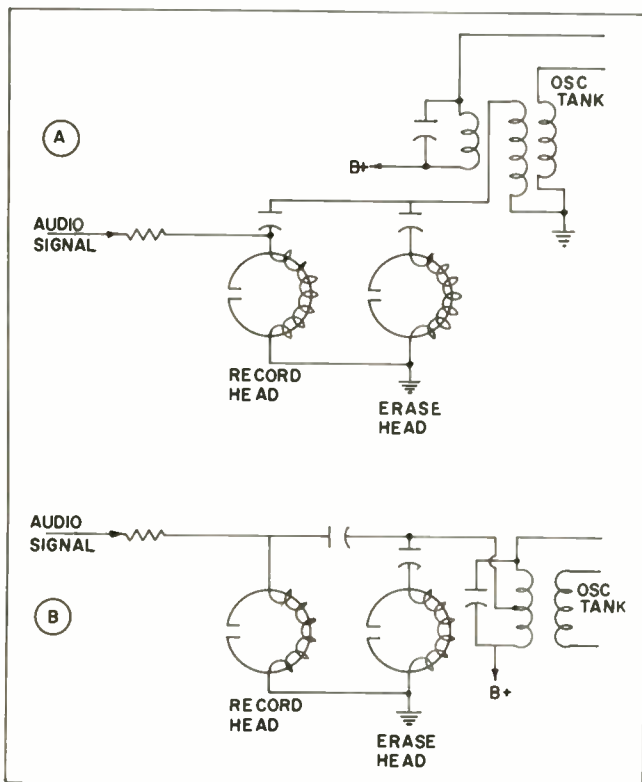

Fig. 5 (A)—Coupling from oscillator to heads with a tertiary winding in the oscillator tank. (B)—Direct coupling system.

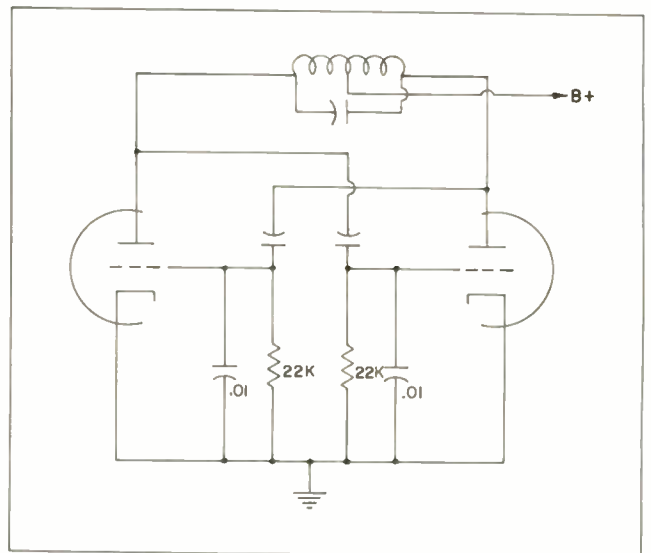

Fig. 6—Typical push-pull oscillator used in professional and home entertainment recorders. Frequency is usually half of single ended types.

a tuned trap circuit, while the feed back type operated on the principle that since a tube has constant gain, a tuned circuit feeding back frequencies out of phase will cause cancellation of those frequencies and in phase (around more than one amplifier or to the cathode of one stage) will cause a boost in those frequencies. Both systems can be found in quality equipment.

### Mechanical Function

Tape recorder motor boards vary more widely than any other section of the recorder. Three basic drives are used in popular recorders now on the market. Puck drive, belt drive and direct drive. In addition to the drive system the speed changing mechanism, tape take up and braking components are located on the motor board.

The puck drive system drives the capstan via an idler wheel held against the motor shaft. A heavy flywheel is usually located on one of these shafts to smooth any variations which take place. The capstan pulls the tape past the recording heads. In recent years, the capstan has invariably been made of metal.

The capstan presses the tape tightly against a rubber roller to feed the tape. Capstan diameter on most recorders falls between  $\frac{1}{4}$  and  $\frac{1}{2}$  in. The puck drive system is shown in Fig. 8.

The next most popular system is the belt drive; many professional recorders use this system. It is basically the same as a puck drive but in place of the idler or puck a belt is used. The belt provides excellent mechanical isolation from the motor and maintains good traction. Belts may be flat composition types or round rubber types.

In recent years there has been a trend toward direct drive systems. In these systems the motor shaft is employed as the capstan. The flywheel on this type drive is mounted directly on the motor shaft.

Since the capstan only serves to pull the tape past the recorder heads, another system is needed to provide take-up and to prevent spillage or tape overflow. Often a separate motor is employed for this function.

Because the speed of the reels changes as the tape is wound from one reel to another (from the change in diameter from full to empty) a

variable speed drive is needed for the reels. Most often this is accomplished with a slip clutch drive. On the supply reel a slipping drive system keeps a constant pressure against the reel in the opposite direction of normal reel travel. Similarly, the take up reel is driven by a slip drive system which keeps a pressure exerted in the same direction of the normal reel travel.

The clutches employed in these systems are varied and easily recognized. Two metal discs, one with a felt pad attached, is the most common type. Slipping cloth belts driving a highly polished pulley are also common.

Braking systems are sometimes easily misadjusted; timing in the braking system is of utmost importance. Usually, the brake is first applied to the supply reel (to prevent spillage) and then to the take up reel. Rapid, hard braking or braking which is too slow causes tape stretching, breaking, or overflow.

Brakes are generally applied to the reel shafts. The brake lining may be either felt or rubber. A high braking pressure is maintained by springs. In place of mechanical trips employed in most braking systems, solenoids are sometimes employed. Both systems are effective, though solenoid powered brakes lessen the mechanical linkage requirements and ease control operation.

### Maintenance

Other than tubes, mechanical  
*Continued on page 51*

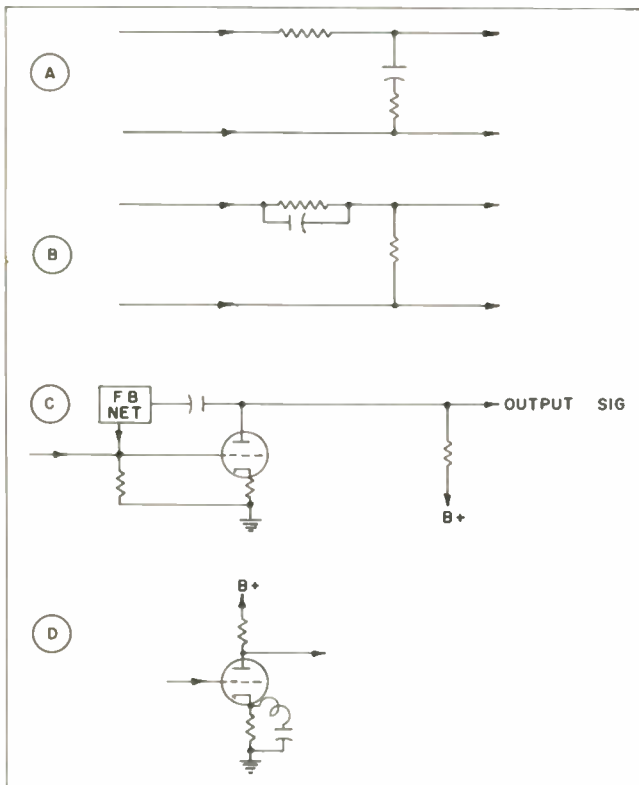

Fig. 7 (A) — Bass boost circuit from lesser type equalization. (B) — Treble boost circuit for RC lesser circuit. (C) — Feedback insertion in a single stage. (D) — Tuned cathode feedback circuit.

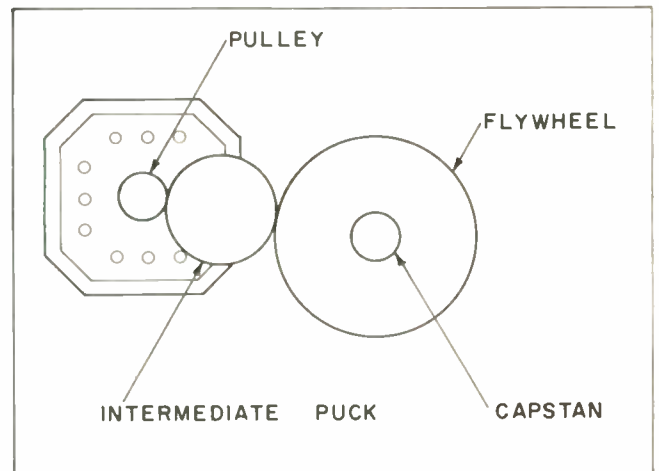

Fig. 8—Intermediate puck drive system used in most home entertainment recorders.

# SERVICING

# REMOTE CONTROLLED

# TV SYSTEMS

Electro-mechanical controllers for two and four function controls are easy to service

by Paul J. Walker

Westinghouse Electric Corp.

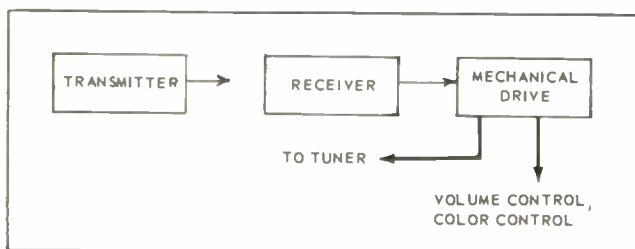

Fig. 1—All remote control systems are composed of some form of transmitter, receiver and mechanical drive.

Remote controlled TV sets are becoming more popular every year. Many technicians pass up chances to make easy repairs on control units which they consider too complex. Although there are as many different control units as there are TV manufacturers, all units perform the same functions of channel and volume changing.

Remote systems are composed of three sections, as shown in Fig 1; transmitter, receiver and mechanical drive. The mechanical drive section needs repairs more often than any other.

### Remote System Requirements

Besides a transmitter and receiver, remote systems must have a motor, gear train and some type of programming for channel changing. To change volume (or color and tint on color TV sets), a stepping relay, stepping switch or small a-c motor is necessary. The two remote systems in general use today are four-function and two-function units, with the two-function controls being most popular.

The four function system is illustrated in Fig. 2 Channels and volume can be changed up or down. When the transmitter channel-up button is pressed, relay K1 is energized and the motor runs. The motor is connected to the tuner through

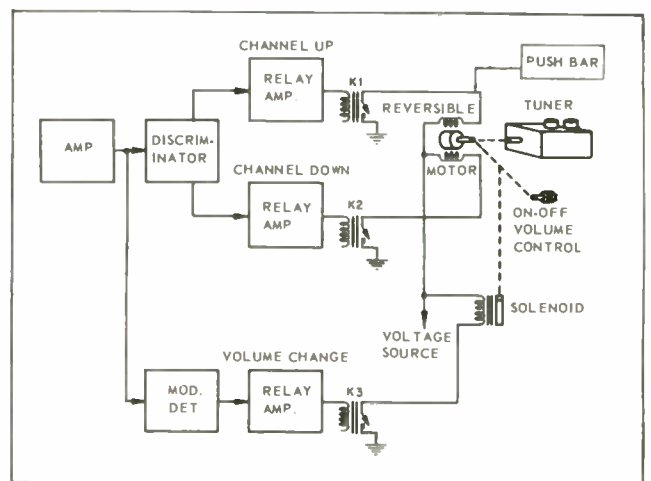

Fig. 2— The four function control system frequently allows volume and channel drive to operate in either direction.

a gear train as shown in Fig. 3. When channel down relay K2 is activated, voltage is applied to the motor through an RC network that shifts the voltage phase applied to the motor windings causing the motor to run in the opposite direction.

When volume-up is desired, relay K1 is energized, turning the motor in an up direction. At the same time, relay K3 closes and energizes a solenoid that pulls the motor shaft into a set of gears. The gears turn the volume control through a slip clutch. If volume-down is desired, relay K2 closes at the same time as K3 and the motor turns in the opposite direction.

Depressing a push bar or button on the front of the TV set allows the motor to change channels, bypassing the remote transmitter and receiver.

A two-function system, commonly used because of its simplicity, is shown in Fig. 4. The channel and volume change is only in one direction.

When a channel change is desired, the channel change relay is

closed, as shown in Fig. 5, and the motor runs. The motor shaft is connected through a set of gears to the indexing wheel shown in Fig. 6. The position of the channel indexers determines where the motor will stop.

When the volume change relay is closed, current through the stepping relay coil moves the stepping ratchet, turning a set of cams which open and close contact points. This action switches resistors in and out of the audio circuit as seen in Fig. 5. The stepping relay and cams are shown in Fig. 7. A stepping switch could be used to switch resistors in and out of the audio circuit. Not all sets shunt the volume control with resistors. Some even have small resistors in series with the speaker leads.

Another method of volume change is to use a small a-c reversible motor connected to the volume control or to a control in the screen grid of the audio i-f tube. The motor is reversed by using a resistor and a capacitor to shift the motor winding voltage phase.

Color control is obtained by motor drives which function similar to motor driven volume control systems.

Programming, or indexing, is an important part of every remote unit. There are many different ways to program but space does not permit a full description of each one. Programming is done so that the tuner will stop on channels that are used in specific areas and skip channels that are not used.

In the many different mechanical arrangements used, a switch is closed to keep the motor running and opened to stop the tuner on a channel. The switch is activated by a mechanical arrangement that is usually set by turning screws, moving sliders or turning tabs on a wheel.

These adjustments may be made from the front or rear of the set, using either the hand or a screwdriver. On more recent remote units, the set's fine tuning knob is turned in one direction to fine tune the set, and turned in the opposite direction to program it.

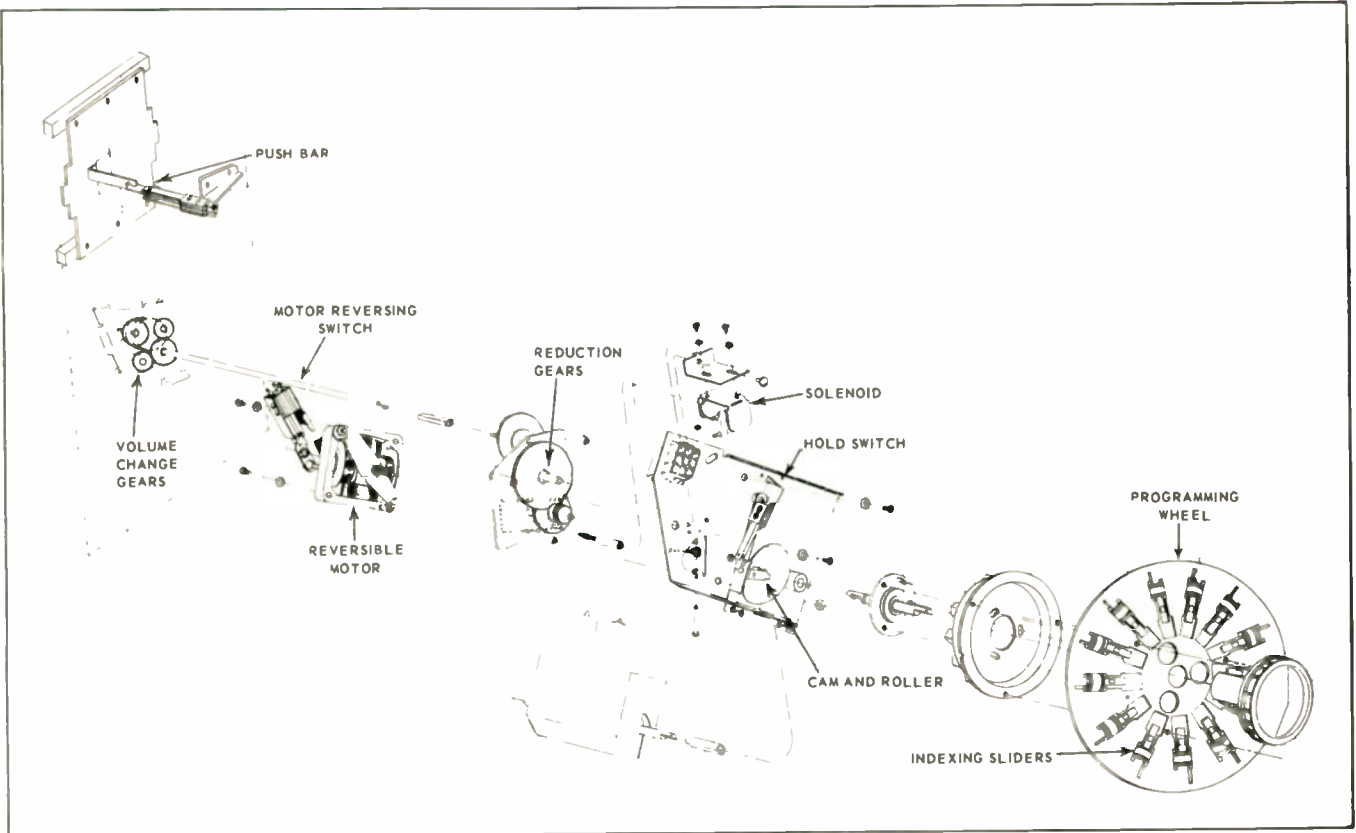

Fig. 3—Mechanical drive assembly used in a four function receiver-drive system.

## General Troubleshooting

The best way to begin troubleshooting any remote system is to activate all the functions on the remote transmitter. If there is no response, make sure the remote on-off switch is turned on. A quick check of the remote transmitter will determine whether a tube or battery can be substituted. Many of the later transmitters are tuned-rod mechanisms which are entirely mechanical and rarely need servicing. Remote receivers using tubes can be checked by substituting new tubes. The mechanical drive section must be examined from a mechanical, rather than an electronic point of view.

Since many sets are equipped with push bars or buttons for local operation, pressing them will check operation of the motor circuit. After doing this, visual checks will clear up most troubles. Common troubles arise in relays, gears and switches. That old enemy of television, dirt, is responsible for a lot of trouble including relay points that won't make contact, jammed or frozen gears and switches that won't do their job.

Be careful when working around relays and switches. Many are connected to line voltage and are a potential shock hazard.

Switches and relay points can be cleaned with a burnishing tool. Relays inside sealed boxes generally

don't get dirty but there is a possibility of arc-cover and contact point pitting.

Many micro switches have long metal extensions that may get bent over a period of time. Springs that return mechanical parts to their original positions may break or lose their tension.

Gear and motor shafts frequently bind where they run through metal supports or brackets when the lubricant becomes dirty and stiff. Whenever a motor drive is worked on, the old lubricant should be flushed out and new lubricant applied. As a final check, tighten all connecting plugs.

## Two and Four Function Systems

In a four function system the motor runs whenever any function is selected. When a channel change occurs, the motor is connected to the tuner and will run in either direction. When a volume change occurs, the motor will again run in either direction but an additional solenoid pulls the motor shaft into the volume control. The push bar or button on the front of the set is connected between the relays and the motor and can be used to check the motor's operation.

Depress either relay manually (using an insulated tool) and see if the motor runs. This checks the channel change function. To check the volume change circuit, the volume change relay must be depressed. If

the motor runs when the channel change relays are depressed, the trouble is in the remote transmitter or receiver. A substitute transmitter is the quickest check.

Most remote units are momentary contact relays which "make" for only an instant. As the motor starts running, a hold switch is mechanically closed and applies voltage to the motor. If the motor starts running, but stops immediately, check the hold switch. This switch will stay closed until the tuner reaches the desired channel where the programming mechanism opens it and the motor is stopped.

Instead of momentary contact relays some remote units use tone modulated reeds operating on low audio frequencies. Once the reed contacts are closed, electrical operation and circuit troubleshooting is the same as for conventional type relays.

Whenever the motor drive runs slow or does not have enough power to change channels, the trouble may be caused by dirty or damaged gears or drive shafts. A possibility, though usually infrequent, is a shorted motor winding.

The two function systems are most common and are easier to repair than four function systems. Manually energizing the channel-change relay applies 117 v directly to the motor and the channels should change in one direction. This system uses a momentary contact relay

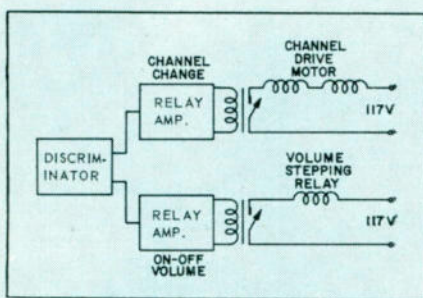

Fig. 4—The two function drive system operates volume and channel controls in one direction only.

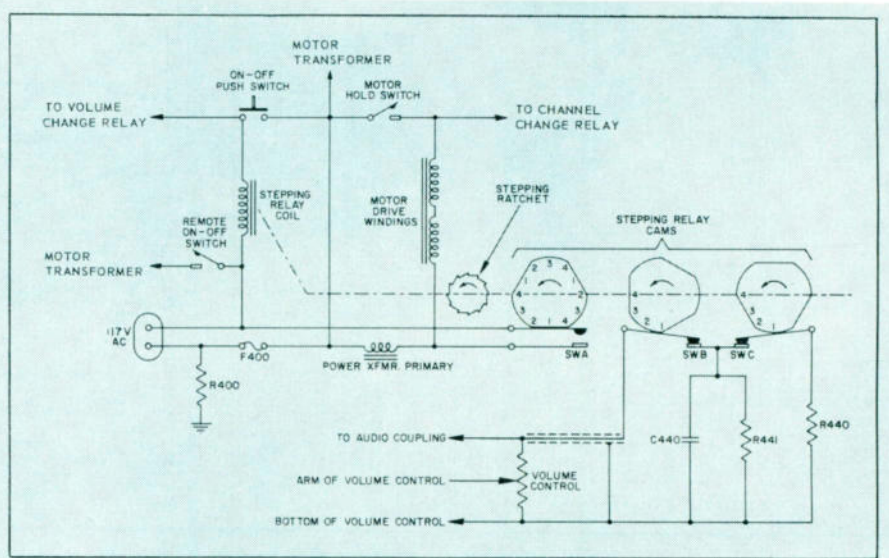

Fig. 5—Electrical-mechanical system used for some channel drives.

that should release immediately after closing. A hold switch is mechanically closed when the motor starts running and keeps it running until it reaches a programmed channel. The motor will keep running if hold switch contacts remain closed. If the switch does not close, the motor may not run long enough to change the channel. Or, the motor may be able to change to the next channel but will stop immediately.

Gear drives between the motor and tuner are much simpler in two function systems, resulting in easier servicing. Cleaning and lubrication is all that is usually required. Some of the latest gear drives are sealed units — mounted inside a riveted case. This keeps much of the dirt off the gears but in areas of heavy dust or sand, the gears may bind. The only way to clean a sealed gear box is to submerge it in a cleaning solution and then lightly oil it.

In the volume change circuit, closing the volume change relay applies live voltage to the stepping relay coil or stepping switch. The volume change relay can be closed manually (using an insulated tool) to check the action of the stepping relay coil. The coil moves a ratchet every time it is activated, which in turn moves a set of cams that open and close contact points. It is possible for the coil to open or any part of the cam-drive linkage to freeze up. The greatest source of trouble is the contact points riding on the cams. When

they become dirty, the TV set may not operate or may have intermittent or no volume.

When a stepping switch is used instead of a stepping relay and cams, the volume may be intermittent at certain levels of sound. There are usually 12 positions on the switch, which is wired to give three levels of sound. The contacts resemble those on tuner wafers and can be cleaned with a tuner or control cleaner.

Color TV sets having remote control usually have one motor that can run in either direction. The motor runs when any function is selected. For channel changing, the motor is connected to the tuner through a gear drive mechanism. As volume, color or tint controls are selected, a solenoid in one of the circuits is connected to the motor drive and the motor turns the control.

In this type of operation it is necessary to activate all the functions. If no functions work, the motor and its drive would be the place to start troubleshooting. If all the functions work only in one direction, the circuit that reverses the motor's rotation should be checked. When any one of the controls fails to operate, its solenoid can be activated.

#### A Few Hints

Motors used for tuner drives may be either 24 or 117 vac types. The voltage rating is usually stamped on the motor. Motor windings, may of course, open or short. An open

winding can be easily found but a shorted winding is very difficult to detect. If a short is suspected, the best thing to do is substitute another motor of the same type and voltage rating as the original.

Some troubles that appear to be caused by the remote receiver may actually be caused by the programming mechanism. The tuner may start to turn but not turn far enough, indicating a possible dirty or bent switch contact. Intermittent operation is usually caused by contact arms that have become bent with age. If the contacts are always closed, the tuner might run continuously. Many of these troubles depend on how the switch is connected in the circuit. Since programming is almost all mechanical, the best way to check the operation is to turn the tuner by hand and watch the action. All used channels will operate the same way.

When repairing a TV chassis with remote control that won't turn on, or has no sound, check all the switches connected with the remote unit. After long periods of use, switches may not function properly.

A final word of caution. When removing a complex mechanical drive from a tuner assembly, be sure to check the manufacturer's literature. Many drive systems have synchronizing marks that must be aligned and relay or solenoid adjustments that must be properly adjusted. ■

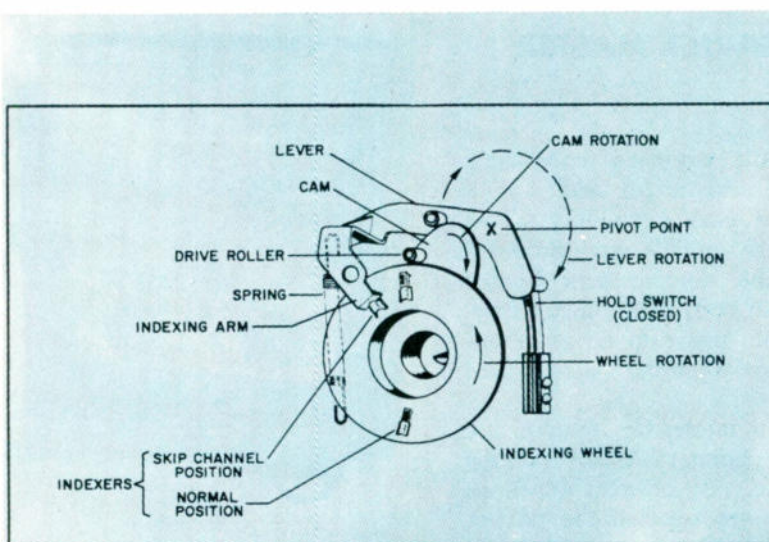

Fig. 6—Indexing wheel used in the system shown in Fig. 5.

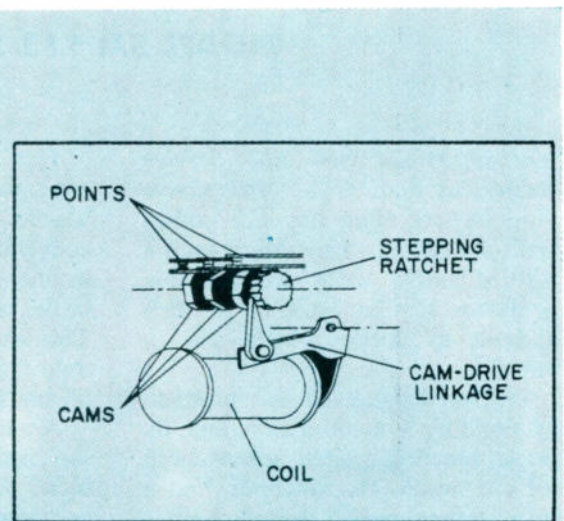

Fig. 7—Stepping relay cam employed in step controlled volume systems.

## MODEL 1100 TUBE TESTER

*Mercury, Model 1100 tube tester, at \$39.50* — Many shops have a large tube tester for shop use but don't have one to take with them on house calls. The model 1100 will merit your consideration if you are looking for a small tester; it will almost fit in a good-sized tube caddy. For the most part, the small size is gained through a well-planned layout and an absolute minimum of controls.

The tester is very simple to operate since only five controls are employed. Two controls are used to set up the meter circuit; one selects the meter limiting resistance; one is a spring return "press for quality" slide switch; and "special" switch which is used for gas-type and certain high voltage tubes,

Shorts can be found between any two elements in a tube by simply rotating two switches to numbers corresponding to the suspected elements' associated pins. Normal testing, however, checks for shorts encountered most frequently.

The unit tests octal, seven, nine and 10 pin miniatures as well as

loctal, nuvistor novar and compactron types. A booklet giving the proper instrument settings is held in the lid by a spring clip. A one year subscription to new tube listings for the tester is offered with the sale of the instrument for \$2.

The over-all size of the test set is 1 $\frac{3}{4}$  x 8 $\frac{3}{4}$  x 3 $\frac{1}{4}$  in.

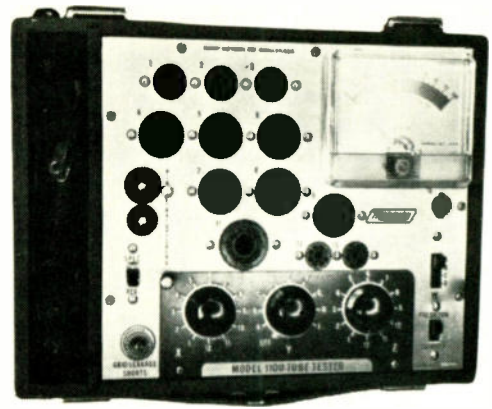

# TEST INSTRUMENTS for Bench and Caddy

## MODEL SM 112 SERVICE MASTER

*Sencore Model SM 112 Service Master, at \$68.55.* — Prospective shop owners often buy test equipment a piece at a time. Since both a VTVM and a VOM are desirable items for service work, it is often difficult to decide which unit to buy first.

Sencore has solved this problem by building a combination unit. A single function switch selects both VTVM and VOM functions, and a single range switch selects ranges for all functions. A plus and a minus d-c volt position is provided for the VTVM.

The unit comes completely equipped with a lid and has a handle for easy portability. Two convenience outlets are provided in the cable compartment located in the main body of the meter case. This should prove to be an often-used feature when the meter is used on house calls.

Another interesting feature are the neon pointers found on the meter face. As different functions or ranges are selected the pointer associated with the proper scale lights. Without this function we feel the meter would at first, have

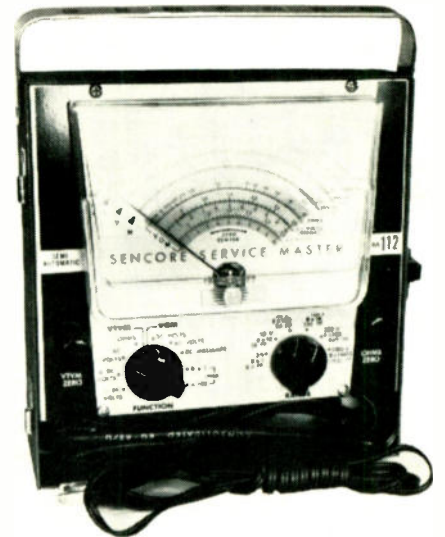

been hard to read. The meter is accurate and should save some space when troubleshooting in the home.



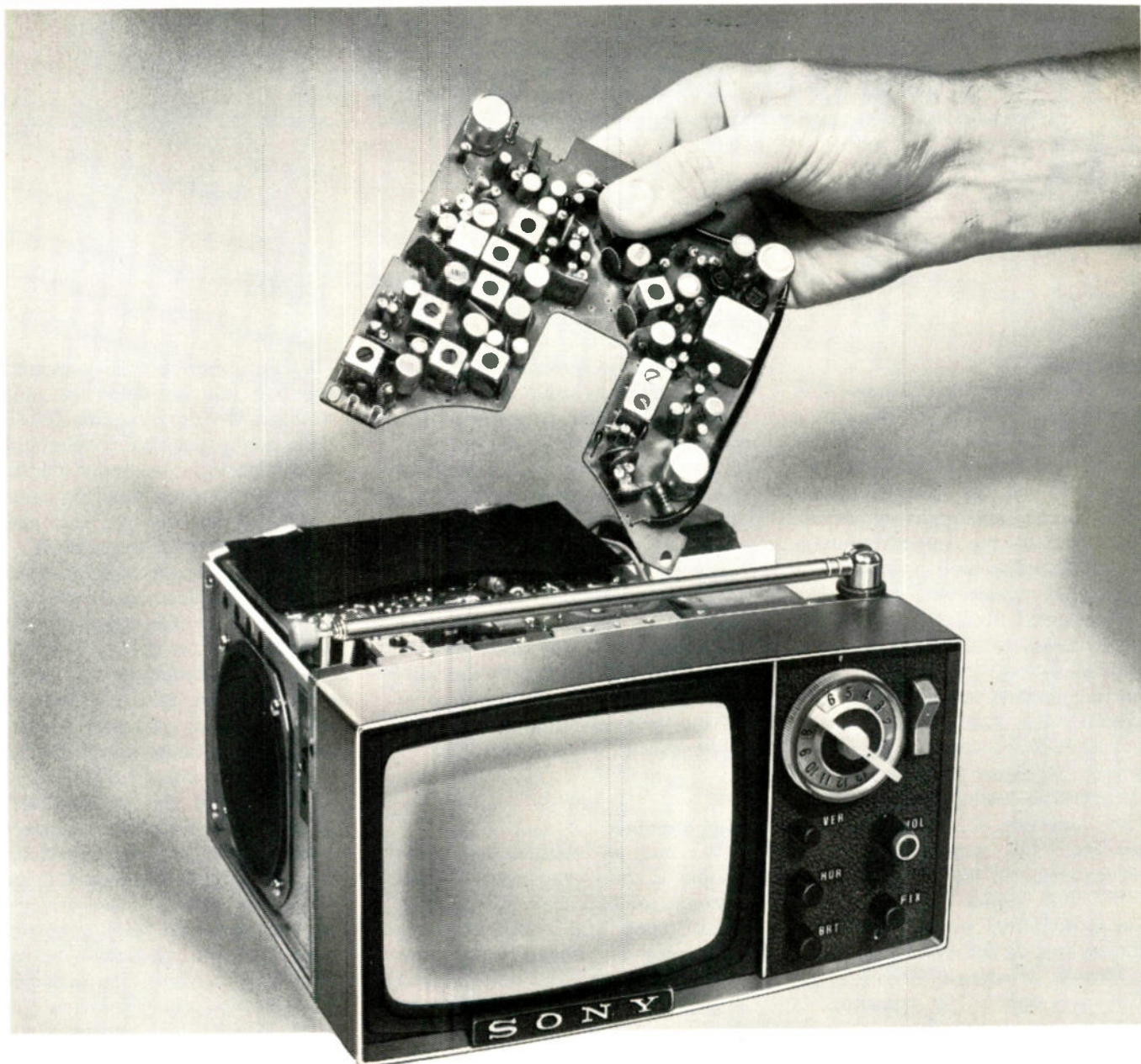

## *Service is easy with the revolutionary New SONY MICRO-TV*

Just about every component in the new SONY Micro-TV is mounted on two printed circuit boards, which makes it refreshingly simple to service. Unlike ordinary sets, there is no heavy chassis to "pull" and complicated wiring to follow. Instead, you quickly isolate the defective component and replace it yourself, or send the whole printed circuit board direct to SONY. In jig time it will be returned, with new component installed, ready

to be snapped back into the set. Interestingly enough, charges are moderate, with plenty of room for markup. Easy service, of course, is only one of the remarkable features of Micro-TV. Others? 8-lb. weight; operates on 2 power sources (117V AC and 12V DC); all-transistorized (24 transistors, 20 diodes); revolutionary picture tube. Size: 7½W x 4¼H x 7¼D. Micro-TV 5-303W list \$229.95. Rechargeable battery pack optional.

**SONY**  
RESEARCH MAKES THE DIFFERENCE

### **SONY CORP. OF AMERICA**

514 Broadway, New York 12, N. Y.

*Regional Offices:*

*Central:* 4959 W. Belmont Ave., Chicago 41, Ill.

*Western:* 627 South Towne Ave., Los Angeles 21, Calif.

Please send me the SONY MICRO TV FACTS booklet.

NAME \_\_\_\_\_

FIRM \_\_\_\_\_

ADDRESS \_\_\_\_\_

CITY \_\_\_\_\_ ZONE \_\_\_\_\_ STATE \_\_\_\_\_

SONY CORP. OF AMERICA 514 B'WAY, DEPT. ET2, NEW YORK 2, N.Y.

- - - for more details circle 48 on post card



## Difficult Service Jobs Described by Readers

### Slow Roll

A Silvertone TV Chassis 456, 51640 was brought to me with a slow vertical roll after a normal warmup time. Voltages on the sync separator and the sync amplifiers were checked and appeared normal. The sync to the vertical multivibrator also appeared normal. The horizontal circuit was not noticeably affected. Replacing one of the filters failed to solve the problem. Further voltage checks were made on the vertical multivibrator and output stage. A lower than normal voltage was indicated at the power supply. Resistors and capacitors in the vertical section were checked. One capacitor, C3c, had excessive leakage, but replacement only slowed the roll rate.

A final power supply voltage check on initial turn on and after the set was on for a while indicated a change of almost 20v. Because C3C was one of the capacitors in a multiunit can (partly in the vertical circuit) the other capacitors in the power supply were checked and ok'd. The output current of the rec-

tifiers indicated a much higher current immediately after turn on and a slow reduction with time. A check of resistor R55 showed it to be heating up with time causing it's resistance to increase and lowering the output voltages of the power supply. A 10 w resistor was indicated on the schematic but only 5 w was in the circuit. Replacing R55 with a 10 w resistor stabilized the vertical roll. The other circuits were obviously affected by the voltage drop, but were not as sensitive as the vertical circuit.—*Kenneth F. Bangsberg, Milwaukee, Wis.*

### High Problem

We had an unusual color TV trouble a short time ago. A good customer of ours had purchased a larger home and called to have their color TV hooked up to the existing antenna. The antenna was an older make and the lead-in wire was four or five years old. B/W pictures were excellent and no color programs were on when the set was checked.

The next morning the customer called and said his color was not working. We drove to his house and checked the color reception and sure enough there was only a little color, just enough to hold the color in sync. We checked the agc, and color killer controls, to no avail.

The TV set was brought into the shop and checked on B/W and color TV. All of the programs were excellent even on color. The TV set was left running in the shop for several days to see if the set was intermittent. Everything was perfect. At the house, however, the TV still had no color.

At this point the antenna was suspected to be bad. The customer stood on his heels and wanted no extra expense, but still wanted color TV. A new color set was brought from the shop and hooked to the antenna, but no color could be received. This convinced the customer that he needed a new antenna and lead-in. A four bay translater antenna was sold. The customer remarked that it was the best color reception that he had ever seen.

Sometimes it seems that this is a long way to go in satisfying a customer, but we didn't want to go on that three-story-high, steep roof too soon anyway!

—*Homer L. Davidson, Fort Dodge, Iowa.*

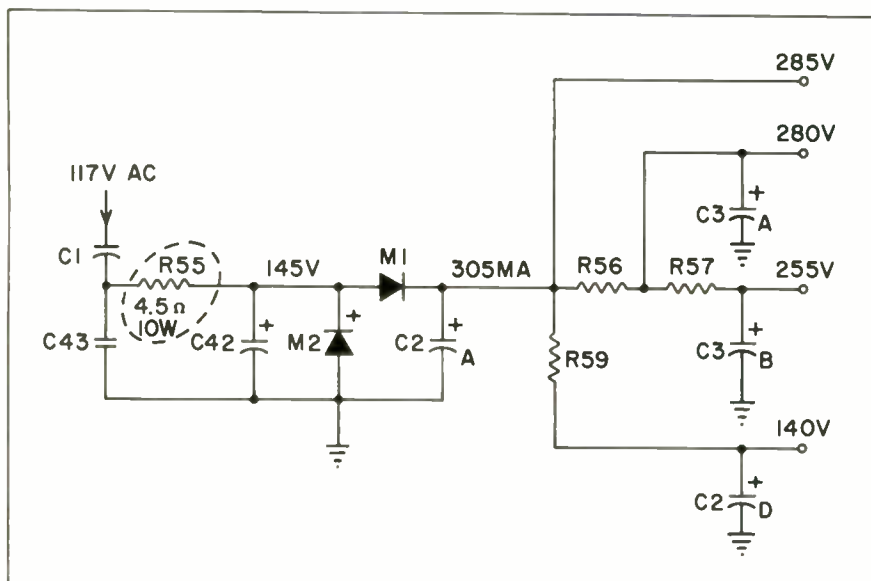

An under-rated resistor in the heart of the B+ supply heated and caused vertical roll.

### TOUGH DOGS WANTED

\$10.00 paid for acceptable items. Use drawings to illustrate whenever necessary. A rough sketch will do. Photographs are desirable. Unacceptable items will be returned if accompanied by a stamped envelope. Send your entries to "Tough Dog" Editor, ELECTRONIC TECHNICIAN, 1 East First St., Duluth 2, Minnesota.

# SENCORE

## SIMPLIFIES SWEEP CIRCUIT TROUBLE SHOOTING

### SS117 SWEEP CIRCUIT ANALYZER

For Color and Monochrome Testing

A professional trouble shooter that helps you methodically walk the trouble out of "tough-dog" sweep circuits in monochrome and color receivers. The SS117 provides a positive but simple push button test on all circuits indicated in the block diagrams. These time-consuming circuits are checked step-by-step with tried and proven signal injection and substitution methods. All checks can be made from the top of the chassis or from under the chassis when it is removed from the cabinet.

TV horizontal oscillator check is made by substituting a universal oscillator known to be good. Horizontal output check consists of a cathode current and screen voltage test. The TV horizontal yoke is checked by substituting a universal yoke from the SS117 and viewing brightness or restoration of 2nd anode voltage. Horizontal flyback is checked dynamically in circuit by measuring the power transfer to the yoke when TV is turned on. TV horizontal sync can be used to control the SS117 horizontal oscillator, providing a positive check on sync from the video amplifier to the TV oscillator. Vertical circuits are tested by simple signal injection from vertical yoke to oscillator for full height on CRT. The SS117 with the CA122 Color Analyzer provides a complete TV analyzer for virtually every stage in monochrome or color receivers.

External checks for AC, DC, peak to peak voltage readings and DC current in the upper right hand corner save using a separate VTVM. Accurate 2nd anode measurements up to 30,000 volts are made with a sensitive 300 microamp meter and the attached high voltage probe. AC outlets, all steel construction and mirror in the cover makes every servicing job easier.

Size: 10¼" x 9¼" x 3½". Wt. 10 lbs.

Dealer Net. . . . . 89.50



The SS117 checks them all



FREE—A 33 RPM half hour permanent record packed with every unit explains each test.

## FOR FASTER MORE ACCURATE TUBE TESTING

### TC114 MIGHTY MITE TUBE CHECKER

This is the famous Mighty Mite, acclaimed by over 25,000 servicemen, maintenance men and engineers as "the best they've ever used." A complete tube tester that is smaller than a portable typewriter yet finds tubes that testers costing hundreds of dollars miss, thus selling more tubes and reducing call backs. A real money maker for the serviceman and a trusty companion for engineers, maintenance men and experimenters. The Mighty Mite has been acclaimed from coast to coast as the real answer for the man on the go. Even though the Mighty Mite weighs less than 8 pounds, new circuitry by Sencore enables you to use a meter to check grid leakage as high as 100 megohms and gas conditions that cause as little as one half microamp of grid current to flow. Thus, too, it checks for cathode current at operating levels and shorts or leakage up to 120,000 ohms between all elements. And it does all this by merely setting four controls labeled A, B, C, & D with new type easy grip knobs. Check these plus Sencore features... Meter glows in dark for easy reading behind TV set... The new Mighty Mite has large size Speedy-Setup Tube Chart inside of cover—cuts setup time for even faster servicing. New stick proof D' Arsonval meter will not burn out even with shorted tube... Rugged, all steel carrying case and easy grip handle.

The improved Mighty Mite will test virtually every radio and TV tube that you encounter, nearly 2000 in all, including foreign, five star, auto radio tubes plus the new Compactrons, Novars, Nuvisitors and 10 pin tubes. Has larger, easy-to-read type set-up booklet for faster testing.

Size: 10¼" x 9¼" x 3½". Weight: 8 lbs.

Dealer Net. . . . . 74.50

### TM116 TUBE TESTER MODERNIZING PANEL

New tube adapter for testing Compactrons, Novars, Nuvisitors and 10 pin tubes in any tube tester except cardomatic types. Plugs into octal socket of your tube tester enabling you to test these new tubes in the same manner



Fast, Accurate . . . never lets you down

A must for color



that your tester checks conventional tubes. Tube set-up chart included with each adapter.

Dealer Net. . . . . 24.95

See your Electronic Parts Distributor

SENCORE, ADDISON, ILLINOIS  
... for more details circle 45 on post card

# SHOP HINTS

TIPS FOR HOME AND BENCH SERVICE

## Anti-Roller

To keep small round tools from rolling off the bench, poke them through a 1/8 in. thick square rubber

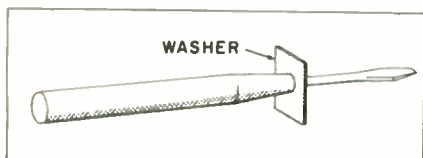

A square washer pressed over round tools prevents them from rolling off the work bench.

or leather washer. Adjust the washer so it doesn't interfere with use of tool and it may be left on permanently.—Henry Mullen, Cleveland, Ohio.

## Tuner Shaft Repair

After Standard Coil tuners become a few years old, the fine tuning fiber piece separates from the metal shaft. Actually the customer turns the fine tuning until the shaft turns inside the fiber piece. A quick and easy way to repair the shaft is to place it lightly in a low vice, with the knob end of the fine-tuner shaft resting on the bench. With a small cold chisel or screwdriver blade placed on the capacitor end of the fine tuning shaft, tap lightly with a

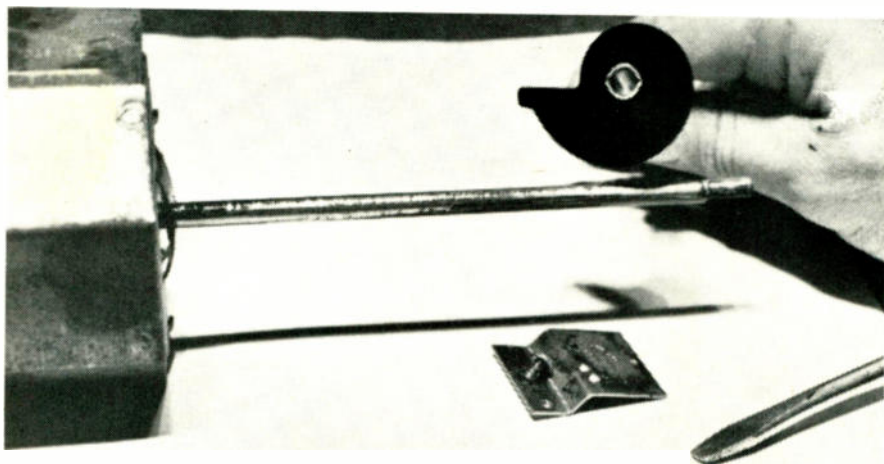

Slipping fiber on fine tuning shaft can be repaired by striking shaft with hammer and chisel to form new indentations.

small hammer to make two indentations in the shaft end at opposite sides. These indents are already on the end of the shaft, but have spread. Ream out the hole with a pocket knife and the shaft is good as new.—H. L. Davidson, Fort Dodge, Iowa.

## Part Holder

Wire solder is an ideal aid to hold and insert small parts; screws, nuts and washers in awkward and hard-to-get-at places. Simply wrap the solder around the part to be inserted and squeeze tight. Because of its ductility, solder can be bent to get it by most obstructions. A loop handle can be bent on one end of the solder to ease handling parts. After the part is secured, the solder can be pulled out of the way.—Jorge L. Gonzalez, Tampa, Fla.

## Emergency Vibrator Repair

When servicing two-way or auto radios vibrator points occasionally stick and blow a fuse; a temporary repair can often be made. Even new vibrators fail to work after long-time storage because of contact cor-

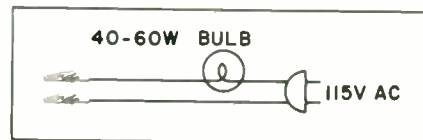

Corroded vibrator contacts can often be freed by applying "sparking" voltage to the power pins.

rosion. A simple way to clean the contacts is shown in the accompanying drawing. The a-c line in series with a 40 to 60 w bulb with alligator clips are connected to the normal "power-in" pins for a few seconds. The higher voltage puts about three out of four vibrators into operable condition.—Wesley Bazell, Yazoo City, Miss.

## Antenna Template for Fenders

When installing an antenna on a car with a new front fender, locating the hole on the "inner fender" can be simplified. The antenna extends through the inner hole when the antenna is mounted. Striking the fender with an ice pick from the underside through this hole causes a raised mark on the fender. The raised mark made by the ice pick can then be center punched from the top. When the hole is drilled, it will line up with the hole in the cowl and inner construction. This eliminates measuring, guesswork and miss-drilling.—Henry Josephs, Sr., Gardenville, Pa.

## SHOP HINTS WANTED!

\$3 to \$10 for acceptable items. Use drawings to illustrate whenever necessary. A rough sketch will do. Photos are desirable. Unacceptable items will be returned if accompanied by a stamped envelope. Send your entries to Shop Hints Editor, ELECTRONIC TECHNICIAN, 1 East First St., Duluth 2, Minnesota.

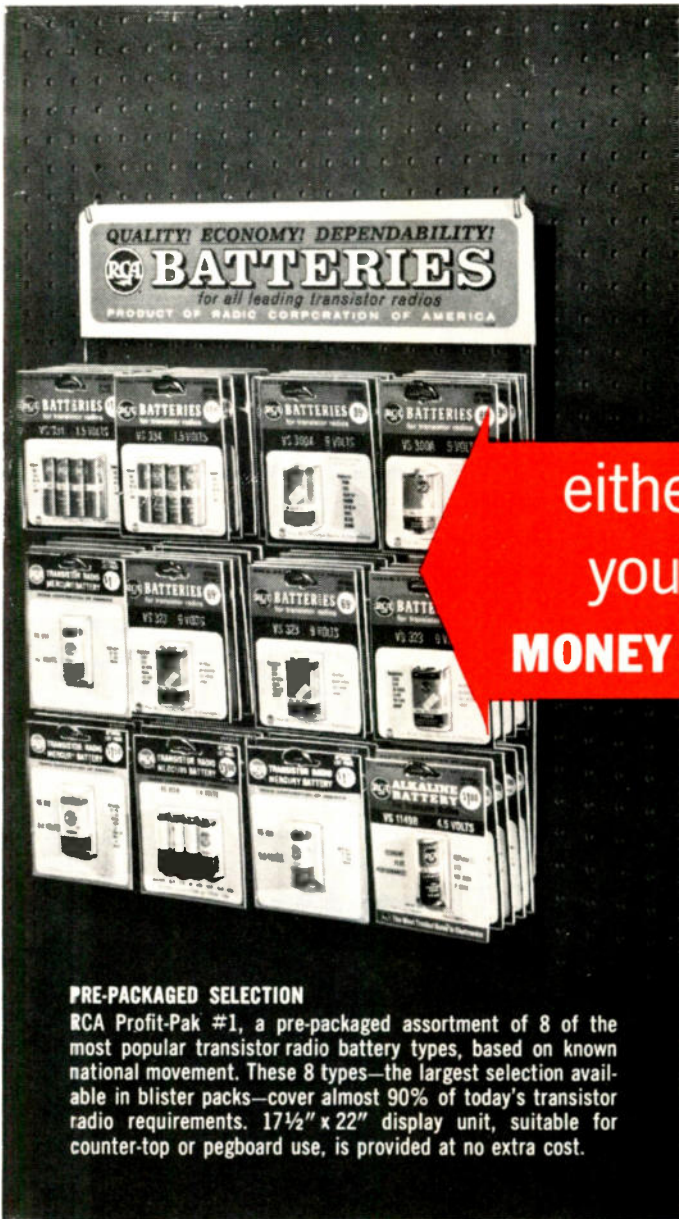

**PRE-PACKAGED SELECTION**

RCA Profit-Pak #1, a pre-packaged assortment of 8 of the most popular transistor radio battery types, based on known national movement. These 8 types—the largest selection available in blister packs—cover almost 90% of today's transistor radio requirements. 17½" x 22" display unit, suitable for counter-top or pegboard use, is provided at no extra cost.



either way  
you'll be  
**MONEY AHEAD...**

**OPEN-STOCK SELECTION**

A 15" x 12" 6-prong wire-rack display provided free with minimum order quantities of any RCA blistered battery types you select. For counter-top or pegboard use. Enables you to feature the types you feel will be most in demand in your area.

# RCA TRANSISTOR RADIO BATTERIES

Now **Blister-Packed** for greater Sales Appeal

The efficiency and sales appeal of modern packaging techniques can now put new life into your transistor radio battery sales. For the first time, RCA transistor batteries are blister-packed and supplied with self-displaying wire racks for use on your counter-top or wall pegboard. Profit-making advantages include:

- **Smart, appealing product display.** Blister-packs protect batteries from dust and dirt, keep them looking fresh.
- **Strong sales reminder to stimulate impulse buying** is provided by blister-pack display units.
- **Savings in in-store time and work.** Batteries arrive ready for display, with all pertinent information (type, size, voltage, replacements) clearly spelled out on each card.

- **Reduced pilfering.** Card-size makes profit-draining pilfering difficult.
- **Prominent RCA identification,** the brand name that sells itself in electronics.

Put one of these sales-making displays to work for you. For details, see your participating Authorized RCA Distributor, or write: Battery Department, RCA Electron Tube Division, Harrison, N. J.



**The Most Trusted Name in Electronics**

# COMPLETE SOLDERING OUTFIT IN PLASTIC CARRYING CASE



## Weller® Expert Soldering Kit

All your soldering needs in a break-proof plastic utility case. Gun features dual heat. 2 trigger positions permit instant switching to low 100-watt or high 140-watt heat. Low heat prevents damage to heat sensitive components. By using high heat only when necessary, you prolong tip life and save current.

Plastic case can be used for carrying or storing tools, parts and equipment—also as a lunch or fishing tackle box. Model 8200PK.

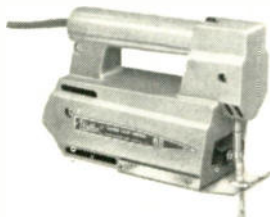

### Weller® Hi-Speed Sabre Saw

For smooth, fast cutting of all kinds on speaker and record player mounting boards, cabinets, walls, etc. Makes its own starting hole for inside cuts. Never splinters or tears wood. 4.8 ampere, heavy-duty reciprocating motor. Model 88.

On sale at your Electronic Parts Distributor

**WELLER ELECTRIC CORP., EASTON, PA.**

- - - for more details circle 54 on post card

## . . . CHROMINANCE VALUES

*Continued from page 25*

generator. When the color receiver is energized by a rainbow generator, remember that the chroma signal from the generator has the same voltage for all signals. Thus, scope checks at the red, blue, and green grids of the picture tube show the signal proportions as noted.

The waveform at the grids of the picture tube is basically a sine wave when rainbow input is used. This signal is shown in Fig. 11. Some receivers provide service controls for obtaining proper proportions of chroma signals. For example, "blue gain control," "(R-Y)/(B-Y) gain control," or "I/Q gain control." Other receivers have fixed gains in the chroma channels which can be changed only by replacement of fixed resistors.

The chroma channel gains which have been discussed thus far concern only the basic reconstitution of chroma values. They do not take into account the problem of differ-

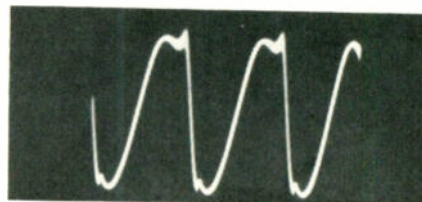

Fig. 11 — Using a rainbow generator, the waveform at the grids of the picture tube is basically a sine wave.

ent phosphor efficiencies in the color picture tube. Sometimes the phosphor efficiencies are equalized by adjustment of d-c voltages to the electron guns. Sometimes efficiencies are equalized by a combination of d-c voltage adjustments and compromises of chroma channel gains.

As a practical example, receiver manufacturer A recommends that channel gains be set up for 1.4 times as much B-Y drive to the picture tube as R-Y drive, and 0.6 as much G-Y drive as R-Y drive. On the other hand, manufacturer B specifies a B-Y drive of 1.1 times the R-Y drive, and a G-Y drive of 0.76 the R-Y drive.

With the foregoing knowledge of unadjusted and readjusted chroma values in mind, the service technician can attack chroma-channel troubleshooting with more confidence and efficiency. It also answers the puzzling questions concerning differing set-ups between receivers. ■

ELECTRONIC TECHNICIAN

# DESIGNED FOR COLOR TV

## WINEGARD COLORTRON ANTENNAS

4 gold anodized models from \$24<sup>95</sup>

\*Pat. Nos. U.S. 2,700,105; 2,955,289 • Canada 511,984 • Others Pending.



### AVAILABLE WITH REVOLUTIONARY NUVISTOR COLORTRON AMPLIFIER...

Now, through continuous Winegard research, a new, improved Electro-Lens yagi has been developed—the New WINEGARD COLORTRON—PERFECT ANTENNA FOR COLOR TV!

Colortrons have a flat frequency response (plus or minus 1/2 DB across any 6 MC channel), no “suck-outs” or “roll-off” on end of bands . . . accurate 300 ohm match (VSWR 1.5 to 1 or better) . . . unilobe directivity for maximum ghost and interference rejection. They deliver today’s finest color reception, give a new picture quality to black and white. Colortrons are the only outside antennas that carry a WRITTEN FACTORY GUARANTEE OF PERFORMANCE.

And Colortrons are built to last. High tensile aluminum tubing for rigidity and stability, insulators with triple moisture barrier, GOLD ANODIZED for complete corrosion-proofing.

There are 4 Colortron models to cover every reception need, from suburbs to distant fringe areas . . . \$24.95 to \$64.95 list.

New Winegard Colortron twin-nuvistor amplifier perfectly matches Colortron antennas. Gives added gain and sensitivity on both color and black and white. Ultra-low noise, high

gain Colortron Nuvistor Amplifier can easily drive 6 or more TV sets.

With revolutionary twin-nuvistor circuit, Colortron amplifiers can handle up to 400,000 micro-volts of signal without overloading. *This is 20 times better than any single transistor amplifier.* The Colortron Amplifier will bring the weakest signals up out of the snow, yet strong local TV & FM signals will not overload it. A special life saver circuit gives the two nuvistors a life of 5 to 8 years.

This amplifier is completely trouble free and the finest performing antenna amplifier you can own.

Completely weather sealed, nothing is exposed to corrode and cause trouble . . . has all AC power supply with 2 set coupler. (Model No. AP-220N, \$39.95 list). Twin transistor model also available up to 80,000 micro-volts input. *New type circuit protects transistor from static electricity built up in lightning flashes.* (Model No. AP-220T, \$39.95 list).

Colortron Amplifier can be added to any good TV antenna for sharper, clearer TV reception.

Ask your distributor or write for technical bulletin.

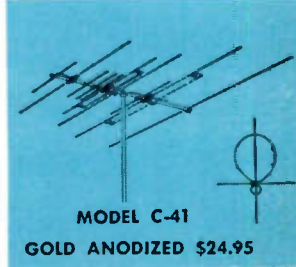
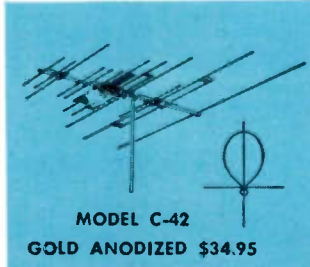
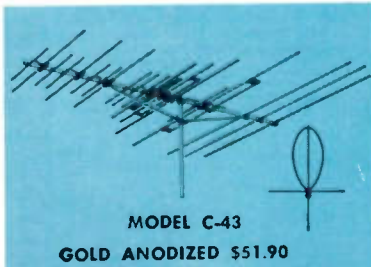

 **Winegard** There's an extra bonus of quality and performance in every Winegard product.  
ANTENNA SYSTEMS

3019-12 Kirkwood • Burlington, Iowa  
for more details circle 55 on post card

## ... CONVERGENCE

Continued from page 27

and vertical bar generator patterns.

After adjusting vertical and horizontal linearity, we returned to the dot pattern and preset the dynamic convergence controls as stated in the manual. Viewing the pattern with the aid of the mirror and adjusting the four magnets for static convergence, we very easily obtained a white dot in the center of the screen. With the aid of a reading glass focused on the center dot, we were able to precisely overlap the

red, green, and blue dots to form a white dot.

Next, we checked color purity using the "Display Off" function of our generator—still conscientiously following the manual. We found some slight adjustments were necessary. Generators not having a "display-off" control must be disconnected.

We rechecked the dots at the center of the screen with the dot pattern on again. Some retouching of the static adjustment magnets was necessary. The final result was a group of white dots in the central

area of the screen with gradual mis-convergence until, at the edges, there were groups of red, green, and blue dots. This was not alarming, since an illustration in the service manual was similar.

The purpose of dynamic convergence, as was discussed earlier, is to obtain white dots over the entire screen area. This is done by injecting current waveforms of proper amplitude and shape into the six electromagnet coils positioned around the CRT neck. Each beam is under the influence of a permanent magnet (two for the blue gun) and also two electromagnets, one for vertical and the other for horizontal dynamic convergence.

There are two controls for each electromagnet, a total of 12 in all. One control is used to vary the amplitude and the other the shape of the currents supplied to the coils.

With this particular receiver, vertical dynamic convergence is performed first. Still using our dot pattern, we manipulated the six controls required for vertical convergence as described in the service manual. A definite procedure is outlined and the technician with little

## Here's why Audio Magazine says Scott® Kits are "Simplest to build..." and have "Engineering of the highest calibre"\*



The exclusive Scott full color instruction book shows every part and every wire in natural color and in proper position. To make the instruction book even clearer, each of the full color illustrations shows only a few assembly steps. There are no oversized sheets to confuse you.

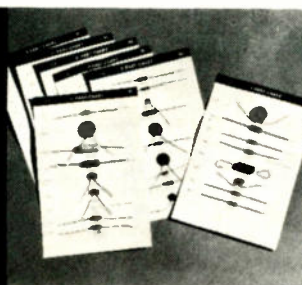

Each full color illustration is accompanied by its own Part Chart—another Scott exclusive. The actual parts described in the illustration are placed in the exact sequence in which they are used. You can't possibly make a mistake.

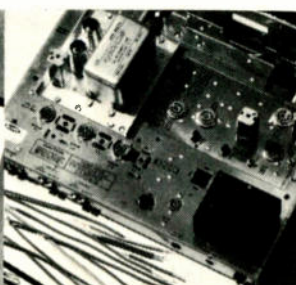

Much of the uninteresting mechanical assembly is completed when you open your Scott Kit-Pak. All the terminal strips and tube sockets are already permanently riveted to the chassis. To insure accuracy all wires are pre-cut and pre-stripped to proper length.

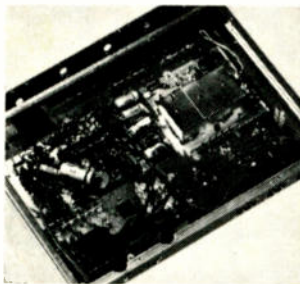

There are certain areas in every professional high fidelity component where wiring is critical and difficult. FM front ends and multiplex sections are an example. In Scott Kits these sections are wired at the factory, and thoroughly tested by Scott experts, assuring you a completed kit meeting stringent factory standards.

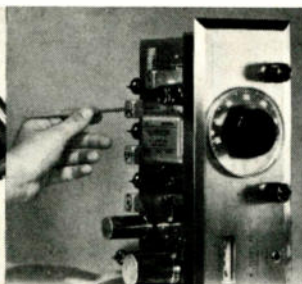

Tuners are aligned with the unique Scott Ez A Line method using the meter on the tuner itself. This assures perfect alignment without expensive signal generators. Amplifier kits require no laboratory instruments for perfect balancing.

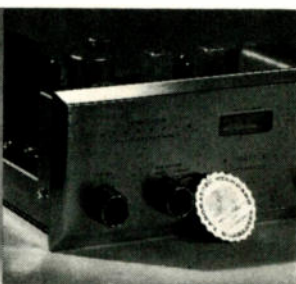

The new Scott Warranty Performance Plan guarantees that your kit will work perfectly when completed. If you have followed all recommended procedures and your kit fails to work, Scott guarantees to put your kit in working order at the factory at minimum cost.

\* Audio — February 1961, Pages 54-56

**SCOTT**  
H. H. Scott Inc., Dept. 140-12  
111 Powdermill Rd., Maynard, Mass.

Please rush me without charge your full color brochure on the complete line of Scott FM stereo tuner, stereo amplifier and speaker kits. A sample 36 page full-color Scott Kit instruction book will be included if you enclose 50¢ in coin or stamps.

Name .....

Address .....

City ..... State .....

If any of your friends would like a copy of the new Scott Kit brochure send us their names and addresses.

Export: Morhen Exporting Corp., 458 Broadway, N.Y.C.  
Canada: Atlas Radio Corp., 50 Wingold Ave., Toronto

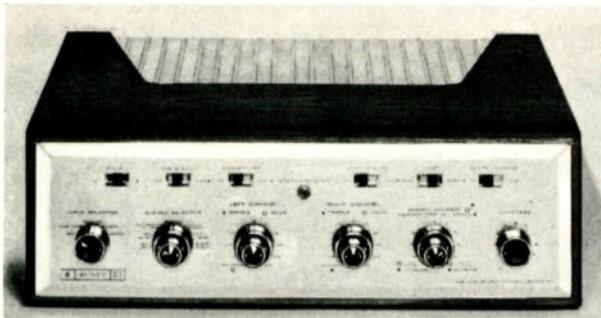

When you finish your kit you'll be delighted by its handsome good looks. And when you turn your Scott Kit system on you'll know for yourself why the expert editors of leading high fidelity magazines like Audio say "... only the most sophisticated engineering thinking could design a kit as simple and foolproof as this. ..."

... for more details circle 44 on post card

## Winegard TV-FM COUPLER

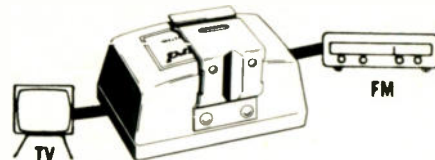

### COUPLES ANTENNAS OR SETS

Couples TV and FM antennas OR couples TV-FM sets to an all-channel antenna. Exact 300-ohm match. No loss ... no interaction. Can be mounted indoors or out. 300-ohm Model CA-FM, \$4.50 list. Also 75-ohm model. Write for Fact-Finder #231.

## WINEGARD COMPANY

3019-12 Kirkwood Ave., Burlington, Iowa

Name .....

Address .....

City ..... State .....

... for more details circle 56 on post card

ELECTRONIC TECHNICIAN



FROM THE LEADING NAME IN WORLD-WIDE COMMUNICATIONS

# BUILD PROFITS WITH QUALITY PRODUCTS



## ITT BATTERIES . . .

. . . are another sales-builder for you from the ITT family of products. This complete line of ultra-pure manganese dioxide batteries are specially designed and manufactured for transistor radios and other low power applications. An extra advantage in addition to the product superiority, is the recognized and accepted prestige label of ITT — backed by a tradition of quality for over half a century.

ITT PART NO.	NEDA EQUIVALENT	VOLTAGE	DESCRIPTION
DPD 105	15	1.5 V	PENLIGHT
DPD 110	1604	9 V	RADIO
DPD 112	1600	9 V	RADIO
DPD 115	14	1.5 V	C CELL
DPD 120	13	1.5 V	D CELL

A complete promotion campaign is designed to pre-sell your customers — magazine advertising promotional material and merchandising aids at all levels.

Join the ITT Partnership in Prestige and Progress program — you can participate in the special awards plan.



DISTRIBUTOR PRODUCTS DIVISION

P. O. BOX 99, LODI, NEW JERSEY

TEL. HUBBARD 9-7800 · CABLE DISTRIBUTOR · TWX HKK 1886

INTERNATIONAL TELEPHONE AND TELEGRAPH CORPORATION

... for more details circle 30 on post card

G-E reporter, Roland Kempton,  
makes the rounds with  
independent service dealers...

 **ELECTRONICS**

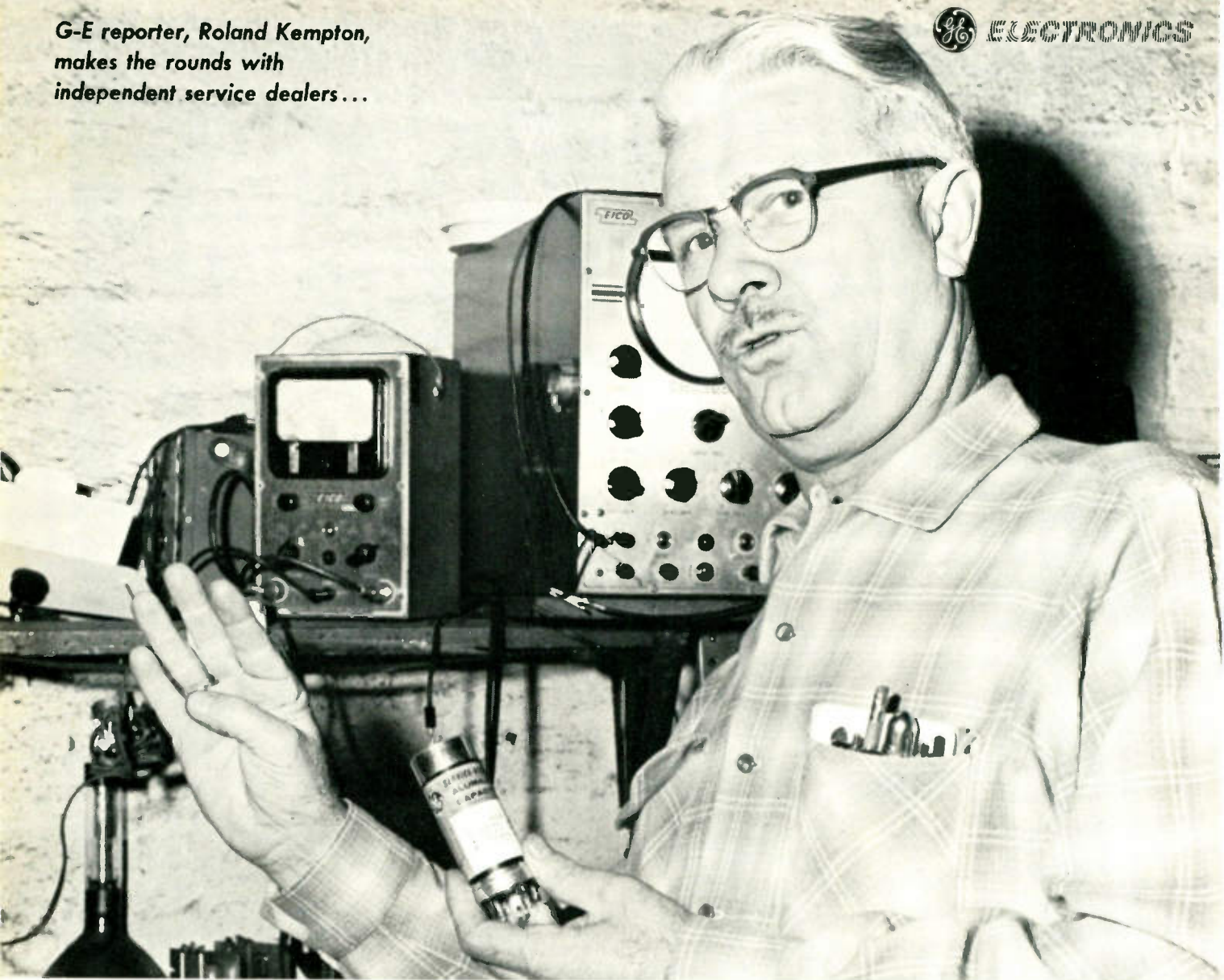

## Ben Follrath says, "It's like having 4 capacitors in each box when you stock G-E *SERVICE-DESIGNED* capacitors"

Because one G-E Service-Designed capacitor takes the place of four ordinary types... Ben Follrath, owner of BEN'S TV, Alameda, Calif., can carry about 20 types in stock and still meet approximately 70% of his replacement needs. That's because G-E Service-Designed capacitors are designed for, and marked with, an "application range" of capacitance (i.e. "40-60 mfd"). One capacitor serves all values within this application range.

To Ben Follrath, and service dealers throughout the country, this means it pays to stock G-E Service-Designed capacitors. They save time, reduce costs

of single-unit ordering and pickup, speed customer service. Like having 4 capacitors in each box.

Get your complete capacitor catalog and replacement guide from your G-E Electronic Components distributor. Ask for ETR-2600, or write to: General Electric Company, Room 1774, 3800 N. Milwaukee Ave., Chicago 41, Illinois.

*Progress Is Our Most Important Product*

**GENERAL  ELECTRIC**

... for more details circle 26 on post card

experience would be wise to follow it to the letter. After some experience with the action of the controls, we found we could deviate somewhat. The technician should use the method best suited to him.

Contrary to the custom of some manuals which advocate the use of lines rather than dots, we found the dot pattern to result in a more accurate convergence. In this manner, we could keep the center dot in convergence with the static convergence magnets, if it should misconverge with manipulation of the dynamic convergence controls.

Horizontal convergence is performed in a similar manner. This time, however, by observing the center horizontal row of dots. Again, we followed the procedure outlined in the manual. Red, green, and blue horizontal phasing controls produce little or no movement in their respective dots unless the corresponding amplitude control is at or near maximum clockwise position. The reverse is also true. Thus when working on the red dots, for instance, place the red amplitude control in its maximum clockwise position

and tune the red phase (or tilt) control for maximum downward displacement of the red dot.

In these positions of the two controls, very slight movements of either one will affect the position of the red dots in the center horizontal row. The same procedure also holds for the other two colors. Horizontal convergence is usually more difficult than vertical convergence, and it has been found helpful in some cases to use the horizontal line pattern of the dot generator in making the preliminary adjustments for horizontal convergence. When this is done, the object is to obtain a white horizontal line through the center of the screen.

Unfortunately, the 12 controls and four magnets can be expected to interact to some degree. In a step-by-step procedure, if the final result does not come up to expectations, then a repetition of the procedure will inevitably improve the results. Too many inexperienced color technicians make the mistake of haphazardly turning the controls when the final result of a convergence adjustment is disappointing. ■

### ... SERVICING TAPE RECORDERS

*Continued from page 35*

malfunctions are most frequent in tape recorders. Usually the trouble is cumulative: a slight distortion, wow or flutter that gets progressively worse and finally total failure.

The most common offenders are, of course, the rubber and composition drive components and friction parts such as the pressure pad which holds the tape against the heads. As with most equipment employing moving parts, the tape recorders metal to metal moving parts require an occasional drop of oil. Care must be taken, however, that oil is applied sparingly. Oil tends to flow more readily when it is warm and may spread to drive wheels or pulleys.

After a recorder is a year or two old, rubber wheels tend to develop flat spots and harden or become polished. Wheels which become polished may be temporarily repaired by holding a piece of sandpaper against them while they turn. This is not a long lasting repair since rubber requiring this treatment is too hard and will probably polish

again rapidly. A rounded edge on rubber drive wheels is not an indication that it needs replacing. These wheels are turned on a lathe-like machine to achieve near perfect concentricity without "flats."

Pieces of rubber or rubber shavings found in the cabinet are usually a good indication that the rubber drive wheels or belts are hardened and should be replaced.

The heads should be inspected with a magnifying glass to check for rough edges along the gap. Excessive head wear may be caused from too much pressure from the pressure pad. The proper pressure is specified by the manufacturer in his service literature. The pad should be flat (a rectangular solid) when it is in good condition.

Electrical problems in tape recorders are generally restricted to checking tubes. When a problem develops in the circuitry, however, the TV technician should be able to draw on his knowledge of Hi-Fi amplifier circuitry and basic oscillator theory. ■



## Two Service Aids Included in New G-E Auto Radio Capacitor Kit

Kit K-202 contains 10 electrolytic twist-prong capacitors (8 most popular types) that will meet the majority of auto radio replacement needs. As a bonus, each kit contains a magnetic service light, tab adjuster and replacement guide... all at no additional charge.

The magnetic service light may be attached to auto dash or radio chassis and aimed where needed. The hollow-tip tab adjuster simplifies twist-prong servicing. Both Service Aids are included at no additional cost.

Get this extra-value kit now from your G-E Electronic Components distributor. Ask your distributor for a copy of the new General Electric Auto Radio Replacement Guide, ETR-3378, or mail coupon to Chicago warehouse address shown.

*Progress Is Our Most Important Product*

**GENERAL  ELECTRIC**

General Electric Company, Dept. 1774  
3800 N. Milwaukee Ave., Chicago 41, Ill.

Please send me a copy of the new G-E Auto Radio Replacement Guide, ETR-3378.

Name \_\_\_\_\_

Address \_\_\_\_\_

City \_\_\_\_\_ Zone \_\_\_\_\_ State \_\_\_\_\_

- - - for more details circle 27 on post card

# NEW PRODUCTS

FOR MORE INFORMATION CIRCLE PRODUCT NUMBERS ON POST CARD FOLLOWING PAGE 74

## TV KIT 200

This High Fidelity TV chassis reportedly incorporates all of the latest TV circuitry for picture definition and reso-

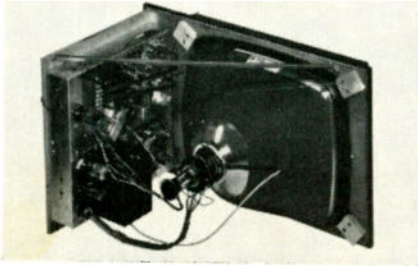

lution. It is said to be the first TV receiver that earns the right to drive a hi-fi system. All critical circuits (tuner, IF strip and hi-voltage sections) are completely factory-built, aligned and tested sub-assemblies which are ready to install on the 16 gage steel chassis. Features include: a 23 in. diagonal, 282 sq in. picture tube with bonded safety glass; a deluxe nuvistor tuner for sensitive fringe area reception; a four pre-assembled and aligned sub-assemblies, including optional UHF; a transformer operated power supply with tube rectifier; a line thermistor for long tube life; a circuit breaker and B+ fuse for circuit protection a gated AGC and noise canceler for peak reception in "any" area; a vertical and horizontal retracing blanding and 20,000 v on 2nd anode for bright sharp pictures. Price: \$169.95. Heath Co.

## AUTOMOBILE ANTENNAS 201

Two "Mark Heliwhip" automobile antennas for citizens band two-way communications are the HWC, for cowl-mounting, and the HWR-42, for roof-top installation. The HWC resembles and is directly interchangeable with standard broadcast antennas. A CBC-1 Accessory Coupler permits it to be used for both CB and standard AM radios. The antenna is made of Fiberglas and has a plastic covering to prevent interference. Top-loaded, 50-ohm load antenna design permits a shorter mechanical structure and

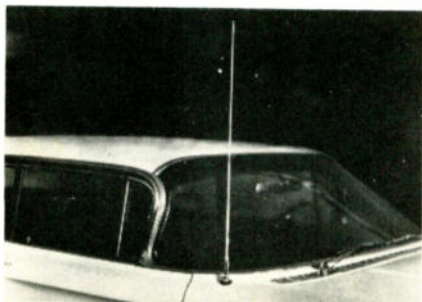

assures proper ground plane, uniform current distribution and 50-ohm match. The HWC is available in three lengths, 18 1.5, 3 and 4 ft. These forms are for 350, 400 and 50 kc bandwidth for 2:1 VSWR. The HWR-42 roof-top CB antenna, similar in design to the HWC except for its mounting is 42 in. long. Price: \$9.95 for the HWC and \$14.95 for the HWR-42. B & K Div. Dynascan Corp.

## SCOPE AID 202

A redesigned "Scope-O-Trol" reportedly features improvements in physical appearance, a new enclosure, more precise regulating components and improved circuitry. Operating components are



located on the panel. A 10 v adjustment potentiometer and vernier adjustment potentiometer are at same operating level. A-c regulation, positive and negative adjustment control, oscilloscope and supply receptacles are positioned for easier use. The unit operates from a 115 v 60 cps circuit and provides an output from 0 to 50 vdc. Input regulation is  $\pm 0.005\%$  for  $\pm 15\%$  line change. Output voltage is adjustable and stabilized  $\pm 0.015\%$  at any selected voltage. Ripple is 0.002% p-p. Acme Electric Corp.

## SOUND SYSTEM 203

According to the manufacturer, this device, designated model AM, makes available new entertainment or information channels for TV systems in motels, hotels, apartment buildings, schools, and other enterprises. Used with a tuner, tape or radio, it yields a variety of background music, broadcasting original programming or announcements. A major advantage reportedly is that it requires no extra distribution equipment, cables or cabinets. Rather, it can be mounted directly into the same housing with other MATV or CATV equipment. When a sound source is plugged in, the unit converts the audio into an actual TV

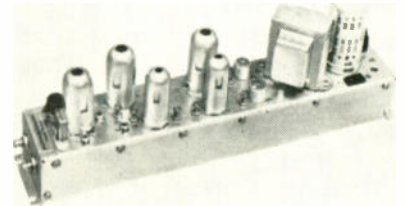

channel by generating a crystal-controlled picture carrier, to coincide with the VHF channel frequency, and a sound carrier 4.5 Mc higher. The audio source serves to modulate the sound carrier. To assure interference-free operation, the video and audio carrier output levels are adjustable. Price: \$175. Blonder-Tongue Labs.

## TESTING DEVICE 204

The "Stethotracer" test instrument and six specialized attachments are packaged into a universal lab set, Model PHD-100 for use in a wide variety of testing applications. The unit which is said to be sensitive enough to detect low level electrical signals in the microvolt region, produces a gain of 1000. The attachments are: a microwave demodulator to detect and demodulate any modulated signal from 30 Mc up to 10 Gc; magnetic tape head (monaural) to monitor recorded information from magnetic

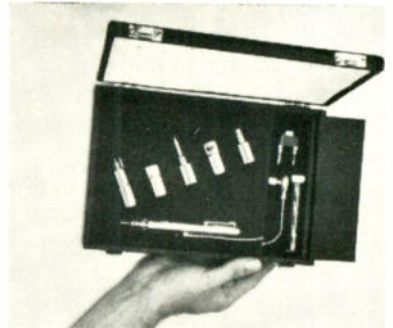

sheet or tape in motion; vibration pickup to detect mechanical vibrations; miniature microphone for frequencies covering the speech range; output adapter to connect the "stethotracer" to the oscilloscope or recording instrument for accurate output measurement and visual observation, and an input adaptor for the connection of the Stethotracer to the output of any device through any standard miniature phono pin plug. Price: \$140. Don Bosco Electronics, Inc.

## INTEGRATED TONE ARM 205

An improved version of the firm's M212/216 integrated tone arm and cartridge, the Model M222 comes equipped

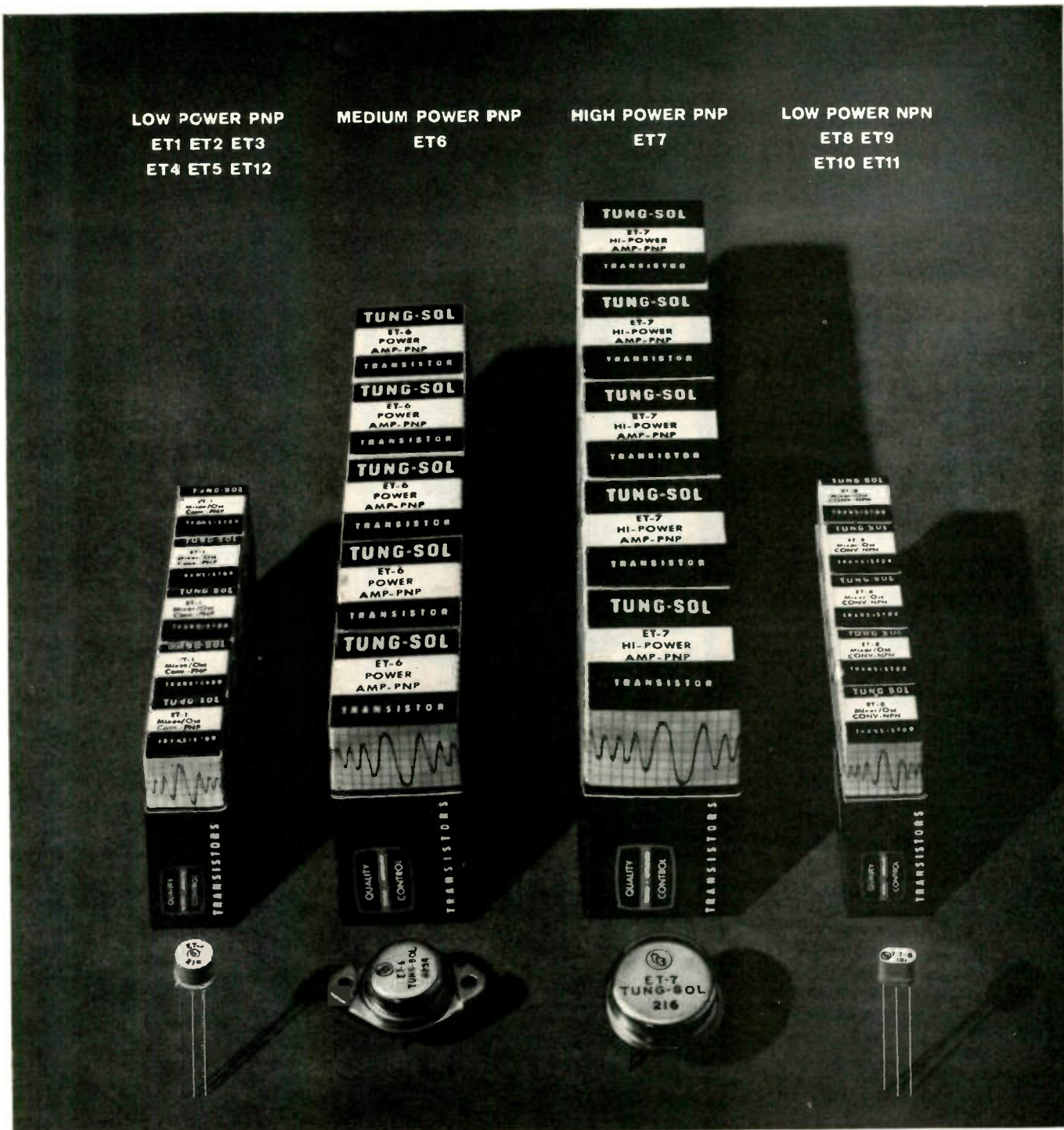

## THE EASY WAY TO SERVICE TRANSISTORIZED AUTOMOBILE AND HOME RADIOS

**STOCK THE TUNG-SOL "ET" TRANSISTOR LINE.** There are many reasons why more and more servicemen are buying the Tung-Sol ET transistor line ■ It's the industry's more comprehensive replacement line, with both PNP and NPN types for 6, 9 and 12 volt supply requirements ■ They are factory-designed for specific service, with the tube cartons plainly marked for functions ■ They are warranted by Tung-Sol to work interchangeably as specified ■ Speaking of interchangeable, the Tung-Sol Interchangeability Guide is the most useful for service work. Ask your supplier for a free copy. Tung-Sol Electric Inc., Newark 4, New Jersey.

TELL YOUR SUPPLIER YOU'D RATHER HAVE  **TUNG-SOL**<sup>®</sup>  
 - - - for more details circle 51 on post card



offers you the **GREATEST VALUE**  
in **TUBE TESTERS**

**TOP QUALITY • SPEED • ACCURACY • LOW PRICES**  
*...sell more tubes—earn more money*

a true **DYNAMIC MUTUAL CONDUCTANCE TUBE TESTER**  
for only **\$79<sup>95</sup>**<sub>Net</sub>

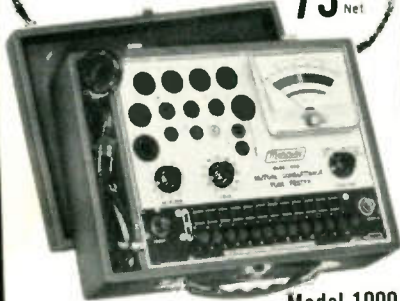

**Model 1000**  
**MUTUAL CONDUCTANCE TUBE TESTER**

Tests for true dynamic mutual conductance (Gm)

Tests for shorts and leakage between any tube elements

Tests for gas and grid emission sensitivity over 100 megohms

Tests picture tubes

Here, for the first time is a true dynamic mutual conductance tube tester to sell for less than a hundred dollars... in fact it bears a price tag of only \$79.95... truly, one of the greatest values in test equipment to come your way in a long time.

Size: 14x9½x4¾"

**Model 1100 TUBE TESTER**

... an outstanding tester—yet amazingly low in price!

Tests for shorts and leakage

Tests for dynamic cathode emission



Tests for grid leakage

Tests for gas content

**\$39<sup>50</sup>**<sub>Net</sub>

Size: only 10¾x8¼x3¼"

Here is the answer to technicians who seek a dependable, professional performing tube tester at a minimum cost. The Model 1100 has a range of operation that will outperform many, more expensive testers. It boasts an exclusive meter bridge circuit, found only in more expensive testers. Conveniently compact in size—a whale of a money-maker.

**ALL MERCURY Tube Testers have these features:**

- Also test the new tube types including Novars, Nuvistors, Compactrons, new 10-pin tubes as well as battery type tubes, auto radio hybrid tubes, voltage regulators, foreign and hi-fi tubes, thyratrons and most industrial tube types.
- Check each section of multi-section tubes separately
- Handsome, two-tone long lasting etched aluminum panel
- Housed in sturdy carrying case with handsome leatherette finish.

**Model 1200**  
**MUTUAL CONDUCTANCE TUBE TESTER**

Tests for true dynamic mutual conductance (Gm)

Tests for shorts and leakage between any tube elements

Tests for gas and grid emission... sensitivity over 100 megohms

**\$119<sup>95</sup>**<sub>Net</sub>



**Deluxe Dynamic Mutual Conductance Tube Tester with FAST PUSH BUTTON SETTINGS**

**TREMENDOUS VALUE!**

Also tests black and white and color picture tubes.

Also tests transistors.

Also tests batteries under load

Size: 18¼x10¾x4¾"

Here is a deluxe dynamic mutual conductance tube tester with a unique push-button set-up method that can be compared with the ease of selecting a record on a juke box. Push buttons provide complete flexibility in accommodating all present and new tube types and basing arrangements. The Model 1200 is the most versatile tube tester available today.

See your electronics parts distributor or write for complete Mercury catalog



**ELECTRONICS CORPORATION**

manufacturers of quality electronic products

111 Roosevelt Avenue, Mineola, New York

EXPORT: EMEC Inc., 127 Grace St., Plainview, N. Y.

... for more details circle 36 on post card

**NEW PRODUCTS**

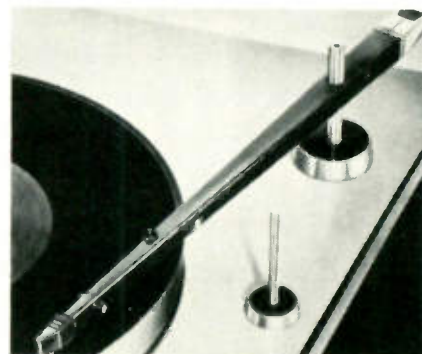

with the N22D tubular stylus with 0.0005 in. diamond and reportedly features significant improvements in the previous arm's major performance characteristics. The new unit is capable of tracking at ¾ to 1½ g reducing record wear negligible. Stylus compliance is 22 x 10<sup>-6</sup> cm/dyne. Frequency response is given as 20 to 20,000 cps with channel separation at 1000 cps of over 22.5 db. Output voltage is 4.5 mv. Price: \$89.50; stylus separately, \$25.75. Shure Brothers, Inc.

**DEGAUSSING COIL 206**

A degaussing coil for color TV servicing is described as a "ruggedly built unit designed for maximum convenience



and ease of use." The coil, which is the firm's Model No. DGC-100, features a 10 ft line cord with a line switch at the coil end. This eliminates the need for repeatedly plugging and unplugging it from the a-c line. Price: \$12.75. Stancor Electronics, Inc.

**COLOR ANTENNA 207**

An all channel Yagi, called the "Colortron," is designed specifically for color and is available with or without a 2

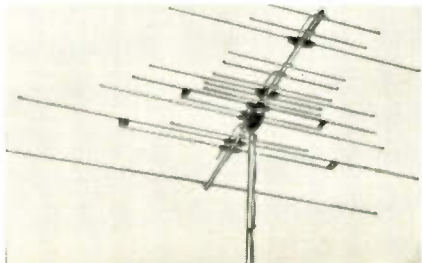

STA-LOC Kits for technicians have been improved again! They're in a brand-new cabinet and are loaded with new convenience features. And they're REAL PROFIT-MAKERS.

Stop constant trips and phone calls to your distributor for replacement controls. With the patented\* STA-LOC System you can make thousands of *exact* replacements—*right in your own shop*. Take your pick—singles, duals, dual-tandem, clutch type, push-pull—for TV, hi-fi, auto, radio, stereo—you name it.

Best of all, STA-LOC controls snap together—and *stay* together—without tools. Rear sections snap on in any of

# NEW STA-LOC® CONTROL KITS are real profit- makers!

three positions—and that's *exclusive* with STA-LOC.

Your Mallory Distributor has STA-LOC stock in depth. He can keep you constantly stocked on fast-moving items. And he has all the pieces for any "odd-ball" control you run into.

STA-LOC kits are inexpensive. The SLD-2B is a complete kit—ready to answer *hundreds* of control requirements. For smaller shops, there's the SLD-1B Kit that you can add to one element at a time if desired. STA-LOC kits are shipped complete with all instructions and cross-reference data. Get the details from your Mallory distributor—he's your headquarters for controls.

\*U.S. Patent 2,958,838

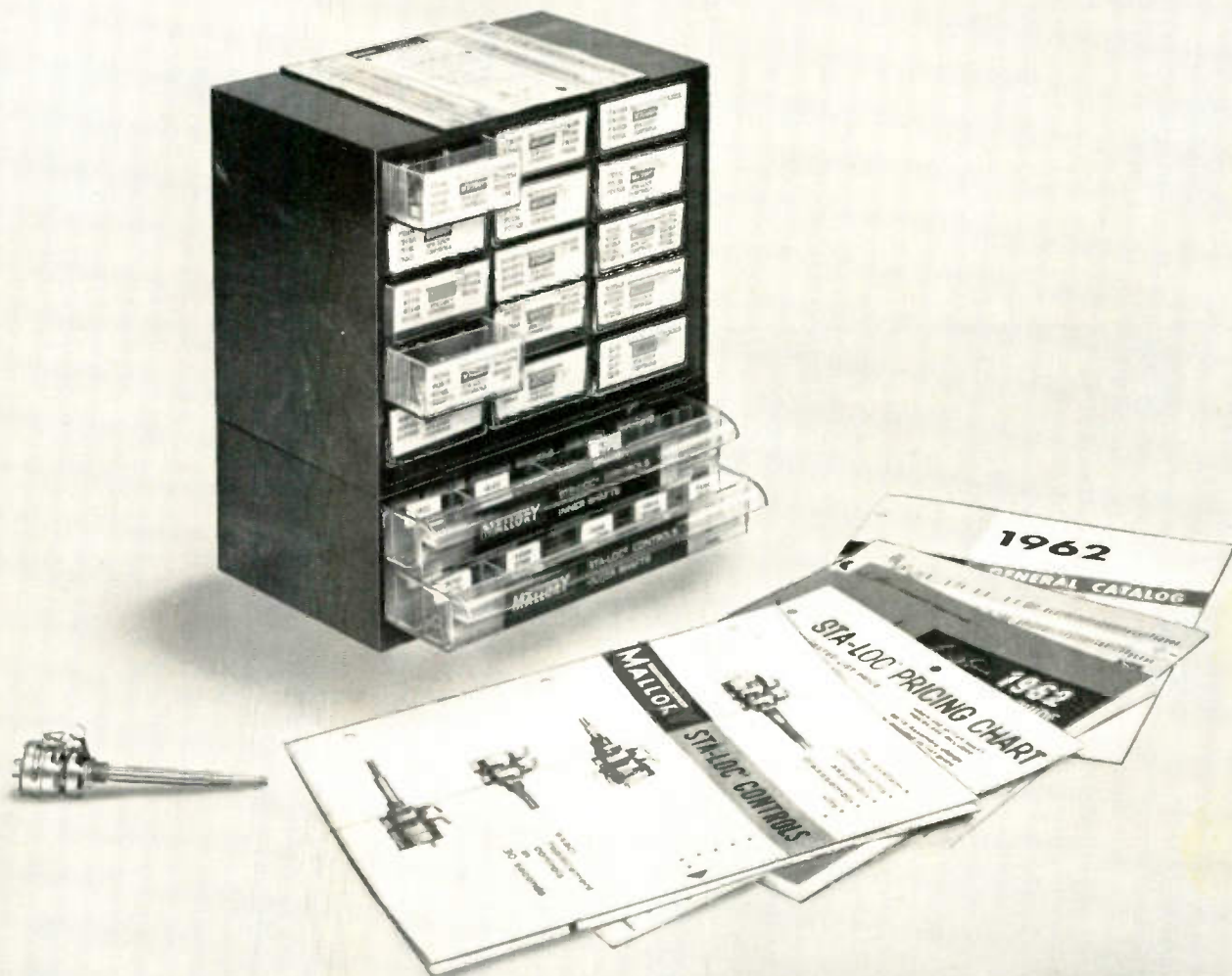

Mallory Distributor Products Company  
P. O. Box 1558, Indianapolis 6, Indiana  
a division of



# MAKING ROOM AT THE TOP

## AC VTVM & AMPLIFIER #250



Kit \$49.95 Wired \$79.95

Phenomenally good AC VTVM, bound to make room for itself at the top of the professional market. 12 ranges from 1 mv to 300 V full-scale, 10c-600kc  $\pm 0$  db response, 10 megohms input impedance,  $\pm 3\%$  of full scale accuracy. At the flick of a switch, the internal wide-band amplifier is available for external use. Provides 8c-800kc  $\pm 0$  db response, 5 VRMS output, 5 kilohm output impedance, gain control, noise  $-40$  db. Regulated power supply, frame grid tubes.

## AC VTVM #255

Kit \$44.95  
Wired \$72.95

All the precision VTVM facilities of the #250, less the external use of the wide-band amplifier.



## ARMED TO THE TEST LEADS FOR THE TRANSISTOR GAME

## TRANSISTOR AND CIRCUIT TESTER #680

Kit \$25.95

Wired \$39.95

Measure ICEO, ICBO &  $dc\beta$  directly,  $ac\beta$  indirectly, without charts or special settings—plus all dc volts, currents, and resistances needed to service transistor equipment. 50  $\mu A$ , 3 1/2" face meter movement provides sensitivity and scale length necessary for accurate measurements. Built-in 20,000 ohms/volt VOM facilities let you work on transistor equipment with minimum equipment tie-up.

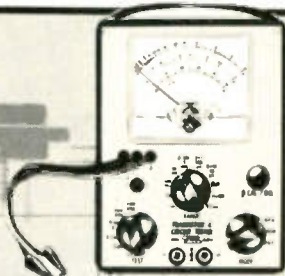

## SITTING DUCKS FOR THIS SNOOPER

## IN-CIRCUIT CAPACITOR TESTER #955

Kit \$19.95

Wired \$39.95

Leave those capacitors where they are! Without unsoldering:

- check for shorts (even in the presence of as little as 1 ohm shunt resistance)
- check for opens (determine the presence of as little as 5mmf in the circuit), and to confirm open indication . . .
- measure capacitance with  $\pm 10\%$  accuracy between 0.1 mf and 50 mf
- measure RC product, convertible into dissipation or power factor.



### Also New From EICO:



Battery Eliminator and Charger #1064  
Kit \$43.95  
Wired \$52.95



AC Bench Supplies Model 1073—  
Kit \$35.95  
Wired \$47.95  
Model 1078—  
Kit \$42.95  
Wired \$54.95



AC Volt-Watt Meter #261\*  
Kit \$49.95  
Wired \$79.95

\*Formerly designated as #260.



For complete catalog of over 106 EICO kits and wired units—hi-fi, test equipment, citizens radio, ham gear—plus name of nearest distributor, write to dept. ET-12  
EICO ELECTRONIC INSTRUMENT CO., INC., 3300 NO. BOULEVARD, L.I.C. 1, N. Y.  
Export Dept, Roburn Agencies Inc. • 431 Greenwich St., New York 13, N. Y.

Add 5% in the West

## NEW PRODUCTS

"Nuvistor" amplifier. There are 4 models. The units reportedly have a flat frequency response of  $\pm 1/2$  db across any 6 Mc channel with no "suck-outs" or "roll-off" on end of bands; accurate 300 ohm impedance match, VSWR 1.5 to 1 or better and unilobe directivity for maximum ghost and interference rejection. All models are gold anodized. The Nuvistor amplifier clamps on the antenna adding a powerful electronic signal boost. Oscillations, strong signal overloading and cross modulation picture interference reportedly are not problems because it will take up to 400,000  $\mu V$  of signal input. It can be used to amplify weak signals from distant FM stations. Price: \$39.95 with two set coupler. Winegard Co.

## MULTIPLEX GENERATOR 208

The Model E-490, is said to be a moderately priced stereo multiplex signal generator. The E-490 is designed for

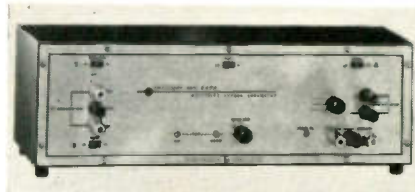

rapid alignment and complete testing of the multiplex circuitry in all FM stereo receivers and multiplex adapters. Channel separation, channel balance, sync pull-in and hold-in range can be measured and adjusted. The controls provide for generating the FCC specified FM stereo multiplex signal. The self contained 1 kc audio oscillator, or an external audio generator, may be switched to generate: left only, right only and sum or difference signals. The pilot signal can be switched on or off, independent of the composite modulation. Precision Apparatus Co., Inc.

## COLOR ANALYZER 209

The Model CA122, is reported to be a complete analyzer that provides all required test patterns and signals for testing from TV tuner to the tricolor tube. The CA122 also generates many additional analyzing signals for injection at each stage including audio, video and

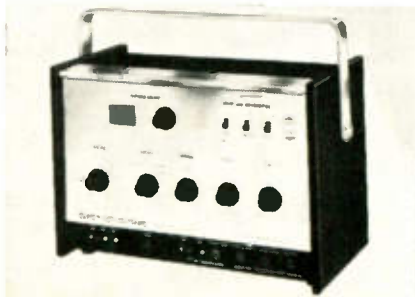

— for more details circle 24 on post card





"One-quarter of all our business comes from the Yellow Pages!" say Mr. & Mrs. Joseph McMillan, owners of the A Bee C Television Service Company, Inc., St. Louis, Mo. "Our Yellow Pages ad sells for us in four ways. First, by attracting new customers. Second, by constantly repeating our selling message to our old customers who recheck the Yellow Pages for our number. Third, by bringing us a sizable 'walk-in' trade. And last, by being the 'anchor' ad for all our other advertising. No doubt about it, dollar for dollar, our Yellow Pages program is our most effective advertising medium!"



Display ad (shown reduced) runs under TELEVISION SERVICE. Call the Yellow Pages man at your Bell Telephone Business Office to plan your program.

It's As Simple As

# A Bee C

**TO SOLVE YOUR TV PROBLEMS**

FACTORY AUTHORIZED SERVICE WITH BEHNING FACTORY PARTS F. O. D.

- ADIRABEL
- CBS-COLUMBIA
- CAPEHART
- CROSBY
- DUMONT
- GENERAL ELECTRIC
- EMERSON
- HALLIBROTTERS
- OLYMPIC
- PHILCO
- RAYTHEON
- RCA-VICTOR
- SERTWEL

SPECIALIZED SERVICE O-4

- MUNTZ
- ZENITH
- WESTINGHOUSE
- SPOONBERG-CAPISON
- ANYONE
- WESTINGHOUSE

- \* RAPID REPAIR: IN YOUR HOME
- \* BUDGET TERMS
- \* BONDED
- \* NO EXTRA CHARGE FOR SUNDAY OR EVENING SERVICE
- \* TUBES CHECKED
- \* IN YOUR HOME
- \* COLOR SETS REPAIRED

**90 DAY GUARANTEE**

**CENTRAL WEST**

PA 6-5555  
PA 5-4000

**NORTH & NORTHWEST**

6212 NATURAL BRIDGE EV 5-1202

**EAST & NORTHEAST**

2740 N. GRAND JE 3-9000

**SOUTH & SOUTHWEST**

5217 GRAVOIS FL 3-1028

TELEVISION SERVICE COMPANY INC.

... for more details circle 10 on post card

# We're pushing the full line...



(of **Centralab** Ceramic Capacitors)

Sometimes we get so wound up in talking about our "only from CENTRALAB" ceramic capacitors that we forget to remind you about the *standard* ones.

CENTRALAB has plenty of both—as well we should. We *pioneered* ceramic capacitors many years ago—and we still give you the finest product and the widest choice.

Discs, tubulars, buffers, trimmers, feed-thrus—for every standard and special application, in radio-tv servicing or industrial use—CENTRALAB makes them and makes them best. That's why CENTRALAB is the best ceramic capacitor line for you to buy.

**Centralab.**

THE ELECTRONICS DIVISION OF GLOBE-UNION INC.  
902M EAST KEEFE AVENUE • MILWAUKEE 1, WISCONSIN  
CENTRALAB CANADA LIMITED—AJAX, ONTARIO

D-61335

**ELECTRONIC SWITCHES • VARIABLE RESISTORS • CERAMIC CAPACITORS**

**PACKAGED ELECTRONIC CIRCUITS • ENGINEERED CERAMICS**

... for more details circle 20 on post card

## NEW PRODUCTS

sync. The unit generates every signal normally received from the TV station plus convergence and color test patterns. Crystal controlled 4.5 Mc and 900 cps audio are available for trouble shooting of audio circuits, as is a new illuminated pattern indicator. Price: \$187.50 Sencore, Inc.

### TAPE DECK

210

A compact magnetic tape deck is claimed to be designed for mounting in minimum cabinet space for a variety of



professional sound and elementary applications. The Series 7000 Deck plays the self-threading "Echo-Matic" tape loop cartridge which automatically rewinds the closed loop as it runs, providing continuous or automatic replay service. Built-in tape guide pins provide accurate alignment of the patented "Friction Free" tape. Magnetic heads and preamplifier electronics can be fastened on a removable component plate for repair and replacement without disturbing other components. Space is provided for a variety of magnetic head configurations. Wow and flutter is less than 0.4% rms. The flywheel is a 17 oz die-casting and provides for tape speeds of 1½ or 3¾ ips. The deck weighs less than 2 lb without electronics, motor and flywheel. Cousino Electronics Corp.

### STEREO TUNER

211

The Model 370 wide-band FM multiplex tuner includes time-switching multiplex circuitry, for maximum stereo separation and off-the-air tape recording, and the "Sonic Monitor." The Sonic Monitor automatically signals when stereo is on the air. The user simply tunes across the dial and listens for a monitor tone over his speaker systems. The Model 370 utilizes a 3-gang tuning capacitor with tuned RF stage to insure high sensitivity. Pure copper provides reportedly maximum signal to noise ratio for

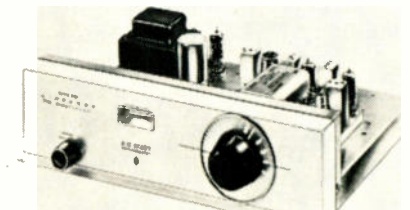



**take these boosters**



**in this caddy/pak**



**on every service call**

## NEW BLONDER-TONGUE CADDY/PAK BOOSTS BOOSTER SALES

TV Technicians — here's a bright new profit idea from Blonder-Tongue. Called the CADDY/PAK, it holds two indoor TV/FM boosters—one a transistor model, the other tubed — and fits easily in your tube caddy. The boosters are: the new all-transistor, model IT-4 Quadra-booster; and the industry's most reliable tubed model, the B-24c.

This combination makes it easy for you to give your customer the right booster for any reception situation. Remember, transistor boosters provide higher gain and are more rugged, but they have one problem — overload (windshield wiper effect, loss or sync). If you use a transistor booster in an area with one or more strong TV or FM signals — you may be buying too much booster. On the other hand, tubed boosters perform very well in these areas.

With the Blonder-Tongue CADDY/PAK you can demonstrate both tubed and transistor models in a jiffy, by con-

necting them to the terminals of the set. Either way your customer gets the finest indoor booster — a Blonder-Tongue.

The CADDY/PAK fits in your tube caddy. It's imprinted with the profit-producing words — “WANT A SHARPER TV PICTURE? ASK ME.” You can place it on the set you are servicing and let it sell for you. And it reminds you and all your technicians to mention boosters on every service call.

You just can't help selling more — having more satisfied customers too — because they have the right booster. Today, see your Blonder-Tongue distributor and get details on how you can get a free CADDY/PAK booster demo kit—the sure-fire approach to boosting booster sales.

engineered and manufactured by  
**BLONDER-TONGUE**

9 Alling St., Newark, 2 N. J.  
Canadian Div.: Benco Television Assoc., Ltd., Tor., Ont.  
Export: Rocke Int'l. Corp., N. Y. 16 - Cables ARLAB

Home TV Accessories • UHF Converters • Master TV Systems • CATV Systems • CCTV Systems

— for more details circle 16 on post card

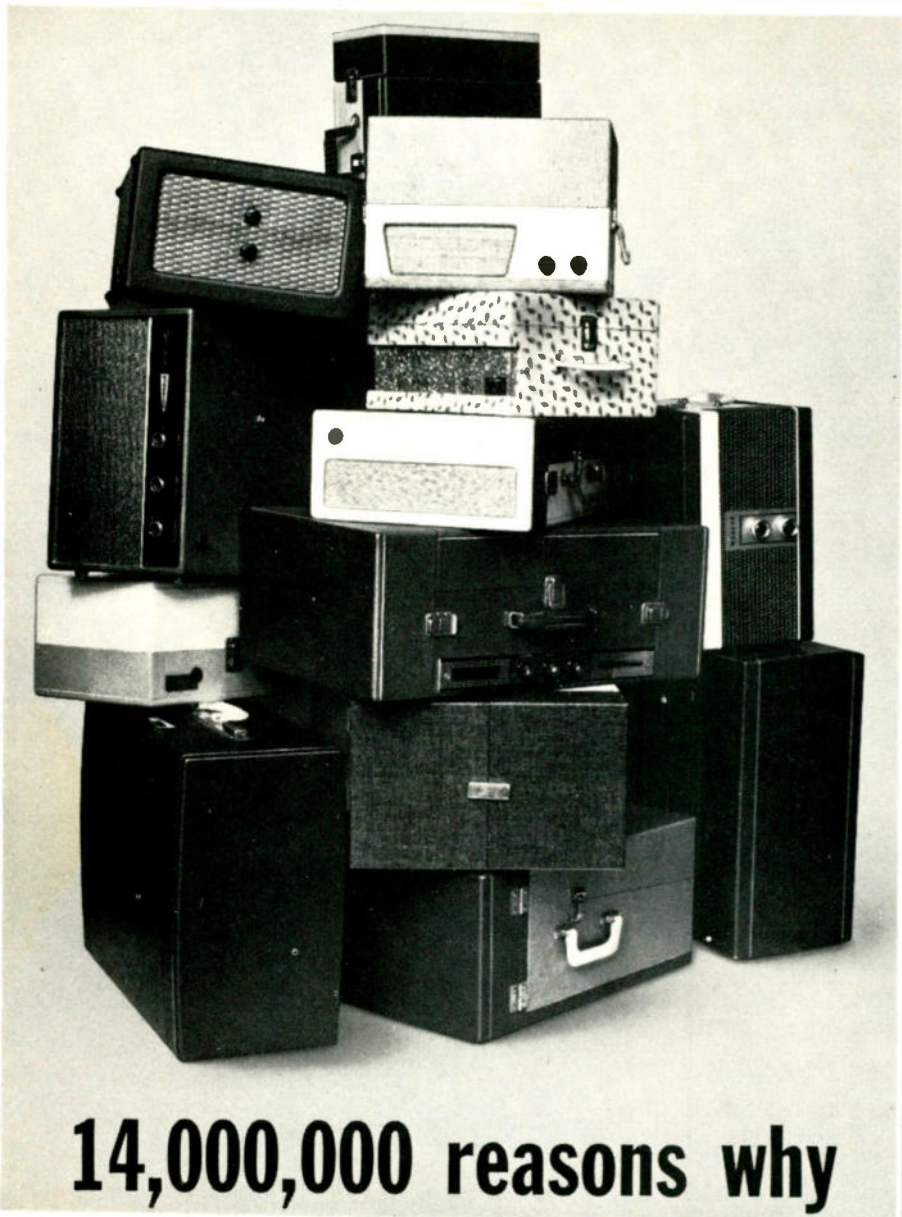

**14,000,000 reasons why**

fewer cartridges ✓ replace more models  
 ✓ tie up less capital ✓ mean greater profits

Leading record player manufacturers—from the low-price mass producers to the well-known high fidelity manufacturers—have chosen to protect the quality of their products with Sonotone—*more than 14 million times!* That's the number of Sonotone cartridges incorporated as original equipment in the products of the nation's leading producers. And, that's also the number of *genuine* direct replacements you can make with Sonotone cartridges.

Normally, it would take a large inventory of cartridge models to provide replacements for 14 million record players. Not with Sonotone. Sonotone has so engineered its line that just a few models make it possible for you to offer a direct *genuine* Sonotone replacement to your share of 14 million potential customers. What's more, with only a few models the Sonotone line replaces the most frequently used cartridges of other manufacturers.

Sonotone has just released a series of new stereo and mono high fidelity ceramic cartridges with the same standard physical dimensions as cartridges now used in over 14,000,000 record players.

*Rely on Sonotone—the line that requires fewer cartridges to replace more models. Now available in the handy 6-Pak at your distributors.*

# SONOTONE® CARTRIDGES

Sonotone® Corporation • Electronic Applications Division • Elmsford, New York  
 Cartridges • Needles • Speakers • Tape Heads • Mikes • Electron Tubes • Batteries • Hearing Aids  
 - - - for more details circle 47 on post card

## NEW PRODUCTS

clean, noise-free reception even on distant stations. Separate level controls permit exact matching of channels. Sensitivity is 3.5  $\mu\text{V}$  (IHF), capture ratio 6 db and selectivity 32 db. Separation is over 30 db and signal to noise ratio is 55 db. Dimension are 15½ x 5¼ x 13¼ in. Price \$169.95. H. H. Scott, Inc.

### CAPACITOR ANALYZER 212

A capacitor analyzer, Model BF-71, tests units with voltage ratings of 1 to 500 v. It measures capacitance without

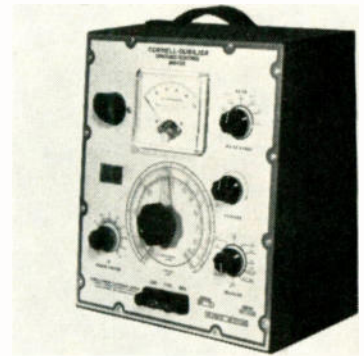

causing damage to capacitors or change in their characteristics. The BF-71 operates on 115 v, 50/60 cps and measures capacitors with values ranging from 10 pf to 2000  $\mu\text{f}$ . Its resistance measurement range is 2.5 ohms to 25 megohms and its current measurement range is 2 ma to 100 ma. These measurements, including voltages from 0 to 500 v are all within 3% accuracy. (Sensitivity is 10,000 ohms per volt). The analyzer is also said to be capable of measuring power factors up to 50%. Cornell-Dubilier Electronics Div.

### ANTENNA AMPLIFIER 213

The "Colortron" antenna amplifier is claimed to eliminate maintenance and replacement problems. Oscillations, strong signal overloading and cross modulation picture interference are not problems with a Colortron amplifier because it will take up to 400,000  $\mu\text{V}$  of



It used to take 2 men to pull  
a color TV set into the shop...

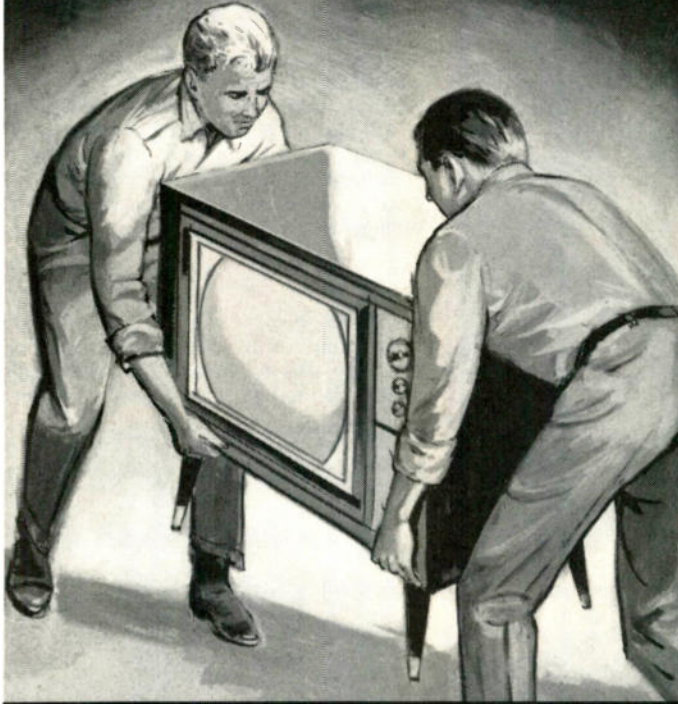

BUT NO MORE

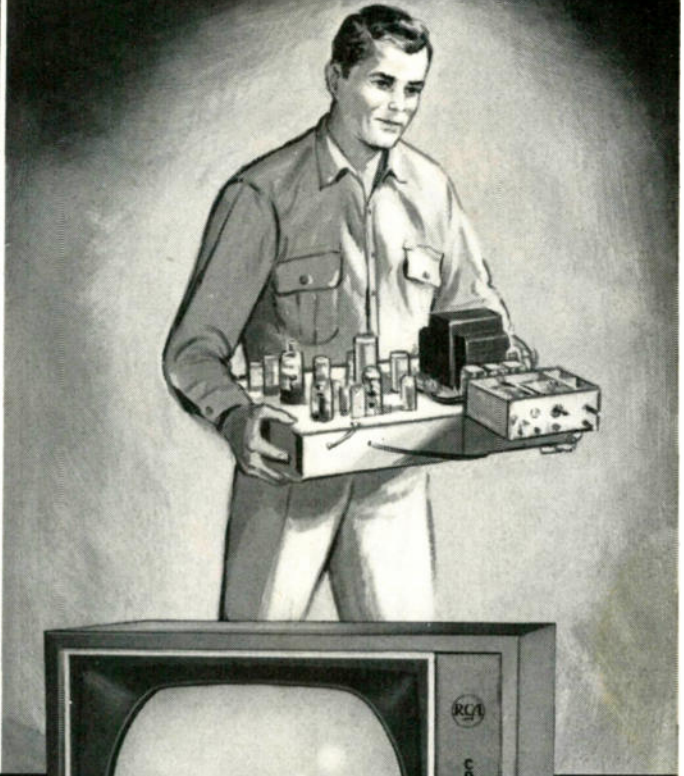

## RCA COLOR TV TEST JIG

Cuts your manhours on Color-TV home service calls

Here is a real "must" for anyone servicing or planning to service color TV sets.

No longer must you send two men to a customer's home to pull in his entire color set. Now, one man can simply remove the chassis and bring it back to your shop for testing, troubleshooting and alignment in your RCA Color TV Test Jig.

Look at some of the extra advantages built into this money-saving unit:

- **Minimizes costly damage claims.** Pulling chassis eliminates possibility of scratching or damaging a customer's cabinet when transporting it to and from his home.
- **Saves time.** Eliminates need to reconverge a customer's set when chassis is returned. Convergence control panel on Test Jig provides static and dynamic convergence for CTC-10, CTC-11 and CTC-12 chassis.
- **Versatile.** Can be used with CTC-4, 5, 7, 9, 10, 11 and 12 chassis.
- **Safe.** Supplied with factory-installed safety glass and kine mask.
- **Complete components kit,** supplied with unit, provides all necessary service components and instructions for installing RCA Color Picture Tube.
- **Professional appearance.** Finish matches that of your other RCA test instruments.

The RCA Color TV Test Jig is available through your Authorized RCA Parts and Accessories Distributor. See him this week to find out how this versatile instrument can help you capitalize on the growing Color TV servicing market.

For information on where you may obtain the RCA Color TV Test Jig, and for additional specifications, fill out and mail the coupon below.

RCA PARTS AND ACCESSORIES, CAMDEN, N. J.



The Most Trusted Name in Electronics

RCA Parts and Accessories  
P.O. Box 654, Camden, New Jersey

Please send me full specifications on the RCA Color TV Test Jig, and the name of the nearest distributor where I may obtain it.

Name \_\_\_\_\_

Company or Service Shop \_\_\_\_\_

Address \_\_\_\_\_

City \_\_\_\_\_ Zone \_\_\_\_\_ State \_\_\_\_\_



Wherever you go...

it's easy to go **STANCOR!**

When you need an exact replacement transformer, check first with your Stancor distributor. He's almost sure to have the unit you need in stock.

That's because Stancor makes the industry's most comprehensive line of exact replacement yokes, fly-backs, and other TV replacements, and Stancor distributors carry complete inventories for your maximum convenience.

How do you find a Stancor distributor? That's easy, too. If he's a leading distributor, who carries the top lines, he'll have Stancor.

*Stancor—the most extensive line with the most extensive distribution*

**STANCOR ELECTRONICS, INC.**

3501 West Addison Street  
Chicago 18, Illinois

**TV TUNERS** \* **REBUILT OR EXCHANGED**  
ALL TYPES

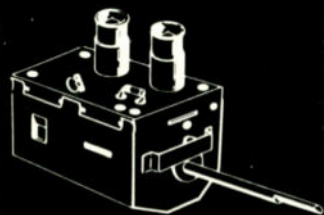

**\$9.95** including parts and labor  
(broken parts at our cost)

- Normally shipped same day received
- 90 day full guarantee
- U/V combinations \$17.95

FREE—If Mailing carton sent to you on request

Phone REpublic 3-9189

**L. A. TUNER EXCHANGE**

4611 West Jefferson Blvd.  
Los Angeles 16, California

**NEW PRODUCTS**

signal input, according to the manufacturer. It can be used to amplify weak signals from far-away stations even though there are strong signals from local TV and FM stations. The amplifier reportedly has a low noise circuit, high amplification, flat frequency response, accurate impedance match (VSWR 1.5 to 1), and no phase distortion. Six to 10 TV sets can be run from one amplifier depending on area. The amplifier is completely weather-sealed. Price: \$39.95. Winegard Co.

**SPEAKER KIT**

**214**

The first of its new line of speaker kits, the SK-4, comes complete with cabinet in walnut, mahogany or unfinished pine or hardwood. Directions are



said to be easy to follow, and the end product is a speaker of "unusual fidelity and handsome appearance." It is patterned after the firms S-3 speaker. Cabinet is factory-assembled and professionally pre-finished. The three-way system has a high compliance, low-resonance woofer and separate mid-range and high-frequency drivers. A multiple crossover network has separate controls for the mid-range and tweeter drivers. H. H. Scott, Inc.

**SIGNAL GENERATOR**

**215**

The model 502 is claimed to be the smallest, lowest priced signal generator on the market today in either wired or kit form. The model 502 has six bands from 115 kc to 110 Mc on fundamentals

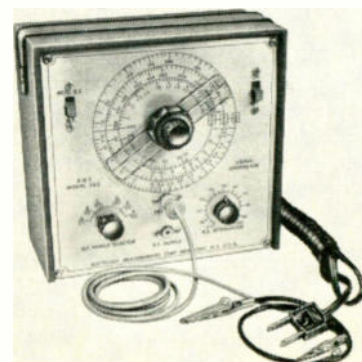

... for more details circle 33 on post card

# The world's largest selling line of P.A. Amplifiers...

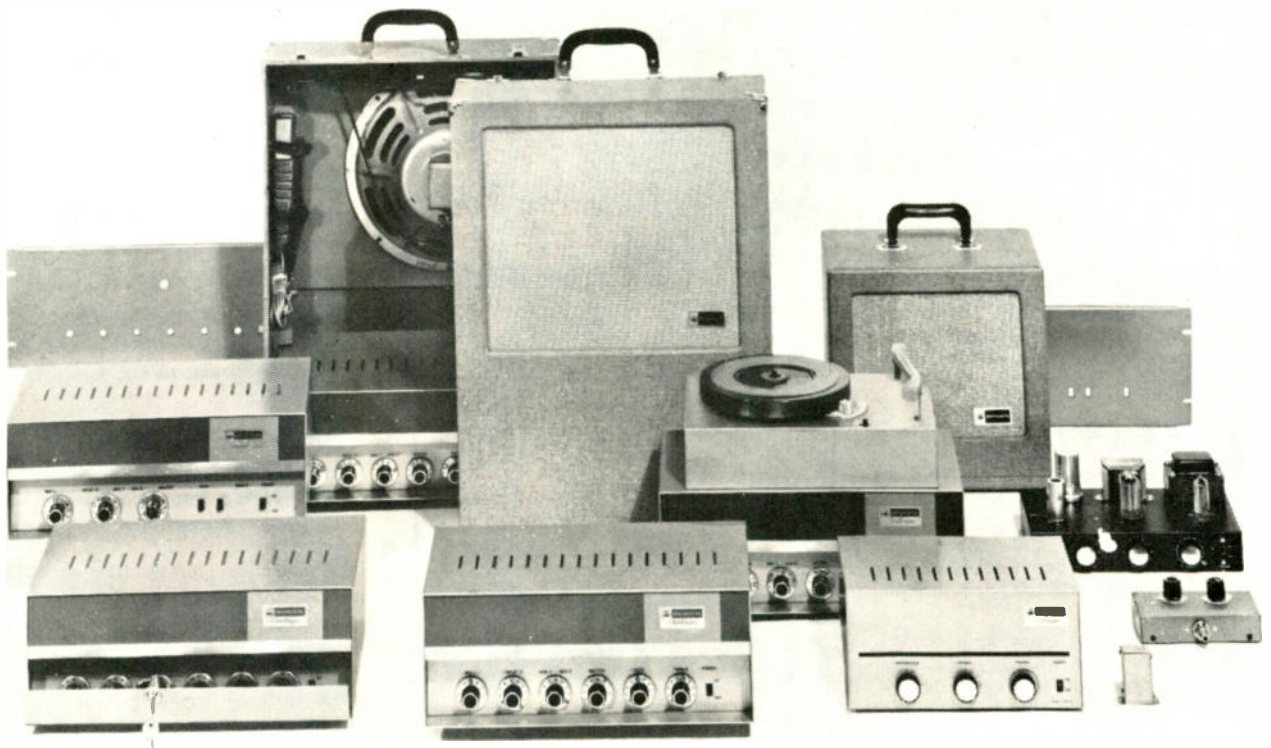

## BOGEN's CHALLENGER "CHB" SERIES!

Easy to stock... styled to please... and engineered to outperform all other P.A. amplifiers—dollar for dollar... that's the BOGEN Challenger CHB series. Ranging in power from 10 to 100 watts, they establish a new industry standard for Reliability—plus—Value. **Versatility.** Designed with many features found only in the exclusive BOGEN Flex-Pak series, including interchangeable phono-top, control locking plate, built-in remote control circuit, circuit protection against accidental speaker-line shorting, master gain control, continuous-duty circuitry, and much more. **Value.** CHB means maximum performance with minimum maintenance, insuring satisfied customers. **Reduced Inventory.** Universal accessories (phono-top, locking plate, carrying case, rack panel, remote controller) fit five models and cover all requirements. **Profit.** Versatility + Value + Reduced Inventory = Profit! CHB, newest P.A. line from BOGEN — pioneer of the most significant developments in P.A.

**BOGEN**  
COMMUNICATIONS DIVISION  
DESK ET-12, PARAMUS, N.J.



LEAR SIEGLER, INC.

- - - for more details circle 17 on post card

**NOW  
YOU CAN BUILD  
A FINE  
Schober Organ  
FOR ONLY  
\$550**



You can assemble this new Schober Spinet Organ for \$550 — or half the cost of comparable instruments you have seen in stores. The job is simplicity itself because clear, detailed step-by-step instructions tell you exactly what to do. And you can assemble it in as little as 50 hours.

You will experience the thrill and satisfaction of watching a beautiful musical instrument take shape under your hands. The new Schober Electronic Spinet sounds just like a big concert-size organ — with two keyboards, thirteen pedals and magnificent pipe organ tone. Yet it's small enough (only 38 inches wide) to fit into the most limited living space.

You can learn to play your spinet with astounding ease. From the very first day you will transform simple tunes into deeply satisfying musical experiences. Then, for the rest of your life, you will realize one of life's rarest pleasures — the joy of creating your own music.

For free details on all Schober Organs, mail the coupon now. No salesman will call.

THE *Schober Organ* CORPORATION

43 West 61st Street, New York 23, N. Y.  
Also available in Canada and Australia.

**MAIL THIS COUPON TODAY**

The Schober Organ Corporation  
Dept. TE-4  
43 West 61st Street  
New York 23, New York

- Please send me FREE booklet and other literature on the Schober Organs.  
 Please send me the Hi-Fi demonstration record. I enclose \$2 which is refundable when I order my first kit.

Name .....

Address .....

City ..... Zone... State.....

... for more details circle 43 on post card

**NEW PRODUCTS**

Individual slug tuned coils are used for each band. Planetary drive tuning condenser for fine adjustment of frequencies, 400 cps internal modulation available and RF accuracy within 1½ % are other features cited. Price: \$24.95, wired or \$17.95, kit. Electronic Measurements Corp.

**TRANSISTOR ANALYZER 216**

The KT-223 is a six-in-one transistor analyzer said to be capable of testing all types of transistors including power



*Winegard*  
**YAGI COUPLERS**

The new low-cost way to tailor-make your own special antenna system using a single down-lead!

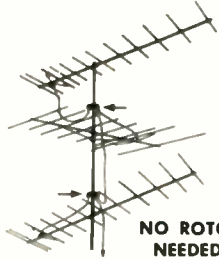

**NO ROTOR NEEDED!**

No interaction. No loss. Couple 2 or more cut-channel yagis to each other, or couple cut-channel yagi(s) with any other VHF broadband or all-channel antenna. Eliminates "mixing networks", rotors, switches. Convenient, automatic. Write for Fact-Finder #231.

**WINEGARD COMPANY**

3019-12 Kirkwood Ave., Burlington, Iowa

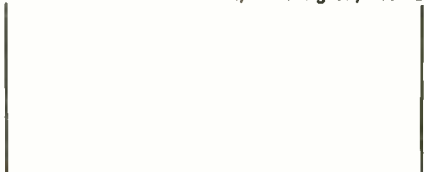

... for more details circle 57 on post card

**8  
WAYS**

*the new 1963 Master helps tv technicians and servicemen*

- 1** Leads to extra service income — in addition to radio and TV products, The MASTER offers thousands of products for profitable hi-fi, sound and industrial servicing.
- 2** Includes new servicing items — color TV, audio test instruments, sub-miniature and printed circuit components.
- 3** Increases profits — technicians can buy and sell direct from The MASTER. It contains prices.
- 4** Eliminates errors in buying — The MASTER makes an excellent common reference when you order from distributors by phone or mail.
- 5** Aids in selecting best product—comparison of specs, features, prices are simplified. All similar products in same product section.
- 6** Locates product you want in seconds — 32 product sections with complete index makes world's biggest electronic catalog also easiest to use.
- 7** Simplifies foreign tube substitutions — New Foreign Tube Interchangeability Guide cross-references virtually all foreign tubes to their American types.
- 8** Saves "shopping" and buying time — no looking from catalog to catalog, no wading through piles of literature. Over 300 manufacturers' products described and illustrated so completely you can purchase directly from The MASTER.



**NEW  
1963  
EDITION**

*1680 pages... get your copy today from your distributor, only \$3.95*

*In Canada \$4.95*

The Radio-Electronic MASTER  
645 Stewart Ave. • Garden City, N. Y.

... for more details circle 41 on post card



# SPACE AGE FUSES by BUSS



Especially designed for  
Squib Circuitry

*Another outstanding  
development by the  
makers of BUSS fuses.*

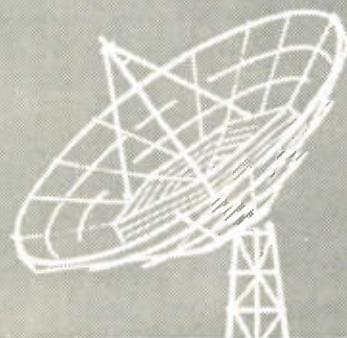

The space-age speeded the need for Squib circuitry—and to meet the need for protection and control of such circuits, BUSS engineers worked closely with the engineers who design and produce Squib circuits.

The result is a line of BUSS Squib fuses that have the needed electrical characteristics and are almost unbelievably accurate and dependable.

Squib fuses are another example of BUSS leadership in the development of the complete line of fuses to keep pace with the needs of *science and industry*.

To the Serviceman or Dealer this means they can save time and trouble by turning first to BUSS for all their fuse requirements. For, BUSS fuses are available in all types and sizes, . . . plus a companion line of fuse clips, blocks and holders.

# BUSS

BUSSMANN MFG. DIVISION

**MAKERS OF THE COMPLETE LINE OF  
FUSES OF UNQUESTIONED HIGH QUALITY**

McGraw-Edison Co. • St. Louis 7, Mo.

— for more details circle 18 on post card

# 7 WAYS

## TO SPEED YOUR PROGRESS IN INDUSTRIAL ELECTRONICS

### ▶ ELEMENTARY INDUSTRIAL ELECTRONICS by Leonard C. Lane

If you're ready to enter the fabulous field of industrial electronics, this two-volume course will arm you with the know-how necessary for success. If you're already in the field — operating equipment, servicing or maintaining it — even selling it, you'll do your job better, because you'll have a firmer grasp of the fundamentals of industrial electronics.

Only a basic knowledge of electricity and electronics is required to get the most out of this two-volume course. All the major areas of industrial electronics that you are likely to encounter are made absolutely clear. ✓ relays and switching ✓ magnetic amplifiers ✓ motor controls ✓ electronic heating ✓ instrumentation and many other topics.

Illustrations, simplified diagrams reinforce and make each technical point understandable. The book bridges the gap between conventional radio and industrial electronics smoothly bringing you into the field. #310, 2 vol. set \$7.80 (\$3.90 ea.)

### ▶ BASIC PRINCIPLES & APPLICATIONS OF RELAYS by Harvey Pollack

Lucid introduction to the construction, operation and application of relays. Discusses relay components — including coils and contacts — in terms of their individual functions. DC relays, their rectifier arrangements selected circuits and contact protection are covered. The chapter on electronic relays, circuit covers thyatron circuits together with various light-operated, cold cathode and combination relays. Time delay circuits are discussed with practical applications. Factors governing the choice of a particular relay for a specific circuit are made clear. #250-1, \$2.90.

### ▶ PHOTOELECTRIC CONTROL by Harvey Pollack

Extremely informative text, illustrates how photoelectric devices are used in industrial electronic systems. It's so easy to understand how these components operate when you read this book. Especially clear circuits and operation descriptions of modern photoelectric devices which control measuring, counting, testing and separating tasks gives you a special insight to their applications versatility. #250-2, \$3.50.

### ▶ INDUSTRIAL CONTROL CIRCUITS by Sidney Platt

Ideal as an introduction to electronic control systems... —ELECTRONIC WORLD. #202, \$3.90

### ▶ HOW TO USE METERS (2nd Ed.) by John F. Rider & Sol O. Prensly

An indispensable addition to the art of meter instrumentation. —DESIGN NEWS. #144, \$3.50

### ▶ BASICS OF PHOTOTUBES & PHOTOCELLS by David Mark

Students, technicians and engineers should find this book of value... — INDUSTRIAL SCIENCE & ENGINEERING. #184, \$2.90

### ▶ METALLIC RECTIFIERS & CRYSTAL DIODES by Theodore Conti

Comprehensive but basic approach... — ELECTRICAL EQUIPMENT. #213, \$3.50

**ORDER TODAY — 10-DAY GUARANTEE**

John F. Rider Publisher Inc. ET-12  
A Division of Hayden Publishing Co., Inc.  
116 West 14th St., New York 11, N. Y.

I have enclosed \$\_\_\_\_\_ Please send:

#310, \$7.80     #250-1, \$2.90     #250-2, \$3.50  
 #202, \$3.90     #144, \$3.50  
 #184, \$2.90     #213, \$3.50

NAME \_\_\_\_\_  
 ADDRESS \_\_\_\_\_  
 CITY \_\_\_\_\_ ZONE \_\_\_\_\_ STATE \_\_\_\_\_

... for more details circle 42 on post card

## NEW PRODUCTS

types. It is: an in-circuit and out-of-circuit transistor checker; a diode and rectifier checker; a signal generator; a battery tester; a voltmeter and a milliammeter. The in-circuit test couples the transistor to a built-in oscillator circuit for an actual performance check. Externally the transistor is checked for leakage on a multi-colored scale and for beta gain in three ranges up to 200. It makes trouble shooting transistor radios easy by supplying a 5 kc test signal with harmonics for checking r-f, i-f and a-f circuits. Up to 12 vdc can be measured on the voltmeter. Current drain up to 80 ma can be checked on the milliammeter. Price: \$12.75. Lafayette Radio Electronics Corp.

**IF YOU CHANGE YOUR ADDRESS**

Notify us at 1 East First Street, Duluth 2, Minn. Please include the address label from a recent issue and allow 30 days for the change.

**THE INDUSTRY'S ONLY COMPLETE "LOOK-ALIKE" LINE**

Exact Replacement Needles/Cartridges



Highest quality guaranteed! At your E-V distributor's or write for FREE replacement guide, today! Electro-Voice, Inc., Buchanan, Michigan. Dept. 12277

**Electro-Voice**

... for more details circle 25 on post card

# Sy says:



## Microphones — Part II

Last column we discussed the carbon microphone. This time we will discuss the crystal microphone and its cousin, the ceramic microphone.

Both the crystal and ceramic microphone are less expensive than the dynamic microphone which we will discuss in the next issue.

The crystal microphone has a high output and a good frequency response. The crystal unit consists of slabs of "Rochelle Salts" which are assembled and mounted so that the diaphragm will apply stress to the "crystal element" in accordance with the sound waves. The bending of the crystal element creates voltages on its surfaces, which are picked off by electrodes. It is a "capacitance" device having a value usually between 600 and 1,500 MMF. It is therefore, a high impedance device whose impedance varies with frequency.

The very similar ceramic microphone has most of the characteristics of the crystal unit, though the output voltage is slightly less. The ceramic unit will, on the other hand, withstand temperature and humidity ranges which might damage a crystal microphone.

Since the ceramic and crystal microphones are both high impedance devices, they can be connected directly to the grid circuit of a vacuum tube. For this reason, they are very popular for public address work, home recording and similar applications. Crystal or ceramic microphones can replace a high impedance dynamic type in most applications, although the performance may be a little different in response, range and level due partly to basic design and partly to any mismatch that might occur.

Ceramic units are not susceptible to nearby magnetic hum fields such as those from the amplifier chassis and this might favor the substitution.

In "exchanging" units, it is always important to compare the stated levels, response ranges and recommended load impedances. Don't go too far afield.

The Astatic Corporation offers a number of crystal and ceramic microphones. The newest being a ceramic mobile microphone Model 511 for Citizen Band application. The Astatic 330 Series units, which are widely used for tape recording and mobile installations, are available in either crystal or ceramic. The famous Astatic D-104, used by Ham operators the world over, is also manufactured as ceramic or crystal.

**THE ASTATIC CORP.**  
 CONNEAUT, OHIO • U.S.A.  
 IN CANADA; Canadian Astatic Ltd., Toronto EXPORT; Roburn Agencies, N. Y. 13, N. Y.

MANUFACTURERS OF  
 PHONOGRAPH CARTRIDGES • NEEDLES  
 • PICKUPS • MICROPHONES • RECORDING TAPE

... for more details circle 13 on post card

ELECTRONIC TECHNICIAN

# What's the difference in loudspeakers that makes Quam so special?

All loudspeakers look pretty much alike, and may even sound pretty much alike—yet Quam speakers are different—in a way that's very important to you who use them!

the  
difference  
lies  
in  
**PERFORMANCE  
RELIABILITY**

When it's a Quam speaker—you install it and forget it. Quam speakers are built to give long, trouble-free performance.

Quam's factory is a manufacturing plant, not merely an assembly shop. By making our own speaker parts, we can guarantee the quality of the materials that go into them. Our voice coils are centered precisely; each and every speaker is thoroughly tested; the product you get meets the standards we have insisted on for almost forty years.

Quam Quality Line speakers are enameled in gold—and while the color has no effect on performance characteristics, it symbolizes the quality and reliability that's built into every Quam speaker.

ASK FOR

# QUAM

**THE QUALITY LINE—  
for all your speaker needs**

QUAM-  
NICHOLS  
COMPANY

--- for more details circle 40 on post card

# ATR PRODUCTS FOR MODERN LIVING



## ATR PLUG-IN TYPE PORTABLE INVERTERS\*

A.C. Household Electricity Models  
 Anywhere . . . in your 6-RMF (6 volts) 60 to 80  
 own car, boat or plane watts. Shipping weight 12  
 Operates Standard A.C. lbs. DEALER NET PRICE . . . \$33.00

- Record Players
- Dictating Machines
- Small Radios
- Electric Shavers
- Heating Pads, etc.

12T-RME (12 volts) 90 to 125 watts. Shipping weight 12 lbs. DEALER NET PRICE . . . \$33.00

\*Additional Models Available



## ATR "A" BATTERY ELIMINATOR

For Demonstrating and Testing Auto Radios—TRANSISTOR or VIBRATOR OPERATED!

Designed for testing D.C. Electrical Apparatus on Regular A.C. Lines—Equipped with Full-Wave Dry Disc-Type Rectifier, assuring noiseless, interference-free operation and extreme long life and reliability.

MAY ALSO BE USED AS A BATTERY CHARGER  
 MODEL 610C-ELIF . . . 6 volts at 10 amps. or 12 volts at 6 amps. Shipping weight 22 lbs.  
 DEALER NET PRICE . . . \$49.95  
 MODEL 620C-ELIT . . . 6 volts at 20 amps. or 12 volts at 10 amps. Shipping weight 33 lbs.  
 DEALER NET PRICE . . . \$66.95

## AUTO-RADIO VIBRATORS



By every test ATR Auto-Radio Vibrators are best! and feature Ceramic Stack Spacers, Instant Starting, Large Oversized Tungsten Contacts, Perforated Reed, plus Highest Precision Construction and Workmanship and Quiet Operation!

There is an ATR VIBRATOR for every make of car!

Ask your distributor for ATR's Low Priced type 1400, 6 volt 4-prong Vibrator; and 1843, 12 volt 3-prong; or 1840, 12 volt 4-prong Vibrator. THE WORLD'S FINEST!



## ATR UNIVERSAL KARADIO MODEL 600 SERIES

Easily installed in-dash or under-dash. Amplifier power-supply chassis may be separated from tuner chassis for installation flexibility and easy servicing. Utilizes 6-tube super heterodyne circuit (2 dual-purpose tubes) with 8-tube performance . . . pulls in those distant stations with good tone and volume. Supplied with separate 5" x 7" speaker which is installed in original automobile speaker compartment for high fidelity performance. Neutral gray-tan baked enamel finish. Overall size 4" deep x 6 1/2" wide x 2" high. Tuner Chassis; with Amplifier Chassis, 2 3/8" deep x 6 1/2" wide x 3 3/8" high. Shipping weight 7 lbs. WILL OUTPERFORM MOST SETS!

Model 612 12 volt Dealer Net Price \$31.96  
 Model 606 6 volt Dealer Net Price \$31.96

Airplane Style Overhead Mounting under Cab Roof NO PRINTED CIRCUITRY

## ATR TRUCK KARADIO



Excellent Tone, Volume, and Sensitivity!

Compact, yet powerful. Fits all trucks, station wagons, most cars and boats. Just drill a 1/8 inch hole in roof and suspend the one-piece unit (aerial, chassis and speaker) in minutes. Watertight mounting assembly holds antenna upright. Yoke-type bracket lets you tilt radio to any angle.

Extra-sensitive radio has 6 tubes (2 double-purpose), over-size Alnico 5 PM speaker for full rich tone. Big, easy-to-read illuminated dial. Fingertip tuning control. Volume and tone controls. 33-in. stainless steel antenna. Neutral gray-tan enameled metal cabinet, 7 x 6 1/2 x 4 in. high over-all. Shipping weight 10 1/2 lbs.  
 Model TR-1279—12A for 12V Dealer Net Price \$41.96  
 Model TR-1279—6A for 6V Dealer Net Price \$41.96

SEE YOUR ELECTRONIC PARTS DISTRIBUTOR WRITE FACTORY FOR FREE LITERATURE . . .

## ATR ELECTRONICS, INC.

Formerly American Television & Radio Co.



Quality Products Since 1931  
 ST. PAUL 1, MINNESOTA—U.S.A.

## FREE LITERATURE

### COMPONENTS 300

The latest in electronics and stereo high fidelity equipment, is said to be featured in this 388 page catalog. Listed items include the firm's own equipment in kit form and completely assembled, as well as the latest stereo high fidelity components of all major manufacturers — tuners, amplifiers, preamplifiers, tape recorders, turntables and speakers. Also offered are complete selections of citizens band equipment, optics, books, tools, radio and TV components and accessories. Lafayette Radio Electronics Corp.

### CAPACITORS 301

Complete electrical and mechanical specifications of newest additions to the "Weecon" line of rectangular, ceramic capacitors designed for printed circuit applications are presented in bulletin NP-131. This new line makes available capacitances to 0.022µf, 100 vdcw, in a case size of only 0.500 x 0.500 x 0.140 in. Frie Resistor Corp.

### MATV SYSTEMS 302

A compact master TV reference manual is designed to guide technicians and TV countermen in the selection of proper systems and equipment. The booklet covers smaller systems only, featuring clear diagrams and descriptions of typical installations that can be placed effectively in TV show-rooms and service shops, apartment houses, as well as hotels, motels and other institutions. A section is also devoted to home systems, enabling technicians to meet the growing demand of multi-set owners for reception outlets throughout the home. Blonder-Touque Labs.

### AUTOTRANSFORMERS

303

Over 200 different models of "Variac" autotransformers are described in a 28-page illustrated brochure. The booklet, Bulletin P, covers motor speed controls, voltage regulators and motor-driven autotransformers, as well as the "Variac" line. General Radio Co.

## PROFESSIONAL technicians

use *Dave Rice's* OFFICIAL

## ORDER BOOKS

for every

## TV-RADIO

service

call



This is the businesslike approach to service record keeping. Triuplicate forms serve as order form, invoice and office record, with spaces for complete information on every job. Separate listings for receiving tubes, pix tube, parts, serial numbers, labor and tax charges, signatures, etc. 75c a book, \$6.50 for dust-proof box of 10. In stock at your distributor.

\*\*\*\*\*

## FREE

Write for your free folder describing Dave Rice's OFFICIAL ORDER BOOKS, including an actual size sample copy of the handy order form.

ELECTRONIC PUBLISHING CO., INC.  
 133 N. JEFFERSON ST.  
 CHICAGO 6, ILLINOIS

## Now.. Tomorrow and for years to come!

# Sonar CITIZENS BAND RADIO

- 8 Channels, crystal controlled transmitter and receiver
- Tunable receiver for 22 channels
- Transmitter 100% Class B modulated
- Adjustable squelch
- Automatic noise limiter
- R. F. Power indicator
- 1 Year guarantee
- Easy to install. Ideal for home, boat, car or business. Weighs only 9 lbs. . . 4 3/4 x 9 1/2 x 11 1/4
- FCC Type accepted\*

\*in preference to only certification

with 1 pair of crystals, microphone and power cables

# \$17950



## Sonar RADIO CORPORATION

73 Wortman Avenue • Brooklyn 7, N. Y.

Please send me complete information on Model "E" CB Radio.

Dept # 213

NAME \_\_\_\_\_  
 ADDRESS \_\_\_\_\_  
 CITY \_\_\_\_\_  
 STATE \_\_\_\_\_

for more details circle 14 on post card

for more details circle 46 on post card



©1962 VOLKSWAGEN OF AMERICA, INC.

## Our truck works on TV.

"Well, you see, the picture just went all fuzzy, and there's the big bowl game on tomorrow, and if you could get out right away, and..."

Sound familiar?

It does, if you're in the service business like Dick Searle. Dick's company (Searle Appliance of Seaside, California) has 3 Volkswagen Trucks.

Each VW is stocked with about 1000

pounds of spare parts (including the weight of the bins).

Yet, the surprising thing is: there's still room inside to tote 800 pounds more.

Which comes in handy when a bulky TV console can't be fixed in the owner's house.

Now then. Suppose you're on the way to fix that set for the guy who wants to see the big game.

And suppose there's a lot of snow and ice on the road.

If you're driving the VW, you'll have a pretty clear channel.

(Because our engine's in the rear. For extra traction.)



Which could very well keep you tuned in to an ultra high frequency of business.

Get the picture?

--- for more details circle 53 on post card

NEW from



hallicrafters...

a truly reliable  
transistorized CB transceiver

The marvel of transistors... unchallenged communications experience... and a big dose of patience: It took the right amount of each to bring you the most imaginative, most practical CB transceiver ever designed.

Let's start with size. 10 1/4" x 8 1/4" x 3 1/4". You can install it in the glove compartment of a Volkswagen and still have room for gloves.

Performance? If you like figures, try these for size: 5 watts in; 100% modulation capability; 1 µv sensitivity for 10 db. S/N ratio; 45 db. adj. channel rej.; 5.0 kc. selectivity @ 6 db.; 300-3,000 c.p.s. audio @ 3 db.; 18 transistors 9 diodes, 3 instant-heating transmit tubes. No vibrator, either. In short — superior.

Convenience? Six crystal-controlled channels. Less than seven pounds light (it's a minimum).

Accessories for  
greatest versatility!



AC POWER SUPPLY—  
CBP-1  
Styled as matching  
pedestal for CB-5.

PORTABLE PAK—  
CBB-1  
12V nickel cad-  
mium recharge-  
able batteries.

TONE-CODED SQUELCH—  
CBT-1  
Full duplex, four trans-  
istors. Installs inside  
CB-5 cabinet.

CB5 CITIZENS BAND  
TRANSCEIVER \$199<sup>95</sup>

accessories optional extra



The Hallicrafters Co.: 5th & Kostner Aves., Chicago 24, Ill.

--- for more details circle 29 on postcard



LEARN FM  
2-WAY RADIO  
SERVICING  
AT HOME

- Earn More Money
- Build a Better Future

Advancement and increased earnings are waiting for you in the expanding communications field. The Motorola Training Institute's home study course in FM 2-way radio servicing can enable you to take advantage of these profitable opportunities now. Learn all about servicing the new transistorized equipment... learn advanced techniques for handling complex service problems easier and faster.

In addition to this wealth of practical application knowledge, you will also be preparing yourself for your 2nd Class FCC Radio-telephone License. For full details, send coupon today. There is no obligation and no salesman will call.



**MOTOROLA TRAINING INSTITUTE**

4545 West Augusta Boulevard • Chicago 51, Illinois • Dep' AEH249

Please send me full details on the Motorola Training Institute's planned home study program on FM 2-Way Radio Servicing.

I now hold \_\_\_\_\_ FCC License.

Name \_\_\_\_\_

Address \_\_\_\_\_

City \_\_\_\_\_ Zone \_\_\_\_\_ State \_\_\_\_\_

--- for more details circle 37 on postcard

SCREW STARTERS?  
take your choice...

If you have been looking for a screw starter for your particular need and have yet to find the proper size and quality, ULLMAN DEVICES CORP. has solved your problem.

Just a simple twist of the high carbon steel bit and the screw is held firm, ready for easy starting or retracting. Releases and sets automatically. Gets into close areas quickly, easily. ULLMAN Screw Starters come in an astonishing variety of sizes and kinds... from 2 1/2" to 15" long. There are four different lengths with slender Duraluminum handles... four more with shock resistant Nylon handles for electrical and electronic work. Or get a set of ULLMAN Screw Starters with MAGNETIZED Phillips heads to hold Phillips screws firmly in a strong magnetic grip. Also in four sizes with your choice of Duraluminum or Nylon handles.

Write for Free B page illustrated Catalog.



STANDARD

MAGNETIZED  
PHILLIPS

ULLMAN

DEVICES

CORPORATION

Ridgely, Connecticut

--- for more details circle 52 on postcard

ELECTRONIC TECHNICIAN

# 1962

## Article Index

All articles appearing in **ELECTRONIC TECHNICIAN** Magazine from January through December, 1962

### Tough Dog Corner

Painful Parasitic .....	Pat E. McGee	1/62-39
Intermittent Transistor Radio	Lambert C. Huneault	1/62-39
Filter Pack Leakage Upsets TV Set .....	H. D. Morgan	2/62-44
Defective Speaker Coil Causes Pix Pulling .....	Jerome J. Hoepfner	2/62-44
HV Cage Missing - Sync Unstable .....	Frank A. Salerno	3/62-33
Static and Varying Sound.....	Thomas E. Gregg	3/62-33
Arcing Capacitor Causes 'Black Snow' .....	Lambert C. Huneault	4/62-52
Video Detector Clips Sync ....	Robert Barron	4/62-52
Video Capacitor Upsets Vertical Sync .....	James E. Searson	5/62-56
Height Control Causes Bends	Albert J. Bergbauer	5/62-56
Video Detector Clips Sync ....	Robert Barron	6/62-42
Slug Trouble .....	Virgil J. Miller	6/62-42
Hot Capacitor Shrinks Picture	Howard Keiholtz	6/62-42
A Dog's 'Dog' .....	Joe DeSabantonio	7/62-42
Intermittent Ground Affects Sync & Sound .....	Paul Holiday	7/62-42
Portable TV 'Tricks' .....	Frank A. Salerno	7/62-42
High Voltage Burns AGC Control .....	H. L. Davidson	8/62-40
Short Burns Out Three Tubes	M. G. Goldberg	8/62-40
Arc Upsets Sync .....	Charles W. Parrott	9/62-30
Factory Fault .....	Reg. Bartlett	9/62-30
Variable Short .....	W. Harder & E. Brandt	9/62-30
Stereo Intermodulation .....	George P. Oberto	9/62-30
Shifty Capacitor .....	Wayne Butts	10/62-46
Faulty Filter .....	Frank A. Salerno	10/62-46
Open Delay Kills Raster .....	F. A. Nichols	10/62-46
Video Output Kills AGC. ....	Frank Salerno	11/62-46
Volume Controls Brightness	Vernon I. Bringol	11/62-46
Slow Roll .....	Kenneth Bangsberg	12/62-42
High Problem .....	Homer L. Davidson	12/62-42

### Editorials

What's Ahead for '62 .....	1/62-29
Technician Know-How for Defense .....	1/62-29
Selling TV Via Supermarket Tapes .....	2/62-27
Licensing Study .....	2/62-27
A Bold Approach to Industry Problems .....	3/62-25

Reminder for the Big Show .....	3/62-25
Get Going with Color TV .....	4/62-33
The Meaning of Free Trade .....	5/62-35
UHF Progress Report .....	6/62-23
Comparing UHF and VHF .....	6/62-23
Keeping Service Independent .....	7/62-23
TV Leads Telephone .....	7/62-23
Satellite TV Broadcasting .....	7/62-23
Color TV is on the Move .....	8/62-23
Memo to EIA: Remember Service .....	8/62-21
Stereo 1963 .....	9/62-17
Timetable for All-Channel TV Sets .....	9/62-17
Transistors are Here to Stay .....	10/62-27
Do-It-Yourself Tube Tester .....	10/62-27
Charge for your Skills .....	11/62-25
Onward & Upward .....	11/62-25
Impressions of Audio Engineering Society .....	12/62-21
Antenna 'Boom' Underway? .....	12/62-21

### Shop Hints

Replacing Changer Ball- Bearings .....	H. Meermans	1/62-42
Peg Boards Upgrade Shop Image .....	Glen F. Stillwell	1/62-42
Prevent Locking of Clock Radio Dial .....	H. L. Davidson	1/62-42
Insulating A-C Plug Terminals	Glen F. Stillwell	2/62-46
Allen Wrench Frees X- former Slugs .....	William N. Keller	2/62-46
Eliminating HV Rectifier Failure .....	Frank Bou	2/62-46
Tube Shield aids Auto Radio Servicing .....	John H. Larry	2/62-46
Coding Transistor Terminals	Frederick J. Seidel	2/62-46
Novel Tool Holders .....	William R. Lacey	3/62-46
Radio Hum Intermittent .....	Philco Businessman	3/62-46
Polish Scuffed Plastic TV Screens .....	M. G. Goldberg	3/62-46
Loctal Tube Conversions .....	Willard Waite	3/62-46
VTVM Probe-Lead Modifica- tion .....	Harold Wolff, Jr.	3/62-46
Altered wrench for Hex-Head Screws .....	Bud Mierkey	3/62-46
Color Test Rig Saves Labor	Harry J. Miller	4/62-54
Booster Replaces Series CRT	H. T. Minewiser	4/62-54

Remounting Loose Meter			
Glass .....	M. E. West	4/62-54	
Pegboard Tool Shelf .....	Glen F. Stillwell	4/62-54	
Tuner Wafer Repair .....	Emil C. Lampe	4/62-54	
Wire Hook Helps Remove			
CRTs .....	Leon C. Blechman	5/62-91	
Handle for Coax Plugs .....	P. Horvath	5/62-91	
Match Starts Small Screws	John Hildreth	5/62-91	
Preventing Shock Through			
Knobs .....	Charles Hartley	5/62-91	
Rosin Aids Dial Restrings	E. B. Kastelberg	5/62-91	
Terminal Board Numbering	RCA Sales Corp.	5/62-91	
Tuning Drum Slips .....	Frank M. Dickinson	5/62-91	
Rabbit-Ears Strain Relief	Gordon E. Gregory	5/62-91	
Seleniums to Silicons .....	Frank M. Dickinson	6/62-44	
'Hot Box' for Intermittents	Harry J. Miller	6/62-44	
Hi-Fi Hum .....	M. G. Goldberg	6/62-44	
Slotting Control Shafts .....	H. L. Davidson	6/62-44	
Handy Bench Mirror .....	H. Leeper	7/62-44	
Steel Wool Holder .....	John A. Comstock	7/62-44	
Variable Capacitor Control			
Repair .....	R. H. Rombough	7/62-44	
Solder Removal .....	GE TV Engineering Dept.	7/62-44	
Bench Light .....	Frank Dickinson	7/62-44	
Tape Aids Dial Stringing .....	H. L. Davidson	7/62-44	
Tube Puller .....	Clyde Pearce	8/62-44	
Rubber Holds Radios .....	Wayne N. Potter	8/62-44	
Tape Tips .....	Sid Elliott	8/62-44	
Load Check Meter .....	Nicholas B. Cook	8/62-44	
Transformer Replacement .....	Walter Savelly	8/62-44	
Parts Box .....	H. Leeper	8/62-44	
Protect TV Antenna Coils .....	Homer L. Davidson	9/62-32	
Soldering Iron Cleaner .....	N. C. Cullinan	9/62-32	
Schematic Reference .....	M. Halpern	9/62-32	
Faster Tube Checks .....	J. G. Gaweau	9/62-32	
Chassis Drilling Aid .....	Harry J. Miller	9/62-32	
Insufficient Width Remedy .....	E. L. Deschambault	9/62-32	
Intermittent Volume Controls	Sylvania Home Elect. Group.	9/62-32	
Poor Focus In Color Sets .....	Zenith Radio Corp.	9/62-32	
Buzz in G-F Chassis .....	Gen. Elect. Co.	9/62-32	
Pilot Replacement .....	Gordon Gregory	10/62-48	
Quicker Heat .....	Luis Morales	10/62-48	
PC Component Removal .....	William Brown Jr.	10/62-48	
Ashes Remove Burn Marks	H. Josephs	10/62-48	
Ford Antenna Installation .....	Homer L. Davidson	10/62-48	
Asbestos Covered Iron .....	Allan N. Walker	10/62-48	
5MK9 Substitute .....	E. L. Deschambault	11/62-49	
Phone Patch Cords .....	Homer L. Davidson	11/62-49	
Correcting Changer Set-Down	Ken Miller	11/62-49	
Cheater Saver .....	Frank H. McComb	11/62-49	
Cash Builder .....	Wm. Schlickbernd	11/62-49	
Tube Puller .....	James L. Lacey	11/62-49	
Renew Safety Glass .....	Leo Kramer	11/62-49	
Wax Eraser .....	Larry Mings	11/62-49	
Anti-Roller .....	Henry Miller	12/62-44	
Tuner Shaft Repair .....	H. L. Davidson	12/62-44	
Part Holder .....	Jorge Gonzalez	12/62-44	
Emergency Vibrator Repair	Wesley Bazello	12/62-44	
Antenna Template for Fenders	Henry Josephs, Sr.	12/62-44	
<b>Industrial Electronics and Communications</b>			
Proximity Detection Systems	Allan Lytel	6/62-30	
Electronic Devices Detect			
Radiation .....	Allan Cantor	3/62-26	
Servicing Two-Way Communications Receivers .....	Don Dudley	9/62-26	
Servicing Remote Controlled Garage Door Openers .....	F. A. Kenom	8/62-34	
Dry Cleaner Electronic Analyzer .....		2/62-31	
Servicing Photometric Instruments .....	Charles Maduell, Jr.	11/62-36	
<b>Components—Tubes—Transistors</b>			
Batteries are for 'Toters' .....	Steven Robb	6/62-24	
Practical 'Tricks' with Transformers .....	M. G. Goldberg	9/62-24	
Universal Replacement Transistors .....	J. S. McGregor	10/62-38	
<b>Test Equipment</b>			
New Test Instruments for Bench and Caddy .....		2/62-36	
New Test Instruments for Bench and Caddy .....		4/62-39	
New Test Instruments for Bench and Caddy .....		5/62-54	
The Versatile Field Strength Meter by Victor Nicholson .....		7/62-39	
New Test Instruments for Bench and Caddy .....		8/62-42	
New Test Instruments for Bench and Caddy .....		9/62-28	
Measuring P-P Voltage with the Scope .....	C. B. Zackman	9/62-18	
Test Instruments for Bench and Caddy .....		10/62-44	
Test Instruments for Bench and Caddy .....		11/62-44	
Take Care of Your Money—Making Tools .....	David King	11/62-26	
Instrument Probes & Their Uses .....	E. M. Frickert	11/62-29	
Check It with a Square Wave Generator .....	Ben Allen	11/62-32	
Caddy Stock and House Call Equipment .....	Aaron Shaw	11/62-40	
Test Instruments for Bench and Caddy .....		12/62-	
<b>B/W TV - Radio</b>			
How to Install and Service UHF Converters .....	Lon Cantor	1/62-30	
Practical Approach to Transistor Radio Service .....	Herb Bowden & Jim Neuman	1/62-33	
Examining 1962 Horizontal Sweep Circuits .....		1/62-40	
Eliminate that CRT Spot .....		1/62-66	
1961 Electronic Statistics .....		1/62-74	
How to Install and Service TV Translators .....	Lon Cantor	2/62-28	
TV Control Problems .....	John Haskell	2/62-40	
Whipping TV Transformer Problems .....	Jack Hobbs	3/62-30	
Professional TV Alignment Techniques .....	Vic Bell	4/62-34	
"Sky Gazing" Explains Some TV-Radio Problems .....	Lambert Huneault	4/62-47	
Locating Radio Oscillator Defects .....	Ben Allen	4/62-34	
Confessions of a "Do-It-Yourselfer" .....	William J. Lynott	5/62-42	
A Technician's View of a Transistor TV .....		5/62-48	
Repairing Vertical Hold Defects .....	Frank Salerno	5/62-38	
Put the Damper on RFI .....	Don Rogers	6/62-38	
TV-R-F Alignment Techniques .....	Enrique Shaw-Galvez	7/62-28	
Japanese Transistor Radio Guide .....		7/62-34	
Making Money on Transistor Radio Repairs .....	Ben Allen	7/62-24	



Tools for Transistorized Circuit Repairs .....	Don Henderson	7/62-36
Transistors the Easy Way ....	William C. Caldwell	8/62-30
D-C Restoration Vs. D-C Coupling .....	Frank Salerno	9/62-21
Servicing Transistorized Hybrid Car Radios .....	S. M. Henderson	10/62-34
Know Your Transistorized Antenna Preamps .....	H. H. Winters	10/62-38
Servicing Remote Controlled TV Systems .....	Paul Walker	12/62-

**Business**

Here's What Louisiana Techs. Think of Licensing ....	2/62-32
TV Industry Advertising Guide .....	3/62-40
Get Your Share of the Citizens Band Service Business..	Leo G. Sands 4/62-42
Get Your Share of Battery Sales .....	A. M. Anderson 6/62-28
Your Stake in Color TV .....	8/62-33
TV Doctor Makes 'House' Calls in Florida Trailer Park	Dave Binns 10/62-41
Beat the Rent 'Squeeze' ....	Harry J. Miller 10/62-42
What About Christmas .....	William Dufer 11/62-43

**Color Television**

Color TV Installation Guide	L. C. Powell	5/62-36
Color TV from A to Z .....	L. C. Powell	8/62-22
New Experimental Color TV Camera		8/62-39
Chroma Alignment .....	L. C. Powell	12/62-28
Color TV Convergence .....	J. Futtermann	12/62-26
Know Your Chrominance Values .....	Robert Middleton	12/62-22

**Audio, Hi-Fi, Pa**

Advanced Alignment Methods for Hi-Fi Tuners .....	Norman H. Cowhurst	1/62-36
Troublesome Hi-Fi Tone Controls .....	Mannie Horowitz	3/62-34
F-M Tuner Specifications .....	E. M. Frickert	5/62-39
How to Install F-M Auto Converters .....	Len Buckwalter	5/62-46
Servicing F-M Stereo Receivers .....	Paul Martin	6/62-34
Eliminating Hi-Fi Equipment Hum .....	L. V. Winston	7/62-32
Know Your Decibels .....	Frederick E. Wuebker	8/62-27
Amplifiers for Stereo Speakers for Stereo Listening .....		9/62-64
Solving Stereo and Hi-Fi Installation Problems ....		9/62-72
Inactive Hi-Fi Components .....		9/62-78
Phono Cartridges and Styli .....		9/62-82
Stereo Records & Tapes .....		9/62-86
Servicing F-M Stereo Receivers & Adapters .....		9/62-90
Selling & Installing Background Music Systems ....		9/62-94
Transistors in Hi-Fi Equipment .....	Eino Neimi	10/62-31
Servicing Tape Recorders .....	L. V. Winston	12/62-32

**NEXT MONTH:** The complete index of Manufacturers Technical Digest will appear.

# 24 HOUR SHIPMENT On One Year Guaranteed RADIO & TV TUBES



**CORNELL**  
**33¢ PER TUBE**  
100 TUBES OR MORE:  
**30¢ PER TUBE**

OZ4	3CS6	5CL8	6AT6	6BN4	6CL8	6EM7	6X4	12A27	12X4
1B3/1G3	3CY5	5CQ8	6AT8	6BN6	6CM7	6E55	6X8	12B4	13DE7
1J3	3DK6	5J6	6AU4	6BN8	6CN7	6E8U	7A8	12BA6	13DR7
1R5	3DT6	5J6	6AU5	6B05	6C08	6E8W	7AU7	12BD6	17AX4
1S4	3Q5	5T8	6AU6	6B06/6CU6	6C36	6G8H	8AWB	12BE6	17DA
1S5	3S4	5U4	6AU8	6B07	6C57	6GM6	8AU7	12BF6	17DQ6
1T4	3V4	5U8	6AV5	6BR8	6CU5	6J5	8BQ5	12BH7	19AU4
1U4	4AU6	5V3	6AV6	6B88	6CUB	6J6	8CG7	12BK5	19BG6
1U5	4BC8	5V4	6AV8	6B89	6CUC	6K6	8CX8	12BL6	25AX4
1V2	4BQ7	5X8	6AWB	6B8U	6CXB	6K6	9AU7	12BQ6	25BQ6
1X2	4BS8	5Y3	6AX4	6BX7	6CY5	6L6	10DE7	12BR7	25CD6
2BN4	4BZ6	6AB4	6AX5	6BY5	6CY7	6S4	10DR7	12BY7	25DN6
2CY5	4BZ7	6AC7	6AX6	6BY6	6D25	6SA7GT	11CY7	12BZ7	25L6
3A3	4CB6	6AF4	6BA6	6BZ6	6DA4	6SC7	12A06	12CA5	25W4
3AL5	4CS6	6AG5	6BA8	6BZ7	6DE4	6SH7	12AD6	12CU5/12C5	25Z6
3AU6	4EW6	6AH4	6BC5	6BZ8	6DE6	6SK7GT	12AF6	12CX6	35A5
3AV6	5AMB	6AH6	6BC8	6BZ8	6DE6	6SK7GT	12AQ5	12D4	35B5
3BC5	5ANB	6AK5	6BD6	6C4	6DG6	6SL7	12AT6	12DQ6	35C5
3BE6	5AQB	6AL5	6BE6	6CB6	6DK6	6SN7	12A7	12K5	35L6
3BN4	5AS4	6AM8	6BG6	6CD6	6DN6	6SQ7	12AU6	12L6	35W4
3BN6	5AT8	6AN8	6BH6	6CE5	6DQ6	6TB	12AU7	12SA7	35Z5
3BU8	5AVB	6AQ5	6BH8	6CF6	6DR7	6U4	12AV5	12SK7	50B5
3BY6	5BK7	6AO7	6BJ6	6CG7	6DT6	6UB	12AV6	12SN7	50C5
3BZ6	5BQ7	6AR5	6BK5	6CG8	6EAB	6VB	12AV7	12SQ7	50L6
3CB6	5BR8	6AS5	6BK7	6CH8	6EB8	6W4	12AX4	12V6	117Z3
3CF6	5CG8	6AS8	6BL7	6CL6	6EMS	6W6	12AX7	12W6	117Z6

**FREE BONUS OFFER**  
Genuine Leather • Hand Tooled Key Case • Yours Free with every order of 25 Tubes or more.

NO TUBE SUBSTITUTIONS MADE WITHOUT YOUR PERMISSION!!  
Tubes are all guaranteed and field tested new, factory seconds or used tubes and are so marked.

If not shipped in 24 hrs. **YOUR ORDER FREE!**

**ATTENTION QUANTITY BUYERS**

- Ask for Special Discounts
- Write for 'Private Brand' Deal
- Submit your Tube needs for price quotation

**TERMS:** All orders over \$5.00 postage free. Under \$5.00 add 50¢ for postage and handling. Send 25% Deposit on all COD Orders. Canadian and Foreign Orders, send approximate postage. All orders subject to prior sale.

**CORNELL ELECTRONICS CO.**  
Dept. ET-12 4217 University Ave., San Diego 5, Calif. • Phone: AT 1-9792

for more details circle 23 on post card

IT'S REALLY  
JUST A PIZZA PIE,  
BUT OF COURSE A  
JENSEN NEEDLE  
MAKES ANYTHING  
SOUND BETTER.



The Customer Reminder Plan is yours—

**FREE! Write**  
**Jensen®**  
**INDUSTRIES, INC.**  
301 Interstate Rd., Addison, Ill.

for more details circle 31 on post card

ADVERTISERS INDEX

American Telephone & Telegraph Co. ....	57	Nation-Wide Tube Company .....	74
Amperex Electronic Corporation ....	2nd Cover	Philco Corporation .....	13
Arco Electronics, Inc. ....	12	Quam-Nichols Company .....	67
Astatic Corporation .....	66	R C A Battery Div. ....	45
ATR Electronics .....	68	R C A Electron Tube Div. ....	4th Cover
B & K Manufacturing Co. ....	19	R C A Institutes, Inc. ....	18
Blonder-Tongue .....	59	R C A Parts & Accessories Div. ....	61
Bogen Communications Division .....	63	R C A Test Equipment .....	17
Bussman Mfg. Division .....	65	Radio Electronic Master .....	64
Cadre Industries Corp. ....	8	John F. Rider Publisher, Inc. ....	66
Centralab, Div. of Globe-Union, Inc. ....	58	Sarkes Tarzian, Tuner Div. ....	4
Channel Master Corporation .....	20	Schober Organ Corporation .....	64
Clarostat Mfg. Company, Inc. ....	3rd Cover	H. H. Scott .....	48
Cornell Electronics Company .....	73	Sencore .....	43
EICO Electronic Instrument Co., Inc. ....	56	Sonar Radio Corporation .....	68
Electro-Voice, Inc. ....	66	Sonetone Corporation .....	60
Electronic Publishing Co., Inc. ....	68	Sony Corp. of America .....	41
General Electric Company .....	50	Sprague Products Company .....	7
General Electric Company .....	51	Stancor Electronics, Inc. ....	62
Greyhound Corporation .....	9	Sylvania Electronic Products, Inc. ....	10-11
Hallcrafters Company .....	70	Test Devices, Inc. ....	6
ITT Distributor Products Div. ....	49	Tung-Sol Electric Inc. ....	53
Jensen Industries, Inc. ....	74	Ullman Devices Corporation .....	70
Jerrold Electronics Corporation .....	3	Volkswagen of America .....	69
L. A. Tuner Exchange .....	62	Weller Electric Corporation .....	46
Lear Siegler, Inc. ....	63	Winegard Company .....	47
P. R. Mallory & Co., Inc. ....	55	Winegard Company .....	48
Mercury Electronics Corp. ....	54	Winegard Company .....	64
Motorola Communications & Electronics .....	70		

**"DO-IT-YOURSELF"**  
**TUBE CHECKERS**  
At 1/5 The Original Cost!  
**\$36.95** Shipped Railway  
Express F.O.B.  
Pays for itself in one month or  
less! Ideal for supermarkets &  
drug stores. Completely recon-  
ditioned, these machines have up-  
to-date charts, lighted back &  
locked compartment that stores up  
to 300 tubes.

**TV CONSOLES**  
• Complete From Knobs To Back  
Cover!  
• No Turned Out Picture Tubes  
Or Transformers!  
Satisfaction Guaranteed Or Your  
Money Back!  
Shipped Railway Express, F.O.B.  
10" —12" —14" \$7.00 (as 18)  
16" —17" —19" —20" —21"  
\$15.00 (as 18)

**ONE YEAR GUARANTEED  
TV PICTURE TUBES**  
Priced As Low As 49¢ Per Inch!  
Here are just a few Spectacular  
sample prices!  
10B1P4—\$4.00 17H2P4—\$19.00  
12I1P4—\$7.10 19A2P4—\$15.75  
14H1P4—\$4.25 21E1P4—\$18.00  
16G1P4—\$8.00 21AMP4—\$22.00  
17B1P4—\$9.00 21E1P4—\$28.00  
NOTE: No Dud Required On Any  
Of The Above Tube Types.  
Attention! All picture tubes sold by Nation-  
Wide contain only new parts except for  
the glass envelope which is reused and has  
been closely inspected prior to manufac-  
ture to insure clear and perfect pictures!  
All picture tubes Shipped F.O.B.  
Send for Nation-Wide's complete picture  
tube list. Dept. CL.

Your terrific response  
overwhelmed us. Please  
be patient on your  
orders!

- BRAND-NEW
- FACTORY SECONDS
- USED TUBES
- Used and/or  
factory second

**\$27**  
per  
**HUNDRED**  
**¢ ea**

For all type  
**TUBES**

FREE POSTAGE ... On All Orders, 25¢  
Handling Charge On Orders Under \$5.00 Deposit of 20% On  
C.O.D.'s Canadian and Foreign orders please send approximate  
postage.  
REMEMBER, if you're not completely satisfied with any merchan-  
dise, Nation-Wide will Refund Your Money within Five (5) days!  
All picture tubes Shipped F.O.B. • Immediate shipment on all orders!  
• All tubes guaranteed for one full year!

**NATION-WIDE TUBE CO.**

NATION-WIDE BLDG.  
HARRISON, N.J. HUmboldt 4-9848 Dept. ET-12

**1-YEAR GUARANTEE ON ALL TUBES!**

Before shipping, each order of tubes is Scientifically Tested by Nation-Wide's own Quality Control Department! All shorted and Low Emission tubes are immediately destroyed! You receive only **TOP QUALITY, LONG-LIFE, Mickok** and set tested tubes! **INDIVIDUALLY BOXED! CODE DATED!**

0Z4	4B2G	6CM7	12AT7
1B3GT	4CB6	6C08	12AU7
1L6	4DT6	6CU6	12AV5
1L8	5AM8	6C08	12AX4GTA B
1LH4	5AN8	6DE4	12AX7
1LN5	5A05	6DQ6 A/B	12A27
1N5GT	5A58	6DT6	12BA
1R5	5AT8	6EA7	12BA6
155	5B7A	6E8	12BE6
1T4	5BR8	6EB8	12BH7 A
1U4	5C8	6EM5	12BQ6
1U5	5CL8A	6ER5	12B7 A
	5C25	6ES5	12CA5
	5J6	6F6GT	12CH6
	5T8	6GM8	12C05/12C5
	5U4C	6H6	12CU6
	5U4CA/B	6J2	12D4 A
	5UB	6J6A	12D85
	5V4C	6K6GT	12DQ6 A/B
	5X8	6K7	12K7GT
	6Y3GT	6L6CA/B/C	12L6GT
	6B8GT	654	12Q7GT
	6B84	65A7	12S8GT
	6AC7	65CT	125A7
	6AF4 A	65M7	125F7
	6AC5	65F7	125M7
	6AHCT	65M7	125N7GT
	6AM6	65TCT	12V6GT
	6AK5	65N7GTA/B	12W6GT
	6AL5	6T8	12X4
	6AMB/A	6T8 A	13D7
	6AN8 A	6T8 A	14A7
	6AQ5 A	6U8 A	14B6
	6A55	6V3A	14F7
	6AT6	6V6GT A	17AV5CA
	6AT8 A	6W4GT A	17AX4CT
	6AL7GT A	6W6GT	19A6GTA
	6AU3GT	6X4	19BC6G A
	6AU6 A	6X5GT	19T8
	6AU8 A	6X8 A	25A3GT
	6AV5CA	6Y6G A	25B06
	6AV6	7A5	25C5
	6AW8 A	7A7	25CD6CA/B
	6AX4CTA B	7B8	25E6GT
	6AX5GT	7AC7	25ON6
	6BA6	7AU7	25DQ6
	6B06	7B4	25GCT
	6B8	7B7	25W4GT
	6B8	7C5	25Z6GT
1X2	6B86G A	7C6	35A5
2E4	6B86	7F8	35B5
2BN4	6B8H	7H7	35C5
2CY5	6B8G A	7M7	35D6GT
3A06	6BK5	7Y4	35W4
3BC5	6B87A/B	8AW8/A	35Y4
3B08	6BL7GT A	8C7	35Z3
3B26	6BN6	8C7	35Z5GT
3C86	6B05	8C7	50A5
3CS6	6B06GTA/B	8C7	50B5
3Q4	6B07 A	8C8	50C5
305GT	6B08	85N7GTB	50EM5
354	6B05CA	9A7	50L6GT
3V4	6B7	9B8A	50V6GT
4A06	6C4	10E7	50V7CT
4BC5	6C86 A	10E7	70L7CT
4BC8	6CD6G A	12AB5	80
4BQ7A	6CL6	12AD6	83
4BS8	6C67	12A05	117Z3
		12AT6	117Z6GT

Partial listing—send for free complete tube listing.  
FREE SURPRISE BONUS ON  
ORDERS OF \$5 OR MORE!

for more details circle 38 on post card

# FAST

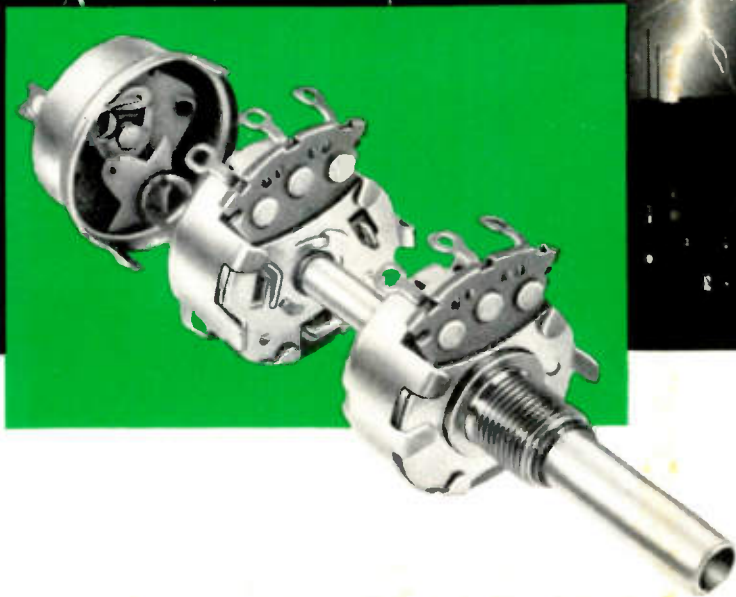

## **CLAROSTAT UNI-TITE CONTROLS**

Lightning fast! Positive dependability too! Clarostat Uni-Tite field-assembled controls assemble in seconds, and stay put under the most rigorous service conditions. It's simply a matter of clicking in the proper shafts, inserting one shaft inside the other, a twist of the wrist and that dual is made automatically—for keeps.

Clarostat offers the most complete line of designed-for-service potentiometers. Write for complete details today . . .

DISTRIBUTOR SALES DIVISION



# CLAROSTAT

CLAROSTAT MFG. CO., INC. DOVER, NEW HAMPSHIRE

--- for more details circle 22 on post card

*An important message to electronic technicians . . .*



**RCA invites you to**

## **PUT YOURSELF IN THE COLOR PICTURE**

Color television today is a 300-million-dollar-a-year business—and the fastest growing segment of the home entertainment industry.

Color TV programming is at an all-time high. If you still limit yourself to black-and-white servicing, you put yourself in the same position as the village blacksmith who considered automobiles a fad.

Leading manufacturers are now turning out color TV sets with the color picture tube developed by RCA. Servicing these sets means big and highly profitable business, but it requires special skills, knowledge, equipment and parts. What are you doing to take advantage of this great new business opportunity?

To the public, *color TV means RCA!* It was RCA who conceived and pioneered the compatible color system in universal use.

*How can you climb on the color bandwagon?* Associate your business strongly with the prestige and customer acceptance of the recognized pioneer of color TV. See your authorized RCA distributor; stock and advertise RCA tubes and associated products for color. Isn't it time you started seeing yourself in color?

RCA ELECTRON TUBE DIVISION, HARRISON, N. J.



**THE MOST TRUSTED NAME IN TELEVISION**