

# TECHNICIAN

## & Circuit Digests

BUYERS DIRECTORY

ANTENNAS

BATTERIES

BOOKS

CABINETS

CAPACITORS

COILS & TRANSFORMERS

CONVERTERS

FILTERS

HARDWARE

RECEIVERS

RESISTORS

SEMICONDUCTORS

SOLDERING IRONS

SOUND, HI-FI

SWITCHES

TEST EQUIPMENT

TOOLS

TUBES

TUBE ACCESSORIES

WIRE



# ASSURED ELECTRICAL ACCURACY BASED ON MANUFACTURERS' PROCUREMENT PRINTS

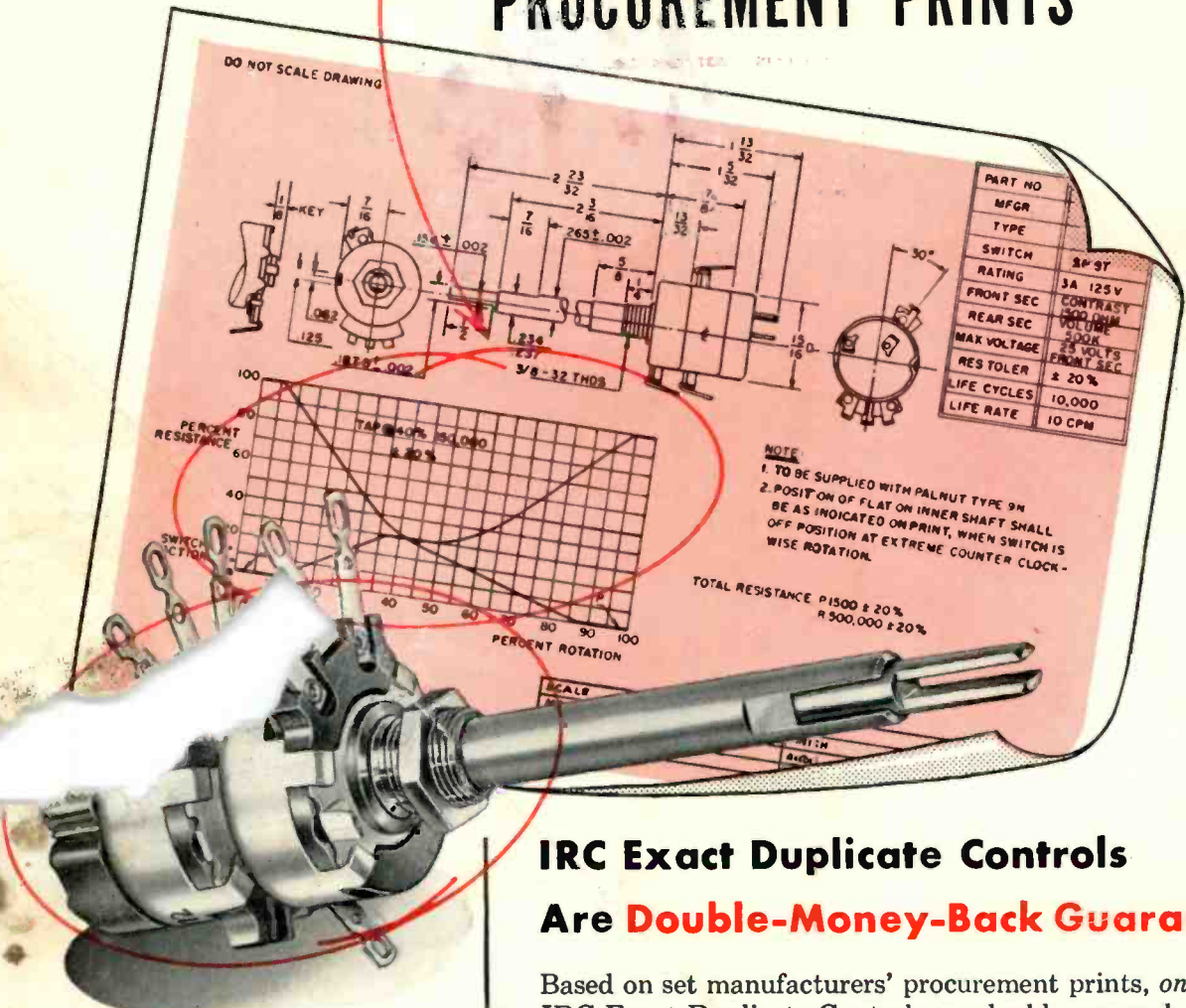

**ONLY IRC GUARANTEES  
ACCURATE ELECTRICAL OPERATION  
AND SATISFACTORY MECHANICAL FIT  
OR DOUBLE-YOUR-MONEY-BACK**

Electrical specifications of this typical manufacturer's procurement print are exactly duplicated by IRC's QJ-412 control (shown). CONCENTRIKIT assembly includes P1-206 and R1-223 shafts with B17-109 and B13-133X Base Elements and 76-1 Switch.

## IRC Exact Duplicate Controls Are Double-Money-Back Guaranteed

Based on set manufacturers' procurement prints, *only* IRC Exact Duplicate Controls are double-money-back guaranteed for accurate electrical operation. This firm guarantee applies to both IRC factory-assembled Exact Duplicates *and* universal CONCENTRIKIT equivalents.

Set manufacturers' electrical specifications are closely followed.

Resistance values are carefully selected to match. Tapers are watched carefully; IRC doesn't arbitrarily substitute tapers to obtain wide coverage.

For exact duplicate controls of guaranteed accuracy, specify IRC. Most Service Technicians do.



## INTERNATIONAL RESISTANCE CO.

Dept. 573, 401 N. Broad Street, Philadelphia 8, Pa.

In Canada: International Resistance Co., Ltd., Toronto, Licensee

Wherever the Circuit Says

# TECHNICIAN & Circuit Digests

TELEVISION • ELECTRONIC • RADIO • AUDIO • SERVICE

M. CLEMENTS *Publisher*  
 O. H. CALDWELL *Editorial Consultant*  
 SIDNEY C. SILVER *Managing Editor*  
 CREIGHTON M. MARCOTT *Assistant Editor*  
 ANN O'ROURKE *Assistant Editor*  
 ALBERT J. FORMAN *Consulting Editor*  
 J. L. STOUTENBURGH *Consulting Editor*  
 DR. A. F. MURRAY *Contributing Editor*  
 CHARLES F. DREYER *Art Director*  
 ELMER KETTERER *Circuit-Digest Production*  
 GEORGE PUGLICI *Circuit Diagrams*

### BUSINESS DEPARTMENT

H. A. REED *Y.P. & General Sales Manager*  
 CHARLES S. ROEVER *District Manager*  
 P. J. CARNESE *Sales Promotion Manager*  
 N. McALLISTER *Asst. Business Manager*  
 A. H. POND *Controller*  
 W. W. SWIGERT *Credit Manager*  
 ELMER DALTON *Circulation Manager*  
 480 Lexington Ave., New York 17, N. Y.  
 Telephone PLaza 9-7880

S. M. GASKINS *V.P. & Western Manager*  
 JOHN D. LUPTON *District Manager*  
 R. E. SCHULTZ *District Manager*  
 201 N. Wells St., Chicago 6, Ill.  
 Telephone RAndolph 6-9225

CHRIS DUNKLE & ASSOCIATES  
*California Representative*  
 3257 W. 6th Street, Los Angeles 5, Calif.  
 Telephone DUnkirk 7-6149

1651 Market Street, San Francisco 3  
 Telephone UNderhill 3-5282



TECHNICIAN & CIRCUIT DIGESTS, May 1955, Vol. 61, No. 5, \$1.00 a copy. Published monthly by Caldwell-Clements, Inc. Publishers also of Mart and TELE-TECH & Electronic Industries. Publication office, Emmett St., Bristol, Conn. Editorial, advertising and executive offices, 480 Lexington Avenue, New York 17. Telephone PLaza 9-7880. M. Clements, President; M. H. Newton, Assistant to President; John J. Borghi, Vice President and Treasurer; M. B. Clements, Secretary.

Entered as second class matter at the Post Office at Bristol, Conn., June 10, 1954. Subscription rates: United States and Canada, \$4.00 for one year; \$6.00 for two years; \$8.00 for three years. Pan-American and foreign countries: \$7.00 for one year; \$10.00 for two years; \$14.00 for three years. Copyright 1955 by Caldwell-Clements, Inc. Title registered in U. S. Patent Office. Reproduction or reprinting prohibited except by authorization. Printed in U. S. A.

MAY, 1955

### FRONT COVER

Despite their staggering number and diversity, parts and components germane to the radio-TV-electronics field can be integrated into coherent, related major groupings, just as many diverse electrical charges are organized into integral atoms. Your "scorecard" to the field is the TECHNICIAN Buyers Directory. An important element of this Directory Issue, it blankets the field with 24 major categories and their many subdivisions.

### FEATURES AND ARTICLES

CRT Checker Measures Gas Content .....	10
New Player Uses "Engraved" Recordings .....	12
Transistorized Auto Radio .....	16
Two-Fisted Action—Here's How (Editorial) .....	21
"Tuning in the Picture" .....	22
Tests for Keyed AGC Systems .....	James A. McRoberts 24
\$ In Mobile Radio Service .....	John Tansey 26
Troubleshooting Hum in TV .....	M. G. Goldberg 27
Top Industry Event—'55 Electronic Parts Show .....	28
"Tough Dog" Corner .....	H. S. Laycock, Frank L. Garkus, Oscar J. Sykes 30
Oscilloscopes for Color TV .....	Robert G. Middleton 31
Let's Look At Circuits .....	Sidney C. Silver 32
PA Installation Problems .....	Bert Ennis 33
Shop Hints .....	H. Josephs, S. Clark, B. O. Riis, J. Amorose 34
New Outdoor TV Antennas .....	36
New Audio Equipment .....	42

### 1955 TECHNICIAN BUYERS DIRECTORY .....

Product Finding Index	Service Technicians Associations
Product Listings	Electronic Parts Distributors
Brand & Trade Name Index	Electronic Representatives
Mfrs. listed with Localizer Index	

### DEPARTMENTS

Letters to the Editor .....	8	News of the Industry .....	50
Calendar of Coming Events .....	23	Catalogs & Bulletins .....	52
New Products .....	35	New Books .....	53
Reps & Distributors .....	38	Service Association Reports .....	56

### CIRCUIT DIGESTS .....

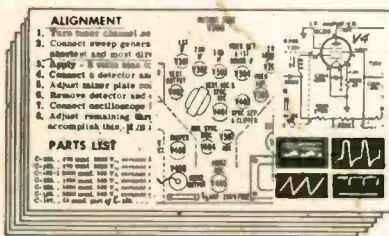

### IN THIS ISSUE

CBS-COLUMBIA: TV Chassis 1603  
 EMERSON: Portable Radio Chassis T20252-B  
 GENERAL ELECTRIC: Portable Radio Models 545-8  
 GRANCO: Table FM Radio Model 610 FM  
 MAGNAVOX: TV Chassis 600 series  
 MOTOROLA: Table AM Radio Chassis HS-422  
 SYLVANIA: TV Chassis 1-526  
 TRAVLER: TV Chassis 417E4

# CHANNEL MASTER

steers you to the  
greatest  
conical values  
ever offered!

the New  
**"MAVERICK"**

Never before such  
a complete line  
of conicals at such  
fabulous **LOW PRICES!**

Low-priced conicals? Here is the **LOW-EST-PRICED**, fullest conical line you've ever seen—a complete series of 22 different models. Checked out and approved by the Channel Master laboratory, every "MAVERICK" antenna provides outstanding Broad Band reception wherever conical antennas find application. Available both "Super-sembled" and non-assembled, the "MAVERICKS" are, without doubt, today's most sensational antenna buy.

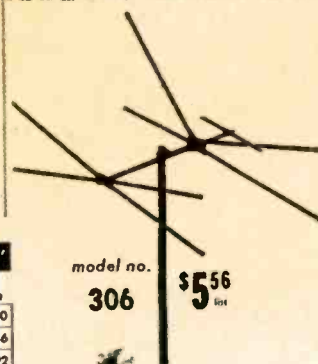
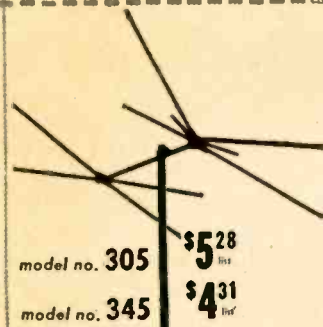
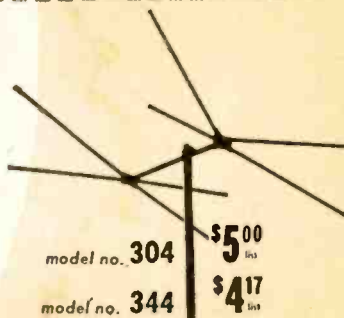
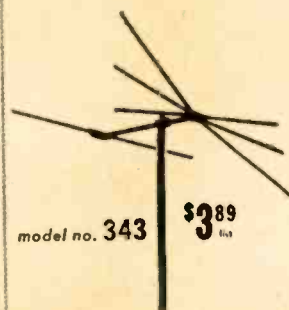
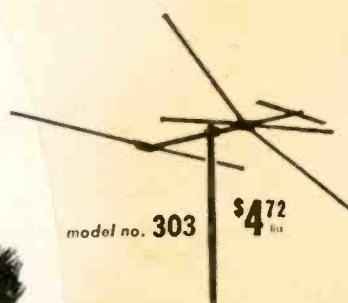
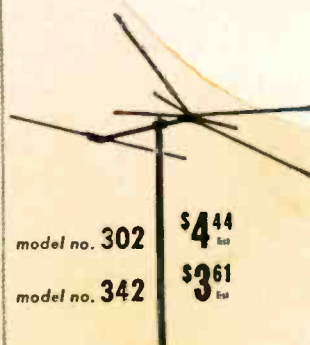
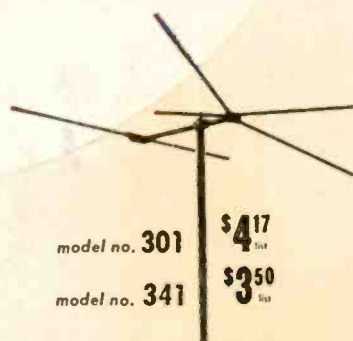

## "MAVERICK 300"

model no.	desc.	pack'd list
301	1-Bay	6 \$4.17
301-2	2-Bay	3 8.75
301-8	2-Bay	1 9.31
302	1-Bay	6 4.44
302-2	2-Bay	3 9.31
302-8	2-Bay	1 9.86
303	1-Bay	6 4.72
303-2	2-Bay	3 9.86
303-8	2-Bay	1 10.42
304	1-Bay	6 5.00
304-2	2-Bay	3 10.42
304-8	2-Bay	1 10.97
305	1-Bay	6 5.28
305-2	2-Bay	3 10.97
305-8	2-Bay	1 11.53
306	1-Bay	6 5.56
306-2	2-Bay	3 11.53
306-8	2-Bay	1 12.08
301-3	Conn. Rods	.56

## "MAVERICK 340"

model no.	desc.	pack'd list
341	1-Bay	6 \$3.50
341-2	2-Bay	3 7.36
341-8	2-Bay	1 7.92
342	1-Bay	6 3.61
342-2	2-Bay	3 7.64
342-8	2-Bay	1 8.19
343	1-Bay	6 3.89
343-2	2-Bay	3 8.19
343-8	2-Bay	1 8.75
344	1-Bay	6 4.17
344-2	2-Bay	3 8.75
344-8	2-Bay	1 9.31
345	1-Bay	6 4.31
345-2	2-Bay	3 9.03
345-8	2-Bay	1 9.58
341-3	Conn. Rods	.56

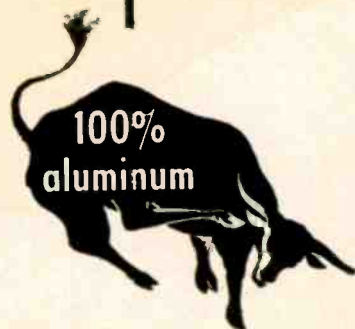

# "MAVERICK 300"

12 different models

Extra "sleeve" on element provides 400% greater strength where it is needed most.



The **first and only** full line of conical antennas completely *"Super-assembled"*

No hardware, no tools, no tightening—pops open, ready for the mast!

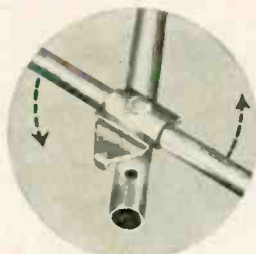

Director bracket.

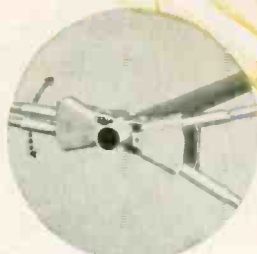

Bracket of N-type reflector.

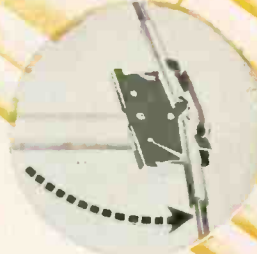

Bracket of straight-bar reflector.

# "MAVERICK 340"

10 different models

Features

**"NOTCH-LOCK"**

Clamp Plate  
Elements can't turn or twist loose!

This exclusive feature, until now, has been available only in much higher-priced models.

**NON-ASSEMBLED\***

***This quality line carries the lowest price-tags ever seen on conical antennas!***

- Installs in a matter of minutes. • Most popular conical arrangements.
- Finest materials; durable, rugged construction.

**\* Extra Preassembly Feature!**

On all models with straight-bar reflectors, the reflector element is completely preassembled for snap-open installation.



**CHANNEL MASTER CORP.**  
ELLENVILLE, N. Y.



**G-C RADIO-TV SERVICE CEMENT**  
Famed high grade adhesive.  
No. 30-2 NET \$0.39



**G-C CEMENT SAMPLER KIT**  
Includes 7 different cements.  
No. 345 NET \$4.95



**G-C SILICONE COMPOUND**  
Permanent waterproof material.  
No. 8100 NET \$0.99



**G-C ELECTRONIC CONTACT CLEANER**  
All-purpose contact cleaner.  
No. 210-2 NET \$0.33



**G-C LONG-REACH LUBRICATOR**  
For hard-to-reach places.  
No. 8690 NET \$0.48



**G-C RUF-KOAT WRINKLE VARNISH**  
Black, Gray, Brown (specify).  
No. 60-2 NET \$0.39



**G-C DIAL LITE COLOR KIT**  
Kit of 5 colors and solvent.  
No. 66-6 NET \$0.72



**G-C GENERAL SCRATCH STIK**  
Removes wood scratches.  
No. 909 NET \$0.30



**G-C TV-RADIO DIAL CABLES**  
Best nylon cord in 25-ft. lengths.  
No. 75-25 NET \$0.84



**G-C DIAL POINTER KIT**  
Box of 25 assorted pointers.  
No. 6805 NET \$3.30



**G-C SHIELDED PICK-UP WIRE**  
Assorted wire lengths.  
No. 1738-E NET \$0.27



**G-C ASSORTED SPAGHETTI KIT**  
Kit of 26 lengths of spaghetti.  
No. 550 NET \$0.30



**G-C NEEDLE-POINT PRODS**  
Brass chucks, 6" test prods.  
No. 7701 NET \$0.30

**GENERAL**



**CEMENT**

*Ask For These*  
**RADIO-TV SERVICE AIDS**

*... at Your Jobber*



**G-C SPRAY DE-OX-ID**  
Cleaner for radio, TV controls.  
No. 19-6 NET \$2.97



**G-C UNIVERSAL TYPE TEST LEADS**  
Heavy duty 6000 V. leads 50" long, 6" handles, solderless tips.  
No. 8463 NET \$1.80



**G-C FIBRELOID SHIMS**  
Kit contains 20 fibreloid shims.  
No. 702 NET \$0.39



**G-C HARDWARE ASSORTMENT**  
Approx. 1,000 screws, nuts, etc.  
No. 6064 NET \$1.08



**G-C TELEVISION SAF-T-RACK**  
Sturdy, safe chassis repair.  
No. 8045 NET \$3.27

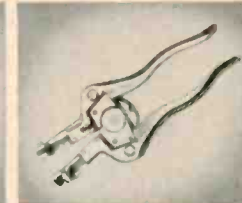

**G-C SPEEDEX WIRE STRIPPER**  
Automatic, delayed action return.  
No. 766 NET \$4.95



**G-C YOKE COIL EXTENSION**  
Service picture tube in set.  
No. 8847 NET \$2.70



**G-C TYPE II PIN CUSHION**  
Reduces fuzzy pin cushion effect.  
No. 8954 NET \$0.60

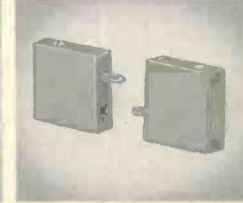

**G-C POLARIZED TV LINE PLUGS**  
For all UHF and VHF lines.  
No. 8596 NET \$0.36



**G-C TV KNOB SPRING-WEDGE KIT**  
100 assorted TV knob springs.  
No. 8858 NET \$2.10



**G-C ADJUST-A-LOOP ANTENNA**  
Eliminates bulky loop antennas.  
No. 8866 NET \$0.60



**G-C SOLDERLESS TERMINALS**  
Handy lugs for 300-ohm TV lines.  
No. 8633-C NET \$2.19

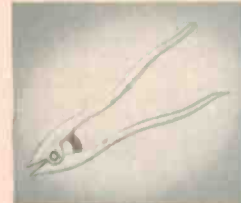

**G-C TV STAND-OFF TOOL**  
Open and close TV stand-offs.  
No. 8450 NET \$0.75

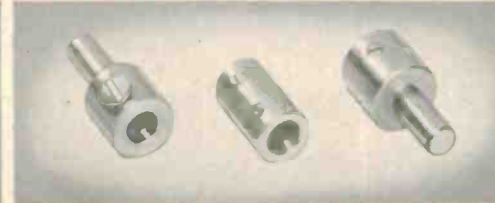

**G-C SHAFT COUPLINGS, EXTENSIONS, REDUCERS**  
Accurately machined brass fittings. Use minimum space.  
No. 6701 1/4" to 3/8" coupling NET \$0.12

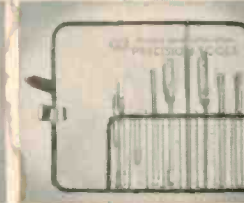

**G-C STD. TV ALIGNMENT KIT**  
Kit contains 9 essential TV tools.  
No. 8455 NET \$4.59

**FREE!** Postcard brings your big G-C Catalog.



*Ask Your Jobber for the*



**SPECIALS OF THE MONTH**



ALL THREE REGULARLY . . . . . \$1.05  
YOUR COST THIS MONTH ONLY . . . 69c!



**GENERAL CEMENT MFG. CO.**

902 Taylor Ave. • Rockford, Illinois

**BUY ALL THREE AND . . . . . SAVE 36c ON THESE HANDY G-C CHEMICALS!**

G-C RADIO-TV SERVICE CEMENT	2-oz. bottle	NET \$0.65
G-C RADIO-TV SERVICE SOLVENT	2-oz. bottle	NET \$0.55
G-C ELECTRONIC CONTACT CLEANER	2-oz. bottle	NET \$0.55

# SETTING THE PACE . . .

in **ALL-CHANNEL**  
fringe antennas!



**SUPER SUN BEAM**  
Model SB662

The new, supe-sharp yagi utilizing the unique Tri-King dipole together with completely insulated parasitic directors and reflectors! Actually two antennas in one for peak high and low band reception.



Clear Beam's **5** peak performers solve all fringe problems\* . . .

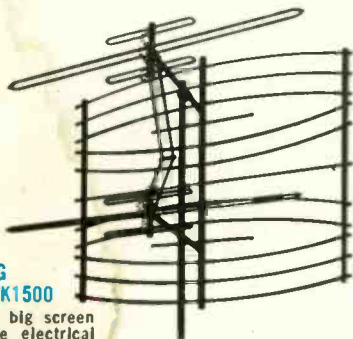

**TRI-KING**  
Model TK1500

Highest gain of the big screen antennas! Half wave electrical spacing. Eliminates ghosts and co-channel interference. Full radar screen - wind tunnel tested!

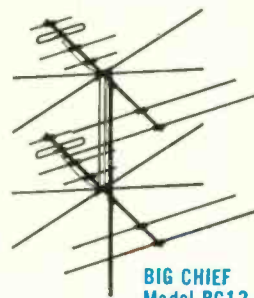

**BIG CHIEF**  
Model BC12-2

An advanced conical-Yagi with element diameters varied for precision tuning, matched sensitivity and peak performance on high and low band!

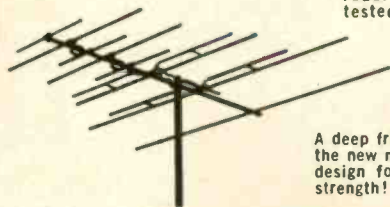

**SKY SWEEP**  
Model MYS8C

A deep fringe yagi incorporating the new magnetic "Focal-Sharp" design for concentrating signal strength!

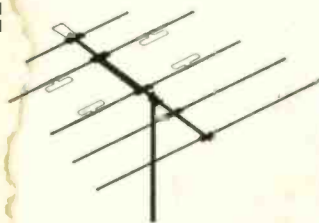

**HUNTER** Model MYH50

New wave trap principle gives extremely high gain, sharp directivity, in-phase tuning on all channels. New, flat design for low wind resistance!

\*Spectrum-tested for balanced color reception!

affiliated with  
TEMPO TV products

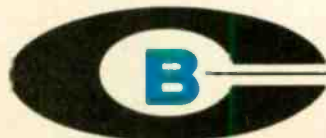

**CLEAR** ANTENNA CORP.  
**BEAM**

Canoga Park, Calif. • Chicago, Ill.

Warehouses In Seattle, Portland, San Francisco, Honolulu, Dallas, Kansas City, Chicago, Detroit, Baltimore

# ANNOUNCING

# a NEW **FINCO**<sup>®</sup>

## MODEL

# F-4

(PAT. PEND.)

with exclusive

# FIDELITY<sup>\*</sup> PHASING

<sup>\*</sup> Dictionary: the highest degree of accuracy in the reproduction of a signal

**Now!**

**Finest Performance  
Ever Achieved  
on LOW-BAND**

**Plus +**

**Acknowledged  
FINCO Superiority  
on HIGH-BAND!**

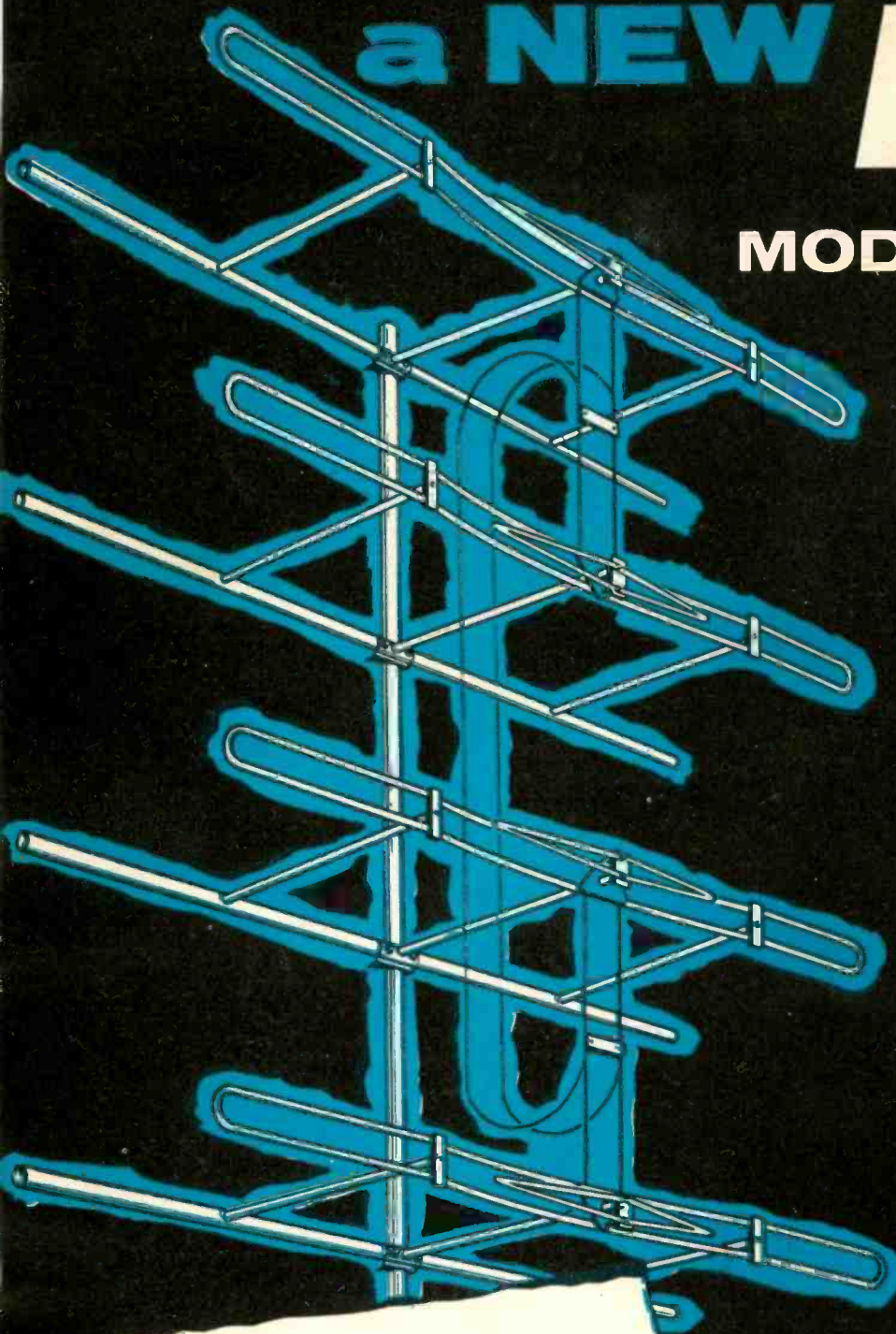



**"We will stake  
our reputation  
on this!"**



M. L. Finneburgh, Vice-President,  
The Finney Company,  
speaking for the entire  
FINCO organization:

**"The new Finco Model F-4 (pat. pend.) is  
the closest approach to perfection yet con-  
ceived in TV antennas. The F-4 gives the  
greatest combined performance ever  
achieved in the Super Fringe Area... on  
both Low and High-band. Upon this, we  
stake our reputation."**

**NEW!**

**SENSATIONAL LOW PRICE  
FIDELITY PHASING  
LOW AND HIGH-BAND SUPREMACY  
ENGINEERED FOR COLOR  
UNCONDITIONAL WRITTEN WARRANTY  
FREE TESTING ANTENNA TO QUALIFYING DISTRIBUTORS**

**WRITE, WIRE  
OR PHONE  
TODAY!**

**The FINNEY Company**

T-55

4612 St. Clair Avenue  
Cleveland 3, Ohio

TEMPERATURE HIGH? HUMIDITY LOW?



## TRY THE TAPE TEST

Make this simple test on the VTVM you're using now. Take a strip of plastic electric tape... press it firmly over the meter face... then pull it off with one quick, sharp tug. Notice that meter deflection? Notice how long it takes to re-zero?

Now, try the same test on a Hycon VTVM. You'll see little meter deflection... and immediate re-zeroing. Hycon's electrostatic shielding is your assurance that even when temperature's high and humidity's low... common conditions around computers, GCA systems and transmitters... you'll get out of your VTVM all the accuracy Hycon builds into it.



### MODEL 614 VTVM

Accuracy at unprecedented low cost... 21 ranges (28 with p-p scales); large 6½" meter; 3% accuracy on DC and ohms, 5% on AC; AC frequency response to 250 MC (with accessory crystal probe). *Test probes stow inside case.*

**\$87.50**

### MODEL 617 3" OSCILLOSCOPE

Designed specifically for color TV and laboratory requirements... 4.5 MC vertical bandpass, flat within ±1 db; high deflection sensitivity (.01 v/in. rms); flat face 3" CRT. *Sharp undistorted trace edge to edge.*

**\$269.50**



See and try these matched, bench-stacking instruments at your local electronic parts jobber.

# Hycon Mfg. Company

2961 EAST COLORADO STREET • PASADENA 8, CALIFORNIA

"Where accuracy counts"

ORDNANCE • AERIAL CAMERAS • ELECTRONIC SYSTEMS • BASIC ELECTRONIC RESEARCH  
ELECTRONIC TEST INSTRUMENTS • AERIAL SURVEYS • GO NO-GO MISSILE TEST SYSTEMS

## LETTERS To the Editors

### Anti "Night Crawlers"

EDITORS, TECHNICIAN:

Recently I tried to establish myself in business. With a pile of experience and plenty of equipment, I set out to see how far is down. To make a long story short, I went broke and ended up by getting myself a job as an electronic tech in a production plant. I am very unhappy about the whole situation because I left an industry that I love.

The main reason for my failure was the many "night crawlers" who, without any outlay of money, find themselves in a part-time business. Many of these men are working in a union shop all day doing drilling, wiring, or what have you. These very men would report me if I would infringe on their jobs. What are we in TV service going to do to curb these wage robbers? Maybe some of you have answers, so please write.

ARTHUR M. VIKLA

Minneapolis, Minnesota

• A big question tied to this problem is, "When is a part-time or basement operator a night crawler?" New blood must enter the expanding service industry in some way or other. Is the part-time element the deciding factor in whether these people are legitimate—or is it simply a question of competence and fair pricing regardless of whether the individual works full or part time? We'd like to hear some views on this from individuals and associations.—Ed.

### Contract Service

EDITORS, TECHNICIAN:

What with all the squawks about cut-price servicing, gyps and fly-by-nights, I sometimes get homesick for the good old days of the service contract. The plan had many drawbacks, but there was always the advantage of a fixed price and no loud complaints about the charge, on individual calls, no shopping around for price. Maybe a financed pay-as-you-go annual contract, with insured guarantees to both parties, is the safest and least painful answer. Now all we need is someone with the cash to sponsor it.

D. LARKIN

Los Angeles, California.

### Retail-Wholesale Mess

EDITORS, TECHNICIAN:

Everyone talks about the rough treatment service technicians and dealers are getting from jobbers who compete with their own customers but, like the weather, nobody does anything about it. The situation will never improve unless someone can come up with a good working plan for cleaning up the mess.

A. BLISS

Toledo, Ohio

• See this month's editorial.—Ed.

# Your best buy!

...for new installations

...for replacement needs!

... the fastest mounting, best performing aerial on the market

RADIART  
**Spee-Dee**  
AUTO AERIAL  
MODEL 8BE

Here is the outstanding, NEW auto aerial and it has everything! Handsome in appearance . . . outstanding in performance . . . and a new design that is a snappy one-two-three installation WITHOUT EVEN LOOKING UNDER THE FENDER!

Here are a few of the features:

- ★ Speedy, one-man installation
- ★ 30° mast adjustment
- ★ Fits all body and fender contours
- ★ 57½" length extended - 18-8 stainless steel
- ★ Extra long, full 42" polyethylene lead-in

1. After dis-assembling, insert the lead and lower section through fender hole and guide the split ring through the fender hole—then draw up tight against fender.

2. Then lower rubber mat insulator and lock nut into position.

3. Just tighten assembly . . . plug lead-in into radio.

FEATURING EASY 1-2-3 INSTALLATION

SUBSIDIARY OF



THE RADIART CORPORATION  
CLEVELAND 13, O.

TV Antennas - Auto Aerials - Vibrators - Rotors - Power Supplies

# Gives your customers brilliant results ...pays off for you!

## NEW SONOTONE 1P CERAMIC CARTRIDGE

CUTAWAY VIEW  
(Actual size 1" long)

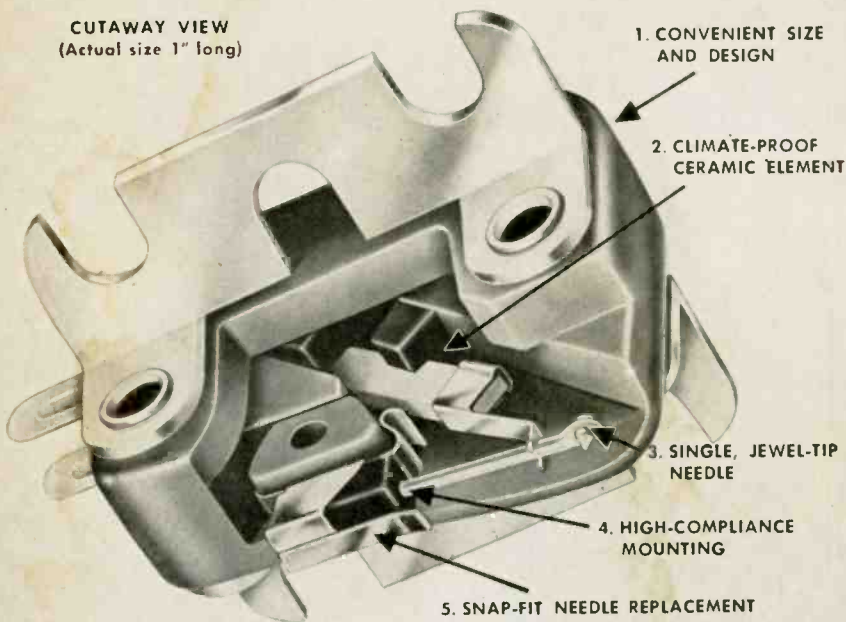

1. Easy to install. Just two models fit most arms now in use. Cartridge is less than 1" long, 8/10" wide with bracket. Time-saving hardware included.
2. Ceramic element gives flat response (see curve) —requires no preamplification or equalization. No deterioration problems as with other

types...virtually immune to hum pickup.

3. Replaceable needle, diamond or sapphire. Models for 33-45 rpm, or 78 rpm.
4. Extreme lateral compliance and low-mass design give superior tracking, low wear.
5. Needles snap in, snap out easily.

### Tap the Huge 33-45 RPM Replacement Market!

Install this new Sonotone 1P, and give your customers exciting, true, wide-range response. At one stroke, you make a good sale, cut installation time, avoid problems found with other types of cartridges...and build your reputation for quality work and professional advice. No other cartridge has all the advantages this 1P gives you! With sapphire, \$8.50; with diamond, \$30.

RESPONSE 30-15,000 ± 3 DB!

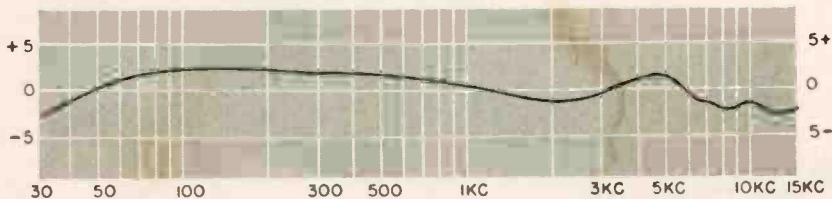

Response to new industrywide RIAA characteristic shows how 1P ceramic cartridge *self-equalizes*, because it works on "amplitude" rather than "velocity" principle. Here's startlingly improved performance for your customers' phonos!

# SONOTONE

CORPORATION  
ELMSFORD, N.Y.

Write Dept. CT-55 for free Phono Modernization Manual

## CRT Checker Measures Gas Content

• There is a good deal of uncertainty in the TV technician's approach to the gassy, or "soft," picture tube. Where "arcing" the cathode to grid in one tube produces a reasonably permanent repair, the same methods employed on another tube may provide adequate brightness and contrast for only a day or so. The gas content of the tube is the determining factor.

The gas ions, being positively charged, are attracted to and absorbed by the barium element which forms the coating of the cathode. They form a film or crust which restricts the cathode's ability to emit electrons. The result is the familiar silvery-gray raster. The emission can be restored, at least temporarily, by blasting the surface of the cathode with a high current, sweeping away the film.

Until now, the technician has had no way of knowing how long the repaired tube would remain usable, because he had no means of measuring the gas content within the envelope. Such an indication can now be had through the "Cum-A-Tron" circuit incorporated in the new "Raytronic Beamer."

### Operation

The instrument works in the following manner. Since the positive gas ions are attracted to the negative element, the cathode, the direction of ion current flow can be changed by making another tube element more negative than the cathode and then metering the resulting current flow through that element. The ion current is very small, in the neighborhood of a few microamps, so a very sensitive detector is needed. The "Cum-A-Tron" incorporates a direct-coupled amplifier with a microamp-metered output circuit.

The gas or ion current is determined by the difference between two readings. The first, as described above, is a composite of the ion current and the leakage in the crt, with a fixed beam current of 650 microamperes. The second reading is taken with the tube biased to cutoff. There is no beam to ionize the gas, hence no ion current. The microammeter reading then will be only the leakage current in the crt—and the difference between the readings will indicate the gas current in the tube. ●

1955 TECHNICIAN  
BUYERS DIRECTORY  
begins on page 63



2 chassis, like the one pictured above (left) were used by Planet TV, B'klyn TV Service Center, to make their fact-finding call-back tests. The results? Planet says:

## "Westinghouse Receiving Tubes Cut Our Call-Backs by More Than 30%!"

One of the oldest and largest TV service organizations in New York—Planet TV—submitted Westinghouse Receiving Tubes and the tubes of other manufacturers to a rigorous, factual "call-back" test.

The test was set up by equipping two identical chassis; one with all Westinghouse types and the other with identical tubes of other manufacturers. The sets were turned on and operated 8 hours per day for 5 consecutive days, the average period during which Planet TV's records show that call-backs normally occur after renewal tube installation.

The chassis equipped with Westinghouse tubes showed no failures. The other chassis showed 3 tube failures—3 potentially costly Planet call-backs.

Why don't you make this simple, profitable call-back test in *your* shop. Prove to yourself, too, that Westinghouse Receiving Tubes can drastically reduce your call-back problems—and increase your profits! See your Westinghouse distributor today! Start using Westinghouse Reliatron® Tubes *right away!*

BREAKDOWNS: SET A (WESTINGHOUSE TUBES ONLY)		BREAKDOWNS: SET B (THREE COMPETITIVE BRANDS)
Monday	None	None
Tuesday	None	5U4G defective
Wednesday	None	None
Thursday	None	6AU6 defective, 5U4G soft
Friday	None	None

ET-95070

YOU CAN BE SURE...IF IT'S  
**Westinghouse**

**RELIATRON® TUBES**

WESTINGHOUSE ELECTRIC CORPORATION, ELECTRONIC TUBE DIVISION, ELMIRA, N. Y.



Service technicians all over the country are saving time, improving service and raising profits through the use of TELAIDES — the travelling TV service guides.

Schematics, tube layouts, parts lists, production changes and service hints are combined in open-flat books for each manufacturer. They are convenient to use in the shop, and are just the thing to take along for in-the-home calls.



**TELAIDES** are now available covering early production through 1955 models for:

EMERSON	RAYTHEON
MOTOROLA	ARVIN
ADMIRAL	PHILCO
SYLVANIA	ZENITH
PHILMORE	STARRETT
TRAY-LER	CROSLY

WESTINGHOUSE  
KAYE-HALBERT  
STROMBERG-CARLSON  
RCA VICTOR  
GENERAL ELECTRIC

For the name of your nearest distributor write:

WALLACE'S TELAIDES INCORPORATED  
134-136 Day Street, Jamaica Plain 30, Mass.

## New Player Uses

### "Engraved" Recordings

Advantages of both disc and tape techniques are realized in a new playback unit that plays *nonmagnetic* engraved tape recordings up to 8 hrs. continuously. A flexible tape of pure vinylite, ½-in. wide, takes an average of 82 parallel grooves. The tape is packaged in a cartridge known as a Sound Book, which is, in fact, about the size of a small volume and bears some resemblance to the cartridge used in



Fig. 1—Compact player is readily loaded.

popular magazine-load movie cameras. One of the many features offered by the Teflon, as the unit has been named, is simplified threading. A loop of the unbreakable vinylite soundband is withdrawn from the cartridge and slipped over the playing wheel of the reproducer, as shown in Fig. 1. A stylus in the pickup head, located next to the wheel, is set against the tape.



Fig. 2—Teflon reproducer during playback.

Some other features offered by the system include: automatic wind and rewind; inexpensive mass production of the "Tefitapes," which can be duplicated in a manner similar to recorded discs; easy selection of individual portions on a single tape; and impossibility of accidental erasure, since the tapes are not magnetic recordings.

(Continued on page 16)

# FIRST V-O-M with ALL in ONE!

# TRIPPLET

MODEL 630-NA  
 Volt-Ohm-Mil-Ammeter  
 DEALER Net Price . . . \$69.50

MODEL 630 Famous  
 Volt-Ohm-Mil-Ammeter \$39.50  
 33 ranges and many other  
 features making this the  
 favorite in a popular V-O-M line

MODEL 630-A Laboratory Type  
 Volt-Ohm-Mil-Ammeter with  
 mirror scales, 1-1/2% DC  
 accuracy and special 1/2%  
 resistors for greater accuracy.  
 Found in the best laboratories  
 and production lines. \$49.50

MODEL 631 Combination  
 V-O-M and VTVM \$59.50  
 This sensational 2-in-1 battery  
 operated combination saves  
 you money — will do all your  
 work easier at half the price.

MODEL 666-R Pocket size  
 V-O-M. Practically a portable  
 laboratory with self contained  
 snap-in type batteries. \$26.50

The above are examples of  
 the complete Triplet V-O-M  
 line in which 10,000 ohms per  
 volt AC sensitivity has been  
 featured for 10 years.

**TRIPPLET HAS THE MOST COMPLETE V-O-M LINE**

BURTON BROWNE ADVERTISING

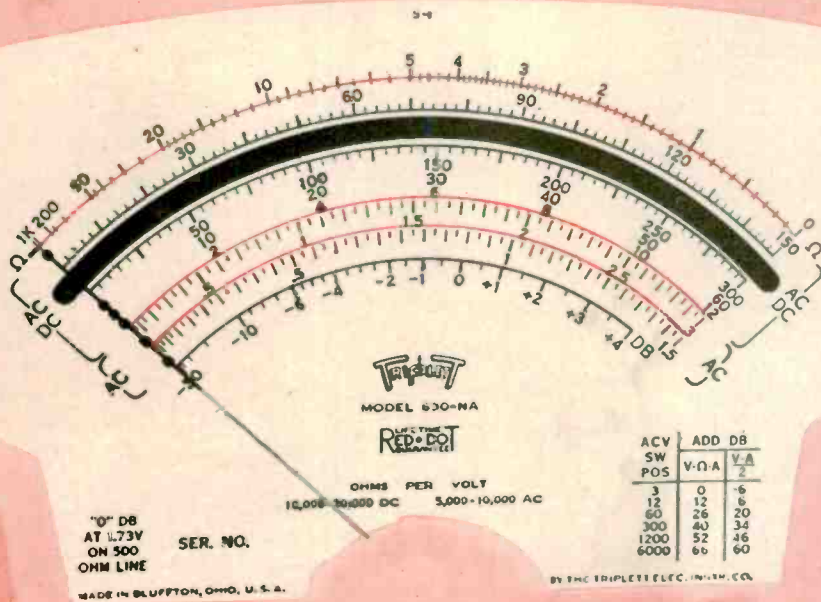

- 70 RANGES . . . nearly double those of conventional testers
- FREQUENCY COMPENSATED . . .  
for accurate readings over entire audio range
- HIGH AC-DC ACCURACY ON SAME SCALE
- ACCURACY: 1-1/2% DC to 1200 Volts, 3% AC to 1200 Volts
- METER PROTECTION AGAINST OVERLOADS
- TEMPERATURE COMPENSATED . . .  
Accurate within a wide range of ambient temperatures
- SIX RESISTANCE RANGES Including 100 Megohms
- COMPLETELY INSULATED Black Molded Case
- MIRROR SCALE And Knife-Edge Pointer

actual size

**ALL TRIPPLET  
 TESTERS APPROVED FOR COLOR  
 see them at your distributors**

**TRIPPLET**  
 TRIPPLET ELECTRICAL  
 INSTRUMENT CO.  
 Bluffton, Ohio

*ask your jobber  
for the whole story  
of the...*

**1st NEW DESIGN  
of selenium rectifiers  
in over 20 years**

because the new Pyramid  
Kool-sel design is so revolutionary  
and because its features  
themselves sell so immediately  
Pyramid has prepared this  
hand-sized flip chart, which  
tells at a glance all about such  
features as No Center  
Mounting and the Secret  
Barrier Layer of Pyramidium  
and explains the principles  
that make Kool-sel rectifiers  
superior to any on the market.

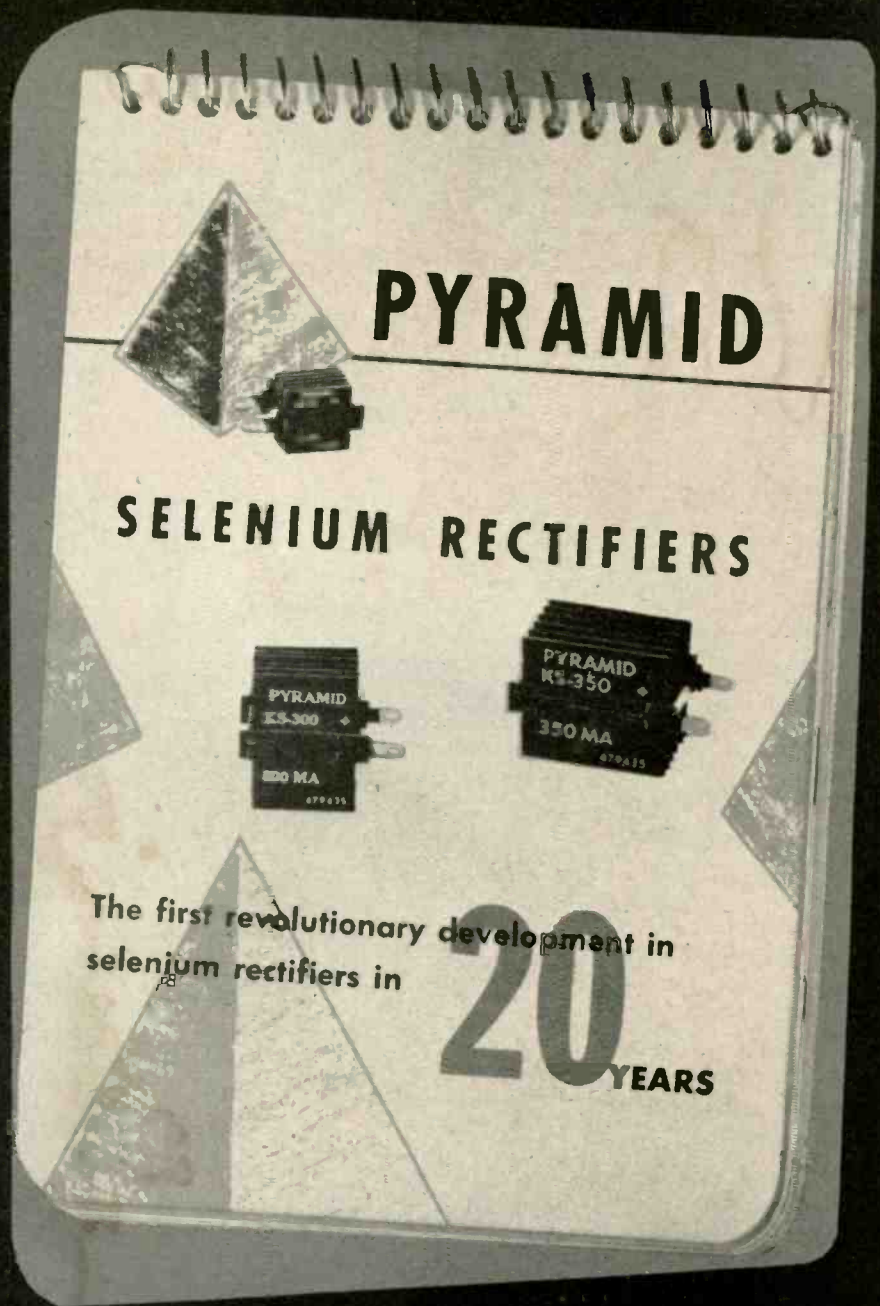

DISTRIBUTOR DIVISION

**PYRAMID**

ELECTRIC COMPANY

1445 Hudson Blvd. • North Bergen, N. J.



# a CHALLENGE by NEW PORTABLE Raytronic Beamer

*to ANY instrument  
for commercial  
TV CR Tube  
service work —  
for a  
COMPARATIVE  
DEMONSTRATION*



This portable instrument, identical in operation with the bench model, will make 8 tests to show, positively and accurately, the condition of any TV picture tube—and whether or not it is repairable.

The exclusive Cum-o-tron improved Raytronic Gas Test is now the only circuit for commercial use that employs the same circuitry and voltages used in picture tube laboratories, giving direct readings in fractions of one micro amp.

The Raytronic Beamer makes 5 repairs capable of restoring up to 85% of repairable tubes to satisfactory service. Endorsed

and used by leading TV tube and set manufacturers and their distributors, after exhaustive tests.

Thousands of users have verified every claim made for this instrument. They are reaping a new harvest of extra volume, extra profits, attracting new customers, winning loyalty and boosting endorsements from old customers.

Compact carrying case contains instrument and accessories—and is light weight, too.



Case cover removed for bench work in horizontal position; rubber base lugs.

## Read What They Say!

(from hundreds of  
written statements)

Raytronic Beamer is the best piece of test equipment I ever used, and will do more for the shop owner. It is actually worth many times its price and is so simple to operate.

J. S. ROHERSON,  
ROHERSON ELECTRIC SUPPLY  
Pontotoc, Miss.

The first day we used the Raytronic Beamer we repaired 20 CRTs—1 27", 4 21", 9 17", 4 16", 1 12", and 1 10". We save at least one CRT per day with this instrument and can't think of anything I would hate to part with more.

A. GLASER  
ALL AMERICAN TV  
Chicago 18, Ill.

**See Raytronic Beamer demonstrated — TODAY!**

## RAYTRONIC LABORATORIES, INC.

Export Representative:  
International Standard Electric Corp.,  
Capehart Division,  
Box 420, Ft. Wayne 1, Ind.

General Offices:

9701 Reading Rd.  
Cincinnati 15, Ohio



more than **5** years

**HUMIDITY — SHELF TEST**

# ELMENCO

## STEATITE PAPER TUBULARS

Tests performed on ELMENCO STEATITE PAPER TUBULAR CAPACITORS which had been aged for more than five years — subject to ALL normal atmospheric variations — revealed that 65% still met original RETMA specifications and all units were still satisfactory for use in most by-pass circuits.



**OFTEN IMITATED—  
STILL UNMATCHED**

### FOR YOU MR. MANUFACTURER:

— A quality component at competitive prices. . . . low cost assurance of a dependable product.

### FOR YOU MR. DISTRIBUTOR:

— A widely-accepted brand name component backed by national advertising and promotional aids. When your customer asks for ELMENCO, have them on hand. No fear of deterioration on your shelves. **They all move fast and stay good.**

### FOR YOU MR. SERVICEMAN:

— Money in the bank!! Put **ELMENCO STEATITES** in a circuit and you can forget them. No call backs, no worries of replacement failure. And you can still use those units you bought months ago with complete confidence. **ELMENCO REPLACES BUT IS NEVER REPLACED.**

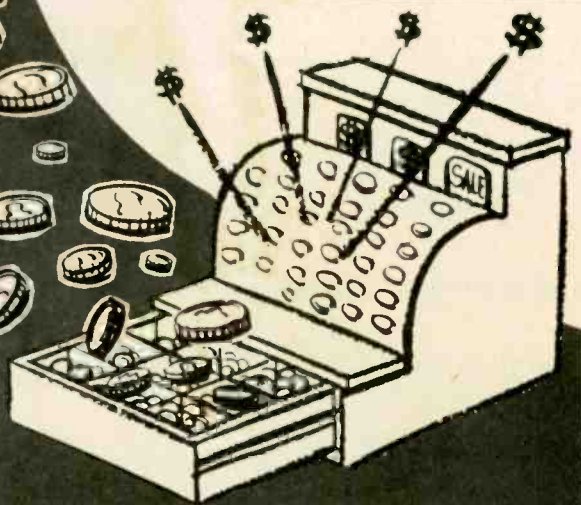

**ARCO**  
ELECTRONICS INC.  
103 LAFAYETTE ST.  
NEW YORK 13, N. Y.

WEST COAST BRANCH—ARCO CAPACITORS INC., 5281 WEST PICO BOULEVARD, LOS ANGELES, CALIF.

(Continued from page 12)

A view of the compact player is shown in Fig. 2 while it is in operation. Also visible are several of the Sound Books (6 by 5½ in.), which can be stored on shelves or in the open in the manner of ordinary books. Individual cartridges will sell from \$10 to \$20, depending upon length. The prices appear low in terms of the amount of continuous music available on each tape. The system is also stated to give high-fidelity performance. The player will be available for under \$100. The first series of releases will include 40 Sound Books covering classical, semi-classical and entertainment music played by leading European orchestras and singers. Ten new Books are planned for release each month.

In addition to the obvious application in home music systems, potential uses in the educational and industrial fields were pointed out. Home study courses could employ the tapes, which could be rotated through the mails easily. The possibility of making Sound Books available on a rental basis opens the door for music rental libraries, as is the practice with books. Such libraries have not become popular with conventional disc or magnetic tape recordings because of drawbacks inherent in these mediums.

Distributors of Teflon in this country will be Audio-Master Corp., 17 E. 45th St., New York 17, N. Y. (Ask for No. 5-70.)

### Transistorized Auto Radio Developed by RCA Scientists

An experimental transistorized automobile radio that operates directly from a 6-v. car battery and requires only 1/10th the power used by a conventional radio has been developed by RCA. Details on the new receiver were given at a recent meeting of the Southern District, AIEE, by an RCA research team.

The new unit employs nine transistors. To emphasize the low power consumption, the RCA scientists pointed out that more than half the current required for the unit is used to light the two pilot lights.

The use of transistors has eliminated the need for the conventional vibrator, power transformer or rectifier. The receiver can be easily adapted to 12-v. operation.

In tests conducted to determine the temperature operating range of the receiver, it performed satisfactorily at temperatures as low as -40°F. and as high as 176°F.



# STAR-HELIX

RAINBOW ANTENNA

A STAR IS BORN!



## THE NEWEST STAR IN THE JFD RAINBOW ANTENNA GALAXY

It's out of this world! . . . A radical new departure in all-channel black and white or color performance—featuring the JFD Hi-Plex folded dipole system—the greatest antenna advance since the origin of the Irline Yagi.

MODEL		LIST
<b>SX711</b>	Single	<b>\$25.50</b>
<b>SX711S*</b>	Stacked	<b>\$52.50</b>

\*Complete with Hi-Gain Stacking Transformers

- SUN** From JFD, the fountainhead of Antenna development
- MOON** As sensitive in signal attraction as the Moon
- VENUS** As beautiful as Venus
- MERCURY** As quick to install as Mercury
- SATURN** As spectacular as Saturn
- JUPITER** As outstanding as Jupiter
- MARS** As powerful as Mars

Look to JFD for Engineering Leadership!



THE MOST OUTSTANDING ANTENNA ADVANCE SINCE THE ORIGIN OF THE INLINE YAGI!



# STAR-HELIX

## RAINBOW ANTENNA

NOW—2 GREAT JFD HELIX RAINBOW ARRAYS TO CHOOSE FROM:

1. Jet-Helix featuring the new JFD Flat Plane Helical-Conical Concept.
2. Star-Helix featuring the new JFD Inline Helical-Yagi Concept.

TOMORROW'S COLOR ANTENNA — TODAY!

A giant in black and white performance. Flat microwave type helical section composed of individual non-linear additive collectors, each tuned separately for highest gain and sharpest directivity on one high band channel.

Revolutionary new Hi-Plex folded dipole design transforms low band collector into 3 half wave length antennas that develop highest in-phase current on high band. Result: sustained high signal magnitude on all low and high band channels — plus sharp forward unidirectional response.

A giant in color performance! Possesses consistently flat gain across the spectrum, uniformly high signal to noise ratio, narrow beam width, and close 300 ohm impedance match essential for fidelity color reception.

Special matching Booster Transformer permits close stacking for maximum high band response and electrical wide stacking for optimum low band response.

Inline designed for physically streamlined appearance. Maximum eye-appeal. Minimum wind resistance.

Completely preassembled. Just flip elements into place. New "Hi-Tension" aluminum brackets lock elements permanently in place. No tools. No screws.

Built for permanence — constructed of matchless aluminum by ALCOA.

300 ohm impedance for 100% signal transfer.

COMPARE THE PERFORMANCE OF THE STAR HELIX WITH ANY VHF ANTENNA YOU ARE NOW USING!

ANTENNA	CHANNELS												
	2	3	4	5	6	7	8	9	10	11	12	13	
"STAR-HELIX" SX711	4.75	5.	6.25	7.25	7.	14.5	14.	13.25	13.5	13.75	13.75	14.5	
"STAR-HELIX" SX7115	8.	8.5	9.	10.5	10.5	17.5	17.	15.75	16.	16.	16.	17.5	
"DODO" Screen Type REFLECTOR	4.75	4.5	7.2	7.1	7.	11.	11.2	11.8	11.5	11.1	12.1	12.	
"SUPER DODO" Screen Type REFLECTOR	6.3	6.8	8.8	7.8	7.5	9.5	11.2	11.8	12	11.1	12.1	12.	
Broad Band Yagi with Phasing Stubs	4.3	5.7	4.5	7.1	9.	13.	14.	13.5	14	13.	14	15.	
Inline Yagi with Phasing Stubs	5.2	5.5	6.	8.	8.	11.5	9.5	10.	9.	11	11.5	11.8	
Inline Yagi with Triple Dipole	5.25	6.25	7.	7.5	7.75	10.5	10.25	8.75	9.5	10.25	11.	11.75	
Super-Inline Yagi with Triple Dipole	6.75	7.	9.2	9.	10.	11.5	12.2	12.8	13.5	13.1	14.6	15.5	

Highest Front-to-Back Ratio ever in Broad Band design

Chan.	DB	Rel. Volt.
2	17.	7:1
3	22.	12.5:1
4	21.	11.5:1
5	20.	10:1
6	20.	10:1
7	10.5	3.5:1

Chan.	DB	Rel. Volt.
8	18.	8:1
9	19.	9:1
10	25.	18:1
11	22.	12.5:1
12	25.	18:1
13	13.	4.5:1

HERE'S HOW THE JFD HI-PLEX SYSTEM WORKS!

### ON LOW BAND



Current Distribution (Channels 2-6)

Full sized low band half wave folded dipole develops maximum in-phase current across its length on low band channels 2 to 6. Entire dipole length acts as effective capturing device because it operates totally on fundamental frequency unimpeded by additional radiating devices used in other broad band systems to raise high band gain.

### ON HIGH BAND



Current Distribution (Channels 7-13) Without Helix

When operating on high band frequencies, JFD Hi-Plex phasers transform each low-band collector extremity into separate high band dipoles. These electrically isolated elements function as independent collectors operating on their fundamental frequency, each developing maximum in-phase current on channels 7 to 13. Out-of-phase voltage of center section of folded dipole is minimized and isolated from other high band dipoles by blocking action of two anterior high band phasing elements.

### ON BOTH LOW AND HIGH BANDS



Current Distribution resulting from connection of Helix (channels 7-13)

Special phasing harness feeds channel 7 to 13 energy produced by flat plane helix into Hi-Plex collector in same phase and magnitude of other 2 high band dipoles. Result in in-phase additive operation of 3 half-wave antennas balanced for increased high band gain and unlimited signal strength on low band channels — Plus 300 ohm impedance to assure 100% energy transfer.

65.6% S/N Figure of Merit\*

\*The S/N Figure of Merit sums up the major individual characteristics of an antenna in one concise value. Write for S/N Figure of Merit engineering folder No. 315 for complete details.

Gain Represents That Over 1/2 Wave Reference Folded Dipole

Up to 18 db on High Band\*

\*Tested in strict accordance with RETMA antenna measuring standards

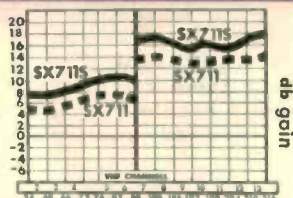

Up to 11 db on Low Band\*

Horizontal Pattern (Relative Voltage) Channel 2-6



Today's Fastest Installing Broad Band Antenna As Easy to Handle as Power Steering. The Slowest Part Is Opening the carton! Remarkable new JFD Hi-Tension Aluminum Bracket Design Cuts Installation Time 250%. No tools or labor necessary. No screws or hardware to tighten. Just flip elements into place.



MANUFACTURING CO., INC. Brooklyn 4, New York

INTERNATIONAL DIVISION

15 Moore Street, New York 4, U. S. A.

# HEAR THE DIFFERENCE !

Based on the famous University model WLC Theater System used so successfully and extensively in deluxe stadium and outdoor theater installations . . . auditoriums, expositions, concert halls and other important applications where only the highest quality equipment is acceptable—University engineers now bring you a smaller, compact version—the BLC—for general application in public address work. The BLC is the New standard for both voice and music, indoors and outdoors. The BLC is now yours, at the low low price of

ONLY  
**\$75**  
LIST



MAKE *Every* P.A.  
A HI-FI INSTALLATION  
WITH THE *New* MODEL  
**BLC**

FULL RANGE  
WEATHERPROOF  
COAXIAL  
SPEAKER



## SPECIFICATIONS

Response 70-15,000 cps  
Power Capacity 25 watts  
Impedance 8 ohms  
Dispersion 120 degrees  
Mounting 180° adjustable "U" bkt.  
Dimensions 22½" diameter, 9" depth

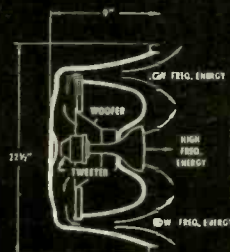

Ask your distributor for a convincing demonstration, and HEAR THE DIFFERENCE !

**Better Lows:** BALANCED "COMPRESSION" TYPE FOLDED HORN, starting with eight inch throat and energized by top quality low frequency "woofer" driver provides more lows than other bulky designs.

**Better Highs:** DRIVER UNIT TWEETER with exclusive patented "reciprocating flares" wide angle horn transmits more highs with greater uniformity . . . high frequency response that you can hear!

### More Efficient:

DUAL RANGE THEATER TYPE SYSTEM permits uncompromising design of the "woofer" and "tweeter" sections for greatest efficiency. Hear it penetrate noise with remarkable fidelity and intelligibility.

**Less Distortion:** SEPARATE LOW AND HIGH FREQUENCY DRIVER SYSTEMS with electrical crossover reduces intermodulation and acoustic phase distortions common to other systems which attempt to use two different horns on a single diaphragm.

**More Compact:** EXCLUSIVE WEATHERPROOF DUAL RANGE COAXIAL DESIGN eliminates wasted space. Depth of BLC is only 9"; can be mounted anywhere, even flush with wall or ceiling.

**More Dependable:** EXPERIENCED MECHANICAL ENGINEERING AND CAREFUL ELECTRICAL DESIGN meet the challenge of diversified application and environmental hazards. Rugged, and conservatively rated—you can rely on the BLC.

Write Desk No. 78 for full descriptive literature.

**University**

**LOUDSPEAKERS INC.**

80 SOUTH KENSICO AVENUE

WHITE PLAINS, N. Y.

this **RAYTHEON** "Bond" ....

pays a 10% "Dividend"\*

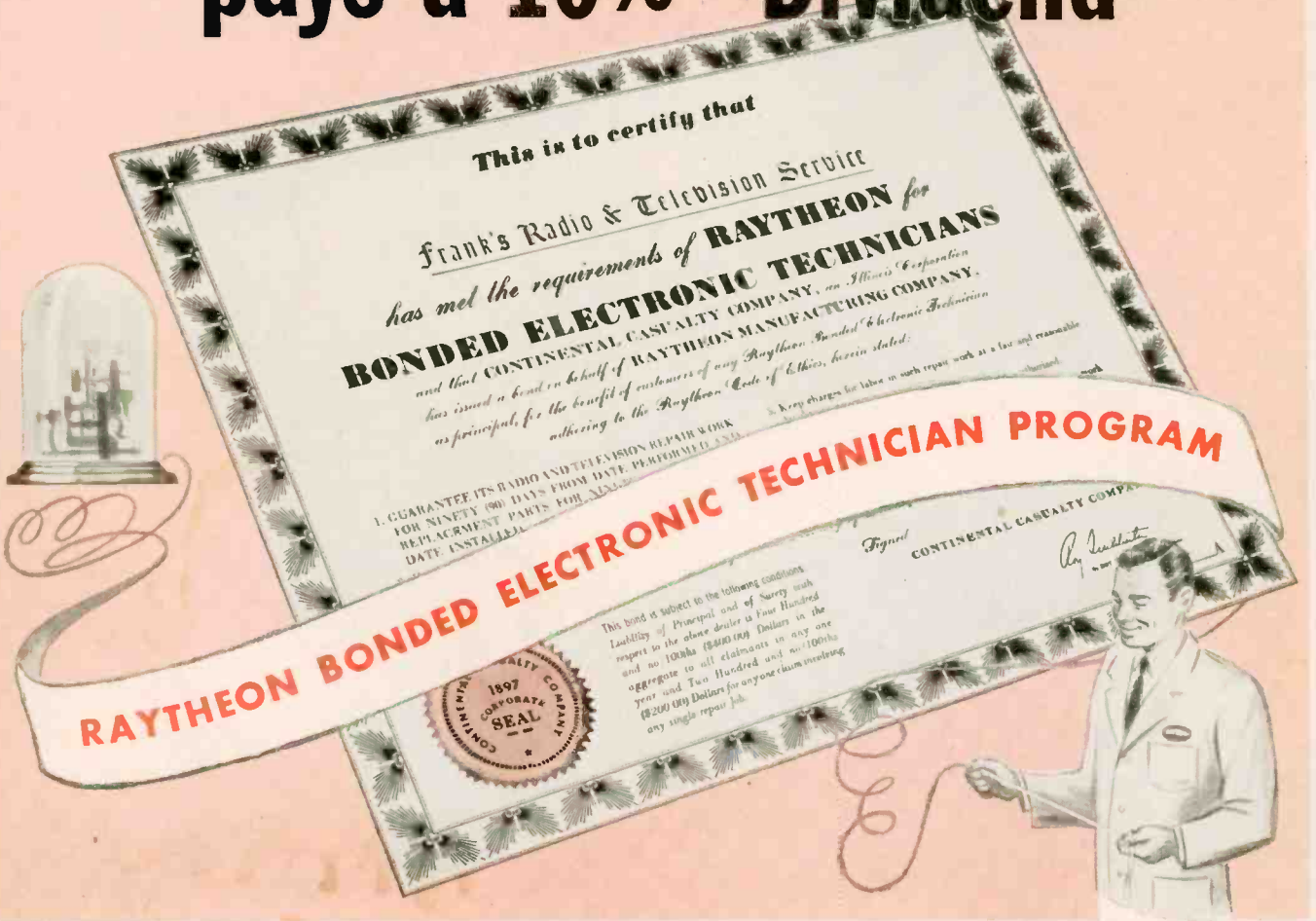

If you are interested in increasing your Radio & TV Service business and profits 10% or more call the Raytheon Tube Distributor in your area right now.

Ask him to tell you how the Raytheon Bond gives you a national backing of your 90 day guarantee, increases customer confidence in you and your shop.

Ask him to show you the many free business builders — Creed Displays, Decals, Certificate, Identification Cards, ad mats, etc. — that Raytheon makes available to you to help you tell your customers and prospects you're "Bonded".

Ask him about the Raytheon national advertising that makes it easy for you to get more business and then ask him if you can qualify for this exclusive Raytheon business builder. If you can, it costs you nothing — it's Raytheon's investment in your future.

\*Recent surveys prove the Raytheon Bonded Program improves business by at least 10 per cent.



**RAYTHEON MANUFACTURING COMPANY**  
 Receiving and Cathode Ray Tube Operations  
 Newton, Mass. • Chicago • Atlanta, Ga. • Los Angeles, Calif.  
 Raytheon makes all these: Receiving and Picture Tubes • Reliable Subminiature and Miniature Tubes  
 Semiconductor Diodes and Transistors • Nucleonic Tubes • Microwave Tubes



# TECHNICIAN & Circuit Digests

CALDWELL-CLEMENTS, INC., 480 LEXINGTON AVENUE, NEW YORK 17, N. Y.

## Two-Fisted Action—Here's How

The trouble with most editorials concerning industry problems is that they examine what's troubling the industry, and then go on to discuss a *general* approach to a solution. This editorial is significantly different. It tells you *specifically* how to attack the two biggest obstacles to making a decent profit: wholesale selling to the public, and cut-throat pricing on servicing.

The corrective measures to be taken are frankly rough-and-tumble, close-in fighting with both fists pumping. It's not for the timid or faint-hearted.

Before you take any of the extreme steps outlined below, we suggest a friendly approach, explaining how the offender's action is hurting you, and asking for corrective action. If this fails, start putting on the pressure.

### Selling Wholesale to Public

Service technicians and dealers account for an estimated 70% of the business done by parts jobbers and distributors. Despite this, many of them continue to sell to the public at the same price charged to professional technicians. Here's how to swing your weight around to make them hang up the "Wholesale to Trade Only" sign. Older trades such as plumbing and automotive do. Inevitably, the electronic trade will too.

1. Hit them in the pocketbook by taking your business to a distributor who cooperates, even if it means an extra 15 minutes of travel. Write to the distributor and tell him what you're doing. Tell him that you are urging all your friends in the business to do so too.

2. Establish a distributor honor roll in your local association publication, listing every distributor in the area who sells wholesale to trade only. Urge members to patronize these supply outlets. Send copies to all distributors in the community.

3. Write to key manufacturers, telling them how the sale of their products to the public at wholesale prices is hurting your business. Name the distributors who are doing it. If a wholesale-to-trade distributor is carrying a brand line not handled by the sell-to-public distributor, write to all competing manufacturers, explaining why you're switching brands.

4. If your city, county or state government has a sales tax on products sold to the public, but an exemption for items sold to dealers, find out if non-cooperative

distributors are collecting the tax. If not, report it to the proper authorities, with written evidence.

5. Find out if cooperative buying direct from the manufacturer is possible through your association.

### Cut Price Servicing

Cut-throat operators may be divided into two main categories: the part-time basement mechanic with no overhead, and the sucker-bait professional with a shop.

Considering the basement mechanic first, we should remember that he has every right to be in business. Many fine shops were started in this way. However, he becomes the enemy of the regular shop owner when he cuts the fair price for servicing in the whole community. Then, and only then, should we go after him.

1. If a friendly talk doesn't work, follow the same procedure as number 4 above, covering sales tax.

2. Is he reporting his extra income in his Federal income tax? Uncle Sam might want to know.

3. If the cut-price part-time technician is working out of a house zoned for residential use only, write to the local zoning commission and demand action.

The sucker-bait professional with a shop is a different problem. He might advertise \$1 home calls, but rest assured that the unwary customer may pay several times over for phoney charges.

1. Try to educate your customers and passersby by posters, cards, conversation, etc., that no one receives something for nothing. Explain to them how the sucker-bait \$1 call works.

2. If misleading ads are being used in newspapers or broadcast, write and call the paper's publisher or the broadcast station's manager and tell him about it.

3. If you have evidence that a cut-price shop is positively defrauding customers, inform the Better Business Bureau and district attorney.

All of the above suggestions are, of course, not applicable in every community. Discriminate selection is required. A number of long range plans not covered here are also necessary.

But here for the first time is a concise program of effective measures you can and should take *now* to rid the industry of its two major problems. Don't let personal inertia keep you from that goal. Act today . . . with both fists flying!

# Tuning In the

**YOU MAY GET FLOORED BY TV** if you go out to buy linoleum carpeting these days. A closed-circuit system bridges a 3-story gap in the manufacturing plant of the Armstrong Cork Co. to help quality control. On the third floor, a workman shovels linoleum mix into a hopper. On the way down, the ingredients undergo intensive mixing to emerge at huge rolls, which form the mix into sheets of flooring. Normally a worker down on the first floor would use a bell system to signal the start or stop of shoveling.

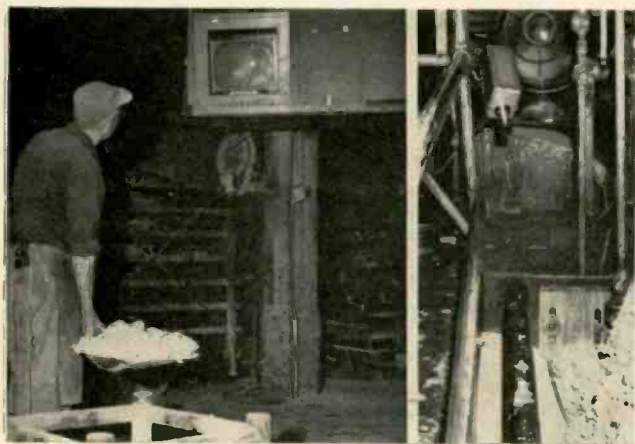

Closed-circuit TV helps insure uniform quality of linoleum flooring.

**TEN YEARS HENCE**—in 1965—there will be at least a twofold increase in the sale of receiving tubes, picture tubes and semiconductors for replacement purposes as compared to this year's figures. So says a report from Raytheon Mfg. Co., in which some other interesting statistics of the future are covered: national population will rise to about 185 million; family units will increase from 48 to 54 million; automobiles on the road will go from 48 to 68 million; TV sets in use will rise from 33 to 65 or 70 million. One-half to two-thirds of the latter will be color receivers, helping to up the tube-in-use figure.

## CALENDAR OF COMING EVENTS

- May 16-19: The 1955 Electronic Parts Show, Conrad Hilton Hotel, Chicago, Ill. Sponsored by Assoc. of Electronic Parts & Equip. Mfrs., Radio-Electronic-Television Mfrs. Assoc., West Coast Electronic Mfrs. Assoc., National Electronic Distributors Assoc., Sales Managers Club (Eastern Group).
- June 6-8: The Fourth Annual Convention and Trade Show for the National Community Television Assoc., Inc., Park Sheraton Hotel, New York, N. Y.
- Aug. 19-21: National Alliance of Television & Electronic Service Assoc. National Service Show, Hotel Morrison, Chicago, Ill.
- Sept. 30-  
Oct. 2: 1955 Hi-Fidelity Show, Palmer House, Chicago, Ill.
- Oct. 3-5: Eleventh National Electronics Conference, Hotel Sherman, Chicago, Ill.

**SHOP OPERATORS IN THE VICINITY** of large military and naval encampments have learned to accustom themselves to dealing with sailors, GI's and other service personnel, and are usually well satisfied with the business relationships presently existing. Many men (and some women) in the armed forces are familiar with servicing, and visit local shops for parts and advice.

**SHOPPERS WITH CHILDREN** to worry about are getting relief from a unique application of closed-circuit TV in Shoppers' World, new center in Nassau County, N. Y. Shopping parents may deposit their offspring in the center's playground and still keep a watchful eye on them while elsewhere in the center. A Farnsworth 600-A camera, focused on the play area, feeds seven monitor receivers. The large-screen monitors, strategically suspended from ceilings throughout the block-long center, are linked in a closed circuit. The system is in continuous operation during the shopping day.

**MINIATURIZATION** of standard components, given impetus by the swing to transistors, continues to turn up new surprises every month. A tiny two-gang variable capacitor, designed for use in "pocket" radios using transistors and printed circuits, just about weighs an ounce. The new model 2851, less than an inch high, was shown at the IRE show in New York by General Instrument Corporation.... Another midget item is a battery the size of a postage stamp. True, it's larger than the dime-size unit shown in this space last month—but the newest one is rechargeable! The silver-zinc storage cell was announced by Yardley Electric. Possible applications are in portable communications, recording, telemetering, and photography. The cell could run an electric wristwatch for about a year!

**THAT TECHNICIAN'S DUMB GIRL FRIEND** is back after recuperating from injuries allegedly sustained when a returning flyback transformer flew in the window of the shop and struck her on the dome.... She thinks a 12X4 tube is too big to be practical in circuitry, that plate dissipation is gluttony, and she'll bet your life that pliers are guys who try to get gals tanked up so that they can break down their resistance.... She's dead certain that a cathode follower is a member of some sort of religious sect. And finally, she made the blunt statement that her efforts at learning how to solder are in a state of flux.

**HIGHLY COMPETITIVE SITUATION** in large cities isn't helping the technician's prestige. Thousands of customers are losing confidence in servicers and shops through the practice of knocking the competitor's work. All too many servicemen called in by customers who have switched are quick to claim that previous repairs were made by a butcher or a dope. In the smaller towns and cities very little of this damaging mud-slinging goes on.



# Picture .....



**SERVICE REVENUE IS DOWN A BIT** in some of the agricultural areas. This is a reflection of reduced income to farmers coupled with the fact that labor, feed, fertilizer and maintenance expense continues to climb.

*TV BY FLYING SAUCER* is a distinct possibility in the not-so-distant future, according to Dr. John R. Pierce of Bell Telephone Labs. Good reception could be relayed across the ocean by using a 100-ft. satellite (man-made moon) circling the earth 22,000 miles up, as a reflecting device. With the right sending and receiving antennas, the transmitter power would have to be only 50,000 watts. . . . Another report, from Prof. S. F. Singer of the U. of Maryland, says that the technical problems connected with a small man-made satellite called the *MOUSE* (Minimum Orbital Unmanned Satellite of the Earth) are well within the range of present techniques.

## MAY 1955 NETWORK COLOR TV SCHEDULE

Sun.	May 1	6:00—7:00 PM (EDT)	"Sunday Supplement" (Film) DuMont
Mon.	May 2	8:00—9:30 PM (EDT)	"Producers' Showcase" (Live) NBC
Wed.	May 4	10:00—11:00 PM (EDT)	"The Best of Broadway" (Live) CBS
Sat.	May 7	9:00—10:30 PM (EDT)	"Max Liebman Presents" (Live) NBC
Sun.	May 8	6:00—7:00 PM (EDT)	"Sunday Supplement" (Film) DuMont
Thurs.	May 12	8:30—9:30 PM (EDT)	"The Shower of Stars" (Live) CBS
Sun.	May 15	6:00—7:00 PM (EDT)	"Sunday Supplement" (Film) DuMont
Sun.	May 22	6:00—7:00 PM (EDT)	"Sunday Supplement" (Film) DuMont
Sun.	May 22	7:30—9:00 PM (EDT)	"Max Liebman Presents" (Live) NBC
Sun.	May 29	6:00—7:00 PM (EDT)	"Sunday Supplement" (Film) DuMont
Mon.	May 30	8:00—9:30 PM (EDT)	"Producers' Showcase" (Live) NBC

## They'll Do It Every Time

Registered U. S. Patent Office

By Jimmy Hatlo



# Systematic Test Procedures

## Variations in Keyed Systems; Check Points for Monitoring;

JAMES A. McROBERTS

• The majority of symptoms in a simple agc system are equally applicable to keyed systems, and have been discussed in a preceding article (April, 1955). Those troubles peculiar to keyed systems only will be treated here.

A short review will refresh the reader's memory. Simple agc is a voltage used to control the gain of amplifier tubes operating at radio frequency (r-f, i-f and mixer) in accordance with the intensity of the station (channel). The video signal (intermediate frequency) is rectified in a peak detector so that only the most negative portions are used. These portions are the horizontal sync pulses plus the vertical sync pulses—plus noise pulses. The noise and the vertical pulses cause undesired variations, so the *keyed* system was developed to permit the source of agc to be connected only during the time of the horizontal retrace, which is approximately the time of the horizontal sync pulse.

Fig. 1 illustrates how this is accomplished. A source of agc at point A is connected to the distribution-isolation system through the

switch labeled 'keyer-amplifier,' here shown as a mechanical switch actuated by the horizontal deflection system. Actually this action is electronic, with a pulse of voltage turning on the "switch." The pulse is developed by horizontal retrace and is usually taken from an agc winding on the flyback or a transformer type width control.

Fig. 2 illustrates the ideal relationship of the 'key' pulse to the horizontal pulse. This key pulse is applied to an electrode of the key tube to turn it on during the time of the horizontal pulse. In absence of this key signal, the key tube is nonconducting due to a fixed bias greater than cutoff. Ordinarily, the key pulse is applied to the plate of the key tube, but may be applied to a screen (compare Fig. 5 with Figs. 3 and 4).

Symptoms of agc faults may take many different forms. Fading in the picture, perhaps also of the sound, may be evident. Overloading, with a tendency to produce negative pictures, may occur on moderate to strong signals. Sync instability may occur on stronger stations. The black-to-white grey scale may be deteriorated, though this symptom

is not always extremely obvious. These symptoms are examples of the receiver behaving as though no agc voltage were present. Of course, such a voltage may be getting developed by the receiver without being applied properly to the grids that should be controlled. That is, point A in Fig. 1 may be in order, but agc voltage may not be reaching points B.

In another category of symptoms, the receiver seems to act as though a simple agc system, rather than a keyed one, were present. The system responds to noise pulses in that we see a variation in signal strength in the presence of noise. The upper portion of the picture may show "hook," "whip," jitter or other evidence that the vertical pulses are influencing agc action. Keyed agc is designed to avoid or reduce sensitivity to noise and vertical pulses.

### Symptoms: "No AGC"

When the receiver behaves as though no agc is present, there are many possible sources of trouble and cures:

a. No agc source voltage is present at point A. The test comprises either dc or ac voltmeter tests for the presence of the signal or control voltage. If a separate agc rectifier is employed, then a test is made for the presence of agc voltage here. If a video signal is employed, then the ac function of the meter is used to check for its presence. Note that there can not be a control signal or voltage is present at A.

Fig. 3 illustrates a rectified agc source. A dc voltmeter will read the agc voltage at point A (to chassis), and also that applied to the control grid of the 6AU6 agc amplifier. Switch to a blank channel to see if what you read is actually agc voltage; none is developed on a blank channel you know.

Fig. 4 illustrates a positive-polarity video signal driving the keyer-amplifier. Use an ac voltmeter on the "output" function, or with a blocking condenser in series with the ac lead (about 0.01 to 0.1 mfd

Fig. 1—Simplified diagram of keyed agc system. Broken lines show alternate use of a separate agc detector to obtain demodulated video signal for keyer tube, instead of using video detector.

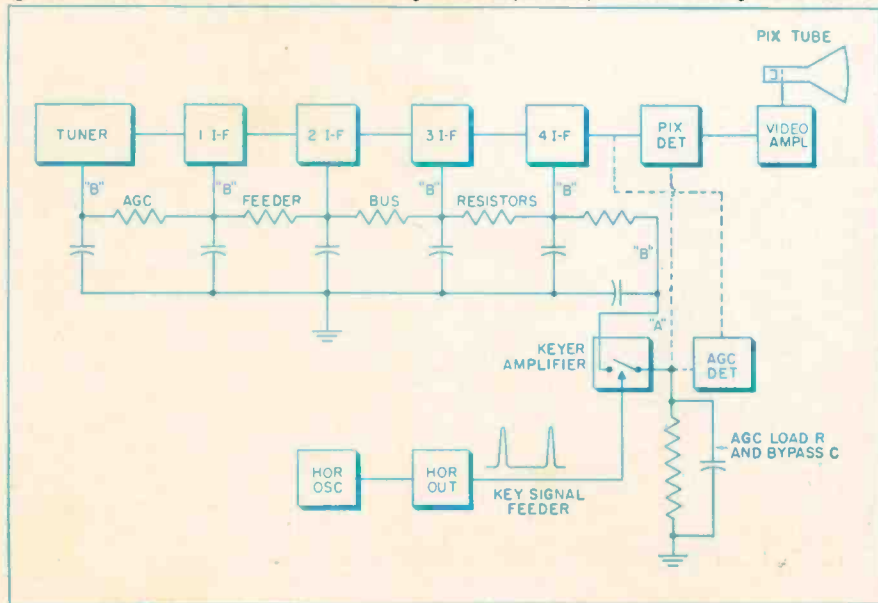

# for Keyed AGC Systems

## Typical Symptoms Associated with Main Classes of Defects

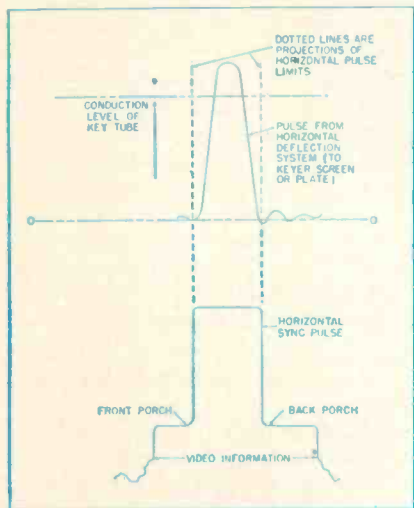

Fig. 2—Keying pulse (from horizontal retrace) occurs at same time as horizontal sync pulse. will do) to check for a composite video signal. An obscure trouble came to the writer's attention recently wherein the values of the resistors forming the voltage divider network ( $R_1$ ,  $R_2$ ,  $R_3$ ) from the video line to the cathode of the agc gate tube had changed. The signal at A was insufficient to drive the gate tube to conduction, which the positive sync pulses must do. Shunting  $R_2$  and  $R_3$  with a variable resistance (a potentiometer hooked up as a rheostat) made the set perform properly, as was indicated by the presence of agc voltage at points B. The resistance was varied until suitable agc voltage was de-

veloped. Fixed resistors of the proper values were then inserted. Some such 'unfortunate' combinations may begin in manufacturing practice and, with aging, the set will conk out.

b. *The keyer does not conduct due to a bad tube.* Just replace the tube.  
 c. *No key signal.* If tube substitution (naturally you try it first instead of second, as I have given) and testing for agc source voltage at point A (Fig. 1) do not turn up the trouble, test for a key or switch signal at the keying electrode (plate of Figs. 3, 4; screen of Fig. 5). If there is no key signal, the key tube cannot pass the source voltage from A to B. In the shop, the oscilloscope may be employed for this test. In the field (or if you do not have a scope) use your ac voltmeter. The peak-to-peak value of the key pulse is usually (see the manufacturer's data sheet, if possible) 325 to 400 volts and will read from about 60 to 80 volts rms, as an approximation. If you do not get a key signal at the keying tube, test towards the source of the key signal (the fly-back or other part of the horizontal deflection system) with your ac voltmeter. Somewhere along the line you either lose the signal or the source is defective; inasmuch as you have horizontal deflection, simple ohmmeter checks will test for defective parts, such as open agc coil or open agc secondary on a width

coil. Also a condenser or resistor in the key signal line may become open or change its value.

d. *The key signal and the horizontal pulse do not occur at the same time.* If the picture is not in sync then no agc may be developed because the key signal must occur during the time of the horizontal sync pulse. This case must be very carefully distinguished from case (a), as no voltage is developed at point A in either case (a) or (d). If the set has a phase control or frequency control, manipulate it with a voltmeter connected to points B. Remember that the key signal must not only be present, but must also be in phase with the horizontal sync pulse; furthermore, ALL TESTS MUST BE MADE WITH THE PICTURE IN SYNC HORIZONTALLY.

e. *The key tube is biased so that it cannot conduct at the normal value of key pulse and input (agc or video).* Improper voltages applied to bias the key tube or to make it nonconductive during the absence of a key signal may be so excessive as also to prevent it from its function of conducting during the presence of the key pulse. For example, change in value of the 4.7 k resistors in the cathode circuit of the 6AU6 gate tube (Fig. 3) or a change in value of resistors  $R_2$  and  $R_3$  of Fig. 4 could do this. Similarly, defects elsewhere in the circuit could

(Continued on page 54)

Fig. 3—Keyed agc system with rectified source of agc voltage.

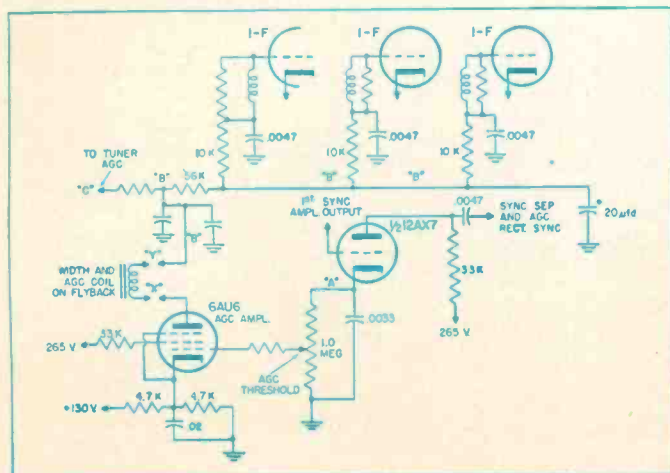
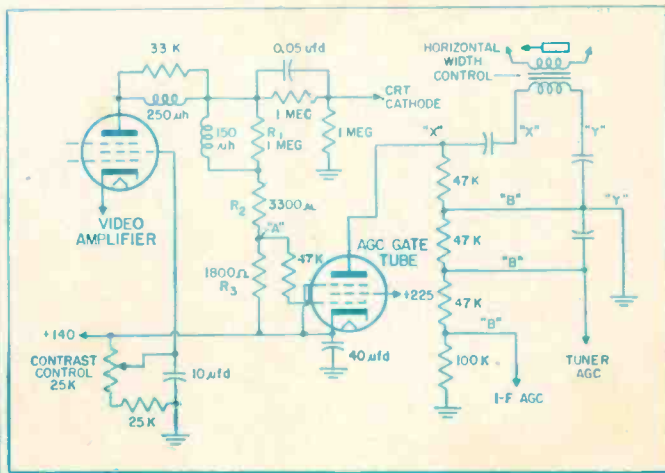

Fig. 4—Keyed agc system using a video signal source for input.



# \$ In Mobile Radio Service

## Tips on How to Get Started in a Fast-Growing Field

JOHN TANSEY,  
NATIONAL COMMUNICATIONS SERV. MGR.,  
MOTOROLA, INC.

• There are more than 350,000 mobile and base station two-way communication units in use today in the United States. As more and more organizations, including taxicabs, railroads, truckers, special emergency organizations, and industrial companies of all types, discover the advantages of two-way communications, this number will rapidly increase. Consequently, the future is bright for those who are in a position to service the units.

Quite frequently, the writer has heard this inquiry on the subject: "What are the requirements for becoming a service technician in the radio communications industry?" The question is generally asked by individuals who desire to establish their own business.

### FCC License Needed

In brief, the prime requirements are a knowledge of the art, practical experience in the application of this knowledge, and evidence, in the form of a Federal Communications Commission license (Second Class Radio Telephone or higher) of authority to adjust radio transmitter equipment.

The most important aspects to be considered are those relating to personnel, facilities and techniques. Among the personnel, there must be those with business experience and those with technical knowledge coupled with practical experience. Of utmost importance, inasmuch as the business is to be conducted for profit, is the need for intelligent management of the operation. Cost records must be maintained, invoices rendered promptly, and credit rating protected.

The practical experience can be gained by servicing a small number of communication units at the outset, while drawing upon the assistance of factory and field representatives of a national service organization. As your knowledge increases and your proficiency improves, you can expand the scope of your operation.

There are two types of servicing

operations in the communications field; namely, "drive-to" and "drive-in" types. "Drive-to" servicing is the type in which a technician performs his work at the site of the customer's operation. To handle this type of work, you must have a mobile service unit outfitted with a replacement parts supply and test equipment to make measurements and adjustments of the power supply, transmitter and receiver, and to check the battery, primary circuit, antenna, control head and associated cables. "Drive-in" servicing is that type where the customer's units are brought to a shop. A larger stock of replacement parts can be maintained here. Also, there should be a test bench equipped with complete facilities for checking out any customer's unit, making frequency and deviation measurements, and performing other tests requiring long periods of time.

Major test equipment necessary to perform efficient service includes: (1) a signal generator capable of making measurements down to one-tenth of a microvolt and covering the necessary range of frequencies, (2) a volt-ohm-meter, (3) a manufacturer's test-set, (4) a power output measuring device, and (5) a frequency and modulation meter.

The service station owner and operator will find it advantageous

to maintain a close affiliation with the national service organization of a manufacturer specializing in radio communications equipment. The foremost advantage is that obtained from being identified as "authorized" by the manufacturer. To the business men in the community, the service station is then thought of as "Mr. Manufacturer." The manufacturer's national advertising programs, promotional efforts and reputation then become working tools and assets of a service station.

### Manufacturer Assistance

Technical information originating at the factory level is furnished to authorized stations at frequent intervals. Also, field lectures and demonstrations conducted by factory representatives are held regularly in strategic locations throughout the country. In addition, further aid is available from field personnel—regional service managers and engineers—specializing in service problems.

Regional service managers are also able to give advice on business matters. They are able to assist you in selecting a job site, choosing a service vehicle, procuring test equipment, arranging your service bench and shop, maintaining stock control,

(Continued on page 61)

One of mobile field service units owned by Wm. Haire of Coastal Electronics Co., New Bern, N.C.



# Troubleshooting Hum in TV

## Hum in the Picture Can Result From Several Defects Part 2

M. G. GOLDBERG

A very unusual case of hum developed in a 1950 16-in. RCA receiver. As the set warmed up uncontrollable oscillation broke out in a pix i-f amplifier, producing an intense white and black herringbone weave over the entire screen. The trouble was so pronounced that in spite of the fact that the replacement of a 6BA6 cured the trouble, the writer was curious enough to investigate further. (See Figs. 6a and 6b.) Fig. 6a shows the normal grid and cathode circuits, while 6b shows the same circuit with the heater wiring added. The position of the short is shown by the dotted line with the cathode bias shorted by the 6.3v. heater winding of the transformer, which has negligible resistance. The bias on the tube will thus vary from 0-9v (peak) 60 times per second producing a strong hum pattern on the screen. In addition, without  $R_x$  (the leakage resistance) in the circuit, the response curve of the stage will shift with bias voltage. For instance, assume a response from three i-f stages operating normally as shown in Fig. 7a. Now let the cathode resistor be shorted out as in Fig. 6b. At some point during each cycle the negative voltage on the cathode (positive on grid) will overcome the negative a-g-c bias at the grid and the gain will be at maximum, causing the response curve to shift as in Fig. 7b. If the curve shifts enough to cause

### CAUSES OF HUM 60 cycle

1. Direct pickup from wiring or unshielded power transformer to video and CRT grids.—Seldom occurs.
2. Cathode to heater leaks or shorts. Worst offender.
3. Open  $\frac{1}{2}$  of power transformer secondary.—Rare.
4. Corroded or poorly soldered or riveted connection to chassis to which various circuit wires are connected causing interaction between circuits.

### 120 cycle

1. Open or low capacity filters. Worst offender.
2. Shorted choke (Rare)
3. Overloaded circuit in receiver drawing excess current causing poor regulation of power supply.
4. Internal plus to plus short in filter can shorting out choke circuit.

curves 2 and 3 to almost coincide, the overall response will take the form of the heavy line and the gain will increase greatly at some frequency  $f$  at which point the i-f amplifier may break into sustained oscillation. A further explanation of how this may come about may be of interest. The input capacity of a tube can change as much as 10% with change in bias voltage (the Miller effect). In most i-f amplifiers the only tuning capacities are those due to wiring and tube interelectrode capacities, and any bias change will detune the circuit somewhat due to change in input impedance of the tube. An unbypassed 47 ohm re-

sistor in the case of the 6BA6 will nullify this detrimental effect to a great extent. If this resistor is shorted out (cathode to heater short) and the bias is increased (positive on cathode) by other means, the input capacity will be decreased and the resonant frequency of the stage will be increased. This may cause the curves shown to coincide instead of being stagger-tuned as in Fig. 7a.

### Split-Sound Receivers

In a split-sound receiver, if turning the fine tuning control to one extreme or the other eliminates both the hum and the picture, this is definite evidence that the cause of the trouble is before the video detector. Hum after the video detector input will usually not be affected by this control, as the response of the video stage or stages is such as to pass both 60 and 120 cycles directly, while hum must ride in on

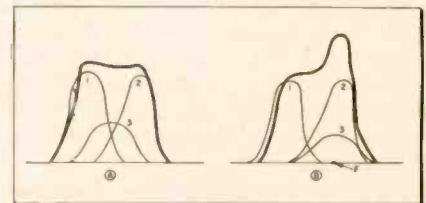
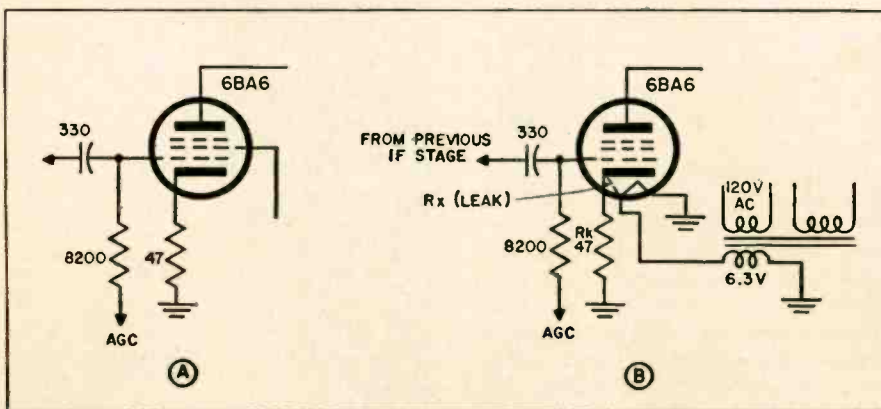

Fig. 7—Hum leakage may shift the resonant frequency of one i-f stage, producing oscillation due to the excessive gain.

Fig. 6—K-F leakage shunts heater winding across  $R_k$ , applies 60 cps bias to tube.



the carrier—piggy back, so to speak—if it is originating ahead of this point in the circuit. Hum due to low value output filter capacitors will usually be present on a full-size raster, while hum of this frequency originating from low value input filters will cause the raster to shrink on all four sides due to the lower B voltages. Waviness, or “pulling,” is a result of hum in the horizontal deflection circuits, usually from a leaky tube, and more often than not fed to the horizontal oscillator or control tubes from some previous stage. Shading bars, either gray and white or black and white, are usually the result of hum being fed to the crt grid directly or from some previous stage. Both of these effects  
(Continued on page 55)

# Top Industry Event —

*Products of 289 Exhibitors Will Be Displayed in Almost*

The 1955 Electronic Parts Distributors Show officially opens its doors at Chicago's Conrad Hilton Hotel on Monday, May 16th at 10 A.M. Products will be displayed by 289 exhibitors in 203 booths in the Exhibition Halls and 174 additional display rooms on the hotel's fifth and sixth floors. The show will run through Thursday, May 19th.

Pre-registration at the show lists distributors from all 48 states and a score of foreign countries, leading the show sponsors to predict one of the most rewarding shows in the industry's history. Leon B. Ungar, of Ungar Electric Tools, Venite, Calif., the show president, will cut the tape at the opening ceremonies. He will be assisted by the Board of Directors, representing all five co-sponsoring trade associations: the Radio-Electronic-Television Manufacturers Assn.; the Association of Parts and Equipment Mfrs.; the Sales Managers Club, Eastern Div.; the National Electronic Distributors Assn. and the West Coast Electronic Mfrs. Assn.

A screening process has been set up to confine the show to exhibitors' distributor customers, including parts distributors and commercial sound distributors. Government personnel and representatives, along with industrial buyers and industrial engineers, will be admitted during the last two hours on the first three days and during the entire last day.

## Products

The scope of displays and products includes everything sold on a national basis to electronic parts distributors: coils, transformers and power supplies; relays and switches; capacitors and resistors; antennas, towers and masts; amplifiers and tuners; speakers and audio accessories; microphones, pickups and phone mechanisms; P.A., intercom and "ham" equipment; tape recorders and enclosures; converters, motors and vibrators; wire and solder;

**The Event:** 1955 Electronics Parts Distributors Show

**The Place:** Conrad Hilton Hotel, Chicago

**The Time:** May 16-19, 10 AM to 6 PM

**Sponsors:** Radio-Electronic-Television Manufacturers Assoc.; Assoc. of Electronic Parts and Equipment Manufacturers; West Coast Electronic Manufacturers Assoc.; National Electronic Distributors Assn.; and Sales Managers Club, Eastern Division.

tubes and rectifiers; test equipment and instruments; batteries and chassis; hardware, components and tools; trade publications and technical manuals, and books.

Theme of the show is "Bring Your Order Pad With You." Distributors attending the show are being urged to bring their purchasing agents with them.

While show dates are May 16-19, the event actually gets under way on Sunday, May 15th, with the arrival of special trains and planes bearing parties of distributors and reps. Largest of these is the New York special train, which this year will consist of 13 cars, complete with entertainment and refreshment facilities. Additional parties are being flown in from various parts of the country.

The first official event is the Board of Directors' reception for overseas and Pan-American visitors on Sunday afternoon. Diplomatic and consular representatives of more than a score of Latin-American and European countries will be the special guests. All overseas and Pan-American visitors are invited, together with a maximum of two

members of each exhibitor's export staff. This reception will be followed by a cocktail party given by the Radio's Old Timers Club on Sunday evening.

Official show hours are 10 A.M. to 6 P.M., daily Monday through Thursday for the exhibition halls. Display rooms may remain open after these hours.

Only bonafide distributors, their personnel, industrial buyers, government officials and industrial engineers, are admitted to the show, in addition to exhibitors, manufacturers and representatives; all under rigidly enforced admission regulations, supervised by credentials committees made up of distributors and manufacturers.

Types of displays are also specified: no home radios, TV sets, diathermy equipment, hearing aids, auto receivers or home phonographs are allowed on display. Only such radio parts and electronic equipment as are generally sold to radio parts and electronic equipment distributors is permitted.

## List of Exhibitors

ACRO PRODUCTS CO., Booth 884  
ADVANCE ELECTRIC AND RELAY CO., Booth 25  
AEROVOX CORP., Booth 590  
ALL CHANNEL ANTENNA CORP., Booth 127  
ALLIANCE MFG. CO., Booth 225, Rooms 610-611  
ALPHA METALS, INC., Booth 781  
ALPHA WIRE CORP., Booth 417  
ALPRODCO, INC., Booth 108, Room 605A  
ALTEC LANSING CORP., Booth 579, Room 637A  
AMERICAN MICROPHONE CO., Booth 303  
AMERICAN PHENOLIC CORP., Booth 882, Rooms 560A-561A  
AMERICAN RADIO HARDWARE CO., INC., Booth 581  
AMERICAN TELEVISION & RADIO CO., Booth 411  
AMES MFG. CORP., Booth 877  
AMPERITE CO., INC., Booth 214  
AMPRO CORP., Room 634A  
ARCO ELECTRONICS, INC., Booth 875  
ARGOS PRODUCTS CO., INC., Room 607  
ASTATIC CORP., Booth 779, Room 605  
ASTRON CORP., Booth 887  
ATL & CABLE CORP., Booth 870  
ATLAS SOUND CORP., Booth 222  
AUDIO DEVICES, INC., Booth 321  
AUDIOGERSH CORP., Room 557A  
AUTHORIZED MFG. CO., INC., Room 609A  
BAKER MFG. CO., Booth 103  
BARKER & WILLIAMSON, INC., Booth 421  
BAUMKER MFG. CO., Booth 120  
BELDEN MFG. CO., Booth 404  
BELL SOUND SYSTEMS, INC., Rooms 524A-526A  
BERLANT-CONCERTONE, Rooms 621-622  
BIRNBACH RADIO CO., Room 656  
B & K MFG. CO., Room 617A  
BLONDER-TONGUE LABS., INC., Booth 133  
DAVID BOGEN CO., INC., Rooms 539 & 553  
BRACH MFG. CORP., Booth 871  
BRITISH INDUSTRIES CORP., Booth 405, Room 537  
BRYAN DAVIS PUB. CO., INC., Room 659  
BUD RADIO INC., Room 534  
BURGESS BATTERY CO., Booth 577  
BUSSMANN MFG. CO., Booth 124

# '55 Electronic Parts Show

## 400 Booths and Display Rooms in Chicago's Hilton Hotel

CANNON ELECTRIC CO., Booth 12  
CARTER MOTOR CO., Booth 672  
CARTER PARTS CO., Booth 785  
CBC ELECTRONICS CO., INC., Booth 3  
CBS-HYTRON, Booth 114, Room 656A  
CENTRALAB, Booth 790  
CENTRAL ELECTRONICS, Room 643  
CHANNEL MASTER CORP., Room 523  
CHICAGO STANDARD TRANSFORMER CORP., Booth 310  
CINCH-JONES SALES, Booth 872  
CLAROSTAT MFG. CO., INC., Booth 583  
CLEAR BEAN-TEMPO, Booth 318  
CLETRON INC., Booth 102, Room 509  
COLLINS RADIO CO., Room 623  
COLUMBIA WIRE & SUPPLY CO., Booth 586  
CONDENSER PRODUCTS CO., Room 504A  
CONRAC, INC., Room 632A  
CONSOLIDATED WIRE & ASSOCIATED CO'S., Booth 307  
CONTINENTAL CARBON, INC., Booth 218  
CORNISH WIRE CO., INC., Booth 683  
\*COWAN PUBLISHING CORP., Rooms 628A-629A  
\*RADIO MAGAZINES, INC., Rooms 628A-629A  
CRESCENT INDUSTRIES, INC., Booth 306  
CROWN CONTROLS CO., INC., Rooms 613 & 614

DAVIS ELECTRONICS, Booth 691  
DAYSTROM ELECTRIC CORP., Room 607A  
DELCO RADIO DIVISION, Booth 783  
D & M PRODUCTS, Booth 13  
DRAKE ELECTRIC WORKS, INC., Booth 592  
DUKANE CORP., Rooms 519A-520A  
ALLEN B. DU MONT LABS., INC., Booth 410  
DUOTONE CO., INC., Rooms 610A-611A  
DYNAMIC ELECTRONICS—NY, INC., Room 645A

EBY SALES CO., Booth 673  
ELCO CORP., Booth 879  
ELDICO OF NEW YORK, INC., Room 504  
ELECTRONIC INSTRUMENT CO., INC., Booth 202  
ELECTRONIC MEASUREMENTS CORP., Booth 112  
ELECTRONIC PUBLISHING CO., INC., Room 619  
ELECTRO PRODUCTS LABS., Booth 587  
ELECTRO-VOICE INC., Booth 123, Rooms 505-507  
ELECTROVOX CO., INC., Booth 309  
EQUIPTO DIV., Booth 682  
ERIE RESISTOR CORP., Room 501

FAIRCHILD RECORDING EQUIPMENT CO., Room 629  
FANON ELECTRIC CO., INC., Room 668  
FEDERAL MFG. & ENG., Room 652  
FEDERAL TELEPHONE AND RADIO CO., Booth 574  
FENTON CO., Booth 205, Room 613A  
FINNEY CO., Booth 777, Room 657A  
FISHER RADIO CORP., Room 664A  
FRED TRANSFORMER CO., INC., Booth 588  
FRETCO INC., Booth 221

GEE-LAR MFG. CO., Booth 126  
G & H WOOD PRODUCTS CO., Booth 873  
GENERAL CEMENT MFG. CO., Booth 320, Room 655  
GENERAL ELECTRIC CO., Booth 209, Room 651A  
GENERAL INDUSTRIES CO., Rooms 619A-620A  
GRAMER-HALLDORSON TRANSFORMER CORP., Booth 418  
GRANCO PRODUCTS, INC., Booth 885  
GRAYHILL, Booth 591  
GREAT EASTERN MFG. CO., Rooms 648A-649A

HALLICRAFTERS CO., Booth 575  
HAMMARLUND MFG. CO., INC., Booth 407  
HARDWICK, HINDLE, INC., Booth 113  
HARMAN-KARDON, INC., Room 507A  
HICKOK ELECTRICAL INSTRUMENT CO., Booth 671, Rooms 542A-544A  
\*HIGH FIDELITY, Room 603A  
HI-LO TV ANTENNA CORP., Booth 211, Room 520  
HYCON MFG. CO., Booth 14, Room 660

IE MFG. CO., Booth 24  
ILLINOIS CONDENSER CO., Booth 578  
INSULINE CORP. OF AMERICA, Booth 403  
INTERNATIONAL RECTIFIER CORP., Booth 782  
INTERNATIONAL RESISTANCE CO., Booth 22

JACKSON ELECTRICAL INSTRUMENT CO., Booth 322  
JAMES VIBRAPORW CO., Booth 208  
J-B-T INSTRUMENTS, INC., Booth 576  
JENSEN INDUSTRIES INC., Booth 402, Room 512A  
JENSEN MFG. CO., Rooms 600-601  
JERROLD ELECTRONICS CORP., Booth 122  
JERSEY SPECIALTY CO., INC., Booth 101  
JFD MFG. CO., INC., Booth 412, Room 620  
E. F. JOHNSON CO., Booth 21, Room 642  
JONTZ MFG. CO., Booth 674, Room 617

KARLSON ASSOCIATES, Room 651  
KAY-TOWNES ANTENNA CO., Booth 5  
KESTER SOLDER CO., Booth 119  
KUEHNE MFG. CO., Booth 888

JAMES B. LANSING SOUND INC., Room 639A  
LAPINTE ELECTRONICS INC., Booth 312, Room 650  
LEADER ELECTRONICS, INC., Room 660A  
LITTELFUSE, INC., Booth 314  
LOWELL MFG. CO., Booth 110

P. R. MALLORY & CO., INC., Booth 416  
MASTER MOBILE MOUNTS, INC., Booth 11  
MECHANICAL STEEL TUBING, Room 616  
MERIT COIL & TRANSFORMER CORP., Booth 689  
JAMES MILLEN MFG. CO., INC., Booth 217  
J. W. MILLER CO., Booth 878  
M. A. MILLER MFG. CO., Booth 317  
MILLER ELECTRONICS, Booth 4  
MODEL ENGINEERING & MFG., INC., Booth 107  
MODERN-AIRE MFG. CORP., Room 654A  
MOSLEY ELECTRONICS, INC., Booth 105  
DON MCGOHAN, INC., Room 560

NATIONAL CARBON CO., Booth 687, Room 618A  
NATIONAL CO., INC., Booth 115, Rooms 550A-551A  
NATIONAL ELECTRIC PRODUCTS CORP., Booth 1  
NEWCASTLE FABRICS CORP., Booth 10  
NEWCOMB AUDIO PRODUCTS CO., Booth 521

OHMITE MFG. CO., Booth 311  
ORRADIO INDUSTRIES INC., Booth 780  
OXFORD ELECTRIC CORP., Rooms 515A-517A

PARKER METAL GOODS, Booth 784, Rooms 626 & 646  
PAR-METAL PRODUCTS CORP., Booth 135  
PERLESS PRODUCTS INDUSTRIES, Booth 681  
PENN TELEVISION PRODUCTS CO., Booth 203, Room 636  
PENTRON CORP., Booth 401, Room 505A  
PERMACEL TAPE CORP., Room 648  
PERMA-POWER CO., Booth 573  
PERMOFLUX CORP., Booth 106, Rooms 625A-626A  
PERMO, INC., Booth 419  
PHALO PLASTICS CORP., Booth 890  
PHASTRON CO., Booth 791  
PHILMORE MFG. CO., INC., Booth 785, Room 513A  
PICKERING AND CO., INC., ROOM 553A  
PILOT RADIO CORP., ROOMS 642A-643A  
PLASTOID CORP., Room 533  
POTTER & BRUMFIELD, Booth 116, Room 612  
PRECISE DEVELOPMENT CORP., Booth 121  
PRECISION APPARATUS CO., INC., Booth 415, Room 602A  
PREMIER METAL PRODUCTS CO., Booth 874  
PRESTO RECORDING CORP., Room 502  
PYRAMID ELECTRIC CO., Booth 213, Room 638A

Q-LINE MFG. CORP., Booth 788, Room 612A  
QUAM NICHOLS CO., Booth 409  
QUIETROLE CO., Room 603

RACON ELECTRIC CO., INC., Booth 313  
RADELCO MFG. CO., Booth 23  
RADIART CORP., Booth 420  
RADIO CITY PRODUCTS CO., INC., Booth 582  
RADIO CORP. OF AMERICA, Booth 130, Rooms 512-513  
RADIO CRAFTSMEN, INC.  
\*RADIO & ELECTRONIC JOBBER NEWS, INC., Room 536  
\*RADIO ELECTRONICS, Room 535A  
RADIO MERCHANDISE SALES, INC., Booth 128  
RADIO CORP., Room 635A-636A  
RADIO RECEPTOR CO., INC., Booth 678  
\*RADIO & TELEVISION JOURNAL, INC., Room 633  
\*RADIO & TELEVISION NEWS, Room 644A  
\*RADIO & TELEVISION WEEKLY, Room 653A  
RADIX WIRE CO., Room 624  
RAM ELECTRONICS INC., Room 509A  
RAULAND-BORG CORP., Rooms 556-557  
RAYTHEON MFG. CO., Booth 422  
RAYTRONIC LABS., Room 635  
RECOBON CORP., Booth 414  
REEVES SOUND-CRAFT CORP., Booth 210  
REGENCY DIV., I.D.E.A., INC., Room 516  
REGO INSULATED WIRE CO., Booth 129, Room 658  
REK-O-KUT CO., Room 522  
\*RETAILING DAILY, Room 625  
JOHN F. RIDER PUBLISHER, INC., Booth 585  
RIVER EDGE INDUSTRIES, Room 521A  
ROCKBAR CORP., Room 561  
ROHN MFG. CO., Booth 201, Room 534A  
RONETTE SALES CORP., Room 616A

S & A ELECTRONIC, Booth 789  
HOWARD W. SAMS & CO., INC., Booth 408  
SAN FERRANDO ELECTRIC MFG. CO., Booth 27  
SANGAMO ELECTRIC CO., Booth 776, Room 618  
SAXTON PRODUCTS, INC., Booth 688  
SECO MFG. CO., Room 661  
SHERWOOD ELEC. LABS., Room 644  
SHURE BROTHERS, INC., Booth 676, Room 640A  
SIGMA INSTRUMENTS, INC., Room 651A  
SIMPSON ELECTRIC CO., Booth 109, Room 539A  
MARK SIMPSON MFG. CO., Booth 118, Rooms 547-549  
SKYLINE MFG. CO., Rooms 621A-622A  
HERMAN H. SMITH, INC., Booth 207  
SNYDER MFG. CO., Booth 305  
SOLA ELECTRIC CO., Booth 215  
SONOTONE CORP., Room 626  
SOUTH RIVER METAL PRODUCTS CO., INC., Booth 774, Room 633A  
SPAULDING PRODUCTS CO., Room 662A  
SPIRLING PRODUCTS CO., INC., Rooms 528A-530A  
SPRAGUE PRODUCTS CO., Booth 584  
STANDARD COIL PRODUCTS CO., INC., Booth 675  
STANDARD ELECTRICAL PRODUCTS CO., Booth 131  
STEPHENS MFG. CORP., Room 653  
STEVENS WALDEN INC., Booth 6  
STROMBERG-CARLSON CO., Rooms 532A-533A  
SUPERIOR ELECTRIC CO., Rooms 614A-615A  
SUTTON ELECTRIC CO., INC., Room 529  
SWITCHCRAFT, INC., Booth 685  
SYLVANIA ELECTRIC PRODUCTS, INC., Booth 680, Rooms 546A-548A

TALK-A-PHONE CO., Booth 880, Room 500  
SARKES TARZIAN, INC., Room 650A  
TECH-MASTER CORP., Rooms 658A-659A  
TECHNICAL APPLIANCE CORP., Booth 686  
TECHNICAL TAPE CORP., Room 604  
\*TECHNICIAN—CALDWELL-CLEMENTS, INC., Room 604A  
TELECTRONIC CORP., Room 652A  
TELE MATIC INDUSTRIES, INC., Booth 572  
TELEX, INC., Booth 2  
TELREX, INC., Booth 223  
TERADO CO., Booth 8  
TEVCO INSULATED WIRE, Booth 793  
THOMAS ELECTRONICS, INC., Booth 204  
THORNTON-MESSNER, Booth 580  
TRIAD TRANSFORMER CORP., Booth 206  
TRICRAFT PRODUCTS CO., Booth 677  
TRINM INC., Booth 589  
TRIO MFG. CO., Booth 876, Room 639-640  
TRIPLETT ELECTRICAL INSTRUMENT CO., Booth 302  
TUNG-SOL ELECTRIC INC., Booth 104  
TURNER CO., Booth 219  
T-V PRODUCTS CO., Booth 315

U M & F MFG. CORP., Booth 787  
UNGAR ELECTRIC TOOLS, INC., Booth 406  
UNITED CATALOG PUBLISHERS, INC., Booth 571, Room 609  
UNITED TRANSFORMER CO., Booth 301, Room 623A  
UNIVERSITY LOUDSPEAKERS, INC., Booth 775, Room 632 & 637  
UTAH RADIO PRODUCTS CO., INC., Booth 212

VACO PRODUCTS CO., Booth 308  
VAN CLEEF BROS., INC., Booth 125  
V-M CORP., Booth 216  
VOKAR CORP., Booth 883, Room 666A

WALDOM ELECTRONICS, INC., Booth 117, Room 536A-537A  
WALACE'S TELAIDES, INC., Booth 26  
P. WALL MFG. CO., Room 641A  
WALSCO ELECTRONICS CORP., Booth 304  
WARD LEONARD ELECTRIC CO., Booth 319  
WARD PRODUCTS CORP., Booth 413  
WEBSTER-CHICAGO CORP., Room 556A  
WEBSTER ELECTRIC CO., Booth 111  
WELLER ELECTRIC CORP., Booth 316  
WENDELL PLASTIC FABRICS, Room 649  
WEN PRODUCTS, INC., Booth 7, Room 634  
WESTINGHOUSE ELECTRIC CORP., Booth 778, Room 630A-631A  
WESTON ELECTRICAL INSTRUMENT CORP., Booth 220, Room 502  
WILCOX-GAY CORP., Booth 684  
WINEGARD CO., Booth 9, Room 657  
WINSTON ELECTRONICS, Room 624A  
WORKMAN TV, INC., Room 655A  
WORNER ELECTRONICS, Booth 881  
G. F. WRIGHT STEEL & WIRE CO., Booth 886

XCELITE INC., Booth 679  
\*Trade Paper Exhibitor

# "Tough Dog" Corner

## Difficult Service Jobs Described by Readers

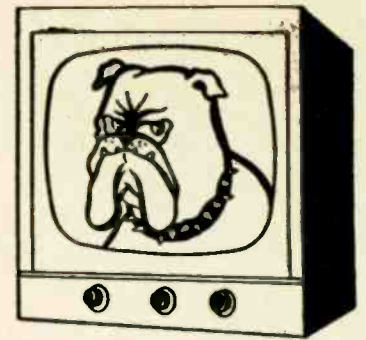

### Tube Bad, Tube Bad

A simple complaint of poor sound, or none at all, had me ready to scrap my test equipment for a while. I noted that misadjusting the fine tuning control away from the picture carrier brought back the sound. Also, turning down the contrast did the same, but left a distinct buzz.

After checking all tubes, I replaced a weak 6BQ7A. There was no improvement, as far as sound was concerned. A check of important voltages showed none outside of normal limits. Tracing with the scope showed normal signals in all stages up to the audio amplifiers. I noticed that, when the video amplifier tube was removed, sound came in loud and clear.

The circuit diagram was then examined in an attempt to link the sound and picture together in the manner demanded by the symptoms. It showed that the first audio amplifier triode was one half of a 12AX7, the other half being used as a sync separator. Video amplifier output was coupled to the grid of this sync separator through a condenser. Careful voltage checks were made on the 12AX7. The grid of the audio triode was noted to be about -10 volts when the picture was normal. Removing the picture by any of the means already noted brought this grid voltage down to less than one volt, with resultant good sound.

Apparently the audio triode section was being biased beyond cutoff by the picture signal. How? I tried the old standby of replacing the tube with a new one. The set worked normally—both picture and sound! I rechecked the faulty tube on the tube tester. It still checked okay on each half. On a hunch, I measured continuity between pins of this tube—and found leakage resistance between the grids of the two triode sections. Evidently this path of about 15 megohms carried the video signal from the grid of the sync separator to the grid of the audio amplifier with the resultant blocking of sound. Naturally a tube tester that checks only one triode section at a time couldn't show up this fault.—*Harland S. Laycock, Falls Church, Virginia.*

### Real Cool Technique

After replacing an intermittent yoke, an open horizontal oscillator coil and a 1000-ohm resistor in the cathode of the horizontal oscillator that had changed to 1 ohm, the set would still not show a raster for the first 5 minutes to half an hour after it was turned on. Every condenser in doubt was checked with a good analyzer, still with no success. In thinking over ways of dealing with the problem, the trick of applying heat to suspected parts occurred to me. However, that is usually used when sets give trouble by quitting after they have been on for some time.

In this case, the situation was reversed. The opposite of the heat kink seemed to be the answer. I walked over to the deep freeze and cracked off a piece of ice. With the long-nose pliers, I applied cold to the suspected components. Sure enough, this approach showed up a defective condenser in the cathode of the phase detector! This kink, which gives positive results, can save hours of work.—*Frank L. Garkus, San Francisco, California.*

### A Case of Bad Lug

The set was a GE model 17C103. Symptoms were foldover at the bottom of the raster and stretching at the top. My first thought was a defective coupling condenser to the vertical output stage. When I measured the grid voltage on this tube, and found it to be about 150 volts, I was sure this would be a quickie.

### \$10 For Your "Tough Dog Story"

Have you tangled with a difficult or obscure service problem recently? Write it up, telling us how you licked it, and send it to "Tough Dog" Editor, TECHNICIAN, Caldwell-Clements, Inc., 480 Lexington Ave., N. Y. 17, N. Y.

How wrong I was! Clipping the condenser loose at the grid end produced no appreciable change in voltage.

With my vtvm probe connected to the grid of the vertical output stage, I now removed the tube from its socket—but the voltage was still present. After reinserting the tube, I disconnected the lead going from the grid to the lug on the terminal board (see the illustration)—and the voltage was gone. A close look at the terminal lug showed nothing hooked to it except the coupling condenser, which had already been checked. I unhooked it again, but the reading on the lug was still 150 volts. I thought of a similar problem a friend had told me about, concerning the breakdown of insulation on a terminal strip between two lugs. A check of adjoining terminals on the board showed that, sure enough, there were 440 volts of boosted B-plus for the vertical output transformer on one of them.

The problem was solved. I bypassed the grid terminal and connected the condenser directly at the socket of the vertical output tube. The set was fixed.—*Oscar J. Sykes, Anderson, Indiana.*

The appearance of B-plus voltage on the grid of this output tube was hard to track down.

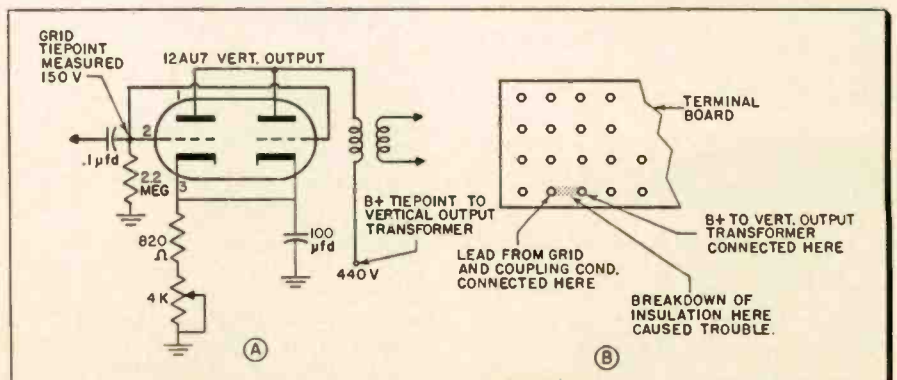



# Oscilloscopes for Color TV

## Sharp Cutoff, Slow Rolloff, Bandwidth—Common Misconceptions

ROBERT G. MIDDLETON  
SIMPSON ELECTRIC CO.

• TV technicians recognize that many of the scopes now in use will not serve for troubleshooting the color sync and other 3.58-mc circuits in the color-TV receiver. Fig. 1 shows the appearance of a horizontal sync pulse with burst on the back porch, as seen on the screen of a scope having full response at 3.58 mc. By way of comparison, Fig. 2 shows the same sync pulse as seen on the screen of a narrow-band scope. It is needless to point out that the display in Fig. 2 is useless for purposes of troubleshooting.

It might be pointed out, incidentally, that the burst seen in Fig. 1 is attenuated. Such attenuation is often the result of inadequate alignment of the r-f and i-f amplifiers. If the burst appeared at full voltage,

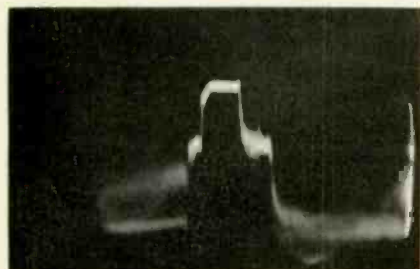

Fig. 1—Color burst shown on wideband scope.

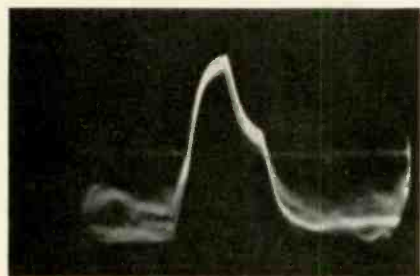
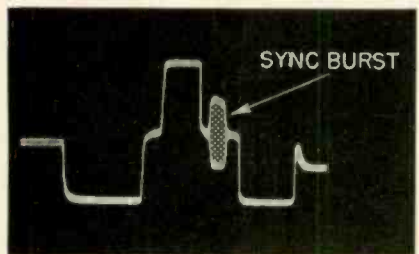

Fig. 2—Color burst seen on narrowband scope.

Fig. 3—Burst in output of a color generator.



the excursion of the burst would be as great as the excursion of the sync tip. Of course, excessive peaking of the tuned circuits at 3.58 mc will cause the burst to exhibit a greater excursion than the sync tip.

A more acceptable display of the sync pulse with burst, incidentally, is shown in Fig. 3. This waveform, without noise or crosstalk to mar the display, may be observed at the output of a color bar generator, but never or seldom in a receiver circuit. Nevertheless, it makes interesting comparison with the comparable receiver waveform already shown in Fig. 1.

Burst attenuation may be due to causes other than misalignment. It may also be caused by mismatch of the lead-in to the front end, combined with a mismatch of the lead-in to the antenna. A case in point is a color receiver which showed a good color picture on one antenna, but only a black-and-white picture on another antenna.

### Color Burst Displays

It is the purpose of this article to set forth the requirements of a scope for making checks of wave forms like that shown in Fig. 1. The first requirement is that the scope should have flat frequency response from 60 cycles to 3.58 mc. Then, the peak-to-peak voltages read on the scope screen will be correct for both the 15,750-cps pulse, and for the 3.58-mc burst. It is not sufficient that the scope should be "useful" at 3.58 mc; the term "useful" can mean anything at all, and the service technician needs full response at 3.58 mc.

Service scopes which have 100% response at 3.58 mc usually are flat to 4 or 5 mc, after which the response drops off quite rapidly, as depicted in Fig. 4. Such scopes are well suited to color-TV service work. Laboratory engineers lacking experience in practical service work sometimes raise their eyebrows at such a flat frequency response with subsequent sharp drop-off, because the scope rings when a fast square wave is applied, as shown in Fig. 5. However, in practical service work, the rise time of the waveforms under investigation is sufficiently slow so

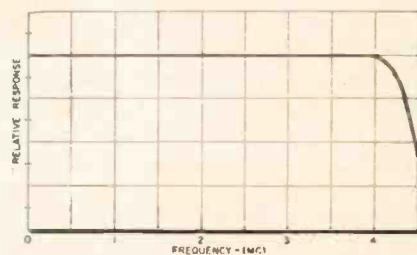

Fig. 4—Wideband, sharp-cutoff scope response.

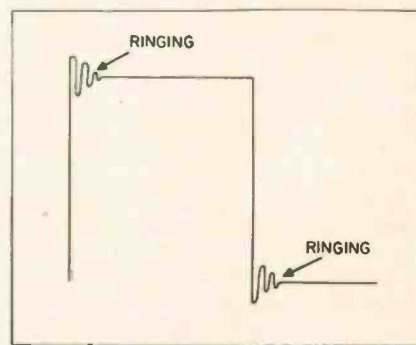

Fig. 5—Sharp cutoff makes square waves ring.

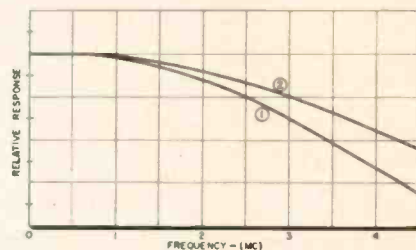

Fig. 6—Scopes with slow roll-off characteristics. Scope 1 rolls off faster than scope 2.

that the scope does not ring.

Theoretically minded persons thus sometimes maintain that the technician is better off using a scope with a roll-off characteristic, such as shown in Fig. 6. It should be noted that roll-off hits the practical man from two directions: 1. The burst will appear at less than its correct relative peak-to-peak voltage. 2. The scope has less gain than a "flat" scope at the higher frequencies, other things being equal.

This discussion does not mean to imply that ringing may not be seen in TV waveforms upon occasion, whether a flat scope or a roll-off scope is used. Fig. 7, for example, shows ringing in the deflection voltage across a yoke. This ringing, however, is caused by the circuit  
(Continued on page 62)

# Let's Look at Circuits

## No. 1: The Phase Detector Horizontal AFC System

SIDNEY C. SILVER, MANAGING EDITOR

In response to numerous requests, we present this series describing operation of fundamental circuits, many of them familiar and some of them new, for instruction and review.

• It is generally known that oscillator frequency is determined by choosing and combining the values of condensers, resistors and coils, and that frequency may be controlled or changed by varying one or more of these components. Oscillators of the type used in TV deflection systems (blocking, multi-vibrator) may be varied in an additional way.

Since such stages are driven to cutoff during part of each cycle of oscillation, a dc voltage may be used for frequency control. A change in bias, for example, will shift the instant at which the tube cuts off. If cutoff occurs sooner, each cycle is shortened so that there are more cycles per second; consequently frequency is increased. If cutoff is delayed so that the tube conducts for a longer period during each cycle, frequency is decreased. These are the conditions for oscillator control by dc voltage. Now we need a circuit for developing the voltage.

Most common arrangement for controlling the TV receiver's horizontal oscillator is the simple twin-diode phase detector. Input to this circuit is from a phase inverter or splitter, which is the last tube in the common sync section. The inverter differs from a normal triode amplifier in one respect: the inverter is loaded so that voltages produced at its plate and cathode are exactly equal in amplitude. In a normal amplifier, plate output is much greater than that at the cathode. In other respects, inverter output resembles that of an ordinary amplifier: waveforms produced at plate and cathode are similar in appearance but opposite in polarity. Plate and cathode inverter outputs are fed to the two diode sections of the phase detector.

One half of the detector (V1) accepts an incoming negative pulse at its cathode. The other half (V2) takes the same pulse, in the positive direction, at its plate. In each diode

the conditions favoring conduction are the same (plate more positive or cathode more negative), and conduction in both takes place at the same instant.

Resistors R1 and R2 are equal in value, usually about 100 K each. As a result, their junction is a midpoint between V1 and V2. As long as the two tubes are conducting symmetrically, the voltages across R1 and R2 will balance out, and no potential will exist at the junction.

### An Added Input Signal

Also fed to both diodes (through C3) is a sawtooth waveform taken from the horizontal output system—usually from a tap on the flyback or from the deflection coils. As this waveshape goes through positive and negative peaks, there is a midpoint between peaks, suggested by the broken line, when the sawtooth is at zero voltage. In the normal condition, the horizontal oscillator (and its dependent output system) is at the same frequency and phase as the incoming sync pulses. The sawtooth voltage will then be at zero when sync pulses are causing V1 and V2 to conduct; hence, the sawtooth will not affect detector operation.

However, the sawtooth is not always exactly matched in frequency and phase to the pulses. If the sawtooth happens to be going through the positive part of its cycle when the diodes conduct, the plate of V1 becomes more positive than normal, and this diode conducts more heavily than its mate. On the other hand, if the sawtooth is in the negative

half of its cycle, the cathode of V2 is favored. In either case, one diode is made to conduct more heavily than its twin, and the opposite-polarity voltages developed across R1 and R2 are no longer equal. This lack of balance, of course, becomes immediately evident at the junction between the resistors, and a potential difference is developed here. It may be negative or positive, depending on the direction in which the sawtooth (and the horizontal oscillator that initiates it) is straying. This voltage is fed back to the oscillator, as shown, where it performs the function described at the outset. That is, it correctly biases the oscillator back to the desired frequency.

In most circuits, the phase detector is followed by a cathode-coupled multivibrator, the control voltage being applied to the grid of the first triode section. R4, C4, R5, and C5 form a long time-constant filter that suppresses noises, preventing these spurious pulses from "fooling" the oscillator. The filter also smooths out the control voltage to prevent "hunting" in the oscillator. The latter might produce such symptoms as instantaneous pulling of some scanning lines, or horizontal jitter. V1 and V2 are generally the two diode sections of a 6AL5. While the circuit is most often used in the simple form shown here, it appears in variations that seem, on superficial examination, to be entirely different. For example, triode sections are sometimes used. A closer look may show that the grids are tied to the plates, however, so that the tubes are effectively working as diodes. •

This twin-diode phase detector controls horizontal oscillator frequency in many TV sets.

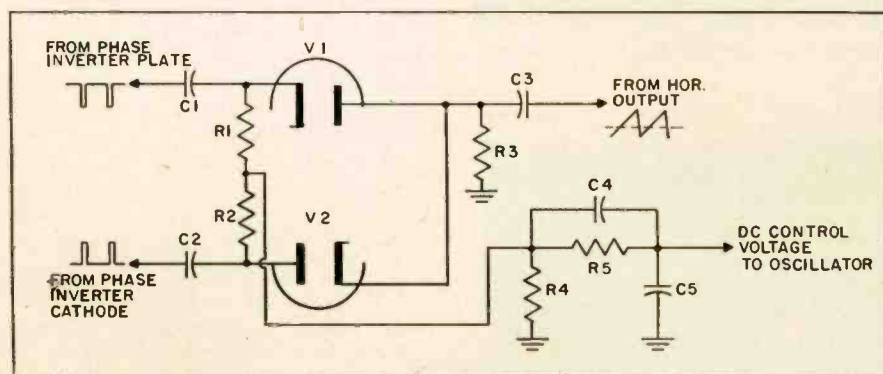

# PA Installation Problems

## Big Specialized Jobs Yield Valuable Clues for General Use

BERT ENNIS  
ALTEC SERVICE CORP.

• The secret of user satisfaction with his public-address system lies in several directions. Proper system design, integrity of the equipment manufacturer and installation "savvy" are of paramount importance. For details on the last mentioned ingredient, the writer went to Martin Bender, recognized as an expert in the field of sound reinforcement. He has been responsible for numerous large-scale sound installations, some of which will be considered here.

While these undertakings have been far more ambitious than the large majority of installations—certainly more complex than any except those that are turned over to large organizations which specialize in PA work—the problems that arise and the techniques employed are worth study by anyone who plans to do this sort of work on any level.

By way of preface, Bender points out that too few installers employ the very necessary procedure of preparing rough sketches to scale to help determine the exact type of equipment required. Such sketches should incorporate information on the type and amount of absorbing material present, the style and number of seats, the volume to be filled, type and manner of operation, and construction details on speaker location.

One noteworthy project was that in the Copernican Room (Hall of the Sun) of famous Hayden Planetarium in New York. The preparatory sketch (Fig. 1) reveals a cylindrical room with low ceiling and a mosaic tile design in the center of the floor. Twelve large supporting columns are spread out in circular fashion on a 20-ft. radius from room center. The ceiling's inner area is covered by complex planet mechanisms rotating around a depiction of the sun.

### Saturation Coverage

Since the seating area lies between the columns and the rear wall, circular in shape (Fig. 2), there was little choice of speaker sites. What is called "saturation coverage" was used. A number of speakers were strategically spotted on a circle midway between the columns and the rear circular wall, together with a series of speakers in the ceiling spaced along the periphery of a circle approx. 50 ft. in diameter. Sixteen speakers in all were used with the *individual output of each* held low enough to keep reverberation down. An attempt to eliminate reverberation completely would have entailed drastic acoustical treatment. Since all visual concentration on the planetary display is upward, speaker placement resulted in a satisfactory "illusion effect."

Another major problem was pre-

sented by the PA requirements of the Grumman Aircraft Engineering Corp., Bethpage, New York. Transmission of speech and music was desired under both operating and non-operating conditions in the plant. The variable noise level (from 70 to 105 db) was an inherent large-scale difficulty. The manufacturing site was 200 by 400 ft., with production line noise level in a constant state of change, and no acoustic treatment of any nature present. Trumpet type speakers were mounted on columns, already part of the structure, every 40 ft. apart. Speakers were directed downward.

More than thirty test listeners were used to report on the intelligibility of speech. An equalization curve was evolved to compensate for peaks and dips in the total system response under operating conditions in the plant, and a corresponding equalizing network was inserted. For non-operating conditions, a switch removed the equalization, no longer needed, and inserted a fixed attenuation to adjust level.

The sound reinforcement system in the Field House of the University of Kentucky illustrates an installation geared to a variety of uses. The auditorium (Fig. 3), which seats 13,000, is used for stage performances embracing speech, vocals, music, and sound effects, but also for a variety of sports. Two types of operation were desired: one where

(Continued on page 60)

Fig. 1—Arrows show speakers on diameter of circle, Copernican Room.

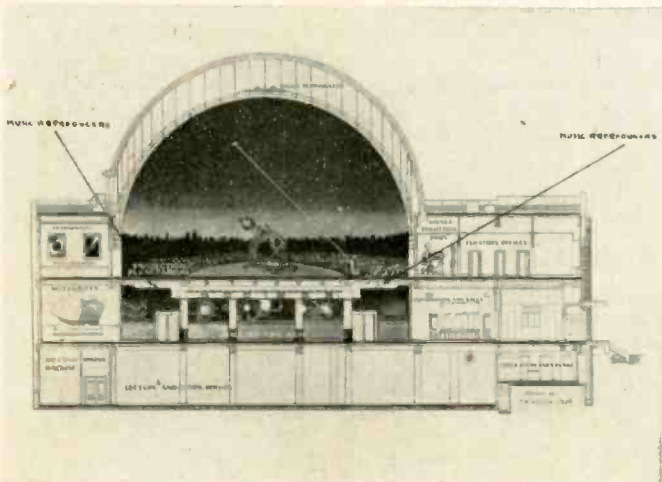

Fig. 2—Saturation coverage used for seating area in circular room.



# Shop Hints to Speed Servicing

Tips for Home and Bench Service Contributed by Readers

## Add Retrace Blanking

Earlier models of Zenith TV receivers, many thousands of which have been sold, lend themselves very readily to the installation of vertical retrace blanking circuits. Since many of these, such as the G2951R, were in the higher price brackets, most owners prefer to keep them rather than replace them. Service technicians who get them into the shop for repair are missing a good bet if they don't get the owner's consent to install the simple blanking circuit shown in the illustration, which

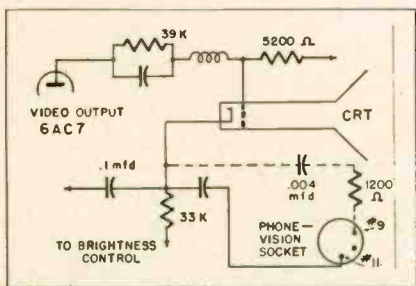

Retrace blanking circuit, early Zenith sets.

takes only a couple of extra minutes and uses only two components. The writer has not encountered a single objection for the slight additional cost for this service. The network is particularly beneficial as the picture tube starts to age. Brightness adjustment has to be advanced—and retrace lines are accentuated. The added circuit, shown in a broken line, is self-explanatory. The two points that are to be connected are only 3 inches apart under the chassis—M. G. Goldberg, St. Paul, Minnesota.

## Self-tapping Screw Holes

Whenever making chassis mounts that require the use of sheet-metal (self-tapping) screws, punch the holes instead of drilling them. Drilling leaves a clean hole with a regular surface. However, the uneven surface left around the hole by punching is more desirable. There is more surface for the screw to cut into in making a grip for itself. Also, the slight hump caused by the punch will pull tighter against the screw.—Henry Josephs, Gardenville, Pennsylvania.

## Work Bench Mobility

Instead of having conventional 8-ft. long work benches in the shop, which are generally fixed in place, we use smaller tables of such a size that three of them side-by-side replace one shop bench. When they are pushed together, we have the equivalent of our old repair table back. However, they allow added flexibility.

Each of the smaller tables is on casters. On the bottom of each is a shelf to hold the cabinet of the TV receiver under repair. If the set has to wait for a replacement part or if it is under prolonged test (as in tracing an intermittent), the table and set are simply pulled away and put aside. Another repair table bearing another repair job is put in the vacant spot.

Another refinement may be added to each table. Atop of each is a plywood panel large enough to hold the set under repair. The plywood top rotates on the regular table top by means of small furniture casters of the flat type. The casters have been countersunk into the table top so that the wheels project upward. The plywood rolls around on these casters, carrying the receiver with it. This minimizes lifting and twisting of the set.—Stanley Clark, E. Bradenton, Florida.

## Odd Buzz Cause

As the saying goes, there is always a first time. Recently we found ourselves face-to-face with a case of "intercarrier buzz" that wouldn't lend itself to the customary cures. After a while, the condition was traced to an open screen bypass condenser in the sound i-f amplifier or ratio-detector driver tube. This was the first failure of its

type in the writer's experience. The information is worth keeping in mind for future reference. It can save the technician considerable time in finding out the hard way that the condition is *not* caused by vertical circuit radiation or undesirable coupling from the sync circuits, before he investigates the simpler possibility.—B. O. Riis, Miami, Florida.

## Simple Cabinet Repair

A neat, quick, long-lasting repair of a broken plastic cabinet can be made by using the method shown in the accompanying drawing. All that is needed is a piece of looped rope, two dowel sticks and some household cement. First fill the cracks with cement. Then loop the cabinet with the rope, and twist one of the inserted dowel sticks toward you, the other one away from you. Place the cabinet on a table and let the cement dry for at least 24 hours.

A strong bond is made because considerable pressure is exerted by the twisted rope. This method is

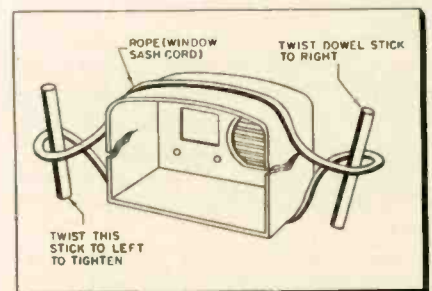

Simple "vise" facilitates cabinet repairs.

more satisfactory than the use of clamps. Wipe away excess cement before it starts to "set" or dry. In this way, no evidence of the crack or of the repair can be seen afterwards.

In putting the cabinet aside to dry, it will be found helpful to place the chassis back in the cabinet. The weight of the chassis will hold the unit down. The twisting action of the sticks in opposite directions will now lock the rope and keep it taut. With this method, I have repaired cabinets broken into as many as four different pieces.—Joseph Amorose, Richmond, Virginia.

## SHOP HINTS WANTED

TECHNICIAN will pay \$5 for acceptable shop hints. We are particularly interested in hints on the following subjects: HI-FI servicing, TV and radio interference, industrial electronics, TV antennas, test equipment and UHF. Unacceptable items will be returned. Send your hints to "Shop Hints" Editor, TECHNICIAN, Caldwell-Clements, Inc., 480 Lexington Ave., N. Y. 17, N. Y.

# New Test Equipment

## Triplet VOM

New volt-ohm-milliammeter, Model 630-NA, incorporates several new features. It has meter protection against overloads; 70 ranges; frequency compensation, up to 20 kc; high accuracy, 1½% dc to 1,200 v., and 3% ac to 1,200 v.; temperature compensation for high accuracy within a wide range of ambient temperatures, and pressure contact switching using double wiping contacts. Test lead connectors are banana plugs. \$69.50. Triplett Electrical Instr. Co., Harmon Rd., Bluffton, O.—TECHNICIAN (Ask for No. 5-80)

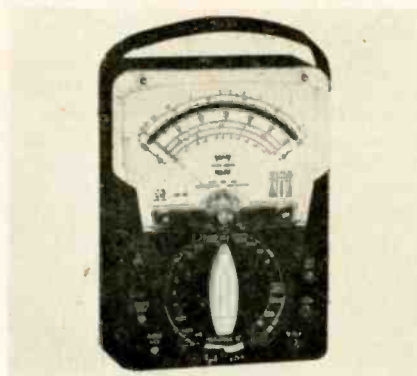

## H-W FIELD STRENGTH METER

Model H-W509 provides an indication of the relative field strength and approximate frequency (within 5%) of r-f energy emitted by a transmitter within the band of 100 to 400 mc. Tuning indicator is a 50- $\mu$ a meter, hermetically sealed. Six-section telescoping antenna plugs into receptacle on the control panel. 90° joint on antenna base permits it to be extended horizontally or vertically. Portable, self-contained; aluminum case. Harvey-Wells Electronics Inc., Southbridge, Mass. TECHNICIAN (Ask for No. 5-42)

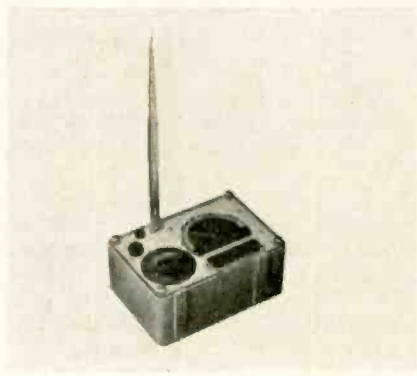

## Phaostron VOM

New "555" metal-cased, pocket size multimeter offers 43 completely unduplicated self-contained ranges with accuracies of 3% on dc and 4% on ac. Loading characteristic is 20,000 ohms/volt on dc; 2,000 ohms/volt on ac. Two jacks. Large 4 7/8-in. meter face. Shatter proof, anti-magnetic chrome and satin case. Packed complete with batteries and specially designed probes in a jewelry type flannel carrying case. 4 5/8 x 6 1/8 x 2 1/8 in. \$39.95. Phaostron Co., 151 Pasadena St., Pasadena, Calif. TECHNICIAN (Ask for No. 5-40)

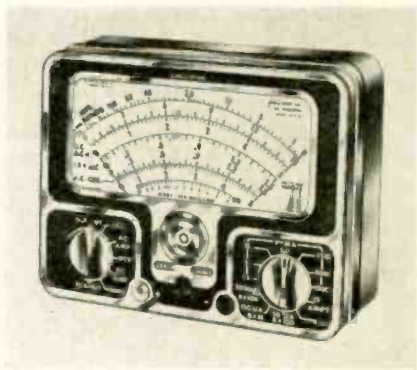

## Precise TUBE TESTER

Model 111 Tube tester checks both emission and mutual conductance of all tubes, including hearing aid, miniatures and crt's. Features include new type switches; voltage sapper check; gas checker; simplified short check and the latest roll chart. Rugged housing; panel is of deeply etched aluminum. Weight is 30 lbs. and the size is 14 x 16 x 6 in. Priced in kit form at \$69.95, and factory-wired at \$139.95. Precise Development Corp., 999 Long Beach, Oceanside, L. I., New York—TECHNICIAN (Ask for No. 5-31)



## RCP Scope

New D.C. Midgetscope, Model #534 combines linear sweep with D.C. amplifier for color television restorer circuits and for complex wave forms. Other features include provisions for A.C. coupling, full vertical and horizontal expansion of trace, automatic astigmatism control circuit, linear time base and sweep—returned trace automatically blanked, vertical or horizontal operation. Frequency range, dc to 500 kc, sensitivity, better than 50 mv; push-pull deflection throughout. \$123.85. Radio City Products Co., Inc., Centre & Glendale Sts., Easton, Pa.—TECHNICIAN (Ask for No. 5-32)

## Hunt ETCHING SOLUTION

New etching solution, Hunt RCE, for use in the field of etched printed circuits claims to give controlled rapid etching speed, permitting standardization of a high production etching schedule; instant and uniform etching over the entire circuit; and full protection to the "tops." Philip A. Hunt Company, Palisades Park, N. J.—TECHNICIAN (Ask for No. 5-1)

## T-M COUNTER

The "Micro" geiger counter features light weight, rugged construction, polished one piece aluminum case, and professional quality, rugged miniature earset. The miniature geiger-mueller tube is shock mounted in live rubber. Through a special power supply, the same 1½ v. 2 oz. mercury battery supplies current for the transistor amplifier and also supplies 300 v. to activate the geiger-mueller tube. \$37.50. Transmiteme Laboratory, Radiation Counter Div., Manteo, N. C.—TECHNICIAN (Ask for No. 5-18)

## Mueller CLIP

New Mini-gator, miniaturized clip, is half the length of the familiar Alligator test clips. Manufactured in both steel (cadmium plated), and solid copper. Separate, one-piece insulators are available in both red and black, permitting on-sight identification of hot and cold test leads. The insulators fit skin-tight and do not materially increase the clip's size. Mueller Electric Co., 15754 E. 31 St., Cleveland 14, Ohio—TECHNICIAN (Ask for No. 5-35)

## MORE TECHNICAL INFORMATION

on new products may be obtained by using the inquiry coupon on page 36 List the code numbers given at the end of each item of interest.

# New Outdoor TV Antennas

High Gain Yagi-Types; Housing, Masonry Anchor

## Trio ANTENNA

The "99" antenna uses two dual purpose active elements each consisting of three half waves in phase on the high channels and, at the same time, a single half wave on the low channels. To this is added a combination of three parasitic elements on the low channels and five on the highs. The mfr. claims high forward gain and maximum side-rear

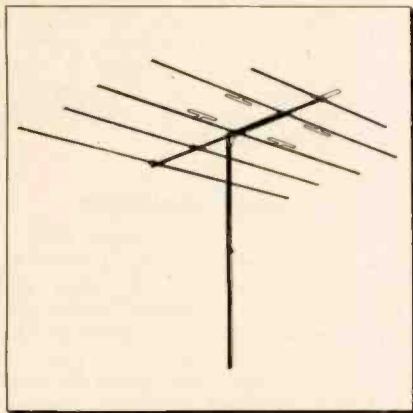

rejection as a result of more critical element lengths and spacing. Constructed of Alcoa aluminum; preassembled; uses "Insta-Lok" clamps for quick, easy installation. Trio Mfg. Co., Griggsville, Illinois. — TECHNICIAN (Ask for No. 5-54)

## B-T MASTER TV HOUSING

Rugged all-purpose housing offering complete weather and radiation protection provides ample mounting surface and full ventilation for all antenna or line master TV equipment. Model MRH features a sealed, front opening door with a sturdy locking hasp and adjustable support bracket for pole or cross arm mounting. Iridite finished, cadmium-plated steel. 18 x 15 x 8 in.; weight 12 lbs. List price \$49.50. Blonder-Tongue Laboratories, Inc., 526-536 North Avenue, Westfield, N. J.—TECHNICIAN (Ask for No. 5-5)

## JFD OUTDOOR ANTENNA

The "Super-Star-Helix" incorporates a special front end modification for peaking channel 13 performance. The change is in the form of an added director and delta-matched helical section, and a shortened stub at the center of the helix. The flat microwave section

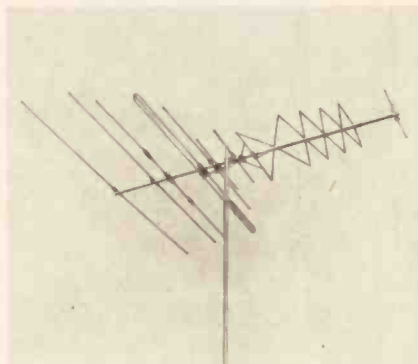

is composed of individual non-linear additive collectors, each tuned separately for high gain and sharp sensitivity on 1 high band channel. JFD Mfg. Co., 6101-16th Ave., Brooklyn, N. Y.—TECHNICIAN (Ask for No. 5-39)

## G-C SLUG RETRIEVERS

"Tuning Slug Retrievers," in 12-in. and 15-in. sizes, are designed to work on all Standard Coil tuners where they are used to recover tuning slugs on the oscillator coils of channel strips. They also are said to fit easily the new wide slotted slug and deep seated tuning units. Precision made alloy blade and Tenite handle. Can also be used to reclaim screws and to start set screws in previously inaccessible spots. Net price, \$2.22 in the 12-in. size, and \$2.97 in the 15-in. size. General Cement Mfg. Co., 919 Taylor Ave., Rockford, Ill.—TECHNICIAN (Ask for No. 5-8)

## Telrex ANTENNAS

"Thunderbird" antennas, series T-100, are loop phased, multi-element, "Beamed Power" arrays for fringe and "sub-fringe" area TV reception. Element functions are duplexed by means

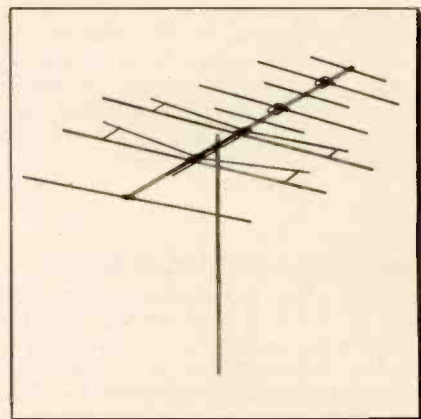

of variable impedance phasing loops to produce effective high-gain yagis for high and low channel VHF bands in an all-in-line array. Features a compensated "T" match for both high and low band operation, designed for use with a single transmission line through a special decoupling system which isolates high and low channel signals to preserve symmetrical single-lobe response on all channels. Side response is negligible on all channels, and back rejection ranges to 25 db. Reactance compensated feed system, achieved by tapering the "T" matching sections, provides an excellent resistive match to 200-300 transmission line. Price, T-100 one bay, packed 2/carton—\$23.60; T-102 stacked—1/carton—\$48.60. Telrex, Inc., Asbury Park, N. J.—TECHNICIAN (Ask for No. 5-53)

## Holub FASTENING KIT

The "Do-It-All" Kit contains 100 No. 12 x 1 in. "Hi" Plastic Screw Anchors, 100 zinc plated sheet metal type screws and one 1/4 in. spiral fluted masonry drill in a handy, transparent plastic box. After the contents are used, the box can be used for small objects. Plastic screw anchors are claimed to hold indefinitely in any material you can drill. A 1/4 in. hole is required; then the screw is pushed into the hole and tightened. The anchors are made of ethyl cellulose, and are unaffected by moisture, corrosion, heat or cold; will not rot, age or otherwise deteriorate. As introductory offer, the Cat. No. K-6 "Do-It-All" Kit is being sold for \$3.95. Holub Industries, Inc., Sycamore, Illinois.—TECHNICIAN (Ask for No. 5-59)

## FOR MORE TECHNICAL INFORMATION ON NEW PRODUCTS OR BULLETINS

Use this convenient coupon. Enter below the reference numbers for all items desired.

New Products Editor  
TECHNICIAN & Circuit Digests  
490 Lexington Ave.  
New York 17, N. Y.

Please send me more information on the following items:

My company letterhead or business card is enclosed.

Name .....

Firm ..... My position .....

Address .....

City ..... State .....

Business address (if different from above) .....

# NEW BETTER WAY

## To Stock, Sell and Service

### PHONO-CARTRIDGE REPLACEMENTS



## NOW SEALED-IN-PLASTIC

This is a big step ahead in cartridge merchandising and servicing! For greater protection and convenience, E-V Replacement Cartridges now come in individual new sealed-in-plastic Blister-Paks, with full model identification, interchangeability chart, and instructions—in colorful display box.

### \$70,000,000 CARTRIDGE REPLACEMENT MARKET

The exclusive new Blister-Pak in the E-V Basic 6 Preferred Types makes it easier to take E-V cartridges along on a service call for immediate replacement. Advanced engineering by E-V assures finer reproduction, longer record and needle life, easy installation, and more satisfied customers.

### NEW E-V MODEL 47 DUAL-SLIDE CARTRIDGE FOR 78, 33-1/3, 45 RPM

Here is a unique new innovation in replacement cartridges! The dual-slide, dual needle Model 47 shown on the Blister-Pak at right makes it possible to replace hundreds of different specialized types with a single general-purpose cartridge—with design and operating features found only in wide range custom built cartridges.



### NEW PACKAGING... NEW MERCHANDISERS

**Make Cartridge Replacements  
Easier and More Profitable than Ever!**

Colorful new 2-drawer metal display-dispenser makes it easier for service-dealers to stock and sell phono-cartridge replacements. Your E-V Distributor is ready to supply you with these merchandisers and other E-V sales aids.

SIZE  
6x13x9 3/4"



## FREE HANDY NEW QUICK-ANSWER Cartridge Interchangeability Guide

This complete, up-to-date cartridge interchangeability guide SA9 is available FREE to service-dealers. A simple turn of the wheel gives you the exact replacement for all current cartridges. Get it now from your E-V Distributor or write to Electro-Voice.

# Electro-Voice®

# IT WON'T COST YOU A RED CENT!

Here's your chance to try this new contact cleaner and lubricant at our expense. You get 3 FREE dispensers when you buy the quart size at only \$2.90. If you're not convinced that "WISSH" is better than your present brand, return the unused portion for a full refund or credit... and keep the 3 dispensers for your trouble! We unconditionally guarantee, there is no better contact cleaner at double this price! Order your "WISSH" from

**Your Favorite Distributor**

Mfg. by: **WORKMAN TV, INC. • TEANECK, NEW JERSEY**



\*\$3.15 WEST OF MISS.



**"WISSH"**

**& 3 FREE DISPENSERS**

"WISSH" is especially formulated for cleaning and lubricating electrical contact points, TV tuners, band switches and carbon controls. It prevents oxidation and gives long-lasting protection to radio and TV equipment. Just a few drops will give you excellent results.

**SEE WTV PRODUCTS AT THE SHOW**

**MAY 16-19**

**ROOM 655-A  
CONRAD HILTON HOTEL  
CHICAGO, ILL.**

## Reps & Distributors

**GERBER SALES CO.** of Boston, mfrs. reps for New England, announce the appointment of **SAM GERSHFIELD** as sales engineer covering industrial accounts in the greater Boston area.

**KRYLON, INC.**, Phila., Penna., announced the appointments of the following reps: **LOUIS R. BIGELOW**, Wayne, Penna. for E. Penna., S. New Jersey, Md., Dela., Va., and Washington, D. C.; **PASTON-HUNTER CO.**, Syracuse, N. Y. for N. Y. state, except metropolitan N. Y. City and **MICHAEL SCOTT CO.**, Wellesley Hills, Mass., for the New England states.

**CENTRALAB**, Milwaukee, Wisc. has been chosen by the National Assoc. of Mfrs. to represent a segment of the electronics industry on the association's TV movie series "Industry On Parade." Check your local station or **CENTRALAB** rep for exact day and time in your city.

**FRED W. ORSENWASSER SALES**, Cleveland, O., has been appointed by **CLEAR BEAM ANTENNA CORP.** to represent them in W. Penna., W. Va. and E. Ohio. . . . **JULES J. BRESSLER**, Union City, N. J., will represent **CLEAR BEAM** in metropolitan New York, Long Island and N. New Jersey.

**DON V. HAMILTON & CO.**, Minneapolis, has been appointed mfrs. rep to industrials and jobbers by **PYRAMID ELECTRIC CO.** of North Bergen, N. J.

**RADIO RECEPTOR CO., INC.** has appointed **VICTORIA SALES CO.**, Chicago, as sales rep in Northern Ill., including Chicago, for its Semi-Conductor Div. . . . **INTER-STATE RADIO & SUPPLY CO.**, Denver, was appointed exclusive wholesale distributor for the state of Colo.

**HENRY VITARELLI ASSOC., N.Y.C.**, have been appointed sales reps in the metropolitan New York area, and **ANDERSON SALES CO.**, Boston, Mass. have been appointed sales reps in New England, by **MARK SIMPSON MFG. CO.**, Long Island City, N.Y.

**PEERLESS PRODUCTS INDUSTRIES**, Chicago, has appointed **RAY R. HUTMACHER ASSOC., INC.** as exclusive sales rep for its antenna sales in the states of Ill. and Wisc.

**OXFORD ELECTRIC CORP.**, Chicago, announces the appointment of **DON V. HAMILTON & CO.**, Minneapolis, to represent them in N. Dakota, Minn., S. Dakota and northwestern Wisc.

**MARTIN MANN ASSOC.**, Los Angeles, have been named sales reps in the  
(Continued on page 40)

**TECHNICIAN BUYERS**

**DIRECTORY begins on page 63**

**ALL-STEEL INTERLOCKING DRAWERS**

**MULTI DRAWERS**

**Solve the SMALL PARTS STORAGE PROBLEM**

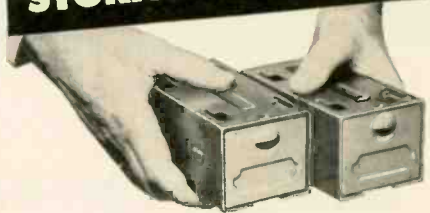

Perfect for storing easily lost, easily-scrambled small parts! Precision-made all-steel drawers finished in two-tone green enamel, complete with card holder. Priced at 42c each in the small size (illus.), or \$1.28 for large size.



**MAKE CABINETS**

Units interlock easily at top, bottom, sides to form rigid cabinets—assemble to fit any space! No framework required.



**DEALERS—JOBBER!**

Once again, enough steel is available to make popular Multi-Drawers available to new dealers! Jobber territories open.

**WRITE TODAY TO DEPT. C FOR DETAILS**

**THE CINCINNATI VENTILATING CO. INC.**  
THIRD & MADISON STS., COVINGTON, KY.

**HERE IT IS... Best Built Highest Gain UHF CORNER REFLECTOR**



The UC-110 Corner Reflector Array

- **LARGER** . . . 1 1/2 times larger than other corner reflector arrays.
- **STRONGER** . . . heavy aluminum, 3-point support for added rigidity.
- **HIGHEST GAIN** . . . performance superior to ordinary stacked arrays.

If your distributor cannot supply you, write to

**Antenna Products**  
3628 N. Lincoln Ave. • Chicago 13, Ill.



Most versatile of all... **NEW**  
**DUTCH BRAND Vinyl**  
**COLOR TAPE**

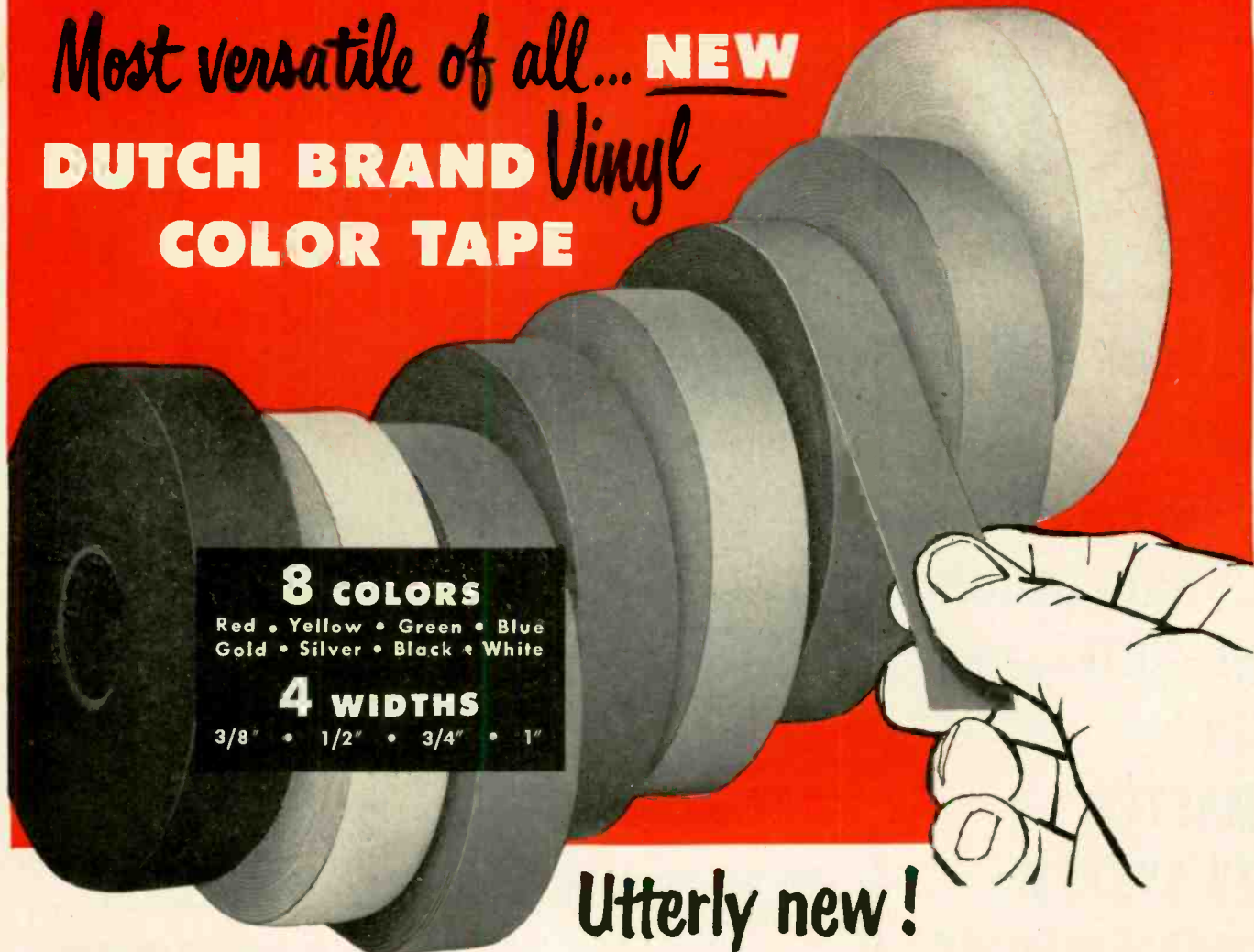

**8 COLORS**  
 Red • Yellow • Green • Blue  
 Gold • Silver • Black • White

**4 WIDTHS**  
 3/8" • 1/2" • 3/4" • 1"

**Utterly new!**

**BETTER FOR ELECTRICAL INSULATING, INDEXING, COLOR CODING**

Color can be a tremendous help to the radio-television technician, and now it is available to him in U.L. listed insulating tapes. Dutch Brand Vinyl Color Tape . . . now on sale at your jobbers . . . is just the thing to simplify hundreds of jobs both in your shop and on service calls.

Insulate in matching colors. Code and index circuits and parts. Wrap tool handles for safe sure grip.

Dutch Brand Color Tape is easy to use . . . conforms to irregular shapes . . . makes every job look better. Get some at once.

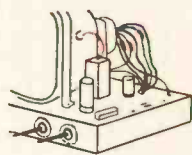

electrical insulating



color coding



electric wiring



tool handles

**The Tape with a Thousand Uses**

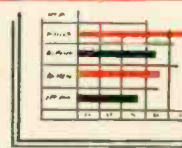

charts and graphs



UL listed

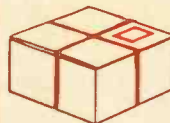

decorating



color indexing

**CHARACTERISTICS**

**Adhesive Value**—28 oz. per inch width (according to ASTM D1000)

**Tensile Strength**—15 lbs. per inch width

**Dielectric Strength**—1000 volts per mil of thickness

**Thickness**—0.006" **Length**—36 yards

**Moisture Vapor Transmission Rate**—Less than 3

**EXCELLENT DISTRIBUTOR PLAN**

**Order from your parts jobber at once!**



**Johns-Manville**  
**DUTCH BRAND**  
**PRODUCTS**

VAN CLEEF BROS., INC. DIVISION  
 7800 WOODLAWN AVENUE CHICAGO 19, ILL.

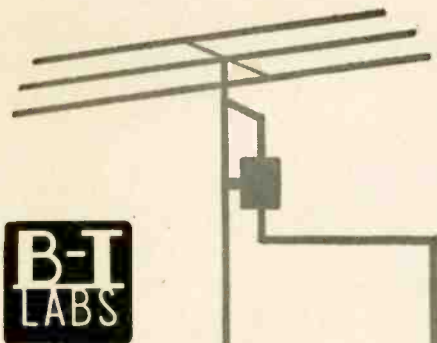

**OFFERS YOU  
FREE  
ENGINEERING  
CONSULTATION  
SERVICE  
ON  
MASTER  
TV SYSTEM  
INSTALLATIONS**

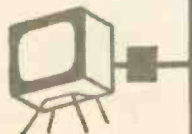

*Will discuss TV distribution problems or provide actual system layouts for specific building plans.*

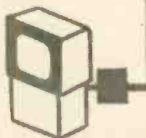

Write for Free Manual

BLONDER-TONGUE LABS., INC., Dept. DE-18  
Westfield, New Jersey

Please send your FREE Manual on Master TV System Installation

Your Name.....

Firm Name.....

Address.....

City..... Zone..... State.....



Leading Manufacturers of Master TV System Amplifiers, Distribution Units, Converters, Boosters, and Accessories.

(Continued from page 38)

territory of Southern Calif. for RAM ELECTRONICS SALES CO., Irvington, N. Y.

AVNET ELECTRONIC SUPPLY CO., New York City, announces its appointment as distributor for tubes manufactured by BENDIX AVIATION CORP., Eatontown, N. J. . . . BAILEY'S INC., Chattanooga, Tenn., has been named distributor in that area for the BENDIX TV and broadcast receiver div.

NESLO ELECTRONIC DISTRIBUTORS, Green Bay, Wisc., has been awarded the ARVIN INDUSTRIES radio-TV franchise for sixteen counties in Northwest Wisc. and twelve counties in Northern Mich.

FRANK J. MOCH, pres. of NATESA, announced the appointment of ALBERT C. W. SAUNDERS, director of SAUNDERS RADIO & ELECTRONIC SCHOOL, to the new post of Technical Director of NATESA.

Officers of the new chapter of NEDA, the Garden State Chapter, are: JOHN DE VINE, pres. and FREDERICK ROSENSTEIN, vice-pres.

THOMPSON & HOLMES LTD., San Francisco, has been named distributor in Northern Calif. and Western Nevada for SYLVANIA radios, TV sets and hi-fi phonos.

AMPLITEL, INC. has moved to new and larger quarters at 342 W. 40th St. New York, N. Y.

F. J. STOKES MACHINE CO., Phila., Penna., has opened a New York district sales office at 26 E. 1st St., Mt. Vernon, N. Y. They are also opening a branch office at 2165 Morris Ave., Union, N. J.

By 1965, there will be a twofold or even greater increase in sales of receiving tubes, TV picture tubes, and industrial tubes for replacement use, it was predicted at an all-day symposium held recently by RAYTHEON MFG. CO., at the Somerset Hotel, Boston.

**MATCH SIZE TRANSISTOR**



No bigger than a match-head, this tiny CBS-Hytron transistor is the smallest commercially available for use in compact new hearing aids. Transistors are hermetically sealed.

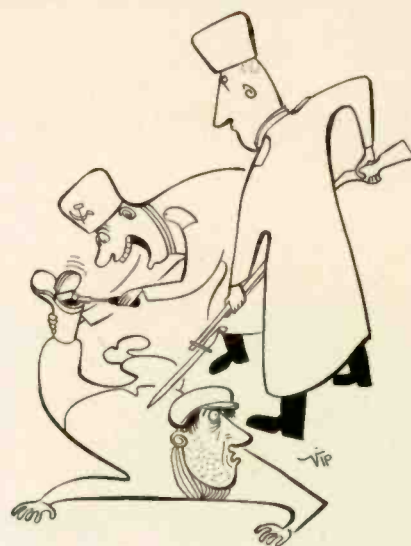

*"Bless these smugglers!  
JENSEN NEEDLES."*

**CLAREMONT**

*"The Finest Tube in Television"*

For years the "TESTED-QUALITY" Replacement Cathode Ray Tube

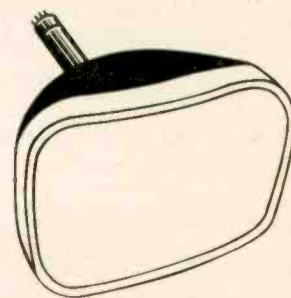

**NEW MAY EXPANSION PROGRAM**

Become a Distributor of one of the finest Cathode Ray Tubes manufactured. Years of experience gives you longer years of tube life.

A profitable distributor franchise may now still be available in your territory. For information write or call

**CLAREMONT TUBE CORP.**

3612—35th Ave.  
Long Island City, N. Y.  
Tel. RAVenswood 1-1206

## New Products

### ASD TUBE TESTER

The TV-20 line of TV tube testers has now been brought up to date to handle all the new 600 mil series and color TV tube types. No roll chart; information on over 200 tubes is included on the

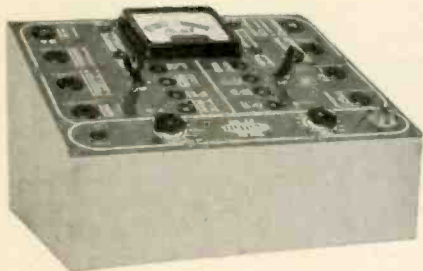

front panel. In three models: the TV20C, counter style case with sloping front panel shown, at \$97.50; the TV-20P, in brown leatherette portable case, at \$119.50 and the TV-20G, in metal utility cabinet, at \$97.50. American Scientific Dev. Co., 334-336 South Main St., Fort Atkinson, Wis.—TECHNICIAN (Ask for No. 5-62)

### Ronette MG CARTRIDGE

Single needle "Fonofluid" Type RA-284P, for use with MG records only, has extremely low intermodulation distortion. It is a constant velocity type when loaded with the correct load resistance of 120K ohms. Designed to feed into any magnetic level input. The extremely small mass and high compliance of the moving system, contribute to its lack of intermodulation distortion and this, together with the gradual rather than sharp rise in the IM distortion curve, permit true center of the groove tracking at velocities as high as 10 to 15 cm/sec., which are often encountered in microgroove recordings. With Swiss-made sapphire needle \$6.60 net; with diamond stylus, \$15.00 extra. Ronette Acoustical Corp., 135 Front Street, New York 5, New York.—TECHNICIAN (Ask for No. 5-49)

### Turner DESK MIKE

The "Chief," a new desk microphone with crystal, ceramic or magnetic interior is recommended for amateur, P.A., tape recording and similar uses. Die-cast alloy case, baked-on grey enamel finish, 6-ft. attached fabric covered cable, and standard 5/8-in. 27 thread adapter for stand mounting. Model 808 is the "Chief" with crystal interior. Response is 70-70,000 cps; level: -46 db. Both have the same list price—\$10.85. Turner Co., 923 17th St., N.E., Cedar Rapids, Iowa.—TECHNICIAN (Ask for No. 5-7)

**TECHNICIAN BUYERS  
DIRECTORY begins on page 63**

**DOES  
YOUR  
RECTIFIER  
Plug In?**  
*all*  
**Sarkes  
Tarzian**  
Replacement Rectifiers  
plug into  
**Conversion Chassis CC-1**  
SEE YOUR DISTRIBUTOR

# New Audio Equipment

## E-V SPEAKER SYSTEM

Multiple-horn system for table, wall or bookcase installation, the "Skylark," consists of an SP8C low-frequency and mid-range producer for 70 to 3,500 cps, and a T35B tweeter which handles the range from 3,500 cps to beyond the range of audibility. Complete frequency range of system is 70 to 15,000 cps,  $\pm 6$  db. The SP8C employs the Radax principle of mechanical crossover and is loaded by two tapered horn ports. Dimensions, 33 x 14 x 10 $\frac{3}{4}$  in. \$89.70. Electro-Voice Inc., Buchanan, Mich. TECHNICIAN (Ask for No. 5-43)



## A-M HI-FI CHANGER

New 3-speed automatic record changer which plays 7 in. or 12 in. records and has a push-pull audio amplifier with frequency response up to 13,000 cps. Components include hi-fi ceramic cartridge, 2 sapphire-tipped permanent needles, dual range twin 6-in. PM heavy Alnico V speakers with a crossover network, variable volume control with automatic bass and variable treble control. Case is Dupont vinyl or rawhide fabrilite. \$114.50. Audio-Master Corp., 17 E. 45th St., NYC—TECHNICIAN (Ask for No. 5-46)



## SWP HI-FI CABINET

"Tune-A-Port" speaker cabinet has a baffleboard adjustable from the outside. Raising or lowering the port is accomplished by means of 2 external small knobs on the sides of the cabinet. Cabinet accommodates 12-in. or 15-in. single, coaxial or triaxial speaker systems. Air mass is 10,000 cu. in. Constructed of full  $\frac{3}{4}$  in. mahogany veneer stock; vibration-free; reverberation is damped by interior acoustic padding. 36 x 24 x 17 in. Standard Wood Prods. Corp., 47 W. 63rd St., N.Y. 23.—TECHNICIAN (Ask for No. 5-44)



## AMP TAPE MAGAZINE

New clip-in tape magazine eliminates objectionable threading and rewinding of magnetic recording tape. Fully enclosed in the magazine, the tape is locked into playing position with slight finger pressure. Unit is 3 $\frac{3}{8}$  x 5 $\frac{1}{2}$  x 1 in., overall. Tape itself is 300 ft. long. At the end of the run a Mobius loop arrangement automatically transfers playback or recording to the opposite side, providing actual length of 600 ft. American Molded Prods., Dept. TNN, 2727 W. Chicago Ave., Chicago 22, Ill. TECHNICIAN (Ask for No. 5-45)

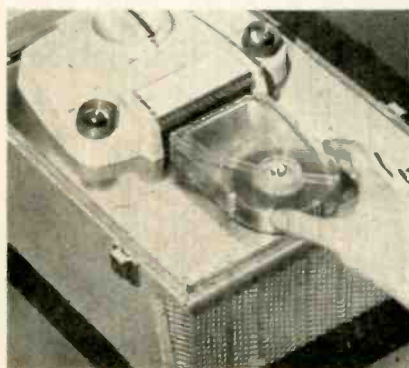

## Ronette TWEETER

New crystal tweeter that requires no output transformer is incorporated in the plate circuit of the output tube permitting wide range response even with extremely low cost output transformers, which are required only to handle the lower frequencies. Blocking condenser used in the tweeter circuit effectively attenuates the lower frequencies and eliminates the need for expensive crossover networks. Frequency correction in the form of a damping network tuned to the resonant frequency of the crystal, which effectively damps the resonance without decreasing the sensitivity at other frequencies, is built into the unit. Ronette Acoustical Corp., 135 Front St., New York 5, N. Y.—TECHNICIAN (Ask for No. 5-15)

## Transvision TV KIT

New television kit for home assembly, Model E1 is designed so that color TV may be added at a later date, according to the mfr. Each part in the kit is individually packaged and marked with a number so that the non-technician can identify the part and follow the step by step instructions. The kit is broken down into nine packages, each of which is a complete circuit which the prospective builder can buy separately, assemble and study. The first package sells for \$15. Kit includes photos and diagrams of each stage of assembly and a service section. Transvision Inc., 460 North St., New Rochelle, N. Y.—TECHNICIAN (Ask for No. 5-4)

## Fenton TAPE PREAMP AND KIT

Designed to provide hi-fi record amplification and playback preamplifications as well as bias/erase oscillator stage for the Fen-Tone Motek Audio-ophile Tape-Deck, the TPR-1 consists of two separate chassis, one for the preamp proper and the other for the power supply inter-connected with a 7 conductor cable. Adjustable hum balance control. Two high impedance inputs. Uses 6E5, 6X5GTA, 6AQ5, 12AT7 and 5879. Specifications: bias and erase frequency: 45-55kc (adjustable). Signal to noise ratio: 55 db. Record frequency: better than 50-10,000 cps  $\pm 3$  db. Playback frequency: better than 50-14,000 cps  $\pm 3$  db. Fenton Co., 15 Moore St., New York 4, N. Y.—TECHNICIAN (Ask for No. 5-6)

**MORE TECHNICAL INFORMATION** on new products may be obtained by using the inquiry coupon on page 36 List the code numbers given at the end of each item of interest.

P. R. MALLORY & CO. INC.  
**MALLORY**  
APPROVED PRECISION PRODUCTS

P. R. MALLORY & CO. INC.  
**MALLORY**  
APPROVED PRECISION PRODUCTS

P. R. MALLORY & CO. INC.  
**MALLORY**  
APPROVED PRECISION PRODUCTS

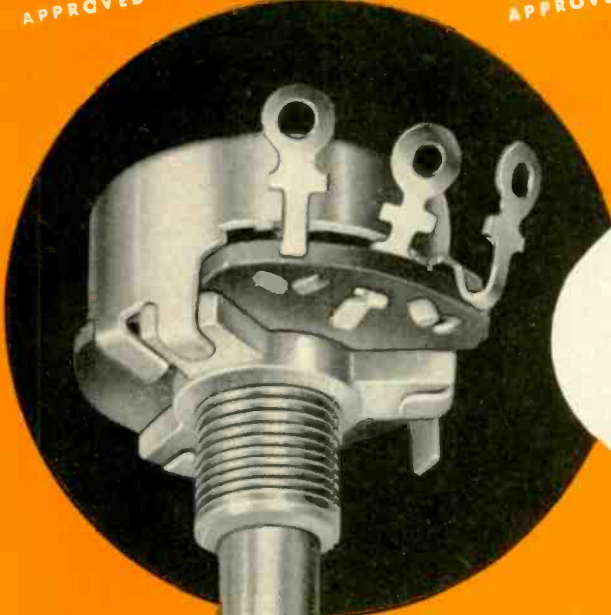

The simplest — and best  
— control replacements  
you can install

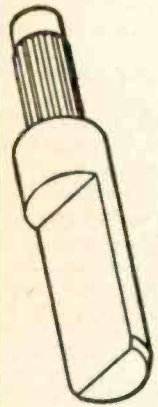

**SAVE YOURSELF TIME** with Mally Midgetrols®—the carbon controls designed for *both* you and your customers. Features like the easily-cut tubular shaft that fits split-knurl or flatted knobs . . . line switches that you attach without disassembling the unit . . . will save valuable minutes of your shop work.

**GIVE CUSTOMERS THE BEST** with Midgetrols—the control that's engineered to equal or exceed the performance of original components. Their precise tapers, noise-free operation and excellent stability add up to the kind of performance that prevents call-backs . . . builds customer good-will.

**ORDER YOUR STOCK TODAY.** Your nearby Mally distributor is ready to supply you with a Control Kit that will equip you to replace controls in 90 per cent of the radio and TV sets in your area.

**BE SURE TO USE . . .**



**MALLY WIRE WOUND CONTROLS** . . . a wide selection of resistance, wattages from 2 to 500, and variety of tapers . . . all designed for cool operation and long life.



**MALLY DEPOSITED CARBON RESISTORS** . . . high stability resistors with tolerances of 1% or 10% . . . at cost substantially lower than wire wounds.

P. R. MALLORY & CO. INC.  
**MALLORY**

CAPACITORS • CONTROLS • VIBRATORS • SWITCHES • RESISTORS  
RECTIFIERS • POWER SUPPLIES • FILTERS • MERCURY BATTERIES  
**APPROVED PRECISION PRODUCTS**

P. R. MALLORY & CO. Inc., INDIANAPOLIS 6, INDIANA

P. R. MALLORY & CO. INC.  
**MALLORY**  
APPROVED PRECISION PRODUCTS

P. R. MALLORY & CO. INC.  
**MALLORY**  
APPROVED PRECISION PRODUCTS

P. R. MALLORY & CO. INC.  
**MALLORY**  
APPROVED PRECISION PRODUCTS

Use the complete line...

# ERIE DISC CERAMICONS®

Erie Disc Ceramicons are available at Distributors in four classes as standard stock:—High Stability General Purpose Ceramicons in a wide range of values, (5mmf to 1800 mmf) with 10% capacity tolerance.—Hi-K By-Pass and Coupling Ceramicons from 470 mmf to .02 mfd GMV.—Hi-K Dual Ceramicons.—High Voltage Ceramicons rated at 1500, 3000, and 6000 Volts, DC. Working. Characteristic of all classes is smallness of size graduating with increase in capacity value. For complete listing of styles and values available write for D-54 Catalog which includes all Erie Distributor products, or ask your nearest Erie Distributor.

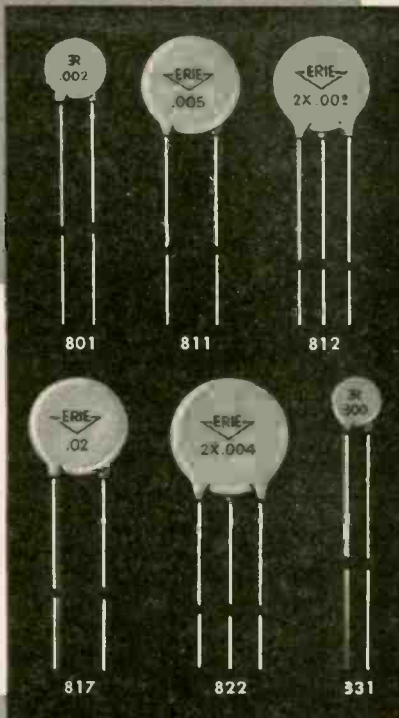

ERIE ELECTRONICS DISTRIBUTOR DIVISION

ERIE RESISTOR CORPORATION  
Main Office: ERIE, PA.

Factories: ERIE, PA. • LONDON, ENGLAND • TRENTON, ONTARIO

# KESTER



Absolutely non-corrosive and non-conductive, KESTER "RESIN-FIVE" CORE SOLDER contains an activated type of resin that gives you that fast, positive action on all your jobs . . . including the most difficult.



KESTER SOLDER COMPANY  
Wrightwood Avenue • Chicago 39, Illinois  
Newark 5, New Jersey • Brantford, Canada

# SOLDER

## NEW PRODUCTS

### Kuehne TV TOWERS

New TV towers have a durable zinc finish bonded to the steel by electroplating for a permanent, high-lustre finish. Completely rust-proof without painting. If painting is desired to match

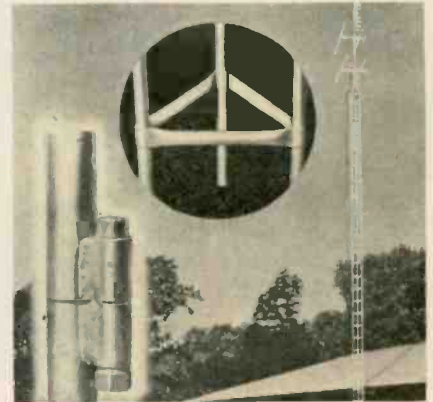

exterior color schemes, the zinc finish provides an excellent base coat. Towers incorporate exclusive lateral load-bearing joints and gird-around cross ties, producing a tower that stands free up to 50 ft. high and is safe in gales up to 80 mph. Kuehne Mfg. Co., TV Tower Div., Mattoon, Ill.—TECHNICIAN (Ask for No. 5-52)

### UPC HAM ANTENNA

New, self-supporting, base insulated, "Lewis Vertical" r-f radiator is equipped with a winch-operated Snorkel Mast which permits varying the electrical length of the antenna up to 18 ft. Self-supporting; guaranteed to withstand winds up to 80 mph. Equivalent conductor diameter is such that it provides excellent aspect ratio for broad tuning. A very desirable low

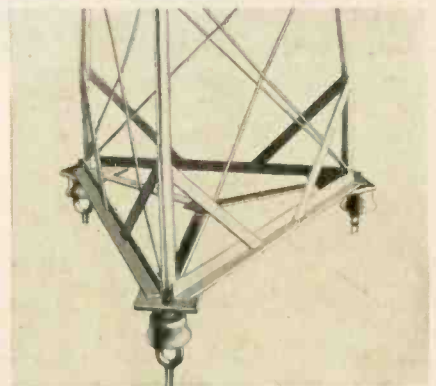

standing wave ratio is attained over both 40 and 80 meter bands, and it performs well without a system of buried radials. Triangular lattice, welded sections are hot-dip galvanized. Three 20 kv base insulators are shielded by heavy, bullet-proof bells. Base is equipped with screw-in ground anchor feet modeled after utility guy anchors. Available in four models in tower heights of 37½, 47, 56½ and 66 ft. Universal Products Company, 4100 Taylor Avenue, Racine, Wisc.—TECHNICIAN (Ask for No. 5-48)

## New Products

### Sylvania CRT CAPS

New "Pin Cushion" plastic protective caps which fit over the base pins of the TV picture tube have been found to greatly reduce accidental damage in

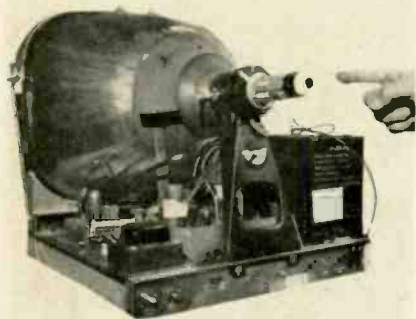

shipment. They are light weight and durable, and fit snugly on picture tube bases. The caps prevent bent or broken pins as the base pins are kept in perfect alignment. Sylvania Electric Products, Inc., 1740 Broadway, New York 19, N. Y.—TECHNICIAN (Ask for No. 5-47)

### Spico OUTDOOR ANTENNA

All-channel TV antenna is claimed to provide uniform high gain on all channels. Narrow beam width eliminates interference and ghosts, gets peak gain in fringe areas. All-aluminum construction, with "Quick-Rig" feature to speed installation. Spirling Prods. Co., Inc., P.O. Box 411, Hicksville, N.Y.—TECHNICIAN (Ask for No. 5-90)

### Knight AMPLIFIER

"Bantam" 12-watt amplifier is designed for low cost hi-fi installations. Measures 3½ x 13 x 10¼ in. Frequency response at 12 watts output is ±0.5 db from 20 to 20,000 cps. Harmonic distortion is less than 1% at rated output; intermodulation distortion is less than 2% at rated output. Five inputs; selection is accomplished with a switch on the front panel, which also provides three positions of equalization. \$59.50. Allied Radio Corp., 100 N. Western Ave., Chicago 80, Ill.—TECHNICIAN (Ask for No. 5-25)

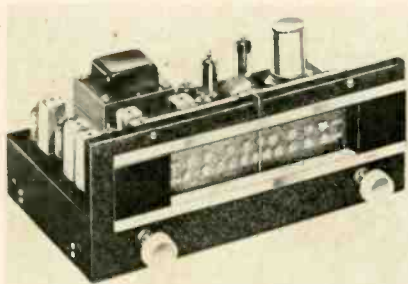

tion is less than 1% at rated output; intermodulation distortion is less than 2% at rated output. Five inputs; selection is accomplished with a switch on the front panel, which also provides three positions of equalization. \$59.50. Allied Radio Corp., 100 N. Western Ave., Chicago 80, Ill.—TECHNICIAN (Ask for No. 5-25)

# How you can make \$50 or more a day in extra profits...with Bogen Complete Public Address Systems



Cash in on PA rentals to clubs, sports events, dances, church bazaars

Almost every day some activity in your area rents a public address system at a cost of twenty-five to fifty dollars or more. Are you letting this business get away from you? Maybe it's because you think installing PA systems presents too many problems...

You don't have to be a 'sound engineer' with Bogen PA. Bogen complete PA systems are the ultimate in easy installation. All you do is connect the microphone, amplifier and speakers and the system is ready to go. Keep both an indoor and outdoor Bogen Complete Public Address System on hand...and start rolling up those extra profits.



J330P Portable 30 watt public address system: J330 Amplifier, microphone, two 12" speakers mounted in snap-together carrying case.

J623TJ 23 watt mobile outdoor public address system: Works on auto battery (for sound trucks) or regular AC current. J623 amplifier with built in phono and shock-mount base, 1 trumpet, microphone.



Cash in on permanent PA installations, too—we'll do all the work!

Bogen engineers are ready to help you draw up plans and specifications for any type job—at a moment's notice... and the Bogen PA catalog can tell you at a glance which system goes where for most installations. Also, don't overlook the profit possibilities in servicing existing PA and intercom installations in your community.

Start getting those extra profits now!



Send for the Bogen complete public address system catalog. Mail this coupon today!

# Bogen

"BECAUSE IT SOUNDS BETTER"

David Bogen Co., Inc., Dept. MO  
29 Ninth Ave., New York 14, N. Y.

Send me the Bogen Complete Public Address System catalog right away.

name \_\_\_\_\_

company \_\_\_\_\_

address \_\_\_\_\_

city \_\_\_\_\_ zone \_\_\_\_\_ state \_\_\_\_\_

**New Products**

**Gahagan DIODES**

The "GC-100" series features hermetic sealing, extremely small size, and ruggedness. It is exceptionally suited to high temperature operation, and is offered with elevated temperature specifications if desired. Available in a wide variety of electrical types. Dimensions of the ceramic body are 0.110 in. diameter by 0.305 in. long. The copper clad tinned lead wire is butt welded to the internal nickle stud, which in turn is soldered to the vitreous ceramic body. Gahagan, Inc., 11 W. 4th St., Bethlehem, Pa.—TECHNICIAN (Ask for No. 5-51)

**CBS-Hytron TRANSISTOR**

P-N-P junction transistor for hearing-aid applications known as the Type 2N38A is especially designed and tested for low noise operation. Peak maximum noise rating is 27 db/mv at a frequency of 1 kc with load resistance of 20,000 ohms and input resistance of 1000 ohms. Differs from its prototype, the 2N38, primarily in the special low noise characteristic. Its nickel silver can, 0.330 in. long by 0.225 in. in diameter, is hermetically sealed against surface contamination, light excitation and humidity. CBS-Hytron, 100 Endicott St., Danvers, Mass.—TECHNICIAN (Ask for No. 5-16)

**Aerovox CAPACITOR PACK**

Power-factor-correction packs for air conditioners, consisting of starting capacitors, running capacitors and fan capacitors, are available in either conduit-type boxes with BX cable and standard fittings, or in special rain-tight containers designed for outdoor mounting. Voltages, capacitance values and wiring of the internal sealed units may be ordered to meet any particular needs. Aerovox Corp., New Bedford, Mass.—TECHNICIAN (Ask for No. 5-36)

**CPC CONDENSER**

New polystyrene capacitor, of extremely high insulation resistance, is designed for use as a charge storage capacitor and as a capacitance divider. The capacitor, except for its studs and aluminum foil winding, is completely plastic. The case itself, which is of plastic tube, has much higher insula-

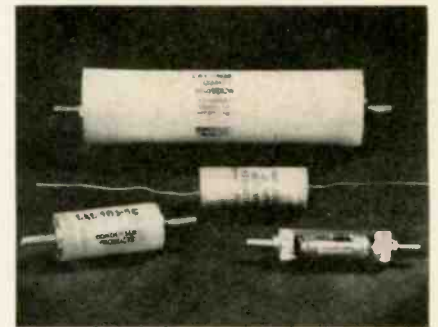

tion resistance than either glass or metal; thus, surface leakage is kept to a minimum. Insulation resistance at room temperature is 30,000,000 meg x mfd at 400 vdc. These resistance values are measured by the time decay of voltage method. Condenser Products Co., Div. of New Haven Clock and Watch Co., New Haven, Conn.—TECHNICIAN (Ask for No. 5-14)

**Claremont CHECK CRT**

The "Fiver," 5XP4 5-in. crt., is designed for testing purposes. It is made with a high voltage electrostatic bent gun which can be used with any conventional values of high voltage. No changes are required when the tube is



employed in an automatic or magnetic focus unit. It can be used with any deflection yoke from 50° to 90° and does not require a focus coil. List price—\$20.95. Claremont Tube Corp., 36-02-3 5th Ave., Long Island City, N. Y.—TECHNICIAN (Ask for No. 5-91)

*Your Ideal*  *SECOND Soldering Tool*



**NEW**  
*Weller Junior*

for your service truck . . .  
service kit . . .  
extra bench tool

MODEL  
8100  
**ONLY**  
**\$795**  
LIST  
over 100 watts

This newest Weller Soldering Gun fills your need for an *extra* soldering tool. Its new, compact design includes *all* regular Weller Gun features, at a rating of over 100 watts. Its new, low price makes it as convenient to buy as it is to own!

SEE THE WELLER *Junior* AT YOUR DISTRIBUTOR NOW

*Weller Junior* **SOLDERING GUN**  
805 Packer Street, Easton, Pa.





**NEW!**

# Sylvania Technical Manual

—the most complete, up-to-date, tube reference available

- Streamline, loose-leaf format makes it easy to use.
- Supplement service keeps you up-to-date month by month.

The new 10th edition of Sylvania's Technical Manual has been brought up to date completely to include the latest receiving tubes, picture tubes, and special-purpose tubes. More pages, more tubes, more features; yet because of its versatile format it's still the handiest, comprehensive manual to use.

Manual owners receive newly released tube data in loose-leaf form regularly so it can be inserted in the manual.

Your copy of the 10th edition of the Sylvania Technical Data Book is available at your Sylvania Distributor—or you can act right now and mail the coupon below.

Lists over 1000 tube types including:

- series-string television types
- color television receiving types
- complete picture-tube listing
- new special-purpose tubes

plus:

- complete characteristic curves on all important types
- tube tester settings for 184 most popular tubes
- new Crystal Diode Chart
- new special-purpose tube chart
- new Resistance-Coupled Amplifier Data.

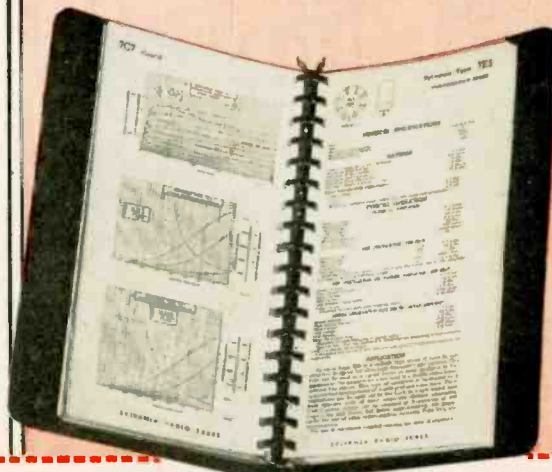

# SYLVANIA

SYLVANIA ELECTRIC PRODUCTS INC.  
1740 Broadway, New York 19, N. Y.  
In Canada: Sylvania Electric (Canada) Ltd.  
University Tower Bldg., St. Catherine Street, Montreal, P. Q.

Department E 39 N  
Sylvania Electric Products Inc.  
1100 Main Street, Buffalo 9, New York  
 check  money order for \$2.00 is enclosed. Please send the 10th Edition of Sylvania Technical Data.

Name \_\_\_\_\_

Address \_\_\_\_\_

City \_\_\_\_\_ Zone \_\_\_\_\_ State \_\_\_\_\_

LIGHTING • RADIO • ELECTRONICS • TELEVISION • ATOMIC ENERGY

## New Tubes

Six new additions are announced to GE's line of "Service-Designed" receiving tubes.

**6BG6-GA**—New beam shield masks off stray electron bombardment from micas and bulb. The new bulb is straight-sided, narrower and shorter. Button stem construction gives shorter, better-separated leads and improves heat conduction. The tube is more shock-resistant with the bottom mica now braced against the glass.

**6CD6-GA** and **25CD6-GA**—New mica design in these horizontal output tubes

prevents arc-over which causes horizontal TV-picture streaking. Plate areas have been increased to provide for 7000-v. positive-pulse peak and 20-watt plate dissipation (as compared with 6600-v. and 15-watt for prototypes). The tubes are smaller in size and sturdier in construction.

**6SN7-GTB**—Features 10.5-sec. heater warm-up to match other heaters in series-string circuits and thus provide even warm-up time. Completely interchangeable with 6SN7-GTA.

**6J6**—Tube elements and structure of tubes now in production have been redesigned to reduce microphonics to a minimum.

**6AV5-GA**—A larger bulb and larger plate radiates more heat and the tube

thus runs cooler than prototypes. Redesigned micas reduce high-voltage arcing. A new beam shield masks off stray electron bombardment from micas and bulb, helping stabilize performance.

Tube Division, R. C. A. announces five new miniature tubes for use in TV receivers.

**6AZ8**—General-purpose multiunit 9-pin miniature tube contains a medium-mu triode and a semiremote-cutoff pentode in one envelope.

The triode unit with its relatively high zero-bias plate current is useful in low-frequency oscillator, sync separator, sync-clipper, and phase-splitter circuits. The pentode unit, which has high transconductance and features a semiremote-cutoff characteristic to minimize cross-modulation effects and overload distortion in picture-i-f stages, may be used as an i-f amplifier, video amplifier, age amplifier, and as a reactance tube. Coupling between the triode and pentode units is virtually eliminated by the basing arrangement and internal construction of the tube.

The RCA-6AZ8 has a maximum overall length of 2-3/16 inches and a maximum diameter of 7/8 inch.

**5AM8** and **6AM8**—General-purpose, multiunit tubes of the 9-pin miniature type. Each contains a high-perveance diode and a sharp-cutoff pentode in one envelope. The diode unit may be used as video detector, dc restorer, and age delay diode. The pentode unit is useful as i-f amplifier, video amplifier, and age amplifier. The 6AM8 heater operates at 6.3 v./0.45 a.; the 5AM8 heater operates at 4.7 v./0.6 a. and is controlled for warm-up time to insure dependable performance in TV receivers utilizing a 600-ma series-heater string arrangement.

**6AW8**—General-purpose, multiunit tube of the 9-pin miniature type containing a high-mu triode and a sharp-cutoff pentode in one envelope. It is designed with a 6.3-volt/0.6 ampere heater having controlled warm-up time to insure dependable performance in TV receivers employing a 600-ma. series-heater string arrangement. The pentode unit may be used as video amplifier, age amplifier, and reactance tube. The triode unit is well suited for use in sync-separator, sync-clipper, and phase-splitter circuits.

**6BZ6**—Semiremote-cutoff pentode of the 7-pin miniature type for use particularly in the gain-controlled picture-i-f stages of TV receivers.

**12CA5**—Beam power tube of the 9-pin miniature type for use particularly in the audio-output stages of TV and radio receivers. It is designed with a 12.6-v./0.6-a. heater having controlled warm-up time to insure dependable performance in receivers employing a 600-ma. series-heater string arrangement.

**GRINDER:** Electric hand grinder gives accurate finger tip control with full visibility, strong motor, 20,000 rpm. \$9.50. Schupack Supply Co., 7331 Cottage Grove Ave., Chicago 19, Ill.—**TECHNICIAN** (As kfor No. 5-30)

### Technicians—"LET'S KEEP IT CLEAN"

*Spray dirt away!*



Use these chemically engineered spray cans to restore contacts



## HUSH

for  
TV TUNERS  
ONLY



6 ounce  
Spray Can

\$2.25 NET

2 ounce and  
8 ounce  
bottles  
available

solution; leaving a film which will not arc or build up dirt layers after application. HUSH is not recommended for Potentiometers, ("volume controls").

Reg. U. S. Pat. Off.

FAST—SAFE—EASY

THE TWO "MUSTS" IN EVERY SHOP  
USED BY LEADING TECHNICIANS,  
MANUFACTURERS AND GOVERNMENT TEST LABORATORIES

Satisfaction Guaranteed  
or Money Refunded

HUSH

For efficient economic results, spray direct to any tuner in the easiest possible manner, even while set is in operation. Will not affect inductance, capacitance or resistance.

Does not react to cold, oil, heat or corrosive

EVER-QUIET

Scientifically developed for the safe and effective cleaning of volume controls (potentiometers), wire or carbon, and all types of electrical contacts. EVER-QUIET is a quality product, lab-tested and approved. Liability protected by one of America's largest underwriters.

Harmless to all metals, insulation and fine finishes. Free flowing, with no powder residue, no effect on I, C or R. Contains no carbon "Tet", gums or other adhesive chemicals.

## EVER-QUIET

for  
CONTROLS  
& CONTACTS



2 1/4 ounce  
Spray Can

\$1.25 NET

2 oz., 8 oz.,  
32 oz. sizes  
available

Sold Coast to Coast—See your distributor

### CHEMICAL ELECTRONIC ENGINEERING, INC.

1025 Broad Street

Plants: MATAWAN, N. J.

Newark, New Jersey

MORGANVILLE, N. J.

from

DELCO RADIO...

One of the Largest Makers  
of High Quality

# SPEAKERS

for Home and Auto Radios,  
Phonographs and Television

Product of combined Delco Radio and General Motors engineering skills, manufactured in plants devoted exclusively to electronic parts, the Delco speaker line embraces 14 standard models for home and auto radios, phonographs, and television—plus the model 8007, a superior Hi-Fi dual-purpose speaker for replacement in AM, FM, TV and phonograph sets, and for use with custom-built high-fidelity audio systems. It's plain to see that here's the speaker line to fill your needs... products of uniformly fine design and construction, *all* of them competitively priced!

**Standard Speaker Features:** Designed and built to R.E.T.M.A. standards; cones uniform in response over operating frequency range; fully dustproofed with drawn brass magnet covers and felted cones; Alnico-V magnets; heavily plated metal parts.

**Model 8007 Hi-Fi Speaker Features:** Size 8"; 50 to 12,500 CPS frequency range; Alnico-V magnet; 10-watt power rating; 4.1 input impedance;  $1\frac{3}{16}$ " voice coil.

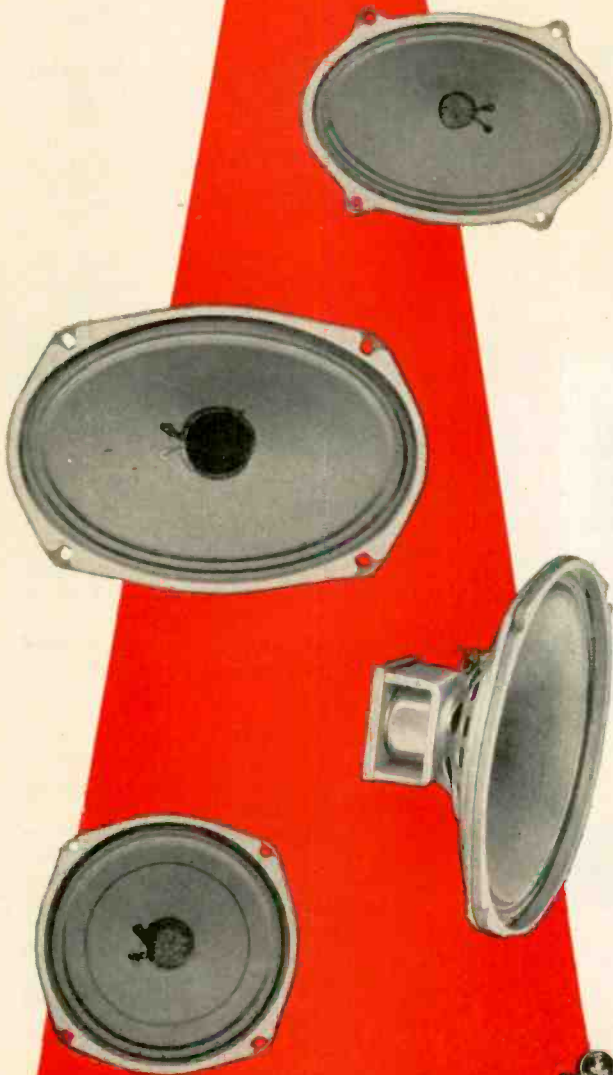

## DELCO RADIO

DIVISION OF GENERAL MOTORS, KOKOMO, INDIANA

GENERAL MOTORS PRODUCT  A UNITED MOTORS LINE

DISTRIBUTED BY ELECTRONICS DISTRIBUTORS EVERYWHERE

Order these quality products of a volume electronics manufacturer through your UMS Electronic Parts Distributor today.

## News of Industry

**FRANKLIN F. WEST** has been appointed mgr. of the new Quality Control Dept. of **CLAROSTAT MFG. CO.**, Dover, N. H.

**STANLEY GRAHAM**, district merchandiser for the radio-TV div. of the **STROMBERG-CARLSON CO.**, in the Southeastern territory, has been transferred to the Mid-West territory.

**CARL J. HERSHBARGER** has been appointed general sales mgr. of the **KAY-TOWNES CO.**, Rome, Ga., antenna mfr.

**JOSEPH H. GILLIES** has been named vice-pres. in charge of manufacturing for **PHILCO CORP.** This is in addition to his present duties as vice-pres. and gen. mgr. of the government and industrial division.

**JACK S. BELDON** has been named mgr. of marketing div. for the **GENERAL ELECTRIC** radio-TV dept. He succeeds **EUGENE F. PETERSON** who was named mgr. of the **INTERNATIONAL GENERAL ELECTRIC CO.'s** consumer goods export dept.

**GUS SNYDER**, partner in **SNYDER MFG. CO.**, has returned from Europe where he visited the Utrecht International Trade Fair in Holland.

**GEORGE T. STEWART** has been named district sales mgr. in Western and Central New York for the radio-TV div. of **SYLVANIA ELECTRIC PRODUCTS, INC.**

**GRADY L. ROARK** will head the newly established "Tube Sales" service organization for electronic tubes and radio and television components at **GENERAL ELECTRIC's** tube dept.



Al C. Olsson



Grady L. Roark

**AL C. OLSSON** has been appointed mgr. of the New York district for **BURGESS BATTERY CO.**, Freeport, Ill.

**ROBERT J. MURRAY** has been named mgr. of the service dept. of the **NATIONAL CO., Inc.**, Malden, Mass.

**ROLAND S. WITHERS** has been appointed general mgr. of **United Motors Service Div. of GENERAL MOTORS.**

**JOHN MILLER**, owner of **MILLER TELEVISION CO.**, Burbank, Calif., has announced the name of the company has been changed to **MILLER ELECTRONICS**, to better reflect the diversification program resulting from their entry into the magnetic recording field.

**RAM ELECTRONICS SALES CO.**, Irvington, N. Y., has inaugurated a series of TV forums to be held in every major television area in the U. S. For details on when a RAM forum will be held in your area, write directly to RAM.

**SYNDICATE PHOTO LABS.**, New York, N. Y. have made three photomurals to depict various country scenes for the "His Honor, Homer Bell" TV show, now being filmed. Believed to be among the largest photomurals in existence, each measures 40 ft. by 20 ft.

**J. J. BANCHI** of the RCA tube div. and **T. D. O'SHEA** of the service section were singled out for the 1954 achievement award of the division's Great Circle Club for the outstanding promotion of the year.

On May 1, **CHARLIE GOLENPAUL**, **AEROVOX** vice-president, celebrates a quarter-century of service with that company. Add to that time a number of earlier years in the infant radio industry . . . when the galena crystal was king and TV was a laboratory gadget.

More News of Industry  
on Pages 38, 40, 56, 57

## LIFE'S "LITTLE" PROBLEMS

ARE EASILY  
SOLVED  
WITH

### LITTLE SPACE

QUAM has a full line of shallow speakers, covering all popular applications.

### LITTLE TIME

QUAM speakers mount quickly and easily in the most difficult installations because of QUAM's unusual mounting bracket.

### LITTLE MONEY

QUAM speakers cost no more—and frequently cost less—than other speakers of the same size and magnet weight.

# QUAM

*Adjust-a-Cone*

# SPEAKERS

*ask for QUAM, the quality line for all your speaker needs*

Quam speakers are listed in Photofact Folders, Counterfacts, File-O-Matic, and Radio's Master.

A FREE copy of the latest QUAM catalog, listing over 100 replacement speakers, is available from your distributor, or from the Quam-Nichols Company.

## QUAM-NICHOLS COMPANY

224 East Marquette Road Chicago 37, Illinois



**“I WANT  
THE TUBES WITH  
THE GOOD  
HOUSEKEEPING  
GUARANTY SEAL!”**

“TV and radio tubes are mysterious things to me, but that Good Housekeeping Seal is a tried and true friend. I trust any product that has earned it. So when you replace tubes in my sets, be sure they’re CBS tubes . . . *the tubes with the Good Housekeeping Guaranty Seal.*”



**Check and Remember**

- 1** It's a *woman* you talk to on most service calls.
- 2** CBS is addressing its national advertising especially to women.
- 3** 53% of *all women* are influenced in their purchases by the Good Housekeeping Guaranty Seal.
- 4** CBS tubes have that Seal.

*Use CBS tubes . . . the tubes in which women have confidence.*



Millions will see or hear about CBS tubes on TV and radio . . . and in national magazines throughout 1955.

**GET YOUR NEW  
CBS Tube SALES PROMOTION KIT**

*Ask your CBS tube distributor for special offer . . . or mail \$2.00 direct for complete Kit.*



**CBS-HYTRON**, Main Office: Danvers, Massachusetts  
A Division of CBS . . . the Columbia Broadcasting System, Inc.

A member of the CBS family: CBS Radio • CBS Television • Columbia Records • CBS Laboratories • CBS-Columbia • CBS International • and CBS-Hytron

"I'VE NOTICED FEWER CALLBACKS"



"Best way I know to keep service customers happy is to install Tung-Sol Tubes—no question about it! Then I'm out servicing new business instead of listening to angry phone calls and losing time and money on callbacks."

## **TUNG-SOL<sup>®</sup>** dependable **PICTURE TUBES**

TUNG-SOL ELECTRIC INC., Newark 4, N. J. Sales Offices: Atlanta, Chicago, Columbus, Culver City (Los Angeles), Dallas, Denver, Detroit, Montreal (Canada), Newark, Seattle.

## **MFRS' Catalogs & Bulletins**

**RECTIFIERS:** A 21-page flip chart describing new Kool-Sel selenium rectifier line is available in 16 in. x 24 in. size and pocket-size from Pyramid Electric Co., 1445 Hudson Blvd., North Bergen, N. J. (Ask for No. B5-1)

**TOWERS & ACCESSORIES:** New brochure describing in detail the complete line of towers, masts, TV tubing and accessories for Rohn Mfg. Co., 116 Limestone, Bellevue, Peoria, Ill. Everything needed for all types of installations is offered in Rohn's "Superior Design Towers and Accessories" folder. For copies, contact Rohn representatives or write direct. (Ask for No. B5-2)

**PRECISION RESISTORS:** Catalog B-9 describes ½-watt molded deposited carbon resistors. Gives comprehensive data on characteristics, applications, tolerance, wattage rating, terminations, dimensions, insulation, etc.—charts and graphs. Available from International Resistance Co., 401 N. Broad St., Phila. 8, Penna. (Ask for B5-3)

**TAPE RECORDER GUIDE:** Practical how-to-do-it manual for recording fans, written in non-technical language, tells how to get the most out of equipment and avoid common errors. "The Revere Tape Recorder Guide" is available in radio, camera, book, music and dept. stores for \$1.95. Tydings Book Publ., Inc., 64 W. Park Ave., Long Beach, N. Y. (Ask for B5-5)

**SPEAKER ENCLOSURES:** An 8-page brochure describing the advantages and disadvantages of the many types of enclosures for high fidelity loudspeakers. Frequency response curves are reproduced to illustrate the characteristics of different enclosure designs. Available from Altec Lansing Corp., 9356 Santa Monica Blvd., Beverly Hills, Calif. or through their dealers. (Ask for B5-6)

**TRANSISTORS:** New catalog of diffused p-n-p junction transistors released by General Transistor Corp., 95-18 Sutphin Blvd., Jamaica 35, N. Y., includes illustrations on a double sealing process (encapsulated in plastic and hermetically sealed in a can) and also covers absolute maximum transistor ratings and characteristics. (Ask for B5-7)

**HI-FI:** "This is High Fidelity" is a 68-page booklet written in non-technical language and explains the functions of the basic units used in home high-fidelity music systems. Included also are complete listings of the latest individual hi-fi components by leading manufacturers in the field. Booklet No. 144 is available without charge from Allied Radio Corp., 100 N. Western Ave., Chicago 80, Ill. (Ask for B5-8)

**ANTENNAS & ACCESSORIES:** A 25-page catalog of antennas and accessories, catalog 55A, incorporates list prices with each item shown, and groups the entire line into various sections for ease in ordering. Conveniently 3-hole punched for ease in inserting into binders, it is available by writing to Catalog Div., Radio Merchandise Sales, Inc., 2016 Bronxdale Ave., New York 62, N. Y. (Ask for B5-9)

**STORAGE EQUIPMENT:** New catalog featuring steel shelving and lockers, as well as other storage and maintenance equipment for industrial and institutional use also contains work of well-known cartoonists and a joke column. For your copy, write Precision Equipment Co., 3636 N. Milwaukee Ave., Chicago 41, Ill. (Ask for B5-11)

**HIGH FIDELITY:** Two-color booklet, "This is High Fidelity," explains hi-fi reproduction of voice and music. It is written in non-technical language and explains the functions of the basic units which are used in home hi-fi music systems. Free. Allied Radio Corp., 100 N. Western Ave., Chicago 80, Ill. (Ask for No. B5-14)

**OBTAIN THE BULLETINS** described here by using the inquiry coupon on page 36. Use the code numbers given at the end of each item of interest.

**CAPACITORS:** Catalog No. 823 gives mechanical and electrical specifications on a new line of fixed and variable air capacitors. Allen D. Cardwell Co., Electronics Productions Corp., Plainville, Conn. (Ask for B5-4)

**INVERTERS:** Chart cross-references all standard ac tape recorder models and the inverters with which they should be used under 4 different conditions: in automobiles, trains, planes or DC districts. Free. American Television & Radio Co., 300 E. 4 St., St. Paul 1, Minn. (Ask for No. B5-15)

## New Books

**TV REPAIR QUESTIONS AND ANSWERS: FRONT ENDS.** By Sidney Platt. Published by John F. Rider Publisher, Inc., 480 Canal St., N. Y. 13, N. Y. 128 pp. Paper cover. \$2.10.

The first in a series planned to cover the TV receiver one section at a time, this volume applies the question and answer technique to the presentation of practical servicing data. In that it gives an informal, easy flow to information that might tend to be on the dry side in some other form of presentation, the approach is successful.

Some typical questions: "The metal rim of a tv knob becomes loose and slips as the knob is rotated. How can the knob be repaired?" "What is the value of measuring the mixer grid voltage when servicing front ends?" "A streaky picture is received on all channels, and the sound is noisy and distorted. Horizontal strips appear to be missing from the picture. What is the probable cause of the trouble?"

As can be seen, the questions cover a wide range of specific troubles and general procedures, mechanical as well as electronic. Many of the answers are step-by-step procedures; all answers are followed by "discussions" that provide background material in addition to the directly pertinent information or cross-refer the reader to other questions that treat related material. Six chapters deal separately with antennas, transmission lines, mechanical and electrical front end troubles, alignment problems, boosters and UHF converters.

**LICENSE MANUAL FOR RADIO OPERATORS.** By J. Richard Johnson. Published by Rinehart & Co., Inc., 232 Madison Ave., N. Y., N. Y. 430 pp. Hard cover. \$5.00.

Keyed to the FCC Study Guide, and following its sequence of presentation, this volume presents full answers for all eight elements in the form to be used when taking the examination. Intended for full study rather than to supply answers by rote, the volume resorts to detailed discussions and illustrations wherever necessary. This feature renders the handbook suitable for use in courses of study. A large appendix section includes a course outline and study program correlated with the material in the book; information about treaties, laws and regulations; and also charts, tables, and source references of value to the reader who has already acquired his license, as well as to the student.

**BASIC VACUUM TUBES AND THEIR USES.** By John F. Rider and Henry Jacobowitz. Published by John F. Rider Publisher, Inc., 480 Canal St., N. Y. 13, N. Y. 208 pp. Paper cover. \$3.00.

Lavishly illustrated with imaginative, cartoon-type sketches, this book tells what goes on inside the miraculous tubes in an absorbing way without leaving the reader behind by soaring up toward the engineering level. It is, in truth, a basic book; but that is not to say that it glosses over its subject. Math is held to a minimum. Where it must appear, it is preceded by a clarifying explanation. For example, *amplification factor* (the authors tell us) equals *small change in plate voltage* divided by *small change in grid voltage*. When the conventional formula for this statement, using all the strange Greek symbols, then appears, it hardly seems frightening at all.

Introductory chapters study the tube itself, and electrons and electron emission. With these basics out of the way, diodes, triodes and multielectrode tubes are treated.

"I'VE NOTICED BETTER PERFORMANCE"



"I don't know a thing about a television set . . . but our serviceman certainly does! When he fixed it, he used a Tung-Sol Tube. And now, thanks to our serviceman, the set plays just like the day it arrived."

## TUNG-SOL<sup>®</sup> dependable TUBES-DIAL LAMPS

TUNG-SOL makes All-Glass Sealed Beam Lamps, Miniature Lamps, Signal Flashers, Picture Tubes, Radio, TV and Special Purpose Electron Tubes and Semiconductor Products.

## Keyed AGC

(Continued from page 25)

change the applied voltages to cathode, control grid, and screen grid of the gate tube. This would not ordinarily happen in the case of Fig. 5 as there is a control to compensate the condition in the cathode of the key tube.

When the receiver behaves as though simple agc were present, the trouble is ordinarily caused by some variation in component parts or

voltages to the gate or key tube, which permit it to remain conducting all the time. This condition allows noise and the vertical pulse groups to affect agc. The tipoff to this trouble usually comes from the customer who complains: My TV is affected by my refrigerator and other appliances, which did not happen when I first got it."

To test for this trouble, disconnect or otherwise disable the key signal. If the key tube permits agc to be generated at the points B with key signal disabled, then the tube itself is leaking. It's as though the key were closed all the time (Fig. 1)

and not affected by the signal from the horizontal amplifier. Your test instrument at points B is your voltmeter on dc function. The trouble is due to any of several causes:

a. *Improper bias on the key tube, due to voltage variation of applied voltages to key tube circuit.* One of the most frequent causes is some shift in the voltages applied to the key tube circuits due to a malfunction or component change elsewhere in the set, which permits the cutoff bias of the key tube to be lost, and thus permits the key tube to conduct all the time. Voltmeter tests will localize this trouble.

b. *Change of components permits key tube to pass the agc when it should be nonconducting.* This cause is similar to the preceding except that the offending parts are located in the key circuit itself. To these cases which are readily located by the voltmeter and ohmmeter, we



MODEL 532

- ELECTRONIC PLATE CONDUCTANCE TUBE ANALYZER
- ACCURATE VOLT-OHMMETER ● DRY BATTERY TESTER
- CONDENSER LEAKAGE TESTER
- ALL IN ONE ATTRACTIVE LUGGAGE TYPE CASE

Here's a new Chicago instrument with more useful features than you will find at anywhere near the price. You can check all receiving tubes (also picture tubes) quickly and accurately.

The Model 532 is strictly a quality Instrument with a patented switching arrangement for quick set-ups to test diodes as diodes, triodes as triodes and pentodes as pentodes. It includes an illuminated roll chart, large 3-color clear plastic meter, picture tube adapter and highly attractive 2-tone Fabricoid covered case.

The V.O.M. is of the same excellent accuracy for which Chicago instruments have long been noted. It has the following ranges:

A.C. Volts: 0-10/100/500/1000  
D.C. Volts: 0-10/100/500/1000  
Ohms: 0-5000/50,000/500,000/50 meg.

**Model 532 Price Complete—**

Only  
**\$90.00**  
net

Model 531 Tube and Battery Tester (not illus.) Similar to Model 532 but for tube and battery testing only. Attractive blue simulated leather covered, wood carry case. This genuine dynamic plate conductance tube analyzer is now yours at the price of an ordinary tester. Its illuminated roll chart lists all receiving tubes including the very latest types now coming on the market.

**Model 531 Price Complete—**

Includes Picture Tube Adapter

Only  
**\$70.00**  
net

Ask your Jobber or write for complete information.

**Chicago** INDUSTRIAL INSTRUMENT CO.

536 W. ELM STREET

CHICAGO 10, ILL.

## NEW . . . COMPLETE PORTABLE SERVICE UNIT

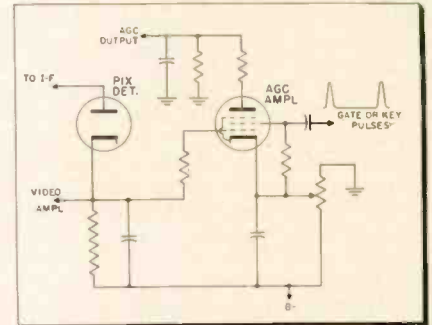

Fig. 5—Keyed system with threshold control.

add the case of excessive video drive (perhaps due to a faulty component in a circuit like Fig. 4 wherein  $R_1$ ,  $R_2$ , and  $R_3$  serve as voltage dividers for the video signal) which permits the blacks of the video signal to drive the tube to conduction. Such a case came to your author's attention recently wherein the customer complained that a 'dark' picture (one with a lot of black in it) got still darker than it should, compared to the previous operation of the set. The trouble was excessive video drive coupled with very little bias between the cathode and control grid to keep the key tube non-conducting.

### Symptom: Partial Keying

Another type of symptom is that caused by incomplete conduction. This results in an insufficient signal at points B or rather an insufficient control voltage at points B. One of these cases was due to insufficient key voltage following the installation of a condenser (to increase the width) across the width coil, whose secondary furnished the agc key



signal. Replacement of the flyback (the true trouble) and removal of the condenser permitted normal functioning of the entire circuit.

Another case of insufficient key signal is remembered in which the oscilloscope picture showed an apparent differentiation of the key signal. Actually the key signal was differentiated due to a high resistance inside the width coil transformer as subsequently verified by an ohmmeter. The symptom was insufficient agc at points B. The differentiation permitted only a very small part of the horizontal pulse to be effective in developing agc voltage. Flyback agc coils can develop similar troubles.

In summary, keyed agc presents the added problems of an amplifier tube biased to cutoff, which nonconduction must be changed to conduction during the period of the horizontal sync pulse by a keyed signal synchronous with the horizontal pulse. A test on the agc bus line will reveal whether or not agc is present (you test at points B) or insufficient. Then you test the source to see whether the key tube is passing agc or not. Removal of key signal tests for the conduction of the key tube when it should not

be conducting, or for partial conduction. The foregoing tests will reveal the locale of the defect. The exact defect is chased down by conventional checks with the ubiquitous meter. •

## Hum in TV

(Continued from page 27)

can, of course, be present at the same time.

Many a baffling cause of hum is due to pickup on wiring in some circuit where component values are high, as in phase detectors. The typical circuit shown in Fig. 8 is for the Trav-ler models 12L50 and 16G50. If the horizontal sync pulses are more than adequate, changing the .001 mfd. capacitors to .0005 mfd. will reduce any small hum voltages fed through to the phase detector. One of the most frequent causes of hum is due to an open .01 mfd. capacitor or one with internal resistance (check on capacitor tester). Values up to .02 mfd. may be helpful, but do not exceed this value as the pulse fed back from the width coil secondary as a comparing volt-

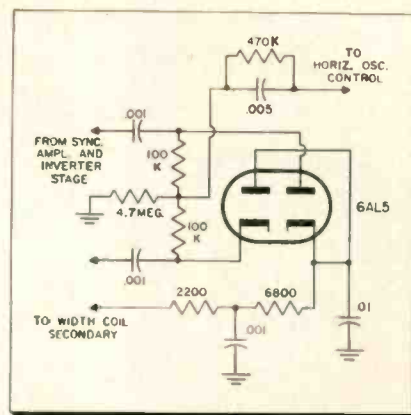

Fig. 8—Hum pickup is common in phase detectors, and other circuits using high value components.

age may be insufficient for proper sync locking. Replacing this capacitor with a new one has resulted in straightening out posts, trees and other vertical objects which have a tendency to weave or "buckle" as the action in the picture changes. Changing the 4.7 meg. resistor to 2.2 megs. has no appreciable effect on the operation but results in slightly less hum pickup. As this circuit is similar to that used in many other receivers it may pay to keep these points in mind when hum trouble from this source arises. •

### NEW!

Miniature and Sub-miniature Electrolytic Capacitors



FAMOUS FOR "Time Tested Quality"

EXPORT  
15 Moore Street  
New York 4, N. Y.  
Cable "Minthorne"

## ILLINOIS the Capacitor Line of Time Tested Quality

NOW PRESENTS

### "HANDEE-PAK" Capacitor Kits

- ELECTROLYTIC CAPACITOR KITS
  - CERAMIC CASED PAPER CAPACITOR KITS
- IN POPULAR CAPACITY AND VOLTAGE RANGES

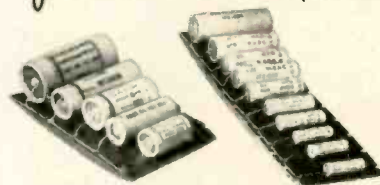

Kits Are Packaged In Polyethylene Bags

Here are the new "ILLINI HANDEE-PAK" Assortment Kits now on display at your jobber. Attractively and conveniently packaged on cards and sealed in transparent polyethylene bags, each of the kits contains the most popular capacity and voltage ranges in use by the service industry.

Each of the ELECTROLYTIC "HANDEE-PAK" kits consists of five popular assorted capacitors. The paper capacitor kits are made up of ten assorted of the new type ITC oil impregnated ceramic cased capacitors, de-

### "STE-TITE" TYPE ITC CERAMIC CASED PAPER CAPACITORS

- Capacity Ranges  
From .0005 to 1.0 mfd.  
200-400-600 & 1600 WVDC
- Excellent Power Factor
  - Accurate Capacity
  - High Insulation Resistance
  - Overload Tested
  - High Temperature Operation
  - Oil Impregnated

scribed below.

These capacitors lead the field in advanced design, superior quality and workmanship and are the ultimate in packaging and convenience. "HANDEE-PAKS" simplify storage, banish shelf-life problems.

A few "HANDEE-PAKS" in your service kit take up little room, serve you by being factory fresh and easily identified. Use them with confidence — millions of capacitors produced to date are your assurance of "Time Tested Quality".

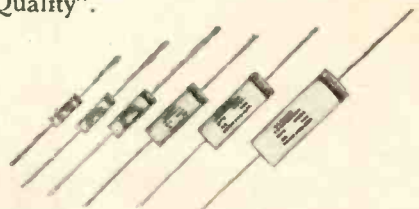

If your jobber cannot supply you, write for catalog and information on the new "HANDEE-PAK" kits.



ILLINOIS CONDENSER COMPANY  
1616 N. THROOP STREET CHICAGO 22, ILLINOIS

# IT'S NEW! FAST SURE CUT TELEVISION SERVICE TIME IN HALF



Model  
TV-20P  
NET  
\$119.50

In brown leatherette portable case

### COMPLETELY UP TO DATE!

The TV-20 Line of Television Tube Testers has just been brought up to date with all of the new 600 mil series and color TV tube types. Over 200 television tubes are included on the front panel.

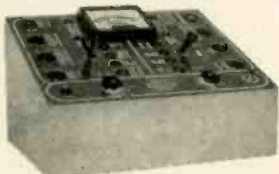

← Model TV-20C  
NET \$97.50

In counter style case with sloping top panel. This model makes tube testing at your store counter profitable.



Model TV-20G  
NET \$97.50

In Metal Utility Cabinet  
(Open Face Style)

- Also available in floor model "self-service" style cabinet! Write for details.

Developed and Manufactured by  
**AMERICAN SCIENTIFIC DEVELOPMENT COMPANY**

334-336 SOUTH MAIN STREET

FORT ATKINSON, WISCONSIN

## "Really Built"

### JONTZ Kwick-Up Telescoping Masts

Jontz Kwick-up telescoping masts are available in 3 lines: The De Luxe 100 series, made from hot-dipped galvanized 16 gauge tubing. The Standard 200 series, made of 16 gauge tubing rolled from galvanized strip. The Standard 300 series made of 18 gauge tubing rolled from galvanized strip with 1 1/4", 16 gauge top.

- Mast sections will not pull apart with the exception of the top section which enables easier antenna mounting.
- New type locking device for faster erection and locking without tools.
- Revolutionary new guy ring eliminates all strain, tension, and friction on the next section to be erected.
- Newly designed companion base assures definite locking, will not turn in the wind.

Sell the Line that is "Really Built" to do the job  
Available at better jobbers everywhere

## JONTZ MANUFACTURING CO.

1101 East McKinley, Mishawaka, Indiana

IN CANADA: Active Radio & TV Distributors  
60 Spadina Ave • Toronto, Canada



## Service Ass'n Reports

### 10th Birthday for "News"

ARTSD News, organ of the Associated Radio-TV Service Dealers, Columbus, O., celebrated its 10th birthday recently by adding several new departments and a "Looking Back" column. Among the worthwhile recommendations offered to ARTSD members was a plea to those technicians who refused to take night service calls. The News urged that the calls be referred to other members. The organization keeps a roster of the technicians interested in taking night service.

### RCA Prize to Kansas Tech

Robert Hester, operator of a radio & TV service firm at 6001 Johnson Dr., Mission, Kans., was presented with RCA's electronic statuette as a symbolic tribute to the 100,000 television technicians throughout the nation. The award was made by W. Walter Watts, exec. vice-pres. of electronic products for RCA following the NBC color telecast of Peter Pan on March 8.

### Seek Licensing Ordinance

Among the plans being considered by the Radio-TV Service Dealers Assoc., Spokane, Wash., to curb activities of the "basement" operators is one which calls for a petition to the city government for an ordinance requiring all persons wishing to enter the TV servicing business to pass a stiff examination, pay a reasonable license fee and post bond to insure execution of high standard work.

### "Dragnet" Tie-In Ad

Two spot announcements preceding the local TV showing of the now-famous Dragnet "TV Gyp" presentation served to call the public's attention to the activities of the King County Television Servicemen's Assoc.

The organization is working closely with the district attorney's office on a case in which customers have been billed for new picture tubes which they did not receive. When and if any publicity breaks, TSA will get credit and mention for their efforts.

### IRTSA Elects Officers

The Indian Head Radio-TV Servicemen Assoc. of Northwestern Wisconsin met in Chippewa Falls on April 12 for the annual banquet and election of officers. Elected for the 1955-56 term were: president, B. F.

O'Connell; vice-pres., Earl Kratch; secy., Upton C. St. Clair; treas., Sherwood Stolp. Elected to the Board of Directors were: Charles Steimke, and Rudy Frick.

### N.Y. Group Opposes Licensing

A sharply defined stand against licensing of TV servicemen has been taken by the Western New York Electronics Guild. The organization's chairman, W. M. Harrington, pointed out that the illegal practices which the licensing bill would be aimed at curbing are already covered by existing laws. In place of licensing the organization recommends setting up local investigating committees to study charges of malfeasance practices and misleading "bait" advertising. It was also pointed out that licensing would put a burden on the one-man shops with possible loss of their services to the public, thereby increasing the cost of TV service because of the non-competitive field.

### Price War in Minneapolis

The official bulletin of MINTSE, the Minnesota Television Service Engineers, reports that in and around Minneapolis service calls are being advertised as low as 95¢ per call. Part-timers and hobbyists are the culprits. Action is being taken to put an end to the practice.

### Condemn Distributor Practices

The executive committee of the Associated Radio & TV Servicemen, 433 S. Wabash Ave., Chicago 5, in a resolution submitted to its members, stated that ARTS members "have long known of and suffered from the practice of indiscriminate selling at wholesale prices to any and all of the consuming public by the radio and electronics parts jobbers and/or wholesalers.

"... Therefore the members of ARTS, Illinois have expressed themselves in opposition to these unfair trade practices."



# CASH IN on Multiple TV installations

for motels, apartments, clubs

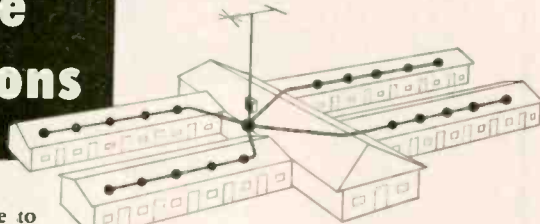

Sell terrific "come-hither" value to motels, tourist courts, apartment houses,

and clubs, by equipping every room with the finest television reception! Sell the single-antenna system that does away with a roof full of costly, dangerous, unsightly separate antennas. Sell the ease of adding receivers without additional roof work.

The Jerrold TV *Multi-Outlet* System feeds snow-free signals to twenty or more sets from one antenna, with full signal strength at every receiver and with no interaction between sets. Heart of the system is the indoor-mounted 5-tube Jerrold ABD-1 Distribution Amplifier, which distributes the sharpest picture attainable in any area, on low-noise coax cable to individual line-tap impedance matchers in each TV-equipped room.

Jerrold engineering simplifies every step of your installation, from the antenna to the receivers. *You save outdoor time and equipment*, and you boost your repeat-service market on individual receivers!

The farsighted motel and apartment owner is going more and more to Jerrold *Multi-Outlet* television. Will you be there when he buys?

Write for free illustrated literature to help you sell.

**JERROLD ELECTRONICS CORPORATION**

1415 S. 26th Street

Philadelphia 46, Pa.

# JERROLD

THE TV RECEIVER for HIGH-FIDELITY SYSTEMS

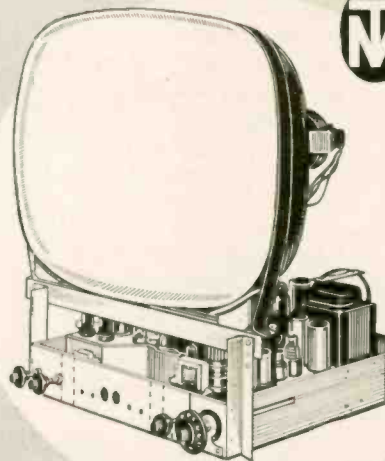

GOLD MEDAL SERIES

# TECH-MASTER



CUSTOM-BUILT CHASSIS FOR CUSTOM INSTALLATIONS

At Leading Radio Parts Distributors

Literature Upon Request

TECH-MASTER Corporation  
75 FRONT ST. • BROOKLYN 1, NEW YORK

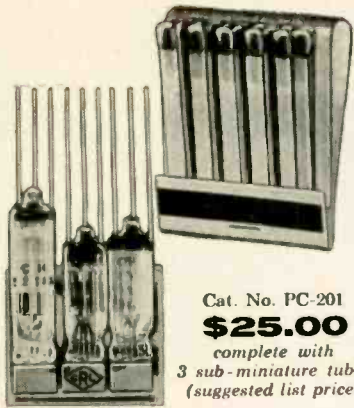

Cat. No. PC-201  
**\$25.00**  
 complete with  
 3 sub-miniature tubes  
 (suggested list price)

## Here's where spare-time fun begins!

### Centralab Ampec® 3-stage P.E.C.\* Audio Amplifiers

You can use them to build all sorts of exciting, miniature projects — pocket radios, mike preamplifiers, signal tracers, portable megaphones, phonograph pick-ups, hearing aids, model controls — even stethoscopes

For your work or your hobby, you can have a "picnic" with Ampec. It's the highest form of Printed Electronic Circuits and provides complete electrical service from input to output. Wiring, capacitors, resistor, and tube sockets are bonded to a single, master plate.

Even with tubes, Model 2 Ampec is smaller than a book of matches. Model 3 is smaller than a postage stamp — and it has a tone circuit, besides! You can get either model with or without tubes. The quality of both models measures up to the same high standards you enjoy in the Centralab components you install every day.

Ask your Centralab distributor to tell you more about Ampec. And send coupon for Booklet 42-142 with complete specifications and application "ideas".

\*Trademark

# Centralab

CENTRALAB  
 A Division of Globe-Union Inc.  
 902E E. Keefe Ave., Milwaukee 1, Wis.

Send me free Booklet 42-142.

Name \_\_\_\_\_  
 Company \_\_\_\_\_  
 Address \_\_\_\_\_  
 City \_\_\_\_\_ ( ) State \_\_\_\_\_

### MARCONI MEDAL AWARDED



Monte Cohen, old-time ship's wireless operator, radio industry pioneer and now pres. of General Instrument Corp., receives Marconi Medal of Achievement from Veteran Wireless Operators Assoc. pres., Wm. J. McGonigle, at VWOA's 30th anniversary dinner in NYC.

**SEL-SON ELECTRONIC TUBE CORP.**, Darby, Penna., has begun initial deliveries of aluminized picture tubes to distributors throughout the country. SEL-SON now offers a line of standard and aluminized picture tubes in all sizes from 10-in. to 27-in.

Announcement has been made by presidents of the respective companies of the acquisition of the **HYCOR COMPANIES** of Calif. and Puerto Rico by the **INTERNATIONAL RESISTANCE CO.** Management of the **HYCOR COMPANIES** will continue operations independently.

A new company has been formed, the **PENNSYLVANIA FLUORO PLASTICS CO.**, Philadelphia, Penna., to make heavy walled tubing of "Teflon" tetrafluorethylene resin. They will supply tubing for application in the electrical, chemical, petroleum and aircraft fields.

**B. J. DeJARNATT WHOLESALE CO.**, Fresno, Calif., was honored for having completed 25 years continuous affiliation with **SYLVANIA ELECTRIC PRODUCTS INC.** as a distributor of receiving tubes, picture tubes and electronic components.

### JSC HALF WAY MARK



Peter Hagedoorn, pres. of Jersey Specialty Co. assembles partial group of prizes in the "Time-of-Your-Life-Vacation Contest," now at half-way mark. Contest ends August 10th.



Shows You  
 Plenty!

Best of all, Walco shows you how to make money — *real money* — with your replacement needle business!

Walco starts you off *right* — with a needle inventory that's light in the right places, and heavy just where it *ought* to be — and then follows through with the most realistic price and discount policy in the industry.

To top it off, Walco backs you up with the strongest needle merchandising program anywhere.

You haven't seen anything, till you see the deal you'll get from Walco. Call your Walco distributor today — *he'll show you plenty!*

Write for a full size print of Hazel, the Walco cutie above, plus vital needle profit information.

NEEDLES FOR EVERY  
 PHONOGRAPH BY

# Walco

Trade Name of Electrovox Company, Inc.  
 60-T Franklin Street East Orange, N. J.

# NEW STOCK OF FIRST QUALITY TELTRON TUBES

**GUARANTEED LOWEST PRICE EVER!**  
All tubes individually boxed  
and unconditionally guaranteed

**GIFT OFFER!** One 6BG6G  
Tube will be shipped FREE  
with any \$10.00 order  
accompanying this ad.

## FREE BONUS OFFER!



Model 625K

- Illum. gear-driven "Speed Rolchart"
  - New lever-action switches for individual testing of every element
  - Tests all conventional and TV tubes
- This Elco Tube Tester is yours FREE when you buy \$100 worth of tubes or more within 60 days at Teltron.  
May be bought outright from Teltron for \$34.95.

TYPE	PRICE	TYPE	PRICE	TYPE	PRICE	TYPE	PRICE
1A7GT	.53	6BA7	.58	6S8GT	.65	12BH7	.61
1H5GT	.51	6BC5	.48	6SA7	.45	12BY7	.65
1L4	.51	6BE6	.46	6SK7GT	.45	12BZ7	.63
1L6	.51	6BF5	.48	6SL7GT	.60	12SA7	.45
1L6G	.49	6BG6G	1.18	6SN7GT	.60	12SL7GT	.60
1N5GT	.51	6BH6	.51	6SQ7	.40	12SK7	.45
1X2	.65	6BJ6	.51	6T8	.71	12SN7GT	.56
2A3	.35	6BK5	.75	6U8	.76	19T8	.71
2A7	.35	6BK7	.78	6V3	.80	25B06GT	.82
305GT	.61	6BL7GT	.78	6V6GT	.48	25C06	1.09
3V4	.48	6BQ6GT	.83	6V4GT	.43	25Z5	.55
5V4G	.49	6BY5G	.60	6W6GT	.53	25Z6GT	.36
5Y3GT	.30	6BZ7	.95	6X4	.37	35B5	.48
5Y4G	.40	6C4	.41	6X5GT	.38	35C5	.48
6A8	.40	6CB6	.51	6X8	.80	35L6GT	.41
6AC7	.65	6CD6G	1.63	7F8	.49	35W4	.33
6AH4GT	.65	6C06	.95	12A15	.43	35Y4	.42
6AK5	.96	6F6	.42	12AT7	.71	35Z5GT	.33
6AL5	.43	6F5GT	.44	12AU6	.43	50A5	.49
6AQ5	.48	6H6	.50	12AU7	.58	50B5	.48
6AR5	.48	6J5GT	.49	12AV7	.73	50C5	.48
6AU5GT	.60	6J6	.61	12AX4GT	.60	50L6GT	.50
6AV5GT	.60	6K6GT	.39	12AX7	.61	117L7GT	1.20
6AV6	.37	6K7	.40	12AZ7	.65	117Z3	.33
6AX4GT	.60	6L6	.78	12B4	.72	117Z6GT	.65
6AX5GT	.60	6Q7	.40	12BA7	.58	80	.40
6BA6	.58	6S4	.41	12BE6	.46	1629	.39

**SPECIALS! THru June 1st**

1B3GT	.59	6AG5	.47
1R5	.45	6AU6	.39
1T4	.45	6BN6	.79
1U4	.45	6BQ7	.79
1U5	.38	7N7	.47
304	.47	12AT6	.34
3S4	.44	12BA6	.39
5U4G	.40	12SQ7	.34
6AF4	.89	25L6GT	.37

**SAME  
DAY  
SERVICE**  
48 Hour Postal  
Delivery To  
West Coast

**TERMS:** Save all freight and postage charges. All orders accompanied by full remittance will be shipped POST-AGE PAID anywhere in the continental U.S.A. 25% deposit required on C.O.D.'s. \$1.00 handling charge on orders under \$10.00. Open accounts to rated firms only.

## TELTRON ELECTRIC COMPANY

DEPT. T-5

428 Harrison Ave., Harrison, N. J.

Humboldt  
4-9848

**DO YOU WANT TO TRAVEL**

**FOR A LEADING**

**COMPONENT MANUFACTURER?**

Nationally known company needs personable, bright young men with good TV training to travel, making talks before groups of service technicians, etc. Please give full resumé of experience and education in first letter. Single men 21 to 28 preferred. Harry P. Bridge Advertising, Att'n Walter J. Werbos, Vice President, 1201 Chestnut Street, Philadelphia 7, Pa.

## CLOSING DATES FOR

### TECHNICIAN & Circuit Digests

- 1st** of preceding month for all ads requiring proofs, composition, foundry work, key changes, etc.
- 10th** of preceding month for complete plates only—no setting.
- 1st** of month—Publication Date. Cancellations not accepted after 1st of preceding month.

**CALDWELL-CLEMENTS, INC.**  
480 LEXINGTON AVENUE, NEW YORK 17

Still Time For You To Win

# A FREE TRIP

To Bermuda or Trinidad

in Jersey Specialty's

## TIME - OF - YOUR - LIFE

## CONTEST!



● **Thousands of entries** pouring in from all parts of the country!

● **Distributors report tremendous interest** shown by dealers!

● **Distributors' orders** for No. 2080 hundred foot TV wire coils flooding JSC plant now running full blast to meet orders from all over the country.

**Dealers! Dealers!**

Rush Your Letter To JSC Today! Coupons mailed to you on receipt of your letter for free wire. Important, coupons redeemed at your wholesale distributor. Write today (your distributor has full details). All entry letters must comply with official contest rules.

**Special May Show Bonus**  
Use the free coupon below  
for your free wire. **Hurry!**  
**Hurry! Hurry!**



**Jersey Specialty Co., Inc.**

Burgess Place, Mountain View, N.J.

Visit Jersey Specialty Co. at  
Booth No. 101 at the Electronic Parts Show.

**Time-Of-Your-Life Contest Extra Show Bonus Coupon**  
This coupon entitles you to a free 100 ft. coil of JSC wire.

Name of your distributor .....

Your name .....

Address .....

City ..... State .....

Mail coupon today to—Jersey Specialty Co., Inc.,  
Burgess Place, Mountain View, N. J.



# RECEIVING and TRANSMITTING TWIN-LEAD

All AMPHENOL twin-leads are made with GENUINE VIRGIN polyethylene. There are no impurities which may increase signal loss. There are no air pockets or voids around the pure copper conductors such as may be found with reground or reclaimed polyethylene twin-leads. AMPHENOL twin-leads are stronger and have a greater resistance to abrasive action, such as scraping against a mortar joint.

You can be sure that genuine AMPHENOL twin-leads will provide longer, trouble-free life and the greatest amount of signal transfer so necessary for brilliant reception.



14-056 Flat Twin-Lead

finest



14-271 Tubular Air-Core Twin-Lead

quality



14-076 1KW Deluxe Air-Core Twin-Lead

for



14-100 Century Twin-Lead

dependable



14-185 Heavy Duty Twin-Lead

performance



14-298 4 Conductor Rotator Cable

\* U.S. Pat. 2,543,696

See your distributor or write directly to AMPHENOL for your copy of the Vest Pocket Guide to Twin-Leads.



AMERICAN PHENOLIC CORPORATION  
chicago 50, illinois

In Canada: AMPHENOL CANADA LIMITED Toronto

## PA Installation

(Continued from page 33)

speech and music were required over the playing and dancing area, and another where coverage over this area was not required. The ceiling-mounted cluster shown in Fig. 4 actually contains two separate speaker systems for effective adaptation to all requirements. When no output is required over the playing floor, a switch takes the four two-way speakers (mounted in the wooden cabinets facing downward)

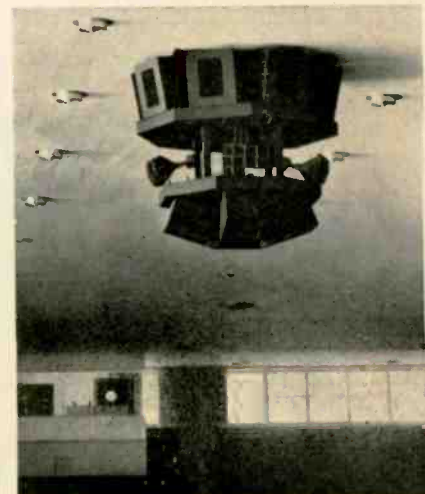

Fig. 3—Field House, U. of Ky., showing large listening area to be covered by sound system.

out of the overall circuit. There is sufficient coverage in the upper cluster to completely handle the balcony area, and even cover under the balcony.

In some concluding comments on installations, Bender cautions against using equalization techniques too freely, despite the fact that one of the examples discussed employed this method. Equalization should be a last resort where ambient noise levels or unfavorable

Fig. 4—Center-mounted speaker cluster (U. of Ky. Field House) uses 8 l-f units and 8 h-f units (into 4 h-f horns) for balcony coverage, plus 4 coax units, facing downward, for optional coverage of playing area when needed.



acoustical conditions preclude the use of straight line frequency reproduction. Often, where reproduction of low frequencies at full power is impractical, it is better to shelve the lows.

If system balance is worked out for a capacity audience, there should be a means of correcting for a half-occupied auditorium, which is commonly encountered.

When equalization techniques are unavoidable, variable equalizers are used to establish desired response, then fixed equalization is inserted after this determination.

Heavy machinery (substantial low-frequency noise levels) may become highly objectionable in the system. The insertion of high-pass filters is a measure worth considering.

Ambient noise levels will be a factor in determining the amount of power required; knowledge of the area to be covered will determine whether speakers are to be cone type, trumpet type, or multicellular horns.

Amplifier selection should be predicated on the mechanics of operation. For example, if the installation requires 24-hr. operation, amplifiers would definitely be of the commercial type rather than of the over-the-counter variety.

Whenever a multiplicity of speakers is used, great care should be taken in phasing all of them, even where they are being operated from separate amplifiers. This is vital to avoid the distortion effect when the listener is in the fringe area where the field from one speaker overlaps the field of another.

## \$ in Mobile Radio

(Continued from page 26)

and obtaining service contracts. Thus, membership in a national service organization effectively increases the force of the service station operator at no expense. These "extra" personnel will sell the station's services to users of communications equipment.

To summarize, here is a program that will enable a service station operator to make the most out of his technical knowledge:

- 1) Become affiliated with a national service organization
- 2) Foster your technical know-how
- 3) Seek and follow advice on business matters
- 4) Obtain service contracts from the manufacturer . . . and keep them by providing satisfactory service. ●

THE NEW MODEL TV-11

# TUBE TESTER



Operates on 105-130 Volt 60 Cycles A.C. Hand rubbed oak cabinet complete with portable cover . . . . . **\$47.50**

● Uses the new self-cleaning Lever Action Switches for individual element testing. ● Because all elements are numbered according to pin number in the RMA base numbering system, the user can instantly identify which element is under test. Tubes having tapped filaments and tubes with filaments terminating in more than one pin are truly tested with the Model TV-11 as any of the pins may be placed in the neutral position when necessary. ● Uses no combination type sockets. Instead individual sockets are used for each type of tube. Thus it is impossible to damage a tube by inserting it in the wrong socket. ● Free-moving built-in roll chart provides complete data for all tubes. ● Phono jack on front panel for plugging in either phones or external amplifier detects microphonic tubes or noise due to faulty elements and loose external connections.

**EXTRA SERVICE**—The Model TV-11 may be used as an extremely sensitive Condenser Leakage Checker. A relaxation type oscillator incorporated in this model will detect leakages even when the frequency is one per minute.

**SHIPPED ON APPROVAL  
NO MONEY WITH ORDER — NO C. O. D.**

Try it for 10 days before you buy. If completely satisfied send \$11.50 and pay balance at rate of \$6.00 per month for 6 months.—No Interest or Finance Charges Added. If not completely satisfied, return to us, no explanation necessary.

**MOSS ELECTRONIC DISTRIBUTING CO., INC.**  
Dept. D-127, 3849 Tenth Ave., New York 34, N. Y.

Please rush one Model TV-11. I agree to pay \$11.50 within 10 days after receipt and \$6.00 per month thereafter.

NAME .....

ADDRESS .....

CITY ..... ZONE ..... STATE .....

**KENCO KATE SAYS**

**"NO INSTALLATION PROBLEMS when you use KENCO MOUNTS"**

**KENCO SPIDER**

**18" ADJUSTABLE WALL BRACKET**

No need to hold bracket while driving screws—Simply drive two top lag screws to within 1/4" of wall, KENCO Drop-Slot permits hanging of bracket for tightening. Special full thread hex head lag screws. Only one wrench required for entire installation. Embossed legs for greater strength. Neat in appearance—No part of bracket extends beyond mast. Available in aluminum or steel-hot dipped galvanized. Shipped fully assembled.

For full information on the complete KENCO line write Dept. "5".

**KENWOOD ENGINEERING CO., INC.**  
Kenilworth, New Jersey

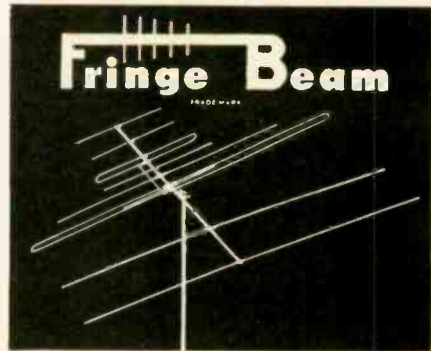

**brings you the  
SKY ROCKET  
Antenna**

Sky Rocket is a broad band inline yagi affording high gain in a compact design. It is a sensational performer, permitting deeper penetration of fringe areas. Has new click-rig element clamps with no nuts to tighten. Just unfold and they lock in place automatically. Mail coupon for details.

**NEAL ELECTRONIC COMPANY, INC.**  
1037 Hall St., Huntsville, Alabama  
Send prices and other details.

Name .....

City ..... Zone .....

State ..... TN

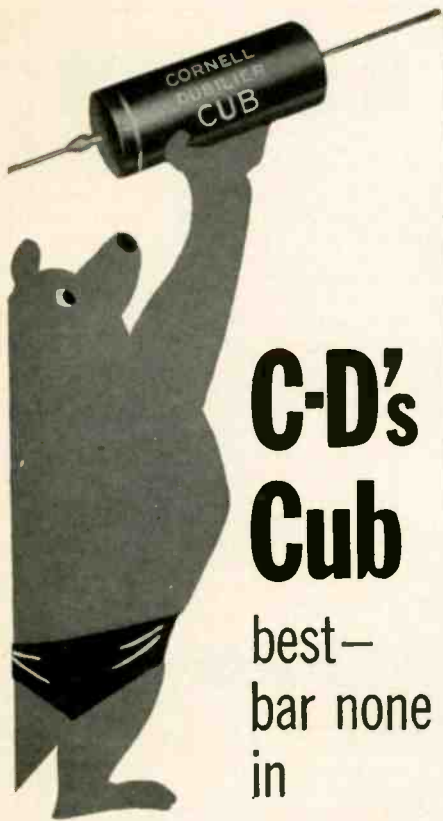

# C-D's Cub

best—  
bar none  
in

## molded tubular capacitors

The C-D "Cub" capacitor has proven itself the best on the market today—by out-lasting, out-performing, out-selling any other replacement capacitor for radio or TV. For consistent high quality—always rely on C-D, the only tubulars with the built-in extras required in servicing sets today. That's why distributors *who know*, carry the complete C-D line.

Special! "Cub-Kit" with bonus plastic service dispenser. IT'S FREE!

Ask your C-D Distributor. He's listed in your local Classified Telephone Directory.

# CORNELL-DUBILIER



THERE ARE MORE C-D CAPACITORS IN USE TODAY THAN ANY OTHER MAKE.

PLANTS IN SO. PLAINFIELD, N. J.; NEW BEDFORD, WORCESTER AND CAMBRIDGE, MASS.; PROVIDENCE AND HOPE VALLEY, R. I.; INDIANAPOLIS, IND.; SANFORD AND PUGWAY SPRINGS, N. C.; SUBSIDIARY, RADIART CORP., CLEVELAND, OHIO.

## Oscilloscopes

(Continued from page 31)

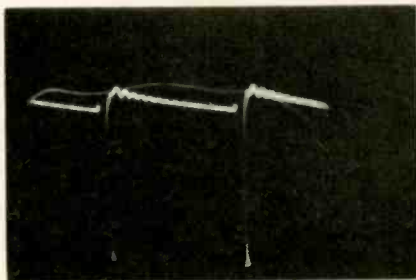

Fig. 7—Ringing in a sweep-circuit waveform.

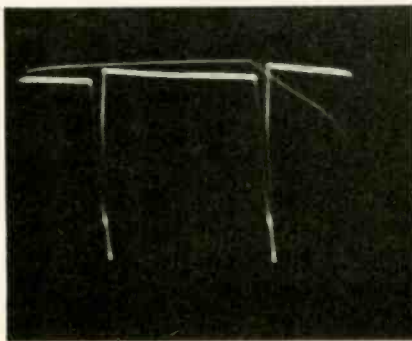

Fig. 8—Display of Fig. 7, defect corrected.

and not by the scope. When the circuit trouble is corrected, the waveform appears as shown in Fig. 8.

Hence, it is clear that the purposes of color-TV service are well served by a scope having flat frequency response to 4 mc, even if the frequency characteristic should drop off sharply past that point. Such a scope will not ring on the waveforms commonly encountered in troubleshooting work. These are points worth noting, as such misconceptions are encountered not only in the service trade, but also in some design laboratories that should know better. •



"Samson doesn't really bite . . . he just nips"

## PERMO'S SALES INDEX

A factor of the relative national rate of movement of each type of needle to other types

Permo Needle Number	1954 List Price	Dealer Price	Color Dot	Low Fr. Ball Size	Ball Size	Type of Mounting Proposal	Permo To Standard & Size	Standard
A-300	52.50	41.50	81.47	7.8	2.3	33 1/2 & 45	Standard Jewel	001
A-304	1.50	90	88	2.3		33 1/2 & 45	Parametal	002
B-310	1.00	50	99	136.3		33 1/2 & 45	Parametal	003
A-316	1.50	90	88	1.3		33 1/2 & 45	Parametal	004
C-320	1.50	90	88	17.9			Parametal	005
B-324	2.50	1.50	1.47	6			Standard Jewel	007
B-326D	25.00	15.00	14.70				Standard Jewel	007
C-360	7.50	1.50	1.47	0			Standard Jewel	007
C-360D	25.00	15.00	14.70				Standard Jewel	007
A-311	1.50	75	73	11.6			Standard Jewel	007
A-311D	25.00	15.00	14.70				Standard Jewel	007
C-312	1.50	75	73	30.2			Standard Jewel	007
C-312D	25.00	15.00	14.70				Standard Jewel	007
AC-313	1.00	1.80	1.76	4.7		33 1/2 & 45	Standard Jewel	007
AC-313D	26.50	15.00	15.00	70		33 1/2 & 45	Standard Jewel	007
A-314	2.00	1.20	1.18	1.4		33 1/2 & 45	Standard Jewel	007
A-314D	25.00	15.00	14.70			33 1/2 & 45	Standard Jewel	007
AC-315	2.50	1.50	1.47	6.7		33 1/2 & 45	Standard Jewel	007

Keeps you from being "STUCK" with once-a-year sellers . . .

## PERMO PHONO NEEDLES



PERMO, INC.

CHICAGO 26

## FLY-BACK INTERVAL & INDUCTANCE CHECKER

AT A GLANCE!



NO DISCONNECTING NECESSARY

EXCLUSIVE

# SECO

## FLY-BACK INTERVAL CHECKER

MAKE THIS 3 WAY CHECK:

1. Fly-back interval (Exclusive Feature!)
2. Checks flyback transformers individually.
3. Checks yokes individually.

See your Jobber or write for literature and prices.

# SECO MFG. CO.

5015 PENN. AVE. S. MINNEAPOLIS, MINN.

On display at Electronic Show, Rm. 661, Conrad Hilton



# 1955 TECHNICIAN BUYERS DIRECTORY

★ Product Finding Index .....	65
★ Product Listings .....	67
★ Brand & Trade Name Index .....	85
★ Service Technicians Associations .....	90
★ Electronic Parts Distributors .....	92
★ Electronic Representatives .....	102
★ Manufacturers, alphabetically listed with Special Localizer Index .....	108

## PRODUCT SECTIONS

ANTENNAS 1

BATTERIES 2

BOOKS 3

CABINETS 4

CAPACITORS 5

COILS & TRANSFORMERS 6

CONVERTERS 7

FILTERS 8

HARDWARE 9

KITS 10

MOTORS 11

PHONOGRAPHS 12

POWER SUPPLIES 13

RECEIVERS 14

RESISTORS 15

SEMICONDUCTORS 16

SOLDERING IRONS 17

SOUND, HI-FI 18

SWITCHES 19

TEST EQUIPMENT 20

TOOLS 21

TUBES 22

TUBE ACCESSORIES 23

WIRE 24

Copyright 1955 ★ Published by

**CALDWELL-CLEMENTS, Inc.**

480 Lexington Avenue, New York 17, N. Y.

**EE-EE-ASY DOES IT...**

**Alprodco's**

**Pop-Up Tower**  
with "Magic Elbow" Action

**"MAGIC ELBOW" ACTION:**  
The tower goes up jack-knife fashion. Note how the "magic elbow" swings the top section into place.

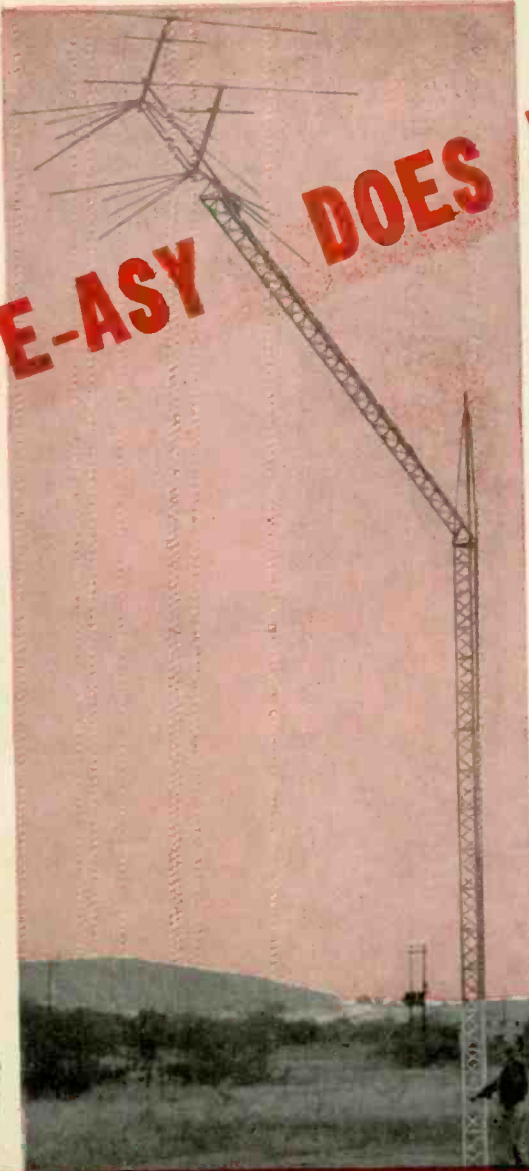

ALPRODCO'S exclusive "magic elbow" eliminates climbing entirely. Just bolt the sections together, install the base and the "magic elbow" swings the top half into position quickly and easily. Swings down just as easily.

ALPRODCO'S Pop-Up Tower is available in three sizes (dealer prices listed for each): 49 ft.—\$53.25; 61 ft.—\$64.45; 73 ft.—\$75.65. Guaranteed to withstand 90 mph winds.

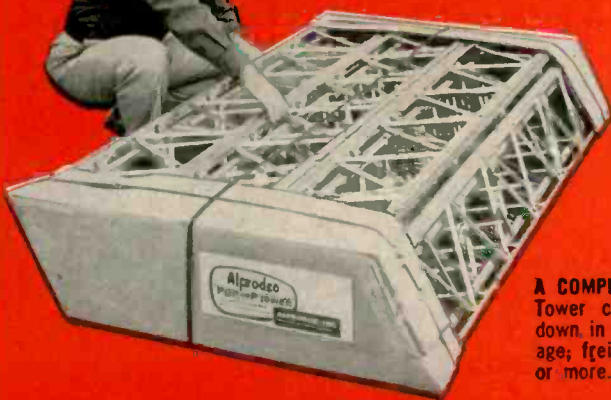

**A COMPLETE PACKAGE:**  
Tower comes knocked down in compact package; freight FREE on 5 or more.



**ADJUSTMENTS:**  
No climbing—no trouble. Tower can be lowered to working position in 10 seconds. Turn crank and it goes up just as easy!

See the ALPRDCO Line  
at the  
**1955 ELECTRONICS PARTS SHOW**  
May 16-19, 1955  
Booth 108 ... and ...  
Room 605-A, Conrad Hilton Hotel  
Chicago, Ill.

**Alprodco, Inc.**

Kempton, Ind. Mineral Wells, Tex. Dublin, Ga.  
Specialists in ALUMINUM TOWERS • SLIP-UP MASTS • ROTATORS • ANTENNAS • ACCESSORIES

# 1955 TECHNICIAN BUYERS DIRECTORY

CLASSIFIED PRODUCTS LISTINGS, PAGE 67

ALPHABETICAL LISTING OF MFRS., PAGE 108

## Product Finding Index

A fast reference guide that enables you to find the product you want in the *Product Directory*—quickly. Here's how to use the *Product Finding Index*: (1) Look for the product you want (under the name you ordinarily use to identify it). (2) Turn to the

section number given in the *Product Finding Index*. (3) From the manufacturers listed in this section, select only those with the code letters (listed in the *Product Finding Index*) after their names. These are the manufacturers of the products you want.

Product	Section No.	Code Letter	Product	Section No.	Code Letter	Product	Section No.	Code Letter	Product	Section No.	Code Letter
Accessories, antenna, Misci.	1	A	Calibrators, voltage	20	E	Controls, loudness, volume, tone, etc.	15	B	Heads, recording, magnetic	18	P
Ammeters	9	A	Capacitors, buffer	5	A	Controls, resistive	15	B	Hearing Aids & Accessories	18	AQ
Amplifiers, milli, micro	20	A	Capacitors, ceramic	5	B	Conversion Strips, UHF	7	E	High Fidelity Equip.	18	R
Analizers, audio	20	A	Capacitors, electrolytic, dry	5	C	Converters, UHF-TV	7	D	Horns, speaker	18	C
Analizers, interference	20	AU	Capacitors, electrolytic, wet	5	M	Converters & Inverters DC to AC	13	B	Indicators, clock, time	11	L
Antenna masts	1	Q	Capacitors, feed-thru	5	N	Copper Braid	24	A	Inductors, toroid	6	M
Antenna mounts	1	R	Capacitors, glass	5	R	Cords, extension	24	J	Inductors, variable	6	L
Antenna Outlets, TV	1	S	Capacitors, mica	5	D	Cords, lacing	24	K	Inserts, 45 RPM	12	L
Antenna strips, lead-in	1	W	Capacitors, molded composition	5	Q	Cords, line	24	L	Insulation, spaghetti sleeving	9	W
Antenna whips, mobile	1	Z	Capacitors, molded, paper & wax	5	E	Couplers, multi-set, TV	1	M	Insulators, antenna	1	O
Antennas, AM outdoor	1	D	Capacitors, oil-filled	5	F	Cradles, chassis bases	9	M	Insulators, feed-through	9	Q
Antennas, auto radio	1	E	Capacitors, paper metallized	5	G	Crimping tools	21	AM	Insulators & Insulating Materials	9	X
Antennas, FM	1	F	Capacitors, paper metal encased	5	T	Custom components	18	H	Intercom Systems	18	S
Antennas, loop, AM	1	G	Capacitors, photoflash	5	H	Decades, capacitance	20	M	Jacks	9	Y
Antennas, loop core AM	1	H	Capacitors, piston trimmer	5	O	Decades, inductance	20	AX	Kits, AM, FM Tuner	10	A
Antennas, TV, indoor	1	AB	Capacitors, silicone-filled	5	I	Decades, resistance	20	K	Kits, audio & phono	10	J
Antenna Systems, TV amplified	1	B	Capacitors, tuning	5	P	Decalcomanias	9	N	Kits, battery charger eliminator	10	B
Antenna Systems, TV, non-amplified	1	C	Capacitors, variable	5	L	Deflection Yokes	6	K	Kits, crystal set	10	H
Antennas, TV, UHF	1	I	Caps, tube (grid & plate)	9	H	Detectors, crystal	16	E	Kits, educational radio-TV	10	L
Antennas, TV, VHF	1	J	Cartridges, ceramic	18	AN	Detectors, diode	22	B	Kits, electric-eye equipment	10	D
Antennas, window	1	K	Cartridges, crystal	18	AO	Dials and dial accessories	9	O	Kits, power supply	10	F
Assemblies, Magic Eye	9	A	Cartridges, magnetic	18	AP	Diodes, crystal	16	B	Kits, radio control	10	G
Attenuators	15	B	Cartridges, phono pickup	12	E	Diodes, germanium	16	C	Kits, short-wave set	10	I
Automatic tuning mechanism	7	F	Carts amplifier carrying	12	G	Diodes, silicon	16	D	Kits, speaker enclosure	10	M
Baffles & Enclosures, speaker	18	B	Cases, meter	4	I	Discs, recording blanks	18	K	Kits, test equipment	10	E
Ballasts	9	C	Cases, phonograph carrying	12	J	Dividers, voltage	13	C	Kits, tool	9	Z
Bases, chassis	9	D	Cases, radio	4	K	Drills, electric	21	N	Kits, TV Booster	10	C
Bases, phonograph mounting	12	B	Cases, record	12	G	Drills, hand	21	O	Kits, TV chassis & control version	10	K
Batteries, dry cell radio	2	A	Casters	9	I	Drivers, nut, screw	21	P	Kits, TV picture tube extension harness	23	C
Batteries, flashlight	2	B	Checkers, condenser	20	F	Drivers, speakers	18	L	Knobs	9	AA
Batteries, hearing aid	2	C	Checkers, CRT	20	AM	Dynamos	11	E	Labels, recording	12	M
Batteries, ignition	2	D	Checkers, fly-back	20	AN	Ejectors, fuse	21	Q	Lamps & Bulbs	9	AB
Batteries, storage	2	E	Checkers, transformer	20	G	Equalizers, phono pre-amp	12	J	Leads, test	21	S
Battery Chargers	13	A	Checkers, vibrator	20	H	Equalizers, tone	12	J	Lightning Arresters	1	P
Battery connectors	2	F	Chemicals, Radio & TV	21	H	Escutcheons	18	M	Limiters, noise	8	F
Battery Eliminators	13	D	Chokes, AF	6	A	Filters, audio	8	A	Line Cords, resistors	15	C
Bearings, panel	9	E	Chokes, filter	6	B	Filters, bandpass	8	B	Loudspeakers	18	U
Benches, work	21	A	Chokes, RF	6	D	Filters, interference	8	C	Lubricants	9	AC
Benders, tubing	21	B	Circuit breakers	9	J	Filters, noise	8	D	Lug Tools	21	AN
Binaural Equipment	18	C	Cleaner, TV lens	21	I	Filters, whistle	8	E	Magnets, TV centering	23	D
Bits, drill	21	C	Cleaners	9	K	Flocking Material	9	R	Magnets, TV focus	23	E
Blowers	21	D	Clippers, sine-wave	20	I	Flux	17	L	Magnets, TV ion trap	23	FT
Blow Torches	21	E	Clips, alligator, test, etc.	21	J	Frequency Standards	20	L	Markers, adhesive	9	AAI
Books & Service Data	3	A	Clocks, program	11	A	Fuses	9	A	Masks	23	AG
Boosters, FM	7	A	Cloth, speaker grille	18	D	Fuse Clips	9	AAI	Microphones power	18	W
Boosters, TV	7	B	Coils, field	6	E	Fuse Holders	9	AAI	Meters, audio	20	S
Boosters, UHF	7	C	Coils, focus	6	F	Gauges, needle pressure	12	K	Meters, coin	20	AL
Brackets, mounting	9	F	Coils, IF, oscillator & RF	6	F	Gauges, wire	24	M	Meters, field-strength	20	T
Brightener	23	C	Coils, peaking	6	G	Generators, audio	20	N	Meters, frequency	20	U
Brushes, record	12	G	Coils, speaker voice	6	H	Generators, color signal	20	AK	Meters, grid-dip	20	V
Bushings, chassis	9	A	Coll Winders	21	K	Generators, marker	20	O	Meters, snap-around	20	AO
Cabinets, custom	4	A	Compensators, record	12	H	Generators, pattern	20	P	Meters, time	20	W
Cabinets, equipment	4	C	Cones, loudspeaker	18	E	Generators, power	13	E	Meters, watt	20	T
Cabinets, metal	4	D	Connectors	9	L	Generators, signal RF, IF	20	Q	Micrometers	21	Y
Cabinets, phonograph	12	D	Connectors, antenna	1	L	Generators, sweep	20	R	Microphones & Accessories	18	X
Cabinets, plastic	4	E	Connectors, audio	18	F	Generators, TV Bar	20	R	Microscopes, stylus	12	N
Cabinets, speaker	4	F	Controls, linearity & width	6	J	Grille, metal & Screen	9	AV	Mirrors, inspection	21	AO
Cabinets, wood	4	H	Calibrators, frequency	20	D	Grommets	9	T	Mixers, audio	18	Y
Cable, auto radio control	24	B				Grounding Equipment	9	V	Motors, antenna rotating	11	D
Cable, coaxial	24	C				Guying Equipment	1	N	Motors, clock	11	K
Cable, intercom	24	D				Hammers	21	R	Motors, phono recording	11	F
Cable, microphone	24	E				Handsets, phone	18	N	Motors, phono turntable	11	J
Cable, phonograph	24	F				Hardware Accessories & Parts	9				
Cable, shielded	24	G				Headphones & Headphone Accessories	18	O			
Cable, telephone	24	H				Heads, recording, disc	18	Q			
Caddy, tube	21	F									
Calibrators, frequency	20	D									

For the purpose of checking violation of the publisher's copyright or other misuse of this directory, the products or listings have been coded. While these lists may be used for mailing purposes by individual manufacturers only, use of the lists by publishers or commercial mailing services, or any reproduction of the lists in part or whole is strictly prohibited.

Product	Section No.	Code Letter	Product	Section No.	Code Letter	Product	Section No.	Code Letter	Product	Section No.	Code Letter
Motors, power plant	11	G	Saws	21	Z	oscillator & RF	6	T	Tuners, remote-controlled	7	L
Motors, spring wound	11	H	Screws, Nuts, Bolts,	9	AZ	Transformers, intercom	6	U	Tuners, TRF broadcast	7	K
Motors, starting capacity	11	I	Washers	16	K	Transformers, isolation	6	V	Tuning Units	7	W
Mounting brackets	23	J	Selectors, crystal	16	AS	Transformers, power	6	W	Turntables	12	AI
Mounts	9	AD	Shafts, control	9	L	Transformers, step-down	6	X	Tweeters	18	AQ
Multimeters	20	Z	Shelving	4	AT	Transformers, variable	6	Y	Tweezers	21	H
Needles, playback	20	F	Shielding	9	AV	Transformers, vibrator	6	Z	Vibrators, auto radio	21	AK
Ohmmeters	20	AA	Shields, tube & coils	9	AU	Transmission line, TV	24	AB	Vises	20	X
Oilers	21	U	Shims, speaker	9	AV	Transistors	16	J	Voltmeters	20	Y
Oscillators, phono	12	O	Sleeves, picture tube	23	I	Trimmers & Padders	5	K	Voltmeters, vacuum-tube	20	AJ
Oscillators, VFO	20	AB	Snaps & Studs	9	AW	Tube Pin Straightener	21	AI	Wave Traps	8	I
Oscilloscope preamplifiers	20	AP	Sockets	9	AX	Tube Pullers	22	AJ	Windows, dial	9	AAF
Oscilloscopes, cathode-ray	20	AC	Solder	17	C	Tubes, ballast	22	D	Wire, antenna	24	O
Padding	9	AE	Soldering Guns	17	E	Tubes, cathode-ray (oscillograph)	22	E	Wire, bus	24	P
Pads, C & L	9	AF	Soldering Irons	17	D	Tubes, cathode-ray (television)	22	F	Wire, grid	24	Q
Pads, H, T, etc.	15	D	Solder Paste	17	B	Tubes, electron-ray (indicator-eye)	22	G	Wire, grounding	24	R
Pads, turntable	12	X	Solenoids	6	N	Tubes, receiving	22	I	Wire, guy	24	S
Paint, Lacquer & Varnish	9	AG	Sound Systems, complete	18	AG	Tubes, subminiature	22	H	Wire, high-voltage	24	T
Panels	9	AH	Spaghetti	9	AAK	Tubing	24	N	Wire, hook-up	24	U
Parts, phono, misc.	12	Q	Speakers	18	U	Tubing, plastic	9	AAE	Wire, litz	24	V
Patch Cords	9	AI	Speaker parts & accessories	18	V	Tuners, AM	7	G	Wire, magnet	24	W
Phono Equip & Access	12	R	Splicers, line	21	AA	Tuners, AM-FM	7	H	Wire, magnetic recording	24	AJ
Photographs	12	I	Splicers, tape	18	AE	Tuners, FM	7	I	Wire, test-lead	24	X
Photoelectric Equip.	13	A	Spools, wire	18	AF	Tuners, front-end TV	7	J	Woolers	18	AA
Pick-ups, telephone	18	Z	Spray Guns	21	AB				Wrenches	21	AK
Plastic	9	AJ	Spray, plastic protective	9	AAA						AL
Plates, transformer	9	AK	Standoffs	1	V						
Pliers	21	V	Standoffs, terminal	9	AAAB						
Plugs, hole	9	AL	Stands, soldering	17	F						
Plugs, power	9	AM	Staplers	21	AC						
Polishes	9	AN	Storage Bins & Cabinets for parts	4	M						
Potentiometers	15	E	Strippers, wire	21	AD						
Power Plants & Supplies	13	F	Stroboscopes	20	AD						
Preamplifiers	18	AA	Suppressors	5	J						
			Suppressors, auto ignition	8	G						

**TECHNICIAN  
BUYERS DIRECTORY**

**PRODUCT FINDING INDEX**

Preamplifiers, antenna matching	1	T	Suppressors, dynamic noise	18	AU
Printed Circuits	9	AO	Suppressors, parasitic	8	H
Probes, meter & scope	20	AQ	Switches, antenna	1	X
Probes, prods	21	AW	Switches, anti-capacity	19	A
Public Address Systems	18	AB	Switches, coaxial	19	B
Pulleys, idler	9	AP	Switches, electronic	20	AS
Punches, Taps, Dies	21	X	Switches, foot	19	C
Quartz sheets	9	AW	Switches, gang	19	D
Radio Hardware, misc.	9	AQ	Switches, knife	19	E
Radio sets, AM	14	AR	Switches, lever	19	F
Radio sets, AM-FM	14	A	Switches, mercury	19	G
Radio sets, FM	14	B	Switches, micro	19	H
Radio sets, transistor	14	C	Switches, power	19	I
Reactivators, CRT	20	F	Switches, push-button	19	J
Reamers	21	AR	Switches, rotary	19	K
Record Changers, automatic	12	AP	Switches, slide	19	L
Recorders, disc	18	T	Switches, snap-action	19	M
Recorders, tape	18	J	Switches, thermal	19	N
Recorders, wire	18	AL	Switches, toggle	19	O
Records	12	AM	Switches, trigger	19	P
Records, test	12	U	Switches, trigger	19	Q
Rectifiers, copper	16	V	Switches, volume control	19	R
Rectifiers, crystal	16	F	Tables	4	N
Rectifiers, diode	16	E	Tape, friction & insulating	9	AAC
Rectifiers, germanium power	16	G	Tape demagnetizers	18	AR
Rectifiers, selenium	16	H	Tape, pre-recorded	18	AV
Rectifiers, silicon	16	I	Tape, recorder test	18	AS
Rectifiers, tube	22	L	Tape, splicing	18	AT
Reels, tape	18	C	Tape, magnetic recording	18	AH
Regulators, voltage	13	AC	Television sets, monochrome	14	D
Relays	6	G	Television sets, color	14	E
Relays, coaxial	6	AF	Terminals	9	AAD
Relays, thermal	6	AA	Testers, battery	20	AE
Relays, time delay	6	AF	Testers, continuity	20	AF
Repeaters, tape recording	18	AB	Testers, metal rectifier	20	AT
Resistors, adjustable, tap	15	AC	Testers, tube	20	AG
Resistors, ballast	15	AD	Thermistors	15	S
Resistors, carbon	15	F	Thermocouples	20	AH
Resistors, fixed, composition	15	G	Timers, clock	11	B
Resistors, fixed, wire wound	15	H	Tips, soldering	17	H
Resistors, flexible	15	I	Tools, alignment	21	AE
Resistors, glass	15	J	Tools, electric	21	AF
Resistors, molded	15	K	Tools, hand	21	AG
Resistors, power	15	T	Tools, soldering	17	G
Resistors, precision	15	L	Torches	21	AH
Resistors, variable carbon	15	M	Towers, TV antenna	1	AA
Resistors, variable wirewound	15	N	Tracers, signal	20	AI
Resistors, vitreous	15	O	Transformers, antenna	1	Y
Rheostats	15	P	Transformers, antenna matching	6	AD
Rotators, antenna	1	Q	Transformers, audio	6	O
		U	Transformers, constant voltage	6	P
			Transformers, elevator	6	AE
			Transformers, filament	6	R
			Transformers, flyback	6	S
			Transformers, IF		

# DON'T BLAME THE POSTMAN

... if this issue is a few days late.

Publication of this May issue of TECHNICIAN was purposely delayed to include important 11th-hour material in both sections of this double-feature issue.

1—The Technician Buyers Directory

2—The Chicago Electronic Parts Show

Just turn the pages and you will recognize the long-time usefulness of this issue.

Also, you will find a buying directory for year-round use, plus the ever-useful regular features such as Circuit Digests.

Take good care of this May issue. You'll be needing it, and reading it, over and over again.

# TECHNICIAN

& Circuit Digests

480 Lexington Avenue, New York 17, N. Y.

PLAZA 9-7880

# 1955 TECHNICIAN BUYERS DIRECTORY

## Product Listings

This is a complete listing of all service and replacement products, component parts, equipment, instruments, and materials in the radio-TV-electronic service industry—with the names and addresses of the

companies that make them. Product categories are arranged according to major group headings. Manufacturers are listed alphabetically under these groups.

### I—ANTENNAS & ANTENNA ACCESSORIES

- Accessories, antenna, misc. . . . . A
- Antenna Systems, TV amplified . . . B
- Antenna Systems, TV non-amplified . C
- Antennas, AM outdoor . . . . . D
- Antennas, Auto Radio . . . . . E
- Antennas, FM . . . . . F
- Antennas, loop, AM . . . . . G
- Antennas, loop-core, AM . . . . . H
- Antennas, TV, indoor . . . . . AB
- Antennas, TV, UHF . . . . . J
- Antennas, TV, VHF . . . . . J
- Antennas, window . . . . . K
- Connectors, antenna . . . . . L
- Couplers, multi-set, TV . . . . . M
- Equipment, guying . . . . . N
- Grounding Equip. (see Sec. 9)
- Insulators, antenna . . . . . O
- Lightning Arresters . . . . . P
- Masts, antenna . . . . . Q
- Mounts, antenna . . . . . R
- Outlets, TV antenna . . . . . S
- Preamplifiers, antenna matching . . T
- Rotators, antenna . . . . . U
- Standoffs . . . . . V
- Strips, lead-in . . . . . W
- Switches, antenna . . . . . X
- Towers, TV antenna . . . . . AA
- Transformers, antenna . . . . . Y
- Whips, antenna, mobile . . . . . Z
- Wire, grounding TV (see Sec. 24)
- Wire, guy (see Sec. 24)

- Abbey-Graham Electronics, 1754 State St., E. St. Louis, Ill.—I,J,AB
- Admiral Corp., 3800 Cortland St., Chicago 47, Ill.—A,B,C,I,J,L,M,O,P,Q,R,S,W,X,Y
- Advance Electronics Co., 8510 North End Ave., Oak Park 37, Mich.—F,I,J
- Aerocoll Inc., 24 Cliff St., Jersey City, N.J.—G,H
- Air-E-O-Electronics, 374 N. 27 St., Milwaukee 8, Wis.—I,J
- Aerolite Electronics, 507 26th St., Union City, N.J.—H,I
- Aeromotor Co. 2500 W Roosevelt Rd., Chicago, Ill.—AA
- Aircraft-Marine Products, 2100 Paxton St., Harrisburg, Pa.—L
- Airlyte Electronics, 21 Cottage St., Bayonne, N.J.
- Aleo Electronics Mfg. Co., 3 Wolcott Ave., Lawrence, Mass.—Z
- Alden Products Co., 117 N. Main St., Brockton 64, Mass.—L,S
- All Channel Antenna Corp., 47-39 49th St., Woodside 77, N.Y.—I,J,AB
- Alliance Mfg., Lake Park Blvd., Alliance, Ohio—I,J,U
- Allied Eng'g. Div., Allied Int'l. Inc., 230 Park Ave., New York 17, N.Y.—A,D,E,F
- Alproco Inc. of Ind., Box 98, Kempton, Ind.—I,J,Q,R,U,V,AA
- Alproco Inc., Mineral Wells, Texas—Q,AA
- American Electronics Co., 1203 Bryant Ave., New York 59, N.Y.—A,F,L,M,X,Y
- American Phenolic Corp., 1830 S. 54th St., Chicago 50, Ill.—A,F,I,J,M,P,Q
- American Radio Hardware Co., 152 MacQuestion Pkwy. So., Mt. Vernon, N.Y.—A
- American Tower Co., Shelby, Ohio—AA
- Amptel, Inc., 342 W. 40 St., New York, N.Y.—B
- Anchor Electronics, Inc., 717 Sip St., Union City, N.J.—H,Y
- Anchor Products Co., 2712 W. Montrose Ave., Chicago 18, Ill.—M,X

- Antenna & Mounting Hardware Co., 9216 Grand Ave., Franklin Park, Ill.—L,M,N
- Antenna Products 3628 N. Lincoln Ave., Chicago 13, Ill.—I,J,Q,R
- Antenna Specialists Co., 12435 Euclid Ave., Cleveland 6, Ohio—D,E
- Antennex Co., 4060 Ocean Park Ave., Venice, Calif.—I,J
- Audio Frods., 2265 Westwood, Los Angeles 64, Calif.—I,P
- Armac Co., P.O. Box 1083, Macon, Ga.—Q
- Baker Mfg. Co., 133 Enterprise St., Evansville, Wisc.—Q,AA
- Barb City Industries, 5 & Girard Sts., DeKalb, Ill.—A,B,C,I,J,N,R
- Baumker Mfg. Co., 3826 Summit St., Toledo 11, Ohio—L,R
- Beam Radionics, 224 N. Desplains St., Chicago, Ill.—AB
- Belrod & Co., 481 Sterling Pl., Brooklyn, N.Y.—E
- Bestcraft Products Co., 626 Broadway, New York 12, N.Y.—I,J
- Best Electronics Corp., 617 19 St., Manhattan Beach, Calif.—J,L,Y
- Bhend Electrical Constr. Co., 437 N. Mich. Ave., Pasadena 4, Calif.—Q
- Birnback Radio Co., 145 Hudson St., New York 13, N.Y.—A,D,L,M,N,O,P,R,V
- Blaco Mfg. Co., 4416 Gamma Ave., Cleveland 5, Ohio—V
- Blonder-Tongue Labs., 526 North Ave., Westfield, N.J.—B,C,L,M,S
- Bogen Co., David 299 Ninth Ave., New York 14, N.Y.—C
- Brach Mfg. Corp., 200 Central Ave., Newark 5, N.J.—A,B,C,D,E,F,G,H,I,J,K,M,P,Q,S,U,Y,AB
- British Electronic Sales, 23-03 45 Rd., Long Island City 1, N.Y.—L,M,S,T,X
- Brooklyn TV Co., 72 Steuben St., Brooklyn, N.Y.—I,J
- Browning Labs., 750 Main St., Winchester, Mass.—F
- Buchan Co., R. J., P.O. Box 9, Bricelyn, Minn.—A
- Bud Radio Inc., 2118 E. 55 St., Cleveland 3, Ohio—Q,R,AA
- Bullet Electronics Corp., 2637 S. Lowell Ave., Springfield, Ill.—A,Q
- Caddell-Burns, 40 E 2 St., Mineola, N.Y.—G,H
- Camburn, Inc., 32-40 57th St., Woodside 77, N.Y.—A,E,F,I,J,K,L,M,Q,V,X
- Camburn Sales & Mfg. Corp., 134 Orchard Ave., Battle Creek, Mich.—A,N,Q,R
- Cass Machine Co., 691 Antoinette St., Detroit 2, Mich.—A,F,I,J,N,O,P,Q,R
- Cayo TV Eng'g. Co., 1904 Mich. Hwy., 139 Benton Harbor, Mich.—A
- CBC Electronics Co., 2601 N. Howard St., Philadelphia 33, Pa.—F
- Centralab Div., Globe-Union, Inc., 902 E. Keefe Ave., Milwaukee 1, Wisc.—O,V,X
- Chance Co., A. B., 210 N. Allen St., Centralia, Mo.—A
- Channel Master Corp., Ellenville, N.Y.—I,J,L,Q,R,U,AA
- Chester Cable Corp., Highview St., Chester, N.Y.—Z
- Cinch Mfg. Corp., 1026 S. Homan Ave., Chicago 24, Ill.—L
- Circon Component Co., 17544 Raymer St., Northridge, Calif.—I
- Circuitron Inc., 155 W. Main St., Rockville, Conn.—F,I,J,M,U,AA
- Clear Beam Antenna Corp., 21341 Roscoe Blvd., Canoga Park, Calif.—A,F,I,J,L,M,N,Q,R
- Cleveland Electronics, Inc., 6611 Euclid Ave., Cleveland 3, Ohio—I
- Coaxial Connector Co., 37, N. 2 Ave., Mt. Vernon, N.Y.—L,S
- Collins Machine Co., 158 Albany Post Rd., Buchanan, N.Y.—I,J
- Collins Radio Co., Cedar Rapids, Iowa—F
- Columbia Products Co., Box 5207, Columbia, S. Car.—Z
- Commercial Products, 417 Main St., Toledo 5, Ohio—A,N,Q,V
- Control Electronics Co., 1925 N. Y. Ave., Huntington Station, N.Y.—I,J,AB
- Cornell-Dublier Elec. Corp., South Plainfield, N.J.—D,E,F,I,J,M,P,U

- Coronet Electronics, 505 N. LaSalle St., Chicago 1, Ill.—AB
- Crowley Co., Henry L., 1 Central Ave., W. Orange, N.J.—H
- Crown Controls Co., 40 S. Washington St., New Bremen, Ohio—M,U
- Danforth Mfg. Co., 531 S. 3rd St., Monmouth, Ill.—I,J,N,Q,R
- Davis Electronics, 4002 Burbank Blvd., Burbank, Calif.—A,B,C,J,L,M,T,X,Y,Z
- Deal Products, Hellertown Rd., MR 37, Easton, Penna.—AA
- Delco Div., General Motors Corp., Kokomo, Ind.—E
- Delson Mfg. Corp., 126-11 Ave., New York 11, N.Y.—Q,M,AB
- DI-CO TV & Plastic Co., 61 Erna St., Milford, Conn.—A,F,I,J
- Duala Co., Box 78, Coal Fork, W. Va.—P
- Dunkle Coil Co., 3257 W. 6 St., Los Angeles 6, Calif.
- Dwyer Eng'g. Co., P. O. Box 483, Nashua, N.H.—P
- Dynamic Electronics, 73-39 Woodhaven Blvd., Glendale L.I., N.Y.—AB
- Eagle Electronics Corp., 177 Hart St., New Britain, Conn.—M
- Easy-Up Tower Co., Racine, Wisc.—N,Q,R
- Eby Inc., Hugh H., 4700 Stenton Ave., Philadelphia, Pa.—V
- Eby Sales Co., 130 Lafayette St., New York 13, N.Y.—A,H,M
- Electronics Hardware Corp., 2420 W. Cermack Rd., Chicago 8, Ill.—A,N,Q,R,V
- Elreco Corp., 2900 Company Ave., Cincinnati 25, Ohio—I,J
- Energy Farm Equipment Co., Monticello, Iowa—Q,R
- Epco Electronics, Inc., 140 Liberty St., New York 6, N.Y.—M,X
- Falmer Mfg. Co., 312 N. Walnut St., Youngstown 2, Ohio—I,J
- Finney Co., 4612 St. Clair Ave., Cleveland 3, Ohio—I,J
- FKB Opticon Co., 1738 E. Calvert St., S. Bend 14, Ind.—J
- Fretco, Inc., 406 N. Craig St., Pittsburgh 13, Pa.—A,D,F,I,J,L,N,O,Q,R
- Fretz, Gross Co., 22 & Sedgley Sts., Philadelphia 32, Pa.—R
- Ge-Lar Mfg. Co., 819 Elm St., Rockford, Ill.—I,J,L,M,N,O,P,Q,R,S,V
- General Cement Mfg. Co., 919 Taylor Ave., Rockford, Ill.—A,G,H,I,J,K,L,M,N,O,P,Q,R,S,V,W,X,AA
- General Instrument Corp., 829 Newark Ave., Elizabeth 3, N.J.—G,H
- Gonset Co., 801 S. Main St., Burbank, Calif.—C,D,E,F,I,J,L,N,O,Q,R,V,X,Z
- Grange Inc., 830 Monroe St., Hoboken, N.J.—B,C,I,J
- Great Eastern Mfg. Co., 163 Remsen Ave., Brooklyn 12, N.Y.—M
- Hamilton Electronics Corp., 2726 Pratt Ave., Chicago 45, Ill.—M
- Heppner Mfg. Co., P. O. Box 608, Round Lake, Ill.—H
- Hillburn Electronic Products Co., 55 Nassau Ave., Brooklyn 22, N.Y.—G,H,Y
- Hi-Lo TV Antenna Corp., 3540 N. Ravenswood Ave., Chicago 13, Ill.—I,J,K,O,P,AB
- Hi-Par Products Co., 347 Lunenburg St., Fitchburg, Mass.—F,I,J,R,V
- H. M. H. T.V. Industries, 746 N. Pickering St., Whittier, Calif.—A,L
- Hutch & Son, 125 S. Elizabeth St., Lima, Ohio—Q
- Hy-Gain TV Products, 1828 N. St., Lincoln, Nebr.—D,I,J,R
- Hy-Lite Antennae, Inc., 242 E. 137th St., New York 51, N.Y.—C,D,F,I,J,K,P
- I. E. Mfg., 325 N. Hoyne Ave., Chicago 12, Ill.—A,B,D,H,I,K,L,M,O,P,Q,R,U,X,Z
- Imperial Radar & Wire Corp., 1661 Boone Ave., New York 60, N.Y.—O,P,R
- Industrial Hdw. Mfg. Co., 109 Prince St., New York 12, N.Y.—L
- Industrial Television, Inc., 369 Lexington Ave., Chifton, N.J.—M
- Insuline Corp. America, 186 Granite St., Manchester N.H.—A,C,D,E,F,I,J,K,L,M,N,O,P,Q,R,S,V,W,X,Z

Isolantite Mfg. Corp., Warren Ave., Stirling, N.J.—A,O,P,V,Z  
 JaMac Products Co., 8845 N.E. Sandy Blvd., Portland 20, Ore.—A,I,J  
 Javex, P.O. Box 646, Redlands, Calif.—A  
 Jerold Electronics Corp., 23 & Chestnut St., Philadelphia 46, Pa.—A,B,M,S,T  
 Jersey Specialty Co., Burgess Pl., Mountain View, N.J.—I,J  
 Jewell, Inc., A. W., 82 Broad St., Elyria 1, Ohio—I,J  
 JFD Mfg. Co., 6101 16 Ave., Brooklyn 4, N.Y.—A,E,I,J,K,L,M,N,P,Q,R,U,V,X,AA  
 Johnson Co., E. F. Waseca, Minn.—O  
 Jones Div. Howard B. Cinch Mfg. Corp., 1026 S. Homan Ave., Chicago 24, Ill.—L  
 Jones & Laughlin Steel Corp., 3 Gateway Center, Pittsburgh 30, Pa.—Q  
 Jontz Mfg. Co., 1101 McKinley, Mishawaka, Ind.—P,Q,R,AA  
 Jordan Mfg. Co., 1100 W. 78 Hwy., Morrice, Mich.—Q  
 Kato Eng'g Co., 1450 1 Ave., Mankato, Minn.—U  
 Kay-Townes Antenna, 1511 Dean Ave., Rome, Ga.—F,I,J,R  
 Kenwood Eng'g Co., 265 Colfax Ave., Kenilworth, N.J.—A,Q,R  
 K-G Electronics Corp., 2738 No. Sheffield Ave., Chicago 14, Ill.—I,J,AB  
 Kings Electronics, 40 Marbledale Rd., Tuckahoe, N.Y.—L  
 Kuehne Mfg. Co., 1401 S. 19 St., Mattoon, Ill.—AA  
 La Pointe Electronics, W. Main St., Rockville, Conn.—F,I,J,M,U  
 Larson Co., C. O., P.O. Box 358, Sterling, Ill.—A  
 Leader Electronics, 2925 E. 56th St., Cleveland 27, Ohio—U,X  
 Lear, Inc., 11916 W. Pico Blvd., Los Angeles 64, Calif.—O  
 Lieco, Inc., 147 Ocean Ave., Lynbrook, N.Y.—L  
 Marjo Technical Products, 1150 E. Henry St., Linden, N.J.—I,J,AB  
 Master Electronics & Television, Rt. 1, Box 36, Libertyville, Ill.—B,C  
 Master Mobile Mounts, Inc., P.O. Box 1817, Los Angeles 36, Calif.—R,Z  
 Mathis Tower & Equip. Co., P.O. Box 126, E. Peoria, Ill.—A,M,Q,R,AA  
 Medal Mfg. Co., 194 E. Silver St., Sharon, Pa.—A,I,J,K,O,Q,R  
 Meritenna Mfg. Co., 120 W. Thomas St., Seattle 99, Wash.—A  
 Midwest Naturlite Co., 6651 N. Clark St., Chicago 26, Ill.—I,J,AB  
 Miller Co., J. W., 5917 S. Main St., Los Angeles 3, Calif.—G,H  
 Miller Electronics, 2840 Naomi St., Burbank, Calif.—I,J,K,M,Q,R,V,AB  
 Milner Mfg. Co., 4359 Northview Dr., Jackson, Miss.—Q  
 Mi Tee Midget Antenna, High Point, N.C.—AB  
 Modern-Aire Mfg. Corp., 4436 W. Roosevelt Rd., Chicago 24, Ill.—A,N,O,Q,R  
 Modern Wire Co., 39-30 Review Ave., Long Island City 1, N.Y.—A,D,P,Q,R,W  
 Monarch Condenser Corp., 550 Westchester Ave., New York 55, N.Y.—A,M,P,X  
 Moore Tower & Equipment Co., 1221 1st Nat'l Bank Bldg., Peoria, Ill.—Q  
 Mosley Electronics, 8622 St. Charles Rock Rd., St. Louis 14, Mo.—A,L,M,O,S,X  
 Mueller Electric Co., 1575Y E. 31 St., Cleveland 14, Ohio—V  
 Mycalex Corp. of America, 125 Clifton Blvd., Clifton, N.J.—O  
 Naer Corp., 11777 Santa Monica Blvd., Los Angeles 25, Calif.—I,O  
 National Co., 61 Sherman St., Malden, Mass.—O  
 National Electric Products Corp., #2 Gateway Center, Pittsburgh 22, Pa.—A,I,J,N,Q,R  
 National Electronic Mfg., 186 Granite St., Manchester, N.H.—A,I,J  
 National Electronics of Cleveland, Delco Building, Cleveland, Ohio—I,J  
 Neal Electronic Co., 1037 Hall St., Huntsville, Ala.—I,J,AB  
 Nicholas Equipment Co., Bellevue, Ohio—U  
 Nichols Products Co., 325 W. Main St., Moorestown, N.J.—A,L  
 Nikoh Tube Co., 5000 S. Whipple St., Chicago 32, Ill.—I,J  
 North Hills Electric Co., 203-18 35 Ave., Bay-side 61, N.Y.—H  
 Ohio Aerial Co., 4553 Lewis Ave., Toledo 12, Ohio—A,I,J  
 Parker Metal Goods Co., 161 Summer St., Worcester 8, Mass.—A,O,P,Q,R,V,W,X,AA  
 Peerless Products Industries, 812 N. Pulaski Rd., Chicago 51 Ill.—A,F,I,J,AB  
 Penn Television Products Co., Allegheny & Trenton Aves., Philadelphia 34, Pa.—I,J,M,X,AA  
 Philco Corp., Tioga & C Sts., Philadelphia 34, Pa.—A,E,F,I,J,P,Q,R,U,V,AA  
 Philmore Mfg. Co., 113 University Pl., New York 3, N.Y.—G,H,L,P,W  
 Philson Mfg. Co., 60 Sackett St., Brooklyn 31, N.Y.—A,D,E,F,I,J,K,R  
 Phoenix Electronics, Inc., 50 Island St., Lawrence, Mass.—A,D,I,J,L,M,O,R,V  
 Pioneer Mfg. Co., Huntley, Ill.—I,J,AA  
 Pipestone Sales Co., P.O. Box 311, Pipestone, Minn.—Q,AA  
 Plymouth Electronics Corp., 50 Kingsbury St., Worcester 3, Mass.—A,B,C,I,J,M,N,R,T,X

Porcelain Products, Inc., 422 W. Sandusky St., Findlay, Ohio—A,O  
 Premax Products Div. Chisholm-Ryder, Niagara Falls, N.Y.—A,E,O,Q,R,V,Z  
 Q-Line Mfg. Corp., 1562 61st St., Brooklyn 19, N.Y.—A,D,F,G,H,I,J,K,L,M,N,O,P,S  
 Rudelco Mfg. Co., 7580 Garfield Blvd., Cleveland 25, Ohio—E,I,J,P,Q,R,Z  
 Radlart Corp., 3455 Vega Ave., Cleveland 13, Ohio—A,E,F,I,J,P,R,U,AB  
 Radio Corp. of America, RCA Tube Div., 415 S. 5 St., Harrison, N.J.—M,P  
 Radio Merchandise Sales, Inc., 2016 Bronxdale Ave., New York 62, N.Y.—A,I,J,K,L,M,N,P,Q,R,S,U,X  
 Radio Supply & Eng'g., 85 Selden Ave., Detroit 1, Mich.—A,I,J  
 Radion Corp., 1130 W. Wisconsin Ave., Chicago 14, Ill.—A,D,F,I,J,P  
 Ramsey Radio & TV Co., 925 St. Louis Ave., Vandalia, Ill.—Q,R,AA  
 Ray Mfg. Co., 441 Summit St., Toledo 4, Ohio—I,J,AA,AB  
 Rohr Mfg. Co., 116 Limestone, Bellevue, Peoria, Ill.—N,Q,AA  
 Ryan Industries, 10910 S. Vermont Ave., Los Angeles 44, Calif.—A  
 S&A Electronics, 1025 Nevada St., Toledo 5, Ohio—I,J  
 Saxonburg Ceramics, Saxonburg, Pa.—O  
 Saxton Products, Inc., 2101 Grand Concourse, Bronx 53, N.Y.—P  
 S C Laboratories, 37 George St., Newark 5, N.J.—I,J,R  
 Scala Radio Co., 2814 19th St., San Francisco 10, Calif.—A,J,AA  
 Scranton Aluminum Mfg. Co., 419 S. Wyoming Ave., Scranton, Pa.—R  
 Service Welding Co., Cedar Grove, Wis.—P,Q,R  
 Sheldon Electric Co., 68 Coit St., Irvington 11, N.J.—P  
 Sherrick Products, 86-11 Sancho St., HoHo 23, L.I., N.Y.—Z



Shore Eng'g, Long Branch, N.J.—I,J  
 Skyline Mfg. Co., 1652 Rockwell, Cleveland 14, Ohio—D,F,I,J  
 Skysweeper Inc., McHenry, Ill.—A,I,J  
 Smith, Inc., Herman H., 2326 Nostrand Ave., Brooklyn 10, N.Y.—A,V,X  
 Snyder Mfg. Co., 22nd & Ontario Sts., Philadelphia 40, Pa.—D,E,F,I,J,K,M,Q,R,V,Z  
 Southern Industries of Md., 1401 Reisterstown Rd., Pikesville, Baltimore 8, Md.—Q  
 South River Metal Products Co., South River, N.J.—A,N,O,Q,R,V  
 Spaulding Products Co., Tipton, Ind.—Q,R  
 Special Instruments Lab., Inc., 312 W. Vine St., Knoxville, Tenn.—I  
 Specialty Assembling & Packing, 79 Clinton Pl., Brooklyn 38, N.Y.—R  
 Spencer-Kennedy Labs., 186 Mass. Ave., Cambridge 39, Mass.—J,M,Q  
 Spiraling Products Co., P.O. Box 411, Hicksville, L.I., N.Y.—I,J  
 Stone City Machine & Tool Co., Bedford, Ind.—R  
 Summit Eng'g Co., 3324 Main St., Hartford, Conn.—I  
 Superex Electronics Corp., 4 Radford Pl., Yonkers, N.Y.—H,M,X  
 Tabet Mfg. Co., 1336 Ballentine Blvd., Norfolk 12, Va.—AA  
 Taylor Mfg. Co., 302 S. Union St., Lima, Ohio—N,R  
 Technical Appliance Corp., 1 Taco St., Sherburne, N.Y.—A,B,C,D,F,I,J,L,M,O,P,Q,R,S,X  
 Tel-A-Ray Enterprises, Inc., Box 332, Henderson, Ky.—C,F,I,J,K,Q  
 Tele-Beam Industries, 6th & Soscol Ave., Napa, Calif.—A,F,I,J,M,Q,S,Y  
 Tele-Ex-Pand Corp., Pine & 4th Sts., Berwick, Pa.—AA  
 Tele-Matic Industries, 16 Howard Ave., Brooklyn 21, N.Y.—L,M,S,X,Y  
 Telesine Antenna Corp., Shreveport 92, La.—I,J  
 Teletenna Co., 1033 Indiana Ave., LaPorte, Ind.—I,J,AB  
 Television Laboratories Inc., Mill St., Wauconda, Ill.—H,I,J  
 Tele-Vue Towers, Inc., Erskine, Minn.—AA  
 Telkor, Inc., Telegraph Rd., Elyria, Ohio—I,K,M  
 Telrex, Inc., Asbury Park, N.J.—D,F,I,J,K  
 Tempo T-V Mfg Corp., 100 Prospect Ave., Burbank, Calif.—A,F,I,J,M,O,P,Q,R,AA  
 Tennialab, Quincy, Ill.—C,J  
 Tenna Trailer Co., 321 Plum St., Pontiac, Ill.—Q  
 Terwilliger TV Mast Co., 531 Lincoln Ave., Pontiac, Ill.—Q  
 Thomas & Betts, 36 Butler St., Elizabeth 1, N.J.—L  
 Thomas Mold & Die Co., Henry & Grant Sts., Wooster, Ohio—AA

Tinnerman Prods., P.O. Box 6688 Cleveland 1, Ohio—A,L  
 Tricraft Products Co., 1535 N. Ashland Ave., Chicago 22, Ill.—A,I,J,O,P,Q,R,V  
 Trio Mfg. Co., Griggsville, Ill.—I,J,U  
 Tru-Tronics Mfg. Co., 7 N. Halsted St., Chicago 6, Ill.—I,J,AB  
 T-V Products Co., 145-68 228th St., Springfield Gardens 13, N.Y.—A,F,I,J,P,Q,R  
 TV Hdw. Mfg. Co., 919 Taylor St., Rockford, Ill.—A,F,G,H,I,J,M,O,P,Q,R,S,V,AA,AB  
 TV Products Co., Platte Center, Kans.—F,I,J  
 UHF Resonator Co., 224 7th St., Racine, Wis.—I,J,K  
 Ultra-Hi TV Mfg., 69 Hammond St., Worcester, Mass.—A,I,J  
 United Technical Labs., Morristown, N.J.—G,H,M  
 Universal Products, 4100 Taylor Ave., Racine, Wis.—I,J,Q,AA  
 Unique Ventilating Co., 615 Tiffany St., Bronx 59, N.Y.—R  
 UR-Rad Inc., St. Joseph, Mich.—I,J  
 Victor Insulators, Inc., Maple Ave., Victor, N.Y.—O  
 Vidair Electronics Mfg. Co., 576 W. Merrick Rd., Lynbrook, N.Y.—A,M,X,Y  
 Video Accessory Mfg. Co., P.O. Box 223, Tulsa 1, Okla.—Q,R  
 Video Electronic Lab., 304 Rodgers Rd., Des Moines, Iowa—E,I,J,R,AB  
 Video Industries Co., 42 Palmer Pl., Port Chester, N.Y.—A,C,I,J,M  
 Waldom Electronics, Inc., 4625 W. 53rd St., Chicago 32, Ill.—B  
 Wallace Supplies Mfg. Co., 1300 Diversey Pkway, Chicago 14, Ill.—I,J,Q  
 Walnut Machine, 722 Western Ave., South Bend, Ind.—AA  
 Walsco Electronics Corp., 3602 Crenshaw Blvd., Los Angeles 16, Calif.—A,F,H,I,J,K,AB  
 Ward Products, Div. Gabriel Co., 4710 S. State St., Ashtabula, Ohio—A,C,D,E,F,I,J,L,N,Q,R,Z,AA  
 Waterproof Electric Co., 801 S. Main St., Burbank, Calif.—A,B,C,D,I,J,L,M,N,O,Q,R  
 Welco Mfg. Co., 225 S. 3 St., Burlington, Iowa—I,J  
 Western Coil & Electrical Co., 215 State St., Racine, Wis.—N,Q,R,V,AA  
 Wheatland Tube Co., Bankers Securities Bldg., Philadelphia 7, Pa.—Q  
 Wilmar Mfg. Co., 2715 E. 14th St., Kansas City 27, Mo.—A  
 Wincharger Corp., E. 7th & Division Sts., Sioux City 2, Iowa—Q,R  
 Wind Turbine Co., E. Market St. & P.R.R., West Chester, Pa.—D,F,N,O,Q,R,U,V,X,AA  
 Winegard Co., 3000 Scotten Blvd., Burlington, Iowa—J  
 Winpower Mfg. Co., 1207 1st Ave., E., Newton, Iowa—AA

## 2—BATTERIES

Batteries, dry cell radio ..... A  
 Batteries, flashlight ..... B  
 Batteries, hearing aid ..... C  
 Batteries, ignition ..... D  
 Batteries, storage ..... E  
 Battery Connectors ..... F

Acme Battery Corp., 59 Pearl St., Brooklyn, N.Y.—A,B,C,D  
 Aircraft-Marine Products, 2100 Paxton St., Harrisburg, Pa.—F  
 Allied Eng'g Div., Allied Int'l, Inc., 230 Park Ave., New York 17, N.Y.—A  
 Bond Electric Corp., New Haven, Conn.—A,B  
 Bright Star Industries, 600 Getty Ave., Clifton, N.J.—A,B,D  
 Burgess Battery Co., Freeport, Ill.—A,B,C,D  
 Cannon Electric Co., 3209 Humboldt St., Los Angeles 31, Calif.—F  
 Cinch Mfg. Corp., 1026 S. Homan Ave., Chicago 24, Ill.—F  
 Delco-Remy Div., Gen'l Motors, Anderson, Ind.—E  
 General Cement Mfg. Co., 919 Taylor Ave., Rockford, Ill.—F  
 General Dry Batteries, 13000 Athens Ave., Cleveland 7, Ohio—A  
 General Electric Co., Apparatus Div., 1 River Rd., Schenectady, N.Y.  
 Industrial Hdw. Co., 109 Prince St., New York 12, N.Y.—F  
 Interelectronics, 2432 Grand Concourse, New York 58, N.Y.—C,E  
 Kellogg Switchboard & Supply Co., 79 W. Monroe St., Chicago 3, Ill.—A,B,E  
 Magnavox Co., Ft. Wayne 4, Ind.—A,B,C  
 Mallory & Co., P. R., 3029 E. Washington St., Indianapolis 6, Ind.—B,C  
 Marathon Battery Co., Henrietta St., Wausau, Wis.—A,B,C,D  
 National Carbon Co., Div. Union Carbide & Carbon Corp., 30 E. 42 St., New York 17, N.Y.—A,B,C  
 Olin Industries, 275 Winchester Ave., New Haven 4, Conn.—A,B,C,D

Pacific Electricord Co., 3217 Exposition Pl., Los Angeles 8, Calif.—F  
 Philco Corp., Tioga & C Sts., Philadelphia 34, Pa.—A,B,D  
 Radio Corp. of America, Tube Div., Harrison, N.J.—A,AB  
 Ray-O-Vac Co., 212 E. Washington Ave., Madison 10, Wisc.—A,B,C,D  
 Raytheon Mfg. Co., Waltham 54, Mass.  
 Sonar Radio Corp., 3050 W. 21 St., Brooklyn 24, N.Y.—E  
 Sonotone Corp., Elmsford, N.Y.—E  
 Trico Fuse Mfg. Co., 2948 N. 5 St., Milwaukee 12, Wisc.—F  
 Trimm, Inc., Libertyville, Ill.—C  
 U.S. Electric Mfg. Corp., 222 W. 14 St., New York 11, N.Y.—A  
 Willard Storage Battery Co., 246 E. 131 St., Cleveland 1, Ohio—A,B,E  
 Yardney Electric Corp., 40 Leonard St., New York, N.Y.—E

### 3—BOOKS & SERVICE DATA

Diagrams, service ..... A  
 Guides, capacitor color code ..... L  
 Guides, component replacement ..... F  
 Guides, pricing ..... K  
 Guides, rectifier replacement, selenium ..... B  
 Guides, resistor color code ..... C  
 Guides, tube replacement ..... D  
 Guides, tube substitution ..... E  
 Manuals, test equipment ..... J  
 Manuals, tube ..... G  
 Reference books ..... I

American Electronics Co., 1203 Bryant Ave., New York 59, N.Y.—I  
 Audel Publishers, 49 W. 23rd St., New York, N.Y.—I  
 Burgess Battery Co., Foot of Exchange St., Freeport, Ill.—A,F,I,K  
 Caldwell-Clements Manuals Corp., 480 Lexington Ave., New York 17, N.Y.  
 Capehart Farnsworth Co., 3702 E. Pontiac St., Fort Wayne 5, Ind.—A,D,F  
 CBS-Hytron, Div. of Columbia Broadcasting System, Inc., Danvers, Mass.—G  
 Centralab Div. Globe-Union Inc., 902Y E. Keefe Ave., Milwaukee 1, Wisc.—C,F,L  
 Cisin, Harry G., Amagansett, N.Y.—A,D,I  
 Clarostat Mfg. Co., 1 Washington St., Dover, N.H.—F  
 Cook Laboratories, 114 Manhattan St., Stamford, Conn.—H  
 Dover Publications, Inc., 1780 Broadway, New York, N.Y.—I  
 Eitel-McCullough, Inc., 798 San Mateo Ave., San Bruno, Calif.—G  
 Electronic Devel. Assoc., 125 E 46 St., New York 17, N.Y.  
 Emerson Radio & Phonograph Corp., 14 & Coles St., Jersey City, N.J.—A  
 Federal Telephone & Radio Co., 100 Kingsland Rd., Clifton, N.J.—B,I  
 General Electric Co., Schenectady, N.Y.  
 General Electric Co., Electronics Park, Syracuse, N.Y.  
 Harper & Bros., 49 E. 33rd St., New York, N.Y.—I  
 International Rectifier Corp., 1521 E. Grand Ave., El Segundo, Calif.—B  
 Lytle Eng'g & Mfg. Co., 105 W. Monroe St., Chicago 3, Ill.—H,I  
 Macmillan Co., 60 5th Ave., New York 11, N.Y.—I  
 Mallory & Co., P. R., 3029 E. Washington St., Indianapolis 6, Ind.—B,F,K,I  
 McGraw-Hill Publ. Co., 330 W. 42 St., New York, N.Y.—A  
 National Radio Institute, 16th & U Sts., Washington, D.C.  
 Oelrich Publications, 4308 Milwaukee Ave., Chicago 41, Ill.—K  
 Pitman Publishing Corp., 2 W. 45 St., New York, N.Y.—I  
 Prentice-Hall, Inc., 70 Fifth Ave., New York, N.Y.—I  
 Radio Corp. of America, Tube Div., Harrison, N.J.—A,F,G,I,J  
 Radio Receptor Co., 251 W. 19 St., New York 11, N.Y.—B  
 Rider, Inc., John F. 480 Canal St., New York 13, N.Y.—A,D,E,F,I,J  
 Rinehart Books, 232 Madison Ave., New York, 16, N.Y.—I  
 Sams & Co., Howard W., 2201 E. 46th St., Indianapolis 5, Ind.—A  
 Scientific Book Publishing Co., Vincennes, Ind.—I  
 Sheldon Electric Co., 68 Coit St., Irvington 11, N.J.—D,E  
 Snyder Mfg. Co., 22 & Ontario Sts., Philadelphia, Pa.—I  
 Supreme Publications, 3727 W. 13th St., Chicago 23, Ill.—I  
 Sylvania Electric Products, Inc., 1740 Broadway, New York 19, N.Y.—D,E,G

Tarzian, Inc., Sarkes-Rectifier Div., 415 N. College Ave., Bloomington, Ind.—B  
 Tung-Sol Electric, Inc., 95 8th Ave., Newark 4, N.J.—G  
 United Catalog Publishers, 110 Lafayette St., New York 13, N.Y.—F,K,I  
 Van Nostrand Co., 250 4th Ave., New York, N.Y.—I  
 Wallace's Telalides, Inc., 136 Day St., Jamaica Plain 30, Mass.—A,F  
 Wiley & Sons, Inc., John, 440 Fourth Ave., New York 16, N.Y.—I

### 4—CABINETS & CASES

Cabinets, chassis ..... A  
 Cabinets, custom ..... B  
 Cabinets, equipment ..... C  
 Cabinets, metal ..... D  
 Cabinets, plastic ..... E  
 Cabinets, speaker ..... F  
 Cabinets, wood ..... H  
 Cases, amplifier carrying ..... I  
 Cases, meter ..... J  
 Cases, phono-carrying (see Sec. 12)  
 Cases, radio ..... K  
 Shelving ..... L  
 Storage Bins & Cabinets for parts ..... M  
 Tables ..... N

Admiral Corp., Molded Prods. Div., P.O. Box 338, W. Chicago, Ill.—E  
 Aids For Good Housekeeping, 21 Plandome Rd., Manhasset, N.Y.—N  
 Akro-Mills, Inc., P.O. Box 989, Akron 9, Ohio—C,D,E,M  
 Alden Products Co., 117 N. Main St., Brockton, Mass.—A,J,S  
 Allied Engraving & Stamping Co., 161 Ellicott St., Buffalo 3, N.Y.—E  
 American Radio Hardware Co., 152 MacQueston Pkwy. So., Mt. Vernon, N.Y.—D,M  
 Arbor Mfg. Co., Depew, N.Y.—I,M  
 Arbuck, Inc., 116 Troutman St., Brooklyn 6, N.Y.—N  
 Argos Products, 310 Main St., Genoa, Ill.—C,F,H,I,J,N  
 Beam Instruments Corp., 350 5 Ave., New York 1, N.Y.—F  
 Bergsma Bros., 1000 36 St. S.E., Grand Rapids 8, Mich.—N  
 Bestcraft Products, 626 Broadway, New York 12, N.Y.—N  
 Blonder-Tongue Labs. Inc., 526 North Ave., Westfield, N.J.—D  
 Bogen Co., David, 29 9th Ave., New York 14, N.Y.—C,D,F,I  
 Bolain Bending Co., 1702 N. Milwaukee Ave., Chicago 47, Ill.—N  
 British Industries Corp., 164 Duane St., New York 13, N.Y.—D  
 Brookcraft Mfg., 123 Lafayette St., New York 13, N.Y.—N  
 Browne Electronics, 12450 W. Washington Blvd., Venice, Calif.—H  
 Bud Radio, Inc., 2118 E. 55th St., Cleveland 3, Ohio—A,B,C,D,F,I,J  
 Burkem Lamination Corp., 811 Whittier St., New York 59, N.Y.—D  
 Camera Equipment Co., 1600 Broadway, New York 19, N.Y.—M  
 Capehart-Farnsworth Co., 3702 E. Pontiac St., Fort Wayne 5, Ind.—A,B,C,F,H  
 Casard Furniture Mfg., 507 E. Russell St., High Point, N. Car.—N  
 Case Mfg. Co., P.O. Box 889, High Point, N. Car.—N  
 Chicago Industrial Instrument Co., 536 W. Elm St., Chicago 10, Ill.—D,E  
 Churchill Lighting Corp., 344 Franklin St., Melrose 76, Mass.—A,B,C,D,F,I  
 Cincinnati Ventilating Co., Third & Madison, Covington, Kv.—M  
 Cline Electric Mfg. Co., 3405 W. 47 St., Chicago 32, Ill.—M  
 Comfort Lines, 1735 Diversey Parkway, Chicago 14, Ill.—N  
 Cooper Industries, 4953 W. Fullerton Ave., Chicago 39, Ill.—L,M  
 D & M Products, 13144 W. McNichols Rd., Detroit 35, Mich.—F  
 Eastern Teletable, 294 Broad St., Lynn, Mass.—N  
 Electro-Sound Corp., 115 Halleck St., Boston 20, Mass.—C,D  
 Emerson Radio & Phonograph Corp., 14 & Coles St., Jersey City, N.J.—D,E,H  
 Equipto Div., Aurora Equip. Co., 422 Cleveland St., Aurora, Ill.—L,M  
 Fisher Co., Oscar, 1000 N. Division St., Peeks-kill, N.Y.—D  
 Gee-Lar Mfg. Co., 819 Elm St., Rockford, Ill.—H  
 General Industries Co., Olive & Taylor Sts., Elvria, Ohio—E  
 G&H Wood Products Co., 75 N. 11 St., Brooklyn 11, N.Y.—K,N

Gonset Co., 801 S. Main St., Burbank, Calif.—A,B,C,D,I,K  
 Gravelly Novelty Furniture, Ridgeway Div., Ridgeway, Va.—N  
 Gusdorf & Son, 6900 Manchester, St. Louis 17, Mo.—N  
 Hi-Lo TV Antenna Corp., 3540 N. Ravenswood Ave., Chicago 13, Ill.—N  
 Hobbs, Inc., Guy, Dallastown, Pa.—N  
 Hoffman Electronics Corp., P.O. Box 2153, Los Angeles 54, Calif.—A,H  
 Hubbell Mfg. Co., H L., Zeeland, Mich.—D, L,N  
 Illinois Wood Products, 1656 N. Besley Ct., Chicago 22, Ill.—N  
 Industrial Television, Inc., 369 Lexington Ave., Clifton, N.J.—D  
 Insuline Corp. America, 186 Granite St., Manchester, N.H.—A,B,C,D,E,F,I,J  
 Jamestown Table Co., Jamestown, N.Y.—N  
 Jensen Mfg. Co., 6601 S. Larimie St., Chicago 3, Ill.—F  
 Karyall Body, Inc., 8221 Clinton Rd., Cleveland 9, Ohio—L,M  
 Kellogg Switchboard & Supply Co., 79 W. Monroe St., Chicago 3, Ill.—A,B,H  
 King & Sons, J. E., Peru, Ind.—N  
 Kleer-Vue Mfg. Co., 636 Penn Ave., Pittsburgh 2, Pa.—M  
 Koch Sons, George, 10 S. 11 Ave., Evansville 4, Ind.—N  
 Kraft Bros., 1299 Jerome Ave., New York 52, N.Y.—I  
 Kuehne Mfg. Co., Mattoon, Ill.—N  
 Lowell Mfg., 3030 Laclede Sta. Rd., St. Louis 17, Mo.—A,B,D  
 Ludgate Assoc., John P., 351 Fifth Ave., Pittsburgh 22, Pa.—N  
 Magic Vue Television Corp., 323 E. 13 St., New York 3, N.Y.—A,F,H  
 Magnavox Co., Ft. Wayne 4, Ind.—H  
 Majestic Radio & TV, Div. Wilcox-Gay Corp., 70 Washington St., Brooklyn 1, N.Y.—A,H  
 Manco Mfg., Washington & Locust Sts., Bradley, Ill.—N  
 Mancor Co., 663 N. Wells St., Chicago, Ill.—N  
 Manfredi Wood Products, 226 N. Y. Ave., Huntington, L.I., N.Y.—N  
 Masco Mfg., 1319 Market St., St. Louis, Mo.—N  
 Masterpiece Custom TV, 715 Flatbush Ave., Brooklyn 26, N.Y.—F,H  
 Mattison Radio & TV Co., 10 W. 181 St., New York 53, N.Y.—A,B,F,H,K  
 McGohan, Inc., Don, 3700 W. Roosevelt Rd., Chicago 24, Ill.—D,F,P  
 Metronics, Inc., U.S. Route 130, Burlington, N.J.—A,D,E,K,M  
 Middletown Mfg. Co., Middletown, Conn.—D, F  
 Midwest Cabinet, 2047 W. Churchill St., Chicago 47, Ill.—N  
 Milford Tool Co., 108 Gulf St., Milford, Conn.—N  
 Muckle Mfg. Co., Owatonna, Minn.—K,M  
 National Teletable Corp., P.O. Box 1289, High Point, N. C.—N  
 Newcomb Audio Products Co., 6824 Lexington Ave., Hollywood 38, Calif.—I  
 O'Brien Electric Corp., 6514 Santa Monica Blvd., Hollywood 38, Calif.—D  
 Par-Metal Products Corp., 32-62 49th St., Long Island City, N.Y.—D  
 Perlot Tables, Henderson, Ky.—N  
 Permoflux Corp., 4900 W. Grand Ave., Chicago 39, Ill.—F  
 Planet Wood Products, 3902 8 Ave., Brooklyn, N.Y.—N  
 Plymouth Electronics Corp., 50 Kingsbury St., Worcester 3, Mass.—D,G  
 Porter Mfg. Co., 1524 Fredrick St., Racine, Wisc.—N  
 Premier Metal Products Co., 3160 Webster Ave., New York 67, N.Y.—A,B,D,F,J  
 Q-Line Mfg. Corp., 1562 61 St., Brooklyn 19, N.Y.—A,D  
 Radio City Products Co., Centre & Glendale Sts., Easton, Pa.—A,C,D  
 Radio Corp. of America, Camden, N.J.—D,H  
 Radio Corp. of America, Tube Div., Harrison, N.J.—C  
 Radionic Laboratories, 1111 State Rd. 67E., Anderson, Ind.—A,F  
 Reclaimo Mfg. Co., 5083 N. Elston Ave., Chicago 30, Ill.—N  
 Regency Div., IDEA Inc., 7900 Pendleton Pike, Indianapolis 26, Ind.—A  
 Reiner Electronics Co., Center & Glendale Sts., Easton, Pa.—A,C,D  
 Ridgeway Div., Gravelly Novelty Furniture, Ridgeway, Va.—H  
 River Edge Industries, 5 River Edge Rd., River Edge, N.J.—B,C,F,H,K,N  
 RJ Audio Products, Inc., 164 Duane St., New York 13, N.Y.—F  
 R. K. Mfg. Co., P.O. Box 112, Marion, Ill.—A,B,O,R,V,W,X,Z  
 Romar Plastics Inc., 1311 E. Main St., St. Charles, Ill.—B,E,J  
 Service Parts Systems, 13380 E. 9-Mile Rd., East Detroit, Mich.—M  
 Shrader Sound, Inc., 2803 M. St., N.W. Washington 7, D.C.—F  
 Standard Wood Prods. Co., 47 W. 63 St., New York 23, N.Y.—H  
 Stephens Mfg. Co., 8538 Warner, Culver City, Calif.—F

Stone City Machine & Tool Co., Bedford, Ind.—D  
 Streamline Wood Products, 4849 N. Cicero Ave., Chicago 30, Ill.—H  
 Stromberg-Carlson Co., 100 Carlson Rd., Rochester 3, N.Y.—F  
 Tabet Mfg. Co., 1336 Ballentine Blvd., Norfolk 1, Va.—A,B,C,D  
 Tech-Master Products, 75 Front St., Brooklyn 1, N.Y.—A  
 Television Engineers Inc., 3325 W. Bryn Mawr, Chicago 45, Ill.—C,H  
 Tel-Rad Mfg. Co., Fennimore, Wis.—H  
 Tell City Furn. Co., Tell City, Ind.—N  
 Transformer Metal Prod., Inc., 343 W. 26 St., New York, N.Y.—A,B,C,D,I,J,K,L  
 U.M.&F. Mfg. Corp., 10929 Van Owne St., N. Hollywood, Calif.—A,B,C,D,I,J  
 United Mfg. Co., Div. W. L. Maxson Corp., 41 Haig St., Hamden 14, Conn.—D  
 Universal Co., High Point, N. Car.—N  
 Universal Toy & Novelty, La Porte, Ind.—N  
 Universal Woodcrafters, La Porte, Ind.—N  
 University Loudspeakers Inc., 80 S. Kensico Ave., White Plains, N.Y.—F  
 Vineta Mfg. Co., 2738 N. Sheffield Ave., Chicago, Ill.—N  
 Waldom Electronics, Inc., 4625 W. 53 St., Chicago 32, Ill.—E,J  
 Waterproof Electric Co., 801 S. Main St., Burbank, Calif.—D  
 Webster Electric Co., 1900 Clark, Racine, Wis.—I

### 5—CAPACITORS

Capacitors, buffer ..... A  
 Capacitors, ceramic ..... B  
 Capacitors, electrolytic dry ..... C  
 Capacitors, electrolytic wet ..... M  
 Capacitors, feed-thru ..... N  
 Capacitors, glass ..... R  
 Capacitors, mica ..... D  
 Capacitors, molded composition ..... Q  
 Capacitors, molded, paper & wax ..... E  
 Capacitors, oil-filled ..... F  
 Capacitors, paper metal encased ..... T  
 Capacitors, paper metalized ..... G  
 Capacitors, photoflash ..... H  
 Capacitors, piston trimmer ..... O  
 Capacitors, silicone-filled ..... I  
 Capacitors, tantalum ..... S  
 Capacitors, tuning ..... P  
 Capacitors, variable ..... L  
 Suppressors ..... J  
 Trimmers & Padders ..... K

Acme Electronics Inc., Sub. Aerovox Corp., 2724 Peck Rd., Monrovia, Calif.—C,G  
 Admiral Corp., Molded Prods. Div., P.O. Box 338, W. Chicago, Ill.—L  
 Aerovox Corp., 740 Belleville Ave., New Bedford, Mass.—A,B,C,D,E,F,G,H,I,M,N  
 Ajax Condenser Co., 932 W. Wrightwood, Chicago 14, Ill.—C,E,F  
 American Condenser Co., 4410 N. Ravenswood Ave., Chicago 40, Ill.—E,F,M  
 American Radionic Co., Inc., 33 Flatbush Ave., Brooklyn 17, N.Y.—B,E  
 Anchor Radio Corp., 2215 St. Louis Ave., Chi-Ave., Chicago, Ill.—E,F,N  
 Arco Electronics, Inc., 103 Lafayette St., New York 13, N.Y.—A,B,D,K,L,N,P  
 Astron Corp., 255 Grant Ave., E. Newark, N.J.—A,C,E,F,G,J  
 Bel Fuse, Inc., 311 Mountain Rd., Union City, N.J.—K,O  
 Berger Communications, 109-01 72nd Rd., Forest Hill, N.Y.  
 Bud Radio Inc., 2118 E. 55 St., Cleveland 3, Ohio—K,L,P  
 Cardwell Electronics Productions, Allen D., 97 Whiting St., Plainville, Conn.—L  
 Centralab Div., Globe-Union Inc., 902Y E. Keefe Ave., Milwaukee 1, Wis.—A,B,K,N,O  
 Chicago Condenser Corp., 3255 W. Armitage Ave., Chicago, Ill.—E,F,N  
 Columbia Resistors, Inc., 23 W. Washington Ave., Pearl River, N.Y.—J  
 Condenser Products Co., 7517 N. Clark St., Chicago 26, Ill.—E  
 Cordover Co., Carl, 100 Warren St., New York, N.Y.  
 Cornell-Dubilier Elec. Corp., South Plainfield, N.J.—A,B,C,D,E,F,G,H,I,J,N,S  
 Corning Glass, Corning, N.Y.—R  
 Corson Elec. Mfg., 540 39 St., Union City, N.J.—F,G,I  
 Cosmic Radio Corp., 853 Whittier St., Bronx, N.Y.—C,E  
 Deuschmann Corp., Tobe, Providence Highway, Norwood, Mass.—C,E,F,G,H,I,J,N  
 Dumont-Airplane & Marine Instruments, Inc., 15 William St., New York 5, N.Y.—C,E,F,G,I  
 Dwyer Eng'g Co., P.O. Box 483, Nashua, N.H.—B

Eagle Electronics, 177 Hart St., New Britain, Conn.—B  
 Electromotive Mfg. Co., Willimatic, Conn.  
 Electronic Fabricators, 682 Broadway, New York 12, N.Y.—D,I  
 Erie Resistor Corp., 644 W. 12 St., Erie 6, Pa.—B,J,K,N,O,R  
 Federal Telephone & Radio Div. of IT&T, 100 Kingsland Rd., Clifton, N.J.—P  
 General Electric Co., 1 River Rd., Schenectady, N.Y.—C,E,M  
 General Instrument Corp., 829 Newark Ave., Elizabeth 3, N.J.—F,K,P,L  
 General Products Corp., 107 Salem St., Union Springs, N.Y.—G  
 Girard-Hopkins, 1000 40 Ave., Oakland 1, Calif.—F,G  
 Good-All Electric Mfg., Ogallala, Nebr.—F,I  
 Gudeman Co., 340 W. Huron St., Chicago 10, Ill.—A,B,F,G,H,I,M,N  
 Hammarlund Mfg. Co., 460 W. 34th St., New York 1, N.Y.—K  
 Illinois Condenser Co., 1616 N. Throop St., Chicago 22, Ill.—C,H  
 Industrial Condenser Corp., 3243 N. Calif. Ave., Chicago 18, Ill.—C,E,F,G  
 Insuline Corp. of America, 186 Granite St., Manchester, N.H.—B  
 Intercontinental Industries, Inc., 555 W. Adams St., Chicago 6, Ill.—D,K  
 International Resistance Co., 401 N. Broad St., Philadelphia, Pa.—Q  
 Jennings Radio Mfg. Co., P.O. Box 1278, San Jose 8, Calif.  
 JFD Mfr. Co., 6101 16th Ave., Brooklyn 4, N.Y.—O  
 Johnson Co., E. F., Waseca, Minn.—K,L  
 Kellogg Switchboard & Supply, 79 W. Monroe St., Chicago 3, Ill.—F,G  
 Magnavox Corp., Ft. Wayne, Ind.—C,M  
 Mallory & Co., P.R., 3029 E. Washington St., Indianapolis 6, Ind.—A,B,C,D,E,F,G,H,L,P  
 Micamold Radio Corp., 1087 Flushing Ave., Brooklyn 37, N.Y.—C,D,E,N  
 Millen Mfg. Co., James, 150 Exchange St., Malden 48, Mass.—L



Miller Co., J.W., 5917 S. Main St., Los Angeles 3, Calif.—K,L  
 Monarch Condenser Corp., 550 Westchester Ave., New York 55, N.Y.—E  
 Morrow Radio Mfg. Co., 2794 Market St., Salem, Ore.—L,P  
 Mucon Corp., 9 St. Francis St., Newark, N.J.—B  
 Mycalex Corp. of America, 125 Clifton Blvd., Clifton, N.J.—B,K  
 National Capacitor Co., 60 Washington Ct., Quincy, Mass.—E,G,R  
 National Co., 61 Sherman St., Malden, Mass.—B,K  
 New York Coil Co., Inc., Phoenixville, Pa.—J,T  
 Oak Mfg. Co., 1260 Clybourn Ave., Chicago 10, Ill.—P  
 Ortho Filter Corp., 196 Albion Ave., Paterson 2, N.J.—J  
 Philco Corp., Tioga & C Sts., Philadelphia 34, Pa.—B,C,E,F,N  
 Philmore Mfg. Co., 113 University Pl., New York 3, N.Y.—J,K,L  
 Planet Mfg. Corp., 225 Belleville Ave., Bloomfield, N.J.—C  
 Plastic Capacitors, Inc., 2511 W. Moffat St., Chicago 47, Ill.—F,I  
 Pyramid Electric Co., 1445 Hudson Blvd., N. Bergen, N.J.—A,C,E,F,G,I,N  
 Radio Materials Corp., 3325 N. California Ave., Chicago 18, Ill.—B  
 Radio Supply & Eng'g., 85 Seldon Ave., Detroit 1, Mich.—A,B,C,D,E  
 Romar Plastics, Inc., 1311 E. Main St., St. Charles, Ill.—D  
 Sangamo Electric Co., Capacitor Div., Box 7, Marion, Ill.—C,D,E  
 Skottie Electronics, Inc., 731 Pleasant Ave., Peckville, Pa.—B  
 Sprague Products Co., N. Adams, Mass.—A,B,C,D,E,F,G,H,M,N  
 Stone City Machine & Tool Co., Bedford, Ind.—K  
 Tarzian Inc., Sarkes, Rectifier Div., 415 N. College Ave., Bloomington, Ind.—L  
 Telkor Inc., Telegraph Rd., Elyria, Ohio—J  
 Thordarson-Meissner, Mt. Carmel, Ill.—L,P  
 Tru-Ohm Products Div., Model Eng'g. & Mfg. Inc., 2800 N. Milwaukee Ave., Chicago 18, Ill.  
 United Condenser Corp., 3400 Park Ave., New York 56, N.Y.—E  
 United Electronic Mfg. Corp., 542 39 St., Union City, N.J.—C  
 Welch Mfg. Co., W. M., 1515 Sedgwick St., Chicago 10, Ill.—F  
 Wilmar Mfg. Co., 2715 14 St., Kansas City 27, Mo.—L

### 6—CHOKES, COILS & TRANSFORMERS

Chokes, AF ..... A  
 Chokes, filter ..... B  
 Chokes, RF ..... D  
 Coils, field ..... E  
 Coils, focus ..... F  
 Coils, IF, oscillator & RF ..... G  
 Coils, peaking ..... H  
 Coils, speaker voice ..... I  
 Controls, linearity & width ..... J  
 Deflection Yokes ..... K  
 Inductors, toroid ..... L  
 Inductors, variable ..... M  
 Relays, coaxial ..... AA  
 Relays ..... AF  
 Relays, thermal ..... AB  
 Relays, time delay ..... AC  
 Solenoids ..... N  
 Transformers, antenna matching ..... AD  
 Transformers, audio ..... O  
 Transformers, constant voltage ..... P  
 Transformers, Elevator ..... AE  
 Transformers, filament ..... R  
 Transformers, flyback ..... S  
 Transformers, IF, oscillator & RF ..... T  
 Transformers, intercom ..... U  
 Transformers, isolation ..... V  
 Transformers, power ..... W  
 Transformers, step-down ..... X  
 Transformers, variable ..... Y  
 Transformers, vibrator ..... Z

Acme Electronics Inc., Sub. Aerovox Corp., 2724 Peck Rd., Monrovia, Calif.—B,D  
 Aero Products Co., 369 Shurs Lane, Philadelphia 28, Pa.—O,W  
 Aero Transformer & Mfg. Corp., 26-02 4 St., Long Island City 2, N.Y.—B,O,R,V,W  
 Adams & Westlake Co., 1175 N. Mich. St., Elkhart, Ind.—AC  
 Advance Electric & Relay Co., 2435 N. Naomi St., Burbank, Calif.—N,AA,AC  
 Aerocoil Inc., 24 Cliff St., Jersey City, N.J.—D,G,M,N  
 Aircraft Transformer Corp., Long Branch, N.J.—B,H,L,M,O,V,W  
 Airdesign, Inc., 241 Fairfield Ave., Upper Darby, Pa.—B,D,O,R,V,W  
 Allied Control Co., 2 East End Ave., New York 21, N.Y.—AF  
 Altec Lansing Corp., 9356 Santa Monica Blvd., Beverly Hills, Calif.—A,B,O,R,W,X  
 Anchor Electronics, Inc., 717 Sip St., Union City, N.J.—D,L,M,N  
 Arco Transformer & Electric Co., 1602 S. Hanna St., Ft. Wayne, Ind.—A,B  
 Atlas Coil Inc., 49 Hawkins St., Derby, Conn.—A,B,D,G,K,O,P,R,T,V,W,X,V,AE  
 Auto-Test, Inc., 600 S. Mich. Ave., Chicago 5, Ill.—O,R,V,W  
 Barry Electronics Corp., 512 Broadway, New York 12, N.Y.—B,I,R  
 Bendix Aviation Corp., Red Bank Div., Eatontown, N.J.—N  
 Best Electronics Corp., 617 19 St., Manhattan Beach, Calif.—AD,AE  
 Blonder-Tongue Labs., 526 North Ave., Westfield, N.J.—AB,AD  
 Bogen Co., David, 29 9 Ave., New York 14, N.Y.—X  
 Brach Mfg. Corp., 200 Central Ave., Newark 3, N.J.—AD  
 Bradford Components, 33 Bishop St., Bradford, Pa.—B,E,G,H,J  
 British Electronic Sales, 23-03 45 Rd., Long Island City, N.Y.—O  
 Bud Radio Inc., 2118 E. 55 St., Cleveland 3, Ohio—D  
 Burnell & Co., 45 Warburton Ave., Yonkers 2, N.Y.—L,M  
 Caddell—Burns, 40 E. 2 St., Mineola, N.Y.—B,D,G,N  
 Campbell X-Ray Corp., 110 Cummington St., Boston 15, Mass.—R,W  
 Carruthers & Fernandez, 1501 Colorado Ave., Santa Monica, Calif.—N  
 Chicago Standard Transformer Corp., 3850 Elston, Chicago 18, Ill.—A,B,F,J,K,L,O,R,S,U,V,W,X,Y,Z  
 Cinaudagraph Corp., 7334 N. Clark St., Chicago 26, Ill.—O,S,W  
 Cline Electric Mfg. Co., 3405 W. 47 St., Chicago 32, Ill.—AC  
 Clippard Instrument Lab., 7350 Colerain Rd., Cincinnati 24, Ohio—D,G,H,T,AD  
 Clum Mfg. Co., 611 W. National Ave., Milwaukee 41, Wis.  
 Coil Co. of America, Northvale, N.J.—B,L,N,O,R,S,V,W,AC  
 Coil Winders, Inc., 100 N.Y. Ave., Westbury, L.I., N.Y.—B,G,H,K,L,M,R,Y



Communication Accessories, Hickman Mills, Mo.—A,B,D  
 Consolidated Radio Products Co., 350 W. Erie St., Chicago 10, Ill.—A,B,E,F,K,O,P,R,S  
 Crest Laboratories, Inc., 8411 Rockaway Beach Blvd., Rockaway Beach 93, N.Y.—A,B,D,H,J,N,O,R,U,V,W,X,Y,Z  
 Crest Transformer Corp., 1834 W. North Ave., Chicago 22, Ill.—A,B,O,R,V,W,X,Z  
 Cunningham Son & Co., James, 33 Litchfield St., Rochester 8, N.Y.—N  
 Cutler-Hammer, Inc., 436 N. 12 St., Milwaukee 1, Wisc.—AC  
 Dane Electronics Labs., P.O. Box 209, Salem, Mass.—AD  
 Davis Electronics, P.O. Box 1247, Burbank, Calif.—AD  
 Delco Radio Div., General Motors Corp., 1446 S. Home Ave., Kokomo, Ind.—G,T,W  
 Dietz Design & Mfg. Co., Box 222, Grandview, Mo.—B,D,G,L,M,N,O,R,V,W  
 Dongan Electric Mfg. Co., 2987 Franklin St., Detroit 7, Mich.—U,W  
 Dormitzer Electric & Mfg. Co., 5 Hadley St., Cambridge, Mass.—B,R,W  
 Dow Key Co., Warren, Minn.—AA,AE  
 Dunkle Coil Co., 3257 W. 6 St., Los Angeles 6, Calif.  
 Durakool Inc., 1010 N. Main St., Elkart, Ind.—AC  
 DX Radio Products Co., 2300 Armitage Ave., Chicago 47, Ill.—A,B,D,E,F,G,H,I,K,L,N,O,R,S,T,V,W,X,Z  
 Ebert Electronics Corp., 212-26 Jamaica Ave., Queens Village, N.Y.—AF  
 Edison Inc., Thomas A., Instrument Div., 93 Lakeside Ave., W. Orange, N.J.—AB,AC  
 Electrical Service Co., 1271 Mission St., San Francisco 3, Calif.—AC  
 Electronic Eng'g Co., 3323 W. Armitage Ave., Chicago 47, Ill.  
 Electro-Tech Equip. Co., 308 Canal St., New York 13, N.Y.—N,W,AC  
 Elly Electronics Corp., 22-02 Raphael St., Fairlawn, N.J.—AB,AC  
 El-Rad Mfg. Co., 2800 W. Cullom Ave., Chicago 18, Ill.—E,G,N,S,T  
 Espey Mfg. Co., 528 E. 72nd St., New York 21, N.Y.—O,P,R,T,U,V,W,X,Y,AE  
 Federal Telephone & Radio Co., A Div. of IT&T, 100 Kingsland Rd., Clifton, N.J.—O,V,W,Z,AA  
 Femco Inc., Irwin, Pa.—B  
 Ferranti Electric Inc., 30 Rockefeller Plaza, New York 20, N.Y.—O,R,V,W  
 Fisher Eng'g Co., Huntington, Ind.—A,B,O,R,W,X  
 Forbes & Wagner, 345 Central Ave., Silver Creek, N.Y.—A,B,D,G,H,J,L,M,N,O,R,S,T,V,W,X  
 Freed Transformer Co., 1718 Weirfield St., Brooklyn 27, N.Y.—A,B,L,O,P,R,U,V,W,X,Z  
 General Electric Co., Electronics Park, Syracuse, N.Y.  
 General Instrument Corp., 829 Newark Ave., Elizabeth 3, N.J.—A,B,D,E,F,G,H,J,K,L,M,N,S,T,AD  
 General Transformer Co., 18240 Harwood Ave., Homewood, Ill.—A,B,O,R,V,W,X,Z  
 Gramer-Halderson Transformer Corp., 2734 N. Pulaski Rd., Chicago 39, Ill.—A,B,D,E,F,J,K,L,M,N,O,R,S,U,V,W,X,Y,Z,AD  
 Great Eastern Mfg. Co., 163 Remsen Ave., Brooklyn 12, N.Y.—H  
 Guardian Electric Mfg. Co., 1621 W. Walnut, Chicago 40, Ill.—N,AC  
 Harnett Electronic Corp., 138 Haven Ave., Port Washington, N.Y.—D,G,L,M,S,T  
 H-B Instrument Co., American & Bristol Sts., Philadelphia 40, Pa.—AE  
 Heath Co., Benton Harbor, Mich.—V  
 Heinemann Electric Co., Plum St. & Penna. Ave., Trenton 2, N.J.—AC  
 Heppner Mfg. Co., Round Lake, Ill.—S  
 Hetherington, Inc., Sharon Hill, Pa.—N  
 Hewi Duty Electric Co., 4212 W. Highland Blvd., Milwaukee, Wisc.—R,W,Y  
 Hillburn Electronic Products Co., 55 Nassau Ave., Brooklyn 22, N.Y.—D,G,H,J,S,T,U  
 Hindle Transformer Co., Flemington, N.J.—B,R,V,W,X  
 Illinois Transformer Co., 412 S. Green St., Chicago 7, Ill.—B,E,O,R,U,V,W,X,Z  
 Insuline Corp. America, 186 Granite St., Manchester, N.H.—D  
 International Resistance Co., 401 N. Broad St., Philadelphia 8, Pa.—D  
 James Vibrapowr Co., 4036 N. Rockwell St., Chicago 18, Ill.—O,R,Z  
 Jerrold Electronics Corp., 23 & Chestnut Sts., Philadelphia 46, Pa.—AD  
 JFD Mfg. Co., 6101 16th Ave., Brooklyn 4, N.Y.—AD  
 Johnson Co., E. F., Waseca, Minn.—D,H,L,M  
 Kellogg Switchboard & Supply, 79 W. Monroe St., Chicago 3, Ill.—K,AC  
 Kenyon Transformer Co., 840 Barry St., Bronx 59, N.Y.—B,O,R,V,W,Y  
 Kings Electronics Co., 40 Marbledale Rd., Tuckahoe, N.Y.—D,AA  
 Kurman Electric Co., 35-18 37 St., Long Island City 1, N.Y.—AA,AC  
 Leach Relay Co., 5915 Avalon Blvd., Los Angeles 64, Calif.—G  
 Lear, Inc., 11916 W. Pico Blvd., Los Angeles 64, Calif.—G  
 Lectrohm, Inc., 5560 Northwest Hwy., Chicago 30, Ill.—B,D,G,L,M,O,P

Leland Inc., G. H., 123 Webster St., Dayton 2, Ohio—N  
 Lepace Mfg. Co., 5932 Putnam Ave., Brooklyn 27, N.Y.—B,L,M,N,O,R,V,W  
 Lumenite Electronic Co., 407 S. Dearborn St., Chicago 5, Ill.—AC  
 Mag-Electric Products, 12822 Yukon Ave., Hawthorne, Calif.—B,D,L,M,R,V,W  
 Mallory & Co., P.R., 3029 E. Washington St., Indianapolis 6, Ind.—J  
 Marine View Electronics, 744 E. 138th St., New York 54, N.Y.—A,B,D  
 Mark Electronics, Inc., 250 Glenwood Ave., Bloomfield, N.J.—B,N,R,S,V,W  
 McIntosh Lab., Inc., 320 Water St., Binghamton, N.Y.—O  
 Merit Coil & Transformer Corp., 4427 N. Clark St., Chicago 40, Ill.—B,D,F,G,H,J,K,O,R,S,T,U,V,W,X,Y,Z  
 Mico Instrument Co., 80 Trowbridge St., Cambridge 38, Mass.—L  
 Microtraa Co., 84-11 Rockaway Beach Blvd., Rockaway Beach 93, N.Y.—A,B,H,I,L,O,R,U,V,W,X,Y,Z,AE  
 Midwest Coil & Transformer Co., 1640 N. Halsted St., Chicago 39, Ill.  
 Miller Co., J. W., 5917 S. Main St., Los Angeles 3, Calif.—D,G,H,J,M,T,AD  
 Millen Mfg. Co., James, 150 Exchange St., Malden 48, Mass.—D  
 Milwaukee Transformer Co., 5231 N. Hopkins St., Milwaukee 9, Wisc.—B,D,O,R,S,W  
 Minneapolis-Honeywell Regulator Co., 2753 4 Ave. S., Minneapolis 8, Minn.—N  
 Moran Electronic Components, 10506 Wheatley St., Kensington, Md.—D,E,G,H,I,J,L,M,N  
 Morrow Radio Mfg. Co., 2794 Market St., Salem, Ore.—Z  
 New London Instrument Co., 82 Union St., New London, Conn.—B,O,R  
 New York Coil Co., Inc., Phoenixville, Pa.—A,D,G,J,N,O,T,X,Z  
 North Hills Electric Co., 203-18 35 Ave., Bay-side 61, N.Y.—G,H,J,M,T  
 Ohmite Mfg. Co., 3601 Howard St., Skokie, Ill.—D,AC  
 Ortho Filter Corp., 196 Albion Ave., Paterson 2, N.J.—O,R,V,W,X  
 Peerless Electrical Products, Div. Altec Lansing Corp., 9356 Santa Monica Blvd., Beverly Hills, Calif.—A,B,N,O,R,V,W,X,Z  
 Penn-Tran Corp., Bellefonte, Pa.—K,S  
 Perma-Power Co., 4727 N. Damen Ave., Chicago 25, Ill.—Y  
 Permoflux Corp., 4900 W. Grand Ave., Chicago 39, Ill.—B,O,W,X  
 Philmore Mfg. Co., 113 University Pl., New York 3, N.Y.—D  
 Potter & Brumfield, Princeton, Ind.—AA,AB,AC  
 Power Transformer Co., 532 Mulberry St., Newark 6, N.J.—B,L,M,O,R,V,W,AD  
 Radio Corp. of America, RCA Tube Div., 415 S. 5 St., Harrison N.J.—F,J,K,S,V,W,Y  
 Radio Music Corp., 84 So. Water St., Port Chester, N.Y.—A,B,O,P,R,V,W,X  
 RAM Electronics Sales Co., So. Buckhout St., Irvington, N.Y.—J,K,T  
 Raynar, Inc., 7810 W. Addison St., Chicago 34, Ill.—G,L,M,R,S,T  
 Raytheon Mfg. Co., Equip. Sales, 100 River St., Waltham, Mass.—L,P,R,V,W,X  
 Retron Corp., 697 Lake Ave., Pasadena 6, Calif.—I,K,L,M,N,S  
 Reynolds Electric Co., 3000 River Rd., River Grove, Ill.—AB  
 Ripley Co., Middletown, Conn.—AF  
 Rogers Electronic Corp., 49 Bleecker St., New York 12, N.Y.—G,K,S  
 Scientific Coil Co., 5619 Broadway, Chicago 40, Ill.—F,G,H,K,L,M,N  
 Skysweeper Inc., McHenry, Ill.—A,B,O,R,U,V,W,X,Z  
 SNC Mfg. Co., P.O. Box 277, Oshkosh, Wisc.—A,B,E,H,I,O,P,R,U,V,W,X,Y,Z  
 Sola Electric Co., 4633 W. 16th St., Chicago 50, Ill.—P  
 S.O.S. Cinema Supply, 602 W. 52 St., New York 19, N.Y.—X  
 Standard Electrical Products Co., 2240 E. 3 St., Dayton 3, Ohio—A,B,L,M,N,O,P,R,V,W,X,Y,Z  
 Standard Winding Co., 44 Johnes St., Newburgh, N.Y.—B,D,G,J,L,M,N,AE  
 Stanwyck Winding Co., 137 Walsh Ave., Newburgh, N.Y.—B,G,H,K  
 Stromberg-Carlson Co., 100 Carlson Rd., Rochester 3, N.Y.—I  
 Struthers-Dunn, Inc., Lambs Rd., Pitman, N.J.—AF  
 Superex Electronics Corp., 4 Radford Pl., Yonkers, N.Y.—D,H,M,AD  
 Tartak Electronics, Inc., 2979 N. Ontario St., Burbank, Calif.—O,R,V,W  
 Tele Matic Industries, 16 Howard Ave., Brooklyn 21, N.Y.—D,Y,AD,AE  
 Television Labs., Inc., Mill St., Wauconda, Ill.—B,F,K,L,O,W,Z  
 Telex, Inc., 1633 Eustis St., St. Paul 1, Minn.—B,I,M,O  
 Tensitron, Inc., Pin Hill, Harvard, Mass.—Y  
 Texas Instruments, Inc., 6000 Lemmon Ave., Dallas 9, Texas—B,D,G,L,M,O,R,T,V,W  
 Thermador Electrical Mfg. Co., Electronics Div., 2000 S. Camfield Ave., Los Angeles 22, Calif.—B,O,R,V,W  
 Thompson Products Inc., 2196 Clarkwood Rd., Cleveland 3, Ohio

Thordarson-Meissner Mfg. Div. Maguire Industries, Inc., 7th & Belmont Sts., Mt. Carmel, Ill.—A,B,D,E,F,G,H,I,J,K,M,O,P,R,S,T,U,V,W,X,Y,Z,AD,AE  
 Tibbetts Industries, Camden, Me.—L  
 Todd-Tran Corp., 156 Gramatan Ave., Mt. Vernon, N.Y.—K,R,S,W  
 Tresco, 3824 Terrace St., Philadelphia 28, Pa.—B,L,M,O,R,V,W,Y  
 Triad Transformer Corp., 4055 Redwood Ave., Venice, Calif.—A,B,E,F,J,K,L,M,O,R,S,U,V,W,X,Y,Z  
 Triwac Transformer Co., 3261 N. Milwaukee Ave., Chicago 12, Ill. R,T,V,W  
 United Transformer Co., 150 Varick St., New York, N.Y.—A,B,L,M,O,P,R,U,V,W,X,Y,Z  
 University Loudspeakers, Inc., 80 So. Kensico Ave., White Plains, N.Y.—I,O,P,U  
 U.S. Relay Co., 1744 Albion St., Los Angeles 31, Calif.—N,AB,AC  
 Varc Mfg. Co., 1801 Walnut St., Garland, Texas—B,L,M  
 Viduere Electronics Mfg. Co., 576 W. Merrick Rd., Lynbrook, N.Y.—AD  
 Vokar Corp., Huron River Dr., Dexter, Mich.—B,D,F,G  
 Wheeler Insulated Wire Co., 150 E. Aurora St., Waterbury 20, Conn.—B,E,F,H,L,O,R,U,V,W,X,Z  
 Wilco Corp., 546 Drover St., Indianapolis 21, Ind.—D,H  
 Wilmer Mfg. Co., 2715 E. 14th St., Kansas City 26, Mo.—D,G,T,AD  
 Wirt Co., 5221 Greene St., Philadelphia 44, Pa.—D,L,M  
 Workman TV, Inc., 309 Queen Anne Rd., Teaneck, N.J.—R

### 7—CONVERTERS & TUNING UNITS

Boosters, FM	.....A
Boosters, TV	.....B
Boosters, UHF	.....C
Conversion Strips, UHF	.....E
Converters, UHF-TV	.....D
Mechanism, automatic tuning, radio	..F
Tuners, AM	.....G
Tuners, AM-FM	.....H
Tuners, FM	.....I
Tuners, front-end TV	.....J
Tuners, remote-controlled	.....L
Tuners, TRF broadcast	.....K

Alco Electronics Mfg. Co., 3 Wolcott Ave., Lawrence, Mass.—I  
 Alliance Mfg., Lake Park Blvd., Alliance, Ohio—D  
 Allied Radio Corp., 100 N. Western Ave., Chicago 80, Ill.—H  
 Altec Lansing Corp., 9356 Santa Monica Blvd., Beverly Hills, Calif.—H  
 Ampro Corp., 2835 N. Western Ave., Chicago 18, Ill.—G  
 Anchor Radio Corp., 2215 S. St. Louis Ave., Chicago 23, Ill.—D  
 Ansley Mfg. Co., Arthur, Doylestown, Pa.—H  
 Approved Electronic Instrument Corp., 928 Broadway, New York 10, N.Y.—G,H,I,K  
 Astatic Corp., P.O. Box 120, Conneaut, Ohio—B,C,D  
 Authorized Mfg. Co., 919 Wyckoff Ave., Brooklyn 27, N.Y.—G,H,I,L  
 Blender-Tongue Labs., 526 North Ave., Westfield, N.J.—B,D  
 Bogen Co., David, 29 9th Ave., New York 14, N.Y.—B,C,D,G,H,I  
 Brach Mfg. Corp., 200 Central Ave., Newark 3, N.J.—B  
 Browne Electronics, 12450 W. Washington Blvd., Venice, Calif.—G,H  
 Browning Labs., Inc., 750 Main St., Winchester, Mass.—H,I  
 Capenart-Farnsworth Co., 3702 E. Pontiac St., Fort Wayne 5, Ind.—E,H  
 CBS-Columbia, Div. CBS Inc., 3400 47 Ave., Long Island City 1, N.Y.—D  
 C.G.S. Laboratories, Inc., 391 Ludlow St., Stamford Conn.—F  
 Channel Master Corp., Ellenville, N.Y.—B  
 Collins Audio Products Co., Route 29, Mountaintop, N.J.—G,H,I  
 Crest Laboratories, Inc., 84-11 Rockaway Beach Blvd., Rockaway Beach 93, N.Y.—D  
 DeWald Radio & TV 35-15 37 Ave., Long Island City 1, N.Y.—G,H,I,K  
 DX Radio Products Co., 2300 Armitage Ave., Chicago 47, Ill.—B,C,D,J  
 Edu-Craft Sales Corp., 150-45 12 Ave., White-stone, N.Y.—I  
 Electro-Voice, Inc., Buchanan, Mich.—A,H,I  
 Espey Mfg. Co., 528 E. 72nd St., New York 21, N.Y.—H,I  
 Fisher Radio Corp., 21-21 44th Dr., Long Island City 1, N.Y.—H  
 Forbes & Wagner, 345 Central Ave., Silver Creek, N.Y.—F,G

Garod Corp., 70 Washington St., Brooklyn 1, N.Y.—G,H  
 General Instrument Corp., 829 Newark Ave., Elizabeth 3, N.J.—C,E,D,F,J  
 Gosnet Co., 801 S. Main St., Burbank, Calif.—A,G,H,I,L  
 Granco Products, Inc., 36-17 20th Ave., Long Island City 5, N.Y.—D,I  
 Graybar Electric Co., 420 Lexington Ave., New York 17, N.Y.—H  
 Hallcrafters Co., 4401 W. 5th Ave., Chicago 24, Ill.—H  
 Hayden Mfg. Co., Torrington, Conn.—G,H  
 Heath Co., 305 Territorial Rd., Benton Harbor, Mich.—G,I  
 Industrial Television, Inc., 359 Lexington Ave., Clifton, N.J.—B,C,D  
 Jerrold Electronics Corp., 23 & Chestnut Sts., Philadelphia 46, Pa.—B,C,D  
 Lytle Engineering & Mfg. Co., 105 W. Monroe St., Chicago 3, Ill.—H,I,J  
 Magnavox Co., Ft. Wayne 4, Ind.—J  
 Mallory & Co., P.R., 3029 E. Washington St., Indianapolis 6, Ind.—B,C,D,G,H,I,J  
 Martin & Co., H.S., 1916 Greenleaf St., Evanston, Ill.—H  
 Mattison Radio & TV Co., 10 W. 181 St., New York 53, N.Y.—B  
 Mercury Marine Electric Co., 2905 Jones St., San Francisco, Calif.—F  
 Miller Co., J.W., 5917 S. Main St., Los Angeles 3, Calif.—G,K  
 Monarch Condenser Corp., 550 Westchester Ave., New York 55, N.Y.—B  
 Morrow Radio Mfg. Co., 2794 Market St., Salem, Ore.—G  
 Oak Electronics, 150 Oak St., Buffalo, N.Y.—B  
 Oak Mfg. Co., 1260 Clybourn Ave., Chicago 10, Ill.—J  
 Pederson Electronic Co., P.O. Box 572, Lafayette, Calif.—H  
 Philco Corp., Tioga & C. Sts., Philadelphia 34, Pa.—E  
 Pilot Radio Corp., 37-06 36th St., Long Island City 1, N.Y.—D,H,I  
 Radiart Corp., 3455 Vega Ave., Cleveland 13, Ohio—B  
 Radio Corp. of America Eng'g. Products Div., Camden, N.J.—G,H,I,J  
 Radio Craftsmen Inc., 4401 N. Ravenswood Ave., Chicago, Ill.—H,I  
 Radio Eng'g. Labs., 36-40 37th St., Long Island City 1, N.Y.—I  
 Radio-Wire TV, 100 6 Ave., New York 13, N.Y.—H,I  
 Recency Div., I.D.E.A., Inc., 7900 Pendelton Pike, Indianapolis 26, Ind.—C,D,G,H,I  
 Remot-O-Matic Sales, 8747 Sunset Blvd., Los Angeles 46, Calif.—L  
 Rex Electronics, 1351 De Loss St., Indianapolis 3, Ind.—D  
 Ryan Industries, 10910 S. Vermont Ave., Los Angeles 44, Calif.—K  
 Sargent-Raymont Co., 1401 Middle Harbor Rd., Oakland 20, Calif.—I  
 Scott Inc., H.H., 385 Putnam Ave., Cambridge 39, Mass.—H,I  
 Service Instruments Co., 422 S. Dearborn St., Chicago 5, Ill.—C  
 Simpson Mfg. Co., Mark, 32-28 49th St., Long Island City 3, N.Y.—B  
 Specialty Assembling & Packing, 79 Clinton Pl., Brooklyn 38, N.Y.—G

Standard Coil Products Co., 2085 N. Hawthorne, Melrose Park, Ill.—E,J  
 Stromberg-Carlson Co., Sound Equip. Div., 1225 Clifford Ave., Rochester 21, N.Y.—G,H,I,J  
 Sutton Electronic Co., 426 W. Short St., Lexington, Ky.—C  
 Tarzian Inc., Sarkes, Rectifier Div., 415 N. College Ave., Bloomington, Ind.—D,J  
 Tech-Master Corp., 75 Front St., Brooklyn 1, N.Y.—D,G  
 Technical Appliance Corp., 1 Taco St., Sherburne, N.Y.—A,B  
 Tele King Corp., 601 W. 26th St., New York 1, N.Y.—D  
 Tele-Matic Industries, 16 Howard Ave., Brooklyn 21, N.Y.—D  
 Television Remote Control Co., 820 No. Fairfax Ave., Los Angeles 46, Calif.—L  
 Thordarson-Meissner, Mt. Carmel, Ill.—G,H,I,K  
 Turner Co., 909 17th St., N.E., Cedar Rapids, Iowa—B  
 TV Tuner Co., 40-09 82 St., Jackson Heights, N.Y.—J  
 Varicon Corp., 65 Hope St., Brooklyn 11, N.Y.—D  
 Videon Electronic Corp., 902 E. Michigan St., Indianapolis 2, Ind.—B,D  
 Waterproof Electric Co., 801 S. Main St., Burbank, Calif.—G,I,J

Dietz Design & Mfg. Co., Box 222, Grandview, Mo.—A,B,C,I  
 Drake Co., R. L., 18 E. Central Ave., Miamisburg, Ohio—C  
 Dunkle Coil Co., 3257 W. 6 St., Los Angeles 6, Calif.  
 DX Radio Products Co., 2300 Armitage Ave., Chicago 47, Ill.—A,B,C,D,I  
 Eagle Electronics Corp., 177 Hart St., New Britain, Conn.—B,I  
 Epco Electronics, Inc., 140 Liberty St., New York 6, N.Y.—C,I  
 Erie Resistor Corp., 644 W. 12th St., Erie 6, Pa.—G  
 Espey Mfg. Co., 528 E. 72 St., New York 21, N.Y.—A,B,C,D,E,F,G,H,I  
 Federal Telephone & Radio Div. of IT&T, 100 Kingsland Rd., Clifton, N.J.—B  
 Filtron Co., 131-15 Fowler Ave., Flushing, N.Y.  
 Fisher Radio Corp., 21-21 44 Dr., Long Island City 1, N.Y.—A,D  
 Forbes & Wagner, 345 Central Ave., Silver Creek, N.Y.—A,B,I  
 Freed Transformer Co., 1718 Weirfield St., Brooklyn 27, N.Y.—A,B  
 General Cement Mfg. Co., 919 Taylor Ave., Rockford, Ill.—G,H  
 General Crystal Co., Box 9, Burlington, Wisc.—B  
 Gramer-Haldorson Transformer Corp., 2734 N. Pulaski Rd., Chicago 39, Ill.—B  
 Gray Research & Devel. Co., 658 Hilliard St., Manchester, Conn.—A  
 Great Eastern Mfg. Co., 163 Remsen Ave., Brooklyn 12, N.Y.—C  
 Gudeman Co., 340 W. Huron St., Chicago 10, Ill.—A,B,C,D,F,G,H  
 Hycor Co., 11423 Vanowen St., N. Hollywood, Calif.—A,B  
 Industrial Condenser Corp., 3243 N. Calif. Ave., Chicago 18, Ill.—C,D  
 Insuline Corp. American, 186 Granite St., Manchester, N.H.—A,C,G  
 Jerrold Electronics Corp., 23 & Chestnut Sts., Philadelphia 46, Pa.—I  
 JFD Mfg. Co., 6101 16 Ave., Brooklyn 4, N.Y.—B,C  
 Krohn-Hite Instrument Co., 580 Mass. Ave., Cambridge 39, Mass.—B  
 Lenr. Inc., 11916 W. Pico Blvd., Los Angeles 64, Calif.—B,C  
 Lepace Mfg. Co., 5932 Putnam Ave., Brooklyn 27, N.Y.—A,B  
 Mac Electric Products, 12822 Yukon Ave., Hawthorne, Calif.—A  
 Mallory & Co., P. R., 3029 E. Washington St., Indianapolis 6, Ind.—D  
 Merit Coil & Transformer Corp., 4427 N. Clark St., Chicago 40, Ill.—C,I  
 Micomold Radio Corp., 1087 Flushing Ave., Brooklyn 37, N.Y.—A,B,C,D  
 Microtran Co., 84-11 Rockaway Beach Blvd., Rockaway Beach 93, N.Y.—A  
 Miller Co., J. W., 5917 S. Main St., Los Angeles 3, Calif.—B,C,D,E,I  
 Monarch Condenser Corp., 550 Westchester Ave., New York 55, N.Y.—C,G  
 Moran Electronic Components, 10506 Whentley St., Kensington, Md.—A,C,I  
 Non-Linear Systems, DelMar Airport, DelMar, Calif.—B,C,D  
 North Hills Electric Co., 203-18 35 Ave., Bay-side 61, N.Y.—A,B,D,E,H,I  
 Ortho Filter Corp., 196 Albion Ave., Paterson 2, N.J.—A,B,C,D,G,H,I  
 Peerless Electrical Products, Div. Altec Lansing Corp., 9356 Santa Monica Blvd., Beverly Hills, Calif.—A  
 Photocircuits Corp., New St., Glen Cove, N.Y.  
 Pioneer Scientific Corp., 161 Great Neck Rd., Great Neck, N.Y.—C  
 Power Supplies, 1005 Olive St., Highland, Ill.—A,C,D  
 Precision Electronics Inc., 9101 King Ave., Franklin Park, Ill.—C,I  
 R. K. Mfg. Co., P.O. Box 122, Marion, Ill.—A,B,E  
 Scott Inc., Herman Hosmer, 385 Putnam Ave., Cambridge 39, Mass.—A,D  
 Service Instruments Co., 422 S. Dearborn St., Chicago 5, Ill.—C  
 Spencer-Kennedy Labs., 186 Mass. Ave., Cambridge 39, Mass.—A  
 Sprague Products Co., N. Adams, Mass.—D  
 Superex Electronics Corp., 4 Radford Pl., Yonkers, N.Y.—D,E,I  
 Tartak Electronics, 2979 N. Ontario St., Burbank, Calif.—A,B,C,D  
 Technical Appliance Co., Sherburne, N.Y.—B  
 Telectro Industries Corp., 35-16 37 St., Long Island City 1, N.Y.—C  
 Tele-Matic Industries, 16 Howard Ave., Brooklyn 21, N.Y.—C,I  
 Telkor, Inc., Telegraph Rd., Elyria, Ohio—C,D  
 Television Labs., Wauconda, Ill.—B  
 Texas Instruments Inc., 6000 Lemmon Ave., Dallas 9, Texas—A,B,C,D  
 Thordarson-Meissner, Mt. Carmel, Ill.—A,B,C,D,E,G,H,I  
 TRESCO, 3824 Terrace St., Philadelphia 28, Pa.—A  
 Triad Transformer Corp., 4055 Redwood Ave., Venice, Calif.—A,B  
 United Technical Labs., Morristown, N.J.—B,C,D  
 United Transformer Co., 150 Varick St., New York 13, N.Y.—A,B,C,D,E,F  
 University Loudspeakers, Inc., 80 S. Kensico Ave., White Plains, N.Y.—A



**8—FILTERS, INTERFERENCE & NOISE**

- Filters, audio ..... A
- Filters, bandpass ..... B
- Filters, interference ..... C
- Filters, noise ..... D
- Filters, whistle ..... E
- Limiters, noise ..... F
- Suppressors, auto ignition ..... G
- Suppressors, parasitic ..... H
- Wave Traps ..... I

Acme Electronics Inc., Sub. Aerovox Corp., 2724 Peck Rd., Monrovia, Calif.—A,B,C,F,I  
 Aero Transformer & Mfg. Corp., 26-02 4 St., Long Island City 2, N.Y.—A,B  
 Advance Electronics Co., 8510 North End Ave., Oak Park 37, Mich.—I  
 Aerovox Corp., 740 Belleville Ave., New Bedford, Mass.—C,D,G  
 Aircraft Transformer Corp., Long Branch, N.J.—B  
 Altec-Lansing Corp., 9356 Santa Monica Blvd., Beverly Hills, Calif.—A  
 American Electronics Co., 1203 Bryant Ave., New York 59, N.Y.—B,C,D,I  
 Anchor Electronics, Inc., 717 Sip St., Union City, N.J.—B,I  
 Astron Corp., 255 Grant Ave., E. Newark, N.J.—C,D  
 Barker & Williamson, 235 Fairfield Ave., Upper Darby, Pa.  
 Bestcraft Products Co., 626 Broadway, New York 12, N.Y.—I  
 Bud Radio Inc., 2118 E. 55 St., Cleveland 3, Ohio—C  
 Burnell & Co., 45 Warburton Ave., Yonkers, N.Y.—A,B  
 Camburn, Inc., 32-40 57th St., Woodside 77, N.Y.—B  
 C.G.S. Labs. Inc., 391 Ludlow St., Stamford, Conn.—D  
 Chicago Standard Transformer Corp., Addison & Elston, Chicago 18, Ill.—A,B  
 Clippard Instrument Lab., 7350 Colerain Rd., Cincinnati 24, Ohio—C  
 Coil Winders, Inc., 100 N.Y. Ave., Westbury L.L., N.Y.—A,B,C,D,I  
 Collins Audio Products, Route 29, Mountain-side, N.J.—A,B  
 Communication Accessories, Hickman Mills, Mo.—A,B  
 Continental Carbon Inc., 13900 Lorain Ave., Cleveland 11, Ohio—G  
 Cornell-Dubilier Elec. Corp., South Plainfield, N.J.—A,B,C,D,F  
 Crest Laboratories Inc., 84-11 Rockaway Beach Blvd., Rockaway Beach 93, N.Y.—A  
 Crest Transformer Corp., 1834 W. North Ave., Chicago 22, Ill.—A,B  
 Delson Mfg. Corp., 126 11 Ave., New York 11, N.Y.—I  
 Deutschmann Corp., Tobe, 921 Piedmont Highway, Norwood, Mass.—A,B,C,D,G

**COLOR CODES**

**Power Transformer Leads:**

Primary	Black
Common (tapped primary)	Black
Tap (tapped primary)	Black-Yellow
Finish (tapped primary)	Black-Red

**Rectifier**

Plate	Red
Plate center tap	Red-Yellow
Filament	Yellow
Filament center tap	Yellow-Blue

**Amplifier**

Filament No. 1	Green
Fil. No. 1 center tap	Green-Yellow
Filament No. 2	Brown
Fil. No. 2 center tap	Brown-Yellow
Filament No. 3	Slate
Fil. No. 3 center tap	Slate-Yellow

**I-F Transformer Leads:**

Primary plate	Blue
Primary B+	Red
Secondary grid	Green
Secondary grid return	White
Full-wave second diode	Violet

**Audio Transformer Leads:**

Primary plate	Blue
Primary B	Red
Primary plate (push-pull)	Blue or Brown
Secondary grid	Green
Secondary return	Black
Secondary grid (push-pull)	Green or Yellow

Vidaire Electronics Mfg. Co., 576 W. Merrick Rd., Lynbrook, N.Y.—B,C,D,I  
 Vokar Corp., Huron River Dr., Dexter, Mich.  
 Waterproof Electric Co., 801 S. Main St., Burbank, Calif.—F  
 Wheeler Insulated Wire Co., 150 E. Aurora St., Waterbury 20, Conn.—A

**9—HARDWARE  
 ACCESSORIES &  
 MISCELLANEOUS PARTS**

adapters ..... A  
 Assemblies, magic eye ..... B  
 Ballasts ..... C  
 Bases, chassis ..... D  
 Bearings, panel ..... E  
 Brackets, mounting ..... F  
 Bushings ..... G  
 Caps, tube (grid & plate) ..... H  
 Casters ..... I  
 Circuit Breakers ..... J  
 Cleaners ..... K  
 Cloth, grille (see Sec. 18)  
 Connectors ..... L  
 Cradles, chassis bases ..... M  
 Decalcomanias ..... N  
 Dials & Dial Accessories ..... O  
 Escutcheons ..... P  
 Feed-through Insulators ..... Q  
 Flocking Material ..... R  
 Fuse Clips ..... AAG  
 Fuse Holders ..... AAH  
 Fuses ..... AAI  
 Grille, metal & screen ..... T  
 Grommets ..... U  
 Grounding Equipment ..... V  
 Insulation, spaghetti sleeving ..... W  
 Insulators & Insulating Materials ..... X  
 Jacks ..... Y  
 Kits, tool ..... Z  
 Knobs ..... AA  
 Lamps & Bulbs ..... AB  
 Lubricants ..... AC  
 Markers, adhesive ..... AAJ  
 Mounts ..... AD  
 Padding ..... AE  
 Pads, C & L ..... AF  
 Paints, Lacquer & Varnish ..... AG  
 Panels ..... AH  
 Patch Cords ..... AI  
 Plastic ..... AJ  
 Plates, transformer ..... AK  
 Plugs, hole ..... AL  
 Plugs, power ..... AM  
 Polishes ..... AN  
 Printed Circuits ..... AO  
 Pulleys, Idler ..... AP  
 Quartz Sheets ..... AQ  
 Radio Hardware, misc. ..... AR  
 Screws, Nuts, Bolts, Washers ..... AZ  
 Shafts, control ..... AS  
 Shielding ..... AT  
 Shields, tube & coil ..... AU  
 Shims, speaker ..... AV  
 Snaps & Studs ..... AW  
 Sockets ..... AX  
 Spaghetti ..... AAK  
 Spray, plastic protective ..... AAA  
 Standoffs, terminal ..... AAB  
 Tape, friction & insulating ..... AAC  
 Terminals ..... AAD  
 Tubing, plastic ..... AAE  
 Windows, dial ..... AAF

Aerolite Electronics, 507-26th St., Union City, N. J.—D,E,G,H,L,U,X,Y,AH,AI,AR,AA,AB, AAD,AAG,AAH  
 Aeronautical Electric Co., 5656 Northwest Hgwy., Chicago 30, Ill.—O,AL,AM,AA,AD  
 Aircraft-Marine Products, 2100 Paxton St., Harrisburg, Pa.—L,AI,AA,AD  
 Alden Products Co., 117 N. Main St., Brockton, Mass.—A,L,O,X,AA,AB,AM,AO,AR, AT,AY,AA,AD,AAG,AAH  
 Allied Engraving & Stamping Co., 161 Ellicott St., Buffalo 3, N.Y.—O,P  
 Allied Industries, 2500 Woodland Ave., Louisville 10, Ky.—A,L,Y,AL,AM  
 American Electronics Co., 1203 Bryant Ave., New York 59, N.Y.—Y,AL,AA,AD  
 American Phenolic Corp., 1830 S. 54th St., Chicago 50, Ill.—H,L,P,Y,AJ,AM,AA,AD  
 American Radio Hardware Co., 152 MacQuesten Pkwy So., Mt. Vernon, N.Y.—A,D,F,G,H, L, M, U, Y, Z, AA, AD, AI, AL, AM, AP, AR,AS,AU,AX,AZ,AA,AD,AAG,AAH,AAI  
 American Screw Co., 1670 W. Main St., Williamantic, Conn.—AZ  
 Anchor Metal Co., 244 Boerum St., Brooklyn 6, N.Y.—C,AT  
 Anchor Products Co., 2712 W. Montrose Ave., Chicago 18, Ill.—A,H  
 Antenna Products, 3623 N. Lincoln Ave., Chicago 13, Ill.—F,AJ,AA,AB  
 AP Electric Lab., P. O. Box 862, Union, N.J.—K,R,X,AC,AG,AJ,AN,AAE  
 Ark-Les Switch Corp., 51 Water St., Watertown 72, Mass.—L,AA,AD  
 Atlas E-E Corp., Bedford Airport, Bedford, Mass.—L,Y,AT,AA,AG,AAH,AAI  
 Audio Development Co., 2833 13th Ave., S., Minneapolis, Minn.—Y,AH,AI  
 Audio Prods., 2265 Westwood, Los Angeles 64, Calif.—AO  
 Automatic Metal Products Corp., 315 Berry St., Brooklyn 11, N.Y.—A,L,Y,AX,AA,AB  
 Barb City Industries, 5 & Girard Sts., DeKalb, Ill.—Z  
 Barco Chemical Products Co., 701 S. LaSalle St., Chicago 5, Ill.—K  
 Baumker Mfg. Co., 3826 Summit St., Toledo 11, Ohio—V,AD  
 Bauer & Black Div., Kendall Co., 309 W. Jackson St., Chicago 6, Ill.—AAC  
 Beck's Inc., 298 E. 5 St., St. Paul 1, Minn.—L,O,X,AO  
 Bentley-Harris, 1000 Lime St., Conshohocken, Pa.—X,AAK  
 Berger Communications, 109-01 72nd Rd., Forest Hills, N.Y.  
 Bestcraft Products Co., 626 Broadway, New York 12, N.Y.—R,T,W  
 Birnbach Radio Co., 145 Hudson St., New York 13, N.Y.—E,F,G,L,Q,V,W,X,Y,AA,AI, AR,AT,AZ,AA,AB,AA,AD,AAE,AA,AG,AAH,AAK  
 Blaco Mfg. Co., 6541 Euclid Ave., Cleveland 3, Ohio—V,AAA  
 Blonder-Tongue Labs., 526 North Ave., Westfield, N.J.—L  
 Blum & Co., Julius, Carlstadt, N.J.—AJ  
 B & M Electric Corp., 838 4 Ave., Brooklyn 32, N.Y.—AB,AM  
 Bogart Mfg. Corp., 315 Siegel St., Brooklyn 6, N.Y.—AAG,AAH,AAI  
 Brach Mfg. Corp., 220 Central Ave., Newark 3, N.J.—L,AA,AD,AAG  
 Brady Co., W. H., 727 W. Glendale Ave., Milwaukee 12, Wisc.—AAC,AAJ  
 British Electronic Sales, 23-03 45 Rd., Long Island City 1, N.Y.—H,L,AF,AX,AA,AD  
 British Industries Corp., 164 Duane St., New York 13, N.Y.—T  
 Browning Laboratories, Inc., 750 Main St., Winchester, Mass.—AO  
 Bud Radio Inc., 2118 E. 55 St., Cleveland 3, Ohio—A,D,E,F,G,H,I,L,O,Q,Y  
 Burken Lamination Corp., 811 Whittier St., New York 59, N.Y.—F,AH  
 Bussmann Mfg. Co., University at Jefferson St., St. Louis 7, Mo.—AAG,AAH,AAI  
 Calif. Plasteck, Inc., 225 E. 4 St., Los Angeles 13, Calif.—N,O,P,X,AA,AAO  
 Cannon Electric Co., 3209 Humboldt St., Los Angeles 3, Calif.—AM  
 Carter Parts Co., 213 Institute Pl., Chicago 7, Ill.—Y  
 Cass Machine Co., 691 Antoinette St., Detroit 2, Mich.—A,D,F,G,X,AA,AD,AP,AR,AW,AZ  
 C.E.M. Co., 24 School St., Danielson, Conn.—G  
 Centralab Div., Globe-Union, Inc., 902Y E. Keefe Ave., Milwaukee 1, Wisc.—F,Q,X,AA, AF,AA,AS  
 Chamroy Record Cleaner Co., Box 532, Rochester, N.Y.—K  
 Channel Master Corp., Ellenville, N.Y.—F,AD  
 Chase & Sons, 19 Highland Ave., Randolph, Mass.—X  
 Chatham Electronics Div., Gera Corp., 630 W. Mt. Pleasant Ave., Livingston, N.J.—AAI  
 Chemical Electronic Eng'g., 1025 Broad St., Newark 2, N.J.—K,AC  
 Churchill Lighting Corp., 344 Franklin St., Melrose 76, Mass.—D,F,AD  
 Cinch-Jones Div., Cinch Mfg. Corp., 1026 S. Homan Ave., Chicago 24, Ill.—L,AL,AM, AX  
 Circon Component Co., 17544 Raymer St., Northridge, Calif.—AO,AR,AX,AZ  
 Circuitron, Inc., 155 W. Main St., Rockville, Conn.—AO  
 Clarostat Mfg. Co., 1 Washington St., Dover, N.H.—C

Coaxial Connector Co., 37 N. 2 Ave., Mt Vernon, N.Y.—A,Y,AH,AI,AL,AM  
 Commercial Products 417 Main St., Toledo 5, Ohio—F,AD  
 Conn-Cord. Inc., Progress Ave., & Monroe Sts., Union, N.J.—L,Y,AL,AM  
 Constat Labs., 146 W. 29 St., New York 1, N.Y.—AG  
 Co-Operative Industries, 100 Oakdale Rd., Chester, N.J.—AT  
 Cornell-Dubilier Electric Corp., 333 Hamilton Blvd., S. Plainfield, N.J.—AO  
 Creative Plastics Corp., Rt. 25-A, Stony Brook, N.Y.—G,U,X  
 Cummins Portable Tools, Div. CBM Corp., 4720 Ravenswood Ave., Chicago 40, Ill.  
 Dage Electric Co., 67 N. 2 St., Beech Grove, Ind.—L,AL,AM  
 Dale Products, Inc., P.O. Box 136 Columbus, Neb.—AA  
 Deal Products, Inc., Hellertown Rd., Easton Pa.—AD  
 Delco Radio Div., General Motors Corp., 1446 S. Home Ave., Kokomo, Ind.—AR  
 Dialight Corp., 60 Stewart Ave., Brooklyn 37, N.Y.—L,O,AB  
 Digital Products, 7643 Fay Ave., LaJolla, Calif.—AO  
 D & M Products, 13144 W. McNicholas Rd., Detroit 35, Mich.—T,AA,AG  
 Dorn Equipment Corp., 88 Broad St., Boston 10, Mass.—A,L,O,Y,AI,AL,AM  
 Drake Mfg. Co., 1713 W. Hubbard St., Chicago 22, Ill.—O,AB  
 Dumont Labs. Inc., Allen B., Mobile Comm. Dept., 1500 Main St., Clifton, N.J.—AI,AL, AM  
 Dwyer Eng'g Co., P.O. Box 483, Nashua, N.H.—AO  
 Eagle Electric, 23-10 Bridge Plaza S., Long Island City, N.Y.—AX  
 Eagle Electronics Corp., 177 Hart St., New Britain, Conn.—AA  
 Eby Co., Hugh H., 4700 Stenton Ave., Philadelphia 44, Pa.—A,B,L,Y,AA,AO,AR,AU, AX,AY,AA,AB,AA,AD,AA,AG  
 Elastic Stop Nut Corp. of America, 2330 Vauxhall Rd., Union, N.J.—AZ  
 Elco Corp., M St. below Erie Ave., Philadelphia 24, Pa.—L,AU,AX  
 Electronic Chemical Corp., 813 Communipaw Ave., Jersey City, N.J.—K,AC  
 Electronic Hardware Co., 2420 W. Cermak Rd., Chicago 8, Ill.—V,AZ  
 Electron-Radar Products, 1041 N. Pulaski Rd., Chicago 51, Ill.—AO  
 Electro-Voice, Inc., Buchanan, Mich.—AF  
 Eltran Corp., 109 W. Station St., St. Anne, Ill.—T  
 Erie Resistor Corp., 644 W. 12 St., Erie 6, Pa.—L,Q,W,AO,AX,AA,BA,AC,AAK  
 Farrington Mfg. Co., 76 Atherton St., Boston, Mass.—AO  
 Federal Screw Products, 3917 N. Kedzie Ave., Chicago 18, Ill.—E,U,W,AA,AL,AR,AZ,AA,AD, AAH  
 Federal Telephone & Radio Div IT&T, 100 Kingsland Rd., Clifton, N.J.—AAG,AAH,AAI  
 Fidelity Chemical Products, 470 Frelinghuysen Ave., Newark 5, N.J.—K,AG  
 Flexo Int'l Co., 3245 W. Lake St., Chicago 24, Ill.—AB  
 Fretco, Inc., 406 N. Craig St., Pittsburgh 13, Pa.—AD,AR  
 Garde Mfg. Co., 588 Eddy St., Providence 3, R.I.—L,X,AL,AM,AA,BA,AD  
 Gee-Lar Mfg. Co., 819 Elm St., Rockford, Ill.—L,Q,T,AA,AD,AX,AAG,AAH  
 General Cement Mfg. Co., 915 Taylor Ave., Rockford, Ill.—F,G,H,I,K,L,M,O,Q,R,T,U,V, W,X,Y,Z,AA,AC,AD,AG,AJ,AL,AN,AO,AR, AT,AV,AW,AX,AY,AZ,AAA,AA,BA,AC,AA,AD, AA,EA,AG,AAH,AAJ,AAK  
 General Electric Co., Construction Material Div., 1285 Boston Ave., Bridgeport 2, Conn.—AAI  
 General Instrument Corp., 829 Newark Ave., Elizabeth 3, N.J.—AO  
 General Products Corp., 107 Salem St., Union Springs, N.Y.—AA  
 Gerrard Steel Strapping Co., 1950 Hawthorne Ave., Melrose Park, Ill.—AR  
 Grant Pulley & Hdw. Corp., 31-85 Whitestone Pkwy., Flushing 64, N.Y.—AR  
 Harper Co., H. M., 8200 Lehigh Ave., Morton Grove, Ill.—AZ  
 Haydu Bros., Box 1226, Plainfield, N.J.—F,H, AD,AW,AA,AD  
 Hi-Lo TV Antenna Corp., 3540 N. Ravenswood Ave., Chicago 13, Ill.—AAG,AAH,AAI  
 Hobson Bros., 4940 W. Lawrence Ave., Chicago 30, Ill.—L,AX  
 Hubbell Co., Harvey, State & Rostwick Ave., Bridgeport 2, Conn.—L,Y,Z,AAI  
 Hudson Lamp Co., 528 Elm St., Arlington, N.J.—AB  
 Hunter Tools, 6608 S. Gretna, Whittier, Calif.—Z  
 Ideal Industries, Inc., Sycamore, Ill.—L,AA,AC, AAG  
 I.E. Mfg., 325 N. Hoyle Ave., Chicago 12, Ill.—D,Q,U,AD,AAG,AAH  
 Imperial Radar & Wire Corp., 1661 Boone Ave., New York 60, N.Y.—F,L,Q,X  
 Industrial Devices, Inc., 22 State Rd., Edgewater, N.J.—AA,AB,AM  
 Industrial Hardware Mfg. Co., 109 Prince St., New York 12, N.Y.—L,AR,AX,AY,AA,AD

Abbott Plastics & Machine Co., 6322 N. Clark St., Chicago 22, Ill.—AJ  
 Accurate Electronics Corp., 1312 Ontario St., Cleveland 13, Ohio—F,G,L,N,O,Y,AH,AL,AM, AX,AZ,AA,AD,AAG  
 Acme Industrial Co., 200 N. Laffin St., Chicago 7, Ill.—G  
 Acromark Co., 309 Morrell St., Elizabeth 4, N.J.—O  
 Aero Tool & Die Works, 4554 Broadway, Chicago 40, Ill.—M  
 Adams & Westlake, 1175 N. Mich. St., Elkhart, Ind.—O  
 Admiral Corp., Molded Prods. Div., P.O. Box 338, W. Chicago, Ill.—O,X,AA

Injection Molders Supply Co., 3614 Lee Rd., Cleveland, Ohio—AAA  
 Insuline Corp. America, 186 Granite St., Manchester, N.H.—A,D,F,H,I,L,O,Q,T,U,V,W,X,Y,Z,AA,AD,AH,AM,AU,AX,AY,AZ, AAB, AAD,AAE,AAG,AAH,AAK  
 Irvington Varnish & Insulator, Div. Minn. Mining & Mfg. Co., 6 Argyle Terrace, Irvington 11, N.J.—X  
 Isolantite Mfg. Corp., Warren Ave., Stirling, N.J.—Q,X,AAAB  
 Jan Hardware Mfg. Co., 75 N. 11th St., Brooklyn 11, N.Y.—G,O,X,AA,ATAAB  
 Javex, P.O. Box 646, Redlands, Calif.—L,Q, AO,AX  
 Jerrold Electronics Corp., 23 & Chestnut Sts., Philadelphia 46, Pa.—L  
 JFD Mfg. Co., 6101 16 Ave., Brooklyn 4, N.Y.—C,F  
 Johnson Co., E. F. Waseca, Minn.—E,G,O,P,Q, X,Y,Z,AU,AX,AY  
 Jones Div. Howard B., Cinch Mfg. Corp., 1026 S. Homan Ave., Chicago 24, Ill.—Y,AH,AL, AM  
 Kellogg Switchboard & Supply Co., 79 W. Monroe St., Chicago 3, Ill.—O,AAD  
 Kenwood Eng'g. Co., 265 Colfax Ave., Kenilworth, N.J.—AD  
 Kerden Chemical Co., 6400 Herman Ave., Cleveland 2, Ohio—K  
 Keystone Electronics Corp., 423 Broome St., New York 13, N.Y.—E,F,G,L,X,Y,AH,AR, AS, AAB, AAD, AAE  
 Kings Electronics Co., 40 Marbledale Rd., Tuckahoe, N.Y.—A,L,Y,AI,AL,AM, AAD  
 Klein & Sons, Mathias, 7200 McCormick Rd., Chicago 45, Ill.—Z  
 Krylon, Inc., 2038 Washington Ave., Philadelphia 46, Pa.—AG,AN,AAA  
 Lee Electronic Labs., 233 Dudley St., Boston 19, Mass.—F,Y  
 Lennard Co., P. M., 671 Bergen St., Brooklyn 38, N.Y.—X  
 Littelfuse, Inc., 1865 Miner St., Des Plaines, Ill.—AAD,AAH,AAI  
 Lowell Mfg. Co., 3030 Laclade Sta. Rd., St. Louis 17, Mo.—F,T  
 Luxo Lamp Corp., 102 Columbus Ave., Tuckahoe, N.Y.—AB  
 Lynn Electronic Research, 9 W. Magnolia Blvd., Burbank, Calif.—L,AX, AAD  
 Lytle Engineering & Mfg. Co., 105 W. Monroe St., Chicago 3, Ill.—D,G  
 Macson Co., 3260 Motor Ave., Los Angeles 34, Calif.—L,AI,AL,AM, AAD  
 Majestic Radio & TV Div. Wilcox-Gay Corp., 70 Washington St., Brooklyn 1, N.Y.—D,E F,M,O,P,T,AG, AH, AP, AR, AY, AAA, AAG, AAH  
 Malco Tool & Mfg., 4025 W. Lake St., Chicago 24, Ill.—AAD  
 Mallory & Co., P. R., 3029 E. Washington St., Indianapolis 6, Ind.—A,O,Y,Z,AA  
 Mandex Mfg. Co., 2608 W. 16 St., Chicago 8, Ill.—A,L,Y,AX,AY, AAD  
 Marion Products, 6953 Murray Ave., Cincinnati 27, Ohio—K  
 Master Appliance Mfg. Co., 715 Ontario St., Racine, Wisc.—M,P  
 Master Mobile Mounts, 1306 Bond St., Los Angeles 15, Calif.—AU  
 Matchless Electric Co., 1700 Washington Blvd., Chicago 12, Ill.—AB  
 Merix Chemical Co., 1021 E. 55th St., Chicago 15, Ill.—K,AC,AN,AAA  
 Metronics, Inc., U.S. Route 130, Burlington, N.J.—T  
 Micro-Circuits Co., New Buffalo, Mich.—AG, AO  
 Millen Mfg. Co., James, 150 Exchange St., Malden 48, Mass.—E,H,O,AA,AT,AU,AV,AY  
 Miller Co., J. W., 5917 S. Main St., Los Angeles 3, Calif.—O,AU  
 Miller Sales, Ken, 627 E. Maumee St., Adrian, Mich.—M  
 Miller Radio & TV, 627 E. Maumee St., Adrian, Mich.—M  
 Mitchell Rand Insulation Co., 51 Murray St., New York 7, N.Y.—X  
 Modern-Aire Mfg. Corp., 4436 W. Roosevelt Rd., Chicago 24, Ill.—F,V,AD  
 Mole-Richardson Co., 937 No. Sycamore Ave., Hollywood 38, Calif.—AB  
 Moody Machine Products Co., 42 Dudley St., Providence 5, R.I.—Z  
 Morrow Radio Mfg. Co., 2794 Market St., Salem, Ore.—AA  
 Mosley Electronics, 8622 St. Charles Rock Rd., St. Louis 14, Mo.—Q  
 Mueller Electric Co., 1583 E. 31 St., Cleveland 14, Ohio—X,V  
 Myxal Corp. of America, 125 Clifton Blvd., Clifton, N.J.—L,Q,QA,AX  
 Naer Corp., 11777 Santa Monica Blvd., Los Angeles 25, Calif.—X,Y,AA,AL,AM  
 Nagel-Chase Mfg. Co., 2811 N. Ashland Ave., Chicago 13, Ill.—I  
 Nameplates, Inc., 425 E. 101 St., Brooklyn 36, N.Y.—O,F,AO  
 National Carbon Co. Div. Union Carbide & Carbon Corp., 30 E. 42nd St., New York 17, N.Y.—AB  
 National Co., 61 Sherman St., Malden, Mass.—O,AA,AL,AM,Z, AAD  
 National Electric Products Corp., #2 Gateway Center, Pittsburgh 22, Pa.—F,AD  
 Nichols Products Co., 825 W. Main St., Moorestown, N.J.—A,G,L,O,X,AJ,AR

Norco Mfg. Co., 392 Bleecker St., New York 14, N.Y.—AB  
 Norsid Mfg. Co., 21 Atherton St., Yonkers 1, N.Y.—N  
 North American Model Products, Inc., 9602 Warwick Rd., Warwick, Va.—AO  
 Nylok Corp., 14 & Grand Central Ave., Elmira Heights, N.Y.—AZ  
 Oxford Electric Corp., 3911 S. Michigan Ave., Chicago 15, Ill.—AB  
 Pacific Electronic Co., 3217 Exposition Pl., Los Angeles 8, Calif.—A,L,Y,AL,AM, AAB  
 Pacific Transducer Corp., 11836 W. Peco Blvd., Los Angeles 64, Calif.—AA  
 Parkor-Kalon, 200 Varick St., New York 14, N.Y.—AZ  
 Permacel Tape Corp., New Brunswick, N.J.—AAC  
 Phen-O-Tron Inc., 455 Main St., New Rochelle, N.Y.—AO  
 Philco Corp., Tioga & C Sts., Philadelphia 34, Pa.—CAAI  
 Philmore Mfg. Co., 113 University Pl., New York 3, N.Y.—Y,AA,AR,AZ  
 Philson Mfg. Co., 60 Sackett St., Brooklyn 31, N.Y.—F  
 Phoenix Electronics, Inc., 50 Island St., Lawrence, Mass.—AD  
 Photocircuits Corp., New St., Glen Cove, N.Y.—AO  
 Plasti-Kote, Inc., 425 Lakeside Ave., N.W., Cleveland 13, Ohio—AG,AAA  
 Plymouth Electronics Corp., 50 Kingsbury St., Worcester 3, Mass.—D,F,AD,AH  
 Polken Products Dept., Kendall Co., 222 W. Adams St., Chicago 20, Ill.—AAC  
 Polymer Corp., Reading, Pa.—AAK  
 Pomona Electronics Co., 524 W. 5 Ave., Pomona, Calif.—A  
 Porcelain Products, Inc., 422 W. Sandusky St., Findlay, Ohio—X  
 Precise Measurements Co., 942 Kings Highway, Brooklyn 23, N.Y.—O  
 Premax Products Div., Chisholm-Ryder Co., Niagara Falls, N.Y.—V,X  
 Quietrol Co., 395 St. John St., Spartanburg, S.C.—AC  
 Radelco Mfg. Co., 7580 Garfield Blvd., Cleveland 25, Ohio—V



Radio City Products Co., Centre & Glendale Sts., Easton, Pa.—A,F,AAA  
 Radio Corp. of America, Tube Div., 415 S. 5 St., Harrison, N.J.—AB  
 Radio Merchandise Sales, Inc., 2016 Bronxdale Ave., New York 62, N.Y.—L,Q,Z  
 Radio Supply & Eng'g., 85 Linden Ave., Detroit 1, Mich.—U,AA,AAI  
 Rare Earths, Inc., Box 488, Pompton Plains, N.J.—AN  
 Raytheon Mfg. Co., Equip. Marketing Div., 100 River St., Waltham, Mass.—Y,AA,AO, AAG  
 Reed & Prince Mfg. Co., 1 Duncan Ave., Worcester 1, Mass.—AZ  
 Rhodes & Sons, 12 Porter St., Taunton, Mass.—AR  
 Rite-Lite Mfg. Co., 3243 W. Lawrence Ave., Chicago 25, Ill.—AB  
 Rogan Bros., 8031 N. Monticello St., Skokie, Ill.—X  
 Rohn Mfg. Co., 116 Limestone, Bellevue, Peoria, Ill.—AD  
 Romar Plastics Inc., 1311 E. Main St., St. Charles, Ill.—O,P,AA,AJ  
 Royal Electric Co., 95 Grand Ave., Pawtucket, R.I.—AAI  
 Saxonburg Ceramics, Saxonburg, Pa.—X  
 Sequoia Process Corp., 871 Willow St., Redwood City, Calif.—AO  
 Shasta Div., Beckman Instruments Inc., P.O. Box 296, Station A., Richmond, Calif.—AA  
 Sightmaster Corp., 111 Cedar St., New Rochelle, N.Y.—AAI  
 Signalite, Inc., Neptune, N.J.—AB  
 Silicone Spray Products, 3514 Lee Rd., Cleveland 22, Ohio—AAA  
 Smith Inc., Herman H., 2326 Nostrand Ave., Brooklyn 10, N.Y.—A,E,F,G,L,U,Y,AA, AI, AL,AR,AS,AU,AZ, AAB, AAD, AAG,AAH  
 South River Metal Prod. Co., 377 Turnpike, S. River, N.J.—A,F,V,AD,AZ  
 Specialty Assembling & Packing Co., 79 Clinton Pl., Brooklyn 38, N.Y.—O  
 Stahl Metal Products, 3490 W. 140 St., Cleveland 11, Ohio—AR  
 Star Fuse Co., 235 Canal St., New York 13, N.Y.—AAG,AAH,AAI  
 Stakes Co., 19 New Park Ave., Hartford 6, Conn.—AAH  
 Stevens, Walden, Inc., 390 Shrewsbury St., Worcester 4, Mass.—Z  
 Stone City Machine & Tool Co., 1206 7th St., Bedford, Ind.—D,F,G,P,T,AD,AR,AU, AAD, AAG,AAH  
 Super Ear Products Co., 675 Merrick Rd., Lynbrook, N.Y.—L,AX

Switchcraft, Inc., 1328 N. Halsted St., Chicago 22, Ill.—A,L,Y  
 Tabet Mfg. Co., 1336 Ballantyne Blvd., Norfolk 12, Va.—AH  
 Technical Tape Corp., W. 177 St. & Harlem River, Morris Hts. 53, N.Y.—AAC  
 Technicraft Co., 1156 Commonwealth Ave., Boston 34, Mass.—O,AJ  
 Tele Plastics Co., Div. 202 Broadway, Brooklyn 11, N.Y.—O,P,AH,AJ,AAF  
 Telex, Inc., 1633 Eustis St., St. Paul 1, Minn.—L,Y,AA,AI  
 Thomas Associates, 4607 Alger St., Los Angeles 39, Calif.—F,AR  
 Thompson-Bremer Co., 520 N. Dearborn St., Chicago 10, Ill.—L,AZ, AAD  
 Tinnerman Products, Inc., Dept. 16, P.O. Box 6688, Cleveland 1, Ohio—AR,AZ  
 Transformer Metal Prods. Corp., 343 W. 26 St., New York 1, N.Y.—T,AR  
 Trico Fuse Mfg. Co., 2948 N. 5 St., Milwaukee 12, Wisc. AAH-AAI  
 Trimm, Inc., Libertyville, Ill.—AH,AI,AL  
 Tru-Pine Co., 7638 Vincennes Ave., Chicago 20, Ill.—K,AG,AAA  
 TV Hdw. Mfg. Co., 919 Taylor Ave., Rockford, Ill.—F,G,L,X  
 T-V Products Co., 145-68 228 St., Springfield Gardens 13, N.Y.—AD  
 U. M. & F. Mfg. Corp., 10929 Vanowen St., N. Hollywood, Calif.—AH  
 United Technical Labs., Morristown, N.J.—A, L,Z,AQ,AAA  
 Univox Corp., 102 Warren St., New York 7, N.Y.—AD  
 U. S. Eng'g. Co., 521 Commercial St., Glendale 3, Calif.—F,G,L,AO, AAD  
 Utica Drop Forge & Tool Corp., 2415 Whitesboro St., Utica 4, N.Y.—Z  
 Utilities Service Co., 1 Pine St., Allentown, Pa.—AZ  
 Vaco Products Co., 317 E. Ontario St., Chicago 11, Ill.—Z, AAD  
 Van Cleef Bros., 7800 Woodlawn Ave., Chicago 19, Ill.—AAC  
 Varflex Corp., 508 W. Court St., Rome, N.Y.—X  
 Vector Electronic Co., 3352 San Fernando Rd., Los Angeles 65, Calif.—L,AX,AY, AAD  
 Victor Insulators, Inc., Maple Ave., Victor, N.Y.—X  
 Vidair Electronics Mfg. Co., 576 W. Merrick Rd., Lynbrook, N.Y.—A  
 Vokar Corp., Huron River Dr., Dexter, Mich.—AO  
 Waldom Electronics Inc., 4625 W. 53 St., Chicago 32, Ill.—E,O,T,U,AA,AI,AR,AU,AV, AZ, AAD  
 Walnut Machine Co., National Bank Bldg., South Bend, Ind.—AD  
 Walsco Electronics Corp., 3602 Crenshaw Blvd., Los Angeles 16, Calif.—Q,R,T,U,W,Z,AC,AG, AL,AN,AO,AR,AZ, AAG,AAK  
 Waterman Products Co., 2445 Emerald St., Philadelphia, Pa.—AU  
 Waterproof Electric Co., 801 S. Main St., Burbank, Calif.—D,F  
 Whitney Blake Co., New Haven 14, Conn.—L  
 Witelrad Electrical Mfg., Stamford, Conn.—AM  
 Zierick Mfg. Corp., Beechwood & Rockdale Ave., New Rochelle, N.Y.—AAG

**10—KITS**

- Kits, AM, FM Tuner ..... J
- Kits, audio & phonograph ..... A
- Kits, battery charger, eliminator .. B
- Kits, crystal set ..... H
- Kits, educational radio-TV ..... L
- Kits, electric eye equipment ..... D
- Kits, power supply ..... F
- Kits, radio control ..... G
- Kits, short-wave set ..... I
- Kits, speaker enclosure ..... M
- Kits, test equipment ..... E
- Kits, TV Booster ..... C
- Kits, TV chassis & conversion ..... K

Allied Radio Corp., 100 No. Western Ave., Chicago 80, Ill.—A,B,D,E,H,I,J,L  
 Approved Electronic Instrument Corp., 928 Broadway, New York 10, N.Y.—A,E,J  
 Brooks Radio & Television Corp., 84 Vesey St., New York 7, N.Y.—K  
 Certified Radio Labs., 5507 13 Ave., Brooklyn 19, N.Y.—K,L  
 Colorton Electronics Inc., 100 Frank Rd., Hicksville, N.Y.—E,F  
 DeWald Radio Mfg. Corp.—United Scientific Labs., 35-15 37 Ave., Long Island City 1, N.Y.—J,K  
 DX Radio Products Co., 2300 W. Armitage Ave., Chicago 47, Ill.—C,H  
 Eby Sales Co., 130 Lafayette St., New York 13, N.Y.—A,F  
 Electronic Instrument Co., 84 Withers St., Brooklyn 11, N.Y.—B,E

Electronic Measurements Corp., 280 Lafayette St., New York 12, N.Y.—E  
 Feiler Eng'g. & Mfg. Co., 8026 N. Monticello, Skokie, Ill.—E,L  
 Fenton Co., 15 Moore St., New York 4, N.Y.—A  
 General Apparatus Co., 344 E. 32 St., New York 16, N.Y.—A,M  
 Heath Co., 305 Territorial, Benton Harbor, Mich.—A,B,E,F,I  
 Hubbell Co., Harvey, State & Bostwick Ave., Bridgeport 2, Conn.—E  
 Klipsch & Associates, Hope, Ark.—M  
 Lee Electronic Labs., 233 Dudley St., Boston 19, Mass.—E,F  
 Mallory & Co., P.R., 3029 E. Washington St., Indianapolis 6, Ind.—E,G  
 Merit Coil & Transformer Corp., 4427 N. Clark St., Chicago 40, Ill.—K  
 Miller Co., J.W., 5917 S. Main St., Los Angeles 3, Calif.—H  
 National Radio Institute, 16 & U Sts., N.W. Washington 9, D.C.—L  
 North American Model Prod., 9802 Warwick Rd., Warwick, Va.—G  
 North Hills Electric Co., 203-18 35 Ave., Bay-side 61, N.Y.—G,L  
 Ortho Filter Corp., 196 Albion Ave., Paterson 2, N.J.—I  
 Paraplegics Mfg. Co., Franklin Park, Ill.—A  
 Pfanstiehl Chemical Co., 104 Lake View Ave., Waukegan, Ill.—A  
 Philmore Mfg. Co., 113 University Pl., New York 3, N.Y.—A,G,H,I,K,L  
 Precise Development Corp., 999 Long Beach Rd., Oceanside, N.Y.—E  
 Radio Corp. of America, RCA Tube Div., 415 S. 5 St., Harrison, N.J.—J,K  
 Radio Craftsmen Inc., 4401 N. Ravenswood Ave., Chicago, Ill.  
 Radio Kits Inc., 120 Cedar St., New York 6, N.Y.—K  
 RAM Electronics Sales Co., S. Buckhout St., Irvington, N.Y.—K  
 River Edge Industries, 5 River Edge Rd., River Edge, N.J.—M  
 Shallcross Mfg. Co., Jackson & Pusey Aves., Collingdale, Pa.—F  
 Sonar Radio Corp., 3050 W. 21 St., Brooklyn 24, N.Y.—I  
 Superex Electronics Corp., 4 Radford Pl., Yonkers, N.Y.—H  
 Tech Master Corp., 75 Front St., Brooklyn 1, N.Y.—A,K,L  
 Triad Transformer Corp., 4055 Redwood Ave., Venice, Calif.—A  
 United Transformer Co., 150 Varick St., New York 13, N.Y.—A

Master Electronics & Television, Rt. 1, Box 36, Libertyville, Ill.—A  
 Pennwood Numechron Co., 7249 Frankstown Ave., Pittsburgh 8, Pa.—A,B,C,K  
 Philco Corp., Tioga & C. Sts., Philadelphia 34, Pa.—D  
 Portable Electric Tools, Inc., 320 W. 83 St., Chicago 20, Ill.—D  
 Rek-O-Kut Co., 38-01 Queens Blvd., Long Island City 1, N.Y.—F,J  
 Sangamo Generators, Inc., 2110 Clear Lake Ave., Springfield, Ill.—E  
 Sessions Clock Co., Forestville, Conn.—B  
 S.O.S. Cinema Supply, 602 W. 52 St., New York 19, N.Y.—E,F,J  
 Tork Clock Co., 1 Grove St., Mt. Vernon, N.Y.—B  
 Wincharger Corp., E. 7th & Division Sts., Sioux City 2, Iowa—E

Bud Radio, Inc., 2118 E. 55 St., Cleveland 3, Ohio—O  
 Califone Corp., 1041 N. Sycamore Ave., Hollywood 38, Calif.—A,R,W  
 Capehart-Farnsworth Co., 3702 E. Pontiac St., Ft. Wayne 5, Ind.—H,Q,R,T  
 Capitol Records Inc., 1730 Broadway, New York 19, N.Y.—R,U  
 Capps & Co., Frank L., 20 Addison Pl., Valley Stream, N.Y.—P  
 Colos-eum Records, 27 William St., New York 5, N.Y.—U  
 Columbia Records, Inc. (Phono Div.), 799 7 Ave., New York 19, N.Y.—R,U  
 Components Corp., Denville, N.J.—W  
 Concert Hall Society, 43 W. 61 St., New York, N.Y.—U  
 Cook Laboratories, 114 Manhattan St., Stamford, Conn.—A,U,V  
 Crescent Industries, Inc., 5900 W. Touhy Ave., Chicago 30, Ill.—R,T  
 Crosley Div. of AVCO Mfg. Co., 1329 Arlington St., Cincinnati 25, Ohio—R  
 Dean Sales, 425 Devoe Ave., New York 60, N.Y.—R,T  
 Decca Records Inc., 50 W. 57 St., New York, N.Y.—R,U  
 D & R Ltd., 402 E. Gutierrez St., Santa Barbara, Calif.—W  
 Dubbings Co., 41-10 45th St., Long Island City, N.Y.—A,E,P  
 Dukane Corp., St. Charles, Ill.—R  
 Duotone Co., Locust St., Keyport, N.J.—L,N,P,Q  
 Dynavox Corp., 40-04 21 St., Long Island City, N.Y.—R  
 Edu-Craft Sales Corp., 150-45 12 Ave., White-stone, N.Y.—R  
 Eicor, Inc., 1501 W. Congress St., Chicago 7, Ill.—S,Q,AH  
 Elercraft Electronics, 32-28 49 St., Long Island City, N.Y.—R  
 Elec. & Musical Industries, 38 W. 48 St., New York, N.Y.—U  
 Electron Enterprises, 6917 Stanley Ave., Berwyn, Ill.—R,T  
 Electronic Crafts, 74 Cortland St., New York, N.Y.—R  
 Electro-Sonic Labs., 35-54 36 St., Long Island City, N.Y.—A,E,P  
 Electro-Voice, Inc., Buchanan, Mich.—A,E,J  
 Electrovox Co., Inc., 60 Franklin St., E. Orange, N.J.—C,K,N,P,X  
 Elektra Records, 361 Bleecker St., New York, N.Y.—U  
 Emerson Radio & Phonograph Corp., 14 & Coles St., Jersey City, N.J.—D,F,R  
 Epeo Electronics, Inc., 140 Liberty St., New York 6, N.Y.—J  
 Esoteric Records, 11 W. 18 St., New York, N.Y.—U  
 Epic Record Co., 243 W. 72 St., New York, N.Y.—U  
 Fairchild Recording Equipment Co., 154 St. & 7 Ave., Whitestone 57, N.Y.—A,E  
 Fanon Electric, 150-09 South Rd., Jamaica, L.I., N.Y.—R  
 Fantasy Record Co., 489 5 Ave., New York 17, N.Y.—U  
 Fenton Co., 15 Moore St., New York 4, N.Y.—A,E,F,L,T  
 Ferranti Electric, Inc., 30 Rockefeller Plaza, New York 20, N.Y.—A,E  
 Fisher Radio Corp., 21-21 44 Dr., Long Island City 1, N.Y.—E,R  
 Garrard Sales Corp., 164 Duane St., New York 13, N.Y.—B,F,K,R,T  
 General Cement Mfg. Co., 919 Taylor Ave., Rockford, Ill.—I,L  
 General Electric Co., Electronics Park, Syracuse, N.Y.—A,E,H,J,P  
 General Industries Co., Olive & Taylor Sts., Elyria, Ohio—I,T,W  
 G & H Wood Products Co., 75 N. 11 St., Brooklyn 11, N.Y.—B,D  
 Gotham TV Corp., 123 W. 64 St., New York 23, N.Y.—H,R,X  
 Grayline Eng'g. Co., 12243 Avenue O, Chicago 33, Ill.—R  
 Gray Research & Devel. Co., 658 Hilliard St., Manchester, Conn.—A,J  
 Greene Co., L. Charlton, 314 Washington St., Newton 58, Mass.—R  
 Hallcrafters Co., 4401 W. 5 Ave., Chicago 24, Ill.—R  
 Hamilton Electronics Corp., 2726 Pratt Ave., Chicago 45, Ill.—R,W  
 Haydn Society Inc., 30 Huntington Ave., Boston, Mass.—U  
 Hedco Mfg. Corp., 161 W. Huron St., Chicago 10, Ill.—R  
 Hinnners-Galanek Radio Corp., 25-14 Broadway, Long Island City 6, N.Y.—R  
 Hoffman Electronics Corp., P.O. Box 2153, Los Angeles 54, Calif.—R  
 Hycor Co., 11423 Vanowen St., N. Hollywood, Calif.—J  
 Ingalls Electronics, 30 W. Putnam Ave., Greenwich, Conn.—X  
 Insuline Corp. of America, 186 Granite St., Manchester, N.H.—B,D,F,Q  
 Jansa Woodworking Corp., 315 Meserole St., Brooklyn, N.Y.—F  
 Jensen Industries, 7333 W. Harrison St., Forest Park, Ill.—E,P  
 Kraft Bros., 1299 Jerome Ave., New York 52, N.Y.—D,F,R,T

## 12—PHONOGRAPHS, PHONO EQUIPMENT & ACCESS.

Arms, pickup ..... A  
 Bases, phonograph mounting ..... B  
 Brushes, record ..... C  
 Cabinets, phonograph ..... D  
 Cable, phonograph (see Sec. 24)  
 Cartridges, phono pickup ..... E  
 Cases, phonograph carrying ..... F  
 Cases, record ..... G  
 Compensators, record ..... H  
 Drives, phonograph ..... I  
 Equalizers, phono preamp ..... J  
 Gauges, needle pressure ..... K  
 Inserts, 45 RPM ..... L  
 Labels, recording ..... M  
 Microscope, stylus ..... N  
 Needles, playback ..... P  
 Oscillators, phono ..... O  
 Parts, phono, misc. ..... Q  
 Phonographs ..... R  
 Record Changers, automatic ..... T  
 Records ..... U  
 Records, test ..... V  
 Turntable Pads ..... X  
 Turntables ..... W

## 11—MOTORS & TIMERS

Clocks, program ..... A  
 Dynamotors ..... E  
 Indicators, time ..... C  
 Motors, antenna rotating ..... D  
 Motors, clock ..... K  
 Motors, phono recording ..... F  
 Motors, phono turntable ..... J  
 Motors, power plant ..... G  
 Motors, spring wound ..... H  
 Motors, starting capacity ..... I  
 Timers, clock ..... B

Aero Instrument Co., 11423 Van Owen St., N. Hollywood, Calif.—C  
 Allied Eng'g. Div., Allied Int'l Inc., 230 Park Ave., New York 17, N.Y.—E,G  
 Bendix Aviation Corp., Red Bank Div., Eatontown, N.J.—E  
 Califone Corp., 1041 N. Sycamore Ave., Hollywood 38, Calif.—J  
 Carron Mfg. Co., 741 W. Harrison St., Chicago 7, Ill.—J  
 Carter Motor Co., 2644 N. Maplewood Ave., Chicago 47, Ill.—E  
 DuMont Labs., Inc., Allen B., Mobile Comm. Dept., 1500 Main St., Clifton, N.J.—E  
 Eicor, Inc., 1501 W. Congress St., Chicago 7, Ill.—E  
 Electric Indicator Co., Box 666, Springdale, Conn.—D,I  
 Electrical Service, 1271 Mission St., San Francisco 3, Calif.—B,C  
 Electro Eng'g Products Co., 609 W. Lake St., Chicago 6, Ill.  
 Espey Manufacturing Co., 528 E. 72 St., New York 21, N.Y.—G  
 General Industries Co., Olive & Taylor Sts., Elyria, Ohio—J  
 Hansen Mfg. Co., 1954 First St., Princeton, Ind.—A,K  
 International Register Co., 2620 W. Washington Blvd., Chicago 12, Ill.—B,K  
 JFD Mfg. Co., 6101 16 Ave., Brooklyn 4, N.Y.—D  
 Kato Engineering, 1451 1 Ave., Mankato, Minn.—G  
 Leader Electronics, 2925 E. 55 St., Cleveland 27, Ohio—D

Admiral Corp., 3800 Cortland St., Chicago 47, Ill.—D,R,T  
 Allegro Electronics Corp., 226 New York Ave., Huntington, L.I., N.Y.—R  
 Alliance Mfg. Co., Lake Park Blvd., Alliance, Ohio—R,W  
 Allied Radio Corp., 100 N. Western Ave., Chicago 80, Ill.—J  
 American Electronics Co., 1203 Bryant Ave., New York 59, N.Y.—V  
 American Elite Inc., 7 Park Ave., New York 16, N.Y.—T  
 American Microphone Co., Elgin Nat'l Watch Affiliate, 370 S. Fair Oaks Ave., Pasadena 1, Calif.—A,E  
 AMI Inc., 1500 Union Ave., S.E., Grand Rapids 2, Mich.—R  
 Angle Genesee Corp., 107 Norris Dr., Rochester 10, N.Y.—D  
 Ansley Mfg., Arthur, Doylestown, Pa.—R  
 Argos Products, 310 Main St., Genoa, Ill.—B,D,F  
 Astatic Corp., P.O. Box 120, Conneaut, Ohio—A,B,E,P  
 Atlantic Recordings, 301 W. 54 St., New York, N.Y.—U  
 Audak Co., 500 Fifth Ave., New York, N.Y.—E  
 Audiogersh Corp., 23 Park Ave., New York 7, N.Y.—T,W  
 Audio Industries, Inc., 532 W. 4 St., Michigan City, Ind.—R,T  
 Audio Master Corp., 17 E. 45 St., New York 17, N.Y.—R  
 Autocrat Electronics Co., 5024 Elm St., Skokie 8, Ill.—R,T  
 Beam Radionics, 224 N. Desplains St., Chicago, Ill.—R  
 Bell Sound Systems, 555 Marion Rd., Columbus 7, Ohio—R  
 Bennett & Co., Paul, 230 E. Ohio St., Chicago 30, Ill.—P,R  
 Bestcraft Products Co., 626 Broadway, New York 12, N.Y.—Q  
 Boetsch Bros., 221 E. 144 St., New York 51, N.Y.—F,R,T  
 Bogen Co., David, 29 9th Ave., New York 14, N.Y.—B,F,H,R  
 B & R Electronics, 1701 Boone Ave., New York 60, N.Y.—R  
 British Electronic Sales, 23-03 45 Rd., Long Island City, N.Y.—A  
 British Industries Corp., 164 Duane St., New York 13, N.Y.—A  
 Brush Electronics Co., 3405 Perkins Ave., Cleveland 14, Ohio—E,M

Kral Products, 1704 Walnut St., Philadelphia, 3, Pa.—C  
 Leru Laboratories, Wayne, N.J.—R  
 Lion Mfg. Corp., 2640 W. Belmont Ave., Chicago 18, Ill.—R  
 Lipps Eng'g, Edwin A., 5485 W. Washington Blvd., Los Angeles 16, Calif.—P  
 Livingston Electronic Corp., Livingston, N.J.—A,K,U,V  
 London Records Inc., 539 W. 25 St., New York 1, N.Y.—R,U  
 Lyrrichord Records, 464 W. 51 St., New York, N.Y.—U  
 Magnavox Co., 2131 Bueter Rd., Ft. Wayne 4, Ind.—R  
 Magnecord, Inc., 225 W. Ohio St., Chicago 10, Ill.—R  
 Majestic Radio & TV Div. Wilcox-Gay Corp., 70 Washington St., Brooklyn, N.Y.—R  
 Major Electronics Co., 42 Meserole St., Brooklyn 6, N.Y.—R  
 Marine View Electronics, 744 E. 138 St., New York 54, N.Y.—J  
 Markel Elec. Prods., 147 Seneca St., Buffalo, N.Y.—T  
 Mattison Radio & TV Co., 10 W. 181 St., New York 53, N.Y.—B,D  
 Mercury Record Corp., 35 E. Wacker Dr., Chicago 1, Ill.—U  
 MGM Div. of Loew's Inc., 701 7 Ave., New York 36, N.Y.—R,U  
 Midwest Radio & Television Corp., 909 Broadway, Cincinnati 2, Ohio—T  
 Miller Mfg. Co., M. A., 4th & Church Sts., Libertyville, Ill.—P  
 Mitchell Mfg. Co., 2525 Clybourn Ave., Chicago 14, Ill.—R  
 Montilla LP Record Co., 447 W. 50 St., New York, N.Y.—U  
 Motorola, Inc., 4545 W. Augusta Blvd., Chicago 51, Ill.—R  
 MP Eng'g. Co., Fairfield 3, Conn.—R  
 Musical Masterpieces, 43 W. 61 St., New York, N.Y.—U  
 Newcomb Audio Products Co., 6824 Lexington Ave., Hollywood 38, Calif.—R  
 North American Phillips Co., 100 E. 42 St., New York 17, N.Y.—R  
 Oceanic Records, 15 Park Ave., New York, N.Y.—U  
 Olympic Radio & TV, 34-01 38 Ave., Long Island City 1, N.Y.—R  
 Optron Mfg. Co., 3223 N. Sheffield Ave., Chicago 13, Ill.—R  
 Pacific Transducer Corp., 11836 W. Pico Blvd., Los Angeles 64, Calif.—A,E,J,K,N,P,Q,V  
 Packard-Bell Co., 12333 W. Olympic Blvd., Los Angeles 64, Calif.—R  
 Permo, Inc., 6415 Ravenswood Ave., Chicago 26, Ill.—C,P  
 Pfanstiehl Chemical Co., 104 Lake View Ave., Waukegan, Ill.—E,P  
 Philco Corp., Tioga & C Sts., Philadelphia 34, Pa.—A,P,R  
 Philharmonic Inc., 235 Jersey Ave., New Brunswick, N.J.—R  
 Pickering & Co., 309 Woods Ave., Oceanside, N.Y.—A,E,H,J,K  
 Pilot Radio Corp., 37-06 36 St., Long Island City 1, N.Y.—R  
 Port-O-Matic Co., 438 E. 91 St., New York 28, N.Y.—R  
 Presto Recording Corp., P.O. Box 500, Paramus N.J.—X  
 Radio Corp. of America, Eng'g. Products Div., Camden, N.J.—E,R,W  
 Radio Corp. of America, Tube Div., 415 S. 5 St., Harrison, N.J.—P  
 Radio Corp. of America, Custom Record Sales Div., 630 5 Ave., New York, N.Y.—U,V  
 Radio Craftman, 4401 N. Ravenswood Ave., Chicago 40, Ill.—R  
 Radio Music Corp., 84 So. Water St., Port Chester, N.Y.—A,J,W  
 Radio Supply & Eng'g Co., 85 Selden Ave., Detroit 1, Mich.—A,R,T  
 Recotone Corp., 52-35 Barnett Ave., Long Island City 4, N.Y.—A,C,L,P  
 Rek-O-Kut Co., 38-01 Queens Blvd., Long Island City 1, N.Y.—A,B,D,F,R,W  
 Remington Records, 551 5 Ave., New York, N.Y.—U  
 Replica Records, 7210 Westview Dr., Des Plaines, Ill.—U  
 Ristaucrat Inc., 1216 E. Wisconsin Ave., Appleton, Wis.—R  
 River Edge Industries, 5 River Edge Rd., River Edge, N.J.—D  
 Robins Industries, 4108 Bell Blvd., Bayside, N.Y.—P  
 Rockbar Corp., 215 E. 37 St., New York 16, N.Y.—R,T,W  
 Romar Plastics, 1311 E. Main St., St. Charles, Ill.—Q  
 Ronette Acoustical Corp., 135 Front St., New York 5, N.Y.—A,P  
 Royal Diamond Tool Co., 172 Green St., Boston 3, Mass.—P  
 Schwann LP Record Co., 131 Clarendon St., Boston, Mass.—U  
 Scott, Inc., Herman Hosmer, 385 Putnam Ave., Cambridge 39, Mass.—B,R,W  
 Scott Radio Labs., Liberty St., Plymouth, Ind.—R  
 Seeburg Corp., J.P., 1510 N. Dayton, Chicago, Ill.—R  
 Seeco Records, 39 W. 60 St., New York, N.Y.—U

Shura-Tone Products, Inc., 440 Adelphi St., Brooklyn, N.Y.—P,R  
 Shure Bros., 225 W. Huron St., Chicago 10, Ill.—A,E,P  
 Siemens & Halske, Wayne, N.J.—R  
 Sightmaster Corp., 111 Cedar St., New Rochelle, N.Y.—T  
 Sonic Industries, 30-30 Northern Blvd., Long Island City 1, N.Y.—R  
 Sonotone Corp., P.O. Box 200, Elmsford, N.Y.—E,P  
 S.O.S. Cinema Supply Corp., 602 W. 52nd St., New York 19, N.Y.—T,W  
 Speak-O-Phone Recording & Equip. Co., 23 W. 60 St., New York 23, N.Y.—P  
 Spectrutone Sound Associates, 66 E. Gloucester Pike, Barrington, N.J.—U  
 Square Root Mfg. Co., 391 Saw Mill River Rd., Yonkers 2, N.Y.—R  
 Steelman Phono & Radio, 230 Anderson Ave., Mt. Vernon, N.Y.—R  
 Stromberg-Carlson Co., 100 Carlson Rd., Rochester 3, N.Y.—R,T  
 Sylvania Electric Prods., Radio-TV Div., 254 Rano St., Buffalo, N.Y.—R  
 Symphonic Radio, 160 Washington St. N., Boston 8, Mass.—R  
 Televox Co., 46 Lakeview Ave., Yonkers, N.Y.—N,P,X  
 Tempo Records Co. of America, 8540 Sunset Blvd., Hollywood 46, Calif.—U  
 Tetrad Co., 62 St. Mary St., Yonkers 2, N.Y.—N,P  
 Thorens Co., Stewart & Atlantic Ave., Garden City Park, N.Y.—R,T  
 Toman & Co., E., 8700 W. 47 St., Lyons, Ill.—A,Q,R  
 Transcriber Co., 70 Pine St., Attleboro, Mass.—P  
 Transformer Metal Prods. Corp., 343 W. 2f St., New York 1, N.Y.—A,D,F,G  
 Trav-Ler Radio Corp., 571 W. Jackson Blvd., Chicago, Ill.—R  
 Truvox Mfg. Co., 208 E. 47 St., New York 17, N.Y.—R  
 Turner Co., 909 17 St., N.E., Cedar Rapids, Iowa—E

Allied Eng'g. Div., Allied Intl. Inc., 230 Park Ave., New York 17, N.Y.—A,B,C,D,E,F,G,H,I  
 American Electric Motors, 4811 Telegraph Rd., Los Angeles 22, Calif.—B,E  
 American Television & Radio Co., 300 E. 4th St., St. Paul 1, Minn.—A,B,D,H  
 Amperex Electronic Corp., 230 Duffy Ave., Hicksville, N.Y.—A,G  
 Anton Electronic Labs., 1226 Flushing Ave., Brooklyn 37, N.Y.—F,G  
 Applegate & Co., C. J., 1816 Grove St., Boulder, Colo.—G  
 Authorized Mfg. Co., 919 Wyckoff Ave., Brooklyn 27, N.Y.—G  
 Barker & Williamson, 235 Fairfield Ave., Upper Darby, Pa.—F  
 Bendix Aviation Corp., Red Bank Div., Eatontown, N.J.—F,G  
 Boland & Boyce, 236 Washington Ave., Belleville, N.J.—F  
 Bradley Laboratories, Inc., 168 Columbus Ave., New Haven, Conn.—A,I  
 Carter Motor Co., 2644 N. Maplewood Ave., Chicago 47, Ill.—B,E  
 C B C Electronics Co., 2601 N. Howard, Philadelphia 33, Pa.—G  
 Chatham Electronics Corp., 630 W. Mt. Pleasant Ave., Livingston, N.J.—A,G  
 Colortone Electronics Inc., 100 Frank Rd., Hicksville, N.Y.—G  
 Cornell-Dubilier Elec. Corp., South Plainfield, N.J.—A,B,D,H  
 Crest Transformer Corp., 1834 W. North Ave., Chicago 22, Ill.—G  
 Delco Radio Div., General Motors Corp., Kokomo, Ind.—E,H  
 DuMont Lab. Inc., Instrument Div., 760 Bloomfield Ave., Clifton, N.J.—I  
 Eicor, Inc., 1501 W. Congress St., Chicago 7, Ill.—B,F  
 Electro-Physics Co., 287-P Broadway, New York 7, N.Y.—I  
 Electro Products Labs., Inc., 4501 N. Ravenswood Ave., Chicago 40, Ill.—A,D,F  
 Electro-Technic Products, 4602 Montrose Ave., Chicago 41, Ill.—A  
 Elgin Electronic Corp., P.O. Box 13, Bluffton, Ind.—A  
 Elly Electronics Corp., 22-02 Raphael St., Fairlawn, N.J.—I  
 Federal Telephone and Radio Co., Division of IT&T, 100 Kingsland Rd., Clifton, N. J.—A,D,G  
 Fisher Co., Oscar, 1000 N. Division St., Peekskill, N.Y.—I  
 Fisher-Pierce Co., 170 Pearl St., S. Braintree 85, Mass.—I  
 G. & M. Equipment Co., 7315 Varna Ave., N. Hollywood, Calif.—B  
 Gordon Enterprises, 5362 N. Cahuenga Blvd., N. Hollywood, Calif.—I  
 Gyro Electronics Co., 325 Canal St., New York 13, N.Y.—A  
 H & H Products Mfg., P. O. Box 2333, Terminal Annex, Los Angeles 54, Calif.—A  
 Heath Co., 305 Territorial Rd., Benton Harbor, Mich.—D  
 Inet Div. Leach Corp., 4441 S. Santa Fe Ave., Los Angeles 58, Calif.—F  
 International Research Assoc., 2221 Warwick Ave., Santa Monica, Calif.—F  
 International Rectifier Corp., 1521 E. Grand Ave., El Segundo, Calif.—I  
 James Vapirapow Co., 4036 N. Rockwell St., Chicago 18, Ill.—B,H  
 Kato Engineering 1450 1 Ave., Mankato, Minn.—A,B,E,F  
 Kav Lab., Box 16, San Diego 10, Calif.—F,G  
 Kellogg Switchboard & Supply Co., 79 W. Monroe St., Chicago 3, Ill.—A,D  
 Keppo Laboratories, 131-38 Sanford Ave., Flushing 55, N.Y.—C,D,F,G  
 Krohn-Hite Instrument Co., 580 Mass. Ave., Cambridge 39, Mass.—F  
 Kurman Electric Co., Inc., 35-18 37th St., Long Island City 1, N.Y.—B,H  
 Laine Electronic & Mfg. Co., 113 Sussex Ave., Newark 4, N.J.—G  
 Lee Electronic Labs., 233 Dudley St., Boston 19, Mass.—F  
 Leland Electric Co., P. O. Box 1060, Dayton, Ohio  
 Mag-Electric Products, 12822 Yukon Ave., Hawthorne, Calif.—D,F,G  
 Mallory & Co., P. R., 3029 E. Washington St., Indianapolis 6, Ind.—A,B,D,E,G,H  
 Marine View Electronics, 744 E. 138 St., New York 54, N.Y.—A,C,E  
 McCoolpin-Christie Corp., 3410 W. 67 St., Los Angeles 43, Calif.—A,B  
 Miller Co., Sanford, 691 Bedford Ave., Brooklyn 6, N.Y.—B,D,F  
 Miller Instruments, Inc., Wm., 325 N. Halstead Ave., Pasadena 8, Calif.—B,G  
 Moran Electronic Components, 10506 Wheatley St., Kensington, Md.—F  
 Multi-Tron Lab., 4624 W. Wash. Blvd., Chicago 44, Ill.—I  
 Ohmrite Mfg. Co., 3601 Howard St., Skokie, Ill.—C  
 Onan & Sons, D. W., 25 & University, S.E., Minneapolis 14, Minn.—A  
 Paraplexics Mfg. Co., 10068 Franklin Ave., Franklin Park, Ill.—F  
 Perma-Power Co., 4727 N. Damen Ave., Chicago 25, Ill.—A,D,G  
 Peschel Electronics, Inc., 13 Garden St., New Rochelle, N. Y.—A,C,D,G



Urania Records Inc., 40 E. 19 St., New York, N.Y.—U  
 Vanguard Recording Society, 256 W. 55 St., New York 19, N.Y.—U  
 Vanity Fair Electronics Corp., 50 S. 4th St., Brooklyn 11, N.Y.—A,D,F,L,Q,R,T,W  
 Video Corp. of America, 229 W. 28 St., New York 1, N.Y.—R  
 V-M Corp., Benton Harbor, Mich.—Q,R,T  
 Vox Productions, 236 W. 55 St., New York 19, N.Y.—U  
 Walsco Electronics Corp., 3602 Crenshaw Blvd., Los Angeles 16, Calif.—I  
 Waters Conley Co., Rochester 1, Minn.—R  
 Weathers Industries, Inc., 66 E. Gloucester Pike, Barrington 6, N.J.—A,E,H,J,K,O,R,V  
 Webster-Chicago Corp., 5610 W. Bloomingdale Ave., Chicago 39, Ill.—R,T  
 Webster Electric Co., 1900 Clark St., Racine, Wis.—A,E,P  
 Westinghouse Electric Corp., Radio & TV Division, Metuchen, N.J.—R,T  
 Westminster Recording Co., 275 7 Ave., New York 1, N.Y.—U  
 Wilcox-Gay Corp., Charlotte, Mich.—R  
 Zenith Radio Corp., 6001 W. Dickens Ave., Chicago 39, Ill.—R

### 13—POWER SUPPLIES & ACCESSORIES, COMPONENTS & PARTS

- Battery Chargers ..... A
- Battery Eliminators ..... D
- Converters & Inverters, DC to AC .. B
- Dividers, voltage ..... C
- Dynamotors (see Sec. 11)
- Generators, power ..... E
- Photoelectric Equipment ..... I
- Power Plants & Supplies ..... F
- Regulators, voltage ..... G
- Selenium Rectifiers (see Sec. 16)
- Vibrators, auto radio ..... H

Acme Electronics Inc., Sub. Aerovox Corp., 2724 Peck Rd., Monrovia, Calif.—A,G  
 Alco Electronics Mfg. Co., 3 Wolcott Ave., Lawrence, Mass.—F,G

Philco Corp., Tioga & C. Sts., Philadelphia 34, Pa.—H  
 Plastic Capacitors, Inc., 2511 W. Moffat St., Chicago 47, Ill.—G  
 Power Supplies, 1005 Olive St., Highland, Ill.—A,B,D,F,G  
 Power Transformer Co., 532 Mulberry St., Newark 5, N.J.—A,B,G  
 Precise Measurements Co., 942 Kings Hwy., Brooklyn 23, N.Y.—B,G  
 Radiart Corp., 3455 Vega Ave., Cleveland 13, Ohio—A,H  
 Radio Corp. of America, Tube Div., 415 S. 5 St. Harrison, N.J.—H  
 Rapid Electric Co., 2881 Middletown Rd., New York 51, N.Y.—B,D  
 Raytheon Mfg. Co., Equipment Marketing Div., 100 River St., Waltham, Mass.—A,G  
 Rectifier Engineering Co., 1803 E. 7 St., Los Angeles 21, Calif.—A  
 Richardson-Allen Corp., 116-15 15 Ave., College Point, N.Y.—F  
 Sangamo Generators Inc., 2110 Clear Lake Ave., Springfield, Ill.—B,E  
 Schauer Mfg. Corp., 4500 Alpine Ave., Cincinnati 36, Ohio—A,D  
 Service Instruments Co., 422 S. Dearborn St., Chicago 5, Ill.—D,G  
 Shalleross Mfg. Co., Jackson & Pusey Aves., Collingdale, Pa.—C  
 Shasta Div., Beckman Instruments Inc., P.O. Box 296, Station A, Richmond, Calif.—F  
 Sola Electric Co., 4633 W. 16 St., Chicago 50, Ill.—G  
 Sonar Radio Corp., 3050 W. 21 St., Brooklyn 24, N.Y.—A  
 S.O.S. Cinema Supply 602 W. 52 St., New York 19, N.Y.—B,E  
 Special Products Co., P.O. Box 188, Rockville 1, Md.—I  
 Stromberg-Carlson Co., 100 Carlson Rd., Rochester 3, N.Y.—D  
 Sterling Mfg. Co., 7201 Wentworth Ave., Cleveland, Ohio—A  
 Summit Eng'g Co., 3324 Main St., Hartford, Conn.—A  
 Telkor Inc., Telegraph Rd., Elyria, Ohio—B,D  
 Terado Co., 1068 Raymond Ave., St. Paul 14, Minn.—B  
 United Mfg. Co., Div., W. L. Maxson Corp., 41 Halg St., Hamden 14, Conn.—F  
 United Transformer Co., 150 Varick St., New York 13, N.Y.—G  
 Universal Motor Co., 465 Universal Dr., Oshkosh, Wis.—A  
 Varo Mfg. Co., 1801 Walnut St., Garland, Texas—F,G  
 Vokar Corp., Huron River Dr., Dexter, Mich.—D,G  
 Ward Leonard Electric Co., 115 MacQuesten Pkwy. S., Mt. Vernon, N.Y.—A  
 Welch Mfg. Co., W. M., 1515 Sedgwick St., Chicago 10, Ill.—A  
 Willard Storage Battery Co., 246 E. 131 St., Cleveland 1, Ohio—A  
 Wilmar Mfg. Co., 2715 E. 14 St., Kansas City 27, Mo.—B  
 Wincharger Corp., E. 7th & Division Sts., Sioux City 2, Iowa—B,E  
 Worner Electronic Devices, Rankin, Ill.—I  
 Yardeny Elec. Corp., 40 Leonnard St., New York, N.Y.—A

#### 14—RECEIVERS

Radio Sets, AM ..... A  
 Radio Sets, AM-FM ..... B  
 Radio Sets, FM ..... C  
 Radio Sets, transistor ..... F  
 Television sets, monochrome ..... D  
 Television sets, color ..... E

Admiral Corp., 3800 Cortland St., Chicago 47, Ill.—A,D,E  
 Allied Eng'g Div., Allied Int'l. Inc., 230 Park Ave., New York 17, N.Y.—A,B,C  
 Altec Lansing Corp., 9356 Santa Monica Blvd., Beverly Hills, Calif.—B  
 American Elite, Inc., 7 Park Ave., New York 16, N.Y.—A,B,C  
 Andrea Radio Corp., 27-01 Bridge Plaza N., Long Island City 1, N.Y.—A,B,C,D,E  
 Ansley Mfg. Co., Arthur, Doylestown, Pa.—B  
 Approved Electronic Instrument Corp., 928 Broadway, New York 10, N.Y.—A,B,C  
 Arvin Industries, Inc., 13 & Big-4 RR, Columbus, Ind.—A,B,D  
 Automatic Radio Mfg. Co., 122 Brookline Ave., Boston 15, Mass.—A,B,C  
 Bell Sound Systems, 555 Marion Rd., Columbus 7, Ohio—B  
 Bendix Radio Div., Towson 4, Md.—A,D  
 Benrus Watch Co., 50 W. 44 St., New York, N.Y.—A,B,C  
 Bogen Co., David, 29 Ninth Ave., New York 14, N.Y.—A,B  
 B & R Electronics, 1701 Boone Ave., New York 60, N.Y.—A,B,C  
 Bulova Watch Co., Bulova Park, Flushing 70, N.Y.—A,B,C  
 Calbest Eng'g & Electronics Co., 828 N. Highland, Hollywood 38, Calif.—A,B,C,D

Caphart-Farnsworth Co., 3702 E. Pontiac St., Fort Wayne 5, Ind.—B,D,E  
 CBS—Columbia, Div. CBS, Inc., 3400—47 Ave., Long Island City 1, N.Y.—A,B,D,E  
 Certified Radio Labs., 5507—13 Ave., Brooklyn 19, N.Y.—D  
 Collins Audio Products Co., Route 29, Mountaintside, N.J.—A,B,C  
 Conrac, Inc., 19217 E. Foothill Blvd., Glendora, Calif.—D,E  
 Crosley Radio & TV Corp., Cincinnati 25, Ohio—A,B,C,D  
 DeWald Radio Mfg. Corp., United Scientific Labs., 35-15—37 Ave., Long Island City 1, N.Y.—A,B,C,D,E  
 Douglas Roesch, Inc., 2200 S. Figueroa St., Los Angeles 7, Calif.—D  
 DuMont Laboratories, Inc., Allen B., 35 Market St., E. Paterson, N.J.—D  
 Dwyer Engineering Co., P.O. Box 483, Nashua, N.H.—B  
 Eckstein Radio & TV, 3400 E. 42 St., Minneapolis 6, Minn.—A,B,C  
 Electron Enterprises, 6917 Stanley Ave., Berwyn, Ill.—A,C,D  
 Emerson Radio & Phonograph Corp., 14 & Coles St., Jersey City, N.J.—A,B,C,D,E  
 Espey Manufacturing Co., 528 E. 72 St., New York 21, N.Y.—B,C  
 Fada Radio & Electric Co., 525 Main St., Belleville, N.J.—A,B,C,D  
 Fisher Radio Corp., 21-21 44 Dr., Long Island City 1, N.Y.—A,B,C  
 Garod Radio, 70 Washington St., Brooklyn 1, N.Y.—A,B,C,D  
 Geiss-America, 6424 Northwestern Ave., Chicago, Ill.—A,B,C  
 General Electric Co., Electronics Div., Electronics Park, Syracuse, N.Y.—A,B,C,D,E  
 Gonset Co., 801 S. Main, Burbank, Calif.—A,B,C  
 Gotham TV Corp., 123 W. 64 St., New York 23, N.Y.—A,D  
 Granco Products, Inc., 36-07—20 Ave., Long Island City 5, N.Y.—B,C  
 Guild Radio & TV Co., 400 N. Eucalyptus Ave., Inglewood, Calif.—A  
 Hallicrafters Co., 4401 W. 5 Ave., Chicago 24, Ill.—A,B,C,D  
 Harman-Kardon, Inc., 520 Main St., Westbury, L.I., N.Y.—E,C  
 Harvey-Wells Electronics, Southbridge, Mass.—A,B,C,D  
 Hastings Products, 171 Newbury St., Boston 16, Mass.—C  
 Heath Co., 305 Territorial Rd., Benton Harbor, Mich.—A  
 Hedco Mfg. Corp., 161 W. Huron St., Chicago 10, Ill.—A,B,C  
 Hinners-Galanek Radio Corp., 25-14 Broadway, Long Island City 6, N.Y.—A,B,C  
 Hoffman Electronics Corp., P.O. Box 2153, Los Angeles 54, Calif.—A,B,D,E  
 Hotel Radio Mfrs., 1040 W. Fort St., Detroit 26, Mich.—D  
 Intercontinental Industries, 555 W. Adams St., Chicago, Ill.—A,B,C  
 International Research Assoc., 2221 Warwick Ave., Santa Monica, Calif.—D,E  
 Kaye-Halbert Corp., 3623 Eastham Drive, Culver City, Calif.—D  
 Kent Television, Inc., 505 Driggs Ave., Brooklyn 11, N.Y.—D  
 Kirby Products Corp., 475 Cosgrove St., Philadelphia 44, Pa.—A  
 Lang Radio Enterprises Inc., 208 E. 88 St., New York 28, N.Y.—A  
 Leru Laboratories, Inc., 490 Black Oak Ridge Rd., Wayne, N.J.—A,B,C  
 Lion Mfg. Corp., 2640 Belmont Ave., Chicago 18, Ill.—D,E  
 Magnavox Co., Fort Wayne 4, Ind.—A,B,D,E  
 Majestic Radio & TV, Div. Wilcox-Gay Corp., 70 Washington St., Brooklyn 1, N.Y.—A,B,D  
 Masterpiece Custom TV, 715 Flatbush Ave., Brooklyn 26, N.Y.—D  
 Mattison Radio & TV Co., 10 W. 181st St., New York 53, N.Y.—D  
 Meck Industries, Plymouth, Ind.—A,B,C,D  
 Mitchell Mfg. Co., 2525 Clybourn Ave., Chicago 14, Ill.—A,B,C,D,E  
 Morrow Radio Mfg. Co., 2795 Market St., Salem, Ore.—A  
 Motorola, Inc., 4545 Augusta Blvd., Chicago 51, Ill.—A,B,C,D,E  
 MP Eng'g. Co., Fairfield 3, Conn.—D  
 Muntz TV Inc., 1000 Grey Ave., Evanston, Ill.—D  
 National Co., 61 Sherman St., Malden, Mass.—A,B,C  
 Olympic Radio & TV Inc., 34-01—38 Ave., Long Island City 1, N.Y.—A,B,C,D  
 Ortho Filter Corp., 196 Albion Ave., Paterson 2, N.J.—A  
 Pacific Mercury, 8345 Havenhurst, Sepulveda, Calif.—D,E  
 Pacific Vogue Radio Co., 215 W. 5th St., Los Angeles 12, Calif.—A,B,C  
 Packard-Bell Co., 12333 W. Olympic Blvd., Los Angeles 64, Calif.—A,B,D  
 Paraplegics Mfg. Co., 10068 Franklin Ave., Franklin Park, Ill.—A,B  
 Philco Corp., The, Tioga & C Sts., Philadelphia 34, Pa.—A,B,C,D  
 Philharmonic Radio & TV Corp., 235 Jersey Ave., New Brunswick, N.J.—D  
 Pickens Import Co., N., 205 E. 14th St., New York 3, N.Y.—A,B,C

Radio Kits Inc., 120 Cedar St., New York 6, N.Y.—A,B,C,D  
 Raytheon Mfg. Co., TV & Radio Operations, 5921 W. Dickens Ave., Chicago 39, Ill.—A,D,E,F  
 Radio Corp. of America, RCA Victor Division, Camden, N.J.—A,B,C,D,E  
 Regency Div.—I.D.E.A. Inc., 7900 Pendleton Pike, Indianapolis 26, Ind.—F  
 Revere Camera Co., 320 E. 21st St., Chicago, Ill.—A,B,C  
 Rex Electronics Corp., 1351 E. DeLoss St., Indianapolis 3, Ind.—C  
 Roland Radio Corp., 716 S. Columbus Ave., Mt. Vernon, N.Y.—A,B  
 Scott, Inc., H. H. 385 Putnam Ave., Cambridge 39, Mass.—B,C  
 Scott Radio Labs., Liberty St., Plymouth, Ind.—A,B,C,D,E  
 Sentinel Radio Corp., 2100 Dempster St., Evanston, Ill.—A,D,E  
 Setchell-Carlson Inc., New Brighton, St. Paul 12, Minn.—D  
 Sonar Radio Corp., 3050 W. 21 St., Brooklyn 24, N.Y.—A  
 Sonora Radio & Television Corp., 2023 W. Carroll Ave., Chicago 12, Ill.—A,B,C,D  
 Spartan Radio-TV, 2301 E. Michigan, Jackson, Mich.—A,B,C,D,E  
 Starrett TV Corp., 601 W. 26 St., New York 1, N.Y.—D  
 Stratford Television Co., 2555 W. 21 St., Chicago 8, Ill.—D  
 Stromberg-Carlson Co., 100 Carlson Rd., Rochester 3, N.Y.—A,B,C,D,E  
 Superex Electronics Corp., 4 Radford Pl., Yonkers, N.Y.—A  
 Sutton, S. J., 228 E. Park, Wheaton, Ill.—A  
 Sylvania Electric Products Inc., 1740 Broadway, New York 19, N.Y.—A,D,E  
 Tech Master Corp., 75 Front St., Brooklyn 1, N.Y.—A,B,D,E  
 Telechrome, Inc., 88 Merrick Rd., Amityville, L.I., N.Y.—E  
 Tele King Corp., 601 W. 26 St., New York 1, N.Y.—A,B,C,D  
 Tequip Radio Co., 2559 W. 21 St., Chicago 8, Ill.—A,C,D  
 Thordarson-Meissner, Mt. Carmel, Ill.—A,B,C  
 Trad TV Corp., 1001 1 Ave., Asbury Park, N.J.—D  
 Transvision Inc., 460 North Ave., New Rochelle, N.Y.—D  
 Trav-Ler Radio Corp., 517 W. Jackson Blvd., Chicago 6, Ill.—A,B,C,D  
 Vanity Fair Electronics Corp., 50 S. 4 St., Brooklyn 11, N.Y.—A  
 Vidair Electronics Mfg. Corp., 576 W. Merrick Ed., Lynbrook, N.Y.—D  
 Videola TV Corp., 447 Broadway, New York 13, N.Y.—D  
 Walsco Electronics, 3602 Crenshaw Blvd., Los Angeles 16, Calif.—D  
 Webster-Chicago Corp., 5610 W. Bloomingdale Ave., Chicago 39, Ill.—A,B,C  
 Wells-Gardner & Co., 2701 N. Kildare St., Chicago 39, Ill.—D  
 Westinghouse Electric Corp., Radio & TV Division, Metuchen, N.J.—A,B,D,E  
 Zenith Radio Corp., 6001 Dickens Ave., Chicago 39, Ill.—A,B,C,D,E

#### 15—RESISTORS & RESISTIVE CONTROLS

Attenuators ..... A  
 Controls, loudness, volume, tone, etc. .... B  
 Line coils, resistor ..... C  
 Pads, M, T, etc. .... D  
 Potentiometers ..... E  
 Resistors, adjustable tap ..... F  
 Resistors, ballast ..... G  
 Resistors, carbon ..... H  
 Resistors, fixed composition ..... I  
 Resistors, fixed wire wound ..... J  
 Resistors, flexible ..... K  
 Resistors, glass ..... T  
 Resistors, molded ..... L  
 Resistors, power ..... M  
 Resistors, precision ..... N  
 Resistors, variable carbon ..... O  
 Resistors, variable wirewound ..... P  
 Resistors, vitreous ..... Q  
 Rheostats ..... R  
 Suppressors, auto ignition (see Sec. 8)  
 Thermistors ..... S

Acme Electric Heating Co., 1217 Washington St., Boston 18, Mass.—J  
 Aerovox Corp., 740 Belleville Ave., New Bedford, Mass.—H,I,J,L,N  
 Allen-Bradley Co., 1326 S. 2 St., Milwaukee 4, Wis.—E,E,I,R,O,P  
 Altec Lansing Corp., 9356 Santa Monica Blvd., Beverly Hills, Calif.—B

American Elite, Inc., 7 Park Ave., New York 16, N.Y.—H,J  
 American Volume Control Co., 554 W. 168 St., New York, N.Y.—B  
 Anchor Electronics, Inc., 717 Sip St., Union City, N.J.—J,N  
 Applegate Co., C. J., 1816 Grove St., Boulder, Colo.—I  
 Arnhold Ceramics, 1 E. 57 St., New York 22, N.Y.  
 Atlas Resistor Co., 24 E. Coulter St., Philadelphia, Pa.—F,G,J,M,P,Q  
 Blonder-Tongue Labs., 526 North Ave., Westfield, N.J.—A  
 Bradford Components, 33 Bishop St., Bradford, Pa.—J,N  
 British Electronic Sales Co., 23-03 45 Rd., Long Island City 1, N.Y.—A,D,N  
 Campbell Industries, Inc., 3806 St. Elmo Ave., Chattanooga 9, Tenn.—N  
 Carborundum Co., Globar Div., Niagara Falls, N.Y.—S  
 Carter Parts Co., 213 Institute Pl., Chicago 7, Ill.—B,D,E,P  
 Centralab Div. Globe-Union Inc., 902Y E. Keefe Ave., Milwaukee 1, Wis.—A,B,D,E,O,P,R  
 Chicago Telephone Supply Corp., 1142 W. Beardsley Ave., Elkhart, Ind.—B,E,P  
 Cima Corp., 119 Braintree St., Allston, Mass.—F,J,N,Q  
 Clarostat Mfg. Co., 1 Washington St., Dover, N.H.—A,B,D,F,G,H,J,K,L,M,N,O,P,R  
 Columbia Resistors, Inc., 23 W. Washington Ave., Pearl River, N.Y.—J  
 Continental Carbon, Inc., 13900 Lorain Ave., Cleveland 11, Ohio—H,I,J,L,N  
 Dale Products Inc., P.O. Box 136, Columbus, Nebr.—E,J,M,N,P  
 Daven Co., 191 Central Ave., Newark 4, N.J.—I,N  
 DeJur Amsco Corp., 45-01 Northern Blvd., Long Island City 1, N.Y.—E,M  
 Delco Radio Div., General Motors, Kokomo, Ind.—B  
 DuMont Labs., Inc., Allen B. Mobile Comm. Dept., 1500 Main St., Clifton, N.J.—A  
 Dwyer Engineering Co., P.O. Box 483, Nashua, N.H.—B  
 Electra Mfg. Co., 2537 Madison Ave., Kansas City 8, Mo.  
 Electron-Radar Products, 1041 N. Pulaski Rd., Chicago 61, Ill.—A,S  
 Electro-Tech Equip. Co., 308 Canal St., New York 13, N.Y.—R  
 Electro-Voice, Inc., Cecil & Carrol Sts., Buchanan, Mich.—D  
 Erie Resistor Corp., 644 W. 12 St., Erie 6, Pa.—N,T  
 Federal Telephone & Radio Co., Div. of IT&T, 100 Kingsland Rd., Clifton, N.J.—N  
 General Electric Co., Apparatus Div., 1 River Rd., Schenectady, N.Y.—J,N,O  
 Hardwick Hindle, Inc., 40 Hermon St., Newark 5, N.J.—E,F,J,M,P,Q,R  
 Helipot Corp., 916 S. Meridian Ave., S. Pasadena, Calif.  
 Hycor Co., 11423 Vanowen St., N. Hollywood, Calif.—A,J,N  
 Instrument Resistors Co., 1036 Commerce Ave., Union, N.J.—J,M,N  
 International Research Assoc., 2221 Warwick Ave., Santa Monica, Calif.—A  
 International Resistance Co., 401 N. Broad St., Philadelphia 8, Pa.—B,E,F,H,I,J,L,M,N,O,P,R  
 I-T-E Circuit Breaker Co., 19th & Hamilton Sts., Philadelphia, Pa.—I,J,N,O,P  
 Jarvis Electronics Corp., 6058 W. Fullerton Ave., Chicago 9, Ill.—E,F,J,N,P,R  
 Jerrold Electronics Corp., 23 & Chestnut Sts., Philadelphia 46, Pa.—A  
 JFD Mfg. Co., 6101 16th Ave., Brooklyn 4, N.Y.—C,G,I,P  
 Lectrohm, Inc., 5560 Northwest Hgwy., Chicago 30, Ill.—J,O,P  
 Mallory & Co., P.R., 3029 E. Washington St., Indianapolis 6, Ind.—A,B,E,F  
 Miller Electro-Research Labs., 5529 S. 5th St., Milwaukee 7, Wis.—J,N,S  
 Milwaukee Resistor Co., 700 W. Virginia St., Milwaukee 4, Wis.—F,J,M,P,Q  
 Model Eng'g & Mfg Co., 50 Frederick St., Huntington, Ind.—J,P  
 Ohmite Mfg. Co., 3601 Howard St., Skokie, Ill.—A,D,E,F,H,I,J,L,M,N,O,P,Q,R  
 Penn Television Products Co., Allegheny & Trenton Aves., Philadelphia 34, Pa.—A  
 Philco Corp., Tioga & C. Sts., Philadelphia 34, Pa.—B,G,I,J  
 Polaroid Corp., 43-20 34 St., Long Island City 1, N.Y.—A  
 Radell Corp., Div. I.D.E.A. Inc., 7900 Pendleton Pike, Indianapolis, Ind.—N  
 Radio Supply & Eng'g. Co., 85 Selden Ave., Detroit 1, Mich.—I,O,P  
 Reon Resistor Corp., 117 Stanley Ave., Yonkers, N.Y.—F,J,M,N,Q  
 Resistance Products Co., 914 S. 13 St., Harrisburg, Pa.—J,N

Resistors, Inc., 5226 W. 26 St., Chicago 50, Ill.—F,J,Q  
 Retron Corp., 697 N. Lake Ave., Pasadena 6, Calif.—J,N,P  
 Shallcross Mfg. Co., 520 Pusey Ave., Collingdale, Pa.—A,D,E,H,I,J,L,M,N,O,P,Q  
 Sprague Products Co., N. Adams, Mass.—J,L,M,N,Q,S  
 Stackpole Carbon Co., St. Mary's, Pa.—B,O  
 Stone City Machine & Tool Co., Bedford, Ind.—S  
 Tech-Ohm Resistor Corp., 36-11 33 St., Long Island City 6, N.Y.—A,F,G,J,N,Q  
 Tele Matic Industries, 16 Howard Ave., Brooklyn 21, N.Y.—A  
 Telex, Inc., 1633 Eustis St., St. Paul 1, Minn.—H,J  
 Tru-Ohm Products Division, Model Engineering & Mfg., Inc., 2800 N. Milwaukee Ave., Chicago 18, Ill.—J,P  
 Vidair Electronics Mfg. Corp., 576 W. Merrick Rd., Lynbrook, N.Y.—A  
 Vukar Corp., Huron River Dr., Dexter, Mich.—J  
 Ward Leonard Electric Co., 115 MacQuesten Parkway, So. Mt. Vernon, N.Y.—E,F,J,M,P,Q,R  
 Wirt Co., 5221 Greene St., Philadelphia 44, Pa.—B,E,J,O,P  
 Workman TV, Inc., 309 Queen Anne Rd., Teaneck, N.J.—I,J,S  
 Yonkers Industries Inc., 28 School St., Yonkers, N.Y.—N

Leland Inc., G. H., 123 Webster St., Dayton 2, Ohio—I  
 Mallory & Co., P. R., 3029 E. Washington St., Indianapolis 6, Ind.—F,I,J  
 Metal Treating Equip. Exchange, 9825 Greeley Ave., Detroit 11, Mich.—I  
 Miller Co., Sanford, 691 Bedford Ave., Brooklyn 6, N.Y.—I  
 Minneapolis-Honeywell Reg. Co., 2753 4th Ave., Minneapolis, Minn.—H  
 National Union Electric Corp., 350 Scotland Rd., Orange, N.J.—C,J  
 Premier Research Labs., 79 7 Ave., New York 11, N.Y.—K  
 Pyramid Electric Co., 1445 Hudson Blvd., N. Bergen, N.J.—I  
 Radio Corp. of America, Tube Div., 415 S. 5 St., Harrison, N.J.—E,I,J  
 Radio Receptor Co., 251 W. 19th St., New York 11, N.Y.—A,B,C,D,E,G,H,I,J,L  
 Rapid Electric Co., 2881 Middletown Rd., Bronx 61, N.Y.—H,I  
 Raytheon Mfg. Co., Receiving & Cathode Ray Tube Operations, 55 Chapel St., Newton 58, Mass.—B,C,D,J  
 Schauer Mfg. Corp., 4500 Alpine Ave., Cincinnati 36, Ohio—F  
 Standard Piezo Co., P.O. Box 513, Carlisle, Pa.  
 Superior Rectifier & Mfg. Co., 3000 Kenwood St., Hammond, Ind.—I  
 Sutton Electronic Co., 424 W. Short St., Lexington, Ky.—J  
 Sylvania Electric Products, Inc., 1740 Broadway, New York 19, N.Y.—A,B,C,D,E,G,H,I,L  
 Tarzian Inc., Sarkes-Rectifier Div., 415 N. College Ave., Bloomington, Ind.—I  
 Texas Instruments, Inc., 6000 Lemmon Ave., Dallas 9, Tex.—B,J  
 Transistor Products Inc., 241 Crescent St., Waltham 54, Mass.—C,H,J  
 Transiron Electronic Corp., 403 Main St., Melrose, Mass.—H  
 Tung-Sol Electric, Inc., 95 8th Ave., Newark 4, N.J.—A,B,C,D,E,F,G,H,I,J,K,L  
 Varo Mfg. Co., 1801 Walnut St., Garland, Texas—I  
 Westinghouse Electric Corp., Electronic Tube Div., P.O. Box 284, Elmira, N.Y.—C,D,G



**16—SEMICONDUCTORS**

Crystal selectors ..... K  
 Detectors, crystal ..... A  
 Diodes, crystal ..... B  
 Diodes, germanium ..... C  
 Diodes, silicon ..... D  
 Rectifiers, crystal ..... E  
 Rectifiers, copper ..... F  
 Rectifiers, diode ..... G  
 Rectifiers, germanium power ..... H  
 Rectifiers, selenium ..... I  
 Rectifiers, silicon ..... L  
 Transistors ..... J

Amperex Electronic Corp., 230 Duffy Ave., Hicksville, L.I., N.Y.—B,C,J  
 Bendix Aviation Corp., Red Bank Div., Eatontown, N.J.—C,D  
 Berkshire Laboratories, 692 Beaver Pond Rd., Lincoln, Mass.—A,B,C,E,G,I  
 Biley Electric Co., Union Station Bldg., Erie, Pa.—A,B,E  
 Bradley Laboratories, Inc., 168 Columbus Ave., New Haven, Conn.—F,I  
 CBS-Hytron, Div., Columbia Broadcasting System, 100 Endicott St., Danvers, Mass.—B,C,D,J  
 Clark Electronic Labs., Box 165, Palm Springs, Calif.—I  
 Conant Laboratories, 6500 "O" St., Lincoln, Nebr.—F,I  
 Cryco Inc., 1138 Mission St., S. Pasadena, Calif.—B  
 Eidson Electronics, 1902 N. 3 St., Temple, Texas—K  
 Electronic Devices, Inc., 429 12th St., Brooklyn 15, N.Y.—I  
 Federal Telephone & Radio Co., 100 Kingsland Rd., Clifton, N.J.—C,I  
 Fretco, Inc., 406 N. Craig St., Pittsburgh 13, Pa.—C,J  
 Gahagan Inc., 11 W. 4 St., Bethlehem, Pa.—A,B,C,E,G  
 General Crystal Co., Burlington, Wis.—A,K  
 General Electric Co., Electronics Park, Syracuse, N.Y.—C,D,J  
 General Transistor Corp., 95-18 Sutphin Blvd., Jamaica 35, N.Y.—C,H,J  
 Germanium Products Corp., 26 Cornelson Ave., Jersey City 4, N.J.—J,L  
 Hughes Aircraft Corp., Culver City, Calif.—C,D,J  
 Hydro-Aire Sub Crane Co., 8000 Winona St., Burbank, Calif.—B,C,D,E,G,H,J,L  
 Intercontinental Industries, 555 W. Adams St., Chicago, Ill.—H,I  
 International Rectifier Corp., 1521 E. Grand Ave., El Segundo, Calif.—B,C,E,G,H,I  
 International Resistance Co., 401 N. Broad St., Philadelphia 8, Pa.—C,D,I  
 Kemtron Electron Products, 14 Prince Pl., Newburyport, Mass.—A,B,C  
 Knights Co., James Sandwich, Ill.—K

**17—SOLDERING IRONS & ACCESSORIES**

Flux ..... A  
 Paste, solder ..... B  
 Solder ..... C  
 Soldering Guns ..... D  
 Soldering Irons ..... E  
 Stands, soldering ..... F  
 Tools, soldering ..... G  
 Tips, soldering ..... H

Acme Electric Heating Co., 1217 Washington St., Boston 18, Mass.—E  
 Alpha Metals, Inc., 56 Water St., Jersey City 4, N.J.—A,B,C,H  
 American Electrical Heater Co., 6110 Cass Ave., Detroit 2, Mich.—E  
 American Solder & Flux Co., 19 & Willard Sts., Philadelphia, Pa.—A,B,C  
 Anchor Metal Co., 244 Boerum St., Brooklyn 6, N.Y.—A,B,C  
 British Electronic Sales Co., 23-03 45 Rd., Long Island City 1, N.Y.—E,F,H  
 Calari Mfg. Co., 15 Union St., Lawrence, Mass.—E  
 CBS-Hytron, Div., Columbia Broadcasting System, 100 Endicott St., Danvers, Mass.—G  
 Cook Laboratories, 114 Manhattan St., Stamford, Conn.—C  
 Drake Electric Works, 3656 Lincoln Ave., Chicago 13, Ill.—E  
 Electric Soldering Iron Co., Deep River, Conn.—D,E,F,G,H  
 Federated Metals Div., American Smelting and Refining, 120 Broadway, New York 5, N.Y.—B,C  
 Gee-Lar Mfg. Co., 819 Elm St., Rockford, Ill.—H  
 General Cement Mfg. Co., 919 Taylor Ave., Rockford, Ill.—A,B,H  
 Gramer-Halldorson Transformer Corp., 2734 N. Pulaski Rd., Chicago 39, Ill.—D  
 Hexacon Electric Co., 161 W. Clay Ave., Roselle Park, N. J.—D,E,F,H  
 Ideal Industries, Inc., Sycamore, Ill.—G,H  
 Insuline Corp., America, 186 Granite St., Manchester, N.H.—E,H  
 Kellogg Switchboard & Supply Co., 79 W. Monroe St., Chicago 3, Ill.—B,C,E,F,H  
 Kester Solder Co., 4201 Wrightwood Ave., Chicago 39, Ill.—A,B,C,F  
 Kwikheat Mfg. Co., Div. Sound Equipment Corp., 3732 San Fernando Rd., Glendale 4, Calif.—E,F,H  
 Lenk Mfg. Co., 30 Cummington St., Boston 15, Mass.—A,B,C,D,E,F,G,H  
 London Chemical Co., 1535 N. 31 Ave., Melrose Park, Ill.—A,C  
 Luma Electric Equip. Co., P.O. Box 132, Toledo 1, Ohio—G  
 Mallory & Co., P. R., 3029 E. Washington St., Indianapolis 6, Ind.—H

**OMISSIONS**

Listings have been omitted in all cases where, after three requests, a company has failed to return our directory questionnaire or otherwise verify its activity.



Mico Instrument Co., 80 Trowbridge St., Cambridge 38, Mass.—A,B  
 Mitchell Industries, Inc., Mineral Wells, Texas—E  
 Modern Wire Co., 39-30 Review Ave., Long Island City 1, N.Y.—C  
 Multicore Sales Corp., 164 Duane St., New York 13, N.Y.—C  
 Phillips Mfg. Co., 2816 Aldrich Ave., S., Minneapolis 8, Minn.—A,D,E,F,G,H  
 Sittler Corp., 18 N. Ada St., Chicago 7, Ill.—G  
 Snap-On Tools Corp., 8104 28th Ave., Kenosha, Wisc.—D,E,G,H  
 Stark Mfg. Co., P.O. Box 489, Tuscaloosa, Ala.—E  
 Technicraft Co., 1156 Commonwealth Ave., Boston 34, Mass.—A,E  
 TV Accessories Co., Box 368, Scottsdale, Ariz.—E,G,H  
 Ungar Electric Tools, 4101 Redwood Ave., Venice, Calif.—E,H  
 Vemaline Products Co., P.O. Box 222 Hawthorne 1, N.J.—E  
 Vulcan Electric Co., 88 Holten St., Danvers, Mass.—E,G,H  
 Wall Mfg. Co., P., Grove City, Pa.—A,B,C,D,E,F,G,H  
 Wassac Electric Products Corp., 126 W. Cass St., Joliet, Ill.—E,G,H  
 Weller Electric Corp., 808 Packer St., Easton, Pa.—D  
 Wen Products Co., 5806 Northwest Hwy., Chicago 31, Ill.—D

### 18—SOUND, RECORDING & HIGH FIDELITY, EQUIPMENT

**Amplifiers** ..... A  
**Attenuators (see Sec. 15)** ..... A  
**Baffles & Enclosures, speaker** ..... B  
**Binaural Equipment** ..... C  
**Cabinets (see Sec. 4)** ..... C  
**Cable, microphone (see Sec. 24)** ..... C  
**Cartridges, ceramic** ..... AN  
**Cartridges, crystal** ..... AO  
**Cartridges, magnetic** ..... AP  
**Cloth, speaker grille** ..... D  
**Cones, loudspeaker** ..... E  
**Connectors, audio** ..... F  
**Cross-over Networks** ..... H  
**Custom Components** ..... I  
**Disc Recorders** ..... J  
**Discs, recording blanks** ..... K  
**Drivers, speaker** ..... L  
**Equalizers, tone** ..... M  
**Handsets, phone** ..... N  
**Headphones & Headphone Access** ..... O  
**Heads, recording magnetic** ..... P  
**Heads, recording disc** ..... Q  
**Hearing aids & accessories** ..... AQ  
**Horns, speaker** ..... R  
**Intercommunication Systems** ..... S  
**Megaphones, power** ..... W  
**Microphones & Accessories** ..... X  
**Mixers, audio** ..... Y  
**Phonographs (see Sec. 12)** ..... Y  
**Pickup Arms (see Sec. 12)** ..... Y  
**Pickups, telephone** ..... Z  
**Preamplifiers** ..... AA  
**Public Address Systems** ..... AB  
**Reels, tape** ..... AC  
**Repeaters, tape recording** ..... AD  
**Sound Systems, complete** ..... AG  
**Speakers** ..... U  
**Speaker parts & accessories** ..... V  
**Splicers, tape** ..... AE  
**Spools, wire** ..... AF  
**Suppressors, dynamic noise** ..... AU  
**Tape demagnetizers** ..... AR  
**Tape, magnetic recording** ..... AH  
**Tape, pre-recorded** ..... AV  
**Tape, recorder test** ..... AS  
**Tape Recorders** ..... AL  
**Tape Splicing** ..... AT  
**Tuners (see Sec. 7)** ..... AT  
**Tweeters** ..... AI  
**Wire, magnetic recording** ..... AJ  
**Wire Recorders** ..... AM  
**Woofers** ..... AK

Alamo Electronics Corp., 1415 N. Brazos St., San Antonio, Texas.—A  
 Allied Electronic Equip. Co., Bldg. 604, Oakland Airport, Oakland Calif.—O  
 Allied Radio Corp., 100 N. Western Ave., Chicago 80, Ill.—A,S,AA,AB,AG  
 Alonge Products Inc., 163 W. 23 St., New York 11, N.Y.—AT  
 Altec Lansing Corp., 9356 Santa Monica Blvd., Beverly Hills, Calif.—A,B,H,R,U,V,X,Y,AA,AB,AG  
 Amerac Inc., 116 Topshild Rd., Wendham, Mass.—A  
 American Elite, Inc., 7 Park Ave., New York 16, N.Y.—X,AL  
 American Microphone Co., Elgin Nat'l. Watch Co. Affiliate, 370 S. Fair Oaks Ave., Pasadena, Calif.—C,N,P,X,AO  
 American Phenolic Corp., 1830 S. 54th St., Chicago 50, Ill.—F  
 Ampex Corp., 934 Charter St., Redwood City, Calif.—A,B,C,I,L,P,R,U,V,Y,AA,AD,AG,AI,AK,AL,AS  
 Amplifier Corp. of America, 398 Broadway, New York, N.Y.—A,AC,AH,AL,AS  
 Ampro Corp., 2835 N. Western Ave., Chicago 18, Ill.—AL  
 Anslay Mfg. Co., Arthur, Doylestown, Pa.—I  
 Applegate Co., C. J., 1816 Grove St., Boulder, Colo.—A  
 Approved Electronic Instruments Corp., 928 Broadway, New York 10, N.Y.—C,AA  
 A R F Products Inc., 7627 Lake St., River Forest, Ill.—U  
 Argos Products Co., 310 Main St., Genoa, Ill.—B  
 Astatic Corp., P.O. Box 120, Conneaut, Ohio —P,X,AN,AO  
 Atlas Sound Corp., 1449 39th St., Brooklyn 18, N.Y.—H,L,R,U,X,AI  
 Audio Devices, Inc., 444 Madison Ave., New York, N.Y.—K,AH  
 Audio Equipment Co., 15749 Wyoming Ave., Detroit 38, Mich.—AQ  
 Audio Industries Inc., 532 W. 4 St., Michigan City, Ind.—J  
 Audio-Master Corp., 17 E. 45 St., New York 17, N.Y.—AH,AL  
 Audio Products, 2265 Westwood, Los Angeles 64, Calif.—A  
 Auth Electric Co., 34-20 45 St., Long Island City 1, N.Y.—S  
 Authorized Mfg. Co., 919 Wyckoff Ave., Brooklyn 27, N.Y.—A,I,M,S,Y,AA,AB,AD  
 AV Tape Libraries Inc., 730 5 Ave., New York 19, N.Y.—AV  
 Beam Instruments Corp., 350 5th Ave., New York 1, N.Y.—A,B,H,I,L,U,AA,AI,AK  
 Becker Electronics Mfg. Corp., 1091 Rockaway Ave., Valley Stream, N.Y.—U  
 Bell & Howell, 7100 McCormick Rd., Chicago 45, Ill.—AL  
 Bell Sound Systems, Sub. Thompson Products, Inc., 555 Marion Rd., Columbus 7, Ohio—A,C,I,J,S,AB,AG,AL  
 Bell Television, 254 W. 54 St., New York 19, N.Y.—A  
 Bennett Laboratories, Inc., 2700 Bay Rd., Redwood City, Calif.—S  
 Berger Communications, 109-01 72nd Rd., Forest Hills, N.Y.  
 Berlant-Concertone, 4917 W. Jefferson Blvd., Los Angeles 16, Calif.—AL  
 Besteraft Products Co., 626 Broadway, New York 12, N.Y.—B,D  
 Bliley Electric Co., Union Station Bldg., Erie, Pa.  
 Bogen Co., David, 29 9th Ave., New York 14, N.Y.—A,B,I,N,S,Y,AA,AB,AG  
 Bohn Sound Eng'g Co., Lincoln Highway East, Ft. Wayne, Ind.—A  
 Bomac Laboratories, Salem Rd., Beverly, Mass.—D  
 Bozak Co., R. T., 114 Manhattan St., Stamford, Conn.—U,AI,AK  
 British Electronic Sales Co., 23-03 45th Rd., Long Island City 1, N.Y.—A,B,F,U,AI,AK,AO  
 British Industries Corp., 164 Duane St., New York 13, N.Y.—A,B,H,I,L,U,AA,AI,AK  
 Brociner Electronics Lab., 344 E. 32nd St., New York 16, N.Y.—A,B,R,U,AA  
 Browne Electronics, 12450 W. Washington Blvd., Venice Calif.—A  
 Brush Electronics Co., 3405 Perkins Ave., Cleveland 14, Ohio—A,C,O,P,X,AA,AC,AH  
 Butler Mfg. Co., 3150 Randolph St., Bellwood, Ill.—B  
 Calbest Eng'g. & Electronics Co., 828 N. Highland Ave., Hollywood 38, Calif.—A,S,AG  
 Califone Corp., 1041 N. Sycamore Ave., Hollywood 38, Calif.—AB,AG  
 Camera Equipment Co., 1600 Broadway, New York 19, N.Y.—AT  
 Cannon Co., D. F., Springwater, N.Y.—O  
 Cannon Electric Co., 3209 Humboldt St., Los Angeles 3, Calif.—F  
 Capehart-Farnsworth Co., 3702 E. Pontiac St., Fort Wayne 5, Ind.—A,B,D,E,H,I,U,AA,AH,AI,AK,AL,AN,AP  
 Capps & Co., Frank L., 20 Addison Pl., Valley Stream, N.Y.—X  
 Carbonneau Industries, 100 Lexington S.W., Grand Rapids 4, Mich.—U  
 Carron Mfg. Co., 741 W. Harrison St., Chicago 7, Ill.—P,Q  
 CBS-Columbia, 3400 47 Ave., Long Island City 1, N.Y.—U  
 Central Electronics, Inc., 1247 Belmont Ave., Chicago 13, Ill.—A

Chicago Standard Transformer Corp., Addison & Elston, Chicago 31, Ill.—A  
 Cinadagraph Corp., 7224 N. Clark St., Chicago 26, Ill.—U,AI  
 Cinch Mfg. Corp., 1026 S. Homan Ave., Chicago 24, Ill.—F  
 Cleveland Electronics Inc., 6611 Euclid Ave., Cleveland 3, Ohio—H,S,U,V,AB,AG  
 Cline Electric Mfg. Co., 3405 W. 47 St., Chicago 32, Ill.—A  
 Codetvper Laboratories, 550 5th Ave., New York 19, N.Y.—S  
 Coil Co. of America, Washington St., Northvale, N.J.—A  
 Collins Audio Products Co., P.O. Box 368, Westfield, N.J.—A  
 Colorstone Electronics Inc., 100 Frank Rd., Hicksville, N.Y.—S  
 Columbia Records, Inc., 799 7th Ave., New York 19, N.Y.—AL  
 Concertapes Inc., 224 S. Michigan Ave., Chicago 4, Ill.—AV  
 Connecticut Telephone & Electric Corp., Meriden, Conn.—O  
 Consolidated Radio Products Co., 350 W. Erie St., Chicago 10, Ill.—N,O,U,V,AK  
 Cook Labs Inc., 114 Manhattan St., Stamford, Conn.—AA  
 Cooper Electronic Products, 5637 Tulip St., Philadelphia 24, Pa.—S  
 Cousino, Inc., 2326 Madison Ave., Toledo 2, Ohio—AE  
 Crescent Industries, 5900 Touhy Ave., Niles, Ill.—U,AL  
 Cryco, Inc., 1138 Mission St., S. Pasadena, Calif.  
 Dalmontron Co., 534 Laurel St., San Carlos, Calif.—S  
 Daystrom Electric Corp., 837 Main St., Poughkeepsie, N.Y.—AL  
 Delco Radio Div., General Motors Corp., 1446 S. Home Ave., Kokomo, Ind.—U  
 Delson Mfg. Corp., 126 11 Ave., New York 11, N.Y.—A  
 DeMars Eng'g & Mfg Co., 360 Merrimack St., Lawrence, Mass.—U  
 DeWald Radio Mfg. Corp.—United Scientific Labs., 35-15 37 Ave., Long Island City 1, N.Y.—A,S  
 Dictograph Products Inc., Hi-Fidelity Music Div., 95-25 149 St., Jamaica 35, L. I., N.Y.—AG  
 D & M Products, 13144 W. McNichols Rd., Detroit 35, Mich.—B,D  
 Dormitzer Electric & Mfg. Co., 5 Hadley St., Cambridge, Mass.—A,S,AA  
 Dubbings Co., 41-10 45 St. Long Island City 4, N.Y.—AH  
 DuKane Corp., 13th and Indiana Sts., St. Charles, Ill.—AL  
 DuMont Labs. Inc., Allen B. Mobile Comm. Dept., 1500 Main St., Clifton, N.J.—A  
 Duotone Co., Locust St., Keyport, N.J.—B,K,U,V,X  
 Dwyer Engineering Co., P.O. Box 483, Nashua, N. H.—A  
 DX Radio Products Co., 2300 Armitage Ave., Chicago 47, Ill.—U,V  
 Dynamic Electronics, 73-39 Woodhaven Blvd., Glendale L. I., N. Y.—U  
 Eagle Speaker Co., 15 S. Fairview, Park Ridge, Ill.—U  
 Eby Sales Co., 130 Lafayette St., New York 13, N.Y.—F  
 Eicor, Inc., Tape Recording Div., 1501 W. Congress St., Chicago 7, Ill.—AL  
 Elco Corp., "M" St. below Erie Ave., Philadelphia 24, Pa.—F  
 Electron Enterprises, 6917 Stanley Ave., Berwyn, Ill.—A,B,AM  
 Electro-Sonic Laboratories, 35-54 36 St., Long Island City, N.Y.—A,J,AL,AP  
 Electro-Voice, Inc., Buchanan, Mich.—A,B,C,L,M,N,R,U,V,X,AA,AI,AK,AN,AO  
 El-Rad Mfg. Co., 2800 W. Cullom Ave., Chicago 18, Ill.—H  
 Eltran Corp., 109 W. Station St., St. Anne, Ill.—U,AI,AK  
 Electro-Sound Corp., 115 Halleck St., Boston 20, Mass.—A,B,S,AA,AG  
 E.M.C. Recordings, 806 E. 7 St., St. Paul, Min.—AV  
 Epco Electronics, Inc., 140 Liberty St., New York 6, N.Y.—AA  
 Espey Mfg. Co., 528 E. 72nd St., New York 21, N.Y.—A,C  
 Executone Inc., 415 Lexington Ave., New York 17, N.Y.—S  
 Fairchild Recording Equipment Co., 154 St. & 7 Ave., Whitestone 57, N.Y.—A,J,AA,AL,AP  
 Federal Mfg. & Eng. Corp., 179 Steuben St., Brooklyn 5, N.Y.—AL  
 Federal Telephone and Radio Co., A Division of IT&T, 100 Kingsland Rd., Clifton, N.J.—S  
 Femco Inc., Irwin, Pa.—A  
 Fenton Co., 15 Moore St., New York 4, N.Y.—AA,AF,AL,AO,APA,Q  
 Fidelitone, Inc., 6415 Ravenswood Ave., Chicago 26, Ill.—P,AF,AH,AJ  
 Fisher Radio Corp., 21-21 44th Dr., Long Island City 1, N.Y.—A,B,L,AA  
 Flexo Int'l. Co., 3245 W. Lake St., Chicago 24, Ill.—X  
 Fonotak Corp., 11 S. LaSalle St., Chicago, Ill.—S  
 Freed Electronics & Controls Corp., 200 Hudson St., New York 13, N.Y.—A

Acoustic Research, Inc., 23 Mt. Auburn St., Cambridge 38, Mass.—U  
 Admiral Corp., Molded Prods. Div., P.O. Box 338, W. Chicago, Ill.—E,N  
 Aero-Tone Mfg. Co., 4836 Joy Rd., Detroit 4, Mich.—U

Garod Radio, 70 Washington St., Brooklyn 1, N.Y.—A,AH  
 Gee-Lar Mfg. Co., 819 Elm St., Rockford, Ill.—D  
 General Apparatus Co., 344 E. 32 St., New York 16, N.Y.—H  
 General Cement Mfg. Co., 919 Taylor Ave., Rockford, Ill.—D  
 General Electric Co., Electronics Park, Syracuse, N.Y.—A,B,I,U,AA,AG,AP  
 General Industries Co., Olive & Taylor Sts., Elyria, Ohio—J,AL  
 General Phones Corp., 5711 Howe St., Pittsburgh 32, Pa.—O  
 G & H Wood Products Co., 75 N. 11th St., Brooklyn 11, N.Y.—B,R  
 G & M Equipment Co., 7315 Varna Ave., North Hollywood, Calif.—A,O  
 Gordon Enterprises, 5362 N. Cahuenga Blvd., N. Hollywood, Calif.—AH,AL  
 Gotham Television Corp., 123 W. 64th St., New York 23, N.Y.—AA  
 Graybar Electric Co., 420 Lexington Ave., New York 17, N.Y.—A,U,X,AA,AB,AA,AL,AK  
 Grayline Eng'g. Co., 12243 Ave "O", Chicago 33, Ill.—A  
 Gray Research & Devel. Co., 658 Hilliard St., Manchester, Conn.—A  
 Greene Co., L. Charlton, 314 Washington St., Newton 58, Mass.—A  
 Gyro Electronics Co., 325 Canal St., New York 13, N.Y.—A  
 Hallcrafters Co., 4401 W. 5 Ave., Chicago 24, Ill.—A  
 Hamilton Electronics Corp., 2726 Pratt Ave., Chicago 45, Ill.—A,S,X,Y,AA,AB,AG  
 Harman-Kardon Inc., 520 Main St., Westbury, L.I., N.Y.—A  
 Hartley Co., H. A., 521 E. 162 St., New York, N.Y.—U  
 Heath Co., 305 Territorial, Benton Harbor, Mich.—A,L,M,U,AA  
 Heppner Mfg. Co., P.O. Box 608, Round Lake, Ill.—U  
 I. G. Textile Co., 30 E. 21 St., New York, N.Y.—D  
 Intercontinental Industries, 555 W. Adams St., Chicago, Ill.—AH  
 Interelectronics Corp., 2432 Grand Concourse, New York 58, N.Y.—A,B,C,F,H,I,M,U,V,W,Y,AA,AK  
 Int'l Electronics Corp., 147 Parkhouse St., Dallas, Tex.—U  
 Int'l Scientific Industries Corp., 3101 42 St., Minneapolis 6, Minn.—AL  
 Int'l Pacific Recording, 7511 Santa Monica Blvd., Los Angeles 46, Calif.—AV  
 Intl Radio & Electronics, 17 St. & Mishauaka Rd., Elkhart, Ind.—AL  
 Int'l. Research Assoc., 2221 Warwick Ave., Santa Monica, Calif.—A,AA  
 Interstate Photo Supply Corp., 17 W. 17th St., New York 11, N.Y.—AM  
 Jensen Mfg. Co., 6601 S. Laramie Ave., Chicago 38, Ill.—B,H,L,R,U,AI,AK  
 Jones Apparatus Co., Walter M., P.O. Box 277, Sheffield, Mass.—H  
 Kaplan Products & Textiles, Inc., 180 W. Randolph St., Chicago 1, Ill.—D  
 Karlson Associates, Inc., 1483 Coney Island Ave., Brooklyn 30, N.Y.—B  
 Kingdom Products, 23 Park Pl., New York, N.Y.—U,AI  
 Kings Electronics Co., 40 Marbledale Rd., Tuckahoe, N.Y.—A,F  
 Klipch & Associates, P.O. Box 64, Hope, Ark.—H,R,AI,AK  
 Krohn-Hite Instrument Co., 580 Mass. Ave., Cambridge 39, Mass.—A  
 Lab. of Electronic Eng'g., 413 L. St., N. W., Washington 1, D. C.—U  
 Langevin Mfg Corp., 37 W. 65 St., New York 23, N.Y.—A  
 Lansing Sound Inc., James B., 2439 Fletcher Dr., Los Angeles 39, Calif.—U,AG  
 Lear, Inc., 11916 W. Pico Blvd., Los Angeles 64, Calif.—A,O,U  
 Lee Laboratories, Genesee, Pa.—A  
 Leru Laboratories, Wayne, N.J.—A,U  
 Lipps Eng'g., Edwin A., 5485 W. Washington Blvd., Los Angeles 16, Calif.—P,Q  
 Livingston Electronic Corp., Livingston, N.J.—C,AL,AV  
 Lore Sound Engrs., J. M., 2171 W. Washington Blvd., Los Angeles 18, Calif.—A,S,AA,AB,AG  
 Lowell Mfg. Co., 3030 Laclede Sta. Rd., St. Louis 17, Mo.—B,S  
 Magnasynic Mfg. Co., 5517 Satsuma Ave., N. Hollywood, Calif.—A,B,AA,AG,AL  
 Magnavox Co., Ft. Wayne 4, Ind.—A,B,E,U,AO  
 Magnecord Inc., 225 W. Ohio St., Chicago 10, Ill.—A,B,P,Y,AA,AH,AL  
 Maico Co., 21 N. 3 Ave., Minneapolis 1, Minn.—AQ  
 Majestic Radio & TV, Div. Wilcox-Gay Corp., 70 Washington St., Brooklyn 1, N.Y.—AL  
 Manfredi Wood Products Co., 226 New York Ave., Huntington, N.Y.—B  
 Murantz S. B., 44-15 Vernon Blvd., Long Island City 1, N.Y.—AA  
 Marine View Electronics, 744 E. 138th St., New York 54, N.Y.—A,C,H,M,S,Y,AA,AB  
 Markell Assoc. Jeff, 764 6 Ave., New York 10, N.Y.—B  
 Martin & Co., H. S., 1916 Greenleaf St., Evanston, Ill.—A

Master Electronics & Television, Rt. 1, Box 36, Libertyville, Ill.—I  
 McGohan Inc., Don, 3700 W. Roosevelt Rd., Chicago 24, Ill.—A,B,R,U,AA,AB,AI,AK  
 McIntosh Lab. Inc., 320 Water St., Binghamton, N.Y.—A,AA  
 Metronics, Inc., U. S. Route 130, Burlington, N.J.—S,AA  
 Michigan Electronics, 854 N. Rockwell St., Chicago 22, Ill.—B,K,M,U,AB,AC,AH,AL,AM,AO  
 Microtran Co., Div. Crest Labs. Inc., 84-11 Rockaway Beach Blvd., Rockaway Beach 93, N.Y.—Z,AR  
 Miller Electronics, 2840 Naomi St., Burbank, Calif.—AH,AL,AV  
 Miller Instruments, Inc., Wm., 325 No. Halstead Ave., Pasadena 6, Calif.—A  
 Minneapolis-Honeywell Regulator Co., 2753 4 Ave. S., Minneapolis 8, Minn.—A  
 Minnesota Mining & Mfg Co., 900 Fauquier Ave., St. Paul 6, Minn.—AH  
 Mitchell Mfg. Co., 2525 Clybourn St., Chicago, Ill.—AL  
 Moran Electronic Components, 10506 Wheatley St., Kensington, Md.—A  
 National Co., Inc., 61 Sherman St., Malden 48, Mass.—A  
 Newest Fabrics, 153 W. 23 St., New York, N.Y.—D  
 Newcomb Audio Products Co., 6824 Lexington Ave., Hollywood 38, Calif.—A,C,Y,AA,AB,AG  
 New London Instrument Co., 82 Union St., New London, Conn.—A  
 Northern Products Co., 2210 N. Clark St., Chicago 16, Ill.—U  
 ORRadio Industries, 120 Marvyn Rd., Opelika, Ala.—AH  
 Oxford Electric Corp., 3911 S. Michigan Ave., Chicago 15, Ill.—U,AI,AK  
 Pacific Transducer T.B. Corp., 11836 W. Peco Blvd., Los Angeles 64, Calif.—M,AP  
 Paraplegics Mfg. Co., 10068 Franklin Ave., Franklin Park, Ill.—A,AA,AG  
 Pathfinder Electronics, 6836 Lexington Ave., Los Angeles 38, Calif.—A,Y,AB



Peirce Wire Recorder Corp., 5900 N. Northwest Hwy., Chicago 31, Ill.—P,Q,AH  
 Pentron Corp., 777 S. Tripp Ave., Chicago 24, Ill.—C,P,Y,AA,AC,AH,AL  
 Perfection Electric Co., 2535 S. Wabash Ave., Chicago 16, Ill.—U,V  
 Permo. Inc., 6415 Ravenswood Ave., Chicago 26, Ill.—AC,AH,AJ  
 Permoflux Corp., 4900 W. Grand Ave., Chicago 39, Ill.—A,B,C,H,I,N,O,U,X,AI,AK,AL  
 Pfanstiel Chemical Co., 104 Lake View Ave., Waukegan, Ill.—AA  
 Philco Corp., Tioga & C. Sts., Philadelphia 34, Pa.—U  
 Philmore Mfg. Co., 113 University Pl., New York 3, N.Y.—A,N,O,U  
 Physical Research Assoc., 1 Azurelee Dr., Malibu, Calif.—A,B,U,AI,AK  
 Pickering & Co., 309 Woods Ave., Oceanside, N.Y.—M,AA,AP  
 Pilot Radio Corp., 37-06 36th St., Long Island City 1, N.Y.—A,IAA  
 Plymouth Electronics Corp., 50 Kingsbury St., Worcester 3, Mass.—H  
 Power Supplies, 1005 Olive St., Highland, Ill.—A  
 Precise Development Corp., 999 Long Beach Rd., Oceanside, N.Y.—AA  
 Precision Electronics Inc., 9101 King Ave., Franklin Park, Ill.—A,C,M,AA,AB,AG  
 Presto Recording Corp., P.O. Box 500, Paramus, N.J.—J,K,AL  
 Quam Nichols Co., Marquette Rd. & Prairie Ave., Chicago 37, Ill.—U  
 Quincy Speaker Mfg. Corp., 221 Oak St., Quincy, Ill.—U,AI,AK  
 Racon Electric Co., 1261 Broadway, New York 1, N.Y.—B,E,H,L,R,U,AB,AK  
 Rada Phone Corp., 609 W. Fulton St., Chicago 10, Ill.—AB  
 Radio Corp. of America, Eng'g. Products Div., Camden, N.J.—A,B,L,S,X,AA,AB,AC,AH,AL  
 Radio Corp. of America, Tube Div., 415 S. 5 St., Harrison, N.J.—U  
 Radio Craftsmen, Inc., 4401 N. Ravenswood Ave., Chicago, Ill.—A,U,AA  
 Radio Kits Inc., 120 Cedar St., New York 6, N.Y.—A,S  
 Radio Music Corp., 84 S. Water St., Port Chester, N.Y.—A,AP  
 Radio Wire Television, Inc., (Lafayette Radio), 100 6 Ave., New York 13, N.Y.—A,U,AM  
 RAM Co., P.O. Box 221, Great Barrington, Mass.—B  
 Rangertone Inc., 73 Winthrop St., Newark 4, N.J.—AL

Rason Mfg. Co., 3050 W. 21 St., Brooklyn 24, N.Y.—AE  
 Rauland-Borg Corp., 3515 W. Addison St., Chicago 18, Ill.—A  
 Raytheon TV & Radio Corp., 5921 W. Dickens Ave., Chicago 37, Ill.—U,AL  
 Recordisco Corp., 396 Broadway, New York 13, N.Y.—K  
 Reeves Soundcraft Corp., 10 E. 52nd St., New York 22, N.Y.—K,AC,AH  
 Regency Div., I.D.E.A. Inc., 7900 Pendleton Pike, Indianapolis 26, Ind.—A,AA  
 Rek-O-Kut Co., 38-01 Queens Blvd., Long Island City 1, N.Y.—A, J, U, AB  
 Retron Corp., 697 N. Lake Ave., Pasadena 6, Calif.—A  
 Revere Camera Co., 320 E. 21 St., Chicago 16, Ill.—AL  
 Ripley Co., Middletown, Conn.—AS  
 River Edge Industries, 5 River Edge Rd., River Edge, N.J.—B  
 R. J. Audio Products, 164 Duane St., New York 13, N.Y.—B  
 Roanwell Corp., 662 Pacific St., Brooklyn 17, N.Y.—N,O,X  
 Robins Industries Corp., 4108 Bell Blvd., Bay-side, N.Y.—AC,AE,AH,AT  
 Rola Co., 2330 Superior Ave., Cleveland 14, Ohio—EU  
 Ronette Acoustical Corp., 135 Front St., New York 5, N.Y.—X,AI,AO  
 Rowe Industries, 1702 Wayne St., Toledo 9, Ohio—A,H,L,R,U  
 Russell Speaker Co., 6158 S. Kedzie Ave., Chicago, Ill.—U  
 Scott Inc., Heyman Hosmer, 385 Putnam Ave., Cambridge 39, Mass.—A,I,J,N,AA,AB,AI,AV  
 Semco Electronics Co., 8407 S. Hoover St., Los Angeles 44, Calif.—A  
 Sentinel Radio Corp., 2100 W. Dempster St., Evanston, Ill.—AL  
 Sherwood Electronic Labs., 2802 W. Cullom Ave., Chicago 18, Ill.—A  
 Shrader Sound Inc., 2803 M. St., N. W., Washington 7, D.C., A,AG  
 Shure Bros., 225 W. Huron St., Chicago 10, Ill.—N,P,Q,X,AN,AO  
 Siemens & Holske, Wayne, N.J.—A,U  
 Sightmaster Corp., 111 Cedar St., New Rochelle, N.Y.—A,U  
 Simpson Mfg. Co., Mark, 32-28 49th St., Long Island City 3, N.Y.—A,J,S,Y,AA,AB,AG,AL  
 Smith Inc., Herman H., 2326 Nostrand Ave., Brooklyn 10, N.Y.—F  
 Smith-Meeker Eng'g. Co., 157 Chambers St., New York 7, N.Y.—AB  
 Sonex, Inc., 245 Sansom St., Upper Darby, Pa.—A,AA  
 Sonic Recording Products Inc., 58 Mill Rd., Freeport, N.Y.—K  
 Sonotone Corp., Elmsford, N.Y.—A,O,U,AI,AK,AN,AQ  
 S.O.S. Cinema Supply Corp., 602 W. 52nd St., New York 19, N.Y.—A,B,J,L,O,Q,S,U,X,AA,AB,AE,AG,AL  
 Speak-O-Phone Recording & Equip. Co., 23 W. 60th St., New York 23, N.Y.—J,K,AH,AL  
 Special Products Co., P.O. Box 188, Rockville 1, Md.—A  
 Specialty Assembling & Packing Co., 79 Clinton St., Brooklyn 38, N.Y.—A,O  
 Standard Wood Products Corp., 47 W. 63 St., New York 23, N.Y.—B  
 Stancil-Hoffman Corp., 921 N. Highland Ave., Hollywood 38, Calif.—AH  
 Standard Piezo Co., P.O. Box 513, Carlisle, Pa.  
 Stephens Mfg. Corp., 8538 Warner Dr., Culver City, Calif.—A,B,E,H,L,R,U,X,AG,AI,AK  
 Stevens Products Inc., 86 Main St., East Orange, N.J.—E,V  
 Stromberg-Carlson Co., Sound Equip. Div., 1225 Clifford Ave., Rochester 21, N.Y.—A,B,I,L,N,R,S,O,U,X,AA,AB,AG,AI,AK  
 Super Ear Products Co., 675 Merrick Rd., Lynbrook, N.Y.—O,X  
 Switchcraft, Inc., 1328 N. Halsted St., Chicago 22, Ill.—Y  
 Tabet Mfg. Co., 1336 Ballentine Blvd., Norfolk 12, Va.—U  
 Talk-A-Phone Co., 1512 S. Pulaski Rd., Chicago 23, Ill.—S  
 Tannoy (America) Ltd. in Assoc. with Tannoy (Canada) Ltd., 36 Wellington St. E., Toronto 1, Ontario, Canada—A,B,U,AA  
 Tape Recorders, Inc., 1501 W. Congress St., Chicago 7, Ill.—AL  
 Tayloreel Corp., 3 Rutter St., Rochester 6, N.Y.—O,AC,AG  
 Tech-Master Corp., 75 Front St., Brooklyn 1, N.Y.—A,AA  
 Technical Tape Corp., W. 177 St. & Harlem River, Morris Hts. 53, N.Y.—AH  
 Telecom, Inc., 1019 Admiral Blvd., Kansas City 6, Mo.—S  
 Telectro Industries Corp., 35-16 37 St., Long Island City 1, N.Y.—A,S,Y,AA,AD,AL,AM  
 Telex, Inc., 1633 Eustis St., St. Paul 1, Minn.—U  
 Tibbetts Industries, Colcord Ave., Camden, Me.—X  
 Transvision Inc., 460 North Ave., New Rochelle, N.Y.—AI,AK  
 Trimm, Inc., 400 Lake St., Libertyville Ill.—N,O  
 Trutone Electronic Eng'g., 812 N. Highland, Los Angeles 38, Calif.—A,AA,AB,AG,AH  
 Turner Co., 909 17th St., N.E., Cedar Rapids, Iowa—X,AO

Ultra Hi Fi Co., 709 Sip St., Union City, N.J.—B,U,AG  
 U. M. & F. Mfg. Corp., 10929 Vanowen St., N. Hollywood, Calif.—B  
 United Audio Products Div., United Optical Mfg. Corp., 202 E. 19 St., New York 3, N.Y.—U,A,I,AK  
 United Transformer Co., 150 Varick St., New York 13, N.Y.—A  
 U. S. Recording Co., 1121 Vermont Ave., N.W., Washington 5, D.C.—AH  
 U.S. Time Corp., The, 500-5th Ave., New York N.Y.—J  
 Universal Microphone Co., 424 Warren Lane, Inglewood, Calif.—X  
 University Loudspeakers, Inc., 80 S. Kensico Ave., White Plains, N.Y.—B,E,H,L,R,U,V,W, A,I,AK  
 Univox Corp., 102 Warren St., New York 7, N.Y.—A,AL  
 Utah Radio Products Co., 1123 E. Franklin St., Huntington, Ind.—B,S,U,A,I,AK  
 Valentino Inc., Thomas Jr., 150 W. 46th St., New York 36, N.Y.—J,AH  
 Varo Mfg. Co., 1801 Walnut St., Garland, Texas—A  
 Vidair Electronics Mfg. Co., 576 W. Merrick Rd., Lynbrook, N.Y.—A  
 V-M Corp., Benton Harbor, Mich.—AL  
 Vocaline Co. of America Inc., Coulter St., Old Saybrook, Conn.—S  
 Waldom Electronics Inc., 4625 W. 53rd St., Chicago 32, Ill.—E,V  
 Warren Corp., 21 Hanse Ave., Freeport, N.Y.—AL  
 Waterproof Electric Co., 801 S. Main St., Burbank, Calif.—A  
 Webster-Chicago Corp., 5610 W. Bloomingdale Ave., Chicago 39, Ill.—AH,AJ,AL,AM  
 Webster Electric Co., 1900 Clark St., Racine, Wisc.—A,O,S,Y,AA,AB,AG,AL,AN,AO  
 Wheeler Insulated Wire Co., 150 E. Aurora St., Waterbury 20, Conn.—N,S  
 White Inc., Stan., Div. Eddie Bracken Enterprises 725 S. LaSalle St., Chicago 5, Ill.—A,U  
 Wilcox-Gay Corp., 604 W. Seminary St., Charlotte, Mich.—A,J,K,AH,AL  
 Wilmar Mfg. Co., 2715 E. 14th St., Kansas City 27, Mo.—S  
 Wright, Inc., 2235 University Ave., St. Paul, Minn.—U  
 Wright-Zimmerman, Inc., 330 5th Ave., New Brighton, Minn.—U,A,I,AK

## 19—SWITCHES

Switches, anti-capacity . . . . . A  
 Switches, coaxial . . . . . B  
 Switches, electronic . . . (see Sec. 20)  
 Switches, foot . . . . . C  
 Switches, gang . . . . . D  
 Switches, knife . . . . . E  
 Switches, lever . . . . . F  
 Switches, mercury . . . . . G  
 Switches, micro . . . . . H  
 Switches, power . . . . . I  
 Switches, push-button . . . . . J  
 Switches, rotary . . . . . K  
 Switches, slide . . . . . L  
 Switches, snap-action . . . . . M  
 Switches, thermal . . . . . N  
 Switches, time . . . . . O  
 Switches, toggle . . . . . P  
 Switches, trigger . . . . . Q  
 Switches, volume control . . . . . R

Alden Products Co., 117 N. Main St., Brockton 64, Mass.—J  
 American Radio Hardware Co., 152 MacQuestion Pkwy. So., Mt. Vernon, N.Y.—A,L,P  
 Ark-Les Switch Corp., 51 Water St., Watertown 72, Mass.—J,K,M,P  
 Arrow-Hart and Hegeman Electric Co., 103 Hawthorn St., Hartford 6, Conn.—F,J,P,Q  
 Auto-Test, Inc., 600 S. Michigan Ave., Chicago 5, Ill.—J  
 Beck's Inc., 298 E. 5 St., St. Paul 1, Minn.—K  
 Birnbach Radio Co., 145 Hudson St., New York 13, N.Y.—E,I,J,K,L,P  
 Boma Laboratories, Salem Rd., Beverly, Mass.—B  
 British Electronic Sales Co., 23-03 45 Rd., Long Island City 1, N.Y.—C,D,F,G,H,I,J,K,L,M,N,P,O  
 Carling Electric, Inc., 505 New Park Ave., West Hartford 10, Conn.—J,K,L,M,P,Q  
 Carter Parts Co., 213 Institute Pl., Chicago 7, Ill.—F,J,P  
 Centralab-Div. Globe-Union Inc., 902Y E. Keefe Ave., Milwaukee 1, Wis.—A,F,I,K,L,P,R  
 Chatham Electronics, Div. Gera Corp., 630 W. Mt. Pleasant Ave., Livingston, N.J.—G  
 Chicago Telephone & Supply, 1142 W. Beardsley Ave., Elkhart, Ind.—M,R  
 Clarostat Mfg. Co., Washington St., Dover, N.H.—I,K,M,R

Clum Mfg. Co., 611 W. National Ave., Milwaukee 4, Wisc.  
 Cutler-Hammer Inc., 436 N. 12 St., Milwaukee 1, Wis.—J,K,M,O,P  
 Ebert Electronics Corp., 212-26 Jamaica Ave., Queens Village 28, N.Y.—G  
 Eby Co. Hugh H., 4700 Stenton Ave., Philadelphia 44, Pa.—J  
 Edison Inc., Thomas A., Instrument Div., 93 Lakeside Ave., W. Orange, N.J.—N,O  
 Electro-Tech Equip. Co., 308 Canal St., New York 13, N.Y.—C,G,M,O,P  
 Elly Electronics Corp., 22-02 Raphael St., Fairlawn, N.J.—M,N,O,P  
 Erie Resistor Corp., 644 W. 12th St., Erie 6, Pa.—F,K  
 Federal Anti Capacity Switch Corp., 72 Kingsley St., Buffalo 8, N.Y.—A  
 Federal Telephone & Radio Co., 100 Kingsland Rd., Clifton, N.J.—A,F  
 Furnas Electric Co., 1000 McKee St., Batavia, Ill.—C,J  
 Gee-Lar Mfg. Co., 819 Elm St., Rockford, Ill.—B,F,I,J,K,L,M,P  
 General Cement Mfg. Co., 919 Taylor Ave., Rockford, Ill.—J,K,L,M,P,Q,R  
 Grayhill, 561 Hillgrove, LaGrange, Ill.—D,J,K,M  
 Haydon Switch, Inc., 232 N. Elm St., Waterbury, Conn.—H,K,M,P  
 H-B Instrument Co., American & Bristol Sts., Philadelphia 40, Pa.—G,N  
 Hetherington Inc., Sharon Hill, Pa.—E,J,K,L,M,P  
 Industrial Instruments, Inc., 89 Commerce Rd., Cedar Grove, N.J.—K  
 Insuline Corp., America, 186 Granite St., Manchester, N.H.—E,K,L  
 International Register Co., 2620 W. Washington Blvd., Chicago 12, Ill.—O  
 J-B-T Instruments Co., 441 Chapel St., New Haven 8, Conn.—F,K,P  
 Kellogg Switchboard & Supply Co., 79 W. Monroe St., Chicago 3, Ill.—C,F,J  
 Laine Electronic Mfg. Co., 113 Sussex Ave., Newark 4, N.J.—G  
 Leader Electronics, Inc., 2925 E. 55th St., Cleveland 2, Ohio—K  
 Lieco Inc., 147 Ocean Ave., Lynbrook, N.Y.—P  
 Mallory & Co., P. R., 3029 E. Washington St., Indianapolis 6, Ind.—B,F,I,J,K,M,R  
 Metronics, Inc., U. S. Route 130, Burlington, N.J.—G  
 Micro Switch Div., Minneapolis-Honeywell Regulator Co., Freeport, Ill.—C,D,F,G,H,J,K,L,M,P  
 Minneapolis-Honeywell Regulator Co., 2753 4 Ave. S., Minneapolis 8, Minn.—G,O  
 Mycalex Corp. of America, 125 Clifton Blvd., Clifton, N.J.—K  
 Naer Corp., 11777 Santa Monica Blvd., Los Angeles 25, Calif.—K  
 Network Mfg. Corp., 213 W. 5th St., Bayonne, N.J.—F,I,J,K,L,M,P  
 Oak Mfg. Co., 1260 Clybourn Ave., Chicago 10, Ill.—J,L  
 Ohmite Mfg. Co., 3601 Howard St., Skokie, Ill.—K  
 Permoflux Corp., 4900 W. Grand Ave., Chicago 39, Ill.—C  
 Philco Corp., Accessory Div., "A" & Allegheny Ave., Philadelphia 34, Pa.—D,E,J,K,L,P,R  
 Philmore Mfg. Co., 113 University Pl., New York 3, N.Y.—E,J,K,L,P  
 Pioneer Electronics Corp., 2235 S. Carmeline, Los Angeles 64, Calif.—H  
 Radio Merchandise Sales, Inc., 2016 Bronxdale Ave., New York 62, N.Y.—E  
 Recora Co., 56 W. 103rd St., Chicago 28, Ill.—C,Y  
 Revere Corp. of America, 845 N. Colony Rd., Wallingford, Conn.—P  
 Reynolds Electric Co., 3000 River Rd., River Grove, Ill.—K,N,O  
 Roanwell Corp., 662 Pacific St., Brooklyn 17, N.Y.—J,M  
 Sessions Clock Co., Forestville, Conn.—M  
 Shallcross Mfg. Co., 520 Pusey Ave., Collingdale, Pa.—D,I,J,K  
 Shure Bros., 225 W. Huron St., Chicago 10, Ill.—K,L,P  
 Smith, Inc., Herman H., 2326 Nostrand Ave., Brooklyn 10, N.Y.—E,J,K,L,P  
 States Co., 19 New Park Ave., Hartford 6, Conn.—E  
 Switchcraft, Inc., 1328 N. Halsted St., Chicago 22, Ill.—F,J,K,P  
 Tele Matic Industries, 16 Howard Ave., Brooklyn 21, N.Y.—N  
 Thompson Products Inc., 2196 Clarkwood Rd., Cleveland 3, Ohio  
 United Electric Controls Co., 85 School St., Watertown 72, Mass.—H,M,N  
 Universal Circuit Control, 3610 Oakton St., Skokie, Ill.—G,L,M,N,P  
 Webster Electric Co., 1900 Clark, Racine, Wis.—C  
 Wirt Co., 5221 Greene St., Philadelphia 44, Pa.—L

For the purpose of checking violations of the publisher's copyright or other misuse of this directory, the products or listings have been coded. While these lists may be used for mailing purposes by individual manufacturers, any use of the lists, in part or whole, by other sources is prohibited.

## 20—TEST EQUIPMENT

Ammeters, milli, micro . . . . . A  
 Analyzers, audio . . . . . AU  
 Analyzers, interference . . . . . B  
 Bridges . . . . . C  
 Calibrators, frequency . . . . . D  
 Calibrators, voltage . . . . . E  
 Checkers, condenser . . . . . F  
 Checkers, CRT . . . . . AM  
 Checkers, fly-back . . . . . AN  
 Checkers, transformer . . . . . G  
 Checkers, vibrator . . . . . H  
 Clippers, sine-wave . . . . . I  
 Decades, capacitance . . . . . J  
 Decades, inductance . . . . . AX  
 Decades, resistance . . . . . K  
 Frequency Standards . . . . . L  
 Generators, audio . . . . . N  
 Generators, color signal . . . . . AK  
 Generators, marker . . . . . O  
 Generators, pattern . . . . . P  
 Generators, signal RF, IF . . . . . Q  
 Generators, sweep . . . . . R  
 Generators, TV Bar . . . . . AV  
 Meters, audio . . . . . S  
 Meters, coin . . . . . AL  
 Meters, field-strength . . . . . T  
 Meters, frequency . . . . . U  
 Meters, grid-dip . . . . . V  
 Meters, snap around . . . . . AO  
 Meters, time . . . . . W  
 Meters, watt . . . . . Y  
 Multimeters . . . . . Z  
 Ohmmeters . . . . . AA  
 Oscillators, VFO . . . . . AB  
 Oscilloscope, preamplifiers . . . . . AP  
 Oscilloscopes, cathode-ray . . . . . AC  
 Probes, meter & scope . . . . . AQ  
 Q-Meter . . . . . AW  
 Reactivators, CRT . . . . . AR  
 Stroboscopes . . . . . AD  
 Switches, electronic . . . . . AS  
 Testers, battery . . . . . AE  
 Testers, continuity . . . . . AF  
 Testers, metal rectifier . . . . . AT  
 Testers, tube . . . . . AG  
 Thermocouples . . . . . AH  
 Tracers, signal . . . . . AI  
 Voltmeters . . . . . X  
 Voltmeters, vacuum tube . . . . . AJ

A.B.T. Mfg. Co., 715 N. Kedzie Ave., Chicago 12, Ill.—A,L  
 Aero Instrument Co., 11423 Van Owen St., N. Hollywood, Calif.—L,U,W  
 Alco Electronics Mfg. Co., 3 Wolcott Ave., Lawrence, Mass.—J,K,T  
 American Scientific Devel., Ft. Atkinson, Wis.—AG  
 American Thermo-Electric Co., 198-11 Hollis Ave., Hollis, N.Y.—AH  
 Anchor Products Co., 2712 W. Montrose Ave., Chicago 18, Ill.—AM,AR  
 Anko Mfg. Co., 5042 W. State St., Milwaukee 8, Wis.—AG  
 Approved Electronic Instrument Corp., 928 Broadway, New York 10, N.Y.—O,P,Q,R,T,AC,AR  
 Authorized Mfg. Co., 919 Wyckoff Ave., Brooklyn 27, N.Y.—Q,R,Z,AC,AI,AJ,AM,AP,AR  
 Auto-Test Inc., 600 S. Michigan Ave., Chicago 5, Ill.—AE  
 Barker & Williamson, 235 Fairfield Ave., Upper Darby, Pa.—C  
 Barrett Electronics, 22319 Kathryn Ave., Torrance, Calif.—F,X,Z,AF  
 Beck's Inc., 298 E. 5 St., St. Paul 1, Minn.—AS  
 Beede Electrical Works, Penacook, N.H.—X,Z,AA  
 Berkshire Laboratories, Greenville, N.H.—D,E,I,AD  
 B&K Mfg. Co., 3731 N. Southport St., Chicago 13, Ill.—AG  
 Boland & Boyce, 236 Washington Ave., Belleville, N.J.—AG  
 Boma Laboratories, Salem Rd., Beverly, Mass.—L  
 Browsing Laboratories, Inc., 750 Main St., Winchester, Mass.—U,AC  
 Brush Electronics Co., 3405 Perkins Ave., Cleveland 14, Ohio—C  
 Burlington Instrument Co., 203 N. 3 St., Burlington, Iowa—A,S,W  
 Burton-Rogers Co., Div. Hoyt Elec. Instr., 42 Carleton St., Cambridge 42, Mass.—A,X,Z,AA,AE,AF  
 Central Electronics, Inc., 1247 Belmont Ave., Chicago 13, Ill.—AG,AR  
 Century Electronics Co., 111 Roosevelt Ave., Mineola, N.Y.—F,AI,AM

Chatham Electronics Corp., 630 W. Mt. Pleasant Ave., Livingston, N.J.—AG,AS  
 Chicago Industrial Instrument Co., 536 W. Elm St., Chicago 10, Ill.—A,C,F,X,Z,AA,AE,AF,AG,AJ,AM,AT  
 Clarostat Mfg. Co., Washington St., Dover, N.H.—K  
 Clippard Instrument Lab., 7350 Colerain Rd., Cincinnati 24, Ohio—J,K,AJ  
 Clough-Brengle Co., 6014 Broadway, Chicago 40, Ill.—C,N,Q,R  
 Colortone Electronics Inc., 100 Frank Rd., Hicksville, N.Y.—D,E,L,U,AC,AJ,AK,AQ  
 Color TV Inc., 973 E. San Carlos Ave., San Carlos, Calif.—AF  
 Cornell-Dubilier Elec. Corp., 333 Hamilton Blvd. S. Plainfield, N.J.—C,J,K,AN  
 Crest Laboratories, Inc., 84-11 Rockaway Beach Blvd., Rockaway Beach 93, N.Y.—P,Q,AR  
 Cutler-Hammer Inc., 436 N. 12 St., Milwaukee 1, Wis.—AS  
 Deltron, Inc., 2905 Leithgow St., Philadelphia, Pa.—C,A,I,AU  
 DuMont Laboratories, Inc., Allen B., 760 Bloomfield Ave., Clifton, N.J.—AC  
 Dynamic Electronics, 73-39 Woodhaven Blvd., Glendale, L. I., N.Y.—V  
 Eby Sales Co., 130 Lafayette St., New York 13, N.Y.—F,N,AF,AI  
 Electro Mechanical Instrument Co., 812 Chestnut St., Perkasie, Pa.—A,X  
 Electronic Instrument Co., 84 Withers St., Brooklyn 11, N.Y.—C,E,F,J,K,N,Q,R,X,Z,AA,AC,AG,AI,AJ,AM,AN,AQ,AS  
 Electronic Measurements Corp., 280 Lafayette St., New York 12, N.Y.—N,O,P,Q,X,Z,AC,AE,AG,AJ  
 Electronic Test Instrument Corp., 13224 Livernois Ave., Detroit, Mich.—AR  
 Electron-Radar Products, 1041 N. Pulaski Rd., Chicago 51, Ill.—AH  
 Electro-Tech Equip. Co., 308 Canal St., New York 13, N.Y.—AE,AG  
 Electro-Technic Products, 4602 Montrose Ave., Chicago 41, Ill.—AG  
 Epcor Electronics, Inc., 140 Liberty St., New York 6, N.Y.—X,Z,AA  
 Epsco, Inc., 126 Mass. Ave., Boston 15, Mass.—B  
 Esco Mfg. Co., Box 344, Summit, Ill.—AD  
 Espey Mfg. Co., 528 E. 72nd St., New York 21, N.Y.—B,L,P,Q,R,X,AJ,AK,AA  
 Federal Telephone and Radio Co., Div. of IT&T, 100 Kingsland Rd., Clifton, N.J.—J,K,AA  
 Feiler Eng'g & Mfg. Co., 8026 N. Monticello, Skokie, Ill.—A,AC,AQ  
 Ferris Instrument Co., 110 Cornelia St., Boonton, N.J.—Q,T,U  
 Fidelity Amplifier Co., 703 Willow St., Chicago 14, Ill.—J  
 Freed Transformer Co., 1718 Weirfield St., Brooklyn 27, N.Y.—C,J,L  
 Frequency Standards, Box 504, Asbury Park, N.J.—L,U  
 Garod Radio, 70 Washington St., Brooklyn 1, N.Y.—AU  
 General Electric Co., Electronics Park, Syracuse, N.Y.  
 General Test Equipment Co., 38 Argyle Pk., Buffalo 22, N.Y.—Q  
 G. & M. Equipment Co., 7315 Varna Ave., N. Hollywood, Calif.—L,Q,R  
 Grayhill, 561 Hillgrove Ave., LaGrange, Ill.—AS  
 Gyro Electronics Co., 325 Canal St., New York 13, N.Y.—AS  
 Haydon Mfg. Co., 245 E. Elm St., Torrington, Conn.—W  
 H-B Instrument Co., American & Bristol Sts., Philadelphia 40, Pa.—AS  
 Heath Co., 305 Territorial, Benton Harbor, Mich.—C,E,F,H,J,K,N,Q,R,U,V,X,Y,Z,AB,AC,AE,AG,AI,AJ,AM,AQ,AS,AV,AW  
 Hewlett-Packard Co., 481 Page Mill Rd., Palo Alto, Calif.—N,O,Q,AU  
 Hickok Electrical Instrument Co., 10514 Dupont Ave., Cleveland 8, Ohio—A,N,O,P,Q,R,S,T,U,X,Y,Z,AA,AC,AE,AG,AJ,AK,AM,AO,AQ  
 Hycor Mfg. Co., 2961 E. Colorado St., Pasadena 8, Calif.—P,R,AC,AG,AJ,AK,AQ  
 Ideal Industries, Inc., Sycamore, Ill.—AF  
 Industrial Devices Inc., 22 State Rd., Edgewater, N.J.—X  
 Industrial Instruments, Inc., 89 Commerce Rd., Cedar Grove, N.J.—AF  
 Industrial Television Inc., 359 Lexington Ave., Clifton, N.J.—T  
 Industrial Test Equipment Co., 55 E. 11th St., New York 3, N.Y.—C,D,F,L,N,W,Y,UAU  
 Instrument Labs., 315 W. Walton Pl., Chicago 10, Ill.—A,Y,Z  
 Instruments for Service, 96 S. Grand Ave., Baldwin, N.Y.—F  
 International Instruments Inc., P.O. Box 2954, New Haven 15, Conn.—AS  
 International Register Co., 2620 W. Washington Blvd., Chicago 12, Ill.—AL  
 International Research Assoc., 2221 Warwick Ave., Santa Monica, Calif.—AS  
 Jackson Electrical Instrument Co., 18 S. Patterson Blvd., Dayton 2, Ohio—D,F,N,O,Q,R,AC,AG,AJ,AK,AM,AT,AU  
 JaMac Products Co., 8845 N. E. Sandy Blvd., Portland, Ore.—Y,AAQ  
 Javex, P.O. Box 646, Redlands, Calif.—AQ

J-B-T Instruments Co., 441 Chapel St., New Haven 8, Conn.—U,W,AH  
 Jerrold Electronics Corp., 23 & Chestnut Sts., Philadelphia 46, Pa.—T  
 Kay Electric Co., 14 Maple Ave., Pine Brook, N.J.—J,K,N,O,Q,R,AAK  
 Kay Lab., Box 16, San Diego 10, Calif.—E,F,AJ  
 Kellogg Switchboard & Supply Co., 79 W. Monroe St., Chicago 3, Ill.—U,AF  
 Kemode Mfg. Co., 161 W. 18 St., New York 11, N.Y.—E  
 Kings Electronics Co., 40 Marbledale Rd., Tuckahoe, N.Y.—Q,R,U,AAU  
 Kirby Products Co., 475 Cosgrove St., Philadelphia 44, Pa.—O,Q,R,X,Z,AA,AC,AE,AF,AG,AJ,AM,AN,AP  
 Knights Co., James, Sandwich, Ill.—L  
 Lampkin Laboratories, Bradenton, Fla.—U  
 Lear, Inc., 11916 W. Pico Blvd., Los Angeles 64, Calif.—T  
 Lee Electronic Labs., 233 Dudley St., Boston 19, Mass.—F,AE,AF,AG,AI  
 Linear Equipment Labs., Brightwater Place, Massapequa, N.Y.—V,AC  
 Link Aviation, Binghamton, N.Y.—AF  
 Lumenite Electronics Co., 407 S. Dearborn St., Chicago 5, Ill.—O,AS  
 Madisco, Inc., 3960 N. 16 St., Philadelphia 40, Pa.—AG  
 Mallory & Co., P.R., 3029 E. Washington St., Indianapolis 6, Ind.—H,AE  
 Marion Electrical Instrument Co., Manchester, N.H.—A,M,S,U,W,X,Z,AA  
 Martindale Electric Co., Box 617, Edgewater Br., Cleveland 7, Ohio—A,X,AA  
 McColepin-Christie Corp., 3410 W. 67 St., Los Angeles 43, Calif.—AE  
 Measurements Corp., Boonton, N.J.—C,Q,S,T,V  
 Meters, Inc., 5353 N. Keystone Ave., Indianapolis 20, Ind.—A,S,X,Z,AA  
 Metronics, Inc., U. S. Route 130, Burlington, N.J.—AS  
 Microtran Co., Div., Crest Labs, Inc., 84-11 Rockaway Beach Blvd., Rockaway Beach 93, N.Y.—AR

Reiner Electronics Co., Center & Glendale Sts., Easton, Pa.—A,C,F,G,N,O,P,Q,R,U,X,Z,AA,AC,AE,AF,AI,AJ,AK,AQ,AAU  
 Revere Corp. of America, 845 N. Colony Rd., Wallingford, Conn.—AH  
 Ripley Co., Middletown, Conn.—AS  
 Rowe Industries, 1702 Wayne St., Toledo 9, Ohio—AE  
 Sargent-Raymont Co., 1401 Middle Harbor Rd., Oakland 20, Calif.—AB  
 Scala Radio Co., 2814 19 St., San Francisco 10, Calif.—D,AI,AAQ  
 Schauer Mfg. Corp., 4500 Alpine Ave., Cincinnati 36, Ohio—H  
 Scott Inc., H. H., 385 Putnam Ave., Cambridge 39, Mass.—S,AJ,AAU  
 Seco Mfg. Co., 5015 Penn Aves., Minneapolis 19, Minn.—G,AG,AN  
 Service Instruments Co., 422 S. Dearborn St., Chicago 5, Ill.—E,Q,AG  
 Shallcross Mfg. Co., 520 Pusey Ave., Collingdale, Pa.—C,J,K,X,AS  
 Shasta Div., Beckman Instruments Inc., P.O. Box 296, Station A, Richmond, Calif.—C,N,U,X,AA,AB,AJ  
 Shurite Meters, 61 Hamilton St., New Haven 8, Conn.—A,AE  
 Simpson Electric Co., 5216 Kinzie St., Chicago 44, Ill.—A,C,F,N,O,S,T,X,Y,Z,AA,AC,AE,AG,AH,AJ,AK,AQ  
 Smithquild, Inc., 360 W. 8th St., Erie 2, Pa.—AF,AG  
 Special Instruments Lab., Inc., 312 W. Vine St., Knoxville, Tenn.—C,W  
 Specialty Assembling & Packing Co., 79 Clinton Pl., Brooklyn 38, N.Y.—X,Z,AA,AJ  
 Spencer-Kennedy Labs., 186 Mass. Ave., Cambridge 39, Mass.—R  
 Sprague Products Co., N. Adams, Mass.—F  
 Sterling Mfg. Co., 7201 Wentworth Ave., Cleveland 2, Ohio—A,X  
 Summit Eng'g Co., 3324 Main St., Hartford, Conn.—C,T,AF  
 Superox Electronics Corp., 4 Radford Pl., Yonkers, N.Y.—AM  
 Superior Instrument Co., 2435 White Plains Rd., New York, N.Y.—P,AG,AN  
 Supreme, Inc., Greenwood, Miss.—A,N,P,X,Z  
 Sylvania Electric Products, Inc., 1740 Broadway, New York 19, N.Y.—O,R,AC,AG,AJ,AAQ  
 Tektronix, Inc., P.O. Box 831, Portland 7, Ore.—AC,AP  
 Telchrome Mfg. Corp., 88 Merrick Rd., Amityville, N.Y.—P,AK  
 Telectro Industries Corp., 35-16 37 St., Long Island City 1, N.Y.—C,Q,T,Z,AA,AH,AJ  
 Tele-Matic Industries, 16 Howard Ave., Brooklyn 21, N.Y.—B  
 Television Engineers Inc., 3325 W. Bryn Mawr, Chicago 45, Ill.—AG,AM  
 Telux, Inc., 1633 Eustis St., St. Paul 1, Minn.—K  
 Telonic Industries, 444 S. Rural St., Indianapolis 1, Ind.—O,P,Q,R,AAK  
 Tensor Elec Dev Co., 343 Classon Ave., Brooklyn, N.Y.—E  
 Texas Instruments, Inc., 6000 Lemmon Ave., Dallas 9, Texas—V  
 Transvision Inc., New Rochelle, N.Y.—AN  
 Triplet Electrical Instrument Co., Harmon Rd., Bluffton, Ohio—A,O,Q,R,S,X,Y,Z,AA,AC,AG,AH,AJ,AAK  
 Triumph Mfg. Co., 1825 S. 55th St., Chicago, Ill.—AC  
 Trojan Electronics, 3706 N. Halsted St., Chicago 13, Ill.—AM  
 Tru-Vue Television Co., 99 Featherbed Lane, Bronx 52, N.Y.—AR  
 United Technical Laboratories, Morristown, N.J.—P  
 United Transformer Co., 150 Varick St., New York 13, N.Y.—X  
 Varo Mfg. Co., 1801 Walnut St., Garland, Texas—U  
 Vidair Electronics Mfg. Co., 576 W. Merrick Rd., Lynbrook, N.Y.—B,AM  
 Visulite Co., 423 Broome St., New York 13, N.Y.—AF,AAQ  
 Waterman Products Co., 2445 Emerald St., Philadelphia 25, Pa.—AC

**TECHNICIAN BUYERS DIRECTORY**

Millen Mfg. Co., James, 150 Exchange St., Malden 48, Mass.—V,AC  
 Miller Electronics, 2840 Naomi St., Burbank, Calif.—AM  
 Mitchell Rand Insulation Co., 51 Murray St., New York 7, N.Y.—H  
 Moran Electronic Components, 10506 Wheatley St., Kensington, Md.—S  
 Moss Electronic Distr. Co., 3849 10th Ave., N.Y.—N.Y.—AG  
 Non-Linear Systems, DelMar Airport, DelMar, Calif.—X,AA  
 Ohmite Mfg. Co., 3601 Howard St., Skokie, Ill.—K  
 Pacific Transducer TB Corp., 11836 W. Pico Blvd., Los Angeles 64, Calif.—N,R,AD  
 Peschel Electronics, 13 Garden St., New Rochelle, N.Y.—AF  
 Phaestron Co., 151 Pasadena Ave., S. Pasadena, Calif.—A,S,X,Z,AA,AF,AJ  
 Philco Corp., Tigra & C. Sts., Philadelphia 34, Pa.—P,Q,R,T,Z,AA,AC,AG,AJ,AM,AQ  
 Philmore Mfg. Co., 113 University Pl., New York 3, N.Y.—E,F,J,L,U,X  
 Polarad Corp., 43-20 34 St., Long Island 1, N.Y.—P,Q,R  
 Pomona Electronics Co., 524 W. 5 Ave., Pomona, Calif.—AM  
 Power Supplies, 1005 Olive St., Highland, Ill.—C,H  
 Precision Development Corp., 999 Long Beach Rd., Oceanside, N.Y.—C,F,J,K,N,O,Q,R,X,AB,AC,AG,AJ  
 Precision Apparatus Co., 70-31 84 St., Glendale 27, L.I., N.Y.—A,N,O,Q,R,X,Z,AA,AB,AC,AG,AJ,AM,AQ  
 Precision Electronics, Inc., 9101 King Ave., Franklin Park, Ill.—A1  
 Pres Probe Co., 4034 N. 6th St., Milwaukee 2, Wisc.—F  
 Probescope Co., 44-05 30 Ave., Long Island City, N.Y.—AC  
 Pyramid Electric Co., 1445 Hudson Blvd., N. Bergen, N.J.—F  
 Radio City Products Co., Centre & Glendale Sts., Easton, Pa.—A,C,F,G,N,O,P,Q,R,U,X,Z,AA,AC,AE,AF,AG,AI,AJ,AK,AM,AN,AR  
 Radio Corp. of America, Tube Div., 415 S. 5th St., Harrison, N.J.—A,D,N,O,P,Q,R,X,Z,AA,AB,AC,AE,AF,AI,AJ,AK,AQ,AAU  
 Radiokits, Inc., 120 Cedar St., New York 6, N.Y.—C,AE,AG  
 Radio Supply & Eng'g Co., 85 Selden Ave., Detroit 1, Mich.—AC  
 Radion Corp., 1130 W. Wisconsin Ave., Chicago 14, Ill.—T  
 Raytronic Labs., Ins., 9701 Reading Rd., Cincinnati 15, Ohio—AM  
 Rectifier Engineering Co., 1803 E. 7 St., Los Angeles 21, Calif.—AE

**CIRCULATION**  
 of this  
**TECHNICIAN**  
**BUYERS DIRECTORY**  
**50,083**



Waveforms, Inc., 333 6 Ave., New York 31, N.Y.—A,N,S,AJ  
 Welch Mfg. Co., W. H., 1515 Sedgwick St., Chicago 10, Ill.—M,X,Y,Z,AH  
 Weston Electrical Instruments Corp., 614 Frelinghuysen Ave., Newark 4, N.J.—A,D,F,O,R,S,X,Y,Z,AA,AC,AG,AH,AJ,AQ  
 Weston Labs., Harvard, Mass.  
 Winston Electronics, Inc., 4312 Main St., Philadelphia 27, Pa.—D,P,T,AF,AK,AN

## 21—TOOLS FOR SERVICING

Benches, work ..... A  
 Benders, tubing ..... B  
 Bits, drill ..... C  
 Blowers ..... D  
 Blow Torches ..... E  
 Caddy, tube ..... F  
 Carts ..... G  
 Chemicals, Radio & TV ..... H  
 Cleaner, TV lens ..... I  
 Clips, alligator, test, etc. .... J  
 Coil Winders ..... K  
 Cradles, chassis ..... L  
 Crimping tools ..... AM  
 Cutters ..... M  
 Drills, electric ..... N  
 Drills, hand ..... O  
 Drivers, nut, screw ..... P  
 Ejectors, fuse ..... Q  
 Hammers ..... R  
 Leads, test ..... S  
 Lug tools ..... AN  
 Micrometers ..... T  
 Mirrors, inspection ..... AO  
 Oilers ..... U  
 Pliers ..... V  
 Probes, prods ..... W  
 Punches, Taps, Dies ..... X  
 Reamers ..... AP  
 Saws ..... Z  
 Soldering Equipment (see Sec. 17)  
 Splicers, line ..... AA  
 Spray Guns ..... AB  
 Staplers ..... AC  
 Strippers, wire ..... AD  
 Timers (see Sec. 11)  
 Tools, alignment ..... AE  
 Tools, electric ..... AF  
 Tools, hand ..... AG  
 Torches ..... AH  
 Tube Pin Straighteners ..... AI  
 Tube Pullers ..... AJ  
 Tweezers ..... AQ  
 Vises ..... AK  
 Wrenches ..... AL

Aeromark Co., 309 Morrell St., Elizabeth 4, N.J.—W,X  
 Aerolite Electronics, 507 26th St., Union City, N.J.—J,S,W  
 Alden Products Co., 117 N. Main St., Brockton 64, Mass.—AG  
 Allied Electronics Enterprises, 4212 Lankershim Blvd., N. Hollywood, Calif.—F  
 Allied Mfg. & Sales Co., 201 N. Wells St., Chicago 6, Ill.—G  
 Alpert Co., Ned. 2950 N. Holten St., Milwaukee 12, Wisc.—M  
 American Machine & Fdry., Electronics Div., 1085 Commonwealth Ave., Boston, Mass.—L,N,T,AF,AK  
 American Mercantile Co., 33 W. 42 St., New York 36, N.Y.—Z  
 American Radio Hardware Co., 152 MacQueston Pkwy. So. Mt. Vernon, N.Y.—J,P,S,W,AE,AG,AL  
 AP Electro Lab., P. O. Box 862, Union, N.J.—H  
 Argos Products, 310 Main St., Genoa, Ill.—F  
 Assoc. Production Co., 162 N. Clinton St., Chicago 6, Ill.—K  
 Barb City Industries, 5 & Girard Sts., DeKalb, Ill.—AG  
 Baumker Mfg. Co., 3826 Summit St., Toledo 11, Ohio—A  
 Biggs Co., Carl H., 2255 Barry Ave., Los Angeles 64, Calif.—H  
 Birnbach Radio Co., 145 Hudson St., New York 13, N.Y.—S,W  
 Black & Decker, Towson 4 Md.—M,N  
 Boland & Boyce, 236 Washington Ave., Belleville, N.J.—W  
 Brach Mfg. Corp., 200 Central Ave., Newark 3, N.J.—A  
 British Electronic Sales Co., 23-03 45 Rd., Long Island City 1, N.Y.—M,AG,AI,AJ,AQ  
 Bruno Tools Inc., 9330 Santa Monica Blvd., Beverly Hills, Calif.—AG

Cass Machine Co., 691 Antoinette St., Detroit 2, Mich.—P  
 CBS-Hytron, Div. Columbia Broadcasting System, 100 Endicott St., Danvers, Mass.—F,AG,AI,AJ,AQ  
 Champion De Arment Tool Co., Meadville, Pa.—AG  
 Chase Mfg. Co., 5008 W. Jefferson Blvd., Los Angeles 16, Calif.—P  
 Chemical Electrical Eng'g Co., 1025 Broad St., Newark, N.J.—H,I  
 Coil Winding Equipment Co., 19 Maxwell Ave., Oyster Bay, N.Y.—K  
 Cooper Industries, 4953 W. Fullerton Ave., Chicago 39, Ill.—A  
 Cosa Corp., 405 Lexington Ave., New York 17, N.Y.—K  
 Cummins Portable Tool Div., DBM Corp., 4740 N. Ravenswood Ave., Chicago 40, Ill.—N,O,Z  
 DI-CO TV & Plastic Co., 61 Erna St., Milford, Conn.—F  
 Dreier Bros., 5642 Lake Park Ave., Chicago 37, Ill.—Z  
 Duro Specialty Co., 8 Bennett St., Lynn, Mass.—AI  
 Eby Sales Co., 130 Lafayette St., New York 13, N.Y.—H,W  
 Ed-Berl Products Inc., 96 S. Grand Ave., Baldwin, N.Y.—C,P,V,AE,AG  
 Electro-Physics Co., 287P Broadway, New York 7, N.Y.—X  
 Enco Mfg. Co., 4522 W. Fullerton Ave., Chicago 39, Ill.—AG,AK  
 Equipto Div., Aurora Equip. Co., 422 Cleveland St., Aurora, Ill.—AG  
 Erie Resistor Corp., 644 W. 12 St., Erie 6, Pa.—AG  
 Erwood, Inc., 1770 Berteau Ave., Chicago 13, Ill.—Z  
 Escro Mfg. Co., Box 344, Summit, Ill.—G  
 Forsborg Mfg. Co., 125 Seaview Ave., Bridgeport 1, Conn.—C,O,P,Z,AF,AG  
 Gee-Lar Mfg. Co., 819 Elm St., Rockford, Ill.—F,J,S,AI,AJ  
 General Cement Mfg. Co., 919 Taylor Ave., Rockford, Ill.—H,I,J,K,L,M,S,W,AD,AE,AF,AG,AI,AJ,AL,AM,AN,AO,AQ  
 Grayhill, 561 Hillgrove Ave., LaGrange, Ill.—J  
 Greenlee Tool Co., 1887 Columbia Ave., Rockford, Ill.—X  
 Haydu Bros., Box 1226, Plainfield, N.J.—AI  
 Heller Co., 2185 Superior Ave., Cleveland 14, Ohio—AC  
 Holub Industries, 413 DeKalb Ave., Sycamore, Ill.—C,D,AD  
 Hunter Tools, 6608 S. Gretna, Whittier, Calif.—R,AG,AL  
 Ideal Industries, Inc., Sycamore, Ill.—D,R,AD,AF,AG  
 Imperial Radar & Wire Corp., 1661 Boone Ave., New York 60, N.Y.—AD  
 Insuline Corp. America, 186 Granite St., Manchester, N.H.—P,S,W,X,AJ  
 JaMac Products Co., 8845 N.E. Sandy Blvd., Portland 20, Ore.—B  
 Jerrold Electronics Corp., 23 & Chestnut Sts., Philadelphia 46, Pa.—AM  
 Kedman Co., 233 So. 5 West, Salt Lake City 1, Utah—P,AG  
 Kellogg Switchboard & Supply Co., 79 W. Monroe St., Chicago 3, Ill.—C,D,E,J,M,O,R,V,Z,AC,AD,AH,AM  
 Keystone Electronics Corp., 423 Broome St., New York 13, N.Y.—J,S,W,AE  
 Kirby Co., 13000 Athens Ave., Cleveland, Ohio 1, AD  
 Klein & Sons, Mathias, 7200 McCormick Rd., Chicago 45, Ill.—V,AG  
 Krauter Co., 563 18 Ave., Newark 3, N.J.—V,AL  
 Lenk Mfg. Co., 30 Cummington St., Boston 15, Mass.—E,AH  
 London Chemical Co., 1535 N. 31 Ave., Melrose Park, Ill.—H  
 Martindale Electric Co., Box 617 Edgewater Br., Cleveland 7, Ohio—AD  
 Merix Chemical Co., 1021 E. 55th St., Chicago 15, Ill.—H,I  
 Mico Instrument Co., 80 Trowbridge St., Cambridge 38, Mass.—M  
 Miller Television Co., 2840 Naomi St., Burbank, Calif.—Y  
 Millers Falls Co., Greenfield, Mass.—M,O,T  
 Milwaukee Truck & Cnster, 6512 W. River Pkwy., Milwaukee 13, Wis.—G  
 Mitchell Mfg. Co., 2525 Clybourn Ave., Chicago 14, Ill.—AL  
 Moody Machine Products Co., 7 Culver St., Providence, R.I.—C,O,P  
 Morton Electronics Corp., Chester, 10 St., & Morton Ave., Chester, Pa.—J,S  
 Mueller Electric Co., 1575Y E. 31 St., Cleveland 14, Ohio—J  
 Norco Mfg. Co., 392 Blecker St., New York 14, N.Y.—H  
 Pacific Electric Co., 3217 Exposition Pl., Los Angeles 8, Calif.—S  
 Parker Metal Goods Co., 161 Summer St., Worcester 8, Mass.—AJ  
 Philmore Mfg. Co., 113 University Pl., New York 3, N.Y.—S,V,W  
 Portable Electric Tools, 320 W. 83 St., Chicago 20, Ill.—N,P,Z,AF  
 Precise Measurements Co., 942 Kings Hwy., Brooklyn 23, N.Y.—M,W  
 Production Tool & Fixture Co., 37 W. Main St., Oyster Bay, N.Y.—AI

Quiltrole Co., 395 St. John St., Spartanburg, S. Car.—H  
 Radio City Products Co., Centre & Glendale Sts., Easton, Pa.—S  
 Radio Merchandise Sales, Inc., 2016 Bronxdale Ave., New York 62, N.Y.—F,J,AJ  
 Ripley Co., Middletown, Conn.—D  
 Rytel Electronics, 8920 Irwin, Inglewood, Calif.—AG  
 Scala Radio Co., 2814 19th St., San Francisco 10, Calif.—W  
 Self-Lifting Piano Truck Co., Findlay, Ohio—G  
 Skil Corp., 5033 Elston Ave., Chicago 30, Ill.—M,N  
 Smith Heat Treating Co., 5865 Wilmington Ave., Los Angeles 1, Calif.—AL  
 Smith, Inc., Herman H., 2326 Nostrand Ave., Brooklyn 10, N.Y.—J,S,W,AE,AI,AJ  
 Snap-On Tools Corp., Kenosha, Wis.—A,C,G,M,N,P,R,T,U,V,X,Z,AD,AF,AG,AL,AO,AP  
 Speed Way Mfg. Co., Div. Thor Power Tool Co., 1834 S. 52 Ave., Cicero 50, Ill.—N,Z  
 Star Expansion Products Co., 147 Cedar St., New York 6, N.Y.—O,AI  
 Stevens Walden, Inc., 300 Shrewsbury St., Worcester 4, Mass.—P,X,AE,AG,AL,AP  
 Superex Electronics Corp., 4 Radford Pl., Yonkers, N.Y.—H  
 Sylvania Electric Products Inc., 1740 Broadway, New York 19, N.Y.—F,G  
 Tatz, Inc., Albert J., 85 Columbia Dr., Williamsport 21, N.Y.—B,M,AG,AM  
 Technicraft Co., 1156 Commonwealth Ave., Boston 34, Mass.—H,Z  
 Tempal Corp., 11 W. 25 St., New York 11, N.Y.—H  
 Tinnerman Prods., P.O. Box 6688, Cleveland 1, Ohio—J,AZ  
 Tipco Co., 5865 Wilmington Ave., Los Angeles 1, Calif.—AD  
 Trio Fuse Mfg. Co., 2948 N. 5 St., Milwaukee 12, Wis.—J,U,V  
 Turner Brass Works, Sycamore, Ill.—AI  
 TV Hdw. Mfg. Co., 919 Taylor Ave., Rockford, Ill.—H  
 U. M. & R Mfg. Corp., 10929 Vanowen St., N. Hollywood, Calif.—G,L  
 Union Plastics Corp., 1627 Paterson Plank Rd., Secaucus, N.J.—S  
 U. S. Products, Inc., 1549 Hutchins St., Columbus, Ind.—A,G  
 Utica Drop Forge & Tool Corp., 2415 Whitesboro St., Utica 4, N.Y.—M,P,V,X,AD,AG,AL  
 Vaco Products Co., 317 E. Ontario, Chicago 11, Ill.—M,P,R,V,AE,AG,AM,AN,AP  
 Viking Tool & Machine Corp., 2 Main St., Belleville, N.J.—AG  
 Visulite Co., 423 Broome St., New York 13, N.Y.—W  
 Wall Mfg. Co., P., Grove City, Pa.—E,W,AH  
 Walco Electronics Corp., 3602 Crenshaw Blvd., Los Angeles 16, Calif.—H,AD,AI,AL,AQ  
 Win Sales Co., 111-55 77 Ave., Forest Hills, N.Y.—AQ  
 Workman TV Inc., 309 Queen Anne Rd., Teaneck, N.J.—H,J,S  
 Xcelite, Thorne Ave. & Bank St., Orchard Park, N.Y.—P,AG,AL,AP

## 22—TUBES

Detectors, diode ..... B  
 Rectifiers, tube ..... C  
 Tubes, ballast ..... D  
 Tubes, cathode-ray (oscilloscope) ..... E  
 Tubes, cathode-ray (television) ..... F  
 Tubes, electron-ray (indicator-eye) ..... G  
 Tubes, receiving ..... I  
 Tubes, subminiature ..... H  
 American Elite Inc., 7 Park Ave., New York 16, N.Y.—B  
 American Standard TV Tube Corp., 94-50 158 St., Jamaica 33, N.Y.—E,F  
 American Vacuum Products Corp., 2242 S. Colby Ave., Los Angeles 64, Calif.—F  
 Ampere Electronic Corp., 230 Duffy Ave., Hicksville, L.I., N.Y.—B,C,H  
 Amperite Co., 561 Broadway, New York 12, N.Y.—D  
 Atlantic Electronics Corp., 91 Jefferson St., Passaic, N.J.—F  
 Beam Instruments Corp., 350 5th Ave., New York 1, N.Y.—E  
 Bendix Aviation Corp., Red Bank Div., Eatontown, N.J.—H  
 Bomac Laboratories, Salem Rd., Beverly, Mass.—I  
 British Electronic Sales Co., 23-03 45 Rd., Long Island City 1, N.Y.—H  
 Calvideo Tube Corp., 5232 W. 104 St., Los Angeles, Calif.—F  
 CBS-Hytron, Div. Columbia Broadcasting System, 100 Endicott St., Danvers, Mass.—B,C,F,I  
 Certified Tube Co., 16 & Luzerne Sts., Philadelphia 40, Pa.—I  
 Chatham Electronics Corp., 630 W. Mt. Pleasant Ave., Livingston, N.J.—D,H,I

Chromatic Television Labs., 703 37th Ave., Oakland, Calif.—F  
 Claremont Tube Corp., 36-02 35th Ave., Long Island City, N.Y.—F  
 Clorostat Mfg. Co., Washington St., Dover, N.H.—D  
 Continental Electric Co., 715 Hamilton St., Geneva, Ill.—F  
 Continental Electronics Corp., 5320 Lancaster Ave., Philadelphia, Pa.—F  
 Dale Electronics Inc., 31 Somerset Pl., Clifton, N.J.—F  
 DuMont Labs., Allen B., Cathode-Ray Tube Div., 750 Bloomfield Ave., Clifton, N.J.—E,F  
 Eitel-McCullough, Inc., 798 San Mateo Ave., San Bruno, Calif.—F  
 Electronic Beam Corp., 923 Old Nepperhan Ave., Yonkers, N.Y.—F  
 Electrons, Inc., 127 Sussex Ave., Newark 3, N.J.—C  
 Federal Telephone and Radio Co., Div. of IT&T, 100 Kingsland Rd., Clifton, N.J.—C  
 Ferranti Electric Inc., 30 Rockefeller Plaza, New York 20, N.Y.—C,E,F  
 General Electric Co., Electronics Park, Syracuse, N.Y.—C,F,H,I  
 General Vacuum Tube Corp., Ardsley, N.Y.—F  
 Graybar Electric Co., 420 Lexington Ave., New York 17, N.Y.—C,I  
 Haydu Bros., Box 1226, Plainfield, N.J.—F,H,I  
 Intercontinental Industries, 555 W. Adams St., Chicago, Ill.—H,I  
 Kenatron Electron Products, 14 Prince Pl., Newburyport, Mass.—B  
 Laine Electronic & Mfg. Co., 113 Sussex Ave., Newark 4, N.J.—D,H  
 Le-Hi Electrical Co., 1108 Grove St., Irvington 11, N.J.—I  
 Madisco, Inc., 3960 N. 16 St., Philadelphia 40, Pa.—I  
 Martin & Co., H.S. 1916 Greenleaf St., Evanston, Ill.—F  
 Matchless Electric Co., 1700 Washington Blvd., Chicago 12, Ill.—D  
 Midland Mfg. Co., 3151 Fiberglass Rd., Kansas City 15, Kans.—E,F  
 Multi-Tron Labs., 4624 W. Wash. Blvd., Chicago 44, Ill.—E,F,G



Naer Corp., 11777 Santa Monica Blvd., Los Angeles 25, Calif.—E,F  
 National Electronics, 628 North St., Geneva, Ill.—C  
 National Union Electric Corp., 350 Scotland Rd., Orange, N.J.—E,F,H,I  
 National Video Corp., 4300 W. 47th St., Chicago 32, Ill.—E,F  
 Philco Corp., Tioga & C Sts., Philadelphia 34, Pa.—B,C,D,F,G,I  
 Pioneer Electronics Corp., 2235 S. Carmelina, Los Angeles 64, Calif.—E,F  
 Practical Electronics, 2214 S. Michigan Ave., Chicago, Ill.—F  
 Radio Corp. of America, Tube Div., 415 S. 5 St., Harrison, N.J.—B,C,D,E,F,G,H,I  
 Radio Supply & Eng'g. Co., 85 Selden Ave., Detroit 1, Mich.—F  
 Rauland Corp., 4245 N. Knox Ave., Chicago 41, Ill.—F  
 Raytheon Mfg. Co., Receiving & Cathode Ray Tube Operations, 55 Chapel St., Newton 58, Mass.—B,C,F,H,I  
 Sheldon Electric Co., 68-98 Coit St., Irvington, N.J.—F,I  
 Sonotone Corp., Elmsford, N.Y.—H,I  
 S.O.S. Cinema Supply, 602 W. 52 St., New York 19, N.Y.—C,I  
 S & R Electronics Inc., 136 Liberty St., New York, N.Y.—B,C,D,E,F,G,H,I  
 Standard TV Tube Corp., 700 Dryades St., New Orleans 12, La.—F  
 Stromberg-Carlson Co., 100 Carlson Rd., Rochester 3, N.Y.—C  
 Super Ear Products Co., 675 Merrick Rd., Lynbrook, N.Y.—H  
 Sylvania Electric Products, Inc., 1740 Broadway, New York 19, N.Y.—B,C,E,F,H,I  
 Taylor Tubes, Inc., 2312 Wabansia Ave., Chicago 47, Ill.—C  
 Tele-Ray Tube Co., 984 Saw Mill River Rd., Yonkers, N.Y.—E,F  
 Tel-O-Tube Corp. of America, 180 Van Riper Ave., E. Paterson, N.J.—F  
 Teltron Electric Co., 428 Harrison Ave., Harrison, N.J.—H,I  
 Texas Instruments, Inc., 6000 Lemmon Ave., Dallas 9, Tex.—C  
 Thomas Electronics, Inc., 118 9th St., Passaic, N.J.—F  
 Tube Service Corp., 2 Gaston Ave., Garfield, N.J.—F  
 Tung-Sol Electric, Inc., 95 8th Ave., Newark 4, N.J.—B,C,D,E,F,G,H,I  
 TV Hdw Mfg Co., 919 Taylor Ave., Rockford, Ill.—AA

Universal Vacuum Tube Co., 137 Alexander St., Yonkers 2, N.Y.—E,F  
 Waterman Products Co., 2445 Emerald St., Philadelphia 25, Pa.—E  
 Westinghouse Electric Corp., Electronic Tube Div., P.O. Box 284, Elmira, N.Y.—B,C,E,H

### 23—TUBE ACCESSORIES, CATHODE-RAY

Brightener ..... J  
 Connectors, 2nd anode ..... B  
 Kits, TV picture tube ext. harness ..... C  
 Magnets, TV centering ..... D  
 Magnets, TV focus ..... E  
 Magnets, TV ion trap ..... F  
 Masks ..... G  
 Mounting Brackets ..... H  
 Sleeves, picture tube ..... I

Anchor Plastics Co., 36-36 36th St., Long Island City 6, N.Y.—I  
 Anchor Products Co., 2712 W. Montrose Ave., Chicago 18, Ill.—C,J  
 Birnbach Radio Co., 145 Hudson St., New York 13, N.Y.—B,G  
 C B C Electronics Co., 2601 N. Howard, Philadelphia 33, Pa.—C,J  
 Clorostat Mfg. Co., Washington St., Dover, N.H.—F  
 Electronic Instrument Co., 84 Withers St., Brooklyn 11, N.Y.—C  
 General Cement Mfg. Co., 919 Taylor Ave., Rockford, Ill.—D,F  
 Haydu Bros., Box 1226, Plainfield, N.J.—B  
 Heppner Mfg. Co., P.O. Box 608, Round Lake, Ill.—D,E,F  
 Industrial Hardware Mfg. Co., 109 Prince St., New York 12, N.Y.—B  
 Mattison Radio & TV Co., 10 W. 181 St., New York 53, N.Y.—G  
 Modern Equipment Co., 17 Bleeker St., New York 12, N.Y.—G  
 Perfection Electric Co., 2635 S. Wabash Ave., Chicago 16, Ill.—D,F  
 Perma-Power Co., 4727 N. Damen Ave., Chicago 25, Ill.—J  
 Philco Corp., Tioga & C Sts., Philadelphia 34, Pa.—B,C  
 Philmore Mfg. Co., 113 University Pl., New York 3, N.Y.—B,D,F,H  
 Quam-Nichols Co., 234 E. Marquette Rd., Chicago 37, Ill.—E,F  
 Radio Corp. of America, Tube Div., 415 S. 5 St., Harrison, N.J.—E,F  
 Radio Supply & Eng'g. Co., 85 Selden Ave., Detroit 1, Mich.—B,E,F,G  
 Rad-Tel Tube Co., 115 Coit St., Irvington 11, N.J.—C,I  
 Stone City Machine & Tool Co., Bedford, Ind.—H  
 Tele-Plastics Co., 202 Broadway, Brooklyn, N.Y.—G  
 Vidair Electronics Mfg. Corp., 576 W. Merrick Rd., Lynbrook, N.Y.—B,C  
 Waldom Electronics Inc., 4625 W. 53 St., Chicago 22, Ill.—B,C,G  
 Waterman Products Co., 2445 Emerald St., Philadelphia 25, Pa.—H

### 24—WIRE & CABLE

Braid, copper ..... A  
 Cable, auto radio control ..... B  
 Cable, coaxial ..... C  
 Cable, intercom ..... D  
 Cable, microphone ..... E  
 Cable, phonograph ..... F  
 Cable, shielded ..... G  
 Cable, telephone ..... H  
 Cords, extension ..... J  
 Cords, lacing ..... K  
 Cords, line ..... L  
 Gauges, wire ..... M  
 Transmission line, TV ..... AB  
 Tubing ..... N  
 Wire, antenna ..... O  
 Wire, bus ..... P  
 Wire, grid ..... Q  
 Wire, grounding ..... R  
 Wire, guy ..... S  
 Wire, high-voltage ..... T  
 Wire, hook-up ..... U  
 Wire, litz ..... V  
 Wire, magnet ..... W  
 Wire, phonograph ..... X  
 Wire, test-lead ..... AA

Accurate Insulated Wire Corp., 25 Fox St., New Haven 13, Conn.—A,C,D,E,G,H,J,L,N,T,U,AA,AB

Aerolite Electronics, 507 26th St., Union City, N.J.—J,AA  
 A-K Mfg. Co., 115 S. Northwest Hwy., Barrington, Ill.—E,G,T,U,AA  
 Alden Products Co., 117 N. Main St., Brockton 64, Mass.—G,L,U,AA  
 All Channel Antenna Corp., 47-39 49th St., Woodside 77, N.Y.—O  
 Allied Industries, 2500 Woodland Ave., Louisville 10, Ky.—C,S,T  
 Alpha Wire Corp., 430 Broadway, New York 13, N.Y.—C,D,E,F,G,H,J,K,L,N,O,P,Q,R,S,T,U,X,AA,AB  
 American Electric Cable Co., 181 Appleton St., Holyoke, Mass.—E,G,H,U,AA  
 American Mercantile Co., 33 W. 42nd St., New York 36, N.Y.—V,W  
 American Phenolic Corp., 1830 S. 54th St., Chicago 60, Ill.—C,E,G,AB  
 Ames Mfg. Corp., 2750 Park Ave., New York 51, N.Y.—D,O,R,S,U,AB  
 Anaconda Wire & Cable Co., 25 Broadway, New York 4, N.Y.—T,W,AB  
 Anchor Products Co., 2712 W. Montrose Ave., Chicago 18, Ill.—F  
 Anchor Wire Corp., 183-16 Jamaica Ave., Jamaica 3, N.Y.—S  
 Ansonia Wire & Cable Co., 63 Main St., Ansonia, Conn.—C,E,T  
 Atlantic Wire & Cable Corp., 119-14 14th Rd., College Point, N.Y.—C,D,E,G,H,I,J,Z,AA,AB  
 Beam Instruments Corp., 350 5 Ave., New York 1, N.Y.—C,D,E,G,H  
 Belden Mfg. Co., 4647 W. Van Buren St., Chicago 44, Ill.—A,C,D,E,F,G,J,O,P,Q,R,U,V,W,AA  
 Birnbach Radio Co., 145 Hudson St., New York 13, N.Y.—A,B,C,D,E,F,G,H,J,K,L,N,O,P,Q,R,S,T,U,W,X,AA,AB  
 B. & M. Elec. Co., 838 4th Ave., Brooklyn 32, N.Y.—J,K,L  
 Brand & Co., Wm., North & Valley Sts., Willimantic, Conn.—C,D,E,F,G,N,O,T,U,AB  
 Buchen Co., R. J., P.O. Box 9, Bricelyn, Minn.—O,AB  
 Calcon Mfg. Co., Oakland Ave., Washington, Pa.—A,B,C,D,E,F,H,J,O,R,U,AB  
 Camburn Inc., 32-40 57 St., Woodside 77, N.Y.—O,S  
 Campbell X-Ray Corp., 110 Cummington St., Boston 15, Mass.—T  
 Capps & Co., Frank L., 20 Addison Pl., Valley Stream, N.Y.—E  
 Cass Machine Co., 691 Antoinette St., Detroit 2, Mich.—O,S,AB  
 C B C Electronics Co., 2601 N. Howard, Philadelphia 33, Pa.—E,G,J,L  
 Chester Cable Corp., Highview St., Chester, N.Y.—A,C,D,E,F,G,H,I,J,O,R,T,U,V,X,AA,AB  
 Clear Beam Antenna Corp., 21341 Roscoe Blvd., Canoga Park, Calif.—O,S  
 Clifton Conduit, Pierceway Div., 75 Montgomery St., Jersey City 2, N.J.—U  
 Coleman & Sons, D., 4515 Addison St., Chicago 41, Ill.—A,B,C,D,E,F,G,H,M,O,Q,R,U,V,W,X,AB  
 Colortone Electronics Inc., 100 Frank Rd., Hicksville, N.Y.—D  
 Co-Operative Industries, Chester, N.J.—A,G  
 Columbia Technical Corp., 5 E. 57th St., New York 22, N.Y.—C  
 Columbia Wire & Supply Co., 2850 Irving Park Rd., Chicago 18, Ill.—A,B,C,D,E,F,G,H,J,L,O,P,R,S,T,U,W,X,AA,AB  
 Commercial Products, 417 Main St., Toledo 5, Ohio—S  
 Consolidated Wire & Associated Cos., 1635 S. Clinton St., Chicago 16, Ill.—A thru AB  
 Copperweld Steel Co., Wire & Cable Div., 9th & Allegheny Aves., Glassport, Pa.—O,R,S  
 Cornish Wire Co., 50 Church St., New York 7, N.Y.—D,E,F,G,J,O,T,U,X,AA,AB  
 Dean Sales Co., 425 Devoe Ave., New York 60, N.Y.—X  
 DuMont Labs. Inc., Allen B., Mobile Comm. Dept., 1500 Main St., Clifton, N.J.—C,AB  
 Eagle Electronics Corp., P.O. Box 775, Meriden, Conn.—E,G,U,AB  
 Essex Wire Corp., 1601 Wall St., Ft. Wayne 6, Ind.—B,D,E,F,J,L,U,W,AA  
 Federal Telephone & Radio Co., 100 Kingsland Rd., Clifton, N.J.—C,D,E,G,H,O,T,U,AB  
 Fenton Co., 15 Moore St., New York 4, N.Y.—C,E,O,R,S,AB  
 Flexo Wire Div., Copperweld Steel, Oswego, N.Y.—A,O,U  
 Fretco Inc., 406 N. Craig St., Pittsburgh 13, Pa.—N,O,R,S,AB  
 Gee-Lar Mfg. Co., 819 Elm St., Rockford, Ill.—L  
 General Cable Corp., 420 Lexington Ave., New York 17, N.Y.—U,W  
 General Cement Mfg. Co., 919 Taylor Ave., Rockford, Ill.—A,K,O,R,S,U,W,AA,AB  
 General Insulated Wire Works, 69 Gordon Ave., Providence, R.I.—C,E,H  
 Gosnet Co., 801 S. Main St., Burbank, Calif.—S  
 Good, Inc., Don, 1014 Fair Oaks Ave., S. Pasadena, Calif.—D,H,N,O,T,U,AA,AB  
 Graybar Electric Co., 420 Lexington Ave., New York 17, N.Y.—C,E,AB  
 Haydu Bros., Box 1226, Plainfield, N.J.—Q  
 Hemingway & Bartlett, 500 5 Ave., New York, N.Y.—K  
 Hi-Lo TV Antenna Corp., 3540 N. Ravenswood Ave., Chicago 13, Ill.—O,AB

Hitemp Wires Inc., 26 Windsor Ave., Mineola, N.Y.—C,G,U,V,W  
 Hudson Wire Co., Winsted Div., Winsted, Conn.—V,W  
 I. E. Mfg., 325 N. Hoyne Ave., Chicago 12, Ill.—N,O,R,S  
 Imperial Radar & Wire Corp., 1661 Boone Ave., New York 60, N.Y.—C,D,E,F,H,J,L,M,N,O,P,Q,R,S,T,U,V,W,AA  
 Insuline Corp. of America, 186 Granite St., Manchester, N.H.—O,R,S,AA  
 Jersey Specialty Co., Burgess Place, Mountain View, N.J.—A,O,U,W,AB  
 JFD Mfg. Co., 6101 16th Ave., Brooklyn 4, N.Y.—R,S  
 Kellogg Switchboard & Supply Co., 79 W. Monroe St., Chicago 3, Ill.—A,D,H,K,U  
 Lenx Electric Co., 1751 N. Western Ave., Chicago 47, Ill.—V  
 Lieco, Inc., 147 Ocean Ave., Lynbrook, N.Y.—C,AB  
 Miller Electric Co., 120 Main St., Pawtucket, R.I.—J  
 Modern-Aire Mfg. Corp., 4436 W. Roosevelt Rd., Chicago 24, Ill.—R,S  
 Modern Wire Co., 39-30 Review Ave., Long Island City 1, N.Y.—O,R,S  
 Mohawk Plastic Corp., 320 River St., Fitchburgh, Mass.—E,G,H,U,AB  
 Morton Electronics Corp., Chester, 10 St. & Morton Ave., Chester, Pa.—J  
 New England Electrical Works, 365 Main St., Lisbon, N.H.—G,V,W  
 Nichols Wire & Aluminum Co., 1725 Rockingham Rd., Davenport, Iowa—S  
 Packard Electric Div., General Motors Corp., Warren, Ohio—J

Parker Metal Goods Co., 161 Summer St., Worcester 8, Mass.—O,R,S  
 Phalo Plastics Corp., 25 Foster St., Worcester 8, Mass.—C,D,E,F,G,H,L,O,T,U,AB  
 Phelps Dodge Copper Products Corp., 40 Wall St., New York 5, N.Y.—C,G,T,W,AB  
 Philco Corp., Tioga & C Sts., Philadelphia 34, Pa.—R,S,AB  
 Plastoid Corp., 42-61 24th St., Long Island City 1, N.Y.—C,D,E,F,G,H,U,X,AB  
 Plymouth Electronics Corp., 50 Kingsbury St., Worcester 3, Mass.—S  
 Radio Supply & Eng'g. Co., 85 Selden Ave., Detroit 1, Mich.—S,T,U,X,AA  
 Radix Wire Co., 26260 Lakeland Blvd., Cleveland, Ohio—O  
 Ray Mfg. Co., 441 Summit St., Toledo 4, Ohio—S  
 Rego Insulated Wire Co., 830 Monroe St., Hoboken, N.J.—AB  
 Reiner Electronics Co., Easton, Pa.—AA  
 Revere Corp. of America, 845 N. Colony Rd., Wallingford, Conn.—G,U  
 Royal Electric Co., 95 Grand Ave., Pawtucket, R.I.—H  
 Runzel Cord & Wire Co., 4727 Montrose Ave., Chicago 41, Ill.—G,U  
 Saxton Products, Inc., 2101 Grand Concourse, Bronx 53, N.Y.—O,R,AB  
 Sequoia Process Corp., 871 Willow St., Redwood City, Calif.—C,D,E,G,H,T,U  
 Sittler Corp., 18 No. Ada St., Chicago 7, Ill.—R,AA  
 South River Metal Prod. Co., 377 Turnpike, S. River, N.J.—R,S

Superior Insulated Wire Co., W. Haverstraw, N.Y.—U,AB  
 Tele-Matic Industries, 16 Howard Ave., Brooklyn 21, N.Y.—J  
 Thomas & Betts, 36 Butler St., Elizabeth 1, N.J.  
 Union Plastics Corp., 1627 Paterson Plank Rd., Secaucus, N.J.—C,E,G,O,U  
 U. S. Wire & Cable Corp., Progress & Monroe Sts., Union, N.J.—C,E,G,J,T,AA  
 Utilities Service Co., 1 Pine St., Allentown, Pa.—S  
 Victor Electric Wire & Cable Corp., 64 Ackerman Ave., Clifton, N.J.—E,J,U,AB  
 Waldom Electronics Inc., 4625 W. 53rd St., Chicago 32, Ill.—L  
 Walsco Electronics, 3602 Crenshaw Blvd., Los Angeles 16, Calif.—S  
 Webster Electric Co., 1900 Clark, Racine, Wis.—D  
 Wheeler Insulated Wire Co., 150 E. Aurora St., Waterbury 20, Conn.—V,W  
 Whitaker Cable Corp., 1301 Burlington Ave., N. Kansas City 16, Mo.—G,T,U  
 Whitney Blake Co., 1565 Dixwell Ave., New Haven 14, Conn.—C,D,E,G,H,J,L,R,AA  
 Wickwire Spencer Steel, 575 Madison Ave., New York 22, N.Y.—S  
 Wind Turbine Co., E. Market St. & Penna. R.R., W. Chester, Pa.—S  
 Witelrad Electrical Mfg. Inc., 74 Pulaski St., Stamford, Conn.—J,L  
 Wright Steel & Wire Co., G. F., 243 Stafford St., Worcester 3, Mass.—S

# 1955 TECHNICIAN BUYERS DIRECTORY

## Brand & Trade Name Index

The brand names of service and replacement products, component parts, equipment, instruments, and materials in the radio-TV-electronic service industry are listed alphabetically, with the name of the manufacturer. The address of

the manufacturer whose brand or trade name is listed may be obtained by referring to the Alphabetical Listing of Manufacturers, beginning on page 108.

- |   |   |   |  |  |   |
|---|---|---|--|--|---|
| ACCOLITE<br>Accurate Insulated Wire               | ADLAKE<br>Adams & Westlake                        | AMERICAN BEAUTY<br>American Electrical Heater Company | AUDET<br>Centralab Div., Globe Union, Inc. | BELAB<br>Browne Electronics                  | BOW<br>Radio Merchandise                        |
| ACCPRENE<br>Accurate Insulated Wire               | ADVANCE<br>Acme Battery                           | AMERITE TV TOWERS<br>American Tower Co.               | AUDIODISCS<br>Audio Devices, Inc.          | BELFONE<br>Bell Sound Systems, Inc.          | BOY-MAR<br>Electrical-Service Co.               |
| ACCTHERM<br>Accurate Insulated Wire               | AEROCOX<br>Aerovox Corp.                          | AMERSTRAND<br>Utilities Service                       | AUDIOFILM<br>Audio Devices, Inc.           | BESTENNA<br>Beskraft Products Co.            | BRADLEYOMETER<br>Allen-Bradley Co.              |
| ACCWIRE<br>Accurate Insulated Wire                | AERODYNAMIC<br>Radio Corp. of America             | AMPEC<br>Centralab Div., Globe Union, Inc.            | AUDIO POINTS<br>Audio Devices, Inc.        | BIG DAN<br>Danforth Mfg. Co.                 | BRADLEYUNITS<br>Allen-Bradley Co.               |
| ACME<br>Aerovox Corp.                             | AEROFILM<br>Aerovox Corp.                         | AMPHENOL<br>American Phenolic                         | AUDIOTONE<br>Peschel Electronics           | BIG INCH<br>JFD Mfg. Co.                     | BRANDES<br>Cannon Co., C. F.                    |
| ACME<br>Trimn, Inc.                               | AEROFLEX<br>Anchor Plastics Co.                   | AMCON<br>Ohmite Mfg. Co.                              | AUTOBOOSTER<br>Industrial Television       | BIG JACK<br>Kay-Townes Antenna               | BRELSCO<br>British Electronic Sales             |
| ACOUSTALLOY<br>Electro-Volco, Inc.                | AEROLENE<br>Aerovox Corp.                         | AMVAC<br>American Vacuum Prods                        | AUTO COUPLER<br>Industrial Television      | BIRAC<br>Bimbach Radio Co.                   | BRENKERT<br>Radio Corp. of America              |
| ACROSOUND<br>Acro Products Co.                    | AEROLITE<br>Aerovox Corp.                         | ANGELUS<br>Don Good, Inc.                             | AUTOPOSITIONER<br>Collins Radio Co.        | BIRCH<br>Boetsch Bros.                       | BRIDGAMATIC<br>S.O.S. Cinema Supply             |
| ACROVISION<br>Acro Products Co.                   | AEROSENSOR<br>Roanwell Corp.                      | ANTENAPLEX<br>Radio Corp. of America                  | AUTOTUNE<br>Collins Radio Co.              | BIRFLENE<br>Bimbach Radio Co.                | BRONZIDITE<br>JFD Mfg. Co.                      |
| ACTO-Tenna<br>Acme Tool & Specialties             | AEROTEMP<br>Aerovox Corp.                         | ANTI-STATIC<br>Merix Chemical Co.                     | AVCOELECTRIC<br>British Electronic Sales   | BIRMINGHAM SOUND<br>British Electronic Sales | BROWN DEVIL<br>Ohmite Mfg. Co.                  |
| ADAPEC<br>Centralab Div., Globe Union, Inc.       | AIRBOY<br>Mitchell Industries Inc.                | ARCOELECTRIC<br>British Electronic Sales Co.          | AVIGATOR<br>Mitchell Industries Inc.       | BIRCH<br>Boetsch Bros.                       | BRUNSWICK<br>Decca Records                      |
| ADAPHONE<br>Fenton Co.                            | AIR-COOLED<br>JFD Mfg. Co.                        | ARHCO<br>American Radio Hardware Co.                  | AXIOHM<br>Ward Leonard Electric            | BIRMINGHAM SOUND<br>British Electronic Sales | BJ<br>British Electronic Sales                  |
| ADAPHONE PILLOW<br>Fenton Co.                     | AIR-CORE<br>American Phenolic                     | ARISTOCRAT<br>Electro-Voice Inc.                      | BALAC<br>Canant Laboratories               | BLACK BEAUTY<br>Sprague Electric Co.         | BLACK BEAUTY<br>Sprague Electric Co.            |
| ADASHAFT<br>Centralab Div., Globe Union, Inc.     | AIRLEAD<br>Don Good, Inc.                         | ARISTOCRAT<br>Electro-Voice Inc.                      | BALINE<br>JFD Mfg. Co.                     | BLACK & WHITE<br>Tru-Pine Co.                | BLAUPUNKT<br>Pickans Import                     |
| AD-A-SWITCH<br>Clorostat Mfg. Co.                 | AKRA<br>Shallcross Mfg. Co.                       | ARISTOCRAT<br>Electro-Voice Inc.                      | BANTAM<br>Aerovox Corp.                    | BLUE JACKET<br>Sprague Electric Co.          | BLUE POINT<br>Astron Corp.                      |
| ADCO ELECTRONICS<br>Advance Electronics Co.       | ALLIED<br>Scranton Aluminum Mfg. Co.              | ARISTOCRAT<br>Trio Mfg.                               | BARONET<br>Electro-Voice, Inc.             | BLUE-POINT<br>Snap-on Tools                  | BLUE SHAFT<br>Centralab Div., Globe Union, Inc. |
| ADCOLA<br>British Electronic Sales                | ALLIED DINTER<br>Allied Eng'g., Allied Int'l Inc. | ARISTOCRAT<br>Turner Co.                              | BASEBALL<br>Antenna Specialists            | B. O. ELIMINATOR<br>Perfection Electric      | BOOST-A-VOLT<br>Workman TV, Inc.                |
| ADD-A-UNIT<br>Blender-Tongue Labs.                | ALPHLEX TUBING<br>Alpha Wire Corp.                | ARKAY<br>Radio Kits Inc.                              | BATTERY-SCOPE<br>McColpin-Christie         | BORO-FILM<br>Aerovox Corp.                   | BOROMM<br>Shallcross Mfg.                       |
| ADDIPHON<br>Metronics, Inc.                       | ALUMAST<br>Channel Master                         | ATLANTICABLE<br>Atlantic Wire & Cable                 | BATRYPOWER<br>Radiart Corp.                | BORON X<br>Technicraft Co.                   | BO-TI<br>Fretco Inc.                            |
| ADDITIVE DRIVE<br>Electro-Voice Inc.              | AMBERYL<br>Voco Products Co.                      | ATOM<br>Sprague Electric Co.                          | BAT WING<br>Telrex Inc.                    |  |   |
| ADELCO<br>Advance Electronics Co.                 | AMBIRITE<br>Micamold Radio Corp.                  | ATTIC-TENNA<br>Control Electronics                    | BEAMAJUSTER<br>Perfection Electric         |  |   |
| ADJUSTA-V<br>Radio Merchandise Sales, Inc.        | AMCON<br>American Condenser Co.                   | ATR<br>American Television & Radio Co.                | BEAMED POWER<br>ROTARIES                   |  |   |
| ADJUST-A-VOLT<br>Standard Electrical Products Co. | AMECO<br>American Electronics                     | AUDAX<br>Audak Co.                                    | BEE LINE<br>Radio Merchandise Sales, Inc.  |  |   |

- CAP-EX**  
Vidair Electronics  
Mfg. Co.
- CARBONFILM**  
Aerovox Corp.
- CARB-OHM**  
Phaostron Co.
- CARBOMITE**  
Continental Carbon Inc.
- CARBOIT**  
A P Electro Lab.
- CARBON-TET**  
Kerdon Chemical Co.
- CARDAX**  
Electro-Voice Inc.
- CARDYNE**  
Electro-Voice Inc.
- CARTON**  
Hudson Lamp Co.
- CARRILON DYNAMIC**  
Miller Mfg. Co., M. A.
- CARTRN-DRY**  
Pyramid Electric Co.
- CARTWHEEL**  
Aerovox Corp.
- CASCADE**  
Industrial Television
- CASCADE YAGI**  
JFD Mfg. Co.
- CASTOHM**  
Shalleross Mfg. Co.
- CATCH THE BEAM**  
Bhend Electrical
- CAVALIER RADIO**  
Hinners-Galanek Radio
- CDP**  
Electro-Voice Inc.
- CEEC**  
Calbest Eng'g &  
Electronics Co.
- CEE-CORS**  
Permoflux Corp.
- CELAB**  
Clark Electronic Labs.
- CENTILATOR**  
Kay Electric Co.
- CENTRATHENE**  
Centralab Div.,  
Globe Union, Inc.
- CEN-TRI-CORE**  
Alpha Metals, Inc.
- CENTURY**  
American Standard TV  
Tube
- CENTURY**  
Electro-Voice Inc.
- CERAMELEX**  
Erie Resistor Corp.
- CERAMICON**  
Erie Resistor Corp.
- CERA-MITE**  
Sprague Electric Co.
- CEROC**  
Sprague Electric Co.
- CETRA-SORIA**  
Capitol Records
- CETRON**  
Continental Electric Co.
- CHALLENGER BY BOGEN**  
Bogen Co., David
- CHALLENGER**  
Turner Co.
- CHALLENGER**  
Welco Mfg. Co.
- CHALLENGER DELUXE**  
Rek-O-Kut Co.
- CHALLENGER RECORDER**  
Rek-O-Kut Co.
- CHAMPION**  
Channel Master
- CHAMPION**  
Permoflux Corp.
- CHANALYST**  
Radio Corp. of America
- CHANGE-A-CYCLE**  
Carter Motor Co.
- CHANGE-A-VOLT**  
Carter Motor Co.
- CHANNEL AUTOBOOSTER**  
Industrial Television
- CHANNEL CHIEF**  
Barb City Industries
- CHANNEL KING**  
Armac Co.
- CHANNEL KING**  
Marjo Tech Products
- CHARGALYZER**  
McColpin-Christie
- CHARGICATORS**  
Hickok Electrical  
Instrument Co.
- CHARGOMATIC 88**  
Electric Cord Co.
- CHASSIS CARRIER**  
Barb City Industries
- CHASSIS SUPPORT**  
Barb City Industries
- CHEMIFLEX**  
Technicraft Co.
- CHEMIGLAS**  
Technicraft Co.
- CHEMIPREG**  
Technicraft Co.
- CHICAGO**  
Klein & Sons
- CHITRAN**  
Chicago Standard  
Transformer Corp.
- CHROMABAR**  
Kay Electric Co.
- CHROMATIC**  
Radio Merchandise
- CHROMATRON**  
Chromatic Television
- CHROMOLYTIC**  
Micamold Radio Corp.
- CIMALOHM**  
Clima Corp.
- CINELITE**  
Mote-Richardson Co.
- CINEMA**  
Aerovox Corp.
- CINEMAPHONE**  
S.O.S. Cinema Supply
- CINEVISION**  
Calbest Eng'g &  
Electronics Co.
- CIRCLE "B"**  
Vocalline Co. of  
America
- CIRCLE-VANE**  
Ward Products Corp.,  
Div. The Gabriel Co.
- CIRCULTRON**  
Electro-Voice, Inc.
- CIRCON**  
Universal Circuit Control
- CIR-Q-LINE**  
Atlantic Wire & Cable  
C LINE
- Clarostat Mfg. Co.**
- CLAMPIPE GROUND  
CLAMP**  
Mueller Electric Co.
- CLARKSTAN**  
Pacific Transducer
- CLARO**  
Clarostat Mfg. Co.
- CLEAR-PIX**  
Superex Electronics
- CLEAR VUE**  
A P Electro Lab
- CLETRON**  
Cleveland Electronics
- CLEVITE**  
Transistor Products Inc.
- CLIPPER**  
Winegard Co.
- CLIX**  
British Electronic Sales
- CLOCK TIMER**  
International Register
- CLOVER-V-BEAM**  
Telrex, Inc.
- COBREFLEX**  
Universal Loudspeakers
- CO-LATEVAL**  
Finney Co.
- COLLINS 37M**  
Collins Radio Co.
- COLORSCOPE**  
Simpson Electric Co.
- COLOR TOPS**  
Trico Fuse Mfg.
- COMET**  
Astron Corp.
- COMETTE**  
Webster Electric Co.
- COMMANDAIR**  
JFD Mfg. Co.
- COMMERCIAL**  
Trim, Inc.
- COMMUNO-PHONE**  
Bogen Co., David
- COMPENTROL**  
Centralab Div.,  
Globe Union, Inc.
- COMPETITOR**  
Turner Co.
- COMPOUND DIFFRACTION  
PROJECTOR**  
Electro-Voice, Inc.
- CONCERT-LINE**  
Shure Bros.
- CONCERTO**  
Jensen Mfg.
- CONCERTONE**  
Berlant Concertone
- CONFIDENCER**  
Roanwell Corp.
- CONICAL-V-BEAM**  
Telrex Inc.
- CONQUEROR**  
Neal Electronic Co.
- CONTACTENE**  
Walco Electronics
- CONTENNA**  
Conn. Telephone &  
Electric Corp.
- CON-YAGI**  
Tennalab
- COPPERCLAD**  
American Phenolic  
Corp.
- COPPEROXIDE**  
Bradley Laboratories  
Inc.
- COPROX**  
Bradley Laboratories  
Inc.
- CORONATION**  
Interelectronics Corp.
- CORONET**  
Camburn, Inc.
- CORONOL WIRE AND  
CABLE**  
General Electric Co.
- CORRIB**  
Ohmite Mfg. Co.
- CORSAIR**  
JFD Mfg. Co.
- CO-TRAP**  
Skyline Mfg. Co.
- COUPLATE**  
Centralab Div.,  
Globe Union, Inc.
- CRAFTSMEN**  
Radio Craftsmen Corp.
- CRESTBRITE**  
Crest Transformer
- CRESTROL**  
Crest Transformer
- CRESTWOOD**  
Daystrom Electric Corp.
- CRL**  
Centralab Div.,  
Globe Union, Inc.
- CROLITE**  
Crowley & Co.,  
Henry L.
- CROLOY**  
Crowley & Co.,  
Henry L.
- CRONAME**  
Waldom Electronics Inc.
- CROWLEY**  
Aerovox Corp.
- CROWN**  
Int'l Radio
- CTS**  
Chicago Telephone  
Supply
- CUE TAPE**  
Rangertone Inc.
- CUNNINGHAM**  
Radio Corp. of America
- CUSTOM**  
Phaostron Co.
- CUSTOM FOUR HUNDRED**  
Stromberg-Carlson Co.,  
Sound Equip. Div.,
- DIRECT-DRIVE**  
Shure Bros.
- DIRECTRON**  
Miller Co., Sanford
- DIRECTPHONE**  
Snyder Mfg. Co.
- DIRON**  
Peerless Products
- DISCOHM**  
Ward Leonard Electric
- DIVIDOHM**  
Ohmite Mfg. Co.
- DON'T IMPROVISE RTV-IZE**  
Clarostat Mfg.
- DREADNAUGHT**  
Wall Mfg. Co., P.
- DROP-LOCK**  
South River Metal Prod.
- DUAL-A**  
Duala Company
- DUAL-MATCH**  
Mosley Electronics
- DUARC**  
Mote-Richardson Co.
- DUETTE**  
Jensen Mfg. Co.
- DUNCO**  
Struthers-Dunn
- DUO-BAND**  
Telrex Inc.
- DUOBEAM**  
Antenna Products
- DUODISC**  
Duotone Co.
- DUOFONIC**  
Paraplegics Mfg.
- DUO-MOUNT**  
South River Metal
- DUO SEAL**  
Welch Mfg. Co., W. M.
- DUOSONIC**  
Sonic Industries
- DUO-VOLT**  
Carter Motor Co.
- EBCO**  
Electronic Beam Corp.
- EBCOR**  
Ed-Berl Products
- ECHOPHONE**  
Hallcrafters Co.
- ECONO-SWITCH**  
Centralab Div.,  
Globe Union, Inc.
- EDISWAN**  
British Electronic Sales
- EICO**  
Electronic Instrument
- 8-BALL**  
Ward Products Corp.,  
Div. The Gabriel Co.
- EIMAC**  
Eitel-McCullough, Inc.
- EKOTAPE**  
Webster Electric Co.
- EL**  
Electronics, Inc.
- ELCOR**  
Eagle Electronics
- ELECTRACER**  
Special Products
- ELECTRALOY**  
Circon Component Co.
- ELECTRICORD**  
Pacific Electriccard Co.
- ELECTRO**  
Electro Products  
Laboratories
- ELECTRO-GRAPHIC**  
Precise Measurements
- ELECTROLOX**  
Schauer Mfg. Corp.
- ELECTRONAMIC**  
Precision Apparatus Co.
- ELECTRO-WIFE**  
Duotone Co.
- ELECTROX**  
Schauer Mfg. Corp.
- ELECTROWRITER**  
Pioneer Electric and  
Research Corp.
- ELEKTRAN**  
Ward Products Corp.,  
Div. The Gabriel Co.
- ELIM-A-TRACE**  
Vidair Electronics  
Mfg. Co.
- ELINCO**  
Electric Indicator Co.
- ELITE**  
Camburn Inc.
- ELPHCO**  
Electro-Physics
- EMC**  
Electronic  
Measurements Corp.
- EMICO**  
Electro Mechanical  
Instrument
- ENCORE**  
Technical Tape Corp.
- ENTISER**  
Master Electronics & TV
- ESICO**  
Electric Soldering Iron
- ESICOLUGER**  
Electric Soldering Iron
- ESL**  
Electro-Sonic Labs.
- E-THERM**  
Sangamo Electric Co.
- EVERLOCK**  
Thompson-Bremer
- EVER-QUIET**  
Chemical Electronic  
Eng'g. Inc.
- EVEREADY**  
National Carbon Co.,
- EVER-KLEER**  
Chemical Electronic  
Eng'g. Inc.
- EXACTOHM**  
Workman TV, Inc.
- EXPANDIT**  
Tele-Ex-Pand Corp.
- EXPRESS CONTROLS**  
Centralab Div.,  
Globe Union, Inc.
- EYE WITNESS**  
Radio Corp. of America
- E-Z**  
Ideal Industries, Inc.
- E-Z-BEE**  
Spiriting Products Co.
- EZC**  
Kleer-Vue Mfg. Co.
- E-Z WIRE STRIPPERS**  
Ideal Industries, Inc.
- FAN FARE**  
Fannon Electric Co.
- FASTATCH**  
Centralab Div.,  
Globe Union, Inc.
- FATHOMETERS**  
Raytheon Mfg. Co.
- FB-7**  
National Co.
- FEATHERIDE**  
Webster Electric Co.
- FEATHERWEIGHT**  
Trim, Inc.
- FEN-TONE**  
Fenton Co.
- FENTUBE-AIRSPACED**  
Fenton Co.
- FENWIRE**  
Fenton Co.
- FERRI-CHOKES**  
Superex Electronics
- FERRI-LOOPSTICK**  
Superex Electronics
- FG-EZ**  
Fretz Gross Co.
- FIBRON PLASTIC TAPE**  
Irvington Varnish &  
Insulator Co.
- FIDELIS**  
V-M Corp.
- FIDELITONE**  
Permo, Inc.
- FIDELITY X-UAR  
STRIPPER**  
Fidelity Chemical
- 50 LINE**  
Walco Electronics
- FILMITE**  
Sprague Electric Co.
- FILM X**  
Good-All Elec. Mfg. Co.
- FILPEC**  
Centralab Div.,  
Globe Union, Inc.
- FILPLATE**  
Centralab Div.,  
Globe Union, Inc.
- FILTERETTE**  
Deutschmann Corp. T.
- FILTERIZED**  
Deutschmann Corp. T.
- FILTEROL**  
Sprague Electric Co.
- FIL-TEST**  
Vidair Electronics
- FIL-TRAN**  
Vidair Electronics
- FINCO**  
Finney Co.
- FINNFLEX**  
Finn & Co., T. R.
- 555 MULTIMETER**  
Phaostron Co.
- FIXED VITROHM**  
Ward Leonard Electric
- FIXTOHM**  
Campbell Industries
- FIXTOHM**  
Clarostat Mfg. Co.
- FLAMENOL WIRE  
AND CABLE**  
General Electric Co.
- FLASH**  
A P Electro Lab.
- FLASH**  
Phillips Mfg. Co.
- FLATOHM**  
Centralab Div.,  
Globe Union, Inc.
- FLEETWAY**  
Conn. Telephone &  
Electric Corp.
- FLEETWOOD**  
Conrac Inc.
- FLEXOHM**  
Clarostat Mfg. Co.
- FLEXITUBE**  
Walco Electronics Cor
- FLEXSHIELD**  
American Electric Cable
- FLUSHLITES**  
Drake Mfg. Co.
- FLUTTER METER**  
Amplifier Corp. of  
America
- FLUXCOTE**  
London Chemical
- F M E**  
Federal Mfg. & Eng'g.
- FOCALIZER**  
Quam Nichols Co.
- FONOFLOUID**  
Ronette Acoustical  
Corp.
- FORMEX**  
Fidelity Chemical  
Products
- FORMEX WIRE AND  
CABLE**  
General Electric Co.
- FORMULA 50**  
Constad Laboratories
- FORMVAR**  
Phelps Dodge Copper  
Products
- FORTISSIMO**  
Permoflux Corp.
- FRAWLEY**  
Hotel Radio Mfrs.
- FRETARAY**  
Fretco Inc.
- FRETLINE**  
Fretco Inc.
- FRINGE BEAM**  
Neal Electronic Co.
- FRINGE LEADER**  
Radio Merchandise
- FSK**  
National Co.
- FSL**  
National Co.



**BRAND & TRADE NAME INDEX**



FSR National Co.  
STV Workman TV, Inc.  
FUSE-LITE Aiden Products Co.  
FUSTRON Bussmann Mfg. Co.  
FUSE-O-LET Hilo TV Antenna Corp.  
FUTURAMIC Channel Master  
FUZ-LOX D & M Products  
FUZOHM Clarostat Mfg. Co.

GAROD RADIO Majestic Radio & TV  
G-C General Cement Mfg. Co.  
GEMCO Great Eastern Mfg. Co.  
GENELEX British Industries Corp.  
GENE-MITE Allied Eng'g Div., Allied Int'l Inc.  
GENEMOTOR Carter Motor Co.  
GENESCOPE Simpson Electric Co.  
GENIE-LIFT-A-DOR Alliance Mfg. Co.  
GEORGIAN Electro-Voice, Inc.  
GI General Industries Company  
GIBSON GIRL Robins Industries  
GLAS-GUIDE Lee Laboratories  
GLASOHM Clarostat Mfg. Co.  
GLASSEAL Pyramid Electric Co.  
GLOBE TROTTER Radio Corp. of America  
GLO-MELT Wasco Electric Products  
GOLD CUP Carboneau Industries  
GOLDEN RIG JFD Mfg. Co.  
GOLDEN THROAT Radio Corp. of America  
GOLDEN WAND Pearlless Products  
GOLD SHIELD JFD Mfg. Co.  
GOODLINE Don Good, Inc.  
GOODMAN Rockbar Corp.  
GP Erie Resistor Corp.  
GRACOIL Gramer-Halldorson Transformer  
GRADIENT Shure Bros.  
GREEN BAND Todd-Tran Corp.  
GREENOHMS Clarostat Mfg. Co.  
GRIP A P Electro Lab.  
GRIP-SPINTITE Stevens Walden Inc.  
GROMMES Precision Electronics  
GYRO-TENNA Delson Mfg. Corp.

HABIRSHAW Phelps Dodge Copper  
HALLDORSON Gramer-Halldorson  
HALLOWELL Standard Pressed Steel  
HALOLIGHT Sylvania Electric  
HAMTENNA Tennalab  
HAN-D-OHM Climo Corp.  
HANDY Akro-Mills  
HARMIC Wall Mfg. Co., P.  
HARMONIC Dean Sales  
HAVEN'S Klein & Sons, M.  
HAZ-BIN Akro-Mills  
HD-A SWITCH Clarostat Mfg. Co.  
HEARD EVERYWHERE Lowell Mfg. Co.  
HEATHKIT Heath Co.  
HFS National Co.

HI Holub Industries, Inc.  
HI-BALL Radiart Corp.  
HI-FARAD Aerovox Corp.  
HI-FYRE Master Electronics & TV  
HI-KAPS Centralab Div., Globe Union, Inc.  
HIK Erie Resistor Corp.  
HI-K CERAMICON Erie Resistor Corp.  
HI-LO Radiart Corp.  
HIPOWER Radiart Corp.  
HI-Q Aerovox Corp.  
HI-Q Johnson Co., E. F.  
HIS MASTER'S VOICE Radio Corp. of America  
HI-STAB Erie Resistor Corp.  
HI-TEMP Consolidated Wire & Associated Companies  
HI-TOP Tele-Ex-Pand Corp.  
HI-VISION Modern Equipment Co.  
HI-VO-KAPS Centralab Div., Globe Union, Inc.  
HI-VOLT VOLTMETER Industrial Devices Inc.  
HOBBY-TIME Western Coil & Electrical Co.  
HOLO Don Good, Inc.  
HONEYWELL MERCURY Micro Switch Div., Minn.-Honeywell Regulator Co.  
HORIZON National Co.  
HORTON SPEAKERS Becker Electronics Mfg. Corp.  
HOUSE OF RESISTORS Clarostat Mfg. Co.  
HOWDY DOODY Shura-Tone Products  
HOYT METERS Burton-Rogers Co.  
HP CERAMICS Aerovox Corp.  
HQ Hammarlund Mfg. Co.  
HRO National Co.  
HUBBELLOCK Hubbell Inc., Harvey  
HUDSON Oxford Electric Corp.  
HUMDINGER Clarostat Mfg. Co.  
HUMIDITITE Sangamo Electric Co.  
HUSH Chemical Electronic  
HYLON Good, Don  
HY/LOW Stevens Products Inc.  
HY-MET Astron Corp.  
HYPASS Sprague Electric Co.  
HYPEX Jensen Mfg. Co.  
HYTEN Good, Don  
HYVOL Aerovox Corp.

ICA Insuline Corp. of America  
ICONIC Altec Lansing Corp.  
IHC Illinois Condenser Co.  
IHT Illinois Condenser Co.  
IMP Carter Parts Co.  
IMP Pyramid Electric Co.  
IMPERIAL Jensen Mfg. Co.  
IMPERIAL Skyline Mfg. Co.  
IMPERIAL Walco Electronics  
IMS RECORD SPRAY Silicone Spray Products  
IN-A-GRIP Stevens Walden Inc.  
INCREDUCTOR C. G. S. Laboratories  
INDCO OIL Industrial Condenser

INDOOR TENNA Spiraling Products  
INDUCT-O-PHONE Fenton Co.  
INDUCTRONICS Edwin I. Guthman Co.  
INDUCTUBE Drake Co., R. L.  
INDUCTUNERS Mallory & Co., P. R.  
INDUSTRAVOX Electronic Eng. Co.  
INLINE American Phenolic  
IN-RES-CO Instrument Resistors Co.  
IN-STA-COM Marine View Electronics  
INTELIN Federal Telephone and Radio Co., Div. of IT&T  
INTERCO Intercontinental Industries, Inc.  
INTERLOCK Hubbell Co., Harvey  
INTER-MATIC International Register Co.  
INVADER Ward Products Corp.  
IRC Int'l Resistance Co.  
IRISH ORRadio Industries Inc.  
IRON GRIP Equiplo Div. Aurora  
IRV-O-VOLT Irvington Varnish & Insulator Co.  
ISI Int'l Scientific Industries  
IT'S THE CATS WHISKERS T-V Products Co.

JACKKNIFE Radio Merchandise Sales  
JACKSON Vulcan Electric Co.  
JAVABOND Javex  
JEC Jarvis Electronics  
JECO Jarvis Electronics Div., Speer Carbon Co.  
JEFFERSON Atlantic Electronics Corp.  
JET Carboneau Industries  
JETENNA JFD Mfg. Co.  
JETOMIC JFD Mfg. Co.  
JET PROBE Workman TV, Inc.  
JETROL Allied Eng'g Div., Allied Int'l Inc.  
JIFFY Akro-Mills  
JIFFY-TENNA Delson Mfg. Corp.  
JK PRODUCTS James Knights Co.  
J-S-C Jersey Specialty Co.

KANTARKS Trico Fuse Mfg. Co.  
KATOLIGHT Kato Engineering  
KEI Kurman Electric Co.  
KENCO Kenwood Eng'g Co.  
KILO Kay Electric Co.  
KINE-LITE Vidalre Electronics  
KINE-TEST Vidalre Electronics  
KIN-EX Vidalre Electronics  
KLEE NEEDLE Robins Industries  
KLEER-IT Superelex Electronics  
KLEIN-KOAT Klein & Sons, M.  
KLEIN-KORD Klein & Sons, M.  
KLIP South River Metal  
KLIPLOK Trico Fuse Mfg. Co.  
KLIPSCHORN Klipsch & Associates  
KLIPZON United Technical Labs.  
K-LOK Erie Resistor Corp.

KNIGHT Allied Radio Corp.  
KNIGHT Espey Mfg. Co.  
KOOLOHM Sprague Electric Co.  
KOOL-SEL Pyramid Electric Co.  
KORD-O-KOIL R. K. Mfg. Co.  
KRAFTONE Kraft Bros.  
KRANK-UP MASTS Jontz Mfg. Co.  
KRYLON ACRYLIC COATINGS Krylon, Inc.  
KURMELEC Kurman Electric Co.  
KWIK South River Metal  
KWICK CLIMB TOWERS Jontz Mfg. Co.  
KWIK-KALL Loge Sound Engrs., J. M.  
KWIK KLIP South River Metal  
KWICK-N-EASY Jontz Mfg. Co.  
KWICK-UP TELESCOPING MASTS Jontz Mfg. Co.

LABCASE Berkshire Laboratories  
LABCHECK Berkshire Laboratories  
LABMARKER Berkshire Laboratories  
LABOHM Berkshire Laboratories  
LABSTROBE Berkshire Laboratories  
LABTRANS Berkshire Laboratories  
LABVOLT Berkshire Laboratories  
LAFAYETTE Espey Mfg. Co.  
LAFAYETTE Radio Wire & TV  
LANSING Altec Lansing Corp.  
LARGO 8 & 12 Permoflux Corp.  
LAZY-X Radiart Corp.  
LC CHECKER Aerovox Corp.  
LEAK British Industries  
LECTERN Loge Sound Engrs.,  
LECTROHM Lectrohm Inc.  
LEDEX Leland Inc., G. H.  
LEE-PAC Lee Laboratories  
LEMCO Lytle Eng'g. & Mfg.  
LERCO Lynn Electronic Research Co.  
LEVER-TYPE Shure Bros.  
LEV-R SWITCHES Switchcraft, Inc.  
LF-JAX Switchcraft, Inc.  
LIFETIME Reeves Soundcraft Corp.  
LIFETONE Duotone Co.  
LIGHTNING JFD Mfg. Co.  
LIGHTNING Vaco Products Co.  
LINE LOK I E Mfg. Co.  
LINE-O-LIFE Carter Motor Co.  
LIPSTIK Altec Lansing Corp.  
LITTEL JAX Switchcraft, Inc.  
LITTEL PLUGS Switchcraft, Inc.  
LITTEL SWITCHES Switchcraft, Inc.  
LITTLE DEVIL Ohmrite Mfg. Co.  
LITTLE GEM Equiplo Div., Aurora Equip.  
LITTLE GIANT Tatu Inc. Albert J.  
LITTLE JEWEL Danforth Mfg. Co.  
LITTLE NIPPER Radio Corp. of America  
LL300 Buchen Co., R. J.  
LL450 Buchen Co., R. J.  
LN Illinois Condenser Co.

LOADED-X Radiart Corp.  
LOCK-TITE Thomas & Betts  
LO-C OSCILLOSCOPE Linear Equipment Labs.  
LOK-ON I E Mfg. Co.  
LONG RANGER Ward Products Corp.  
LOOPSTICK Superelex Electronics  
LOREZM Kingdom Products  
LOTEN Good, Don  
LO-VOLT TESTER Industrial Devices  
LUSTERIZED American Electric Cable  
LUXTRON Bradley Laboratories  
LYNN Vaco Products Co.  
LYTICAP Planet Mfg. Co.  
LYT-L TUNER Lytle Engineering

McMITE McCoy Electronics Co.  
MACSON Mason Co.  
MAGIC EYE Radio Corp. of America  
MAGIC MONITOR Radio Corp. of America  
MAGIC-TEE Plymouth Electronics  
MAGIC-TIP Hunter Tools  
MAGMOTOR Carrier Motor Co.  
MAGNAPHONIC Magnasync Mfg. Co.  
MAGMA-TORC Hansen Mfg. Co.  
MAGNECORDER Magnecord Inc.  
MAGNECORDETTE Magnecord Inc.  
MAGNELOOP Amplifier Corp. of America  
MAGNEMITE Amplifier Corp. of America  
MAGNEPAINT Micro-Circuits Co.  
MAJOR Allied Eng'g Div., Allied Int'l Inc.  
MAJORETTE Major Electronics Co.  
MAJOR RECORDS Valentino Inc., Thomas J.  
MAMCO Master Appliance Mfg.  
MANDEX Mandex Mfg. Co.  
MANHATTAN Radio Corp.  
MARATHON BATTERIES Marathon Battery Co.  
MARBELITE Good-All Elec. Mfg.  
MARINERS PATHFINDER Raytheon Mfg. Co.  
MARKA Kay Electric Co.  
MARK TWAIN Raytheon Mfg. Co.  
MARMA Fidelity Amplifier Co.  
MARTIN MELODY Fidelity Amplifier Co.  
MARVELITE CBC Electronics Co.  
MASC Simpson Mfg. Co., Mark  
MASTERLINE Blower-Tongue Labs.  
MASTER-TENNA Radio Corp. of America  
MAVERICK Channel Master  
MAX-MIXER Special Products  
MECHANOPHASE Electro-Voice Inc.  
MEGA-PIX Kay Electric Co.  
MEGA SWEEP Kay Electric Co.  
MEG-O-MAX Sprague Electric Co.  
MEISSNER Thordarson-Meissner  
MELLOTONE Electronic Enterprises  
MELLOTONE Wendell Plastic Fabrics  
MELODIER Waters-Conley Co.  
MELCDIST Altec Lansing Corp.

MERCURY Electro-Voice, Inc.  
MERCURY Vulcan Electric Co.  
MERITONE Autocrat Electronics Co.  
MERM Miller Electro-Research  
MESSAGE REPEATER Michigan Electronics  
METALITE Astron Corp.  
METALLIZED International Resistance  
METEOR Astron Corp.  
METER-MATIC International Register  
METRO Radion Corp.  
METROLITE Metronics, Inc.  
METROPOLITAN Radion Corp.  
MICAFILE Cosa Corp.  
MICAP Micamold Radio Corp.  
MICRO Kay Electric Co.  
MICRO CIRCLE Precise Measurements  
MICROLATOR Kay Electric Co.  
MICROLYTIC Micamold Radio Corp.  
MICROMETER Lamkin Labs, Inc.  
MICROPAINT Micro-Circuits Co.  
MICROTHERM Raytheon Mfg. Co.  
MICROTRAN Crest Laboratories Inc.  
MICROVOLTER Ferris Instrument Co.  
MIDDLESEX Bogen Co., David  
MIDGET Sprague Electric Co.  
MIDGETAPE Michigan Electronics  
MIDGETESTER Simpson Electric Co.  
MIDGETROLS Mallory & Co., P. R.  
MIGHTY MIDGET JFD Mfg. Co.  
MILCAPS Dumont-Airplane & Marine  
MILLIMAG Transistor Products, Inc.  
MINIBOX Bud Radio Inc.  
MINI-COR JFD Mfg. Co.  
MINI-COUPLES Javex  
MINIFON Interstate Photo  
MINI-MAX National Carbon Co.,  
MINIMITE Astron Corp.  
MINI-MIX Switchcraft, Inc.  
MINI-PLATES Javex  
MINI-SOCKETS Javex  
MINI-VOLT VOLTMETER Industrial Devices Inc.  
MIN-KAPS Centralab Div., Globe Union, Inc.  
MIRO-POINT Duotone Co.  
MIRROR-TONE Scott Radio Labs.  
MI-TEE-RAY Fraco Inc.  
M-IAX Switchcraft, Inc.  
MOBILPHONE Radionics Labs.  
MOBIL-MIKES Electro-Voice Inc.  
MOLARC Male-Richardson Co.  
MOLD-EASE PER Merlx Chemical Co.  
MOLDTITE United Condenser Corp.  
MOLD-X American Radionic Co.  
MONARCH British Electronic  
MONOMATIC Pentron Corp.  
MONOSET Telex, Inc.  
MORRICE Jordan Mfg. Co.  
MOTEX TAPE DECK Fenton Co.  
MOTORLYTIC Micamold Radio Corp.

**MOUNTIE**  
Danforth Mfg. Co.

**MOVIE-CLEAR**  
Sylvania Electric Products

**MT**  
Illinois Condenser Co.

**MUGWUMP**  
Radio Merchandise

**MULTIBOOSTER**  
Industrial Television

**MULTICABLE**  
Good, Don

**MULTI-GATE**  
Hammarlund Mfg. Co.

**MULTI-MODE**  
Tele-Beam Industries

**MULTI-RAY**  
Barb City Industries

**MULTI-SPEED**  
Pentron Corp.

**MULTIPLE UNIT**  
Hevi Duty Electric Co.

**MULTIPLX**  
Chicago Ind. Instrument

**MULTITESTER**  
Barrett Electronics

**MULTIVOLT**  
Ohmite Mfg. Co.

**MU-NET**  
F. W. Sickles Div.

**MUTED STYLUS**  
Shure Bros.

**MYKAPLAST**  
United Condenser Corp.

**NA-ALD**  
Alden Products Co.

**NATCO**  
National Co.

**NAVARRÉ**  
Videon Electronic Corp.

**NECK BAND**  
Loge Sound Engrs., J. M.

**NEPCO**  
National Electric Products Corp.

**NEPCOLINE**  
National Electric Products Corp.

**NEVATIP**  
Radio Merchandise

**NEVER-STAIN**  
Nichols Wire & Aluminum Co.

**NEW LIFE**  
A P Electro Lab

**NINE LIVES**  
National Carbon Co.

**99**  
Blonder-Tongue Labs.

**99 LINE**  
Walsco Electronics Corp.

**NIPPER**  
Radio Corp. of America

**NOBLELOY**  
Continental Carbon, Inc.

**NOBLETTE**  
Continental Carbon

**NO NOISE**  
Electronic Chemical

**NO-OX**  
Walsco Electronics Corp.

**NO-STRIP**  
JFD Mfg. Co.

**NUMECHRQN**  
Pennwood Numechron

**NYC**  
National Video Corp.

**NYCO**  
New York Coil Co., Inc.

**OACO**  
Ohio Aerial Co.

**O-GYRO**  
Dynamic Electronics

**OHM**  
Shallercross Mfg. Co.

**OILMITE**  
Deutschmann Corp. T.

**OLSON**  
Lipps Eng'g., Edwin A.

**OMEGATAPE**  
Int'l Pacific Recording

**OMNI-GLOW PILOTLIGHT**  
Industrial Devices

**OMNITENNA**  
Tennalab

**102 BALANCE**  
Self-Lifting Piano Truck Co.

**OPTO-MATIC**  
Trico Fuse Mfg. Co.

**ORTHOGONAL TORQUE-DRIVE**  
Electro-Voice, Inc.

**ORYX**  
TV Accessories Co.

**OSCIL-O-PEN**  
General Test Equipment Co.

**OV-O-LINE**  
Atlantic Wire & Cable Corp.

**P. A.**  
Aerovox Corp.

**PACE**  
Precision Apparatus Co.

**PACE-SETTER**  
JFD Mfg. Co.

**PAD HACKSAW**  
American Mercantile

**PAGEANT**  
Pederson Electric Co.

**PAINTON**  
British Electronic

**PAL**  
JFD Mfg. Co.

**PAMCO**  
Paraplegics Mfg. Co.

**PANCOUSTIC**  
U. S. Recording Co.

**PANDUX**  
Pacific Transducer

**PAN-I-LITE**  
Alden Products Co.

**PANORAMA**  
JFD Mfg. Co.

**PANORAMIC**  
Radio Merchandise

**PARABORAY**  
Neal Electronic Co.

**PARA-BOW**  
JFD Mfg. Co.

**PARACON**  
Ward Products Corp.

**PARA-FLUX**  
Radio Music Corp.

**PARANITE**  
Essex Wire Corp.

**PARFEX**  
Good, Don

**PARLON**  
Good, Don

**PATRICIAN**  
Electro-Voice, Inc.

**PARTRIDGE**  
British Electronic Sales

**PE**  
Illinois Condenser Co.

**P.E.C.**  
Centralab Div., Globe Union, Inc.

**PECO**  
Pomona Electronics Co.

**PEERAGE**  
Electro-Voice Inc.

**PEERLESS**  
Altec Lansing Corp.

**PEE-WEE**  
Mueller Electric Co.

**PELLETS**  
Tempil Corp.

**PENDET**  
Centralab Div., Globe Union, Inc.

**PENN-TRAN**  
Penn Transformer Corp.

**PEN-OSCIL-LITE**  
General Test Equipment

**PEPCO**  
Altec Lansing Corp.

**PERCO**  
Linell Eng'g Corp., C. S.

**PE REX**  
Fenton Co.

**PERMALINE**  
Columbia Wire & Supply

**PERMASEAL**  
Sprague Electric Co.

**PERMA-TUBE**  
Jones & Laughlin Steel

**PERMO**  
Fidelitone, Inc.

**PERMO MAGNETIC**  
Fidelitone, Inc.

**PERMO-SWITCH**  
Centralab Div., Globe Union, Inc.

**PET LINES**  
Portable Electric Tools

**PFAN-TONE**  
Pfanstihl Chemical Company

**PHANTOM PLASTICS**  
Tele-Beam Industries

**PHAZOR**  
Industrial Test Equip.

**PHOENIX SPEED-TENNAS**  
Phoenix Electronics, Inc.

**PHONO-DOODLE**  
Shura-Tone Products

**PHONOLA**  
Waters Conley Corp.

**PHONOSTROBE**  
Berkshire Laboratories

**PHOTOTRON**  
Thomas Electronics, Inc.

**PICBOOST**  
CBC Electronics Co.,

**PICK-A-SHAFT**  
Clarostat Mfg. Co.

**PIC-SYNC TAPE**  
Fairchild Recording Equip. Co.

**PIC-TRON**  
Tube Service Corp.

**PILOT**  
Pilot Radio Corp.

**PILOTONE**  
Pilot Radio Corp.

**PILOTUNER**  
Pilot Radia Corp.

**PINHEAD**  
Sprague Electric Co.

**PIN POINTER**  
Radio Merchandise Sales

**PISTOGRIP**  
Wall Mfg. Co., P.

**PLAQOHH**  
Ward Leonard Electric

**PLASTICON**  
Condenser Products Co.

**PLASTICORD**  
Chester Cable Corp.

**PLASTICOTE**  
Chester Cable Corp.

**PLASTIK-707**  
United Technical Labs.

**PLASTIK-707**  
United Technical Labs.

**PLEXICON**  
Erie Resistor Corp.

**PLYMOUTH**  
Colortone Electronics

**POCKETSCOPES**  
Waterman Products Co.

**POLYPHANE**  
Technical Tape Corp.

**POLYTHENE EXTRUSIONS**  
Anchor Plastics Co.

**PORTA-KALL**  
Loge Sound Engrs., J. M.

**PORTY-A-PHONE**  
Feller Eng'g & Mfg. Co.

**PORTAPLEX**  
Chicago Ind. Instrument

**PORTROLA**  
Bell Sound Systems

**POSTLITES**  
Drake Mfg. Co.

**POWR BLOX**  
Authorized Mfg. Co.

**POWRMIKE**  
University Loudspeakers.

**POWR-RIB**  
Ohmite Mfg. Co.

**PRECEDENT**  
Radio Engineering Labs.

**PREFAB**  
Radio Merchandise

**PRINTED WIRING**  
Aerovox Corp.

**PRIVATE LINE**  
Conn. Telephone & Electric Corp.

**PROFESSIONAL**  
Trimm, Inc.

**PROKAR**  
Sprague Electric Co.

**PRO-LOAD**  
S.O.S. Cinema Supply

**PROTEX**  
Good, Don

**PULSESCOPES**  
Waterman Products Co.

**"P" WEE CHOKES**  
Superech Electronics

**PYROHM**  
Aerovox Corp.

**PYROMARK**  
Tempil Corp.

**PYROUAC**  
Eitel-McCullough, Inc.

**Q LACE**  
Edwin I. Guthman & Co.

**QT**  
Superech Electronics Corp.

**QUAD**  
Beam Instruments Corp.

**QUADNURAL**  
Dynamic Electronics

**QUADRILINE**  
Radio Engineering Labs.

**QUAM ADJUST-A-CONE**  
Quam-Nichols Co.

**QUARTZ**  
Califone Corp.

**QUICK-WEDGE**  
Kedman Co.

**QUIK-RIG**  
Radiart Corp.

**QUIK-SHOT**  
Kemado Mfg.

**QUIK-RIG**  
JFD Mfg. Co.

**QUINTETTE**  
Radio Merchandise Sales

**QWIK**  
American Phenolic Corp.

**R & A**  
British Electronic

**RADA**  
Kay Electric Co.

**RADALIGNER**  
Kay Electric Co.

**RADAMETER**  
Raytheon Mfg. Co.

**RADARANGE**  
Raytheon Mfg. Co.

**RADAR-TENNA**  
Brach Mfg. Corp.

**RADAX**  
Electro-Voice, Inc.

**RADAX PRINCIPLE**  
Electro-Voice, Inc.

**RADAX SUPER-EIGHT**  
Electro-Voice, Inc.

**RADAX SUPER-FIFTEEN**  
Electro-Voice, Inc.

**RADAX SUPER-TWELVE**  
Electro-Voice, Inc.

**RADIOCRAFTER**  
Technicraft Co.

**RADIODYNE**  
Western Coil & Electrical Co.

**RADIOHM**  
Centralab Div., Globe Union, Inc.

**RADIOLA**  
Radio Corp. of America

**RADIO'S MASTER**  
United Catalog Pub.

**RADIOTRON**  
Radio Corp. of America

**RAKSCOPES**  
Waterman Products Co.

**RALTEX**  
Technical Tape Corp.

**RAREOX**  
Rare Earths, Inc.

**RAT-SCOPE**  
Di-Co TV & Plastic Co.

**RHYTHMASTER**  
Rek-O-Kut Co.

**RICHMOND**  
Lowell Mfg. Co.

**RICHOMATIC**  
Television Remote Control Co.

**RIFLEX**  
Ward Leonard Electric

**RITEOHM**  
Ohmite Mfg. Co.

**RIVIERA**  
All Channel Antenna R. M. C.

**RMS**  
Radio Merchandise

**ROCKETENNA**  
T-V Products Co.

**ROHCO**  
Hull & Co., R. O.,

**ROLLOCON**  
Circon Component Co.

**ROLLPIN (R)**  
Elastic Stop Nut Corp.

**ROOF-THRU**  
Masley Electronics

**ROSCO**  
Ed-Berl Products

**ROTAK**  
Good, Don

**ROTALYZER**  
Kay Electric Co.

**ROTENNA**  
JFD Mfg. Co.

**ROTOMATIC**  
Johnson Co., E. F.

**ROTO-RANGER**  
Simpson Electric Co.

**ROTOR QUEEN**  
Radio Merchandise Sales

**ROYAL**  
Permoflux Corp.

**RPC**  
Resistanco Products Co.

**RSE**  
Radio Supply & Eng'g Co.

**RTV-PROGRAM**  
Clarostat Mfg. Co.

**SAFE-T-KLIP**  
Industrial Devices Inc.

**SAFETVISION**  
Bennett Laboratories,

**SAFETY MARGIN**  
Astron Corp.

**SALON**  
Videon Electronic Corp.

**SAMPSON-GLO**  
Sampson Chemical & Pigment Corp.

**SAND SCOTT**  
Halub Industries, Inc.

**SAUCERLINE**  
Fretco Inc.

**SAVOY**  
Videon Electronic Corp.

**SAXL**  
Tensitron, Inc.

**SCAPCO**  
Sampson Chemical & Pigment Corp.

**SCOTCH**  
Minnesota Mining & Mfg. Co.

**SCREWBALL**  
Fretco Inc.

**SCRIBE**  
Permoflux Corp.

**SECRET RECORDER**  
Amplifier Corp. of America

**SEEZAK PRODUCTS**  
U. M. & F. Mfg. Corp.

**SELECTOHH**  
Chicago Industrial Instrument Co.

**SELETRON**  
Radio Receptor Co.

**SELFOCUS**  
DuMont Labs, Allen B.

**SENTRY**  
JFD Mfg. Co.

**SERAMELITE**  
Goad-All Elec. Mfg. Co.

**SERCO**  
Service Instruments Co.

**SERRASOID**  
Radio Engineering Labs.

**SERV-A-UNIT**  
Alden Products Co.

**SERVICE ENGINEERED**  
Jackson Electrical Instrument Co.

**SERVOTRON**  
Raytheon Mfg. Co.

**707**  
Anchor Electronics, Inc.

**7 STAR**  
Tele-Ex-Pand Corp.

**SF-JAX**  
Switcraft, Inc.

**SHEATH-LEED**  
Don Good, Inc.

**SHOPMATE**  
Portable Electric Tools

**SHORTHORN**  
Klipsch Associates

**SHURFLO ROSIN CORE**  
Anchor Metal Co.

**SIEMENS**  
Leru Laboratories

**SIGNALLETTE**  
Lytle Eng'g. & Mfg.

**SIGNALMAR**  
Wilmar Mfg. Co.

**SIGNA-MATCHER**  
Centralab Div., Globe Union, Inc.

**SIGNATURE**  
Lansing Sound Inc., James B.

**SILERTEX**  
Erie Resistor Corp.

**SILVER CAP**  
F. W. Sickles Div.

**SILVERLINE**  
General Instrument

**SILVER WAND**  
Peerless Products

**SIMPLEX**  
Chicago Industrial Instr. Co.

**SK**  
Skottie Electronics Inc.

**SKYCHIEF**  
Camburn Inc.

**SKY-HI**  
Thomas Mold & Die Co.

**SKYLARK**  
Electro-Voice, Inc.

**SKY-LITE**  
Hy-Lite Antennas, Inc.

**SKY-LOK**  
JFD Mfg. Co.

**SKY-MASTER**  
Jewell Inc., A. W.

**SLAKOUT**  
Ohio Aerial Co.

**SLENOYNE**  
Shure Bros.

**SLIDEOHM**  
Aerovox Corp.

**SLIMAIR**  
Electro-Voice, Inc.

**SLIP-DRIVE**  
Clarostat Mfg. Co.

**SLUMBERTONE**  
Electro Sound Corp.

**SMA**  
Lytle Eng'g. & Mfg. Co.

**SMART SET**  
Calbest Eng'g & Electronics Co.

**SMATCO**  
Stone City Machine

**SMITH-BALDWIN**  
SPEAKERS

**SMITTY**  
Hunter Tools

**SMT**  
Illinois Condenser Co.

**SNS**  
Special Products

**SNAPPER CLIP**  
Mueller Electric Co.

**SNUPEC**  
Centralab Div., Globe Union, Inc.

**SNYDERMATIC**  
Snyder Mfg. Co.

**SODEREZE**  
Phelps Dodge Copper

**SOLARSPTS**  
Male-Richardson Co.

**SOLAVOLT**  
Sola Electric

**SOLDER MASTER**  
Haxacon Electric Co.

**SOLDER MICROFORMS**  
Anchor Metal Co.

**SOLDER-QUIK**  
Stark Mfg.

**SOLDERWHIZ**  
Wassco Electric Products Corp.

**SOLID-ROD**  
JFD Mfg. Co.

**SOLVALL**  
A P Electro Lab

**SONA**  
Kay Electric Co.

**SONALINE**  
Kay Electric Co.

**SONARMETER**  
Raytheon Mfg. Co.

**SONAX**  
Electro-Voice, Inc.

**SONODYNE**  
Shure Bros.

**SOUNDCRAFT**  
Reeves Soundcraft Corp.

**SOUNDMIRROR**  
Brush Electronics Co.

**SPEAR**  
British Electronic Sales

**SPECO**  
Special Products

**SPECTRUM**  
Fretco Inc.

**SPEECH MASTER**  
Jensen Mfg. Co.

## TECHNICIAN BUYERS DIRECTORY

### BRAND & TRADE NAME INDEX

- SPEED-CESSORIES**  
Phoenix Electronics, Inc.
- SPEED-DEE**  
Radiart Corp.
- SPEDEX**  
General Cement Mfg.
- SPEED-MOUNTS**  
Phoenix Electronics, Inc.
- SPEEDTENNAS**  
Phoenix Electronics
- SPEED-X**  
Johnson Co., E. F.
- SPHEREX**  
Electro-Voice, Inc.
- SPICO SUPER PHANTOM**  
Spiraling Products Co.
- SPINLAB**  
Special Instruments Lab., Inc.
- SPINTITE**  
Stevens Walden Inc.
- SPIRAL-TENNA**  
Hilo TV Antenna Corp.
- SPONGEE**  
Imperial Radar & Wire Corp.
- SPRAYWAY**  
Tru-Pine Co.
- SPRING-ACTION**  
Sheldon Electric Co.
- SP SYSTEMS**  
Service Parts Systems
- SRX**  
Pioneer Electric & Research Corp.
- STABELEX CAPACITORS**  
Industrial Condenser Corp.
- STACO**  
Standard Electrical Products Co.
- STA-KON**  
Thomas & Betts Co.
- STANCOR**  
Chicago Standard Transformer Corp.
- STANDEE**  
Claroast Mfg. Co.
- STA-PUT**  
Consolidated Wire & Associated Cos.
- STAR-**  
J F D Mfg. Co.
- STAVOLT**  
McColpin-Christie Corp.
- STEACAP**  
Micamold Radio Corp.
- STENO**  
Crescent Industries
- STENTORIAN**  
Beam Instruments Corp.
- STERLING CABLE**  
Beam Instruments Corp.
- STOP ARK**  
A P Electro Lab
- STRATE-LINE**  
Radiart Corp.
- STRATFORD**  
Telegrip Radio
- STRATO**  
Spiraling Products Co.
- STRATOBAM**  
Antenna Products
- STRAT-O-FLITE**  
Whitney Blake Co.
- STRAT-O-LITE**  
Stratosol Mfg. Co.
- STRATO RAY**  
Fretco Inc.
- STRATO TOWERS**  
Pipestone Sales Co.
- STRIPMASTER**  
Ideal Industries, Inc.
- STRIPOHM**  
Ward Leonard Electric
- STYROFLEX**  
Phelps Dodge Copper
- SUBURBAN**  
Radion Corp.
- SUPERBULLSEYE**  
Radlon Corp.
- SUPER CAP**  
United Electronic Mfg.
- SUPERCON**  
Antenna Products
- SUPERFAN**  
Channel Master
- SUPERIOR**  
Brach Mfg. Corp.
- SUPERIOR**  
Radiart Corp.
- SUPERIOR**  
Wall Mfg. Co., P.
- SUPERJET**  
JFD Mfg. Co.
- SUPER KATY**  
Kay-Townes Antenna
- SUPERKIT**  
Suprex Electronics
- SUPER KWICK CLIMB**  
TOWERS
- TOWERS**  
Jontz Mfg. Co.
- SUPER MARKER INJECTOR**  
Scala Radio Co.
- SUPEROTOR**  
Leader Electronics
- SUPER PHANTOM**  
Spiraling Products Co.
- SUPER-PRO**  
Hammerlund Mfg. Co.
- SUPER Q**  
Edwin I. Guthman Co.
- SUPER ROYAL**  
Permoflux Corp.
- SUPER 60**  
All Channel Antenna
- SUPER-SONAX**  
Electro-Voice, Inc.
- SUPER SPECTRUM**  
Fretco Inc.
- SUPER-STRUCTURE**  
Radiart Corp.
- SUPERTENNA**  
Tennalab
- SUPER-VEE**  
Radiart Corp.
- SUPER-X**  
Camburn, Inc.
- SWING-BIN**  
Akro-Mills
- SWITCHMAT**  
Recara Co.
- SWIVELBEAM**  
Radio Merchandise
- SWIVLTOP**  
Moody Machine Products Co.
- SYMPHONETTE**  
Hedco Mfg. Corp.
- SYNCHRON**  
Hansen Mfg. Co.
- SYNCROLL DRIVE**  
Fairchild Recording Equip. Co.
- SYNKOTE**  
Plastoid Corp.
- SYNTHINOL**  
Consolidated Wire & Associated Cos.
- SYNTHOLVAR**  
Variflex Corp.
- TACO**  
Technical Appliance
- TACOPLEX**  
Technical Appliance
- TALKMASTER**  
Dalmotron Co.
- TAPE-O-MATIC**  
V-M Corp.
- T & B**  
Thomas & Betts Co.
- TEK-STAND**  
Shasta Div.
- TELAIDES**  
Beckman Instruments
- TELAIDES**  
Wallace's Telades
- TEL-AIR**  
Tele-Beam Industries
- TELA-SET**  
Telex, Inc.
- TEL-ATTEN**  
Vidair Electronics
- TELCO**  
General Cement Mfg.
- TELEAD**  
Don Good, Inc.
- TELEBINDER**  
Wallace's Telades
- TELEFABLE**  
Whitney Blake Co.
- TELECAP**  
Sprague Electric Co.
- TELECHIEF**  
Sangamo Electric Co.
- TELECON**  
Teletenna Co.
- TELECORD**  
Whitney Blake Co.
- TELELECTRO-TOPE**  
Teletrosonic Corp.
- TELE-COUPLER**  
Vidair Electronics
- TELEDUCT**  
Whitney Blake Co.
- TELEFUNKEN**  
London Int'l Records
- TELEFUNKEN**  
American Elite, Inc.
- TELEMAGNET**  
Michigan Electronics
- TELE-MATCH**  
Vidair Electronics
- TELEMETRON**  
Deutschmann Corp. T.
- TELEMETROSCOPE**  
Deutschmann Corp. T.
- TELE-MOBILE**  
Tele-Ex-Pand Corp.
- TELE-PLEX**  
JFD Mfg. Co.
- TELEPHONE**  
Whitney Blake Co.
- TELERING**  
Telkor Inc.
- TELETALK**  
Webster Electric Co.
- TELETEST**  
Anko Mfg. Co.
- TELETRON**  
DuMont Labs., Allen B.
- TELE-VANES**  
Ward Products Corp.,
- TELEVER SWITCHES**  
Switchcraft, Inc.
- TELEVOLT**  
Sola Electric
- TELEVOLTER**  
Jackson Electrical Instrument Co.
- TEL-OHMIKE**  
Sprague Electric Co.
- TELTENNA**  
Television Labs.
- TELVAC**  
Television Accessories
- TEMP-ALARM**  
Tempil Corp.
- TEMPALL**  
Deutschmann Corp T.
- TEMPILAQ**  
Tempil Corp.
- TEMPILSTIK**  
Tempil Corp.
- TEMPLEX**  
Good, Don
- TENNA-CLAMP**  
Mueller Electric Co.
- TENNA-CLIP**  
Industrial Television,
- TENNA-LINER**  
Crown Controls Co.
- TENNA-MASTER**  
Spiraling Products Co.
- TENNA-MATCH**  
Vidair Electronics
- TENNA ROTOR**  
Alliance Mfg. Co.
- TENNA SCOPE**  
Alliance Mfg. Co.
- TENNA-SHINGLE**  
Javex
- TENNA-SWITCH**  
Leader Electronics
- TENNA-TEK**  
Radio Merchandise
- TENNA-TOP**  
Electro-Voice, Inc.
- TENNATUBE**  
National Electric Products Corp.
- TENNA-TUBE**  
Javex
- TENNA TUNER**  
Kato Engineering
- TEN SPOT**  
Fenton Co.
- TESCON**  
T-V Products Co.
- TEST-GLO**  
Ideal Industries
- TEST MASTER**  
Precision Apparatus Co.
- TEST-O-LITE**  
Brach Mfg. Corp.
- TETRAD DIAMOND**  
NEEDLE
- TETRAD**  
Tetrad Co.
- THERMINDEX**  
Tempil Corp.
- THERMO**  
Ideal Industries, Inc.
- THERMOCUBE**  
Radio Engineering Labs.
- THERMO-GRIP**  
Ideal Industries
- THERM-O-METER**  
Simpson Electric Co.
- THERMO-TIP**  
Ideal Industries, Inc.
- THESAUROS**  
Radio Corp. of America
- THOMASOPRENE**  
Whitney Blake Co.
- 3-IN-ONE**  
JFD Mfg. Co.
- THRUPASS**  
Sprague Electric Co.
- TI-MATCH**  
Camburn, Inc.
- TIME-ALL**  
International Register
- TIMES RECORDS**  
Cook Laboratories, Inc.
- TIMEX**  
U. S. Time Corp.
- TINI-JAX**  
Switchcraft, Inc.
- TINI-PLUGS**  
Switchcraft, Inc.
- TINY GLOW**  
Industrial Devices Inc.
- TINYFORMER**  
Gramer-Haldorson
- TIOGA**  
Sheldon Electric Co.
- TIPWRENCH**  
Smith Heat Treating Co.
- TITE**  
A P Electro Lab
- TITONE**  
Sonatone Corp.
- T-JAX**  
Switchcraft, Inc.
- TOBE**  
Deutschmann Corp.,
- TOBEMITE**  
Deutschmann Corp. T.
- TOKAVOX**  
Cooper Electronic Prod.
- TOMAHAWK**  
Stevens Walden Inc.
- TOMBONE**  
Ward Products Corp.
- TOM THUMB**  
Automatic Radio Mfg.
- TOM THUMB**  
Spiraling Products Co.
- TONETEX**  
Electro-Voice Inc.
- TOPPER**  
Camburn, Inc.
- TORQUE-DRIVE**  
Electro-Voice, Inc.
- TOWN & COUNTRY**  
Kraft Bros.
- TRACEOMETER**  
Hickok Electrical Instrument Co.
- TRAK**  
C. G. S. Laboratories
- TRANSALYZER**  
Kay Electric Co.
- TRAV-ELECTRIC**  
Terado Co.
- TREASURE CHEST**  
Jensen Mfg. Co.
- TRIAKIAI**  
Jensen Mfg. Co.
- TRI CEPTOR**  
Alliance Mfg. Co.
- TRI-FLY**  
Tape Recorders, Inc.
- TRIG-R-HEAT**  
Wall Mfg. Co., P.
- TRI-O-MATIC**  
V-M Corp.
- TRI-PLEX**  
Jensen Mfg. Co.
- TRI-TRAN**  
Triwac Transformer Co.
- TROMBONE**  
Ward Products Corp., Div. The Gabriel Co.
- TROPICAP**  
Micamold Radio Corp.
- TRUCKARADIO**  
Sutton, S. J.
- TRUCRAFT**  
Ed-Berl Products
- TRU-MATCH**  
Quam Nichols Co.
- TRU-OHM**  
Model Eng'g. & Mfg. Co.
- TRU-RIP**  
Whitney Blake Co.
- TRU-SONIC**  
Stephens Mfg. Corp.
- TRYLON**  
Wind Turbine Co.
- TUBE-MASTER**  
Precision Apparatus Co.
- TUCK**  
Technical Tape Corp.
- TUF-GUY**  
Fenton Co.
- TUNE-A-SCOPE**  
JFD Mfg. Co.
- TUNE-O-MATIC**  
Electro-Voice, Inc.
- TUNERASER**  
Suprex Electronics
- TUNER-TONIC**  
Electronic Chemical Corp.
- TUNE TAPE**  
Miller Electronics
- TURBO**  
Brand & Co. Wm.
- TURBOLENE**  
Brand & Co. Wm.
- TURBOLEX**  
Brand & Co. Wm.
- TURBOTHERM**  
Brand & Co. Wm.
- TURBOTRANS**  
Brand & Co. Wm.
- TURBOTUF**  
Brand & Co. Wm.
- TV SERVICE**  
Lee Electronic Labs.
- TV TELE-CLEAR**  
Merix Chemical Co.
- 23-CLIPPER**  
Centralab Div., Globe Union, Inc.
- TWILT**  
Electro-Voice Inc.
- TWIN-LEVER**  
Shure Bros.
- TWINSET**  
Telex Inc.
- TWIN-TILT**  
Electro-Voice Inc.
- TWIN-TRAX RECORDER**  
Amplifier Corp. of America
- TWIN TUBE**  
North American Model Prod.
- TWISTLOCK**  
Hubbell Inc., Harvey
- TWIST-LOK**  
Sprague Electric Co.
- TWIST-MOUNT**  
Pyramid Electric Co.
- TWISTUBE**  
Fenton Co.
- 260**  
Simpson Electric Co.
- TWO-TIMER**  
Vocalline Co. of America Inc.
- TYNEE-DRY**  
Pyramid Electric Co.
- TYNISWITCH**  
Sessions Clock Co.
- U-ASK-IT**  
Electronic Eng. Co.
- ULTRA**  
Kay Electric Co.
- ULTRA-BEAM**  
Camburn Inc.
- ULTRADAPT**  
Radio Merchandise
- ULTRA-LINEAR**  
Acra Products Co.
- ULTRA-MATIC**  
Radiart Corp.
- ULTRA-TELECON**  
Teletenna Co.
- ULTRATONE**  
Audio Industries Inc.
- ULTRAVERTER**  
Blowder-Tongue Labs.
- UMC**  
Illinois Condenser Co.
- UMP**  
Illinois Condenser Co.
- UMS**  
Illinois Condenser Co.
- UMT**  
Illinois Condenser Co.
- UNECAP**  
United Electronic Mfg.
- UNICON**  
United Condenser Corp.
- UNI-CORE**  
Alpha Metals, Inc.
- UNIDIAL**  
Chicago Ind. Instrument
- UNIDYNE**  
Shure Bros.
- UNIMATIC**  
Calbest Eng'g & Electronics Co.
- UNIPOINT**  
Shure Bros.
- UNI-RACK**  
Aidan Products Co.
- UNIVERSAL**  
Mueller Electric Co.
- URBAMETTE**  
Video Electronic Corp.
- USALITE**  
U. S. Electric Mfg.
- USECC**  
U. S. Eng'g Co.
- UTC**  
United Transformer Co.
- UTONE**  
Utah Radio Products Co.
- VAM**  
Video Accessory Mfg. Co.
- VARFLO**  
Variflex Corp.
- VARIABLE D**  
Electro-Voice, Inc.
- VARICON**  
Elec Corp.
- VARIDOT**  
Simpson Electric Co.
- VARI-LOOPSTICK**  
Suprex Electronics
- VARIPOLE**  
California Corp.
- VARI-TENNA**  
Suprex Electronics
- VARPAK**  
Deutschmann Corp. T.
- VASCO**  
Mitchell Industries Inc.
- VEE-D-X**  
Lapoints Electronics
- V-4**  
Fretco Inc.
- VERSACONE**  
Radio Merchandise
- VERSA-TOOL**  
Phillips Mfg. Co.
- VERSI-MOUNT**  
Radio Merchandise
- VIBRAPACK**  
Malory & Co., P. R.
- VIBRALYZER**  
Kay Electric Co.
- VICO**  
Video Industries Co.
- VICTOR**  
Radio Corp. of America
- VICTORIA**  
Fretco Inc.
- VICTROLA**  
Radio Corp. of America
- VIDEO**  
Tech Master Corp.
- VIDEOLA**  
Tech Master Corp.
- VIDE-C-BEAM**  
Camburn, Inc.
- VIDEOMETER**  
Hickok Electrical Instrument Co.
- VIDEOTRON**  
National Union Radio
- VIKING**  
Forsberg Mf. Co.
- VIKING**  
Johnson Co., E. F.
- VIKING SPEAKERS**  
Jensen Mfg. Co.
- VIL-MAGNEMITE**  
Amplifier Corp. of America
- VIPOWER**  
Radiart Corp.
- VISTRON**  
Rauland Corp.
- VIS-U-ALL**  
Television Engineers Inc.
- VISULITE**  
Keystone Electronics Corp.
- VITAMIN Q**  
Sprague Electric Co.
- VITROHM**  
Ward Leonard Electric
- V-M, THE VOICE OF MUSIC**  
V-M Corp.
- VOCATRON**  
Vocalline Co. of America
- VOICE OF THE THEATRE**  
Altec Lansing Corp.
- VOLTAGE**  
Sittler Corp.
- VOLT-A-TEST**  
Sittler Corp.
- VOLTOHYMST**  
RCA Corp. of America, RCA Tube Dept.
- VORTEXION TAPE**  
Fenton Co.
- VOYAGER**  
Fidelity Amplifier Co.
- V-2**  
Fretco Inc.
- WALCO**  
Electrovox Co.
- WALDEN**  
Stevens Walden Inc.
- WALL-THRU**  
Masley Electronics, Inc.
- WALLY**  
Wall Mfg. Co., P.
- WEATHER MASTER**  
Jensen Mfg. Co.
- WEBCOR**  
Webster-Chicago Corp.
- WEE-PEE-WEE CLIP**  
Mueller Electric Co.
- WELDPPOWER**  
Raytheon Mfg. Co.
- WHALE**  
Forsberg Mfg. Co.
- WHARFDALE**  
British Industries Corp.
- WHETHA-TUBE**  
Wheatland Tube Co.
- WHIZ-SAWS**  
Forsberg Mfg. Co.
- WIDNEY-DORLEC**  
British Industries Corp.
- WILCOX GAY**  
Majestic Radio & TV
- WILKOR**  
Aurovox Corp.
- WINCHESTER**  
Olin Industries
- WINCO**  
Wincharger Corp.
- WIN-TRONIX**  
Winston Electronics Inc.
- WIPE**  
Merix Chemical Co.
- WIRE LUBE**  
Ideal Industries
- WIRENUT**  
Ideal Industries
- WIREWATT**  
Ohmrite Mfg. Co.
- WISSH**  
Workman TV, Inc.
- WONDEROD**  
Columbia Products Co.
- XCEL**  
Xcelite, Inc.
- XELA**  
Klein & Sons, M.
- XTALATOR**  
Kay Electric Co.
- X-VAR**  
Fidelity Chemical Products
- YARDARM**  
Radio Merchandise Sales
- YOK-EX**  
Vialgre Electronics
- ZAK**  
U.M.&F. Mfg. Corp.
- ZIG-ZAG**  
Trio Mfg. Co.
- ZINKTRON**  
Constad Laboratories
- ZIPPERS**  
Centralab Div., Globe Union, Inc.
- ZOOM-UP**  
Camburn, Inc.

# Service Associations "On Parade"

1955 Roster Compiled by Technician Shows Big Gain in Membership Organizations — now 192 — Standard Bearers of Professional Advancement and Public Interest

## ALABAMA

ALABAMA CITY—Radio & TV Technician's Guild Inc  
315 N 24 St Guy Brooks Secy

## ARIZONA

PHOENIX—Better Electronic Service Technicians (BEST)  
Box 1284 David P Malone Secy  
TUCSON—Electronic Assoc of Tucson Ariz 2616 E Broadway Arthur Wheeler Pres

## ARKANSAS

HOT SPRINGS—Hot Springs Radio Servicemen's Assoc  
608 W Grand Ave W Malsoli Secy  
NORTH LITTLE ROCK—TV Service Assoc of Arkansas  
P O Box 542 James E Tyson Secy

## CALIFORNIA

ANAHEIM—RTA of Orange County P O Box 105 James L Liedtke Secy  
COLTON—Citrus Belt Radio Technician Assoc Box 344 Roy Clark Recording Secy  
GLENDALE—Radio Technicians Assoc 1745 W Glenoaks Dell Davls  
HOLLYWOOD—Society of TV Engineers KTTV 5746 Sunset Blvd Herbert Pangborn Pres  
LONG BEACH—Radio TV Technicians Assoc P O Box 4085 Harry E Ward Gen'l Chairman  
LOS ANGELES—Electric League of Los Angeles Inc 2508 W Olympic Blvd Glen L Logan Managing Director  
LOS ANGELES—Radio & TV Assoc 3257 West 6 St C Dunkle Pres  
MAR VISTA—Cinema Technicians' Society 520 Postal Place Anton F Brans Secy  
OAKLAND—TV & Radio Assoc of Alameda County Inc 4223 E 14 St Fred W Rock Pres  
POMONA—Pomona Valley Radio-TV Assoc P O Box 567 Carl Misarra Pres  
RICHMOND—TV & Radio Servicemen's Assoc of Contra Costa County P O Box 1334 L C Wade Pres  
SAN FRANCISCO—Radio & TV Dealers Assoc 6299 Mission St T R Hogman Pres  
SAN MATEO COUNTY—Television Service Dirs Assoc W D Haines Chairman  
SANTA MONICA—Radio TV Technicians Assoc P O Box 275 Ocean Park Station Herb Sulkin Secy  
SANTA PAULA—Radio Electronics Specialist Assoc 622 Main St Gene Ornsteln Pres  
VAN NUYS—Society of Radio & TV Technicians P O Box 126 Arnold J Meyer Pres

## COLORADO

ARVADA—Rocky Mt Radio-TV Guild 8201 W Grandview Mile G Scram Pres  
COLORADO SPRINGS—Radio TV Technician Assoc 905 Sal Animas C E Wells Secy  
GREELEY—Rocky Mountain Radio & TV Guild Greeley Chapter 814 16 St Ray Smith Secy  
PUEBLO—Pueblo Radio Servicemen's Assoc P O Box 3063 George E Nix Sec-Treas

## CONNECTICUT

BRIDGEPORT—Radio & TV Dealers Assoc 1243 Main St Thomas P Cafora Pres  
NEW BRITAIN—TV Service Assoc 20 Orange St Thaddeus Grygoc Secy  
WATERBURY—Waterbury TV Technicians Assoc P O Box 683 Mario Ferri Recording Secy

## DISTRICT OF COLUMBIA

WASHINGTON—National Community TC Assoc 71D 14 St NW M F Malarkey Jr Pres

## FLORIDA

JACKSONVILLE—Jacksonville Electronics Technician Society 1526 Gary Thomas Thompson Pres  
MIAMI—Radio & TV Technicians Guild 119 NW 19 Ave John R Mitchell Secy  
PENSACOLA—Pensacola Radio Service Dealers Assoc 106 E Wright St W J Corner Jr Secy  
TAMPA—Radio & TV Service Assoc 9302 Dartmouth Ave Raymond Murphy Secy

## IDAHO

BOISE—Radio & TV Technicians Assoc 1724 Fairview Horace Collins Secy

## ILLINOIS

BERWYN—Professional TV Service Assoc 2137 S Euclid Ave Miles Svoboda Secy  
CHICAGO—Associated Radio & TV Servicemen 433 S Wabash Ave Del Kotrba Secy  
CHICAGO—National Alliance of TV & Electronic Service Assoc 5908 S Troy St Frank J Moch Pres  
CHICAGO—TV Installation Service Assoc 5908 S Troy St Frank J Moch Pres

DECATUR—Radio Assoc of Macon County 753 N Water St P R Hollingsworth Pres  
JOLIET—Joliet Assoc of Commerce 35 W Van Buren St Arthur J Lumsden Exec VP  
JOLIET—Will County Radio & TV Assoc 470 N Chicago St Donn Wright Pres  
PERKIN—Certified TV Service Dealers Assoc John Senninger  
ROCKFORD—Rockford CTIS Assoc Inc 100 W Jefferson St Roy Pearson Pres

## INDIANA

ANDERSON—Radio & TV Service Engineers Assoc 1624 W 9 St Joe Groves Pres  
COLUMBUS—Radio-TV Service Dealer Assoc 1824 Home Ave Henry L Perry Corres Secy  
EVANSVILLE—Ethics in TV Committee 117 Main St Wm Reed Secy  
EVANSVILLE—Radio Service Men's Assoc 105 N Spring St Ray Temple  
SEYMOUR—TV Servicemen's Assoc RFD CIH Lockman Pres

## IOWA

DES MOINES—TV Servicemen's Assoc (TSA) 1487 Keosauqua Edwin Villmek Secy  
FT DODGE—Assoc of Radio Technicians 1726 Central Ave Homer L Davidson Pres  
OTTUMWA—Ottumwa TV Service Dealer Assoc 515 Church St Gerry Brown Secy

## KANSAS

SALINA—Radio & TV-Service Dealers Assoc 227 S Santa Fe L Lantz Pres  
SALINA—Radio Service Dealers Assoc (Salline Chapter) 682 S 9 E A Redmon Pres  
WICHITA—Radio Service Dealer's Assoc of Kansas 1024 S Broadway Ted Combs Pres  
WICHITA—Wichita Appliance Dealers Assoc 815 Central Bldg C D Hughes Secy

## MARYLAND

SALISBURY—Del Marva Radlomen's Assoc 219 Highland Ave Russell Mayor

## MASSACHUSETTS

ARLINGTON—Radio-TV Technicians Guild of Boston 210 Mass Ave Gilbert Clark Secy  
BOSTON—Radio TV Technicians Guild of N E 137 Federal St Gil Clark Secy  
CAMBRIDGE—Assoc of TV Service Engineers 18 Jackson St I Werlin Pres  
FALL RIVER—Radio-TV Technicians Guild of Greater Fall River P O Box 1307 Maurice Provost Pres  
NEW BEDFORD—Radio Technicians Guild 110 Topham St James L Shepley Secy

## MICHIGAN

BATTLE CREEK—TV Assoc of Battle Creek 55½ E Michigan J H Alexander Secy  
DETROIT—Electronic Service Assoc 1763 E Seven Mile Rd T T Czarnocki Secy  
DETROIT—TV Service Assoc of Mich 1415 Dime Building Harold Chase Chairman of Board  
E DETROIT—McComb TV Service Assoc 22391 Gratoit Ave  
KALAMAZOO—Radio TV Assoc of Kalamazoo PO Box 773 Wm G West Pres

## MINNESOTA

MINNEAPOLIS—Assoc of Radio and TV Service 1100 1st National Bank Building Miles Chadwick Pres  
MINNEAPOLIS—Minn TV Service Engineers 800—44 Ave NE  
MINNEAPOLIS—Radio Servicemen of America 1010 Second Ave S J R Trovall  
MINNEAPOLIS—Radio & TV Assoc 2451 Hennepin Harold Simmonson Pres  
ROCHESTER—Rochester Radio & TV Servicemen's Assoc 1205 2 St NE George McKinzie Pres  
ST PAUL—Radio TV Service Assoc of St Paul 635 S Smith Ave Joe Driscoll Pres

## MISSOURI

JOPLIN—TV Technicians & Electronics Assoc 1418 Main St Wm Thomas Secy  
KANSAS CITY—Electric Assoc of Kansas City 2201 Grand St John S McDermott Exec Mgr  
KANSAS CITY—TV Service Engineers Inc 7149 Prospect Walter L Niswonger Jr Secy  
ST LOUIS—TV Installation Service Assoc 1724 S 39th St William Fraser Secy

## NEBRASKA

LINCOLN—Lincoln Electronics Service Assoc 243 S 11 St T M Duffield Pres

LINCOLN—Nebraska Electronics Service Assoc 1617 S 17 St H M Tanquary Pres  
OMAHA—TV & Electronics Service Assoc 1104 Woodman of World Bldg Wm Briza Pres

## NEW HAMPSHIRE

MANCHESTER—Radio TV Assoc of New Hampshire 334 Mitchell St Harvey O'Dowd Pres

## NEW JERSEY

BRIGANTINE—Electronic Technicians Assoc of S J 234 34 St P J Palmer  
IRVINGTON—W J Radio Appliance Dealer's Assoc 1156 Springfield Ave W A Bohr Pres  
MARGATE—Electronic Technicians Assoc of S J 220 N Argyle Ave Wm J McGill Secy  
PATERSON—Radio & TV Servicemen of N J 211 Market St M B Rhodes Pres  
PERTH AMBOY—TV Technician of Perth Amboy 414 Amboy Ave Bud Anderson Pres  
PITMAN—Allied TV Technicians Assoc H Donald Brown  
TRENTON—Delaware Valley Radio Assoc 315 Beechwood Ave Lester H Ailen Pres  
TRENTON—Radio Servicemen's Assoc of Trenton 1101½ Hamilton Ave George Owens Secy  
TRENTON—Radio Servicemen's Assoc 72 S Olden Ave Charles Rebman Secy

## NORTH CAROLINA

CHARLOTTE—Radio & TV Service Assoc 1300 E 4 St A C Kimbiri Pres  
GASTONIA—Universal TV & Appliance Co Jim Pruett  
GREENSBORO—Radio Servicemen's Assoc George Kiser

## NEW YORK

ALBANY—Albany TV Service Assoc 364A Central Ave Mr O'Dea  
BEACON—Hudson Valley Electronic Technician Assoc 55 Prospect St Thomas P Thorne Assoc Mgr  
BETHPAGE—Radio & TV Guild of L I P O Box 87 Murray Barlowe Pres  
BINGHAMTON—Southern Tier Chapter Radio Servicemen of America 85 Robinson St Harold Hazard Pres  
BRONX—Empire State Federation of Electronic Technicians Assoc 1215 Thierlot Ave O Capitelli Pres  
BROOKLYN—Associated Radio & TV Servicemen of NY 1431 Flatbush Ave Jacob Allen Secy  
BROOKLYN—Certified Electronic Technicians Assoc (CETA) 75 Ocean Ave E D Tillin Secy  
BROOKLYN—Natl' Electronic Technician Service Dirs Assoc 1431 Flatbush Ave Max Leibowitz Pres  
BROOKLYN—Radio & Electronic Dealers & Servicemen's Assn 1044 Rutland Rd Irving Horowitz  
BROOKLYN—TV Radio & Appliance Dealers Assn 925 Kings Highway E Y Perlman  
BUFFALO—Buffalo Radio Institute Alumni 45 W Mohawk St Robert Dorlo Recording Secy  
BUFFALO—Radio Technicians Assoc 657 Broadway Theodor J Talaak Pres  
BUFFALO—Radio TV Service Assoc Station E Box 28 F J Lynn Pres  
BUFFALO—Western New York Electronics Guild 2011 Hertel Ave W Harrington Chairman  
DELHI—Catskill Mt Radio Servicemen's Assoc Radio Service Labs A Hayes Pres  
ELNIRA—Southern Tier Electronics Assoc Box 442 419 Balsam St Richard J Marshall Pres  
FOREST HILLS—Forest Radio & TV Assoc 109-D1 72 Rd G Berger Pres  
HEMPSTEAD—Standard Parts 277 N Franklin St Earl Horton  
JAMESTOWN—Electronic Technicians Assoc 21 Lake St Kermit Johnson Secy  
KINGSTON—Kingston Radio Servicemen's Assn 107 Henry St Hilton B Matthews  
KINGSTON—Ulster Electronic Technicians Assoc 94 Furnace St Charles A Kohl Secy  
MINEOLA—National Electronic Technicians & Service Dealers Assoc 138 Jerome Ave John A Wheaton Secy  
MT VERNON—Independent Radio & TV Technicians of Westchester County 60 S 3 Ave H Wiegand  
NEW YORK—Alumni Assoc of RCA Institute 350 W 4 St John Mustillo Secy  
NEW YORK—Radio & TV Electronics Technicians Assoc 52E 19 St Chas Vassalo Pres  
OCEANSIDE—Long Island Electronic Technician's Assoc 88 Fourth St Wm A Carey Pres  
PORT EWEN—Kingston TV Service Assoc Floyd Light  
POUGHKEEPSIE—Poughkeepsie TV Service Assoc Violet Ave Fred Booth  
ROCHESTER—Radio Technicians Guild 703 Temple Bldg Alfred L Best Pres  
SYRACUSE—Syracuse TV Technician's Assoc 500 Lafayette Bldg Gordon M Vrooman Secy

YONKERS—TV Contractors Assoc of NY 855 Midland Ave A E Rhine Pres

**OHIO**

AKRON—Akron Radio Technician Assoc 41 S High St D C Bruner  
 CANTON—Canton TV Assoc 1410 7 St NW W H Blecker Pres  
 COLUMBUS—Associated Radio-TV Service Dealers 2552 N High St Robert Duckworth Secy  
 DAYTON—TV Service Guild 333 W Monument Ave Marshall Rankin Secy  
 HILLSBORO—Southern Ohio Radio TV Technicians Assoc 345 W Main St Ralph M Rogers Secy  
 SPRINGFIELD—Radio & TV Assoc of Springfield Ohio 1805 Edwards Ave Marvln A Miller Pres  
 TOLEDO—Electronic Technicians Assoc of Toledo 1002 Adams St Orville G Shanteau Secy

**OKLAHOMA**

OKLAHOMA CITY—Oklahoma Radio & TV Assoc 111 NW 9 Walter Slox Secy  
 OKLAHOMA CITY—Oklahoma Radio & TV Service Assoc 2908 NW 23 Rd H O Eales Pres

**PENNSYLVANIA**

ALTOONA—Altoona Radio & TV Service Engineers 800 Chestnut Ave William Moffett  
 ALTOONA—Blair County Assoc of Radio Service Engineers 1812 4 Ave W J Lansberry Secy  
 BETHLEHEM—Lehigh Valley Radio Servicemen's Assoc 221 Summit St George Lange  
 BETHLEHEM—Lehigh Valley Servicemen's Assoc 1335 N Long St Claude Kramer  
 CARBONDALE—Federation of Radio Servicemen's Assoc P O Box 61 Leon J Helk Secy  
 CHESTER—TV Serv Dealers Assoc of Del Co P O Box 355 Wm H Morrow Pres  
 EPHRATA—Northern Lancaster County Electronics Servicemen's Assoc P O Box 264 H R Snader Secy  
 ERIE—Erie County TV & Radio Assoc Jim Higgins Secy  
 HARRISBURG—Embassy Television & Sound Service 1845 Whitehall St Frank R Fetrow Jr Mgr  
 HARRISBURG—Mid-State Radio Servicemen's Assoc of Penna 1519 N 4 St L B Smith Pres  
 HERSHEY—Mid-State Radio Servicemen's Assoc Box 162 L P Smith  
 HOLLIDAYSBURG—Blair County Assoc of Radio Service Engineers 103 Broad St David I Dodson Pres  
 JOHNSTOWN—Greater Johnstown TV Assoc 109 Haynes St Paul L Weir Pres  
 KINGSTON—Radio Servicemen's Assoc of Luzerne County 94 W Bennett St Milan J Cooper  
 LANCASTER—The Conestoga TV Assoc 530 High St Robert G Weigand  
 OLYPHANT—Lackawanna Radio Technicians Assoc 104 Hall Ave Henry Govan Secy  
 PHILADELPHIA—Council of Radio & TV Service Assoc 1300 N 3 St Albert Haas Pres  
 PHILADELPHIA—Northeast TV Dealers Service Assoc 6321 Frankford Ave R H Cherrill Secy  
 PHILADELPHIA—Phila Radio Servicemen's Assoc 1307 W Rockland St Samuel M Brenner Pres  
 PHILADELPHIA—TV Contractors Assoc 123 S 46 St William Well Secy  
 PHILADELPHIA—TV Service Dealers Assoc 6017 Ogontz Ave L J Smith Secy  
 PITTSBURGH—Radio & TV Servicemen's Assoc of Pittsburgh P O Box 6844 Tom Ging Recording Secy  
 READING—Berks County Electron Service Dealers Assoc 524 Windsor St Joseph A Kasper Secy-Treas  
 READING—Reading Radio Service Technicians 704 Walnut St John C Rader Secy  
 SCRANTON—Lackawanna Radio Technicians Assoc Box 51 RD 2 Howard Greene Secy  
 STEELTON—Mid-State Radio Servicemen's Assoc 22 S Front St Fred J Schmidt Secy  
 WASHINGTON—Radio TV Service Assoc 471 W Chestnut St Carl J Wagner Secy-Treas  
 WILKES-BARRE—Radio & TV Servicemen's Assoc of Luzerne County P O Box 309 Milan J Krupa Secy  
 WILLIAMSPORT—Associated Radio Servicemen of Central Pa 1643 Memorial Ave Phil Marchioni Secy  
 YORK—Southern Pa Radio & TV Assoc 736 E Market St Carl E Sheffer Secy

**RHODE ISLAND**

PROVIDENCE—Rhode Island Radlomen's Business Assoc P O Box 800 Hugo Olobri Pres

**SOUTH CAROLINA**

CHARLESTON—Charleston TV & Appliance Dealers Assoc 285 Meeting St J A Hood Jr

**TENNESSEE**

CHATTANOOGA—Radio & TV Service Assoc 3509 Ross-ville Blvd David Oehlson Secy  
 KINGSPORT—Bays Mountain Radio Club c/o Tennessee Eastman Recreation Club  
 MEMPHIS—TV Installations and Service Assoc 966 E McLemore Ave Nelson Burns Pres

**TEXAS**

DALLAS—Dallas Radio-TV Sales & Service Assoc P O Box 2955 LeRoy Archer Secy  
 CORPUS CHRISTI—Corpus Christi Radio & TV Assoc 1109 Santa Fe Eddie Fox Pres  
 FORT WORTH—Fort Worth Radio & TV Assoc 1610 8 Ave Truett Kimzey Pres  
 GRAND PRAIRIE—Dallas Radio Sales & Service Assoc Floyd & Dickey Radio Shop Roger Dickey Pres  
 HOUSTON—Texas Electronic Technicians Assoc P O Box 15011 Al Gaskey Assoc Mgr  
 SAN ANTONIO—San Antonio Radio & TV Assoc 520 W Hildebrane Ave H M Willmann Secy

**UTAH**

SALT LAKE CITY—Utah Assoc of Radio & TV Servicemen 418 Frick Bldg 23 E 1 S John F Burns Pres

**VIRGINIA**

NEWPORT NEWS—Tidewater Radio Servicemen's Assoc 4313 Hunt Ave David Heorn Pres  
 NORFOLK—Tidewater Radio Servicemen's Assoc 343 S Diney Rd E C Sholar Secy

**WASHINGTON**

SEATTLE—North West Appliance & TV Assoc 512 1 Ave N Ed Smith Exec Secy  
 SNOHOMISH—Everett Radio Servicemen's Club 1120 1 St Joe Mulholland Pres  
 YAKIMA—Radio TV Service Assoc P O Box 852 Clarence Scott Secy

**WEST VIRGINIA**

HUNTINGTON—Electronic Technicians Assoc P O Box 262 Scott Adams Pres

**WISCONSIN**

EAU CLAIRE—Indianhead Radio-TV Servicemen's Assoc 602 Water St B. F. O'Connell  
 MADISON—Radio Technician Assoc 1314 Williamson St  
 MILWAUKEE—Milwaukee Assoc of Radio & TV 1312 W Atkinson St Carl Lenz Pres

**WYOMING**

CHEYENNE—Cheyenne TV Technicians Assoc 1020 E Pershing Homer E Mover Pres

**CANADA**

HAMILTON ONTARIO—Radio Electronic Technicians Assoc of Ontario 29 Wavell Ave J Forde Pres  
 KELOWNA B C—Assoc Radio Technicians of B C 519 Osprey Ave Ralph Mattie  
 MILNER B C—Assoc Radio Technicians of B C R R 1 Fraser Valley Roy Tom  
 ORGANEVILLE ONTARIO—Radio Electronic Technician Assoc Box 414 V E Sharp  
 VANCOUVER B C—Assoc Radio Technicians of B C 918 Rogers Bldg W Munton  
 VICTORIA B C—Victoria & Island Chapter Radio Elec Technicians Assoc 783 Fort St D Banfield Pres  
 WINNIPEG MANITOBA—Manitoba Radio Service Assoc Box 1394 G H Sloker  
 WINNIPEG MANITOBA—Radio Electronic Technicians Assoc Box 391 C Harder Secy

Copyright 1955  
 Caldwell-Clements, Inc.

# TECHNICIAN and Circuit Digests

... winner of  
 18 manufacturers'  
 independent  
 surveys ...

## FIND OUT FOR YOURSELF!

TECHNICIAN is the preferred publication of the service trade. Still in effect is Caldwell-Clements' "prove it yourself" offer to reimburse manufacturers who make their own verification surveys.

The use of classified telephone directories as the source of names for a survey is a fair and equitable one for all publishers. These lists represent 100% of the TV service business locally, excluding experimenters and consumers. Most important of all, these directories are available to all publishers who are sincere in their effort to build a publication for the servicing trade.

Is this not significant, too? No other service publication (only TECHNICIAN) has published an offer to underwrite a manufacturer's own poll of servicemen's preference.

Find out for yourself about TECHNICIAN'S overwhelming preference—120% over the second publication as certified by Ross Federal Research Corporation.

Have your advertising agency poll all the servicemen in a city or cities of your choice, at our expense. First, write us for full details.

**TECHNICIAN**  
 & Circuit Digests

480 Lexington Avenue,  
 New York 17, N. Y.  
 PLaza 9-7880

**WILL YOU HELP US?**

... By giving us the name of the technical association to which you belong? We'd like this information as part of an editorial survey which we're conducting.

Service Association: .....

Address .....

Manager or Recording Secretary's Name: .....

Phone: .....

Your Name: .....

Your Address: .....

Mail to: Associations Editor, TECHNICIAN,  
 480 Lexington Avenue, N.Y.C. 17, N.Y.

# TECHNICIAN BUYERS DIRECTORY

## Distributors

These are the names and addresses of organizations handling the distribution of radio-TV-electronic parts and equipment in the United States. Listings are alphabetical under states and cities. Asterisk (\*) indicates membership in National Electronic Distributors Association (NEDA).

### ALABAMA

**ANNISTON**  
Dickert Supply Co 130 W 11 St AD 5-3933  
Radio Dist & Supply 109 W 10th St AD 6-0671

**BESSEMER**  
Bessemer Radq Supply 114 N 20 St 5-9573

**BIRMINGHAM**  
Ack Radio Supply 3101 4th Ave SE 4-0588  
Air Engineers 1529 2 Ave 54-3431  
Auto Service 1916 S 4 Ave 4-4102  
Clark & Jones 1601 2 Ave S 4-4529  
\*Clary Co J W 1713 2 Ave S 4-2488  
Electric Constructors 3000 3rd S 3-3243  
Forbes Distr 2600 3 Ave S 3-4105  
Graybar Elec 709 1 Ave N BI 4-1861  
Lewis Supply Co 1025 N 19 St 7-1148  
Long Lewis Hdwe 840 4th Ave  
McDavid & Co R P 1430 2 Ave S 7-7165  
Radio Parts & Equip 1909 5 Ave N 4-4405  
\*Reid Distributing 1724 5 Ave N 4-7357  
Steel City Supply 600 N 7 St 4-0433

**DECATUR**  
Radio & Television Supply 415 Bank 2231

**DOTHAN**  
Carmichael Wholesale 140 S Foster St 2-1255  
Hand Supply Co 705 S Oates 4-3300  
Signal Supply Co 248 E Troy 4-0360

**GAOSEN**  
Radio Dist & Supply Co 219 E Broad St 5241  
Southeastern Radq Parts 120 Chestnut St 6-9761

**HUNTSVILLE**  
Carle Radio Supply Co 406 Meridian JE 4831

**JASPER**  
Ramo Radio Supply 20 St & 2 Ave 2-5321

**MOBILE**  
Emrich Radio Supply 656 Dauphin St HE 8-2596  
Forbes Electronic Distributors 57 N Washington  
General Elec 54 Esriava St 8-4571  
Graybar Elec Supply 701 N Joachim St MO 2-3511  
Harris Supply 10 N Water 2-0541  
McDavid & Co 120 Water St 8-1691  
McGowin-Lyons Water & St Louis Sls 2-8721  
\*Nelson Radio 451 St Louis 2-0411  
Radio Labs 111 N Royal 2-1715

**MONTGOMERY**  
Nollin-McInnis 205 Commerce 7323  
Southeastern Radio Parts 224 N Court St 3-6488  
Teague Hardware PO Box 240 2-0541  
Walther Bros 2245 W Fairview Ave

**SYLACAUGA**  
Campbell Distributing Co 300 W 1 St 2-4122

**TUSCALOOSA**  
\*Allen & Jemison Co 8-2781  
Radio Parts 402 20 Ave 8-5585

### ARIZONA

**PHOENIX**  
Aral Radio Parts 532 W Van Buren AI 3-4023  
Dalis Bros 528 W Jefferson St  
Electrical Comm 202 E Fillmore AI 2-8248  
Electrical Equip 1 Ave at Madison 3-3186  
General Electric Supply 1102 N 22 Ave AL 8-6721  
Gough Industries 917 W Madison See Los Angeles  
Graybar Electric 434 W Madison AL 2-2375  
Mathias & Co Albert Hdqrs El Paso Tex  
Midland Specialty 233 S 11 Ave AL 4-7351  
Momsen-Dunnegan-Ryan 11 E Buchanan  
\*Radio Parts of Ariz 214 S 11 Ave AI 8-6476  
Radio Spec & Appl 305 E Roosevelt AL 4-7184  
Redmond Supply J F 625 W Madison  
Southwest Wholesale Radio 126 S 2 St AL 2-6539  
Western Radio & Equip 1915 E Wash 4-7084  
Westinghouse Elec 1110 N 21 AL 8-8211

**TUCSON**  
Art Electronic Supply 145 S Park 4-4413  
General Electric Supply 2 E 6 St 3-4773  
\*Elliott Electronics 418 N 4 Ave 4-2473  
\*Standard Radio Parts 218 N 1 Ave 3-2545

### ARKANSAS

**BLYTHEVILLE**  
Blytheville Radio Supply 112 S 1 St 4467

**FORT SMITH**  
Carter Electronic 805 N 11 St 3-4129  
Interstate Electric Hdqrs Shreveport La  
Lyon Co Frank 101 N 2 St  
\*Wise Radio Supply 1001 Towson Ave Sunset 3-8926

**HOT SPRINGS**  
White Radio Supply 643 Malvern Ave 2038

**LITTLE ROCK**  
\*Crittton Wholesale 109 W 9 St 27-9248  
Connerly Radio Distributors 1201 E 2 St FR 2-7917  
General Electric Supply 601 E Markham 5-5328  
Graybar Electric 417 Byrd St LI 5-1246  
Frank Lyon 214 E Markham St FR 5-5311  
O'Bannon Bros 409 Shall St FR 2-2211

Southern Radio 1419 Main St FA 2-4198  
Thurman Supply 115 W 11 St 7308  
Westinghouse Elec 119 Sherman 2-5154  
\*White Radio Supply 1222 Main FR 6-1391

**NORTH LITTLE ROCK**  
Rye Wholesale 117 W Washington FR 5-2426

**PARAGOULD**  
Martin Wholesale 1207 W Kings Highway CE 6-4049

**PINE BLUFF**  
White Radio Supply David 615 Main St 3888

**TEXARKANA**  
Interstate Electric Co Hdqrs Shreveport La  
\*Lavender Radio Supply 520 E 4 St 2-4195  
McCulloch Whse TV 305 E Front St 22-8411

### CALIFORNIA

**ALHAMBRA**  
\*Coast Electronic Supply 527 W Main Co 3-4049

**BAKERSFIELD**  
Arbeckle J C 500 E 19 St 5-5816 Hdqrs Fresno  
Gough Industries 3125 Jewett St  
Valley Radio Supply 716 Baker St FA 7-8831

**BERKELEY**  
Pacific Radio Supply 1940 Ashby Ave TH 3-8900

**BURBANK**  
Dean's Electronics 1500 W Burbank Ch VI 9-2277  
Pacific Radio Exch 4101 W Burbank Hdqrs Hollywood

**VALLEY**  
Valley Electronic Supply 1302 N Magnolia Blvd

**CATHEDRAL CITY**  
Wholesale Electronic Specialists 573 Broadway FA 8-3302

**CHICO**  
Kemp Co E M 851 Main St FI 2-8703  
Radio Television Products 738 Cherry FI 2-8140

**COMPTON**  
Electronic Parts Distributors 1508 E Compton Blvd NE 1-7227

**CULVER CITY**  
Stewart & Stevens 8525 Steller Dr TE 0-6511

**EL CENTRO**  
Alnza-Huffman Distributors 1125 W Main 2307

**EL MONTE**  
Kimball-Stark 713 S Tyler FO 0-2594

**EUREKA**  
Commercial Radio & Elec 317 W 7 St HI 2-4179  
Redwood Electronics 313 W 7 St HI 2-1301

**FRESNO**  
Arbeckle J C 2349 Kern 4-6555  
Billings Wholesale Radio 260 Fulton St  
DeJarnatt Whse B J 223 Fulton 2-2153  
Dooley Harry 725 L St 2-4108  
Fresno TV Supply 1449 Broadway 6-9666  
General Elec Supply 1234 O St 4-4746  
Graybar Electric 101 Van Ness Ave FR 2-4175  
Hoffman Sales 1740 Van Ness 6-8321  
Kierulff & Co 725 L St Hdqrs Los Angeles  
Kinney & Faust 1740 Van Ness 6-8321  
Meyberg Co L J 2930 Butler Hdqrs San Francisco  
Ports Mfg Co 3265 Belmont 3-6728  
Schleifer Sound 2121 Blackstone 7-7234  
Westinghouse Elec 2608 Calif 4-5091

**FULLERTON**  
United Radio & Electr 122 S Pajona St LA 5-3424

**GARDENA**  
Video Suppliers 14526 Crenshaw DA 9-4053

**GLENDALE**  
Haegerty Radio 6826 San Fernando Rd TH 8-2453  
\*Weatherford Co R V 6921 San Fernando RD 9-2281

**HOLLYWOOD**  
Hollywood Radio 5606 Hollywood HO 4-8321  
Pacific Radio Exch 1407 Caluenna HW 2-1393  
Western States Elec 1509 N Western Ave HO 5-7185  
Yale Radio Elec 6616 Sunset Blvd GL 4169

**HUNTINGTON**  
Martin Dist Co 2475 E Florence Ave

**INGLEWOOD**  
Acron Radio 599 S. La Brea DR 8-5344  
Cook Electronics 210 E Hardy St OR 8-7644  
Inglewood Electronics 836 S LaBrea OR 4-2366

**LONG BEACH**  
Cal-Tenna Electronic 363 South St LB 20-7954  
Dean Co F S 969 American 6-5281  
General Electric Supply 840 W 12 St 3-5311  
Gough Industries 838W12 Hdqrs Los Angeles  
Graybar Electric 800 W 16 St LO 70-2911  
Kierulff & Co 1760 Pacific Ave 6-8268  
Ley Co Elwyn W 5550 Dairy Ave 20-5444  
Lynde Electronics 1526 E 4 St 7-4807  
Radio & TV Equip 2227 Pacific Hdqrs Santa Ana  
\*Scott Radio Supply 266 Alamitos 7-8629  
Waller Inc H T 645 W 15 St 35-4844  
Westinghouse Elec Supply 901 W 12 St

**LOS ANGELES**  
Allied Radio Supply 7319 S Normandie Ave PL 2-3134  
American Electronic 567 S Fairfax Ave YO 5181

Basford Co H R 3320 Leonis Blvd LU 1-6258  
Bell Radio Supply 1311 W Florence Ave PL 2-7191  
Calif Electronic Supply 11801 W Pico Blvd BR 2-2126

Ceazan J N Co 3535 S Broadway AD 1-9133  
Central Scientific Co 6446 Telegraph Rd RA 3-6141  
Dunkle Radio Parts 2506 W 8 St  
\*Federated Purchasers 11275 W Olympia Blvd BR 2-0831

Figart's Radio 6320 Comm Sloat Dr YO 6218  
General Elec Supply 700 Turner St MA 5-7141  
Gerstman Dist 414 S. Western DU 8-2238  
G.L. Electronics 905 S Vermont DU 7-5104  
Gough Industries 560 S Mission Rd MA 6-2474  
Graybar Electric 210 Anderson AN 3-7282  
Henderson Co 628 N Alvarado DU 2-8301

Henry Radio Shop 11240 W Olympic Blvd GR 7-6701  
Hollywood Electronics 7460 Melrose Ave WE 3-8208  
Kerwin Co JJ 1525 S Flower St PR 5323  
Kierulff Electronics 820 W Olympic RI 7-0271  
K & L Radio Parts Co 1406 Venice Blvd RI 9-0553  
Los Angeles Radio 10217 Venice TE 0-5862  
Martin Dist Co 2475 E Florence LO 5-7111  
Meyberg Co Leo J 2027 S Figueroa St RI 7-4451  
Winthorne Music 2920 W Pico Blvd RE 4-2177

National TV Supply 4032 S Figueroa AD 3-8058  
Olympic Elec 7636 Santa Monica Blvd HD 4-9144  
Pacific Radio Exch 1407 Caluenna Blvd HU 2-1393  
Pacific Television 4032 S Figueroa AD 3-8058  
\*Paper Bros 2605 E 4 St AN 2-5151  
Quality Dist 2545 S Yates Ave RA 3-7321  
Radio Doc 721 S Main St VA 3104

\*Radio Equip Dist 1340 S Olive St PR 9151  
Radio Parts Sales 5220 S Vermont TV 9178  
\*Radio Prod Sales 1501 S Hill PR 7471  
Radio Spec 1956 S Figueroa PR 7271  
Radio TV Sup 341 W 18 St RI 9131  
Ravenscraft Co 2320 S Hill PR 1317  
Shelley Radio 2008 Westwood GR 7-6741  
United Radio & Elec 1924 S Grand RI 7-0441  
\*Univ Radio Sup 1729 S Los Angeles PR 5241  
Victor Distr Co 2027 S Figueroa RI 7-4457  
Westinghouse Elec Sup 905 E 2 MA 9-4161  
Wholesale Radio & TV Sup 4305 S Figueroa St AD 3-8171

**MALIBU**  
Telcoa 1 Azurcee Dr GL 6-2611  
Yale Radio Electric 6616 Sunset Blvd GL 4169

**MARYSVILLE**  
\*Dunlap Whse Radio 826 5 St Hqrs Stockton

**MAYWOOD**  
Kierulff 6058 Watker Ave LO 5-5461

**MODESTO**  
Dunlap Whse Radio 1216 K St Hdqrs Stockton  
Pacific Electronic & Radio Sup 417 7 St 3-7751

**MONTREY**  
Wholesale Electronics 229 Alvarado St 2-7642

**NORTH HOLLYWOOD**  
Hycor Sales 11423 Vanowen St  
N Hollywood Radio 4212 Lankershim Blvd St 7-3063

**OAKLAND**  
Basford Co H R 2101 Bush St GL 1-0314  
BRIH Co W D 198 10 St TE 2-6100  
Cass Altschler Co 6038 Telegraph Ave OL 3-7557  
Electric Supply 140 11 St HI 4-7011  
\*Elmar Electronics 140 11 St HI 4-7011  
General Electric Supply 5400 Hollis St OL 3-4433  
Graybar Elec 1911 Union St GL 1-5451  
\*Millers Radio & TV 336 E 8 St TW 3-3848  
Raycraft Co 568 3 St TW 3-9698  
Wenger Co E C 1450 Harrison Gl 1-1020  
Westinghouse Elec 711 E 8 TE 4-9900

**PALO ALTO**  
Associated Radio Distr 459 California Ave DA 3-3173  
Zack Radio Supply 525 High St DA 5-5678

**PASADENA**  
Dow Radio 1759 E Colorado SY 3-1196  
Electronic Supply 2615 E Foothill SY 5-8902  
Emoire Electronic Dis 37 E Union st RY 1-7671

**POMONA**  
Anderson-Manns 1095 E Third LY 9-9669

**REDWOOD CITY**  
Electronic Supply 1740 Broadway EM 8-4093  
Television-Radio Supply 415 Lathrop St Hdqrs San Francisco

**RICHMOND**  
Millers Radio & TV Supply 319 37 St BE 5-4424

**RIVERSIDE**  
Electronic Supply 2486 3 St OV 3-8110  
Mass-v's Radio Supply 2992 8 St

**SACRAMENTO**  
Brolli-Parks 2225 19 St GI 2-2983  
Brown Co C C 1714 10 St GI 3-5931  
Capitol Electronics 1714 10 St GI 3-5931  
\*Dunlap Whse 1628 "S" St GI 2-1031 Hdqrs Stockton

General Elec Supply 1131 "S" St GI 3-9001  
Graybar Electric 1900 14 St GI 2-8976  
\*Kemp Co E M 1115 R St GI 3-4668  
Meyberg Co Leo J 1730 8 St GI 2-5837  
Radio Television Prod 2012 19 St GI 2-7691  
\*Sacramento Electronics 1219 "S" St HU 1-4821  
Westinghouse Elec 1730 14 St GI 3-6525

**SALINAS**  
Peninsula TV & Radio 42 W Gabilan 2-6503

**SAN BERNARDINO**  
Arrowhead Radio & Television 418 Base Line 2-5181  
Electronic Equip 1123 W Base Line  
Featherstone Radio & TV 1010 E St 81-1306  
General Elec Supply 485 S "H" St 5135  
Gough Industries PO Box 222 Hdqrs Los Angeles  
Graybar Electric 655 S "H" St SA 9-1051  
HIFI Supply 418 Baseline 2-5181  
\*Inland Electronic Supply 843 Colton Ave 6-5571  
Kierulff & Co 1123 W Base Line Hdqrs Los Angeles

**SAN DIEGO**  
Ceazan Co J N 1945 E Harbor Dr BE 9-1301  
Electric Snoolies Dist 435 2 Ave  
Electronic Equip Dist 1228 2 Ave BE 2-3155

General Elec Supply 450 2 Ave BE 9-0271  
 Gough Industries 3255 5 Ave W 0659  
 Graybar Electric 720 State St BE 3-1361  
 Kleruff & Co 2426 4th Ave  
 Radio Parts Co 2060 India BE 9-9361  
 Shanks & Wright 2045 Kettner F BE 9-0176  
 Silvergate Radio Supply 2361 India FR 9-6125  
 Western Radio & TV 1419 India St BE 9-0361

**SAN FRANCISCO**  
 \*Assoe Radio Distr 1929 Market St HE 1-0212  
 Basford Co H R 235 15 St MA 1-8545  
 \*Brown Co C C 61 9 St MA 1-7000  
 Century Distr 1111 Front St YU 2-1480  
 \*Eber Electronics 160 10 St MA 1-4332  
 Edwards Co Frank 382 6 St MA 1-9700  
 Ete-Hoklin & Galvan 551 Mission St EX 2-0432  
 General Electric Supply 1201 Bryant St UN 3-4000  
 Graybar Electric 1750 Alameda St MA 1-5131  
 Kaemper & Barrett 1850 Miss UN 3-3080  
 \*Mayberg Co L J 33 Gough St MA 1-3400  
 Offenbach & Remus 1564 Market St KL 2-2100  
 \*Pacific Whistle 1850 Mission St UN 1-4843  
 Popkey Co G M 1201 Howard St KL 2-3488  
 Radio Parts Supply 281 9 St MA 1-0552  
 \*San Francisco Radio 1284 Market UN 3-6000  
 \*Smith & Crawford 789 Stevenson St UN 3-2045  
 Tel-Radio Supply 408 Market EX 2-2898  
 \*Television Radio Supply 326 Market St EX 2-2898  
 Tilton Industries 1850 Mission St UN 1-4843  
 Westinghouse Elec 201 Potrero UN 1-5051  
 \*Wholesale Radio 140 9 St HE 1-3680  
 \*Zack Radio Supply 1424 Market MA 1-1424

**SAN JOSE**  
 Peninsula TV & Radio 881 S 1 St CY 4-8781  
 \*Queent Inc Frank 161 W San Fernando St  
 CY 4-0464  
 San Jose TV Supply 986 The Alameda CY 4-7900  
 Schad Electronic Supply 256 W San Fernando  
 CY 7-5858  
 Westinghouse Electric 292 Stockton Ave CY 5-3707

**SAN LEANDRO**  
 Millers Radio & TV Supply 1600 150 Ave BR 6-3214  
 Styles & Engleman 2255 Bancroft Ave LO 9-9433

**SAN MATEO**  
 Associated Radio Distributors 1701 Gum St FI 5-3575

**SAN RAFAEL**  
 Abbett Co E B 345 Francisco GL 3-1130

**SANTA ANA**  
 Graybar Electric 301 French St KI 3-8309  
 Hurley Electronics 1434 S Main KI 3-9237  
 Radio & TV 207 Oak KI 2-6741

**SANTA BARBARA**  
 Channel Radio Supply 523 Anacapa W 2-3429  
 Gough Industries 404 State St Hdqrs Los Angeles

**SANTA CLARA**  
 Central Scientific Co 1040 Martin Ave AX 6-6650

**SANTA MARIA**  
 Dealers Wholesale Supply 310 W Main WA 5-7213

**SANTA MONICA**  
 Santa Monica Radio 117 Santa Monica EX 3-8231

**SANTA ROSA**  
 Santa Rosa Electro 1066 Santa Rosa Ave 7708

**SHERMAN OAKS**  
 Oak Radio Supply 13454 Ventura ST 7-6666

**SOUTH GATE**  
 Mae's Radio Supply 8320 Long Beach KI 4111

**STOCKTON**  
 DeJannatt Whistle B J 515 N Hunter Hdqrs Fresno  
 \*Denlap Whistle Radio 27 N Grant HO 6-7907  
 General Electric Supply 24 N Aurora ST HO 5-7231  
 Kemp Co E M 50 N Wilson Way HO 5-5976  
 Sacramento Electro Supply 710 E Main St HO 5-2691  
 \*Stockton Electronics 710 E Main St HO 5-2691

**VALLEJO**  
 Associated Radio Distr 1927 Solano Ave VA 3-4531  
 Walker Co R Lyman 1401 Hiway 40 VA 3-5675

**VAN NUYS**  
 Tags Radio & TV Supply 14530 Calvert St ST 5-3123

**VENTURA**  
 Dealer's Whistle 265 S Laurel MI 3-6147

**VERNON**  
 Westinghouse Elec Supply 4601 S Boy L St KI 0141

**WALNUT CREEK**  
 Millers Radio 2497 Mt Diablo Blvd YE 4-8404

**WEST LOS ANGELES**  
 California Electronics 11801 W Pico BR 2-2126

**COLORADO**

**BOULDER**  
 Boulder Distr Co 1633 18 St HI 2-8750

**COLORADO SPRINGS**  
 D & M Electr Supply 717 N Weber St ME 3-0902  
 Murray Radio Co 9 E Vermijo ME 3-8248  
 Walker Radio Co L B 324 N Tejon ME 3-5426

**DENVER**  
 Electric Accessories 1959 Stout St  
 Electronic Parts Co 1322 Lincoln St  
 Fiestels Radio 1085 Lincoln St MA 3-3197  
 General Electric Supply 1429 18 St KE 4-6301  
 Graybar Elec 104 Wazee Market TA 5-7116  
 Hasso Inc 1745 Wazee Keystone 4-8151  
 Hendrie & Bolthoff 1635 17 St KE 4111  
 Inter-State Radio 1200 Stout St TA 5347  
 Larson Distrs 550 Lincoln St  
 Niles Phonograph & Radio 1254 Arapahoe TA 5-7776  
 Radio Parts Distr 3040 W Colfax CH  
 Radio Products Sales 1237 16 St CH 6591  
 Sweeney Co B K 1601 23 St KE 6211  
 Ward Terry 70 Rio Grande Blvd  
 Walker Radio L B 620 Broadway Hdqrs Pueblo  
 AL 5-3695  
 Wreco Parts of Colorado 780 Broadway

**GRAND JUNCTION**  
 Radio & Elec Supply 511 Ute Ave 486  
 Walker Radio Co L B 962 North Ave 3698

**PUEBLO**  
 Pueblo Radio TV Supply 211 Polk 8515  
 \*Walker Radio Co L B 100 N Victoria Ave LI 2-1924

**CONNECTICUT**

**BRIDGEPORT**  
 Coastal Radio 1106 Barnum Ave 5-7441  
 D'Elia Distributors 1330 Fairfield Ave ED 3-0195  
 General Elec Supply 1899 Seaview Ave FO 8-1621  
 \*Harty of Bridgeport 1700 Main St 5-3124  
 Kaufman Electronics 1710 Main St ED 3-1842  
 Sprague Electrical Supplies 347 RR Ave 6-2535  
 Waldhaus L N 1132 Norman St FA 5-7985  
 \*Westchester Electronic 195 Colorado Ave FO 7-7747

**DANBURY**  
 Pilgrim Electronics 11 Spring St 3-4617

**EAST HARTFORD**  
 Radio & Appliance Dist 673 Connecticut JA 8-6544

**EAST HAVEN**  
 J V Electronics 677 Main St HO 7-3034

**HARTFORD**  
 Capital Light & Supply 6 Huntley Pl JA 7-8115  
 D'Elia Distributors Inc 217 Walnut St JA 2-1252  
 Emerson Radio 20 Chestnut St JA 5-1476  
 Freed Electronics Inc 1301 Main St CH 9-7579  
 General Elec Supply 2964 Main St JA 2-4111  
 \*Harty of Hartford 203 Ann St JA 7-1881  
 \*Moses Radio & Elec 54 Flower St 7-2747  
 Orkin Inc P O Box 208 HA 8-6581  
 Roskin Distributors 275 Park Ave 89-9361  
 Seiff & Co R G 78 Maple Ave JA 2-1144  
 Signal Center 21 New Britain Ave JA 2-9393  
 Westinghouse Elec 185 Ann St 2-9203  
 Wood-Alexander Co 100 Locust St  
 Yale Radio Electronics 1215 Main JA 2-9300

**KENSINGTON**  
 \*Modern Radio 131 Farmington Ave NB 4-0840

**NEW BRITAIN**  
 Radio & TV Supply 183 Arch St 5-3024  
 \*United Radio Supply 53 E Main St 3-2731  
 Universal Radio Co 61 E Main St

**NEW HAVEN**  
 Amerling 203 Henry St SP 7-7383  
 American Distr 76 Franklin UN 5-0861  
 American TV B4 Commerce St LO 2-6122  
 Amrad Co 843 Grand Ave UN 5-4508  
 \*Brown Co T H 15 Whiting St ST 7-2297  
 Congress Radio 207 Congress UN 5-6365  
 Connecticut Appl Distrs 140 Ferry St LO 2-9941  
 Dale Electronic Div Dale-Conn Inc 150 James  
 SP 7-5555  
 Electronic Sales 353 Crown St UN 5-0161  
 General Elec Supply 74 Forbes St HO 7-6331  
 Graybar Electric 25 Union St UN 5-4163  
 \*Harty of New Haven 77 Broadway ST 7-5921  
 Plymouth Electric 393 Chapel St. ST 7-0291  
 Radio Shack Corp 230 Crown St SP 7-6871  
 Tower Distr H M 48 County St SP 7-5320  
 Westinghouse Elec 240 Cedar SP 7-3601  
 Yale Radio-Electric 680 Chapel MA 4-0834

**NEW LONDON**  
 Aikins Electronic 531 Broad St GI 2-4407

**NORWICH**  
 Aikins Electronic Supplies 98 Water St TU 9-8427

**STAMFORD**  
 \*Harty of Stamford 97 Main St  
 Stamford Radio Supply 562 Atlantic St  
 Westchester Elec Supply 181 Stillwater Ave FI 8-5397

**WATERBURY**  
 \*Bond Radio Supply 439 W Main St 3-2149  
 General Elec Supply 23 Nichols Dr PL 4-2143  
 \*Harty of Waterbury 89 Cherry 5-1181  
 Mae's Radio & Electronic 200 Bank St  
 Pilgrim Electronics 312 Walnut St PL 6-0063

**WEST HARTFORD**  
 Graybar Electric 453 New Park Ave AD 3-2631

**DELAWARE**

**WILMINGTON**  
 Almo Radio 1122 French St Hdqrs Philadelphia Pa  
 WI 5-5161  
 D & M Radio & Electronics 215 W 4 St 2-0424  
 General Electric Supply 310 S Market St 5-5561  
 Graybar Electric 1005 W 4 St WI 4-6245  
 Radio Electric 3 & Tattall Sts 8-8664  
 Westinghouse Electric 400 S Market 5-9611  
 Wholesale Electronic Supply 3rd & Monroe Sts 6-1144  
 Wilmington Elec Supply 405 Delaware Ave 5-4321

**DISTRICT OF COLUMBIA**

**WASHINGTON**  
 \*Capitol Radio 2120 14 St N W HO 2-0800  
 Educational Labs 1625 Conn N W DU 3434  
 \*Electronic Wholes 2345 Sherman N W HU 5200  
 General Electric Supply 705 Edgewood St N E  
 HU 3-6800  
 Graybar Elec 60 Fla Ave N E AD 4-4800  
 Kenyon Radio Supply 2020 14 St DE 2-5800  
 Mid-Atlantic Appl 2040 W Va Ave NE LA 6-5500  
 \*Rueker Electronic 1312 14 St NW AD 2-8554  
 \*Silberner Radio 3308 11 St NW HO 2-7000  
 SE Radio Wholesalers 2027 Nichols SE LU 4-5142  
 \*Southern Electronics 3405 Georgia NW TV 2-5000  
 Southern Whistlers 707 Edgewood NE HU 3-3422  
 Sun Parts Distr 514 10 St ME 8-2697  
 Westinghouse Elec 1216 K St NW NA 9700  
 Zamolski Jos M 2122 24th NE LA 6-3300

**FLORIDA**

**DAYTONA BEACH**  
 Hammond Electronics 719 N Ridgewood 2-0704

**FORT LAUDERDALE**  
 Certified Radio TV 2606 S Federal Hwy 3-6451  
 Gouddard Distr 2113 S Andrews Ave Hdqrs W Palm  
 Beach  
 Graybar Electric 845 N W 6th Ave FO 3-9672

**FT PIERCE**  
 McNeas Radio Supply 900 S Dixie Hwy 2728

**GAINESVILLE**  
 Baird Hardware Co 101 E Main St 8531

**JACKSONVILLE**

Aemo Electronics Distr 811 Main St 6-0485  
 Bent Distributing Co 4012 W Beaver St  
 General Elec Supply 530 E Forsyth St EL 3-9011  
 Graybar Electric 12 & Main Sts JA 6-7611  
 Kinkade Radio 1402 Laura Hdqrs Tampa  
 Major Appliances 536 E 4 St Hdqrs Miami  
 Peard Electronic Supply 672 E 8th St  
 Pathway Co C F 2231 W Beaver 6-1591  
 Radio Parts Co 1411 Main St  
 Southeast Radio Co 930 W Adams St 4-6372  
 Southern Hardware 11 S Newman St  
 \*Thurow Distributors 15 E Church St 5-3727  
 Westinghouse Elec 545 E 4 St 3-7431

**KEY WEST**

Certified Radio TV 903 Duval St 2-8550

**LAKELAND**  
 Hammond Electronics 116 W Lemon St Hdqrs Orlando  
 MU 6-9121  
 Radio Accessories 1054 S Florida Ave Hdqrs Orlando

**MIAMI**

Certified Radio TV Supply 675 NW 11 St 82-1637  
 East Coast Radio 1932 N W Miami Ct 82-4636  
 Electronic Supply 61 N E 9 St 9-4512  
 Emerson Radio of Fla 131 NE 10th St  
 Flagler Radio Co 1068 W Flagler St  
 Flagler Radio Supply 2770 N W 24 St 65-1361  
 General Electric Supply 2111 N W 22 Ave MI 65-1411  
 Graybar Electric 2111 N W 23 St 82-5431  
 \*Herman Radio Supply 1365 N W 17 Ave 3-5533  
 Major Appliances 2201 N W 3 Ave 2-7441  
 Radio Parts Inc 325 N W 7 Ave 65-1389  
 Sanders Electronics Co 3408 NW 27 St 9-1761  
 Sea Coast Appl Dist 1481 N E 2 Ave 9-6571  
 \*Thurow Distributors 2207 N E 2 Ave 9-4794  
 \*Walder Radio & Appl 1809 N E 2 Ave 9-4794  
 Westinghouse Electric 3400 N W 31 St 82-3691  
 Wholesale Appliance 965 S W 8 St

**ORLANDO**

General Electric Supply 523 N Garland 3-6407  
 Goddard-Orlando 631 W Central Ave 5-5531  
 Graybar Electric 400 Pittman St OR 5-4551  
 Hammond-Adams Inc 533 W Central Ave  
 Radio Accessories Co 2305 McRae St 5-2677  
 \*Thurow Distributors 625 W Central Ave

**PANAMA CITY**

Thompson Appliance 316 Laverne Ave SU 5-4821

**PENSACOLA**

Grice Radio & Elec 300 E Wright St HE 3-4616  
 Gulf Elec & Howe 115 E Gregory St 6146  
 Hundley Distributing 1110 N 13 Ave HE 2-5457  
 Nelson Radio & Supply PO Box 3014

**ST. PETERSBURG**

Cooper Radio Co 648 2 Ave S 7-7120  
 Graybar Electric 1900 1 Ave S ST 7-4161  
 Southern Electronic Labs 938 9 St S 75-2911  
 Tee-Vee Parts 702 3 St S 7-0533  
 \*Thurow Distr 342 3 Ave S  
 Welch Radio Supply 408 9 St S 7-8655

**TALLAHASSEE**

General Elec Supply 705 S Woodward St 3-0520  
 Radio-Television Supplies 1320 S Adams St 3-2337  
 \*Thurow Distributors 739 Monroe St 2-1263

**TAMPA**

Elc Supply Co 106 S Franklin St 2-3745  
 Emerson Radio of Fla 209 S Franklin St  
 General Electric Supply 514 S Morgan Ave 8-3117  
 Goddard Distr 1502 Grand Central Ave 2-4621  
 Graybar Electric 416 Ellamae Ave TA 2-4621  
 Kinkade Radio Supply 1707 Grand Central 8-6043  
 Major Appliances 419 Ellamae Hdqrs Miami  
 Radio Accessories Co 135 S Franklin Hdqrs Orlando  
 \*Thurow Distributors 134 S Tampa St 2-1885  
 Westinghouse Electric 417 Ellamae Ave 2-4271

**WEST PALM BEACH**

Gouddard Distributors 1309 N Dixie 3-5701  
 McNeas Radio Supply 805 N Dixie 3-9969  
 \*Thurow Distr 327 Okeechobee Rd

**GEORGIA**

**ALBANY**  
 General Electric Supply 410 Hodges Ave HE 5-5631  
 Specialty Distributing 104 Pine Ave Hdqrs Atlanta  
 Stewart's Radio 212 N Washington 2-1072  
 Westinghouse Elec 610 N Washington 667

**ATLANTA**

Atlanta Phonograph 27 Pryor SW WA 3380  
 Beck & Gregg Hardware 217 W Luckie St N W WA  
 2010  
 Brown Distributing Co 731 Glenn St SW RA 6137  
 Economy Auto 1130 Bankhead N W AT 1672  
 Edwards-Harris 258 Peachtree NW LA 5668  
 Electrical Whise 229 Whitehall St SW CY 3431  
 Garvin Electric 69 Forsyth St  
 General Electric Supply 172 Haynes St S W MA 3811  
 Georgia Appliance 1405 Spring St N W  
 Graybar Electric 333 North Ave N W CY 1751  
 Hopkins Equip 418 W Peachtree CY 6031  
 Jackson Electronic Sp 840 Marietta St NW EL 5808  
 Martin Distr C S 1000 Marietta NW  
 Southeastern Radio Parts 400 W Peachtree 6-9761  
 Specialty Distributing 425 Peachtree EL 5816  
 Thomas Electronics H 331 Luckie St NW LA 8477  
 Westinghouse Elec 1299 Northside Dr N W AT 2721  
 Yancey Co 1500 Northside Dr N W EL 8843

**AUGUSTA**

General Elec Supply 1547 15 St 6-8422  
 \*Prestwood Electronics 1445 Greene St 4-3444  
 Specialty Distributing 644 Reynolds St Hdqrs Atlanta

**COLUMBUS**

\*Radio Sales 1326 1 Ave  
 Westad 1047 13th St

**MACON**

\*Electronic Distr 995 Riverside Dr 3-9379  
 Hatcher Co A S 586 3 St 3-5464  
 Specialty Distributing 539 Arch St Hdqrs Atlanta  
 White Radio Co 654 Mulberry St 3-3768

**BOME**

Electronic Supply 217 E 1st St 7842

**SAVANNAH**

General Electric Supply 301 E Bay St 4-2231  
 Graybar Electric 2601 Whitaker St SA 2-1121  
 Southeastern Radio Parts 38 Montgomery St 7562  
 Specialty Distributing 411 E Broughton St  
 Tuten & Long 1508 E 50 St  
 Westinghouse Elec 580 Indian 3-9682  
 Yancey Co 666 Indian St 4-1611 Hqrs Atlanta

**IDAHO**

**BOISE**  
 \*Craddock Radio Sup PO Box 297 2-6471  
 General Electric Supply 618 S 8 St 4343  
 Graybar Electric 1325 Idaho St 80 2-4501  
 \*Kopka Electronics 3113 Rosehill 2-2371  
 Robbles Radio 4001 Hill Rd 2-8892  
 Westinghouse Electric 318 S Capital Blvd 2-3531

**IDAHO FALLS**

Schwendman Dist 380 E St 4393

**POCATELLO**

Ballard-Carter 840 N Main St  
 Billmeyer's Wholesalers 240 S Arthur St

**TWIN FALLS**

Craddock Radio Supply 310 2 Ave E 971  
 United Automotive 304 3 St E 2390

**ILLINOIS****ALTON**

Ehinger Radio 2416 E Broadway 2-0521  
 Radonics Alton Inc 1320 E Broadway AL 2-0076

**AURORA**

Pioneer Radio Supply 103 S La Salle St

**BELLEVIEW**

\*Lurtz Electric 219 N Illinois St AD 3-0942

**BENTON**

\*Lampley Radio 802 N McLeanshore 5111

**BLOOMINGTON**

Alverson Sales Co 217 E Front St 2-8380  
 Arco Electric Supply 908 S Lee St 2-5145  
 RPD-Arthur Nagel Inc 506 W Market 4-5109

**CALUMET CITY**

Chaunceys Inc 136 Pulaski Ave Hqrs Chicago

**CENTRALIA**

Centralia Elec Supply 108 S Chestnut 7111

**CHAMPAIGN**

Electronic Parts Co 905 S Nelli St 9525  
 Radio Doctors 340 N Hickory

**CHICAGO**

\*Allied Radio 100 N Western Ave HA 1-6800  
 Alton Electronic 2737 N Ashland GR 7-5386  
 American Electronic 621 W Randolph DE 2-5226  
 Arpo Sales 4305 Lincoln St WE 5-7781  
 Ashbach Enterprises 743 N LaSalle St WH 4-0077  
 Atronic Sales 6566 Sheridan Rd 1-2424  
 \*Bowman & Co J G 515 E 75 St TR 4-8070  
 Broadwin TV & Radio 5004 Broadway UP 8-6060  
 Central Scientific 1700 Irving Park Rd WE 5-8600  
 \*Chaunceys Inc 4740 W Chicago Ave ES 8-0830  
 Chicago Electronic 420 E 87 St HU 3-9700  
 Chicago Radio Apparatus 415 S Dearborn HA 7-2276  
 Clayton Radio 2749 N Ashland GR 7-1075  
 \*Electronic Expeditors 2909 W Devon Ave RO 4-8640  
 General Elec Supply 845 S Clinton WA 2-5656  
 Graybar Electric 850 W Jackson Blvd CA 6-4100  
 Green Mill Radio Supply 145 W 111 St PU 5-9840  
 Grove Electronic Sup 4645 S Cottage Grove WA 4-5452  
 Howard Electr 4140 Archer Ave CI 4-1777  
 Joseph Radio Parts 5959 W Fullerton NA 2-3914  
 Lake Radio Sales 3458 W Fullerton DI 2-2310  
 Lukko Sales Corp 5024 Irving Park Rd AV 3-4800  
 Mid-States Electronic 5028 N Bldg LD 1-2894  
 \*Midwest Electr 6907 N Western Ave RO 1-1160  
 Mort's Radio Shack 1920 N Milwaukee BR 8-5600  
 Nagel Inc Arthur 918 E 55 St BU 8-5050  
 Nation Wide Radio 572 W Randolph St DE 2-6509  
 Newark Electric 223 W Madison St 2-2950  
 Olson Radio 623 W Randolph DE 2-5226  
 Pilgrim Distributing 1230 E 53 St FA 4-6043  
 Pioneer Radio Supply 5243 W Diversey Ave  
 Premier TV Radio 3239 W North St AR 6-5550  
 \*Radio Parts Co 612 W Randolph DE 2-5556  
 Radio Parts Distr 925 E 55 St BU 8-5050  
 Radio Parts Outlet 4305 Lincoln Ave WE 5-7781  
 RCA-TV Supply 4345 W Armitage Ave HU 9-3311  
 RCA Victor Distr 445 N Lake Shore Dr WH 4-4600  
 Star Electronic 7736 S Halsted HU 3-8440  
 Stolz-Wicks 8110 S Western WA 5-6210  
 Triangle Industries 600 W Adams AN 3-5060  
 U S Radio & TV 6346 S Ashland WA 5-4111  
 \*Walker-Jimison 311 S Western Ave CA 6-2525  
 Westinghouse Elec 113 N May St HA 1-7474

**BANVILLE**

Aflon Electric 18 E North St  
 Bad Electronic 118 Van Buren St E 925  
 Westinghouse Electric 603 N Gilbert 1901

**DECATUR**

Crum Dist 704 N Monroe 3-7776  
 Loughnane & Co 802 N Water St 2-4187  
 York Radio & TV 801 N Broadway 3-3484

**DIXON**

Illinois Appliance 407 W 1 St

**ELGIN**

Elgin Electronic 157 Brook 7635  
 Fox Electric Supply 67 N State St

**ELMHURST**

Malone Electronics 123 Addison St TE 4-5110

**EVANSTON**

Chaunceys Inc 1908 Central St Hqrs Chicago

**WARRISBURG**

Standard Radio 523 W Poplar 640

**JACKSONVILLE**

Baptist Radio & TV 419 S Mauvalsterre 2526

**JOLIET**

Joliet Radio Supply 460 N Chicago 3-9328

**KANKAKEE**

Radio Doctors 892 W Station St 2-4726

**MATTOON**

Furste Auto Supply 5418  
 Mattoon Radio & TV 1219 Broadway 8414

**MOLINE**

\*Lofgran Dist Co 1202 4 Ave MO 4-7436

**MT. CARMEL**

Wabash Electronics 700 Plum St 728

**OAK PARK**

\*Melvin Electronics 541 Madison VI 8-3960

**PEORIA**

Graybar Electric 704 S Adams PE 3-8516

Grimm Distributing Co 400 Franklin St

\*Herberger Radio Supply 136 1 St

Klaus Radio & Electric 707 Main St

Peoria Elec Appl 631 Franklin 3-3847

Rohn Electronic 2108 Main St 4-9156

Ross Radio 1915 Main St 3-3721

Warren Radio 308 S Oak St

Westinghouse Electric 2800 N Adams St 2-5456

Williams Inc 828 S Adams St 3-4446

Yeomans Distributing 3302 N Adams 5-7631

**QUINCY**

\*Cooper Supply 419 S 10 St 237

Quincy Electronic 310 Hampshire

**ROCKFORD**

General Electric Supply 810 20 St 5-0551

H & H Electronic Supply 510 Kishwaukee St 5-4625

Johnson Sales Art A 1117 Charles St

J & M Radio & Telev 1133 Railroad Ave

Mid-West Associated 506 Walnut St 4-5843

State-Wide Wholesaler 913 S Main St

Superior-Rockford 2310 Charles St 3-6451

Westinghouse Elec Supply 323 S Main St 5-0577

**ROCK ISLAND**

\*Cameron Co 114 17th St 8-7457

\*Tri-City Radio Supply 1919 4 Ave 8-5681

**ST. JACOB**

Michael's Electrical Supply 4th & Douglas 3200

**SPRINGFIELD**

\*Bruce Harold 1120 E Capitol Ave 8-7523

General Electric Supply 1007 E Jefferson 3-4509

Graybar Elec Co 405 N MacArthur Blvd SP 8-0484

Sasco United Tel 217 E Washington 2-6837

Sater TV Supply 1500 E Sangamon Ave 8-7369

\*Wilson Supply 106 W Jefferson

**STERLING**

Hardware Products 201 Locust ST 70

**TUSCOLA**

Moulden Distributing 106 W N Central Ave 163

**WAVERLY**

Waverly Wholesale 7471

**WHEATON**

Gaskins Distributor 1005 S Aurora Way

**INDIANA****ANDERSON**

Seyberts Radio Supply 1331 Main St 3-5431

**ANGOLA**

Lakeland Radio Supply 525 S West St 70

Shaw Electronic Supply 200 S Darling St 291

**BLOOMINGTON**

Stansifer Radio 1805 S Walnut St

**COLUMBUS**

Williams Co HA 1003 Washington St 7646

**CROWN POINT**

\*Hub Distributors 106 N Main St 1110

**ELKHART**

Electronics Parts Inc 725 S Main St 2-1208

**EVANSVILLE**

Castrup's Supplies 1014 W Franklin St 2-7618

Ewald Distributing Co 1100 S Grand 3-1852

Ferbend Inc S U 1901 W Maryland 5-8193

General Electric Supply 2000 N New York Ave 5-2655

Graybar Electric 1709 E Columbia St EV 6-1357

Hatch & Son 919 Vine St 4-6731

Ohio Valley Sound Service 20 E Sycamore 5-6173

Wesco Radio Parts 428 Penn St 2-2141

Westinghouse Electric 201 N W 1 St 5-7276

**FORT WAYNE**

Fort Wayne Electronics Supply 223 E Main St

AN 7388

General Electric Supply 1609 S Calhoun St HA 3243

Pemberton Labs 236 E Columbia E-1812

Protective Elec 130 W Columbia A-9331

Van Sickle Radio 1320 S Calhoun E-4136

Wall Distributing 241 Pearl St E 2027

\*Warran Radio Co 1716 S Harrison St

Wayne Hardware 254 W Main A-7153

Westinghouse Elec Supply Meyer Rd & New U S 30 E

**FRANKFORD**

Dossett Co M H 855 Burlington 5394

**GARY**

Cosmopolitan Radio 524 Washington 5-7746

R-B Distr 3763 Broadway GA 4-8824

Walker-Jimison 615 W 11 Ave GA 5-5501

**HAMMOND**

Broadwin Radio & TV 6516 Calmet St RU 6940

General Elec Supply 506 Fayette St SH 5155

Graybar Electric 6445 Indianapolis Blvd SH 5830

Nation Wide Radio 7015 Calmet Ave WE 2-8410

Westinghouse Elec 6341 Ind Blvd RU 9400

**HUNTINGTON**

Colfax Co 67 E State 3610

**INDIANAPOLIS**

Appliance Dist Inc 415 Mass Ave ME 4-6391  
 Associated Distr 210 S Meridian St LI 2593  
 General Electric Supply 1250 Stadium Dr ME 4-8445  
 Gibson Co 433 N Capitol Ave LI 3321  
 \*Graham Electronics 102 S Penna St ME 4-8487  
 Graybar Electric 1300 W 16 St AT 2351  
 Griffith Distr 321 W Maryland  
 Hooser Radio Supply 701 N III St LI 3010  
 Indianapolis Radio 912 N III St LI 8970  
 Klefer-Stewart Co 122 S Senate Ave LI 4321  
 Meanler Radio Supply 524 N Illinois St LI 8884  
 Peerless Electric 122 S Meridian PL 2361  
 Peaslee-Gambert 1401 Stadium Dr  
 Radio Distributing 1013 N Capital Ave ME 5-8311  
 Radio Equipment Co 1010 Central Ave PL 6453  
 Rodefeld Co 614 N Capital LI 8331  
 Sanborn Electric 311 N III St PL 9584  
 Warren Radio 908 N III St LI 5566 LI 8970  
 Hqrs Toledo Ohio  
 Westinghouse Elec Supply 139 S Penna St MA 3301

**JEFFERSONVILLE**

Moakler Electronic 949 E Maple 2-2229

**KOKOMO**

George's Electronic 125 N Buckeye 6771

Radio TV Distr 507 N Washington 2-5651

RPD-Arthur Nagel Inc 219 W Main 2-8932

**LAFAYETTE**

Holmes Radio Store Rd 25 Box 559 2-6845

Lafayette Radio Supply 408 E North St 2-5217

**LOGANSPORT**

Conrad Co A E RFD #4 2606

Television-Radio Dist 431 E Market 2879

**MARION**

Mobile Radio Supply 507 N Washington 5734

Myers Radio Supply 115 W 22 St 1357

**MICHIGAN CITY**

Tri-State Electrical 601 W 10th 2-5551

**MUNCIE**

General Electric Supply 904 Burlington Dr MU 6614

Manclo Electronics 305 N Madison 8837

Standard Radio Parts 1104 S Walnut 5525

Westinghouse Electric 2315 N Walnut St 3-6335

**PERU**

Clingaman Sound Equip Co 814 W Main St 9151

Warberger Supply Co 8 W 2 St 5541

Television-Radio Distr 812 W Main 2005

**RICHMOND**

Fox Electronics 711 S 9 St 2-4676

Radio & TV Dist 717 S 5 St 2-4752 Hqrs South

Band

Rinehart Inc 511 Main 2-2581

Rodefeld Co 96 W Main St 2-4088

**SOUTH BEND**

Cloud Bros 110 E Western Ave 6-0395

Colfax Co 802 S Main AT 9-5548

Comm Sound & Radio 528 E Colfax 3-9394

General Elec Supply 422 E Monroe St 6-3411

Radio Distributing 432 S Carroll St AT 9-0365

Radio Equipment Co 1202 S Lafayette 6-9551

*Melvin*  
**ELECTRONICS, INC.**

541 W. Madison St.  
**OAK PARK, ILLINOIS**

As near to you as  
 your telephone

Village 8-3960      Columbus 1-7273  
 Suburban              Chicago

**LARGEST  
 ELECTRONIC DISTRIBUTOR**  
 in the  
**LARGEST VILLAGE  
 IN THE WORLD**

**Service Our Greatest Asset**

Leading lines of parts, industrial  
 and mobile equipment.

Catalog Available to Authorized  
 Dealers & Technicians.



Radio & TV Distr 116 N Hill St 3-9394  
 Ridge Co 315 W Jefferson Blvd 4-3145

**TERRE HAUTE**  
 Archer & Evinger 1216 Wabash Ave CR 7757  
 General Elec Supply 801 Ponlar St CR 9-695  
 Terre Haute Radio PO Box 804 2-6025  
 Walker Electric Supply 126 S 3 St

**VALPARAISO**  
 \*Bowman & Associates Jess 257 W Lincolnway 3-4301

**IOWA**

**BURLINGTON**  
 Union Supply Co 409 Washington 7270 PL 2-5444

**CEDAR RAPIDS**  
 \*Gifford-Brown 726 S St SE 4-2491  
 Iowa Radio Supply 508 3 Ave S E 4-5346  
 Ken-El's Radio Supply Co 67 16 Ave SW 4-1172  
 Midwest Specialty 53 16th Ave SW 3-3609  
 Westinghouse Elec Supply 210 2 St SE CR 1385

**COUNCIL BLUFFS**  
 \*World Radio Labs 3415 W Broadway 2-0277

**DAVENPORT**  
 Crescent Elec Supply 505 Parshing Ave 2-6273  
 Graybar Electric 206 E 5 St DA 3-2769  
 Havercamp Co 402 E Locust St 3-1857  
 \*Midwest-Timmerman 114 Western Ave 7-5288  
 RCA Victor Distr 1235 W 5 St 4-9847  
 \*TCR Distrs 1205 E River Dr 3-8051  
 Union Supply Co 324 E 4 St 6-3713  
 Westinghouse Electric 402 E 4 St 3-9996

**DES MOINES**  
 General Electric Supply 108 E 4 St 8-7401  
 \*Gifford-Brown Inc 14 & Walnut St 3-1257  
 Graybar Electric 24 11 St DE 3-8614  
 \*Iowa Radio Corp 1212 Grand 2-8197  
 \*Mid-State Distr 1201 Grand 8-7231  
 \*Midwest-Timmerman 812 Tottle St Hdrs Davenport

Onthank Co G W 10 & Mulberry 3-8166  
 \*Radio Trade Supply 1224 Grand 8-7237  
 Schneiderhahn Co A 319 SW 5th St  
 Sidles Co 8 7 St 4-0138  
 Sorenson Co H E 100 S W 1 St 4-6267  
 Westinghouse Elec Supply 2515 Dean Ave 2-0244

**DUBUQUE**  
 \*Boe Distributing 1605 Rockdale Rd 3-5795

**FORT DODGE**  
 \*Ken-El's Radio Supply 501 1st Ave WA 3880

**MASON CITY**  
 \*Ray-Mac Supply Co 307 9 St 5900

**OTTUMWA**  
 \*Friday-Lynch Radio 429 W 2 St MU 2-5407

**SIOUX CITY**  
 Brown Radio Supply 1317 Dace St 2-3163  
 Burghardt Radio 611 E 5th St 5-0854  
 \*Duke's Radio 209 6 St 5-5056  
 Graybar Elec Co 510 Pearl St 8-7507  
 Omaha Appliance Co 1411 Jackson 2-2625  
 \*Power City Radio 410 Jones St 5-5992  
 \*Warren Radio Supply 617 Douglas 2-2731  
 Westinghouse Electric 1005 Dace St 5-7634

**WATERLOO**  
 Farnsworth Radio & TV 201 E Mullen Ave AD 4-6682  
 \*Ray-Mac Supply Co 200 Ballou St AD 3-5296  
 Westinghouse Electric 300 W 3 St 4679

**KANSAS**

**ATCHISON**  
 Bilsh, Mize & Shuman 223 S 5th St

**COFFEYVILLE**  
 Four State Radio 117 W 7th 693

**GREAT BEND**  
 \*Radio Supply Co of Great Bend 1109 Main 9491

**HUTCHINSON**  
 Acme Radio & Television 327 W 4th St 5-8443  
 \*Interstate Electronic Supply 325 W 4 St 2-7941  
 Wholesale Electronics 1019 E "A" Ave 2-4456

**KANSAS CITY**  
 RCA Victor Fairfax & Funston Rd AT 3075

**PITTSBURG**  
 Pittsburg Radio Supply 212 S Broadway 356

**SALINA**  
 \*Radio Supply Co 533 N Santa Fe 7-3841  
 \*Western Distr 227 Santa Fe N 7-0561

**TOPEKA**  
 \*Acme Radio Supply 412 E 10 St 5-1363  
 Costelow Co J A 125 Kansas Ave 3-6598  
 General Elec Supply 115 Jackson 5-4474  
 \*Overton Electric 522 Jackson St 3-3261

**WICHITA**  
 \*Amateur Radio 1203 E Douglas HO 4-3579  
 \*Excel Distributors 118 W 2 4-4783  
 General Electric Supply 801 E 1 St AM 5-0627  
 Graybar Elec 424 N Rock Island AM 7-1364  
 \*Interstate Elect 230 Ida HO 4-6318  
 McClelland Sound 229 W William 4-4455  
 \*Radio Supply Co 1125 E Douglas 7-5218  
 RCA Victor Distr 725 E Lincoln AM 7-1252  
 Westinghouse Electric 233 S St Francis 3-8215

**KENTUCKY**

**ASHLAND**  
 Ashland Radio Supply 2125 Winchester 3125

**BOWLING GREEN**  
 Crescent Radio Supply 212 W 10 St VI 2-2444

**HARLAN**  
 General Elec Supply Hoskins St 815

**HOPKINSVILLE**  
 Randolph & Hale 2325 S Virginia TU 5-8696

**LEXINGTON**  
 Electronic Distr 134 W 3 St 2-7414  
 General Electric Supply 309 N Ashland Ave 2-1887  
 Ky Radio Supply 376 E Main St 2-3373  
 Lex-Tronics 810 E 3rd St 4-3470  
 Miller's Barney 232 E Main 2-9622  
 \*Radio Equip Co 480 Skain Ave 3-1577

**LOUISVILLE**  
 Arcby Electronics Hancock & Gray WA 8851  
 Barks Co P 1 911 W Broadway JA 7323  
 Ewald Distributing 309 S 9 St JA 8227  
 Falls City Supply 315 Roland WA 7447  
 General Electric Supply 2311 S Brook St CA 3651  
 Graybar Electric 614 Myrtle CA 5411  
 \*Peerless Elec Equip 2210 S 7 St CA 7678  
 R-K Distr 801 W St Catherine JA 5349  
 Universal Radio Supply 533 S 7 St JU 4-4166

**NEWPORT**  
 Apex Distributing 506 York St AX 1949  
 Holab & Hogg Co 217 E 10 St HE 4211

**OWENSBORO**  
 Centronics Inc 600 W 3 St 3-6727  
 Peerless Elec Equip 1206 Triplett hqrs Louisville

**PADUCAH**  
 Warren Radio 455 S 31st St 2-4367  
 Westinghouse Electric 1000 Broadway Ave 2-2753  
 W Ky Electronic 1205 Broadway 4503

**LOUISIANA**

**ALEXANDRIA**  
 Brown-Roberts Hdw Supply 1810 3rd St.  
 \*Central Radio Supply 601 N 3 St 3-4517  
 Columbia Radio & Supply 2140 Lee hqrs New Orleans

**BATON ROUGE**  
 Electronic Supply 1753 N 21 St 2-0517  
 Gautreaux's 1324 Government St 2-2025  
 General Electric Supply 5575 Adams Ave 7-7586  
 Graybar Electric 2442 T Dunham Ave BA 3-3427  
 La Radio TV Distr 1645 Plank Rd 8-1456  
 Ole Miss Supply 1801 N Boulevard 3-4035  
 \*Ralph's Radio Electronic Supply 812 Main St  
 Westinghouse Electric 2511 Michell Dr 3-2873

**BOGALUSA**  
 Gautreaux's 1101 Columbia St RE 2-3234

**LAFAYETTE**  
 Batcher Bros 438 Jefferson  
 \*Ralph Radio & Electronic 1419 Cameron St

**LAKE CHARLES**  
 \*Ralphs Radio Electronic 1127 Broad St  
 Wholesale Radio Equip 324 Ryan St HE 9-9017

**MONROE**  
 C & O Electronics 500 N 3 St 3-5732  
 \*Hale & McNeil 421 Walnut 2-5136  
 Poulans Electrical Co 501 Morris Ave 3-7701

**NEW ORLEANS**  
 Allen Supply Co W B 1601 Orleans Ave  
 Audiotronics Supply 1834 N Claiborne VI 5579  
 Bail Radio Supply 2625 Tulane Ave  
 \*Columbia Radio & Supply 3940 3 St UN 2731  
 \*Crescent Radio & Supply 1600 Baronne St CA 3112  
 Eaco Inc 601 S Peters St  
 Electronic Supply Co 201 Magazine St  
 Electronic Distrs 1526 Magazine MA 6700  
 Gautreaux's Elec Supply 2746 Orleans Ave AU 1619  
 General Elec Supply 4221 Bienville GA 5771  
 Graybar Electric 1116 Magnolia St CA 6263  
 Industrial Sales 2927 Jackson Ave  
 Interstate Electric 1001 S Peters CA 8541  
 Ole Miss Supply Co 901 Carondelet St TU 3555  
 Pee-Jay Radio 2306 Tulane Ave AU 0807  
 Pelican Radio Supply 824 N Broad St  
 Radio Parts Inc 807 Howard Ave CA 0217  
 Radio Specialty 3119 S Carrollton Ave.  
 Shuler Supply 250B Tulane Ave RA 2166  
 \*Southern Radio Supply 1900 Tulane  
 Stratton-Baldwin PO Box 253  
 Telev & Appl Distrs 500 N Carrollton  
 Walther Bros 1722 Poydras St CA 7731  
 Westinghouse Elec 2538 Poydras TU 5411

**OPALOUSAS**  
 Wholesale Radio Equipment 230 N Court 7856

**SHREVEPORT**  
 Baggott Radio 620 La Ave 2-5137  
 Duncelman Distributing Co 119 Beech St 2-8452  
 General Electric Supply 1430 Dalzell St 5-8631  
 Graybar Electric 90 Fannin St SH 5-3271  
 Interstate Electric Co 1419 Culepeper St 3-6131  
 \*Kooleray Sales Co 2530 Linwood Ave 3-4256  
 \*Lavender Radio & TV 936 Milam St  
 Ports Electronics Parts 309 Airport Dr 2-2193  
 Westinghouse Electric 120 Caddo St 3-0583

**MAINE**

**AUBURN**  
 \*Radio Supply Co 26 Cross St 4-5486

**AUGUSTA**  
 Westinghouse Electric 98 Water St 2040

**BANGOR**  
 Commercial Distrs 135 Exchange St  
 General Elec Supply 840 Hammond St 7331  
 \*Maine Electronic Supply 494 Broadway  
 Radio Serv Lab 16 Salem CT 7396  
 Radio Supply Co 151 Center St 6416  
 Westinghouse Elec Supply 175 Broad St 6487

**HALLOWELL**  
 \*Powell Radio 115 Water St 3-3839

**PORTLAND**  
 Brown Co F M 12 Free St 3-4791  
 Commercial Distributors 35 Commercial St  
 General Electric Supply 170 Anderson St 2-3721  
 Graybar Electric Center & Commercial Sts PO 3-1766  
 Hub Distributors 81 Franklin 2-4679  
 \*Maine Electronic 148 Anderson 4-0301  
 Radio Serv Lab 1004 Congress 3-0297

**MARYLAND**

**BALTIMORE**  
 American Distr Co 1200 N Fulton LO 6-8930  
 Berman H O Co 10 E Lombard LE 9-7002  
 D & H Distr Co 25 S Liberty SA 5100  
 Electronic Parts 4530 Harford HA 6-2808  
 General Elec Supply 1500 Barclay LE 9-3565  
 Graybar Electric 100 South St SA 7-5050

\*Kann-Ellert Electronics 9 S Howard SA 4242  
 Lytron Distr Co 1338 W North Ave LA 3-8880  
 \*Radio Elec Serv 5 N Howard LE 9-3835  
 Spartana Ca A R 239 Gay St N SA 7-5762  
 Video Electronics 5617 Belair Rd HA 6-7913  
 Westinghouse Electric 2415 W Franklin LO 4400  
 \*Wholesale Radio Parts 308 W Rudwood St MU 5-2134

**CUMBERLAND**  
 \*Zimmerman Wholesalers 162 Bedford 920

**FREDERICK**  
 Hankel's Radio & TV 404 Elm St MO 2-1381

**HAGERSTOWN**  
 General Elec Supply 1095 Jefferson Blvd. 6216  
 Stoddard Supply Co 354 S Cannon 6342  
 York Radio & Ref 67 W Franklin 5586  
 \*Zimmerman Wholesalers 114 E Washington St 408

**SALISBURY**  
 Almo Radio Co 219 Highland Ave 317 Park Heights 2-1395  
 Aircraft Elec Calvert & Baptist St  
 Standard Electronics 301 Snow Hill Rd 7593

**SILVER SPRINGS**  
 Rucker Electronics 8049 13 St JU 7-6700  
 Silver Spring Electronic 948 Silgo JU 8-3567

**MASSACHUSETTS**

**BOSTON**  
 Acme Distributors 1103 Columbus Ave HI 2-1400  
 Adams Distr 70 Brookline Ave CO 7-2940  
 Arvedon Distributors 73 Portland CA 7-4034  
 Brattle Radio Co 42 Brattle St CA 7-7529  
 Barke Co J H 39 Brighton Ave AL 4-4050  
 Commercial Radio 36 Brattle RI 2-1241  
 \*Cramer Electronics 811 Boylston CO 7-4700  
 Del Padre Assoc L L hqrs Springfield  
 \*DeMambo Radio 1111 Commonwealth St 2-7870  
 Electro Sales Co 50 Eastern Ave CA 7-3456  
 General Electric Supply 145 N Beacon AL 4-5300  
 \*Gerber Radio Supply 1900 Columbus GA 7-1144  
 Graybar Electric 287 Columbus KE 6-4567  
 \*Matry & Young 811 Boylston St CO 7-4700  
 Herman Co L M 885 Boylston St CO 7-5620  
 Lincoln Electronic 790 Commonwealth BE 2-8550  
 Mattapan TV Distr 16 Glimmer St  
 \*Mayer Co A W 895 Boylston CO 7-5530  
 McAllister L J 243 Columbus CO 7-2500  
 Northeastern Distrs 588 Commonwealth CO 7-2000  
 \*Radio Shack 167 Washington LA 3-3700  
 Radio Wire TV 110 Federal St HU 2-7850  
 Sager Elec Supply 201 Congress St LI 2-2281  
 Tee-Vee Supply 3211 Washington JA 2-9380  
 Westinghouse Elec 95 Brookline Ave CO 7-3100  
 Yankee Electronics 257 Huntington Ave CO 6-0212

**BROCKTON**  
 \*Ware Radio Supply 913 Centre St 8-0810

**CAMBRIDGE**  
 Eastern Co 620 Memorial TR 6-4720  
 \*Electrical Supply 1739 Mass Ave UN 4-6300  
 HIFI Lab 89 Mt Auburn St TR 6-2666  
 Selden Distr Co 800 Mass Ave KI 7-0920

**FALL RIVER**  
 Ross & Co E A 341 Columbia St 3-0921

**FITCHBURG**  
 \*Young & Young 372 Water St 3-3078

**HOLYOKE**  
 Holyoke Radio Supply 215 Main St  
 Springfield Radio Co 93 High St JE 2-8302  
 Tel-O-Wire Sound Co 24 Newton PI 5626

**LAWRENCE**  
 \*Young & Young 262 Lowell St 7171

**LITTLETON**  
 Weston Electronic Sales

**LOWELL**  
 \*McCartin Co F P 181 Market St 9751

**LYNN**  
 Des Roberts Elec 24 Mt Vernon St LY 5-0015

**MEDFORD**  
 Durrell Distr 222 Mystic Ave MY 6-8780

**MELROSE**  
 \*Melrose Sales Co 60 Essex St ME 4-3821

**NATICK**  
 Willett Radio Supply 11 Court 1313

**NEW BEDFORD**  
 \*Beckman Co C E 11 Commercial 6-8201  
 Ross & Co E A 1663 Purchase St 3-7878

**NEWTON**  
 Delta Distr 314 Washington BI 4-1560  
 Leonard Greene-Shaw 342 Watertown St DE 2-9300

**NORTHAMPTON**  
 C & J Distributors 228 Pleasant St 3138

**PEABODY**  
 TeeVee Supply 39 Main St JE 5-4359

**PITTSFIELD**  
 \*Pittsfield Radio 41 West St

**QUINCY**  
 Gerber Radio Supply 1153 Hancock St MA 9-4300

**SPRINGFIELD**  
 \*Cushing T F 349 Worthington St ST 8-7341  
 \*Del Padre Assoc L L 236 Chestnut 9-5658  
 General Electric Supply 484 Worthington RE 4-8255  
 Graybar Electric 32 Patton SP 7-4373  
 N E Service Center 891 State St RE 6-5641  
 Regent Sales 236 Chestnut ST  
 \*Soundco Electronic 147 Dwight RE 7-3425  
 Spinney Co B H 153 Plainfield ST RE 4-8284  
 \*Springfield Radio 405 Dwight ST RE 2-3411  
 Tarbell-Walters 144 Chestnut 6-1841  
 Western Mass Distr 1 Belmont Ave RE 6-6374  
 Westinghouse Elec 46 Hampden 4-3101  
 \*Young & Young 169 Spring St RE 4-1138

**TAUNTON**  
 \*Dean & Co D B 85 Cohannet St TA 4-4117

**WALTHAM**  
 Weston Electronics 717 Main St WA 5-9140

**WEBSTER**  
 Lanman 10 Ardlock Place

**WORCESTER**

\*DeMambo Radio Supply 222 Summer St hqrs Boston  
 General Elec Supply 163 Mechanic 6-4351  
 Graybar Electric 108 Grove W 6-4311  
 Johnson Electronic 12 E Worcester St PL 6-7136  
 \*Radio Electronic Sales 52 Chandler St PL 7-5671  
 \*Radio Maint Supply 80 Thomas St PL 6-8311  
 Westinghouse Elec 107 Thomas St 7-5641

**MICHIGAN****ANN ARBOR**

Purchase Radio 605 Chorch 8696  
 \*Wedemeyer Electronic 214 N 4 Ave 2-4457

**BATTLE CREEK**

\*Electronic Supply 94 Hamblin 2-9515

**BAY CITY**

Klinde Distr Co 504 Washington St 7461

**BENTON HARBOR**

Benton Electronic 643 W Main 5-1373  
 Radio & TV Distr Co 1331 M-139 WA 5-3301

**CADILLAC**

Straits Distributors 417 N Mitchell PR 5-3895

**CHEBOYGAN**

\*Straits Distributors 412 N Main St 960

**DETROIT**

Detroit Electronic 8000 Grand River TY 6-9500  
 Duffy & Co 311 N 2040 Grand River W 3-2270  
 Falk Distr Co 9339 Grand River TE 4-0625  
 \*Ferguson Radio 2306 Puritan Ave UN 1-6700  
 General Elec Supply 680 Antoinette St TR 5-9400  
 \*Glendale Supply Co 12866 Woodward Ave TU 3-1500  
 Graybar Electric 15045 Hamilton Ave TO 8-5550  
 Hi-Park Distrs 155 La Belle Ave TO 8-9409  
 \*KLA Labs 7422 Woodward TR 4-1100  
 Mercury Distr Co 3727 Woodward TE 2-7720  
 Nor-West TV & Radio 21223 Grand Ave KE 5-0300  
 Perkins Sales 20480 Woodward TO 8-7020  
 RCA Victor Distr 7400 Intervale TE 4-3500  
 Radio Distr 15401 Woodrow Wilson TO 9-7900  
 Radio Electronic 1112 W Warren TE 2-5611  
 \*Radio Specialties 456 Charlotte TE 2-0800  
 \*Radio Supply 85 Selden TE 1-3171  
 Reno Radio Co 1314 Broadway W 2-6851  
 \*Rissi Electronic 1112 W Warren TE 2-5611  
 Rizzo Radio Dist 8801 Fenkel Ave WE 3-9829  
 Universal Broadcasting System 8000 Grand River TY 6-9500  
 Westinghouse Electric 2211 W Edsel Ford Expressway TY 8-9000  
 \*West Side Radio 8140 Mich LU 4-0120

**ESCANABA**

Felton Radio 1617 Ludington 2855

**FERNDALE**

Erickson's Electronic 23525 Woodward LI 5-6710

**FLINT**

General Electric Supply 4705 N Dort Hwy SU 9-9101  
 Graybar Electric 2424 Kansas FL 2-4101  
 \*Lifsey Distr Co 1409 N Saginaw CE 5-6657  
 Radio Tube Merch Co 508 Clifford CE 4-3654  
 \*Shand Radio Spec 2608 Leith St CE 2-9714  
 Westinghouse Electric 2330 N Dort H'way 4-8623

**GRAND RAPIDS**

Bursma Radio Supply 870 Grandville CH 5-0501  
 General Electric Supply 305 Fulton St W 9-3243  
 Graybar Electric 432 Monroe Ave N W GL 1-2561  
 Perkins Sales Co 12 Oakes S W hqrs Detroit  
 \*Radio Electronic 505 Jefferson S E 9-4611  
 Radio Equip Co 13 Ionia Ave S W GL 6-9551  
 Radio Parts Inc 542 S Division 9-0247  
 Republic Distr 19 La Grava Ave  
 Warren Radio 24 Logan St SW  
 Westinghouse Elec 511 Monroe Ave N W 9-4664  
 Wholesale Radio Co 24 Logan S W GL 6-1432

**JACKSON**

\*Falton Radio 1208 Greenwood St 4-6106  
 Matteson Electronic 1000 E Michigan 4-4450

**KALAMAZOO**

\*Electronic Supply 906 E Mich Ave hqrs Battle Creek  
 General Electric Supply 112 Parkway 3-2645  
 Ralston Co R M 201 N Park St 5-0189  
 Stevens Radio Parts 713 Portage St  
 \*Warren Radio 713 Portage St

**LANSING**

\*Elec Product Sales 427 E Mich Ave 24-123  
 General Elec Supply 428 N Grand IV 7-5401  
 Graybar Elec Supply 421 E Elm St LA 4-5434  
 Morley Bros 1330 S Harrison  
 \*Owenhauer Co 227 W Washentaw 2-9896

\*Wedemeyer Electronic 800 Merrill St 5-7727  
 Westinghouse Elec Supply 2730 Alpha St

**LAURUM**

\*Northwest Radio 435 Tamarack 797

**LINCOLN PARK**

Glendale Electronic Sup 1067 Southfield DU 3-0740

**MANISTEE**

Gardner Radio 258 River St 1653

**MUSKEGON**

Bell-Lourim 1839 Peck St 2-6019

Bursma Radio 1211 Pine St 6334

\*Fitzpatrick Elec 444 Irwin 2-6621

**MUSKEGON HEIGHTS**

Western Electronic 517 W Broadway 3-1639

**PONTIAC**

\*Electronic Supply 248 E Pike St FE 2-8341

**PORT HURON**

Main TV Supply 1503 24 St YU 5-5103

**SAGINAW**

Carson Distrs 708 N Washington Ave 5-5301

General Elec Supply 125 Davenport St 3-6474

Morley Bros 115 N Washington

Orem Distributing 801 E Genesee

\*Radio Parts Co 803 S Washington 5-5338

Saginaw Distributors 1751 E Genesee Ave 3-5444

Westinghouse Electric 221 S Jefferson St 4-2640

**SAULT STE MARIE**

Straits Distributors 144 Ridge St W ME 5-5461

**MINNESOTA****AUSTIN**

Radio Elec 219 N Franklin 7-4214 hqrs Minneapolis

**DULUTH**

Bonn Co Lew 228 E Superior RA 2-5568

General Electric Supply 246 Lake Ave S 2-0826

Graybar Electric 320 W 1 St DU 2-6646

Kelley How Thomson 309 S 5 Ave W 2-5881

\*Northwest Radio 123 E 1 St RA 7-1565

Popkey G M 206 E 1 St

\*Stark Radio Supply 109 Lake Ave S

Westinghouse Elec 230 Lake Ave S ME 2-2625

**HOPKINS**

Wolter Electronic Co 710 Ave N HO 3632 hqrs Fargo N Dak

**MANKATO**

Southern Minn Supply 2 & Main Sts. 4501

**MINNEAPOLIS**

\*Bauman Co 3033 Lyndale Ave S GI 1745  
 \*Bonn Co Lew 67 S 12 St FI 6351  
 Ecklen Radio 114 N Lyndale Ave AT 0516  
 \*Electronic Center 107 3 Ave N LI 8678  
 Forster Distr 1122 Harmon Pl AT 5471  
 General Electric Supply 63 S 13 St BR 3266  
 Graybar Electric 824 S 4 St GE 1621  
 Hayer Co F C 250 3 Ave N AT 1401  
 Larson Elec J H 114 Glenwood Ave FI 2761  
 National Electronics 1215 Nicollet BR 2185  
 Northwest Radio 52 S 12 St FI 6346  
 Radio Elec Supply 2451 Nicollet GE 7733  
 Radio Maintenance 3016 1/2 27th Ave S DR 7546  
 Reinhard Bros 11 S 9 St K GE 2681  
 Roycraft Co 1625 Hennepin Ave GE 8881  
 Spencer George 444 Stinson St GR 7241  
 \*Stark Radio Supply 71 S 12 St GE 4623  
 Sterling Electric 33 S 5 Ave NA 4571  
 Westinghouse Electric 515 S 7 St LI 7001

**ROCHESTER**  
 Elliott & Hanson 119 1 Ave N W 2-2778  
 S Minn Supply 902 7 St N W 2-3218

**ST. PAUL**  
 Bonn Co Lew 141 W 7 St CA 4-2821  
 \*Electronic Distr 856 Raymond PR 3911  
 General Electric Supply 540 N Fairview Ave PR 2761

Gopher Electronics 370 Minnesota St CA 4-9666

Graybar Electric 717 N Prior Ave NE 2631

\*Hall Electric Co 566 N Robert St GA 5696

\*Northwest Radio & Electronic 194 W 4 St GA 3801

\*Stark Radio Supply Co 250 W Kellogg Blvd CE 1994

Westinghouse Electric 253 E 4 St GA 7441

**WADENA**

Central Co-op Wholesale hqrs Superior Wisc

**MISSISSIPPI****BILOXI**

Nelson Radio Supply 613 Caillavet St 2-8651

**COLUMBUS**

Swan Distributing Co 724 5 St S 1513

**GREENVILLE**

Goyer Supply Co 815 Alexander St 8151

**GULFPORT**

Grescent Radio Supply 1311 28 Ave 4854

**HATTIESBURG**

Swan Distributing Co 506 Bouie St JU 4-5494

**JACKSON**

\*Cabell Elec Co 422 S Farish 2-2624

Ellington Radio 816 S Gallatin St 3-1327

General Electric Supply 610 Gesco Pl 2-5041

Graybar Elec 154 E Porter St JA 3-6316

Industrial Supplies Highway 80

May & Jackson Dist Co 628 S State St 5-6880

Orsill Bros Hdw 301 W Pearl St

Radio & TV Supply Co 328 N West St

Ryan Supply Co 208 S State St 5-2241

Southern Distributors 1400 Terry Rd 2-3456

Swan Distr Co 342 N Gallatin 2-5516

Television & Radio 323 N West 5-6406

Westinghouse Elec 325 S Farish 4-8354

**LAUREL**

Radio & TV Essentials 448 Auburn Ave 6104

**MERIDIAN**

Grimm Radio Supply 2511 8 St 6174

Radio Supply Co 909 24 Ave 8802

Ryan Supply Co 814 21 N E

**MISSOURI****BUTLER**

Henry Radio Co 211 N Main St 395

**CAPE GIRARDEAU**

General Electric Supply 402 S Sprigg 805

\*Suedekum Electronic 2215 Broadway 5-8202

**HANNIBAL**

York Radio & TV 2205 Market St

**JEFFERSON CITY**

\*Central Mo Distr Co 324 E Capital Ave 6-3149

**JOPLIN**

\*Brotherson Co M 515 N Byers Ave 1596

\*Four States Radio 201 Main St 979

General Electric Supply 922 Penna Ave MA 4-5622

**KANSAS CITY**

\*Burststein-Applebee 1012 McGee St BA 1155

Columbian Elec 2603 Grand Ave GR 1001

Continental Electric 1321 W 13 GR 1180

Electronics Supply 3536 Main St WE 3383

Gaines & Co J G 1730 Grand BA 4-8888

General Elec Supply 2101 Broadway HA 7447

Graybar Elec Co 1644 Baltimore Ave BA 1644

\*Henshaw Radio 3617 Troost Ave WE 5550

\*Manhattan Radio & Equip 1732 Grand Ave BA 9797

\*McGee Radio & Electric 1422 Grand Ave VI 9045

RCA Victor Distr Corp 2113 Broadway HA 0300

Radiolab 1612 Grand Ave HA 0171

\*Walter's Radio Supply 3645 Main St

**MOBERLY**

Central Missouri Dist Co Clark & Coates St 260

**POPLAR BLUFF**

\*Tri-State Radio 536 E Pine Blvd 2821

**ST. JOSEPH**

\*Acme Radio Supply 819 S 8 St 4-0651

American Electric Co 116 N 4 St

\*St Joseph Radio 720 S 9 St 2-8000

**ST. LOUIS**

\*Ashe Radio Co Walter 1125 Pine CH 1125

Brightman Distr 4421 Ridgewood SW 7575

Brown Radio Co Tom 3924 Washington St JE 1-2259

\*Eblinger Radio 2501 S Jefferson MO 4-7700

Fridley Bros 6510 Page St PA 1-8600

General Elec Supply 2653 Locust St JE 1-3000

Gordon Radio 1118 Pine St CE 4777

Graybar Electric 2642 Washington Ave JE 1-4700

Hollander & Co 3900 W Pine OL 3900

\*Interstate Supply 24 S 10 St CH 2325

Napper Electronic Supply 6253 Natural Bridge Ave GO 8358

Phone Craft Co 427 N Euclid RO 3147

Radio Communications 1921 Olive CE 9754

\*Radontics 5040 Easton Ave FO 1-7311

Stone Distr 1933 Washington MA 1200

Toler Radio Ralph 4855 Easton Ave FO 1-9169

\*Van Sickle Radio 1113 Pine St CH 1814

Westinghouse Elec 1011 Spruce St 2000

**SPRINGFIELD**

Four States Distr 700 E Brower

Gaines & Co J G 351 Boonville hqrs Kansas City

General Elec Supply 1301 W Webster 2-1722

Graybar Electric Co 524 St Louis St SP 2-0587

\*Reed Radio Supply Harry 805 Boonville St 4-0752

Stout Radio Supply 702 Boonville 2-9444

**MONTANA****BILLINGS**

American Appliances 2505 Montana St

Central Distr Co P O Box 1551 8-8447

Electronic Supply 214 11 St W 2-2197

General Elec Supply 2710 Montana Ave 9-4559

Heard Supply 3008 1st St N

Marshall-Wells Co

Midland Implement 2301 Montana Ave

Northwestern Auto 420 N Broadway 3-3146



**Grow With  
 The Electronic  
 Business  
 Keep In Touch  
 With Your RCA  
 Distributor**

**RCA Picture Tubes  
 RCA Receiving Tubes  
 RCA Batteries  
 RCA Test Equipment  
 RCA T. V. Components  
 RCA Hi Fi Components**

**DEPENDABLE SERVICE—IMMEDIATE DELIVERY  
 OUR BADGE OF SUCCESS**

**CARSON DISTRIBUTORS, INC. Phone 5-5301  
 708 N. Washington, Saginaw, Michigan**

Smith Supply 2521 Montana Ave 9-2055  
Westinghouse Electric 302 N 15 St 9-2813

**BUTTE**  
General Electric Supply 900 E Front St 2-2314  
Graybar Electric 604 E Aluminum St BU 3233  
Smith Supply 425 S Arizona 2-8278  
Smitty's Electronics 126 W Broadway  
Westinghouse Electric 949 S Montana St 2-1269

**GREAT FALLS**  
Bakers Rainbow Radio & TV Supply 20 2 St S 2-7825  
Lindgren Co Geo 16 4 St N W 8-8721  
Radio Electronic Box 1376 6-6645  
Smith Supply Co 808 Central Ave 2-4834  
Valley Motor Sup 512 1 Ave S 6-6557

**HAYRE**  
Land O B 426 1st St  
Valley Motor Supply Box 1271

**HELENA**  
Latus & Co DN 1531 Nat'l Ave 3182

**MISSOULA**  
Northwest Distr 509 S Higgins 4-4311

### NEBRASKA

**GERING**  
Messersmith-Corr Radio-TV Supply 1345 S St W 625

**HASTINGS**  
Central Radio Supply 518 W 1 St 2-2139

**KEARNEY**  
Western Radio 1400 W 22 St 2-3521

**LINCOLN**  
General Radio & TV 322 S 12 St 2-6000  
\*Nicks Radio Co 1422 "H" St 2-7561  
\*Leuck Radio Supply 243 S 11 St 2-2797  
Scott Electronic Supply 2201 0 St

**NEBRASKA CITY**  
Arbor Radio TV Supply 921 Central 757

**OMAHA**  
Alico Radio 4011 Cumling St WA 8461  
BI-State Distr Corp 911 Douglas St  
General Appliance 1101 Harney WE 4620  
General Elec Supply 914 N 18 St JA 0456  
Graybar Electric 3626 Martha St WE 7676  
\*JB Distr Co 1616 Cass St AT 5525  
Noli Co H C 2226 Harney St  
Omaha Appl 18 & St Mary's AT 3440  
\*Radio Equip Co 2852 Douglas AT 7700  
\*Sidles Co 502 S 19 St WE 8400  
Westinghouse Elec 117 N 13 HA 8700

**SCOTTSBLUFF**  
Joachim Radio 1913 Broadway 109  
Raber Supply 1305 1st Ave 700

**YORK**  
Radio Supply 110 E 7 37

### NEVADA

**LAS VEGAS**  
Electronic Supply 8 E Charleston  
Metcall's Radio 25 E California St 5585  
Saviers Elec Prod 110 E Charleston 4818

**RENO**  
Osborne & Dermody 255 Chestnut St 2-6957  
Saviers Elec Prod 640 Sierra St 2-9134

### NEW HAMPSHIRE

**CONCORD**  
\*Evans Radio PO Box 312 CA 5-3358

**DOVER**  
\*American Radio Corp 6 St 404

**MANCHESTER**  
\*DeMambo Radio Supply 1308 Elm St 4-4006  
General Elec Supply 57 Bedford 5-5418  
Graybar Electric 103 Hampshire Lane MA 4-4341  
\*Radio Serv Lab 670 Chestnut 5-5444  
Westinghouse Electric 147 Hanover 5-5456

**RYE BEACH**  
Delta Distributors South Rd RY 127

### NEW JERSEY

**ATLANTIC CITY**  
Almo Radio Co 4401 Ventnor Ave AT 2-5928  
BR Elect Supply 926 Atlantic Ave AT 5-3448  
\*Kearns Inc Harrisburg & Atlantic AT 5-3233  
M & H Sporting Goods hdqrs Philadelphia Pa  
\*Radio Elec Serv 452 N Albany Ave 5-8525

**BLOOMFIELD**  
Berger Electronic 241 Bloomfield BL 2-7900

**BRADLEY BEACH**  
Holman's Radio & TV 504 Main PR 5-5870

**BRIDGETON**  
\*Joe's Radio Shop 67 S Pearl 9-0251

**CAMDEN**  
Almo Radio Co 1133 Haddon Ave EM 5-1960  
General Radio 600 Penn St WO 4-8393  
Radio Elec Service 513 Cooper St WO 4-2830

**CLIFFSIDE PARK**  
Nidisco-Cliffside 658 Anderson Ave CL 6-0510

**CLIFTON**  
Eastern Radio 1074 Main Ave GR 1-2800  
Graybar Electric 1454 Main Ave SH 2-7868

**COLUMBIA**  
Columbia Distr Route 8 PO 42 CO 4-2500

**EAST ORANGE**  
Gross Service 444 William St OR 6-7500  
\*International Distr 185 Central OR 5-1927

**ELIZABETH**  
Bridge Electronics 502 Bayway EL 3-4147  
Jersey Radio-TV Supply 1068 Elizabeth Ave EL 2-7324  
New Jersey TV Supply 906 E Westfield EI 3-6166

**FARMINGDALE**  
Holmans Radio & TV Supply 85 Main St

**HACKENSACK**  
American Distr 115 Hudson St hdqrs North Bergen  
Nidisco-Hackensack 55 State St HU 9-2000

Radio & Elect Supply Co 756 Main St HU 7-1267  
Trade Radio Sales 14 Essex St HU 7-5512

**HIGHLAND PARK**  
Park Electr Rt 37-Lincoln Hwy KI 5-3363

**HILLSIDE**  
Sherwood Distr 1255 Liberty Ave EL 2-1126

**HOBOKEN**  
Grange Inc 830 Monroe St WH 3-5793

**JERSEY CITY**  
\*Hallmark Electric 592 Communipaw DE 2-9696  
Nidisco-Jersey City 713 Newark JO 2-2360

**LAKEWOOD**  
Cooper Sales Co 110 2 St LA 6-2911

**LYNDHURST**  
\*Economy Electronics 624 Ridge Rd WE 9-7418

**MORRISTOWN**  
M & H Television 7 Maple Ave MO 4-5274

**MORRIS PLAINS**  
Continental Sales 642 Speedwell Ave MO 4-8223  
Park Electronics 187 Speedwell MO 4-6922

**MOUNTAINSIDE**  
Federated Purchaser 1021 Route 22 WE 2-8200

**NEWARK**  
All-State Distr 457 Chancellor WA 3-4900  
Apollo Distr Co 15 Shipman MI 2-7266  
\*Continental Sales 521 Bloomfield HU 2-8223  
Electronic Marketers 25 Hoyt St WA 3-2516  
Emerson-New Jersey 985 Broad MA 2-2217  
\*Federated Purchaser 114 Hudson MA 4-3915  
General Elec Supply 254 Elizabeth Ave BI 2-1600  
Graybar Electric 2 Liberty St MA 2-5100  
Gross Distr Co 49 Edison PI MA 2-8028  
Hudson Radio & TV 35 Market St MA 4-5151  
Igoe Bros 35 Halsey St MA 4-2000  
\*Krich-New Jersey 428 Elizabeth BI 8-7408  
\*Lippman & Co Aaron 99 Newark St MA 3-9477  
Mytelka & Rose 1020 Broad St 3-6272  
O'Loughlin & Co T A 88 Washington St MI 3-8200  
Pyramid Supply 343 W Market MA 3-7800  
Radio Wire Television 24 Central Ave MA 2-1661  
Tubes of New York 944 18 Ave ES 2-2631  
Varley Electric 468 Broad MA 2-6760  
Westinghouse Elec Supply 528 Ferry MI 2-3450

**NEW BRUNSWICK**  
Graybar Electric 2762 Livingston Ave CH 9-4300  
Park Electronics RDS 37 Lincoln KI 5-3363  
William Radio Supply 265 Woodbridge CH 7-4908

**NORTH BERGEN**  
American Distr 6335 Hudson Blvd UN 5-8027

**OCEAN GROVE**  
Asbury Electronic 108 S Main St PR 6-7070

**PASSAIC**  
Nidisco-Passaic 294 Passaic St PR 9-4962

**PATERSON**  
General Elec Supply 561 E 31 St La 5-5100  
\*Jersey Electronic Distr 524 21st Ave LA 5-3134  
Trade Radio Sals 780 E 18 St hdqrs Hackensack

**PERTH AMBOY**  
Bennett's Radio 327 Maple St PE 2-1736

**PHILLIPSBURG**  
\*Williams Co C B 154 S Main St 5-1245

**PLAINFIELD**  
Lafayette Radio 139 W 2 St PL 6-4718  
Union TV Parts 403 Watchung Ave PL 4-6930

**RED BANK**  
Monmouth Radio 404 Shrewsbury RB 6-3300

**RIDGEFIELD PARK**  
NRW Wholesale Radio 284 Teaneck Rd HU 7-0715

**TEANECK**  
Ross Homer M 367 Queen Anne Rd TE 6-5331

**TRENTON**  
Allen & Hurley 23 S Warren LY 9-4535  
Allied Electric 333 S Warren TR 9-4535  
Cooper Sales 508 Hamilton Ave EX 2-8008  
Dragon Co 959 Liberty St 4-1479  
Fineburg's 547 S Broad TR 4-5125  
General Elec Supply Brunswick Circle Ext 5-3453  
Nidisco 126 S Warren St EX 3-4536  
Westinghouse Electric 745 E State TR 5-5421

### NEW MEXICO

**ALBUQUERQUE**  
General Electric Supply 820 1 St NW 2-5246  
Midland Specialty 1712 Lomas Blvd  
Miller Supply 211 W Coal Ave 2-3450  
Radio Equip Co 523 Central Ave N E 2-5681  
Tel-Radio Supply 205 Central NE 2-1141  
Walker Radio L B 114 W Granite St  
Westinghouse Electric 816 1 St N W 3-3708

**LOS ALAMOS**  
Valley Eng'g Co 601 Cedar St 2-4883

**ROSWELL**  
R & R Supply Co 605 E 2 St 3512  
Supreme Radio 129 W 2 St 148

**SANTA FE**  
A-1 Communications 110 W Palace Ave

### NEW YORK

**ALBANY**  
Air Wave Electr Rad Distr 213 Hudson  
\*Ft Orange Radio 904 Broadway 5-1594  
Graybar Electric 40 Van Woert AL 5-1564  
R T A Distrib 36 Broadway PR 5-7346  
\*Taylor Co E E 465 Central 8-8713  
Wayne Merrilam A Maplewood Ave Ext  
Westinghouse Electric 19 R R Ave 8-7801

**AMSTERDAM**  
\*Adirondack Radio Supply 185 W Main St VI 2-8350

**AUBURN**  
\*Dare Radio 22 Genesee 2-0441  
Roberts & O'Brien 191 Hardenbergh Ave 2-6561

**BAYSHORE** See Long Island

**BELLROSE** See Long Island

**BINGHAMTON**  
Broome Distr 221 Washington St 2-4273  
\*Federal Radio 188 State 2-2394  
Int'l Radio & TV 138 Beethoven St  
L & K Electric 72 State St 2-7261  
Morris Distr 195 Water 4-2461  
Stack Electronic Supply 25 State St 3-7337

**BUFFALO**  
Bergman Co W Oak & Eagle MO 6300  
Bison Electrical 1137 Main St LI 8447  
Buffalo Radio 219 E Genesee WA 9004  
\*Dymac Inc 2329 Main PA 2300  
Faysan Distrib 506 7th St SU 1300  
General Electric Supply 960 Bustel EL 5100  
\*Genesee Radio & Parts 205E Genesee CL 1970  
Graybar Electric 180 Perry WA 3700  
\*Huron Electronics Supply 324 W Oak St MO 6865  
RCA Victor Dist 1209 Broadway F1 1209  
Radio Elec Prods 186 E Genesee CL 6457  
Radio Equipment 147 E Genesee MA 9676  
Rains Co W E 11 W North GR 4944  
Scheller Radio 269 Oak WA 3081  
Standerd Elect 1501 Main GA 5000  
Strass Co Joseph 25 High SU 8080  
Summit Distrib 916 Main GR 3100

**CORTLAND**  
Winchell Radio 149 Main St SK 3-0868

**ELMIRA**  
\*Harrison Co F C 108 W Church 3-5676  
LeValley-McLeon 312 State St 6167  
Rose-Kimball-Barker 511 Baldwin St

**FARMINGDALE** See Long Island

**FLUSHING** See Long Island

**FREDONIA**  
Barker-Higbee 27 Water 2-8666

**GLENS FALLS**  
\*Ray Distr 284 Glen 2-5848

**GLOVERSVILLE**  
Fulton County Dist 16 Bleeker 5-2515

**GREAT NECK** See Long Island

**HEMPSTEAD** See Long Island

**HICKSVILLE** See Long Island

**HORNELL**  
Hornell Elec Motor 286 Main St 2451

**ITHACA**  
\*Stallman of Ithaca 123 S Tioga 4-9918

**JACKSON HEIGHTS** See Long Island

**JAMAICA** See Long Island

**JAMESTOWN**  
Johnson Radio 119 Hunt Rd 8916  
Warren Radio 31 Forest 9-8185

**JOHNSON CITY**  
Westinghouse Elec 419 Grand Ave 9-1561

**KINGSTON**  
\*Arace Electronics 25 Henry 6622

**LOCKPORT**  
Standard Electronics 8 Elm St 4-3684

**MALONE**  
Pond Electric 123 E Main St 135  
Ray Distr 55 W Main St 1966  
Vermont Hdq hdqrs Burlington VT

**MASSENA**  
Beacon Electronic Inc 252 E Orvls St 2250

# NIDISCO

television, radio and electronic  
parts distributors—  
conveniently located at:

## JERSEY CITY

713 Newark Avenue  
JO 2-2360

## TRENTON

126 S. Warren Street  
EXport 3-4536

## PASSAIC

294 Passaic Street  
PRescott 9-4962

## CLIFFSIDE

658 Anderson Avenue  
CLiffside 6-0510

## HACKENSACK

55 State Street  
HUbbard 9-2000

**MIDDLETOWN**  
 Artec Distr 17 Cottage 3173  
 \*Certified Elect Montgomery Rd 2-1055  
 Certified Radio Supply Wickham Ave Ext 2-1055  
 Roskin Bros 27 W Main  
 S & L Electronics 17 Cottage 3175

**MINEOLA** See Long Island

**MONTICELLO**  
 Felsler Distrs 248 Broadway 1820

**MOUNT VERNON**  
 Davis Radio 70 E 3 MO 4-0747  
 Radeleo Inc 246 W 1 MO 8-6173

**NEWBURGH**  
 Chief Electronics 248 Washington St  
 Newburgh Distr 354 Liberty St 4830  
 Shapiro Distrs 315 Broadway  
 Westinghouse Electric 26 Liberty 5420

**NEW YORK CITY, BRONX & STATEN ISLAND**  
 Adson Radio & Elec 221 Fulton BA 7-3629  
 Avnet Electronic 34 N Moore St BE 3-5780  
 \*Bay Electronics 1736 Jerome Ave LU 3-2384  
 \*B & D Distr 639 Tompkins Staten Island GI 7-2660  
 Bonafide Radio 89 1/2 Cortlandt WO 2-5960  
 Bronx Whse Radio 470 E Fordham Rd FO 4-4662  
 \*Bruno-New York 460 W 34 LD 4-2425  
 Commercial Radio-Sound 231 E 47 PL 9-5100  
 Concord Radio 55 Vesey DI 9-1133  
 Consolidated Radio 768 Amsterdam AC 2-2678  
 Dale Distr Co 40 E 32 MU 9-2522  
 Dalis Inc H L 175 Varick AL 5-3000  
 Dorfman Co L E 40 E 32 MU 9-5252  
 Dorsin Distr 10 W 13 OR 5-6765  
 Douglas Radio Sup 128 Greenwich St WO 4-0470  
 DuMont Labs Allen B 1114 1 TE 8-8100  
 Edlie Elect 154 Greenwich DI 9-3143  
 Electronic Wholesalers 5047 Broadway LO 9-4906  
 Electronics Center 118 Duane St BA 7-2241  
 Emiltone Electronics 71 Broadway RE 2-1696  
 Emerson-N Y Inc 111 8 Ave WA 9-2264  
 \*Federated Purchaser 66 Dey St DI 9-3050  
 Federated Semi-Conductor 66 Dey DI 9-3050  
 \*Fischer Distr 118 Duane St BA 7-1511  
 \*Fordham Radio 265 E 149 St LU 5-0330  
 General Electric Supply 585 Hudson AL 5-3300  
 Goldman Louis 251 W 42nd St BR 9-8872  
 Graybar Electric 420 Lexington LE 2-4000  
 Greylock Electronics 115 Liberty BE 3-0224  
 Gross Distrs 214 W 14th St WA 4-5900  
 Haas Electronics 862 Southern BA 9-1466  
 Harrison Radio 225 Greenwich BA 7-7777  
 Harvey Radio 103 W 43 LU 2-1500  
 Hobb Electrical 541 W 34 St LA 4-9200  
 Hoffman Elect 253 E 72 RH 4-0400  
 \*Hudson Radio & TV 48 W 48 Cl 6-4060  
 HuGo Radio & TV 1275 Webster LU 8-0991  
 Lafayette Radio 342 E Fordham Rd FO 7-8813  
 Latham & Co E B 250 4 Ave AL 4-2200  
 Leader Elec & TV 215 Fulton St WO 4-2882  
 \*Leonard Radio 69 Cortlandt CO 7-0315  
 Metropolitan Sound Systems 216 W 14 St Ch 3-9112  
 Midway Radio 60 W 45 MU 7-5053  
 \*Milo Radio & Electronics 200 Greenwich BE 3-2980  
 Moss Electronic Distr 3849 10 Ave WI 2-0292  
 \*National Radio 1165 Southern Blvd DA 8-8800  
 North Radio 172 Washington CO 7-1430  
 O & W Radio 141 Cedar CO 7-2635  
 \*Powell Radio 142 W 169 CY 3-2623  
 Radio Wire TV 100 6 Ave RE 2-8600  
 Rand Radio Corp 84 Cortlandt St CO 7-7368  
 \*Sanford Elect 157 Chambers DI 9-0550  
 \*State & Co 2755 Webster LU 4-0614  
 \*Stan-Burn Radio 1697 Broadway CO 5-8138  
 Steve-EI Electronics 61 Reade St CO 7-0086  
 Sun Radio & Electronics 650 6 Ave DR 5-8600  
 \*Sylvan-Wellington 269 Canal CA 6-5811  
 TAB Co 111 Liberty St RE 2-6245  
 \*Termini Radio 85 Cortlandt WO 4-3311  
 Time Electronic Sales 368 Broadway BA 7-3922  
 Tri-Par Distr 1403 Bronx River Ave TY 3-7060  
 United Audio Products 202 E 19 St GR 3-4372  
 \*United Radio 181 West End Ave EN 2-9695  
 Western International Co 45 Vesey DI 9-2276  
 Westinghouse Electric 40 Wall WH 3-4321  
 Wholesale Electronics 673 Elton Ave LU 5-6705  
 \*Wilco Radio 383 E 138 MO 9-1654

**LONG ISLAND**

**BRONKLYN N Y**  
 Ace Electronics 2610 E 16 St NI 8-5212  
 Acme Electronics 74 Willoughby TR 5-3833  
 Benray Electronics 485 Coney Island BU 7-9650  
 Brooklyn Hill Sound Center 2128 Coney Ave BU 2-5300  
 \*Buckman Radio 492 Atlantic UL 5-5143  
 Dial Electronics 20 Willoughby St MA 4-5270  
 Electronic Equip 2912 Atlantic TA 7-6300  
 General Electric Supply 135 Kent EV 7-1020  
 \*Green Tele-Radio 472 Sutter HY 5-0200  
 Hygrade Electronics 1509 E N Y HY 4-9237  
 Laco Electronics 4924 4th Ave HY 5920  
 \*National Radio Parts Distr's 572 Albany PR 8-0800  
 \*Stan Burn Radio 558 Coney Island LU 3-0700  
 Witalm Electronic 126 Manhattan EV 8-0945

**BAY SHORE**  
 L I Electronic Supply 226 E Main St

**BELLEROSE**  
 Long Island Teleparts 248-52 Jamaica FL 4-2273

**FARMINGDALE**  
 \*Strong Television 286 Main St FA 2-2004

**FLUSHING**  
 \*Melville Radio 134 Dahilla Ave FL 8-9150

**FOREST HILLS**  
 Berger Distr 109-01 72 Rd

**GREAT NECK**  
 Rotary Electronic 10 Grade Ave GR 2-0902

**HEMPSTEAD**  
 Arrow Electronics 215 Front St  
 \*Davis Electronics 204 Main St IV 3-9200  
 \*Island Radio 412 Fulton HE 2-1097

\*Standard Parts 277 N Franklin IV 1-9010  
 Westinghouse Elec 42 Chasner HE 2-1816

**HICKSVILLE**  
 Gam Electronics Distr 236 Broadway HI 3-3400  
 General Electric Supply 4 & Bway HI 3-1890

**JACKSON HEIGHTS**  
 \*National Radio Distr 73-20 Northern Blvd MA 6-0040

**JAMAICA**  
 Bear Electronics 138-55 Jamaica Ave JA 3-1353  
 \*Chanrose Radio 170-16 Jamaica OL 8-2900  
 Electronic Maintenance 172-24 Jamaica Ave JA 3-2870  
 Harrison Radio Corp 144-24 Hillside Ave RE 9-4102  
 \*Norman Radio 94-29 Merrick Rd RE 9-4651  
 Peerless Radio Distr 92-32 Merrick Rd RE 9-6080

**LONG ISLAND CITY**  
 Electronic Supply 41-08 Greenpoint ST 6-2730  
 Graybar Electric 21-15 Bridge Plaza EX 2-2000  
 Mannfred Electronics 21-26 36 Ave Ex 2-6000  
 Philco Distr 47-51 33 St ST 6-8400  
 Robinson TV Electronics 26-06 Jackson  
 Westinghouse Elec 29-50 Northern Blvd HU 6-7700

**MINEOLA**  
 Emerson-Long Island Inc GA 7-1506  
 Schwaber Electronics 122 Herricks GA 7-6520

**PATCHOGUE**  
 South Bay Radio 159 W Main St PA 3-4488

**RIDGEWOOD**  
 Green Tele-Radio 67-15 Fresh Pond Rd EV 2-8281

**WOODSIDE**  
 Boro Electronics 69-18 Roosevelt Ave HA 6-9718  
 (end of Long Island)

**NEW YORK**

**NIAGARA FALLS**  
 General Electric Supply 11 & Whitney 6921  
 Niagara Falls Radio 1363 Pierce N 1-5531  
 Niagara Radio & Parts 1518 Main  
 Radio Equipment Corp 1363 Pierce Ave NI 5531  
 Standard Electronics 419 24 St 4-0437

**OLEAN**  
 Radio Equip Corp 449 N Union St OL 8560  
 Standard Electronics Olean Corp 514 W State St  
 2-0109  
 Wanmaker & Redstone 415 N Union St

**ONEONTA**  
 Grouch Distr 202 Main 2596

**PEEKSKILL**  
 B & B Electronics 1607 Main 7-3150



**PLATTSBURG**  
 Ray Distr 13 Sully Ave 3371

**PORT CHESTER**  
 Ratec Inc 136 Irving PC 5-0051

**POUGHKEEPSIE**  
 Mid-Hudson Elec 408 Main St  
 Victory Specialties 6 Raymond 7247

**ROCHESTER**  
 American Electronic 554 Clinton Ave N LO 7228  
 Bickford Bros 208 St Paul BA 7300  
 Erskine-Healy 420 St Paul LO 7980  
 General Electric Supply 67 Mortimer HA 7500  
 Graybar Electric 186 N Water BA 7700  
 \*Hi-C Radio Electronics 109 State St BA 8119  
 Hunter Electronics 233 E BA 8110  
 Kemp Equipment 57 Mt Hope HA 8050  
 Masline Radio 192 Clinton N HA 0790  
 National Sales 56 Retter St GL 9270  
 RCA Victor Distr 120 Portland Ave LO 4180  
 Radio Parts & Equip 108 Sylvan RD MO 5272  
 \*Rochester Radio 114 St Paul LO 9900  
 Silver Corp M E 208 St Paul St BA 7300  
 Westinghouse Electric 1 McKee RD MO 1635

**ROME**  
 Rome Electronic Supply 102 Erie Blvd E 2215

**SARANAC LAKE**  
 Starks & Co G L 8 Woodruff Ave

**SCHENECTADY**  
 \*Electric City Radio 1566 State  
 Schenectady Electronic Distr 1667 Broadway 4-8520  
 Schwartz & Son Maurice FO 730 Broadway 6-4717

**SYRACUSE**  
 Baldwin-Hall Co 475 Oswego 3-5103  
 \*Berndt Co W E 655 S Warren 2-3385  
 Broome Distributing 100 Tully 75-3176  
 City Electric 514 W Genesee 3-5171  
 Gordon Dist Co L 935 W Genesee ST 74-3338  
 Graybar Electric 327 N West SY 2-1281  
 Kari-William Co 404 S Crosse 75-2755  
 Lincoln Supply 109 Otisco 4-3170  
 Morris Distr 1153 W Fayette 75-0791  
 Onondaga Supply 344 W Genesee 74-1251  
 Paul-Jeffrey Co 519 Erie E 75-4126  
 Penfield Mfg 516 Erie 75-4154  
 \*Radio Supply 200 Walton 3-3197  
 Reliance Distr 343 W Jefferson 75-2157  
 \*Roberts & D'Brien 839 Hlawatha Blvd 2-0421  
 \*Smith Inc S W 325 E Water 2-7768  
 Spinney Co BN 1129 W Fayette 75-2153  
 Stage Roy C 265 Erie Blvd W 2-8686  
 Syracuse Radio 620 S Salina 74-2927  
 Syracuse TV Accessory 217 W Willow 74-3978  
 Thelsen Inc 935 Erie E 75-4126  
 \*Westinghouse Electric 961 W Genesee 74-3331

**TROY**  
 Empire State Wholesale 218 Congress St AS 2-6160  
 McRae & Co H A 137 River 2-8720

Q & Q Electronic Supply 801 Jacob St AS 4-7323  
 \*Trojan Elec Sup 15 Middleburg St AS 4-4481

**UTICA**  
 Associated Elect Supply 1427 Sunset Ave 3-1695  
 \*Beacon Electronics 411 Columbia St 5-4411  
 \*Electronic Lab 1415 Oriskany W  
 Langdon & Hughes 233 Elizabeth St  
 Miller Electric 11 Hopper St  
 Vaeth Electric 35 Genesee 2-5177  
 Westinghouse Elec 112 N Genesee St 4-8116

**WATERLOO**  
 \*Beacon Electronics 680 Mill St 911  
 Watertown Electronics 352 Court St 863  
 Westinghouse Electric 245 State 6527

**WHITE PLAINS**  
 Emerson Radio 285 Mamaroneck WH 6-3816  
 Hub Electronics 249 Tarrytown Rd WH 6-3121  
 \*Melville Radio 259 Mamaroneck WH 8-6131  
 \*Westchester Elec 602 Mamaroneck WH 9-5765

**YONKERS**  
 General Electric Supply 16 Harrison Ave 8-3700  
 Yonkers Elec 541 Nepperhan YO 9-6044

**NORTH CAROLINA**

**ASHEVILLE**  
 \*Freck Radio Supply 38 Biltmore Ave 3-3633  
 General Electric 47 Ranklin Ave 2-4481  
 Graybar Electric 221 Patton Ave AS 3-4761  
 \*Longs Distr 12 Biltmore Ave 3-4371

**BURLINGTON**  
 Womack Electric Supply 623 Worth St

**CHARLOTTE**  
 Allison Erwin 209 E 5th St  
 \*Dixie Radio 1431 Bryant St ED 4-6488  
 General Electric Supply 700 Tuckaseegee FR 5-7321  
 Glasgow Supply Co 224 S Cedar St FR 6-2457  
 Graybar Electric 120 W Morehead CH 6-4886  
 Major Appliance Distr 1231 W Morehead  
 \*Radiotronic Distr 208 N College 2-1258  
 Shaw Distr 205 W First St FR 6-3533  
 Southern Radio 1625 W Morehead 6-4461  
 Walker-Martin 2315 N Davidson St 4-4613  
 Westinghouse Electric 324 N College 5-3715

**DURHAM**  
 Graybar Electric 303 S Duke DU 2113  
 \*Womack Electric Supply 304 S Dillard 5197

**FAYETTEVILLE**  
 Eastern Radio 532 Hay 2-7161  
 General Electric Supply 461 Robeson St 2-5143

**FOREST CITY**  
 McElhenney Co 114 Thomas 2652

**GASTONIA**  
 Bryant Supply 605 E Franklyn 5-3466

**GOLDSBORO**  
 Signal Radio Kinston Hwy 3234  
 \*Womack Electric Supply 405 W Walnut 2252

**GREENSBORO**  
 General Electric Supply 1111 Willowbrook 3-8208  
 \*Johannesen Elec 312 N Eugene 3-6906  
 \*Southeastern Radio Hdqrs Raleigh  
 Westinghouse Elect 1410 Westover Ter 3-8661

**GREENVILLE**  
 Carolina Sales Corp 1410 Evans St 3143  
 General Electric 200 Hooker RD 5104

**HICKORY**  
 Victor Radio & TV 1058 3 Ave Dr NW 2-6927

**HIGH POINT**  
 \*Womack Radio Supply 654 N Main St

**MOREHEAD CITY**  
 Machine & Supply Co 2-5971

**RALEIGH**  
 Allied Electronics 413 Hillsboro 3-4627  
 Electrical Wholesalers PO Box 247 3-5588  
 General Electric Supply 800 W Poole 3-4691  
 Nash-Steale-Warren 615 W Hargett St  
 \*Southeastern Radio 414 Hillsboro 3-1936  
 Walker-Martin P O Box 391 LD 950  
 Westinghouse Electric 319 W Martin 3-4841

**ROCKY MOUNT**  
 Graybar Electric 761 Planters St RO 2-5171  
 \*Womack Electronics 105 Marigold St 2-6153

**SALISBURY**  
 Leonard Electronics 316 N Depot St 5280

**WASHINGTON**  
 Jowdy Distributing 110 N Respass St 40

**WILMINGTON**  
 French Radio 1220 Dock 9878

**WINSTON SALEM**  
 \*Dalton-Hege 924 W 4 2-5141  
 Graybar Electric 955 Brookstown WI 4-2461  
 Leonard Electronic Supply 409 W End Blvd  
 Williams Radio C R 211 S Liberty

**NORTH DAKOTA**

**BISMARCK**  
 Bristol Dist Co 227 W Broadway 4341

**FARGO**  
 \*Bristol Distr 419 Northern Pacific Ave 2-7493  
 Dakota Electric 1017 4 N 2-3301  
 Fargo Radio 515 3rd Ave 2-1872  
 General Electric Supply 69 1/2 Broadway 2-8131  
 Hayer Co FC 714 1st Ave N 2-7479  
 Low Bonn Co 313 N P Ave 5321  
 Radio Equipment 624 2nd Ave N 5462  
 Westinghouse Elec 109 Roberts 2-4446  
 Walter Electronics 65 S St N 4886

**GRAND FORKS**  
 Bristol Dist Co 1017 S Washington St 4-5611

**MINOT**  
 Bristol Dist Co 58 Main St 5-3216  
 McFall Radio 5 N Main St

**OHIO**

**AKRON**  
 Akron Radio/TV Parts 107 S Arlington St PD 2-8818  
 Electronic Engineering 362 W Bowery FR 6-3191  
 General Electric Supply 225 E Mill FR 6-8195

Graybar Electric 185 Carroll JE 5-4143  
Main TV Supply 1013 N Main St WA 8-2117  
Olson Radio 73 E Mill St JE 9191  
Saeck Electrical 605 S Main St JE 8196  
Strong-Carlisle-Hammond 422 S Broadway Hqrs  
Cleveland  
\*Sun Radio 110 E Market St HE 2171  
\*Warren Radio 71 S Broadway HE 4-2729

**ASHTABULA**  
\*Morrison's Radio 331 Center St 3-9336

**CANTON**  
Armstrong Electr Center 1261 Cleveland N  
\*Barroughs Radio 711 2 St NW 5-0273  
Fall Radio Supply 410 Arlington Ave NW 5-8451  
General Electric Supply 123 6 St SW 4-5187  
Sommer Electric 818 3 St NE 5-9454

**CHILLICOTHE**  
Chillicothe Hardware 148 N Hickory St

**CINCINNATI**  
\*Chambers Electronic 1669 Central Pkwy MA 1-7616  
General Electric Supply 215 W 3 St GA 1750  
Graybar Electric 115 W McKimken MA 0600  
Herrlinger Distr 15 & Vine Sts CH 7273  
Holab & Hogg 1400 Sycamore St CH 7974  
\*Hughes-Peters 1128 Sycamore St DU 7625  
Loekie & Glenn 2110 Gilbert W0 3396  
Mytronic 121 W Central Pkwy GA 2245  
Ohio Appl 804 Sycamore St DU 5430  
Peaslee-Gaulbert 2844 Spring Grove Ave MU 6300  
Radio/TV & Refr 1129 Walnut MA 2940  
\*Scheater Electric 321 E 8 St CH 7610  
\*Steinbergs 633 Walnut St CH 1880  
Teletronic Supply 3935 Montgomery Rd  
Tri-State Distr 8th & Broadway DU 7400  
United Radio 1314 Vine St CH 6530  
Westinghouse Elect 3011 Stanton CA 1300

**CLEVELAND**  
Broadway Electric 6209 Broadway DI 1-8500  
Carnegie Radio Distr 2536 Prospect Ave CHI-2433  
Euclid Radio 16379 Euclid GL 1-1375  
Freshman Chas 6610 Euclid Ave EX 1-8723  
General Electric Supply 4958 Woodland Ave HE 1-7280  
General Radio Supply 1588 Hayden Ave UL 1-0700  
Goldhamer 2239 E 14 St CH 1-1690  
Graybar Electric 1010 Rockwell CH 1-1360  
Kane 1666 E 40 St EX 1-4800  
Main Line Cleveland 5005 Euclid EX 1-1800  
Northern Ohio Appl 5403 Prospect Ave HE 2-0500  
\*Northern Ohio Labs 2073 W 85 W0 1-2756  
Olson Radio 2020 Euclid MA 1-6187  
\*Pioneer Electronic 2115 Prospect Ave SU 1-9410  
Progress Radio 413 Huron Rd CH 1-5630  
\*Radio & Electronics Parts 3235 Prospect Ave UT 1-6060  
Strong & Carlisle-Hammond 2801 St Clair MA 1-9165  
Taylor G W 2157 Fairhill Rd. SW 1-5442  
Tecca Distr 4501 Prospect HE 2-1040  
Television Distr 3600 Ridge Rd ME 1-7100  
Westinghouse Elect 1809 E 22 To 1-5660  
\*Winteradio 1468 W 25 St MA 1-9383

**COLUMBUS**  
Bennett Distrs 1051 W Goodale Blvd CA 4-5216  
Backeye Electronics 242 E Long St CA 8-2697  
\*Electronic Supply 134 E Long St  
General Electric Supply 146 N 3 St CA 8-4371  
Graybar Electric 3 & Chestnut St FL 3811  
\*Hughes-Peters 111 E Long CA 1-4356  
Kane 168 N 3 St Hqrs Cleveland  
Ohio Appliances 1171 W Goodale Blvd CA 1-6847  
Thompson Radio 182 E Long CA 1-7434  
Tracy-Wells 175 N Front St  
Westinghouse Electric 266 N 4 St MA 5571  
\*Whitehead Radio 124 E Long St AD 6131

**DAYTON**  
\*Allied Supply 359 W Monument MI 9833  
General Electric Supply 601 E 3 St MI 0781  
Graybar Electric 332 W Monument Ave MI 5665  
\*Hughes-Peters 300 W 5 St MI 8555  
Miami Valley Dist 8 N Keowee St HE 1135  
Moore Equip Inc 18 Bruen St HE 2841  
Ohio Appliances 430 Leo St MI 0343  
\*Srepro 314 Leo St MI 3874  
Stotts-Friedman 135 E 2nd St MI 8373  
Thompson & Hamilton 118 S Terry AD 9193  
Westinghouse Electric Supply 226 W 5 St MI 0331  
Yonts Radio & Appl 531 E 3 St HE 6777  
York Supply 531 E 3 St AD 5177

**E LIVERPOOL**  
D & R Radio Supply 631 Dresden Ave FU 5-2422

**ELYRIA**  
Ei-A-Co 235 Lodi St 2169

**LANCASTER**  
Bietzacker Electronics 135 W Chestnut St 2137  
Snyder Electric 319 Forest Rose 2986

**LIMA**  
Allied Supply 460 S Main St 3-0645  
\*Hutch & Son 125 S Elizabeth St 9-8411  
\*Lima Radio Parts 600 N Main St 6-6551  
Northwestern Radio 131 S Elizabeth St 4-2878  
\*Warren Radio Co 222 S Elizabeth St 7-2011

**MANSCHELD**  
\*Burrnoughs Radio 218 E 2nd St 1691-6  
Main TV Supply 488 Johns Ave  
Wholesaling Inc 775 Springmill 7287-6

**MARIETTA**  
Marietta Radio & Elect 221 2 St 1677

**MARION**  
Bell Radio 527 N Main St 2-5513  
Dillman Radio Supply 389 W Center St 2-8063  
Servex Distributing 213 N Main St 2-0031

**MASSILLON**  
Martin M H 1118 Lincoln Way TE 2-7467

**PAINESVILLE**  
Morrison's Radio 36 S State St EL 2-3444

**PORTSMOUTH**  
General Electric Supply 1723 10 St 3-2341  
Graybar Elec Co 923 Washington St PO 3-1766  
King & Irwin 1007 Lawson St  
Sound Elec Supply Co 7 & Finley St

**SANDUSKY**  
Barco Electronic Parts 119 E Water 2471

**SPRINGFIELD**  
Eberle's Radio Supply 522 W Main St 3-8552  
Standard Radio 119 W Main St 2-1297  
Wholesale Supply 256 E Main St

**STUEBENVILLE**  
D & R Radio Supply 221 S 3 St AT 3-3643  
\*Hausfeld Radio Supply 116 N 3 St 2-4391

**TIFFIN**  
Hutch & Son 278 N Washington 4607  
Servex Electronic 215 Jefferson St 4905

**TOLEDO**  
Arnold's Equipment 1212 Norwood Ave  
Arnolds Furnace & Equip 2911 Stickney  
Benarr Distrs 1034 Grand Ave GA 6753  
General Electric Supply 28 N St Clair's GA 8661  
Gerlinger Equipment 1001 Adams St  
Graybar Elec 1700 Canton Ave MA 9166  
Harry's Auto-Radio 113 Adams St FA 3447  
\*Howard's Electronic 735 17 AD 2277  
Lifetime Electronics 1501 Adams St MA 5643  
Main Line Distributors 380 S Erie St GA 4996  
Selectronic Supplies 1320 Madison Ave FU 3361  
\*Toledo Radio Spec 1215 Jackson St AD 5828  
\*Warren Radio 1002 Adams St FU 3364  
Westinghouse Electric 1225 Indiana AD 6184

**WARREN**  
D & J Electronic 236 Vine Ave SE 3721-6  
\*Radio Specialties 136 Pine St SE 5877-0  
Sommer Electric 2609 Youngstown Rd 7-5055

**WASHINGTON COURT HOUSE**  
\*Hutch & Son 209 E Market 5-6961

**YOUNGSTOWN**  
Appliance Wholesalers 1197 Wick Ave  
General Electric Supply 265 W Rayen Ave RI 6-6511  
Graybar Elec 602 W Rayen Ave RI 4-0124  
Hamburg Bros 360 E Federal 3-2101  
Hood Electric Co 128 W Rayen Ave 4-0255  
Radio Parts 230 E Boardman St Hqrs Pittsburgh Pa  
Ross Radio 325 W Federal St RI 6-6388

**ZANESVILLE**  
Thompson Radio 135 S 6 St 2-7311

**OKLAHOMA**

**LAWTON**  
\*Radio Supply Box I 387 7220  
\*Reynolds Radio 909 1/2 C Ave 1292

**McALISTER**  
S E Oklahoma Radio Supply 325 W Jackson 1240

**MUSKOGEE**  
\*Muskoonee Electronic Supply 229 Court St 2-9651

**OKLAHOMA CITY**  
Admiral Distrs 1017 W Reno St  
Capitol Distr 1017 W Reno St  
Dufaney's 100 N W 44 St JA 5-1511  
Electronic Supply 212 N W 10 CE 2-5215  
Foster Co M L 27 E Grand St  
General Electric Supply 127 E Calif Ave FO 5-5475  
Graybar Electric 12 E California FO 5-9351  
Johnson Wholesale 416 N Lee FD 5-6388  
Maxwell Co Leo 409 N Classen St  
\*Miller-Jackson 121 E Calif St FO 5-0761  
Modern Parts Distr 15 E Grand RE 9-1523  
\*Radio Supply 724 N Hudson St CE 2-6128  
Southwest Radio & Equip 3N E 8 St RE 6-8535  
Westinghouse Electric 850 N W 2 St 2-7101  
Wolfe Distr 710 N W 2 St

**TULSA**  
Electronic Supplies 219 E 1 St 4-6129  
Engineering Supply 1124 E 4 St 3-8122  
General Electric Supply 18 N Guthrie St 3-6121  
Graybar Electric 2406 E 12 St TU 6-2121  
Industrial Electronic Supply 1124 & 4 St  
Midwest Electronic 219 E 1 St 54-6129  
Oil Capitol Electronics 923 E 4 5-7214  
Patterson Radio 211 E 13 5-3179  
\*Radio Inc 1000 S Main 4-9127  
Southwest Radio & Equip 34 N Madison TU 2-5113  
\*S & S Radio 537 S Kenosha St 54-5264  
Westinghouse Electric 307 E Brady St 3-7155  
Wholesale Radio Supply 538 S Lewis St

**OREGON**

**EUGENE**  
\*Carlson Hatton & Hay 96 E 10  
Eoff Electric 556 N Charnelton St 5-4349  
Gilbert Bros 424 Charnelton St hqrs Portland  
Graybar Electric 2180 6 Ave W EU 4-2224  
\*United Radio Supply 712 W 6 Ave 5-8547

**KLAMATH FALLS**  
R F Supply 2367 S 6 St

**MEDFORD**  
General Electric Supply 121 W 4 St 3-2423  
United Radio Supply 301 S Front 3-4003  
\*Walker Co V G 205 W Jackson 2-4558  
Westinghouse Elec Supply Co 1233 Court St

**PENDLETON**  
Harolds Radio Supply 320 SW Court Ave 1956

**PORTLAND**  
Appliance Whole 600 N W 14 AT 6584  
\*Central Distrs 1131 NW Couch AT 0146  
Connolly Co F B 905 NW 12th Ave CA 1755  
Eoff Electric 509 NW 10 St CA 9411  
General Electric Supply 300 NW 14 Ave BR 0651  
Gilbert Bros 826 SW 2 Ave BR 5641  
Graybar Electric Park & Flanders BR 6641  
Home Makers Supply 824 S W 18 St CA 9385  
H & R Radio Supply 5210 NE Sacramento TR 0057  
Instrument Lab 1728 SW Harbor Dr CA 6863  
Johnson Co Lou 1506 NW Irving  
Marshall Wells 1420 NW Lovejoy BR 6421  
North Pacific Supply 2025 NW Overton AT-9576  
Northwest Radio Supply 110 SE 8 Ave FI-9787  
Pacific Stationery 414 SW 2 CA 4221  
\*Portland Radio 1234 W Stark St AT 8647  
Saelens Radio 1605 NW Everett BE 2423

\*Stubbs Electric 33 NW Park Ave BR 5404  
Television & Radio 720 SE Alder EA 1104  
\*Tracey & Co NW 10 & Gilsan Sts BE 6263  
\*United Radio Supply 22 NW 9 Ave BE 6323  
Westinghouse Elec 815 NW 12 Ave CA 9851

**SALEM**  
Eoff Electric Co 156 N Front St 3-9251  
Gilbert Bros 355 N High St Hqrs Portland  
Johnson Co Lou 1051 S Commercial 3-5955

**PENNSYLVANIA**

**ALLENTOWN**  
Bell & Co Chas 14 & Gordon Sts 3-5101  
\*Federated Purchaser HE 3-7411 hqrs New York NY  
General Electric Supply 16 & Summer St HE 3-5206  
Graybar Electric 1941 Hamilton HE 4-9341  
Luckenbach & Johnson 1828 Tighman St HE 4-6235  
Peters A A 231 N 7 St HE 4-9361  
Radio Electric Service 1042 Hamilton hqrs Philadelphia  
Steedle Norman D 1005 N 19 HE 5-5441  
Westinghouse Elect 745 Union Blvd HE 4-5105

**ALTOONA**  
Altoona TV Supply 1713 Union Ave 4-0827  
General Electronics 508 Creston Rd 3-6666  
\*Hollenback's Radio Supplies 2221 8th Ave 6171  
Kennedy's Radio Supply 1500 7 Ave

**AMBRIDGE**  
Barrett Bros 127 Merchant St AM 6-6750

**BEAVER FALLS**  
Reliable Motor Parts 1700 7 Ave 4925

**BETHLEHEM**  
\*Buss Radio Electric 431 W Broad St UN 6-0634

**BLOOMSBURG**  
Beers Electric Co E R 143 W Main St 600

**BRADDOCK**  
Marks Parts Co 313 Braddock Ave EL 1-1314

**BRADFORD**  
Johnson Radio & Electronics 4130

**BRISTOL**  
Cooper Sales Co 449 Mill St BR 8-6577

**BUTLER**  
Barron's Radio 333 E Jeff 7-5930

**CHESTER**  
A C Radio Supply 126 E 24 St 2-6181  
Bell Radio & TV 307 Edgemont Ave

**DREXEL HILL**  
General Elec Supply 3417 Garret Rd CL 9-6440

**EASTON**  
\*Federated Purchaser, 925 Northampton 4259 hqrs  
New York N Y  
Radio Electric Service 916 Northampton

**ELKINS PARK**  
A G Radio Parts 939 Township Line TU 6-5100

**ERIE**  
B & D Whole Distr 502 E 10 St  
\*Duncombe Co J V 1011 W 8 St 4-5278  
General Electric Supply 824 E 9 2-1477  
\*Jordan Electronic Co 1130 German St 2-2462  
\*Warren Radio 1315 Peach St 4-5286  
Westinghouse Elec 1820 State 4-8191  
Young Brothers 1909 Peach St 4-5297

**GETTYSBURG**  
Hartley & Co M A 101 Carlisle St 799

**GREENSBURG**  
General Electronics 504 New Alexander Rd 1440

**HARRISBURG**  
Blessing Co John A 48 N Cameron St 6-9311  
D & H Distr 311 S Cameron St  
Excelsior Radio 17 & Derry St CE 8-8261  
Graybar Electric 1039 S 13 HA 8-7303  
Harrisburg Radio 1124 Market St 6-2755  
Knerr C G 317 S Cameron St  
\*Radio Distr 915 S 13 4-0139

**HAZELTON**  
Cerallo Electric 39 S Vine 1296  
Moyer Electronic 758 N Locust

**INDIANA**  
Superior Distr 334 Philadelphia St

**JOHNSTOWN**  
\*Baker Radio Electric 111 John St  
\*Cambria Equip 17 Johns 6-1291  
Dick's Automotive 633 Napoleon St  
General Electric Supply 80 Hickory 7-5101  
Radio Parts Co 325 Bedford St 9-1458  
TV & Radio Parts 226 Main St 7-5345  
Westinghouse Electric 75 Hickory St 8-1293

**LANCASTER**  
Barbey Co G D 622 Columbia Ave 4-0558  
Eshelman Supply 110 N Water 8183  
York Radio 519 W King St 4-2669

**LEBANON**  
Barbey Co Geo D 821 Quentin Rd

**McKEESPORT**  
\*Barno Radio 321 6 Ave  
McKeesport Electronics 1661 5th 8-5111

**MEADVILLE**  
Meadville Electronics ME 5-9182  
Warren Radio inc 1057 S Main St 5-4131

**MONESSEN**  
Mon Valley Electric 456 Schoonmaker Ave 1233

**NANTICOOK**  
Modern Electronic 102 S Market 583

**NEW BRIGHTON**  
Television Parts Co 509 5 Ave 5085

**NEW CASTLE**  
Midwestern Elec 235 W Grant OL 4-9961  
Reliable Radio & TV 1015 S Mill OL 4-9233

**NEW KENSINGTON**  
Bearer Electric 1017 5 Ave ED 5-5801

**NORRISTOWN**  
Almo Radio Co 550 Markely St NO 8-7580  
General Radio Supply 624 W Atry St NO 8-8115  
Kratz Bros Kohn & Oak NO 5-4379

**OIL CITY**  
Barron's Radio hqrs Butler

**PHILADELPHIA**

\*A C Radio 1539 W Passyunk HO 2-9379  
 \*A G Radio 3552 N 17 St SA 2-0505  
 \*Allied Electric 1320 W Erie Ave BA 9-8800  
 \*Almo Radio 412 N 6 St WA 2-5153  
 \*Barnett Bros 117 N 7 LO 3-3947  
 \*Burns Co Jndson C 31 & Oxford St 4-5600  
 \*Consolidated Radio 612 Arch St LO 3-7871  
 \*Emerson Radio 223 N Broad LO 4-3350  
 \*Everybody's Supply 810 Arch St WA 2-7800  
 \*General Electric Supply 401 E. Hunting Park Ave GA 6-8800  
 \*Graybar Electric 910 Cherry WA 2-5405  
 \*Herbach & Rademan 1204 Arch LO 7-4309  
 \*Lazar Radio 4231 Lancaster Ave BA 2-5604  
 \*Lectronic Research Lab 715 Arch NA 7-6771  
 \*M & H Sporting Goods 722 Market LO 7-2587  
 \*Nadisco 3960 N 16 BA 6-2020  
 \*Nemher H K 1539 Race St LO 7-2125  
 \*Pelree-Phelps 2000 N 59th St GR 7-9000  
 \*Penn Electronic 5303 Frankford JE 5-1533  
 \*Radio Electric 3412 Germantown BA 9-5900  
 \*Radio Elec Serv 7 & Arch LO 3-5840  
 \*Radio Parts Equip 3319 N Broad RA 5-5322  
 \*Rosen & Co Raymond 2121 Market St EV 2-5000  
 \*Rumsey Electric 1007 Arch St MA 7-6900  
 \*Steinberg & Co 2520 N Broad BA 3-9400  
 \*Westinghouse Electric 141 N 11 St WA 2-8950  
 \*Wile Eugene G 218 S 11 St KI 5-8370

**PITTSBURGH**

\*Cameradio Radio 1121 Penn Ave  
 \*Electronic Parts 5744 Baum Blvd MD 1-6413  
 \*General Electric Supply 200 W River Ave FA 2-1530  
 \*Graybar Electric 900 Riage Ave AL 1-4100  
 \*Hamburg Bros 213 Galveston Ave AL 1-2400  
 \*Keps Electric 5000 Baum Blvd MU 3-3300  
 \*Mansfield Co MV 937 Liberty Ave GR 1-4175  
 \*Marks Parts Co 508 E Ohio St FA 1-5300  
 \*Marshall Co John 201 Anderson FA 1-5400  
 \*Pittsburgh Prods Reedsdale & Fontella Sts AL 1-3400  
 \*Radio Parts 6339 Penn Ave EM 1-6053  
 \*Rogers Co C R 5210 Liberty Ave MA 1-4700  
 \*South Hills Electric 1420 W Liberty Ave FI 1-6200  
 \*Superior Distr 5124 Liberty Ave MU 1-4311  
 \*Tydings Co 5000 Baum Blvd MU 3-3710  
 \*Variety Electronics 605 Bigelow Blvd EX 1-1524  
 \*Westinghouse Elec 209 W Gen'l Robinson AL 1-5500

**POTTSVILLE**

\*Moyer Electronic 330 E Norwegian 3742  
 \*Schuykill Electric 611 Mauch Chunk St 4404

**READING**

A G Radio Parts 628 Schuykill Ave  
 \*Barbey Geo D 155 Penn St 6-7451  
 \*Barnett Bros 201 S 4 6-4814  
 \*General Electric Supply 447 N Front St 4-2169  
 \*Graybar Electric 22 S 3 St RE 6-1581  
 \*Westinghouse Electric 4 & Elm Sts 6-7236

**ROCHESTER**

Reliable Motor 402 Adams St

**ROSLYN**

Grove Enterprises 1373 Easton Rd

**SAINT MARYS**

\*B & R Electric 26 Railroad St 4-4918

**SCHUYLKILL HAVEN**

Ace Electronics 33 Stanton St 304-R

**SCRANTON**

Consolidated Distr 844 Capouse DI 7-6380  
 \*Emerson Radio of Pa Penn Ave & Poplar DI 7-1134  
 \*General Electric Supply 204 Monroe Ave DI 4-8563  
 \*General Radio & Refr 1013 Capouse Ave DI 7-5033  
 \*Morris Distr 616 Mulberry St  
 \*Pursell Fred P 1221 N Washington Ave  
 \*Scott Charles B 119 Franklin Ave 8-2221  
 \*Scranton Radio/TV Supply 419 Poplar St DI 3-1259

**SHARON**

Sharon Electronics Supply 1336 E State 3014

**SUNBURY**

Big Boys Distr 132 S 2 St 990  
 \*Electronic Sales 734 Market St 911J  
 \*Moyer Electronic 5 Haas Ave

**UNIONTOWN**

TV & Radio Parts 1 Mill St GE 7-7551  
 \*Superior Distr 25 Dunbar St GE 8-2357  
 \*Zimmerman Wholesalers 104 W Peter St GE 7-6110

**WILKES-BARRE**

General Electric Supply 85 E Union St VA 2-5106  
 \*General Radio 396 S Main 4-7881  
 \*Modern Electronic hdqrs Nantleoke Radio Service 346 S Main 3-7713  
 \*Sonoret Tele-Radio Co 36 Woodbury St VA 2-2431  
 \*Electronics Merchandisers—Tubes, Antennas, Accessories, Wire, Parts, Batteries, Tuners, UHF Strips, Television, Radio, Phono, Recorders, Test Equipment, Tools, Allied Items, "DeWald", "Meck", "Roland", "Crescent", "Sonora", "Olympic", "Standard Coil", "Chicago Instruments", "Olin", "Ame", "Synkote", "Youngstown", "R.M.S." etc.  
 \*Wall R B 16 E Union St VA 4-2411

**WILLIAMSPORT**

Alvo Electrs Distrs 240 Pine St  
 \*Electric Appliance 329 E 4 St  
 \*Westinghouse Electric 465 Heppburn St 2-6183  
 \*Williamsport Radio 518 W 3 St 7696

**YORK**

Eshelman Supply 10 Broad St hdqrs Lancaster Pa  
 \*J R S Distr 646 W Market 4-3217  
 \*Minnich Radio & Sound 624 W Market St  
 \*Mottter Electric 815 N George St  
 \*Westinghouse Elec Ogantz St & 6 Ave WD 5556  
 \*York Radio & Refrgr 263 W Market St 8-1588

**RHODE ISLAND****CRANSTON**

Rimaco Sales 218 1/2 Warren Ave East Prov 1-5213

**PROVIDENCE**

Adams Distr 116 Broadway DE 1-9200  
 \*Dandreta & Co Wm 129 Regent Ave UN 1-2800  
 \*DeMambre Radio 90 Broadway

Dero Electronics 78 Atwell DE 1-6272  
 \*Eddy & Co 43 Hospital St GA 1-2045  
 \*Edwards & Co W H 94 Broadway GA 1-6158  
 \*General Electric Supply 241 Harris Ave GA 1-6523  
 \*Graybar Electric 194 Richmond DE 1-8100  
 \*Television Access Hesse 41 Broadway JA 1-7513  
 \*Westinghouse Elec 233 Harris GA 1-6484

**SOUTH CAROLINA****ANDERSON**

A & S Electronics 205 W River St CA 5-8260  
 \*Dixie Radio Supply 211 W Whitener St 7567

**CHARLESTON**

Butt's Elec Supply 480 E Bay St 2-4085  
 \*Perry-Mann Electric 70 Romney St 2-6691  
 \*Radio Labs 215 King St 3-5328  
 \*Wholesale Radio 78 1/2 Calhoon St

**COLUMBIA**

Associated Distr 822 Gervais St  
 \*Dixie Radio Supply 1700 Laurel 4-0383  
 \*Electronics Inc 1513 Taylor St  
 \*Graybar Electric 710 Lady St CO 2-2125  
 \*Horlacher & Barrett 1909 Main  
 \*Krell Radio 1714 Main 2-2103  
 \*McElhenney Co 1215 Henderson  
 \*Perry-Mann Electric 901 Taylor St 2-4375  
 \*Southeastern Radio Parts 1606 Gregg St 2-1141  
 \*Southern Radio 1929 Hampton Ave  
 \*Westinghouse Electric 915 Lady 8145

**FLORENCE**

Dixie Radio Supply 234 E Evans 8201  
 \*Florence Radio 355 N Irby St 2-1446

**GREENVILLE**

Carolina Radio 225 W Wash 2-6740  
 \*Dixie Radio Supply 306 Wade Hampton Blvd 2-5357  
 \*Gilliam Radio 802 Buncombe St 5-0438  
 \*Perry-Mann Electric 400 Rhett St 5-1677  
 \*Westinghouse Electric 205 Airport Rd 3-6201

**SPARTANBURG**

McElhenney Co 481 Union St 6309

**SUMTER**

Florence Radio 8 E Hampton Ave SP 3-2080

**SOUTH DAKOTA****ABERDEEN**

Burghardt Radio Supply 102 S 2nd St 2469  
 \*Graybar Electric 224 1 Ave S E AB 2974

**BROWNINGSVILLE**

Electronic Equip & Eng'g 1154 E Madison 2-4222

**CORPUS CHRISTI**

\*Electronic Equip 805 S Staples 3-9271  
 \*General Electric Supply 1134 E Port Ave TU 2-9237  
 \*Graybar Electric 1311 Agnes Co 4-6374  
 \*Hayes Radio Sup 1116 S Staples St 4-1991  
 \*Westinghouse Elec 110 N Staples St 2-3351  
 \*Wicks Radio Equip 513 S Staples St 4-8285

**DALLAS**

Adleta Co 1914 Cedar Springs PR 7576  
 \*All State Distr 2411 Ross Ave RI 1295  
 \*Crabtree Whole Radio 2608 Ross St 5361  
 \*Dallas Electric 1800 Magnolia RI 5396  
 \*Engineering Supply 6000 Denton Dr FL 7-2861  
 \*General Electric Supply 1811 N Lamar St RA 2201  
 \*Graybar Elec 717 Latimer RA 6452  
 \*Industrial Electronic 134 Leslie 8-8122  
 \*Medaris Co 1202 Drago N St PR 4841  
 \*Ra-Tel 2409 Ross Ave PR 8689  
 \*Southern Radio 3004 Ross Ave VI 6396  
 \*Southwestern Co 1202 Dragoon PR 4841  
 \*South West Radio 1820 N Harwood RI 6272  
 \*Wanslow & Co 912 N Peak St TA 9836  
 \*Westinghouse Electric 601 Latimer St RA 2401  
 \*Wholesale Electronic 2800 Ross Ave ST 5738  
 \*Wilkinson Bros 2406 Ross Ave PR 1571

**DENISON**

\*Denison Radio Supply 310 W Woodard 45

**EL PASO**

Elec & Mech Supply 2000 Texas St 2-4614  
 \*General Electric Supply 300 Dallas St 3-3407  
 \*Graybar Electric 3513 Ross St EL 3-7561  
 \*McNicol C C 811 W Estrella 5-3992  
 \*Midland Specialty 425 W San Antonio 3-2401  
 \*Momsen-Dunnagan-Rynn 800 E Overland 3-1621  
 \*Reeves Radio Supply 720 N Stanton 3-5752  
 \*Sunland Supply 2200 E Missouri 3-7400  
 \*Walz Co W G 500 San Francisco St 3-1677

**FORT WORTH**

\*Electronic Equip 917 Florence St ED 5407  
 \*Fort Worth Radio Supply 1201 Commerce FO 7107  
 \*General Electric Supply 409 Jones St FA 5385  
 \*Graybar Electric 1107 Forth St ED 4525  
 \*H & L Radio Supply 1608 Commerce St FA 7311  
 \*"Scooter's" Radio 509 Commerce St FO 7448  
 \*Shields Co 1008 Maccn St FA 3111  
 \*Sutton's Electronics 104 S Main St  
 \*Swineo Co 1518 E Lancaster FA 7157  
 \*United Electronics 403 Jones ED 9295  
 \*WestInnhouse Elec 205 NE 7 FO 5611

**GALVESTON**

R C & L F Hall of Galveston 1803 Tremont St 3-1656

**HOUSTON**

Automatic Distr 100 Jackson CA 0261  
 \*Beyer & Co A R 1318 Polk Ave CA 8-7491  
 \*Bassacker Electric 1721 Waugh Dr JU 5546  
 \*City Radio & TV Parts Co 2321 Milam JA 1556  
 \*Covington Distr 34 N Hamilton CA 0326  
 \*Crampacker Distr 1200 National CH 9366  
 \*Electrotex Electronics 2401 Taft St LY 3211  
 \*Electro-Mechanical Prods 1510 Lombard AT 7910  
 \*Franklin Co R E 1905 Chartres St CA 0194  
 \*General Electric Supply 1312 Live Oak FA 3121  
 \*Geophysical Supply 1311 Dallas Ave BL 0561  
 \*Graybar Elec 1702 Cullen AT 4571  
 \*Gulf Coast Electronic 1110 Winbern St W-1551  
 \*Hall Inc R C & L F 1301 Polk CA 9731  
 \*Harrison Equip 1422 San Jacinto AT 6315  
 \*Houston Radio Supply Clay at La Branch CA 6261

**MEMPHIS**

Allen Co Glen 1146 Union Ave GL 2-1685  
 \*Bluff City Distr 234 East St 36-4501  
 \*Boyd Electronic Supply 1153 Union Ave 2-5565  
 \*Electronic Supply 1100 Union Ave 0-3666  
 \*Finmer Co Arthur 296 Monroe Ave 5-5711  
 \*General Electric Supply 500 S Front St 37-5531  
 \*Graybar Electric 1474 Lamar Ave ME 7-7150  
 \*Lavender Radio Supply 180 S Casper 36-2757  
 \*McGregor's 1071 Union Ave 36-3301

**PHILADELPHIA**

\*A C Radio 1539 W Passyunk HO 2-9379

**PITTSBURGH**

\*Cameradio Radio 1121 Penn Ave

**ROCHESTER**

Reliable Motor 402 Adams St

**SCRANTON**

Consolidated Distr 844 Capouse DI 7-6380

**WILKES-BARRE**

General Electric Supply 85 E Union St VA 2-5106

**YORK**

Eshelman Supply 10 Broad St hdqrs Lancaster Pa

**PHILADELPHIA**

\*A C Radio 1539 W Passyunk HO 2-9379

**PITTSBURGH**

\*Cameradio Radio 1121 Penn Ave

**ROCHESTER**

Reliable Motor 402 Adams St

**SCRANTON**

Consolidated Distr 844 Capouse DI 7-6380

**WILKES-BARRE**

General Electric Supply 85 E Union St VA 2-5106

**YORK**

Eshelman Supply 10 Broad St hdqrs Lancaster Pa

**PHILADELPHIA**

\*A C Radio 1539 W Passyunk HO 2-9379

**PITTSBURGH**

\*Cameradio Radio 1121 Penn Ave

**ROCHESTER**

Reliable Motor 402 Adams St

**SCRANTON**

Consolidated Distr 844 Capouse DI 7-6380

**WILKES-BARRE**

General Electric Supply 85 E Union St VA 2-5106

**YORK**

Eshelman Supply 10 Broad St hdqrs Lancaster Pa

**PHILADELPHIA**

\*A C Radio 1539 W Passyunk HO 2-9379

**PITTSBURGH**

\*Cameradio Radio 1121 Penn Ave

**ROCHESTER**

Reliable Motor 402 Adams St

**SCRANTON**

Consolidated Distr 844 Capouse DI 7-6380

**WILKES-BARRE**

General Electric Supply 85 E Union St VA 2-5106

**YORK**

Eshelman Supply 10 Broad St hdqrs Lancaster Pa

**PHILADELPHIA**

\*A C Radio 1539 W Passyunk HO 2-9379

**PITTSBURGH**

\*Cameradio Radio 1121 Penn Ave

**ROCHESTER**

Reliable Motor 402 Adams St

**SCRANTON**

Consolidated Distr 844 Capouse DI 7-6380

**WILKES-BARRE**

General Electric Supply 85 E Union St VA 2-5106

**YORK**

Eshelman Supply 10 Broad St hdqrs Lancaster Pa

**PHILADELPHIA**

\*A C Radio 1539 W Passyunk HO 2-9379

**PITTSBURGH**

\*Cameradio Radio 1121 Penn Ave

**ROCHESTER**

Reliable Motor 402 Adams St

**SCRANTON**

Consolidated Distr 844 Capouse DI 7-6380

**WILKES-BARRE**

General Electric Supply 85 E Union St VA 2-5106

**YORK**

Eshelman Supply 10 Broad St hdqrs Lancaster Pa

**PHILADELPHIA**

\*A C Radio 1539 W Passyunk HO 2-9379

**PITTSBURGH**

\*Cameradio Radio 1121 Penn Ave

**ROCHESTER**

Reliable Motor 402 Adams St

**SCRANTON**

Consolidated Distr 844 Capouse DI 7-6380

**WILKES-BARRE**

General Electric Supply 85 E Union St VA 2-5106

**YORK**

Eshelman Supply 10 Broad St hdqrs Lancaster Pa

**PHILADELPHIA**

\*A C Radio 1539 W Passyunk HO 2-9379

**PITTSBURGH**

\*Cameradio Radio 1121 Penn Ave

**ROCHESTER**

Reliable Motor 402 Adams St

**SCRANTON**

Consolidated Distr 844 Capouse DI 7-6380

**WILKES-BARRE**

General Electric Supply 85 E Union St VA 2-5106

**YORK**

Eshelman Supply 10 Broad St hdqrs Lancaster Pa

**PHILADELPHIA**

\*A C Radio 1539 W Passyunk HO 2-9379

**PITTSBURGH**

\*Cameradio Radio 1121 Penn Ave

**ROCHESTER**

Reliable Motor 402 Adams St

**SCRANTON**

Consolidated Distr 844 Capouse DI 7-6380

**WILKES-BARRE**

General Electric Supply 85 E Union St VA 2-5106

**YORK**

Eshelman Supply 10 Broad St hdqrs Lancaster Pa

**PHILADELPHIA**

\*A C Radio 1539 W Passyunk HO 2-9379

**PITTSBURGH**

\*Cameradio Radio 1121 Penn Ave

**ROCHESTER**

Reliable Motor 402 Adams St

**SCRANTON**

Consolidated Distr 844 Capouse DI 7-6380

**WILKES-BARRE**

Lenert Co 2213 Congress Ave CH 2663  
 Moore Bros 3401 Millam St JU 4175  
 \*Radio Parts 902 Crawford BL 0137  
 Sound Sales & Engineering 2005 La Branch  
 \*Sterling Radiol P O Box 1746 BL 1321  
 Straus-Frank 4000 Leeland CA 1201  
 Tele-Radio 1721 Waugh Dr JA 9777  
 Walsh & Co J A 4301 Gulf Freeway CA 3-4281  
 Westinghouse Elect 1903 Rulz CA 7272

**LAREDO**  
 Guarantee Radio 1314 Iturbide St 3-6913  
 Pan American Electronic 1015 Iturbide St 3-6242  
 Radio & Electronics Supply 1219 Lincoln St

**LONGVIEW**  
 Wholesale Electronic 203 S High St

**LUBBOCK**  
 Anderson-Young 2002 Clovis Rd 5-8581  
 \*B & L Radio & TV Supply 2424 Texas Ave PO 5-6352  
 General Electric Supply PO Box 1361 PO 3-8271  
 \*R & R Supply 1607 Ave G PO 5-5737  
 Westinghouse Electric 605 Main St 3-0425  
 West Texas Radio Supply 1009 Ave Hdqrs Amarillo

**LUFKIN**  
 Radio Parts Co 1010 N Raquet

**McALLEN**  
 \*Rio Radio Supply 608 S Broadway 6-5781

**ODESSA**  
 Midland Specialty 2101 Andrews Hwy

**PORT ARTHUR**  
 Diehl Radio & TV Supply 1927 7 St 2-6311

**SAN ANGELO**  
 Gunter Wholesale Co 606 Irving St 3455

**SAN ANTONIO**  
 Alter Radio 359 E Crockett St  
 Amateur Headquarters & Supply 828 Brooklyn GA 7388  
 Electronics Inc 512 Broadway CA 4-8381  
 General Electric Supply 1801 Broadway CA 7-1261  
 Graybar Elec 1401 N Hackberry FA 6274  
 Lamp's Electronics 828 Brooklyn Ave CA 7-7388  
 \*Mission Radio 521 Broadway CA 7-8323  
 Modern Radio Supply 635 Soledad St CA 6-0175  
 Olsen Radio Supply 412 Pereda St  
 \*Radio & TV Parts 116 7 St F-5329  
 Sherman Electronics 722 San Pedro CA 6-0247  
 South Texas Appl. 641 S Flores St  
 Straus-Frank Box 600 CA 6-0101  
 Warncke Co R 121 Navarro St  
 Westinghouse Electric 1211 E Houston GA 9271

**TEMPLE**  
 Central Radio & Supply 410 E Ave A

**TEXARKANA**  
 \*Lavender Radio Supply 520 E 4 St. 2-9981

**TYLER**  
 General Electric Supply 416 N Bway 2-1673  
 \*Lavender Radio Supply 503 E Oakwood St  
 Radio Service 111 University 4-4441

**VICTORIA**  
 L & G Electronic 1412 N Main HI 3-2272

**WACO**  
 General Elec Supply 217 S 4 St 2-1611  
 \*Hargis Co 1205 Washington Ave 4-5667  
 L & M Sales 1307 Austin Ave 2-3391

**WICHITA FALLS**  
 \*Clark & Gose Radio 1203 Indiana St  
 \*Mooney Radio 1635 Huff 2-0731

**UTAH**

**OGDEN**  
 Ballard & Carter 2428 Grant 3-7844  
 Iverson Radio 265 25 St 6286  
 Tri-State Electronic 2217 Klesel Ave 4-3438

**SALT LAKE CITY**  
 Ballard & Carter 1486 Major St 7-0671  
 Blintz Co W H 433 W 3rd S St  
 Central Supply Co 47 E 5th St S 3-2631  
 Filnt Distr Co Box 1470  
 General Electric Supply 312 W 2 S St 3-3911  
 Glenn Earl 245 S 1st West 3-7601  
 Graybar Electric 336 N 3 St W SA 9-8771  
 Kimball Distr Co 115 S W Temple St  
 Lloyd Co W B 51 S 2nd W 3-3825  
 Moore Radio Supply 157 Motor Ave  
 O'Loughlin's Radio Supply 113 E 3 S St 4-5051  
 Radio Supply 157 Motor Ave 5-2817  
 Ross S R 1212 S State St 6-8607  
 Standard Supply 225 E 6 St 5-2971  
 Stravell-Paterson 126 S W Temple 22-5795  
 Westinghouse Elect 210 Rio Grande 5-2972

**VERMONT**

**BURLINGTON**  
 General Electric Supply 316 Pine St 3-3424  
 Hagar Hardware & Paint 164 St Paul St 4-6842  
 Radio Service Lab 703 Pine St 2-5771  
 Vermont Hdw 180 Flynn Ave 4-6835  
 Westinghouse Electric 208 Flynn Ave 4-9985

**RUTLAND**  
 Oakman Electric Supply 12 Water St 594

**VIRGINIA**

**ALEXANDRIA**  
 Certified Radio 1330 Powhatan St KI 8-5115  
 Suburban Distr 222 S Henry St KI 9-6804

**ARLINGTON**  
 Rucker Electronic 1906 N Moore St JA 7-7903

**BRISTOL**  
 Bristol Radio 31 Moore St N-3544

**CHARLOTTESVILLE**  
 Virginia Radio 715 Henry Ave 3-3928

**DANVILLE**  
 \*Womack Radio 502 Craghead 4622

**HAMPTON**  
 General Elec Supply 1247 39 St Hwy 3-6526

**LYNCHBURG**  
 Eastern Electric Co 920 Commerce St 2-3497  
 Lynchburg Battery 406 5 St 2-1236

**NEWPORT NEWS**  
 General Supply 4215 Huntington 2-4007

**NORFOLK**  
 General Electric Supply 709 E 26 St 2-7183  
 Goodman Electric Supply 3610 Hampton 4-8233  
 Graybar Electric 1081 W 35 St NO 5-7441  
 \*Radio Equip 821 W 21 St MA 7-4534  
 \*Radio Parts Distr 128 W Olney MA 2-5711  
 \*Radio Supply 711 Granby St MA 7-9211  
 Schultz Inc G J 639 W 24 St PH 2-7985  
 Trant, Inc R F 924 W 21st St MA 2-2683  
 Westinghouse Elec 2600 Hampton 5-0525  
 Wyatt-Cornick 919 W 21 St MA 5-6737

**PETERSBURG**  
 Electronic Supply 13 E Washington St PE 481  
 Virginia Battery 21 E Bank St RE 2-5051

**RICHMOND**  
 Commonwealth Sales 1601 Summit Ave  
 Cottrell Jr W C 408 E Main St 3-2402  
 Crump Co Benj T 1310 E Franklin  
 Duval Distr Co 1221 Admiral St  
 General Elect Supply 1505 Sherwood 6-4941  
 Graybar Electric 10 S 6 St RI 7-3491  
 Johnson Co D R 1315 E Cary St 7-3617  
 \*Johnston-Gasser Co 3023 W Marshall 6-9405  
 Mattson's Electronics 519 W Broad St 3-6011  
 Meridan Electronic 1001 W Broad 5-2834  
 \*Radio Supply 3302 W Broad St 6-5565  
 Richmond Office Supply 816 E Main St 7-3054  
 Tiller, Inc A R 957 Myers St  
 Trant Dist R F 1221 Admiral St 2-2805  
 Westinghouse Electric 511 E Byrd St 3-0111  
 \*Winfree Supply Co 800 W Cary St  
 Wyatt-Cornick 1705 Brook Rd 3-1945

**ROANOKE**  
 \*Baker Sales HC 19 Franklin Rd 4-9209  
 General Elec Supply 515 Norfolk Ave SW 3-1564  
 Graybar Elec 601 Salem Ave RO 3-3615  
 \*Leonard Electronic 131 Center Ave N W 3-9339  
 Peoples Radio & TV 1015 Moorman Rd NW 8900  
 \*Radio Supply 2009 Williamson Rd 4-6288  
 Roanoke Electronic 1322 Williamson 4-6612  
 Wyatt-Cornick 605 3 St S E Hdqrs Richmond  
 Westinghouse Electric 732 1 St SE 7771

**STAUNTON**  
 Hartley & Co 327 N Central 5-2333  
 Radio Electric Products 114 N Central  
 Southern Electric 818 Greenville Ave 5-2313

**WINCHESTER**  
 Leonard Electronics 213 S Braddock 8668

**WASHINGTON**

**BELLINGHAM**  
 Waitkus Supply 110 Grand Ave 274

**BREMERTON**  
 \*C & G Radio Supply 1301 Pacific Ave 7-5515

**ELLENBURG**  
 Gelger Radio W A 1101 Columbia 2-7701

**EVERETT**  
 \*Pringle Radio Whole 2514 Colby Ave

**KENNEWICK**  
 Wible Radio Supply Inc 13 S Dayton Ave 3591

**SEATTLE**  
 Alaska Radio Supply 1846 Westlake N AL 8777  
 Associated Industries 1752 Rainier St MI 4400  
 Central Electronic 2023 7th Ave  
 Coast Radio 110 University St MA 9133  
 Connolly Co F B 1015 Republican St SE 4155  
 Electronic Supply 5601 Calif Ave  
 Fidelity Electric 960 Republican St SE 5100  
 Garrettson Radio Supply 2416 2 Ave MU 4380  
 General Elect Supply 1212 1 Ave S SE 6400  
 \*General Radio 100 Wall St  
 Graybar Elec King & Occidental MU 0123  
 Instrument Lab 934 Elliott W AL 4940  
 Marshall-Weils 1258 1 SE 7447  
 \*Radio Products Sales 1214 1st Ave MA 1035  
 Radio TV & Appl 500 Westlake Ave N MA 0787  
 Ratelco Inc 820 Minor N SE 7770  
 \*Seattle Radio Supply 2117 2 Ave SE 2345  
 Stusser Electric 2246 1st Ave S SE 5285  
 \*Western Electronic 717 Dexter Ave SE 3200  
 Westinghouse Elec 1051 1 Ave S EL 7001  
 Westlake Electronic 511 Westlake N MA 6601  
 Zerega Distr 515 Westlake N MU 2525  
 \*Zobrist Co H E 2121 Westlake MU 2121

**SPOKANE**  
 Columbia Electric S 123 Wall St RI 3131  
 Connolly Co F B S 124 Wall St RI 6174  
 Frank's Radio Supply 161 S Adams St MA 8108  
 General Electric Supply E 1805 Trent Ave KE 0431  
 Graybar Electric 1033 W Gardner Ave EM 6611  
 Johnson Co E M W 615 1 Ave RI 5432  
 \*Northwest Electr N 102 Monroe MA 9289  
 Prudential Distr 318 W Trent Ave MA 6002  
 Spokane Radio Supply 301 W 2 Ave RI 8441  
 Standard Sales 1219 W 1 Ave RI 7196  
 Taylor Distributing E 206 Augusta EM 3301  
 Westinghouse Elec N 1023 Monroe EM 3371

**TACOMA**  
 \*C & G Radio Supply 2502 Jefferson Ave BR 3181  
 General Electric Supply 2316 A St BR 8454  
 Graybar Electric 2112 A St Ma 0164  
 Stewart Co A T 711 Broadway BR 3174  
 Westinghouse Elec 1930 Pacific BR 8417  
 \*Wible Radio Supply 2360 S Fawcett St BR 8395

**YAKIMA**  
 Lay & Nord 112 S 2 St 3-5591  
 Westinghouse Elec 210 W B YA 3-4701  
 Yakima Wholesale Radio 506 S 1st 4670

**WEST VIRGINIA**

**BECKLEY**  
 \*Chemelty Radio & Elec 340 B Prince St 2-5353

**BLUEFIELD**  
 Bluefield Supply 6121  
 Dixie Appliance 232 Bluefield Ave  
 \*Meyers Electronics 813 Bluefield Ave  
 Whitehead Radio Co 367 Bluefield Ave

**CHARLESTON**  
 Charleston Elect 914 Kanawha 6-0321  
 \*Chemelty Radio & Elect 103 Clendenin St 2-8151  
 Eskew Smith & Cannon 802 Brooks St 2-1171  
 Hicks Radio Supply 10 Virginia St 3-5583  
 Mountain Electronics 708 Bigley 3-9582  
 Virginian Electric Michigan Ave 6-0631

**CLARKSBURG**  
 Mountain Electronics 433 Clark St 4-5559  
 Trenton Radio Co 414 Clark St 4-4141  
 Westinghouse Electric 315 N 4 4-6311  
 White Electric 903 W Pike St 4-5591

**ELKINS**  
 M & M TV & Radio Co 3 Pleasant Ave  
 W VA Radio & TV 444

**HUNTINGTON**  
 \*Electronic Supply 422 11 St 8779  
 \*King & Irwin 314 11 St 3-8414  
 Mountain Electronics 1127 3 Ave 2-0339  
 \*TV Supply 1226 3 Ave 6639  
 Van Zandt Supply 1123 4 Ave JA 5-5193  
 Virginian Electric 740 6 Ave 2-8396

**MARTINSBURG**  
 Plummers Radio 526 W King St 3821

**MORGANTOWN**  
 Trenton Radio 507 Beechurst Ave 5637

**PARKESSBURG**  
 Charleston Elect Supply 227 Ann St 7-4513  
 Cox Radio Supplies 554 7 St  
 General Electronics 512 7 St 8-3391  
 Radio & Hornbrook 536 7 St 8-3391

**WHEELING**  
 General Electric Supply 1818 Eoff St WH 2555  
 General Electronics 735 Main St 5738  
 Hamburg Bros 360 National Rd 727  
 \*Radio Parts Co 1332 Main St  
 Westinghouse Electric 1803 Eoff St 3980  
 Wheeling Radio Supply 924 Market St Wh 1077

**WISCONSIN**

**APPLETON**  
 Appleton Radio Supply 1217 N Richmond St 3-3345  
 General Electric Supply 1307 W Spencer St AP 4-7155  
 Valley Radio Distr 518 N Appleton St 3-6012

**CHIPPEWA FALLS**  
 Bushland Radio Specialties 6052

**EAU CLAIRE**  
 Bushland Radio Spec 419 Water 7425  
 Larson Electrical J H 402 Water St 9716

**FENIMORE**  
 Tel Rad Mfg Co 7 Madison St

**FOND DU LAC**  
 \*Harris Radio 289 N Main St 8204

Features of forthcoming issues

of

**TECHNICIAN**  
 & Circuit Digests

June—Audio

July—Tubes

August—Test Equipment

September—Antennas

Plus . . . regular monthly Circuit Digests—articles—data—vital technical, business, and equipment information for TV-electronic servicemen.

50,083



circulation

Caldwell-Clements, Inc.

480 Lexington Avenue,

New York 17, N. Y.

Plaza 9-7880

**GREEN BAY**  
 Electronic Expeditors 420 N Clay St HE 2-4165  
 Graybar Elec Co 1140 N Irwin Ave HE 7-3284  
 Neslo Electronic 308 N Chestnut HE 5-4881  
 \*Northern Radio & TV 708 S Broadway HE 5-3789  
 Westinghouse Electric 619 Main HO 8200

**HUDSON**  
 Larson Elec Co J H 109 Walnut St 248 W  
 Progress Supply 1321 3 St 828

**JANESVILLE**  
 Goodenough Radio 111 N Jackson St 7033

**KENOSHA**  
 Badger Electronic Parts 4050 7 Ave 4-1484  
 Chester Electronic 2012 52nd St OL 2-8607  
 Midwest Electronics 5515 22 Ave OL 4-1732

**LA CROSSE**  
 General Electric Supply 222 Pearl St 2-7802  
 Lew Bonn Co 115 Pearl St 4-7378  
 Southern Minn Supply 122 N Front St 2-9660  
 \*Stark Radio Supply 131 S 6 St 2-3186

**MADISON**  
 Graybar Elec Co 103 N Park St MA 5-5005  
 \*Radio Distr 701 E Johnson St AL 6-6801  
 \*Satterfield Electronics 326 W Gorham AL 6-0267  
 Superior Radio Parts 2211 Atwood CH 9-2191  
 Westinghouse Elect 1022 E Washington 5-4868

**MANITOWOC**  
 \*Harris Radio Corp 115 N 10 St 9313

**MARINETTE**  
 Popkey Co G M Main & 9 Sts

**MILWAUKEE**  
 \*Ackermann Radio 3861 N 35 HI 5-1860  
 \*Acme Radio 1009 N Water St BR 1-0641  
 \*Central Radio 1723 W Fond du Lac Ave WE 3-2982  
 Electronic Expeditors 2205 W Villet WE 3-5804  
 Electro-Plance Distr 2458 W Lisbon Ave DI 2-9240  
 General Electric Supply 540 S J BR 6-7730  
 Graybar Elec 180 N Jefferson BR 6-8400  
 Jeneau Radle Sup 3110 W Lisbon Ave DI 4-2266  
 \*Marsh Radio Supply 838 N 4 St BR 6-1320  
 Mid-City Electronic 2327 W Wells WE 3-8304  
 Pritzoff John Hdw 333 N Plankinton Ave BR 1-1965  
 \*Radio Parts Co 538 W State MA 8-4048  
 Radio Specialty 829 N Bway MA 8-2060  
 Roth Appl 647 W Virginia BR 1-1111  
 Seemath Distr 2406 W Lisbon St DI 2-9240  
 Slevert Distr 1415 W Mithell St OR 2-9000  
 State Distr Co 3500 W Pierce St EV 3-6200  
 Stolz-Wieks 4120 W Fond du Lac HI 4-9585  
 Taylor Elec 4080 N Pt Wash Rd WO 4-4321  
 Television Parts 714 W State BR 2-6111  
 Westinghouse Elec 546 N Bway DA 8-1800

**OSHKOSH**  
 Electronic Expeditors 1244 6th St BL 5718  
 Jeneau Radio Supply 3110 W Lisbon Ave

**RACINE**  
 Allen's Merchandising 1206 N Wisconsin St 3-8589  
 Badger Electronic 856 Washington 3-4024  
 \*Standard Radio Parts 1244 State St 4-3634  
 Superior-Racine 908 State St 2-5142

**SHEBOYGAN**  
 Koepsell Co J J S 9 at Commerce 3646  
 Nitze's 1129 N 8 St 9531

**STEVENS POINT**  
 AMCO Electronics N 2nd & Franklin 3351

**WAUSAU**  
 \*Radio Service & Supply 615 3 St 3272

General Electric Supply 428 S Elm St 2-7333

**CHEYENNE**  
 \*Houge Radio & Supply 4012 Central 2-6474

**SHERIDAN**  
 Barton Battery & Electric Co 102 Grinnell St 59

**WYOMING**

**CASPER**  
 Casper Supply 444 S Center St

**ALASKA**

**ANCHORAGE**  
 Yukon Radio Supply Box 406 2-7964

**TECHNICIAN BUYERS DIRECTORY of**

*Representatives ("Reps")*

This section of the 1955 Technician Buyers Directory lists those representatives operating as independent "reps" who handle two or more lines. They do not include factory staff salesmen. "Reps" are listed alphabetically under states and cities. Asterisks (\*) indicate membership in "The Representatives" of Electronic Product Manufacturers, Inc. Telephone numbers are given to speed contacts.

**ALABAMA**

**BIRMINGHAM**  
 Nordstrom & Co R C 580 N Woodward Ave J 4-6129

**ARIZONA**

**PHOENIX**  
 Moore Sales Co Harry A Box 7245 AM 5-4662  
 Sheffer Co H George Box 1587 AL 8-7893

**CALIFORNIA**

**LOS ANGELES AREA**

\*Appleton Co Harry 136 San Fernando CA 1-2171  
 Barron-Jurco 817 S Hoover St DU 3-5248  
 \*Barstow & Doran 1406 S Grand Ave RI 6191  
 Baughman Co E J 350 S Central Ave MA 9-1403  
 \*Becker Co Herb 1140 Crenshaw Blvd WE 1-1257  
 Berman Co J 1141 LaCienega St BR 2-9138  
 Cohn S H 1769 S Holt Ave TE 0-4398  
 \*Cochrane Co Irv M 408 S Alvarado DU 5-1715  
 Craig Ralph P 715 N Harper Ave WE 0468  
 Davidson & Assoc Joe PD Box 108 (South Gate) NE 6-2245  
 \*Davis Sales Co George 5259 E Beverly Blvd UN 3-3594  
 Dunkle B 3257 W 6 St  
 \*Ealy Co M D 633 S La Brea WE 5-0771  
 \*Edwards & Co Jackson 6047 Hollywood Blvd NO 5-1141  
 \*Emmet F A 2837 W Pico Blvd RE 1-8211  
 \*Feldman Co Henry 1244 S Grand PR 8803  
 Fox Associates 5401 Santa Monica Blvd HO 3-7194  
 Hardie Co R M 901 S Manhattan PI RE 4-2752  
 \*Harmon Co W S 121 N Robertson Blvd (Beverly Hills) BR 2-3321  
 \*Harris A W P D Box 1116 (Gardena) or 8-4817  
 Hast Nate 301 S Reeves Dr (Beverly Hills) CR 5-2652  
 \*Hastings Sales Co 4942 Vineland Ave (N Hollywood)  
 \*Hill Sales Co J T 800 W 11 St RI 7-5384  
 \*Hitt Co W C 1169 S Broadway PR 2105  
 King Co W C 1355 Westwood Blvd GR 8-8679  
 \*Kittleson Co 7614 Melrose Ave WH 1167  
 \*Knight Co W Bert 10373 W Pico Blvd BR 2-5647  
 \*Koessler Sales 6907 Melrose Ave YO 6271  
 La Moree G D 1325 San Julian RI 6378  
 Larshan Inc 1409 Wilshire Blvd (Santa Monica) TE 0-8489  
 \*Lasure Co Harry A 9041 W Pico Blvd BR 2-7805  
 \*Loukota Co Douglas 1052 W 6 St MA 6-4505  
 Lynch & Son C R 3307 Glendale Blvd NO 3-8236  
 Lynn & Brooks 3055 Wilshire Blvd DU 2-2255  
 Mann Assoc Martin 8346 Beverly Blvd WE 3-8528  
 \*Marsh Co J W 4216 W Jefferson RE 2-0145  
 \*Marshall Co G S 40 S Los Robles (Pasadena) SY 5-2022  
 \*Marshank Sales 672 S Lafayette Ph DU 7-8235  
 Maynard Sales Co 6214 W Manchester OR 8-3150  
 \*Miller Co Gerald B 1550 N Highland (Hollywood) HO 2-1195  
 Mitchell Co C H 256 S LaPeer Dr Beverly Hills BR 2-0183  
 \*Neely Enterprises 7422 Melrose Ave WE 3-9201  
 Olander & Co Roland 7225 Beverly Blvd WY 0028  
 Osborne R E 1044 S Park View DU 8-1039  
 \*Owens Co Lee H 3331 W Washington RE 0230  
 Perlmuth-Colman & Assoc 2419 S Grand Ave RI 7-4321  
 \*Power Ralph L 767 Castelar St MU 5277  
 Renz Roy E 207 S Orange St (Glendale) CH 5-2047  
 \*Rissi Al J 2724 S Peck Rd (Monrovia) DO 6-2135  
 \*Roberts & Assoc E V 5068 W Washington WE 8-2541  
 \*Rapp Co V T 2230 W 11 St DU 3-4197  
 \*Saul & Assoc Howard M 5015 San Vincente Blvd. WE 8-3591  
 \*Selgel Co Samuel 1133 S LaCienega Blvd BR 2-4183  
 Slevers Edward S 5171 Hollywood Blvd NO 2-1105  
 Smedley A B Box 67-C (Pasadena) SY 8-1174  
 Snitzer T Louis 5777 W Pico Blvd WE 1-5566

Starr Edwin E 4101 Rhodes Ave (N Hollywood) ST 7-5879  
 \*Stolaroff Co M A 4614 Northridge Dr AX 3-6219  
 \*Stone Assoc Carl A 1102 S Western Ave R 2-8103  
 \*Stone Sales Co R L 9548 W Pico Blvd BR 2-4916  
 \*Strassner Co Conrad R 1865 N Western Ave HO 7-7086  
 Tivy George S 1148 S Grand Ave RI 7-7553  
 \*Tubergen Assoc 2232 W 11 St DU 9-3173  
 Uecke E H 4938 Neola Pl CL 7-9611  
 Van Groos Co 14515 Dickens St (Sherman Oaks) ST 7-7882  
 Vermilye Co Charles 3440 Wilshire Blvd DU 2-5695  
 \*Wallace & Wallace 1206 Maple Ave RI 7-0401  
 \*Weber Co Wedge 1217 Venice Blvd DU 7-2111  
 \*Western Electronic Enterprises 3348 W Compton Blvd (Gardena) OR 8-4817  
 \*Wiley Paul F 1632 Silverlake Blvd NO 3-8028  
 \*Wood Co A M Box 150 (Elmonte) CU 3-1201

**SACRAMENTO**

\*Neely Enterprises 309 Oschner Blvd GI 3-7461

**SAN FRANCISCO AREA**  
 Ault C E 625 Laurel Ave (Menlo Park) DA 5-4983  
 \*Barstow & Doran 248 9 St UN 3-2079  
 \*Belchamber P A 1401 Middle Harbor Rd (Oakland) GL 1-4460  
 \*Berman Co E L 780 Natoma St UN 3-0317  
 Brainard W V 721 Clementina St UN 1-2569  
 Detsch & Co 341 10 St MA 1-2788  
 Eichorn & Melchior 500 Minn. St UN 1-8309  
 Frazer & Hansen Ltd 301 Clay St EX 2-5112  
 \*French S P 721 Garland Dr (Palo Alto) DA 3-0597  
 Harris Sales Co L H 383 Brannan St YU 6-1084  
 Held Herman E 147 10 St UN 3-4250  
 \*Hermanns Co James P 1234 Folsom St MA 1-4166  
 Hitt Co W C 1355 Market St KL 2-2311  
 \*Hodges Elmer C 1264 Folsom St UN 1-2367  
 \*Howard G M 782 Bryant DO 2-6320  
 Jewett Samuel O 13537 Addison St (Sherman Oaks) ST 9-6027  
 Kittleson Co 2166 Market St HE 1-5304  
 \*Lewis Assoc Dean 219 9 St UN 3-1414  
 \*Logan Assoc 725 Greenwich GA 1-0076  
 \*Logan Sales Co 530 Gough St HE 1-5127  
 Marshall Harry E 104 Olive St OR 3-2173  
 \*Meyer & Ross 113 10 St HE 1-0480  
 \*Moulthrop & Hunter 165 11 St HE 1-2624  
 Moxon Sales G E 422 LaJolla Ave (San Mateo) FI 5-2866  
 \*Neely Enterprises 2830 Geary Blvd WA 1-2361  
 \*Nickerson & Rudat 381 Brannan St YU 2-2982  
 \*Nott & Co L A 1061 Howard St HE 1-4738  
 \*Pardy Co W J 312 7 St UN 3-4321  
 \*Ross Co David H 534 El Camino Real (San Carlos) LY 3-8224  
 Scales Co James M 1355 Market St KL 2-2311  
 \*Sinal Arnold A 65 9 St UN 1-6259  
 \*Tompkins & Co W W 941 Newell Rd (Palo Alto) DA 3-3270  
 West Coast Electronics 1013 S Claremont (San Mateo) DI 3-4700

**COLORADO**

**BOULDER**  
 \*Gollither W B 1003 Grandview Ave HI 2-7899

**COLORADO SPRINGS**  
 \*Peysor W J 1501 N Weber 4-3401

**DENVER**  
 \*Bowen Co Ronald G 446 Broadway SH 4-2501  
 Bower Co C R 2759 W 33 Ave GR 7292  
 \*Connors Co W H 375 Birch St DE 3-7608  
 Halliday Gall 2576 S Milwaukee St PE 2650  
 \*Hyde Sales Co 3250 S Dexter SK 6-7151  
 \*McLoud & Raymond 5528 E Colfax FR 3067  
 Mueller Mark G 1644 Blake St AC 3515  
 \*Nelson Co A J Box 5502 KE 6751  
 O'Brien Sales A J Box 1681 BE 3-4845  
 \*Pearson & Co Mel 1011 S Josephine St SP 7-7878  
 \*Williams Co Allen I 124 W 12 Ave MA 0343

**Thank You**  
**WISCONSIN SERVICEMEN**  
**AND DEALERS**

*It has been our privilege to serve you for 21 years distributing nationally advertised quality lines.*

*Your patronage has been and will continue to be appreciated.*

**SATERFIELD ELECTRONICS, INC.**  
 326 West Gorham Street  
 Madison 3, Wisconsin  
 Phone Alpine 6-0267



FT COLLINS  
Leeper & Assoc Wilson Box 324 3-0444J  
GREGLEY  
\*Moss Gordon G 1530 13 Ave 770

### CONNECTICUT

ANDOVER  
\*Seyd Ernest K Long Hill Rd Pilgrim 2-6604  
BRANFORD  
Steel Assoc Joseph R 41 W Main St  
BRIDGEPORT  
Hannigan Co Wt 1115 Main St ED 3-2772  
Reynolds Co Harrison 211 State St BR 5-9634  
CANAAH  
\*Holliday-Hathaway Co Box 797 CA 8-7215  
DARIEN  
Jacobson Leo 3 Bellevue Rd ST 3-0828  
EAST HAVEN  
\*Steele Assoc Joseph R 22 Green Garden HO 7-5864  
HARTFORD  
Gibson Engineering Co 119 Anin St CH 7-6919  
Hutton & Co Arthur T 955 Asylum Ave 5-2159  
\*Kahn Assoc Irving 541 Windsor St 46-7431  
MANCHESTER  
\*Gates Alexander W 46 1/2 Summer St MI 9-7761  
MERIDEN  
\*Lavin Assoc Henry Box 196 BE 7-4555  
NEW HAVEN  
Gerber Sales Co 42 Church St UN 5-2147  
Hasso Sales 880 Elm St UN 5-2806  
RIDGEFIELD  
\*Abbott & Hustis Box 52 6-7477  
WEST HARTFORD  
Pettigrew & Co R S 62 La Salle Rd HA 3-8533  
WESTPORT  
Niel Assoc P W 15 Dak St CA 7-9834

### DISTRICT OF COLUMBIA

WASHINGTON  
Burlingame Assoc 2017 S St NW DE 8-2000  
Commissioned Electronics 2503 Champlain St NW  
NO 7-4392  
Fields Associates 422 Wash Bldg ST 3-3480  
Henry & Co 3741 Jocelyn St NW KE 7-1448  
Jodon Inc F R 3000 Conn Ave NW NO 7-1715  
Kronstadt Mat 3009 Erie St SE LU 1-7745  
MacDonald S K 217 Riggs Bldg CO 5-3938  
Maclen Corp 7705 Georgia Ave NW TU 2-6666  
Massey Associates 1 Thomas Circle NW NA 8-1957  
Rich Industries 1025 Connecticut Ave ST 5141

### FLORIDA

FORT MYERS  
Lynch Arthur H & Assoc Box 466 ED 4-4431  
JACKSONVILLE  
\*Cole Harry A 534 10 Ave 5-2971  
LUTZ  
\*Wallace Assoc Stanley K PO Box 744 TA 99-3241  
MIAMI  
Gibbons Electron Sales R J 3051 NW 4 St 64-6256  
MIAMI BEACH  
Gaertner Co Jack 823 86 St 86-6664  
ORMOND BEACH  
\*Smith Co Maitland K 462 Riverside Dr 3-5853  
SARASOTA  
Haseimer & Assoc W L 236 S Washington Dr RI  
8-2612  
TAMPA  
\*Cartwright & Bean 4525 S Lois Ave 61-4529  
Minthorn Co Leonard L 409 E Cass St 2-8631  
\*Wallace Assoc Stanley K 207 W Alfred St TA 24-4221  
WINTER HAVEN  
Taylor Co Morris F 940 Lake Elbert Dr 22-684  
Van Dusen R H 940 Lake Elbert Dr 4-6671

### GEORGIA

ATLANTA  
\*Adair Clark 1426 High Point PI NE VE 3053  
Blivins & Caldwell 267 E Paces Ferry Rd NE CH  
7522  
\*Burwell Co Henry W 1025 Ponce de Leon Ave AT  
2127  
\*Cartwright & Bean 3230 Peachtree Rd NE EX 2273  
\*Duckett Sales Co Grady 26 E Andrews Dr NE CH  
5308  
Erickson Co Herb PO Box 7036 Sta C AT 8266  
\*Fausett & Son F 777 Pinehurst Tr SW RA 3104  
Glenn & Larson 172 Simpson St NW WA 4906  
Hart Engrg & Sales Co 132 Walker St SW AL 9854  
\*Hollingsworth & Still 508 Whitehead Bldg MA 5878  
\*Hutto V 1036 Peachtree St NE AT 6858  
\*Joynor J E PO Box 341 Station A FR 4910  
Lewis Co Carl A 627 Peachtree St NE VE 1457  
\*Millar Assoc James 1036 Peachtree NE EL 0919  
\*Murphy & Cota 1409 Peachtree St NE EL 3020  
\*Nickerson F C 901 Bernina Ave NE LA 6878  
\*Pepper & Assoc John B PO Box 7036 Sta C AT 8266  
Rogers & Assoc C B 1000 Peachtree St NE EL 1733  
\*Smith Co Maitland K 317 Forrest Ave NE WA 6094  
Taylor Co Morris F 1426 High Point Rd NE EM 3979  
\*Thompson John F 315 Forrest Ave NE  
Thornwell E A 217 Whitehall St SW WA 3548  
\*Wallace Assoc Stanley K 2151 Beecher Rd SW  
RA 8463  
Wood & Co L K 1299 W Peachtree St NE EL 5683  
DECATUR  
\*McCorvey Co V Avis 215 Church St CR 6167  
EAST POINT  
\*Hayden Assoc Paul 118 W Nabell Ave FA 9646  
\*Little W T 704 Lupton St

### ILLINOIS

CHICAGO AREA  
American Mfrs Agency 208 N Wells St RA 6-6311  
\*Angel & Co Jay C 2743 W Peterson Ave UP 8-0653  
\*Arnold-Vore Assoc 1321 Rosedale Ave ED 4-6457

\*Beebe Assoc 1155 Waukegan Rd (Glenview) CO  
7-2292  
\*Bauman W J 2753 W North Ave HU 6-6809  
\*Beler Co Laroy W 6518 W North Ave BE 7-2420  
Berggren & Assoc 2015 S Michigan Ave CA 5-1450  
\*Blazat Co Rene 2842 N Cicero Ave PE 6-2238  
Bomke Sales Co WFE 6966 W North Ave ME 7-8433  
\*Booth Claude R 400 W North Ave CA 7-2810  
\*Broillette & Assoc 5049 Quincy St MA 6-0499  
Bruning Co A H 2215 W Wilson Ave DE 2-2769  
\*Burgoyne Wm E 7001 N Clark St HO 5-2112  
\*Calne Sales Co 3020 N Cicero Ave SP 7-4022  
Cappels & Assoc J L 1214 W Madison TA 9-1818  
Carroll & Carroll 3223 W Armitage Ave DI 2-9878  
Chambers Co Larry A 5906 North Ave TU 9-4884  
Champion Earl T 6459 N Sheridan Rd AM 2-3565  
\*Cole Co G McL 4753 N Broadway LO 1-7611  
Cozzens W B 220 Kedzie St (Evanston) DA 8-4800  
\*Crossley & Assoc 4501 N Ravenswood UP 8-1141  
\*Cumming & Assoc Bruce 6029 W Belmont Ave ME  
7-3770  
Cushing Co L G 605 N Michigan Ave DE 7-6456  
\*Diehlert Co Russ 2030 W Montrose St LO 1-6831  
\*Dolin Sales D 1200 N Ashland Ave BR 8-1515  
Dorae Sales Co 5804 N Western Ave UP 8-9562  
\*Doyle Co W J 7002 N Western Ave RD 1-3130  
\*Elinger Sales Co 6540 Northwest Hwy RO 3-1570  
\*Elinger Sales Co WH 6571 N Olmsted St RO 3-4154  
Ellis Co Arthur J 1607 Howard St AM 2-2708  
Engineered Sales Co 3592 Milwaukee Ave PE 6-0555  
\*Engle Co Karl D 4724 N Sheridan Rd UP 8-6363  
Eschner Co 9 S Clinton St CE 6-1533  
Everett Associates 6744 N California AM 2-3702  
\*Felleisen & Assoc 5839 W Montrose Ave WH 4-4822  
Fistell Harry 1838 S Halsted St SE 3-3076  
Gaskins T 1005 S Aurora Ave (Wheaton)  
\*Gassner & Clark Co 6644 N Western Ave RO 4-6121  
\*Gebhard Co Harry W 5129 W Devon Ave RO 3-3636  
\*Glanaras Sales Co 2345 W Devon Ave AM 2-2100  
\*Gotten Co Jerry 2750 W North EV 4-5959  
Granat Gary 330 S Franklin St WE 9-4595  
\*Green & Assoc L F 4949 W Diversey Ave NA 2-2370  
Haines E Ralph 949 Lake St (Oak Park) UE 6-4476  
\*Hallnton Co Harry 5500 W Devon Ave RO 3-2132  
Haskell Assoc 1033 Ontario St (Oak Park) UE 6-5741  
Hetter & Assoc E G 612 N Michigan DE 7-1160  
\*Higgins Co Royal J 10105 S Western Ave CE 3-7388  
\*Hill-Gray 41 1/2 Harrison St (Oak Park) ES 8-7050  
\*Hitcheck Material Sales R C 2949 W Diversey SP  
2-3410  
Horlacher Sales WA 7070 N Clark St RO 4-9487  
Hower & Pretat 4 N Cicero Ave CO 1-3146  
\*Hunter Assoc Thomas B 4441 W Irving Park Rd SP  
7-2500  
\*Hutmacher Assoc R R 6647 N Oliphant NE 1-3248  
\*JKM Inc 13 W Hubbard St WH 4-6345  
\*Jones Mel M 2800 N Milwaukee Ave EV 4-2646  
\*Kadell Sales Assoc 2406 W Bryn Mawr LO 1-3042  
Kahan I J 333 N Michigan Ave FR 2-1478  
Kelburn Eng'g Co 600 W Jackson Blvd DE 2-2827  
\*Kleker Co Jerome H 177 Sunset Ave (Glen Ellyn)  
GL 2297  
\*Knuepfer Geo 2650 W Belden Ave DI 2-2650  
\*Langhaus-Lery Assoc 315 W Walton WH 4-2120  
Levin & Assoc Sol 2823 W Chase Ave RD 4-7082  
\*Linz Co W M 7115 N Mobile Ave RO 3-3326  
Lombard Co V Box 26A (Grayslake) KI 6-1760  
\*Lund-Hansen Co 1900 Montrose Ave LO 1-2551  
\*McBride Sales Co J J 14107 Merchandise Mart DE  
7-3575  
\*McCarthy Co L C 5933 Addison St KI 5-7976  
\*Magnuson Associates 3347 W Irving Park Rd  
KE 9-7555  
Memae Sales Co 9 S Clinton AN 3-5728  
Miles Paul H 333 N Michigan Ave FR 2-7100  
\*Monson Corp 6059 Belmont Ave 7-3226  
\*Mulay Sales 4308 W Armitage Ave BE 5-7411  
\*Newman-Krause Co 5306 W. Lawrence Ave PE 6-6776  
\*Pettit Co George 349 Ashland Ave (River Forest)  
CD 1-0342  
Pivan Eng'g Co 2871 N Lincoln Ave DI 8-6885  
Powers Co J J 4938 W Irving Pk Rd PA 5-3888  
Quackenbush Al 2629 N 77 Ct FR 2-7100  
Ridgeway Eng'g Co L L 1137 W Sheridan BR 4-2628  
\*Ridley Assoc 1551 N Austin Blvd TU 9-2940  
\*Ritter Sales Co 5839 W Montrose Ave WU 5-7440  
\*Rose & Co J K 2323 W Devon Ave AM 2-5584  
Rosenblum & Co Murray 1818 W North Ave EV 4-  
6565  
\*Ryan Co Gerald G 549 Washington Blvd ST 2-7665  
\*Saffro-Gettleman Co 227 W Chicago Ave DE 7-5092  
\*Sarkis & Co Henry 6560 N Sheridan Rd HO 5-1481  
Smith Co Oreg H 221 W Huron St SU 7-7919  
\*Stemm R Edward 5681 W Lake St CO 1-2227  
\*Stemm Royal A 21 E Van Buren St WE 9-4840  
\*Strauss-Whitmore 639 Diversey Pkwy WE 5-6460  
\*Sullivan Ralph T 1551 N Austin Blvd NA 2-4074  
Sutton S J 228 E Park Ave (Wheaton) 8-2409  
\*Swinke & Co W F 541 Diversey Pkwy BI 8-4343  
\*Tatro & Assoc F B 6022 N Rogers Ave JU 8-0333  
\*Taylor Co R F 308 W Washington St AM 3-1808  
\*Twintronic Sales Co 2949 W Diversey Ave SP 2-3410  
\*Twist Co J G 2800 N Milwaukee Ave HU 9-2550  
\*Victoria Sales Co 7522 N Sheridan Rd BR 4-5400  
\*Voltassociates Ltd 2154 N Halsted St LA 5-7755  
Ward Co E M 8307 S Racine Ave VI 6-6300  
\*Warner Co D L 15423 Honore Ave (Harvey) WA  
8-8060  
\*West Jack 6747 N Octavia Ave RO 3-3500  
Wiley Co S J 2629 W Fitch Ave SH 3-6548  
\*Wilson Sales Agency 2750 W North Ave CA 7-6600  
\*Withers & Ropak 5439 W Division St AU 7-7292  
SPRINGFIELD  
Kloppenberg H M 6 Circle Dr 4-4323

### ANGOLA

\*Clancy & Co Joe PO Box 267 793

### INDIANA

Law Instrument Co 519 W Gilmore St 177  
FORT WAYNE  
\*Bieberich Walter W 2817 Plaza Dr K-2928  
\*Central Sales Co 255 Central Bldg EA 4635  
\*Fish & Assoc Bud 419 W Sherwood Terr HA 1089  
\*Hoemig Sales Co Butler Ct AN 2083  
\*MacPherson-Thomas 601 Ft Wayne Bank Bldg AN  
9460  
\*Southern Sales Co 1605 Lincoln Tower AN 5278  
\*Valentine Forrest C 511 Ft Wayne Bk Bldg AN 9122  
INDIANAPOLIS  
Blind & Co Harrison J 1616 Cord St BE 0191  
Chatfield C E 503 Illinois Bldg PL 1838  
Grandall & Assoc R M 6220 E 56 St CH 8373  
\*Cunningham Assoc Quinn 6101 College Ave GL 3222  
\*DeVoe Co Leslie M 4010 Washington Blvd HU 1395  
Everett Associates 5308 W 10 BE 4893  
\*McNabb V C 909 Westfield Blvd BR 6770  
\*MacPherson-Thomas 5818 N Ewing St GL 6915  
Murphy Joe 202 Pam Rd R 4-7202  
\*Nelsen Marvin E 5376 E Washington St. IR 7664  
\*Pheasant Charles E 186 N Bolton Ave BL 6176  
Ridgeway Eng'g Co 1608 N III HI 9576  
\*Schulz Co Edwin A 721 Sherwood Dr BR 1993  
\*Whitesell & Assoc Robert O 2208 E Washington St  
ME 2-8517  
\*Wright Eng'g Co 4241 Melbourne Rd. HU 8800  
MARION  
Meuser Victor W 608 W 2 St NO 2-7874

### IOWA

BURLINGTON  
Kelly Co W G 303 Belle Air 1202  
CEDAR RAPIDS  
\*Vrbik Jerry 621 Guaranty Bldg 4-0833  
DES MOINES  
Samy F R 2221 34 St 7-7909  
Silverman Jack 1201 Grand St 8-7231  
IOWA CITY  
Zimmer Sales 21 E Bloomington 5346

### KANSAS

IOLA  
Russell Sales 315 N Jefferson 64  
WICHITA  
Harris Co Municipal Airport 62-2731

### KENTUCKY

LOUISVILLE  
Cobb Sales Co 1629 Portland Ave GL 9406  
Wright Eng'g Co 912 S 2 St JA 0295

### LOUISIANA

NEW ORLEANS  
Bornemann W E 4719 Cartier Ave  
\*Cartwright & Bean 821 Pontalba St AU 2264  
Corigan & Parkerson 504 Delta Bldg RA 5644  
Moore Co Earl K 4108 Clermont Dr CR 4182  
Redmann Stephen M Box 1325 UP 3767

### MARYLAND

BALTIMORE  
Davn Bros 3851 Boarman Ave LI 9644  
Goodman Co S W 32 W Biddle St VE 7-2240  
Hile Co Charles R 5006 Kenwood BU 1202-J  
\*H-E Electronic Sales Box 6844 VA 5-4441  
Martin & Co Ed 3405 Alto Rd MO 4-6857  
\*Randall Co Ken 1303 Midvale Ave RI 7-5260  
\*Winkless R L Maxalea Dr TO 7800  
COLLEGE PARK  
Maclen Corp 5005 Calvert Rd WA 7-7404  
SILVER SPRINGS  
\*Lienau & Co CW 9427 Georgia Ave JU 7-5888  
Peel Sales PO Box 826 Wheaton Sta LO 5-5144  
\*Taylor Co Morris 9431 Georgia Ave JU 9-4002  
TOWSON  
Barnhill & Assoc R B 412 Woodbine Ave VA 5-3431  
Closs T H 21 W Penna Ave VA 5-4445  
\*J-M Electronic Sales Box 6844 VA 5-4441  
Maguire & Co 29 Alleghany Ave VA 5-3836

### MASSACHUSETTS

BELMONT  
MacArthur R S 211 Beach St BE 5-4613  
BEVERLY  
Kelly & Co W T 77 Lovett St 65  
BOSTON AREA  
\*Abbott & Hustis 1105 Commonwealth Ave AL 4-8100  
\*Akeroyd A E 2311 John Hancock Bldg HA 6-2433  
\*Anderson Sales Co 177 State St CO 2-2980  
\*Broger Instrument Sales 739 Boylston St CO 7-0061  
\*Brown, K L 54 Atherton Rd (Brookline) BE 2-3969  
\*Chamberlin Harold A 31 Milk St HU 2-7022  
\*Coakley Tim 148 Needham St (Newton Highlands)  
DE 2-4800  
Electrical Apparatus Co 1200 Soldiers Field Rd  
ST 2-7440  
Garner Frank W 110 Arlington St LI 2-7428  
\*Gerber Sales Co 739 Boylston St CO 7-0061  
Gibson Eng'g Co 1018 Commonwealth Ave AS 7-5074  
\*Goss Co Jack Colgan Bldg (Somerville) PR 6-2262  
\*Gray R W 572 Washington St (Wellesley) WE 5-  
5296  
\*Greene Dan PO Box 124 (Cambridge) UN 4-2220  
\*Haanigan Co Walter T 272 Centre St (Newton) DE  
2-6020  
\*Harris Co Stanley A 317 Chestnut St (Needham)  
NE 3-4780  
Hart Co Frederick H 115 Pond St (Nahant) JU  
1-0381  
Hendrickson Co Wm A Lawson Park (Saugate) SC  
652  
(Massachusetts Continued next page)

(Massachusetts Continued)

- \*Hathaway Electronics Glenn M 238 Main St. (Cambridge) EL 4-1751
  - \*Hooker Samuel C 397 Highland Ave (Winchester) WI 6-2745
  - How Inc J D 445 Statler Office Bldg HU 2-4638
  - \*Lavin Assoc Henry 82 Curve St (Needham) NE 3-3446
  - Limanni Co M A 115 Garden St (Lawrence) 2-8638
  - \*Macdonald-Wadman Co 457 Stuart St CO 6-2337
  - \*MacInnis N R 53 Youte St (Melrose)
  - Mosher & Peyser 1116 Gr Plain Ave (Needham) NE 3-3773
  - Nickerson Clayton S 206 Somerset Ave (Winthrop) OC 3-3276
  - Herman Norman 55 Lawrence Ave (Roxbury) GA 7-2198
  - Parker Blair H 610 Atlantic Ave LI 2-9214
  - Pearce Eng'g & Sales 457 Stuart St CO 6-3532
  - \*Perron & Co Ray 1870 Centre St FA 3-1008
  - \*Pray Sales W B 18 Brewster Rd (Wellesley Hills) WE 5-3199
  - \*Schaal Assoc 4 Waltham St (Lexington) LE 9-3578
  - Scholl Co C E 89 Brighton Ave AL 4-2005
  - \*Scott Co Michael 90 Edmunds Rd (Wellesley Hills) WE 5-0102
  - \*Reynolds Co Harrison 313 Washington St (Newton) DE 2-4620
  - Segel Co Charles 143 Newbury St KE 6-9755
  - \*Segel Co Inc Henry P 143 Newbury St KE 6-3012
  - \*Sturgeon P R 25 Huntington Ave CO 7705
  - \*Wadman Eugene 457 Stuart St CO 6-2337
  - Waters & Drew 64 Gray St (Arlington) 5-9496
  - \*Waters Inc R A 4 Gordon St (Waltham) WA 5-6900
  - \*White Sales Co 1116 Great Plain Ave (Needham) NE 3-3676
  - Yewell Assoc 751 Main St (Waltham) WA 5-7420
- LINCOLN
- \*Stevens & Co K C Box N CL 9-8408
- SHARON
- Cloagh A P 10 Winstow Rd SH 506
- SPRINGFIELD
- Rodgers Assoc 198 Farm Rd 3-8428

MICHIGAN

DETROIT AREA

- Adams Co R A 17636 EdInborough Rd KE 1-7000
  - ABM Sales 2450 Fenkell Ave UN 2-1300
  - \*Beltel Co Wayne 139 W Maple (Birmingham) MI 6-0311
  - Brotherson R 16156 Rosemont Rd KE 5-1140
  - \*Bucraw & Co K C 22128 Grand River Ave KE 3-7700
  - Carrier & Gable 414 Murphy Bldg WD 1-1786
  - Eynon-Daking Co 9900 Freeland Ave TE 4-7700
  - \*Fitzner Co B J 8803 Michigan Ave LU 4-0180
  - Fordon Sales 2256 Penobscot St WO 1-1471
  - Haggerty Sales Co 1507 W Saratoga Ave (Ferndale) LI 2-0811
  - Hill Co Beryl R 19481 James Couzens Highway VE 8-3460
  - Koehler-Pasmore Co 11833 Hamilton TO 8-3322
  - \*Lee W S 22128 Grand River Ave KE 3-7700
  - \*Liddle Edwin F 18925 Grand River VE 7-5310
  - McCarthy Co J A 13104 W Lincoln (Huntington Woods) LI 4-1380
  - \*Merchant R C 4829 Woodward Ave TE 1-1677
  - \*Misk Co Robert 19763 James Couzens Hwy BR 3-2930
  - Moore Sales Co 418 Savannah W TU 3-0218
  - \*Nordstrom & Co R L 300 N. Woodward Ave. (Birmingham) JO 4-6129
  - Odell Co M P 16918 W Seven Mile Rd BR 3-5399
  - Satullo Co 4512 N Woodward Ave (Royal Oak) LI 9-3910
  - \*Shaffer Co Grant 14241 Fenkell Ave BR 3-5390
  - Sterling Co S 15310 W McNichols Rd BR 3-2900
  - \*Thorpe Jack M 4390 Haverhill TU 5-4438
  - Tri-onic Sales Inc 10116 Portlan Ave UN 1-4434
  - Vogt Martin 1328 Maxwell Ave (Royal Oak) LI 1-1192
  - \*Walton Co H E 76 Kerehwal TU 1-5858
  - \*Zmna Co L F 14611 Alma Ave WA 1-4442
- JACKSON
- Jordan E H 2024 Glen Dr 2-0694
  - \*Wilson Sales Gerald 403 2 St 4-3692

MINNESOTA

MINNEAPOLIS

- Allan Inc T B 3918 Beard Ave S WH 3861
  - Bartleson Co Bill 330 Oak Grove AT 6709
  - Brady & Assoc Paul 3624 Blaisdell Ave RE 5213
  - Eiler Equipment Co 1107 S 2 St MA 8881
  - Foster Mel 1036 Lumber Exchange Bldg GE 5622
  - Franklin Co Merrill 338 E Franklin Ave GE 1805
  - Gibb Co C R 1409 Hennepin Ave LI 2550
  - Hagestad & Assoc E O 5032 Halifax Ave WA 2-4608
  - Heilmann Co 1711 Hawthorne MA 5457
  - Hill Co Fred B 6110 Excelsior Blvd MO 9-6727
  - Kirkeby Marvin H 437 Oliver Ave S GE 4945
  - Ozman E W 12 E 25 St FI 3298
  - Pinkney & Hine 1925 Nicollet Ave LI 0523
  - Richardson & Co H M 9 E 22 St GE 4078
  - Rouzer Sales Co 1037 Thomas Ave S KE 0579
  - Schultz Co D A 801 SE 8 St FI 7701
  - Walkowski Al 2760 W River Rd PA 4-3384
  - Warner Co A J 5022 29 Ave S PA 4-1895
- ST PAUL
- Benson Co E R 2651 University Ave MI 5197
  - Engelbretsen Co W M 906 Ottawa Ave CE 2338
  - \*Laub-Dale Co 1951 University Ave NE 7911
  - Ragon Inc R G 1406 W Idaho Ave NE 6937

MISSOURI

CLAYTON

- \*Maynard Co L W 139 N Central PA 5-3723

FENTON

- \*Wellman Co W N Box 166 DA 6-0313

JEFFERSON CITY

- \*Padon Co Ward Box 569 5-1023

KANSAS CITY

- Automatic Gen'l Sales 6650B Troost Ave JA 7375
  - \*Battis Co Maury E 406 W 34 St LO 0772
  - \*Clemenson Co R E 1206 E 9 St HA 4428
  - Everett Assoc 1629 E 31 St AR 9539
  - \*Farris Co W 406 W 34 St LO 7495
  - \*Fry & Co W E 406 W 34 St JE 5236
  - Harris-Hanson Co 7916 Paseo HI 6744
  - \*Kay Sales Co 2600 Grand BA 3800
  - \*Larabee Co Fred H 4608 Nicholas Pkwy LO 2520
  - Lee Mark Assoc PO Box 8467 DE 5480
  - \*McGrade Co E W 213 W 75 St DE 9242
  - \*Myers-Young-Forristal 4538 Main St JE 7221
  - Pomerenok Co H C 4700 Roonoke Parkway LO 2296
  - Radio-Technical Sales 4910 Lane Rd LI 5591
  - \*Roes & Co H A 2601 Cherry St HA 2036
  - \*Schmitz Co J O 917 VFW Bldg LO 9824
  - \*Scholz Co Paul G 210 W 8 St HA 7111
  - \*Schryver Sales Co Clyde H 4550 Main St WE 4660
  - \*Somers & Co F C Grand Ave Bank Bldg GR 1335
  - \*Terwilliger Sales Co 7133 W 80 St (Overland Park) 2421
  - \*Thibau Co A R 402 Mfrs Exchange Bldg VI 7057
- ST LOUIS
- Benske Co Jules 575 Arcade Bldg CE 1677
  - Borghoff Co Wm 1210 Edgewater Dr
  - Bullivant F J 1913 Washington Ave CH 6510
  - Harris-Hanson Co 5506 S Kings Hwy FL 1-5584
  - Hessel & Co H 722 Chestnut St CE 1-0905
  - \*Kathrinus & Co 4356 Duncan Ave OL 2-7005
  - \*Knags Co H W 106 Lucas St CE 1-1853
  - Levin Mfg Agency Sidney M Box 405 WI 2869
  - \*Lowell Theodore B Box 21 Normandy BR MU 7803
  - Mayerson-Follman Co 2342 Olive St CH 1-1122
  - McGary Co William T 6635 Delmar Blvd DE 5-6430
  - McGrade Co E W 1110 S Brentwood PA 5-6550
  - \*Myers-Young-Forrestal 8147 Delmar Blvd DE 5-7701
  - Rose Equipment Co W L 317 N 11 St CH 7247
  - \*Sebright & Co Russ D 6344 Clayton Rd MI 5-8871
  - \*Waelterman L F 3938 Lindell Blvd OL 6455
  - Wells-White Co 6625 Delmar Blvd PA 7-7622
  - Winslow Design & Sales Co 106 W Madison St (Kirkwood) YO 5-8880
- UNIVERSITY CITY
- Jaques L E 8112 Tulane Ave CA 5349



NEW JERSEY

- NORTHERN NJ (See New York NY Area)
- SOUTHERN NJ (See Philadelphia Pa Area)

NEW MEXICO

ALBUQUERQUE

- Burk Co Paul O PO Box 8155 5-8634
- C G Electronics Corp 305 Dallas NE 6-6121
- Gates Franklin Y 122 Harvard DR SE
- Kittleson Co 106A Cornell Dr SE 2-9581
- Miller Co Gerald B 327 Wyoming SE 5-8606

NEW YORK STATE

ALBANY

- Carle Electric Corp 100 State St 3-3628

BINGHAMTON

- \*Holliday-Hathaway Co 124 Chenango St 3-1511

BUFFALO

- \*Ball Assoc 54 E Quaker St (Orchard Park) ID 4416
- Eyre Phillip B 89 Pearce Dr CI 0534
- \*Farber Assoc Maury 1210 Hertel Ave RI 2423
- Fillmore & Fillmore 647 Elmwood Ave SU 3355
- \*Jackson Co Robert W 833 Ellcott Sq Bldg MA 3306
- Johnson Agencies 3331 Bailey Ave WI 1431
- Keller Industrial 33 E Hazeltine Ave RI 3938
- Lamb Robert F 1807 Elmwood Ave BE 3757
- Mitscher Co R W 487 Ellcott Sq Bldg WA 2517
- Shea S E 735 Ellcott Sq Bldg WA 8240
- Wink Willis 235 Hendricks Blvd AM 6426

DE WITT

- Taylor Co Frank W Box 222 SY 72-5198

FAYETTVILLE

- Andrews Martin P 10 Mott Road 65-8405
- Rosen Assoc P O Box 6 65-8917

HAMBURG

- Cooper-Morgan Inc Box 152 EM 3405

LIVERPOOL

- \*Wadsworth Mfg Assoc 509 Balsam St 69-7043

PHELPS

- \*LeRoy & McGuire Inc RD 1 228

ROCHESTER

- Glaslon Gilbert 617 Case Bldg LO 8323
- Johnson Agencies Inc H C 111 Mt Hope Ave HA 1090
- Kaufman Warren 90 Norton St CO 2728
- Keller Industrial Products 217 East Ave HA 3255
- \*LeRoy Gordon C 29 Bancroft Dr CH 3872
- Ossmann & Assoc E P 3 Juniper St CU 7640
- Reed Co Mort 1515 Clover St HI 2712
- \*Richter William 3 Juniper St CU 7635
- Schmitz A W 82 St Paul St HA 3090
- \*Wolfe-Marsey Sales Co 74 Park Ave GR 9088

SCHENECTADY

- Johnson Agencies 727 DeCamp Ave SC 4-5901

SYRACUSE

- \*Allen Leonard D 2401 S State St 4-4195

CARDUNER SALES COMPANY

Intensive coverage of PARTS DISTRIBUTORS in the NEW YORK METROPOLITAN AREA

SALESMEN

164 DUANE ST. NEW YORK 13, N. Y. Walker 5-0900

WAREHOUSING FACILITIES

Andrews & Andrews 521 Cumberland Ave 72-0531  
 Naylor Electric Co State Tower Bldg Rm 317 2-3894  
 Ossmann & Assoc E A 308 Merritt Ave 9-3825  
 Paston-Hunter Co 609 Demong Dr 72-0656  
 Ryerson Assoc J D 412 E Genesee St 76-8344  
 \*Stone John L 1445 Teall Ave 73-4280  
 \*Swank Wally B 2310 Bellevue 4-2141  
 \*Wolf O C 15 Centennial Dr 4-7223  
 Wolfetange Jr F 326 State Tower Bldg 3-8013  
 \*Zimmerman W H PO Box 224 3-6405

**TROY**  
 HindsH Elec Co 225 River St AS 2-0700  
**NEW YORK CITY METROPOLITAN AREA** (Including Northern NJ)

\*Aaron Paul D Professional Bldg (P&T Wash NY) PO 7-5670  
 Adeiman Co Leon L 25 Chittenden Ave TO 7-1145  
 American British Tech 57 Park Ave MU 9-2595  
 \*Banfield Assoc Carroll S 104 Mountain Way (Rutherford NJ) WE 9-6784  
 \*Barrett Border 10 Highwood Ave (Tenally NJ) EN 3-2354  
 \*Baum Sydney H 70-15 Fleet St (Forest Hills NY) BO 3-8101  
 \*Be-Esco Associates 395 Broadway WO 4-7321  
 Berger G E 109-01 72 Rd (Forest Hills NY)  
 Blakek Assoc Samuel 205 E 42 St MU 4-1655  
 \*Bittan Co D R 53 Park Pl BA 7-2789  
 Blttan-Shafer Sales 120 E 32 St MU 4-2229  
 \*Blair-Steinberg Co Broadway WO 4-7321  
 \*Bloom Associates 7 Huntwood Pl (Mt Vernon NY) WO 7-5063  
 \*Boeck G A 81 Lake Dr (Mountain Lakes NJ) DE 4-2921  
 \*Bloch-Weinberg Co 60 E 42 St MU 7-6667  
 Bradrock E Browning Lane (Haddenfield NJ) 9-0087  
 \*Brennan Co F X 180 Glenridge Ave (Montclair NJ) 3-2461  
 \*Bressler Jules J 4808 Bergenline Ave (Union City NJ) UN 4-9577  
 \*Breuer Co R E 250 W 57 St CO 5-0440  
 \*Brown Irv 1500 Carroll St (Brooklyn NY) HY 3-1379  
 \*Brown Assoc Jack 207 Rosedale Rd (Yonkers NY) SP 9-7330  
 Burlingame Assoc 103 Lafayette St DI 9-1240  
 \*Camber Marty 1700 York Ave EN 9-4222  
 \*Carduner Sales Corp 164 Duane WA 5-0900  
 \*Carr & Co Art 744 Broad St (Newark NJ) MI 2-6734  
 Christle & Co R S 175 S 5 Ave GR 7-4226  
 Components Sales Corp 218 E Hartsdale Ave (Hartsdale NY) SC 5-1050  
 \*Cooper DIBiasi 259 W 14 St WA 9-3920  
 Daleo G C 2876 Fulton St (Brooklyn NY) MI 7-3700  
 Detwiler L K 443 Broad St (Newark NJ) HU 5-9000  
 \*Diamond Simon 75 West St WH 4-2970  
 Director Assoc Murray 115-62 237 St (Elmont NY) CU 5-6823

\*Egert & Fields Co 11 Park Pl WO 4-0996  
 \*Electronic Components 81 Lake Dr (Mountain Lakes NJ) BO 8-2921  
 Electronic Sales Co 136 Liberty St WO 4-6193  
 \*Electro Tech Associates 207 Rosedale Rd (Yonkers NY) SP 9-7330  
 Engel & Assoc G Curtis 75 N Maple Ave (Ridgewood NJ) GI 4-0878  
 \*ERA Inc 340 Great Neck Rd (Great Neck NY) HU 2-9320  
 \*Erde S S 271 Hempstead (Malverne NY) LY 9-6900  
 \*Finlay Robert Lincoln Bldg (Ridgewood NJ) OL 2-0088  
 \*Forrest Bernard J 102 Warren St CO 7-1712  
 \*Forshey John M 27 Park Pl BA 7-4977  
 Frazer & Hansen 120 Broadway WO 4-3454  
 \*Freed & Co Leo 420 Lexington Ave LE 2-4771  
 \*Friedman Co A 519 S 5 Ave (Mt Vernon NY) 4-4866  
 \*Galasso David P 921 Bergen Ave (Jersey City NJ) JO 4-7277  
 \*Garfinkle Co Wm L 17 E 42 St MU 2-6770  
 Garten & Assoc Louis A 25 Valley Rd (Montclair NJ) MU 3-0257  
 \*Gary-Martin 232 Bread Ave (Pailsades Park NJ) WI 7-0300  
 Gawler-Knoop Co 178 Eagle Rock Ave (Roseland NJ) CA 6-4545  
 Gelst-Creaser Assoc 60 E 42 St MU 7-1550  
 \*Gelb B W 1777 Grand Concourse TR 8-6084  
 Ginsbury Sylvan 8 W 40 St PE 6-8239  
 Goldman & Co Louis R 251 W 42 St BR 9-8872  
 Gray Harold 21-10 33 Rd (Long Island City NY) YE 2-3825  
 Greenberg Jerry 29 Woodmere Blvd (Woodmere NY) FR 4-3748  
 \*Gross Assoc Adolph 23 Park Pl WO 4-8585  
 \*Harris Arthur M 210-02 43 Ave (Bayside NY) 9-7447  
 Haviland Assoc 1217 California Rd (Tuckahoe NY)  
 \*Hess Assoc Art 62-07 68th Ave (Brooklyn NY) HY 7-7498  
 \*Hicks W M & Keeneth J A 42 3rd Ave (Mineola NY) GA 3-0110  
 Holiday-Hathaway Co 270 Park Ave MU 8-5858  
 Howley Sales Co 318 Beach 31 St (Far Rockaway NY) 7-7588  
 \*Hughes Co Kenneth E 4808 Bergenline (Union City NJ) UN 7-3204  
 \*Hy-Art Co 136 Liberty St WO 4-5087  
 Instrument Center 55 Reade St WO 7-1290  
 \*Jacobs & Assoc Jack 1800 E 12 St (Brooklyn NY) DW 9-4374  
 \*Joseph Ben 521 5th Ave MU 2-8986  
 \*Kaelber & Mack 1 Park Ave (Manhassat NY) MA 7-1459  
 Kahgan Jack J 1261 Broadway MU 4-7772  
 Kahant Assoc 11 Park Pl CO 7-5326  
 (New York Continued)



**BLAIR-**

**STEINBERG CO.**

**12 Men Covering**  
 Metropolitan N. Y.,  
 New Jersey, New York  
 State, Eastern Pennsylv-  
 ania, Delaware, Mary-  
 land, District of Colum-  
 bia and Virginia.

**REPRESENTING**  
 CORNELL DUBILIER ELECTRIC CORP.  
 DAVID BOGEN CO., INC.  
 UNIVERSITY LOUDSPEAKERS, INC.  
 PHAOSTRON COMPANY  
 MIDDLESEX WOOD PRODUCTS

**BE-ESCO ASSOCIATES**

**REPRESENTING**  
 THE RADIART CORP.  
 AMERICAN MICROPHONE  
 JACKSON ELECTRICAL INST. CO.  
 TODD-TRAN

Phones:  
 Worth 4-7321-2-3-4

**395 BROADWAY**

**NEW YORK 13, N.Y.**



**LOUIS R. GOLDMAN & CO.**

**National Sales Representatives**

**251 W. 42nd Street, New York 36**

**Bryant 9-8872**

**SPECIALIZING IN TELEVISION, RADIO, T.V. AC-  
 CESSORIES AND ELECTRICAL APPLIANCES TO THE  
 DEPARTMENT STORES, SYNDICATE BUYING OF-  
 FICES, KEY ACCOUNTS AND CHAINS.**

**EXCLUSIVE LIST OF  
 ELECTRONIC REPRESENTATIVES**

devoted exclusively to electronic representatives.  
 Arranged alphabetically according to states and  
 cities, it gives the names and addresses of all in-  
 dependent "reps" throughout the country. It is the  
 most complete and authoritative representatives  
 list ever published.

**TECHNICIAN**  
 & Circuit Digests

*more man hours per line!*

Eleven outside men give active, frequent service  
 on selected outstanding lines. Point of purchase  
 service and jobber promotions stimulate con-  
 tinued sales by jobber salesmen and counter-  
 men through programs tested by twenty-five  
 years' experience.

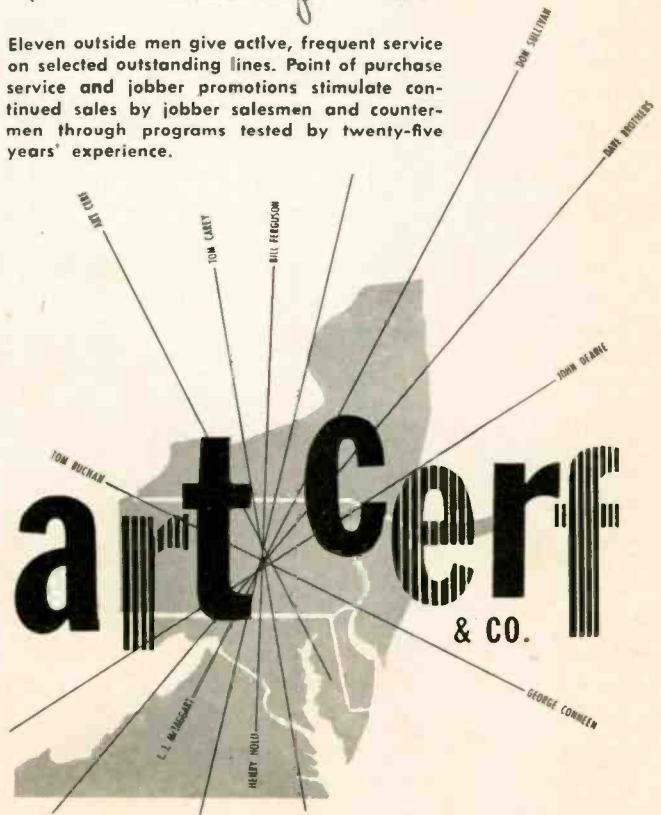

ART CERF & CO. 744 BROAD ST., NEWARK 2, N. J. PHONE: MITCHELL 2-6734  
 Branches: Philadelphia, Pa. Easton, Pa. Buffalo, N.Y. Syracuse, N.Y. Washington, D.C.  
 Representing Manufacturers of Television, Radio and Phonograph Products

(New York Continued)

- Kee Enterprises Inc 10 Murray St WO 4-0973
- \*Kopple Assoc J J 9 W Prospect Ave (Mt Vernon NY) 4-5577
- Kubrick Dave 200 W 34 St BR 9-6517
- \*Land-C-Alr Sales Co 42 Oak Ave (Tuckahoe NY) 3-5500
- \*Landis Sales Co Cliff 81-11 Roosevelt Ave (Jackson Hts NY) IL 8-7900
- Lawton Co 12 Foster Rd (Tenafly NJ) EN 3-3979
- Lerman Leonard S 1093 Salem Rd (Union NJ) MU 8-9406
- L & M Assoc 253 Boulevard (Hasbrouck Heights NJ) 8-2665
- \*Levison Melvins 5 Waverly Pl DR 4-4464
- \*Lichter Wm 90 W Broadway RE 2-5228
- \*Luce & Co R P 480 Morris Ave (Summit NJ) SU 6-9211
- Masn Co O F 1 Wolf's Lane (Pelham) PE 8-4510
- \*Miller Ben 401 Broadway WA 5-3964
- \*Miller Co Harry 27 Mechanic St (Red Bank NJ) 6-9300
- Mingins Sales Co 107-37 71 Ave (Forest Hills NY) 80 3-1643
- \*Morse Sales Irv 150 Broadway CO 7-2913
- Moyer H A PO Box 14 (Haddonfield NJ) 9-6347
- National Sales Devel Co 7 E 42 St MU 7-7255
- \*Newhope Corp 6 E 39 St LE 2-7372
- \*Nichols Paul 42 Oak Ave (Tuckahoe NY) TU 3-5500
- Nief Assoc Paul W 7 Greenridge Ave WH 8-1454
- Norton Cliff 60 Park Pl (Newark NJ) MA 2-4728
- Novack Assoc B 15-35 129 St (College Point NY) IN 1-73
- \*Pickett James M 205 E 66 St TR 9-9520
- Reppo 5 Whittier St (Lynbrook NY) LY 9-4875
- RMC Assoc 170 E 80 St TR 9-2023
- Roekbar Corp 211 E 37 St Va 6-3463
- \*Ross-Pilshner 550 5 Ave JU 6-0653
- \*RSA Co 15 Park Ave (Rutherford NJ) GE 8-4200
- Rutt William 401 Broadway CA 6-7545
- \*Ryan Assoc John L 263 Edgemont Pl (Teaneck NJ) TE 6-1075
- \*Saffler Perry 53 Park Pl RE 2-5333
- Sanford L C 202 Woodland (Rutherford NJ) WE 9-0979
- Scheffer & Yurman 330 Front St (Hempstead NY) IV 3-4585
- \*Schmitt Co F Edwin 136 Liberty St WO 2-6550
- Schottenberg R T 152 Merlon Ave (Haddonfield NJ) HA 9-6347
- \*Schwartz Adolph 15 Exchange Pl (Jersey City NJ) DE 3-2424
- \*Shaw Co S A 92 S Central Ave (Hartsdale NY) WH 8-5015
- \*Shulan & Co Wally 136 Liberty St WO 2-0365
- Silver Assoc Lou 1665 Warwick Rd (Hewlett NY) FR 4-2093
- \*Simberkoff Sales Co 68 Hudson St (Hoboken NJ) HO 2-5211
- Smith Co 16 Northfield Ave (W Orange NJ) OR 6-6818
- Smith-Benny Sales Co 11 W 42 St CH 4-1642
- \*Smith Howard F 259 W 14 St CH 2-2398
- Snyder Milton C 205 E 42 St MU 4-1314
- Snyder Sales 194 Frellinghousen Ave (Newark NJ) BI 2-0349
- \*Sonkin David 10 Fiske Pl (Mt Vernon NY) MO 8-9809
- \*Sprung Joseph 254 W 31 St LO 5-1820
- \*Stang Sales 1 Crestwood Lane (New Rochelle NY) NE 6-6622
- Stollmack MW 277 Broadway CO 7-4330
- \*Sussman & Co Jules 130 Lafayette St WO 2-7766
- \*Taylor Co B B 241 Sunrise Highway (Rockville Ctr NY) RO 6-1014
- Technical Representatives 69-10 140 St (Flushing NY) LI 4-5058
- \*Tubias & Co D F 30 Church St CO 7-4350
- Turney & Beale 214-27 Northern Blvd (Bayside NY) 4-4000
- Varrelman-Gorman Co 11 Sunnyfield Rd (Hicksville NY) HI 3-7452
- Verte Sales Co 1195 Sherman Ave CY 3-0211
- Weber Assoc Jack Lake & Main Sts (Tuckahoe NY) 3-0893
- Welland G. H. 77-43 166 St (Flushing NY) OL 8-4061
- \*Weinberg Harry 60 E 42 St VA 6-1399
- Weir R Donald Box 153 (Netcong NJ) NE 2-0221
- \*Wells & Associates W W 509 5 Ave MU 2-8949
- \*Willgold Electronic Sales 350 5 Ave LO 4-2525
- \*Wineblatt Sales Co E 10 Fiske Pl (Mt Vernon NY) 4-3216
- \*Wolfe Michael 136-52 71 Rd (Flushing NY) BO 3-1400
- \*Woolf Assoc Irving W 135 Liberty St RE 2-9673
- Zlowe Leonard 764 6 Ave CH 3-3142

**NORTH CAROLINA**

**CHARLOTTE**

- \*Cartwright & Bean Box 9203 Plaza Sta FR 6-8648
  - Electronic Equip Sales Agency 418 Wilder Bldg 7-6193
  - Farman & Assoc C M Jr PO Box 2624
  - Gardner & Henry Co 122 Brevard St FR 4-9739
  - Glenn & Larson 123 Brevard Ct 4-3994
  - Hightsmith & Co James L Box 1011 5-6436
  - \*Howard Co Foy M 2908 Arvonale Ave 5-6646
  - Ranson, Wallace & Co 116 1/2 E 4 St 4-4244
- GREENSBORO**
- \*Atcheson & Adams 601 N Elm St Bldg 2-6838
- WILMINGTON**
- \*Manufacturers Sales 307 Electric Bldg. 5749

**OHIO**

**CANTON**

- Conrad & Assoc E T 516 38 NW 2-5450

**CINCINNATI**

- \*Baehr Albert M 3916 St Johns Terr TW 3827
- Beedle Equip Co Roselawn Center Bldg JE 2640
- Henger Fairfield Co 124 E 7 St MA 4749
- Herrick Co G L 2087 Sherman Ave JE 7542
- Laing Co W C 3253 Lambert Pl EA 1435
- Wahl Co A C 416 W Benson St VA 3270

**CLEVELAND AREA**

- Ambos Jones Co 3951 Lee Rd. SK 2-3030
- Baehr Albert M 11621 Detroit Ave LA 1-8468
- \*Baler & Co Arthur H 12429 Cedar Rd FA 1-5644
- Brandes C O 4900 Euclid Ave HE 1-0414
- \*Brauer & Assoc Walter J 15631 Lakewood Hts Blvd LA 1-7268
- Clark Sales Box 708 Warrensville Br PR 1-2241
- Crahn Brennen & Assoc 521 Citizens Bldg CH 1-0779
- Dannemiller Assoc J R 1791 Oakmont St EV 1-5100
- \*Daugherty Co F A 1120 Croyden Rd HI 2-3311
- Dietrich Co Earl S 320 Hanna Bldg CH 1-7770
- Dolfuss Jr Chas H 2108 Payne Ave PR 1-1270
- \*Edwards-Lohse & Co 2123 E 9 St TO 1-5753
- Elliott Co Howard C 3412 E 147 St WA 1-4206
- Harrington-Flishei Co 512 Engineers Bldg SU 1-6612
- Henger-Fairfield Co 1812 Columbus Rd CH 1-1018
- Herrick Co G L 15326 Lorain St WI 1-4406
- Hoskins Nell K 210 S Franklin St (Chagrin Falls) CH 7-6136
- Jay Eng'g Co 5413 Pearl Rd TU-4-4080
- Jubell Associates 2036 E 22 St MA 1-6560
- Kohler Assoc Ernie 8905 Lake Ave OL 1-1242
- \*Landfear Co J M 12429 Cedar Rd FA 1-4533
- Lehner J C 4301 Daisy Ave SH 1-0903
- \*Levin & Assoc Sid 4217 Okalona Rd EV 2-2734
- Maerlender Co H G 351 Cornwall Rd (Rocky River) LA 1-0435
- \*Midwest Sales Co 3219 W 117 St WI 1-2700
- \*Morrow Co Les A 3123 W 117 St CL 1-5700
- Moss Co Chas R 16956 Van Aken Blvd (Shaker Hts) WY 1-6018
- \*Nace Allen S 7601 Parkview Rd (Brecksville) JA 6-7300
- Odell Co M P 2536 Euclid Ave PR 1-6171
- \*Olson Co John O 16201 Shaker Blvd WY 1-2624
- Rosenwasser Sales F A 1581 Coventry Rd (E Cleve) FA 1-0463
- Roth Sales Co Mike 13947 Cedar Rd YE 2-4262
- \*Rauer Frank W 4144 Marvin Ave ME 1-8350



- Satollo Co 16801 Euclid Ave IV 1-6200
  - \*Scott & Steffen 1836 Euclid Ave MA 1-1286
  - Silverman Lou 2300 Payne Ave CH 1-7559
  - Staff Co R A 1213 W 3 St MA 1-4063
  - Sterling Co S 13431 Cedar Rd
  - Thomas Eng'g Co Ellendale Rd (Chagrin Falls) CH 7-7786
  - Valentine Forest C 6408 Euclid Ave EN 1-4343
  - White & Co C E 637 Balkley Bldg MA 1-8410
- COLUMBUS**
- Derr Co Norbert F 937 S Ashburton Rd DO 2603
  - \*Lehner Co J W 367 Brynild Rd LU 5260
  - \*McFadden William E 150 E Broad St CA 1-3363
  - \*Pugh Co C L 2144 Riverside Dr KI 4855
  - \*Walter-Rahe Co Box 212 (Worthington) FR 2-7819
- DAYTON**
- \*Bear Corp Neal 1110 Broad Blvd OX 3041
  - Boehme Associates B-4 Talbott Bldg FU 8188
  - Bruno Laurence D Far Hills Branch PO Box 61 WA 8703
  - Burtner Robert K Ear Hills Branch PO Box 529 OX 3980
  - Crosley & Assoc Alfred 53 Park Ave OX 3594
  - Epps & Fedotin 1434 Vancouver Dr TA 9345
  - Grimm A N 1731 Ruskin Rd OR 1496
  - Jay Eng'g Co 1721 E 3 St KE 2151
  - Klein Wm 1472 Earlham Dr RA 0943
  - Magee Edward E 5845 Paddington Rd OX 2333
  - Odell Co M P 2676 Salem Ave OR 4441
  - Ohmer George H PO Box 34 Sta D WA 3761
- LIMA**
- Hecht Co Fred J 1832 Wendell Ave 9-4378
- LONDON**
- Schenck Assoc Earl W PO Box 223 1555
- MAUMEE**
- Henger Fairfield Co 1130 Key St 3-3211
- MIDDLETOWN**
- Wright Eng'g 1304 Elwood Ave
- WEST RICHFIELD**
- \*Bear Corp Neal 3435 Streetsboro Rd 100
- WORTHINGTON**
- \*Weller-Rahe Co PO Box 212 FR 2-7819

**OREGON**

**PORTLAND**

- \*Burcham Co Don H PO Box 4098 BR 3830
- Eckersley James W 3150 SW Hamilton St AT 0308
- Hawthorne Electronics 700 SE Hawthorne Blvd FI 9375
- \*Legg Co Richard 2118 SE Division St EM 8918
- \*Minthorne Co L L 7521 NE Gilsan St KE 0010
- \*Weber Co Dale 234 Sherlock Bldg AT 5403

**PENNSYLVANIA**

**PHILADELPHIA AREA**

- \*Andress Co Philip M 3823 Oak Rd VI 4-9100
- Barol Assoc Leonard 1501 Finance Bldg RI 6-8473

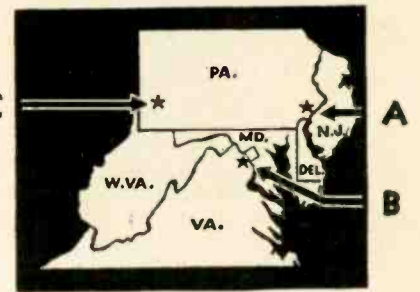

- A—Philadelphia—Main Office
- B—Washington Office
- C—Pittsburgh Office

**SAMUEL K.  
(MAC) MACDONALD  
INC.**

**MANUFACTURERS'  
REPRESENTATIVE**



**1531 SPRUCE STREET  
PHILADELPHIA 2  
PENNSYLVANIA**

*Other Offices*

**PITTSBURGH  
WASHINGTON D.C.**



*Covering*

**PENNSYLVANIA  
NEW JERSEY  
DELAWARE  
MARYLAND  
DISTRICT OF COLUMBIA  
VIRGINIA  
WEST VIRGINIA**



*Associates*

**NOBLE SHILT  
JIM FARIES  
JACK MAHONEY  
JOHN LARKIN  
JACK D'ANGELO  
"BEANIE"**

\*Bell Tom Jacksonwald Ave (Easterly) RE 5-6837  
 Bierbaum John W 835 W Sav Fnd Bldg PE 5-3738  
 \*Biggs & Co J Alan Box 450 (Doylestown) 9457  
 \*Biffan-Boenecke 210 N 6 St (Camden N J) WO 4-8650  
 Blumenthal Assoc 5040 City Line Ave TR 7-4116  
 \*Brookfield R F 55 Cricket Ave (Ardmore) MI 2-6911  
 \*Cooper Richard 3507 Wellington MA 4-5486  
 Connen Geo M 16 Trent Rd AR 6052W  
 \*Cordray W Henry 12 W Chelton Ave VI 8-0447  
 \*Danco Corp (Fairview Village) NO 5-2600  
 Densham Harry W 250 S 17 Kl 5-1947  
 Dlanes Co H L 7341 Woodbine Ave TR 7-7831  
 \*Edmonds E J 102 W Lexington (Havertown)  
 \*Estersohn Harry 395 E Cliveden St VI 8-2836  
 \*Fairbanks Howard J 1615 Darby Rd (Havertown) GR 2-2467  
 \*Foley Andrew A 640 Federal St (Camden N J) WO 6-2550  
 \*Friedman Martin 1006 Western Sav Fnd Bldg PE 5-4778  
 \*Fryberg Charles H 111 S 22 St RI 6-5699  
 Gatty Sidney 11 N Clermont St (Margate N J) 2-1361  
 Girard Co W E 715 Fairfield Rd (Glenside) OG 0071  
 Hile Co Charles R Hillview Rd Box 144 (Paoli) EL 6-2266  
 Hilliard Assoc 1125 Old York Rd (Abington) OG 3249  
 \*Jeffries S A 105 Forrest Ave (Narberth) MO 4-8500  
 \*Keefe Electronic Sales Co 201 N 6 St (Camden N J) WO 4-3970  
 Krieger Sales Co 300 S Broadway (Camden N J) WO 3-5951  
 Lawton Co 836 Mason Ave (Drexel Hill) SU 9-2146  
 \*Leban & Graham 1412 Manoa Rd MI 2-9047  
 Lewis Herman 1622 68 Ave LI 8-1281  
 \*Lowery Inc L D 50 E Wynnewood Rd (Wynnewood) MI 2-9100  
 \*Maddonald Inc S K 1531 Spruce St KI 5-1205  
 \*Maguire & Co J A 116 N 7 St (Camden NJ) WO 6-3118  
 Massey Assoc 529 Brookhurst Ave (Narberth) MO 4-4200  
 \*Meyer H A PO Box 14 (Haddonfield N J) 9-6347  
 \*Meggelworth J C 324 Hadden Ave (Collingswood N J) 5-7200  
 \*Wanda In L Parker Suburban Sta Bldg RI 6-3185  
 \*Newson Jr C H 150 Terminal Ave CH 8-0282  
 Nolan J J 314 W Sparks St WA 4-1595  
 Orsi Co John F Box 346 (Bryn Mawr) CO 6-2698  
 Paragon Sales Co 111 S 22 St RI 6-5699  
 Pearl Eng'g & Tool Co 8056 Rodney St LI 8-4103  
 Perna Co Frank J 2015 Chestnut St LO 4-3954  
 \*Quintan D G 4700 Frankford Ave JE 3-0650  
 \*Randall Co Ken 121 N Broad St LO 4-2151  
 Rallinger Co A R 3617 N 8 St SA 2-0500  
 Robinson Co I E 7404 W Chester Pike (Upper Darby) SH 8-1294  
 \*Shelps George A 2604 W Cheltenham Ave WA 4-7634  
 Shubin & Co Lewis 1067 Drexel Bldg WA 2-6740  
 Snyder Co V A 1526 Broad St ST 4-9141  
 Stinson Co J T 219 Sagamore Rd (Havertown) HI 7-0922  
 \*Stratton Co C H 7852 Montgomery Ave (Elkins Park) MA 5-2231  
 \*Tech Representation 25 S Easton Rd (Glenside) YU 1325  
 \*Trinkle Wilmer S PO Box 40A (Hatfield) SO 3-9425

Weber Linz Assoc 238 Shelmlre St CH 3161 J  
 Wilkinson Co R L Finance Bldg 6 & Cooper Sts (Camden NJ) WO 3-2679  
 \*Williams V W 5 Circle Dr (Margate NJ) AT 2-7859  
**PITTSBURGH**  
 Airgood Joseph M 742 Berwin Ave LE 1-3539  
 Brown Co R E 311 Ross St AT 1-2142  
 Burke Elec Equip Co 416 Maple Ave PE 1-5357  
 Clark Co Russell F 1404 Clark Bldg AT 1-8089  
 Grotzinger Co H W 410 E Genl Robinson AL 1-6280  
 Kaufman Sales Jerry Plaza Bldg AT 1-0206  
 Levine Albert 11 Jonquil Pl LO 1-7027  
 Lips E C 1565 McFarland Rd FI 1-5100  
 Lowry-Dietrick Co 1404 Swantek St WA 1-2959  
 Lsdgate Assoc John P 345 4 Ave AT 1-1805  
 \*Maddonald Inc Samuel K 715 State Theatre Bldg AT 1-2253  
 Mates Hyman 5510 Hobart HA 1-8998  
 Odell Co M P 750 Penn Ave FR 1-1231  
 Olsan Co John O 2046 Brookfield Rd BR 2083  
 \*Pedolny James H 4716 Celeridge St HI 1-0800  
 Ransford Co H E 2601 Grant Bldg GR 1-1880  
 Shaw S J 7308 Church Ave PO 6-8000  
 Squires Co M B 1202 Grant Bldg GR 1-5566  
 Stover & Co S H 5495 Penn Ave EM 1-7533  
 \*Tanner & Covert 600 Grant St 1-0131  
**READING**  
 Loese & Co W L 646 Gordon St RE 2-7094

**TENNESSEE**  
**CHATTANOOGA**  
 Johnson Jesse P 413 Dome Bldg 5-3463  
**KNOXVILLE**  
 Hough Co A B 3601 Chapman Hwy 7-6660  
**MEMPHIS**  
 \*Cartwright & Bean 1336 Madison Ave 2-1914  
 Engelman Jesse Co 3205 Crump Ave 48-6263  
 Moody Co Joe 1215 Central Ave 2-1607

**TEXAS**  
**DALLAS**  
 Allied Components 100 Glass St ST 2826  
 \*Anderson Co Geo E 1901 Griffin St RI 5931  
 \*Aymond Co Edward F 4312 Maple Ave LO 5233  
 Bee Sales Co 4200 Sherry Lane FO 8-7084  
 \*Berthold Sales Co 4411 Maple Ave LO 8329  
 \*Branam Co PO Box 10204 RI 4743  
 \*Camplon Sales Co PO Box 4116 Sta "A" RA 6620  
 Communication Service 3209 Cantore St PR 1852  
 \*Corry Co Hal F 3111 Knox St JU 9172  
 \*Crockett-Lundt & Co 2204 Griffin St RA 5764  
 \*Delzell-Maynard Sales 3409 Oaklawn Ave JU 2411  
 Engineering Products Co 5005 W Lovers Lane EL 1179  
 Folsom Sam W 411 N Bishop St YU 9560  
 Green Co John A 6815 Oriole Dr DI 9918  
 \*Guenther John B 7322 Marquette Ave EM 6286  
 \*Heldenreich Co 6115 Denton Dr FO 8-6763  
 Lipscomb Assoc Earl PO Box 7084 EL 5345  
 \*McKinney Sales Co Jack F 1330 N Industrial Blvd ST 1997  
 \*Sehounmaker Co J Y 2011 Cedar Springs ST 3335  
 \*Smith Co J Earl 505 N Ervay St RA 2966  
 \*Texport Co 726 Meadows Bldg FO 8-4422  
 \*Wilks Co Ernest I 1212 Camp St RI 4059  
 \*Yount Jack 1431 Pleasant Dr EX 0988  
**FT WORTH**  
 Harris Co 716 Dan Waggoner Bldg 0738

**HOUSTON**  
 Calmes & Assoc D 4605 Locest St MO 5-1704  
 Harrison Equipment Co 1422 San Jacinto St AT 6315  
 \*Kilberger Co M F Box 3113 JA 8459  
 Pachard J & D 770 M & M Bldg CA 7349  
 \*Smith Co J Earl 6610 Salem St  
 \*Wilkinson Co G G 1821 W Alabama JU 1634  
**WACO**  
 Brockenbrough & Sanders PO Box 291 4-0441

**UTAH**  
**SALT LAKE CITY**  
 \*Gates Co 200 S Main St 9-1101

**VIRGINIA**  
**ALEXANDRIA**  
 American Eng'g Equip PO Box 186 TE 6-1718  
 Brown & Assoc W A 3610 Mt Vernon Ave OV 3-6100  
**RICHMOND**  
 Simpson & Son P M 717 Byrd Park Ct 84-1519

**WASHINGTON**  
**SEATTLE**  
 Baeker Co Jas J 2321 2 Ave MA 8811  
 Carlson Co Fred W 2307 5 Ave EL 6630  
 \*Haight Co Fred H 3212 Eastlake EA 1818  
 Howell Sales 1250 1 St S EL 4214  
 Jensen Co Vernor O 2616 2 Ave MU 2929  
 \*Lee Co Dave M 2517 2 Ave MA 5512  
 Levinson Co Harry 1117 2 Ave MA 5317  
 \*Marsh Agencies 2601 1 Ave MA 8761  
 \*Meritt Co Ron 120 W Thomas GA 6644  
 Meredith Co Ron 2410 Beacon Ave FR 8040  
 Norris Co George D 3010 1 Ave EL 6662  
 \*Northwestern Agencies 4130 1 Ave S EL 8882  
 \*Parsons & Co C B 3028 1 Ave MU 3933  
 \*Porter Co Burt C 4310 Roosevelt Way ME 6828  
 \*Strum Co S N 1612 Broadway FR 7515  
 \*Weuel Co Frank 3215 Western Ave GA 0222  
 \*Wladekind Co M K 216 1st Ave NE EL 6981

**WISCONSIN**  
**MILWAUKEE**  
 \*Aaren & Assoc I I 829 N Marshall St BR 6-8515  
 Dickinson & Assoc E A 744 N 4 St BR 2-0517  
 Knauth Co L B 704 E Pleasant St DA 8-3434  
 Loeb Sales Co Eugene R 5052 N Shoreland Ave WO 4-2155

**RACINE**  
 Darnold D H 914 Kentucky St

**WYOMING**  
**LARAMIE**  
 \*Claph Stan 555 N 12 St 4075

**CANADA**  
**VANCOUVER**  
 \*McKenna Ltd D Eldon 2191 W 1 Ave BA 2898

**HAWAII**  
**HONOLULU**  
 Brenna & Browne Inc 211 Honolulu Merchandise Mart 6-6005  
 Plety Gene 2030 Home Sales St 8-3105

An Exclusive Service for Television Technicians—

## SINGLE SCHEMATICS, 25¢ Each

The publishers of **TECHNICIAN** are receiving so many requests for reprints or additional copies of its Circuit Digests that it is now making single schematics available at 25¢ each, post paid and the complete group, as published in any issue, for 50¢ post paid. For overnight service, air mail

special delivery, add 25¢. Schematics for all receivers indexed on these pages are in stock. This offer covers only schematics which have been published in Circuit Digests. Be sure to order by Circuit Digest number and give brand name and chassis number to prevent error.

**TECHNICIAN**  
 & Circuit Digests

Address Reader Service Dept., **TECHNICIAN**, 480 Lexington Ave., New York 17  
 Currency or postage must accompany order.

# 1955 TECHNICIAN BUYERS DIRECTORY

## *Alphabetical Listing of Manufacturers*

### WITH THE NEW, EXCLUSIVE **LOCALIZER INDEX**

A complete listing of the names and addresses of manufacturers of service and replacement products, component parts, equipment, instruments and materials as well as technical publishers. In the LOCALIZER INDEX listings a number of manufacturers have listed such data as home office telephone numbers, executive personnel, brand names, products, branch and regional offices as well as local reps. The LOCALIZER IN-

DEX provides the shortest means of contacting any manufacturer. Symbols show type of sales:

BO branch office  
D distributor  
DS distributor sales  
GV government sales  
IDS indus & distr sales  
IS industrial sales  
R representative  
SE sales engineer

Indented listings are advertisements.

Abbey-Graham 1754 State St E St Louis III  
Abbott Plastics & Mach 6322 N Clark St Chicago 26 III  
Abel Mfg Co 32-20 37 Ave Long Island City 1 NY  
ABT Mfg Co 715 N Kedzie Ave Chicago 12 III  
Accurate Electronics 1312 Ontario St Cleveland 13 Ohio  
Accurate Insulated Wire 25 Fox St New Haven 13 Conn  
Acme Battery Corp 59 Pearl St Brooklyn NY  
Acme Electric Corp 31 Water St Cuba NY  
Acme Electr Heating 1217 Washington St Boston 18 Mass  
Acme Electronics Sub Aerovox Monrovia Calif  
Acme Industrial Co 200 N Laflin St Chicago 7 III  
Acoustic Research 23 Mt Auburn St Cambridge 38 Mass  
Aeromark Co 309 Morrell St Elizabeth 4 NJ  
Aero Products Co 369 Shurs Lane Philadelphia 28 Pa  
Aero Tool & Die Works 4554 Broadway Chicago 40 III  
Aero Transformer 26-02 4 St Long Island City 2 NY  
Adams & Westlake 1175 N Michigan Ave Elkhart Ind  
Admiral Corp 3800 Cortland St Chicago 47 III  
Admiral Corp Molded Prods PO Box 338 W Chicago III  
Advance Electr & Relay 2435 N Naomi St Burbank Calif  
Advance Electronics 8510 N End Ave Oak Park Mich  
Aerocoil Inc 24 Cliff St Jersey City NJ  
Aero Instrument 11423 Vanowen St N Hollywood Calif  
Aermotor Co 2500 W Roosevelt Rd Chicago III  
Aeroflite Electronics 507 26 St Union City NJ  
Aeronautical Electric 5656 N W Hwy Chicago 30 III  
Aero-Tone Mfg Co 4836 Joy Rd Detroit 4 Mich  
Aerovox Corp 740 Belleville Ave New Bedford Mass  
Aids for Goodhousekeeping 21 Plandome Manhasset NY  
Aircraft Marine Prods 2100 Paxton St Harrisburg Pa  
Aircraft Transformer West & Willow Aves Long Branch NJ  
Airdesign Inc 241 Fairfield Ave Upper Darby Pa  
Air-E-O Electronics 374 N 27 St Milwaukee 8 Wis  
Airflyte Electronics 21 Cottage St Bayonne NJ  
Ajax Condenser Co 932 W Wrightwood Chicago 14 III  
A-K Mfg Co 115 S Northwest Hwy Barrington III  
Akro-Mills Inc 820 E Market St Akron 9 Ohio  
Alamo Electronics 1415 N Brazos St San Antonio Tex  
Alco Electronics Mfg Co 3 Wolcott Ave Lawrence Mass  
Alden Products Co 117 N Main St Brockton 64 Mass  
All Channel Antenna Corp 47-39 49 St Woodside 77 NY  
Allegro Electronics 226 New York Ave Huntington NY  
Allen-Bradley Co 1326 S 2 St Milwaukee Wis  
Alliance Mfg Co Lake Park Blvd Alliance Ohio  
Allied Control Co 2 East End Ave New York 21 NY  
Allied Electronic Bldg 604 Oakland Airport Oakland Calif  
Allied Eng'g Div 230 Park Ave New York 17 NY  
Allied Engraving & Stamping 161 Ellicott St Buffalo NY  
Allied Industries 2500 Woodland Ave Louisville 10 Ky  
Allied Mfg & Sales Co 201 N Wells St Chicago 6 III  
Allied Radio Corp 100 N Western Ave Chicago 80 III  
Alonge Products 163 W 23 St New York 11 NY  
Alpert Co Ned 2950 N Holton St Milwaukee 12 Wis  
Alpha Metals Inc 56 Water St Jersey City 4 NJ  
Alpha Wire Corp 430 Broadway New York 13 NY  
Alproco Inc Mineral Wells Texas  
Alproco Inc of Ind Box 98 Kempton Ind  
Alter Lansing 9356 Santa Monica Beverly Hills Calif  
American Condenser 4410 N Ravenswood Ave Chicago III  
American Electric Cable 181 Appleton St Holyoke Mass  
American Electric Motors 4811 Telegraph Rd Los Angeles  
American Electrical Heater 6110 Cass Detroit Mich  
American Electronics 1203 Bryant Ave New York 59 NY  
American Elite Inc 7 Park Ave New York 16 NY  
American Meh & Fdry 1085 Commonwealth Boston Mass  
American Mercantile Co 33 W 42 St New York 36 NY  
American Microphone 370 S Fair Oaks Pasadena Calif  
American Phenolic Corp 1830 S 54 St Chicago III  
Amer Radio Hdw 152 S MacQuesten Pkwy Mt Vernon NY  
American Radionic Co 33 Flatbush Ave Brooklyn 17 NY  
American Scientific Devel Ft Atkinson Wis  
American Sew Co 1670 W Main St Willimantic Conn  
American Solder & Flux 19 & Willard Philadelphia Pa  
American Standard TV Tube 94-50 158 St Jamaica NY  
American Tower Co Shelby Ohio  
American TV & Radio Co 300 E 4 St St Paul 1 Minn  
American Vacuum Prods 2242 S Colby Los Angeles Calif  
American Volume Control 554 W 168 St New York NY  
Ames Mfg Corp 2750 Park Ave New York 51 NY  
AMI Inc 1500 Union Ave SE Grand Rapids 2 Mich  
Amperex Electronic Corp 230 Duffy Ave Hicksville NY

Amperite Co 561 Broadway New York 12 NY  
Amplex Corp 934 Charter St Redwood City Calif  
Amplifier Corp of America 398 Broadway New York NY  
Amplitec Inc 362 W 57 St New York NY  
Ampro Corp 2835 N Western Ave Chicago 18 III  
Anaconda Wire & Cable 25 Broadway New York 4 NY  
Anchor Electronics Inc 717 Sip St Union City NJ  
Anchor Metal Co 244 Boerum St Brooklyn 6 NY  
Anchor Plastics 36-36 36 St Long Is City 6 NY  
Anchor Products 2712 W Montrose Ave Chicago 18 III  
Anchor Radio Corp 2215 S St Louis Ave Chicago III  
Anchor Wire Corp 183-16 Jamaica Ave Jamaica 3 NY  
Andrea Radio 27-01 Bridge Plaza N Long Island City NY  
Angle Genesee Corp 107 Norris Dr Rochester 10 NY  
Anko Mfg 5042 W State St Milwaukee 8 Wis  
Anslay Mfg Co Arthur Doylestown Pa  
Ansonia Wire & Cable Co 63 Main St Ansonia Conn  
Antenna & Mounting Hdw 9216 Grand Franklin Park III  
Antenna Products 3628 N Lincoln Ave Chicago 13 III  
Antenna Specialists 12435 Euclid Ave Cleveland Ohio  
Antennex Co 4060 Ocean Park Ave Venice Calif  
Anton Electronic Labs 1226 Flushing Brooklyn 37 NY  
A P Electro Lab PO Box 862 Union NJ  
Applegate & Co C J 1816 Grove St Boulder Colo  
Approved Electronic Instr Corp 928 Bdw NY 10 NY  
Arbor Mfg Co Depew NY  
Arbuck Inc 116 Troutman St Brooklyn 6 NY  
Arco Electronics 103 Lafayette St New York 13 NY  
Aero Transformer & Electric 1602 S Hanna Ft Wayne Ind  
ARF Products 7627 Lake St River Forest III  
Argos Products 310 Main St Genoa III  
Ark-Les Switch 51 Water St Watertown 72 Mass  
Armac Co PO Box 1083 Macon Ga  
Arrow-Hart & Hegeman 103 Hawthorne Hartford 6 Conn  
Arvin Industries 13 & Big 4 RR Columbus Ind  
Associated Production 162 N Clinton St Chicago 6 III  
Astatic Corp PO Box 120 Conneaut Ohio  
Astron Corp 255 Grant Ave E Newark NJ  
Atlantic Electronics 91 Jefferson St Passaic NJ  
Atlantic Recordings 301 W 54 St New York NY  
Atlantic Wire & Cable 119-14 14 Rd College Point NY  
Atlas Coil Inc 49 Hawkins St Derby Conn  
Atlas E-E Corp Bedford Airport Bedford Mass  
Atlas Resistor Co 24 E Coulter St Philadelphia Pa  
Atlas Sound Corp 1449 39 St Brooklyn 18 NY  
Audak Co 500 5th Ave New York NY  
Audel & Co 49 W 25 St New York 10 NY  
Audio Development 2833 13 Ave S Minneapolis Minn  
Audio Devices Inc 444 Madison Ave New York NY  
Audiogersh Corp 23 Park Ave New York 7 NY  
Audio Industries 532 W 4 St Michigan City Ind  
Audio-Master Corp 17 E 45 St New York 17 NY  
Audio Products 2265 Westwood Los Angeles 64 Calif  
Auth Electric 34-20 45 St Long Island City 1 NY  
Authorized Mfg Co 919 Wyckoff Ave Brooklyn 2 NY  
Autocrat Electronics Co 5024 Elm St Skokie 8 III  
Automatic Metal Products 315 Berry St Brooklyn 11 NY  
Automatic Radio Mfg 122 Brookline Ave Boston Mass  
Auto-Test Inc 600 S Michigan Ave Chicago 5 III

Baker Mfg Co 133 Enterprise St Evansville Wis  
Barb City Industries 5 & Girard Sts OkCalb III  
Barco Chemical Prods 701 S La Salle Chicago 5 III  
Barker & Williamson 235 Fairfield Ave Upper Darby Pa  
Barratt Electronics 22319 Kathryn Ave Torrance Calif  
Barry Electronics Corp 512 Broadway New York 12 NY  
Bauer & Black Div Kendall 309 W Jackson Chicago 6 III  
Baumker Mfg Co 3826 Summit St Toledo 11 Ohio  
Beam Instruments Corp 350 5th Ave New York NY  
Beam Radionics 224 N Desplains St Chicago III  
Becker Electronics Mfg Corp Valley Stream NY  
Becks Inc 298 E 5 St St Paul 1 Minn  
Beede Electrical Instrument Co Penacook NH  
Belden Mfg Co 4647 W Van Buren St Chicago 44 III  
Bell Fuse Inc 311 Mountain Rd Union City NJ  
Bell & Howell 7100 McCormick Rd Chicago 45 III  
Bell Sound Systems 555 Marlon Rd Columbus 7 Ohio  
Bell Television 254 W 54 St New York 19 NY  
Belford & Co 481 Sterling Pl Brooklyn NY  
Bendix Aviation Corp Red Bank Div Eatontown NJ

Bendix Radio Div Bendix Aviation Towson 4 Md  
Bennett & Co Paul 230 E Ohio St Chicago 30 III  
Bennett Laboratories 2700 Bay Rd Redwood City Calif  
Benrus Watch Co 50 W 44 St New York NY  
Bentley-Harris Mfg 1000 Lime St Conshohocken Pa  
Bergsma Bros 1000 36 St SE Grand Rapids 8 Mich  
Berkshire Laboratories Greenville NH  
Berlant-Concertone 4917 W Jefferson Los Angeles Calif  
Best Electronics 617 19 St Manhattan Beach Calif  
Besteraft Products Co 626 Broadway New York 12 NY  
Bhend Electrical 437 N Michigan Ave Pasadena 4 Calif  
Biggs Co Carl H 2255 Barry Ave Los Angeles 64 Calif  
Birnbach Radio Co 145 Hudson St New York 13 NY  
B & K Mfg Co 3731 N Southport Chicago 13 III  
Black & Decker Mfg Co Towson 4 Md  
Blaco Mfg Co 6541 Euclid Ave Cleveland 5 Ohio  
Billie Electric Co Union Station Bldg Erie Pa  
Blonder-Tongue Labs 526 North Ave Westfield NJ  
Blum & Co Julius Carlstadt NJ  
B & M Elec Co 838 4th Ave Brooklyn 32 NY  
Boetsch Bros 221 E 144 St New York 51 NY  
Bogart Mfg Corp 315 Selgel St Brooklyn 6 NY  
Bogen Co David 29 9th Ave New York 14 NY  
Bolain Bending Co 1702 N Milwaukee Ave Chicago 47 III  
Boland & Boyce 236 Washington Ave Belleville NJ  
Bomac Laboratories Salem Rd Beverly Mass  
Bond Electric Corp New Haven Conn  
Bozak Co R T 114 Manhattan St Stamford Conn  
Brach Mfg Corp 200 Central Ave Newark 3 NJ  
Bradford Components 33 Bishop St Bradford Pa  
Bradley Laboratories 168 Columbus Ave New Haven Conn  
Brady Co W H 727 W Glendale Ave Milwaukee 12 Wis  
Brend & Co Wm North & Valley Sts Willimantic Conn  
B & R Electronics 1701 Boone Ave New York 60 NY  
Bridgeport Brass Aerosol Div Bridgeport Conn  
Bright Star Industries 600 Getty Ave Clifton NJ  
British Electronic 23-03 45 Rd Long Island City 1 NY  
British Industries Corp 164 Duane St New York 13 NY  
Broelmer Electronics Lab 344 E 32 St New York 16 NY  
Brookeraft Mfg 123 Lafayette St New York 13 NY  
Brooklyn TV Co 72 Steuben St Brooklyn NY  
Brooks Radio & TV Corp 84 Vesey St New York 7 NY  
Browning Labs Inc 750 Main St Winchester Mass  
Bruno Tools 9330 Santa Monica Blvd Beverly Hills Calif  
Brush Electronics 3405 Perkins Ave Cleveland Ohio  
Buchen Co R J PO Box 9 Bricelyn Minn  
Bud Radio Inc 2118 E 55 St Cleveland 3 Ohio  
Bullet Electronics 2637 S Lowell St Springfield III  
Bulova Watch Co Bulova Park Flushing 70 NY  
Burgess Battery Co Freeport III  
Burkem Lamination 811 Whittier New York 59 NY  
Burlington Instrument Co 1102 4 St Burlington Iowa  
Burnell & Co 45 Warburton Ave Yonkers 2 NY  
Burton-Rogers Co 42 Corleton St Cambridge 42 Mass  
Bussmann Mfg Co 2536 W University St Louis 7 Mo  
Butler Mfg Co 3150 Randolph St Bellwood III

Caddell-Burns 40 E 2 St Mineola NY  
Calbest Eng'g 828 N Highland Ave Hollywood 38 Calif  
Calcon Mfg Co Oakland Ave Washington Pa  
Caldwell-Clements Manuals 480 Lexington New York NY  
Callifone Corp 1041 N Sycamore Ave Hollywood 38 Calif  
California Plasteck 225 E 4 St Los Angeles 13 Calif  
Calliri Mfg Co 15 Union St Lawrence Mass  
Calvide Tube Co 5232 W 104 St Los Angeles 54 Calif  
Camburn Inc 32-40 57 St Woodside 77 NY  
Camburn Sales & Mfg 134 Orchard Ave Battle Creek Mich  
Camera Equipment Co 1600 Broadway New York 19 NY  
Campbell Industries 3806 St Elmo Chattanooga 9 Tenn  
Campbell X-Ray Corp 110 Cummington Boston 15 Mass  
Cannon Co C F Springfield NY  
Cannon Electric 3209 Humboldt St Los Angeles Calif  
Capehart-Farnsworth Co 3702 E Pontiac St Ft Wayne Ind  
Capitol Records Inc 1730 Broadway New York 19 NY  
Capps & Co Frank L 20 Addison Pl Valley Stream NY  
Carboneau Industries Grand Rapids 4 Mich  
Carborundum Co Global Div Niagara Falls NY  
Cardwell Electronics Productions Allen Plainville Conn  
Carling Electric 505 New Park Ave West Hartford Conn

Carron Mfg Co 741 W Harrison St Chicago 7 Ill  
Carruthers & Fernandez 1501 Colorado Santa Monica  
 Calif  
 Carter Motor Co 2644 N Maplewood Ave Chicago 47 Ill  
 Carter Parts Co 213 Institute Pl Chicago 7 Ill  
 Casard Furniture 507 E Russell St High Point N Car  
 Cass Mfg Co PO Box 889 High Point N Car  
 Cass Machine Co 691 Antoinette St Detroit 2 Mich  
 Cayo TV Eng'g 1904 Mich Hwy 139 Benton Harbor Mich  
 CBC Electronics Co 2601 N Howard Philadelphia 33 Pa  
 CBS Columbia 3400 47 Ave Long Island City 1 NY  
 CBS Hytron 100 Endicott St Danvers Mass  
 C E M Co 24 School St Danielson Conn  
 Central Div 900 E Keefe Ave Milwaukee 1 Wisc  
 Central Electronics Inc 1247 Belmont Ave Chicago Ill  
 Century Electronics Co 111 Roosevelt Ave Mineola NY  
 Certified Radio Labs 5507 13 Ave Brooklyn 19 NY  
 Certified Tube Co 16 & Luzerne Sts Philadelphia 40 Pa  
 CGS Labs Inc 391 Ludlow St Stamford Conn  
 Champion de Arment Tool Co Meadville Pa  
 Chamroo Record Cleaner Co Box 532 Rochester NY  
 Chance Co A B 210 N Allen St Centralia Mo  
 Channel Master Corp Ellenville NY  
 Chase & Sons 199 Highland Ave Randolph Mass  
 Chase Mfg Co 5008 W Jefferson Blvd Los Angeles 16  
 Chatham Electronics 630 W Mt Pleasant Livingston NJ  
 Chemical Electronic Eng'g 1025 Broad St Newark 2 NJ  
 Chester Cable Corp Highview St Chester NY  
 Chicago Condenser 3255 W Armitage Chicago 47 Ill  
 Chicago Industrial Instr Co 536 W Elm St Chicago 10 Ill  
 Chicago Standard Transformer 3850 Elston Chicago 18 Ill  
 Chicago Telephone Supply 1142 W Beardsley Elkhart Ind  
 Chromatic Television Labs 703 37 Ave Oakland Calif  
 Church III Lighting 344 Franklin St Melrose 76 Mass  
 Clma Corp 119 Braintree St Allston Mass  
 Clnaudograph Corp 7334 N Clark St Chicago 26 Ill  
 Clinch-Jones Div Clinch Mfg 1026 S Homan Ave Chi Ill  
 Cincinnati Ventilating Co 3rd & Madison Covington Ky  
 Circon Component Co 17544 Raymer St Northridge Calif  
 Circutron Inc 155 W Main St Rockville Conn  
 Cisl Harry G Amagansett NY  
 Claremont Tube 36-02 35 Ave Long Island City NY  
 Clark Electronic Labs Box 165 Palm Springs Calif  
 Clarostat Mfg Co Washington St Dover NH  
 Clear Beam Antenna 21341 Roscoe Blvd Canoga Park  
 Calif  
 Cleveland Electronics 6611 Euclid Ave Cleveland Ohio  
 Clifton Conduit Piereway 75 Montgomery Jersey City NJ  
 Cline Electric Mfg 3405 W 47 St Chicago 32 Ill  
 Clippard Instrument Lab 7350 Colerain Cincinnati Ohio  
 Clough-Brenole Co 6014 Broadway Chicago 40 Ill  
 Clum Mfg Co 611 W National Ave Milwaukee 41 Wisc  
 Coaxial Connector Co 37 N 2 Ave Mt Vernon NY  
 Codelyter Laboratories 550 S 5 Ave New York 19 NY  
 Coll Co of America Washington St Northvale NJ  
 Coll Winders Inc 100 NY Ave Westbury LI NY  
 Coll Winding Equipment 19 Maxwell Ave Oyster Bay NY  
 Coleman Cable & Wire 4525 W Addison St Chicago 41 Ill  
 Collins Audio Products Route 29 Mountalnside NJ  
 Collins Machine Co 158 Albany Post Rd Buchanan NY  
 Collins Radio Co Cedar Rapids Iowa  
 Colosseum Records Oakwood Rd Norwalk Conn  
 Colortone Electronics 100 Frank Rd Hicksville NY  
 Color TV Inc 973 E San Carlos Ave San Carlos Calif  
 Columbia Products Co Box 5207 Columbia S Car  
 Columbia Records 799 7 Ave New York 19 NY  
 Columbia Resistors 23 W Washington Pearl River NY  
 Columbia Technical Corp S E 57 St New York 22 NY  
 Columbia Wire & Supply 2850 Irving Park Rd Chicago Ill  
 Comfort Lines 1735 Diversey Pkwy Chicago 14 Ill  
 Commercial Products 417 Main St Toledo 1 Ohio  
 Communication Access Hickman Mills Mo  
 Components Corp Denville NJ  
 Conant Laboratories 6500 O St Lincoln Nebr  
 Concert Hall Society 43 W 61 St New York NY  
 Condenser Products Co 7517 N Clark St Chicago 26 Ill  
 Conn-Cord Inc Progress Ave & Monroe Sts Union NJ  
 Connecticut Telephone & Electric Corp Meriden Conn  
 Conrac Inc 19217 E Foothill Blvd Glendora Calif  
 Consolidated Radio Products 350 W Erie St Chicago Ill  
 Consolidated Wire 1635 S Clinton St Chicago 16 Ill  
 Constad Laboratories 146 W 29 St New York 1 NY  
 Continental Carbon 13900 Lorain Ave Cleveland Ohio  
 Continental Electric Co 715 Hamilton St Geneva Ill  
 Continental Electronics 5920 Lancaster Ave Phila Pa  
 Control Electronics 1925 NY Ave Huntington Sta NY  
 Cook Laboratories 114 Manhattan St Stamford Conn  
 Cooper Electronic Prods 5637 Tulip St Philadelphia Pa  
 Cooperative Industries Inc Chester NJ  
 Copper Industries 4953 W Fullerton Ave Chicago 39 Ill  
 Copperwell Steel Co Wire & Cable Div Glassport Pa  
 Cordover Co Carl 100 Warren St New York NY  
 Cornell-Dubiler Elec Corp S Plainfield NJ  
 Corning Glass Co Electronic Div Corning NY  
 Cornish Wire Co 50 Church St New York 7 NY  
 Coronet Electronics Inc 505 N LaSalle Chicago 1 Ill  
 Corson Electric Mfg 540 39 St Union City NJ  
 Cosa Corp 405 Lexington Ave New York 17 NY  
 Cosmic Radio Corp 853 Whittier St Bronx NY  
 Cosino Inc 2326 Madison Ave Toledo Ohio  
 Creative Plastics Corp Rt 25-A Stony Brook NY  
 Crescent Industries 5900 Touhy Ave Milledale Ill  
 Crest Labs 84-11 Rockaway Beach Blvd Rockaway Beach  
 93 NY  
 Crest Transformer Corp 1834 W North Ave Chicago 22 Ill  
 Crosley Radio-TV 1329 Arlington Cincinnati 25 Ohio  
 Crowley & Co Henry L 1 Central Ave W Orange NJ  
 Crown Controls Co 40 S Washington St New Bremen Ohio  
 Cryco Inc 1138 Mission St S Pasadena Calif  
 Cummins-Chicago 4740 N Ravenswood Chicago Ill  
 Cunningham Son James 33 Litchfield Rochester 8 NY  
 Cutler-Hammer Inc 436 N 12 St Milwaukee 1 Wisc

Dane Electronic Labs PO Box 209 Salem Mass  
 Danforth Mfg Co 531 S 3 St Monmouth Ill  
 Daven Co 191 Central Ave Newark 4 NJ  
 Davis Electronics 4002 Burbank Blvd Burbank Calif  
 Daystrom Electric 753 Main St Poughkeepsie NY  
 Deal Products Heltertown Rd MR 37 Easton Penna  
 Dean Sales Co 425 Devoe Ave New York 60 NY  
 Decca Records Inc 50 W 57 St New York NY  
 Deico Radio 1446 S Home Ave Kokomo Ind  
 Delco-Remy Div General Motors Corp Anderson Ind  
 Delson Mfg Corp 126 11 Ave New York 11 NY  
 Delltron Inc 2905 N Leithgow St Philadelphia Pa  
 DeMars Eng & Mfg Co 360 Merrimack St Lawrence Mass  
 Deutschmann Corp Tobe Norwood Mass  
 DeWald Radio & TV 35-15 37 Ave Long Island City NY  
 Diallight Corp 60 Stewart Ave Brooklyn 37 NY  
 DI-CO TV & Plastic Co 61 Erna St Millford Conn  
 Dictograph Prods HI-Fi Music 95-25 149 Jamaica NY  
 Dietz Design & Mfg Co Box 222 Grandview Mo  
 Digital Products Inc 7643 Fay Ave LaJolla Calif  
 D & M Products 13144 W McNichols Rd Detroit 35 Mich  
 Dongan Electric Mfg 2987 Franklin St Detroit 7 Mich  
 Dormitzer Electric & Mfg 5 Hadley St Cambridge Mass  
 Dorn Equipment Corp 88 Broad St Boston 10 Mass  
 Douglas Roesch Inc 2200 S Figueroa Los Angeles 7 Calif  
 Dover Publications Inc 1780 Broadway New York NY  
 Dow-Keel Co Warren Minn  
 D & R Ltd 402 E Gutierrez St Santa Barbara Calif  
 Drake Co R L 8 E Central Ave Miamisburg Ohio  
 Drake Electric Works 3656 Lincoln Ave Chicago 13 Ill  
 Drake Mfg Co 1713 W Hubbard St Chicago 22 Ill  
 Dreler Bros 5642 Lake Park Ave Chicago 37 Ill  
 Dubbings Co 41-10 45 St Long Island City 4 NY  
 Duala Co Box 78 Coal Fork W Va  
 DuKane Corp St Charles Ill  
 DuMont-Airplane & Marine Instruments Clearfield Pa  
 DuMont Labs Allen B Cathode Ray Tube Div 750  
 Bloomfield Ave Clifton NJ  
 DuMont Labs Inc Instr Div 760 Bloomfield Ave Clifton NJ  
 DuMont Labs Allen B Tele-set Div 55 Market St E  
 Paterson NJ  
 Duotone Co Locust St Keyport NJ  
 Durakool Inc 1012 N Main St Elkhart Ind  
 Duro Specialty Co 8 Bennett St Lynn Mass  
 Dwyer Eng'g Co PO Box 483 Nashua NH  
 DX Radio Products Co 2300 Armitage Ave Chicago 47 Ill  
 Dynamic Electronics 73-39 Woodhaven Glendale LI NY  
 Dynavox Corp 40-04 21 St Long Island City NY

Eagle Electric 23-10 Bridge Plaza S Long Island City NY  
 Eagle Electronics Corp 177 Hart St New Britain Conn  
 Eagle Speaker Co 15 S Fairview Park Ridge Ill  
 Eastern Teletable Corp 294 Broad St Lynn Mass  
 Easy-Up Tower Co Racine Wisc  
 Ebert Electronics 212-26 Jamaica Queens Village NY  
 Eby Co Hugh H 4700 Stenton Ave Philadelphia 44 Pa  
 Eby Sales Co 130 Lafayette St New York 13 NY  
 Eckstein Radio & TV 3400 E 42 St Minneapolis 6 Minn  
 Ed-Berl Products Inc 96 S Grand Ave Baldwin NY  
 Edison Inc Thomas A W Orange NJ  
 Edu-Craft Sales Corp 150-45 12 Ave Whitestone NY  
 Eico 84 Withers St Brooklyn 11 NY  
 Elocor Inc 1501 W Congress St Chicago 7 Ill  
 Eldon Electronics 1902 N 3 St Temple Texas  
 Eitel-McCullough 798 San Mateo Ave San Bruno Calif  
 Elastic Stop Nut Corp 2330 Vauxhall Rd Union NJ  
 Eloc Corp M St below Erie Ave Philadelphia 24 Pa  
 Elcraft Electronics 32-28 49 St Long Island City NY  
 Elec & Musical Industries 38 W 48 St New York NY  
 Electric Indicator Co Camp Ave Springdale Conn  
 Electric Soldering Iron Co Deep River Conn  
 Electrical Service 1271 Mission St San Francisco Calif  
 Electro Eng'g Products 609 W Lake St Chicago 6 Ill  
 Electro Mechanical Instrument 812 Chestnut Perkasie Pa  
 Electromotive Mfg Co Willimantic Conn  
 Electron Enterprises 6917 Stanley Ave Berwyn Ill  
 Electronic Beam Corp 923 Old Nepperhan Ave Yonkers NY  
 Electronic Chemical 813 Communipaw Ave Jersey City NJ  
 Electronic Crafts 74 Cortland St New York 7 NY  
 Electronic Draft Assoc 125 E 46 St New York 17 NY  
 Electronic Eng'g 3323 W Armitage Ave Chicago 47 Ill  
 Electronic Fabricators 682 Broadway New York 12 NY  
 Electronic Hardware Co 2420 W Cermak Rd Chicago 8 Ill  
 Electronic Instrument 84 Withers St Brooklyn 11 NY  
 Electronic Measurements 280 Lafayette St New York NY  
 Electronic Test Instrument Corp 13224 Livernols Ave  
 Detroit Mich  
 Electron-Radar Prods 1041 N Pulaski Rd Chicago 51 Ill  
 Electrons Inc 127 Sussex Ave Newark 3 NJ  
 Electro-Physics Co 287P Broadway New York 7 NY  
 Electro Products Labs 4501 N Ravenswood Chicago Ill  
 Electro-Sonic Labs 35-54 36 St Long Island City NY  
 Electro Sound Corp 115 Halleck St Boston 20 Mass  
 Electro-Tech Equip Co 308 Canal St New York 13 NY  
 Electro-Technic Prods 4602 Montrose Ave Chicago 41 Ill  
 Electro-Voice Inc Buchanan Mich  
 Eletrovox Co 60 Franklin St E Orange NJ  
 Electymc Motor Products Corp Genoa Ill  
 Elektra Records 361 Bleeker St New York NY  
 Elgin Electronic Corp PO Box 13 Bluffton Ind  
 El-Rad Mfg Co 2800 W Cullom Ave Chicago 18 Ill  
 Ely Electronics Corp 22-02 Rappahat St Fairlawn NJ  
 Elreco Corp 2900 Company Ave Cincinnati 25 Ohio  
 Eltran Corp 109 W Station St Anne Ill  
 E M C Recordings 806 E 7 St St Paul Minn  
 Emerson Radio & Phonograph 14 & Coles St Jersey City  
 NJ  
 Energy Farm Equipment Co Monticello Iowa  
 Enco Mfg Co 4522 W Fullerton Ave Chicago 39 Ill  
 Enco Electronics Inc 140 Liberty St New York 6 NY  
 Enco Record Co 243 W 72 St New York NY  
 Equipto Div Aurora Equip 422 Cleveland St Aurora Ill  
 Erie Resistor Corp 644 W 12 St Erie 6 Pa  
 Erwood Inc 1770 Rerteau St Chicago Ill  
 Esco Mfg Co Box 344 Summit Ill  
 Esoteric Records 11 W 18 St New York NY  
 Espy Mfg Co 528 E 72 St New York 21 NY  
 Essex Wire Corp 1601 Wall St Ft Wayne 6 Ind  
 Executone Inc 415 Lexington Ave New York 17 NY

Fada Radio & Electric 525 Main St Belleville NJ  
 Fairchild Recording Equipment Co Whitestone 57 NY  
 Falmer Mfg Co 312 N Walnut St Youngstown 2 Ohio  
 Fanon Electric 150-09 South Rd Jamaica LI NY  
 Fantasy Records 489 S 5 Ave New York 17 NY  
 Farrington Mfg 76 Atherton St Boston Mass  
 Federal Anti Capacity Switch 72 Kingsley Buffalo NY  
 Federal Mfg & Eng'g Corp 199 Steuben St Brooklyn 5 NY  
 Federal Screw Products 3917 N Kedzie Ave Chicago 18 Ill  
 Federal Telephone & Radio 100 Kingsland Rd Clifton NJ  
 President—R S Perry  
 Vice Pres—G T Schaffenberg  
 Vice Pres-Apparatus Div—T M Douglas  
 Vice Pres-Components Div—S J Powers  
 Vice Pres-Dir Purchases—C G Sherwood  
 Vice Pres-Comptroller—R de F Osborne  
 General Sales Mgr—J A Frabutt  
 Components Sales Mgr—D W Potter  
 Sales Mgr Semi-Conductors—J E Van Wageningen  
 Sales Mgr Wire & Cable—A Anderson  
 Distributor Sales Mgr—E L Shaw  
 Mgr Sales Service—J T Kane  
 Germanium Diodes Only  
 Columbus-IDS—Jack W. Lehner 367 Bryhill Road  
 Covers Ohio-West Virginia-Pennsylvania (that  
 portion of the State lying West of but not in-  
 cluding the Counties of Tioga, Lycoming, North-  
 umberland, Dauphin, and York)  
 Dallas-IDS—Dellzell, Maynard 3409 Oaklawn Ave  
 Justin 2411 Covers Oklahoma-Arkansas-Louisia-  
 siana-Texas (Except El Paso County)  
 Selenium Rectifiers—Coaxial Cable  
 Germanium Diodes  
 Atlanta-IDS—Cartwright & Bean 3230 Peachtree Rd  
 NE Exchange 2273 Covers Alabama-Florida-  
 Georgia-Mississippi-North Carolina-South Caro-  
 lina-Tennessee  
 Atlantic City-IDS—Victor W Williams 5 Circle Drive  
 Margate Atlantic City 2-7859 Covers Maryland-  
 District of Columbia-Delaware (Counties of  
 Kent and Sussex)-Virginia  
 Boston-IDS—Abbett & Hustis 1105 Commonwealth  
 Avenue ALgonquin 4-8100 Covers Maine-New  
 Hampshire-Vermont-Massachusetts-Rhode Island-  
 Connecticut  
 Boston-IDS—Robert W. Gray Inc 572 Washington  
 Street Wellesley 81 Wellesley 5-5296, 5-0191  
 Covers Connecticut (except Counties of Fair-  
 field, New Haven and Middlesex) Maine-Massa-  
 chusetts-New Hampshire-Rhode Island-Vermont  
 Buffalo-IDS—R W Mitscher 487 Elliott Square  
 Building Washington 2517 Covers New York  
 (except Counties of Bronx, Kings, Nassau, New  
 York, Queens, Richmond, Rockland, Westches-  
 ter, Suffolk)  
 Charlotte-North Carolina-IDS—Cartwright & Bean  
 PO Box 9203 Franklin 6-8648 Covers Alabama-  
 Florida - Georgia - Mississippi - North Carolina -  
 South Carolina-Tennessee  
 Chicago-IDS—Leroy W Beier Company 6518 West  
 North Avenue Berksire 7-2420 Covers Illinois-  
 Wisconsin (South of an East-West Line through  
 La Crosse but not including the City of  
 La Crosse and East of a North-South Line  
 through Ironwood, Michigan)  
 Dallas-IDS—Campion Sales Company\* 208 West  
 Avery St Randolph 6620 Covers Oklahoma-  
 Arkansas-Louisiana and Texas (except El Paso  
 County)  
 \*Dayton-IDS—Neal Bear Corp 1110 Broad Blvd  
 OXmore 3041 Covers Ohio-West Virginia-  
 Pennsylvania (that portion of the State lying  
 West of but not including the Counties of  
 Tioga, Lycoming, Northumberland, Dauphin  
 and York)  
 Denver-IDS—Hyde Sales Company 3250 South Dexter  
 Street Skyline 6-7151 Covers Colorado-Wyoming-  
 Utah-Montana (Eastern half of the State to the  
 boundaries of Hill, Chateau, Judith Basin,  
 Wheatland, Sweetgrass and Park Counties) Idaho  
 (Southern half of State including the counties  
 of Washington, Gem, Boise, Custer, Clark and  
 Fremont)-New Mexico-Texas (El Paso County)  
 Detroit-IDS—K C Buraw and Company 22128 Grand  
 River Avenue Kenwood 3-7700 Covers Michigan  
 Indianapolis-IDS—Quinn Cunningham & Associates  
 6101 College Avenue Glendale 3222, 0225  
 Covers Indiana-Kentucky  
 Kansas City-IDS—F C Somers 18th and Grand Ave-  
 nue Office Grand 1355 Covers Iowa-Nebaska-  
 Missouri-Kansas  
 Los Angeles-IDS—J W Marsh Company 4216 W Jef-  
 ferson Blvd Republic 2-0145 Covers California-  
 Nevada-Arizona  
 Memphis-IDS—Cartwright & Bean 1336 Madison  
 Avenue Memphis 2-1914 Covers Alabama-Flori-  
 da - Georgia - Mississippi - North Carolina -  
 South Carolina-Tennessee  
 Minneapolis-IDS—H M Richardson\* 9 East 22nd  
 Street Geneva 4078 Covers Minnesota-North  
 Dakota-South Dakota-Wisconsin (the Section  
 North of an East-West Line through LaCrosse  
 including the City of LaCrosse and West to a  
 North-South Line to Ironwood Michigan)  
 Philadelphia-IDS—J R Benge Technical Representa-  
 tion 25 S Easton Road Suite 200 Glenside Pa  
 Turner 1325 and 1326 Covers Delaware (New  
 Castle County)-New Jersey (Radio Corp of Ameri-  
 ca at Princeton the City of Phillipsburg the City  
 of Trenton, and all area south of the City of  
 Trenton), Pennsylvania (all the area West to  
 and including the Counties of Tioga, Lycoming,  
 Northumberland, Dauphin, and York)  
 (Listings continued next page)

(Federal Continued)

Philadelphia-15—J R Bengt Technical Representation 25 South Easton Road Suite 200 Glenside Pa Turner 1325 and 1326 Covers Maryland-District of Columbia and Delaware

Phoenix-1DS—J W Marsh Company 1011 West Whitton AveHerst 6-9124 Barney Schlecht Covers California-Nevada-Arizona

Ridgefield-Conn-DS—Abbett & Mustis 52 Main St Covers Connecticut - Maine - Massachusetts - New Hampshire-Rhode Island-Vermont

Son Francisco-1DS—J W Marsh Company 1258 Fitzgerald Avenue VAlencia 4-6714 Covers California-Nevada-Arizona

Santa Fe-NM-DS—Hyde Sales Co 206 Lugar De Monte Vista SAnta Fe 3-7884 Covers New Mexico-Texas (El Paso County)-Utah-Wyoming

Seattle-1DS—Fred H Haight Company 3212 East Lake Avenue EAst 1818 Covers Oregon-Washington-Idaho (Northern half of the State including Counties of Adams, Walley, Lemhi)-Montana (Western half of State including Counties of Hill, Choteau, Judith Basin, Wheatland, Sweetgrass, and Park)

Tompa-1DS—Cartwright & Bean 3610 Kensington Ave Covers Alabama-Florida-Georgia-Mississippi-North Carolina-South Carolina-Tennessee

Westfield N J-1DS—H G Richter 467 Hillside Avenue Westfield 2-4615 and Miggins Soles 107-37 71st Avenue Forest Hills Long Island New York Boulevard 3-1643 Covers New York City (including Counties of Nassau, Rockland, Westchester, and Suffolk)-New Jersey (except Radio Corp of America at Princeton, the City of Phillipsburg, Trenton and the area South of Trenton)-Connecticut (Counties of Fairfield, New Haven, and Middlesex)

West Hartford-Conn-15—Robert W Gray Inc 10 N Main St Adams 3-5629 Covers Connecticut (except Counties of Fairfield, New Haven and Middlesex)-Maine-Massachusetts-New Hampshire-Rhode Island-Vermont

West Richfield Ohio-1DS—Neal Bear Corporation\* 3435 Streetsboro Rd West Richfield 100 Covers Ohio, West Virginia, Pennsylvania (that portion of the State lying West of but not including the Counties of Tioga, Lycoming, Northumberland, Dauphin, and York)

\*Selenium Rectifiers and Coaxial Cable Only

Federated Metals 120 Broadway New York 5 NY

Feller Eng's Mfg 8026 N Monticello Ave Skokie Ill

Femco Inc Irwin Pa

Fenton Co 15 Moore St New York 4 NY

Ferranti Electric 30 Rockefeller Plaza New York 20 NY

Ferris Instrument Co 110 Cornellia St Boonton NJ

Fideltone Inc 6415 Ravenswood Ave Chicago 26 Ill

Fidelity Amplifier Co 703 Willow St Chicago 14 Ill

Fidelity Chemical 470 Frellinghuysen Ave Newark 5 NJ

Filtron Co 131-15 Fowler Ave Flushing NY

Finney Co 4612 St Clair Ave Cleveland 3 Ohio

Fisher Co Oscar 1000 N Division St Peekskill NY

Fisher Eng'g Co Huntington Ind

Fisher-Pierce Co 170 Pearl St S Braitree 85 Mass

Fisher Radio 21-21 44 Dr Long Island City 1 NY

FKB Opticon Co 1738 E Calvert St South Bend 14 Ind

Flexo Int'l Co 3245 W Lake St Chicago 24 Ill

Flux Wire Div Copperweld Steel Co Oswego NY

Fonotalk Corp 11 S LaSalle St Chicago Ill

Forbes & Wagner 345 Central Ave Silver Creek NY

Forsberg Mfg Co 125 Seaview Ave Bridgeport 1 Conn

Fortane Records 11629 Linwood St Detroit 6 Mich

Freed Electronics & Controls 200 Hudson New York NY

Freed Transformer 1718 Weirfield St Brooklyn 27 NY

Frequency Standards Box 504 Asbury Park NJ

Fretze Inc 406 W Craig St Pittsburgh 13 Pa

President—Joseph V Fisher  
 Vice Pres—Frank H Robinson  
 Sales Eng—Dave Hall

Products: TV antennas and accessories—open wire lead-in—ground wire—aluminum tubing—transistors—semiconductor-relays

Brand Names: Super Spectrum—Victoria—Fretzray, Spectrum—Customliner—V-2—V-4—Mi Tec Ray—Bo-Ti—Stroto-Ray—Saucerline and Fretline

Representatives:

CALIF—David Ellis David Ellis Co 91 E Foothill Blvd Altadena Ryan 19108 Territory: Southern Calif—Ariz—Las Vegas, Nev

CALIF—Nickerson & Rudot 381 Brannon St San Francisco Calif Yukon 22982 Territory: San Francisco & Sacramento Calif—Hanolulu—Hawaii

D C—L H Leiser International Buyer Service 217 Bond Bldg Territory: Cuba

ILL—George E Lewis G E Lewis Inc 5420 W Fullerton Ave Chicago 39 Territory: Ill—Wis—Minn

MISSOURI—Ward Paden Co Box 569 Jefferson City Mo 51023 Territory: Mo—Kan—Iowa—Neb

NEW YORK—H/V Associates 136 Liberty St NY 6 NY Worth 46193 Territory: NY—NJ down to Trenton

PA—Herman Lewis 1622 68th Ave Philadelphia Pa Livingston 81281 or 88487 Territory: Del—Md—NJ & Eastern Pa

TEXAS—Harry Birenbaum Bee Soles Co 4200 Sherry Lane Dallas Forest 87084 Territory: Texas—La—Okla—Ark

WASH—M K Widdekind 216 First Ave N Seattle Wash Elliott 6981 Territory: Idaho—Mont—Ore—Wash

CANADA—Mike Rosen (Harold Rosen) Active Radio & TV Distrs 58 Spadina Ave Toronto

Fretz Gross Co 22 & Sedgley Philadelphia 32 Pa  
 Furnas Electric Co 1000 McKee St Batavia Ill

Gahagan Inc 11 W 4 St Bethlehem Pa  
 Galbraith & Son 450 6 Ave New York 11 NY

Garde Mfg Co 588 Eddy St Providence 3 RI

Garod Radio 70 Washington St Brooklyn 1 NY

Garrard Sales Corp 164 Duane St New York 13 NY

Gee-Lar Mfg Co 819 Elm St Rockford Ill

Gaiss-America 6424 Northwestern Ave Chicago Ill

General Apparatus Co 344 E 32 St New York 16 NY

General Cable Corp 420 Lexington Ave New York 17 NY

General Cement Mfg Co 919 Taylor Ave Rockford Ill

General Crystal Co Box 9 Burlington Wis

General Dry Batteries 13000 Athens Cleveland 7 Ohio

General Electric Co 1285 Boston Ave Bridgeport 2 Conn

General Electric Co 1 River Rd Schenectady NY

General Electric Co Electronics Park Syracuse NY

General Industries Co Oliver & Taylor Sts Elyria Ohio

General Instrument Corp 829 Newark Ave Providence RI

General Insulated Wire 69 Gordon Ave Pittsburg 32 Pa

General Phones Corp 5711 Howe St Pittsburg 32 Pa

General Products Corp 1707 Salem St Union Springs NY

General Test Equipment Co 38 Argyle Pl Buffalo 22 NY

General Transformer Co 18240 Harwood Ave Homewood Ill

General Transistor 95-18 Sutphin Blvd Jamaica 35 NY

General Vacuum Tube Corp Ardsley NY

Germanium Prods Corp 26 Cornell Ave Jersey City NJ

Gerrard Steel Strap A J 1950 Hawthorne Melrose Park Ill

G & H Wood Products Co 75 N 11 St Brooklyn 11 NY

Girard Hopkins 1000 40th Ave Oakland 1 Calif

G & M Equipment Co 7315 Varma Ave N Hollywood Calif

Gosnet Co 801 S Main St Burbank Calif

Good-All Elec Mfg Co Ogallala Nebr

Good Inc Don 1014 Fair Oaks Ave S Pasadena Calif

Gordon Enterprises 5362 N Cahuena N Hollywood Calif

Gotham Television Corp 123 W 64 St New York 23 NY

Gramer-Hallorson Transformer 2734 N Palaski Chicago

Granco Products 36-07 20 Ave Long Island City 5 NY

Grange Inc 830 Monroe St Hoboken NJ

Grant Palley & H J 31-85 Whitestone Pkwy Flushing NY

Gravelly Novelty Furniture Ridgeway Va

Graybar Electric Co 420 Lexington Ave New York NY

Grayhill 561 Hillgrove LAgrange Ill

Grayline Eng'g Co 12243 Ave O Chicago 33 Ill

Gray Research & Devel 658 Hilliard St Manchester Conn

Gray Eastern Mfg Co 163 Remsen Ave Brooklyn 12 NY

Greene Co L C 314 Washington St Newton 58 Mass

Greenlee Tool Co 1887 Columbia Ave Rockford Ill

Guardian Electric Mfg Co 1621 W Walnut Chicago 40 Ill

Gudeman Co 340 W Huron St Chicago 10 Ill

Gulld Radio & TV Co 400N Eucalyptus Ave Inglewood Calif

Gusdorf & Son 6900 Manchester St Louis 17 Mo

Gyro Electronics Co 325 Canal St New York 13 NY



Hallierafters Co 4401 W 5 Ave Chicago 24 Ill

Hamilton Electronics 2726 Pratt Ave Chicago 45 Ill

Hammarlund Mfg Co 460 W 34 St New York 1 NY

Hansen Mfg Co 1954 First St Princeton Ind

Hardwick Hindle Inc 40 Hermon St Newark 5 NJ

Harmon-Kardon 520 Main St Westbury 11 NY

Harnett Electric Corp 139 Haven Ave Port Washington NY

Harper & Bros 49 E 33 St New York NY

Harper Co H M 8200 Lehigh Ave Morton Grove Ill

Hartley Co H A 521 E 162 St New York NY

Harvey-Wells Electronics Southbridge Mass

Hastings Products 161 Huntington St Boston 16 Mass

Hayden Society Inc 30 Newington Ave Boston Mass

Hayden Mfg Co 245 E Elm St Torrington Conn

Hayden Swith Inc 232 N Elm St Waterbury Conn

Haydu Bros Box 1226 Plainfield NJ

H-B Instrument American & Bristol Sts Philadelphia Pa

Heath Co 305 Territorial Benton Harbor Mich

Hedeo Mfg Co 161 W Huron St Chicago 10 Ill

Helmemann Electric Plum St & Panna Ave Trenton NJ

Heller Co 2135 Superior Ave Cleveland 14 Ohio

Hamlngway & Bartlett 500 5 Ave New York NY

Hepner Mfg Co PO Box 608 Round Lake Ill

Hetherington Inc Sharon Hill Pa

Hewi Duty Electr 4212 W Highland Blvd Milwaukee Wis

Hewlett-Packard Co 481 Page Mill Rd Palo Alto Calif

Hexacon Electric Co 161 W Clay Ave Roselle Park NJ

H & H Products PO Box 2333 Tert Annex Los Angeles

Hlekok Electrical Instr 10514 Dupont Ave Cleve 8 Ohio

Hillburn Electronic Prods 55 Nassau Ave Brooklyn 22 NY

Hi-Lo TV Antenna 3540 N Ravenswood Ave Chicago 13 Ill

Hindle Transformer Co Woods Church Rd Flemington NJ

Hinners-Galanek 25-14 Broadway Long Island City 6 NY

Hi-Par Products Co 347 Lundenburg St Fitchburg Mass

Hitemp Wires Inc 26 Windsor Ave Mineola NY

H M H TV Industries 746 N Pickering St Whittier Calif

Hobbs Inc Guy Dallastown Pa

Hobson Bros 4940 W Lawrence Ave Chicago 30 Ill

Hoffman Electronics PO Box 2153 Los Angeles 54 Calif

Holub Industries 413 DeKalb Ave Sycamore Ill

Hotel Radio Mrs 1040 W Fort St Detroit 26 Mich

Hubbell Co Harvey State & Bostwick Bridgeport 2 Conn

Hubbell Mfg Co H L Route 21 Zealand Mich

Hudson Lamp Co 528 Elm St Arlington N J

Hudson Wire Co Winsted Div Winsted Conn

Hughes Aircraft Semiconductor Div Culver City Calif

Hull & Co R O 1300 Parsons Ct Rocky River Ohio

Hunter Tools 6608 S Gretna Whittier Calif

Hutch & Son 125 S Elizabeth St Lima Ohio

Hycor Mfg Co 2961 E Colo St Pasadena 8 Calif

Hycor Co 11423 Vanowen St N Hollywood Calif

Hydro-Altre Sub Crane Co 3000 Wilona St Burbank Calif

Hy-Gain TV Products 1828 N St Lincoln Nebr

Hy-Lite Antennae Inc 242 E 137 St New York 51 NY

Ideal Industries Inc Sycamore Ill

I E Mfg 325 N Hoyne Ave Chicago 12 Ill

I G Textile Co 30 E 21 St New York N Y

Illinois Condenser 1616 N Throop St Chicago 22 Ill

Illinois Transformer 412 S Green St Chicago 7 Ill

Illinois Wood Prods 1656 N Besley Ct Chicago 22 Ill

Imperial Radar & Wire 1661 Boone Ave New York 60 NY

Industrial Condenser 3243 N Calif Ave Chicago 18 Ill

Industrial Invents Inc 22 State Rd Edgewater NJ

Industrial Hdw Mfg Co 109 Prince St New York 12 NY

Industrial Instruments 89 Commerce Rd Cedar Grove NJ

Industrial Television 369 Lexington Ave Clifford NJ

Industrial Test Equip Co 55 E 11 St New York 3 NY

Inet Div Leach Corp 4441 S Santa Fe Los Angeles Calif

Ingalls Electronics 30 W Putnam Ave Greenwich Conn

Injection Molders Supply 3514 Lee Rd Cleveland Ohio

Instrument Laboratories 315 W Walton Pl Chicago Ill

Instruments Resistors Co 1036 Commerce Ave Union NJ

Insuline Corp America 186 Granite St Manchester NH

Intercontinental Industries 555 W Adams St Chicago 6 Ill

Interelectronics 2432 Grand Concourse New York 58 NY

Int'l Electronics Corp 147 Parkhouse St Dallas Texas

Int'l Instruments Inc PO Box 2954 New Haven 15 Conn

Int'l Radio S 17 & Mishawaka Elkhart Ind

Int'l Rectifier Corp 1521 E Grand Ave El Sagundo Calif

Int'l Research Assoc 2221 Warwick Ave Santa Monica Calif

Int'l Resistance Co 401 N Broad St Philadelphia 8 Pa

Int'l Register Co 2620 W Washington Blvd Chicago 12 Ill

Int'l Scientific Indust 3101 42 St Minneapolis Minn

Interstate Photo Supply 17 W 17 St New York 11 NY

Irrington Varnish & Insulator 6 Argyle Terr Irvington 11 NJ

Isolantite Mfg Corp Warren Ave Stirling NJ

I T E Circuit Breaker Co 19 & Hamilton Sts Philadelphia Pa

Jackson Electrical Instr Co 18 S Patterson Dayton Ohio

JaMac Products 8845 N E Sandy Blvd Portland 20 Ore

Jamestown Table Co Jamestown NY

James Vibrapow Co 4036 N Rockwell St Chicago 18 Ill

Jan Hardware Mfg Co 75 W 11 St Brooklyn 11 NY

Jansa Woodworking Corp 315 Meserole St Brooklyn NY

Jarvis Electronics 6058 W Fullerton Ave Chicago 39 Ill

Javex PO Box 646 Redlands Calif

J B T Instruments 441 Chapel St New Haven 8 Conn

Jennings Radio Mfg Co PO Box 1278 San Jose 8 Calif

Jensen Industries 733 W Harrison St Forest Park Ill

Jerrold Electronics 23 & Chestnut St Phila 46 Pa

Jersey Specialty Co Burgess Place Mountain View NJ

Jewell Inc A W 82 Broad St Elyria 1 Ohio

JFD Mfg Co 6101 16 Ave Brooklyn 4 NY

President—Julius Finkel  
 VP—Albert Finkel  
 Gen Sls Mgr—Edward Finkel  
 Traffic Mgr—Raymond Mastrobuoni  
 Credit Mgr—Marvin Westin  
 Export Mgr—L L Minthorne Co

Trade Names—Star Helix Rainbow, Jet-Helix Rainbow, Fireball, Yagi-Helix, Roto-King Rotator, Diatomic, Baline, Bowtie-Flector, Cascade, Commandair, JeTenna, Jetomic, Lightning Sentry, Pace-Setter, Plug-In, Quik-Rig, Safe TV Guard, Sky-Stream, Sky-Top, Sten-Guard, Super-Beam, Superjet, Ultra V-Beam, Bronzidite, PAL, 3-in-1, Tune-A-Scope, Color-Tenna, Tele-Plex, Venus

Baltimore-SE—Dave Brothers, 3851 Baumon Ave Liberty 9644 Covers MD-Va

Belleville Illinois-SE—Herb E Knaggs 7503 Melba Ave Covers Mo-Neb-Iowa-Kansas

Birmingham Mich-SE—Wayne C Beitel Co 139 W Maple Covers Mich

Boston-SE—Abbett-Mustis Co 1105 Commonwealth Ave Covers Me-NH-Vt-Mass-RI-Conn

Charlotte-SE—Foy M Howard 2908 Hutchinston Ave Covers N Car-S Car-Ga-Fla-Tenn-Ala-Miss

Chicago-SE—Arnold-Vore Assn 1321 Rosedale Ave SUNnyside 4-5217 Covers Minn-N Dak-S Dak-Wisc

Chicago-SE—George Pettit 549 Washington Blvd RANDolph 6-0582 Illinois

Cleveland-SE—Mike Roth Sls Co 13947 Cedar Road Covers Ohio-W Va-Pa (Only Erie-Pittsburgh-Beaver Falls-Altouna-New Kensington-Washington)

Colorado Springs-SE—Bill Peyser 1501 N Weber St Covers Colo-N Mex-Utah-Wyo

Columbus Ohio—Robert W Sansbury 908 Grandon Ave Covers Ohio

Dallas-SE—The Export Co 706 Meadows Bldg Covers Ark-La-Okla & Texas

Esterly Po-SE—Thomas Beil Jacksonwald Ave Reading 5-6837 Covers Del-Pa (Only Allentown - Phila - Easton - Lancaster - Scranton - Norristown - Harrisburg - Wilkes-Barre)

Indianapolis-SE—Queen Cunningham 6101 College Ave Bldg Indianapolis 20 Ind Covers all Indiana

Kenmore NY-SE—L J McTaggart 116 Eisman Ave Los Angeles-SE—Erlanger Sls Co 4217 W Jefferson Blvd Covers Ariz-Col (Only Alhambra-Bakersfield - Burbank - Glendora - Hollywood - Inglewood - Long Beach - Los Angeles - Pasadena-Riverside - San Diego - San Pedro - Santa Ana - Ventura)

Manlius NY-SE—William Ferguson 117 Foyette St MANlius 2-2692

Mt Vernon NY-SE—Ed Wineblatt 10 Fiske Place Covers Westchester & NYC

Nashville Tenn—George Weakly 834 Gale Lane Covers Miss-Tenn-Ala

Newark-SE—Art Cerf Co 744 Broad St Mitchell 2-6734 Covers NY-Va-Del-Md-Eastern Pa

New York City-SE—Art Cerf Co 744 Broad St Newark 2 N J Ed Wineblatt res Mount Vernon, above



Orlando Florida—Dwight Clexton 2900 Westmorland Dr Covers all Florida  
 Philadelphia-SE—George M. Condon 614 Dutton Circle Springfield Pa R1 6-3458  
 Ridgefield Conn—Walter Hustis P O Box 52 Covers New England  
 San Francisco-SE—Nickerson & Rudot 381 Brannon St Covers Nev-Hawaii, North California  
 Seattle-SE—Ron Merritt 120 W. Thoma St SEneca 4948 Covers Mont-Ore-Wash-Idaho-Western Canada-Br Columbia  
 Export Office—Jack Churchin L L Minthorne Co Inc 15 Moore St NYC All countries except Canada Hawaii and USA  
 Toronto-SE—John R. Tilton 1166A Lakeshore Rd Long Branch Toronto 14 Canada Covers E Con

Johnson Co E F Waseca Minn  
 Jones Apparatus W M PO Box 277 Sheffield Mass  
 Jones Div H B Clinch Mfg 1026 S Homan Ave Chicago III  
 Jones & Laughlin 3 Gateway Center Pittsburgh 30 Pa  
 Jontz Mfg Co 1101 McKinley Mishawaka Ind  
 Jordan Mfg Co 1100 W 78 Hwy Morrisc Mich

Kaplan Products 180 W Randolph St Chicago 1 III  
 Karlson Associates 1483 Coney Island Ave Brooklyn NY  
 Karyall Body Inc 8221 Clinton Rd Cleveland 9 Ohio  
 Kato Eng'g 1451 1 Ave Mankato Minn  
 Kay Electric Co 14 Maple Ave Pine Brook NJ  
 Kay Lab Box 16 San Diego 10 Calif  
 Kaye-Halbert Corp 3623 Eastham Dr Culver City Calif  
 Kay-Townes Antenna 1511 Dean Ave Rome Ga  
 Kedman Co 233 S 5 W Salt Lake City 1 Utah  
 Kelllogg Switchboard 79 W Monroe St Chicago 3 III  
 Kemode Mfg Co 161 W 18 St New York 11 NY  
 Kemtron Electron Prods 14 Prince St Newburyport Mass  
 Kent TV Inc 505 Driggs Ave Brooklyn 11 NY  
 Kenwood Eng'g Co 265 Colfax Ave Kenilworth NJ  
 Kenyon Transformer Co 840 Barry St Bronx 5 NY  
 Kepco Laboratories 131-38 Sanford Ave Flushing NY  
 Kerden Chemical Co 6400 Herman Ave Cleveland 2 Ohio  
 Kester Solder Co 4264 Wrlightwood Ave Chicago 29 III  
 Keystone Electronics 423 Broome St New York 13 NY  
 K-G Electronics 2738 N Sheffield Ave Chicago 14 III  
 Kingdom Products 23 Park Pl New York NY  
 Kings & Sons J E Para Ind  
 Kings Electronics Co 40 Marbledale Rd Tuckahoe NY  
 Kirby Co 13000 Athens Ave Cleveland Ohio  
 Kirby Products Corp 475 Cosgrove St Philadelphia 44 Pa  
 Kleer-Vae Mfg Co 636 Penn Ave Pittsburgh 2 Pa  
 Klein & Sons Mathias 7200 McCormick Rd Chicago 45 III  
 Kilpsch & Associates PO Box 64 Hope Ark  
 Knights Co James Sandwich III  
 Koch Sons Geo 10 S 11 Ave Evansville 4 Ind  
 Krauter & Co 563 18 Ave Newark 3 NJ  
 Kraft Bros 1299 Jerome Ave New York 52 NY  
 Kral Products 1704 Walnut St Philadelphia 3 Pa  
 Krohn-Hite Instrument 580 Mass Ave Cambridge 39 Mass  
 Krylon Inc 2038 Washington Ave Philadelphia 46 Pa  
 Kuehne Mfg Co 1401 S 19 St Matteson III  
 Kurman Electric 35-18 37 St Long Island City 1 NY  
 Kwikheat Mfg Co 3732 San Fernando Rd Glendale 4 Calif

Lab of Electronic Eng'g 413 L St N W Washington DC  
 Laine Electronic & Mfg 113 Sussex Ave Newark 4 NJ  
 Lamplin Laboratories Bradenton Fla  
 Langevin Mfg Corp 37 W 65 St New York 23 NY  
 Lang Radio Enterprises 203 E 88 St New York 28 NY  
 Lansing Sound James B 2439 Fletcher Dr L A Calif  
 LaPointe Electronics Inc W Main St Rockville Conn  
 Larson Co C O PO Box 358 Sterling III  
 Leach Relay Co 5915 Avalon Blvd Los Angeles 3 Calif  
 Leader Electronics 2925 E 55 St Cleveland 27 Ohio  
 Lear Inc 11916 W Pico Blvd Los Angeles 64 Calif  
 Ledtronix Inc 5560 Northwest Hwy Chicago 30 III  
 Lee Electronic Labs 233 Dudley St Boston 19 Mass  
 Lee Laboratories Genesee Pa  
 Le-Hi Electrical Co 1108 Grove St Irvington 11 NJ  
 LeLand Inc G H 123 Webster St Dayton 2 Ohio  
 Lenk Mfg Co 30 Cumminston St Boston 15 Mass  
 Lennard Co P M 671 Bergen St Brooklyn 38 NY  
 Lenz Electric Co 1751 N Western Ave Chicago 47 III  
 LePace Mfg Co 5932 Putnam Ave Brooklyn 27 NY  
 Lera Labs Inc 490 Black Oak Ridge Rd Wayne NJ  
 Lieco Inc 147 Ocean Ave Lynbrook NY  
 Linear Equip Labs Brightwater Pl Massapequa NY  
 Link Aviation Binghamton NY  
 Lion Mfg Corp 2640 Belmont Ave Chicago 18 III  
 Lipps Eng'g 5485 W Washington Los Angeles Calif  
 Littlefuse Inc 1865 Minner St Des Plaines III  
 Livingston Electronic Corp Livingston NJ  
 Loge Sound 2171 W Washington Blvd Los Angeles Calif  
 London Chemical Co 1535 N 31 Ave Melrose Park III  
 London Records Inc 539 W 25 St New York 1 NY  
 Lowell Mfg Co 3030 Laclede Sta Rd St Louis 17 Mo  
 Ludgate Assoc John P 351 S Ave Pittsburgh 22 Pa  
 Luma Electric Equip Co PO Box 132 Toledo 1 Ohio  
 Lumenite Electronic Co 407 S Dearborn St Chicago III  
 Luxo Lamp Corp 102 Columbus Ave Tuckahoe NY  
 Lynn Electronic Res 9 W Magnolia Blvd Burbank Calif  
 Lyrichord Records 464 W 51 St New York NY

McColpin-Christie 3410 W 67 St Los Angeles 43 Calif  
 McGohan Inc Don 3700 W Roosevelt Rd Chicago 24 III  
 McGraw-Hill Publ 330 W 42 St New York NY  
 McIntosh Lab Inc 320 Water St Binghamton NY  
 MacMillan Co 60 S Ave New York 11 NY  
 Macon Co 3260 Motor Ave Los Angeles 34 Calif  
 Madisoe Inc 3960 N 16 St Philadelphia 40 Pa  
 Mag-Electric Prods 12822 Yukon Ave Hawthorne Calif  
 Magic Vue TV Corp 323 E 13 St New York 3 NY  
 Magnavox Co Ft Wayne 4 Ind  
 Magnecord Inc 225 W Ohio St Chicago 10 III  
 Maleo 21 N 3 St Minneapolis 1 Minn  
 Majestic Radio & TV 70 Washington St Brooklyn 1 NY  
 Major Electronics Co 42 Meserole St Brooklyn 6 NY  
 Maleo Tool & Mfg Co 4025 W Lake St Chicago 24 III  
 Mallory & Co P R 3029 E Wash St Indianapolis Ind  
 Manco Mfg Washington & Locust Bradley III

Manor Co 663 N Wells St Chicago III  
 Mandex Mfg Co 2608 W 16 St Chicago 8 III  
 Manfredi Wood Products 226 NY Ave Huntington NY  
 Marantz S B 44-15 Vernon Blvd Long Island City 1 NY  
 Marathon Battery Co Henrietta St Wausau Wisc  
 Marlin Products 6953 Murray Ave Cincinnati 27 Ohio  
 Marine View Electronics 744 E 138 St New York 54 NY  
 Marlon Electrical Instrument Co Manchester NH  
 Marjo Technical Products 1150 E Henry St Linden NJ  
 Mark Electronics Inc 250 Glenwood Ave Bloomfield NJ  
 Markel Electric Products 147 Seneca St Buffalo NY  
 Markell Assoc Jew 764 E Ave New York 10 NY  
 Martin & Co H S 1916 Greenleaf St Evanston III  
 Martindale Electric Box 617 Edgewater Br Cleveland Ohio  
 Masco Mfg 1319 N Market St St Louis Mo  
 Master Appliance Mfg Co 715 Ontario St Racine Wisc  
 Master Electronics & TV Rt 1 Box 36 Libertyville III  
 Master Mobile Mounts 1306 Bond St Los Angeles 15 Calif  
 Masterpiece Custom TV 715 Flatbush Ave Brooklyn NY  
 Matheless Electric 1700 Washington Blvd Chicago III  
 Mathis Tower & Equip Co PO Box 126 E Peoria III  
 Mattison Radio & TV Co 10 W 181 St New York NY  
 Measurements Corp Boonton NJ  
 Meek Industries John Plymouth Ind  
 Medal Mfg Co 194 E Silver St Sharon Pa  
 Mercury Marine Electric 2905 Jones San Francisco Calif  
 Mercury Record Corp 35 E Wacker Dr Chicago III  
 Merit Coil & Transformer 4427 N Clark St Chicago 40 III  
 Meritenna Mfg Co 120 W Thomas St Seattle 9 Wash  
 Merix Chemical Co 1021 E 55 St Chicago 15 III  
 Metal Treating Equip 9825 Greeley Ave Detroit 11 Mich  
 Meters Inc 5353 N Keystone Ave Indianapolis 20 Ind  
 Metronics Inc U S Route 130 Burlington NJ  
 MGM Div of Loews Inc 701 7 Ave New York 36 NY  
 Micomold Radio Corp 1087 Flushing Ave Brooklyn 37 NY  
 Michigan Electronics 854 N Rockwell St Chicago 22 III  
 Mico Instrument 80 Trowbridge St Cambridge 38 Mass  
 Micro-Circuits Co New Buffalo Mich  
 Micro Switch Div Minneapolis-Honeywell Freeport III  
 Microtron Co 84-11 Rockaway Beach Blvd Rockaway Beach NY  
 Middletown Mfg Co Stack St Middletown Conn  
 Midland Mfg Co 3151 Fiberglass Rd Kansas City Kansas  
 Midwest Cabinet 2047 Churchhill St Chicago 47 III  
 Midwest Coil & Transformer 1640 N Halsted Chicago III  
 Midwest Nutrilite Co 6651 N Clark St Chicago 26 III  
 Midwest Radio & TV Corp 909 Broadway Cincinnati Ohio  
 Milford Tool Co 308 Gulf St Milford Conn  
 Miller Mfg Co James 150 Exchange St Malden 48 Mass  
 Miller Co J W 5917 S Main St Los Angeles 3 Calif  
 Miller Co Sanford 691 Bedford Ave Brooklyn 6 NY  
 Miller Electric Co 120 Main St Pawtucket RI  
 Miller Electronics 2840 Naomi St Burbank Calif  
 Miller Electro-Research Labs 5529 S 5 Milwaukee Wisc  
 Miller Instr Inc Wm 325 N Halstead Ave Pasadena Calif  
 Miller Mfg M A 4 & Church Sts Libertyville III  
 Miller Radio & TV 627 E Maume St Adrian Mich  
 Millers Falls Co Greenfield Mass  
 Milner Mfg Co 4359 Northview Dr Jackson Miss  
 Milwaukee Resistor 700 W Virginia St Milwaukee 4 Wisc  
 Milwaukee Transformer 5231 N Hopkins St Milwaukee  
 Milwaukee Truck 6512 W River Pkwy Milwaukee Wisc  
 Minn-Honeywell Reg 2753 4 Ave S Minneapolis Minn  
 Minnesota Mining & Mfg 900 Faucher St Paul 1 Minn  
 Mitchell Industries Inc Mineral Wells Texas  
 Mitchell Mfg Co 2525 Clybourn Ave Chicago 14 III  
 Mitchell Rand Insulation 51 Murray St New York 7 NY  
 MI-TEE Midget Antennas High Point N Car  
 Model Eng'g & Mfg Co 50 Frederic St Huntington Ind  
 Modern-Aire Mfg 4436 W Roosevelt Rd Chicago 24 III  
 Modern Equip Co 17 Bleeker St New York 12 NY  
 Modern Wire Co 39-30 Review Ave Long Is City 1 NY  
 Mohawk Plastic Corp 320 River St Fitchburg Mass  
 Mole-Richardson 937 N Sycamore Ave Hollywood 38 Calif  
 Monarch Condenser 550 Westchester Ave New York 55 NY  
 Montilla LP Record Co 447 W 50 St New York NY  
 Moody Machine Products 7 Culver St Providence RI  
 Moore Tower & Equip 321 Nat'l Bank Bldg Peoria III  
 Moran Electronic 10506 Wheatley St Kensington Md  
 Morrow Radio Mfg Co 2794 Market St Salem Ore  
 Morton Electronics Chester 10 St & Morton Chester Pa  
 Mosley Electronics 8622 St Charles Rock Rd St Louis Mo  
 Motorola Inc 4545 Augusta Blvd Chicago 51 III  
 MP Eng'g Co Fairfield 3 Conn  
 Muckle Mfg Co Owatonna Minn  
 Mucron Corp 9 St Francis St Newark NJ  
 Mueller Electric Co 1583 E 31 St Cleveland 14 Ohio  
 Multicore Sales Corp 164 Duane St New York 13 NY  
 Multi-Tron Lab 4624 W Washington Blvd Chicago 44 III  
 Muntz TV Inc 1000 Grey Ave Evanston III  
 Musical Masterpieces 43 W 61 St New York NY  
 Mycalox Corp of America 125 Clifton Blvd Clifton NJ

Naer Corp 11777 Santa Monica Blvd Los Angeles 25 Calif  
 Nagel-Chase Mfg Co 2811 N Ashland Ave Chicago 13 III  
 Nameplates Inc 425 E 101 St Brooklyn 36 NY  
 National Capacitor 60 Washington St Quincy Mass  
 National Carbon Co 30 E 42 St New York 17 NY  
 National Co 61 Sherman St Malden 48 Mass  
 Nat'l Electric Products 2 Gateway Center Pittsburgh Pa  
 National Electronic Mfg 186 Granite St Manchester NH  
 Nat'l Electronics of Cleveland Delco Bldg Cleveland Ohio  
 National Radio Inst 16 & U Sts NW Washington 9 DC  
 National Teletable PO Box 1289 High Point N Car  
 National Union Electric 350 Scotland Rd Orange NJ  
 National Video Corp 4300 W 47 St Chicago 32 III  
 Neat Electronic Co 1037 Hall St Huntsville Ala  
 Network Mfg Corp 213 W 5 St Bayonne NJ  
 Newcastle Fabrics Corp 153 W 23 St New York NY  
 Newcomb Audio 6824 Lexington Ave Hollywood 38 Calif  
 New England Electrical Works 365 Main St Lisbon NH  
 New London Instrument 82 Union St New London Conn  
 New York Coil Co Phoenixville Pa  
 Nichols Equipment Co Bellevue Ohio  
 Nichols Products Co 325 W Main St Moorestown NJ  
 Nichols Wire & Alum Davenport Iowa  
 Ntkoh Tube Co 5000 S Winpiple St Chicago 32 III  
 Non-Linear Systems DelMar Airport DelMar Calif

Norco Mfg Co 392 Bleeker St New York 14 NY  
 Norsid Mfg Co 21 Atterton St Yonkers 1 NY  
 North American Model Prods 9802 Warwick Rd Warwick Va  
 North American Phillips 100 E 42 St New York 17 NY  
 Northern Products Co 2210 N Clark St Chicago 14 III  
 North Hills Electric 203-18 35 Ave Bayside 61 NY  
 Nylok Corp 14 & Grand Central Ave Elmira Heights NY

Oak Electronics 150 Oak St Buffalo NY  
 Oak Mfg Co 1260 Clybourn Ave Chicago 10 III  
 O'Brien Electric 6514 Santa Monica Blvd Hollywood Calif  
 Oceanic Records 15 Park Ave New York NY  
 Oetrich Publications 4308 Milwaukee Ave Chicago 41 III  
 Ohio Aerial Co 4553 Lewis Ave Toledo 12 Ohio  
 Ohmite Mfg Co 3601 Howard St Skokie III  
 Olin Industries 275 Winchester Ave New Haven 4 Conn  
 Olympic Radio & TV 34-01 38 Ave Long Island City NY  
 Onan & Sons D W 25 & University SE Minneapolis Minn  
 Optron Mfg Co 3223 N Sheffield Ave Chicago 13 III  
 ORRadio Industries 120 Marvyn Rd Opelika Ala  
 Ortho Filter Corp 196 Albion Ave Paterson 2 NJ  
 Oxford Electric 3911 S Michigan Ave Chicago 15 III

Pacific Electricord Co 3217 Exposition Los Angeles Calif  
 Pacific Mercury 8345 Havenhurst Sepulveda Calif  
 Pacific Transducer 11836 W Peco Blvd Los Angeles Calif  
 Pacific Vogue Radio 215 W 5 St Los Angeles 12 Calif  
 Packard Bell Co 12333 W Olympic Blvd Los Angeles Calif  
 Packard Electric Div General Motors Corp Warren Ohio  
 Paraplegics Mfg 10068 Franklin Ave Franklin Park III  
 Parker-Kalon 200 Varick St New York 14 NY  
 Parker Metal Goods Co 161 Summer St Worcester 8 Mass  
 Par-Metal Products 32-62 49 St Long Island City NY  
 Pathfinder Electronics 6836 Lexington Los Angeles Calif  
 Pederson Electronics PO Box 572 Lafayette Calif  
 Peerless Elec Prods 9356 Santa Monica Beverly Hills Calif  
 Peerless Products Ind 812 N Paliski Rd Chicago 51 III  
 Pelree Wire Recorder 5900 N Northwest Hwy Chicago III  
 Penn Transformer Corp Bellefonte Pa  
 Penn TV Prods Allegheny & Trenton Aves Philadelphia Pa  
 Penwood Numechron 7249 Franktown Ave Pittsburgh Pa  
 Pentron Corp 777 S Tripp Ave Chicago 24 III  
 Perfection Electric 2635 S Wabash Ave Chicago 16 III  
 Period Tables Henderson Ky  
 Permacel Tape Corp New Brunswick NJ  
 Perma-Power Co 4727 N Damen St Chicago 25 III  
 Permo Inc 6415 Ravenswood Ave Chicago 26 III  
 Permolux Corp 4900 W Grand Ave Chicago 39 III  
 Peschel Electronics Inc 13 Garden St New Rochelle NY  
 Plansteh Chemical Co 104 Lake View Ave Waukegan III  
 Phalo Plastics Corp 25 Foster St Worcester 8 Mass  
 Phaostron Co 351 Pasadena Ave S Pasadena Calif  
 Phelps Dodge Copper Prods Corp 40 Wall St NY 5 NY  
 Phen-O-Tron Inc 455 Main St New Rochelle NY  
 Phileo Corp Tioga & C Sts Philadelphia 34 Pa  
 Philharmonic Radio & TV 235 Jersey New Brunswick NJ  
 Phillips Mfg Co 2816 Aldrich Ave S Minneapolis 8 Minn  
 Philmore Mfg Co 113 University Pl New York 3 NY  
 Philson Mfg Co 60 Sackett St Brooklyn 31 NY  
 Phoenix Electronics Inc 50 Island St Lawrence Mass  
 Photocircuits Corp New St Glen Cove NY  
 Physical Research Assoc 1 Azurelee Dr Malibu Calif  
 Plekens Import Co H 205 E 14 St New York 3 NY  
 Pickering & Co 309 Woods Ave Oceanide NY  
 Pilot Radio Corp 37-06 36 St Long Island City 1 NY  
 Pioneer Electronics 2235 S Carmelina Los Angeles Calif  
 Pioneer Mfg Co Huntley III  
 Pioneer Scientific 161 Great Neck Rd Great Neck NY  
 Pipestone Sales Co PO Box 311 Pipestone Minn  
 Pitman Publishing Corp 2 W 45 St New York 3 NY  
 Planet Mfg Corp 225 Bellevue Ave Bloomfield NJ  
 Planet Wood Prods 3902 8 Ave Brooklyn NY  
 Plastic Capacitors 2511 W Moffat St Chicago 47 III  
 Plastic-Kate 425 Lakeside Ave NW Cleveland 13 Ohio  
 Plastold Corp 42-61 24 St Long Island City 1 NY  
 Plymouth Electronics 50 Kingsbury St Worcester 3 Mass  
 Polaroid Corp 43-20 34 St Long Island City NY  
 Polyken Prods Dept Kendall Co 222 W Adams Chicago III

### LOCALIZER SYMBOLS

The following symbols after the name of each city indicate the type of representative in a particular area.

DS	Distributor Sales
IS	Industrial Sales
IDS	Indus & Distr Sales
D	Distributor
BO	Branch Office
GV	Government Sales
R	Representative
SE	Sales Engineer

Polymer Corp Reading Pa  
 Pomona Electronics Co 524 W 5 Ave Pomona Calif  
 Porcelain Products Inc 422 W Sandusky St Findlay Ohio  
 Portable Electric Tools 320 W 83 St Chicago 20 III  
 Porter Mfg 1524 Frederick St Racine Wisc  
 Port-O-Matic Co 438 E 91 St New York 28 NY  
 Potter & Brumfield Princeton Ind  
 Power Supplies 1005 Olive St Highland III  
 Power Transformer Co 532 Mulberry St Newark 5 NJ  
 Practical Electronics Mfg 2214 S Michigan Chicago III  
 Precise Development 999 Long Beach Rd Oceanide NY  
 Precise Measurements Co 942 Kings Hwy Brooklyn 23 NY  
 Precision Apparatus 70-31 84 St Glendale 27 LI NY  
 Precision Electronics 9101 King Ave Franklin Park III  
 Premax Products Niagara Falls NY  
 Premier Metal Products 3160 Webster Ave New York NY  
 Premier Research Labs 79 7 Ave New York 11 NY  
 Prentice-Hall Inc 70 5 Ave New York NY  
 Pres Probe Co 4034 N 6 St Milwaukee 2 Wisc  
 Presto Recording Corp PO Box 500 Paramus NJ  
 Proscope Co 44-05 30 Ave Long Island City NY  
 Production Tool & Fixture 37 W Main Oyster Bay NY  
 Pyramid Electric Co 1445 Hudson Blvd N Bergen NJ

Telephone Union 5-1776  
 VP-Gen Sls Mgr—Arnold R Andrews  
 Sls Mgr—Jobber Div—Jack K Poff  
 Brand Names—Cartrij-Dry; Glosseol; IMP; Metl can;  
 Twist-Mount; Tynee-Dry; Kool-Sel  
 Representatives

Atlanta—Frank C Nickerson & Co 901 Bernina Ave  
 NE Lamar 6878 Covers Fla (except Pensacola)  
 Go-N C (jobbers only)-S C  
 Baltimore—R B Bornhill & Assoc 412 Woodbine Ave  
 Valley 5-3431 Covers Md—Del—D C—Va—N C  
 Burlington (Ia)—William G Kelly 303 Belle Air  
 Plaza 4-5151 Covers Ia-Nebr  
 Chicago—Arnold-Vore Assoc 1321 Rosedale Ave  
 Edgewater 4-6457 Covers Eastern Wis-Mo-  
 Northern III (jobbers only)  
 Chicago—Caine Sales Co 3020 N Cicero Ave  
 SPring 7-4022 Covers Northern III-Ia-Eastern  
 Wis (industrial only)  
 Cleveland—Mike Roth Sales Co 13947 Cedar Rd  
 Yellowstone 2-4262 Covers Ohio-Western Pa-  
 W Va  
 Dallas—J Earl Smith 505 N Ervay St RAndolph  
 2966 Covers Ark-La-Okla-Tex (Except El Paso)  
 Denver—McLoud & Raymond Co 5528 E Colfax Ave  
 Fremont 7-3067 Covers Colo-N M-El Paso  
 (Tex)-Utah-Wyo  
 Havertown (Pa)—Howard Fairbanks 1615 Darby Rd  
 Granite 2-2467 Covers Southern N J-Eastern  
 Pa (industrial only)  
 Indianapolis—Wright Engineering 4241 Melbourne  
 Rd Humboldt 8800 Covers Ind-Ky  
 Los Angeles—Jack Bermon Co 1141 S LaCienega  
 Blvd 8Rdshaw 2-9138 Covers Ariz-Southern  
 Calif-Clark Co (Nev)  
 Memphis—Engelmon-Jesse Co 3205 Crump Ave  
 Phone 48-6263 Covers Ala-Miss-Tenn-Pensacola  
 (Fla)  
 Minneapolis—Don V Hamilton & Co 6516 Norman-  
 dale Rd West 9-8286 Covers Minn-N D-S D-  
 Western Wis  
 Needham (Mass)—Mosher & Peysler Co 1116 Great  
 Plain Ave NEedham 3-3773 Covers New Eng-  
 land  
 Newark—Art Cerf & Co 744 Broad St Mitchell  
 2-6734 Covers D C-Del-Md-N J-N Y-Eastern Pa-  
 Va (jobbers only)  
 North Syracuse (N Y)—William A Franklin 3 Holly  
 Rd SYracuse 54-3383 Covers N Y (except Metro-  
 politan NYC  
 Palisades Park (N J)—Gary Martin 232 Broad Ave  
 WI 7-0300 Covers Metropolitan N Y-Long Is-  
 land-Northern N J (industrial only)  
 St. Louis—Theodore B Lowell PO Box 21 Normandy  
 Br EVERgreen 5-7803 Covers Southern III-Kan-Mo  
 San Francisco—E L Bermon Co 758 Natoma St  
 UNderhill 3-0317 Covers Northern Calif-Nev  
 (except Clark Co)  
 Seattle—Frank Wedel Co 3215 Western Ave GARfield  
 0222 Covers Ore-Wash-Northern Ida-Western  
 Mont-Alaska-British Columbia  
 Honolulu (Hawaii)—Brenna & Browne 211 Honolulu  
 Merchandise Mart Covers Hawaii  
 Montreal-Que-Canada—William Cohen 4890 Plamond-  
 on Suite 10 REGent 7-5944 Covers Canada (ex-  
 cept British Columbia)

Pyramid Instrument Corp 630 Merrick Rd Lynbrook NY

Q-Line Mfg Corp 1552 61 St Brooklyn 19 NY  
 Quam-Nichols Marquetti & Prairle Ave Chicago 37 III  
 Quatrefo Co 395 St John St Spantburg 5 Car  
 Quincy Speaker Mfg Corp 221 Oak St Quincy III

Racon Electric Co 1261 Broadway New York 1 NY  
 Rada Phone Corp 609 W Fulton St Chicago 10 III  
 Radelec Mfg Co 7580 Garfield Blvd Cleveland 25 Ohio  
 Radell Corp 7900 Pendleton Pike Indianapolis Ind  
 Radlart Corp 3455 Vega Ave Cleveland 13 Ohio  
 Radio City Products Centre & Glendale Sts Easton Pa  
 RCA Victor Div Radio Corp of America Camden NJ  
 Radio Corporation of America Tube Division Harrison N J

D Y Smith—Vice President and General Manager  
 L F Holleran—General Marketing Manager  
 L F Holleran—Sales Manager (Acting)  
 D M Branigan—Manager Distributor Sales  
 Distributor Sales Regional Sales Offices:  
 Northeastern District—RCA Room 2301 200 Berkeley  
 St Boston Mass Hubbard 2-1700  
 Eastern District—RCA 36 W 49th St New York NY  
 Circle 6 4030

Southeastern District—RCA 522-33 Forsyth Bldg.  
 Forsyth & Luckie Sts NW Atlanta Ga LAmAr  
 7703  
 East Central District—RCA 718 Keith Bldg 1621  
 Euclid Ave Cleveland Ohio Cheryl 1-3450  
 Central District—RCA 666 N Lake Shore Dr Chicago  
 III DElaware 7-0700  
 West Central District—RCA 340 Dierks Bldg 1006  
 Grand Ave Kansas City Mo HARRison 6480  
 Southwestern District—RCA 1907-11 McKinney Ave  
 Dallas Texas RIVERSide 1371  
 Western District—RCA 1560 N Vine St Hollywood  
 Calif HOLLYwood 9-2154

RCA Tube Div Radio Corp of America Harrison NJ  
 RCA Victor Record Div 630 5 Ave New York NY  
 Radio Craftsmen Inc 4401 N Ravenswood Ave Chicago III  
 Radio Eng'g Labs 36-40 37 St Long Island City 1 NY  
 Radio KIts Inc 120 Cedar St New York 6 NY  
 Radio Materials Corp 3325 N Calif Ave Chicago III  
 Radio Merchandise Sales 2016 Bronxdale Ave NY NY  
 Radio Music Corp 84 S Water St Port Chester NY  
 Radion Corp 1130 W Wisconsin Ave Chicago 14 III  
 Radionle Laboratories Anderson Ind  
 Radio Receptor Co 251 W 19 St New York 11 NY  
 Radio Supply & Eng'g Co 85 Selden Ave Detroit 1 Mich  
 Radio Wire TV 100 6 Ave New York NY  
 Radix Wire Co 26260 Lakeland Blvd Cleveland Ohio  
 Rad-Tel Tube Co 115 Coit St Irvington 11 NJ  
 RAM Electronics Sales Co S Buckhout St Irvington NY  
 Ramsey Radio & TV Co 925 St Louis Ave Vandalia III  
 Rangertone Inc 73 Winthrop St Newark 4 NJ  
 Rapid Electric Co 2881 Middletown Rd New York 51 NY  
 Rare Earths Inc Box 488 Pompton Plains NJ  
 Rason Mfg Co 3050 W 21 St Brooklyn 24 NY  
 Rauland-Borg Corp 3515 W Addison St Chicago 18 III  
 Rauland Corp 4245 N Knox Ave Chicago 41 III  
 Ray Mfg Co 441 Summit St Toledo 4 Ohio  
 Ray-O-Vac Co 212 E Washington Ave Madison 10 Wisc  
 Ray-Par Inc 7810 W Addison St Chicago 13 III  
 Raytheon Mfg TV-Radio Div 5921 W Dickens Chicago III  
 Raytheon Mfg Rec'v & CRT Div 55 Chapel Newton Mass  
 Raytheon Mfg Co 55 Chapel St Newton 58 Mass

(Receiving and Cathode Ray Tube Operations)

Atlanta—R C Nickerson Co 901 Bernina Ave NE  
 Lamar 6878 Covers N & S Car-Ga-E Fla  
 Boston—Arthur E Akeroyd John Hancock Bldg Rm  
 2311 HANcock 6-2433 Covers Me-NH-Vt-Conn-  
 Mass-Ri  
 Buffalo—Art Cerf & Co L J McToggart, 116 Eisen-  
 man Ave Kenmore 17 NY Buffalo Riverside 1009  
 Covers Western NY State  
 Chicago—E Ralph Haines 949 Lake St Oak Park  
 III EUclid 6-4476 Covers E Wis-III  
 Cleveland—Neal Bear Corp 3435 Streetsboro Road  
 West Richfield Ohio Phone W Richfield 100  
 Covers Ohio-W Pa-W Va  
 Dallas—Campion Sales Co 208 W Avery Covers  
 Tex-La  
 Dayton—Neal Bear Corp R E Whelan 136 W  
 Second St  
 Denver—Ronald G Bowen & Co 446 Broadway  
 SHERman 4-2501 Covers E Mont-Wyo-Utah-Colo-  
 N Mex  
 Des Moines—Roy Sales Co Ralph Shorp 3807  
 Adams St DEs Moines 5-4584  
 Detroit—K C Buraw Suite 207 22128 Grand River  
 Ave KENwood 3-7700 Covers Michigan  
 Kansas City—Roy Sales Co 2600 Grand Ave BA-  
 3800 Covers Neb-Iowa-Mo-Kan-Ark-Okla  
 Los Angeles—Perlmuth-Colman & Assoc 2419 S  
 Grand Ave Richmond 7-4321 Covers S Cal-Ariz-  
 Hawaii  
 Louisville—Cobb Soles Co 1629 Portland Ave CLay  
 9406 Covers Ind-Ky  
 Memphis—A S Engleman Co 3205 Crump Ave  
 MEmpHis 48-6263 Covers Tenn-Ala-Miss-N W Fla  
 Minneapolis—Fred B Hill Co 6110 Excelsior Blvd  
 MOhawk 9-6727 Covers N & S Dak-Minn-W Wis  
 Philadelphia—R L D Lowery Inc 50 E Wynnewood  
 Rd Wynnewood Pa Midway 2-9100 9101 9102  
 Covers E Penna-N J-Md-Dist Col-Del-Va  
 Portland—Don H Burcham Co 510 NW 19th Ave  
 Broadway 3830 Covers Wash-Ore-Idaho-W  
 Mont-Alaska-Br Columbia  
 San Francisco—Harold L Newman 420 Market St  
 YUkon 6-3897 Covers N Cal-Nev  
 Seattle—Dan H Burcham Co R M Loughrey 1327  
 Norcross Way  
 Syracuse—Art Cerf & Co William Ferguson 117  
 Fayette St Manlius NY MANlius 62-3301 Covers  
 E NY Stote  
 Toronto—John S Plewes Co 52 Humbercrest Blvd  
 JUnction 2051 Covers Quebec-Ont  
 Raytronic Labs Inc 9701 Reading Rd Cincinnati 15 Ohio  
 Reclamo Mfg 5083 N Elston Ave Chicago 30 III  
 Recora Co 56 W 103 St Chicago 28 III  
 Recordisc Corp 395 Broadway New York 13 NY  
 Reconton Corp 52-35 Barnett Ave Long Island City NY  
 Rectifier Eng'g 1803 E 7 St Los Angeles 21 Calif  
 Reed & Prince Mfg Co 1 Duncan Ave Worcester 1 Mass  
 Reeves Soudercraft Corp 10 E 52 St New York 22 NY  
 Regency Div IDEA 7900 Pendleton Pike Indianapolis Ind  
 Rego Insulated Wire Co 830 Monroe St Hoboken NJ  
 Reiner Electronics Center & Glendale St Easton Pa  
 Rek-O-Kut Co 38-01 Queens Blvd Long Island City NY  
 Remington Records 551 5 Ave New York NY  
 Remot-O-Matic Sales 8747 Sunset Los Angeles Calif  
 Reon Resistor Corp 117 Stanley Ave Yonkers NY  
 Replica Records 7210 Westview Dr Des Plaines III  
 Resistance Products 914 S 13 St Harrisburg Pa  
 Resistors Inc 5226 W 26 St Chicago 50 III  
 Retron Corp 697 N Lake Ave Pasadena 6 Calif  
 Revere Camera Co 320 E 21 St Chicago 16 III  
 Revere Corp of America Wallingford Conn  
 Rex Electronics 1351 De Loss St Indianapolis 3 Ind  
 Reynolds Electric Co 3000 River Rd River Grove III  
 Rhodes & Sons 12 Porter St Taunton Mass  
 Richardson-Allen 116-15 15 Ave College Point NY  
 Rider Publisher J F 480 Canal St New York 13 NY

Rinehart & Co 232 Madison Ave New York 16 NY  
 Ripley Co Middletown Conn  
 Rlstaucrat Inc 1216 E Wisconsin Ave Appleton Wisc  
 Rite-Lite Mfg Co 3243 W Lawrence Ave Chicago 25 III  
 River Edge Industries 5 River Edge Rd River Edge NJ  
 R J Audio Products 164 Duane St New York 13 NY  
 R K Mfg Co Box 1122 Marlon III  
 Roanwell Corp 662 Pacific St Brooklyn 17 NY  
 Robins Industries Corp 4108 Bell Blvd Bayside NY  
 Rockbar Corp 215 E 37 St New York 16 NY  
 Rogan Bros 8031 N Monticello Skokie III  
 Rogers Electronic Corp 49 Bleeker St New York 12 NY  
 Rohn Mfg Co 116 Limestone Bellevue Peoria III  
 Rola Co 2330 Superior Ave Cleveland 14 Ohio  
 Roland Radio Corp 716 S Columbus Ave Mt Vernon NY  
 Roman Plastics Inc 1311 E Main St St Charles III  
 Ronette Acoustical Corp 135 Front St New York 5 NY  
 Rowe Industries 1702 Wayne St Toledo 9 Ohio  
 Royal Diamond Tool Co 172 Green St Boston 3 Mass  
 Royal Electric Co 95 Grand Ave Pawtucket RI  
 Runzel Cord & Wire 4727 Montrose Ave Chicago 41 III  
 Russell Speaker Co 6158 S Kedzie Ave Chicago III  
 Ryan Industries 10910 S Vermont Ave Los Angeles Calif  
 Rytel Electronics Mfg 9820 Irwin Ave Inglewood Calif

S & A Electronics 1025 Nevada Toledo 5 Ohio  
 Sams & Co H W 2201 E 46 St Indianapolis 5 Ind  
 Sangamo Electric Co Box 7 Marlon III  
 Sangamo Generators 2110 Clear Lake Springfield III  
 Sargent-Raymont 1401 Middle Harbor Oakland 20 Calif  
 Saxtonburg Ceramics Saxtonburg Pa  
 Saxton Products Inc 2101 Grand Concourse Bronx 53 NY  
 S C Laboratories 37 George St Newark 5 NJ  
 Scala Radio Co 2814 19 St San Francisco 10 Calif  
 Schauer Mfg Corp 4500 Alpine Ave Cincinnati 36 Ohio  
 Schwann LP Record Co 131 Clarendon St Boston Mass  
 Scientific Book Publishing Co Vincennes Ind  
 Scientific Coll Co 5619 Broadway Chicago 40 III  
 Scott Inc H H 385 Putnam Ave Cambridge Mass  
 Scott Radio Labs Liberty St Plymouth Ind  
 Scranton Aluminum Mfg 419 S Wyoming Ave Scranton Pa  
 Seco Mfg Co 5015 Penn Ave Minneapolis 19 Minn  
 Seeburg Corp J P 1510 N Dayton Chicago III  
 Seeco Records 39 W 60 St New York NY  
 Self-Lifting Piano Truck Co Findlay Ohio  
 Semco Electronics 8407 S Hoover Los Angeles 44 Calif  
 Sentinel Radio Corp 2100 Dempster St Evanston III



Sequoia Process Corp 871 Willow St Redwood City Calif  
 Service Instrument 422 S Dearborn St Chicago 5 III  
 Service Parts Systems 13380 E 9 Mile Rd E Detroit Mich  
 Service Welding Co Cedar Grove Wisc  
 Session Clock Co Forestville Conn  
 Setchell Carlson 330 5 Ave N New Brighton 12 Minn  
 Shalleross Mfg Co 520 Pusey Ave Colingdale Pa  
 Shasta Div Beckman Instrum Box 296 Sta A Richmond  
 Calif  
 Sheldon Electric Co 68-98 Colt St Irvington NJ  
 Sherrick Products 86-11 Sancho St Hollis LI NY  
 Sherwood Electronic Labs 2802 W Cullom Chicago 18 III  
 Shure Eng'g Co Long Branch NJ  
 Shrader Sound Inc 2803 M St NW Washington 7 DC  
 Shura-Tone Products Inc 440 Adelphi St Brooklyn NY  
 Shure Bros 225 W Huron St Chicago 10 III  
 Shurite Meters 61 Hamilton St New Haven 8 Conn  
 Slicks F W Div Gen Inst Chicopee Mass  
 Siemens & Halske Wayne NJ  
 Sightmaster Corp 111 Cedar St New Rochelle NY  
 Signalite Inc 37-41 Neptune Hwy Neptune NJ  
 Silicone Spray Products 3514 Le Rd Cleveland 22 Ohio  
 Simpson Electric Co 5200 W Kinzie St Chicago 44 III  
 Simpson Mfg Co Mark 32-28 49 St Long Island City NY  
 Sittler Corp 18 N Ada St Chicago 7 III  
 Skill Corp 5023 Elston Ave Chicago 30 III  
 Skottle Electronics Inc 731 Pleasant Ave Packville Pa  
 Skyline Mfg Co 1652 Rockwell Cleveland 14 Ohio  
 Skysweeper Inc Mettury III  
 Smithgullid Inc 360 W 8 St Erie 2 Pa  
 Smith Heat Treating 5865 Wilmington Los Angeles Calif  
 Smith Inc Herman H 2326 Nastrand Ave Brooklyn 10 NY  
 Smith-Meeker Eng'g Co 157 Chambers St New York 7 NY  
 Snap-On Tools Corp 834 28 Ave Kenosha Wisc  
 SNC Mfg Co PO Box 277 Oskosh Wisc  
 Snyder Mfg Co 22 & Ontario St Philadelphia 40 Pa  
 Soia Electric Co 4633 W 16 St Chicago 50 III  
 Sonar Radio Corp 3050 W 21 St Brooklyn 24 NY  
 Sonex Inc 245 Sanson St Upper Darby Pa  
 Sonic Industries 30-30 Northern Blvd Long Island City  
 NY  
 Sonic Recording Products Inc 58 Mill Rd Freeport NY  
 Sonora Radio & TV 2023 W Carroll Ave Chicago 12 III  
 Sonotone Corp PO Box 200 Elmford NY  
 SOS Cinema Supply Corp 602 W 52 St New York 19 NY  
 Southern Industries 1401 Reisterstown Rd Baltimore Md  
 South River Metal Prod Co 377 Turnpike S River NJ  
 Spartan Radio-TV 2301 E Michigan Jackson Mich  
 Spaulding Products Co Tipton Ind  
 Speak-O-Phone Recording & Equip Co 23 W 60 St NY NY  
 Special Instruments Lab 312 W Vine St Knoxville Tenn  
 Special Products Co PO Box 188 Rockville 1 Md  
 Speciality Assembling & Packing 79 Clinton Brooklyn NY  
 Spectratone Sound Assoc 66 E Gloucester Barrington NJ  
 Speed Way Mfg 1834 S 52 Ave Cleere 50 III  
 Spencer-Kennedy Labs 186 Mass Ave Cambridge 39 Mass  
 Spirling Products Co PO Box 411 Hicksville LI NY

Sprague Products Co N Adams Mass  
 Stancil-Hoffman 921 N Highland Ave Hollywood 38 Calif  
 Standard Coll Prods 2085 N Hawthorne Melrose Park Ill  
 Standard Electrical Prods 2240 E 3 St Dayton 3 Ohio  
 Standard Piezo Co PO Box 513 Carlisle Pa  
 Square Root Mfg Co 391 Saw Mill River Rd Yonkers NY  
 S & R Electronics Inc 136 Liberty St New York 6 NY  
 Stahl Metal Prods 3490 W 140 St Cleveland 11 Ohio  
 Standard TV Tube 700 Dryades St New Orleans 12 La  
 Standard Winding Co 44 Johns St Newburgh 23 NY  
 Standard Wood Prods 47 W 63 St New York 23 NY  
 Stanwyck Winding 137 Walsh Ave Newburgh 23 NY  
 Star Expansion Products 147 Cedar St New York 6 NY  
 Star Fuse Co 235 Canal St New York 13 NY  
 Stark Mfg Co PO Box 489 Tuscaloosa Ala  
 Starrett TV Corp 601 W 26 St New York 1 NY  
 States Co 19 New Park Ave Hartford 6 Conn  
 Steelman Phono & Radio 230 Anderson Ave Mt Vernon NY  
 Stephens Mfg Corp 8538 Warner Dr Culver City Calif  
 Sterling Mfg Co 7201 Wentworth Ave Cleveland 2 Ohio  
 Stevens Products Inc 86 Main St E Orange NJ  
 Stevens Walden 300 Shrewsbury St Worcester 4 Mass  
 Stone City Machine & Tool 1206 7 St Bedford Ind  
 Stratford TV Co 2555 W 21 St Chicago 8 Ill  
 Streamline Wood Prods 489 N Cicero Ave Chicago Ill  
 Stromberg Carlson Co 100 Carlson Rd Rochester 3 NY  
 Struthers-Dunn Inc Lambs Rd Pitman NJ  
 Summit Eng'g Co 3324 Main St Hartford Conn  
 Super Ear Products Co 675 Merrick Rd Lynbrook NY  
 Superex Electronics 4 Radford Pl Yonkers NY  
 Superior Instrument 2435 White Plains Rd New York NY  
 Superior Insulated Wire W Haverstraw NY  
 Superior Rectifier 3000 Kenwood St Hammond Ind  
 Supreme Inc Greenwood Miss  
 Supreme Publications 3727 W 13 St Chicago 23 Ill  
 Sutton Electronic Co 426 W Short St Lexington Ky  
 Sutton S J 228 E Park Wheaton Ill  
 Sylvania Inc 1328 N Halsted St Chicago 22 Ill  
 Switchcraft Inc 1740 Bdwy New York NY  
 Symphonic Radio 160 Washington St N Boston 8 Mass

Tabet Mfg Co 1336 Ballentine Blvd Norfolk 1 Va  
 Talk-A-Phone Co 1512 S Palmski Rd Chicago 23 Ill  
 Tanny America Ltd 36 Wellington St E Toronto 1 Ontario Canada

Tape Recorders Inc 1501 W Congress St Chicago Ill  
 Tartak Electronics 2979 N Ontario St Burbank Calif  
 Tarzian Inc Sarks 415 N College Ave Bloomington Ind  
 Tatu Inc Albert J 85 Columbia Dr Williamsville NY  
 Taylor Corp 3 Rutter St Rochester 6 NY  
 Taylor Mfg Co 302 S Union St Lima Ohio  
 Taylor Tubes Inc 2312 Wabasha Ave Chicago 47 Ill  
 Tech Master Corp 75 Front St Brooklyn 1 NY  
 Technical Appliance Corp 1 Taco St Sherburne NY  
 President—H H Brown  
 Vice Pres Sales—Tare Lundohl  
 Vice Pres Eng—Kendrick Lippitt  
 Sales Pro Mgr—Fred R Voorhaar  
 Credit Mgr—William H Resch  
 Chairman of Board—Carl Goudy  
 Purchasing Agent—Harold Senkel  
 Buffalo—Leonard D Allen Inc 109 Easton Ave Humboldt 6551

Casselberry (Fla)—John C Wagner Atcheson & Adams Box 105 Fern Park Post Office Winter Park 27-2562  
 Chicago—A H Bruning Co 2215 Wilson Ave EDgewater 4-0989, 4-0990, 4-0991  
 Cincinnati—John O Olsen Co 6225 Joyce Lane Jefferson 3998  
 Cleveland—John O Olsen Co 16201 Shaker Blvd Wyoming 1-2624  
 Dallas—John B Guenther 7322 Marquette Ave Emerson 6286  
 Detroit—R C Merchont Co 4829 Woodward Ave Temple 1-1677  
 Englewood (Colo)—Bob Cox Sales Co 1411 East Bates Ave Parkway SUnset 1-0866  
 Greensboro—Atcheson & Adams Suite 315 601 North Elm St Bldg Phone 2-6838  
 Kansas City—W E Fry & Co 406 West 34th St Jefferson 5236  
 Los Angeles—Lee H Owens Co 2331 W Washington Blvd REpublic 0203  
 Minneapolis—The Heimann Co 1711 Hawthorne Ave MAin 5457  
 Nashville—E E Scott Atcheson & Adams PO Box 157 DOnelson 31  
 Needham (Mass)—Stanley A Harris Co 317 Chestnut St Phone 3-4780  
 New York—Cliff Landis Sales Co 81-11 Roosevelt Ave ILLinois 8-7900  
 Philadelphia—Samuel K Macdonald Inc 1531 Spruce St Kingsley 5-1205  
 Pittsburgh—John O Olsen Co 776 Cook Drive Lehigh 1-6279  
 San Carlos (Cal)—David H Ross Co 534 El Camino Real Lytell 3-8224  
 Seattle—James J Bocker Co 2321 Second Ave MAin 8811  
 St Louis—W E Fry & Co 1778 Nemnich Underhill 7-6749  
 Syracuse—Leonard D Allen Inc 2401 South State St Phone 4-4195  
 Toronto—Hackbusch Electronics Ltd 23 Primrose Ave Melrose 2453  
 Washington—Samuel K Macdonald Inc 217 Riggs Bank Bldg 3308-14th St NW Columbia 5-3938

Technical Tape W 177 & Harlem River Morris Hts NY  
 Technicraft Co 1156 Commonwealth Ave Boston 34 Mass  
 Tech-Ohm Resistor 36-11 33 St Long Island City NY  
 Tektronix Inc PO Box 831 Portland 7 Ore  
 Tel-A-Ray Enterprises Inc Box 332 Henderson Ky  
 Tele-Beam Industries 6 & Soscol Ave Napa Calif  
 Telephone Mfg Corp 88 Merrick Rd Amityville NY  
 Telecom Inc 1019 Admiral Blvd Kansas City 6 Mo  
 Teletro Industries 35-16 37 St Long Island City NY  
 Tele-Ex-Pand Corp Pine & 4 Sts Berwick Pa

Tele King Corp 601 W 26 St New York 1 NY  
 Tele Matc Industries 16 Howard Ave Brooklyn NY  
 Tele Plastics Co 202 Broadway Brooklyn 11 NY  
 Telegrip Radio Co 2559 W 21 St Chicago 8 Ill  
 Tele-Ray Tube Co 984 Saw Mill River Rd Yonkers NY  
 Telesine Antenna Corp Shreveport 92 La  
 Teletenna Co 1033 Indiana Ave La Porte Ind  
 Televex Co 46 Lakeview Ave Yonkers NY  
 Television Engineers 3325 W Bryn Mawr Chicago 45 Ill  
 Television Labs Inc M111 St Wauconda Ill  
 Television Remote Control 820 N Fairfax Los Angeles  
 Tele-Vue Towers Inc Erskine Minn  
 Telex Inc 1633 Eustis St St Paul 1 Minn  
 Telcor Inc Telegraph Rd Elyria Ohio  
 Tell City Furn Co Tell City Ind  
 Telonic Industries 444 S Rural St Indianapolis 1 Ind  
 Tel-O-Tube Corp 180 Van Riper Ave E Paterson NJ  
 Tel-Rad Mfg Co 7 Madison St Fennimore Wis  
 Telrex Inc Asbury Park NJ  
 Teltron Electric Co 423 Harrison Ave Harrison NJ  
 Tempil Corp 11 W 25 St New York 11 NY  
 Tempo Records of America 8540 Sunset Hollywood Calif  
 Tennalab Quincy Ill  
 Tenna Trailer Co 321 Plum St Pontiac Ill  
 Tensitron Inc Pin Hill Harvard Mass  
 Tensor Elec Devel 343 Classon Ave Brooklyn NY  
 Terado Co 1068 Raymond Ave St Paul 14 Minn  
 Terwilliger TV Mast 531 Lincoln Ave Pontiac Ill  
 Tetrad Co 62 St Mary St Yonkers 2 NY  
 Texas Instruments Inc 6000 Lemmon Ave Dallas Tex  
 Thermador Elec 2000 S Camfield Ave Los Angeles Calif  
 Thomas Associates 4607 Alger St Los Angeles 39 Calif  
 Thomas & Betts 36 Butler St Elizabeth 1 NJ  
 Thomas Electronics Inc 118 9 St Passaic NJ  
 Thomas Mold & Die Co Henry & Grant St Wooster Ohio  
 Thompson-Bremer Co 521 N Dearborn St Chicago 10 Ill  
 Thompson Products 2196 Clarkwood Rd Cleveland 3 Ohio  
 Thordarson-Melissner 7 & Belmont St Mt Carmel Ill  
 Thorens Co Stewart & Atlantic Ave Garden City Park NY  
 Tibbetts Industries Colcord Ave Camden Me  
 Tinerman Products PO Box 6688 Cleveland 1 Ohio  
 Tipco Co 5865 Wilmington Ave Los Angeles 1 Calif  
 Todd-Tran Corp 156 Gramatan Ave Mt Vernon NY  
 Toman & Co E 8700 W 47 St Lyons Ill  
 Tork Clock Co 1 Grove St Mt Vernon NY  
 Trad TV Corp 1001 1 Ave Asbury Park NJ  
 Transformer Co 70 Pine St Attleboro Mass  
 Transformer Metal Prod Inc 34 3 W 26 St New York NY  
 Transistor Products 241 Crescent St Waltham 54 Mass  
 Transistron Electronic Corp 403 Main Melrose Mass  
 Transvision Inc 460 North Ave New Rochelle NY  
 Trav-Ler Radio Corp 571 W Jackson Blvd Chicago Ill  
 TRESCO 3824 Terrace St Philadelphia 28 Pa  
 Triad Transformer Corp 4055 Redwood Ave Venice Calif  
 Trico Fuse Mfg 2948 N 5 St Milwaukee Wis  
 Tricraft Products 1535 N Ashland Ave Chicago 22 Ill  
 Trimm Inc 400 W Lake St Libertyville Ill  
 Trio Mfg Co Griggsville Ill  
 Triplett Electrical Instr Co Harmon Rd Bluffton Ohio  
 Triumph Mfg Co 1829 S 55 St  
 Triwee Transformer 3261 N Milwaukee Ave Chicago Ill  
 Trojan Electronics 3706 N Halsted St Chicago 13 Ill  
 Tru-Ohm Products 2800 N Milwaukee Ave Chicago Ill  
 Tru-Pine Co 7638 Vincennes Ave Chicago 20 Ill  
 Tru-tone Electronic Eng'g 812 N Highland Los Angeles Cal  
 Tru-Tronics Mfg Co 7 N Halsted St Chicago 6 Ill  
 Truvox Mfg Co 208 E 47 St New York 17 NY  
 Tru-Vue TV Co 99 Featherbed Lane Bronx 52 NY  
 Tube Service Corp 2 Gaston Ave Garfield NJ  
 Tung-Sol Electric Inc 95 8 Ave Newark 4 NJ  
 L E Cotsen Mgr Renewal Sales  
 Sales Offices: Tung-Sol Sales Corp  
 Eastern Div—95 8th Ave Newark 4 NJ W R Oflsen Mgr  
 Atlanta—1859 Cheshire Bridge Rd NE J B Secrist  
 Chicago—315 E Grand Ave D L Lindborg Mgr  
 Columbus—755 W Goodale Blvd J N Hoover Mgr  
 Culver City—8575 Washington Blvd Charles Silvey Mgr  
 Dallas—The Branum Co 1518 Slocum St Mose Branum  
 Denver—The James H Blinn Co 1140 Speer Blvd James H Blinn  
 Seattle—Ron Merritt Co 120 W Thomas St Ron Merritt

Turner Brass Works Sycamore Ill  
 Turner Co 909 17 St NE Cedar Rapids Iowa  
 TV Accessories Co Box 368 Scottsdale Ariz  
 TV Hardware Mfg Co 919 Taylor Ave Rockford Ill  
 TV Products Co Phtite Center Kansas  
 TV Prods Co 145-68 228 St Springfield Gardens NY  
 TV Tuner Co 40-09 22 St Jackson Heights NY

UHF Resonator Co 224 7 St Racine Wis  
 UI-Rad Inc Rt 1 Box 62 St Joseph Mich  
 Ultra HI-Fi Co 709 Sip St Union City NJ  
 Ultra-Hi TV Mfg Co 69 Hammond St Worcester Mass  
 U M & F Mfg 10929 Van Owen St N Hollywood Calif  
 Ungar Electric Tools 4101 Redwood Ave Venice Calif  
 Union Plastics 1627 Peterson Plank Rd Secaucus NJ  
 Unique Ventilation Co 615 Tiffany St Bronx 59 NY  
 United Audio Prod 202 E 19 New York NY  
 United Catalog Publishers 110 Lafayette St New York NY  
 United Condenser Corp 3400 Park Ave New York 56 NY  
 United Electric Controls Watertown 72 Mass  
 United Electronic Mfg 542 39 St Union City NJ  
 United Mfg Div W L Maxson Hamden 14 Conn  
 United Technical Labs Morristown NJ  
 United Transformer Co 150 Varick St New York NY  
 U S Electric Mfg Corp 222 W 14 St New York 11 NY  
 U S Eng'g Co 521 Commercial St Glendale 3 Calif  
 U S Relay Co 1744 Albion St Los Angeles 31 Calif  
 U S Recording Co 1121 Vermont Ave NW Washington DC  
 U S Wire & Cable Progress & Monroe Sts Union NJ  
 Universal Circuit Control 3610 Oakton St Skokie Ill  
 Universal Co High Point N Car  
 Universal Microphone 424 Warren Lane Inglewood Calif  
 Universal Motor Co 465 Universal Rd Oskosh Wis

Universal Products 4100 Taylor Ave Racine Wis  
 Universal Vacuum Tube Co 137 Alexander St Yonkers NY  
 Universal Woodcrafters LaPorte Ind  
 University Loudspeakers 80 S Kenosha White Plains NY  
 President—Irving Galin  
 Sales Mgr—Lawrence J Epstein  
 Dir of Eng—Sidney Levy  
 Mgr Eng Dept—Abraham B Cohen  
 Purchasing Agt—Seymour Blumenfeld  
 Sls Prom Mgr—Irving Greens  
 Univox Corp 102 Warren St New York 7 NY  
 Urania Records Inc 40 E 19 St New York NY  
 Utica Drop Forge & Tool 2415 Whitesboro St Utica 4 NY  
 Utilities Service Co Allentown Pa

Vaco Products Co 317 E Ontario Chicago 11 Ill  
 Valentino Inc Thomas J 150 W 46 St New York 36 NY  
 Valpey Crystal Corp 1244 Highland St Holliston Mass  
 Van Cleef Bros 7800 Woodlawn Ave Chicago 19 Ill  
 Vanguard Recording 256 W 55 St New York 19 NY  
 Vanity Fair Electronics 50 S 4 St Brooklyn 11 NY  
 Van Nostrand Co D 250 4 Ave New York 3 NY  
 Varflex Corp 508 W Court St Rome NY  
 Varicon Corp 65 Hops St Brooklyn 11 NY  
 Varo Mfg Co 1801 Walnut St Garland Texas  
 Vector Electronic 3352 San Fernando Los Angeles Calif  
 Vemalina Products Co PO Box 222 Hawthorne N J  
 Victor Electric Wire & Cable 64 Ackerman Clifton NJ  
 Victor Insulators Inc Maple Ave Yonkers NY  
 Vidair Electronics 576 W Merrick Rd Lynbrook NY  
 Video Accessory Mfg Co PO Box 223 Tulsa 1 Okla  
 Video Corp of America 229 W 28 St New York 1 NY  
 Video Electronic Lab 304 Rodgers Rd Des Moines Iowa  
 Video Industries Co 42 Palmer Pl Port Chester NY  
 Videola TV Corp 447 Broadway New York 17 NY  
 Videon Electronic Corp 902 E Mich Indianapolis 2 Ind  
 Viking Tool & Machine 2 Main St Belleville NJ  
 Vineta Mfg Co 2738 N Sheffield Ave Chicago 14 Ill  
 Visulite Co 423 Broome St New York 13 NY  
 V-M Corp Benton Harbor Mich  
 Vocaline Co of America Coulter St Old Saybrook Conn  
 Vokar Corp Huron River Dr Dexter Mich  
 Vox Productions 236 W 55 St New York 19 NY  
 Vulcan Electric Co 88 Holten St Danvers Mass

Waldom Electronics Inc 4625 W 53 St Chicago 32 Ill  
 Wallace Supplies Mfg 1300 Diversey Pkwy Chicago 14 Ill  
 Wallace's Telalids 136 Day St Jamaica Plain 30 Mass  
 Wall Mfg Co PO Box 71 Grove City Pa  
 Walnut Machine Co 732 Western Ave S Bend Ind  
 Walco Electronics 3602 Gresham Los Angeles 16 Calif  
 Ward Leonard 115 MacQueen Pkwy S Mt Vernon NY  
 Ward Products Corp 4710 State Ave Ashtabula Ohio  
 Atlanta—Mairland K Smith Co 317 Forrest Ave WAI-nut 60194 Covers Alabama; Florida; Georgia; North Carolina; South Carolina  
 Boston—Anderson Sales Co 177 State St Capitol 7-2980 Covers Connecticut; Maine; Massachusetts; New Hampshire; Rhode Island; Vermont  
 Charlotte-NC—Jim Clymer 2422 Marlow Ave Covers Ala-Fla-Ga-N C-S C  
 Chicago—William M Linz Co 7115 North Mobile RO 3-3326 Covers Illinois; East Wisconsin  
 Columbus—C L Pugh Co 2144 Riverside Hudson 8-4855 Covers Ohio; West Pa; West Virginia  
 Dallas—Mose Branum Co 1518 Slocum St Riverside 4995 Covers Oklahoma; Texas—except El Paso; Tex Arkana-Ark  
 Denver—Wm H Connors Co 375 Birch St Dexter 3-6233 Covers Colorado; Idaho; Montana; Nebraska; Nebraska; Utah; Wyoming  
 Detroit—Grant Shaffer Co 14241 Fenkell Ave Broadway 3-5390 Covers Michigan  
 Flushing—Mike Wolfe 136-52 71 Road Covers New York; Erie, Pa  
 Fort Wayne—Southern Sales Co 1605 Lincoln Tower ANthony 5278 Covers Indiana; Kentucky  
 Jersey City—Adolph Schwartz Co 15 Exchange Place DElaware 3-2424-25 Covers Delaware; Maryland; New Jersey; New York City; East Pa; Washington D C  
 Kansas City Mo—R W Farris Co 406 W 34 St Logan 7495 Covers Alton Belleville Berto & St Jacob Illinois; Iowa; Kansas; Missouri; Nebraska—except Scottsbur  
 Los Angeles—Barron-Jur Co P O Box 653 Encino California DUnkirk 3-5248 Covers South California  
 Memphis—Cartwright & Bean 1336 Madison Ave Tel 2-1914 Covers Arkansas; Louisiana; Mississippi; Tennessee; Virginia  
 Minneapolis—Bill Bartleson Co Suite 502 330 Oak Grove Atlantic 6709 Covers Minnesota; North Dakota; South Dakota; West Wisconsin  
 Ormond Beach-Fla—John Thompson 462 Riverside Dr Covers Ala-Fla-Ga-N C-S C  
 Phoenix—H Geo Shaffer Co P O Box 1587 Tel 2-4487 Covers Arizona; Nevada; New Mexico; El Paso Texas  
 Portland Ore—James W Eckerley 3150 SW Hamilton Alwater 0308 Covers Oregon; Washington  
 Rochester—Wolf-Morse Sales Co 74 Park Ave Greenfield 9088 Covers New York State; Erie Pennsylvania  
 San Francisco—Arnold A Sinai 65 9th St Underhill 1-6259 Covers North Calif  
 Honolulu-Hawaii—Branna & Browne 211 Honolulu Mori Bldg Honolulu Hawaii Telephone 6-6005  
 Warren Corp 21 Hanse Ave Freeport NY  
 Wassco Electric Products 126 W Cass St Joliet Ill  
 Waterman Products 2445 Emerald St Philadelphia 25 Pa  
 Waterproof Electric Co 801 S Main St Burbank Calif  
 Waters-Cortley Co Rochester 1 Minn  
 Waveforms Inc 333 6 Ave New York 31 NY  
 Weathers Industries 66 E Gloucester Pike Barrington NJ  
 Webster-Chicago 5610 W Bloomingdale Chicago 39 Ill  
 Webster Electric Co 1900 Clark St Racine Wis  
 Welch Mfg Co W M 1515 Sedgwick St Chicago 10 Ill  
 Welco Mfg Co 225 S 3 St Burlington Iowa

Weller Electric Corp 808 Packer St Easton Pa  
 Wells Gardner & Co 2701 N Kildare Chicago 39 Ill  
 Wen Products Inc 5806 Northwest Hwy Chicago 31 Ill  
 Western Coil & Electric 215 State St Raelin Wisc  
 Westinghouse Electric Corp Electronic Tube Div Elmira NY  
 Westinghouse Electric Radio-TV Div Metuchen NJ  
 Westminster Recording Co 275 7 Ave New York NY  
 Weston Elec Instr 614 Frelinghuysen Ave Newark 5 NJ  
 Weston Labs Harvard Mass  
 Wheatland Tube Co Bankers Securities Bldg Phila 7 Pa  
 Wheeler Insulated Wire 150 E Aurora St Waterbury Conn  
 Whitaker Cable 1301 Burlington N Kansas City 16 Mo  
 White Inc Stan 725 S LaSalle St Chicago 5 Ill  
 Whitney Blake Co 1565 Dixwell Ave New Haven 14 Conn  
 Wickwire Spencer Steel Co 575 Madison Ave New York NY  
 Wilcox Corp 546 Drovers St Indianapolis 21 Ind  
 Wilcox-Gay Corp Charlotte Mich  
 Wiley & Sons John 440 4 Ave New York 16 NY  
 Willard Storage Battery 246 E 131 St Cleveland 1 Ohio  
 Willmar Mfg Co 2715 E 14 St Kansas City 27 Mo  
 Win Sales Co 111-55 77 Ave Forest Hills NY  
 Wincharger Corp E 7 & Division Sts Sioux City 2 Iowa  
 Wind Turbine Co E Market St & P R R W Chester Pa  
 Winegard Co 3000 Scotten Blvd Burlington Iowa  
 Winpower Mfg Co 1207 1st Ave E Newton Iowa  
 Winston Electronics 4312 Main St Philadelphia Pa  
 Wirt Co 5221 Green St Philadelphia 44 Pa  
 Witehrad Electrical Mfg 76 Pulaski St Stamford Conn  
 Workman TV Inc 309 Queen Anne Rd Teaneck NJ  
 Worner Electronic Devices Rankin Ill  
 Wright Inc 2235 University Ave St Paul Minn  
 Wright Steel & Wire 243 Stafford St Worcester 3 Mass  
 Wright-Zimmerman Inc 330 5 Ave New Brighton Minn  
 Xcelite Thorne Ave & Bank St Orchard Park NY  
 Yardney Electric Corp 40 Leonard St New York NY  
 Yonkers Industries Inc 28 School St Yonkers NY  
 Zenith Radio Corp 6001 Dickens Ave Chicago 39 Ill  
 Zierick Mfg Beechwood & Rockdale New Rochelle NY

### Telex RECEIVER

Wider band width and ultra-thin size are features of a new magnetic transistor receiver developed for use in portable amplifiers, hearing aids, ear-phones and other electro-acoustical devices. Receiver is available in three impedances—128 ohms, 500 ohms and



1,000 ohms. Average sensitivity is 120 db. above .0002 dynes/cm.<sup>2</sup> per milliwatt power input, and band width extends from 20 to 3,000 cps. Thickness of the unit is only 1/8 in.; diameter is less than 7/8 in., and weight (minus cord) is 1/4 oz. Polarized contacts and flesh-colored plastic cover. Dept. KF, Telex, Inc., Telex Park, St. Paul 1, Minn.—TECHNICIAN (Ask for No. 5-21)

## New Products

### Stephens SPEAKER SYSTEM

Model 432 theater speaker system is particularly suitable for stereophonic sound installations. The high frequency unit is mounted on a board so that proper phasing of the sound may be achieved. Fine high-frequency response is provided by a Tru-Sonic P-30 high

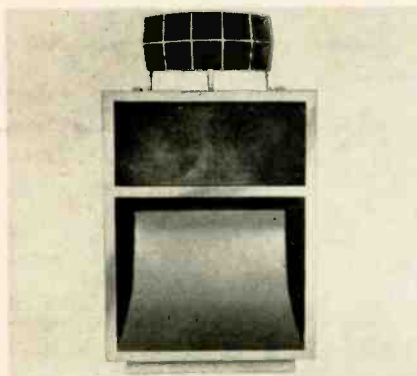

frequency driver and attenuator with 10 cell exponential horn and 600 cycle crossover. Full bass response is provided by two 103LX low frequency drivers. Unit is 69 in. high, 36 in. wide, 30 1/2 in. deep. \$504.00. Stephens Mfg. Corp., 8538 Warner Drive, Culver City, Calif.—TECHNICIAN (Ask for No. 5-23)

**PENETRANT:** Non-oily penetrant for loosening corroded nuts or bolts and larger sized parts of appliances and other electrical or mechanical equipment is non-flammable and odorless. Claimed to be more effective than oil. Fast acting; does not spread over the work. Applied by pour spout or squirt gun. Olin Mathieson Chemical Corp., 10 Light St., Baltimore 3, Md.—TECHNICIAN (Ask for No. 5-37)

### Knight AM-FM TUNER

Model 728 FM-AM tuner, for hi-fi music systems, features a highly sensitive circuit and automatic frequency control. Sensitivity on FM is 5 µv for 20 db quieting; AM sensitivity is 5 µv for 1 v. output. Clean frequency response from 15 to 15,000 cps ±1 db. The Function Selector provides convenient selection of AM reception, or FM reception with or without the automatic frequency control feature. Tuner includes a separate tape recorder output jack which permits making tape recordings of FM or AM programs while they are being played through the high fidelity system. Complete with indoor FM-AM antenna, 56 in. output cable and gold-finish escutcheon, \$89.50, net f.o.b. Chicago. Allied Radio Corp., 100 N. Western Ave., Chicago 80, Ill.—TECHNICIAN (Ask for No. 5-57)

### Granco AM-FM RECEIVER

AM-FM radio, Model 710, offers exceptional tone quality. The 1 1/2 watt amplifier drives an extended-range Alnico V 6 in. oval speaker. Exclusive Granco coaxial tuner with associated circuitry is claimed to provide exceptional sensitivity together with sharp selectivity and stability to lock in desired FM programs. Includes 7 tubes and a selenium rectifier. Built-in AM and FM antennas. Available in ebony finish at \$39.95 retail, and in walnut and ivory at slightly higher prices. Granco Products, Inc., 36-07 20th Ave., Long Island City, N. Y.—TECHNICIAN (Ask for No. 5-60)

## ADVERTISERS INDEX MAY, 1955

Alprodc, Inc. ....	64
American Phenolic Corp. ....	60
American Scientific Development Co. . .	56
Antenna Products .....	38
Arco Electronics Inc. ....	16
Blonder-Tongue Labs., Inc. ....	40
Bogen Co., Inc., David .....	45
Caldwell-Clements, Inc. ....	59
CBS-Hytron Div., Columbia Broadcast- ing System, Inc. ....	51
Centralab Div. of Globe-Union Inc. . .	58
Channel Master Corp. ....	2, 3
Chemical Electronic Engineering, Inc. 48	
Cincinnati Ventilating Co., Inc. ....	38
Chicago Industrial Instrument Co. . . .	54
Claremont Tube Corp. ....	40
Clear Beam Antenna Corp. ....	5
Cornell-Dublier-Electric Corp. . . .	9, 62
Delco Radio Div. of General Motors 49	
Electro-Voice, Inc. ....	37
Erie Resistor Corp. ....	44
Finney Co. ....	6, 7
General Cement Manufacturing Co. . . .	4
Hycon Manufacturing Co. ....	8
Illinois Condenser Co. ....	55
International Resistance Co. . . .	Cover 2
JFD Manufacturing Co., Inc. ....	17, 18
Jensen Industries Inc. ....	40
Jerrold Electronics Corp. ....	57
Jersey Specialty Co., Inc. ....	59
Jontz Manufacturing Co. ....	56
Kenwood Engineering Co., Inc. ....	61
Kester Solder Co. ....	44
Mallory & Co., Inc., P. R. ....	43
Moss Electronic Distributing Co., Inc. .	61
Neal Electronic Co., Inc. ....	61
Permo, Inc. ....	62
Pyramid Electric Co. ....	14
Quam-Nichols Co. ....	50
Radiart Corp. ....	9
Radio Corp. of America ....	Cover 4
Raytheon Manufacturing Co. ....	20
Raytronic Laboratories, Inc. ....	15
Sarkes Tarzian, Inc. ....	41
Seco Manufacturing ....	62
Sonotone Corp. ....	10
Sprague Products Co. ....	Cover 3
Sylvania Electric Products Inc. ....	47
Tech-Master Corp. ....	57
Teltron Electric Co. ....	59
Triplett Electrical Instrument Co. . . .	13
Tung-Sol Electric Inc. ....	52, 53
University Loudspeakers Inc. ....	19
Van Cleef Bros. Inc. Div. of Johns-Manville .....	39
Walco-Electrovox Co., Inc. ....	58
Wallace's Telalides Inc. ....	12
Weller Electric Co. ....	46
Westinghouse Electric Corp. ....	11
Workman TV, Inc. ....	38

While every precaution is taken to insure accuracy, we cannot guarantee against the possibility of an occasional change or omission in the preparation of this index.

# capacitor replacements

## FOR SETS OF THE MONTH

### SYLVANIA CHASSIS 1-526

Symbol No.	Rating $\mu\text{F}$ @ WVDC	Sylvania Part No.	Sprague Replacement
C175	140 @ 300	151-1018	R-1653
C176	140 @ 300/200+30+5 @ 150	161-4016	R-1553
C177	200+5 @ 150	161-2013	
C213	20 @ 450	161-1017	
C214	10 @ 400	161-1013	

### TRAV-LER CHASSIS 417E4

Symbol No.	Rating $\mu\text{F}$ @ WVDC	Trav-ler Part No.	Sprague Replacement
EC-16	40+40 @ 450	TV-EC-16	TVL-2764
EC-17	40 @ 450/50 @ 50	TV-EC-17	{ TVA-1713 TVA-1308
EC-20	10 @ 50	TV-EC-20	TVA-1304
EC-25	30 @ 450/50 @ 200	TV-EC-25	{ TVA-1711 TVA-1713
EC-27	100 @ 25	TV-EC-27	TVA-1207
C87 } R79 }	Vertical Integrator	TV-CC-26	V-1

### MAGNAVOX CHASSIS 600

Symbol No.	Rating $\mu\text{F}$ @ WVDC	Magnavox Part No.	Sprague Replacement
C413	10 @ 350 (INP)	270027-26	R-1468
C501	70+40+10 @ 350/50 @ 50	270021-52	{ TVL-3792 TVA-1308
C502	30+5 @ 350/100 @ 200	270021-55	TVL-3762
PC301	Vertical Integrator	250186-1	V-1

Sprague makes more capacitors . . . in more types . . . in more ratings . . . than any other capacitor manufacturer. Send 10¢ for the 65-page giant seventh edition TV Replacement Manual to Sprague Products Co., 65 Marshall St., North Adams, Mass., or get it FREE from your Sprague distributor.

### EMERSON CHASSIS 120252-B

Symbol No.	Rating $\mu\text{F}$ @ WVDC	Emerson Part No.	Sprague Replacement
C18 } C22 } C23 }	40+40 @ 150/250 @ 10	925302	R-1392
C12 } C13 } C14 } C15 } C16 }	Multiple Capacitor Plate	928034	34C8

### G.E. MODEL 645

Symbol No.	Rating $\mu\text{F}$ @ WVDC	G.E. Part No.	Sprague Replacement
C17	90+40 @ 150/400 @ 10	RCE-212	R-1998

### GRANCO MODEL 610FM

Symbol No.	Rating $\mu\text{F}$ @ WVDC	Granco Part No.	Sprague Replacement
	80+50 @ 150 2 @ 50	AC471	R-1534 TVA-1301

### MOTOROLA CHASSIS HS-422

Symbol No.	Rating $\mu\text{F}$ @ WVDC	Motorola Part No.	Sprague Replacement
C4	50+30 @ 150	23B632015	TVL-2432
C2	.05 @ 200	8R120842	*25E-547
C3	.05 @ 400	8K121268	*45E-547
C5	.03 @ 200	8K122226	*25E-533
CR-1	Audio Coupling Plate	21B630180	DT-2

\* Replacements shown are "single-end" units for upright mounting.

### CBS-COLUMBIA CHASSIS 1603

Symbol No.	Rating $\mu\text{F}$ @ WVDC	CBS-Columbia Part No.	Sprague Replacement
C1-5 } C4-5 }	10 @ 150	21001081	TVA-1406
C12-11 } C16-5 }	140+10 @ 300/100 @ 25	21001001	R-2009
C6-3 } C11-3 } C16-6 }	5 @ 475/100 @ 300/200 @ 150	21000991	R-2010
C6-4	10 @ 300	21001071	TVA-1604
C16-4	140 @ 200	21000981	TVL-1540

DON'T BE VAGUE...INSIST ON

# SPRAGUE

(Distributors Div. of the Sprague Electric Co.)

