

CALDWELL-CLEMENTS'

RADIO & TELEVISION RETAILING

December • 1951

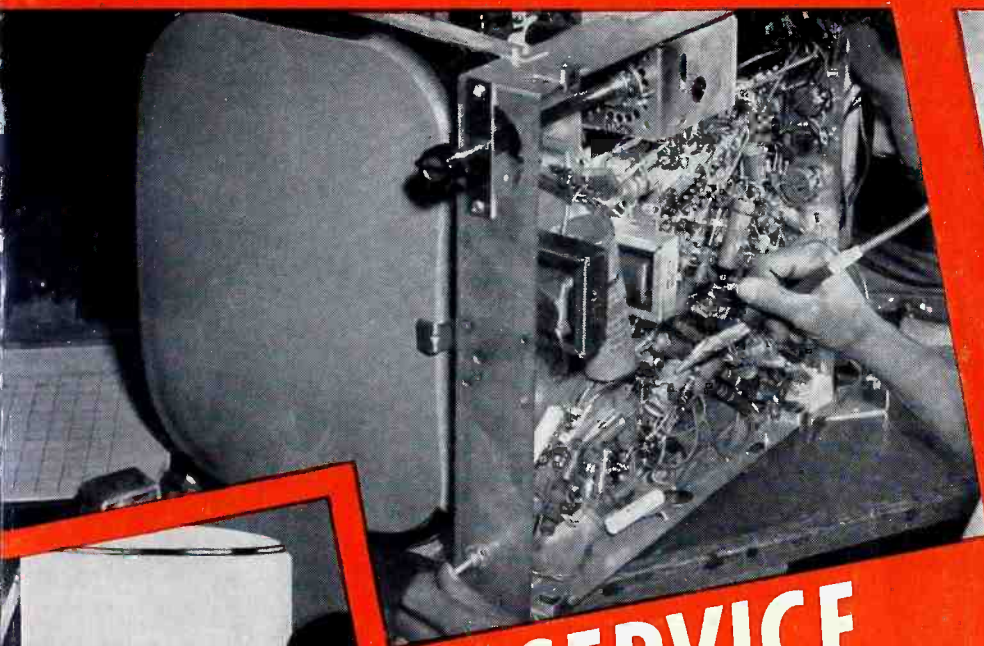

Your **SERVICE**
Department,
Plus Aggressive Merchandising

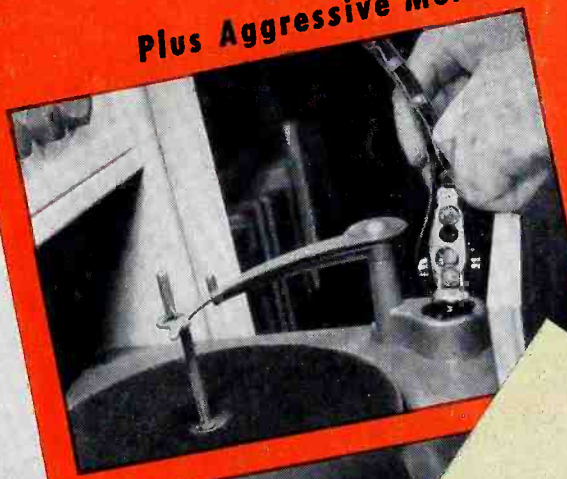
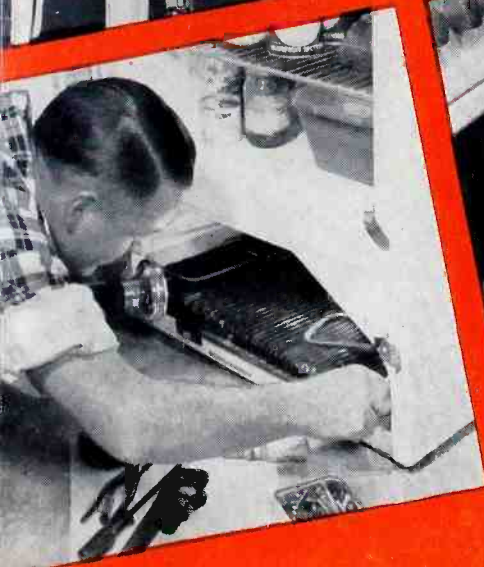

WILL MAKE MONEY FOR YOU IN '52 !

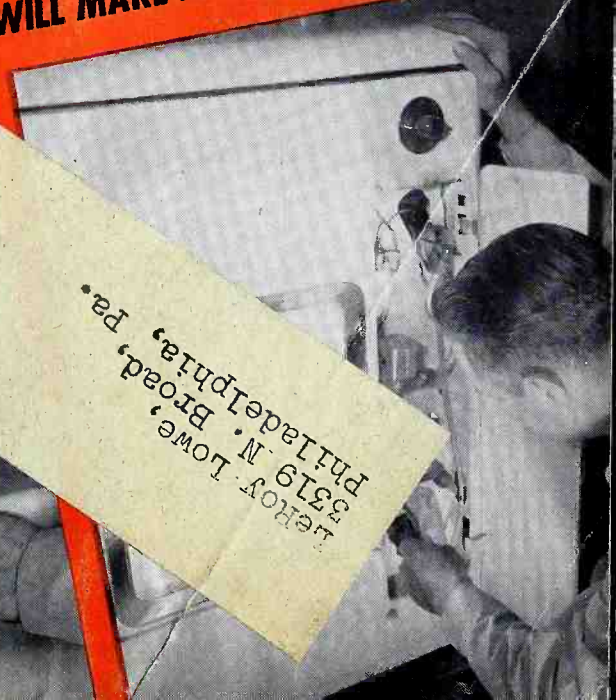

JEHOY Lowe,
5319 N. Broad,
Philadelphia, Pa.

U.S. POSTAGE
5¢ Paid
New York, N.Y.
Permit No. 3605

IT'S STARTED!



4,000,000 PICTURE TUBE REPLACEMENTS COMING!

Get YOUR Share!

MOST HYTRON TOOLS AVAILABLE AGAIN!

Materials shortages are tough. But most of the Hytron tools are available now. Only the 7-Pin and 9-Pin Straighteners will be scarce. Aluminum and stainless steel are tight . . . and we won't give you an inferior tool.

A word to the wise: order now while these famous tools are available. Put them to work for you. They'll save your time . . . temper . . . dollars. Order today from your Hytron jobber.



Pick-Up Stick, 5¢ net

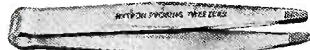

Probing Tweezers, 35¢ net



Tube Tapper, 5¢ net



Soldering Aid, 49¢ net



Tube Lifter, 15¢ net



Tube Puller,
75¢ net



7-Pin and 9-Pin
Straighteners,
55¢ ea. net

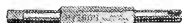

Auto Radio Tool,
24¢ net

Over 4,000,000 TV sets are now over two years old. Just as electric-light bulbs dim with age, the picture tubes in these sets are failing.

A tremendously profitable replacement market (conversions too) is now yours for the selling. And you have lots to sell when you sell CBS-Hytron picture tubes: The original *studio-matched* rectangular — made in the world's most modern picture-tube plant.

You get better than new set performance with greatly improved tubes. A new black face for better contrast. Convenience of the Hytron Easy Budget Plan. And a generous six-months-from-date-of-sale guarantee. A guarantee you can depend on . . . because it is backed by CBS-Hytron.

Go after your share of this tempting business now! Remember: demand for TV picture and receiving tubes is expected to exceed supply. Military requirements and serious materials shortages are the reason. Tubes in your stock will be better than gold. Don't over-buy, but buy enough. CBS-Hytron will do its utmost to help you.

MANUFACTURERS OF RECEIVING TUBES SINCE 1921
HYTRON
RADIO AND ELECTRONICS CO.
A DIVISION OF COLUMBIA BROADCASTING SYSTEM, INC.



MAIN OFFICE: SALEM, MASSACHUSETTS

RADIO & TELEVISION RETAILING

Including "RADIO & TELEVISION"
"RADIO & TELEVISION TODAY"
and "ELECTRICAL RETAILING"

IN THIS ISSUE

DECEMBER, 1951

ORESTES H. CALDWELL
Editorial Director

M. CLEMENTS
Publisher

JOHN L. STOUTENBURGH
Executive Editor
EDWARD A. CAMPBELL
Managing Editor
JOHN G. McGEOY
Assistant Editor
CHARLES GRAHAM
Technical Editor
CHARLES F. DREYER
Art Director

BUSINESS DEPARTMENT
M. H. NEWTON
Business Manager
HOWARD A. REED
Assistant Sales Manager
DIXON SCOTT
District Manager
N. McALLISTER
Asst. Business Manager
A. O'ROURKE
Production Supervisor
MARTHA H. SAVILLE
Director, Reader Service

BRANCH OFFICE
CHICAGO 6

S. M. GASKINS, Western Manager
JOHN D. LUPTON, District Manager
201 N. Wells St., Randolph 6-9225

LOS ANGELES 5
CHRIS DUNKLE & ASSOCIATES
Southern California Representative
2506 W. 8th Street, Dunkirk 7-6149

B. V. SPINETTA, Directory Manager
WARREN S. BROWN, Circulation Mgr.

W. W. SWIGERT, Credit Manager

RADIO & TELEVISION RETAILING*

December, 1951, Vol. 54, No. 6, 35 cents a copy. Published monthly by Caldwell-Clements, Inc., 480 Lexington Ave., New York 17, N. Y. PL 9-7880. M. Clements, President; Orestes H. Caldwell, Treasurer. Subscription rates United States and U. S. Possessions \$2.00 for one year, \$3.00 for two years, \$4.00 for three years. Canada \$3.00 for one year, \$4.00 for two years, \$5.00 for three years. Pan American Countries \$4.00 for one year, \$5.00 for two years, \$6.00 for three years. All other countries \$5.00 for one year, \$7.50 for two years, \$10.00 for three years. Printed in U.S.A. Entered as second class matter, November 16, 1950, at the Post Office at New York, N. Y., under the act of March 3, 1879.

*Trade-Mark Reg. U. S. Pat. Off.
Copyright 1951 by
CALDWELL-CLEMENTS, Inc.
Publishers also of TELE-TECH

* AM, FM, Television

| | |
|--|------------|
| Cover—Service Plus Selling Can Make Money for You in '52 | |
| What's Ahead—In Radio, Appliances, Records and Television..... | 17, 18, 19 |
| How to Speed Up Your Inventory Taking..... | 22, 23 |
| High Sales Record All Year 'Round..... | 24, 25 |
| Bank On Your Service Department for the Coming Year..... | 26, 27 |
| Successful Selling in Farm Areas..... | 28, 29 |
| New Model Radio and Television Sets..... | 36 |
| Antenna Kits for Dealer's Use and for Resale..... | 68 |

* Records, Phonographs, Accessories

| | |
|---|-------------------|
| Boost Your Disc Sales During the Xmas Season..... | 30, 31 |
| Typical Album Releases for Yuletide Selling..... | 32 |
| News and Trends of the Phono Record Market..... | 18, 19 |
| Happenings in the Disc Industry..... | Begins on page 34 |

* Electrical Appliances

| | |
|---|------------|
| How One Dealer Maintains Year 'Round Sales..... | 24, 25 |
| Specifications of Latest Model Hand Irons..... | 42, 44, 46 |
| New Model Electric Appliances..... | 48 |
| Marketing Trends in the Electric Appliance Field..... | 17, 18, 19 |
| Recent Industry News Events..... | 94 |

* Servicing and Sound

| | |
|--|--------|
| Reduce Your Customer Turnover..... | 70 |
| The Why and How of DC Reinsertion in TV Sets..... | 52, 53 |
| How the Automatic Focus Picture Tube Operates..... | 56, 57 |
| Printed Circuits Widely Used in Current Sets..... | 60, 61 |
| Shop Shortcuts Speed Servicing..... | 66 |
| Latest Technical New Products..... | 62 |
| For the Custom Builder..... | 64 |

Latest Product Specifications, Directories, etc.,

that have appeared in RADIO & TELEVISION RETAILING:

Specifications:

| | |
|-------------------------------|------------------|
| Recorders..... | Apr. '50, p. 62 |
| Room Air Conditioners..... | Mar. '51, p. 60 |
| Home Radios..... | Apr. '51, p. 58 |
| Portable and Auto Radios..... | Apr. '51, p. 56 |
| Washing Machines..... | May '51, p. 84 |
| Vacuum Cleaners..... | July '51, p. 67 |
| Refrigerators..... | Sept. '51, p. 65 |
| Dishwashers..... | Oct. '51, p. 62 |
| Television Receivers..... | Nov. '51, p. 42 |
| Ironers..... | Nov. '51, p. 50 |
| Hand Irons..... | Dec. '51, p. 42 |

Directories:

| | |
|--------------------------------|------------------|
| Distributors..... | Jan. '51, p. 115 |
| TV & FM Antenna Mfrs..... | Mar. '51, p. 36 |
| Custom Component Mfrs..... | Apr. '51, p. 34 |
| Test Instruments..... | May '51, p. 100 |
| Electric Housewares..... | June '51, p. 36 |
| Phono Record Mfrs..... | July '51, p. 42 |
| Roster of Representatives..... | Oct. '51, p. 101 |

Reference Charts:

| | |
|--------------------------------|-------------------|
| FM Coverage Areas..... | July '50, part II |
| Battery Replacement Chart..... | Apr. '51, p. 73 |
| Four Field Statistics..... | Jan. '51, p. 38 |
| UHF Coverage Areas..... | Aug. '51, p. 44 |
| TV Sets in Use..... | June '51, p. 20 |

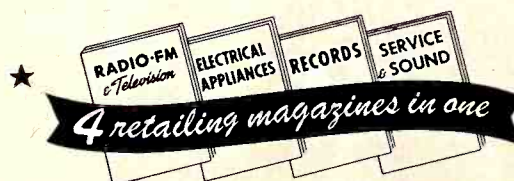

Caldwell-Clements, Inc., 480 Lexington Ave., New York 17, N. Y.

Motorola TV

first again with sensational TV NEWS

DOZENS OF NEW WAYS AND PLACES TO ENJOY NEW "TAKE ALONG" TV



EXTRA SET for large families or to enjoy in rumpus room, dining room, nursery or den.



VACATIONS won't mean giving up TV because this one can be taken along just like luggage!



CLASSROOM enjoyment of special programs of historical or national interest.



CLUBS will enjoy special TV shows at meetings or parties, members need not miss TV.

EVERY IMPORTANT FEATURE BUILDS SALES!

EXCLUSIVE GLARE-GUARD anti-reflection screen and reflection-proof tube eliminate up to 98% of light reflection interference.

ALL-CHANNEL UHF TUNING needs no future changes or additions for complete continuous tuning of both VHF and UHF channels.

INSTANT "TARGET" TUNING automatically synchronizes both picture and sound exactly with a single control.

SUPER-POWER "FRINGE" PICKUP for good reception in both local and distant "difficult" signal areas where many other TV sets fail to perform or offer faulty reception.

"GOLDEN VOICE" TONE naturally rich . . . in perfect pitch and clarity at all times.

LONG-RANGE DEPENDABILITY for better performance throughout the years . . .

PLUS 3 NEW SMARTLY STYLED Motorola TV SETS

IN ADDITION TO A FULL LINE OF 1952 MODELS

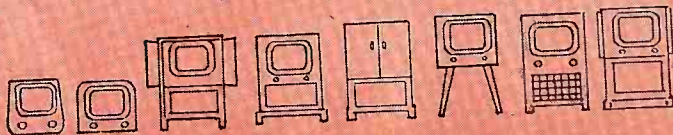

MODEL 20T3

Styled like a console in rich Mahogany . . . giant 20 inch pictures, Glare-Guard, instant tuning, Built-in-Antenna.

\$279⁹⁵*

Lined Oak \$299.95*

NOW! FIRST BIG SCREEN PORTABLE TV!

14 INCH PICTURE

SUPER-POWER PERFORMANCE

Here's a set that will actually walk right out with the customer! Compact as a piece of luggage and covered with good-looking California Tan Leatherette, this portable TV is real sales excitement!

All the famous Motorola TV features that customers know they can depend on for the finest in TV viewing and performance: Electro-Lock Focus, Filter-Clear picture circuits, instant tuning, and plug-in "Golden Beam" antenna.

MODEL 14P1

\$199⁹⁵*

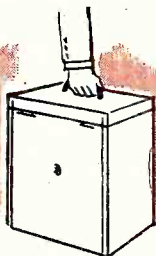

JUST IN TIME FOR CHRISTMAS GIFT SALES!

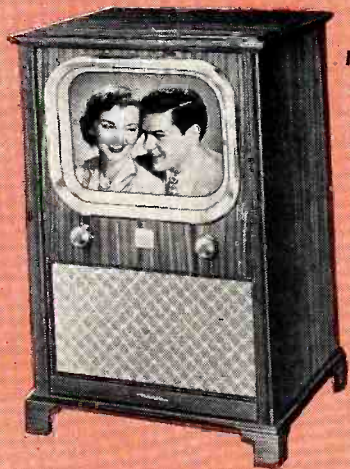

MODEL 20K6
20 Inch screen console in fine mahogany . . . Built-in-Antenna, Glare-Guard, "Golden Voice" sound.

\$339⁹⁵*

Limed Oak
\$359.95*



MODEL 17F11

Thrilling 3-way combination! Big 17 inch TV . . . Multi-Play phono plays 78, 45, 33-1/3 rpm records . . . "Golden Voice" AM radio. De luxe Mahogany cabinet.

\$399⁹⁵*

*These retail prices include Federal Tax. Some prices slightly higher South and West. Prices and specifications subject to change without notice.

AT YOUR DISTRIBUTORS NOW! **Motorola TV**

Where will she go shopping?

Here's an important sales fact for you to remember: Mrs. Housewife in your community relies on the 'yellow pages' of the telephone directory for buying information. Surveys prove that year in, year out, 9 out of 10 shoppers throughout the nation use the 'yellow pages.'

You can direct the housewives in your community to *your* radio and television store by using the 'yellow pages' to advertise your business. Simply have your name listed under the branded products and services you offer.

Your directory representative will be glad to furnish facts about the 'yellow pages' as an effective sales tool. Check with him on his next visit; or better still, call your local telephone business office now for further information.

AMERICA'S BUYING
GUIDE FOR OVER
60 YEARS



Make Your Store Gift Headquarters



with Colorful Display Kit from

Admiral



This colorful new display kit has been designed to provide sparkling bright, Christmasy decorations that will *stop traffic* and *sell merchandise*. Includes life-size 62" Santa, another that's 14" high, and two sets of dimensional figures, all lithographed in full color. A pair of eye-catching window posters are also included. Make *your store* Admiral gift headquarters in your community. Get in touch with your Admiral distributor today!



In your window . . . or in your store . . . this colorful display will help you sell Admiral television sets, radios, ranges and refrigerators.



Sentinel
**Living Pictures*
mean a floor stock
that's truly
Alive!



Bursting at the seams, that's the condition of the public's pockets today—income is at a new high level. Savings deposits are bulging. Banks' "statements of condition" prove it. So does the sales-volume of *Sentinel* dealers! For these new *Sentinel LP*-TV sets (Living Picture Television)* are alive with exciting beauty of cabinets, thrilling fidelity of sound, dramatically "living" pictures. Make your profit-sheet throb with new life, too! Call your *Sentinel* distributor—or *Sentinel* direct—TODAY.



Model 443 CVML
The Lauderdale
21" Screen

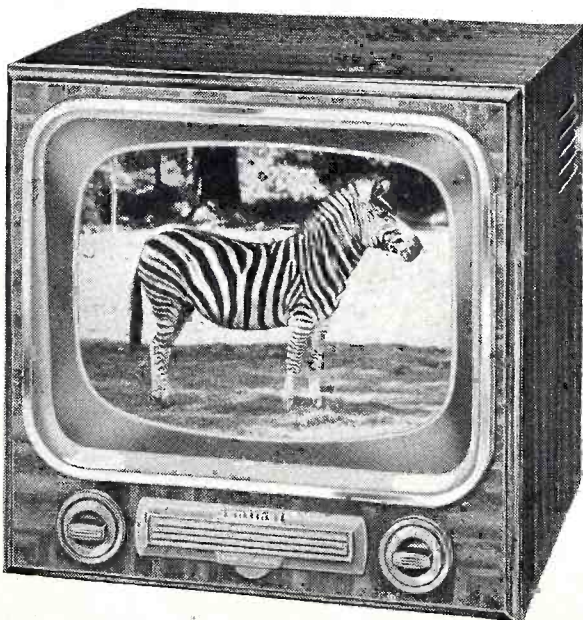

Model 438 TVM
The Deerfield
17" Screen

Sentinel

Television

Sentinel Radio Corporation
Evanston, Illinois

INSIST on this label...

Admiral Bendix Television SCOTT hallicrafters

Magnavox

CROSLY

Motorola

Kuys-Halbert

Stewart-Warner

PILOT

Hoffman

Starrett

Imperial

Tele King

Westinghouse

Olympic

Packard Bell

Calbest

TEI

Replace with
the Exact
original equipment

Thomas
PHOTOTRON
TELEVISION
PICTURE TUBE

Thomas Electronics Inc., Passaic, New Jersey, U. S. A.

Replacement **16CP4A** Tube Chart

| GROUP | LENGTH | ENVELOPE | DEFLECTION ANGLE | ION TRAP | CAPACITANCE (μf) | TYPE FACE PLATE |
|--------|--------|----------|------------------|----------|------------------|-----------------|
| 16AP4 | 21½" | M | 52 | D | N | Clear |
| 16AP4A | 21½" | M | 52 | D | N | Clear |
| 16CP4 | 21½" | G | 52 | D | 2000 | Clear |
| 16CP4A | 21½" | G | 52 | D | 2000 | Clear |
| 16LP4 | 22¼" | G | 52 | S | 2000 | Clear |
| 16LP4A | 22¼" | G | 52 | D | 2000 | Clear |
| 16TP4 | 22¼" | G | 52 | D | 2000 | Grey |
| 16TP4A | 22¼" | G | 52 | D | 2000 | Grey |

Meck

... it's your guarantee* of quality.

It means you're replacing a picture tube with the exact original equipment... chosen by these 20 manufacturers (and many more!) because of proved superior performance.

This means less time-killing tube call-backs: more profit

for you in each replacement! So, insist on this label... and get the best — THOMAS!

*Every THOMAS Phototron picture tube is guaranteed for 6 months from the actual date of installation; regardless of how long the tube remains on your shelf.

Contact your jobber or distributor for the complete THOMAS Phototron line... or write THOMAS direct.



Phototron picture tube

ELECTRONICS Inc. PASSAIC, NEW JERSEY

Export Rep: Joseph Plasencia - 401 Broadway, New York, N. Y.

Canadian Rep: Charles W. Pointon - 1926 Gerrard St. E., Toronto, Ontario

HIS CHOICE IS

Regency

CHARLIE GOLENPAUL
EMINENT DISTRIBUTOR SALES MANAGER
AEROVOX CORPORATION
PHOTOGRAPHED IN HIS HOME

LARGEST SELLING BOOSTER
AT ANY PRICE

THE PICTURE WITH THE



BILLION DOLLAR BACKGROUND

Bendix Magic Interlace

GIVES YOUR CUSTOMERS THE BEST VIEWPOINT Gives You the Best Sales Point!

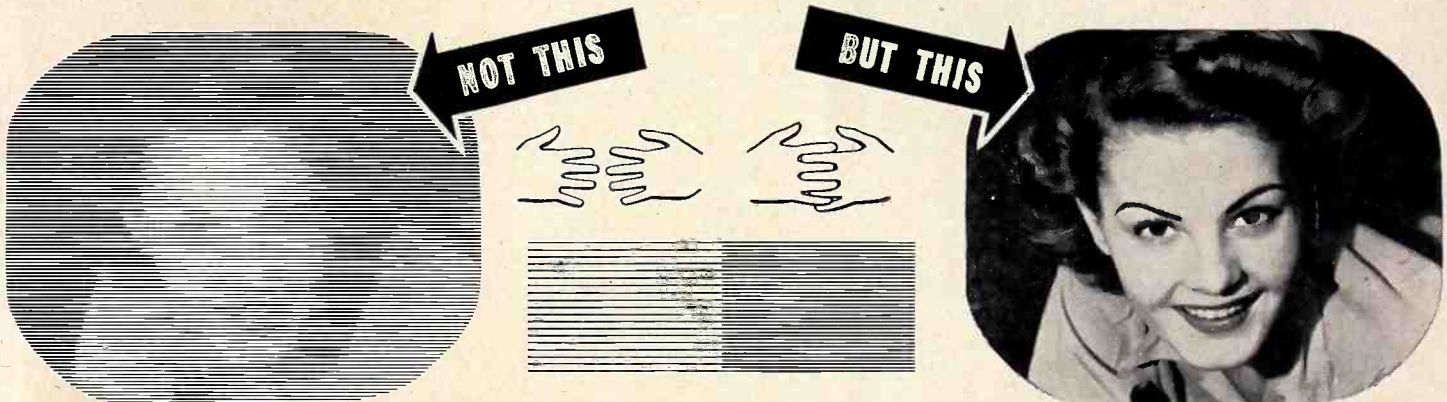

Here's what people see when you turn on a set without Bendix Magic Interlace. The picture is coarse, dull, and incomplete, because the set shows only one of the two series of horizontal lines broadcast from the studio. For a perfect picture, both must be clearly visible.

Look at the sensational difference when you turn on a Bendix. Magic Interlace makes visible and interlaces both sets of broadcast lines instantly and automatically, and locks them in place. The picture is always clear, solid, complete and easy on eyes—a revelation in realism.

Showmanship Sells T-V... HERE ARE THE "PROPS" THAT WILL PUT YOU IN SHOW BUSINESS!

FREE **6** DEMONSTRATION KIT!



Back up your selling with a real touch of showmanship. Bendix gives you the stage-settings in this big promotion kit. Bendix also gives you a fascinating story that once more makes television new and dramatic. It's the Magic Interlace story! Tell it! Explain it with your hands (see illustration above) and with the intriguing pocket demonstrator. Then turn on a Bendix set and show your prospects the vivid, living pictures it presents. These selling steps turn the spotlight on Bendix Magic Interlace... the headliner that will pull in the sales.

*REG. U.S. PAT. OFF.

Bendix* TV sets are designed so that both UHF and Color Converters may be attached. This is your protection against obsolescence.

Do Business with Bendix—IT PAYS!

Product of Bendix Aviation Corporation

BENDIX RADIO TELEVISION AND BROADCAST RECEIVER DIVISION • BALTIMORE 4, MARYLAND

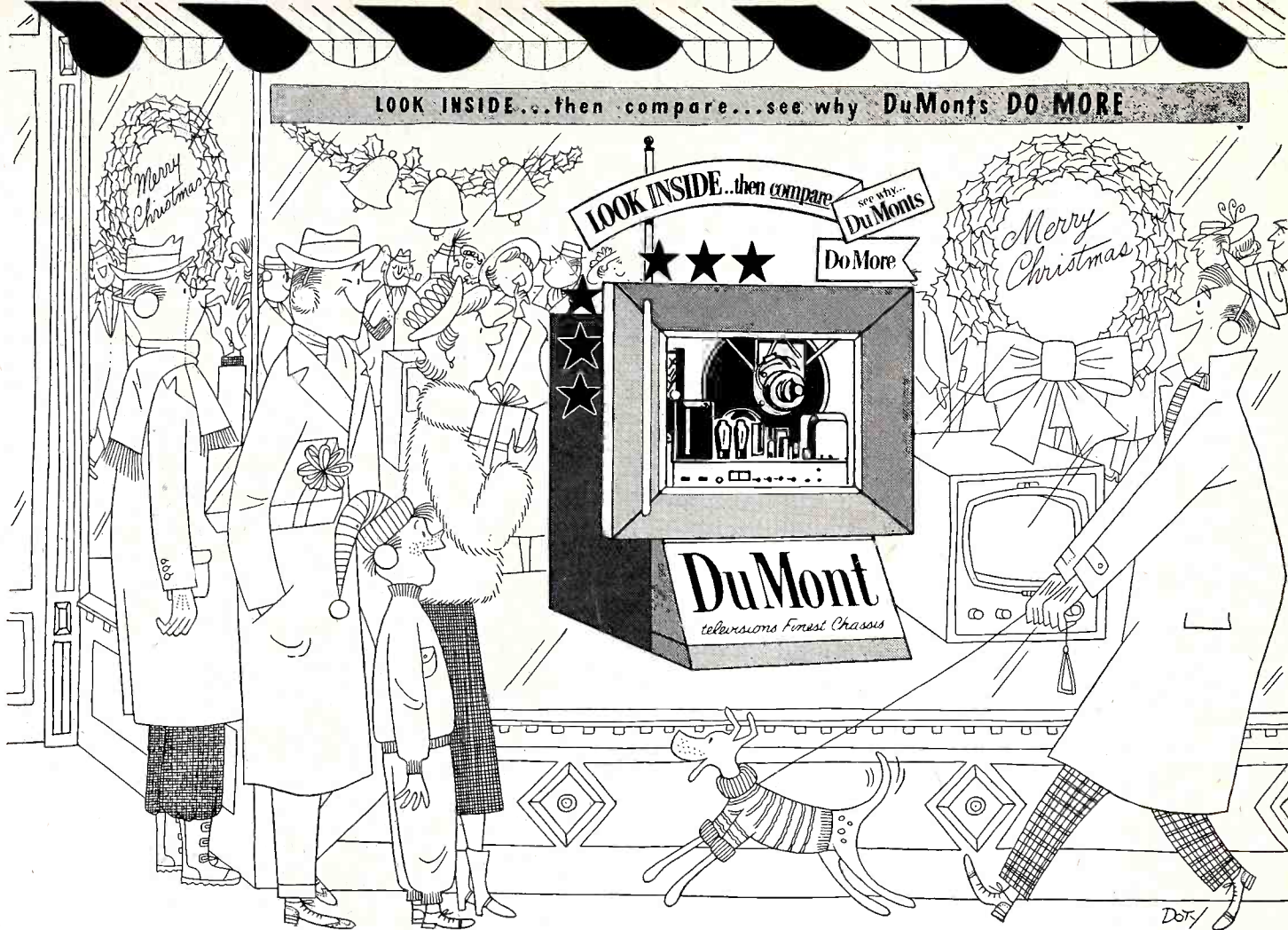

Look inside — SEE WHY THE
DU MONT "CHASSIS STORY"

brings customers inside to buy!

LIKE MOST good promotional ideas, this one is simple. It's been a terrific success from the start with DuMont dealers from coast to coast. People are flocking in by dozens and scores—to look inside—to compare—to see why! The more they see of the DuMont chassis—the more questions they ask—the more they want a DuMont. They like seeing for themselves just *why* DuMont always comes through with television's finest performance. A chassis that can

stand up to this test has to be good! This is a striking example of why a DuMont dealership is the most coveted franchise in television today. If you haven't taken advantage of this outstanding promotion, get in touch with your DuMont distributor . . . who has the package all wrapped up for you. There is still time to have that cash register beating out good Christmas business.

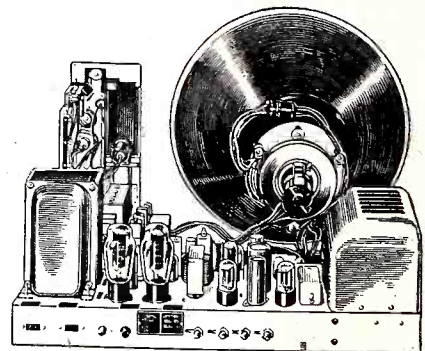

DU MONT *First with the finest in Television*



When it's time for a new tube—it's time for a DuMont Teletron* in any set

Allen B. DuMont Laboratories, Inc., Television Receiver Division, East Paterson, N. J., and the DuMont Television Network, 515 Madison Ave., New York 22, N. Y. *Trade Mark

LOOK— NO NOISE!

Boosts the signal . . .
not local lead-in noise!

Eliminates effect of
external interference!

Gives higher signal-to-
overall-noise ratio!



Tunes itself automatically
on all channels.

Lowest internal noise
factor—means less "snow."

Exclusive all-electronic
4-tube broadband circuit.

Uniformly high usable gain—
no limiting peaks.

Single twin-lead line* carries
power up—signal down.

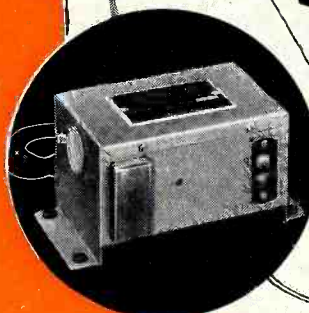

Junction Box
Concealed Behind
TV Set

AUTOMATIC SELF-TUNING Tenna-Top TV BOOSTER

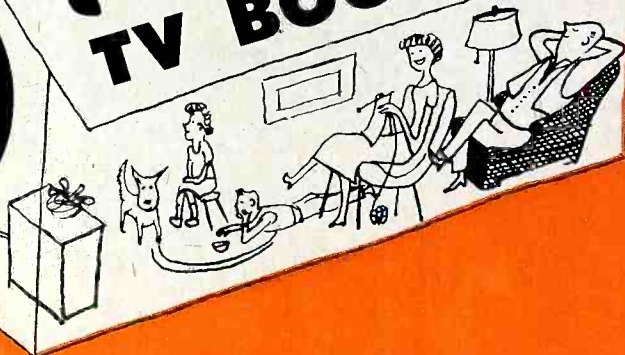

PICTURES ARE SHARPER, BRIGHTER! SOUND IS CLEARER!

You can see and hear the difference when you hook up the TENNA-TOP. Because it is mounted at the antenna ahead of the lead-in...it amplifies only the wanted TV signals, not any local noise interference produced by automobile ignition systems, neon signs, diathermy, or other external noise picked up by the lead-in. You have the further advantage of E-V low-noise circuit. All this guarantees the best possible results with any TV set anywhere...even in toughest fringe areas or in all noisy locations. The TENNA-TOP is completely automatic. Turns "On" or "Off" with the TV receiver switch. It is easy to install, highly stable, trouble-free.

Model 3010 Tenna-Top TV Booster. List Price . . . \$89.50

Send today for Bulletin No. 163



E-V Tune-O-Matic TV BOOSTER

First with completely automatic self-tuning. Turned "On-Off" by TV receiver switch. Instantly boosts signal on any channel selected on TV set. Uniform high gain—low noise circuit assures better pictures and sound. Easily concealed in or behind TV set or elsewhere. All-electronic. Insures long-life service. Proved in thousands of installations.

Model 3000. Super Tune-O-Matic. 4-stage. List \$59.50
Model 3002. Tune-O-Matic. 2-stage. List . . . \$39.50

Electro-Voice

422 CARROLL STREET • BUCHANAN, MICHIGAN
Export: 13 E. 40th St., New York 16, U.S.A. Cables: Arlab
TV BOOSTERS • MICROPHONES • HI-FI SPEAKERS • PHONO-PICKUPS

*Patent Pending

Appliance buyers prefer a complete dealer financing package



Commercial Credit Creates Good Will. Dealers are able to cash in on the repeat business they get through COMMERCIAL CREDIT financing. That's why *more* dealers finance *more* home appliances through COMMERCIAL CREDIT than any other national financing plan.



Reputation for Integrity. Dealers everywhere like to know they can depend on *financing as usual* during times of plenty, times of shortages . . . war, peace, prosperity or depression. And they *know* they can depend on COMMERCIAL CREDIT service at all times. Customer financing includes all details of credit investigation, collection, insurance, adjustment and prospect follow-up.



Customers Benefit from Insurance Coverage. Property Insurance protects customers in event of loss of, or damage to, merchandise as outlined in policy. Life Insurance coverage cancels unpaid balance in event of purchaser's death.

EIGHT WAYS BETTER!

- ❶ Wholesale Financing
- ❷ Fast Credit Approval
- ❸ Life Insurance Protection
- ❹ Property Insurance Protection
- ❺ Automatic Sales Follow-up
- ❻ Tested Collection Service
- ❼ Builds Customer Good Will
- ❽ Nationwide Facilities

MOST APPLIANCE BUYERS are time buyers. They not only want credit and expect credit . . . but they need it . . . many can't buy without it. COMMERCIAL CREDIT is nationally known and highly regarded by millions of time buyers who have already financed home appliances, automobiles, etc. When you offer the COMMERCIAL CREDIT PLAN, you offer "brand name" financing that is preferred by customers . . . and dealers too.

COMMERCIAL CREDIT offers dealers a *complete* financing package . . . from wholesale plan down to the smallest details of retail financing. Dealers control the financing of their stock from distributor to consumer . . . deal with one reliable source . . . eliminate the necessity of tying up needed capital in inventories or instalment sales. Ask your distributor about this plan or call your nearest COMMERCIAL CREDIT office for complete details.

COMMERCIAL CREDIT CORPORATION

A subsidiary of Commercial Credit Company, Baltimore . . . Capital and Surplus over \$100,000,000 . . . offices in principal cities of the United States and Canada.

Know Your Prospects. This interesting study contains facts about the Time Sales Market that can be valuable to you in the year ahead. Ask your distributor for a copy . . . or call your nearest COMMERCIAL CREDIT office.

New ZENITH "FRINGE-LOCK" CONTROL CIRCUIT



**New Zenith Invention
Brings World's Finest
Fringe Area Picture**

See the picture at left above? That's fringe area reception on ordinary TV. Vertical "wobble" and horizontal "roll" are caused by ordinary fringe area interference. New Zenith "Fringe Lock" Control Circuit blocks out interference, concentrates on picture signal alone, gives you far better picture shown at right.

Only Zenith has it!



**Sells television's toughest customers on sight!
Means faster, easier sales, more profits for You!**

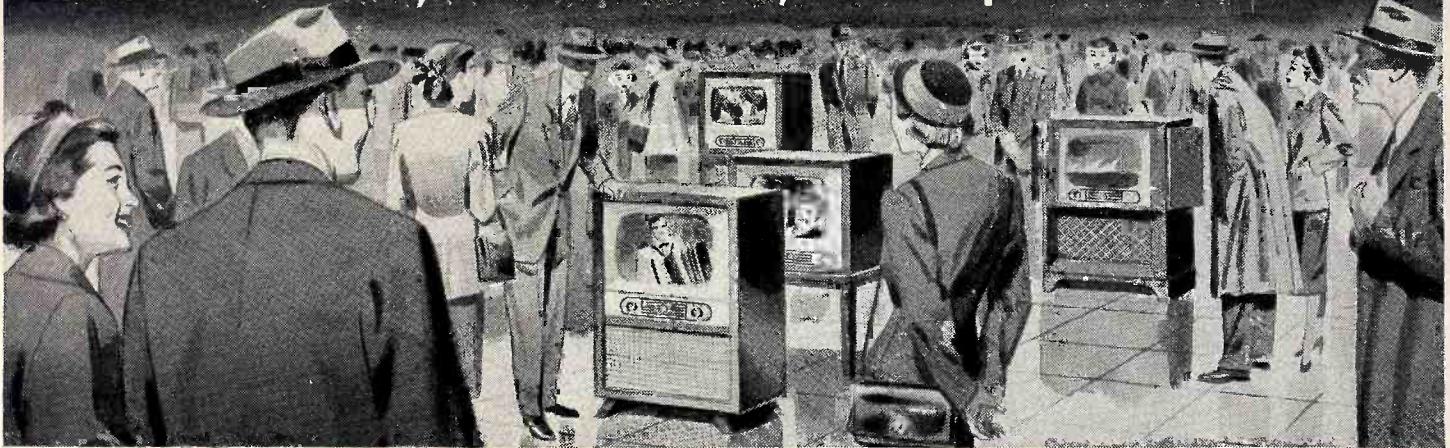

They're television's toughest customers . . . the folks who live in remote "fringe areas." But show them Zenith's remarkable new Distance-Reception, and, brother, you've made yourself a whole stack of sales!

It's Zenith's new "Fringe Lock" Control Circuit in action . . . bringing the finest fringe area picture in television! What's more, this sensational Zenith invention teams up with Zenith's "Electronex" Tube, Custom-Tuned Miracle Turret Tuner . . . and with long-famous Zenith

built-in quality . . . to sell *all* your prospects quickly and *keep* them sold! You get *more* sales, *more* satisfied customers, *less* dissipation of your profits through costly customer complaints and "call back" servicing.

Check your Zenith Distributor now about these three new 1952 models. See them. Demonstrate them. They'll prove to you beyond a doubt that—in fringe area and TV center alike—Zenith sales are easier sales. Zenith profits are profits you can keep!

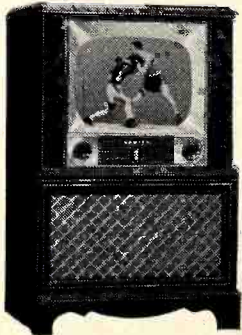

1952 Zenith "Galsworthy" Console. 18th Century motif in Mahogany veneers and hardwoods. 17-inch Electronex Tube for world's finest "full-focus" picture. New Dust-Proof Picture Screen. Model J2042R



1952 Zenith "Kipling" TV-Radio-Phonograph—17-in. "Electronex" Tube. Cobra-Matic Record Player, Super-Sensitive FM and Long Distance AM. Mahogany solids and veneers. Model J2868R

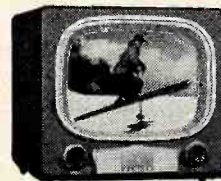

1952 Zenith "Fielding" Table Model. A sales sensation! Mahogany Pyroxylin. 17-inch "Electronex" Tube. Also in Blonde Model J2030R

ZENITH RADIO CORPORATION • Chicago 39, Illinois



A Star Market

**GIFTS
FOR THE
HOME**

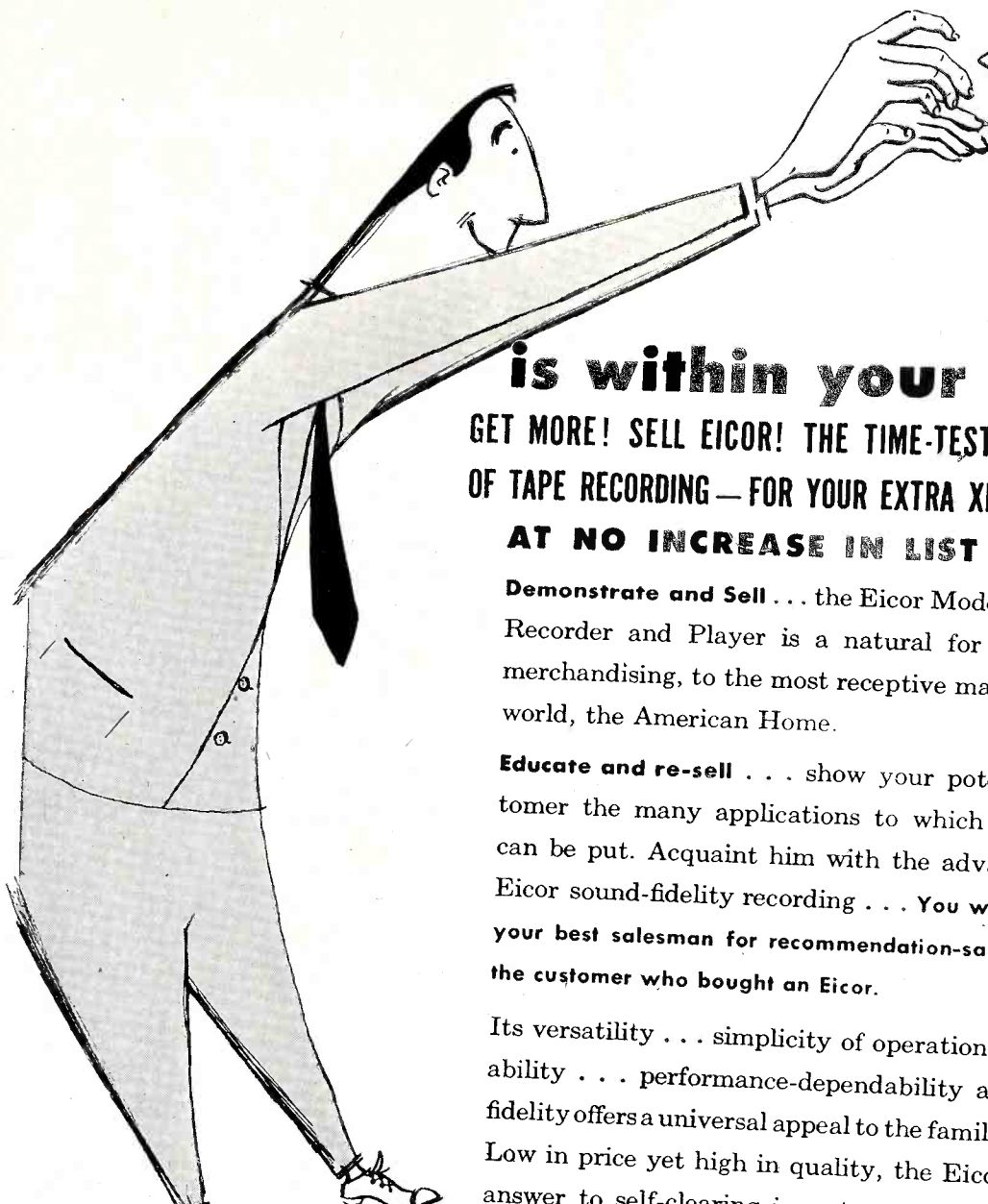

is within your reach
GET MORE! SELL EICOR! THE TIME-TESTED STANDARD
OF TAPE RECORDING — FOR YOUR EXTRA XMAS DIVIDEND!

AT NO INCREASE IN LIST PRICE!

Demonstrate and Sell . . . the Eicor Model 115 Tape Recorder and Player is a natural for Christmas merchandising, to the most receptive market in the world, the American Home.

Educate and re-sell . . . show your potential customer the many applications to which the Eicor can be put. Acquaint him with the advantages of Eicor sound-fidelity recording . . . You will find that your best salesman for recommendation-sales will be the customer who bought an Eicor.

Its versatility . . . simplicity of operation . . . portability . . . performance-dependability and sound fidelity offers a universal appeal to the family market. Low in price yet high in quality, the Eicor is your answer to self-clearing inventory worries both on Christmas and year-round sales.

DEALERS—for information on contacting your nearest distributor write to us . . .
Department TR-25.

List Price slightly higher
west of the Rockies.



Model 115 . . .
includes microphone and
one full reel of tape.

\$144.95 List Price

Conversion kit 4150 . . .
\$5.00 List Price

TAPE RECORDER DIV.

EICOR, INC., 1501 W. Congress St., Chicago 7, Ill.

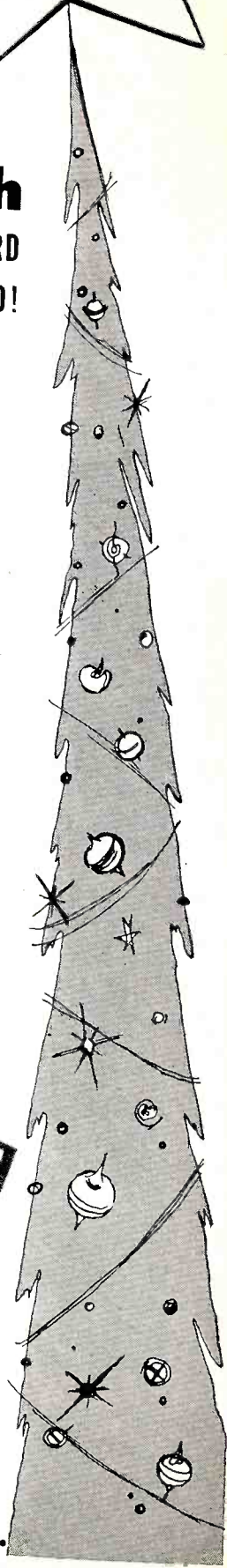

BIGGEST BUY IN TV TODAY!

Raytheon *tv*

3-way combination

17" TV • AM RADIO • all-speed PHONO

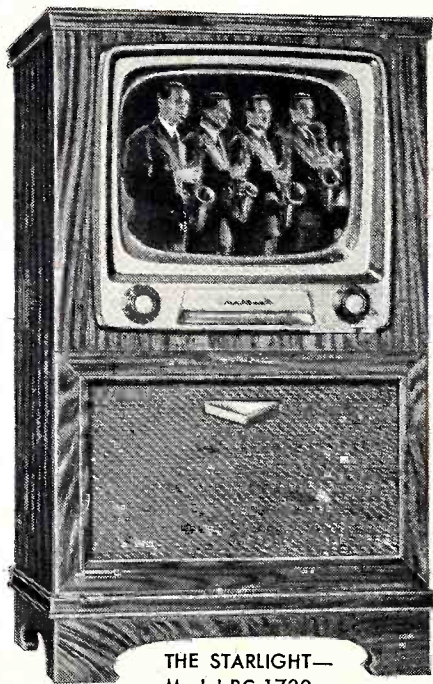

THE STARLIGHT—
Model RC-1720



COMPARE THESE ALL-STAR FEATURES

- ★ FULL 17" PICTURE TUBE—clear, sharp, steady pictures!
- ★ FINE AM RADIO—hairline tuning, extra sensitive!
- ★ ALL-SIZE, ALL-SPEED PHONOGRAPH—full, rich sound!
- ★ EASY-TO-USE "RAY-DIAL" TUNER—dial TV like a radio!
- ★ FINE-FURNITURE CABINET—sturdy, beautiful, dark mahogany!
- ★ SPACE-SAVING SIZE—combination in size of TV alone!
- ★ BUILT-IN "RAY-TENNA" ANTENNA—gets all channels!
- ★ FAMOUS FOR FRINGE-AREA PERFORMANCE—super-powerful!
- ★ 10" BALANCED DYNAMIC SPEAKER—built-in tone balance control!
- ★ TILTED PICTURE WINDOW—eliminates reflections and glare!

Was \$469⁹⁵
Inc. tax and warranty

\$369⁹⁵

RETAIL
INCLUDING
FED. EXCISE TAX.
1 YR. WARRANTY
NO EXTRAS



RAYTHEON—A famous name in electronics, one of the world's largest tube manufacturers, a pioneer in radar, communications, marine and industrial electronic equipment.

NOW ONLY

COMPARE THIS RAYTHEON VALUE
WITH OTHER BRANDS OF COMPARABLE QUALITY

| | |
|------------------------|------------------------|
| Brand "A".....\$399.95 | Brand "D".....\$429.95 |
| Brand "B"..... 379.95 | Brand "E"..... 549.95 |
| Brand "C"..... 395.95 | |

YOUR CUSTOMERS SAVE FROM \$10 to \$180 OR MORE!

TELL IT! SELL IT! PROFIT!

Belmont Radio Corp., Subsidiary of RAYTHEON MFG. CO.
5921 W. Dickens Ave., Chicago 39, Ill.

© Belmont Radio Corp.

For your best Christmas business...

Stromberg-Carlson



has the right combination

The right combination is a Stromberg-Carlson. Six Dual-Beauty combinations from which to choose. Beautiful performance that comes only from famous Stromberg-Carlson engineering . . . *plus* beautiful cabinetry.

It's the convincing, easy-to-tell, all-inclusive story of Stromberg-Carlson superiority. Your customers can *see* the beauty. You can *sell* the beauty.

And remember: Stromberg-Carlson combinations are furniture styled for every customer preference . . . with every wanted tube-size from 17" to huge, newspaper-size 24" . . . and priced from \$439.95 to \$975.

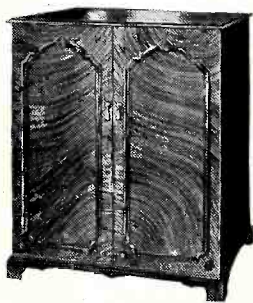

18TH CENTURY. 20" TV . . . AM-FM Radio . . . 3-speed automatic record-player. Exquisite period cabinet, completely hand-rubbed. Model 20 RPM, \$785*



STANCLIFFE. Huge 24" tube — newspaper-size pictures. AM-FM radio . . . 3-speed automatic record-player. Model 24 RPM, \$975*

PEMBROKE. Handsome compact combination 17" TV . . . AM radio . . . 3-speed automatic record-player. Inclined reflection-free safety glass. Mahogany veneers. Model 317 RPM, \$439.95*

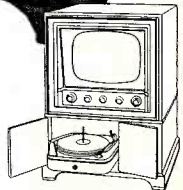

*Zone 1. Includes excise. Installation, warranty extra.

Stromberg-Carlson television is priced from \$289.95 to \$975 including excise tax, warranty extra. Radios and radio-phonograph from \$34.95 to \$289.95 (Slightly higher South and West)

"There is nothing finer than a STROMBERG-CARLSON"

Stromberg-Carlson Company, Rochester 3, N. Y. — In Canada, Stromberg-Carlson Co., Ltd., Toronto

RADIO & TELEVISION RETAILING

Including "RADIO & TELEVISION,"
"RADIO & TELEVISION TODAY,"
and "ELECTRICAL RETAILING"

O. H. CALDWELL, Editorial Director



M. CLEMENTS, Publisher

STEADY INCREASE IN SALES by retailers reducing inventories of TV sets and appliances, but the market isn't as vigorous as many hoped it would be by this time. Meanwhile, "shopping" tours reveal a continuing lack of aggressive sales effort. In spite of a healthy flow of store traffic, too few salesmen really try to sell; too few obtain names of visitors for follow-up calls; too few know the products well enough to stress the salient features.

TENTATIVE PROGRAM OF EVENTS AT THE CHICAGO PARTS SHOW, May 19-22 lists the first three Show days for distributors only, and a fourth for industrial buyers, engineers and government agencies. Education programs are listed for the second and third days.

PRICE-CUTTING ON PHONO RECORDS SEEN AS ON THE DECLINE. Recent surveys by RADIO & TELEVISION RETAILING show a trend away from slashing lists on long-playing discs, a practice which lately had been widespread, particularly in the metropolitan centers. Tendency away from price-cutting is due to the inability of dealers to continue to operate at less than the classical mark-up without a large volume of sales. Small number of price-cutters are surviving because they have been able to build up a large clientele, or are operating with low overhead, etc.

HIGH INCOME HOMES BUY ON TIME. A study of the Milwaukee market conducted by the Milwaukee Journal shows the use of instalment credit is becoming more widespread. While most frequently used by middle-income families, it is used by 37.8 per cent of families in the \$6,000 to \$7,500 income group and by 25.8 per cent of those families with incomes of \$7,500 and more. TV sets headed the list of products bought on time.

THE INDUSTRY WILL PROBABLY END 1951 with a total sale of about a million farm and home food freezers. The frozen food bill will probably total three-quarters of a billion dollars in 1951.

NEW OPEN-HANDLE IRON RECENTLY ANNOUNCED by Westinghouse now available with aluminum base. Original model had cast iron sole plate, and weighed 4 lbs. New one weighs 3 lbs., and sells at same price as other—\$12.95.

DESCRIBING THE PRESENT MARKET as a fairly "normal" one, Edward R. Taylor, vice-president, Hotpoint, Inc., defines a normal condition as "one in which salesmen call on customers to sell their goods, rather than waiting for customers to walk into the store."

NUMBERS OF DISTRIBUTORS REPORTING a very low fold-up rate among their dealer-customers in spite of the tough going the latter experienced during the long period from Spring to late Summer in 1951. Some of the reasons given for survival: Increased service revenue, chopping out unnecessary expense, closer supervision, and extra sales effort born of sheer necessity.

PICTURE TUBES MAILABLE in parcel post if outside carton measurements total less than 100 inches. This measurement is the sum of the circumference and the height of the carton. As an example, a 20CP4 carton measures 98 inches (being a rectangular tube), but the 16DP4 carton measures 102 inches. A new regulation, however, slated to go into effect January 1, 1952, will limit parcel post to 72 inches, which will probably eliminate all but 10 and 12 inch tubes from the mails.

WITH A NUMBER OF STATES LOOKING FOR NEW REVENUE, 1952 will probably see continuing pressure for increased taxes against corporate income. So far as individual income tax increases are concerned, Vermont is the only state thus far this year to boost its rates.

"TO STATE THAT A DEALER EITHER GIVES SERVICE or he doesn't is the same as stating that a dealer is either in business or he is on his way out. To sell, the dealer must give service. Service and sales go hand in hand."—H. E. Putnam, customer service manager, Landers, Frary & Clark, New Britain, Conn.

THE NEW TV STATION AT BUENOS AIRES, now operating on Channel 7, has the highest effective radiated power of any station in the Western Hemisphere, 45 KW. The station was supplied through International Standard Electric Corp., an associate of I.T.&T. One of the features of the modern station is a unique 8-bay triangular loop antenna.

A DECISION TO TAKE THE BULL BY THE HORNS and clean house is a good way for any dealer to start the New Year right. He can, for instance, get rid of inefficient help (even if they're relatives). He can make every effort to liquidate stagnant stocks. He can start in really training his salesmen. He can review the brands he carries, dropping the slow-moving makes (even if he's sentimentally inclined toward them). And he should eliminate all unnecessary expense.



What's Ahead! — in Radio,

ONE YEAR AGO, EVERYBODY WAS TALKING ABOUT POSSIBLE SHORTAGES just as they are doing today. However, in December, 1950, there was an acute shortage of parts, notably in resistors, and in some tubes. Last December saw dealers heavily stocked with TV sets, with many who had gone overboard in buying describing such TV receivers as "gold", basing their valuation on the prospects of shortages. Right now, dealers are still working off earlier bought inventories, which have been sharply reduced during the last three months, and there is virtually no buying being done on the premise that a killing can be made later.

ALL-OUT SALES EFFORT OF A HIGHLY COMPETITIVE NATURE by manufacturers is a straw in the wind. Some super campaigns have been launched recently, and the advice being passed on to distributors and retailers of TV, radio and appliances is to fight hard for sales. Though the civilian production picture is a perplexing one, and there are some shortages of some models in lines, it's felt that the safest course the dealer can pursue is to forget the shortage angle, and gear up to sell strenuously. The heavy money being invested in the promotion of their products by manufacturers is an indication that many think there will be enough to go around well into '52.

FM STATION WGBH HAS COMMENCED BROADCASTING in the Greater Boston area. With 20,000 watts effective radiated power, the station is broadcasting to a potential audience of some 208,000 families. 14.4 per cent of all homes in the 67-mile radius of the transmitter have FM receivers. Zenith dealers of Northeastern Distributors, Inc., saluted the new station with a 2-time, 1600 line ad in the Boston Herald-Traveler.

"THE PRICE-JUGGLER DOES A SLEIGHT OF HAND TRICK with prices to trick his customers and destroy his competitors. . . . The loss-leader artist is juggling his prices, not cutting them. He marks down a few national brands and he marks up a lot of unknown goods."—Maurice Mermey, director, Bureau of Education on Fair Trade.

THE VERSATILE FOOD FREEZER IS SERVING the public in a great many ways, and here's another new kink: Golfers who hole up for the winter are storing golf balls in the freezers, claiming this keeps them "fresh" and resilient!



WATCH FOR JUST ABOUT EVERYBODY AND HIS BROTHER to feel that a TV set is a must in the home as the political campaigns of '52 really commence rolling. There will be a great many new TV homes created, and slews of small-screen receivers will be traded in. In TV and non-TV areas, radio sales should also go up sharply as a result of the terrific interest in this presidential election year, with portables affording the opportunity for folk to hear no matter where they happen to be. Public address business should increase also and, many a smart dealer will sell recorders to local politicians.

NPA's "NEW MODEL FREEZING" ORDER becomes law on Feb. 1. It limits priority ratings on machine tool purchases, but since most TV and appliance manufacturers are tooled up for new 1952 models at this time, or have already brought such models out, effects of the order are not likely to be felt for some time.

MARKED TREND IN THE DISPLAY OF PHONO RECORDS by dealers to racks which show a large number of long-playing album jackets. Visual appeal plus descriptive information on jackets aids browsing customers and stimulates "self-service" sales.

TAPE RECORDING CONTINUES TO TAKE OVER IN NEW FIELDS. With the setting up by Cornell University of a tape library and duplicating center for the educational institutions of New York State, recognition is shown of the increasing acceptance of, and advantages to be had from tape teaching. A catalog of recordings which the center will make free for New York institutions (who supply their own raw tape) lists 500 subjects, covering everything from radar to cabbage bugs.

TELE-LITE is a plastic magnifier for TV programs, which can be read in the dark by aid of its self-contained flashlight. Newspaper program clippings are manipulated between two split rollers, like film in a camera. Raymond Asner, 70 Summer Street, Worcester, Mass., is inventor of the device which retails at \$1.49.

A PROPOSED CHANGE IN METHOD OF ASSESSING STORE inventories in Idaho is being studied by the legislative committee of the County Assessors Assn. Under the proposed change, assessments would be based on the figures merchants use for income tax purposes, rather than taking the merchants' word on their inventories, as at present.

RECORDERS AS SECRETARIES HELPING MANY a business executive solve the problem of the shortage of the human variety, it's pointed out by Webster-Chicago Corporation, makers of tape and wire units. According to the Webcor people, the electronic secretary doesn't go down for coffee twice a day. It doesn't get personal phone calls at 4:30 when the mail is due to go out. It doesn't take a day off after a late date the night before. It doesn't get married during the busy season. Disadvantages, it must be admitted, include the fact that there's not much pulchritude to an electronic dictation machine.

THEATRE TELEVISION AND HOME TELEVISION can and eventually should function as complementary media, said Joseph B. Elliott, vice-president in charge of consumer products, RCA Victor, in a recent address. He pointed out that an RTMA committee is working on a plan under which theatre TV and home TV can operate to their mutual benefit, citing this project to squelch a rumor that home TV interests are building up a war chest to do battle with theatre TV.

INCREASE IN BOTH CORPORATE AND INDIVIDUAL income taxes are included among a number of new and increased levies proposed to finance a veterans' bonus program approved by the Oklahoma legislature for submission to the voters in 1952.

Appliances, Records and Television

ON THE ROAD TO HIGH SATURATION, THERE ARE THREE MENTAL conditions, progressively experienced by the guy who hasn't discovered that Saturation is a nebulous will-o'-the-wisp. The three conditions are Elation, Determination and Frustration. *Elation* occurs when the product commences to take hold. *Determination* crops up when it's been shown that aggressive effort can skyrocket sales, and *Frustration* creeps in when high Saturation has been reached because it's then believed that the potential is no longer large.

JUST WHY IT IS THAT IN SPITE OF SATURATION figures crawling up uncomfortably close to the 100 per cent mark, American manufacturers sell more and more of the highly saturated products, no one knows, not even the brainiest fellow in the world figure out what becomes of the old stuff in the homes. It just appears to disappear into thin air—most of it, anyway.

LOOK AT THE RECORD OF RADIO, and take heart in spite of what some analysts are saying about TV dropping down to a few million sets a year as the saturation figure grows. In 1922 we sold a total of 100,000 sets, and 260,000 homes had radios. 10 years later, in 1932, there were 18 million sets in use in the country, a higher relative saturation than TV now has! And in 1932 the industry sold 3 million sets! In 1948, with 74 million radios in use, American consumers bought 16 million sets! Moral: Less than 15,000,000 TV sets now in use!

AND LOOK AT THE RECORD WITH SOME OTHER PRODUCTS as outlined by J. B. Croskery, of Gibson Refrigerator Co., in a speech before distributors, in which he pointed out that the appliance market just grows and grows as the country grows. For instance, he said that the U. S. sells more candles now than ever before in spite of modern lighting; that prophets of doom saw the auto tire business all washed up when new processes greatly increased tire mileage!

WIDE ACCEPTANCE OF AUTO RADIOS revealed by Pittsburgh survey made by Guide-Post Research. In a study of cars actually in use, conducted at the drivers' window at traffic bottle-neck points, 72% were found to have auto radios. In a typical period between 4 and 5 PM, 29.8% of cars have the radio turned on.

POTENTIAL SERVICE BUSINESS is revealed in the same survey, for it was found that of the 72% of the cars in use which had an auto radio, one out of every 14 is broken. Thus, the survey reveals that of the 40,000 cars which were on the road in Allegheny County (Pa.) at 4 PM, 28,800 had radios, and of these, 2,057 radios were broken. If these figures could be projected to the country as a whole, it would mean a tremendous potential business for auto radio servicers.

READER AL ROBERTSON, WHO RUNS a radio-appliance business bearing his name in Oklahoma City, calls our attention to the fact that we erred recently in publishing an item to the effect that Kansas is the only state prohibiting the selling of appliances by mail. He points out that Oklahoma has had such a statute on the law books for many years. Thanks to this merchant for the information, and also for saying that, "In this part of the country we enjoy very much your fine magazine."

LAST-MINUTE ADVICE ON GETTING set for Christmas business comes in the form of some questions for dealers provided by the Harry Alter Company, Chicago distributors: "Why not take a good look at the store itself. Look at it with the eyes of a stranger. Ask yourself, 'Is it clean?' 'Is it orderly?' 'Is everything on display that should be?' 'Is there junk on display that could be cleaned out?'"

BOOK TELLING CONSUMERS HOW TO repair their own TV sets being plugged on some radio stations. Among the subjects treated is advice on how to get big discounts in buying receivers.

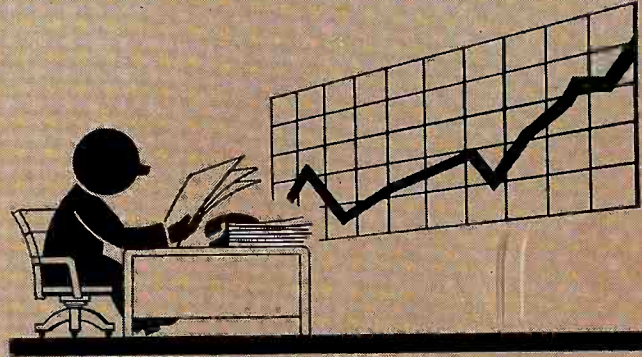

THE JANUARY, 1952, ISSUE OF RADIO & TELEVISION RETAILING will feature annual statistics and forecasts on radio, TV, electrical appliances, phono records, and will also highlight the 30th anniversary of radio with many interesting pictures and articles. The January number will contain the annual Distributors' Directory, a buying guide for retailers; a distribution guide for manufacturers. Wholesalers will be listed alphabetically under states and cities, together with products sold. Advice to readers: Hang onto the January issue! It will be valuable to you all the rest of '52!

"SOUND MUFFLER" ON AIR CONDITIONING units announced by Mitchell Manufacturing Co., Chicago. "Muffler" consists of a chamber placed in front of the fan mechanism. The air, which is primarily responsible for noise, is routed through the chamber instead of being discharged directly into the room. Here it is forced against a special material which deflects it into the room and at the same time absorbs most of the sound waves. New Mitchell room air conditioners, which will be introduced next month, will have this new feature.

Future Events of Interest to Readers

- Jan. 7-18: Furniture and Home Furnishings Winter Market, American Furniture Mart, 666 Lake Shore Drive, Chicago, Ill.
- Jan. 7-18: International Home Furnishings Market, Merchandise Mart, Chicago, Ill.
- Jan. 13-15: Nat'l. Appliance and Radio Dealers Assoc. Annual Convention, Hotel Stevens, Chicago, Ill.
- Jan. 13-18: New York Lamp Show, Hotel New Yorker, N. Y.
- Jan. 17-24: National Housewares Show, Navy Pier, Chicago.
- Feb. 4-8: Winter Market, Western Mdse. Mart, San Francisco.
- Feb. 11-12: NAMM Southeastern Regional Conference, Hotel Ansley, Atlanta, Ga.
- May 19-22: 1952 Radio Parts and Electronic Equipment Show, Hotel Stevens, Chicago.
- Sept. 22-25: 3rd National Convention of the National Electronic Distributors Association, Ambassador Hotel, Atlantic City, N. J.

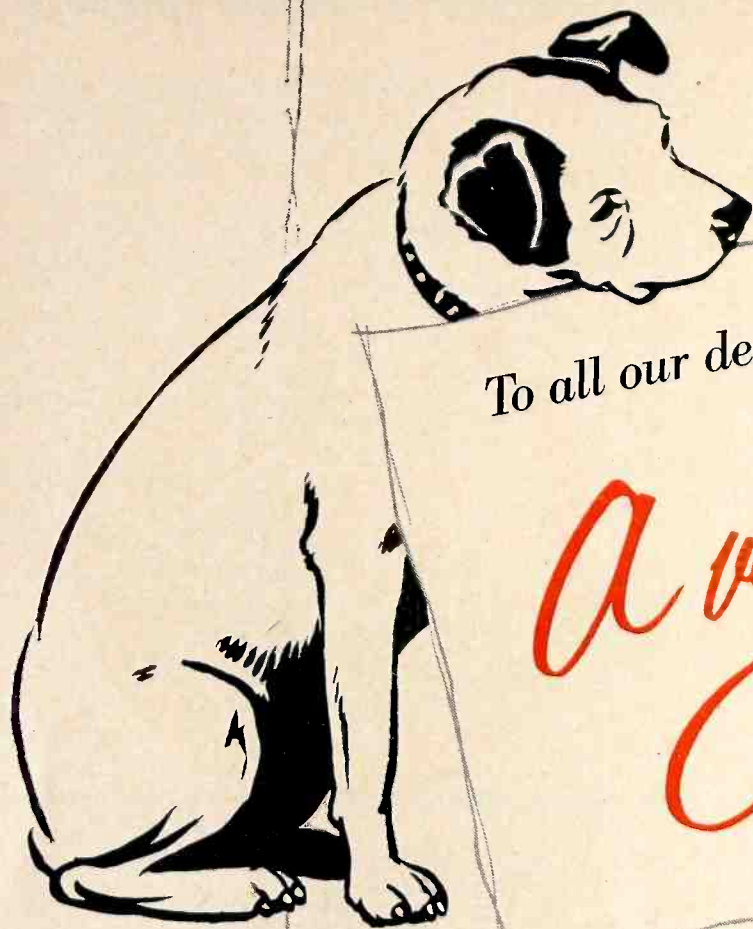

To all our dealers and distributors

A very Merry Christmas

The RCA Victor Blaine 1X51



The RCA Victor Personal B411



The RCA Victor Carlisle A108



"Victrola" 45 Complete Automatic Phonograph 45EY2

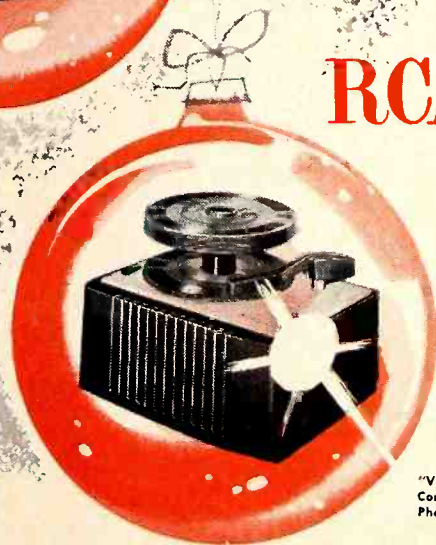

RCA VICTOR

"The Gift That is better"

... And A Happy, Prosperous New Year

New TV Super Sets

with "PICTURE POWER"



17" RCA Victor
Caldwell 17T162



21" RCA Victor
Rockingham 21T178



21" RCA Victor
Clarendon 21T179



17" RCA Victor
Kendall 17T174



17" RCA Victor
Cavington 17T170



Keeps on Giving[®]
than ever this year.



ONLY RCA VICTOR HAS
THE "GOLDEN THROAT"

RCA VICTOR  
DIVISION OF RADIO CORPORATION OF AMERICA

World Leader in Radio . . . First in Recorded Music . . . First in Television

How to Speed Up Your

There Are Ways to Get the Job Done Quickly

• Retailers who have long faces and headaches on New Year's Eve may be anticipating the year-end physical inventory. Boring though this inventory-taking task may be it is a must that all stock be counted and listed at the end of the year.

Income tax, sales tax, excise tax, property tax, sales-planning, turnover rates, new profit . . . all are associated with inventory of the stock in a store.

Following are a number of suggestions designed to make your physical inventory taking task quick, easy and accurate.

1. *Sell the Importance of Inventory:* Salesmen and service men who are called in for the inventory may not realize how important it is to have an accurate count of all sets and parts. Naturally, they will be interested in getting through as quickly as possible, but they may not know that the inventory has a bearing on income tax, sales tax, net profit, and the future profitable operation of the store. Telling them how important inventory is before it starts will give these men a different attitude about the work.

2. *Encourage and Accept Suggestions:* While selling the importance of the annual inventory, many radio and television merchants have found that it is wise to encourage and accept all employe suggestions. Slow counting and listing methods can be changed for a quicker and a better way. Then, too, the employes who submit these suggestions feel they are

more important in the annual stock count and will turn in a better performance.

3. *Carefully Select Employes:* Some retailers have discovered that not all their employes are able to handle the work of the inventory. Some, for instance may not pay enough attention to detail and will list one stock number, give a different description, and still another price on the set being inventoried. This causes confusion later when the inventory is being analyzed for overages, shortages, or for stock planning. Every employe selected for this important task would measure up on the physical, mental, and moral qualities that are required in the annual stock count.

4. *Provide Adequate Instructions:* Some retailers lose valuable counting and listing time by not explaining how to count, how to list, which way to move in the parts bins, and how to handle special problems that arise in valuing used sets and appliances which have been traded in. Pre-inventory training on the all important "how" will make the stock count more accurate and will insure a quicker completion.

5. *Establish Inventory Rules:* Inventory rules are important for a quick and orderly physical stock count. During the inventory the employes may forget the regular store rules and cause confusion. The setting up of inventory rules during the pre-inventory meeting will pay.

6. *Draw an Inventory Floor Plan:* A rough map of the store with all counters, shelf sections, floor display areas, window displays, and ledge displays designated is all that is needed. This will insure a complete count of all stock. A floor plan also provides a handy place to record all inventory sheets issued and returned for a double check on coverage of all sections of the store.

7. *Organize Stock Early:* Regardless of how good a housekeeper the service man is there will be some parts in the wrong bin. Checking over all sections of the parts and service department will bring to light any places where there is a duplication of storage, and where parts have been returned to the wrong section. Stock on the sales floor can usually be arranged so that some listings can be eliminated in the final inventory report.

8. *Price Stock Right:* Current prices should be used in determining the inventory price for the parts in the service department. Floor stock, such as receivers and appliances should be checked to be sure they are correctly priced, based on current market conditions. Used radios, TV sets and appliances should be valued at fair reselling prices. Adjusting any prices on new and used products before inventory will make the final total more accurate and will keep profits in line.

9. *Liquidate Odds and Ends:* Before-inventory liquidation sales are popular for two reasons: (1) They give the retailer an opportunity to hold a special sale and clear up his "cats and dogs"; (2) They give the customer a good "reason-why" the price is being reduced. During the heavy traffic of the holiday shopping season it is possible to work off some of these odds and ends that have been accumulating in stock. Products on hand that have been approved for return should be sent back to the distributor to save counting and listing time. Everything included in the final inventory should be good saleable stock.

Here Are Answers to Such Questions As—

Should stock, parts, etc. be listed at retail or cost values?

(See paragraph 11). How should receivers, appliances and

other products on consignment be carried? (See 15). How

can the dealer make sure than an accurate inventory count

is being made? (See 16). What's the best way to make sure

that no sections of the store will be skipped? (See 6). Is

there a way to speed counting by one man? (See 17).

Inventory-Taking

and Accurately, and They're Listed in This Article

10. Count Reserve Stock First: Stockroom and warehouse stock can be counted before the final cut-off date. When this is done there should be some system established for withdrawal from this pre-counted reserve stock to insure an accurate total. Parts that are needed for last-minute repairs can be kept on a separate tally and a record kept of all sets delivered from the warehouse after the stock has been counted. These withdrawals, of course, should be deducted from the final total determined for the store.

11. Use a Standard Valuation: Some merchants are in favor of listing the stock at retail prices and others use the cost value of the stock. Taking the inventory at retail is quicker, but when the retail is reduced to cost there may be some difference in the final figure that will be an overstatement of profit. Cost inventories are more time consuming, are more accurate, yet let employes know what the various products in stock cost the dealer.

Regardless of which method is used for the inventory the same valuation should be used throughout the store. When it is impossible to use the same valuation in both the parts department and the sales floor, for instance, the listing sheets should be clearly marked with either "cost" or "retail" to avoid confusion in the tabulation of the figures.

12. Number Listing Sheets Serially: Standard inventory forms have a space for a sheet number. By assigning a serial number to each sheet and recording this number on the floor plan any lost sheets can be traced quickly. Then, too, this provides a check on the completeness of the final tabulation of the inventory.

13. List Stock In Duplicate: Two definite purposes are served when the inventory listing is made in duplicate. First, it provides an easy way to check the accuracy of column totals. One tabulator can be given the original and another the duplicate sheet for extension

and totaling. When these two sheets correspond in total it can be assumed that the valuation of the sheet is correct.

Some retailers have their inventory taken without any cost or selling figures. Then the price of the merchandise is placed on the listing sheets in the office from price books that give a cost figure. Using the same system of having two people complete the sheets provides a double-check on the accuracy of the figures.

Most retailers file the original listing sheet with their permanent records. By having a duplicate listing of the inventory it is helpful in sales and stock planning for the next year.

14. Make a Special List of Old Stock: Obsolete parts, discontinued models, and used products that have been used in stock for a long time can be eliminated quicker if a record is kept of them. Some retailers make a special list of all stock to be liquidated and count this stock every month. Mark-downs or other appropriate action is taken to reduce this amount and by counting every month it keeps everyone in the store interested in liquidation of such merchandise.

15. Check Consignment Stock: Merchandise that is placed on the sales floor for sale but whose title is still with the distributor comes in this classification. Stock of this nature requires special handling during inventory. (1) It should not be included in the regular store's inventory. (2) A separate count of all consignment stock should be made. (3) This total should be deducted from the total amount of consigned stock received. (4) This difference should be deducted from the gross sales to reflect the true cost of sales for the store.

16. Spot Check Counting and Listing: Periodic spot checks during the actual stock count will insure a more accurate inventory. Re-counting certain sections of the service department to be sure the count is correct, checking out-of-the-way spots in the store, calling attention to empty cartons or sets



The physical inventory-taking chore is a big job, but the records resulting are invaluable to the dealer in his ahead-planning, and in the study of his turn-over rates.

that have been sold and not delivered, and checking extensions and sheet totals in the tabulation will uncover some errors. Then, too, this spot checking helps keep everyone on his toes.

17. Use Recording Equipment: Some dealers have discovered that recording equipment can be used to advantage at inventory time. With either a wire or a tape recorder one person can count and dictate to the recorder the amount of the stock on hand. This is a fast method of counting and listing and the written records can be prepared later when the inventory pressure is off.

They Keep Sales Volume UP

Des Moines Dealership Uses Novel Promotions, Radio and Phone Book

• Beaverdale Radio Sales & Service Company of Des Moines, Iowa, has consistent sales all seasons of the year because the owner, Earl T. Holst *plans what to sell, and how to sell*, so volume keeps at a good even pace all year round.

Although the Beaverdale Radio Sales & Service was started by Holst in 1938, it was six years ago that the business was expanded to include appliances. It was also at this time that he began promotions of various kinds to boost sales of everything he sells.

Last Summer he used a promotional selling plan under which he contacted five different women's societies and invited them into the store for an evening's demonstration, offering to pay 50¢ for each lady who attended. About sixty women attended each demonstra-

tion, watching the actual operation of washing machines, dryers, and electric ranges and roasters.

As an added touch to the demonstration, the women were served coffee, ice cream and doughnuts. Seventy-five per cent of the women had not been in the store before, and the owners estimate that most of them came back later, bought merchandise and became regular customers.

Show-windows are important in originating sales according to the owner of Beaverdale. The small show-window is kept for display of records, and the larger window for radios, television sets, and refrigerators.

The TV-radio-appliance service department of this store is one of the best in Des Moines. All makes are repaired.

Holst believes that the best place for service advertisement is in the yellow pages of the phone book. Ever since the store opened, he has used $\frac{1}{3}$ of a page, and he knows that it brings in a good percentage of all the service business. Besides his own large ad in the yellow pages he ties in with smaller space along with advertisements of manufacturers.

Sold on Radio Advertising

Beaverdale Radio's owner is thoroughly sold on radio advertising and feels that it does a tremendous job in getting prospects interested in the store, getting them into the store, and helping to sell. He has used all six radio stations in Des Moines and has used different types of programs. He is always on the air on some station, advertising his store and merchandise.

For some time he used eight consecutive Sundays of advertising over KCBC, the Des Moines music and news station; and Beaverdale Radio used eleven out of their twelve hours of broadcasting. The second month of Sunday advertising Beaverdale realized a good percentage of sales results. Holst used five of the hours for television advertising, two hours for records, and the rest of the time for appliance advertising.

At another time he used KCBC advertising nightly from 11 P.M. until midnight, because he figured this was the time when folks turned off their TV sets and began listening to radio. He also used three fifteen-minute programs during the week on three different days, plus using two hours on Sundays in four half-hour periods—one in the morning, one early afternoon, one late afternoon, and one evening. Holst did so, because he figured he would reach someone in the family on one of the Sunday programs.

The homey TV lounge at Beaverdale Radio is something new, and is proving effective in closing sales. A show-window sign reads: "Come in and see our TV lounge." This attracts people's attention and curiosity. They do come in and ask

Earl Holst, owner of Beaverdale Radio Sales & Service demonstrates a washer and ironer to a prospective customer who may be out shopping for a very worthwhile Christmas gift.



All Year 'Round!

Advertising to Bring More Business, Steady Business



Mary Rutledge of the record department makes friends of customers, and has some good advice on selling more discs. Read the selling points outlined by Miss Rutledge in this article.

what the lounge is, and ask to see it.

The lounge is bigger than an ordinary sized family living room, with large comfortable chairs along the one long side, and a few chairs in the two small sides. Across from the long side filled with chairs are a number of makes of TV sets all hooked up. Customers come and bring the whole family and watch an evening's TV, and many end up by buying and also telling friends about Beaverdale's TV lounge.

Active Record Department

Managing Beaverdale Radio's record department is Mary Rutledge. This young woman's keen interest in her customers does much to promote the record business for Beaverdale Radio.

Mary Rutledge says, "Courtesy is one of the big things in dealing with record customers. If you can call your customers by their first names after they have been in three times, you are taking a good step to help increase your record business.

"I have used several selling methods, which have brought good results. Sometimes when a record isn't moving, I'll suggest to each customer who comes in that he buy this particular record. If he doesn't

want to buy it, he will be very frank and tell me why, but many times such effort helps a lot to sell the record.

"If I get in a record which I believe certain of my customers will like I telephone them," says Miss Rutledge. "I tell them I have the

record on hand. They like this personal angle, which makes them feel that we are thinking about them, and generally they'll come in and buy it. I plan later on to have a special mailing campaign telling about the records we have in stock.

Appeals to the Kiddies

"I think it is wise to pay special attention to the children, and try to remember their names. Lots of times the mother will buy what the child wants, particularly if you have been nice and noticed the child. Since I have two girls of my own, I believe I understand children, and know what records can do for them. A child will be contented for hours listening to records."

Earl Holst knows that congeniality toward employes as well as customers is one of the most important things in keeping a business running smoothly. He does everything possible to keep a harmonious organization. Things are talked over between employer and employes of Beaverdale Radio, and everyone is made to feel that what he has to say is important.

Good service has built a good reputation for Beaverdale, and has helped make many sales. Scene shows technicians working at the bench.



Bank on Your

Service Department to

Stepped-Up Maintenance Operation on Radio-TV-Appliances Needed to Insure

• An efficient, profitable service department is always an important asset to a radio-TV-appliance merchant, but its place in the 1952 picture promises to be more prominent than at any time since World War II. This will be true even considering the fact that the strong spotlight which TV has brought to bear on the service operation has already increased its importance (and its income) beyond all previous limits. The reason is simple: unlimited supplies of new merchandise will no longer be available.

We are naturally reluctant to put any strong emphasis on the term "shortages," since this word fell into disrepute during 1951. But we must emphasize that the seers who foresaw shortages in 1951 were not entirely wrong. The predictions were premature, but were based on sound premises. One, simple, unexpected turn of events threw the whole thing into a cocked hat—and that was a prolonged buyers' strike. This situation can be considered typified by what happened in TV. Whereas in the six months of 1950 from March to August inclusive we sold approximately 2.75 million TV sets (and although, due to the continuing expansion of TV we could expect to sell *more* than that in

1951), the public took home only about 1.8 million sets in the same period of 1951. And the 1951 sales were stimulated by considerable price reductions, sales, premiums and inducements of various kinds which greatly reduced profits.

The net result of declining sales in almost all branches of consumer merchandising was to make existing inventories of merchandise and replacement parts *more* than adequate. This was coupled with the fact that the government defense production plans were put in motion more slowly than anticipated.

The alert dealers and distributors will not, however, be misled by the copious inventories which they "enjoyed" during 1951. The shortages which were expected due to government purchases of materials, to government orders for military equipment, and to government limitations on civilian production are now definitely in the cards for 1952.

What does this portend for the servicing operation of the radio-TV-appliance dealer? First, his sales volume and his profit from the sale of end products (sets, appliances, etc.) will be limited by the supplies of these products available. In order to keep his volume up, he must aim for increased rev-

enue from an expanded service department. Second, the consumer's inclination to maintain present equipment in working order will be enhanced by the difficulty of getting new ones.

In other words, the customer will need more service to maintain his equipment and the dealer will need more service to maintain his volume. The dealer will also need more and better service in order to maintain customer good-will.

The moral to this little story is obvious: somebody is going to get this business. Will it be you? This will depend to some extent on how aggressively and intelligently you go after it.

Service Must Be Sold

Increased service business will not be had just for the asking. Shortages can exist in replacement parts and equipment for servicing, as well as in end products. In addition, labor will also be a problem. Already we have been faced with a declining supply of skilled help (in the face of an increasing demand for it) coupled with a rising level of wages. This situation is not likely to improve in 1952. Another factor to consider is the maintenance of the servicing "plant," which encompasses such things as trucks, machinery, testing equipment, etc.

None of the foregoing problems is apt to assume the magnitude it did during World War II (assuming, naturally, that we don't get into an all-out war in '52), but this fact in itself puts extra pressure on the dealer. Here's why: during the last war we know that (unfortunately) many dealers treated their customers on a take-it-or-leave-it basis, with the hackneyed phrase, "Don't you know there's a war on?" But in 1952 (as in 1951) the customer will not allow himself to be cornered that way. You will notice that we said that the customer will have an *inclination* to keep present equipment in working order. But the dealer will have to *sell* to turn that inclination into

TV servicers shown in photo are working in the up-to-date service department at the Freedman store, Main Street, Springfield, Mass. (Article on this store's successful operation appeared in the October, 1951 issue of this magazine).

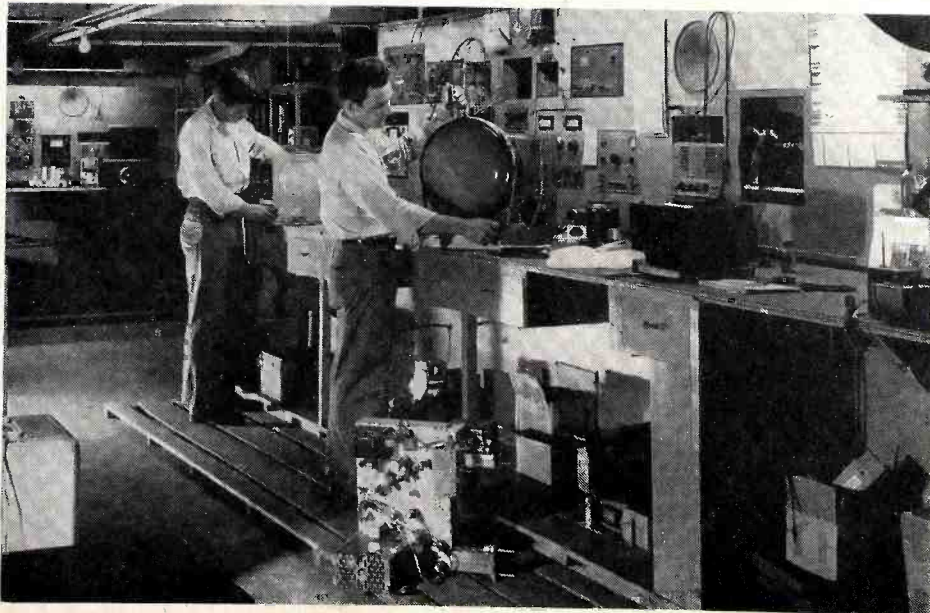

Carry You Through in '52

Volume Next Year in Face of Shortage Threat on New Products for Sale

a profit. And he can't sell purely on a scare basis.

Summing up, we can see that service income can be very important to the radio-TV-appliance dealer in 1952; and that, as a matter of fact, the dealer *needs* to increase his service revenue in order to maintain his overall volume which is likely to decline due to smaller supplies of finished goods available for sale. He must examine his plant and facilities to make sure that they are capable of handling a larger volume of work. He must plan (starting right now) a promotion program which will get more service business for him. He must plan (starting right now) a streamlining and a conservation program in his service operation in order to 1. Insure profits in face of rising costs combined with consumer resistance to high prices, and 2. Make possible a greater volume of business in face of dwindling supplies of parts and equipment for servicing.

Keep Customer Good-Will

And he must conduct this operation so as to create, increase and maintain customer good-will. Service is always important in this respect, since it is the tie that binds the customer to the store between sales of new merchandise, and helps to insure that the customer *will* come back to the store to buy again. In times of shortages, it is even more important because it maintains good relations with the customer even when the dealer has nothing to sell. Service thus serves a two-fold purpose. It creates present business and paves the way for future sales.

In streamlining your service department for more efficient operation, it is well to plan on an increase in the skill and facilities of this operation, where practicable. In other words, be sure that your service department can *repair* as well as *replace*. In times of scarcity it is often necessary to repair an item which in normal times would be replaced because it is relatively

cheap. Shops with machine tools, for instance, are often a focal point for the repair or overhaul of equipment which cannot be handled in the average small service department.

Profit from Reconditioning

In this connection, the service department can be utilized for the repair and reconditioning of traded-in items for profitable resale; that is, where adequate facilities have been provided. This might involve such things as rewinding motors, spraying and/or baking white goods cabinets, refinishing wood cabinets, fabricating small parts for record changers, electric clocks, etc.

This is not a *new* idea, but it is one which very few dealers exploit to the fullest of its possibilities. In times of shortages, the sale of reconditioned appliances can be a very important source of revenue, but full profit cannot be realized unless you can handle the work in your own store, and are able to

stand behind your work at all times.

We have discussed all the foregoing in reference to prospects for 1952. The conditions outlined here are actually very apt to extend far beyond that. Although Mr. Wilson has expressed his intention that we should be able to have our cake and eat it too, it is likely to be several years before we can return to unlimited, unregulated civilian production. Shortages won't come upon us suddenly (we already have some) nor will they leave us suddenly. The immediate prospect is that they will slowly and gradually get worse for at least two years. Consequently the program which we suggest that the dealer be planning should be a long range one.

The dealer who doesn't already have a plan in operation which provides for increasing reliance on his service department should sit right down and start on it now, and get it into operation by the first of the year. This will be one of the most important keys to profitable operation in 1952.

The Radio-TV-Appliance Dealer's Service Department Can

1. Maintain Sales Volume in Face of Threatened Shortages of New Products
2. Maintain Customer Good-Will Between Purchases
3. Accomplish Reconditioning of Trade-In Products for Profitable Resale

The Radio-TV-Appliance Dealer's Service Department Needs

1. *A Streamlining and a Conservation Program*
 - To Insure Profits in Face of Rising Costs
 - To Insure Profits in Face of Consumer Resistance to High Prices
 - To Insure Volume in Face of Dwindling Supplies of Parts & Equipment
2. *Skilled Personnel and Adequate Equipment*
 - To Make Repairs in Face of Threatened Parts Shortages
 - To Recondition Traded-In Products
 - To Maintain Customer Satisfaction Over Long Periods of Maintenance

Successful Selling of Television-Radio,

New Orleans Dealer Does Cold Canvassing in Rural Areas—

• “Selling to the farmer and rural resident is as different as day from night, compared to the kind of selling that clicks with city residents. When a salesman talks to the farmer, he sells by what might be called indirection. He looks over the cattle, talks about the weather, drinks a cup of coffee in the kitchen. Then maybe he brings up the subject by remarking that some of the farmer’s neighbors are installing TV and getting good results by using special fringe antennas. From there, he unfolds a slow, low-pressure sales presentation.”

That is the report of a man who knows his rural selling methods. He

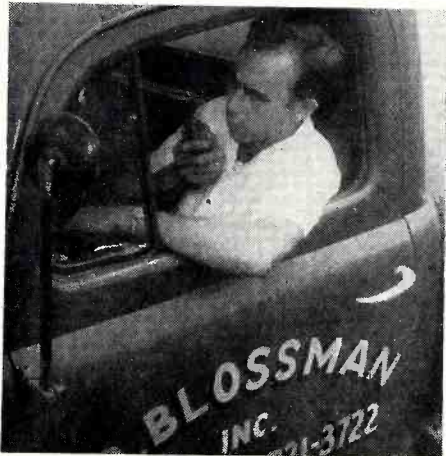

A radio-equipped Blossman truck can usually answer a rural service call within a couple of hours. This makes a hit with farmers.

is Dave Blossman, sales manager of A. R. Blossman, Inc., 9001 Airline Highway, New Orleans. The Blossman store has a strategic location—half in, half out of the city—for accessibility to both urban and country customers. The firm goes after sales in both groups. But in selling to the farmer, even more than in selling to his city cousin, it’s necessary to carry the sale to the prospect. Dave Blossman cites the ways in which rural salesman-ship and service facilities must differ from city tactics if they are to bear long green fruit:

“First,” he says, “it takes an entirely different brand of salesman-ship. As I noted, this calls for an even lower-pressure sort of tech-



Profitable rural selling calls for low-pressure techniques, and familiarity with the farmer’s problems. Dave Blossman, at desk, maps out new canvassing campaign with salesman Ward Fendlason.

nique than even the lowest-pressure city salesman-ship.

“To begin at the beginning, we do not work so much from leads although these, of course, are followed up closely. We have found that the best policy is to put a salesman at the head of a road and turn him loose with instructions to knock upon every farm door along the length of that road. We go after the gravel roads and the dirt roads as well as the much-traveled concrete highways. The fighting is harder for sales along the main highways. We want those sales, of course, and we go after them. But the sales come easier along the dirt roads and the secondary gravel highways. A salesman is a welcome visitor there. And he has few other salesmen after the same order.”

Blossman salesmen begin at the end of a road, and knock on every door. The firm canvasses those dirt roads and little-traveled ones, as well as the important highways.

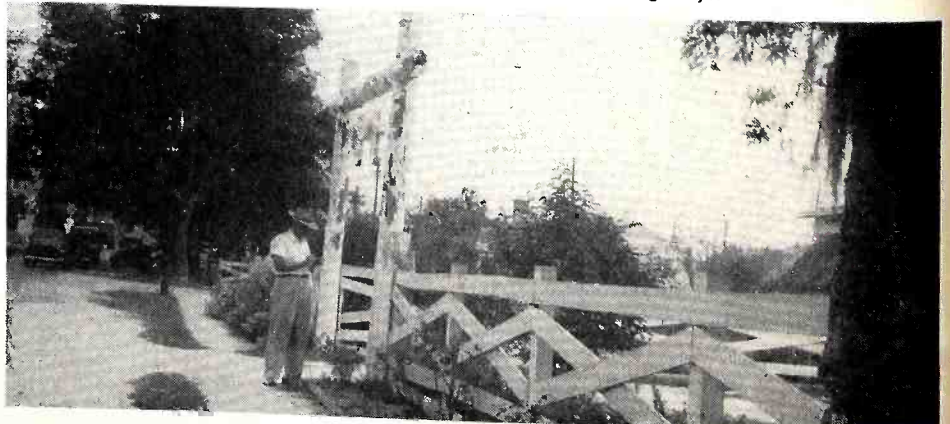

When he starts along the road to knock upon every farm door, what sort of gimmick does a Blossman salesman use to get an audience?

“None,” points out Dave Blossman. “Unlike city selling, no gimmick is needed. The farmer is not so suspicious of door knockers as the city resident. Nor does he erect an immediate wall of sales resistance as soon as he finds out the mission of his caller.

“Still, even though the salesman gets in easily, he has to know his farm selling in order to get out with an order. Jumping right into even the smoothest, hardest-hitting kind of radio, TV or appliance presentation is a mistake. Farm folks take a visit seriously. They extend real hospitality to a salesman—regard him as a guest rather than a nuisance. It is a breach of etiquette

Appliances to Farmers

Two-Way Radio in Trucks Speeds Servicing



The A. R. Blossman store is located conveniently for both rural and urban customers.



Kitchens are very important places on farms, and the new range is something for the farm folk to talk about. The dealer who sells and installs the right way sets himself up for plenty of repeat business.

begin trying to cram a product down the farmer's throat, right off the bat. Instead, our salesmen are taught how to *visit*. They stroll around the farm with the host, see the new herd of cattle he wants to buy off, discuss the lack of rainfall, and a number of other topics. They go into the kitchen and sit down for a friendly cup of coffee. It is then we teach them to look around for sales opportunities.

"Almost anything can serve as a low pressure opening here—the installation of TV in another farm down the road, the fact that the farmer has a new refrigerator and might want TV or a new radio-phonograph combination as well." In the Blossman system of rural selling, these outside salesmen are dubbed "Route Managers." Each has a specific territory. Calling regularly upon the same farm folk, he soon gets to know them intimately, learns their problems and their ways—and knows when a sale opportunity is at hand.

But what about service? A. R. Blossman has found that swift service is an important thing in selling to the farmer. "We try to give our rural customers service as fast as a city resident would get," says Dave Blossman.

"We have found it impractical to try handling more than the very smallest of small repairs in the home," says Blossman. "Instead, we try to bring sets into our shop for service. We have installed two-

way radios in our service trucks. When a call is received from a farm customer, the service pickup truck is there—in most cases—within a couple of hours. In the shops, schedules are expedited in order to return sets, wherever possible, the next day."

The store has found it wise policy to insist upon service contracts with every TV sale. "When it comes to the city resident, you can,

as some stores do, wash your hands after the sale has been closed in the event the customer does not want to pay for the regular 3-month service contract which, in this area, costs about \$15.00," Blossman says. "But the country customer is different. He cannot call easily upon other service shops because there

(Continued on page 41)

Farmers Are Highly Service-Conscious

They know the importance of prompt maintenance on equipment used in the fields and barn. They expect fast service on radios and appliances in the home, as well. Dealer Blossman, of New Orleans, has two-way radio equipment installed in his trucks, and can make extra fast repair pickups as a result. Carefully trained salesmen from Blossman's make informal calls on rural residents, and sell them on the store's reliability, and on its ability to keep products in tip-top working condition after the sale has been made.



Boost Your Disc Sales

Here Are Some Suggestions for Increasing Your



• We're now in the midst of a peak selling season for phono records. The Christmas season this year, as every year, will see sales soaring on all types of merchandise, and especially so on gift items, among which phono records, albums, players and accessories rank high. The disc merchant who's on his toes will take advantage of this peak season, and use all his merchandising know-how to boost his sales.

A general sharpening-up of all your selling methods and techniques is in order. Get your entire store, stock and sales staff into top operating condition. Each phase of your activity will bear looking into, and revamping if it's not as it should be. Special emphasis, however, on three basic operations, will be especially rewarding: 1. get more people to come into your store; 2. make a sale to every person who enters your store; and 3. attempt to make additional sales to every customer.

To accomplish the first of these, building up your store traffic, you

should already be running local advertising and mail campaigns announcing your special Christmas merchandise. But beyond the extra traffic built by your advertising, there's a lot of buying power in the sidewalk traffic which passes your store. During the next few weeks this sidewalk traffic will be comprised mainly of Christmas shoppers. Your most powerful means of attracting this crowd is your store front and show-window.

Remember that most of these folk will be on gift-buying trips when they pass your store. Even those who are not will be easily reminded of their Christmas shopping if you suggest it in your show window. It's the thing that's on most folk's minds at this time of year, and they'll respond readily to any reference to it. So be sure your show-window not only "sings out" with the Christmas spirit, but also suggests all displayed merchandise as appropriate gift material. You should also include a sign telling

about your gift-wrapping service.

Select your show-window display material for its wide general appeal and its seasonal timeliness. This material will appeal to folk who are looking for a "general" type of gift which they can feel sure will be pleasing. For those who are looking for a specific type of music or artist, you can suggest stepping inside your store and seeing the wide selection available from your stock.

Unless your store front is of the modern, all glass design, there's more to it than the show-window. And there's your front door, too. All of this should be decorated. It's your frontage. Think of it as advertising space for proclaiming the Christmas spirit, and make the most of it.

Make a Sale Every Time

Once you get the people into your store, the most important thing is to sell them something. In general, those who come in are one of two types: either they already have decided on what they are going to buy, or have not made up their mind and are looking for suggestions or advice. The latter group might sometimes try your patience, especially during rush times, but handle them with care, for they are the folk who can make this Christmas season a whopping success for you. They are real, live, honest-to-goodness red-hot prospects, presenting themselves in your store, with open minds and cash in their pockets, asking for you to "sell" them! The dealer who lets these people walk out of his store empty handed need look no further for the reason for a mediocre sales record.

Make a determined effort to make a sale to every single person who enters your store. True, there are some cases you cannot possibly satisfy, but these are few and far between. Most folk will buy if you make the right suggestion. Don't suggest albums or artists at random. This will only serve to confuse the customer. Rather start with the broad categories such as classical, pop, Western, etc. Then narrow down to the more specific, like operas, show albums, etc. In

During the Xmas Season

Volume by Selling More to Each Customer

this way you let the customer know how you arrived at a specific choice, and lead the final decision to a choice of *which one*, instead of *yes* or *no*.

In suggesting different types of material you might use the same grouping you use for your record stock. If you hit on any one category, but can't get down to anything more specific, you can point out a rack, display or section to the customer and let him browse. But keep an eye on him, and don't leave him alone for too long. He may become bewildered and decide to call the whole thing off. Let the customer browse, but be attentive and ready to offer advice and assistance; don't rush him or appear eager, but keep pushing for a decision. And remember, the decision should never be "What?" but always "Which one?"

Keeping the Christmas spirit in your salesmanship is important, too. Remember that this is a time for "giving," and the buying which results is done in a spirit of generosity and good fellowship. Fall in with this feeling and encourage it. Don't dwell on price and value unless it's obviously a big factor to the buyer. Mention instead the end result, the happiness and pleasure which will be derived from the discs, again and again all through the year. The person who gives a present of phono records wants to give pleasure, not an impression of expensiveness.

Push for Add-On Sales

Now for the part that will really send your sales volume to new highs, the add-on sales. Try for as many of these as you can make between now and Christmas. You might ask "Why now? I do that all the time." It's true that add-on sales should be attempted all year 'round, but they're especially appropriate during the Christmas season because they're easier to make. This is so because there are so many possible reasons for a customer making that additional purchase. There are always more presents to be bought, or add-on items which will make the original gift a more complete one.

For the additional gifts, suggest larger items such as albums, phonographs, radios, television sets, and combinations. It may seem like reverse procedure to sell a TV-radio-phono combination as an add-on item to a record album sale, but Christmas buying is like that. When folk go out to buy a number of gifts, both large and small, in the short span of a few weeks, they don't necessarily buy them in any particular order. The merchandise you suggest might be appropriate for a large gift which the customer has not yet bought.

Many Items Are Appropriate

For the add-on items to go along with the phono record purchase, all types of accessories are appropriate. These would include record brushes, static remover, blank record albums, racks and needles. These make especially good gift items because they're the sort of thing a person might need but just not get around to buying for themselves, but are quite pleased to receive as gifts.

A good way to break into an add-on sales pitch is with the question, if it hasn't already been asked, "Is this for a gift?" The additional items can then be suggested either as appropriate gifts or for the customer's own use, as the case may be. Doing this puts a lot more punch into the sales talk. A person pays much more heed to a sales message

if it seems to be delivered especially for him.

This is shown by the results of a little survey wherein phono record customers were asked why they had purchased a particular record or album. Three times as many sales resulted from the recommendation of the salesman as from newspaper ads. This does not mean that newspaper advertising is not effective, but on the contrary, shows the great effectiveness of the salesman's recommendation.

It's this recommendation that you make, and the extent to which you use your selling know-how, which will determine the success of your add-on sales attempts. And the number of add-on sales you make will greatly affect the success of your Christmas season. Remember that even though a customer might enter your store with a specific item in mind, he is still open to suggestion for additional items. The business of selling phonograph records is still mainly a matter of good salesmanship.

In the course of conversation the good disc salesman should be able to find out such things as: whether the customer is concentrating on one gift or still has a number to buy; whether the person for whom the gift is intended owns a 3-speed player, record racks or albums, record brush, etc.; whether the customer himself owns these things. This, or similar information, is all that is needed to give the alert

(Continued on page 34)



For Higher Christmas Disc Sales

1. Get more people to come into your store
2. Make a sale to every person who comes in
3. Try for add-on sales to each customer

Phono Records for Xmas Sales

Albums Featuring Music and Artists Especially Appropriate for This Season

• Although practically all records enjoy higher sales during the Christmas season, there are always certain records which sell especially well. It might be traditional Christmas music, or a single or album of a favorite artist, but always there's that certain "something" which makes it a good Xmas sales builder.

There's a wealth of material being offered this year, some exclusively Yuletide material, some timed for gift-giving. The following are some of the more featured items, which are representative of the wide assortment of Christmas albums available.

Combining traditional Christmas songs and the popular Mario Lanza, **RCA Victor Records** heads its Yuletide offerings with the Red Seal album "Mario Lanza Sings



Christmas Songs." (WDM 1649). This contains six devotional songs, including four traditional hymns. On the pop label RCA Victor offers "Perry Como Sings Merry Christmas Music."

Another combination of ever popular artist and traditional Xmas songs is found in **Columbia Rec-**



ords' "Songs For Christmas," done by Nelson Eddy. (ML4442) The thirteen songs on this 12-inch LP disc cover practically all of the "group-sing" type of Christmas songs. Another LP collection of "Christmas Hymns and Carols," a 10-inch disc by the Columbia Choristers, is also offered.

A universal approach to the season is offered in **Decca Records'** new release, "Christmas With the



Trapp Family Singers." (DL9553) This collection of 18 songs includes traditional songs from many lands, sung by the world renowned folk-song singers, the Trapp Family.

Songs of foreign lands as well as songs of the old world are included in the **Capitol Records** Yule-



tide album, "Christmas in the Air." (CON9016) The eight sides in this album are sung by the male and female choir known as "The Voices of Walter Schumann."

Another "direct from the soundtrack" album by **MGM Records**, "Quo Vadis," (E103) ties in with the spirit of Xmas by presenting music similar to that heard by the Romans during the reign of Nero. It includes many of the instruments of that era. Recorded in England,

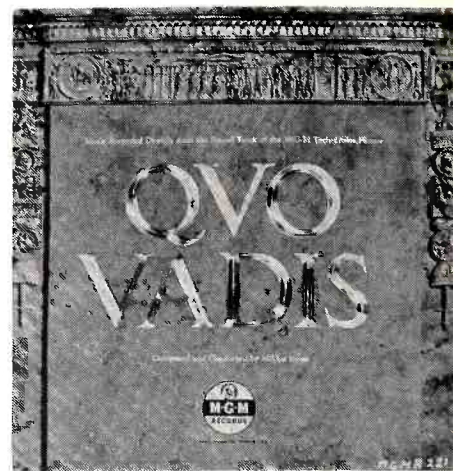

the score includes an orchestra of 75 and a chorus of 100.

Again in the conventional vein, **Coral Records** offers from its



catalog an album called "Christmas Time," featuring Owen Bradley; an organ and chimes rendition of nine traditional Christmas songs (CRL-56012).

Special Christmas music for the small fry is offered by **Young People's Records**. "We Wish You a Merry Christmas" backed by "Round and Round the Christmas Tree" feature Tom Glazer and the Gene Lowell Chorus. Earmarked for the 2 to 10 age group, the disc is a "music participation" number.



pick the right needle with...



THE
Jensen
"JENSELECTOR"

For Fast, Easy, Replacement Needle Selling

This new Jensen Needle Guide will give the exact needle replacement number for any record player made, without knowing the model or cartridge number. It's as easy as A.B.C. See your distributor for your "Jenselector" or write directly to Jensen.

Your local radio parts distributor has Jensen needles in stock

Jensen No. 32 Dealer Pack

This pack contains a balanced assortment of 32 needles of the best proven sellers. Packaged in an attractive plastic box that contains an automatic inventory feature.

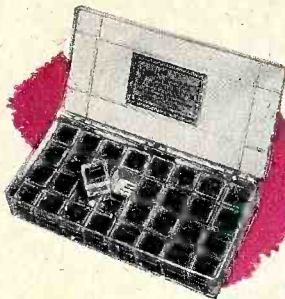

JENSEN — The Oldest Name in Sound Engineering

Jensen INDUSTRIES, INC.
 332 South Wood St., Chicago 12, Ill.
 CANADIAN BRANCH
 Duplate Canada Ltd.
 50 St. Clair Ave., West, Toronto 5, Canada

Xmas Disc Sales

(Continued from page 31)

dealer his cue. After getting the information he wants, he need only decide in which direction there is the greatest potential for add-on sales, and the rest depends on his own ingenuity and salesmanship.

There are great selling possibilities presented to the dealer by his store traffic, and the dealer who uses an organized plan for building add-on sales during this Christmas season can capitalize on those possibilities to boost his disc sales as well as his sales of sets and accessories. In a sense, he will find himself ringing out the old year and ringing in the new with the bell on his cash register.

Disc For Bird Lovers

A new 10-inch, 78 RPM, unbreakable record called "How to Teach Your Parakeet to Talk" has recently been announced. Listing at \$1.95, the disc contains instructions for teaching a parakeet on one side, and the voice of a real parakeet on the other. Record is made by Arthur C. Barnett, 520 N. Michigan Ave., Chicago 11, Ill.

Decca-Universal Deal

Decca Records, Inc., has completed arrangements for acquiring 271,900 shares of common stock of Universal Pictures Company, Inc. Milton R. Rackmil, president of Decca, has announced "The ownership of these shares will bring about a close association between our two companies. We have kindred interests in the entertainment business. These interests can be developed for our mutual benefit."

Magnavox Disc Tie-In

The Magnavox Company is helping its dealers to capitalize on their record departments as a prime source of radio-phono prospects. Keystone of the promotion is a printed invitation prepared by Magnavox for its dealers to present to record customers. "Play your new records on a Magnavox radio-phono in our audition room before you leave," it says. "Hear these superior recordings at their very best . . . you'll be amazed at the tone!"

Jensen Cutting Needles

Jensen Industries, Inc., 329 S. Wood St., Chicago 12, Ill., has announced that it has added record cutting needles to its line. Available in steel, stellite, and sapphire, they list from 50¢ to \$7.25.

New Capitol Offices

Glenn E. Wallich, president of Capitol Records, Inc., has announced that Capitol's New York executive offices will be moved to the new Mutual Life Building, Broadway at 56th Street. Offices will occupy 5000 sq. ft. on the ground floor, which will provide 80 ft. of window display space. Move will be made on January 1.

"Space-Maker" Record Rack

This new rack is designed specifically for LP and 45 RPM records. Supplied unfinished, in two models,

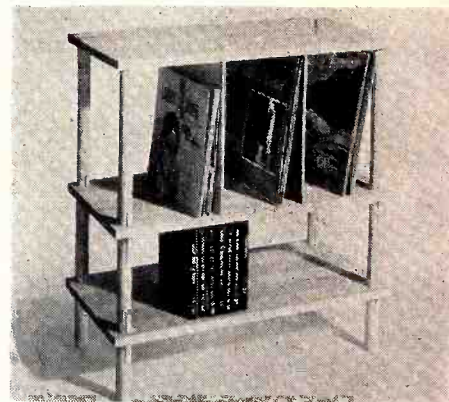

for different arrangement of records. List is \$13.95 and \$14.95. The Dennis Co., 23 Nairn Place, Newark 8, N.J.

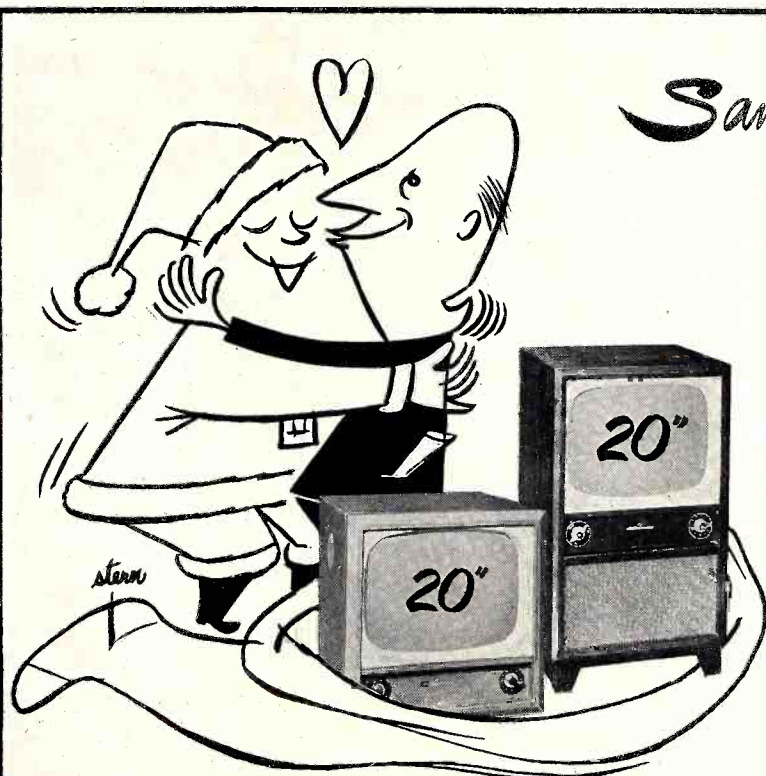

Santa himself couldn't give you a bigger-better **TV LINE**

Philharmonic

What makes a TV line bigger? Better? Proven Sales.

PHILHARMONIC with an enviable record of successful selling is now available *nationally* as a result of their new plant, increased production. With PHILHARMONIC you get these *bigger-better values* at practically *give-away prices!*

In PHILHARMONIC you'll find:—

- | | |
|------------------------------|--|
| Wonderful wide angle picture | Stabilized vertical hold |
| Adaptable to UHF | Stabilized brightness control |
| Standard turret tuner | Super sensitive — no special arrangements needed for top performance in fringe areas |
| Converter for color | 12 channel coverage |
| Built-in antenna | Two knobs—dual controls |
| Black Picture tube | Furniture quality, deluxe cabinetry |
| FM audio circuit | |
| AFC horizontal hold | |

Wire or call at once!

Get all the amazing facts . . . record breaking sales, immediate delivery, franchised territories.

choice territories
open for
franchised
distributors

An Instrument Worthy of the Name

Philharmonic Radio & Television Corp.

Main Offices and Plant: New Brunswick, N. J.



260
260
260
260
260
260
260
260
260
260

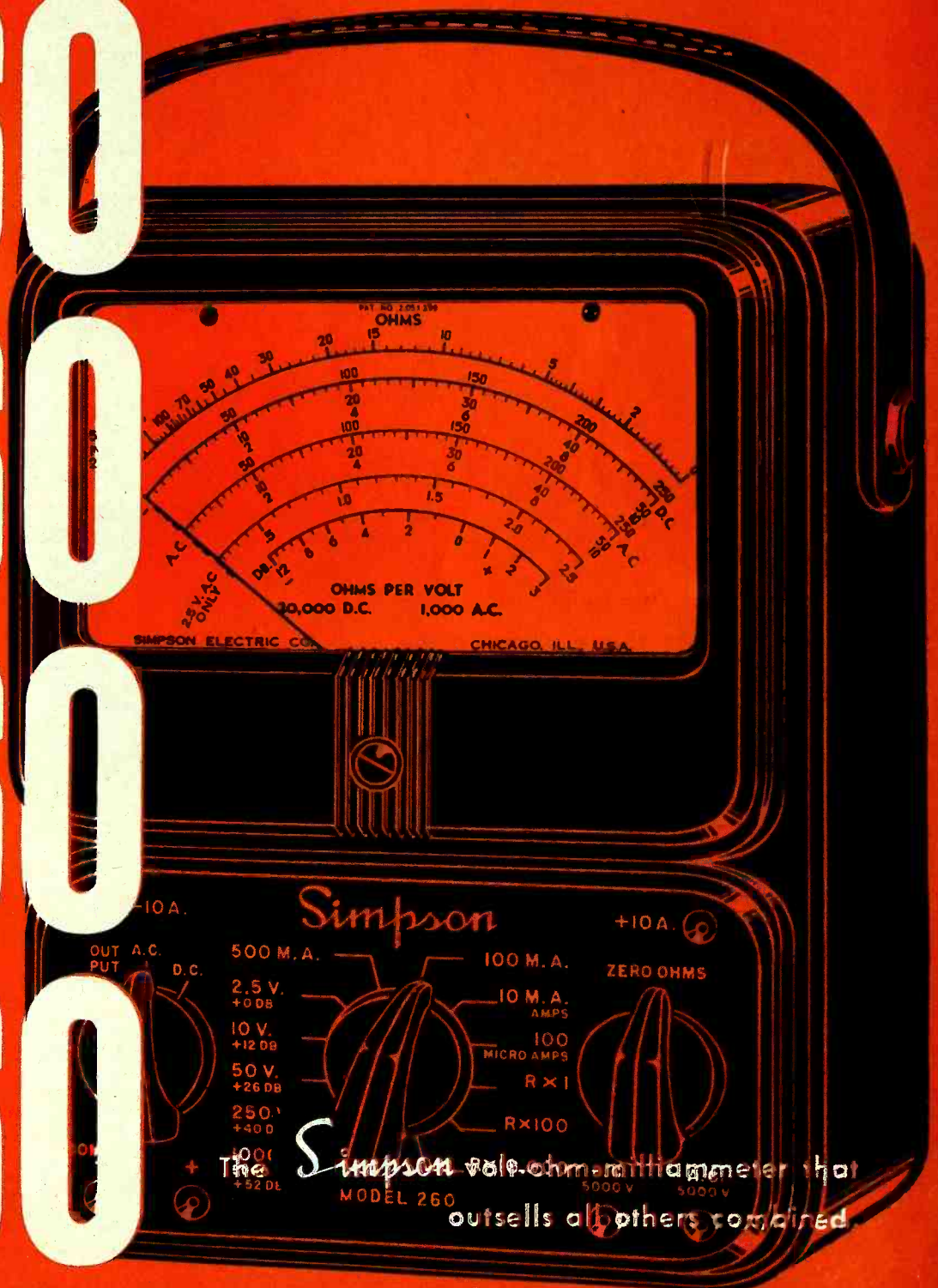

The Simpson volt-ohm-milliammeter that outsells all others combined.

New Radio, Phono, TV Sets

This and following pages describing manufacturers' new merchandise are compiled by our editors. This information is presented as a news service to our readers entirely without any advertising consideration whatsoever.

Capehart FALL '51 LINE

Twenty-four TV sets, 2 combinations, 9 radio-phonos, and clock, table and personal portable radios make up the new line. The new "Courtland," shown here, is a 20-inch TV set in a corner cabinet. Called model 338-MX, it lists at



\$650. Other TV sets introduced include 17-inch sets 1T17M, the Clermont, \$249.95 in zone 1, and 3C17M, Jamestown console model, \$279.95. Twenty inch sets are the Amherst, table model 2T20M, \$229.95; and three consoles, 339-MX, Shenandoah, \$389.95; 336-FX, Cordovan, \$469.95; and 340-X, Bennington, \$469.95. Fifteen other TV models, previously introduced, are continued in the line.

A new personal portable radio, model 10, is available in taupe, maroon and green, \$29.95. The radio line includes six models ranging in price from the "Classic," model 1005-M, at \$239.95, to the Futura, model 1010-B, at \$445. Also continued in the line is the clock radio, model TC-20, \$49.95 and table radio T-30, \$32.95; Capehart-Farnsworth Corp., Fort Wayne 1, Ind.—RADIO & TELEVISION RETAILING.

Pentron PHONOGRAPH

Recent addition to the line is a 3-speed automatic phonograph. Features include intermix of all sizes in all speeds, automatic shut-off, push-pull amplifier, full range tone and volume



controls. Luggage-type carrying case. List price is \$99.50. Pentron Corp., 221 E. Cullerton St., Chicago 16, Ill.—RADIO & TELEVISION RETAILING.

V-M PHONO LINE

Two new features have been added to models in the phonograph line. They are the "siesta switch" and "lazy lite." The "siesta switch" is an automatic switching arrangement which turns off the radio section of combinations, or the amplifier, as in the case of the model 971 shown here, as well as an external lamp or appliance, when the last record



has played. The "lazy lite" is a combination of indicator light and external reject button, which permits a record to be rejected without lifting the lid of the unit. These features have been added to the line at no change in model prices. V-M Corp., 280 Park St., Benton Harbor, Mich.—RADIO & TELEVISION RETAILING.

Emerson NEW TV SETS

Two table models and one console have been added to the 17-inch TV line. The table models, no. 700 in ma-

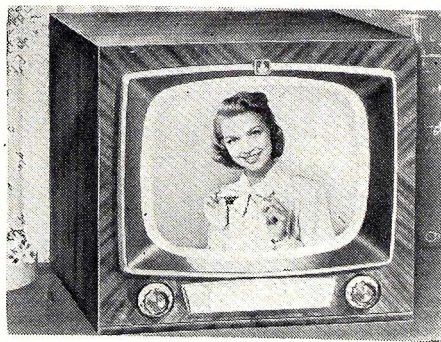

hogany and blond, at \$249.95 and \$259.95 respectively, and the console, no. 701, at \$299.95, feature built-in antenna, single knob control, Alnico 5 PM speaker. Emerson Radio and Phonograph Corp., 111 Eighth Ave., New York 11, N. Y.—RADIO & TELEVISION RETAILING.

Newcomb PORTABLE PHONO

Model RC-12 features a 5-watt, AC, Newcomb amplifier, 3-speed Webster record changer, and 6x9" Alnico V PM speaker, all enclosed in a plywood carrying-case covered with washable fabricoid material. Operating panel includes a tone control, volume control and pilot light. Total weight is 31½ pounds and the unit is U/L approved. Newcomb Audio Products, 6824 Lexington Ave., Hollywood 38, Calif.—RADIO & TELEVISION RETAILING.

Stromberg 20-INCH TV SETS

Three new models, one of them in two finishes, comprise the newly an-

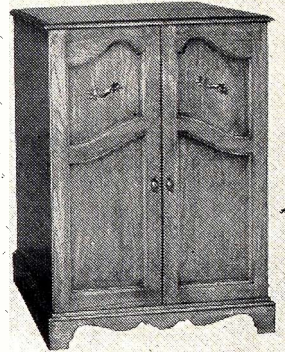

nounced 321 series. The French Provincial, model 321CF shown here, leads the group. Cabinet is cherry wood, hardware is antiqued. List price is \$495. Other models are the Futura, 321CD2M, and the Cavalier, 321C2M. The Futura is available in mahogany at \$459.95, and in blond oak (321CD20) at \$419.95. Prices include excise tax. Stromberg-Carlson Co., Rochester 3, N. Y.—RADIO & TELEVISION RETAILING.

EC KIDDIE PHONO

Electronic Creations has announced a Peter Pan phonograph, a tie-in item between the phonograph manufacturer and Peter Pan Records. A complete line of phonos in the Peter Pan design is being offered. They include an acoustic unit, single and 3-speed units, and a radio-phono combination. List prices start at \$12.98. Electronics Creations, Inc., 367 Greenwich St., New York 13, N. Y.—RADIO & TELEVISION RETAILING.

Esquire CLOCK-LAMP-RADIO

A clock-radio with table lamp combined, has been introduced. Sessions' clock movement turns the radio or the

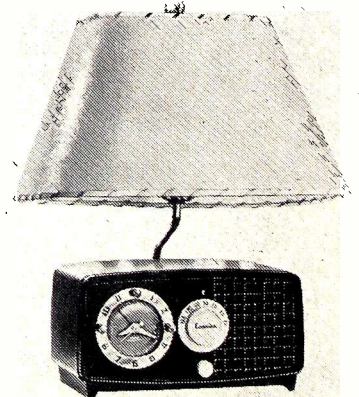

lamp, or both, on at a pre-set time. In addition, it serves as an appliance switch. Lamp features a Fiberglas shade. Esquire Radio Co., 62-01 15th Ave., Brooklyn, N. Y.—RADIO & TELEVISION RETAILING.

Emerson gives your TV sales



Emerson TV

specially engineered
for each TV area!

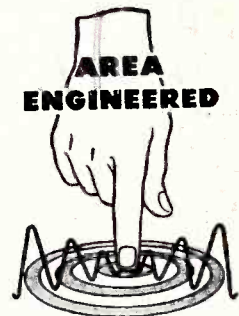

PROVED! THE MOST IMPORTANT SALES FEATURE IN TELEVISION HISTORY!

Emerson's Area Engineering promotion is only weeks old... but the sales results *prove* that here is the biggest sales-maker ever!

As often as you demonstrate Emerson Area-Engineered TV, *you yourself* will be amazed at the sensational Emerson TV picture and sound. There's never been anything like it... and no wonder! Emerson — and *only* Emerson — is *specially engineered for your own viewing area.*

Emerson field engineers have checked reception in your area... checked *local* reception... and have individually adjusted Emerson television for best reception of your TV stations.

This is the secret of Emerson's miracle of reception... the *essential extra* that Emerson offers *you and your customers!*

*Prices slightly higher in South and West.
Prices plus federal Excise Tax and warranty.*



**20"
ENSEMBLE**

EMERSON MODEL 697. Built-in antenna. Super-powered Long Distance Circuit. One-knob *Simplimatic* Tuning. Mahogany veneer cabinet ensemble complete with revolving-top table.

\$279⁹⁵



17" VALUE LEADER

EMERSON MODEL 696. Built-in antenna. Super-powered Long Distance Circuit. One-knob *Simplimatic* Tuning. Graceful, curved-top mahogany veneer cabinet.

\$199⁹⁵



Emerson LIFE-TESTED Television and Radio

EMERSON RADIO AND PHONOGRAPH CORPORATION, NEW YORK 11, N. Y.

NEMA Gift Certificate



Gift certificate (above) is one of the selling aids offered to dealers in connection with the Electric Housewares Gift Campaign of the National Electrical Manufacturers Association. Certificate has been developed to help dealers in two ways, closing sale when customer is in doubt, and creating double traffic of giver and receiver. Dealer's cost is \$9.00 per 100, from the Electric Housewares Section of the Association, at 155 East 44 St., N.Y. 17, N.Y.

Ten New Members Join The Representatives

Four new senior and six new associate members have been elected to membership in "The Representatives" of Radio Parts Manufacturers, Inc., announced L. W. Beier, national treasurer.

New senior members include: Anthony C. Wahl, P. O. Box 8, Cincinnati 18, of the Buckeye Chapter; Sherwood P. French, 721 Garland Drive, Palo Alto, of the California Chapter; John B. Guenther, 7322

Marquette Ave., Dallas 5, Texas of the Southwestern Chapter; and Jack M. Thorpe, 4390 Haverhill, Detroit 24, of the Wolverine Chapter.

Associate members elected were: O. E. Christianson, 1011 W. Bancroft St., Toledo 6, and Frank P. Yarussi, 335 5th Ave., Pittsburgh, joining the Buckeye Chapter; Burt Homsher, 912 Ft. Wayne Bank Bldg., Fort Wayne 2, recently added to the Hoosier Chapter; and Walter C. Burns, 6-248 General Motors Bldg., Detroit 2; John P. Driver, 50820 Lempke Rd., New Baltimore, Mich., and Martin O. Vogt, 1328 Maxwell, Royal Oak, Michigan, recently elected to the Wolverine Chapter.

Texas Dealers Form State Association

Representatives of the following local associations met in Austin, Texas to complete the formation of a state organization of associations. Delegates were present from the Dallas Radio Sales & Service Ass'n., Inc., of Dallas; Texas Electronic Technicians Ass'n. of Houston; San Antonio Radio & Television Ass'n. of San Antonio; and the Texas Radio Service Ass'n. of Austin. This meeting followed two earlier meetings where the proposed set-up had been thoroughly discussed. Also present at this meeting were representatives

from Ft. Worth, Galveston, and Lockhart. At this time the Texas Electronic Association was organized as a State group of the local associations. Its purpose is to unify and bring together the programs of the local groups into a cooperative effort, to advance the cause of the radio and television technicians of Texas, and to provide a means for watching for any proposed legislation that would affect the welfare of these technical men. The State Association is supported by the initiation fee paid by each local association upon joining by regular dues assessments.

To Promote Parts Show

Ad agencies serving manufacturers who will exhibit at the 1952 Electronic Parts Show at the Conrad Hilton (Stevens) Hotel in Chicago next May, were recently invited to participate in an advisory capacity in plans for promoting the Show, in accordance with a resolution approved by the board of directors of the Radio Parts & Electronic Equipment Shows, Inc., the Show's sponsors.

To Distributor Sales Post

Edward V. O'Hara has been appointed radio-TV sales manager for the Westinghouse Electric Supply Company in the central district, and George Filson has been named district specialties salesman.

What other television line on your floor is so certain to STAY SOLD that you'd dare back it like this with your own money and reputation?

You know the parts and servicing picture in TV retailing today. The complaints. The kickbacks. The temperamental performance of many sets. What line on your floor could inspire an offer like this one by Denels, prominent West Coast dealer?

Sparton dealers dare make guarantees because they know Sparton. Because they know that ever since 1926 Sparton radios have earned an unmatched reputation for dependability . . . for long, service-free performance.

And they know that Sparton's TV line is equally sound and well-built. It's a line that *sells*. A line that will *sell!* A LINE THAT DEALERS CAN GUARANTEE!

Sparton franchises are limited to one exclusive dealership in a shopping area. Perhaps a Sparton franchise is open in your area. Why not write?

Sparton RADIO • TELEVISION
JACKSON, MICHIGAN

Do you have a Guarantee? We have an offer on our Sparton color television sets that will give you the best of both worlds. Buy one Sparton color television set and we will give you a \$25.00 gift certificate to use on any other Sparton television set. This is a guarantee of value that is yours to use. It's a guarantee that is yours to use. It's a guarantee that is yours to use. It's a guarantee that is yours to use.

**A DOUBLE
money-back Guarantee
on SPARTON TV!**

At Denels only—Today, Friday, Saturday



Sparton prices
start at
\$229.50
for 17-inch
Table Model 5110

Why Denels dares to make this precedent-shattering announcement:

Denels believes that there is no better way to make a TV set than to make one that costs up to \$100 more than the price of a Sparton. Denels will do more than claim this superiority—it will prove it by standing behind its guarantee. After 22 years in business, Denels knows that 93% of all customers are honest—and that they will not take unfair advantage of a sincere offer of guarantee.

Therefore, Denels lets you try Sparton television in your home up to five days. If—during that time—you and your family are not convinced that Sparton is a wonderful investment, or that it is not giving you the enjoyment you expect, return it under the terms of this **DOUBLE MONEY-BACK GUARANTEE!**

A BONA-FIDE OFFER
Read these facts:

Buy any Sparton Television on a minimum 12% down payment required by tradition. We will do a special deal for you. In Denels stores, credit approval and customer service costs if not in required. In some customer returns have during 15-day period. Denels will promptly return cash to your payment plus \$25.00 BONUS.

TRADE-INS ACCEPTED
In most cases your trade-in accepted for full allowance on required 15% down payment. (Trade-ins held in garage during five-day trial period.)

Open Evenings 4:30 p.m. Free Parking in the rear

Established for 22 years
Denels Music Shop
6634 Hollywood Boulevard • HOLLYWOOD 9-8121

Eliminates mismatch! Outperforms standard Yagis!

Z-MATCH YAGI*

600 Series

Reaches farther for single-channel reception.

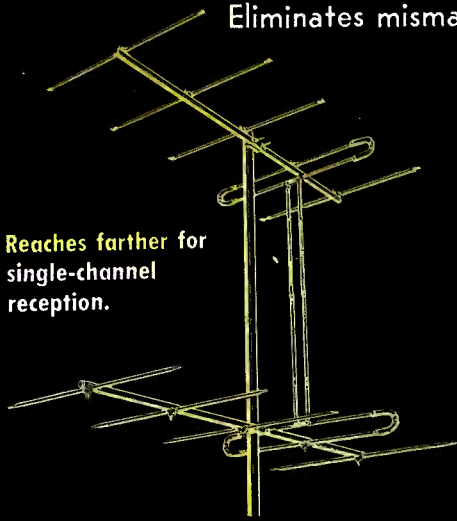

- Perfect match to 300 ohm line, single or stacked.
- Wider spaced elements for higher gain.
- 100% gain in stacking!
- Completely preassembled.

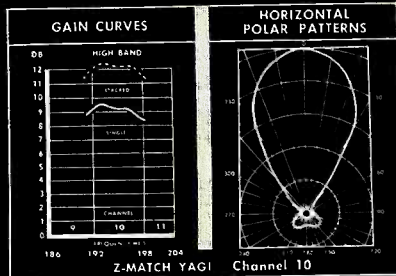

*Patent Applied For

How The Z-Match Yagi Works

When antennas are stacked, the center feed bars of the folded dipoles are removed, automatically creating a perfect 300 ohm match for the entire stacked Yagi array. These same center bars are then used as half-wave connecting rods. This means

YOU DON'T PAY FOR STACKING BARS!

developed by

CHANNEL MASTER



For "Far Reaching" Results

There's only ONE SUPER FAN

313 Series

Reaches farther for multi-channel reception.

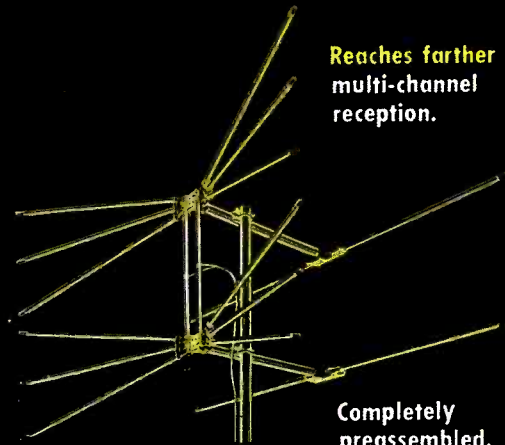

Completely preassembled.

new! TOWERS

by Channel Master

- Steel tubular uprights.
- Built-in ladder with no obstructions.
- One standard interchangeable section which can be used as a top, middle or bottom section.
- Universal base mount.
- Dual purpose mast or rotator mounting brackets.

The most widely used antenna in the nation.

The highest gain broad-band antenna ever developed.

New reinforced fibreglas inserts in all elements and reflectors.

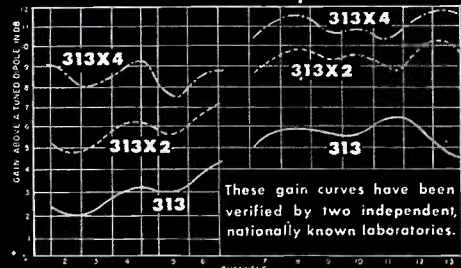

These gain curves have been verified by two independent, nationally known laboratories.

Write for technical literature on these 3 outstanding products.

CHANNEL MASTER CORP. ELLENVILLE, N. Y.

**RCA Victor
Christmas Angels**



Record display shown above and a "Street Scene" instrument display are being offered by RCA Victor. Both displays are in full color. They continue the well known RCA Victor Angel motif, which was first used in 1948.

**Columbia Records
Sales Promotion Manager**

The appointment of Irving Townsend as sales promotion manager for Columbia Records, Inc., has been an-

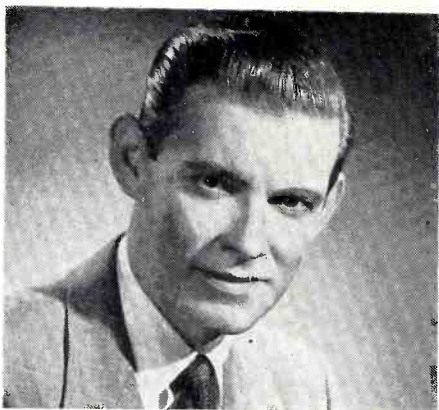

Irving Townsend, newly appointed sales promotion manager for Columbia Records, Inc.

nounced by Albert B. Earl, advertising manager of the company. Townsend will supervise album cover design and packaging for Columbia as well as all sales promotion activity.

Miller Diamond Needles

The M. A. Miller Mfg. Co., 1165 E. 43rd St., Chicago 15, Ill., has announced that it is now furnishing, on request, diamond styli for all phonograph replacement needles listed as sapphire tips. In the case of dual tipped needles, they are available with one or both tips of diamond.

Associated Names Warner

Russell A. Warner has been appointed store manager of the Associated Store Tampa operation, it was announced by C. R. Courtleigh, general manager of the Florida chain of retail TV, radio, phono record and appliance stores.

Record Industry Assoc.

Membership drive by the newly organized Record Industry Association of America, Inc., is meeting much success, reports Milton R. Rackmil, president of Decca Records and temporary president of the association. Frank Walker, president of MGM Records, is acting as treasurer. Temporary board includes the presidents of Decca, Capitol and MGM. Permanent officers will not be elected until wide industry membership is attended. Quite a few record manufacturers have already joined the association.

Jensen's "Jenselector"

Jensen Industries, Chicago phono needle manufacturer, has announced that there are 125,000 "Jenselectors" in use. The Jenselector is the device that tells the exact replacement needle for any make phonograph.

Music Box Record

The Bornand Music Box Record Co., 139 Fourth Ave., Pelham 65, N.Y., is offering a special "Music Box Medley of Christmas Songs," long playing 10-inch recording of Christmas songs recorded from music boxes. The half hour of recorded music includes 14 songs. Price is \$3.50.

HEART  OF A *good* RECORD-CHANGER

It's General Industries' turret-type, 3-speed motor, currently being supplied to record-changer manufacturers.

In this highly efficient design, turntable speeds of 33 1/3—45 and 78 RPM are secured through three separate pulleys mounted on a turret plate. By means of a simple lever, the desired pulley is brought into contact with the idler wheel. The two pulleys not in contact with the idler wheel remain stationary.

In addition to this turret-type motor, General Industries also offers the popular Model TR turret-type, manual 3-speed motor, as well as the Model TS belt-driven 3-speed motor for both manual and record-changer applications. Write today for full information on all models.

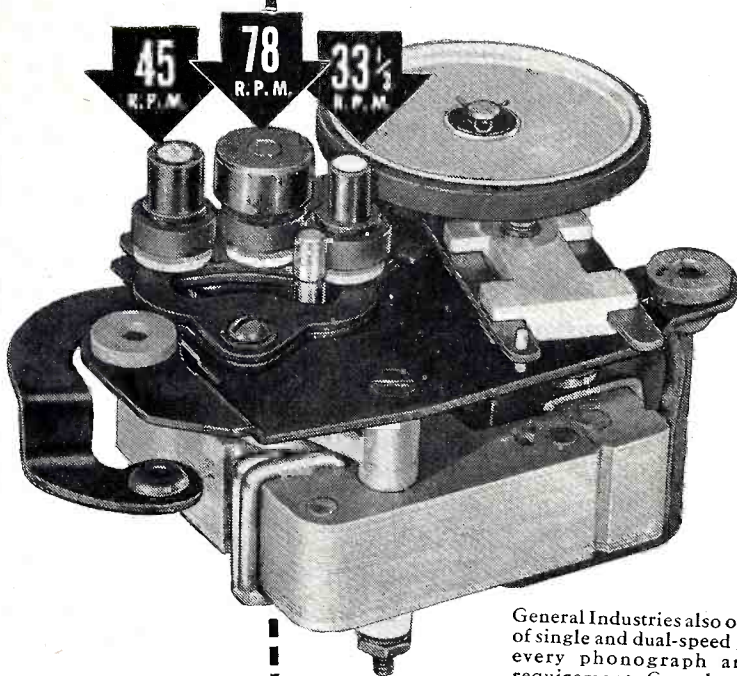

General Industries also offers a complete range of single and dual-speed phonomotors to meet every phonograph and record-changer requirement. Complete details on request.



The GENERAL INDUSTRIES Co.
DEPARTMENT I • ELYRIA, OHIO

Farm Sales

(Continued from page 29)

aren't any close to him. As a result, if he has trouble he has to come back to the dealer from whom he bought. Without a service contract there has to be a service charge for these calls, and farm folks are likely to regard this as an imposition."

When it comes to TV selling in rural areas, problems crop up. "There is only one station here and no others for hundreds of miles," says Dave Blossman. "If a farm home is too far away, naturally no satisfactory reception can be expected. So even if the prospect wants to buy TV, we try to tone down his desire if we believe he's too far distant from WDSU-TV to receive a good picture. However, with a high antenna, reasonably good reception can be had for a lot of miles away from the station. Out in the country, we try to impress the need for such an installation."

The advertising methods that work for city selling are not always best in going after the farmer, A. R. Blossman has discovered. The store uses the *Times-Picayune*, a "dominant" daily paper that has a huge rural circulation, in order to contact both rural and urban prospects. "In addition," points out Dave Blossman, "we use radio time extensively. Particularly early-morning programs beamed to the farmer. Later in the day we purchase time on small town stations for programs and announcements for the farm wife. Our radio formats include farm reports, newscasts, hillbilly and Western singers."

But the advertising alone won't sell; it must be backed up with outside work, and to us that calls for a salesman, stationed at one end of a road with instructions to knock upon every farm door until he reaches the other end of the road, and to use *indirect* selling tactics when someone answers the door," says Dave Blossman.

Florida Rep Firm

Maxim Hershey, manufacturers' sales rep. of 1326 S.W. 6th St., Miami, 35, Florida, has announced that the firm is now representing the following manufacturers: Camburn, Inc., Woodside, N.Y.; Automatic Radio Mfg. Co., Boston, Mass.; Phillips Mfg. Co., Minneapolis, Minn.; and Philmore Mfg. Co., New York, N.Y.

RTMA Names Merriam

Glen McDaniel, president of the Radio-Television Manufacturers Association, has announced the appointment of E. W. Merriam, former chairman of the RTMA Service Committee, as service manager for the assn.

NARDA Sends Protest

Mort Farr, president of the National Appliance and Radio Dealers Association, has written to Defense Mobilizer Charles E. Wilson in protest against suspending further color television developments. Mr. Farr urged the Defense Mobilizer to give every encouragement possible to the

advancement of color television and "every other form of technological progress which will help our economy hold up after the cessation of hostilities in Korea."

Cramer Joins Crosley

The appointment of Leonard F. Cramer as assistant general manager of the Crosley Division, Avco Mfg. Corp., has been announced by John W. Craig, Avco vice-president and general manager of Crosley. Cramer has been associated with the Allen B. DuMont Labs., Inc., for the past 16 years, most recently as executive vice-president and director.

SHERATON SUPER VIDEO DX TELEVISION REACHES OUT FOR WEAK SIGNALS

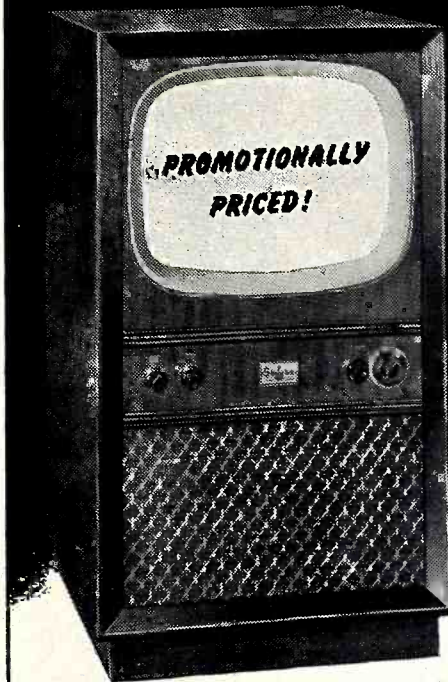

Yet costs no more than ordinary sets

UP TO 200 MILE RECEPTION!

NEW!
CASCADE CIRCUIT TUNER

Latest TV Development
Minimizes "Snow"
Expressly Designed for
Problem Reception Areas
Adaptable for UHF

The Sheraton Super Video DX

TV receiver will bring in better reception up to 200 miles, without the use of boosters. It will work where other sets have failed . . . in fringe areas with an ordinary antenna—in the city with merely an indoor antenna.

The Amazing High Powered Super Video DX 26-Tube Chassis (Incl. 2-Rect.) with 4-Microvolt Sensitivity—TEN TIMES THE SENSITIVITY OF STANDARD SETS.

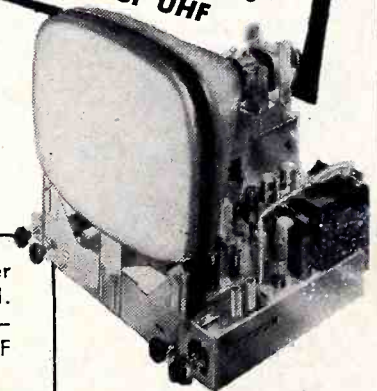

SHERATON TELEVISION CORP. Red Bank, N. J.
Affiliate of Video Products Corp.

DISTRIBUTORS - REPRESENTATIVES Choice Territories Now Available!
CONTACT OUR NEW YORK SALES OFFICE, 2061 B'WAY, N. Y. C.

Specifications of Current **HAND IRONS**

AMERICAN Electrical Heater Co., Detroit 2, Mich.

AMERICAN BEAUTY: Lightweight 33AB automatic model, 3 pounds, 1000 watts, \$13.95. Medium weight 79AB automatic model, 4½ pounds, 1000 watts, \$13.95. Both models come with colored plastic handles, which are replaceable without removing hood or other parts of iron. Both irons are equipped with "Thermoscopes"; temperature indicating devices, marked for various fabrics. The soleplate of the no. 33AB is aluminum alloy and that of the no. 79AB is cast iron.

AMERICAN Electric Mfg. Co., Div. of Steam Electric Mfg. Co., 3456 S. Grand Ave., St. Louis, Mo.

THE CHIEF: DC-501, steam iron, 4½ pounds, AC-DC, 600 watts, stippled finish, less cord, \$12.95. **CHIEF PERMAFIL** steam iron: 4½ pounds, AC-DC, 600 watts, complete with Permafil attachment, less cord, \$14.95. Both irons are non-automatic types.

ARVIN Industries, Inc., Columbus, Ind.

ARVIN: 2300, 3¼ pounds, AC only, 1000 watts, deluxe dual-control automatic electric iron. Convenient thumb control on comfort grip handle with special plastic heat shield. "Magic Watchman" temperature indicator. Eight-foot cord—reversible for right or left hand use. \$14.95. Model 2100, 3 pounds, AC only; 1000 watts, streamlined automatic. Rod-type heating elements embedded in aluminum sole plate. Extra low heat range for safe ironing of synthetic fabrics. Cool, maroon colored plastic handle with maroon control knob and cord to match. \$12.95. Model 2200, 3 pounds, AC only, 1000 watts, automatic. Aluminum-alloy sole plate, with rod-type imbedded heating element. Extra-low heat range for safe ironing of synthetic fabrics. Cool, easy-grip handle. \$11.95.

BERSTED Mfg. Co., Div. of McGraw Electric Co., Fostoria, Ohio.

BERSTED: FOSTORIA, VICTORIA. 505, 550 watts, non-automatic, streamline design, chromium plated shell, tip-up heel rest, extra-wide, beveled sole, \$3.90. Model: 507, 550 watts, non-automatic, streamline design, genuine walnut handle, extra-wide beveled sole, reliable indicator, tip-up heel rest, \$4.60. Model 506, 350 watts, traveling iron, 2 pounds 2 oz., length 7¼ inches, width 3¾ inches, height 4½ inches. Currents of air flowing through the slots in all models keep the tip-up rest and plug guard cool and prevent scorching ironing-board cover or clothes when iron is tilted up on heel rest. List: \$3.70.

CASCO Products Corp., Bridgeport 2, Conn.

Model 51 steam and dry iron retails at \$19.95. Uses tap water. Weighs 3½ lbs. Features: Provides steam for 1½ hours; has Du-All fabric dial, handy button nooks, and air-cooled handle.

CHICAGO Electric Mfg. Co., 6333 W. 65th St., Chicago 38, Ill.

HANDYHOT: 1175 automatic iron, 3 pounds, AC only, 1000 watts. Accurate temperature control for every fabric, Temp-o-lite tells you when to iron. \$10.95. Model 1178, deluxe travel iron, 2 pounds, AC-DC, 400 watts. Heat indicator tells correct temperature for ironing various fabrics. Patented safety latch—no burned fingers. Comes with smartly styled suede traveling case at \$6.95.

DOMINION Electric Corp., Mansfield, Ohio.

DOMINION: 1011, "Adjusto-Cord" automatic iron, 3 pounds 7 oz., AC only, 1000 watts. "Adjusto-Cord"—reversible for right or left hand ironing, special maroon colored plastic handle with con-

DOMINION (Continued)

trol knob, nameplate and cord to match. Scientifically designed to give natural grip, constantly cool. \$9.95. Model 1013, automatic; 4 pounds, AC only, 1000 watts. Wood handle is formed to fit the hand and do away with strain. When iron is attached to current jewel indicator will glow. When it ceases to glow iron has reached desired ironing temperature. \$8.95. Model 1007, automatic, weighs 4 pounds; AC only, 1000 watts. Large beveled base makes it convenient for ironing around buttons, pleats, etc. \$8.95. Model 1004, "Light-O-Matic", 4 pounds, AC only, 1000 watts. Fingertip heat control knob; jewel indicator. Plastic handle molded to fit the hand; built-in thumb rests on each side. \$9.95.

GENERAL Electric Co., Bridgeport, Conn.

GE. Model 149F40, steam and dry iron, 3½ pounds, AC only, 1000 watts. Air-cooled handle with double thumb rests. Steam shuts off automatically when the iron is set on its heel rest. Has push-button control, flip up and it's a steam iron, push down and it's a dry iron. Steam vents on ironing surface are surrounded by smooth soleplate. No continuous groove to cause wrinkling. \$18.95. Model 139F23, automatic "Visualizer" iron; 2¾ pounds, AC only, 1000 watts. Red light on back of handle lets user know when iron has reached right temperature. "Visualizer" fabric-dial conveniently located on front of handle gives fingertip control of ironing temperatures for all fabrics. Has double button nooks. \$12.95. Model 119F32, automatic "budget" iron; 4¼ pounds, AC only, 1000 watts. Has "Dial-the-Fabric" indicator, balanced heel rest, molded plastic handle designed with double thumb rests. Suitable for right or left-hand ironing; high-precision thermostat. Lists at \$9.95.

(Continued on page 44)

American Beauty A257

American El. Mfg. Chief

Arvin 2300

Bersted 507

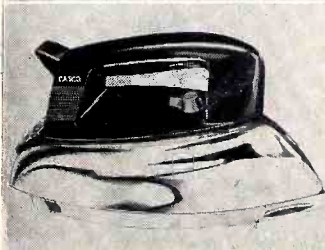
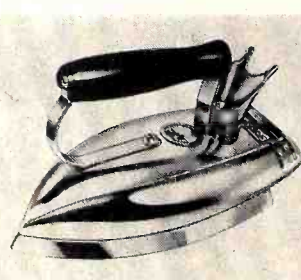
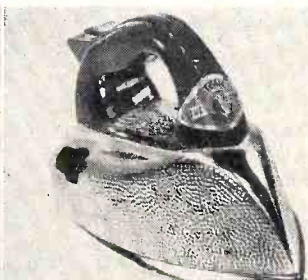
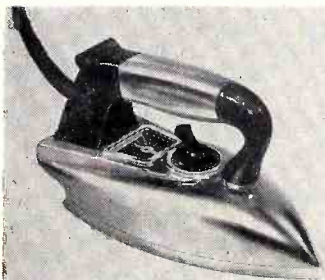

Casco 51

Chicago Handyhot 1175

Dominion 1004

GE 149F40

CBS-Columbia

destined to be America's

Leading Line

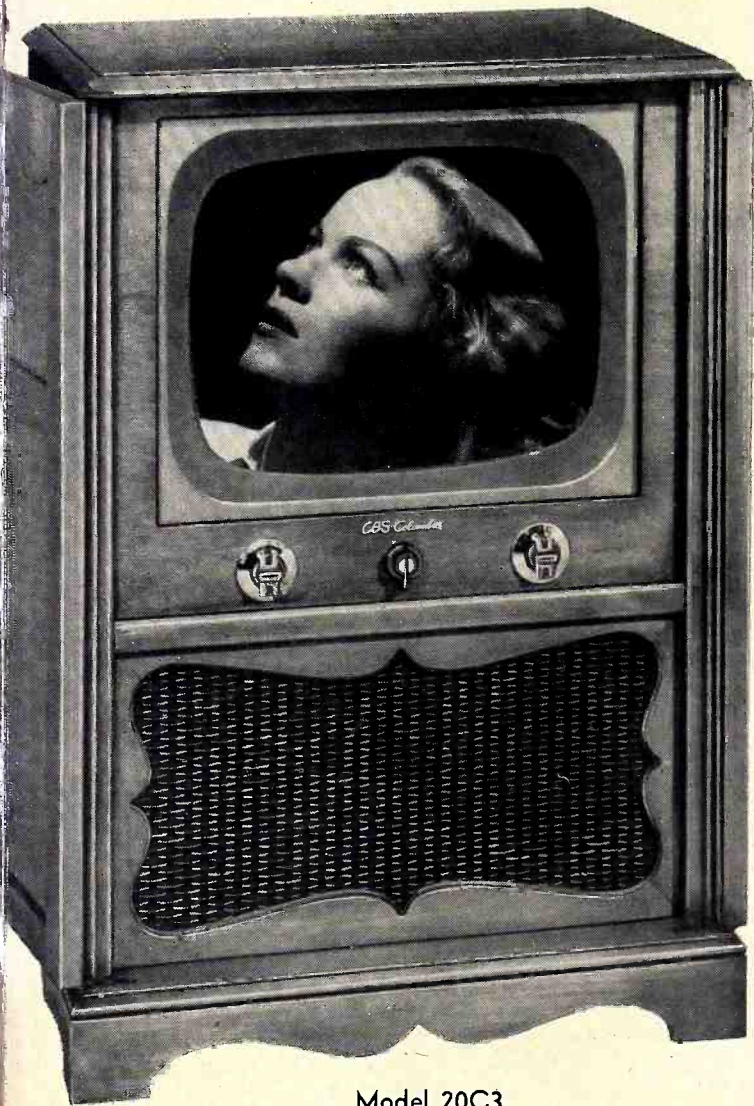

Model 20C3

Other models from
\$199.95 to \$399.95.
Slightly higher South and West.

Be sure you get the whole story
about the new

CBS-COLUMBIA TELEVISION

You've read about it in the trade papers — you've read about it in the newspapers. A famous name in broadcasting — now a famous name in Television Receivers.

You are invited to see the

**CBS-Columbia
1952**

"CUSTOM-TUNED"

Television Receivers

at the

January Furniture Show

Congress Hotel

Chicago

January 7th thru 18th

Custom-tuned for

CBS-Columbia

your neighborhood.

CBS-COLUMBIA INC., 170-53rd STREET, BROOKLYN 32, NEW YORK

Specifications of Current **HAND IRONS**

(Continued from page 42)

GENERAL Mills, Inc., Home Appliance Dept., 1620 Central Ave. N. E., Minneapolis, 13, Minn.

TRU-HEAT: GM1BB automatic; 3 pounds 2 oz., AC only, 1100 watts. Has tapered heel, safety side rests, Perma-chrome finish, new Permarod heating element, fabric selector dial, button-saver edge. Sells at \$14.95. GM 4A, steam ironing attachment, turns Tru-Heat iron into a modern steam iron in a jiffy. Lists at \$8.95.

HOOVER Co., N. Canton, Ohio.

Easy-set "Pancake Dial" gives accurate heat, Koolzone handle is comfortable in the hand, always stays cool, broad heel rest prevents tipping. Fully automatic. Retail at \$13.95.

KNAPP-MONARCH Co., St. Louis, Mo.

K-M. Copper-Magik Iron, no. 19-510; 4 pounds. New type iron with copper-clad sole plate. Selector heat control dial and Tel-a-Matic signal light for ironing all types of fabrics. Right and left hand thumb rests and twin side rests; AC only, 1000 watts. Lists at \$12.95. Gad-A-Bout iron, no. 17-501, 3 pounds; AC-DC; full-sized folding plastic handle with positive locking arrangement when handle is in upright position. Handle may be easily folded down and packed in its carrying case. Twin side rests, fabric heat indicator, detachable cord; 400 watts. \$8.95. Automatic iron, no. 19-507; AC only. Cool handle curved to fit hand; finger-tip fabric selector, dial control, right and left hand thumb rests, button-nook on both sides; 1000 watts. \$8.95.

KORAL Electric Mfg. Co., 43-22 Van Dam St., Long Island City 1, N. Y.

B-12 automatic; 4 pounds, AC only. Ventilated to prevent overheating of upper shell. Thermostat adjustable to fabrics; wide beveled edge for under

KORAL (Continued)

button ironing, \$7.95. Model B-11, non-automatic, 5 pounds; AC-DC. Heat resistant, hardwood handle, wide beveled edge for under button ironing. Lists at \$6.95.

LANDERS, FRARY & CLARK, New Britain, Conn.

UNIVERSAL: "Stroke Sav'r" automatic, AC only. Covers the most of fabric in one motion; can move in any direction without twisting, turning or wrinkling. Its wide sloping bevel extends all around the extra large sole plate (37½ sq. inches). Hand-i-Set dial, recessed in handle, gives positive thermostatic control of ironing temperatures for every fabric. Plastic handle is cool. Air cooled, upper deck has ventilating ports. Finish is heavily plated, polished and buffed chromium on nickel plate; 1100 watts. Sells at \$13.95.

NATIONAL Pressure Cooker Co., Eau Claire, Wisc.

PRESTO. Automatic vapor-steam iron model S-10, 3½ pounds, AC only. Uses ordinary tap water. Wide spout makes filling easy and fast. Features fingertip temperature selector, sole plate heat indicator, visible indicator to stop guess work, and prevent scorched fabrics and slow, under-heat ironing. Wrinkle-proof round heel. Sturdy, scorch-proof metal stand with asbestos tubing is given with every Presto iron. 1100 watts. Sells at \$19.95.

PROCTOR Electric Co., 3rd St. & Hunting Park Ave., Philadelphia 40, Pa. Automatic Never-Lift steam iron model 990; 3¾ pounds, AC only. Reservoir weighs ¼ pound, and converts from steam to dry and back again by simple turn of precision valve in reservoir. Instant steam, converts water to steam drop by drop. Dual-action thermostat, double thumb rests, new, improved Never-Lift action, one trigger control.

PROCTOR (Continued)

Sturdy, rust-proof reservoir made of durable plastic in one piece. 1150 watts \$16.95; reservoir: \$5.95. Automatic Never-Lift model 991; 3 pounds, AC only. New improved Never-Lift action, dual-action thermostat, clear-view button ledges. Plastic heat shield covers entire area just below handle. Leg support exceptionally stable single rod design, snag-proof, operated by foolproof over-center spring action, 1150 watts. Sells at \$14.95. Champion iron, model 989; 2¾ pounds, AC only. Cool, comfortable handle with built-in thumb rest, air cooled heat shield, easy-to-read fabric dial, clear-view button ledges. New, improved dual-action, assures right heat from start. Near vertical position of coil spring cord guard is designed for left hand ironers. 1150 watts. \$12.95 retail price.

RIVAL Mfg. Co., Kansas City, Mo.

STEAM-O-MATIC. Fully automatic steam and dry iron, no. R-500B; 3 pounds empty—3½ lbs. full. AC only. Tilt-top visual filling; uses ordinary tap water. 1000 watts. Sells at \$19.95. Features: Visual filling, new fabric selector dial, "Buttoneer" toe, stainless steel steam chamber, "No Bunching" bevel back. Traveling case combination, no. R-500BK. Dimensions of case: length 11¼", width 6½", height 7". Lists at \$22.95 (case and iron). Case and iron may be purchased separately.

SILEX Co., Hartford 2, Conn.

Steam or dry iron, no. DS1; weighs less than 2¾ pounds, has patented "Y" shaped sole plate steam grooves for over-all steam distribution. Handle designed for cool ironing with air space between handle and iron. Easy to fill, with fill plug in front. Iron rests firmly on broad heel base when not in use. "Easy Set" dial, once set it stays set at correct heat for fabric selected. Lists at \$19.95.

(Continued on page 46)

Gen. Mills GM1BB

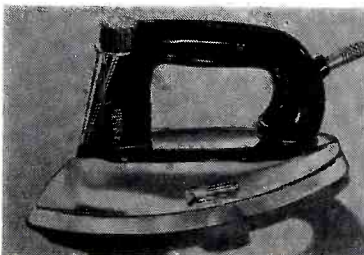

Hoover

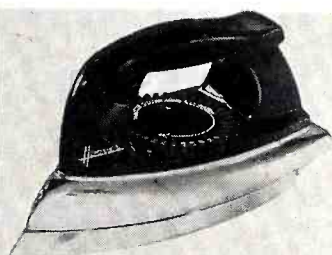

Knapp-Monarch 19-510



Koral B-12

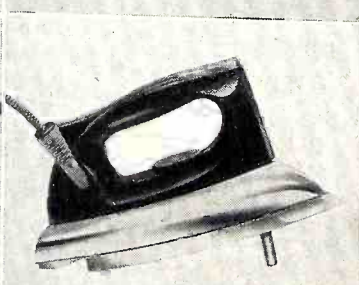
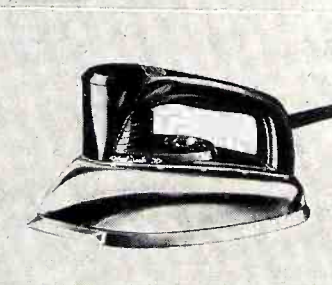
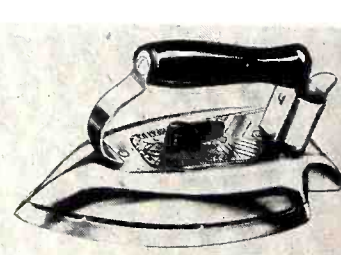

Landers, Frary & Clark Stroke Sav'r Nat'l Pressure Cooker Presto.

Proctor 991

Rival R500B

Good Time for the Holidays

SYLVANIA RADIO-CLOCK

is NEW...it's a NATURAL...it's a SYLVANIA EXCLUSIVE

YOUR CHRISTMAS SHOPPERS will go for this exciting Sylvania Radio-Clock. They've been reading about it in national magazine advertising... they know it's good... they will be wanting it.

For here's a real clock—a BIG clock, easy-to-read, classic in appearance, beautiful, and desirable because it's different.

One knob controls the radio, manually or automatically. There's also a plug-in for automatic appliance operation.

Radio is a UL approved AC-DC radio with 4 tubes and rectifier giving 6 tube performance, featuring Studio-Clear* sound from a five-inch speaker. This is a larger, better quality speaker than used in most radio-clocks—gives you a strong competitive advantage.

Eight different exquisite colors for every taste—and colors that will add a festive touch to your display: Bottle Green, Cardinal Red, Char- treuse, Ebony, Hickory Brown, Ivory, Mahogany and Primrose Yellow.

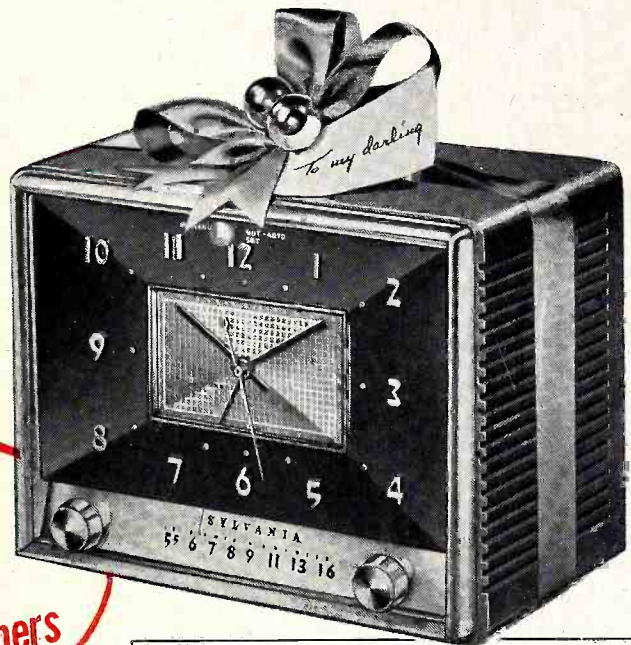

Get these on display quick—ready for the very first of the Christmas Shoppers



You'll find added sales power in the matching Sylvania Table Radio. It has the same chassis, same super-power sound and speaker equipment as the Radio-Clock... and comes in the same colors. Interesting new design catches the eye... and sells!

BOTH the Radio-Clock and Table Radio, in all eight colors, are being nationally advertised in a full-page, four-color advertisement designed to create gift buying.

Put this high-power promotion to work for you—feature it in your store.



CALL YOUR DISTRIBUTOR NOW! Get the full story on this line... and plan your stock on a fast mover for the holidays

Another Sylvania Exclusive...Greatest Sales Feature in TV SYLVANIA HALOLIGHT*

Prospects can see HALOLIGHT—it sells itself as the greatest development in viewing comfort since TV began.

It's another Sylvania first, and exclusive. You are always ahead with Sylvania.



The JEFFERSON 20" with HALOLIGHT

SYLVANIA



Established 1901—Great Name in Electronics

*Sylvania Trademark

TELEVISION SETS; RADIO TUBES; TELEVISION PICTURE TUBES; ELECTRONIC PRODUCTS; ELECTRONIC TEST EQUIPMENT; FLUORESCENT LAMPS, FIXTURES, SIGN TUBING, WIRING DEVICES, LIGHT BULBS; PHOTOLAMPS; RADIOS. SYLVANIA ELECTRIC PRODUCTS INC., RADIO & TELEVISION DIVISION, 254 RANO STREET, BUFFALO 7, NEW YORK

Specifications of Current **HAND IRONS**

(Continued from page 46)

SON-CHIEF Electrics, Inc., Winsted, Conn.

Automatic iron model no. 380; 2¾ pounds, AC only. Air cooled Bakelite handle, its shape is designed for complete protection of the hand from heat and ironing fatigue. Wide, flat top prevents hand from slipping sideways. Fabric dial indicator, complete with attached cord and plug. 1000 watts; \$9.75. Automatic model no. 388; 4½ pounds, AC only; air cooled handle. Fabric dial indicator. 1000 watts; \$9.75. Automatic model no. 334; 4 pounds, AC only. New thermostat is fully automatic and adjustable. Ivory enameled handle with double thumb rests. 1000 watts. Retail at \$5.50, without cord. Indicator Iron no. 302SN, AC-DC, non-automatic. Fabric dial indicator. Has thumb-rest and smooth enameled handle. 500 watts. \$3.95, without cord.

STERN-BROWN Inc., 42-24 Orchard St., Long Island City, N. Y.

SUPERSTAR. Folding iron, individually packed with cloth kit, model no. 80, AC-DC; 2¾ pounds. Raise handle to upright position, tighten finger-tip threaded knob and iron is ready to use. When not in use, unscrew knob, release handle to folded position, 400 watts. Lists at \$6.50.

SUNBEAM Corp., 5600 Roosevelt Rd., Chicago 50, Ill.

Steam or dry Ironmaster automatic, model no. S2; 2¾ pounds, AC only, 1000 watts. Retail at \$15.95. Steam Plug-In, model no. S2A, consists of deep steam dome, steam cord and steam plug-in, selling at \$5.95. Automatic Ironmaster, model A4, weighs 4 pounds; model A9 weighs 2½ pounds, AC only. Thumb-tip heat control dial up in the handle, a finger-touch sets it for the correct heat desired. Has air-cooled,

SUNBEAM (Continued)

wrist-resting handle, larger ironing surface, permanently attached cord set. Both irons feature double-automatic heat controls. 1000 watts. \$14.95 for either model. (Left-hand Ironmasters are available at same price.)

SUPERIOR Electric Products Corp., Cape Girardeau, Mo.

SUPER-LECTRIC. Automatic iron no. 220; 4 pounds, AC only. Sole plate has beveled edges and rounded corners to slide easily under buttons and into pleats. Air-cooled Bakelite handle with thumb rest; permanently attached cord, side mounted for free motion. 1000 watts; \$8.95. Automatic no. 204; 4 pounds, AC only; separate cord, Form-fit handle and thumb-rest. Has heat indicator; \$6.95. Model no. 82; 5 pounds, AC-DC, non-automatic; has heat indicator. 550 watts. \$4.95 list.

WARING Products Corp., 25 W. 43 St., New York 18, N. Y.

"Triple-Purpose" steam iron, automatic, AW-1; 4 pounds, AC only. Features controlled steam. Low, medium or high volume of steam is obtained by the twist of the red knob on the handle. Generous, one-cup reservoir is sufficient to deliver up to half an hour of continuous steam, more if used intermittently. Steam automatically shuts off when the iron is rested on the heel. 1000 watts. Retail at \$19.95.

WESTINGHOUSE Electric Corp., Mansfield, Ohio.

Adjust-O-Matic iron, model LPC-941; 4 pounds, AC only. Streamline design; cool, fatigue-proof handle with thumb rest shaped to fit hand easily, beveled-edge tapered point. Sturdy, attached heel stand. 1000 watts. Sells at \$10.95. Streamliner Adjust-O-Matic model no. ID-74 with "Personalized" temperature

WESTINGHOUSE (Continued)

control; 4 pounds, AC only. Jewel signal light in handle, tapered point. Fabric selector dial. 1000 watts. Sells at \$12.95. Adjust-O-Matic model ID-505; one-piece plastic handle, fabric selector dial, sloping edge, tapered point, Uni-therm thermostat, supersensitive bimetallic strip-type, 800-watt tubular "Corox" heating element. Lists at \$8.95. New "Open Handle" iron weighs 4 pounds; AC only. The front of the handle is open. A newly-designed fabric temperature control that the user can feel click into position for any one of the seven fabric settings was developed for the Westinghouse Open Handle iron. The control knob rotates inside this ring and has a transparent plastic finger button under which is the Westinghouse Circle-W insignia in gold and white. The control dial is set off with a gold-plated escutcheon. 1000 watt Corox heating element. \$12.95, list.

WINSTED Hardware Mfg. Co., Winsted, Conn.

DURABILT. Automatic folding iron, model 193; 2½ pounds, AC only. Positive heat control, steel soleplate. 750 watts. Sells at \$10.95. Dual-voltage folding travel iron, model 505A; 2½ pounds, AC-DC, a travel iron for the globe trotter to take anywhere in the world. Complete with electrical adaptors for foreign outlets, it folds into a compact unit. Extra-large soleplate gives 22 sq. in. of ironing surface. Proper adaptor can easily be snapped on the plug, and fits virtually all types of foreign outlets. Easy-setting plastic knob can be set to 230 volts for foreign use, 115 volts for domestic use. 375 watts. Extra 4-amp. fuse included with iron at \$12.95. Companion travel iron, model 401; 2 pounds, AC-DC. Features heat indicator, and a cool plastic handle flips quickly into ironing position. Folds flat for easy packing. Detachable long-life cord set. \$7.95 list.

Silex DS1

Son-Chief 380 & 388

Stern Brown Superstar Travel

Sunbeam Ironmaster

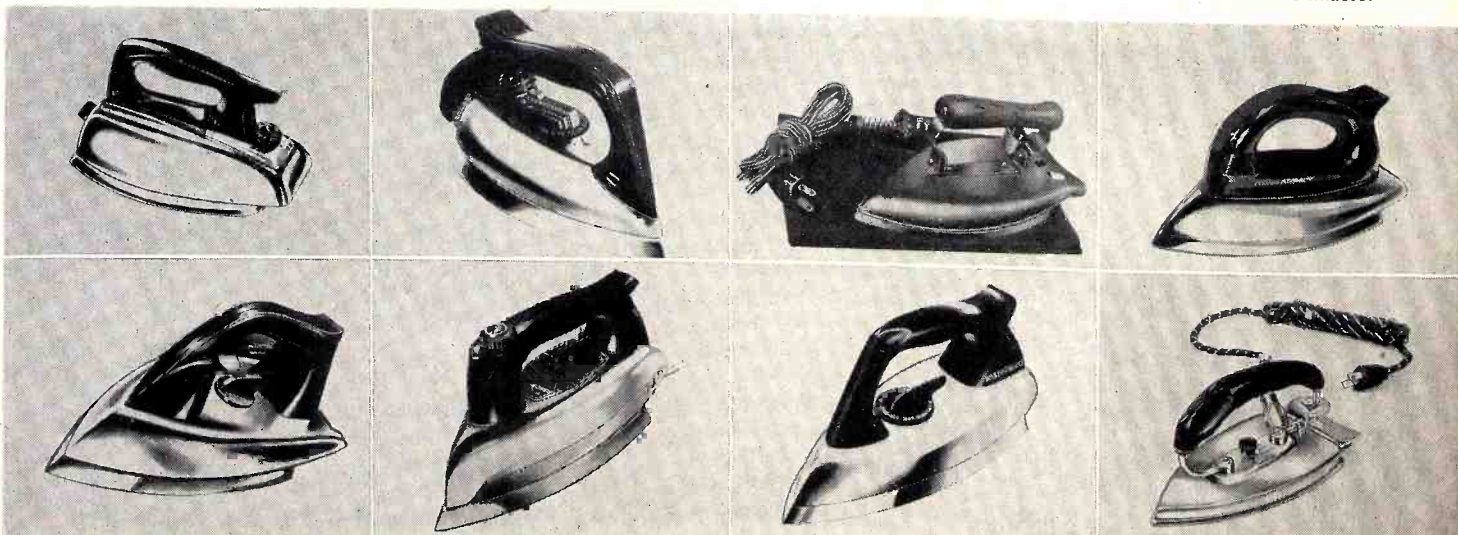

Superior 220

Waring AW1

Westinghouse LPC941

Winsted 193

Tele King

STYLE MASTERPIECES

America's Smartest TV Line for 1952

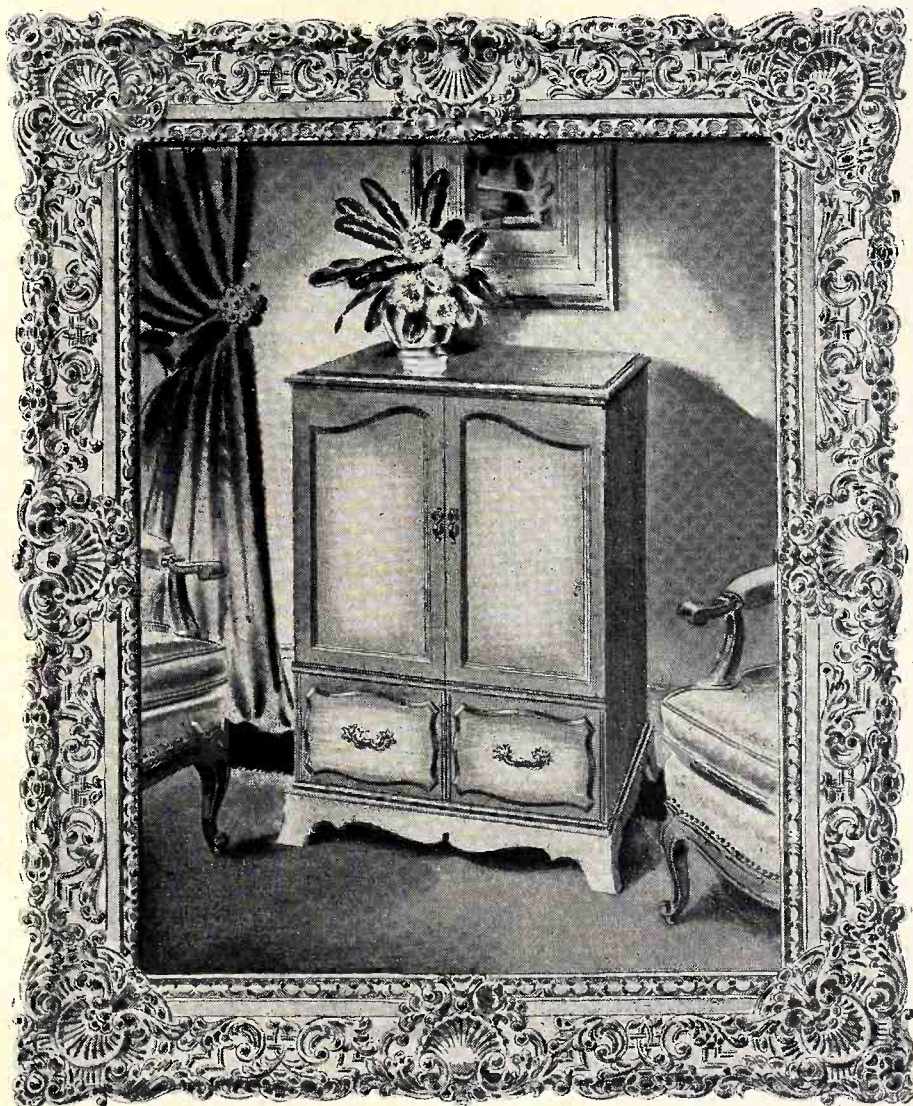

Tele King for 1952 has been styled for the American Home. Leading designers translated proven consumer style preferences into cabinets that blend with and enhance any home decor. The result is a combination of beauty and quality that will win immediate consumer acceptance.



Tele King for 1952 is America's greatest profit line! Every Tele King, from the lowest priced table model, offers the dealer an unbeatable profit mark-up. Every time you ring up a Tele King television sale you earn a bigger profit and build greater consumer acceptance in the process.



Add your name to the ever growing list of franchised Tele King dealers, America's No. 1 profit line. For full information see your distributor or write direct to factory.

Attention Distributors! A number of distributor franchises available in profitable areas. Write for details!

TELE KING CORPORATION



601 WEST 26th ST., NEW YORK 1, N. Y.

New Electrical Appliances

This and following pages describing manufacturers' new merchandise are compiled by our editors. This information is presented as a news service to our readers entirely without any advertising consideration whatsoever.

GE ELECTRIC RANGE

A new double oven electric range with push-button controls for the surface cooking units has been introduced. The range carries a recommended national retail price of \$349.95. Known as the "Constellation," the range has a large master oven and a slightly smaller companion oven. Each oven is equipped with 3000-watt bake unit and a 4000-watt broil unit. The master oven can be operated by an automatic timer, which also times one of the appliance outlets on the control panel. Surface units include two 8-inch units, one 6-inch utility unit and one 6-inch extra-high speed unit. Range also has two storage drawers. General Electric Co., Appliance Div. Bridgeport 2, Conn.—RADIO & TELEVISION RETAILING.

Jefferson ELECTRIC CLOCK

A new model electric clock, the Golden Hour, has been introduced. Billed as the "clock you can see through," the unit features a transparent face, giving the appearance of the hands being suspended in midair.

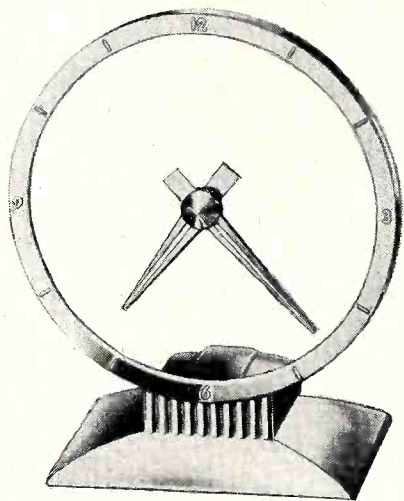

Minute hand is attached to the crystal, which rotates, thus actuating the hour hand. Mechanism is built into the base. Stands 8 $\frac{3}{8}$ inches high. List price is \$22.50 plus tax. Jefferson Electric Co., Bellwood, Ill.—RADIO & TELEVISION RETAILING.

Philco WINTER COVERS

Winter covers for air conditioner units are offered. Made of heavy gauge water-repellent red-brown Vinylite, the cover protects that part of the unit which is exposed to the elements. It also prevents drafts and keeps the unit clean. Fits Philco and many other make units. Comes in two sizes, AD-1688, for use on F and G type Philco units, listing at \$6.25, and AD-1689, for use on older model Philco and other make units, listing at \$6.95. Philco Corp., Appliance Div., C & Tioga Sts., Philadelphia 34, Pa.—RADIO & TELEVISION RETAILING.

Gibson 1952 NEW LINES

Announcement has been made of the new lines introduced by Gibson. Nine refrigerator models have been presented. Model 702, the smallest, is 7 cu. ft. Has 20 lb. freezer. Priced at \$209.95. Model 722, also 7 cu. ft., has 26 lb. freezer, "Butt'ry," and full length door, \$249.95. Leading the 9 cu. ft. series is the 942, with wall-to-wall freezer locker, \$319.95. Automatic defrosting model 962 is framed in blue inside the full length door, has 45 lb. freezer capacity, \$369.95. Model 982, also 9 cu. ft., has 53 lb. freezer capacity, two 13-qt. crispers, \$399.95. A leader in the line is the 1102, 11 cu. ft.



model, with freezer, crispers, "Butt'ry," door racks, etc., \$379.95. Model 1072, 10 cu. ft. model, features 54 lb. freezer capacity as well as the other features, \$459.95. Two 10 cu. ft. two door models, the 1052 at \$499.95, and 1082, at \$549.95, both deluxe models, complete the refrigerator line.

The electric range line includes eight models. Two apartment size models, the A-3 and A-4, at \$174.95 and \$184.95, have 3 and 4 surface units, respectively. Both have oven, broiler, and 7-speed cooking units. Leading off the full size ranges is model C. Includes deepwell cooker, lists for \$229.95. Top model in the range line is the two oven model H, shown here. Offers a deepwell cooker which is convertible to a surface unit, push-button control, and many other features. List: \$449.95. Other models in the line are the model D, \$284.95; model E, \$319.95; model F, \$339.95; model G, \$399.95. Gibson Refrigerator Company, Greenville, Mich.—RADIO & TELEVISION RETAILING.

Mitchell AIR CONDITIONERS

The 1952 line of Mitchell room air conditioners and the 1952 Mitchell dehumidifier has been announced. Among the many new features in the line is the Mitchell "Weather Dial," with which the user can control the level of cooling, dehumidification, ventilation and room air exhaust by a single control. Mitchell Mfg. Co., 2525 N. Clybourn Ave., Chicago, Ill.—RADIO & TELEVISION RETAILING.

Olin FLASHLIGHT

A new angle-head flashlight has been announced. Among its many features is a clip which permits user to attach the light to belt or clothing while in

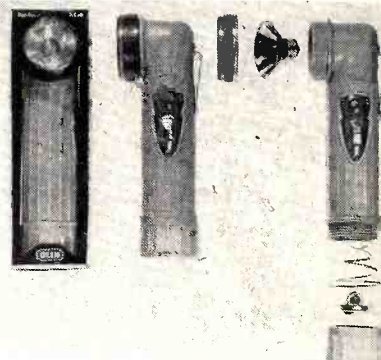

use. The entirely new flashlight is the second to bear the name Olin, a companion to a previously announced two-cell straight model. It has a three-position safety-lock switch, spare lamp carrier, barrel length ribbing for firmer grip. Suggested retail price is \$2.15, without batteries. Olin Industries, Inc., Electrical Div., New Haven 4, Conn.—RADIO & TELEVISION RETAILING.

Perfection REFRIGERATORS

Two new refrigerator models have been added to the Perfection electric products line. Models C-9 and C-10, 9 and 10 cu. ft. models, each have hermetically-sealed Tecumseh condensing units. Each has 3-inch thick, non-sag-



ging fiber glass insulation on all six sides. Refrigerant used is Freon-12. Model C-10 (shown) has 70 lb. capacity freezer chest, three ice cube trays, two crisper pans, dri-storage compartment, and a butter keeper built into the door. Model C-9 has 52-pound capacity freezer, two ice cube trays, meat freezer and frozen food tray, and 10-qt. crisper pan. Perfection Stove Co., 7609 Platt Ave., Cleveland 4, Ohio.—RADIO & TELEVISION RETAILING.



RCA VICTOR
Announces the
RCA ROOM
AIR CONDITIONER

The expansion of RCA Victor's activities into the room air conditioning field is destined to represent a major element in your profit picture as an appliance dealer. Look for more information to be released in January by your distributor of RCA Victor products.

Radio Corporation of America
RCA Victor Division



This TV team is what you need



for sure television capacitor replacements

When you replace television capacitors you want to *know* that your replacements won't cause "headaches" in unnecessary call-backs because of premature failure. You *can* be sure that these Sangamo TV replacements will live up to their reputation. Used as original equipment, they're "tops" for dependable replacements.



THE REDSKIN is a molded paper tubular, especially adapted to television. It's easy to work with—the leads are securely imbedded in a hard plastic case and have been especially designed to resist breakage. The REDSKIN is strong and it's dependable at 85° C, even under extreme humidity.

THE CHIEFTAIN is a dry electrolytic that fits anywhere! Tiny, but durable, it is ideal for application in tight spots beneath a chassis. Bare tinned-copper wire leads make it easy to mount. Maintains uniform capacity when subjected to high ripple currents at 85° C.

REMEMBER . . . these are only two of a complete line of mica, paper and electrolytic capacitors that will take care of practically any replacement requirement in the radio and television field.



Your Assurance of



Dependable Performance

SANGAMO ELECTRIC COMPANY

MARION, ILLINOIS

IN CANADA: SANGAMO COMPANY LIMITED, LEASIDE, ONTARIO

SERVICE & SOUND

Section of **RADIO & TELEVISION RETAILING**

Reduce Customer Turnover

What the TV Servicer Can Do to Keep People Satisfied

• With most service departments overloaded with TV service, many customers are switching dealers in an effort to get speedier service, and servicers are telling tales about the "big one that got away." It is much easier in the long run to hold old customers than it is to find new ones, and there are several tactics which can be employed to try to lick the turnover problem.

These tactics come under two headings. One is "techniques for servicing," and the other is "techniques for handling customers." Establishing some of the ideas which will be discussed under these heads may be difficult, but it must be emphasized that solution of the problem is a *must*. The service manager who is faced with more work than he can handle may think that there is no possibility of his ever being out of work. But word of mouth notoriety from dissatisfied customers can upset this apperception in a few months.

Under the first category (techniques for servicing) we must briefly review current practices. Operating on the theory that a TV set is big and complicated and may take a long time to repair, many dealers, service departments and service companies have developed an unwritten time limit for home calls, after which the set will be brought into the shop. The extreme of this point of view is represented by the development of the "tube jerkers" and "chassis pullers" on the one hand and "bench men" on the other hand.

It will always be true that to spend too long in the home working on a "back-breaker" will create the impression in the customer's mind that the serviceman is picking up his education at the customer's expense. But the tube-jerker and chassis-puller do little to dispel this illusion. Instead of getting an occasional impression that the serviceman can't tell an open circuit from a hole in the ground, the customer gets this impression *every time* his set is serviced. As a matter

of fact, he usually calls up and says, "Why don't you stop sending boys up here and send me some-one who can fix the set!"

But that's only one side of the story. This carbon-copy of mass-production technique usually isn't economical for the average service department. As mentioned in previous articles on the cost of servicing, the cost of labor and vehicle expense involved in calling for a set, bringing it to the shop and then returning it is ridiculously high. Furthermore, the shop gets piled up with sets and then the delays start. This is the most tantalizing thing to the customer—namely, being without his set for a week, and many times longer, and not being able to find out just when he will get it back.

Improve Home Servicing

Consequently, it is important for three reasons to fix as many sets in the home as possible: 1) To avoid creating a bad initial impression in the customer's home, 2) To cut down on expense of carting the set back and forth, and 3) To keep the shop from looking like a warehouse and to avoid delays in servicing which try the customer's patience. There will, of course, be cases where shop servicing is unavoidable, and we will come to the techniques of handling such cases in a minute.

But first, how to improve house servicing. The service manager or store owner must start out with the philosophy that all sets will be fixed in the home where possible. This means using experienced, well-trained men, for one thing.

Many service departments put their best men on the bench and break in the new men out in the field. This is like calling on your girl friend in your most frayed old suit. Naturally you need really skilled trouble-shooters on the bench. But you can also break in new men there. As we know, there are a lot of jobs which are just time-consuming, once the trouble has been located; for instance, replacing a power transformer, or putting in a new tube socket. Where time permits,

it is possible to let these men look for troubles (instead of just making repairs). A bright man can learn weeks faster by doing such work where he can freely ask questions, refer to notes, etc.

At any rate, send good men out to the homes. This is the firing line, where customers (not only for service work, but for future sales of radio, TV and appliances) are made or lost.

Also send such men out as adequately equipped with test equipment, spare tubes and parts and service notes as is humanly possible. Plumbers are famous for leaving tools behind. Don't let your serviceman get equally "well" known.

The well-trained, well-equipped serviceman can fix *almost* anything in the home. This makes the customer happy and saves money for the boss.

Once in a while, however, he will come up against a stumper, or one where the replacement of the needed part would take too long. Then the chassis goes into the shop and the problem of customer handling comes to the fore.

One solution which usually takes all the sting out of shop servicing is to

(Continued on page 70)

The well-trained, well-equipped serviceman who can fix the set in the home makes the customer happy and saves money for the boss.



The How and Why of

Basic Theory Reviewed and Brought Up to Date by Analysis

By Solomon Heller

• In DC restoration (also called DC reinsertion or clamping) something is given back to the video signal, which it lost on its trip to the cathode-ray tube. To know what this something is, we must first make sure that we understand the nature of the video signal, as well as its effect on the CRT.

The video signal contains units of picture information representing light intensities varying from white to black. The white sections of the signal are those that have the smallest amplitude, reckoning from the baseline of the total signal (see fig. 1); the black sections of the signal are those that have the greatest signal amplitude. The sync pulses have a greater amplitude than the blackest picture signals, and appear in the "blacker-than-black" region.

Nature of Video Signal

The video signal must be negative-going, when it is applied to the grid of the cathode-ray tube (that is, most negative at greatest amplitude). (If the signal is applied to the cathode, which is 180-degrees out of phase with the grid, it must be positive-going.) Then the black portions of the video signal will drive the CRT grid most negative, causing minimum current to flow through the CRT, and thus producing least light, or no light, on the fluorescent screen; the white parts of the signal will drive the CRT least negative, allowing maximum current to flow through the CRT, and thus producing maximum illumination of the picture screen. In this way, the picture recreated on the CRT will have

the same light values as the televised scene.

Now, such a charming state of affairs will not occur unless the DC level of the received video signal is the same as the DC level of the corresponding video signal at the transmitter. To clarify this statement, let's analyze what we mean by DC and AC signal levels.

DC Is Reference Level

When an AC signal (fig. 2) is applied to some circuit point, like the grid of a tube, that is at zero potential to chassis, it will cause the grid-to-ground voltage to vary above and below zero, in accordance with the signal's AC fluctuations. When the positive half of the signal is coming in, the grid voltage will rise above zero in the positive direction; when the negative half of the signal makes its bow, the grid voltage will drop below zero—that is, move in the negative direction. The average level, or the DC level, of the grid signal voltage will be zero, because the voltage excursions above and below the zero level are equal.

If the grid to chassis voltage is not zero, but is, say, $-3V$, the situation will change. The AC signal will now cause the grid voltage to fluctuate around a level of $-3V$, not zero. That is, the AC signal will add to, or increase, the grid's $-3V$ DC level during the negative part of its cycle; it will subtract from, or decrease, the grid's $-3V$ DC level during the positive part of its cycle. The average voltage on the grid, or the DC voltage, will now be -3 , not 0, as in the preceding case.

Now the video signal, after detec-

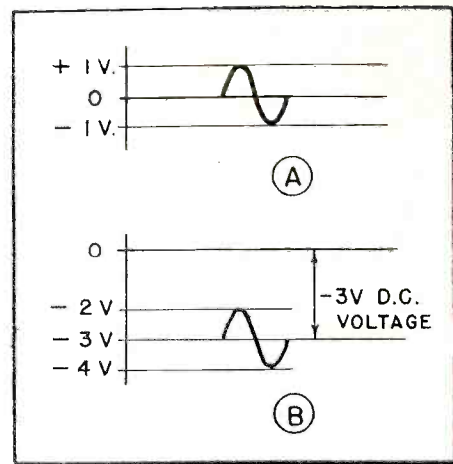

Fig. 2. (A) An AC signal superimposed on zero DC voltage. (B) An AC signal superimposed on minus 3 VDC.

tion, has AC and DC components. The AC component is the picture information itself, which is varying constantly due to the amount of light (or absence of it) which the camera at the Xmitter "sees" in the subject. The DC component is the reference level from which the picture signal varies (fig. 3). This DC component is added to the AC signal at the Xmitter, and establishes the brightness level of the televised scene, since it is the average of all the excursions from light to dark in all the lines in one frame. It is therefore also considered to be the level of background illumination of a scene.

DC Component Is Lost

This DC component, when added to the fixed bias on the kine of the receiver (which is established by adjustment of the brightness control) establishes the operating point of the kine so that the blanking pulses will cut off the beam. In this way we can be sure not only that the average background illumination of the scene is correctly reproduced, but also that the kine will always be cut off during retrace, and retrace lines will not appear.

If we did not have this DC reference level (and it can be lost, as is explained later on), we should have to adjust the brightness control every time the average background illumination of the scene changed. As it is, the only time we have to change the receiver fixed bias on the kine (or in other words, the setting of the brightness control) is when changing from one station to another with a vastly different received signal strength. And

Fig. 1. Amplitudes of different sections of the composite video signal.

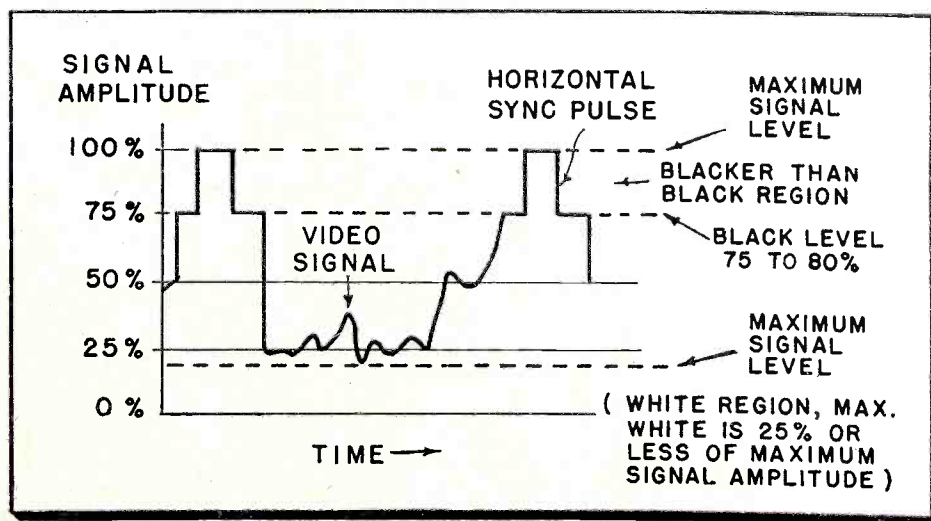

DC Reinsertion in TV Sets

of Practices Employed in Current Model Sets of Various Makers

even this change is made unnecessary (to a great degree) in sets with AGC and/or Automatic Black Level.

Now, the indispensable DC signal level is present at the output of the video detector. Between the video detector and the cathode-ray tube, however, the video signal generally passes through one or more R-C (resistance-capacitance) coupling networks. Since a condenser blocks DC, the DC level of the video signal is lost (fig. 4). It must therefore be restored or replaced. This is done by the DC restoration circuit. (It should be noted that in some receivers, no condensers are used in the coupling employed between the detector and the cathode-ray tube. No DC restorer is generally found in such sets.)

Restoring DC Manually

To better understand the action of the DC restoration circuit, let's consider in detail what would happen if it weren't present.

Suppose that light scene was followed by a dark scene. The set viewer has adjusted the brightness control while the light scene is coming in, to eliminate vertical retrace lines, and to give an approximately correct rendition of the tonal values present. The scene now changes to a much less brightly lit one. The vertical blanking pulses received during such a scene will no longer drive the CRT bias to cut-off, and vertical retrace lines will be visible on the picture screen (fig. 4). Furthermore, black signals will not drive the CRT grid negative enough to reproduce black on the picture screen. Black and grey tones will therefore be too light.

If the viewer reduces the brightness setting, thereby increasing the CRT bias, the undesired symptoms just described will be eliminated. When the scene illumination increases considerably, however, white and grey picture information will appear too dark, and the background illumination will

Fig. 5. Typical circuit showing how DC restoration can be restored by grid-leak bias in the final video amplifier, provided direct coupling is used from the plate of that tube to the grid of the kine.

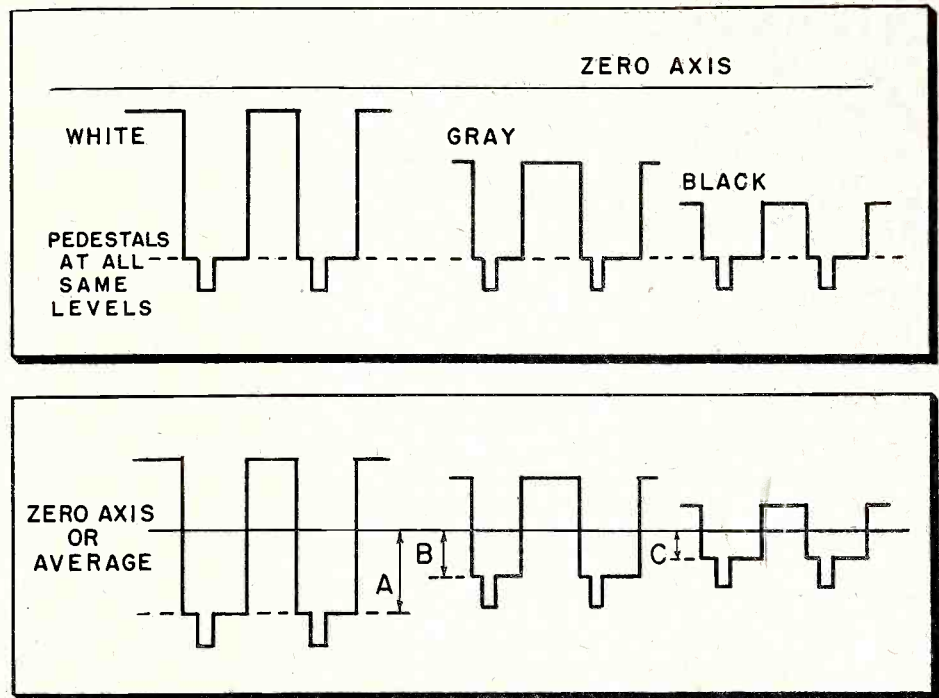
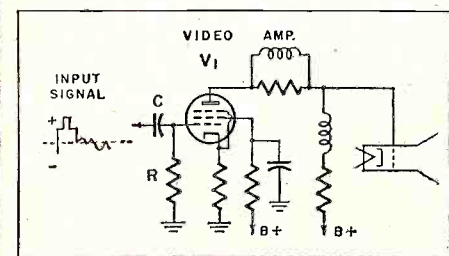

Fig. 3 (above, top). Light, medium and dark background pictures as they are transmitted. With the correct DC component included, the black and blacker-than-black information will, as shown, always cut off the kine in the receiver. Fig. 4 (above, bottom). The same signals as in fig. 3, but with the DC component removed, and the signals shown averaged around a zero axis as they would be after passing through a condenser. A, B and C show the DC components which must be added in each case to properly line up the black levels once more.

similarly be too dark. Another resetting of the brightness control will now become necessary.

The DC restoration circuit eliminates the symptoms cited by restoring the correct DC level to the video signals. Two types of DC restorers are in common use: 1—The grid-leak DC restorer; 2—The diode restorer. Let's consider first how the grid-leak restorer (fig. 5) functions.

Grid Leak DC Restorer

No special circuit is needed for this type of restoration. The DC signal level is restored because of the grid-leak action of R and C. When the composite video signal arrives at the grid of V_1 , its polarity is positive (courtesy of the preceding stage or stages).

The positive portions of the signal will drive the grid positive with respect to the cathode during the first few cycles, causing grid current to flow, and a negative grid-leak bias to be developed. During subsequent cycles, only the positive peaks of the signal—that is, the sync pulses—will exceed or overcome the negative grid-leak bias, and cause grid current to flow momentarily.

Now, the grid-leak bias developed is a DC voltage. This DC voltage establishes a reference level for the video

AC voltage coming in. For correct DC restoration to occur, the DC level must be proportional to the DC level originally present. Let's see how this is achieved.

If we examine the predominantly black and predominantly white signals shown in figs. 3 and 4, we see that the white signal—that is, the signal with a bright background—will, after the loss of its DC component, have a much greater peak-to-peak amplitude than the signal with the dark background. The light background signal has lost more DC voltage than the dark background one, and will need more to be restored to it. In other words, the darker the background of the signal, the smaller is the DC voltage that must be restored to it, and vice versa. Let's see how the grid-leak restorer fulfills this requirement.

When a light background signal is coming in, this high-amplitude signal will produce the largest DC grid-leak bias (since the grid-leak bias is proportional to the amplitude of the incoming signal). On the other hand, with a dark background signal coming in, a small DC voltage will be added to the video signal voltage. Thus the correct DC levels are restored to the signal, and since direct coupling to the CRT is used, no loss of the restored DC component occurs. (To be concluded next month.)

Good business is coming your way

Sales promotional plans must be flexible to meet changing market conditions — the market for television antennas, rotators, boosters, lightning arrestors, towers, etc. The intense consumer interest in television which began about 3½ years ago is now settling into normal levels and becoming a more stable business. Following the line of least sales resistance and being content to be mere order-takers is no longer going to be profitable for any of us. Many consumers have already had their first TV installation and are now looking more carefully for better televising. To put it briefly, competition has set in. Dealers handling quality products and reliable "names" are getting the jump on this

competition. Amphenol has always made **QUALITY** TV Antennas, Rotators, Lightning Arrestors, Lead-In, etc. So if you are an Amphenol Dealer, you have but to get your stock of Amphenol TV equipment ready for name-product business.

To help stimulate this consumer demand for Amphenol products, we have prepared a functional, useful and consumer appealing plan. A plan that will influence the consumer TV market and thereby create a more substantial sales opportunity for you and Amphenol alike.

The three ads reproduced on this page are going to appear in Popular Mechanics magazine telling the reader about Amphenol **QUALITY** TV products. It is estimated that 4,300,000 readers will see one or more of these ads. In the ads, the reader is asked to write for a new informative book which will counsel on all the various factors influencing better picture quality.

NOTE: The ads reproduced on this page do not include the current ad running in the December issue of Popular Mechanics.

Better TV PICTURE Quality



AMPHENOL In-Line Antenna
AMPHENOL Lightning Arrestor

Actual laboratory and field tests have proven that the In-Line antenna is superior to any other broadband antenna system. The Amphenol In-Line Antenna not only features better picture quality, but also superior mechanical construction — a safe installation is important too! Amphenol Lightning Arrestors provide positive protection against damage to home or TV set from lightning striking the antenna and traveling through the transmission line. Underwriters' Laboratories Approved.

--- send 10¢ ---
for this valuable book — all factors influencing Better TV Picture Quality.

Address Dept. 66
AMERICAN PHENOLIC CORPORATION
1930 SOUTH 54TH AVENUE • CHICAGO 30, ILLINOIS

Protect YOUR HOME and TV SET



with an **AMPHENOL LIGHTNING ARRESTOR**

Send 10c and coupon below for complete information on safe antenna installation and better TV picture quality.

To prevent loss of life and property, the National Electric Code requires an approved lightning arrestor on every unshielded outdoor antenna lead-in. The Amphenol Lightning Arrestor is Underwriters' Laboratories Approved. It is small and simple to install — no cutting or splicing of the transmission line. For proper mounting and installation procedures, send the coupon below. Play safe, ask your TV service-man for an Amphenol Lightning Arrestor TODAY!

AMERICAN PHENOLIC CORPORATION
1930 SOUTH 54TH AVENUE
CHICAGO 30, ILLINOIS

Send me this book at safe antenna installation and all factors influencing TV picture quality. 10c enclosed for postage and handling.

NAME _____
ADDRESS _____
CITY _____ STATE _____

Better Televising ON ALL CHANNELS!



AMPHENOL "AUTO-DIAL" TV ANTENNA ROTATOR

A strong signal is essential to a good TV picture. In most localities TV stations are situated at some distance from each other, and it is impossible to install a stationary antenna to receive from all directions. Even in some metropolitan areas TV stations are situated at widely divergent points. In some areas use of the rotator permits receiving same channel in different cities, but on the same channel. The Amphenol "Auto-Dial" Rotator will literally "aim" your antenna at the sending station, so accurate is this rotator that the and returned to by simply setting the dial at the "lagged" position.

--- send 10¢ ---
for this valuable book — all factors influencing Better TV Picture Quality.

Address Dept. 67
AMERICAN PHENOLIC CORPORATION
1930 SOUTH 54TH AVENUE • CHICAGO 30, ILLINOIS

These ads will be placed before 4,300,000 readers

Stock **AMPHENOL** for customer preference...

-BE READY

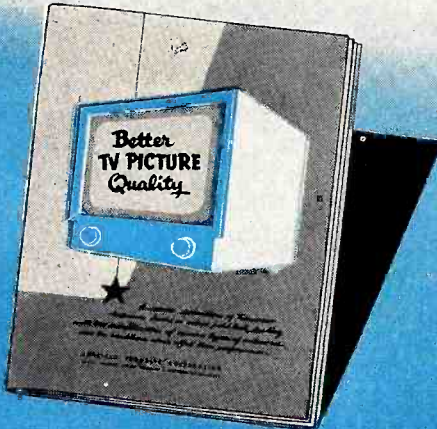

This is the book your customers will send for . . . it will lead a greater volume of profitable business to your door

For the first time, complete information on the various types of antennas and their various characteristics, how to mount them and where to mount them; the need of lightning arrestors, proper and improper methods of installing them; rotators and their purpose; television reception in the so-called "fringe" areas; and all other factors which contribute to, or influence better picture quality is available in a concise readable form. This 20-page book contains all the basic information that the reader will need to make a good TV installation. It emphasizes the importance of purchasing quality TV equipment. It points out that use of cheap, inferior equipment is not an economy, because it only necessitates expensive replacement. It also emphasizes the importance of a safe, secure installation. This book constitutes a real service to the investor in TV reception and will be a valuable aid to you in selling quality and performance to meet today's demand for better picture quality.

The Amphenol INLINE Antenna, "Auto-Dial" Rotator and Lightning Arrestor are packaged to give the investor a complete QUALITY installation and to give you sales tools commensurate with QUALITY products. The INLINE Antenna is packaged complete with everything needed for installation.



AMERICAN PHENOLIC CORPORATION
830 SOUTH 54TH AVENUE • CHICAGO 50, ILLINOIS

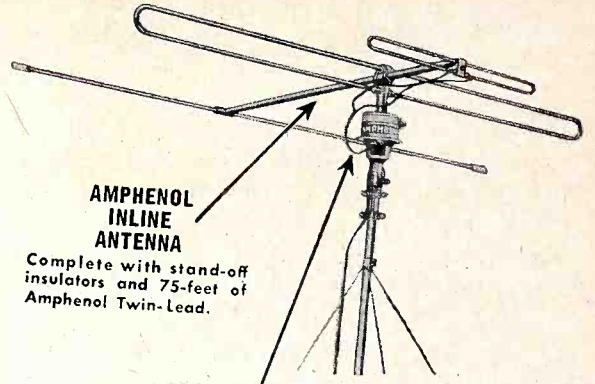

AMPHENOL INLINE ANTENNA
Complete with stand-off insulators and 75-feet of Amphenol Twin-Lead.

AMPHENOL "AUTO-DIAL" ROTATOR
Complete with Control Unit, Rotator with Cone Adapter, Mast Support and 100-feet of Amphenol Conductor Cable.

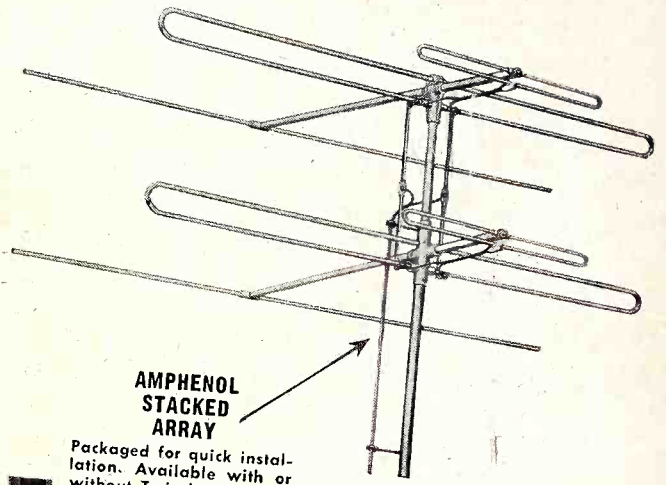

AMPHENOL STACKED ARRAY
Packaged for quick installation. Available with or without Twin-Lead.

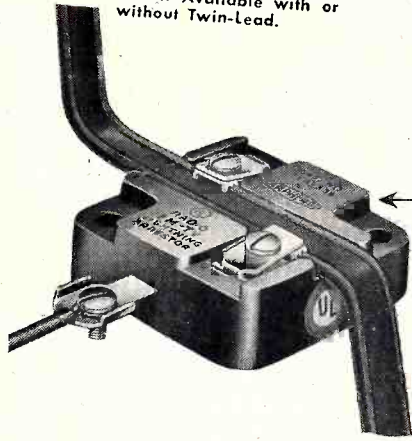

AMPHENOL LIGHTNING ARRESTORS
Supplied in a colorful counter box containing 12 individually boxed arrestors. Complete with mounting bolts and screws.

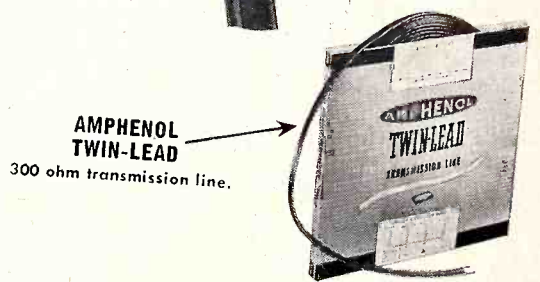

AMPHENOL TWIN-LEAD
300 ohm transmission line.

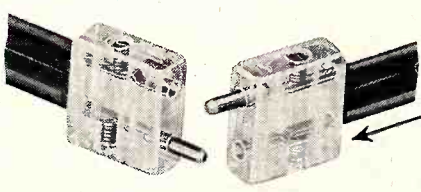

AMPHENOL TWIN-LEAD CONNECTOR
For solderless, low-loss splicing of 300 ohm transmission line.

See your AMPHENOL Distributor-NOW!

How New Automatic Focus

One Design Replaces Both Electrostatic-Focus and Magnetic-Focus Types.

By Charles Graham, Technical Editor

• After changes in the design of cathode-ray picture tubes which have involved TV sets (and consequently servicemen) with *five* different beam focus-and-deflection systems, a means has at last been devised which provides a simpler way of focusing the electron beam than have any of the previous five. In addition, there are a number of advantages attendant upon this design which will further simplify the task of the technician who finds himself confronted with the job of replacing a weak or burned-out picture tube, or converting a small screen set to a larger size.

History of Developments

When non-mechanical TV was in its infancy there were two electron guns used. One was in CRT's like the present 5 and 7 inch oscilloscope tubes, and both beam deflection and beam focus were accomplished electrostatically. The other was a combination of magnetic deflection and electrostatic focus. This design was used in tubes as large as the 12 inch size. Unfortunately, when the circuit constants, line voltage, etc., varied, often the degree of focus did also.

The difficulty of manufacturing these guns resulted in higher priced tubes, and with the advent of tubes with wide deflection angles, the guns were unable to produce pictures of sufficient quality.

Meanwhile set designers switched over to the system of magnetic deflection and magnetic focus which is now familiar, and which is still the most widely employed system. When shortages were threatened last year, and it became clear that sooner or later set designs would have to be pared of excess metals, tube engineers went to work to try eliminating focus coil

and focus magnet. Improvements in quality control of electron-gun production, and advances in research allowed them to come up with a system of electromagnetic deflection and electrostatic focus which was better than that obtainable before magnetic focus had become universal. Too, this time they were able to apply electrostatic focus to tubes of even a 20-inch diagonal (a size which was regarded so huge two years before that the tube had to be *specialy* ordered, and it sold in the trade for over \$200!).

A large number of these tubes, called electrostatically-focused, or simply "electrostatics", are today being used in TV sets. But although the use of electrostatics does save copper and cobalt (in focus coils and permanent magnets), it requires a focus voltage rectifier tube, a potentiometer, and at least three other small parts.

Low-voltage Focus

A partial solution to *this* problem (the requirement for the parts which make up the focus anode supply) was found soon after when some companies started engineering and producing *low-voltage* electrostatics. These picture tubes required, instead of one-quarter the second anode voltage, or about 2500-3000 V., only a

few hundred volts. This eliminated need for the focus rectifier tube and some other parts, but it still called for a focus potentiometer across the B+ supply.

Now on the market, both for replacement tubes and as initial equipment in new TV receivers, are automatic-focus tubes. This means that whereas in all previous models there has been some sort of adjustment (either a manual one, as with permanent-magnet focus devices, or an electrical control to vary the focus current or potential) now the serviceman will be required to make no manual adjustment of beam focus at all.

Zero Voltage Focus

In sets which use electrostatically focused tubes the new type tube can be substituted directly. No changes are necessary. Of course the focus control ceases to have any function.

As will be observed in the accompanying drawing, the electron gun of the new picture tube is similar in construction to the previous electrostatic type. The main difference is in the shape and placement of the focus anode. This electrode, together with the other grids and the second anode, forms an *electrostatic lens*. The purpose of the lens is to keep the electron beam sharp, of constant size, and as nearly circular in shape as is possible, throughout its trip down and across the face of the tube.

The resistor shown in the circuit between the focus anode and the cathode provides isolation for the focus anode for two reasons: 1. It reduces the input capacity of the tube in the case of cathode video drive. 2. Some manufacturers use little filtering of the second anode supply. Thus anode supply pulses might be coupled to the tube through the interelectrode capacity of the focus electrode were it not for the isolating resistor.

It was found that by increasing the

Procedure For Installing Automatic-focus Tubes

1. Remove focus coil from neck assembly.
2. Install centering device only when no variable DC centering is available through the yoke.
3. Plug new type CRT in and start operation.
4. Change ion trap if necessary. Correct type stated by tube mfr., and depends on amount of second anode voltage. Trap is adjusted for max brightness only.

Fig. 1. On the left is shown a diagram of the electron gun for the older type of electrostatic focus. At the right may be seen the new automatic-focus electron gun.

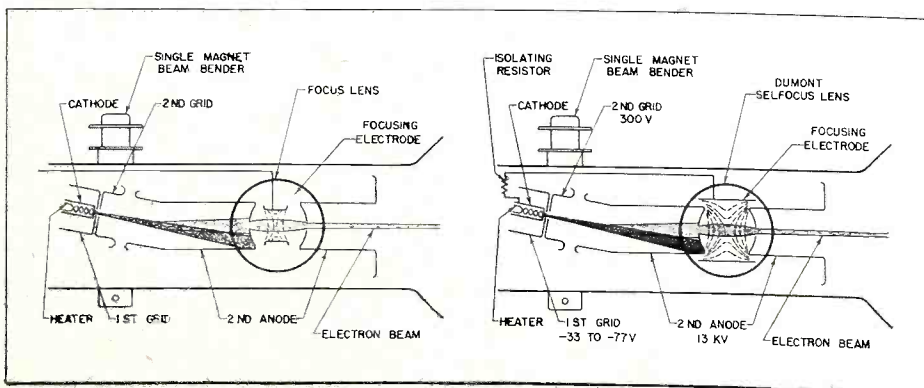

Picture Tube Operates

Requires Neither Focusing Coil Nor Electrode Supply

diameter of the focus electrode and giving it overlap rather than fit between the two adjacent elements, it was possible to make many of the gun dimensions less critical. It also allowed more substantial physical mounting for this electrode, as can be seen in the photograph of the electron gun, fig. 2.

In sets which have electromagnetically-focused tubes as original equipment, the focus coil can simply be dismounted from the neck assembly and pushed down on the side of the chassis out of the way. Or the focus coil may be removed completely and resistor of the proper size installed to take the place of the focus coil. (In the case of permanent focus magnets, naturally there is no need to keep the magnet once the new tube is installed.)

Focus Regulation

When the focus potential is a sizeable percentage of the second anode voltage, as in the case of electrostatically-focused tubes, variations in the focus potential, or in the second anode voltage can cause a change in the degree of focus attained unless these voltages vary in direct proportion. This is one problem partially eliminated in the development of the v -voltage electrostatics. By reducing the percentage of the second anode voltage which the focus potential represented, better regulation of the beam focus in relation to potential variations was accomplished. But it is still only a relative degree of regulation.*

In developing this newest electron gun, for automatic-focus tubes, DuMont engineers found that they had achieved almost perfect regulation of

* A high degree of regulation, or good regulation is attained when the ratio of variation in the output or product is small compared to changes in the supply or the size of the load. Thus a power supply would be described as having poor regulation if doubling its load from normal cut the voltage supplied in half.

Fig. 2. Photograph shows DuMont electron gun for no-focus voltage picture tube.

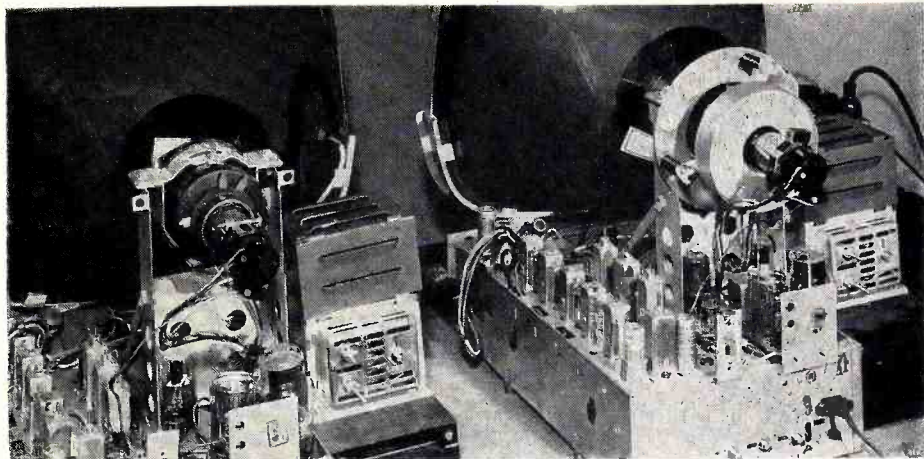
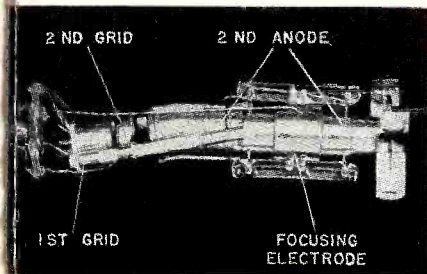

Fig. 3. DuMont set on left has simpler neck assembly due to new style picture tube. Small centering magnet at rear of yoke is required only on with sets having no DC centering.

beam focus. That is, through the design of the electrostatic lens system in the electron gun, they had made the degree of focus sharpness almost entirely independent of reasonable variations in the second anode voltage. (Naturally, lowering of anode voltage will still produce dimmer pictures.) In addition, variations in beam current which previously caused changes in the size of the spot and focus were lessened in the new gun.

Finally, the new design increased the amount of the normal focus independence of line voltage variations and set warm-up. In the earlier sets, it was often necessary to readjust the focus control due to the warm-up.

Customer neglect of focus adjustment has much of the time resulted in an inferior picture which was not the fault of the set or installation. This tube removes the necessity for that adjustment.

Because of the shape of the new electrostatic lens system, there appears to be slightly better resolution of the beam at the edges of the pictures. This too has been a problem with some other tubes.

Conversion Steps

In converting sets the advantage of using this type of tube may be easily seen. In conversions previously it was necessary to go through three separate steps:

1. Cabinet work.
2. Deflection circuit changes —
 - (a) usually changing horizontal output stage for more sweep and higher second supply.
 - (b) changing yoke from 50 to 70 degrees.

3. Focus changes due to higher anode voltage, (and sometimes due to the requirements of the tube itself.)

- (a) More focus current was usually required.
- (b) Frequently a different focus coil was required.
- (c) The range of the focus control often had to be changed.

In converting to larger tube sizes with the automatic-focus type the third set of conversion requirements is eliminated. As a sales point, too, the customer can be honestly assured that this tube is the "latest" engineering development in cathode-ray tubes.

Cuts Inventory

The advantage of using this type of picture tube for all replacements is obvious when one considers that instead of having to keep on hand a 17-inch electrostatic-focus tube and a 17-inch magnetic focus tube, the serviceman or dealer can take care of either type with only one 17-inch replacement. The same applies to the 20-inch replacement stock problem. In this way the inventory of replacement picture tubes for smaller shops may safely be halved.

The cost of the automatic focus tubes is at present set the same as the price of the equal size rectangular tubes of other focus systems. DuMont is producing the 21KP4A, the 17KP4 and the 20JP4. Thomas Electronics is producing some of these tubes, and GE has announced the 17RP4. At presstime other manufacturers had indicated that they would soon produce these tubes, but could not yet make official announcements.

Only G-E Tube Dealers

G-E Aluminized Tube makes your picture better than new!

Here's proof in black and white

At the bottom, the better the picture tube, the better the picture. G-E Aluminized Tubes make the picture better than new. You see, they are made of a special material that is coated with a thin layer of aluminum. This layer reflects the light back into the picture tube. The result is a picture that is sharper, brighter, and has more detail than any other picture tube. It's the best picture tube you can buy.

But with the G-E Aluminized Tube, up to 100% more light is reflected back into the picture tube. This means a picture that is sharper, brighter, and has more detail than any other picture tube. It's the best picture tube you can buy.



What a difference a G-E tube makes! Now our picture is better than new!

At the bottom, the better the picture tube, the better the picture. G-E Aluminized Tubes make the picture better than new. You see, they are made of a special material that is coated with a thin layer of aluminum. This layer reflects the light back into the picture tube. The result is a picture that is sharper, brighter, and has more detail than any other picture tube. It's the best picture tube you can buy.



You can put your confidence in—
GENERAL ELECTRIC

"The most eye-opening proof I've ever seen!"



G-E Aluminized Tube made our set BETTER THAN NEW!

At the bottom, the better the picture tube, the better the picture. G-E Aluminized Tubes make the picture better than new. You see, they are made of a special material that is coated with a thin layer of aluminum. This layer reflects the light back into the picture tube. The result is a picture that is sharper, brighter, and has more detail than any other picture tube. It's the best picture tube you can buy.

But with the G-E Aluminized Tube, up to 100% more light is reflected back into the picture tube. This means a picture that is sharper, brighter, and has more detail than any other picture tube. It's the best picture tube you can buy.



At the bottom, the better the picture tube, the better the picture. G-E Aluminized Tubes make the picture better than new. You see, they are made of a special material that is coated with a thin layer of aluminum. This layer reflects the light back into the picture tube. The result is a picture that is sharper, brighter, and has more detail than any other picture tube. It's the best picture tube you can buy.

But with the G-E Aluminized Tube, up to 100% more light is reflected back into the picture tube. This means a picture that is sharper, brighter, and has more detail than any other picture tube. It's the best picture tube you can buy.

You can put your confidence in—
GENERAL ELECTRIC

are backed up by regular full-page tube advertisements in LIFE and the POST!

LIFE

THE SATURDAY EVENING
POST

READ BY
24,000,000
PEOPLE!



Only G-E Tube Dealers

can write letters like these, proving how powerfully G-E tube advertising helps at point-of-purchase!

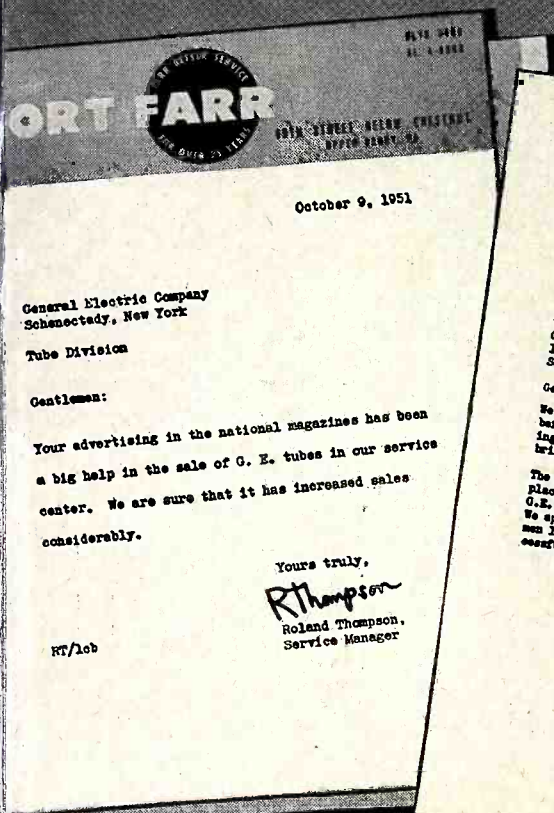

General Electric Company
Schenectady, New York

Tube Division

Gentlemen:

Your advertising in the national magazines has been a big help in the sale of G. E. tubes in our service center. We are sure that it has increased sales considerably.

Yours truly,

R. Thompson
Roland Thompson,
Service Manager

RT/lob

DELTA RADIO & TELEVISION
7837 NEW HAMPSHIRE AVENUE
TAKOMA PARK, MARYLAND
SHIPPING CASE

October 1, 1951

Tube Division
G.E. Company
1 River St.,
Schenectady, N.Y.

Gentlemen:

We put the new G.E. tube deal in our window about a week before your recent ad appeared in *Life Magazine*, the one showing this sign and talking about the G.E. Aluminized Tube and its brightness.

The day of the ad in *Life*, new people started coming in our place, and this has kept up ever since. Your advertising and the G.E. tube deal are a team that pulls its weight and then some. We appreciate the help that General Electric is giving service men like ourselves, and hope you will continue your very successful advertising of picture tubes.

Yours very truly,

J. L. Baird

BELMONT RADIO SERVICE
2414 - 14th Street, N. W.
North 2100 Washington 9, D. C.

October 3, 1951

General Electric Co.
Electronic Division
Tube Department
Schenectady, N.Y.

Gentlemen:

You are the only manufacturer that advertises picture tubes regularly in the big magazines, and this has TV owners in Washington all talking General Electric tubes. It helps sales, for our G.E. tubes move fastest of all, and show us a nice profit.

Yours truly,

Casper Shuman

Increase your profits—speed turnover

—by handling the tubes that *national*

advertising pre-sells for you! Your local

General Electric tube distributor will

be glad to assist. Phone him today!

You can put your confidence in

GENERAL



ELECTRIC

Printed Circuits Widely

New Units Gain Acceptance Because of Saving of Labor and Space

• When Grandad made his first superregenerative receiver from plans in the daily paper, he was told to use a lead pencil mark between "A" and "B", to make a resistor.

This *simple* resistor was one of the first clues to present-day printed-circuit techniques, and as a starter it lay almost absolutely still for about twenty years. Present-day printed-circuits have several advantages, yet the keynote to them all is *simplicity*. The pencil mark represents about the simplest component we could hope for, and our modern printed circuits aren't that simple. But they are made by mass-production methods, which is something Grandad wasn't able to accomplish. Today there are over 15 million printed circuit components in civilian sets. (Figures on military sets are still secret, but it is known that previous to civilian use the military necessity for compact parts and assemblies required large quantities of such components.)

Because they are showing up increasingly in television receivers and other common electronic devices, a brief discussion of the construction, applications, and advantages of printed circuits is in order.

Just as miniature tubes were developed during the last war, and have now come into general use, so it is likely that a great many other miniaturizations, including printed circuits, will soon be used in everyday sets even more than they are now, due to defense research.

When "printed circuits" are mentioned, many technicians tend to think of the stamped metal antennas which have been widely employed in AC-DC sets. Or they recall the turret tuner which has its coils photo-etched in thin copper. But the type of printed circuit most widely employed today is neither of these. Printed circuits as they are used at present in TV and radio receivers are flat rectangular plates, generally between $\frac{3}{4}$ " and $1\frac{1}{2}$ " long, about an inch or less high, and $\frac{1}{8}$ " thick. They are ceramic plates onto which have been bonded metallic paints and compounds to form resistances and small condensers in circuits where these parts are commonly used in the various sets with the same values frequently chosen. The vertical integrator plate, for example (See Fig. 2) is a combination of several condensers and several resistors in a circuit which is pretty standardized throughout the industry. Since the same circuit values can be used for this circuit (the vertical integrating

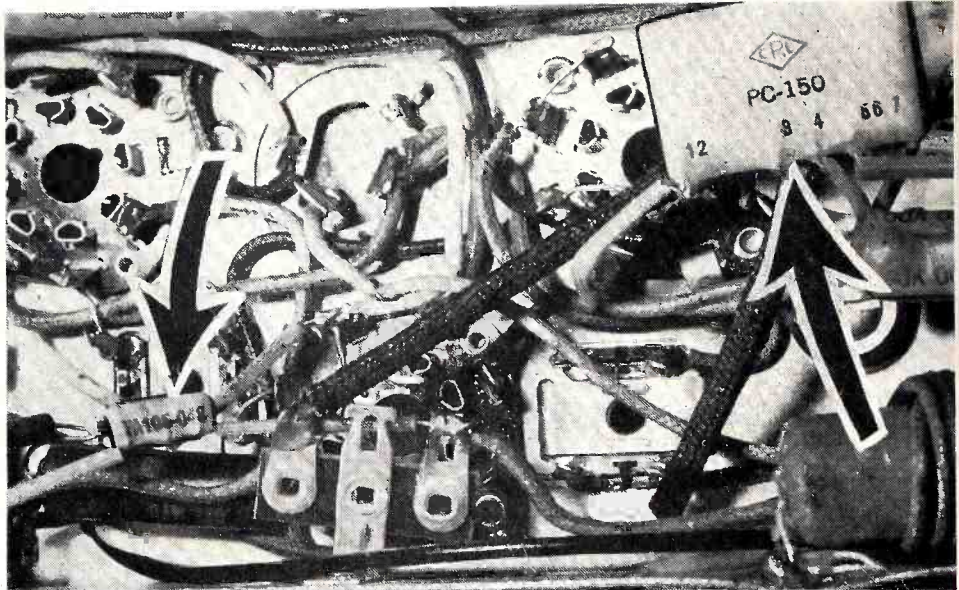

Fig. 1. Olympic AC-DC radio set shown above employs a printed circuit triode coupling plate (upper right). The smaller printed circuit plate directly above is a diode load network. At right here is reproduced part of schematic from Sentinel service notes showing triode coupling plate.

network) in most TV sets, the circuit lends itself admirably to the use of a printed circuit plate. Another place where standardization of circuitry has progressed in the industry to a comparable point is in the coupling network between the output of the det-AVC-first audio stage and the power amplifier stage of small radios. Consequently, a large number of sets now employ printed circuit plates in this part of their circuit.

These components are most widely used in TV sets. Most hearing aids use printed circuits, naturally, because of the extreme small size available, and many portable and AC-DC table sets are including them.

Both resistors and condensers may be made by the printed circuit technique, and when both are fabricated in various combinations, they save not only space, but a great deal of time and work in the manufacture of the circuits they are part of. This is because they incorporate so many circuit components into one piece, with the common, internal connections already made, and hidden in the body of the piece.

See Fig. 1 for diagrams which compare the number of soldering and wiring connections normally required in the construction of a plate coupling network with the number needed with the use of a printed circuit unit. In this audio coupling network between a pentode voltage amplifier and the

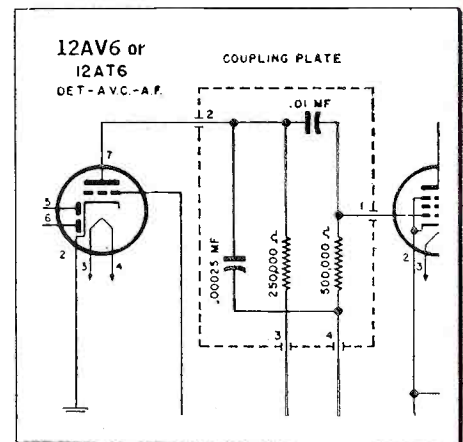

next stage, it will be seen that ordinarily *eleven* various points and *five* components would have to be connected together with *eight* or more soldering and twisting operations. With the printed circuit unit this is reduced to five soldering points, and *one* component.

The best example of this sort of saving is in the vertical integrator plate, however. Here *eight* parts become *one*, and *twelve* or more interconnections become *three* soldering operations!

There are over twenty different printed circuit components being produced today. Of these, the vertical integrator network (See drawing, Fig. 2) is the most widely employed, being used at present in over three million TV receivers. Running a close second is the printed circuit coupling plate*, with over 2,750,000 in portable and table radios. There are also over a million small filter networks* already sold to set manufacturers and almost as many printed output

Used in Current Sets

in the Manufacture and Servicing of Radio TV and Equipment

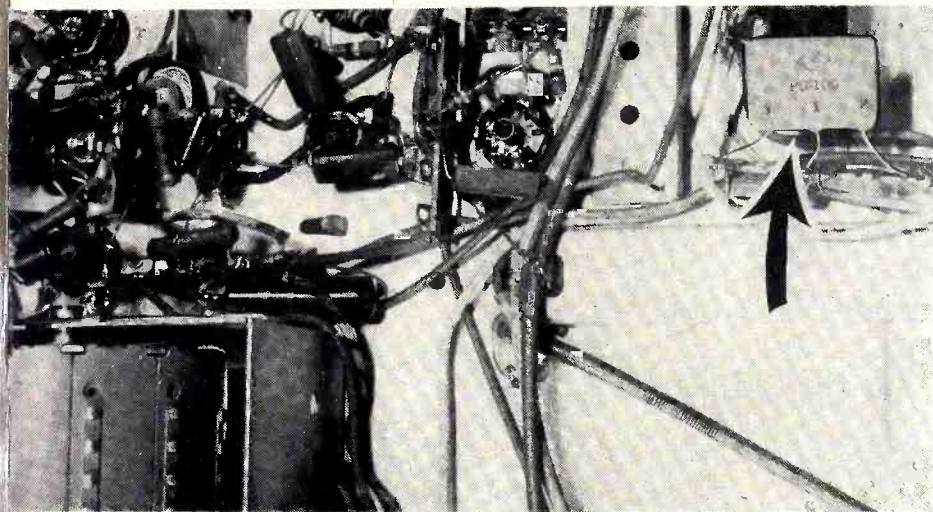
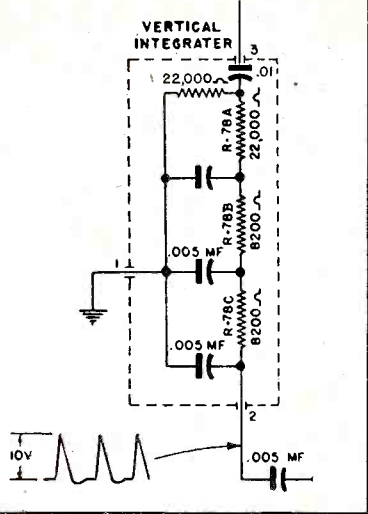

Fig. 2. Photograph above shows most common printed circuit component in use today. It is the vertical integrator plate. Typical manufacturer's service diagram is partially reproduced at left to show (inside dotted lines) the eight parts which are included in single printed circuit part. Only three external soldering connections are made.



reasons not in civilian use. When they can be released for public benefit, they will change the appearance of home receivers even more than did the advances made during the last war.

In another type of printed circuit metallic paints are sprayed or painted onto insulating surfaces to form the "wire" connections between various circuit components. A different composition of paint is subsequently applied at the proper points to serve as resistor. This sort of printed circuit is used in many hearing aids.

Naturally, such resistors cannot be employed in parts of the circuit which carry substantial current. They are, generally speaking, good in circuits where up to 1 or 2 watt values are usually specified, but not in power output or supply sections.

If part of a printed circuit were to be replaced, as for example, in a hearing aid, the simplest solution would be replacement of the entire printed unit. Failing that, in many cases, it is possible to replace just the faulty condenser or resistor. If this cannot be done, as for example, when several resistors and condensers are contained physically in the same unit, then it is necessary to replace the entire printed unit.

In some cases it is possible to replace just the faulty part, with paint from kits which are now commercially available for the purpose. If a resistor were to be replaced, metallic paint of the appropriate kind would

be applied, the resulting resistance measured with a volt-ohmmeter, and more paint added, or some scraped away, until the proper resistance value was obtained.

Regular condensers (or even resistors) can be soldered into printed circuit, as parts replacements, if care is observed not to damage the insulating plates and other circuit parts. Solder which has some silver content is needed for this sort of soldering, however. One caution is in order. When a printed circuit plate is to be replaced in a receiver, often the numbers which identify the leads projecting from the plate are numbered in a different order from the lead numbers which are on the original part. In such cases, the new part should have its leads soldered in the same order, counting from left to right, into the circuit, without regard for the numbers shown. A physical comparison is used—not the numbers.

The advantages which the manufacturer obtains from the use of printed circuit components in his sets may be summarized as follows: (1) Several parts may be replaced by one part. (2) Installation time on the production line is saved through fewer connections to be wired and soldered. (3) Since there are fewer connections to be made by the assemblers, there is lower probability of mistakes. (4) Space is saved—allowing smaller chassis, or more room for other, outsized, or non-standard parts.

These advantages are leading more and more manufacturers to the use of printed circuit components, so we will continue to find more and more of them in the radio and TV sets of today and tomorrow.

Motorola table set shown below uses connections with a P.C. plate.

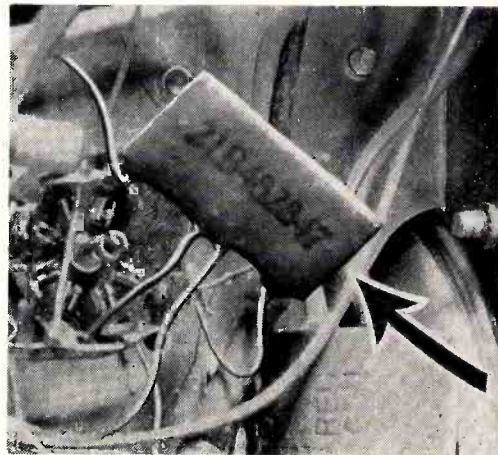

Centralab's trademarked names for these components are Couplate, Filpec, and Audet, respectively.

Television Technician

Section of RADIO & TELEVISION RETAILING

JFD OPEN WIRE LINE

"Super-Gain" is an open wire transmission line for TV. The line is made of copper wire with a steel core and is insulated by polystyrene spacers. The firm states that the new line delivers 1/6 the DB loss of regular 300-ohm twinex. "Super-Gain" is said to assure maximum reception in weak signal areas, and to be more than adequately strong for long runs. For literature on the TW6 open wire line, write Advertising Dept., JFD Mfg. Co., 6101 Sixteenth Ave., Brooklyn 4, N. Y.—RADIO & TELEVISION RETAILING.

Radiart ANTENNA ROTATOR

The firm's Tele-Rotor "Cub" model now incorporates further developments and improvements, it has been announced. Using the same motor as Radiart's heavy-duty model, the "Cub" can handle a wide range of applications, although primarily designed for average installations. It features in-line

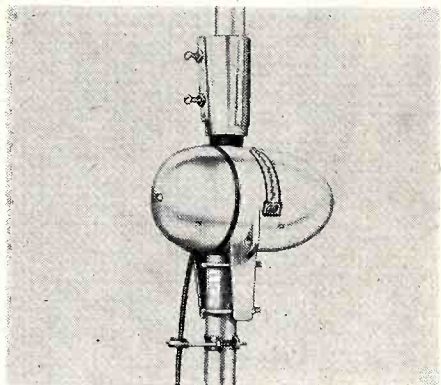

thrust between antenna and mast, and utilizes a 3/4" steel shaft with in-line, oilless bearings that rotate on a case-hardened steel ball. Available in model 502B with a mahogany plastic cabinet containing an indicating meter, it lists for \$44.95 and uses a 5-wire cable. Radiart Corp., 3571 W. 62 St., Cleveland 2, Ohio.—RADIO & TELEVISION RETAILING.

Meritenna MAST CLAMPS

The M-20 is an adjustable worm-drive guy wire clamp featuring simplicity and versatility. Movable guy wire clips are fastened to the guy wire and slipped onto the clamp (either before or after antenna is in position). Can be adjusted to fit masts from 3/4 to 1 1/2" OD. Meritenna Mfg. Co., 217 9th Ave. N., Seattle, Wash.—RADIO & TELEVISION RETAILING.

Camburn INDOOR ANTENNAS

New Video Beam indoor TV antennas are available with either two or three section dipoles, and with clear glass non-tilt base or bakelite base. Catalog describing these and other Camburn antennas available on request. Camburn, Inc., 32-40 57th St., Woodside, L. I., N. Y.—RADIO & TELEVISION RETAILING.

E-V BOOSTER

The new Model 3002 booster utilizes two of the new 6BK7 tubes in a low-noise circuit. It provides high gain with low internal noise. Tuning is automatic, and the booster is concealed in or behind the TV set, and is turned on or off by the TV receiver switch. The model 3002 Tune-O-Matic TV booster is finished in baked lacquer coppertone. It is 7" x 3" x 3 1/2". List price is \$39.50. For complete data, write to Electro-Voice, Inc., Buchanan, Michigan.—RADIO & TELEVISION RETAILING.

RAM SWEEP TRANSFORMER

The new X054 autotransformer is said to require less driving power than a true transformer and yet provide ample high voltage and sweep for tube sizes up to 21" rectangular. It is designed for use with the RAM Y70F30, a 30 mh

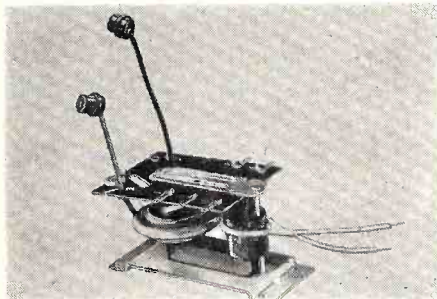

ferrite cosine yoke. In sets with 250 V. B supply, the X054 produces 13.5 KV with a boost voltage of 430 V.; with standard power supplies it produces 15 KV with a boost voltage of 500 V. For further details write RAM Electronics Sales Co., 7 South Buckhout St., Irvington-on-Hudson, N. Y.—RADIO & TELEVISION RETAILING.

GC TENNA-KLIP

The colorful plastic Tenna-Klip for quick connection of TV antennas is designed for use where frequent changes and rapid connections are needed as on demonstration floors or on the service bench. The clip is spring-loaded, with metal contacts to insure positive and secure connection at all times. No soldering is needed—wires fasten under screws. General Cement Mfg. Co., 919 Taylor Ave., Rockford, Ill.—RADIO & TELEVISION RETAILING.

Vidaire TV SOUND AMPLIFIER

The A-130 push-pull sound amplifier is designed to be used with TV sets which have a single output tube for the sound. Maker states that by removing the existing audio output tube and plugging in the A-130 amplifier, the overall frequency response is improved greatly. Amplifier response is stated to be 80-20,000 cps \pm 1.5 DB. Dealer net price is \$14.95. Vidaire Electronics Mfg. Co., 576 West Merrick Road, Lynbrook, N. Y.—RADIO & TELEVISION RETAILING.

Vee-D-X ANTENNA SYSTEM

The "MDOB" is a new single channel multiple dwelling antenna system that enables TV dealers and installers to use materials regularly carried in stock. It permits an inexpensive installation requiring one antenna, a Vee-D-X "Rocket" booster at the antenna, regular 300 ohm Xmission line, new Vee-D-X coupling and termination blocks which effect voltage distribution, line balance and proper impedance termination, and a Vee-D-X "Outboard" booster at each receiver. The latter not only boosts the signal but eliminates re-radiation from one set to another. Up to 12 sets can be connected. For complete information, write La Pointe Plascomold Corp., Windsor Locks, Conn.—RADIO & TELEVISION RETAILING.

Alprodco TV TOWER

The new Tower Rig is a telescoping aluminum TV tower, mounted on a two-wheel trailer, that can be raised to 72 feet in 15 seconds. The complete unit consists of three 24-foot lengths that telescope together, all mounted on a framework fastened to the trailer. The

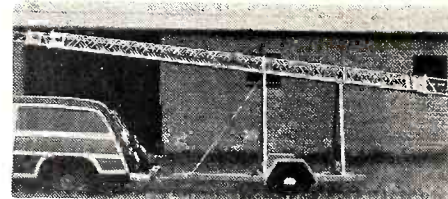

trailer is equipped with jacks to level and steady it while in use. The unit can be used for both demonstrations and permanent installations, and can be erected by two men. Alprodco, Inc., Kempton, Indiana or Mineral Wells, Texas.—RADIO & TELEVISION RETAILING.

Transvision CRT REACTIVATOR

Reactivation with this new unit can be performed without removing the picture tube from the customer's set, and is said to improve light emission and picture brightness. Unit operates on the theory that, with use, CRT cathode is "poisoned" by gases released within the tube. Reactivator temporarily increases cathode temperature and emission, which renews the cathode surface, the maker states. Weighing 3 lbs. the portable unit is priced at \$14.95 net. Transvision Inc., New Rochelle, N. Y.—RADIO & TELEVISION RETAILING.

Stancor TV YOKES

Two new deflection yokes, DY-8 and DY-9, are designed with cosine distributed windings to provide anti-astigmatic focusing over the entire picture area. Both are 70 degree ferrite core units. DY-8 has a horizontal inductance of 8.5 mh., the DY-9 is 13.5 mh. Stancor bulletin 387 describing both yokes is available on request. Standard Transformer Corp., 3580 Elston Ave., Chicago, Ill.—RADIO & TELEVISION RETAILING.

IMMEDIATE



Hallicrafters

new Continental Radio

Here's the success story from ONE test market ... 1/2 page ad ... ONE newspaper ONLY!

1,000 Sold by 2nd Day!
Over 1,600 by 3rd Day!

Similar success in other markets

ALL YOUR FAVORITE RADIO PROGRAMS

Plus

GUARANTEED WORLD-WIDE RECEPTION!
.... or your money back

ONLY \$39⁹⁵

ULMER TURNER Says:
I listened from the radio to the news reports you bring to me every night. I have your radio for my reception. I have your Hallicrafters direction receiver. It may seem to you that you are not getting it, but the Continental is a radio that will let you hear what you want to hear!

NEWS ... YOU GET IT FIRST, and you get it DIRECT. Authentic, on-the-spot reports from the blazing war fronts ... the swirling Middle East ... the vital nerve centers of the world.

THE "WAR OF WORDS" ... propaganda from behind the Iron Curtain, and our answers in 14 languages over the "Voice of America."

HEAR EXOTIC MUSIC ... from Egypt, Africa, the Far East ... Spanish bands from Havana or Rio ... fine orchestras from London, Paris!

Good results can be obtained in most localities with the 15 foot antenna INCLUDED with a very compact set. An antenna 20 to 40 feet long (ordinary wire) may be necessary in case reception is poor.

Try the Continental in your own home ON THIS NO-RISK, TODAY-MONEY-BACK OFFER.

No other set at three times the price can compare in LONG DISTANCE RECEPTION!

FREE 8-PAGE RADIO LOG BOOK

Where, where, when, when to listen to on Foreign Broadcasts, the answer!

GET YOUR COPY NOW AT ANY OF THESE DEALERS

In Smart House & Garden Colors: Dove Gray, Sandalwood, Forest, Hallicrafters Smoke Black, Air Force Blue.

You Can Prove...

It's the Hottest Radio in 20 Years! Most Unusual Gift on the Market!

Fastest Moving Radio You've Ever Sold!

WORLD'S LEADING MANUFACTURER OF PRECISION RADIO & TELEVISION — CHICAGO 24

For the Custom Builder

Stancor AMPLIFIER KIT

Components for the famous Williamson amplifier, consisting of the output transformer, power transformer, and power supply choke, plus detailed schematic, small parts lists and chassis layout drawings, are now being supplied for the assembly of this high-

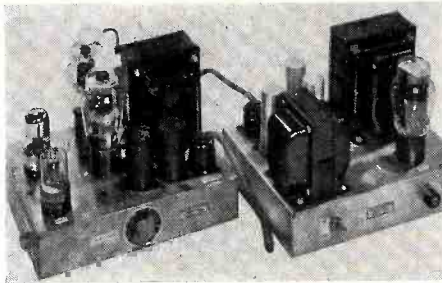

quality audio amplifier. At 8 watts the intermodulation distortion is less than 3%, and the harmonic distortion negligible. Bulletin 382, giving the schematic, parts list, and layout, is free of charge. The firm also makes available a punched and finished chassis for use with this kit, and is sold under Stancor part No. WM-8. Standard Transformer Corp., 3580 Elston Ave., Chicago 18, Ill.—RADIO & TELEVISION RETAILING.

V-M CHANGER

A new three-speed record changer called the Tri-O-Matic model 920 which incorporates all of the features of previous V-M changers is now on the market. It has its own base, is made of mottled mahogany plastic, and has a price of \$39.95. V-M Corp., Benton Harbor, Mich.—RADIO & TELEVISION RETAILING.

H. H. Scott MUSIC AMPLIFIER

This new type 214-A amplifier has an 8-position switch to adjust for all record characteristics, selector for phono, tuner, TV, or other high-level input, and an automatic loudness control to boost treble and bass at decreasing volumes. It also has individual continuously-variable bass and treble tone controls, input-level adjustment for matching to

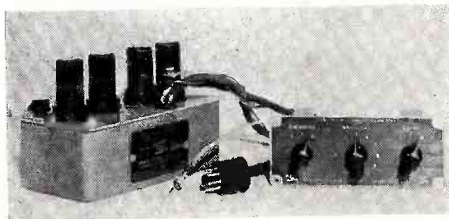

various magnetic pickups, frequency response flat from 18-22,000 cps, and 20 watts output. Its hum is 84 db below full output, harmonic distortion less than 0.5% at full output and it uses a DC operated pre-amplifier. Matches speaker impedances from 1-24 ohms. Provision is made for adding separate Dynaural noise suppressor. Furnished with 6 ft. remote control cable. Longer cables available. Bulletin on request. H. H. Scott, Inc., 385 Putnam Ave., Cambridge 39, Mass.—RADIO & TELEVISION RETAILING.

Bogen AMPLIFIER

A new hi-fi audio system has been announced, consisting of the H010 10-watt, all-triode amplifier and the RXPX remote controller and preamplifier. Maker states that the H010 delivers 10 watts with less than 1.3% distortion

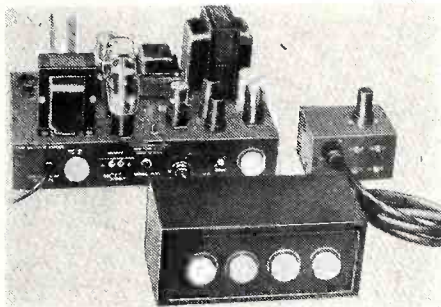

over the entire range from 20-20,000 cps and will deliver 25 watts at less than 5% distortion. The RXPX provides control of function selection, volume, tone and record equalization at distances up to 25 feet from the amplifier. For full specifications write David Bogen Co., Inc., 663 Broadway, New York 12, N. Y.—RADIO & TELEVISION RETAILING.

Collaro RECORD CHANGER

A new series of 3-speed record changers includes model 3RC521 for all 3 sizes of records, not mixed; RC522 will mix 10's and 12's and 3RC522 will mix all 3 sizes. A muting switch operates during change cycles. Idler is re-

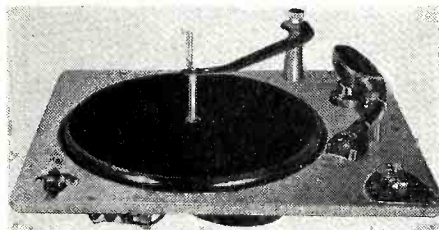

tracted when not in use to prevent flats which would cause "wow." Heavy-duty, shielded motor is said to eliminate magnetic hum pickup and turntable rumble. Manufactured by Collaro, Ltd. of England, the changers are represented exclusively in the United States by the Rockbar Corp., 13 E. 40th St., New York 16, N. Y.—RADIO & TELEVISION RETAILING.

Brush HEADPHONES

New headphone receiver features high fidelity and smooth frequency response, low distortion and excellent bass response without need of large cushions. The phones are equipped with a Metalseal Crystal element, designed to eliminate problems caused by low or high humidity. The new unit is available in the following styles: Double headset BA-206, single headset BA-207, and Lornette style BA-208. Brush Development Co., 3405 Perkins Ave., Cleveland 14, Ohio.—RADIO & TELEVISION RETAILING.

Milwaukee RECORD CHANGER

The new model 12300 3-speed automatic record changer is recommended for modernization of TV and radio sets with 1 and 2-speed units. It features a single switch control, automatic shutoff

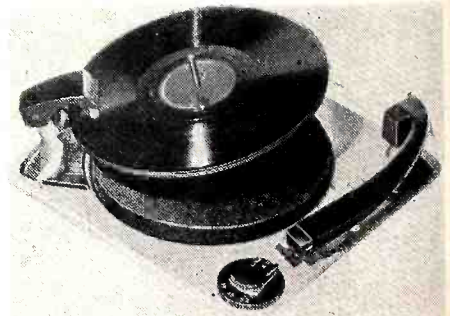

after last record and fast change cycle. This model can be furnished with GE triple-play cartridge. Metal mounting base also available. Milwaukee Record Changer Corp., 39 Warren St., New York 7, N. Y.—RADIO & TELEVISION RETAILING.

Craftsmen AMPLIFIER

Model 500 is a hi-fi all-triode amplifier based on the Williamson circuit. The performance of this amplifier has been accomplished by closely following D. T. N. Williamson's choice of output tubes and original requirements for the out-

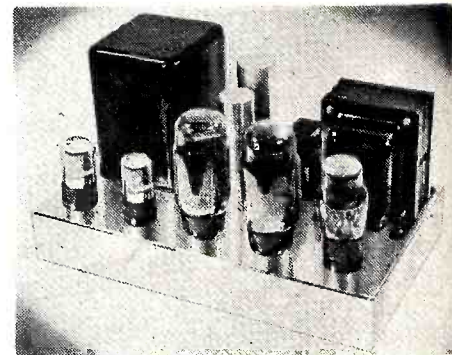

put Xformer. Nominal output is 15 watts, frequency response ± 1 DB from 20-20,000 cps. Sensitivity is 1.5 volts RMS, overall gain 70 DB (470,000 ohm input resistance), output impedances 8 and 16 ohms. List price \$166.00. Radio Craftsmen, Inc., 4401 N. Ravenswood Ave., Chicago 40, Ill.—RADIO & TELEVISION RETAILING.

Regal TV CHASSIS

A new 22-tube chassis recently announced is said to provide better reception, particularly in fringe areas. Chassis is capable of driving 16, 17, 19 and 20-inch CRT's, and incorporates horizontal AFC, 70-degree yoke, turret tuner, four IF stages, a power line filter and automatic brightness control. Ease of installation and service have been considered in the design. The new 22-tube chassis is available at parts jobbers and distributors. Regal Electronics Corp., 605 West 130 St., New York, N. Y.—RADIO & TELEVISION RETAILING.

JUST DIAL THE TYPE...

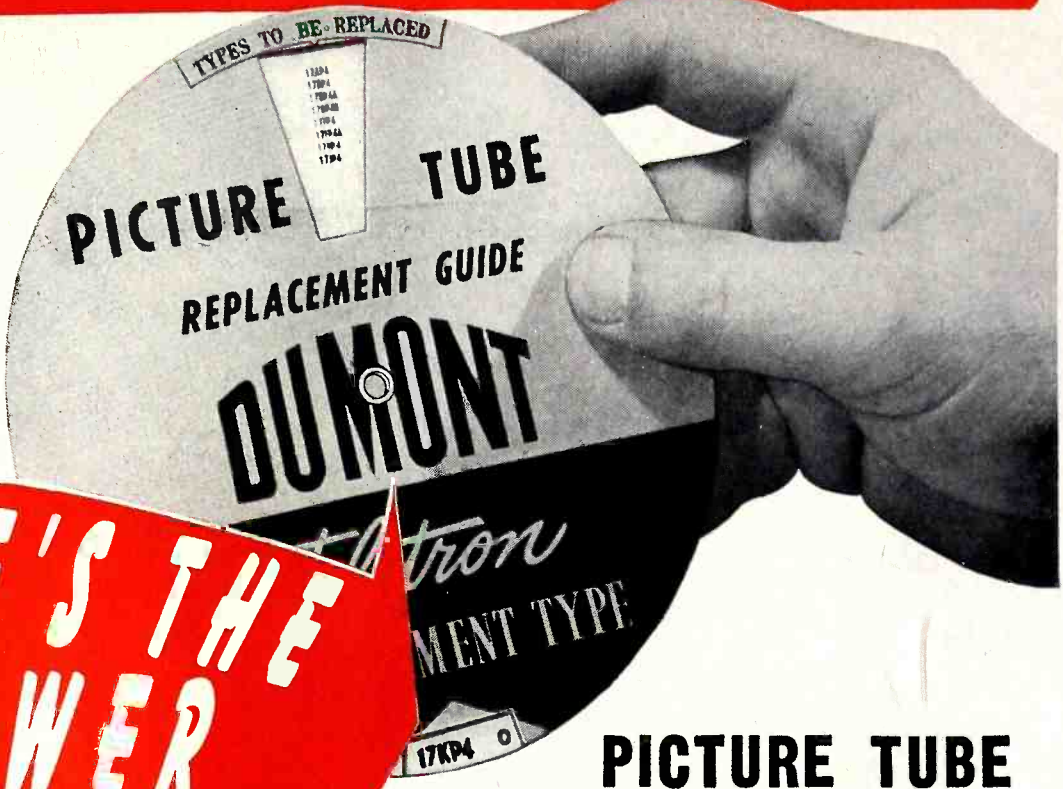

PICTURE TUBE REPLACEMENT GUIDE

No thumbing through pages and comparing characteristics to arrive at the correct replacement — merely turn the dial to the desired tube type and PRESTO! there's the correct replacement type. These Du Mont TV Picture Tube Selectors are available through your Du Mont Teletron distributor. Get yours today.

The Du Mont replacement type will appear on the smaller window directly below.

- If the tube to be replaced can be found in more than one window, refer to the Data and the Selfocus Teletron note.
- Performs an automatic search for the Du Mont replacement type in the dial, will be found in the Data and Code keys on this side. It will also find you in selecting the new dial. Du Mont replacement type which more than one may be used.
- If the tube to be replaced is present in lighter type, meter mechanical changes may be necessary before installing the Du Mont replacement type selected.

DATA

| | | | | | | | |
|----------------|---------|--------|---------|---------|---------|---------|---------|
| Overall Length | 18 1/2" | 7 1/2" | 15 1/2" | 18 1/2" | 15 1/2" | 18 1/2" | 15 1/2" |
| Beam Angle | 15° | 15° | 15° | 15° | 15° | 15° | 15° |
| Beam Current | 100 mA | 100 mA | 100 mA | 100 mA | 100 mA | 100 mA | 100 mA |
| Beam Voltage | 100V | 100V | 100V | 100V | 100V | 100V | 100V |
| Beam Strength | 100 | 100 | 100 | 100 | 100 | 100 | 100 |

TYPICAL OPERATING CONDITIONS

NOTES

- All Du Mont Teletron replacement types listed on this standard type selector have been tested and approved for use in the standard type selector.
- All Du Mont Teletron replacement types listed on this selector are of the same design, except the type 17K14A which employs a double field magnet.
- When selecting a magnet for other than a standard type selector, allow an increase in diameter of magnet to 1/8" for each 25V higher above or below the type's rated voltage.

CODE KEY

RD—Round
RT—Rectangular
C—Clear Face Plate
G—Grey Alloy Face Plate
N—Normal Conductive Coating

THE SELFOCUS TELETRON

Several advantages may be realized by using the Selfocus Teletron for replacement. Operation is easy in that both are self-adjusting and require no manual adjustment. To replace the Selfocus Teletron for a tube on which a PM is using, use a standard, simply remove the PM and replace the picture tube.

Unique structure of the Selfocus line system provides picture quality by eliminating adverse aberrations. Eliminate face tube design.

If a factory seal is used, remove and replace with an equivalent resistance. Minimum resistor should be 300 ohms.

Cathode-ray Tube Division
© ALLEN B. DU MONT LABORATORIES, INC.
750 Bloomfield Avenue, Clifton, N. J.

Electrical characteristics of each replacement type are shown on the rear of the Selector when the type is dialed. This is the information necessary for those conversion jobs that spell profits for you.

ASK YOUR DU MONT DISTRIBUTOR

CATHODE-RAY TUBE DIVISION
ALLEN B. DU MONT LABORATORIES, INC.
CLIFTON, N. J.



*TRADE MARK

Shop Shortcuts Speed Servicing

Tips for Home and Bench Service Contributed by Readers

Tube Tester Shortcut

When using tube tester charts, a lot of time and patience is lost trying to keep one's eye on the right line of the chart, where usually four or five lines show at once. This is especially true where different settings are required for two and three section tubes. The serviceman can save time and energy by using this simple kink which I

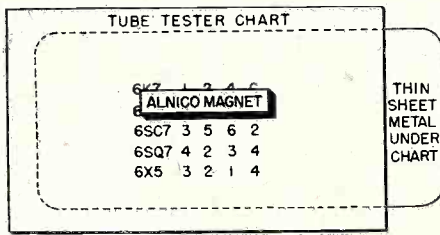

have found very successful in my work. Place a flat sheet of iron metal under the chart and use an Alnico bar magnet to hold the place on the chart at the point showing the tube tester settings for the particular tube being tested (Good on radio diagrams, too). This is better than using a ruler or piece of paper to mark the spot, for these markers slide. Then tube settings have to be sought out again. —J. D. Amorose, Amorose Radio, Richmond, Va.

TV Chassis Holder

It is often necessary to pull the TV chassis part-way out of its cabinet

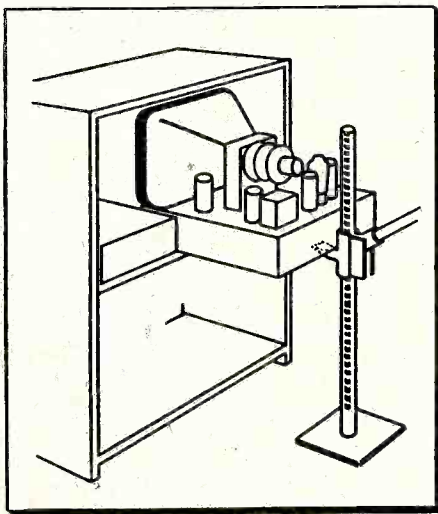

in order to get at tubes or components on the front (where there is little handroom in the cabinet) or to get at the underneath part of the chassis. I have found that an automobile bumper jack serves very well as a device to support the rear of the chassis in such cases. This eliminated the

SHOP HINTS WANTED

Payment of \$5.00 will be made for any service hint or shop kink accepted by the editors as usable on this page. Unacceptable items will be returned to the contributor. Send your ideas to "Technical Editor, RADIO & TELEVISION RETAILING, 480 Lexington Ave., New York 17, N. Y."

hazards associated with the use of the customer's tables, chairs, telephone books, etc. The bumper jack is handy because it is relatively compact to carry and can be adjusted to any height required, and also carries all the weight you need. The clamp which usually hooks on the bumper will hook on the back edge of the chassis; however, it's a little too large, and you should make sure it doesn't short out any parts on the inside of the chassis. I found it so practical that I made a new clamp just the right size for the chassis, and bolted it on. This way I can still use the jack on my truck if I should get a flat. —Arthur Davis, New York, N. Y.

Use TV Clamp on Flashlight

Flashlights have a habit of rolling off benches, or off roofs, on those not-

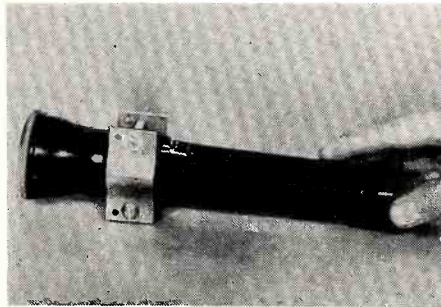

so-rare occasions when an antenna is being checked around dusk. By attaching a mast clamp around the flashlight, the shape is made irregular, so that it will stay put practically anywhere. If proper clamp type is not easily available, one can be made from scrap metal and two bolts. (Ed. Notes: In buying a flashlight, the same end result can be accomplished as suggested here, if a light with an "L" shaped case is obtained. Such flashlights were extensively issued in the US Army during the last War, and have been the official flashlight for the Boy Scouts for a number of years.) H. Leeper, Canton, Ohio.

Good-Will Builder

Here is an idea that I have found very useful. While making service calls in the homes I found almost all the radio and television sets in people's living rooms. Naturally the floors had nice rugs or waxed hardwood floors. I knew the owners didn't appreciate my setting tool boxes and tube kits directly onto the floors. To

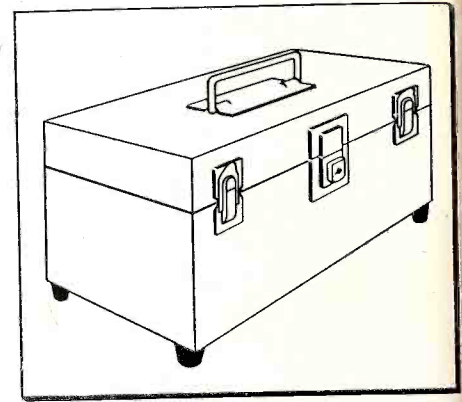

take care of this problem, I have put small rubber feet on both the tube kit and the tool chest. They leave no marks on the rugs and no scratches on the hardwood floor, but do leave a good impression on the customer which I'm sure helps to create repeat business. (Ed. Note: Some servicers also use a drop cloth for this purpose. An impression of tidiness and of a regard for the customer's home is always a good-will builder and is a must for the successful servicer.—John Hermes, Wyoming, Illinois.

Dial Stringing Aid

On some of the more complicated dial-stringing jobs (particularly slide rules), the problem arises that the string falls off one pulley while you are stringing it on a second one. A very simple solution to this problem is to use Scotch tape to hold the string in place as you go along. When the job is complete, the Scotch tape can easily be removed, especially since it doesn't stick very well to metal.

Noisy Vibrators

A chattering noise in an auto radio is often caused by the vibrator can striking the chassis or some metal part. The reason for this is that the sponge rubber pad used to hold the vibrator in place deteriorates or shrinks so that it no longer exerts pressure on the can. To remedy this, wedge a piece of heavy cardboard between the pad and the vibrator can.

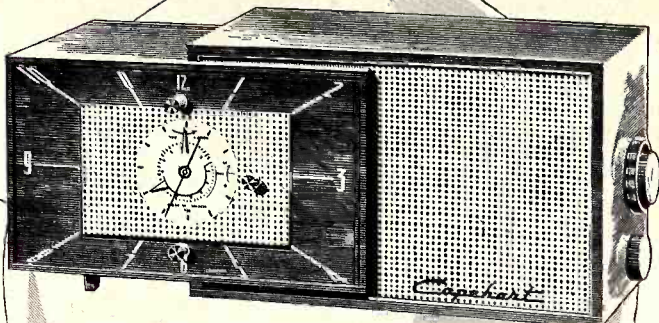

The CAPEHART Clock Radio. The fastest selling clock radio on the market—the most wanted, the highest-styled now available. Beautiful plastic cabinet in choice of colors. Only \$49.95*

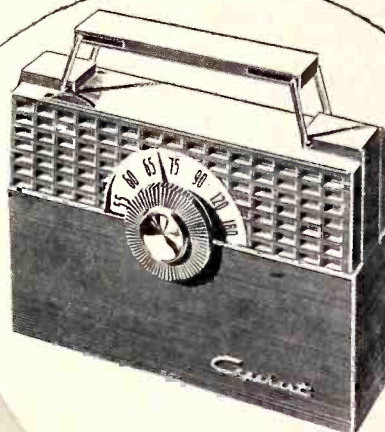

The CAPEHART Personal Portable Radio. Plays where you play. Handsomely styled to lead its field in looks and performance. Modern design in choice of colors. Only \$29.95*

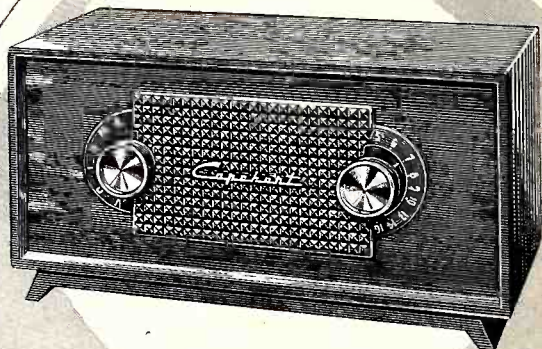

The CAPEHART Table Radio—True Capehart quality in miniature. Distinguished design beyond compare. Unbelievably beautiful tone. Choice of colors. Only \$32.95*

Capehart

SALES GOING UP!

Get set with goods that **SELL**
in the selling season

● Here they are—"small goods" items that mean more holiday profits for you! There's nothing else like them on the market. None can match the Capehart Clock Radio, the Capehart Table Radio and the Capehart Personal Portable for beauty of design . . . for reliable performance. None can touch them as sure sight-sellers. Be sure your stocks are adequate for the selling season ahead. Check your Capehart distributor or write E. Patrick Toal at Fort Wayne.

CAPEHART-FARNSWORTH CORPORATION, Fort Wayne 1, Indiana

An Associate of International Telephone and Telegraph Corporation

*prices for Zone 1.

AN **ITT**
ASSOCIATE

TV Antenna Kits for Use and Resale by Dealers

By K. S. Brock, Ward Products Corp.,
Div. of the Gabriel Co.

Television retailers, servicemen, and installers are constantly beset with the TV antenna problem. The difficulty is usually not one of selecting the proper antenna for the job, for this is easily determined. Rather, the problem is how to handle antennas and accessories profitably. The many components involved in a complete installation result in an inventory problem, and control of material costs is a constant headache. These difficulties have led to acute price consciousness, and, to meet low price levels, frequently a lowering of product quality.

For the service manager or the service company, the currently common practice of buying antennas, masts, lead-ins, screw-eyes, chimney mounts and many other materials required has many pitfalls to accurate cost control and profitable handling of a major portion of the average installation cost. To boost his profit, the dealer has carefully investigated labor costs and many other costs he faces. Possibly, though, he could make further savings in his material costs, as will be pointed out in the alternative purchasing policy outlined below.

New Antenna Sales Potential

Besides the material handling costs attendant upon TV installations, still another problem faces the retailer. This is the customer who wants to make his own installation. Here's plus business the retailer could have if he could handle it profitably. But here again he faces the same problem, that of handling a costly inventory of antennas, masts, lead-in and the several other components necessary for an antenna installation.

One solution to both of these problems of the dealer—namely, the sale or the installation of TV antennas, is antenna installation kits. A typical kit consists of an antenna, mast, lead-in, screw-eyes and stand-offs, lag bolts, base, pipe or chimney strap, and a guy ring. With all these parts in one package and covered by one stock number the complete installation is quickly and easily provided.

Now, let us consider some of the advantages in handling installation kits.

To his customer who wishes to make his own installation, the retailer has available a single package. Easy for him to stock, it eliminates

cutting lead-in and assembling and the many components. He can buy economically in quantities to suit his needs. Since he buys a single unit, he can easily and quickly compute a profitable resale price. Typical kits would be the Ward Products TV-105, utilizing a single-stack conical, or the TVS-103, with a double stack conical.

With kits, the service-manager can uncover many hidden profits, too. Since his business requires the profitable handling of TV installation ma-

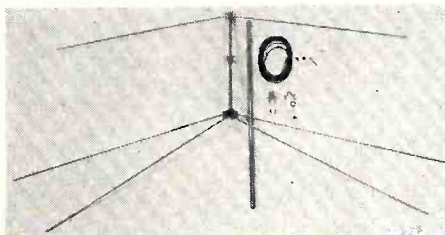

Ward Antenna Installation Kit Model TV-105.

terials, he would do well to investigate the opportunities in using kits.

He will save installation time with kits. His man will not have to spend time cutting in transmission line. Prior to the installation, he will cut down his time in assembling the necessary components. He will know that when he arrives at the installation, he will have all the necessary material for the job. Since the material is all in one package, it will be easier for him to carry and will help to keep all parts together. Installation time is an important factor to a cost-conscious installer. With kits, he can lessen the problem a great deal.

He will save material costs. The manufacturer, selling throughout the country, can purchase in huge quantities and obtain the lowest possible material costs. Thus, when these materials are assembled in a complete kit, the price is frequently lower than the installer would pay for purchasing them separately.

In the so-called "hidden" costs, the service-manager will realize his greatest savings. Since he will know the exact material used on a job, and its cost, it will be a simple task to determine whether or not a particular job was profitable. Furthermore, it will give him an exact, indisputable figure on which to base his rates. Losses due to errors in estimating can be substantially eliminated.

When buying separate components in large quantities, the service-manager is faced with the problem of waste

inventory. The short, unusable length of transmission line at the end of a roll, for example. Or bent stand-offs from excessive handling—or misplaced small parts—or bent antenna elements—all individually small, it's true, but in total representing a large, unsalvageable loss. With a kit, there is no waste. The entire kit is charged into a job at an accurate price, and left over material, if any, can be salvaged for extra profit, or discarded with no loss. Since the kit is in its package up to the time of actual installation, there is practically no opportunity for loss or damage.

These are typical "hidden" costs. There are others. Working capital, for example, can be aided by kits. When buying individual components in the large quantities necessary to secure economical prices, the service-manager is forced to tie up many dollars in inventory. With kits, he does not face so severe a problem, for the bulk of the quantity savings have been passed on by the manufacturer in the form of lower unit prices.

Materials Control Aided

And an important consideration is the manner in which the kit virtually eliminates pilferage losses. Being conveniently packaged, complete inventory can be taken at a glance. By charging a kit against a job, there can be no question of loss. Management completely controls the amount of material that will be used.

Inventory control savings are obvious. With but two or three easily counted items, as compared to fifteen or twenty individual components, record keeping is greatly simplified. And, with kits, inventory is automatically balanced. Frequently we hear of the dealer overstocked with a particular item because he made a "good buy." With kits, he has, in exact proportions, the right number of antennas, masts, lead-in and other parts. His inventory is more flexible since he does not run the risk of overstock.

These are some of the advantages of kits. Some others worthy of mention are less storage space, single buying units, and neater inventorying.

Many progressive cost-conscious dealers have proved the value of kits by assembling them in their own shop. Several distributors have done likewise as a service to their customers. But, this can be done generally more efficiently and cheaply at the factory.

3 Important Rauland Policies

...Are they
paying off for you?

1 Did you know that Rauland's Replacement Picture Tube Warranty and Adjustment Policy provides a 6 months warranty from the date of purchase by the consumer? And that all Rauland replacement tubes now carry a triple registration card providing protection for jobber, dealer and consumer?

2 Did you know that Rauland provides a full 120-day price protection on distributor inventory of replacement picture tubes? That Rauland distributors can carry a stock adequate for their territories without risk of loss through price adjustment?

3 Did you know that Rauland offers valuable premium points for the prompt return of warranty registration cards? Each card returned promptly entitles dealer and distributor to premium points redeemable in valuable merchandise prizes.

• • •

If you have not received full details on all of the above, write, phone or wire your distributing contact on Rauland tubes. If you have not received your prize merchandise catalog, use the coupon below today.

THE RAULAND CORPORATION

Perfection Through Research

4245 N. KNOX AVE. • CHICAGO 41, ILLINOIS

The Rauland Corporation
4245 N. Knox Ave., Chicago 41, Illinois

Please rush premium merchandise catalog and full information on:

Earning Premium Prizes 6 Months Warranty
 Distributor Price Protection

Name _____

Address _____

City _____ State _____



Customer Turnover

(Continued from page 51)

lend the customer a set. Many dealers use this technique, with two variations. Some dealers buy or obtain from their own trade-in operation used, small-screen sets which are loaned to the customer during servicing. Some other dealers lend the customer a current model which is better than the one he now owns (especially if the customer has a small-screen set) hoping thereby to pave the way for the sale of a new set. Either of these is effective.

Failing this, the customer is going to be without Hoppy for a while, and he is apt to be hopping. First, the serviceman who makes the call should be courteous and helpful but should not make any rash promises. He should explain that the repair job is such that it will take too long to do in the house, or it requires facilities available only in the shop. But he should avoid leaving the impression that the set is a hopeless wreck, because the customer paid what is to him a lot of money for it, believes it should last for a long time, and would hate to think he got a lemon. Second, he should say that it will not take long to fix, but that he is not at liberty to say just how long without consulting the shop manager's schedule. However, he will notify the customer if the repair will take over 24 hours, stating just how long it will take.

Now the set comes into the shop. The service manager must have a schedule and must make an earnest effort to maintain this schedule. Under such conditions, he should be able to estimate to within 24 hours, how long it will take. On the day following the day the set comes in (or the chassis, as is usually the case), he will have a form card sent to the customer (if it will take more than 24 hours to return) saying words to this effect: "Dear Mrs.——: We wish to acknowledge that the chassis from your X brand TV set was brought in to our shop yesterday for servicing. We regret the inconvenience that this has caused you and will make every effort to get the set back to you as soon as possible. We expect to be able to deliver it on such-and-such a day." You will be surprised how much a card like this will do to soften the blow.

Then your only problem will be to get the set back on the appointed day. If you are unavoidably unable to do so, call the customer that day, apologize, and set a new date. When the set goes out, have the serviceman phone the customer to make sure she will be home to receive it—and not just once in the day. This is another source of customer annoyance; that is, to find that the serviceman was there

(Continued on page 72)

"Workshop DUBL-VEE antennas
are second to none."

Francisco Laboratories

EQUIPMENT REPAIRED, REMANUFACTURED AND EXCHANGED

3015 GLENDALE BOULEVARD
LOS ANGELES 24 CALIFORNIA
39 NORMANBY 8476
OLYMPIA 0602

20 August 1951

Workshop Associates, Inc.
135 Crescent Road
Needham Heights 94, Massachusetts

Gentlemen:

Having originated products in other fields, we can appreciate to the fullest extent a quality product. We have used Workshop DUBL-VEE antennas extensively since they were first introduced to the Southern California market. The results of tests in low signal fringe areas convinced us that the Workshop TV antennas are second to none.

There are many imitators of your products, as you are doubtless aware, but the differences are apparent once the DUBL-VEE is compared in operation against the others. Your engineering department is to be complimented for originating what we believe is one of the finest television antennas on the market.

Yours very truly,

FRANCISCO LABORATORIES

Wallace E. Francisco
Wallace E. Francisco

"The Workshop-patented DUBL-VEE is tops for all-channel performance. And remember last winter? Rugged DUBL-VEE's stood up best. Specify DUBL-VEE and be sure."

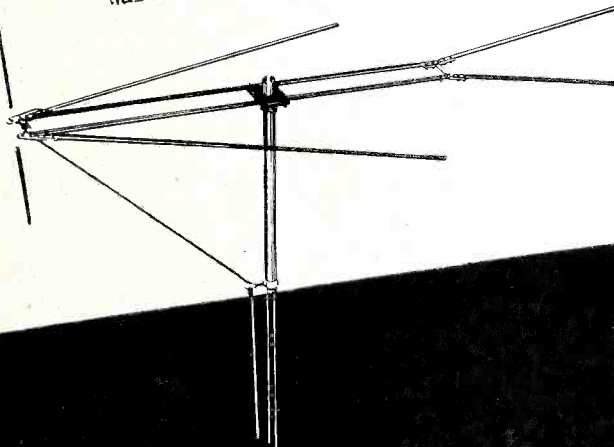

The WORKSHOP ASSOCIATES

DIVISION OF THE GABRIEL COMPANY

Specialists in High-Frequency Antennas

135 Crescent Road, Needham Heights 94, Massachusetts





ALL RANGES WITH THIS ONE CONTROL

Just *one* knob—extra large—easy to turn—flush with the panel, controls all ranges. This one knob saves your time—minimizes the chances of “burn-outs” because you don’t have to remember to set another control. You can work fast with Model 630 with your eyes as well as your hands. Look at that scale—wide open—easy to read, accurately. Yes, this is a *smooth TV* tester. Fast, safe, no projecting knobs, or jacks, or meter case. Get your hand on that single control and you’ll see why thousands of “Model 630’s” are already in use in almost every kind of electrical testing

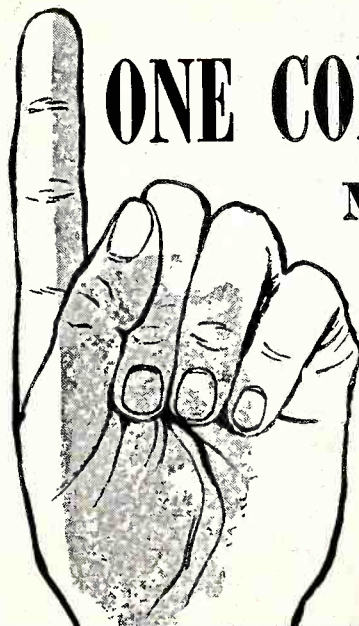

**Model
630**

FOR THE MAN WHO TAKES PRIDE IN HIS WORK

Triplet

TRIPLET ELECTRICAL INSTRUMENT COMPANY · BLUFFTON, OHIO, U.S.A.



NEW
SIGNAL STRENGTH
FOR SINGLE CHANNEL
RECEPTION

with the
SENSATIONAL
ROCKET
A POWERFUL
MAST MOUNTED
BOOSTER

Research and laboratory tests have long proved that the best point to boost a TV signal is at antenna height — where the most favorable signal-to-noise ratio exists. But it remained for VEE-D-X engineers to perfect the extremely powerful Rocket Booster that delivers an 18 db gain with full 5 megacycle band width. The Rocket Booster has two components — (1) the booster itself, and (2) a control unit. It is factory preset for peak performance on any desired channel and once installed needs no further adjustment. For complete information on the sensational new Rocket Booster see your distributor or write to The La-Pointe-Plascomold Corporation, Windsor Locks, Conn.

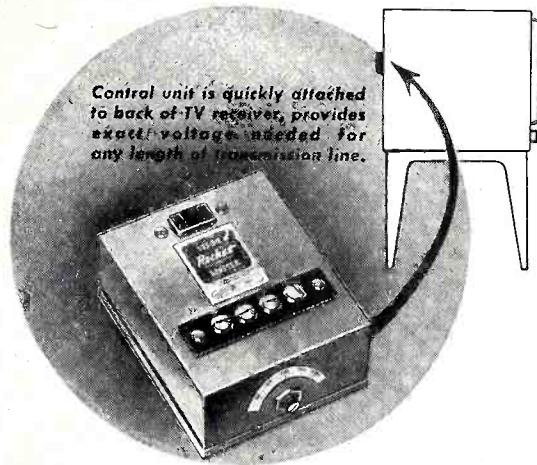

Control unit is quickly attached to back of TV receiver, provides exact voltage needed for any length of transmission line.



VEE-D-X

MAKERS OF THE WORLD'S MOST POWERFUL ANTENNA SYSTEMS

Customer Turnover

(Continued from page 70)

during the only 10-minute period in the whole day when she was not at home.

Following these techniques to 1) Cut down the volume of shop servicing, and 2) Properly pacify the customer during shop servicing will go a long way toward holding the customers you have and getting new ones by recommendation.

RCA Tube Dept. Bonus

RCA tube distributors are offering dealers and servicemen a three-ring leatherette binder at no extra charge when the latter purchase RCA Victor service literature costing \$10 or more. The binders are intended for the filing of individual RCA Victor service data booklets.

NU Names Huber

Vin Ulrich, manager of National Union's renewal sales division has announced the appointment of Edward G. Huber as district sales manager for eastern Pennsylvania, south Jersey, Delaware. This is an addition to the New Jersey territory now being handled by Huber.

Insuline Appointment

G. W. Delzell, 643 Coombs Creek Drive, Dallas, Texas, has been appointed sales representative for the Insuline Corporation of America, 36-02 35th Avenue, Long Island City, N. Y., according to Bernard L. Cahn, general sales manager of the company.

New Eico Sales Rep

Harry R. Ashley, president of Electronic Instrument Co., Inc., 276 Newport St., Brooklyn, N. Y., manufacturer of the Eico line of test instruments and kits, has confirmed the appointment of Robert A. Stang as the authorized Eico sales representative for the territory of metropolitan New York, New Jersey, eastern Pennsylvania, Maryland, Delaware and District of Columbia.

Utah Names JKM

JKM, Inc., 510 N. Dearborn St., Chicago, manufacturers' representative, announced that it has been appointed to represent the Utah Radio Products Co., speaker manufacturer of Huntington, Indiana, in the Illinois and Wisconsin area. Both Oden Jester and Bob Karet of the rep firm were originally connected with the Utah Radio Products Co., the former as vice-president and the latter as jobber sales manager, from 1935 through 1945.

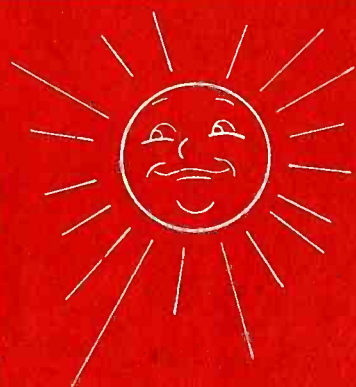

Right for Sight!

Announcing
CORONA INHIBITOR

the new



development that keeps

**TELEVISION
PICTURE TUBES**

at peak performance

Rain or Shine

Now, for the first time, you can get television picture tubes that are *not affected by atmospheric conditions*. Ordinary picture tubes may lose as much as one-tenth of their brightness on humid rainy days, but RAYTHEON made Tubes with CORONA INHIBITOR are 100% efficient *rain or shine*.

This amazing new weather-proofing is so effective, that even when tested with a water spray on the high voltage contact, RAYTHEON Tubes with the CORONA INHIBITOR showed *no loss of brightness* due to arcing around the high-voltage connection.

Ask your RAYTHEON Tube Distributor for Raytheon Picture Tubes with CORONA INHIBITOR. Our customers will like them... and so will you.



Excellence in Electronics

RAYTHEON MANUFACTURING COMPANY

Receiving Tube Division

Newton, Mass., Chicago, Ill., Atlanta, Ga., Los Angeles, Calif.

RADIO AND TELEVISION RECEIVING TUBES, PICTURE TUBES, SPECIAL PURPOSE TUBES, SUBMINIATURE TUBES, MICROWAVE TUBES

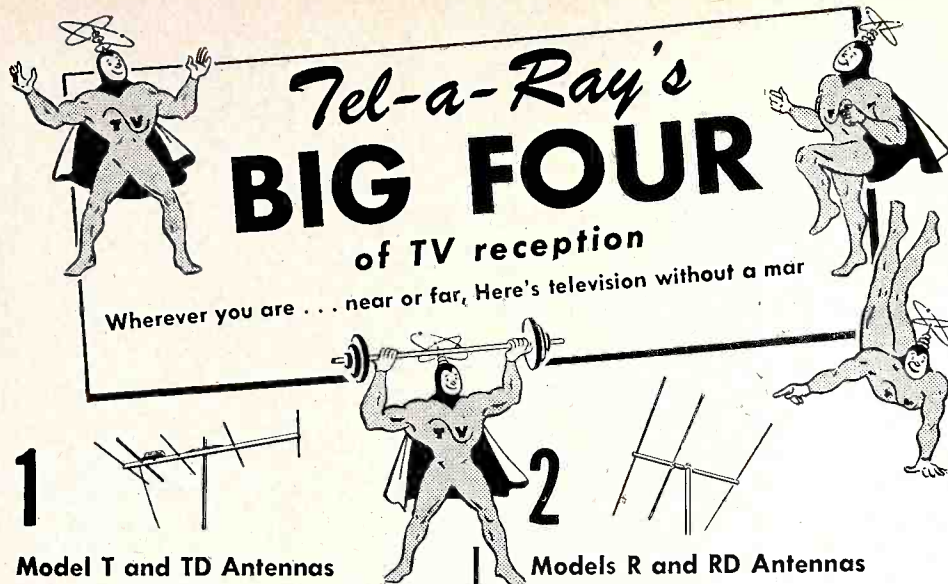

Ferruccio Tagliavini and his wife, Pia Tassinari accept a Sylvania HaloLight television set from Mrs. James G. Schaefer, (left) who presents the set on behalf of a Bronxville, N.Y. civic group in return for a concert Tagliavini gave to raise funds for their scholarship fund.

Sylvania TV Service Plan Available to Dealers

The Sylvania Pay Back Service Plan makes available to the dealer a factory-controlled service plan which incorporates a contract with coupons, one of which is surrendered by the customer on each service call. Unused coupons may be returned by the customer to the factory for a refund of up to 42% of the original service cost. Typical contracts cost the consumer \$26.00 for a 90-day contract (2 coupons) or \$32.00 for a console combination (3 coupons), and \$55.00 for a 1-year contract (5 coupons) or \$67.00 for a console combination (7 coupons). Antenna installation is not included in any of the contracts. Dealers are paid a \$3.00 commission on every 90-day contract and \$8.00 on every 1-year contract. For complete details, dealer may write Parts and Service Dept., Sylvania Electric Products, Inc. (Radio & Television Div.), 1292 Niagara St., Buffalo 13, N. Y.

To Stancor Sales Post



Robert J. Reigel, above, has been appointed distributor sales coordinator of the Standard Transformer Corp., according to an announcement by Jerome J. Kahn, president.

HERE'S OPPORTUNITY TO MAKE YOUR PROFITS FAR BIGGER, YOUR WORK FAR EASIER!

With Tel-a-Ray's "Big Four," it's easy to sell television to the huge, wide-open market beyond the service areas. Easy to sell the growing replacement market in primary service areas. Easy to solve reception problems everywhere . . . in a jiffy and without call-backs. These products are in a class by themselves in performance . . . in quality appearance . . . in their construction of the finest corrosionproof materials and unconditional guarantee against wind and weather damage.

Tel-a-Ray, America's most progressive antenna manufacturer, has applied to the FCC to operate a UHF television station on Channel 50 . . . Tel-a-Ray's research engineers, keeping pace with America's fastest-growing industry, have developed an effective UHF antenna. Such progress assures you better television.

Take this opportunity to up your profits with less work. Send the coupon for full information and the name of your nearest Tel-a-Ray distributor.

MAIL TODAY

Tel-a-Ray ENTERPRISES, INC.

P. O. Box 332R, Henderson, Ky.



Yes . . . I'd like descriptive literature on the Tel-a-Ray line and the name of my nearest Tel-a-Ray distributor.

Name.....

Company.....

Address.....

**Aluminum Voice Coil
SPEAKERS**



DAVE MARKS, President
Fort Orange Radio Distributing Company, Inc.
Albany, New York

**"OUR FASTEST SELLING SPEAKER LINE
FOR THE PAST 7 YEARS!"**

**Quality Product Plus Smart Promotion
Spell Success for Aggressive Parts Jobber**

MY dealer customers don't bother to open the cartons — as they do with other brands — before buying G-E speakers. They know that General Electric factory-packed Alnico units come to them in perfect shape, ready for use. Customer confidence pays off. Because I stock all 27 G-E models, my dealers know I can fill any speaker need."

What Dave Marks does not mention is that his merchandising skill has made him one of the top parts distributors in the East. He makes frequent and profitable use of all G-E sales tools: catalogs, booklets, envelope stuffers, display pieces of all kinds. They're available to you, too, through your General Electric distributor or representative. Call him today for your share of these sales helps.



Drive-In Theatre Speaker Sales Hot! With G.E.'s special weather-tested outdoor speaker, Dave Marks, shown here with general manager Ted Sharaf, has increased his drive-in business four times over in two years!

DEALERS AND SERVICEMEN

Here's a complete new service manual on all General Electric television receivers — 102 models manufactured since 1945! You get 80 pages packed with circuit diagrams, symbols and numbers, tube locations, top and bottom chassis views. Plus photographs and lists of service aids. Mail coupon for it today. Only \$1.00.



General Electric Company, Section 26121
Electronics Park, Syracuse, New York

Send me.....copies of the new 80-page service manual on General Electric TV receivers at \$1.00 each. I enclose \$.....

Check Money Order

NAME.....

ADDRESS.....

CITY..... STATE.....

GENERAL  ELECTRIC

Emerson Sales Manager



The appointment of Martin L. Scher (above) as national sales manager of Emerson Radio and Phonograph Corporation has been announced by Stanley M. Abrams, director of sales of the company.

To Crosley Sales Post

Herbert F. Koether has been named to the newly created post of manager of the radio sales section of Crosley Division, Avco Manufacturing Corp., W. A. Bles, Avco vice-president and general sales manager of Crosley, announced.

Lubet Joins Jewel

Don J. Ferraro, president of Jewel Radio Corp., Long Island City, N. Y., has announced the appointment of Herman N. Lubet as advertising manager and export manager. Lubet has



Herman N. Lubet

been ad manager of Fada Radio & Electric Co., Inc., for the past six years. Lubet's wide experience in sales and promotion, and his following in the export field are in accord with Jewel's expansion program which included the recent opening of a five story plant in East Newark, N. J.

New Hedco Plant

Hedco Manufacturing Corp., manufacturer of private label record players, has announced that the new and modern facilities of its plant at 161 W. Huron St., Chicago, is now in production. The company, which also manufactures under the trade name of Symphonette, was formerly located in Mt. Vernon, N. Y.



LEND ME YOUR EAR

*EKOTAPE
Tape Recorder
manufactured by
Webster Electric Co.
Racine, Wisconsin*

We, at Oxford, would welcome the opportunity of "borrowing your ear" to tell you about **OXFORD SPEAKERS**, manufactured by speaker specialists for over a quarter of a century—to show you how **OXFORD SPEAKERS** meet the specific need of the Webster Electric recorder for smooth, clean performance.

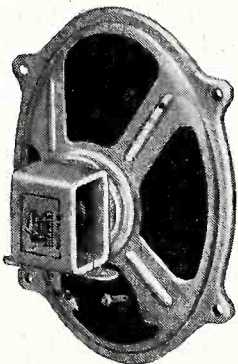

We cannot tell you in person, but we suggest you test a Webster Electric recorder—notice the fine tone quality—the excellent reproduction, and hear for yourself why **OXFORD SPEAKERS** are used in Webster Electric products.

Leading jobbers carry the complete OXFORD line... for TV, FM, AM, AUTO, PA, and outdoor applications.

Our latest catalog is available upon request.



OXFORD ELECTRIC CORPORATION

3911 South Michigan Avenue • Chicago 15, Illinois
EXPORT: ROBURN AGENCIES, NEW YORK CITY

THE **OB** outstanding single channel booster

Installed on back of TV cabinet — out of sight.

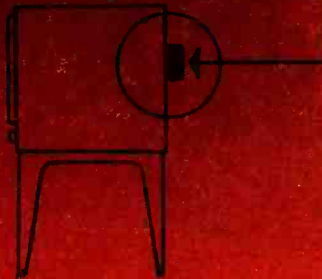

INSTALL IT!—FORGET IT!

Bothersome tuning completely eliminated



VEE-D-X *Outboard* BOOSTER

Model OB

\$ **19**⁹⁵

Only

LIST

Biggest Improvement To Single Channel TV Reception Since The VEE-D-X "J" Series Yagi

So good—so successful—and so important to better single channel reception. The "OB" already has a "Chinese copy" on the market. But, if you want the *original* and *best*, you will settle only for the VEE-D-X *Outboard*. Delivers powerful 18 db gain with full 5* megacycle band width—yet it costs much less than any tuned booster on the market. Pre-set for any desired channel. Fits snugly against back of any TV set—out of the way . . . out of sight . . . with no knobs or wires exposed to TV viewers. The unique RF assembly, heart of the booster, is precision engineered into a single unit. And remember—when you use the "OB" with the famous VEE-D-X "JC" Yagi—you get the world's most powerful combination for single channel reception. The LaPointe-Plascomold Corporation, Windsor Locks, Connecticut.

BEWARE OF CHINESE COPIES . . .

INSIST ON *Genuine* **VEE-D-X**

ORIGINATORS of The World's Most Powerful Antenna Systems

12

OUTSTANDING FEATURES

- 18 db gain with full 5* megacycle band width
- Costs less than any tuned booster
- Turns on and off with set automatically
- Cannot oscillate — has 6J6 push-pull cross-neutralized amplifier
- Out of sight — no wires or gadgets showing
- Easily and quickly installed
- Unique RF assembly
- Excellent signal-to-noise ratio
- Maximum gain on desired channel because individual plate and grid adjustments assure perfect alignment
- All metal case has beautiful Hammertone finish
- Fool-proof construction — Install it! — Forget it!
- Performance proven

*TV channel transmission 4.5 mc wide

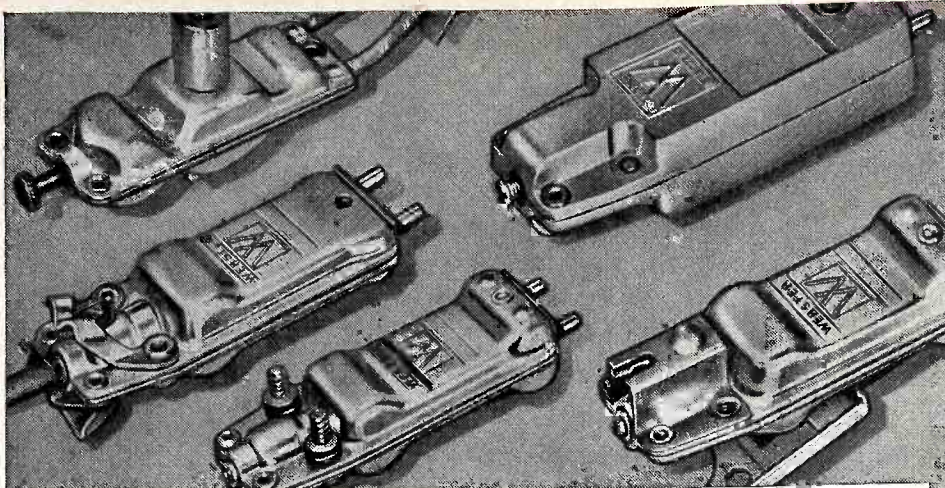

WEBSTER ELECTRIC one of the original manufacturers of crystal cartridges

FOR OVER **20** YEARS

a complete line of cartridges

Engineered to meet your requirements

Webster Electric has been making cartridges for years and years . . . starting way back when cartridges were nearly as big as baseballs. The line of cartridges has constantly changed and improved to meet current requirements. Each year has brought improvements until cartridges are now available in thumb-nail size and versatile enough to meet the requirements of 78, 33½ and 45 RPM.

Webster Electric has the experienced engineers, manufacturing know-how and long-range experience to make cartridges to meet all of the industry's requirements.

When you need a new cartridge submit your problem to Webster Electric. When your record players or changers are equipped with Webster Electric cartridges, you can be assured of the best in dependable performance.

Webster Electric Company, Racine, Wis., Established 1909

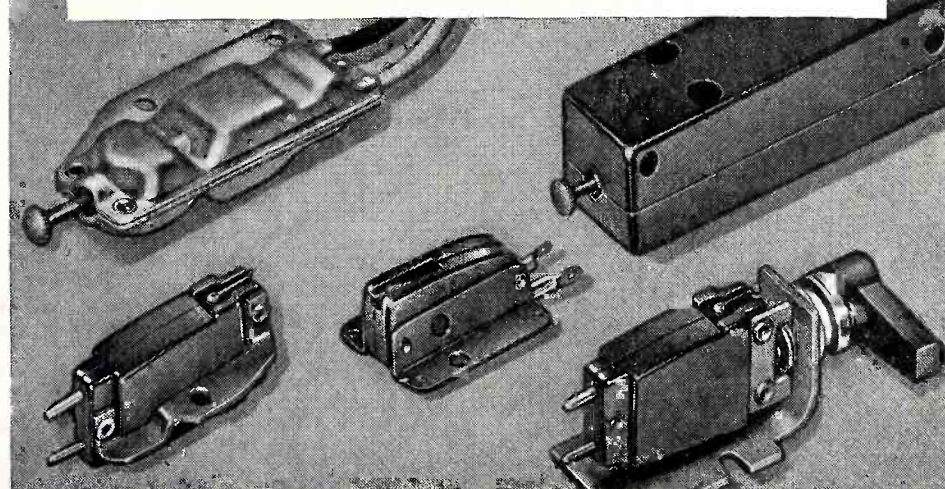

WEBSTER  **ELECTRIC**
RACINE ♦ WISCONSIN

"Where Quality is a Responsibility and Fair Dealing an Obligation"

Fada Ad Manager



Charles Roberts, above, has been appointed advertising and sales promotion manager of the Fada Radio & Electric Co., Inc., it was announced by Jack M. Marks, president.

Du Mont Names Hunt

John Hunt has been appointed manager of the newly formed New Jersey distributorship of Allen B. Du Mont Laboratories, Inc., it was announced by Ernest A. Marx, general manager of Du Mont's receiver sales division.

New Tonepak Catalog

The Lee Electric Company, Electronic & Amplifier Division, 321 Fort Lee Road, Leonia, N. J., has brought out a catalog of the Tonepak line of bells, buzzers, chimes, signaling transformers, push buttons, and electrical specialties.

Anchor Booster Meeting

One hundred dealers and servicemen turned out recently for a symposium on boosters held in Springfield, Mass. Meeting was jointly sponsored by Anchor Radio Corp., Art Cerf & Co., Hatry & Young, L.L. Del Padre & Assoc., Springfield Radio, and Springfield Sound. Many items of interest were discussed pertaining to successful booster application and use.

Named to NPA Committee



Calvin Bell, (above) 26-year-old executive vice-president of Tele King Corporation, TV manufacturer, has been appointed to the Electronics Products-End Equipment Industry Advisory Committee of the National Production Authority.

Now this precision-matched miniature Pliers Kit yours **FREE**



IT'S SYLVANIA'S
GREATEST
PREMIUM YET!



...with every 100 Sylvania Receiving Tubes or 3 Picture Tubes purchased between Nov. 15th and Dec. 15th

MAN, WHAT A
TIME AND WORK
SAVER!



Here's exactly the tool kit every radio and TV serviceman has always needed. A complete miniature pliers kit. It contains:

- Slip-Joint Pliers:** 4¾ inches long with adjustable two-position slip-joint.
- Needle-nosed Pliers:** 5¼ inches long for inaccessible wiring and terminals.
- Parrot-nosed Pliers:** 4½ inches long, with adjustable three-position slip-joint.

All have precision-matched jaws with finely-milled teeth, forged from the finest steel by a leading manufacturer of surgical instruments. Regular \$4.50 value!

This kit, packed in sturdy plastic case, is yours absolutely free when you buy just 100 Sylvania Receiving Tubes or 3 Sylvania TV Picture Tubes from your Sylvania Distributor. But, please hurry! Offer closes Dec. 15th. Your regular Sylvania Distributor has these kits now. Call him TODAY!

WHY YOU'LL WANT THESE PLIERS

1. Especially designed for radio and television service work.
2. A craftsman's tool... forged from highest quality steel, not cold-rolled or stamped.
3. Precision-matched jaws... sure grip, finely-milled teeth.
4. Needle-nosed and parrot-nosed pliers wonderful for inaccessible wiring.
5. A regular \$4.50 value.



SYLVANIA



RADIO TUBES; TELEVISION PICTURE TUBES; ELECTRONIC PRODUCTS; ELECTRONIC TEST EQUIPMENT; FLUORESCENT TUBES, FIXTURES, SIGN TUBING, WIRING DEVICES; LIGHT BULBS; PHOTOLAMPS; TELEVISION SETS

Hudson Names Baume

Max Baume has been appointed manager of the sound department of the Hudson Radio & Television Corporation, 48 West 48th St., New York 19, N. Y., according to Adolph Gross, president of the company.

Roto-Vision Trademark

"Roto-Vision" is now the registered trademark for the rotating top television table line manufactured by Illinois Wood Products Corp., Chicago, M. Rose, sales manager announced.

Dean Ads Five Reps

George H. Fass, president and sales manager of Dean, 35 Fifth Avenue, Brooklyn, N. Y., manufacturer of phonographs, announced the addition of five new regional sales reps to handle the complete line. They are: Milton E. Havelick, 4827 Marietta St., Houston, Texas; Murphy & Cota, 1409 Peachtree St., N. E., Atlanta, Ga.; Hoyle Smith, 2616 N.W. 16th St., Oklahoma City, Okla.; Robert J. Bond & Associates, 497 Chestnut St., Waban, Mass.; Al J. Rissi, 1169 S. Broadway, Los Angeles, Calif.

Philco Allocation

In a recent statement by William Balderston, president of Philco Corporation, he said that Philco factory and distributor-dealer inventories of TV sets which reached a high point during the summer, are now depleted, and the demand for Philco 1952 models is so great that the entire production is on an allocation basis to distributors and dealers.

New Lindberg Home

John E. Lindberg, Jr., president of Lindberg Instrument Co., Berkeley, California, recently announced that the company has moved to larger headquarters. The new plant and offices at 1808 Harmon Street, Berkeley 3, California, are four times larger than the building formerly housing the Lindberg operation.

Lewyt on Army TV Show



Alex Lewyt (at left), president of the Lewyt Corp. appeared on "Headquarters-New York", a television program seen over NBC-TV, where he was interviewed by Ben Grauer (at right). He was the first civilian ever to appear on this program, which is sponsored by the First Army.

Proctor Defense Project

A. H. Caesar, vice-president in charge of production, Proctor Electric Co., Philadelphia, has announced that the company's Philadelphia plant will be closed during the month of December, in order to accomplish conversion necessary to a special defense project. Proctor has taken measures to protect the toaster and iron requirements of its customers. The nature of the defense work was not disclosed.

Arnett Joins Du Mont

Keeton Arnett has been named general assistant to the president of Allen B. Du Mont Laboratories, Inc., Clifton, New Jersey, it was announced by Dr. Allen B. Du Mont, president.

Web-Cor Sales Plan

A merchandising program which more than quadrupled sales of wire and tape recorders was used recently by R. O. McCloud, merchandise manager of the Rudolph Wurlitzer Company. The plan, built around Webster-Chicago wire and tape recorders, was to have at least one person in each store who was especially trained to talk and demonstrate the recorders expertly.

By any standard of comparison,
whether it be

**PRICE—
QUALITY—
PERFORMANCE...**

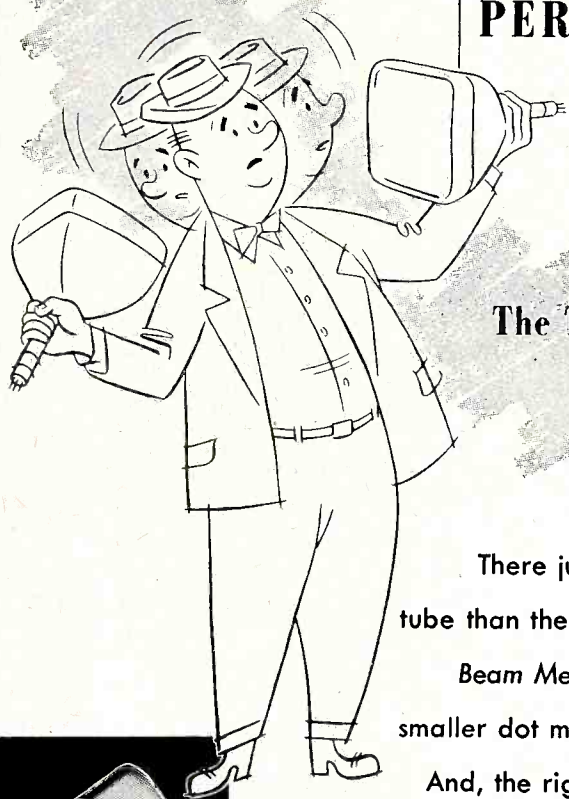

You can't beat
The **TARZIAN TUBE**

There just isn't any better picture tube than the TARZIAN Tube. "The Fine Beam Means Fine Screen." Yes, the smaller dot makes for a better picture.

And, the rigid quality control assures complete customer satisfaction.

Want to know how greater profits await you in the replacement field? Write—Wire—Call

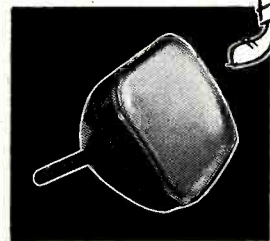

SARKES TARZIAN, Inc., Tuner Div., Bloomington, Ind.

TARZIAN MADE PRODUCTS

Tuners Air Trimmers Selenium Rectifiers Cathode-Ray and Receiving Tubes

STATIONS WITH 15000 WATTS AND WTTV (CHANNEL 10)
OWNED AND OPERATED BY SARKES TARZIAN IN BLOOMINGTON

Golden Opportunity

to prepare for better pay jobs in

Television Servicing

for men in
radio-electronics



YOU STUDY AT HOME

In your spare time, you learn pre-tested "How-to-do-it" techniques with "How-it-works" information in easy-to-study lessons. The course is based on the experience of the RCA Service Company in servicing thousands of home television receivers.

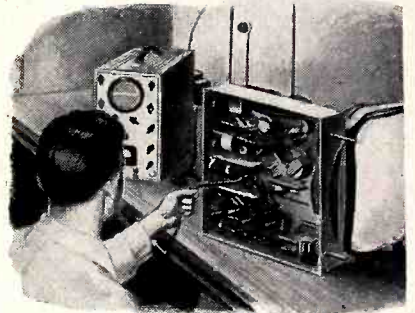

YOU KEEP WORKING ON YOUR JOB

Because you work in the radio-television-electronics industry, your job provides the laboratory work of the course. There are no kits, parts or equipment to buy. Self-employed independent radio and television servicemen are eligible for enrollment.

RCA INSTITUTES Home Study Course in TELEVISION SERVICING—

A Service to the Industry

Because of the critical shortage of TRAINED and EXPERIENCED TV SERVICEMEN, RCA Institutes is offering this highly specialized and practical home study course as a service to the working members of the radio-television-electronics industry. Its object is to train more *good* servicemen and to help make good servicemen *better*.

Never before has this course been available to anyone outside of RCA. It is now offered to *you*, through RCA Institutes, one of America's oldest and most respected technical training schools. The course covers most major makes and types of TV receivers. Available exclusively to men in the radio-television-electronics field. Not offered to the general public, or under G.I. Bill.

The cost is low . . . only \$9 a unit for 10 units or \$90 total, on an easy pay-as-you-learn plan. At successful completion of the course you earn an RCA Institutes certificate that can lead straight to a better job at higher pay.

No vocational field offers more opportunities for "career" jobs and good pay than television—America's fastest growing industry. The demand for TRAINED and EXPERIENCED TV SERVICEMEN is growing. There is a big shortage of such men now and will be for several years to come.

PLENTY OF GOOD JOBS OPEN TODAY

Radio-Television jobbers, dealers and service companies offer lifelong opportunities with excellent salaries for qualified service technicians. Manufacturers of television receivers are looking for men with good service training as inspectors, testers and troubleshooters. Many experienced servicemen go into business for themselves. Others hold their regular jobs and earn extra money servicing TV receivers in their spare time.

Radio-electronics manufacturers busy with defense equipment contracts offer excellent job opportunities for men with a television technician background. Servicemen called into military service are further reducing the supply of skilled TV servicemen available for civilian activities. Think what television servicing offers *you* in terms of a lifetime career and financial security.

SEND FOR FREE BOOKLET. Find out complete details of the RCA INSTITUTES Home Study Course in TELEVISION SERVICING. Don't pass up this opportunity to prepare yourself for a money-making career in the television industry. Illustrated booklet explains all the features of the course. Mail coupon in an envelope or paste on a penny postcard—NOW!

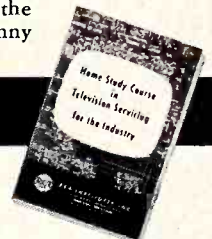

MAIL COUPON NOW!

RCA INSTITUTES, INC.
Home Study Department, RT-1251
350 West Fourth Street, New York 14, N.Y.

Without obligation on my part, please send me copy of booklet "RCA INSTITUTES Home Study Course in TELEVISION SERVICING." (No salesman will call.)

Name _____ (Please Print)

Address _____

City _____ Zone _____ State _____



RCA INSTITUTES, INC.
A SERVICE OF RADIO CORPORATION of AMERICA
350 WEST FOURTH STREET, NEW YORK 14, N.Y.

Second Year Warranties

Optional second year parts warranties providing full protection of all electronics parts are now being offered by National Electronics, 314 W. 58 St., Los Angeles 37, Calif., on all television receivers produced by the company, according to Myron Blackman, general sales manager. National Electronics manufactures two lines of TV receivers: The 21" Natalie Kalmus and the 20" Cinema.

Clarostat Appointments

Two appointments having to do with the scheduling and expediting of production were announced by Walter

J. Mucher, plant manager of Clarostat Mfg. Co., Inc., Dover, N. H. Arthur G. Jordan replaces Joseph F. Cook in the scheduling and follow-up of all wire-wound fixed resistors and Robert Levitre becomes the new expeditor in the production control department.

Stromberg Distributors

Hynes and Waller, 1210 K St., N.W., Washington, D. C., have been appointed as distributors for the entire line of Stromberg-Carlson radio and television products, in D.C., and adjoining counties in Md., Va., and W. Va.

Tele King Contest Winner



Richard Barrett of Mount Vernon, Ohio, and his wife, are greeted by Harvey Pokrass, (left) president of Tele King Corp. upon the couple's arrival in New York. Barrett was the winner of Tele King's recent sales contest, open to all managers, and as an award was given a three-day trip to New York with his wife.

Distributor Appointee

Harry C. Chrabot has been appointed assistant to the general manager of Zenith Radio Distributing Corp., Chicago, it was announced by C. F. Parsons, vice-president and general manager. In addition to his new work, Chrabot continues in charge of advertising and sales promotion for the sales subsidiary.

Land-C-Air Adds New Line

Land-C-Air Sales Co., 1819 Broadway, New York 23, N. Y., has announced the addition of the Macson Company line of electrical connectors to its expanding industrial sales division. The Macson Company, Los Angeles, California, specializes in cable connectors, and connectors for special applications.

Distributor Ad Manager

Max I. Epstein, president of Federated Purchaser, industrial electronics distributor, recently announced the appointment of John B. Patterson as national advertising manager. Patterson was formerly with Telrex, Inc., of Asbury Park, N. J.

Westinghouse TV on Ships



The crew enjoys television aboard Great Lake freighters. Westinghouse sets have been installed on 24 vessels of the Pittsburgh Steamship Company. Crews have programs available for 2 1/2 days of the normal 6 1/2 day cruise. Special non-directional antennas have been installed.

STOP

your
dud
is
worth
MONEY!

you can trade
your Dud
for a
NEW
first-quality
TV tube . . .

WITH THE TV-"Q" PLAN

you can actually get trade-in value on your old CR tubes and replace them with brand new tubes of identical size and style . . . from 12" to 21" in glass or metal, and guaranteed for one year.

Distributors Report a "tremendous increase" in Business since Handling the NEW Tube Exchange Program.



Manufacturers of the Custombilt CR Tubes

IN SPITE OF THE THREAT OF IMMINENT SHORTAGES . . .

TV-Q can assure you of a substantial supply of Cathode Ray Tubes—the same Custombilt tubes purchased by prominent set manufacturers.

*Reflection-free, Mirrorized and Electrostatic Tubes
Now Available in 16", 17", 20" and 21".*

**WRITE FOR INFORMATION ON TV-Q MASKS,
RECEIVING TUBES AND OTHER PRODUCTS**

A FEW TERRITORIES STILL OPEN FOR
MANUFACTURERS REPRESENTATIVES

TV-"Q"

Custombilt Corp., Tube Division

170 Fifth Avenue, Hawthorne, New Jersey

Introducing...

THE MAGIC OF MODEL M

"The Magic of Model M" . . . a new trend for TV antennas! And Walsco introduces the *first* antenna with chromate-coated Magnesium cross-arms. Structural strength is almost equal to steel, and yet is 1/3 lighter than aluminum. Once you install, *that's all!* No costly call-backs that eliminate your profit. Chromate-coating assures positive corrosion resistance. Elements are made of high-conductivity, super-strength aluminum alloy, reinforced with Swiss "Permalum." Guaranteed sturdier, more dependable under severest weather conditions. Equipped with famous Walsco "signal director" and unbreakable insulator. Same high standards of Walsco crystal-clear TV reception.

*** NEW**
WALSCO
TV ANTENNA Model M

Once you install... that's all!

WALTER L. SCHOTT CO., 3225 Exposition Place, Los Angeles 18, Calif.

Branch: Chicago 6, Ill.

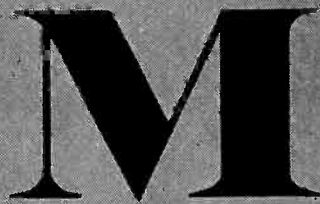
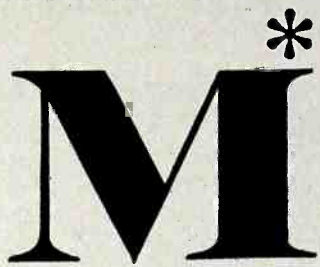

Structural strength
almost equal to steel

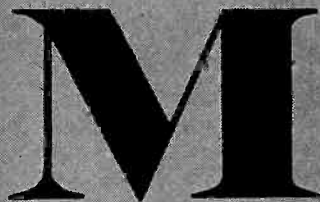

One-third
lighter than aluminum

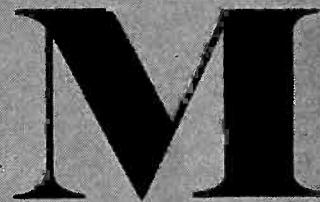

Chromate-coating for
positive corrosion resistance.

AVAILABLE AT PARTS JOBBERS EVERYWHERE

Model 4090 M—Single Bay —List \$ 9.25

Model 4092 M—Dual Array —List \$19.85

Model 4094 M—4 Bay Stack —List \$44.50

All prices without mast.

Walsco quality earned its reputation

WALSCO

To Standard Coil Post

Louis Martin has been appointed to the newly created post of general sales manager of Standard Coil Products Co., Inc. of Chicago, Los Angeles and Bangor, Michigan, announced Robert E. Peterson, vice-president in charge of sales.

CBS-Columbia Distributors

CBS-Columbia, Inc., has announced a new list of distributors for the CBS-Columbia line of TV and radio receivers: Callander-Lane Co., Columbus, Ohio; Lack's Wholesale Distributors, Houston, Texas; Maletio Electric

Supply Co., Dallas, Texas; General Radio & Electronics Co., Wilkes-Barre, Pa.; Appliance Distributors, Denver, Colo.; Montana Electric Supply, Billings, Mont.; Electric Supply Co., Albuquerque, New Mexico.

New Javex Reps

Javex, Garland, Texas, has announced that it has appointed two more manufacturers' representatives for its line of high voltage test equipment and radio and TV hardware. The new reps are: Herb Erickson Co., 201 N. Maine St., Hendersonville, N.C., and Fred H. Larrabee Co., 6033 Main St., Kansas City, Mo.

Motorola UHF

Some 35 Motorola distributors, distributor salesmen and regional and factory personnel recently viewed actual UHF telecasts brought in by Motorola's new UHF adapter. Host was Peter J. Carr, president of Post & Lester Company, Hartford, Connecticut, Motorola distributor.

RCA Service Co. Has New Protection Plans

Two new service plans have been announced by the RCA Service Company. One plan provides protection on the kinescope alone, for one year, for \$5.00 (on a 17-inch tube). The second plan covers complete installation, instruction, parts and tube coverage, and one service call during the year, for \$24.50 for a 17-inch set with built-in antenna. Additional service during the year will be charged at a flat rate of \$3.95 per job, if set is brought in, and \$5.95 in the home. With standard outdoor antenna installation, the cost of the plan for a 17-inch set is \$49.50.

Named Thomas Sales Rep

Robert E. Burrows, general sales manager for Thomas Electronics, Inc., Passaic, N. J., producer of Thomas Phototron TV picture tubes, has announced the appointment of the Les A. Morrow Company of Cleveland, Ohio, as sales representative for Thomas.

Emerson Fall Campaign

Newly developed "Area Engineering" is the standout feature of the Fall promotion campaign which has been announced to distributors by Gerald Light, sales promotion manager of Emerson Radio and Phonograph Corporation, 111 Eighth Ave., N. Y. 11. He advised that the promotion has been created to educate the consumer and dealer on the design-development field-engineering of Emerson TV receivers.

To Krich-N.J. Sales Post

Frederic M. Comins has been appointed vice-president in charge of sales for Krich-New Jersey, Inc., 428 Elizabeth Ave., Newark, exclusive New Jersey distributors of RCA Victor products, it was announced by Max H. Krich, president.

Web-Cor Predicts High Recorder Sales

W. S. Hartford, vice-president in charge of sales of Webster-Chicago Corp., said recently that the magnetic recorder is rapidly outgrowing the status of a limited-volume special-purpose product and promises to become the next mass-market item in many retail stores. Hartford attributed this coming wide appeal to the many uses to which the magnetic recorder can be put.

"CONICAL-V-BEAMS"

REGISTERED TRADE MARK

Keep in Step WITH ANTENNA PROGRESS

-INSTALL *Telrex* "CONICAL-V-BEAMS"

for finer TV performance in every type of signal area!



Near or far, you can rely on Telrex "Conical-V-Beams" for full audio and video bandpass, high gain and high signal to noise ratio. Telrex quality of construction assures a lasting installation, full customer satisfaction and a minimum of service callbacks. Don't settle for less than the best! Check with Telrex on your next antenna requirements. Write for latest catalogs.



TELREX MODEL 8X-TV Famous for high gain. Will out-perform any other type antenna. "If the 8X-TV does not provide a usable signal, TV reception is impractical."

"CONICAL-V-BEAMS" are produced under Re-issue Patent No. 23,346
CANADIAN AND FOREIGN PATENTS PENDING

THE SKILL TO DESIGN...
THE FACILITIES TO PRODUCE...
THE ABILITY TO DELIVER



CONICAL-V-BEAMS

AMERICA'S STANDARD OF COMPARISON

ASBURY PARK 2, NEW JERSEY

Raytheon Price Changes

TV price adjustments designed to eliminate the practice of marking up parts warranty charges in order to compensate for close or loss pricing on sets were announced for Raytheon TV sets by Belmont Radio Corp., Chicago. The company's announcement pointed out to distributors that shortage of TV sets due to the government's increasing curtailment of strategic materials are again developing and that the outlook for the first quarter of 1952 is serious.

The new suggested retail price list for Raytheon's TV line, including federal excise tax and one-year parts warranty, is as follows: M-1626, \$219.95; M-1711, \$249.95; M-1712, \$249.95; M-1725, \$279.95; M-2007, \$299.95; M-2008, \$309.95; C-1714, \$329.95; C-1715, \$359.95; C-1724, \$349.95; C-2001, \$399.95; C-2002, \$469.95; C-2006, \$379.95; RC-1718, \$449.95; RC-1720, \$369.95; RC-2005, \$750.

Hallcrafters CONTINENTAL

Recently announced home radio model, the Continental, is shown here being admired by Rollie Sherwood (left) vice-pres., and W. J. Halligan, Jr. (right) radio sales manager of the Hallcrafters Company. At \$39.95, the set

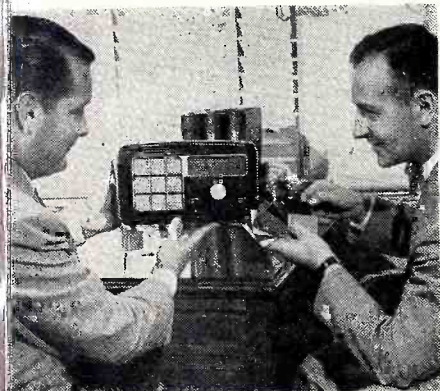

carries the lowest price tag in the firm's line. Provides short-wave and standard broadcast bands, is available in five colors, black, blue, gray, tan, and green. Case is plastic. The Hallcrafters Company, 4401 W. Fifth Ave., Chicago 4, Ill.—RADIO & TELEVISION RETAILING.

Motorola NEW TV SETS

A 14-inch portable television set, and five others with 17 and 20-inch tubes, have been added to the 1952 line by Motorola. Portable is in wood cabinet covered in simulated leather. List price is \$199.95, model number is 14Pl. A mahogany table model, 20T3, is \$279.95; in limed oak, 20T3B, \$299.95. A console model in mahogany, 20K6, lists for \$339.95; in limed oak, 20K6B, \$359.95. New combination model in mahogany, 17F11, lists at \$399.95. All new models are available with built-in UHF all-channel tuner for an additional \$40. A UHF adapter unit can also be purchased as an accessory for \$49.95 which can be installed by set owner. Motorola, Inc., 4545 Augusta Blvd., Chicago 51, Ill.—RADIO & TELEVISION RETAILING.

Joins Oxford Electric

John J. Proctor, Jr., general sales manager of Oxford Electric Corporation has announced the appointment of V. E. Wolfgang, Jr., to its sales department.

Advisory Panel Set Up

The Joint Electronics & Radio Committee on Service, 158 N. 20th St., Phila. 3, Pa., has announced the establishment of a technical education advisory panel, composed of the service managers of contractors, dealers and distributors in Philadelphia. Panel will determine what educational projects are needed by TV technicians.

To Distribute Du Mont

The Bock Corporation, 2133 Cedar Springs Avenue, Dallas, Texas, has been appointed distributor for Du Mont television receivers in the Dallas-Fort Worth area, Ernest A. Marx, general manager, receiver sales division, Allen B. Du Mont Laboratories, Inc., has announced.

Ampro Names Weiss

Arthur Weiss has been appointed Ampro sales representative to serve dealers in the New England territory, according to an announcement by Howard Marx, vice-president and general sales manager of Ampro Corp., 2835 N. Western Ave., Chicago 18, Ill.

Now BLONDER-TONGUE BRINGS YOU FOR THE FIRST TIME IN TV HISTORY

An ALL-CHANNEL MASTER ANTENNA SYSTEM that YOU can install—in a matter of minutes—that is guaranteed to out-perform any other system.

...AND AT THE LOWEST COST!

NO Special connectors
NO Matching transformers
NO Engineers
NO Individual channel equipment

Distribution Amplifier
8 TV Outlets at Lowest Cost



Model #DA8-1-M
\$87.50

Model #DA8-1-M Distribution Amplifier

Full electronic isolation (min. 35db. between outlets). Amplifies as it distributes... Variable Gain Control. No signal loss. Automatic All-Channel transmission. Ordinary screw terminals assure faster, simpler installation.



MODEL #DA2-1-M
List Price \$39.50
Distribution Amplifier
2 TV Set Outlets



Model #CA-1-M. List Price \$77.50. Commercial Antensifier (30 Times Gain). Use As Pre-Amplifier, Line Amplifier or de-luxe Booster.

Combine these B-T units to serve up to 2,000 TV sets from 1 antenna.



Literature on Request write Dept. F-1
Mt. Vernon, N.Y.

Model #HA-2-M
HOME ANTENSIFIER — Fully automatic, all-channel TV booster. 16 times gain. In metal cabinet. 57.50

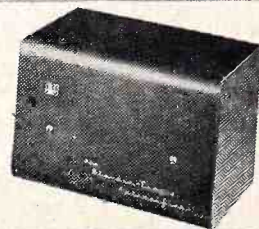

NEDA Appointments

Announcements by George Wedemeyer, president of the National Electronic Distributors Association include that of Aaron Lippman, Aaron Lippman & Co., Newark, N. J., as chairman of the 1952 NEDA Convention. Also announced was the appointment of V. N. Zachariah, Zack Radio Supply, San Francisco, Calif., to the board of directors of the Radio Parts & Electronic Equipment Show, Inc.

Elected officers of the Southern California Chapter are as follows: president and director, R. V. Weatherford, R. V. Weatherford Co., Glendale, Calif.; secretary-treasurer, Edward E. Spigel, Radio Equipment Distributor, Los Angeles.

St. Louis Chapter has announced the election of Owen Griffith, Van Sickle Radio Co., St. Louis, Mo., as president and director of the chapter.

Sylvania Names Penfield

Robert Penfield has been promoted to the position of advertising and sales promotion supervisor of Sylvania Electric Products. Penfield was formerly editor of the Sylvania house organ "Sylvania News." C. J. Luter has been named to the post formerly held by Penfield.

New Products for Dealers

Kenwood PARAPET MOUNT

Model 108 parapet mounting bracket accommodates TV antenna masts up to 1 1/2" in diameter. It consists of a frame with four claw-like members which clear the coping and extend to the wall. A set screw on each clamp makes positive contact with the wall. Walls up to 1 3/4 inches in thickness can be covered by the bracket, which is individually packaged and shipped complete with all hardware. Kenwood Engineering Co., Inc., 265 Colfax Ave., Kenilworth, N. J.—RADIO & TELEVISION RETAILING.

Precise DE LUXE VTVM

Among the features of the new model 907 VTVM are a 7 1/2" meter for better visibility and accuracy, and the fact that it can be built either horizontally or vertically to meet any requirements. Ranges include AC, DC and minus DC from 0-1000 volts in 5 ranges, ohms from .01 to 1 billion in 5 ranges, and DB from -20 to +55. Accessory probes (extra) increase range to 250 MC and 30 KV. Dealer net is \$38.98 kit and \$57.98 wired. Precise Development Corp., Oceanside, L. I., N. Y.—RADIO & TELEVISION RETAILING.

United SHIELDED LEADS

Type S "Klipzon" shielded leads are designed with proportioned air and polyethylene dielectric for low capacitance and losses even at UHF and without sacrifice of durability and flexibility.



The leads are supplied in three foot lengths and with approximate OD of 9/32" and have a maximum capacity of 25 mmfd. Color coded "Mini-Prod" connectors are provided at the ends. United Technical Laboratories, Morristown, N. J.—RADIO & TELEVISION RETAILING.

Precision MOLDED SELENIUMS

All ratings up to 200 ma.DC in the "Plasticel" line of miniature selenium rectifiers are molded in similar to small tubular condensers. The outer case is spiral-wound phenolic tubing filled with wax, and pigtail leads of bare or in-

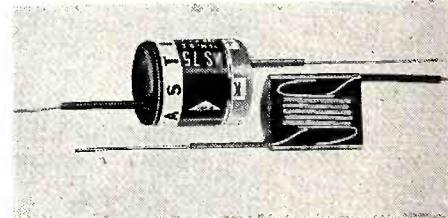

sulated tin-copper are provided. In ratings from 250-500 ma.DC the standard open-plate construction is used. Both molded-in and open stacks are made to a standard equivalent to 130 VAC into a condenser. Precision Rectifier Div., Electronic Devices, Inc., 429 12th St., Brooklyn, N. Y.—RADIO & TELEVISION RETAILING.

Clinton PHONOS

A new line of record players and combinations has been announced. Shown here is the model 400 deluxe radio-phono combination. The line in-



cludes single speed players, 3-speed manuals, 3-speed automatics, open-face models and transcription players as well. Clinton Radio and Phonograph Corp., 103 Lafayette St., New York.—RADIO & TELEVISION RETAILING.

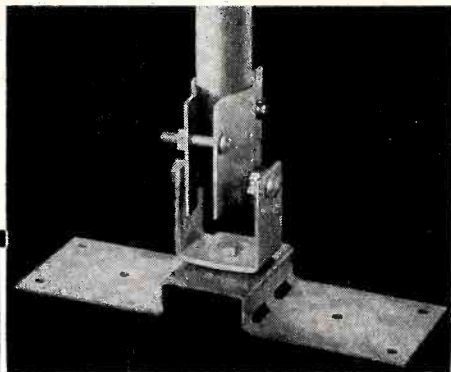

Pat. applied for

A ONE-MAN JOB

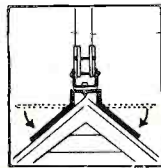

Do it the Easy, Low Cost Way!

USE THE

WAMCO

#177

UNI-BASE

Real one-man mounting—fits any surface—flat, gable or ridge—only 3 parts and 4 bolts—360° rotation—Full hinge action for raising mast and guying—strong, durable, rust-resistant. Packed—in carton. List Price, \$3.25. Single sample \$1.95 postpaid. See your local distributor or use coupon below.

Walnut Machine Co.
1529 South Walnut St.
South Bend 14, Ind.

Kindly send me (state how many)
WAMCO #177 UNI-BASES, at \$1.95.

Name

Street

City Zone State

WALNUT MACHINE CO.

1529 South Walnut Street

South Bend 14, Indiana

Joins Regal Electronics



Murray Weinstein, above, consulting engineer in the radio-TV industry, is now associated with Regal Electronics Corp., New York, manufacturer of Regal TV sets and radios, according to an announcement by Walter Spiegel, president.

Shallcross Expansion

A building program by the Shallcross Manufacturing Company, Colingdale, Pa. now nearing completion includes a new wing on the main factory building; expansion of the firm's instrument laboratory, and separate quarters for a large component development laboratory. President John S. Shallcross reports a substantial increase in production during recent months and, with completion of the present expansion program, anticipates still further progress.

Names Three Sales Reps

Richard Mayerson, jobber sales manager of RAM Electronics Sales Company, has confirmed the appointment of the following Reps: Henry Lavin, Meriden, Connecticut; Murphy & Cota, Atlanta, Georgia; and Lawrence Elliot Co., Cleveland, Ohio.

Cleveland Homes to Have TV Antenna Systems



Sherwood Forest, a 250 home development being constructed in Euclid, Ohio, will feature a multiple built-in TV outlet system installed as part of the initial wiring contract. The system, manufactured by the Brach Div. of the General Bronze Corp., consists of a single TV antenna, a 4-outlet distribution unit, and 4 concealed TV outlets. Shown above reviewing the installation are (left to right) Roy M. Howard, Midwest Sales (Brach midwest representative); Benton Leffon, president of the development; Herbert Farr, Jr., president, Pioneer Radio Supply Co., Cleveland (Brach distributor); and standing, Ira Kamen, director of television sales, Brach Mfg. Corp., Newark, N. J.

New Du Mont Sales Rep

Elliott Equipment Co., 712 Sixth Ave., South Minneapolis, Minn., has been named sales representative for the cathode-ray tube division, Allen B. Du Mont Laboratories, Inc., Bill C. Scales, the division's general sales manager announced.

Jensen "Viking" Speakers

Formerly a "Jensen" private brand line for low cost replacement purposes, Viking loudspeakers are now being identified by the phrase "Viking by Jensen" according to an announcement by Ralph P. Glover, product mgr. of Jensen.

Named Distributor Mgr.

The J. E. Miller Co., Inc., 5748 Baum Blvd., Pittsburgh 6, Pa., distributors for Philco and Horton products in western Pennsylvania, recently announced the appointment of John F. Laxton as manager of the parts department.

To Motorola-N. Y. Post

Appointment of Harry Schecter as field sales manager of Motorola-New York, Inc., has been announced by Nathan Cooper, president of the New York radio and television distributorship.

The New Precision Engineered OAK BOOSTER! for TV-FM by OAK ELECTRONICS \$39.95

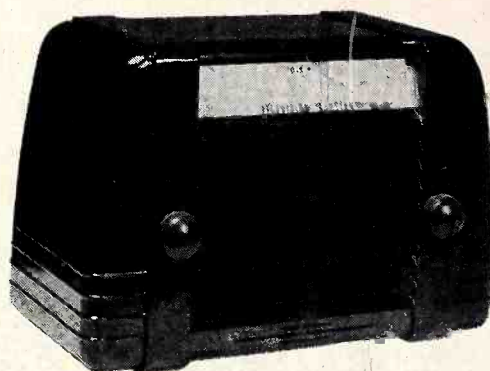

▲ KNOB DOES IT:

The booster that finally satisfies your demands by succeeding where others have failed. The OAK BOOSTER uses Mallory INDUCTUNER (same as used in Dumont, Crosley and Stromberg Carlson TV sets) in a newly engineered circuit on which patent is pending. Provides variable bandwidth to control adjacent channel interference and reduce noise to a minimum. Uses new "Q" multiplier circuit to increase gain enormously.

- A. Turns on Booster & TV set.
- B. Changes "Q" of circuit from 50 to 300 thru new "Q" multiplier circuit (See May "Electronics")
- C. Varies bandwidth from 0.5 MC. to 12 MC.
- D. Allows gain to be controlled from a low value comparable to any other booster, to a high value no other booster can match.

Other boosters use this knob only for On-Off switch, or to switch from low to high channels. OAK REALLY USES THIS KNOB.

- ✓ Highest gain of any booster
- ✓ Dual Input
- ✓ Dual Output
- ✓ Gain adjustable from front knob
- ✓ Automatic On-Off
- ✓ Variable bandwidth controllable from front panel

Only Oak has all the features that count

| FEATURES | BOOSTER CHECK LIST | | | | | | |
|---|--------------------|-----|-----|-----|-----|-----|-----|
| | Oak Booster | A | B | C | D | E | F |
| Automatic On-Off | Yes | Yes | Yes | No | No | No | No |
| Variable Bandwidth | Yes | No | No | No | Yes | No | No |
| Amplifies Fm | Yes | Yes | Yes | No | No | No | Yes |
| 75 or 300 Input | Yes | No | No | No | No | No | No |
| Variable Sensitivity | Yes | No | No | No | No | No | No |
| Highest Gain 2-6 | Yes | No | No | No | No | No | Yes |
| Highest Gain 7-13 | Yes | Yes | Yes | No | No | No | Yes |
| 75 or 300 Output | Yes | Yes | Yes | No | No | No | No |
| Widest bandwidth of any booster | Yes | No | No | No | No | No | No |
| Square Wave Type Band Pass Characteristic | Yes | Yes | No | Yes | No | Yes | No |

No untuned boosters are rated, as performance is not equal to any tunable boosters.

Order Oak Booster from your jobber today

SALES REPRESENTATIVES

- Atlanta, Ga. — HENRY BURWELL Co.
- Chicago, Ill. — JEROME KLEKER Co.
- Cleveland, O. — EDWARDS & LOHSE
- Fort Wayne, Ind. — WALTER BIBERICH
- Houston, Tex. — H. H. WILLISON
- Los Angeles — CARL A. STONE ASSOCIATES
- New York City — BURLINGAME ASSOCIATES

Write for specifications and discounts

OAK ELECTRONICS
150 Oak Street, Buffalo, N. Y.

RCA Victor Names Boss

William E. Boss, formerly field sales representative in upstate New York for the RCA Victor Home Instrument Department, has been appointed staff assistant to J. B. Elliott, vice-president in charge of the company's consumer products.

Astron Expansion

To meet the increased demand for its complete line of capacitors and RF interference filters, Astron Corporation, 255 Grant Avenue, East Newark, N. J. has consummated a long term lease for additional space which virtually doubles production facilities.

JFD Appoints Spiro

Frank K. Spiro has been named assistant advertising manager of the JFD Manufacturing Company, 6101 Sixteenth Ave., Brooklyn, New York, producers of TV antennas and accessories.

Visit Capehart Plant

Five representatives of the Argentina State Telephone System (Telefonos del Estado) arrived in Fort Wayne to visit the Capehart-Farnsworth Corporation and view its TV manufacturing facilities on the same day television was inaugurated in Buenos Aires.

Waldorf-Astoria Installs Master TV System

An elaborate TV distribution system is operating now in the Hotel Waldorf-Astoria in New York City. Designed by RCA engineers and Master Video Systems, Inc., it provides ghost- and snow-free reception on the seven TV channels, in addition to closed circuit TV, for all of the hotel's private rooms and for its public meeting rooms. In the meeting rooms up to 200 sets may be installed by simply plugging them in and making appropriate connections at the distribution panel in the control room. Closed circuit TV is available between any of the meeting rooms so that people in more than one room may see demonstrations, speakers, or people in other rooms.

TV signals are picked up on the roof by 7 yagi antennas, cut individually for each channel. Each channel signal is amplified separately, sent to one of the distribution points amplified again, combined with the other signals, and sent out to the separate rooms.

Du Mont Vice-President

Rear-Admiral Stanley F. Patten, U.S.N. (Ret.) has been elected vice-president of Allen B. Du Mont Laboratories, Inc., by the board of directors, it was announced by Dr. Allen B. Du Mont, president of Allen B. Du Mont Laboratories, Inc. Admiral Patten has been with the Du Mont organization as assistant to the president since July, 1947.

Circle-X Round up

The Circle-X Antenna Corp., 500 Market St., Perth Amboy, N. J., has opened a hundred thousand dollar sales campaign with incentive merchandise ranging in price from several hundred dollars to a few dollars to all jobber salesmen to promote the sale of Circle-X antennas. The campaign is known as the Circle-X Round Up.

Raytheon Service Method

A new approach to service of TV sets has been announced by the Belmont Radio Corp., makers of Raytheon television. It features a service manual and presentation that direct TV servicemen to the picture for their clues to circuit troubles. Titled "How to Interpret What You See," the presentation has carried its message to 850 TV technicians in Philadelphia and Chicago.

Tacoplex Antenna Systems

Lincoln, Nebraska, a relatively small city of 100,000 people now boasts 17 Tacoplex master antenna systems installed in apartment houses, according to Louis Leuck of Leuck Radio Supply, the local Taco jobber.

**ANSWERS YOUR
PILLOW
SPEAKER
PROBLEM!**

**PICTURED IN
ACTUAL SIZE!**

3" diameter, 7/8" thick

A compact speaker-microphone with a thousand uses that makes your product more saleable.

The Wright-Zimmerman Model 300 Dynamic Reproducer is virtually indestructible, attractively styled and light as a feather. Ideal for personalized pillow speaker use with excellent tone and as a dynamic microphone.

Protected under Patent #2523802—
Other Patents pending

**NEW PATENTED
MODEL 300
DYNAMIC
PILLOW SPEAKER**

**Wright
Zimmerman Inc.**

NEW BRIGHTON, MINN.

New Rider Books

"TV and Electronics as a Career," a new book by Ira Kamen and Richard H. Dorf, published by John F. Rider Publisher, Inc., 480 Canal St., New York, N. Y., is now available at the publisher's distributors. Engineering, broadcasting, manufacturing, servicing, parts and receiver distributing, sales representation, retailing, and electronics in the armed forces are discussed. Written in an easy-to-read style, "TV and Electronics as a Career" contains 325 pages with 136 illustrations and is priced at \$4.95.

Volume 22 of the AM-FM service data series has been shipped to distributors, and covers productions for the period November 1950 through August 1951. The latest manual contains 1520 pages covering AM-FM receivers, auto radios, record changers, and disc and tape recorders of 62 manufacturers. It is priced at \$18.00.

Also announced is the "First Supplement, Receiving Tube Substitution Guide Book," by H. A. Middleton. Maintaining the same popular format used in the original edition of this Rider publication, the first supplement lists approximately 700 new radio-TV tube substitutions. Accompanying wiring instructions and illustrations further simplify the accomplishment of substitutions. All individuals and organizations faced with depleted tube stocks and the problem of tube allocation and shortages in the near future will find this book an indispensable tool. The First Supplement contains 48 pages and is priced at 99 cents.

Tricraft Names Potashnik

Tricraft Products Company has announced the appointment of Lou Potashnik as sales manager. The Tricraft Products Company, manufacturer of antennas and accessories, is located at 1535 North Ashland Avenue, Chicago 22, Illinois.

Stocks Oxford Speakers

Oxford Electric Corporation, 3911 S. Michigan Ave., Chicago, manufacturers of Oxford speakers, has made arrangements with Perlmuth-Colman & Associates, West Coast sales representatives organization to maintain a complete stock of speakers in the PCA Los Angeles warehouse.

New TV-"Q" Location

TV-"Q" Custombuilt Corporation, manufacturers of TV picture tubes, has acquired a new building at 170 Fifth Avenue, Hawthorne, N. J., as part of an expansion program, it has been announced by Victor E. Havers, president. Executive and administrative offices will be located in the new plant, which also adds much factory space. The plant totals more than 5000 sq. ft. of floorspace.

New JFD Sales Rep

The appointment of Albert M. Solen of 1225 East 17th Avenue, Denver, Colorado as Rocky Mountain area and El Paso, Texas, representative of the JFD Mfg. Co., Brooklyn, New York was announced by Edward Finkel, JFD sales manager.

Rep Firm Expands

Harry Estersohn, manufacturers' representative at 395 East Cliveden St., in Philadelphia has announced the addition of Lester Brown to his organization. Concurrently the name of the organization is being changed to Harry Estersohn & Co.

Stromberg Division Moves

The Sound Equipment Division of the Stromberg-Carlson Company has announced that it has moved to a new address: 1225 Clifford Ave., Rochester 21, New York. The move to the larger, remodeled plant makes new and better facilities available to the division.

Oak Appoints Paul

Appointment of Lawrence O. Paul as operating manager of the engineering department of Oak Mfg. Co., 1260 Clybourn Ave., Chicago, Ill., was announced by Robert A. O'Reilly, president.

OAK RIDGE CRT TESTER



"CATHETTE"

is the **ONLY** CRT Tester*

that checks **ALL** the following:

- HIGH VOLTAGE BREAKDOWN
- BEAM CURRENT MEASUREMENT
- ELECTRON GUN CONDUCTANCE
- SHORTS BETWEEN ANY ELEMENTS

*Pat Applied For

Plus these additional features:

- Checks gas between elements in Electron Gun
- Checks gas between High Voltage Anode and Electron Gun
- Checks conductance between Cathode, Control Grid, and Screen Grid
- Checks filament continuity
- Checks high voltage on Anode
- Checks Screen to Control Grid voltage from set
- Checks Control Grid to Cathode voltage from set
- Checks leakage
- Tests and positions Ion Trap
- Checks brightness control voltage
- Easy-to-read calibrated DC Voltage scales (0-500V, 0-15KV)
- Easy-to-read tube test scales
- Supplied with duo-decal plug and socket. (Special adaptors available as accessories)
- Pocket size: 5 1/2 x 3 7/8 x 2 1/4". Shpg. wt. 3 lbs.

Ask to see this **INDISPENSABLE** new tool at your nearest jobber. You'll agree that it's a **MUST** for every TV Serviceman today! **\$29⁹⁵**

MODEL 108 POWER SUPPLY (Pocket Size, same as above), used in conjunction with Cathette CRT Tester, permits testing of Picture Tubes in carton! **\$19⁹⁵**

Send **NOW** for your copy of our complete new catalog, illustrating and describing the above equipment, as well as all other OAK RIDGE TV Test Instruments.

Cable Address: "UNIONTEX" N.Y.



OAK RIDGE PRODUCTS

37-01 Vernon Blvd., Long Island City 1, N. Y.
Mfg. Division of VIDEO TELEVISION, INC.

OAK RIDGE PRODUCTS, Dept. RR
37-01 Vernon Blvd., Long Island City 1, N. Y.

Please send your complete new OAK RIDGE Catalog at once, to:

Name

Address

City..... State.....

NEW! STANCOR



Here are three of the newest additions to the most complete transformer replacement line in the industry.

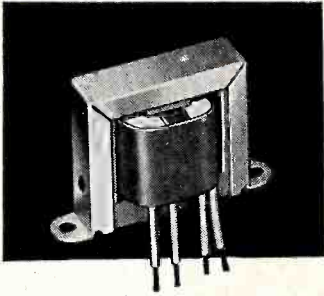

A-8124, VERTICAL BLOCKING-OSCILLATOR TRANSFORMER

A three winding transformer for replacement in 7 Dumont models, 9 Crosley models and Stromberg-Carlson model TV-125. See Stancor Bulletin 384.

For use with picture tubes up to 24". Equivalent to RCA 202D2. See Stancor Bulletin 383.

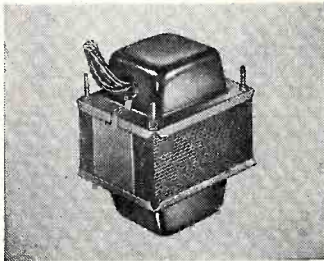

FC-11, FOCUS COIL

P-8163, TV POWER TRANSFORMER

Equivalent to RCA 75508 (971316-1), used in 28 RCA models. See Stancor Bulletin 388 for a complete list.

Other new Stancor TV components include **DY-8**, **DY-9**, and **DY-10**, 70° deflection yokes with ferrite cores, nylon coil bobbins and anti-astigmatic focusing (resulting from "cosine" distributed windings) for tubes up to 24". **A-8131**, an air core "flyback" for direct drive circuits, to be used with **DY-10**.

Your Stancor distributor has data sheets on these new Stancor TV transformers. Ask him for the latest Stancor Bulletins.

STANCOR TV TRANSFORMER CATALOG AND REPLACEMENT GUIDE lists transformer replacements for over 1500 TV models and chassis. Available **FREE** from your Stancor Distributor.



STANDARD TRANSFORMER CORPORATION

3586 ELSTON AVENUE, CHICAGO 18, ILLINOIS

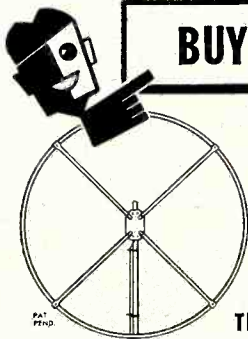

BUY A BETTER ANTENNA

It's Circle-X for clear, sharp pictures on all channels, compare it and note the superiority . . .

Buy Circle-X chimney mounts, twin lead, guy wire, ground rods, wrenches, etc.

TRY A CIRCLE-X ON YOUR NEXT INSTALLATION

Air express or parcel post, special delivery direct from factory to you through your distributor.

CIRCLE-X ANTENNA CORP.
511 MARKET ST., PERTH AMBOY, N. J.



Sams Appoints Renner

Howard W. Sams, president of Howard W. Sams & Co., Indianapolis, publishers of Photofact television and radio service and electronic technical manuals, has announced the appointment of W. D. Renner as manager of sales engineering.

New ITI Facilities

Industrial Television, Inc., 359 Lexington Ave., Clifton, N. J., has announced the completion of new development and test facilities at the Clifton, New Jersey, plant for VHF and UHF boosters, tuners, and converters. According to Horace Atwood, Jr., president, a newly completed shielded laboratory has been built.

Newcomb PHONOGRAPH

Recently announced model RC-12, 3-speed automatic phonograph model, features a 5-watt amplifier, AC only, Webster record changer, and 6 by 9 inch Alnico PM speaker. Operating panel in-

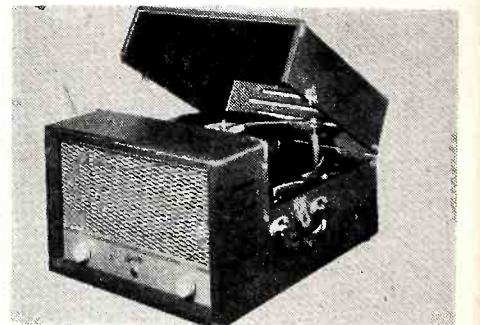

cludes tone control, volume control and pilot light. Carrying case is constructed of plywood, covered with fabricoid material. Newcomb Audio Products Co., 6824 Lexington Ave., Hollywood 38, Calif.—**RADIO & TELEVISION RETAILING.**

Kaye-Halbert TV COMBO

A new 20-inch television, 3-speed phonograph combination has been added to the line. List price is \$419.95 in walnut. Other models are available

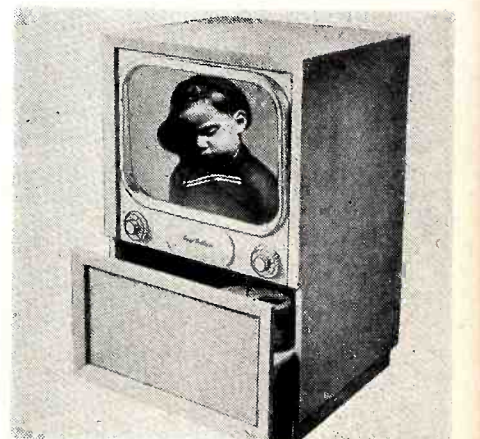

at slightly higher price. Phonograph is automatic, with automatic shutoff after last record has played. Kaye-Halbert Distributors, Inc., 5729 W. Jefferson Blvd., Los Angeles 16, Calif.—**RADIO & TELEVISION RETAILING.**

To Regional Sales Post



The appointment of Phillip J. Wood (above) as regional sales manager of the far southwestern area was announced by Edward L. Taylor, general sales manager of Stewart-Warner Electric, the radio and television division of the Stewart-Warner Corporation.

RSM Service Forums



Marty Bettan, above, sales manager for Radio Merchandise Sales, Inc., New York 59, N.Y., discusses theory, design and installation of television antennas and open-wire transmission line at the RMS technical service forums being held throughout the U.S. and Canada for TV jobbers and their customers.

RCA Victor Appointees



Seated around the table with L. S. Thees (center), general sales manager of the RCA Victor Tube Department, are four appointed to newly created posts as district managers for the company's renewal sales activities: W. H. Garrett, central district; W. H. Allen, eastern district; C. A. Brokaw, western district; and Victor Williams, southeastern district. Standing, from left, are H. F. Bersche, manager, RCA renewal sales section; W. L. Rothenberger, manager, sales operations; and L. J. Battaglia, manager of the renewal sales field force.

New Youngstown Booklets

Two new booklets on the Youngstown Kitchens Jet-Tower dishwasher, one for consumers and one for retail salesmen, are available to dealers. Consumers booklet is a four page folder in color which illustrates and describes features of the Jet-Tower. The ten section salesmen's booklet, "How to Sell Dishwashers," contains a note which offers \$5 for each idea on how to sell the Jet-Tower dishwasher.

"Attracto-Sales" Display

A new type of animated point-of-sale display unit called "Attracto-Sales" is being placed on the market by Victor Achison, president of the

Uni-Ventions Company, 303 Fifth Ave., N. Y. Unit features a 39 letter message, whose letters rotate in "scrambled" fashion, all falling in place at the same time to spell out the message.

GE Range Sales Aids

Two new point of sale displays designed to merchandise General Electric's "Stratoliner" range have been made available to distributors and dealers by the company. The first display features flashing lights which point up top Stratoliner features. The second display employs colorful circles against a bright orange background to list individual range features.

tops!
IN EYE APPEAL
IN EAR APPEAL

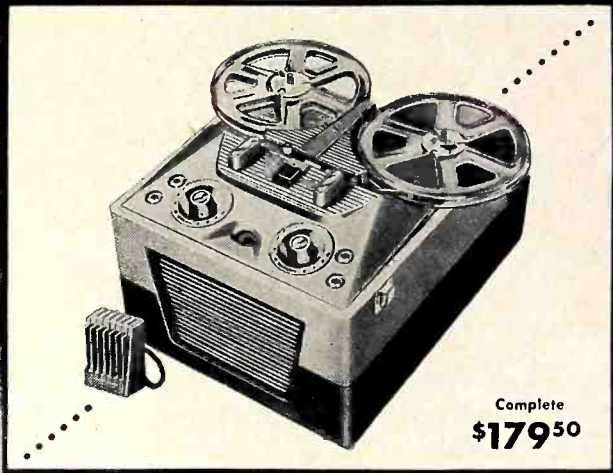

Complete
\$179⁵⁰

ALL *new* PENTRON TAPE RECORDER

The Smartly Styled New DUO-SPEED combines beauty with incomparable performance . . . the finest in portable recorders. Records anything, plays back instantly with a tone quality equal to the finest FM radio. Big market in homes, schools, churches and business. *Hurry! Be first to Profit . . . Send for Details Today!*

Weights Only 27 lbs. • 2 Hours Continuous Recording or Playback • Editing Key Corrects while Playing • Push-Button 3¼ and 7½" Speeds • Super-Speed Rewind and Forward • Automatic Amplifier Equalization in Either Speed • Available with Dual Track or Single Track Heads

**DUO-SPEED
 PENTRON
 TAPE RECORDER**

THE PENTRON CORP.

221-R EAST CULLERTON ST., CHICAGO 16, ILLINOIS

Name..... Street.....
 Firm..... City..... State.....

Celebrates TV Sales

J. Adam Frisch of 280 George Street, New Brunswick, N. J. celebrated the successful closing of a Stromberg-Carlson TV promotion by treating the personnel, whom he works closely with, of Gross Distributing Corporation, 49 Edison Place, Newark 2, N. J., to dinner at the Chanticleer, Milburn, N. J.

Viking Rotator

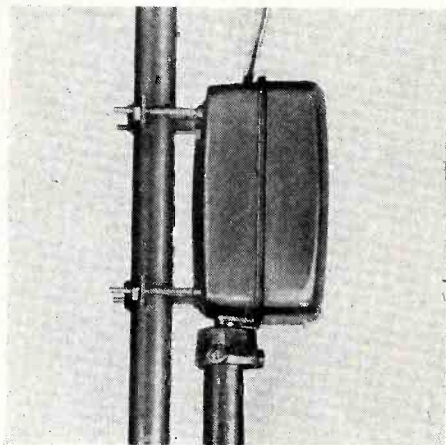

Powered by a simply designed impulse motor, this antenna rotator made by the Viking Tool and Machine Corp. of Belleville, N.J., assures full starting torque of 50 inch-pounds to give it maximum advantage in icy and adverse weather conditions. Unit comes with remote control box and is priced at \$34.95.

Emerson Show Window Contest Winners

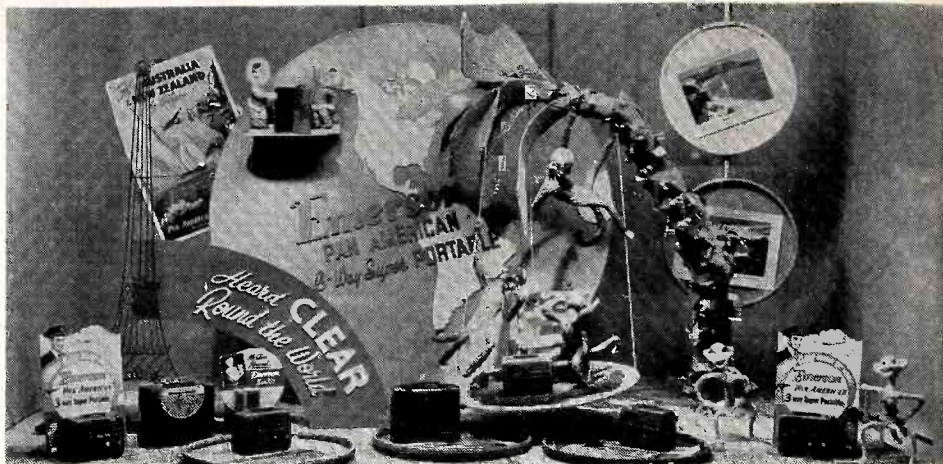

Window display, above, at A. Victor & Co., Buffalo, N.Y., won first prize for the eastern section in "Emerson-Pan American Portable" window display contest conducted by Emerson Radio and Phonograph Corp., N.Y. Four other first prizes, 7-day trips to Mexico for two, were won by Hay's Coshocton, Ohio; Webb's City, Inc., St. Petersburg, Fla.; Parker Music Co., Houston, Texas; and Raskin's, Oklahoma City, Okla.

Second prizes were awarded to: Stone & Thomas, Charleston, W. Va.; A. R. Blossman, Inc., New Orleans, La.; Brodkey Jewelry Co., Omaha, Nebr.; Power's Furniture Co., Portland, Ore.; Kapahulu Appliances, Honolulu, T.H.

Third prizes were awarded to: Montano Bros. National Electric Co., New Haven, Conn.; Kronenberg's, Inc., Hamburg, N.Y.; Railey-Milan, Inc., Miami, Fla.; South Center Dept. Store, Chicago, Ill.; Leilehua Motors, Ltd, Wahiawa, Oahu, T. H.

Westinghouse Names Brown

James L. Brown has been appointed sales manager for Westinghouse receiving tubes and cathode ray tubes, Harold G. Cheney, the company's electronic tube sales manager has announced.

To Distributor Ad Post

Franklin R. Davis has recently been appointed advertising manager of Arvin Distributors, Inc., 8 W. 30 St., New York 1, N. Y., distributors of Arvin radios, TV and home appliances for the metropolitan New York area.

Trav-Electric

MIGHTY MIDGET CONVERTER

2 1/2" x 2 1/2" x 3 1/2" Converts 6 volt D.C. to 60 cycle A.C. 40 Watts, 110 volts. Just plug in cigar lighter. Fully Guaranteed. Trav-Electric operates small Radios, Electric Shavers, Phonographs, Small Electric Soldering Irons, Small Dictating Machines. Popular with Salesmen, Truckers, Sportsmen, Service men.

Model 6-1160
List Price \$15.95





Trav-Electric Sales prove its popularity. Small inventory, good turnover, fine profit. Write for details today.

1000's in use
Attractive Discounts to Jobbers and Dealers

TERADO COMPANY

1068 Raymond Ave., St. Paul 8, Minn.

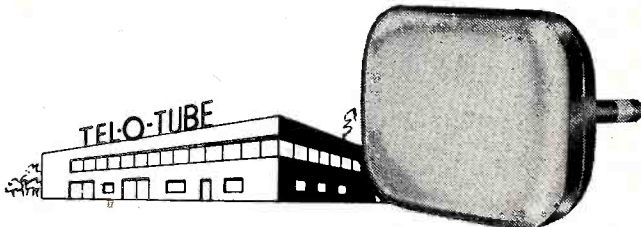

TEL-O-TUBE

The World's Finest Television Picture Tube

10 to 20 inches Round and Rectangular

Electrostatic Focus Tubes

Send Today For Complete Specifications

TEL-O-TUBE CORPORATION OF AMERICA

E. PATERSON NEW JERSEY

Sales Office: Tel-O-Tube Sales Corporation
580 5th Ave. New York 19, N. Y.

Sangamo General Manager



H. Lawrence Kunz, above, newly appointed general manager of the Sangamo Electric Company's capacitor division, located at Marion, Illinois. Kunz has been sales manager of the division for the past six years.

Named to Motorola-NY



William W. Cone (above) has been appointed vice-president in charge of sales for Motorola-New York, it was announced by William H. Kelley, general sales manager of Motorola Inc., Chicago television-radio-communications firm.

Magnavox Sales Plan

The Magnavox Co., Fort Wayne, Ind., has inaugurated a dealer sales plan built around 12 "Famous Magnavox Firsts" and 12 "Famous Magnavox Features." An integral part of the new merchandising program is a handy pocket-size salesman's guide to Magnavox "Firsts" and "Features." Lauren K. Hagaman, Magnavox director of advertising and public relations, points out that the merchandising plaques used are semi-permanent and with their built-in easel may be used on or near Magnavox sets.

GE DISPOSAL UNIT

Announcement has been made that GE will henceforth market a single garbage disposer model, available with or without a flow switch. Until now the company has sold two units, one with slightly larger waste storage capacity than the other, both equipped with the flow switch. The disposer with the flow switch, FA-4, lists at \$124.95; the unit without the switch, FA-14, lists at \$109.95. General Electric Company, Appliance Div., Bridgeport 2, Conn.—RADIO & TELEVISION RETAILING.

Profit
The Indoor Antenna for YOU
in '52

Model T-52*

List Price
\$9.95

- ▼ **Tops in performance**
- ▼ **Excellent reception on Hi and Lo bands**
- ▼ **No dangling, unsightly wires (lead wire is concealed)**
- ▼ **Two-toned leatherette blends with any TV set**
- ▼ **Creates "impulse buying" — sells itself!**

Sold through jobbers only!

Tricraft Products Co.
1535 North Ashland Ave., Chicago 22, Ill.

*Licensed by Hi-Lo TV Antenna Corp., U. S. Pat. No. 2,495,579; Canadian Pats. 1951

Manufacturers of complete line of Television, FM and AM antennas and accessories

THANKS
and
SEASON'S GREETINGS

These past weeks in the hospital have been made more pleasant by the countless messages, remembrances and visits we have received from friends far and near.

To all who have shown their interest we send our sincere thanks . . . it was so good of you!

Our best wishes and hearty Season's Greetings to all friends of ours and of Masco.

MARK & MIRYAM SIMPSON

Thousands sold . . . making possible a . . .

NEW LOW PRICE!

on the new **Tele-Tune** ★
TV BOOSTER ANTENNA

Greatly reduced price will give you a greater retail sales volume.

TERRITORIES STILL AVAILABLE FOR LIVE WIRE DISTRIBUTORS — WRITE!

CITY TOOL ACCESSORIES CORP. • 3831 W. Lake St. • Chicago 24

4
QUICK-SELLING FEATURES

- Vastly improves reception of television sets.
- Rejects and reduces "Ghosts," Noise and "Snow."
- Provides additional pickup.
- Enhances any room with its rich appearance.



VIBRATORS!

By every test

ATR

is Best!

**ATR
AUTO RADIO
VIBRATORS**

have Ceramic Stack Spacers



A COMPLETE LINE OF VIBRATORS . . .

Designed for Use in Standard Vibrator-Operated Auto Radio Receivers. Built with Precision Construction, featuring Ceramic Stack Spacers for Longer Lasting Life.

Backed by more than 19 years of experience in Vibrator Design, Development, and Manufacturing.

**ATR PIONEERED IN THE
VIBRATOR FIELD.**

**NEW MODELS NEW DESIGNS
NEW LITERATURE**

"A" Battery Eliminator, DC-AC Inverters
Auto Radio Vibrators

See your jobber or write factory

ATR

AMERICAN TELEVISION & RADIO CO.

Quality Products Since 1931

SAINT PAUL 1, MINNESOTA—U. S. A.

**Universal Major
Appliance Co. Formed**

Landers, Frary & Clark, New Britain, Conn., has announced the sale of the Universal electric range, washing machine and water heater business to a newly formed corporation, Universal Major Appliance Co. The new company was formed by Artkraft Mfg. Corp., Lima, Ohio, Baltimore Porcelain Steel Corp., Baltimore, Md., and Landers, Frary & Clark. For the past two years Artkraft has been producing Universal refrigerators under contract with Landers, Frary & Clark.

The new company plans to produce ranges and washing machines in the Baltimore, Md. plant, and refrigerators and home freezers at the Lima, Ohio plant.

Officers of Universal Major Appliance Co. are: Morton L. Clark, president; R. R. Trubey, board chairman; Harry Parsons, exec. vice-pres., sales; E. L. Farquharson, vice-pres., laundry equipment sales; Harry Payor, vice-pres., range and water heater sales; R. H. Money, vice-pres., engineering; Andrew R. Grierson, vice-pres., manufacturing; and George J. Madill, vice-pres. and works manager of the Lima plant.

IH Sales Top Quota

International Harvester Company has revealed that its recent refrigeration sales campaign went over its quota of 70,000 refrigerators and freezers with 115,665 sales—165.2 per cent of national quota.

Hotpoint TV Show

"Today's Teens" is a new weekly TV panel show being sponsored by Hotpoint, Inc., in the Chicago area to reach an age group that will become an important potential market for appliances. The program is seen each Friday evening over WENR for the benefit of the 367 Hotpoint dealers in the greater Chicago area.

To Maytag Sales Post

David B. Birrell, 108 Wyatt Drive, Rochester, New York, has been named a regional sales manager in charge of thirteen counties in New York state by The Maytag Company of Newton, Iowa, home laundry equipment manufacturer. Birrell will work under Charles B. Mason, manager of the Newark branch office.

GE Blanket Plan

A new "service-exchange" program for service complaints on General Electric automatic blankets has been instituted by the company. Under the plan, an owner of an inoperative GE blanket or blanket control takes it to the servicing dealer or distributor and exchanges it for a brand new unit. The plan covers all GE blankets manufactured since 1945.

Blackstone Distributors

Blackstone Corporation, Jamestown, New York, manufacturers of household washers, dryers, and ironers, announced the appointment of the Oberrecht-Harton Distributing Company, Roselawn Center Bldg., Cincinnati, Ohio, to distribute its products. They will replace the branches of Ohio Appliances, Inc. located in Cincinnati and Dayton. Also appointed as distributor is H. Schultz & Sons, 620 Market Street, Newark, N. J., which replaces E. B. Latham & Company.

Raytheon TV Promotion

A recent Raytheon television promotion staged by Belmont Distributor, Inc., in the Chicago area featured display of Raytheon TV sets in 120 A&P Food Stores and customers contests with Raytheon "Rockets," 17-inch table models, as prizes.

Arvin GRILL-WAFFLER

Introduction of a smartly streamlined and redesigned Letric Cook has been announced. By rounding off all exterior surfaces and edges, Arvin designers have succeeded in "streamlining" the appearance of the product, and at the same time conveying a visual effect of lower height. The full base on the older model has been replaced by "pontoon" type feet on two sides and elbow-shaped rests front and back executed in brown plastic. The Arvin trade name and a decorative swirl are engraved on the top. While apparently more compact, the new Cook, bearing model number 3550, is of the same large capacity with 190 square inches of cooking surface, an area, when opened flat, equal to that of three 10-

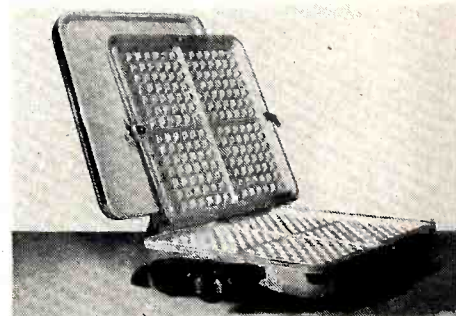

inch skillets. Closed, the Cook is twelve inches square and four inches high. Used as a Cook, the product grills, fries and toasts, and quickly converts to a fully automatic waffle baker with insertion of four aluminum waffle grids. All other features of the former model, including the signal light, drip spouts, enclosed expanding hinge that permits grilling thick cuts of meat on both sides at once, and handy sandwich spacers, are continued in the new model. The Cook operates on AC only, 110-120 volts, 1320 watts. The new model 3550 is being marketed at the same price carried by the former model and is designed to retail at \$29.95 complete with removable waffle grids. Arvin's 40% dealer discount applies to the new product. Arvin Industries, Inc., Electric Housewares Div., Columbus, Indiana.—RADIO & TELEVISION RETAILING.

The Largest Selling
LIGHTNING ARRESTER
At Any Price!

NO. AT102



APPROVED



Protects Home and TV
Set Against Lightning
Hazards **\$2.25** LIST
U.S. Patent No. D-4664

- Installs anywhere
 - No wire stripping, cutting or splicing
- (Complete with strap and ground wire.)
OVER 1,000,000 IN USE TODAY!
See Your Jobber or Write for
Form No. 84



JFD MANUFACTURING CO., Inc.
6103M 16th AVENUE, BROOKLYN 4, N. Y.
FIRST in Television Antennas and Accessories

INDEX TO ADVERTISERS

DECEMBER, 1951

| | |
|---|------------|
| Admiral Corp. | 5 |
| American Phenolic Corp. | 54, 55 |
| American Telephone & Telegraph Co. | 4 |
| American Television & Radio Co. | 94 |
| Anchor Radio Corp. | Cover 3 |
| Bendix Radio Television & Broadcast Receiver Division | 9 |
| Blonder-Tongue Labs. | 85 |
| Capehart-Farnsworth Corp. | 67 |
| CBS-Columbia, Inc. | 43 |
| Channel Master Corp. | 39 |
| City Tool Accessories Corp. | 93 |
| Circle-X Antenna Corp. | 90 |
| Commercial Credit Corp. | 12 |
| DuMont Labs., Inc., Allen B. | 10, 65 |
| Eicor, Inc. | 14 |
| Electro-Voice | 11 |
| Emerson Radio & Phonograph Corp. | 37 |
| General Electric Co. | 58, 59, 75 |
| General Industries Co. | 40 |
| Hallicrafters Co. | 63 |
| Hytron Radio & Electronics Co. | Cover 2 |
| Jensen Industries, Inc. | 33 |
| JFD Mfg. Co., Inc. | 95 |
| LaPointe-Plascomold Corp. (VEE-D-X) | 72, 77 |
| Motorola, Inc. | 2, 3 |
| Neal Products Co. | 96 |
| Oak Electronics | 87 |
| Oak Ridge Products | 89 |
| Oxford Electric Corp. | 76 |
| Peerless Products Industries. | 95 |
| Pentron Corp. | 91 |
| Philharmonic Radio & Television Corp. Radio Corp. of America | 34 |
| 20, 21, 49, 81, Cover 4 | |
| Rauland Corp. | 69 |
| Raytheon Mfg. Co. | 73 |
| Raytheon Television | 15 |
| Regency Div., I.D.E.A. | 8 |
| Sangamo Electric Co. | 50 |
| Sarkes Tarzian, Inc. | 80 |
| Schott Co., Walter L. | 83 |
| Sentinel Radio Corp. | 6 |
| Sheraton Television Corp. | 41 |
| Simpson Electric Co. | 35 |
| Simpson, Mark & Miryam. | 93 |
| South River Metal Products Co., Inc. | 96 |
| Sparks-Wifthington Co. | 38 |
| Standard Transformer Corp. | 90 |
| Stromberg-Carlson Co. | 16 |
| Sylvania Electric Products, Inc. | 45, 79 |
| Tel-A-Ray Enterprises, Inc. | 74 |
| Tele King Corp. | 47 |
| Tel-O-Tube Corp. of America. | 92 |
| Telrex, Inc. | 84 |
| Terado Co. | 92 |
| Thomas Electronics, Inc. | 7 |
| Trade Associates, Inc. | 95 |
| Tricraft Products Co. | 93 |
| Triplett Electrical Instrument Co. | 71 |
| T.V. Wire Products | 96 |
| TV "Q" Custombilt Corp. | 82 |
| Walnut Machine Co. | 86 |
| Webster Electric Co. | 78 |
| Workshop Associates | 70 |
| Wright Zimmerman Inc. | 88 |
| Zenith Radio Corp. | 13 |

While every precaution is taken to insure accuracy, we cannot guarantee against the possibility of an occasional change or omission in the preparation of this index.

The Name ...
SUPERTUBE

On New or Rebuilt
CATHODE RAY TUBES
Means ...

Full 18-Month Guarantee

Hold your service customers for 18 months with the SUPER TUBE Guarantee.

EVERY SUPERTUBE IS INDIVIDUALLY PROCESSED AND CHECKED AFTER EACH OF ITS 20 MANUFACTURING OPERATIONS—NOT MASS PRODUCED.

Write for details and prices

Manufacturers
and
Distributors



of
Electronic
Equipment

TRADE ASSOCIATES INC.

128 So. 1st St., Brooklyn 11, N. Y.
Phone EVERgreen 8-9720

Improve Your TV Picture

with
GOLDEN WAND



Order from your Wholesaler

TWO MODELS
Model 50TV
Model TG84
(shown)
\$6.95 list

GOLDEN WAND Indoor TV Antennas produce a better, clearer picture with any TV receiver because of their carefully engineered low-loss design. Admiralty brass dipoles with jamless action and perfect electrical connections at all joints—Polystyrene insulators—terminals and connections completely enclosed to prevent breakage—make GOLDEN WAND easier to sell and keep sold.

GOLDEN WAND
INDOOR Television ANTENNA

PEERLESS PRODUCTS INDUSTRIES
820 N. Pulaski Rd. Chicago 51, Ill.

Appointed Ad Manager



Harold S. Stamm, member of the RCA Tube Department, at Harrison, N. J., since 1945, has been appointed manager of advertising and sales promotion of the department, succeeding Lawrence LeKashman, who resigned

Graybar District Manager

W. E. Guy has been named Chicago district manager of the Graybar Electric Company succeeding G. J. Cossman who has retired with more than 51 years of service, A. H. Nicoll, company president, has announced.

Erie Names Groth

Gordon Groth has been appointed executive vice-president of the Erie Resistor Corporation, it was announced by G. Richard Fryling, president of the firm.

Scott TV COMBO

The "Ashby," a new TV-radio-phono combination has been announced. Has 20-inch picture tube and Scott Silver Anniversary TV chassis. The AM-FM radio has separate power amplifier and 12" coaxial speaker. Phonograph is

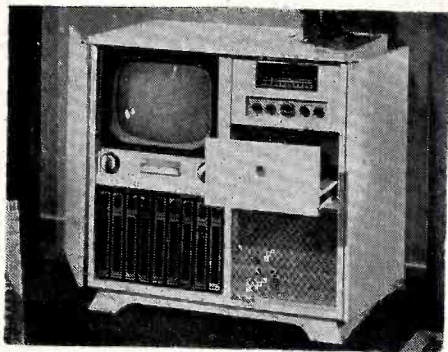

3-speed automatic. Cabinet has full length doors, is made of limed oak. Hardware is brass. Suggested list price is \$815. Available without the television (as the Ashurst) at \$575. Scott Radio Labs., Inc., 4541 Ravenswood, Chicago 40, Ill.—RADIO & TELEVISION RETAILING.

Maytag Names Green

William C. Green, regional sales manager for The Maytag Company in Newton, Iowa, has been assigned managership of fifteen counties in Indiana. He is replacing the late R. E. Jacobs.

Named NEMA President

J. F. Lincoln, president, The Lincoln Electric Co., Cleveland, Ohio, has been elected president of the National Electrical Manufacturers Association. He succeeds C. W. Higbee, manager, electrical wire and cable department, United States Rubber Co., New York. Five vice-presidents elected are: Arthur A. Berard, president, Ward Leonard Electric Co., Mount Vernon, N. Y.; J. W. Corey, president, The Reliance Electric & Engineering Co., Cleveland, Ohio; J. H. Jewell, vice-president, Westinghouse Electric Corp., Pittsburgh, Pa.; A. F. Sheldon, president, Kennecott Wire & Cable Co., Phillipsdale, R. I.; and H. P. Steele, exec. vice-president, Benjamin Electric Mfg. Co., Des Plaines, Ill.

New Recoton Quarters

Recoton Corp., manufacturers of phono needles, recording and cutting styli, discs and tape, has moved to larger quarters at 147 West 22 St., New York 11, N. Y.

Arvin Display

Arvin Industries, Inc., is backing up its newly introduced Custom Model 3550 Lectric Cook with display material featuring the new appliance as well as other items in the Arvin electric housewares line, says James M. Jewell, advertising manager.

Waring Blendor on TV



Louise Leslie (left), TV star of Homemakers' Exchange, now demonstrates the Waring Blendor in nearly half a million homes each Friday over 16 CBS-TV stations. Shown above with her are C. H. Halverson, (rear) account executive, Hicks & Greist, Inc., and J. P. McIlhenny, (right) vice-president in charge of sales, Waring Products Corporation.

RCA Victor TV Set

The Covington (Model 17T-172), a TV console with a 17-inch tube, is the latest addition to the RCA Victor line of television Super Sets. Has half-doors and the new Super Set chassis, designed to produce clear, dependable pictures in difficult fringe areas. The cabinet is traditional in design, and is modeled after the RCA Victor Fairfield, which proved quite popular. The Covington carries the suggested retail price of \$379.50 in mahogany or walnut finish, \$389.50 in limed oak.

GLAMORIZE YOUR DELIVERIES

It shows what you think of your merchandise



What it means to YOU

- Customers say, "How nice you handle your television sets"...
- Customer does not look for scratches on these kind of deliveries...
- Clean the sets in your store and set them in your customers house spotless...

Mr. Dealer... You have a wonderful opportunity to build good will, plus getting your store recommended to your customers' friends...

IT PAYS BIG DIVIDENDS
Order Today



#222 x #60LD



#350

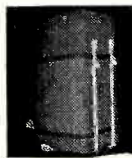

#200 x #100

- #300 TV Console cover 16.50 ea.
- #222 TV Comb. and Range... 19.95 ea.
- #350 TV Table model cover.... 9.50 ea.
- #200 Refrig. 4' to 12' cover... 21.95 ea.
- #90LD E-Z-LIFT Kit shown on #222 and #200..... 12.95 ea.
- #100HD E-ZEE-LIFT KIT 19.50 ea.

Circular on request

NEAL PRODUCTS CO.
Marlboro 37, Massachusetts

1/6 the LOSS WITH PERMANENT OPEN LINE

BY T. V. WIRE PRODUCTS

Guarantees lowest loss... holds the signal stronger on short or long runs (1/2 mile to mile with minimum loss) ... resists disastrous atmospheric conditions indefinitely!

Through Your Distributor — or Write:

T. V. WIRE PRODUCTS

THE PERFECT FINAL TOUCH TO QUALITY INSTALLATIONS



NOW AT A NEW LOW PRICE!

102 PROSPECT AVE., BURBANK, CALIF.

ROckwell 9-2562

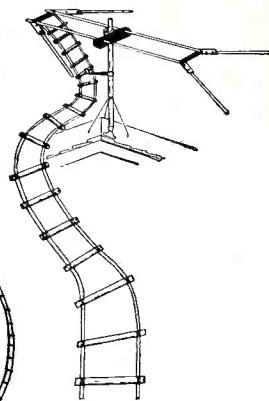

If you haven't received your copy of the new **1952 SOUTH RIVER CATALOG** on the World's Finest Antenna Mounting Materials just mailed to all Jobbers, Dealers and Service Men, write

SOUTH RIVER METAL PRODUCTS CO., INC.
South River, New Jersey

ANCHOR Boosters

**Best in Preference!
First in Fringe
Reception!**

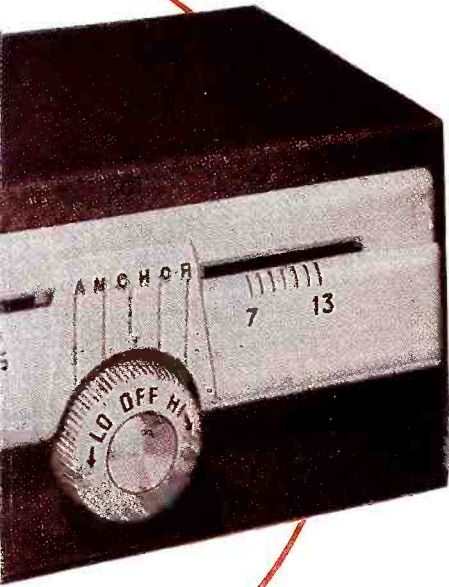

REACHING NEW

horizons

*Anchor engineering
always a year ahead!*

ANCHOR RADIO CORP.

2215 SOUTH ST. LOUIS AVENUE
CHICAGO 23, ILLINOIS

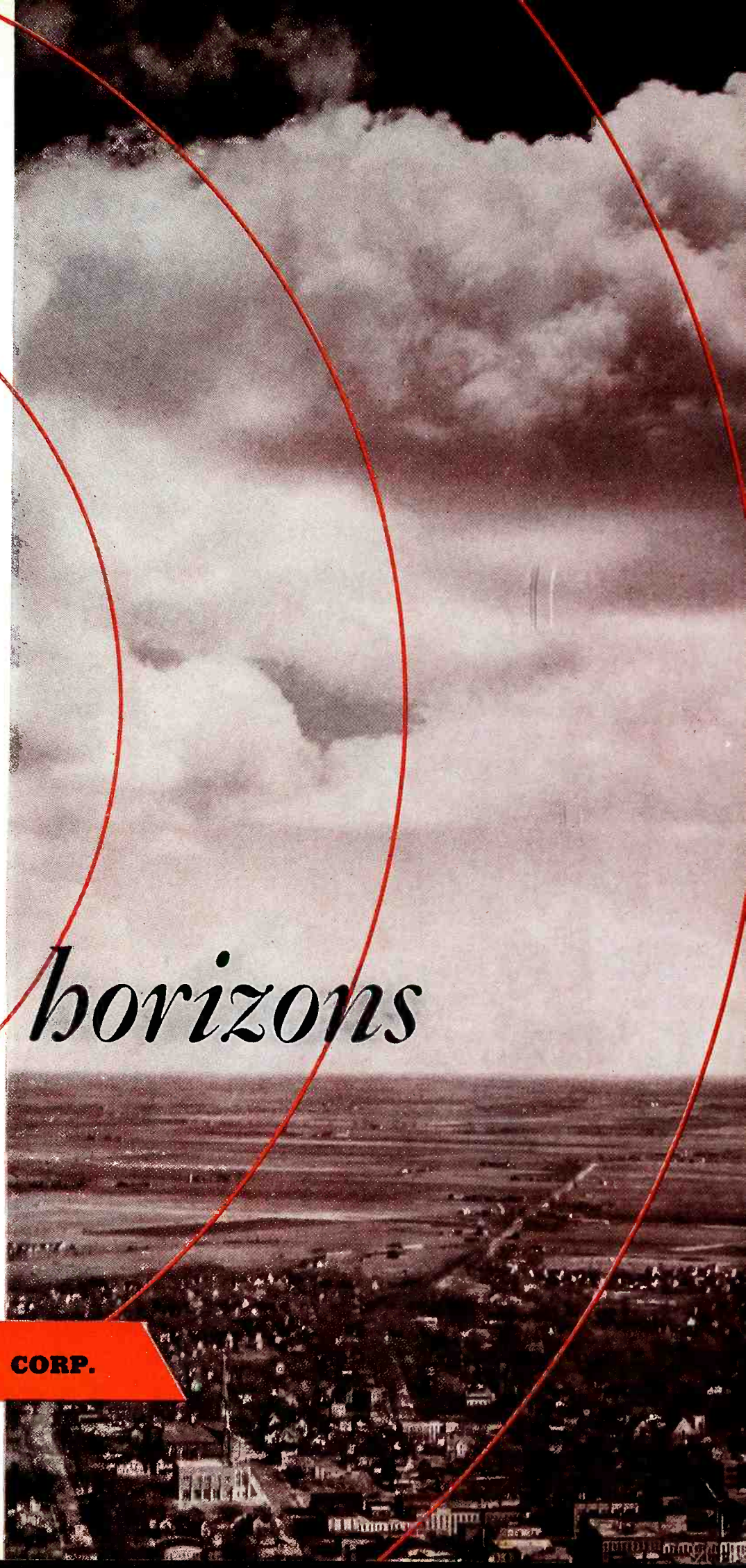

THE QUALITY OF RCA TUBES IS UNQUESTIONED

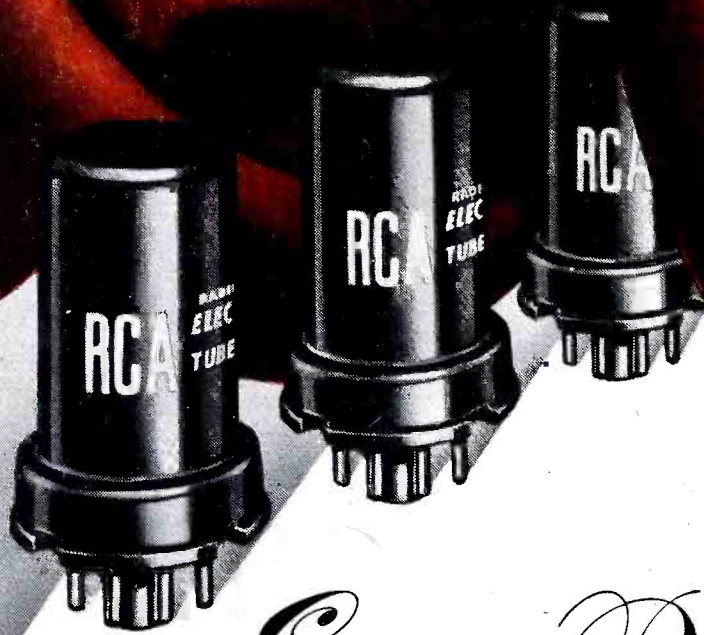

Extra Performance

as a matter of course...with RCA tubes

The RCA-developed "A" frame construction—used in 6 of the metal-type r-f amplifiers—is one of the many improvements that contribute to the *extra* performance of RCA tubes.

The "A" frame—shown in red—consists of a top member, two vertical members, and a bottom cross member. The ribbed uprights are welded to the cross member . . . the feet of the uprights are welded to the grounded metal header. In effect a truss, this rigid "A" frame acts as the supporting member for the tube elements. Its increased resistance to vibration reduces the possibility of electrode displacement due to wear on the holes in the mica spacers . . . and thereby

plays an important role in reducing microphonics and maintaining uniform tube characteristics.

In addition to imparting rigidity to the tube elements, the top and bottom members of the "A" frame serve as shields. The two ears on the top member add to its effectiveness in reducing grid-to-plate capacitance . . . the tab on the lower member—which extends down to the stem—provides additional shielding between grid and plate leads.

The *extra* performance built into RCA tubes accounts for their high quality, long life, and dependability. They cost no more. Why not use them for your daily tube requirements?

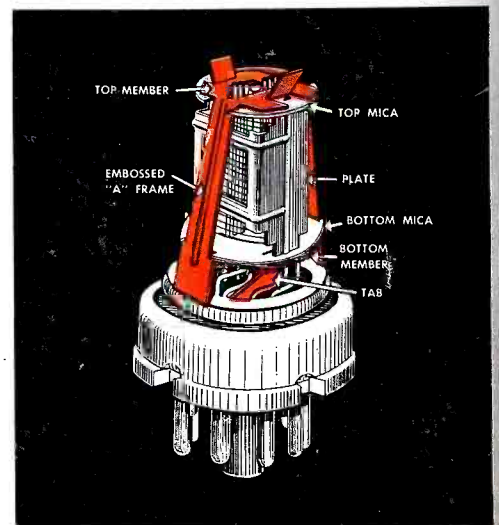

Keep informed—keep in touch with your RCA Tube Distributor



RADIO CORPORATION of AMERICA
ELECTRON TUBES
HARRISON, N. J.