

Special TELEVISION Issue . . . STATISTICS of Radio, Records, Appliances

Jan 48

RADIO & TELEVISION RETAILING

C A L D W E L L - C L E M E N T S , I N C .



The Man of the Year '48
THE RADIO RETAILER
*The Success of Television
and of FM Depend on Him
and His Service Dept.*

JANUARY 1948

Quiet as a Moonbeam Falling on Velvet



It's Impossible to Hear a Mallory Control Operate!

Ultra-sensitive sound testing meters built for the U. S. Navy prove that the noise level of the Mallory control in operation is so low as to be totally inaudible!

Contact with the talcum-fine carbon element is made by a special Mallory Alloy that passes over it smoothly and silently.

You can use Mallory Volume Controls, Capacitors and Vibrators with complete confidence. They are carefully built to assure ease of installation and complete customer satisfaction. Mallory's standardized range of sizes and types makes the Mallory line a profitable line to stock.

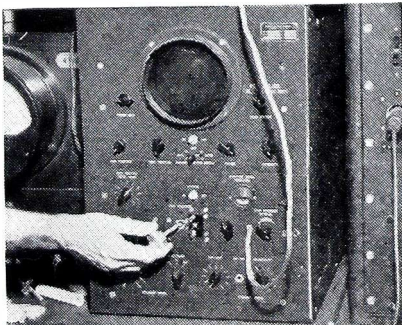

Meter used in the noise level test. Readings were taken on volume controls of all leading manufacturers. Mallory controls gave no audible sound, registered 22% below all others in inaudible sound vibrations.

The things you look for in a control are low noise level, long life, accurate resistance values and smooth, uniform tapers. Competitive tests prove that Mallory leads the field on all four points!

"Good Service for Good Business"

A Mallory plan to build business for radio-electronic service shops.

There's a unique customer follow-up system that will produce repeat business. There's a close tie-in with the Mallory trade mark. Ask your distributor about it!

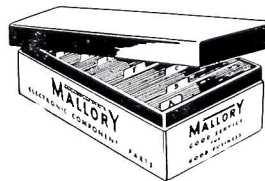

P. R. MALLORY & CO., Inc.
MALLORY

CAPACITORS . . . CONTROLS . . . VIBRATORS . . .
SWITCHES . . . RESISTORS . . . RECTIFIERS . . .
VIBRAPACK* POWER SUPPLIES . . . FILTERS

*Reg. U. S. Pat. Off.

APPROVED PRECISION PRODUCTS

P. R. MALLORY & CO., Inc., INDIANAPOLIS 6, INDIANA

RADIO & TELEVISION RETAILING

ORESTES H. CALDWELL
Editorial Director

M. CLEMENTS
Publisher

JOHN L. STOUTENBURGH
Executive Editor

DARRELL BARTEE
Managing Editor

HAROLD R. ELLIS
Technical Editor

RUTH MORRIS
Records Editor

M. R. LABATT-SIMON
Assistant Editor

CHARLES F. DREYER
Art Director

BUSINESS DEPARTMENT

LEE ROBINSON
Sales Manager

M. H. NEWTON
Business Manager

EDWIN WEISL, JR.

A. R. FISKE
Promotion Manager

BETTY HALL
Production

BRANCH OFFICES

CHICAGO 6

R. Y. FITZPATRICK, Manager
S. GASKINS

201 N. Wells St. RAN. 9225

LOS ANGELES 5

THE ROBERT W. WALKER CO.
684 S. Lafayette Park Pl.

Drexel 4388

SAN FRANCISCO 4

68 Post St. Sutter 1-5568

CIRCULATION DEPARTMENT

B. V. SPINETTA
Circulation Director

W. W. SWIGERT
Credit Manager

RADIO & TELEVISION RETAILING
January, 1948, Vol. 47, No. 1, 35 cents
a copy. Published monthly by Cald-
well-Clements, Inc. Publication Office
1309 Noble St., Philadelphia 23, Pa.
Editorial, Advertising and Executive
Offices 480 Lexington Ave., New York
17, N. Y. M. Clements, President;
Orestes H. Caldwell, Treasurer. Sub-
scription rates United States and U. S.
Possessions \$2.00 for one year, \$3.00
for two years, and \$4.00 for three years.
Pan American Countries \$4.00 for one
year, \$5.00 for two years, \$6.00 for
three years. Canada \$3.00 for one
year, \$4.00 for two years, \$5.00 for
three years. All other Countries \$5.00
for one year, \$7.50 for two years,
\$10.00 for three years. Printed in U.S.A.
Entered as second class matter March
20, 1947, at the Post Office at Phila-
delphia, Pa., under the act of March
3, 1879. Member of Audit Bureau of
Circulation. Copyright by Caldwell-
Clements, Inc., 1947.

*Trade-Mark Reg. U. S. Pat. Off.

IN THIS ISSUE • JANUARY, 1948

COVER—*The Man of the Year '48*



Photo • Ewing Galloway

★ Radio, FM, Television

EDITORIAL—'48 Will Be Great	45
STATISTICS OF RADIO FOR 1948	46
TELEVISION—A BILLION DOLLAR INDUSTRY	49
TELEVISION IS GOING PLACES FAST	50
WHAT TELEVISION MAY DO IN 5 YEARS	51
WHAT TELEVISION MANUFACTURERS SAY	52
TELEVISION SELLING REQUIRES NEW METHODS	54
TV SETS FOR GREAT NEW MARKET	56
ROSTER OF TV SET MAKERS	58
TV ANTENNA MANUFACTURERS	60
NEW RADIO SETS FOR 1948 SELLING	64
NEW LINES FOR DEALERS	66
FM MEANS MORE MONEY	72

★ Records, Phonographs, Accessories

COVER—Platter Profit Pointers	75
TRAINING TO SELL DISCS	77
PROFIT PICTURE FOR 1948	78
NEW PHONO LINES	84

★ Electrical Appliances

COVER—Appliance Production Statistics	87
REFRIGERATOR, RANGE, AND WATER HEATER SALES	89
THIS FIRM, A "HARDEE" PERENNIAL	90
NEW ELECTRICAL PRODUCTS	94

★ Service and Sound

COVER—Practical Television Service Flashes	97
SERVICING ALL BAND TV	99
CLEARING TV PIX OF INSTALLATION TROUBLES	102
NEW AIDS TO TELEVISION SERVICERS	104
NEW UNITS FOR QUALITY SOUND JOBS	106

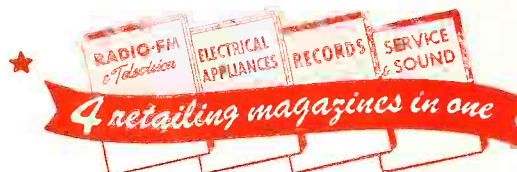

Member of AUDIT BUREAU OF CIRCULATION

CALDWELL-CLEMENTS, INC.

Publication Office 1309 NOBLE ST., PHILADELPHIA 23, PA.
Editorial, Advertising & Executive Offices 480 LEXINGTON AVE., NEW YORK 17, N. Y.

Westinghouse newspaper

HERE'S AD POWER!

We tell 'em with dominating feature-packed ads!

Right now—in January, '48—Westinghouse Radio puts the greatest force of ad power in its history behind your sales effort, right in your own powerful local papers. Leading big-circulation dailies in the important major markets that account for over 70% of all U. S. retail sales, will carry dominating ads month after month all through the year. Westinghouse Radio paves the way, in your own home city, for you to sell your merchandise easier.

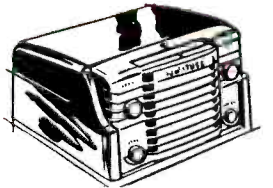

Westinghouse Duo. World's most revolutionary radio-phonograph. Has a LIFT-OUT, carryabout radio for use in any room.



Westinghouse Model 168. Handsome radio-phonograph with super-quiet, super-sensitive Rainbow Tone FM. It incorporates the Westinghouse speed record changer.

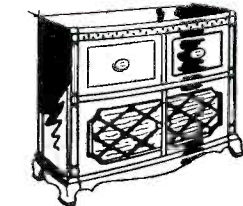

Westinghouse Model 166. Concert-hall performance in a masterpiece of cabinet craftsmanship. Westinghouse Rainbow Tone FM, Electronic Feather, Automatic changes.

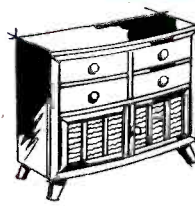

Westinghouse Model 167. A stunning modern console radio-phonograph providing true-to-life reproduction of programs and records.



IN THE DUO
Westinghouse
works radio magic
TO DOUBLE YOUR LISTENING PLEASURE!



Beautiful streamer cabinet, only 9" x 14 1/2" x 19", in mahogany or honeytone finish. See ad here. The Duo at your dealer's, \$99.95.

See the Westinghouse Consistor, a small size radio-phonograph-combination with big performance. Has all the Duo's exclusive features, plus more record storage space than most full-sized sets. \$139.50*

Tune in Ted Malone, Monday thru Friday, at 11:45 a.m., E.S.T., A.B.C. Network

Listen... and you'll buy Westinghouse
PLAYS IN 35 CITIES OFFICIAL INVESTMENT



Procol!... the DUO's an amazing radio-phonograph that plays up to 50 minutes of uninterupted music.



Change!... it has a LIFT-OUT, carryabout radio for use in any room in your home.



Exclusive... Westinghouse. Pleas-power provides the extra reserve of power you need for true-to-life performance.

IN THE DUO

Westinghouse
works radio magic
TO DOUBLE YOUR LISTENING PLEASURE!



Beautiful streamer cabinet, only 9" x 14 1/2" x 19", in mahogany or honeytone finish. See ad here. The Duo at your dealer's, \$99.95.

See the Westinghouse Consistor, a small size radio-phonograph-combination with big performance. Has all the Duo's exclusive features, plus more record storage space than most full-sized sets. \$139.50*

Tune in Ted Malone, Monday thru Friday, at 11:45 a.m., E.S.T., A.B.C. Network

Listen... and you'll buy Westinghouse
PLAYS IN 35 CITIES OFFICIAL INVESTMENT

Radio's first name is

Radio breaks the greatest campaign in its history!

HERE'S SALES POWER!

DEMONSTRABLE FEATURES LIKE THESE MOVE WESTINGHOUSE RADIOS OFF YOUR FLOOR—FAST!



Plenti-power gives the extra reserve of power needed for true-to-life performance.



Electronic Feather is the revolutionary Westinghouse tone arm that does away with needle scratch without loss of musical highs.

You sell 'em with feature-packed sets from the industry's outstanding radio line

Each Westinghouse Radio in the great line-up below has sales advantages you can demonstrate to your customers. These advantages are sales features your customers can see and hear for themselves. So, tie in with the comprehensive Westinghouse monthly promotions. Concentrate on the selected sets . . . stimulate sales by using Westinghouse promotion material . . . know your features and demonstrate.



Rainbow Tone FM is the quietest, most sensitive FM ever made for home use. No static. No fading. It delivers every colorful note exactly as broadcast.



Extra Large Record Storage Space is an important sales feature in all Westinghouse console radio-phonographs. Some sets hold up to 52 albums or 350 records.

HOME RADIO DIVISION • WESTINGHOUSE ELECTRIC CORP. • SUNBURY, PA.



Westinghouse Little Jewel. A console radio in capsule form, with power and tone you'll have to hear to believe.



Westinghouse Model 157. A compact and beautiful table set with Plenti-power. Twice the undistorted power output for true-to-life performance.

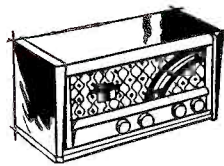

Westinghouse Model 161. Finest FM-AM table model ever built. Features exclusive Westinghouse Rainbow Tone FM, beautiful Rainbow Dial.

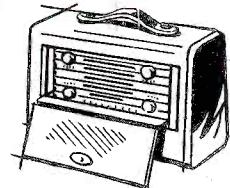

Westinghouse Model 163. Smartly-styled 3-way portable with exceptional sensitivity and tone. No wait . . . no warm-up—on AC-DC or battery.

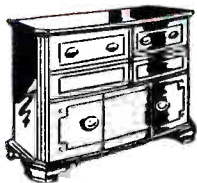

Westinghouse Model 169. A luxurious radio-phonograph offering the ultimate of performance in an exquisite cabinet.



Westinghouse Model 171. The only compact Console that's a 3-in-1 instrument: a LIFT-OUT radio . . . automatic record changer . . . big set record storage space.



Westinghouse Model 178. An outstanding battery radio with twice the power of comparable prewar sets, provides true-to-life reproduction.

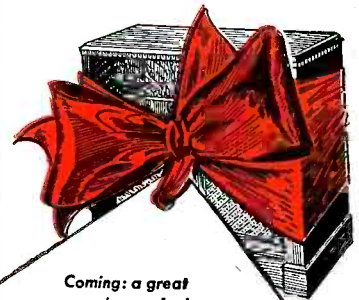

Coming: a great new value-packed set for you to sell. Watch for it.

Westinghouse

PLANTS IN 25 CITIES

OFFICES EVERYWHERE

'48 Is The Year To Top 'Em All

OLD POP TIME, as is his annual custom, has just deposited a bundle of twelve new months on our doorstep. The label reads "1948."

NO ONE KNOWS for sure just what will pop out. But get set for the biggest and best in '48. Dealers, distributors and manufacturers have got to be ready to answer trip-hammer knocks of opportunity, for we are heading into a radio-television-appliance year to top all others in dollar volume.

CONSIDER THE FARMER.

There's a merry jingle in his jeans and he whistles at his work. His income is the highest in history. His farms are being rapidly electrified to the tune of approximately 800,000 since the war, bringing the total close to three and a half million in the nation.

THE DEALER who doesn't sit on his hands but studies this market and then gets out and *sells* is going to have a banner year for himself in radios and appliances. As a starter take a good look at the February issue of **RADIO & TELEVISION RETAILING**. The spotlight will be turned on the farmer as a market.

KEEP YOUR EYE ON FM. It's here—and due to be there and everywhere almost before you know it. The day is rapidly approaching when manufacturers would as soon make sets without FM as without cabinets. Transmitters are multiplying at an unprecedented birth rate. There is a profit harvest in FM for the dealers who follow through vigorously. Don't miss the special FM March Issue of **RADIO & TELEVISION RETAILING**. It will show how the FM means *For More* profits.

TELEVISION is the magic word in 1948. It's bringing the "new look" to radio so fast that in a few years New Yorkers are going to be televiewing California's Rose Bowl Game on New Year's Day. 1948 will bring many new stations, will see sets manufactured in greater volume than ever and for less.

LOOK TO APPLIANCES to soar to the greatest dollar volume in history in '48. It's a seller's market everywhere. It hasn't really been tapped since the war. From the farmer to the city apartment dweller a tremendous need exists for replacements and for new products. As scarcity headaches are given the aspirin treatment this year, your sales will go UP and then UP some more.

'48 WILL BE GREAT for the retailer who is ready—who knows how to merchandise and sell and who knows his markets. This is the year when the "No Sale" sign in your cash register will go into permanent hibernation.

—THE PUBLISHERS



Merit, now entering its
24th year has given a
new meaning to trans-
formers — Merit Quality



MERIT COIL & TRANSFORMER CORP.

TELEPHONE

4427 North Clark St.

Long Beach 6311

CHICAGO 40, ILL.

FOR 17 YEARS *Radio Dealers*
(as well as the public) *Have said:*

"When there's a choice —
it's a **PHILCO**"



IN the great selling season just passed, for the first time in six years, buyers were able to walk into radio dealers' stores and *choose* the makes and models they really wanted on the basis of tone, performance and reputation.

The record now shows they chose Philco in greater numbers than ever before. Yes, again the choice was Philco — the brand they have trusted for 17 years to give the utmost in value plus years of service and satisfaction.

And, again, Philco was the chief source of volume and profits for radio dealers . . . gave dealers the biggest turnover on dollars invested, *plus* the highest average unit of sale.

Here's up-to-the-minute evidence on which you can make your plans for the year ahead. *Concentrate* your efforts where they will yield the biggest results — on Philco. Build your business with Philco, the leader, for profits today and customer Good Will tomorrow.

PHILCO *Famous for Quality the World Over*



Listen...
2 COMPLETELY NEW
Jensen Hypex*
PROJECTORS

MODERN requirements for general purpose sound equipment have outmoded older designs. Replacing Models UH-20 and UH-24, these new JENSEN Hypex Projectors answer the demand for something new, better, more reliable, and at lower cost. Power handling capacity 25 watts maximum speech and music signal input. Voice coil impedance 16 ohms.

MODEL VH-20 (ST-684). For speech and music reproduction where principal requirement is for speech. Frequency range 140 to 6000 cps. Developed acoustic path length 52 inches. Coverage angle 80°. Mouth diameter 20¾ inches; length 20¼ inches. List price \$63.00.

MODEL VH-24 (ST-685). For speech and music reproduction. Superior to Model VH-20 for music because of larger size. Frequency range 110 to 6000 cps. Developed acoustic path length 58 inches. Coverage angle 75°. Mouth diameter 24¾ inches; length 22¾ inches. List price \$74.50.

JENSEN MANUFACTURING COMPANY
 6625 South Laramie Avenue, Chicago 38
 In Canada: Copper Wire Products, Ltd., 11 King St., W., Toronto

*Trade Mark Registered

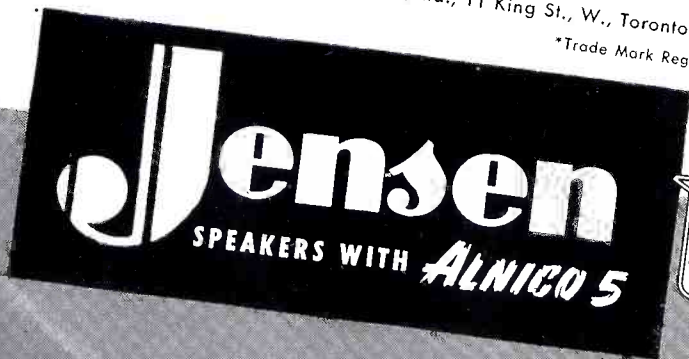

- Featured by*
1. Non-ferrous and stainless steel rustproof fittings.
 2. Rustproof, weatherproof terminal box.
 3. No exposed terminals. No soldering to connect.
 4. Completely new shielded and enclosed **ALNICO 5** driver unit.
 5. Entire structure an integral assembly. No taking units off and putting on. Will withstand plenty of abuse.
 6. Improved weatherproof finish on all metal parts.
 7. Non-metallic diaphragm of war-developed material.
 8. Attached adjustable bracket guaranteed to hold projector in position simply by tightening two nuts with small wrench.
 9. JENSEN patented Hypex formula for improved acoustical performance.
 10. Driver unit removable for replacement without special tools.

Designers and Manufacturers of Fine Acoustic Equipment

BOBBY-SOXERS

play their radios long and hard
.. buy plenty of tubes, parts, and repair time
.. will patronize your shop once they see the G-E monogram

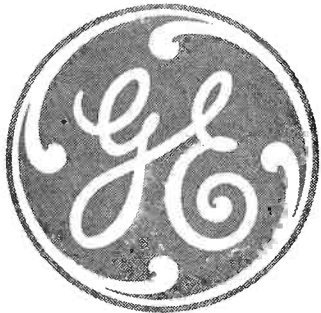

RADIO TUBES

DON'T begrudge 'em their fun. It's the last fling before demure seventeen, studious nineteen, and engaged twenty-one . . . Jive aside, they're smart kids—and loyal. When they buy, it's with an eye to established reputation.

General Electric? *Natch!* . . . Brought up in homes bright with G-E lamps, where breakfast toast—when they take time to eat it—jumps up out of a G-E toaster, where food stays fresh in a G-E refrigerator, time is kept by G-E electric clocks, and G-E fans hum softly in summer . . . these youngsters know the familiar G-E monogram as a friend to be trusted.

Their radio tube and repair business—plenty of it in your area!—goes to the serviceman with the General Electric sign. And years from now they'll still be customers.

Only with larger home sets, meaning a bigger service potential. Start now to make these clients-of-tomorrow patrons of *your* shop. Display and handle General Electric radio tubes! *General Electric Company, Electronics Department, Schenectady 5, New York.*

G-E miniatures, other tubes of all types for servicing portables and home receivers are listed, rated, and described in G.E.'s complete Tube Characteristics Booklet ETR-15. Write for your free copy.

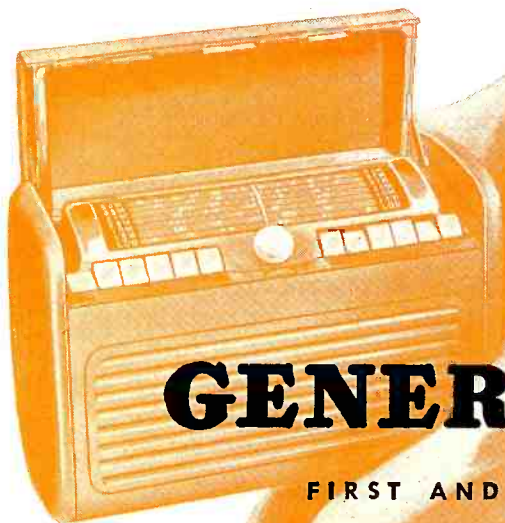

GENERAL  **ELECTRIC**

176-GA2-8850

FIRST AND GREATEST NAME IN ELECTRONICS

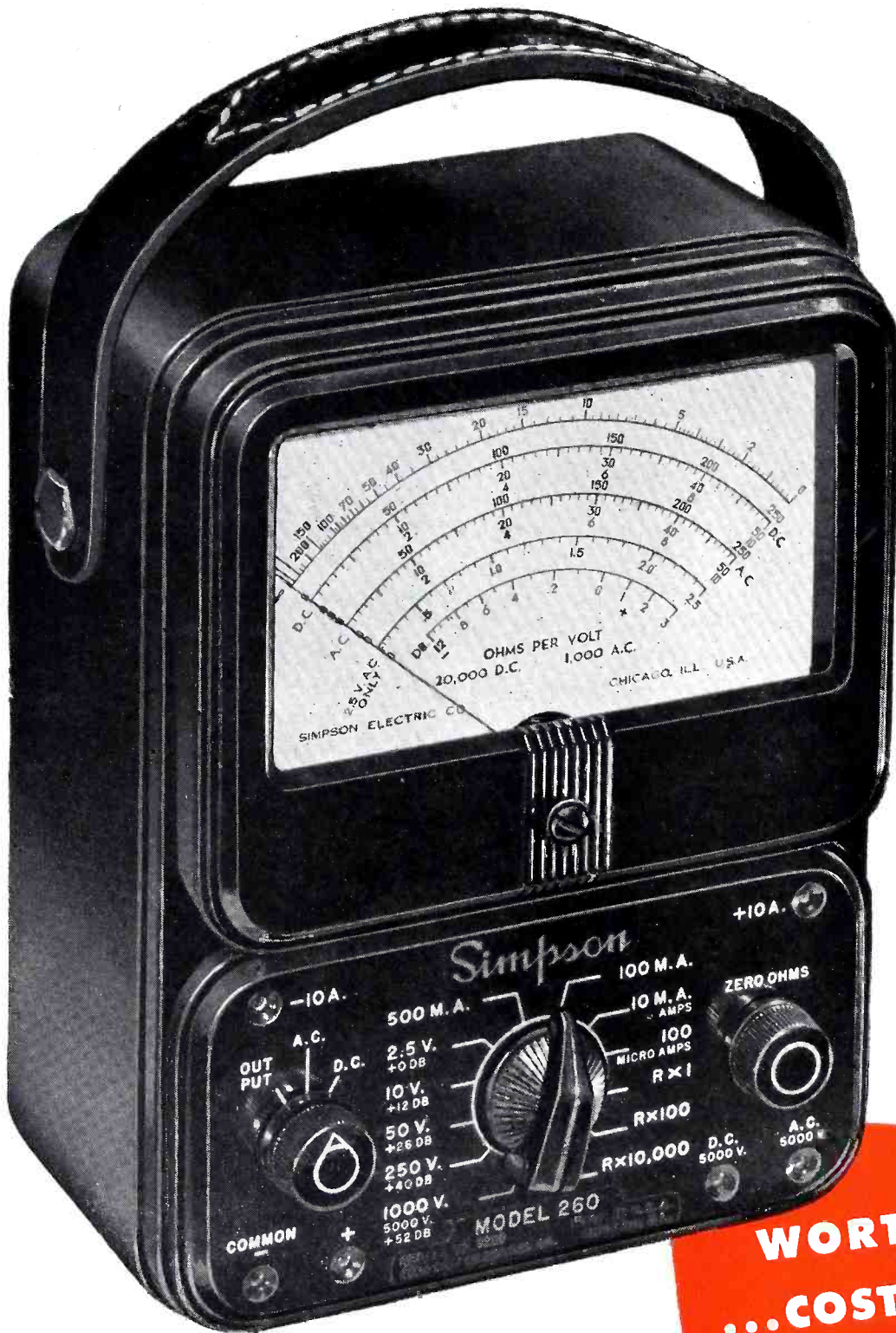

**MODEL 260
VOLT-OHM-MILLIAMMETER**

20,000 Ohms per Volt D.C.
1,000 Ohms per Volt A.C.

Volts, A.C. and D.C.: 2.5, 10, 50, 250, 1000, 5000.

Milliamperes, D.C.: 10, 100, 500.

Microamperes, D.C.: 100.

Amperes, D.C.: 10.

Decibels (5 ranges): -10 to 52 D.B.

Ohms: 0-2000 (12 ohms center).
0-200,000 (1200 ohms center).
0-20 megohms (120,000 ohms center).

Model 260—Size 5¼" x 7" x 3⅛"
\$38.95

Model 260 in Roll Top Safety Case
—Size 5¾" x 9" x 4¾". \$43.75

Both complete with test leads and
32-page Operator's Manual*

ASK YOUR JOBBER

**WORTH MORE...
...COSTS NO MORE!**

For what it buys in sensitivity, precision, and useful ranges, the price of Model 260 has always purchased value far beyond that of even remotely similar test instruments. Today this famous volt-ohm-milliammeter is a finer instrument than ever, with added ranges and with a new sub-assembly construction unmatched anywhere in strength and functional design.

The price is the same. That means, of course, that your investment today buys even more in utility and the *staying* accuracy that distinguish this most popular high-sensitivity set tester in the world.

*No other maker of test instruments provides anything to approach the completeness of the pocket-size 32-page Operator's Manual that accompanies Simpson Model 260. Illustrated with 12 circuit and schematic diagrams. Printed on tough map paper to withstand constant usage.

Simpson
INSTRUMENTS THAT STAY ACCURATE

SIMPSON ELECTRIC COMPANY • 5200-5218 W. Kinzie Street, Chicago 44, Ill.
In Canada, Bach-Simpson Ltd., London, Ont.



GAROD

dependable for 26 years,
now presents the

"Royal" TELEVISION COMBINATION

5-WAY CONSOLE with ★ TELEVISION
★ AM ★ FM ★ SHORT WAVE ★ AUTOMATIC
RECORD CHANGER plus RECORD COMPARTMENT

All at an exceptional low price!

Television with 12-inch Tube (72 square-inch screen)

Here is Garod's greatest achievement in 26 years of outstanding radio manufacture. Here is a Television receiver the whole country has been waiting for. Here is the ultimate in sight and sound, the pinnacle of performance, the most for the money. Here is Television as it should be . . . audibly and visually tops!



RETAIL
PRICE

\$695

Plus Installation Charge
and Federal Excise Tax



The "Thriftee"

This is your new Garod price leader for 1948. A really unusual set at a price that more than matches all competition. Handsome plastic case, finished in walnut. (Slightly higher priced in ivory.)

RETAIL PRICE **\$1795**



The "Starlet"

3½ pounds of glamorous, power-packed radio. Metal and plastic two-tone combinations, with Lucite dial and inlaid gold design. Open the lid and it plays . . . close the lid and it shuts off automatically.

RETAIL PRICE **\$2995**
less batteries

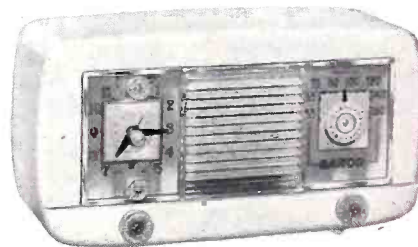

The "Radalarm"

Combination radio-clock, that automatically wakes you to music. Incorporates a fine Garod radio with famous Telechron electric clock. Luxurious Ivory plastic case with Lucite panel over contrasting color for clock and dial face.

RETAIL PRICE **\$3995**



Write for latest brochure giving details on the complete GAROD line.

GAROD ELECTRONICS CORPORATION

70 WASHINGTON STREET • BROOKLYN 1, NEW YORK

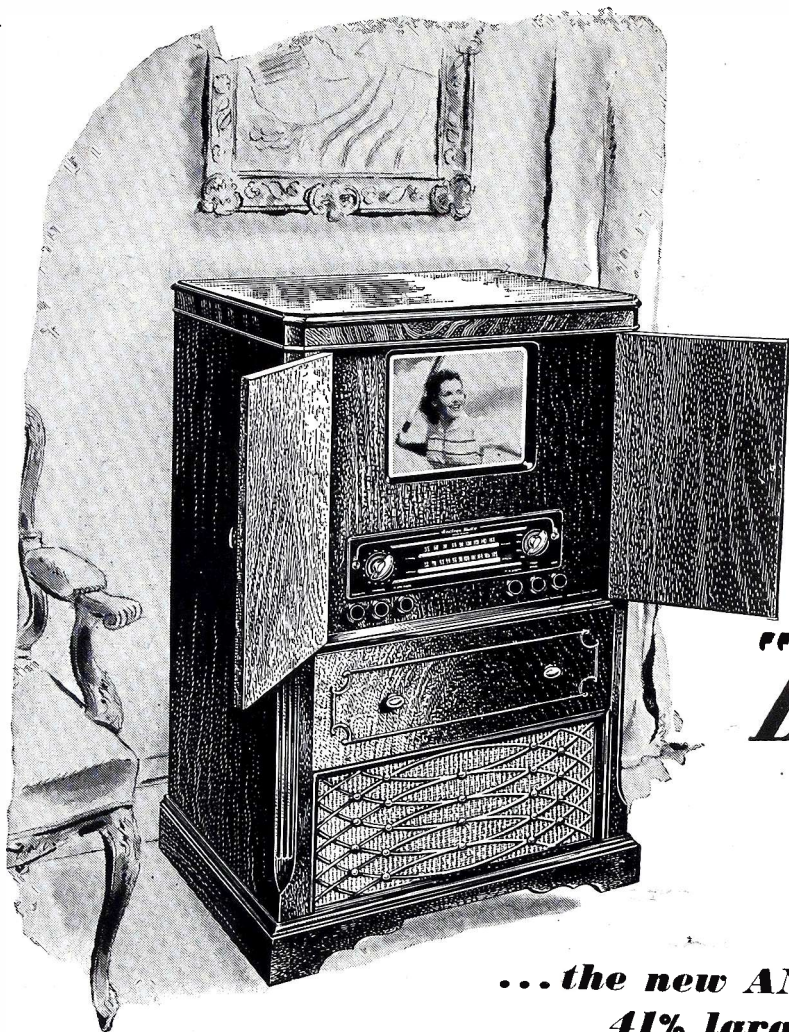

ANDREA DE LUXE COMBINATION—Television, AM, FM, and Automatic Phonograph . . . all 4 in a handsome, hand-finished mahogany console.



ANDREA TABLE MODEL—One of the finest table models on the market. Complete chassis, large 12-inch picture tube, plus AM and FM.

ANDREA DE LUXE CONSOLE—for those who want television, AM, FM in a modern, open-faced console.



Now...
"BIG PICTURE"
 Television

... the new ANDREA offers a
41% larger picture in all models!

Most television consoles today under \$1,000 have only a 10-inch picture tube, or smaller. ANDREA "Sharp-Focus" Television gives your customers the BIG 12-inch picture tube that more and more buyers are asking for. Yes, that's approximately 75 sq. in. of action, a 41% larger picture—and in all models.

In addition, ANDREA gives you these BIG talking points: 4-in-1 . . . Television AM, FM and Automatic Phonograph. Complete 28-tube plus 3 rectifier tube chassis. Interference insurance—with the ANDREA "Picture Lock". Super-selector turret covering all 13 television channels.

A "BIG PICTURE" for the Dealer and Jobber, Too

Three custom-built models for the class of customer who wants the best—DeLuxe Combination, Open-faced Console and the Table Model. "Profit-plus" discount policy that gives you a better deal all around. And—the reliability of F. A. D. Andrea's 27 years of radio pioneering, 10 years in television. Write ANDREA for details.

ANDREA RADIO CORP., 27-01 Bridge Plaza North, Long Island City 1, N. Y.

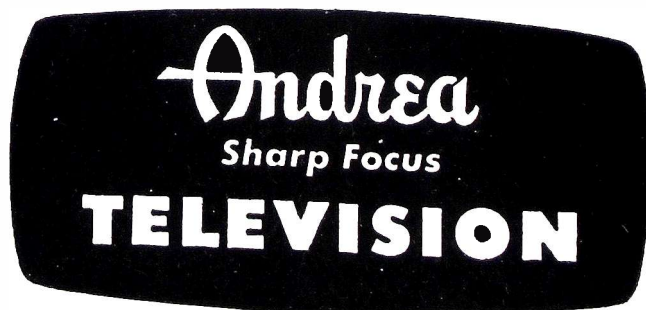

TRADE MARK

BIGGER! BIGGER! BIGGER!

GENERAL ELECTRIC RADIO AND TELEVISION ADVERTISING
IN 1948... TO SELL 'EM

FASTER! FASTER! FASTER!

YOU CAN'T AFFORD NOT TO HANDLE G. E.

PEOPLE READ G-E ADS

G-E Radio and Television ads are stoppers! Year after year they have led in "Seen Most" and "Read Most" Starch ratings. With full pages, most of them in full color, in these 8 great national magazines—the great G-E story reaches over 70 million readers every month. That's the power that backs up your selling.

Magazine	Insertions	Readers per insertion
LIFE	25	26,000,000
LOOK	13	15,650,000
POST	13	13,750,000
Colliers	12	11,100,000
THE AMERICAN WEEKLY	3	23,000,000
Country Gentleman	6	6,670,000
Farm Journal	6	6,278,000
Progressive Farmer	6	3,600,000
THE NATIONAL GEOGRAPHIC	12	5,700,000
This Week	3	19,500,000

BIG AIR COVERAGE

G.E. is back on the air with the great General Electric House Party that reaches over 7 million radio homes every month, on 161 CBS stations. It's YOUR program because it has the highest sponsor identification of any daytime program. All this, plus the G-E Fred Waring program Monday nights over NBC.

COAST TO COAST NEWSPAPER BARRAGE!

Smashing full page newspaper ads, masterpieces of retail merchandising, are scheduled to run in leading newspapers from coast to coast. These ads follow the spectacularly successful pattern of G-E Radio pre-Christmas advertising in 1947.

LEADER IN RADIO, TELEVISION AND ELECTRONICS

GENERAL ELECTRIC

• For full information about G-E radio and television receivers, write your G-E radio distributor, or General Electric Company, Receiver Division, Electronics Park, Syracuse, New York.

PORTABLES • TABLE MODELS • CONSOLES • FARM SETS • AUTOMATIC PHONOGRAPH COMBINATIONS • TELEVISION

Now, for 1948
TELEVISION
worthy of the name
STROMBERG-CARLSON

with everything to make people
STOP!—LOOK!—and LISTEN!

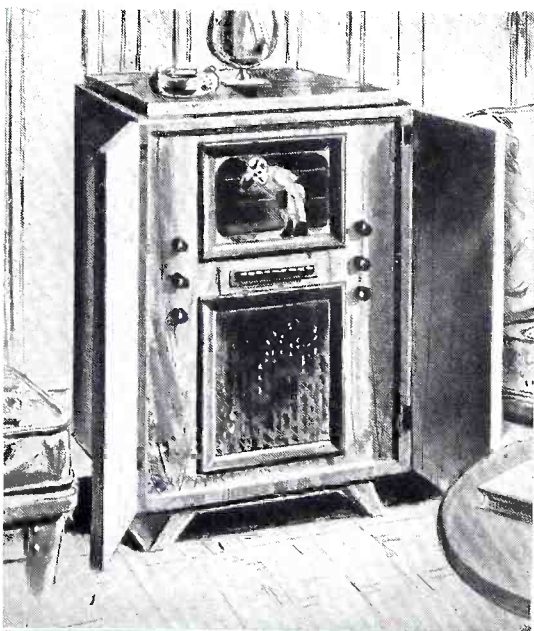

TV-10-L. Characteristic of Stromberg-Carlson's advanced design and engineering. Improved cathode ray tube gives a clearer, sharper picture on a 10" screen. Powerful 8" Alnico V Speaker. Housed in beautiful hand-rubbed cabinet of ribbon-striped walnut or toasted walnut.

Television that meets Stromberg-Carlson's highest standards. Skillfully engineered to advanced reception standards. Housed in cabinets of traditional Stromberg-Carlson craftsmanship. Yes, for watching *and* listening pleasure, Stromberg-Carlson offers your customers superior television performance today.

Television that completes your quality line. Quality that makes and *keeps* friends for you. Now when your customers *Stop!—Look!—and Listen!* you can offer them the *right* model for *every* need—from the finest table radios and radio-phonograph combinations to television and radio-phonograph-television combinations—*all* backed by the Stromberg-Carlson name.

Television that keeps pace with newest developments. More Stromberg-Carlson television models are coming. They will be styled and engineered to meet the expanding needs of this important new market. In 1948, as for the past quarter of a century, you can assure your customers that—in radio, radio-phonographs, FM, and *Television*—

THERE IS NOTHING FINER THAN A



TV-10-P. Ultimate in Stromberg-Carlson home entertainment. De luxe radio-phonograph-television model. Standard broadcast, 2 FM bands, 12" Alnico V Speaker. Automatic record changer with automatic stop; "QT" Crystal type pick-up. Smart cabinet of modern design in mahogany or bleached mahogany. 10" direct-view cathode ray television tube.

STROMBERG-CARLSON

Stromberg-Carlson Company, Rochester 3, N. Y.—In Canada, Stromberg-Carlson Co., Ltd., Toronto

NOT SINCE



Model #165

\$9⁹⁵

Superheterodyne circuit.
Walnut plastic case.

Model #166

\$16⁹⁵

Convenient carrying handle.
Superheterodyne circuit.
Built in loop antennae.
Solid color ivory plastic case.



1939 **SUCH PRICES! PROFITS! VALUES!**

Tele-tone's

1-2 SALES PUNCH

KEYNOTING THE GREATEST PRICE-PROMOTION IN TEN YEARS

NOW . . . 2 sensationally priced sets that can't miss. Check the features:

- Both sets have superheterodyne circuits.
- Both sets have practically unbreakable plastic cabinets.
- Both sets have Alnico speakers.
- Smart, modern streamlined solid color plastic cabinets.
- Model # 166 has convenient carrying handle.
- Notice the unusual discounts.

EASY TO ORDER—EASY TO STOCK

Tele-Tone's basic stock plan makes it simple to order. You buy in cartons of 5 sets of each model. One carton equals 5 of model #165 and 5 of model #166. They come packed 10 to a carton . . . Minimum order — 1 carton.

Tele-tone

540 West 58th Street, New York City

Tele-Tone, 540 W. 58th St., New York City

Please send me..... cartons, model #165, #166. (Each carton to contain 5 sets model #165 and 5 sets model #166) at list \$134.50, cost \$94.15, F.O.B., N. Y.

Note: A few dealerships are still available on Tele-Tone Radios. Call, write or wire today.

Name.....

Address.....

City..... State.....

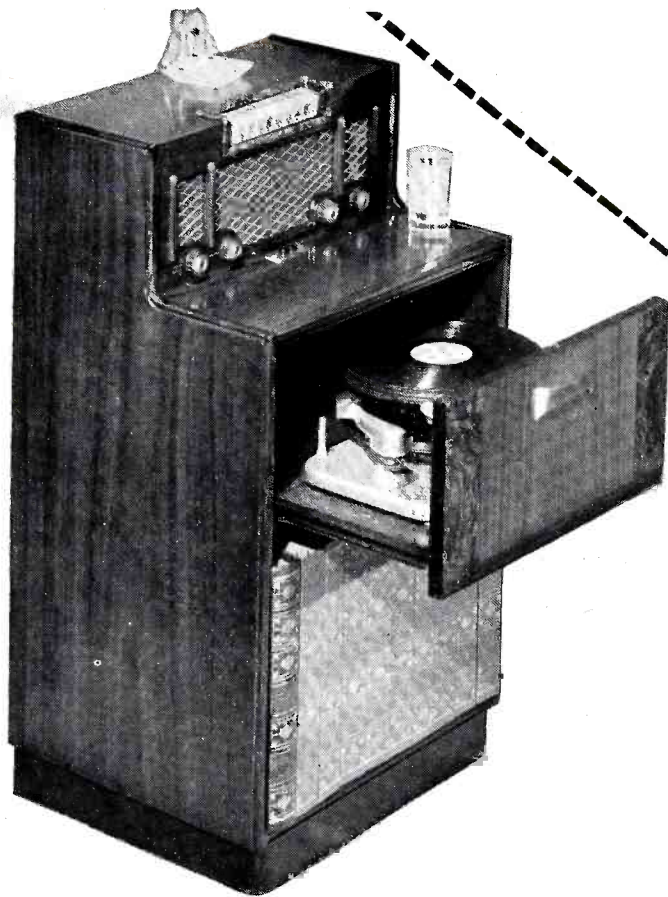

THOUGH IT'S ON YOUR FLOOR

She can SEE it in

HER HOME!



It's EASY to sell new 1948

Furniture Styled
Motorola
A-M
F-M Radios

Motorola
 PROVIDES A RADIO
 for Every Home—
 EVERY
 PURPOSE

This is what you have been waiting for—radios that sell *because* of their cabinet design, not in spite of it. Your customers can immediately see Motorola Furniture Styled Radios as a part of their home, so they stop to listen—and when they listen they're sold! Motorola's thrilling beauty, Motorola's Golden Voice tone, and Motorola's dozens of wonderful features give you radios that virtually sell themselves. This year more than ever before—*it will pay you to feature Motorola.*

Motorola Inc. 4545 Augusta Blvd., Chicago 51, Illinois



In television... it's



INSTRUMENTS

TUBES

TRANSMITTERS

CAMERAS

ANTENNAS

RELAY EQUIPMENT

STUDIO EQUIPMENT

SOUND EQUIPMENT

FILM EQUIPMENT



Brig. General David Sarnoff
President and Chairman of the Board
Radio Corporation of America

In television... it's **RCA** . . .

TELEVISION PROGRESS

TELEVISION, a fast growing new industry in the United States, is the spearhead of radio progress. So strong will be television's impact as a major economic and social force in 1948, that I believe it will make this new year one of the greatest in the history of radio, as a science, an art and an industry.

Scientifically, television reached a stage of development in 1947 where it provided highly satisfactory results. Favored by the American competitive system of private initiative and free enterprise, television in the United States leads the world in every phase of its development.

Industrially, television in 1947 established a firm base for accelerated manufacturing activities, and in the coming year production should expand substantially.

Economically, television—in addition to its importance in manufacturing and employment—is introducing new methods of merchandising and marketing. It is an advertising medium with an unparalleled appeal to a daily-increasing audience.

Culturally, television is creating new art forms for the presentation of entertainment, education and news. Its possibilities in these fields are unlimited.

Progressive radio men—scientists, industrialists and broadcasters alike—now think in terms of both sound-and-sight; they plan in sound-and-sight. Television charts their future—it will be the dominant factor in the Radio of Tomorrow.

Factors creating the promising outlook for television in 1948 include: an increasing number of television stations throughout the country; a vastly enlarged audience; the establishment of cable and radio relay facilities linking stations into inter-city networks; the general improve-

ment of programs; increased advertising support; and vigorous competition, as the new industry takes form on a nation-wide scale.

There are now 18 stations on the air with regular television programs. In 1948, it is estimated that there will be approximately 50 television stations in operation; there may be more.

A television network now links Washington, Baltimore, Philadelphia, New York and Schenectady. In November, a radio relay link was opened between Boston and New York, so that programs can be picked up along that route. Congress and the White House, through this television network, can on special occasions be viewed by hundreds of thousands of people throughout the East. Congress was televised for the first time on January 7, 1947, when President Truman addressed a joint session. He again was seen over a seven-station network in the first telecast from the White House on October 5. The World Series of 1947 was another "first" telecast. Such events together with football, basketball, hockey, parades, dramas of the Theatre Guild, and other programs of national interest, emphasize the value of a television receiver in the home. . . .

In radio, pioneering never ends; it continually calls for initiative, faith and exploration in unknown fields. The scientists and research men of the industry who throughout 1947 blazed new trails, true to the traditions of radio, are to be congratulated upon their achievements. Especially to be commended are workers on the production line through whose craftsmanship the finest radio and television apparatus in the world is made available to the American people. Further, through the efforts of manufacturers, engineers and broadcasters it is possible for the radio voice of America to travel afar and bespeak freedom, friendship and peace.

David Sarnoff



THE 730TV2 . . .
 52-square-inch picture, AM-FM radio, Victrola phonograph with automatic record changer and the "Silent Sapphire" jewel pick-up.

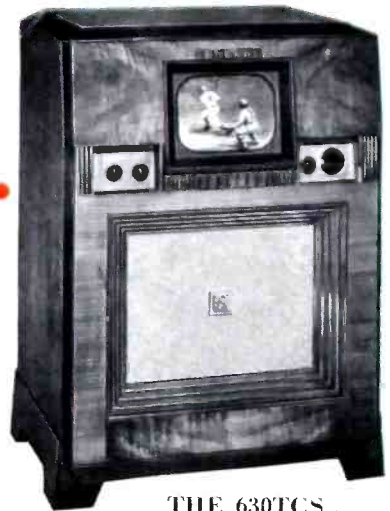

THE 630TCS . . .
 52-square-inch picture, FM television sound, beautiful walnut finished cabinet with sliding tambour doors to conceal controls.



THE 648PTK . . .
 300-square-inch picture accomplished by projection from within, Standard Broadcast, Short Wave and FM radio bands.



THE 721TCS . . .
 52-square-inch picture, a popular priced console television model with all the most advanced RCA Victor developments.

In television... it's **RCA** . . .

.. and in television instruments it's **RCA VICTOR**

RCA Victor is the manufacturing division of the Radio Corporation of America. From this great plant have come the instruments in which the eager public has already invested many millions of dollars.

The superb line of RCA Victor television instruments, shown here, incorporate many RCA Victor developments . . . an all-13-channel station finder that works as easily as push-button tuning . . . brilliant, *locked-in-tune* pictures with the amazing Eye-Witness Picture synchronizer . . . the "Golden Throat" tone-system which brings listeners television sound in all its clear, static-free naturalness. *And*, these instruments are covered by the famous RCA Victor Television Owner policy—complete installation and assured performance for a full year—at a modest fee.

These superb instruments backed by powerful advertising and dramatic merchandising are in demand wherever people want high-quality television instruments. And there is an RCA Victor television instrument in every price class.



THE 641TV . . .
52-square-inch picture, Victrola phonograph with the "Silent Sapphire" jewel pick-up, AM, FM and Short Wave bands.



THE 721TS . . .
52-square-inch screen, a popular priced instrument featuring all the most advanced RCA Victor developments.



THE 730TV1 . . .
52-square-inch picture, Victrola phonograph with automatic record changer and the "Silent Sapphire" jewel pick-up, AM and FM radio.

"Victrola"—T. M. Reg. U. S. Pat. Off.

32 telecasters from coast to coast have already
chosen RCA television transmission equipment

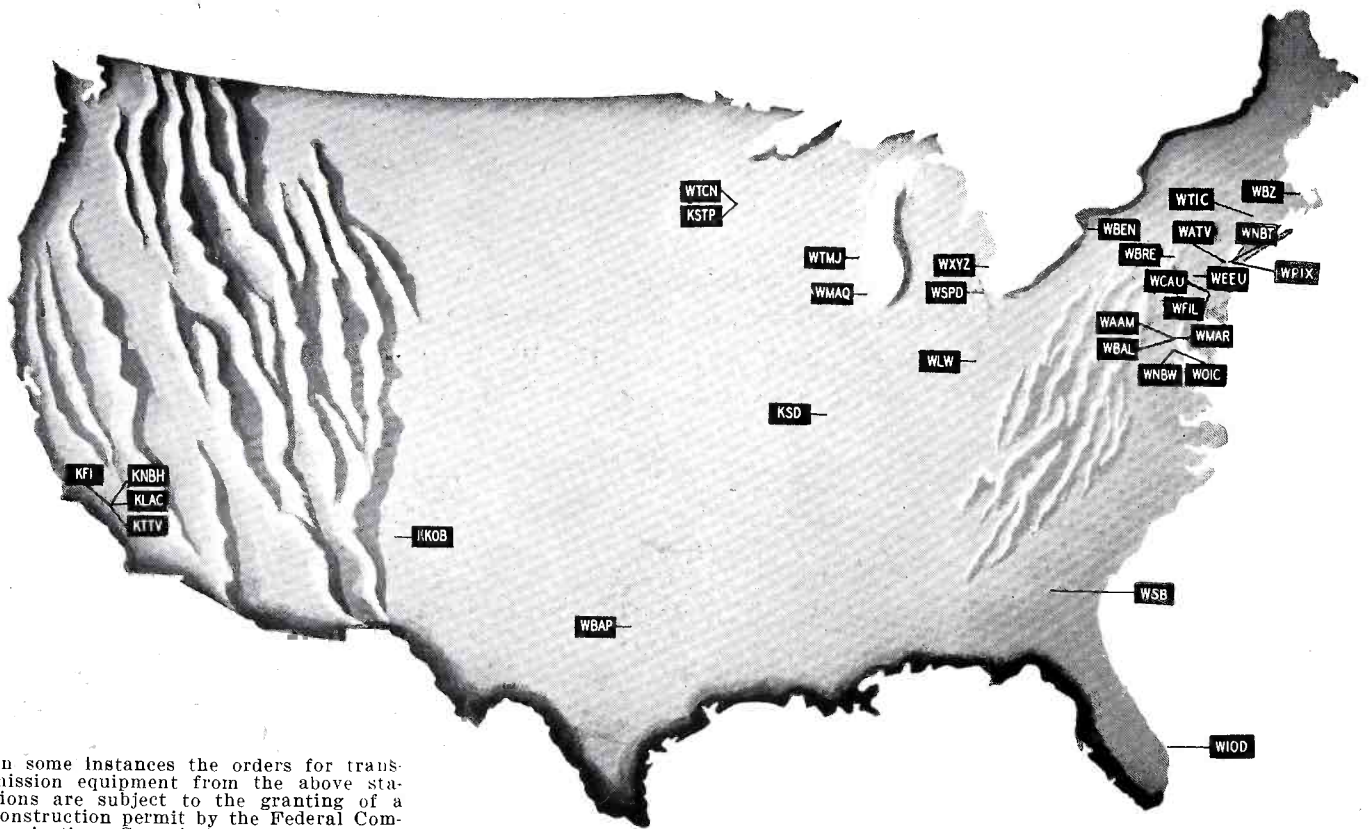

In some instances the orders for transmission equipment from the above stations are subject to the granting of a construction permit by the Federal Communications Commission.

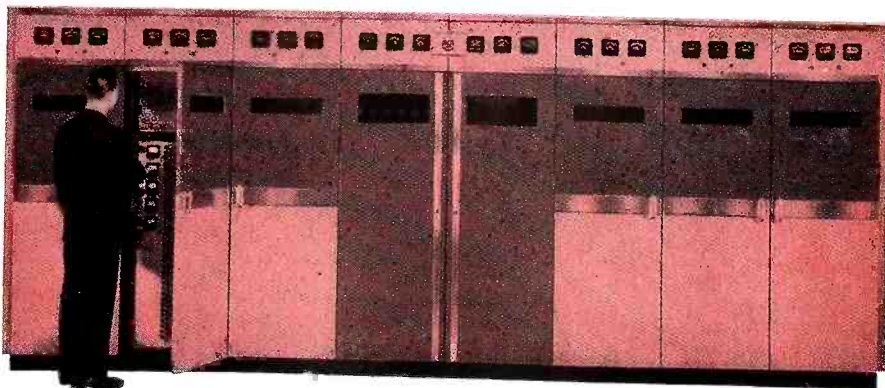

RCA's 5-kilowatt television transmitter. The choice of leading broadcasters across the nation . . . a real assurance of brilliant, sharp, crystal-clear telecasting.

Yes, television is moving fast. By the end of '48, RCA equipped stations *alone* will be bringing television within the reach of more than 40,000,000 people.

Already eight RCA transmitters are on the air . . . 12 more delivered . . . the balance being shipped at the rate of three per month.

With most of these stations *completely* equipped by RCA—from image-orthicon field cameras to Super-Turnstile antennas—audiences from coast-to-coast will be assured high-definition telecasts . . . presentations of sports, studio shows, and films at their best.

In television... it's **RCA** . . .

the fountainhead of modern tube development is RCA

RCA has consistently maintained engineering leadership in electron tube research and design. As a result of this pioneering, most of the great advances in all-electronic television can be attributed to the development and manufacture of new and revolutionary types of electron tubes by RCA.

RCA Orthicon and iconoscope camera tubes, together with kinescope picture tubes, made all-electronic television a reality. Further important contributions were made by RCA miniatures and

new power tubes, to complete the picture of modern television. These tubes are the foundation of a new and immense industry now in the making.

Now, as in the past, the vast engineering resources of RCA are dedicated to the development of progressively better electron tubes for every phase of television, from the transmitter to the receiver. RCA's extensive manufacturing facilities and "know-how" are working constantly to improve the quality and lower the prices of tubes for television.

The World's most modern tube plant—
Lancaster, Pennsylvania.



In television... it's **RCA**

Here's why:

RESEARCH

RCA recognizes research as the basic guarantee of progress in the art of television. In RCA research laboratories—among the foremost in the world—scientific investigators are unlocking new discoveries that will continue to bring you the latest developments in television broadcasting and reception.

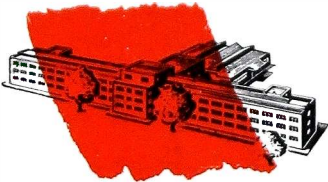

ENGINEERING

Every major chapter in television development has been written by RCA engineering. And every RCA television achievement is backed by engineering experience second to none. A reputation for a high engineering quality, performance, and reliability has been earned by RCA tubes and equipment throughout the television industry.

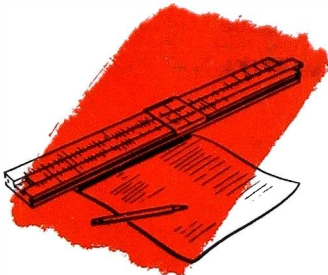

MANUFACTURING

Bold planning for the future in the past now makes RCA manufacturing facilities for television the most extensive in the world. Precision manufacturing methods, ultra-modern production line, rigid quality control, skilled assembly technicians combine to bring you the finest-built tubes and equipment you can buy.



Form 1S3576

DISTRIBUTION

Distribution centers, located at strategic points throughout the country, are equipped to give you maximum service at maximum speed. Streamlined order service makes RCA television tubes and equipment readily accessible—for fastest delivery and lower cost to you.



SERVICE

RCA maintains a nationwide service organization for all television receivers. Professional technicians *engineer* every RCA television receiver installation for maximum performance—and stand ready to keep these receivers in continuous top-running order. Genuine assurance to you of satisfied customers.



ADVERTISING

Powerful newspaper and magazine advertising, plus a top radio program, bring the story of RCA television to a nation-wide audience—year after year. Timely sales promotion supports this effort—opens the door to bigger sales.



Printed in U. S. A.



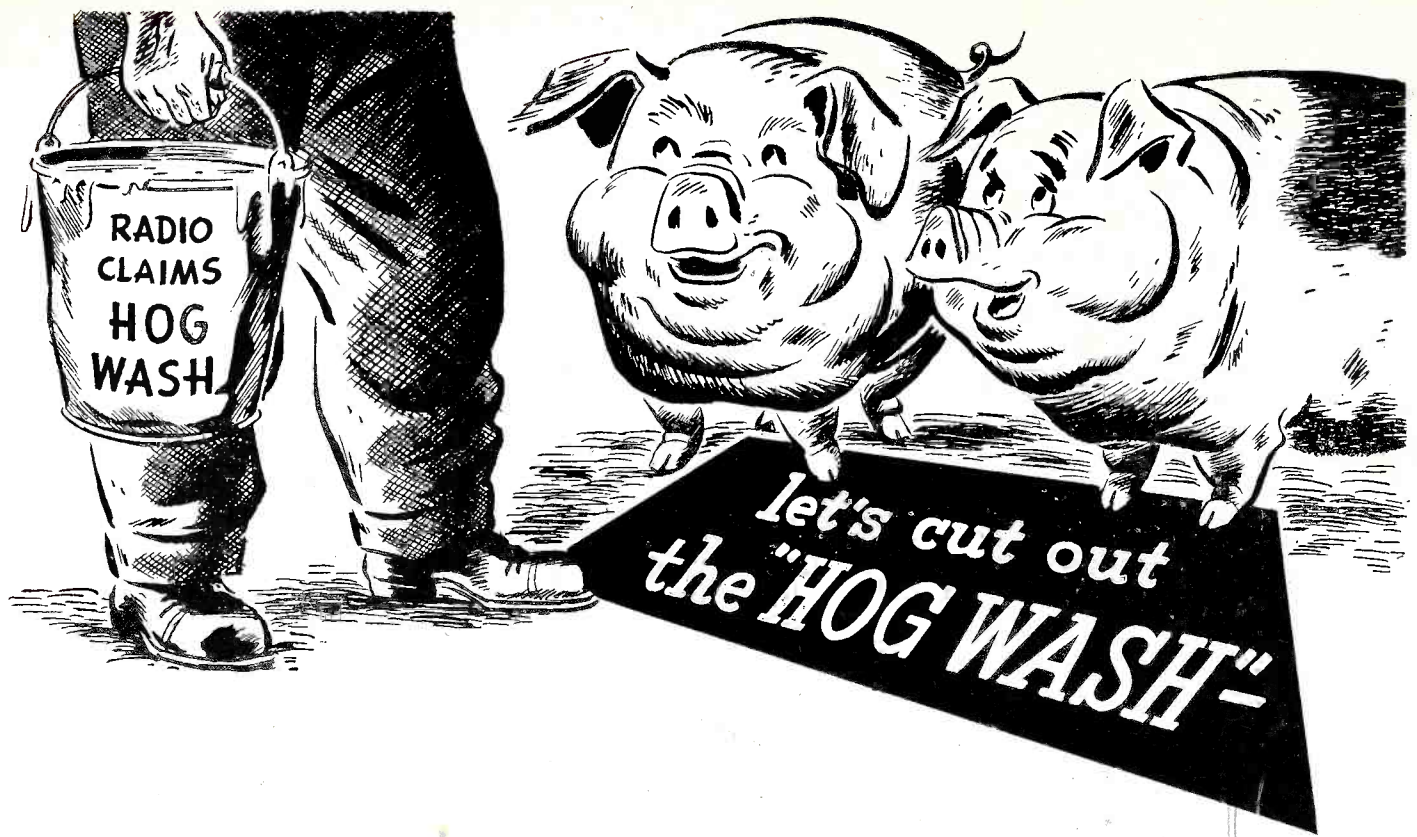

You're in the business of selling Radios *to make MONEY!*

Here is a statement of *fact*. Clarion Radio Distributors and Dealers *have made money consistently* with "Audibel Rated" Clarion Radios and Radio-phonographs for more than 18 years. Mere 'claims' are so much "Hog Wash."

You can sell Clarion with confidence because it is

America's *only* pre-tested and pre-proved Home Radio, thanks to Audibel Rating, the new, scientific measure of *superior* radio performance. Clarion has what it takes in value to satisfy the most discerning buyer . . . distinctive, authentic furniture styling coupled with facsimile tonal performance from record and radio that is truly amazing.

Yet Clarion Radios are popular priced!



Look at the two models on the left.

The Clarion MASTERPIECE AM-FM Radio-Phonograph Console is truly a lovely instrument. A luxurious, hand-rubbed Mahogany Cabinet houses an advanced Superheterodyne chassis with 10 tubes and dual Selenium Rectifiers together with a Symphonized Record Player and Automatic Record Changer. Natural static is eliminated in radio operation.

The Clarion MARVEL, a compact, AC-DC Table Model, is "tops" in its price class. There's a dash to its smartly styled Polystyrene Cabinet that appeals to everyone. Available in 4 refreshing colors.

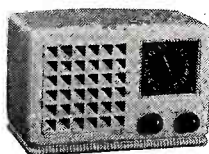

Write, wire, or phone—today—for complete information on Clarion— "the Fine Old Name in Radio."

WARWICK MANUFACTURING CORP.
4640 WEST HARRISON STREET • CHICAGO 44, ILLINOIS

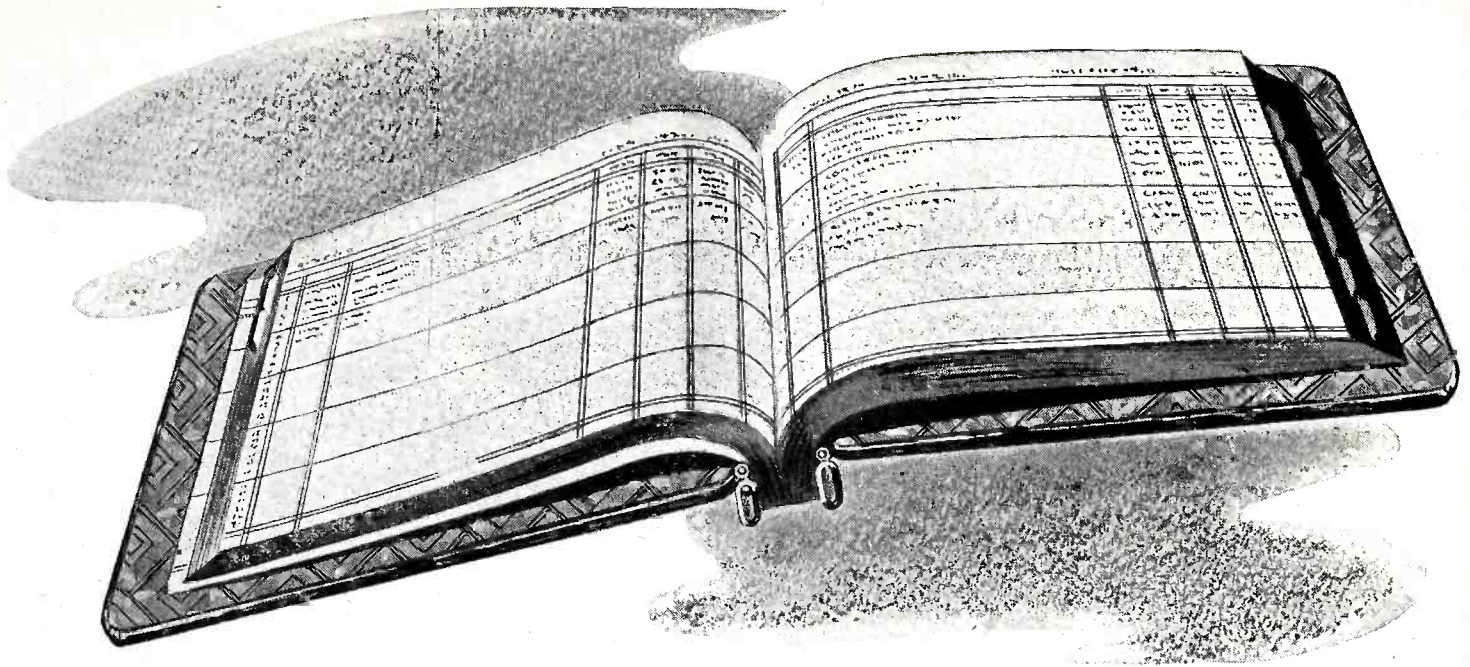

Look at your books before you come to the show

Do YOUR ledgers show profits in keeping with the rosy pictures of radio retailing that were painted a few years ago?

Or have they been chiseled away by price-fights, dumping, back-door peddling at your source of supply?

If you're not making the profits you deserve, why not have a talk with us?

Let us tell you about the SCMP—Sparton Co-operative Merchandising Plan—the system of radio distribution that takes

the headaches out of retailing. Let us show you how Sparton's policy of exclusive dealerships, factory-to-dealer shipments, and fair-play tactics can mean real profits for you.

Drop in at the Sparton booth anytime during the January Furniture Market (Chicago, Jan. 5-17) and talk over your problems with us.

Maybe that visit will be the most profitable call you've made in your life!

THE SPARKS-WITHINGTON COMPANY
JACKSON, MICHIGAN

Sparton RADIO'S RICHEST
FRANCHISE

LOOK US UP

We'll be at

BOOTH 509-B,

January

Furniture Market,

Chicago,

Jan. 5th to 17th

One SPARTON dealer in each community

Check these profit-increasing features

- One exclusive dealer in each community
- Direct factory-to-dealer shipment
- Low consumer prices
- National advertising
- Factory prepared and distributed promotion helps
- Seasonal promotions
- Uniform retail prices
- Products styled by outstanding designers

WHY NOT write us today and ask whether the Sparton franchise is still available in your community?



MODEL 1010. Automatic radio-phonograph with built-in Giantenna, enclosed dust-proof back, vacuum-lift lid. Mahogany veneer finish.

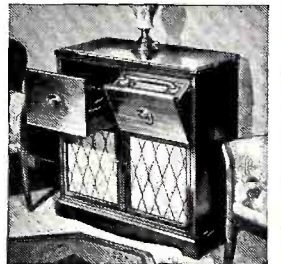

MODEL 1037. Tilt-front cabinet, automatic record changer. In mahogany veneer (shown) or modern blonde finish (Model 1035).



MODEL 10-BM-76-PA. Automatic radio-phonograph with FM. "Roll out" phonograph drawer, 10" speaker. In mahogany or walnut veneers.

TELEVISION LEADERSHIP



— in television receivers

— in television transmitters

— in telecasting

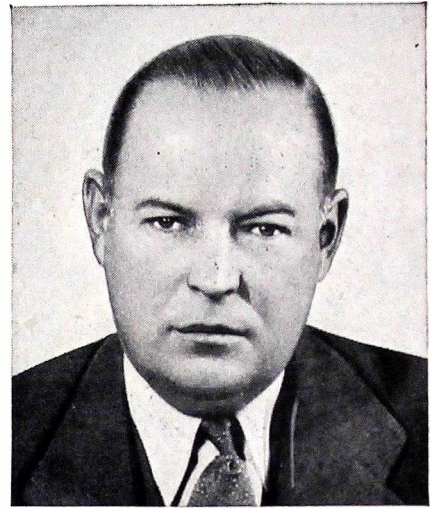

DR. ALLEN B. DU MONT

Heart of television is the cathode-ray tube; and the cathode-ray tube, as we know it today, is largely the work of Dr. Allen B. Du Mont. He found it a laboratory curiosity . . . expensive, undependable, of little practical use.

His development made it a precision instrument which could be mass-produced at a reasonable cost.

By this development, Du Mont made practicable television, radar, loran, the oscillograph and other scientific instruments.

Today, the Allen B. Du Mont Laboratories are the world's largest makers of scientific instruments based on the cathode-ray tube.

Du Mont was first to market a television receiver (1939); and first with post-war receivers (1946). It offers the most complete line from table models to the largest receiver made — equipped with a 20-inch tube.

Du Mont is one of the largest manufacturers of television transmitting equipment, having built 6 of the television stations now on the air — stations located in New York, Washington, Detroit, Chicago, Los Angeles and Cleveland.

Du Mont also operates the world's first television network; its key station WABD, New York, being the world's most powerful television station with the largest and best equipped studios.

DU MONT  *Precision Electronics and Television*



DU MONT TELESETS

There's a Du Mont Teleset to fit every need — every budget — every decor. A few of the more popular are shown here.*

THE CHATHAM. Table-top model. Mahogany finish. 72 square inch screen, FM. **\$445**

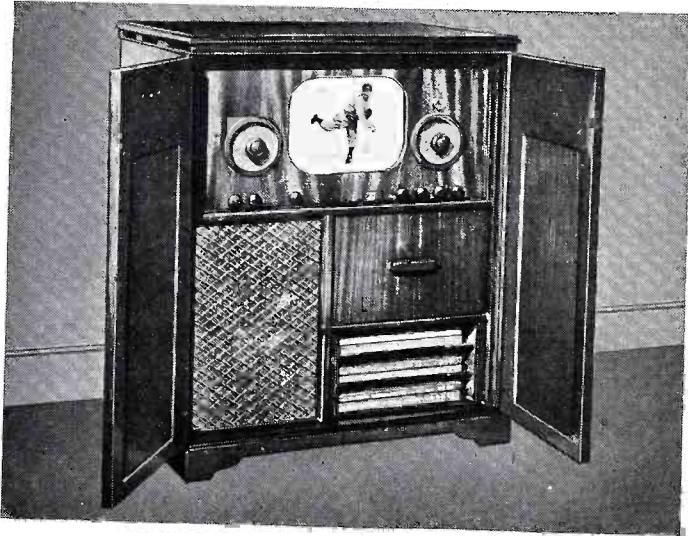

THE SAVOY. Compact console. Traditional design in mahogany finish. 72 square inch screen. AM, FM and automatic phonograph. **\$795**

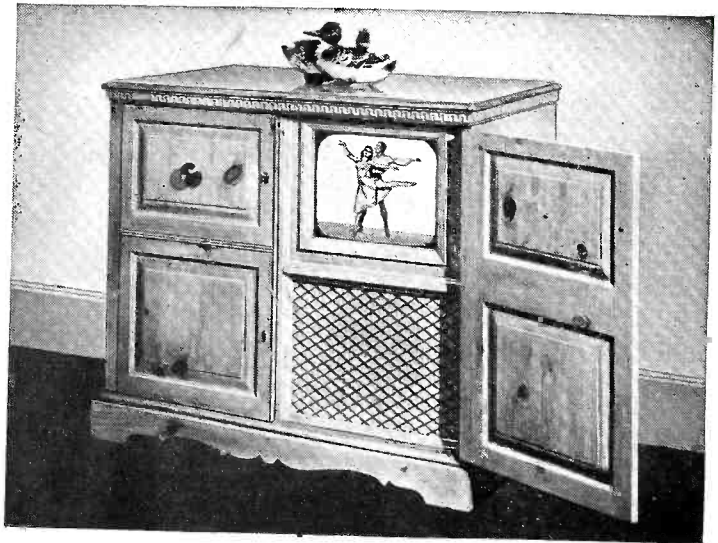

THE PLYMOUTH. Knotty pine in Early American design. A decorator's piece. 116 square inch screen. AM, FM and short-wave radio. High-fidelity automatic phonograph. **\$1795**

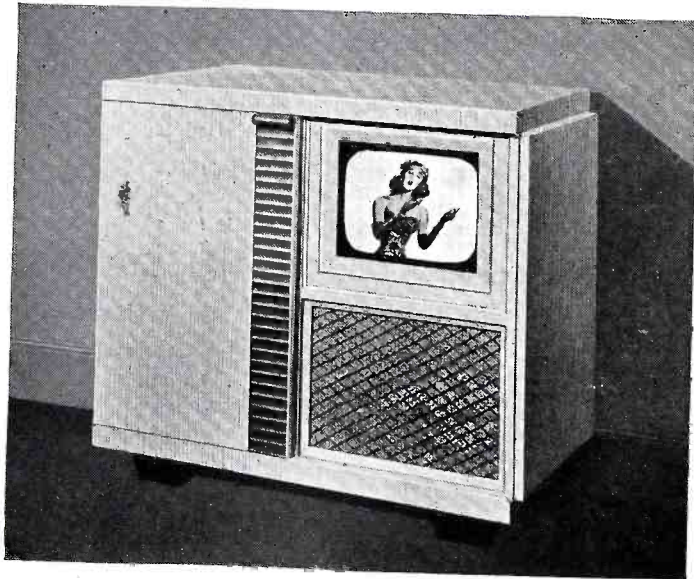

THE DEVONSHIRE. Smart modern in blond hardwood. 116 square inch screen. AM, FM and short-wave radio. High-fidelity automatic phonograph. **\$1795**

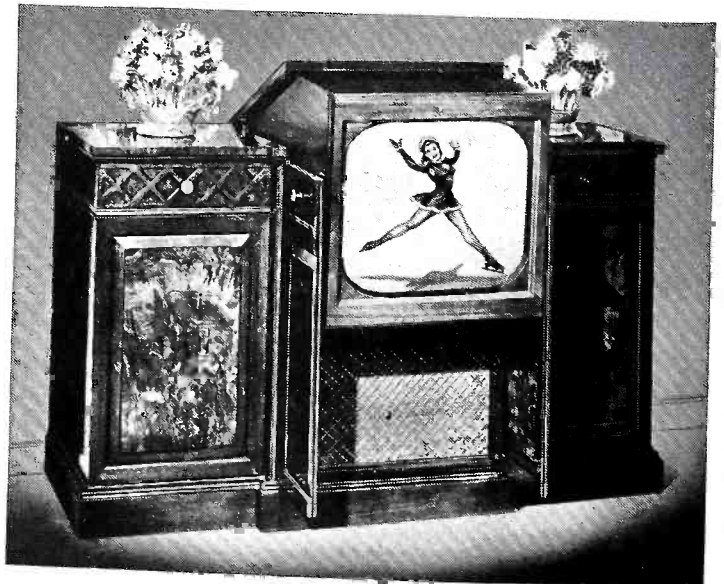

THE WESTMINSTER. Classic design in beautifully matched mahogany veneers. World's largest direct-view screen—213 square inches. AM, FM, world-wide short wave radio; high-fidelity automatic phonograph with generous album storage. **\$2495**

*Trade Mark

Note: Prices do not include tax or installation.

TIME TRIED

for top quality telecasts

DUMONT

Transmitting Equipment

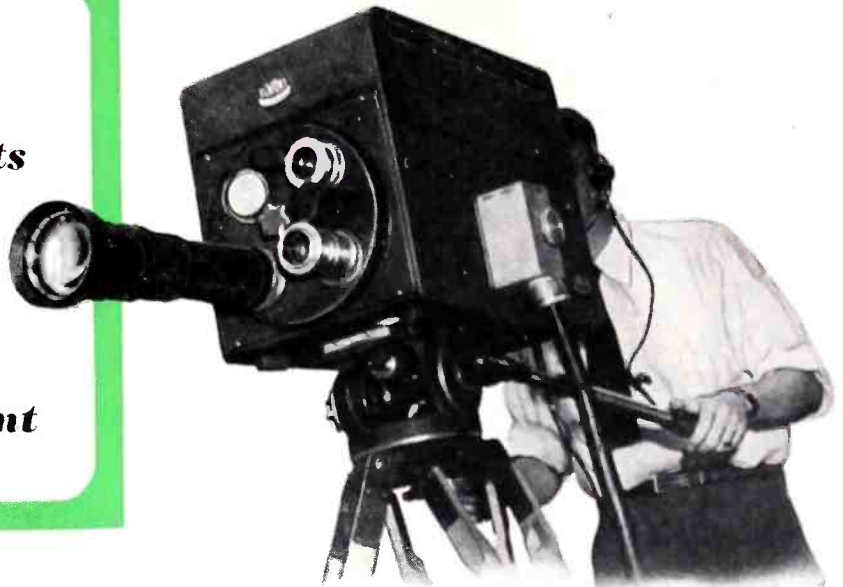

→ It's Du Mont all the way — from camera to control room and to transmitter, and again to the Du Mont Teleset — for “tops” in television.

Through the operation of pioneering station WABD since 1939, Du Mont engineers have gained “on the job” experience with their equipment. Each new idea, each improvement, each refinement, has had a practical workout. Out of this extraordinary experience has come the second-to-none Du Mont television transmitting equipment in general use today.

Many of tomorrow's leading telecasters are starting out today on a modest scale with the Du Mont “Acorn Package” or basic transmitting equipment, which grows with telecasting needs. And many of tomorrow's engineers, operators, cameramen and other telecast technicians are receiving their basic training at Du Mont's.

From camera to receiver, today and tomorrow, it's Du Mont with the “First with the Finest in Television.”



← OSCILLOGRAPHS

For the servicing of television and other radio equipment, as well as in countless other fields where simple or intricate electrical phenomena are checked and studied, it's Du Mont for oscillographs. Du Mont is the largest manufacturer of oscillographs in use throughout the world. A wide choice of types meets every standard need. Such equipment is made in the Clifton plant.

CATHODE-RAY TUBES →

The expanded Du Mont plant at Passaic is devoted entirely to cathode-ray tube production—Du Mont's original business. Made in all types and sizes — from the simplest 3” oscillograph tube to the giant 20” direct-viewing television tube. Always remember — Du Mont makes both — the equipment and the tube — for proper balance and satisfaction operation. And Du Mont supplies tubes to other manufacturers.

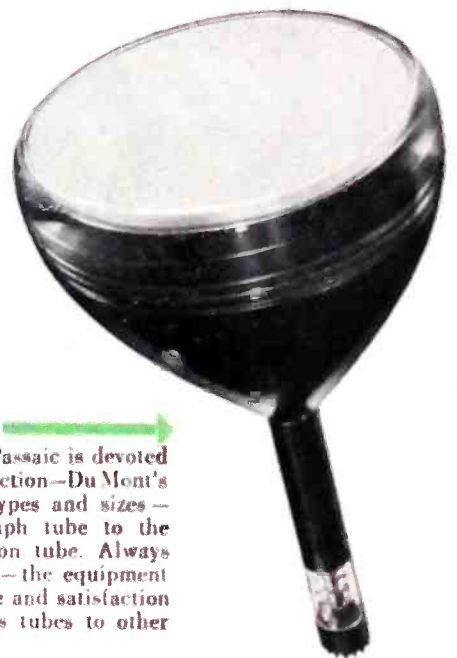

DUMONT

First with the Finest in Television

ALLEN B. DU MONT LABORATORIES, INC. • HOME OFFICES AND PLANTS, PASSAIC, N. J.
TELEVISION EQUIPMENT DIVISION, 42 HARDING AVE., CLIFTON, N. J. • DUMONT NETWORK AND STATION WABD, 515 MADISON AVE., NEW YORK 22, N. Y.
DU MONT'S JOHN WANAMAKER TELEVISION STUDIOS, WANAMAKER PLACE, NEW YORK 3, N. Y. • STATION WTTG, WASHINGTON, D. C.

DU MONT—PIONEER IN TELECASTING

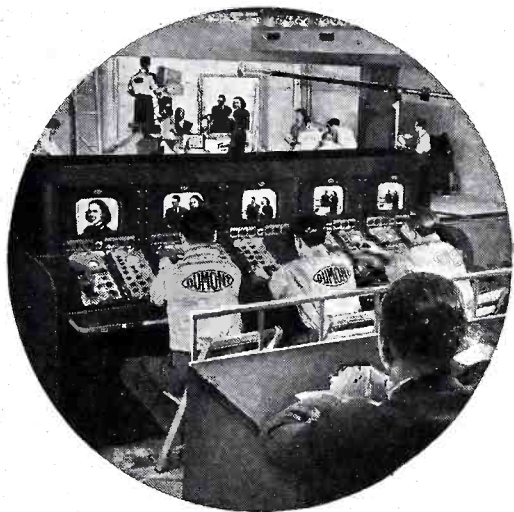

Much of the intricate electronic equipment used in telecasting was developed by Du Mont.

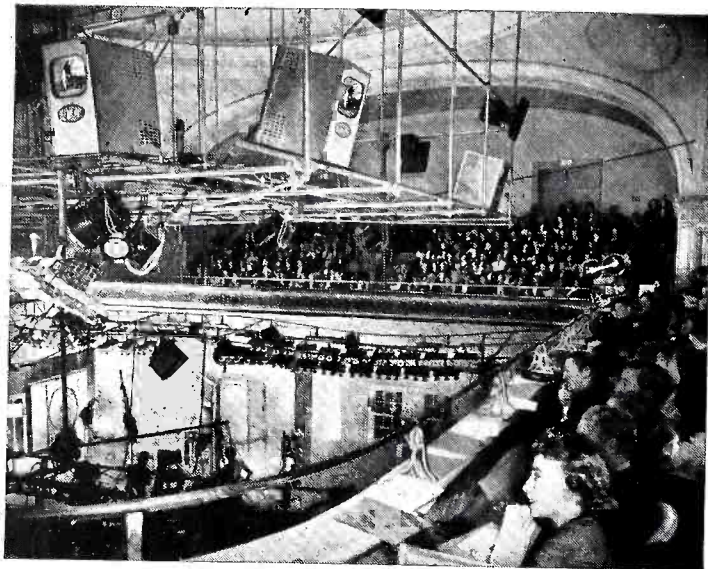

Station WABD—New York, key station of the Du Mont Network and the world's largest television studio. 700 guests in the gallery can watch the action on several stages below and at the same time see the program on the overhead viewing screens just as it is going out over the air.



Du Mont's mobile units pick up action wherever it occurs and relay it back to the transmitter.



Many programs now originate in WTTG, the first television station in the nation's capital and the Du Mont network's Washington outlet.

DU MONT *First with the Finest in Television*

New!
Revolutionary!

Admiral

RADIO
PHONOGRAPH
TELEVISION

Matched Unit Ensemble

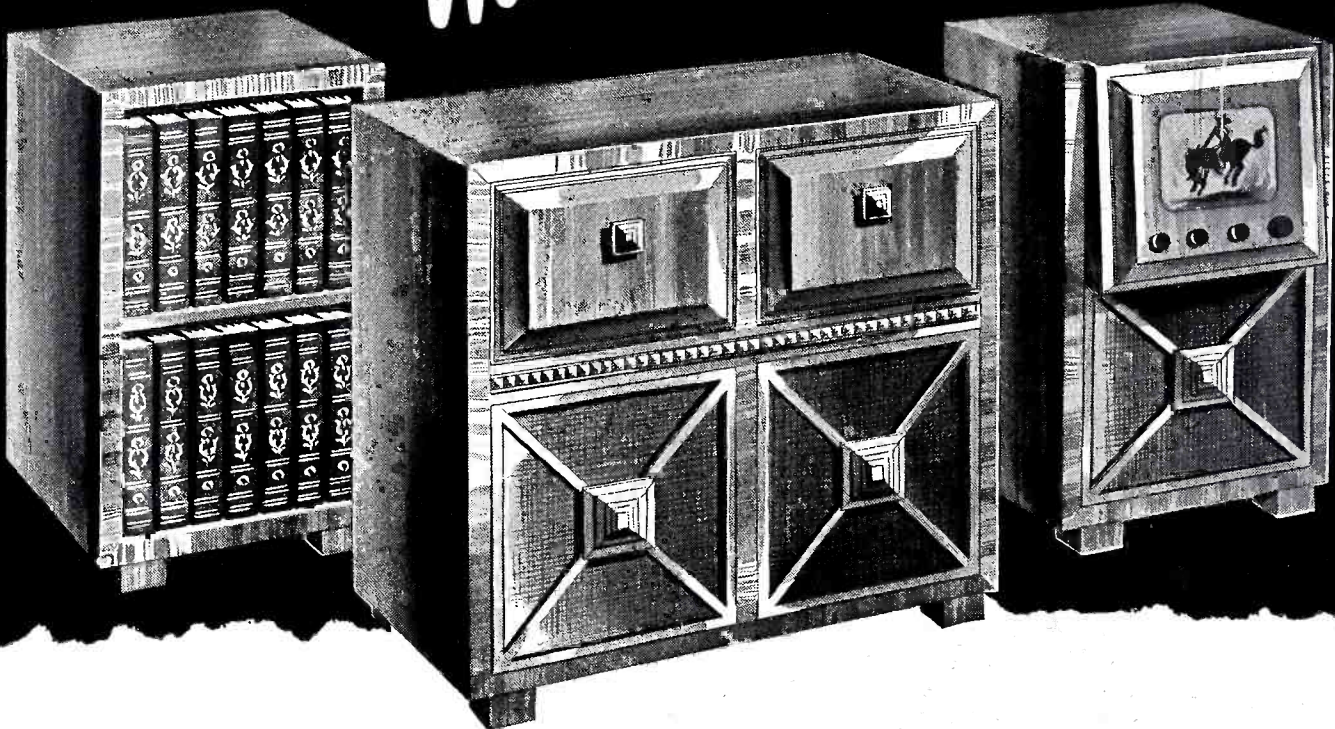

A Great New Idea in Merchandising

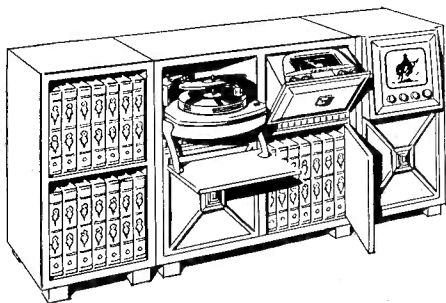

Here's a *complete* Radio-Phonograph-Television ensemble your customers can buy in *easy stages*. Each unit duplicates the styling of the other two. Buy one unit first . . . add the other two later on. That's the way it works.

Sound merchandising? Sure! and here's why:—television alone won't satisfy your prospects. They want AM-FM radio and automatic record playing too. Currently, the price of all three combined in one cabinet is far beyond their ability to buy. But they can buy Admiral's Matched Unit Ensemble . . . one unit at a time . . . and spread the purchase price out.

Heavy inventory on radio-phonograph combinations without television is no problem either, when you handle the Admiral line. Admiral combinations CAN'T GO OUT OF DATE. The matching television unit can always be added later. See your Admiral Distributor now for complete details.

*Beauty!
Performance!
Value!*

The New Model 810
FADA
Radio

Radio-Phonograph
Combination



FADA Model 810
Radio-Phonograph Combination.
Plays 10 twelve inch or 12 ten
inch records automatically. Hand
rubbed Mahogany cabinet.
\$89⁹⁵
List

... has everything! ... simple, classical, mahogany veneer line cabinet, rubbed by hand to a beautiful piano finish. The automatic record changer offers a full hour of fine listening pleasure with one loading of 10 twelve inch or 12 ten inch records. Get unlimited hours of listening pleasure too from the Fada A. C. Superheterodyne radio receiver, our ace performer! This is but one of Fada's 'New Day' Style line making radio history.

Fada Radios
priced list
from
\$17.95

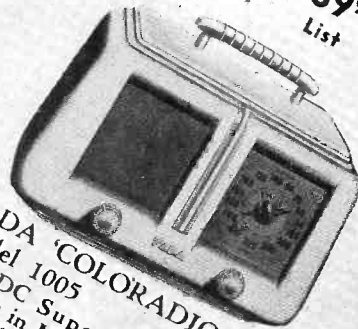

FADA 'COLORADIO'
Model 1005
AC-DC Superheterodyne re-
ceiver in Maroon, Ivory or Mot-
tled Blue plastic.
\$27⁹⁵
List



FADA 'COLORADIO'
Model 700
AC-DC Superheterodyne re-
ceiver. Choice of 5 beautiful
'Fada-Lucent' Cabinets.
\$34⁹⁵
List

Coming!

A keen surprise
awaits you... The New
Fada Television Receiver
will be the last word in
outstanding beauty and per-
formance. Announcement is
just around the corner... watch
for it soon.

THE RADIO OF TOMORROW — TODAY

FADA RADIO & ELECTRIC COMPANY, INC.
BELLEVILLE, NEW JERSEY

"SINCE BROADCASTING BEGAN"

The Story of Farnsworth Television

(CABLE ADDRESS-TELEVISION)

IT is no coincidence that the word "Television" is the cable address of the Farnsworth Television & Radio Corporation. Farnsworth is the inventor of the first successful system of electronic television . . . and the name Farnsworth and the science of television have been linked more than two decades.

Today Farnsworth continues to be recognized as the Home of Television.

Activity in television research and engineering has gone on uninterruptedly at Farnsworth ever since the *early 1920's* when Philo T. Farnsworth began work on the first all-electronic television system. This record remained unbroken even during World War II, the company being one of two engaged to develop television equipment for the Army and Navy. As a result, Farnsworth has compiled a notable list of "firsts" in television.

Furthermore, the company has concentrated exclusively on the development and production of electronic products—devoting its entire research, engineering and manufacturing facilities to refining the services that these products make possible. Farnsworth has blazed—not followed—the trail of progress in television.



Farnsworth

a company of experience
and VISION

Farnsworth places emphasis on three distinct phases of operation: research, engineering, manufacturing. Hundreds of important patents owned by the company are the proof that the huge investment of time and money that have gone into the Farnsworth research laboratories has been well spent; the very latest and finest engi-

neering principles incorporated in all Farnsworth products are the result of the work of a large staff of experienced electronic engineers; television receivers and other radio-electronic products bearing the Farnsworth name are produced in modern factories that have earned a nation-wide reputation for precision workmanship.

Television activity at Farnsworth is increasing steadily and will continue to gain in the months ahead. The company's latest-model home television receivers, incorporating significant new electronic developments, are now available in certain television cities. Farnsworth also has developed and introduced, since the end of the war, the first successful industrial television system and the first remote-controlled rotatable television antenna.

To the distributor, the dealer and the consumer, the name Farnsworth means *leadership in television.*

L. C. Nicholas

President.



LOOK FOR THESE POINTS OF FARNSWORTH TELEVISION EXCELLENCE

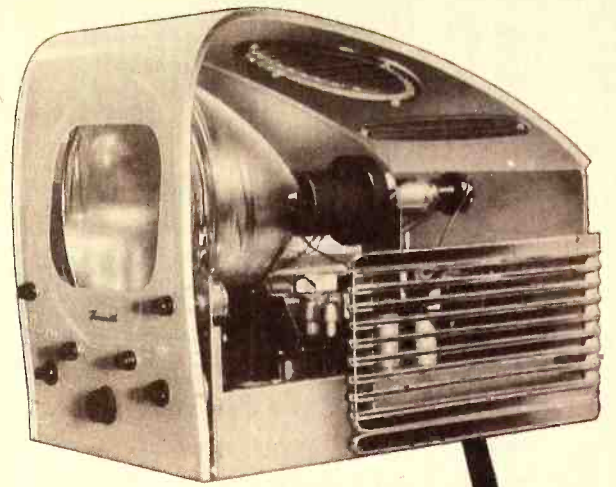

- Made by the Creator of Electronic Television.
- Capable of Complete Coverage of All Commercial Television Channels Designated by the FCC.
- Completely new 10" Flat-Face Picture Tube Provides Brilliant, Steady, High-Definition 52-Square Inch Image Which Can Be Viewed in Full Daylight.
- Wide Band Amplifiers Achieve Highest Picture Definition and Clarity.
- Mirror-Backed Picture Tube Extends Tube Life—Increases Picture Brilliance.
- Metal Screening, Safety Glass and Interlock Assure Full Protection to Receiver, Absolute Safety in its Operation.
- Maximum Efficiency from Compact Chassis Design—Power Costs Approximately That of Two 100-Watt Light Bulbs.
- Electronic Beam Relaxor Results in Simplicity of Electrical Circuit Design—Permits More Economical Set Maintenance.
- Use of Standard Receiving-Type Tubes Achieves Longer Tube Life and Results in Minimum Tube Replacement.

The highly desirable compactness resulting from skillfully-engineered circuits by Farnsworth is evidenced in this display unit.

Farnsworth is proud of the many fundamental contributions it has made to the development of television—is gratified that so many thousands will see television today as Farnsworth scientists visualized it, when developing the world's first practical all-electronic television system two decades ago.

- Simplified Operation—All Major Television Controls Front-Mounted. One Selector Switch for All Receiving Functions.
- Versatile Antenna Input Characteristics Allow Use of Either a Co-axial Cable or Inexpensive Transmission line.
- Audio System, Utilizing Exclusive FM Techniques Plus a 6" PM Alnico Speaker, Provides Exceptional Tonal Fidelity.
- Listed by Underwriters' Laboratories, Inc.
- Complete Installation and Maintenance Covered by Sales-Service Policy if Desired.

For those seeking the very best in modern styling and finish, Farnsworth offers this cabinet in mahogany veneers which accent the smooth simplicity of cabinet design. New 10" flat-face tube—52-square inch image. Cabinet 22" L, 18" H, 16" W.



TELEVISION TODAY and TOMORROW



Television already is beginning to reach technical and economic maturity. Today it is available in many of the nation's larger cities, and its important service is being expanded rapidly. By the end of 1948 television outlets will serve areas including more than 40 per cent of the nation's population.

During the past year nearly a dozen new television stations have begun telecasting regularly. Twelve months from now there will be several dozen stations carrying highly-developed television programs to an eager public. Altogether, there are now more than a hundred television outlets either operating, under construction, or with applications pending.

A television network already established along the Eastern Seaboard—connecting such cities as New York, Philadelphia, Boston, Washington and Schenectady—is rapidly being extended westward and southward, so that within a few more years it will be possible to televise programs from coast to coast, to smaller cities as well as metropolitan areas. Tens of thousands of new television receivers are going into use in homes every month, and the list of commercial sponsors participating in television is mounting daily.

Television is expanding. And Farnsworth, The Home of Television for more than two decades, is expanding with it.

FARNSWORTH TELEVISION & RADIO CORPORATION Fort Wayne, Indiana

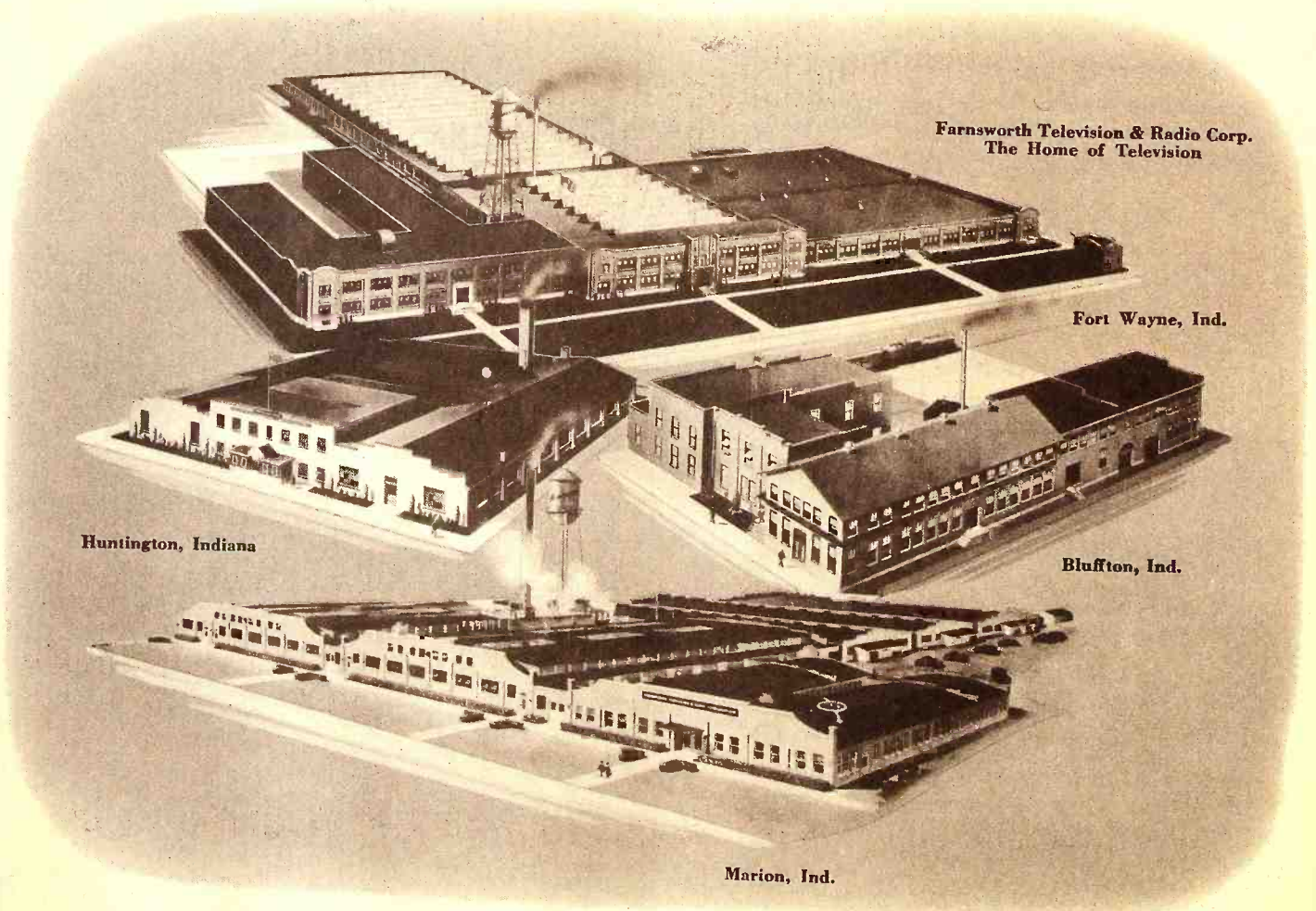

OVERWHELMING ACCEPTANCE!



• Month after month, RCA Batteries continue to smash all previous sales records.

The reasons for this unprecedented acceptance are conclusive—

RCA Batteries are designed for *radiomen* . . . to sell through *radio* outlets. And they're backed by the greatest name in radio—RCA.

RCA Batteries are your assurance of immediate customer acceptance and greater profits.

SELL RCA BATTERIES—THE COMPLETE LINE FOR THE RADIO AND ELECTRONIC TRADE

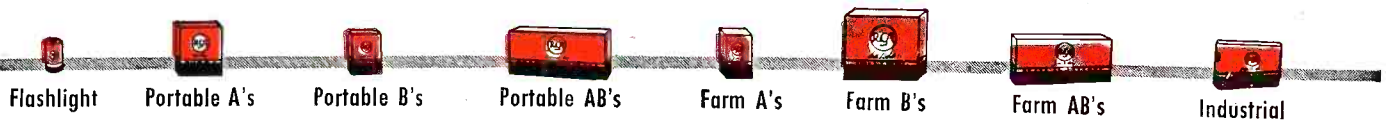

Flashlight

Portable A's

Portable B's

Portable AB's

Farm A's

Farm B's

Farm AB's

Industrial



TUBE DEPARTMENT

RADIO CORPORATION of AMERICA

HARRISON, N. J.

Terrific Big PROFIT Opportunity for DEALERS and DISTRIBUTORS

Exclusive Franchises Still Available
for

TeleKing



the *Only*
**Television
Receiver with
the amazing**

**ACRO-COUPLING
CIRCUIT**

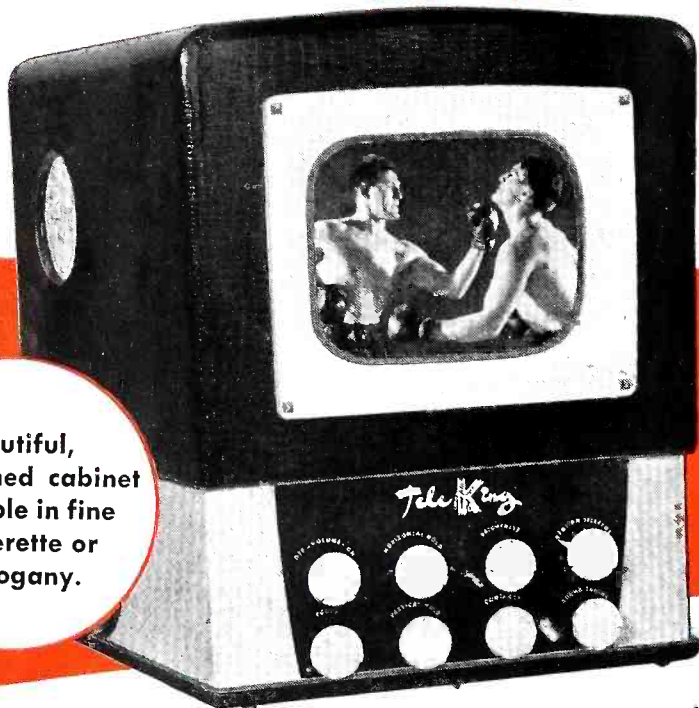

Beautiful,
streamlined cabinet
available in fine
leatherette or
mahogany.

SUPERIORITIES THAT MAKE TELEKING EASY TO SELL

1. Big, clear, sharp, bright, steady, 15 inch tube, *direct view pictures*. So clear that you can enjoy them as much at fifty feet away, as at six.
2. Automatic picture level. You can't miss getting the broadcast right on the beam—because it's all automatic. Just turn the knob.
3. Wonderful natural tone . . . just as clear and true as your own voice—at any distance.
4. Lowest operating cost. TELEKING is so perfected that with its acrocoupling circuit it has less parts, gives less heat, uses less current . . . has less possibility of any kind of trouble.

TELEKING is now enjoying terrific acceptance all over the country. Orders and re-orders are pouring in—because TELEKING is noticeably superior to any other television receiver on the market. To one distributor in each market—the CONSOLIDATED TELEVISION CORPORATION offers an exclusive franchise — for TELEKING, the finest television receiver ever designed . . . a real steady profit-maker.

The TELEKING franchise is an exclusive franchise . . . backed by the powerful TELEKING SALES AND MERCHANDISING PLAN—backed by national advertising and promotion that's sure to bring in steady profits to the holder of each franchise. Write today and find out whether the TELEKING franchise is still available in your community.

CONSOLIDATED TELEVISION CORPORATION
601 WEST 26th STREET, NEW YORK 1, N. Y.

MAKING TUBES IS EASY..

If YOU KNOW HOW!

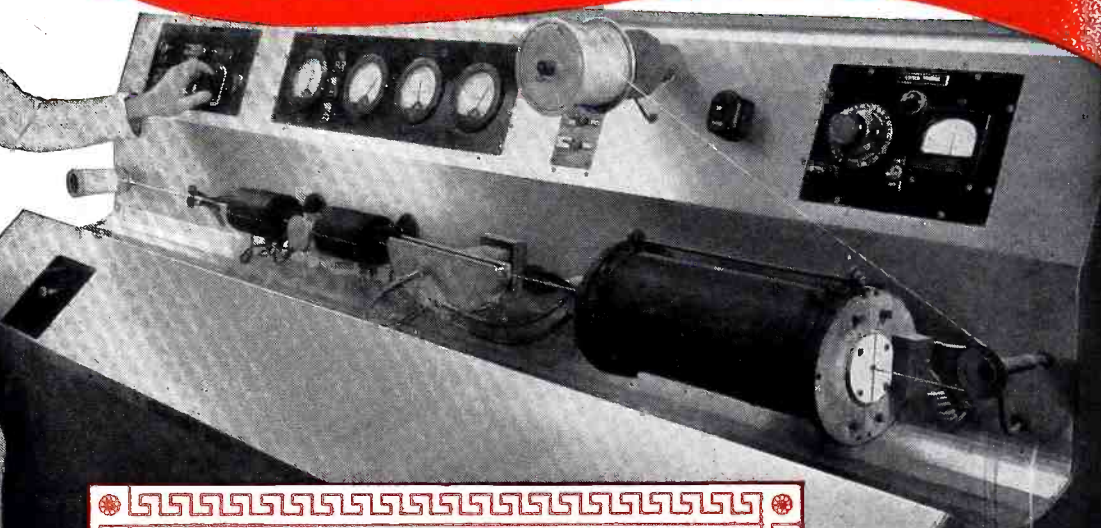

ΚΑΤΑΦΟΡΗΣΙΣ
*...filament coating
 made Easier... Better*

HYTRON CATAPHORESIS COATING MACHINE—Filament wire proceeds from the large spool at top center through oxidizing oven, cataphoresis coating bath, and two small ovens. Finally, the coated wire is wound on the cylinder at the left.

A jawbreaker from the Greek, cataphoresis means simply "the movement of suspended particles through a fluid under the action of an applied electromotive force." At Hytron, filaments are not *sprayed* with electron-emissive coating, because that way precise control cannot be achieved. Rather, coating is electrically deposited by the cataphoretic movement of the carbonate molecules.

Drawn through a special coating solution, the filament wire itself serves as the anode; and a metallic plate, as the cathode. The solution consists of a triple precipitate of barium, calcium, and strontium carbonates plus a binder—all suspended in a special organic medium. A precisely adjusted electromotive

force uniformly deposits and bonds the electrically-charged salts onto the filament wire. Baking problems are simplified; coated wire is spooled directly on a cylinder, ready for use.

This new Hytron method of filament coating is so simple, so precise as to texture, weight, and adhesion. One wonders why it is not universal. The answer is simple. Cataphoresis coating is easy *only* if you possess the trade secret of the Hytron coating formula. Also, the applied voltage, timing, and resultant control of texture and emissive qualities in mass production represent months of persistent research. You profit by superior performance from all Hytron coated-filament tubes.

SPECIALISTS IN RADIO RECEIVING TUBES SINCE 1921

HYTRON

RADIO AND ELECTRONICS CORP.



MAIN OFFICE: SALEM, MASSACHUSETTS

THE NEW

Super-Distance Champions



YOUR customers want sharp, clear television pictures. They get them with G-E. They want super-distance reception. G-E television receivers give it. They want handsome cabinets. G.E. has them. They want dependability and advanced design. They can rely on General Electric. For 20 years General Electric has pioneered in bringing television from a laboratory experiment to its present state of perfection. Ask your G-E radio distributor about a G-E television franchise, or write *Receiver Division, General Electric Co., Electronics Park, Syracuse, N. Y.*

**Super-Distance Television,
FM, AM, Phonograph.
Has Everything—All in One!**

Big (10") direct view picture tube. All the action in *natural clarity*. Exclusive G-E Automatic Clarifier. All 13 U. S. television channels. Both FM and AM radio. Magnificent automatic phonograph with the sensational G-E Electronic Reproducer. Beautiful period cabinet paneled in richly grained mahogany. Model 802.

**Sensational
New G-E
Table Model
Coming!**

**G-E Super-Distance Television
With Standard Radio.**

Big (10") direct view picture tube. Exclusive G-E Automatic Clarifier. All the action in *natural clarity*. All 13 U. S. television channels. Automatic synchronization with tuned-in station. Standard radio (540—1600 kc). 12" Dynapower speaker. Handsome period cabinet paneled in genuine mahogany. Model 801.





Electronic TELEVISION

ONLY G-E TELEVISION HAS ALL THESE FEATURES

- ★ Natural clarity of pictures. Better than front-row-seats at the world's greatest entertainment.
- ★ G-E Automatic Clarifier to enhance picture detail and guard against outside disturbance.
- ★ All 13 U. S. television channels, each with its individual factory pre-tuned circuit.
- ★ Automatic synchronization with station.
- ★ Oversize Dynapower Speaker.
- ★ Unusually low-power consumption. Compare!



G-E Projection Television With 3 Square Foot Screen.

Schmidt Optical System projection. Screen 3 square feet in area. AM, FM, and short-wave radio, and automatic phonograph with the sensational G-E Electronic Reproducer. All in a magnificent Sheraton-inspired cabinet of genuine mahogany fashioned by master craftsmen. Model 901.



Full-page ads in Life, Collier's, and the National Geographic are pre-selling your customers on the Super-Distance Champion G-E Television Receivers.

GENERAL  **ELECTRIC**

TUNE IN
the G-E House Party every weekday afternoon over CBS and the Fred Waring Show Monday nights on NBC.



Westinghouse *unveils* Television *that will* sell on sight!

performance... THAT SELLS ON SIGHT!

Here's a set you can really demonstrate... the picture is the proof. For the big 52 sq. in. screen brings to your fireside the living image of the live telecast. The Westinghouse Automatic Focuser brings in all telecast stations perfectly tuned, pictures perfectly focused and firmly synchronized. What's more, every colorful note is reproduced exactly as recorded—no static, no fading—thanks to Westinghouse FM.

appearance... THAT SELLS ON SIGHT!

Styled in authentic Chinese Chippendale, the Westinghouse Model 181 is a fitting companion of finest furniture. Exquisite console cabinet of choice mahogany veneers is an ideal small size to enhance any room arrangement. It's 43" high, 23½" wide, 20½" deep. Every way you look at it, the Westinghouse Model 181 is the direct view television receiver that sells on sight. It's the only popular-priced set built into a really fine piece of furniture.

HOME RADIO DIVISION • WESTINGHOUSE ELECTRIC CORP. • SUNBURY, PA.

look... listen... and you'll buy

Westinghouse
 PLANTS IN 25 CITIES OFFICES EVERYWHERE



RADIO & TELEVISION RETAILING

Including Radio and Television Today

O. H. CALDWELL, Editorial Director



M. CLEMENTS, Publisher

1948 WILL BE GREAT—

for the Retailer Who's Ready!

In facing 1948, the alert merchant needs to turn his back on 1947. That's the past! What the future holds is the all-important thing!

From all indications, it seems safe to assume that the radio/appliance retailer will be operating under quite different business conditions in the new year from those which have prevailed for several years past.

Some of the "conditions" will be brand-new. Still others will be revivals of old methods which have lain dormant during the period of merchandise scarcity.

For instance, one of the "new" conditions promises to be the greater importance of *how to sell merchandise* over the fast-disappearing problem of *where to get products* for resale.

Another "new" is the changed time-payment proposition now that government regulations have been removed. (See article, "Get Set for Time-Buying Increase," in Appliance Section, Dec. 1947 issue.)

Then too, there is *new* merchandise requiring fast-paced selling, displaying and demonstrating techniques. Television, for example, starting in a big way to get off toward its billion-dollar goal—five years hence; FM sets to bring in extra profits—and numbers of *new* electrical appliances including dishwashers, food freezers, electric blankets, clothes dryers and disposal units, to mention but a few.

Greater supplies of the "regulars"—radios, phono players, refrigerators, washers, ironers, ranges, and small appliances will mean that the dealer can devote his energies once again toward *selling* instead of *seeking*. He'll need to go back to the *old* fundamentals of merchandising because *old*, familiar forms of competition will crop up again.

The dealer will have to *sell* his service facilities in order to insure a steady income for his repair department, viewing as he does the end of the fevered period of emergency maintenance.

In 1948, he will have to exercise greater vigilance over such old problems as credit and collection in order to maintain his own financial stability, which will increase daily in importance from here on.

1948 promises to be an exciting, do-business year. It'll be filled with new opportunities for the dealer who gears himself to its pace. But there will be tough-sledding for the merchant who fails to realize that from here on products *must be sold*.

Statistics of

THE RADIO-ELECTRONIC INDUSTRY

Data Covers Year Ended December 31, 1947

	Total Investment	Annual Gross Revenue	Number of Employes	Annual Payroll
Radio manufacturers (1100)	\$60,000,000	\$ 450,000,000	80,000	\$110,000,000
Radio distributors, dealers, etc.	300,000,000	1,000,000,000	125,000	240,000,000
Broadcasting stations (1800) including talent costs	125,000,000	410,000,000	*20,000	70,000,000
Commercial communication stations	60,000,000		15,000	8,500,000
Listeners' sets in use (66,000,000)	3,000,000,000			†500,000,000

* Regular staff—not including part-time employes, artists, etc., who number at least 30,000 more.

† Annual operating expense for listeners' sets, for tube replacements, electricity, servicing, etc.

ANNUAL BILL OF U. S. FOR RADIO

Sales of time by broadcasters, 1947	\$350,000,000
Talent costs	60,000,000
Electricity, batteries, etc., to operate 66,000,-000 receivers	220,000,000
17,000,000 home radio receivers, at retail value	800,000,000
170,000 television receivers, at retail value	120,000,000
Phonograph records, 325,000,000	300,000,000
Radio repairs and supplies:	
66,000,000 replacement tubes	90,000,000
Radio parts, accessories, etc.	100,000,000
Labor	75,000,000
TOTAL	\$2,115,000,000

RADIO SETS IN U. S.; WORLD

	January 1, 1948
United States homes with radios	37,000,000
Secondary sets in above homes	16,000,000
Sets in business places, institutions, etc.	4,000,000
Automobile radios	9,000,000
TOTAL sets in United States	66,000,000
Total radio sets in rest of world:	
North America, 4,500,000; South America, 5,000,000; Europe, 46,-500,000; Asia, 6,500,000; Australia, 2,500,000; Africa, 1,000,000	66,000,000
TOTAL sets in world	132,000,000

Radio's Two Billion Dollars

--- Where It Comes From and Where It Goes

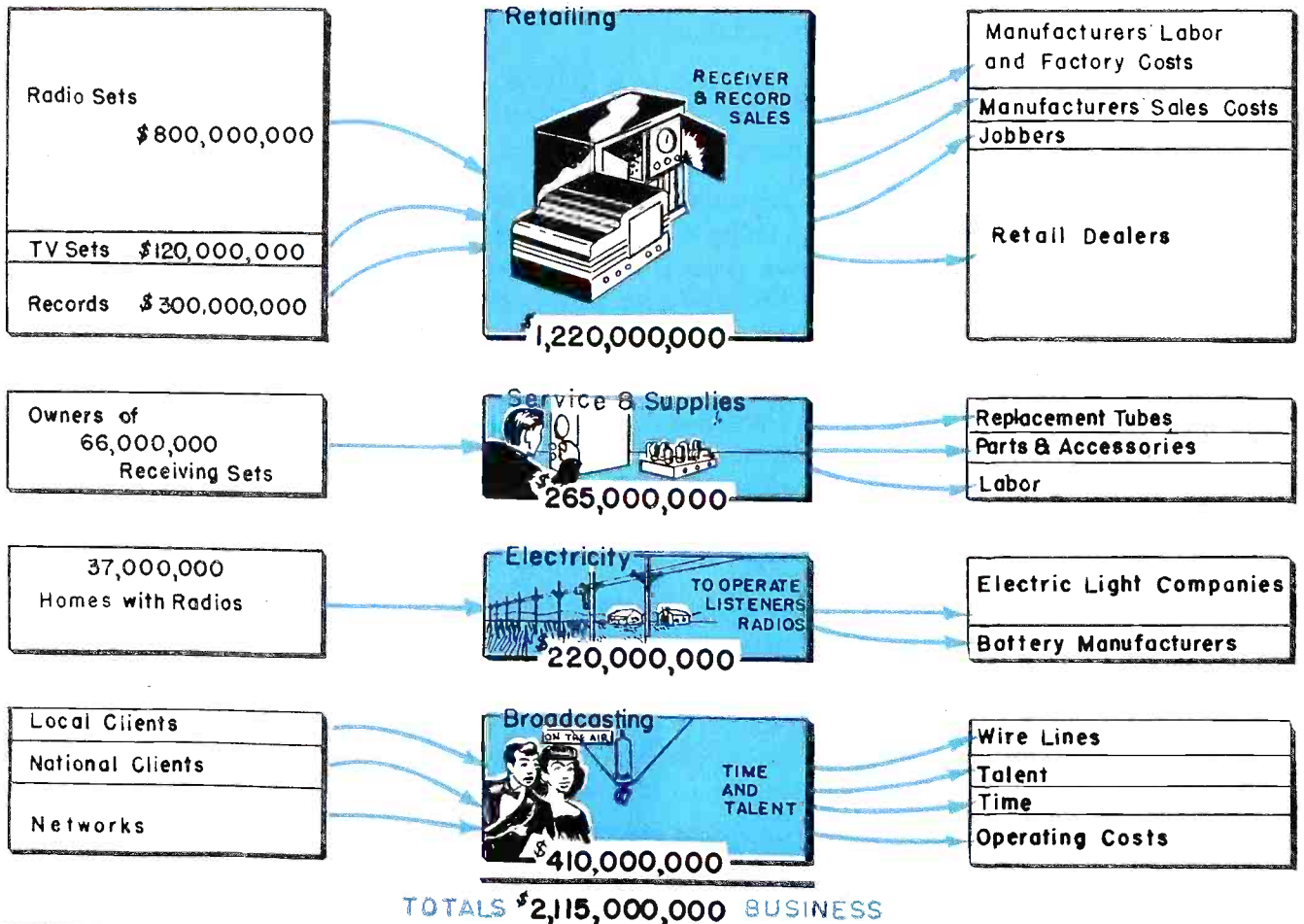

Radio for 1948

Total AM Broadcast Stations Authorized	2,000
AM Broadcast Stations Operating	1,500
Total FM Broadcast Stations Authorized	1,100
FM Broadcast Stations Operating	400
Total Television Stations Authorized	70
Television Stations Operating	20
Total Stations All Broadcast Services	3,700
Total Police Radio Systems	1,500
Total Special Service Stations; marine, aeronautic, railroad, fire, forestry, etc.	39,000
Commercial radio operators licensed	340,000
Amateur operators (80,000) stations	75,000
Radio-equipped vehicles (2-way service)	30,000
Record-player units of all types	18,000,000

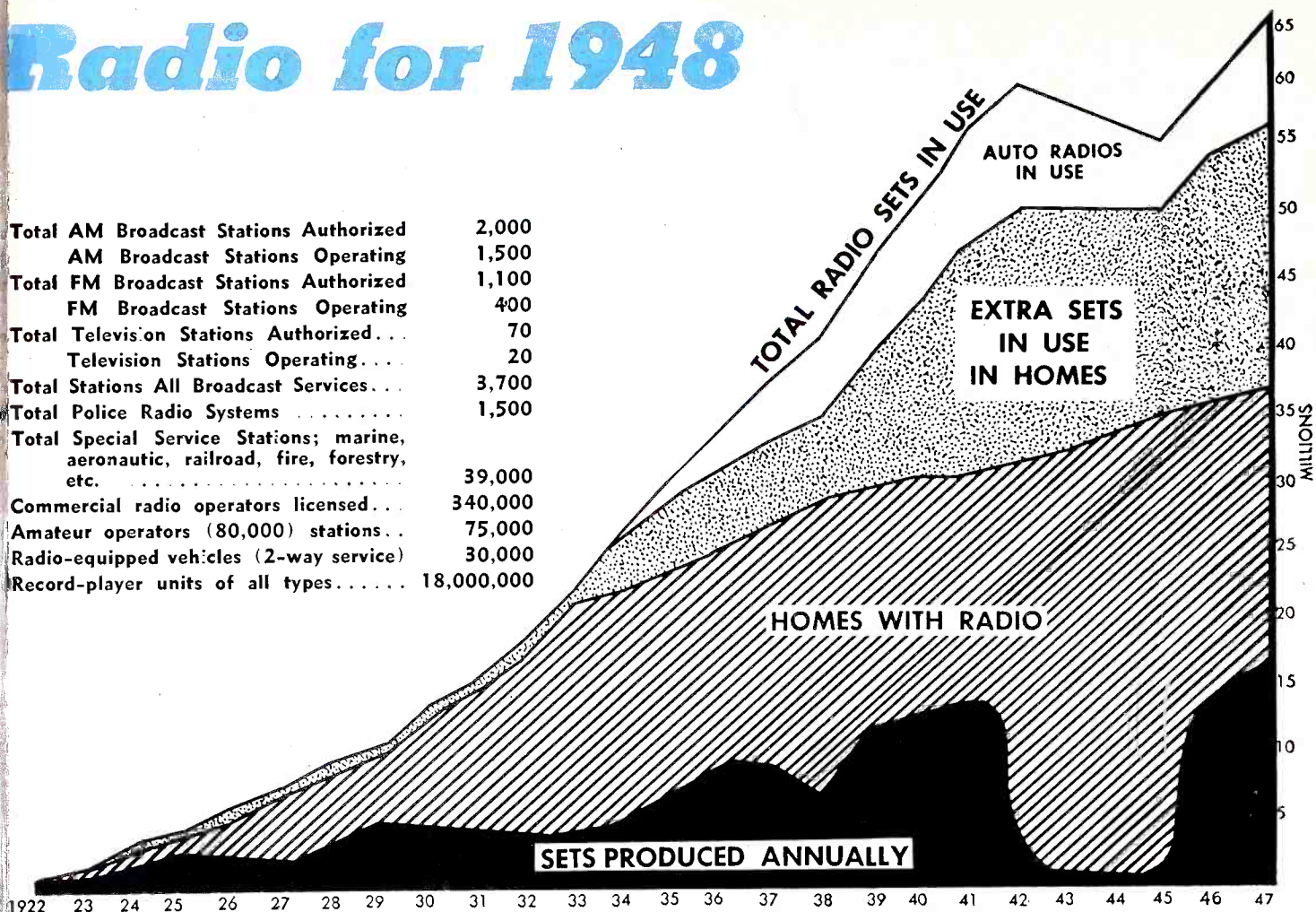

Tracing the production and use of radio-broadcast receivers by the American public. For 26 years the present editors and publishers of this magazine, have been compiling basic statistics of the radio industry, which are here again presented as the new year opens.

PRODUCTION OF CIVILIAN RADIO EQUIPMENT—1922 TO 1947

Year	Total Civilian Sets Manufactured		Total Civilian Tubes Manufactured		Automobile Sets Manufactured		Total Reception Equipment	Auto Sets in Use	Homes with Radio Sets	Total Radio Sets in Use in U. S.	At Close of
	Number	Retail Value	Number	Retail Value	Number	Retail Value	Value	Number	Number	Number	Year
1922	100,000	\$ 5,000,000	1,000,000	\$ 6,000,000			\$60,000,000		260,000	400,000	1922
1923	550,000	30,000,000	4,500,000	12,000,000			151,000,000		1,000,000	1,100,000	1923
1924	1,500,000	100,000,000	12,000,000	36,000,000			358,000,000		2,500,000	3,000,000	1924
1925	2,000,000	165,000,000	20,000,000	48,000,000			430,000,000		3,500,000	4,000,000	1925
1926	1,750,000	200,000,000	30,000,000	58,000,000			506,000,000		5,000,000	5,700,000	1926
1927	1,350,000	168,000,000	41,200,000	67,300,000			425,600,000		6,500,000	7,000,000	1927
1928	3,281,000	400,000,000	50,200,000	110,250,000			690,550,000		7,500,000	8,500,000	1928
1929	4,428,000	600,000,000	69,600,000	172,500,000			842,548,000		9,000,000	10,500,000	1929
1930	3,827,800	300,000,000	52,000,000	119,600,000	34,000	\$3,000,000	496,432,000		12,048,762	13,000,000	1930
1931	3,420,000	225,000,000	53,000,000	69,550,000	108,000	5,940,000	300,000,000	100,000	14,000,000	15,000,000	1931
1932	3,060,000	140,000,000	44,300,000	48,730,000	143,000	7,150,900	200,000,000	250,000	16,809,562	18,000,000	1932
1933	3,806,000	180,500,000	59,000,000	49,000,000	724,000	28,598,000	300,000,000	500,000	20,402,333	22,000,000	1933
1934	4,084,000	214,500,000	58,000,000	36,600,000	780,000	28,000,000	350,000,000	1,250,000	21,456,000	26,000,000	1934
1935	6,026,800	330,192,480	71,000,000	50,000,000	1,125,000	54,562,500	370,000,000	2,000,000	22,869,000	30,500,000	1935
1936	8,248,000	450,000,000	98,000,000	69,000,000	1,412,000	69,188,000	500,000,000	3,500,000	24,600,000	33,000,000	1936
1937	8,064,780	450,000,000	91,000,000	85,000,000	1,750,000	87,500,000	537,000,000	5,000,000	26,666,500	37,600,000	1937
1938	6,000,000	210,000,000	75,000,000	93,000,000	800,000	32,000,000	350,000,000	6,000,000	28,000,000	40,800,000	1938
1939	10,500,000	354,000,000	91,000,000	114,000,000	1,200,000	48,000,000	375,000,000	6,500,000	28,700,000	45,300,000	1939
1940	11,800,000	450,000,000	115,000,000	115,000,000	1,700,000	60,000,000	584,000,000	7,500,000	29,200,000	51,000,000	1940
1941	13,000,000	460,000,000	130,000,000	143,000,000	2,000,000	70,000,000	610,000,000	8,750,000	29,700,000	56,000,000	1941
1942	4,400,000	154,000,000	87,700,000	94,000,000	350,000	12,250,000	360,000,000	9,000,000	30,800,000	59,340,000	1942
1943			17,000,000	19,000,000			75,000,000	8,000,000	32,000,000	58,000,000	1943
1944			22,000,000	25,000,000			85,000,000	7,000,000	33,000,000	57,000,000	1944
1945	500,000	20,000,000	30,000,000	35,000,000			105,000,000	6,000,000	34,000,000	55,000,000	1945
1946	14,000,000	700,000,000	190,000,000	200,000,000	1,200,000	72,000,000	900,000,000	7,000,000	35,000,000	60,000,000	1946
1947	17,000,000	800,000,000	220,000,000	260,000,000	2,500,000	150,000,000	1,100,000,000	9,000,000	37,000,000	66,000,000	1947

Figures for sets give value with tubes in receivers. In normal years, replacement tubes have run 25% to 40% of total tube production. All figures are at retail values. (Statistics Copyrighted by Caldwell-Clements, Inc.)

~~CROSLEY~~ TELEVISION DEALERS

ARE GETTING

DELIVERIES PROFITS NOW!



these great new
~~CROSLEY~~
TELEVISION RECEIVERS
now in mass production!

The CROSLEY Deluxe Spectator—This one really brings 'em in to look—listen—buy! It's a 5-way combination for complete home entertainment. Features TELEVISION—STANDARD RADIO—FM RADIO—SHORT-WAVE—AUTOMATIC RECORD PLAYER—all in a magnificent furniture-crafted cabinet. Exclusive sales-clincher advancements include the Swing-A-View, adjustable for viewing from either side or in front of the console—"Picture Pilot" sealed tuning units for *automatic* station selection.

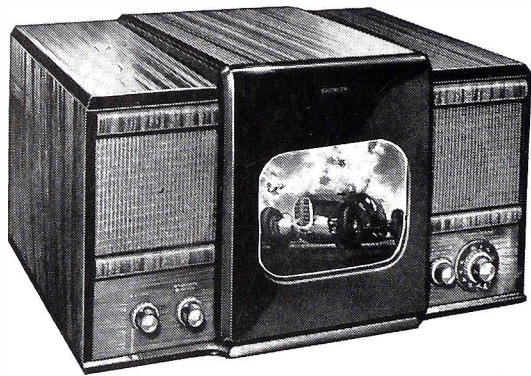

The CROSLEY SPECTATOR 307TA—Here's a handsome, compact television receiver that produces bright, clear pictures 52 square inches in area, big enough to be enjoyed by a roomful of people. Exclusive Lok-In-Tune Synchronizer keeps pictures steady through varying types of electrical interference. Superbly engineered for carefree, dependable performance.

HOW BRIGHT IS YOUR TELEVISION SALES PICTURE?

Are you pointing for big profits in this booming new industry? Are you teamed up with a known, dependable manufacturer who is making deliveries now—helping you establish your store as television headquarters—build prestige and profits *now* and for years to come? Is the television line you carry or plan to carry backed by an adequate manufacturer's installation and service plan? The answers? YES, everytime, if you're a Crosley Television Dealer (or plan to be one)!

count on

~~CROSLEY~~

—one of the oldest
names in radio—for
the best in radio and
television.

~~CROSLEY~~

Division—*AVCO* Manufacturing Corporation - Cincinnati 25, Ohio

A Billion-Dollar Industry!

Lady Luck has guided the footsteps of almost all of those fortunate enough to have walked in on the ground-floor of something really big. Though pioneering required vision, few, if any, of those responsible for launching numbers of our giant industries had the opportunity to *know*—to *foresee for certain* that their “babies” would grow to gigantic proportions.

The element of “gamble” was much more apparent than the chance for success in the early days of radio, automobiles, motion pictures and aviation. The men who put money and energy into the before-mentioned industries were almost always looked upon as visionary dreamers. Bankers gave them the cold-shoulder. The man in the street gave them the old horse-laugh. And most of the smart-money investors shuddered at even the thought of putting so much as a dime into the hands of the struggling experimenters. . . .

Of course, what we’re leading up to is *Television*.

Television—America’s next billion-dollar industry.

Television which appears to be a coming *first* in American business annals. *First*, because it extends an invitation to get in on the ground-floor of a *sure thing!*

We know *now*—we can see *in advance*, in plenty of time, that Television is headed for the high places! We’re so much more fortunate than the industry pioneers who had to *guess* and to *hope* that they were on the right track.

We know!

And we haven’t seen anything yet, either. Television is just barely under way at this time. That’s why those who jump aboard the TV band-wagon are getting in on the ground-floor.

The opportunity in Television is not just knocking at America’s door now—it’s making the call with a fanfare which doesn’t spare the decibels.

Unlike most other ground-floor enterprises, Television has got what it takes, right now, to insure its success.

Television has:

1. Complete public acceptance.
2. Huge resources back of it.
3. Adequate manufacturing facilities in operation.
4. Technical know-how at every hand; in manufacturing, broadcasting and merchandising.

What a picture! What a grand and glorious feeling it is to know that we’re part of such a profit-promising, interest-intriguing industry.

Words may fail us in doing a good job of describing Television’s brilliant future, but the nationwide *picture* of it is here for all of us to see—bright, beautiful, stimulating.

And, not being in business for our respective healths, we might add—“There’s that billion dollars to think about too.”

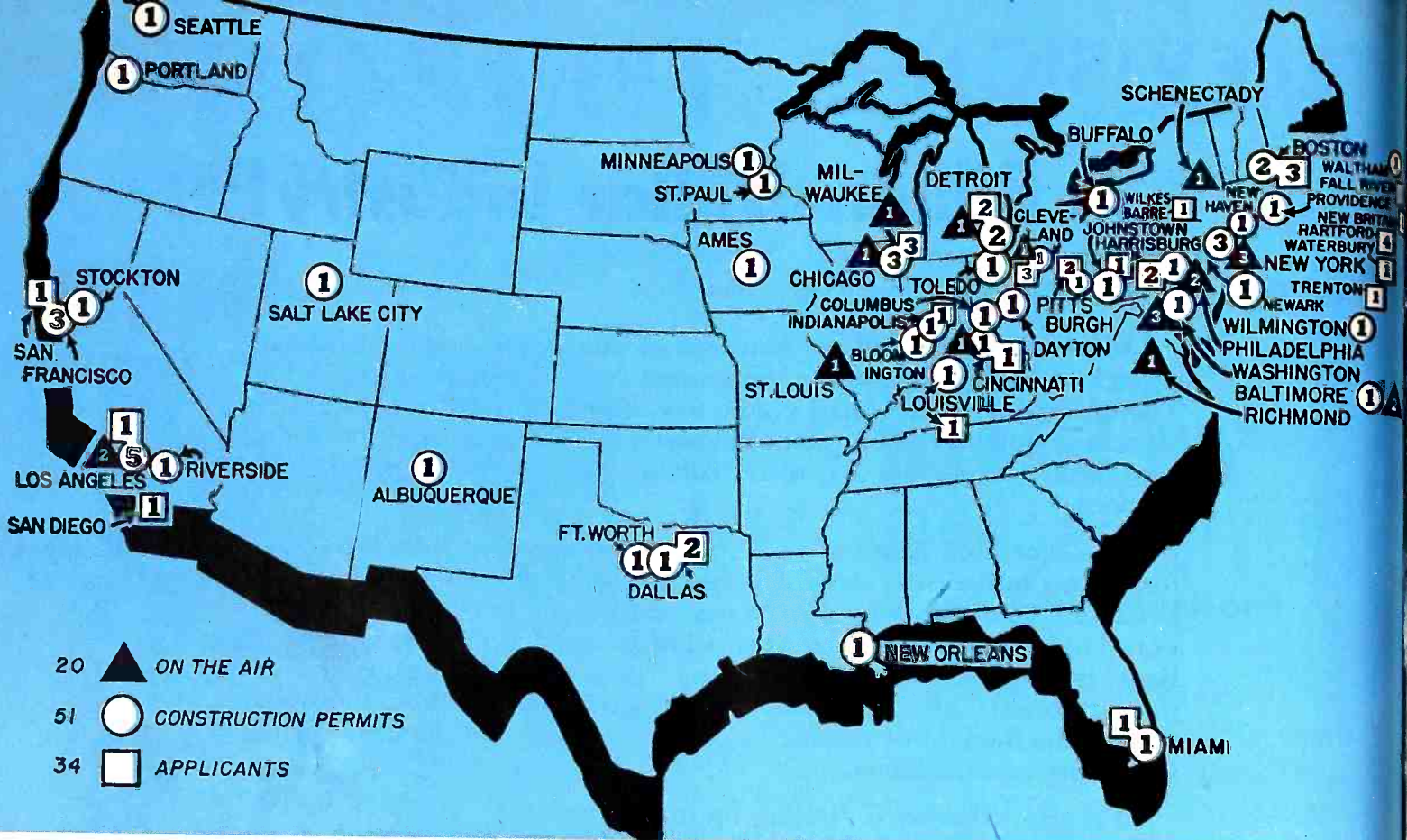

TV COVERAGE PICTURE, above, shows how video broadcast stations cover the U. S. via transmitters on the air and those to come. Many cities have three symbols; for instance Los Angeles accounts for 8 stations—two on the air, five with construction permits and one applicant. Totals are charted at left.

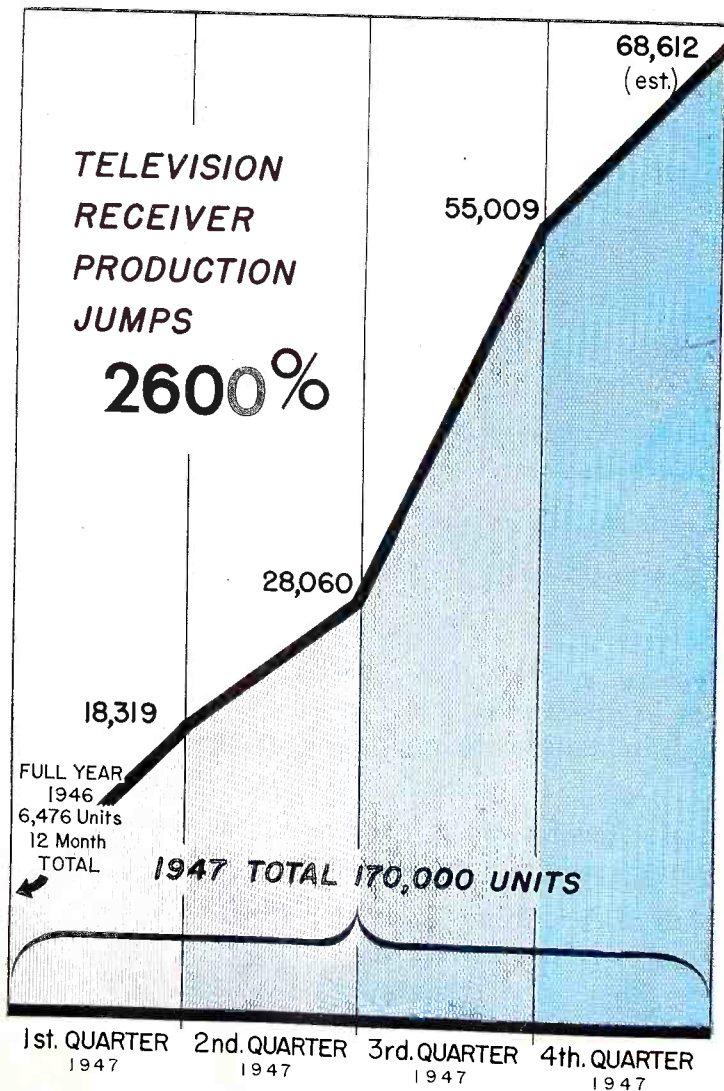

TELEVISION is Going Places Fast!

Dealers and servicers can see from the accompanying figures that television has at last established itself on a nation-sweeping scale. As the map above indicates, TV broadcasting service is to be available in most key cities. The picture changes rapidly, but as late bulletins are added, the whole station group includes 55 cities, located in 29 different states. Total number of stations involved is 111, and counting those who were scheduled to finish testing by Jan. 1st, 20 of them are on the air. These are located in Los Angeles, Washington, Chicago, Baltimore, Detroit, St. Louis, New York, Schenectady, Cincinnati, Cleveland, Philadelphia, Richmond, Va., and Milwaukee.

The next "TV cities" to be added to the operating group, all of which are scheduled to start by Spring of 1948, are Newark, N. J.; Boston, Buffalo, Albuquerque, Ames, Iowa; Columbus, Dayton, Ft. Worth, Indianapolis, Providence and Toledo.

To provide all these areas with sets, manufacturers have geared up their production to the extent that 1947 TV set production is charted as 2600% above the 1946 receiver output.

The line-up of the TV manufacturers, as shown also in this section, reveals that 43 of them are in the business, offering from one to nine models each, making a total of 114 models available to dealers. Of this total, 59 are consoles, 32 are table models, 13 are kits or assemblies, and 10 are custom or chassis jobs. The average of the prices given is \$836.

* For List of 45 NATIONAL ADVERTISERS on TV, See Page 107

What TELEVISION MAY DO IN 5 YEARS

The whole country's **TELEXCITED!** Television has commenced rolling with rocket-like speed along its golden course. The TV industry has its foot on the gas pedal—right down to the floor! Great new profits will come to the manufacturer, distributor and dealer. A great new art will come to the home. Figures on this page forecast this brilliant TV future. . . . Television—America's next billion-dollar enterprise.

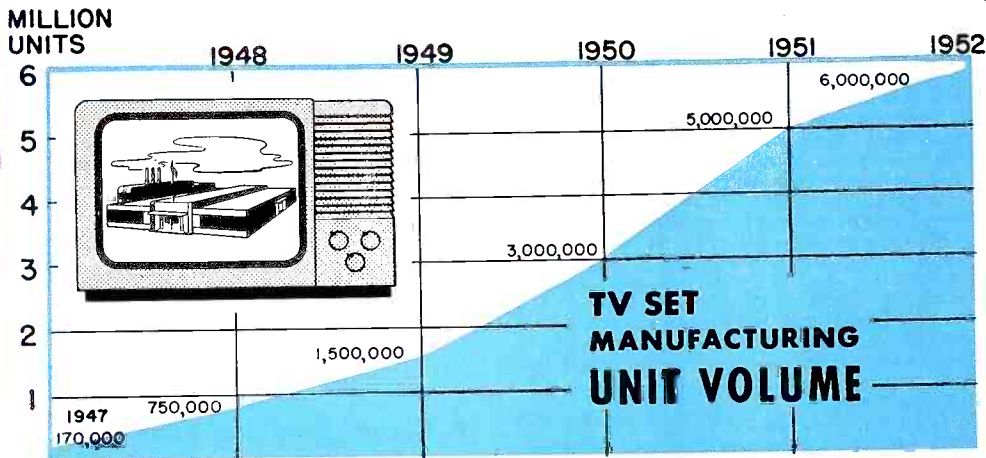

\$ 840,000,000

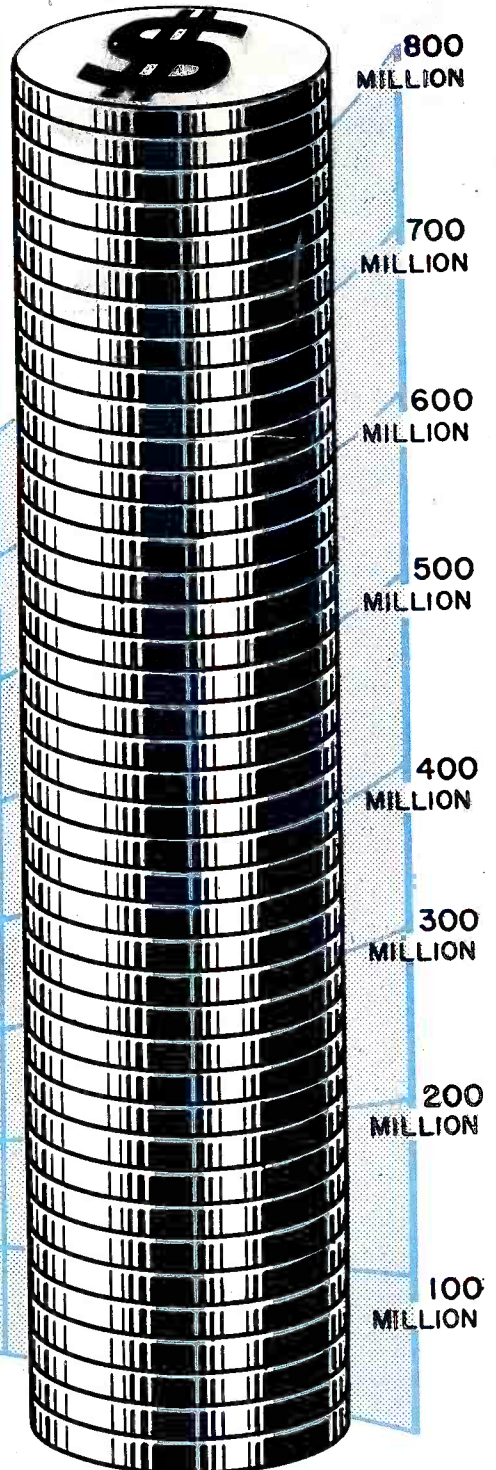

DOLLAR VOLUME CASH VALUE (Retail)

STARTING WITH 170,000 UNITS IN 1947

TOTALING \$120,000,000

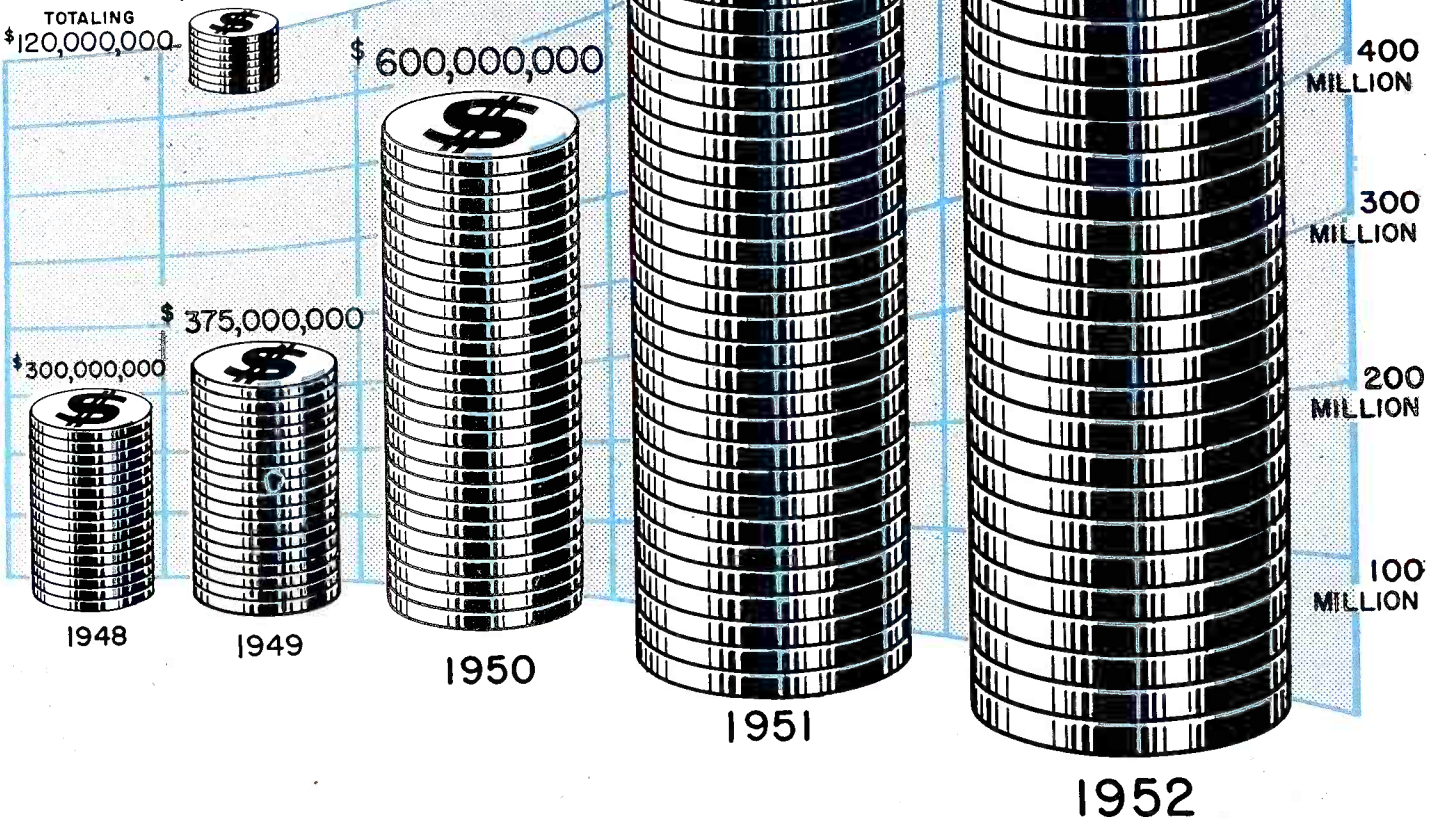

What Television Sets

Clearer Pictures in '48 . . .

The general outlook for television development in 1948 is exceedingly promising. Television has unqualified consumer acceptance, the spur to production and mass sales.

All top line radio-television manufacturers are devoting a large percentage of their expenditures to promote research and expand laboratory facilities.

We may reasonably expect to see sharper, clearer television pictures in 1948. "Ghosting", fading, and "picture noise", troublesome now, are being conquered. Tuning will be easier, more simple. Average picture size will be larger.

Cabinet styling will be more varied. Consoles are on the upgrade. They will be more compact, more tastefully designed. Many consoles will include AM, FM, and automatic phonograph in addition to television, although the high price on single unit combinations of this nature preclude mass market sales.

I estimate that approximately 350,000 television receivers having a total retail value of \$140,000,000 will be built and sold in 1948.

Ross D. Siragusa, president,
Admiral Corporation, Chicago, Ill.

★ ★ ★

Tremendous Future Seen . . .

While I can properly claim to be one of the pioneers in television, (since the Andrea Radio Corp. offered a television line, complete with consoles, combinations, table models and kits as early as 1938), I have never agreed with some of the extravagant estimates of television receivers to be made and sold during 1947 and 1948. However, I am a firm believer in the tremendous future in store for television and when the final figures are reached, I think they will show for 1947 a very encouraging volume of production and sales.

We at Andrea are planning for a constant increase in our television production for the next five years at least, and our efforts will be confined to the manufacture of a quality line, containing all that we believe best in present engineering development.

F. A. D. Andrea, president,
Andrea Radio Corporation,
Long Island City, N. Y.

★ ★ ★

1948, Important Video Year . . .

I am of the opinion that the entire television picture from the broadcasting, manufacturing, distributing and retailing angles will be much more important in the year 1948, especially the second half of that year, than many in this industry had originally planned earlier this year.

While there is no significant downward trend in the price of conventional AM, FM and short-wave radio sets, I feel that increased production brought about as a result of increased consumer demand will bring the price of television receivers down. With the increasing number of television stations and more efficient operation as time goes on, the necessity for highly sensitive sets will not be as great as it is today. This will aid manufacturers considerably in pricing their new models lower. The increasing demand for large-size pictures will hold the average retail selling price, exclusive of installation and service charges, above \$400.00.

I feel that a minimum of 700,000 television sets will be manufactured in 1948.

N. C. Macdonald, general sales manager,
Crosley Division AVCO Mfg. Corporation,
Cincinnati, Ohio

The Pioneering Days Are Over . . .

Merely extend that rising curve—and I mean rising in the accelerating sense—of television acceptance another twelve months and you have a safe prediction for 1948. For after years of promises and false starts, television definitely has the goods, and the goods now enjoy public acceptance. The pioneering days are over. We have arrived at an established art, industry, and new way of life.

While close to 80% of all television receivers produced in 1947 went into the New York area, the steadily increasing production will soon make television receivers available in the several dozen telecasting areas. This past year there were four major manufacturers of television receivers. In 1948 there will be from 15 to 20 major manufacturers, producing upwards of 60,000 television receivers. I look for an average price of \$400 retail, or a total trade of \$240,000,000. That means almost a quarter of a billion dollars! Add to that huge sum the expenditures for telecasting equipment, for programs, for installation and maintenance, and television achieves the stature of "Big Business".

Definitely, 1947 was the turning point—the first postwar year for unbridled television progress—the real springboard for that all-or-nothing leap into the future. The television industry is now in the midst of that leap. That the performance will surpass our fondest expectations for 1948, I am quite certain.

Dr. Allen B. Du Mont, president,
Allen B. Du Mont Laboratories, Inc.,
Passaic, N. J.

★ ★ ★

A Promising Outlook . . .

The general outlook for television development in 1948 is very promising. Indications are that prices will be considerably lower, predicated on engineering and manufacturing techniques coupled with economies to be effected as a result of larger production. I prefer not to forecast the price level, except to say that prices can be expected to be considerably lower than prevail at the present time.

My estimate of the number of television sets to be produced in 1948 is near the million mark, and my estimate as to the dollar value translated at retail prices would be close to three hundred million dollars.

Benjamin Abrams, president,
Emerson Radio & Phonograph Corporation,
New York, N. Y.

★ ★ ★

To Surpass Boom Days of 1920 . . .

Television in 1948 should experience a year of growth surpassing even the memorable radio-boom days of the 1920's. The demand for television has grown rapidly in recent months and will continue to grow in the year ahead. With several dozen television stations scheduled to inaugurate regular service during the next 12 months, television will be available in areas including more than 40 percent of the nation's population by the end of 1948. Barring unforeseen economic developments and material shortages, the radio and television industry in 1948 will produce approximately 750,000 video sets having a retail value between \$350,000,000 and \$400,000,000. By the end of next year television should have a viewing audience of more than 5,000,000 persons.

E. A. Nicholas, president,
Farnsworth Television & Radio Corporation,
Fort Wayne, Ind.

Supply Won't Exceed Demand . . .

Advancements in television techniques in 1948 will be more or less demanded by the public. Based on consumer acceptance and approval of television as we have it today in eight cities, the average buyer is deeply concerned with more improvements and refinements.

We are anticipating this specific demand on the part of the public and we will announce our exclusive developments at a time when they are commercially possible. At present, we are concentrating our production on a five-in-one instrument including TV-AM-FM-SW and automatic record changer. It is difficult to determine how many units we will produce, but our production schedule is high.

One thing we are sure of, is that our supply will never exceed demand. Every unit we will produce for the coming year is already sold.

Louis Silver, vice-president,
Garod Electronics Corporation,
Brooklyn, N. Y.

★ ★ ★

A Record-Breaking Year . . .

The outlook for television in 1948 is extremely encouraging and many factors are now discernible which assure rapid progress in all phases of television during the coming year.

It can be expected that the number of television stations on the air will increase rapidly; program service between the nation's large cities will be speeded up tremendously by means of microwave radio relays; that the number of firms sponsoring television programs will increase; that an increasing number of radio manufacturers will be producing television receivers; and that production of television receivers in 1948 will be four or five times greater than in 1947.

Favored by the outlook that general business conditions will remain good and the fact that the development of television has been planned soundly, the industry can look forward to a record-breaking year.

W. R. G. Baker, vice-president,
General Electric Company,
Syracuse, N. Y.

★ ★ ★

Bullish About Television . . .

Here at Hallcrafters we're bullish about television. Within a few months more than 50% of our production facility will be devoted to television. Even then we know we will be unable to keep up with a demand that transcends anything we have ever experienced.

Television will make more progress in the next ten months than it has made in the last ten years.

W. J. Halligan, president,
The Hallcrafters Co.,
Chicago, Ill.

★ ★ ★

TV Audience Grows and Grows . . .

1948 should be television's first big year. According to present indications, regularly scheduled television programs will be available in most cities throughout the United States whose total population represents about 50% of the entire country by the end of the coming year.

Motorola Inc. has just introduced a new table model television set with a 7" picture tube at a list price of \$179.95. Our other model, a television console set which includes FM and AM standard broadcast radio and a 10" picture tube, will retail at \$495.00.

Manufacturers Say

The introduction of low-priced television receivers by Motorola Inc., as well as by other manufacturers, will act as a tremendous impetus to the rapid acceleration of sales of television receivers throughout the country.

Based on the capacity of components parts manufacturers, it would seem that total production of television sets during 1948 will amount to somewhere between 700,000 and 900,000 units. Although it is difficult to predict the proportionate production of various priced receivers in 1948, it seems likely that the average retail price will be somewhat in the neighborhood of \$400.00.

**Paul V. Galvin, president,
Motorola, Inc.,
Chicago, Ill.**

★ ★ ★

Fastest Growing Postwar Industry . . .

Television today is America's fastest growing post-war industry. Day by day it is increasing in size, importance and popular appeal. The quality of programs now is far superior to what was six months ago. Great additional progress can be looked for. The whole microwave link development is proceeding with tremendous speed, and will help make television available over wider areas.

We are concluding the first real year of television, and probably 175,000 television receivers will be sold in 1947. Tremendous as this is, it represents only the beginning. 1948 should see the sale of at least 500,000 television sets worth over \$200,000,000. As one of the leaders in television research and development, Philco is putting its full weight behind this great new industry which offers such tremendous opportunities for its distributors and dealers and a great new source of entertainment for the public.

**Larry E. Gubb, chairman of the board,
Philco Corporation, Philadelphia, Pa.**

★ ★ ★

Creates Pre-Sold Customers . . .

In the last 14 months, the number of television receivers in the hands of the American public has grown approximately 2500 percent! It is estimated that about 175,000 sets are in use today. That, phenomenal as this growth may seem, during 1948 it is expected to be many times greater. By the end of 1948—when, according to forecasts and estimates, approximately 67 television stations will be in operation in 43 major cities—some five times as many television receivers will have been distributed as were placed in the public's hands during the entire period since television's inception! We can look forward to about 750,000 television receivers in use by the end of 1948.

The adventure and entertainment, education and social aspects of television have captured the public's imagination and created pre-sold customers for the sight-and-sound entertainment instruments.

The retailer has a rich opportunity to hold business volume high, to supplement his radio set business by actively going after this new business. Television has arrived. It arrived in 1947. And, in 1948, the dealers who take intelligent advantage of the opportunities television offers will attain new, unprecedented stature and increased profits.

**Joseph B. Elliott, vice-president in charge of
RCA Victor Home Instrument Department,
Camden, N. J.**

TV Proceeding by Leaps and Bounds . . .

Television today is proceeding at such rapid strides that it is almost impossible to give exact predictions. While there are only about 15 stations on the air today, by the end of 1948 we should have at least 40 or 50 stations in operation. Moreover, by the end of 1948, there will probably be close to one million television receivers in American homes. That means a retail television business of about 250 to 300 million dollars in 1948.

More important than that, the art of television performance is proceeding by leaps and bounds. Already many fine live television shows are being planned, and we shall soon see many fine movie shorts produced especially for telecasting.

There is no doubt that television will be a great adjunct to the AM and FM radio business, and 1948 television sales will not even scratch the surface of the potential market.

**Joseph Gerl, president,
Sonora Radio & Television Corporation,
Chicago, Ill.**

★ ★ ★

Conventions to Stimulate Sales . . .

We are going ahead with our television station as soon as a suitable location can be obtained for an efficient antenna system. We are in production on our own design of television receiver and have definite commitments for the production of between 7,000 and 10,000 large TV receivers incorporating FM, AM and phonograph—in addition to direct viewing 12" picture-tube television equipment.

Our overall television production for 1948 will depend largely on the capacity of our plant to produce the equipment, as we expect there will be sufficient demand for good television receivers to absorb all of the production of the industry during 1948. Demand in the eastern part of the country will be greatly stimulated by the televising of both the political conventions in Philadelphia.

**Ray H. Manson, president,
Stromberg-Carlson Company,
Rochester, N. Y.**

★ ★ ★

To Revolutionize Broadcasting . . .

Television will revolutionize broadcasting just as the talkies did the movies, but the biggest problems today are in developing and financing programming rather than in the manufacturing of receivers and transmitters.

Most of the technical problems involved in television, with the exception of color transmission, have been solved. Production problems are being ironed out as the unit volume increases, and as production rises the average unit cost, and doubtless the unit price, will gradually be lowered.

However, despite the growing popularity of television and the probability that it eventually will dominate radio in the field of home entertainment, I do not believe that radio broadcasting as such will entirely disappear or become merely an auxiliary to video transmission.

**Max F. Balcom, vice-president and treasurer,
Sylvania Electric Products, Inc.,
New York, N. Y.—President RMA.**

Low Price Market Promising . . .

Eventually, as in the radio field, the low income groups will be the widest and best market for television, since these groups will come to depend so heavily on video sets for their entertainment. Tele-tone plans quantity production of a table model TV receiver this winter at a price that cannot fail to stimulate greatly the mass consumer market in interest in television. The availability of low-priced television sets will result in an avalanche of business, and the increased distribution will be an important factor in bringing immeasurably improved programs. The growth of audiences will make it worthwhile for sponsors to pay for finer programs.

**John S. Mills, vice-president in charge of
sales and advertising,
Tele-tone Radio Corporation, New York.**

★ ★ ★

Sell All Sets Made in '48 . . .

1948 will be Television's first big year.

The better programs, the great increase of stations and the relay of programs over great distances will cause the sale of all television sets that can be produced in 1948. Production will probably reach six to seven hundred thousand sets. All sets made should be sold and 1949 should start with a back-log of orders in set manufacturer's hands.

The trend is toward home television sets, mainly 10 inch table models. However larger pictures will be sought for by those who can afford them, since they are far more satisfactory in size and easier on the eye. The trend in public place sets will be to bigger, brighter pictures achieved by projection. First to produce a projection set, the nine years spent by United States Television concentrating on television will keep it in the lead with reliable, tested big clear pictures for 1948.

**Hamilton Hoge, president,
United States Television Mfg. Co.
New York, N. Y.**

★ ★ ★

Brightest Year in History . . .

Television, supported by plain hard work on the part of industry during 1948, faces the brightest year in its history. These prospects will be realized by increased production of television receivers with emphasis on less expensive table and console models. At the same time, with additional studio and transmitter equipment, new television stations will make this media available in many cities throughout the nation.

Although the bane of the television industry has long been over-optimistic predictions, this firm belief in the future of television during 1948 and the coming years is the basis for Westinghouse action in the television broadcasting and receiver fields. The new Westinghouse television station WBZ-TV will provide service in the Boston area during the coming year and the Home Radio Division, after extensive research in the television receiver field, plans wide distribution of new television sets.

**Walter Evans, Vice-President,
Westinghouse Electric Corporation,
Sunbury, Pa.**

**For Specifications of New TV
Sets, see pages 58 and 59**

TV Sets for Great New Market

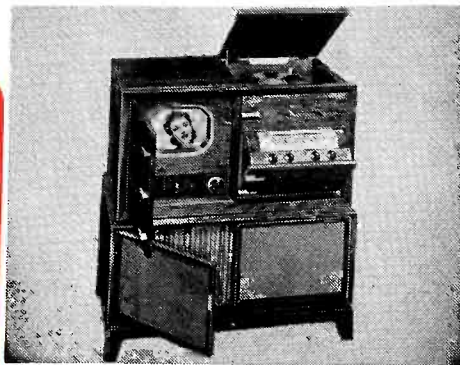

New RCA-Victor four-service "Eye Witness" unit.

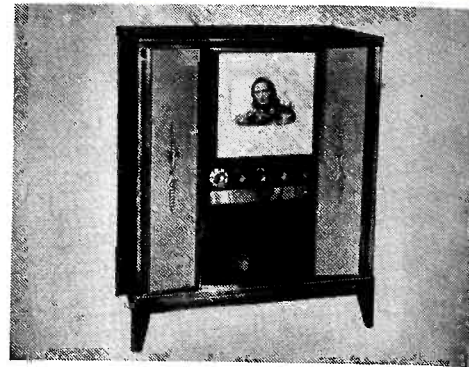

Philco 1050, 54 sq. in. picture, same chassis as 1000.

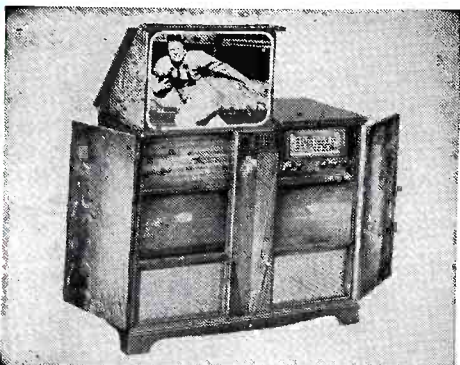

GE projection Model 901 has picture 18" x 24".

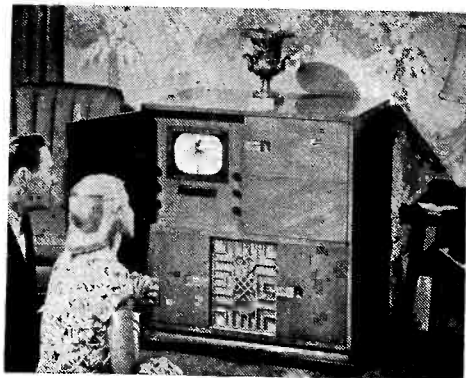

New Stromberg-Carlson TV10P console combo.

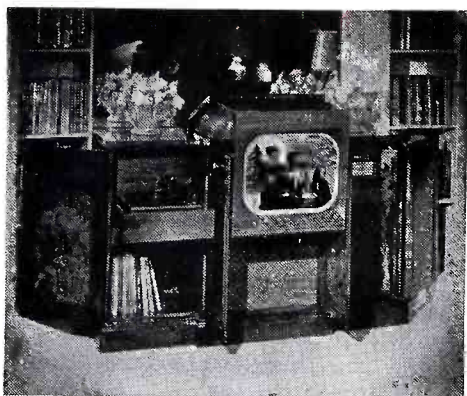

DuMont "Westminster", AM-FM-SW, with 20" tube.

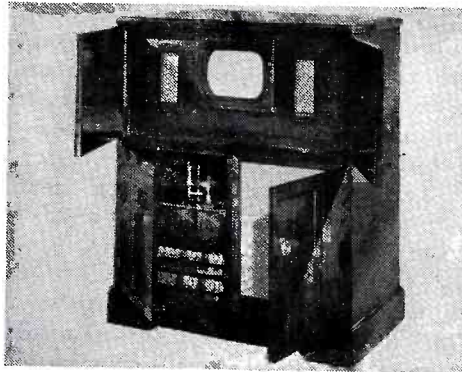

New Hallicrafters console 504 AM-FM combo.

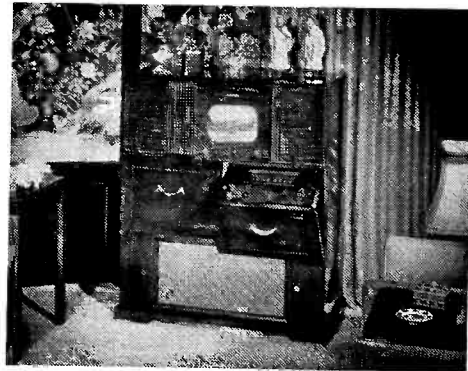

Crosley 348-CP combo with AM-FM-SW, direct view.

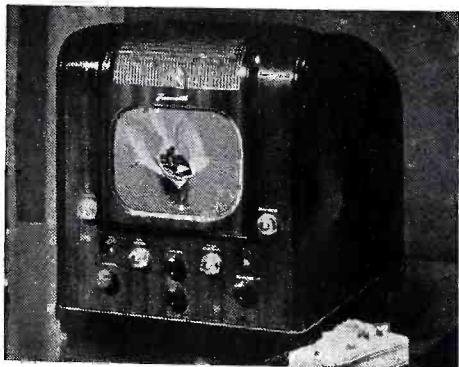

Farnsworth table model with 52 sq. in. picture.

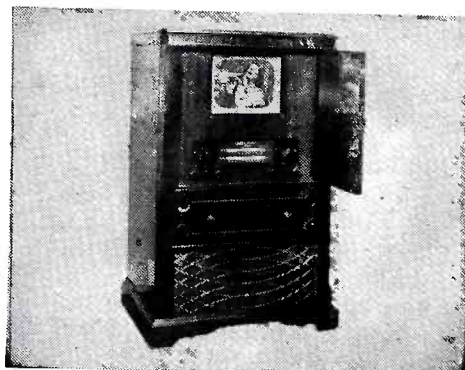

Andrea combo CO-VJ12 has pull-out disc-player.

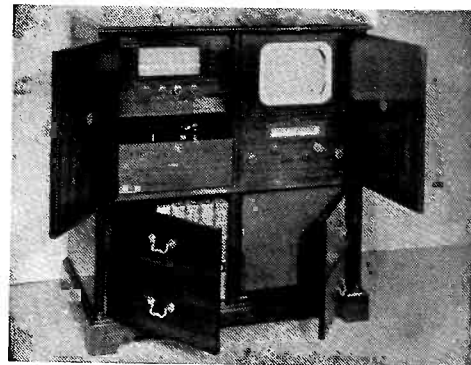

Garod four-service unit, with 54 sq. in. picture.



Westinghouse "High-Boy" direct view Model H-181.

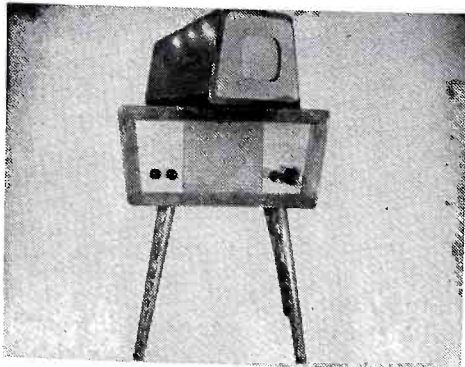

Cleervue has modern styling on "Hollywood" unit.

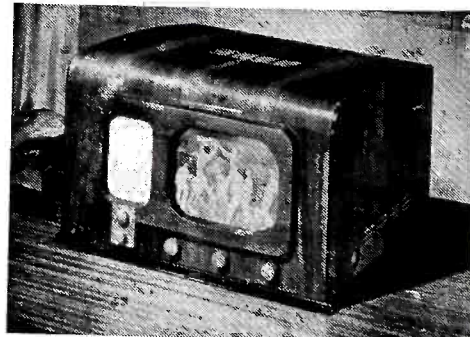

New Sonora unit with automatic linearity control.

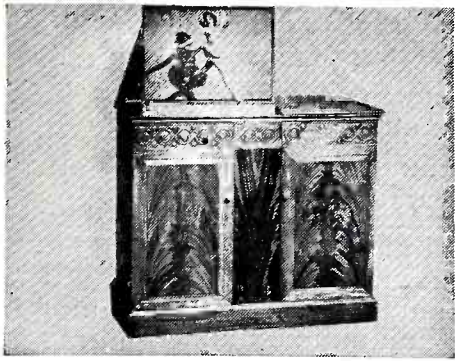

UST projection Model T-621, "Hamilton" combo.

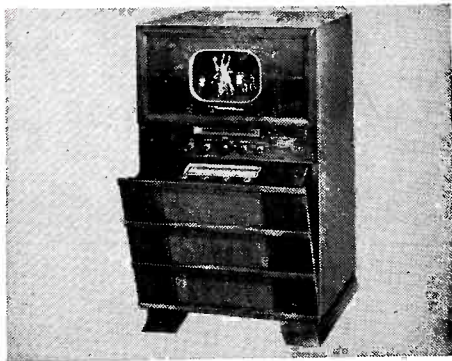

Motorola has AM-FM service, 55 sq. in. screen.

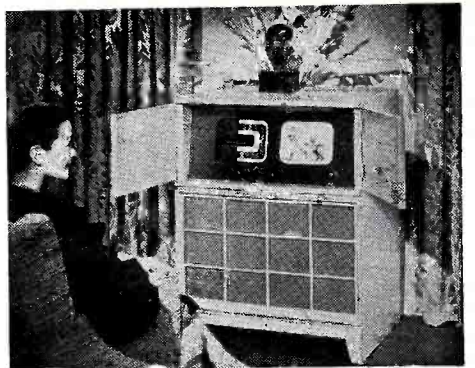

Stewart-Warner "Videorama", bleached walnut.

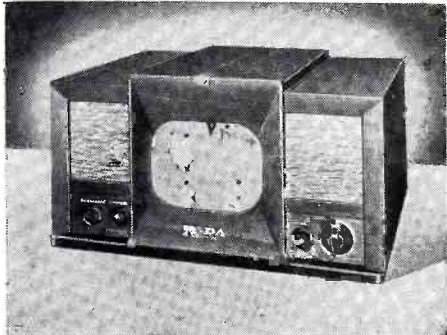

Fada 799 table unit with 6 3/8" x 8 1/2" picture.

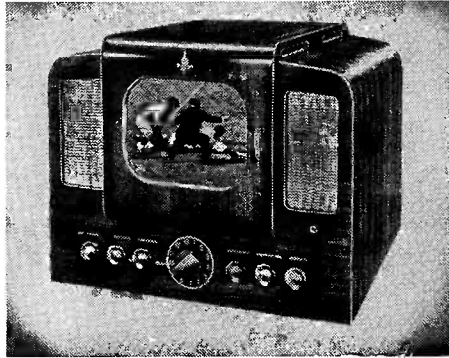

Emerson table Model 545 has 52 sq. in. picture.

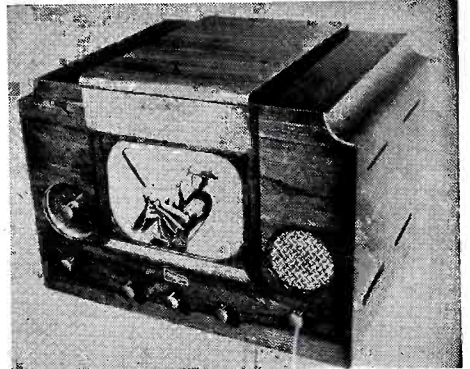

Transvision kit 12D has picture of 75 sq. in.

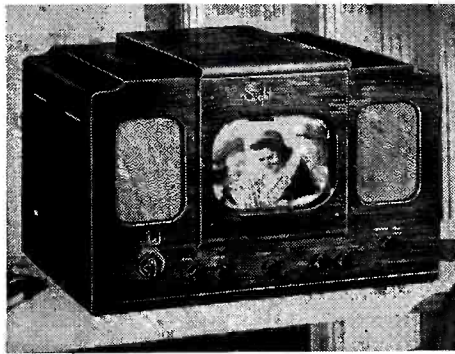

New Sightmaster table model includes FM radio.

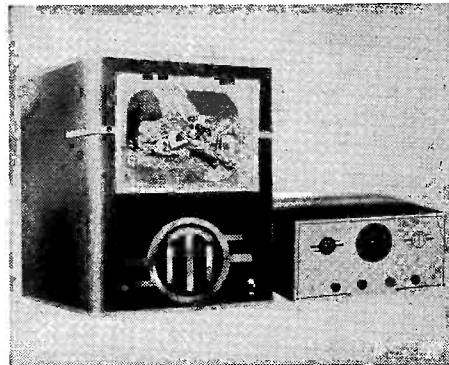

Industrial has big screens on remote units.



Belmont table Model 21A21, with 7" picture tube.

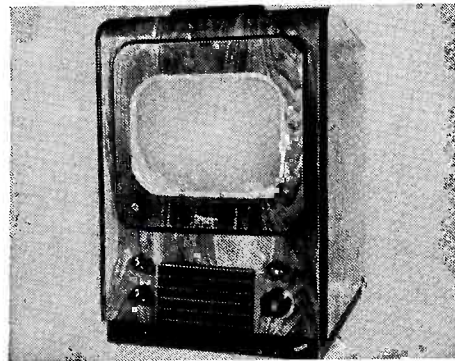

Colonial club model has picture of 222 sq. in.

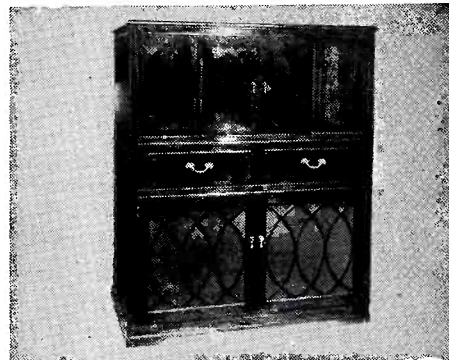

New Tradio combo has AM-FM in Georgian cabinet.

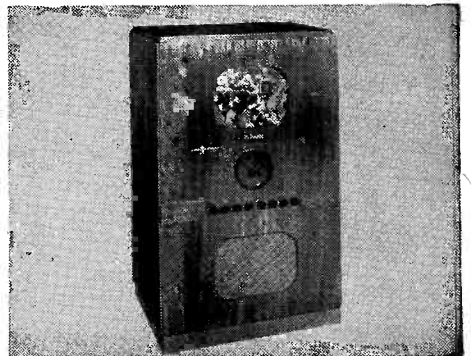

Remington "Rembrandt" console is direct view.

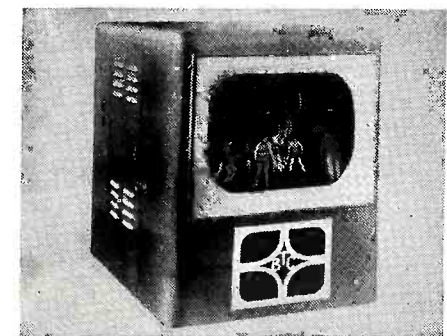

Bace remote-controlled unit has 15" picture tube.

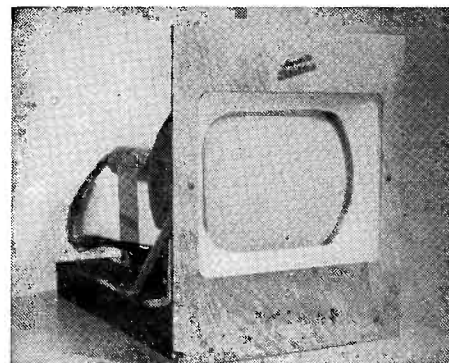

New Republic kit TC-10, with 55 sq. in. picture.

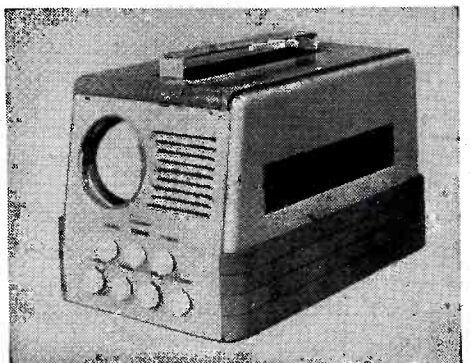

Espey basic-parts TV3K kit has 3" picture tube.

ROSTER OF

Manufacturer	Type (Table, Console, Kit, or Commercial)	Model Number	Picture Type	Price	Screen Size	No. of Tubes	Horizontal Sync. & Hold Control	Sound (Discriminator or Detector)	Record Player	Installation Policy
Andrea Radio Corp. 27-01 Bridge Plaza No., Long Island City 1, N. Y.	Table	T-VJ12	Dir.	\$695	7 1/2" x 10"	31	A.F.C.	Det.	No.	Choice of two plans—approved dealer or Andrea agency. Fixed charge of \$60 for install. and 3-mo. warranty—\$23.50 for next 9 mos. (\$65 and \$30 for CO-VJ12)
	Console	C-VJ12	Dir.	\$795	7 1/2" x 10"	31	A.F.C.	Det.	No.	
	Cons. combo	CO-VJ12	Dir.	\$995	7 1/2" x 10"	21	A.F.C.	Det.	Yes	
Atlas Development Labs., Inc. 26 Journal Square, Jersey City 6, N. J.	Table	100	Dir.	\$195	26 sq. in.	19	Stabilized	Dis.	No.	One-year guarantee if desired. Serviced at factory cost after warranty period.
	Table	200	Dir.	\$295	52 sq. in.	22	Stabilized	Dis.	No.	
	Table	300	Dir.	\$355	75 sq. in.	22	Stabilized	Dis.	No.	
Bace Television Corp. Green & Leuning Sts. So. Hackensack, N. J.	Table remote control	150	Dir.		120 sq. in.	39	{Pre-set}	Dis.	No.	Installation by authorized service organizations only. Service policy after warranty period if desired.
	{Home and comml. }	200	Dir.		222 sq. in.	39	{A.F.C.}	Dis.	No.	
Belmont Radio Corp. 5921 W. Dickens Ave., Chicago 39, Ill.	Table	21A21	Dir.	\$250	7" tube	21		Det.	No.	Installed by dealers with required equipment, or by service organizations they select. Post-warranty service handled by Belmont authorized firms.
Bendix Radio, Div. of Bendix Aviation Corp., Baltimore 4, Md.	AM-FM-SW Cons. combo	TRP-10	Dir.		10" tube		A.F.C.	Dis.	Yes.	To be announced.
Brunswick Div., Radio & Television, Inc., 244 Madison Ave., New York, N. Y. —PANATROPE	Console	3500P	Proj.	\$3000	4'x3'	40	Automatic	Dis.	Yes.	One year service.
	Console	3501P	Proj.	\$2750	4'x3'	40	Automatic	Dis.	No.	
	Console	3000P	Proj.	\$1750	15" x 20"	38	Automatic	Dis.	Yes	
	Console	2500D	Dir.	\$1250	10" x 12 1/2"	33	Automatic	Dis.	Yes	
	Console	1500D	Dir.	\$750	6 1/4" x 8 1/4"	30	Automatic	Dis.	Yes	
Certified Radio Labs., 5507 13th Ave., Brooklyn 19, N. Y.	Kit	47-71	Dir.	\$89.95	7" tube	17	{Multi-}	Det.	No.	(Model 47-71 is priced at \$129.95 complete. Other prices are less tubes.)
	Kit	48-81	Dir.	\$89.95	7" tube	19	{Vibrator}	Dis.	No.	
	Kit	48-101	Dir.	\$129.95	10" tube	23	Block. Oscill.	Dis.	No.	
Cleary Television Corp., 81 Willoughby St., Brooklyn 1, N. Y.	Console	Regency	Dir.	\$750	15" tube	30	A.F.C.	Dis.	No.	Qualified and approved dealer plan. Insurance policy to cover parts, labor, and service.
	Console	Hollywood	Dir.	\$450	10" tube	30	A.F.C.	Dis.	No.	
	Console	Suburban	Dir.	\$399.50	10" tube	30	A.F.C.	Dis.	No.	
	Console	Twin Set	Dir.	\$695	10" tube	30	A.F.C.	Dis.	Yes	
Colonial Television Corp., 780 E. 137th St., Bronx, N. Y.	Comm'l table	1500	Dir.	\$950	130 sq. in.	22			No.	Installation and one-year guarantee \$125 on 1500, 2000, and 1545. For 6300 (illuminated tavern unit) the fee is \$150.
	Comm'l table	2000	Dir.	\$1350	222 sq. in.	32			No.	
	Console	1545	Dir.	\$950	130 sq. in.	23			No.	
	Comm'l. Console	1530	Dir.	\$995	130 sq. in.	23			No.	
	Comm'l. Proj.	2300	Proj.	\$2195	7'x9'	33			No.	
Coronet Radio & Television Corp., 500 W. 52 St., New York, N. Y.	Table	1401	Dir.	\$347.50	10" tube	30			No.	To be announced.
Crosley Division, AVCO Mfg. Corp., Cincinnati 25, Ohio	Table	307-TA	Dir.	\$375	6 3/8" x 8 1/2"	30	A.F.C.	Dis.	No.	Installation by each Crosley distributor's TV service department with factory-approved personnel. Qualified service agencies used in some areas.
	AM-FM-SW Cons. combo	348-CP	Dir.		6 3/8" x 8 1/4"	34	A.F.C.	Dis.	Yes	
Allen B. Du Mont Labs., Inc., 515 Madison Ave., New York 22, N. Y.	AM-FM-SW Cons. combo	RA-101-A1	Dir.	\$2495	17 1/4" x 12 7/8"	39	A.F.C.	Dis.	Yes.	For standard install., fee is \$55 for table, \$75 for consoles, \$100 for commercial. Covers 3-mo. service; for subsequent period, authorized dealers and service agencies arrange own contracts.
	AM-FM-SW Cons. combo	RA-101-A2	Dir.	\$2495	17 1/4" x 12 7/8"	39	A.F.C.	Dis.	Yes	
	AM-FM-SW Cons. combo	RA-101-A3	Dir.	\$1795	12 3/4" x 9 1/2"	39	A.F.C.	Dis.	Yes	
	AM-FM-SW Cons. combo	RA-101-A5	Dir.	\$1795	12 3/4" x 9 1/2"	39	A.F.C.	Dis.	Yes	
	AM-FM-SW Cons. combo	RA-101-A5	Dir.	\$1795	12 3/4" x 9 1/2"	39	A.F.C.	Dis.	Yes	
	AM-FM-SW Cons. combo	RA-101-A6	Dir.	\$1795	12 3/4" x 9 1/2"	39	A.F.C.	Dis.	Yes	
	Comm. AM-FM	Club	Dir.	\$1095	12 3/4" x 9 1/2"	31	A.F.C.	Dis.	No	
	Comm. AM-FM-SW	Custom	Dir.	\$1795	17 1/4" x 12 7/8"	39	A.F.C.	Dis.	No	
	Table	RA-103	Dir.	\$445	7 1/2" x 10"	27	A.F.C.	Dis.	No	
Duval Radio & Television Corp., 423 Grove St., Jersey City 2, N. J.	Wired Assembly	15C	Dir.		15" tube	28	Block. oscill.	Dis.	No.	Factory guaranteed for 3 mos.
Electro-Technical Industries, 121 N. Broad St., Phila. 7, Pa.—"TELEKIT"	Kit	10	Dir.	\$124.50	10" tube	19	{Block oscill}	Dis.	No.	Prices are less tubes.
	Kit	7	Dir.	\$77.50	7" tubes	19	{Block oscill}	Dis.	No	
Emerson Radio & Phonograph Corp., 111 8th Ave., New York 11, N. Y.	Table	545	Dir.	\$375	52 sq. in.	26	Automatic	Dis.	No.	One year guarantee \$55.
Espey Mfg. Co., Inc., 528 E. 72 St., New York, N. Y.	Kit	TV3K	Dir.	\$59.50	3" tube	18	Block. oscill.	Dis.	No.	Price covers basic parts only.
Fada Radio & Electric Co., Inc., 525 Main St., Belleville, N. J.	Table	799	Dir.		6 3/8" x 8 1/2"	30	A.F.C.	Dis.	No.	Install. and servicing policies sublet to servicing agencies.
Farnsworth Television & Radio Corp., Fort Wayne 1, Indiana	Table	GV-220	Dir.	\$349.50	52 sq. in.	22	Beam Relaxer	Dis.	No.	\$45 for installation and 90-day guarantee, or \$65 for installation and one-year guarantee. After warranty period service at discretion of service depot.
Garod Radio Corp., 70 Washington St., Brooklyn 1, N. Y.	AM-FM-SW Cons. combo	42FMPT2	Dir.	\$695	54 sq. in.	39	{"Bird's Eye- View" Image}	Yes.		Garod TV service organization in tele cities.
General Electric Co., Receiver Div., Electronics Park, Syracuse 1, N. Y.	Console	801	Dir.	\$625	10" tube	24	A.F.C.	Dis.	No.	Install. and service contract by jobber, qualified retailer, or service agency. 3-month factory guaranteed; dealer or jobber for next 9 mos.
	AM-FM Cons. combo	802	Dir.	\$750	10" tube	26	A.F.C.	Dis.	Yes	
	Table AM-FM	803	Dir.	\$475	10" tube	26	A.F.C.	Dis.	Yes	
	AM-FM-SW Cons. combo	901	Proj.	\$2250	18" x 24"	43	A.F.C.	Dis.	Yes	
	Chassis	910	Proj.	\$1500	18" x 24"	43	A.F.C.	Dis.	No	
Hallcrafters Co., 4401 W. 5th Ave., Chicago 24, Ill.	Table		Dir.	\$169.50	7" tube	19			No.	To be announced.
Industrial Television, Inc., 36 Franklin Ave., Nutley 10, N. J.	Comm. remote	ITIR	Dir.	{ \$450 to \$1995 }	{ 12 3/4" x 17 1/4" or 9 1/4" x 12 3/4" }	42	Flywheel	Dis.	No.	Accredited dealers. List price includes installation 6-mo. warranty for service by dealer and parts replacement by factory.
Motorola, Inc., 4545 Augusta Blvd., Chicago 51, Ill.	Table	VT71	Dir.	\$179.95	4 1/2" x 6"	18	{ Inter-Carrier Sound System }		No.	Now being formulated.
	AM-FM Console	VK101	Dir.	\$495	8 1/2" x 6 3/8"	29			No	

Copyright, 1948 by Caldwell-Clements, Inc.

V SET MAKERS

Manufacturer	Type (Table, console, kit or commercial)	Model Number	Picture Type	Price	Screen Size	No. of Tubes	Horizontal Sync. & Hold Control	Sound or (Discriminator)	Record Player	Installation Policy
Philco Television Corp.	Console	1018 AM	Dir	\$550	8 1/2" x 6 1/2"	20	A.F.C.	Dis	No	To be announced.
Philco Television Corp.	Console	1018 RM	Dir	\$600	8 1/2" x 6 1/2"	20	A.F.C.	Dis	No	To be announced.
Philco Television Corp.	Custom Built	5905	Dir	\$250	7" tube				No	Prices do not include cabinet.
Philco Television Corp.	Custom Built	5096	Dir	\$296	12" tube				No	
Philco Television Corp.	Custom Built	5907	Dir	\$329	12" tube				No	
Philco Television Corp.	Portable Service	A-100	Dir		3" tube				No	
Philco Television Corp.	Table	44-700	Dir		7" tube	25	Amplitude Sync	Det	No	Approved servicemen. Install. warranty of one year on picture tube. Standard Philco parts warranty for 90 days. Post-warranty service by dealer. Install. and warranty charge is \$45 for 700 and 1000; \$50 for 1050; \$85 for 2500.
Philco Television Corp.	Table	44-1000	Dir	\$795	34 sq in.	26	Sync	Det	No	
Philco Television Corp.	Console	44-1050	Dir	\$449.50	34 sq in.	26	Horizontal	Det	No	
Philco Television Corp.	Console	44-2500	Dir	\$795		29	Overall	Det	No	
Philco Television Co.	Table	N-12B	Dir	\$775	12" tube	24	Front Control	Dis	No	\$55 install. charge. Service policy included in install. price.
Philco Television Co.	Table	621-T8	Dir	\$250	6 1/2" x 5 1/2"	21		Dis	No	RCA TV Owners Policy for \$45 on 621, \$55 on 630-TS and 721-T8, \$65 on 630-TCS, \$69 on 730-TV1 and 730-TV2, \$79 on 641-TV and \$95 on 648PTK. Policy covers antenna, installation, instruction, one year's service on maintenance, antenna adjustment and parts replacement. Policy may be renewed for second year for \$30 up.
Philco Television Co.	Table	630-T8	Dir	\$275	6 1/2" x 5 1/2"	20		Dis	No	
Philco Television Co.	Table	630-TCS	Dir	\$450	6 1/2" x 5 1/2"	20	Triggered Sync	Dis	No	
Philco Television Co.	AM-FM SW Console	641-TV	Dir	\$795	6 1/2" x 5 1/2"	41	Eye Witness	Dis	Yes	
Philco Television Co.	AM-FM Console	645-PTK	Dir	\$1195	13 1/2" x 10"	48		Dis	No	
Philco Television Co.	Table	721-T8	Dir	\$425	6 1/2" x 5 1/2"	21		Dis	No	
Philco Television Co.	AM-FM-SW Console	730-TV-1	Dir	\$495	6 1/2" x 5 1/2"	30		Dis	Yes	
Philco Television Co.	AM-FM-SW Console	730-TV-2	Dir	\$475	6 1/2" x 5 1/2"	30		Dis	Yes	
Philco Radio Corp.	Console	83	Dir	\$395	80 sq in.	25		Dis	No	Installation fee of \$100. One year service guarantee; 90-day guarantee on parts.
Philco Radio Corp.	Console	130	Dir	\$495	130 sq in.	25		Dis	No	
Philco Television, Inc.	Kit	T1-4	Dir	\$165	23 sq in.	20	Multi-Vibrator	Lim.	No	90-day guarantee on defective components.
Philco Television, Inc.	Kit	T1-10	Dir	\$129.50	55 sq in.	20		Dis.	No	
Philco Television, Inc.	Conversion Kit	T1-10	Dir	\$112.50	55 sq in.				No	
Philco Labs., Inc.	Console AM-FM	100	Dir	\$573	10" x 7 1/2"	32	Automatic Lock-In	Dis	No	Dealer installs after brief factory training or may authorize TV service agencies. Picture tube guaranteed one year; set for 90 days. Service provided in installation cost—choice of policies covering 90 days to one year.
Philco Radio Corp.	Table FM Radio	10-8-1	Dir	\$375	10" tube				No	Installation fee covers one-year warranty policy by authorized Sigmastar Service agency.
Philco Radio Corp.	Table FM Radio	10-8-1	Dir	\$475	12" tube				No	
Philco Radio Corp.	Table AM-FM	10-10-1	Dir		10" tube				No	
Philco Radio Corp.	Table AM-FM	12-10-1	Dir		12" tube				No	
Philco Radio Corp.	AM-FM Console	12-10-1	Dir		12" tube				Yes	
Philco Radio Corp.	AM-FM Console	12-10-1	Dir		15 1/2" tube				Yes	
Philco Television, Inc.	Table	TV-150	Dir	\$347	10" tube	23	Automatic Phase Control	Dis	No	Installation through local service organization. Replacement of defective parts provided after warranty period.
Philco Television, Inc.	Console	TRK-301	Dir	\$495	10" tube	33		Dis	Yes	
Philco Radio Corp.	Console	12-11	Dir	\$675	10" tube	23	A.F.C.	Dis	No	Installation fees from \$64 to \$75. Cover all labor, materials, parts and tubes (including picture) to maintain sets for one year. Service companies being appointed.
Philco Radio Corp.	Console	T1-12	Dir	\$695	10" tube	23	A.F.C.	Dis	No	
Philco Radio Corp.	Console	TV-731	Dir	\$495	10" tube	23	A.F.C.	Dis	No	
Philco Radio Corp.	Console	TV-10-1	Dir	\$495	8 1/2" x 6 1/2"	26	A.F.C. plus noise clipped sync.	Dis	No	Regular 90-day factory guarantee on parts. This period plus 9 months covered by TV Service Policy providing one year typical installation and service for \$67 on the TV-10-1 and for \$87 for TV-10-P.
Philco Radio Corp.	AM-FM Console	TV-10-P	Dir		8 1/2" x 6 1/2"	34		Dis	Yes	
Philco Radio Corp.	Table		Dir							
Philco Assembly Co.	Home	M-100	Dir	\$600	12" tube	30	Block oscil.	Dis	No	Installation is optional. Dealer TV service guaranteed one year.
Philco Assembly Co.	Commercial	M-1500	Dir	\$1050	15" tube	30		Dis	No	
Philco Dev. Labs., Inc.	Table		Dir	\$225	25 sq in.	20		Det	Yes	Installation through dealers. Factory service in N. Y. area.
Philco Dev. Labs., Inc.	Kit		Dir	\$132.50	25 sq in.	20		Det	No	
Philco Dev. Labs., Inc.	Comm'l. Cons.	100 Club	Dir	\$1095	24" x 18"	43	A.F.C.	Lim.	No	
Philco Dev. Labs., Inc.	Comm'l. Cons.	100 Club	Dir	\$1095	24" x 18"	43	A.F.C.	Dis.	No	
Philco Dev. Labs., Inc.	Comm'l. Home Cons.	100 Club	Dir	\$1495	20" x 15"	43	A.F.C.		No	
Philco Dev. Labs., Inc.	Console or talk with or without remote service	5-PT	Dir	\$670	6 x 8"	39		Dis	No	Installation by dealer or factory at option of dealer. After warranty period, plug-in parts may be returned to factory service dept. for repair.
Philco Dev. Labs., Inc.	Table	10-11	Dir	\$170	6 x 8"	39		Dis	No	
Philco Dev. Labs., Inc.	Table	10-11	Dir	\$170	6 1/2" x 8 1/2"	39	RCA	Dis	No	
Philco Dev. Labs., Inc.	Table	12-11	Dir	\$120	8 x 10"	30	Synchro-Lock	Dis	No	
Philco Dev. Labs., Inc.	Table	15-11	Dir		9" x 12"	39		Dis	No	
Philco Dev. Labs., Inc.	Table	20-11	Dir		20" tube	39		Dis	No	
Philco Dev. Labs., Inc.	Kit	7D	Dir	\$380	25 sq in.	18	Fixed Sync.		No	
Philco Dev. Labs., Inc.	Kit	12D	Dir	\$490	25 sq in.	23	Adjust. control		No	
Philco Dev. Labs., Inc.	AM-FM-SW Console	4-507	Dir	\$1795	21 1/2" x 16"	37	A.F.C.	Dis	Yes	Install. and 90-day warranty \$125 for 507 and 502. For 5.5 and 530 fee is \$150.
Philco Dev. Labs., Inc.	AM-FM-SW Console	4-507	Dir	\$895	10" tube	34	A.F.C.	Dis	Yes	
Philco Dev. Labs., Inc.	Comm'l. AM-FM-SW Console	4-525	Dir	\$495	23 1/2" x 16"	31	A.F.C.	Dis	No	
Philco Dev. Labs., Inc.	AM-FM-SW Console	4-530	Dir	\$495	30" x 21 1/2"	37	A.F.C.	Dis	No	
Philco Dev. Labs., Inc.	AM-FM-SW Console	4-531	Dir	\$495	22 1/2" x 16 1/2"	37	A.F.C.	Dis	Yes	
Philco Television Co.	Table	A-10-D	Dir	\$995	10 1/2" x 12 1/2"	30	Direct	Dis	No	Installation fee of \$100 includes regular RMA Guarantee. Service and one-year guarantee on picture tube.
Philco Electric Corp.	Console	D-81	Dir	\$475.00 \$590.00 \$4	52 sq in.	27	Block oscil.	Det	No	To be announced.
Philco Television, Inc.	Table	T-10	Dir	\$198.50	23 sq in.	21	A.F.C.	Dis	No	Service policy for one year. Install. fee of \$45 for 107 and 110; \$55 for 120.
Philco Television, Inc.	Table	T-110	Dir	\$299.50	32 sq in.	23	A.F.C.	Dis	No	
Philco Television, Inc.	Table	M-10-W	Dir	\$38.85	75 sq in.	24	A.F.C.	Dis	No	

To be added to this listing are two additional TV manufacturers, whose information arrived too late for this listing. These are Consolidated Television Corp., 101 W. 26th St., New York, N. Y., and Telecton Television Corp., 313 W. 42nd St., New York, N. Y.

TV Antenna Manufacturers

MANUFACTURER	MODEL NUMBER	TYPE	PRICE	MANUFACTURER	MODEL NUMBER	TYPE	PRICE
Aeronics, Inc. 132 Nassau St., New York 7, N. Y.	ATR-1.....	Simple dipole and reflector.....	\$ 15.	LaPointe-Plascomold Corp.....	Vee D-X.....	Long-distance four-bay array	
	ATR-2.....	Folded dipole and reflector.....	\$ 17.	Unionville, Conn. "Vee-D-X"			
American Phenolic Corp.....	114-005.....	Double folded-dipole array.		Oak Ridge Antenna Co.....	D-4.....	Single dipole.....	\$ 8.00
1830 S. 54th Ave., Chicago 50, Ill. —"AMPHENOL"				28 Clinton St., Yonkers, N. Y. —"RIG-FAST"	DR-4.....	Dipole reflector.....	\$ 13.75
Andrew Co.....	710.....	Di-Fan TV-FM.....	\$ 20.		DDR-4.....	Double dipole, double reflector.....	\$ 25.
363 E. 75th St., Chicago 19, Ill.					FD-4.....	Folded dipole.....	\$ 10.50
Ber-Mac Television Mfg. Corp.....		Indoor deluxe.....	\$ 9.95		FDR-4.....	Folded dipole with reflector.....	\$ 15.00
1381 Lexington Ave., N. Y. 28		Indoor-Master Deluxe (by channels).....	\$ 25.		CVS-4.....	Conversion kit, from D-4 to DR-4 or FD-4 to FDR-4.....	\$ 6.45
Birnback Radio Co.....	7027.....	Flexible indoor dipole.....	\$ 1.75	Philco Corp.....	45-1561.....	High frequency dipole.....	\$ 7.00
145 Hudson St., New York, N. Y.				Philadelphia 34, Pa.	45-1563.....	Low frequency.....	\$ 8.95
L. S. Brach Mfg. Corp.....	337.....	Straight dipole and reflector.....		Philson Mfg. Co., Inc.....	FD-160.....	Rotatable folded dipole with tunable (center "Signalator").....	\$ 17.
200 Central Ave., Newark 4, N. J.	338.....	Double broad-band dipole.....		156 Chambers St., New York 7, N. Y.			
	344.....	FM and TV double dipole multi-band.....		Premax Products, Div. of.....	FMTL-254.....	Extended "V" dipole.....	\$ 20.
Camburn, Inc.....	T31X.....	Dipole.....		Chisholm-Ryder Co., Inc.....	FMTL-330.....	Adjustable "V" dipole.....	\$ 17.
32-40 57th St., Woodside, L. I., N. Y. —"CAMCO FEATHERLITE"	T33X.....	Dipole and reflector.....		Niagara Falls, N. Y.			
	T32X.....	Folded dipole.....		Rad-El-Co. Mfg. Co.....	HD-22.....	Folded dipole.....	\$ 9.95
	T35.....	Rotatable "Double Decker" dipole and reflector.....		6300 Euclid Ave., Cleveland 3, Ohio		(Reflector kit available, \$3.95)	
Collins Machine Co.....	TFM-300R.....	Dipole with reflectors.....		Radio Corp. of America.....	226.....	Bi-directional TV-FM.....	
56-21 Northern Blvd., Woodside, N. Y.	TFM-200.....	Dipole.....		Tube Dept., RCA-Victor Div., Harrison, N. J.	225.....	Uni-directional TV-FM.....	
	TFM-301R.....	Dual dipole and reflector.....	\$ 25.				
	TFM-201.....	Dual dipole.....	\$ 18.	S/C Laboratories, Inc.....	704-2A.....	Stacked array.....	\$ 27.50
Dielectric Products Co., Inc.....	72M.....	Folded dipole and reflector.....	\$ 23.25	20 Van Wagenen St., Newark 4, N. J.	704-A.....	Single array with reflector.....	\$ 15.
125 Virginia Ave., Jersey City 5, N. J.	72MW.....	Folded dipole.....	\$ 13.		705-A.....	Single array with reflector.....	\$ 9.75
Electronic Indicator Corp.....	300D.....	Straight dipole.....	\$ 8.		706-A.....	Single array with reflector.....	\$ 8.75
35-44 61st St., Woodside, L. I., N. Y. —"ELINCOR"	300-DR.....	Dipole with reflector.....	\$ 15.	Shur-Antenna Mount, Inc.....	3E-62.....	"Hi-Gain" interceptor (custom built).....	\$ 24.
	300-FD.....	Folded dipole.....	\$ 11.	266 Sea Cliff Ave., Sea Cliff, N. Y.	SH-62.....	H type interceptor.....	\$ 23.
	300-FDR.....	Folded dipole with reflector.....	\$ 18.		D-62.....	Dipole.....	\$ 6.75
	310-FDR.....	Folded dipole with reflector.....	\$ 15.40		JD-62.....	"Jiffy" dipole.....	\$ 7.40
	310-SA.....	H Type stacked array.....	\$ 21.50		DD-62.....	"DeLux" dipole.....	\$ 8.
	350-SA.....	H Type stacked array.....	\$ 30.		DFI-62.....	"DeLux" folded interceptor.....	\$ 11.50
	250.....	TU and FM.....	\$ 30.		DID-62.....	"DeLux" dual interceptor.....	\$ 16.50
	250-R.....	TU and FM with reflector.....	\$ 42.		DI-62.....	"DeLux" interceptor.....	\$ 14.
Farnsworth Television & Radio Corp., Ft. Wayne 1, Ind.		Remote controlled variable robot.....		Technical Appliance Corp.....	435.....	Double-doublet antenna-reflector.....	\$ 23.
Insuline Corp. of America.....	6055.....	Simple dipole.....	\$ 9.95	Sherbourne, N. Y. —"TACO"	436.....	H-Type dipole array.....	\$ 17.
36-02 35th Ave., Long Island City 1, N. Y.	6057.....	Simple dipole with adjust. reflector.....	\$ 15.75		440.....	Adjustable folded dipole.....	\$ 21.
	6056.....	Folded dipole.....	\$ 12.45			Antenna-reflector combination	
	6058.....	Folded dipole with adjust. reflector.....	\$ 17.35		441.....	Folded dipole.....	\$ 14.
	6009.....	Flexible dipole (indoor).....	\$ 2.45		455.....	Dipole antenna-reflector.....	\$ 16.25
Intra-Video Corp. of America.....		Master system for multiple receivers.....			453.....	Single dipole.....	\$ 11.
851 Madison Ave., New York 21, N. Y.					457.....	Double-V dipole.....	\$ 18.
JFD Mfg. Co., Inc.....	TA-100.....	Dipole.....	\$ 12.	Tricraft Products Co.....	300.....	All wave double dipole (in kit form).....	\$ 19.75
4109 Ft. Hamilton Pkwy., Brooklyn 19, N. Y.	TA-101.....	Dipole and reflector.....	\$ 17.25	1535 N. Ashland Ave., Chicago 22, Ill.			
	TA-102.....	FM-TV double dipole with reflector.....	\$ 30.	Tuck Electronic Corp.....	"Pray".....	Folded difan TV-FM.....	
	TA-103.....	Folded dipole.....	\$ 13.50	76 Montgomery St., Jersey City 2, N. J.			
	TA-104.....	Folded dipole with reflector.....	\$ 18.75	Vertrod Corp.....	332.....	TV-FM single dipole.....	\$ 10.40
	TA-105.....	FM-TV Double folded dipole with refl.....	\$ 35.	17 Williams Ave., Brooklyn 7, N. Y.	444.....	TV-FM dipole and reflector.....	\$ 14.80
	TA-106.....	FM-TV multi element with reflectors.....	\$ 35.	Ward Products Corp.....	TV-88.....	Straight dipole.....	\$ 10.30
	TA-107.....	FM-TV multi-element stocked array.....	\$ 85.	1523 E. 45th St., Cleveland 3, Ohio	TV-94.....	Folded dipole.....	\$ 12.00
	TA-108.....	FM-TV dual band with folded lobe.....	\$ 35.		TVR-92.....	Reflector Kit.....	\$ 6.45
Kings Electronics Co., Inc.....	A-1000.....	"Roto Beam" rotating double dipole.....	\$ 115.	Workshop Associates.....	TV-57, 63, 89.....	Custom built single channel.....	\$ 32.50
872 Classon Ave., Brooklyn 5, N. Y.	A-1100.....	Tunable dipole for TV and FM.....	\$ 24.95	66 Needham St., Newton Highlands 61, Mass.	79, 85 for channels 2, 3, 4, 5, 6		
		and.....	\$ 19.				
	A-1200.....	Dipole, TV and FM.....	\$ 8.45				
	A-1300.....	Tunable dipoles with tunable parasitic element.....	\$ 43.50				
	A-1400.....	Double dipole.....	\$ 11.85				

THREE TELEVISION SERVICE ARTICLES

Don't miss:

● TV Service Flashes — Page 97

● Servicing All-Band Tele — Page 99

● Solving Special TV Problems — Page 102

In this month's Service & Sound Section of RADIO & TELEVISION RETAILING

TELEVISION LEAPS AHEAD 10 YEARS!

Cleervue Television Presents...

THE FINEST TELEVISION TO DATE

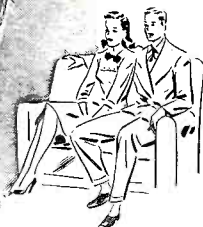

the sensational *Hollywood*

With history-making SWIVEL SCREEN, which can be focused 180 degrees in any direction. 75 square inch screen.

HISTORY IN THE MAKING!—SOMETHING EVERYBODY WILL APPRECIATE! TELEVISION LEAPS AHEAD 10 YEARS WITH THE EXCLUSIVE CLEERVUE 5-DECK CONSTRUCTION!

Each set has 5 separate "plug-in units", easy to remove, repair, or replace! No more pleasure-curtailling delays—*immediate* repairs when needed. Units allow 10-minute trouble-shooting and no wiring, no soldering, no expensive repairs!

UNITS AND PARTS FULLY GUARANTEED FOR 1 YEAR, PLUS FULL ADVANTAGES OF CLEERVUE 1-YEAR SERVICE POLICY!

"Engineered by Television Pioneers"

INDUSTRY AND DEPARTMENT STORE HEADS ASTOUNDED BY REMARKABLE DEMONSTRATION AT NEW YORK'S HOTEL RUSSELL!

At last

Television pioneers get together, pool their know-how and experience, and produce first-class Cleervue Television.

Yes, background is everything! Cleervue master engineers are designing, producing, and multiple-testing the most amazing television development in decades—Cleervue. And when we say Cleervue we mean clear view! Jitter-free pictures, clear images, beautifully finished cabinets, breathtaking designs, impeccable reception—all together to prove that not only is television the scientific wonder of our time—but that Cleervue is the great demonstration of the fact.



the distinctive *Regency*

To beautify the home while offering peerless reception. Large 15" cathode tube, 108 square inch screen.

—PLUS OTHER FINE TELEVISION MODELS!

CLEERVUE TELEVISION CORPORATION

81 WILLOUGHBY STREET • BROOKLYN 1, NEW YORK

WE HAVE A LIMITED NUMBER OF DEALER FRANCHISES OPEN.

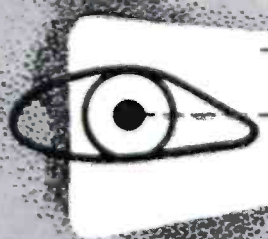

hallicrafters

PRESS BOX



... Pull up a chair to the windows of the world. A reserved seat is yours with Hallicrafters Press Box. Cabinet design by Raymond Loewy, famed designer.

\$18950

hallicrafters RADIO

THE HALLICRAFTERS CO., MANUFACTURERS OF RADIO AND ELECTRONIC EQUIPMENT, CHICAGO 16, U. S. A.
Sole Hallicrafters Representatives in Canada:
Rogers Majestic Limited, Toronto-Montreal

Presenting a whole new view of the radio-television business

Hallicrafters presents the "Press Box"—a high quality, high precision television receiver made—as only Hallicrafters can make an instrument like this—to sell for \$189.50.

Sharp, clear, steady pictures that put you down front and center in the best seats in the house for the most exciting spectacles in the coming era of sight and sound.

Price and precision coupled with Hallicrafters character and quality make a combination that cannot be equalled. The "Press Box," an extraordinarily fine and sensitive instrument, is the direct result of Hallicrafters 15 years specialization in the development of advanced high frequency circuits.

Modernly designed cabinet of grayed bleached mahogany, perfectly adapted to the function of the receiver. 7" electrostatic tube provides a picture size 4" by 5 $\frac{7}{8}$ " with perfect, continuing clarity. Controls for contrast, brightness, volume, horizontal and vertical hold, fine tuning and 13 push buttons for channel selectivity. Uses inter-carrier modulation type FM sound system and a built-in 4" by 6" oval PM dynamic speaker.

A special automatic gain control circuit controls the I. F. system to maintain constant reception in spite of atmospheric or other variations in signal strength from the transmitting station. Sensitivity and distance reception of the "Press Box" is amazing and comparable to those in the much higher brackets. The set has three stages of I. F. using iron core I. F. Transformers. 22 tubes. Comes complete with cathode tube installed. No extra assembly required.

Hallicrafters "Press Box" is exciting in appearance, magical in performance and tremendously significant in its pricing. It is the fore-runner of important developments to come including projection-type television in the great Hallicrafters Carnegie Hall series of console combinations.

hallicrafters
PRESS BOX

TELEVISION BY HALLICRAFTERS

New Radios for 1948 Merchandising

Motorola TABLE TV SET



Model VT71 table television receiver with picture 4½" by 6". Fifteen tubes, 2 rectifiers, Germanium crystal detector, 7" picture tube. Three controls—8-position tuning knob adjustable to any 8 of 13 channels, 6½" PM Alnico 5 speaker. Inter-carrier sound system, automatic brightness stabilizer, AVC, chassis shielded against oscillator radiation. Sliding metal door on bottom of cabinet for easy servicing. Safety interlock disconnects power cord from chassis whenever protective back is removed from cabinet. Compact, lightweight (26½ lbs.) design, available in walnut, blonde or mahogany. Measures 9¼" high by 16½" deep by 16¾" wide. \$179.95. Motorola Inc., 4545 Augusta Blvd., Chicago 51, Ill.—RADIO & Television RETAILING

Coin-RECORDIO

Completely automatic Wilcox-Gay coin-operated recorder, to provide disc "voice letters" for stores, schools, hotels, theaters, etc. When quarter is placed in slot, a blank disc goes on turntable; operator lifts telephone hand-set, and speaks or sings for 2 minutes. Machine then plays the record back through phone or loud-speaker and delivers it automatically. Illuminated instruction panel, hum control, automatic gain, shaver collector finger,



sapphire-tipped playback needle. Compact, semi-portable cabinet in three units, measures 29½" high by 21¼" wide by 28¾" deep (without base.) \$645 without base. Wilcox-Gay Corp., Charlotte, Mich.—RADIO & Television RETAILING

cue index, and index pads included. Modern styling, core mahogany veneer panels, hand-rubbed. Lear, Inc., 110 Ionia Ave., N. W., Grand Rapids, Mich.—RADIO & Television RETAILING

Howard AM-FM RADIO

Model 474-I ac-dc receiver tuning 535 to 1650 kc on standard and 88 to 108 mc for FM. Built-in antennas for both AM and FM, 5 tubes plus selenium rectifier (3 dual purpose), 4-gang tuning condenser, 5" Alnico 5 speaker. Full vision, clock-type dial. Ivory molded plastic cabinet measures 9¾" wide by 6½" high by 5¼"

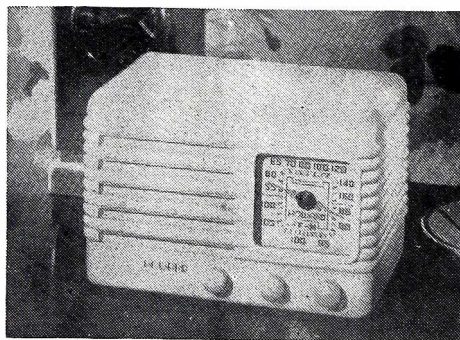

deep. (Model 474-M is walnut plastic) Howard Radio Co., 1735 Belmont Ave., Chicago 13, Ill.—RADIO & Television RETAILING

Philco COMBO



Model 1282 radio-phonograph superhet with PM dynamic speaker. Smooth-action automatic disc changer handles up to 12 records. Figured console cabinet of "classic modern" design, African striped mahogany. \$179.95; slightly higher Denver and West. Philco Corp., Tioga & C Streets, Philadelphia 34, Pa.—RADIO & Television RETAILING

Dynatone COMBO-RECORDER

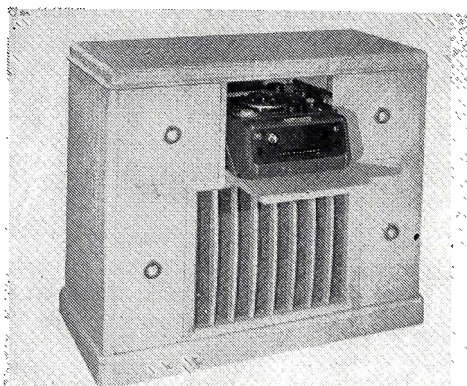

Deluxe modern model Lear AM-FM radio-phonograph recorder equipped with Learrecorder wire recording unit. Provides completely automatic recording of radio and phono music or speech, push-button operated. Single-record phono turntable plus automatic intermix disc changer. Fifteen-inch coaxial speaker mounted in bass reflex acoustic projector. Leartron pickup, separate bass and treble controls, Leartronic scratch filter. Microphone, wire spool with

PhonOcord COMBO

Packard-Bell Model "Wilshire" 1472 radio-phono-recorder AM-FM combination, with 12 tubes plus rectifier and tuning eye. Both Hi-Q loop antenna and FM dipole aerial 12" electro-dynamic speaker floated in live rubber. Two turntables—Webster #56 disc changer plus recording turntable, Silentrone crystal pickup, lifetime needle, studio type microphone, PA system, dual tone controls, push-pull audio system. Re-



ording unit on pull-out drawer. In \$600 bracket. Packard-Bell Co., 3443 Wilshire Blvd., Los Angeles 5, Calif.—RADIO & Television RETAILING

Another

ST



IN STYLE
AND
PERFORMANCE!

THE PHANTOM GRILLE

AND ONLY
Bendix Radio
HAS IT!

- LOOKS LIKE RICH CABINetry!**
- IMPROVES LISTENING PLEASURE!**
- THE FEATURE WOMEN BUY ON SIGHT!**

Any radio dealer will recognize that the Phantom Grille is a feature he can sell on sight. For the first time, the promise of true furniture styling is fulfilled in the appearance of rich wood cabinetry *throughout the set!* Furthermore, acoustics and listening pleasure are markedly improved, because thousands of invisible perforations let sound come through unimpeded from the loudspeaker to the ear. Men and women alike will go for it on first sight—and be convinced on the first listen!

Only Bendix Radio-phonographs combine all these advancements
Hush-O-Matic... Swing-A-Door automatic record player... Phantom Dial... New Phantom Grille...
Bendix Ratio Detector FM circuit... crystal-controlled FM... true furniture styling... Aviation Quality

Don't miss the Bendix Radio permanent display at the Winter Market—January 5-17
American Furniture Mart, Chicago
Space 545-D, 5th Floor

BENDIX RADIO DIVISION OF
BALTIMORE 4, MD.



New Lines for Dealers

Magnavox COMBO

"Traditional" console fine-furniture radio-phonograph with 12" Duosonic speaker. Eight tubes plus rectifier, 10-watt power output, fully automatic disc changer with "pianis-



simo" pickup. Storage space for records. Authentic period style cabinet in mahogany. \$235. (With Armstrong FM, 14 amplifier tubes, two rectifiers and one tuning tube, the price is \$300) Magnavox Co., 2131 Beuter Rd., Ft. Wayne 4, Ind.—RADIO & Television RETAILING

Crosley RADIO

Model 56TY table receiver, 5-tube superhet tuning 540 to 1600 kc. Power output of 1 watt minimum, ac-dc, i-f of 455 kc. Two controls. Crosley Division, Avco Mfg. Corp., 1329 Arlington St., Cincinnati 25, Ohio—RADIO & Television RETAILING

Magnesonic RECORDER

Magnetic tape recorder and reproducer for home recording, offices, schools, etc. Single switch sets for microphone recording, radio pickup, radio public address, or



playback; separate switches for tone and volume. Six tubes, including two dual purpose, audio frequency response range 30 to 20,000 cycles. High frequency magnetic erasing. Recording and playback time per tape is 30 min. List under \$200. Sound Recorder & Reproducer Corp., 5501 Wayne Ave., Philadelphia 44, Pa.—RADIO & Television RETAILING

Garod AM-FM TV COMBO

Model 42FMPT2 "Royal" console with television, AM-FM, shortwave and automatic disc changer. Tunes 13 TV channels, 540 to 1650 kc for standard, 5.3 to 18.5 mc for shortwave and 87.5 to 108.5 mc for FM. Thirty-four tubes, 4 rectifiers, 10" picture tube giving 54 sq. in. picture (Available with 12" tube giving 75 sq. in. image). Spotlight channel selector, "Bird's-Eye-View" image synchronizer, direct view. Two-post automatic changer handles twelve 10" discs or 10 12" records—automatic stop. Disc storage provided. Mahog-



any cabinet in 18th Century style. \$695 plus installation. Garod Radio Corp., 70 Washington St., Brooklyn 1, N. Y.—RADIO & Television RETAILING

Masco INTERCOMS

Three intercommunication "packaged" systems in low-priced field. First is 2-way master-and-remote-station system with tubes and 50 ft. cable, for upstairs-downstairs use in homes, doctor-to-nurse, boss-to-secretary, etc. Second is master-and-5-remote-stations hook-up, for 2-way coverage of medium-sized groups. Third system is all-master setup, linking up to 6 master stations, for even greater coverage. Mark Simpson Mfg. Co., Inc., 32-38—49th St., Long Island City, N. Y.—RADIO & Television RETAILING

Jordaphone COMMUNICATOR

Console type ac communicating device, designed for group telephone conversations without use of individual headsets. When used on incoming or outgoing phone calls, the phone handset is lifted from the cradle and placed in Jordaphone. Operator is then

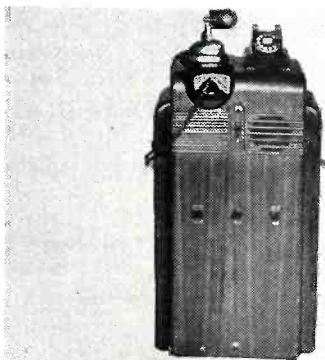

free to talk and listen, with no handset or switches to handle. Phone calls thus may be person-to-group or group-to-group. No physical connection to phone line. Uses some 20 tubes, weighs about 80 lbs. Cabinet is 30" high, a foot square in width and length. Jordanoff Corp., Electronics Division, 595 Madison Ave., New York 22, N. Y.—RADIO & Television RETAILING

Air King RADIO

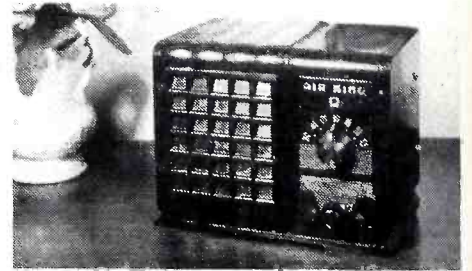

Model A-400 "Minstrel" table superhet, ac-dc with Alnico 5 PM speaker. Four tubes, including rectifier, AVC. Plastic cabinet in ebony, walnut or ivory. Measures 7" long by 5½" high by 4½" deep. \$13.95 for ebony. (Walnut is \$14.95 and ivory is \$15.95) Air King Products Co., Inc., 1523 63rd St., Brooklyn 19, N. Y.—RADIO & Television RETAILING

Hoffman AM-FM RECORDER-RADIO-PHONO

Model C-1007 "Sheraton Symphonic" console AM-FM automatic radio-phonograph with "Wirecord" feature, 5-station push button tuning. Twenty tubes plus two rectifiers and tuning eye, push-pull power amplifier, 10" "dia-cone" electro-dynamic speaker, bass boost and separate antennas for AM and FM. Recorder works in units of 15 min. to an hour, recording from radio,

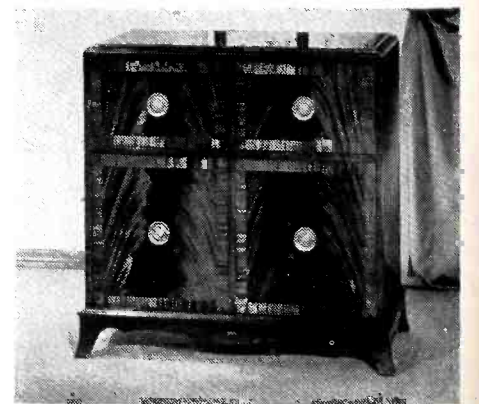

phono or mike. Slide-out automatic record changer has automatic shut-off; disc storage space provided. Authentic Sheraton style cabinet of crotch mahogany veneers. Measures 37½" high by 38" wide by 18" deep. (Model C-1006 is Sheraton Symphonic without Wirecord) Hoffman Radio Corp., 3761 S. Hill St., Los Angeles 7, Calif.—RADIO & Television RETAILING

Stewart-Warner
 for 1948
 Radio-Phonographs
 with Stobo-Sonic Tone

This Year of all years, the really lucky dealer is the Stewart-Warner dealer. No one has new models with more *self-selling appeal*. No one has new models better designed for the home of *today*. No one has *quality* models more attractively priced.

NEW FEATURES, too . . . that people *want!* The brilliant new Shadow-Box Dial. The amazing new Electro-Hush Reproducer. The retractable, unbreakable Dura-point. And the famous Stobo-Sonic Tone System.

GREAT PERFORMANCE is the result: performance that *sells* when your customers *listen!*

A Model for Every Purpose—
 a Radio for Every Room

Stewart-Warner

AM RADIOS FM • RADIO-PHONOGRAPHS • TELEVISION

CHICAGO



ILLINOIS



THE ALLEGRO—old-world mahogany in the popular 18th Century style; bronze grille; AM plus automatic phonograph. The name that's *big news* in top-quality entertainment!



THE GAD-ABOUT—1948's popular portable; AC, DC, safe *dry* cells. Recharges on house current. Brilliant, powerful!



THE NEW MINSTREL—smart, contemporary styling in smooth walnut; AM plus automatic phonograph.

LET THIS "ALL-STAR SALESMAN" CLOSE YOUR SALES!



Wonderfully effective special demonstration recording . . . made with a famous symphony orchestra! Works for you like a Trojan . . . sells each feature by demonstration . . . in your store. Just like a big-time radio show right on your sales floor!

Don't let another day pass without putting this great "salesman" to work for you. Get it *now* from your Stewart-Warner distributor!

You'll do best



**GORGEOUS NEW PULL-OUT CONSOLE
A DELUXE RADIO PHONOGRAPH
AT A PRICE THAT'S RIGHT FOR '48!**

MODEL 402A
\$229⁹⁵

(in Mahogany)

Model 402A. Here's top value from every angle: Peerless contemporary design . . . powerful AM and Short-Wave reception . . . quick-action automatic record playing . . . "Clear as a Bell" tone on radio or records . . . 12" Concert Dynamic Speaker. There's nothing comparable at the price in nationally-advertised consoles! And you can offer the 402 in stunning blonde finish or rich mahogany. Hitch your sales-wagon to the brightest console star in the 1948 radio sky!

Model 40F2. With advanced FM-AM reception. In blonde finish or mahogany. In mahogany, **\$269.95**

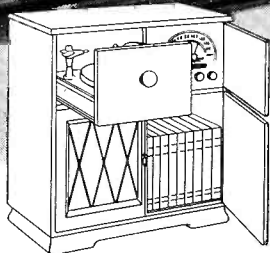

Clear as a Bell

Sonora
Clear as a Bell

Presents the "401"

**PHENOMENAL
Radio-Phonograph
Console Value at**

\$99⁵⁰

(In Walnut)

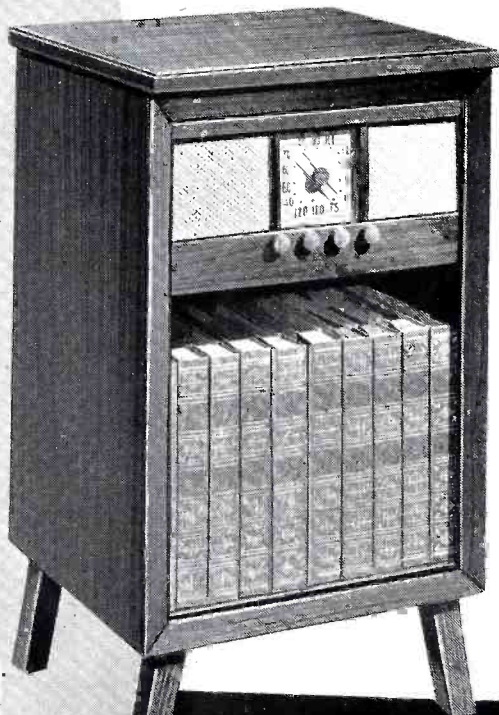
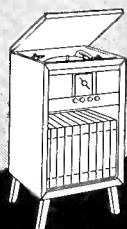

**SMART . . . COMPACT—COSTS
NO MORE THAN MANY
TABLE COMBINATIONS**

Corner the small console business with this exceptional SONORA offering! Think of it—the lowest-priced nationally-advertised console on the market—a quality "Clear as a Bell" Radio-Phonograph, complete with automatic Record Changer at \$99.50! The "401" is a cinch to sell—just get it on your floor. Ask your customers to *listen*. Ask them to *look*. Then show them the price tag—and watch your console business boom!

Available also in blonde finish or mahogany.

Sonora
Clear as a Bell

**RADIO & TELEVISION CORP.
CHICAGO 12, ILLINOIS**

in '48 with Sonora

Clear as a Bell



**\$50 to \$75 BELOW
COMPARABLE MODELS**

\$149⁹⁵

(In Mahogany)

Model WTRU-254A. You'll want the selling advantages this big-value model gives you in the console market. Just check them—low, low price—"Clear as a Bell" radio, standard broadcast and Short-Wave . . . quick-action Automatic Record Changer . . . amazingly fine furniture in choice mahogany veneers, with generous record storage space. You'll do your best in '48 with this outstanding SONORA Console Radio-Phonograph. *Available also in blonde finish.*

Model WKRU-254. Radio-Phonograph as illustrated, with advanced FM-AM. Available also in blonde finish. In Mahogany **\$179.95**

SENSATIONAL FM-AM TABLE MODEL

Model WEU-262. There's a big demand for this red-hot number—absolutely the lowest-priced nationally-advertised FM-AM table model in its quality class. Sell it with complete confidence in its dependable FM-AM performance, tone quality, and appealing beauty!

\$64⁹⁵

(In Mahogany Plastic)

Model WEU-240. *In sleek Ivory plastic.*



**A BETTER TABLE MODEL —
GREAT FOR '48**

Model 100. You'll meet and beat any kind of competition with this better-than-ever SONORA superhet. Priced with the lowest, yet it's far above the average in performance. Your customers will *hear* the difference in "Clear as a Bell" tone; they'll see the difference in a plastic cabinet that's bright with beauty!

\$19⁹⁵

(In Mahogany)

Also available in luxurious Ivory finish.



Clear as a Bell

Prices slightly higher in the far South and West.

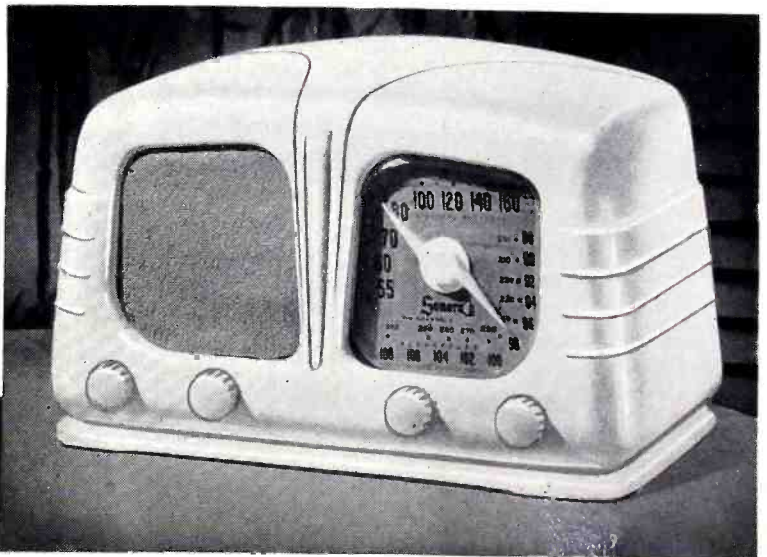

Known for Tone Since 1914



FM

Means More Money

• As the radio men of the country face the new year of merchandising, it is perfectly clear that the FM sales picture has improved to a mighty interesting extent.

Some of the new sales factors are those which would appear in any industry that is new. Other developments are those which would naturally happen in the radio business—an industry which makes the special demand that a retailer be equipped to **SERVICE** as well as to **SELL**.

There are at least six developments in the FM business which the dealer should be aware of as the new year opens.

First, FM is one of the *cooperative* branches of the radio industry. Its nature is such that broadcasters must work with the sellers of sets. This has become increasingly apparent as new stations went on the air in 1947 and receivers were sold and installed for a brand new broadcasting service. Lines of action, whereby the local distribution of sets depends upon the origin of the signals (and vice versa), have now been established. It's important for retailers and broadcasters to develop them further in 1948.

Complete Service

Second, dealers got a new lesson in service and installation. They were faced with more and more evidence that a radio is not actually sold until it is giving the new owner good results in his home. If this were true of AM, it is doubly true of FM. Generally speaking, the retailers realized this, and went to work on the technical background. They got plenty of help from the manufacturers, and the whole matter can now be said to be past the preliminary stage. But a great many tried-and-tested technical-sales aids—those which now have real experience behind them—are available to those dealers who feel unsteady on this score.

Third, the public has become more quality-conscious. The musical population has had a taste of full-fre-

quency-range records, as well as new deluxe radio-phonos that beat anything of previous years. In the whole radio field, there has been an important number of improvements in tone reproduction and noise elimination. All this develops the popular taste for quality and that's where FM gathers favor.

Fourth, for the people who cannot afford the deluxe instruments, the new year will offer a great variety of lower-priced models. There has been a brisk and rewarding competition developed among the manufacturers specializing in this price bracket. Expert designers spent the last months of 1947 beating each other to the draw, with the result that FM is reaching "the other side of the tracks" in a big way.

The Last Word

Fifth, a lot of prospective radio buyers are being "sold" on the instrument which offers "complete radio service" as the main set in the home. Millions of Americans always want the "latest," and they are finding out that the up-to-the-minute radio console is one which gives out with FM, AM, television, automatic record playing and shortwave. This line of thought would mean, certainly, that the modern radio fan would not want to be without FM—at least for the bigger console that entertains the family in the living room.

Sixth, the average retailer is beginning to realize that FM sales success is now a competitive matter. That is, he's no longer the only retailer on Main Street who has FM sets to sell. He is not the only one in town who can tell the prospect what FM is, in an accurate and straightforward manner. And he's not the only merchandiser who can confront the prospect with FM units in various styles, sizes and prices. The picture is competitive and a dealer has to be certain of his ground. It is time to develop new sales promotional methods specially suited to FM.

boost
your
midwinter
profits



*sell fast
and stay sold
-at a Profit!*

When you sell Arvin Radios,
you're selling dependability
and satisfaction.

Every Arvin set is soundly
engineered. Every Arvin set
is listed with Underwriters'
Laboratories. It costs more
to build radios that way,
but it's the safe way, the
Arvin way. And every Arvin
Radio is priced to give you
a reasonable profit. Compare
model for model in each
price range. Compare
discounts. Then push the
strongly advertised line
that gives you and your
customers the most for
the money—ARVIN!

3 New 1948 ARVINS

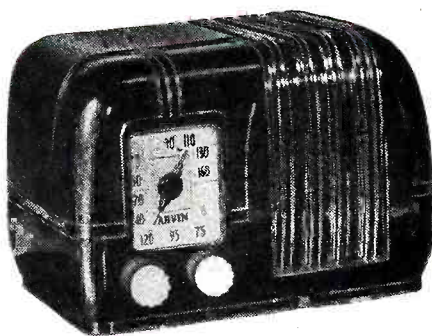

\$17⁹⁵ buys unmatched
looks and
performance!

Model 547 in ebony finished plastic is an
eyecatcher for looks and quality perform-
ance. It's an exceptional value for power,
tone, and selectivity. Everything you're
accustomed to find in sets selling at \$19.95
and up. Make it a featured leader in your
display and watch it build midwinter sales
for you!

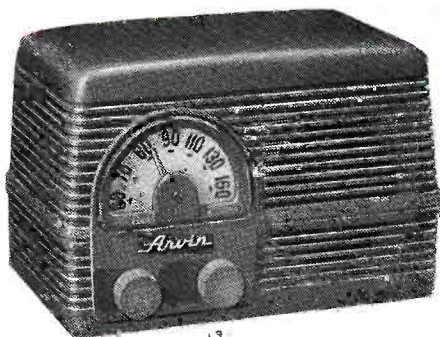

\$19⁹⁵ Model 152-T sets
new value standards
at this popular price

Model 152-T in grained walnut plastic
(153-T in Ivory) steps boldly into the
\$19.95 price class with an array of wanted
features. Look at the intriguing modern
design! The easy-to-read lighted dial is a
masterpiece of simplicity. It has a lot
more of everything than you'll be seeing
in many sets at this price!

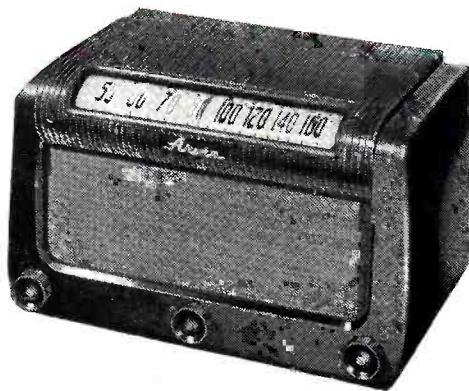

\$29⁹⁵ Model 160-T
The Arvin model that
makes value history

Here is the challenger model of the Arvin
line. A smart, new, distinctive styling in
a plastic cabinet with tone and perform-
ance to match. Features include a 3-gang
condenser, extra heavy Alnico-V speaker,
continuous variable tone control, lighted
slide-rule dial . . . everything at a price
that can't be duplicated by competition.
Model 161-T in ivory at \$31.95.



Count on ARVIN for real quality — at a real profit!

NOBLITT-SPARKS INDUSTRIES, INC.
Columbus, Indiana

Only Recordio brings you
these profitable

"Sales Records"

DEMONSTRATION DISCS

TWO BRILLIANT NEW
FM MODELS FOR 1948



THE *Towne*
Model 7D44

A striking new RECORDIO Console, built especially for full FM enjoyment. Provides realistic radio or microphone recording—natural, noise-free FM from huge accoustical tone chamber—automatic phonograph—selective AM radio and built-in home sound system. What an instrument! What a profit-producer for you! Shown in blonde finish. Also available in rich mahogany.



THE *Metropolitan*
Model 7E44

Trim, tidy and terrific is the description of this newest member of the famed RECORDIO family of fine home recording instruments. Offers simplified push-button selection of radio or microphone recording—AM-FM radio—automatic phonograph or built-in public address system. This is one for the books . . . your sales books! Shown in blonde finish. Also available in rich mahogany.

● Here's the line that's big, beautiful and bountifully endowed with every desirable feature. RECORDIO offers your customers the fascinating fun of original home recording in addition to advanced FM and everything they look for in a fine radio-phonograph combination. What's more, you can give them something no other ordinary radio dealer can—a complimentary recording disc made in your store. These are profitable "sales records" and they are yours with RECORDIO. Don't cheat yourself . . . sell RECORDIO, the complete home entertainment instrument.

Recordio
T. M. REG. U. S. PAT. OFF.

by WILCOX-GAY

the **RECORDING** *radio-phonograph*

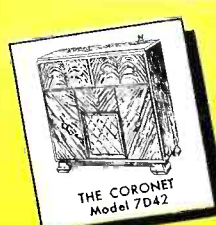
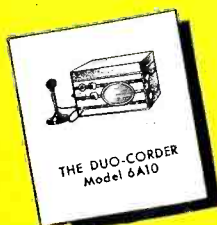

**WILCOX-GAY
CORPORATION**
CHARLOTTE, MICHIGAN

In Canada . . . Canadian MARCONI Company

153-M

RECORDS

Section of **RADIO Television RETAILING**

Platter Profit-Pointers

\$ **END OF SCHOOL TERM** this month offers retailers an excellent promotional opportunity. Merchants can offer to donate prize albums to school music clubs and orchestras as prizes for outstanding music students. A contribution to the school's record library is another means of creating additional good-will, and bringing the business your way.

\$ **SPECIAL ATTENTION** to special customers is a good idea to follow. Collectors who buy records at regular intervals will welcome receiving postal-cards listing albums "just received" which may be of particular interest to them. Sales clerks should be provided with mimeographed cards which they can fill in and mail to their "good" customers.

\$ **FEBRUARY**, the month of presidential birthdays, is coming up. Dealers might do well in planning a good tie-in window with the events, featuring collections of patriotic music and poetry, as well as some children's albums about Washington and Lincoln.

\$ **EDUCATIONAL RECORDS** should be played up for the start of the Spring school term. Window and interior displays should be planned, and an envelope stuffer prepared for mailings to parent-teacher associations and similar groups.

\$ **ONE DEALER** maintains a bulletin board on which local groups can post notices of interest to the community. Customers read the items avidly, and the club members go out of their way to buy things in his store, as a means of showing their thanks for his cooperation.

\$ **NATIONAL ADVERTISING** by record and accessory manufacturers in consumer publications can be the subject of an eye-filling window display. Place the magazines and blow-ups prominently in the window; run bright red ribbon markers directly from the magazine pages to the window glass. Manufacturers welcome this type of dealer cooperation, and provide ample display material for such use.

\$ **MANY NEW ARTISTS**, heretofore familiar only to night-club goers and concert hall devotees, have been signed to recording contracts for the coming year. This "new blood" recruited from other entertainment fields should create many additional sales for retailers.

\$ **RECORDED CONCERTS** at scheduled hours have become extremely popular with customers and dealers alike. Retailers with adequate facilities, such as tele theatres, large demonstration rooms, etc., have found these programs paying off in increased store traffic, sales, and favorable customer reaction.

\$ **THIS IS A GOOD TIME** to bring mailing lists up to date. It's a waste of money to maintain duplicate names and other "dead-wood" on these lists. Additional names can be picked up from new customer lists, as well as from local, school, and fraternity papers, and from the phone book.

1947 Sales Estimates of Records and Needles Compiled by RADIO & Television RETAILING

RECORDS		Total No. of Units	Total Retail Value
Popular	243,750,000		
Classical	48,750,000		
Children	32,500,000		
Total		325,000,000	\$300,000,000
PLAYING NEEDLES			
Steel (Approximately 40% manufactured in foreign countries)	100,000,000		
Precious Jewels (Sapphire, Rubies, Diamonds)	1,000,000		
Precious Metals	15,000,000		
Total		116,000,000	\$28,100,000

performance

is the only proof of leadership!

CUSTOMERS in the market for recorders these days are apt to be confused by the many new recording mediums.

Some of these are good, to be sure. But remember: The disc as a recording medium answers *all* the needs of the great majority of users. And its reliability is proven by years of operation.

For all-purpose use and trouble-free operation Presto K-8 is still out in front. Presto K-8 is tested by years of use in dozens of different fields . . . proven in design, material and performance by the experience of thousands of users.

So when customers who depend on your judgment ask for recorders, recommend Presto K-8. Then you can *be sure* they're on the right road to lasting satisfaction.

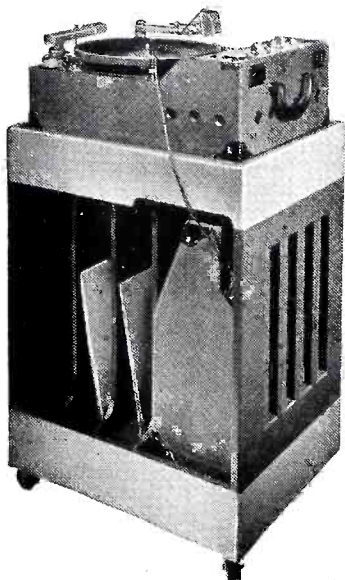
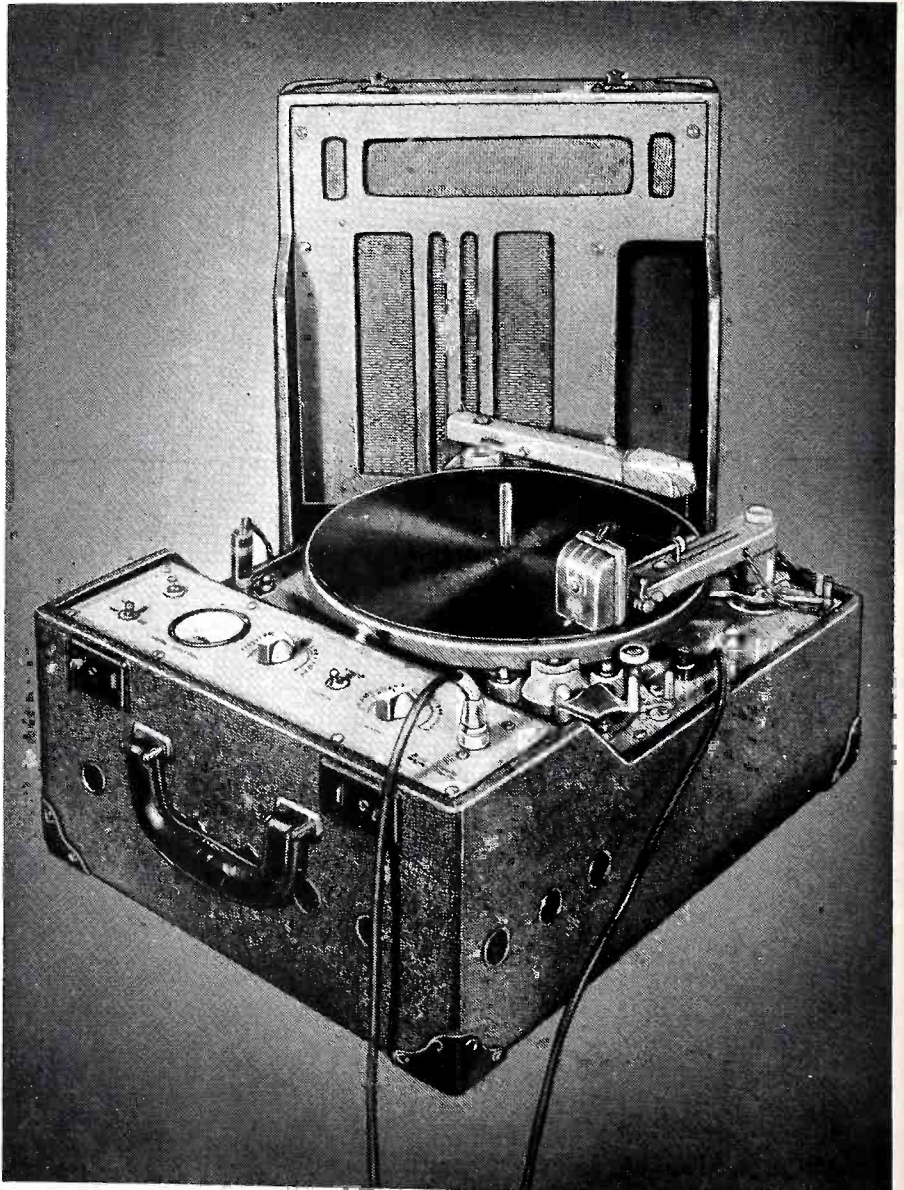

NEW—The K-8 movable console. It's a caster-mounted cabinet that can be easily rolled from room to room. Holds the speaker and disc albums below, K-8 recorder on top.

**PRESTO**

RECORDING CORPORATION
242 WEST 55TH STREET, NEW YORK 19, N. Y.
Walter P. Downs, Ltd., in Canada

WORLD'S LARGEST MANUFACTURER OF INSTANTANEOUS SOUND RECORDING EQUIPMENT & DISCS

Training to Sell Discs

Prepare Store Clerks for Specialty Merchandising of Platters

● With the books closed on '47, dealers are planning for a busy and prosperous '48. New ideas, sales stimulants, and better merchandising methods top the record retailers list of resolutions for the New Year.

At a time when so many merchants are planning to improve their business operation, the problem of hiring and training additional sales clerks is particularly important. The hiring of a salesperson should be regarded as an investment the dealer is making of his time and money. It is the training period that determines whether or not his investment will pay off. The degree of efficiency of an establishment's selling staff determines the amount of profits, and will help or hinder the store's ultimate growth.

Retailers who are looking for people to sell records, realize that it is not necessary or advisable to hire an "encyclopedia of musical knowledge." Factors such as personality, general intelligence, appearance and interest in the product to be sold should be considered instead. Future potential and past experience are equally important. Record customers have no preference as to male vs. female clerks, therefore the sex of the applicant should not influence the store owner.

After the qualifications are weighed, and the person hired, "in-the-store" training determines the success or failure of the individual. It is up to the proprietor to see that the clerk is provided with the working information that will prepare him to sell records.

Instruction Necessary

If the person hired is a "beginner" steps should be taken to see that he is put at his ease, and that all elements contributing to nervousness and tension are eliminated. In the case of an experienced applicant, the dealer might forego presenting some of the more basic fundamentals of selling, but he still should not take too much for granted. No matter how much past experience a salesman has under his belt, he is "green" until he has learned the ropes in a new store.

In presenting the successful "formula for sales" the store proprietor

should make a special effort to maintain the interest of the person being trained. One of the reasons for hiring the individual was his apparent ability to learn about records, coupled with his desire to do so. That wish "to learn" should be concentrated on by the dealer.

Selling Aids

The clerk should be provided with material from the manufacturers which tell about the new releases and company artists. Folders which are distributed among customers and by direct mail should be read from cover to cover by the sales force. Trade papers are the most valuable single source of specialized knowledge available to the record clerk. He should be provided with back copies of these papers to get a good working knowledge of the industry.

Before a salesperson steps out on the floor to sell, he should be familiar with the store catalogs and filing systems, as well as other "quick aids" and record listings which the dealer receives.

It is a good idea to introduce the distributor's representative to the "in-training" clerk. The local representative of the manufacturer is thor-

oughly familiar with his product, and usually filled with a boundless enthusiasm for it. The record clerk can learn a great deal from this source, which he in turn can pass on to the store's customers.

Actual selling techniques especially adapted to record merchandising should be reviewed with the newcomer. Fundamental concepts of courteous service, such as a friendly greeting on entering, waiting on customers in the order of their entrance, and a cordial "thank you" at the conclusion of the sale should be stressed.

Other Techniques

The "suggestion" method of selling is particularly effective with record purchasers. Sales personnel should be taught the importance of suggesting additional albums and singles to the customer's attention, and the necessity for suggesting something else if the requested number is not in stock. Trainees should also be warned against "forcing a sale." Music-minded customers welcome advice, but they do not like to be pushed into a sale. It is also recommended practice for the clerk to use some impersonal title in address-

(Continued on page 85)

Clerks should be instructed to take orders on records not in stock, as well as to suggest other items.



**New "Talent Finds"
for the New Year
Will Bring Extra
Sales to Retailers**



The Paganini Quartet made its recording debut for RCA Victor in Beethoven's "Razoumovsky Quartet" series. The group is on a cross-country concert tour. Local dealers will do well to tie-in with the event.



Alvy West, left, a Columbia Records discovery, is shown rehearsing with his group. West's refreshing brand of music is available in a collection entitled "Originals by Alvy West and the Little Band."



Sultry Lena Horne's "I Feel So Smoochie" is her first release under her new MGM recording contract.



Left: Songstress Mindy Carson makes her first appearance on records under the Muscraft label.



Lower left: Monica Lewis has been signed by Decca, to take a place on its roster as top feminine singer.

Picture for 1948



ATCHER, BOB: "Signed, Sealed and Delivered" — "Mountain Maw." Columbia 37991

Devotees of Westerns will love this coupling.

AUTRY, GENE: "Pretty Mary" — "Dixie Cannon Ball." Columbia 37963

"... Mary," a homespun tune of a young girl going out with her beau. Autry does the folk tune on the reverse in the "sweet" style that has made him famous.

BENSON, RED: "Slap 'Er Down Agin, Paw" — "Gonna Get a Girl." Rainbow 10034

Benson's waxing of "Rosalinda" for this label was so successful, that firm decided to issue additional discs in a similar vein. New coupling proves Benson knows how to put a song across.

MONTANA SLIM: "Hang the Key on the Bunk House Door" — "Rye Whiskey." RCA Victor 20-2561

Two sides bound to appeal to Western and hill-billy fans.

O'DAY, MOLLY, and the Cumberland Mountain Folks: "When God Comes to Gather His Jewels" — "The Tear Stained Letter." Columbia 37981

Group does religious folk music of rural Southern areas. The statement and response type of number is coupled with a love ballad.

ROBISON, CARSON: "Shady Valley Waltz" — "Some Day You Gotta Make Up Your Mind." MGM 10110

Folk Singer Robison puts across some dandy whistling on the waltz side of the platter; reverse is a folk story tune.

SONS OF THE PIONEERS: "A Hundred and Sixty Acres" — "The Last Roundup." RCA Victor 20-2569

Group does two numbers from its latest movie, "The Last Round-up."

WILLS, BOB: "A Sweet Kind of Love" — "Cowboy Stomp." Columbia 37988

Humorous Western singer tells a tale of his wonderful gal on the first

side; Wills and the Texas Playboys go all out on the instrumental.

WILLS, LUKE, Rhythm Busters: "High Voltage Gal" — "Cain's Stomp." RCA Victor 20-2577

Lively doings in the fiddle section characterize this platter, which pairs story of an "ideal girl" with an instrumental.

WINDY CITY FIVE: "The Gay Gray Horse" — "A Rose." Columbia 37969

"... Grey Horse" a spirited polka; coupled with a waltz.



ANDREWS, ERNIE: "Soothe Me" — "Hickory Dickory Dock." Columbia 37975

Good rhythm combo accompanies this smooth singer, who is new to the Columbia label.

AMBROSE, and his orchestra: "Dance of the Potted Puppet" — "Swing Low, Sweet Clarinet." London Gramophone 108

Full range recording made in England features excellent arrangement and music. Collectors of dance music in this country will recognize the name of Ambrose.

BAKER, "TWO TON": "Too Fat Polka" — "With a Hey and a Hi and a Ho Ho Ho." Mercury 5079

Pairing of these novelty ditties a good selling combination.

CARLE, FRANKIE: "Corabelle" — "Who Were You Kissing." Columbia 37972

"Corabelle," a novelty that hits home when sparked by Carle's piano: flip, a torch-type tune done by Marjorie Hughes.

CARMICHAEL, HOAGY: "Put Yourself in My Place, Baby" — "A Tune for Humming." Decca 24247

Two catchy tunes put across in the singer-composer's natural style, interspersed with a bit o' whistling on the flip.

CLARK, BUDDY: "You Are Never Away" — "All Dressed Up With a Broken Heart." Columbia 37985

"Never Away" tune is from "Al-

legro"; Clark's vocalizing of "Broken Heart" number will help boost it to nation's best-seller lists.

CLARK, BUDDY: "Ballerina" — "It Had to Be You." Columbia 38040

Story ballad coupled with standard from the new film, "It Had to Be You," makes for a delightful Clark recording.

COBB, ARNETT: "When I Grow Too Old to Dream," Parts I and II. Apollo 775

Instrumental version of familiar standard backed by band and vocal chorus.

DALE, ALAN: "The Wildest Gal in Town" — "I Never Loved Anyone"; "All Dressed Up With a Broken Heart" — "My Cousin Louella." Signature 15169, 15174

Crooner's version of these top tunes, plus a specialty, "Louella," should enable him to keep up with the success of his previous "Oh, Marie" disc.

DAY, DENNIS: "Sincerely Yours" — "Melancholy." RCA Victor 20-2574

Day's melodic tenor lingers over these two haunting tunes in a memorable manner.

FARNEY, DICK: "I'll Never Make the Same Mistake Again" — "Made for Each Other." Majestic 7273

First side, a smooth ballad; flip is romantic tune, tailor-made for the tenor's delivery.

FLOWERS, PAT: "Find Out What They Like" — "Carolina in the Morning." RCA Victor 20-2579

Sparkling piano technique highlights old favorite, "Carolina," and the Fats Waller "Find Out What They Like."

FORREST, HELEN: "Don't You Love Me Any More?" — "Don't Take Your Love From Me." MGM 10105

Restyled for a new Forrest interpretation, first side of this platter bound to find many old friends, as well as new.

GRECO, BUDDY: "Ooh! Look-A There, Ain't She Pretty?" — "Don't You Think I Ought to Know?" Musicraft 515

First recording made by this trio has leader Greco on the piano and

(Continued on page 80)



Keynote presents the Fine Arts Quartet for the first time on records in the Shostakovich String Quartet No. 3.



The two handsome crooners seen in profile are (l. to r.): Dean Martin of Apollo Records, and Signature's Alan Dale.



Capitol's sensation of the year is Nellie Lutcher, and her original songs.



Red Benson's wax break came with the Rainbow recording of "Rosalinda."

Profit Pictures for 1948

(Continued from page 79)

on the vocals. First side has been creating a stir among disc jockeys and in juke boxes.

GREEN, LARRY: "Gonna Get a Girl"—"Song of New Orleans." RCA Victor 10-2560

Some tricky piano playing highlights Green's rendition of old ditty, ". . . Get a Girl."

GODFREY, ARTHUR: "A Porter's Love Song to a Chambermaid"—"I'm a Ding Dong Daddy." Columbia 37986

Judging by sales of "Too Fat Polka," by this same artist, coupling of novel ditty with a familiar fast-talk favorite should pull equally well.

HAINES, CONNIE: "But What Are These?"—"They're Mine . . ."; "Will You Still Be Mine?"—"You Made Me Love You." Signature 15167, 15168

Label is giving songstress a big build-up. Two platters combine old and new songs styled for listening, and dancing to the music of Ray Bloch.

HAMPTON, LIONEL: "Hamp's Got a Duke"—"Gone Again." Decca 24248

Instrumental paired with a torchy ballad.

HARRIS, PHIL: "Loaded Pistols, Loaded Dice"—"Now You've Gone and Hurt My Southern Pride." RCA Victor 20-2575

Harris' particular brand of comedy stylizing makes his rendition of "Loaded Pistols" and fast-talking ". . . Southern Pride" personal triumphs.

HILL, TINY: "Mickey"—"Angry." Columbia 37987

Re-issue of an old Okeh record that's still popular.

HORNE, LENA: "I Feel So Smoochie"—"Take Love Easy." MGM 10108

Lena Horne's followers, who know her from her personal appearances, will welcome the ". . . Smoochie" disc. New fans will appreciate the rhythmic delivery, and the Horne personality as it is captured on wax.

HOUSTON, BOB: "A Fellow Needs a Girl"—"The Cutest Little Red-Headed Doll." MGM 10109

First side is from musical, "Allegro"; flip, about ". . . Red-Headed Doll," is undergoing extensive promotion by manufacturers of a toy

doll, in conjunction with the record company.

JONES, ETTA: "What Every Woman Knows"—"Overwork Blues." RCA Victor 20-2564

Blues at its wailing best demonstrated by songstress on this waxing.

KAYE, SAMMY: "Oh, What I Know About You"—"It's Kind of Lonesome Out Tonight." RCA Victor 20-2558

Don Cornell and Laura Leslie do lyrics on first side; reverse is a sad lament.

KENTON, STAN: "I Told Ya I Love Ya, Now Get Out"—"Unison Riff." Capitol 15018

June Christy does the first side vocals; flip is a dance instrumental.

LAURENZ, JOHN: "The Treasure of Sierra Madre"—"I Understand." Mercury 5086

Romantic-voiced Laurenz performs two soft ballads.

LUTCHER, NELLIE: "Do You or Don't You Love Me,"—"The Song Is Ended." Capitol 40063

This side is in the mood and manner of the previous "He's a Real Gone Guy." Standard tune on the reverse is done in a slow and easy tempo, but spiced up with the Lutcher touches.

MARTIN, FREDDY: "Why Does It Have to Rain on Sunday"—"Beginner's Boogie." RCA Victor 20-2557

Cute tune paired with a rhythmic instrumental featuring the orch's piano.

MARTIN, TONY: "Forever Amber"—"My Sin." RCA Victor 20-2576

Martin's romantic voice and smooth phrasing makes new "Amber" tune a lush number; "My Sin" is familiar to Martin fans.

MERCER, JOHNNY: "Never Make Eyes at a Gal"—"That's the Way He Does It." Capitol 15016

Two tunes with a cute story line, done in the unique Mercer manner.

MONROE, VAUGHN: "Passing Fancy"—"In a Little Book Shop." RCA Victor 20-2573

The singing maestro, backed by his Moon Maids vocal group performs the romantic wax coupling in a smooth, and sales-appealing manner.

PASTOR, TONY: "Your Red Wagon"—"Gonna Get a Girl." Columbia 37973

Pastor's unique handling of novelty tunes is well-known to his disc

(Continued on page 85)

11,989,000 CHILDREN'S BIRTHDAYS IN 1948*

Cash in on this huge
birthday gift market!



Christmas isn't the only selling season for Columbia's Childrens Albums. There will be a million birthdays each month for youngsters between the ages of five and nine alone! Play up to this lively gift market every day of the month and every month of the year. Feature these

stunning Columbia album sets—tailored to the juvenile taste. Columbia will provide plenty of help—timely merchandising and advertising material that tells and sells the children as well as those who shop for them!

*From 5 to 9 years, 1947 census.

NEW RELEASES!

BONGO (Sinclair Lewis) (Adapted by Ralph Rose) from the Walt Disney Production, "Fun and Fancy Free." DINAH SHORE with supporting cast. Orchestra under the direction of Sonny Burke. Set MJ-41.

RUMPELSTILTSKIN presented by LET'S PRETEND (Written and directed by Nila Mack) (Original music composed and conducted by Maurice Brown). Set MJ-40.

ALICE IN WONDERLAND (Lewis Carroll) (Adapted and produced by Ralph Rose) (Original music by Carmen Dragon) JANE POWELL (MGM Star) with supporting cast, and orchestra under the direction of Carmen Dragon. Set MM-713.

Favorites in the Fun Parade!

by Isabel Manning Hewson

The Land of the Lost SET MJ-38

Starring David Allen

Kankie and the Concertina SET MJ-39

Goldilocks and the Three Bears SET MJ-36

The Gingerbread Boy SET MJ-37

Starring Gene Kelly

Nursery Songs—Vol. I SET J-26

The Little Red Hen SET MJ-27

The Shoemaker and the Elves SET MJ-29

Starring the "Let's Pretenders"

Jack and the Beanstalk SET MJ-31

Cinderella SET MJ-32

Starring Don Lyon

Little Black Sambo SET MJ-28

CONTACT
YOUR

COLUMBIA RECORDS

DISTRIBUTOR
FOR STOCK

"Willie, write

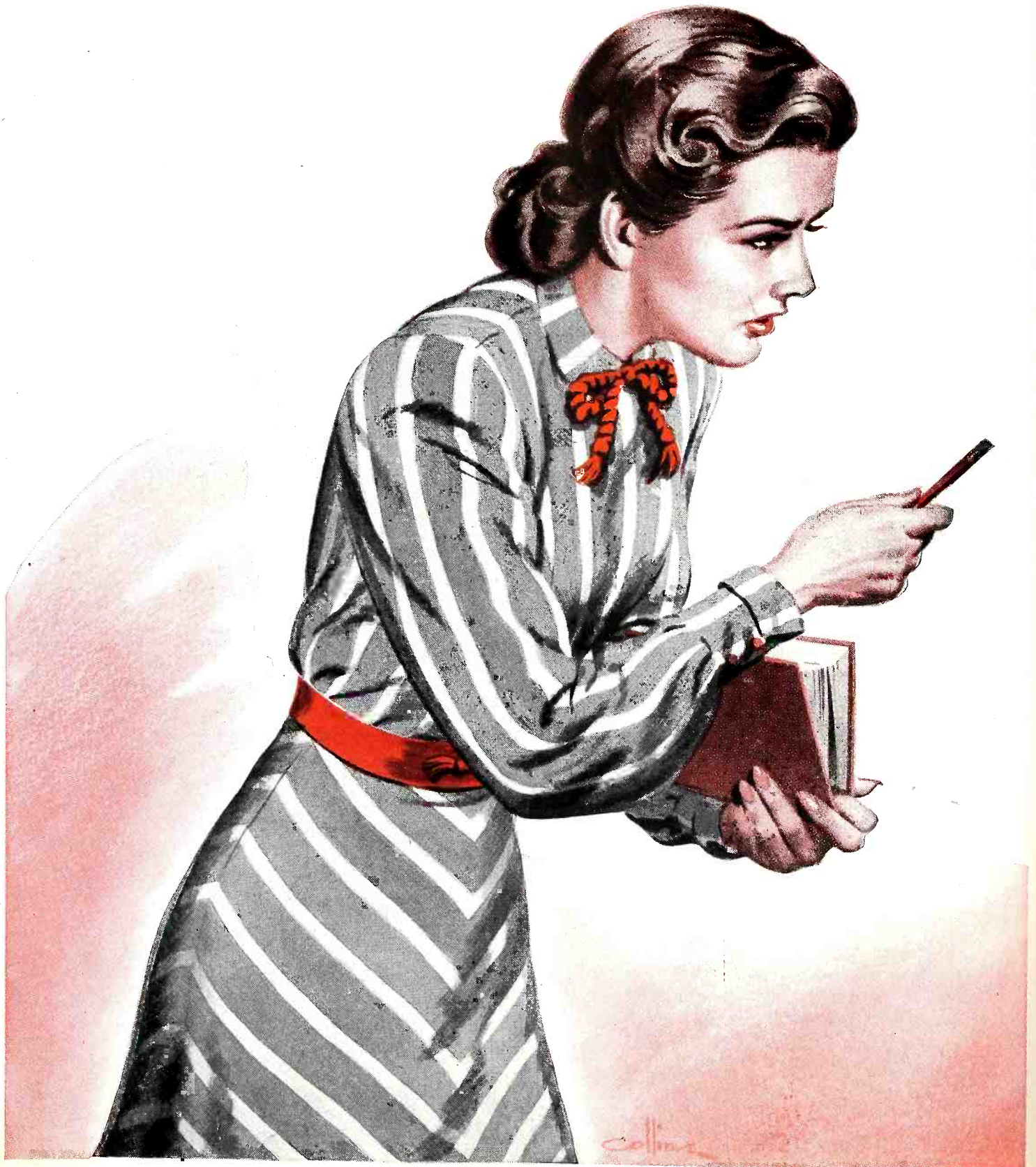

that down 50 times!"

To build selling impressions...to make them stick...a product needs the old hammer, hammer treatment. Not just some advertising, but advertising *Continuity*.

The more often advertising tells 'em, the more often it sells 'em.

To tell them more often, advertisers use Collier's.

In Collier's, advertisers achieve *Continuity*—regular, close-spaced, well-timed messages addressed to millions. This mass circulation impact—without let-up—gives advertising the power-drive that tougher competition demands.

Continuity in Collier's tells 'em more often . . .

SO YOU CAN SELL 'EM MORE OFTEN

Collier's for Continuity



New Phono Lines

Latest Disc-Playing Accessories and Equipment

Fon-O-Pal RECORD PLAYER

Model TM-147 "Kidette" electric table model phonograph for children. Crystal pickup, 2-tube amplifier, 5" Alnico 5 speaker, ac motor, plays both 10" and 12" discs. Cabinet frame of kiln-dried white pine, buff color; sides of pressed masonite in brown pebble grain color. All finishes are washable. Measures 13 $\frac{3}{4}$ " long by

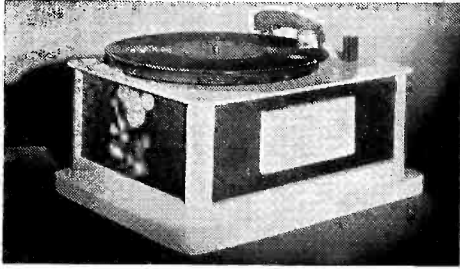

8" high by 10 $\frac{1}{2}$ " wide. \$19.95. Universal Mart Associates Corp., 15 Moore St., New York 4, N. Y.—RADIO & Television RETAILING

Air King PORTABLE PHONO-RECORDER

Model A-750 portable combination wire recorder and record player with 5-tube (including rectifier) amplifier, radio attachment cord. Compact design wire-records from radio or phonograph direct from amplifier—without using microphone. Or voice can be dubbed in from mike while recording from radio. Automatic shut-off after wire rewinds, safety lock to prevent accidental erasures, visual tone indicator to show proper recording level. Permanent needle, plays 10" or 12" discs. Mic-

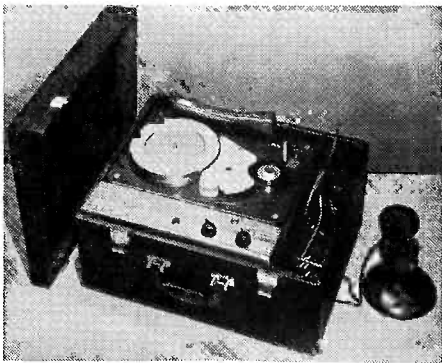

rophone with table stand included. Luggage type carrying case. Fair trade price is \$129.50 including tax. Air King Products Co., Inc., 170 53rd St., Brooklyn 32, N. Y.—RADIO & Television RETAILING

Webster-Chicago NEEDLE

"Black Nylon" phonograph needle with new metal tip of osmium alloy—formed by powered metallurgy on a base of the rare mineral element—osmium. Micro-ground

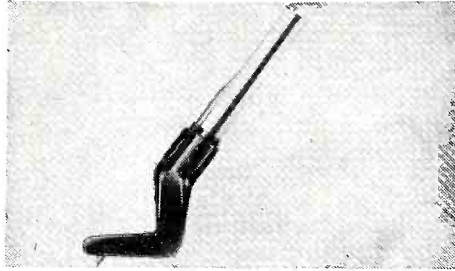

to special finish, for improved reproduction of both vocal and instrumental recordings and for elimination of needle scratch. Knee-action design. Jewel case style package of clear plastic. \$2.50. Webster-Chicago Corp., 5622 Bloomingdale, Chicago 39, Ill.—RADIO & Television RETAILING

Magnetape PORTABLE RECORDER

Portable series, tape recorders-and-playback instruments, compact design. Each system includes two matched carrying cases—one for the self-contained recording and playback unit—the other for microphone & cable, extension line cord, space for 25 reels of Magnetape (E-Z-Cue), and maintenance accessories. Readily adapted for 6-volt auto use via simple converter. Will operate in any position; unaffected by external vibrations. Available with provision for use with external playback equipment. One-year guarantee against construction defects. Cases covered with brown leatherette. Four models (of various frequency responses) from \$259 to \$420. Magnephone Division, Amplifier Corp. of America, 396 Broadway, New York 13, N. Y.—RADIO & Television RETAILING

Visatone TALKING MOVIE

New design record player and records which projects talking motion pictures automatically. (Model H illustrated) Offered as low-cost, simple device for homes, schools, churches, salesmen, industry, etc. Engineered to eliminate handling of film, re-winding and threading. Provision for

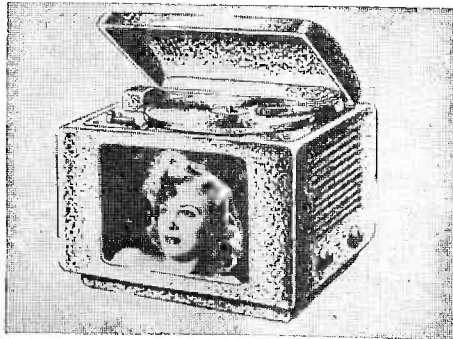

adding sound to home movies already made. Phonovision Corp. of America, 6636 Hollywood Blvd., Hollywood 28, Calif.—RADIO & Television RETAILING

RCA-Victor RECORD PLAYER

Model 6-J compact phonograph attachment to play through radio. Features the Victor "Silent Sapphire" pickup, to reduce needle noise and eliminate needle changing. Tone arm fits into recess on cabinet, is released by slight pressure to the right; motor starts automatically when arm goes to playing position. Walnut plastic cabinet trimmed in gold-toned lacquer, measures



12" wide by 9" deep by 3 $\frac{1}{2}$ " high. Suggested list is \$16.95. RCA Victor Home Instrument Dept., Radio Corp. of America, Camden, N. J.—RADIO & Television RETAILING

Musagrاند RECORD CABINET

Model 4885 modern style record storage cabinet with room for 22 albums or 264 discs. Interior has upright dividers to hold records erect. Dull finish brass hardware. Designed to harmonize with any style, size or finish of radio-phonograph on the market. Finish of sunny blonde mahogany veneer.

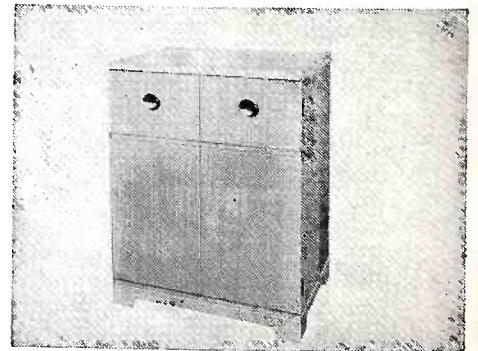

(Model 4885-W is walnut.) Measures 16 $\frac{1}{4}$ " by 23 $\frac{1}{2}$ " by 31 $\frac{1}{16}$ ". Shipping weight approximately 40 lbs. Eckenroth Co., Inc., 32-50 Ross St., Brooklyn 11, N. Y.—RADIO & Television RETAILING

NEW RADIOS—pp 64 and 66

NEW APPLIANCES—page 94

NEW SOUND AND SERVICE

EQUIPMENT pp 104 and 106

Profit Pictures

(Continued from page 79)

buyers, and these two Pastor sides fit right into the familiar Pastor pattern.

SABLON, JEAN: "A Tune for Humming"—"Falling in Love Again." RCA Victor 20-2568

"Tune for Humming," a new song, especially written for the Sablon delivery. Reverse is old favorite of years back.

SHELTON, ANNE: "Down at the Old Bull and Bush"—"Lover Man"; "Eili, Eili"—"My Yiddische Momma"; "How Deep Is the Ocean?"—"For Once in Your Life." London Gramophone 102, 103, 109

Three records by the popular English songstress were recorded in England, and boast high fidelity reproduction. The selections are varied enough to suit any American taste.

SHORE, DINAH: "The Best Things in Life Are Free"—"At the Candlelight Cafe." Columbia 37984

Familiar favorite from hit show, "Good News," is on first side. Flip-over is in a mellow mood, replete with Gypsy violins.

SINATRA, FRANK: "You're My

Girl"—"Can't You Just See Yourself?" Columbia 37978

Popular tunes from "High Button Shoes" combining love and whimsy are done by the crooner for another top-selling disc.

TORME, MEL: "Magic Town"—"The Best Things in Life Are Free." Musicraft 15118

Unique vocal phrasing on these two Torme sides, from the films, "Magic Town" and "Good News," excellent for listening—and dancing.

Disc Training

(Continued from page 77)

ing people across the counter until he can learn the customer's name.

Record clerks should be impressed with the importance of knowing the exact prices of all the merchandise. It may be difficult to mark each sleeve or album cover with the exact price, therefore price listings should be kept in strategic spots. Excise taxes, etc., are frequently confusing to the novice sales clerk.

The importance of making a good parcel for the records is another important angle. In most stores the person who makes the sale, also takes the cash and packs the records. When selling singles, a piece of cardboard should be inserted in each bag. Al-

bums, too, have to be protectively wrapped to prevent breaking.

"Off" hours need not be wasted hours. The sales staff should be taught to utilize their spare time, not to waste it. Displays can be straightened and stock filled in during the lulls. In addition, newcomers should study the location of the merchandise, and watch other members of the store staff at work.

When constructive criticism is called for, the "boss" should undertake the job. But all comments of a corrective nature should be given in private, out of hearing of others. Proprietors should remember that it is the sincerity of their criticism that will prove most effective, not the severity of it.

These fundamental training rules apply even if there is one clerk in the establishment. In addition, some definite tasks should be assigned every member of the staff. Each individual should be delegated some responsibility in addition to his job of "selling" to make him feel more a part of the business.

If this training system is put into practice and followed through, the dealer will find his time and energy rewarded by increased sales, a satisfied personnel, and a pleased customer following.

Electronic Engineering Handbook

By Ralph R. Batcher, E.E. and William Maulic

ALL That the Name IMPLIES

A handbook—a helping handbook you will want at your fingertips on those frequent occasions when the right answer can save you hours of effort.

For radio-electronic specialists this Caldwell-Clements book provides a convenient, authentic source of formulas and principles, as well as the latest in electronic applications. Section I covers Vacuum Tube Fundamentals; Section II, Electronic Circuit Fundamentals; Section III, Electronic Applications; Section IV, Vacuum Tube Data.

456 Pages • 560 Illustrations • \$4.50
Bound in limp leatherette, opens conveniently flat. 6 x 9 in.

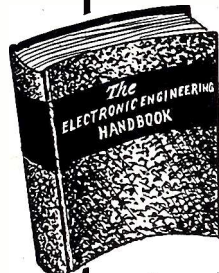

Once You Get This Book in Your Hands You'll Always Have It at Your Fingertips

No Risk—5 Day Approval

CALDWELL-CLEMENTS, INC.

480-D Lexington Ave.  New York 17, N. Y.
Publishers to the electronic industries since 1925

Send book. If not satisfied, will return within five days. Otherwise will remit payment.

ELECTRONIC ENGINEERING HANDBOOK \$4.50

Name.....

Address.....

City and State.....

Company Name.....

DON'T SEARCH FOR FAVORITE RECORDS USE...



NEW!

PEERLESS VISIBLE INDEX ALBUMS

SEE TITLES AT A GLANCE

NO SEARCHING — NO MANIPULATION

The Peerless Visible Index Album is always in full view. Titles are written or typed on ruled strips and easily inserted under cellophane covering. An extra ruled strip is supplied with these exclusive albums.

See your Peerless distributor.

The
PEERLESS



ALBUM COMPANY

352 Fourth Avenue, New York 10, N. Y.

For added sales
(and profits!)



demonstrate

the amazing Shockproof

nylon needle*

by

DUOTONE

Actually b-o-u-n-c-e the whole
tone arm on a record without
effect. A spring steel shaft and
nylon elbow—that is the secret!

\$2.50
LIST

*pat. pending



The Sparkling New

Empire
IRONER

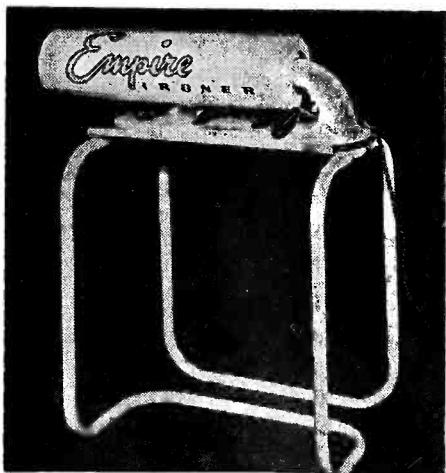

Irons all from shirts to sheets • Elbow control
Both Hands Free • Exclusive Guide Spring Re-
turns Ironed Clothes Without Wrinkling • Beau-
tiful Design • Light Weight • Easy to Handle.

GUARANTEED UNDERWRITERS' APPROVED
COMPLETE IRONER \$69.95 LIST!

Dealers—Distributors Write for Prices,
Allocations and Information to

EMPIRE APPLIANCE COMPANY

480 Lexington Avenue New York 17, N. Y.
(Factory: Cincinnati 2, Ohio)

Columbia Sponsors Air Shows to Push Sales

Columbia Records Inc., has embarked on a new two-million-dollar radio promotion program. Plans include many new additions to the list of recorded popular, folk and classical sponsored radio programs. In addition, plans have been completed for an extended service to radio disc jockeys throughout the entire United States.

Columbia executives feel that regular promotion through specific radio programs week after week is one of the best means of local promotion for dealers. Also, the weekly airers provide a good sampling medium for the consumer.

A novel disc jockey airer is planned, utilizing a "hit-of-the-week" record.

Other air-time Columbia promotions include the Freddie Robbins transcribed "Record Shop," the "Masterworks of Music" program for Masterworks records, and "Record Roundup" programs for hill-billy and Western discs in the catalog.

Keynote-Mercury Deal

John Hammond, president of Keynote Records, and Irving Green, president of Mercury, announced the completion of arrangements for the production and distribution of the vast library of classical records obtained by Keynote, under an exclusive rights arrangement with the Gramophone Industries of Czechoslovakia.

Under the terms of the four year agreement, the new line of records from the Czech catalogue will be manufactured and distributed by Mercury under the label "Keynote Classics". Present plans call for between 30 and 50 classical works to be issued each year.

Tiffany Album

Tiffany Records has released a children's album entitled "Mr. Bitzel," incorporating story, songs and games in a new combination package for juvenile entertainment. The album contains three ten-inch records on unbreakable material, a jig-saw puzzle of scenes and characters from the story in a pocket on the inside back cover, together with song sheets of the numbers from the album.

RCA Victor Jobbers Attend Sales Clinic

The RCA Victor Record Department has announced the inauguration of a series of one-day sales clinics for its record distributors with the initial meetings attended by distributors and their key officials from New York, Newark, Washington, Baltimore, Harrisburg and Philadelphia. Discussions of the record department's sales, advertising, and promotion plans for 1948 featured the conference.

The meeting, first of the scheduled series which will eventually cover all RCA Victor record distributors, was presided over by James W. Murray, vice-president in charge of the record department, who expressed great optimism over the potentiality of record sales during the coming year.

RCA Victor Display



Center Music Store, New York City, features an RCA Victor window with Nipper and the trademark prominently in view.

NAMM Message

In a "Year-End Message" to members of the National Association of Music Merchants, Louis G. LaMair, president, reviewed the accomplishments of the organization during '47. Included were: (1) All major segments of the industry united to promote music. (2) The American Music Conference was incorporated and is now operating. (3) The first industry-sponsored nation-wide consumer opinion survey was completed. (4) Undertaking several public-relations projects. (5) Widespread publicity in national magazines resulting from direct promotional efforts.

Apollo Distributors

New distributors appointed by Apollo Records, New York City are: Vita Record Distributing Co., Los Angeles; Barnett Distributing Co., Baltimore; Dixie Record Suppliers, Richmond; David Rosen, Inc., Philadelphia.

Columbia Artist



tailors' stores across the country have been meeting with great enthusiasm. Shown here are Elliot with disc jockey Rush Hughes, surrounded by fans in the record department of Lammert's, St. Louis.

Elliot Lawrence's series of "coke" dates in re-

ELECTRICAL APPLIANCES

Section of **RADIO & Television RETAILING**

Appliance Production Statistics

Estimated by RADIO & TELEVISION RETAILING for
12 months, ending December 31, 1947

LARGE APPLIANCES

		Total No. of Units	Total Retail Value
REFRIGERATORS (Household Electric (
Sizes from less than 5 cu. ft. to 13 cu. ft. and over		3,400,000	\$765,000,000
FOOD FREEZERS (Home)		350,000	122,500,000
ROOM COOLERS (Compressor Types)		61,000	12,200,000
LAUNDRY EQUIPMENT			
Washers, Automatic	1,000,000		\$185,000,000
Washers, Non-Auto- matic (Wringer, Spinner)	2,865,000		458,400,000
Washers, Midget	507,595		22,841,000
Total		4,372,595	\$666,241,000
IRONERS (Rotary)		505,000	65,650,000
CLOTHES DRYERS		40,000	9,200,000
RANGES, ELECTRIC (Household Non-Portable)		1,200,000	252,000,000
VACUUM CLEANERS			
Hand	140,000		2,800,000
Standard Size (Uprights, Tanks)	3,420,000		205,000,000
Total		3,560,000	208,000,000
DISHWASHERS		100,000	30,000,000
DISPOSAL UNITS		100,000	15,000,000
WATER HEATERS, Domestic (All Sizes)		940,000	141,000,000

INCANDESCENT and FLUORESCENT LAMPS

LAMPS				
Fluorescent (All Sizes)	75,000,000	\$120,000,000		
Incandescent (All Sizes)	1,000,000,000	200,000,000		
Total			1,075,000,000	\$320,000,000

SMALL APPLIANCES

BLANKETS, Electric		475,000	23,750,000
BROILERS, Electric		500,000	6,000,000
CLOCKS, All Types		10,000,000	70,000,000
COFFEE-MAKERS, Electric (Metal-Glass)		6,100,000	30,500,000
FANS (All Types)		3,450,000	50,600,000
HEATERS, SPACE, Electric (with and without fans)		2,800,000	36,400,000
HEATING PADS		3,300,000	19,800,000
HOT PLATES		4,000,000	16,000,000
IRONS, HAND (Automatic, Non-Automatic, Steam and Travel)		10,450,000	112,000,000
MIXERS, FOOD		1,900,000	58,000,000
ROASTERS		400,000	13,200,000
TOASTERS			
Automatic	3,400,000		61,200,000
Non-Automatic	3,900,000		23,350,000
Total		7,300,000	84,550,000
WAFFLE IRONS, SANDWICH GRILLS (Including "Combinations")		4,411,000	48,521,000

"We have reasons to believe the 'best dealer in town'—the Norge Dealer!—will enjoy a glow of satisfaction when he inspects this new line. We have done our best to make it the



Greatest Line in Norge History

and to deliver it in greatly increased quantities!"

HOWARD E. BLOOD, *president.*



"Independent research has proven that Norge washers deserve their increasing popularity—I predict that the '48 line will be the most popular we have ever had."

PAUL BERNER,
sales manager, laundry equipment.



"We are getting a real kick out of announcing this new line to our retailer friends and, as Howard says, it's the greatest line in Norge history!"

M. GLENN (Uncle Mike) O'HARRA,
vice-president and director of sales.



General Sales Manager,
H. L. (Red) CLARY, says:

"That's right, Glenn! This whole new Norge line is hotter'n a firecracker! Full of features that prospects will go for—but fast!"



"Norge freezers, and the entire Norge line of refrigeration specialties will enable Norge retailers to cash in on a vast profit opportunity. Our future never looked brighter."

E. N. GUILD,
sales manager, refrigeration specialties.



"You know what we did in '47—our electric ranges and water heaters were the talk of the industry—and '48 will be even greater".

H. J. (Harry) HOLBROOK,
sales manager for electric ranges and electric water heaters.



Products of
BORG-WARNER



Norge products, distributed worldwide, are typical examples of the values made possible by the American system of free enterprise.

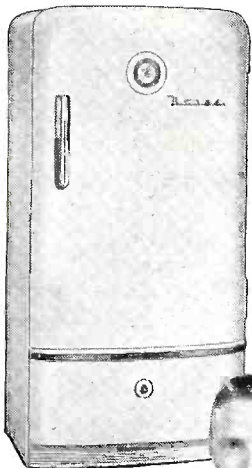

"The new refrigerator line includes 6's, 8's and 10's—with more food storage space in all eight zones—and featuring the new Norge "Night-Watch" Self-D-Froster. Here is a line with a terrific sales wallop."

W. S. (Bing) LAW,
refrigerator sales manager.

"Just take a good look at the new 'Concentrator' burner on these better gas ranges . . . and take another look at the smart new home heaters . . . any one could sell 'em . . . and there'll be more of 'em to sell!"

W. M. (Walt) DAVIS,
sales manager for gas ranges and home heaters.



NORGE DIVISION, BORG-WARNER CORP., 670 E. WOODBRIDGE ST., DETROIT 26, MICH. • In Canada: Addison Industries, Ltd., Toronto, Ont.

SEE
NORGE
BEFORE YOU BUY

Refrigerator, Range and Water Heater Sales by States

Distributor and Dealer Sales for First Nine Months of 1947— See Note*	Ranges, Electric	Refrigerators, Household Electric	Water Heaters, Electric Storage
STATES	UNIT SALES	UNIT SALES	UNIT SALES
Alabama	11,203	23,212	5,379
Arizona	1,817	8,807	1,291
Arkansas	3,372	15,854	1,343
California	29,088	147,139	15,928
Colorado	4,763	18,150	3,465
Connecticut	9,123	35,185	4,179
Delaware	1,346	4,512	719
District of Columbia	5,401	23,152	2,130
Florida	16,687	32,769	10,866
Georgia	14,931	34,840	7,306
Idaho	4,770	7,152	3,680
Illinois	35,268	135,530	15,913
Indiana	21,412	60,436	12,404
Iowa	12,150	37,286	8,789
Kansas	5,205	18,958	1,768
Kentucky	5,691	24,190	2,543
Louisiana	2,387	23,993	612
Maine	3,935	10,317	1,510
Maryland	6,505	29,774	3,129
Massachusetts	12,688	62,518	2,376
Michigan	36,012	99,787	10,334
Minnesota	14,602	41,440	10,403
Mississippi	3,831	13,776	1,388
Missouri	17,524	64,236	9,136
Montana	3,686	6,917	1,402
Nebraska	6,242	20,270	4,042
Nevada	1,679	3,435	1,306
New Hampshire	3,063	7,267	725
New Jersey	11,379	81,710	5,968
New Mexico	562	4,352	199
New York	27,148	212,504	11,260
North Carolina	16,711	33,677	9,693
North Dakota	2,845	6,953	1,045
Ohio	43,943	134,250	16,704
Oklahoma	2,947	22,676	564
Oregon	19,105	26,179	7,669
Pennsylvania	42,646	157,802	19,323
Rhode Island	3,409	16,877	366
South Carolina	6,701	15,717	3,905
South Dakota	2,805	7,287	1,723
Tennessee	21,304	36,749	10,066
Texas	13,587	98,769	3,632
Utah	6,530	10,861	3,944
Vermont	1,648	3,961	698
Virginia	11,881	29,887	6,764
Washington	27,443	35,332	10,701
West Virginia	8,574	25,731	2,736
Wisconsin	15,648	45,451	8,927
Wyoming	870	2,737	443
TOTAL UNITED STATES	-A- 582,067	-B- 2,021,364	-C- 270,396

A—17 companies reporting. B—11 companies reporting. C—22 companies reporting.

*—Source of data—National Electrical Manufacturers Association. The unit sales shown in this summary are not factory sales nor do they reflect the sales of *all* manufacturers—but rather distributor and dealer sales of only those participating companies numbered above.

This Firm

25 Years of Steady Growth Due to How N. Y. Dealer Reached Quarter-



● J. E. Hardee, owner and founder of the J. E. Hardee Co., Jamaica, N. Y., has seen his electrical home appliance firm grow steadily since he established it in 1922. Today, he's doing more than \$250,000 a year, with service income representing almost a third of the total.

Two RADIO & Television RETAILING editors visited Mr. Hardee for the purpose of finding out, for the readers of this magazine, the answers to two questions. First, where such a large volume of business comes from, and, even more important, why-and-how the Hardee organization is able to roll up such an

Appliance sales and service headquarters of the J. E. Hardee Co., 144-35 Jamaica Ave., Jamaica, N. Y., and at right, the founder and owner of the firm bearing his name. Below, at left, a photograph of some of the employees taken during the days of NRA. Five persons shown in the picture are still with the organization. At right, new store a block away from the original one, was opened to accommodate large flow of merchandise.



Below, interior of the new showroom, showing Mr. Hardee demonstrating an appliance. Hardee does not sell "up". Instead, he starts at the top, showing the best first. This technique is found to be highly successful.

Thousands of dollars worth of appliances have been sold in this showroom in the original store, below. "Live" demonstrations clinch many a sale. A huge stock of standard brands is carried by the 22-year-old firm.



a "Hardee" Perennial

**Top-Flight Sales and Service—
Million Dollar Volume**

enviable record of sales, increasing its business year after year, and maintaining at all times a sound profit margin.

To begin with, it didn't take long to discover that the Hardee Company is an institution not only founded upon top-flight service, but, more important, a firm continuing to use its maintenance department as its chief source of sales and repair business revenue.

But the fact that service plays such an outstanding role in this firm should not lead the reader to believe that the merchandising end has been neglected. Hardee maintains two beautiful show-rooms, well-stocked with practically *all* of the leading brands, and here the original and unique Hardee type of salesmanship is successfully practiced. (More about this later on.)

Since Hardee has sent "quiz letters" to more than 25,000 persons who have done business with him from time to time, he has a pretty good idea as to *where* the bulk of his business comes from. An analysis shows the sources to be about as follows, in order of importance: 1. Repeat business from steady customers. 2. Business from new customers recommended by "regular" ones. 3. From ads in the classified telephone



Efficient bookkeeping and collection methods are effectively employed here. Miss Nathalie Freer, shown at desk, is office manager. She has been with firm 21 years.

directory. 4. From factory-recommended patrons.

The *why-and-how* angle of this store's operation is inspirational. Through the whole-hearted cooperation of the owner, we are able to learn just how Hardee's success formula works. We discover *why* customers *prefer* to do business with

this firm and *how* the organization *prefers* to do business with such customers.

In the large Hardee service department (situated in the basement) there is not only the very best in servicing equipment, and a complete stock of all parts, but there is a

(Continued on next page)

Dealer Hardee takes an active interest in civic affairs. At left, a few of the many citations he has received from various organizations. Below, a window demonstration in progress at the new store.



"Hardee" Perennial

(Continued from preceding page)

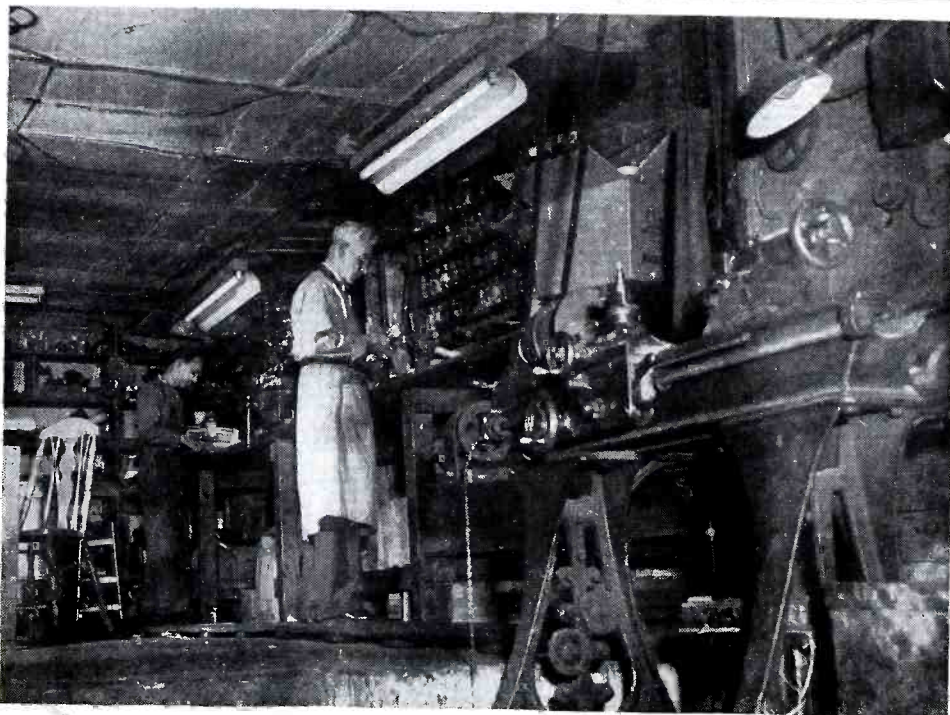
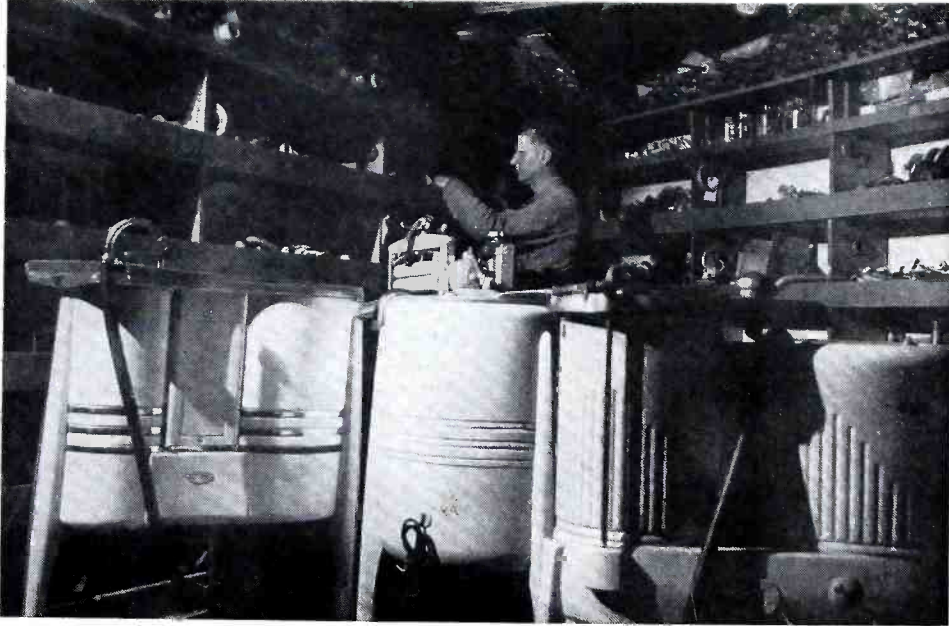

willingness and know-how to do the best work on the part of Hardee's sales-minded servicers. Some of the mechanics here have been with Mr. Hardee since he founded his business, and all of the others have been with the firm for many years.

The Hardee servicers know how to meet the public in a receptive manner. Because Hardee has always selected his personnel with the greatest care, and pays them well, a remarkably apparent spirit of cooperation and interest in the firm's welfare exists.

The Hardee servicers are all salesmen. Whenever one of the attractively-lettered, well-kept service trucks leaves the place it is manned by a "crew" having a two-fold mission in mind; to render efficient, fast repair service, and to sell merchandise and good-will for the firm.

It is a significant and unusual fact that most of the leads, and many of the sales are brought in by the servicemen, which goes to prove that if a firm selects the right sort of men it can depend upon them to account for many sales of merchandise.

Service, Sales Tie In

So far as servicing facilities go, the Hardee organization has practically everything needed to turn out good work with speed, and without lost motion. There are lathes, buffers, grinders and other power-driven machines, plus a complete assortment of hand-tools. One of the unique pieces of equipment is a motor-driven "dunker" where washing machine chassis get baths in a non-inflammable cleaning solution. The device was built from an old "Locomotive" washer, a make which will be remembered by many old-timers in the business.

Service charges at Hardee's may be termed adequate, but not exorbitant. The firm gets a good price for good work. There are few, if any, complaints on charges, and the reason seems to be that most customers are perfectly satisfied to pay an adequate service cost if the work performed is satisfactory. On the other hand, they will complain about even a low price where the quality of the repair service is also low.

●
Top, Steve Banach, shop foreman, selects a part from the well-supplied bins. Center, extreme left, Ed. Reddy and Ed. Brodowski; extreme right, Arthur Reddy. Bottom picture shows Stanley Zaleski, left; E. Williams, who's been with the company 22 years, at right. All of the Hardee servicers are top-flight mechanics as well as being sales-minded.

Just before the war, Mr. Hardee decided that he would "survey" his customers for the purpose of finding out several things. First, he wanted to know whether they were satisfied with their dealings with the firm. Second, he wanted to find out exactly whether his men in the field were continuing to practice satisfactory relationships with the customers. Third, he wanted to know whether the customer would continue to do business with him, and fourth, he sought to find out *how* the client first happened to come to the Hardee store. Following is the form letter he sent out to thousands of new customers, and to old ones who hadn't been heard from for some time:

"We wonder if you are thoroughly pleased with the service work we recently did for you, and if our representatives, both in the store and in your home, were fair and courteous in the handling of your service request? Our Replacement Parts and Repair Department has grown so large, that at times we feel that with so many employees, an expression from our customers, either good or bad, would be very helpful in correcting mistakes or improving existing conditions unknown to the management. For that reason, we make this personal appeal to you, with the earnest request that you use the enclosed, self-addressed, stamped envelope in replying to the few questions below.

1. Was the repair work done satisfactorily?
2. If the required service was not caused by wear and tear with ordinary usage, but by neglect or improper care, did our representative explain this to you so as to avoid a recurrence?
3. Will you continue to call us for service?
4. Was your patronage a result of advertising or customer recommendation? If neither, please explain.
.....
.....

The purpose of this letter or questionnaire, is to obtain constructive criticism, which we will very much appreciate, as it will enable us to render the public a more efficient and economical service, with a resultant feeling of good will amongst all concerned.

Very truly yours,
J. E. HARDEE COMPANY,
J. E. Hardee."

Hardee got a tremendous response to the mailing. Though he knew that he was giving first-class service to the best of his ability at all times,

he had no idea that there would be so few complaints.

As a matter of fact, the RADIO & Television RETAILING editors went through a great pile of the responses, and were able to find but one "kick"—and that over a \$2.50 minimum service charge.

"There are some other complaints in those other piles of answers", Mr. Hardee said, pointing to a "mountain" of responses beside his desk, but the editors didn't feel it necessary to go through them, having sampled a large enough cross-section of the replies to get a sufficient idea of how the others would stack up.

"Live" Demonstrations

This letter was a great good-will builder. It flattered the customer. Made him feel important, and it certainly pointed out to the customer the reliability of the dealership.

The show-windows and salesfloors of both Hardee stores are skillfully designed to display lots of merchandise, to make selling easy, and to create the desire to buy. The "new" Hardee store is but a block away from the original one, and was opened specifically to make room for the large stock of merchandise which was commencing to "overflow" in the old place.

The Hardee organization goes all out for "live" demonstrations—even on gas ranges, and demonstrates appliances strictly upon the merits of the make itself. By this we mean that Hardee does not do "competitive selling" in the sense that he makes comparisons with other brands. His method is to "soft-pedal" competitive products preferring to bear down heavily—but not aggressively—on the merits of his own.

While there's plenty of sparkle to a Hardee sales presentation there isn't a semblance of high-pressure. The Hardee plan is a forthright exposition of the features and worth of the product, simply presented, honestly described.

Earlier in the article a mention was made of the "original and unique Hardee type of salesmanship." Here it is: Hardee *does not try to sell a customer "up"*—from a lower-priced item to a higher one. Since he does not advertise any sort of loss-leaders, and does not feature low-priced merchandise, the technique he uses is not embarrassing to the customer, nor does it arouse such skepticism in the prospective purchaser as often prevails in cases where the buyer had come in to ask specifically for some item which had been advertised as "bait."

The Hardee selling plan is to start at the top. Show the best first! Show the "biggest" too, where skillfully worded questions disclose the actual needs of the customer for large size. Hardee is sincere in his efforts to sell the customer the right size appliance. A refrigerator, washer or a range of adequate capacity will please the customer much more after purchase than will one of smaller size, sold "down" to meet price competition. The small difference in price will be quickly forgotten, Hardee believes.

Still another ingredient in the Hardee formula for success is the owner's buying ability in choosing the right lines and models for the customers in his territory. He knows what sort of merchandise the local consumer wants; he knows how the various localities in his trading area stack up so far as incomes go. In fact, Hardee knows his territory thoroughly, and such knowledge has paid off well.

Tied right in with his familiarity of markets and merchandise is the enviable credit reputation he has built up for his firm. This much-desired situation has enabled him to buy heavily, obtain the best brands, and to be able to "pioneer" many of the new appliances such as clothes dryers, etc., which may not sell as quickly as the old, familiar products.

Gets the Money In

Among the brand-names seen on appliances at this store are GE (major appliances—exclusive on refrigerators), Easy, Apex, Bendix, Savage, Thor, Hamilton, Dutch Oven, Deepfreeze, Premier, Royal, Universal (Landers, Frary & Clark), Westinghouse, Proctor, Rex Cole (fans), Telechron, Speed Queen, Monitor, Dormeyer and Maytag.

Another success ingredient is a collection system that works. Hardee makes no bones about being a hard-boiled merchant when it comes to getting in money that's owed him, but he goes after collections on a basis best described as being considerate, entirely fair, yet strictly purposeful.

Here's the way the Hardee collection system works. Immediately a bill is past due, the delinquent customer gets a polite letter, requesting payment in full or in part on or before a certain date. If the letter is ignored, a visit is made to the home. If the money is not collected via call, a definite promise to pay on a certain date is sought.

In cases where all reasonable effort

(Continued on page 110)

New Electrical Products

Variety of Appliances Available for Dealer Selling

Hotpoint RANGE

Masterpiece electric range, features sealed oven heat, faster heating and cooling action and new streamlining. Completely automatic, the model provides 33 percent more surface cooking capacity.

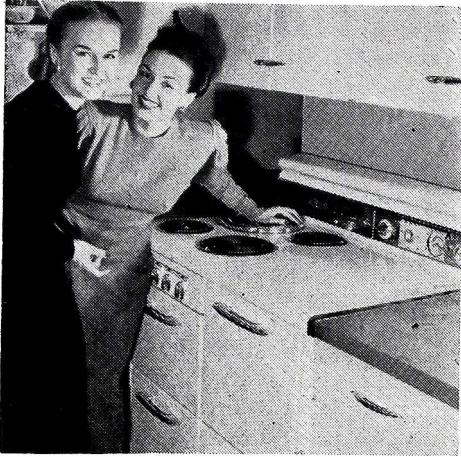

Calrod heating unit is smaller in actual cooking area, although increased turns of tubing gives increased heat and flexibility. The other features of the 1947 models have been retained. Hotpoint, Inc., 5600 W. Taylor St., Chicago 44, Ill.—RADIO & Television RETAILING

Sani-Way GARBAGE ELIMINATOR

Automatically macerates food waste into minute particles and flushes them into sewage system. Extra wide drain opening permits easy recovery of silverware, etc., if they are accidentally inserted. Suitable for installation in any cast-iron, formed steel, vitreous enamel or stainless metal sink having proper size drain opening. Thomas W. Berger, Inc., 6 E. 4 St., Cincinnati, O.—RADIO & Television RETAILING

Consol-ette BAR

Refrigerated bar combines eighteenth century and contemporary styling with a refrigerated bar, all under lock and key. Unit manufactures its own ice cubes, provides 3½ cu. ft. refrigerated space, plus a concealed compartment for liquor storage with automatic switch-off. Mirrored section for glasses, etc. No special installation needed. Overall dimensions: 42 inches x 42 inches x 18 inches. Available in veneered mahogany, walnut or limed oak. Refrigerated Equipment Sales, 149 Broadway, New York 6, N. Y.—RADIO & Television RETAILING

GE BUTTER CONDITIONER

Conditioning device to keep butter at smooth spreading temperature is incorporated

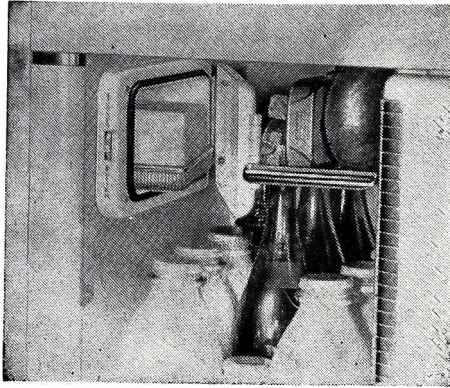

rated in the improved model of the company's deluxe 8 cu. ft. refrigerator. The conditioner holds a pound of butter. General Electric Co., 1285 Boston Ave., Bridgeport 2, Conn.—RADIO & Television RETAILING

Homecraft BROILER-TOASTER

Broiler, toaster and hot plate, made of heavy gauge spun aluminum. Stainless, heat-resistant legs and handles of new patented plastic. Homecraft Electronic Products, Chicago 23, Ill.—RADIO & Television RETAILING

Chromalox HOT PLATE

Double-unit hot plate, attractively designed for small homes, grills, clubs, etc. Units are same type as those used on commercial electric ranges. The frame of the unit is one-piece heavy gauge metal stamping, with acid-resisting white porcelain enamel finish. Edwin L. Wiegand Co., 7542 Thomas Blvd., Pittsburgh 8, Pa.—RADIO & Television RETAILING

Splend-Aire VENTILATOR

Exhaust type portable electric window ventilator, supplies 12 complete air changes hourly for average size room. Easily installed; does not interfere with window operation. In the kitchen, the ventilator disposes of cooking odors. Available in three models: fitting windows 22 to 27 inches, 24 to 31 inches, and 27 to 36 inches. Finished in ivory enamel with chrome trimmings. Metal-Tex Corp., 1600 Junction Ave., Racine, Wis.—RADIO & Television RETAILING.

Rittenhouse DOOR CHIME

"Symphonette" model door chime. Sounds two notes for the front door, one for the rear. Has simple, rectangular lines and measures approximately 9 inches by 4½ inches. Available in several color combinations. Rittenhouse Co., Honeoye Falls, N. Y.—RADIO & Television RETAILING

Superstar TOASTER

Model 500 automatic; Model 510 non automatic toaster. Size: 7¼ inches high, 6 inches wide, 10½ inches deep. Toasts two slices at the same time; adjustable control knob permits toast done to taste; removable crumb tray. Streamlined and chromium plated. Stern-Brown, 42-24 Orchard St. Long Island City, N. Y.—RADIO & Television RETAILING

Continental Ovenette

Complete electric kitchen unit features a large grate and range, disappearing griddle, a separate cooking range to be used when griddle is in use, and an installed toaster. Dimensions: width 22 inches, height 16 inches, depth 15 inches, broiler opening 9 inches. Mirror finished polished stainless steel. Continental Appliances Inc., 475 Fifth Ave., New York, N. Y.—RADIO & Television RETAILING

Kitchen Princess PERCOLATOR

Electric percolator, retails at approximately \$4.98. Royal Kitchenware, Inc., 2787 E. 14 St., Brooklyn 29, N. Y.—RADIO & Television RETAILING.

Smith VENTILATOR

Exhaust-type ventilator features single automatic control, new high efficiency in air movement, and easy installation and maintenance. It is designed for use in kitchens, laundries, recreation rooms, bath-rooms etc. One control opens and closes the outside door, and starts and stops the fan automatically. Adaptable to many wall thicknesses, the standard ventilator fits walls from 5" to 9½" thick, and up to 13⅞", with an extra sleeve. Grille is finished in white enamel. Retail price is \$24.95. F. A. Smith Mfg. Co., Inc., Rochester, N. Y.—RADIO & Television RETAILING.

**“Now I know
where I stand—
all the time!”**

Register all the facts in
one writing - quickly, easily!

STANDARD FORM-FLOW REGISTERS supply all the
information you need to run your business at peak efficiency!

Now you can have more accurate records with *less* writing, in *less* time. Think what this means to you! It means complete control of all the functions of your business. A quick check of your Standard records will show you—at any given time—*exactly* how much money you have in cash, and in accounts receivable and payable; *exactly* how much inventory is on hand. What's more, mistakes and misunderstandings are eliminated. And tax recording, bookkeeping are greatly simplified. Remember, *only* Standard Form-Flow Registers offer you *all* these important advantages for your business.

The Standard Register Company, 108 Campbell Street, Dayton 1, Ohio.
Pacific Coast: Sunset McKee-Standard Register Sales Co., Oakland 6,
California. Canada: R. L. Crain Limited, Ottawa. Great Britain: W. H.
Smith & Son, Ltd., London.

**CHECK ALL THESE WAYS
STANDARD REGISTERS HELP YOU!**

In one writing you:

- 1. Control Cash!** Every cash transaction is recorded clearly in detail.
- 2. Control Inventory!** Records show what is in stock, on order.
- 3. Protect Merchandise!** Because *every* fact is known, losses are cut.
- 4. Prevent Costly Errors!** Like faulty billing, misplacing, wrong shipping.
- 5. Fix Responsibility!** Clearcut facts determine responsibility.
- 6. Check Against Loss!** Cash and Stock Losses can be caught in time.
- 7. Record Every Transaction!** Completely, clearly in your handwriting.

Standard Register

MANUFACTURERS OF
REGISTERS AND FORMS FOR ALL BUSINESS AND INDUSTRY
Dayton 1, Ohio

FREE! Mail Coupon for copy of Free Digest about your business.

THE STANDARD REGISTER COMPANY
Dept. 1301, Dayton 1, Ohio

Please send me Free Standard Register Business Digest which
tells me how I can write better records in my business . . . easier
. . . simpler . . . faster!

Name

Company

Street

City Zone State

Now—**UNIVERSAL**
Traffic Appliances
...via Graybar everywhere

Off to a fast start for '48, Graybar Electric Company becomes national distributor of the famous Universal brand of traffic appliances (formerly available from us only in certain territories).

Now dealers everywhere can get local delivery from Graybar of all these fast-selling Universal products:

Coffee Percolators	Toasters
Heating Pads	Waffle Irons
Hot Plates	Mixers
Irons	Blankets (Electric)
Pressure Cookers	

The quality Universal line is a happy addition to the Graybar family of radio and appliance lines, which includes many of the biggest names in electrical merchandise.

Dealers get more than local deliveries of top-flight merchandise from Graybar. They get lots of good ideas from our Merchandising Specialists—ideas for training personnel... ideas for improving store layout, window display, advertising and promotion. *Merchandising Department, Graybar Electric Company, Inc. ... in over 90 principal cities. Executive offices: Graybar Bldg., New York 17, N.Y.*

4801

FAST-SELLING RADIOS . . .
POPULAR APPLIANCES . . .
PROFIT-BUILDING IDEAS . . .

recommended by
Graybar

SERVICE & SOUND

Section of **RADIO & Television RETAILING**

Practical Television Service Flashes

• As every servicer with preliminary experience in television work knows, most of the troubleshooting work in that field is concerned with the installation, rather than the receiver. For the practical worker, therefore, here are little tricks which simplify installations and forestall complaints. They're hard to beat!

Figure 1, a surprisingly obvious idea, is rarely applied to television. As indicated, simply twisting the 300-ohm unshielded transmission line will, in communities where ignition and stray noise is a problem, materially lessen the interference pickup from that source.

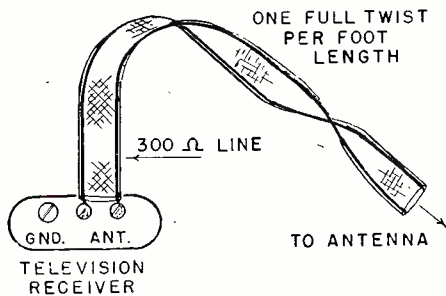

Fig. 1. Reducing transmission line noise pickup.

This method, while not nearly as effective as shielded coaxial line, permits some amount of noise cancellation without the attenuation attending the use of coax, an important feature in areas of low signal strength where signal loss cannot be tolerated.

Figure 2 gives the measurements for a "trombone tuner". This is basically a $\frac{1}{4}$ -wave open-end stub of 300-ohm line, working as a wave trapped to the frequency of an interfering FM station. The stub is not unfamiliar to active television servicers, but the addition of a tinfoil slider is a great improvement, per-

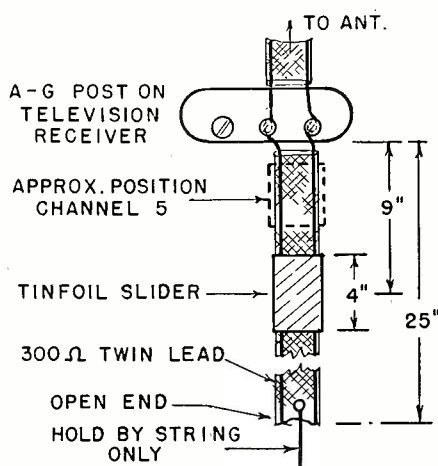

Fig. 2. Trombone tuner for FM interference.

mitting the use of the one stub on several channels, allowing for the appearance of new FM stations, and for the changes in adjustments that seem to be required because of changes in weather conditions.

Since the stub part of the tuner is sensitive to the presence of the user's hand, only the slide itself and the string shown should be touched during adjustment. No attempt has been made to utilize the device on the upper television bands which are, of course, unoccupied at this time. It may well prove to be useful only on the lower frequencies.

Easy To Construct

Figure 3, the third item, is a helpful suggestion which can be used in conjunction with the "trombone tuner". In areas of low signal strength, the desired signal loss which inevitably accompanies the device's use makes advisable its disconnection whenever conditions permit, such as on channels without interference, or at times when the interfering station

is off the air. To do this easily, an ordinary porcelain receptacle, three-way connector and line plug can be rigged up as shown. As an added use, where individual dipoles are used to "spot" stations lying in different directions, their lead-ins may be quickly exchanged without the need for a more expensive switching box.

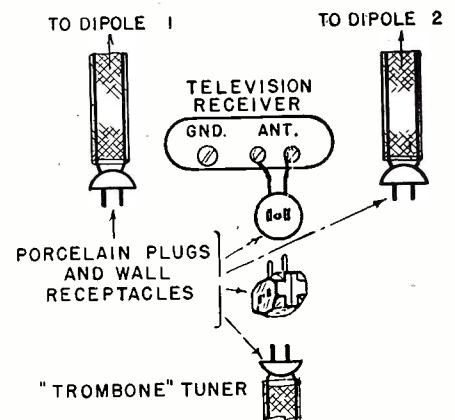
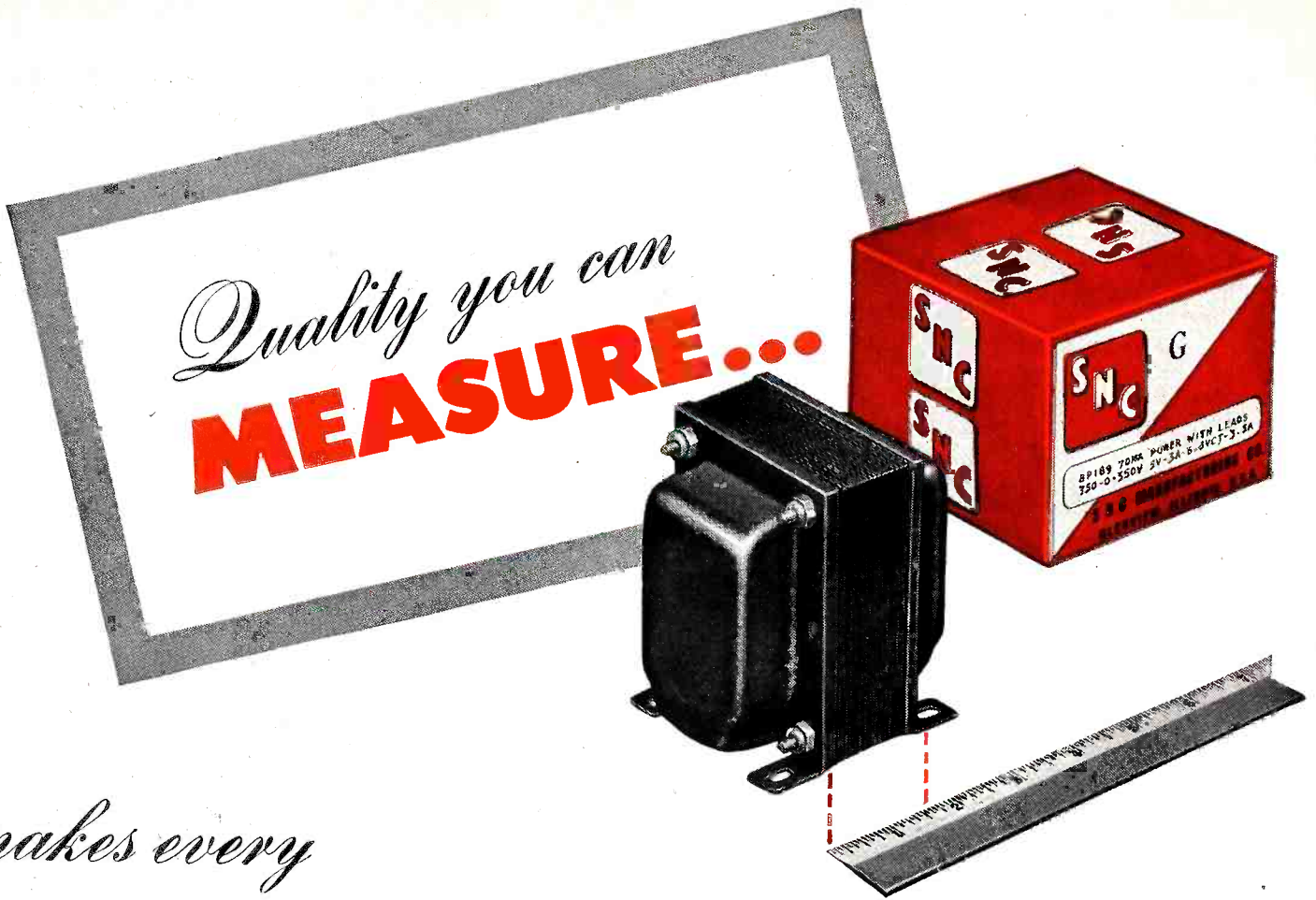

Fig. 3. Home-made switch for trombone tuner.

These three ideas will undoubtedly be of help to all television servicers. How about chipping in your own suggestions? Excessive "secrecy" about novel ideas for television installation will harm all dealers, while cooperative give-and-take will cut costs everywhere.

"HOW SUCCESSFUL SERVICERS SPEND ADVERTISING \$\$\$" is the title of the third report on John F. Rider's nationwide radio service survey, to appear in the February issue of **RADIO & TELEVISION RETAILING**.



makes every
SNC TRANSFORMER *give outstanding performance*

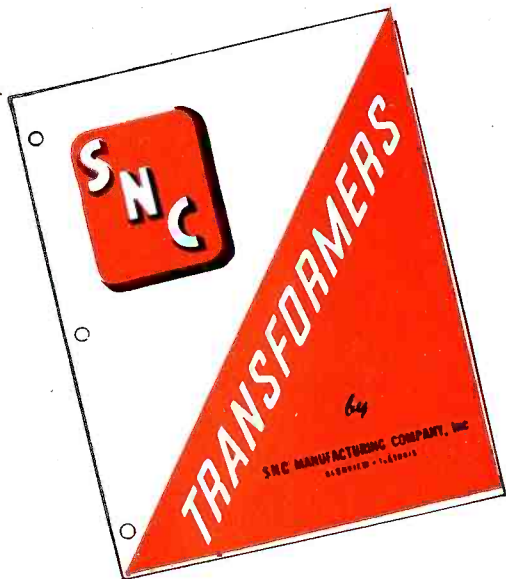

Join the increasingly large number of manufacturers, retailers, hams and other component part buyers who rely on SNC for quality, trouble-free equipment. Write for catalog today.

Place a rule against the stack of an SNC No. 8P189 transformer and the *extra* width clearly indicates the added quality built into every item in the complete SNC line.

Skillful engineering, latest production techniques and highest quality materials . . . backed by careful workmanship, exacting step-by-step inspection and rigorous final testing . . . are just a few of the reasons why SNC transformers keep rejects at a minimum and give outstanding performance.

Remember! SNC gives MORE applications with SMALLER inventories for GREATER profits!

SNC MANUFACTURING CO., INC.
Quality Transformers

WEST LAKE AVE. NEAR LEHIGH • GLENVIEW, ILLINOIS
 Export Department, 308 W. Washington St., Chicago 6, Ill., U. S. A.

Serviceing **ALL-BAND** **TELEVISION RECEIVERS**

● Television is the most *different* thing that has ever hit radio retailers. Few, if any, would challenge that statement. So much the more amazing, therefore, is the fact that to so *different* a situation so few radio

shown on next page. This is a very handy chart for television servicers. To fit it best to your own requirements, the space provided below the frequencies should be filled in with the call letters of each new television

the operation of any one is not so great a task. To do the same for *all* these shown, and ten times as many not shown, is a very first essential, and an undertaking that must be planned.

Having mastered the individual circuits, you must learn to your very finger tips the inter-relation between all the circuits, and the manner in which the incoming signal becomes a picture and a sound. Without a free-flowing understanding of this sort, you will spend unprofitable hours, instead of extremely profitable
(Continued on page 100)

How Television Servicing Differs . . .

- 1 You Need a Thorough Grounding in Fundamentals Plus Added Understanding of Many New Circuits
- 2 You Need a Well Equipped Service Bench Plus Several New Types of Equipment
- 3 You Need Plenty of Experience to Do a Profitable Service Job with a Guarantee
- 4 You Need to Chart the Reception Conditions Throughout Your Service Area
- 5 You Need to Know the Building Codes.

servicers have responded with a properly realistic and business-like attitude.

Barring the most drastic and unforeseen calamities, the next few years will likely see the creation of thousands of new personal fortunes . . . large and small . . . in the television industry. Largest in numbers, if not necessarily in total earnings, will be that category embracing the radio dealer and servicer.

Hundreds have already staked their claim. Some quietly, some with great fanfare, are raking in more chips than their competitors realize. These are the men who have taken the bold approach, have already engraved their name on the slender young oak.

The recent announcements of manufacturers presenting table-model television at astoundingly low prices should serve to awaken many radio-men to the market that shortly will be screaming for their services. For those who intend to waste no more time getting into this soaring industry, down-to-earth practical guides are offered on these pages.

Television today lies in a spectrum divided into thirteen television channels as well as frequency bands for a number of other radio services, as

station in your area, as they go on the air, and the chart saved for permanent reference.

Now, if you intend to *service* television, ask yourself this question: "Do I have a good grounding in fundamental theory and practical, efficient troubleshooting?" Unless you can answer *yes* to that question, television servicing is not yet for you, and attempting to repair television receivers at present may cause you more financial loss than gain.

For "Practical" Men Too!

On the other hand, successful *installers* do not absolutely have to have a thorough theoretical training. Many a careful, thoughtful technician who successfully troubleshoots radio purely from practical experience can, by spending a sufficient amount of time preparing, do a fine job on installing television.

The troubleshooting and repairing of television sets themselves, however, must be left to those with adequate theory, or those willing to acquire that theory during the next few years. Some of the usual circuits found in television receivers are shown here. To become familiar with

NEW CIRCUITS TO KNOW

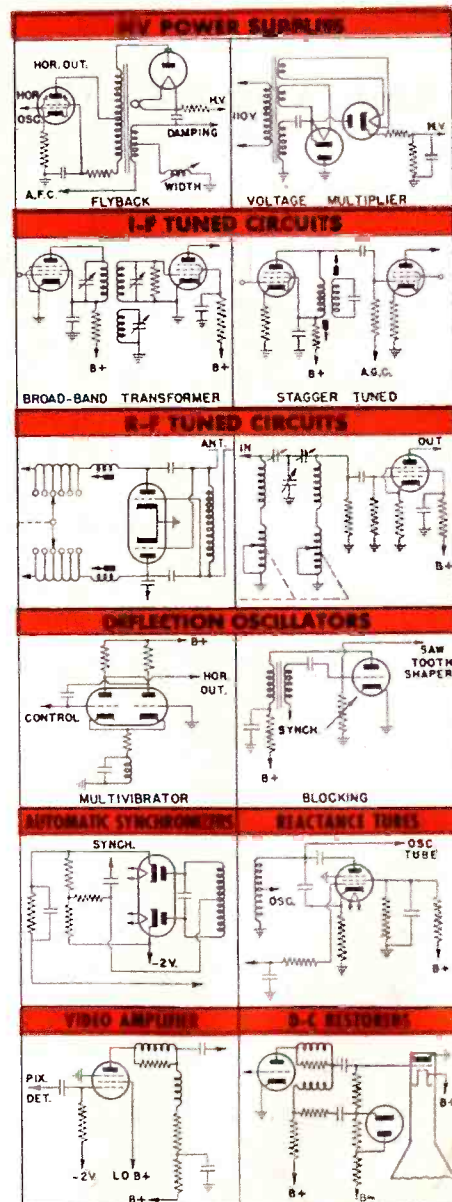

Servicing All-Band TV Receivers

(Continued from page 99)

minutes, stumbling about among some 18 to 40 tubes.

Finally, to a far greater extent than in ordinary radio, you must have in

relatively large reserve must be added simply because television and television servicing is new, and is bound to spring costly surprises upon the

inexperienced television servicer.

In this connection, a close familiarity with two other factors is important. First, without any waste of time, the expectant servicer or installer should become aware of all local regulations regarding building

(Continued on page 109)

TELEVISION CHANNELS and CARRIER FREQUENCIES

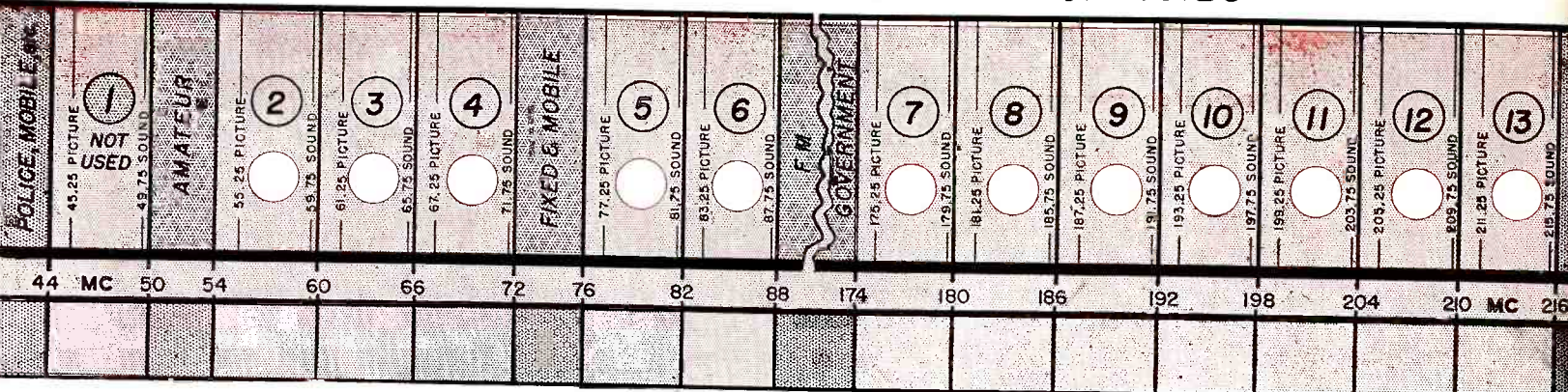

This chart of television channels and the carrier frequencies of both picture and sound will be useful for a long time to come. Write in the call letters of each station as it comes on the air, in the space provided below the frequencies, and save for future reference.

your mind a familiarity with parts values and tolerances that will enable you to peer into your oscilloscope and easily judge which component has produced *this* kind of pattern instead of *that* kind.

For work such as this, of course, new types of equipment have been developed, heretofore used mostly by servicers doing a sort of "super" job on ordinary radio, as well as by engineers and experimenters. Some of these devices are described briefly at lower right.

New test equipment costs money, and right here is the first big investment. Add to it, however, capital for spare parts . . . some quite expensive. For example, stocking various types and sizes of cathode ray tubes is a good idea, and important for efficient work. However, the total investment for even one each of a 5", 7", 10" electrostatic deflection, 10", 12", 15" and 20" magnetic deflection, and perhaps one or two projection types, is much more than a drop in anybody's bucket.







More Things To Buy

Additional replacement parts, other than standard radio component types, include a collection of HV filters and by-pass capacitors, television-type amplifier and rectifier tubes, oscillation, output and power transformers, and items peculiar to each set.

For both installation and servicing, a car is an essential, plus installation tools such as a portable telephone or intercom, powerful electric drill, "walkable" antenna, etc. Finally, to the immediate capital expenditures a

THE EQUIPMENT NEEDED FOR TV SERVICE

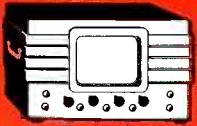
(In addition to all the usual test bench apparatus)

Image	Purpose and Circuit Covered	Desirable Specifications	Price Range
	Align RF, picture IF and sound IF tuned circuits (used with sweep generator). Check video amplifier frequency response (used with square wave generator). Examine waveforms in clipper, synch and deflection circuits.	Vertical amplifier frequency response as high as 1.5 mc. Sawtooth sweep to as high as 200 kc.	\$60 to \$550
	Align RF, picture IF and sound IF tuned circuits (used with oscilloscope).	Frequency ranges: 20-30 mc 40-90 mc with 10 mc 170-220 mc sweep width	\$70 to \$440
	Provides frequency calibration points during alignment with oscilloscope and sweep generator. Provides signal on which to set traps.	Accurate calibration. Two or three different frequencies available simultaneously.	\$60 to \$400
	Reveals faults in phase and frequency response of video amplifiers.	Cleancut square wave fundamental variable from 200 cycles to as high as 400 kc.	\$75 to \$150
	Test customer's location before sales is completed, helps sell.	Light, small, rugged.	\$60 to \$350
	Miscellaneous instruments and equipment to aid installing and servicing, such as portable dipoles with long masts and temporary supporting bases, multi-step attenuator boxes, 13-channel interference eliminators, sound-powered telephones, HV multiplier probes, dipole switching and equalizer boxes, r-f booster amplifier, 9-pin tube tester socket adapter, VTVM, volt meter, spare cathode ray tubes, etc.		\$250 total



**The first truly practical all-purpose
HIGH-TEMPERATURE MOLDED
paper tubulars—New type TM**

• Highly heat resistant

- Moisture resistant
- Non-inflammable
- Conservatively rated
- Small in size
- Mechanically rugged
- Completely insulated

After more than four years of intensive research, plus one of the largest retooling programs in its history, Sprague announces a complete line of high-temperature molded paper tubular capacitors that offer far-reaching advantages for a long list of products ranging from home or auto radios and electrical appliances to military equipment. These new molded types will be known as "TM" units. Basically, because of its completely new method of construction, this Sprague TM unit is so far ahead of anything now available, it should

have the same effect on the paper tubular capacitor business that bakelite molded resistors had in the resistor field years ago.

The unique high-temperature molded construction of these new capacitors assures maximum dependability even under extremes of heat, humidity, and physical stress. Thus the new TM types have virtually universal application in modern equipment. **YOU CAN STOCK ONE BRAND FOR ALL REQUIREMENTS—SPRAGUE TM'S!**

Reach for a Sprague and know you're right!

CAPACITORS

SPRAGUE

*KOOLOHM
RESISTORS

*T.M. Reg.
U.S. Pat. Off.

SPRAGUE PRODUCTS COMPANY, North Adams, Mass.

(JOBGING AND DISTRIBUTING ORGANIZATION FOR THE PRODUCTS OF THE SPRAGUE ELECTRIC COMPANY)



**"It's the one that
REALLY WORKS"**

Reports Pilzer Twigg

You all remember Pilzer from way back before the war. He repairs radios at the Acme Radio Emporium. After field-testing advance samples of the new Sprague TM, Mr. Twigg reports:

"Up to now I couldn't keep a tubular in the auto radio in my Model T long enough to bother with puttin' one in. Now motoring is fun again. The radio coos like a baby. Sprague TM's are the only ones that really work!"



Clearing TV Pix of Installation Troubles

Tearing, Tone Reversals, Distortion and Ghosts Can All Be Caused by Signal Pickup System. Part II

By M. J. Morris and T. W. Buchter

● In the December issue of RADIO & TELEVISION RETAILING a procedure had been developed for correctly locating, and installing the proper type and number of antennae, for any particular receiver installation in a metropolitan area. At the conclusion of the article, three antennae had been located, oriented, installed, and their respective transmission lines had been run to the receiver location.

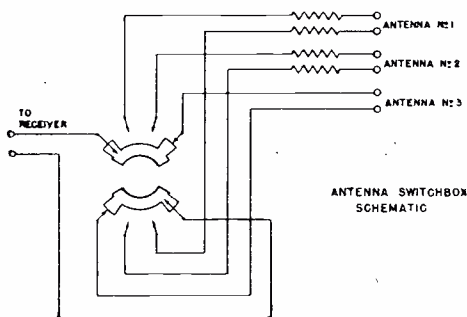
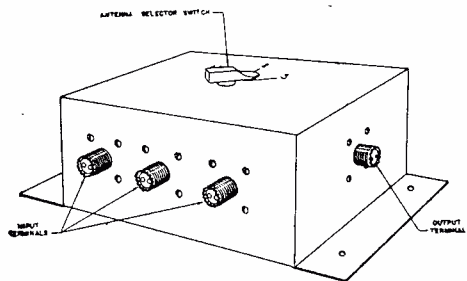

Fig. 1. Above, wiring of typical switchbox. Across each input add a terminating resistor to match individual transmission line. Below, switchbox used by U. S. Television Mfg. Corp., N. Y. for multiple installations of low-impedance coaxial lines.



The remaining problems involve the attenuation of excessive signal levels, the further reduction of any remaining ghosts, and the installation of a device to provide for the selection of the proper antenna for the channel desired.

Since as many as three antenna leads are to be terminated and selected under present conditions, the obvious solution is the use of a switch selector which will accommodate up to three inputs and one output. Particular care must be taken in the design and construction of the switch selector to secure a minimum impedance mismatch and minimum

distributed capacity, in order to prevent standing waves which would give rise to ghosts and other accompanying difficulties.

It should be noted that toggle switches should not be used for this purpose, as the distributed capacity and construction of this type of switch will introduce shunt capacitance in the transmission line with attendant mismatch and signal loss. Wafer switches for the requisite number of contacts and decks are highly recommended for this service. However, these must have proper ceramic UHF insulation, the selection of which must be made with care.

Construction Pointers

A metal box suitable for the construction of the antenna selector should provide clearance around the switch and ample room for the transmission line terminals. In addition, space should be left for the inclusion of attenuator pads as described later. In the sample installation described last month, coaxial transmission line was used, and therefore standard coaxial fittings were mounted on the sides of the box and the switch was mounted on one face. A bottom cover plate was fabricated to totally shield the switch, and to provide a means of mounting the complete switch box to the cabinet or wall.

The internal wiring of the switch box should conform to the schematic, Fig. 1. All wiring within the switch box should be made of the same impedance as the antenna down-leads, and each position of the switch selector should be properly identified, for ease of selection by the owner or operator.

If the antennas are now connected to the three respective input connectors and the output of the switchbox is connected to the input of the receiver, it will be possible to receive signals on three channels from the three antennas as desired.

At this time a close study should be made of the picture from each transmitter in order to observe the strength of signal and the number

of ghosts on each channel. If on any channel the picture can be made to distort or tear or show signs of tone reversal when the gain or contrast control is advanced to its maximum position, some method of signal attenuation must be provided.

In the sample installation this condition was noted on the two "line of sight" stations, while the third station exhibited none of these phenomena on maximum gain setting

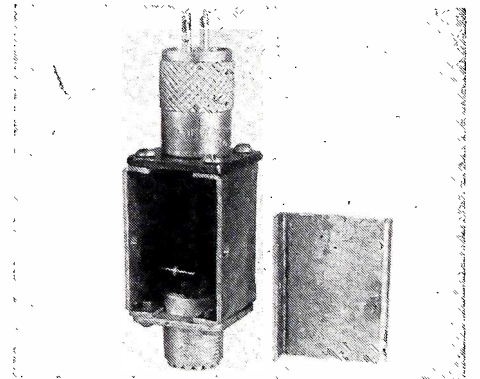
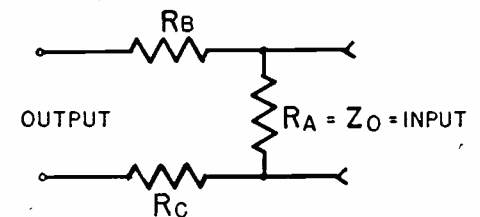

Fig. 2. Above, attenuation pad for single coaxial line. Self-supporting, it plugs into receiver input terminals. Bottom connector goes to antenna. In schematic below, R_b and R_c are equal, while R_a matches line impedance.



In order to determine quickly the required amount of attenuation for the two powerful stations, a variable pad box should be inserted in one antenna lead at a time, between the end of the antenna transmission line and the input to the switchbox.

With the variable pad box connected and the contrast control set for maximum, the variable attenuator should be adjusted to the point where the distortion, tearing or tone reversal is eliminated. All normal conditions of excessive signal strength should be accommodated by the pad box which should have an attenuation range from three to thirty decibels.

(Continued on page 108)

DOBLER BROS.
RADIO
SALES & SERVICE

A SIGN OF SUCCESSFUL *Servicing*



**DOBLER has all
16 RIDER MANUALS!**

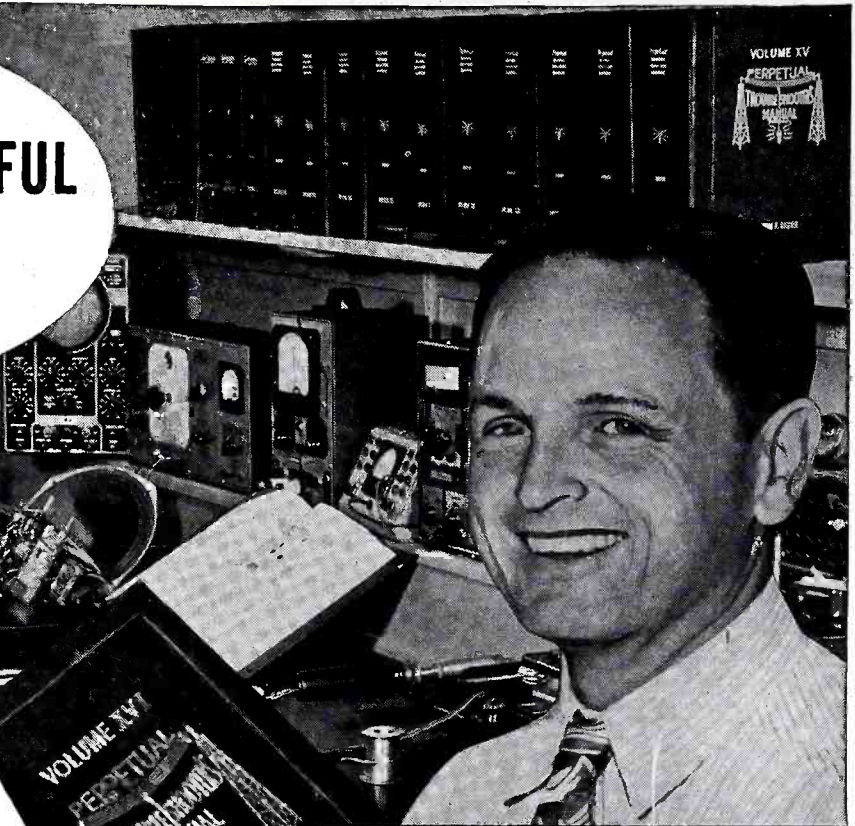

"Successful radio servicing means fast servicing. Fast servicing means quick diagnosis. Quick diagnosis means access to dependable data. Dependable data suggests Rider Manuals. That's why we have all sixteen volumes," says R. W. Dobler of Dobler Bros., San Diego, Calif.

Three times a year Rider Manuals are published. Hundreds and hundreds of times a year they supply time-saving servicing information to each of the thousands upon thousands of men at the benches of Successful Servicing shops throughout the world.

This because nowhere else—nowhere else but in Rider Manuals, can be found the wealth of authoritative* radio service data needed to quickly diagnose the troubles in ailing American-made receivers issued since 1920. Here is all the material our "Seventeen Years of Continuing Service to the Servicing Industry" has proved necessary.

Rider Manuals keep pouring out profits for servicemen year after year. They're a sound investment. They're a sign of Successful Servicing. Your shop should have all sixteen. Order from your jobber today.

* Rider Manual data is the OFFICIAL AUTHORIZED servicing data right from the service departments of the companies that made the sets. No one knows better than the manufacturer what servicing procedures are best for his product. This is the basis for the authority and the success of Rider Manuals.

JOHN F. RIDER PUBLISHER, Inc., 404 Fourth Avenue, N. Y. 16
Export Agent: Rocke International Corp., 13 E. 40th St., N.Y.C. Cable ARLAB

YOU NEED ALL 16

- Volume XVI \$ 6.60
- Volume XV 18.00
- Volumes XIV to VII (ea. Vol.) . . 15.00
- Volume VI 11.00
- Abridged Manuals 1 to V (one volume) 17.50
- Record Changers and Recorders 9.00
- Master Index, covering Rider Manuals, Vols. 1 to XV 1.50

**PUT THIS OVER
YOUR BENCH TODAY!**

VOL. XVI
768 Pages
PLUS SEPARATE
'HOW IT WORKS'
BOOK
\$6.60



Vol. XVI contains data from 94 manufacturers—a greatly increased percentage of "clarified-schematics"—a generous number of photographs on small table models and a separate "How It Works" book, in addition to the usual authoritative information you have come to depend upon in previous Rider Manuals—and this is made available to you in Volume XVI at the greatest possible economy; less than a penny a page. Get it from your jobber today!

24 HOUR DATA SERVICE

On November 30, 1947, we instituted our new photostat service to supply you with information on any newly issued, or old, receivers. For 10c (stamps are OK) we will send you the schematic, voltage data and parts list and everything else which will fit on the two pages. Additional manufacturers' data is 5c a page with a maximum charge of 35c for everything up to seven pages. If the manufacturers' data requires more than seven pages, each additional page is 3c. Here is a way to get whatever service data you need between Rider Manual publication dates.

ADDING FURTHER WEIGHT TO THE VALUE OF OUR "SEVENTEEN YEARS OF CONTINUING SERVICE TO THE SERVICING INDUSTRY"

RIDER MANUALS MEAN SUCCESSFUL SERVICING

New Aids to Television Servicers

Electronic Development Lab OSCILLOSCOPE

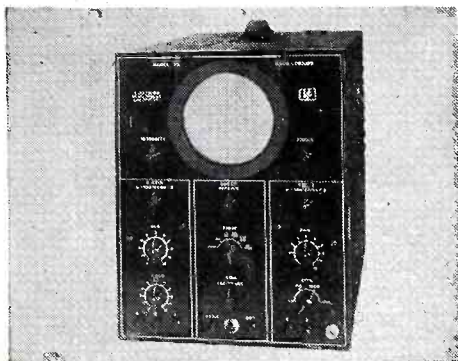

Model 75 oscilloscope has a vertical amplifier response within 2 db from 10 cycles to 5 megacycles, permitting direct observation of the composite video signal. Its vertical input impedance with probe is .1 megohm in parallel with 14 mmf., and the sweep is variable between 10 cycles and 60 kc. A self-contained voltage calibrator is accurate within 5%. Electronic Development Lab., 2655 W. 19th St., Chicago 8, Ill.—RADIO & Television RETAILING

Star 9-PIN TUBE TOOLS

Miniature socket wiring plugs and miniature tube pin straighteners for the new nine-pin tubes are available immediately. Radio Accessory Div., Star Expansion Products Co., Inc., 147 Cedar St., New York 6, N. Y.—RADIO & Television RETAILING

Temco TELEBOOSTER

The Telebooster is a flexible, high gain amplifier used with any type of television receiver and 72 or 300 ohm transmission lines to raise signal strength. Self-powered, operating from 115V a-c, it uses three tubes, measures about 4" x 8" x 1½", and has a switch for selecting one of three channels. Temco Service Corp., 345 Hudson St., New York 14, N. Y.—RADIO & Television RETAILING

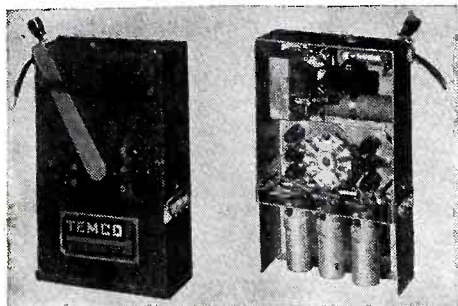

Electronic Engineering Svc. R-F POWER SUPPLY COIL

The new line of r-f power supply transformers for television receiver oscilloscopes and other high-voltage equipment provides 1, 2½, 4, 5, and 10 KV at 250 microamps. All coils, Q-Max treated, have primaries, secondaries, feedback, and rectifier filament windings, and are priced from \$2 to \$8 each. Electronic Engineering Service, P. O. Box 72, Ridgewood, N. J.—RADIO & Television RETAILING

Kay MEGA-MARKER



A variable marker oscillator for all video i-f frequencies between 19 and 29 mc., plus a crystal oscillator of 10.7 mc for FM i-f amplifiers, a 12" circumference calibrated scale permits readings with an accuracy of .02 mc. The crystal oscillator also provides recurring check points. Kay Electric Co., 34 Marshall St., Newark, N. J.—RADIO & Television RETAILING

U. S. Instrument Corp. SOUND POWERED PHONE

The two-way sound powered telephone system is used to simplify tuning and orientation of television antennas. No batteries

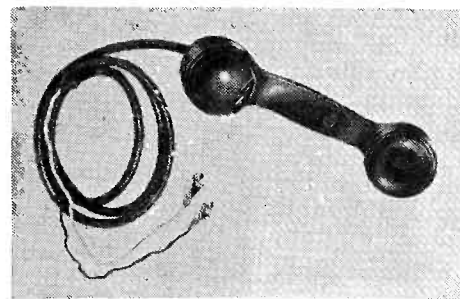

or other power are required, and the servicer supplies his own line or makes use of the television transmission leads. Also used for communication or intercom as far as 30 miles. United States Instrument Corp., Summit, N. J.—RADIO & Television RETAILING

RCA TV REPLACEMENT PARTS

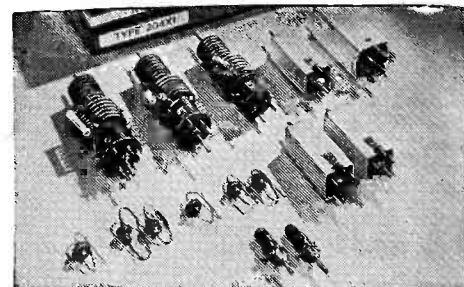

All RCA parts distributors are carrying standard parts replacements for several of their television receivers. Width and linearity controls, i-f and video coil kits (see illustration), horizontal synch-discriminator transformers, filament chokes, deflection yokes and hoods, focus coils, ion-trap assemblies, horizontal and vertical output transformers and horizontal and vertical blocking transformers are among the parts offered. RCA-Victor Div., Harrison, N. J.—RADIO & Television RETAILING

Brach ANTENNA COUPLER

A cast metal box about the size of a box of household matches, containing a cathode follower stage powered by a connection to the receiver serves to connect multiple television sets of any impedance to a common dipole system without need for complex matching networks. Sold as separate unit, for installation by servicer, becomes a complete system with dipole and coaxial line. L. S. Brach Mfg. Corp., 200 Central Ave., Newark, N. J.—RADIO & Television RETAILING

C-B Kilovolt

A 4000V to 6000V supply for television receivers, the Model 6 Kilovolt is especially adapted to replacement of burned-out high-voltage transformers for sets using 7" cathode ray tubes. The small, light supply uses an r-f oscillator of about 300 kc, and is applicable to the soon-to-be-available 10" electrostatic-deflection tube. C-B Mfg. Co., 412 W. 37 St., New York, N. Y.—RADIO & Television RETAILING

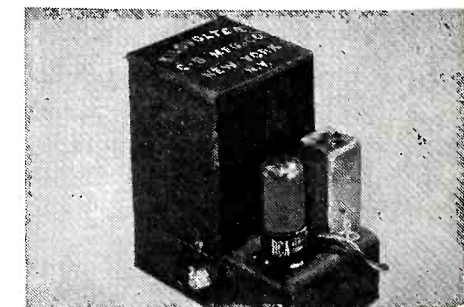

F

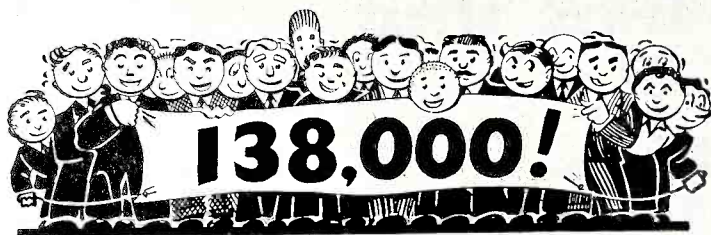

READERS INCREASE MUCH MORE...

RADIO & TELEVISION RETAILING will be like the nursery rhyme lady who lived in a shoe—because an average of almost five persons now read every copy of this magazine, according to a recent survey. Back in the '30's there were only three to four readers per copy. Today's heartening popularity indicates that **RADIO & TELEVISION RETAILING** has a 1948 audience in the radio-appliance field of 138,000 important people. *Advertising dollars certainly go farther and buy more in RADIO & TELEVISION RETAILING.*

Significantly Enough...

Index To Prosperity

This increase is indicative of the upsurge in employment in radio-appliance stores everywhere. It reflects the doubling of industrial production volume and the resultant selling and marketing PUSH now gaining momentum. It shows that thousands throughout the industry are **SELLING** television, radios, radio-phonographs, records, appliances and service as never before and are finding the merchandising help they need in **RADIO & TELEVISION RETAILING.**

Effectively Yours

"Pass-on" readership is an important key to the effectiveness of a magazine as an advertising medium. No greater audience has ever read **RADIO & TELEVISION RETAILING** which means that advertisers are getting a huge plus over and above the regular circulation—are bringing their sales stories to thousands new to the industry who need help. This readership is another good reason why **RADIO & TELEVISION RETAILING** is first on advertising schedules for 1948.

RADIO & TELEVISION RETAILING

Circulation 28,000 ABC

Caldwell-Clements, Inc. 430 Lexington Ave., New York 17, PL. 3-1340
CHICAGO 6 • LOS ANGELES 5 • SAN FRANCISCO 4

Also publishers of TELE-TECH and ELECTRONIC INDUSTRIES & ELECTRONIC INSTRUMENTATION

New Units for Quality Sound Jobs

Klipsch Wide Range SPEAKER SYSTEM

Model 1A is a new 20W, 2-way reproducer covering fundamentals from 30 to 15,000 cycles, using horns for low as well as high frequencies, as contrasted with the usual method of using a cone speaker for the low range. Using the corner of the room as an integral part of the acoustic system, the listener is literally inside the loudspeaker, providing low frequency response equivalent to a horn many times more bulky than the 14 cubic feet of space

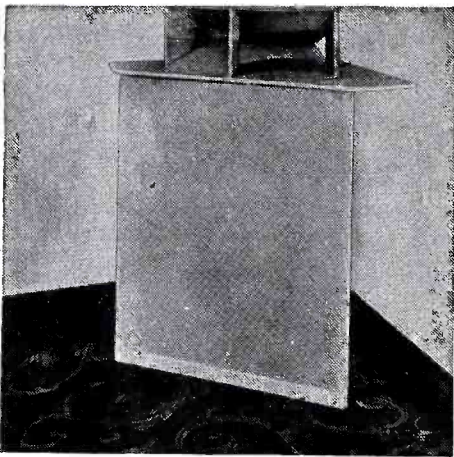

used by the Klipsch system. The high range horn need not be attenuated. Extremely low distortion and transients are claimed, due to the non-resonant character of this system. The high range horn has a horizontal distribution pattern of 90° above 500 cycles, the cross-over frequency. Brociner Electronics Laboratory, 1546 Second Ave., New York 28, N. Y.—RADIO & Television RETAILING

Vibromaster ADAPTER FOR GE PICKUP

Type M adapts Western Electric 5A arm to accommodate General Electric variable reluctance or Pickering 120M cartridges. Interchangeable with 9A heads, it provides correct balance when used with the 5A arm and either cartridge described above. Technical Products International, 453 W. 47th St., New York 19, N. Y.—RADIO & Television RETAILING

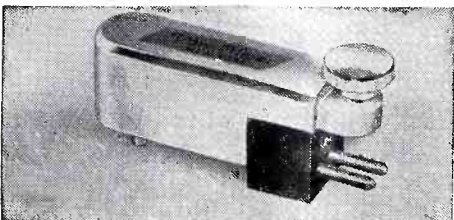

Stephens Tru-Sonic CO-SPIRAL SPEAKER

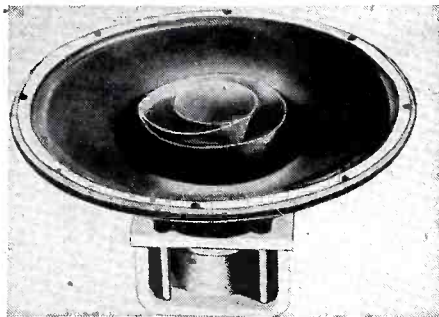

For converting existing equipment to high fidelity, Model P-52FR co-spiral speaker embodies the novel "differential diffuser", accomplishing dispersion of highs with an almost 100% spherical polar pattern of over 90°. With a frequency range from 40 to 14,000 cycles, the characteristic has been calculated to attenuate record motor rumble below 70 cycles, emphasize a band in the "power" range around 500 cycles, accentuate "presence" by arise at 2300 cycles, and subdue high frequency "hash" by a gradual roll-off from 8000 cycles. Available in both 12" and 15" cone diameters, with either 8 or 16 ohm voice coils and 2½ lb. Alnico V magnet, the units handle 15W input. Stephens Mfg. Corp., 10416 National Blvd., Los Angeles 34, Cal.—RADIO & Television RETAILING

Amperite VELOCITY MIKE

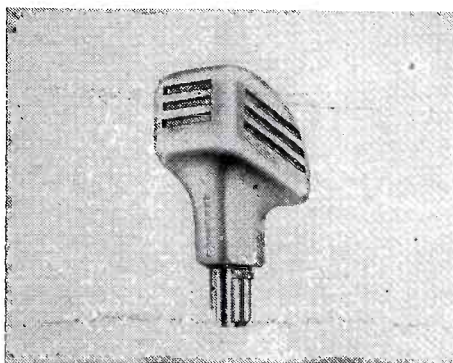

The new velocity microphone gives high fidelity reproduction on either close talking or distant pickup, with harmonic distortion of less than 1%. With a frequency response of 50-11,000 cycles \pm 2 db, the output is -62 db. The discrimination with angle from 60 to 10,000 cycles is less than 5%. The microphone comes complete with cable connector and a switch that is "hidden" in the back of the microphone in such a way as to prevent tampering. Model RBHG is high impedance, and Model RBLG 50-200 ohms. Amperite Co., Inc., 561 Broadway, New York 12, N. Y.—RADIO & Television RETAILING

Knight HI-FIDELITY AMP

The new Knight 20W amplifier for phono records and AM or FM tuners has a response with 1 db from 20 to 20,000 cycles, with less than 2% harmonic and 8% intermodulation distortion. Individual bass and treble controls permit both boosting and attenuation, while a gain of 78 db is achieved with a hum level better than -75 db from rated output. Adjustable automatic volume expansion, with action independent of the volume control setting, dual impedance inputs selected by a switch, and output impedances of 4, 6, 8 and 500 ohms are provided. Allied Radio Corp., 833 W. Jackson Blvd., Chicago 7, Ill.—RADIO & Television RETAILING

Electro-Voice CENTURY MIKES

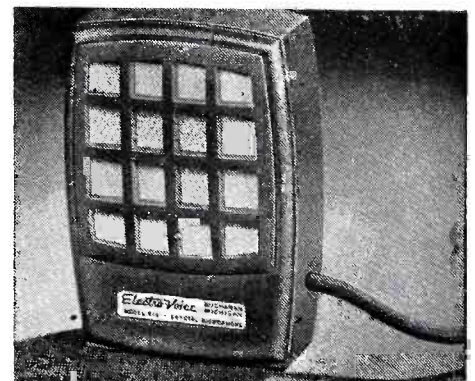

The Century series of microphones are designed for low-cost PA, paging, recording and communications. A choice of three generating elements is offered: crystal, dynamic and carbon. The crystal type, Model 915, with an output of -50 db and a response of 60-7500 cycles lists for \$10.00; the high impedance dynamic type has -57 db output and a response of 55-7500 cycles, listing for \$16.50; while the single button carbon mike, at an \$8.25 list, has a speech response (200-4000 cycles) with very low hiss level and low distortion, and an output of 22 db below 6 mw for 10 dynes/cm². Electro-Voice, Inc., Buchanan, Mich.—RADIO & Television RETAILING

Astatic LT CARTRIDGE

Type LT crystal phono cartridge is a new, low needle talk reproducer in the low price field. With a 1V output averaged at 1000 cycles, ¾ oz. needle pressure, and 4000 cycle cutoff, the cartridge uses a replaceable type T needle with a precious metal playing tip. Astatic Corp., Conneaut, Ohio.—RADIO & Television RETAILING

Philco TV Sales



Henry T. Paiste, who has been with Philco Corp. for 19 years, has been named special television sales representative for the firm. He was previously general manager of the Philco service division.

Some National Advertisers On TV

- Admiral Corp.
- American Tobacco Co.
- American Oil Co.
- Atlantic Refining Co.
- B. T. Babbitt Co.
- Benrus
- Borden Co.
- Botany Worsted Mills
- Bristol-Meyers
- Brown & Williamson Tobacco Co.
- Bulova Watch Co.
- B. V. D. Corp.
- Certo
- Chevrolet
- Cluett-Peabody
- Allen B. DuMont Laboratories
- Elgin Watch Co.
- Everess
- Ford Motor Co.
- General Electric
- General Foods
- General Motors
- Gillette Safety Razor Co.
- Gulf Oil Corp.
- Hat Research Foundation
- Hoffman Beer
- Kelvinator
- Knox the Hatter
- Kraft Foods
- LaPointe-Plascomold Corp.
- Lektrolie Corp.
- Longines-Witnauer
- Maxwell House
- Moquin Wine
- Norge
- Oldsmobile
- Pabst Beer
- Pepsi-Cola
- Philco Corp.
- Radio Corp. of America
- Sanka Coffee
- Sears Roebuck
- Alexander Smith
- Southern Pacific
- Swift
- U. S. Rubber

BEAUTY FOR DUTY

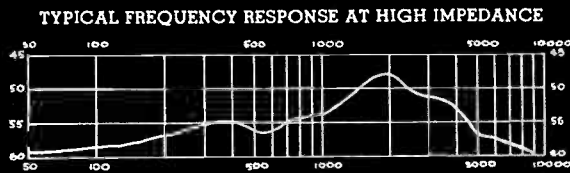
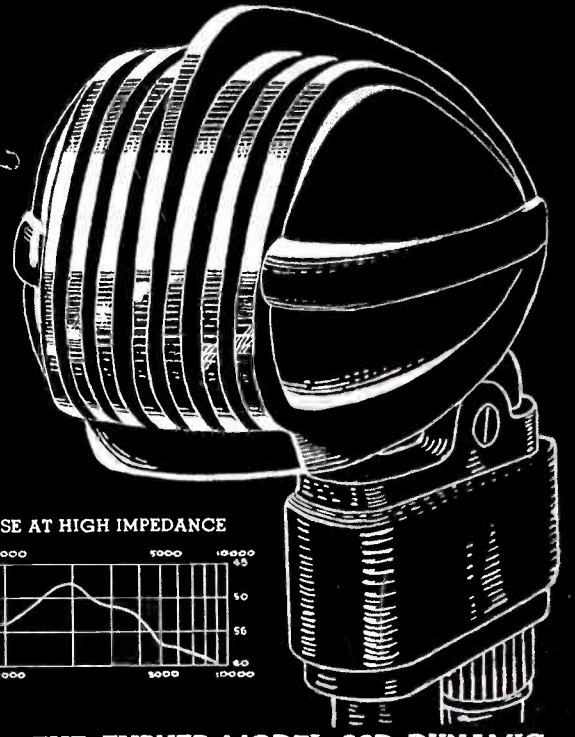

THE TURNER MODEL 33D DYNAMIC

The Turner 33D Dynamic microphone is designed with an exceptionally smooth wide-range response and high effective output. It is ideal for both voice and music pickups where quality of reproduction is desired. Engineered with Alnico magnets and Turner precision diaphragm for maximum sensitivity. The entire circuit is well shielded to prevent extraneous pickup. Modern streamline design and rich satin chrome finish matches the quality of its performance. Recommended for recording, public address and call system, and amateur work. Also available as Model 33X with high quality crystal circuit.

SPECIFICATIONS

- Level* 54db below 1 volt/dyne/sq. cm. at high impedance.
- Response* Flat within \pm 5db from 30 to 9000 c.p.s.
- Impedance* 50, 200, 500 ohms, or high impedance.
- Directivity* Semi-directional. Non-directional when tilted full 90°.
- Cable* 20 ft. shielded, removable cable set.
- Coupler* Standard $\frac{5}{8}$ "—27 thread.

WRITE FOR COMPLETE TURNER CATALOG

THE TURNER COMPANY

903 17th Street N. E.

Cedar Rapids, Iowa

**FOR ACCURACY, RELIABILITY, AND SOUND PERFORMANCE
TURN TO MICROPHONES BY TURNER**



Microphones licensed under U. S. patents of the American Telephone and Telegraph Company, and Western Electric Company, Incorporated. Crystals licensed under patents of the Brush Development Company.

Clearing TV Pix

(Continued from page 102)

To make a permanent pad box, several methods may be used. For a pad box to be used on a single antenna installation with coaxial transmission line, the method shown in Fig. 2 is highly satisfactory. Here a metal box with snap-on cover plate has been fabricated with suitable coaxial connectors attached to each end. Since the distance between connectors is relatively short, the pigtailed of the series resistors were used for the thru connections.

For Better Matching

It is of interest to note that the series resistors cannot be seen in Fig. 2 because they are contained within the shank of the male connector. This expedient was chosen so that the series resistors would be as near the receiver input as was possible. Because of the rugged design of this attenuator no additional mechanical mounting is necessary. When the outer threaded coupling sleeve of the male connector is threaded completely into the female receptacle, the box becomes rigid.

If, as in the sample installation, two or three antennas are used, of which two or all three require padding, the single padded box described is not suitable and a different method of inserting pads is necessary. Since a switch box has already been fabricated and provision made for installation of attenuator pads within the box, the proper values of resistance

can be connected in shunt and series between the proper switch positions and the antenna inputs.

In actual practice, the switchbox would not be wired until the proper pad values had been determined by means of the variable pad box connected between the antenna lead and the receiver. Then the switchbox is wired to include the necessary permanent pads and connecting leads.



Fig. 3. Left, commercially-available variable pad box. A servicers' instrument, it gives values for set's permanent pad box such as shown at right. Made by Roger Television, Inc., 366 Madison Ave., N. Y., for 300 ohm lines.

The remaining problem to be solved is the reduction of ghosts that still may be present. Considerable mention has been made in these articles about maintaining correct impedance matching throughout the entire antenna system, and any device inserted in the transmission line must be given careful consideration and treatment of impedance mismatches are to be avoided. The basic reason for this is that impedance mismatches cause standing waves on the transmission line. This will result in closely spaced ghost signals.

Basic theory dictates that for op-

timum reception correct impedance matching and no standing waves are desirable. However, it has been found that a deliberate standing wave may be generated on the transmission line which, when properly phased, may aid in partial or complete cancellation of existing closely spaced ghosts, caused by multiple paths.

To Balance Out Ghosts

There are no fixed rules for the application of this procedure, and ghost elimination can be determined only by experimental cut and try methods. The following suggestions will serve as a guide in the use of this method. It may be necessary to increase or decrease the value of the terminating shunt resistance, or to eliminate it completely, or to terminate the receiver end of the attenuator resistors with an experimental value of resistance. The magnitude of the mismatch will control the amplitude of the standing wave produced, while the phasing of the standing wave may be altered by unbalancing the transmission line on either side. This may be done by connecting one of the coax conductors to ground and experimentally reversing the connections to the receiver.

It is hoped that the foregoing experiences and suggestions will prove helpful in the alleviation of the many problems encountered in multi-station reception under unfavorable metropolitan conditions and that they will provide incentive for further study of installation problems and procedures.

Unit Assembly for Build-Your-Own Television

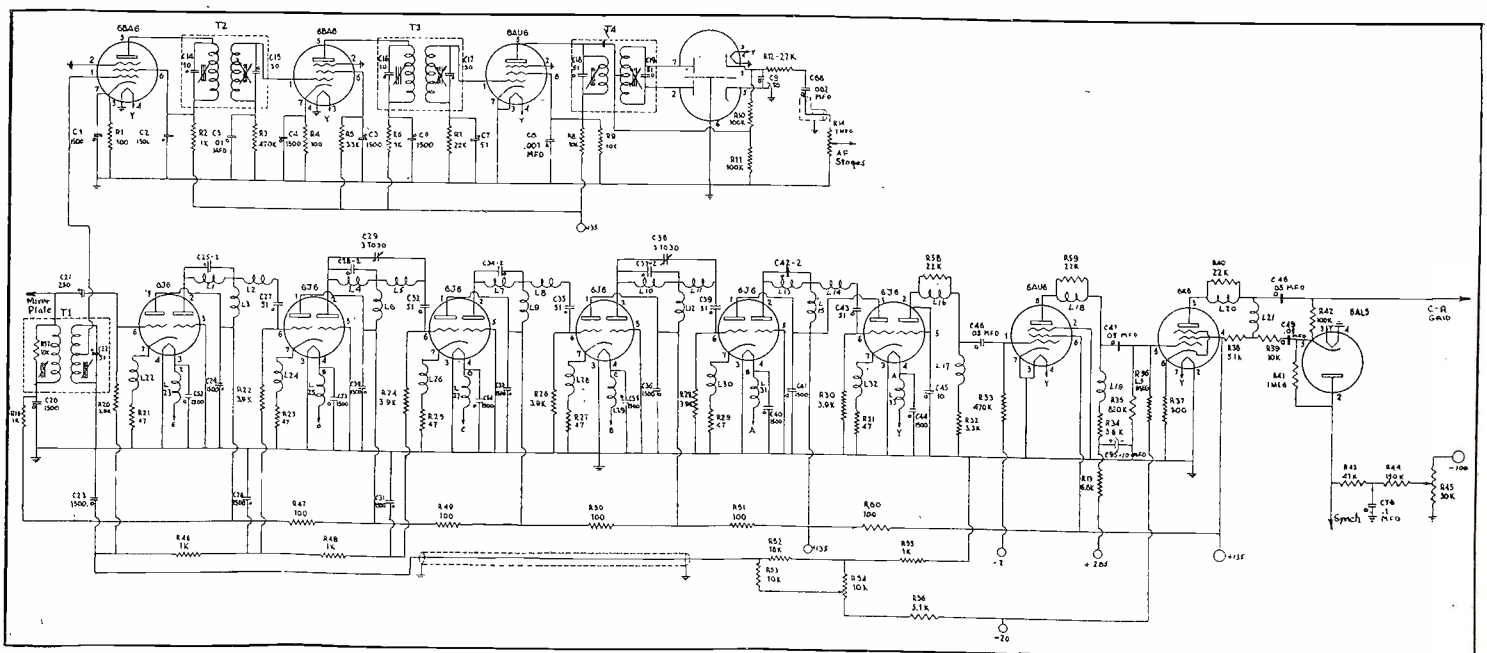

A unique assembly is the heart of the build-your-own television receiver sold by Television Assembly Co., 387 Bushwick Ave., Brooklyn 6, N. Y. The fully assembled and wired unit consists of a two-stage i-f amplifier, limiter and discriminator for television sound, plus a five tube picture i-f amplifier in which five 6J6 double-triode tubes are used in a grounded-grid circuit. Included also are a video detector, two video amplifiers and a synch clipper. Condensed into a long narrow strip, the unit is sold with the other assemblies and components for an entire 10" or 12" tube receiver.

Millionth Speaker

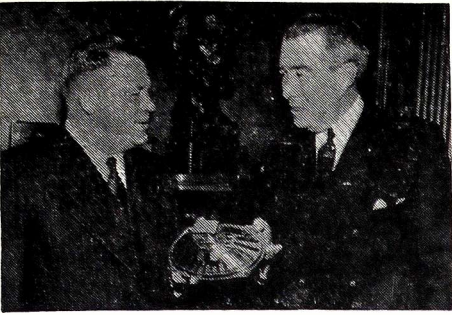

The millionth speaker to come off new production lines of Zenith Radio Corp. is presented by W. (Bill) Dumke, left, vice-president, to Comdr. E. F. McDonald, Jr., Zenith president. The company is now geared for 2,000,000 speakers annually.

TV Servicing

(Continued from page 100)

and fire codes, insurance and underwriter requirements, and landlord practices.

The second factor comes mainly with experience and can best be taken care of by the creation of a continually-developing chart of reception conditions in each area, block, house, and even apartment-house floor, throughout the entire area of operation of the servicer.

Manifestly, it will be impossible to do this on any but a gradual, continuing basis. A good-sized map of the community should be secured, and as information on conditions is found, filled in day by day. Such factors as low signal field strength, severe ghosts, strong short-wave or FM interference, high noise level, difficult landlords, etc., should all be charted.

If servicers in a given community can arrange to swap information on this subject, the task of making up a reception-conditions chart will be lightened for all. The same idea, of course, is true of most servicers' problems . . . but here it is very timely indeed.

"Calculaide"

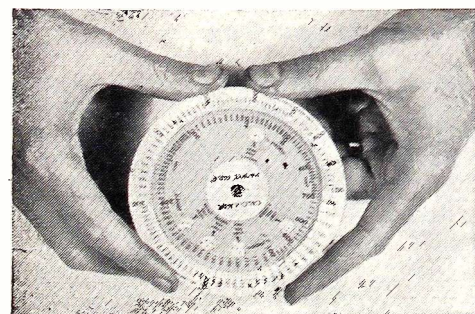

Answers to problems in profits, prices, costs, discounts, percentages, etc., are quickly given by the new "Calculaide" Profit Rule introduced by American Hydromath Co., 145 W. 57th St., New York 19, N. Y. This simple device eliminates tedious longhand calculations in all fields of business where percentage computations are made.

Announcing... Sports-View TELEVISION

The Finest in Television

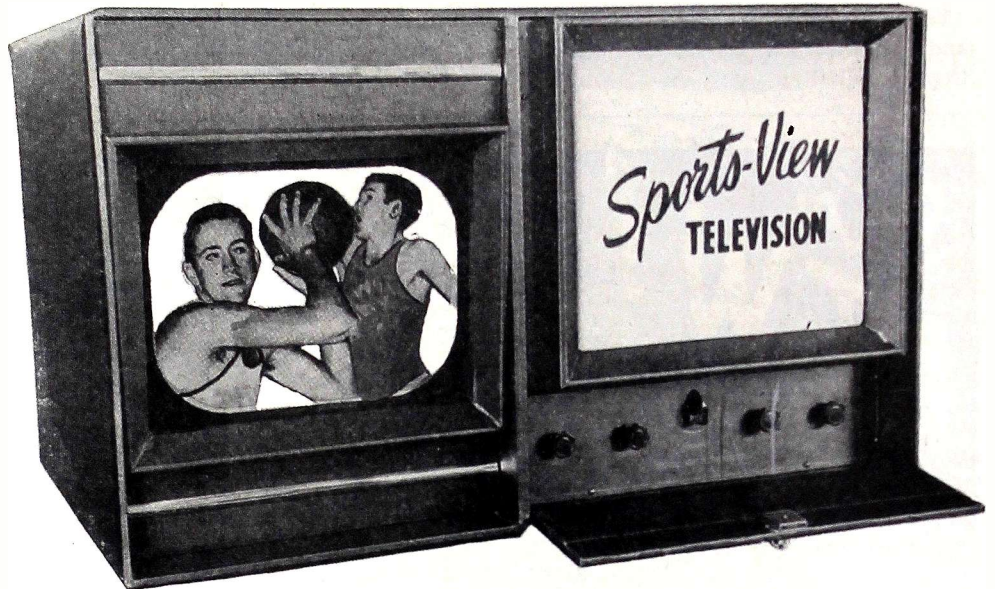

featuring the CLUB MODEL

The Club Model has a slanted picture for comfortable eye-ease viewing. Attractive, smart leather finish covered cabinet, complete with lock and key.

- ★ 30 TUBES
- ★ TRUE FM SOUND
- ★ 4.5 MC/S BAND WIDTH FOR HIGH PICTURE DEFINATION
- ★ COVERS ALL 13 CHANNELS
- ★ 12" HEAVY DUTY PM AL-NICO #5 SPEAKER SUPPLIED
- ★ HANDSOME LEATHER FINISH CABINET WITH TAMPER-PROOF CONTROLS

15" DIRECT VIEW — 120 Sq. In.

The sensitivity of the Sports-View Television Receiver was specially developed for fine reception in fringe areas as well as central areas.

\$1050⁰⁰ LESS INSTALLATION

CLUBS ★ SUPPER CLUBS ★ COCKTAIL LOUNGES

Sports-View is the logical receiver for those places of business where the public expects the finest in everything.

Write for List of Territories Still Available

Sports-View TELEVISION

540 BUSHWICK AVE.

BROOKLYN 6, N. Y.

"Hardee" Perennial

(Continued from page 93)

to collect a bill fails, Hardee sends the customer a registered letter advising the delinquent that if payment is not made by a certain date, a suit will be brought. If this procedure does not bring results, the firm actually brings suit—and brings it on the date set up.

"Too many merchants fool around with collections," Hardee says. "They threaten all sorts of suits, and, in the end do nothing about them. When I say I'm going to

sue, I mean it. I have the reputation for being a tough bill-collector. This type of reputation does me no harm. As a matter of fact, it is a valuable business asset because it keeps the dead-beats away, and doesn't worry the reliable customer."

Hardee makes a good point for other merchants to remember too, when he says that it pays to make it a hard-and-fast rule never to accept a partial payment without coming to a definite understanding with the person as to the exact date, and exact amount of the next payment.

"In cases where mitigating cir-

cumstances prevail, I make things as easy as I can for the delinquent customer," he says. "The willingness to pay sometimes exists where the ability to do so does not. In such instances, I will play ball with the customer who keeps in touch with us."

Hardee distrusts all delinquents who ignore requests for payment of bills.

As a result of his consistent collection practices, Hardee has an almost unbelievably low "bad account" rate.

The firm "finances" numbers of purchases, borrowing the money through a commercial lending agency, "with recourse," but administers the contract itself, and makes all collections. The finance company, one of the largest in the world, has recognized the fact that Hardee's collection system is a wonder-worker; his repossession rate extremely low.

The store is located in a thickly populated area of Long Island. It is part of Greater New York, and is the third largest trading area in the State. The population is "mixed" so far as income-brackets are concerned. Due to his long establishment, Hardee draws business from a very large territory, which includes Queens, Nassau and Suffolk counties, as well as from Brooklyn and Manhattan.

Mr. Hardee is widely known throughout the territory as a tireless and faithful worker in all sorts of civic enterprises. He has been active in charitable drives, and has held offices in many of the leading organizations. At present he is president of the Jamaica Chamber of Commerce.

This progressive firm, employing fourteen people, continues to grow because it is founded upon sound business methods which have proven to be the right kind over the years past, and which will keep the business forging steadily ahead in the years to come.



ESPEY Television Training Kit

Learn television through this unique "assembly line" procedure. Modern circuits and postwar design make up-to-the-minute training an absolute necessity. This ESPEY television training kit will help you understand and gain a working knowledge of TELEVISION—the latest development in electronics. FREE with every kit—a new type of pictorial instruction book, giving easy-to-follow, step by step method. No previous knowledge of television necessary to build—and LEARN from—this ESPEY kit.

FEATURES

- 18 tubes, including 15 miniatures.
- 3 stage, stagger tuned pix i.f.
- 21.25 Mc sound i.f. Trap tuned.
- Balanced FM discriminator.
- Portable—weighs only 17 lbs.
- Uses 3" low-cost cathode ray tube. Magnifier makes 20 sq. in. picture.
- Can be aligned with ordinary test oscillator and V. T. Voltmeter.

KIT INCLUDES: all i.f. power, blocking oscillator transformers, chokes, capacitors, resistors, controls, speaker, and sockets riveted into place on punched and welded chassis. All tubes are easily-obtainable types available through Distributors everywhere.

**FOR FURTHER DETAILS
WRITE TODAY TO:**

ESPEY MANUFACTURING COMPANY, INC.
528 EAST 72ND STREET-NEW YORK 21, N. Y.

Transparent Box



New display container for the Universal electric blanket made by Landers, Frary & Clark, is a clear acetate box. This eye-catcher has a built-in platform to hold the "Slumber Sentinel" control and cord. Box may be kept for display, or sold to customers as gift package.

RCA Tube Dept. Offers Line of PM Speakers

A standard line of PM speakers for general replacement and PA work has been announced by the renewal sales section of the RCA Tube Department. The line includes a "controlled resonance" 12" speaker, 4" and 5" speakers, a 4" by 6" and a 2" by 3" elliptical speaker. Rated at 12 watts power handling capacity, the 12-inch speaker has a one-piece stamped

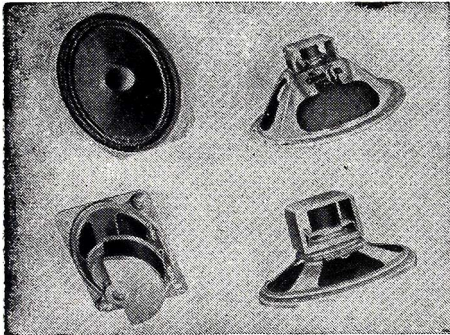

PM units with Alnico 5 and other features.

steel frame for rattle-free operation, a high-frequency filter for needle scratch, an adjustable voice coil mounting, welded bottom dust cap, moistureproof voice coil suspension, and an Alnico magnet locked into position by a 70-lb. pressure clamping spring.

Phila. Technicians Meeting

Television and FM will come "out of the clouds and down to the work-a-day level of shop and field service" at the Town Meeting of Radio Technicians to be held at the Bellevue-Stratford Hotel in Philadelphia January 11, 12 and 13, promises Harry A. Ehle, chairman of the event for the sponsoring Radio Parts Industry Coordinating Committee.

A technical program built around the Philadelphia independent technicians' needs for concrete, comprehensive information related to this rapidly expanding television area is being prepared, said Ehle. The first television session, on Monday morning, Jan. 12, will be devoted to practical antenna installation and adjustment, with a second paper on installation and customer instruction in the use of the equipment.

In the afternoon of the same day, attention will turn to service in the owner's home, including diagnosis of trouble with elementary test equipment, while a fourth will cover shop service, up to alignment.

Similarly explicit papers will cover FM in four Tuesday sessions, while test equipment sessions for both days will be worked out jointly by John F. Rider of New York and Howard W. Sams of Indianapolis. Other sessions will cover matters pertaining to advertising, selling, accounting and budgeting.

Distribute Hallicrafters

All-State Distributors, Inc., of 30 Warren Place, Newark, New Jersey, announces its appointment as exclusive distributors for Hallicrafters New Carnegie Hall Series for northern New Jersey.

Get brilliant,
ghost-free reception
on all channels
of Both bands...

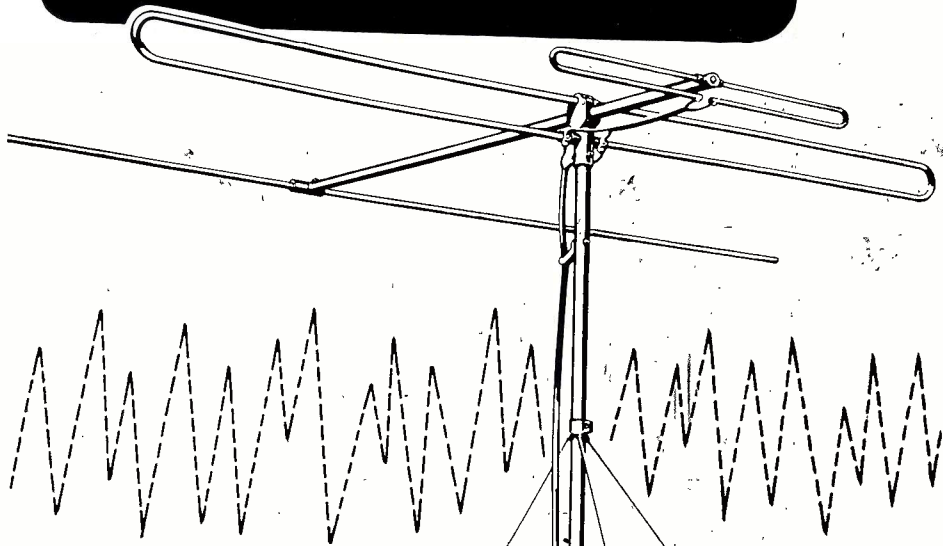

install this new

AMPHENOL

TELEVISION Array

Today, in most communities, a single 54-88 mc folded dipole television antenna is all you need.

Tomorrow, with two television bands in use, an ordinary TV antenna designed for service on either the 54-88 mc, or the 174-216 mc band will not satisfactorily receive the other. So, if you want brilliant reception on all channels, in both bands, and don't want to buy two antennas, this new Amphénol Television Array is the one to buy.

This antenna array is unique. Its two broadband folded dipoles and reflectors have a common transmission line. This permits the large folded dipole to also serve as a reflector for the small folded dipole.

Amazing as it seems, this arrangement produces more gain than a dipole. This is true over the whole high frequency band, and also over most of the low. In areas of low signal strength, this array delivers brighter, clearer pictures. Also, its highly directional pattern virtually eliminates "ghosts."

Antenna elements and supports are of sandblasted aluminum tubing and aluminum alloy castings. The five foot mast is of cadmium plated steel tubing. Designed to withstand high winds and ice loading, the antenna is easily assembled with ordinary tools. No element length adjustment is required.

Swivel mounting plate and guy clamp permit installation on every type roof. Seventy-five feet of low-loss Amphénol 300 ohm, Twin-Lead, which matches the input of most television receivers, is included. A good impedance match is achieved on both bands.

See your jobber, or write direct, for prices and complete technical data.

AMERICAN PHENOLIC CORPORATION

1830 SOUTH 54TH AVENUE, CHICAGO 50, ILLINOIS

COAXIAL CABLES AND CONNECTORS • INDUSTRIAL CONNECTORS, FITTINGS AND CONDUIT •
ANTENNAS • RADIO COMPONENTS • PLASTICS FOR ELECTRONICS

Jensen Names Reps

Jensen Industries, Inc., of Chicago, manufacturers of a complete line of phonograph needles, has announced the appointment of five representatives. Oden Jester, general sales manager of the company, reported that the appointments were effective immediately.

Herbert G. Arcadius, who was formerly associated with Mr. Jester at Meissner Radio, will be the new Mid-West representative with territory including Indiana, Illinois, Michigan and southern Wisconsin.

Robert M. Hardie, former sales manager of Thordarson, was named representative for southern California. A. J. Nelson received the appointment for the Rocky Mountain area.

A. T. R. Armstrong, now operating the Controlite Engineering & Sales, Ltd., of Toronto, will be the new Jensen representative in the Dominion of Canada outside of British Columbia and Alberta.

R. T. Bork was appointed representative for Jensen in the Minneapolis-St. Paul area.

Heads Appliance Sales

William S. Combs, well-known in the appliance merchandising field, has been appointed general sales manager of Cleveland Distributing Co., Cleveland, Ohio, according to George L. Schwartz, vice-president and general manager of the company.

N-U Sales Head

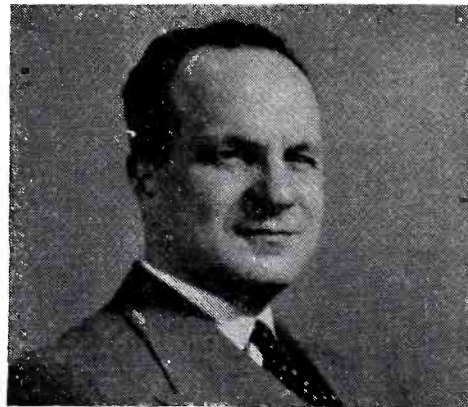

The new vice-president in charge of sales for National Union Radio Corp., Newark, N. J., is George A. Bodem. He comes to N-U from Detroit, where he was vice-president and general manager of the radio division.

Radio Set Production Hits New Monthly High

Latest industry figures from the Radio Manufacturers Association shows that "for the first time in the industry's history more than 2,000,000 radio and television receivers were made by RMA member-companies in one month." The report showed that for the month of October, 1947, the total set production for all sets, including AM-FM and television, was 2,002,303.

FM-AM sets produced in October numbered 151,244 and were well above the production of any other month of 1947. Television receivers manufactured also reached a new high of 23,693 although the September reported figure of 32,719 was higher due to the inclusion of 16,991 sets produced earlier but not reported.

FM-AM sets for the first ten months of 1947 totalled 830,106, while television receivers for the same period numbered 125,081. The television set production in October represented an increase of 110 percent over the average output for the previous nine months.

October FM-AM sets included 49,319 table models, 555 converters and tuners, 656 consoles, and 100,714 radio-phonograph consoles. Television receivers included 13,503 radio table models, 10,181 consoles and radio-phonograph combinations, and 9 converters.

No New Models, Bendix Head Tells N. Y. Jobbers

With demand still exceeding production, current models of the Bendix automatic washer will be continued "for some time," Judson S. Sayre, president of Bendix Home Appliances, Inc., has advised Irving Sarnoff, vice-president of Bruno-New York, Inc., which distributes the machines in Metropolitan New York.

"Due to the continuing great demand for our product, it would be unfair to our dealers and the public to introduce new models in the foreseeable future," Mr. Sayre said.

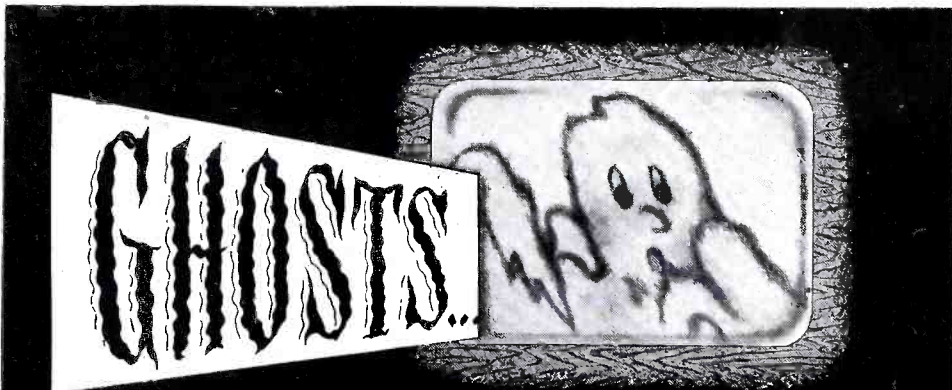

GHOSTS that haunt your television customers can be laid at rest. Workshop antennas, *custombuilt for television*, eliminate ghosts, fading, noise and interference. In many locations the "signal strength" of ordinary "broad-band" antennas is insufficient for sharp detail and contrast.

Workshop TV antennas, because of their inherent high gain and precise impedance matching, provide clear, brilliant reception. Even on adjacent channels their performance is exceptional.

FEATURES

- Three elements for "high-gain" performance.
- Engineered for each channel, but sufficiently broad-band to cover all present channels (should be installed for the weakest channel).
- The "feed point" is completely protected from the weather by a rugged plastic head.
- Elements made of 1/2-inch duralumin tubing.
- Rigid tubular steel mast 7 1/2 feet high. No guy wires necessary. Withstands high winds and ice loading.
- Streamlined design makes clean-cut, attractive installation.

AVAILABLE AT YOUR DEALER

DEALERS...

You know and we know that almost any "AM wire" will bring in TV if it is close to the transmitter. For the suburbs or out-of-town installations a Workshop TV antenna will bring in a much stronger signal. This means increased sales opportunities for you — plus superlative reception that you can sincerely recommend. Your local jobber has Workshop antennas. Get in touch with him or write direct.

THE WORKSHOP ASSOCIATES, INC.

Specialists in High Frequency Antennas
66 Needham Street Newton Highlands 61, Mass.



New Books

Modern Radio Instruments and Testing Methods

Published by the Coyne Electrical and Radio School, Chicago 12, Ill., 350 pages—Price: \$3.50.

Different in several ways from any other book on the subject of test equipment, this work by the staff of the Coyne Electrical & Radio School is thoroughly and completely practical, written by and for the practical radio servicer.

Illustrated with simplified schematics and stripped-down photos of the equipment discussed, the book takes nothing for granted in explaining the use, adjustment and repair of indicating meters and every type of modern test equipment.

Used both for self-study and as a reference, the valuable volume covers the basic methods of measurement, including all pertinent theory, measuring bridges, analyzers and multimeters, electronic voltmeters, signal tracing, signal generators and oscillators, tube testers, cathode ray oscilloscopes and a special chapter on oscilloscope tests and measurements.

RCA Receiving Tube Manual

Published by Commercial Engineering Section, RCA Tube Dept., Harrison, N. J.—price: 35c.

Technical Series RC-15, the new RCA receiving tube manual, is a comprehensive reference book, familiar to servicers, engineers, amateurs and experimenters, covering essential technical tube data from elementary theory to descriptions of the latest receiving-tube applications. The present edition is the first since 1939.

Large portions of the book have been completely revised, and other new sections added on new FM developments, miniature tubes, television, etc. The tube and circuit theory section has been enlarged to 55 pages. The manual will be distributed through RCA tube distributors.

Stromberg FM Pamphlets

As part of its increasing efforts to promote the popularity of FM, Stromberg-Carlson has prepared an attractive counter card holding consumer booklets devoted to a simple explanation of frequency modulation. The pamphlets and display cards have been made available to authorized Stromberg-Carlson dealers for distribution to store customers.

New Solar Catalog

A complete new 1948 catalog showing popular types of capacitors and radio noise filters used in servicing radios and industrial electronic equipment, is now available from authorized Solar distributors, or directly from Solar Capacitor Sales Corp., 1445 Hudson Blvd., North Bergen, N. J.

Rembrandt... FINEST IN TELEVISION-FM CONSOLE RECEIVERS TELEVISION

Remington presents two masterpieces in design, performance and quick sales appeal.

MODEL 80—78 SQ. IN.—DIRECT VIEW—LIST \$695
MODEL 130—128 SQ. IN.—DIRECT VIEW—LIST \$895

REMBRANDT TELEVISION PROTECTS YOUR PROFIT AND GOOD WILL

For integrity of engineering and craftsmanship, Rembrandt large-screen television is second to none. Its high quality is unmarred by things experimental. The basic Rembrandt design is enhanced and fortified in important ways, among which are:

- 1—It incorporates the famous Dumont Inputuner, providing continuous tuning from 44 to 216 megacycles on television, FM, amateur and aviation bands, including all 13 channels.
- 2—It features the Remington Automatic Picture Stabilizer, providing clearer, brighter, steadier reception.
- 3—It has essential, time-proved features licensed by RCA and Hazeltine Research Laboratories.
- 4—Its vital cathode ray tubes are all DUMONT-made.



DISTRIBUTORS and DEALERS — Write at once for full specifications and merchandising plan.

REMINGTON RADIO CORPORATION WHITE PLAINS, N. Y.
Phone White Plains 9-7006

Camco television antennas

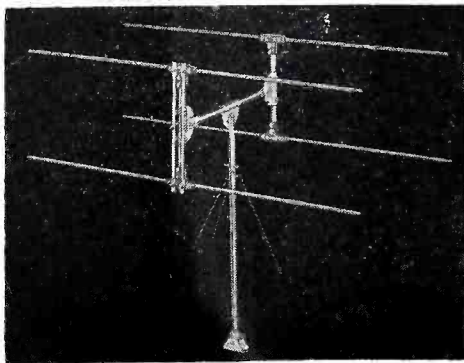

"DOUBLE DECKER" DIPOLES and REFLECTORS

Illustrated is the New Camco Model T35 "Double Decker". Designed for maximum efficiency and the most favorable standing wave ratio over the entire range of television frequencies.

See your jobber or Write Dept. RT for literature on complete line of Camco Television and FM Antennas.

CAMBURN, INC.
32-40 57th ST., WOODSIDE, N. Y.

Rauland

ELECTRONIC SOUND



INTERCOMMUNICATION

The New AMPLICALL, America's finest Business Communication Systems, with exclusive new design and operating features.

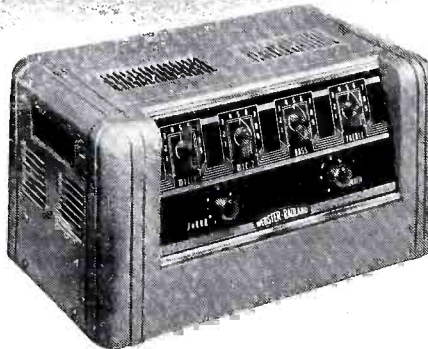

PUBLIC ADDRESS

RAULAND Audio Amplifiers and Complete Sound Systems for every Public Address need. The preferred line in modern Electronic Sound.

the COMPLETE LINE!

RAULAND Electronic Sound is the *complete*, universally-accepted line—the *selling* line that covers *every market* and *every need* in Public Address, Intercommunication and Sound Distribution. RAULAND'S remarkable acceptance in each of these Sound fields is built on a great record of proved performance. The RAULAND name is a guarantee of advanced design, superior tonal fidelity, full output adequacy, maximum flexibility and complete dependability. These are the qualities and selling advantages that build *profitable* business for you on the *complete* line of RAULAND Electronic Sound.

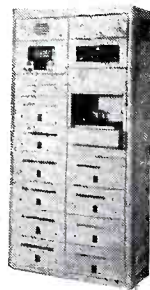

SOUND DISTRIBUTION

RAULAND Centralized Paging and Sound Distribution Systems for every type of industrial and institutional application.

See your RAULAND Distributor for full details on the complete Electronic Sound Line. For your own profit and reputation—get behind RAULAND—the line that sells on its performance, the line that stays sold!

Electroneering is our business

SOUND
TELEVISION

Rauland

INTER-
COMMUNICATION

THE RAULAND CORP. • 4247 N. KNOX AVE. • CHICAGO 41, ILL.

Permoflux SPEAKERS

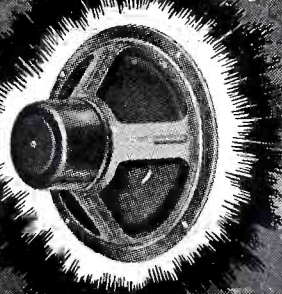

YOUR JOBBER CAN SUPPLY YOU!

Permoflux quality and dependability—the same as supplied to the major set manufacturers—is your assurance of complete customer satisfaction. You'll find Permoflux Speakers easy to install and readily available in both PM and Electrodynamic types. You'll find too, that it pays to give your customers "tops in tone" with a Permoflux Replacement Speaker.

TWO COMPLETE
FACTORIES TO SERVE YOU

PERMOFLUX

WRITE FOR
FREE BULLETIN

PIONEER MANUFACTURERS OF PERMANENT MAGNET DYNAMIC TRANSDUCERS

PERMOFLUX CORPORATION

4900 W. GRAND AVE., CHICAGO 39, ILL.

236 S. VERDUGO RD., GLENDALE 5, CALIF.

New DeWald Tuner

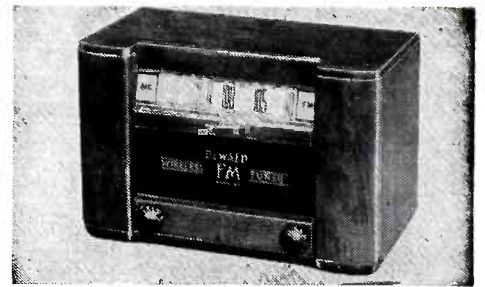

DeWald Radio Mfg. Co., 35-15 37th Ave., Long Island City, N. Y., has announced the new "wireless" FM tuner, retailing at \$34.95. Device has active radiation so that receivers within 10 to 20 feet will pick up and reproduce FM stations. Has 5 tubes plus rectifier, superhet circuit, AC/DC operation.

Astatic Promotes Two

The Astatic Corporation, Conneaut, Ohio, has announced the promotion of J. K. Poff, former service engineer of the company's jobber division, to the office of general sales-service engineer for manufacturer as well as jobber divisions. Mr. Poff, widely known through published technical articles concerning the use of crystal devices, has been associated with The Astatic Corporation since 1945, following his discharge from the U. S. Navy. Coincident with Mr. Poff's advancement announcement was made of the promotion of William Schmid from chief draughtsman to the office of assistant engineer.

Named by Phila. Jobbers

The appointment of James J. Shallow as general sales manager and Jerry Newkirk as television sales supervisor of Philco Distributors, Inc., Philadelphia, is announced by Sol Schiff, general manager of the Philco wholesale distribution organization in the Philadelphia area.

Minerva Head



New president and general manager for Minerva Corp. of America, 238 William St., New York 7, is Joseph P. Thompson, who was formerly general manager for Trav-Ler. The Minerva firm has been purchased by General Phoenix Corp. and is operated as a G-P-C subsidiary. Minerva sets, combos and portables are now in full production.

Silex Sales Manager



J. H. Townsend is the new sales manager for the Silex Co. He has been in merchandising for 24 years and joined Silex in 1944. Also announced by vice-president Charles H. Newman was the promotion of Paul R. Curtis from the sales staff to the post of assistant sales manager.

Utah Names Koenig for Missouri Valley Area

G. L. Koenig of Koenig Sales, Kansas City, Missouri, has been named representative for Utah Radio Products in the Missouri Valley Area. The appointment was announced by Hugo Sundberg, sales manager of Utah's jobber sales division.

According to Mr. Sundberg, the company's recent consolidation has made possible an expansion of the sales force and Mr. Koenig's appointment is in line with Utah's plan for a more concentrated national coverage. The sales organization for Utah's replacement speakers embraces all key areas of the country. The fifteen representatives and their locations are:

J. H. Blinn, Denver; M. C. Branum, Dallas; Art Cerf, Newark; S. S. Egert, New York City; M. K. Franklin, Minneapolis; J. T. Hill, Los Angeles; Lloyd Marsh, Seattle; Robert Milsk, Detroit; C. L. Pugh, Columbus, Ohio; Salescrafters, Inc., Chicago; E. K. Seyd, Andover, Conn.; A. A. Sinai, San Francisco; M. K. Smith, Atlanta; W. Oldenberger, Mexico City; and Mr. Koenig.

Portable Display



New display cards have been released to dealers by Leander Industries, Inc., Richmond Hill, L. I., makers of 3-way portables. Top radio is Model 707 at \$21.95; bottom unit is Model 700, \$26.95.

New Service Dealers for Stewart-Warner Television

Twelve more appointments under the installation and service plan for Stewart-Warner "Videorama" television receivers are announced by N. J. Cooper, service manager of the Radio Division of Stewart-Warner Corporation.

Named as "Authorized Stewart-Warner Television Service Stations" for their respective cities or territories were Highland Radio and Electric, Highland, Ill.; Electronics, Mechanicville, N. Y.; Ben Ruyle Radio Repair, Alton, Ill.; Davidson Radio Service, Belleville, Ill.; Television Installation and Maintenance Company, Detroit, Mich.; Alpha Television and Radio Services, Mount Vernon, N. Y.; Schordine Appliances, Patchogue, L. I., N. Y.; Konig, Inc., Milwaukee, Wis.;

Seidel Electric Shop, Milwaukee, Wis.; Television Installation, Mount Ephraim, N. J.; Precision Radio Company, New Haven, Conn., and Williams Radio Service, Waterbury, Conn.

The plan, which was announced late last spring, calls for appointment of one or more authorized television service stations in each active television transmitting area in the nation. Those appointed are under direct contract with Stewart-Warner but also are subject to supervision by the company's territorial distributor.

Trilmont Lowers Price

Trilmont Products Company, Philadelphia, has informed dealers and distributors that the retail price of the Trilmont Safety Heater has been cut, effective at once, from \$33.00 to \$19.95.

MR. RADIO RETAILER

A MUST for NOISE-FREE STORE DEMONSTRATION . . .

BRACH

PURATONE*

SIGNAL BOOSTER

CARRIES AM, FM and TV ANTENNAS ALL ON THE SAME MAST

Increase your radio sales by bringing home-like reception to any AM, FM and TV set in your showroom . . . eliminating all interference and bothersome noises.

HERE'S HOW: The Puratone Signal Booster System is easily installed on the roof of your building. A shielded coaxial cable runs directly from the mast to the concealed amplifier on the display floor.

From the amplifier a radiating wire is placed inconspicuously around the display space. No direct wire connection to radio sets required. One system serves any number of floor models. Dual wave traps in the video-type AM-FM amplifier bring in all stations at an average tone-level. 30-40 DB gain on FM; 40-60 DB gain on AM. Effective for any radio department layout.

Write for illustrated circular.

L.S. BRACH MFG. CORP.

200 CENTRAL AVE., NEWARK 4, N. J.

*Reg. U. S. Pat. Office

MASCO Leads the Parade of Value with the Only Complete U. L. Approved Line of Quality Sound Equipment



MA-17N

A 17 watt amplifier. 2 mic. and 1 phono input. Bass and treble tone controls. List price, less tubes, \$64.75



MA-35N

A 35 watt amplifier. 3 mic. and 1 phono input. Bass and treble tone controls. List price, less tubes, \$102.50



MA-75N

A 75 watt amplifier. 4 mic. and 1 phono input. Bass and treble tone control. List price, less tubes, \$164.50

These and other items of the new Masco line are illustrated in our new catalog. Write for it.



MC-25PN

A mobile 25 watt amplifier. Self contained phono unit, 3 mic. and 1 phono input. Bass and treble tone controls. List price, less tubes, \$149.50

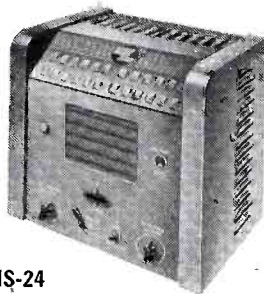

MS-24

A compact and versatile 24-room combined intercommunication and centralized control sound system. List price, \$169.50. Also available for fewer rooms.

West of Rockies add 5% to above list prices.

MASCO

MARK SIMPSON MANUFACTURING CO., Inc.
32-28 49th Street, Long Island City 3, N.Y.

SOUND SYSTEMS and Accessories

RAvenswood 8-5810-1-2-3-4

WANTED!

DEALERS: TO HANDLE NATIONALLY ADVERTISED TELEVISION SETS FOR RENTAL TO BARS, GRILLS & INDUSTRIAL LOCATIONS. NO INVESTMENT — YOU SELL LOCATIONS — WE INSTALL TELEVISION SETS — YOU PROFIT

FOR FURTHER DETAILS, WRITE OR CALL

BELL TELEVISION INC.

11 WEST 42nd ST.
NEW YORK 18, N. Y.
LOngacre 4-8754

Named by Norge



M. C. (Craig) Miller has been appointed manager of sales promotion and sales training for Norge. He has been in home appliances for over 20 years and joins Norge following his recent discharge from the Navy as lieutenant-commander.

JFD Has Ad Assistance Program for Jobbers

The JFD Manufacturing Co., Inc., Brooklyn, N. Y., has instituted an advertising assistance program for radio jobbers. Mats and electros of all JFD products are available for use in preparation of ads, catalogs and mailing pieces. In addition, JFD has prepared 4" x 6" stuffers covering the more popular servicemen's items. These stuffers are available to all jobbers for distribution, without charge. Space has been provided on these stuffers for the jobber to imprint or stamp his own name.

"Wheel" Display



Unusual and eye-catching sales aid is this new display by Stromberg-Carlson, which has a "wheel background" center that revolves and enumerates radio features. Includes also a 12-minute demonstration talk on each of the S-C combos in the 1121, 1210 or 1235 series.

Rider Contest Judges and the Winner



Above, the judges and the winner in the recent John F. Rider manual contest. Mr. Rider signs the checks; at his right is Albert N. Giddis, service manager, Gaumont Bros., radio dealers, Lowell, Mass., winner of the \$500 first prize. Henri Jappe of A. W. Mayer Co., Boston jobbers, also received \$100 prize money as Giddis' jobber. Judges, left to right, John L. Stoutenburgh, executive editor, Radio & Television Retailing; Herman L. Finn, CPA; and Lansford F. King, advertising expert.

Free Book Aids Servicemen Seeking Specialty Work

Servicemen expecting to bid for repairs on two-way radio, police, fire department and other municipal radio services, and airplane, marine or other radio or radar devices using transmitters have to be equipped with an FCC operator's license. To help prepare servicemen to get the necessary license, the Cleveland Institute of Radio Electronics, RR-1 Terminal Tower, Cleveland 13, Ohio, has published a 40-page booklet entitled "How to Pass FCC License Examinations," explaining all that applicants have to know.

Pointing out that radiotelephone operators' licenses do not require a knowledge

of the code, the booklet gives many sample technical questions from the FCC "study guide," full step-by-step instructions, basic excerpts from the laws and regulations, addresses of all local examining offices, and many other invaluable pointers. Servicemen interested in preparing for a license to work on specialty radio equipment should write for their free copy, to the address given above.

Joins Altec Lansing

Melvin C. Sprinkle, formerly manager of radio sales and service of Jordan Piano Co., Washington, D. C., has joined the sales engineer staff of Altec Lansing Corp. in the New York office at 250 W. 57th St., New York 19.

TV Pictures in the Playroom Shown by Bace



Illustrating the use of TV screens in a cellar playroom—this custom-installed unit by Bace Television Corp., Green & Leuning Sts., S. Hackensack, N. J., is one of the multi-viewers hooked to a central control set elsewhere in the house.

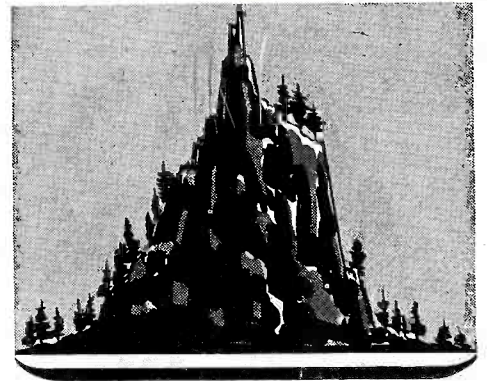
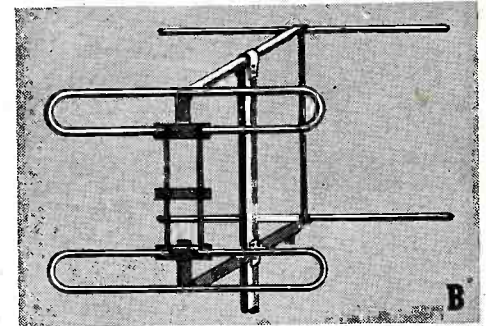
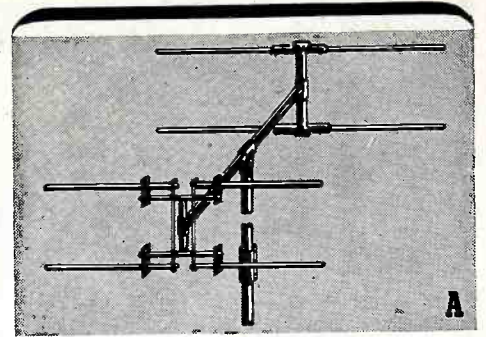

"TOPS"

IN TELEVISION

★What performance! That's what set-owners say about their TACO Television and FM antennas. ★H-type with reflector (A) covers two television bands plus FM bands. Frequency response flat within 3 db. Single H-type adequate within 15-20 miles of typical television transmitter; beyond, with reflector. ★Latest Type stacked folded dipole (B) intended for subnormal signal areas. Stepped-up gain. Highest signal-to-noise ratio. Makes television and FM feasible in otherwise hopeless locations. ★And very important, TACO-antennas are exceptionally rugged.

State your reception requirements. Your jobber will provide the correct TACO antenna — for television, FM, AM or short-wave. Latest catalog on request.

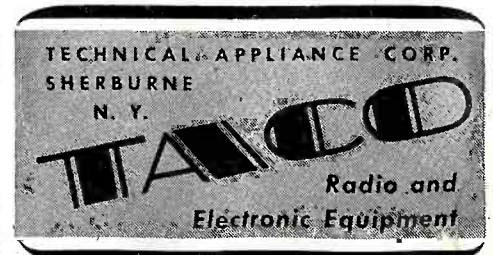

In Canada: STROMBERG-CARLSON, LTD. TORONTO, CANADA

Network Show Starts

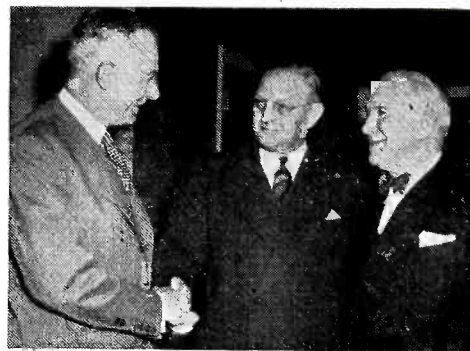

E. A. Nicholas, center, president of Farnsworth receives congratulations from George A. Sloan, left, chairman of the board of directors of the Metropolitan Opera Association, and Edward Johnson, right, general manager of the Met, following completion of plans to resume radio broadcasts of the Metropolitan Opera Auditions of the Air. The Farnsworth-sponsored program is on the ABC network Sundays at 4:30 p.m. (EST).

Du Mont Expands Plant

Still another expansion of the several plants of Allen B. Du Mont Labs., Inc., in Passaic and Clifton, N. J., is announced. The addition is to the Du Mont tube plant in Passaic, for the purpose of tripling the requirements of both Du Mont television receivers and those produced by other manufacturers. The company has adequate facilities for meeting the large demand for the cathode-ray oscillograph tubes.

Stromberg Sales Increase

Sales of Stromberg-Carlson table model radios are five times greater than in the company's last normal postwar year of 1940, it has been revealed by Cliff L. Hunt, manager of radio sales.

The figures were released by Mr. Hunt in a report to employees on the first anniversary of the company's opening of its Erie, Pa., plant for the production of small radios.

TV Sales Plan



F. Wakefield Minor, sales manager, Sightmaster Corp., 220 Fifth Ave., New York, N. Y., is explaining the firm's merchandising plan which "assures protected sales and income to qualified franchise appointees." The Sightmaster TV lines includes 10", 12" and larger table models, consoles, combos, and commercial club units.

THE FINEST NAME IN AMPLIFIED PHONOGRAPHS

Dynavox

AN-ALL-AMERICAN SELECTION! 3-WAY PERSONAL PORTABLE

(AC-DC-Battery)

Here it is—a true champion in smartness and sales-appeal . . . Styled and made by DYNAVOX, the name that has always meant "high quality", this is the ideal radio for Home, Beach, Country, and for Traveling.

BIGGEST VALUE at this price! This is one of our fastest-selling models—has more features, better reception than anything in its price class:—

- 4 Tubes plus Selenium Rectifier
- 4" Alnico V Speaker • Vernier Tuning
- Concealed Dyna-scope Loop • Super Selectivity
- Operates on 110V-AC-or DC-or Batteries
- Simplicity in changing batteries
- Uses 1—67½V "B" and 2—1½V "A" Batteries
- Size: 7¾"x5½"x4½"; wgt. 5¼ lbs. with batteries
- Licensed under R.C.A. and Hazeltine patents

Two-tone color schemes are available in the following combinations: Brown-White; Red-White; Blue-white; Red-Blue.

Write Dept. RTR for further particulars and prices

Dynavox

CORPORATION
40-05 21 ST., LONG ISLAND CITY I, N. Y.

Model 3P-801
List \$26.95 less batteries
Price slightly higher west of the Rockies.

TELECTRO PICTURE TUBE MASKS



BACE
(Industrial application)

*The choice
of
television
manufacturers*

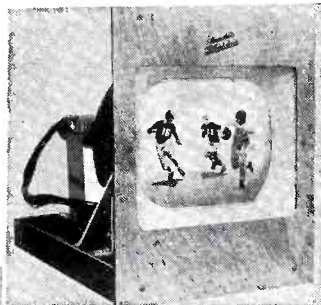

REPUBLIC
(Kit application)

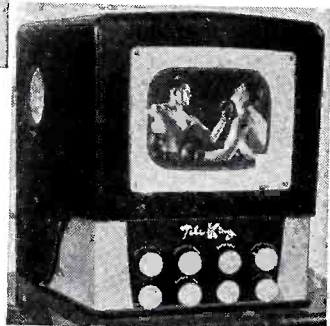

CONSOLIDATED
(Industrial and home set application)

Available in sizes to fit all industry-standard tubes, cabinets and panels, this new TELECTRO plastic mask is preferred for its convenience, safety, simplicity, saving of space and weight. The TELECTRO mask is non-shatterable. The transparent viewing area is outlined by an opaque border which is attached to the cabinet or panel.

TELECTRO furnishes a smooth, optical mask clear across the face of the tube. It thus provides absolute safety and perfect visibility, adequately framing the picture and utilizing the full area of the tube.

TELECTRO COMPONENTS

141 Belleville Avenue
Belleville 9, N. J.

"Good Service for Good Business"



The entire sales organization of P. R. Mallory & Co., Inc., Indianapolis, Ind., got together at the local Athletic Club to hear about the new Mallory "Good Service for Good Business" plan launched by the wholesale division. The plan offers complete materials for aiding service men to develop their business; meetings are now being held by Mallory jobbers for repair men in their areas.

RCA Built-In Television Units Are Announced

Introduction of the first RCA Victor built-in television units, designed to blend harmoniously with the rich decor of board rooms, executive offices, clubs, hotels, restaurants, smart cocktail lounges, or any location where luxurious interiors are featured, has been announced by the consumer custom products department of the RCA Victor Division.

Characterized as "television in good taste," the new custom units are completely built-in and afford an opportunity for unobtrusive installation of television receivers individually decorated to match rich surroundings. Installation of the first such unit, designated "The Clubman," was recently completed in the Television Lounge of the Sherry-Netherland Hotel in New York City. Matching the smart black, gold and green treatment of the lounge, the built-in television unit has a 15 by 20 inch viewing screen (300 square inches of picture area) mounted flush in the wall and framed in gold-leaf. The speaker is also flush with the wall surface

and mounted to form a graceful extension of the screen frame. The frame is hinged and controls of the receiver are located out of sight behind it.

Almost as large as a full-size newspaper page, the screen may be comfortably viewed from all sections of a large room or lounge. A hundred or more can view it in complete comfort.

UST Reduces Prices

Due to engineering developments which have lowered costs, the price of its direct-view home console television-radio-phonograph model has been reduced by United States Television Mfg. Corp., it was announced by Hamilton Hoge, UST president. The list price of the compact model will be \$745, a reduction of \$150.

Recently United States Television reduced prices on all its projection type television sets. The only model in production at that time which was not lowered in price was the direct-view console set. Greater mass production and the absorption of development costs by heavy sales throughout the nation were responsible for the previous price reductions.

Ready to Market a New Table TV Receiver



Officials of Tele-tone Radio Corp. are planning a big sales promotion for the firm's new low-priced television set, to appear soon. Left to right, Ben Rice, N. Y. sales manager; Mike Raymond, executive of Lester Harrison advertising agency; John S. Mills, Tele-tone vice-president; Martin Zatulove, national sales manager; and Ralph Sterling, assistant to Mr. Mills.

TRANSVISION

7" TELEVISION KIT
with COMPLETE FM RADIO

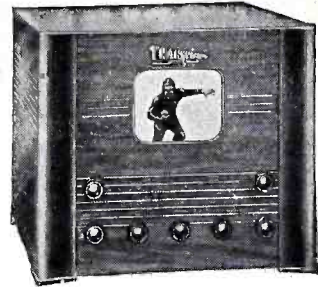

**COVERS
ENTIRE
FMBAND**

(87.5 TO
108.5 MC)

TRANSVISION 7" De Luxe Television Kit with FM Radio Receiver. Easy to assemble; no technical knowledge required. 18 tubes and picture tube. Folded Dipole Antenna and 60 ft. low-loss lead in cable. List \$199.00

7" Standard Television Kit List \$169.00

Table Model Cabinets for above List \$ 32.50

10" CONVERSION KIT with 10" Electrostatic Tube and Directions. Converts any 7" Television Kit to 10" size. List \$ 69.00

Also **10" STANDARD TELEVISION KIT** List \$239.00

Table model cabinet List \$ 35.00

Transvision Picture Blow-Up Lens

Brilliantly enlarges any 7" television picture to equivalent picture of 10" television set.

Has adapter arrangement for Transvision Panels and cabinets. Optically ground and polished to high accuracy. Plastic, gives 50% greater light transmission than equivalent glass lens.

. List \$19.95

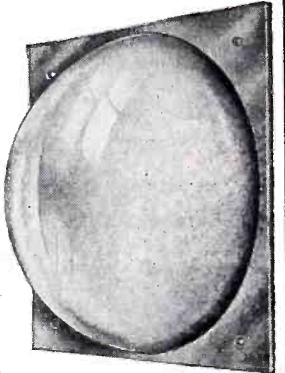

Transvision 8-Tube FM Radio Receiver

Covers entire FM Band (87.5 to 108.5 mc).

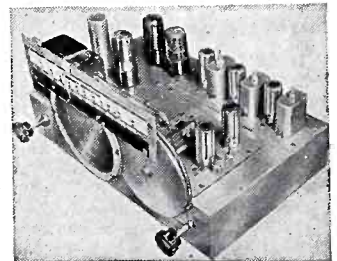

No technical knowledge required for assembly. Makes an FM Radio Receiver worth 2 to 3 times cost of kit. **Model FM-1 8-tube FM Radio Receiver Kit** with 10" Speaker and Tubes. List \$64.95
FM CONVERSION KIT enables you to incorporate a complete FM Radio into your present television receiver. List \$29.95

HIGH-FIDELITY FM TUNERS

Model FMF-2 2-tube Tuner Front End (less tubes) List \$21.65

Model FMF-3 3-tube Tuner Front End (less tubes) List \$30.75

Model FM-107R 3-tube IF Amplifier Kit (less tubes) List \$21.65

Model FM-107 6-tube IF Amplifier Kit (less tubes) List \$41.20

All prices fair traded. All prices 5% higher west of the Mississippi River.

See your local distributor, or for further information write to:

TRANSVISION, INC. DEPT. R.T.R.

385 North Ave.

New Rochelle, N. Y.

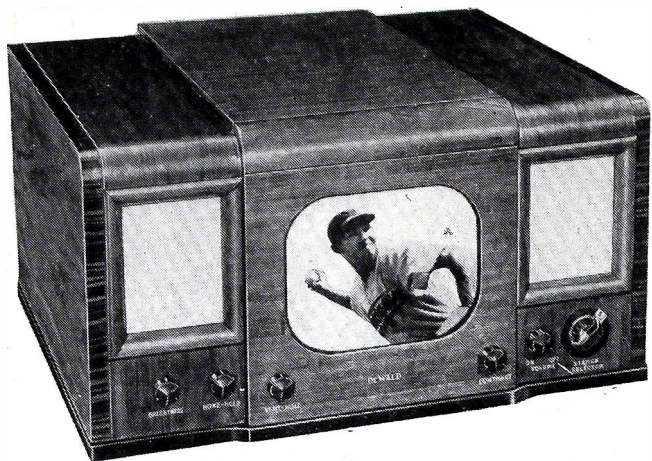

"A famous name in radio since 1921" is proudly placed upon Model B.T. 100 television receiver

TELEVISION . . . in the traditional excellence

- ✓ Tubes—27 plus 3 rectifiers.
- ✓ 13 Channels.
- ✓ 10-inch direct view picture.
- ✓ Simplified Audio-Video adjustment controls.
- ✓ Safety high voltage supply.
- ✓ Excellent signal to noise ratio, assuring excellent tone quality and high degree of picture contrast.
- ✓ Full FM Audio circuit.
- ✓ Balanced antenna input circuit.
- ✓ Housed in a fine hand-rubbed hardwood walnut cabinet in a handsome design.

DEWALD

A superb receiver reflecting DeWald's 26-year record in radio—electronics—television

The quality and value in this new DeWALD Television Receiver is emphasized throughout our complete radio line which starts at \$14.95

JOBBERS—Some choice territories now available.

DeWALD RADIO MFG. CORP., 35-17 37th Ave., LONG ISLAND CITY 1, N. Y.

Stewart-Warner Raises Prices on 3 Consoles

Telegrams announcing an immediate increase in the list price of three console models in the Stewart-Warner line of radios have been received by Stewart-Warner radio distributors throughout the country. The telegrams stated the firm would make no other radio price increases this year.

Models affected by the increase were the period-styled Allegro radio-phonograph combination, increased from \$169.95 to \$174.95; the natural mahogany Interpreter radio-phonograph console, from \$179.95 to \$189.95, and the modern, blonde mahogany Interpreter, from \$184.95 to \$194.95.

"Increased cost of basic materials and production heretofore absorbed by Stewart-Warner now necessitates list price increases on three console models only," the telegram stated.

Garod Names New Sales Representatives

Lou Silver, vice-president of the Garod Electronics Corporation, has announced the appointment of three new district sales representatives for the Garod Radio line.

Albert Levine, with headquarters at 1222 Arkansas Avenue, Pittsburgh 16, Pa., will call on Garod distributors in western Pennsylvania, the state of West Virginia, and the state of Kentucky.

Tom Dwyer will cover the states of North and South Dakota, Minnesota and Wisconsin. His offices are located in the Commerce Building, St. Paul, Minn.

Gamble & Mattes Co., of 322 Godchaux Building, New Orleans 16, La., will have their sales organization call on Garod distributors in the state of Louisiana.

Buy National Union Stock

Acquisition of a substantial stock interest in National Union Radio Corporation, Newark, N. J., by members of a new group including Harry E. Collin, Toledo, Ohio, and Forrester A. Clark, Boston, Mass., who were elected to the board of directors of the company, has been announced by C. Russell Feldmann, board chairman.

Heads Sylvania Division

The appointment of J. Arden Still as manager of the Southwestern division, distributor tube sales, Sylvania Electric Products Inc., has been announced by C. W. Shaw, general sales manager of the radio tube division. Mr. Still succeeds Ray Carson, representative of the Southwestern for the past 11 years, who has resigned division to establish his own business as manufacturers' agent in San Antonio, Texas.

Represents Hoffman Radio

Paul F. Van Dusen, factory representative for the Hoffman Radio Corp., Los Angeles, in the Western state, will now work out of Portland, Ore., at 2725 N. E. Junior St. He will service distributors in Portland, Seattle, Salt Lake City and Denver.

You satisfy every **COMMERCIAL** and **INDUSTRIAL** SOUND NEED with the complete line of

BELL SOUND EQUIPMENT

and at the same time

- Simplify Your Inventory
- Increase Stock Turnover
- Boost Your Profits



Ask your nearby Bell distributor for details

BELL SOUND SYSTEMS, INC.

1186 Essex Avenue
Columbus 3, Ohio

Big New TIME SAVING Profit Makers for TELEVISION SERVICERS

OWN ONE OF THESE: Roger Tele-Pad. Television servicers' instrument for strong signal areas. Tells instantly: (a) if dipole is mismatched to receiver; (b) if tearing pictures are caused by excessive signal; (c) if attenuation pad is needed; and (d) gives circuits and exact resistor values to use. **Model RQ-30.**



SELL HUNDREDS OF THESE: RogerTel-Adjust.



Signal selector and equalizer for 1 to 3 dipoles. Comes with full instructions, ample equalizing resistors, values given by Tele-Pad, above. Stop service call-backs, sloppy profitless constructions. Pencil in local TV call letters. **Model RQ-33.**

See your distributor or write:

Roger TELEVISION, INC.
366 MADISON AVE., NEW YORK 17

New Majestic Wire-Recorder



Speech teachers get interested in features of Majestic's new wire-recorder radio phonograph table Model 7YR753. E. A. Tracey, president of Majestic, looks on as R. B. Meade of Abbott School of Speech, Elgin, Ill., holds microphone for Marge Radoff, Abbott instructor. E. G. Waggoner of Elgin High School, looks on at left, while Ruth Blattspieler peers over Connie Herbert's head—both are Elgin High instructors.

Join Bickford Brothers

Appointments of new personnel to the staff of Bickford Brothers Company, Buffalo, N. Y., RCA Victor and appliance distributors in western New York and northern Pennsylvania, were announced by Paul Wolk, president of the distributing firm.

Joseph J. Tambine, formerly assistant to the vice-president in charge of sales, Gillette Safety Razor Co., and more recently with the Union News Company, has been appointed assistant to Mr. Wolk.

A newcomer to Bickford's record sales staff is John Moore, formerly in the wholesale automobile replacement parts line.

Music Conference Official

The election of George M. Bundy, of New York, manufacturer and a nationally known musician, as a vice-president of the American Music Conference has been announced by Louis G. LaMair, president of the recently formed musical organization.

Television Gets a Play at a Home Show



New TV models of the Remington Radio Corp., 80 Main St., White Plains, N. Y., are shown in their feature display booth at the Westchester Home Show, local exposition which attracted thousands of householders, many of them new home-makers.

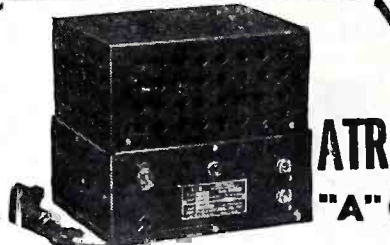

BATTERY ELIMINATORS For DEMONSTRATING and TESTING AUTO RADIOS

New Models . . . Designed for Testing D.C. Electrical Apparatus on Regular A.C. Lines. Equipped with Full-Wave Dry Disc Type Rectifier, Assuring Noiseless, Interference-Free Operation and Extreme Long Life and Reliability.

- Eliminates Storage Batteries and Battery Chargers.
- Operates the Equipment at Maximum Efficiency.
- Fully Automatic and Fool-Proof.
- Type 60-ELIA . . . Rated Output 6.3 Volts at 6.5 Amperes.
Dealer Net Price \$22.80
- Type 120C-ELIO . . . Rated Output 6.3 Volts at 14 Amperes.
Dealer Net Price \$37.20



ATR AUTO RADIO VIBRA- TORS

Designed for Use in Standard Vibrator-Operated Auto Radio Receivers. Built with Precision Construction for Longer Lasting Life. Prices are app. 15% lower.

ATR STANDARD AND HEAVY DUTY INVERTERS



For Inverting D. C. to A. C. Specially Designed for Operating A.C. Radios, Television Sets, Amplifiers, Address Systems, and Radio Test Equipment from D.C. Voltages in Vehicles, Ships, Trains, Planes and in D.C. Districts.

Write for New ATR Catalog—Today!

AMERICAN TELEVISION AND RADIO CO.
Quality Products Since 1931
SAINT PAUL 1, MINNESOTA — U. S. A.

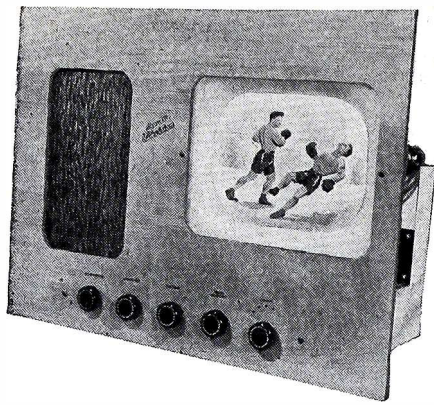

KIT TL-4, ABOVE, 7" TUBE. \$165.00
KIT TL-10, WITH 10" TUBE. . 199.50

KITS

EASY
TO
BUILD

You can profitably sell Republic Television kits because the work is so simple and the results so sure. Clear, bright, steady pictures plus static-free FM sound. No experience, no special tools needed. A Republic kit is a super-kit of high quality components, perfectly designed, prefabricated. Produced by men who have been important factors in television engineering. Shipped in knock-down form. Difficult sections are pre-wired and pre-tuned. Kits are complete, even to antenna. Nothing more to buy. And here's why kits are bought: 1—Television enjoyment at half the cost. 2—Thrill of building your own. 3—Educational value.

SELL Republic TELEVISION

For your customers who now have a 5" or 7" television set and wish to convert it to a 10" set at low cost, Republic Television offers you a thoroughly engineered Conversion Kit with all necessary components and parts and easy-to-follow instructions. Kit includes Sylvania 10" tube, high-voltage booster, optical mask, satin-finish front panel, drilled chassis, hardware, etc. Write today for complete details of Kits and Converters.

BIG - PICTURE CONVERSION

Doubling picture area of 5"-7" sets

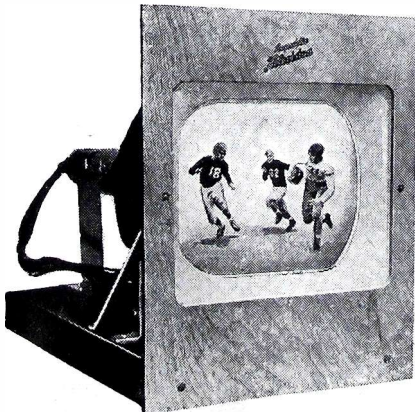

REPUBLIC TELEVISION, INC.
DUMONT NEW JERSEY

Promotions at Emerson

Dorman D. Israel was elected executive-vice-president and Edward J. Kelly vice-president and works manager at the regular board of directors meeting of Emerson Radio and Phonograph Corporation.

Mr. Israel has been with Emerson Radio for twelve years serving as vice-president in charge of engineering and production. Prior to joining Emerson he was chief engineer at the Crosley Radio Corporation. Mr. Kelly came to Emerson Radio last year after serving as vice-president of the North American Phillips Company. He was associated formerly with RCA for twenty-five years.

Stewart-Warner Jobbers

Appointment of seven new distributors of Stewart-Warner radio to augment the existing distributor organization is announced by Floyd D. Masters, sales manager for the Radio Division of Stewart-Warner Corporation.

The distributors are Anderson-Young Electric Co., Lubbock, Texas; Elcon Products Co., Minneapolis, Minn.; A. H. Marshall Co., Inc., Plattsburg, N. Y.; Wilkins Distributing Co., Salt Lake City, Utah; Scott Sales Co., Toledo, Ohio; Graybar Electric Co., Eugene, Oregon, and Looboyle Refining Co., Tulsa, Okla. All companies are exclusive distributors in their cities.

Philco Jobber Expands

Due to increased business, T. A. O'Loughlin & Company, state distributors for Philco radio and television products and other lines, have taken a term lease on the property at 397-399 Broad Street, Newark, with frontage on State Street.

The building leased is a one story, brick showroom and garage type structure consisting of approximately 20,000 square feet. It will be used for the operation and maintenance of television, radio, electronic devices, electrical and mechanical household equipment and for the servicing and distribution of Philco products.

Starlet on a Stage

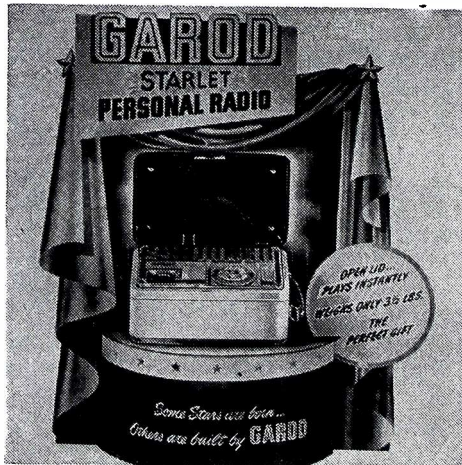

One of the colorful units of Garod's new series of dealer displays is this lithographed stand for the "Starlet" portable. Miniature "stage" design in color gets extra attention for the unit.



FASTER SIGNAL TRACING!

Signalette

MULTI-FREQUENCY GENERATOR

Generates R.F., I.F., and AUDIO Frequencies, 2500 cycles to over 20 megacycles, using new electronic multi-vibrator radar principle. Completely self-contained—fits coat pocket or tool chest. Just plug into A.C. or D.C. LINE AND CHECK RECEIVER SENSITIVITY, AUDIO GAIN, R.F. and I.F. alignment, auto radio aerial peaking or shielding, breaks in wires, stage by stage signal tracing, tube testing by direct comparison, etc., etc. Sturdy construction, handsome appearance! See at your distributor or write for details. Shipping Wt. 13 oz.

PRICE

\$9.95

at distributor
or F.O.B.
Cincinnati

Recognized Jobbers—wire, write
for details of territory open!

CLIPPARD INSTRUMENT
LABORATORY, INC.
Dept. R, 1125 Bank Street
Cincinnati 14, Ohio



Super

TELEVISION HI-VOLTAGE COILS

SUPER Precision Coils like the 10-watt coil shown above, are used in hi-voltage television power supplies to furnish the high voltages needed by all picture tubes. The use of this coil results in a substantial saving in the weight, size and cost of RF power supplies dispensing with old-type high-voltage transformers and eliminating the problems of 60 cycle filtering.

With half-wave rectifier, voltages from 2,000 to 10,000 are obtainable. Coil is suitable for doubling to 20,000 or tripling to 30,000 volts. Can be designed for voltages as high as 90,000.

There are also available complete power supplies utilizing this hi-voltage coil.

SUPER ELECTRIC PRODUCTS CORP.

1057 Summit Ave., Jersey City 7, N. J.

"I'm Sitting Pretty with Leander"

3 Way (AC-DC-Battery) Portables"

Leander is a portable you can recommend with confidence — at a mark-up that allows a worthwhile profit. When you sell Leander, you're free of franchise obligations . . . free to merchandise the way you prefer.

- ★ 4 tubes plus selenium rectifier.
- ★ Operates on 110 volt AC-DC or battery.
- ★ 5" Alnico V speaker.
- ★ Advanced superheterodyne circuit.
- ★ Slide rule dial.
- ★ Handsome leatherette covered cabinet.
- ★ Size 10" x 5" x 6 1/4", Wt 5 1/2 lbs.
- ★ Economical battery replacement (1-67 1/2 v "B", 1-4 1/2 v "A").
- ★ Standard RMA guarantee.

Newspaper mats, copy and layouts on request.



West of Chicago — 22.95 List
 Model 700 — 26.95 List
 (Deluxe case, plastic fittings)
 Prices F.O.B. factory —
 subject to usual discounts



Leander INDUSTRIES Inc.
 Virginia 9-4217
 130-43 91st Avenue • Richmond HM 18, L. I.

BACE CUSTOM TV ASSURE

**TOP
 PERFORMANCE
 TOP
 PROFITS**



REMOTE CONTROL
 operates 6 viewing screen-sound units.

Designed and built by pioneer television engineers. Exclusive advancements give superior performance and easiest servicing! First quality, tested parts and materials. BACE sets are big—showing 120 and 236 sq. in. pictures. Priced lower than all competitive models! Check these exclusive features: 4 simple operating controls. Pre-Set Brilliancy control. AFC Horizontal Hold, Locked-in Vertical Hold. Noise Saturation Circuits. Other features include 13 channel Station Selector. FM Sound-improved Audio system. 4 Megacycle band width on video. Bright, sharp focus.

Write today for details on territory franchises, discounts.

BTC BACE TELEVISION CORP.
 Green & Leuning St., So. Hackensack, N. J.

Television Antennas

FMT-254—Get both TV and FM on this Premax Antenna. Full range between 44 and 216 mc. Compensates for distortion in congested areas. Light weight, strongly constructed; easy to install. Permits proper impedance matching to 300 ohm line.

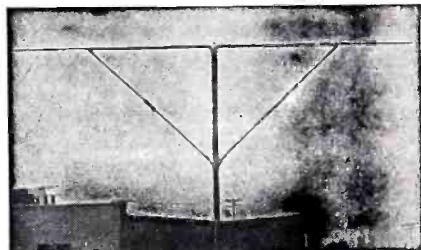

PREMAX FMT-254

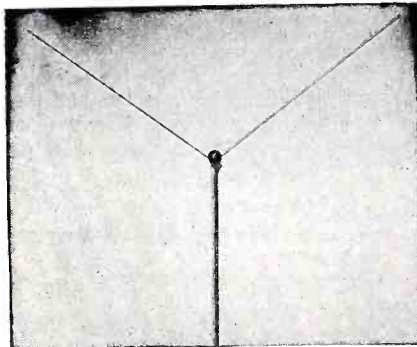

PREMAX FMT-330

FMT-330 — Special dipole type for both TV and FM reception. Simple, light-weight design with pleasing appearance. Each dipole arm adjustable for any angle, insuring maximum response. May be used with 100 to 300 ohm transmission line.

At your radio jobber, or write direct for Catalog.

Premax Products
 DIV. CHISHOLM-RYDER CO., INC.
 4827 Highland, Niagara Falls, N. Y.

30,000 SUCCESSFUL RADIO SERVICE- TECHNICIANS READ



EVERY MONTH

RADIO MAINTENANCE today fills a breach that has existed in the radio field for a long time. Already 30,000 technicians read RADIO MAINTENANCE every month because it is devoted entirely to the radio serviceman.

The RADIO MAINTENANCE staff specializes in the preparation of articles on every phase of Radio Maintenance in series form which may be filed and used for reference. The leading articles cover everything for the radio serviceman on Television, FM and AM; Test Equipment; Electronic Appliances; Tools; Antennas; Alignment; Troubleshooting; Repair; Construction; Pick-Ups and Sound Amplification and Reproduction Equipment. Also, in RADIO MAINTENANCE each month there are departments on hints and kinks, the latest news of the trade, review of trade literature, radiomen's opinions, new products and news from the organizations. All articles are presented in a step-by-step precision style, clearly illustrated with schematics, accurate photographs, specially prepared drawings, white on black charts, color diagrams, isometric projections and exploded views.

Binders in beautiful green simulated leather are now available for your RADIO MAINTENANCE magazines. See the current issue for details.

RADIO MAINTENANCE MAGAZINE RTR
1
460 Bloomfield Avenue,
Montclair 6, N. J.

Please send me RADIO MAINTENANCE for
 2 years, \$5 1 year, \$3
 Payment enclosed Bill me later

Name
 Address
 City—State
 Occupation
 Title
 Employed by

• Independent Serviceman—Dealer Serviceman—Service Manager—Dealer—Distributor—Jobber

BOLAND & BOYCE INC., PUBLISHERS

At Tube Plant



George Weakley (center), parts dept. manager of Braid Electric Co., Nashville, Tenn., is shown as a guest at RCA tube dept. home offices, Harrison, N. J. Hosts showing him the RCA "radio-engineered" batteries are Len Battaglia, left, renewal sales, and A. C. "Cam" Duncan, battery sales manager.

Rheem Display Sign

A decorative lighted dealer identification display sign, 11 x 15 inches has been made available by Rheem Manufacturing Company, 570 Lexington Ave., New York, to its authorized dealers.

Executed in sheet steel and three colors with streamlined curved edge effect this sign is attractively designed for use on counter or in window display. A light behind the lucite Rheem trademark illuminates the message.

The sign comes complete with varnished oak stand, light, electric cord inspected by the Underwriters' Laboratory and with the name of the individual dealer in decal lettering. For this effective dealer merchandising aid the company is charging a nominal price of \$5.25.

Rheem Manufacturing Company is a major producer of water heaters, soft water appliances, home heating equipment and steel shipping containers.

Lindholm Vice-President

A. J. Lindholm, general sales manager for Majestic Radio & Television Corp., Elgin, Ill., was elected a vice-president at the recent board of directors' meeting in New York City, it was announced recently by Parker H. Erickson, vice-president in charge of sales. Mr. Lindholm, well known in the trade for many years and respected for his merchandising ability, has been with Majestic for three years and has had more than 20 years of diversified experience in retail, wholesale and factory sales posts in the radio industry.

GE Promotes Cassatt

Robert E. Cassatt, for the last two years advertising and sales promotion manager of the Specialty Division, General Electric Company, has been appointed assistant advertising and sales promotion manager of the Receiver Division.

In his new position as assistant to Fred A. Parnell, he will be primarily responsible for exploitation of component and universal parts and, at the same time, he will continue to direct the advertising and sales promotion activities of the Specialty Division.

SENSATIONAL SELLER!

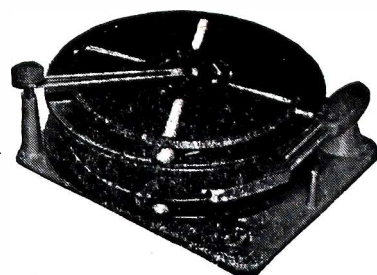

LAKE DELUXE CHANGER

Revolutionizes the Industry!
An Excellent Seller!

11 Outstanding Features:

- Positive Intermix
- Service Adjustments Eliminated
- Minimizes Record Wear
- Single Knob Control
- Plays ALL Records
- Pick-up arm may be grasped at any time and changer will not be thrown out of adjustment
- Resonance-free ball bearing tone arm
- Easily operated—any child can do it
- Completely Jam-proof
- Records Gently Lowered on Spindle—*not* dropped
- Automatic Shut-off on last record

Dimensions: 13 13/16" W x 12 1/4" D x 7 3/8" H.
No. 116A.....YOUR NET

\$28.73

— FREE —

DEALERS and SERVICEMEN: Write for our NEW 16-page 1948 illustrated catalog on radio parts, tubes, accessories, cabinets, sets, electrical appliances, etc. Get on our mailing list today!

Lake Radio Sales Co.
615 W. Randolph Street
Dept. B
Chicago 6, Ill.

SERVICEMEN...
RADIO DEALERS...
AMATEURS

GUARANTEED FRESH STOCK ONLY
Source Of Supply kit

BUY NOW AND SAVE!

600 VOLTS PAPER TUBULAR CONDENSERS

WAX FILLED WITH HIGH MELTING POINT WAX... FLASH TESTED 3 TIMES RATED VOLTAGE... CONDENSER WINDINGS IMPREGNATED UNDER HIGH VACUUM

KIT CONSISTS OF:

- 2—No.-6100-.1
- 2—No.-6050-.05
- 2—No.-6020-.02
- 2—No.-6010-.01
- 2—No.-6005-.005



MAIL CHECKS OR
MONEY ORDERS TO

BAUMAN & BLUZAT
2753 WEST NORTH AVENUE
CHICAGO 47, ILLINOIS

Increase your business now, with the fast selling



Perma-Power

(THE IMPROVED PORTA-POWER)



Convert Battery Radios to all electric operation

Get the extra business from the hundreds of battery radio sets in your area. Perma-Power, the modern battery eliminator, is your answer—

1. when your customer asks how to convert a battery set to all electric operation.
2. when your customer has a battery set available and wants an extra radio in the kitchen, bedroom, playroom or workroom.
3. when you accept a battery set as trade-in, and you need to modernize the set for resale at a profit.



Dealers everywhere are finding these three methods profitable in adding new customers.

See Your Favorite Jobber . . . Today!

Manufactured by
GENERAL TRANSFORMER CORPORATION
4321 N. KNOX AVE. CHICAGO 14, ILL.

Features that assure Customer Satisfaction

- ★ GUARANTEED electrically for 3 years
- ★ YEAR AFTER YEAR trouble-free performance
- ★ SELENIUM RECTIFIERS—no tubes
- ★ UNDERWRITERS LABORATORIES approval
- ★ RADIO PLAYS INSTANTLY—hum-free
- ★ UNIVERSAL PLUGS for all battery radios

EFFECTIVE
on both television bands
and all F-M stations

The **LABORATORY**
ENGINEERED Antenna

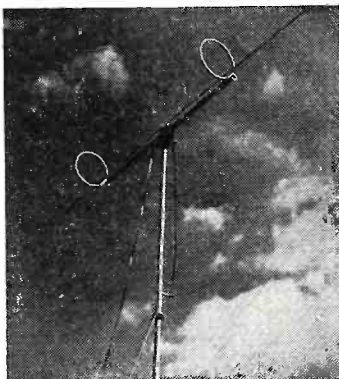

for Television and F-M Receivers

Model 300 ALLWAVE TELEVISION F-M Antenna

Effective on all stations, not just one station . . . no extra attachments to buy to reach all channels or new stations . . . full coverage . . . reduces noise . . . low standing wave ratio . . . easy to install . . . comes complete . . . striking appearance . . . all metal construction. Designed to match all sets with the standard 300-ohm input . . . **ECONOMICALLY PRICED.**

ALSO AVAILABLE—MODEL M-100
"Under-carpet F-M Antenna" . . . low cost . . . ideal reception . . . complete in individual carton . . . ready to install . . . can be hung vertically, behind drapes, etc. Write for illustrated literature and prices.

AVAILABLE AT LEADING JOBBERS

Jobbers: Write for illustrated and technical literature and quantity prices.



TRICRAFT PRODUCTS COMPANY
1535 N. Ashland Ave. Chicago 22, Ill.
DEPT. R
Manufacturing specialists of special antennae

Sightmaster

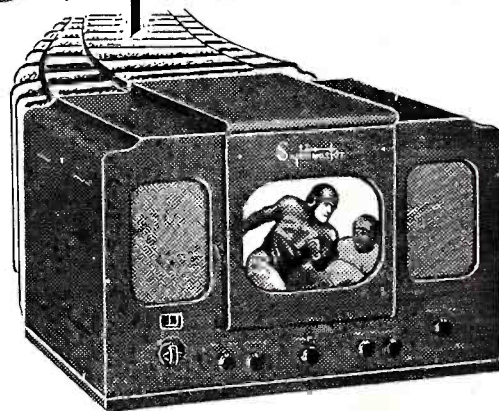

THE FASTEST-SELLING LINE IN TELEVISION . . . a complete line, distinguished in quality, popular-priced!

EXCLUSIVE FRANCHISES

GOING FAST—CALL, WIRE, or PHONE TODAY FOR FULL DETAILS—

SIGHTMASTER CORP.

220 Fifth Ave., New York

MUrray Hill 3-6086

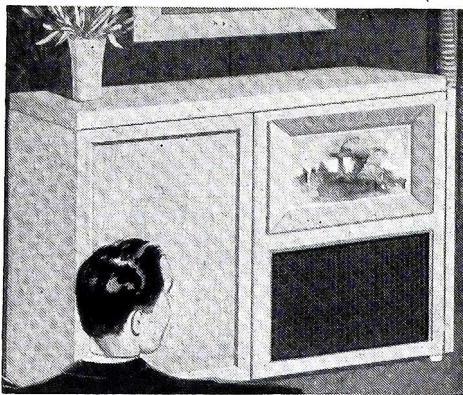

TELEFILTER

The FIRST OPTICAL IMPROVEMENT
IN TELEVISION
SINCE THE MAGNIFYING LENS

SHARPENS CONTRAST—no longer necessary to dim lights or draw blinds. TELEFILTER intensifies the image by blocking out surrounding light from the screen. Result . . . sharper, clearer pictures.

REDUCES GLARE—continued viewing of a television screen is a strain on your eyes. TELEFILTER eliminates this glare by optical filtering.

EASIER ON THE EYES—normal room lighting . . . sensible screen brilliance . . . relaxing light shades contrasted with darker blacks . . . permit hour after hour of comfortable television viewing with TELEFILTER.

TELEFILTER is an optically sound lens that adds pleasure to your enjoyment of television by the application of sound optical principles. A television screen is illuminated by a combination of light from the television picture tube itself, plus the surrounding light of the room. Since bright surrounding light subtracts from picture brilliance, the television screen appears washed out—with both blacks and whites in shades of gray.

TELEFILTER optically filters out this unwanted surrounding light and prevents it from reaching the face of the screen. As a result the light from the picture tube is passed in its full range of shades, with the blacks intensified and the grays toned up. This difference of shade—or contrast—makes the picture sharp and clear under all conditions of room illumination.

Wherever shown, the amazing new TELEFILTER has won the immediate approval of television engineers, broadcasters, eye specialists and television fans in all walks of life.

Distributors—Some choice territories still available. Contact

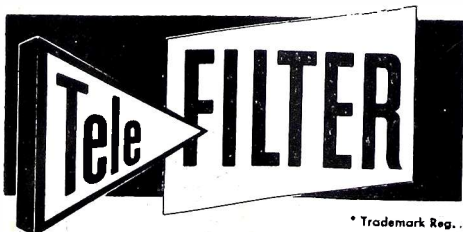

* Trademark Reg.

The HOUSE OF TELEVISION*

475 Fifth Avenue, New York, N. Y.

Kit for Serviciers

A new combination kit of Olson "Akrad" electrolytic condensers known as the "Cap Chest" has been made available to radio repairmen by Olson Radio Warehouse, Inc., 73 E. Mill Street, Akron 8, Ohio. The chest contains a selected assortment of 27 of the most popular 25V, 150V and 450V condensers which servicemen need. These are packed in a walnut finished wood chest with six adjustable compartments. A hinged lid keeps the contents in clean, orderly array, and always ready for use.

Mueller Display Boards

The Mueller Electric Co., Cleveland 14, Ohio, announces new display boards are now available for the radio-electrical and automotive jobbers.

The boards show the complete line of Mueller Clips and may be mounted on a wall or placed on a counter. Identifying code numbers are printed under each item and the clips are detachable from metal pegs on which they are secured.

Two New Aero Reps

W. F. "Bill" Hemminger, president of Aero Needle Company, Chicago, announces the appointment of two new representatives for Aeropoint long-life phonograph needles. The first, W. C. Cartwright, of 4030 Club Drive NE E., Atlanta, Georgia, will serve Aero in the tri-state area which includes Florida, Georgia and South Carolina. Second Hemminger appointee was Everett P. Bean, Box 201, Memphis 4, Tennessee. Bean—who also represents Air King, Stancor, Astatic and Sangamo—now is Aero's "rep" in Tennessee, North Carolina, Virginia and Alabama.

Heads GE Section

Robert D. Partlow has been named sales manager of the General Electric's sunlamp and heater section, it has been announced by D. C. Spooner, Jr., manager of the division. Mr. Partlow joined GE in 1937 as a clerk.

New Listing of Parts

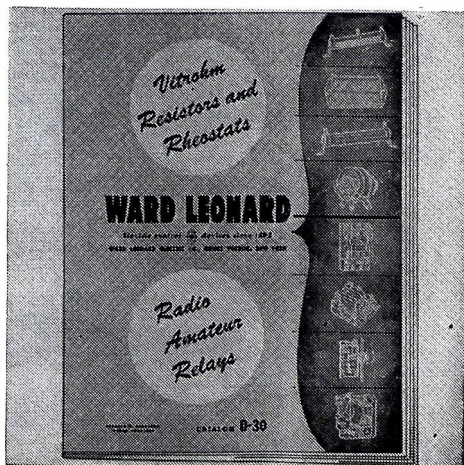

Ward Leonard Electric Co., Mt. Vernon, N. Y., has just published this Catalog D-30 which shows and describes a comprehensive line of stock units in resistors, rheostats and radio amateur relays.

DO YOU HAVE

IHT?

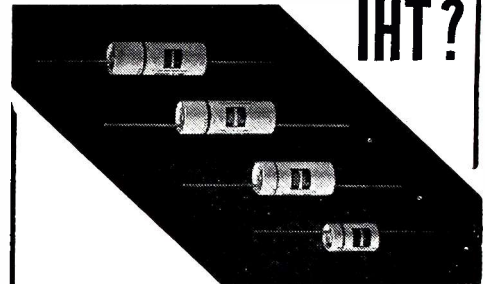

ILLINI-HYCAPS . . .

Type IHT—tubular electrolytics are always ready to fill your need for capacitors of superior quality and ability. A complete line of these tubular electrolytic capacitors are now available.

Included in the list of old standbys are NEW types especially designed for use in voltage doubling circuits. With either tube or selenium rectifiers these units are superior because of their ability to stand up under higher temperatures, handle larger voltage and current surges, last longer because of their new and special engineering design.

NOTE: A new supplement, listing these new condensers, along with other high voltage high capacity types, has been added to our catalogue. Write today for your copy.



ILLINOIS CONDENSER CO.
1616 NORTH THROOP STREET • CHICAGO 22, ILL.

Rig-Fast

ANTENNAS

for the best reception
in TELEVISION and FM

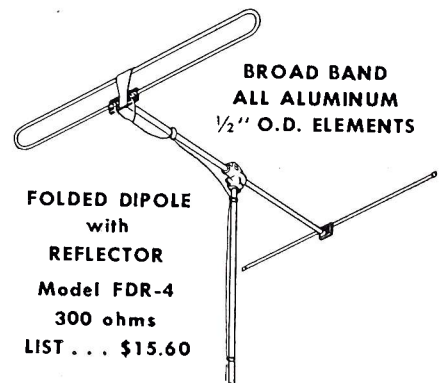

BROAD BAND
ALL ALUMINUM
1/2" O.D. ELEMENTS

FOLDED DIPOLE
with
REFLECTOR
Model FDR-4
300 ohms
LIST . . . \$15.60

"Rig-Fast" quality means greater turnover . . . more profit. New Model 4 line elements are pressure sealed, reinforced at terminal ends. Alignment assured with Key Slot Ring. "Rig-Fast" models interchangeable. Rig complete with accessories. Inquiries invited.

OAK RIDGE ANTENNAS
717 SECOND AVE. • NEW YORK

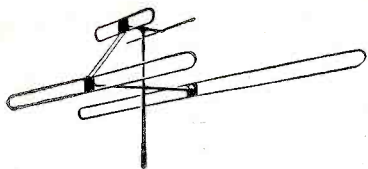

TYPE TFM-301R (with Reflectors) pictured above, has patented circuit features to meet critical conditions in video and audio reception on all 13 television channels and FM on all channels from 88 to 108 megacycles.

Exclusive feature is its uni-directional field pattern. Antenna will not develop 2 or 3 lobes of maximum reception for stations in front of antenna in the higher channels. Has exceptionally flat frequency characteristics.

In reality, consists of two broadband dipoles connected by special frequency selective circuits to a common transmission line. Interaction between sections controlled by inherent harmonic suppression. Can also be supplied without reflectors—Model TFM 201.

Excellent proposition for
DISTRIBUTORS — DEALERS
MANUFACTURERS

For
**STRONGER
CLEARER
TELEVISION
& FM**

Use

THE NEW

**COLLINS
All-channel
ANTENNA**

Maximum response on each channel.

Simple, lightweight, easy to erect.

May be used with 75 to 300 - ohm transmission line.

Licensed — Amy, Aceves & King, Inc. patents, issued and pending.

Collins Machine Co.

56-21 Northern Boulevard, Woodside, N. Y.

**Precision Built for
Precision Work...**

VACO Break-proof,
Shock-proof
Screw and Nut Drivers



Top quality in tools has always been a "must" in radio. Only precision built driver equipment prevents burred screw slot edges... provides sureness in making delicate adjustments... draws metal or wood firmly together. Break-proof, shock-proof Vaco screw and nut drivers are your assurance of the right tool for the job. Write for descriptive catalog, today. Vaco Products Co., 317 E. Ontario Street, Chicago 11, Illinois.

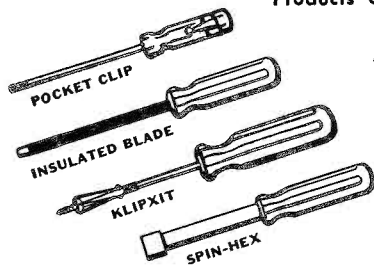

173 TYPES AND SIZES



NEW... Colored Spin-Hex Handle Caps

Developed by Vaco to end confusion of similar sizes, speed up production. Color of cap indicates size of driver.

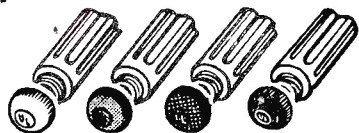

**NEW! WALCO
TELE-VUE-LENS
TELEVISION
IMAGE MAGNIFIER**

- ★ FITS ANY SMALL OR MEDIUM SIZE TELEVISION SCREEN
- ★ INCREASES PICTURE SIZE UP TO 300%
- ★ ABSOLUTELY NO DISTORTION OF PICTURE
- ★ UP TO 45 DEGREE VIEWING ANGLE
- ★ ACTUALLY INCREASES CLARITY AND DETAIL
- ★ INSTALLS IN SECONDS
- ★ NO SKILL REQUIRED TO MOUNT

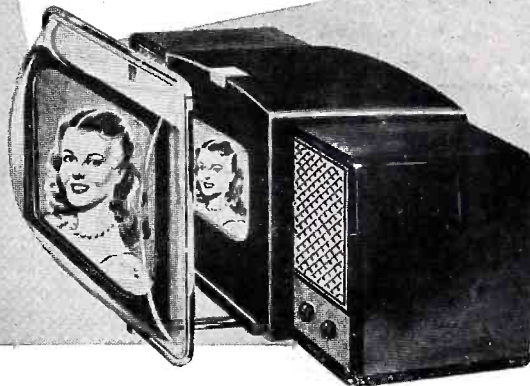

A REAL PROFIT ITEM!

The new WALCO TELE-VUE-LENS is the hottest news in television today. In a matter of seconds any table model receiver can be converted into a GIANT PICTURE SET equal to those costing \$1800.00 or more simply by installing this amazing new WALCO magnifier.

You simply slide the mounting bracket under the set and adjust image to suit the viewer. In a matter of seconds you have a tremendously improved image—bigger, brighter, better, and so much easier on the eyes.

SELLS ON SIGHT!

Taverns, restaurants, clubs as well as home television owners are sold the instant they see this new WALCO product. One quick demonstration sells the WALCO TELE-VUE-LENS image magnifier. Once sold it stays sold. There are no "call-backs" either because the lens requires no service, no tedious adjustment. It's profitable, priced to sell, gives you a lightning fast turn-over.

DEALERS AND SERVICE MEN!

Don't Miss This Opportunity — Write for Complete Details and Descriptive Literature Today

SOLE DISTRIBUTORS U. S. A.

WALCO SALES CORP.

68 FRANKLIN STREET EAST ORANGE, N. J.

The Action Display-Way
To Boost Your Sales . . .

KASSON Roto-Sho ELECTRIC TURNTABLES

A ROTO-SHO revolving display in your window will attract many times more customers than any "still" display . . . and quickly pay for itself in increased business. *Clocking tests prove it!*

The standard ROTO-SHO comes complete with 18" table. It's sturdy, dependable, all steel, and carries up to 200 lbs. AC only. Attractive build-up fixtures available too.

Leading wholesalers country-wide carry ROTO-SHO in stock for immediate delivery, and more merchants than ever before have discovered its profit-making appeal. Why not write us TODAY for our complete new turntable catalog.



URNS
THREE
TIMES
A
MINUTE

GENERAL DIE & STAMPING COMPANY
Dept. TV, 262 Mott St., New York 12, N. Y.

Heads Colonial Radio

The election of Edward E. Lewis as president of Colonial Radio Corporation, Buffalo, N. Y., was announced recently by Don G. Mitchell, president of Sylvania Electric Products Inc., of which Colonial Radio is a wholly owned subsidiary. Mr. Lewis was formerly executive vice-president of Colonial, having been elected to that post on July 1, 1947. He has been associated with Sylvania as an independent industrial consultant since 1945.

Speaker Size Fits Need

A 2½" speaker, designed to fit the need for a unit with full rounded bass response and lying in between present available sizes of 2" and 3½" speakers. has been announced by Perfection Electric Co., 829 South State St., Chicago 5, Ill. Known as series 25, its cone or diaphragm response goes as low as 175 cycles, and it is suggested for portable radios, small house sets, call-systems and other compact apparatus.

Point-of-Sale Aids

Release of a new series of point-of-sale aids featuring its wire recorder are announced by Webster-Chicago Corporation.

These sales aids consist of two attractive, compelling counter and window display cards that demonstrate uses of the Webster-Chicago wire recorder. Also included is a large window streamer urging passers-by to see the wire recorder demonstrated.

New RCA Motor, Turntable

A quick-starting, constant-speed two-pole motor, fan cooled, is used to rim-drive a flock-covered 9" turntable in this 78RPM phonograph motor and turntable unit announced by RCA Tube Department, Harrison, N. J. The turntable shaft uses oil-less bearings.

In the same announcement is featured a new radio-phono switch which is easily

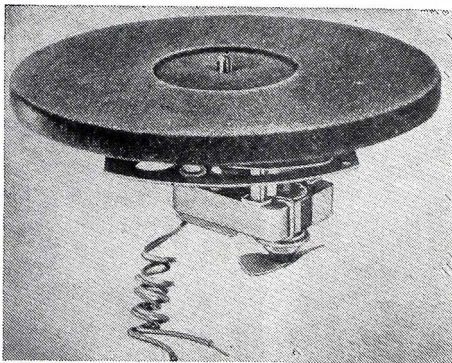

The RCA tube department's new phonograph motor and turntable is recommended by the firm for special installation or replacement work.

installed by means of a plated steel frame, permitting changeover from radio to phono while maintaining and isolating bias and other d-c circuits in the receiver, and without introducing hum or affecting tone quality. Each switch has a 15" length of shielded lead with tip plug and jack.

S/C LABS TELEVISION ANTENNA

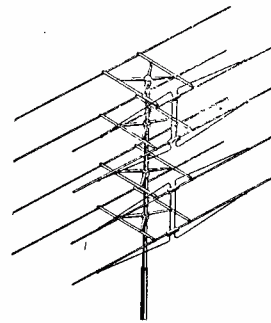

High-Gain
Broad-Band
★
Type 704-2A
Television
★
For Multiple
Stacking

More signal guaranteed. A mechanical perfection. Will outlast and out-perform any antenna. Save yourself those extra service calls due to faulty antenna design. Endorsed and used by leading service organizations where other makes fail. Designed for multiple stacking. All aluminum construction. Easily installed and priced in competition to any antenna of its type.

Immediate Shipment. Send for Particulars

S/C LABORATORIES, INC.

37 GEORGE ST., NEWARK 5, N. J.

CANADA: Frank's Agencies
1708 6th Ave., N. W., Calgary, Alberta

EXPORT: The Radelma Co.
53 Park Place, New York 7, N. Y., U.S.A.

COMBINATION Model "DYNOPTIMUM" 802-N TUBE and SET TESTER

An efficient
low-priced
instrument
for
greater
profits

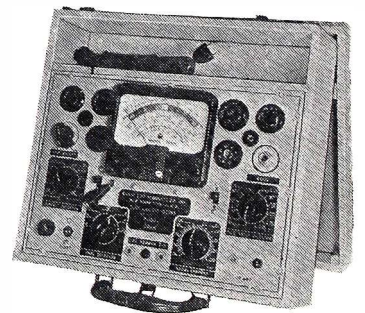

Only
\$59.50

Multiply your productive service time with this completely modern, accurate tube and multi-tester. It provides maximum test operations with minimum switch settings—speeds your service checks for field and counter work. Order from your local jobber. Write for catalog.

Check these features:

- Simple to operate as a tube tester or set tester—combining accuracy and speed.
 - Usual AC voltage errors due to frequency and temperature virtually eliminated with germanium crystal rectifier.
 - Tests paper, mica and electrolytic condensers for leakage.
 - Resistance measurements through a 200 million to 1 range.
 - Famous Dynoptimum circuit for tube testing—giving accurate speedy tests for quality—short—leakage and noise.
 - Set tester includes AC-DC voltmeter—output meter—decibel meter—ammeter—milliammeter—ohmmeter—all multirange.
- R.C.P. INSTRUMENTS—BEST FOR EVERY TEST

RADIO CITY PRODUCTS CO., INC.

152 West 25th Street, R.P. New York 1, N. Y.



Serving the
RADIO TRADE
since 1929

BATTERY PLUGS

Complete line, sold individually and in handy kits. BP100MC 100 asstd. . . . Net \$7.33



DIAL BELT KITS

3-ply woven fabric belts, in kits of 25, 50 and 100. B25A Kit of 25. List \$6.70



"Handyspool" DIAL DRIVE CORD Servicemen's Bench Rack

No. 5R100 — 5 Metal Spools of assorted dial cord and cable, each 100-ft. in moisture-proof dispenser type plastic container. . . List \$19.66



DIAL POINTERS

All types, sold individually and in handy kit. No. 8-10 10 asstd. pointers. List \$2.90

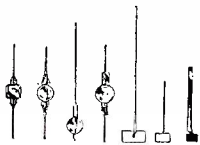

Buy these essential JFD parts from your Nearest Parts Jobber



Write for COMPLETE JFD CATALOG today!

MANUFACTURING CO. Inc.
4111 Fort Hamilton Parkway
Brooklyn 19, New York, U.S.A.

Telectro PRESENTS
The **Tavern-Tel**

DUMONT TUNER
COVERS ALL TELEVI-
SION & FM STATIONS
TWO SPEAKERS

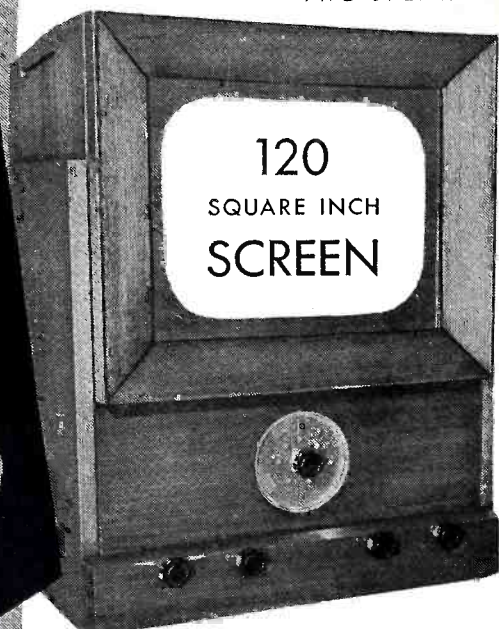

120
SQUARE INCH
SCREEN

TELEVISION CONSOLE MODELS AVAILABLE
DEALERS & DISTRIBUTORS WANTED

FOR FURTHER INFORMATION CONTACT

TELECTRO CORPORATION, 385 FLATBUSH AVE., BROOKLYN, N. Y.

Electro
ELECTRICAL AND RADIO EQUIPMENT

**BATTERY
ELIMINATORS**

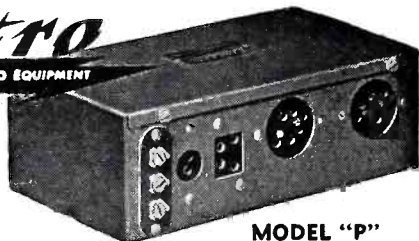

MODEL "P"

A Complete Line for Every Requirement!

Models to convert dry battery radios to efficient AC receivers. Other models to convert dry battery radio for use only with 6 volt storage battery.

Cost but a few cents per hundred hours of operation. Completely filtered—hum free—silent and efficient. Sturdily constructed—no liquids or moving parts—operate in any position.

MODEL "Q"—Operates any 1.4 volt 4, 5 or 6 tube radio from 6 volt storage or dry battery, or Wincharger. Ideal for farms, camps, autos, boats, etc.

MODEL "R"—Operates 2 volt 4, 5, 6 or 7 tube radio from 6 volt storage or dry battery, or Wincharger. (0.5 Amp. filament max.)

MODEL "P"—Operates any 1.4 volt 4, 5 or 6 tube radio from 110 volt 60 cy. source. Cuts down current use and saves batteries for portable use.

MODEL "F"—Operates any 2 volt 4, 5, 6 or 7 tube radio from 110 volt, 60 cy. source. (0.5 Amp. filament max.)

Canadian representative, **ATLAS RADIO CORP.**, Toronto, Canada

ELECTRO PRODUCTS LABORATORIES

Pioneer Manufacturers of Battery Eliminators
549 WEST RANDOLPH STREET CHICAGO 6, ILL.

**Trylon has the answers to
F-M and TELEVISION
TOWER PROBLEMS**



Complete towers at one price — no extras.

Made of hot-dipped galvanized steel under rigid Army-Navy specifications.

Copper bearing steel.

Prefabricated guys.

"Palnut" locknuts for every bolt.

Designed for 100 m.p.h. winds.

Easy-to-climb ladder on one face.

Six standard towers for heights from 10 to 400 feet.

The way to sell more F-M and Television is to assure first class reception—and that's where Trylon Steel Ladder Towers come into the picture in a big way. They're inexpensive, easy to install, available in six standard types and adaptable to either rooftop or earth surface mounting. Sell one of them with every job. Garbled, fringe area stations will be received with amazing clarity, customers will be more than pleased—and your own profits and prestige in this fast-growing field will be enhanced accordingly.

Write for Trylon Tower Circulars

Trylon Tower Division, Wind Turbine Co., West Chester, Pa.

DEALERS WANTED. Write for details of Trylon Tower dealership in your community. Get in on the "ground floor" of a profitable, fast-growing phase of the business!

TRYLON TOWERS

Guyed Towers — F-M and Television Antenna Supports —
Amateur Radio Towers of All Types, etc.

TELEVISION

DIRECT VIEW—LARGE SCREEN

← 15-INCH

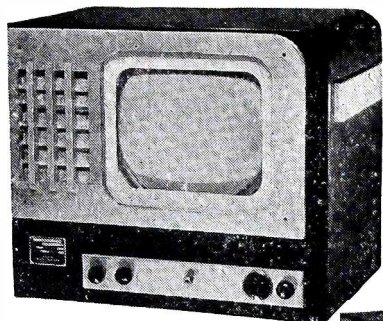

"COMMERCIAL JUNIOR"

130 Sq. Inches
List* . . . \$860

Brightest, clearest pictures—All 13 channels—Very compact—Designed for rugged service.

15-INCH →
RCA
CONVERSION

List* . . . \$595

Complete set—not a kit—Ready to install in home or industrial location—The poor man's large-screen set.

*Price installed in N. Y. metropolitan area.

Also — 20-inch, 240 square inches, LIST* . . . \$1,185.

Remember

- 1—We developed automobile television.
- 2—We developed bank television (Now in operation, New Franklin Sq. National Bank).
- 3—We are strictly a television centre.

JAMAICA TELEVISION CO.

— 148-18 Jamaica Avenue, Jamaica, New York —

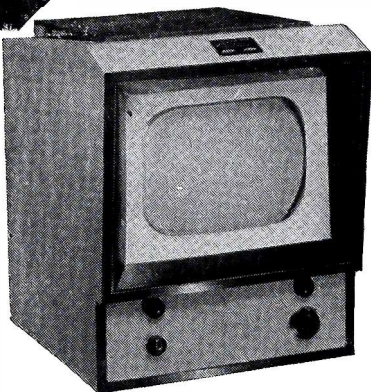

NEW HAVEN QUILT & PAD CO.'S PADDED COVERS ELIMINATE DAMAGE CLAIMS

Completely covers all standard floor models. Waterproof canvas outside, mole-skin lined. Send for catalog of all appliance covers.

RADIO COVERS

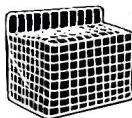
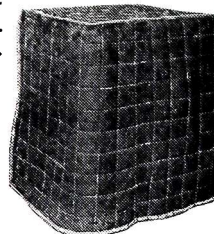

One-Piece Padded Range and Stove Covers

NEW HAVEN QUILT & PAD CO.
86-88 Franklin St., New Haven 11, Conn.

GREYLOCK

A Dependable Name in
RADIO TUBES

GT, Glass, and Miniature Types.

12SA7, 12SK7, 12SQ7, 50L6, 12AT6, 12BA6, 12BE6,
35W4, 50B5 each 39c
1R5, 1S5, 1T4, 3S4, 3Q4, 6AK5, 6AC5, 6AC7, 6AQ5,
6BE6, 6BA6, 6AU6, 6BJ6, 6X4 each 49c
32L7, 70L7, 117L7 each 59c

All Tubes Carry RMA 90-Day Guarantee

PM SPEAKERS

4" Alnico No. 5 each \$1.19
5" Alnico No. 5 each 1.29

TERMS: Net C.O.D. No order accepted for less than \$5.00
WRITE FOR BARGAIN CATALOG R-1

GREYLOCK ELECTRONIC SUPPLY CO.

30 Church Street New York 7, N. Y.

SALES MANAGER

One of the South's leading Radio and Appliance Distributors has an opening for high type Sales Manager. Prefer man with experience in Radio and Major Appliance wholesaling. Opportunities unlimited for the right man. Give experience and references. Box 101, Radio & Television Retailing, 480 Lexington Ave., New York 17, N. Y.

PHILSON F-M and TELEVISION ANTENNAS

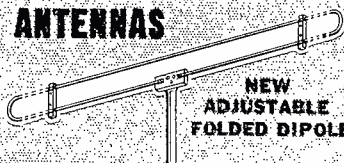

Adjustable from 88" to 100". 4 Ft. Upright. All Aluminum Construction, with Lucite Insulation. MODEL FP-150 List Price 13.50

Because F-M and Television operate on very high frequencies, it is necessary to make extremely exacting adjustments for maximum results in reception. This "trombone type" Dipole enables you to make critical antenna adjustments in a matter of seconds, to get the perfect antenna length for a particular location. Another advantage of the Adjustable Folded Dipole is that adjustments can be made to changes in frequency as more channels are added.

A complete line of F-M and Television antennas with or without reflectors. Write for catalog.

PHILSON MANUFACTURING CO. Inc.

156 CHAMBERS STREET NEW YORK 7, N. Y.

TEST INSTRUMENTS

at NEW LOW
REDUCED PRICES!
BUY NOW and SAVE!!

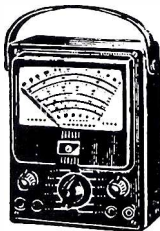

Model 260

BRAND NEW!
McMurdo-Silver
909 FM/TV
Signal Generator
2-226 Mc.
ONLY \$49.50!

- SIMPSON 230. Volt-Ohm-Milliammeter. Formerly \$24.75. REDUCED to \$19.45
- SIMPSON 240. The famed "Hammer". Formerly \$26.50. REDUCED to \$21.31
- SIMPSON 260. New Model! 20,000 ohms per volt. Top value! Net price \$38.17
- SIMPSON 260-RT. With new roll front cover. Outstanding! Net price \$42.87

Other Simpson models in stock.

SPECIAL REDUCTION!

TRIPLETT model 2432 Signal Generator. Turret type coils. 75 Kc.—50 Mc. Regularly \$88.50. SLASHED TO \$65.00

Send 25% Deposit With C.O.D. Orders



Model 240

FREE!!
Neon voltage tester
with each order.
Reg. 50c Value.

—SCENIC RADIO

& ELECTRONICS COMPANY
53 Park Pl. • Dept. T • New York 7, N. Y.

CLOSING DATES FOR

RADIO Television RETAILING

- 5th** of preceding month for all ads requiring proofs, composition, foundry work, key changes, etc.
- 10th** of preceding month for complete plates only—no setting.

1st of month—Publication Date.

Cancellations not accepted after 5th of preceding month.

CALDWELL-CLEMENTS, INC.

480 LEXINGTON AVENUE, NEW YORK 17

INDEX To Advertisers

JANUARY, 1948

Admiral Corp.	31	New Haven Quilt & Pad Co.	130
American Phenolic Corp.	111	Noblitt-Sparks Industries, Inc.	73
American Television & Radio Co.	121	Norge Div., Borg-Warner Corp.	88
Andrea Radio Corp.	10		
Bace Television Corp.	123	Oak Ridge Antenna Co.	126
Bauman & Bluzat	124	Peerless Album Co.	85
Bell Sound Systems, Inc.	120	Permoflux Corp.	114
Bell Television, Inc.	116	Philco Corp.	5
Bendix Radio Div., Bendix Aviation Corp.	65	Philson Mfg. Co., Inc.	130
Boland & Boyce, Inc.	124	Premax Products Div., Chishalm-Ryder Co., Inc.	123
Brach Mfg. Corp., L. S.	115	Presto Recording Corp.	76
Burgess Battery Co.	131		
		Radio City Products Co., Inc.	128
Caldwell-Clements, Inc.	85, 105	Radio Corp. of America: RCA Victor Div.	Insert
Camburn, Inc.	113	Tube Department	37, Cover 4
Chicago Tribune	70, 71	Rauland Corp.	114
Cleervue Television Corp.	61	Remington Radio Corp.	113
Clippard Instrument Laboratory, Inc.	122	Republic Television, Inc.	122
Collier's	82, 83	Rider Publisher, Inc., John F.	103
Collins Machine Co.	127	Roger Television, Inc.	120
Columbia Records, Inc.	81		
Consolidated Television Corp.	40	S/C Laboratories, Inc.	128
Crosley Div., Avco Mfg. Corp.	48	Scenic Radio & Electronics Co.	130
		Seeburg Corp., J. P.	Cover 3
DeWald Radio Mfg. Corp.	120	Sightmaster Corp.	125
DuMont Laboratories, Inc., Allen B. 27, 28, 29, 30		Simpson Electric Co.	8
Duotone Co.	86	Simpson Mfg. Co., Inc., Mark	116
Dynavox Corp.	118	SNC Mfg. Co., Inc.	98
		Sonora Radio & Television Corp.	68, 69
Electro Products Laboratories	129	Sparks-Withington Co.	26
Empire Appliance Co.	86	Sports-View Television, Inc.	109
Espey Mfg. Co., Inc.	110	Sprague Products Co.	101
		Standard Register Co.	95
Fada Radio & Electric Co., Inc.	32	Stewart-Warner Corp.	67
Farnsworth Television & Radio Corp.	Insert	Stromberg-Carlson Co.	12, 13
		Super Electric Products Corp.	122
Garod Radio Corp.	9		
General Die & Stamping Co.	128	Technical Appliance Corp.	117
General Electric Co.	7, 11, 42, 43	Telectro Components	118
General Transformer Corp.	125	Telectro Corp.	129
Graybar Electric Co.	96	Tele-Tane Radio Co.	14, 15
Greylock Electronic Supply Co.	130	Templetone Radio Mfg. Corp.	38
		Transvision, Inc.	119
Hollicrafters Co.	62, 63	Tricraft Products Co.	125
House of Television	126	Turner Co.	107
Hytron Radio & Electronics Corp.	41	U. S. Television Mfg. Corp.	39
Illinois Condenser Co.	126	Vaco Products Co.	127
		Walco Sales Corp.	127
Jamaica Television Co.	130	Warwick Mfg. Corp.	25
Jensen Mfg. Co.	6	Westinghouse Electric Corp.	2, 3, 44
JFD Mfg. Co., Inc.	128	Wilcox-Gay Co.	74
		Wind Turbine Co.	129
Lake Radio Sales Co.	124	Workshop Associates, Inc.	112
Leander Industries, Inc.	123		
		Zenith Radio Corp.	132
MaHory & Co., Inc., P. R.	Cover 2		
Merit Coil & Transformer Corp.	4		
Motorola, Inc.	16		

While every precaution is taken to insure accuracy, we cannot guarantee against the possibility of an occasional change or omission in the preparation of this index.

HOW BURGESS BUILDS BATTERY SALES FOR YOU!

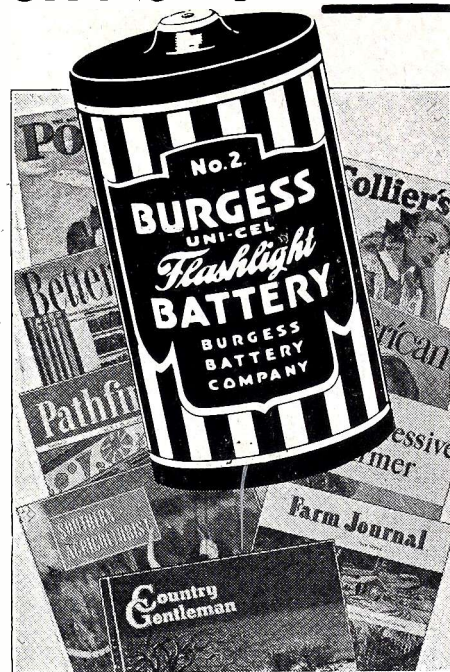

Famous National Magazines
Sell **BURGESS** to
40 MILLION BATTERY
BUYERS!



**BURGESS
GIVES YOU FREE
WINDOW
STREAMERS
ADVERTISING
MATS
COUNTER and
WINDOW
DISPLAY
MATERIAL
ENCLOSURES
DISPLAY
PACKAGING**
Ask Your Burgess Distribu-
tor for This FREE Help

BURGESS
BATTERY COMPANY
FREEPORT, ILLINOIS



Push RCA Tubes and Watch Your Business Grow!



Sell more service . . . sell more RCA tubes . . . by displaying this dramatic 8-color, 22" x 28" girl poster.

In miniatures . . . it's RCA!

THE TREND IS TO MORE MINIATURES . . . in midget and auto sets . . . FM and TV receivers . . . commercial and industrial equipment.

Whether miniature, or metal, or glass . . . RCA provides you with the greatest line of tubes to sell . . . and the outstanding line of sales promotion displays to help you sell them.

When you push RCA tubes you're selling the brand

that holds No. 1 customer acceptance. RCA tubes help your business grow because they build store traffic . . . lead customers to count on you for *all* their radio needs.

So . . . *Push RCA Tubes and watch your business grow!* For full details on sales promotion displays, see your local RCA Tube Distributor today.

THE FOUNTAINHEAD OF MODERN TUBE DEVELOPMENT IS RCA



TUBE DEPARTMENT

RADIO CORPORATION of AMERICA

HARRISON, N. J.