

1947 AUGUST

RADIO
& Television
RETAILING

CALDWELL-CLEMENTS, INC.

RADIO·FM

APPLIANCES

RECORDS

SERVICE

Inside and out...



The Story of
MALLORY
VIBRATORS
is a story of
PREMIUM QUALITY

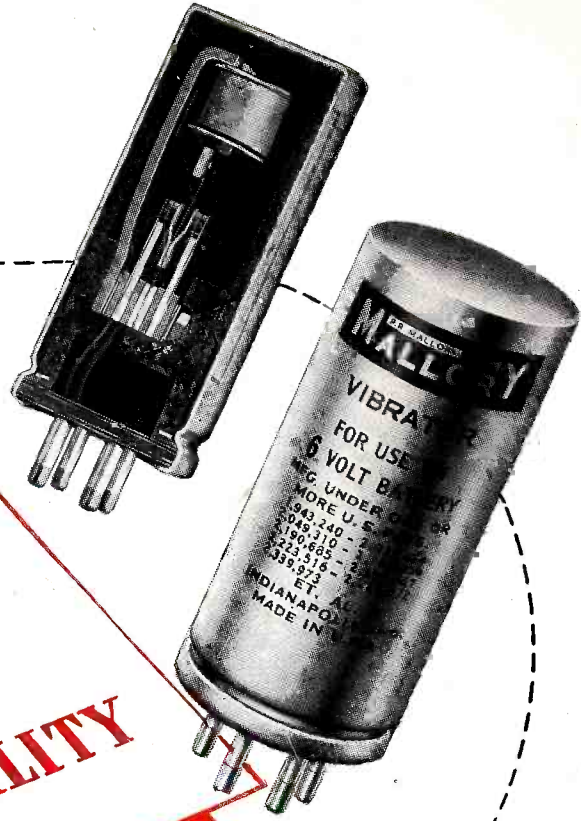

THE Mallory vibrator is a collection of wire, steel, contacts, insulation, rubber and other materials — so assembled that it adds up to the finest product of its kind in the world. Clever engineering and precision manufacture tell the story in part. But it's **PREMIUM QUALITY** that adds the final touch.

For instance, the specifications covering all materials that go into Mallory vibrators are the most rigid that can be met by modern manufacturers. In addition, the materials are carefully matched item by item according to tolerance, so that each component "balances"

the other exactly. All Mallory vibrators are "selectively assembled" to give you dependable performance.

Extra heavy cans that deaden sound — high-grade clock spring steel that eliminates reed breakage — 105-strand wire that defies vibration — special Mallory contacts that make for longer life — yes, Mallory vibrators include them all. But it's because every part is exactly matched that you get a true "Approved Precision Product." Mallory distributors are conveniently located and able to help you on *all* your vibrator problems.

See Your Mallory Distributor for a free copy of the 1947 Replacement Vibrator Guide

P. R. MALLORY & CO. Inc.
MALLORY
VIBRATORS . . . VIBRAPACKS* . . . CAPACITORS . . . VOLUME CONTROLS . . . SWITCHES . . . RESISTORS . . . FILTERS . . . RECTIFIERS . . . POWER SUPPLIES.
*Reg. U. S. Pat. Off.
APPROVED PRECISION PRODUCTS
P. R. MALLORY & CO., Inc., INDIANAPOLIS 6, INDIANA

Established in 1922 as ELECTRICAL RETAILING

RADIO & Television RETAILING

Including RADIO & Television TODAY

ORESTES H. CALDWELL

Editorial Director

M. CLEMENTS

Publisher

JOHN L. STOUTENBURGH

Executive Editor

DARRELL BARTEE

Managing Editor

HAROLD R. ELLIS

Technical Editor

RUTH MORRIS

Records Editor

M. R. LABATT-SIMON

Assistant Editor

CHARLES F. DREYER

Art Director

BUSINESS DEPARTMENT

LEE ROBINSON

Sales Manager

M. H. NEWTON

Business Manager

EDWIN WEISL, JR.

R. A. WHITE

BETTY HALL

Production

CIRCULATION DEPARTMENT

B. V. SPINETTA

Circulation Director

W. W. SWIGERT

Credit Manager

BRANCH OFFICES

CHICAGO 6

R. Y. FITZPATRICK, Manager

S. GASKINS

201 N. Wells St. RAN. 9225

LOS ANGELES 5

THE ROBERT W. WALKER CO.

684 S. Lafayette Park Pl.

Drexel 4388

SAN FRANCISCO 4

68 Post St. SUtter 5568

RADIO & Television RETAILING

August 1947, Vol. 46, No. 2. 25 cents a copy. Published monthly by Caldwell-Clements, Inc. Publication Office 1309 Noble St., Philadelphia 23, Pa. Editorial, Advertising and Executive Offices 480 Lexington Ave., New York 17, N. Y. M. Clements, President; Orestes H. Caldwell, Treasurer. Subscription rates United States and Latin American countries \$1.00 for one year, \$2.00 for three years. Canada \$1.50 for one year, \$3.00 for three years. All other countries \$2.00 for one year, \$4.00 for three years. Printed in U. S. A. Entered as second class matter March 20, 1947, at the Post Office at Philadelphia, Pa., under the act of March 3, 1879. Member of Audit Bureau of Circulations. Copyright by Caldwell-Clements, Inc., 1947.

*Trade-Mark Reg. U. S. Pat. Off.

IN THIS ISSUE

AUGUST, 1947

★ Radio, FM, Television

COVER—The Big Four

EDITORIAL—Corner on Cash 31

WHAT'S AHEAD!—IN RADIO, APPLIANCES, RECORDS, AND TELEVISION 32

DISPLAY MAKES BUSINESS PAY 36

IT PAYS TO KNOW WHERE YOU STAND 38

SALES AND SERVICE WORK TOGETHER 40

MANY COMPETITIVE BRANDS OR A FEW—SURVEY 43

NEW LINES FOR EARLY FALL SALES 44

★ Records, Phonographs, Accessories

RECORD COVER—Platter Profit-Pointers 51

SELL FOREIGN DISCS 53

PLATTERS PAY BIG PROFITS 54

DISC SALES SPURT 58

NEW PHONO LINES 60

NEWS OF THE RECORD INDUSTRY Begins on Page 62

★ Electrical Appliances

APPLIANCE COVER—One Sale to Bring in Others 69

SELL MORE MIDGETS 71

WORKING PAPERS FROM PAPERWORK 72

NEW ELECTRICAL HOME APPLIANCES 74

HANDLING MERCHANDISE 76

LIGHTING SALES TIPS 78

APPLIANCE SERVICE 80

NEWS OF THE INDUSTRY Begins on Page 84

★ Service and Sound

SERVICE COVER—Save Time on New Set Trouble 87

OPEN-AIR CONCERTS NEED PA 89

ALIGNING PERMEABILITY TUNERS FOR RADIO 90

HOW NEW TELE SWEEPS WORK 94

TAVERN PA 96

NEW HELPS FOR BUSY SERVICERS 100

NEWEST SOUND ITEMS FOR PA PROFITS 102

JOBBERS IN ACTION 106

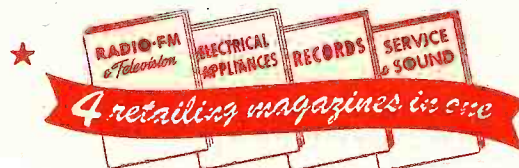

**29,000 COPIES
THIS ISSUE**

Member of
AUDIT BUREAU
OF CIRCULATIONS

CALDWELL-CLEMENTS, INC.

Publication Office 1309 NOBLE ST., PHILADELPHIA 23, PA.
Editorial, Advertising & Executive Offices 480 LEXINGTON AVE. NEW YORK 17, N. Y.



Has Battery Inventory GOT YOU UP A TREE?

Simplify with one complete line—
"EVEREADY" RADIO BATTERIES!

Do you ever feel your radio-battery stock owns you? Plenty of dealers do. Because they're loaded up with "specials"...odd brands...mushroom-growth additions to the radio-battery field!

If you're up that kind of a tree...here's the way down:

Specialize on "Eveready" radio batteries. They fit virtually *all* makes of sets—with *less* inventory and *more* customer confidence. And, size for size, "Eveready" "Mini-Max" batteries will outlast any others!

You can get them NOW—in quantity...you *don't* have to buy any other items! And you can sell them more easily—and more profitably!

*The registered trade-marks
"Eveready" and "Mini-Max"
distinguish products of
National Carbon Company, Inc.*

EVEREADY
TRADE-MARKS
MINI-MAX
RADIO BATTERIES



NATIONAL CARBON COMPANY, INC.
30 East 42nd Street, New York 17, N. Y.
Unit of Union Carbide and Carbon Corporation

UCC

Go to a Radio Manufacturer for Radios—a Battery Manufacturer for Batteries!



MODEL A-400
\$13⁹⁵
 SLIGHTLY HIGHER
 WEST OF ROCKIES

AIR KING *Minstrel...*
 ...designed for selling!

Here is a new, compact quality radio at a price that is sure to stimulate consumer buying today! The Air King Minstrel "has everything"—amazing power—rich tone—quality construction—and a price that will overcome consumer resistance.

FEATURES THAT YOU CAN SELL!

Four tubes (including rectifier) superheterodyne • Automatic volume control • Exclusive Air King Circuit • Alnico V PM Speaker • AC-DC • Size: 7" long x 5½" high x 4½" deep
 Model A-400 Ebony \$13.95. Available in three colors.

Another **AIR KING** spectacular value!

Perfection in plastic cabinet design plus superb tone, extreme sensitivity and precision engineering make the Air King Prince the outstanding radio value of the year—one of the best buys in the entire industry.

CHECK THESE FEATURES:

Precision die-cut antenna • Modern, illuminated airplane type dial
 Five tubes (including rectifier) superheterodyne • Latest Air King circuit design • Alnico V PM Speaker • 2 Gang rubber mounted tuning condenser • Beam power pentode audio system • AC-DC
 Size: 9¼" long x 6" high x 5½" deep • Available in Walnut (model A-511) and Ivory (model A-512; \$21.95).

The Royalty of Radio Since 1920

AIR KING
RADIO

Division of HYTRON RADIO & ELECTRONICS CORP.



IN WALNUT
\$19⁹⁵
 SLIGHTLY HIGHER
 WEST OF ROCKIES

★ We Have a Limited Number of Distributor and Dealer Territories Open ★

Write or wire (New Address): Air King Products Co., Inc., 170 53rd Street, Brooklyn 32, N. Y. • Export Address: Air King International, 75 West Street, New York 6, N. Y.

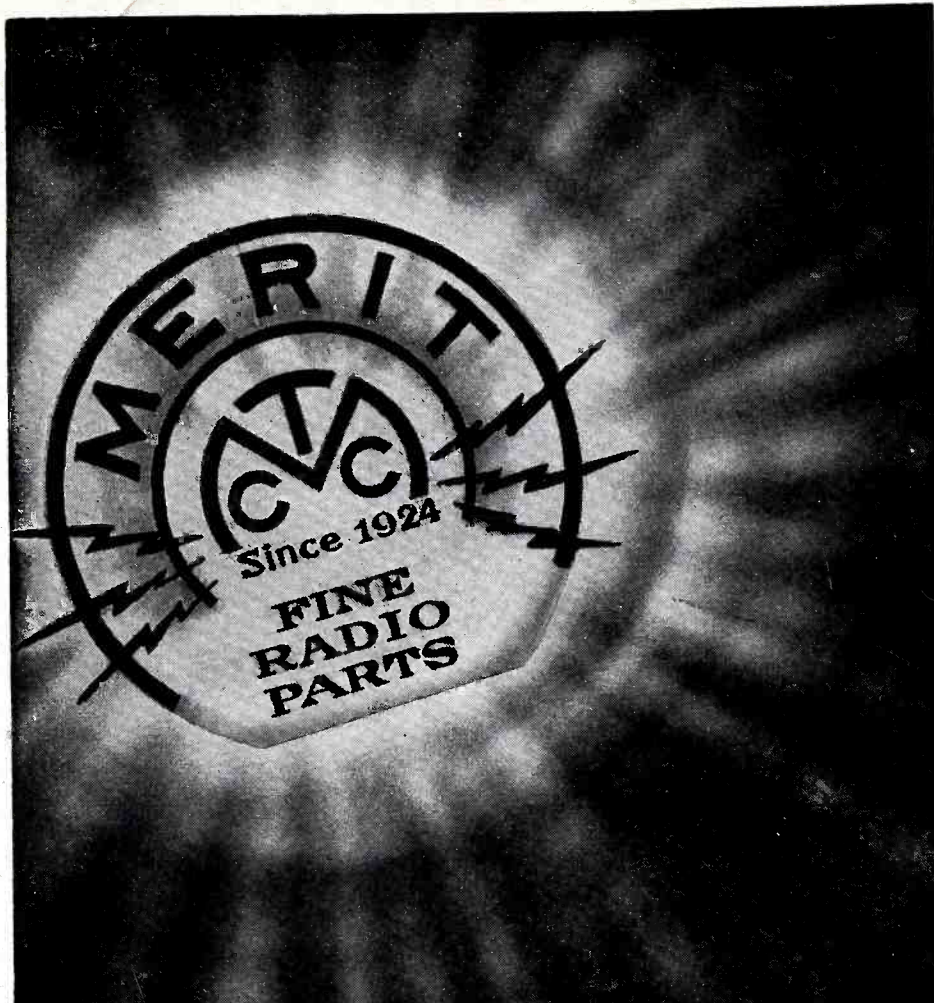

TRANSFORMER

"A device for transferring energy in an a.c. current from one circuit to another." But what characteristics must be provided before the transformer fulfills *your* needs! Include Merit **QUALITY!**



MERIT COIL & TRANSFORMER CORP.

TELEPHONE 4427 North Clark St. Long Beach 6311 CHICAGO 40, ILL.

The Publishers Sound Off . . .

BIG-SCALE DRIVE by the Radio Manufacturers Association, in the interests of "Radio in Every Room" promises to teach the trade a thing or two about saturation. In this business, which is capable of a monthly crop of new circuits, designs and developments, there's practically no such thing as "sold" families. Smaller sets are individual equipment for kitchen, bedroom, den and travel; consoles are home entertainment centers with pictures, personal recordings, shortwave, record-playing and full-range radio. Improvements cool forever in the heat of competition.

FIGURES ARE FLYING around the trade on the subject of FM. Manufacturers are adding new models and the set business shows potentialities of a Fall boom. The broadcasters got several nice breaks on programming. Dealers are sailing into FM merchandising because of brand new business, higher unit prices, traffic in accessories, etc. Smart radio men—suppliers and retailers alike—are deciding just what their commercial position is, and making it known to everybody.

SIT-DOWN SELLING, which is the kind of drowsy merchandising left over from the seller's market, still haunts some corners of radio. Some of the arch-experts are recommending a faster return to the fiercely aggressive call-on-everybody style of merchandising. One way to accomplish this is to give the retailers something to work with, and to advertise the fact that the selling tools are available. It requires a certain amount of action on the part of manufacturers and distributors to get action out of retailers.

HUNDREDS OF PRODUCTS are now being listed for the big September Directory issue of RADIO & Television RETAILING. It will be an up-to-the-minute and accurate listing of merchandise which makes money for dealers and jobbers. To help the merchandisers of the country learn the rest of the story, we believe that the suppliers should give the readers the complete "dope" on the individual promotional energy behind these products.

TV CAN'T REST, now that the pictures have been sampled by thousands of eager fans. When news reports in these columns mention 73 transmitters in 25 states, readers write hastily to RADIO & Television RETAILING asking for the details. There's a real band-wagon interest among retailers in most territories. Already 25 million people are in television reception areas.

—THE PUBLISHERS

"Selling Days are Here Again!"



The one theme that was stressed in the Philco Convention at Atlantic City in June was "Back to Normal." At one point, the entire assembly of Philco distributors broke into song to hail the theme... "Selling Days are Here Again!"

It was the high spot of the presentation of Philco's advertising and promotional plans for 1947 and '48. It brought back memories of Philco's sales achievements when everybody said that "times were tough" in the radio business. Those were the days when Philco rose to leadership and showed the industry what it means to sell.

The buyer's market is coming back... but Philco isn't waiting. Official newspaper advertising figures for the first quarter of 1947 showed that Philco advertising lineage totalled more than 50% of the radio industry!

And that's only the beginning! Selling days are here again... and wise radio dealers know that those are the days when it pays in sound sales and profits to concentrate on Philco.

For 17 years, America has said...

When there's a choice, it's a

PHILCO

Meissner

PRESENTS THE NEW BREWSTER LINE OF TABLE MODEL RADIOS

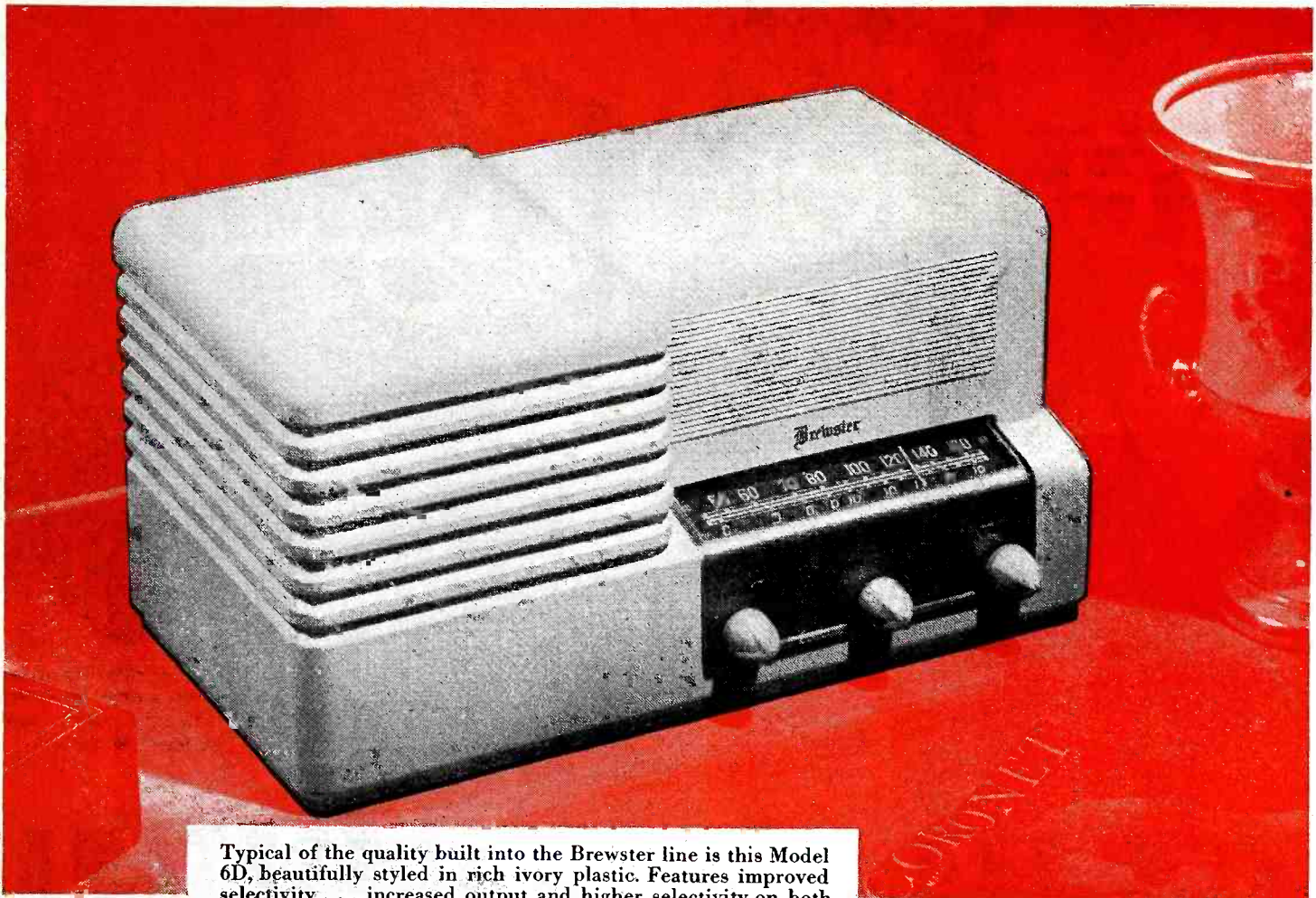

Typical of the quality built into the Brewster line is this Model 6D, beautifully styled in rich ivory plastic. Features improved selectivity . . . increased output and higher selectivity on both broadcast and shortwave bands. Broadcast 540 to 1400 kcs, short-wave 5.75 to 18 mcs. Built-in loop antenna . . . 5 tubes plus rectifier. Operates on 110 volts AC or DC.

Here in these new Brewsters is the outstanding line you have been waiting for! Superbly designed, unmatched for sheer beauty of tone, these completely new sets reflect the skill and craftsmanship that have made the name Meissner a byword for quality in the trade. Encased in cabinets of surpassing charm, they are easily superior to anything now being offered in this field.

Smartly designed, quality engineered, these sets are being manufactured by Meissner for exclusive distribution through parts jobbers only. No quotas, no high-pressure tactics, no "special deals", no sales direct to dealers or special distributors . . . in fact, nothing that might even remotely interfere with your merchandising this new, exclusively-jobber line to the hilt. More than this . . . Meissner unconditionally guarantees the prices on these new Brewsters against reduction for the balance of the year.

This complete line is available for delivery NOW. Wire or write today for full information, prices and illustrated folder.

Meissner

**ELECTRONIC DISTRIBUTOR AND
INDUSTRIAL SALES DEPARTMENT**

MAGUIRE INDUSTRIES, INCORPORATED
936 NORTH MICHIGAN AVENUE • CHICAGO 11, ILLINOIS

EXPORT DIVISION • SCHEEL INTERNATIONAL INCORPORATED
4237 NORTH LINCOLN AVENUE, CHICAGO 18, ILLINOIS • CABLE ADDRESS HARSHEEL



Says the service expert who values his good reputation and the repeat business that goes with it—

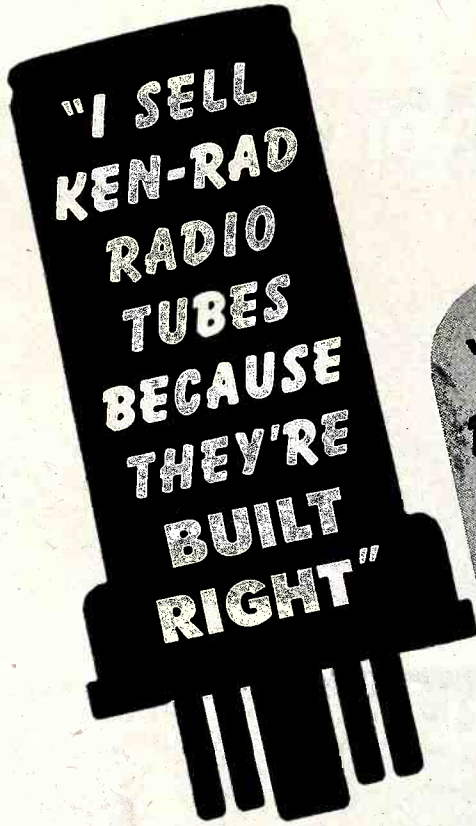

—asserts the tone-conscious radio owner who appreciates the superior quality of Ken-Rad tubes.

KEN-RAD ~~DOUBLE~~ ACCEPTANCE

puts profits in the repairman's pocket

● You're glad to install Ken-Rad tubes because their reputation stands high with you, as well as with other service experts. And Ken-Rad tubes reward this enthusiasm by helping you secure a bigger repeat business—based on clients' faith in your standards of work as shown by the quality tubes and parts you use.

DOUBLY ACCEPTED . . . by you and your customers! That's why Ken-Rad tubes hold a coast-to-coast margin of popularity. Radio owners endorse their finer tone, their long-

playing life. *You* prefer to sell Ken-Rad tubes—*customers* want to buy them! It's a favorable meeting of minds, creating more sales and greater profits.

NOW is the time to impress your name and high-grade repair facilities on your neighborhood! Radio-set production is large; owners' service needs will grow. Ken-Rad tubes can help you gain wider, friendlier local recognition, with the increased business "take" that will result. Install and sell Ken-Rad *doubly-accepted* radio tubes!

● HERE'S REAL ADVERTISING HELP! Ken-Rad Booklet ETR-62 illustrates and tells about the big, elaborate line of display and promotion material (it's tops in the trade) available to help you sell more radio tubes as well as *more repair service*. Write for your free copy!

176-F7-6600

KEN-RAD *Radio Tubes*

PRODUCT OF GENERAL ELECTRIC COMPANY

Schenectady 5, New York

Western Electric announces a complete

DIRECT RADIATORS



728B—12" direct radiator.



756A—10" direct radiator.



755A—8" direct radiator.

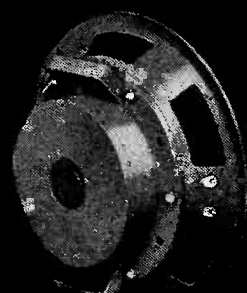

754A—12" direct radiator.
754B (not shown) 12" direct radiator for outdoor use.

HIGH FREQUENCY RECEIVERS AND HORNS



713B & C—High frequency receivers

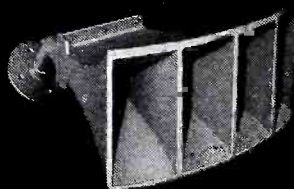

KS-12024—Sectoral high frequency horn. 50° coverage angle.

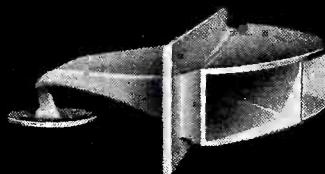

KS-12027—Sectoral high frequency horn. 90° coverage angle.

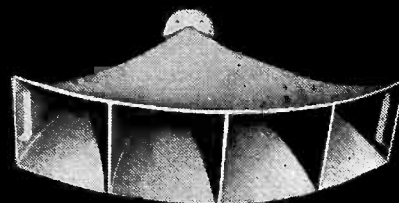

KS-12025—Sectoral high frequency horn. 80° coverage angle.

COMBINATIONS . . .

757A—dual unit system.

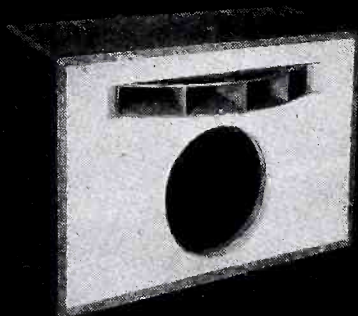

HIGH LEVEL SYSTEMS
for indoor and outdoor use.



Distributed by
Graybar
OFFICES IN 93 PRINCIPAL CITIES

— QUALITY COUNTS —

line of High Quality, wide range loudspeakers

- 1 Sizes and combinations to meet every sound radiation problem . . .
- 2 Power capacities from 8 to 120 watts . . .
- 3 Frequency ranges as wide as 60-15,000 cycles . . .
- 4 All units designed by Bell Telephone Laboratories . . .

IT'S a thrilling, satisfying experience to listen to reproduced sound that is truly *high quality*. The new line of wide range Western Electric loudspeakers was designed to make that experience available to all . . . to provide a complete line of loudspeakers with the ability to reproduce sound of unmatched brilliance and tone.

Whatever your loudspeaker needs, there's a Western Electric loudspeaker to meet them . . . to provide you with sound that's based on a whole new concept of high quality reproduction. Examine the following table to see how your requirements are met, or mail the coupon below for literature describing this new line of equipment.

HERE'S HOW YOUR QUALITY REQUIREMENTS ARE MET

TYPE	POWER HANDLING CAPACITY	FREQUENCY RESPONSE (cycles)	INPUT IMPEDANCE	COVERAGE ANGLE	EFFICIENCY (Sound Level of 30' on Axis)	WEIGHT	SPEAKER DIMENSIONS	ENCLOSURE REQUIRED	RECOMMENDED CABINET DIMENSIONS (Sloping front)
755A 8" direct radiator	8 watts	70-15,000	4 ohms	70°	81.5 db above 10 ⁻¹⁶ watts per sq. cm. at 8 watts input	Speaker—4½ lbs.	Dia.—8½" Depth—3½" Baffle Hole Dia.—7"	2 cu. ft.	Width—16" Height—21" Top Depth—9½" Bottom Depth—12"
756A 10" direct radiator	20 watts	65-10,000	4 ohms	60°	89.5 db above 10 ⁻¹⁶ watts per sq. cm. at 20 watts input	Speaker—10 lbs.	Dia.—10½" Depth—3½" Baffle Hole Dia.—8½"/16"	2½ cu. ft.	Width—19" Height—22" Top Depth—8½" Bottom Depth—11½"/16"
728B 12" direct radiator	30 watts	60-10,000	4 ohms	50°	93.5 db above 10 ⁻¹⁶ watts per sq. cm. at 30 watts input	Speaker—17 lbs.	Dia.—12½"/22" Depth—3½"/22"	3 cu. ft.	Width—21"

- 754A**
12" direct radiator
- 754B**
12" direct radi (outdoor type)
- 757A**
2 unit system
- 713B**
high frequency receiver
- 713C**
high frequency receiver
- KS-12027**
high frequency horn
- KS-12024**
high frequency horn
- KS-12025**
high frequency horn
- High Level Speaker Sys**
(For indoor or outdoor use)

Profit Notes to Dealers

This is the first in a series of ads in trade and technical magazines to publicize the sensational new line of high quality loudspeakers designed by Bell Telephone Laboratories and manufactured by Western Electric.

Under a new distribution policy, these loudspeakers will be available to dealers—you can stock and sell them at a good profit.

Demand for these speakers—particularly the new, smaller, finer direct radiators—is already widespread. Your customers will be asking for them.

Call the nearest Graybar Electric Co. office (located in 95 principal cities) or write Graybar, 420 Lexington Ave., New York 17, N. Y., for prices and additional information.

SEND FOR COMPLETE INFORMATION →

_____ to _____
 _____ receivers, and _____
 KS-12024 or KS-12025 _____
 horns _____ 78" x 52" x 48"

Graybar Electric Co. RI
 420 Lexington Ave., New York 17, N. Y.
 Gentlemen: Please send me literature describing the new line of Western Electric loudspeakers.

Name _____
 Company _____
 Address _____

FASTER RESULTS!

with
the
**Chicago
Tribune's**
Selective
Area
Advertising
Plan

Your advertising dollars do a far better job when you identify your dealers in their local markets under the Tribune's Selective Area Advertising Plan. No medium penetrates the Great Chicago Market like the Tribune. Tribune rates per line per 100,000 circulation are among the lowest in America.

When your sales message highlights the name of your dealer in the prospect's own neighborhood, more customers are attracted to his store. Multiply this many times throughout the Great Chicago Market and you'll see why the Tribune's Selective Area Advertising Plan promises faster results.

It's designed to give you and your dealers the kind of sales-winning campaign you both want. Under the plan—

EACH DEALER GETS:

- 1 Selective coverage of his local market
- 2 Prominent display of his name and location
- 3 The low rate of just 2½¢ a line!

YOU GET:

- 1 Better identification of your local outlets
- 2 Enthusiastic dealer support
- 3 Advertising that pays off right away!

Join forces with your dealers and use the Tribune's Selective Area Advertising Plan to corral more of the Great Chicago Market . . . a market so large it can take all or the greater part of many manufacturers' production. Through the Plan you can best implement the significant facts revealed in the Tribune's Durable Goods Study among consumers and dealers. To learn how this Plan fits your specific needs, contact your nearest Tribune representative as shown below.

Chicago Tribune

The World's Greatest Newspaper

June average net paid total circulation:
Daily, over 1,035,000 • Sunday, over 1,500,000

MEMBER: AMERICAN NEWSPAPER ADVERTISING NETWORK, INC., FIRST 3 MARKETS GROUP, AND METROPOLITAN SUNDAY NEWSPAPERS, INC.

A. W. Dreier, Chicago Tribune
810 Tribune Tower, Chicago 11

E. P. Struhsacker, Chicago Tribune
220 E. 42nd St., New York City 17

Fitzpatrick & Chamberlin
155 Montgomery St., San Francisco 4

W. E. Bates, Chicago Tribune
Penobscot Building, Detroit 26



Lily Pons says:

... star of Columbia Records, appearing in the United Artists' release "CARNEGIE HALL".

"The most perfect record reproduction I've ever heard"

Lily Pons made the above statement to Paul L. Chamberlain, Manager of Sales, Receiver Division, after hearing G-E Model 417A in her own home.

Your customers will agree with Lily Pons when they hear G-E Model 417A!

DEMONSTRATE! That's the easy way to sell G-E Model 417A. Let prospects hear how much better favorite records sound when touched by the magic of the G-E Electronic Reproducer. They listen, and they're ready for the dotted line.

Model 417A is loaded with other sales points, too. It has genuine FM (both bands), two short-wave spread bands,

and push-button tuning of standard broadcasts. The beautiful 18th Century period cabinet, veneered in genuine Honduran mahogany, has generous storage space for approximately 120 records. For full information write today to your General Electric radio distributor or General Electric Company, Electronics Park, Syracuse, New York.

This powerful endorsement by Lily Pons will be featured during September in smashing full pages in ...

**POST • LIFE
LOOK • COLLIER'S
COUNTRY GENTLEMAN
FARM JOURNAL
PROGRESSIVE FARMER**

LEADER IN RADIO, TELEVISION AND ELECTRONICS

GENERAL ELECTRIC

175-PA

PORTABLES • TABLE MODELS • CONSOLES • FARM SETS • AUTOMATIC PHONOGRAPH COMBINATIONS • TELEVISION

Designed for Giving

THE FARNSWORTH TRIPLE PLAY

Model GP-350

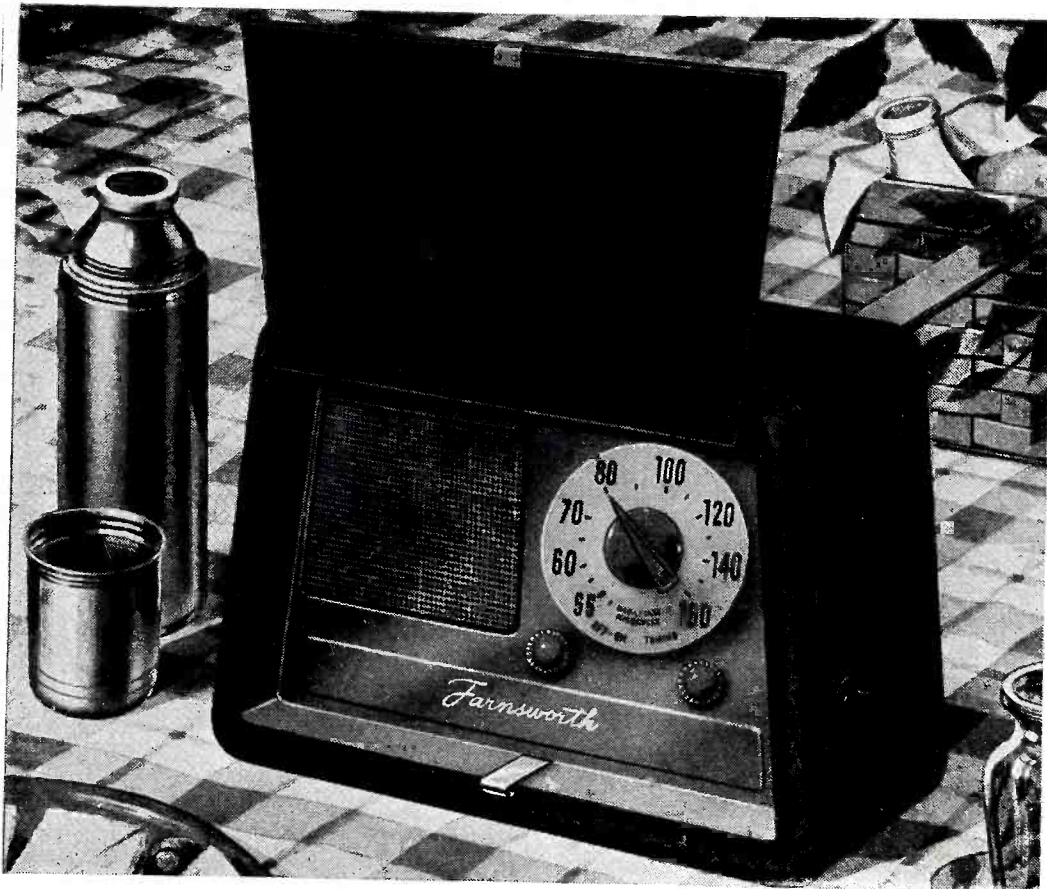

It's a tuneful, colorful personal portable that looks and carries like a smart vanity case. In rich, brown leatherette. Contrasting, easy-to-read dial. Plays like a dream—at home or on the go. Remarkably-clear tone. Battery, AC or DC operation. And when your customers see the name, Farnsworth, they'll know it's *dependable*. They'll buy it for gifts—they'll buy it for their very own.

Customers count on Farnsworth for fidelity, for performance, for style, for superb engineering. They know that every Farnsworth

model—phonograph-radio, telet, portable or table model—is built to exacting standards of quality. Each reflects traditional Farnsworth craftsmanship. There's a Farnsworth radio for everyone—proving that excellence need not be expensive . . . combining quality with modest cost in every price range.

With protected prices, proper margins and "room to sell," the Farnsworth dealer finds his franchise more valuable every day. Farnsworth Television & Radio Corporation, Fort Wayne 1, Indiana.

Farnsworth
Television • Radio • Phonograph-Radio

Farnsworth Radio and Television Receivers and Transmitters • Aircraft Radio Equipment • Farnsworth Television Tubes • Mobile Communication and Traffic Control Systems for Rail and Highway • The Farnsworth Phonograph-Radio • The Capehart • The Panamuse by Capehart



A Farnsworth Table Model



Farnsworth Chairside



Farnsworth Combination



Farnsworth Television Table Model



Farnsworth Heppelwhite



Farnsworth Chippendale

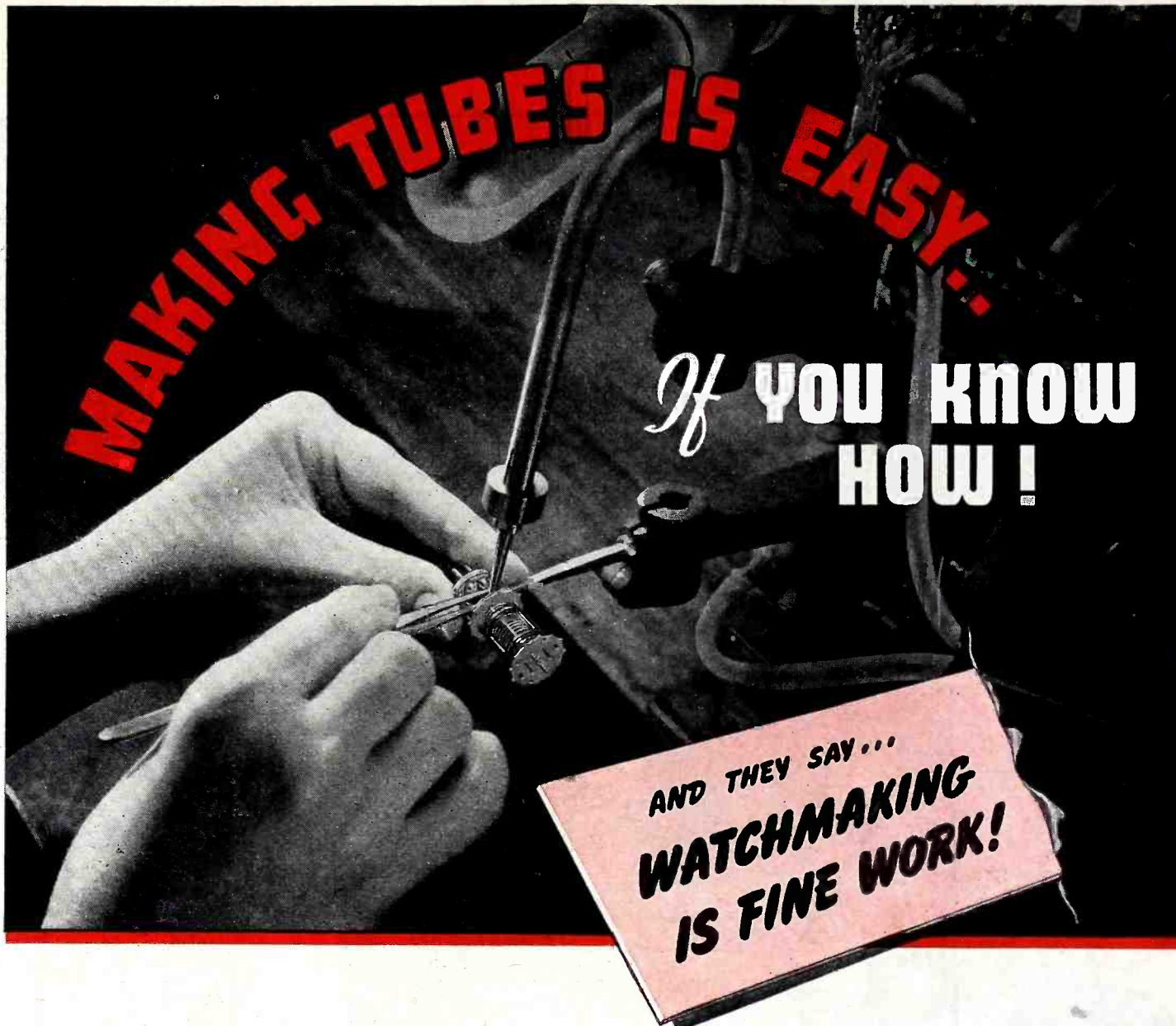

MAKING TUBES IS EASY...

If **YOU KNOW HOW!**

**AND THEY SAY...
WATCHMAKING
IS FINE WORK!**

A fine watch—delicate Italian lace—these are synonymous with superb craftsmanship. But imagine such hand-to-eye co-ordination at mass production speeds. The mount operator who assembles with a small spot welder the tiny internal parts of your Hytron tubes displays just such craftsmanship. Despite painstaking engineering and intricate machinery, it is finally her accuracy, speed, perseverance, and appreciation of fine tolerances which build Hytron quality. Assembly mistakes once sealed within a tube cannot be corrected.

That is why Hytron is so fussy about selecting and training its mount operators. Each applicant must pass exacting tests for eyesight and for finger and tweezer dexterity. Then begins a long training cycle: two months to master a single constructional step; up to two years to

develop the versatility of the expert mounter.

Every possible aid is given to the Hytron mount operator. Work simplification helps her co-ordinate smoothly and efficiently motions of eyes, hands, and feet. Parts design is simplified; supporting micras serve as templates. Welding is automatically timed. Tight spacing tolerances (.003") and frequent engineering changes prohibit widespread use of jigs and fixtures. Magnification is impracticable, because of width and depth of field. Major effort must always be to train the mounter's keen eyes and nimble fingers to assemble delicate parts to fine tolerances, despite varying materials and machine set-ups.

Yet the Hytron mounter works so effortlessly that it all looks easy. It is easy only because she has the know-how. Next time you pick up a Hytron tube, examine her handiwork.



SPECIALISTS IN RADIO RECEIVING TUBES SINCE 1921

HYTRON

RADIO AND ELECTRONICS CORP.

MAIN OFFICE: SALEM, MASSACHUSETTS





For Peak Performance

Depend on
RAYTHEON BONDED
ELECTRONIC TECHNICIANS

Bonded by 

HE'S AT A LOSS, SO
TELL HIM, BOSS...
YOU'RE ALWAYS RIGHT
WITH RAYTHEON

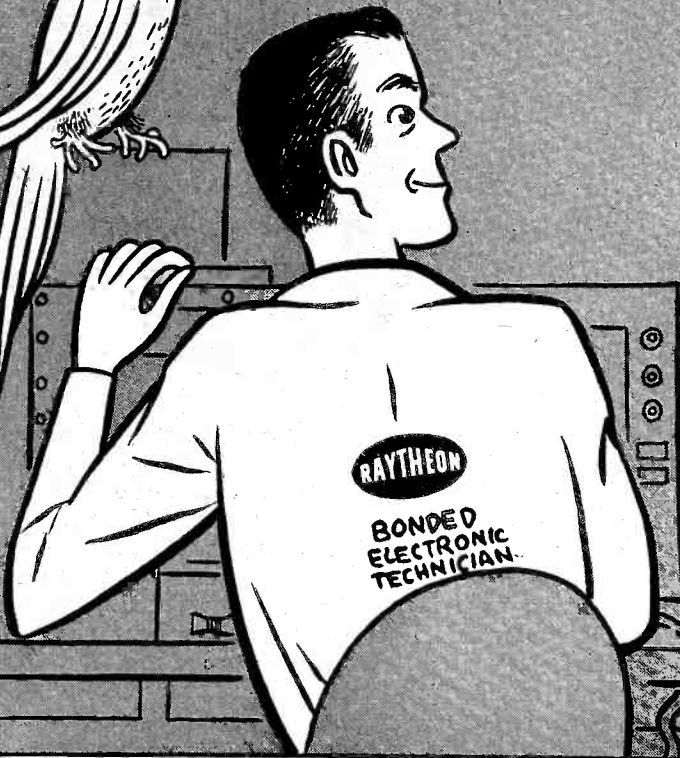
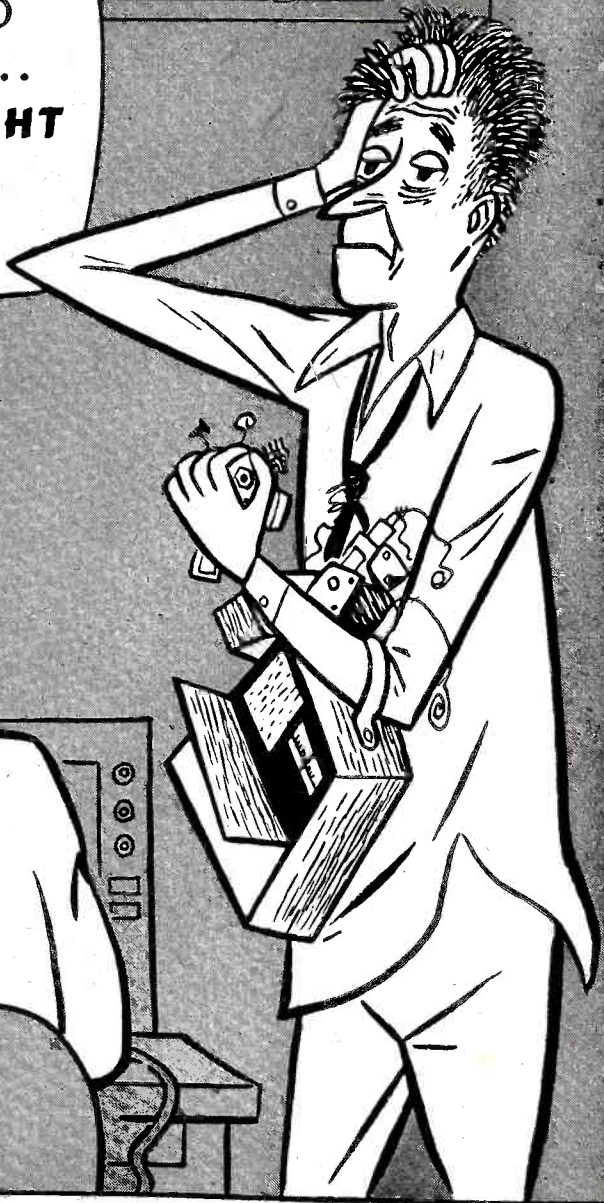

For Quality Tubes that give Peak Performance see your RAYTHEON DISTRIBUTOR.

RAYTHEON MANUFACTURING COMPANY
RADIO RECEIVING TUBE DIVISION
NEWTON, MASSACHUSETTS CHICAGO, ILLINOIS



Excellence in Electronics

- RADIO RECEIVING TUBES
- SPECIAL PURPOSE TUBES
- TRANSMITTING TUBES
- HEARING AID TUBES

FADA

MODEL P80

Jobs them All!

FADA P80 — 3 way personal portable has captured the small portable market. Jobbers and dealers everywhere acclaim it as the acme in style — performance and popular price appeal.

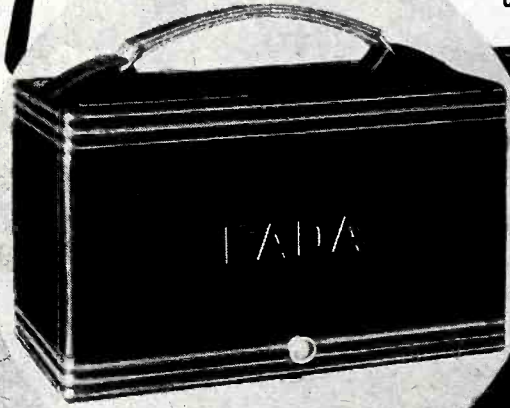

\$ 34⁹⁵ LIST

LESS BATTERIES
(IN GLEAMING EBONY PLASTIC)

- ★ Unusual sensitivity and selectivity.
- ★ New SELINIUM long-life rectifier... heats up instantly.
- ★ Iron core I. F. transformers and oscillator coil. All controls on front as illustrated.
- ★ Four colors in FADA glamour-plastic . . . sparkling ebony . . . rich walnut . . . translucent maroon . . . genuine ivory.
- ★ With genuine leather carrying handles.

THE RADIO OF TOMORROW — TO-DAY

FADA RADIO & ELECTRIC COMPANY, INC.
BELLEVILLE, NEW JERSEY

"SINCE BROADCASTING BEGAN"



Listen
...IT'S A
Jensen

MODEL VH-91
*Hypex** **SPEECHMASTER**

Delivering good quality, intelligible speech with maximum "punch" to override high noise levels, the Model VH-91 Speechmaster is recommended for paging and intercommunication applications. Hypex horn formula gives useful output over a 100° angle.

Especially efficient for voice, the VH-91 has a frequency range of 400-5,000 cycles. Power handling capacity: 15 watts maximum speech signal input. Designed for both inside and out-of-door use, VH-91 will withstand extreme weather conditions, including exposure to salt spray. Nominal voice coil impedance 8 ohms. Transformer number Z-3345, with $\frac{5}{8}$ " x $\frac{5}{8}$ " core available for 45-ohm use. Bell diameter, $8\frac{3}{8}$ inches; height, $9\frac{1}{16}$ inches; weight, $4\frac{1}{4}$ pounds.

Universal mounting bracket adjusts projector to any direction, locks securely in position by a single wing nut, has facilities for mounting transformer.

Jensen VH-91 Speechmaster Projector (ST-171).....\$32.50

*Trade mark registered

JENSEN MANUFACTURING COMPANY
6625 S. LARAMIE AVE., CHICAGO 38, U. S. A.
In Canada: Copper Wire Products, Ltd., 11 King St., W. Toronto 1



*Designers and Manufacturers
of Fine Acoustic Equipment*



Again
CROSLEY

is there!

NOW WITH THE SENSATIONAL

CROSLEY *S***pectator**

...the perfected TELEVISION receiver with FM sound

table model—priced for Mass Selling!



AND YOU'RE THERE, TOO, WITH THE
CROSLLEY *S*pectator
on your floor—in your windows—featured in your ads!

Are you one of the many Crosley Dealers lucky enough to be located in a community within range of telecast programs? Then here is wonderful profit news for you—the Crosley SPECTATOR—the *perfected* table model Television Receiver with FM sound—is priced for *mass selling*! Not an experiment, the amazing Crosley SPECTATOR is the triumphant result of years of development and research by the very electronic engineers who filled many of our Country's wartime television needs. The Crosley SPECTATOR is a major scientific victory—it's in full production now—you can make immediate deliveries! And every Crosley SPECTATOR you sell makes new friends for you—*important profits* today and in the future!

What it is The amazing Crosley SPECTATOR is cased in a richly grained walnut table cabinet (14½" x 26" x 19"). The "Global View" Picture Screen is 52 square inches in area, framed in darker walnut to improve viewing, and protected by a sheet of plate glass that minimizes light reflections. The Lok-in-Tune synchronizer automatically "locks" the SPECTATOR in tune with the selected station; holds pictures steady and clear through electrical disturbances caused by appliances, signs, door bells, storms. All-13 Channel Selector provides quick, easy tuning of all 13 television channels. The SPECTATOR produces clear, brilliant pictures and static-free *natural* quality sound even in weak signal areas.

How it works The Crosley SPECTATOR is as easy to operate as a table model radio. Stations within receiving range are represented by numbers from one to 13 on the dial of the All-13 Channel Selector. To tune, simply turn Selector switch to the number assigned to the desired station—and pictures from that station are automatically locked in tune—clear, bright, lifelike, on the "Global View" Screen. Precision control of high fidelity FM sound is provided by a radio-type knob on the front panel. So brilliant are the steady, perfectly focused pictures seen on the "Global View" Screen that it is never necessary to darken the room for perfect reception.



Here it is

Who are your prospects? Your best prospects for wonderful Crosley SPECTATOR are . . . everyone who can afford a medium priced console-type radio-phonograph combination! Remember—every Crosley SPECTATOR you sell almost immediately sells several more! The new owner, proud of his SPECTATOR, invites his friends to see the big show in his living room. The Crosley "Global-View" Picture Screen is large enough to afford as many as 12 persons a perfect "divorced seat view," each set you sell becomes, overnight, the talk of the neighborhood—seen, heard, admired *and wanted* by scores of people with the money to buy! The SPECTATOR in your window, on your floor or in your customer's living room, is its own salesman!

THE
CROSLEY
*S*pectator

SPECIFICATIONS

27 tubes, 3 rectifiers. All-13 Automatic Channel Selector. All-13 Channel coverage—44-216 m.c. Area of "Global View" Picture Screen, 52 square inches. Image size, $6\frac{3}{8}$ " x $8\frac{1}{2}$ ". Pictures electronically stabilized by Lok-in-Tune Synchronizer. Pictures are bright and clear without room darkening. High sensitivity. F-M sound system. 5" Speaker. All controls on front panel. 4 watts maximum power output. Smart, modern walnut cabinet, $25\frac{1}{2}$ " wide, $14-11/16$ " high, $19-1/16$ " deep. AC power requirement: 105-125 Volts, 60 cycles. Power consumption: 380 Watts. Weight, 85 lbs. Shipping weight, 98 lbs. Underwriters' Laboratories Approved. Guaranteed by CROSLEY Division—AVCO Manufacturing Corp., Cincinnati 25, Ohio.



AND YOU'RE THERE, TOO, WITH THE

CROSLY *S*pectator

on your floor—in your windows—featured in your ads!

Are you one of the many Crosley Dealers lucky enough to be located in a community within range of telecast programs? Then here is wonderful profit news for you—the Crosley SPECTATOR—the *perfected* table model Television Receiver with FM sound—is priced for *mass selling!* Not an experiment, the amazing Crosley SPECTATOR is the triumphant result of years of development and research by the very electronic engineers who filled many of our Country's wartime television needs. The Crosley SPECTATOR is a major scientific victory—it's in full production now—you can make immediate deliveries! And every Crosley SPECTATOR you sell makes new friends for you—*important profits* today and in the future!

What it is The amazing Crosley SPECTATOR is cased in a richly grained walnut table cabinet (14½" x 26" x 19"). The "Global View" Picture Screen is 52 square inches in area, framed in darker walnut to improve viewing, and protected by a sheet of plate glass that minimizes light reflections. The Lok-in-Tune synchronizer automatically "locks" the SPECTATOR in tune with the selected station; holds pictures steady and clear through electrical disturbances caused by appliances, signs, door bells, storms. All-13 Channel Selector provides quick, easy tuning of all 13 television channels. The SPECTATOR produces clear, brilliant pictures and static-free *natural* quality sound even in weak signal areas.

How it works The Crosley SPECTATOR is as easy to operate as a table model radio. Stations within receiving range are represented by numbers from one to 13 on the dial of the All-13 Channel Selector. To tune, simply turn Selector switch to the number assigned to the desired station—and pictures from that station are automatically locked in tune—clear, bright, lifelike, on the "Global View" Screen. Precision control of high fidelity FM sound is provided by a radio-type knob on the front panel. So brilliant are the steady, perfectly focused pictures seen on the "Global View" Screen that it is never necessary to darken the room for perfect reception.

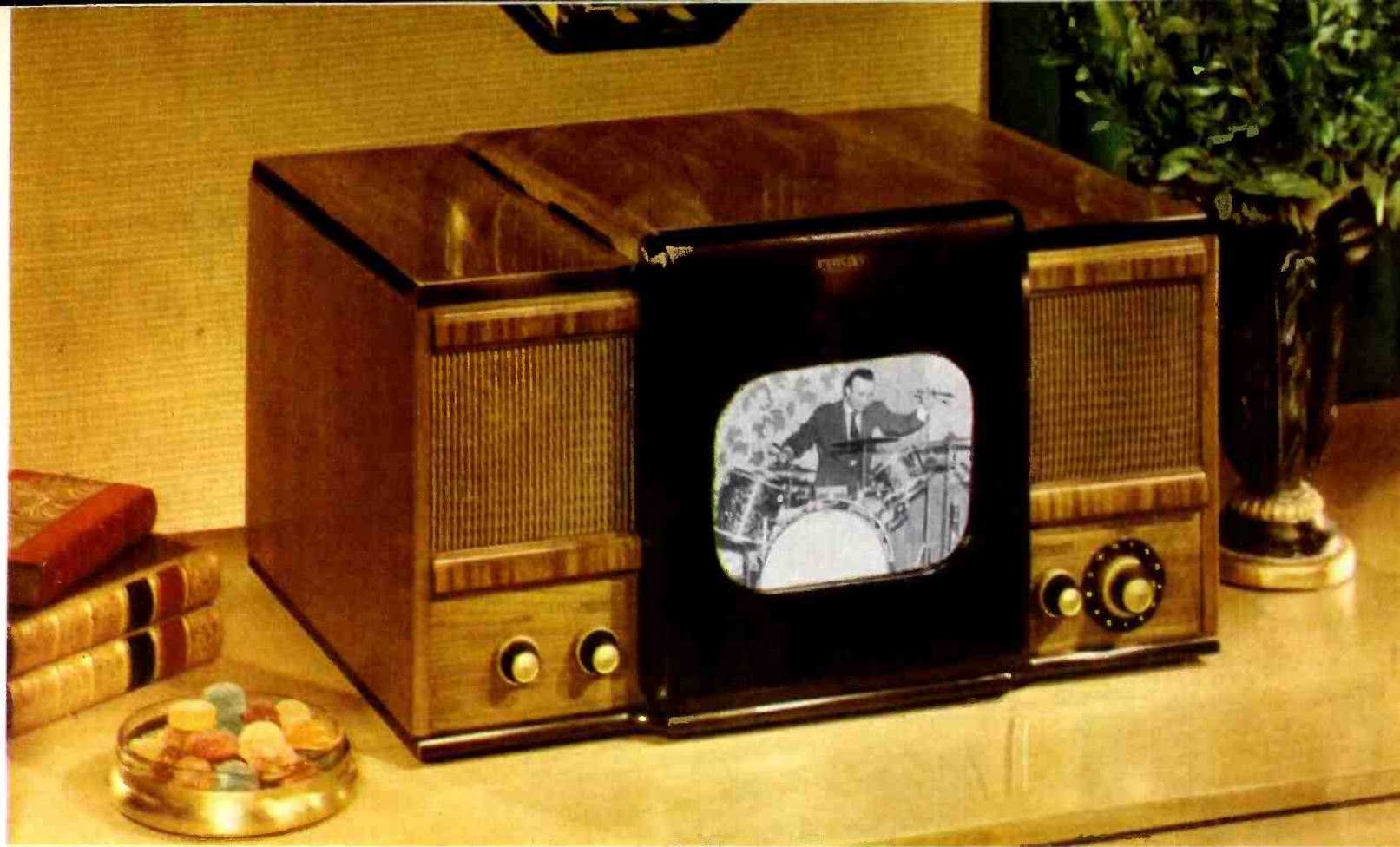

Here it is

Who are your prospects? Your best prospects for the wonderful Crosley SPECTATOR are . . . everyone who can afford a medium priced console-type radio-phonograph combination! Remember—every Crosley SPECTATOR you sell almost immediately sells several more sets! The new owner, proud of his SPECTATOR, invites friends to see the big show in his living room. Since the Crosley "Global-View" Picture Screen is large enough to afford as many as 12 persons a perfect reserved seat view," each set you sell becomes, overnight, the talk of the neighborhood—seen, heard, admired *and wanted* by scores of people with the money to buy! The SPECTATOR in your window, on your floor or in your customer's living room, is its own best salesman!

THE
CROSLEY
Spectator

SPECIFICATIONS

27 tubes, 3 rectifiers. All-13 Automatic Channel Selector. All-13 Channel coverage—44-216 m.c. Area of "Global View" Picture Screen, 52 square inches. Image size, $6\frac{3}{8}$ " x $8\frac{1}{2}$ ". Pictures electronically stabilized by Lok-in-Tune Synchronizer. Pictures are bright and clear without room darkening. High sensitivity. F-M sound system. 5" Speaker. All controls on front panel. 4 watts maximum power output. Smart, modern walnut cabinet, $25\frac{1}{2}$ " wide, $14-11/16$ " high, $19-1/16$ " deep. AC power requirements: 105-125 Volts, 60 cycles. Power consumption: 380 Watts. Weight, 85 lbs. Shipping weight, 98 lbs. Underwriters' Laboratories Approved. Guaranteed by CROSLEY Division—AVCO Manufacturing Corp., Cincinnati 25, Ohio.



AND YOU'RE THERE, TOO, WITH THE

CROSLEY Spectator

on your floor—in your windows—featured in your ads!

Are you one of the many Crosley Dealers lucky enough to be located in a community within range of telecast programs? Then here is wonderful profit news for you—the Crosley SPECTATOR—the *perfected* table model Television Receiver with FM sound—is priced for *mass selling!* Not an experiment, the amazing Crosley SPECTATOR is the triumphant result of years of development and research by the very electronic engineers who filled many of our Country's wartime television needs. The Crosley SPECTATOR is a major scientific victory—it's in full production now—you can make immediate deliveries! And every Crosley SPECTATOR you sell makes new friends for you—*important profits* today and in the future!

What it is The amazing Crosley SPECTATOR is cased in a richly grained walnut table cabinet (14½" x 26" x 19"). The "Global View" Picture Screen is 52 square inches in area, framed in darker walnut to improve viewing, and protected by a sheet of plate glass that minimizes light reflections. The Lok-in-Tune synchronizer automatically "locks" the SPECTATOR in tune with the selected station; holds pictures steady and clear through electrical disturbances caused by appliances, signs, door bells, storms. All-13 Channel Selector provides quick, easy tuning of all 13 television channels. The SPECTATOR produces clear, brilliant pictures and static-free *natural* quality sound even in weak signal areas.

How it works The Crosley SPECTATOR is as easy to operate as a table model radio. Stations within receiving range are represented by numbers from one to 13 on the dial of the All-13 Channel Selector. To tune, simply turn Selector switch to the number assigned to the desired station—and pictures from that station are automatically locked in tune—clear, bright, lifelike, on the "Global View" Screen. Precision control of high fidelity FM sound is provided by a radio-type knob on the front panel. So brilliant are the steady, perfectly focused pictures seen on the "Global View" Screen that it is never necessary to darken the room for perfect reception.



Here it is

THE
CROSLEY
Spectator

SPECIFICATIONS

Who are your prospects? Your best prospects for the wonderful Crosley SPECTATOR are . . . everyone who can afford a medium priced console-type radio-phonograph combination! Remember—every Crosley SPECTATOR you sell almost immediately sells several more sets! The new owner, proud of his SPECTATOR, invites friends to see the big show in his living room. Since the Crosley "Global-View" Picture Screen is large enough to afford as many as 12 persons a perfect reserved seat view," each set you sell becomes, overnight, the talk of the neighborhood—seen, heard, admired *and wanted* by scores of people with the money to buy! The SPECTATOR in your window, on your floor or in your customer's living room, is its own best salesman!

27 tubes, 3 rectifiers. All-13 Automatic Channel Selector. All-13 Channel coverage—44-216 m.c. Area of "Global View" Picture Screen, 52 square inches. Image size, $6\frac{3}{8}$ " x $8\frac{1}{2}$ ". Pictures electronically stabilized by Lok-in-Tune Synchronizer. Pictures are bright and clear without room darkening. High sensitivity. F-M sound system. 5" Speaker. All controls on front panel. 4 watts maximum power output. Smart, modern walnut cabinet, $25\frac{1}{2}$ " wide, $14-11/16$ " high, $19-1/16$ " deep. AC power requirement: 105-125 Volts, 60 cycles. Power consumption: 380 Watts. Weight, 85 lbs. Shipping weight, 98 lbs. Underwriters' Laboratories Approved. Guaranteed by CROSLEY Division—AVCO Manufacturing Corp., Cincinnati 25, Ohio.

Promotion like this

TELLS YOUR CUSTOMERS

"You're really **THERE** with your **CROSLEY** **Spectator**

Spectator

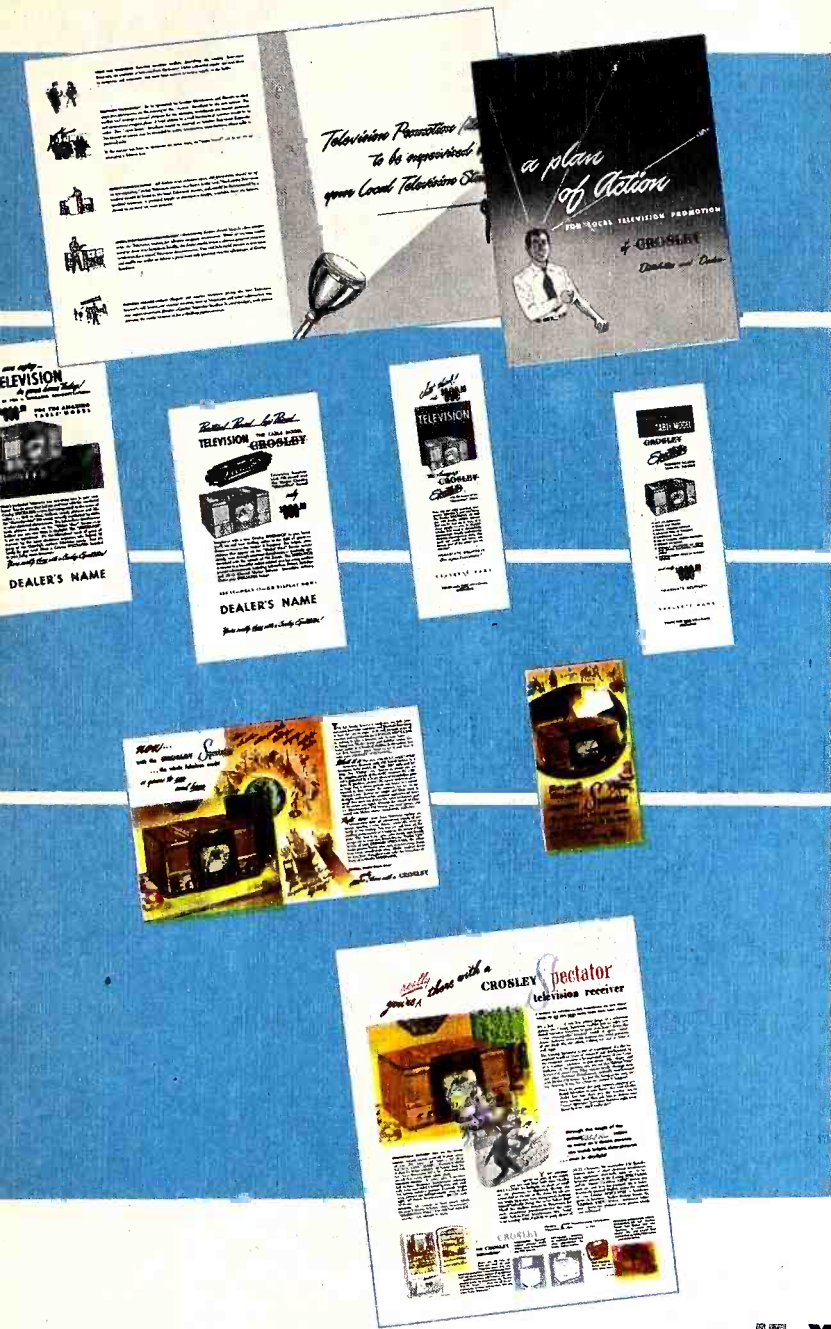

TELEVISION PROMOTION MANUAL . . . Packed with sure fire ideas and suggestions you can use to promote TELEVISION and the sale of the Crosley SPECTATOR in your territory. Contains tie-in ideas for dealers and television stations, ad patterns for dealer and station use, radio spot announcements, publicity releases—all in one bundle to boost your sales and store traffic!

NEWSPAPER ADS . . . Co-operative ads in mat form to run over your signature. They'll arouse interest . . . create store traffic—put money in your till! Readers of your local newspapers will see and read these compelling messages—come to your store for a demonstration of the Crosley SPECTATOR!

COLORFUL PASS-OUT PROMOTION . . . Eye-attracting folders tell the SPECTATOR story in dramatic, sales-stimulating words and pictures. Ideal for store pass-out and to use as direct mail promotion. Include one with each monthly statement to your customers!

BIG, ALL-COLOR NATIONAL AD . . . Hard-hitting — the type of ad that will really make people *want* the SPECTATOR! Builds sales for you, too! Think of how many of your customers read the Saturday Evening Post, Colliers, and the magazine supplement in leading Sunday newspapers. These mass circulation publications will carry the SPECTATOR story—*your* story—to homes in your territory. Reprints will be available for mailing—and blow-ups for window, store and counter display. It all adds up to a spectacular promotion for a spectacular money maker—the SPECTATOR — by Crosley!

IF YOU'RE A CROSLEY DEALER

YOU'RE REALLY THERE WITH THE **CROSLEY** **Spectator**

CROSLEY

Division—**AVCO** Manufacturing Corporation
Cincinnati 25, Ohio

Shelvardor* Refrigerators • Frostmasters • Kitchen Sinks and Cabinets • Ranges • Radios • Radio-Phonographs • FM—Television • Short Wave • Home of WLW

*Trade-mark Reg. U. S. Pat. Off.

For the Man Who Takes Pride in His Work

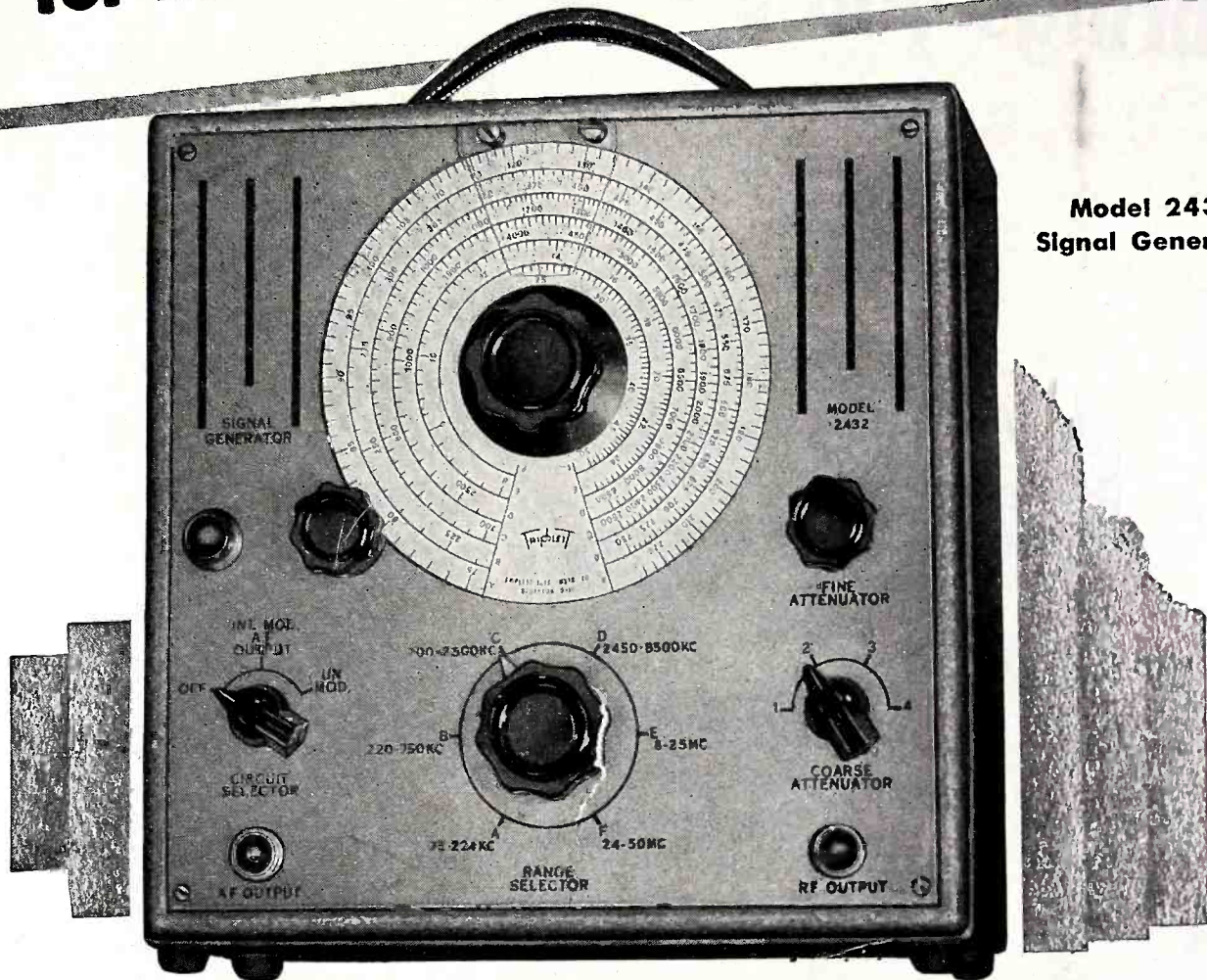

**Model 2432
Signal Generator**

**FM AND TELEVISION BAND COVERAGE ON STRONG HARMONICS
STRONG FUNDAMENTALS TO 50 (MC)**

Another member of the Triplet Square Line of matched units this signal generator embodies features normally found only in "custom priced" laboratory models.

FREQUENCY COVERAGE—Continuous and overlapping 75 KC to 50 MC. Six bands. All fundamentals. **TURRET TYPE COIL ASSEMBLY**—Six-position turret type coil switching with complete shielding. Coil assembly rotates inside a copper-plated steel shield. **ATTENUATION**—Individually shielded and adjustable, by fine and course

controls, to zero for all practical purposes. **STABILITY**—Greatly increased by use of air trimmer capacitors, electron coupled oscillator circuit, and permeability adjusted coils. **INTERNAL MODULATION**—Approximately 30% at 400 cycles. **POWER SUPPLY**—115 Volts, 50-60 cycles A.C. Voltage regulated for increased oscillator stability. **CASE**—Heavy metal with tan and brown hammered enamel finish.

There are many other features in this beautiful model of equal interest to the man who takes pride in his work.



Triplet

ELECTRICAL INSTRUMENT CO. BLUFFTON, OHIO



Westinghouse Radio brings you a POWERFUL 5



1

DOMINATING NATIONAL ADS
POST, Sept. 13 & 27 • LIFE, Sept. 22 & Oct. 6
COLLIER'S, Sept. 20 & Oct. 4
28,000,000 Readers

2

**FREE HARD-HITTING AD
MATS AND SPOT RADIO
ANNOUNCEMENTS**

3

**EYE-CATCHING 4 COLOR
BILLBOARD INSERT**

RADIO'S FIRST NAME IS

PIECE back-to-school promotion

featuring

THE WESTINGHOUSE "LITTLE JEWEL"

The console radio in capsule form that has plenty of sales appeal and plenty of sales advantages you can demonstrate.

THE WESTINGHOUSE "DUO"

The revolutionary new radio-phonograph with lift-out, carryabout radio that's packed with features for you to sell.

THE WESTINGHOUSE "LIBRARY MODEL"

Here's big radio performance at small radio price that you can demonstrate to any prospect.

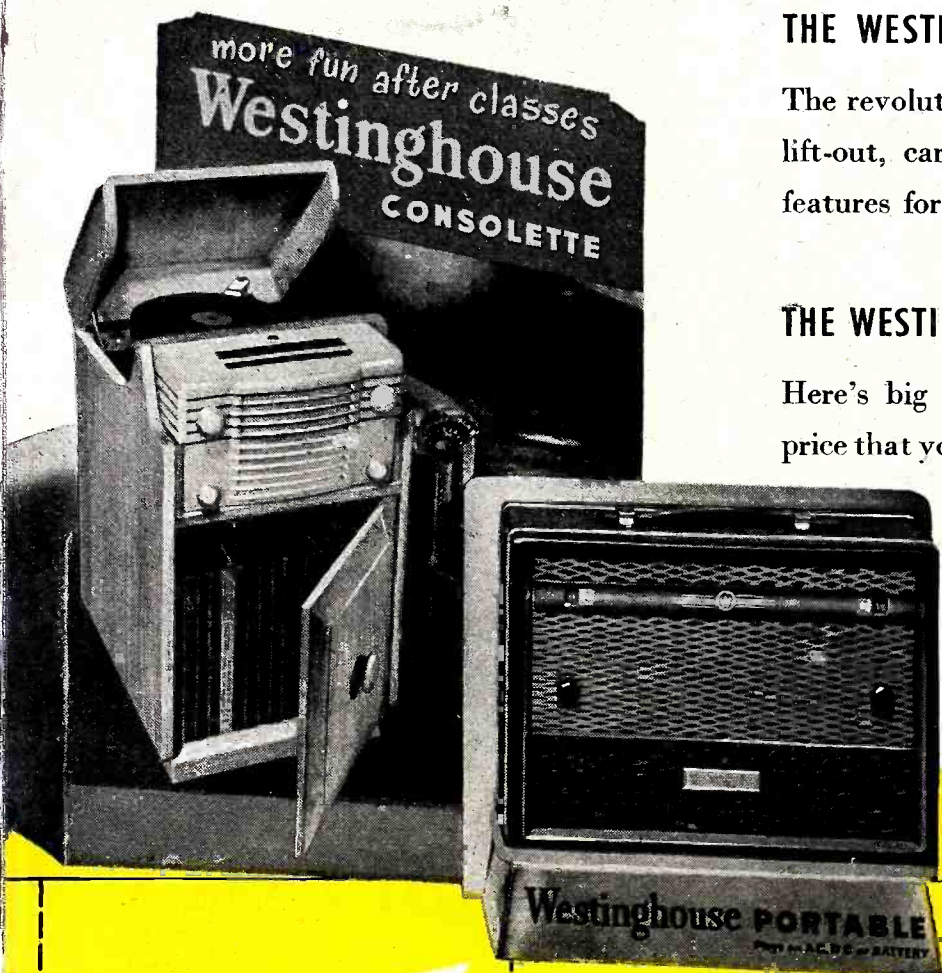

3 dimensional, 9 piece full natural color display features five fast moving Westinghouse Radios.

4

POWERFUL RETAIL
SELLING HELPS

5

TRAFFIC-STOPPING
WINDOW DISPLAY

THE WESTINGHOUSE "CONSOLETTA"

Has three big sales features in one . . . lift-out radio, automatic record changer, more record storage space than most consoles . . .

THE WESTINGHOUSE "148 PORTABLE"

Loaded with selling features, this distinguished looking, 3-way portable has twice the sensitivity of pre-war models.

Westinghouse

RADIO TELEVISION

Tune in Ted Malone, Monday through Friday,
at 11:45 A. M., E. D. T., A. B. C. Network

Home Radio Division, Westinghouse Electric Corporation, Sunbury, Pa.

The demand is for the

FINEST

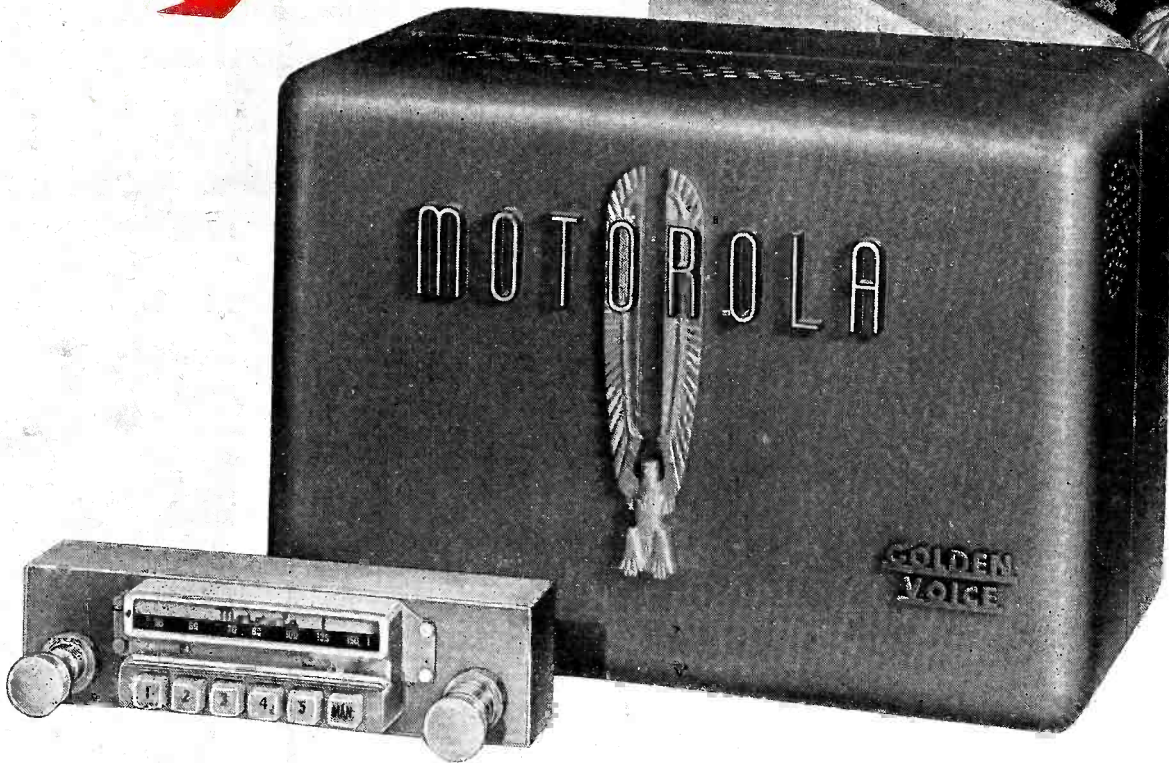
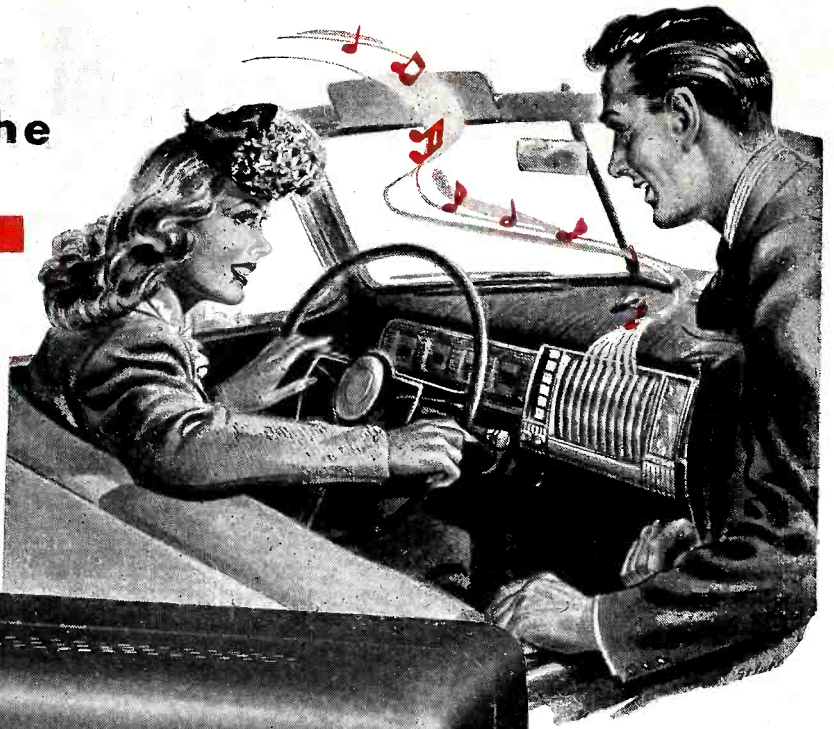

There's no denying it: Never in all the history of auto radio manufacture have so many wanted so many! You're seeing it happen more and more each day as Motorola auto radio production shifts into high.

Your Motorola sales activity has the combined support of an almost unlimited car-owning customer potential and a powerful national advertising campaign... plus the inescapable fact that there's no finer auto radio than Motorola... at *any* price.

Motorola Inc. CHICAGO 51, ILLINOIS

GET MORE OUT OF LIFE WITH TELEVISION



Illustrated: The Westminster—
with Television, FM-AM Radio,
Automatic Phonograph—Cabinets
designed by Herbert Rosengren,
Interior by W. & J. Sloane.

Get the most out of television with Du Mont prestige

Du Mont . . . the most-sought franchise in the television field, because:

Du Mont carries the prestige of leadership;

Du Mont enables the dealer to demonstrate television at its finest;

Du Mont dealerships are restricted to a

few outstanding stores in each market.

DU MONT

First with the finest in Television

DU MONT TELEVISION STATION

W A B D

is broadcasting all the home games of the
NEW YORK YANKEES
BOTH DAY AND NIGHT

ALLEN B. DU MONT LABORATORIES, INC. • GENERAL TELEVISION SALES OFFICES AND STATION WABD, 515 MADISON AVENUE, NEW YORK 22, N.Y. • HOME OFFICES AND PLANTS, PASSAIC, NEW JERSEY
Copyright 1947, Allen B. Du Mont Laboratories, Inc.

★ UNITED STATES TELEVISION ★ LEADS AGAIN... WORLDS LARGEST PICTURES - 3 1/3 SQ. FT!

NEW... World's Largest Screen - 3 1/3 Sq. Ft.
So big, your customers will see every detail from anywhere in the tavern or club! 475 square inches of brilliant Television pictures!

NEW... UST Visual Static Suppressor

No flickering pictures, no blurred images. Kills static caused by ringing doorbells, refrigerators, elevators, other electrical devices.

NEW... Beautiful Pic (Picture Frame) Cabinet

Designed by Daleo... a new high in television cabinetry... makes any tavern, club, or restaurant look far more attractive.

NEW... Amazing Sound Quality

The super-sized baffle assures clear, faithful sound reproduction.

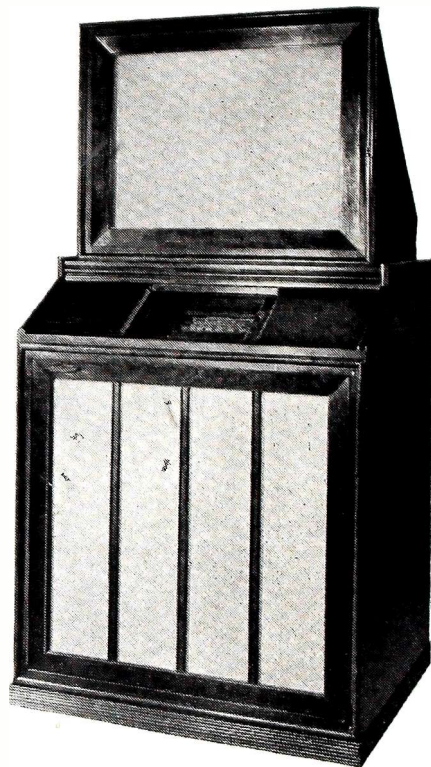

UST TAVERN TELE-SYMPHONIC. 30 tubes (plus 5 rectifier tubes). Gets all stations in all cities. Only UST has the famous Bausch & Lomb television coated lens and the unique UST refractive optical projection system. Controls lock and disappear under sliding panel. Includes FM, AM, Short-wave radio. Immediate delivery!

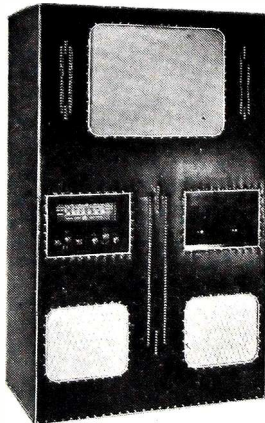

UST TAVERN TELE-SYMPHONIC, Decorator model in leatherette. Same television features as PIC MODEL. Available in a rainbow of colors: wine, blue, green, brown and cream. Blends delightfully with any color scheme. Includes FM, AM, Short-wave radio. Immediate delivery!

\$1995 including federal tax, plus \$100 installation charge with 3-month service guarantee. (Unconditional parts guarantee.)

\$1995 including federal tax, plus \$100 installation charge with 3-month service guarantee. (Unconditional parts guarantee.)



The UST TELESONIC, graciously styled in a beautiful period console cabinet, offers brilliant 10" direct-view pictures that can be seen without dousing lights. Includes FM, AM, Short-wave radio plus automatic phonograph. It's the complete entertainment instrument for the home, a 5-in-1 console available for immediate delivery. Also available in distinguished modern cabinet.

\$895 including federal tax, plus \$100 installation charge with 3-month service guarantee. (Unconditional parts guarantee.)

Big Profits for You! The beautiful UST Telesonic answers America's need for a moderately-priced television console. It is stocked by leading dealers from coast to coast. Almost every dealer has a dozen potential customers for the Telesonic.

The UST Tavern Tele-Symphonic is a big money-maker for dealers everywhere! Small aggressive dealers have earned gross profits of more than \$10,000 a month on just one UST Tavern model. Three out of every four public-view "Big Picture" projection television sets are products of the United States Television Mfg. Corp., pre-war pioneer in television. Cash in on the big demand for television NOW—represent UST!

Dealers! Send for free booklet, "How To Sell Television Sets Profitably."

"One Full Year Ahead"



★ **UNITED STATES TELEVISION** MFG. CORP.

3 WEST 61st STREET, NEW YORK 23, N. Y.

Telephone Circle 6-4255

Sonora for '48!

Clear as a Bell

32 SPARKLING SELLERS WITH ALL-AMERICA APPEAL

featuring
NATIONALLY ADVERTISED



Clear as a Bell Tone

**PRIDE-OF-POSSESSION STYLING
PERFORMANCE THAT STAYS SOLD**

SEE THE COMPLETE PRESENTATION
IN THIS HANDSOME BROCHURE

Backed by SONORA'S
Sound Dealer Policy

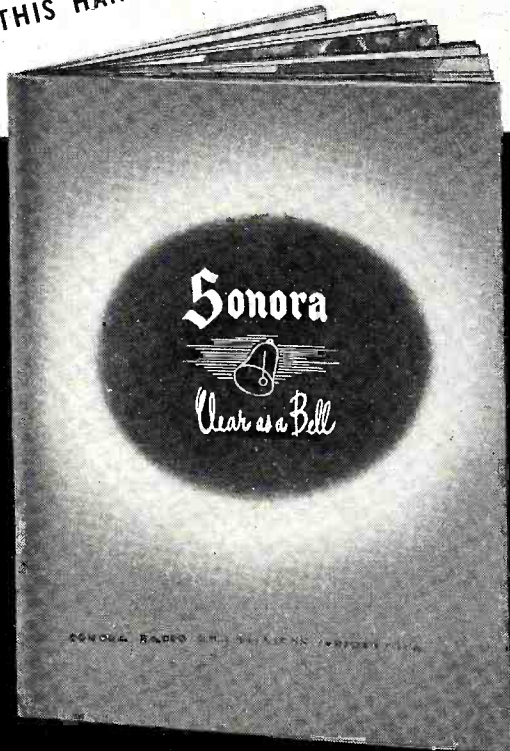

FM MODELS
5 Great New Models, including striking new plastic table model

PHONOGRAPH-RADIOS
11 Magnificent Instruments—Floor and Table Models

FLOOR MODELS
7 Distinctive Furniture Creations—each with phonograph

TABLE MODELS
9 Beautiful Numbers, in striking plastic and wood design triumphs

3-WAY PORTABLES
•
FARM RADIOS

WRITE FOR YOUR COPY TODAY 

SONORA RADIO & TELEVISION CORP.
325 North Hoyne Ave., Chicago 12, Illinois

Please send us a copy of your brochure presenting the 1948 SONORA Line of Radios and Phonographs. No obligation.

NAME _____

COMPANY _____

ADDRESS _____

CITY _____ ZONE _____ STATE _____



Clear as a Bell Tone

**SONORA RADIO & TELEVISION CORP.
CHICAGO 12, ILLINOIS**

The radio world
says "YES"!



SPARTON PERIOD MODEL NO. 1007

THIS BEAUTY is the Period Model of the new Sparton Challenger Line. Other models: The Modern . . . The Contemporary . . . and a variety of table and utility models. We wish this picture could show the wonderful quality of reception as well as the obvious quality of the handsome cabinet, but believe us, it's there, too. Yes, the Sparton Challengers offer you, in every way, more selling features than any other radio.

SEE THE NEW SPARTON CHALLENGERS AT PERMANENT SHOWROOM NO. 509-B AMERICAN FURNITURE MART

Sparton

Radio's Richest Franchise

THE SPARKS-WITHINGTON COMPANY • JACKSON, MICHIGAN

New Sparton Challengers
SMASH HIT
of the Chicago Show

DON'T mind our puffed-out chests! We're just back from the Summer Furniture Show in Chicago, and we're bustin' with pride!

The new Spartons are *the hit of the Show!*

We told you that we'd surprise the radio world with this new Challenger line . . . and the crowds at the show responded with an emphatic "Yes!"

Yes, we've really got something here . . . and offered right in the middle of the industry off-season, too! What handsome models these new Sparton Challengers are!

The *performance* of these stunning new Spartons measures right up to their good looks! The fidelity of tone and reception is an adventure in sound!

If you didn't get to the show, remember you can drop in anytime at the permanent Sparton exhibit in the American Furniture Mart in Chicago (Space 509-B). Check these amazing new Sparton Challengers point for point against anything on the market.

Even the
Price is
Sweet Listening

CHOICE OF CABINET
\$229⁹⁵ and Sweet
Selling, too

(All prices East of the Rockies)

SCMP* makes value like this possible:

* Sparton Cooperative Merchandising Plan is the secret! Without SCMP, Sparton could never give you *all* the brilliant sales features in the new Challenger Line. See why it pays to be a Sparton dealer.

- One exclusive dealer in each area
- National advertising that works locally
- Direct factory to dealer shipment
- Low consumer prices
- Factory prepared and distributed promotion helps
- Seasonal promotions
- Uniform retail prices
- Products styled by outstanding designers



Announcing
the arrival of the newest

Recordio

T.M. REG. U. S. PAT. OFF.



NAME..... *The Manhattan*

SIZE..... *Junior Console*
(24 3/8" x 16 1/2" x 37 1/2")

PARENTS..... *The Wilcox-Gay Corporation*

BORN AT..... *Charlotte, Michigan*

TALENTS..... *Recorder, Radio, Phonograph,*
Amplifier

OUTSTANDING
ATTRIBUTE... *Makes records from own*
radio or microphone

FUTURE..... *Terrific!*

ON DISPLAY... *At your Recordio distributor*



WILCOX-GAY CORPORATION
CHARLOTTE, MICHIGAN

THE
Manhattan

Latest addition to the famed series of world's finest home recording instruments:

- ★ Automatic record changer that glides out at a finger touch.
- ★ Records from self-contained microphone or built-in radio.
- ★ Pushbutton selection of radio recording, microphone recording, radio, phonograph or public address system.
- ★ New type, lightweight crystal microphone fits into palm of hand.
- ★ Crystal pickup with replaceable needle.
- ★ Electron-ray tuning and recording volume indicator.
- ★ Lightweight tone arm with spring-action needle.
- ★ Shock-mounted, recording turntable assembly with heavy duty motor.

130-44



LOOK...
AT WHAT YOU'RE GETTING!

It's the Greatest Advertising Backing
in Stromberg-Carlson History

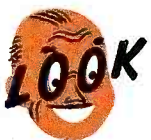

at the magazines! Life, Saturday Evening Post, American, National Geographic, New Yorker, Collier's, Better Homes and Gardens, House Beautiful . . . all great national magazines read the country over!

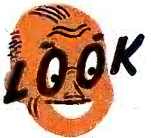

at the circulation! The combined circulation of these magazines is nearly *20 MILLION!* Not only mass coverage, but specialized audiences of home makers!



how often these advertisements appear! *Every* month from September through December. Consistency that clinches their effectiveness!



at the audience they reach! Over *72 MILLION* sales-stimulating ad impressions covering prospective radio buyers from coast to coast!



at the "extras"! You'll not only be getting this great national advertising support, but hard selling merchandising and sales promotion programs will help make this a mighty profitable year for all authorized Stromberg-Carlson dealers!

It's all designed to make your customers **LOOK** and **BUY!** And you can **LOOK** for greater Stromberg-Carlson sales and profits than even!

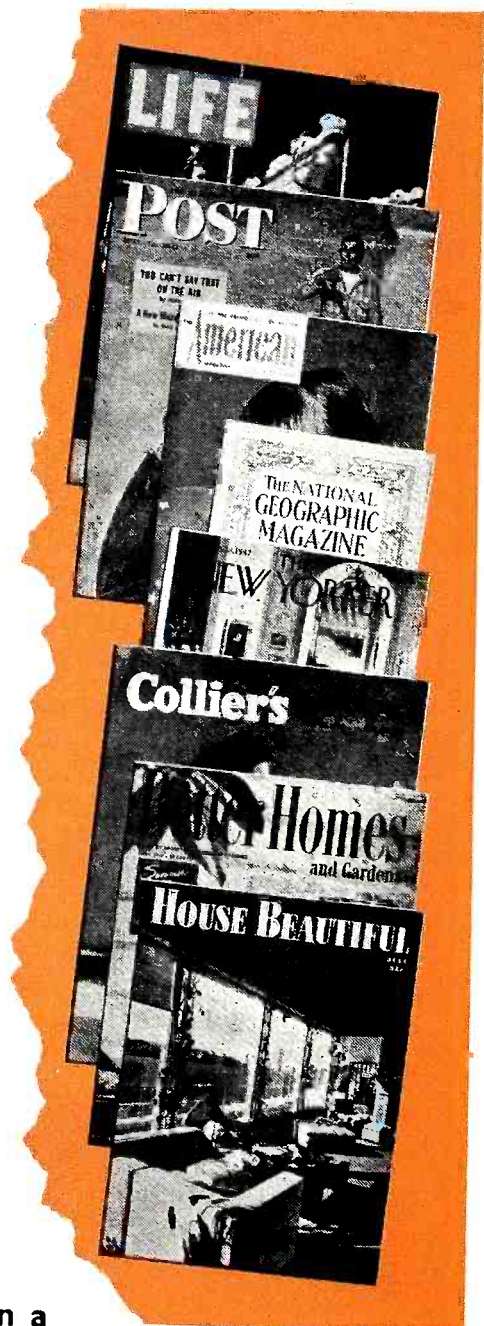

There is nothing finer than a
STROMBERG-CARLSON

Rochester 3, N. Y.

RADIO *& Television* RETAILING

Including Radio and Television Today

O. H. CALDWELL, Editorial Director



M. CLEMENTS, Publisher

A Corner on the Cash

The Fall months of this year have a come-and-get-it signal for the radio/appliance retailer.

It happens that this Autumn is the season which has the sharpest impact on the profitable handling of radios, appliances, records and service. Events begin to take place in each of these departments. Unusual forces begin to operate in all four sections of the store just as the first signs of Fall appear, and it's all beneficial to the aggressive retailer.

Under the circumstances, if a dealer does not take the fullest advantage of this set-up, he is missing the chance for some slick promotion. It is one of the spots where the retailer can best rush into action against the freshly competitive character of the market.

As for radio, the 39,000,000 families of this country are winding up their outdoor activities and are now thinking of inside-the-house entertainment. Radios, combinations and records provide the finest answers. With the added luxuries of FM, television, new recorders, and "radio for every room" the appeal is universal. In the stiff words of the analyst, the surface factors of the radio market are extremely favorable; in the words of the field merchandiser, sales are a cinch.

In the appliance market, an essential fact is that an enormous number of new homes are being completed one way or another and they all need merchandise. Plus the indisputable rule that a long string of seasonal appliances, led by multiple products connected with full-time indoor living, will move by the millions.

In servicing it is enough to say that the U. S. radio receiver must be in proper shape when the million-dollar broadcasts hit the air for the new season. It means a strong spurt in the repair business, in addition to the extra work in installation and maintenance of oncoming video and FM.

Changes for the better are thus operative in all parts of the store. If a retailer is looking for a smart spot for the opening of an even-better go-out-and-sell program, this is it!

What's Ahead!—in Radio,

PRICE-CUTTING FEVER DYING DOWN as stocks of slow-moving, too-high-priced merchandise dwindle throughout the nation. Most of those who featured loss-leaders lately reported that results were not good, but that business on regular-priced items continued to be satisfactory.

MANUFACTURERS AND TRADE ASSOCIATIONS becoming more and more helpful to dealers in the proper merchandising of FM. Meanwhile, those merchants who put sizzle into their salesmanship on high-fidelity receivers are finding out that RADIO and Television RETAILING wasn't fooling when it told them that "FM Means Folding-Money!"

UPSWING IN BUYING BY RETAIL OUTLETS being reported by many jobbers an encouraging sign since it means that several things are happening, among them: 1. Inventories of cats-and-dogs are being depleted. 2. Effects of the verbal drive to cut prices at retail levels are dying down. 3. Dealers are optimistic over the prospects for an increased Fall business.

HOTPOINT HAS DEVELOPED A WATER heater that draws its heat from the surrounding air by means of a heat pump. According to J. C. Sharp, vice-president of engineering for the firm, "no move to manufacture the machine in the predictable future will be made, but exhaustive studies . . . will continue." An efficiency coefficient of 3 to 1 has been obtained in the laboratory.

PROCTOR ELECTRIC WILL TAKE OUT DESIGN PATENTS, as well as mechanical patents to protect itself against imitators, according to Joseph Myers, vice-president in charge of research. The latter said that two firms had copied Proctor's Champion iron design. "One of the copies is so flagrant a 'steal' that the shell, handle, cord and backplate could be used interchangeably with ours," Mr. Myers stated.

THERE IS STILL A HUGE POTENTIAL MARKET for record players of all sorts. The present-day let's-put-it-off buying public will make a rush for disc-players some time before long, and will junk its obsolete turntable equipment in favor of quality merchandise. More records will be sold as a result, and more storage devices too. The smart dealer will do all in his power to push the sale of record cabinets of all sorts. The customer who has platters poured all over the house often hesitates to buy more because he dislikes adding to the present confusion.

LARGE REFRIGERATORS NOW DEMANDED by customers. John Q. Public is certainly reversing the stand he took a few years ago when makers and merchants were the ones who tried to push the big sizes. Now, unless space is strictly regimented, the buyer won't go for the smaller boxes. Some of the largest manufacturers see near-future demands for still bigger refrigerators on the part of the consumer.

"RADIO-APPLIANCE ADVERTISING—Another Source of Local Radio Advertising" is the title of a large, comprehensive printed presentation which has been sent to radio station managers in 160 communities by the Columbia Broadcasting System. The data for this air-time selling aid was prepared solely from material appearing in RADIO & Television RETAILING's nation-wide survey which was published in its issues of January and February, 1947.

UNIT SALES ON WASHERS OF ALL types should exceed 1946 figures by 50 per cent this year, according to E. L. Farquharson, sales manager of the home laundry division of Landers, Frary & Clark. The Universal executive predicts that wringer washers alone in units should exceed the total production of all washers, wringer, automatic and spinner type for the year 1946.

IN SPITE OF SHORTAGES IN STEEL and other essential supplies, the washing machine industry continues to pile up totals far in excess of its highest pre-war output. Nationwide sales reported for the first five months of this year amounted to 73 per cent of all 1941, record pre-war year, and 70 per cent of 1946.

CYLINDER TYPE VAC CLEANER AND A HAND IRON will be manufactured by the Hoover Company, it is reported.



MERCHANDISE FAMINE "OVERLORDS" who can't accustom themselves to the requirements of modern salesmanship being let out by progressive merchants who had to tolerate them during the personnel famine. The salesperson turnover rate is increasing by leaps and bounds.

RECORD AIR EXPRESS CONSIGNMENT BY EMERSON consisted of 8,824 pounds of receivers and combos sent from New York to a radio distributor in Havana, Cuba. The shipment was made up of 185 cartons.

FRIGIDAIRE's NEW LINE includes an automatic washer, described by the firm as "revolutionary," and which will sell at \$299.75; an automatic electric dryer, at \$229.75, and an ironer to be marketed at \$189.75.

MORE THAN 200 VAC CLEANER BRAND-NAMES are on equipment in the hands of the American consumer.

Appliances, Records and Television

THOUGH MOST OF THE INDUSTRY leaders have stocks of steel sufficient to last them for some time, many of the smaller plants will soon be dipping out of the bottom of the barrel.

AN ILLINOIS STORE SOLD A COUPLE OF THOUSAND phono records in one week via advertising announcing the appearance of a recording star.

"EVERYTHING BUT THE KITCHEN SINK" is more truth than poetry, as any dealer in "complete kitchens" can testify. The shortage continues, and it may be made worse by the recent coal crisis.



GREAT FM EXPANSION SEEN by end of 1947. The number of FM stations will be more than doubled at the close of this year, and the service provided by this increase will cover 80 per cent of the population, says Roy Hofbeinze, president of the FM Assn.

HUGE FALL SALES PROMOTION project being readied by Chicago's Electric Association. Dealers and utilities are being asked to put \$60,000 into the advertising jack-pot.

SMALLEST MOTORS IN MASS PRODUCTION are the one-ten-thousandth horsepower units that turn the tiny shaft in an electric razor 6,000 times a minute. One of the largest AC motors yet installed in America is the 40,000 horsepower giant used in a plane-testing wind tunnel, according to the National Electrical Manufacturers Assn.

THE WEATHER MAN HELPS—Twenty-nine of the 52 wash-days of the year are not suitable for drying clothes outdoors, points out L. F. Worth of Bendix Home Appliances, quoting government weather statistics. Mr. Worth is manager of the guess-which section.

JUST WHEN WE THOUGHT ALL THE USES for the versatile infrared lamp had been publicized, along comes a Western utility company with suggestion that the bulbs can be used by working girls to heat rolls piping hot in the morning. "Simply place the lamp about 14 to 16 inches from the plate of rolls and they'll be warm in a very few minutes," advises the utility company's bulletin.

RECORD SALES OF "COMFORT" APPLIANCES on the way as dealers prepare to do a land-office business in space heaters, electric blankets, heat pads, and therapeutic lamps this coming Fall and Winter.

NATIONAL ASSOCIATION OF MUSIC MERCHANTS' 1949 annual convention site now under consideration, with bids having been submitted by New York City and Atlantic City.

REPORTS FROM DEALERS SHOW A GROWING trend toward more and more use of radio advertising. All over the country, merchants are using local stations for spot announcements and programs to plug specific items, or for the purpose of keeping their names in front of the residents of the communities.

"EVERY EMPLOYEE IS A SALESMAN, regardless of his position," believes Leland B. Flint, general manager of Flint Distributing Co., Salt Lake City. He implements this opinion through the cost-free enrollment of all employees in a speech development class conducted twice each week by Dr. Royal Garff. The firm distributes Bendix home appliances in Utah.

TELEVISION WILL BECOME A BILLION DOLLAR BUSINESS, eventually surpassing the automobile business, James Carmine, Philco vice-president, predicted at a meeting in New York.



THERE'S A GLINT OF GOLD IN TELEVISION'S shining countenance as a number of new factors promise greater impetus. For example, several of the giants in the industry are now underway with large production schedules; ambitious plans call for new territories to be opened, and day by day the public is seeing more and better television shows.

TELE UPPING BAR AND GRILL business in New York City. A record number of tavern owners have bought video receivers during the past two months. Bar operators report hundreds of new faces as a result of the magic sign, "Television", displayed outside their establishments. Reception is quite satisfactory, though some installers have had themselves headaches in a few of the locations.



Audiences at the "Golden Throat" Demonstration compared tone of the piano on stage with that broadcast through the "Golden Throat" of the RCA Victor "Crestwood."



"Golden Throat" demonstration amazes music merchants and piano technicians at NAMM convention

THE dramatic two-piano performance proved to all present that the RCA Victor "Golden Throat" tone system reproduces sound with amazing fidelity. No one who witnessed the demonstration was able to correctly identify the source of the music . . . the piano on the stage before them, or the piano being broadcast through the "Golden Throat" tone system of the RCA Victor "Crestwood."

Perhaps you were among the 2,000 who witnessed the RCA Victor "Golden Throat" Demonstration at the NAMM Convention in Chicago. If so, you know how perfectly the "Golden Throat" reproduced the tones of the piano . . . convinced listeners that the "Golden Throat" is really the finest tone system in RCA Victor history.

This amazing tone fidelity will help you sell more RCA Victor instruments. *Now*, your customers can hear *pure* tone . . . they can hear all the beauty of the artist's performance.

The "Golden Throat" is a new perfection in balance of electronic amplification, speaker and cabinet. This exclusive 3-way sound system is the result of RCA's 27 years of electronic engineering skill and Victor's 48 years of leadership in the reproduction of sound.

 ONLY RCA VICTOR MAKES THE VICTROLA



Miss Marie Carlile played the piano on stage—demonstrated perfect tone of the "Golden Throat" by alternating the performance with . . .



Miss Barbara Wayne whose share of the performance was broadcast through "Golden Throat" tone system of the RCA Victor "Crestwood."



Participants from the audience used this signal switch to indicate their "guesses" as to which of the two pianos they were hearing—the one on the stage or the one in the broadcast studio. The "Shadow Box" and industrial indicators (shown at extreme left of picture on left hand page) registered each contestant's "score."

Two pianos demonstrate perfect tone reproduction of the RCA Victor "Golden Throat"

THE Two-Piano Team of Carlile and Wayne performed in the "Golden Throat" Demonstration. Miss Carlile played the piano that stood on the stage beside an RCA Victor "Crestwood." The other piano played by Miss Wayne was in a broadcast studio in another part of the building. An RCA microphone picked up the music from the second piano and fed it to an RCA transmitter which broadcast to the "Crestwood."

Miss Carlile and Miss Wayne played alternately . . . unexpectedly switching the performance from the piano on the stage

to the piano in the studio which was heard through the "Golden Throat" of the RCA Victor "Crestwood." No one who heard the performance could definitely identify the source of the music except when Miss Carlile raised her hands to show she was not playing.

At the conclusion of each piece of popular music, participating members of the audience were scored on their indication of the number of times the pianists changed. Estimates ranged from 3 to 12. The actual number was 28 changes.



The public showing of the "Golden Throat" Demonstration was inaugurated at the RCA EXHIBITION HALL—July 21 to August 2. When you're in New York City, don't miss the many electronic wonders on display at the Exhibition Hall. Open, free to all. 36 West 49th Street.

Mr. Edward Volkmar—Chicago Piano Technician and Tuner—stated:

For the first time in my 40 years as a piano tuner, I have heard all the tones of the piano reproduced *exactly* by a radio. The RCA Victor "Golden Throat" brings all the beauty of the piano to the listener as played by the artist.

Signed *Edward Volkmar*

5156 W. St. Paul Ave., Chicago, Illinois

Mr. Benjamin Kaye—President of the famous Liberty Music Shops, New York—stated:

This demonstration proves the "Golden Throat" reproduces even the tone of the piano perfectly. No one present could detect the slightest difference between the piano on the stage and the "Golden Throat."

Signed *Benjamin Kaye*

Liberty Music Shops, New York City, N. Y.



RCA VICTOR

DIVISION OF RADIO CORPORATION OF AMERICA

"Victrola"—
T.M. Reg. U. S. Pat. Off.

Good Display Makes Business Pay

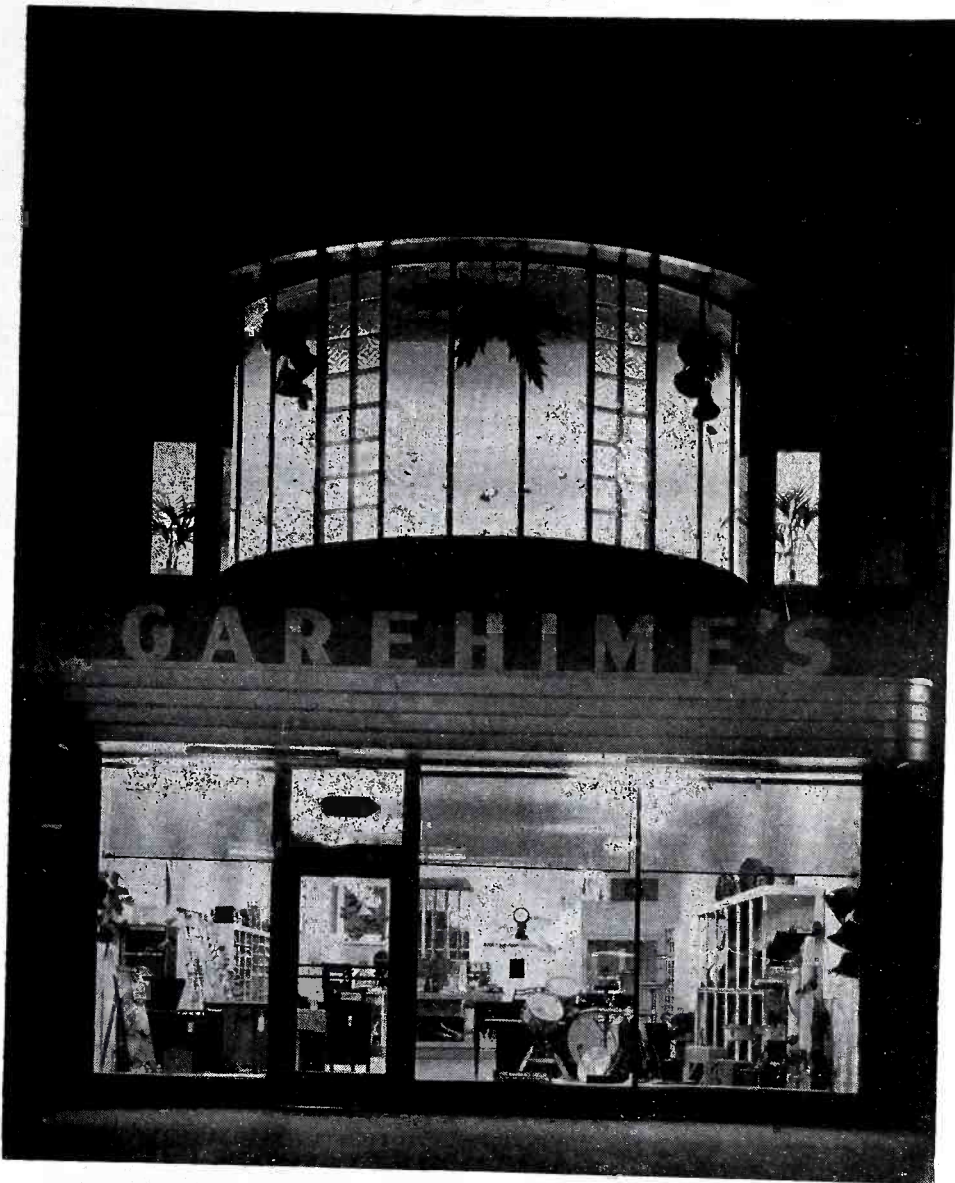

Examples of Windows
Designed by Dealers
From Coast-to-Coast
As Attention - Getters

The recently remodeled front of the Garehime Music Company of Las Vegas, Nevada, proves that a large plate glass facade can make a show window of the entire store. The upper story presents unusual opportunity for atmospheric display.

Below, Left: Linn Scruggs, of Decatur, Illinois, used this bedroom-suite recently as an attractive tie-in with the window promotion of Universal electric blankets. Below, Right: Many retail stores in Oklahoma took advantage of a special Proctor toaster display sponsored by Tom P. McDermott, Inc., Tulsa distributor. Shown, is the window of the Banks Good Housekeeping Shop of Sapulpa, Oklahoma.

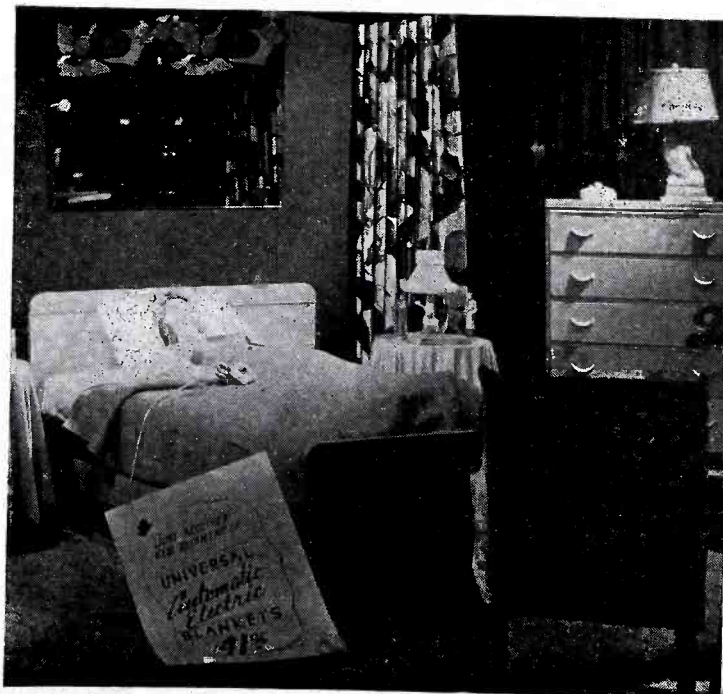



▲ Appliances Ltd., of Los Angeles, California, opens its doors in true Hollywood style. Another example of utilizing the entire store as a show window by means of a plate glass front.

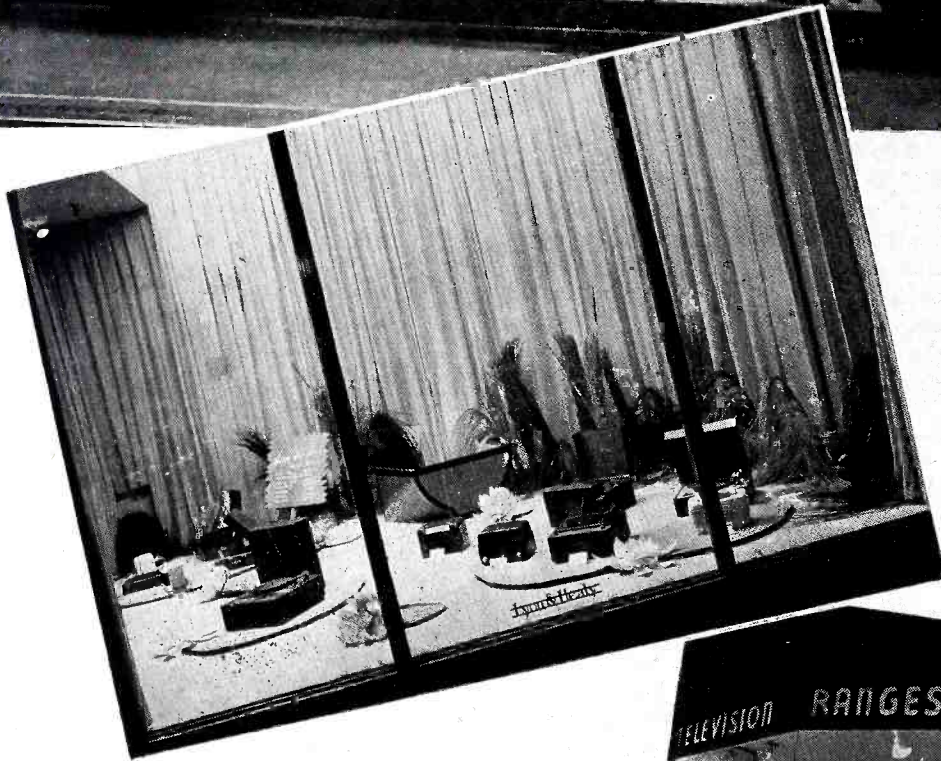

Left: Lyon and Healy, of Chicago, present a simple, but striking window through the use of a few props and dramatic lighting.

▼ Powers, Newark, New Jersey dealer, shows both major and small appliances in a well balanced display.

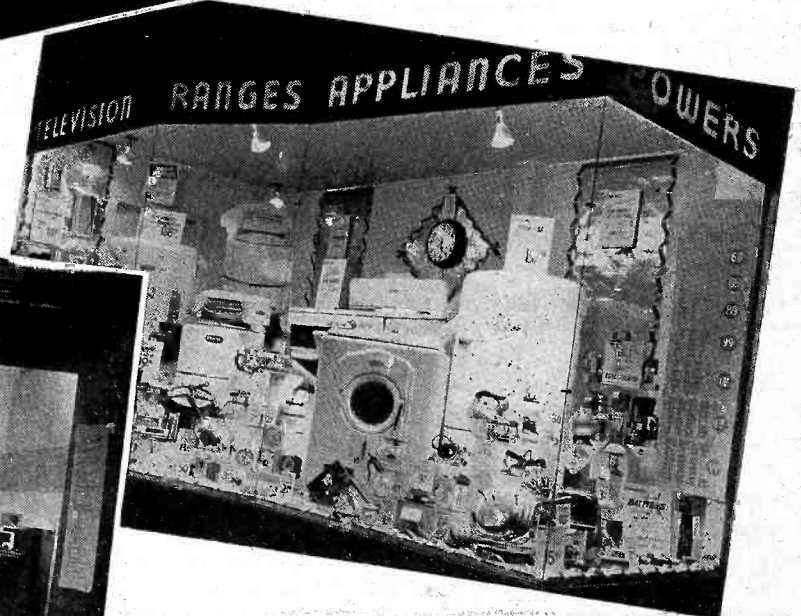

This attractive window, devoted to Zenith receivers, helped draw more than 100,000 persons into the Home Appliance Fair staged by Spear's, of Pittsburgh, Pa.



It **PAYS** to **KNOW**



Progressive Illinois Merchant Has the Facts at Hand— Merchandising and Cost-Control

This article tells why Dealer John F. Dacy's firm is really going places in a city of 8000 population.

• Good business management, coupled with active merchandising and salesmanship pays off well for John F. Dacy, president of Dacy Electric Co., Woodstock, Ill.

There are a number of reasons why Dealer Dacy does so well in this small city, located in the heart of one of the most important milk-producing counties in the country. One of the principal reasons for the success of this dealership lies in the fact that the proprietor always knows just where he stands. (See accompanying tables.) He has a monthly and a yearly audit of his books made for

and rural accounts. Therefore, he sold this business to another dealer.

Last year, this firm did a gross business of \$271,611.29 in a town of 8,000 population. With his staff of eight people, Mr. Dacy expects to equal in 1947 the 1946 total.

The firm is now spending about \$3,000 per year for advertising, mostly in newspapers. The Dacy advertising takes a commanding position in the paper, usually a quarter or a half page. A couple of large highway signs also call attention to the organization's facilities for merchandising and servicing.

since 1938 in this area.

Dacy's show window, too, is unusual for a small city. It is done up right and sells a great deal of merchandise for him. The window area is 9 x12 feet and has plenty of light. A special room above the window space carries all the windowtrim accessories and is readily accessible.

From this point on, Mr. Dacy believes promotions are necessary to hold up appliance volume. He is getting ready to stage at least one promotion per month, covering a wide range of appliances. On these promotions he will have demonstrations. He has discovered that some such promotions can be put on without prizes or other inducements, and he will try both kinds, as in pre-war days.

During the past year he realized the demand for oil burner conversion units. He trained a couple of men

Comparative Statement of Dacy's Profit and Loss for Nine Years

	1938	1939	1940	1941	1942	1943	1944	*1-'45 to 9-'45	*9-'45 to 1-'46	1946
NET SALES.....	\$16,373.97	\$31,432.87	\$55,526.70	\$73,489.73	\$69,084.86	\$97,050.87	\$81,028.70	\$83,165.69	\$60,525.63	\$271,611.29
DIRECT COSTS.....	10,000.00	14,400.00	39,945.76	58,268.57	51,232.48	72,515.31	61,094.48	49,599.89	33,034.50	202,600.26
Gross Profit.....	\$ 6,373.97	\$17,032.87	\$15,580.94	\$15,221.16	\$17,852.38	\$24,535.56	\$19,934.22	\$33,565.80	\$27,491.13	\$69,011.03
OVERHEAD EXPENSE.....	3,500.00	9,800.87	2,209.57	2,960.36	4,031.59	5,757.08	8,242.22	13,788.14	12,339.62	43,449.71
Profit from Sales.....	2,873.97	7,232.00	13,371.37	12,260.80	13,820.79	18,778.48	11,692.00	19,777.66	15,151.51	25,561.32
GENERAL AND ADMINISTRATIVE EXP.....	1,500.97	3,430.00	5,020.44	7,128.63	4,256.70	6,966.77	6,059.56	10,653.43	7,326.22	13,335.07
Operating Profit.....	1,373.00	3,802.00	8,350.93	5,132.17	9,564.09	11,811.71	5,632.44	9,124.23	7,825.29	12,226.25
FINANCIAL INCOME ADDED.....	18.00	9.00	309.82	720.87	347.66	753.34	1,098.95	717.66	101.61	1,014.06
Total.....	\$ 1,391.00	\$ 3,811.00	\$ 8,660.75	\$ 5,853.04	\$ 9,911.75	\$12,565.05	\$ 6,731.39	\$ 9,841.89	\$ 7,926.90	\$13,240.31
FINANCIAL EXPENSES DEDUCTED.....	389.40	113.80	430.59	824.59	862.84	597.05	219.25	285.80	64.33	774.99
Total Net Profits.....	\$ 1,001.60	\$ 3,697.20	\$ 8,230.16	\$ 5,028.45	\$ 9,048.91	\$11,968.00	\$ 6,512.14	\$ 9,556.09	\$ 7,862.57	\$12,465.32

*The 1945 business is divided into two parts. On Sept. 1, 1945, Dacy Electric Company became a corporation.

him by a competent accountant, and this enables him to know just what his business is doing month by month.

Mr. Dacy pays \$50 per month to the accountant, and he also pays \$200 a month salary to his secretary. He says that this \$250 monthly expense is an excellent investment for him because it enables him to get any information he wants in a hurry. For example, the monthly audit revealed to him, he states, that he was losing about \$200 per month on bottled gas sales, even though he had 350 city

During the past three years Dacy has sold 400 farm freezers. In the past year he sold 250 electric refrigerators, 150 Bendix washers, and many other appliances.

To date, Dacy has not had to do any outside selling, but he expects to do so in fall and winter. He is a firm believer in display of merchandise, plus good advertising, and good service. This has kept the business rolling in, because the Dacy firm has had an excellent reputation for quality merchandise and excellent service

to handle this phase of the business. More than 75 of these jobs were sold and installed by the Dacy firm during the past year. His crew converts furnaces to oil burning equipment, no matter what the previous type of heating system.

This venture into oil-burning conversion business caused Mr. Dacy to purchase a furnace cleaning unit. This unit is in constant use and has proved very profitable, he says. Many oil burner conversion unit prospects do not like to install con-

Where You Stand!

Ups Business From \$16,373.97 in 1938, to \$271,611.29 in 1946.

Know-How Brings Profits

version units without having their heating systems cleaned, and thus the Dacy cleaning unit comes in very handy.

In the basement of the store, Dacy has an excellent service department. Radios, washing machines, vacuum cleaners, refrigerators, washers and other appliances are repaired and serviced. This shop was very busy during wartime. Dacy reports that by circularizing wartime service accounts he is now making many sales of new appliances.

Traffic Builders

Wartime taught Mr. Dacy many lessons as did early postwar, and he has benefited from some of them, he says. For example, he is keeping his paint line, for it has proved very profitable. However, his hardware store department, strictly an experiment, was thrown out. The hardware store fixtures were used to take care of an augmented electrical supplies department, and this division has been doing very well.

Dacy is not one to pass up profits on sales of small items. For example, he carries a large stock of vacuum cleaner belts. Customers know this. The profit on the line is small, but Dacy sells more than 50 such belts per week and augments his store traffic considerably. An excellent stock of fractional horsepower belts, too, is bringing in customers.

Lighting Displays

The lighting fixture department moved from the back of the store to a new location up near the office at the center of the store boosted fixture volume exactly 1000 per cent, says John Dacy. 72 "live" fixtures are arranged in a beautiful ceiling display spot.

Dacy also has an excellent stock of electric light bulbs and sells many of them. Recently he cooperated with the Boy Scouts in an electric light sales campaign which gave the store \$1500 light bulb sales in one week. The Boy Scouts,

(Continued on page 82)

Dacy's Operating Statement for the Year 1946

Just where the money goes is of utmost importance to the retail merchant. It permits him to make budgets, and to analyze various costs. This progressive Illinois dealer has a monthly audit at hand too, and this enables him to get any information he wants in a hurry. The following figures will be of utmost value to other dealers for the purpose of making comparisons, preparing budgets, etc.

INCOME

Merchandise	\$209,315.70	
Service	23,029.05	
Service Parts	7,421.97	
Merchandise Sold for Resale	27,120.40	
Rental Income — Public Address System	2,665.00	
Sales in Interstate Commerce	2,059.17	\$271,611.29

COST OF SALES

Physical Inventory — Merchandise 1/1/46	\$ 45,433.68	
Purchases:		
Merchandise	\$192,386.51	
Services	9,115.63	
Service Parts	7,869.81	
Contract Labor	1,256.72	
Discounts Earned	1,014.06	
Freight and Express	3,066.27	
Overcharges Refunded	57.60	
Buying Expense	93.07	\$212,831.55
	\$258,265.23	
Inventory — Merchandise 12/31/46	\$ 56,679.03	\$201,586.20

GROSS PROFIT

\$ 70,025.09

SALES EXPENSES

Selling Wages	\$ 5,640.32
Service Wages	15,510.61
Office and Administrative Wages	2,299.44
Officer's Salaries: J.F.D.	7,800.00
Social Security Expense	292.27
State Unemployment Compensation Tax	628.72
Federal Unemployment Compensation Tax	98.09
Compensation Insurance	109.81
Advertising and Travel	3,228.05
Truck Expense	2,635.39
Sales Tax	3,984.57
Bad Debt Reserve	681.95
Commissions Paid	85.70
Infringement Fees	51.55
Selling Expense	20.00
Discounts Given	189.95
Cash Short	17.40
Customer Gifts	167.17
Employee's Meal Expense	8.72
	\$ 43,449.71

SALES PROFIT

\$ 26,575.38

GENERAL EXPENSE

Office Expense and Supplies	\$ 856.47
Interest Paid	651.91
Bank Charges	123.08
Credit Bureau Dues	38.80
Rent	3,103.00
Taxes	251.47
Dues	69.25
Insurance	2,131.36
Telephone	909.59
Refuse Removal	95.00
Light, Water and Heat	805.56
Supplies	320.60
Donations	471.25
Repairs	1,585.32
Legal and Audit	548.44
Customer's Finance Company Payments	100.00
Miscellaneous	101.77
	\$ 12,162.87

OPERATING PROFIT

\$ 14,412.51

DEPRECIATIONS

Trucks and Cars	\$ 1,343.65
Tools	99.96
Fixtures and Machinery	593.58
	\$ 1,947.19

NET PROFIT

\$12,465.32

Sales and Service

Maintenance and Merchandising—A Real Money-Making

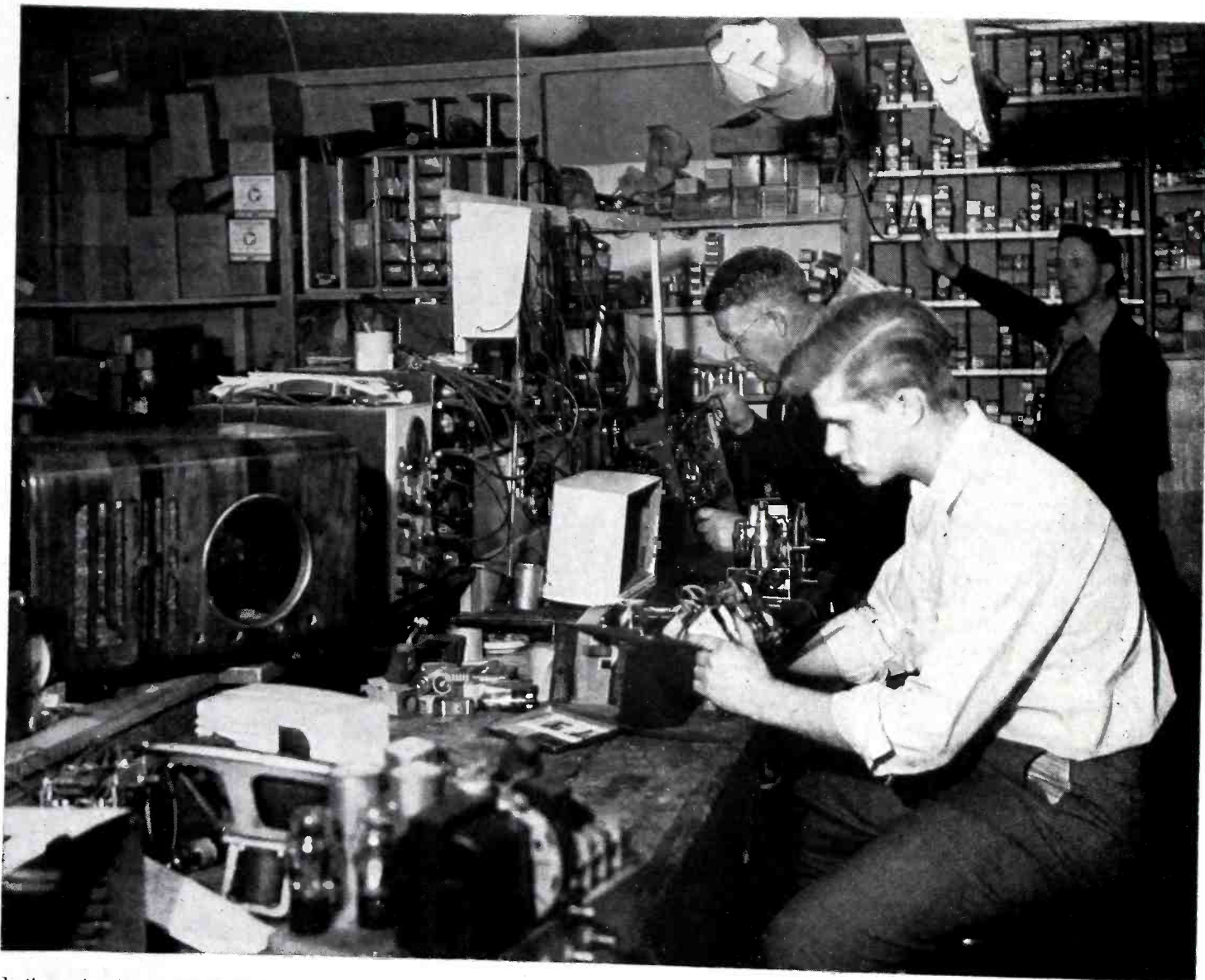

In the service shop of Arnold's Radio, the proprietors make a point of technical know-how and no kickbacks. Careful records are kept and all work is cash.

● On the neat brick building occupied by Arnold's Radio, at 1801 Prospect Road, Peoria, Ill., it says "SALES AND SERVICE." And when the co-owners, J. Lee Arnold and Clyde Shepard, put in the word "service," they were not fooling.

This firm, which is 17 years old, is an aggressive merchandiser, but emphasizes service to the extent that the phrase, "Not a Hobby or Side Line—It's Our Business" always appears with the name of the company.

Arnold graduated from a department store radio service job to a shop of his own in the rear of his home. Then he moved to the pres-

ent location and took in ex-employee Shepard as a partner when he came back from the war.

When more room was available at the new location, Arnold expanded the selling end of his business. He now handles nine lines of radios—Zenith, RCA, Westinghouse, Stewart-Warner, Lear, Farnsworth, General Electric and Sentinel. He also handles Motorola car radio.

The service department acts as a feeder for new sales of radios and helps to sell other items. "While our service department is prolific in prospects for new radios," says Mr. Arnold, "we do not high-pressure

any customer into buying a new one. If a customer wants our candid opinion on whether his radio is worth repairing or should be replaced with a new one, we will tell him the truth."

Irons in the Fire

The store has a 16' x 34' display room and a 22' x 26' shop. In both sales and service, the firm lives implicitly up to the slogan. In addition to the servicing work for its own customers, the store does service work on contract for one jobber and for three furniture stores having radio departments. Service work is

Work Together

Team for This Illinois Retailer

done not only on radios but on everything else electrical. The company specializes on the installation and service of permanent sound systems. In this it has built up a considerable business with churches, schools, etc., within a radius of 75 miles from Peoria.

"We work on a flat rate system," says Mr. Arnold. "By doing this, there are no favorites—all customers pay the same fees for the same work. Every operation has a fixed charge, which we think is fair to the customer, to ourselves and to our workmen."

The shop is equipped with the latest practical devices for repair work, all instruments needed for maintaining service, and all kinds of special tools necessary. The equipment includes an analyzer, an oscillograph for fine alignments, and a signal generator. Mr. Arnold has also built up a transformer with attached apparatus for thoroughly testing every radio job that goes out.

Standards Kept High

"We don't believe in slap-bang artist service," says Mr. Arnold. "We want no kickbacks and so we make sure that our work is perfect before it leaves the shop."

A large inventory of parts for all radios is carried. These are classified and arranged on shelves. The inventory is double-checked every month. One of these is an actual physical inventory and is checked against what was used on jobs during the month. Anything needed is immediately ordered after the inventory. Of course, if a special run occurs on any of them between times, it is ordered at once so the stock will not become exhausted.

"We believe," says Mr. Arnold, "that half of the ordinary radio repair shop's profits are lost if it has to buy parts whenever the need arises instead of carrying a sufficient inventory."

Mr. Arnold also believes in an accurate record of every job done in the shop and having this record available at a minute's notice. For this, a coded card is used for each job and this is filed in the office. By this method, he can tell five or ten years

later just what work was done on the radio covered by the card. This is not only of much use for giving information to the customer but is also an effective insurance against unjust complaints.

In handling a job, the usual procedure is as follows: The call usually comes in by phone. The name, address and time to pick up is entered on the three-way job card. The number of the job is placed on all three parts of the card in code. The code number is made up first, of the figures representing the month, day of month and the last two figures of the year; second, a letter, which is the initial letter of the first name of the person taking the order; and third, the consecutive number of the job for the day.

The pick-up man takes the three-division card with him. He writes on the original section what the customer thinks is wrong with the radio. He tears off one division of the card and gives it to the customer as a check for the radio. On one end of the card there is a tag. He next ties the tag to the radio and brings it in. When the work is completed, the

parts and time used, and the cost of parts and labor, are entered on the original part of the card. This division is torn off and filed in the office after an invoice is made to give to the owner. The third division, the tag, is left attached to the radio. The firm name and address appears on this as well as on the check copy given to the customer. By leaving it attached, the customer knows whom to call for future service.

What the Job Requires

Outside jobs and shop jobs run just about even. Only jobs requiring minor work are done in the home. "We do not believe," says Mr. Arnold, "that a set can be adequately serviced in a living room or on a kitchen table where we have to use soldering irons or instruments. If a minor job, we fix it on the spot. If not, we bring it in and it goes through the regular procedure. If a radio is not brought in, the technician going out fills out the work done on the three-way card. When we get through with any job, we know just what we have made."

(Continued on page 120)

A ledge runs along the wall of the Peoria store, to add interest to the display of new consoles.



MANY Competitive

Which Should

52% VOTE FOR MANY MAKES

48% VOTE FOR LIMITED NUMBER

That's how evenly opinion is divided among a cross-section of leading radio-appliance dealers who replied to RADIO & Television RETAILING'S questionnaire

● When it comes to the question of whether a dealer should sell many competitive brands or specialize in a few, opinion is about evenly divided, a survey made among leading radio/appliance merchants by RADIO & Television RETAILING reveals.

Some of the most prominent wholesalers were quizzed too, with the majority favoring concentration of selling effort on a few brands. Because of lack of space it is not possible to quote from all of the answers received from jobbers and retail merchants, but the ones printed are typical of all the replies received.

"A merchant is a dealer in radio and appliances who carries a wide assortment of leading makes . . . the more he has on display, the more likely he is of doing a large volume business . . ." **Harry Alter*** (distributor), **The Harry Alter Co., Chicago, Ill.**

"We agree on not being exclusive. Have three lines and it has worked out successfully. No one line has everything."—**Schmohl Bros., Inc., Mobile, Ala.**

Dealer Harold C. Morrison, Pappillon, Neb., votes "100 percent" for handling many brands, as does the proprietor of **Leon's, Cambridge, Mass.** "Many lines—the cream of all you can get," is the advice of **Gillmer Sound Systems, Ames, Iowa.**

"Have tried both ways over a period of several years . . . and found that many lines is the best business volume deal . . . any product that can't hold its own in keen competition is a poor product," is the way **J. Janning, manager Universe Radio Co., Indianapolis,** puts it.

A prominent **Long Island, N. Y. dealer,** who will not permit use of his name, votes far as many lines as he can get. "All too many customers come in asking for specific makes," he asserts. "In most cases, a brand-sold buyer will go to the competitor in spite of the best salesmanship there is. So why not stock 'em all?"

F. H. Frantz, Philadelphia, Miss. votes for many makes, as does another southern dealer, **Bellevue Radio & Appliance Co., Memphis, Tenn.** "We do not feel obliged to take certain numbers in any one line which we do not feel will be hot for this particular territory, which, however, might go well in another place. We run, own and operate our business and do not like to have the high-pressure boys tell us what to put on the floor," writes **Merchant C. A. Sherman, Rockland, Me.**

... "Prefer a number of leading makes rather than an exclusive line," is the way **Petruff Radio Sales & Service, Miami, Fla.,** feels about it. Other votes for multi-brand selling come from **Eakers Radio Sales & Service Co., Morehouse, Mo.,** and from **Dealer Zebor, Akron, Ohio.**

"Not less than two leading lines should be carried, but not more than four," believes **Jack Wittman, Anacortes, Wash.,** retailer. "I am in favor of many competitive brands," says **Philadelphia retailer Robert Elmott.**

"If you handle only one make and that turns out to be a 'lemon', you're sunk, according to **F. F. Violyn, Amsterdam, N. Y.** retailer.

Classic Radio Sales & Service, Detroit, Mich., reports: "We like to handle four or five different brands . . . we have a better chance to sell more radios this way."

Dealer Richard A. Bryan, Columbus, Miss., says: "I believe in handling as many good brands as financially possible."

A **Bronx, N. Y. merchant** feels that the dealer who carries a selection of brands is performing a service to the customer as well as insuring greater volume for his business.

Many brands are favored by **Retailer Paul J. Rayburn, Chadds Ford, Pa.,** and also by **Conte Radio & Electrical Co., 989 Broadway, Bayonne, N. J.**

"I compete with large department stores," says a **Chicago retailer,** "and therefore find that I must carry as many brands as I can get in order to provide the same sort of selection the department store offers the customer.

His views are seconded by a prominent **New York merchant** who says: "This is an era of selective buying. If you haven't what the customer asks for you'll lose sales."

"I am in favor of handling many competitive brands of radios and appliances," asserts **C. A. Werrmann, Fort Thomas, Ky.,** merchant.

Wholeheartedly in favor of merchandising many brands is the **Hill Radio & Appliance Co., Denver, Colo.** From **Baltimore, Md.,** **Minor's Radio & Television Co.,** sends in a vote in favor of selling a number of competitive makes.

Peter K. Beam, Beam Radio & Television Co., Washington, D. C., believes in handling a number of brands. "I believe in stocking many lines and throwing out the lemons as they appear," says a **Milwaukee merchant.**

In favor of specialization with a few makes are a number of leading wholesalers. Executives of six of the country's major distributing firms explain reasons for their stands in statements appearing on page 48 of this issue. Following are some excerpts: . . .

... "One of the difficulties that dealers are already experiencing is the fact that they have too many lines . . ." **Irving Sarnoff, vice-president, Bruno-New York, Inc.**

... "Specialize on a few . . ." **Benjamin Gross, Gross Distributors, Inc., New York, N. Y.**

... "Advantage to a dealer to be identified as headquarters for some famous, nationally advertised make . . ." **Ludwig Hommel, president, Ludwig Hommel & Co., Pittsburgh, Pa.**

Brands or **FEW**— the Dealer Carry?

... "Dealers who concentrate on a few lines invariably do a much better merchandising job . . ." **Thomas F. Joyce, Raymond Rosen & Co., Philadelphia, Pa.**

... "As a consumer, I like to buy from a merchant who sells an exclusive line or a limited number of lines . . ." **T. Pierson, secretary, Onondaga Supply Co., Inc., Syracuse, N. Y.**

... "I don't agree 100% with Mr. Alter's remarks. I believe in a middle of the road policy . . ." **L. J. Strauss, president, Joseph Strauss Co., Inc., Buffalo, N. Y.**

A cross-section of the United States is represented in replies from retail merchants, a few of which are printed in this issue:

"A salesman cannot be fair with himself, boss or customer in trying to sell many brands," according to an official of **Modern Electric Co., Vermillion, So. Dak.**, who continues, as follows: "If the appliance business were like the drug and dime store business this (many brands) might work." Modern Electric feels that too many brands confuse customers, and that a salesman can do a much better job concentrating on one or two makes.

"Specialize on a few, then you really know what you are selling," advises **M. C. Long, Tupelo, Miss.**, merchant. Similar advice comes from **T. W. Garrod, Jr., of Laramie, Wyo.**, who says: "Specialize in one or two top lines. Do a good selling job." Says radio and appliance retailer **T. B. Winstead, Elm City, N. C.**: "I prefer to handle a few standard brands. I don't see how a company can handle many unless it has a very large store and plenty of capital."

"I believe that dealers and distributors should specialize in one line," writes **Dealer R. E. McCarthy, Des Moines, Iowa**, who continues with the statement that "the advantages of that policy are too numerous to mention here."

Voting for exclusive operation, **Ralph A. Baker, of Appliance Sales & Service, Pascagoula, Miss.**, believes in "specializing in a few best brands producing first class merchandise."

Concentrating on a few makes is best, believes **Arthur Collman, of Collman Radio & Electric, Johnson, Neb.** He says: "One can make more sales by having a thorough knowledge of the product he is selling."

"I want my store to be known as headquarters for the complete line of products," declares a **New Jersey dealer.**

"This way I get full benefit of the huge advertising campaigns launched by the company."

... "have to have a warehouse instead of a store," comments **John R. Boggess, of Boggess Radio & Appliance Sales & Service, Greenville, Ky.** He continues: "If 'we service what we sell,' which is a motto of ours, we should have to have another warehouse for stock parts. How many dealers have enough capital to stock a lot of different brands of appliances for a hundred or so different types?"

From **Bellevue, Wash., Bellevue Radio & Appliance Co.**, comes a vote for specializing in a few makes, and another from **N. C. Eason, Lindale, Tex.** Its vote for a few brands is qualified by **Murray Electric & Radio Co., Scranton, No. Dak.**, with the statement "we are too far away from the best wholesalers."

"We prefer a few leading makes; also a few lesser-known brands with longer discounts," says **Oliver's, Danielson, Conn.**

ley votes for specialization on a few standard brands. **Dick Nevottl, Omaha, Neb.**, feels the same way about it.

Excerpts from some replies, picked at random, present good arguments pro and con the question. A few of these follow: "Many makes bewilder a salesman. He ends up favoring a single brand, anyway. . . . Many makes for a retailer, yes, for a wholesaler, no, no, no! (A distributor). . . . Take on all the good ones if you can get 'em."

"If you build up a good make in your area, they'll take it away from you and split up the territory. . . . Be a specialist in one make. The Ford dealer doesn't handle Chevrolet, too. . . . Many makes of small appliances, a very few of large ones. That's my angle. . . . A sign in my window lists a flock of famous makes I service, and this brings in sales for them as well. . . . Many as I can get. I don't want customers asking me where I can buy so-and-so. I want to be the one to sell them what they want. . . ."

Some PRO and CON Points—

Greater selection

Stronger competitive position

Stops buyers from shopping around

NON-EXCLUSIVE BASIS

Saves selling time

Salesmen know product better

Large parts stock not needed

EXCLUSIVE BASIS

Specialization seems best to **Frederick's, Wash., D. C.**, dealer, as it does to **E. M. Kerrigan, of K & M Radio Sales Co., Charlotte, N. C.** "We handle only two makes—this city of 16,000 is not large enough to justify more," says **L. C. Bush, Atchison, Kan.**

From **Gainesville, Ga., Dealer J. L. Kleck-**

The retailer who figures out all of the elements associated with this problem in his territory usually comes out with a solution best fitted to his particular needs.

*For more detailed statements by distributors see page 48.

New Lines for Early Fall Sales

Philco TELE RECEIVER

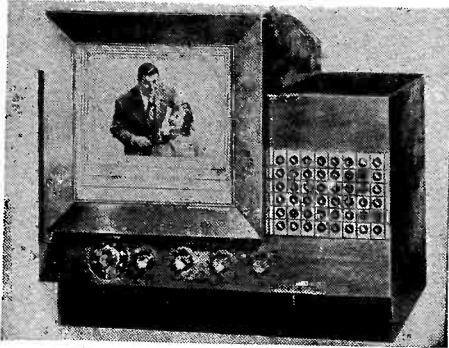

Model 1000 table model television receiver with 10" picture tube providing image of 54 sq. in. "Electronic Control" feature for automatic tuning, focusing and synchronizing. Automatic Level Control to avoid fading and variations in sound and picture. Five controls include two for picture brilliance and contrast, two for sound volume and tone and one for channel selection. \$395 plus excise tax of \$1.25 and \$45 installation and warranty charge. Philco Corp., Tioga & C Streets, Philadelphia, Pa.—RADIO & Television RETAILING.

Wilcox-Gay RECORDIO

Model 6B45 "Manhattan" compact console radio-recorder-phonograph for small home and apartment market. Automatic record changer glides out at finger touch. Records from built-in radio or crystal microphone, electron-ray tuning and recording volume indicator. Automatic shaving collector on recording arm, separate recording channel circuit. Low-hum microphone pre-amplifier. Crystal pickup, replaceable spring-action needle, shock-mounted turntable assembly with heavy duty motor. Four Plexiglas push buttons for finger-tip selection of microphone recording, radio recording, phono, radio or public address. Storage space for 25 record albums. Measures 24 3/8" wide by 16 1/16" deep by 37 1/2"

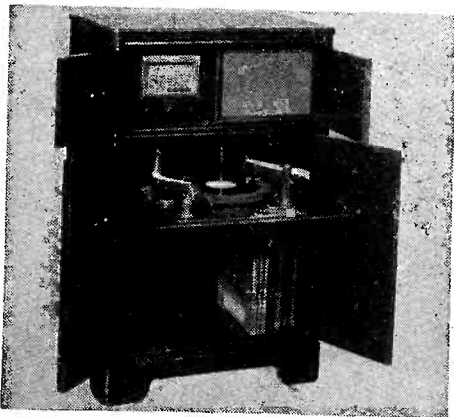

high. Walnut or mahogany models list at \$265; desert blonde at \$275. Wilcox-Gay Corp., Charlotte, Mich.—RADIO & Television RETAILING

E-L COMBINATION

Model 711 RP superhet radio-phonograph console with two speakers and two separate amplifiers for individual tone control. Ten tubes, push-pull output, automatic volume control, Electronic vario-tuner. Built-in Hi-Q antenna, ac operation but dc may be used with addition of inverter at slight extra cost. Automatic intermixed 10" or 12" record changer, automatically stops on last record. Storage space for 10 albums or 120 records. Piano finish

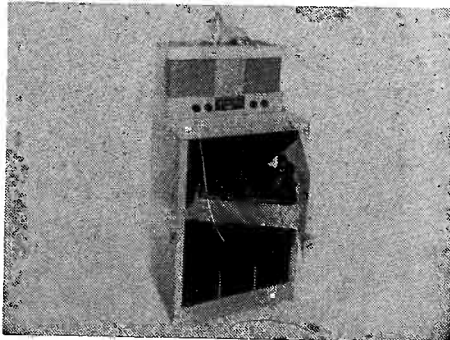

cabinets in mahogany, walnut or blonde. \$99.95. Electronic Laboratories, Inc., 24 W. 24th St., Indianapolis, Ind.—RADIO & Television RETAILING

Admiral FARM RADIO

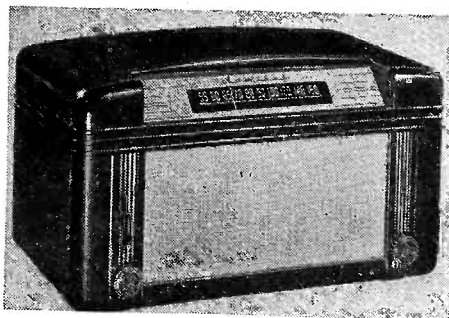

Model 7T12-4B1 table receiver, battery-operated superhet. Permeability tuner, beam power output, automatic volume control, economizer switch, 6" PM Alnico 5 speaker. Tunes 540 to 1630 kc, slide rule dial, 4 tubes. Uses 1.5 and 90 volt standard AB battery pack. Streamlined all-plastic cabinet with mahogany finish. Measures 17 5/8" wide by 9 5/8" high by 9 1/2" deep; shipping weight about 16 1/4 lbs. \$37.95 Admiral Corp., Chicago 47, Ill.—RADIO & Television RETAILING

Camco FOLDED DIPOLE

Model F24 "Featherlite" folded dipole and reflector, for FM reception where high signal strength and maximum rejection of unwanted interference is required. No adjustment of antenna-reflector spacing is required; can be tilted for correct polarization or rotated for maximum directivity. (Model F24X is the same with 60 ft. of 300-ohm twin lead) Camburn Inc., 32-40 57th St., Woodside, L. I., N. Y.—RADIO & Television RETAILING

Smokerette RADIO

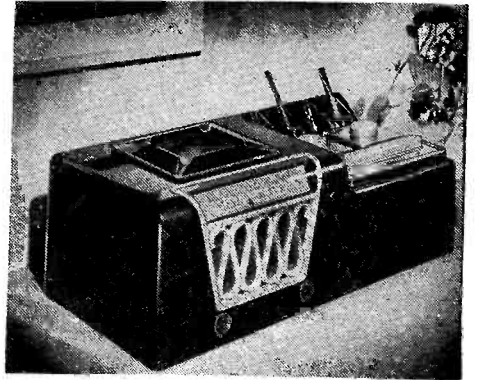

Combination radio and smoke set for table or chairside use. Stewart-Warner superhet in jet mahogany plastic cabinet designed by Barnes & Reinecke. Smoker set includes two humidors for cigars and tobacco; a double humidor for cigarettes; a 4-pipe rack; and jumbo ash tray. Porto Products, Inc., 412 N. Orleans St., Chicago 10, Ill.—RADIO & Television RETAILING

Arvin COMBO

Model 150TC table combination superhet tuning 535 to 1650 kc. Five miniature tubes (installed horizontally) plus rectifier, 5 1/4" Alnico 5 PM speaker, full rf stage. Continuously variable tone control, edge-lighted dial, built-in loop antenna plus connection for external aerial, beam power output. Cam-type automatic record changer plays ten 12" records or twelve 10" discs, single button control. Full-grained mahogany veneer cabinet (Model 151TC is walnut). Maroon colored plastic grille front, trans-



lucent plastic escutcheon. Measures 9 1/2" high by 14 7/8" wide by 16 5/8" deep. Noblitt-Sparks Industries, Inc., Columbus, Ind.—RADIO & Television RETAILING

(Continued on page 46)

Compare them all... Zenith is still
THE STYLE LEADER

31 years experience in Radionics Exclusively
pays off for you with sales-making features!

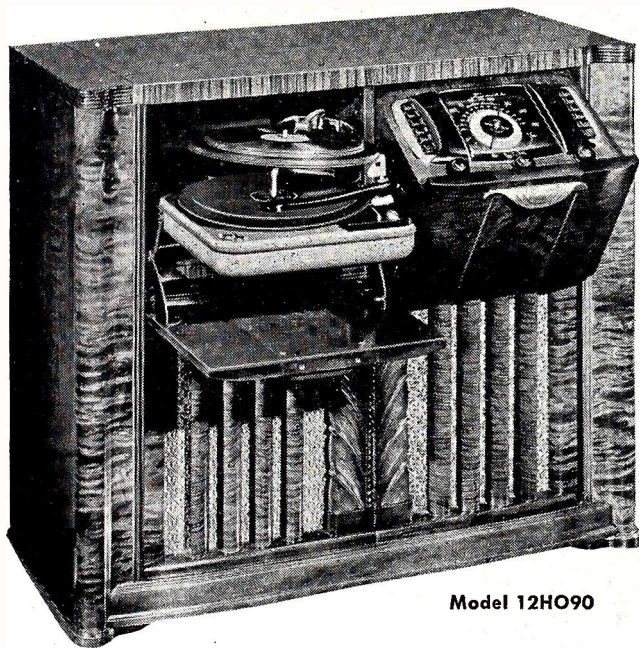

Model 12HO90

Zenith radios and radio-phonographs, long famous for their leadership in engineering and in performance, are today equally noted for leadership in style and value. The features that are most important in prospects' minds are *Zenith*-developed features. That's why value-wise shoppers insist on Zenith—the originator—and will not accept imitations or substitutions. That's why Zenith is first in demonstrability, first in performance, first in style, first in *value*. That's why Zenith is the most wanted radio-phonograph on the market . . . why Zenith radios and radio-phonographs are so *easy to sell*.

**Here Are The Style
and Value Features
Your Customers Want**

● **TILT-OUT CONTROL PANEL . . .** This Zenith design, now widely-copied, brings the entire control panel into an accessible, easily viewed position.

● **E-Z-OUT PHONOGRAPH . . .** A touch of the phonograph door glides the entire record-changer unit out within easy reach.

● **FLAT-TOP CABINET . . .** The entire top may be used for flowers, vases, books or decorative pieces. There are no lids to lift to operate either the radio or the phonograph.

● **AMPLE RECORD STORAGE SPACE . . .** The big storage compartment in the Zenith console combination cabinets is an important feature. Show it to your prospects!

● **THE COBRA TONE ARM . . .** The tiny filament gently floats in the record grooves; reproducing every note, every shading.

● **SILENT-SPEED RECORD CHANGER . . .** Changes both 10- and 12-inch records intermixed, so as to provide an almost continuous flow of music.

● **ZENITH—ARMSTRONG FM . . .** FM at its best—wide-band, true fidelity, static-free FM as developed by Major Armstrong and Zenith engineers.

● **THE RADIORGAN . . .** Radio's most demonstrable tone control. 64 different tonal effects provide just the tone emphasis desired.

Keep An Eye On



Zenith Radio Corporation • 6001 Dickens Ave • Chicago 39, Ill.

More New Lines Ready

Approved FM TUNER

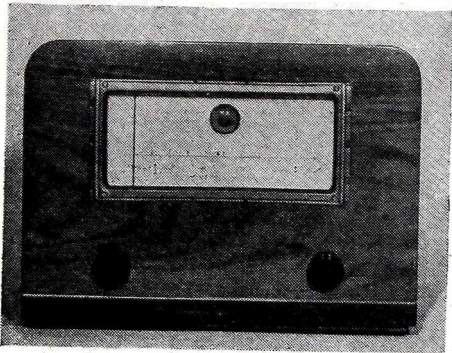

FM superhet tuner using resonant line tuning in rf stages—containing no slides, iron core slugs or variable—to provide stable, non-microphonic quality. Built-in power supply, 8 tubes, hum level 70 db below average output. Frequency drift negligible after 5 minutes. Tuning ratio of 16 to 1, 300-ohm line dipole antenna, steel cadmium plated chassis. Band width of 150 kc. Front end of unit construction, floated. Cabinet of hand-rubbed walnut veneer, packed weight is 15 lbs. \$59.50 net. Approved Electronic Test Instrument Corp., 142 Liberty St., New York, N. Y.—RADIO & Television RETAILING

Bowers COMBO

Model CCL83 console superhet ac radio-phonograph with shortwave and standard covering 500 to 1700 kc. Slanted dial panel, 8 tubes including rectifier, 3-gang tuning condenser, built-in loop antenna with connection for external aerial. Slide rule dial, 12" Alnico PM speaker. Webster roll-out automatic changer playing twelve 10" records or ten 12" discs. Finished back of cabinet acts as sounding board. Two compartments for disc storage. Cabinet in walnut or mahogany finish measures 36³/₄" high by 36³/₄" wide by 17¹/₂" deep. Bowers Battery & Spark Plug Co., 1728 Fairmount Ave., Philadelphia, Pa.—RADIO & Television RETAILING

Tricraft FM-TV ANTENNA

Model 300 all-wave television and FM antenna consisting of thin dipole a half wave long at 70 mc placed near a thicker dipole a half wave long at 128 mc. Covers both TV bands and permanent FM band. Works with 300-ohm transmission line, easy to assemble and install. Lightning protec-

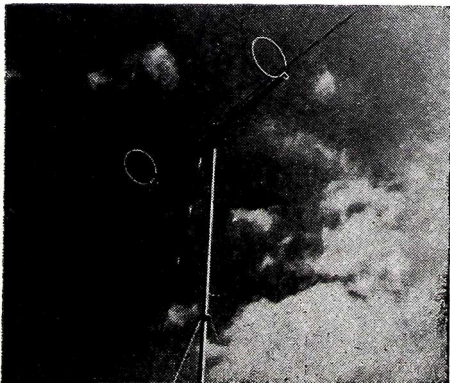

tion provided—all elements of antenna grounded to support member. Designed to emphasize better electrical performance characteristics. Tricraft Products Co., 1535 N. Ashland Ave., Chicago 22, Ill.—RADIO & Television RETAILING

Andrea TV RECEIVER

Model T-VJ12 table video set with "Sharp Focus" features. Same basic chassis as previously described for console model, except with 5" or 6" speaker. All 13 TV channels, screen 7¹/₂" by 10". Covers 88 to 108 mc for FM and 540 to 1650 kc for standard. Station Lock tele selector, 31 tubes with picture unit and 3

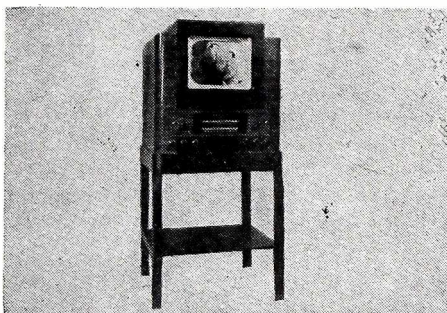

rectifiers. Cabinet of hand-rubbed finish measures 22¹/₂" wide by 22¹/₂" high by 21¹/₂" deep. \$695 list. Andrea Radio Corp., 27-01 Bridge Plaza North, Long Island City 1, N. Y.—RADIO & Television RETAILING

Sonora RADIO

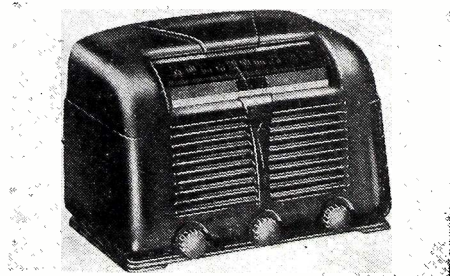

Model RZU-248 table superhet, ac-dc tuning 535 to 1620 kc. Two-position tone control, built-in loop—no aerial or ground required. Special design louvre speaker grille, dynamic speaker. Walnut plastic-molded cabinet measures 12¹/₄" long by 7¹/₂" deep by 8¹/₄" high. Sonora Radio & Television Corp., 325 N. Hoyne Ave., Chicago, Ill.—RADIO & Television RETAILING

Maring LITE-TROL

Control unit whereby yard lights or small motors may be controlled from multiple remote locations. Weather-proof case containing transformer, fuses and alternate impulse type relay—to be mounted on yard light pole or near light. Only one wire used to inter-connect remote push-button (switch) controls. Low voltage throughout eliminates need for expensive heavy code wiring and switches. Maring Mfg. Co., Albia, Iowa—RADIO & Television RETAILING

RTD FM TUNER

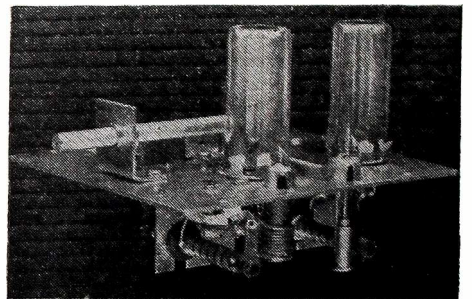

FM tuner covering 87.5 to 108.5 mc with image ratio of 120-1 minimum. Positive mechanical drive, 180 degree dial rotation. Input matches 300-ohm line. Rated as having no perceptible frequency drift from cold start. Tracking error of 3 db or less. Chassis measures 4¹/₂" by 4¹/₂". Radio Tuning Devices, 392 State St., Stamford, Conn.—RADIO & Television RETAILING

Regal PORTABLE RADIO

Model 747 personal 3-way portable superhet with 4¹/₂" PM speaker. Four tubes plus selenium rectifier. Uses standard batteries—five A's and one B with average life of 100 hours, in addition to ac-dc. Built-in Regalloop. Hinged plastic front and rear covers; aluminum case in choice of 5 colors. Measures 4" wide by 5" high by 8" long; weighs 5³/₄ lbs. with batteries. \$29.50 less batteries. Regal Electronics Corp., 603 W. 130th St., New York 27, N. Y.—RADIO & Television RETAILING

RCA-Victor FM COMBO

Model 711V2 radio-phonograph with tilt-out 3-band radio covering FM, international shortwave and standard broadcast. Big record storage compartment, 12" electro-dynamic speaker. Roll-out phonograph has automatic changer handling up to 12 discs. Silent Sapphire permanent pickup point. Modified modern styling, available in either

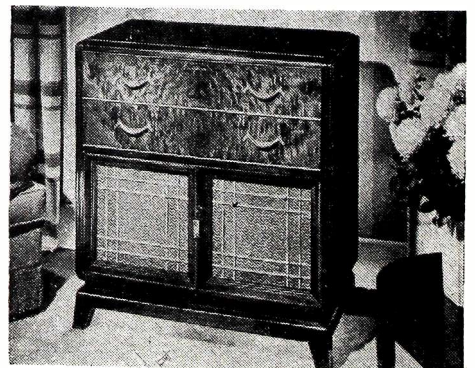

walnut or mahogany. Retails around \$395. RCA Victor Division, Radio Corp. of America, Camden, N. J.—RADIO & Television RETAILING

* * *

NEW APPLIANCES, page 74
NEW PHONO LINES, page 60

**Top Wartime Secret Becomes
Record Playing Sensation in**

Admiral
**MIRACLE
Tone-Arm**

The new Miracle tone arm is
STANDARD EQUIPMENT on all
Admiral Radio-Phonographs.



America's Smart Set!

Model No. 7C73

**Wartime Secret Formula Makes Possible
Ultra-Sensitive Energy Converter . . .
Replaces Ordinary Crystal Pick-up**

During the war it saved countless American lives . . . today this remarkable secret formula has made possible the greatest advance in high-fidelity record reproduction since the invention of the automatic changer. Encased in a permanently sealed all-plastic cartridge, which snaps into the "Miracle" Tone Arm, this ultra-sensitive electronic energy converter uses no coil, no crystal, no filament, no special tube. Re-creates tonal values faithfully, brilliantly, clearly at both high and low volume. Banishes needle scratch, hiss, talk-back. See, hear this amazing instrument today! And remember . . . the "Miracle" Tone Arm is an Admiral exclusive!



**YOU GET ALL
THREE WITH**

Admiral

WORLD'S LARGEST MANUFACTURERS OF RADIO-PHONOGRAPHS WITH AUTOMATIC RECORD CHANGERS

Leading Jobbers on

Many vs. Few Brands

Under the title, "A Merchant or a Stooge," a newsletter from the Harry Alter Co., well-known Chicago distributors, urged retailers to carry a wide assortment of refrigerators, radios, washers, etc. Following are some of the high-lights from the Alter bulletin:

"... The more he has on display, the more likely he is of doing a large volume of business, because he creates a favorable impression on his customer of being a merchant, not just an agency. The customer feels that the merchant has no axe to grind in praising any one refrigerator over another... Thus, the merchant can show the customer a lot of different refrigerators and by good tactful salesmanship sell the particular refrigerator he wants to sell.

"How different when a dealer handles one make exclusively! Everything he says... is taken 'with a grain of salt' by the customer because his viewpoint is obviously biased and obviously selfish... he gets into the bad habit of knocking other products, causing still more loss of confidence.

"Last, but not least, once a dealer signs that exclusive franchise... he is forever a stooge of that manufacturer... must have all models (even 'lemons') on display, must buy many sundry kinds of promotional material and finally, at the whim of a new sales manager or district representative, may wind up cancelled out and the guy down the street having his line.

"... this exclusive idea is old stuff—we tried it back in 1929. Just another beautiful theory that doesn't come near working out in practice—it is the lazy man's way of doing business."

Know One Product Well

In a statement made to RADIO & Television RETAILING, Irving Sarnoff, vice-president of Bruno-New York, prominent wholesalers, takes a totally different view from that of Mr. Alter. Says Mr Sarnoff:

"I am in complete disagreement with his (Harry Alter's) position... The average dealer, if he wants to remain in business, in my judgment must limit his number of lines and must confine them to important brand

names. Time and again, when the dealer handles too many lines, his capital is quickly tied up and he does not develop into an important account for anyone. Also, he does not know one product well enough to make him an authority in his community... I don't think it is advisable for a dealer to go exclusive now but neither is it smart business to take on the whole world! Somewhere in-between lies the proper answer."

Want to be Sold

"Alter is wrong," says Benjamin Gross, of the well-known firm of Gross Distributors, Inc., New York, veteran wholesalers.

"Specialize on a few. The dealer must know his products to intelligently and aggressively sell. Customers prefer to be sold, not merely to buy."

For Exclusive Basis

Ludwig Hommel, president of Ludwig Hommel & Co., Pittsburgh, Pa., distributors, stresses a number of points in favor of operating on an exclusive basis, as follows:

1. A manufacturer must count upon obtaining sales volume in proportion to the potential of each section of territory. Our manufacturers expect the proper share from us, and we, in turn, must expect the proper share from each of our dealers.

"2. In small communities in which the sales potential is too small to support more than one dealer, we grant exclusive dealership. It is only fair to expect a dealer to be exclusive on our line, in return. He could not obtain the proper volume for us if he divided his efforts among several makes of an appliance.

"3. In large cities, we need more than one dealer and cannot expect these dealers to be exclusive. However, even there, we cannot agree on the fairness of Mr. Alter's advice... that 'the more he has on display, the more likely he is of doing a large volume of business,' and we disagree for the very reason that Mr. Alter... 'by good tactful salesmanship (he can) sell the particular refrigerator he wants to sell.' Thus, if he carries ten makes and

makes a little more profit on one of those ten, where do the other nine come in? We know of an actual case where a large dealer carried nineteen makes of refrigerators and always endeavored to sell his own brand. He used the nationally advertised brands to bring people to his store so he could 'switch' them to his own brand.

"4. Mr. Alter overlooks the advantage to a dealer to be identified as headquarters for some famous, nationally advertised make. In many cases, that is an asset to the dealer.

"5. The factors to be considered are those of fair dealing and of making money. If the dealer makes money out of a valuable franchise, perhaps he may be quite content to be what Mr. Alter calls a 'stooge.'"

A Place for All

T. Pierson, of Onondaga Supply Co., Inc., Syracuse, N. Y., declares that "Mr. Alter has certainly made up his own definition of the word 'merchant.'" The Onondaga Supply executive goes on to say: "There is a place for the exclusive dealer, there is a place for the dealer handling a limited number of lines, and there is a place for the dealer handling a wide range of lines... I would think a little more of Mr. Alter's arguments if... he said that the merchant selling a number of lines would sell his customer the particular refrigerator best suited to his needs.

"As a consumer, I like to buy from a merchant who sells an exclusive line, or a limited number... that merchant is sold on his product and will give me the best possible reasons for buying... I like to feel that the people I buy from are sold on the products they are selling. I like to feel that it is part of a dealer's responsibility to select a better product for me.

"I don't see how I could feel that way with a dealer who says, 'Here they all are. I don't care what you get as long as I get the order.'"

Greater Net Profit

Thomas F. Joyce, vice-president of Raymond Rosen & Co., Philadelphia, feels that concentrating on a few

(Continued on page 108)

A BETTER VALUE...

FEATURE FOR FEATURE...

DOLLAR FOR DOLLAR

STEWART-WARNER



Strobo-Sonic Tone



Value is once more the real test of any radio. That's why Stewart-Warner sets keep on being *easier to sell* to people who demand their full money's worth. They're built right and *priced right* for today's market.

THE MUSIDORA Strobo-Sonic tone at its finest! For records and radio, FM and AM, with full-cycle AC tonal range . . . so important for symphonic reproduction. *Improved* FM circuit. Two built-in Radair Antennae; 2 tuners operated by one knob; AM push-button tuning; 8 tubes plus rectifier tube. Automatic record changer. Everlastingly beautiful Sheraton design in old-world mahogany.

Musidora De Luxe—intermix record changer and 2 roomy album compartments. A great value!

Musidora Master—standard automatic record changer, single compartment. Most for the money!



THE BALLADEER Today's finest value in FM-AM table radio! AC-DC, 7 tubes *plus* selenium-type dry rectifier, 2-gang AM condenser, 3-gang FM condenser with tuned RF stage. High-impedance AM loop with inverse feedback, PM dynamic speaker. Out in front . . . in styling and fine engineering! Fine wood cabinets, desert tan or walnut.

A Model for Every Purpose—a Radio for Every Room

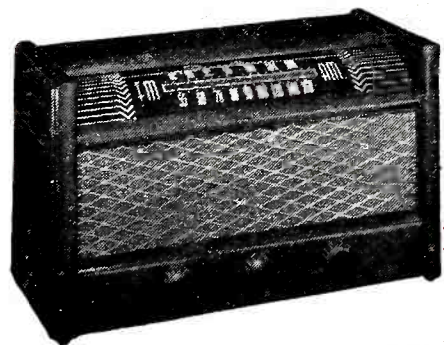

Stewart-Warner

FM *Radios* **AM** *Radio-phonographs* *Television*

CHICAGO 14



ILLINOIS

What do YOU call it?

★
"Free Enterprise" ★

★
"American way
of life" ★

No matter what you may call it—most Americans believe in it!

But right now, forces from within the country as well as without—ranging all the way from complacent indifference to highly organized propaganda—are tending to alter, to disparage, and—yes—even to destroy the ideals which made America great and which, if supported, can keep America great.

THE AMERICAN MAGAZINE is quick to spot these un-American evils and "isms"—and put the finger on them. We are seeking them out, one by one—exposing their threats to American life and business—and flood-lighting the scene with the clear truth that has always guided America's true citizens in time of crisis.

In the past year alone, 26 such articles have been featured in THE AMERICAN MAGAZINE. And this alertness is no new-born virtue. For nearly forty years, THE AMERICAN MAGAZINE has fought for American ideals.

Thus, over the years, it has built a special character and reputation which make THE AMERICAN MAGAZINE's audience one of the most responsive in the whole field of publishing. To demonstrate this, we have prepared a presentation which tells the unique story of what we are now doing to safeguard American life and business.

This presentation bears the same title as this advertisement. If you'd like to see it, let's make a date.

★
"Human
Freedom" ★

★
"Capitalism" ★

★
"The Profit
System" ★

★
"Democracy" ★

The
American
Magazine

250 PARK AVENUE, NEW YORK 17, N. Y.

The Crowell-Collier Publishing Co., New York, Publishers of The American Magazine, Collier's, and Woman's Home Companion

RECORDS

Platter Profit-Pointers

\$ **SUMMER LETHARGY** chasers for store employes can be readily provided by paying more attention to "the little things in life." Cold water that is readily available, fans that are utilized to maximum use, doing tedious "checking-in" of discs in the morning before the heat saps everyone's strength, and maintaining a neat-looking store, are a few of the things that will make life more pleasant for everyone concerned.

\$ **DEALERS** suddenly "discovered" kiddie records several years ago, with the result that this revitalized branch of the record industry is flourishing. The same opportunity awaits enterprising dealers who are willing to latch onto "foreign" discs as a new source of profitable trade. (See story page 53)

\$ **DESPITE SHORTAGES** of building materials, many dealers have succeeded in remodeling their stores. Ample use of glass for fronts and store interior, curved counters with built-in fluorescent lighting, liberal use of the new "light" woods, and spacious floor layout have characterized the improvements. Most outstanding development has been the evolution of the record counter to a completely functional unit, equipped in many instances with ear-phones, and having ample storage space below, and a wall rack which can be filled from the rear of the store.

\$ **FAULTY PLAYING** equipment in some dealer stores can hurt sales of classical recordings. Record players should be kept in excellent condition, to avoid record scratch, dissonance, voice distortion and loss of fidelity. The music lover buys not only the composition, or the artist—but the quality of the recording.



\$ **FOUR MORE MONTHS** until Christmas. It won't be long now before retailers will have to make definite orders for Xmas records, accessories and displays. This Christmas may well be the most important holiday selling season the industry has ever seen in terms of variety and availability of merchandise.

\$ **GLASS LISTENING** BOOTHS are whole-heartedly endorsed by one retailer, who says he'll never be satisfied with anything else. It cuts down scribbling on walls and posters; eliminates breakage, and prevents non-buyers, procrastinators and nuisances from dreaming and dawdling in the booths.

\$ **DISC PRICES** have remained relatively constant, with no appreciable lowering seen in sight. One manufacturer has instituted a line of lower-priced discs, another has been forced to raise the price of his waxings, while a third effected an overall price decrease. These, however, are isolated instances, and indicate no industry-wide trend, as yet. Retailers still find that if the public wants a particular record badly enough, "They'll pay for it. And if it's not a seller, you can't give it away."

\$ **THE RECORD MANUFACTURERS** are planning renewed and revitalized national advertising campaigns and dealer aids this Fall. Retailers can get a line on these forthcoming promotion plans from local jobbers, and plan to capitalize on them.

\$ **MOVIE TIE-INS** have moved straight from the dealer's window into the theatre lobby. Motion picture operators are encouraging retailers to set up record counters in the theatre, with both parties finding that the double promotion works to their mutual advantage.

\$ **CO-OPERATIVE DISC JOCKEY** shows, sponsored jointly by local jobber and dealers, is a new twist in co-operative advertising. A Philadelphia distributor has arranged for dealer spot announcements to be aired on almost every platter show in town.

Your SEPTEMBER ADS will skyrocket these RCA VICTOR releases

Full page in "LIFE" Sept. 1

... plus ads in "LOOK," "MADEMOISELLE," "MODERN SCREEN," "MOVIELAND," "PHOTO-PLAY," "SEVENTEEN," "BANDLEADERS." It's a whale of a promotion blanketing the young and prosperous crowd in your neighborhood ... a country-wide total of over 12 million reader impressions!



Tommy Dorsey's "All Time Hits"

This top seller is getting another big ad push ... and you'll get a flood of easy profits! Includes: Hawaiian War Chant, After You've Gone, Boogie Woogie, Chicago, On the Sunny Side of the Street, Opus No. 1, Embraceable You, Somewhere a Voice is Calling. RCA Victor Album P-163, \$3.15.



"The Three Suns Present"

First RCA Victor album by a crew that's becoming a country-wide craze. Eight of their top hits: Twilight Time, When Day Is Done, Deep Purple, Dardanella, The Breeze and I, Sunrise Serenade, I'll Never Wish for More Than This, Hindustan. Order Album P-185, \$3.15.

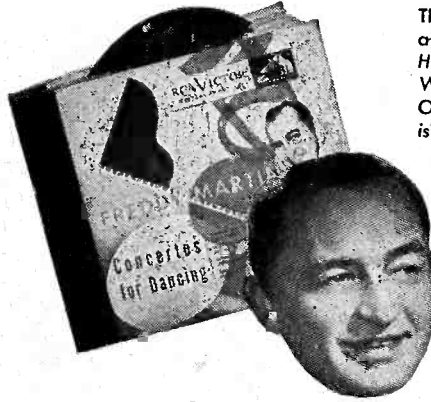

Freddy Martin's "Concertos for Dancing"

Another profit powerhouse it'll pay you to display next month! Includes: Tchaikovsky Piano Concerto No. 1, Cornish Rhapsody, Intermezzo, Grieg Piano Concerto, Night and Day, Symphonie Moderne, Warsaw Concerto, Rachmaninoff Piano Concerto No. 2. P-169, \$3.15.

Full page in "LIFE" Sept. 29

... plus full page in "TIME" Sept. 8

"LIFE" will announce your entire Red Seal listing for September, headlining Toscanini, Kirsten and Mitropoulos. "TIME" will feature the new Mitropoulos recording. Get set for sales with a dramatic tie-in promotion!



ARTURO TOSCANINI,
and the NBC Symphony Orchestra:
A Wagner Program: Siegfried Idyll,
A Faust Overture, Die Walküre: Act III; Ride of the Valkyries. RCA Victor Red Seal Album M/DM 1135, \$4.85.



DIMITRI MITROPOULOS,
Conductor; Minneapolis Symphony Orchestra. Minstrel Show —Morton Gould. RCA Victor Red Seal Record 11-9654, \$1.00.



DOROTHY KIRSTEN,
Soprano: Dorothy Kirsten Sings Victor Herbert Melodies: "Kiss Me Again," "Moonbeams," "Indian Summer," "Neath the Southern Moon," "A Kiss in the Dark," and "Romany Life." With Russ Case and his Orchestra and Chorus. M-1069, \$3.85.

PLUS YOUR RCA VICTOR SHOW...
starring Robert Merrill. Outstanding items in your current stock get extra promotion on this popular Sunday show (2 o'clock EDT, all NBC stations.) Tune in ... and follow up with tie-in display!

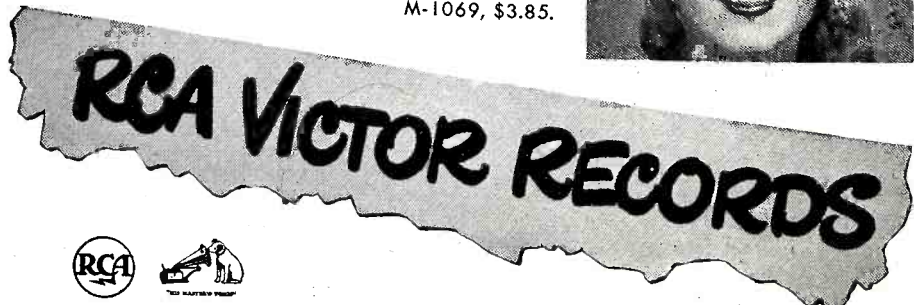

Prices shown are suggested list, exclusive of taxes





**Big Profit Potential
Awaits Interested Dealers
Who Investigate Market**

Sell Foreign Discs!

Enterprising merchants in every section of the country have discovered that there is a prosperous market for discs that feature the music and the language of people of foreign lands. More and more dealers are realizing that many extra dollars can be garnered from the sale of discs of this type. Record manufacturers have been equally alert in responding to the revitalized demand for "foreign" records and they have been waxing additions to current catalogs, as well as re-pressing many established favorites.

Of significance to merchants is the tremendous listening audience of foreign language radio stations. Dealers have found sponsorship of fifteen-minute recorded segments or airing of spot announcements on these stations, to be an effective means for bringing customers into the store. Air advertising has proven so productive, because listening audiences are composed entirely of people who understand, like, or are interested in the language—therefore they are the logical customers for the dealer's foreign records.

Big Audience

Much of the music that can be classified as "foreign," is universal in its appeal—as shown in the current craze for the rumba and the samba, and the enthusiasm of folk dance groups who perform dances like the schottische, mazurka and polka.

It goes without saying that dealers contemplating setting up a foreign-language record department must know their trading areas intimately.

They must have a clear-cut picture of the tastes and cultural background of the people in the community. In those areas where there are large numbers of persons of foreign extraction, dealers will find it relatively easy to establish or expand their "foreign" sections.

Basic Stock

One manufacturer advises dealers who are reluctant to start a language disc department because of lack of space, to try this plan: Order a small quantity of different singles in the various languages. Label the spine of a storage album, French, German, Italian, Polish, Spanish, Jewish, etc., and place the records in it. Keep the various albums together, and display them prominently. When the customer enters, give him the complete album of the language he requested, and allow him to listen and choose the desired discs. Then reorder in small quantities as sales warrant.

Advantages of this suggested plan are obvious. The dealer can cover a variety of recordings, in a number of languages, without tying up too much capital by maintaining such a minimum basic inventory.

Window displays play a particularly important part in notifying the public that Dealer X is now carrying foreign records. Pressers will provide retailers with streamers, displays and window strips publicizing the fact, but dealers can plan many of their own exciting and colorful windows. Display material to tie-in with the discs can be obtained from the various tourist agencies, and for-

eign consuls. Non-competitive stores may cooperate in lending peasant costumes, Spanish scarves, wooden slippers, etc., which can be used to create colorful, sales-making show-window exhibits. Windows that have been given some creative thought, will receive attention from people who are familiar with the lands represented and by those who hope to visit them someday.

Foreign language newspapers are another excellent vehicle for acquainting prospective purchasers with foreign discs in stock. In most localities, certain church groups, clubs and students are good parties for the dealer to contact in going after the foreign record trade. An offer to provide music for a festival, or party, or for use at weddings in the community, will usually be welcomed, and may bring many of the guests into the dealers' store to buy a recording heard at the celebration.

Publicize Records

If the area is predominantly populated with people of foreign extraction, it may pay the dealer to employ a clerk who speaks the predominating language. A sign in the window reading, "Aqui se habla Espanol," (Spanish is spoken here,) or one in Russian, Jewish, Italian, etc., may bring in many customers, who might otherwise feel timid about entering such store.

Some of the foreign-language platters are recorded abroad, some in this country. But all record firms, large and small, are realizing that the market for discs of an "international" scope is growing right here at home.

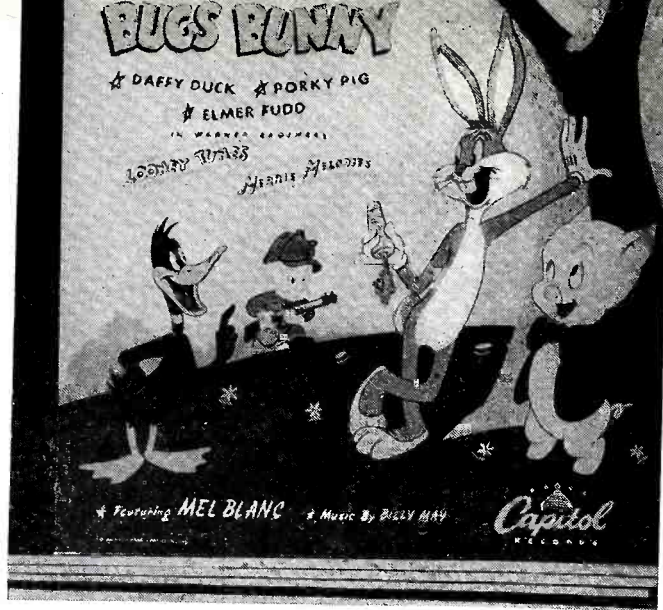

Platters Pay

▲ Top: Album cover of the new Columbia collection of "Billie's" most famous songs.
▶ Top right: Capitol's latest children's album, featuring favorite cartoon characters.



▲ Fred Waring and Bing Crosby blend their respective talents for Decca on two releases.
▶ Larry Douglas sings "You Do" and "Sleep, My Baby Sleep" on his current Signature discing.



LIGHT CONCERT FAVORITES

"DIE FLEDERMAUS WALTZES," by Johann Strauss, Jr., Leopold Stokowski and the Hollywood Bowl Symphony Orchestra. RCA Victor 10-1310

Waltz is given melodic symphonic treatment.

"KREISLER FAVORITES," Charlie Spivak and his orchestra. RCA Victor P-179

The Spivak horn and the Kreisler music blend into one indefinable whole—making for good listening, as well as dancing.

PONCE: "Estrellita," — KORN-GOLD: "March," Jascha Heifetz, violinist, Emanuel Bay, piano. RCA Victor 10-1314

Heifetz' interpretations of these two favorites will be popular with long-hairs and casual customers alike.

STRAUSS, JOSEF: "Music of the Spheres." Columbia 125799D
Lilting rendition of an old favorite.



ANDREWS SISTERS: "The Turntable Song"—"The Lady From 29 Palms." Decca 23976

The first side is from the film, "Something in the Wind." Flipover is a novelty tune.

ARNAZ, DESI: "Tabu"—"La Camparsita"; "Babalu"—"Brazil"; "Tico Tico"—"Peanut Vendor"; "Siboney"—"Green Eyes." RCA Victor 20-2279-80-81-82

Eight sides styled in the Latin-American way for listening and dancing.

CARLE, FRANKIE: "There's That Lonely Feeling Again"—"Lazy Mood." Columbia 37484

Two top ballads are paired on this platter.

CARROLL, HELEN, and the Satisfiers: "Smoke Dreams"—"Do You Love Me Just as Much as Ever?" RCA Victor 20-2300

First side is theme of air show on which group is featured.

CROSBY, BING—HAYMES, DICK—ANDREWS SISTERS: "There's No Business Like Show Business"—"Anything You Can Do." Decca 40039

Three top-notch artists, doing two top-notch Berlin tunes from Broadway hit, "Annie Get Your Gun."

CROSBY, BING, and **FRED WAR-ING GLEE CLUB:** "Whiffenpoof Song"—"Kentucky Babe." Decca

Bing and the chorus blend voices in an outstanding waxing of two favorites.

CROSBY, BING, and **THE JESTERS:** "Feudin' and Fightin'"—"Goodbye, My Lover, Goodbye." Decca 23975

These two are done in a hill-billy manner à la Crosby.

CROSBY, BING, with the Skylarks: "I Do, Do, Do Like You"—"The

**Popular Songs for Dancing and Listening—
Serious Music to Please Discriminating
Concert-Goers—Foreign, Children's and
Novelty Records Offered This Month**



A Victor's William Kapell performs Beethoven's "Piano Concerto No. 2 in B Flat."
V Jimmy Durante makes his MGM debut with two tunes familiar to his comedy style.

Big Profits

Old Chaperone. Decca 23954
First side is done in a Calypso rhythm; reverse is novelty.

CUGAT, XAVIER: "Come to the Mardi Gras"—"Miami Beach Rhumba." Columbia

South America has its sway in these two rhumba rhythm tunes.

DAMONE, VIC: "You Do"—"Angela Mia." Mercury 5056

Young Vic Damone sings the two love ballads nicely.

THE DARDANELLE TRIO: "As Long as You Think of Me"—"You Gotta Crawl Before You Walk." RCA Victor 20-2254

Dardanelle and her side men have been making the rounds of many night-clubs in the East, and the audience who go for her unusual music-making is rapidly increasing.

("Popular Music" continued on page 62)

CLASSICAL WORKS

BACH: "Suites," No. 2, in B Minor, No. 3, in D, Boston Symphony Orchestra, Serge Koussevitzky, conductor, George Laurent, solo flute. RCA Victor DM 1123

Bach Suites were recorded in the Tanglewood Concert Theater at last year's festival, and are particularly timely because Koussevitzky is appearing at the current Berkshire Festival. An interesting note is that relatively the same size orchestra as was common in Bach's time was used for this recording.

BEETHOVEN: "Concerto No. 2 in B Flat"; **BRAHMS:** "Inter-

mezzo in E," William Kapell, pianist, NBC Symphony Orchestra, Vladimir Golschmann, conductor. RCA Victor DM 1132

This Beethoven concerto recorded by Kapell will fill an important place in the dealer's catalog. Listeners who bought Kapell playing more "contemporary" music will be interested in hearing his interpretation of an old master.

GLAZOUNOFF: "Music from the ballet 'Raymonda,'" Boston "Pops" Orchestra, Arthur Fiedler, conductor. RCA Victor M or DM 1133

The audience for ballet music is growing larger each season; this collection sure to appeal.

HANDEL: "Concerto in B Minor"; **KREISLER:** "Praludium and Allegro," William Primrose, violist, RCA Victor Orchestra, Frieder Weissmann, conductor. RCA Victor M or DM 1131

Viola artist William Primrose does an outstanding job on the Handel concerto arranged by Henri Casadesus.

HANDEL: "Water Music Suite," the Philadelphia Orchestra, Eugene Ormandy, conductor. Columbia X-MX-279

Brilliant and refreshing interpretation of this famous music.

LISZT: "Mephisto Waltz"; **WOLFF-FERRARI:** "The Secret of Suzanne, Overture Part 1." Columbia X-MX-281

Liszt music dealing with popular Faust theme done in stirring style.

"PIATIGORSKY IN RUSSIAN



MELODIES," Gregor Piatigorsky, 'cello, Ralph Berkowitz, piano. Columbia M-MM-684

From the repertoire of Cui, Rachmaninoff, Rubenstein, Rimsky-Korsakov, Tchaikovsky, Mr. Piatigorsky presents the greatness of nineteenth century musical Russia.

PROKOFIEFF: "Romeo and Juliet," Ballet Suite No. 2, Boston Symphony Orchestra, Serge Kousse-

(Continued on page 56)



Romeo Loves Juliet



Left to right: Album cover of Rainbow Records original collection of songs, called "Romeo Loves Juliet"; Roberta Lee, Sonora songstress; Chet Tyler, American folk singer featured on Disc records in "Chime Bells" and "Cattle Call"; Chuchó Martínez, Apollo recording artist.

Platters Pay

(Continued from page 55)

vitzky, conductor. RCA Victor M or DM-1129

Shakespeare's famous love story, told in music, is familiar to ballet fans. Album good follow-up to Prokofieff's "Fifth Symphony."

RACHMANINOFF: "The Bells," Jacques Rachmilovich and the Santa Monica Symphony Orchestra. Disc Co. of America

Composition inspired by Edgar Allan Poe's poem, stirringly done, with a chorus of seventy-two voices. Album cover features a reproduction of the poem, plus a testimonial message from Arturo Toscanini.

SCHUBERT: "Impromptu in G Major" — "Schubert Waltzes," Maryla Jonas, piano. Columbia 72047-D

In her first single since her debut album, Miss Jonas captures the tenderness of Schubert's "Impromptu" and the "dance" qualities of the "Waltzes."

SHOSTAKOVITCH: "Symphony No. 9, Op. 70," Philharmonic Symphony of New York conducted by Efrem Kurtz. Columbia M-MM-688

The Ninth Symphony announced the final triumph and upsurge of joyous feeling for the end of the war. This mood is captured in the tremendous crescendoes and lyrical passages of the Kurtz interpretation.

WIENIAWSKI: "Concerto No. 2 in D Minor for Violin and Orchestra, Opus 22," Isaac Stern, violin, with Efrem Kurtz conducting the Philharmonic-Symphony Orchestra of New York. Columbia M-MM-656

Violin virtuoso Isaac Stern meets every taxing demand called upon by the unique score of this concerto.



ALMA, MARIA: "Noche en Venecia"—"Regresa." Seeco 588 Boleros.

BARI, TONI: "Tango of the Roses"—"Mama." Apollo 152 Italian classics sung in English.

CAPO, BOBBY: "El Cantante"—"Dejame Hablarte." Seeco 590 A guaracha and a bolero.

CARUSO ACCORDION TRIO: "Gray Mare Polka"—"New London Polka." Continental C-1209 Talented instrumental trio renders two polkas that can be appreciated by any folk group.



L. to R.: Coney, Verne recording star; Eva Garza, new Seeco artist.

GARZA, EVA: "Frio En El Alma"—"Sera por Eso." Seeco 609 Two Spanish bolero tunes.

MERESCO, JOE: "Cuckoo Polka"—"New Warsaw Polka." Apollo 149 Authentic Polish polkas.

SABLON, GERMAINE: "The Other Side of the Street"—"Accordion Mood." Continental C-1400 Popular French songs, sung by Miss Sablon, a night-club favorite.

YANKOVIC, FRANK: "Daisy Polka"—"Jingling, Tingling Polka." Continental C-418 Slovenian polkas; instrumentals.



ANDERSON, MARIAN: "Oh! Men From the Fields"—"Bright Phoebus." RCA Victor 10-1300

Miss Anderson's many fans will be delighted with this recording of two of her concert favorites.

"GLADYS SWARTHOUT SINGS," Gladys Swarthout, mezzo-soprano, with Russ Case and his orchestra. RCA Victor M-1127

The popular opera star sings songs by some of the most famous light opera composers of the day—Rodgers & Hart, Vincent Youmans, Cole Porter and Kurt Weil, in this new collection.

MacDONALD, JEANNETTE: "Mi Chiamamo Mimi"—"Un Bel Di, Vedremo." RCA Victor 11-9599

Two popular arias from "Madame Butterfly" and "La Boheme," coupled with the star's personal appeal, will ring up sales.

"NELSON EDDY IN SONGS FROM 'NORTHWEST OUTPOST,'" Nelson Eddy, baritone, with orchestra and chorus conducted by Robert Armbrustor

Baritone sings songs by Rudolf Friml, from his latest movie. Dealers should find ample tie-in opportunities.

"WAGNERIAN EXCERPTS," Torsten Ralf, tenor, with the Metropolitan Opera Orchestra conducted by Fritz Busch. Columbia M-MM-634

Mr. Ralf makes his Columbia Records debut singing melodic selections, including "Prize Song," "Trial Song," selections from "Lohengrin," "Tannhauser," and "Parsifal." The

(Continued on page 64)

Columbia's Sensational "Tailored Tip" Sapphire

priced to create the mass demand you need for profitable, fast turnover!

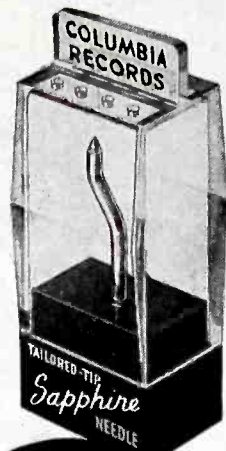

RETAILS FOR ONLY
\$1.50

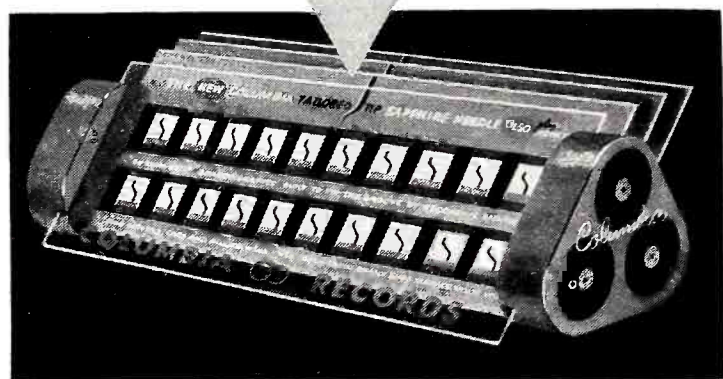
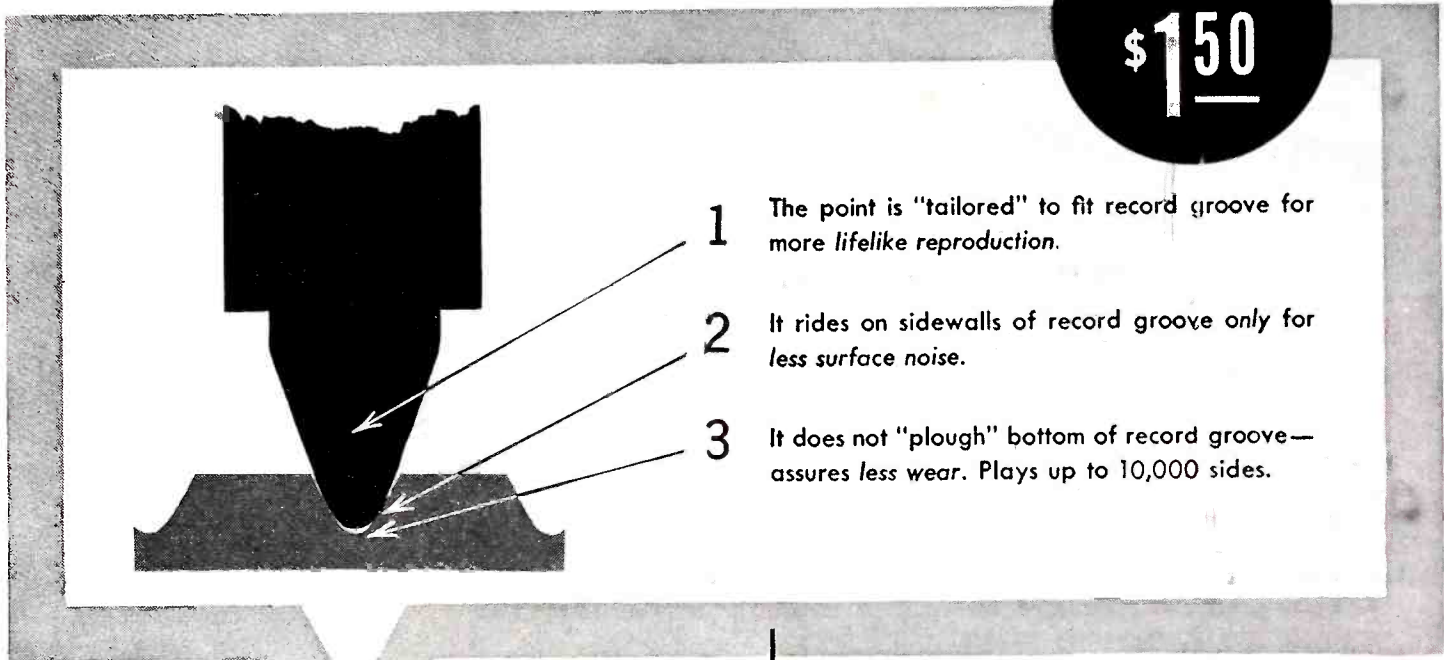

Sell from this beautifully constructed needle display case!
Holds 60 needles.

"Tailored" to fit the groove by master recording engineers.

Microscopically shaped and designed for amazing clarity, brilliance and fidelity with long life.

Shadowgraphed for uniform perfection!

Backed by advertising in Life, Saturday Evening Post, Time, American Record Guide and Saturday Review of Literature's supplement, "Recordings". . . 500 radio stations!

Columbia Records Inc.

Trade-marks "Columbia" and  Reg. U. S. Pat. Off.





"Patio" entrance to specialty radio department in the rear.

Disc Sales Spurt

Buying Encouraged in Luxurious Atmosphere of Palm Beach Store

● The Salon of Music in Palm Beach, Florida, owned and operated by Russell Downes, is divided into three distinct departments—records, radios and musical merchandise.

The customer is pleasantly impressed by the spaciousness of his surroundings, and the feeling of luxury carried out by the green foliage, rich mahogany, and fine rugs which he sees as he enters the store.

Mr. Downes founded his establishment in 1944, and assisted by his wife, Maybelle Downes, built up an extremely profitable record clientele.

Business continued to grow, and after the war, it was decided to expand even further into other lines.

A "patio" was designed for the rear of the store, across from the record department, and adjacent to the service store. This addition took the shape of a large, mahogany panelled "drawing room."

The radio section was designed specifically to display "furniture" pieces in a home-like atmosphere. The room features a large plate-glass picture window, opening out on an arcade, which leads to the front

of the record department. The ceiling is made of acoustic absorbent veneer, bleached and pickled to blend with the lushest of Palm Beach settings. Drapes and a velvet rug complete the interior.

The adjoining patio is furnished with outdoor furniture and clients are encouraged to spend time here.

Cater to Customers

Each time a combination is sold, the customer is conducted to the record department. Trained personnel sell the platters, and encourage purchasers to browse in the store. A record bar, a colorful wall display of albums, a children's disc corner, and comfortable listening booths are all at the customer's disposal.

The customer and his wishes are the all-important factor in this unique establishment. Mr. Downes keeps his store open all during the summer months, and customers have a standing invitation to utilize the Patio salon for Sunday musical appreciation sessions.

The Salon's service department is under the supervision of Lou Cilin. Much work is done on designing and constructing remote control installations, as well as on repairing old sets and maintaining the new instruments.

Salon of Music store front, as entered from the street.

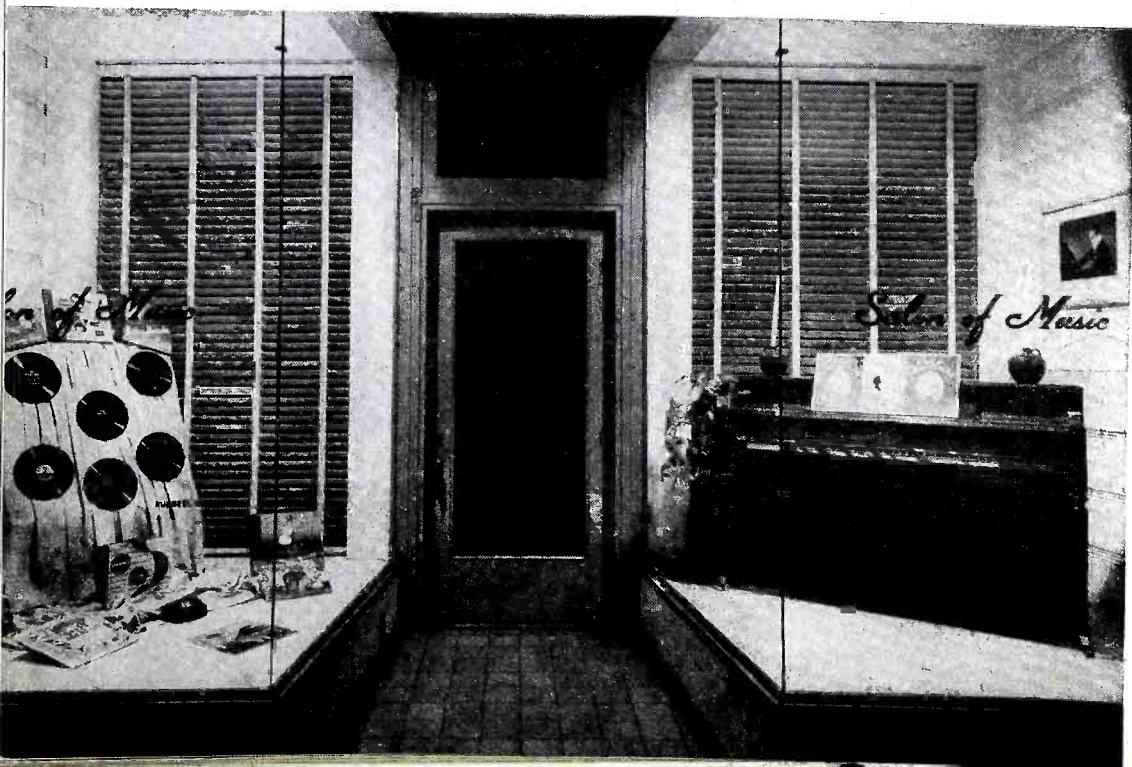

WEBSTER CHICAGO

**Solid Advertising and Merchandising Support
to increase your sales and profits**



WIRE RECORDERS

Webster-Chicago, the top line of record changers, phonographs and wire recorders, back you with hardhitting national advertising and solid merchandising.

IN LEADING MAGAZINES having a combined readership of more than **65 MILLION** each issue. Webster-Chicago advertising reaches the people in your community — your prospects and customers. Webster-Chicago national advertising — regularly scheduled — backs you up **100%**.

AT POINT OF SALE — Webster-Chicago offers a complete **ADVERTISING and SALES PROMO.** TION service — supplying you with free mats, mailing pieces, consumer literature, window and counter displays, and permanent counter merchandisers. Get in touch with your Webster-Chicago distributor today.



NYLON PHONOGRAPH NEEDLE

WEBSTER  CHICAGO
5610 BLOOMINGDALE AVE., CHICAGO 39

The Choice of Music Lovers



BUSINESS WEEK
JUNE 28 1947

Fortune



**RECORD CHANGERS
PHONOGRAPHS**



FREE MAT SERVICE

POINT OF SALE LITERATURE

DISPLAY MATERIAL

New Phono Lines

Latest Disc-Playing Equipment and Accessories

Portofonic RECORD CARRYING CASE

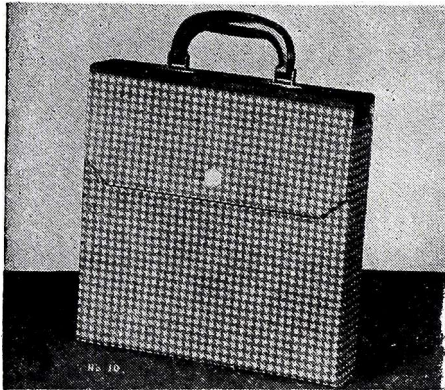

Model 10 lightweight case for carrying records, with capacity of twelve 10" discs. Patented permanent index protects records. Fibre construction, covered with simulated leatherette. Lists at \$1.95. Portofonic Mfg. Corp., 54 Franklin St., New York 13, N. Y.—RADIO & Television RETAILING

Chapman CABINET

Models MCC-25 and MCC-30 (the former for Detrola changer or blank; the latter for Detrola, Seeburg, Webster 50 and 56 changers or furnished in blank) all-ply-wood cabinet for portable automatic phonographs. Leather strap or post handle, suitcase lock and key, anti-rattle hinges, wire mesh reinforced and press shaped speaker and ventilator grills. Separate speaker baffle, metal or rubber bumpers. Cloth-backed leatherette in varied grains and colors—single tone outside, two-tone inside. MCC-25 is \$8.85. MCC-30 is \$9.85. Mark Chapman Co., Inc., 44 Court St., Brooklyn 2, N. Y.—RADIO & Television RETAILING

Musitron RECORD PLAYER

Model 107 Piccolo hand-wound portable phonograph with single-spring governor-controlled synchronized mechanical motor with 9" turntable. Acoustical tone arm and reproducer head. Tone chamber of molded paper mounted in base of case below motor board. Groove-locked corner construction, brass hardware fittings, plastic

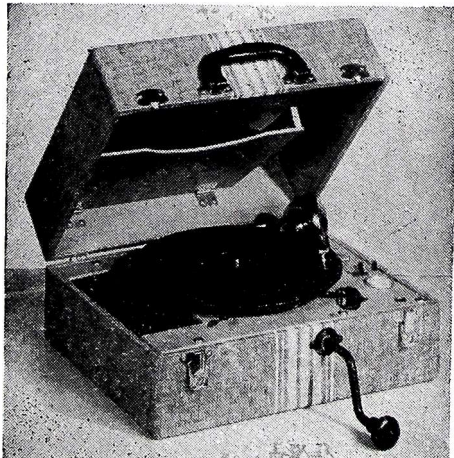

handles to match case, cabinet covered with pyroxylin-coated airplane tweed leatherette in either one or two stripes. \$19.95. Musitron Co., 223 W. Erie St., Chicago 10, Ill.—RADIO & Television RETAILING

Emerson RECORD PLAYER

Model 549 all electric automatic record player with 3-tube amplifier. Plays 10" or 12" discs, 6" oval Alnico 5 PM dynamic speaker. Self-starting constant speed ac

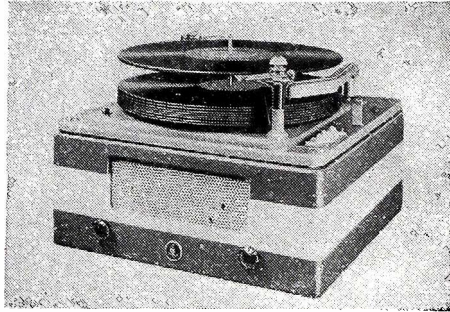

motor. Finished in 2-tone simulated leather. Emerson Radio & Phonograph Corp., 111 Eighth Ave., New York 11, N. Y.—RADIO & Television RETAILING

Furniture Specialties RECORD CABINET

Model 350 large size de luxe record cabinet with top large enough to hold biggest table model combination. Fine furniture construction of hardwoods; walnut or mahogany finish. Measures 24" wide by 18" deep by 26" high. Weight packed is

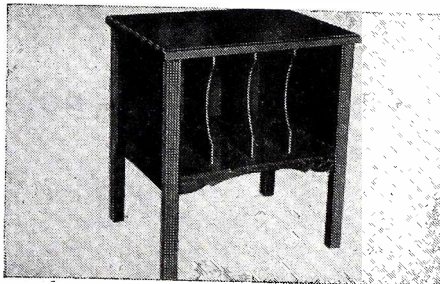

23 lbs. Minimum shipment is 4 pieces. Furniture Specialties Co., 15th St. & S. Penn Square, Philadelphia, Pa.—RADIO & Television RETAILING.

Brown-Crane WIRE RECORDER

Compact wire recorder with self-contained speaker, recording on 12,000 ft. of .004 in. wire per spool, with recording time of one hour. Lighted index showing time range 0 to 66 minutes. Inputs for radio, microphone or phonograph. Low impedance output for loudspeaker or auxiliary speaker with telephone jack. Essentially flat frequency range from 100 to 8,000 cps—can be extended to 40 to 15,000 range; 5 receiver-type tubes. Records at cost of about 1c per hour—wire recording can be regarded as permanent or erased and re-used unlimited times. Brown-Crane Wire Recorders, Inc., 1340 W. Washington Blvd., Chicago 7, Ill.—RADIO & Television RETAILING

Malone RECORD CABINET

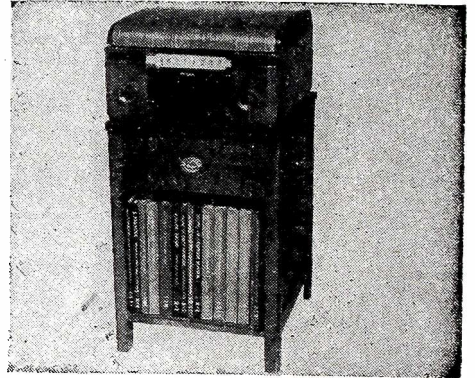

Model 150 disc storage cabinet, made of birch and finished in either walnut or mahogany. Top dimensions are 18½" by 17¾"; height is 26". Cabinet shown here with RCA Model 65-U; Admiral Models 6RT43 and 7RT42 also fit, as well as most phono-radios on the market. Retailers at \$24 to \$25. Malone Products Corp., 1451 Broadway, New York 18, N. Y.—RADIO & Television RETAILING

Audar RECORD PLAYER

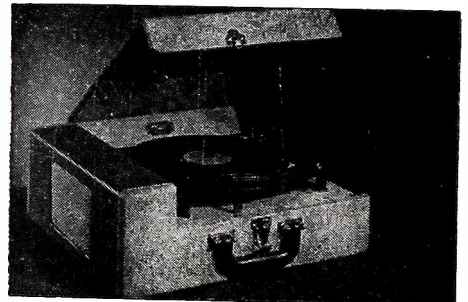

Model P-7 electric portable phonograph will play 12" discs with lid closed. Tone compensated amplifier, speaker matched to acoustically designed case. Compact, two-toned leatherette-covered cabinet measures only 14½" by 15¼" by 6½". Lightweight design—11 lbs. Audar, Inc., Argos, Ind.—RADIO & Television RETAILING

Trylon PHONOGRAPH

Model 100 portable electric record player with 3-tube amplifier playing 10" and 12" records. Variable tone control, needle scratch filter, automatic bass compensation, ac. Shure crystal pickup, Alnico 5 PM



speaker. Luggage DuPont fabric-covered case in choice of 2-tone color combinations. Trylon Radio Laboratories, Philadelphia 40, Pa.—RADIO & Television RETAILING

**EXCLUSIVE PHONO LA
DISTRIBUTORS EVERYWHERE***



Phonola

ACOUSTIC AND ELECTRONIC PHONOGRAPHS

Phonola is proud of its more than a quarter century record of leadership in the portable field, and proud, too, of the fast-growing network of exclusive distributors . . . with others being added to give world wide coverage.

*A few exclusive territories are still available for the Waters Conley distribution franchise.

Eastern Sales Office
17 E. 42nd St. • New York 17, VA. 6-2079

Midwestern and Western Sales Office
224 S. Michigan Ave. • Chicago 4, HAR. 1880

Factory and Engineering Laboratory
Rochester, Minn.

WATERS CONLEY COMPANY
ROCHESTER, MINNESOTA

- ARIZONA, Phoenix
Albert Mathias & Company
- ARKANSAS, Little Rock
Home Appliance Distributors of Ark.
- CALIFORNIA, Los Angeles
Sues, Young & Brown, Inc.
- CALIFORNIA, San Francisco
H. B. Basford Company
- CONNECTICUT, Hartford
Roskin Distributors, Inc.
- DISTRICT OF COLUMBIA, Washington
Washington-Columbia Wholesalers
- FLORIDA, Jacksonville
Cahn and Bultman, Inc.
- GEORGIA, Atlanta
The Yancey Company, Inc.
- ILLINOIS, Peoria
Williams, Inc.
- INDIANA, Indianapolis
Radio Equipment Company
- IOWA, Des Moines
The Roycraft-Iowa Company
- KENTUCKY, Louisville
Electric Appliance Distributors of Ky.
- LOUISIANA, New Orleans
Walker Brothers Company
- MAINE, Portland
Ferrer-Brown Company
- MARYLAND, Baltimore
Joseph M. Zamoiski Company
- MASSACHUSETTS, Boston
Columbia Wholesalers, Inc.
- MINNESOTA, Minneapolis
The Roycraft Company
- MISSOURI, Kansas City
Federal Distributing Company
- MISSOURI, St. Louis
The Artophone Corporation
- NEW JERSEY, Newark
E. B. Nathan and Company
- NEW YORK, Albany
Roskin Brothers, Inc.
- NEW YORK, Buffalo
Western Merchandise Distrs., Inc.
- NEW YORK, Middletown
Roskin Brothers, Inc.
- NEW YORK, Rochester
Chapin-Owen Company, Inc.
- NEW YORK, Syracuse
Onondaga Supply Company
- NORTH CAROLINA, Charlotte
Southern Bearings and Parts Co.
- NORTH DAKOTA, Fargo
The Larson Company
- OHIO, Cincinnati
Modern Distributing Company
- OHIO, Cleveland
Strong, Carlisle & Hammond Co.
- OREGON, Portland
Appliance Wholesalers
- PENNSYLVANIA, Philadelphia
Trilling and Montague
- RHODE ISLAND, Providence
Simons Distributing Company
- TENNESSEE, Memphis
Woodson & Bozeman, Inc.
- TEXAS, Dallas
The Southwestern Company, Inc.
- TEXAS, El Paso
Albert Mathias & Company
- TEXAS, Houston
Crumpacker-Covington Company
- TEXAS, San Antonio
Southern Equipment Company
- VIRGINIA, Richmond
B. T. Crump Company, Inc.
- WASHINGTON, Seattle
Radio Television & Appliance, Inc.
- WEST VIRGINIA, Charleston
Charleston-Electrical Supply Co.
- WISCONSIN, Milwaukee
Radio Specialty Company

(Partial List of Phonola Distributors)

Victor "Now" School



Shown at the opening session of the RCA Victor dealer training "now" school at the Eastern Co., Cambridge, Mass., are (L. to R.): J. W. Potter, George Fearnought, RCA Victor records sales supervisor, Boston; David Rockman, and Jack Rafferty, of the Eastern Co.

Duotone Sound Lab

Stephen Nester, president, Duotone Co., 799 Broadway, New York City, announced that his firm was erecting an extensive sound laboratory near Red Bank, N. J., for the purpose of supplying true and factual information on present day sound equipment.

Mr. Nester stated that there was a growing need for unbiased and extensive research on present-day needles, record changers, pick-ups and discs, which would give the consumer the true facts about their qualities. The laboratories will be sound-proofed with sound control walls and will be equipped with all the latest electronic testing equipment.

A monthly bulletin, written under the unbiased supervision of a group of the nation's leading sound engineers, will be released to dealers and consumers.

A special department in the new building, estimated to be costing the Duotone Company in excess of \$100,000, will include a special department for the testing of home recording equipment where developments in transcription needles and discs will be given special attention.

New Decca Record Series

Decca Records, Inc., has announced a new fifty-cent record series on its "Blue Label," which will enable the company to have records in each price class, and permit reissuing of titles which have been unavailable for some years.

The new series will not interfere with any of the company's other prices. The first records to be released under the Blue Label include: Dick Robertson's "The Gang That Sang Heart of My Heart"; orchestra recordings by Dick Kuhn, Terry Shand, Freddie "Schnickelfritz" Fisher and Bob Howard and a record by the Three Suns.

Platters Pay

(Continued from page 55)

DORSEY, JIMMY: "Ballerina" — "Love's Got Me in a Lazy Mood." *MGM 10035*

Bob Carroll does the vocals on the first side haunting ballad; Dee Parker sings the reverse slow blues number.

DORSEY, TOMMY; and his Clambake Seven: "But I Do Mind if Ya Don't" — "That's Life I Guess." *RCA Victor 20-2302*

Hannah Williams, a Broadway favorite of years back, does the lyric on these two lilting sides.

FITZGERALD, ELLA: "Oh, Lady Be Good!" — "Flying Home." *Decca 23956*

Groovy platter that has Ella singing first chorus, and then scatting for remainder of first side.

HARRIS, PHIL: "I'm So Right Tonight" — "George Washington, Abraham Lincoln, Ulysses S., Robert E. Lee." *RCA Victor 20-2301*

A romantic ditty and an original minstrel show song receive a lusty Phil Harris rendition.

HAYMES, DICK: "I Wish I Didn't Love You So" — "Naughty Angelina." *Decca 23977*

Crooner does two catchy tunes sure to appeal.

JAMES, HARRY: "Tomorrow" — "Something for Nothing." *Columbia 37388*

Good dance numbers featuring the James trumpet.

MADRIGUERA, ENRIC: "The Cowbell Song" — "Guatemala." *National 9031*

First side is a catchy new novelty rhumba; reverse is a rhythmic samba foxtrot.

MARTIN, FREDDY: "Something for Nothing" — "Last Night in a Dream." *RCA Victor 20-2318*
Styled for dancing.

MARTIN, TONY: "Too Marvelous for Words" — "Ain'tcha Ever Comin' Back." *RCA Victor 20-2293*

First side ballad was featured in film, "Dark Passage," and Martin delivers in a romantic vein. Plattermate provides good contrast in lilting rhythms.

MARTINEZ, CHUCHO: "Say No More" — "Roses in the Rain"; "La Paloma" — "Ay! Ay! Ay!" *Apollo 1069-150*

These are the first records released by Apollo featuring Martinez, billed as the "Voice of Romance."

MONROE, VAUGHN: "Tallahassee" — "I Wish I Didn't Love You So." *RCA Victor 20-2294*

Maestro Monroe vocalizes two top movie tunes, the first from "Variety Girl," flipover from "Perils of Pauline."

SHORE, DINAH; HERMAN, WOODY: "Tallahassee" — "Natch." *Columbia 37387*

This is a first together for this pair, and the result is an attractive blending of contrasting voices.

SHORE, DINAH; SINATRA, FRANK: "My Romance" — "Tea for Two." *Columbia 37528*

Combination of two top singers on this platter is for the benefit of the Damon Runyon Memorial Fund, to which proceeds will go. Aside from the worthy cause, disc features two top tunes.

SINATRA, FRANK: "Almost Like Being in Love" — "There But for You Go I." *Columbia 37382*

Two top tunes from the Broadway musical, "Brigadoon," that are tailored to Sinatra's voice.

ALBUMS

"**BILLIE HOLIDAY,**" and her orchestra. *Columbia C-135*

Selections include: "Until the Real Thing Comes Along," "I Cover the Waterfront," "When a Woman Loves a Man," "He's Funny That Way," "Summertime," and "Billie's Blues."

"**CARLE COMES CALLING,**" Frankie Carle with rhythm section. *Columbia C-129*

Styled for good dancing and easy listening, this Carle collection has a variety from "Star Dust" to "Chopin's Polinaise in Boogie," to please.

"**NEW FRIENDS OF RHYTHM,**" under the direction of Sylvan Shulman. *International Records*

An album for "music lovers," for longhairs and hepsters, suggests the album fly-leaf. Personnel features: Sylvan Shulman, Bernard Robbins, Ralph Hersh, Alan Shulman, Laura Newell, Tony Colluci, Hank D'Amico and Harry Patent.

"**ROMEO LOVES JULIET,**" featuring Larry Clinton and his Orchestra, Marshall Young, and Janette Davis. *Rainbow Records*

Something new in record albums is this "original musical," told through eight new popular songs, with musical interludes continuing the story at the end of each record. Piano and clarinet play an integral part, along with the voices of hero and heroine in the play. Top tunes are "For a Penny," "The Wheels Keep Spinning Around" and "Walk Before You Run."

(More Record Listings on page 64)

*No finer
needle
at any
price*



\$2.50



Beautifully packaged
in a useful record
brush

Through the unending efforts of PERMO
engineers and technicians,
you have the spring-action Fidelity
Supreme... the needle you can recommend with
the full knowledge
"there's no finer needle at any price".

PERMO, Incorporated
CHICAGO 26

More Permo Needles sold than all other longlife needles combined

Platters Pay

(Continued from page 56)

arias are sung in German, in the grand opera style that has made Torsten Ralf famous.



ACUFF, ROY, and His Smoky Mountain Boys: "I Talk to Myself About You" — "Short-Changed in Love." Columbia 37505

Western balladeering in the plaintive vein.

AUTRY, GENE: "The Angel Song" — "When the Snowbirds Cross the Rockies." Columbia 37390

Favorite singer of cowboy songs, Autry does two new ballads in the sentimental manner of a prairie gentleman.

DEXTER, AL, and his troopers: "Maybe, Baby, It's Me" — "Love Lands of Yesterday." Columbia 37538

Prairie songs by Al Dexter, sung by Al Dexter.

JOHNSON, BILL: "That Night We Said Goodbye" — "Sharkies' Boogie." RCA Victor 20-2298

"The Crying Singer," Gus Gordon does "Goodbye" vocals; reverse is a hot licks number.

LAWSON, JIMMY: "Dangerous Ground" — "Some Folks Call It Texas." Columbia 37548

Typical western songs.

PRESTON, JACKSON, and his New Orleans Band: "Snuff Dripping Woman" — "The Blues Stay With Me." RCA Victor 20-2306

Old fashioned blues rhythm done on first side makes this a colorful waxing.

ROGERS, ROY: "On the Old Spanish Trail" — "I've Got a Feelin'." RCA Victor 20-2320

Rogers is star of film "On the Old Spanish Trail," so dealers should find some good tie-ins for this disc.



"BUGS BUNNY," Capitol CC-64

Mel Blank, the voice of many cartoon characters in the movies, presents his original Bugs Bunny, Daffy Duck, Porky Pig and Elmer Fudd in this album. Other cartoon personalities are included, backed by the music of Billy May, to help carry out the mood.

"CIRCUS DAY WITH UNCLE DON," "UNCLE DON ON THE

FARM." Sonora albums UD-1, UD-2.

Uncle Don and his piano tell stories for the kiddies.



"GOSPEL MUSIC," by the Humbird Family. Sacred Records

Western style presentation of religious hymns including: "I've Got That Old Time Religion," "Everybody Will Be Happy Over There," and "Holy Be."

"PRAYERS AND SONGS OF THE JEWISH SABBATH," Dr. Stephen S. Wise and the Choir of the Free Synagogue. RCA Victor

Recordings include prayers and ceremonial songs of the Jewish Sabbath, and feature Dr. Wise reciting the Twenty-third Psalm. This collection is particularly timely with the Jewish Holy Days due next month.

TUCKER, RICHARD: "Kol Nidre" — "Eli, Eli." Columbia 72198-D

"Kol Nidre" is sung on the Eve of the Day of Atonement; reverse is a traditional Jewish melody. Opera star, Richard Tucker, imparts fervor to both.

IF IT'S LATIN-AMERICAN RECORDS YOU WANT . . . YOU WANT

Seeco Records

The largest manufacturer of Latin-American recordings in the world, featuring

RHUMBAS - GUARACHAS - BOLEROS - SAMBAS

By These and Many Other FAMOUS ARTISTS:

CHUCHO MARTINEZ GIL
TRIO SERVANDO DIAZ
BOBBY CAPO
JOHNNY RODRIQUEZ
DANIEL SANTOS
DAVILITA
LAURITA and REY
POLITO GALINDEZ

RITA MARIA RIVERO
NORO MORALES and
His ORCHESTRA
TRIO LOS PANCHOS
CELSE VEGA and His
CBS QUINTET
GUILLERMO PORTABLES

MIGUELITO VALDES
GRUPO MARCANO
CONJUNTO MATAMOROS
CONJUNTO CHANO POZO
LOPE BALAGUER
ARMANDO and His
JACK'S CLUB BAND
EVA GARZA

DEALERS PRICE: 49c, tax included

Write for our Complete Catalog.

SEECO RECORDS, INC.

1393 FIFTH AVENUE

NEW YORK 29, N. Y.

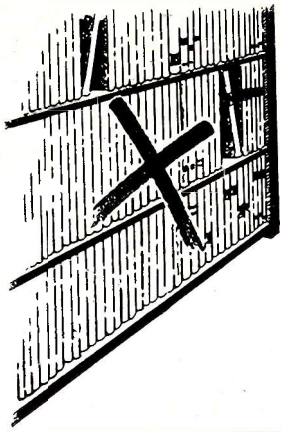

Here is the newest equipment for the **MERCHANDISING of RECORDS & ALBUMS**

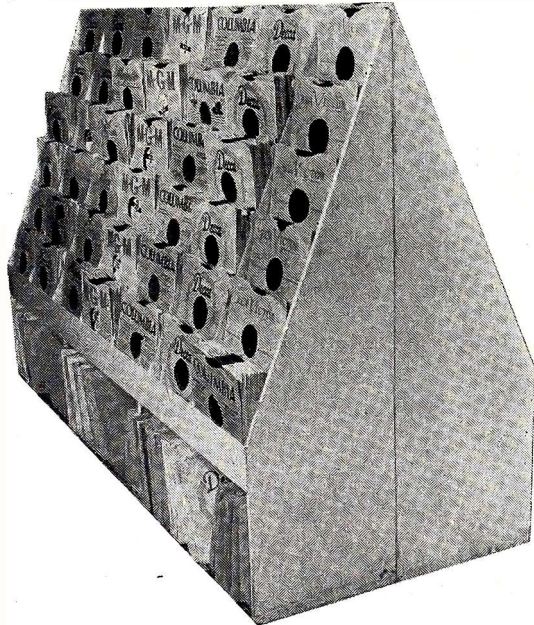

The new **RECORD RACK**
100% visibility for all of your
FEATURED RELEASES and
popular numbers.

Two racks shown back to back. Racks come for either 10 or 12-inch records with album storage space underneath. Dimensions: 6'4" wide, 1'3" deep, 4'5 1/2" high.

Price **\$32.50** each, F.O.B. Gettysburg, Pa.

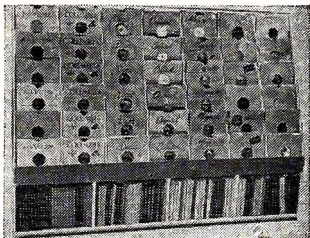

CAPACITY—10-inch rack has 42 compartments each holding 20 records. 12-inch rack has 30 compartments each holding 15 records. Under each rack is space for storage of 90 10 or 12-inch albums.



The new
ALBUM VISUALIZER
brings albums out
where people can see them.

Visualizer comes in two models, Popular and Classical. 48 record albums shown in full face display with storage space for 90 albums in base of rack. Dimensions: 6'4" wide, 1'3" deep, 4'5 1/2" high.

Price **\$55.00** each F.O.B. Gettysburg, Pa.

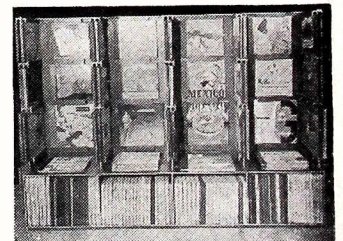

CAPACITY — Popular Visualizer holds 32 10-inch and 16 12-inch albums. Classical Visualizer displays 32 12-inch and 16 10-inch albums. Under each Visualizer is space for storage of 90 albums.

Record Racks and Album Visualizer are of same dimensions, thus allowing them to be placed back to back in any combinations. They can be used in combination as an island display in the middle of the store or can be placed singly against a wall. All racks are sturdily constructed of seasoned wood and masonite and finished in light oak lacquer.

1/3 deposit with order, balance COD. Specify freight or express.

"SPACE-SAVER" RECORD DISPLAYS ARE DESIGNED BY RAYMOND L. GREEN

RAYMOND L. GREEN • THE RECORD SHOP • 32 N. Main Street
Chambersburg, Pa.

Smooth RECORDING...
Smooth PLAYBACK with
**GI DUAL-SPEED HOME
 RECORDING ASSEMBLY**



CUTS RECORDS UP TO 10" DIAMETER

PLAYS RECORDS UP TO 12"

ONE BUTTON CONTROLS SPEED
 78 or 33 1/3 R.P.M.

JUST LOWER CUTTING ARM TO START RECORDING

MODEL GI-R90
 DUAL-SPEED HOME
 RECORDING AND
 PHONOGRAPH ASSEMBLY

You'll get quick response when you offer your customers this simple, dependable, Dual-Speed Home Recording Assembly.

It's simple as ABC to operate, with high-quality recording and fine reproduction. The sturdy, *Smooth Power* mechanism will stand up faithfully under hard home use—and it's remarkably low-priced to help you build volume sales.

Send for details. Ask us for complete information on the GI-R90 Home Recording and Phonograph Assembly—and on our complete line of Phonomotors, Recorders and Combination Record-Changer Recorders.

**THE GENERAL
 INDUSTRIES CO.**

DEPT. MV . ELYRIA, OHIO

Gene Steffens Presides at Permo Dealer Party

In a gala inaugural atmosphere, Permo, Inc., entertained a gathering of nearly 250 record dealers and clerks at a recent party in the ballroom of the Edgewater Beach Hotel, Chicago. It was the first of three such get-togethers in Chicago and about 60 more to be held in other cities throughout the country.

The occasion for these Fidelity parties is the showing of Permo's sound-movie, "Points of Distinction," and a social evening filled with enjoyable entertainment. This event was conducted by E. C. (Gene) Stef-



"Judge" Gene Steffens awards cash prizes to two record clerks who found their "twin" numbers, in the crowd at the Permo party for record dealers and clerks.

Electronic Engineering Handbook

By Ralph R. Batcher, E.E. and William Moulic

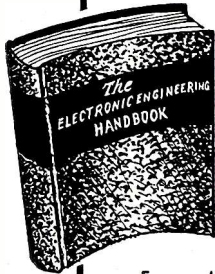

**ALL
 That the Name
 IMPLIES**

A handbook—a helping handbook you will want at your fingertips on those frequent occasions when the right answer can save you hours of effort.

For radio-electronic specialists this Caldwell-Clements book provides a convenient, authentic source of formulas and principles, as well as the latest in electronic applications. Free from involved mathematical explanations. Section I covers Vacuum Tube Fundamentals; Section II, Electronic Circuit Fundamentals; Section III, Electronic Applications; Section IV, Vacuum Tube Data.

456 Pages • 560 Illustrations • \$4.50
 Bound in limp leatherette, opens conveniently flat. 6 x 9 in.

CALDWELL-CLEMENTS, INC.

480-D Lexington Ave.  New York 17, N. Y.
 Publishers to the electronic industries since 1925

Send book. If not satisfied, will return within five days. Otherwise will remit payment.

ELECTRONIC ENGINEERING HANDBOOK \$4.50

Name.....

Address.....

City and State.....

Company Name.....

Once You
 Get This
 Book in
 Your Hands
 You'll Always
 Have It
 at Your
 Fingertips

**No Risk—
 5 Day
 Approval**

fens, Permo vice-president and general sales manager, who acted as M. C. He was assisted by R. F. (Dick) Goetzen, assistant sales manager and Eddie Crowley, representative for the Chicago territory.

The audience was visibly impressed by the movie which, in interesting narrative form, takes one through the successive, intricate steps in the manufacture of Fidelity needles.

In addition to the showing of this movie at parties in more than 60 distributing centers, Permo plans to have all "reachable" dealers and clerks view "Points of Distinction" during coming months.

Dumor Record Compound

Dumor Plastics, Inc., Atco, N. J., makers of a new material specifically designed for the manufacture of phonograph records, is initiating an intensive promotion and trade advertising campaign based on endorsements of the Dumor records by record companies, recording artists, dealers, etc.

The compound was developed by A. H. Ciaglia, the firm's vice-president and research director. Dumor Plastics, Inc., is now supplying about 100 tons of the material a month to the record industry.

Columbia District Managers Visit "Finian" Cast



Columbia's district managers paid a backstage visit to "Finian's Rainbow" and met the show's stars, Dorothy Claire, Carroll Brooks, David Wayne and Donald Richards. Paul Southard, vice-president in charge of sales and advertising (second from left), was Columbia's pilot backstage.

Keynote to Distribute Record Guild Discs

Keynote Recordings, Inc., New York, has been appointed national sales representative for the Record Guild of America, manufacturers of children's illustrated unbreakable records.

This announcement was made jointly by Keynote's president, John Hammond and Record Guild's president Harold L. Friedman.

Apollo Distributor

Apollo has appointed the Millner Record Sales Co., St. Louis, Mo., as distributor for the states of Kansas, Nebraska and Missouri.

Dillon with Continental

Anthony Dillon has been appointed sales manager of Continental Record Distributing Co., announced Donald Gabor, president.

Present MGM Hit Album



Pictured above presenting the first release of MGM's album of song hits from "Till the Clouds Roll By" to Mayor Hartsfield of the City of Atlanta are (l. to r.): Dan Hornsby, manager of record sales for the Graybar Electric Co. in Atlanta; Boyd Frye, manager of Laew's Grand Theatre, Atlanta; H. E. Giles, Graybar southern district merchandising manager, and Mayor Hartsfield.

RCA Victor Contest, and Dealer Aids to Selling

RCA Victor has just completed sponsorship of a nationwide contest among record dealers to create interest in the Spade Cooley recording of "Red Hair and Green Eyes."

The contest was to find the nation's prettiest red-haired, green-eyed girl. Contestants had to submit a 25-word statement: "Why I Like Spade Cooley's RCA Victor recording of 'Red Hair and Green Eyes'."

Dealers have a good opportunity for more tie-ins with the Roy Rogers Thrill Circus, which will hit Phila., St. Louis and Detroit during September.



DUOTONE

THE GREATEST NEEDLE LINE IN THE WORLD

THESE world-beating Duotone needles are examples of the painstaking research and technical skill of Duotone engineers. They characterize the superiority of the entire Duotone line of record accessories.

When you sell Duotones, you're sure of enthusiastic customer approval and higher profit margins.

Stock Duotone and watch it pull! There's a Duotone product for every customer.



The Duotone Diamond
The world's finest needle for the world's finest phonographs. A jeweler's masterpiece. \$50.00 retail.



The "Star" Sapphire
Completely handmade with a sapphire point. Cherished by record collectors. \$5.00 retail.



The Duotone Ruby
Brilliant achievement of the jeweler's art. A ruby tipped needle that's really new. \$3.50 retail.



The Regent Sapphire
Outstrips competition in any demonstration. Affords the kind of profit margin you like. \$2.00 retail.

OTHER WELL-KNOWN DUOTONE PRODUCTS

Miropoint Needles Transcription Needles Cactus Needles Chromium Needles Coin Machine Needles	Recording Heads Steel Cutting Needles Sapphire Cutting Needles Duodiscs Record Preserver
--	--



DUOTONE

DUOTONE COMPANY
799 Broadway, New York 3, N. Y.



The Filter Point
Filters surface noise and reproduces with high fidelity. Plays longer. Package of 35—25¢ retail.



The Durpoint
Fast-moving, high-profit needle with excellent tonal reproduction. Attractively packaged. \$1.00 retail.



The New Lifetone
This superb osmium tip needle surpasses any other needle in its immediate price range. \$1.50 retail.

"YOU'VE GOT TO MAKE YOUR QUOTA"

"WE'LL GET ANOTHER DEALER"



"YOU'LL HAVE TO TAKE THIS TIE-IN"

"Nobody has me under his thumb

... I have a franchise with a future
... a complete line of major
and minor home appliances"



We believe in strong dealers.
And the only way to build a strong
dealer organization is to pick
'em carefully and then

do everything to help them grow. That is why we urge every
independent appliance dealer to investigate Monitor. You'll find that Monitor's attitude
toward its dealers is refreshingly different.

You'll find the franchise is long on territorial and other protection for the dealer . . . is very
reasonable in what it asks of him. You'll find that 83% of Monitor volume is in the
profitable "majors." And you'll find Monitor is the fastest growing appliance line.
As a Monitor dealer, your direct contact would be with a distributor who is an owner-member
of the Monitor organization. Let us put you in touch with him now. Let him
tell you about sales policies. Ask to see the simple, liberal dealer's contract. We think
you are going to like the whole Monitor set-up.

MONITOR HOUSE, Riverdale-on-Hudson, New York 63, N. Y.

MONITOR

The most distinguished family of home appliances



of the independent
by the independent
for the independent

TOP-TEN* COMEDY
RECORDS BY:
AMOS 'N' ANDY
JACK BENNY
EDGAR BERGEN AND
CHARLIE McCARTHY
BURNS AND ALLEN
EDDIE CANTOR
ED (ARCHIE) GARDNER
FIBBER McGEE AND
MOLLY

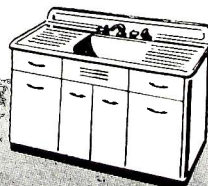
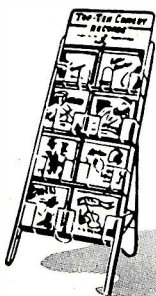

*TRADE MARK

ELECTRICAL APPLIANCES

Section of **RADIO & Television RETAILING**

How to Use One Sale to Bring in Others

It Pays to Arrange Group Demonstrations in the Home of the New User

After-sale demonstration in the home builds customer good-will, and it is also a first-rate way to cut down on the number of service calls under the guarantee period.

There's something else worthwhile in after-sale demonstrations in the consumer's home too, and that's the opportunity to sell appliances to the customer's neighbors.

A leading Eastern dealer capitalizes on a unique and entirely practicable plan which he has been following for some years. It works like this: Whenever he sells a major appliance, say, for instance, an automatic washer, he offers a small present—for example, a toaster or an electric clock, to the new owner if she will agree to invite some of her neighbors in to see the appliance demonstrated by an expert from the store.

This plan works out very well, and results in many new sales. The visitors who call to see Mrs. Smith's new washer in actual operation are impressed with the importance of the fact that Mrs. Smith chose it. They have confidence in her judgment, and when they see the shiny new appliance miraculously performing tasks which hitherto had been difficult and distasteful, the desire to own is greatly enhanced.

There are many angles and twists to the plan. The dealer who has installed an electric kitchen in the home of a customer might well stage, with the owner's consent, what could almost amount to a "cooking school," where his salesmen could interest

visitors in purchasing similar set-ups for their homes. Such a meeting would be a fine method of introducing some of the newer things in the modern kitchen, the dishwasher and the disposal unit, for example.

Modern laundry equipment lends itself well to group demonstration too. The dealer can show the new owner how to use the new appliances, and, at the same time, explain their salient features to the visitor.

In addition to offering to give a present in return for the use of the home as a gathering place for friends and neighbors, the dealer could offer to pay a commission on sales made at such meeting, or resulting later.

In planning all such events, it goes without saying that the merchant should never exert any pressure on the customer in seeking permission of the home-owner for the mass demonstration.

In most cases, though, if the idea is carefully presented, owners will be entirely willing to accept the plan. They will do this not so much for the slight material gain as for the sheer enjoyment of the thing. "Pride of ownership," though a more or less hackneyed phrase, still effectively describes the feeling of the owner for the new labor-saving appliances.

(Continued on page 82)

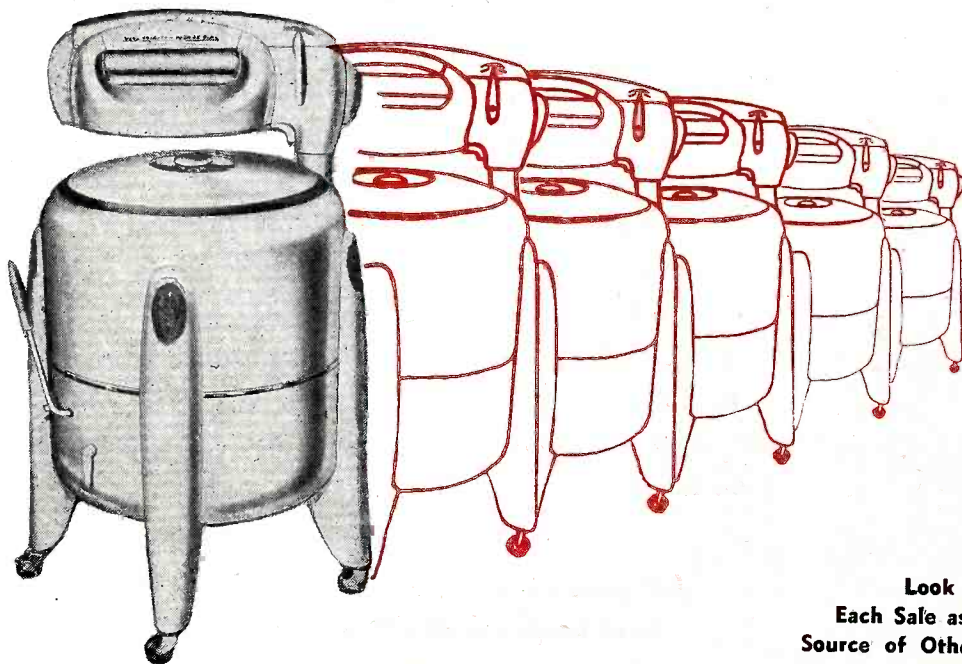

**Look at
Each Sale as a
Source of Others**

WHAT HAPPENS when buyers want YOU?

This OR This ?

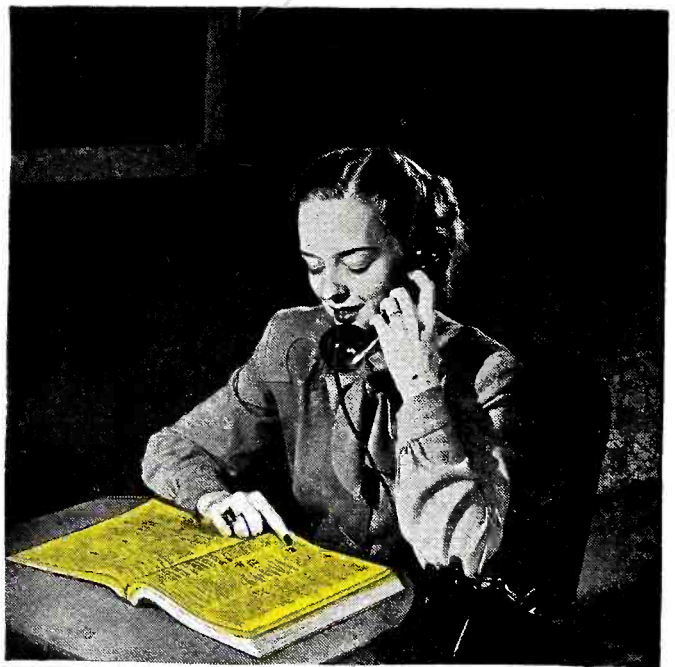
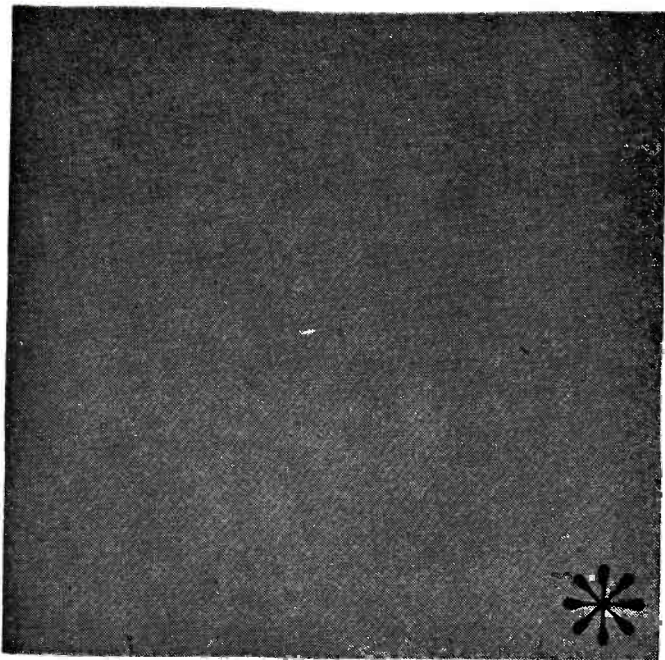

*** ABSOLUTELY NOTHING HAPPENS
WHEN THEY CAN'T FIND YOU EASILY**

But when your advertising appears in the 'yellow pages' of your Telephone Directory, it's a cinch this happy combination will result: *they'll get your telephone number and you'll get their business.*

You see, shoppers everywhere have formed the habit of looking it up in the 'yellow pages' when they're ready to buy the goods or services you offer. They're looking for you . . . want to find you quickly and with the least trouble. Why not make it easier for them?



*For further information, call your
local telephone business office.*

Current Models of Some Small Washers



Menasco Mfg. Co., Burbank, Cal.

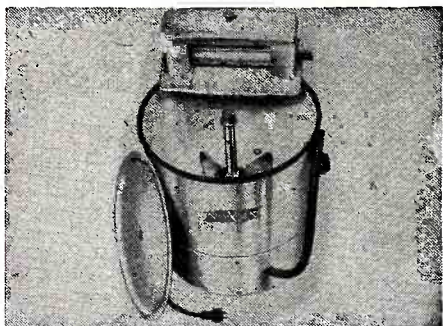

Naxon Utilities Corp., Chicago.

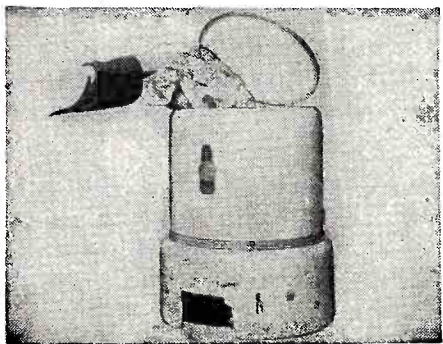

Nineteen Hundred Corp., St. Joseph, Mich.



Easy Washing Mach. Co., Syracuse, N. Y.

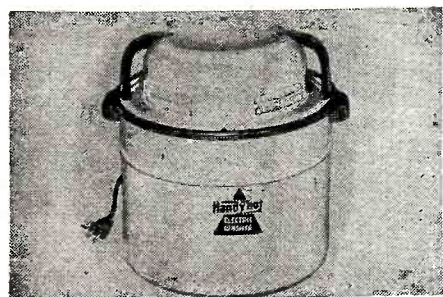

Chicago Elec. Mfg. Co., Chicago.

Sell More Midgets!

There is a great opportunity today to increase sales of midget washers. A number of factors contribute to build up the large potential for sales of the small washing machine, with the present congested housing conditions appearing to be foremost among them.

While it is true that the urban and suburban communities hold the greatest number of prospective purchasers, the small jobs can be sold almost anywhere if the right sort of sales presentations and promotions are employed.

Because midget washers do not look like their larger relatives, and because there were very few of them made in the pre-war period, dealers should always use identifying material in displaying them. This will prevent confusion in the minds of customers. There is no percentage in having a window-shopper stare at a midget on display, wondering whether it's a new sort of pressure-cooker, or a canning kettle.

The first step in building satisfactory sales volume on the midgets is to *tell the people* in your community about them. Explaining, for example, that they take up no more room than a large kettle. That they wash about three pounds of clothes, (or more as the case may be); that they are *not* toys but practical appliances which perform efficiently at very low operating costs.

There are numerous ways to *tell* prospective customers why they should own small washers. Newspaper advertising space can be used effectively. The copy should be brief, simple to understand and explanatory. The ad should tell: 1. What a midget washer is. 2. What it will do. 3. How *little* room it occupies. 4. Who *makes* it. 5. How *little* it costs to buy. And, of course, the dealer's name. Even if his supply is adequate, the dealer should throw the phrase "immediate delivery" into his ad because many people are still shortage-conscious.

The midgets should occupy prominent places on the sales floor and in the show window too. The same sort of copy suggested for newspaper ads can be used along with the displays. Manufacturers' streamers, cards, etc., should be used too.

In-store demonstration will *sell*

numbers of small washing machines on the spot. Since the purchase price of the midgets is comparatively low, the necessity for protracted sales negotiations can often be bypassed.

The portable washer is just what the doctor ordered for the cramped quarters of many a city dweller. One of the chief reasons why the saturation point in washer sales in great cities has always been unsatisfactorily low is because of lack of space. So here comes the midget to make a bid for business in this fertile field!

Prospects Everywhere

To do a good job, the salesman must "sell" himself on the midget. He should know how to operate it, and enough about washing clothes to make a creditable sales presentation. He must know all the short-cuts in filling and emptying the tub, methods of water extraction, etc., and should be able to tell the customer whether or not the portable can be used for "dry cleaning", and if so, how to go about it, and what fluids to use.

Prospects for small washers are everywhere. The large home can buy one in *addition* to a full-size model, to be used for small batches of clothes. The smallest family—a couple—needs a midget, and where there are babies in the household, the small washer will pay for itself.

The job to do is to *promote* the sale of midgets. In cases where a few models are placed about willy-nilly, with no descriptive display material with them, they will be ignored, for the most part, by the store visitor and, which is just as bad, by the dealer himself. Results will be limited sales. The little washers won't sell themselves—but they will move if properly presented. They have plenty of sales appeal, and are reasonably priced.

Manufacturers who make, or plan to make portable washing machines include Easy Washing Machine Co., Syracuse, N. Y., Horton Mfg. Co., Fort Wayne, Ind., Naxon Utilities Corp., Chicago; Nineteen Hundred Corp., St. Joseph, Mich., Chicago Electric Mfg. Co., Chicago; Kamkap, Inc., New York City; Menasco Mfg. Co., Burbank, Cal., John Tjaarda & Associates, Detroit, Mich., Kitchen Queen, Inc., Chicago.

Making Working

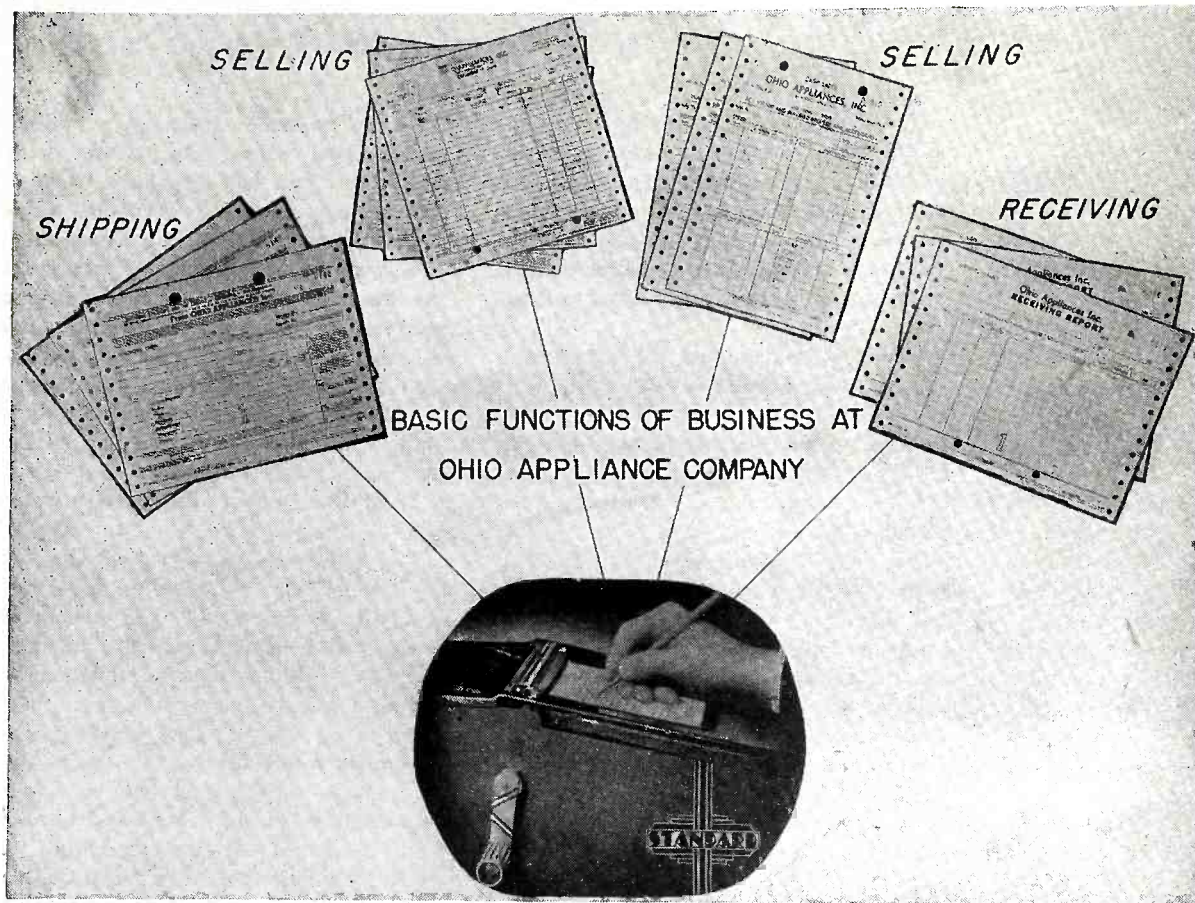

A simple and complete system is worth its weight in business life time.

● Facts and information, readily at hand, play an important part in the administration of any business. Developing a system that gives full facts costs nothing, but is worth its weight in business life time. That's why the careful thought and application of a few simple basic principles of common sense business administration at Ohio Appliances in Columbus, Dayton and Cincinnati have done so well in keeping step with the industry's changing complexion.

Ohio Appliance's paperwork systems involve basic reasoning so fundamental and simple that bookkeeping knowledge of a highly specialized nature is unnecessary for the proper operation of the systems. Here are the fundamentals:

1—*Make a record by hand* over the basic functions of the business. Receiving, selling, shipping are the three unchanging activities in any business. Control these and you control the facts of life of your company.

2—*Make sufficient copies for all parties.* When you can get as many copies as you desire from one writing, with no handling of carbons, lost time in shuffling papers, take advantage of it. Prepare yourself, your

customer, and your office with sufficient information, so that each person involved in the transaction knows what he's getting, what he's paying, the terms, delivery facts and all the other information that will ever be needed.

3—*Set up a system of control that affects all items,* at all times. It's not enough to control only larger items. That leaves your business unprotected from loss, mishandling, improper treatment of smaller, individual items which may be more important in terms of dollar volume than your larger equipment.

4—*Be certain that numerical control,* and where required, locked records of every transaction are available to management at all times. In other words, enforce, through the system you install, a complete comprehensive chain of written events which reflect the exact nature of everything that happened at each of the points at which the system is installed.

With over 800 franchised dealers in the three main areas of Ohio Appliance's operations, the first item of control must be exercised over goods received. Since the company receives large items, such as Coolerator

refrigerators, Blackstone washing machines, Peerless stoves as well as a host of smaller traffic items and houseware, the receiving system is set up to control *all* items moving into its warehouse in downtown Columbus. As goods are received, receiving reports are written on the surface of the register provided for that purpose specifically.

The machine is conveniently located on the receiving floor of the warehouse where all incoming shipments arrive. Copies are written so that a receipt is issued, an office copy is made, and a locked copy folded into the register in a single writing.

Complete Facts

The next item of control in Ohio Appliance's paperwork system is over sales. Here again, a handwritten system is used, which also utilizes a register turning out sufficient copies to insure complete facts to all handling departments. Forms for the machines are printed in continuous strips and locked copies of the records in exact numerical order insure complete details over all invoices.

Another section of the selling function is handled at the record de-

Papers Out of Paperwork

**A Case Study of How, Why, and Where Ohio Appliances,
With Over 800 Franchised Dealers, Writes Records**

partment of Ohio Appliances. Here, because the nature of most of the transactions calls for cash on delivery, the register in use is equipped with a cash drawer which opens only when a set of forms is issued. This system also uses the locked copy of the transaction written at the point of sale. By the locked copies re-folded in the register, facts and cash in the drawer of the register are always available for immediate check.

Because of the heavy volume of shipments at Ohio Appliances, a complete system for writing details of every type of shipping is set up

to handle the traffic. One register system involves the use of specially printed express receipts in continuous form, rather than the conventional padded forms supplied by carriers.

No Bottleneck

This means that without stopping to handle and rehandle loose or padded forms, express receipts are always in writing position in as many copies as desirable. Carbons remain stationary in the registers and need not be shifted more than once or twice a day. Time is thus saved in what is normally a bottle-

neck since forms don't have to be handled and rewritten continually.

For handling the same function, on other shipments, bills of lading are written in the same manner as express receipts. The bills of lading carry preprinted items so that time which would normally be consumed in the writing and rewriting of the same information is thus eliminated.

These principles, properly developed as they are at Ohio Appliance, render information which gives accurate, quick control over the basic functions of business, receiving, selling and shipping. Actually, they em-

(Continued on page 122)

Headquarters, Ohio Appliances. The inset photos show, at top, A. V. Bice, vice-president, general manager, and below, from left to right, Wayne V. Wright, Dayton branch manager, Colonel Raymond Strasburger, Columbus branch manager, and Captain Tom Mason, Cincinnati branch manager.

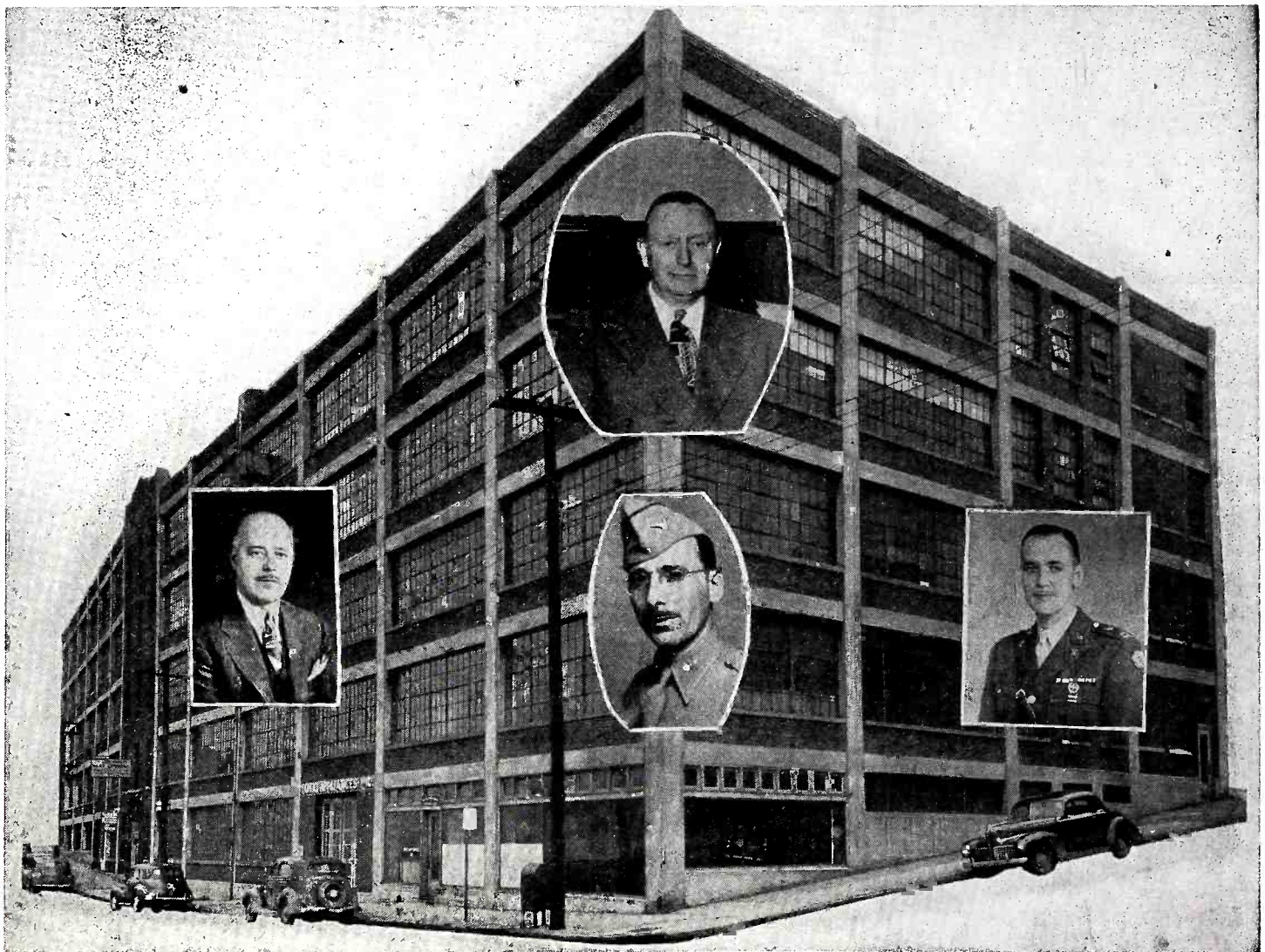

Refrigerators *

* Washers

* Ironers *

* Ranges

* Vacuum Cleaners *

* Food Freezers

New Electrical

Gibson REFRIGERATOR

Model F-777, net capacity 7 cu. ft.; shelf area 11.5 sq. ft. Increased size of freezer locker provides 1.05 cu. ft. of below-freezing space for 36.9 lbs. of frozen foods. Fresh'ner shelf, just below, for cold-con-

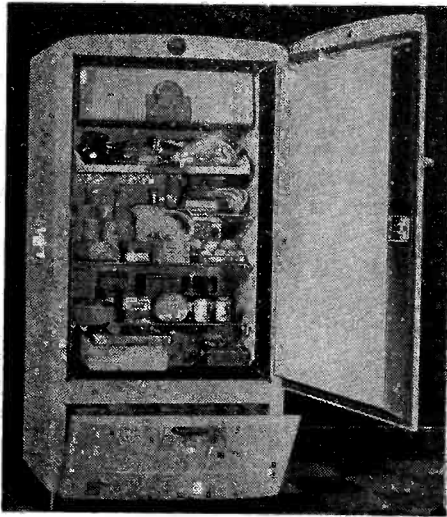

ditioning of fresh meats, chilling and crisping salads. Outside dimensions: 61 15/16 inches high, 30 1/8 inches wide, 27 5/16 inches deep. Gibson Refrigerator Co., Greenville, Mich.—RADIO & Television RETAILING

Simplex IRONER

Model S-477. Features: rotary ironer, complete open roll 22" long, 5" in diameter,

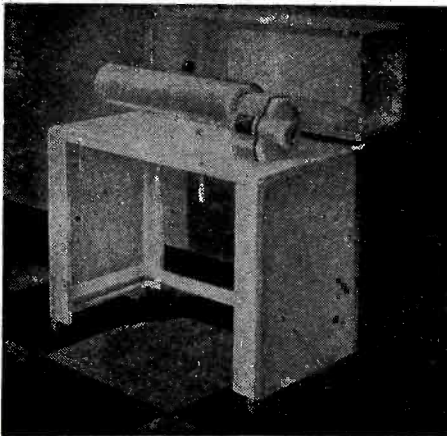

requires 31"x13" floor space; automatic pilot light, adjustable thermostat-heat range from off position to 450 degrees. Shoes can be tilted face up for steaming. Automatic knee press control. Retail price under \$100.00. American Ironing Machine Co., Algonquin, Ill.—RADIO & Television RETAILING.

Universal WASHER

Model WM2701 with pump (WM 1701 without pump), 2-speed washer, has a 9 lb. capacity. Features: new massive streamlining; white baked enamel wringer; pro-

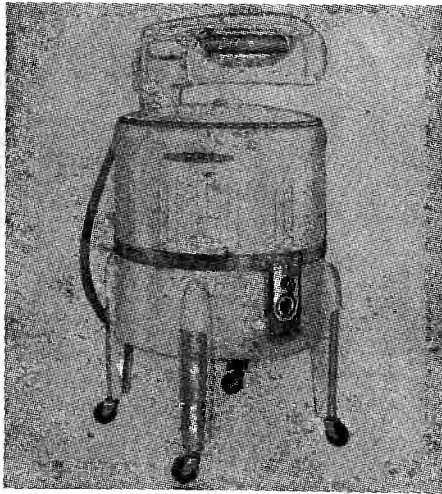

ected feeding zone; select-a-matic pressure indicator; stainless steel trim; time-a-matic timer; overload protecto-switch; wind-away cord hooks, bullet type fluted tub; five-position wringer. Dimensions: overall height, 49 1/2 in., height to edge of tub, 35 in., floor space, 29 x 29 in. Landers, Frary & Clark, New Britain, Conn. — RADIO & Television RETAILING

Hotpoint REFRIGERATOR

Model EC10-1, new 10 cu. ft. model refrigerator, features: speed freezer capacity of almost one cu. ft.; flexi-cold storage compartment adjustable to several positions for refrigeration of meat; additional storage space for bottles provided by removable top shelf; two high-humidity storage compartments have plate glass



tops. Another innovation is the "basket sliding adjustable shelf." Dimensions: 63 in. high, 30 in. wide, 29 in. deep. Hotpoint Inc., 5600 W. Taylor St., Chicago 44, Ill.—RADIO & Television RETAILING

ABC IRONER

Ironer features: continuous rotary action for flat work; stationary pressing action; exclusive to-and-fro shirt-ironing action. Patented foot control stops or starts roll

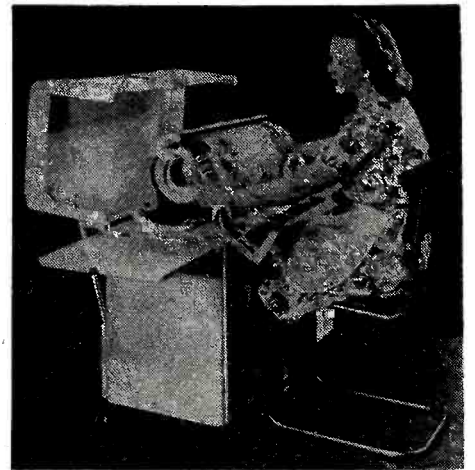

instantly. Two open, usable ends permit ironing of wide pieces. Dimensions: height 36"; width 18"; length 36". Occupies a floor space 18" x 36". Altorter Bros. Co., East Peoria, Ill.—RADIO & Television RETAILING

Home Appliances

★ Toasters
★ Roasters
★ Hand Irons
★ Mixers
★ Clocks
★ Coffee Makers

Frigidaire LAUNDRY EQUIPMENT

New line of home laundry equipment featuring automatic electric clothes washer, ironer and dryer. Suggested retail price for the new washer has been established at \$299.75, dryer will sell for \$229.75 and the ironer at \$189.75. Washer employs principle known as "live-water" action. One setting of single control dial necessary to operate washer. Ironer roll is 30 inches in length; resilient padding protects buttons; a special switch control allows high or low-speed operation. The new dryer is completely automatic, thickly-insulated, and equipped with a glass window. Frigidaire Div., General Motors Corp., Dayton 1, O.—RADIO & Television RETAILING

GE WASHER

Model AW-332 wringer washer, with a full-length, to-the-floor skirt. Purpose of the skirt, which is finished in white baked enamel, beside aiding appearance, is to conceal and protect the mechanism and pump. Holding 8 lbs. of dry clothes, the porcelain-enameled, self-draining tub is

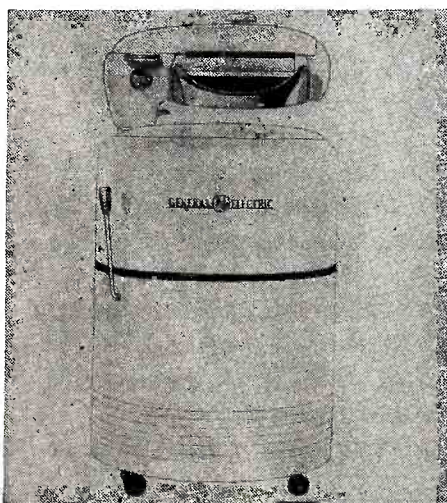

mounted on a rubber gasket to absorb vibration. One-control wringer automatically goes forward or backward, or starts or stops. Washer is 26½ inches in diameter and 47½ inches high. General Electric Co., 1285 Boston Ave., Bridgeport 2, Conn.—RADIO & Television RETAILING

Westinghouse REFRIGERATOR

Model MF-7-47 7 cu. ft. two-temperature refrigerator, will hold 56 lbs of frozen food in the freeze chest and ice storage tray. Freeze chest has a capacity of 1¼ cu. ft.; ice storage tray is rated at four-tenths of a cu ft. Dimensions are: 30¼ in. wide, 57⅝

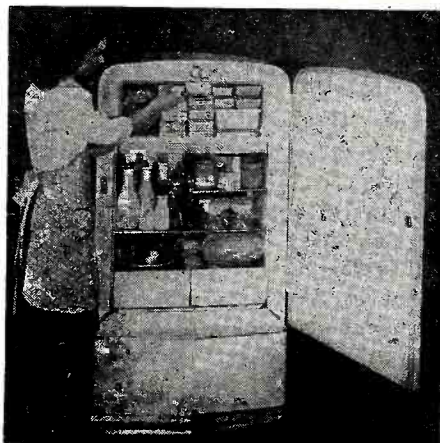

in. high, 25¾ in. deep. Food liner is white porcelain on steel, with acid-resisting bottom. Equipment includes two "select-o-cube" ice trays, two vegetable crispers. Westinghouse Electric Appliance Div., Mansfield, O.—RADIO & Television RETAILING

Philco REFRIGERATOR

Model 773 refrigerator features "summer-winter" control for moist food storage, oversize freezer compartment for frozen foods, adjustable shelves permitting more than 14 different arrangements for keeping foods and beverages accessible. Increased freezer locker size, holds 32 lbs. frozen foods. Includes separate vegetable bin, two glass-covered sliding crisper drawers, sliding meat storage drawer, porcelain interior with automatic light. Dimensions: 59⅝ inches high, 30¼ inches wide, 26¼ inches deep. Priced at \$294.50. Philco Corp., Philadelphia, Pa.—RADIO & Television RETAILING.

Apex WASHER

Model 820. Chassis and wringer assembly finished in white baked enamel.

Eight lbs. dry clothes capacity. Dome-shaped tub, 23 inches in diameter. Heavy duty, splash proof motor ¼ H. P. Model 820-P has intermittent, self-emptying, motor

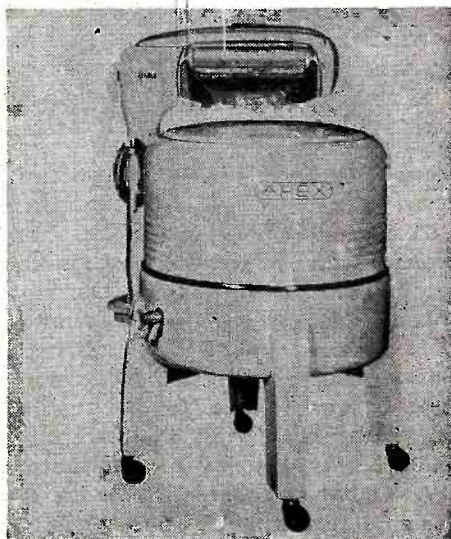

driven pump and drain hose with swivel nozzle. Model 820-G is equipped with 2/3 H. P. gasoline engine. Apex Electrical Mfg. Co., Cleveland, O.—RADIO & Television RETAILING

Vaculator COFFEE FILTER

"Automatic Flavor Control" coffee filter, automatically controls liquid flow by spring action, thereby controlling flavor. Spring action also serves as a safety valve which prevents more than normal brewing pressure from building up during coffee-making process. Filter is made of durable porcelain and stainless steel. Hill-Shaw Co., 311 No. Desplaines, Chicago 6, Ill.—RADIO & Television RETAILING

Nicro COFFEE MAKER

Model 472 stainless steel coffee maker complete with upper and lower bowls; Features: high polish finish 8-cup capacity, "flavor insurance" filter, bakelite handle with stainless steel band and cover with clamp and plastic knob. Nicro Steel Products, Inc., 3534 No. Spaulding Ave., Chicago 18, Ill.—RADIO & Television RETAILING

Your Merchandise Deserves Proper Handling

New Devices for Transport of Appliances Save Dealers Money and Time

● In selling and moving major appliances, it's a big help to a dealer if he knows that he has the equipment for handling the merchandise easily, quickly and efficiently.

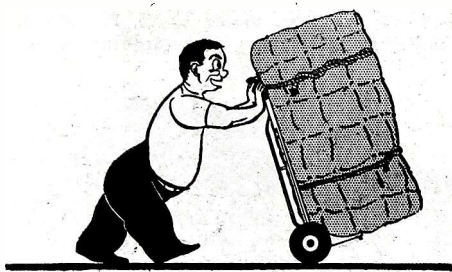

If a retailer must worry and fuss around with makeshift methods in loading and hauling his merchandise, it is a headache and an expensive one. It is certainly one of the things that a dealer should not be bothered about, as it becomes necessary for him to concentrate on getting the stuff sold under highly competitive conditions.

Available to the retailer today is a complete string of up-to-the-minute devices for the proper and convenient handling and moving of his major appliances. These products are made by a dozen or so manufacturers and they include wrap-around quilts, motor scooters, hand trucks, trailers, hoists, slings, etc.—to form enough of a selection to settle the problem once and for all.

What most dealers think about in moving their appliances between the store and the customer, or in shifting products around within the store, is to get the job done without marring the finish. That is, without chipping the surface of an appliance, or scratching the finish of a radio console.

Money-saving Equipment

But these new devices which have been designed for just this work have a number of additional advantages. Dealers find, for instance, that the equipment cuts personnel costs in the store. It requires fewer men to

move and to transport heavy merchandise; it allows more of the highly paid salesmen to stay on the job of selling and service men to stay at the repair bench. It makes possible the delivery of a 9 cu. ft. refrigerator without interrupting the whole store and its staff.

Helps Entire Store

Dealers also find that this moving equipment is a factor in improving the display of appliances on the sales floor and in the windows. A retailer is better equipped for *change*, if he has the right equipment for rolling the heavy pieces around the store. He'll find that he will change his windows more often and make them more effective. And he'll find that he will re-arrange the floor displays whenever he has a better idea, or whenever new lines come in.

In this respect, the appliance-

moving equipment is a tonic for the entire establishment. If the retailer has a mezzanine floor, or if he has special showrooms or salon enclosures around the place, the hand trucks and accessories become even more important and convenient. Dealers are only human; if moving the heavy pieces to new positions is difficult and tricky, they are likely to do less of it.

As far as deliveries are concerned, no customer is going to be happy with any kind of a flaw in the finish of an appliance. When the product is brought to the home in a way that is awkward and dangerous, the retailer's reputation for "good service" begins to suffer. The least that a dealer can do, when he makes delivery on a major appliance, is to get the whole matter off on the right foot by seeing that the unit is in perfect shape.

(Continued on page 82)

MANUFACTURERS OF "MOVING" EQUIPMENT

- American Moto-Scoot Co., 1319 W. Carroll Ave., Chicago 7, Ill.—Motor scooters.**
- Colson Equipment & Supply Co., 1317 Willow St., Los Angeles 13, Calif.—Appliance hand trucks.**
- Handees Co., Bloomington, Ill.—Hand trucks.**
- Keen Mfg. Co., Flat Rock, Mich.—Delivery aids.**
- Mack Mfg. Co., Dyersville, Iowa—Appliance push trucks.**
- Magnelux, Inc., 628 S. Clarence St., Los Angeles, Calif.—Appliance hand trucks.**
- New Haven Quilt & Pad Co., Franklin St., New Haven, Conn.—Protective coverings and accessories.**
- Parsons Engineering Corp., 2546 E. 79th St., Cleveland 4, Ohio—Appliance delivery equipment.**
- Stevens Appliance Truck Co., Augusta, Ga.—Appliance hand trucks.**
- Walton Wheel Co., Milwaukee 1, Wis.—Hand trucks.**
- Warmac, Inc., 1059 Main St., Buffalo 8, N. Y.—Charioteer appliance trailer.**
- Webb Mfg. Co., 2918 N. 4th St., Philadelphia, Pa.—Protective coverings and accessories.**

HEADING YOUR WAY...



NORGE'S BIGGEST NATIONAL MAGAZINE PROGRAM
to date!



THE NORGE SELLING MESSAGE WILL REACH THE BUYING PUBLIC 172,433,617 TIMES, JULY THROUGH DECEMBER

Get set for *action*—coming your way is the new Norge advertising campaign . . . the biggest yet, and the most *powerful!* It has the **BROAD COVERAGE** of 14 leading national magazines . . . the **STRIKING POWER** of full pages and color insertions . . . the **PROFIT-BUILDING PUNCH** of the Norge story, forcefully and convincingly presented.

Yes, your Norge advertising support is growing fast . . . and so are your opportunities for profit. With the seven great Norge lines . . . the "passkeys to profits" . . . you're in "big business" today, ready for even bigger business tomorrow! Norge Division, Borg-Warner Corporation, Detroit 26, Michigan.

"The Best Dealer in Town Sells NORGE!"

Products of BORG-WARNER



Norge products, distributed worldwide, are typical examples of the values made possible by the American system of free enterprise.

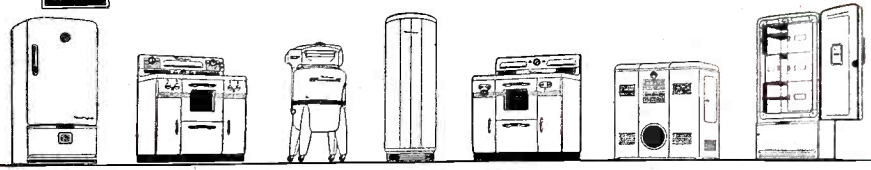

Refrigerators Electric Ranges Washers Electric Water Heaters Gas Ranges Home Heaters Home & Farm Freezers

SEE NORGE BEFORE YOU BUY

Your Merchandise Deserves Proper Handling

New Devices for Transport of Appliances Save Dealers Money and Time

● In selling and moving major appliances, it's a big help to a dealer if he knows that he has the equipment for handling the merchandise easily, quickly and efficiently.



If a retailer must worry and fuss around with makeshift methods in loading and hauling his merchandise, it is a headache and an expensive one. It is certainly one of the things that a dealer should not be bothered about, as it becomes necessary for him to concentrate on getting the stuff sold under highly competitive conditions.

Available to the retailer today is a complete string of up-to-the-minute devices for the proper and convenient handling and moving of his major appliances. These products are made by a dozen or so manufacturers and they include wrap-around quilts, motor scooters, hand trucks, trailers, hoists, slings, etc.—to form enough of a selection to settle the problem once and for all.

What most dealers think about in moving their appliances between the store and the customer, or in shifting products around within the store, is to get the job done without marring the finish. That is, without chipping the surface of an appliance, or scratching the finish of a radio console.

Money-saving Equipment

But these new devices which have been designed for just this work have a number of additional advantages. Dealers find, for instance, that the equipment cuts personnel costs in the store. It requires fewer men to

move and to transport heavy merchandise; it allows more of the highly paid salesmen to stay on the job of selling and service men to stay at the repair bench. It makes possible the delivery of a 9 cu. ft. refrigerator without interrupting the whole store and its staff.

Helps Entire Store

Dealers also find that this moving equipment is a factor in improving the display of appliances on the sales floor and in the windows. A retailer is better equipped for *change*, if he has the right equipment for rolling the heavy pieces around the store. He'll find that he will change his windows more often and make them more effective. And he'll find that he will re-arrange the floor displays whenever he has a better idea, or whenever new lines come in.

In this respect, the appliance-

moving equipment is a tonic for the entire establishment. If the retailer has a mezzanine floor, or if he has special showrooms or salon enclosures around the place, the hand trucks and accessories become even more important and convenient. Dealers are only human; if moving the heavy pieces to new positions is difficult and tricky, they are likely to do less of it.

As far as deliveries are concerned, no customer is going to be happy with any kind of a flaw in the finish of an appliance. When the product is brought to the home in a way that is awkward and dangerous, the retailer's reputation for "good service" begins to suffer. The least that a dealer can do, when he makes delivery on a major appliance, is to get the whole matter off on the right foot by seeing that the unit is in perfect shape.

(Continued on page 82)

MANUFACTURERS OF "MOVING" EQUIPMENT

- American Moto-Scoot Co., 1319 W. Carroll Ave., Chicago 7, Ill.—Motor scooters.
- Colson Equipment & Supply Co., 1317 Willow St., Los Angeles 13, Calif.—Appliance hand trucks.
- Handees Co., Bloomington, Ill.—Hand trucks.
- Keen Mfg. Co., Flat Rock, Mich.—Delivery aids.
- Mack Mfg. Co., Dyersville, Iowa—Appliance push trucks.
- Magnelux, Inc., 628 S. Clarence St., Los Angeles, Calif.—Appliance hand trucks.
- New Haven Quilt & Pad Co., Franklin St., New Haven, Conn.—Protective coverings and accessories.
- Parsons Engineering Corp., 2546 E. 79th St., Cleveland 4, Ohio—Appliance delivery equipment.
- Stevens Appliance Truck Co., Augusta, Ga.—Appliance hand trucks.
- Walton Wheel Co., Milwaukee 1, Wis.—Hand trucks.
- Warmac, Inc., 1059 Main St., Buffalo 8, N. Y.—Charioteer appliance trailer.
- Webb Mfg. Co., 2918 N. 4th St., Philadelphia, Pa.—Protective coverings and accessories.

HEADING YOUR WAY...

NORGE'S BIGGEST NATIONAL MAGAZINE PROGRAM
to date!



THE NORGE SELLING MESSAGE WILL REACH THE BUYING PUBLIC 172,433,617 TIMES, JULY THROUGH DECEMBER

Get set for *action*—coming your way is the new Norge advertising campaign . . . the biggest yet, and the most *powerful!* It has the **BROAD COVERAGE** of 14 leading national magazines . . . the **STRIKING POWER** of full pages and color insertions . . . the **PROFIT-BUILDING PUNCH** of the Norge story, forcefully and convincingly presented.

Yes, your Norge advertising support is growing fast . . . and so are your opportunities for profit. With the seven great Norge lines . . . the "passkeys to profits" . . . you're in "big business" today, ready for even bigger business tomorrow! Norge Division, Borg-Warner Corporation, Detroit 26, Michigan.

"The Best Dealer in Town Sells NORGE!"

Products of



Norge products, distributed worldwide, are typical examples of the values made possible by the American system of free enterprise.

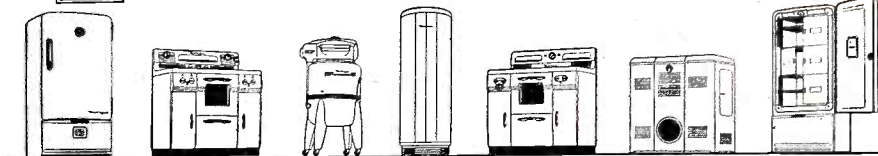

Refrigerators Electric Ranges Washers Electric Water Heaters Gas Ranges Home Heaters Home & Farm Freezers

SEE NORGE BEFORE YOU BUY

Lighting Sales Tips

New Products, New Ideas, Help to Make More Money

Offer Maintenance Manual

Copies of the Sylvania Fluorescent Service and Maintenance Manual are now available at \$1 each from Sylvania Electric Products Inc., 211 Derby St., Salem, Mass.

Fostoria Issues Booklet

"Balanced Lighting" is the title of an interesting booklet available from the Fostoria Pressed Steel Corp., Fostoria, Ohio.

Lighting Guide Available

The new Guth Portfolio of Planned Lighting Equipment has just been made available. It contains descriptive literature in loose-leaf form on a representative group of Guth fluorescents.

The information in this literature has been prepared with the consumer's and the lighting counselor's viewpoints in mind. The Portfolio gives complete details on the construction and performance of these lighting fixtures, so it is easy for the consumer to make a comparison and choice. It also provides helpful lighting data and reliable light-engineering factors that enable the lighting man to accurately predetermine lighting results.

Copies may be procured from the Edwin F. Guth Co., 2615 Washington Ave., St. Louis, Mo.

Fixture Makers at Show

Among the manufacturers of lighting fixtures who participated in the GE exhibit at the First Annual Store Modernization Show, at the Grand Central Palace, New York, July 7-12, were:

All-Bright Electric Products Co. Chicago, Ill., Benjamin Electric Mfg. Co. Des Plaines, Ill., Curtis Lighting, Inc. Chicago, Ill., Day-Brite Lighting, Inc. St. Louis, Mo., Eastern Fixture Co. Boston, Mass., and Electro Manufacturing Corp. Chicago, Ill.

GE Lamp Sales Manual

General Electric's booklet, "How to Shine Behind a GE Bulb Counter," is now available to dealers through distributors. Modern merchandising methods are stressed along with information on displays and basic lamp facts.

Shadow Banishing Fluorescent on Market

By new special design a fluorescent lamp has been created that banishes shadows. It is the product of Homecraft Electronic Products, 1208 South Kedzie Ave., Chicago 23, Ill. It diffuses a clear, even "daylight" into every nook and corner; in kitchen, bath, basement, halls, workshop, etc.

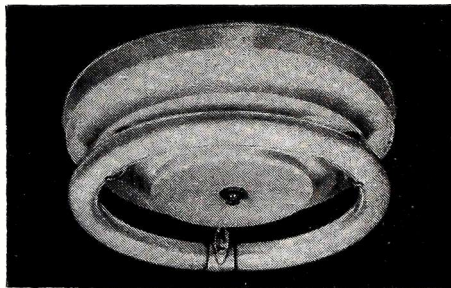

The new "Homecraft" is a fixture of beauty—heavy white enamel base, with clear Plexiglass lamp holders. The lamp is 32 watt, 12 inches diameter. Installation is easy and secure—flush to ceiling. Easy cleaning is another feature. A new spring type knockout button for pull chain or dropcord is incorporated in the unit. Listed as approved by Underwriters Laboratories.

Mitchell Desk Lamp

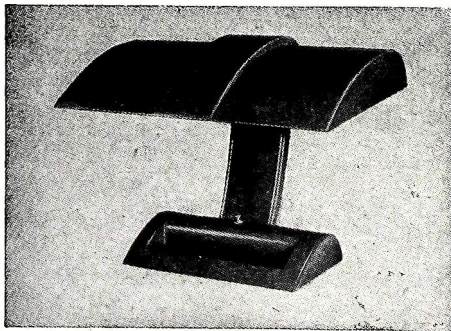

Model 731 is manufactured by the Mitchell Mfg. Co., Chicago, Ill. Maker stresses its non-glare feature.

Colorful Lamp Displays

Electric light lamps, along with the bright display pieces from the manufacturer, join to make one of the store's most colorful display combinations, and, when used in the store and show-window, they create many an on-the-spur-of-the-moment sale.

New Swivelier Units

A new line of adjustable screw-in hood-shade Lighting units has been made available by Swivelier Company, Inc., 124 East 16 St., New York. Descriptive folders showing the new products, and listing prices will be sent upon request to the firm at the before-mentioned address.

Decorative Lamp Book

Copies of a booklet, showing its complete line of desk, table and bed-lamps, including a page showing actual colors stocked, is available from Acme Fluorescent Lamp Co., 565 Fifth Ave., New York City.

How to Sell the "Specials"

Every time he sells a batch of regular lamps for illumination purposes, the clever salesman tries to interest the customer in buying one or more "specials"—an infrared or a sunlamp, for instance.

Low Fixture Prices

Through installation of modern machinery and application of efficient methods of production, fluorescent lighting units manufactured by the Westinghouse Lighting Division today are selling at from 4 to 21 percent below the prices of 1940.

A comparison of the list prices of two of the most popular products is indicative of the entire line.

	1940	1947
	Price	Price
40-watt commercial unit	\$73.30	\$56.45
40-watt industrial unit	\$24.75	\$23.75

Cash in on Interest in Modern Kitchens

Lighting is one of the most important parts of the up-to-date electric kitchen in new homes and old. The lighting merchant can secure much of this business if he is set up to make himself become known as an illumination specialist. Fixtures and lamps can be sold for home modernization projects as well as to new home builders. Radio/appliance retailers who have model kitchens set up can use these layouts to demonstrate lighting as well as to show how the various products work.

Will You Miss the Boat?

Plicote . . . the NEW liquid Finish is getting under way fast. Initial volume in '46 was heavy. '47 is snow-balling as the public reacts to the satisfaction of Plicoting.

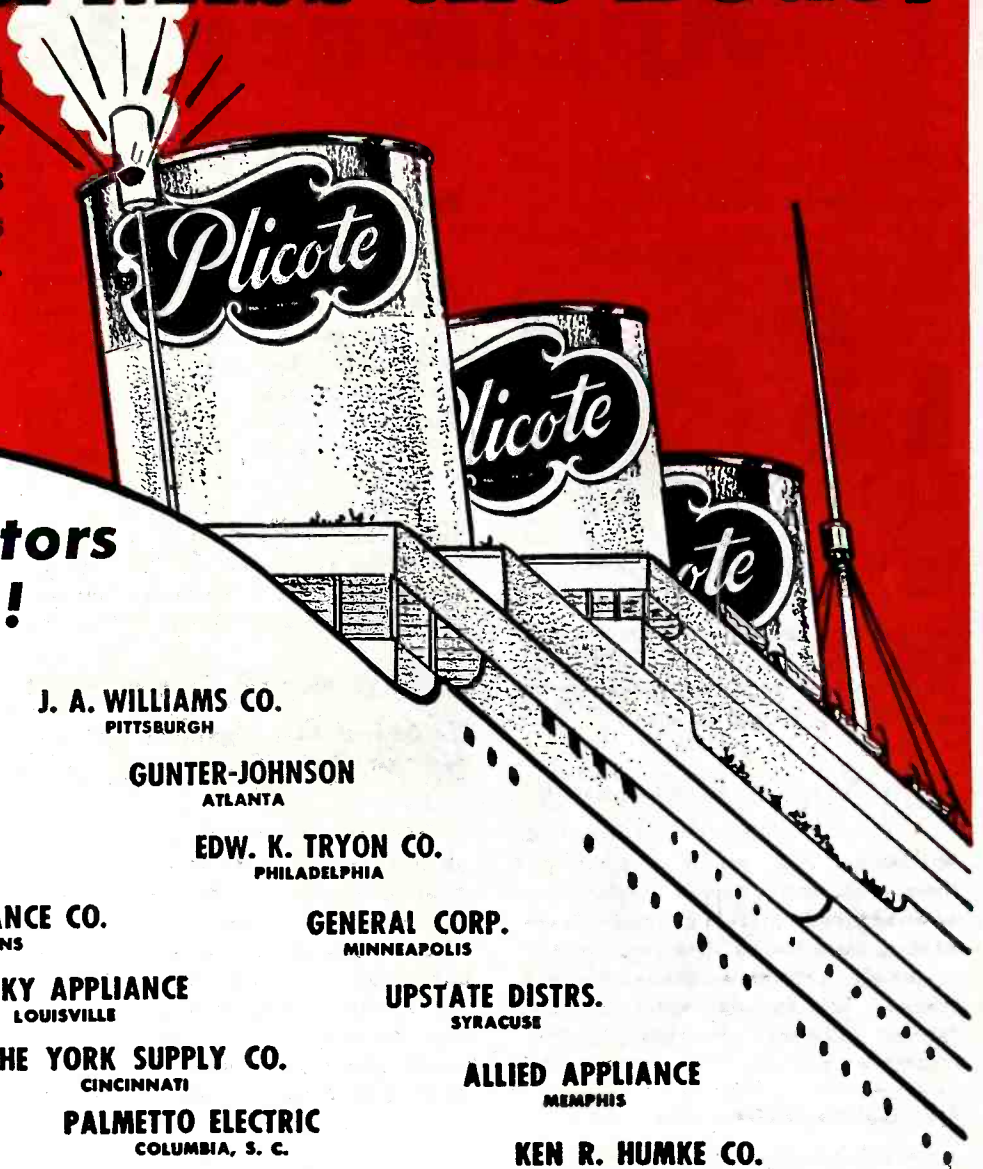

These Distributors Are On Board!

TOWNLEY METAL & HDWE. CO.
KANSAS CITY

J. A. WILLIAMS CO.
PITTSBURGH

SCHNEIDERHAHN CO.
DES MOINES

GUNTER-JOHNSON
ATLANTA

APPLIANCE DISTRs.
INDIANAPOLIS

EDW. K. TRYON CO.
PHILADELPHIA

MODERN APPLIANCE CO.
NEW ORLEANS

GENERAL CORP.
MINNEAPOLIS

KENTUCKY APPLIANCE
LOUISVILLE

UPSTATE DISTRs.
SYRACUSE

JONES & GOWING, INC.
LOS ANGELES

THE YORK SUPPLY CO.
CINCINNATI

ALLIED APPLIANCE
MEMPHIS

THE YORK SUPPLY CO.
DAYTON

PALMETTO ELECTRIC
COLUMBIA, S. C.

KEN R. HUMKE CO.
PORTLAND

BOREN BICYCLE CO.
LITTLE ROCK

BLDG. PRODUCTS SPEC.
DENVER

THOMPSON'S WHLSE. HDWE.
DALHART, TEXAS

PUGET SUPPLY CO.
SEATTLE

ELECTRIC CONTR'S.
BIRMINGHAM

WATKINS-COTTRELL CO.
RICHMOND

DALLAS PLICOTE
DALLAS

GEO. C. WETHERBEE & CO.
DETROIT

STRAUS FRANK
SAN ANTONIO



58 Million Readers

PLICOTE-48 New Colors

The cream of the buying public is being reached through powerful sales messages in Better Homes and Gardens, Ladies' Home Journal, American Home, Woman's Home Companion and McCall's.

\$1.95
QUART
RETAIL

Distributors Investigate

PLICOTE Inc., General Sales Office, 664 N. Michigan Ave., Chicago

Appliance Service

New Arvin Tester

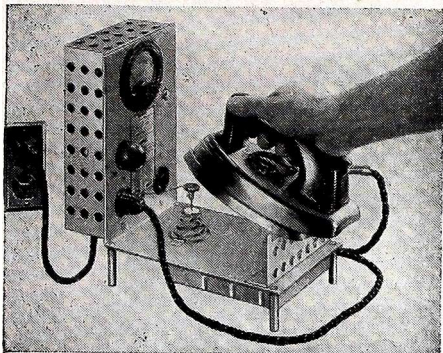

Test instrument provides an instant check for grounds or shorts, accurate measurement of heat development at various settings of automatic electric irons, and makes possible accurate adjustments of temperature control. Made by Noblitt-Sparks Industries, Inc., Columbus, Indiana.

Keep Service Data Handy

A file of appliance service manuals will save the repairer time and money. Manuals can be kept in manila folders in a steel cabinet drawer. Most dealers file the information under the appliances themselves, for instance, placing various data under "irons, toasters, refrigerators, etc."

Cleaning Sun-Kraft Tube

In cleaning the Sun-Kraft quartz tube, use alcohol or cotton. Hot water and soap may be used if precaution is taken to rinse thoroughly; otherwise the exterior of the tube will fog. It is not necessary to remove the tube in order to clean it. It is important to keep the quartz tubes clean because ultraviolet rays will not pass through a soiled tube.

Installing Door Chimes

The best location for a door chime is generally in or near the front entrance hall. In homes having no separate entrance hall, the chime may be installed on the wall near the front door. To give the best appearance, it is most important that the chime be mounted at the proper height on the wall. A height of about 6 to 7 feet above the floor is recommended for most installations. The foregoing tips come from The Rittenhouse Co., chime manufacturers, Honeoye Falls, N. Y.

Sell the Complete Job

In estimating a repair job on an appliance for a customer it is always safer and better to include *all necessary* new parts in addition to the repair itself. In other words, if a toaster is brought in for element replacement, and the service cord and plug are in poor condition, include new ones in the total figure. This eliminates the possibility of a misunderstanding with the customer. Complete overhauls and repairs cost the customer a little more but are always more satisfactory in the long run.

Lubrication System of Norge Rollator

An oil reservoir is provided in the bottom of the Rollator housing. Attached to the lower end of the eccentric shaft and immersed in the oil, is an oil impeller.

The rotation of the oil impeller discharges oil upwards through an oil discharge tube into the refrigerant discharge chamber. Oil passages lead from this chamber back to the shaft and other moving parts.

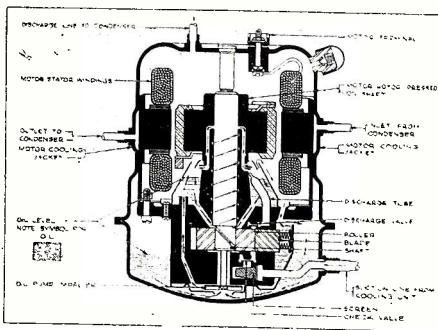

Oil circulation in sealed-in Rollator.

The oil is also carried up the shaft through oil grooves in the bearing plate. As the oil leaves the oil grooves, it tends to raise the eccentric shaft slightly upward, allowing it to ride in a floating position on a cushion of oil.

The spill-over back to the discharge chamber contains a rotating oil slinger which aids in the distribution of the oil and liberation of the refrigerant. Excess oil returns to the reservoir at bottom of housing.

Universal Tank Cleaner

The mechanism for the "Tattle-Tale" warning light on the model E65 Universal Clean-Air tank vacuum cleaner is located on the underside of the cleaner. The light is so adjusted that it will go on when a 12 ounce weight is placed on the plate located in the cylinder underneath the dust bag. It may be regulated by adjusting the set screw in the mechanism.

Protecting Repaired Items

Most dealers believe it is good practice to wrap up all repaired small appliances which are awaiting delivery or pick-up by the customer. Such procedure eliminates the necessity for re-cleaning and re-polishing.

Appliance Service And Business Tips

A good way to build up appliance service volume is to send out a return postal card mailing to a selected list of customers. On the return side, list a number of appliances leaving a place for a check-mark opposite each product. Request the customer to check appliances needing repair, and advise that servicer will call for the items promptly following receipt of the card by the dealer.

* * *

Neat show window signs calling attention to the fact that the dealer services a variety of large and small home appliances brings business. Some merchants have been successful in listing a number of specific items the firm repairs.

* * *

During slow periods it is good business to have the repairers work on reconditioning traded-in appliances, putting them in shape for resale. In many localities there is a steady demand for large and small used appliances.

* * *

Every servicer should carry an outlet testing device of some sort when out on calls. This may be a simple pig-tail socket and lamp. With a tester, the mechanic can tell in a jiffy whether the trouble is in the customer's appliance or in the outlet.

Simplify your BOOKKEEPING Job



REGISTER every transaction by hand . . .

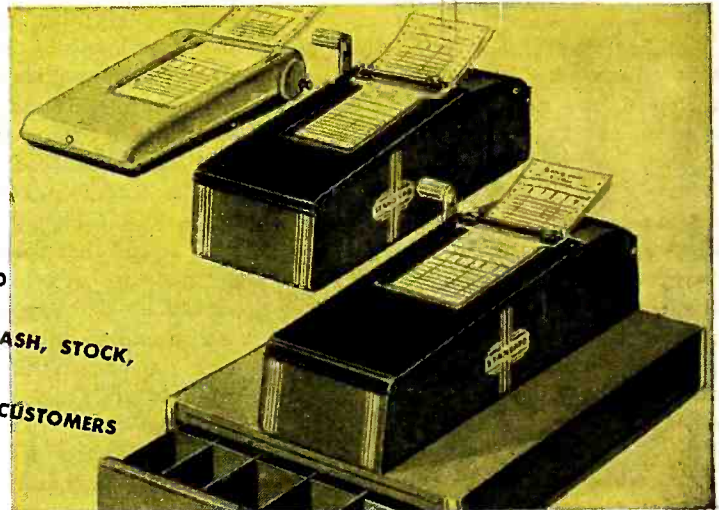
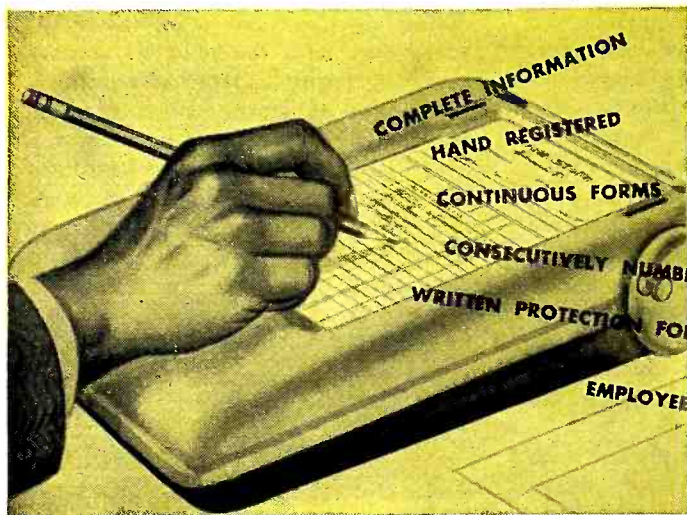

the modern STANDARD REGISTER way!

DISCOVER how much easier, *faster*, you can make the records you need—with the Standard Form-Flow Register. Learn how it simplifies bookkeeping, tax and financial reports. See how it checks carelessness, misunderstandings, dishonesty . . . protects your cash, merchandise, *people* involved in every transaction. And see how it helps give you the fast, accurate picture of inventory you need, today. Mail the coupon, *now*, learn *all* the ways a Standard Register can help you operate more profitably.

FREE! WRITE FOR FOLDER which tells how Standard Form-Flow Registers and pre-tested Standard Register systems can give you more complete records with less writing, less work—in your particular business.

THE STANDARD REGISTER COMPANY
 Manufacturers of Registers and Forms
 for ALL Business and Industry
 DAYTON 1, OHIO

Appliance Dealers

GET THESE SPECIAL BENEFITS

- All records clear, legible at one writing.
- Copies for customer, office, delivery and locked-in audit records.
- Foolproof check against lost records.
- Fixed responsibility, including delivery receipt.
- No confusion on terms of sale, payment or delivery instructions.
- Complete legal contract and copies with one customer signature.

THE STANDARD REGISTER COMPANY

Dept. 1308, Dayton 1, Ohio

Please send me Free Standard Register Business Digest which tells me how I can write better records in my business...easier...simpler...faster!

NAME

COMPANY

STREET

CITY.....ZONE....STATE.....

Pacific Coast: Sunset McKee-Standard Register Sales Co., Oakland 6, Calif. Canada: R. L. Crain, Ltd., Ottawa. Great Britain: W. H. Smith & Son, Ltd., London

Named by Westinghouse



J. H. Stickle is the new manager of advertising and sales promotion for the home radio division of Westinghouse Electric Corp.

One Sale Brings More

(Continued from page 69)

Because customers who like to show others the things they have purchased, are not always moved to do so in the hopes of gaining some material reward, does not mean that a gift or a commission check won't be most acceptable to them. In this instance, the dealer should make certain that he fulfills all his stipulated obligations to the customer—promptly and willingly.

Even the purchaser who is well off financially will appreciate some material recognition by the dealer to whom the house has been opened.

While such gatherings should be informal, they should not be conducted on a hit-and-miss basis. There must be orderly procedure, and there must be expert demonstration if desired results are to be obtained.

Real Demonstrations

In the electric kitchen, actual cooking may be done, and "refreshments" may be served to the guests. The demonstrator must know every piece of equipment so thoroughly that operation of the appliances seems easy—not difficult or complicated.

Laundry equipment should be used to wash "actual" clothes—not props. Here, the demonstrator must know several things. He must know how to operate all of the controls; must know how to wash clothes, and, if an ironing machine is involved, must know how to iron more or less complicated pieces of clothing.

Prior to staging the in-home demonstration, the merchant should be furnished a list of the guests the owner is to invite. At the meeting, these guests should be introduced

to the dealer or his salespeople. The owner should choose the visitors.

Dealers who have successfully used this plan do not believe that sales pressure should be brought to bear on those attending, but rather that they be invited to the store, and, if they do not come in, they should be followed by letter, telephone or personal call.

Handling Appliances

(Continued from page 76)

Buyers are much more fussy about this than they used to be. Chipped surfaces and sloppy delivery methods are apt to become reasons for major complaints. This is just another aspect of the buyer's market in which the customer is always right. Also, in the case of a new home, where the entire house is a matter of pride for the new housewife, she wants everything to be perfect and any small injury to her new merchandise is considerably magnified.

It has been found that the new and streamlined hand-truck equipment will often replace more expensive "lifting" equipment of the more permanent and costly type. Retailers have found that they can save money by making a selection among the portable all-purpose units rather than installing expensive apparatus as a permanent fixture which often requires architectural changes in the building.

Once the dealer is equipped with the right hand conveyors and accessories, it is important that the entire staff of the store be aware of their many uses and conveniences. Display men, repair men, office help, salesmen—all of them should know how the new units operate and what they will do. They will all find uses for the equipment that will save

Steam Iron "Salesman"



An attention-catching display, incorporating the Monitor all-metal ironing board, shows off the Monitor steam iron and is now offered to retailers by Monitor Equipment Corp., Riverdale, New York 63, N. Y. At the right of the colorful display is a pocket for descriptive leaflets.

Bendix Appliance Official

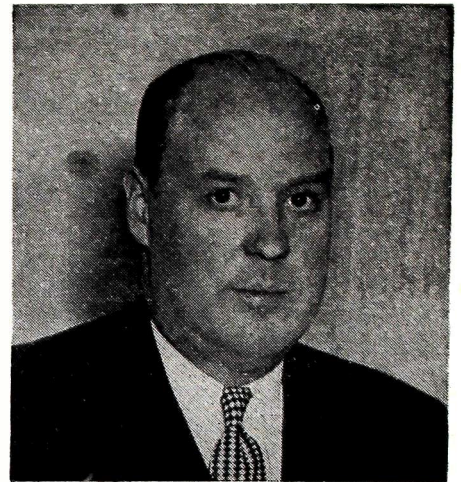

Stewart Roberts has been appointed director of advertising and sales promotion for Bendix Home Appliances, Inc.

them a surprising amount of time and trouble.

In this period when radio men begin to trot out all the merchandising devices they can think of, there may be a tendency to emphasize the "front" factors of the business, such as store design, display, promotion and advertising. But the best idea is not to neglect the "behind the scenes" elements of merchandising. And certainly one of these elements is the smooth and efficient handling of the products being sold.

Know Where You Stand

(Continued from page 39)

anxious to earn \$15.00 uniforms, went out and sold light bulbs house-to-house, and received commission on sales they made. On all calls made, these boys mentioned Dacy Electric Company, and this, Mr. Dacy feels, will bring many future repeat sales.

At a recent Farm and Home Show in Woodstock, Dacy had two large booths, showed numerous appliances and got many prospects, as well as making many sales. More than 7,000 people visited this show in three days.

Mr. Dacy sees an excellent future in the appliance business for quality merchandise. He believes that there are many more customers that can be secured by outside selling and sales promotion. Now is the time, he declares, to use good salesmanship to get the extra sales.

Brands sold in this store include such names as Kelvinator, General Electric, Bendix, Thor, Duchess, Sparton, Stromberg-Carlson, Zenith, Conlon, Apex, Premier, Duo-Therm, Timken, Sunbeam, Electromaster, etc.

FEATURE
THE

Gibson

Double Feature

FOR FASTER, EASIER SALES!

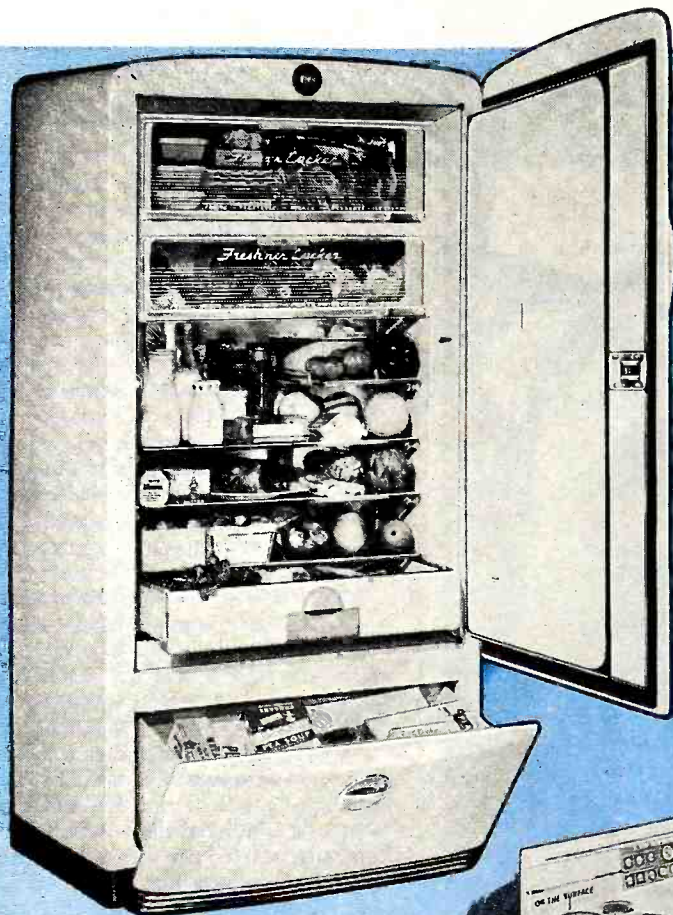

FIRST FEATURE FREEZ'R LOCKER

A Gibson first that strikes the fancy of your prospective customer . . . the lady of the house. Unobstructed, wall-to-wall freezing space for scientific preservation of frozen foods. Family favorites are always "in season" with the original Gibson Freez'r Locker.

SECOND FEATURE FRESH'NER LOCKER

Salads, fruits and vegetables retain their moist freshness when stored in the Gibson Fresh'ner Locker. A roomy, moist-chilled storage compartment designed to keep fresh foods at the peak of taste perfection . . . designed to simplify your sales job.

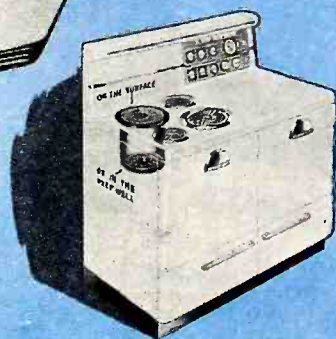

GIBSON KOOKALL AUTOMATIC ELECTRIC RANGE

Replete with features that make cooking easier. Ups-A-Daisy, for example . . . the Gibson innovation that provides four surface units or three surface units plus deepwell Kookall. Two ovens . . . one banquet size. Concealed oven vent to prevent wall stains.



GIBSON HOME FREEZER

Upright construction for downright profitable sales. Eliminates fumbling for food packages. Broad, generous-sized shelves protected by clear-glass doors to enable the user to quickly identify each package. Freezes and preserves great quantities of meat, fish, fowl for months at sub-zero temperatures.

GIBSON REFRIGERATOR COMPANY

GREENVILLE, MICHIGAN

Copyright 1947, Gibson Refrigerator Co.

*Announcing a distinctive
new toaster by Proctor!*

The only toaster that measures actual bread temperature for delicious toast!

WOMEN chose this design — preferred its light, graceful lines, its rich dignity. In every one of our "design polls," throughout the country this was the winner. Beneath this smart exterior is a toasting mechanism of remarkable accuracy. Toast color is controlled by an exclusive method, the Proctor "Color Guard."

It toasts like a charm because it measures actual toast temperature to automatically allow more time for moist bread... less time for dry. Produces delicious toast, popped up silently when browned to your personal taste. Many other features... sliding crumb tray, permanent crumb tray, permanently-attached cord, long-lived dependable control. But above all, the "Color Guard" thermostat — and genuine distinction.

See it now, during its premier showing at your dealer's. It's new... it's exclusive... it's Proctor!



The New
1948

PROCTOR

Automatic
Pop-up
Toaster!

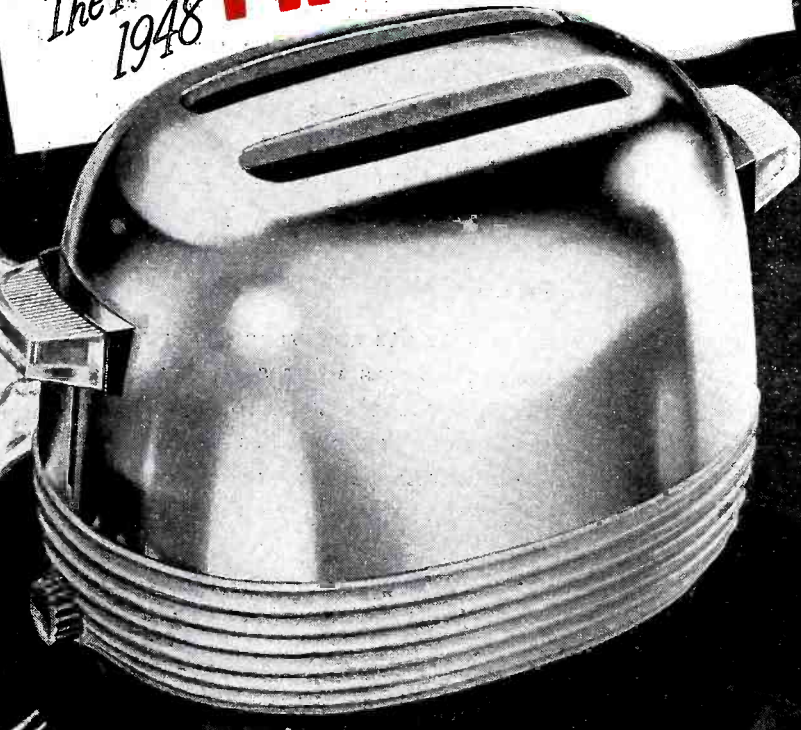

A MILLION ADS A DAY TO CREATE DEMAND!
Full Pages, Full Color Ads... will appear in *Ladies' Home Journal*, *McCall's*, *Good Housekeeping*, *American Home*, *Better Homes & Gardens*, *True Story*... an unprecedented campaign for 3 solid months.

Ask your distributor for details about a big simultaneous tie-in announcement activity beginning with—
A. MAGNIFICENT FULL-COLOR, DOUBLE-PAGE, SPREAD IN THE OCTOBER 4th ISSUE OF THE SATURDAY EVENING POST.

PROCTOR ELECTRIC COMPANY, PHILADELPHIA 40, PENNSYLVANIA

Field Service Rep



Robert W. Rivett has been named factory field service representative for Gibson Refrigerator Co., Greenville, Mich.

Westinghouse Adjusts Refrigerator Prices

Westinghouse Electric appliance division, Mansfield, Ohio, has issued a 3.75% average price rise on its line of refrigerators now in production. The change is based on projected production for the balance of the year and went into effect June 30th.

"This minimum increase is in line with the company policy of doing everything possible to hold price increases to a minimum," according to G. H. Meilinger, manager, household refrigerator department. He said that the small increase was made possible by improved manufacturing techniques and in spite of greatly increased labor and material costs.

Model B-7 was changed from \$224.95 to \$229.95; MF-7 from \$289.95 to \$299.95; and D-9 from 274.95 to \$299.95.

Pacific Rep Available

Word from Western Electronic Enterprises, 3348 W. Compton Blvd., Gardena, Calif., is that the firm "is looking for at least two additional lines to handle." The company, started early this year, provides sales and engineering representation on the Pacific Coast for eastern manufacturers, calling on "electronic jobbers, electronic manufacturers and the aircraft industry." The firm is headed by Alfred W. Harris.

Altec Lansing Executive

Harold Wengler is the new manager of advertising and publicity for Altec Lansing Corp., 250 W. 57th St., New York 19, N. Y. He has rejoined the firm in that capacity; he had been the first advertising manager for Altec at the time of its inception in 1937.

Crosley Market Analyst

The appointment of Thomas Penfield as market analyst of the Crosley Division, Avco Mfg. Corp., has been announced by S. D. Mahan, director of sales and advertising.

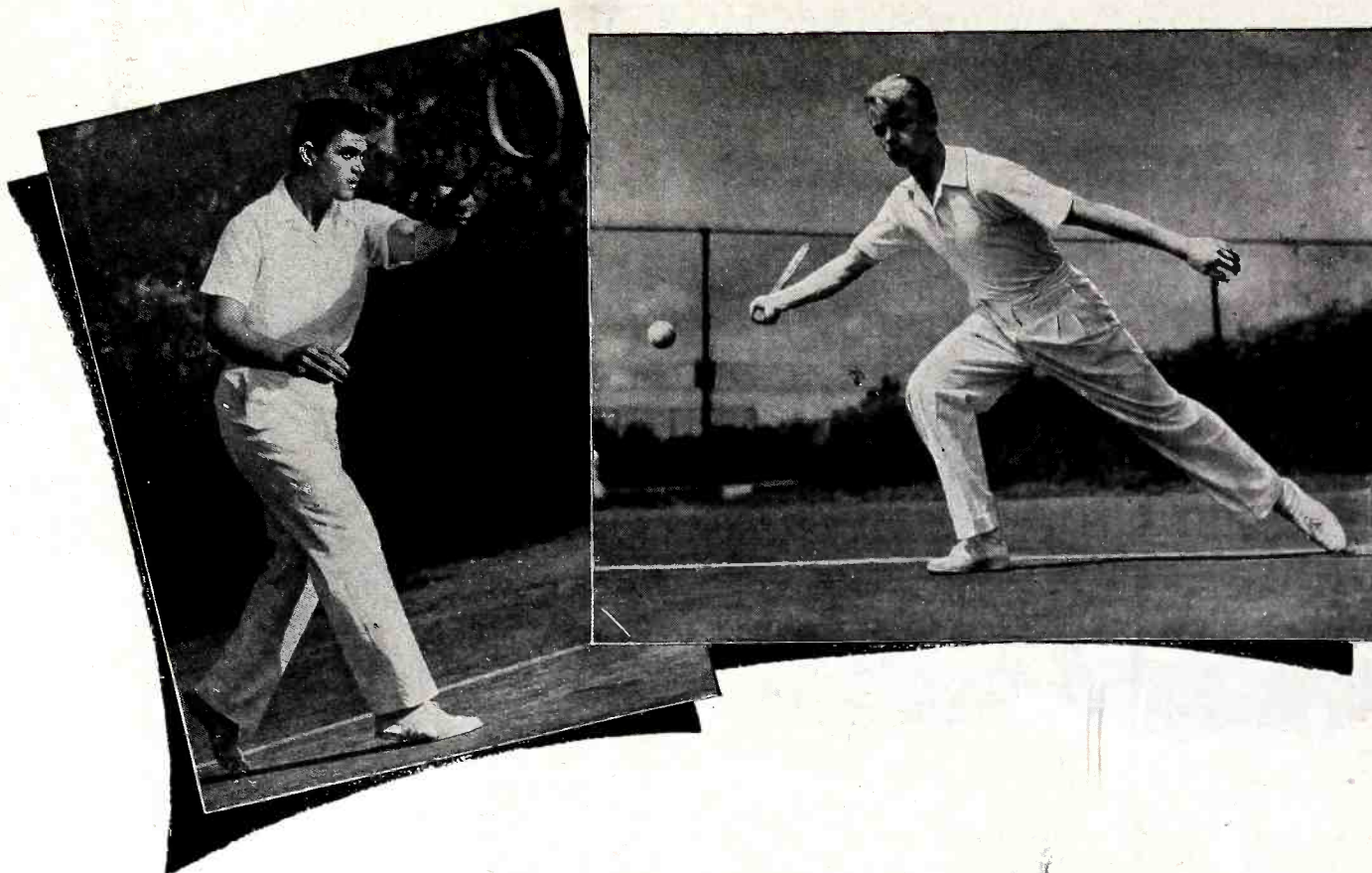

Which one will be **TOMORROW'S CHAMP?**

Bet you'll agree it's easier to predict a tennis trophy winner than it is to predict the No. 1 sales winner in tomorrow's merchandise competition!

In comparing radios or refrigerators . . . washers or waffle irons . . . you've got to consider performance, manufacturer's reputation, price, special features, advertising effectiveness, market conditions. It takes broad experience — close familiarity with many lines under all conditions — to pick those that will sell best . . . be most profitable . . . year in, year out.

As a solidly established, national distributor of leading appliances and home radios, Graybar has

had the opportunity to acquire this experience. Moreover, Graybar is *free* to select lines on the basis of saleability. Graybar has the confidence of top-flight manufacturers — yet has remained an independent, self-directing organization.

That's why Graybar dealers can have faith in the recommendations of our Merchandising Specialists. The best proof that these recommendations pay in practice is the success of Graybar dealers throughout the nation. *Merchandising Department, Graybar Electric Company . . . offices and warehouses in over 90 principal cities.*

4781

When a product is recommended by Graybar, you can be sure it is (1) easy to sell, (2) honestly advertised, (3) backed by a warranty which protects both dealer and consumer.

recommended by
Graybar

RADIOS, COMBINATIONS • MAJOR APPLIANCES • TRAFFIC APPLIANCES

Why Mallory-Made Vibrators make the Best Replacements:



MORE MALLORY-MADE VIBRATORS ARE IN USE TODAY THAN ALL OTHER MAKES COMBINED

There are excellent mechanical and engineering reasons why more Mallory-made vibrators are used in original equipment than all other makes combined.



TWELVE MALLORY VIBRATORS ANSWER 90% OF YOUR REPLACEMENT NEEDS

Make replacements easily and quickly. Thanks to the Mallory program of standardization, the number of vibrators you need to meet most of your requirements is materially reduced—only twelve in all.



MALLORY HAS A COMPLETE VIBRATOR LINE

In addition to the 12 basic units, Mallory also makes 39 other replacement vibrators so that even when you meet a rare or unusual service problem, your Mallory distributor can supply the answer. The Mallory line leaves *nothing out*—it's a complete line that rounds out your business.

See Your Mallory Distributor for a free copy of the 1947 Replacement Vibrator Guide.

P. R. MALLORY & CO. Inc.

MALLORY

VIBRATORS . . . VIBRAPACKS* . . . CAPACITORS . . . VOLUME CONTROLS . . . SWITCHES . . . RESISTORS . . . FILTERS . . . RECTIFIERS . . . POWER SUPPLIES.

*Reg. U. S. Pat. Off.

APPROVED PRECISION PRODUCTS

P. R. MALLORY & CO., Inc., INDIANAPOLIS 6, INDIANA

SERVICE & SOUND

Section of **RADIO & Television RETAILING**

Save Time on New Set Troubles

Tips from Factory Service Managers Clear Benches for Fresh Business

• The progressive radio servicer today must remain alert to all opportunities to expand his work into fields other than home-style AM. Television, FM, auto-radio, PA, record changers, and a host of smaller sections of the electronics industry are blossoming like the trees in Spring.

Since every man's time is limited, one of the urgent needs of the serv-

versing the power cord plug at the a-c electric outlet, or placing the

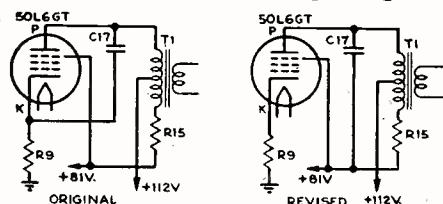

Fig. 2. RCA "before and after" diagrams.

radio in another location. If, even with the plug reversed, a rough modulation hum is produced when the user's hand is brought near to or touches the cabinet, proceed as follows, referring to Fig. 1.

Curing Modulation Hum

First, the low ends of the loop aerial and variable capacitor are disconnected from the AVC circuit and connected to the chassis. Next, a .00025 mf mica capacitor is connected in series with the grid of the 1N5GT r-f tube. Finally, a new d-c grid return is made by connecting the grid through a 1 megohm resistor to the AVC circuit.

To do this whole job in a matter of a very few minutes, without removing the chassis, install a 3-terminal mounting strip under the head of the left-hand screw holding the small mounting plate which is found on the gang condenser. Mount the condenser and resistor in series on this strip, and switch the 1N5GT green grid lead from the trimmer to the middle strip terminal.

Now run a lead from the other end of the .00025 mf to the trimmer, disconnect the orange wire that now goes to the lug on the tuning con-

denser, and connect it to the open end of the 1 meg. resistor. To finish it off, connect a short wire from the tuning condenser stator to the chassis.

A simple change which results in improved tone quality due to increased high frequency response in RCA 65X1 and 65X2 (RC-1034) radios, is suggested by their service department. As shown in Fig. 2, ca-

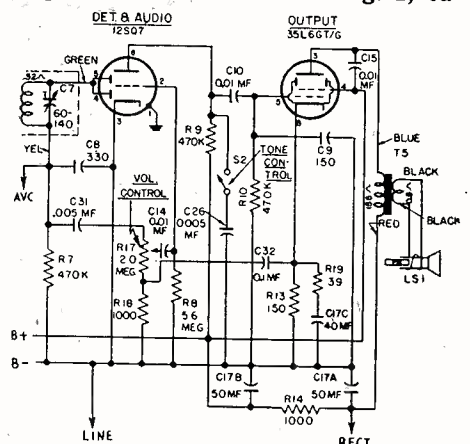

Fig. 3. General Electric avc-audio circuit.

capacitor C17, which is originally connected between the plate and cathode of the 50L6GT output tube, is now connected between the plate and screen grid.

In the RCA 66X series (RC-1038, RC-1038A), a similar capacitor C16, originally placed between the plate and cathode of the 35L6GT output tube is now connected between the plate of the 35L6GT and the red lead of the output transformer.

According to W. L. Parkinson, technical service supervisor for General Electric, hum in the Model 321,

(Continued on page 104)

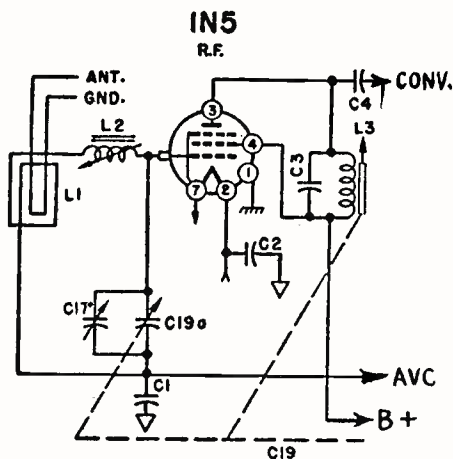

Fig. 1. Admiral circuit before making changes.

icer who has his ear to the ground, is to find ways of saving time in his main preoccupation—AM servicing. To help him do this, RADIO & Television RETAILING continues to publish advice from the factory service managers.

M. J. Schinke, service manager of Admiral Corporation, suggests the following change to eliminate hum in the portable 6E1 chassis. This change should be made only after checking to see whether the hum can be sufficiently eliminated by re-



**A
POWERFUL
SELLER!**

6 reasons why you're in the lead with RCA RADIO BATTERIES

1. They're especially designed for radio—RCA Batteries are *performance-matched* for extra listening hours.
2. They're sold primarily through radio outlets—this means concentrated volume, and more people coming to you for RCA Radio Batteries.
3. They're fresh—8 warehouses are handily located to serve you quickly.
4. They're a comprehensive line—they cover the replacement needs of almost every battery-operated receiver.

5. They're distinctive—the eye-catching red-white-and-black package and the RCA emblem have ready-made customer acceptance.

6. They're backed by the greatest name in radio—RCA.

JUST OFF THE PRESS . . .

One of the most comprehensive battery catalogs ever published. Also includes terminal connections and specifications of all types of RCA Radio Batteries. Get yours now—from your RCA Tube Distributor.

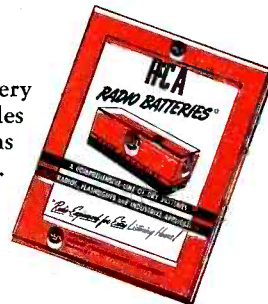

Flashlight

Portable A's

Portable B's

Portable AB's

Farm A's

Farm B's

Farm AB's

Industrial



TUBE DEPARTMENT

RADIO CORPORATION of AMERICA

HARRISON, N. J.

Open-Air Concerts Need PA

Are You Competing for the Big-Fee Rentals of Sound Equipment in Outdoor Music?

• Installations of sound equipment for the reinforcement of outdoor symphonic concerts are among the most difficult ever encountered by the sound dealer. To do an indoor concert job which will satisfy the well-tempered ear of the concert management is difficult enough. Upon moving high fidelity outdoors, however, a successful installation can be made only by the highest type of technician.

The yearly festivals of the Essex County Symphony Society at the Newark, N. J., City Schools Stadium provide an excellent illustration of the correct method of handling this problem. Here, under the guidance of field engineers from the Langevin Company, a three-channel stereophonic system is set up each year.

The stadium, used principally for athletic events, is by no means ideal for musical affairs. Its long, oval construction poses the necessity of projecting sound for a good deal more than 100 yards, while the high-tiered stone bleachers and back wall could easily create strong reverberations or echoes. Furthermore, in the interests of realism, it was desirable

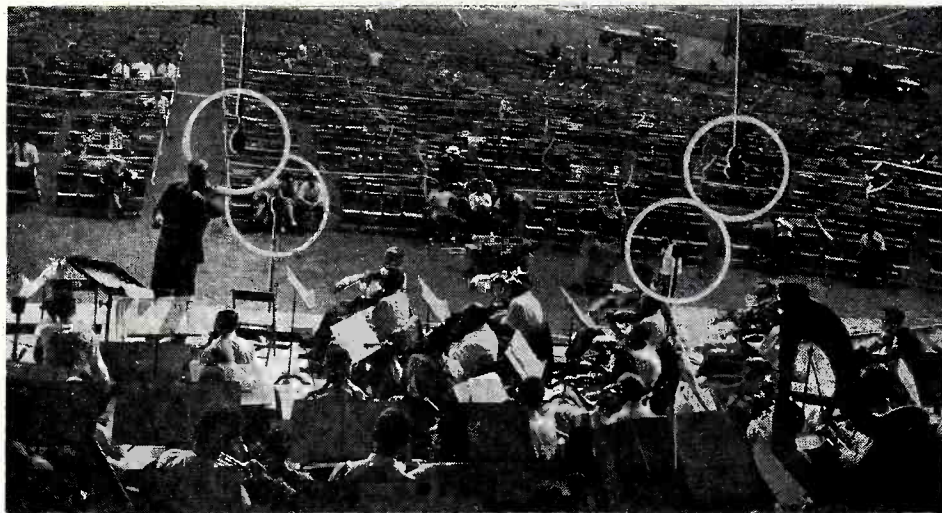

Setting up the field and sound system during rehearsal time. View looking through center window of stage's inside rear wall shows center and right-side hanging and floor mikes.

to have the reinforced sounds appear to originate from their natural locations.

The use of Langevin's stereophonic system dates back to 1936, where it was first employed at the Texas Centennial Exposition, in Dallas. It has also been heard at the Pacific International Exposition, San Diego, Cal., the railroad show in New York's World Fair and the Cavalcade of the

Golden West at San Francisco.

As shown in the layout sketch of the stadium, three pairs of two speakers each are used, with one speaker from each pair facing to the left-side seating sections, and the other three facing the right-side seating sections.

Sound for each speaker pair, whether at left, right or center of the overhanging proscenium, is picked

(Continued on page 104)

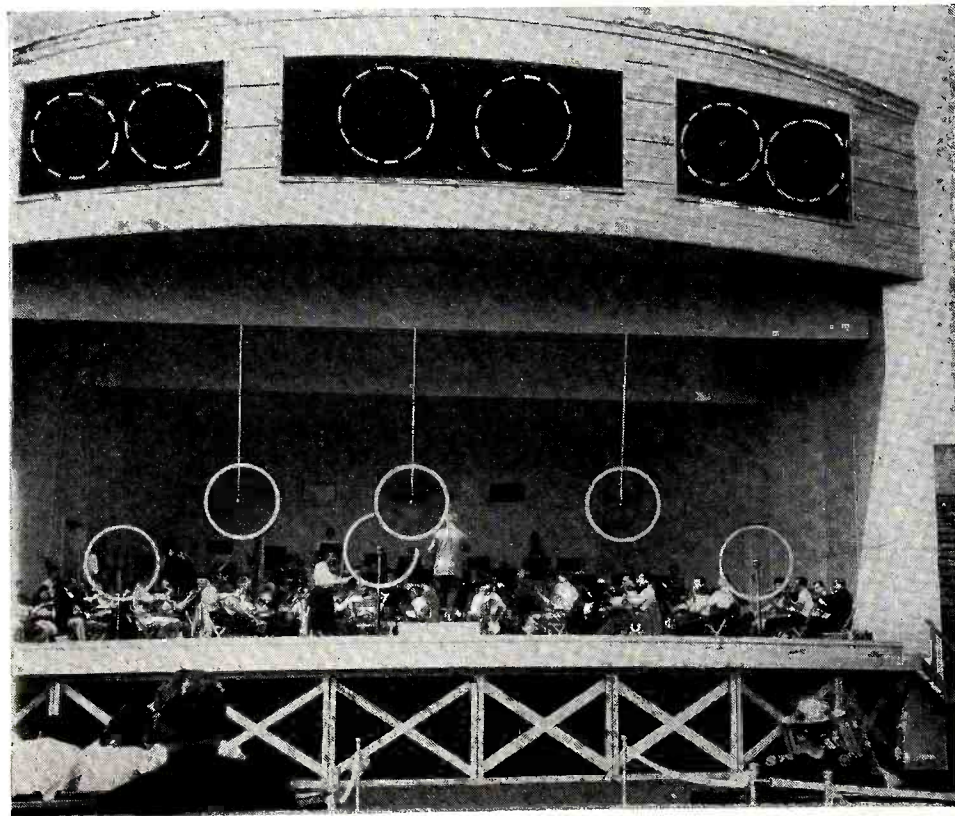

◀ Six Langevin loudspeakers are housed behind three screened panels on upper proscenium arch. Three hanging microphones and three floor-stand microphones are grouped in pairs; all are Western Electric 639B.

▼ Overhead and side views of stadium, showing main seating sections. Tiered seats cut off reflections from back wall B, which otherwise would interfere with listeners in field seats. Topmost row was not entirely free from this trouble. Reflections from sides, A, are broken up by angled surfaces and seats.

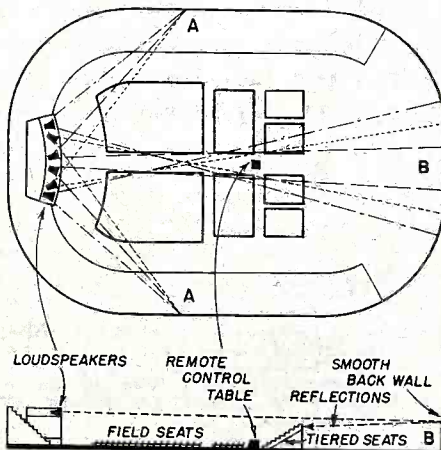

Aligning Permeability

First Article of Series Explains How to Track Increasingly Popular Inductive Devices. Makes and Models Named

● Variable ganged inductances, performing a function similar to that of variable ganged capacitors, have been familiar in certain types of radios for more than just the last year or so. Permeability tuning units, for example, were used in the prewar auto radio receivers.

During 1946 and 1947, however,

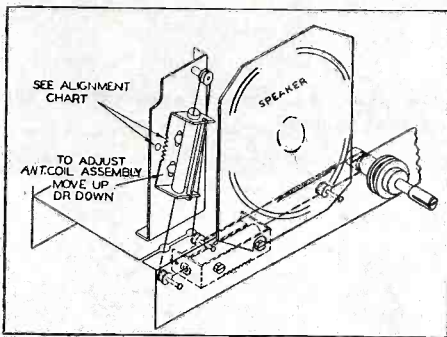

Fig. 1. Grantline models 500 & 501, Series A.

aside from being used in the majority of auto radio, variable inductance tuning has been incorporated into great numbers of broadcast, short-wave, FM and television receivers.

Unlike the highly standardized ganged capacitors, these new units are being used in a large variety of basically different styles. Not only are the mechanical structures unlike, but the principles which are used to secure a varying inductance, as well as the methods of tracking the oscillator are widely diversified.

The most immediate conclusion

that every practical radio servicer must draw from all this, is that his entire background of knowledge and procedure in superheterodyne alignments and tracking will have to be re-examined and brought up to date. More explicitly, the performance of the radio utilizing an inductive-tuning system will be completely

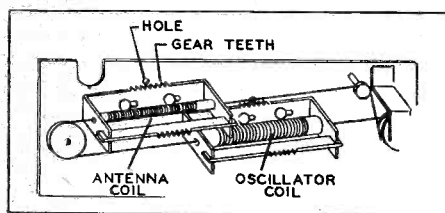

Fig. 2. Truetone model D2665, typical of many.

mishandled if the usual alignment procedure, which is ordinarily practiced upon capacitively-tuned receivers, is applied.

In view of the great number of circuit types in the sets now on the market, this short series of articles will, in a practical manner, explain the essential theory, illustrating the various types of broadcast band circuits as actually used in current radio production, give approximate and in some cases exact alignment instructions, and proceed to short-wave, FM and television counterparts. Auto-radio units, already discussed in our Feb., 1947, issue, will be treated in detail in a later article.

At this writing three main methods

of varying the inductance of an r-f tuner are being used: 1.—Changing permeability by moving the core in relation to a coil or a transmission line; 2.—Changing the number of turns in the portion of the coil being used, by rotating the coil in contact with a moving nib acting like a trolley on one of the turns; 3.—Changing the inductance of each turn and also the mutual inductance between them by inserting a silver-plated brass blade between the turns.

While the latter two methods have seen application in present-day production only in short-wave bands, FM and television, the first one is already widely employed for broadcast as well as short-wave bands, and will therefore be discussed first.

Two basic mechanical means of changing the coil's core permeabil-

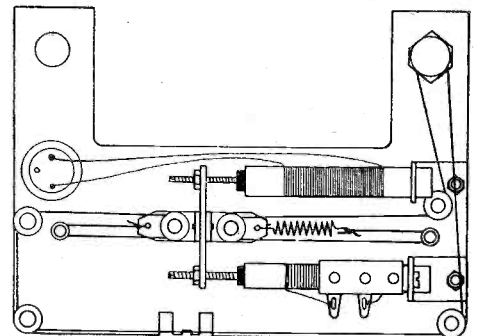

Fig. 3. Aermotive 5" slide-rule dial tuner.

ity are illustrated in Figures 1, 2 & 3. The type using a pulley and cord

CHART A—Alignment of Padded Inductive Tuners

Step	Sig Gen Setting	Receiver Dial Setting	Adjustment	Examples
1	1600 kc, mod.	1600 kc calibr.	Osc. trimmer Ct	Aviolo model 509 (Note 1) Clearsonic 5C66
2	1400 kc, mod.	Tune to 1400 kc generator signal	R-F trimmer Ct	Coronet model C-2 Dalbar Barcombo, Jr. & Sr., Series 100-1000 (Note 2)
3	600 kc, mod.	Rock dial around 600 kc	Osc. coil Lv	Electro B-20 General Electric 303 (Note 3) Learadio 565, 565BL, 566, 567, 568, 6617 PC
4		Repeat all steps until changes are slight.		Majestic 7C432, 7C447 (Note 4) Ray Energy AD4 Renard L-1A, PT-1A, 1B5T-1 Temple G-515 Watterson 4582

Exact alignment frequencies and dial pointer settings must be secured from service manuals or folders. In some sets, step 4 calls for the repetition only of steps 1 & 2. steps 1 & 2 are repeated.

NOTE 2—Steps 1 & 2 are performed together at 1620 kc; then in an added step tune the radio to the 1400 kc signal generator and adjust the antenna coil core; then continue with step 3 and repeat steps 1 & 2.

NOTE 3—Steps 1 & 2 performed together at 1620 kc. Step 3 performed at 1500 kc, without rocking; then tune to 1000 kc signal from generator and vary antenna coil adjustment. Repeat all steps.

NOTE 4—Perform steps 1 & 2 together at 1500 kc. Rock tuner at 600 kc while varying antenna coil; then reset oscillator trimmer at 1500, without touching antenna trimmer.

Tuners in New Radios

CHART B—Alignment of Non-Padded Inductive Tuners

Step	Sig Gen Setting	Receiver Dial Setting	Adjustment	Examples
1	1600 kc, mod.	1600 kc calibr.	Osc trimmer Ct	Airline 64BR-1205A, 64BR-1206A, 64BR-1808A, 64BR-2701A, 64WG-2009A, 64WG-2009B
2	1600 kc, mod.	Tune to 1600 kc generator signal	R-F and ant trimmers (Ct)	Audar model PR-6
3	1400 kc, mod.	Set pointer to 1400 kc mark on dial scale. DO NOT tune to generator signal	Osc, r-f and ant coils or core slug positions (Lv)	Automatic model 620 Belmont 4B112, 4B113, 5D110(A), 8A510(A) Coronado 43-7651, 43-8160, 43-8312A, 43-8471 Grantline 500, 501(A), 502, 503(A) Hoffman A202, A309
4	1600 kc, mod.	Same as step 3, at 1600 kc	Osc trimmer Ct	Meck (Plymouth) PM-5C5, PW-10
5	1600 kc, mod.	Tune to 1600 kc generator signal	R-F and ant trimmers (Ct)	Silverstone 6200A, 6220, 6220A
6	1400 kc, mod.	Tune to 1400 kc generator signal	R-F and ant coils or core slug positions (Lv)	Skyrover N5-R-D-250, N5-R-D-251 Stewart Warner 61T16, 61T26, 62T16, 62TC16, 62TC26, 62TC36, 51T46, 51T56 Truetone models D1747, D1748 Woolaroc models 3-1A, 3-2A

NOTE: This chart is taken from Stewart Warner's revised alignment instructions. It represents, however, the general case of the non-padded tuner. For sets not using a tuned antenna or r-f stage, delete the corresponding procedures. If much resetting is needed in step 4 or 5, repeat steps 1 to 5 one or more times. Finish off with step 6. Types of core adjustments vary. They often consist of rotating the cores which are threaded into the mounting bar, or moving the coil in slotted mounting holes. Be sure to re-cement core adjusting screws.

drive lends itself especially well to employment in very compact receivers and is sometimes seen tucked away into rather unusual corners as in the Grantline models 500 and 501, Series A (Figure 1).

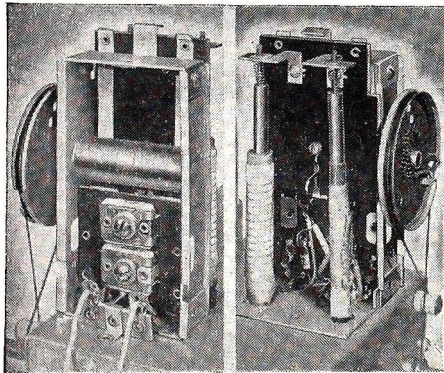

Fig. 4. Electronic Laboratories Vario-Tuner.

A more usual location for the pulley and cord ganged tuning coils is behind and under the front edge of the chassis, as in the Truetone Model D2665 and in others such as the Belmont Models 4B112 and 4B113, the Airline Models 64BR-1205A and 1206A and the Learadio Models 6617PC, 565, 565BL, 566, 567 and 568.

The second mechanism for moving the coil core slugs is also widely used in midget sets. Since some form of mounting plate, bar or frame is used to "gang" the cores, it generally takes up a square or oblong shaped space, large enough to be preferably

located above the chassis, where ordinarily the ganged capacitor is found.

Two such devices are illustrated. In Figure 3 is the slide rule type of tuner mechanism as produced by the Aermotive Equipment Corp., 1632 Central, Kansas City, Mo.

Figure 4 illustrates the Vario-Tuner manufactured by Electronic Labs., Inc., Indianapolis, Ind., the type of assembly which is adaptable to the rotating dial indicator.

Short wave bands may also be found incorporated into these inductive tuning devices, as seen in Figure 9, showing the use of short wave bands in the Airline Models 64BR-2710A-1808A, Truetone D1747, 8, as well as the Belmont 8A510, Coronado 43-7651, and in several other makes and models.

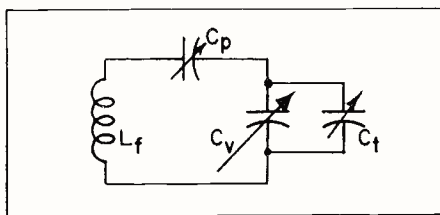

Fig. 6. Padded ganged capacitor oscillator circuit.

While the mechanical construction varies considerably among manufacturers, the basic circuits fall into fairly regular groups. First of all, it will be remembered that there are two common methods of tracking

ganged variable capacitors. One makes use of padding capacitors in an oscillator circuit having a ganged section identical with the one used in the r-f circuit and the other utilizes a variable having specially cut plates in the oscillator section.

The latter method is found only on single-band sets. For short-wave receivers, only the padding capacitor method is used, although in actual practice this padder may be of a fixed value instead of adjustable.

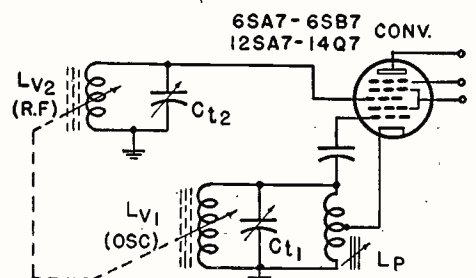

Fig. 7. Simplified diagram of a typical padded oscillator ganged inductive tuner circuit.

Similarly, in ganged permeability-tuned inductances, tracking may be accomplished either by a padder arrangement or by specially cut oscillator section elements. In the latter case, also used on broadcast only, there are three things which may be varied in order to track the oscillator to the r-f circuits. These are shown in Figure 5.

Where short wave is used . . . and on many broadcast-band sets using permeability tuning . . . a padding arrangement is employed. In order to understand how the various padding adjustments are made, it is necessary to review the procedure in setting the padder of a ganged-capacitor oscillator circuit, such as the one shown in Figure 6.

(Continued on page 93)

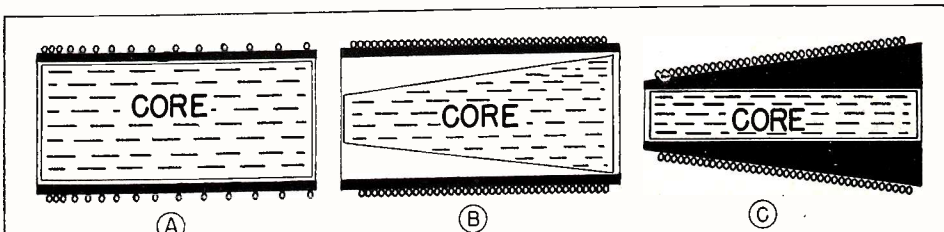
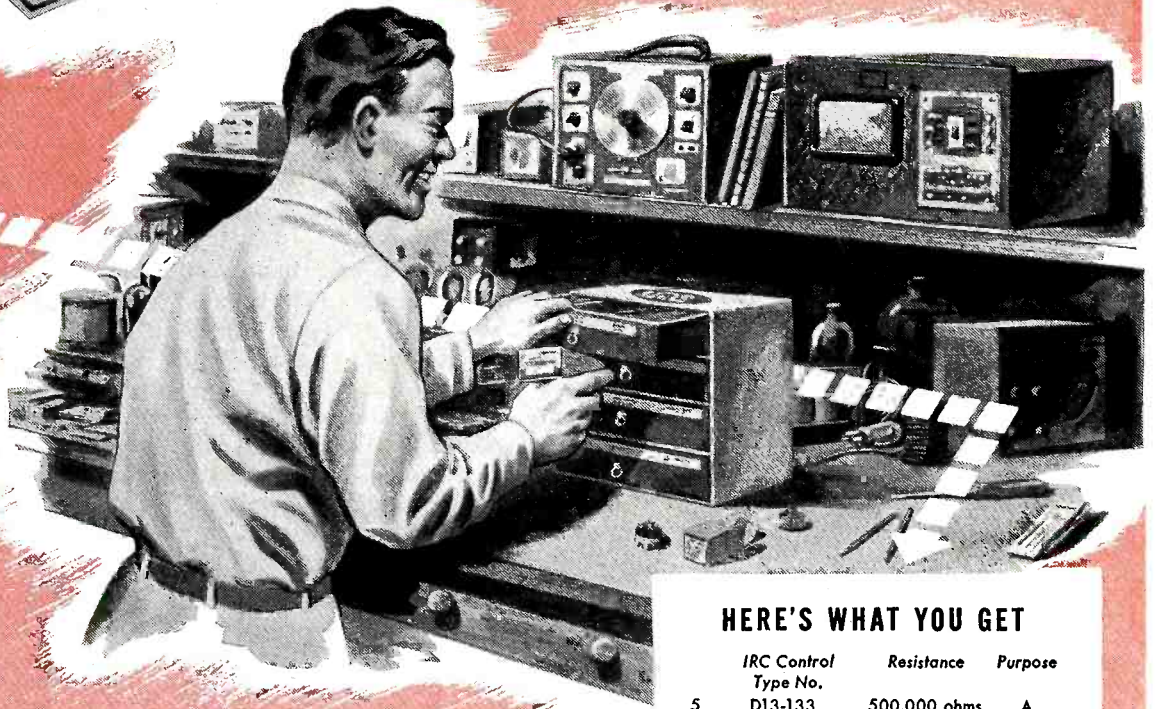

Fig. 5. Non-padded oscillator tuning coils. A, progressively wound; B, tapered core; C, tapered form.



This New IRC JUNIOR Control Cabinet Belongs on Your Bench



Here's one selection of 9 "hot-number" controls, switches and shafts you'll use every day! The new IRC Junior Control Cabinet contains 9 of the most-used 1/2, 1 and 2 meg. type D controls with the added adaptability of the tap-in shaft feature—plus 4 switches and 4 special shafts.

This inexpensive assortment of popular controls will save you time and money, and reduce your need for exact replacements. Factory-packed in a handsome four drawer cabinet of sturdy cardboard. Cabinet attractively finished in blue, yellow and silver with twelve individually identified compartments. Order the new inexpensive JUNIOR Control Cabinet from your IRC Distributor today. International Resistance Company, 401 N. Broad Street, Philadelphia 8, Pennsylvania. In Canada: International Resistance Company, Ltd., Toronto, Licensee.

HERE'S WHAT YOU GET

	IRC Control Type No.	Resistance	Purpose
5	D13-133	500,000 ohms	A
1	D13-133X	500,000 ohms	B
1	D13-137	1.0 meg.	A
1	D13-137X	1.0 meg.	B
1	D13-139	2.0 meg.	A

Purpose: A-Tone or Audio Circuit control; B-Tapped for tone compensation.

SWITCHES

3	#41	S.P.S.T.
1	#42	D.P.S.T.

SHAFTS

1 Type "A" double-flatted tap-in shaft is included with each control—plus:

3 Type "E" with universal knurl for special type push on knobs.

1 Type "H" with universal groove for many Delco, RCA, Sears-Roebuck and Westinghouse models.

INTERNATIONAL **IRC** RESISTANCE COMPANY

Wherever the Circuit says 



Inductive Tuners

(Continued from page 91)

When a padded oscillator circuit such as this is aligned to an r-f stage tuned circuit, both operating off separate identical sections of a ganged capacitor, perfect tracking can be had only at three spots in the band. If separate curves of the frequency of each of these tuned circuits versus dial setting were plotted on the same graph, they would be found to coincide only at these three points, where they would "cross over." Elsewhere there would be found a mis-tracking of up to about 5 kc.

To align the usual ganged-capacitor superhet, a trimmer Ct is provided to bring the tuned circuits into alignment at the high frequency end of the band, generally in the neighborhood of 1600 kc on broadcast.

For low-end adjustment, the padding capacitor Cp is rocked to find the cross-over point of tracking at the 600 kc region. With both of these adjustable capacitors provided, the inductance of the coil Lf determines the frequency of the third or mid-point cross-over. This is almost invariably a matter of design.

Where adjustable coils are provided with ganged capacitor tuning, it will generally be found that the padder Cp is fixed, and the coil core adjustment takes over its function. Of course, by the use in manufacturing of carefully selected parts, both types of padding adjustment are often dispensed with, leaving only Ct adjustable, while Cp is fixed.

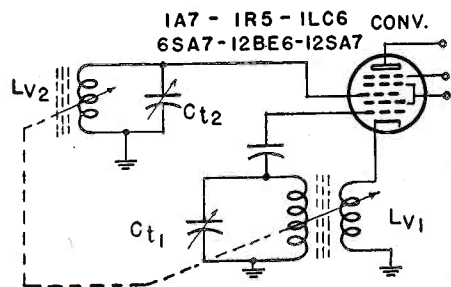

Fig. 8. Simplified diagram of a non-padded oscillator ganged inductive tuner circuit.

In a similar design for a ganged-inductance permeability-tuned radio, each coil could be exchanged for a capacitor, and each capacitor for a coil, with perfectly good results. In practice, however, that exact combination has apparently not been used to date.

As a matter of fact, a great variety of circuits have been used in post-war receiver production, some of which will be shown. Of greatest interest, however, is the padded-oscillator type used most frequently,

illustrated in simplified form in Figure 7.

Here, Lv1, although of different inductance from Lv2, is wound in regular form, and the core is of the same general type as that used in the r-f circuits. Trimmer Ct1 is the high-end oscillator calibrating adjustment, Ct2 is the high-end r-f aligning adjustment, and Lp is the low-end oscillator tracking adjustment.

The frequencies at which these trimmers and padders should be adjusted depend upon the make and model of the radio. In every case, a reliable service manual or folder should be studied to get the exact frequencies and dial pointer settings.

In general, however, the frequencies and procedures will follow the form given in the padded-oscillator alignment table Chart A. (This chart is not intended as a complete list of all radios using the circuit, but only as examples.)

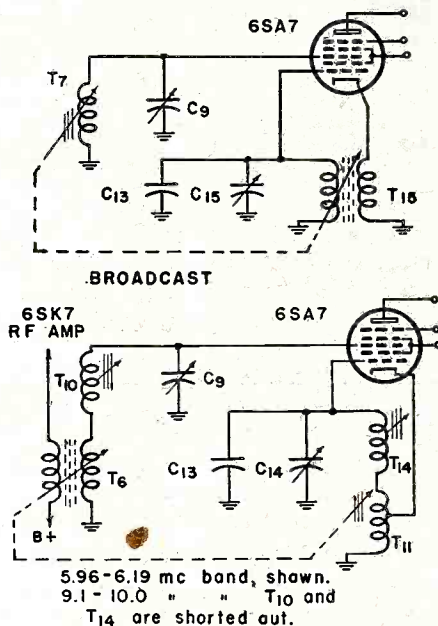

Chart B illustrates the typical procedure for adjusting the non-padded-oscillator type of inductively-tuned circuit. A typical simplified circuit of the most familiar type of such circuit is shown in Figure 8.

It will be noted that in this case the r-f and oscillator circuits look pretty much alike on paper, except for the feedback primary winding on the oscillator coil. In actual construction, however, an inspection of the coil will reveal that in one of the three respects shown in Figure 5, the r-f section differs from the oscillator in more than total inductance.

The most generally used arrangement for non-padded operation (analogous to ganged-capacity tuners using smaller, cut-plate oscillator sections) employs a "progressively wound" oscillator coil. While often difficult to notice, the oscillator coil

in these circuits will be found to have a varying number of turns along the length of the form, with the smaller number at the high-frequency end of the coil (the side where the core slides out at 1600 or 1700 kc).

Just as in the case of the ganged-capacity cut-plate radios, there is neither provision nor need for making an oscillator padding adjustment at the low end. However, coil core adjustments are so simple and convenient in permeability-tuned systems, that all the manufacturers include them.

Choosing Frequencies

Generally, either the oscillator coil or the r-f coil core is adjusted . . . occasionally both or all three, if an antenna tuned circuit is used. In the case of the oscillator coil, the core adjustment is generally made at a high-end setting of the dial, in the

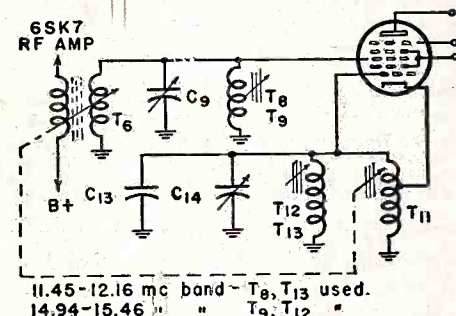

Fig. 9. Circuit breakdowns for the broadcast and short wave bands of the tuning units used in Belmont model 8A510. On broadcast, a non-padded arrangement is employed, with capacitors C9 and C15 for trimmers. On short waves, other tuning coils are switched in, and padding is accomplished by means of series or parallel adjustable coils. The variable coil cores are threaded into rubber bushings and mounted on a moving bar. Although not indicated in the manufacturer's literature, they are sometimes adjusted by rotating, and must then be cemented into position by means of collodion. The series connections are effective as high-end trimmers, while the paralleled coils are more effective as low-end padders.

vicinity of 1400 or 1500 kc. In the case where the r-f coil alone is adjusted, the setting is usually made at some point in the low frequency end of the band, perhaps 700 kc.

While the listing in Chart B gives the approximate frequencies and procedures, a very serious warning must be sounded here. Lest any servicer pass lightly over this point, we will refer to a letter from N. J. Cooper, Service Manager of Stewart Warner's electrical products division, who states:

"Since permeability tuning mechanisms permit adjustment of the inductance as well as capacity in a tuned circuit it is necessary to observe certain precautions in order to obtain accurate alignment. There is an all important difference between the gang condenser type of tuning arrangement and the inductive.

(Continued on page 104)

How New Tele

Fourth of Series Begins Tracing Through

• Before very long, the new television receivers that are commencing to pour from production lines will be in every big city, and many smaller towns. Servicers should lose no time in becoming familiar, at least on paper, with the circuits that they will be called upon to install, explain, adjust and maintain.

Continuing with our analysis of the new circuits as they are an-

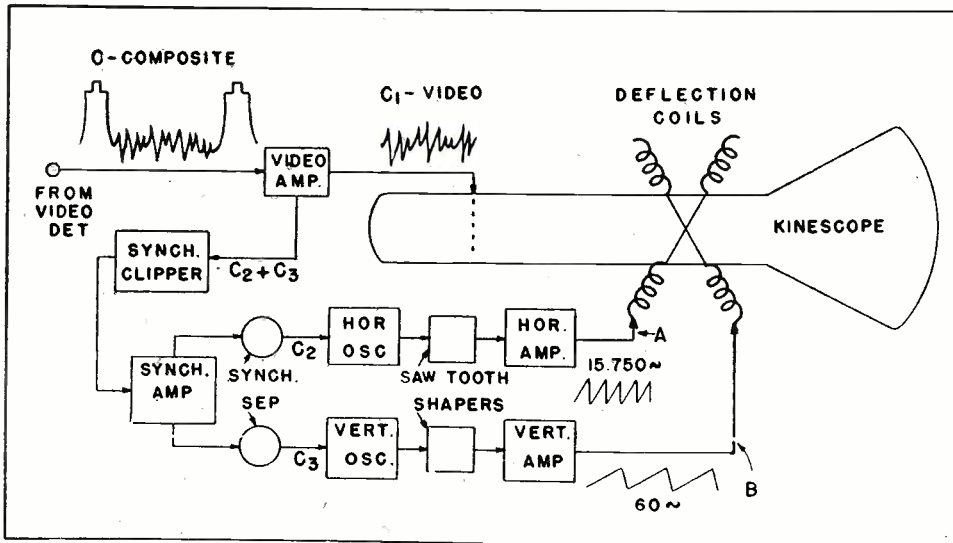

Fig. 1. Three varying signals control the moving spot of light which forms a picture on the cathode ray tube's screen. Signals A and B control the position, while signal C controls the brightness of the spot and supplies synchronization. "Free running" horizontal and vertical oscillators produce a "raster" of generally uncontrolled lines, locked in by synchronizing signal.

nounced, the present article takes up the relatively well-known vertical deflection circuits, which will be followed in the next installment with the more unusual horizontal sweep components.

As explained in the first article of this series (April, 1947), the moving spot of light on a television receiver's kinescope or picture tube forms a picture under the control of three varying signals, shown as A, B and C in the block diagram, figure 1.

Two of these, A and B, are sawtooth waves. A 15,750 cycle signal of this type, generated by an oscillator within the television receiver, is applied to the picture tube's horizontally-deflecting plates or coils. Similarly, on separate vertically-deflecting plates or coils a 60 cycle signal, also generated by an oscillator in the set, is applied.

Triple-Purpose Wave

The third controlling signal, C, called a "composite" wave, is broadcast by the television station's transmitter. After being picked up, selected, amplified and detected, it has three duties to perform; to perform these separate jobs it has three component waves, C₁, C₂ and C₃.

C₁, known as the "video" wave, contains the picture information. This video wave is applied to the control grid or intensity grid of the

kinescope, so that as the spot moves across and down the screen under the influence of the saw tooth waves A and B it varies in intensity, thus creating a picture.

Provided the locally-generated saw tooth waves A and B are perfectly regular and stable, the picture formed by the varying spot intensity will exactly reproduce the picture which originally created the video wave C at the transmitting station's studio camera.

This is true, however, only if the receiver's saw tooth waves are ex-

actly in step with similar saw tooth waves which at the studio camera sweep the camera pickup tube's electron beam about its own screen. To synchronize the receiver's and transmitter's oscillators is the main function of the two remaining waves C₂ and C₃ which are present in the composite signal.

Waves C₂ and C₃ are in the form of almost rectangular pulses, one of which repeats at a frequency of 15,750 cycles per second, and the other at 60 cycles per second. These synchronizing pulses are separated from the video wave C₁ by means of "synch clipper" circuits, and separated from each other by "synch separator" circuits. Then they are applied to "lock in" the local saw tooth oscillators' frequencies with those of the transmitter.

Inside the Wave Shaper

What we have thus far called a saw tooth oscillator is in reality composed of three circuits: an oscillator, a saw tooth shaper, and an amplifier. Various types of combinations of oscillators and saw tooth shaping circuits will be found in the newly-marketed television receivers. In general, however, they fall into two categories: the multivibrator, and the blocking oscillator.

The newest television receivers in-

Fig. 2. RCA 10" table model 630TS uses a blocking oscillator in the vertical deflection circuit.

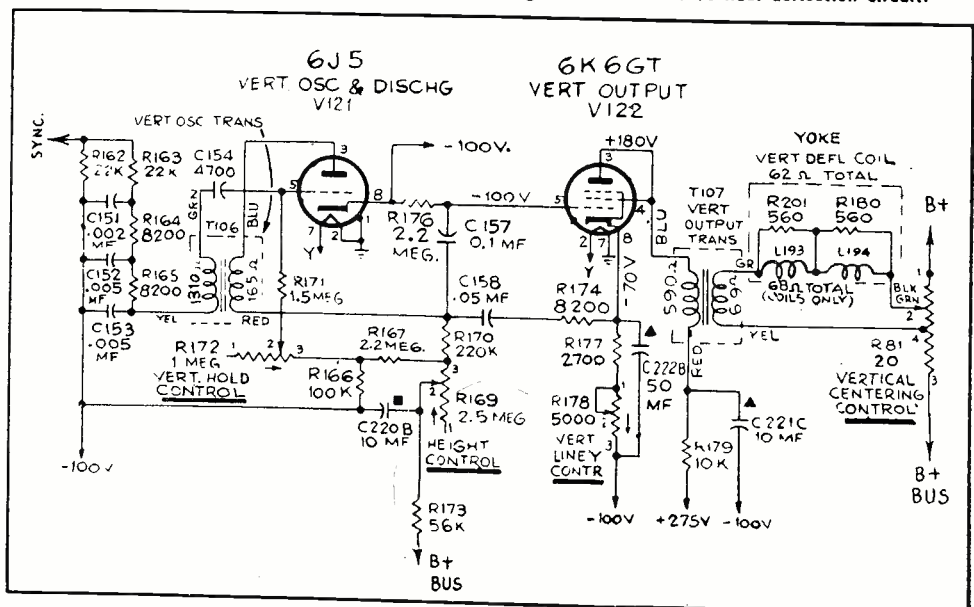

Sweeps Work

Deflection Circuits of Latest Television Viewers

corporate vertical deflection oscillator circuits which are variations of those used in prewar viewers.

Figure 2 shows the blocking oscillator used in the RCA Model 630TS (10" table) vertical circuit. Appearing similar to an ordinary audio oscillator, it has in reality several essential differences, such as the lack of a resonating "tank" capacity. On the contrary, a high L/C ratio, with low distributed capacity is required, to reduce the natural tendency to regular, repeated oscillation.

The aim is to make the oscillator produce one sharp cycle, followed by a longer period of inactivity, and to

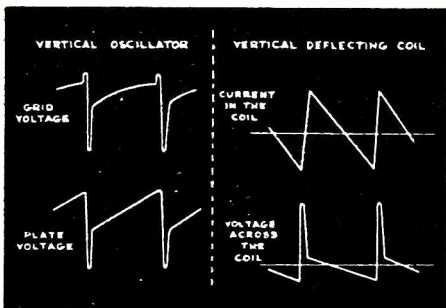

Fig. 3. Voltage and current relations in the oscillator and deflecting coil.

repeat this sequence continually. The sharp surge of plate current needed by the oscillator during its active time is secured by discharging capacitor C158 of figure 1; the capacitor having built up this charge from the B+ supply during the oscillator's inactive periods. The resulting voltage across C158 has the general form of a saw tooth wave.

How RCA Circuit Works

To describe briefly the circuit's operation: When C158 is discharged, the V121 plate current drops sharply. The inductance of T106 causes a sharp "kick" of positive voltage, which is transferred to the grid. The resulting rectified grid current builds up a heavy negative voltage across resistors R171, R172 and divider R166-R167.

The relatively large values of these resistors and the grid capacitor C154, result in a long time constant; too high to permit the rectified grid voltage to leak off rapidly enough, it causes the tube to block for a period of time, until the grid is cleared.

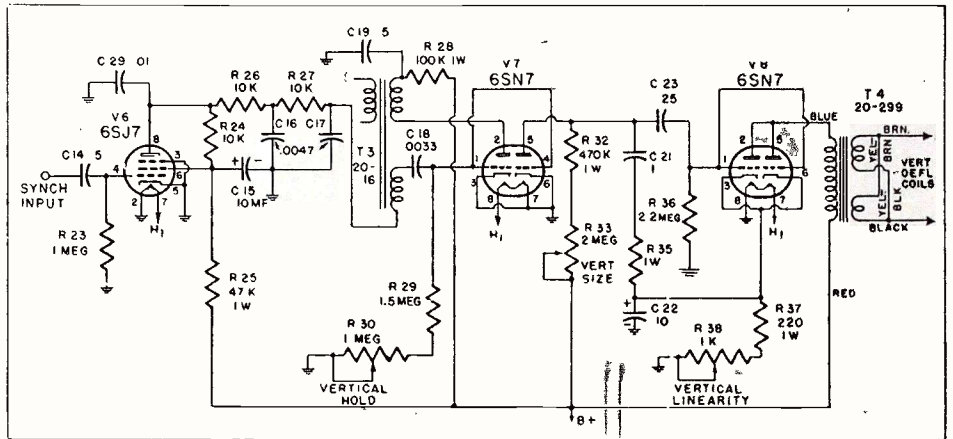

Fig. 4. Dumont Teleset Type 266 uses double-triode 6SN7 (V7) to separate vertical blocking oscillator circuit from wave-shaping components. V8 is amplifier tube.

Meanwhile, with the plate current cut off, the voltage drop causes R170 and R169 decreases, causing a rising plate voltage, slowed down only by the charging current of C158. All the while, however, the grid blocking charge has been leaking off, and when low enough the tube begins to conduct. Aided by the in-phase feedback via T106, the plate current rises very sharply, quickly discharging the energy stored in C158, and repeating the cycle.

The wave form drawings at the left of figure 3 show the effect of the sharp, single oscillation of grid voltage on the plate current. The long sloping line represents the charging cycle of C158. It will be noted that this charging cycle seems to start rather abruptly part way up the plate voltage curve. The resultant sharp negative pulse is required, and the process of securing it by means of resistor R174 is unknown as peaking. Peaking is caused by the inability of C158 to discharge completely during the period of plate current

drain, because of the long time constant introduced by R174. In a magnetic-deflection kinescope tube, the vertical deflection coil inductance is in the order of 50 millihenries . . . relatively small. As a result, in order to produce a linear change of current and magnetic field around it, a linear voltage change is needed, as shown by the sloping portion of the plate

voltage and the voltage across the coil.

The retrace, however, is very fast, and the 50 millihenry inductance naturally shows a very much greater reactance. Therefore a large pulse of voltage is needed, for a rapid retrace. The resultant current in the deflection coil itself, of course, is saw-toothed, as shown.

V122 is a triode-connected amplifier, with an output transformer to match the deflection coils. Advantage is taken of the fact that varying the bias on V122 will vary the shape of the saw-tooth wave being amplified, to make corrections and secure a more linear picture.

R178, which is the linearity control regulating this, also affects the gain, and therefore the vertical size of the picture. The height control R169 is thus adjusted first, to fit the screen's panel mask or cutout; then the linearity control is sent, and then the process is repeated for best results.

(Continued on page 120)

Fig. 5. General Electric Model 801 vertical section uses a multivibrator circuit, eliminating transformer coupling. C37 and R95 comprise wave-shaping elements, with direct output coupling to vertical output amplifier.

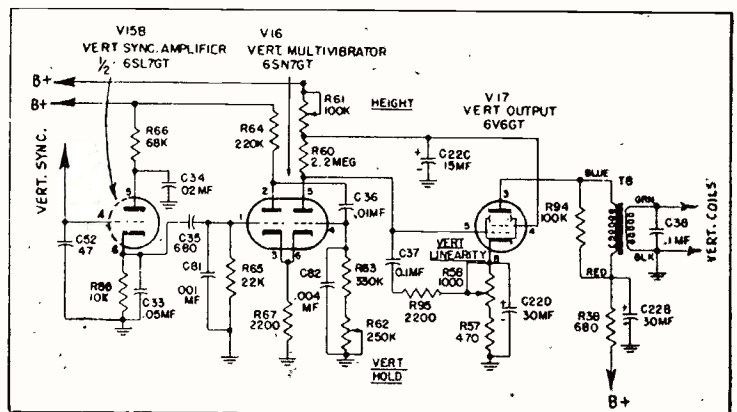

Multi-System Tavern PA

Night Spots and Roadside Cafes Use Plenty of Sound. It's Good Business for Them . . . and You

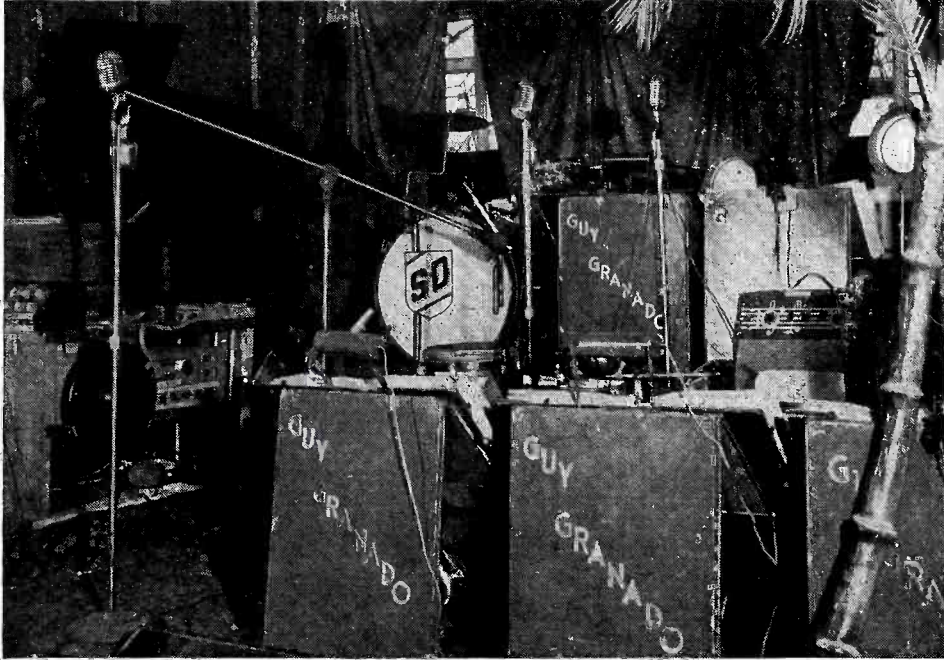

Liberal use of sound equipment is one secret of Maksik's success. Above, a corner of the bandstand and stage is shown, while center picture, below, shows the Masco system which takes over during band "breaks."

● The entertainment industry has been keeping many sound dealers occupied, currently. In taverns and night clubs, sound can play a big part in ordinary "everynight" operation. Pictured here is the equipment recently installed in Maksik's, a popular roadside cabaret and restaurant in New York, by Benray Sound Co.

Several systems are in use. The

main stage amplifier is a Masco MA-50, feeding into eleven small speakers. Operating at low volume, these speakers are mounted in every "terrace" section and at various points in the main room. A 250 ohm line connects them all in parallel, except for the two bar speakers, which have a separate volume control at the bartender's station.

During "breaks" in the orchestral

entertainment, soft music from a Webster 56 changer with its own amplifier takes over. This second amplifier's output line is connected directly across the stage unit's line.

Four microphones are used on the stage. The feature singer's mike, the one seen alongside the drummer's position, and one suspended near the piano are Electro-Voice Cardyne I, Model T-26, while a Shure Unidyne, Model 55C, is seen at furthest right.

Three Atlas mike stands are uprights. The Atlas boom stand, shown suspended over the piano's sounding board, is handy for quickly "spotting" soloists.

Centralized Control

At furthest left on the stage, is a six-position mixer which, together with the light dimmer below it, is worked during all types of performances. At furthest right is a Masco musical amplifier for the guitar.

The manager's station is well fortified with sound. By means of a custom-built intercom, the cabaret chief can keep in close touch with every part of the establishment. At top left, upon the stone pillar, is a three-tube amplifier with a single 50L6 output. This amplifier powers the entire 8-station intercom, with two

(Continued on page XX)

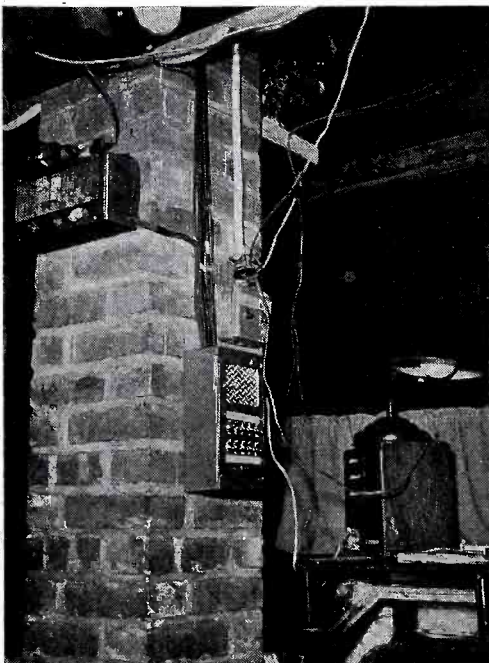

← Custom built by Benray Sound, the intercom amplifier on post at upper left provides power for 7 master stations and one Atlas HU-15 speaker in the kitchen. → Master stations contain only signal light, speaker and switches; the signal chime is mounted separately.

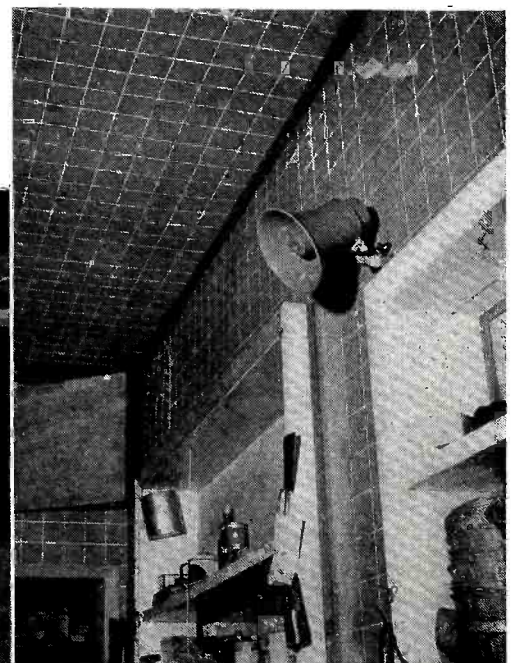
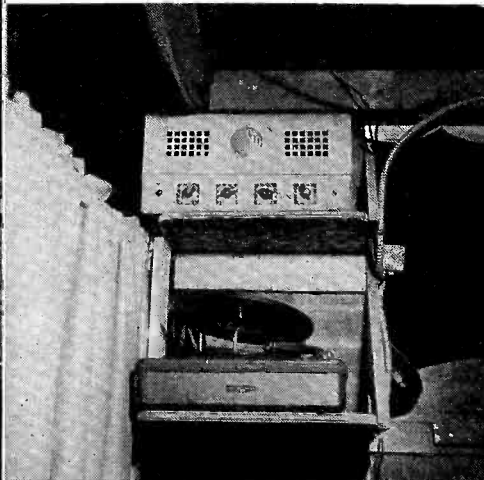

**W.J. COUCH & CO.
RADIO**

A SIGN OF SUCCESSFUL SERVICING

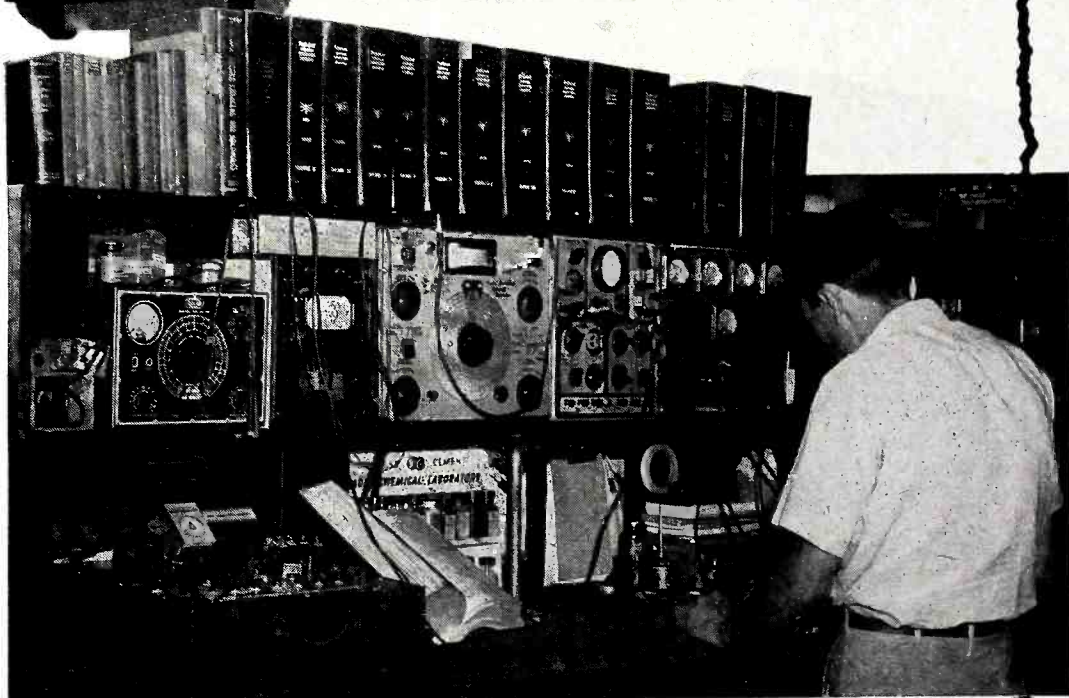

Couch has all fifteen RIDER MANUALS

W. J. Couch & Company of Tullahoma, Tenn., was recently featured in a national radio publication because of the completeness of its servicing equipment. In the Couch shop, as in thousands of other successful servicing establishments, you'll find all fifteen Rider Manuals in daily use. From no other single source is such data available.

Comprehensive servicing information is essential to shops called upon to service all makes and all types of radio receivers—of all ages. That's why the first fourteen volumes of Rider Manual are so time-savingly valuable to the average shop. These volumes alone cover the years when 82% of the sets now in American homes were issued. (From 1920 to April 1942 inclusive.)

And, the information on these receivers is the OFFICIAL, AUTHORIZED servicing data direct from the service departments of the manufac-

turers who made the sets. No one knows better than the manufacturer what procedures are best for his product. That is the foundation on which Rider Manuals are built.

Volume XV, covering sets issued during 1946, plus some unpublished pre-war models, is the result of "Seventeen Years of Continuing Service to the Radio Servicing Industry". It is full of exclusive features. For example, the 520 "clarified-schematics", which break down composite diagrams of complicated multiband receivers into individual schematics of each circuit as it exists with each turn of wave band or equipment switch.

With each Volume XV is the 200-page "How It Works" book, a guide to the theory of operation of new technical features in latest receivers. Volume XV also has all popular "Ham" communication receivers, Scott receivers, Magnavox RA combinations and record player combinations. These you find only in Rider Publications.

Rider Manuals are an investment which keeps pouring out profits for you. Those who bought Volume I, 17 years ago, are still benefitting from it. Be sure your shop has the Sign of Successful Servicing—all fifteen Rider Manuals.



**VOL. XV
JUST OUT!**

2000 pages, plus
200 page "How
It Works" Book.
\$18.00 complete

Volumes XIV to VII (each volume).....\$15.00
Volume VI 11.00
Abridged Manuals I to V (one volume)..... 17.50
Record Changers and Recorders 9.00

RIDER MANUALS

MEAN SUCCESSFUL SERVICING

SEND IN YOUR ENTRY
NOW!

There are
224
Opportunities
to WIN

RIDER MANUAL CONTEST

\$4,325.00
WORTH
OF

CASH PRIZES

AND
SERVICING
EQUIPMENT

JUST TELL WHY
(in 100 Words or Less)

**"RIDER MANUALS
MEAN
SUCCESSFUL SERVICING"**

That's all you need do. Nothing to buy. Nothing difficult. No need for fancy writing. Write your entry on official blank, obtainable from your parts jobber, in plain everyday English. The first thing you write may win you one of the 224 valuable prizes. Call your jobber.

**GET THE OFFICIAL
ENTRY BLANK
FROM YOUR JOBBER
TODAY!**

**JOHN F. RIDER
Publisher, Inc.**

404-4th AVE., N. Y. 17, N. Y.

Export Division,
Rocke International Corp.,
13 E. 40th St., New York City
Cable ARLAB

MAKE YOUR SERVICE

—with these Technical Hints

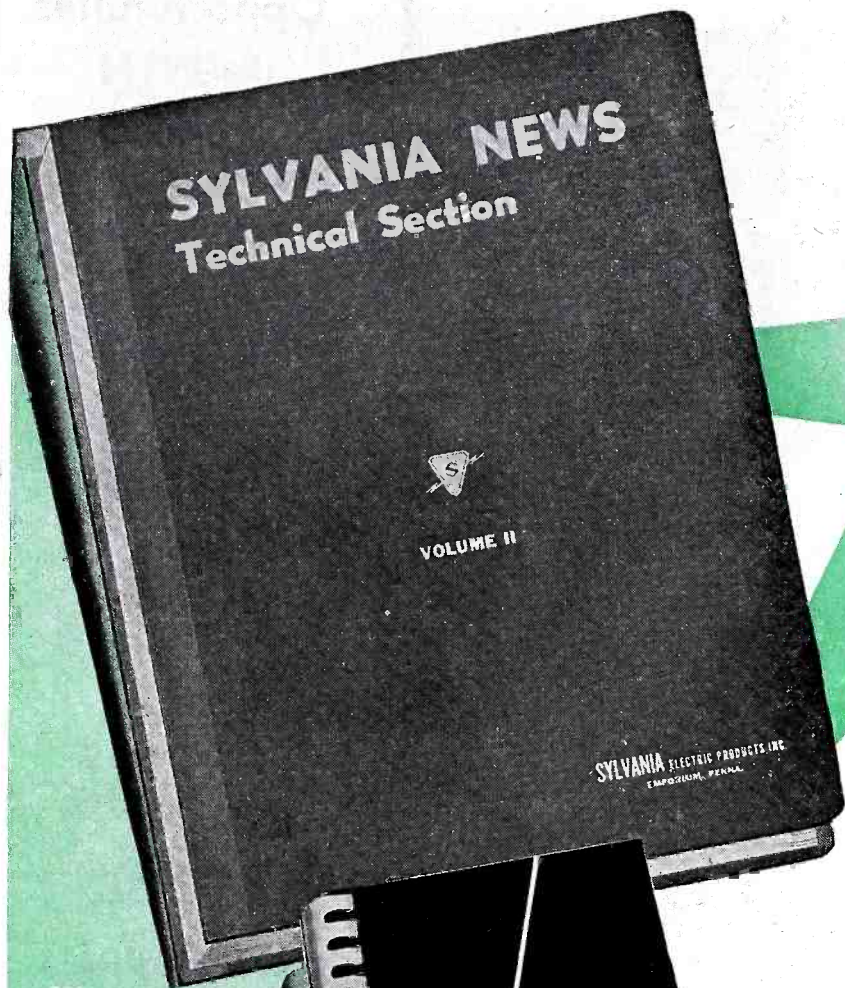

**220
TECHNICAL SECTION
BINDER**

Containing all back issues of Technical Sections from May, 1935. Vol. 1 (May 1935 to Jan. 1941) \$1. Vol 2 (Jan. 1941 to date) \$1.

202
Complete data on Sylvania Receiving Tubes 85¢

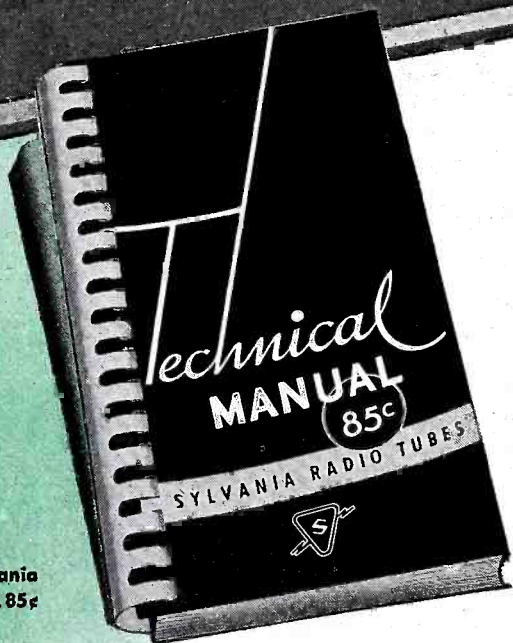

Once again Sylvania brings you a carefully selected group of technical aids which they honestly believe will help make your job easier.

These expertly compiled technical manuals, service guides and shop aids are based on Sylvania's many successful years of experience in the radio field. They will improve the speed and efficiency of your service work. Naturally, this will permit you to repair more sets every day and increase the volume of your service work.

So—why not get the *most* out of your store? First, handle a full line of Sylvania tubes—the finest line of radio tubes made. Second, invest the few cents necessary to obtain this splendid group of technical hints—and see how much they repay you in increased sales.

Order from Sylvania Distributors or write Sylvania Electric Products Inc., Emporium, Pa.



SYLVANIA

MAKERS OF RADIO TUBES; CATHODE RAY TUBES; ELECTRONIC DEVICES;

JOB EASIER!

and Shop Aids

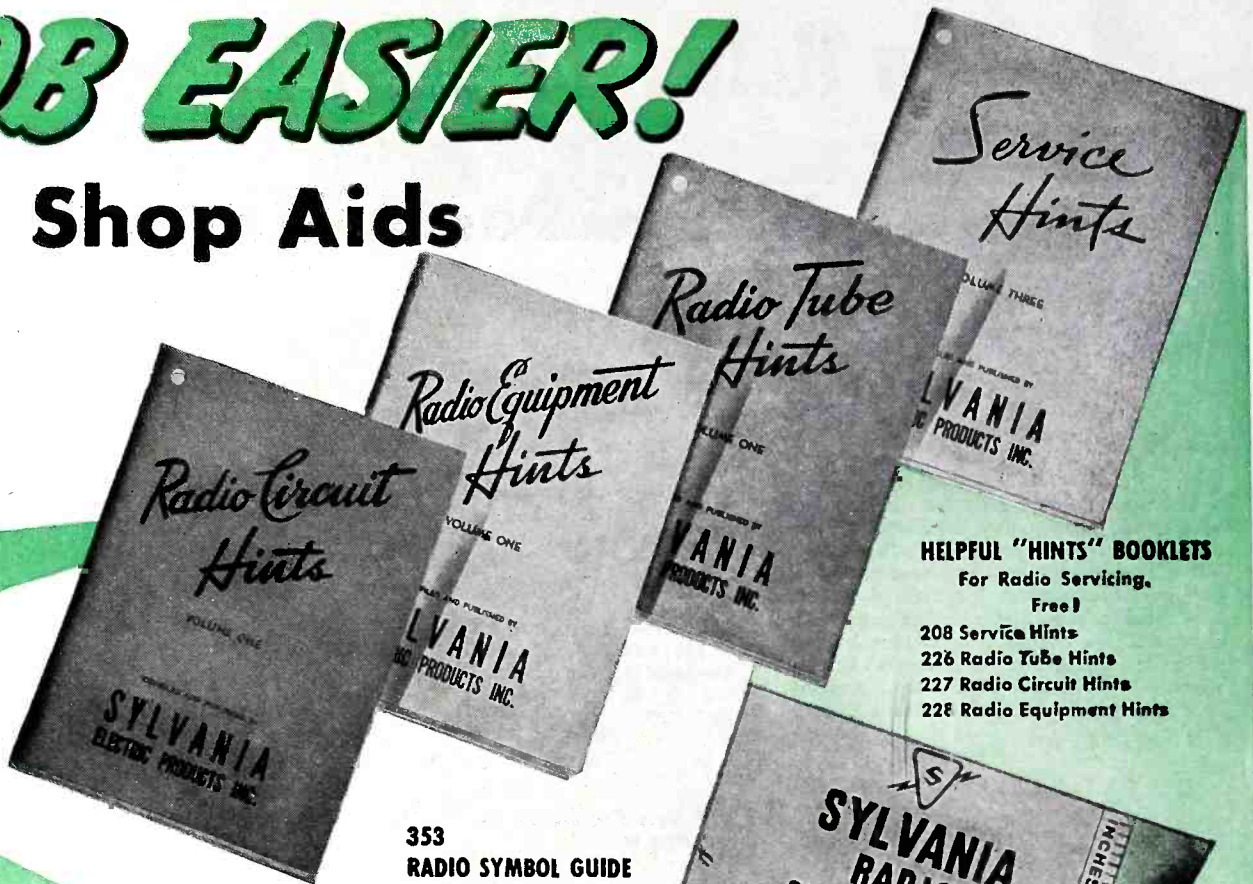

HELPFUL "HINTS" BOOKLETS
For Radio Servicing.
Free!

- 208 Service Hints
- 226 Radio Tube Hints
- 227 Radio Circuit Hints
- 228 Radio Equipment Hints

353
RADIO SYMBOL GUIDE
Made of durable plastic.
Adds neatness to your
schematics. 25¢ each.

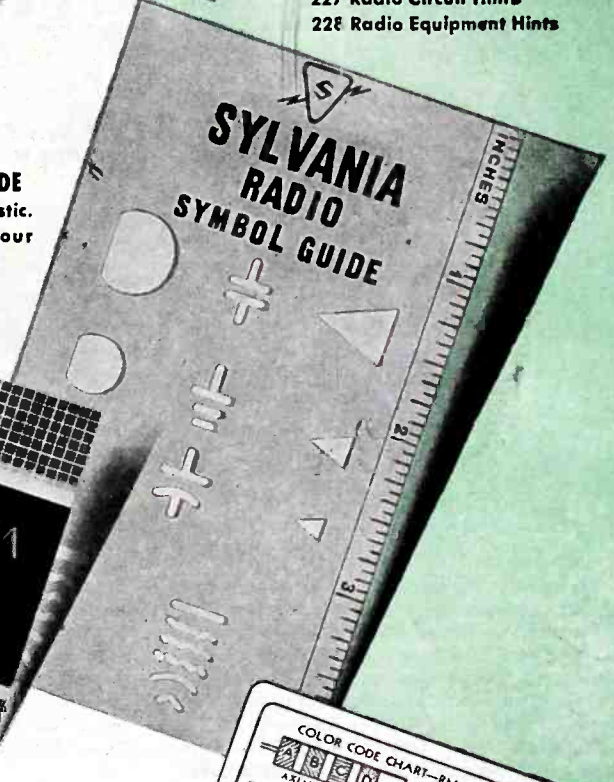

211
CHARACTERISTICS SHEET
Characteristics of Sylvania
tubes and panel lamps
with tube base views. Free!

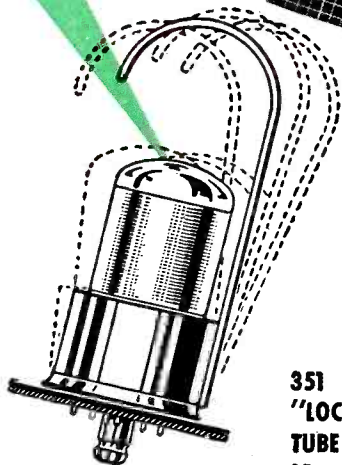

351
"LOCK-IN"
TUBE PULLER
35¢ each.

238
COLOR CODE CHART
Resistor Values and
Ohms Law. Free!

COLOR CODE CHART—RMA STANDARD			
AXIAL TYPE LEADS		RADIAL TYPE LEADS	
A	B	C	D
Black	0	Brown	1000
Brown	1	Red	100
Orange	2	Orange	10
Yellow	3	Yellow	1
Green	4	Green	0.1
Blue	5	Blue	0.01
Purple	6	Purple	0.001
White	7	White	0.0001
Gold	± 5%	Gold	± 5%
Silver	± 10%	Silver	± 10%
No Color	± 20%	No Color	± 20%

Resistor Color Codes: The A color of a resistor denotes the first significant figure and the B color the second significant figure after the first zero significant figure. The C color denotes the tolerance value of the resistor.

Examples:
Band A (Axial Type) or Band 1 (Radial Type) = 1000
Band B (Axial Type) or Band 2 (Radial Type) = 00000
Band C (Axial Type) or Band 3 (Radial Type) = 0000000
Value of Resistor = 23000 Ohms

ELECTRIC

FLUORESCENT LAMPS, FIXTURES, WIRING DEVICES; ELECTRIC LIGHT BULBS

New Helps for Busy Servicicers

Brach ARRESTER

The Vis-O-Glow Lightning Arrester for radios uses a highly sensitive rare gas tube in multiple with heavy conductive plates, forming an auxiliary air gap. The air gap plates function when the current enters the antenna in excess of the capacity of the tube which takes care of inductive discharge. The casing has a slow-burning inhibitor. Listed by Underwriters' Laboratories, L. S. Brach Mfg. Corp., Newark, New Jersey.—RADIO & Television RETAILING

Radio Specialty CALIBRATION OSCILLATOR

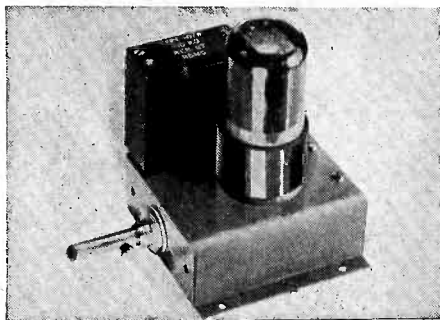

Frequency checkpoints for receivers and signal generators are supplied by this calibration oscillator utilizing a 100 kc crystal and an oscillator circuit rich in harmonics to frequencies as high as 100 mc. The unit mounts inside the generator with filament and plate supply taken from the equipment. Radio Specialty Mfg. Co., Portland 14, Oregon.—RADIO & Television RETAILING

Electronic Instrument VTVM-SIGNAL TRACER

Model 210 reads up to 5000 volts DC with a specially designed high-voltage test probe on a large 8½ in. meter. AC measurements from 20 cycles to 100 mc are made

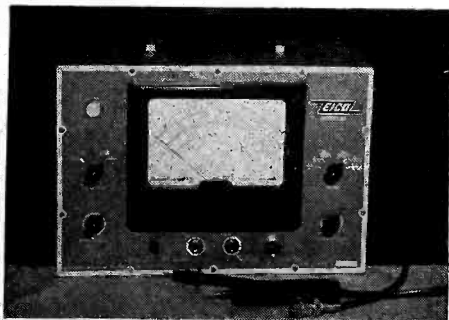

with another probe using a UHF diode giving linear rectification and using a linear scale with an outside diameter of 1 in. Constant DC input resistance of 25 megohms on DC and 7 mmf on the AC ranges, maximum error 2%. 29 separate ranges including DC resistance and decibel readings are available. 6 ohmmeter ranges cover from ¼ ohm to 1000 megohms using a 1½ volt internal battery. Electronic Instrument Co., Inc., 926 Clarkson Ave., Brooklyn 3, N. Y.—RADIO & Television RETAILING

Electro Products 6-12 VOLT SUPPLY

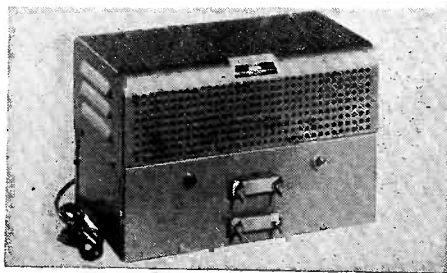

The two 6 volt 7.5 ampere filtered DC power sources contained in Model A power supply unit, can be placed in parallel for 15 ampere continuous service or in series for 12 volt 7.5 ampere continuous service. A high instantaneous power output permits operation of push-button auto radios even though the continuous output rating is exceeded. Electro Products Laboratories, Inc., 549 West Randolph St., Chicago 6, Ill.—RADIO & Television RETAILING

Federal POWER SUPPLY

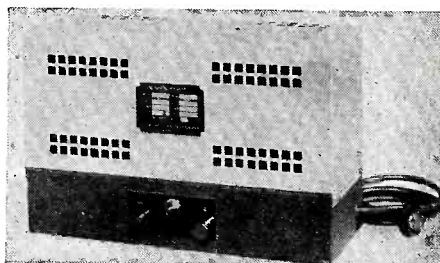

FTR 3246-BS is a test bench power supply for auto radio sets. A ripple of under .3 volts with regulation of approximately 6 volts at 10 amperes and 8 volts at 2½ amperes, is available in this 30 lb. selenium rectifier unit measuring 14 in. wide, 9 in. high, 6 in. deep. Federal Telephone & Radio Corp., Newark, N. J.—RADIO & Television RETAILING

rms Electronics MULTIMETER

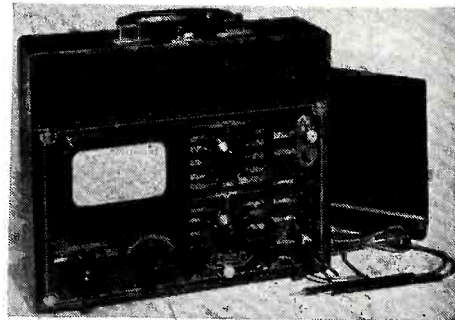

Byohmmeter 796 Multimeter makes resistance and leakage measurements directly without unsoldering leads. 6 full scale ranges from 1 volt to 10,000 volts DC at 20,000 ohms per volt, as well as 1000 ohms per volt, with the latter 6 ranges available for AC measurements, 7 current ranges from 50 microamps full scale to 10 amperes full scale and 5 resistance ranges from .01 ohms to 5 megohms plus 5 db ranges may be read directly, with an accuracy within 1%. A 3-position switch inserts a fuse into the meter, protects it for carrying and measures the condition of the internal batteries directly on the meter without removing them from the case. rms Electronics Inc., 73-39 68th Ave., Middle Village, N. Y.—RADIO & Television RETAILING

RCP MULTITESTER

Model 449A has a DC sensitivity of 5000 ohms per volt for measuring low-current circuits where loading must be held at a minimum. A Germanium crystal rectifier permits AC measurement from 30 cps to 50 kc without temperature errors. The three-inch square meter is accurate to 2 per cent with metallized voltage multipliers of 1% tolerance used. Four AC and four DC voltage ranges up to 1000V, four current ranges up to 1000 ma, and four resistance ranges to 1 megohm are available through pin jack terminals on the front panel. Radio City Products Co., Inc., 127 West 26th St., New York 1, N. Y.—RADIO & Television RETAILING

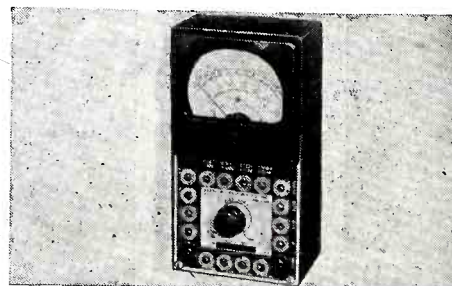

DESIGNED FOR THE BETTER SERVICE SHOP . . .



RCA's NEW TEST OSCILLATOR
 . . . a second unit of a
 revolutionary new line

**Reduces testing and alignment time
 by as much as 50 per cent**

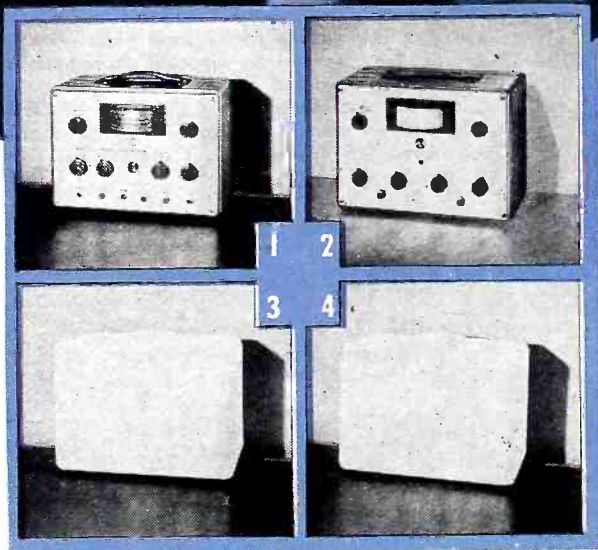

ON THE WAY—a superior line of test equipment that puts time-consuming service jobs on a profitable, production-line basis . . . that anticipates all FM and television needs. Matched styling of all instruments permits attractive, convenient grouping. Watch for announcements of the other units in this new line.

● The WR-67A is a time-saver that adds *profitable* hours to your service day . . . puts you dollars ahead.

When aligning a receiver, for example, you can switch from a pretuned i-f signal to pretuned broadcast-band signals without dialing or retuning. The range switch gives you three fixed frequencies: 1500, 600, and 455 kc. It also permits instant switching to any other frequency you select between 100 kc and 30 mc by presetting the smoothly variable tuning control.

Other outstanding features include: a signal injection probe for high-speed servicing . . . a four-step attenuator with fine control . . . double

shielding . . . miniature-type tubes throughout . . . a six-band drum dial with an easy-to-read, four-foot scale spread . . . adjustable modulation level for internal and external modulation . . . a two-stage power-line filter to minimize leakage, and a 400-cycle *audio* signal source.

Every RCA WR-67A is factory-tested with the finest precision measuring equipment. Heavy-duty components—plus the WR-67A's ability to withstand rigorous "drop," "shake," and humidity tests—add up to real on-the-job reliability. A new bulletin is yours for the asking. *Keep in touch with your RCA Test Equipment Distributor.*



TEST AND MEASURING EQUIPMENT
RADIO CORPORATION of AMERICA
ENGINEERING PRODUCTS DEPARTMENT, CAMDEN, N.J.

In Canada: RCA VICTOR Company Limited, Montreal

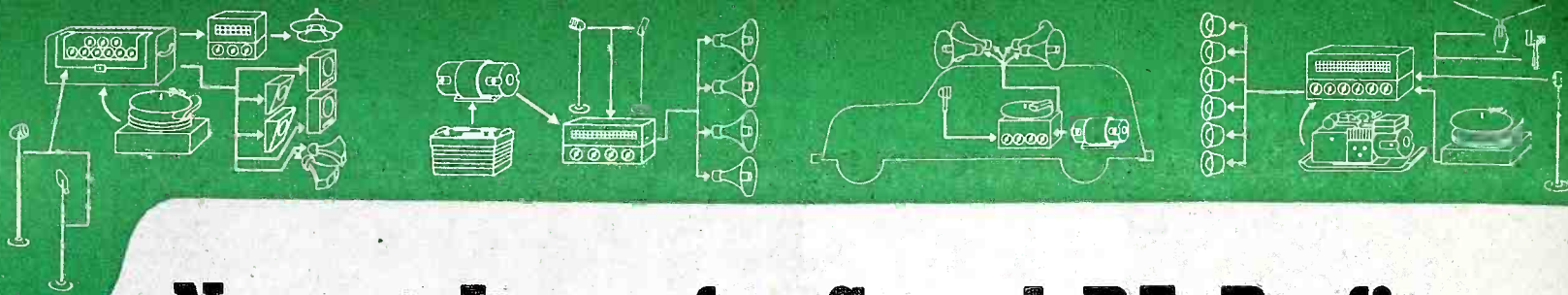

Newest Items for Sound PA Profits

University DRIVER UNIT

Model MAH is a 12 watt unit which covers a frequency range from 100 cycles to 6000 cycles at 8 ohms impedance. The voice coil is wound on a duralumin band, while the one-piece phenolic diaphragm is immune to temperature extremes and corrosion. The rim-centering construction eliminates aligning pins, and the unit is hermetically sealed. University Loudspeakers, Inc., 225 Varick St., New York 14, N. Y.—RADIO & Television RETAILING

Masco HIGH FIDELITY

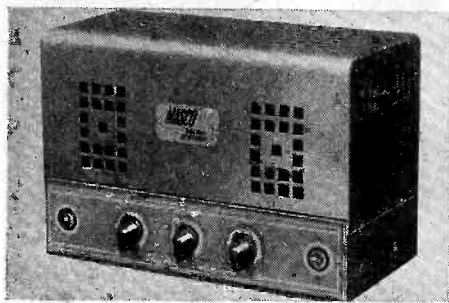

The MA-121 high fidelity amplifier produces 12 W with a frequency response within 2 db from 50 cycles to 10,000 cycles. Separate line and voice coil output impedances are supplied, and individual bass and treble equalizers appear on the front panel. There are two high impedance inputs, one compensated for crystal pickup, the other for signal of constant amplitude. The amplifier is easily adapted for low impedance input. Mark Simpson Mfg. Co., Inc., 32-28 49th St., Long Island City 3, N. Y.—RADIO & Television RETAILING

D & M PHONO OSCILLATOR

A compact one-tube phono oscillator can be used to link a record player with any standard broadcast receiver. Weighing

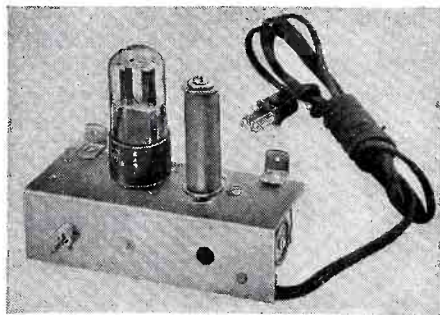

12 oz., the unit uses a 12SL7 with a slug-tuned coil preset to 600 kc. The frequency may be easily reset anywhere from 550 kc to 1550 kc. A 2-10 foot antenna is used within 50 feet of the receiver. D & M Mfg. Co., 51 Lincoln Ave., Midland Park, N. J.—RADIO & Television RETAILING

Pickering CARTRIDGE

A high impedance magnetic pickup, which can be installed in conventional record changers or players by means of a specially designed clip, the Pickering

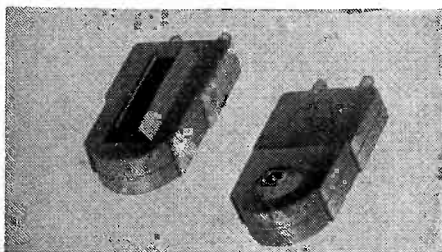

Cartridge has a frequency response flat within 2 db over the range of 40 to 10,000 cycles. Unaffected by temperature and humidity changes, it is equipped with a permanent sapphire stylus. Record pressure is 1/2 ounce. Pickering & Co., Inc., 29 W. 57 St., New York 19, N. Y.—RADIO & Television RETAILING

Instrument Electronics AUDIO VOLTMETER

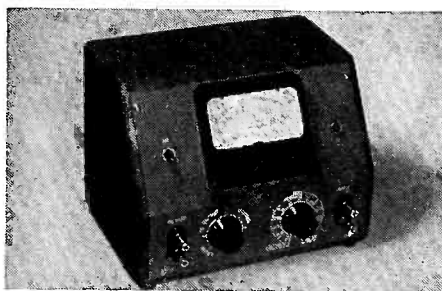

Model 47 audio frequency voltmeter measures as low as 50 microvolts to 500 volts in 13 steps of 10 VU each in the range from -84 VU to +55 VU. Provision is made for simultaneous use as an amplifier and voltmeter. The amplifier has a gain of 40,000. The input impedance is 1 megohm at 12mmf. For frequencies from 15 cps to 30 kc. Eight tubes are used. Instrument Electronics, 42-17 Douglaston Pkwy., Douglaston, N. Y.—RADIO & Television RETAILING

Universal FREQUENCY RECORD

The new pressing of the D61A frequency check record offers "double value" over the old, being recorded on two duplicating sides. Designed for direct checking of the response characteristics of phono pickups, lateral disc recording and reproducing systems, it is popularly used also for checking amplifiers, loudspeakers, room acoustics, etc. On a 12 inch Vinylite 78 RPM disc, it covers from 50 to 10,000 cycles in three volume steps, each identified, then

produced 1000 cycles in 6 steps of 2 db, and finally 400 cycles at a steady 18 db. Universal Microphone Co., Inglewood 2, Cal.—RADIO & Television RETAILING

Western Electric HORN

The 32A horn is an exponential type for use in a wide angle tweeter unit in dual speaker systems, or as an independent speaker for announcing purposes or for

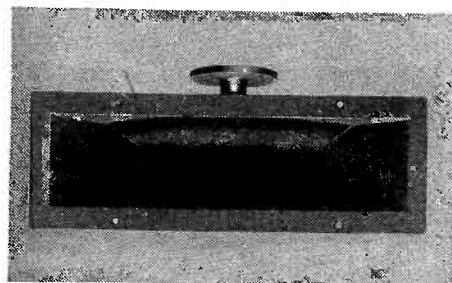

installations where a high background noise level must be overridden. Combined with a 720A or 722A receiver (driver unit) the full undistorted output of a 25 watt amplifier in the range from 600 cycles to 8500 cycles can be handled on speech or music, provided frequencies around and below 500 cycles are attenuated. Distributed by Graybar Elec. Co., 420 Lexington Ave., New York 17, N. Y.—RADIO & Television RETAILING

Fairchild AMPLIFIERS

The No. 620 power amplifier is the first of 12 matched sound equipment units being currently announced; the others includ-

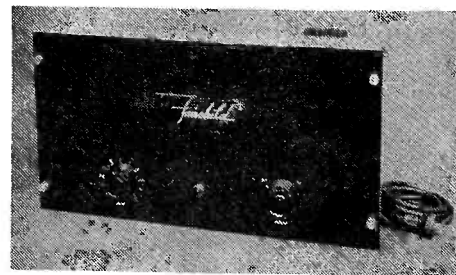

ing No. 621 mike pre-amplifier, line preamps and boosters, switch panels with volume indicators and monitor take-offs, mixers, equalizers, bridging devices and auxiliary power supplies. No. 620 delivers 35W into 500 ohms isolated output with less than 5% distortion, within 1 db from 30 to 15,000 cycles. Input impedance is 600 ohms, isolated, and gain is 75 db. C. V. Kettering, Fairchild Camera & Instrument Corp., 88-06 Van Wyck Blvd., Jamaica 1, N. Y.—RADIO & Television RETAILING



SPEAKERS

ALUMINUM FOIL BASE VOICE COILS PROVIDE

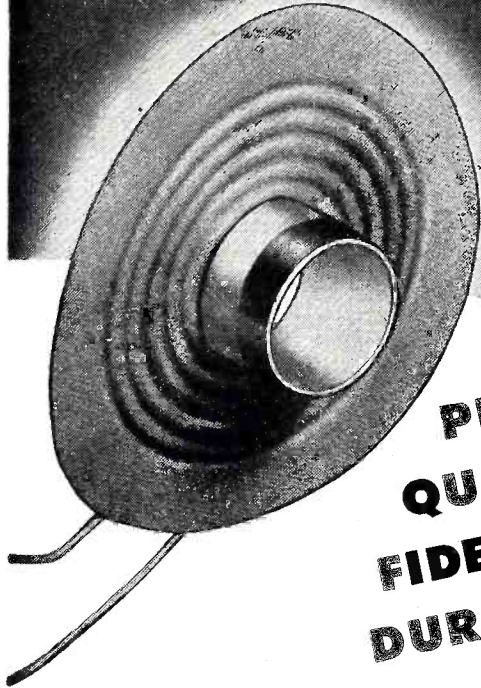

**PERFORMANCE
QUALITY
FIDELITY
DURABILITY**

EVERY General Electric Speaker—from the smallest to the largest—has aluminum foil base voice coils. This G-E development makes possible their high quality performance, tone fidelity, and operating durability. Whether you use them by the hundreds of thousands in production lines, or purchase a single unit for an individual replacement, your customers will appreciate the extra quality performance of G-E Speakers.

G-E Speaker construction gives you these excellent features which assure dependable performance and fine quality reproduction:

- High wattage handling capacity. The metal construction provides much better heat dissipation. This permits operation of the speaker at increased wattages.
- No warping of voice coil. The metal base will not introduce internal stresses, and it is not subject to separation of laminations or to other adverse effects which might result in distortion.
- The aluminum foil base voice coil will not absorb moisture under high humidity conditions.
- Internal stresses which result in dimensional distortion are eliminated through the aluminum foil base voice coil construction.
- Metal construction assures better control of clearance between moving parts.
- Better tone quality and reproduction.

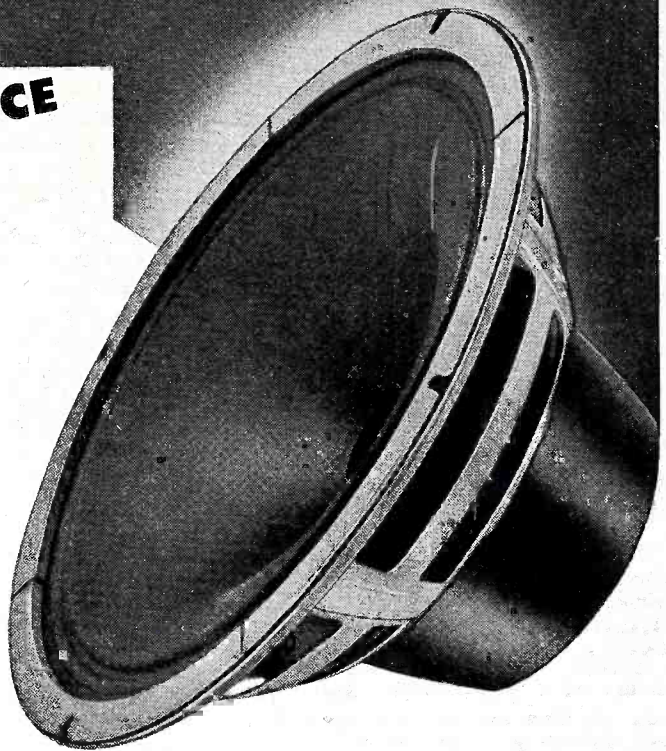

PLUS...

● **ALNICO-5 PERMANENT MAGNETS FOR OVERALL EFFICIENCY AND SENSITIVITY.**



● **DURABLE CONSTRUCTION THROUGHOUT.**

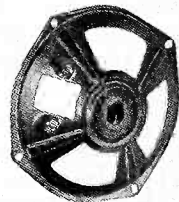

Write now for complete information on speakers to: *General Electric Company, Electronics Department, Syracuse 1, New York.*

GENERAL ELECTRIC

169-F7

Inductive Tuners

(Continued from page 93)

"In the former there was generally no means of adjusting the inductance of a coil and when the field service man resonated the particular tuned circuit by adjusting the trimmer he automatically obtained the correct L/C ratio.

"On the other hand it should be apparent that since both inductance and capacity are adjustable in a permeability tuner, the service man could conceivably obtain a wide variety of L/C ratios, only one of which would be correct for proper tracking and dial scale calibration. Thus the importance of adhering to the manufacturer's recommended alignment procedure, without deviation, should be strongly emphasized.

"The procedure outlined is a modification of the original recommendation which was shown in our service data sheets for the models listed. By using this revised procedure, it will be possible to obtain more uniform sensitivity and better tracking across the tuning range of the receiver.

"It will be apparent that there is a certain amount of repetition and some field service personnel may get the impression that the repeated operations are unnecessary and can be dispensed with. Therein lies the danger of performing the alignment inaccurately and I cannot emphasize too strongly that every bit of repetition in the procedure is absolutely essential."

While the two most familiar circuits have been shown here, there are perhaps a dozen more which are in current use . . . in some cases in volume production by large manufacturers. These will be covered in the next article in this series.

Open Air Concerts

(Continued from page 89)

up from similarly-situated microphone pairs. Thus, for example, one hanging mike and one floor mike are seen at the left hand side of the stage; these feed through individual remotely-controlled pre-amp mixers to a common line amplifier, thence through separate 50 watt boosters to the wide-range loudspeakers.

This same setup is used also for center-stage and right-hand side sound, as indicated in the block diagram. Two additional pre-amps handle a control room and a stage announcement mike.

Gain of the mixer pre-amps is controlled by running long cables from the bias circuits to potenti-

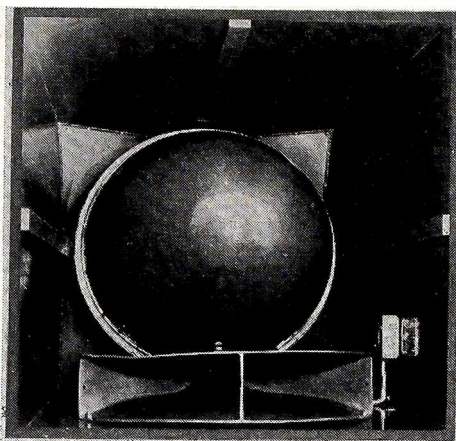

Langevin L-3118-A 2-unit wide range speaker.

ometers in the portable control cabinet set up in the field. By this means, the three suspended mikes are varied in unison, while each floor and announce mike has its own separate control.

Due to the tendency for string music to attenuate rapidly with distance in the open air, the three floor-stand mikes were needed, achieving a balance with the brass sections. Simple bass-cutout filters connected between the three-line amplifiers and the three pairs of booster amplifiers acted to prevent excessive "boom" due to an acoustic resonance of the chamber in which the loudspeakers were housed.

Telephone communication was included in the 10-conductor cable which connects the remote table with the amplifier room.

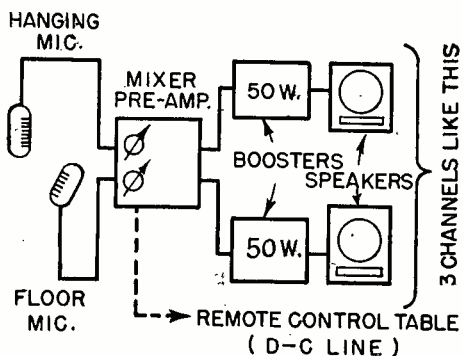

Above, block diagram of one of three similar channels in the "stereophonic" system. The center-stage channel also has mixer pre-amp circuits for two announcement mikes. Below, is a detail schematic of the mixer pre-amp, showing the remote control connection. One remote control handles all three hanging mikes, while all other mikes have individual controls.

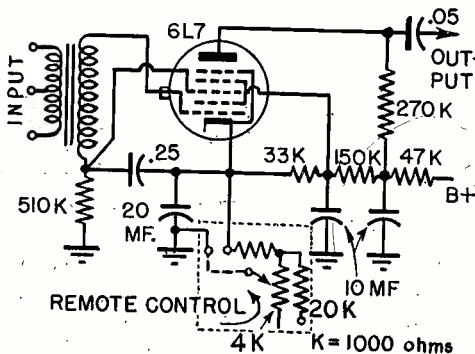

New Set Troubles

(Continued from page 87)

if heard only when the volume control is advanced, may be traced to capacitor C31, shown in Fig. 3. The outside foil (ground end) of this .005 mf audio coupling and d-c blocking capacitor should connect towards T4, the inside end connecting to the volume control.

Hum in the General Electric models 219, 220 and 221, in a few cases, cannot be reduced in the normal manner. In these instances, they may be corrected by adding degeneration in the cathode circuit of the 35L6GT output tube, by disconnecting one end of R17, removing R17 and C29C from the circuit.

Tavern PA

(Continued from page 96)

channels to spare for future additions. In this setup, every station is a "master" type, if desired.

Stations are placed at each waiter's position, and at the bar, kitchen, door and manager's desk. A soft chime and a small pilot light on each intercom station indicate a call, to avoid disturbing patrons with loudly-amplified voices. Volume of the speech is kept very low, so that only the user can hear.

The intercom system has proved to be a very important acquisition for the tavern. Previously, waiters had a long, twisting walk through the tables, to order food and drink at the kitchen and bar. This was complicated by the subdued lighting.

With the intercom in use, more than half of the waiter's time, formerly spent in waiting or walking, is saved . . . and food and drink business has picked up sharply.

Another use for the intercom is for instant communication with waiter captains and maitres, which diminishes incidents involving forgetful patrons and minors attempting to "crash."

The kitchen intercom station uses an Atlas HU-15 speaker, rather than a cone type, as protection against smoke, grease, heat and moisture common to such places. It also acts to increase the volume manyfold as compared to the small cone speakers, a necessary feature in the noisy kitchen.

This type of moderate-sized restaurant and tavern, found in great numbers in every section of the country, affords an increasing and worthwhile field for many medium and small sound dealers. Are you making an effort to cover their needs?

IMPORTANT ANNOUNCEMENT to my Servicemen friends:

In just one year, PHOTOFACT has become the leading Radio Data Service. I owe this success to you. Your support has made it possible for the SAMS organization to provide you with the most complete, accurate and uniform service information ever published. Your backing has encouraged us to extend our activities. As part of our continuous program in behalf of the Servicing profession, I am happy to announce two important new publications. Like PHOTOFACT Folders, they meet a real need—you've told us so. And like PHOTOFACT, these new publications are based on our own actual study of the equipment covered. I am confident these new books will help your business . . . To each and every one of you I say a heartfelt "Thanks!"

Howard W. Sams

NEW! HOWARD W. SAMS

DIAL CORD STRINGING GUIDE

Only Book of its Kind!

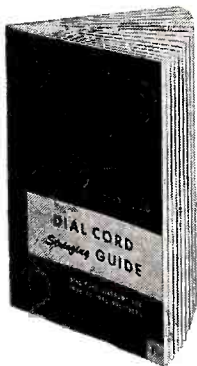

There's only one *right* way to string a dial cord. And there's only one book that shows you how. It's the Howard W. Sams DIAL CORD STRINGING GUIDE. Here, for the first time, in one pocket-sized book, are complete dial cord diagrams and data covering 1938 through 1946 receivers. Actually, there are many ways you can go about stringing a dial cord—but only one is *right*. You know from your own experience that if you get started the wrong way, you can waste hours of your valuable time and work yourself into a nervous lather. You can say "goodbye" to wasted time when you have a SAMS DIAL CORD STRINGING GUIDE. It licks the knottiest dial cord problem in a matter of minutes. This low-cost book is a "must" for servicing. You'll want two copies—one for your tool kit and one for your shop bench.

ONLY

75c

Handy pocket size
Over 96 pages

Easy to read

diagrams and data

ORDER YOUR COPIES TODAY!

NEW! HOWARD W. SAMS 1947

AUTOMATIC RECORD CHANGER MANUAL

There's Nothing Like It!

COVERS MORE THAN 40 DIFFERENT POST-WAR MODELS! A DeLuxe volume, packed with ORIGINAL data based on actual study of the equipment covered. Absolutely accurate, complete, authoritative. No other information like it available: Shows exclusive "exploded" views; photos of top, side, bottom and rear views. Tells you manufacturers who use the equipment. Gives full change-cycle data. Complete information on all adjustments. Invaluable Service hints and kinks. Shows complete parts lists keyed to diagrams and photos. Uniform treatment for each piece of equipment. PLUS—for the first time in any publication—complete, accurate service data on leading WIRE, TAPE, AND DISC RECORDERS! No modern service shop can afford to be without this book!

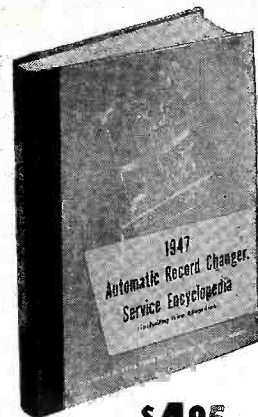

ONLY **\$4.95**

416 pages • Hard Cover
Smythe-sewed—opens flat
Hundreds of photographs
and diagrams

ORDER YOUR COPY TODAY!

New Aids Make PHOTOFACT FOLDERS More Useful Than Ever!



They're yours for the asking: **PHOTOFACT CUMULATIVE INDEX**—Complete Index to first 20 Sets of PHOTOFACT Folders; your guide to more than 1800 receiver models and chassis (1946 and 1947 models). **HOW TO FILE FOLDER**—shows 5 good ways to file PHOTOFACT Folders, including new "30-Second" filing method. Ask your parts jobber for FREE copies of these PHOTOFACT aids, or write us direct.



SETS NO. 22 AND NO. 23 } 160 pages of valuable, needed data covering
NOW AVAILABLE! } current models. Same low price of \$1.50 per set.

HOWARD W. SAMS & CO., INC.
INDIANAPOLIS 6, INDIANA

Export—Ad. Auriema—89 Broad St., New York 4, N. Y.—U. S. of America
Canada—A. C. Simmonds & Sons, 301 King St., East—Toronto, Ontario

PHOTOFACT SERVICE

"The Service that pays for itself over and over again"

MAIL THIS ORDER FORM TO YOUR PARTS JOBBER TODAY—or send directly to HOWARD W. SAMS & CO., Inc., 2924 E. Washington St., Indianapolis 6, Ind.

My (check) (money order) for \$..... enclosed.

- Send SAMS' DIAL CORD STRINGING GUIDE(S), at \$0.75 per copy.
- Send SAMS' 1947 AUTOMATIC RECORD CHANGER MANUAL(S), at \$4.95 per copy.
- Send PHOTOFACT Set No. 22 (at \$1.50).
- Send PHOTOFACT Set No. 23 (at \$1.50).
- Send PHOTOFACT Volume No. 1 (including Sets Nos. 1 through 10) with DeLuxe Binder, \$18.39.
- Send PHOTOFACT Volume No. 2 (including Sets Nos. 11 through 20) with DeLuxe Binder, \$18.39.
- Send FREE Cumulative Index.
- Send FREE "How to File" Folder.

Name.....

Address.....

City.....State.....

Texas Distributor Expands Services

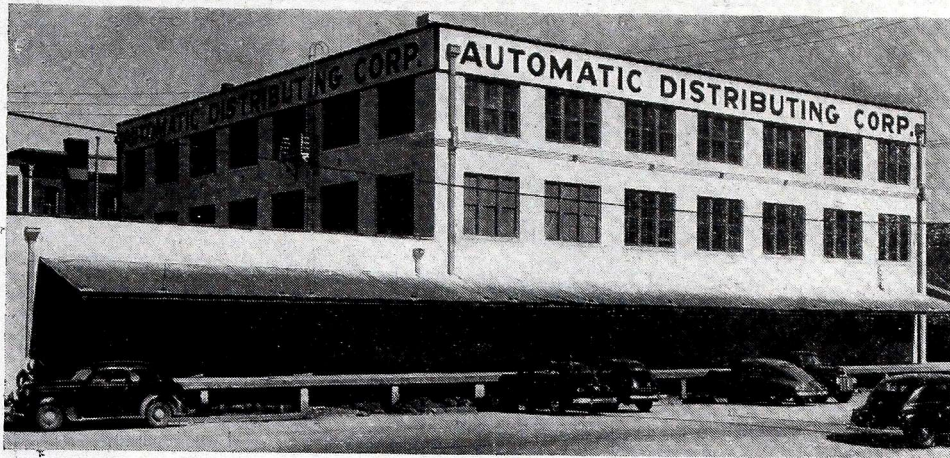

Big new plant of Automatic Distributing Corp., 100 Jackson St., Houston, Tex., has railroad spur, phone record selling station, warehouse space, complete appliance repair shops, etc. The firm handles Norge, Zenith, Ironrite, Proctor, MGM discs and other lines. Head men are Willard M. Wood, president; Ralph H. Fite, general manager, and Willard K. Wood, sales manager.

MEMPHIS, TENN.—At the National Home Show here, one of the highly successful exhibits was that of *McDonald Brothers*, distributors. The booth featured ABC washers and ironers and attracted many of the estimated 100,000 persons who attended the event. McDonald covers Memphis and the mid-south area, serving over 500 franchised dealers.

LOS ANGELES, CALIF.—*Radio Products Sales Co.*, 328 W. 15th St., has been named Garod Radio distributor in Southern California.

CHICAGO, ILL.—Jack Frohlich, sales manager for the appliance division of the *Sampson Co.*, distributors, has announced the appointment of T. E. "Stan" Fremont as radio sales manager for the firm.

Jobbers in Action

Distributor News Across the U. S.

SEATTLE, WASH.—Bendix Radios are now being distributed in the Seattle and Spokane territories by the *F. B. Connelly Co.*, according to word from J. T. Dalton, general sales manager for radio and television, Bendix Radio Division. Operations are headed by Kenneth A. Connelly, president, and Frank C. Porter, vice-president and general manager, from headquarters here. To expand Bendix activities, Connelly has opened a Spokane subsidiary under Frank G. Connelly, president.

The radio division will travel its own salesmen and handle its own promotion under radio manager Keith Davis. The 60-year-old Connelly Co. recently held open-house for all radio dealers in the Seattle territory.

CHARLOTTE, N. C.—Work is being completed on a new \$100,000 warehouse and office building for the *Twin States Distributing Co.*, distributor of Farnsworth radios and phonograph-radios in North Carolina and part of South Carolina. The new structure is located at 515 W. Palmer St.

BOSTON, MASS.—Hundreds of dealers from Boston, Nashua, Manchester, Haverhill, Lawrence, Lowell and outlying towns in eastern Massachusetts attended a Howard dealer meeting held last month at the Hotel Bradford here. They were guests of the *Louis M. Herman Co.*, distributor. L. MacNeil of the Commercial Credit Corp. was a speaker and explained the "Floor Plan" and time payment selling. Herman Smith, Eastern representative for Howard, presented the new Howard FM models which are now being delivered. Louis M. Herman stated that "Television will do for the industry what all-electric radios did in 1927-8 and dealers should get on the band-wagon."

PITTSBURGH, PA.—Leroy Williams, president of *J. A. Williams Co.*, has announced the appointment of Kenneth Brody as sales manager of the appliance division. The firm has for the last half century been one of Western Pennsylvania's leading distributors of radios, appliances, hardware, house furnishings and toys.

OAKLAND, CALIF.—Bert M. J. Conlin has been named Oakland branch appliance manager of *Westinghouse Electric Supply Co.*, succeeding Mowry Irwin, who passed away on May 10th.

RICHMOND, IND.—*The Rodefald Co., Inc.*, Zenith distributor here, recently renewed a pre-war custom by entertaining employees and their wives or husbands at a dinner party. This one was held at the Richmond Leland Hotel.

LITTLE ROCK, ARK.—The prominent distributing firm of *555, Inc.*, here has celebrated its 30th birthday, noting its progress from a one-room store in 1917 to a huge plant now occupying an entire city block from 2nd to 3rd St. on Broadway. Roy E. Stueber is president of the organization.

Connecticut Cook Tries a New Range



Fred Cook does some cooking—at the factory test kitchens of Landers, Frary & Clark to demonstrate the new Universal Tru-Bake oven. Mr. Cook, of American Distributors, New Haven, Conn., is accompanied, left to right, by Philip Parker, Universal sales rep; John Woods, Edmund Wade, and Clyde Heywood of the jobber firm.

Bendix FactoMeter to Help Sell FM

To enable the dealer's salesmen to go out and sell static-free FM to a new summer market, is an important objective of the new FactoMeter announced by Bendix Radio Div., Bendix Aviation Corp., Balto. 4, Md.

Consisting of a standard Bendix FM chassis wired with a field strength indicating meter and collapsible antenna into a completely portable case, the unit is plugged into the prospective FM radio buyer's light socket, immediately demonstrating reception possibilities, best antenna and installation positions in the home, and permits a quick, dramatic comparison between AM and FM reception.

Rider Triples Service

Three manuals per year instead of one, will be published hereafter by John F. Rider, Publisher, Inc., 404 Fourth Ave., New York City. Commencing with Volume XVI, to be distributed shortly, all standard features of the familiar Rider manuals will be included, covering radios and other equipment produced up to about 5 weeks before publication date.

Containing from 700 to 750 pages, each volume will sell for \$6.60 . . . approximately one third the cost of the yearly volumes.

Announced simultaneously is another Rider innovation . . . the 99¢ technical bookshelf of 100 books. The first group of strongly-bound soft-covered books, each containing from 128 to 160 pages covering one particular servicing problem or type of circuit, will be offered during 1947.

Heads Orthosonic Sales

It has been announced by Walter E. Peek, vice-president of Electronic Laboratories, Inc., Indianapolis, Ind., that Sid Joffe will now sell the entire line of "Orthosonic" radios on a national basis. Mr. Joffe, who has been in radio for 28 years, will have headquarters at 192 Lexington Ave., New York City. Sales will be direct from factory to dealers.

Miniature Electrolytic

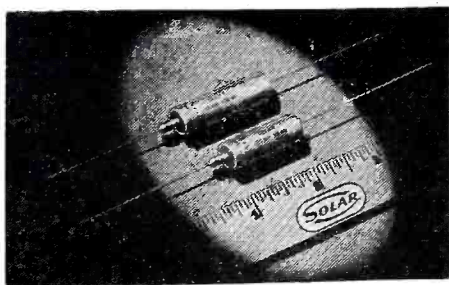

Solar Mfg. Corp. is now ready with first series of Type LB "truly miniature" dry electrolytic capacitors. Design is based on new method of producing high-gain and stable etched foil.

America's *Most Convenient* Radio-Phonograph

**NOTED
FOR TONE!**

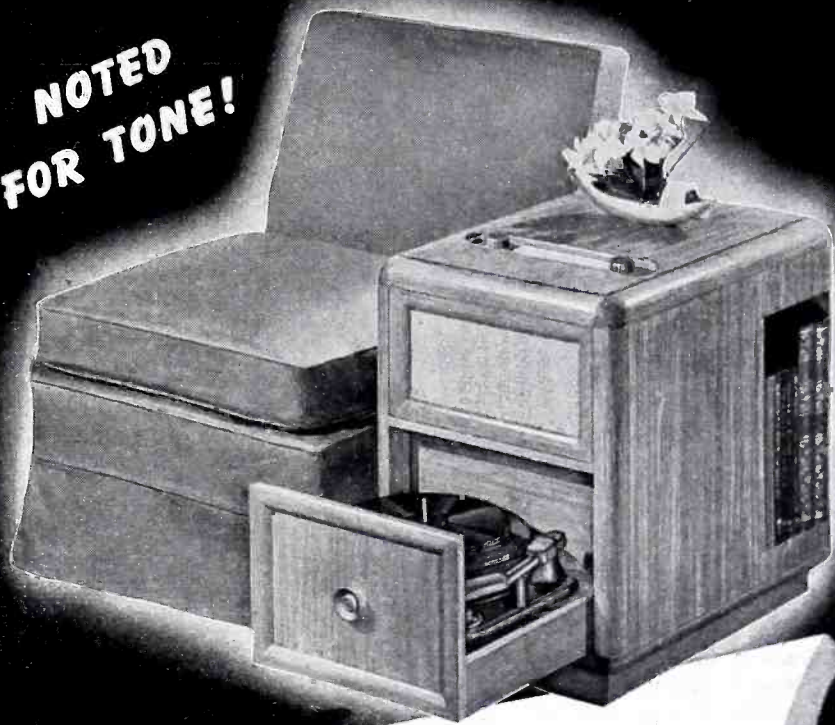

The Beautiful New

HOWARD FM · AM CHAIRSIDE

This great new Howard provides thrilling musical reproduction on both FM and AM radio and automatic phonograph.

It may be conveniently placed on either side of a chair. Roomy record storage compartment is accessible regardless of position. Radio or phonograph may be operated without disturbing the cabinet top.

The hand-rubbed cabinet of rare Primavera and mahogany woods, with finish available in blonde or dark mahogany, is a fitting companion to the finest surroundings.

**No Top to Lift . . . Roll-Out Changer
Child-Proof Lock**

HOWARD RADIO COMPANY

CHICAGO 13, ILLINOIS

America's Oldest Radio Manufacturer

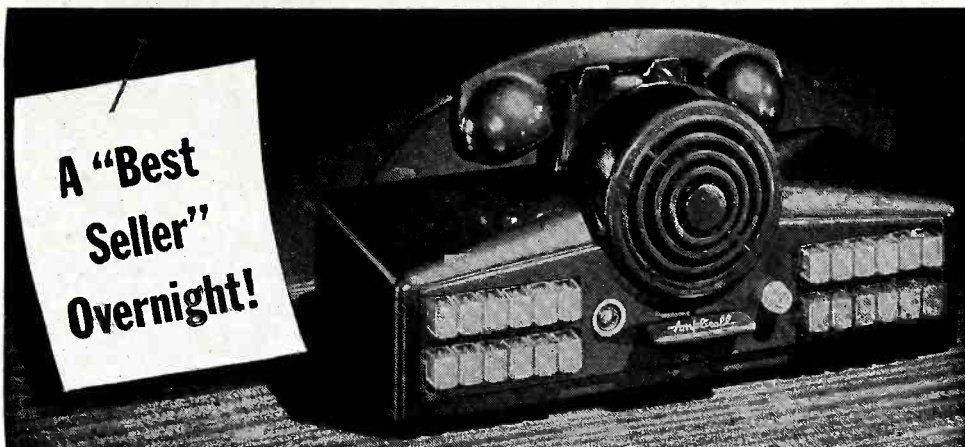

THE NEW



With the Exclusive Features that Sell for You!

America's Finest Business Communication System is a selling sensation! Overnight, businessmen everywhere are asking about, *buying* the New AMPLICALL. The reasons are obvious: Irresistible plastic styling—exclusive new advantages—simon-simple operation—incomparably natural speech. Add them up, and you get an exclusive selling appeal that puts profits in your pocket. The New AMPLICALL gives you "selling horizons unlimited"—a complete line with systems available for every conceivable requirement—exclusive features never before made available. Here's your opportunity to sell Intercommunication as you've never sold before!

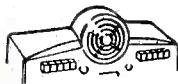

Striking Plastic Beauty—a "hit" on sight—because it creates an immediate desire for possession.



"Busy" Signal—neon bulb visual signal—indicates instantly when station being called is busy.



Handset—professional type for complete privacy—optional with Master Stations.



Translucent Volume Control—lighted to indicate that Master Station is turned "on."



Balanced Line Cable—cuts wiring costs—eliminates shielded line to Remote units.

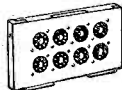

Plug-in Type Masters—allows quick transfer or exchange of Masters—cuts installation wiring costs by one-third.

SEE YOUR AUTHORIZED AMPLICALL DISTRIBUTOR. Get the complete selling story on the New AMPLICALL! Ask your Authorized AMPLICALL Distributor for full details and descriptive catalog. There's a New AMPLICALL System for every business prospect—a system that sells on sight and superior performance. Don't miss out on the biggest profit opportunity ever to come your way in the Intercommunication field

Electroneering is our business

SOUND
TELEVISION



INTER-
COMMUNICATION

THE RAULAND CORP. • 4247 N. KNOX AVE. • CHICAGO 41, ILL.

FOR SALE or LEASE RADIO ELECTRONIC - TELEVISION - ELECTRICAL PLANT

15,000 Sq. Ft. All on Street Floor

FULLY EQUIPPED • IMMEDIATE POSSESSION

- Very reasonable. Including offices and laboratory.
- Light and bright for ideal working conditions.
- Subway and trolley at door.
- Excellent local labor.
- Railroad siding available.
- Garage-type building.
- Conveniently located in Brooklyn.

WRITE BOX 802 RADIO & TELEVISION RETAILING
480 LEXINGTON AVE., NEW YORK 17, N. Y.

How Many Brands?

(Continued from page 48)

lines is advantageous to the dealer. He writes in part: "The appliance radio and television business is a specialty business. It is not a grocery business. Concentration on a few lines results in better salesmanship, better displays, more sales, fewer mark downs and greater net profit.

"What is wrong with an 'agency'? How many people would give their right arm today for a Ford agency, a Chevrolet agency or any one of the other major automobiles?"

Investment Too Large

President L. J. Strauss, of Joseph Strauss Co., Inc., Buffalo, N. Y., makes the following interesting comment:

"I don't agree 100% with Mr. Alter's remarks. Extremes are not good in anything. If a dealer carries only one line, all that Mr. Alter says could be true. On the other hand, if the dealer carries too many lines, he is in even worse trouble. He has too large an investment in inventory, too much floor space tied up, his own men and his customers are confused; and in the final analysis, he doesn't do a good job for any distributor and loses their support.

"I believe in a middle of the road policy. I think a dealer should carry the minimum of duplicating lines. Dealers should put more effort into real schooling of themselves and their men on the lines they carry. They then become a sales organization instead of order-takers who need a great variety of stock to make up for their deficiencies in salesmanship."

Majestic Ad Director

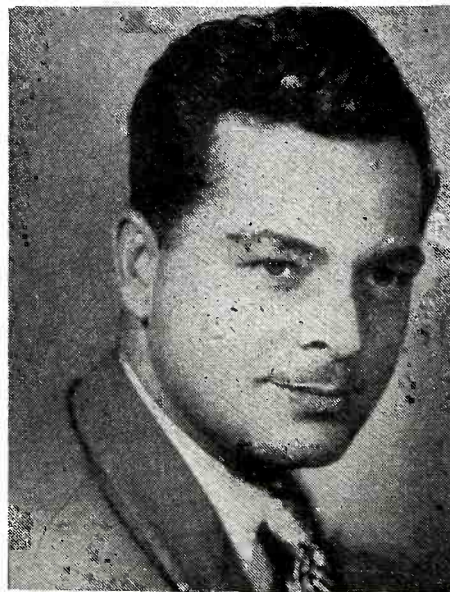

Leo B. Pambrum has been appointed director of advertising, sales promotion and public relations by Majestic Radio and Television Corp.

New Tele Sweeps

(Continued from page 95)

R81, by varying the d-c current through the coils, can be used to center the picture in the vertical direction, while R172 by controlling the rate at which the grid blocking charge leaks off, determines the frequency of the oscillation. It is adjusted to hold the picture steady, and is therefore called the hold control.

R173 and C220B, as well as R179 and C221C are isolating networks, preventing oscillation and transients on the wave shape. It should be clear by now, that certain replacement parts require exact duplication . . . for example the interstage and oscillation transformers . . . while the values of others are critical, such as C158 and R174.

See Figures Page 95

Figure 4 shows the vertical deflection circuit of the new Type 266 DuMont Teleset. From the preceding discussion, most of the components may readily be identified. Notice, however, that V7 is a double triode, having grids and cathode connected together, but with separate plate circuits. The purpose of this variation of the blocking oscillator is to separate the wave-shaping circuit from the oscillating circuit.

C21 and R35 are the saw tooth discharge capacitor and peaking resistor, respectively, while R32 and R33 determine the value reached by the charge before the abrupt plate current discharges C21. The amplifier V8 has its two sections completely paralleled.

Typical of these circuits is the vertical linearity control which affects not only the bias of V8, but also the time constant of the wave-shaping circuit. The various values have a predetermined ratio which can most nearly produce linearity.

The new General Electric Model

Dual Capacitor

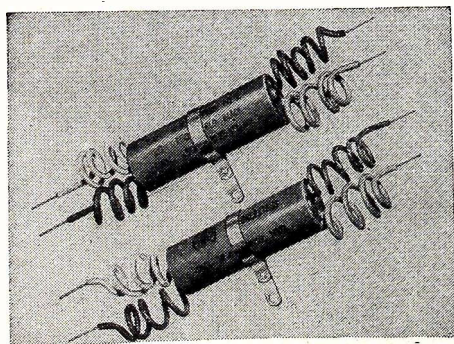

Cornell-Dubilier Electric Corp. has introduced the new type BRL-2215SS dual 20-mfd. 150 W. V. capacitor. It has two leads for each 20-mfd. section, allowing many combinations not possible with a common negative.

801 television receiver's vertical deflection circuit represents the other type of oscillator frequently employed, cathode-coupled multivibrator.

To describe its functioning: When a more positive voltage on grid 1 (that is, tube pin #1) causes a less positive voltage at plate 2, a negative voltage greater than required for cutoff is placed on grid 4 through C36. Due to the long time constant of R62 and R63, the charge on capacitors C36 and C82 leak off slowly. When it reduces below cutoff, plate 5 begins to draw current.

The increasing current through

R67 develops a larger bias at grid 1, and therefore an increasing positive voltage at plate 2, in turn reflected as a positive grid 4 voltage, and an increasing plate 5 current. The increasing current is drawn from sawtooth capacitor C37 and peaking resistor R95. This small amount of energy in these components is quickly discharged, so that the plate current is limited by the high value of R20. This limited value of plate current being lower than that which occurred during the discharge period of C37, the R67 voltage drop is reduced, the grid 1 voltage becomes less negative, and thus the cycle is ready to repeat.

STOP LOOK BEFORE YOU BUY TELEVISION

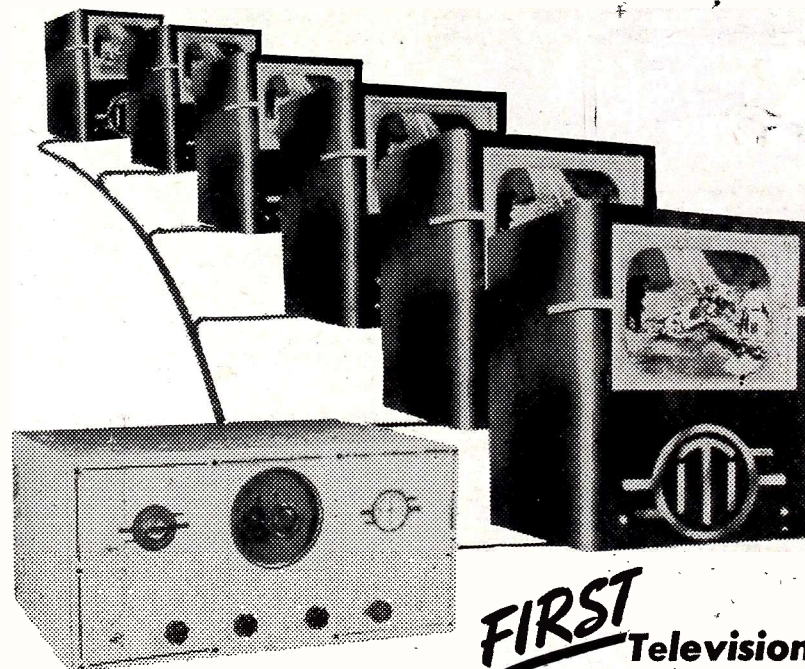

FIRST Television to Feature . .

Two unit construction permits multiple viewing screens and controls to be placed in the most advantageous locations. Continuous coverage of all 13 Television Channels and FM. — Two direct view picture sizes available: 12¾ x 17¼ or 9½ x 12¾ inches. Four megacycle bandpass in all video circuits. — Flywheel synchronization and regulated focus — Audio is push-pull throughout. Heavy duty mechanical and electrical design.



INDUSTRIAL TELEVISION INC.

34 FRANKLIN AVE., NUTLEY 10, NEW JERSEY · NUTLEY 2-4506

PLEASE WRITE OR CALL FOR COMPLETE INFORMATION

NAME _____ ADDRESS _____ TEL. _____ Dept. D T-2

Make more money with more to sell!

THE COMPLETE, NEW '47 LINE

"It makes a big difference to have a complete line that meets every sales situation in the community," say Stromberg-Carlson Sound Equipment dealers.

The complete line is one great advantage, but here are more! The Stromberg-Carlson name stands for extraordinary designing, engineering and manufacturing skills. It has a sound reputation for customer acceptance. Stromberg-Carlson products have proved their profit-making qualities with scores of satisfied dealers.

Today, the widening sound equipment market welcomes the newest of Stromberg-Carlson scientific advances and the latest modern developments that make the line more complete than ever before. Why not inquire about a dealership? A limited number are still available.

Here are a few typical products

PORTABLE SOUND SYSTEM, MODEL P532

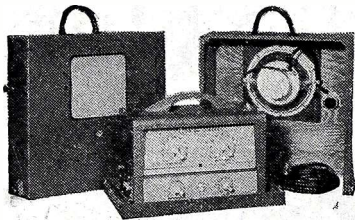

Portable system in a three-section, compact case. 15 watt amplifier with one phonograph and two microphone inputs, two heavy duty Alnico V reproducers, and 25 feet of durable cord with connectors attached. One case acts as the reproducer receptacle for connecting in cascade. Underwriters approved.

AMPLIFIER, MODEL AU 35

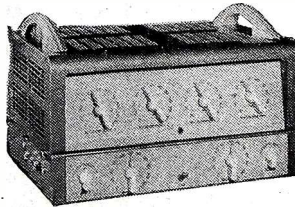

One phonograph and three microphone high impedance inputs, separate bass and treble controls, 50 watt divided output with separate master volume control. Additional amplifier jack for tandem operation. Hum adjuster, resistor board construction and rugged copper plated steel chassis. Underwriters approved.

AMPLIFIER, MODEL AR 37

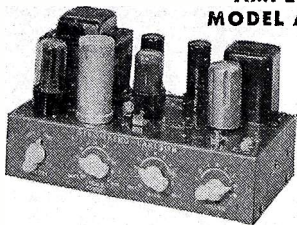

Two input jacks, one provides equalization network for crystal pick up, the other may be bridged across 500-600 ohm circuits, without change in level. Treble attenuation and boosts, bass boost, bass compensator volume control give the finest in record and wired-music reproduction.

SOUND SYSTEM, MODEL 55 750

A completely pre-engineered system. Incorporates AM-FM radio tuner, record changer, controls, and 90 watts of audio-power divided into four output circuits. Wired for optional remote control turret. Rugged all-metal cabinet with glacier-grey finish. Underwriters approved.

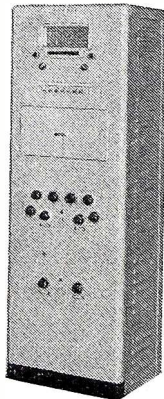

Sparton Officials Launch New Set Line

"These are boom times," E. C. Bonia, vice-president in charge of sales of the Sparks-Withington Company, told dealers at a meeting in New York, where the company's new line of Sparton receivers was shown.

Mr. Bonia cited present high levels in employment and in wages, plus tremendous buying power in the hands of the consumer to back up his statement. He said that a return to good salesmanship

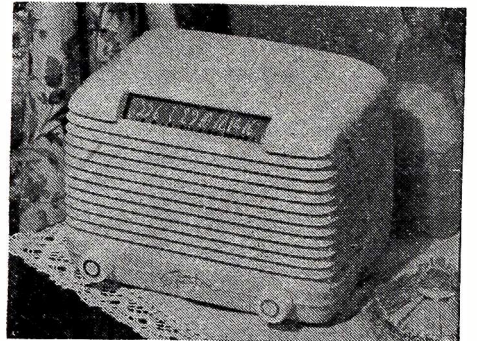

New table Model 100 is ac-dc superhet, 5" speaker, ivory finished bakelite, modern design.

is all that is needed to counteract pessimism on the part of the merchant. He described the features of the new line, stressing the low prices of all the models, and outlining the firm's successful effort in maintaining its list price.

Sparton's coordinated advertising plan, designed as "national advertising that works locally" was described by Mr. Bonia, and also by C. C. Wilmot, treasurer of the firm's ad agency, Brooks, Smith, French & Dorrance. Mr. Wilmot urged dealers to give more thought to the preparation of their own advertising copy. He said that the dealer is in a good position to get results from the ads he writes because he knows his own territory better than anyone else.

A high-light of the meeting was a talk by Harry G. Sparks, Sparton president. He promised his hearers good merchandise, competitive prices, and sincere co-operative effort.

Sparton's "Cooperative Merchandising Plan" was featured in a talk by Victor Meyer, New York district merchandiser. He stressed the value to the dealer of low consumer prices, factory promotions, the one-dealer-in-each-area franchise, and

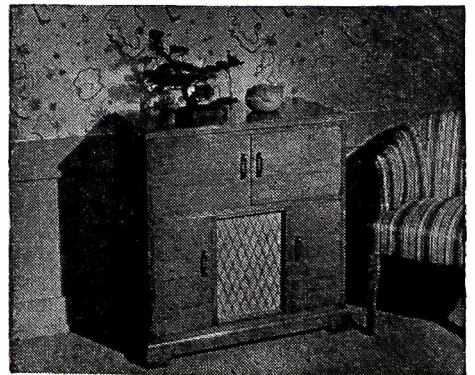

Sparton's Model 1005 has hand-rubbed golden wheat finish, satin gold trim; room for 200 discs.

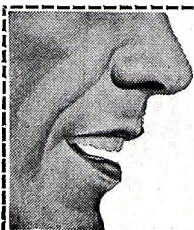

STROMBERG-CARLSON

STRAIGHT-LINE



COMMUNICATION



uniform retail prices.

Included in the new line are six table models, priced from \$19.95 to \$79.95 (the latter a combination, and three console combinations, each with FM, selling at \$229.95. The consoles are eight-tube jobs, having two-post changers, increased record storage space, and permanent needles. A new portable, selling at \$34.95 was also introduced.

New Hytron Miniature

The Hytron Preferred Type 12AL5 is a newly-developed high-perveance, twin diode having a miniature button 7-pin base, replaceable for type 12H6GT in new equipment. Because of its high perveance, the 12AL5 will undoubtedly be found in the detector circuits of wide-hand amplifiers. Its low internal voltage drop produce increased output voltage with a low-resistance load in discriminator, ratio or diode detector, avc diode, clipper or low-power rectifier. Engineering samples as well as production quantities may be ordered for immediate delivery, from Hytron Radio & Electronics Corp., Salem, Mass.

Solar's New Offices

Solar Mfg. Corp. and its wholly owned subsidiary, Solar Capacitor Sales Corp., has moved its general offices to its main eastern plant at 1445 Hudson Blvd., North Bergen, N. J. The offices were formerly located at 285 Madison Ave., New York, N. Y.

Officers and Directors Elected for NAMM

New officers of the National Association of Music Merchants, Inc., are headed by Louis G. LaMair as re-elected president of the organization. Vice-president George L. Byerly, who conducted the highly successful membership campaign during the past two years, was also re-elected for another term. Hugh F. Randall was elected secretary and E. D. Turner, Jr., was named treasurer.

Eight new members were elected for a period of 3 years to the NAMM board of directors. These are S. H. Almanrode, Ted Brown, Arthur E. Godfrey, C. W. Gould, Stuart D. Julius, B. E. Neal, William R. Richardson and J. M. Wylie.

Top Officers Elected for Weston Corporation

Weston Electrical Instrument Corp., has announced the election of officers as follows: chairman of the board, Edward F. Weston; chairman of the executive committee, Caxton Brown; president, Earl R. Mellen; vice-president in charge of sales, H. Leigh Gerstenberger; vice-president in charge of manufacturing, Reginald R. Lambe; vice-president and chief engineer, John H. Miller; secretary and treasurer, Ross Nichols; and comptroller and assistant secretary, F. G. Hawthorne.

The firm's policy is to transfer the

guidance of the corporation's affairs to younger officers through a transition period, rather than by abrupt separation of top management personnel.

Big Expansion Move by Air King Products Co.

Air King Products Co. has taken over an additional plant at 170 53d St., Brooklyn, N. Y., in an expansion move for its radio sets. The company will continue to operate its present factories.

The new plant has 110,000 sq. ft. of space and occupies a whole city block. It contains the most modern fixtures and facilities with air conditioning and fluorescent lighting throughout. David H. Cogan, president of the 27-year-old firm points out that the move will make possible the straight line manufacture of radios on one floor.

Mr. Cogan said that this expansion move was made necessary by Air King's wire recorder, FM and television program in addition to its increased radio receiver commitments.

Radio Golf Outing

Plans have been made for the Inter Association yearly Golf Outing on August 29th at the Elmhurst Country Club, Chicago. Members of the Chicagoland Chapter of "The Representatives," Electronic Parts and Equipment Manufacturers, and National Electronic Distributors Association will gather for a day of golf and a steak dinner—complete with prizes.



YOUR RADIO STORE



OLSON RADIO WAREHOUSE, INC. AKRON 8, O.

New Comic Poster

FREE!

TO DISPLAY IN YOUR WINDOW:
Another OLSON crowd-puller! Get this new giant-size Window Poster absolutely FREE, postpaid, just by sending the coupon below. Actual size of Poster, 17" x 22". It explains in pictures and easy-to-understand words how Electrolytic Condensers work. The upper half is a large diagram showing the parts of a Condenser, and the lower half has five big, amusing cartoons comparing the Condenser with a cheese sandwich and the corroding agent as a mouse. People will STOP and look at this swell Poster in your window or Service Dept. Along with the Poster you get a FREE CATALOG listing Olson's famous Radio Parts at prices that will save you plenty!

PASTE THIS COUPON ON A POSTCARD AND MAIL TODAY

OLSON RADIO WAREHOUSE
73 E. MILL ST., DEPT. 94, AKRON, OHIO

Yes sir! Send me the New Comic Poster free.

NAME _____
COMPANY _____
ADDRESS _____
CITY _____ STATE _____



NEW! OLSON "AKRAD" CONDENSER
FREE YOUR RADIO OF HUM!

SEPARATORS Highest purity cellulose, loaded with dry paste. Electrolyte.

CATHODE Pure aluminum foil makes contact with electrolyte.

ANODE Processed for uni-directional conductivity.

BEAUTY TUBE Flint finish with spun ends insulates, protects and identifies every OLSON "Akrad" Condenser.

POLYTYC P.D. 8 V. 450V

SEAL TUBE Aluminum shell, hermetically sealed to withstand moisture and shock.

LEADS Will load on a breadboard better than any other.

Guarantee "Akrad" Condensers are unconditionally guaranteed for one year when used at rated voltages. If Condenser "Akrad" fails, full purchase price will be refunded.

WHAT IS AN ELECTROLYTIC CONDENSER?



Condensers made by cheaper methods and with poor materials "short out," a process which can be compared to a mouse eating out the cheese from our cheese sandwich.



But in the Olson "Akrad" Condenser sandwich, the "mouse" or corroding agent finds the going tough and he retreats in defeat, leaving the Condenser intact.

ACTUAL POSTER HAS 5 CARTOONS
THESE TWO ARE ENLARGED TO SHOW DETAIL

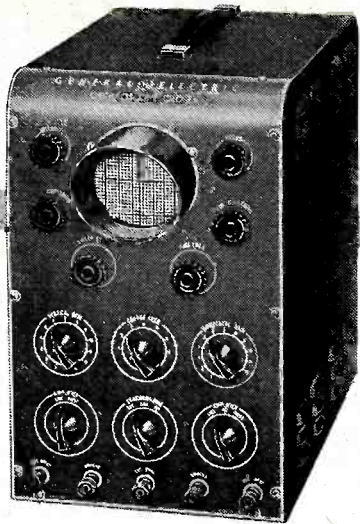

**TYPE
CRO-3A**

EXTRA SENSITIVITY in this GENERAL ELECTRIC OSCILLOSCOPE

SENSITIVITY over and above ordinary requirements—sensitivity for special or unusual problems—sensitivity that makes the CRO-3A *must* equipment on every serviceman's bench.

Built to do a wide variety of jobs and do them well, the CRO-3A has been designed for simple, easy operation. All controls are conveniently located on the front panel; a daylight viewing screen gives excellent visibility without strain; sweep rates from 20 to 30,000 cycles per second, adjustable by a 7 point switch with vernier for fine adjustment. Portable, the unit is housed in a welded steel case in gray wrinkle finish with etched aluminum front panel. Weight: 25 lbs.

Here are the jobs the CRO-3A can help you to do more rapidly:

- Routine service work
- Study wave shapes and transients
- Determine peak voltages
- Trace electronic tube characteristics
- Determine the speed of small motors at no load or unknown frequencies, when used with a Beat-Frequency Oscillator of proper design.

New Free Booklet on FM Servicing available.

For more information on the CRO-3A and other quality service test equipment write: *General Electric Co., Electronics Department, Syracuse 1, New York.*

GENERAL  ELECTRIC

164-F6

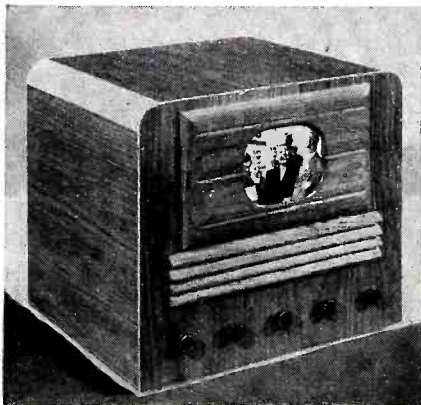

Dynamic

Television

**TELEVISION
KIT**

\$159.50

including leatherette cabinet

\$174.50

with solid mahogany, walnut or birch cabinet

Has the following features:

- New and brighter DuMont 7" Cathode Ray Tube
- New advanced TRUE FM sound included
- Non-flicker pictures
- Latest electronic holding circuits
- Simple wiring from large, clear, schematics
- All parts individually wrapped and packaged
- High frequency I.F.'s conforming to latest I.R.E. standards

Sold ONLY through reputable distributors

DYNAMIC TELEVISION ASSOCIATES, INC.

Manufacturers, Television and Electronic Equipment

Production now at an all-time high

155 PRINCE STREET

BROOKLYN, N. Y.

Retailers See New Philco Product Lines

New developments made by Philco Corp. in projection television, FM, record reproduction, portable radio and refrigeration were presented by the firm to 1,000 retailers of the New York and New Jersey areas last month at the Waldorf-Astoria

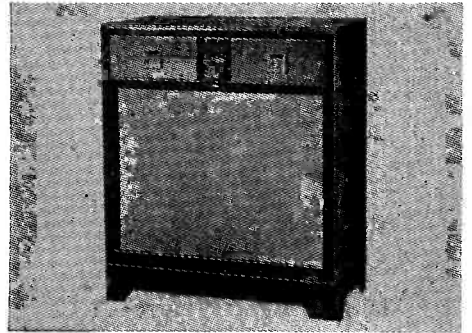

Philco's new Model 1260 console radio-phonograph with the slide-in record player. The unit is \$129.95 in mahogany or \$134.95 for blonde.

Hotel in New York City. It was a local showing following the big debut of Philco lines at Atlantic City.

On the program were the Philco executives James H. Carmine, Thomas A. Kennally, Larry F. Hardy, Hal Sheer and John M. Otter.

The featured merchandise included the projection television Model 2500 with the picture 15" by 20"; twelve models with FM; the electronic "scratch eliminator"; a new portable set; and the new refrigerator with the "Summer-Winter" control device.

Says Dealer Should Prefer Buyer's Market

The appliance merchandiser should look forward to a great and profitable business immediately ahead, according to the view taken by Paul B. Zimmerman, the well known merchandising expert who is executive vice-president of Monitor Equipment Corp., Riverdale, N. Y.

Mr. Zimmerman gave five reasons for this outlook:

1. More homes have more income than ever before in history.
2. The American home likes mechanical appliances and will not give them up.
3. The home is less than half mechanized so we have a market equal to all past sales with old customers.
4. We must build and equip nearly a million new homes each year.
5. The housewife also wants a forty-hour week and must look to mechanical servants to obtain it.

"The electrical dealer and his salesman have made a great contribution to the higher standard of living in the average home by the missionary work he has accomplished at the doorstep. Through the salesman's creative work, new-found luxuries have become a necessary servant in most homes, but even now the art is too new to leave the marketing entirely to the chain or non-electrical store which does not specialize on after-service.

"The American home is beginning to

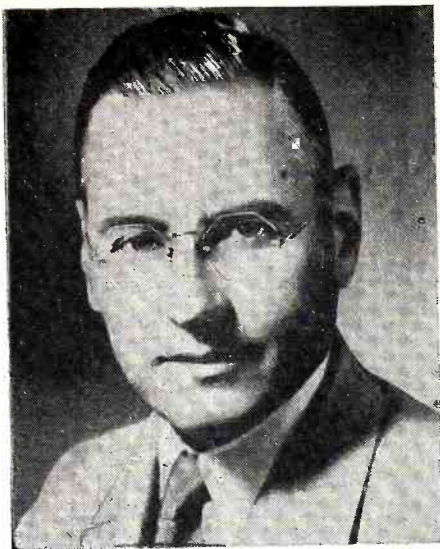

Paul B. Zimmerman

find that it needs two things in buying appliances. First, a good product and second, a nearby after-service. As we add motors, automatic controls, etc., the man of the home is no longer sufficient for service. Neighborhood service will become as important for appliances as it is for motor cars.

"The community electrical dealer has immediately ahead of him his one great opportunity, if he will first sell a good product and second and just as important, sell himself as a specialist on the proper use and after-service of the product. The home needs information and advice on all new mechanical products and will generally buy from the neighborhood dealer if he is first to describe a new product. With the first major product installed, the community merchant has the first opportunity to aid the home in selecting additional appliances.

"We are entering a buyer's market. The public wants to quit its unnatural position of seeking to buy at a premium, and to be sold in the old and new fashioned way, namely, to have a salesman smilingly take a great interest in its problems, understand these and show how best to supply their needs.

The electrical dealer and salesman is again challenged to take first place in selling better and happier living in the home.

Fair Trade Rules Are Emphasized by Proctor

The Proctor Electric Co., has re-emphasized and amplified its Fair Trade notice to its distributors and retailers in a new price sheet in which a new product, the Proctor Roast-Or-Grille, is also announced.

The notice says that "Resale prices on these goods are fixed by agreement under applicable Fair Trade Acts, and hence such resale prices must be observed by law—Under our Fair Trade Policy, shop-worn or damaged merchandise may not be sold at less than the fair trade retail price unless (a) it has first been offered to Proctor for purchase at the price paid for the merchandise by the retailer, and (b) unless it is offered and sold to the public as such shop-worn or damaged merchandise."

Drive to Sell More Millions of Sets

The Radio Manufacturers Association has revealed details of its big merchandising campaign to increase the general sale of sets.

This drive will further the industry's aim for radio for every room and every purpose, and will achieve that objective with an approach acceptable to the consumer. The basic theme will be a radio for every member of the family—radio as an individual possession.

The theme will be expressed to consumers in advertising and in newspaper and magazine publicity. Films, promotional material, point-of-sale pieces, etc., are all included in the program designed to give every help in selling more radios.

Specifically, the program aims to: (1) Maintain the present or normal demand, (2) Expand this demand and thus develop new markets, (3) Obsolete radios, and (4) Minimize the problem of trade-ins.

Admiral Corp. Opens Another New Factory

A new assembly plant at Harvard, Ill., 80 miles northwest of Chicago, has been opened by Admiral Corp., to handle much of the production of the firm's small sets. At the opening ceremony, Admiral vice-president R. A. Graver presented the first set off the line to J. L. McCabe, mayor of Harvard.

Admiral also has two main plants and a cabinet factory at Harvard, and recently acquired another cabinet plant at Shelbyville, Ind.

MASCO Brings You NEW BUSINESS on a SILVER PLATTER



MASCO'S De Luxe Portable 16 in. Transcription Player with Built-in 5 Watt Amplifier Enjoys a Ready-Made Market

Recording studios, broadcasting stations, schools, theatrical and advertising agencies and others who "sell" professional and radio entertainment are natural customers for Masco's De Luxe 16 in. Professional Transcription Player.

"One of the finest portable transcription players ever made," state outstanding factors in the industry who tested it.

List Price with tubes \$134.50
West of Rockies add 5%

Contact your local Masco distributor for immediate delivery. For descriptive literature or other information write directly to factory, Dept. D.

It has everything required:

- Built-in high fidelity amplifier of wide range frequency response.
- Heavy duty 10" P.M. Alnico Y magnet speaker.
- Speaker mounted in removable cover of portable case which serves as an excellent baffle.
- Plays 16" and standard recordings. 12" turntable.
- Operates at either 78 or 33 1/3 rpm.
- Master gain control.
- New low pressure high fidelity astatic Q-T-M cartridge in No. 400 arm.
- Two input channels, for microphone and phonograph.
- Individual bass and treble equalizers, allowing for accurate tonal settings.

MASCO

MARK SIMPSON MANUFACTURING CO., Inc.
32-28 49th Street, Long Island City 3, N.Y.



SOUND SYSTEMS and Accessories

Ravenswood 8-5816-1-2-3-4

CAPACITORS and RESISTORS

JIFFY CHECKED

with the

AEROVOX MODEL 76 BRIDGE



DEALER'S NET
\$44.75

● A twist of the knob . . . the positive wink of the indicator eye . . . a glance at the big, easy-to-read dial through the precision pointer . . . another glance at the multiplier switch—and you've got your capacitance or resistance reading. Power factor and leakage readings also available with equal simplicity. Checks for shorts and opens. It's all done in a jiffy—yet with real accuracy. That's what you get in the Aerovox Model 76 Capacitance-Resistance Bridge just emerged from the Aerovox Engineering Laboratory in response to the demand for a simple, accurate, moderate-priced instrument for use in service shop, laboratory, or out in the field. You just can't afford to get along without it in this fast-moving postwar era!

● ● ● ● ●
Ask your Aerovox distributor or write us for the "Jiffy Checking" descriptive bulletin. Have your distributor show you this instrument and try it for yourself. You'll want to take one with you!



**FOR RADIO-ELECTRONIC AND
INDUSTRIAL APPLICATIONS**

AEROVOX CORP., NEW BEDFORD, MASS., U.S.A.
Export: 13 E. 40th St., New York 16, N.Y. • Cable: 'ARLAB'
In Canada: AEROVOX CANADA LTD., Hamilton, Ont.

TV MERCHANDISING NEWS

Television Sets in Use, 50,000

Manufacturers' figures on production and sale of television sets indicate that as of July 1, 50,000 TV sets were in use in U. S. (38,000 built since Jan. 1, 1947; 6,000 built in 1946; 6,000 to 8,000 pre-war sets).

Following is basis of distribution of sets now coming off production line:

	Per Cent
New York	38.0
Newark	12.0
Philadelphia	13.0
Albany-Schenectady	2.6
Chicago	13.0
Los Angeles	9.0
Detroit	6.6
St. Louis	3.2
Hartford & Southern Conn.	1.5
Washington	.6
Baltimore	.5

Following is an estimate of sets in use July 1, by areas:

New York-Newark-Conn.	30,000
Chicago	6,500
Philadelphia	5,000
Los Angeles	2,500
Washington	1,000
Detroit	600
Schenectady	600
St. Louis	500

RMA figures show that 8,000 to 10,000 TV sets are now being produced monthly (this monthly output may reach 20,000 to 25,000 by the end of year).

TV Sales Manager

The naming of Edwin B. Hinck as sales manager of Industrial Television, Inc., 36 Franklin Ave., Nutley 10, N. J., has been announced by Horace Atwood,

Jr., president. Mr. Hinck was formerly with the transmitter sales department of Allen B. DuMont Laboratories, Inc.

Industrial is manufacturing large, direct-vision, remotely controlled television receivers suitable for installation in taverns, clubs, hotels, and lodges. In addition to the feature of remote control, it is possible to employ many viewing screens with one control unit.

Mr. Hinck's advertising and promotion duties will include the appointing of dealers.

Video Market Estimated at Twenty-five Million

Television is now reaching regions in which nearly 25,000,000 people live in eight metropolitan markets, Dan Halpin, RCA Victor television receiver sales manager, told members of the Electric Institute in an address in Washington. He estimated that by 1948, television broadcast service will be extended to cover the area in which 10,000,000 additional people live. The stations going on the air between 1948 and mid-1949 will bring television service to, conservatively, 15 additional cities, he added.

Oak Ridge Cuts Prices

Leon G. Friedman, general manager of the Oak Ridge Antenna Co., 717 Second Ave., New York, N. Y., has announced a series of price cuts ranging from ten to twenty per cent on all television and FM antennas. He said that the prices had been slashed in line with President Truman's appeal.

Oak Ridge has recently added to its line of all-aluminum antennas, the DDR-3 model—a double dipole with double reflectors antenna. The company is also marketing an all-aluminum wall mount which is priced under \$1.50.

Master Antenna System for Urban TV

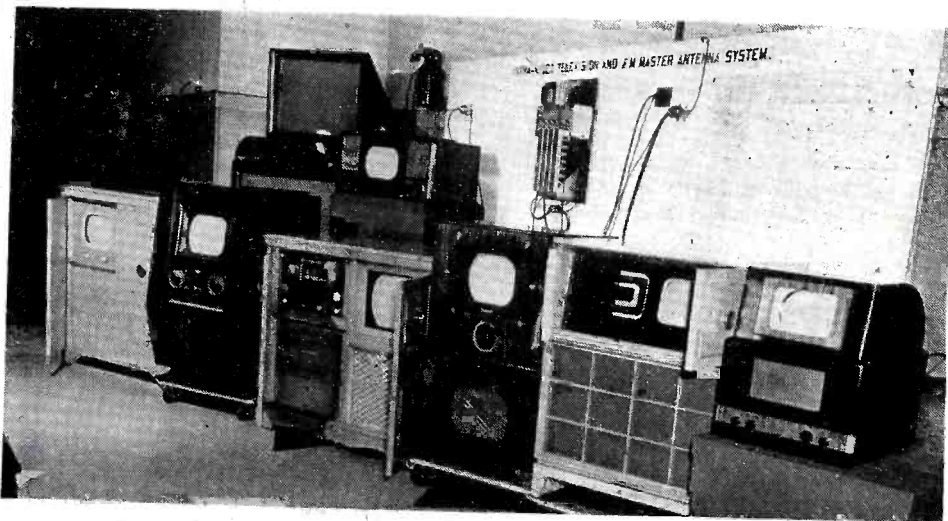

These eight TV sets are hooked to the new Intra-Video antenna system for multiple dwellings shown by Telicon Laboratories, 851 Madison Ave., NYC. This master aerial handles any number of sets, requiring but one master for each TV station. Front row sets are, left to right, United States Television; two by Dumont; Remington; Stewart-Warner; and Viewtone. Telicon and RCA are in back row. Philco was included but is not shown here.

Philco Projection TV Set

Wide interest among television people has been aroused by Philco's new projection model 2500 with its "dark background" picture, 15 by 20 inches, achiev-



Philco's Model 2500 projects picture from the front, upon special high-gain Micro-Lens screen.

ing an image brilliance some four times that of earlier projection sets.

A diagrammatic sketch of the arrangement of the 4-inch tube, Schmidt lens, reflecting mirror, and inclined specular ("micro-lens") screen, was shown in the March issue of this magazine, page 68.

Production models have now been demonstrated before audiences in several cities, confirming earlier claims that the large bright picture is clearly visible in daylight or in a lighted room. The 2500 is priced at \$795 plus excise tax of \$1.41 plus installation-warranty charge of \$85.

Norge Adjusts Refrigerator Prices

Increases in costs of materials and wages have forced the Norge division of Borg-Warner Corp. to raise prices "to a moderate extent" on four models of refrigerators, according to Howard E. Blood, president of the division. The average retail price increase for the entire line will amount to less than 2½ per cent. The refrigerator models affected are in the lower price range; increases amount to from \$10 to \$20 on four models.

Album Mfr. Seeks Rep

A manufacturers representative to call on dealers and distributors is sought by the L. H. Symons Associates, 345 Hudson St., New York, N. Y. He will handle an exclusive line of blank record albums, photo albums and scrap books in all territories.

Speaker Prices Down

Altec Lansing Corp., 250 W. 57th St., New York 19, N. Y., has announced substantial reduction in net prices on its Duplex and Dia-cone line of loudspeakers. The cut was effective July 15th.

LOOK to WARD

Ward FM antennas stand head and shoulders above the field for value. Available in straight or folded dipole types (with or without reflector kit), they adapt easily to varying individual requirements. Providing the maximum electrical efficiency needed for finest FM reception, they are easy to install securely. Their trouble-free operation assures you extra profits. Write for free catalog today.

for OUTSTANDING FM Antennas

WARD

THE WARD PRODUCTS CORPORATION
1523 EAST 45th STREET, CLEVELAND 3, OHIO

Aerials

EXPORT DEPARTMENT: C. W. Brandes, Manager, 4900 Euclid Ave., Cleveland 3, Ohio
IN CANADA: Atlas Radio Corp., 560 King Street W., Toronto 1, Ontario, Canada

MORE, BETTER JOBS PER DOLLAR.

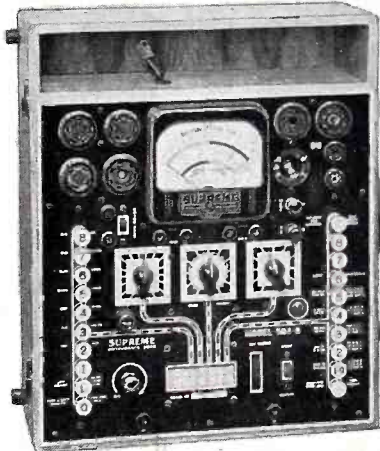

SUPREME 504-B TUBE AND SET TESTER—

the portable lab that gives you everything.

ASK YOUR SUPREME
JOBBER FOR A FREE
DEMONSTRATION

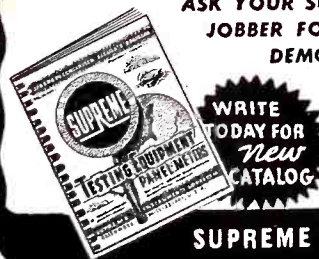

WRITE
TODAY FOR
New
CATALOG

HERE'S WHY AND HOW

- METER—large 4-inch square-face meter, 500 microampere.
- SPEED—push-button operated.
- FLEXIBLE—simple, yet Universal Floating Filaments feature insures against obsolescence.
- SIMPLICITY—roll chart carries full data for tube setting. No roaming test leads when using multi-meter—only push a button.

SPECIFICATIONS

DC VOLTS—1000 Ohms per volt: 0-5-25
100-250-500-1000-2500.
AC VOLTS—0-5-10-50-250-1000.
OUTPUT VOLTS—0-5-10-50-250-1000.
OHMMETER—0-200-2000-20,000 Ohms,
0-2-20 Megohms.

Condenser Check:

Electrolytics checked on English reading scale at rated voltages of 25-50-100-200-250-300-450 volts.

Battery Test:

Check dry portable "A" and "B" batteries under load.

SUPREME

EXPORT DEPT.: The American Steel Export Co., Inc.
347 Madison Ave., New York 17, N. Y., U. S. A.

SUPREME INSTRUMENTS CORP., Greenwood, Miss., U. S. A.

CAPACITORS and RESISTORS

JIFFY CHECKED

with the

AEROVOX MODEL 76 BRIDGE



● A twist of the knob . . . the positive wink of the indicator eye . . . a glance at the big, easy-to-read dial through the precision pointer . . . another glance at the multiplier switch—and you've got your capacitance or resistance reading. Power factor and leakage readings also available with equal simplicity. Checks for shorts and opens. It's all done in a jiffy—yet with real accuracy. That's what you get in the Aerovox Model 76 Capacitance-Resistance Bridge just emerged from the Aerovox Engineering Laboratory in response to the demand for a simple, accurate, moderate-priced instrument for use in service shop, laboratory, or out in the field. You just can't afford to get along without it in this fast-moving postwar era!

Ask your Aerovox distributor or write us for the "Jiffy Checking" descriptive bulletin. Have your distributor show you this instrument and try it for yourself. You'll want to take one with you!



FOR RADIO - ELECTRONIC AND
INDUSTRIAL APPLICATIONS

AEROVOX CORP., NEW BEDFORD, MASS., U.S.A.
Export: 13 E. 40th St., New York 16, N.Y. • Cable: 'ARLAB'
In Canada: AEROVOX CANADA LTD., Hamilton, Ont.

TV MERCHANDISING NEWS

Television Sets in Use, 50,000

Manufacturers' figures on production and sale of television sets indicate that as of July 1, 50,000 TV sets were in use in U. S. (38,000 built since Jan. 1, 1947; 6,000 built in 1946; 6,000 to 8,000 pre-war sets).

Following is basis of distribution of sets now coming off production line:

	Per Cent
New York	38.0
Newark	12.0
Philadelphia	13.0
Albany-Schenectady	2.6
Chicago	13.0
Los Angeles	9.0
Detroit	6.6
St. Louis	3.2
Hartford & Southern Conn.	1.5
Washington	.6
Baltimore	.5

Following is an estimate of sets in use July 1, by areas:

New York-Newark-Conn.	30,000
Chicago	6,500
Philadelphia	5,000
Los Angeles	2,500
Washington	1,000
Detroit	600
Schenectady	600
St. Louis	500

RMA figures show that 8,000 to 10,000 TV sets are now being produced monthly (this monthly output may reach 20,000 to 25,000 by the end of year).

TV Sales Manager

The naming of Edwin B. Hinck as sales manager of Industrial Television, Inc., 36 Franklin Ave., Nutley 10, N. J., has been announced by Horace Atwood,

Jr., president. Mr. Hinck was formerly with the transmitter sales department of Allen B. DuMont Laboratories, Inc.

Industrial is manufacturing large, direct-vision, remotely controlled television receivers suitable for installation in taverns, clubs, hotels, and lodges. In addition to the feature of remote control, it is possible to employ many viewing screens with one control unit.

Mr. Hinck's advertising and promotion duties will include the appointing of dealers.

Video Market Estimated at Twenty-five Million

Television is now reaching regions in which nearly 25,000,000 people live in eight metropolitan markets, Dan Halpin, RCA Victor television receiver sales manager, told members of the Electric Institute in an address in Washington. He estimated that by 1948, television broadcast service will be extended to cover the area in which 10,000,000 additional people live. The stations going on the air between 1948 and mid-1949 will bring television service to, conservatively, 15 additional cities, he added.

Oak Ridge Cuts Prices

Leon G. Friedman, general manager of the Oak Ridge Antenna Co., 717 Second Ave., New York, N. Y., has announced a series of price cuts ranging from ten to twenty per cent on all television and FM antennas. He said that the prices had been slashed in line with President Truman's appeal.

Oak Ridge has recently added to its line of all-aluminum antennas, the DDR-3 model—a double dipole with double reflectors antenna. The company is also marketing an all-aluminum wall mount which is priced under \$1.50.

Master Antenna System for Urban TV

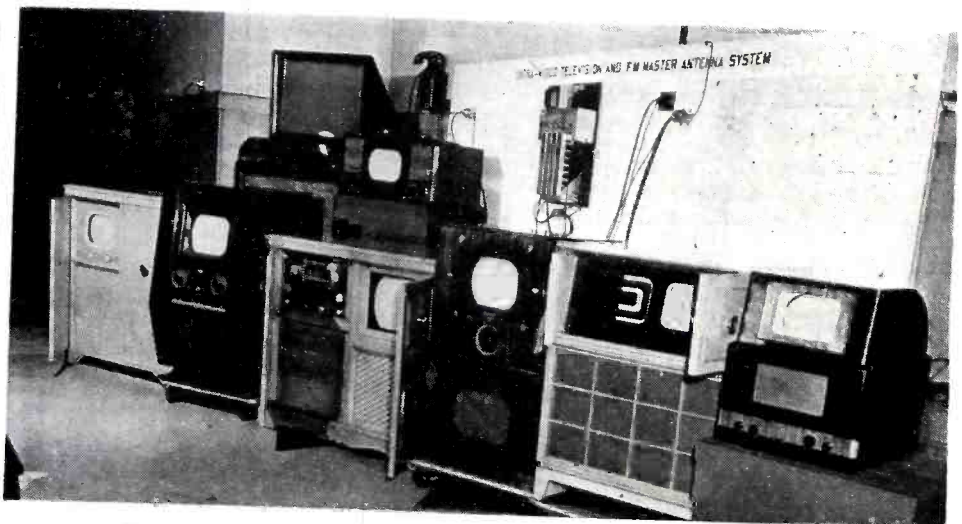

These eight TV sets are hooked to the new Intra-Video antenna system for multiple dwellings shown by Telicon Laboratories, 851 Madison Ave., NYC. This master aerial handles any number of sets, requiring but one master for each TV station. Front row sets are, left to right, United States Television; two by Dumont; Remington; Stewart-Warner; and Viewtone. Telicon and RCA are in back row. Philco was included but is not shown here.

Philco Projection TV Set

Wide interest among television people has been aroused by Philco's new projection model 2500 with its "dark background" picture, 15 by 20 inches, achiev-



Philco's Model 2500 projects picture from the front, upon special high-gain Micro-Lens screen.

ing an image brilliance some four times that of earlier projection sets.

A diagrammatic sketch of the arrangement of the 4-inch tube, Schmidt lens, reflecting mirror, and inclined specular ("micro-lens") screen, was shown in the March issue of this magazine, page 68.

Production models have now been demonstrated before audiences in several cities, confirming earlier claims that the large bright picture is clearly visible in daylight or in a lighted room. The 2500 is priced at \$795 plus excise tax of \$1.41 plus installation-warranty charge of \$85.

Norge Adjusts Refrigerator Prices

Increases in costs of materials and wages have forced the Norge division of Borg-Warner Corp. to raise prices "to a moderate extent" on four models of refrigerators, according to Howard E. Blood, president of the division. The average retail price increase for the entire line will amount to less than 2½ per cent. The refrigerator models affected are in the lower price range; increases amount to from \$10 to \$20 on four models.

Album Mfr. Seeks Rep

A manufacturers representative to call on dealers and distributors is sought by the L. H. Symons Associates, 345 Hudson St., New York, N. Y. He will handle an exclusive line of blank record albums, photo albums and scrap books in all territories.

Speaker Prices Down

Altec Lansing Corp., 250 W. 57th St., New York 19, N. Y., has announced substantial reduction in net prices on its Duplex and Dia-cone line of loudspeakers. The cut was effective July 15th.

LOOK to WARD

Ward FM antennas stand head and shoulders above the field for value. Available in straight or folded dipole types (with or without reflector kit), they adapt easily to varying individual requirements. Providing the maximum electrical efficiency needed for finest FM reception, they are easy to install securely. Their trouble-free operation assures you extra profits. Write for free catalog today.

for
**OUTSTANDING
FM
Antennas**

WARD

THE WARD PRODUCTS CORPORATION
1523 EAST 45th STREET, CLEVELAND 3, OHIO

Aerials

EXPORT DEPARTMENT: C. W. Brandes, Manager, 4900 Euclid Ave., Cleveland 3, Ohio
IN CANADA: Atlas Radio Corp., 560 King Street W., Toronto 1, Ontario, Canada

MORE, BETTER JOBS PER DOLLAR.

**SUPREME 504-B TUBE
AND SET TESTER—**
the portable job that gives you everything.

HERE'S WHY AND HOW

- METER—large 4-inch square-face meter, 500 microampere.
- SPEED—push-button operated.
- FLEXIBLE—simple, yet Universal Floating Filaments feature insures against obsolescence.
- SIMPLICITY—roll chart carries full data for tube setting. No roaming test leads when using multi-meter—only push a button.

SPECIFICATIONS

DC VOLTS—1000 Ohms per volt: 0-5-25
100-250-500-1000-2500.
AC VOLTS—0-5-10-50-250-1000.
OUTPUT VOLTS—0-5-10-50-250-1000.
OHMMETER—0-200-2000-20,000 Ohms,
0-2-20 Megohms.

Condenser Check:
Electrolytics checked on English reading scale at rated voltages of 25-50-100-200-250-300-450 volts.

Battery Test:
Check dry portable "A" and "B" batteries under load.

**ASK YOUR SUPREME
JOBBER FOR A FREE
DEMONSTRATION**

WRITE
TODAY FOR
new
CATALOG

SUPREME

EXPORT DEPT.: The American Steel Export Co., Inc.
347 Madison Ave., New York 17, N. Y., U. S. A.

SUPREME INSTRUMENTS CORP., Greenwood, Miss., U. S. A.



ATLAS

The Seal of
Sound Supremacy



REENTRANT PROJECTORS



DRIVER UNITS



BOOSTER UNITS

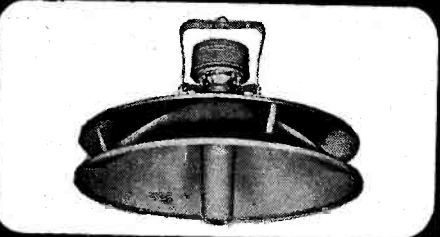

RADIAL PROJECTORS



"MIKE" STANDS

- Baffles
- Enclosures
- Desk Stands
- Speaker Stands
- Adaptors
- Wall Boxes
- Boom Stands

Write for illustrated catalog sheets

ATLAS SOUND CORPORATION

1451—39th Street, Brooklyn 18, N. Y.

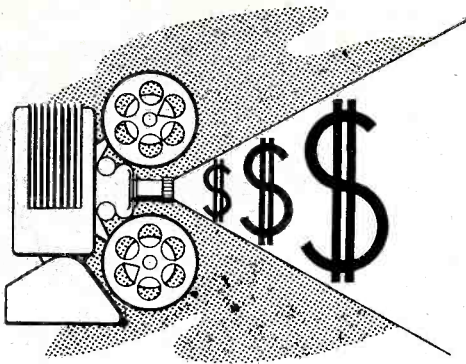

HOME MOVIE BUSINESS

There's a great new interest in home movies, and business in this field promises to go ahead rapidly. Numbers of dealers are setting their sights on large-volume goals, planning active participation in merchandising more cameras, projectors, movie films and accessories.

New and exciting things are happening in the home movie industry which are bound to be most appealing to the consumer. There's color, there's sound, and most significantly, there is a definite trend toward popular-priced sound projectors.

The dealer handling home movie equipment has more than entertainment to offer his customers, because the educational value of modern films is well known to all, and presents a first-rate sales argument in behalf of investment in equipment.

The dealer who has been handling movie and photographic equipment for some time has learned many things which have helped to steer him straight along a profitable merchandising course.

For instance, he has found out that such equipment cannot be properly sold if it is treated as a fill-in, or as a step-child line. If a merchant decides to sell home movie products he should also decide to consider such lines as important adjuncts to his business, and should then proceed to set up proper display and demonstrating facilities for selling them.

The demonstration angle is particularly important. A good projector sells for a worthwhile price, and will not be bought by a person who knows nothing about its features, even though the brand-name may be familiar to him.

What the projector will do for the customer's entertainment and enlightenment must be stressed by the salesman, and the prospective buyer must be shown to be convinced.

Salespeople who know little or

ANNOUNCING

... *New*
OHMITE
5-Watt
BROWN DEVIL
RESISTORS

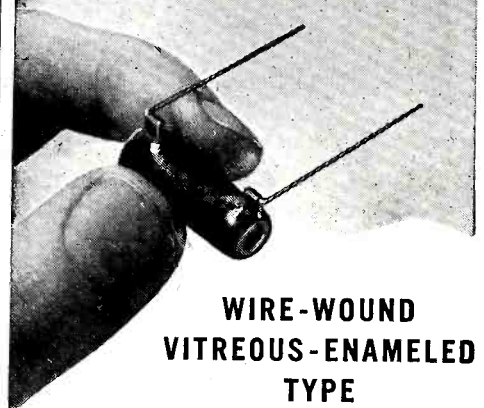

WIRE-WOUND
VITREOUS-ENAMELED
TYPE

Provide Utmost Dependability
in a New Small Size

Now you can get an Ohmite wire-wound vitreous-enameled resistor... of proved reliability... in the 5-watt size. This new resistor has the same rugged construction... the same unfailing dependability... as larger Ohmite industrial units. Yet it is small enough to fit practically any installation. Easily mounted by its 1½-inch, tinned copper-wire leads. Tolerance ± 10%. Available in a wide range of resistance values. Where you need a small resistor that you can install and forget—use this new Ohmite unit.

OHMITE MANUFACTURING CO.
4871 Flournoy Street Chicago, Illinois

NEW Ohm's Law Calculator

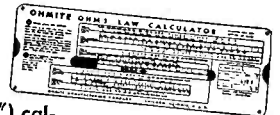

A new and improved handy pocket size (9" x 3") calculator. All computing scales are on one side. Shows RMA resistor color code. Mail 25c in coin for your copy.



Be Right with...

OHMITE

RHEOSTATS • RESISTORS • TAP SWITCHES

nothing about the operation and features of movie cameras, projectors, etc., should not be permitted to try to handle sales. Such uninformed personnel will find themselves utterly confused in trying to talk to hobbyists, with the latter losing all confidence in the store, and they will not be able to sell the layman either because they don't know enough about the subject to whet the layman's buying appetite.

However, selling movie, photographic and film equipment and accessories is not necessarily a complicated process. Any intelligent salesperson can learn to do a good job in a short time by operating the products, reading manufacturers' literature, plus learning the basic technical information.

The thing to remember is that every man, woman and child knows and loves movies. There is a world of interest at hand upon which the smart merchandiser can capitalize.

If the customer has the money to buy, for example, a good movie camera and a good projector, either sound or silent, he is more than likely to be a first-rate prospect. With the camera he can record valuable family pictures, scenes of memorable vacations, etc. With the projector, he can always revive pleasant memories, or can buy or rent films featuring sports, comedy, tragedy, travel, instruction, and numerous other subjects.

Customers Come Back

Customers who own, or have owned home movie equipment are always interested in seeing anything new the dealer has to offer, and, therefore, as soon as he gets something new in he should contact his prospect list via telephone or mail, inviting prospects to visit the store.

The majority of owners who have the more simple equipment will certainly be interested in projectors having smoother operation, less flicker, stop motion and back motion features, improved cooling methods, and new type lenses which provide more screen brightness. They will be interested in all of such features if the dealer presents such desirable qualities in an interest-intriguing fashion.

Many of those prospects who have never before owned movie equipment have seen "shows" in the homes of others. The desire to own is very strong in most of such persons. In-store demonstration can bring many newcomers into the ever-increasing ranks of home movie enthusiasts.

*Every Radio Serviceman
Needs This* **FREE**

AC-DC BALLAST TUBE MANUAL 68 PAGES



To get YOUR FREE COPY of this indispensable manual (value \$1.50) merely mail in to JFD Factory 12 flaps from JFD Radio Dial Belt envelopes; include 10¢ in postage to cover mailing cost. (Buy your JFD Dial Belts and Belt Kits from your nearest parts jobber.)

JFD's new 68-page Ballast Manual is a treasury of information for Radio Servicemen and Dealers — AND IT'S FREE! It lists more than 3000 radio ballasts — ACDC Ballasts for Fluorescent lights and electrical appliances — 220 volt to 110 volt Stepdown Ballasts.

Be sure to include 12 flaps from JFD Dial Belt Envelopes with your request for your copy of this valuable booklet.

Send 12 Envelope Flaps to:
J.F.D. MANUFACTURING CO. INC.
4109-4123 FORT HAMILTON PARKWAY, BROOKLYN 19, N. Y.

**ESTABLISH YOURSELF AS
INTER-COMMUNICATION
HEADQUARTERS**



Make sales hum! Profits soar! You most certainly can with Talk-A-Phone's latest business boosting Ad Mats . . . and they are yours *absolutely free*.

Send today for folder picturing these new Talk-A-Phone business go-getters. Put them to work for you . . . use them in ads, folders, catalogs. They are attractively illustrated . . . eye catching . . . loaded to the hilt with what it takes to attract volume trade . . . to establish *you as intercommunication* headquarters. Just say: "Send us folder of FREE Ad Mats." Address Dept. R T.



Talk-A-Phone Co.
1512 S. Pulaski Road Chicago 23, Ill.

Most Outstanding of All

FLEXIFONE

INTERCOMMUNICATION EQUIPMENT!

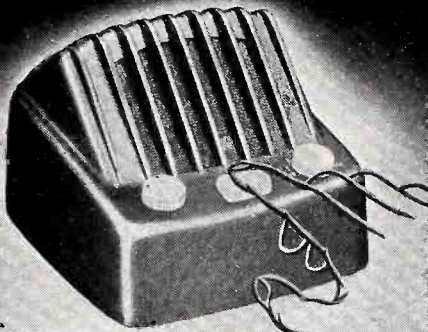

FLEXIFONE
6-STATION MASTER

*"Official" and
"Supervisor"
Models*

... THE LINE THAT GIVES YOU
SALES LEADERSHIP TODAY!

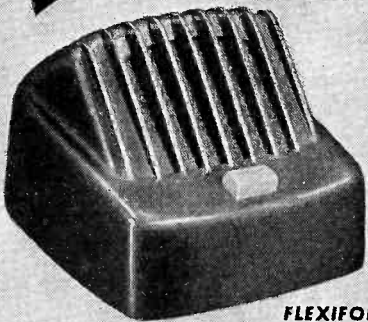

FLEXIFONE
SPEAKER STATION

**FLEXIFONE Models Are
Available Now!**

FLEXIFONE offers you two profit lines, Official and Supervisor Models for small, low-cost systems and Executive Models for large installations. FLEXIFONE's smart new styling, quality construction, and free sales helps mean new business for you! . . . Investigate FLEXIFONE today!

★ **NATIONALLY ADVERTISED** in TIME, FORTUNE, U. S. NEWS, BUSINESS WEEK, MODERN INDUSTRY, AMERICAN BUSINESS and other best-read magazines.

**OPERADIO MFG. CO., DEPT. RTR-13
ST. CHARLES, ILL.**

Gentlemen:
Please send us the profit story on
FLEXIFONE Executive and Supervisor
intercommunication systems.

Name _____
Address _____ State _____
City _____

OPERADIO

FLEXIFONE

INTERCOMMUNICATION SYSTEMS

Winning Window

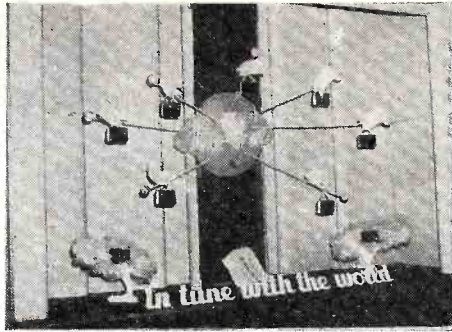

First prize in Tele-tone's window display contest among U. S. dealers was this eye-catcher at William H. Block Co., Indianapolis. Block used the global trade mark with Dyna-Mite sets, won \$250. Second prize of \$100 went to Root Music Co., Battle Creek, Mich., and third award of \$50 to the Grimes store in Pittsburgh, Pa.

**New Members Added
to Reps Roster**

"The Representatives" are continuing their activities by frequent, live meetings by all chapters and addition of members by six of the chapters, according to Dave Tobias, the Reps' newsman.

The California chapter has added Dean A. Lewis, 65 Ninth St., San Francisco, Calif. The Los Angeles chapter reports the addition of Harold A. Kittleson, 623 Guaranty Bldg., Hollywood, Calif.; and Arthur W. Philo, 470 E. Orange Grove Ave., Pasadena, Calif., associate.

Other chapters report the addition of one member each: Buckeye chapter, Walter J. Brauer, 15631 Lakewood Ave., Lakewood, Ohio; Chicagoland chapter, Alek A. Gianaras, 3624 W. North St., Chicago, Ill.; New England chapter, Irving I. Kahn, 3324 Main St., Hartford, Conn.; and the Dixie chapter, V. Hutto, 255 Mathews Ave., N. E., Atlanta, Ga.

**Waldom Electronics
in Expansion**

It has been announced by Waldom Electronics, Inc., 911 N. Larrabee St., Chicago 10, Ill., that Jerome "Zim" Prince has joined the firm as an officer of the company in charge of sales and promotion of new products. Mr. Prince was for many years sales manager of Carron and until recently was sales manager for Utah.

Waldom manufactures a full line of replacement cones, and will shortly be ready to market universal field coil replacements. The firm uses Hawley diaphragms in its products.

A complete catalog of Waldom parts is now being issued, containing all of the company's latest listings.

Vibrator Inverter Price

The model 2115 vibrator inverter which was described among "New Lines" on page 58 of the June issue of RADIO & Television RETAILING, was incorrectly priced at \$39.95. The correct price for the unit, which is made by Electronic Laboratories, Inc., 24 W. 24th St., Indianapolis, Ind., is \$59.95.

**MORE JOBS
NO HEADACHES
MORE MONEY**

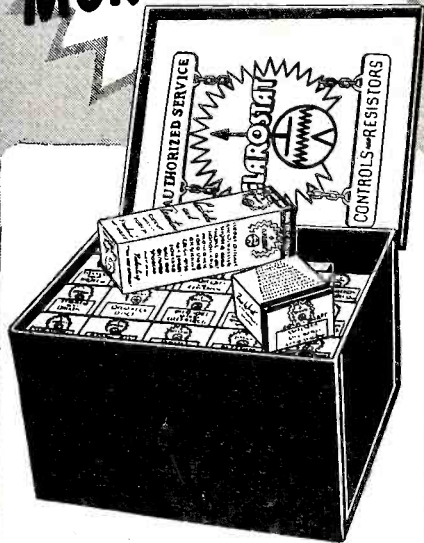

**CLAROSTAT
KIT NO. 4**

★ Hundreds upon hundreds of volume control replacements were analyzed. And Clarostat arrived at the minimum number of types for the maximum number of standard set replacements. And this is it—the No. 4 Kit—servicing upwards of 95% of standard radios.

CONTENTS . . .

17 selected volume and tone controls of most popular ohmage and taps.

8 selected Ad-A-Switches. Both S.P. and D.P. types.

4 Glasohm (glass-insulated flexible resistors) for use in tight spots.

Plus Authorized Service plaque. Plus Volume Control Selector. Plus latest Clarostat catalog.

All packed in handsome steel cabinet—free of all advertising labels.

A total value of \$29.65 list, for only \$17.79, your net cost.

★ **Ask Your Jobber . . .**

Order this "special" today—before the supply runs out. At least ask for the latest Clarostat catalog listing widest choice of resistors, controls, and resistance devices. Or write us direct.



CLAROSTAT MFG. CO., Inc. - 285-7 N. 6th St., Brooklyn, N. Y.

RMA Increases Its Industry Services

Further action on promotional material for National Radio Week, to be celebrated Oct. 26-Nov. 1, has been taken by the Radio Manufacturers Association, so that both dealers and broadcasters will be well prepared for the event. An appropriation of \$20,000 for the material was made by the retiring RMA board of directors.

This was one of the steps taken at the recent RMA convention, which outlined greatly expanded industry services to be undertaken by the organization. New officers and directors, headed by Max F. Balcom as the new president, were also named by the group to guide the membership through these activities. Mr. Balcom succeeds R. C. Cosgrove, who concluded three years as RMA head.

Treasurer Leslie F. Muter was re-elected RMA treasurer for his thirteenth term. Dr. W. R. G. Baker was re-appointed director of the RMA engineering department and remains a member of the board of directors.

A special committee was appointed by President Balcom to set up the machinery by which a monthly panel survey of the movement and sale of radio sets can be made.

Chairman Galvin of the set division was appointed chairman of this committee, and the other members are Directors H. C. Bonfig, Larry F. Hardy and R. C. Sprague, the latter representing the parts manufacturers, and Frank W. Mansfield,



New RMA head, Max F. Balcom of Sylvania.

chairman of the industry statistics committee. The board appropriated \$10,000 to finance the activity.

R. E. Carlson, vice-president of Tung-Sol Lamp Works and W. J. Barkley, executive vice-president of the Collins Radio Co., were elected new vice-presidents.

The directors also re-elected three other vice-presidents: Paul V. Galvin, J. J. Kahn, and Allen Shoup. The four new RMA directors elected for three-year terms are H. L. Hoffman, Harry C. Sparks, E. N. Wendell and W. A. MacDonal.

Mr. Carlson succeeds Mr. Balcom as chairman of the tube division and F. D.

Wilson is the head of the amplifier and sound equipment division. The respective divisions re-elected Mr. Galvin as chairman of the set division, Mr. Kahn as chairman of the parts division and S. P. Taylor as chairman of the transmitter division.

Directors who were re-elected for three-year terms are—for the set division, E. Alschuler, G. M. Gardner, Joseph Gerl, Ray H. Manson and Harold C. Mattes; for the tube division, R. E. Carlson; for the transmitter division, H. J. Hoffman; for the parts division, Ernest Searing, Ray F. Sparrow and R. C. Sprague; for the amplifier and sound equipment division, Allen Shoup.

The RMA directors re-elected Bond Geddes, executive vice-president and secretary, and re-appointed John W. Van Allen, of Buffalo, N. Y., as general counsel. Chairman Kahn of the parts division was re-elected RMA representative on the board of the Radio Parts Show Corporation.

Former president Cosgrove will continue active in the RMA. In addition to being added to the finance committee, Mr. Cosgrove has been appointed by president Balcom as chairman of the RMA-NAB Committee for liaison with the National Association of Broadcasters on major industry problems. Mr. Cosgrove also has been added to the executive committee of the set division and to the committee for liaison with the FM Association. Director L. F. Hardy continues, by re-appointment, as chairman of the RMA-FMA Liaison Committee.



the Service line
of **CORDS and CORD SETS**
specified by top manufacturers of

LAMPS

RADIOS

IRONS

FANS

PORTABLE TOOLS

VACUUM CLEANERS

REFRIGERATORS

RANGES

HEATERS

WASHERS

MIXERS



A full line of Flexible Cords for the repair and service industry, obtainable through jobbers and distributors.

CORNISH WIRE CO., INC.
15 Park Row • New York City, 7

TELEVISION

Build it YOURSELF

... with Republic's new Kit

This is your chance to have a television set of your own—you can build it yourself, for half the cost of comparable sets now on the market. It is easy to assemble in a few hours, with this complete kit, engineered for simplicity of construction and quality of reception.

OUTSTANDING FEATURES

- "FM" sound
- High fidelity
- 20 tubes - pre-tested
- DC restorer
- 5 channel RF units. 3 tuned and wired.
- 3.5 megacycle band width.
- Permeability pre-tuned IF's
- 7" Brand picture tube
- Complete antenna, 60' lead-in
- Hardwood veneer front panel

See every big sports event! Large screen, will entertain 10 or more of your friends in your living-room. Hundreds of sets have been built successfully by novices—Order yours today!



FOR ONLY

\$165⁰⁰

FOB Dumont

Trade Inquiries Invited
\$35 Deposit on C.O.D.'s—Pressed Plywood Cabinet available, \$40 extra.

Republic Television, Inc.

DEPT. RR 1, DUMONT, NEW JERSEY

Ever Sit On A Gold Mine?



YOU can build a business of your own NOW — either part or full time—with TRADIO, the radio functionally designed for coin-operation in hotels, motels, stop-overs, hospitals, etc. Big earnings . . . Steady income . . . and no clock to punch unless you want to.

★ Only Small Investment Needed

Tradio has pioneered in this new and fast-growing industry. Get in on the ground floor and assure yourself of financial independence for life.

★ Tradio—Tried, Tested, Proven

Thousands of others all over the country have learned that "Tradio Pays While it Plays." Send for complete information today. Write to Dept. X-8.

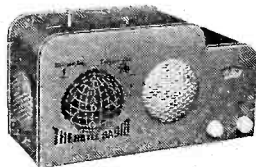

TRADIO, Inc. ASBURY PARK NEW JERSEY

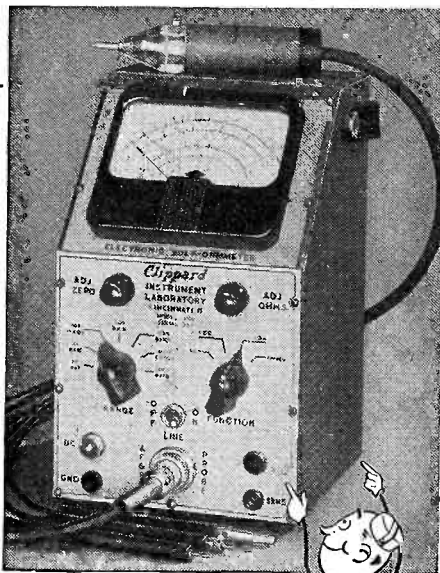

ACCURATELY TESTS ALL F.M. CIRCUITS

Clippard

Model 406 Electronic Volt-Ohmmeter

We invite comparison of this instrument with any at any price for appearance, ruggedness, accuracy, stability. 0-1 to 1,000 volts U. H. F., A. C., D. C., 0-1,000 megohms. Pen-type dual-diode A.C. probe. No extras to buy. Send for details or order today.

\$89.50
From Jobber or F. O. B. Cincinnati

CLIPPARD INSTRUMENT LAB., Inc.
1135 Bank St., Dept. 5 Cincinnati 14, Ohio

Farnsworth Sales Manager



Just appointed manager of the sales division of Farnsworth Television & Radio Corp., is E. J. (Joe) Hendrickson, succeeding E. H. McCarthy, retired because of ill health. Mr. Hendrickson has been in radio merchandising nearly 25 years.

Sales and Service

(Continued from page 41)

Two expert radio technicians are employed part time. Both are engineers at the local Station WMBD, who work for Arnold on their days off. Arnold also employs his son-in-law and daughter, Mr. and Mrs. Duane Brighton, in the bookkeeping and delivery departments.

All repairs are cash. Radios are sold on time and customers get their choice as to financing plans.

To get business, the Arnold concern depends chiefly upon a telephone book ad and word-of-mouth advertising from satisfied customers. Only a little newspaper advertising is done. About each sixty days, printed postal cards are mailed to the customer list to remind them of the Arnold service.

The large telephone book ad is in the classified section. It contains a picture of "Your radio as we see it" — the circuit diagram of a radio. The striking statement below the picture, "There are 363 reasons for failure of your radio," also commands attention. The ad has been very effective; numerous callers say they saw it in the telephone book. The part of the three-way card given to the customer has this same circuit illustration.

"We do not believe in promoting our own business by running down other outlets. We believe that by a sincere and honest effort to do our best and live up to our slogan, we will get the business of many who will eventually come to a real radio repair shop rather than to the corner drug store or gas station. There is as much sense in buying a radio at a place that cannot service it as to buy a set of teeth in a lumber yard."

You satisfy every
COMMERCIAL
and
INDUSTRIAL
SOUND NEED

with the
complete line of
BELL SOUND
EQUIPMENT

and at the same time

- Simplify Your Inventory
- Increase Stock Turnover
- Boost Your Profits



Ask your nearby Bell distributor for details

BELL SOUND SYSTEMS, INC.

1186 Essex Avenue
Columbus 3, Ohio

Dealers & Manufacturers

DOUBLE YOUR PROFITS

NEW RADIO TUBES

80,000-1619 @ 22c ea. 900-954@ 70c ea.
4,000-1625 @ 22c ea. 500-VR90 ...@ 26c ea.
300-1624 @ 22c ea. 300-12SJ7 ...@ 22c ea.

G.E. Neon Glow Lamps, 1/4 watt, 125 V., T4 1/2 clear D.C. base. \$2.50 C
G.E. Handlantern, 2.6V. G8 bulb .8amp D.C. Base 2.50 C
5 Ft. Jaek Cords with PL55 & JK26 on ea.\$30.00 C
T-17D Hand Mikes with switch PL-68 Plug \$2.50 ea.
BC-606-D interphone control box.\$50.00 C
CD 604-6" cord with transformer 300 ohm X 3000 Ohm.\$15.00 C
30 Ft. coils 8 conductor rubber covered shielded\$25.00 C
5 Ft. Lengths 10 cond. shielded cable rubber cov.\$17.50 C
Teletype tool sets 39 items #81124.\$300.00 C
Jewel Lights with #47 Bulb Red Diamond Cut\$15.00 C
Little Fuse Kit—One Double Mounting 3 Fuses 2 clips.\$12.00 C
Telephone Jacks JK24.\$15.00 C
Acro Switches #R07-8586.\$10.00 C
Counterpoise Reel Assemblies 4 Ply x 100' long on 16 M.M. Reel.\$50.00 C

All items subject to prior sale.

FINK & OLSWANG

27 S. Desplaines St., Chicago 6, Ill.
RANdolph 2338

SPECIALS FOR AUGUST

FIREPROOF HOOK-UP WIRE

22 Ga. stranded wire. Pliofilm, asbestos and glass insulation. Available in various tracer colors. Special for a limited time only.

100 Ft. Coil\$0.42
1000 Ft. Spool 3.75

TWISTED PAIR WIRE

22 Ga. solid wire with plastic and lacquered cotton insulation. Ideal for intercom and burglar alarm installation, and many other uses. An exceptional value.

100 Ft. Coil\$0.59
1000 Ft. Spool 5.50

PLASTIC TUBING ASSORTMENT

100 ft. assortment of various sizes of plastic insulating sleeving that could not be duplicated for many times this very low price.

Per Assortment\$0.33

We carry in stock for immediate delivery many types of wire and cable in gauges of from 23 to 2, in addition to various types of multi-conductor cable for many uses. We also manufacture cord sets and cables to specifications. Send us your inquiries for prompt attention.

Our new catalog is now ready for distribution. See your local jobber or write direct.

COLUMBIA WIRE & SUPPLY CO.

5734 ELSTON AVE., CHICAGO 30, ILLINOIS

THE OUTSTANDING FM TUNER OF THE YEAR

RESONANT LINES TUNED FRONT END — NO SLIDES, STABLE NON-MICROPHONIC NO IRON CORE SLUGS NO VARIABLE

\$5950
NET



SPECIFICATIONS

Power Supply: 117 volts, 60 cycles. Power Consumption: 35 watts. Circuit: Superheterodyne. Tuning Range: 88-108 Mc. Intermediate Frequency: 10.7 Mc (iron core tuned, ceramic insulation). Band Width: 150 KC. Sensitivity: 10 microvolts for full limiting. Frequency Drift: Negligible after 5 minutes. Output Volts: Average 2 volts RMS. Output Impedance: 500,000 Ohms. Hum Level: 70 DB below average output. 8 Tubes: 1—6AG5 RF Amplifier, 1—6J6 OSC., Mixer, Detector, 2—6SH7 I.F. Amplifiers, 1—6SH7 Limiter, 1—6AL5 Discriminator, 1—5Y4 Rectifier, 1—6G5 Indicator (Tuning Eye). Antenna: 300 Ohm line (Dipole). Chassis: No. 16 U.S.S.G. steel cadmium plated .0003. Weight: Approx. 15 lbs. (packed). Chassis Dimensions: 8x12x3x8 1/2". Dial: Slide rule. Dial Opening: 3x7 3/8. Pointer Travel: 6". Tuning Ratio: 16:1. Tuned Lincs: Brass, silver overlay .0005 thick. Contact Springs: Phosphor bronze, silver overlay, .0005 thick. Contact Arms: Lucite bars. Front End: Unit construction, floated. Cabinet: Walnut veneer, hand rubbed. Controls: Tuning, volume with "on/off" switch. Chassis, complete with tubes, built in power supply, installed in illustrated cabinet.

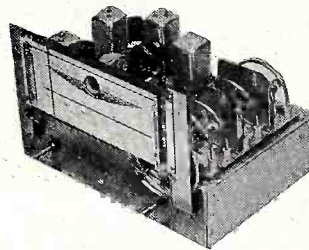

Dealers and Jobbers, Write or Phone for Full Particulars to:

APPROVED ELECTRONIC INST. CORP.

142 LIBERTY ST., NEW YORK 6, N. Y.

BARCLAY 7-9830

CABLE: FREQMOD

NEW HAVEN QUILT & PAD CO.'S PADDED COVERS ELIMINATE DAMAGE CLAIMS

Completely covers all standard floor models. Waterproof canvas outside, mole-skin lined. Send for catalog of all appliance covers.

RADIO COVERS

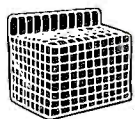

One-Piece Padded Range and Stove Covers

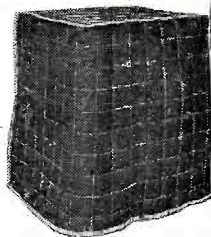

NEW HAVEN QUILT & PAD CO.
86-88 Franklin St., New Haven 11, Conn.

CLOSING DATES FOR

RADIO Television RETAILING

5th of preceding month for all ads requiring proofs, composition, foundry work, key changes, etc.
10th of preceding month for complete plates only—no setting.
1st of month—Publication Date.

Cancellations not accepted after 5th of preceding month.

CALDWELL-CLEMENTS, INC.
480 LEXINGTON AVENUE, NEW YORK 17

NOW! END WORRY... MESS... UNCERTAINTY OF STORAGE BATTERIES!

Enjoy

PERFECT Radio Reception When Servicing Car, Marine and Aircraft Radios!

NEW *Electro* ELECTRICAL AND RADIO EQUIPMENT

Model "A"
POWER SUPPLY

DC Output

Operates latest type auto radios with solenoid tuning and tone controls . . . also 12 volt marine and aircraft radios.

Height, 7 3/4"
Width, 7 3/4"

Length, 11 3/4"
Ship. Wt. 31 lbs.

Always dependable! Reserve power a-plenty! Big, heavy duty transformers and chokes — large capacity condensers, for exceptional voltage regulation — instantaneous power for solenoid operation. Two separately filtered DC output sources: in parallel supply 6V at 15 amps. series, 12V at 7 1/2 amps. Separately 6V at 7 1/2 amps. Compact. Sturdy. 18-gauge steel construction. Handsome blue Hammerloid finish. Comes completely equipped including 6' rubber cord and plug. Vastly superior and costs no more than batteries for equal service.

Send for complete description of this up-to-the-minute power supply.

ELECTRO PRODUCTS LABORATORIES

Pioneer Manufacturers of Battery Eliminators

549 West Randolph Street

Chicago 6, Illinois

Camco

FEATHER-LITE

TELEVISION and F. M. ANTENNAS

The requirements of superior Television and Frequency Modulation reception dictate a precisely designed and engineered antenna. Your receiver is no better than your antenna. The Camco "Feather-lite" Antenna gives you all the latest design features at low cost.

It is extremely simple to install, since it is pretuned at the factory. No length adjustment is required. It is cut to deliver optimum signal over the entire Frequency Range.

WRITE FOR DESCRIPTIVE LITERATURE

CAMBURN, INC.

32-40 57th ST., WOODSIDE, N. Y.

In CANADA—The ASTRAL ELECTRIC COMPANY, Scarborough Bluffs, Ontario

PERMEABILITY TUNERS

SUPERHETERODYNE TUNERS

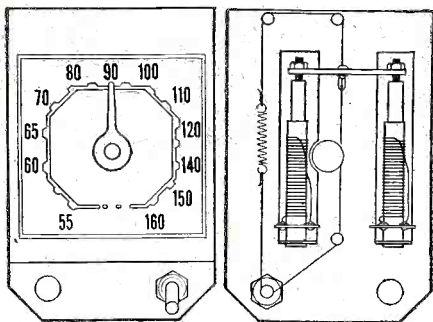

- 535 to 1660 KC Complete
- 3 Color Dial and Drive
- All units Pre-Tracked at Factory

ALSO NEW F.M. TUNER

AERMOTIVE EQUIPMENT CORP.

1632 Central St. Kansas City, Mo.
New York Office H. BRAVERMAN
161 Washington St. N. Y. 6, N. Y.

New Emerson

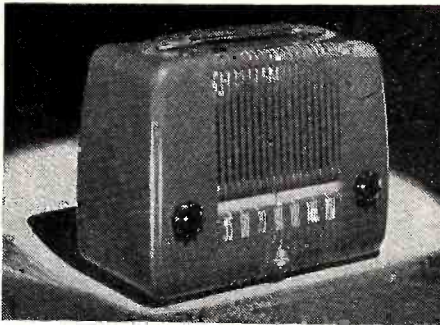

Emerson's new portable Model 560 priced at \$19.95 is one of a string of new models shown by the firm. Three more portables are included—No. 551-A is a 3-way, 5-tube superhet at \$49.95; No. 558 is the battery pocket unit at \$34.95; and No. 548 is the 3-tube automatic record player at \$59.95. There's also the ivory plastic table model (547-A) at \$19.95.

Working Papers

(Continued from page 73)

body no specialized approach to the problem of bringing clarity to what would ordinarily be a mass of unrelated pieces of paper because they involve the very simple formula:

- 1—Make the records by hand.
- 2—Make them for every transaction.
- 3—Control the basic functions of the business (receiving, selling, shipping).

A. V. Bice, general manager of Ohio Appliances, traces his grounding in the appliance field back to 1927, when he was sales manager for appliances with General Electric's Columbus distributor. In 1932 he took on the same activity in Cincinnati and in 1935 came back to Columbus as appliance manager until 1944.

Ray Strasburger, Ohio Appliance's Columbus manager's background in technical development of radio dates back to the late 20's when merchandising of appliances was still in its early stages. Ray had an opportunity to develop a natural inclination to radio along with a first rate sales career in several Ohio retail and wholesale organizations, including a period in his own business.

In addition to selling and merchandising radios and appliances, Strasburger has a distinguished army career during which he rose from the ranks of enlisted men to a full colonelcy, and won decorations in the recent war, including the Legion of Merit, Bronze Star, the Croix de Guerre with Palm, presented by General DeGaulle, and the Croix de Guerre with Star from General de Tassigny. During his entire Army career he was in close contact with radio as a communications officer.

Tom Mason in Cincinnati and Wayne Wright in Dayton handle Ohio Appliance's local offices in those cities.



Lubricant Phono Needle

Ne-O-Lite Tester—Spray Kits



G-C MASTER POINT PHONO NEEDLE

The "Concert Grand"—our finest needle; scratch-free reproduction, long-life, special metal tip, for use on automatic record players, No. 1436 List \$1.50 each

G-C PHONO TURNTABLE MOTOR & GEAR LUBRICANT

Special lubricant for phonographs; formulated so lubricant clings to surface of parts. Eliminates repair trouble. No. 1223—tube List 42c



G-C FELT-KOAT FLOCK FINISH SPRAY KITS

Easy to apply flock for refinishing turntables, cabinets, grilles, etc. Kit contains specially designed spray gun, 2 colors flock, undercoats, thinner, brush, instructions, etc. No. 180-2 List \$10.75

G-C NE-O-LITE TESTER

Handy, inexpensive, applicable for countless uses. For 60 V. A.C. to 500 V. A.C. or D.C. No. 5100-D—display of 20 #5100. List \$10.00

Write for the new G-C 147 and Hardware Catalog of over 4000 items

RADIO DIVISION DEPT. G

GENERAL CEMENT Mfg. Co., Rockford, Ill., U.S.A.
Manufacturers of over 3,000 products
Sales offices in principal cities

RADIO HARDWARE TREASURE. An indispensable assortment of approx. 1000 screws, nuts, lugs, washers, etc. 49

TUBE SPECIALS

Well-known brands in perfect condition, but not in sealed cartons. Most types in stock at up to 80% off list. All guaranteed 90 days.

#20, 26, 27, 46 or 5629
#42, 45, 75, 77, 78, 80, 89, 5Y3, 6H6 or 6K739
#35, 38, 37, 39, 84, 5Y4, 6A8, 6C5, 6D6, 6F5, 6J7, 6N7, 6U7, 6SA7, 6SK7, 12SA7, 12SK7, or 12SQ749
#1A7, 1H5, 1N5, 6A3, 6U5, 6X5, 7A7, 7C5, 7C6, 7Y4 or 5059
TUBE CARTONS: Plain white. GT size (1 1/4" sq.; 3 1/4" L.). Per 100	1.25
Medium size (1 1/2" sq.; 4 3/4" L.). Per 100	1.49
#47 Pilot Lamps (Mazda). Min. bay. 10 for58
Neon Glow Lamps (GE), 1/4 watt, D. C. bay. base. Clear bulb—23c ea. 10 for	1.95
9" McGuire Changer Pick-Up Arms (Astatic). Brown enam. finish. Less L-70 cartridge69
Grille Cloth. Gold or silver weave. Per sq. ft.20
Victor Power Transformer for models R-32, 45, 52 or 75. Unshielded	5.95

SERVICEMEN'S KITS

#2—Speaker Cones; 12 asstd. 4" to 12" moulded & free-edge (magnetic incl.). Less voice coils	2.00
#3—MOULDED BAKELITE CONDENSERS, 50 asstd., .00001 to .2 mfd., 200-600 WV. Clearly marked	2.95
#4—TUBULAR BY-PASS CONDENSERS, 50 asstd., .001 to .25 mfd., 200-600 WV. Standard brands	2.49
#6—Dial Scales; 25 asstd. airplane & slide-rule (acetate & glass included)	2.98
#7—Escutcheon Plates; 25 asstd. airplane, slide-rule & full-vision types	2.95
#17—Dial Windows; 12 asstd. including flat & moulded acetate & glass	1.29
#20—SPEAKER REPAIR KIT. A real time & money saver. Contains: 25 asstd. paper rings, 10 spiders, 25 asstd. voice coil forms, 3 yds. felt strips, 20 chamois leather segments, kit of 16 shims & tube of cement	2.49
#23—RADIO CEMENT & SOLVENT. 3 oz. each of all-purpose cement & thinner. With brush69
#26—SPEAKER CONE RINGS. 50 asstd. cardboard rings in popular sizes from 3" to 12"	1.49

PROMPT SERVICE ON ALL SPEAKER & PHONO PICK-UP REPAIRS
Minimum Order \$2.00—20% Deposit Required on All Orders. Please Add Sufficient Postage.

LEOTONE RADIO COMPANY
67 DEY STREET, NEW YORK 7, N. Y.

MONEY SAVING BARGAINS!

PARABOLIC REFLECTORS 15-inch spun Alum Alzak Fin. Ideal for 1200 Mc and up	\$ 3.95
KLYSTRON OSC. TUBE 2K25/723 AB. operates on 3 cm.	5.75
ALLWAVE TELEVISION and FM ANTENNA complete with mounting pole, guy wires and 300 ohm line lead-in, from 55 to 195 Meg	11.85
BATHTUB CONDENSERS—various capacities 100 assorted	5.00
PHONOGRAPH OSCILLATOR—with selenium rectifier	5.29
PHONOGRAPH AMPLIFIER 1 tube AC-DC with P. M. speaker	9.95
PHONOGRAPH AMPLIFIER 3 tube AC	12.95
CABINET to hold Phono Osc. and Record Changer	2.59
PORTABLE CARRYING CASE for Phonograph and Record Changer. Leatherette finish	7.95
RESISTORS 1/2 and 1 watt assorted 1000	14.95
assorted 500	7.95
assorted 100	1.89
CAPACITORS ELECTRO. 40-40 250 volts 6 for	1.95
VIBRATORS—7 prong 2 volt for GE portables	1.59
MICRO AMMETER—Beede 0-200 DC	3.29
MILLIAMMETER—Beede 0-1000 DC	3.95
METER RECTIFIERS Full Wave	.95
Half Wave	.65
WIRE-WOUND RESISTORS vitreous enameled 10 watt 1, 100, 40, 2000 and 25000 ohms 25 watt 12, 1000 and 5000 ohms per 100	6.50

WRITE FOR OUR BARGAIN CIRCULAR
AMERICAN SALES COMPANY
 1811 West 47th Street
 Chicago 9, Ill.

LAKE AMPLIFYING SYSTEM



Excellent designed, compact amplifiers, ideal for students, professional entertainers, homes, factories, schools, etc. Perfect for voice, musical instruments, pickups and contact microphones; clear, rich tone; heavy plywood in luxurious leatherette covered, stream-lined portable cabinets. As listed below:

No.	Watts	Inputs	List	Your Cost
A16	16	4	\$110.00	\$62.50
A15	15	3	97.50	52.86
A12	12	2	87.50	45.00
A 8	8	3	87.50	45.00
A 6	6	2	75.00	44.10
A 5	5	2	60.00	26.95

Hawaiian Electric Guitar

—Beautiful black plastic finish, trimmed with chrome. 23" scale, 4 1/2 octaves of playing range.
 List—\$50. Your Cost—**\$29.40**

SERVICEMEN and RETAILERS

Write today for our new, illustrated 16-page catalog NR-116. It's free. Get our mailing list! Write for our special catalog on microphones, amplifiers and sound equipment.

Lake Radio Sales Co.
 615 W. Randolph Street
 Dept. B
 Chicago 6, Ill.

INDEX To Advertisers

AUGUST, 1947

Admiral Corp.	47
Aermotive Equipment Corp.	122
Aerovox Corp.	114
Air King Radio Div. Hytron Radio & Electronics Corp.	3
American Magazine	50
American Sales Co.	123
American Telephone & Telegraph Co.	70
Approved Electronic Inst. Corp.	121
Atlas Sound Corp.	116
Bell Sound Systems, Inc.	120
Caldwell-Clements, Inc.	66
Camburn, Inc.	122
Chicago Tribune	10
Clarostat Mfg. Co., Inc.	118
Clippard Instrument Lab., Inc.	120
Columbia Records, Inc.	57
Cornish Wire Co., Inc.	119
Columbia Wire & Supply Co.	121
Crosley Div. Avco Mfg. Corp.	Insert
DuMont Laboratories, Inc., Allen B.	25
Duotone Co.	67
Dynamic Television Assoc., Inc.	112
Electro Products Laboratories	121
Fada Radio & Electric Co., Inc.	15
Farnsworth Television & Radio Corp.	12
Fink & Olswang	120
General Cement Mfg. Co.	122
General Electric Co.	11, 103, 112
General Industries Co.	66
Gibson Refrigerator Co.	83
Graybar Electric Co.	85
Howard Radio Co.	107
Hytron Radio & Electronics Corp.	13
Industrial Television, Inc.	109
International Resistance Co.	92
Jensen Mfg. Co.	16
J.F.D. Mfg. Co., Inc.	117
Ken-Rad Div. General Electric Co.	7
Lake Radio Sales Co.	123
Leotone Radio Co.	122
Maguire Industries, Inc.	6
Mallory & Co., Inc., P. R.	86, Cover 2
Merit Coil & Transformer Corp.	4
Monitor Equipment Corp.	68
Motorola, Inc.	24
National Carbon Co., Inc.	2
New Haven Quilt & Pad Co.	121
Norge Div., Borg-Warner Corp.	77
Ohmite Mfg. Co.	116
Olson Radio Warehouse	111
Operadio Mfg. Co.	118
Permo, Inc.	63
Philco Corp.	5
Plicote Inc.	79
Proctor Electric Co.	84
Quam-Nichols Co.	123
Radio Corp. of America:	
RCA Victor Div.	34, 35
RCA Victor Records	52
Test & Measuring Equipment	101
Tube Department	88, cover 4
Rauland Corp.	108
Raytheon Mfg. Co.	14
Record Shop	65
Republic Television, Inc.	119
Rider Publisher, Inc., John F.	97
Sams & Co., Inc., Howard W.	105
Seeburg Corp., J. P.	cover 3
Seeco Records, Inc.	64
Simpson Mfg. Co., Inc., Mark	113
Sonora Radio & Television Corp.	27
Sparks-Withington Co.	28
Sprague Products Co.	124
Standard Register Co.	81
Stewart-Warner Corp.	49
Stromberg-Carlson Co.	30, 110
Supreme Instruments Corp.	115
Sylvania Electric Products Inc.	98, 99
Talk-A-Phone Co.	117
Radio, Inc.	120
Triplett Electrical Instrument Co.	21
U. S. Television Mfg. Corp.	26
Vornish Wire Co., Inc.	119
Ward Products Corp.	115
Waters Conley Co.	61
Webster Chicago Corp.	59
Western Electric Co.	8, 9
Westinghouse Radio Corp.	22, 23
Wilcox-Gay Corp.	29
Zenith Radio Corp.	45

While every precaution is taken to insure accuracy, we cannot guarantee against the possibility of an occasional change or omission in the preparation of this index.

What

Adjust a Cone
 Means to **YOU**

The patented Adjust-A-Cone construction provides a method for precision centering of the voice coil in every Quam Speaker before it leaves the factory.

With ordinary speaker construction, such precision is almost impossible, even under the most ideal production methods, and, as a result, the slightest warping or expansion of the cone may produce a rubbing voice coil.

Rubbing voice coils, so frequent with speakers of conventional construction, are practically eliminated in Quam Speakers.

Always specify Quam Speakers for finest performance and long, trouble-free service.

Write for Catalog

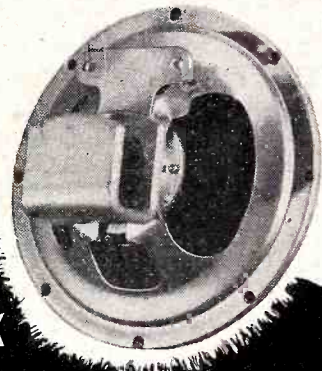

LOOK
 for the
 'U'-SHAPED COIL POT

QUAM

Adjust a Cone

SPEAKERS

QUAM-NICHOLS COMPANY

33rd Place and Cottage Grove
 Chicago 16, Illinois

SPRAGUE TRADING POST

SWAP - BUY OR SELL

FOR SALE—Hammerlund HQ-129R with speaker, \$155. New RCA 50-watt 90w. max., 11 tubes; 2 RCA reentrant baffles, 2 RCA 15w. units, 2 adjustable floor stands for speakers. R. M. Siegel, 306 James street, Syracuse 3, N. Y.

FOR SALE—Thordarson transformers—110 v.—60 cycles, plate supply 660-0-660, 990-0-990, 1075-0-1975; 435-0-435 h.v.—bias @ 80v and fila. at 1.5v CT (2) 2.5v CT, 5v & 6.3v CT. Tapped filament 6.3v CT—10v—7.5v—6.3v—5v. (1) 2.5v CT—(1) 5v CT (1) 7.5v CT filaments only. Sell or trade for Rider's or what have you? C. Moran, 3335 W. 23rd st., Chicago 23, Ill.

FOR SALE—Radio City products 705A signal generator 100kc to 25 mc. on fundamentals. Used only few times, \$40. V. Narvydas, 542 Lorimer st., Brooklyn 11, N. Y.

FOR SALE—Rider's manuals abridged 1 to 5 and 11. Also 450 Superior tube tester, nearly new. Hubert Singleton, Radio & Fix-It Shop, Albion, Ind.

TRADE OR SELL—DeForrest radio and television course and NRI radio course. Also have other technical books. Want a Sprayberry course. B. J. Cantwell, 293 String st., Concord, N. C.

FOR SALE—AC-DC 2-speed turntable, Audak D31E high-fidelity high-impedance pick-up and Audak recording cutter 8 ohm coil slightly used. Write for particulars. C. Vicario, 30 Sutton place, New York 22, N. Y.

FOR SALE—Radio sales and service shop. Complete stock, instruments, etc. Good location, lease and building. \$1250 plus flexible inventory. P. R. Cooper, 2015 Second ave., Los Angeles 22, Calif.

FOR SALE—Solar CE exometer; RCA 155-C scope; approved A-200 signal generator. All instruments used but in A-1 condition. Also new and used HO and TT gauge model railroad equipment for sale or swap. Ralph H. Ott, Box 21, Glen Mills, Pa.

TRADE OR SELL—50 even speed, 78 rpm phono motors and turntables, \$2.25 ea., or what have you? Dynamic Radio Laboratory, 489 Graham ave., Brooklyn 22, N. Y.

FOR SALE—Supreme 500 automatic tube tester and multimeter including a-cv., d-cv., d-c mills 0 to 1400 resistance 0 to 20 megs; output meter and capacitor checker. Also radio engineer's library like new. G. L. Humbarger, 622 W. Evans, Florence, S. C.

FOR SALE—Jackson condenser tester 650-A new, \$49. Tony Zimak, 1795 E. 63rd st., Cleveland 3, Ohio.

FOR SALE—Home-made superhet ACN dial, Millen coils, Hammerlund condensers with 4 tubes, power supply, speaker. \$35. Vernier drive, split loaded gears 72-1; good for VFO, \$4. Robert Malter, 1050 Bryn Mawr, Chicago 40, Ill.

SELL OR TRADE—General Electric GD 60 set, used. Morris Strygler, 622 Brighton Beach ave., Brooklyn, N. Y.

FOR SALE—Hickok #203 VTVM, used 3 months. RCP #804 tube and set tester, \$130 for both or \$65 ea. Henderson's Radio Service, 124 S. 15th st., Sebring, Ohio.



FREE! This Giant Sprague TEL-U-HOW WALL CHART

— from your Sprague Distributor

Ask your nearest Sprague jobber for your copy of the SPRAGUE TEL-U-HOW WALL CHART. Just the thing for hanging on the wall of your shop. Its professional appearance impresses customers. The material it contains will help you do jobs easier, better, faster.

Beautifully lithographed in colors, size 22" x 28", the chart includes handy service application data; diagrams and descriptions of common circuit troubles involving capacitors; general replacement data on electrolytics; formulas; transformer, resistor and capacitor color codes; schematic; and similar invaluable service information. Everything is arranged for quick, easy reference. Popular Sprague Capacitors and Koolohm Resistors are illustrated. Don't miss it!

FOR SALE—Signal generator E-200; condenser tester; tube tester; V.O.M.; Feller Signal Tracer; 80 tubes; 41 tubular condensers; 18 electrolytic condensers; 5 volume controls, kit of IRC Resistors, and 5 Supreme Manuals Worth \$400. Will sell for \$250. Willis J. Biltrey, 3071 North 20th st., Milwaukee, Wis.

FOR SALE—41 used radio tubes. Good filaments. Cheap if sold in one lot. William Elder, Jamestown, North Dakota.

FOR SALE—Radio repair equipment including instruments, complete stock of tubes, replacement parts for all types of radio, phonographs and appliances. Will sell as whole or in part. Joseph Jaffee, 146 Suffolk st., New York, N. Y.

SELL OR TRADE—G-E exposure meter DW-58 with leather case, instructions and G-E exposure data book, \$25. Want signal tracer and scope. John Reed, Reed Radio Repair, Mansfield, Mo.

FOR SALE—Vibroplex "original." De-Luxe finish, speed key, complete with cord and wedge. All parts chrome plated, \$19.50. Joe Confino—1759 West 2nd st., Brooklyn, N. Y.

SELL OR TRADE—Transmitting condensers, 2MF—1000 v., (2) 2MF—1500 v., (10) .5MF—2000 v. Oil filled in aluminum cans new. Also ¼ wt. neon glow lamps, screw base, 4 for \$1. Sell or trade for most anything of equal value. Albert H. Anderson, 605 S. Broadway, Scottsdale, Pa.

FOR SALE—Hammerlund Super Pro (BC-1004) .54 to 20 mc. new, in original carton. \$250. E. B. McIntyre, 2200 Forest Glen road, Silver Spring, Md.

SELL OR TRADE—5BPI & socket, 2X2A, GL-884 tubes; (1) 700V., C.T., 50Ma., 2.5v., 2 amp., 3 amp., 6.3v., 2 amp. Transformers; (1) 10H, 40 ma. filterchoke; 3 selector switches, (1) Dykanol A capacitor, 2000 D.C.V. Oil. 5 tube sockets, misc. For small 5 tube radio using AVC. Robert H. Seaver, Bristol, N. H.

FOR SALE—Several battery-operated radios complete with tubes. Excellent for experimenters. All in good working condition. Harry Matzko, New Auburn, Wis.

WILL TRADE—Hickok 210X jumbo 9-inch infinity ohm per voltmeter. Want tubes or signal generator. Write for details. E. Sujak—4209 Elston ave., Chicago 18, Ill.

FOR SALE OR SWAP—BC 654 transmitter receiver, A-1 condition, \$25. Partially complete B-C 375, less tubes, meters and tuning units, \$10. 10 meter xtal, \$4.50. Homemade receiver, used tubes, etc. Write, Frank H. Carlson, New London, Iowa.

WANTED—Instruction manual for Hickok signal generator DS-7. Write stating price. J. V. Hosford, Box 38, Monterey, Minn.

FOR SALE—2-meter converter to be used with any good communications receiver. \$19.50 net. Bruce Radio, 1171 Union st., Manchester, N. H.

SELL OR TRADE—Trela automatic record changer; R.T.A. home radio course; used volt and ampere meters (6); new and used radios (12). Also fly pole and new 22 automatic pistol. Want good condenser tester. Selfert Radio Service, Utica, Minn.

FOR SALE—Balance of stock, tubes, parts, crystal kits, etc., from our radio department. Dealer cost \$275. Will sell as lot or in part. High-Tor Radio Center, Haverstraw, N. Y.

SELL OR TRADE—Brewster frequency modulation tuner; giant 9" Jewell meter, 3½ ma; Readrite 710 set tester, \$5; Precision 832-S tester, wire recorder. Want, McElroy tape puller, model TP-890-742; Aerovox L-C checker. Stanley Roszewski, 22 Ellington ave., Rockville, Conn.

FOR SALE—Triplet signal generator #2432, \$83, and RCP Dynoptimum tube tester #322, \$43. Both brand new with instructions. Harno Kawamoto, Andrade Camp, Pepeekeo, Hawaii.

WILL TRADE—Mark II, \$78.50, 2-8 megacycles receiver-transmitter with hi-fidelity and intercom included. Never used. Want good signal tracer or condenser checker or what have you? Richard A. Schneider, 40-05 150 St., Flushing, Long Island, N. Y.

FOR SALE—QST complete from 1930 to 1935. Also Univex 8mm projector with carrying case A-1 condition; Univex camera 8mm with special lens, \$40. V. V. Vaught, 114 W. 19th Ave., Pine Bluff, Ark.

FOR SALE—Hallcrafters S40 used only one month. Turner 99 dynamic mike, two new 815 tubes. F. E. Nolkemper, 3206 A. Kossuth Ave., St. Louis 7, Mo.

FOR SALE—Radio News 1945-1946 and May to Sept., 1944, \$2.50. Also other radio books and Sams Photofact folders vol. 1. Four 24A tubes, \$3.20; one 6SQ7, \$1 and one 6L6, \$1.70. Dan and Ted's Radio Shop, 4355 S. Honore St., Chicago 8, Ill.

WANTED—1939 or later good used radio service books by Hicks, Simon, Moyer & Wostrel, Ghirardi, Rider and RCA Designers' Handbook. Also good used recent model National SW3, James Bezoft, 2732 Salina, Dearborn, Mich.

FOR SALE—Hallcrafters S-41C, less than year old, good condition, \$30. A. E. Arndt, 1716 East 67th St., Kansas City 5, Mo.

FOR SALE—Florida radio shop complete, modern. Wonderful location on Gulf of Mexico netting \$3,600 per year. Long lease. Write Gulf Radio Lab, Locker 666, Port St. Joe, Florida.

WILL SWAP—Westinghouse 2-speed battery charger, violin case, watch tools and movements, 4 Gerod \$1 phono needles. Want a tubeset tester combination in good condition. Victor D. Letourneau, Jr., 179 Main St., Holyoke, Mass.

FOR SALE—Model RAZ-1 all-steel low-frequency (15kc to 600 kc) Radio Marine radio set. Also antenna booster that can be converted to 110 volts operation. Bryan E. Sulz, Box 506, Beach, N. Dak.

FOR SALE—RCA Voltomyst Jr. in excellent condition, \$45; Philco beam changer, as is, \$10. All inquiries answered. George Greenberg, Radio & Television Service, 821 Porter St., Philadelphia 48, Pa.

WANTED—Rider manuals. State how many volumes and price on lot. M. Ocles, 4252 N. Marmora Ave., Chicago 34, Ill.

YOUR OWN AD RUN HERE FREE

The Sprague Trading Post is a free advertising service for the benefit of our radio friends. Providing only that it fits in with the spirit of this service, we'll gladly run your own ad in the first available issue of one of the six radio magazines in which this feature appears. Write CAREFULLY or print. Hold it to 40 words or less.

Confine it to radio subjects. Make sure your meaning is clear. No commercial advertising or the offering of merchandise to the highest bidder is acceptable. Sprague, of course, assumes no responsibility in connection with merchandise bought or sold through these columns or for the resulting transactions.

Send your ad to Dept. RRT-87

SPRAGUE PRODUCTS COMPANY, North Adams, Mass.

(Jobbing distributing organization for products of the SPRAGUE ELECTRIC COMPANY.)

ASK FOR SPRAGUE CAPACITORS and *KOOLOHM RESISTORS by name!

*Trademark Reg. U. S. Pat. Off.



More sales appeal

**... thanks to
a better changer**

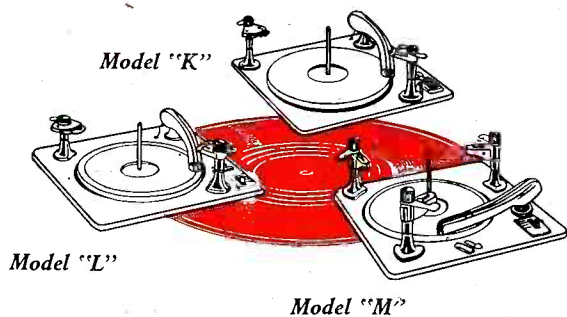

From symphony to swing . . . from classics to conga—records have never been more in demand. It's logical then that the record changer frequently influences the sale of a radio-phonograph combination. That's why so many leading radio manufacturers have made Seeburg Record Changers standard equipment on their fine combination instruments.

Seeburg makes three fine changers. While each is for sets of varying price range, all are engineered to provide simple, reliable, trouble-free performance . . . the last word in listening pleasure.

Plan now to build more sales appeal into your instruments by equipping them with Seeburg Changers. Seeburg's broad experience in the design and manufacture of all kinds of changing mechanisms is your guarantee of satisfaction.

Seeburg

RECORD CHANGERS ★ MUSIC SYSTEMS

J. P. SEEBURG CORPORATION
1500 N. Dayton St., Chicago 22

You're in the lead with RCA... *here's why*



Support... **RCA backs you up with the best in sales aids**



"Sally Service," the high-powered little saleslady up there on the desk, is typical of the dynamic promotional support you get with time-tested RCA sales aids.

This new full-color cutout and a whole new group of eye-catching posters and displays, apply powerful display techniques to the job of stopping, reminding *and* selling prospects. They are designed by merchandising experts to give your store more *sell* and more profit.

Ask your RCA Distributor to give you the new RCA Sales Aids Booklet. It describes all of the business boosters that are available to you.

The point-of-sale support of RCA sales aids, is one more powerful reason why *you're in the lead with RCA*. So, push RCA tubes and watch your business grow!

THE FOUNTAINHEAD OF MODERN TUBE DEVELOPMENT IS RCA



TUBE DEPARTMENT

RADIO CORPORATION of AMERICA

HARRISON, N. J.