

Established in 1922 as ELECTRICAL RETAILING

MAY 1946

# RADIO & Television RETAILING

Including Radio and Television Today

Including  
**ELECTRICAL  
APPLIANCES**  
Section

IN THIS ISSUE

MAY, 1946

**ORESTES H. CALDWELL**  
Editor

**M. CLEMENTS**  
Publisher

**JOHN L. STOUTENBURGH**  
Managing Editor

**STEPHEN I. HALL**  
Merchandising Editor

**DARRELL BARTEE**  
News Editor

**HELEN THURMAN**  
Associate Editor

**CHARLES F. DREYER**  
Art Director

Assistant Editors

**RUTH MORRIS**

**E. T. BENNETT**

BUSINESS DEPARTMENT

**LEE ROBINSON**  
Sales Manager

**M. H. NEWTON**  
Business Manager

**EDWIN WEISL, JR.**

**B. V. SPINETTA**  
Circulation Manager

**BEN MORRIS**  
Promotion Manager

**J. COSIN**      **B. HALL**  
Research      Production

Branch Offices

CHICAGO

**R. Y. FITZPATRICK**  
201 N. Wells St.  
RAN. 9225

CLEVELAND

Citizens Bldg., 850 Euclid Ave.  
MAin 8270

LOS ANGELES

**ROBERT W. WALKER**  
Walker & Minton  
405 W. 8th St.  
VAndyke 9348

SAN FRANCISCO

**ELI G. MINTON**  
Walker & Minton  
68 Post St.  
SUtter 5568

## ★ Radio, Television and Records

COVER: And Now to Deliver the Goods!

YOUR NEW OPPORTUNITIES IN A NEW AMERICA .....	35
RADIO, ELECTRICAL APPLIANCES, RECORDS, AND TELEVISION TODAY .....	36
DELIVERIES CAN BECOME AN ASSET .....	38
PLANNED LOCATION PAYS DEALER .....	40
ALL EYES ON 1946 CHICAGO SHOW .....	42
STORE DISPLAY DOES THE JOB .....	44
NEW MODELS READY FOR THAT WAITING MARKET .....	46
WHERE RADIO SERVICE GUIDES SALES .....	50
COLORADO STORE IS A GIANT SHOWCASE .....	52
CUSTOMERS LIKE TO BUY RECORDS HERE! .....	54
THE RECORD BOOM IS ON! .....	56
<b>DIRECTORY OF RADIO AND TELEVISION MANUFACTURERS</b> .....	<b>60</b>

## ★ Electrical Appliances

COVER: Mrs. America, In Your New Kitchen You Will Need  
These Conveniences

TRAIN TO UPGRADE SALES .....	63
SELF-SERVICE FOR DEMAND ITEMS .....	64
RADIO SERVICE BUILDS APPLIANCE SALES .....	66
LATEST ELECTRICAL APPLIANCE MODELS .....	68
HOW TO WRITE ADS THAT "PULL" .....	74
ELECTRICAL TOYS .....	78
<b>DIRECTORY OF ELECTRICAL APPLIANCE MANUFACTURERS</b> .....	<b>80</b>
SELLING THE NEW RADIO CABINETS .....	82

## ★ Service and Sound

EXPERT SERVICE STRESSED .....	87
CIRCUIT DATA FOR FOUR POPULAR NEW RADIO SETS .....	88
HUM-DINGERS NEED NOT BECOME TIME-WASTERS! .....	90
ADVICE ON TOUGH ALIGNMENTS .....	92
TIME-SAVING HINTS .....	94
SERVICE BRINGS SALES .....	50
SOUND RENTAL PROGRAM .....	96
NEW TECHNICAL PRODUCTS .....	98, 100
TELEVISION TODAY .....	112
DISTRIBUTORS IN ACTION .....	116
NEWS OF THE INDUSTRY .....	81-166



**27,000 COPIES  
THIS ISSUE**

CALDWELL-CLEMENTS, INC.—TEL.: PLAZA 3-1340—480 LEXINGTON AVE., NEW YORK

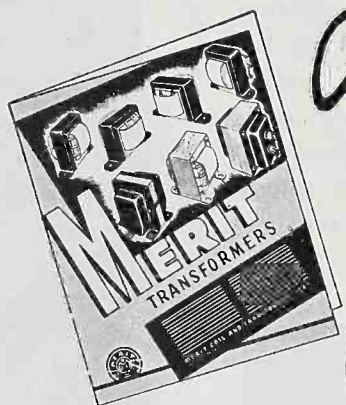

*Ask for  
Our  
New  
Catalog*

**BOOTH 52**  
**RADIO PARTS SHOW**  
Stevens Hotel — Chicago  
**MAY 13-16**



**MERIT COIL & TRANSFORMER CORP.**

TELEPHONE  
4427 North Clark St. Long Beach 6311 CHICAGO 40, ILL.

**A Statement from the  
Publishers on Long-Term  
Business**

How many radios can America absorb? Or, how many radios will you be able to sell?

In twenty-five years that radios have been produced and sold this nation has built up a total of some 60,000,000 sets in homes. This probably runs from a few of the old crystal sets (remember those ear-phones and catwhiskers?) to the ultra-modern radio-FM-phonograph and recorder combinations. They also include auto radios and portables.

Almost ninety percent of the 37,000,000-odd homes of the U.S. have radios. So we can occasionally wonder just how many more can be absorbed — your long-term prospects for selling merchandise. Rest assured that once sets begin to come off production lines, literally, the sky is the limit.

Your very big market is for replacement sets. The only possible saturation we can really see, however, is a radio in every room of every home, in every car, and a portable for each member of the family. Take 37,000,000 homes, multiply by 4.73, the median number of rooms per home, then add as many million auto radios as you think possible. Then, if you're not already feeling better, throw in several million portables.

Besides the new and replacement market, two additional sales opportunities present themselves. Only one half of one percent of the nation's radios have FM bands; its uses are increasing from mere static-free reception to the only means of overcoming previously insoluble man-made disturbances. And television offers such a virgin market that for long-term selling it is far larger than anything else.

The conditions which have beset us for the past five years have re-established the basic "health" of the trade. More than ever, it has re-emphasized the need of radio in this nation. Already we can report an upswing—slow yet, but definitely on the move—in radio production. In the months and years ahead, RADIO & Television RETAILING will continue to report and to help this industry make still greater contributions to our national comfort and well-being.

*The Publishers*

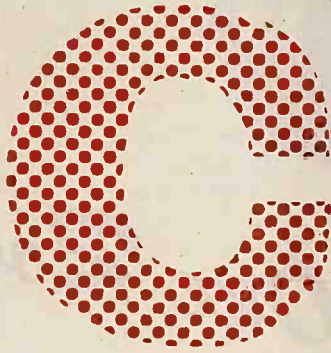

*apacitor*

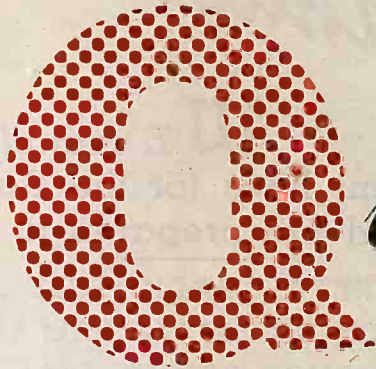

*uality...*

To Solar "CQ" means Capacitor Quality because Solar lives up to its famous by-word "Quality Above All" . . . by manufacturing every type of capacitor, from tiny tubulars to solder-sealed high-voltage oil papers, with uniform care and modern engineering skill.

To millions of users, Solar's "Quality Above All" Sealdtite wax-molded paper tubulars mean an ultra-neat, ultra-rugged, moisture-proof capacitor with a longer life expectancy than any other tubular on the market. Solar's "Minicap" cartridge dry electrolytics are famous among radio servicemen for their tiny size, excellent electrical characteristics and long life.

Thousands of radio service dealers have given Solar a well-merited reputation for a complete line of "Quality Above All" capacitors. "Sets repaired with Solar capacitors don't come back to the shop", they say, and that's why they stick to Solar for safety and satisfaction.

Why not join the thousands of service dealers and repairmen who have benefited by Solar's "Quality Above All" standards. Get in touch with your nearest Solar distributor today.

**SOLAR CAPACITOR SALES CORP.**  
285 Madison Avenue • New York, New York



**ELECTROLYTIC, PAPER AND MICA CAPACITORS**

Ⓢ 1075 X

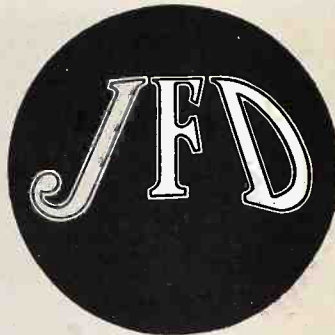
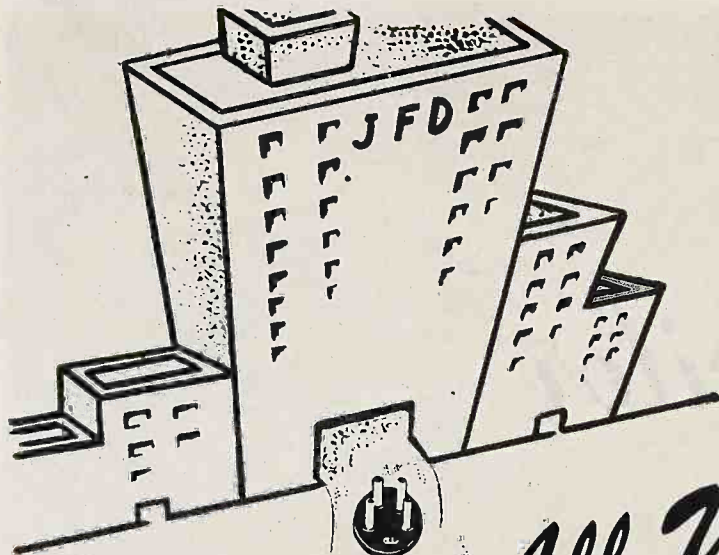

*All Under One Roof*



**W**E manufacture over 25 different lines for the Radio service trade and are prepared to ship

- JFD "SOCKETTE" RADIO TUBE ADAPTERS
- JFD EXACT DUPLICATE BALLAST TUBES
- JFD PHOSPHOR BRONZE DIAL CABLE
- JFD BATTERY ADAPTER HARNESSSES
- JFD ADJUSTABLE BALLAST TUBES
- JFD RESISTANCE CORD ADAPTERS
- JFD PHONO ADAPTER SWITCHES
- JFD MICROPHONE CONNECTORS
- JFD MIDGET JACKS & PLUGS
- JFD PHONOGRAPH NEEDLES
- JFD RESISTANCE CORDS
- JFD AC SERVICE CORDS
- JFD TOGGLE SWITCHES
- JFD AUTO CONDENSERS
- JFD SPEAKER CEMENT
- JFD ANTENNA LOOPS
- JFD AUTO ANTENNAS
- JFD BATTERY PLUGS
- JFD TUBE SHIELDS
- JFD RADIO WIRE
- JFD SUPPRESSORS
- JFD DIAL BELTS
- JFD DIAL CORD

WRITE FOR LITERATURE ON ANY OF THESE UNEXCELLED PRODUCTS

Serving the radio trade since 1929

**J.F.D. MANUFACTURING CO.** 4111 FT. HAMILTON PARKWAY  
BROOKLYN 19, N. Y.



**Like the tree you once shook for ripe apples . . .**

**A PROFIT-laden market  
awaits dealers who handle**



**RADIO TUBES**

**T**HE juicy winesaps in grandfather's sunny orchard were no finer or more plentiful than the profit opportunities from today's market for G-E radio tubes! Demand is the biggest in history. YOU, as a G-E dealer, can get the lion's share of this business, because you handle the brand which an overwhelming majority of radio owners know, respect, and will buy.

Magic of the G-E monogram, famous symbol of quality, draws purchase-dollars from a public already familiar with G-E lamps, fans, refrigerators,

irons and other appliances, as well as radios and tubes. Your market for tubes is *pre-sold* on the G-E brand! And tremendous national G-E electronics advertising — in magazines with 30,000,000 circulation — boosts the demand still higher! Write for information on tube selling rights to *Electronics Department, General Electric Company, Schenectady 5, N. Y.*

Every tube dealer and service man should have G.E.'s Tube Characteristics Booklet ETR-15. Send for your free copy today!



**GENERAL  ELECTRIC**

176-E3-8080

FIRST AND GREATEST NAME IN ELECTRONICS

**T**HORDARSON  
**M**EISSNER  
**R**ADIART

# QUALITY PRODUCTS-

FOR YOUR EXACTING  
 ELECTRONIC REQUIREMENTS

## ONE SALES SOURCE!

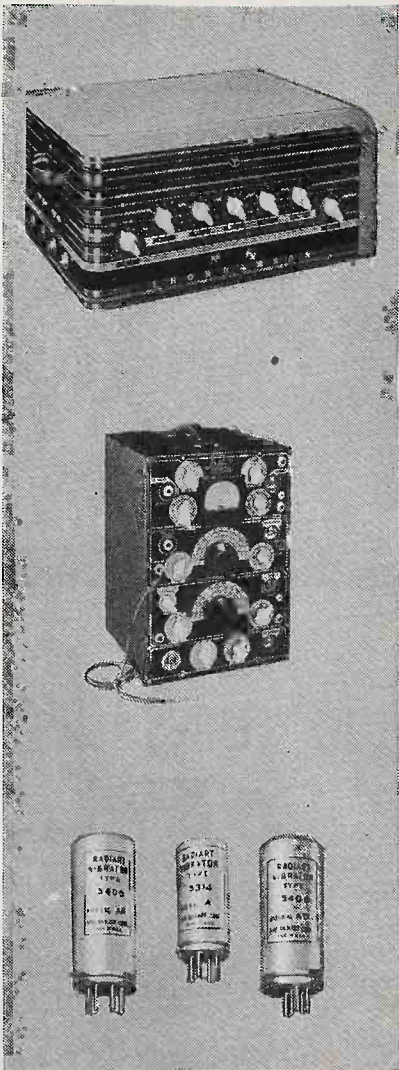

### THORDARSON

**TRU-FIDELITY AMPLIFIERS—TRANSFORMERS**  
*Transformers*—Backed by a fifty year reputation for quality design and highest precision manufacture... replacement, communications, sound amplifier, industrial, experimental and amateur. *Tru-Fidelity Amplifiers* feature extremely wide range advanced tone compensation, conservative ratings, ample ventilation, low hum level, maximum flexibility of controls, etc.

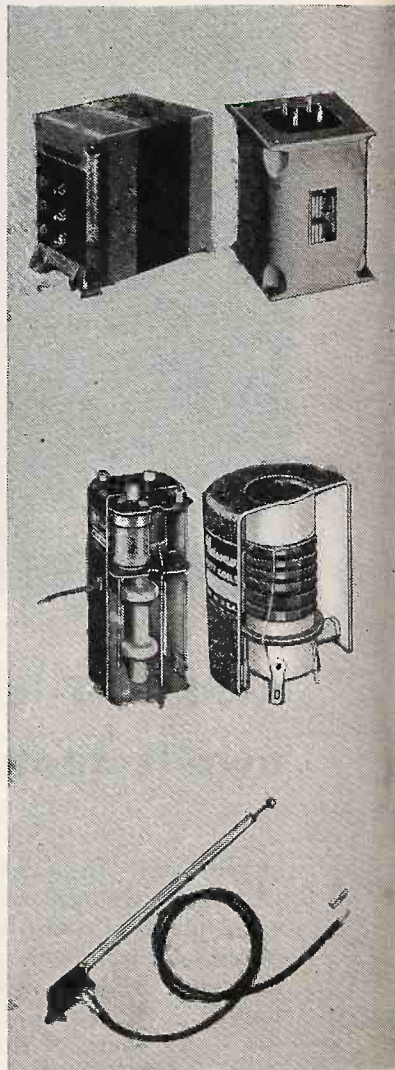

### MEISSNER

**MEISSNER COMPONENTS—SERVICE INSTRUMENTS**  
*Components*—Antenna, R.F. and oscillator coils; standard, plastic and Ferrocarril I.F. Transformers; windings, coils, chokes and accessories. *Service Instruments*—efficient, completely equipped, accurately calibrated, laboratory-tested... completely wired... aligned and ready to go to work.

### RADIART

**RADIART VIBRATORS, RUST-PROOF AERIALS**  
*Vibrators*—There is a correctly engineered Radiart Vibrator for every known make and model of auto radio... *Rust-Proof Aerials*, newly designed to fit all cars... cowl, hood and under hood types; precision-engineered for maximum performance and maximum life.

SEE OUR EXHIBIT AT THE RADIO PARTS SHOW (BOOTHS 81-94-153) HOTEL STEVENS, CHICAGO

**ELECTRONIC DISTRIBUTOR AND  
 INDUSTRIAL SALES DEPARTMENT**

**T**HORDARSON  
**M**EISSNER  
**R**ADIART

# QUALIFIED MEN-

TO GIVE YOU FASTER-BETTER-MORE-  
 COMPLETE SALES ENGINEERING SERVICE

# ONE SALES FORCE!

The combined quality products of the Thordarson and Meissner Divisions of Maguire Industries and the Radiart Corporation are now sold from a single source... by men qualified to render a new high in time-saving satisfactory service. Located strategically across the country these men understand your problems and are prepared to help you solve them promptly and efficiently. For more information, see your representative or write to the address below;



**ROBERT M. KARET**  
 Sales Manager, Electronic Distributor and Industrial Sales Dept. of Maguire Industries.



**JACK GOSS**  
 New England and New York area outside of Metropolitan area. Hdqtrs., 25 Hall St., Somerville, Mass.



**ROY THOMPSON**  
 Metropolitan New York, Hdqtrs., Maguire Industries, 500 5th Ave., N.Y. C.



**ELLIOTT MARCH**  
 N. Jersey, Eastern Pa., Del., Md., Va., and Dist. of Columbia. Hdqtrs., Maguire Industries, 500 5th Ave., N.Y. C.



**AVIS McCORVEY**  
 N. Car., S. Car., Georgia, Ala., Tenn., Fla., and Miss. Hdqtrs., 145 Greenwood Place, Decatur, Ga.



**JACK YOUNT**  
 Texas, Okla., La., Ark. Hdqtrs., Pleasant Grove Sta. Dallas, Texas.



**CHARLES DWYER**  
 Mo. and Kansas. Hdqtrs., 936 N. Mich. Ave. Chicago, Ill.



**JERRY KLEKER**  
 Minn., No. and So. Dakota, Iowa, Neb., and Wisc., Hdqtrs., 936 N. Michigan Avenue, Chicago, Ill.



**BOB HARDIE**  
 West Coast Sales Mgr., Cal., Ariz., and Nevada. Hdqtrs., Hotel Mayfair, Los Angeles, Cal.



**DAVE LEE**  
 Pacific Northwest, Hdqtrs., 2626 2nd Avenue, Seattle, Wash.



**GAIL HALLIDAY**  
 Covers Rocky Mountain area Hdqtrs., 1526 Ivy Street, Denver, Colorado.

# MAGUIRE INDUSTRIES, INC.

36 NORTH MICHIGAN AVENUE, CHICAGO 11, ILLINOIS

# The Case Of His Majesty, The King



**F**OUR years of war wrought many changes in the petroleum industry. New products were developed and new merchandising programs were being considered. Inevitably the question arose among the oil companies: What, exactly, do our customers expect from the postwar service station?

A sales executive in a leading company discussed the problem with the Hearst Advertising Service man. How could they sample the thinking of millions of motorists from coast to coast? The whole industry, and the American Petroleum Institute itself, were looking for an answer.

With newspapers in 10 great markets, located from coast to coast, at its beck and call, H-A-S went to work. Swiftly it got ready to put in motion the *newspaperman's* machinery for tapping the minds of millions.

A committee representing many major oil companies conferred with A.P.I. officials and H-A-S representatives. Together they evolved a questionnaire the answers to

which would throw the bright light of day on a confused situation.

As a preliminary test, H-A-S newspapers in an east and west coast city sent out 4,000 and 5,000 questionnaires respectively. Thousands of motorists responded. Right royally they knew what they wanted.

The assembled information from both coasts was presented to the A.P.I. at a convention in Chicago. As a result similar studies were launched in the eight other H-A-S cities extending from one end of the country to the other.

H-A-S is proud to cooperate with the A.P.I. in rendering this service to another great American industry. It shows better than anything else could, the scope of the service that *newspapermen* can offer *saleswise* to farsighted executives in today's changing markets. Whether your problem be nation-wide, or confined to one of the great markets listed below, H-A-S stands ready to help. Call in the H-A-S man now.

## CALL THE H-A-S MAN

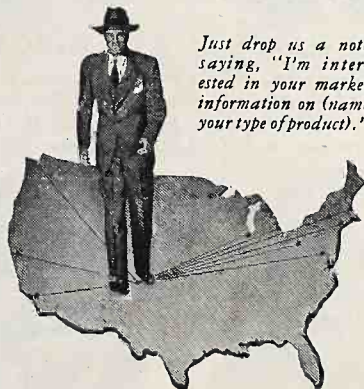

*Just drop us a note saying, "I'm interested in your market information on (name your type of product)."*

# HEARST ADVERTISING SERVICE

HERBERT W. BEYEA, Manager

959-8th Ave., New York 19, N. Y.—Offices in principal cities

Representing:

New York Journal-American • Pittsburgh Sun-Telegraph • Chicago Herald-American  
Baltimore News-Post-American • Boston Record-American-Advertiser • Detroit Times • Albany Times-Union  
San Francisco Examiner • Los Angeles Examiner • Seattle Post-Intelligencer



Announcing  
the new  
and  
revolutionary



**SELF-CHARGING  
PORTABLE**

RENEWS ITS POWER OVER AND OVER AGAIN!



**First and only PORTABLE RADIO OF ITS KIND!**

ANOTHER OUTSTANDING PRODUCT OF G-E ELECTRONIC RESEARCH

**GOODBYE TO BATTERY WORRIES**

Because this new G-E Portable does what no other radio ever did before. It renews its battery power over and over again. *It's self-charging!* Customers can play it all they please with never a worry about the expense and trouble of battery replacements. And its full constant power provides big set performance, big set tone, big set selectivity and sensitivity.

**BATTLESHIP CONSTRUCTION**

Open the back. Look at the marvelous design, engineering, construction. Notice the die-cast aluminum case and how all vital parts are protected and electronically shielded in sturdy die-cast aluminum compartments—the first peace-time use of such compact rugged design. *Here is a portable radio you can sell from the inside!*

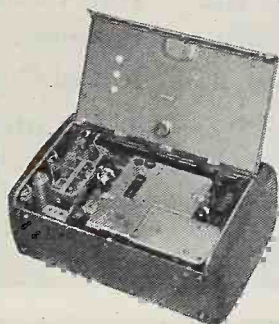

**A GREAT CAMPAIGN TO SPEED YOUR SALES**

Consumer ads, folders, window streamers, window and counter display, featuring 2 G-E Portables (open front and open rear views) are now ready. If your G-E distributor's salesman hasn't contacted you about this great new radio and campaign—get in touch with your distributor now. Place your order for G-E Self-Charging Portables and campaign material . . . TODAY!



The tiny leak-proof, airplane-type storage battery furnishes full constant power at all times.



Ordinary portables use dry batteries—performance is limited—power fades rapidly as batteries age.

THE FIRST AND GREATEST NAME IN ELECTRONICS

**GENERAL  ELECTRIC**

PORTABLES • TABLE MODELS • CONSOLES • FARM SETS • AUTOMATIC PHONOGRAPH COMBINATIONS • TELEVISION

# RADIO SALES MAGIC...



## The Trick:

To find yourself on top of the world, happy, successful—enjoying increased profits as well as the goodwill of your community.

To be accepted as *the* expert in your field, have a host of satis-

fied customers, a fast-growing business that will *keep* you on top of the world.

It's an easy trick to do—and it works like *magic*.

(see next page)



# SYLVANIA

MAKERS OF RADIO TUBES; CATHODE RAY TUBES; ELECTRONIC DEVICES;

## How It's Done:

Radio sales magic is done with Sylvania national advertising—pages of it—that builds goodwill and does a lot of selling for you.

It's done with impartial, Sylvania coast-to-coast surveys that find interesting facts on the radio market, tell you what the public wants.

It's done with valuable business and technical aids for the radio retailer—finger-

tip data to help streamline your business, assure accurate servicing.

And for the final touch: Sylvania's complete line of receiving tubes. They mean satisfied service customers—the best source for new set sales.

Your Sylvania Electric distributor has these famous tubes, plus a long list of aids to your business. Let him tell you more about this Sylvania magic.

### SYLVANIA BUSINESS and TECHNICAL AIDS

Among the Sylvania aids for you are handy business forms, attractive letterhead stationery, a simplified bookkeeping system . . . valuable technical information in the form of booklets, charts and manuals.

The complete line of Sylvania receiving tubes adds goodwill to your business as well as quality to your repair work. This line includes the famous Lock-In tube and the mighty little T-3 tube, of proximity fuze fame.

Sylvania Electric Products Inc.,  
Emporium, Pa.

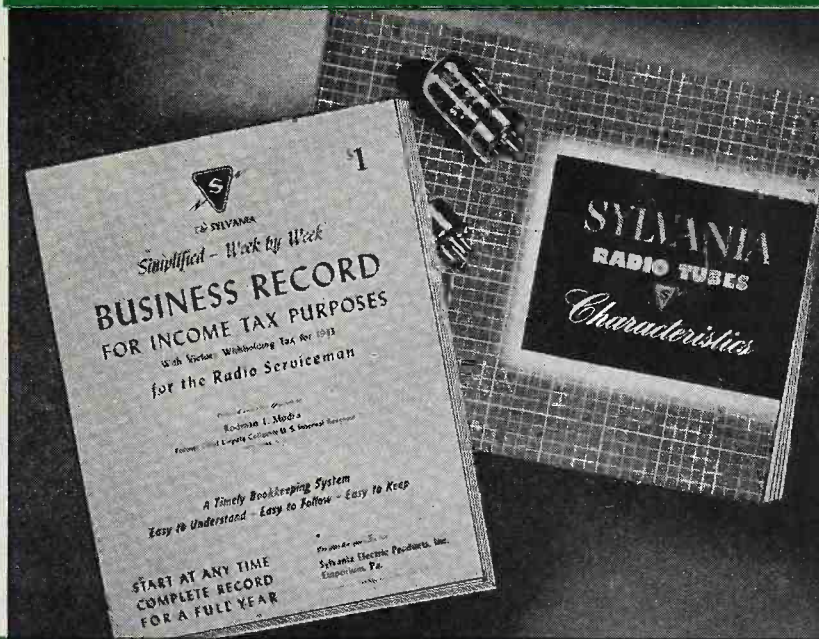

### A LINE OF FAMOUS SYLVANIA RECEIVING TUBES—CATHODE RAY TUBES

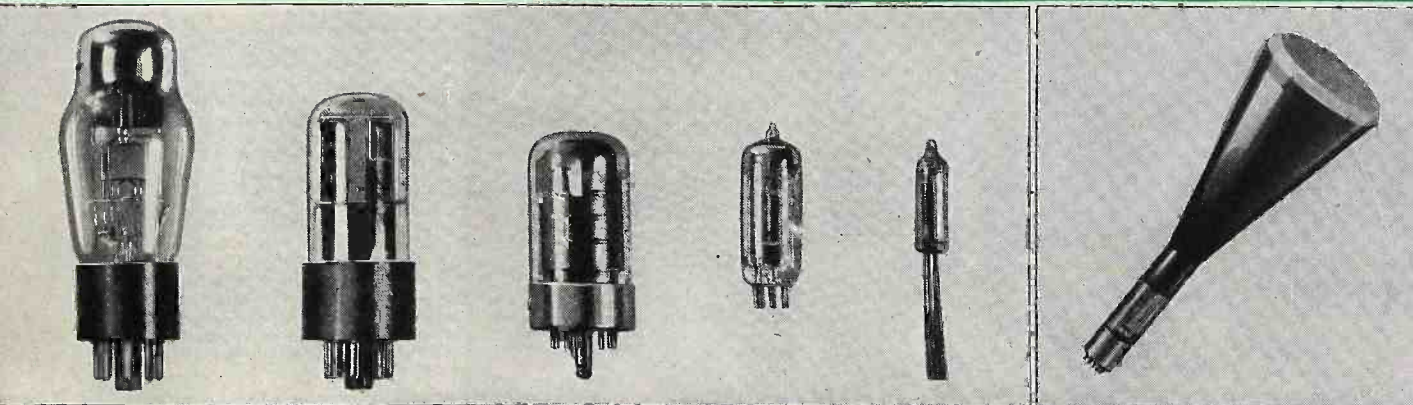

# ELECTRIC



FLUORESCENT LAMPS, FIXTURES, WIRING DEVICES; ELECTRIC LIGHT BULBS

# \$4,496,734,000

## ANSWER TO

## YOUR SALES PROBLEM!

### THE MARKET



You can get double duty out of your first year's selling by concentrating on the rich, compact, \$4,496,734,000 market that is located right at the heart of America—the great Chicago market. And you can get started fast—be set solidly for the days ahead when the first easy selling conditions pass and the competition becomes tough.

### THE MEDIUM



One single powerful medium reaches this easily accessible market—the Chicago Tribune. On weekdays, one out of every three families in the 756 cities and towns of 1,000 or more population in this strategic area reads the Tribune; on Sundays, it is practically every other family. In the important Chicago area the Tribune is bought, read and bought from as in no other single medium.

### THE RESULTS



Here is a market with a huge pent-up demand for automobiles, washing machines, refrigerators, radios and "big unit" products generally . . . famous for its volume purchases . . . one that has repeatedly broken factory and branch sales records. Here are the *immediate* volume and the consumer buying you want . . . because here you will find billions in savings and an area well fortified by diversified income.

Now is the time to get going. Available for your study and use is a specific Tribune sales program based on the findings of an auto and household appliance investigation among consumers and dealers. Moreover, only the Tribune gives you a choice of monochrome, color, comic, newsprint color, or black and white printing at milline rates which are among the lowest in America.

## CHICAGO TRIBUNE

*The World's Greatest Newspaper*

March average net paid total circulation:

Daily, over 1,040,000; Sunday, over 1,450,000

To get the pertinent facts of the Tribune sales program, Address: C. S. Benham, Manager, National Advertising, Chicago Tribune, Tribune Tower, Chicago 11, Illinois.

because

# Bendix Radio

listened to your prospects



your prospects will listen to YOU



Radio Buyers said:

"GIVE US  
FURNITURE STYLED  
RADIOS"

*here's  
the  
answer*

THE INVISIBLE RADIO

with the

*PHANTOM DIAL*

A Sheraton end table of outstanding beauty with the most demonstrable radio feature in the industry! Sells itself on sight!



ON—The Real  
Voice of Radio



OFF—  
A  
Sheraton  
end  
table

Radio Buyers said:

"GIVE US CONSOLE  
COMBINATIONS THAT  
WILL FIT IN  
ANYWHERE"

*here's  
the  
answer*

The Space-Saver

Consolette

Radio-Phonograph

"Chair-size"  
with full auto-  
matic record  
changer and  
amazing record  
storage space.  
Big console-type  
performance.



Radio Buyers said:

"GIVE US A REALLY  
PRACTICAL  
TABLE RADIO"

*here's  
the  
answer*

THE PLASTIC

with the  
BUILT-IN  
HANDLE



Radio's most convenient table model! A room-to-room portable in fully enclosed one-piece plastic cabinet. Obtainable in rich brown, ebonized black and ivory finishes.

Bendix Radio Division, Bendix Aviation Corporation, Baltimore 4, Maryland

**BENDIX RADIO**  
REC'D. U.S. PAT. OFF.

These are but a few of Bendix Radio "firsts" in features, styling and performance, that will clinch demonstrations with quick, easy, profitable sales. All backed by one of the greatest national advertising campaigns in the industry.

**BUILD BEST WITH BENDIX ... FOR PRESTIGE ... PROFIT ... PERMANENCE !**

PRODUCT OF  
Precision  
Equipment  
**Bendix**  
AVIATION CORPORATION

For the complete line of  
portable phonographs . . .  
get a line on



# Phonola



**ACOUSTIC AND ELECTRONIC  
PORTABLE PHONOGRAPHS of  
every popular description,  
in every popular price line!**

Exclusive distributors everywhere.  
For your distributor contact our  
nearest Sales Office:

**Eastern and Export Sales Office**  
17 E. 42nd St. ★ New York 17, VA. 6-2079

**Midwestern and Western Sales Office**  
224 S. Michigan Ave. ★ Chicago 4, HAR. 1880

**Factory and Engineering Laboratory**  
Rochester, Minnesota

**WATERS CONLEY COMPANY**  
ROCHESTER, MINNESOTA

there are no short cuts to *Quality*

*e/c/a*

radio's high standards insure lasting customer satisfaction . . .

It's mighty tempting to use *any* available components to get more radios on the market *quickly*. But what about tomorrow—when customers will turn their backs on dealers who "short-changed" them with inferior radios?

ECA Radios are made to extremely high standards. Components *must* meet ECA Radio's rigid specifications to be accepted. For only first quality parts can make first quality radios, with the fine tone and superior performance of ECA Radios that make loyal, satisfied customers for your store.

ECA Radio quality is backed up by an informative Warranty Tag of Accurate Performance Rating. This Warranty Tag, attached to every ECA Radio, not only gives your customers the facts they need to know about their radio . . . but enables them to *compare* the ECA Radio with any other set selling at a *comparable* price.

ECA Radios are sold direct to a limited number of selected dealers, insuring heavier deliveries to each dealer. Retail prices maintained, dealer profits protected. Freight paid to your city. Complete range of models and prices.

*A few franchises still open.  
Write for details today.*



**\$7995**

incl. tax

ECA Radio-Phono Combination Model 106 Automatic. Plays ten 12" records or twelve 10" records automatically with lid closed. Continuously variable tone-control. Exclusive ECA Radio DI-FUSA-TONE\*



**ELECTRONIC CORP. OF AMERICA** 170 53rd STREET • BROOKLYN 32, N. Y.  
RADIO • RADIO PHONOGRAPHS • PORTABLES • FM • TELEVISION • RECORD PLAYERS

# Your best customers know and



People *pay attention*



# refer Post-advertised lines



When a manufacturer asks you to "watch for our ads in the Post," he's calling your attention to the *best* kind of local support.



For advertisements in the Post reach your *best* customers—the *leaders*, who are first to buy the new and better things.



And advertisements in the Post get attention. For people *like* to read ads in the Post—far more than in *any other magazine*.



# when they see it in the **POST**

# OUT OF THIS

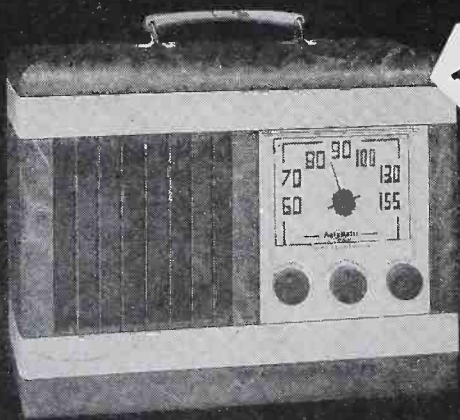
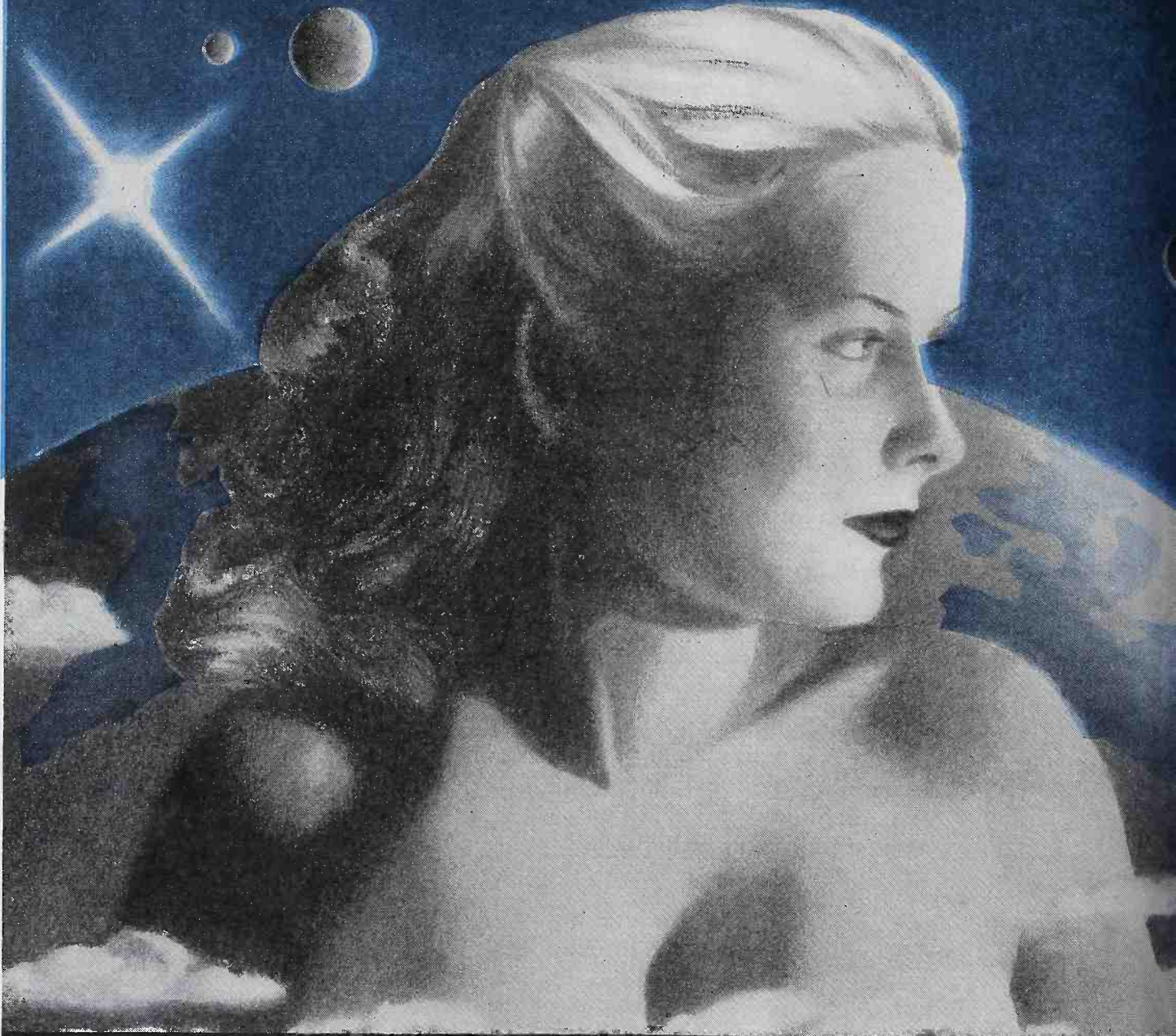

**REJUVENATION**  
Pat. No. 2222199

MODEL C-60

Powerful portable operates on batteries and A.C.-D.C. current five-tube superheterodyne with seven-tube performance. Large built-in Automiscope loop and equipped with Automatic patented battery Rejuvenator—increases life of batteries 2 to 3 times normal. Case is finished in two-tone simulated leather.



# Automatic

RADIO MANUFACTURING CO., Inc.

122 Brookline Avenue, Boston, Mass.

Makers of AUTOMATIC & TOM THUMB Radios

# WORLD!



### MODEL 670

Classic modern phono-radio combination with automatic record changer that automatically changes ten 12" records or twelve 10" records — also equipped with automatic reject switch. Lightweight crystal pickup, long life needle, powerful six-tube superheterodyne with eight-tube performance. A.C. operation only. Richly grained hand-rubbed walnut cabinet.

Beautiful, eye-appealing designs, plus performance that are "out of this world"! Wide range and selectivity second to none—there is a set to meet every demand—fine table sets in walnut and ivory finishes, phono-radio combinations with record changer, portables with the famous Automatic Radio patented battery Rejuvenator.

Yes, and with all this, Automatic Radio jobbers and dealers, are making a reasonable profit. Ask about the Automatic Radio selling plan now!



### MODEL 660

Deluxe two-band six-tube set with eight-tube performance by the use of two dual-purpose tubes. Equipped with powerful P.M. Speaker — large built-in Automatscope loop and illuminated easy-vision dial. A new high in sensitivity, selectivity and tone control. Beautifully hand-rubbed grained walnut cabinet. Standard Broadcast and entire Int. Short Wave Band.

### MODEL 612X

Six-tube superheterodyne with eight-tube performance. Features R.F. stage for increased sensitivity, P.M. dynamic speaker with new improved magnet. Built-in Automatscope loop. Automatic volume control, A.C.-D.C. operation, beam power output. Beautiful hand-rubbed walnut cabinet.

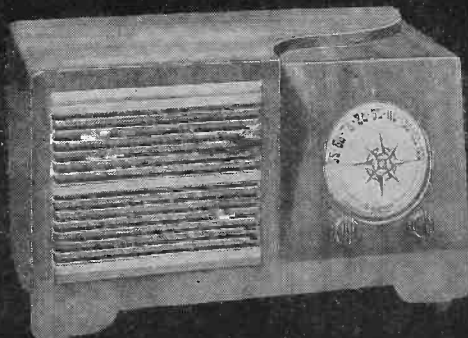



*We're coming in...*

*A* static has made a lot of "pick-ups" along the line and here we are ... breezing through the azure blue ... headed for the Show ... and you. It's going to be fun ... shaking hands with the old gang again ... and the new-comers, too. We'll be holding forth at the Stevens, where you'll find Astatic Microphones, Phonograph Pickups and Cartridges ... including many new and improved models ... on display. We'll be seein' you!

*Hotel Stevens*

CHICAGO, ILL.  
Headquarters for  
Radio Parts National Trade Show  
May 13, 14, 15 and 16

THE

ASTATIC

*Astatic*

CORPORATION  
CONNEAUT, OHIO

In Canada: Canadian Astatic, Ltd. Toronto, Ont.

Only **ZENITH** has this!

# COBRA TONE ARM

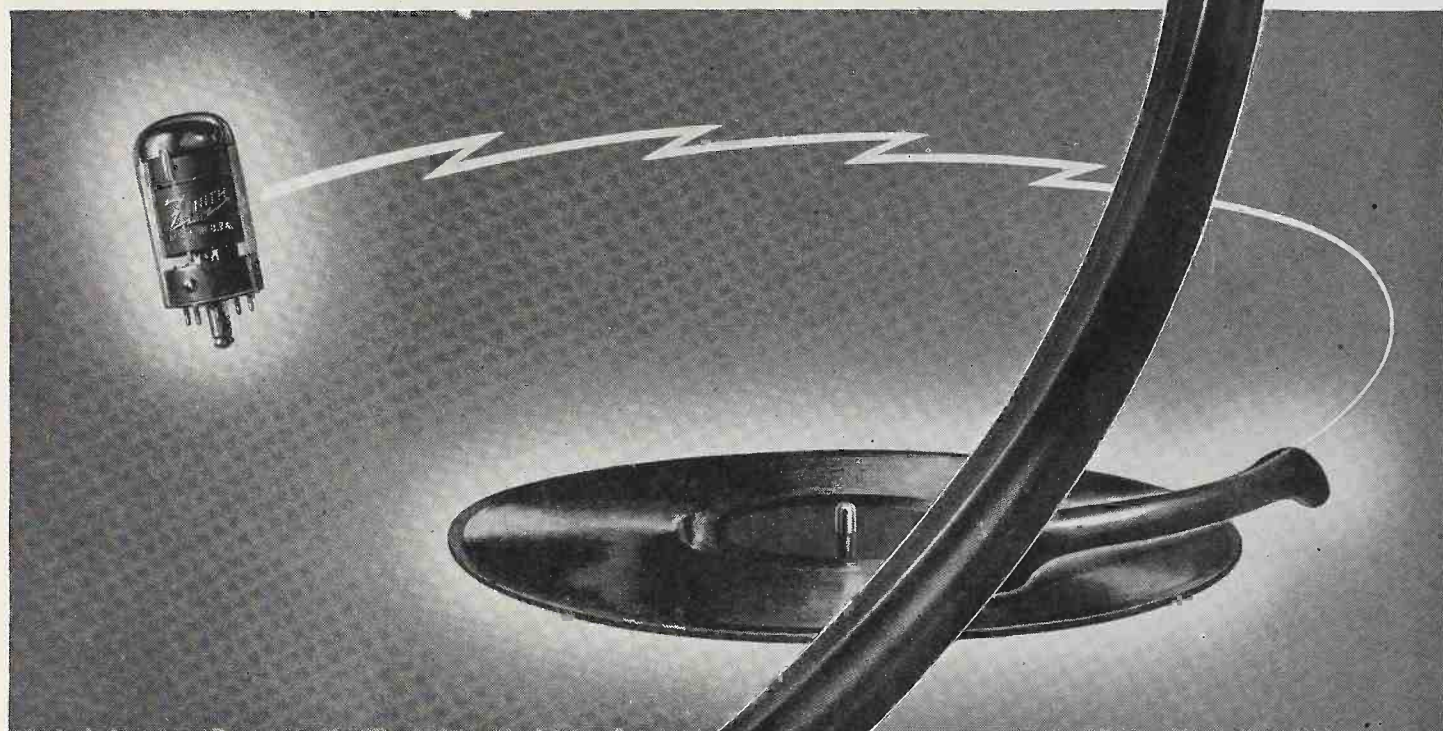

**The Heart of Zenith's**  
*Sensational*  
**NEW WAY TO PLAY RECORDS**

**ZENITH RADIO CORPORATION • 6001 DICKENS • CHICAGO 39, ILLINOIS**

*Backed by 30 Years of "Know How" in Radionics Exclusively*

# NEW

... and Individually Marked

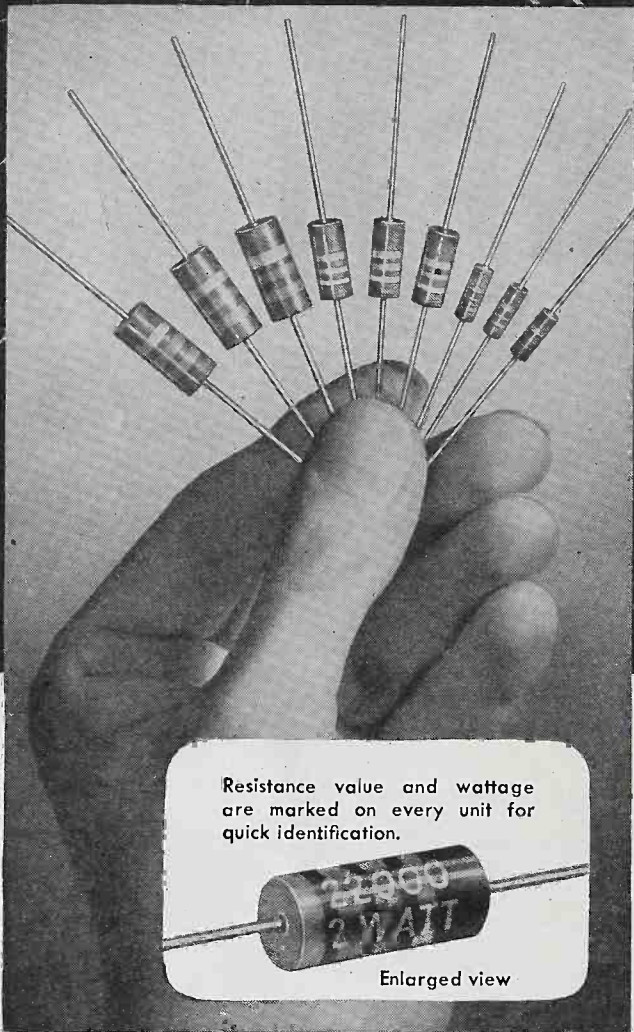

Resistance value and wattage are marked on every unit for quick identification.

Enlarged view

Meet Joint Army-Navy Specification JAN-R-11  
AVAILABLE FROM STOCK IN STANDARD  
RMA 10% TOLERANCE VALUES

TYPE	SIZE		RESISTANCE RANGE	MAXIMUM VOLTS	LIST PRICE
	LENGTH	DIAM.			
1/2 Watt	3/8"	9/64"	10 Ohms to 22 Meg.	500	1
1 Watt	9/16"	7/32"	10 Ohms to 22 Meg.	1000	7
2 Watt	1 1/16"	5/16"	10 Ohms to 22 Meg.	3 000	25c



Send Now for  
BULLETIN No. 127

Gives complete data and list of RMA values. Includes dimensional drawings and handy color code. Write for it today!

# OHMITE

## Little Devil

### INSULATED COMPOSITION RESISTORS

1/2 Watt • 1 Watt • 2 Watt • ±10% Tolerance

NOW . . . OHMITE makes available to you three *Little Devils* of exceptional ruggedness and stability!

Millions of these tiny molded fixed composition resistors have been used in critical war equipment and in the nation's foremost laboratories. They meet Joint Army-Navy Specification JAN-R-11, including salt water immersion cycling and high humidity tests. They can be used at their full wattage ratings at 70°C (158°F) ambient temperature. They dissipate heat rapidly—have low noise level and low voltage coefficient.

Ratings for maximum continuous RMS voltage drop are high: 500 volts for the 1/2 watt unit—1000 volts for the 1 watt unit—3500 volts for the 2 watt unit. Units have high insulation breakdown voltage.

*Little Devils* are completely sealed and insulated by their molded plastic construction. Leads are soft copper wire, hardened immediately adjacent to resistor body—strongly anchored—and hot solder coated.

Light, compact, easy to install. All units color coded. Resistance value and wattage are marked on every unit for quick identification. Available from stock in Standard RMA values from 10 ohms to 22 megohms.

*Little Devils* are ready for any job . . . anywhere. And they're low in cost. Order them now!

AVAILABLE ONLY THROUGH OHMITE DISTRIBUTORS

**OHMITE MANUFACTURING COMPANY**

4871 FLOURNOY STREET, CHICAGO 44, U.S.A.

Visit Booth No. 72 at the Radio Parts and Electronic Equipment Show, Chicago, May 13-16

Be Right with

# OHMITE

RHEOSTATS • RESISTORS • TAP SWITCHES • CHOKES • ATTENUATORS

# THORENS

MADE IN SWITZERLAND

## LEADS AGAIN



Starts and stops automatically



**HINGED**  
TONE ARM

**REJECTS** RECORD  
IF DESIRED

**REPEATS** WHOLE OR PART  
OF RECORD

**PAUSES** BETWEEN RECORDS IF DESIRED

**RECORD CHANGER  
CD40**

## PLAYS 10" and 12" RECORDS MIXED

PLAYS MIXED 10 OR 12 IN. RECORDS in any order (8 records continuously). **REJECTS** any record if desired, and goes on to next. **REPEATS** PART OR WHOLE RECORD AT ANY DESIRED POINT. **PAUSES** BETWEEN RECORDS IF DESIRED. No interference from

vibration, or with radio reception. Crystal pick-up. 15" x 12". Height 5". Tone-arm is hinged for greatest convenience in changing needles. AC motors 100 to 250 volts, 50 to 60 cycles. Also will be available with motor for both AC and DC.

**REXON, INC.**, GENERAL DISTRIBUTORS, 295 FIFTH AVENUE, NEW YORK 16, N. Y.  
SERVICE DEPARTMENT AND WAREHOUSE, REXON, INC., 122 FIFTH AVENUE, NEW YORK 11, N. Y.

ON DISPLAY AT THE RADIO PARTS AND ELECTRONIC EQUIPMENT SHOW • HOTEL STEVENS, CHICAGO MAY 13-16

# REPLACE CAPACITORS Faster...Better...at Less Cost

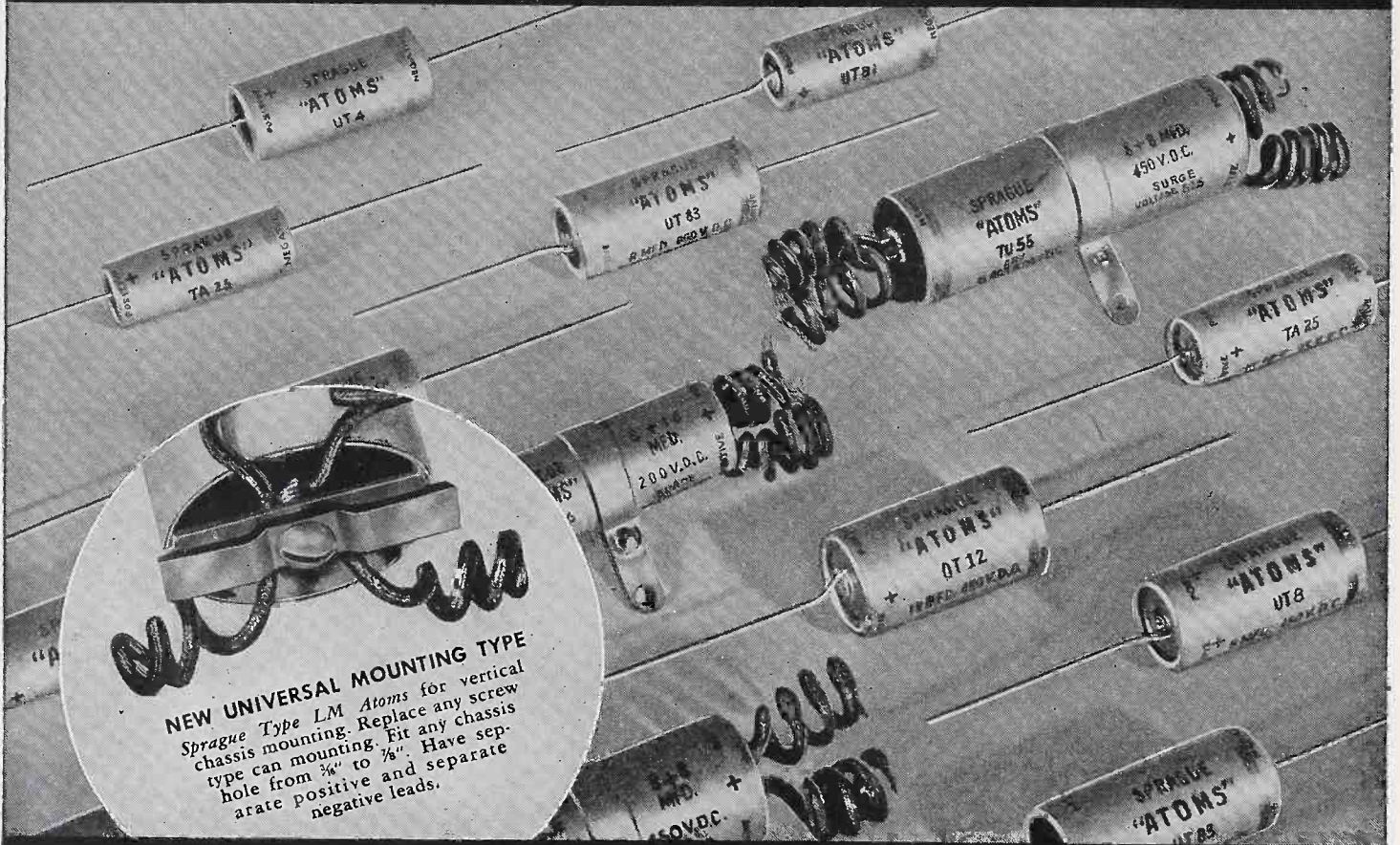

**NEW UNIVERSAL MOUNTING TYPE**  
 Sprague Type LM Atoms for vertical chassis mounting. Replace any screw type can mounting. Fit any chassis hole from  $\frac{3}{16}$ " to  $\frac{1}{4}$ ". Have separate positive and separate negative leads.

## with **SPRAGUE** A T O M S



### NEW CATALOG—JUST OUT!

The finest, most complete and most helpful Sprague catalog ever issued! Contains complete details, dimensions, data, etc. on Sprague Capacitors and \*Koolohm Resistors for every service, amateur and experimental need. \*Trademark Reg. U. S. Pat. Off.

SEE US AT BOOTH 132—CHICAGO SHOW!

- Use them universally for ALL dry electrolytic replacements.
- A small supply equips you for ANY job—any voltage, capacity or capacity combination.
- Order them by name—be sure of getting genuine, factory-fresh Sprague Atoms—the kind that will not let you down.

**SPRAGUE PRODUCTS COMPANY**  
 North Adams, Mass.

JOBGING DISTRIBUTING ORGANIZATION FOR PRODUCTS OF THE SPRAGUE ELECTRIC CO.



# FADA

*sparkles in Times Square*



FADA 6 tube models are equipped with the new FADA "Sensitive-Tone" . . . assuring greater sensitivity and clearer reception.



In the heart of Times Square a new FADA "spectacular," one of the most dramatic electric signs in all America, blazons the name FADA to millions of people, every day of the year. More such signs are planned throughout the United States to spotlight FADA'S reputation as "the radio of tomorrow — TODAY."

And — this is just one of a long list of FADA sales promotion activities designed to augment the universal consumer acceptance enjoyed by FADA "since broadcasting began."

For sales — this year and next year and the years to come — you, too, can depend upon FADA, "the radio of tomorrow — today"!



**YOU CAN ALWAYS DEPEND ON**

# FADA

## Radio

*Famous Since Broadcasting Began!*

**652 SERIES  
ONE OF FADA'S  
NEW TABLE  
MODELS**

6 Tube A.C.-D.C. Superheterodynes with the R.F. Noise Reducing Stage with Slide Rule Dial in Gemlike "FADA-LUCENT" Cabinets.

6 tube radio with 8 tube performance. Features include the new Lock in type tubes; Beam Power Output System; New Wonder Speaker ALNICO V; Automatic Volume Control and FADA-SCOPE built-in LOOP ANTENNA. Housed in beautiful "FADA-LUCENT" Cabinets in Five Gorgeous COLOR COMBINATIONS resembling precious stones.

**FADA RADIO AND ELECTRIC COMPANY, INC., LONG ISLAND CITY, N. Y.**

# Collier's

*The Connecting Link  
...for Action*



*People who think ahead read Collier's*

Parents with teen-agers are men and women who naturally think ahead—and Collier's stays right in step, with fiction that's modern and exciting, and feature articles that "keep up with the world." Which explains why, week after week, Collier's counts among its most faithful readers the more alert, more progressive families of our nation. They are the recognized community leaders in cities, towns and rural sections everywhere; they are ambitious, they know what they want . . . they are at *the age of acquirement*, with the means and the mind to possess the new and better things of life. What finer market could any advertiser ask?

## **MILESTONES IN MAGAZINE HISTORY**

*The Short Short Story . . . A New Idea*

Collier's published the first **SHORT SHORT** in the issue of Sept. 12th, 1925. Other magazines have adopted the idea since, but Collier's remains the No. 1 magazine for **SHORT SHORTS**.

# Collier's



*Advertisers who think ahead use Collier's*

"We saw it advertised in Collier's" is a buying slogan of more and more American families every day. Through the magazine of action, advertiser and customer reach a complete understanding because both are thinking ahead. They are real partners in progress, working together to improve the American standards of living and meeting eye to eye every week through the up-to-the-minute pages of Collier's. *Action* to Collier's means the movement of goods across the country's sales counters and every issue of this great national weekly is packed with appeal for the more progressive families—the thinking millions whose buying habits influence the entire market.

*Thinks Ahead*



Model A-81 Cabinet

Model A-121 Cabinet

Model A-151 Cabinet

THE FAMOUS

*\* Bass Reflex*

REPRODUCERS IN NEW,  
BETTER-THAN-EVER DESIGNS

True high-fidelity reproducers with the famous and exclusive *Jensen Bass Reflex* principle of design are now available in improved postwar cabinets. *Jensen Bass Reflex* reproducers give crisp, extended range reproduction . . . no back-side radiation . . . full bass with no boom.

*Bass Reflex* Reproducers are widely used in broadcast monitoring and in recording work. They are ideal for ham shack use and are in much demand for phonographs, FM reception, and general sound reinforcement applications.

*Jensen Bass Reflex* Reproducers are available in sizes for 8-inch, 12-inch and 15-inch loud speakers and are designed for floor or wall installation. The 15-inch cabinet is designed for both Type J and Type H *Jensen Coaxial Speakers* and for single-radiator 15-inch speakers.

Write for complete literature.

\* Trade Mark Registered



**Jensen**  
SPEAKERS  
WITH  
**ALNICO 5**

The Jensen exhibit will be in Booth 68 at the 1946 Radio Parts Show in Chicago's Stevens Hotel, May 13th through 15th. Old and new friends alike are cordially invited to see the 1946 line of Jensen fine acoustic equipment.

JENSEN RADIO MANUFACTURING COMPANY  
6625 SOUTH LARAMIE AVENUE • CHICAGO 38, ILLINOIS  
In Canada: Copper Wire Products, Ltd., 137 Oxford Street, Guelph, Ontario

*Specialists in Design and Manufacture of Fine Acoustic Equipment*

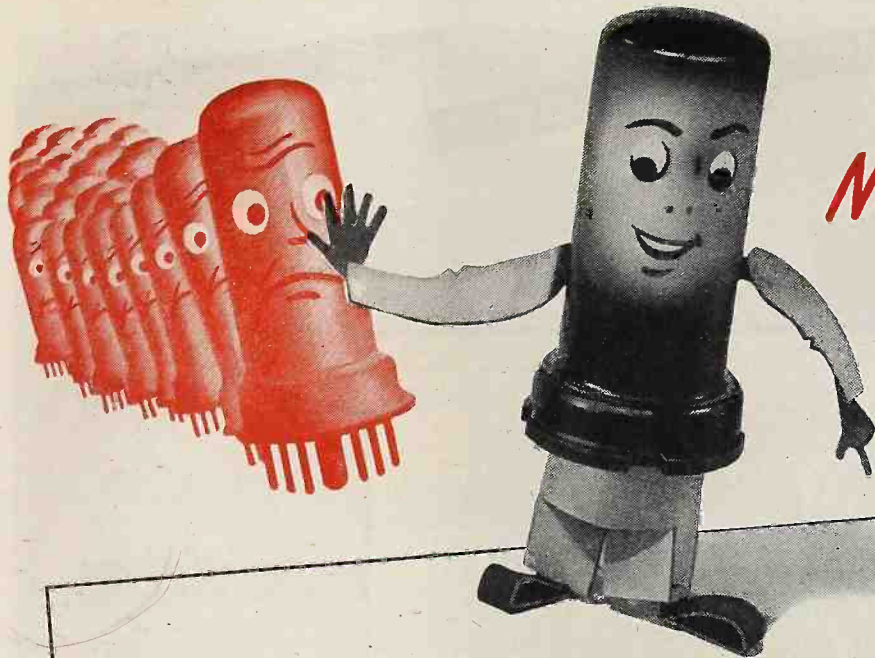

**NOW-** REPLACE OVER 875  
TYPES OF BALLAST TUBES WITH  
ONLY 10 N.U. UNIBALLASTS

# N.U. UNIBALLAST

COVERS YOUR REPLACEMENT NEEDS WITH  
ONLY 10 FAST-SELLING PROFITABLE TYPES

**YOU BET** Uniballast are a real profit-maker for service men. With only 10 types of N.U. Uniballast to carry, you keep your investment constantly turning, and putting profits in your pocket. Order Uniballasts today from your N.U. Jobber. And ask him for the "N.U. Uniballast Service Manual" or write—National Union Radio Corporation, Newark 2, New Jersey.

## SPECIFICATIONS

- Uniballast—the universal ballast tube—small—compact—easy, quick installation.
- Metal envelope is excellent heat radiator. "Plug-in" simplicity.
- Provides proper operating current conditions regardless of variations in line voltage and in the characteristics of tube heaters and pilot lights.
- Even if one or more pilot lights burn out Uniballast continues to operate the tube filaments in the string, at efficient current range.
- Resistance is self-compensating—adjusts itself automatically—true ballast action. Voltage dropping range is indicated on every Uniballast.

## NATIONAL UNION RADIO TUBES AND PARTS

Transmitting, Cathode Ray, Receiving, Special Purpose Tubes • Condensers •  
Volume Controls • Photo Electric Cells • Panel Lamps • Flashlight Bulbs



Actual size  
Ov. Length 3 1/8"  
Seated Ht. 2 1/16"  
Diameter 1"

**Order Today from your N.U. Jobber**



# Sonora speaks for itself with "Clear as a Bell" tone



RY-224: 5 tube superhet red and tan portable, 3 way reception; battery, AC, DC. Big dynamic speaker gives "Clear as a Bell" tone of fine home radio, anywhere, any time.

This 5-tube AC combination radio and phonograph features featherweight crystal pickup with permanent needle, famous SONORA tone that's "Clear as a Bell." Handsomely styled cabinet in walnut (RGF-212), or blonde primavera (RGF-230).

When your customers choose a radio—portable, table or console—they always choose the radio with superior tone. It's *tone* that makes the *sale*. And every SONORA radio speaks for itself in tone that's "Clear as a Bell."

Sonora speaks for itself in another way, too, in a powerful, national advertising campaign. In the radio industry's most dramatic campaign, SONORA challenges your customers to *compare* SONORA's tone with any other radio in its price class . . . confident that no other set out-performs SONORA. Yes, SONORA is building traffic, sales and goodwill for you. Not with fancy talk, but with simple, straightforward facts that put the burden of proof on SONORA's Clear as a Bell Tone.

watch Sonora  
go places!



RCU-208: Deluxe 6-tube AC-DC superhet table model in walnut. Newly perfected patented chassis circuit gives big set reception.

## THE RADIO QUESTION OF THE MONTH

Asked by Sonora Dealer Hugh Sterchi of Reed and Hugh Sterchi Furniture Company, Knoxville, Tennessee.

Answered by Joe Gerl, president of Sonora

Q.: When do you believe price control on radios will be lifted?

A.: The radio industry will have produced, by July, about four million radio sets. The OPA estimates a backlog of consumer demand of five million sets. With such a large proportion of the demand satisfied, and in the face of the new, liberal OPA policy, I feel that price ceilings on radios will be removed by July.

*Joe Gerl*

**Sonora**  
Clear as a Bell

HOME ENTERTAINMENT AT ITS BEST

SONORA PRODUCTS, Inc., 2023 W. Carroll, Chicago 12

RADIOS . . . FM COMBINATIONS . . . TELEVISION . . . RECORDS . . . PHONOGRAPHS . . . RECORDERS

HOW DOES  
**STROMBERG-CARLSON**  
 GET SUCH  
**BIG-SET PERFORMANCE**  
 IN ITS TABLE SETS?



It's a revelation, when you check the performance—capacities of these remarkable Series 1101 Stromberg-Carlsons! You'll find true 'big-set type performance' in every one of these four fine table sets.

For Stromberg-Carlson gives you three design features usually limited to larger, and more expensive, receivers. Three important improvements you'll search a long time for among other table models.

1. Three-gang tuned radio frequency for extreme selectivity and clear reception—a feature hitherto found on only more expensive models.
2. New, powerful, electro-dynamic speakers, and scientifically designed tone chambers to assure excellent tone and a minimum of alien sounds.
3. Six tubes, including rectifier.

These superior, attractively priced, and fast selling Stromberg-Carlsons are now coming off the production line in quantity. In two or three months their production should reach an all-time high—thanks to increased plants capacity. They are backed by a vigorous national advertising campaign both in newspapers and in magazines, and give to Authorized Stromberg-Carlson Dealers a wonderful opportunity for business in 1946!

**1101-HI—DYNATOMIC**—Ultra-modern in design, and with 3-gang tuned radio frequency for 'big-set performance'. Concealed handhold for easy portability. \$31.95. Also available in brown—1101-HB, \$29.95.

**1101-HM—SONNET**—A cabinet of classic simplicity graces this popular 3-gang AC-DC table radio. Lighted slide-rule dial for easy tuning, \$43.50.

**1101-HW—NOCTURNE**—This 3-gang AC-DC table radio will be completely at home in either modern or traditional surroundings, \$41.50.

**1101-HY—ETUDE MODERNE**—Fitting almost anywhere in the modern home, the outstanding performance of this 3-gang AC-DC table radio matches the functional simplicity of its design, \$39.95.

All prices shown are OPA approved retail ceiling prices in Zone 1. 5% higher in Zone 2. Including excise tax.

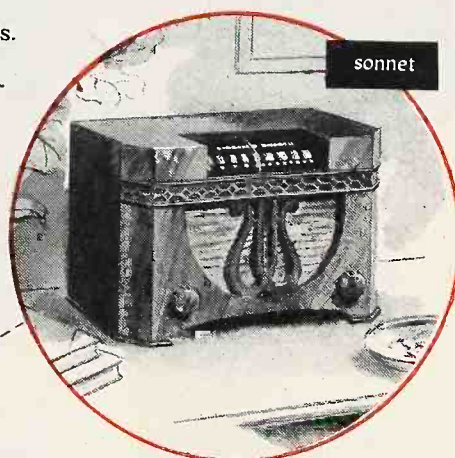

sonnet

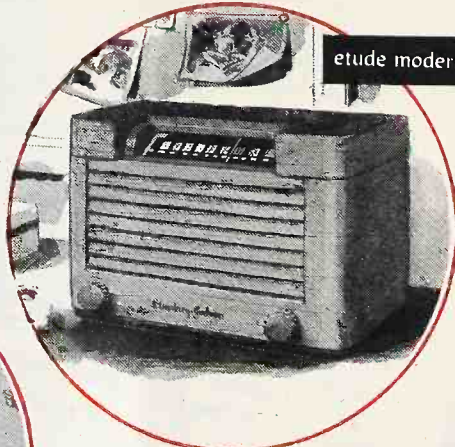

etude moderne

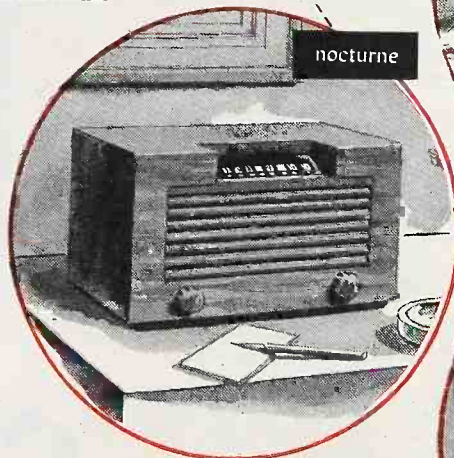

nocturne

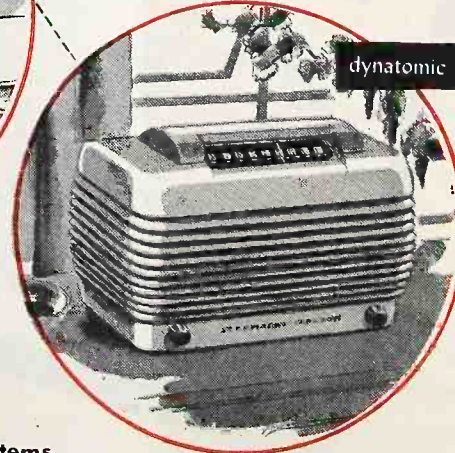

dynatomic

**STROMBERG-CARLSON**

ROCHESTER 3, NEW YORK

Radios, Radio-Phonographs, Television  
 Sound Equipment and Industrial Systems

Telephones, Switchboards, and Intercommunication Systems



# RADIO & Television RETAILING

Including Radio and Television Today

O. H. CALDWELL, Editor ★ M. CLEMENTS, Publisher ★ 480 LEXINGTON AVENUE, NEW YORK 17, N. Y.

## **Your New Opportunities in a New America!**

As a radio-electrical appliance dealer, you face a new America—one which is basically different from pre-war days.

There is, of course, a pent-up demand for the products you sell, caused by the long wartime blackout of factories from the production of durable peacetime goods. But this alone does not begin to describe your actual market.

Vast changes have taken place in the country's economic picture. The outlines of the new nation-wide postwar market are just beginning to emerge. The country now has more of every factor which makes a market for your merchandise.

**MORE FAMILIES.** The war caused a tremendous upswing in marriages, the economic results of which are just beginning to be understood.

**MORE CHILDREN.** There will be about 4,000,000 more children under 14 by 1950 than in 1940.

**MORE POPULATION.** The new youngsters, of course, add to the country's net population. As these children grow up and marry, this upward trend in population will be extended through the coming decades.

**MORE SAVING.** To create markets, wealth is needed, as well as people. The liquid assets of the country have increased to 130 billion dollars, as reflected by bank deposits, money in circulation and war savings bonds. The *increase* over the pre-war figure of 33 billion dollars would be enough to buy at current values the common stock of every company listed on the New York Stock Exchange!

**MORE INCOME.** There is record and prodigious current income as well. Payments to individuals in 1945 exceeded \$160 billion.

**MORE HOMES.** For the first time, millions of families, old and new, have the means to make their dreams of living comfort come true. This will mean millions of new homes, replete with new radios and electrical appliances—perhaps 5 million new homes by 1950 and upwards of a million a year for a number of years thereafter.

Nor should we overlook the nearly 40 million present homes, many of which will be modernized, with new radios and electrical appliances throughout.

But you can sell only your own market, not the entire country. And competing against you may be at least twice as many dealers as before the war.

It is important for you to grasp the extent of these changes which are taking place in your own area. Analyze your market to determine what changes will occur.

Then set about to get your share.

# RADIO, Electrical Appliances,

**LATEST CONSUMER BUYING TREND** pattern well-defined. Many shifting major appliance orders from one dealer to another, hoping for faster delivery. . . . Today's consumers are definitely "shopping," seeking brands they know in radios/appliances, resisting unfamiliar ones. . . . Six months ago they might have taken "anything", but now they believe big-production in immediate offering. . . . Customers tell dealers they think prices will continue to go up, basing this on recent OPA-authorized increases.

**SCARCE RADIO/APPLIANCE MATERIALS** include copper, mining and refining of which has been slowed by strikes. To compensate for this, the U. S. Government has been digging into its half-million ton stockpile.

**"ODD-LOT" RADIO MAKERS**, lured into field by big backlog of demand for sets, are finding more and more sales resistance to their wares by retailers who now foresee well-known brands soon in good production. Another reason retail outlets are turning down most "loft" stuff is because consumers have not been over-willing to accept such merchandise even during the height of the set famine.

**22 MILLION SETS BEFORE END OF '46**, results of survey by FCC indicates. 85 manufacturers gave figures of probable production, with breakdown as follows: AM band only, 16,736,862; FM only, 86,286; AM-FM, 1,689,750; tele band only (channels 1-13), 44,706; AM-FM-Television (video 1-13), 54,606; AM-television (video 1-13), 500; FM-television (video 1-13), 500; television, bands (1-6), 4,000; AM-television (1-6), 10,000; miscellaneous, 21,250, and unspecified, 2,481,300.

**RMA WORKS TO REPEAL OR REDUCE TAX**—The Radio Manufacturers Assn. has appointed a special committee to urge repeal or reduction of the 10 per cent federal excise tax on radio sets. Emerson's President Ben Abrams is chairman; A. H. Gardner, president of Colonial Radio Corp., is vice-chairman.

**MULTI-PURPOSE ELECTRIC APPLIANCES** something new in field. For use at the table, some appliances make coffee, toast, fry eggs, etc. Others double as heaters and coolers. Some clothes washers have attachments for cleansing dishes. Many refrigerators have food-freezing compartments, and there are combination radios and electric clocks. Combination sandwich grills and waffle irons started the dual-purpose trend before the war.

**STORAGE BATTERIES MAY REMAIN SCARCE** as a result of the current shortage of lead. Mine operators claim a price rise is needed to stimulate production, while OPA stoutly maintains none will be forthcoming.

**LIFTING CREDIT RESTRICTIONS** "as soon as possible" is favored by President Truman. But this leaves unanswered just when that will be. Best guess seems to be that Regulation "W" and other credit restrictions will stay in effect during the rest of 1946 as anti-inflation measures.

**RADIO SET PRICE INCREASES?** OPA studying receiver price set-up, is reviewing the price factor of 10.5 to 15% established last October. The aim is to bring sets in line with recent price increases authorized for certain components and for wage increases. The 15.5% rise on tubes is one of the most recent permitted by OPA, and this is another factor which increases the cost of radio receiver production.

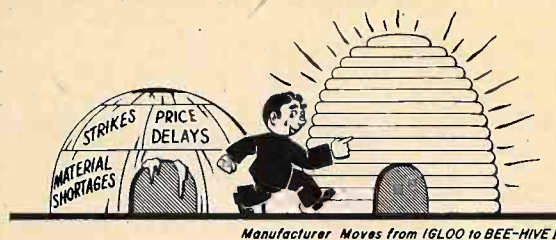

**PRODUCTION IS THAWING OUT**—Following a winter of enforced hibernation, manufacturers of radios and electrical appliances now believe that the day of full-scale production is not too far distant. Most strikes have been settled and the entire labor situation appears to be brighter. With men returning to man the machinery, one angle of the difficulty has been eliminated. The great remaining problem is that of obtaining the necessary components.

**UPSWING IN INSTALMENT SELLING** is expected within a few months. Confidential surveys show that two-thirds of the nation in the lower income groups have total savings of only about \$500 each in any form. Even these savings are sometimes being dissipated before needed appliances and radios can become available.

## FIRST 15 NIGHT AIR PROGRAMS as "Hooperated":

Fibber McGee and Molly	30.4
Bob Hope	29.8
Charlie McCarthy	26.6
Red Skelton	26.3
Radio Theatre	26.1
Bing Crosby	23.5
Jack Benny	22.6
Screen Guild Players	21.7
Fred Allen	21.6
Jack Haley with Eve Arden	21.2
Mr. District Attorney	21.0
Eddie Cantor	19.6
Amos 'n' Andy	19.5
Walter Winchell	19.3
Abbott and Costello	18.0

**NOISE-MONITORING JUKE BOX** device which varies volume according to ambient background noise is part of Aireon's new automatic music machine. The Kansas City firm's product uses a total of 31 tubes, has 50% fewer moving parts than previous models.

**SEVEN MILLION DISCS PER MONTH** is Decca's present production rate. The firm has two factories in New York City, one in Bridgeport, Conn., and one in Richmond, Ind.

# Records, and Television, **TODAY**

**MANUFACTURERS NOT HOARDING**—A spot check in plants of 34 well-known producers of radios and electrical appliances by the Civilian Production Administration disclosed no excessive stocks of finished products being withheld.

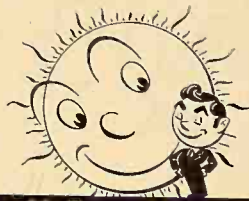

....in the Sun  
Once Again!

**BRAND-NEW TREND ON SALES FRONT** presents a paradoxical picture. With the largest accumulated consumer demand the country has ever experienced in our midst, very few salesmen are being hired by wholesalers and retailers. For economic reasons, most firms have been working with skeleton staffs, but when the radios and appliances start rolling in large quantities, the salesman will come into his own again—and will be the most sought-after class of employee.

**TRANSMITTER GO-AHEAD**—Builders of new studios and transmitters for FM and television naturally looked with apprehension at curbs on new construction, established by CPA to aid veterans' housing. At this point, popular guess is new-station interests actually have little to worry them; Washington sources reveal CPA exempts all station equipment, and anyway, the construction shortages may be cleared up before television really gets going. Also, many stations could be set up in existing or modified buildings, with repairs via the CPA \$1000 expenditure exemption. Further, there are many U. S. areas where no housing shortage exists, and the local committees of federal housing agencies in those sectors are expected to be liberal.

**LISTENERS ALOFT**—All-out luxury of the new \$500,000 passenger planes will include radios with individual seat-back speakers, if the preferences of 19,000 potential patrons are credited by the ship designers. Over 70% of them voted for these receivers when United Air Lines sent out a you-help-us-build-it questionnaire. Over 55% also wanted television on the giant 52-passenger mainliners which cut the ether at 300 miles per.

**A TOAST**—To the Retailer . . . whose yard-wide counter represents the last long mile in the translation of the inventor's ideas and manufacturer's processes into tangible merchandise that can be of public service only when put into the hands of America's millions.

**VETS LIKE THE RETAIL FIELD**, and the radio and appliance business appeals to them the most, according to a Government report. Broken down into types, the results show that 48.8 per cent of the vets want to become retailers; 13.6 desire to enter servicing field, 4.7 manufacturing, 3.9 wholesaling, 2.8 construction and contracting and 0.8 transportation, communication and utilities.

**COMING CHICAGO MUSIC SHOW** creating wide interest. Staged by the National Assn. of Music Merchants, the event will be held at the Palmer House, July 15 to 18. Radios, records, sheet music and musical instruments will be featured.

**MADE 7,500 WASHERS—SOLD NONE**, Speed Queen executives reveal. In spite of strikes in plants of its suppliers, the Wisconsin firm produced a considerable number of finished products in 1945 but sold none because it was "very much impeded . . . by the delays and procrastinations" of OPA, according to H. A. Bumby, president.

**HAMS GET SLICE OF 80 METER BAND** returned. The frequencies from 3.7 to 4 megacycles in the 80 meter band, have been given back to the radio amateurs by the FCC. These are the first reliable channels for medium distance communications released to the Hams since the war ended.



**CHANNEL CORRUPTION**—Playing around with a walkie-talkie these days, you're apt to tune in on a sinister item like this: "Hey, Blackie! Ya better blow. Coupla bulls comin'." It may not be a gag, either. A pair of up-to-date burglars in Illinois have admitted they used the radios on their jobs. One of them stayed outside as a guard, while the other ransacked buildings and kept tuned for warning. One decent sparkler, and the sets have paid for themselves.

**250,000 HAMS**—Number of amateur radio addicts in the U.S. is expected to leap from 60,000 prewar licenses to 250,000 enthusiasts in postwar times, providing a 60 to 80 million dollar market. Bands will be crowded, and there's a movement afoot to encourage the hams to play around with higher frequencies.

In This Issue — **THREE MAGAZINES IN ONE**, covering **RADIO; ELECTRICAL APPLIANCES; SERVICE**  
Latest Radio Merchandise, pages 46 to 49

New Things for Service and Sound, pages 98, 100

Newest Electrical Appliances, pages 68 to 73

Listing of Radio Manufacturers, page 60

Listings of Electrical Appliance Makers, page 80

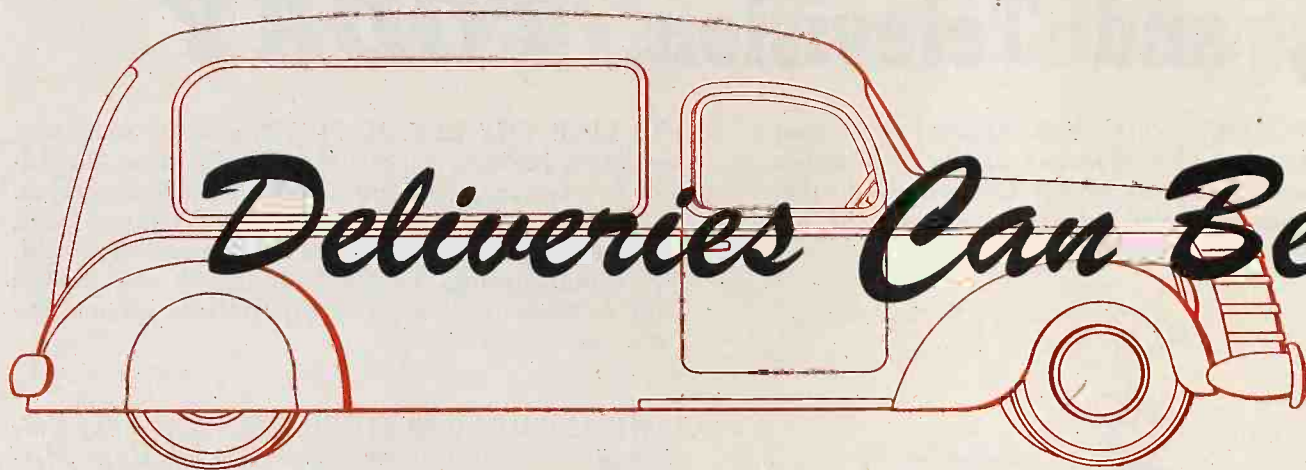

# Deliveries Can Become

## **Proper Handling of Your "Rolling Stock" and Proper Procedure Will Reduce Costs and Build Business**

● The return of merchandise, welcome as it is, brings with it many problems of cost. With narrowed trade discounts, dealers are scrutinizing each element of expense to keep it in line. One of the important expenses with such bulky merchandise as radios and electrical appliances is that of delivery.

One source of mounting delivery expense is needless call-backs. You can avoid many of these by planning.

### **Wasteful Calls Unnecessary**

Some radio-appliance dealers make it a habit to call up the entire list of customers before the delivery man sets out on his route. By doing so they are able to make arrangements by asking the housewife what to do about delivering the merchandise if she will not be at home. Sometimes it is possible to arrange to leave the merchandise with a neighbor. In the case of heavy appliances or radios perhaps the housewife is willing to leave a key with a neighbor in order to allow the delivery man to enter her home and make the delivery.

Your best defense against unnecessary loss due to damaged goods and equipment is to keep a record of all goods damaged by your delivery man and of the condition of

- Avoid needless call-backs by planning route in advance
- Control damage to equipment, merchandise, through records
- Reduce warranty - period calls by better installation
- Capitalize on advertising value of equipment with signs

the equipment which he is required to maintain. These records are actually your only basis of control. Without them your losses through this source may mount to considerable totals over a period of time.

One hidden source of considerable expense arises through the necessity to coordinate the work of the delivery department and the service department in installing new appliances and radios.

It is usually a wasteful procedure to have the delivery man and service man arrive at a home at the

same time. Instead it is better to have the delivery man deliver the merchandise first and then let the service man come in at a later time on his own route.

Against this method you must balance the fact that customers want their goods as promptly as possible and are loath to see merchandise stand in their homes for any considerable period of time before the service man comes to install it. Promptness of delivery and service must be weighed carefully against the extra cost which it brings.

### **Prompt Service Important**

Another source of needless call-backs is the necessary service calls which arise during the warranty period, on both radios and electrical appliances. Some of these calls are, of course, necessary from a psychological standpoint, to keep the customer happy, even though there is nothing basically wrong with the product.

Many calls under warranty agreements can, however, be eliminated, saving not only the time of the service man but also gasoline, tires and wear and tear on the automotive equipment used.

Have your service men deliver and install each new appliance or

# an Asset

radio set as a definite part of the sales expense. Instruct them to teach the customer carefully how to operate and maintain the product in use.

This policy will cut down materially the needless running around of your service men later on.

You can do more than merely reduce the cost of operating your delivery and service equipment. You can actually transform the equipment into an asset to your store.

Your delivery system is a potential means of advertising your store and the products you sell. It may be considered to be your cheapest advertising medium because it costs you only the amount of paint and sign work needed to transform your equipment.

## Use Vehicle for Publicity

Your truck can become a moving billboard. Movement always attracts attention so that the message is a more valuable advertising medium than as if it were standing still.

Have the advertisements on your delivery equipment interesting and appealing to the eye. If you have not exploited this means of advertising fully as yet you may be surprised at the amount of public recognition it will win for you.

There are several methods of advertising on delivery trucks. One way is to use a permanent paint job.

Some dealers go in for varying colors of their trucks in order to attract attention. These color



Customers eagerly await the day when your truck pulls up to the door with their merchandise. (See front cover.) Delivery debits can be turned into profit-makers if opportunely managed.

schemes include the use of bright colors such as lemon yellow and checkerboard designs.

Another kind of advertisement is the use of decalcomanias on your truck. Some of these are furnished by manufacturers.

Some dealers have achieved unusual results in advertising their store through the use of unusual paint jobs on their delivery equipment. One dealer operates delivery trucks that he has painted white and on which he has placed the sign "Radio Hospital". This dealer has all his employees wear white coats to add to the hospital atmosphere.

It is a good idea for you to stress your service department in your advertising on your delivery truck. This is because the merchandise you carry tends to change so rapidly that specific advertising of it on your truck becomes difficult.

## Advertising Ideas

Some dealers put frames on the sides of their trucks which will hold sign cloth. On this sign cloth they paint banners for special events. This sign cloth lasts for as many

weeks as they need, usually well over a month depending upon whether it is a dry or rainy season.

These sign cloths can be painted in bright colors and give a most attractive appearance to the truck. The fact that the messages change means that people will continue to look at your delivery equipment and will notice it with considerably greater interest than as if you have merely a paint job.

## Make Deliveries Pay

Try to be as individual in your treatment of your delivery equipment as possible. Select a color that is different from that of other dealers in your area. Individuality of color in identification marks will help make your delivery equipment stand out and act as a valuable advertising medium for your store.

There are always two ways to think of delivery in your store. One is as an expense and the other is as a means of building business. If you will seek to reduce your expense and at the same time to increase your sales you will make your delivery methods a constructive part of the merchandising methods of your store.

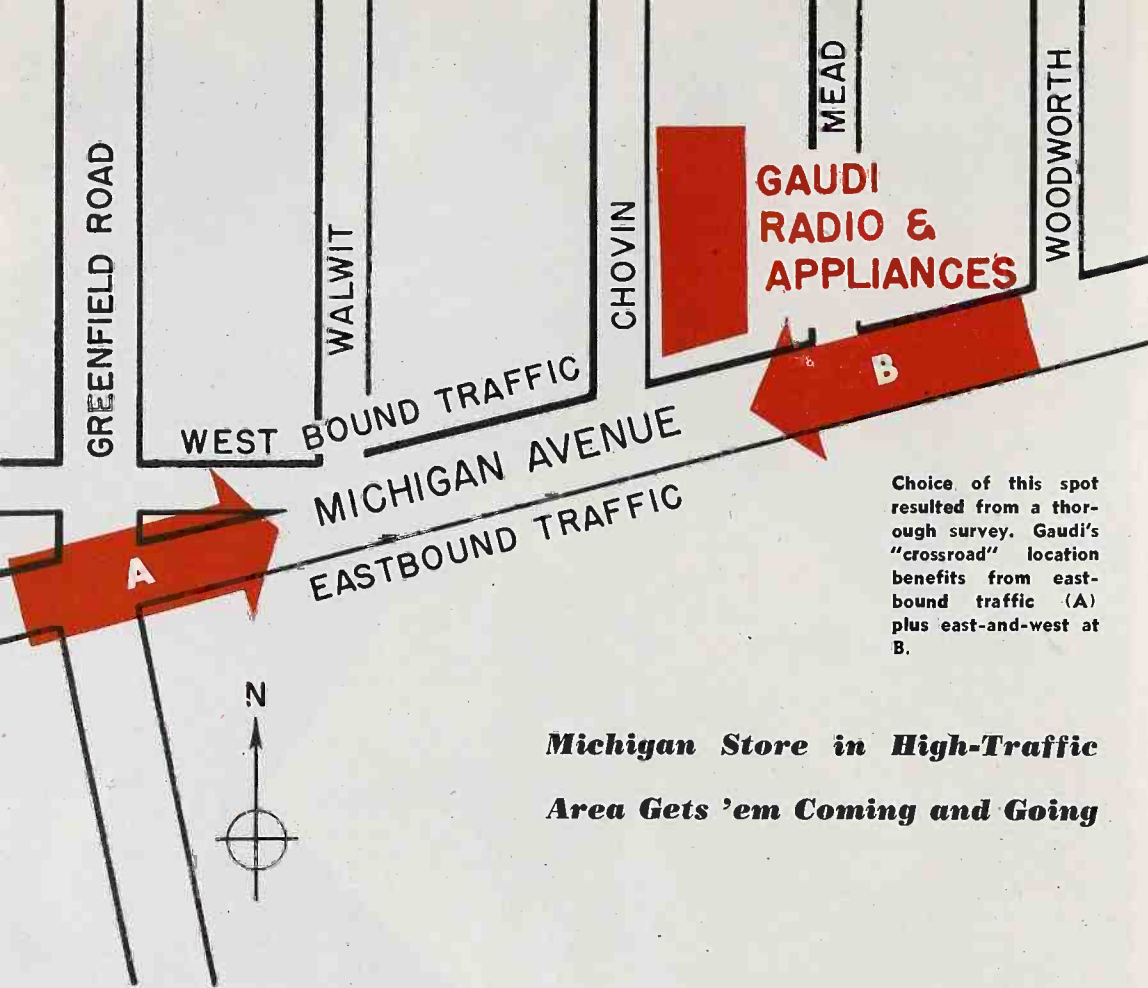

Choice of this spot resulted from a thorough survey. Gaudi's "crossroad" location benefits from eastbound traffic (A) plus east-and-west at B.

**Michigan Store in High-Traffic Area Gets 'em Coming and Going**



## PLANNED LOCATION PAYS

● One of the factors which make for the successful operation of a radio and electrical appliance store is location. When A. Gaudi set about looking for a spot to establish his business, this was foremost in his mind.

This dealer's store, the Gaudi Radio & Appliance Shop, 15044 Michigan Ave., Dearborn, Mich., is now situated at a location where business is fine! However, Gaudi did not choose his location simply by sticking a pin into the map of Dearborn!

Plenty of thought went into the choosing of the present location. As a result, the store is now situated in an area favorable to business, and all indications point to consistently profitable operation.

### **Knew What He Wanted**

When Gaudi was deciding where to locate his store, he wanted a place which would be:

1. Comparatively inexpensive in land value.
2. Be located in a growing part of the city.
3. Have a great deal of traffic.

What this radio and electrical appliance dealer had in mind, when thinking of a site which would insure profitable operation, was to choose a location which was off the beaten track. Gaudi's successful business is proving that he was on the right track when he chose his present location.

"We realized that the choice of a correct location is very important," this dealer declared, "and that this decision might either make us or break us. That's why we gave plenty of thought before we built the store here.

"While it is usually wise to locate in an established neighborhood with sufficient pedestrian or auto traffic, we decided to choose a location which was in a relatively unsettled section of the city. However, we figured that by establishing ourselves in a rapidly growing community, we could get a head start on business in this area.

"In locating our establishment," Gaudi continued, "we took some advice offered in the book published by RADIO & Television RETAILING entitled, 'Get Ready Now to Sell Television', which gave tips on

selecting the proper location."

As a result of his practical planning, Retailer Gaudi built an attractive, modern store in which to sell and service new radios and electrical appliances.

Since he started operation, the community in which he is located has already started to grow. Expanding sales indicate that he has got in "on the ground floor" in this area.

The store's excellent location in a high auto-traffic area has begun to pay off. Many of the cars which pass by here are "stopped" by the eye-catching establishment.

### **All Eyes on Store**

Michigan Ave., on which the store is situated, is one of the main thoroughfares for the western half of the city of Detroit. One block from the establishment, Michigan Ave. blends into a two-way street from a dual-lane super-highway.

All the in-bound traffic from Wayne, West Dearborn, Inkster, Eloise, and several other communities west of Detroit make this turn from the two-lane to a one-lane



# DEALER!

road. The turn itself is about 200 feet long, and during the process of making the swing all cars are pointed directly at Gaudi's store.

A large amount of auto traffic means a high sales volume for this store. A recent traffic count of cars going both ways in front of the establishment showed that 18,000 autos passed here on an average day.

Customers coming to the store for sales or service indicate a desire to trade here. No horoscope is needed to show that the firm is headed for a steady, repeat business.

Salesmen and representatives from various distributors in Detroit have also shown a great deal of enthusiasm for the establishment. The future looks bright!

When the store was built at its present outlying location, away from Dearborn's main business district, it was with the hope that other independent merchants would soon move out there also.

This hope has already been realized, as there is not a single lot for sale for four blocks east of the establishment, and three blocks

west of it. Across the street from the store, there are about twelve lots which are up for sale. However, these are only in 20 foot lots scattered over seven full business blocks.

Gaudi's ability to predict a trend in the development of the area in which the store is located is beginning to prove itself. Many retailers in different types of businesses have begun to move out this way. All signs indicate that this section of the city will rapidly become a busy shopping center.

Most of the lots on the same side

## How Gaudi Hit the Spot!

**He chose an inexpensive location.**

**He foresaw future growth in section.**

**Passing traffic was counted.**

**Saw location promising him a head-start in vicinity.**

**Knew eye-catching store would "stop" motorists.**

**Studied tips in RTR handbook.**

**Saw streets as business-bringers.**

of the street as the Gaudi Radio & Appliance Shop have already been sold to independent dealers. Many of these merchants are building now, or intend to do so as soon as building materials become available. In addition to the independent stores, there are a theatre, two nationally-known chain grocery stores, and two Detroit chain drug stores.

Since the store is now in a position to sell and service sets and appliances for residents in the entire southwestern section of Detroit and vicinity (approximately 250,000 population in these communities), it feels that its set-up can compare

favorably with any independent merchant's establishment in this area.

The store itself is very attractive, and is designed with an eye toward practicability and comfort. It measures approximately 22 by 70 feet. Both interior and exterior have plenty of eye-appeal and are inviting to sales.

### *Efficient Store Layout*

The salesroom measures 20 by 46 feet, and it is equipped with the latest in store fixtures. Walls are finished in an off-white color; the floor is of walnut asphalt tile. Attractive lighting is supplied by two rows of fluorescent fixtures.

Two dual blower gas unit heaters keep the interior of the store at a comfortable temperature during the cold months of the year. An 8 by 10 foot room serves as an office, while the maintenance and storage room measures 12 by 20 feet. There are two lavatories and a 3 by 5 foot closet.

The exterior of the building is painted an attractive shade of blue. Door frames and the frame of the bay window are painted in white. The homey appearance of the storefront has a pleasing effect on customers.

For display of table model radios, small electrical appliances, and other goods, the store has built-in wall display shelves. Ease of arrangement and effective display supply the keynote of the establishment's sales floor.

### *Geared for Service-Selling*

As Gaudi expects to do a big job in servicing receivers and electrical appliances, he has provided facilities for this work. A large window at the rear of the salesroom permits over-the-counter handling for radio maintenance, as the radio test and work bench are behind this window.

On the other side of a center door, this same arrangement permits conversation and handling of forms, money, etc., between the office and salesrooms. This layout has proved successful for speeding the handling of sales and service.

Gaudi will sell lines of refrigerators, washers, radios, ranges, and table appliances. Franchises have already been granted for merchandising well-known brands.

With an excellent location, an attractive store, the ability to see ahead, good merchandise and service, this retailer feels that he faces a profitable future.

# Store Display Does the Job

**New Jersey Dealer Has a Money-Making Formula for Showing, Demonstrating and Selling New Merchandise**

• Powers, Inc., 887 Broad St., Newark, N. J., has formulated sales policies which are paying off in cash.

To "stop" passers-by on the street and attract them into the store, the firm's window displays are sure-fire sales builders. The eye-catching, well-arranged windows, filled chock-full of the latest radios and electrical appliances are bringing droves of prospects into the establishment.

A close-up of the Powers style of radio display is shown on the opposite page. The appliance display appears on the April cover of the "Electrical Appliances" section.

And once inside the store, Lewis C. Barron, one of the owners and managers of the organization, has his sales plans so well-organized that buyers are "sold" on the establishment and the goods on sale there.

## First Models Starred

Taking his cue from an article in RADIO & Television RETAILING entitled "Use What You HAVE to Make the Sale", Barron has squeezed the last drop of sales value from his radio and electrical appliance demonstrator models.

Using his demonstrators, in addition to circulars, ads, and blow-ups, he is displaying these items where they do the most good—in the windows. As a result, these outside showcases give the store a prosperous, well-stocked appearance.

By massing his displays in the windows, Barron is taking advantage of the heavy flow of street

traffic. This dealer has found it profitable to crowd his windows (still keeping them attractive) with nationally-known brands of receivers and appliances.

Persons walking by the Powers establishment are drawn to the windows by smart displays. To excite attention to the window displays and keep eyes glued there, every item shown is clearly marked with a price.

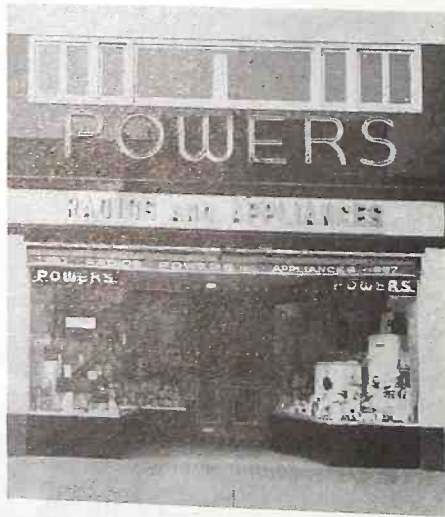

"The chief advantages of attaching prices to goods on display," Barron stated, "is to assure customers that fair prices are charged to all, and that there is no discrimination in our sales policies."

Window displays are changed every month to maintain constant interest.

The store-front itself has a great deal of "class". The exterior is panned in black glass to give a smart, modern appearance. Marble pilas-

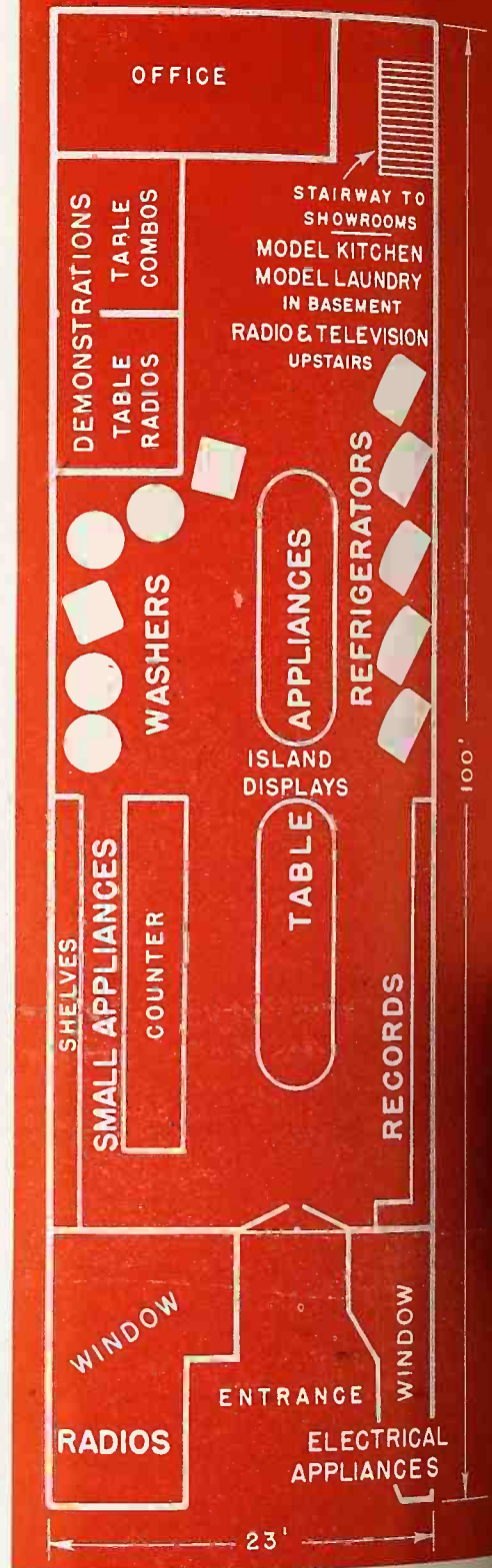

The above arrangement of merchandise has proved its worth for the Newark, N. J., retailer.

This store has started at the front with the idea that Powers must look like headquarters.

ters on the sides of the building lend dignity to the store.

Since the establishment opened its doors for business eight months ago, profits have been climbing. The store's records show in blue ink that the firm is making money—despite the shortages in merchandise.

Barron's many years of radio-appliance merchandising experience have gone into the sales policies used by the firm. And these profit-



pulling methods are clicking with the public!

"We're out to make our customers 'Powers Conscious,'" Barron explained. "We believe that there are two ways to sell a receiver or an appliance: (1) To make a quick sale regardless of the future; (2) To make customer contacts which will bring in a steady business. We have chosen the second course."

The backbone of the company's sales formula is that "customers must be pleased at any cost". When a customer enters the store, the salesmen have explicit instructions that he, the buyer, is right—right or wrong. This policy is paying off, as a glance at the sales figures shows.

### Ready with Refunds

A "must" with the firm is its unlimited refund program. Any item bought at the store can be returned by the buyer with no questions asked, and no stalling on the part of the salesman.

To determine future buying poli-

cies, patrons are often asked just why they are dissatisfied with their purchases. However, this point is not pressed.

A direct result of this refund program is the large amount of friends the store is making. Much goodwill is being built.

Customers will frequently not accept a cash refund—although the firm will readily offer to do so—but will insist on buying something else in the establishment.

### Customer's King

A profitable repeat business is being created by the store by knowing that:

1. Patrons are grateful when salesmen go out of their way to help them.

2. Customers enjoy buying in a clean, well-lighted establishment.

3. Radios and appliances with well-known, well-advertised names help to sell themselves.

To build a profitable mailing list, the organization "registers" pur-

chasers who wish to buy a set or table appliance which is not in stock. These prospects write their names and addresses on a card and are told that they will be notified as soon as the goods ordered arrive at the store.

### Ideas That Work

When the receiver or appliance comes to the establishment, customers are notified immediately and these goods held for a week. Customers are approving this policy and many friends have been won by the store.

Barron insists on hiring experienced salesmen only. By paying these men well (three are employed at present), the firm is assured of honest and sound salesmanship. These men are well "up" on customer psychology.

Salesmen are instructed to treat all customers alike, regardless of the size of purchases. Strict adherence to the "customer is always right" policy is demanded from the

(Continued on page 108)

Within a striking "frame" of black glass panels, Powers combines mass display with decorative trims. See appliance window April 1946 Issue.



# ALL EYES ON 1946

Huge Attendance Expected at Stevens. Exhibits to Accent Reconversion, Feature



Left to right, this page: Kenneth C. Prince, gen. mgr. Radio Parts & Electronic Equipment Shows, Inc. H. W. Clough, vice-president Belden Mfg., Chicago, is the Show's president. Aerovox's sales mgr. Charley Golenpaul, serves as vice-president of the Show's organization. The Show's secretary is J. J. Kahn, president Standard Transformer Corp., Chicago. Show treasurer Sam Poncher is one of the guiding lights of Newark Electric Co., Chicago & N. Y. Distributors

## GREETINGS

### to those participating in the 1946 RADIO PARTS and ELECTRONIC EQUIPMENT SHOW!

During the War you fellows produced, supplied and expedited deliveries of the finest equipment the world has ever seen. You out-thought, out-smarted and out-produced the enemy at every turn. You guarded the Nation's top-secrets with meticulous care.

In addition to contributing so greatly to the war effort, your factories supplied parts to the home-front whenever and wherever possible.

Now war is a thing of the past. You face a multitude of problems in the desire to do a good job with the task of whittling down the prodigious back-log of civilian demand.

Let's all hope that this 1946 Chicago Show will pull the trigger on the production starting gun. Let's hope that we'll all be hitting our strides in manufacturing and supplying—and we mean in a big way—within a very short time!

• With every prominent manufacturer in the country represented on the exhibit floor, the 1946 Radio Parts and Electronic Equipment Show will get under way in the Stevens Hotel, Chicago, on May 13, and will entertain visiting manufacturers, distributors and sales representatives for four days, ending May 16.

Marking the first industry-wide meeting of the postwar period, and ushering in what appears to be the first real start of big-scale production, the show will accent new developments in radio parts, tools and electronic equipment.

## LIST OF EXHIBITORS

	Booth
Aerovox Corp., New Bedford, Mass.....	90
Alliance Mfg. Co., Alliance, Ohio.....	98
Alpha Wire Corp., 50 Howard St., New York.....	141
American Coil & Engineering Co., 1271 North Hermitage Ave., Chicago.....	136
American Condenser Co., 4410 North Ravenswood Ave., Chicago.....	129
American Phenolic Corp., 1830 South 54th Ave., Cicero, Ill.....	38
American Radio Hardware Co., Inc., 152 MacQuesten Parkway, Mt. Vernon, N. Y.....	29
Amperex Electronic Corp., 79 Washington St., Brooklyn, N. Y.....	67
Amperite Co., 561 Broadway, New York.....	133
Astatic Corp., Conneaut, Ohio.....	95
Atlas Sound Corp., 1443 39th St., Brooklyn, N. Y.....	80
Audio Devices, Inc., 444 Madison Ave., New York.....	96
Belden Mfg. Co., P. O. Box 5070A, Chicago.....	87
Bell Sound Systems, Inc., 1183 Essex Ave., Columbus, Ohio.....	13
Bliley Electric Co., Erie, Pa.....	6
David Bogen Co., 663 Broadway, New York.....	40
Brand & Co., William, 276 Fourth Ave., New York.....	105
British Industries Sales Corp., 276 Fourth Ave., New York.....	158
Brush Development Co., 3405 Perkins Ave., Cleveland, Ohio.....	65
Bud Radio, Inc., 2118 East 55th St., Cleveland.....	54
Burgess Battery Co., Freeport, Ill.....	156
Camburn, Inc., 490 Broome St., New York.....	22
Cardwell Mfg. Corp., Allen D., 81 Prospect St., Brooklyn 1, N. Y.....	97
Carron Mfg. Co., 415 S. Aberdeen St., Chicago.....	84
Centralab, 900 E. Keefe Ave., Milwaukee, Wis.....	39
Cinaudagraph Corp., Stamford, Conn.....	161
Clarostat Mfg. Co., Inc., 130 Clinton St., Bklyn.....	124
Communication Measurements Lab., 120 Greenwich St., New York.....	28
Continental Carbon Inc., 13900 Lorain Ave., Cleveland, Ohio.....	149

	Booth
Continental Electric Co., Geneva, Ill.....	25
Corning Glass Works, Corning, N. Y.....	66
Croname, Inc., 3701 N. Ravenswood Ave., Chicago.....	45
Crystal Research Laboratories, Inc., 29 Allyn St., Hartford, Conn.....	137
DeMornay Budd, Inc., 475 Grand Concourse, New York.....	111
Deutschmann Corp., Tobe, Canton, Mass.....	76
Dial Light Co. of America, Inc., 900 Broadway, New York.....	60
Drake Electric Works, Inc., 3656 Lincoln Ave., Chicago.....	73
Dumont Electric Corp., 34 Hubert St., New York.....	164
Duotone Co., Inc., 799 Broadway, New York.....	21
DX Radio Products Co., 1200 N. Claremont Ave., Chicago.....	109
Eastern Amplifier Corp., 794 East 140th St., New York.....	125
Eastern Electronics Corp., 41 Chestnut St., New Haven, Conn.....	134
Electronic Soldering Iron Co., Inc., Deep River, Conn.....	93
Electrical Reactance Corp., Franklinville, N. Y.....	91
Electro Products Laboratories, 549 West Randolph St., Chicago.....	127
Electronic Engineering Co., 3223 W. Armitage Ave., Chicago.....	42
Electro-Voice, Inc., 1239 South Bend Ave., South Bend, Ind.....	15
Erwood Co., 223 West Erie St., Chicago.....	104
Freed Transformer Co., 72 Spring St., New York.....	114
General Cement Mfg. Co., 919 Taylor Ave., Rockford, Ill.....	79
General Electric Co., Schenectady, N. Y.....	58
General Electronics, Inc., 1917 N. Springfield Ave., Chicago.....	33
General Industries Co., Elyria, Ohio.....	120
General Transformer Corp., 1250 W. Van Buren St., Chicago.....	59
Gothard Mfg. Co., 2110 Clear Lake Ave., Springfield, Ill.....	150
Guardian Electric Mfg. Co., 1400 W. Washington Blvd., Chicago.....	51

	Booth
Guthman & Co., Inc., Edwin I., 15 S. Throop St., Chicago.....	115
Haldorson Co., 4500 N. Ravenswood Ave., Chicago.....	44
Hallcrafters Co., 2611 Indiana, Chicago.....	35
Hardwick, Hindle, Inc., 40 Hermon St., Newark, N. J.....	130
Hammarlund Mfg. Co., Inc., 460 W. 34th St., New York.....	147
Hewlett-Packard Co., 395 Page Mill Road, Palo Alto, Cal.....	126
Hickok Electrical Instrument Co., 10514 Dupont Ave., Cleveland, Ohio.....	99
Hytron Radio & Electronics Corp., Salem, Mass.....	69
Indiana Steel Products Co., 6 North Michigan Ave., Chicago.....	113
International Resistance Co., 401 N. Broad St., Philadelphia.....	103
Insuline Corp. of America, 36-02 35th Ave., Long Island City, N. Y.....	34
Jackson Electrical Instrument Co., 16-18 Patterson Blvd., Dayton, Ohio.....	53
Jackson Industries, 1708 S. State St., Chicago.....	37
Jefferson Electric Co., 25th Ave. & Madison St., Bellwood, Ill.....	157
Jefferson-Travis Corp., 245 East 23rd St., New York.....	159
Jensen Radio Mfg. Co., 6601 S. Laramie Ave., Chicago.....	68
J. F. D. Mfg. Co., 4117 Fort Hamilton Parkway, Brooklyn, N. Y.....	118
Johnson Co., E. F., Waseca, Minn.....	92
Lectrohm Inc., 5129 W. 25th St., Cicero, Ill.....	63
Lenz Electric Mfg. Co., 1751 N. Western Ave., Chicago.....	152
Littlefuse, Inc., 4757 North Ravenswood, Chicago.....	123
Madison Electrical Products Co., 78 Main St., Madison, N. J.....	55
P. R. Mallory & Co., Inc., 3029 East Washington St., Indianapolis, Ind.....	36
Marion Electrical Instrument Co., Manchester, N. H.....	17
Mark Simpson Mfg. Co., 186-194 West 4th St., New York.....	46
Meck Industries, John, Liberty St., Plymouth, Ind.....	163

# CHICAGO SHOW

Far-born Achievements. Show Seen Marking Start of Big-Scale Production.

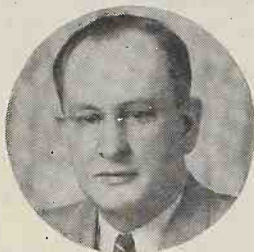

Left to right, this page: Leslie F. Muter, president The Muter Co., is a director. J. A. Berman, Shure Bros., Chicago, sales mgr., in addition to being show director, is president of the Assn. of Electronic Parts & Equipment Mfrs., an exhibit sponsor. Show director R. P. Almy, Sylvania executive, is Sales Managers Club (Eastern div.) chairman, also a sponsoring organization. W. O. Schoning, Lukko Sales Co. official, serves as a show director. He is also president of the Natl. Electronic Distributors Assn. R. C. Sprague, president of Sprague Products Co., is chairman, parts division, radio Manufacturers Assn., show sponsors.

Sponsored by the National Electronic Distributors Assn., Radio Manufacturers Assn. (parts division), Sales Managers Club (Eastern division) and the Assn. of Electronic Parts and Equipment Manufacturers, the event has been planned and carried out by the Radio Parts and Electronic Equipment Shows, Inc., of which Kenneth C. Prince is general manager. Following are the officers and directors: H. W. Clough, vice-president Belden Mfg. Co., president; Charles Golenpaul, sales manager Aerovox Corp., vice-president; J. J. Kahn, president Standard Trans-

former Corp., secretary; Sam Poncher, Newark Electric Co., treasurer; Leslie F. Muter, president The Muter Co., J. A. Berman, sales manager Shure Bros., R. P. Almy, manager district sales, Sylvania Electric Prod., Inc., and W. O. Schoning, Lukko Sales Co., directors. Chicago advertising man, H. H. Teplitz, is advertising counsel of the Show.

Coming as it does upon the heels of good news along the labor fronts, the Show timing could not have been better.

In addition to this almost perfect timing, the Show will also pro-

vide many heretofore top-secret items for public inspection for the first time.

In addition to seeing the new things on exhibit, Show officials feel that this get-together of industry people will do much toward solving their mutual problems.



	Booth
Meissner Mfg. Co., Mt. Carmel, Ill. ....	81
Merit Coil and Transformer Corp., 4427 N. Clark St., Chicago .....	52
Millen Manufacturing Co., Inc., James, 150 Exchange St., Malden, Mass. ....	57
Milwaukee Stamping Co., 800 South 72nd St., Milwaukee .....	19
Muter Co., 1255 S. Michigan Ave., Chicago .....	89
McGrade Mfg. Co., E. W., Porter Building, Kansas City, Mo. ....	24
McMurdo Silver Co., 1240 Main St., Hartford, Conn. ....	16
National Co., Inc., 61 Sherman St., Malden, Mass. ....	108
National Union Radio Corp., 15 Washington St., Newark, N. J. ....	9
New York Transformer Co., 62 William St., New York .....	140
Ohio Tool Co., 3160 W. 106th St., Cleveland, Ohio. ....	131
Ohmite Mfg. Co., 4835 Flournoy St., Chicago. ....	72
Operadio Mfg. Co., St. Charles, Ill. ....	155
Oxford-Tartak Radio Corp., 3911 S. Michigan Ave., Chicago .....	5
Park Metalware Co., Inc., Bank St., Orchard Park, N. Y. ....	128
Par-Metal Products Corp., 32-62 49th St., Long Island City, N. Y. ....	3
Permo, Inc., 6415 Ravenswood Ave., Chicago. ....	117
Permolux Corp., 4900 W. Grand Ave., Chicago. ....	32
Philmore Mfg. Co., 113 University Pl., New York. ....	119
Potter & Brumfield Mfg. Co., 549 W. Washington St., Chicago .....	12
Precision Apparatus Co., 92-27 Horace Harding Blvd., Elmhurst, N. Y. ....	143
Premax Products Division, Niagara Falls, N. Y. ....	18
Presto Recording Corp., 242 W. 55th St., New York. ....	135
Price Electric Corp., East Church & 2nd Sts., Frederick, Md. ....	30
Quam-Nichols Co., 33d Pl. & Cottage Grove Ave., Chicago .....	82
Racon Electric Co., Inc., 52 E. 19th St., New York. ....	122
Rad-El-Co Mfg. Co., 6300 Euclid Ave., Cleveland, Ohio .....	160

	Booth
Radiart Corp., 3571 W. 62nd St., Cleveland, Ohio. ....	153
Radio City Products Co., Inc., 127 West 26th St., New York .....	62
Radio Essentials, Inc., 110 East 3rd St., Mt. Vernon, New York .....	71
Radio Mfg. Engineers, Inc., 300-306 First Ave., Peoria, Ill. ....	77
Rauland Corp., 4245 N. Knox Ave., Chicago .....	83
RCA, Camden, N. J. ....	145
Raytheon Mfg. Co., Newton, Mass. ....	110
Recordisc Corp., 395 Broadway, New York .....	2
Reiner Electronics Co., Inc., 152 W. 25th St., New York .....	48
Rek-O-Kut Co., 146 Grand St., New York .....	70
Schott Co., Walter L., 9306 Santa Monica Blvd., Beverly Hills, Cal. ....	116
Shur-Antenna-Mount, Inc., Sea Cliff, N. Y. ....	162
Shure Brothers, 225 W. Huron St., Chicago. ....	85
Simpson Electric Co., 5200-18 W. Kinzie St., Chicago .....	112
Snyder Mfg. Co., 22nd & Ontario St., Philadelphia. ....	50
Solar Mfg. Corp., 285 Madison Ave., New York .....	148
Spirling Products Co., Inc., 60-62-64 Grand St., New York .....	10
Sprague Products Co., North Adams, Mass. ....	132
Stamford Electric Products Co., Inc., Stamford, Conn. ....	14
Standard Transformer Corp., 1500 North Halsted, Chicago .....	88
Stromberg-Carlson, Rochester, N. Y. ....	144
Stupakoff Ceramic & Mfg. Co., Latrobe, Pa. ....	138
Supreme Instruments Corp., Greenwood, Miss. ....	101
Sylvania Electric Products, Inc., Emporium, Pa. ....	86
Talk-A-Phone Mfg. Co., 1512 S. Pulaski Rd., Chicago. ....	121
Technical Appliance Corp., 41-06 DeLong St., New York .....	146
Telegraph Apparatus Co., 412 S. Green St., Chicago .....	4
Thordarson Electric Mfg. Div., 500 W. Huron St., Chicago .....	94
Trimm, Inc., 1770 W. Berteau Ave., Chicago .....	74
Triplett Electrical Instrument Co., Bluffton, Ohio. ....	139
Tung-Sol Lamp Works, Inc., 95 Eighth Ave., Newark, N. J. ....	61

	Booth
Turner Co., Cedar Rapids, Iowa .....	49
United Transformer Corp., 150 Varick St., New York .....	20
Universal Microphone Co., Inglewood, Cal. ....	41
University Laboratories, 225 Varick St., New York. ....	56
Utah Radio Products, 820 N. Orleans St., Chicago. ....	106
V-M Corp., 4th & Park Sts., Benton Harbor, Mich. ....	154
Ward Leonard Electric Co., Mt. Vernon, N. Y. ....	100
Ward Products Corp., 1523 East 45th St., Cleveland, Ohio .....	102
Waterman Products Co., Inc., 2445-63 Emerald St., Philadelphia .....	26
Webster-Chicago Corp., 5610 Bloomingdale Ave., Chicago .....	43
Webster Electric Co., Clark & DeKoven Ave., Racine, Wis. ....	151
Weller Mfg. Co., Easton, Pa. ....	47
Westinghouse Electric Corp., Pittsburgh, Pa. ....	7
Weston Electrical Instrument Corp., 614 Frelinghuysen Ave., Newark, N. J. ....	75
Wirt Co., 5221 Greene St., Philadelphia .....	78
Workshop Associates, 66 Needham St., Newton Highlands, Mass. ....	142
Worner Electronic Devices, 609 W. Lake St., Chicago .....	8

## The "Reps" on Hand

The Representatives of Radio Parts Mfrs. will find the Show helps them to meet business acquaintances, renew friendships. Shown right is Irvin L. Aarons, Milwaukee, "Reps" president.



# ALL EYES ON 1946

Huge Attendance Expected at Stevens. Exhibits to Accent Reconversion, Features



Left to right, this page: Kenneth C. Prince, gen. mgr. Radio Parts & Electronic Equipment Shows, Inc. H. W. Clough, vice-president Belden Mfg., Chicago, is the Show's president. Aerovox's sales mgr. Charley Golenpaul, serves as vice-president of the Show's organization. The Show's secretary is J. J. Kahn, president Standard Transformer Corp., Chicago. Show treasurer Sam Poncher is one of the guiding lights of Newark Electric Co., Chicago & N. Y. Distributors

## GREETINGS

### to those participating in the 1946 RADIO PARTS and ELECTRONIC EQUIPMENT SHOW!

During the War you fellows produced, supplied and expedited deliveries of the finest equipment the world has ever seen. You out-thought, out-smarted and out-produced the enemy at every turn. You guarded the Nation's top-secrets with meticulous care.

In addition to contributing so greatly to the war effort, your factories supplied parts to the home-front whenever and wherever possible.

Now war is a thing of the past. You face a multitude of problems in the desire to do a good job with the task of whittling down the prodigious back-log of civilian demand.

Let's all hope that this 1946 Chicago Show will pull the trigger on the production starting gun. Let's hope that we'll all be hitting our strides in manufacturing and supplying—and we mean in a big way—within a very short time!

• With every prominent manufacturer in the country represented on the exhibit floor, the 1946 Radio Parts and Electronic Equipment Show will get under way in the Stevens Hotel, Chicago, on May 13, and will entertain visiting manufacturers, distributors and sales representatives for four days, ending May 16.

Marking the first industry-wide meeting of the postwar period, and ushering in what appears to be the first real start of big-scale production, the show will accent new developments in radio parts, tools and electronic equipment.

## LIST OF EXHIBITORS

	Booth		Booth
Aerovox Corp., New Bedford, Mass.....	90	Continental Electric Co., Geneva, Ill. ....	25
Alliance Mfg. Co., Alliance, Ohio.....	98	Corning Glass Works, Corning, N. Y.....	66
Alpha Wire Corp., 50 Howard St., New York.....	141	Croname, Inc., 3701 N. Ravenswood Ave., Chicago..	45
American Coil & Engineering Co., 1271 North Hermitage Ave., Chicago .....	136	Crystal Research Laboratories, Inc., 29 Allyn St., Hartford, Conn. ....	137
American Condenser Co., 4410 North Ravenswood Ave., Chicago .....	129	DeMornay Budd, Inc., 475 Grand Concourse, New York .....	111
American Phenolic Corp., 1830 South 54th Ave., Cicero, Ill. ....	38	Deutschmann Corp., Tobe, Canton, Mass.....	76
American Radio Hardware Co., Inc., 152 MacQuesten Parkway, Mt. Vernon, N. Y. ....	29	Dial Light Co. of America, Inc., 900 Broadway, New York .....	60
Amperex Electronic Corp., 79 Washington St., Brooklyn, N. Y. ....	67	Drake Electric Works, Inc., 3656 Lincoln Ave., Chicago .....	73
Amperite Co., 561 Broadway, New York.....	133	Dumont Electric Corp., 34 Hubert St., New York...164	
Astatic Corp., Conneaut, Ohio .....	95	Duotone Co., Inc., 799 Broadway, New York.....	21
Atlas Sound Corp., 1443 39th St., Brooklyn, N. Y..	80	DX Radio Products Co., 1200 N. Claremont Ave., Chicago .....	109
Audio Devices, Inc., 444 Madison Ave., New York..	96	Eastern Amplifier Corp., 794 East 140th St., New York .....	125
Belden Mfg. Co., P. O. Box 5070A, Chicago.....	87	Eastern Electronics Corp., 41 Chestnut St., New Haven, Conn. ....	134
Bell Sound Systems, Inc., 1183 Essex Ave., Colum- bus, Ohio .....	13	Electronic Soldering Iron Co., Inc., Deep River, Conn.	93
Bliley Electric Co., Erie, Pa. ....	6	Electrical Reactance Corp., Franklinville, N. Y.....	91
David Bogen Co., 663 Broadway, New York.....	40	Electro Products Laboratories, 549 West Randolph St., Chicago .....	127
Brand & Co., William, 276 Fourth Ave., New York..105		Electronic Engineering Co., 3223 W. Armitage Ave., Chicago .....	42
British Industries Sales Corp., 276 Fourth Ave., New York .....	158	Electro-Voice, Inc., 1239 South Bend Ave., South Bend, Ind. ....	15
Brush Development Co., 3405 Perkins Ave., Clevel- and, Ohio .....	65	Erwood Co., 223 West Erie St., Chicago.....	104
Bud Radio, Inc., 2118 East 55th St., Cleveland..	54	Freed Transformer Co., 72 Spring St., New York..114	
Burgess Battery Co., Freeport, Ill. ....	156	General Cement Mfg. Co., 919 Taylor Ave., Rock- ford, Ill. ....	79
Camburn, Inc., 490 Broome St., New York.....	22	General Electric Co., Schenectady, N. Y.....	58
Cardwell Mfg. Corp., Allen D., 81 Prospect St., Brooklyn 1, N. Y. ....	97	General Electronics, Inc., 1917 N. Springfield Ave., Chicago .....	33
Carron Mfg. Co., 415 S. Aberdeen St., Chicago....	84	General Industries Co., Elyria, Ohio .....	120
Centralab, 900 E. Keefe Ave., Milwaukee, Wis.....	39	General Transformer Corp., 1250 W. Van Buren St., Chicago .....	59
Cinaudagraph Corp., Stamford, Conn. ....	161	Gothard Mfg. Co., 2110 Clear Lake Ave., Spring- field, Ill. ....	150
Clarostat Mfg. Co., Inc., 130 Clinton St., Bklyn..124		Guardian Electric Mfg. Co., 1400 W. Washington Blvd., Chicago .....	51
Communication Measurements Lab., 120 Greenwich St., New York .....	28		
Continental Carbon Inc., 13900 Lorain Ave., Clevel- and, Ohio .....	149		
		Guthman & Co., Inc., Edwin I., 15 S. Throop St., Chicago .....	115
		Haldorson Co., 4500 N. Ravenswood Ave., Chicago..	44
		Hallicrafters Co., 2611 Indiana, Chicago.....	35
		Hardwick, Hindle, Inc., 40 Hermon St., Newark, N. J. ....	130
		Hammarlund Mfg. Co., Inc., 460 W. 34th St., New York .....	147
		Hewlett-Packard Co., 395 Page Mill Road, Palo Alto, Cal. ....	126
		Hickok Electrical Instrument Co., 10514 Dupont Ave., Cleveland, Ohio .....	99
		Hytron Radio & Electronics Corp., Salem, Mass....	69
		Indiana Steel Products Co., 6 North Michigan Ave., Chicago .....	113
		International Resistance Co., 401 N. Broad St., Philadelphia .....	103
		Insuline Corp. of America, 36-02 35th Ave., Long Island City, N. Y. ....	34
		Jackson Electrical Instrument Co., 16-18 Patterson Blvd., Dayton, Ohio .....	53
		Jackson Industries, 1708 S. State St., Chicago....	37
		Jefferson Electric Co., 25th Ave. & Madison St., Bellwood, Ill. ....	157
		Jefferson-Travis Corp., 245 East 23rd St., New York.159	
		Jensen Radio Mfg. Co., 6601 S. Laramie Ave., Chicago .....	68
		J. F. D. Mfg. Co., 4117 Fort Hamilton Parkway, Brooklyn, N. Y. ....	118
		Johnson Co., E. F., Waseca, Minn.....	92
		Lectrohm Inc., 5129 W. 25th St., Cicero, Ill.....	63
		Lenz Electric Mfg. Co., 1751 N. Western Ave., Chicago .....	152
		Littlefuse, Inc., 4757 North Ravenswood, Chicago..123	
		Madison Electrical Products Co., 78 Main St., Mad- ison, N. J. ....	55
		P. R. Mallory & Co., Inc., 3029 East Washington St., Indianapolis, Ind. ....	36
		Marion Electrical Instrument Co., Manchester, N. H. 17	
		Mark Simpson Mfg. Co., 186-194 West 4th St., New York .....	46
		Meck Industries, John, Liberty St., Plymouth, Ind..163	

# CHICAGO SHOW

War-born Achievements. Show Seen Marking Start of Big-Scale Production.

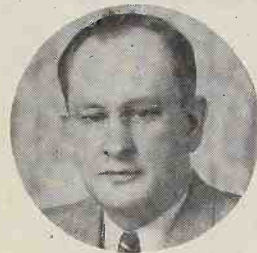

Left to right, this page: Leslie F. Muter, president The Muter Co., is a director. J. A. Berman, Shure Bros., Chicago, sales mgr., in addition to being show director, is president of the Assn. of Electronic Parts & Equipment Mfrs., an exhibit sponsor. Show director R. P. Almy, Sylvania executive, is Sales Managers Club (Eastern div.) chairman, also a sponsoring organization. W. O. Schoning, Lukko Sales Co. official, serves as a show director. He is also president of the Natl. Electronic Distributors Assn. R. C. Sprague, president of Sprague Products Co., is chairman, parts division, radio Manufacturers Assn., show sponsors.

Sponsored by the National Electronic Distributors Assn., Radio Manufacturers Assn. (parts division), Sales Managers Club (Eastern division) and the Assn. of Electronic Parts and Equipment Manufacturers, the event has been planned and carried out by the Radio Parts and Electronic Equipment Shows, Inc., of which Kenneth C. Prince is general manager. Following are the officers and directors: H. W. Clough, vice-president Belden Mfg. Co., president; Charles Golenpaul, sales manager Aerovox Corp., vice-president; J. J. Kahn, president Standard Trans-

former Corp., secretary; Sam Poncher, Newark Electric Co., treasurer; Leslie F. Muter, president The Muter Co., J. A. Berman, sales manager Shure Bros., R. P. Almy, manager district sales, Sylvania Electric Prod., Inc., and W. O. Schoning, Lukko Sales Co., directors. Chicago advertising man, H. H. Teplitz, is advertising counsel of the Show.

Coming as it does upon the heels of good news along the labor fronts, the Show timing could not have been better.

In addition to this almost perfect timing, the Show will also pro-

vide many heretofore top-secret items for public inspection for the first time.

In addition to seeing the new things on exhibit, Show officials feel that this get-together of industry people will do much toward solving their mutual problems.



	Booth
Meissner Mfg. Co., Mt. Carmel, Ill. ....	81
Merit Coil and Transformer Corp., 4427 N. Clark St., Chicago .....	52
Millen Manufacturing Co., Inc., James, 150 Exchange St., Malden, Mass. ....	57
Milwaukee Stamping Co., 800 South 72nd St., Milwaukee .....	19
Muter Co., 1255 S. Michigan Ave., Chicago .....	89
McGrade Mfg. Co., E. W., Porter Building, Kansas City, Mo. ....	24
McMurdo Silver Co., 1240 Main St., Hartford, Conn. ....	16
National Co., Inc., 61 Sherman St., Malden, Mass. ....	108
National Union Radio Corp., 15 Washington St., Newark, N. J. ....	9
New York Transformer Co., 62 William St., New York .....	140
Ohio Tool Co., 3160 W. 106th St., Cleveland, Ohio. ....	131
Ohmite Mfg. Co., 4835 Flournoy St., Chicago. ....	72
Operadio Mfg. Co., St. Charles, Ill. ....	155
Oxford-Tartak Radio Corp., 3911 S. Michigan Ave., Chicago .....	5
Park Metalware Co., Inc., Bank St., Orchard Park, N. Y. ....	128
Par-Metal Products Corp., 32-62 49th St., Long Island City, N. Y. ....	3
Permo, Inc., 6415 Ravenswood Ave., Chicago. ....	117
Permolux Corp., 4900 W. Grand Ave., Chicago. ....	32
Philmore Mfg. Co., 113 University Pl., New York. ....	119
Potter & Brumfield Mfg. Co., 549 W. Washington St., Chicago .....	12
Precision Apparatus Co., 92-27 Horace Harding Blvd., Elmhurst, N. Y. ....	143
Premax Products Division, Niagara Falls, N. Y. ....	18
Presto Recording Corp., 242 W. 55th St., New York. ....	135
Price Electric Corp., East Church & 2nd Sts., Frederick, Md. ....	30
Quam-Nichols Co., 33d Pl. & Cottage Grove Ave., Chicago .....	82
Racon Electric Co., Inc., 52 E. 19th St., New York. ....	122
Rad-El-Co Mfg. Co., 6300 Euclid Ave., Cleveland, Ohio .....	160

	Booth
Radiart Corp., 3571 W. 62nd St., Cleveland, Ohio. ....	153
Radio City Products Co., Inc., 127 West 26th St., New York .....	62
Radio Essentials, Inc., 110 East 3rd St., Mt. Vernon, New York .....	71
Radio Mfg. Engineers, Inc., 300-306 First Ave., Peoria, Ill. ....	77
Rauland Corp., 4245 N. Knox Ave., Chicago .....	83
RCA, Camden, N. J. ....	145
Raytheon Mfg. Co., Newton, Mass. ....	110
Recordisc Corp., 395 Broadway, New York .....	2
Reiner Electronics Co., Inc., 152 W. 25th St., New York .....	48
Rek-O-Kut Co., 146 Grand St., New York .....	70
Schott Co., Walter L., 9306 Santa Monica Blvd., Beverly Hills, Cal. ....	116
Shur-Antenna-Mount, Inc., Sea Cliff, N. Y. ....	162
Shure Brothers, 225 W. Huron St., Chicago. ....	85
Simpson Electric Co., 5200-18 W. Kinzie St., Chicago .....	112
Snyder Mfg. Co., 22nd & Ontario St., Philadelphia. ....	50
Solar Mfg. Corp., 285 Madison Ave., New York .....	148
Spirling Products Co., Inc., 60-62-64 Grand St., New York .....	10
Sprague Products Co., North Adams, Mass. ....	132
Stamford Electric Products Co., Inc., Stamford, Conn. ....	14
Standard Transformer Corp., 1500 North Halsted, Chicago .....	88
Stromberg-Carlson, Rochester, N. Y. ....	144
Stupakoff Ceramic & Mfg. Co., Latrobe, Pa. ....	138
Supreme Instruments Corp., Greenwood, Miss. ....	101
Sylvania Electric Products, Inc., Emporium, Pa. ....	86
Talk-A-Phone Mfg. Co., 1512 S. Pulaski Rd., Chicago. ....	121
Technical Appliance Corp., 41-06 DeLong St., New York .....	146
Telegraph Apparatus Co., 412 S. Green St., Chicago .....	4
Thordarson Electric Mfg. Div., 500 W. Huron St., Chicago .....	94
Trimm, Inc., 1770 W. Berteau Ave., Chicago .....	74
Triplett Electrical Instrument Co., Bluffton, Ohio. ....	139
Tung-Sol Lamp Works, Inc., 95 Eighth Ave., Newark, N. J. ....	61

	Booth
Turner Co., Cedar Rapids, Iowa .....	49
United Transformer Corp., 150 Varick St., New York .....	20
Universal Microphone Co., Inglewood, Cal. ....	41
University Laboratories, 225 Varick St., New York. ....	56
Utah Radio Products, 820 N. Orleans St., Chicago. ....	106
V-M Corp., 4th & Park Sts., Benton Harbor, Mich. ....	154
Ward Leonard Electric Co., Mt. Vernon, N. Y. ....	100
Ward Products Corp., 1523 East 45th St., Cleveland, Ohio .....	102
Waterman Products Co., Inc., 2445-63 Emerald St., Philadelphia .....	26
Webster-Chicago Corp., 5610 Bloomingdale Ave., Chicago .....	43
Webster Electric Co., Clark & DeKoven Ave., Racine, Wis. ....	151
Weller Mfg. Co., Easton, Pa. ....	47
Westinghouse Electric Corp., Pittsburgh, Pa. ....	7
Weston Electrical Instrument Corp., 614 Frelinghuysen Ave., Newark, N. J. ....	75
Wirt Co., 5221 Greene St., Philadelphia .....	78
Workshop Associates, 66 Needham St., Newton Highlands, Mass. ....	142
Worner Electronic Devices, 609 W. Lake St., Chicago .....	8

## The "Reps" on Hand

The Representatives of Radio Parts Mfrs. will find the Show helps them to meet business acquaintances, renew friendships. Shown right is Irvin L. Aarons, Milwaukee, "Reps" president.



# Store Display Does the Job

**New Jersey Dealer Has a Money-Making Formula for Showing, Demonstrating and Selling New Merchandise**

• Powers, Inc., 887 Broad St., Newark, N. J., has formulated sales policies which are paying off in cash.

To "stop" passers-by on the street and attract them into the store, the firm's window displays are sure-fire sales builders. The eye-catching, well-arranged windows, filled chock-full of the latest radios and electrical appliances are bringing droves of prospects into the establishment.

A close-up of the Powers style of radio display is shown on the opposite page. The appliance display appears on the April cover of the "Electrical Appliances" section.

And once inside the store, Lewis C. Barron, one of the owners and managers of the organization, has his sales plans so well-organized that buyers are "sold" on the establishment and the goods on sale there.

## First Models Starred

Taking his cue from an article in RADIO & Television RETAILING entitled "Use What You HAVE to Make the Sale", Barron has squeezed the last drop of sales value from his radio and electrical appliance demonstrator models.

Using his demonstrators, in addition to circulars, ads, and blow-ups, he is displaying these items where they do the most good—in the windows. As a result, these outside showcases give the store a prosperous, well-stocked appearance.

By massing his displays in the windows, Barron is taking advantage of the heavy flow of street

traffic. This dealer has found it profitable to crowd his windows (still keeping them attractive) with nationally-known brands of receivers and appliances.

Persons walking by the Powers establishment are drawn to the windows by smart displays. To excite attention to the window displays and keep eyes glued there, every item shown is clearly marked with a price.



"The chief advantages of attaching prices to goods on display," Barron stated, "is to assure customers that fair prices are charged to all, and that there is no discrimination in our sales policies."

Window displays are changed every month to maintain constant interest.

The store-front itself has a great deal of "class". The exterior is pannelled in black glass to give a smart, modern appearance. Marble pilas-

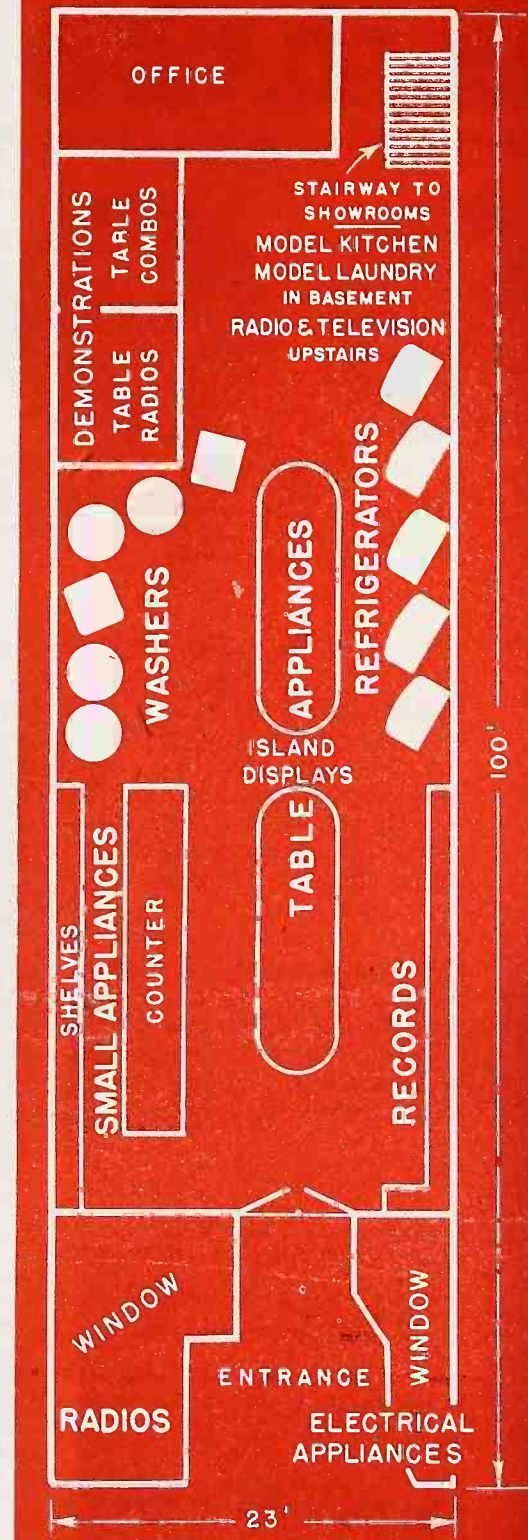

The above arrangement of merchandise has proved its worth for the Newark, N. J., retailer.

This store has started at the front with the idea that Powers must look like headquarters.

ters on the sides of the building lend dignity to the store.

Since the establishment opened its doors for business eight months ago, profits have been climbing. The store's records show in blue ink that the firm is making money—despite the shortages in merchandise.

Barron's many years of radio-appliance merchandising experience have gone into the sales policies used by the firm. And these profit-

pulling methods are clicking with the public!

"We're out to make our customers 'Powers Conscious,'" Barron explained. "We believe that there are two ways to sell a receiver or an appliance: (1) To make a quick sale regardless of the future; (2) To make customer contacts which will bring in a steady business. We have chosen the second course."

The backbone of the company's sales formula is that "customers must be pleased at any cost". When a customer enters the store, the salesmen have explicit instructions that he, the buyer, is right—right or wrong. This policy is paying off, as a glance at the sales figures shows.

### Ready with Refunds

A "must" with the firm is its unlimited refund program. Any item bought at the store can be returned by the buyer with no questions asked, and no stalling on the part of the salesman.

To determine future buying poli-

cies, patrons are often asked just why they are dissatisfied with their purchases. However, this point is not pressed.

A direct result of this refund program is the large amount of friends the store is making. Much goodwill is being built.

Customers will frequently not accept a cash refund—although the firm will readily offer to do so—but will insist on buying something else in the establishment.

### Customer's King

A profitable repeat business is being created by the store by knowing that:

1. Patrons are grateful when salesmen go out of their way to help them.

2. Customers enjoy buying in a clean, well-lighted establishment.

3. Radios and appliances with well-known, well-advertised names help to sell themselves.

To build a profitable mailing list, the organization "registers" pur-

chasers who wish to buy a set or table appliance which is not in stock. These prospects write their names and addresses on a card and are told that they will be notified as soon as the goods ordered arrive at the store.

### Ideas That Work

When the receiver or appliance comes to the establishment, customers are notified immediately and these goods held for a week. Customers are approving this policy and many friends have been won by the store.

Barron insists on hiring experienced salesmen only. By paying these men well (three are employed at present), the firm is assured of honest and sound salesmanship. These men are well "up" on customer psychology.

Salesmen are instructed to treat all customers alike, regardless of the size of purchases. Strict adherence to the "customer is always right" policy is demanded from the

(Continued on page 108)

Within a striking "frame" of black glass panels, Powers combines mass display with decorative trims. See appliance window April 1946 issue.



# New Models Ready for

## Stromberg Carlson COMBO

Model 1120-PLW, the "Federal" is a radio-phonograph with 8 push buttons (six for stations, two for radio or phono



selection) and 12" electrodynamic speaker. Cabinet comes in walnut or mahogany, designed with American Federal influence, double lift lids. (Model 1020-PLW has escutcheon of moulded wood, rather than plastic). Standard broadcast, plus American-For-foreign spread-band short wave, automatic volume control. Measures 34½" high, 34" wide, 18" deep. OPA price, \$180. Stromberg-Carlson Co., Rochester 3, N. Y.—RADIO & Television RETAILING

## Olympic RADIO

Model 6-602 is a 6-tube ac receiver, with standard (535 to 1700 kc) and short wave (5.6 to 18.2 mc). Circuit has 3-gang condenser used with one stage of r-f ahead of converter tube. Automatic volume control, "Tru-Base" expansion of audible range, 5 w output.



Connections for television, FM, and phono, 6" x 9" oval electrodynamic speaker, built-in antenna. Walnut cabinet, 16½" by 9¾" by 8", with concave grille. Packed weight, 25 lbs. Hamilton Radio Corp., 510 Ave. of the Americas, New York 11, N. Y.—RADIO & Television RETAILING

## Teletone RADIO

Model 160 is 6-tube ac-dc superhet, in "transitional modern" cabinet of walnut veneer. Features include "Ra-

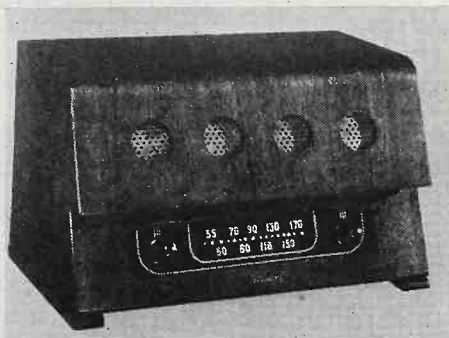

diotikon supersensitive antenna and Harmonique tone chamber." Alnico 5 speaker. \$31.95. Teletone Radio Co., 609 W. 51st St., New York 19, N. Y.—RADIO & Television RETAILING

## Sonata PHONOGRAPH

Electric record player is a 3-tube amplifier unit with Webster motor. Designed for convenience in carrying, in-



cluding handle. Sonata Electronics Corp., 624 S. Michigan Ave., Chicago 5, Ill.—RADIO & Television RETAILING

## Bendix RADIO

Model 736-A is a console with 7-tube superhet circuit, standard broadcast, 535 to 1725 kc. Two short wave bands, band spread tuning, 4 push buttons.



5.7 to 12 mc and 12 to 22 mc. Three-color, 3-dimensional dial. Three-gang condenser, tuned r-f amplification. Push pull beam power output and 10" electrodynamic speaker. Connections for phono and television. Beam antenna. Walnut cabinet is 38" high, 28½" wide and 13⅝" deep. Bendix Radio Division, Bendix Aviation Corp., Baltimore 4, Maryland—RADIO & Television RETAILING

## Hoffman COMBO

Model A 501 is the "Malibu" radio-phonograph, a 9-tube unit with standard broadcast and two short wave bands. Push button tuning, automatic volume control, separate base and treble. Loop antenna, 12" electrodynamic speaker. Plays ten 12" or twelve



10" records automatically. Rubbed finish in mahogany, walnut or blonde wood. Roomy compartment for disc storage. Malibu is 34" high, 18" deep, 34" wide. Hoffman Radio Corp., 3420 S. Hill St., Los Angeles, Calif.—RADIO & Television RETAILING



# That Waiting Market

## Jelco RADIO

Five-tube superhet comes in four finishes: walnut (as shown herewith), black and white, two-tone light blue,



and ivory shaded. Jameson Electronic Laboratory Co., Inc., 115 Cooper Lane, Dayton 3, Ohio—RADIO & Television RETAILING

## Tropic Master RADIO

Model W-117 trans-ocean superhet in all-metal case, specially designed for overseas duty. Standard and short wave (latter range is 5.6 mc to 19 mc), 8 tubes, ac-dc, bus bar wiring, push pull power amplifier output, 6" PM



speaker. Protective front cover, disappearing handle, drop leaf writing panel, plastic dial. Sliding steel chassis, cadmium plated. Weighs 22 lbs. \$75. Minerva Corp. of America, 238 William St., New York 7, N. Y.—RADIO & Television RETAILING

## Meissner COMBOS

FM-AM "fine furniture" radio-phonograph comes in 6 cabinet styles. Two are modern, the Primavera and the Modern. Four are period style: Regency, Chippendale, Sheraton and 18th Century. "Modern" model shown here is fine figured striped mahogany veneer, with leather panels set in doors. Measures 34 $\frac{3}{8}$ " wide, 20 $\frac{3}{4}$ " deep and 36 $\frac{1}{2}$ "



high. Features include 3 built-in antennas, for standard and shortwave, push-button tuning, and FM, with automatic change-over system. Four controls each for bass and treble; 6 push-buttons for stations. (setting can be changed via 6 disappearing knobs); 1 for phono. Inter-mix type automatic record changer, 2-way selectivity switch, horn type coaxial speaker with dividing networks. Two i-f stages on AM, 3 on FM; 2 limiters. Amplified, delayed AVC; separate tuning indicator amplifier. Meissner Mfg. Division, Maguire Industries, Inc., Mt. Carmel, Ill.—RADIO & Television RETAILING

## Pan American RADIO

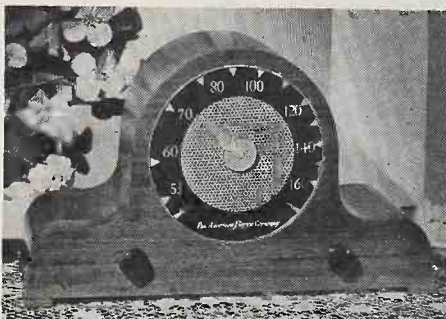

Clock-like model is a 5-tube, ac-dc superhet with 5" P.M. dynamic speaker. Has beam power output, built-in loop, plastic dial. Comes in walnut or mahogany cabinet. \$29.95. Pan American Electric Co., Inc., 132 Front St., New York 5, N. Y.—RADIO & Television RETAILING

## Emerson RADIO

Model 503 is the ac-dc table model with 5 tubes, 5" PM speaker, and the

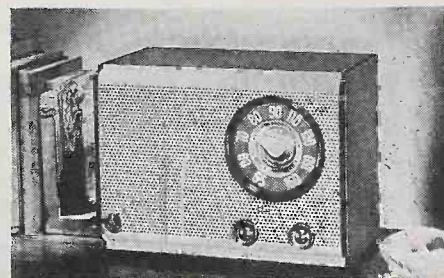

overall "perfo-grille". Features include "visio-dial, enclosed Super-Loop, heavy voice coil and boom capacity speaker." \$32. Emerson Radio & Phonograph Corp., 111 Eighth Ave., New York 11, N. Y.—RADIO & Television RETAILING

## Motorola AUTO RADIO



Model 705 car receiver is an 8-tube radio with 3-gang permeability tuning, push pull. Tone control and 5 push buttons. Instrument panel or 8" separate speaker. Galvin Mfg. Corp., 4545 Augusta Blvd., Chicago 51, Ill.—RADIO & Television RETAILING

## 20th Century RADIO

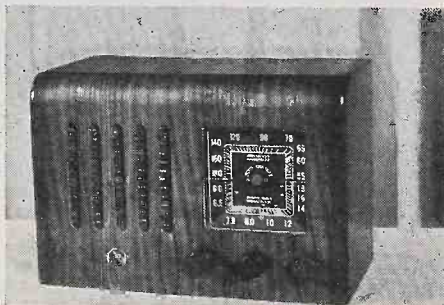

Model 100-X is a 6-tube, ac-dc unit with two bands and Alnico 5 speaker. Walnut finish cabinet. OPA price \$33.95. Electronic Devices Co., 601 W. 26th St., New York, N. Y.—RADIO & Television RETAILING

(Continued on page 48)

# More New Lines Move

## Hallicrafters S-40

Communications receiver, Model S-40, is powered by 9 tubes, with rectifier. Four-band reception covers 550 kc to 44 mc. Special marking of controls, in red, designed to facilitate family use on standard broadcast. Cabinet finished in

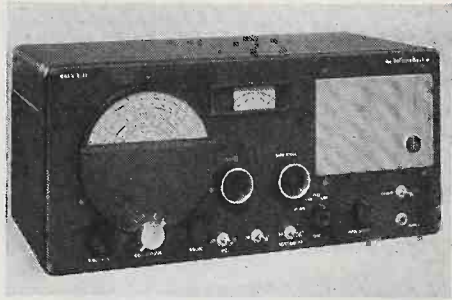

satin grey, with chrome trim; entire top section made of "aerodized" steel and set on piano hinge to increase accessibility of parts. \$79.50. The Hallicrafters Co., 2611 Indiana Ave., Chicago 16, Ill.—RADIO & Television RETAILING

## Telequip PHONOS

Model 5135 portable electric phono has 4 tubes, 5" permanent magnet Alnico speaker. Power output of 4 watts. Plays 10" or 12" records with lid closed. Has space in cover for carrying ten discs. OPA price \$47.70.

Model 5136 (shown) is same design.



as model 5135. Available in walnut or prima vera. OPA price \$51.95. Telequip Radio Co., 1901 S. Washtenaw Ave., Chicago, Ill.—RADIO & Television RETAILING

## GE AUTO ANTENNAS

New line of auto antennas ranging in size from 56" to 100", for any type of mounting in vehicles. Radar-type shielded leads and connections. Angular adjustment, and detachable lead-ins (ferrule-tipped with bayonet adaptors) to increase flexibility and ease of in-

stallation. Constructed of admiralty brass and chrome plated. Mounted with ceramic chrome-trimmed stanchions. Silver-to-silver contacts used to cut down effect of weather exposure. General Electric Co., Specialty Division, Wolf St. Plant, Syracuse, N. Y.—RADIO & Television RETAILING

## Fada RADIO

The 609 series has a 5-tube superhet ac-dc circuit, tunes 528 to 1680 kc. Automatic volume control, beam power output system. Alnico 5 speaker and output of 2 w. Loop antenna and

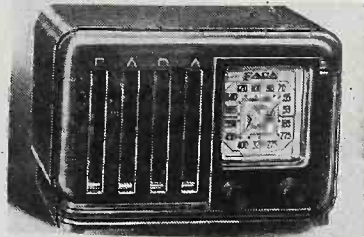

"Golden-Glo" dial; cabinet is 9 1/8" wide, 5 7/8" high, 5 1/2" deep. Weighs 6 1/2 lbs. Walnut plastic is \$19.95; ivory plastic is \$21.95. Fada Radio & Electric Co., Long Island City, N. Y.—RADIO & Television RETAILING

## Duotone

### Diamond Phonograph Needle

New phono needle with shank specially designed to contain a diamond tip. Professionally polished; tolerance is rated by manufacturer at 1/10,000 of an inch at the needle tip's radius. \$50. Duotone Co., Inc., 799 Broadway, New York 3, N. Y.—RADIO & Television RETAILING

## Webster-Chicago

### RECORD CHANGER

Model 50 automatic record changer, compact design for use in smaller combinations, or for replacement. Plays ten 12" records or twelve 10" discs, with change cycle of about 4 seconds.

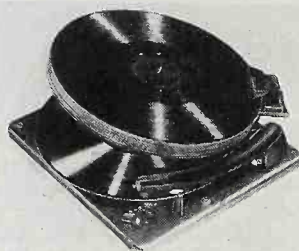

Can be installed from the top on standard 5/8" mounting board. Overall dimensions, 12" by 12 7/8" by 9", 6 1/2" above the main plate, and 2 1/2" below. Webster Chicago Corp., 5610 Bloomingdale Ave., Chicago 39, Ill.—RADIO & Television RETAILING

## Raytheon RADIOPHONE

Transmitter and receiver in single compact unit with 14 w output on 3105 kc, for personal planes. Superhet cir-

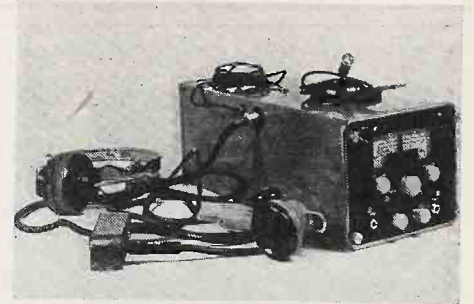

cuit designed to utilize features of low frequencies and VHF facilities for airways. Fixed tuned VHF channel on 75 mc for receiving Fan and Z markers; continuous tuneable coverage from 195 to 410 kc and 540 to 1600 kc; transmission is on standard private aircraft frequency of 3105 kc. Volume control circuit controls RF sensitivity on the range band, and audio gain in the broadcast band. Range filter is incorporated. Radiation and modulation continuously indicated on panel. DF loop may be added for radio navigation. Available in three models for dc input of 6, 12, or 24 volts. This 14-lb. unit is 5" x 5 1/4" x 14 1/4". Raytheon Mfg. Co., Belmont Radio Corp. Division, 60 E. 42nd St., New York 17, N. Y.—RADIO & Television RETAILING

## Airtec RADIO

Model SW-139 is a 5-tube ac-dc superhet with 5" PM speaker, two bands. (standard, 550 to 1700 kc; short wave, 5 to 15 mc). Walnut veneer cab-

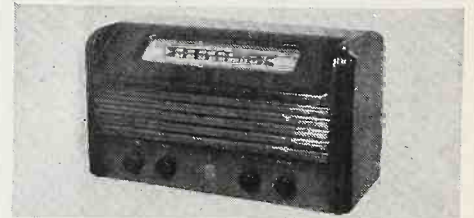

inet with contrasting wood grille. Dimensions are 13 5/8" by 6" by 7"; packed weight is 10 1/4 lbs. OPA price \$29.95. Pro-Electronics Corp., 44 DeKalb Ave., Brooklyn 1, New York—RADIO & Television RETAILING

## Telex PILLOW SPEAKER

Electro-magnetic sound-generating unit, designed for use under a pillow in homes, hospitals, hotels, trains, etc., as a "personal" radio speaker. Hermetically sealed, smooth plastic construction, 3 5/8" in diameter, 1 3/32" thick. Electrical input, 5 mw. Model B 2236 has 2,000 ohms impedance, Model 2243 has 100 ohms. Electro-Acoustic Division, Telex, Inc., Minneapolis, Minn.—RADIO & Television RETAILING

# Into the Profit Picture

## Coronet RADIO

Five-tube superhet has speaker openings on both sides, in a dial-on-the-top design to "look well any place." Built-in aerial, ac-dc. Two-tone cabinet available in four color combinations. Measures 12" by 7 $\frac{1}{4}$ " by 6". \$29.75. Crystal Products Co., 1519 McGee St., Kansas City 8, Mo.—RADIO & Television RETAILING



able in four color combinations. Measures 12" by 7 $\frac{1}{4}$ " by 6". \$29.75. Crystal Products Co., 1519 McGee St., Kansas City 8, Mo.—RADIO & Television RETAILING

## Philtone PHONOGRAPH

Model P-6 is a 3-tube ac phonograph with electrodynamic speaker and record changer with automatic shut-off.



Plays both 10" and 12" discs. Voltage doubler circuit. The case has air luggage finish, three tone style. OPA price, \$66.75. Philtone Electronic Co., Inc., 35 Fifth Ave., Brooklyn 17, N. Y.—RADIO & Television RETAILING

## Radiart AUTO AERIALS

New "de luxe" line of auto radio aerials includes 6 models, designed to fit all cars, fender or cowl. These units feature static muffler balls, phosphor bronze anti-rattler strips, insulators designed to fit curves of any auto body or fender, "antimonial admiralty brass" construction, and the use of polyethe-

lene and vinylite. Lengths range from 19" to 58", to 29" to 102". Prices run from \$4.75 to \$6.95. The Radiart Corp., 3571 W. 62nd St., Cleveland 2, Ohio—RADIO & Television RETAILING

## GI RECORD-CHANGER & RECORDER

Model GI-RC130 has a changer automatically playing twelve 10" records or ten 12" discs. One lever changes from one record size to another, removes records, or switches to manual operation or recording. Plastic trims on both the pickup and the recorder arm are engraved "Reproducer" and "Recorder". Recorder cuts discs up to 10" diameter, starting automatically when cutting arm is lowered. Retractable record driving pin in 10" weighted turntable permits

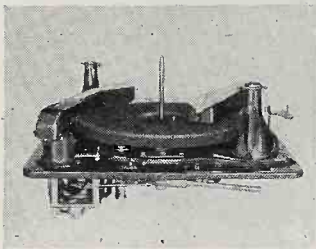

playing standard discs without adjustment. Rim drive, dynamically balanced motor, 78 RPM. This model has standard pressure crystal pick-up; RC-130-L has low pressure crystal pick-up. Base plate is 14" by 14" by  $\frac{3}{8}$ ". General Industries Co., Elyria, Ohio—RADIO & Television RETAILING

## Filmgraph Sound-On-Film Recorder

Model JVC is a portable device for permanently recording and reproducing sound on film instantaneously, without processing—a method for making "Talkies" by adding voice, titles or sound effects to 16 mm or 8 mm home movies. This recorder-reproducer has a built-in motor and drive, dual purpose recorder-reproducer head, film

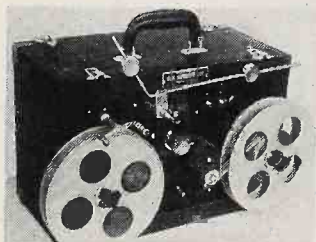

chute, sapphire stylus, take-up and feed reel, capacity up to 500 ft. of film, manual sound track shift permitting up to 40 sound tracks, built-in amplifier, speaker, controls and microphone. For 16 mm projectors, recordings may be made on owner's film, or on Filmgraph

special film. Cabinet is 9" deep, 10" high, 14" long; weighs 23 lbs. Can be used as PA system for small audiences. Miles Reproducer Co., Inc., 812 Broadway, New York 3, N. Y.—RADIO & Television RETAILING

## Promenette RADIO

Model 501 has 5 tubes and a 4" PM speaker, an ac-dc unit in simulated leather covered wood cabinet. It meas-

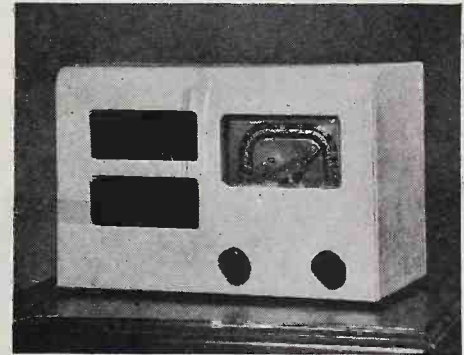

ures 10 $\frac{5}{8}$ " by 6 $\frac{7}{8}$ " by 5  $\frac{13}{16}$ ". OPA price, \$25.95. Promenette Radio & Television Corp., 1721 Elmwood Ave., Buffalo, N. Y.—RADIO & Television RETAILING

## Steelman PHONOGRAPH

Table model phonograph 350 has dual-channel input circuit, 5 watt output, 6 $\frac{1}{2}$ " Alnico speaker; 3 tubes. Elec-



tronic tone control. OPA price is \$47.85. Steelman Radio Corp., 742 E. Tremont Ave., New York 57, N. Y.—RADIO & Television RETAILING

"WHAT'S NEW" IN ELECTRICAL TOYS, ON PAGE 78.

FOR LATEST ELECTRICAL APPLIANCES, SEE PP. 68, 69, 70, 72, 73.

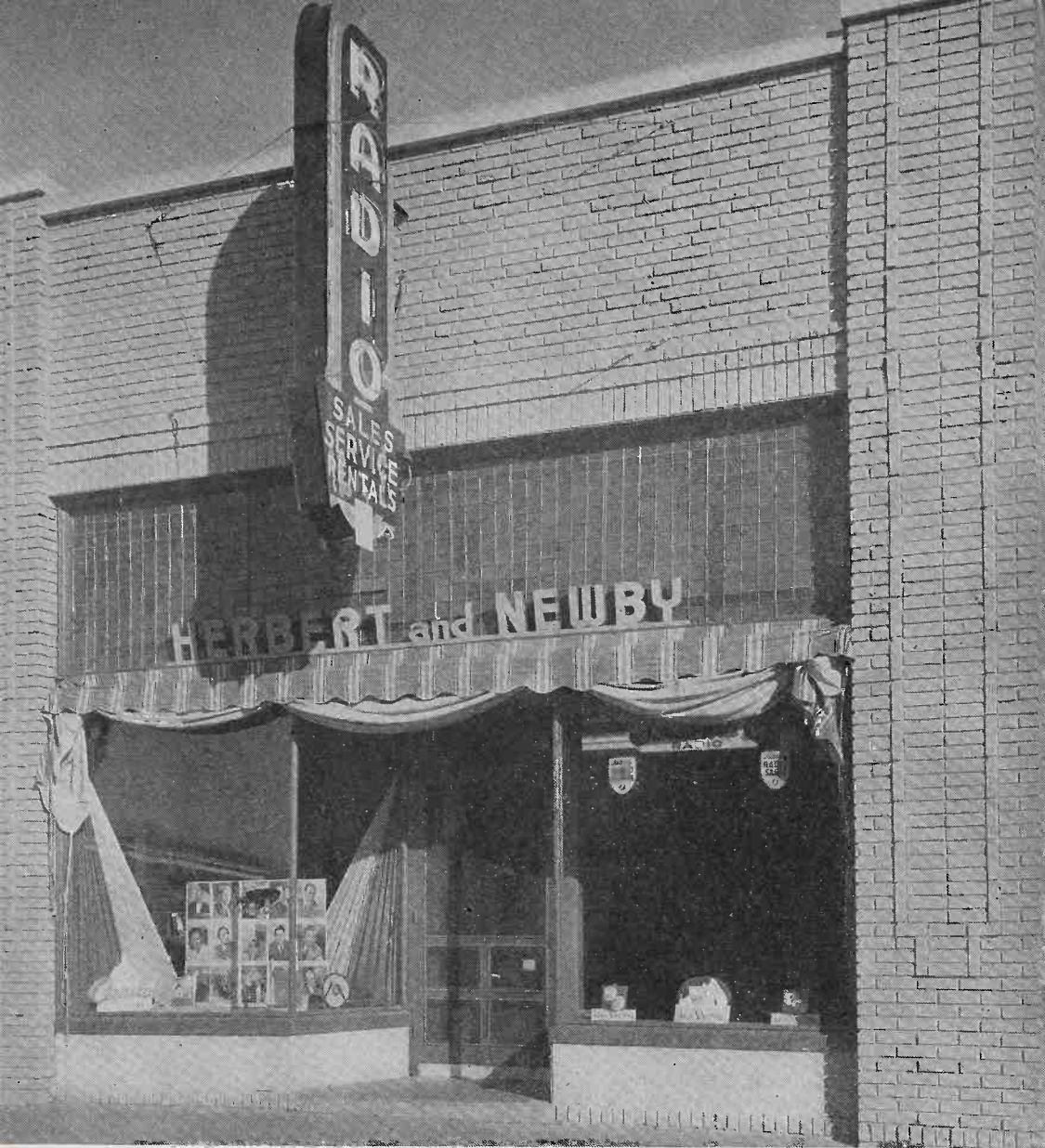

Here is the neatly refurbished establishment of the Kansas dealer whose long suit is service.

# Where Radio Service Guides Sales

anticipate the whole mass of market trends and engineering developments; part of the H & N policy is to keep abreast of the national radio trends, news and predictions—but the consumer has the final word.

## **Notable in the Operation of This Mid-Western Dealer Is the Alert Use of Tips from the Maintenance Dept.**

• In the brightly remodeled radio establishment of Herbert & Newby at 110 S. Hillside Ave., in Wichita, Kansas, the operating principle is that a store emphasis on *radio repair* is the best and the most steady method for maintaining significant contact with a large number of people.

Through good times and the bad ones, when merchandise is available and when it is not, the ever-present business of servicing for Wichitans goes on forever, and pays off in more ways than one. Lawrence O. Herbert and Harold H. Newby are the partners.

The idea is that when a dealer makes service a specialty, there is always enough "radio contact" with enough people for an alert businessman to find out what the pub-

lic wants now, and what it will want tomorrow. That is, if you continue to do efficient repair work for a large number of people and handle them intelligently, you can get the most valuable tips on how to stock and how to sell.

### **Stocks the "Wanted" Items**

It is pointed out that this is an entirely different merchandising policy from that of the radio proprietor who tries to sell anything to the public which had been offered to him by suppliers as "a good deal." The Wichita shop is in a position, through its service department, to start with the consumer; to check with him first. However, the management of course cannot wait for the consumer to

### **Gets Valuable Ideas**

A sharp test of this principle took place at the Herbert & Newby store during the war, when the shop could do little else besides radio repair. The shop did *not* make a practice of grabbing a guy's money and sending him home with the repaired receiver. They found out what his radio/appliance ideas were, present and future. When the time came to order postwar merchandise, the store knew exactly where it stood. In a sensible way, the management had studied national trends, and linked them to local preferences.

Recently the H & N shop found that at least 45% of the people had a rising interest in radio-phono combinations. So a Record Bar was installed and the shelves fully stocked with appropriate discs; the store began a general emphasis of record-players and combos in its merchandising. Herbert & Newby

(Continued on page 104)



In the Herbert & Newby service department are, left to right, Charles Mott, Kenneth Katz and Armin Fisher, at their individual benches. Note the neat shelves in the corner, where an orderly supply of parts and tubes provides a "master" stock for the three repairmen. This view of the shiny sales room of the Wichita store shows co-owner Lawrence O. Herbert at right. Mrs. Herbert is in charge of the new Record Bar, installed in the company when it was found that prospects in this community had real interest in records and combos.

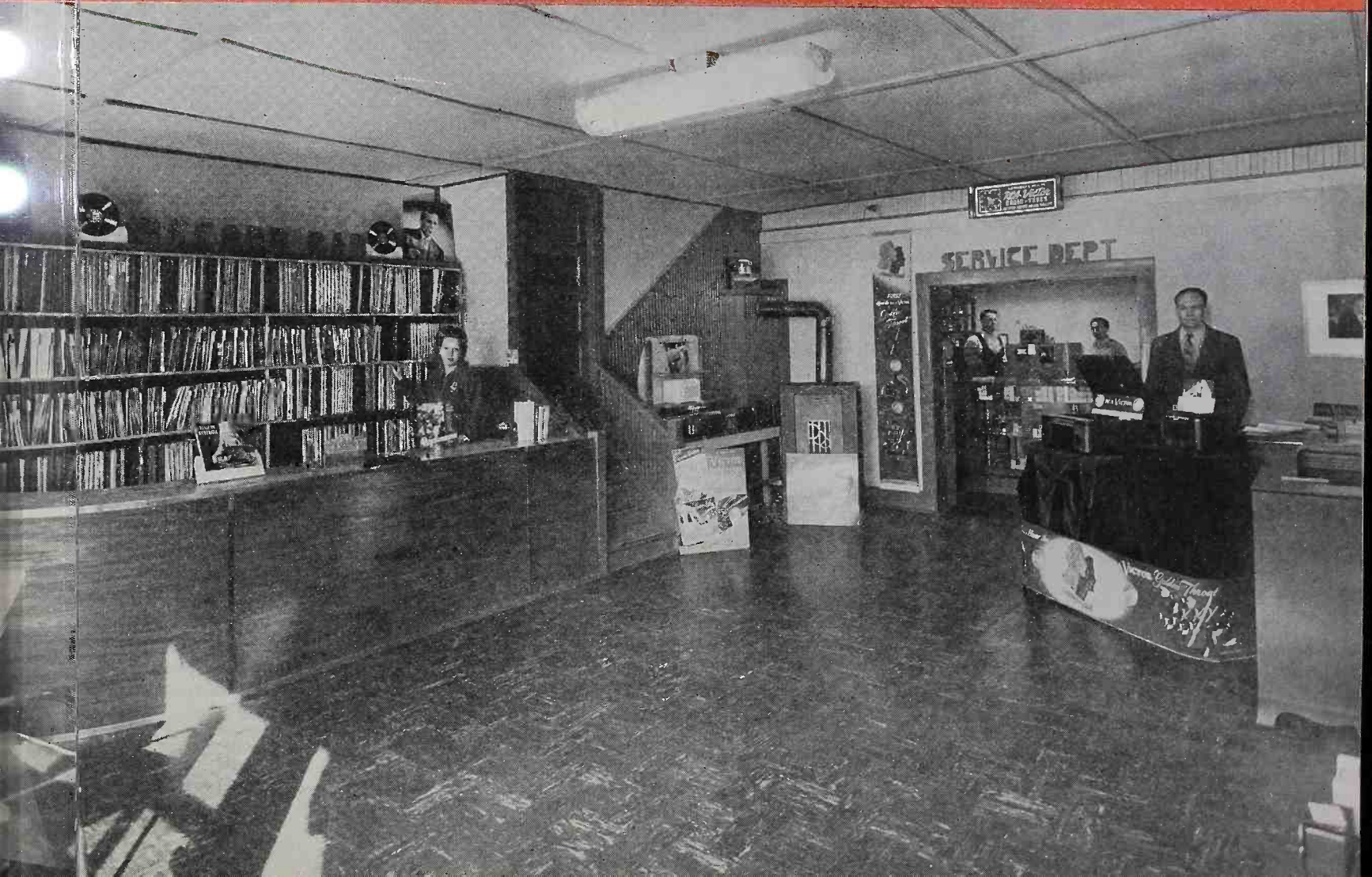

# VIDMAR-MATHIS APPLIANCES & MUSIC



The front of the Pueblo store is almost solid glass, extending from ceiling to sidewalk. The glistening panels are set at an eye-catching angle.

## COLORADO STORE IS

### **Striking Design of New Establishment in Pueblo Makes the Store a Vast Display Window for Appliances and Music**

• "We feel like gold fish!" says Lou Mathis as he describes the big, new store of Vidmar-Mathis at 516-18 N. Main St., Pueblo, Colo., "The whole darned store is one big show window!"

But the newly designed store pays off, because Mr. Mathis and J. T. Vidmar, Jr., proprietors, have noticed a rare increase in store traffic. The organization had previously operated in a conventional-type store at another site on Main Street and although the outfit has hundreds of friends in Pueblo, the come-in traffic at the new "house of glass" is beyond all expectations, and includes plenty of people who are new acquaintances.

Through the all-glass front of the new store, Pueblo shoppers can

see clearly all the way to the rear of the store. And they're very apt to stop and peer, too, because the full-story-height glass front is set at an angle and is as modernistic an eye-catcher as ever hit Main Street. At least while the new washers, refrigerators and ranges are up front, and their gleaming white surfaces make the display look like a million bucks, the whole set-up practically "owns the block".

#### **Lights to Burn**

The lights in the main showroom are inset ceiling fluorescent fixtures, which add to the modern and squared-off look of the place. There are enough of them to eliminate

the need for any counter-height lights elsewhere, and appear to be streamlined evidence that the store is after all an electrical one.

#### **Home Equipment Lines**

Vidmar-Mathis is a great believer in diversification and will stock any and all items of home equipment that strike them as appropriate and profit-making. That is, up to the point where the store starts to look loaded, and to lose its identity as a specialist in "appliances and music". Just now, the new appliances are at the front, the phono record department at the rear of the main floor, and a complete electric kitchen and automatic laundry is being installed,

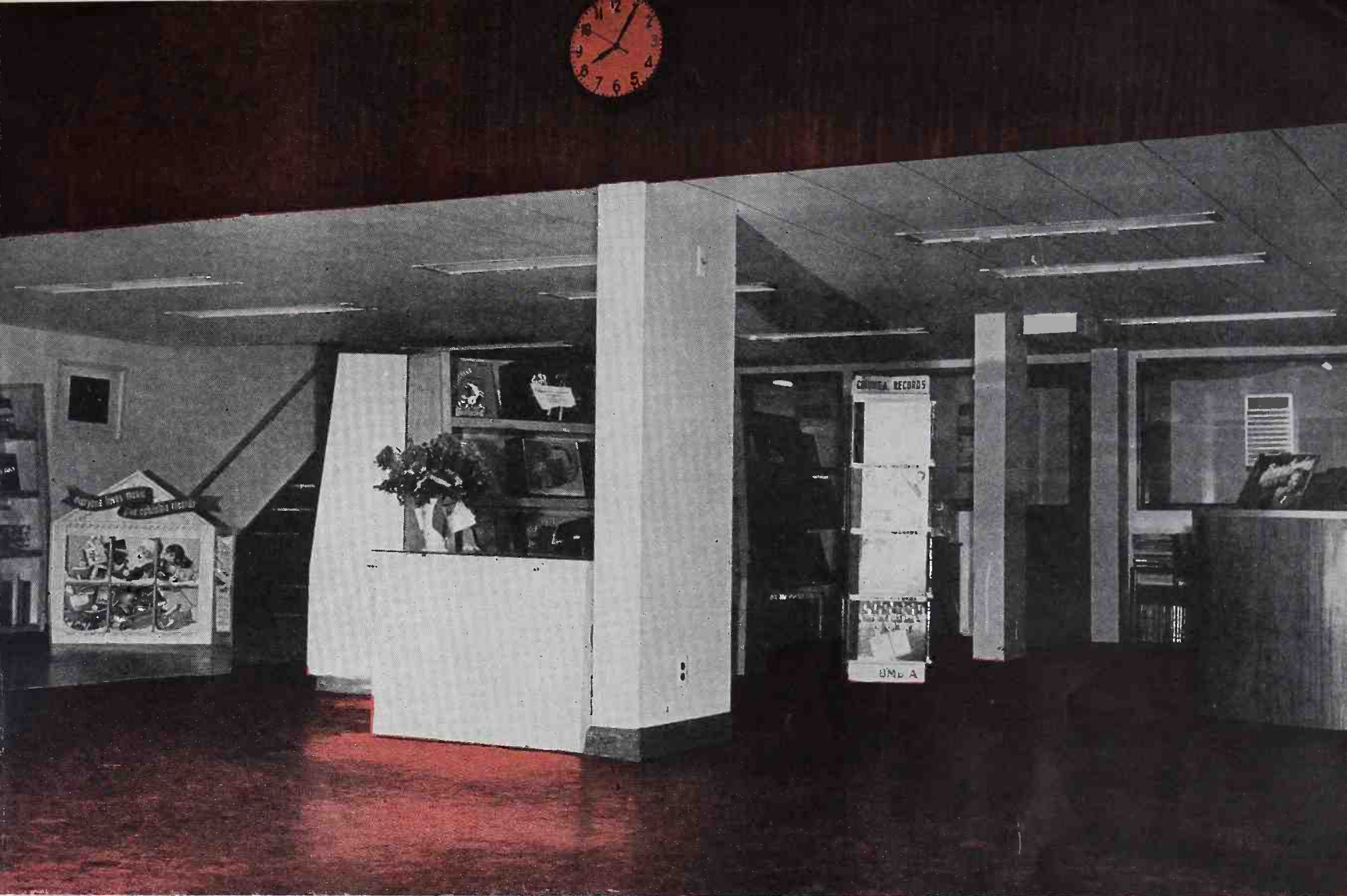

The new record dept. at Vidmar-Mathis reaches full width across the rear of the store. There's a half-circle counter and mass display of albums.

# A GIANT SHOWCASE

straight wall style, also on the 1st floor.

Sample radios, as they become available, are also being spotted in the main showroom, near the record department. The main radio sales room, however, is the balcony location which Mr. Mathis has

picked as an ideal spot for radio demonstrations. The "radio room" is another brightly lighted area, where set salesmen can operate quietly above the bustle of the main showroom.

For the glass-work arrangement of the store front, Vidmar-Mathis

depended upon designers furnished by a glass manufacturer. But the interior of the place is "engineered for sales" according to the conclusions reached by the company after 8 years of doing business in Pueblo. It amounts mainly to a loose and accessible arrangement of merchandise with a minimum of island displays, and a desk at the center. Elaborate and expensive fixtures are not greatly needed in the showroom—the front conveys all the "style" that's needed.

## TO GRAB THE EYE —

1. Unusual design featuring glass walls in front
2. New appliances near entrance, with high polish
3. Fluorescent lighting fixtures of modern design
4. Open and convenient placing of merchandise

### "Dream" Come True

In years gone by, the proprietors caught themselves saying "when we have a new store we're not going to crowd the ranges in a row against the wall". Today, the new store does have all the features the two executives ever wanted, soundly based on what they learned from the public itself.

# CUSTOMERS LIKE TO



Luxury listening of a private and convenient nature is something that customers remember.

facedly to the counter, still in its wrapper, and said, "I'll take this one." Sam knew that the record was broken because he heard it click in the bin, and he did not let the boy buy it.

The Music Shop offers credit on record purchases, except to youngsters whose parents do not know of it. The matter is handled on a personal, community-style basis,

## ***Iowa Dealers' Store Has "Personality" that Clicks with Patrons; Friendly Dealings Bring More Profit from Discs***

● To step into The Music Shop in Council Bluffs, Iowa, is to be confronted by thousands of records which are conspicuously arranged so that they seem to be yelling to be picked up, played, bought.

It is a bright and lively place, with rotating displays, giant dummy albums plastered all over the walls, and a couple of brisk gentlemen ready to aid their customers. That is, if a customer should need help, in a store whose design is strictly a come-and-get-it proposition.

### ***Store Attracts Buyers***

Maurice Bennett and Sam Stout have made the store into a big help-yourself salon, a champion of freedom for the customer. It is an outfit with an informal and friendly atmosphere, nevertheless a

neat and trim lay-out where store manners are watched. The place has personality, and it does plenty of business.

### ***Purchasers Charge It***

Every record in the store is kept within reach of buyers and it has been found that about a third of them can wait on themselves completely. Some 40% of them locate the discs they want with just a minimum amount of help. There are very few cases in which the customers mix up the stock to any serious degree, because a majority of them will ask for help if they find that they cannot return a record to the place where it obviously belongs. Breakage is almost negligible.

The last time a young customer accidentally broke a record, Sam reports, the lad brought it shame-

and losses have been very slight.

The name and address of every visitor to the Music Shop is taken, so that everyone can be mailed the store bulletins on record arrivals and specials. These direct mail pieces reflect the personalities of Maurice and Sam, and the two experts have become widely known in Council Bluffs by their first names.

### ***Builds Much Good-Will***

Orders are taken for radio and appliances, without deposits. The business philosophy at the Music Shop decrees that people should not be required to "freeze" their money for such extended periods of time. Doing the folks this favor, it is said, is appreciated by the public to the extent that the store will get more than its share of the business when the merchandise is available.



# BUY RECORDS HERE!

The Music Shop has five different types of displays, including the rotating island. There are the wall racks, the straight islands, and the smaller cabinet types. All of them are privately designed to meet the needs of a store with a personality of its own. A row of listening booths are air-conditioned and glassed-in, and there are "open" listening posts for more casual playing of records.

A slightly modernistic note for the whole atmosphere comes from the use of the dummy jumbo al-

bums on the walls. Most of them are 45 times natural size; this decorative theme conveys the idea that the store is mainly musical, although the demonstrator radios and appliances are also shown.

Whenever a musical movie arrives in Council Bluffs, the Music Shop switches the related music

to a separate island and makes a special display out of the tunes that the town is humming. When the picture "Rhapsody in Blue" came along, the store was ready with its own splash on Gershwin music. This routine is something that can be done by every dealer, Maurice points out, in spite of any hook-



Above, this view of the Iowa store shows fingertip accessibility of large stock of records. Left, Maurice Bennett, standing, and Sam Stout, managers, believe in the informal brand of selling. They use the slogan, "If It Isn't Right, We Are Wrong."



ups that the theater might have with a single retailer.

### Aim Is High Price Sales

Sam is the expert on classical music. Right now he has a theory for more and higher-unit-price sales. He points out that *new* long-hair fans are not being created every day, under current conditions, because of the lack of new combinations of the quality type. The others, the music lovers of long standing, have had plenty of time to be "saturated" with the familiar classics. The thing to do is to bring out more of the unfamiliar, or less known, works of the major composers. Sam says there's a first-rate market for them.

# The RECORD

**Music-Makers Are Money-Makers for You . . . Keep Your Cash Register Ringing with Disc Sales! The Public Wants More Records Today Than Ever Before**



◀ Columbia's Eugene Ormandy will conduct The Philadelphia Orchestra in public appearances in 28 cities, under the recording firm's sponsorship.



▼ Monica Lewis, nightery star, records for new Signature discs. Her latest: "In Love in Yain".



▲ Decca's Carmen Cavallaro has cut a complete new set of masters on his first album "Dancing in the Dark", featuring old popular favorites.

● Music Week (May 5-12) and the Music Industry Show in Chicago (July 15-18) are both good for putting new zip into your record merchandising methods. The biggest market in platters and albums is here! Disc makers and their artists are more than equal to giving the dealers splendid support!

Columbia continues to offer an excellent selection of classics and populars. Its *Disc Digest* and *Promotion News*, issued monthly, are well worth dealers' attention. *Digest* gives the

month's list of masterworks and pop discs. The *News* recounts promotion readied for retailers.

One of Columbia's biggest dealer opportunities is its sponsored cross-country tour of The Philadelphia Orchestra this Spring. Opening in Saginaw, Mich., May 6, it will bring this orchestra, under the direction of Eugene Ormandy, to audiences in at least 28 cities. Tie-in promotion kits for dealers are ready.

Big news from Decca is its second language course. Because the Spanish course was such a successful  
(Continued on page 58)

# BOOM IS ON!



➤ Fred Kirby sings folklore of the southern hills in Sonora's album "Hill - Billy Tunes."

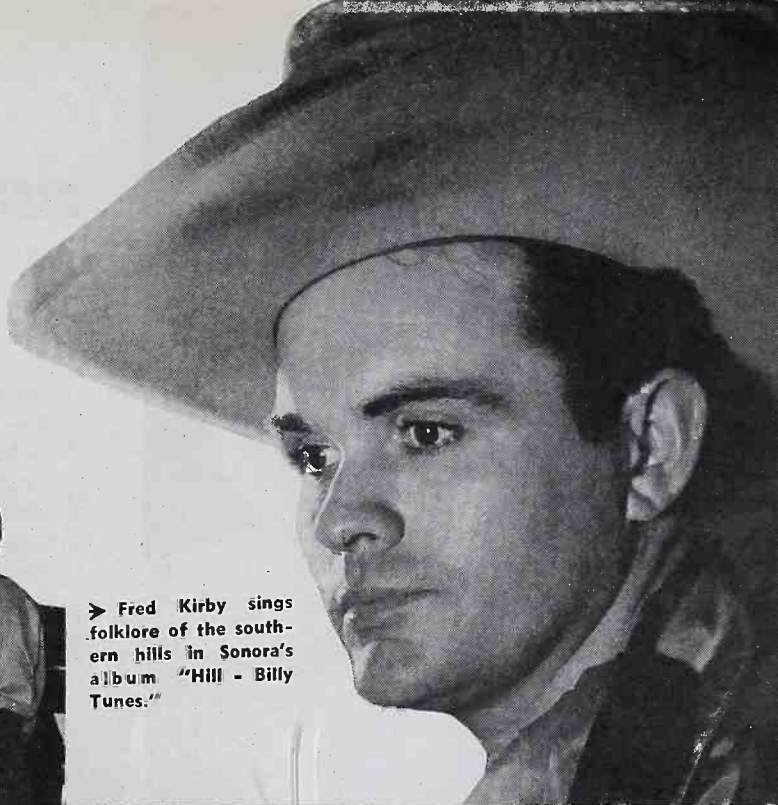

▲ Majestic's Louis Prima recording at its New York studios. His "Hey! Ba-Ba-Re-Bop!" slated for a hit!  
➤ Mildred Bailey waxes a platter for Crown. Victor's Lauritz Melchior pulls 'em in at the ♡ Willis Music Co. in Cincinnati. Both pop fans and long-hairs love him!



▲ Miguelito Valdes and his orchestra give Latin American flavor to Musicraft's "Rumba Rhapsody" and "Babalu".

# RECORDS

(Continued from page 56)

seller, a French course has been launched, due in May. Window display for both the Spanish and French courses will be ready this month.

More news from Decca is the cutting of a complete set of new masters of Carmen Cavallaro's first album, "Dancing in the Dark." To be ready around the 20th of this month, it will include "Cocktails for Two," "The Very Thought of You," "If I Had You," etc.

Decca's new show album is "Sing Out, Sweet Land," from the show of the same name, featuring the hit tunes, and starring Burl Ives and Alfred Drake, from the original cast.

## Victor's Variety

Victor's May list has exceptional variety. It includes organist Virgil Fox, conductor Hans Kindler and the National Symphony, the Don Cossack Chorus, piano-team Luboshutz and Nemenoff, James Melton in selections from "Carousel," the Boston Pops, Koussevitzky and the Boston Symphony, Bach Choir, and Fritz Kreisler.

Music week streamers by Victor highlight the "give music" slogan with special emphasis on de luxe recordings.

A new Lauritz Melchior single, "Because" and "The House I Live In," is due this month. Appealing to followers of classic and popular music alike, Melchior is a natural for promotion of more record sales!

Victor's new magazine for pop record fans, *In the Groove*, will issue monthly, and is ready for dealers' distribution to their customers. Space is provided for dealer imprint.

## Capitol Expands

Capitol Records of Hollywood has acquired the Scranton Record Co. Heading the enlarged operation at Capitol are: B. G. DeSylva, board chairman; Johnny Mercer, president; and Glenn E. Wallichs, vice-president. With showman DeSylva, composer Mercer, and merchandiser Wallichs (who started life as a music merchant, just like you and you and you!) in the driver's seat, dealers are in for an increased opportunity to make money on Capitol records!

Among its new releases are an

Andy Russell single, "They Say It's Wonderful," from the new musical "Annie Get Your Gun," and a new album, "Piano Cocktails," featuring Buddy Cole at the piano, playing some of the old pop favorites, including "Night and Day," "Body and Soul," "Stardust," and others.

## Majestic's New Package

Majestic Records has created a double-sales feature in the packaging of its disc No. 5000, "Majestic Invites You to Rumba with Morales." The record, featuring Noro Morales, Latin American band-leading composer, in "Walter Winchell Rumba," is encased in a one-pocket folder, the cover of which is handled in attention-getting album style. When folder is opened, spread reveals diagrams and detailed instructions for basic rumba steps, as outlined by the dance-famous Arthur Murray!

Majestic's Louis Prima, just completing a stay at New York's Strand Theatre, will head West for personal appearances. His slogan "Play Pretty for the People" will be the title of his first Majestic album, due in July or August. Currently ready is his "Josephine Don't Lean on the Bell." Certainly due for a four-star hit is Prima's recent recording of "My Valentine" and "Hey Ba-Ba-Re-Bop"!

## Bus Line Tie-in

Due for release this month is Majestic's cutting of "Love on a Greyhound Bus" with George Paxton. Tie-in for promotion is planned with the Greyhound lines. Song is from the new MGM flicker, "No Leave, No Love".

New Majestic artists are Jimmy Lunceford and Eddie Howard. Mildred Bailey has cut a release for this month, "Penthouse Serenade".

Sonora continues its new policy of issuing a single pop record twice monthly, supplementing its monthly album of standard music. New signers for singles are Jerry Wald and his orchestra and Bob Chester and his band.

## Musicraft Distribution

Musicraft is readying full production and expects to have 26 distributors lined up by May 1. Among its new releases are Miguelito Valdes and his orchestra in "Rumba Rhapsody"; Mel Torme and his Meltones in two of Torme's own ballads, one

(Continued on page 138)



▲ New singer introduced by Disc in "Stella Brooks Album of Jazz Songs". Disc's promotion of Miss Brooks included a recital at New York's Town Hall.

▼ Cosmo's Nancy Reed, thrush on one of Hal McIntyre's latest platters, "It Couldn't Be True".





The scientists of the Philco laboratories have fulfilled the promise of modern electronic research. Exclusive developments like the revolutionary Advanced-FM System and the sensational, patented Philco Dynamic Reproducer bring you the new joys you have hoped for from radio and recorded music. Hear the 1946 Philco and judge for yourself.



Another dramatic Philco ad - "Prestige Selling Power" beyond anything ever developed - in this distinctive new Philco Campaign in all leading magazines!

**PHILCO**  
*Famous for Quality the World Over*

# PRODUCTS OF RADIO AND TELEVISION MANUFACTURERS

Listing the companies whose lines cover one or more of the six groups of greatest importance to retailers and distributors

The following manufacturers of radio receivers have returned our editorial questionnaire giving the information needed for these listings	Home A.M.-F.M.	Combinations	Television	Auto Radio	Amateur	Commercial*	Manufacturers not listed may furnish data for the next issue. No advertising obligation. Additions or revisions will be made monthly.	Home A.M.-F.M.	Combinations	Television	Auto Radio	Amateur	Commercial*
Abbott Instrument, Inc., 8 W. 18th St., New York, N. Y.							Magnavox Co., 2131 Bueter Rd., Ft. Wayne 4, Ind.						
Admiral Corp., 3800 W. Cortland St., Chicago, Ill.							Maguire Industries, Inc., W. Putnam Ave., Greenwich, Conn.						
Aero Communications Co., 231 Main St., Hempstead, L. I.							Majestic Radio & Television Corp., St. Charles, Ill.						
Air Associates, Inc., 5827 W. Centry Blvd., Los Angeles 45, Calif.							Marco Industries, 245-A So. Beverly Dr., Beverly Hills, Calif.						
Air Communications Co., 2233 Grand Ave., Kansas City, Mo.							Mason Radio Products Co., Kingston, N. Y.						
Aireon Corp., Fairfax & Funston Rds., Kansas City, Kans.							McGrade Mfg. Co., 406 W. 34th St., Kansas City, Mo.						
Air King Prod. Co., Inc., 1523 63rd St., Brooklyn, N. Y.							Mec-Rad Div., Black Industries, 1400 E. 222nd, Cleveland 17, O.						
Airplane & Marine Instruments, Clearfield, Pa.							John Meek Industries, Plymouth, Ind.						
Allied Radio Corp., 833 W. Jackson Blvd., Chicago 7, Ill.							Mectron Corp., Lawrence, Mass.						
American Communications Co., 306 Broadway, New York, N. Y.							Medco Corp., 5 W. 45th St., New York, N. Y.						
American Radio Co., 611 E. Garfield Ave., Glendale 5, Calif.							Megard Corp., 1601 S. Burlington Ave., Los Angeles, Calif.						
Andrea Radio Corp., 43-20 34th St., Long Island City, N. Y.							Meissner Mfg. Co., 936 N. Michigan Ave., Chicago, Ill.						
Ansley Radio Corp., 41 St. Joes Ave., Trenton, N. J.							Mercury Electronic Labs., Inc., 622 W. Kinzie St., Chicago 10, Ill.						
Apex Industries, 192 Lexington Ave., New York 16, N. Y.							Metropolitan Electronics & Instr. Co., 6 Murray St., New York						
ARF Products, 7627 Lake St., River Forest, Ill.							Midland Mfg. Co., Decorah, Iowa						
Atomic Heater & Radio Corp., 104 Park Row, New York, N. Y.							Midwest Radio Corp., 909 Broadway, Cincinnati, Ohio						
Autocrat Radio Co., 3855 N. Hamilton Ave., Chicago							James Millen Mfg. Co., 150 Exchange St., Malden, Mass.						
Automatic Radio Mfg. Co., Inc., 122 Brookline Ave., Boston							Minerva Corp. of America, 238 William St., New York, N. Y.						
Aviola Radio Corp., Phoenix, Ariz.							Molded Insulation Co., 335 E. Price St., Philadelphia 44, Pa.						
Baronette Radio & Tube Corp., 220 Fifth Ave., New York, N. Y.							Monitor Equipment Co., 110 E. 42nd St., New York, N. Y.						
Barr Electric Co., 1314 Forest Ave., Dallas, Texas							Music Master Radio Corp., 750 Main St., Hartford, Conn.						
Rex Bassett, Inc., 311 N. W. 1st Ave., Ft. Lauderdale, Fla.							Musitron Co., The 223 W. Erie St., Chicago, Ill.						
Bell Radio Co., 125 E. 46th St., New York, N. Y.							National Co., Inc., 61 Sherman St., Malden, Mass.						
Belmont Radio Corp., 5921 W. Dickens Ave., Chicago, Ill.							National Design Service, 96 Liberty St., New York, N. Y.						
Bendix Radio, Div. of Bendix Aviation Corp., Baltimore, Md.							Noblitt-Sparks Industries, Inc., Columbus, Ind.						
Biltmore Radio Corp., 15 Ave. "A", New York 3, N. Y.							Northern Engineering, Inc., Canal St., Manchester, N. H.						
Cavalcade Industries, 39 S. La Salle St., Chicago, Ill.							Northern Radio Co., 2208 4th Ave., Seattle, Wash.						
City Radio Co., 504-6 E. Washington St., Phoenix, Ariz.							Packard-Bell Co., 3443 Wilshire Blvd., Los Angeles, Calif.						
Collins Radio Co., 2920 First Ave., Cedar Rapids, Iowa							Packard Mfg. Corp., 2900 Columbia Ave., Indianapolis, Ind.						
Colonial Radio Corp., 254 Rano St., Buffalo, N. Y.							Pan American Electric Co., Inc., 132 Front St., New York, N. Y.						
Columbia Electronic, Inc., 185 E. 122nd St., New York, N. Y.							Panoramic Radio Corp., 242 W. 55th St., New York 19, N. Y.						
Communications Co., Inc., 300 Greco Ave., Coral Gables, Fla.							Phileo Corp., Tioga & C Sts., Philadelphia, Pa.						
Communications Equip. Corp., 134 W. Colo. St., Pasadena 1, Cal.							Philharmonic Radio Corp., 528 E. 72nd St., New York, N. Y.						
Concord Radio Corp., 901 W. Jackson Blvd., Chicago							Pilot Radio Corp., 37-06 36th St., Long Island City, N. Y.						
Continental Electronics Ltd., 81 Pine St., New York, N. Y.							Port-O-Matic Corp., 985 Madison Ave., New York, N. Y.						
Coronet Radio and Television Corp., Lynbrook, L. I.							Precision Specialties, 210 N. Western Ave., Los Angeles, Calif.						
Crosley Corp., 1329 Arlington St., Cincinnati, Ohio							Premier Crystal Laboratories, Inc., 63 Park Row, New York						
Crystal Products Co., 1519 McGee Trafficway, Kansas City, Mo.							Press Wireless, Inc., 1475 Broadway, New York 18, N. Y.						
Delco Radio, Div. of General Motors Corp., Kokomo, Ind.							Pro Electronics, 44 DeKalb Ave., Brooklyn, N. Y.						
DeWald Radio Mfg. Corp., 440 Lafayette St., New York, N. Y.							Promenette Rad. & Telev. Corp., 1721 Elmwood Av., Buffalo, N. Y.						
F. E. Dine & Co., Inc., 2221 Warwick, Santa Monica, Calif.							Purotone Radio Corp., 355 Main St., Poughkeepsie, N. Y.						
Allen B. DuMont Laboratories, 515 Madison Ave., New York							Quality Industries, 25 E. Jackson Blvd., Chicago 4, Ill.						
Dynavox Corp., 40-35 21st St., Long Island City, N. Y.							Radio Craftsmen, Inc., 1341 S. Michigan Ave., Chicago						
Eastern Electronics Corp., 41 Chestnut St., New Haven, Conn.							Radio Devel. & Research Corp., 233 W. 54th St., New York 19						
Echophone Radio Co., 2611 So. Indiana Ave., Chicago, Ill.							Radio Engineering Laboratories, Inc., 36th St., L. I. City, N. Y.						
Eckstein Radio & Television Co., 1400 Harmon Pl., Minneapolis							Radio Laboratories, 2701 California Ave., Seattle 6, Wash.						
Electrical Research & Mfg. Co., 3001 E. Pico Blvd., Los Angeles							Radio Mfg. Engineers, Inc., Peoria 6, Ill.						
Electronic Mfg. Co., 88 University Pl., New York, N. Y.							Radio Navigational Inst. Corp., 305 E. 63rd St., New York 21						
Electronic Corp. of America, 45 W. 18th St., New York, N. Y.							Radionic Equipment Corp., 170 Nassau St., New York, N. Y.						
Electronic Devices Co., 601 W. 26th St., New York, N. Y.							Radio Process Co., 7618 Melrose Ave., Los Angeles, Calif.						
Electronic Engineers, 611 E. Garfield Ave., Glendale 5, Calif.							Radio Receptor Co., 251 W. 19th St., New York, N. Y.						
Electronics, Inc., 645 Iowa St., Dubuque, Iowa							Radio & Television, Inc., 244 Madison Ave., New York, N. Y.						
Electronic Specialty Co., 3456 Glendale Blvd., Glendale, Calif.							Radio Wire Television Inc., 100 Ave. of the Americas, New York						
Emerson Radio & Phono Corp., 111 8th Ave., New York, N. Y.							Rapar Products Corp., 60 E. 42nd St., New York 17, N. Y.						
Eapey Mfg. Co., Inc., 33 W. 46th St., New York, N. Y.							Rauland Corp., 4245 N. Knox Ave., Chicago 41, Ill.						
Fada Radio & Electric Co., Inc., Long Island City, N. Y.							RayEnergy Radio & Television Corp., 32 W. 22nd St., New York						
Farnsworth Television & Radio Corp., Fort Wayne, Ind.							RCA Victor Div., Radio Corp. of America, Camden, N. J.						
Federal Telephone & Radio Corp., 591 Broad St., Newark, N. J.							Record-O-Vox, Inc., 721 N. Martel Ave., Hollywood 46, Calif.						
A. E. Ferrar, 55 W. 26th St., New York, N. Y.							Regal Electronics Corp., 20 W. 20th St., New York, N. Y.						
Fisher Radio Co., 41 E. 47th St., New York, N. Y.							Remler Co., Ltd., 2101 Bryant St., San Francisco, Calif.						
Fisher Research Lab., 1961 University Ave., Palo Alto, Calif.							Rex Electronics Corp., 1313 W. Randolph St., Chicago, Ill.						
Five Star Radio Co., 416 Broadway, Cambridge, Mass.							RGH Mfg. Corp., 214 E. 41st St., New York, N. Y.						
Flush Wall Radio Co., 15 Washington St., Newark, N. J.							Rock-Ola Mfg. Corp., 800 N. Kedzie, Chicago, Ill.						
F. M. Radio Mfg. Co., Inc., 10314 Superior, Cleveland, Ohio							E. M. Sargent Co., 219 9th St., Oakland, Calif.						
Freed Radio Corp., 200 Hudson St., New York, N. Y.							Schuttig & Co., 9th & Kearny Sts., N.E., Washington, D. C.						
Calvin Mfg. Corp., 4545 Augusta Blvd., Chicago, Ill.							Scophony Corp. of America, 527 5th Ave., New York, N. Y.						
Garner Electronics Corp., 1100 W. Washington Blvd., Chicago 7							Scott Radio Labs., Inc., 4450 Ravenswood Ave., Chicago, Ill.						
Garnet Radio Corp., 69 Glenwood Place, E. Orange, N. J.							Searle Aero Industries, Inc., P. O. Box 111, Orange, Calif.						
Garod Radio Corp., 70 Washington St., Brooklyn, N. Y.							Selectograph Mfg. Co., 502 W. Colo. Ave., Colorado Spgs., Colo.						
Gem Radio & Television Co., 140 Liberty St., New York 16, N. Y.							Sentinel Radio Corp., 2020 Ridge Ave., Evanston, Ill.						
General Electric Co., Bridgeport, Conn.							Setchell-Carlson, Inc., 2233 University Ave., St. Paul, Minn.						
General Television & Radio Corp., 2701 Lehmann Ct., Chicago							Sheridan Electronics Corp., 2850 S. Michigan Ave., Chicago						
Gibllan Bros., 1815 Venice Blvd., Los Angeles, Calif.							Signal Electronics, Inc., 114 E. 16th St., New York, N. Y.						
Globe Electronics, Inc., 225 W. 17th St., New York, N. Y.							Silver Co., McMurdo, 1240 Main St., Hartford 3, Conn.						
Gray Radio Co., W. Palm Beach, Fla.							Sonora Radio & Television Corp., 325 N. Hoyne Ave., Chicago						
L. Charlton Greene Co., 9 Eliot St., Watertown 22, Mass.							Sparks-Withington Co., Jackson, Mich.						
Hallcrafters Co., 2611 S. Indiana Ave., Chicago, Ill.							Speak-O-Phone Recording & Equip. Co., 23 W. 69th, New York						
Hamilton Radio Corp., 510 6th Ave., New York, N. Y.							Stewart-Warner Corp., 1826 Diversy Pkwy., Chicago, Ill.						
Hammarlund Mfg. Co., 460 W. 34th St., New York, N. Y.							Stromber-Carlson Co., 100 Carlson Rd., Rochester, N. Y.						
Harris Mfg. Co., 2422 W. 7th St., Los Angeles							Symphonic Radio & Electronic Corp., Main St., Cambridge, Mass.						
Harvey Machine Co., Inc., 6200 Avalon Blvd., Los Angeles							Tac Industries, 44 DeKalb Ave., Brooklyn, N. Y.						
Harvey Radio Labs., Inc., 447 Concord St., Cambridge, Mass.							Tabern Equipment Co., 120 Greenwich St., New York, N. Y.						
Harvey-Wells Electronics, Inc., Southbridge, Mass.							Tech-Master Products Co., 123 Prince St., New York, N. Y.						
Herbach & Rademann Co., 522 Market St., Philadelphia, Pa.							Teletop Radio Co., 1901 S. Washtenaw Ave., Chicago, Ill.						
Higgins Industries, 2221 Warwick Ave., Santa Monica, Calif.							Teletone Radio Co., 609 W. 51st St., New York, N. Y.						
Hoffman Radio Corp., 3430 So. Hill St., Los Angeles, Calif.							Telex, Inc., 451 S. 5th Ave., Mt. Vernon, N. Y.						
Howard Radio Co., 1735 Belmont Ave., Chicago, Ill.							Telicon Corp., 851 Madison Ave., New York, N. Y.						
Hudson-American Corp., 25 W. 43rd St., New York 18, N. Y.							Templetone Radio Mfg. Corp., New London, Conn.						
Industrial Electronic Corp., 505 Court St., Brooklyn 31, N. Y.							Transmitter Equipment Co., 345 Hudson St., New York 14, N. Y.						
Industrial Tool & Die Works, Inc., Minneapolis, Minn.							Trav-Ler Karenola Radio & Tel. Corp., 571 W. Jackson, Chicago						
International Detrola Corp., Beard Ave., Detroit, Mich.							Trebor Radio Co., Box 497, Pasadena, Calif.						
Islip Radio Mfg. Corp., Beech St., Islip, New York							Union Electronics Corp., 38-01 Queens Blvd., Long Island City						
Jameson Electronics Lab. Co., Inc., 115 Cooper Lane, Dayton, O.							United States Television Mfg. Co., 3 W. 61st St., New York, N. Y.						
Ray Jefferson, Inc., 40 E. Merrick Rd., Freeport, L. I., N. Y.							Vibracolor Mfg. Co., 325 Miguel St., San Francisco, Calif.						
Jefferson-Travis Radio Mfg. Corp., 245 E. 23rd St., New York							Viewtone Co., 203 E. 18th St., New York, N. Y.						
Jewel Radio Corp., 583 Sixth Ave., New York 11, N. Y.							V-lectrical Engineering Co., 828 N. Highland Ave., Los Angeles						
Kaar Engineering Co., 619 Emerson St., Palo Alto, Calif.							Walker, Inc., 403 W. 8th St., Los Angeles, Calif.						
Keith Radio Products, Bedford, Ind.							Warwick Mfg. Corp., 4640 W. Harrison St., Chicago, Ill.						
Kinetic Electronics Corp., 235 E. 42nd St., New York 17, N. Y.							Waterson Radio Mfg. Co., 2700 Swiss Ave., Dallas, Texas						
Kingston Radio Co., Inc., Kokomo, Ind.							Wells-Gardner & Co., 2701 N. Kildare Ave., Chicago, Ill.						
Kluge Electronics, Inc., 1031 N. Alvarado St., Los Angeles 36, Cal.							Western Electric Co., 120 Broadway, New York						
La Magna Mfg. Co., 51 Clinton Pl., E. Rutherford, N. J.							West'n Sound & Elec. Labs., Inc., 2512 W. St. Paul Av., Milwaukee						
Laurehk Radio Mfg. Co., 3931 Monroe Ave., Wayne, Mich.							Westinghouse Electric Corp., Receiver Div., Sunbury, Pa.						
Lavoie Laboratories, Matawan-Freehold Rd., Morganville, N. J.													

Section of **RADIO & Television RETAILING**

# ELECTRICAL APPLIANCES



**MRS. AMERICA, IN YOUR NEW KITCHEN YOU WILL NEED THESE CONVENIENCES:**

Broiler  
Cabinets  
Coffee brewer  
Dishwasher  
Disposal unit

Electric clock  
Exhaust fan  
Fluorescent lighting  
Food mixer  
Freezer

Hand iron  
Liquefier  
Radio  
Range  
Refrigerator

Sandwich grill  
Toaster  
Ventilating fan  
Waffle baker  
Water heater



**NEW 5-WAY HEAT CONTROL**  
 regulates the iron temperature as desired, ranging from a low heat of 125° to a high of approximately 500°

**Immediate Delivery!**

*The New Improved*  
**GREYHOUND**  
**LIGHT-WEIGHT HOUSEHOLD and TRAVEL IRON**

It's modern as tomorrow...sleek, light, perfectly balanced, thermostatically controlled. Five temperatures make ironing of synthetic fabrics safe—ironing of cotton, wool or linen easy. Available for immediate delivery. Orders will be shipped to you approximately two weeks after receipt.

MIDDLETON & MEADS INC.  
 announce the appointment of  
**L. K. FRANKLIN CO.**  
 as exclusive  
 national distributors



**CHECK THESE SALES POINTS**

- ✓ Light Weight—2¼ lbs.
- ✓ Automatic Thermostatic Control
- ✓ 5-Way Heat Control
- ✓ Handle detachable for easy packing when traveling
- ✓ 6 Month Guarantee
- ✓ Solid Aluminum Sole
- ✓ Complete with stand and cord
- ✓ OPA List—\$6.20—Zone 1  
                   \$6.50—Zone 2

**L. K. FRANKLIN CO.**  
 1251 S. HILL ST., LOS ANGELES 15, CALIFORNIA

FOR IMMEDIATE DELIVERY  
 ORDER DIRECT FROM  
 L. K. FRANKLIN COMPANY



# Train to Upgrade Sales

**Education by Dealer Can Improve Entire Process of Selling Merchandise**



• The occupation of retail selling cannot be classified as a profession. There are no bar examinations, no license requirements, and no long years of study.

A dealer can, however, develop the vocation of retail selling into an art and a science, complete with a code of ethics. He can achieve for it in his community the recognition and honor of a profession.

The extent to which he can elevate the sales efforts of any salesman in his employ to this level depends only partly on the dealer himself. He should provide adequate sales training. But the powers of the individual salesman to absorb this training must also be taken into account.

Thinkers are divided into three fundamental types — those who think in terms of ideas, those who think in terms of people and those who think in terms of things. The ones who have formed the habit of thinking about ideas are the potentially prosperous ones. These are the men most likely to raise their selling ability to the status of a recognized profession.



Although one of the finest benefits to be gained from a college education is the training of the ability to think in terms of ideas, a college education is not a requisite for successful selling. Education for selling is specific, not general. Practically any man who possesses an average amount of intelligence and ambition can be made into a highly productive salesman.

The dealer charged with sales training duties should line out his educational planning under three separate headings—the product, the customer, and the salesman himself. Each of these three phases

will require research and advancement to keep pace with changing conditions.

An inconsistent outpouring of haphazard homilies will not suffice a successful dealer sales organization, even when supported by expensive advertising programs from the manufacturers whose products are handled. Though sales axioms and adages furnish important ammunition for “pep” meetings, only planned and well-organized educational training can develop the full effectiveness of a dealer organization.

Product education should cover every point concerning the need, use, serviceability, history, construction and advantages of the product. The dealer should do extensive foraging in order to furnish information and material to the salesman not contained in factory advertising programs.



Competitive brand information and specifications should be accumulated in quantity to help the salesmen develop defensive tactics.

Salesmanship is a completely mental process. Force, hypnotism or coaxing will not induce a customer to buy against his will. Only after true convictions of the advantages of the offer in the salesman's mind have been transferred to the customer's sub-conscious mind can a buying urge be established.

To carry firm convictions to the sub-conscious train of thought in the customer's mind of sufficient quantity and quality to be effective, the salesman must be imbued with a mental storehouse of answers to every conceivable objection to the sale as well as every advantage to be gained from buying the commodity.

It is the first responsibility of the dealer to supply material for this storehouse of knowledge. His system of product education should place an answer for every point of possible controversy, even those

only remotely connected, at the command of every salesman.

Sales training in customer and prospect reaction is usually the most neglected phase of a program; yet it is one of the most important.

Specialty commodities are normally produced in quantities greater than demand calls for. They are also varying in price, style and utility. Hence, customers must be created and guarded against other influencing factors.



All too often, the retail salesman misses a heavy percentage of the full effectiveness of his sales aids through improper sales strategy. Too often, the dealer presents a wonderful program of manufacturers' sales aids, then neglects to ascertain that the salesmen in the field know how to effectively use those aids.

The principles of selling are a science. The application of those principles is an art. It is a waste of time to argue whether a good salesman is born or self-made.

## **Road to Success**

Any salesman worth his salt is ambitious to learn both the scientific and artistic aspects of selling. It should be the third part of the dealer's job to furnish planned and workable training to every salesman for this purpose.

This training should include a thorough and understandable basic course in salesmanship. It should also treat every step in the progress of a sale from the approach to closing. Elaboration on the many points in the progress of a sale will be a continuous job, year-in and year-out. Every possible means must be utilized to convey a steady stream of educational material to the salesman.

This is the road to successful sales training. Let systematized planning be the keynote, work be the medium; and increased sales volume will be a sure return.

# Self-Service for

**Display Your Small Products on Open Tables and Shelves to Increase Sales Volume and Reduce Cost of Operations**

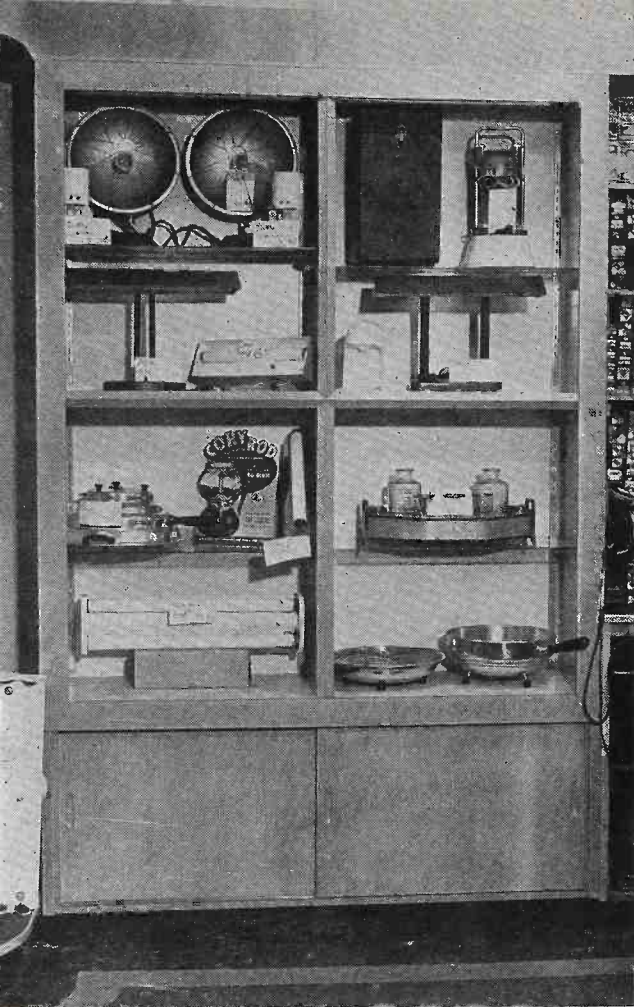

Modern wall cases present small merchandise attractively and make it accessible

• When your back was turned, they crept into the store. Those hundreds of small products you never thought you would handle.

Now that major merchandise is returning to your store, you have the problem of deciding what to do with these small items. You may be wondering whether or not to eliminate some of them entirely.

There are a variety of these items which dealers stock because their customers come in and ask for them. They include such things as flashlight bulbs, wire, plugs, fuses and batteries. Appliance accessories and radio tubes are also demand items.

Many dealers keep these demand items on shelves at the back of the store. Others keep them in boxes or drawers or wherever they will be "out of the way".

### **Rapid Turnover**

Some dealers refuse to display demand items because they say they constitute penny-ante business and there is little profit in them. But this is not entirely true. Their turnover is high and their volume great. They help to pay fixed expenses in any store and thus increase profits on the entire operation.

Some dealers feel that they do not need to display a demand item because people come in and ask for it and hence will buy it anyway. This is not exactly the case. People do come in and ask for the item. Nevertheless, a dealer can sell more of this demand item if he shows it to the customer than he will sell if he keeps it hidden.

It is necessary for you to stock and display demand items in order to hold your customers and prevent them from drifting away from you. If you show them a variety of merchandise that they are in the habit of demanding they will be satisfied, will buy it from you and will refrain from entering other stores where your competitors may sell them the high-profit merchandise that you are anxious to sell yourself.

Then too, the sale of demand items is important to you in other ways and warrants the display space you give to them. They are chiefly responsible for the fact that your customer is in the store in the first place.

### **Sales Stimulators**

Mrs. Jones has come in to get something she wanted and this has created your store traffic. Once she is in there and has bought the demand item she is in a buying mood. She may very well purchase some of your high profit items before she leaves the store. In this way demand item sales result in the sales of other goods in at least a certain percentage of the cases.

In order to reduce your cost of handling this merchandise to a bare minimum you should place it out on tables where your customers can pick up the items and serve themselves. Less of your time is

consumed than as if you are forced to hunt through a stock and pick out the article yourself whenever a customer demands it. Further you give your customers quick service and do not force them to wait.

For the smallest demand items you will want to use tables having bin compartments. Place the higher profit items within easiest reach of the customer and the low profit demand products in the center of the tables.

### **How to Use Shelving**

In extreme cases of cramped quarters and large numbers of these demand items it may be necessary for you to resort to shelving to hold this merchandise. Records and albums, for example, are often stocked in wall shelving. If you use shelving, have it out where your customers can get directly at it. Eliminate any counters in front of it.

If you have several hundred such items to display, your next step is to arrange these into a dozen or so groups of similar merchandise. Then arrange each group vertically with one article above the other. Place the most profitable item in each group closest to the eye level of your customers and the low margin goods either above or below this eye level.

Some products, like radio tubes and accessories, such as antenna and ground wire, may need to be carried in shelves that are not accessible to the customer. Stock everything in fixtures open to the customer unless the loss from theft or damage is prohibitive.

Special products require special store fixtures. You may need a wall type display for your phonograph records and an inverted V type of floor island display rack to

# Demand Items

hold your albums and permit self-service. You may also want to install a self-service display unit for single discs.

When the use of these modern store fixtures is carried to its final extreme the result is a self-service operation. These newer types of fixtures pay for themselves very rapidly in increased sales. By increasing self-service, they may also reduce selling costs.

Some of your departments naturally lend themselves to self-service operation more than others. Your demand items including small appliances are frequently adaptable to self-service. Many stores have had a degree of success with self-service phonograph record departments.

The thing to remember in arranging self-service display is that you

can use this principle in some degree for all products. It will cut your overhead perhaps to set up your fixtures so that you can offer self-service even though not all of your customers prefer to buy in this way.

## **Maintain a Happy Medium**

Complete self-service operation may drive away from your store those customers who want personal attention and who are willing to pay for it. By having self-service types of displays you can allow those customers who want to select their own merchandise to do so. By having enough clerks in your store you can offer service to those people who seem to want it even though the fixtures are adapted for self-service.

Modern store fixtures will make possible some measure of self-service for your smaller appliances. Thus some of the burden of personal salesmanship will be taken off your staff so that they can spend most of their time on the large items which represent much greater individual profit.

Most dealers are agreed that record selling should be a combination of self-service and service. They display albums and single records on double-sided island racks to encourage self-service. But in addition, behind the wrapping counter they stock conventional shelves of staple records.

Somewhere in the range between complete self-service and complete service lies the proper method of operation for every department in your store.

Tables within easy reach and shelves which permit display of the entire stock are features of the modern technique for presenting small items shown in these interior views of Louis Pincus' store in Germantown, Pa.





# Radio Service Builds

Maintenance and Phonograph Record Customers Best Foundation

● "Who will be one of the outstanding neighborhood electrical appliance dealers in Chicago?" we asked the sales manager of a large major appliance manufacturer.

"Well, of all the dealers I know," he replied, "I would name Emergency Radio Service, at 4439 West Madison St."

"Emergency Radio SERVICE!" we gasped. "An outstanding electrical appliance dealer!"

"Yes," replied the sales manager. "The firm has done it before, and it can do it again. Before the war, it was one of the best electrical appliance dealers we had. And the store sold a large volume of merchandise profitably. It never had to slash its prices to close a major deal. It sold on a sound basis, by thorough demonstration."

And so we went out to see.

We met the sole proprietor of Emergency Radio Service, a slight, unassuming man named John F. Beranich, who likes to be called "Johnny." He has a store which occupies 50 by 60 feet on two floors. The second floor is used for service and

storage. He also owns an adjacent garage.

The exact number of radio sets he services is something his competitors would love to know. But it is common knowledge that it is well over 12,000 sets a year.

We asked Beranich to tell us the story of his business career.

"I started this business," he said, "with a service department in 1933 on a capital of \$25. I gradually added radio receivers, then phonograph records, then electrical appliances, both large and small.

### Firm Foundation

"Just before the war, we had a general line of radios, two lines of electric refrigerators, two lines of washers, electric and gas ranges, and many lines of cleaners and traffic appliances.

"We sold several hundred major appliances a year. But we weren't too much interested. We were just growing, and we didn't realize then the potentialities the electrical appliance business has to offer.

"During the war, we were thrown right back where we started, to radio service and records, except on a

much larger scale. And it is on this same foundation, our service and phonograph record customers, that we intend to rebuild our electrical appliance business to a new high level of sales.

"The people who use our service and buy our phonograph records are buyers of small and large appliances, and they have had favorable experience with our dealings, so that we shall be picked first. We have a complete file of all these customers.

"They already know that we intend to have a complete appliance supply. Several months ago we mailed a form letter listing the products we will handle. The response was terrific.

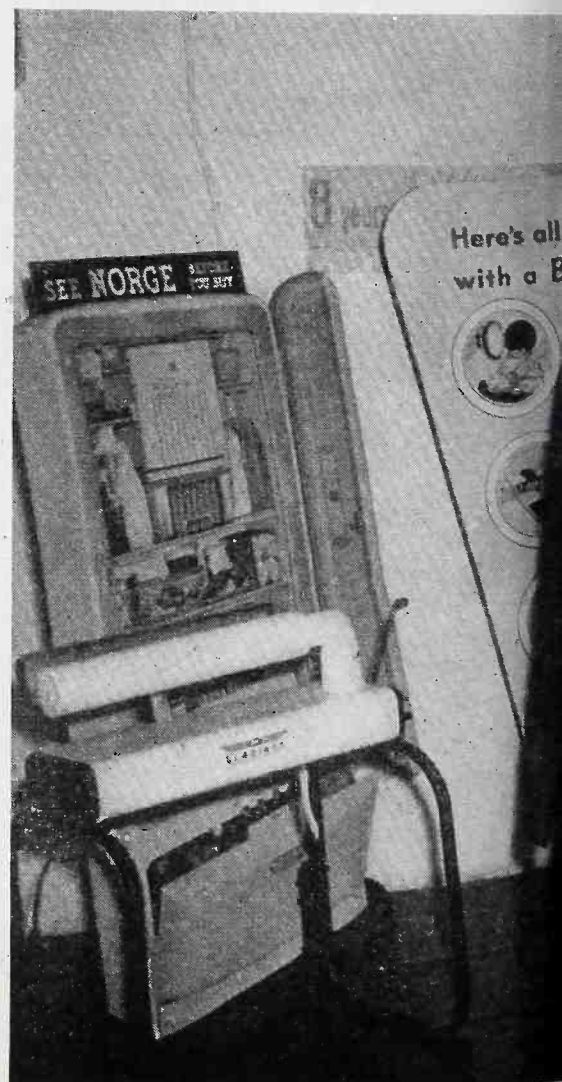

"These files that give detailed information on thousands of satisfied service and record customers will be the foundation of our electrical appliance business. I'm afraid it will be tough for some of the newcomers who don't have such lists of satisfied customers. The family that buys a major appliance will want to know that the dealer is reliable.

"We have a special file that we have built up in the past two or three years. It contains the names of people who want to buy large and



# Appliance Sales

for Customer Confidence. Service Is Door-Opener.

Dealer Beranich (upper left) has supervised the building up of a huge file of service customers, while his sister (upper right) has compiled an equally extensive list of phonograph record buyers. The use of these lists for direct-mail advertising will, they feel, bring many of these customers back into the store, like the ones witnessing a washing machine demonstration by Beranich (below).



small appliances, as well as radios. If only one-fourth of them 'pop' we will have an enormous volume.

"But we shall not depend on these things alone. We had two outside salesmen before the war. We will put back more — three or four men at least. We will pay them on a drawing account and commission basis. They will take the leads developed in the maintenance department.

"You see, our service men get in the homes and get a good idea of what the customer might be interested in. That's how we got leads for a lot of sales before the war.

"We paid the service men a commission of \$1 on every lead for a small appliance ranging to \$15, and from 2% to 5% on products over \$15. We pay the major appliance salesman the balance of the commission."

## Appliance Manager

Beranich recognizes that he is more service-minded than sales-minded. So he will have a sales manager to direct the new appliance end of the business.

"I've got a man coming in who has had seven or eight years of experience as sales manager for another appliance dealer. He will train and direct the salesmen, set up store demonstration policies, help plan layout and create the atmosphere we need for major appliance sales.

"To make complete demonstration selling possible, we are installing a kitchen, and will put in it a selection of equipment made by three or four appliance manufacturers.

"For this kitchen we now plan a range, a refrigerator, an automatic washer, a clothes dryer, an ironer and kitchen cabinets. These items will be selected from the five lines of major appliances we will handle.

"In addition, we have bought display fixtures from many of the major companies.

(Continued on page 108)

Refrigerators  
 Washers  
 Ironers  
 Ranges  
 Vacuum Cleaners  
 Food Freezers

# Latest Electrical

### Whirlpool IRONER

Deluxe ironer with open roll for feeding clothes. Knee control; thermostatically controlled heat; special safety finger guard; adjustable speeds; self-adjusting shoe; tuck-away shelves for

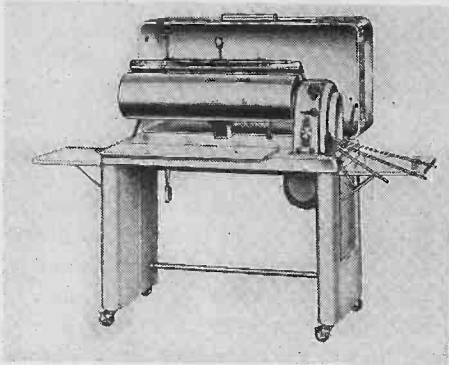

damp and finished clothes; 4-arm rack for folded work. Ironer is Bonderized and rust-proofed. Nineteen Hundred Corp., St. Joseph, Mich.—RADIO & Television RETAILING

### Wit-eez AUTO FAN

In winter, fan acts to defrost windshield and windows; circulate warmth. In summer, fan cools and ventilates. During rain, prevents fog from forming

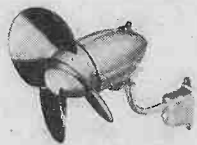

on windows. Three 6" rubber blades anchored in nose piece of motor; controlled by specially designed positive action switch. Interchangeable band or clamp bracket insures easy installation. Wittie Mfg. & Sales Co., 1414 S. Wash Ave., Chicago 5, Ill.—RADIO & Television RETAILING

### Dominion WAFFLE IRON

No. 1301, "modern mode" automatic waffle iron. Automatic regulator can be set for desired degree. Indicator light glows when iron is connected to current; goes out when waffle is ready for baking; lights again when waffle is

completed. Modern design; chromium plated; concealed feet prevents marring of table; ac only; 7 1/2" cast aluminum

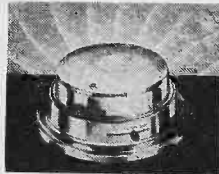

grid. OPA price, including excise tax, \$9.30. Dominion Electrical Mfg., Inc., Mansfield, Ohio.—RADIO & Television RETAILING

### Horton WASHER

Features supersensitive pressure dryer; 9-lb. capacity; double-wall insulated tubs; permanent lubricated motor; self-

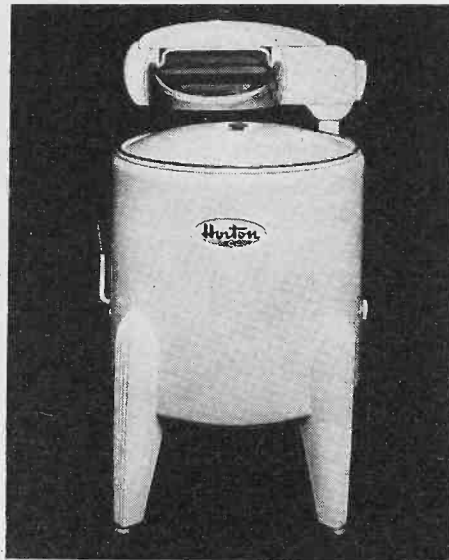

adjusting soft balloon type rolls; automatic type drain board; precision-built motor. Horton Mfg. Co., Fort Wayne, Ind.—RADIO & Television RETAILING

### Gits LUMINOUS SWITCH PLATES

Switch plates of new luminous plastic material which emit blue-white glow in the dark after exposure to light. Single gang plates are 25¢; double gang 42¢. Gits Molding Corp., 4600 W. Huron St., Chicago—RADIO & Television RETAILING

### International Harvester HOME FREEZER

10 cu. ft. home freezer for freezing and storage of foods. One of first refrigeration products scheduled for produc-



tion by this company. International Harvester Co., 180 No. Michigan Ave., Chicago 1, Ill.—RADIO & Television RETAILING

### Prevore TABLE BROILER

Model #BR4PN deluxe chromium plated electric table broiler with heat indicator. Triple plated with chromium. Aluminum gravy plate with gravy well;

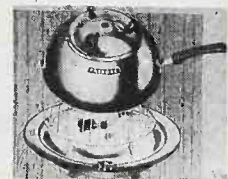

adjustable wire rack; 2-heat cord set; detachable hinged cover for fingertip lifting. Size 8 1/2" high, serving tray 16 1/2" wide. Can be used as an electric stove. Prevore Electric Mfg. Co., 122 18 St., Brooklyn 15, N. Y.—RADIO & Television RETAILING

### Schick ELECTRIC SHAVER

"Super" model, catalog No. 270. Precision-built comb-type V-16 head, made of surgical steel with double acting interceptor bars for closer shaves; ac or

# Appliance Models

★ Toasters  
★ Roasters  
★ Hand Irons  
★ Mixers  
★ Clocks  
★ Coffee Makers

dc. Ivory plastic with ribbed grip. Hinged bronze whisk-its catch beard



clippings. Comes complete with cord, cleaning brush and head-guard. List price \$18.00. Schick Inc., Stamford, Conn.—RADIO & Television RETAILING

## Raytheon PRECIPITATOR

Precipitator package unit comprises power supply, ionizer, dust collector cell and blower. Capable of handling 1200 C. F. M. per minute. Unit will re-



move 90% of all dust particles above 1/10 of a micron in air passing through unit. Raytheon Mfg. Co., Industrial Electronics Div., Waltham 54, Mass.—RADIO & Television RETAILING

## Westinghouse STERILAMP

Bacteria are destroyed by rays of Sterilamp. Natural air currents lift bacteria into range of lamp's invisible "bullets" of ultraviolet light. Suspended by picture hooks, the Sterilamp wall fixture is connected to regular lighting circuit. Westinghouse Electric Corp., Lamp Div., Bloomfield, N. J.—RADIO & Television RETAILING

## Holland-Rieger SWEEPER-VAC

Model T-100 cylinder cleaner features toe tap switch control to eliminate bending; super-speed nozzle with brush

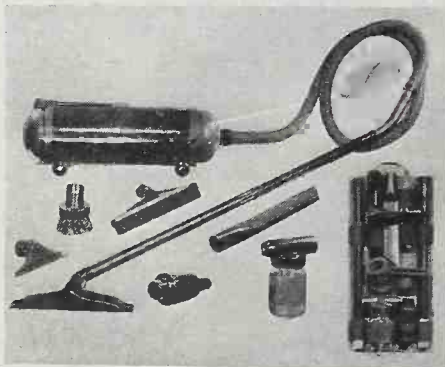

for use under low furniture; dust proof filter; powerful accessory tools. Deluxe brown webite finish. Holland-Rieger, Sandusky, Ohio—RADIO & Television RETAILING

## Seth Thomas ELECTRIC CLOCK

Electric alarm clock, "pyper" model. Case of lustrous molded ivory plastic. Dial mounted at angle to facilitate reading. Square plastic crystal superim-



posed over dial; practically unbreakable. Choice of plain or luminous model. Height 4 7/8", width 4 1/4", depth

2 1/2". Seth Thomas Clocks, Div. of General Time Instruments Corp., Thomaston, Conn.—RADIO & Television RETAILING

## Bersted TWIN WAFFLER

Model No. 255. Modern design; chrom-plated; long-life heating element in cover and base; twin heat indicators.

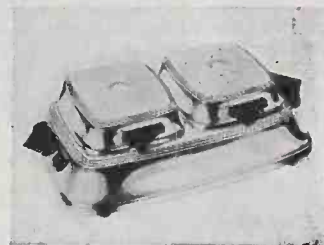

Makes two waffles at a time, each 5" x 5 3/4". Priced at \$9.30. Bersted Mfg. Co., Fostoria, Ohio—RADIO & Television RETAILING

## Sunbeam TOASTER

Double thermostatic control for even toasting; can be set to any shade of toast desired. Can be set to "pop" toast up, or keep it "warm" inside the toaster;



has signal light to indicate when toaster is on, and if toast is done. Crumb tray at bottom snaps down for easy cleaning. Sunbeam Corp., 5600 Roosevelt Rd., Chicago 50, Ill.—RADIO & Television RETAILING.

## Helmco HOT CUP

37 oz. ac-dc waterproof, universal type, hot cup. Useful as utility portable heater for all hot drinks, canned foods, boiling eggs, etc. Helmco Inc., Lacy Products Div., 1215-31 Fullerton Ave., Chicago 14, Ill.—RADIO & Television RETAILING

(Continued on page 70)

# Electrical Appliances

## Miracle ELECTRIC IRON

Automatic electric iron, No. 160. Features: twin points for ironing in small spaces without reversing; safely rests on side when not in use; air-

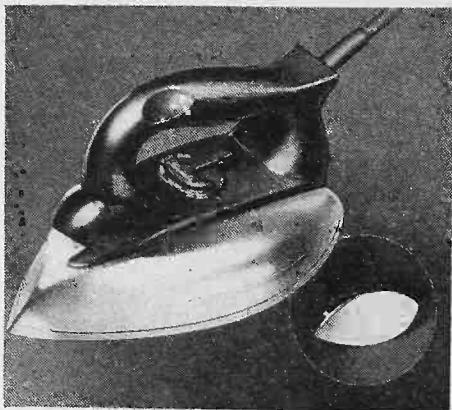

cooled handle and sole; accurate thermostatic fabric heat selector. Handle equipped with a wrinkle-finder headlight. Operates on ac only. Miracle Electric Co., 36 S. State St., Chicago 3, Ill.—RADIO & Television RETAILING

## Polar Cub FAN

16" oscillating fan, with Gilbert induction motor. Operates on 110-120 volts, ac, 60 cycles. Self-aligning, oil impregnated, graphite bronze bearings

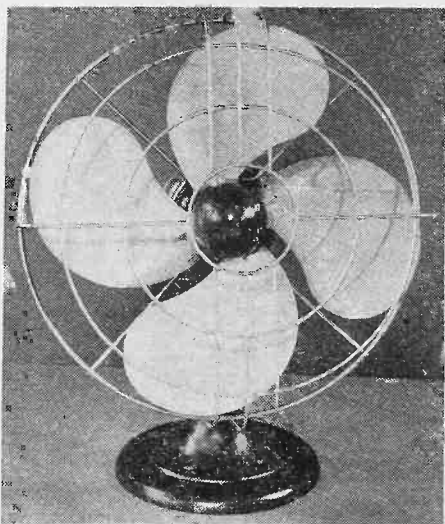

with oil reservoir and felt oil retainer. Oscillating movement supported on ball race thrust bearing. May be operated as non-oscillating fan. A. C. Gilbert Co., New Haven, Conn.—RADIO & Television RETAILING

## Royal VACUUM CLEANER

Super grand Royal, model 177, has new type metal covered motor-driven brush; three adjustments for height. Trigger switch located at finger tips in

handle; wide opening bag; streamline design; nozzle adjustment; "adjustorite" efficiency indicator for showing correct nozzle height. P. A. Geier Co., Cleveland, Ohio—RADIO & Television RETAILING

## Vaculator HOT PLATE

Deluxe 2-heat hot plate designed for use with glass coffee makers. Equipped with 2-heat switch, one heat for brewing and one for keeping coffee warm.



Combination of highly polished, chrome-plated shell atop black plastic base; will not scorch or scratch. List price is \$5.25. Hill-Shaw Co., Chicago 6, Ill.—RADIO & Television RETAILING

## "Comfort-Air" HUMIDIFIER

Model No. 600 humidifier; can also be operated dry as a fan; water and ice may be used for more cooling effect. 16 1/2" high, 12" diameter, weighs 15 lbs. Hil-Lor Mfg. Co., 1431-1433 E. 67 St., Chicago 37, Ill.—RADIO & Television RETAILING

## Handyhot PORTABLE WASHER

Portable washer, 13" in diameter, 10" high, with two strong black enameled handles at top. Smooth, three-blade agi-



tator to keep clothes and water in constant motion; oscillating movement. Motor air-cooled and especially designed; permanently lubricated gears; removable top; heavy duty rubber covered

cord and plug cap permanently attached. Companion item is 8" portable rubber wringer which attaches to side of tub; has covered clamps to protect finish. OPA price is \$18.55 in zone 1, and \$20.55 in zone 2. Chicago Electric Mfg. Co., 6333 W. 65th St., Chicago 38, Ill.—RADIO & Television RETAILING

## GE TUNE-A-LARM

Clock can be set to turn radio on at certain hour; if clock is not shut off a few minutes after radio starts, a conventional type alarm goes off. Plastic

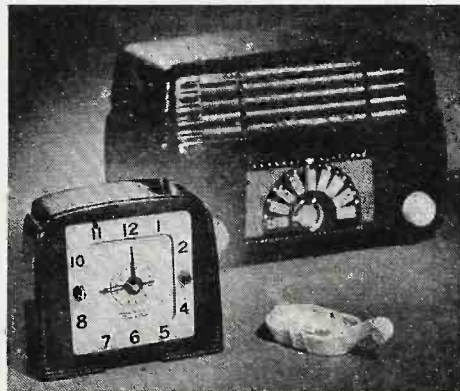

case of mottled mahogany; maroon numerals on grey background with light tan alarm face. General Electric Co., 1285 Boston Ave., Bridgeport 2, Conn.—RADIO & Television RETAILING

## Knapp-Monarch MIXER

Quiet power mixer for mixing, whipping, stirring, beating and extracting fruit juices. Detachable motor; revolving

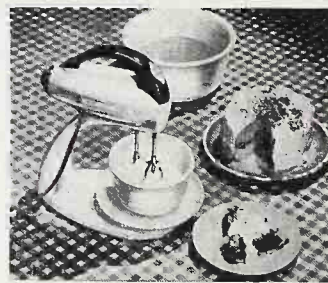

turn-table; large and small mixing bowls; removable beaters. Knapp-Monarch Co., 3501 Bart Ave., St. Louis, Mo.—RADIO & Television RETAILING

## Onan GENERATING PLANT

Electric generator with capacity of 3000 watts; ac-dc current. Features: heavy duty construction, extra heavy shafts; high-low selector switch for high charging rate for low batteries; generator and engine directly connected forming single unit; engine has extra large rods and crankshaft, gear-driven oil pump to supply constant

(Continued on page 72)



# *Style* comes to **ELECTRIC COOKING** sleek as a **STREAMLINED TRAIN**

Now! an electric range to give Mrs. America the style she has dreamed of to "dress up" her kitchen. Gleaming white porcelain enamel and smooth, flowing lines with no cracks, corners or crevices, make Admiral ranges easy to clean and keep clean. Here is truly America's most beautifully styled electric range.



## *Plus* **FEATURES**

- Flex-O-Heat "no-skip" surface unit controls.
- Automatic cooking . . . now simple as ABC.
- White plaskon hardware with chrome trim.
- Big oversize oven.
- Roomy warming drawer.
- 7-qt. deep well cooker with Flex-O-Heat control.
- Two convenient outlets (one automatic).

# *Admiral*

## **ELECTRIC RANGES**

ALSO DUAL-TEMP REFRIGERATORS • HOME FREEZERS • RADIOS . . . ADMIRAL CORPORATION, CHICAGO

# Profits in Appliances

flow of oil to bearings; special attachments are available for running plant on Butane, Propane and Natural gas. Dimensions: 35" long, 30½" high, 18" wide. D. W. Onan & Sons, 39-51 Royalston Ave., Minneapolis 5, Minn.—RADIO & Television RETAILING

## Broilking TABLE BROILER

"Regent" model 551, in round shape. Cover has double lock hinged to hold hood upright; louvers in cover to provide air circulation. Heat indicator; high and low heat; heating element removable for cleaning. Steel wire grill adjustable to two heights; removable gravy



pan; heavy gauge steel body; chromium plated. Dimensions: diameter of base, 11"; width, including side handles 15"; height 7½". International Appliance Corp., Metropolitan and Morgan Ave., Brooklyn, N. Y.—RADIO & Television RETAILING

## Regina CAN OPENER

"Smoothcut" can opener, deluxe household model; wall type. Double-angle cutter. All parts die-cast. Com-

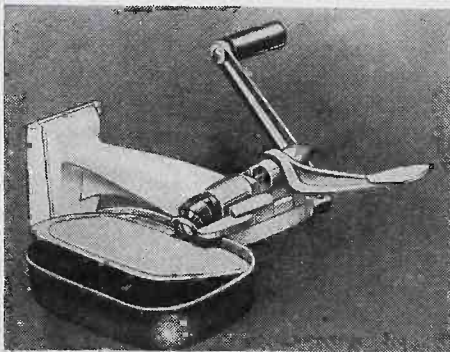

pensating spring allows cutter to operate smoothly. Easy-pierce cam facilitates piercing. White enamel, and polished chrome with red plastic handle.

\$3.45 retail, (\$3.55 West of Rockies). Regina Corp., Rahway, N. J.—RADIO & Television RETAILING

## Tutt TOASTER

Toaster equipped with warming "oven". When toasting process is com-

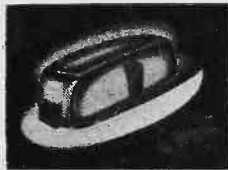

pleted, bread is mechanically placed in oven. The Tutt Co., 4107 Willys Parkway, Toledo, Ohio—RADIO & Television RETAILING

## Featherline ELECTRIC IRON

Model #103. Precision automatic iron with folding handle: Feature: Dial for



## Hotpoint KITCHEN

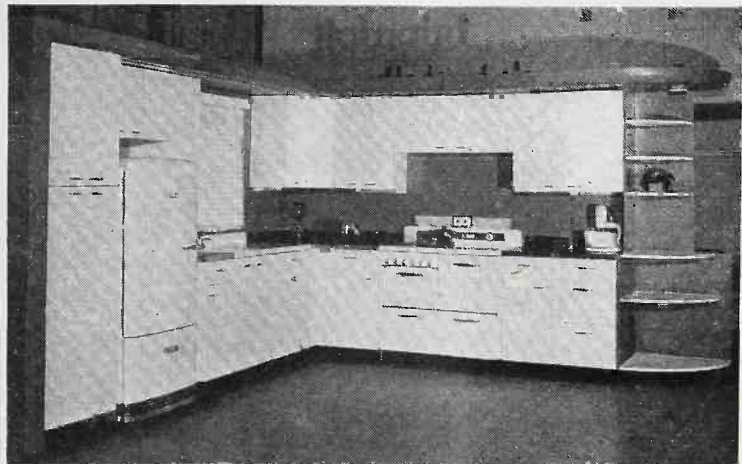

Kitchen includes double "jumbo" utility cabinet, 24" wide x 24½" deep x 84" high. Cabinet over refrigerator is 36" wide x 13" deep x 18" high, joined by wall cabinet 15" wide x 13" deep x 30" high. Corner cabinet left of window is 25 x 25 x 30 inches; next wall cabinet is 24 x 13 x 30 inches; cabinet over range is 36 x 13 x 18 inches; cabinet extreme right is 30 x 13 x 30 inches. Base cabi-

net; fabric heat control; over-all heating element; 1100 watts; evertight folding handle; weighs 3½ lbs.; firmly attached cord held out of the way by spring; interchangeable parts. OPA priced at \$9.95. Featherline Corp., 299 Madison Ave., New York 17, N. Y.—RADIO & Television RETAILING

## Oster MASSAGETT

Model No. 4, electric massager for home use. Motor suspended on a frame at the front end, and rotates on ball bearing eccentric; at rear, motor pivots



on a spring. Action is imparted to finger-tips. Compact, weighs 22 oz. Operates on ac and dc. Equipped with a 9 ft. cord. Priced at \$16.50. John Oster Mfg. Co., Racine, Wis.—RADIO & Television RETAILING

FOR LATEST RADIO MERCHANDISE SEE PAGES 46 TO 49.

## Maytag GAS RANGE

Dutch oven gas range features automatic time device which turns range off, seals flue vents, and permits heavily insulated oven to continue cooking. Visual height controls; all-welded steel chassis; roomy storage compartments.



Two standard size, one giant size, top burners, and a 6-quart Dutch cooker-well gives maximum cooking capacity. White, porcelain enamel, chrome trimmed. The Maytag Co., Newton, Iowa—**RADIO & Television RETAILING**

## Vogue TOASTER

Manual pop-up toaster, model T-25A. Toasts two slices of bread, both sides at same time; manual pop-up conven-



ience. Chrome finish. Size 7½" x 6¼" x 6⅞". Sheridan Electronics Corp., 2850 S. Michigan Ave., Chicago 16, Ill.—**RADIO & Television RETAILING**

## Fayson HEATER

Electric heater with stainless steel reflector; safety guard; metal top handle for carrying. Baked, wrinkled, neutral tan finish; ac and dc. Quick heating. Size: 15" x 13½". Complete with 6' cord, priced at \$10.05. Fayson Appliance Co., Inc., 1875 Broadway, New York 23, N. Y.—**RADIO & Television RETAILING**

## AuthOtone MUSICAL KNOCKER

Suburban model with colonial knocker, which issues two-toned chime; finished in polished brass, with ivory enamel chime for inside. Dimensions: 8¾" high x 3" wide. Mounts directly on door; actuated by mechanical movement—not electrical. Auth Electrical Specialty Co., Inc., 422 E. 53rd St., New York 22, N. Y.—**RADIO & Television RETAILING**



WITH

# Gibson

## YOU SHOW THEM WHAT THEY'RE SHOPPING FOR!

Prospects become customers *quicker* when you show the Gibson line. Exclusive features women have *always* wanted. "Plus" values in construction that assure years of economical, service-free operation. Go Gibson for the shorter line with the quicker turn-over!

- **FREEZ'R SHELF REFRIGERATOR.** Clear-across, wall-to-wall shelves of *different* temperatures—humidities. Freez'r Locker for frozen foods. Perfect preservation of *every* food. Moist Chiller—and other *additional* Gibson "originals."
- **KOOKALL ELECTRIC RANGE.** The "dream" stove. Fully automatic—turns itself on and off. Set it, forget it! Waist high broiler—banquet size oven—PLUS the UPS-A-DAISY—a secret today that will capture every woman's heart tomorrow!
- **HOME FREEZER.** It's UPRIGHT—no more "grab-bag" groping! Wall-to-wall shelves—glassed-in doors—offer clear view, instant identification, easy selection. Direct contact assures faster, more economical freezing. It's the NEWER freezer of unmatched convenience and profit possibilities!

**GIBSON REFRIGERATOR COMPANY**  
GREENVILLE, MICHIGAN

# The White House

OUR RADIO WAS STILL TELLIN' US THAT THE STEEL STRIKE WAS ended when a certain comely young lady rushed in to ask us if she could get her new General Electric refrigerator and electric range in a week or ten days, now that the strike is over. Gosh! We hate to say "no"—but even worse we hate to make promises we can't keep. Way it looks now, it'll be five or six weeks (at least) before refrigerators, ranges, washing machines reappear—maybe even longer. Meanwhile we'll do our best to get all the good radios, records and appliances we can. (Note the word GOOD!)

THIS IS A HECK OF A STORE! . . . (in a way) . . . WE DON'T TAKE orders or down payments or make definite delivery promises or even sell our best products (at present only). We do take listings which we honor as orders though. Here's how we do it—we'll be glad to take your name, address, and phone number and list it for any of the General Electric, Zenith, Motorola, Emerson, Crosley, Thor, Sonora, RCA-Victor (or any other) good products which we'll have later. When these appliances are available—we'll call you. You're under no obligation to us and if you can get 'em elsewhere we'll expect you to! However—we'll follow our lists even if we don't have a friend left when things are plentiful again. It's the fairest policy we can figure out!

"BUYERS WON'T BE PUSHOVERS" READS A HEADLINE IN A TRADE BULLETIN. Gee Whiz! We've known that all along! Smart buyers will stick to 'name brand' merchandise—particularly in Radios and major home appliances. Beware of unproven, "off brand" goods. (We've turned down more than a thousand new radios from five different firms because they weren't up to our quality standards!)

WE'RE BATTERED AND BRUISED AND BEATEN LIKE A BORROWED HORSE but (we hope) by the end of the week to have two new booths ready for you in our spacious record department. You can select and hear your favorite records in comfort. Bill Caffee has been brinin' discs in by the truckload and his list on page 12 of The Topics is terrific! (Spike Jones, Hubba-Hubba 'n everything!) For the boogie beaters and tub-thumpers we have a sizable stack of superb sizzlers!

HONESTLY—WE HAVEN'T MUCH TO SELL EXCEPT RECORDS AND RESPONSIBLE repair service, and the following:

- Mitchell 3-Way Floor Lamps
- White Cross Coffee Makers
- Silex Repair Parts
- Electric Juicers and Broilers
- Door Chimes
- Lumline Light Bulbs
- Electric Heating Pads
- Musitron Record Players
- Fluorescent Lamps
- General Electric Clocks (commercial)
- General Electric Lamps
- Regina Can Openers
- Burnproof Ironing Board Covers
- Infra-Red and Quartz Therapy Lamps

THE BROAD HIPPLE BUSINESS MEN'S ASSOCIATION IS GIVING A FREE Chili supper for its members at 6:30 Wednesday, February 27th at the Masonic Hall in Broad Ripple, so put the cat out and wear a red necktie so the soup spots won't show next Wednesday!

# The White House

910 E. 63rd. Street

BR. 6411

We're Here 9:00 a. m. to 8:00 p. m.

A typical Jack White writing job which appeared in a local newspaper — makes 'em sit up and take notice.

# How to

## Hoosier Merchant's Chatty Newspaper Copy Keeps Old Customers Informed; Brings New Ones to Store

● Do people come into your store because you ran a sparkling ad in the local newspaper? Do you receive compliments on the way you use your advertising space? Do people want to meet the ad writer in your store because he writes such interesting ads?

If you can answer "yes" to these questions, you know that you have accomplished the first purpose in advertising: You have attracted attention. You have drawn people into the store, and these people are all potential customers.

### He Gets Results

There is a radio merchant in Indianapolis who can answer "yes" to all of the above questions. His name is Jack White. Mr. White and his wife are co-owners of the store, named The White House, located at 910 E. 63rd St., in Indianapolis. This is a radio, record and appliance store.

### Ads Appeal to Public

Not a day passes but that two or three persons come into this store and mention these ads written by Mr. White. In fact, that is the way this article happened to be written. The writer went into the store and asked: "Who writes the ads here?" If a former ad-writer is that attracted to another advertiser's work, it is little wonder that it appeals to the general public.

In the first place, Mr. White practices the art of being himself in writing these ads. He is down-to-earth, unpretentious, chatty and

# Write Ads That "Pull"

informal. He doesn't hesitate even to laugh at himself, at times, which of course, adds humorous appeal as well as human appeal. For instance, this is what he says in one of his ads:

"This is a heck of a store . . . (in a way) . . . We don't take orders or down-payments or make definite delivery promises or even sell our best products (at present only). We do take listings which we honor as orders though. Here's how we do it—we'll be glad to take your name, address, and 'phone number and list it for any of the General Electric, Zenith, Motorola, Emerson, Crosley, Thor, Sonora, RCA Victor (or any other) good products which we'll have later. When these appliances are avail-

public. Above all, Mr. White is honest in his advertising. He does not pretend that the store is working on a peace-time basis, as yet, because everyone knows that the merchandise just isn't available. He is so surprisingly frank, that the effect is often startling. The customer or prospective customer reading the ad may say to himself: "You are so right, Mr. Ad Writer, but how come any merchant dares to be THAT frank? Is this something new in advertising?"

## Honesty Best Policy

As to The White House radio repair service, he says: "Radio Repair Service is no better than the firm which does it. We guarantee

days" and found that "a few days" might mean a few months, it is refreshing to hear the unadorned truth. To know what to expect!

The majority of people like to read ads that are *easy to read; entertaining, if possible; informative, truthful, honest, and frank!* They like ads that are *direct* and to the point, even if there is an extra amount of wordage, and especially, if it is written in an *easy informal style*. They like ads that *inspire confidence*. They like to be "talked to" in a down-to-earth-manner. If they like the ads, they usually patronize the store.

As for professional and grammatical rules in writing ads, they are often violated in the best of writing—but for a purpose. If end-

---

## KEEPS HIS BUSINESS IN THE PUBLIC EYE

Dealer White demonstrates that local newspaper advertising can be made to pay.

People watch for his weekly "column"—and are attracted by its frankness; intrigued with its humor—benefited through its informative content.

"White House" advertisements provide retailers with ideas to adapt to their own businesses—Getting clear-cut ad messages down in black-and-white, will help any dealer keep out of the red.

---

able—we'll call you. You're under no obligation to us and if you can get 'em elsewhere we'll expect you to! However—we'll follow our lists even if we don't have a friend left when things are plentiful again. It's the fairest policy we can figure out!" This is only a part of one ad written in this style and this weekly feature is titled "News From The White House."

Mr. White is exceptionally frank, even if it is at his own expense. This gains the confidence of the

our repairs for three months."

All of these ads are direct and to the point, in spite of their chatty, conversational style. They are *informative* and they really say something. They are particularly appealing at this time, when everyone is trying to recover from wartime blues and wondering where to turn next in their search for scarce merchandise. Because customers have so often been turned away from some stores with the promise "it will probably be here in a few

ing a sentence with a preposition makes it sound more conversational and less pretentious, why not write it that way? Probably there is a place for the staid, conventional, type of advertising, but not at The White House!

Even a college professor may chuckle when he reads some of these ads, and may say: "What a shame! The way they 'mutilate' the English language!" But if he reads it, that is the important thing!



**ROY CUNNINGHAM,**  
*District Merchandising Manager,*  
PITTSBURGH



**"CAP" CAPELLI,**  
*District Merchandising Manager,*  
LOS ANGELES



**RAY ADE,**  
*District Merchandising Manager,*  
JACKSONVILLE



**VIC STALFORD,**  
*District Merchandising Manager,*  
DETROIT



**JIM MARTINEAU,**  
*Merchandising Manager,*  
SALT LAKE CITY



**FRED EGGAR,**  
*District Merchandising Manager,*  
MINNEAPOLIS



**JIM CORSARO,**  
*Divisional Merchandising Manager,*  
BUFFALO



**CARL HALLER,**  
*District Merchandising Manager,*  
CINCINNATI



**TED BRIEM,**  
*District Merchandising Manager,*  
SEATTLE



**JACK PARKER,**  
*District Merchandising Manager,*  
RICHMOND



**ERNIE MESERVE,**  
*Divisional Merchandising Manager,*  
NEW YORK



**JOHN WEAR,**  
*District Merchandising Manager,*  
PHILADELPHIA



**HARRY GILES,**  
*District Merchandising Manager,*  
ATLANTA



**LES SHAW,**  
*District Merchandising Manager,*  
CHICAGO



**BOB JANDA,**  
*District Merchandising Manager,*  
ST. LOUIS



**VIC ELMBLAD,**  
*District Merchandising Manager,*  
DALLAS

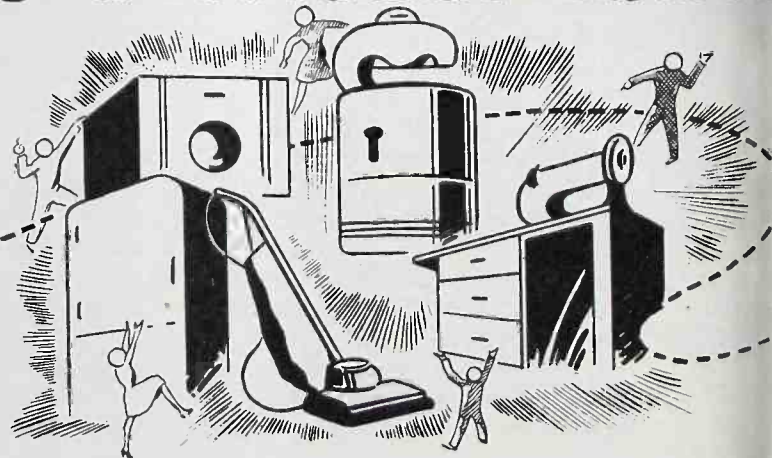
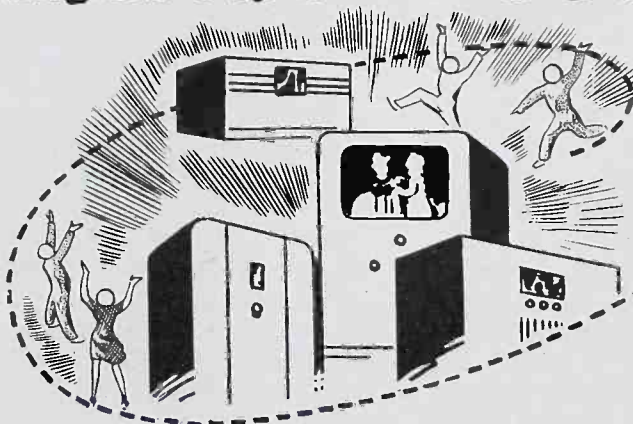

# Graybar

## MERCHANDISING MEN

*can help you sell MORE  
RADIOs and APPLIANCES*

**Y**our success as a dealer depends largely on how you solve your everyday problems of sales selection, personnel training, product service, accounting, store layout, advertising. These are the very activities in which Graybar Merchandising Men are highly experienced.

Some of these specialists you see here. There are many more, at strategic points throughout the nation. Each is familiar with sales conditions in his area. Thus, when Graybar works with you, you're sure of highly effective merchandising — sound selling methods geared to the preferences of *your* customers.

The lines that Graybar distributes include the big names in home radio and appliances. Our nation-wide warehousing system gives you quick deliveries. As a Graybar dealer, you get the best merchandise — prompt attention — outstanding service — and powerful merchandising help. *Graybar Electric Company. Executive offices: Graybar Building, New York 17, N. Y.*

4651



JACK O'DONNELL,  
District Merchandising Manager,  
BOSTON



"TRACE" TRACEWELL,  
District Merchandising Manager,  
CLEVELAND



BLAINE LIND,  
Merchandising Manager,  
SAN FRANCISCO



LARRY BRAY,  
District Merchandising Manager,  
KANSAS CITY

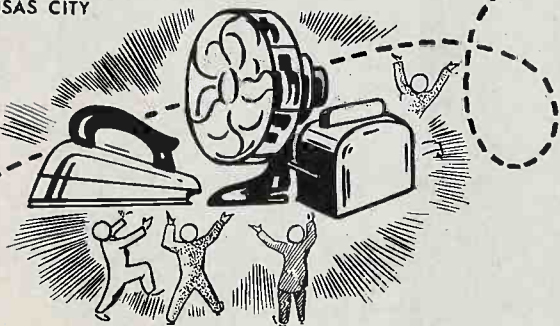



*One Stroke  
gets the Juice*

• It's juice in a jiffy with JUICE KING. Single-Stroke handle cuts squeezing time in half! Little wonder that the beautiful new JUICE KING reigns the popular favorite with housewives—a profitable line with dealers.

And—here are FIVE more PLUS features that confirm JUICE KING supremacy; Patented Juice-All Strainer \* Deep-Well Cup \* Interlocking Cup, Strainer and Base \* Steel Handle \* Open Design.

JUICE KING models retail from \$4.95 to \$9.95. For the finest in home juicers—feature JUICE KING!



Watch for the registered JUICE KING trademark in leading national publications.

**Juice King**  
FINEST HOME JUICER

**NATIONAL DIE CASTING COMPANY**  
Touhy Ave. at Lawndale  
Chicago 45, Ill.

## New Electrical Toys

### Jim Prentice **ELECTRIC** **BASEBALL GAME**

Batter presses a control button as the ball goes by home plate; pitcher controls speed of steel ball. Two play at a

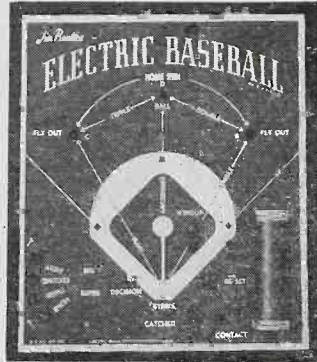

time. The play flashes on the multiple lighted electric diamond. Operates on two standard flashlight batteries, or on a special transformer unit. Electric Game Co., Inc., Holyoke, Mass.—**RADIO & Television RETAILING**

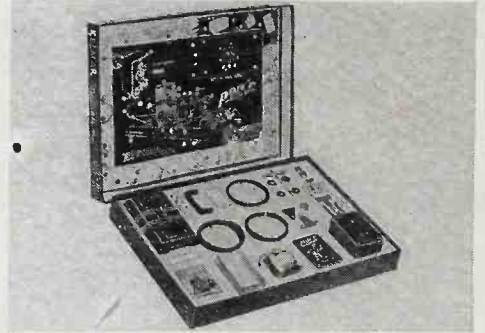

ferris wheels, merry-go-rounds, calipos, etc. Kelmar Corp., Wisconsin Tower, Milwaukee, Wis.—**RADIO & Television RETAILING**

### **ECA PIANOTUNE**

Chromatic toy piano, finished in Chinese red lacquer, plastic keys. Covers almost 2½ octaves, stands 24" high.



Removable legs, and bench to match. \$25. Electronic Corp. of America, 45 W. 18th St., New York 11, N. Y.—**RADIO & Television RETAILING**

### **Empire TOY ELECTRIC RANGE**

No. 212, electric range, with "signal" light; 15" x 12¾" x 7¾". Fully enclosed, heavy-duty, insulated, safety burners. "Signal" light indicates when range is connected. Movable play switches on



chromium panels. Large capacity oven has porcelain type unit. Six utensils including top-of-range "play" cooker. Heavy, welded steel construction. Enameled and trimmed, complete with cord set attached. Priced at \$6.50. The Metal Ware Corp., Two Rivers, Wis.—**RADIO & Television RETAILING**

### **Pow'r House ELECTRIC** **ASSEMBLY KIT**

Junior model electric toy motor and transformer assembly kit; completely equipped. Easy to follow instruction book, illustrated with comics packed with each game. OPA priced at \$6.95. Additional assembly kit groups include

### **ElecToy CANNON**

Fitted with magazine to feed wooden pellets into breech, cannon fires in rapid succession by electric control. Op-

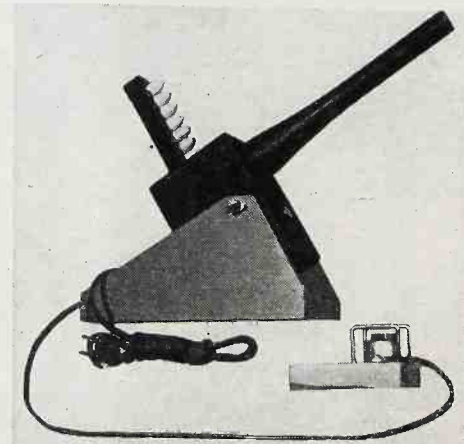

erates from ordinary electric outlet. Fires 10 wooden shells, but is harmless. Electronic Labs Inc., 122 W. New York St., Indianapolis, Ind.—**RADIO & Television RETAILING**



# “COMPARISON”

Measured by the yardstick of experience, this dealer's choice is Commercial Credit service.

**T**he years we have done our financing with you have been unusual, first being a volume period and then war times. We have found you flexible under both conditions and invariably willing to take care of our needs and to be of assistance in our plans.

“Prior to our connection with you in 1938 we used several other financing connections so when we say your service is excellent we have a basis for **COMPARISON**.”

“We have nothing but praise for the cooperation you have always extended to us.”



*John T. Vidmar Jr.*

Vidmar Mathis Appliance Co.  
Pueblo, Colo.

## COMMERCIAL CREDIT COMPANY

BALTIMORE 2, MARYLAND

Capital and Surplus more than \$80,000,000

# PRODUCTS OF ELECTRICAL APPLIANCE MANUFACTURERS

Listing the companies whose lines cover one or more of the seven groups of greatest importance to retailers and distributors.

The following manufacturers of electrical appliances returned our editorial questionnaire giving the information needed for these listings

Refrigerators  
Laundry Equip.  
Vac. Cleaners  
Elec. Ranges  
Gas Ranges  
Freezers  
Traffic Appl.

- Adel Precision Products Co., No. Hollywood, Calif.
- Admiral Corp., 3300 W. Cortland St., Chicago
- Airmaster Corp., 4317 Ravenswood Ave., Chicago, Ill.
- Air Way Electric Appliance Corp., Toledo, Ohio
- Altorf Bros. Co. (ABC), East Peoria, Ill.
- Amana Society, Refrigeration Division, Amana, Iowa
- American Electrical Ap. Co., 5014 Ft. Hamilton Pkwy, Brooklyn
- American Electrical Heater Co., Detroit, Mich.
- American Ironing Machine Co., Algonquin, Ill.
- American Refrigerator & Machine Co., No. Minneapolis, Minn.
- American Stove Co., 4301 Perkins Ave., Cleveland, Ohio
- Apex Electric Mfg. Co., Cleveland, Ohio
- Appliance Indus. of Amer., 666 Lake Shore Dr., Chicago 11, Ill.
- Appliance Mfg. Co. (Duchess), Alliance, Ohio
- Aray Mfg. & Supply Co., 3107 Pine St., St. Louis, Mo.
- Armstrong Products Co., Huntington, W. Va.
- Automatic Washer Co., Newton, Iowa
- Barlow & Seelig Mfg. Co. (Speed Queen), Ripon, Wis.
- Barr Mfg. Co., Weedsport, New York
- Barton Corp., West Bend, Wis.
- Beam Mfg. Co., Webster City, Iowa
- Bell Appliance & Radio, 125 E. 46th St., New York, N. Y.
- Bendix Home Appliances, Inc., South Bend, Ind.
- Ben-Hur Mfg. Co., 634 E. Keefe Ave., Milwaukee, Wis.
- Berger Electric Co., 109-01 72nd Forest Hills, N. Y.
- Bersted Mfg. Co., Fostoria, Ohio
- Birtman Electric Co., 4140 Fullerton Ave., Chicago, Ill.
- R. H. Bishop, Champaign, Ill.
- Blackstone Corp., Jamestown, New York
- Buffalo Forge Co., 205 Mortimer St., Buffalo, N. Y.
- Calkins Appliance Corp., South Bend, Ind.
- Camco Products, Inc., 57 William St., New York, N. Y.
- Camfield Mfg. Co., Grand Haven, Mich.
- Casco Products Co., 512 Hancock Ave., Bridgeport, Conn.
- Cavalcade Industries, 39 S. LaSalle St., Chicago 3, Ill.
- Central Rubber & Steel Corp., Findlay, Ohio
- Chicago Dryer Co., 2210 No. Pulaski Road, Chicago, Ill.
- Chicago Electric Mfg. Co., 6333 W. 65th St., Chicago, Ill.
- Circulators & Devices Mfg. Corp., 100 Prince St., New York, N. Y.
- Clayton & Lambert Mfg. Co., 1427 Tireman, Dearborn, Mich.
- Clements Mfg. Co. (Cadillac), Chicago, Ill.
- Clock Products Co., 55 E. Washington St., Chicago, Ill.
- Coldaire Corp., 56 E. Walton Pl., Chicago 11, Ill.
- Columbia Associates, 141 W. 24th St., New York 11, N. Y.
- Complete Refrigerator Supply, 92 7th Ave., New York, N. Y.
- Conlon Corporation, 1824 So. 52nd Ave., Chicago, Ill.
- Cooler Corp., Duluth, Mich.
- Copeland Refrigeration Corp., Sidney, Ohio
- Cory Glass Coffee Brewer, 221 N. LaSalle St., Chicago
- Cribben & Sexton Co., 700 No. Sacramento Blvd., Chicago
- Crosley Corporation, Cincinnati, Ohio
- Deepfreeze Division, Motor Products Corp., N. Chicago, Ill.
- Dejur Electric Works, 124 Blecker St., New York, N. Y.
- Delco Appliance Division, General Motors, Rochester, N. Y.
- Detroit Michigan Stove Co., 6900 E. Jefferson, Detroit
- Dexter Company, Fairfield, Iowa
- Domestic Sewing Mach. Co., Main Ave. & Elm St., Cleveland, O.
- Dominion Electric Mfg. Co., Mansfield, Ohio
- F. A. Dormeyer Mfg. Co., 4316 N. Kilpatrick Ave., Chicago
- Dual-Air Fan Co., So. Elgin, Ill.
- Easy Washing Machine Co., Syracuse, N. Y.
- Economaster Products Co., 9th Ave., Nashville, Tenn.
- Edison G. E. Appliance Co. (Hotpoint), Chicago, Ill.
- Edwards Company, Norwalk, Conn.
- Electric Steam Prods. Corp., Detroit, Mich.
- Electro-King Mfg. Co., 503 N. LaSalle St., Chicago, Ill.
- Electromaster, Inc., 1803 E. Atwater St., Detroit, Mich.
- Electromode Corp., Div. Am. Foundry Eq. Co., Mishawaka, Ind.
- Emerson Electric Mfg. Co., 1824 Washington Ave., St. Louis, Mo.
- Empire Appliance Co., 480 Lexington Ave., New York
- Empire Ironer, Inc., 817 Main, Cincinnati, Ohio
- Esco Cabinet Co., Esco Bldg., W. Chester, Pa.
- Estate Stove Co., Hamilton, Ohio
- Eureka Vacuum Cleaner Corp., 6060 Hamilton Ave., Detroit
- Expert Die & Stamping Co., Grand Rapids, Mich.
- Faraday Electric Co., 11 S. LaSalle St., Chicago, Ill.
- S. W. Farber, Inc., 141 S. 5th St., Brooklyn, N. Y.
- Fayson Appliance Co., Inc., 1875 Broadway, New York, N. Y.
- Finders Mfg. Co., 3669 S. Michigan Ave., Chicago
- Florence Stove Co., Gardner, Mass.
- Fogel Refrigerator Co., Eadon & Kennedy Sts., Philadelphia, Pa.
- Franklin-McAllister Corp., 135 S. LaSalle St., Chicago, Ill.
- Free Sewing Machine Co., Rockford, Ill.
- Fresh-nd Aire Co., 210 N. Clinton St., Chicago, Ill.
- Ed. Friedrich, Inc., San Antonio, Texas
- Frigidaire Div., General Motors Corp., Dayton, Ohio
- Froster Div., General Tire & Rubber Co., 332 S. Mich. Ave., Chicago
- P. A. Geier Co. (Royal), 540 E. 105th St., Cleveland, Ohio
- General Aircraft Equipment, Inc., So. Norwalk, Conn.
- General Die & Stamping Co., 262 Mott St., New York, N. Y.
- General Electric Co., Appl. & Merch. Dept., Bridgeport, Conn.
- General Mills, Inc., Chamber of Com. Bldg., Minneapolis, Minn.
- Getz Power Washer Co., 1025 Walnut St., Morton, Ill.
- Gibraltar Mfg. Co., 403 Communipaw Ave., Jersey City, N. J.
- Gibson Refrigerator Co., Greenville, Mich.
- A. C. Gilbert Co., 319 Peck St., New Haven, Conn.
- William L. Gilbert Clock Co., Winsted, Conn.
- Gilfillan Bros., Inc., 1815 Venice Blvd., Los Angeles
- Gilson Electric Mfg. Co., 216 No. Clinton St., Chicago, Ill.
- Glenwood Range Co., Taunton, Mass.
- Globe-American Corp., 101 E. Broadway, Kokomo, Ind.
- Go Electric Corp., 200 William St., New York, N. Y.
- Grand Home Appliances Co., 2323 E. 67th St., Cleveland, Ohio
- Gray & Dudley Co., 222 3rd Ave., Nashville, Tenn.
- Hamilton Beach Co., Div. of Seville Mfg. Co., Racine, Wis.
- Hamilton Mfg. Co., Two Rivers, Wis.
- Hammond Instrument Co., 2915 N. Western Ave., Chicago, Ill.
- Hardwick Stove Co., Cleveland, Tenn.
- Health-Mor, Inc., 203 N. Wabash Ave., Chicago
- Heinz & Munschauer, 20 Superior St., Buffalo, N. Y.
- Hill-Shaw Co. (Vaculator), 311 No. Desplaines St., Chicago
- Hobart Mfg. Co. (Kitchen Aid), Troy, Ohio
- Holland Rieger Corp., Sandusky, Ohio
- Hoover Co., 8 So. Michigan Ave., Chicago, Ill.
- Horton Mfg. Co., 131 Osage St., Ft. Wayne, Ind.
- Hunter Fan & Ventilating Co., 92 Warren St., New York
- Hurley Mach. Div. (Thor), Elec. Household Util. Corp., Chicago
- Hydro-Aire Co., 626 N. Robertson Blvd., Los Angeles, Calif.
- Ilg Electric Ventilating Co., 2874 N. Crawford Ave., Chicago
- E. Ingraham Co., Bristol, Conn.
- International Appl. Corp., 1027 Metropolitan Ave., Brooklyn
- International Detrola Corp., 1501 Beard St., Detroit, Mich.
- International Harvester Co., 180 N. Michigan Ave., Chicago
- Interstate Electric Supply Co., 4754 N. Clark St., Chicago, Ill.
- Ironrite Ironer Co., 38 Piquette St., Detroit, Mich.
- F. L. Jacobs Co. (Lauderall) 1043 Spruce St., Detroit

Manufacturers not listed may furnish data for the next issue. No advertising obligation. Additions or revisions will be made monthly.

Refrigerators  
Laundry Equip.  
Vac. Cleaners  
Elec. Ranges  
Gas Ranges  
Freezers  
Traffic Appl.

- Jewett Refrigerator Co., 10 Letchworth St., Buffalo, N. Y.
- Radnor Refrigerator Co., 235 N. Broad St., Philadelphia, Pa.
- Kalamazoo Stove & Furnace Co., Kalamazoo, Mich.
- Kelvinator Leonard Div., Nash Kelvinator Corp., Detroit, Mich.
- Kisco Co., Inc., St. Louis, Mo.
- Knapp Monarch Co., 3501 Bent Ave., St. Louis, Mo.
- Koral Elec. Mfg. Co., 43-22 Van Dam St., L. I. City, N. Y.
- Landers, Frary & Clark, 47 Center St., New Britain, Conn.
- Leach Relay Co., 5915 Avalon Blvd., Los Angeles, Calif.
- A. G. Lindemann & Hoverson Co., Milwaukee, Wis.
- Lovell Mfg. Co., Erie, Pa.
- Lowell Mfg. Co., 589 E. Illinois Ave., Chicago, Ill.
- Lydon-Bricher Mfg. Co., St. Paul, Minn.
- Magic-Aire, Inc., 1730 Ivanhoe Rd., Cleveland, Ohio
- Majestic Electric Appliance Co., Inc., Galion, Ohio
- Malleable Iron Range Co. (Monarch), Beaver Dam, Wis.
- Manning Bowman & Co., Meriden, Conn.
- Marlin Mfg. Co., 37 E. 21st St., New York, N. Y.
- Martin-Parry Corp., York, Pa.
- Mat Matic Home Ap. Corp., Div. Matam Corp., 45-18 Ct. Sq., LIC
- Maytag Co., Newton, Iowa
- Menasco Mfg. Co., Burbank, Calif.
- Merit-Made, Inc., 94 Elm St., Buffalo, N. Y.
- Herman Miller Clock Co., Zeeland, Mich.
- Miracle Electric Co., 36 So. State St., Chicago, Ill.
- Modern Maid Co., Inc., 122 S. Michigan Ave., Chicago 3, Ill.
- Moe-Bridges Corp., 1415 Illinois Ave., Sheboygan, Wis.
- Mounting Stove Works, 2011 N. Columbus Blvd., Portland, Ore.
- Morrow Co., 400 W. Madison St., Chicago, Ill.
- Morton Appliance Co., 666 Lake Shore Drive, Chicago, Ill.
- National Die Casting Co., Touhy & Lawndale Ave., Chicago, Ill.
- National Motor Co., 5500 Chene St., Detroit, Mich.
- National Stamping & Elec. Wks. (White Cross), W. Lake, Chicago
- Naxon Util. Corp., 2101 W. Walnut St., Chicago, Ill.
- New Haven Clock Co., 133 Hamilton St., New Haven, Conn.
- Nineteen Hundred Corp., St. Joseph, Mich.
- Northlight Sparks Industries (Arvin), Columbus, Ind.
- Norge Div., Borg-Warner Corp., E. Woodbridge, Detroit, Mich.
- Northeastern Radio Co., 799 Broadway, New York, N. Y.
- Nu-Tone Co., 821 E. 3rd St., Cincinnati, Ohio
- One Minute Washer Co., Kellogg, Iowa
- Panelectric Products Div., Gen. Aire. Eq., South Norwalk, Conn.
- Phileco Corp., Tioga & C Sts., Philadelphia, Pa.
- Portable Elevator Mfg. Co., Refrig. Div., Bloomington, Ill.
- Portable Products Corp., 420 Blvd. Allies, Pittsburgh, Pa.
- Premier Vacuum Cleaner Div., General Electric Co., Cleveland, O.
- Pressed Steel Car Co., 122 S. Michigan Ave., Chicago, Ill.
- Prevore Elec. Mfg. Co., 122 18th St., Brooklyn, N. Y.
- Proctor Elec. Co., Div. Proctor & Schwartz, Inc., Philadelphia
- Quillen Bros. Refrig. Co., 1639 Lafayette Rd., Indianapolis, Ind.
- Redi-Electric Co., 141 W. 24th St., New York, N. Y.
- Refrigeration Corp. of America, 225 W. 57th St., New York, N. Y.
- Regina Corp., Rahway, N. J.
- Revere Clock Co., McMillan at Dover, Cincinnati, Ohio
- Rexair, Inc., Fisher Bldg., Detroit, Mich.
- Reynolds Elec. Co., 2650 W. Congress St., Chicago, Ill.
- A. E. Rittenhouse Co., Inc., Honeoye Falls, N. Y.
- Rival Mfg. Co., Westport and Broadway, Kansas City, Mo.
- Robbins & Burke, Inc., 29 Lansdowne St., Cambridge, Mass.
- Robbins & Myers, Inc., Springfield, Ohio
- Roberts & Mander Stove Co., Hathoro, Pa.
- Robeson-Rochester Corp., 176 Anderson Ave., Rochester, N. Y.
- Geo. D. Roper Corp., Blackhawk Div., Rockford, Ill.
- Rotor-Beam Corp. of America, Inc., 1008 Dakin St., Chicago, Ill.
- Round Oak, Dowagiac, Mich.
- Rutanber Electric Co., Marion, Ind.
- Samson United Corp., 1700 University Ave., Rochester, N. Y.
- Sanitary Refrigerator Co., Fond du Lac, Wis.
- Savage Arms Co., Turner St., Utica, N. Y.
- Schaefer, Inc., 801 Washington Ave., Minneapolis, Minn.
- Schelm Bros., East Peoria, Ill.
- Scott & Fetzer, 11401 Locust Ave., Cleveland, Ohio
- Seeger Refrigerator Co., Arcade & Wells Sts., St. Paul, Minn.
- Seeger Sunbeam Elec. Mfg. Co. (Coldspot), Evansville, Ind.
- Servel, Inc., Evansville, Ind.
- Sessions Clock Co., Forestville, Conn.
- Seth Thomas Clock Co., Div. Gen. Time Inst. Corp., Thomaston, Ct.
- Sheridan Electronics Corp., 2850 S. Michigan Ave., Chicago, Ill.
- Signal Electric Mfg. Co., Menominee, Mich.
- Silex Co., 80 Pliny St., Hartford, Conn.
- F. A. Smith Mfg. Co., 801 Davis St., Rochester, N. Y.
- Son-Chief Electrics, Inc., Winsted, Conn.
- Sparks-Withington Co., Jackson, Mich.
- Sperti, Inc., Beech & Kenilworth Sts., Cincinnati, Ohio
- Standard Gas Equip. Corp., Bayard & Hamburg, Baltimore, Md.
- Stern Electric Co., Grand & Potomac St., St. Louis, Mo.
- Stern Brown, Inc., Long Island City, N. Y.
- Stiglitz Furnace & Foundry Co., Portland Ave., Louisville, Ky.
- B. F. Sturtevant Co., Hyde Park, Boston, Mass.
- Sunbeam Corp., 5600 Roosevelt Blvd., Chicago, Ill.
- Sun Kraft, Inc., 213 W. Superior, Chicago, Ill.
- Superior Electric Prod. Corp., Cape Girardeau, Mo.
- Swartzbaugh Mfg. Co. (Everhot), 1336 W. Bancroft St., Toledo
- Tarrant Stove Co., Inc., Mansfield, Ohio
- Thermador Electric Mfg. Co., S. Riverside Dr., Los Angeles, Calif.
- Thermo-Broiler Co., 23 Flatbush Ave., Brooklyn, N. Y.
- Timm Ind., Inc., 5225 W. San Fernando Rd., Los Angeles 26, Cal.
- Toastmaster Prod. Div., McGraw-Electric Co., Elgin, Ill.
- Toastwell Co., 620 Tower Grove Ave., St. Louis, Mo.
- Trilmont Prod. Co., 24th at Walnut, Philadelphia, Pa.
- Tutt Co., 4107 Willys Pkwy., Toledo 12, Ohio
- Tyler Fixture Co., Niles, Mich.
- United States Time Corp., 630 5th Ave., New York, N. Y.
- Victor Electric Prod., Inc., 2950 Robertson Ave., Cincinnati
- Victor Products Corp., Hagerstown, Md.
- Vidrio Prod. Corp., 134 W. 54th St., Chicago, Ill.
- Voss Bros. Mfg. Co., Davenport, Iowa
- Wagne Mfg. Co., 632 N. Albany Ave., Brooklyn, N. Y.
- Ward Refrigerator & Mfg. Co., 6601 So. Alameda, Los Angeles
- Waring Products Corp., 331 Madison Ave., New York, N. Y.
- Warren Telechron Co., Ashland, Mass.
- Waverly Tool Co. (Steam-O-Matic), Grove St., Irvington, N. J.
- Weber Showcase & Fixture Co., Avalon Blvd., Los Angeles, Calif.
- Welbilt Stove Co., Maspeth, L. I., N. Y.
- Westclox Div., General Time Instrument Co., LaSalle, Ill.
- Western Stove Co., Culver City, Calif.
- Westinghouse Electric Corp., Appliance Div., Mansfield, Ohio
- Whisk-Brush Vacuum Mach. Co., 571 8th Ave., New York, N. Y.
- Wilson Cabinet Co., Smyrna, Del.
- Winslow Mfg. Co., 114 Manhattan St., Stamford, Conn.
- Winpower Mfg. Co., Newton, Iowa
- Winsted Hardware Mfg. Co., Winsted, Conn.
- Wittie Sales & Mfg. Co., 1414 S. Wabash Ave., Chicago, Ill.
- Zenith Electric Appliance Co., 129 Crosby St., New York, N. Y.
- Zenith Machine Co., Duluth, Mich.

## Named Norge Official



W. S. (Bing) Law has been appointed manager of refrigeration sales for the Norge division of Borg-Warner Corp., announced M. G. O'Harra, vice-president and general sales manager.

## Universal Plans Sales and Advertising Campaign

"Hoist Your Sales" is the slogan of Universal's 1946 sales campaign as announced by Landers, Frary & Clark, New Britain, Conn. A new plan designed to provide a tie-up for Universal dealers, with consumers throughout the country has been developed by the company.

Concurrent with national advertising, Universal will supply dealers and distributors with complete promotional material. Sales kits, floor and window displays, banners, news mats, calendars, and other specifically designed sales aids will be given to dealers as part of the "Hoist Your Sales" Plan.

Universal's national magazine advertising campaign will feature the phrase, "Designed for beauty . . . perfected for performance." Nearly a million dollars in advertising and promotion is being expended by the company.

## Show Appliance Cover To Sell Merchandise

You can use the cover which opens the electrical appliance section as a sales tool, both in your store and in outside calls. It will help your customers visualize how the electrical appliances you sell will fit into their new kitchens.

The kitchen shown on the cover has been installed in the store of Lewis & Conger, house furnishings store at 45th St. and Ave. of Americas, New York City. This kitchen, designed by Cox, has the following products:

- GE refrigerator
- GE Range
- Cory coffee brewer and stove
- Toastmaster toaster
- Mixmaster mixer
- Flush Wall radio
- Rival broiler
- Sylvania fluorescent lamps
- Cox cabinets and fixtures

# Why let fuel-ish notions

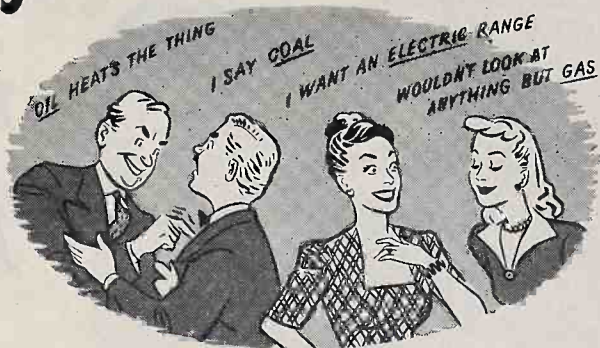

## knock you out of the sale?



## Line up with the "Fuel-Proof" line

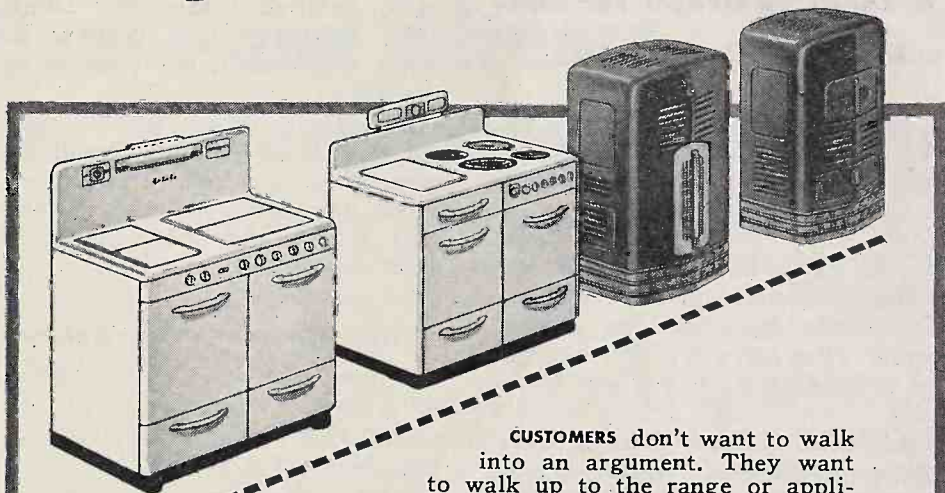

CUSTOMERS don't want to walk into an argument. They want to walk up to the range or appliance for the fuel they prefer. That's why more and more leading dealers are lining up with Estate Heatrola . . . the one line of cooking and heating appliances for all fuels . . . all sold under one famous trade name.

**BIG NATIONAL ADVERTISING** in color in *The Saturday Evening Post*, *Good Housekeeping*, *Woman's Home Companion*, *Better Homes & Gardens*, and *Country Gentleman* is pre-selling your best prospects on Estate Heatrola Gas and Electric Ranges with the famous Bar-B-Kewer. Write today for full facts and name of your nearest distributor.

# ESTATE Heatrola RANGES & HEATERS

Ranges for City Gas, LP-Gas, Electricity • Heaters for Coal, Wood, Oil

THE ESTATE STOVE COMPANY, Hamilton, Ohio • House founded in 1842

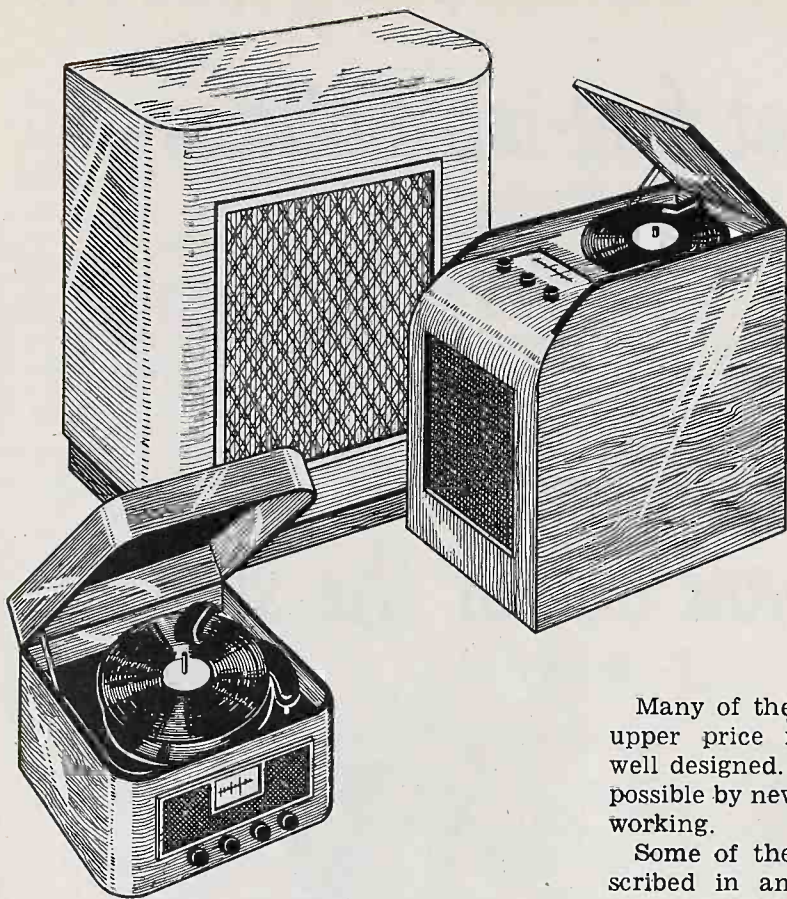

# Selling the New Radio Cabinets

## **Changes in Buying Habits and Innovations in Design Require New Selling Methods by Dealer for Con- sole and Table Models**

• The radio dealer is up against a new public to-day. He may think he recognizes the same faces he knew before the war. But their buying habits have changed.

His customers have bought no new radio receivers for several years. They have, however, done a lot of reading, dreaming and planning.

As a result, cultural standards are higher. There is a vast and extended market for more beautiful home interiors.

People have a greater appreciation of good design. They will select new and better radio cabinets for these interiors.

### **Better Looking Cabinets**

Concepts of customers have not been the only change in the radio industry. The appearance of radio cabinets has been radically improved.

The radio receivers being made to-day represent a strong pick-up from the general pre-war level of beauty. This is true of consoles and table models alike.

Many of the new consoles in the upper price range are especially well designed. This has been made possible by new techniques in wood-working.

Some of these changes were described in an exclusive interview given by George N. Lamb, Secretary of the Mahogany Association, Inc. of Chicago.

"There have been tremendous technological improvements in the production of mahogany plywood which is used for many console radio cabinets," said Mr. Lamb. "The industry made perhaps 25 years of peacetime progress during the war.

"Much of this revolutionary change has arisen from the development of synthetic resin glues. These new adhesives make a bond that is stronger than the wood itself.

### **New Manufacturing Methods**

"These glues have also enabled radio cabinet designers to develop new shapes and forms. Before the war, plywood was bent only after it was made. The new method is to place the plywood in forms before the glue hardens, and mold it to any shape desired, using electronic heat instead of time drying.

"Plastic materials are used to improve the finish of radio cabinets as well. They give a hard, pre-finished surface that will resist the heaviest type of service.

"These phenolic resin finishes don't check and craze, as is often the case with old varnishes. They also make possible the use of the more highly-figured woods without having them check later.

"Another development which has improved the appearance of new radio cabinets is the foolproof wood

bleaches invented during the war. Earlier bleaches had a tendency to bleed. The newer ones are much more potent than those that were being used before the war.

"It seems likely that radio manufacturers will not go back to the light blond finishes that came out in some models before the war. Instead, new cabinets are appearing in intermediate honey tones. These colors show the wood to good advantage, and give it character, life and depth."

### **Feature "Furniture" Pieces**

This upgrading both of public taste and of radio cabinet design constitutes a challenge to the alert radio dealer to-day. It is up to him to select and sell the radios which will meet the new public demand.

The live radio merchandiser will seize the opportunity to sell radios not only as receivers but as part of the home interior. Department and furniture stores are already doing ensemble selling of a complete living room. The radio ought to find its place in that room.

After all, radios are seen more than they are heard. Housewives listen to a radio only a few hours of the day, but they see it during all their waking time.

### **Point-Up Styling**

With the variety of beautiful models now being made available, the radio can be the focal point of home decoration as well as of interest. And when the radio dealer sells style, he is building on the soundest possible basis. This is because when he adds style changes to those of technological improvements, he assures himself of a greater volume of replacement business than ever before.

# SEE what RCA has at the Chicago Radio Parts Show!

STEVENS HOTEL—MAY 13-16



## Make tracks for display Room 10— 3rd floor—and witness Merchandising History in the Making



### MEET THE GANG AT "RCA HEADQUARTERS"

(See Hotel Bulletin Board or RCA  
Booth for Room Number)

See the display in Room 10 by all means  
—but don't forget the gang at "RCA  
Headquarters" want to see you, too.

Drop around anytime for a bit of friendly  
conversation—and refreshments. But  
make it a date for sure.

The Fountainhead of  
Modern Tube Development is RCA

IT'S NEW... IT'S STARTLING... it's one of RCA's contributions to the advancement of electron tube and parts distribution. Distributors throughout the country will hail it as the answer to one of their tube- and parts-selling problems.

What is it? It's *store selling in modern form*... lifted to new peaks of efficiency through the design of special sales-servers *adaptable to any floor layout*... geared to accommodate *any business volume*.

You'll see the complete line of sales-servers... hear how they can bring more business your way. You'll be shown model store layouts that will help you visualize just how this new store-selling technique can build your business. Bring your floor plan dimensions with you and let's discuss and lay out an effective store arrangement for you.

Listen to "THE RCA SHOW," Sundays, 4:30 P.M.,  
EST., NBC NETWORK.



TUBE DEPARTMENT

**RADIO CORPORATION of AMERICA**

HARRISON, N. J.

Only



Only RCA VICTOR makes the

RCA VICTOR has the

“Golden Throat”



VICTROLA\*

Victrola \*T. M. Reg. U. S. Pat. Off.



LOOK AT  
THAT RADIO,  
ISN'T IT SMART!

WHAT SELLS  
ME IS  
RECEPTION

**It's a Split Decision!**

**STROMBERG-CARLSON**

Even emphatically well-mated souls,  
May have different reasons to want the same goals.

You may sell the *wife* on the basis of beauty,  
But *he* wants *reception*, not mere tutti-frutti.

If you are in business for more than your health,  
Then appeal to *both* sexes, and wallow in wealth.

How to accomplish this *dual* appeal?  
Ask *Stromberg Carlson*, they'll gladly reveal—

The American Magazine double-exposes  
Their ads to both sexes, it's under both noses.

Double exposure, the singular buy,  
Makes certain both sexes will give you the



*The*  
**American**  
*Magazine*

**DOUBLE-EXPOSES  
ELECTRICAL ADS  
TO BOTH SEXES**

THE CROWELL-COLLIER PUBLISHING COMPANY, 250 PARK AVENUE, NEW YORK 17, N. Y.  
PUBLISHERS OF THE AMERICAN MAGAZINE, COLLIER'S, AND WOMAN'S HOME COMPANION



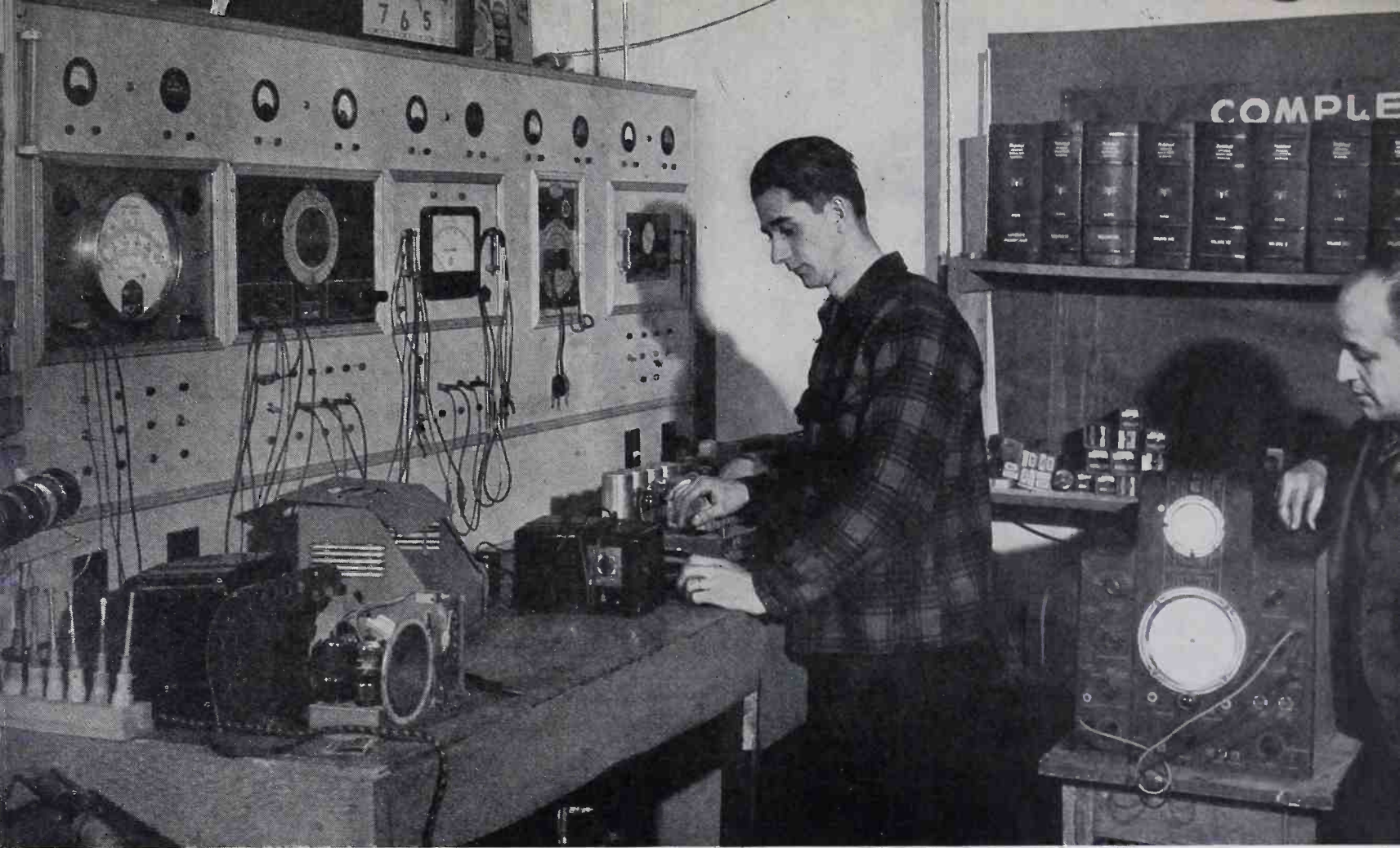

Service trainee and owner Wilfred J. Dion, right, at oscilloscope. Instrument panel and work bench designed and built by Dion.

# Expert Service Stressed

*New England Firm Specializes in Domestic and Commercial Radio Work*

• A radio service business today should not limit itself to the maintenance of home and auto sets, says Wilfred J. Dion, owner of the Eastern Radio & Electric Supply Co., Portsmouth, N. H. His thriving business on Islington St. in the New England town, which Mr. Dion opened after serving with the Signal Corps in Greenland, is "paying"!

Eastern Radio has a flair for selling, too, in addition to service, and the store will be stocked with a complete assortment of new radios and appliances as the merchandise becomes available. But meanwhile Mr. Dion developed the maintenance business to its most profitable point and concluded that "to have several irons in the fire" is a money-making policy.

Specifically, Mr. Dion gives his

attention to the servicing of aircraft radio, leased equipment, taxicab radio and (in a preliminary way) television. To do these jobs successfully, a well trained technician is required. But Mr. Dion has been in some phase of the radio business since 1920, and has made it a point to keep abreast of what's new and what's coming up. He has equipped his shop with test apparatus that is complete, modern and impressive.

In a town the size of Portsmouth, which has a population of about 15,000, Mr. Dion has found that a maintenance man must be exceptionally careful and competent in his work. A radio man in such a location necessarily does business in a "community way" and word-of-mouth reports on the quality of

his work are circulated around town in short order. Besides, in Portsmouth, the local broadcast facilities go off the air early in the evening and radio listeners must then switch to stations in Boston, New York, or other more distant points. Mr. Dion must keep this in mind, in order to give his customers the best in radio reception.

In order to be fully prepared for television, and to have himself locally identified as the expert on the new art, Mr. Dion does more than to read about the subject. He is constantly building experimental tele apparatus when he has the time, and recently came up with a complete television camera. He expects to be several months ahead of the game, when television hits Portsmouth on a full scale.

# Circuit Data for Four

Aligning Zenith 6D014 & 6D029, Arvin 4

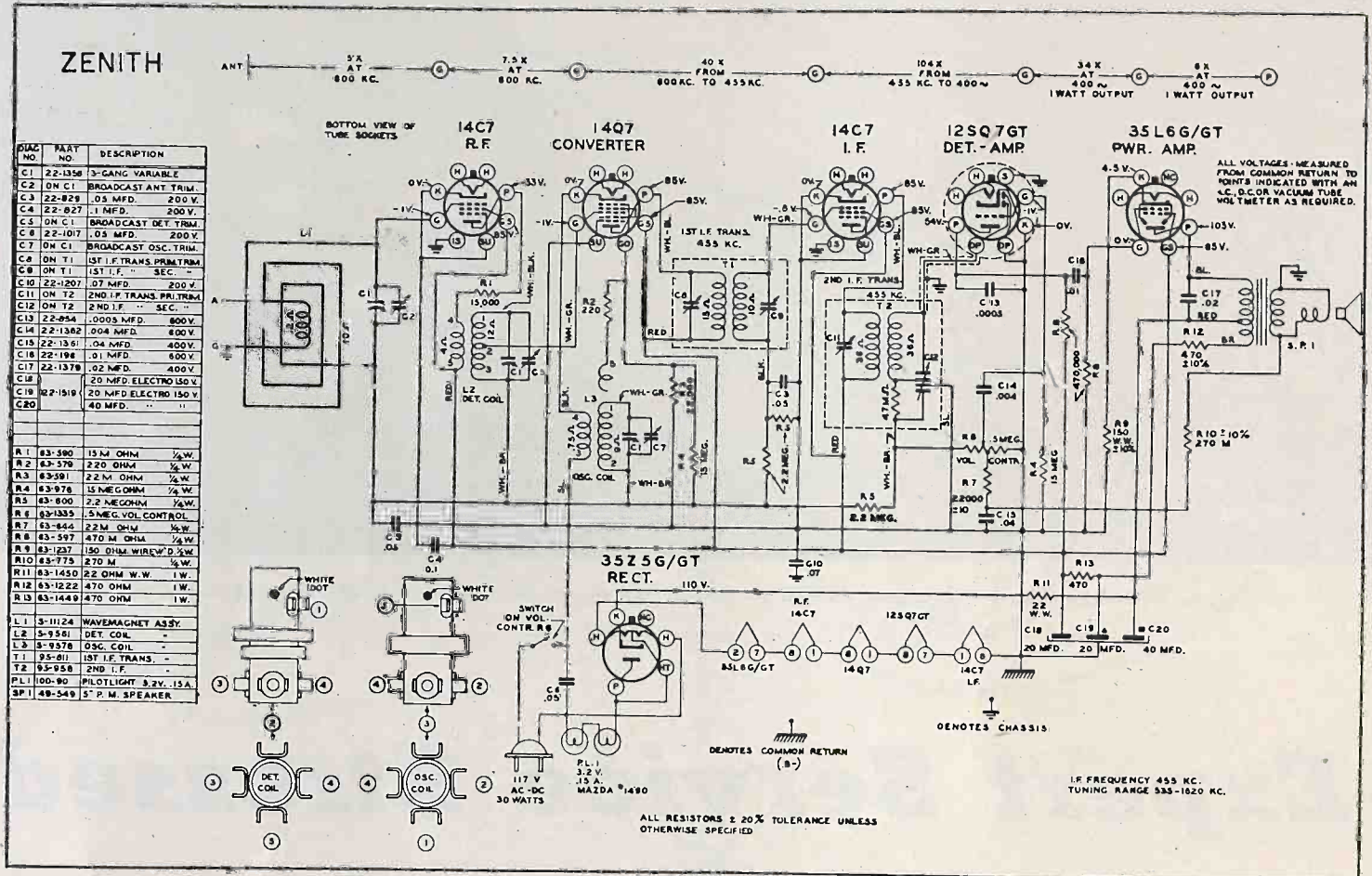

● Zenith chassis 6C01 used in Models 6D014 and 6D029 is a 6-tube 1-band ac-dc set, using a 5 in. "Alnico 5" PM speaker. The receiver utilizes positive feedback in the audio circuit to boost the bass tones,

especially on low volume. In-phase audio voltage from the voice coil is fed back to the first audio grid (12SQ7) through the low-pass filter composed of R10, R7 and C15, to a tap on the volume control R6. One

side of the output transformer is grounded. Which side is grounded, determines the phase relationship of the feedback voltage. When replacing the output transformer, therefore, be certain the proper end of the secondary is grounded. Otherwise degeneration will result. To check, operate the set on low volume, with the feedback lead disconnected at the voice coil. Then re-make the connection. The volume, especially the bass tones, should increase.

Hum-balancing is accomplished by means of an output transformer tapped off-center. This tap is the B+ connection from the 35Z5 cathode to the 35L6 plate. The lower connection of the output transformer primary supplies B+ through the carefully-adjusted hum filter comprised of R12, R13, C18 and C19, to the 35L6 screen and the rest of the tubes in the set. Power supply ripple currents flowing through each part of the primary induce hums of

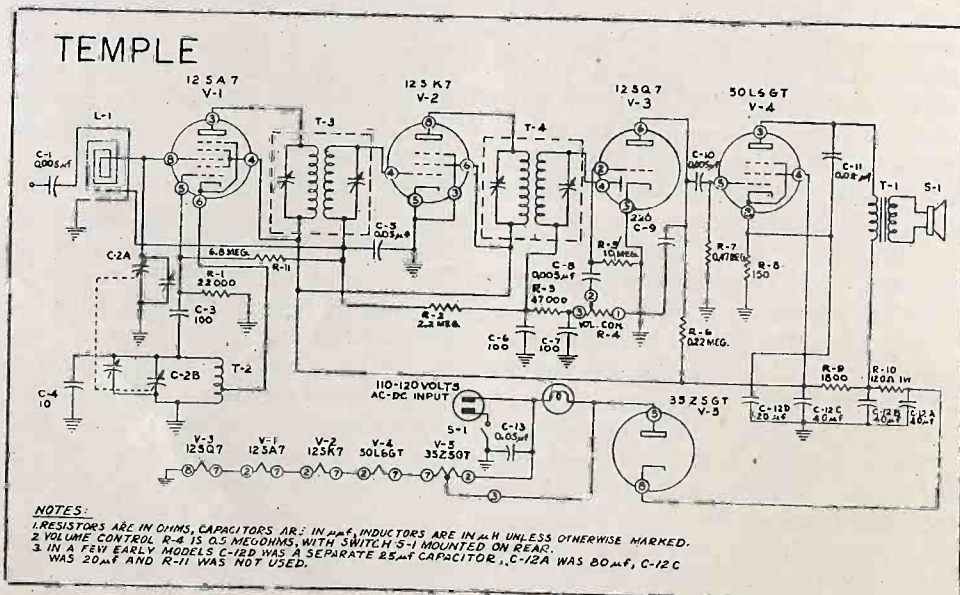

# Popular New Radio Sets

Westinghouse H-122 & H-130, Temple E-510

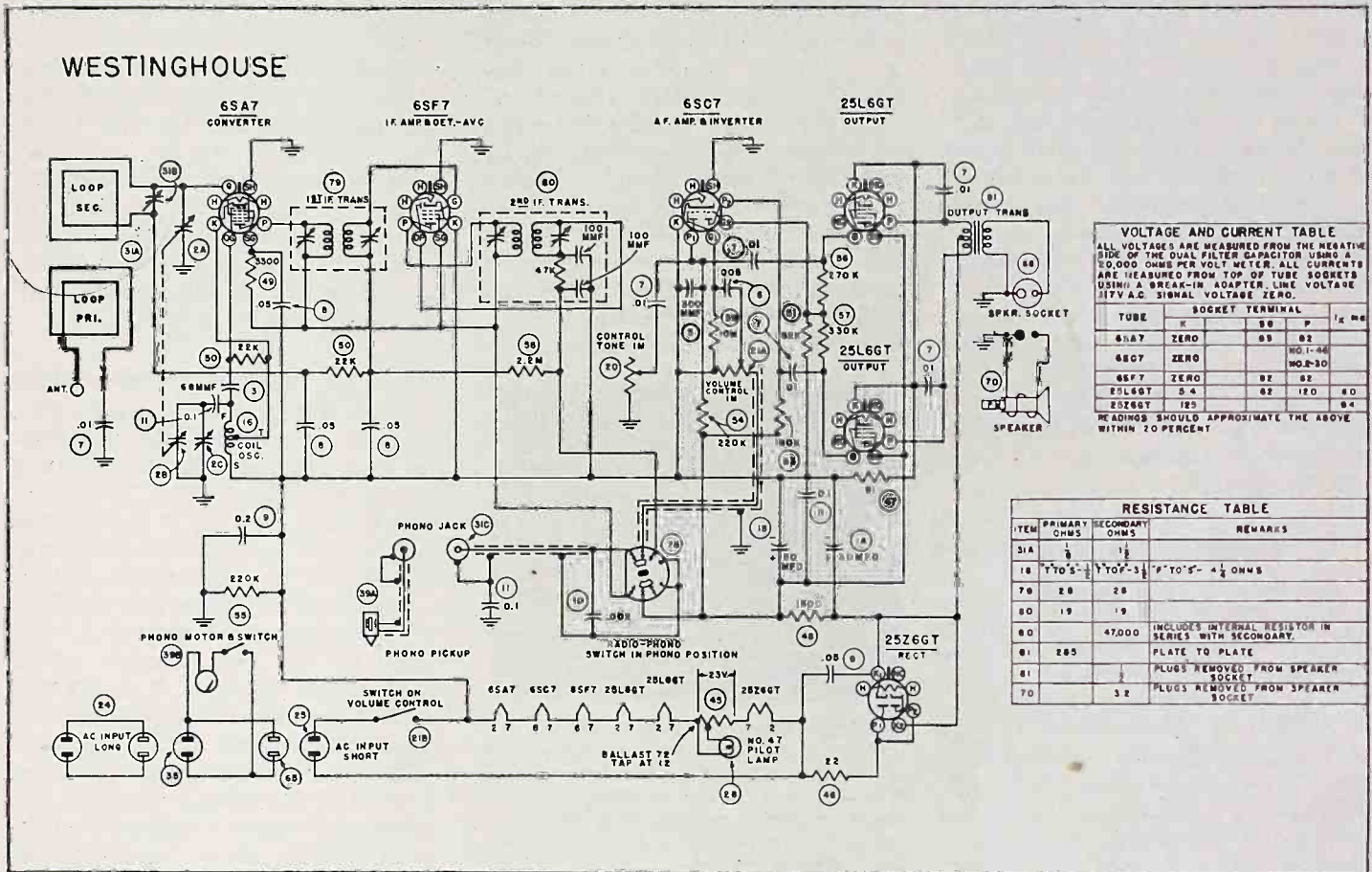

equal voltage but of opposite phases in the secondary, where they cancel out. This circuit allows a higher effective plate voltage on the 35L6 for increased power output.

Temple Model E-510 is a 5-tube ac-dc set in which B— is connected to chassis ground. It covers the range from 535 to 1700 kc. A conventional superhet circuit is used, except that a filter choke is obviated by a two-section resistance-capacity hum filter, tapped after the first section to feed the power amplifier plate.

Westinghouse Models H-122 and H-130 utilize the same 6-tube ac-dc superhet chassis. Model H-122, however, is made as a phono-radio combination, using an ac record changer, and so may be used only on ac. Push-pull 25L6's driven by a 6SC7 phase inverter, deliver 3.5 watts of undistorted audio into the 3.2 ohm voice coil of a 6-5/8 in. PM dynamic. A high impedance crystal pickup is used. The common B—

connects to a floating ground.

Arvin Models 444 and 444A use the 4-tube ac-dc type RE-200 chassis. Maximum power output of 2.5 W is fed into a 3.2 ohm, 4 in. PM speaker. Undistorted power output

is .8 w. Some early models have an additional .005 mf capacitor and a 150 ohm resistor in the oscillator circuit. R-11, a 15 ohm resistor, and the tap on the primary of the i-f

(Continued on page 104)

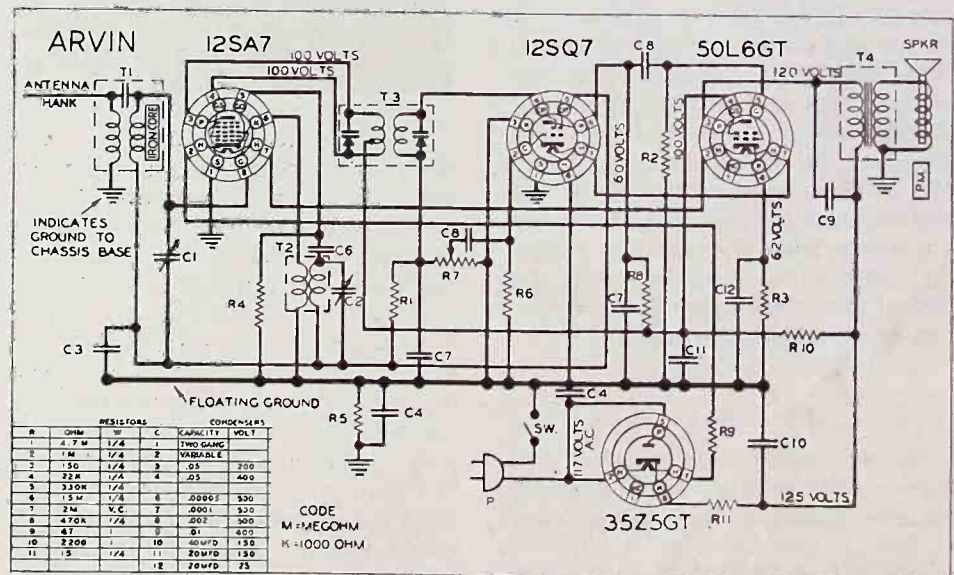

# HUM-dingers Need Not

Distinct Procedure for Each Basic Type—

• Hum symptoms caused by gross power supply defects are fairly easy to service, and have been diagnosed in several previous issues of RADIO & Television RETAILING.\* The troubleshooting of other types of hum, however—the kind which tie up bench space and boost service fees—is not quite as simple. This first of two articles proposes to classify the more difficult hum troubles into two categories: *steady*, or *audio system hum*, and *tunable hum*. A logical approach to each will be presented. It will be assumed that the most common category of all, power supply hum, has already been eliminated.\*

## Classify Hum, Try Tubes

Most experienced radiomen insist upon checking tubes as the first step of any general troubleshooting procedure. Some, however, feel that this is a slow process which should be avoided in those stages of the set where the trouble cannot originate. In the present case, the latter viewpoint is well worth considering. Since many tube checkers are weak on tube causes of hum, testing by replacement is the best bet. In some instances, testing by replacement involves the breaking open of stock tube cartons. Naturally, this should be kept to a minimum. Therefore, even before testing tubes, a preliminary classification of the hum is in order.

*Use your ears.* If the hum is steady, always present, independent of any signals being received, attention should be focused upon the part of the set between the input to the second detector and the speaker. On the other hand, when the trouble seems to ride in on the station carrier, look for the cause anywhere from the antenna to the last i-f circuit. From here on, the logical procedure depends upon how you've classified the trouble.

## First Basic Hum Type

*Steady, or audio system hum.* It's rather obvious, that even a slight cathode-filament leak in a tube

\*January '42, p. 56; December '44, p. 72; July '45, p. 76.

used in the second detector or first audio stage of a receiver may result in a bad hum output from the final audio amplifier. This is dishearteningly true of p-a systems and other high-gain audio amplifiers. So by all means start swapping tubes from the low-level or second detector end of the set. Yet don't neglect the output stage, for unbalanced or unmatched push-pull tubes can cause much hum in sets using low-capacity paper filter capacitors.

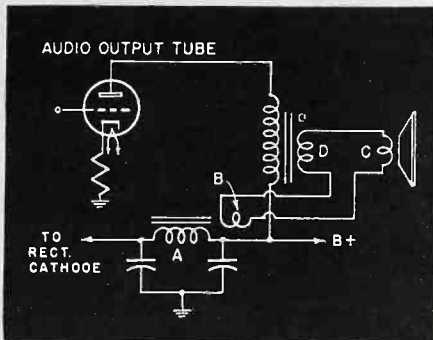

▲ No-signal plate current in P1 and B+ current in P2 cause equal but out-of-phase emfs to cancel in S. Resistor R adjusts balance. ▼ Speaker field A used as filter choke, induces hum emf in bucking coil B which, connected in opposite phase to hum emf in winding D, balances out at C.

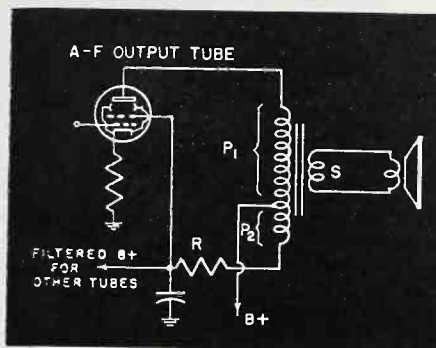

When separate push-pull tubes are used, change both together, using two of the same brand if possible. Single-ended outputs, generally employing high gain, can also cause hum in bad cases of tube leakage. It is also wise to watch out for some variation of the hum-balancing circuit in which a tapped primary is used in the output transformer. In these circuits (see diagram) the no-signal plate current of the output tube must bear a predetermined relation to the rest of the B supply currents. Wartime tube substitutions are a possible

cause of unbalance of this relationship.

True, a shorted plate or screen decoupling capacitor could also provide the unbalance and therefore the hum. Experience, however, indicates that, apart from the hum, no signal would then be heard; in which case the hum is the least of the troubles, and should not be given a second thought until the set is passing a signal.

## How to Localize Hum

If replacing tubes has no effect, an attempt must be made to localize the defective stage. A handy trick, in sets using avc, is to turn the volume control; if the hum is fully controlled by this adjustment, the trouble is in the detector—first audio stage. If it controls the hum *partially*, or not at all, check once more on the power supply. This test should be made with the receiver tuned to a frequency at which no signal is received.

An easy, and most reliable, means of localizing hum to one stage, is to shunt a large capacitor, of .1 mfd or more, from control-grid to ground at each audio tube in turn, starting with the detector end of the audio section. When the shunt capacitor stops the hum, the source of trouble will be found in the grid circuit being shunted, or the plate circuit immediately preceding it. Shunt the capacitor from that plate to ground. If the hum is stopped, the plate circuit is at fault.

If the hum is not stopped, the grid circuit components must be checked. The same method of localizing hum to a stage, and then isolating it to a circuit, can be practiced in reverse, by starting with the final audio's plate, and working back to the detector diode.

## Watch for Radio Ground

Occasionally a radioman will attempt to localize the hum in this manner, and discover that the hum is made worse by the shunting capacitor, sometimes seeming to change tone or "quality" at the same time. In these cases, a radio ground is probably being employed

# Become Time-Wasters!

## Most of 2 Parts Traces A-F System Causes

in the set, and in the shunting tests, the negative or ground lead of the test capacitor should be returned not to the chassis, but to the radio or floating ground.

### Where to Connect Ground

This radio ground can be quickly located. The negative filter capacitor leads are attached to it as a rule, and in ac-dc sets the line switch also contacts it. Other points where the radio ground generally may be found, are at all cathode returns, and the grid return of the mixer. See illustration below, for more likely points.

Having isolated the trouble to a specific circuit, the next step is to find the component or condition which is creating the hum. Shunt the plate or grid decoupling capacitors with another of approximately the same value.

Especially in smaller midgets, cramped space may cause the designers to permit ac-carrying filament or line-current leads to run dangerously close to low level audio circuits. Even a slight movement of such leads may cause hum. This

increases the possibility of hum developing from inept service technique.

Upon turning over the chassis, look for other servicing errors—resoldered connections may indicate incorrectly re-routed leads, wrong placement of new audio transformers, and the like. Especially when, for some reason, an extra audio stage has been added.

Even a slight unplanned coupling can induce a bad hum from a power transformer or choke into a first audio transformer, or from ungrounded filament wiring (even twisted) to a grid lead running 2-3 inches away. Filaments wired in parallel should be grounded at either side or center tap. Above all, in cases of high gain amplifiers, use plenty of braided shielding. Connections to volume controls and phono jacks frequently pick up hum.

### Check These Common Bugs

If a transformer has been replaced, demount it from the chassis, clip a grounding connection to the frame or core, and rotate it experi-

mentally until the hum pickup is at a minimum. Remount the transformer in that position.

If a metal tube has been substituted for a glass tube, make sure the envelope connection is grounded. If an electrolytic capacitor has been replaced, see if the leads are connected as originally, including the original ground connection, and see too, that the capacitor is well clear of grid and diode leads.

### Investigate Coil Leads

Glance at the speaker connections. If a dynamic (field coil) speaker is used, be sure the leads to the field coil or hum-bucking coil have not been reversed. If you see evidence of tampering, try reversing the leads on either coil (but not both). See illustration. The same idea can be applied to one of the filter chokes in the power supply.

When the process of localizing the trouble leads to the detector, several items will stand an immediate check. Does the set have a combination volume control and line switch? How is the line switch connection made? If, in the case of an ac-dc set, one side of the switch goes to a lug on the volume control, and through the control, allegedly to the grounded frame or shaft, beware of poor contacts and consequent common coupling between audio volume control circuit and line ac voltage. Invest a brief moment or two in installing separate ground connections.

### Take Nothing for Granted

Occasionally, an internal leak within the composition case of the control will be evidenced by the hum clearing up when the switch wires are temporarily connected to operate the set without benefit of the switch. A-c sets are no exception in this case.

Another hum source derives from the line voltage running so low as to cause indirectly-heated tube cathode temperatures to vary, with a consequent variation in emission and a resulting hum. A rare case, yet many a naughty word has been spoken by a radioman caught napping by an outlying power.

The radio ground, isolated from the chassis by a d-c blocking capacitor, can usually be contacted at these points: A, line switch; B, 2nd detector filament; C, filter capacitor negative; D, mixer grid return; E, cathode returns. The i-f and r-f grid returns cannot generally be used.

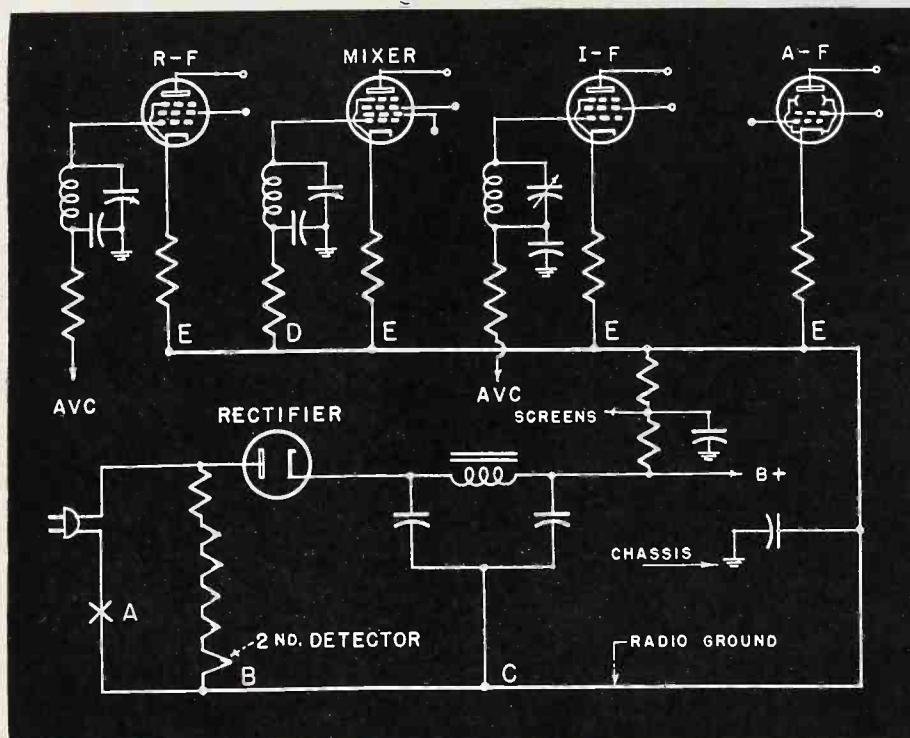

# Advice on <sup>Tough</sup> Alignments

**R-F Coil Replacement Is Easy, When Basic Tracking Ideas Are Known.**  
**Article Explains Complete Procedure for Antenna, R-F Coil Changes**

• Previous articles of this series have explained the normal realignment of superhets. We will now consider the abnormal case—the complete alignment and tracking job called for by the replacement or repair of an r-f or oscillator coil. Substitution with a stock coil other than an exact replacement, or the winding of one by hand to avoid waiting for delivery, may cause serious alignment and tracking complications. These can, however, be licked by the servicer who understands a few simple facts.

## The A-B-C of Tracking

The first fact to keep in mind is that all r-f and oscillator variable tuned circuits must cover the same number of kilocycles. This is true even though the oscillator works at a higher or lower frequency than the r-f. In other words, if the mixer grid circuit tunes from 540 kc to 1620 kc, a coverage of 1,080 kilocycles, the r-f, antenna and oscillator circuits must also tune through 1,080 kilocycles. This means, in the case of a set having a 455 kc i-f, that the oscillator would tune from  $540 + 455$ , or 995 kc, to  $1620 + 455$ , or 2075 kc. This too is 1,080 kilocycles in all. The remaining tuned circuits would tune to the same frequencies as the mixer.

The second fact to remember, is that the same number of kilocycles can be covered at a higher frequency with less capacity variation than is needed at a lower frequency. Therefore the oscillator section of

When the variable has equal-value oscillator and r-f sections, an oscillator series padder C<sub>2</sub> makes both sections cover the same total number of kilocycles.

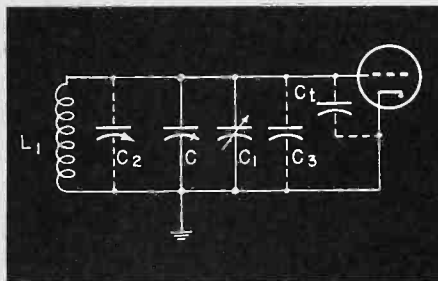
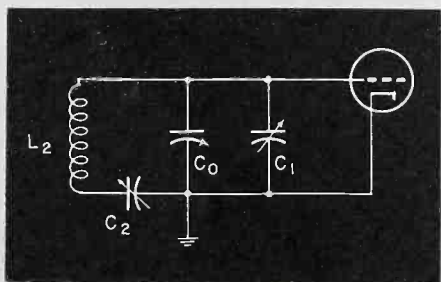

Hidden elements in every tuned circuit include: C<sub>2</sub>, coil inter-turn capacities; C<sub>3</sub>, stray wiring capacities; C<sub>t</sub>, tube grid-to-cathode interelectrode capacity. Total minimum capacity also includes trimmer C<sub>1</sub> and the residual capacity of variable C.

a ganged variable capacitor is either smaller in size than the r-f, antenna and mixer sections, or is arranged through the use of a series padder to have less effect.

The third important fact is that the amount of frequency coverage secured by a given variable capacitor is limited by the minimum capacity left in the circuit when the plates are completely unmeshed at the high frequency end of the band. This minimum capacity, as shown by the illustration, is the sum of several hidden capacities.

## Some Dangers to Avoid

Putting together the three basic facts outlined above, certain enlightening conclusions may be drawn at once. An early issue takes up the question of a replacement oscillator coil. For now, consider the r-f circuits.

If the inductance of the replacement r-f coil is too low, the natural tendency will be to squeeze the r-f trimmer tight, in order to peak it at the high frequency end of the band. The resulting high minimum capacity will prevent the r-f circuit from covering its allotted number of kilocycles, even though it be possible to reach a peak during the alignment. As a result, the r-f circuit is gradually left behind by the other circuits in tuning toward the low frequency end of the band. Poor low frequency sensitivity . . . even a "dead" portion of the band . . .

is the almost inevitable result.

If, on the other hand, the inductance of the replacement coil is too high, the trimmer will be loosened excessively during alignment. The frequency coverage will be too great, and as the set is tuned to the low frequency end of the band, the r-f will run ahead of the other circuits. Again, the low frequencies will be insensitive.

Sometimes a universal-wound coil, which has a low distributed capacity is replaced by a bank-wound coil which has a much higher capacity. Although the values of inductance may be identical, the excessive capacity will force the removal of several turns of wire, to allow the trimmer to reach a peak during the high frequency alignment. The result is the same as in the first case.

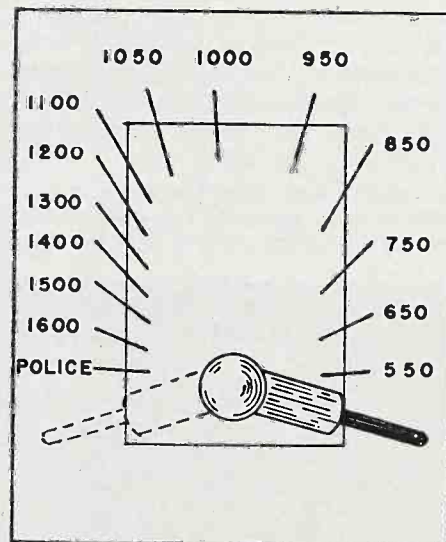

The dial pointer should make the same angle at both limits of its rotation.

Conversely, if a bank-wound coil is replaced by a universal-wound coil, the coverage may be greater than originally planned. This is a relatively minor problem. If there should not be sufficient spare capacity in the trimmer capacitor, a 10 mmf to 20 mmf mica or ceramic capacitor may be wired across the circuit.

Let us get down to cases. For example, here is an old midget superhet in which the antenna coil,

mounted horizontally above the two-section variable capacitor, is in very sad shape. It needs replacement. The only one in stock is not an exact replacement. But like the old one, it is universal-wound. Good enough . . . but now, with the new coil installed, the set needs careful alignment and tracking adjustments.

Checking the i-f stages for alignment needs no explanation. Next, make sure that the pointer of the receiver's dial is tightly mounted, and not bent, and corresponds with its original position. As a rule, if it is suspected that the dial has been disturbed, the approximately correct setting can be found by swinging the tuning control from one extreme to the other, and setting the pointer to make the same

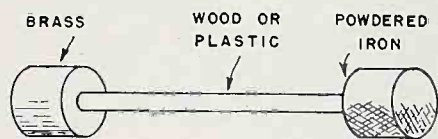

Tuning wand raises or lowers inductance.

angle with the horizontal on both sides.

A glance at the manufacturer's service data sheet reveals that in this case no low frequency alignment check point is given. Since any dial calibrated frequency just short of the low frequency limit of the band will do, we arbitrarily select 600 kc, to which to set the receiver. Having coupled the signal generator to the antenna in the manner previously described in these pages, we vary its frequency until the tone-modulated signal is picked up in the receiver. Turn the generator's attenuator low, to prevent confusions due to double peaks, broad tuning and strong harmonics.

### How to Set Low Frequency

If the signal comes in at or very near 600 kc on the dial, the local oscillator needs no setting. If far off calibration, however, and if the local oscillator uses a padding capacitor, it should be adjusted until the generator signal comes in on calibration at 600 kc. Now the problem is to adjust the r-f tuned circuit to 600 kc at this same position of the dial and variable capacitor.

Turning the r-f trimmer capacitor should affect the signal strength. If the new r-f coil is far off its proper inductance, the difference may not be detectable. In which case, a

fixed mica capacitor of 50 mmf can be touched across the r-f stage's variable capacitor. Larger and larger values can be substituted, until the signal is finally affected. If the effect of adding capacity is to decrease the signal strength, less inductance is needed in the coil. If the signal strength increases, instead, more inductance is wanted.

### Handy Way to Save Work

If a single-layer or bank-wound coil is used, sometimes much work can be saved when the frequency is only slightly higher than 600 kc, by squeezing some coil turns together. If the frequency is too low, spread the last few outside turns. In the case of a universal-wound coil, or in any case where the frequency is far off, remove a turn or two at a time when the frequency is too low, or add a turn or two when the frequency is too high.

Working on the coil has as its purpose to bring the resonant frequency to 600 kc with all test capacitors removed, and with the trimmer at about mid-open position, so that varying it either way

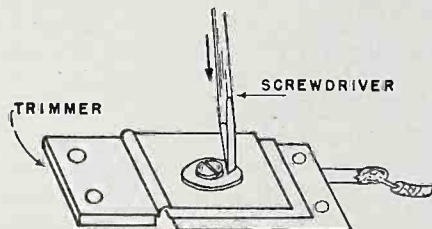

Press trimmer to lower circuit frequency.

will slightly decrease the signal strength.

A very convenient testing gadget for this kind of coil work is the **tuning wand**. This is a wooden or plastic stick with a powdered-iron slug at one end and a brass slug at the other end. Dipping the iron slug into the coil form will increase the inductance of the coil, while doing the same with the brass end will lower the apparent inductance.

With the inductive alignment accomplished at 600 kc, turn the receiver and signal generator to the high frequency calibration point specified by the manufacturer . . . in this instance 1600 kc. Adjust the oscillator trimmer for maximum signal. Since the r-f alignment frequency is specified as 1500 kc in this receiver, set both generator and receiver dial to that value and turn the r-f trimmer for the strongest signal output.

Any trimmer adjustment is bound to affect the low frequency tuning calibration to some extent. There-

fore turn back to 600 kc to check the r-f coil again, in the same manner as described before. This time, however, it is essential not to disturb the r-f trimmer setting. Here, once more, the tuning wand is a great convenience.

### Two Alignment Tricks

Other ways of experimentally lowering the frequency can be devised. For example, most servicemen practice the trick of pressing with the screwdriver on the insulating washer underneath the adjusting screw of a mica compression-type trimmer. Do not attempt this on the ceramic, rotating-type trimmer. Another gadget, popular among troubleshooters in radio factories, deserves more attention from independent radiomen. As seen in the illustration, it is simply a piece of celluloid (possibly from an old wallet) thin enough to slip easily between the plates of a meshed variable capacitor. Its purpose is to add a small amount of capacity by changing the dielectric constant of the variable.

### Check Overall Tracking

The final alignment check should be made at the high frequency end of the band. In the case of a larger set, using a three-section variable and two tuned r-f coils, the procedure given thus far must be expanded. Not only must the new coil be adjusted to cover the correct band of frequencies, it must also match the other r-f stage's coil and band, and do this all over the dial. That is why in such a case, the replacement coil chosen should duplicate the old one as closely as possible.

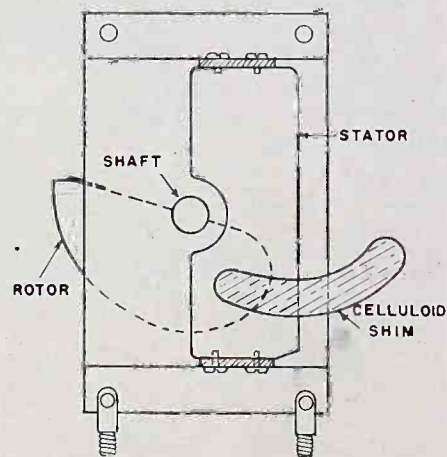

A celluloid shim is slipped between the plates of a variable capacitor to raise its capacity. The celluloid should be thin enough to prevent the plates from being forced out of line and shorting.

# Time-Saving Hints

## Safety-Tester

A fuse block and several inches of space on wall or workbench support may save burnt transformers, fuses and fingers, as well as time. Connect the fuse block to the lighting line, with a jumper wire across the load terminals as shown. Insert a 25-watt lamp into one fuse receptacle, and a screw-in adapter for a line plug into the other.

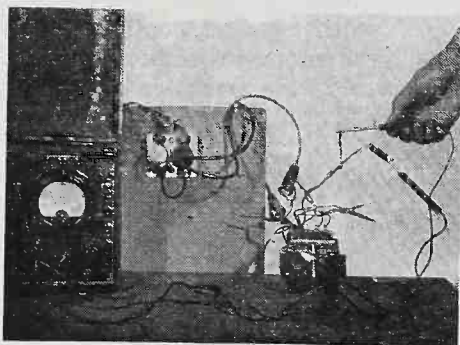

Use an ohmmeter to pair off leads.

A line plug is connected to two wires having insulated clips on the opposite ends. These clips are attached to the leads of any device to be tested, making a series circuit through the safety-tester. To identify and test the windings of a replacement power transformer, use the following procedure.

First use an ohmmeter to find the terminals or leads showing continuity. Loosely twist them, being careful not to leave the bare ends shorted together. The pair of leads showing the highest d-c resistance (usually 200 ohms or more) is probably the high-voltage winding, and these leads, including the center tap, should be taped while making further tests.

Since the primary's d-c resistance may be as low as 1 ohm, it will be

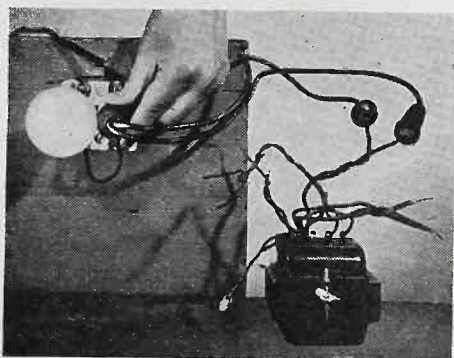

First connect clips, then plug in tester.

more practical to use the safety-tester, rather than the ohmmeter, to select the primary from among the remaining leads. Connect the test clips to each pair in turn, insert the plug as shown, and observe the relative brightness of the lamp.

If connected to a filament winding, the lamp will glow brightly. Only a faint glow will be visible, however, when the primary leads are selected. Having found the primary, it should be left connected, and a fuse substituted for the lamp, as shown in the second illustration. This places the full line voltage upon the primary, so that the filament voltages may be checked with an a-c voltmeter.

## Tape High Voltage Leads

The high-voltage winding should be handled with great caution to avoid dangerous shocks and instrument blowouts. This is especially important in view of the increasing popularity, in large urban centers, of television receivers which use transformers supplying extremely high and deadly voltages.

The safety tester should be used for troubleshooting any radio or appliance in which a partial or complete short is suspected. For units drawing large amounts of power, a larger-size bulb should be used. The safety-tester can also be used to burn dust out of variable capacitors which cannot be reached with a blower or pipe-cleaner, and for quickly checking quantities of low-value paper and mica capacitors for shorts.

## RCA 811K

If this set is noisy and lacks pep, check the 82,000-ohm  $\frac{1}{4}$ -watt resistors in series with the 6K7 i-f amplifier. If the screen voltage is far off 95 volts, replace the resistor with a  $\frac{1}{2}$ -watt or 1-watt type.

## Should Be 45Z5

A letter from David H. Mullenix of Macon, Ga., has called our attention to an error appearing on page 88 of the March issue. In an article entitled Resistor Cord Replacement, the rectifier tube mentioned several times should have been designated 45Z5, instead of 45Z3.

## Avoid Needless Call-Backs

The aerial and ground wires are often exactly alike in appearance and when once disconnected from the radio may be reversed.

While the serviceman is able to identify these wires the customer cannot. The customer may disconnect for housecleaning or other



Any quick-drying enamel can be used. Put a dab both on the wire and on the corresponding side of the terminal strip.

purposes and if reconnected improperly will blame the serviceman for defects in the radio.

The serviceman may save unprofitable trips by marking the aerial wire and aerial terminal with a dab of white paint as illustrated, when leaving the job.

These markings should of course be explained to the customer.

## Farm Radio Battery Substitution

When difficulty is experienced in getting a stock of  $4\frac{1}{2}$ -volt batteries for farm type radios, connect six

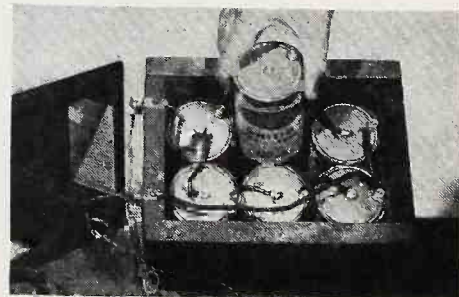

Three cells are wired in series to produce  $4\frac{1}{2}$  volts. The two series sets, connected in parallel, double service life.

standard No. 6 dry cells in series parallel. The batteries should be enclosed in a neat wood case, and wired out to terminals from an old "B" battery.



# AMPHENOL

## Covers the Spectrum

**WITH CABLES  
AND CONNECTORS  
FOR EVERY FREQUENCY**

Amphenol serves the electrical and electronic industries with the most complete line of cables, connectors, plugs and fittings for every application. No matter what the need—from high-current, low-voltage cables and connectors such as are used in power lines, to high-voltage, high-frequency components required in the upper regions of the spectrum—there is an Amphenol product for the job. Amphenol cables and connectors are used in Radar, F.M., Television, Standard Broadcast, electronic controls and equipment... and in numerous industrial applications.

Amphenol connectors are engineered and constructed so as to afford the absolute minimum of loss of power, potential or waveform even at the highest frequencies. These components reflect the greatest advancement in all phases of electrically correct design and mechanically correct manufacture. Amphenol makes the most complete line of cables, connectors, plugs and fittings for the most efficient transmission of power at all frequencies.

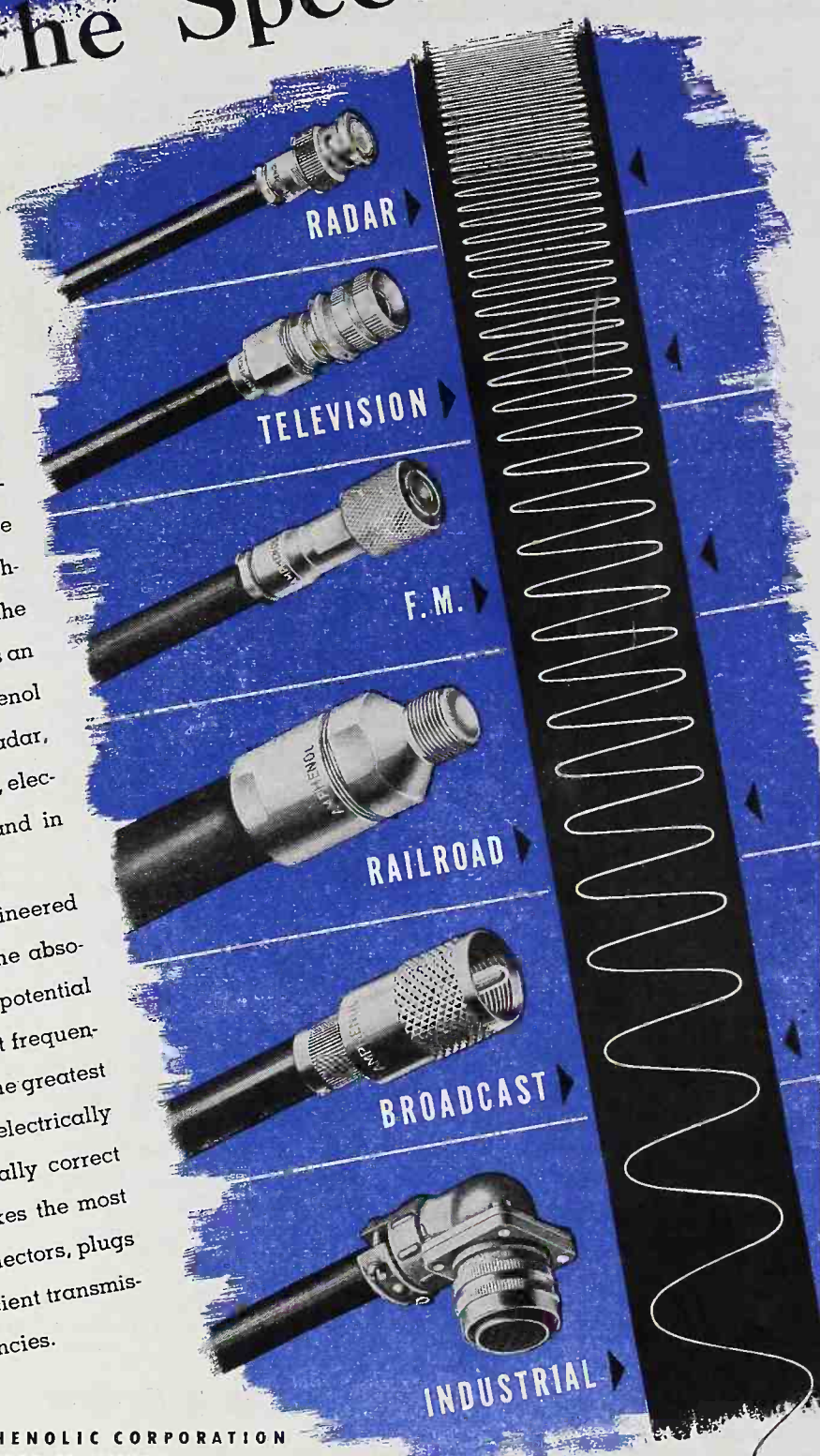

**AMERICAN PHENOLIC CORPORATION**  
CHICAGO 50, ILLINOIS

In Canada • Amphenol Limited • Toronto

COAXIAL CABLES AND CONNECTORS • INDUSTRIAL CONNECTORS, FITTINGS AND CONDUIT • ANTENNAS • RADIO COMPONENTS • PLASTICS FOR ELECTRONICS



## LONG PROGRAMS

## OUTDOOR ADVERTISING

## SHORT SPEECHES

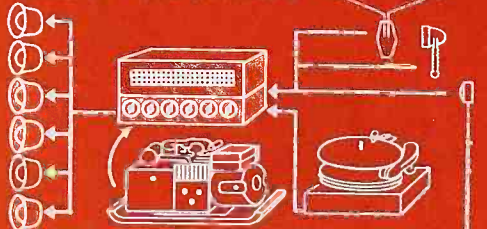

Used for:—

CONCERTS, CLAMBAKES, BARBECUES, PICNICS, FAIRS, ATHLETIC FIELD DAYS, COUNTRY CLUB EVENTS

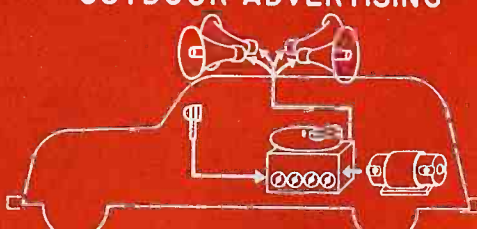

To Advertise:—

MOTION PICTURES, POLITICAL CANDIDATES, SPECIAL SALES, SAFETY CAMPAIGNS, FUND-RAISING CAMPAIGNS

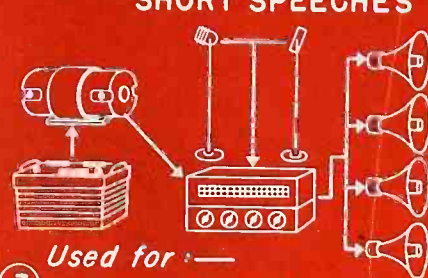

Used for:—

ELECTION RALLIES, BOAT LAUNCHINGS, DEDICATIONS, MUNICIPAL EVENTS

(1) Gasoline-powered portable generator provides 110 volts for long programs over 50-60 watt system run "cool". Suspend microphones for orchestral concerts; use hand-held type for athletic events. An automatic record player keeps music in the air. Bull horn dynamics, good for music, are concentrated up front for concerts, spread about area for other events. Use cardioid microphone in noisy locations. (2) Sound truck needs 25-50 watt amplifier with separate battery charging off

## OUTDOOR

oversized car generator. Turntable often mounted atop amplifier. Four reflex projectors deliver clear speech and accent highs to combat street noise. Driver's hand-held microphone available for "commercials". Check with municipality about license. (3) For short ceremonies, heavy-duty battery powers a 25-watt amplifier for 3-4 hours. Turntable for national anthem is optional. Elements should be rugged but presentable, able to stand repeated transport from one site to another.

# Sound Rental Program

• For certain dealers, sound rentals have always been profitable. For others, it represents only a distasteful subject. What makes the big difference?

Like PA sales and installation, PA rental is an established trade. Unlike sales, however, the capital outlay for rental is small. The past year's huge increase in the ranks of radio shops, therefore, has been paralleled by a still greater increase of those who rent sound equipment.

Some see this work as a small-scale easy-money sideline. Others rate PA rental as a "charity" contribution, handled as a convenience to certain customers. Both groups use a minimum of equipment, usually of poor quality.

There are other dealers, however, for whom PA rental is a serious business, which during certain periods pays off rather well. These men seek moderate-to-large rentals. They advertise quality, and have the equipment to back the claim. Highly efficient, with little waste time, they do technically superior installations.

In return, they charge respect-

able prices. Few will touch jobs for less than \$25. Many, estimating free over the phone, ask \$10 for a personal visit. This fee becomes a first payment, if they get the job. They bid with confidence for even the largest rentals.

Typical rental prospects are suggested on this page. Other lead sources are redbook ads, sound-car signs, and placards at rentals. Sound-effects record lists suggest other users. Special selling effort should be concentrated in advance of holidays, resort seasons, and election or community campaigns.

### Selecting Equipment

Of prime importance, is to plan the basic equipment to suit a large variety of jobs. 25 watt amplifiers with automatic record players are used for battery-powered outdoor jobs, as well as unattended indoor rentals. 50-60 watt systems take care of virtually all other work. For even greater power, use two or more amplifiers as separate channels or as boosters. Carry in the car a spare amplifier with power

source, and several replacement microphones and speakers.

Carry also 2,000 feet of spare cordage suitable for extending microphone, speaker and power leads. Standardize the cordage connectors in order to cut setup and replacement time to a minimum. Make a chart of all speaker combinations likely to be used, showing the proper connections. Use the amplifier's 500-ohm output, with matching transformers at the speakers.

After acquiring PA experience, a renter learns to swing his selling efforts toward a permanent installation, when the customer seems predisposed in that direction. The biggest, de-luxe installations are avoided, however. Requiring high-pressure selling, strong contacts, big capital, specialization, and access to sources of scarce materials, they are outside the scope of the average dealer's setup.

Moderate and large sized rentals, although requiring adequate technical preparation and promotional selling, have always been profitable for certain dealers. Why not make that apply to you?

(4) Auditorium jobs need 50-60 watts top quality sound. If amplifier has frequency-divider network, use coaxial speakers. Control panel and desk microphone on attendant's table lend professional air. Recorder-playback unit makes extra money at conventions, graduations. (5) Two bull horn dynamics, 25 watt amplifier and automatic player make up unattended system popular with main-street shops. (6) Enclosed controls on 50-60 watt amplifier prevents tampering,

at entertainments. Two large speakers, preferably coaxial, flank main center of attraction. Separate woofers, tweeters may be used. Smaller speakers for balcony or rear. Overhead 360-degree speakers are suspended in separate rooms or over noisy areas. Optional booster amplifier handy for larger jobs. Turntable for unattended systems should use "child-proof" type tone arm. One microphone is used by band. Any unit within reach of guests needs extra protective measures.

## INDOOR

### AUDITORIUM AFFAIRS

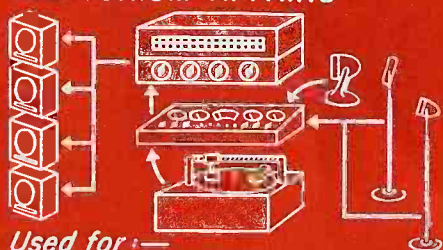

Used for:—

SCHOOL GRADUATIONS, MEETINGS & CONVENTIONS, RECITALS, CONCERTS, AUCTIONS, FIGHTS, RALLIES, LECTURES

### SOUND EFFECTS

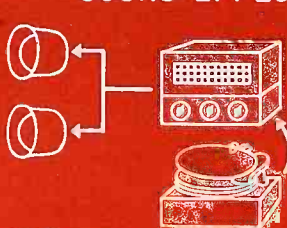

Used for:—

CHRISTMAS CAROLS, CHIMES & CARILLONS, STORE WINDOW DISPLAYS, FAIR & EXHIBITION BOOTHS

### ENTERTAINMENTS

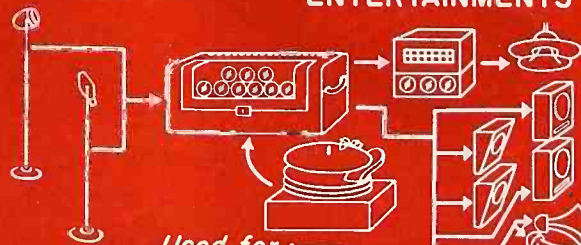

Used for:—

DANCES, BINGOS, PARTIES, SHOWS, TESTIMONIAL BANQUETS, SOCIAL AFFAIRS & DINNERS

# Emerson Radio

## YOUR "Indispensable Line"



**Model 505**—AC-DC three-way Portable, 3 times the power of pre-war radio... (Less batteries). \$40

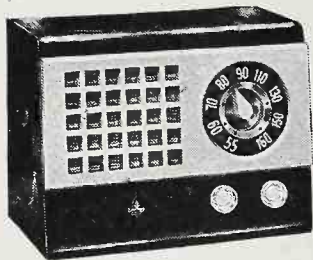

**Model 520**—AC-DC compact. Modern plastic cabinet. Enclosed super-loop. Visio dial. \$35

*Better Style, Tone, Performance, Value*

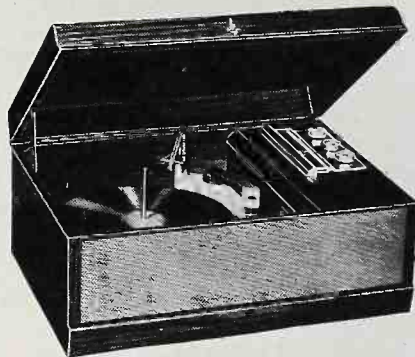

**Model 506**—Phonoradio with automatic record changer. Plastic tuning panel against rare woods. A marvel of tone and performance. \$100

*Prices OPA Approved*



**Model 503**—AC-DC compact. Handsome wood cabinet with overall grille. Enclosed super-loop. \$32

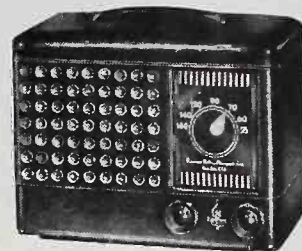

**Model 509**—AC-DC compact. Walnut patterned plastic cabinet. Enclosed super-loop. \$20

## 4 Point Quality

BY THE SPECIALISTS IN SMALL RADIO

On every count—Style, Tone, Performance, Value—they're BETTER. At every step, from blue-print to ultimate performance, QUALITY is the CHARACTER our engineers have built into every part of every new 1946 model.

With TREBLED manufacturing capacity—with production increasing as rapidly as materials become available—Emerson is geared for all industry opportunities.

*The Emerson Radio Franchise  
is Your No. 1 Asset*



Emerson's merchandise allocation policy—EQUALIZED ALLOTMENTS—commands the respect of all distributors and dealers alike. We are keeping faith with the trade.

*Emerson's promotion is in all ways CONSTRUCTIVE—keeping the public informed today, building an ever larger and stronger background for tomorrow's selling.*

*Ask Emerson Radio Distributor  
for Complete Details*

EMERSON RADIO AND PHONOGRAPH CORPORATION, NEW YORK 11, N. Y.  
*World's Largest Maker of Small Radio*

# New Technical Products

## Masco AMPLIFIER

50 watts at less than 5% distortion from four 6L6's in Class A push-pull parallel operation is provided by the Ma-50 Amplifier. Separate bass and treble equalizers are employed. The frequency range of 30 to 10,000 cycles is covered flat within  $\pm 2$  db. Two microphone and one phono high-impedance

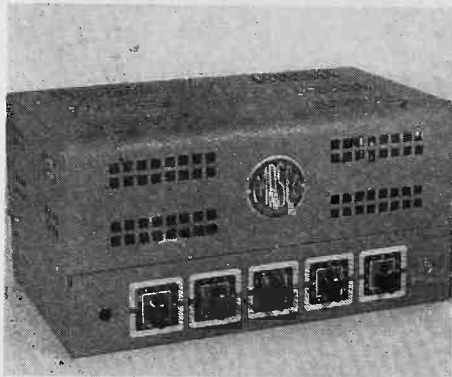

inputs have terminals at the rear, with separate controls on the front of the amplifier. Output taps are 500-15-8-4-2 ohms, to accommodate from 2 to 12 speakers. Operates on 115 volts, 60 cycle a-c. Mark Simpson Mfg. Co., 188 West 4th St., New York, N. Y.—RADIO & Television RETAILING

## Western Electric LOUD SPEAKING RECEIVER

Uniform sound coverage throughout a horizontal angle of 120 degrees and a vertical angle of 40 degrees is achieved by Western Electric's 720A type loud speaking receiver mounted on a 31A type horn by means of a 27A receiver

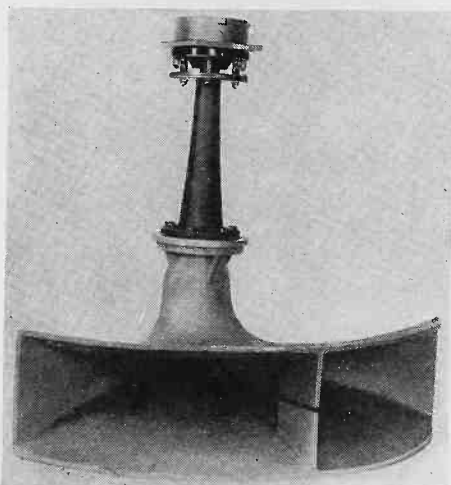

coupling attachment. An input of 30 watts within the range of 300 to 6,000 cycles is handled by this permanent magnet unit. Voice coil impedance is 8 ohms. Designed for reproducing music as well as speech. Western Electric Co., Inc., 195 Broadway, New York 7, N. Y.—RADIO & Television RETAILING

## Aviometer MICROPHONE

This compact hand-held microphone has a finger switch for press-to-talk operation. Designed especially for use

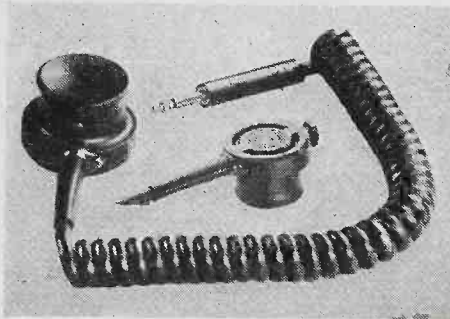

in noisy surroundings, the high frequency response goes up to 5,000 cycles. The unit is equipped with a flexible Retrax cord, which extends 40" on less than a two-pound pull. A normal close-speaking voice will produce 8 milliwatts of audio output. Aviometer Corp., 370 W. 35th St., New York.—RADIO & Television RETAILING

## Vertrod ANTENNAS

Model 10 is a 9-foot hard aluminum rod, that can be reduced to 6 or 3 feet in length. It is completely weather repellent and has a patent rotary base that can be turned 180 degrees. This base permits mounting of the aerial on any four-inch surface—on window-sill, wall or roof—with just a screw-driver.

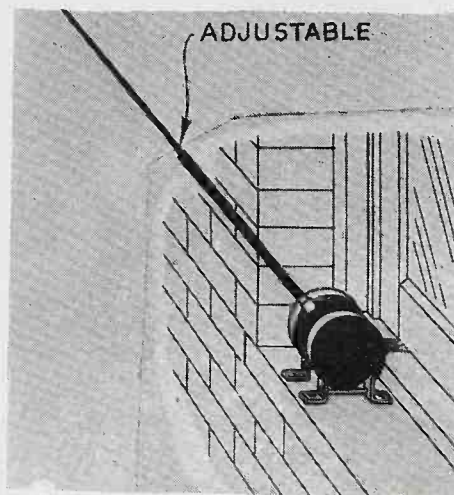

The antenna may be rotated to any desired position or angle. List is \$5.50, complete with accessories.

Model 103 is similar, but has an antenna transformer hermetically sealed into its base. This transformer matches the impedance of the rod to the transmission cable. Another transformer, sealed in a plastic shell, matches the impedance of the transmission cable to that of the radio set input. This electrical combination forms a completely balanced transmission system capable of piping radio frequency signals from 550 kc to 30 mc (600 to 10 meters) from

rod to radio input. List price of Model 103 is \$12.50. Vertrod Corporation, 17 Williams Ave., Brooklyn 7, N. Y.—RADIO & Television RETAILING

## Hickok VOLT-OHM-MILLIAMMETER

This compact Model 203 is a combination v-t-vm for a-c and d-c, and a wide-range ohmmeter, milliammeter and capacity meter as well. Ranges are: 0-3-12-30-120-300-1200 volts a-c, and d.c. and milliamperes d-c. Ohm ranges are: 0-1,000-10,000-100,000 ohms, and 0-10-100-1,000 megohms. Capacity

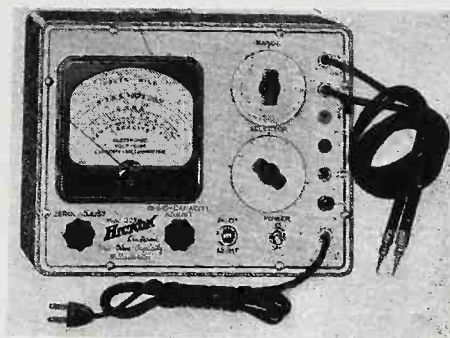

ranges are: 0-10,000 mmf in 2 ranges, and 0-1,000 mf in 5 ranges. Provision is made to test from 50 millihenries to 100 henries of inductance. The input impedances are: 15 megohms to d-c; 12 megohms shunted by 100 mmf to a-c. Hickok Electrical Instrument Co., 10523 Dupont Ave., Cleveland 8, Ohio RADIO & Television RETAILING

## Measurements Corp. FM GENERATOR

Model 78FM is a frequency modulated signal generator covering the newly assigned FM band from 88 to 108 mc. Two reactance tubes across the carrier provide a frequency deviation to over 300 kc. The distortion at 75 kc deviation

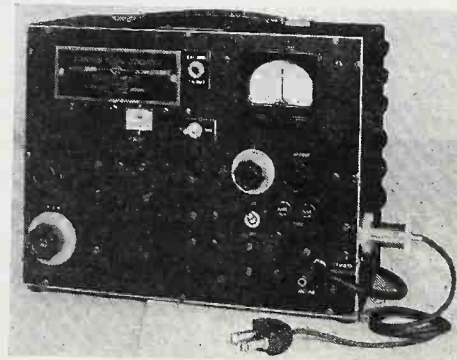

is less than 1%. The audio fidelity is flat within  $\pm 2$  db, from d-c to 15,000 cycles. The attenuator is calibrated from 1 to 100,000 microvolts, and the output impedance is constant at 17 ohms. Measurements Corp., Boonton, N. J.—RADIO & Television RETAILING

(Continued on page 100)

*Compact-Efficient*

**AN IDEAL REPLACEMENT UNIT**

*Model*  
**50**



## **WEBSTER RECORD CHANGER**

Model 50, compact and efficient, embodies proved mechanical principles so successfully used on larger Webster changers. Achieving the famous Webster standard of brilliant, dependable performance, Model 50 is an ideal replacement for outmoded changers, particularly in small radio-phonograph combinations.

- ☐ Fast change cycle — about 4 seconds.
- ☐ Simple to operate. Fool-proof and non-“jamming.”
- ☐ Compact — fits in most cabinets.
- ☐ Feather-light horizontal and vertical needle pressure.
- ☐ Velocity trip — changes many records which cannot be played automatically on other makes.
- ☐ Automatically plays all standard records; twelve 10" or ten 12".
- ☐ Dependable heavy duty Webster motor — cushion mounted for silent operation. No audible rumble or “waw”.
- ☐ Quiet record drop — velvet soft heavy-pile turn table covering.
- ☐ Stainless steel spindle for durability — cushioned for record protection.
- ☐ Quick, easy mounting — installation done from top.
- ☐ Heavy duty plated parts — fewer service calls — greater customer satisfaction.
- ☐ Simplified construction — clean handsome lines.



**YOUR DISTRIBUTOR  
HAS ALL DETAILS**

**WEBSTER**



**CHICAGO**

5610 BLOOMINGDALE AVENUE  
CHICAGO 39, ILLINOIS

**32 YEARS OF CONTINUOUS SUCCESSFUL MANUFACTURE**

# New Technical Products

## RPC PRECISION RESISTORS

These precision resistors for indicating meters are protected against humidity, fungus, salt corrosion and dust. The nickel-chrome and copper-nickel alloys are wound non-inductively on a steatite form. The units come in five sizes and

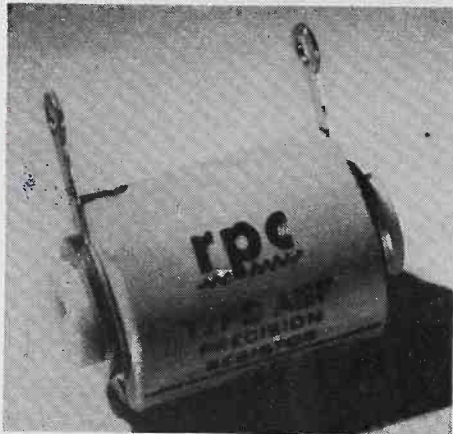

shapes. Type AGF, illustrated, measures  $\frac{5}{8}$ " maximum diameter, by  $\frac{3}{4}$ " between terminal lugs. Two smaller and two larger sizes are available. The standard tolerance is  $\pm 1\%$ . Tolerances of  $\pm \frac{1}{2}$ ,  $\frac{1}{4}$ , and  $\frac{1}{10}\%$  can be furnished on request. Resistance Products Co., Div. of Electronic Mfg. Co., 140 S. 2nd St., Harrisburg, Pa.—RADIO & Television RETAILING

## Eveready MINI-MAX BATTERIES

Mini-Max batteries currently reaching the market are designed to meet the requirements of extremely small space. Shown in the illustration is Eveready's Mini-Max B battery No. 412 for pocket



receivers (right). It produces  $22\frac{1}{2}$  volts, weighs  $1\frac{1}{2}$  ounces, and measures 2" high,  $1\frac{1}{32}$ " wide and  $\frac{5}{8}$ " thick. It is shown compared with the No. 950 for standard flashlights, which produces  $1\frac{1}{2}$  volts (left). National Carbon Co., Inc., 30 E. 42nd St., New York 17, N. Y.—RADIO & Television RETAILING

## Universal MICROPHONE MOUNTING

The A31 microphone mounting is a combination desk stand and handle. The wooden upright is attached to the

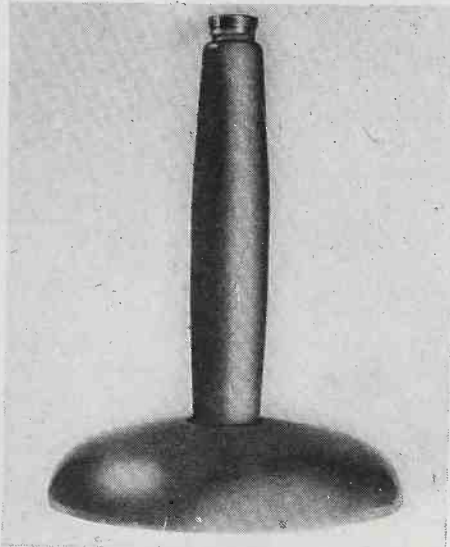

metal base by push-in beveling, without threading or screws. Used in this manner it becomes a balanced desk stand having rubber feet on the base and finished in brown enamel. When demounted from the base, the wooden upright is used as a handle for a hand-held microphone. Universal Microphone Co., Inglewood, Cal.—RADIO & Television RETAILING

## RCP VOLT-OHM-MILLIAMMETER

Models 424 and 424P Volt-Ohm-Milliammeters measure 0-2.5-10-50-250-1000 volts d-c and 0-10-50-250-1000 volts a-c with 1000-ohms-per-volt sensitivity. D-c milliammeter ranges are 0-10-50-250-1000 ma. Ohmmeter ranges are 0-500-

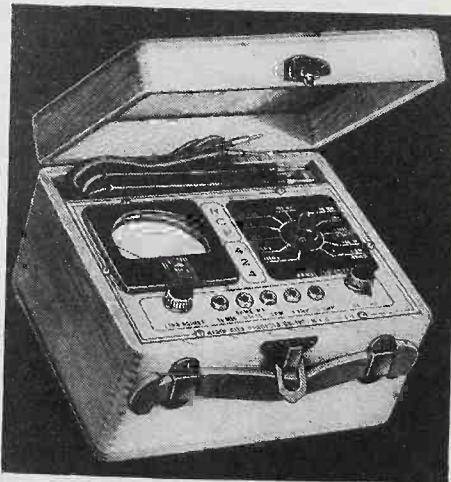

100,000 ohms and 1-10 megohms. The four decibel scales read: -10 to +15; -4 to +29; -18 to +43; -30 to +55; and are calibrated for a line of 500 ohms impedance. Correction charts are supplied for lines of other impedances. Model 424 is an open-faced type, while Model 424P is portable, and is mounted in a hardwood case with test leads, handle and removable cover. Radio City Products, 127 West 26 St., New York 19, N. Y.—RADIO & Television RETAILING

## General Test PEN-OSCIL-LITE

Basically, the Pen-Oscil-Lite is a 700-cycle buzzer and a pen-light battery housed in a fountain-pen type of case. The wave form of the interrupted cur-



rent is of the multivibrator type, which is extremely rich in harmonics. These 700-cycle harmonics cover the entire frequency range from 700 cycles (a-f) up through i-f, broadcast, short-wave and UHF frequencies, to over 200 megacycles (VHF) with a generally constant intensity. The frequencies appear at the short needle probe for coupling to any circuit by radiation or direct connection. It is useful for signal tracing and trouble-shooting any kind of receiver or audio amplifier and AVC testing. General Test Equipment Co., 38 Argyle Park, Buffalo 9, N. Y.—RADIO & Television RETAILING

## Schott FINISHING KIT

Contains all materials for flock finishing, including flock gun, two shades of felt flock, undercoats, thinner, brush and instructions. The hand-operated flock gun is intended to provide the radio serviceman with equipment that can supply a professional finish. Walter I. Schott Co., Beverly Hills, Calif.—RADIO & Television RETAILING

## Buggie LEAD-THRU CLAMP

This new type of cable clamp anchors various sizes of jacketed cables and feeds them through obstructions without cutting into the insulation. The pressure element is a rubber gasket which provides a water-tight seal. Tightening the nut at the rear of the clamp places pressure on the internally-mounted captive rubber gasket. This pressure causes the rubber ring to flow inward, taking an evenly-distributed grip upon the cable. H. H. Buggie & Co., Toledo 1, Ohio.—RADIO & Television RETAILING.

NEW ELECTRICAL APPLIANCES, PP. 68, 69, 70, 72, 73.

NEW RADIO SETS, PP. 46 TO 49.

Both mean...

"PRE-PROVED"

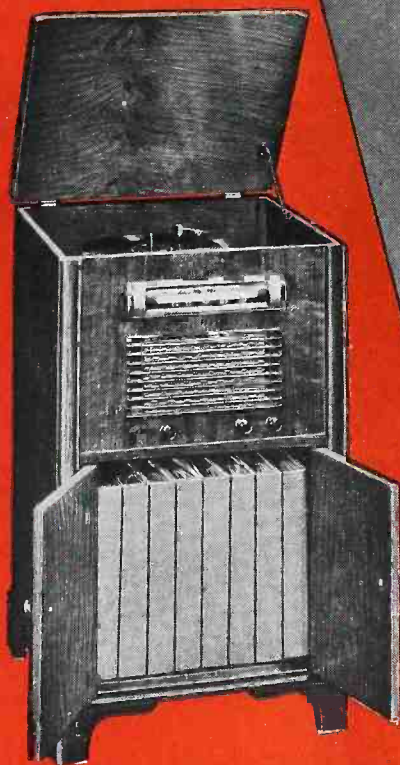

The CLARIONETTE (Model C105) World's most compact radio-phonograph combination.



The SARATOGA (Model C101) Table radio-phonograph combination with automatic record changer.



The ARISTOCRAT (Model C103) Ivory or walnut plastic. 6-tube superheterodyne.



"Audibel Rating" is as much an expression of CLARION policy as it is a sensational new development in electronic radio features. It is a warranty of "pre-proved" performance.

By assuming this new measure of responsibility to the consumer, CLARION management marks a new era in the relationship between factory, marketing organization, and the public.

"Audibel Rating" expresses the spirit of the CLARION manufacturing policy which covers 15 fundamentals.

This declaration, soon to be released, typifies today's trend toward more cordial human relations in business. Watch for it.

**WARWICK MANUFACTURING CORP.**  
4640 W. Harrison St. Chicago 44, Illinois

**Clarion**  
AMERICA'S FIRST  
AUDIBEL RATED  
**RADIO**



## 8 GREAT CLARION FEATURES

- New postwar FM circuit.
- Touch-button electric motor tuning.
- New low impedance Super-Interceptor Antenna.
- New Iso-Tron "climate protected" coils.
- Large Alnico No. 5 speaker magnet.
- 3-Dimensional "magnoscopic" dial.
- Jam-proof, rapid cycle automatic record changer.
- Latest full-floating, high fidelity record-saving Transducer, with permanent needle.

YEARS OF PROVED PERFORMANCE

# There's a Trip

in this broader... brand-new line!

No matter what your requirements, there's a Triplett for you! Every model of this brand-new, broader line features improvements to help you save time and render more accurate service. Included are *all* those elements required for modern servicing—*greater* readability . . . *longer* scale length . . . *larger* instruments . . . *wider* ranges . . . compact cases styled in keeping with modern merchandising, an important quality of each model. *Every* provision has been incorporated to make the new Triplett line the best—*mechanically* and *electrically*—geared to your specific needs. So plan your tests with Triplett in '46!



Model 3212 — Counter-type, short-open element, standardized value, tube tester with roll chart.



Model 666H—Pocket size volt-ohm-milliammeter.



Model 337-AVP—Polarity, voltage, phase rotation, line voltage tester.

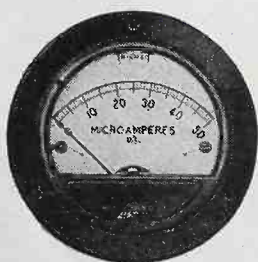

*Precision first*

See the 1947 Triplett Models.

Radio Parts Show Booth 13



# Let for You.



Model 2405 — Ultra-sensitive AC-DC volt-ohm-milliammeter-ammeter.



Model 1632—Ten-range, AC, 100 KC-120 MC, signal generator with internal modulation.



Model 2413—Compact, flexible, standardized value, short-open element trans-conductance comparison tube-tester.

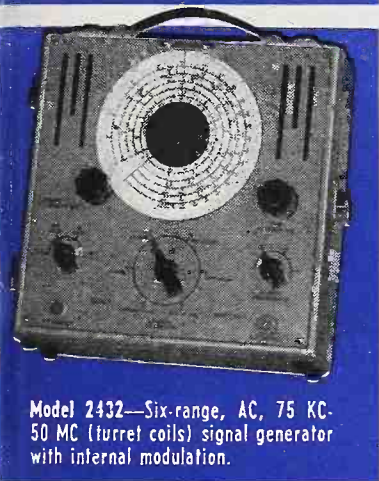

Model 2432—Six-range, AC, 75 KC-50 MC (turret coils) signal generator with internal modulation.



Model 2000—Compact volt-wattmeter appliance tester, AC.



Model 2450—AC DC electronic volt-ohm-milliammeter-microfarad meter.



Model 2425—Transconductance micro-ohm scale tube-tester with gas check.



Model 625N—Portable, ultra-sensitive, multi-range volt-ohm-milliammeter.



Model 2400—AC DC volt-ohm-milliammeter-ammeter.

# to last **Triplet**

The Triplett Electrical

Bluffton



Instrument Company

Ohio

## Circuit Data

(Continued from page 89)

transformer were not included in the first sets.

In alignment, the dial pointer is set at 54 with the variable fully meshed. A .05 mf capacitor is used between the signal generator lead and the 12SA7 grid for 455 kc i-f adjustment, while a 50 mmf capacitor is required to couple to the antenna lead, in setting the oscillator trimmer at about 1400 kc. Since the antenna section of the variable has no trimmer, the oscillator adjustment is made while rocking the ganged capacitor for maximum possible output.

Check the sensitivity at 600 kc. If weak, bend the slotted antenna section plates. A tuning wand is very helpful during this operation.

### Zenith 6D014 & 6D029

In the aligning of r-f and oscillator circuits, a single-turn loop of wire connected to the signal generator is coupled loosely to the wave-magnet loop. The oscillator is calibrated at 1600 kc, while the r-f and antenna trimmers are varied for maximum signal at 1400 kc. Specially-cut plates are used in the variable, in order that the antenna, r-f, and oscillator circuits may track throughout the band. This makes unnecessary the use of a padder capacitor.

### Westinghouse H-122,130

The i-f is aligned at 455 kc. For r-f alignment, a 200 mmf capacitor couples the signal generator to the antenna terminal on the back cover and loop assembly. With the signal generator at 1615 kc, and with the receiver variable fully unmeshed, adjust the oscillator trimmer for maximum output. To adjust the antenna trimmer, disconnect the generator from the antenna terminal, and bring the lead near to the antenna loop. Adjust the r-f trimmer, which can be found at the back of the set, at 1400 kc, and only with the chassis replaced in the cabinet.

### Temple E-510 Series

For alignment, four fine marks are engraved on the dial plate. These represent the pointer settings for 1550 kc, 1000 kc, 600 kc and with capacitor plates fully meshed. In 455 kc i-f alignment, couple the

signal generator through a .01 mf capacitor to the r-f section of the variable. To align the r-f, connect the 1700 kc generator lead to three turns of wire forming a self-supporting loop, placed about a foot away from the receiver's loop antenna.

After setting the dial pointer at the fourth dial plate mark, fully unmesh the variable plates and adjust the oscillator trimmer (front section). Readjust both the generator and receiver dial to 1550 kc, and vary the r-f trimmer (rear section) for maximum response. With capacitor plates fully meshed, the set should tune to 535 kc; however, no adjustment is required at this point, since cut plates are used in the variable.

## Service Pays

(Continued from page 50)

have always preferred the "uptown" location, about a mile from the downtown business center of Wichita, and do not depend upon street traffic. The general character of the district is a good one for recorded music, including classical stocks.

The new emphasis on records and record-playing devices will not be an experiment for this shop. It has been checked according to the likes and dislikes of a sizable group of service customers coming into the store. Whether it is ahead or behind a national trend makes little difference in an operation aimed at local needs.

This does not mean that the shop would hesitate to undertake an "educational" program on a brand new product. The proprietors would simply think, "Mrs. Jones would like it, Mrs. Smith would respond, Mrs. Brown would take to the idea." The point is, Herbert & Newby have taken the pains to keep the typical reactions on tap.

### Compact for Speed

While the merchandise fads come and go, and while deliveries have their violent ups and downs, the "service" emphasis in the store is plain to see. Repairmen do their work at a trio of novel "benches." All of the test equipment has not been lumped into a single-bench installation, as is most often the case. It was found here that the repairmen can work faster and with much greater freedom if each has his individual bench and is responsible for it. They are bril-

liantly lighted and fully equipped; this has required extra wiring but it's worth it. And it gives the service department the impressive look of "production-line" operation.

Another example of the straightforward quality of the H & N business is this: the two proprietors can see no point in a stay-out-of-my-life attitude toward other radio dealers in town. In fact, they make an effort to cooperate in every way possible. When a reporter for this magazine went to Wichita to cover the trade, several of the downtown radio merchants asked, "Have you been to the Herbert & Newby radio shop? You ought to take a run out there—they're a couple of good guys and they know what they're doing. Friends of ours."

## BOOKS

### Practical Radio & Electronics Course

By M. N. Beitman, published by Supreme Publications, Chicago, Ill., 332 pages—price \$3.95

This home-study text in radio and electronics is an ambitious attempt to cover a great many subjects in a comparatively brief space. Chapters are divided into lessons, with review questions at the end. Beginners may find the book a useful introduction to radio servicing.

### Inside the Vacuum Tube

By John F. Rider, published by John F. Rider Publisher, Inc., New York, 424 pages—price \$4.50

"Inside the Vacuum Tube" is intended to give the radio technician a solid understanding of the theory and operation of the basic types of tubes. Mathematical equations and calculations have been kept to a minimum.

Unconventional illustrations are used, that depict electrons and other particles as animated little people. This helps make abstract principles more easy to visualize.

Diodes, triodes, tetrodes and pentodes are covered. The final chapter contains brief descriptions of the acorn-type, cathode-ray and gas-filled tubes, and photo-electric cells.

Radio servicemen who would like a deeper knowledge of what goes on in vacuum tubes will find this a helpful text.

# **Record Sales Today . . .**

# **Radio Sales Tomorrow**

Thousands of radio dealers recognize records as one of their most valuable sources of extra profit . . . as one of their surest traffic builders.

But important as records are today, it is in the months and years ahead that Majestic dealers will really cash in on the Majestic records they are selling now—and on the Majestic records they'll be selling then.

Millions of Majestic records being bought today are building greater-than-ever familiarity with the Majestic name . . . helping to create greater-than-ever demand for Majestic radio-phonographs. It's a demand that will be valuable as radio production begins to match the market. It's a demand that will be invaluable as the normal buyer's market returns.

Of course, not all radio dealers have—or can have—the advantage of selling records that bear the same brand-name as the radios and radio-phonographs they handle. This is a particular advantage of the Majestic franchise. If you'd like to know more about it, and about Majestic's unique Controlled Distribution Plan which makes it possible for radio dealers to operate on a sounder, more profitable basis . . . Get in touch with the Majestic distributor in your territory. Or write Majestic Radio & Television Corporation, St. Charles, Illinois.

**Majestic Means Business**  
**. . . and lots of it!**



*New!  
Complete!*  
**RADIO  
CATALOG**  
*Free!*



Mail  
Coupon for  
**FREE**  
Copy!

**RADIO SETS**  
**AMPLIFIERS**  
**RADIO PARTS**  
**ELECTRONIC EQUIPMENT**

Your copy of the complete, new Concord Catalog is ready! It offers you the greatest selection of guaranteed quality RADIO SETS, PHONORADIOS, RADIO PARTS, TEST INSTRUMENTS, BOOKS, TOOLS, AMPLIFIERS AND ACCESSORIES, AMATEUR KITS AND SUPPLIES . . . page after page of post-war-engineered equipment and parts you have long been waiting for. All standard, top-quality lines. Thousands of items. Money-saving prices. See the thrilling MULTIAMP Add-A-Unit Amplifiers, brand new in the field, with sensational new flexibility, fidelity and power—EXCLUSIVE with CONCORD. Your copy is ready . . . and it's FREE. Rush this coupon today.

**CONCORD**  
RADIO CORPORATION  
LAFAYETTE RADIO CORPORATION  
**CHICAGO 7** ★ **ATLANTA 3**  
901 W. JACKSON BLVD. ★ 265 PEACHTREE ST.

Concord Radio Corporation, Dept. RT-56  
901 W. Jackson Blvd., Chicago 7, Ill.  
Yes, rush FREE COPY of the comprehensive new Concord Radio Catalog.

Name.....  
Address.....  
City..... State.....

# Sales Helps

## "The Clinch" in Eight Colors



New card available from distributors.

A new window display for radio service dealer windows has been released by the Radio Tube Division of Sylvania Electric Products Inc.

The "G.I. Joe and his dream girl" display comes in eight colors with a double effect stopper headline, "Back Again." The base of the card carries a jumbo sized illustration of the lockin style tube.

This is part of a complete line of point-of-purchase sales and service helps which will be released by Sylvania during 1946. Distribution is being made through Sylvania jobbers.

## Boosting Sales of Needles

A series of merchandising displays to stimulate sales of phono needles have been prepared by Jensen Industries, Inc., 329 S. Wood St., Chicago 12, Ill. One has a velour tray for 12 of the sapphire needle packages, with full color backboard. Another upright card shows off a dozen of the "Concert" needle packs, and a third one called the "Displaykit" is a folding counter unit holding three sapphires and three of the concert type.

## Walsco Features Its "40" Line

New promotional campaign has been started by the Walter L. Schott Co., Beverly Hills, Calif., makers of the Walsco line of electronic hardware including over 250 separate items used by radio repairmen, technicians and experimenters. The campaign features the Walsco one-price merchandising plan, and the packaging of each item in separate dust-proof, cellophane bags.

Keynote of the drive is the "40" line of parts. The campaign includes jobber co-

operation to get the line to the attention of the trade and to identify the "40" line with Walsco. The line is a feature at the Walsco booth (No. 116) at the Radio Parts Show in Chicago, where Walter L. Schott and Donald J. Terwilliger will be on hand to meet radio men.

## Flasher Display



Counter merchandiser containing small assortment of 60-watt and 100-watt insect repellent lamps manufactured by Verd-a-Ray Corp., Toledo, Ohio. Display comes equipped with a flasher socket and 6 ft. extension cord.

## Four-Color Card for "88" Needle

The Aero Needle Co., 619 N. Michigan Ave., Chicago 11, Ill., has a new counter display card to be used in promotion of the Aeropoint "88" plastic insulated phonograph needle.

The card comes in four colors and is set



Display edged with 18th Century design.

in a "Masterpiece" picture frame, 18th Century style. It is 17½" long and 13" wide.

Features of the "88", prices, and packaging are appropriately highlighted.

# PREMIER

THE RADIO THAT'S ENGINEERED FOR EXCELLENCE

*Here it is!*

A top-quality radio to appeal to the discriminating buyer in the mass market. Here's why:

For seventeen years Premier has been a leader in the engineering and production of electronic equipment requiring utmost precision and painstaking craftsmanship. This same leadership... this same engineering... this same craftsmanship have gone into the *new* Premier radio.

And Premier promises continuous improvements. Even now, Premier is preparing to put out the first of a series of **crystal controlled** radios. You can count on getting ahead—and *keeping ahead*—with Premier!

## CHECK THESE FEATURES:

- 1... Genuine solid hardwood cabinet—lustrous walnut finish.
- 2... Three-dimensional inclined dial, with edge lighting.
- 3... Five-tube ac-dc superheterodyne circuit.
- 4... Ingenuity in circuit layout provides sharper tuning with outstanding sensitivity and selectivity.
- 5... Ample reserve power—gives finer tone at high volume levels.
- 6... Tone enhanced by extra power... Alnico #5 p.m. dynamic speaker... heavy, rigid cabinet.
- 7... Lasting customer satisfaction assured by rugged, quality construction.



## Beauty:

Superb styling—neither dull nor gaudy, but in good taste for the discriminating customer. Fits into any home.

## Performance:

Ingenuity of design, adherence to high standards and skill in craftsmanship give the Premier radio greater selectivity, wider range, better tone.

## Dependability:

Lasting customer satisfaction is assured by rugged construction... quality components... careful workmanship... thorough inspection.

The Premier line will help you build for a lasting, profitable future. Premier supplies arresting window displays and counter cards—in compelling color—to help you display the Premier radio to best advantage. Dealers and distributors are now being selected. Write on your letterhead for details.

First in the Premier line is the Model 15—beautifully styled to appeal to the discriminating buyer of quality radios—the buyer with Future buying power as well as Present! Filled with features — packed with plus values. Watch for later models!



67 PARK ROW (PULITZER BLDG.) • NEW YORK 7, N. Y.  
**PREMIER CRYSTAL LABORATORIES, INC.**

# Store Display

(Continued from page 45)

sales staff by the management.

When a customer steps into the store, he is impressed at once with its smart appearance. The walls of the establishment are papered with bleached mahogany paper which looks like wood panelling. This paper is also inexpensive. Modern lighting fixtures are built into the ceiling, which is roofed with sound-proof blocks.

For display and demonstration of straight table model radios, a special room has been set aside on the main floor. Shelves have been constructed in this room to permit effective display, and leisurely examination of small receivers.

Plenty of electrical outlets are provided in this room to make demonstrations easy and convenient. This arrangement avoids messy wires, and makes for more attractive display. Proper reception is assured by soundproofed walls.

## Table Combos Featured

Immediately adjacent to this display room is another, which is reserved solely for table model radio-phonograph combinations. This demonstration room is also designed to make sales easy and pleasant. Three shelves line the walls to accommodate these sets. The shelves are properly spaced to permit the lifting of cabinet lids when combinations are being demonstrated.

## Ready to Serve

The radio-phonos are also properly hooked up and ready to play when turned on. Soundproofed walls permit faithful tonal reproduction for exacting music lovers.

Traffic items, including table model radios, will be sold on the street floor for quick sales. More expensive consoles and television sets will be merchandised on the second floor, which will be turned into an attractive sales floor as soon as conditions permit.

The opening of the second floor permits the firm to sell high priced radio-phonograph combinations and video sets under the most favorable conditions. In order to sew up orders for high ticket items, Barron plans a studio on this floor with comfortable chairs, attractive rugs, etc., where patrons can enjoy broadcasts or television shows under home-like conditions.

Approximately 2,300 square feet

of space is available on the second floor where such leading brands as Philco, GE, Zenith, Bendix, etc., will be displayed.

An arrangement similar to that of the second floor will soon be put into effect in the store's basement. This area measures 23 by 120 feet and will be used to display and demonstrate kitchen and laundry equipment under actual working conditions.

A model kitchen and laundry will be on exhibit to show homemakers the way electrical appliances will look in their homes. Barron hopes in this way to make many tie-in sales of related electrical merchandise.

## Service Combats Chains

To round out its sales program, the company has facilities available for expert servicing on radios and table appliances. A skilled technician is on the premises all day to give speedy maintenance work.

In this establishment's trading area there are many large "chain" stores which will compete with the firm for the consumer's radio and appliance dollar. To combat any "chain" competition, Barron will capitalize on the store's service facilities.

"Chain stores are not equipped to give good maintenance on the goods they sell," Barron asserted. "Establishments of this type send service work to central offices, thereby entailing much delay and inconvenience for their customers. I've been employed in the past by 'chains' and I am well aware of their lack of service facilities.

"We're going to cash in on the 'chain's' failing. We'll sell fine merchandise under the most pleasant conditions, and back up our sales with service."

## Service Sells

(Continued from page 67)

"For our seven lines of small appliances, however, we shall make up our own display fixtures. These will be tables.

"The largest table will be a step-up table, 20 feet long, oval in shape. We shall place this in the center of the store."

## Advertising Aids

Advertising presents no more of a problem than store display. For one thing, Beranich intends to keep right on advertising his service department as he is doing now.

"As a form of direct-mail advertising," said dealer Beranich, "we acknowledge a service job after the work has been done; and assure the customer that we want to satisfy. We get a lot of varied comments but, after all, that's what we want. Customer opinions are important.

## Newspapers Effective

"We now advertise our service department through newspapers. We use both the metropolitan section of one large newspaper, and local neighborhood papers. We use mostly the classified section for service, but plan to run some display advertising for electrical appliances.

"We advertise in street cars, restricting this to the Madison line which runs past our store. We also use a direct-mail blotter system, daily radio spot announcements, and a weekly advertisement that appears in 7,000 pamphlets distributed weekly in the church I attend.

## Dual Tie-In

"We shall use these same media to advertise electrical appliances and radios. But unlike some other dealers, we don't intend to abandon advertising our service department.

"In fact, I feel there will be more service than ever, after a year or two. There will be that many more appliances and radios to service!

"I expect to add one or two men to the service department just to handle warranty service alone. We intend to repair all appliances here, except perhaps refrigerators, if any exception is made.

"Another branch of service that will get larger is that of automobile radios. We are a warranty station on automobile radios for five companies."

Beranich operates a drive-in station for automobile radios. He can do this because he owns and operates the garage adjacent to his store, which goes in an L-shape around the store itself. The entire building occupies 100 by 125 feet.

## Foundation Sound

On this simple, clear-cut basis of honest dealing, Emergency Radio Service has built a tremendous volume of business. And it seems clear that the sales manager was right when he predicted that on this foundation, this radio dealer will build one of the largest and soundest businesses in appliance retailing in Chicago.

**THE ODDS  
ARE STILL**

**6 to 1**

**AFTER** World War I, no less than 886 different brands of radio sets were offered to the public.

By 1940, no less than 742—83.7 per cent—were discontinued.

They were orphans.

Of course, no one—dealer or customer—wants a prospective orphan, but the odds are still 6 to 1 that the average buyer will choose just such a set.

One way *you* can be sure of good will and good business—not just for the moment, but for years to come—is to sell a radio line that you know *won't* become an orphan.

Stewart-Warner is such a radio, and has been for 22 years. The world-famous \$50,000,000 Stewart-Warner institution guarantees it.



**Stewart-Warner Table Radio-phonograph**—a triumph of advancement in radio and record reproduction! Tamper-proof record changer plays up to 12 records. Tone you'd expect only in a big console. And 4 screw-in-type legs make this model into the consolette.

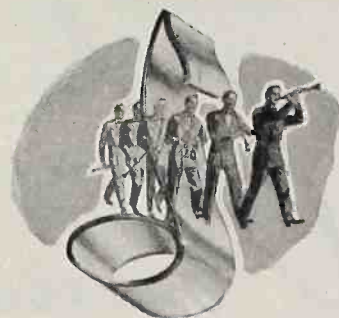

**Strobo-Sonic  
TONE**

... so faithful you can distinguish every instrument, understand each word, hear music in its true dimensions, picture-clear. A revelation in radio-listening pleasure! An exclusive Stewart-Warner feature.

**THESE GREAT FEATURES MEAN  
THE BEST FOR YOU**

**Radair Antenna**—actually repels annoying static; brings in even the weakest signals.

**Signal Sentry**—bars the hum and sizzle, helps bring in the most distant stations.

**Selectivity and Sensitivity**—now 60 per cent improved over prewar models.

**Strobo-Sonic Tone**—living-room performance with concert-hall reality. Exclusive!

**MORE THAN EVER, YOU CAN DEPEND ON**

**Stewart-Warner**

*Radios  
Radio-phonographs*

**CHICAGO 14**



*A value range equal to  
its frequency range...*

**... A LABORATORY-TYPE SIGNAL GENERATOR FOR SERVICEMEN**

We've been designing and producing signal generators for a good many years—each one the best we were able to produce in that year. They have always been pace-setters. Over the years they have become the standard of utility in such instruments for servicemen—distinguished always by that inbuilt Simpson accuracy that stays accurate. Every new model has stepped up the value, dollar for dollar, of the serviceman's investment.

Now this Model 415, with the widest frequency range of them all, tremendously widens the value range as well. Every dollar of its price buys more than a dollar ever bought before, even in a Simpson instrument. We know, for instance, of several

signal generators built for laboratories only, selling at twice and three times the price of the Model 415, that will do very little more than this new Simpson Wide Range Signal Generator for AM and FM. And no serviceman's instrument we know of even approaches Model 415 in range, control, constancy of output, completeness of attenuation and degree of utility. Here is another of Simpson's 1946 developments in instruments for radio and television servicemen, the product of long and rewarding research.

We offer Model 415 in the proud knowledge that it is not likely to see its peer for a long time to come.

1. Direct reading dial with continuous coverage from 70 Kilocycles to 130 Megacycles in the following ranges: 75-200; 200-600; 600-1750 Kilocycles and 1.5-4.5; 4-15; 14-30; 29-65; 58-130 Megacycles.
2. Model 415 is practically independent of line voltage fluctuation. Calibration is stable regardless of wide variations in line voltage.
3. RF output is controlled through its entire range, eliminating the necessity of a separate connection for high uncontrolled output as found in other signal generators.
4. RF output voltage is practically constant throughout the entire frequency range.
5. Modulation from 0 to 100% using either the 400 cycle internal sine wave or an external source. A range from 0 to over 20 volts of 400 cycle sine wave is available for external use.
6. High fidelity modulation up to 100% from below 60 cycles per second to over 10 Kilocycles per second.
7. No unwanted frequency modulation present.
8. Each Signal Generator is individually calibrated against a crystal controlled frequency standard.
9. Substantial construction assures maintenance of calibration accuracy indefinitely.

**PANEL**—Lustrous black anodized aluminum. Dial is encased in a molded bakelite escutcheon with glass covering for protection against damage and dirt. Functional switches and controls are mounted on engraved molded bakelite panels.

**CASE**—Steel, copper plated for shielding effect and finished in black durable wrinkled enamel. Leather carrying handle.

**SHIELDING**—In addition to the overall shielding offered by the case and panel, the coils and tuning condenser are individually shielded, then an additional shield is placed over these two assemblies. This series of shields together with other factors reduce leakage to an absolute minimum.

**COILS**—Low loss RF coils are individually calibrated by means of variable inductance and variable minimum capacitance. These adjustments provide the means for greatest possible accuracy in calibration.

**BAND SELECTOR**—The rotating turret coil assembly permits the use of shortest possible wiring, resulting in minimum circuit capacitance and permits quick selection of any frequency range.

**CONDENSER**—A two section tuning condenser using either one section or the other provides for ideal inductance to capacity ratio on all bands. Smooth vernier tuning permits accurate adjustment of the selected frequency.

Price .....\$115.00

ASK YOUR JOBBER

SIMPSON ELECTRIC COMPANY  
5200-5218 W. Kinzie St., Chicago 44, Illinois

**Simpson**  
INSTRUMENTS THAT STAY ACCURATE



**NEW SIMPSON  
WIDE RANGE  
SIGNAL GENERATOR  
FOR AM AND FM**



WATCH FOR NEW SIMPSON DEVELOPMENTS... THEY ARE WORTH WAITING FOR

# TELEVISION TODAY

## More Tele Applicants in Seven States

The Federal Communications Commission has stepped up its processing of applications for commercial television stations and has set the dates for hearings in 11 cities. These began April 15 and will continue until July 15. The FCC had announced plans for handling all existing tele applications before the end of the year.

The eleven cities for which the hearing dates have been set are Harrisburg, Lancaster, Pittsburgh and Philadelphia, Pa.; San Francisco, Los Angeles, Detroit, Baltimore, Cleveland, New York City, and Providence, R. I.

Among the applicants in these hearings are Philco, Detrola, DuMont, Westinghouse and Raytheon. The others, besides the broadcasters, are mostly newspaper and motion picture interests.

## Viewers in Three Cities See Bomb Test

An example of the alert and advanced programming methods now practiced in television is seen in the announcement that six television companies will cover the coming atomic bomb test in the Pacific. Television viewers in Chicago, Philadelphia and New York will be treated to feature films brought back by tele-camermen from Bikini Atoll.

The six participants in the dramatic "Operation Crossroads" are CBS, ABC,

DuMont, NBC, Philco, and Balaban & Katz. They have received permission from Joint Task Force One to film the event, and after the films have been passed by the Navy, they will be available for telecast use. Films taken by official photographers will also be available for telecasting.

## Pictures Demonstrated as Merchandisers

The first demonstration of television as a vehicle for presenting a sales and merchandising program to company officials was held when the RCA tube department used NBC's television facilities to present to top management executives of the RCA Victor Division its plans for production, merchandising, advertising, and sales through 1946.

The program was regarded as a successful test of television techniques for such commercial applications as the visual transmission of executive messages, statistical exhibits, and product demonstrations to groups of executives, salesmen, or engineers gathered together at meetings.

## Promotion by Air

Speakers, charts, and selected product exhibits were picked up by the television cameras in NBC's television studio on the third floor of the RCA Building in Radio City, New York, and images were transmitted by special wire to the Tube Department's demonstration room on the

ninth floor of the same building. NBC's television production staff assisted in staging the unique event.

Advertising and promotion plans were presented by the sales managers for each of the departments' product lines. New developments in RCA electron tubes which will reach production status this year were presented.

## Tele Aid to Education, Say DuMont Officials

Contributions which can be made by the television industry and the television broadcaster to the field of education were outlined recently by Herbert E. Taylor, Jr., director of transmitter equipment sales for Allen B. DuMont Laboratories, Inc., and Robert F. Jamieson, assistant manager of DuMont television station WABD, before a meeting in New York.

"The television industry is eager to aid education as much as possible," Mr. Taylor said, "because this will further the sale of receivers, it offers a large market for intra-school and intra-city television installations, it is a satisfying type of activity and such aid can result in finer public service programs."

DuMont engineers meanwhile continued receiver improvements and announced a new "Mallory-Ware Inductuner"—a continuously variable tuner, which covers (without switching) the entire frequency range from 44 to 216 mc

## New Brilliance for Larger Video Screens

A new factor in the design of large-screen television sets is an aluminum-backed television tube announced by General Electric Co. GE says that "the revolutionary features of the tube will triple the brilliance and clarity of the viewing screens of home television models."

The new 5" tube is backed with aluminum so thin that electrons from the cathode will penetrate it and activate the screen. This prevents saturation of the screen and reflects extra light out through the face. The tube was developed by GE engineer Vincent J. Schaeffer.

## Big Tele & Movie Studio Planned

A 6-story clubhouse at Lafayette and Oxford streets in Brooklyn, N. Y., has been taken over by Lafayette Television & Motion Picture Studios, Inc., where the firm will spend \$500,000 to convert the building into "the largest motion picture and television studio in the East."

It is expected that the studios will be ready by the end of May. The company plans to offer the facilities for the production of television, commercial, industrial, educational, and religious motion pictures.

## New Low-Priced Receiver from Chicago Plant



First model of the new television line of Belmont Radio Corp. division of Raytheon Mfg. Co. is this \$150 unit scheduled for delivery in July. It has 2 tuning bands for full coverage of assigned video channels, 7" picture tube, total complement of 20 tubes.

# a NEW GREATER Aviola



## Aviola Radio Moves To Big New Arizona Home . . .

Aviola Radio Corporation takes another important step forward with the purchase of the former AiResearch plant at Sky Harbor, Phoenix, Arizona. Aviola's expansion plans made necessary the move from its former location in Glendale, California. Here at Phoenix the skill—the engineering genius—the "know how" that made Aviola a wartime radar leader, will be afforded new and greatly enlarged production facilities. The giant new building

will house Aviola's entire manufacturing operation, including the cabinet shops, heretofore located away from the main plant. All units brought together under one roof means greater volume of production, greater efficiency and economy. It means more than ever now that the name Aviola on a radio, phonograph combination, or record player is your guarantee of the finest materials and craftsmanship. Associate yourself now with the new, greater Aviola—Contact the Aviola jobber in your territory.

**AVIOLA RADIO CORPORATION  
PHOENIX, ARIZONA**

Creator of the  
Beautiful New  
Desert Blende Cabinets



COUNT ON  
**Aviola**  
FOR QUALITY

# TELEVISION TODAY

## More Tele Applicants in Seven States

The Federal Communications Commission has stepped up its processing of applications for commercial television stations and has set the dates for hearings in 11 cities. These began April 15 and will continue until July 15. The FCC had announced plans for handling all existing tele applications before the end of the year.

The eleven cities for which the hearing dates have been set are Harrisburg, Lancaster, Pittsburgh and Philadelphia, Pa.; San Francisco, Los Angeles, Detroit, Baltimore, Cleveland, New York City, and Providence, R. I.

Among the applicants in these hearings are Philco, Detrola, DuMont, Westinghouse and Raytheon. The others, besides the broadcasters, are mostly newspaper and motion picture interests.

## Viewers in Three Cities See Bomb Test

An example of the alert and advanced programming methods now practiced in television is seen in the announcement that six television companies will cover the coming atomic bomb test in the Pacific. Television viewers in Chicago, Philadelphia and New York will be treated to feature films brought back by tele-cameramen from Bikini Atoll.

The six participants in the dramatic "Operation Crossroads" are CBS, ABC,

DuMont, NBC, Philco, and Balaban & Katz. They have received permission from Joint Task Force One to film the event, and after the films have been passed by the Navy, they will be available for telecast use. Films taken by official photographers will also be available for telecasting.

## Pictures Demonstrated as Merchandisers

The first demonstration of television as a vehicle for presenting a sales and merchandising program to company officials was held when the RCA tube department used NBC's television facilities to present to top management executives of the RCA Victor Division its plans for production, merchandising, advertising, and sales through 1946.

The program was regarded as a successful test of television techniques for such commercial applications as the visual transmission of executive messages, statistical exhibits, and product demonstrations to groups of executives, salesmen, or engineers gathered together at meetings.

## Promotion by Air

Speakers, charts, and selected product exhibits were picked up by the television cameras in NBC's television studio on the third floor of the RCA Building in Radio City, New York, and images were transmitted by special wire to the Tube Department's demonstration room on the

ninth floor of the same building. NBC's television production staff assisted in staging the unique event.

Advertising and promotion plans were presented by the sales managers for each of the departments' product lines. New developments in RCA electron tubes which will reach production status this year were presented.

## Tele Aid to Education, Say DuMont Officials

Contributions which can be made by the television industry and the television broadcaster to the field of education were outlined recently by Herbert E. Taylor, Jr., director of transmitter equipment sales for Allen B. DuMont Laboratories, Inc., and Robert F. Jamieson, assistant manager of DuMont television station WABD, before a meeting in New York.

"The television industry is eager to aid education as much as possible," Mr. Taylor said, "because this will further the sale of receivers, it offers a large market for intra-school and intra-city television installations, it is a satisfying type of activity and such aid can result in finer public service programs."

DuMont engineers meanwhile continued receiver improvements and announced a new "Mallory-Ware Inductuner"—a continuously variable tuner, which covers (without switching) the entire frequency range from 44 to 216 mc.

## New Brilliance for Larger Video Screens

A new factor in the design of large-screen television sets is an aluminum-backed television tube announced by General Electric Co. GE says that "the revolutionary features of the tube will triple the brilliance and clarity of the viewing screens of home television models."

The new 5" tube is backed with aluminum so thin that electrons from the cathode will penetrate it and activate the screen. This prevents saturation of the screen and reflects extra light out through the face. The tube was developed by GE engineer Vincent J. Schaeffer.

## Big Tele & Movie Studio Planned

A 6-story clubhouse at Lafayette and Oxford streets in Brooklyn, N. Y., has been taken over by Lafayette Television & Motion Picture Studios, Inc., where the firm will spend \$500,000 to convert the building into "the largest motion picture and television studio in the East."

It is expected that the studios will be ready by the end of May. The company plans to offer the facilities for the production of television, commercial, industrial, educational, and religious motion pictures.

## New Low-Priced Receiver from Chicago Plant



First model of the new television line of Belmont Radio Corp. division of Raytheon Mfg. Co. is this \$150 unit scheduled for delivery in July. It has 2 tuning bands for full coverage of assigned video channels, 7" picture tube, total complement of 20 tubes.

# a NEW GREATER Aviola



## Aviola Radio Moves To Big New Arizona Home . . .

Aviola Radio Corporation takes another important step forward with the purchase of the former AiResearch plant at Sky Harbor, Phoenix, Arizona. Aviola's expansion plans made necessary the move from its former location in Glendale, California. Here at Phoenix the skill—the engineering genius—the "know how" that made Aviola a wartime radar leader, will be afforded new and greatly enlarged production facilities. The giant new building

will house Aviola's entire manufacturing operation, including the cabinet shops, heretofore located away from the main plant. All units brought together under one roof means greater volume of production, greater efficiency and economy. It means more than ever now that the name Aviola on a radio, phonograph combination, or record player is your guarantee of the finest materials and craftsmanship. Associate yourself now with the new, greater Aviola—Contact the Aviola jobber in your territory.

**AVIOLA RADIO CORPORATION  
PHOENIX, ARIZONA**

Creator of the  
Beautiful New  
Desert Blend Cabinets



COUNT ON  
**Aviola**  
FOR QUALITY

## How Many Slices in a Loaf of Bread?

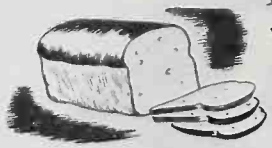

It's unimportant unless there aren't enough to go around. When the loaf isn't large enough to feed everyone who asks for a slice, the problem becomes involved. The size of each slice takes on significance.

We, at Stancor, are confronted with a parallel situation. A day never passes that we don't risk offending valued customers by keeping the slices as thin as feasible... that everyone may have his fair share.

We know how you feel about this. You need transformers, desperately perhaps, and it's been a long time since Stancor has been able to supply all you want. We're certain, however, that you would not condone a sacrifice of quality for quantity. In a sense, then, you dictate Stancor policy.

Because of our insistence on high standards of quality, production and delivery have never stayed apace with Stancor sales. Today there is a greater gap than ever. We feel you understand the reasons for this, since our current problems are also yours.

Soon, we hope to be able to meet your constantly increasing demands. Meanwhile, there can be no change in the Stancor policy of quality. We know you wouldn't want it any other way.

*Jerome J. Kahn*  
PRESIDENT

**STANDARD TRANSFORMER CORPORATION**

1500 NORTH HALSTED STREET • CHICAGO 22, ILLINOIS



## New Booklets

The Ward Leonard Electric Co., Mount Vernon, N. Y., has issued a new bulletin, #130, listing additional electric controlling devices which the firm manufactures.

A new folder on the subject of how and why home recording is as "simple as 1, 2, 3" with the use of Recordio products, has been issued by Wilcox-Gay Corp., Charlotte, Mich.

An elaborate 6-page illustrated bulletin has been released by Newcomb Audio Products Co., 2815 S. Hill St., Los Angeles, Calif., describing the firm's new amplifiers and portable PA accessories. Both the De Luxe "K-Series" and "H-Series" are included.

A new 50-page "Electronics Digest" which describes and illustrates some of the newest developments in the field, is now available from Westinghouse Electric Corp., Box 868, Pittsburgh 30, Pa. Included in the booklet is an explanation of the electron theory and basic electronic devices.

The Sunroc Refrigeration Co., Glen Riddle, Pa., has issued a 2-color booklet containing full information about the firm's postwar line of ac and dc water coolers.

"An Engineer Looks at ILG" is the title of a new booklet issued by the ILG Electric Ventilating Co., Chicago. It is a word and picture story of what a consulting engineer sees as he visits the ILG plant. Copies of the book are available without charge from the home office, or one of the forty ILG branch offices. It is helpful to men in the business of specifying, designing, purchasing or installing ventilating or heating systems.

Now ready for dealer use is a new advertising mat book, offered by Scott Radio Laboratories Inc., Chicago. It includes newspaper adaptations of newly created national magazine copy on the new Scott radio-phonograph. Precision craftsmanship and interior workmanship of the Scott chassis are emphasized.

Tappan Stove Co., Mansfield, O., has issued a "New Freedom Gas Kitchen" booklet, stressing the theme of convenience, attractiveness and individuality with kitchen plans adaptable to the various income brackets.

A new catalog, just off the press, describing the 1946 Nemco line of auto-radio antennas, has been released by the National Electronics Manufacturing Co., 22-27 Steinway St., Astoria 4, New York.

The catalog gives complete details of the five types of Nemco auto-radio antennas; each one available in various lengths. The catalog features several new departures in design and engineering.

# It's been a long time!

SINCE 1941, in fact...and a lot of things have happened to make a lot of changes in the industry.

**PRESTO** has packed a *lifetime* of development into the war years. Today, using what we have learned between 1941 and 1946, we're going top-speed to bring you the results of those wartime developments. Results which show up in *better* engineering and *better* performance of PRESTO recording equipment.

**PRESTO** dealers and distributors want increased production. We will give it to them just as fast as PRESTO engineering standards permit. Equal and fair distribution of this stepped-up volume is wanted—and that, too, we pledge to every one of our dealers and distributors.



**WELCOME** to the 1946 Radio Trade Show! Let us show you why PRESTO will set the pace again—just as in prewar days!

 **PRESTO** RECORDING CORPORATION  
242 West 55th Street, New York 19, N. Y.  
WALTER P. DOWNS, LTD., in Canada

WORLD'S LARGEST MANUFACTURER OF INSTANTANEOUS SOUND RECORDING EQUIPMENT

# Distributors in Action

## Midwest Wholesaler Sees Big Electronic Field

It makes a significant stir in the radio parts distributing business of the Midwest when a firm, which is one of the very oldest companies in the area, decides that it is time to go hot and heavy into electronic supplies.

Interstate Distributors, 1236 East Douglas, Wichita, Kan., has its electronic interests plastered prominently all over its promotions and its policies, as a kind of a keynote for postwar distribution of parts. The firm has 750 accounts among dealers and servicemen in Kansas and Oklahoma. It formerly operated as Stewart Warner Products Co. at 415 East 2nd St., in Wichita.

Only one other thing, besides electronics, will get the emphasis, according to J. D. Pottenger, manager, and S. J. Lyon, sales manager. Interstate will also accent a half dozen specialty items of the traffic appliance type.

Mr. Pottenger has analyzed the special nature of the electronic supply market in the Kansas-Oklahoma area, and has made his plans according to the kinds of industries which flourish there. In general, these industries are dominated by the production of oil and gas, and the handling of grain. The best electronic bets in the area are believed to be: (1) Equipment for heat treating, (2) Temperature and fuel controls for refineries, (3) Spot-welding apparatus, and (4) Devices used in automatic accounting in offices.

For the more general needs of the area,

Interstate will have expanded stocks of industrial type tubes, magnetic chucks, photo-cell units, relays, etc., as well as the most advanced special types of public address equipment.

The firm is expanding its staff to provide its accounts with more engineering aid as needed. The company is aware of the fact that many radio men, particularly the newcomers to the trade, will need special help to develop the electronic business. But Interstate has found that dozens of radio dealers and servicemen are keenly and intelligently interested in the field.

These Wichita jobbers believe that after the so-called sales bonanza in radio and appliances arrives and departs, the radio man with a stake in electronics will find himself in a highly profitable position.

## Jobber Starts "Preventative" Service

The policy of sending a man out to check on all radios before the dealer offers them to buyers, has been adopted by the H & S Distributing Co., the Lear distributors in Philadelphia. The plan was started by Art Gerbig, the H & S sales manager.

Mr. Gerbig uses one or more radio engineers on his staff to follow each shipment of sets to dealers, and to check every unit after it arrives in the store. Retailers have instructions not to sell any set before the check-up by the trained H & S engineer.

Nate Hast, the merchandise manager of Lear's home division, who signed up the H & S firm as a Lear jobber, heartily rec-

## Via Air Freight



Radios were among the first products to be shipped via United Air Lines new daily air freight service, now flying coast to coast. This Zenith set was one of those going from Chicago to West Coast distributors.

ommends the plan. Hast pointed out that "No matter how well a set is constructed, the handling that it gets between factory and the customer's hands is terrific. After all, a radio is a delicate instrument, and cannot stand such rough treatment without occasional breakdowns. Mr. Gerbig's plan will pay off heavily in goodwill for the retailer, for the distributor, the manufacturer and the industry as a whole. I certainly hope that others will take this suggestion to heart and do something like it."

## Distributes Clarion

Seattle Radio Supply, Inc., with headquarters in Seattle, Washington has been appointed distributor for the new Clarion line of radios and radio-phonograph combinations for the Seattle, Washington, Spokane, Washington and Portland, Oregon territories, according to Reau Kemp, Clarion sales manager.

Glen A. Reeves is president of the firm, which has branch offices in Spokane and Portland. Tom Howe is manager of the Spokane office and Art Fite is the Portland manager.

## DeMambro Appointed

Allan R. Royle, sales manager, sound equipment division, Stromberg-Carlson Company, has announced that the DeMambro Radio Supply Company of Boston, Mass., was the latest area distributor to join the Stromberg-Carlson roster. Joseph A. DeMambro, president, signed the 52-year old company's sound equipment distributor franchise covering the full line of sound, amplifying and intercommunications equipment produced at the local plant.

## Milben Opens

New distributing firm just opened in Maryland is Milben Distributors, Inc., located in the Earle Building, 74 W. Washington St., Hagerstown.



Interstate Distributors, the Wichita, Kan., jobbers with a feature interest in electronic equipment, use only one color in their big store, solid white.



# YOU ARE SELLING QUALITY ENTERTAINMENT...



# WHEN YOU SELL MEISSNER!

Meissner quality instruments . . . accepted by artists and music lovers alike . . . are fashioned for pleasure and surpassing in charm . . . true perfection in fine music and authentic cabinet design.

Examine the completely new Meissner line with its many outstanding features. You will want this new, superior radio phonograph for your discerning customers and for yourself. For full information, write to Meissner, 936 N. Michigan Ave., Chicago, Ill.

Watch Meissner's great new consumer advertising campaign currently appearing in Fortune, National

Geographic, House Beautiful and other class publications. Inquiries are pouring in and consumer acceptance is on the march.



**MEISSNER MANUFACTURING DIVISION OF MAGUIRE INDUSTRIES, INCORPORATED**

# Distributors in Action

## Midwest Wholesaler Sees Big Electronic Field

It makes a significant stir in the radio parts distributing business of the Midwest when a firm, which is one of the very oldest companies in the area, decides that it is time to go hot and heavy into electronic supplies.

Interstate Distributors, 1236 East Douglas, Wichita, Kan., has its electronic interests plastered prominently all over its promotions and its policies, as a kind of a keynote for postwar distribution of parts. The firm has 750 accounts among dealers and servicemen in Kansas and Oklahoma. It formerly operated as Stewart Warner Products Co. at 415 East 2nd St., in Wichita.

Only one other thing, besides electronics, will get the emphasis, according to J. D. Pottenger, manager, and S. J. Lyon, sales manager. Interstate will also accent a half dozen specialty items of the traffic appliance type.

Mr. Pottenger has analyzed the special nature of the electronic supply market in the Kansas-Oklahoma area, and has made his plans according to the kinds of industries which flourish there. In general, these industries are dominated by the production of oil and gas, and the handling of grain. The best electronic bets in the area are believed to be: (1) Equipment for heat treating, (2) Temperature and fuel controls for refineries, (3) Spot-welding apparatus, and (4) Devices used in automatic accounting in offices.

For the more general needs of the area,

Interstate will have expanded stocks of industrial type tubes, magnetic chucks, photo-cell units, relays, etc., as well as the most advanced special types of public address equipment.

The firm is expanding its staff to provide its accounts with more engineering aid as needed. The company is aware of the fact that many radio men, particularly the newcomers to the trade, will need special help to develop the electronic business. But Interstate has found that dozens of radio dealers and servicemen are keenly and intelligently interested in the field.

These Wichita jobbers believe that after the so-called sales bonanza in radio and appliances arrives and departs, the radio man with a stake in electronics will find himself in a highly profitable position.

## Jobber Starts "Preventative" Service

The policy of sending a man out to check on all radios before the dealer offers them to buyers, has been adopted by the H & S Distributing Co., the Lear distributors in Philadelphia. The plan was started by Art Gerbig, the H & S sales manager.

Mr. Gerbig uses one or more radio engineers on his staff to follow each shipment of sets to dealers, and to check every unit after it arrives in the store. Retailers have instructions not to sell any set before the check-up by the trained H & S engineer.

Nate Hast, the merchandise manager of Lear's home division, who signed up the H & S firm as a Lear jobber, heartily rec-

## Via Air Freight



Radios were among the first products to be shipped via United Air Lines new daily air freight service, now flying coast to coast. This Zenith set was one of those going from Chicago to West Coast distributors.

ommends the plan. Hast pointed out that "No matter how well a set is constructed, the handling that it gets between factory and the customer's hands is terrific. After all, a radio is a delicate instrument, and cannot stand such rough treatment without occasional breakdowns. Mr. Gerbig's plan will pay off heavily in goodwill for the retailer, for the distributor, the manufacturer and the industry as a whole. I certainly hope that others will take this suggestion to heart and do something like it."

## Distributes Clarion

Seattle Radio Supply, Inc., with headquarters in Seattle, Washington has been appointed distributor for the new Clarion line of radios and radio-phonograph combinations for the Seattle, Washington, Spokane, Washington and Portland, Oregon territories, according to Reau Kemp, Clarion sales manager.

Glen A. Reeves is president of the firm, which has branch offices in Spokane and Portland. Tom Howe is manager of the Spokane office and Art Fite is the Portland manager.

## DeMambro Appointed

Allan R. Royle, sales manager, sound equipment division, Stromberg-Carlson Company, has announced that the DeMambro Radio Supply Company of Boston, Mass., was the latest area distributor to join the Stromberg-Carlson roster. Joseph A. DeMambro, president, signed the 52-year old company's sound equipment distributor franchise covering the full line of sound, amplifying and intercommunications equipment produced at the local plant.

## Milben Opens

New distributing firm just opened in Maryland is Milben Distributors, Inc., located in the Earle Building, 74 W. Washington St., Hagerstown.



Interstate Distributors, the Wichita, Kan., jobbers with a feature interest in electronic equipment, use only one color in their big store, solid white.

# YOU ARE SELLING QUALITY ENTERTAINMENT...



# WHEN YOU SELL MEISSNER!

Meissner quality instruments . . . accepted by artists and music lovers alike . . . are fashioned for pleasure and surpassing in charm . . . true perfection in fine music and authentic cabinet design.

Examine the completely new Meissner line with its many outstanding features. You will want this new, superior radio phonograph for your discerning customers and for yourself. For full information, write to Meissner, 936 N. Michigan Ave., Chicago, Ill.

Watch Meissner's great new consumer advertising campaign currently appearing in Fortune, National

Geographic, House Beautiful and other class publications. Inquiries are pouring in and consumer acceptance is on the march.

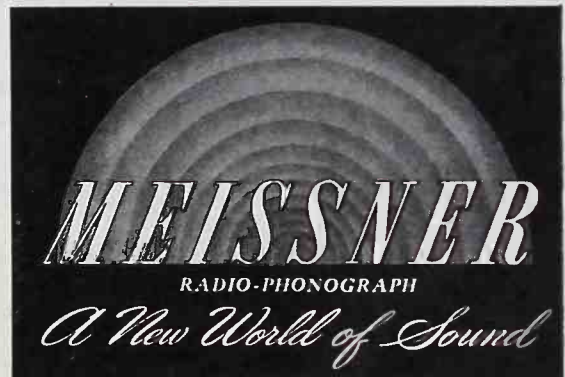

**MEISSNER MANUFACTURING DIVISION OF MAGUIRE INDUSTRIES, INCORPORATED**

# Sales Building MUSIC RACKS

for  
**SHEET MUSIC, FOLIOS, BOOKS  
and OCTAVO SIZE MATERIAL**

Display your stock to the best advantage in these Attractive, Space-Saving, Inexpensive Racks. Sturdily constructed in wood, metal and wire.

**Choose from SEVEN different Superior models designed to fit your particular needs. Priced from \$3.00 to \$13.00 according to size.**

These racks are easy to move, convenient to ship, and combine showmanship with sales appeal—let them work for you! Fill in and mail the coupon below and we will send you our illustrated MUSIC RACKS circular which gives complete information about each rack.

Carl Fischer, Inc., famous as the One-Stop music jobber, supplies your needs for the music of all publishers at the lowest prevailing prices.

Our "Unit Plan" for stocking and selling popular music can help you establish a profitable sheet music department on a minimum initial outlay. The coupon below may be used for requesting further information about the plan.

## CARL FISCHER, INC.

62 Cooper Square, New York 3, N. Y.

BOSTON • CHICAGO • DALLAS • LOS ANGELES

Department R.  
CARL FISCHER, INC.  
62 Cooper Square  
New York 3, N. Y.

Gentlemen:  
 Kindly send me further details about your new MUSIC RACKS.  
 I am interested in details of your "Unit Plan" for popular sheet music.

Check items you are interested in.

Name .....

Address .....

City ..... State .....



## Rejoins Tele-tone Reps



After a colorful 31 years in the Army, Col. Allison J. Holifield of the AAF is back with his brother and partner, W. L., at Holifield & Co., Jackson, Miss. The firm represents Tele-tone radio in Mississippi and Alabama.

## Omaha Jobber Opens New Quarters

Mueller & Selby, Omaha, Neb., distributors, have opened their new, modernized quarters at 2615 Farnam St. in Omaha.

The 50 by 132 foot building has been completely remodeled with all physical changes designed to streamline operational efficiency. A large paved parking space adjoins the building with a driveway direct to the 50 by 50 foot "Drive-In" radio repair and parts department. This feature will greatly facilitate the loading and unloading of dealers service trucks.

One of the standout features of the new set-up is the 24 by 30 foot sound-proof audition studio. Here, in an acoustically perfect room, dealers can listen to the new home and auto radios, and order their stock with a complete knowledge of the sets. The general offices and accounting department occupy one entire side of the building. Mueller & Selby are Motorola jobbers.

## Allied Stages Garod Show

A local "merchandise mart" was staged recently by the Allied Electric Supply Co., Pittsburgh, Pa., in the city's William Penn Hotel. Bernard Samuels, head of the organization distributing Garod radios in western Pennsylvania and a portion of West Virginia, reported that the loudest demand among retailers at his 3-day showing was for more merchandise.

Dealers were told that factories are stepping up deliveries, and soon hoped to fulfill all the urgent requests for shipments.

## Jobber Becomes Banker

R. H. Johnson has left his position as sales manager of the Fort Orange Radio Distributing Co., Albany, N. Y., and has accepted an appointment as assistant vice president with the Mechanics & Farmers Bank, in Albany.

# Sounds like the Professor **IN PERSON** to Mrs. Kay Kyser!



## Olympic's 'TRU-BASE' makes the wives of radio stars your star salesmen!

Every month, in America's leading national magazines, the wives of high-rating radio stars tell readers why they choose Olympic over all other radios. They tell of their first thrill at hearing their husbands' voices and music reproduced with in-the-room fidelity. *Theirs is the most convincing testimony any radio could have.* Testimony featured *only* in Olympic advertising.

In June and July, it's lovely Georgia Carroll (Mrs. Kay Kyser). She feels that listening to Olympic's 'Tru-Base' is like listening to the Professor *in person!* That statement will reach an audience of over 19 million readers. It will get attention. It will create belief in Olympic. It will build Olympic consumer demand — *for you!*

And 'Tru-Base' *lives up to that promise!* For it gives even moderately priced table models the glorious tones of the *costliest* consoles.

You, yourself, know that consumers will want, and are *entitled to*, the electronic advances developed during the war. These advances, *when used*, make a startling difference in fidelity of

radio reception. Olympic *has* these advances in 'Tru-Base.' *Your customers* will appreciate the advantages of Olympic's exclusive electronic development the moment they hear it compared with other radios.

And that's not all! Beauty of design is combined with this beauty of tone. Olympic Radios are fine furniture. Handsomely modern, not fustily "modernistic," Olympic cabinets are styled by an internationally famous designer in rare-grained hardwoods and lustrous plastics.

Millions of Americans are learning the dramatic 'Tru-Base' story. Millions of American families will want Olympic table radios, radio-phonograph combinations, portables!

**Olympic**  **Radio**  
The only radio with 'Tru-Base'

Olympic Division of Hamilton Radio Corporation, New York, N.Y.

And **NOW!** a "Pocket-size" OSCILLOSCOPE

# The POCKETSCOPE



See the  
**POCKETSCOPE**  
at the show:  
Booth 26  
Stevens Hotel  
May 13-16

- So **SMALL** in size (4" x 5½" x 10")
- So **LIGHT** in weight (5½ lbs.)
- So **COMPLETE** in performance
- So **INEXPENSIVE** in price
- Plus **WIDE-ANGLE VISION**: on shelf, on floor, on bench
- Plus **RETRACTABLE LIGHT SHIELD**: for increased visibility

## FOR DELIVERY:

Contact your nearest jobber. If he doesn't have the **POCKETSCOPE** available, contact us direct.

**\$55** net

**WATERMAN PRODUCTS CO.**  
INCORPORATED  
Phila. 25, Pa.



**WATERMAN PRODUCTS**

## Frigidaire Holds Nat'l Sales Training Meetings

The Frigidaire Div., General Motors Corp., conducted the first of a series of training programs for more than 300 district personnel in Dayton, Ohio. 75 appliance sales managers and district repre-



Looking at Frigidaire refrigerator model DI-7, (l. to r.): H. S. Kropp of J. J. Pocock, Inc., Phila.; N. E. Naugle, Frigidaire branch, Kansas City; and M. C. Werner, Frigidaire branch, Denver.

sentatives of the 44 Frigidaire distributing organizations throughout the country, together with factory sales department people, were in attendance.

Phases of organization, products, advertising, sales promotion, publicity, sales, distribution and service were discussed. Succeeding schools will be attended by district commercial sales managers, sales promotion managers, district representatives, and other key salespeople.

## Atlanta Firm for Cosmo Records

The Barnett-Hooker Co., 102 Cain St., N.W., Atlanta, Ga., has been appointed exclusive distributor for Cosmo records for the states of Georgia, Florida, North and South Carolina, and West Virginia.

Officials of the jobber firm are Milton I. Barnett, director of sales and promotion, and E. M. Hooker, who is in overall charge. N. Emerson Bledsoe, formerly branch manager for Decca and Victor in Atlanta, has been added as a branch supervisor for Cosmo releases.

## Increases Staff

Mill Distributors, Inc., Charlotte, N. C., have added P. G. Griffin and R. H. Roscoe to their sales staff servicing Garod radio dealers in North Carolina and a portion of South Carolina.

## Reps Annual Dinner

The annual meeting and dinner of the New York Chapter, Representatives of Radio Parts Mfrs. was held April 11, with President Leo Freed presiding.

# NOW READY!

## Woodall's Brand New Mailing Lists of the RADIO and ELECTRICAL TRADES

### Coast-to-Coast Coverage—Wholesale & Retail Outlets

- |                           |                                |
|---------------------------|--------------------------------|
| 1 Super Dealers           | 8 Furniture Stores             |
| 2 Class A Dealers         | 9 Hardware Stores              |
| 3 All Dealers             | 10 General Stores              |
| 4 Service Organizations   | 11 Contractors                 |
| 5 Record and Music Stores | 12 Sound Equipment Specialists |
| 6 Chain Stores            | 13 Manufacturers' Agents       |
| 7 Department Stores       | 14 Wholesalers                 |

### Coded—Classified—and Guaranteed

Everyone of these lists is coded and classified to permit selection of the best sales outlets for all kinds of radio and electrical appliances or products. Classified for selection by States or counties—likewise large, medium or small sized cities and towns—or by your individual jobber territories.

Don't use pre-war lists—they're NOW 50-90% waste. Your new products and new sales plans deserve up-to-date lists of present day dealers. *Every* name on these BRAND NEW Woodall Radio and Electrical lists has been

checked against Dun's Register, new telephone directories and other records of known accuracy. So we can and do guarantee *every* one of these new names 100% against post office returns.

These lists are the latest addition to the famous group of Woodall "Bull's Eye" lists—the lists that give you the right man in the right place.

Use them for all of your sales promotion work and get the best possible distribution and maximum results from your direct-mail campaigns.

*Write or wire today for full information, list counts and prices.*

## THE W. P. WOODALL CO., INC.

153 WAVERLY PLACE

CHelsea 3-0965

NEW YORK 14, N. Y.

## Phila. Servicers Sign Mutual Assistance Pact

A unique contract between Radio Station WFIL and the Philadelphia Radio Service Men's Association suggests a new angle for service groups throughout the country. Finding that members of the P.R.S.M.A. had benefitted greatly from past advertising programs on WFIL, the Association worked up a new agreement which in effect exchanges the advertising facilities of the store-owners on the one hand, and the radio station on the other.

WFIL will supply commercial spots, a new musical program over WFIL and WFIL-FM, car and bus card promotion, and answer phone inquiries from listeners. In return, Association members will display in their windows WFIL placards, include WFIL inserts in outgoing mail,

and distribute survey questionnaires to their customers.

Newly-elected officers of P.R.S.M.A. for 1946-47 are: Dave Krantz, president; Peter Rapagnanni, vice-president; Stanley Myers, treasurer; Fred Keil, recording secretary. New advisory board members are: F. B. Guthrie; George Greenberg; Robert McGrath; Lew Witte, and Harry Small.

## Handweg Back to North Central Area

Howard Handweg of Motorola has left the production dept. and has returned to the sales division of the Galvin Mfg. Corp. Mr. Handweg is now contacting dealers and distributors in South Dakota, North Dakota, Wisconsin, Minnesota, Nebraska, Iowa and Northern Illinois.

## Connecticut Preview



Lynn Eaton, eastern regional sales manager of Bendix Home Appliances, shows Mory Isaacs, head of Mory Sales Co., New Haven, Conn. distributors, the new Bendix automatic home dryer.

# News of the Industry

## Dealer Group Acts to Change OPA Pricing

Radio dealers in New Orleans have taken action to let the OPA know how they feel on the matter of the current pricing policies. A strongly worded resolution has been adopted by the Radio Dealers Association of New Orleans and sent to all members of Congress from the state of Louisiana.

The resolution was prepared by the retailers to act "as our request to them (the Congressmen) to use their power and influence to offer the radio industry the relief it so sorely needs, by either having the OPA restore the 40% discount to retail radio dealers, or if necessary, to work for the elimination of price control on this commodity."

The resolution contained eight of the "Whereas" clauses, which are as follows:

1. The margin of profit as determined by the Office of Price Administration does not afford a reasonable profit for the retail and wholesale radio dealers.
2. The costs of all service, material and salaries necessary to conduct a retail or wholesale radio business has substantially increased during the last five years.
3. The retail and wholesale radio dealers, because of their inability to acquire merchandise, were not in a position to obtain the benefits of business during the war and in many instances operated at a loss.
4. The price differential between the sale price and cost price on radio sets for retail and wholesale radio dealers does not leave a fair margin of profit in order to pay the increased expenses and hire the necessary labor and thus aiding in the reconversion of industry.
5. The extremely small profit which now prevails on radio sets will definitely promote and encourage a "Black Market".
6. A discount of at least 40% is required, in lieu of 29.9% now prevailing, in order to properly conduct a retail radio business.

7. The margin of profit as set up by OPA is completely unfair to the retail and wholesale radio dealers now in operation.

8. If the above mentioned conditions are not remedied, irreparable damage and loss will be suffered by the retail and wholesale radio dealers.

## Standards for Sound Equipment in Schools

The School Equipment Committee of the Radio Manufacturers Association has met with representative educators of the U. S., and there has been a joint approval of a program for the standardization of radio and sound equipment for schools. The announcement was made by RMA.

Plans now in the hands of the RMA engineering and sound system sections for final drafting call for the establishment of a set of minimum standards for school radio and sound facilities to protect the institutions from inadequate equipment

and to permit free exchange of radio educational material.

Tentative specifications for the school radio equipment were drawn and approved at a meeting in Cleveland of the RMA Committee and representatives of the National Education Association, the Association for Education by Radio and the U. S. Office of Education.

The specifications cover five classifications of school radio and sound amplifying equipment—central program distribution systems, classroom receiving sets, portable transcription players, speech input units and recorders.

The purpose of establishing a set of minimum standards for school radio facilities is to provide a guide for teachers, supervisors, school administrators and school purchasing agents in the selection and purchase of sound equipment to protect them from:

1. Inferior equipment.
2. Purchase of equipment not designed to meet the kinds of instructional applications in which schools are interested.
3. Difficulties which arise from attempting to use equipment for applications other than those for which it was intended.

In addition, RMA officials pointed out that standardization of school sound facilities will encourage exchange of material between various organizations and school groups, thus reducing the costs of radio educational programs.

## Heads Ken-Rad Plants

L. K. Alexander has been named manager of the Ken-Rad Division of General Electric's Electronics Dept. with headquarters at Owensboro, Ky.

Mr. Alexander will be in charge of the operations of G.E. Ken-Rad plants at Owensboro, Ky., and Huntingburg, Ind., and also will be responsible for the management of government-owned G.E. company plants at Bowling Green, Ky., and Tell City, Ind.

## Sylvania Sales Exec



Harold P. Gilpin has been appointed by Sylvania Electric Products Inc., as assistant general sales manager of its radio division. He's been with the firm for 16 years and formerly headed up equipment tube sales.



1926 to 1946



*Sparton*  
Radio's richest voice since 1926

Compare the value in this superb new 1946 Sparton Radio Photograph with any new model you see rich voice features—almost and mahogany.

Value No. 1—Seven tube superheterodyne receiver with 3 wave bands—standard, and two short wave.

Value No. 2—Automatic trouble-free record-changer that plays twelve 10-inch or ten 12-inch records monthly.

Value No. 3—Two spacious record-storage compartments.

Value No. 4—Built by Sparton craftsmen—highest quality throughout—superior piece of furniture.

Value No. 5—The Sparton plan of selling direct to exclusive reputable dealers (only one in each community) insures you better radios at lower prices. For proof of this—LOOK AT THIS PRICE!

Now on display by your Sparton dealer. Complete the "Sparton" section of your local telephone directory. **\$149.95**

The Sparks-Withington Co., Jackson, Michigan  
Sparton of Canada, Limited, London, Ontario

*Sparton's*

*This ad appeared in the May 27th issue of Life*

greatest campaign is beginning to roll . . .

WHEN you open your copy of LIFE for May 27 you'll see another full page, full color advertisement in the new 1946 Sparton campaign, greatest in Sparton's 20-year history.

You'll notice two things especially—the warm, human interest paintings by Michael, well-known magazine illustrator . . . and the direct color photographs that capture the full beauty of the featured Sparton radios.

And if you're a Sparton dealer, you'll be glad to know that along with LIFE, you're getting this distinguished advertising in SATURDAY EVENING POST and COLLIER'S . . . which means each Sparton advertisement appears in about 10,000,000 copies of these three magazines.

Come May, there'll be a trainload of fine new merchandising aids for you on this great cam-

aign—newspaper ads, displays, banners, mat service, and other ideas you'll want to use. You can look forward to a portfolio of solid, usable material.

With hundreds of thousands of owners already convinced of Sparton's trouble-free performance . . . and millions of prospects seeing this great new campaign . . . Sparton is really beginning to roll!

THE SPARKS-WITHINGTON CO., Jackson, Mich.

**SPARTON**

RADIO'S RICHEST VOICE SINCE 1926



there  
is

# NO SUBSTITUTE

for good, honest WIRE, unwinding itself  
cross-country, through mighty public buildings and  
humble cottages, in and out of America's radio sets and  
legion other communications units. You are getting some  
CORWICO Wire now . . . and more is on the way . . .

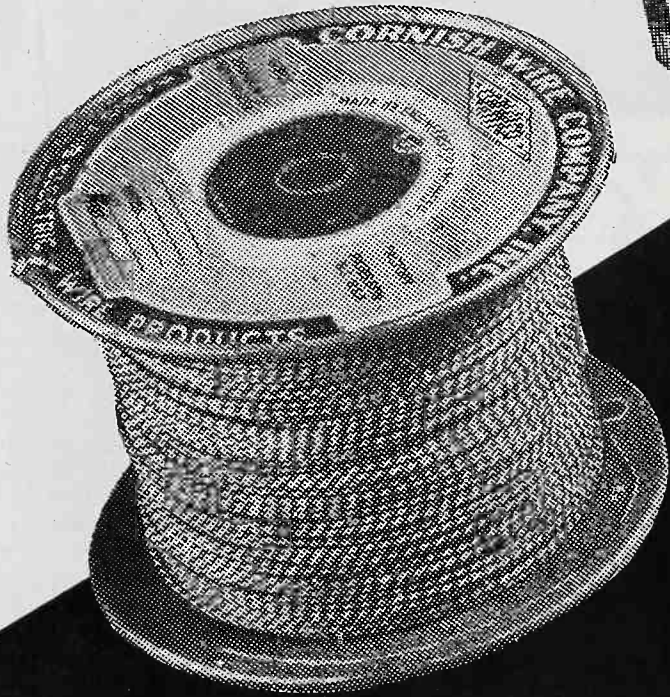
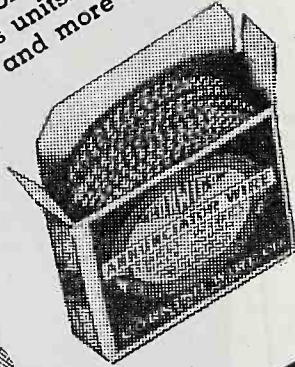

## cornish

WIRE COMPANY, INC.

15 Park Row, New York 7, N. Y.

*"Made by Engineers for Engineers"*

### Owesen & Co. Obtains Westinghouse Line

Owesen & Co., Pacific Coast wholesalers with headquarters at 101-105 Front St., San Francisco, has taken on the complete line of Westinghouse electrical appliances and radios, according to announcement by Col. Oliver Vickery, sales and traffic manager.

Established 35 years ago by A. B. Owesen, the present head of the firm, the organization maintains offices at San



Col. Oliver Vickery

Pedro and New York, and is opening another branch in New Orleans. In addition to its activities in distributing home appliances, Owesen & Co. is prominent in the marine electrical supply business.

### Boston Company Expands Lines and Staff

Equipment Distributors, Boston, the jobber for Monitor products in eastern Massachusetts, have moved into new quarters, with 14,000 sq. ft. of space at 594 Newbury St. Expansion includes a number of new franchises, according to president Alvin C. Zises, including Westinghouse air conditioning, Miracle, Jabar, Modern Maid, Victor fans, Mectron radios and phonographs, LeWinter, A. C. Gilbert, Bersted, Savage and Plymodern furniture.

Added to the sales organization are Samuel Kravath, Hudson Sacks, Ted Lapidus, Roy Corey, and Philip Orenberg. Specialty sales groups will be formed for each major department.

### "Please Don't Send Flowers!"

When Sunset Electric Co., jobbers of Portland, Ore., held "open house" at their new building at 1035 N.W. 14th Ave. the invitation cards sent out by the company carried a note which attracted wide attention.

What the card said was, "We consider ourselves a very live organization, so please don't send flowers. Instead, give your dollars to help your Red Cross."

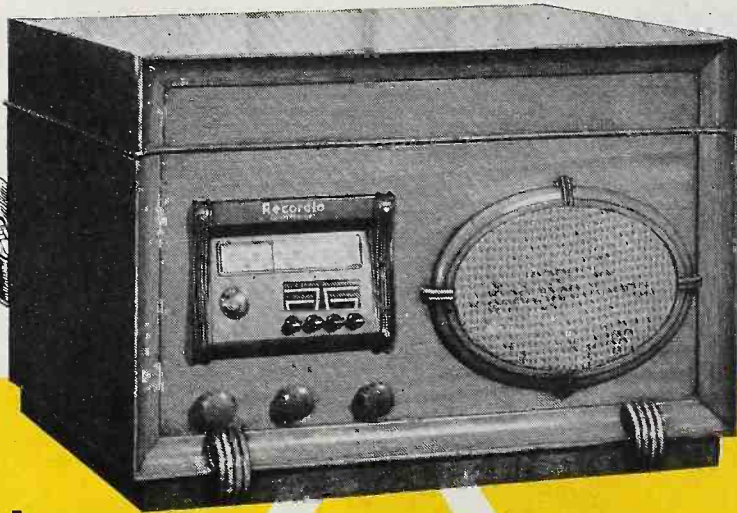
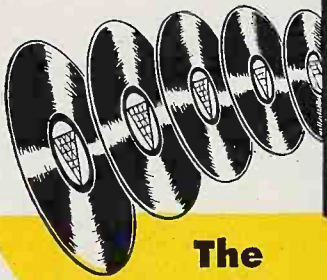

The  
Radio-  
Phonograph  
with the  
**BIG PLUS...**

*The World's Finest Home Recording Instrument*

**Recordio**  
TRADE MARK REGISTERED

*You'll profit handsomely*  
**with its Big Plus Feature!**



...is today's  
busiest  
franchise!

During May... in your store... America will see RECORDIO, that superb radio-phonograph with the postwar's biggest plus feature... the world's finest home recording instrument.

During May, RECORDIO launches its dynamic national magazine campaign. A page advertisement in color, in Ladies' Home Journal and Better Homes and Gardens, accelerates the rush

of prospects to your door by inviting all America to come in for free recording... to see that recording with RECORDIO is simple as 1... 2... 3.

The high fidelity radio and phonograph are companions of quality for this... the world's finest home recording instrument. The profits that accrue from selling this unbeatable combination America can't resist will be yours.

**Recordio**

RECORDING INSTRUMENTS FOR HOME,  
COMMERCIAL AND PROFESSIONAL USE

by  
**WILCOX-GAY CORPORATION, Charlotte, Mich.**  
*Also Manufacturers of famous*

WILCOX-GAY CORPORATION  
Charlotte, Michigan  
Gentlemen: Tell me more about the RECORDIO opportunity that is still open in my territory.

Store Name.....  
Address.....  
City..... Zone... State.....  
R & TR-546

86-2911

**Recordio Discs and Recordiopoint**

CUTTING AND PLAYBACK NEEDLES

## ALWAYS ROOM FOR ONE MORE



The unusually flexible switching system in your Jackson Dynamic Tube Tester is designed to check new tubes for receivers as they come out. New roll charts supplied when necessary. Spare socket positions are also provided.

### MODEL 636 DYNAMIC TUBE TESTER

with built-in rotary tube chart

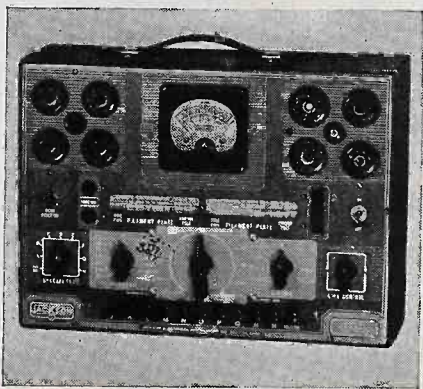

**"Dynamic" Method of Test**—Makes a better test on every tube. The "Dynamic" method is more accurate, frequently finding poor tubes which might pass for good in ordinary testers.

**New High-Voltage Power Supply** is a feature of this tester. By testing tubes

at higher plate voltages (over 200 V. for some types), more accurate results are obtained.

**Tests All Tubes**—ALL of the popular receiving types and television amplifiers, including BMTAMS—LOCTALS—SINGLE ENDED—HIGH VOLTAGE FILAMENT TYPES AND MINIATURES. Provision for many more. The tester is protected against obsolescence in every possible feature.

**Roll Chart tube index**—simplifies correct settings.

**Full Range Filament Selections**—From  $\frac{3}{4}$  V. to 115 V. Selector marked directly in volts. This feature eliminates guess work and helps operator to avoid mistakes.

**Most Improved Type of Switching System**—Spare circuits and switch positions provided for future use. Two "spare" socket positions.

**Noise Test jacks** are provided for audible test of possible tube noise.

**Portable Model:** Grey leatherette case, 14" long x 12" x 5 $\frac{1}{2}$ ". Weight: 11 lbs. Hinged lid removable.

**Bench Model:** Welded steel cabinet, 13" long x 9 $\frac{1}{2}$ " x 5 $\frac{1}{2}$ ". Weight: 10 lbs. Rubber bumpers on base and back.

# JACKSON

*Fine Electrical Testing Instruments*

JACKSON ELECTRICAL INSTRUMENT COMPANY, DAYTON, OHIO

### Pennsylvania Distributors Enlarge Facilities

Pennsylvania Wholesale Distributors, Philadelphia, have acquired 3,000 sq. ft. of extra showroom and office space across the street from their headquarters at 132 N. Fourth St. Ted Freedoff and David Shinberg are partners in the firm.

This expansion was needed for the addition of 22 more lines of home furnishings. Pennsylvania's sales force now does its merchandising in 37 states.

Several new electrical appliance lines will soon be handled by Pennsylvania, and a table model radio is being marketed nationally. Juvenile furniture will also be featured.

### Hydraulic Device Helps Deliveries

Now that radio appliance delivery matters again claim the attention of jobbers and dealers, one jobber has solved the problem of damage-in-handling by installing a new hydraulic tail-gate on delivery trucks.

The Harry Alter Co., Chicago distributors for Crosley and Coleman, have equipped their new 2-ton vehicles with the new device which lowers (or lifts) products "gently and quickly to sidewalk level without the slightest jar." The firm says that "no more refrigerators, radios, heaters or heavy appliances will be dropped from the tail-gate."

### Rejoins Southern Firm

Lee T. Davis has rejoined the Van Zandt Supply Co., wholesalers of Huntington, W. Va. Mr. Davis was formerly with this firm as a specialist on gas appliances; his new duties will include the sale and promotion of Coleman products, Servel refrigerators, and American kitchens.

### With Bruno-New York



Sid Pressler, ex-Army, is the new radio parts manager for Bruno-New York, Inc., RCA Victor and Bendix laundry equipment distributor in New York. Pressler will manage a greatly-expanded dept., now being developed along new lines.

# MAKING TUBES IS EASY...

*If* YOU KNOW HOW!

## HOW HYTRON CATHODE COATINGS ARE MADE

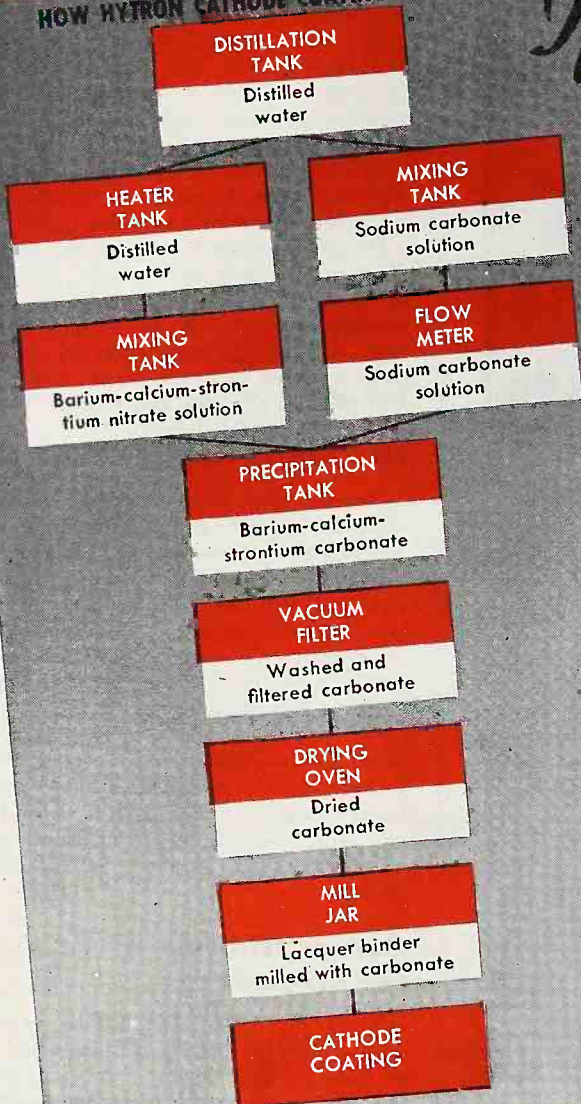

First floor of Hytron chemical precipitation system. Note the flow meter, precipitation tanks, and ceramic vacuum filters. Spotless cleanliness is vital to avoid contamination of carbonates precipitated for cathode coatings.

## AGAIN HYTRON KNOW-HOW WORKS FOR YOU...

**T**HIS photograph and flow chart may look strange in an advertisement on radio tubes. Chemistry and metallurgy, however, are a vital part of Hytron engineering. The picture illustrates the first of three floors used by Hytron's chemical system which precipitates the carbonates for cathode coatings.

Prewar, Hytron purchased such carbonates—as did most other tube manufacturers. Wartime mass production demanded much better quality control than suppliers offered. By doing the job itself, Hytron gained extra know-how which serves you in peacetime.

For these carbonates, absolute control is required of formulation, crystal size and shape, density, purity, and

viscosity. Most cathode coatings are prepared from carbonates compounded of barium, calcium, and strontium. The percentage of each of these elements affects the performance of different types of tubes. Crystal size and shape, density, freedom from impurities, all determine the degree of electronic emission. Variations in viscosity must be minimized to assure uniform application of coating on the cathode.

There is still much "black magic" in obtaining proper cathode emission. But Hytron makes easier the problems involved by accurate chemical and metallurgical controls. No research is too tough or too unrelated, if it leads to know-how which will give better performance of the Hytron tubes you buy.

OLDEST MANUFACTURER SPECIALIZING IN RADIO RECEIVING TUBES



# HYTRON

RADIO AND ELECTRONICS CORP.

MAIN OFFICE: SALEM, MASSACHUSETTS



**CLAROSTAT** FOR BEST RESULTS

*Controls and Resistors*

CLAROSTAT MFG. CO., INC.  
285 NORTH 6TH STREET  
BROOKLYN 14, N. Y.

**ATTENUATORS  
FIXED RESISTORS  
SLIDER RESISTORS  
POWER RESISTORS  
POWER RHEOSTATS  
BALLAST RESISTORS  
GLASOHM RESISTORS  
GREENOHM RESISTORS**

## Those Green Cartons . . .

★ Look for them on your Clarostat jobber's shelves. These new green cartons bring you the greatest selection of resistors, controls and resistance devices yet made available to the radio-electronic worker. ★ Also be sure to ask that jobber for your copy of the Clarostat postwar catalog. It's just chuckful of concise data and listings on everything you need for your resistance and control problems. ★ Or if you prefer, write us.

**CLAROSTAT**

*Controls and Resistors*

CLAROSTAT MFG. CO., Inc. · 285-7 N. 6th St., Brooklyn, N. Y.

### Plenty of Sets in Six Months

H. Leslie Hoffman, president of the Hoffman Radio Corp., Los Angeles, was heard over local KECA on the "What's New" program, and revealed his views on postwar radio receivers as well as television and FM.

Mr. Hoffman cited a general improvement with quieter reception and the development of tubes and speakers. To the question on when dealer shelves will be full so customers can take their pick of radio merchandise, he predicted that this will happen in 6 months if no new and unforeseen complications arise.

He also predicted that by the middle of 1947 television sets will be available in volume production with three price brackets. He cited the advantages of FM over AM as the separation of stations close together plus the clear and crisp reproduction of voice and music.

### IRC Shifts Reps

Robert Butler, former manager of IRC's customer service dept. at International Resistance Co., Philadelphia, has replaced Victor Nicholson as merchandise division sales engineer and will continue contact with IRC distributors in the Philadelphia office territory, comprising eastern Pennsylvania, New Jersey, Delaware, Maryland, Virginia and Washington, D. C.

Mr. Nicholson moves to the Harry B. Segar Co., manufacturers' representatives, Buffalo, N. Y., to assist Frank Taylor, Segar manager, in handling sales of IRC and other products to manufacturers and distributors in the upper New York State territory.

### Covers Midwest for Stromberg

T. R. Mathews of Des Moines, Ia., has been named a district merchandiser for 10 states of the Midwest, Stromberg-Carlson has announced. The appointment is part of an intensified "dealer-help" program. Mr. Mathews, recently of the Army, will cover the states of Michigan, Indiana, Wisconsin, Iowa, Minnesota, Nebraska, Missouri, Kansas, Oklahoma, and Colorado.

### AAF Vet in Business

Don Sparks has returned to his home in Jackson, Mich., and after three years in the Air Force he will head up the Dorsan Co., which he recently organized in Jackson. The Dorsan firm will distribute products of the radio and appliance division of Sparks-Withington, in the state of Michigan.

### Wants More Export Lines

Edward A. Fiedler, owner of the United Radio & Electronic Service, retail establishment at 144 E. 61st St., New York City, is again expanding the export department of the store. Mr. Fiedler has been active in export for 15 years. He is now in position to represent additional manufacturers in this field.

See the Turner Exhibit at the Parts Show,  
Booth 49, Stevens Hotel, Chicago, May 13 to 16.



SWING OUT WITH TURNER

# COLORTONE

## Microphones

Turner pioneers again! *Colortones* are here to bring distinctive beauty to microphone applications.

Especially created for bands, television studios, entertainment spots and home recorders, these rugged plastic microphones come in a range of gem-like colors.

Their lustrous, streamlined beauty will blend, harmonize or contrast with any setting.

And new inside too! Improved crystal and dynamic circuits result in smoother, more accurate reproduction.

Write for complete specifications and information on *Colortone* colors now available.



Designed by  
ARTHUR HAGGSTROM,  
Noted Industrial Designer

### The **TURNER** Company

903 17th Street, N. E., Cedar Rapids, Iowa

**TURNER**-Pioneers in the  
Communications Field



Licensed under U. S. Patents of the American Telephone and Telegraph Company, and Western Electric Company, Incorporated.  
Crystals licensed under patents of the Brush Development Company



"Riggs says his Duotone 'Star' Sapphire needle has more *allegro* and *fortissimo*!"

## ... AND MORE SALES APPEAL, TOO!

The Duotone line means more profits for more dealers every day. Duodiscs, cutting needles and phonograph needles led by the famous five dollar "Star" Sapphire are quality-tested, profit-proven record accessories.

Every item in the Duotone line is attractively packaged to keep pace with the trend of "impulse buying" at the point-of-sale. New, eye-catching displays help sell Duotone products faster—again and again.

Carry Duotone. Sell it and it stays sold. Write us now for details and prices.

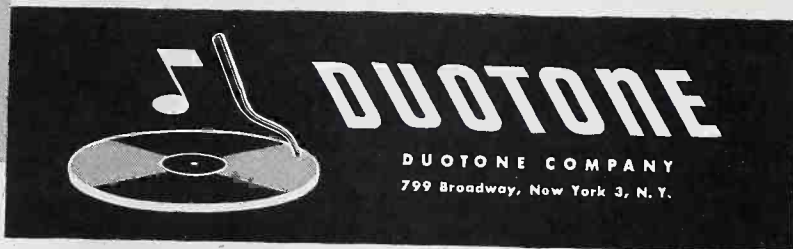

## YOUR VACUUM CLEANER BELT PROBLEM *Solved!*



No more worrying about the makes and models they fit **BECAUSE** every bag is marked with make and model number. The transparent bags keep the belts fresh and clean. The price problem is solved because the price is prominently printed on each bag. **ORDER NOW.** 8 assorted belt cards consisting of 96 belts will fit 130 makes and models. **YOUR COST, \$19.00 net, plus postage.** Retailers for \$24.00.



**FREE CATALOG** Our new catalogue listing 4531 items and 2911 illustrations giving list prices and your cost in code.

## The JESSE COMPANY

2438 W. NORTH AVE. CHICAGO 47, ILL.

## New Portable for Summer Selling

A new portable record-player with automatic record changer has been introduced by Duosonic Radio Corp., 414 Tremont Ave., Bronx, New York with an

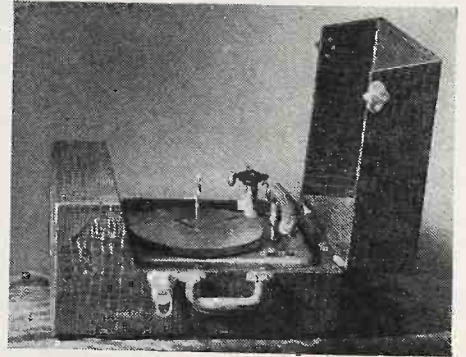

Timely portable by Duosonic.

OPA price of \$55.40 in Zone 1. This is model DA-31, with 3 tubes, volume and tone control and a 5" Alnico speaker.

This unit, ready for the summer market, comes in a simulated alligator case, and plays either 10" or 12" discs, 1½ w. output.

## Second New York Store for Newark Electric

A third store at 212 Fulton St., New York City, in the heart of "Radio Row" of downtown Manhattan, has been acquired by Newark Electric Co., 323 W. Madison St., Chicago, and 115 W. 45th St., New York City.

A full line of electronic equipment for industrial users, servicemen and radio amateurs will be carried. A large stock already is at hand with which to fill orders. The New York stores are under the supervision of Adolph L. Gross and Dave Ormont, while the Chicago branch is handled by Sam Poncher.

## Dealers Featured in Jobber's Ads

A new and attention-getting newspaper advertising campaign conducted by a radio distributor is the current "dealer support" series sponsored locally by Wilson Distributing Co., Columbia, S. C., jobbers for Garod radio. The ad messages, inserted three times weekly, carry testimonials of franchised dealers who praise the Garod line.

## Trilmont Heater Wins Safety Award

The Trilmont Safety Heater, made by the Trilmont Products Co., Philadelphia, and designed for complete safety in home use, was the winner of the First Annual Home Safety Award given by Lewis & Conger, New York housewares firm.

David M. Trilling, the Trilmont president, accepted a large bronze plaque at the climax of the competition in which 3,000 manufacturers were invited to participate.

Products receiving honorable mention were the Kler-Vue knife rack, the Mason bath mat, and the Luminite lighting switch plate.



## Vet Trainees See Jobbers and Dealers Work

Ten young veterans who are being groomed for important jobs at the RCA-Victor were recently guests of Raymond Rosen & Co., Philadelphia distributors as part of their "field" training. The 10 men, two from each branch of the services, were selected for special extended training from the outstanding college-graduate veterans who entered the service directly from school and therefore possessed no re-employment rights.

First sessions at Raymond Rosen's were devoted to a general study of the wholesaler's operating procedure in handling merchandise, delivery, show-room display and promotional activities. Later periods were spent visiting outstanding retail dealers and analyzing the business methods of different type stores. The special sales procedures for selling to stores of different categories was reviewed by the distributor's field salesmen.

## New Burkaw Manager Announces Lines

The new manager of the Burkaw Electric Co., 105 E. 29th St., New York City, is Jerry Herold. Mr. Herold was formerly the director of purchases for Emerson Radio & Phonograph Corp. and previously had been an assistant director of purchases for General Electric.

The Burkaw firm is marketing a full line of phonographs and amplifiers; the first models were two junior phonographs for children. Model JE-1 is electric and JM-1 is mechanical, both with an OPA price of \$16.50, including tax. To be released shortly is a record-player and re-



Jerome Lee Herold

order, Model PR-40, with 4 tubes and a 6" speaker. This will be paired with Model PC-40, a portable phonograph with a record changer, 4 tubes, 6" speaker.

Also on the Burkaw production schedule are two new amplifiers, each having 3 tubes and 5" speakers. PE-30 is a portable and TE-30 is a table model. The company is also ready with a new electric floor polisher.

**NOTED FOR TONE**

**HOWARD RADIO PHONOGRAPHS**

*with Sensational Acousticolor*

## Pretty, Aren't They?

Without the magic of Aladdin's Lamp, we've been depending more and more upon our own resourcefulness and engineering skill to keep production rolling. In order to bring you as many units as possible, more and more of the fine components that go into Howard Radios and Radio-Phonographs are being made in our own factory.

In the face of Howard demand, our best efforts still do not make it possible to get into production on some of the new models we have designed. The situation however is improving each week. Soon, we hope, we will be able to say more than "Pretty, aren't they?"

## HOWARD RADIO COMPANY

Chicago 13, Illinois

PIONEERS IN FM RADIO

*America's  
Oldest Radio  
Manufacturer*



## Expansion Move by Musitron

Expansion of business on a large scale has been started by the Musitron organization, manufacturers of portable phonographs of all types, transcription playback units and sound equipment.

Musitron, which was formerly known as the L. M. Sandwick Associates, has recently changed the name to the Musitron Company. L. M. Sandwick is no longer associated with this organization. The management of the company has not changed in any way and is still headed by Leo Frankel, general manager and a well-known engineer in the fields of radio, television, motion picture cameras and projectors.

Gerald H. Rissman, a junior executive with the firm for several years, is now

sales manager of Musitron. Mr. Rissman is one of the youngest executives in the radio industry.

A line is being produced "embodying many entirely new developments". Mr. Frankel states that there will be no change in Musitron's location or general policy, although the sales and manufacturing headquarters at 223 W. Erie St., Chicago, have undergone complete remodeling and modernization.

## Comdr. Scott Back to RWT in Boston

Lt. Comdr. Michael Scott, a radio man for 20 years, has been placed on inactive duty by the Navy and has returned to Radio Wire Television Inc., Boston, Mass., as vice president and general manager.

Comdr. Scott has been with Radio Wire



Lt. Commander Michael Scott

# Thank You!

Your cooperation has made it possible for us to grow. Now we are moving to our own newly erected and completely modern building where we will be able to serve you with ever better models and increased production.

Please address all future orders and correspondence to us at our new address...



Television Inc. since 1934 and has been vice president and general manager of the Boston branch since 1937. He is reorganizing his staff of 35, including 20 veterans, to initiate new merchandising plans in the distribution of radio-electronic components and equipment.

## Bert Knight Is Host to Radio Men

S. Bert Knight, manufacturers rep of Los Angeles, was host to a group of radio men at a party at which S. N. Shure of Shure Bros., and L. B. Calamaras, national secretary of NEDA, were special guests.

Others on hand for the event were: Charles Kierulff, Kierulff & Co.; Larry Lange and Ed Cook, Leo J. Meyberg Co.; Ken Sloan, Radio Parts of Arizona; Tom Lynch, Radio Products Sales Co.; Dick Weatherford, Radio Specialties Co.; Francis Hall and Don Randall, Radio & Television Equipment Co.; Jack Moulthrop, Radio Television Supply Co.; Jack Magner, Ravenscroft Co.; Ed Cherry and Harold Scott, Scott Radio Supply Co.; J. T. Waring and Phil Kudler, Universal Radio Supply Co. Assisting Mr. Knight were his staff members Al Rissi and C. J. Nace.

## Manufacturers Settle Dispute

The suit begun late last year by Templetone Radio Mfg. Corp., New London, Conn., against Teletone Radio Corp., New York City, has been settled in Hartford. Under the terms of settlement, the Teletone firm will hereafter hyphenate its radio name thus: TELE-TONE. Both firms waive all claims of conflict in their trade names. All future advertising and literature of Teletone will carry the hyphenated trade name.

## S. I. Ward Honored

Samuel I. Ward, president and general manager of Crystal Research Labs, Inc., New York, has been appointed a member of the International Economic Relations Committee of the National Association of Manufacturers. Mr. Ward was named by Robert R. Wason, president of NAM.

# On the way TO YOUR CUSTOMERS!

● Full page advertisements in leading national magazines... like the one shown below... will sell radios for Arvin dealers in months ahead as fast as we can deliver them—and we're doing our level best!



*This Little Beauty*  
ONLY \$12.95\*



**ARVIN**  
*Top Flight*  
**RADIOS**

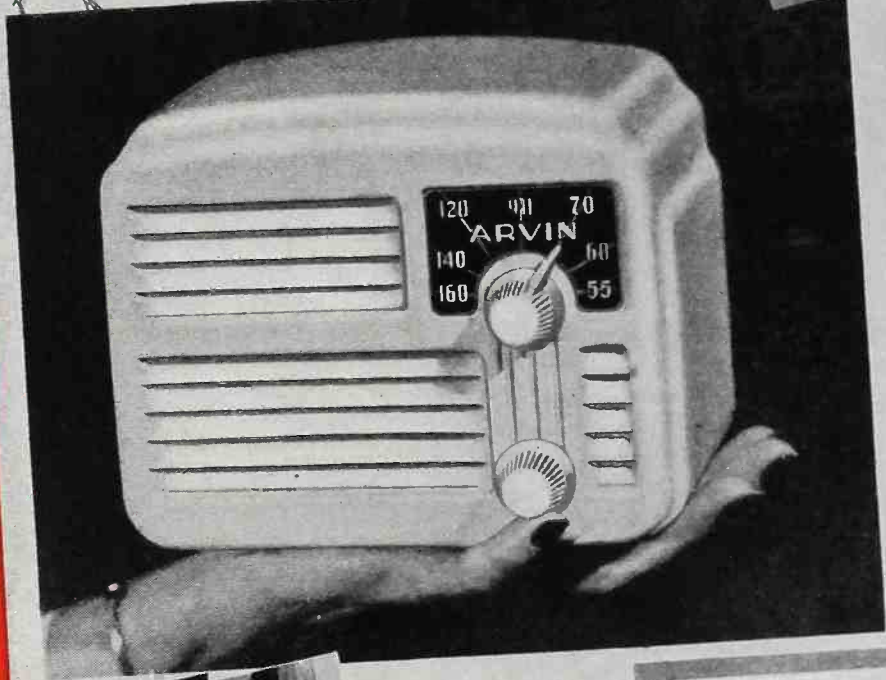

**Smart, Trim and Dainty**—this tiniest of the new Arvins is typical of many dependable radio values for which Arvin has long been known.

**So Small and Compact**—it takes but little table-space—no larger than a woman's hand. You can tuck it in your bag when you travel.

**So Big in Power and Tone**—it's a mighty fine performer, with room-filling volume... a genuine superheterodyne, with 4 tubes including rectifier for AC or DC operation.

**So Attractive in Design**—everyone admires its practical, non-breakable cabinet, with mar-resistant ivory or brown finish.

**So Low in Price**—many people are buying three or more... for use upstairs, downstairs and all through the house.

\*ARVIN Model 444A illustrated. Model 444 in brown finish only \$12.95. Prices include federal tax—slightly higher in far west.

UPSTAIRS...



DOWNSTAIRS...



MOST FAMILIES  
NEED 3 OR MORE  
ARVINS...

ALL THROUGH THE HOUSE



OTHER ARVINS You'll See at Radio Stores  
at Low Prices Everyone Can Afford



A really powerful table radio... 5 tubes, AC-DC, including rectifier; fine reception and clear tone with plenty of volume from built-in loop and electrodynamic speaker; colorful illuminated dial; lustrous ivory or rich walnut plastic cabinet. Ask to see Arvin model 543A.



This set has everything most people want in a table radio... highly sensitive super-het circuit, 6 tubes with rectifier, big volume, continuous tone control; fine permanent magnet speaker, built-in loop; ivory or walnut plastic cabinet. Ask to see Arvin model 553.

ARVIN is the name on many fine products of **MOBLITT-SPARKS INDUSTRIES, INC.**, Columbus, Indiana  
ARVIN Electric Irons • Electric Heaters and Appliances • Metal-Chrome Dinette Sets • Outdoor Metal Furniture • Laundry Tubs • Ironing Tables • Car Heaters

**TWO COMPLETE LINES**  
of *Newcomb Quality*  
**AMPLIFIERS**

Newcomb now offers the first truly post-war amplifiers... the result of advanced electronic engineering, backed by experience and a strict insistence upon perfection.

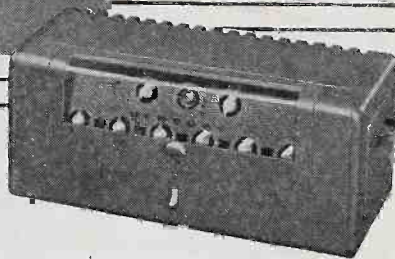

*Deluxe K Series*



*Standard H Series*

**DELUXE K-SERIES:** designed to fill a growing demand for the finest possible amplification equipment. The superb operation of K-Series amplifiers signals an outstanding achievement of modern electronic research. . . **STANDARD H-SERIES:** offers characteristic Newcomb quality for applications in which economy must be considered, but dependability and performance cannot be sacrificed. . . Both series feature the exclusive hum-free, plug-in transformer for instant conversion from high to low impedance. . . both offer quality heretofore not available to the public address field.

"NOT MERELY AS GOOD AS THE OTHERS . . . BUT BETTER THAN ALL OTHERS."

THE SOUND OF QUALITY

*Newcomb*  
**AUDIO PRODUCTS CO.**  
MANUFACTURERS  
DEPT. A. 2815 S. HILL STREET, LOS ANGELES 7, CALIFORNIA

**Rejoins Garod Corp.**

Emanuel Weintraub has rejoined the Garod Radio Corp., Brooklyn, N. Y., as purchasing agent, heading all procurement activities for the company's complete line



Emanuel Weintraub

of radio receivers, radio-phonographs, and electronic products. Last December, Mr. Weintraub was released from the U. S. Naval Reserve after 30 months of service. Prior to his entrance in the naval service, the Garod executive had been associated with the organization for five years as director of material procurement and production planning.

**Gibson Service School**

Representatives of Gibson distributors and dealers over the nation are attending classes in refrigeration at the company's service school in Belding, Mich. The course consists of a week of daily classroom sessions, and is given under the supervision of Ray O. Clark, school director, and W. D. Krauter, Gibson national service manager.

Tentative plans call for continuing the school through June. For the benefit of its far-west representatives, a series of special sessions were held on the Pacific Coast.

**Duotone Expansion**

New plant of the Duotone Co., makers of phonograph needles, in Merrick, Long Island, N. Y., is now complete, with 15,000 sq. ft. of space and a capacity of over 3,000,000 needles per week plus 75,000 Duodiscs for home recorders. Duotone president Stephen Nester and sales promotion manager William A. Boeger have started a campaign in national magazines to interest the public in the record accessory field.

**Wolin Leaves Solar**

Sylvan A. Wolin has resigned his post as sales promotion manager of the Solar Mfg. Corp., New York City. He has announced no definite plans except that he will take a short vacation. Mr. Wolin had been with Solar for 14 years, during which he was successively advertising manager and jobber sales manager before he finally headed up the firm's promotion.

**OLSON** brings you the amazing new time-saver tool...

**PHILCO'S ALL-PURPOSE Radio Pliers**

FOR WIRING JOBS!

Philco's No. 1 Wiring Secret!

No change in grip—  
No other tools needed

The experts use these all-purpose Pliers for faster, easier, better wiring. Try it—the perfect "all in one" tool for cutting wire, removing insulation, wrapping wire, trimming excess. You'll say it's a crackerjack!

GRIP-TOOTH ENDS

BROAD CRUSHER JAWS

WIRE CUTTER BLADES

PRICED ONLY \$1.95 POSTPAID

Write for our monthly BARGAIN CATALOGS They're free!

This offer good only in U. S. A.

**OLSON RADIO WAREHOUSE**  
73 E. Mill St. Dept. 25, Akron, Ohio

Order Yours TODAY

Stock X-33

Send me..... All-Purpose Radio Pliers @ \$1.95 postpaid. I enclose \$..... (No C.O.D. Orders.)

NAME .....

ADDRESS .....



## *The Mark of Quality*

With the dawn of the new electronic era CENTRALAB again dominates the scene. The "CRL IN THE DIAMOND" identifies a group of QUALITY components engineered to the exacting requirements of the new electronic age . . . . always specify CENTRALAB.

# Centralab

Division of GLOBE-UNION INC., Milwaukee

PRODUCERS OF



Ceramic Trimmers  
Bulletin 695.



Variable Resistors  
Bulletin 697

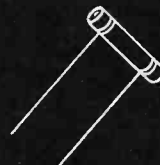

Tubular Ceramic  
Capacitors  
Bulletins 630 and 586

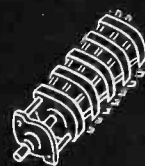

Selector Switches  
Bulletin 722



Ceramic High Voltage Capacitors  
Bulletin 814

# For Economic Operation EVERY SERVICE DEPT. REQUIRES RIDER MANUALS



FOR THE PAST 16 YEARS  
Standard Equipment in Successful  
Service Shops Throughout the World!

Rider Manuals are musts for the efficient operation of any radio and phonograph service department. They enable the serviceman to quickly locate the source of trouble in any ailing receiver. The actual "repair" time spent on a set is frequently a matter of minutes, but the localizing of the trouble is often a long and time-consuming operation. Rider Manuals, by furnishing authentic servicing data and circuit diagrams, simplify the tracing of troubles and reduce the servicing time per set. In use throughout the world,

these reference books are the recognized standard of the trade—A sign of the successful repair shop. The reason: They quickly pay for themselves in the time they save—They pay continuing dividends.

Sold by leading radio parts jobbers throughout the world.

ORDER  
TODAY



Rider Manuals Save Servicing Time  
—Increase Production and Profits

Volumes XIV to VII (each volume)	\$15.00
Volume VI	11.00
Abridged Manuals I to V (1 volume)	17.50
Automatic Record Changers and Recorders	9.00

JOHN F. RIDER PUBLISHER, INC. 404 Fourth Avenue, New York 16, N. Y.  
Export Division—Roca-International Electric Corp. 13 E. 40th Street New York City Cable ARLAB

## RIDER MANUALS *are complete* IN 14 VOLUMES

They Provide Schematics and Essential Servicing Data  
on American Made Radio Receivers.



THE DISC LABEL OFFERS ON HIGH FIDELITY PRESSINGS A COMPLETE CATALOGUE OF AUTHENTIC FOLK ITEMS — BASIC CLASSICAL AND JAZZ MUSIC — PERFORMED BY TOP ARTISTS—WITH SPECIAL ATTENTION TO INTERNATIONAL FOLKWAYS

DISC COMPANY OF AMERICA

117 WEST 46TH ST.

NEW YORK 19, N. Y.

OFFICIAL RECORD PRODUCERS FOR THE  
FRENCH - AMERICAN CULTURAL EXCHANGE  
AND PRODUCERS OF USSR RECORDS

## Kings Electronics New V.P.



J. H. (Robby) Robinson, appointed vice-president and general sales manager of Kings Electronics Co., 372 Classon Ave., Brooklyn, N. Y., says "it's great to be back selling jobbers again". The firm makes co-axial cable connectors, wave traps, plugs and jacks, etc., and has a new line of the latter to eliminate leakage in PA systems.

### "The Reps" in Action

Six new reps have been added to the roster of The Representatives of Radio Parts Manufacturers, Inc., according to an announcement from Ben Joseph, publicity counsel to the Industry Relations Committee.

The Missouri Valley chapter accepted the membership applications of Matthew H. Zimmermann, 5520 Westover Road, and Fred H. Larrabee, 6300 Main St., both of Kansas City, Mo.

J. M. Landfear, 1223 Sylvania Road, Cleveland Heights 21, Ohio, has joined the Buckeye Chapter and Paul Aron, 74 Arlington Ave., Brooklyn 7, N. Y., has become a member of the New York Chapter.

New members-at-large are D. E. Bursell, 2233 University Ave., St. Paul 4, Minn., and Art Nelson, Box 2244, Denver, Colo.

### Went to Chicago

The Chicagoland chapter of The Reps sent the following as delegates to the national convention in Chicago: Fred Ellinger, Harry Halinton, and L. W. Beier with Russ Diethert as alternate. The New York chapter sent Sam Egert, Art Cerf, LeRoy Schenck, David Tobias, Irv. Nevins and Dan Bittan with Ben Joseph and Jules Sussman as alternates.

### Buckeye Officers

The following officers for 1946-47 were elected by the Buckeye Chapter of The Representatives: C. L. Pugh, pres.; L. H. Jackman, vice-pres.; and E. C. Edwards, secty-treas. Delegates to the national convention were: C. L. Pugh, George Tanner and Earl Dietrich with L. H. Jackman, John Olson and E. C. Edwards as alternates.



more efficient  
...in miniature

To accommodate the reading matter we find between the covers of a small book would have required several dozen unwieldy, hand inscribed, parchment scrolls in Roman days. This is a striking example of greater efficiency in miniature but no more so than TUNG-SOL Miniature Electronic Tubes.

From everyone's viewpoint Miniatures are superior, especially for high frequency circuits. More compact equipment and less storage space are obvious advantages of Miniatures to both manufacturers and dealers. The engineer, however, sees their greater resistance to the effects of vibration

Visit our booth No. 61 at the  
**RADIO PARTS AND ELECTRONIC EQUIPMENT SHOW**  
STEVENS HOTEL, CHICAGO, MAY 13 to 16

and shock, lower lead inductance, lower inter-element capacities and higher mutual conductance.

New radio sets and other electronic equipment with Miniature Tubes are appearing on the market. Dealers, therefore, must have miniatures as well as large type tubes available. TUNG-SOL Jobbers and Dealers are in position to furnish miniatures, G-Gt's-metal and large glass tubes for servicing every type of equipment.



ACTUAL SIZE

# TUNG - SOL

*vibration-tested*

**ELECTRONIC TUBES**

**TUNG-SOL LAMP WORKS, INC., NEWARK 4, NEW JERSEY**  
Sales Offices: Atlanta • Chicago • Dallas • Denver • Detroit • Los Angeles • New York  
Also Manufacturers of Miniature Incandescent Lamps, All-Glass Sealed Beam Headlight Lamps and Current Intermittors

*Better*  
**ATLAS SOUND**   
**Equipment**  
*Ready for YOU*



**DOUBLE REENFRANT PROJECTOR**

Many sizes. From 15 in. air column to 6 foot air column.



**360 RADIAL, CHANDELIER PROJECTORS**

Double Reentrant. For driver units. 3 and 4 foot air column lengths.



**DRIVER UNITS**

Various Power Handling Capacities. Newest types of Indestructible Phenolic Diaphragms.

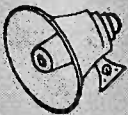

**MINIATURE TYPE REENFRANT PROJECTORS— BOOSTER SPEAKERS**

High-efficiency. Weather-proof. Complete with Driver Unit and Universal Bracket.



**CONE TYPE PARABOLICS and CHANDELIER BAFFLES**

for all size cone speakers. Wooden and Metal Cone Speaker Enclosures, Baffles, Carrying Cases, Loud Speaker Support Stands and Brackets.



**MICROPHONE SUPPORT STANDS**

20 types and sizes. All Fittings, Adaptors and Accessories. Floor Stands, Desk Stands, Banquet Stands, Boom Stands.

Visit our Display at BOOTH 80. The Parts and Electronic Equipment Show—Hotel Stevens—May 13th to 16th. Write for New Illustrated Catalog Sheets.

**ATLAS SOUND CORPORATION**

1451 39th St., Brooklyn 18, N. Y.

**Brunswick Ready with Furniture Combos**

Seven models of new Brunswick Radio-Panatrope combinations, in traditional furniture cabinets, have been announced by Radio & Television, Inc., 244 Madison Ave., New York 16, N. Y. All of these units are 19-tube AM-FM combos, except the "Tuscany", which is an 8-tube AM model.

This line includes two chairside models, in Sheraton and Hepplewhite styles. There

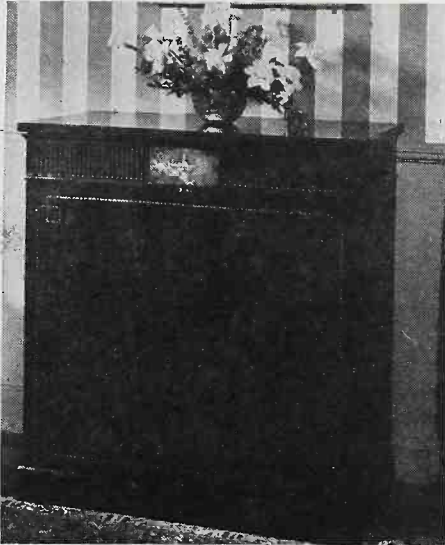

In Adam style, this is Model BK-6886, one of the seven new traditional-design combinations released by Brunswick.

are four wall consoles, of Early American, Adam, Modern and French Provincial designs. The remaining combination is a Duncan Phyfe "drum table". All are custom designed units with hand-rubbed finishes, and special emphasis on authentic traditional style. The Tuscany and the Drum Table have genuine leather tops; other sets come in genuine mahogany, birch or beech, hand-glazed knotty pine (for Early American), or natural prima vera.

Each of the sets has a de luxe Panatrope automatic record changer with permanent sapphire crystal cartridge.

**Akeroyd Resigns**

A. E. Akeroyd, manager of distributors sales for Raytheon Mfg. Co., has resigned his position which he held for the past 14 years. He was the originator of the Raytheon merchandising drive known as Bonded Electronic Technician program. Prior to his association with Raytheon, Mr. Akeroyd was with RCA Victor, Grigsby-Grunow and E. T. Cunningham. He will announce his future plans shortly.

**Recoton Exec to Europe**

Herbert H. Borchardt, executive vice-president of Recoton Corp., makers of Recoton steel and sapphire needles, has left for a trip to Europe where he will visit the plants where Recoton's steel needles are fabricated on special screw turn machines.

**A CORDIAL INVITATION**

TO ALL

- Representatives
- Manufacturers
- Servicemen
- Distributors

WELCOME TO

**BOOTH 101**

**RMA**

**NATIONAL PARTS**

**SHOW**

**STEVENS HOTEL**

**CHICAGO—MAY 13-14-15**

**See SUPREME'S**

**NEW LINE OF POST-WAR**

**RADIO, TELEVISION and**

**ELECTRONIC TEST EQUIPMENT**

Supreme Engineers, Technicians and Salesmen will be on hand to show the line and answer all questions.



**SUPREME INSTRUMENTS CORP.**

**GREENWOOD, MISS. U. S. A.**

Export Department:  
**THE AMERICAN STEEL EXPORT CO., Inc**  
374 Madison Ave., New York 17, N. Y.



# MINERVA CORPORATION OF AMERICA

presents

## The Radio of the Year



During the war the Minerva Corporation of America produced radios exclusively for the armed forces and organizations working in the interest of servicemen. The reputation of the Minerva radio as a "performer" has become world famous. Now, the same critical engineering . . . the same excellent performance . . . goes into every Minerva Radio now being built for the general public.

### "The Aristocrat of Home Radios" Models W710 and W711

Six Tube AC-DC Superheterodynes

Model W710 — Truly an outstanding achievement in design and performance.

- Large Hand Rubbed Walnut Cabinet (15½" long, 9½" high, 8½" wide)
- Full Sized Chassis • Gyro-drive Tuning Control (Effortless Station Selector)
- "Acousti-grille" Speaker Baffle • Continually Variable Range Tone Compensator • "Accura-tone" Six-inch Permanent Magnet Speaker • High Sensitivity with no objectionable hum.

Model W711 — (illustrated). Similar to W710 except 2 shortwave bands.

### The MINERVA "Portabout"

Eight multi-purpose tubes in a super-sensitive superheterodyne circuit receives standard broadcasts anywhere.

Operates on batteries, AC or DC currents.



*Scheduled for  
Production*



Minerva Radios scheduled for production include Television, F.M., Combinations, Consoles and Catalin Table Models.

# MINERVA CORPORATION OF AMERICA

Manufacturing Quality Radios Since 1919

238 William Street • New York 7, N. Y.

# The NEW Wave Master

## AUTOMATIC RECORD CHANGER — 2 POST



Plays 12 10-inch or 10 12-inch records continuously. Converts any radio into combination phonograph. Fully automatic. Silent 110 volt A.C. motor. Shuts off automatically after last record. Assures perfect reproduction at all times. Handsome walnut finished wood cabinet.

OPA retail price .....\$33.95  
Dealers Price .....\$22.98

## PORTABLE PHONOGRAPH

WITH

### Automatic 2-Post Record Changer

New 1946 portable phono in smart two-tone leatherette case. Fully automatic, plays 12 10-inch or 10 12-inch records at one loading. Three tube amplifier and speaker. Provides one hour of record playing entertainment. Easy to operate—automatic shutoff. Beautiful tone. Equipped with 2 locks and keys. Very attractive, fine quality throughout, with good hardware. Size 13½ x 17½ x 9½ in. high.

OPA Retail Price .....\$66.75  
Dealers Price .....\$42.55

Above prices include Federal excise tax  
All prices F.O.B. New York

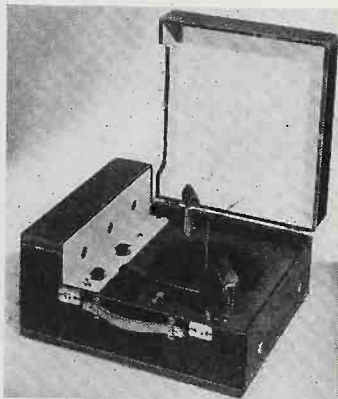

## IMMEDIATE DELIVERY

**HAROLD CO.**

New York 11, N. Y.

Distributed by

**PAX UNIVERSAL**

96 5th Ave., New York 11, N. Y.

**CHICAGO**

Meet us in Person  
at Booth 162  
Chicago Radio Show  
Stevens Hotel  
to see the  
new improved  
Shur Interceptor  
& Antenna Mount

**Shur - Antenna - Mount, Inc.**

Eastern Division  
266 SEA CLIFF AVENUE  
SEA CLIFF, N. Y.

Western Division  
PORTER BUILDING  
KANSAS CITY, MO.

## Kits

### for EVERY PURPOSE

at the following dealer prices:

EASY-BUILT #1 crystal kit suitable for the youngest boy. . . price \$2.15 ea.

EASY-BUILT #2 one tube AC-DC or battery operated complete with tube and cabinet . . . . . price \$7.15

5 TUBE SUPER HETRODYNE. All parts except wire and solder contained in most broadcast receivers . . . . . price \$9.45

5 TUBES consisting of one each 6SK7, 6SQ7, 6SA7, 12SN7 (used as rectifier), 1631 (used as replacement for 25L6) suitable for above kit . . . . . price \$3.75

CABINET, walnut wood finish, suitable for above kit. . . . . \$2.95

PORTABLE ELECTRO-PHONO-KIT, containing Phono motor, pick up speaker and all parts necessary for a 3 tube amplifier, excluding wire and solder . . . . . price \$14.95

PORTABLE PHONO CABINET all wood leatherette large enough for 12" records and suitable for above kit . . . . . \$7.95

3 TUBES suitable for above kit \$1.85

Also a variety of radio parts, test equipment, etc. Free Catalogue on request.

## RADIO DEALERS SUPPLY CO.

135 Liberty Street, New York City, N. Y.

## ECA Radios Under Fair Trade

Electronic Corp. of America, makers of ECA radios, are marketing their sets under fair trade practice, according to an announcement by Jack Geartner, sales manager. The firm is operating under fair trade practice laws in all parts of the United States where enabling legislation exists.

Mr. Geartner said that "A study of the ECA informative label attached to each set will show that our prices are fully justified on the basis of performance. We will, therefore, not tolerate backdoor sales, price cutting, or other practices which tend to undermine confidence."

## Sylvania's Merchandising Head

Raymond W. Andrews former Commander in the Navy, is the new merchandising manager in the Radio Division of Sylvania Electric Products Inc. His activities in the radio and electronic fields for 20 years have included sales, production and technical service for wholesalers, retailers and manufacturers.

Mr. Andrews will now specialize in the development and sale of special Sylvania products to be sold through radio parts jobbers.

## APJA Convention in Iowa

The latest meeting of the Appliance Parts Jobbers Association was held April 29th at the Ft. Des Moines Hotel, Des Moines, Iowa. The organization, which is national in scope and is composed of washing machine parts distributors, holds its meetings twice a year.

At the three-day meeting in Iowa, officers were elected, and members were treated to visits to washer factories in the nearby cities of Newton and Kellogg.

## Simplex Executive



Robert D. Haeger has been appointed assistant to Joseph Groshans, general sales manager of the American Ironing Machine Co., Algonquin, Ill.

**ANOTHER DISTINGUISHED  
TELE-TONE CREATION!**

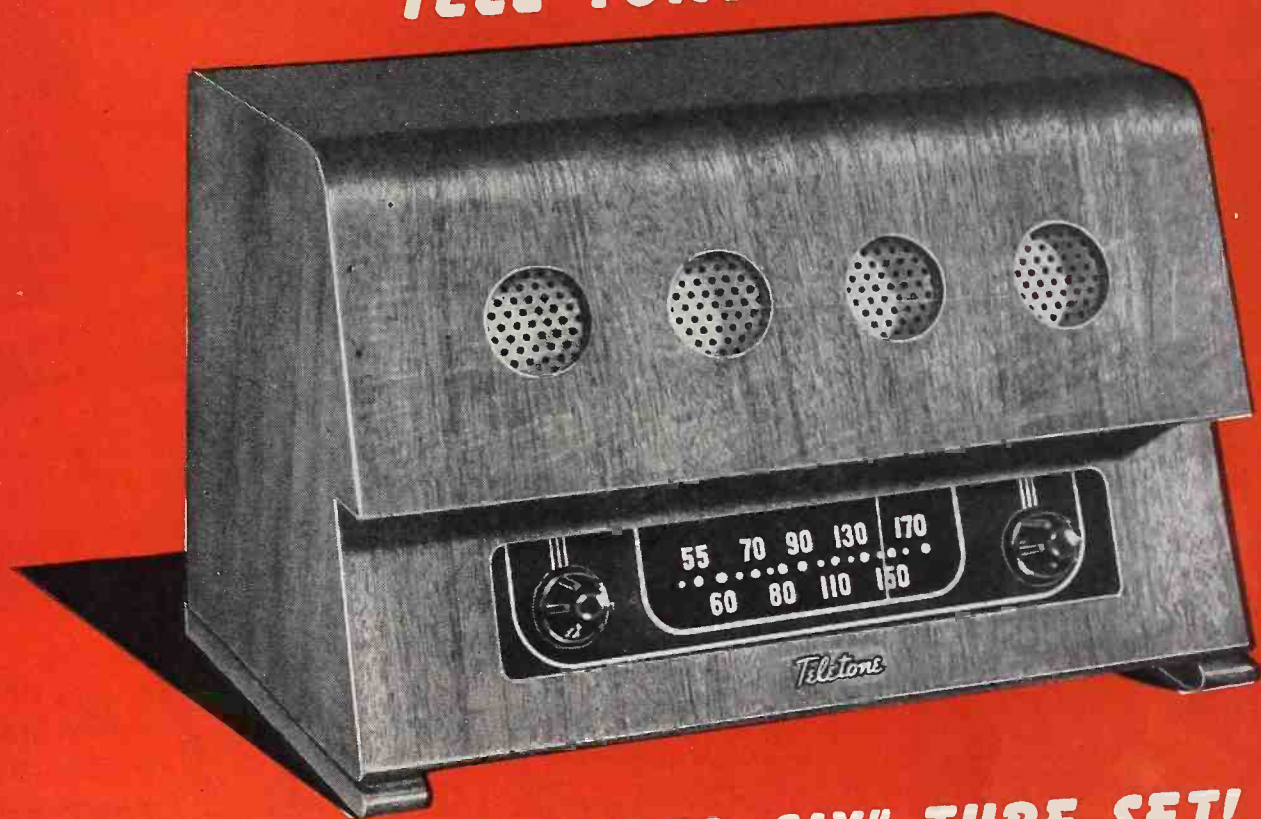

**NOW - A "SUPER SIX"-TUBE SET!**

RADIO DEALERS acclaim this new triumph for TELE-TONE master craftsmen and small-radio specialists. For this is a compact 6-tube set of transitional modern design, with beautiful walnut veneers.

It has every worthwhile feature plus TELE-TONE'S exclusive **RADIOPTIKON** and **HARMONIQUE** tone chamber that insures superior tone blending and mixing.

**WE'LL BE IN CHICAGO - MAY 13-16 - AT THE HOTEL STEVENS**

**Tele-tone**

**"In Tune With The World"**  
RADIO • FM • TELEVISION



**TELE-TONE RADIO CORPORATION, 609 W. 51st St., New York 19, N. Y.**  
Producers of Small Radios and Small Radio-Phonographs Exclusively



# Bogen SOUND and COMMUNO- PHONE Equipment

Look for us at the  
**RADIO PARTS AND ELECTRONIC  
EQUIPMENT SHOW—BOOTH NO. 40**

**NATIONALLY ADVERTISED,  
READILY ACCEPTED!**

Backed by a nation-wide advertising and sales promotion campaign, the BOGEN line of inter-communication and paging systems is finding enthusiastic acceptance in industrial and consumer applications. With its reputation for quality earned over the years, and more recently its importance in war—from engineering, efficiency and dependability standpoints—specification of BOGEN Products by name is understandable. For new developments, sales possibilities and substantial profit potential in inter-communication and paging systems, investigate BOGEN.

Address Inquiries to Department W

### BOGEN EX 35 DELUXE AMPLIFIER

Delivers 35 watts undistorted power. 4 input channels with simultaneous mixing. Electronic tone corrected for perfect tone control.

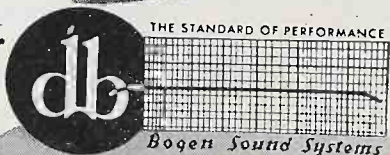
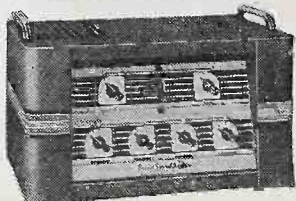

**David Bogen CO. INC.**

663 BROADWAY, NEW YORK 12, N. Y.

BOGEN SOUND SYSTEMS • AMPLIFIERS  
COMMUNO-PHONES • ELECTRONIC EQUIPMENT

## Topeka's RETA in the News

The Radio & Electronic Technicians Association of Topeka, Kan., has elected its new officers for the year. They are: Doug Darnall, Darnall Radio Service, president; John Lundberg, Lundberg Radio Service, vice-president; Lloyd G. Denham, Denham Radio-Electric Co., treasurer; and C. L. St. Clair, St. Clair Radio Service, secretary.

Members of the RETA Board of Directors are O. C. Zehner, Zehner Radio Service; Chester W. Parks, Shutt Radio Service; A. C. Morse, A. C. Morse Appliance Service; and J. F. Schmitt, Jenkins Music Co.

Recent meetings have featured local jobbers as speakers, with brisk discussions on the subject of "Who should buy wholesale?" It has also been the policy of RETA to invite representatives of well known radio makers as guest speakers.

General program of the organization is several-fold: to discourage "fly-by-night" radio outfits in the area; to emphasize technical know-how among local servicemen; to exchange credit data and practical servicing information; and to help to lift the general professional standards of the maintenance business. The group has an official stamp for all members to use on sets serviced, with the data in code so that the status of the job is clear.

## Reps for Vertrod Aerials

Vertrod Corp., 60 E. 42nd St., New York City, makers of aerials for AM, FM, television, communications, shortwave, broadcast, etc., have announced a complete roster of 13 reps for the U. S. and Canada.

For the Radio Parts Show, all these representatives and the officials of Vertrod will entertain in their suite at the Continental Hotel, 505 N. Michigan Ave., Chicago.

## Spectacular Corner



At one of the "crossroads of the world" in Times Square, N. Y., is this jumbo ad for Fada radio, 43rd St. at Broadway.

Check These Exclusive

# KWIKHEAT SOLDERING IRON Advantages!



- ★ SAVES TIPS
- ★ SAVES TIME
- ★ SAVES EFFORT
- ★ SAVES WEIGHT
- ★ SAVES CURRENT
- ★ SAVES THE IRON

**HOT IN 90 SECONDS  
READY FOR USE..!**

Kwikheat's built-in thermostat maintains proper, even heat for most efficient, economical operation. Can't overheat . . . saves tips . . . requires less retinning. Powerful, 225 watts, yet light weight (14 oz.), well-balanced with cool, protecting handle. With choice of any one tip .....\$11.00

### 6 TIP STYLES

Interchangeable

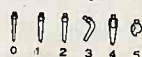

... ASK YOUR JOBBER!

# Specified

## BY AMERICA'S MOST CRITICAL SERVICE ENGINEERS

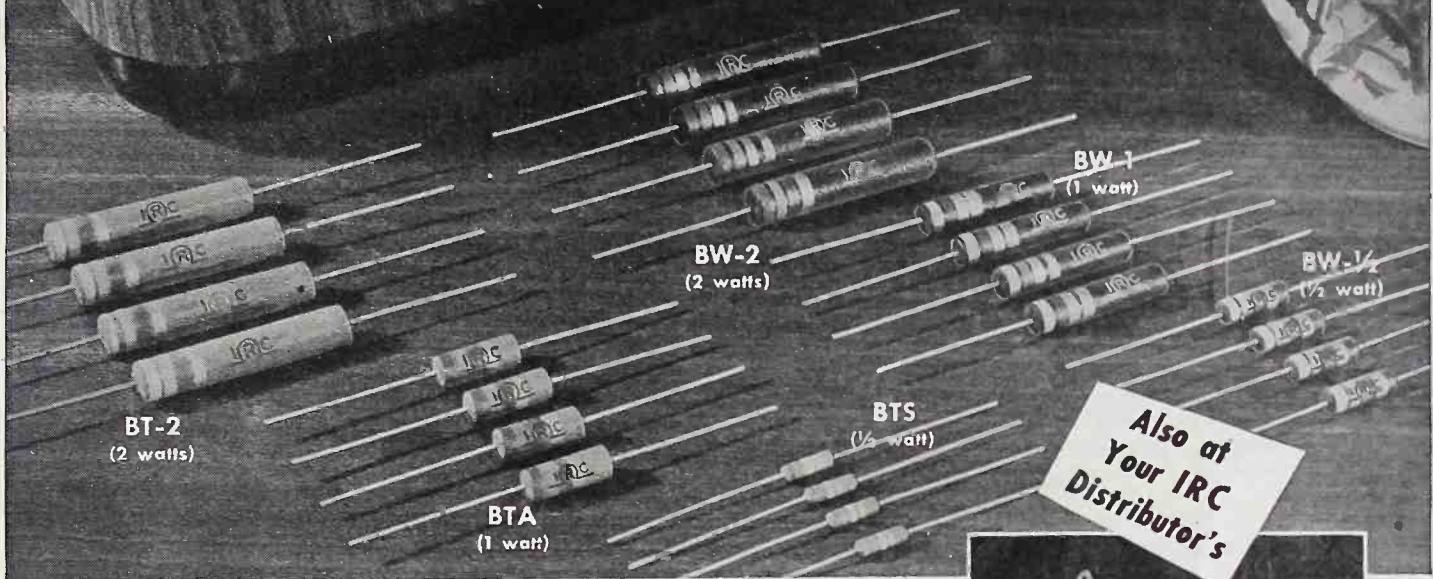

### TYPE BT INSULATED Metallized RESISTORS TYPE BW INSULATED Wire Wound RESISTORS

... the perfect combination for speedy, dependable servicing!

Almost any piece of carbon is a "resistor". But a really good resistor, scientifically designed to meet every requirement of exacting radio and other electronic servicing, is something else again. For example, users of the famous Type BT have found that IRC's exclusive Metallized filament-type construction is a far cry from ordinary resistors. Since the beginning of Radio, this unique design principle has made possible far greater stability, more rugged construction and complete dependability in a very compact, low-cost unit.

Now, two new BT types, the BTS and BTA, are available. Designed to meet all the exacting requirements of modern servicing, they are conservatively rated at 1/2 watt and 1 watt, respectively, and incorporate all the excellent characteristics of older, larger types in a much smaller, more convenient size.

For greater stability and all-around efficiency in the lower ranges, the IRC Type BW Insulated Wire Wounds are recommended. A stock of these units and the Type BT in assorted ranges and wattages give you the ideal combination to solve almost any servicing problem... quickly and profitably.

#### The Resistor You Need . . . When You Need It!

Your local IRC Distributor now has quite complete stocks of BT's and BW's, in standard RMA ranges, ready for you. You'll find him a dependable source (and a very cooperative guy) for all of the IRC products shown on this page. He'll also be glad to give you your copy of IRC Service Catalog #50.

FOR BETTER-THAN-STANDARD QUALITY

Standardize on



### INTERNATIONAL RESISTANCE CO.

Dept. 21-E, 401 N. Broad Street, Phila. 8, Pa.

Makers of more types of resistance units, in more shapes, for more applications, than any other manufacturer in the world.

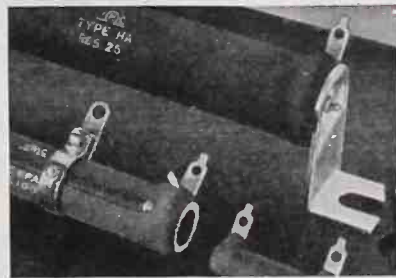
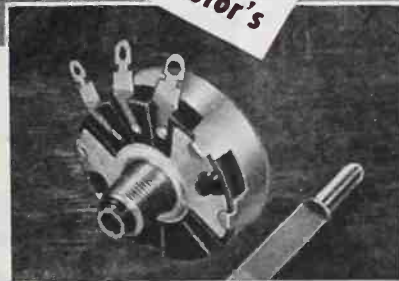

## Radio Prize for a Wounded Vet



The overseas-type "Tropic Master" set made by Minerva Radio Corp. of America is presented to an injured vet at Halloran Hospital, N. Y., as a door prize at a party given by Hospitality House Party. L. to r., Mrs. James Doolittle, Simon Barere, Pfc. L. Kelly and Paramount starlet Marion Carter.

## Newcomb Ready with New Sound Equipment

A new line of amplifiers and public address accessories is being marketed by Newcomb Audio Products Co., 2815 S. Hill St., Los Angeles, Calif. The units are in two groups; a de luxe K series of four models and a lower-priced H-series also of four models. These are offered in finished welded steel cabinets, compactly designed.

The Newcomb line of portable sound accessories includes a portable sound system, record players, dual speaker assemblies, cases for speakers and amplifiers, and a power supply.

## Premier Will Add Bigger Sets

The Amphitron division of Premier Crystal Laboratories, Inc., 53-63 Park Row, New York 7, N. Y., which has already entered the radio market with a table model receiver, has announced that this initial model will shortly be followed by an 8-tube 2-band set. The latter unit will be followed in turn by the introduction of radio-phonograph combinations.

The company's first radio, on which the trade promotion is well underway, is a 5-tube set, with a cabinet of solid wood, furniture finish. This is the ac-dc super-het Model 15.

## Insuline Makes Two Appointments

Lester R. Belmuth, ex-Captain of the Army Air Force, is now sales representative for the Insuline Corp. of America. He will cover the New York-Eastern Pennsylvania-Virginia area. He holds the Purple Heart, Distinguished Flying Cross and the Air Medal with two clusters.

Another appointment at Insuline is that of Adelbert R. Morton, as chief engineer of the firm's electronic division. He previously held engineering posts with Ansley, Ford Instrument, and Western Electric, as well as the Navy Dept.

## Regional Head

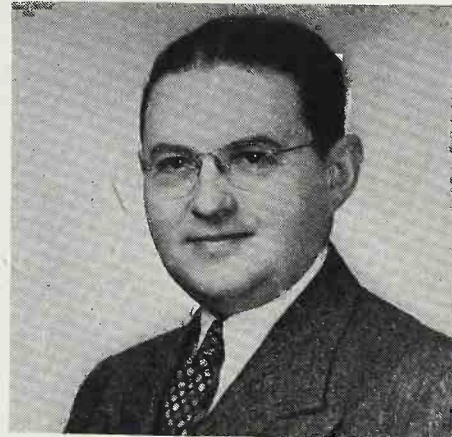

Paul R. Dye is the newly appointed regional manager for all products of the Admiral Corp., Chicago.

**BIG,  
TINY, AND  
IN BETWEEN**

Whether the job is tough or trivial, it can be done easier, faster and more efficiently with a

**VACO  
AMBERYL**

**Shock-Proof • Break-Proof  
Screw Driver**

From a "Man Mountain" size, down to the tiny midget shown, there is a VACO screw driver for every industrial and home need. Write for catalog.

**VACO 173 TYPES  
PRODUCTS CO.**

317 E. ONTARIO ST., CHICAGO 1, ILL.  
In Canada: 560 King St. W., Toronto 2, Ont.

**Electro**  
LECTRICAL AND RADIO EQUIPMENT

**BATTERY ELIMINATORS**

**FEATURING! OUR NEW MODEL "Q"**

For use anywhere beyond high line connections. The better eliminator every farmer, camper, sportsman, trailer or boat owner, etc., has been waiting for. Lifts battery radio reception to new heights of satisfaction for isolated listeners. For auto service will save three-quarters of normal battery drain.

**OPERATES ANY 1.4 VOLT—4, 5 OR 6 TUBE RADIO FROM 6 VOLT STORAGE OR DRY BATTERY OR WINCHARGER**

Costs but a few cents per hundred hours of operation. Sturdily constructed—no liquids or moving parts—operates in any position. Completely filtered—hum free—silent and efficient in operation. Universal plugs and sockets to fit any radio. Weight packed—only 3½ lbs.

**FOR 2-VOLT RADIO FROM STORAGE BATTERY SOURCE—  
SELL OUR MODEL "R"**

**VISIT OUR BOOTH NO. 127—RADIO PARTS SHOW—  
STEVENS HOTEL — CHICAGO — MAY 13TH -16TH**

**ELECTRO PRODUCTS LABORATORIES**  
Pioneer Manufacturers of Battery Eliminators  
549 WEST RANDOLPH STREET CHICAGO 6, ILL.  
Canadian representative, ATLAS RADIO CORP., Toronto, Canada

# THE PAST DIRECTS US TO A GREAT FUTURE

Good ideas come from a restless urge to improve. That urge is encouraged at Utah.

Continual improvement in product engineering, in production methods, in distribution, represent our courage to heed the urge. That courage, ever apparent in the past, directs us to a great future.

Improvement is evident in any major change in the Utah structure. The evidence will be displayed in the Utah exhibit in the 1946 Radio Parts and Electronic Equipment Show in Chicago. See us there.

**SEE US IN DISPLAY 106**

**RADIO PARTS AND ELECTRONIC EQUIPMENT SHOW  
MAY 13-16 STEVENS HOTEL CHICAGO**



**UTAH RADIO PRODUCTS DIVISION**

*International Detrola Corporation*

General Offices, Beard at Chatfield, Detroit

**WHOLESALE AND SOUND DIVISION**

107 South Clinton Street, Chicago

PHILTONE  
*Presents*  
THE NEW  
**CHARM TONE**  
*Portable*  
AUTOMATIC  
PHONOGRAPH

**RECORD CHANGER:** Plays 12 ten inch records or 10 twelve inch records.

**TONE:** Full tone with emphasis on the treble or bass by a graduated smooth acting tone control.

**BEAUTY:** Selected covering in three-tone leatherette.

**PORTABLE:** Plays anywhere. Just plug it into wall. Operates on A.C. current only.

**ENGINEERED:** War time research and post war engineering created tomorrow's Charm-tone amplifier today. Using three tubes and the famous Voltage Doubler Circuit, Charm-tone permits increased efficiency from the Beam Tetrode output tube which is correctly matched to the Electro-Dynamic Reproducer.

**DELICATE TOUCH:** One-ounce needle pressure prevents record wear. Permanent needle.

**AUTOMATIC SHUTOFF:** Charm-tone automatically stops playing after the last record.



**WRITE TODAY**

Sole Distributors ..... **FIFTH AVENUE DISTRIBUTING CO.**  
35 Fifth Avenue, Brooklyn, New York

Manufactured by..... **Philtone Electronics Co., Inc.**

A *Handy* SALESKIT  
FOR RADIO SERVICEMEN

A real saleshelp exclusively for Radio Servicemen... the Jensen Phonograph Needle Saleskit is just the thing for demonstrating fine needles. What's more, Jensen needles augment your work, assure full, clear tone of the instruments you repair, make all records sound better.

Colorful, convenient, compact... the Saleskit slips easily into your pocket. Take it on service calls. It contains 3 Jensen Concert Needles retailing at \$1 each and 3 Jensen Genuine Sapphire Needles at \$2.50 each.

Available NOW at your jobber. WRITE TODAY for complete details and our better than usual discount to servicemen.

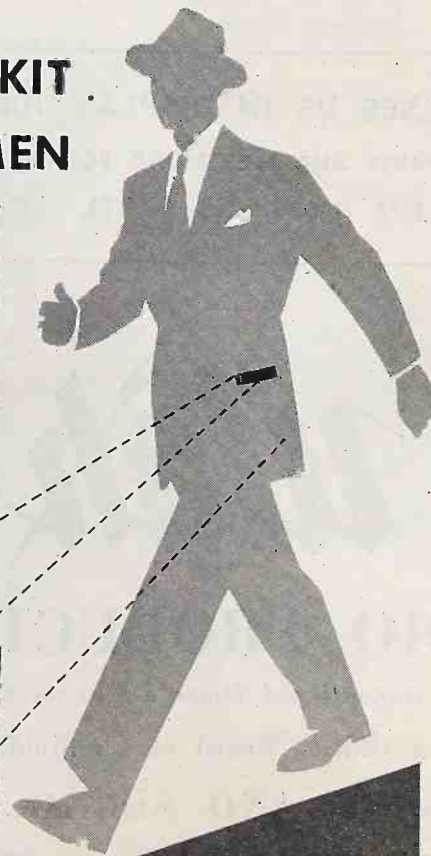

**JENSEN INDUSTRIES, INC.**  
329 SOUTH WOOD STREET  
CHICAGO 12 ILLINOIS

**Pioneers Combined**



Bruce A. Coffin, the Hytron president who has announced big-scale expansion as a result of the Air King acquisition. The two firms have 8 modern plants for new tubes and sets.



J. P. Lieberman, president of Air King Products Co., Inc., whose big plant in Brooklyn, N. Y., now operates as a division of Hytron Radio & Electronics Corp., and will manufacture a complete line of AM, FM, and video sets.

**OPA Prices for Scott**

OPA has approved retail prices on the Chippendale model Scott radio-phonograph, series 800, now in the hands of franchised dealers, according to E. J. Halter, vice-president of the Scott Radio Laboratories, Inc., Chicago.

In Zone 1, the price is \$937.50. A tag of \$692.60 for the chassis of the same model was also approved. This includes the speaker, radio, amplifier, and instrument panel, but not the phonograph. For Zone 2, the price is \$984.35. For those who wish to purchase the chassis alone, the charge in this zone is \$727.15.

**Famous Radio Wives Okay Olympic Sets**

The series of color ads running in national magazines, on Olympic radios made by Hamilton Radio Corp., 510 Ave. of the Americas, New York City, is featuring "famous radio wives" and their testimonials on the quality of Olympic sets.

The first was Mrs. Jack Benny (Mary Livingstone) and this will be followed by Mrs. Phil Harris, Mrs. Kay Kyser, Mrs. Andy Russell, Mrs. Edgar Bergen, and the children of Fibber McGee and Molly. The series will run through 1946.



# Brother, want 3 extra hands?

Then drop a few seeds in the mailbox! C-D has them ready for you . . . punchy mailing pieces . . . to let the whole neighborhood know you're alive. And that's only one part of a complete promotional program we've prepared for you. Look around! The field is getting crowded; now is the time to promote yourself. And here is a program—complete—packaged—tha'll give you three extra hands and make you "the" service shop in your community.

And watch the customers grow! You can't expect radios will break down faster to help your volume . . . but when they do get out of wack, you can bet the customers will take them to shops they've heard about. So get the ball rolling with the new C-D Sales Promotional Program that will help you grow—not only in 1946—but in 1947 and 1948.



## USE THESE C-D HELPS AVAILABLE THROUGH YOUR LOCAL JOBBER!



NEWSPAPER MATS

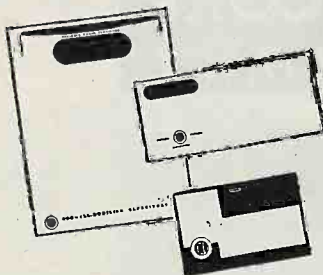

STATIONERY LABELS



DECALS



WINDOW CARDS



POSTCARDS — just address and drop in mailbox!



MATCH BOOKS —

**KEEP YOUR REPUTATION GROWING WITH TOP QUALITY PARTS**

C-D's "dwarf tigers" are long life units. Heat and humidity don't get them out of the picture. Real quality . . . real reputation-builders.

**OF COURSE YOU'LL WANT YOUR FREE SUBSCRIPTION TO THE "CAPACITOR"**

All the important radio data condensed for you. Write now: Cornell-Dubilier Electric Corp., South Plainfield, New Jersey.

NAME \_\_\_\_\_  
 ADDRESS \_\_\_\_\_  
 CITY \_\_\_\_\_  
 STATE \_\_\_\_\_  
 ZONE \_\_\_\_\_

ALL AVAILABLE THROUGH YOUR LOCAL C-D JOBBER

# Cornell-Dubilier WORLD'S LARGEST MANUFACTURER OF Capacitors



MICA • DYKANOL • PAPER • ELECTROLYTICS

It's a

# VERTROD

Product — THE FINEST

VERTROD'S

fourteen models of  
ANTENNA



a model for every purpose—are in production. "And, we are keeping faith with our old customers, and ready to make new friends by producing the finest antenna known to radio, using the same or better, quality and quantity materials and laboratory tests, on each antenna, without raising our prices above 1941 pre-war prices."

Write to Dept. 4512

During RADIO PARTS SHOW—May 13 to 16, visit our exhibit at the Congress Hotel—opposite the Stevens



## VERTROD CORP.

60 EAST 42nd ST.

NEW YORK 17, N. Y.

**Face-to-face  
contact  
instantly  
with  
AMPLICALL**



Executives in all parts of the nation are becoming more conscious of the value offered by Rauland AMPLICALL Intercom, Paging and P A Systems. The war years have proved AMPLICALL's day-in-and-day-out dependability, multiple uses, the superiority of its flexible design to meet expanded needs and clear tone quality. These facts, plus nationwide AMPLICALL advertising, are enabling Rauland distributors to report a bigger sales volume than ever!

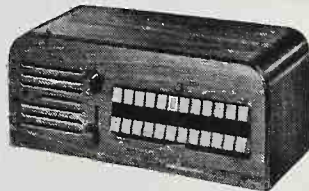

AMPLICALL  
Intercommunication unit, available for two-way communication between multiple stations.

Make Rauland Booth No. 83 your headquarters while at Radio Parts and Electronic Show, Stevens Hotel, Chicago, May 13-16

*Electroneering is our business*

RADIO · RADAR  
SOUND

# Rauland

COMMUNICATIONS  
TELEVISION

THE RAULAND CORPORATION • CHICAGO 41, ILLINOIS

### Majestic Vice-President



Ben Selvin, director of artists and repertoire for Majestic Records, Inc., was elected a vice-president of the company at a meeting of its board of directors held in New York. Mr. Selvin is shown here directing a recording session.

### JFD Announces Big Expansion

The JFD Mfg. Co., 4109-23 Ft. Hamilton Pkway., Brooklyn 19, N. Y., has acquired a new 50,000 sq. ft. factory site for further expansion according to Julius Finkel, president. JFD now has 5 plants operating in Brooklyn. The newly acquired site is on 16th Ave. and extends from 61st to 62nd St. Present plans call for this site to become the largest of the JFD plants.

Mr. Finkel stated that as soon as construction materials are available—a modern two story building will be erected, with air conditioning and the latest in production technique. A recreation hall and cafeteria will be features.

### Commins Joins Tele-Tone Corp.

Major John Gray Commins, who has been the director of procurement and production of receiving and transmitting radio, radar and meteorological test equipment for the Signal Corps, has joined Tele-Tone Radio Corp., New York as purchasing director. Major Commins was formerly connected with B. F. Goodrich and U. S. Rubber companies.

### Irish Radio Rep Wants Lines

A letter from Dublin, Ireland, reveals that Arthur Sevitt of Irish Radio Hospitals, Ltd. is now visiting the U. S. and contacting his radio acquaintances here. He is interested "in taking back to Europe merchandise in the electrical and radio fields" and can be reached at 460 Beach, 138th St., Belle Harbor, New York. His Dublin address is New Add. 2, St. Andrew St.

### INSIDE

Yes, look inside the Temple chassis. Examine its skillfully engineered, painstaking construction — extras in craftsmanship that make it an outstanding performer.

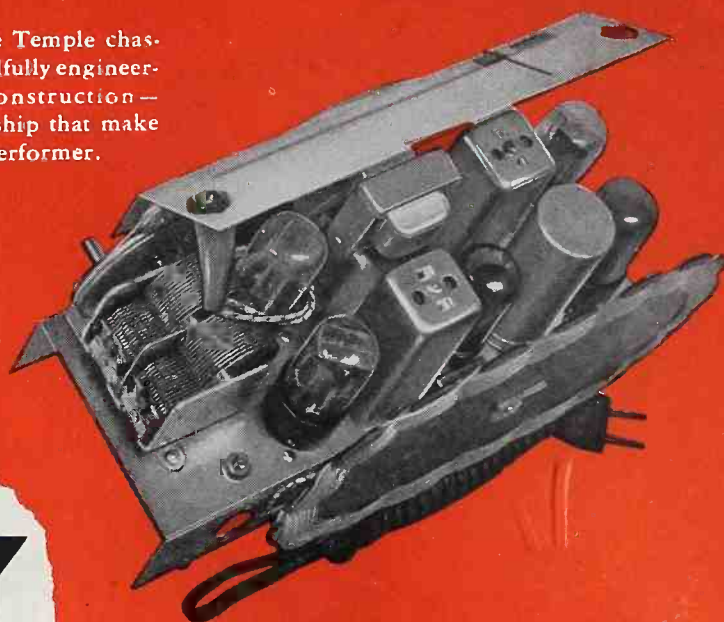

**QUALITY  
WHICHEVER  
WAY YOU LOOK AT IT!**



**MODEL E-514**

*A Standout in Performance  
and Appearance*

### OUTSIDE

Every inch Temple-built, this handsome cabinet of fine walnut or mahogany veneers is not only attractive artistically — but also perfect acoustically.



**TEMPLE TONE RADIO MFG. CORP., New London, Conn.**

Executive Offices — 220 East 42nd St., New York, N. Y.

**"FM that also means Finest Made"**



Raytheon tubes give peak performance. They have been built to this high level of maintained quality through continual testing and research by a company that is recognized everywhere as one of the advanced guard leading the way into the new era of electronics.



*Excellence in Electronics*  
**RADIO RECEIVING TUBE DIVISION**  
 NEWTON, MASS. • CHICAGO

## “Keynote” Dinner At the Parts Show

One of the biggest of the preliminary events at the 1946 Radio Parts & Electronic Equipment Show in Chicago is the Keynote Dinner, at 7 p. m. in the grand ballroom of the Stevens Hotel, May 13.

The capacity number of 1500 guests is expected at the event, which is a \$5-per-plate affair. On the program is a nationally known business man as featured speaker.

## Milton K. Grey Named Hill-Shaw Vice-Pres.

Milton K. Grey has been named executive vice-president of Hill-Shaw Co., Chicago, Ill., manufacturers of Vaculator glass coffee makers, according to an announcement by Henry Perlman, president of the company. Mr. Grey will be in charge of



Milton K. Grey

all sales activities in the consumer and restaurant-institution divisions. Mr. Grey joined the Hill-Shaw Co. as advertising manager in 1937 after operating his own advertising agency in Chicago. In 1939 he was appointed director of sales and named general sales manager in 1941.

Captain Joe E. Fishelson has been appointed general sales manager, with headquarters at the company's executive offices in Chicago.

Jon Zitz, until recently central division sales manager, has been advanced to the post of assistant general sales manager and executive assistant to vice-president Grey.

In line with a greatly increased promotional budget on Vaculator products, J. C. Callahan has been appointed director of advertising and public relations. A new customers relation's department has been opened under the direction of Mrs. Adele Eichhorn.

## Haines Joins Hytron

Hytron Radio & Electronics Corp., Salem, Mass., has appointed Donald G. Haines as sales and commercial engineer, in its Chicago office. Mr. Haines had formerly worked with RCA, Ken-Rad, Zenith and National Union.

VELOCITY
P.G. DYNAMIC

THE FINEST MICROPHONES

# AMPERITE

FOR PUBLIC ADDRESS & RECORDING

**KONTAK MIKES**

*M*ICROPHONES THAT SURPASS THE HIGHEST REQUIREMENTS OF BROADCASTING, PUBLIC ADDRESS, AND RECORDING

Write for Catalog

**AMPERITE COMPANY**  
 561 BROADWAY • NEW YORK, N. Y.

## IMMEDIATE DELIVERY!

### 2-Post Record Changer

*Automatically Intermixes*

Record changer completely assembled—with amplifier ready to play. Dimensions 8" H. x 15½" x 15¼" D. Grilled speaker front, acoustic chamber 15" W. x 4" D. with rear louvre for eliminating cabinet resonance. Genuine walnut cabinet with decal trim, nickel plated mounting hardware, tone and volume control mounted on changer 6" heavy duty dynamic speaker. AC amplifier with power transformer, AC power cord and plug. 3 tubes 1-6V6, 1-6C5 and 1-5Y3. \$44.50 Net

Cabinet less changer and amplifier. \$9.50 Net  
 Accommodates Webster and V-M Changers

20% Deposit required on all orders

## UNION Radio Corporation

328 S. Paulina • Chicago 12, Ill.

We tell the LEAR STORY  
over 80,000,000 times



America's leading national weeklies, monthlies and industry trade papers keep up a rapid-fire barrage of advertisements about the new Lear Radios. These ads appear in full color and black and white, in full page space and in half pages.

And altogether, more than 80,000,000 readers will see them.

This is one step in the promotion of Lear Radios. A whole program of supporting material is planned to send people to Lear Dealers eager to see these new radios with the Lear Tape Recorder, the new remote tuning control, the high fidelity FM and the improved short wave.

Rapidly growing public acceptance of Lear Radios is making the Lear Franchise a particularly valuable property. You should have all the details about it. Get them by writing LEAR, Incorporated, Home Radio Sales and Merchandising Division, 110 Ionia Avenue, N.W., Grand Rapids 2, Michigan.



# TRANSFORMERS

INbuilt Quality for  
OUTstanding Performance

A Superior Product

S  
N  
C

A Noteworthy Policy

Characteristic Quality

See Your  
Nearest Distributor

**SNC MANUFACTURING COMPANY**

WEST LAKE ST. • GLENVIEW, ILL.

Export Agents: Scheel International • 4237 N. Lincoln Avenue • Chicago, U.S.A.

## FULL SOLDERING HEAT

in 5 Seconds

### SPEED IRON\* TIME SAVERS

STAYS TINNED-  
NO TIP BURNING



SEE WHAT  
YOU SOLDER



SOLDER AROUND  
CORNERS

Ask for SPEED IRON at  
your RADIO PARTS DISTRIBUTOR

FAST heating speeds your work. A new transformer principle is applied to soldering for producing high current at low voltage, generating heat in tip almost instantly. SPEED IRON is always ready for use.

- 100 WATTS—115 VOLTS—60 CYCLES
- INTERMITTENT OPERATION THROUGH TRIGGER SWITCH
- NOTHING TO GET OUT OF ADJUSTMENT
- TIP COOLS AS FAST AS IT HEATS
- HANDLE STAYS COOL
- CAN'T OVERHEAT OR BURN OUT

**WELLER MFG. CO.**

516 NORTHAMPTON ST. • EASTON, PA.

\*TRADE MARK REG. U. S. PAT. OFF.

See us at the Radio Show—Booth 47

### Logan, General Mills, On Bigger Appliance Demand

James R. Logan, division vice-president in charge of General Mills, Inc., Minneapolis, Minn., home appliance manufacturing department, forecasts a bright future for the appliance industry.

"Even when the days of the seller's market have passed," he says, "there will be great demand for home appliances which make a definite and constructive contribution to the ease and convenience of the homemaker. Despite the alarmed cries of economic pessimists, the American standard of living is steadily rising—and good appliances are an important part of that standard."

### Father's Day Credo

The National Father's Day Committee has prepared a general statement for retailers to use in connection with Father's Day, June 16, advertising and publicity.

This year's slogan is "Honor Our Veterans—Give Thanks This Father's Day." The committee's statement says:

"The best way stores can tie-in with Father's Day which 'Honors Our Veterans' is to see that veterans are supplied with the things they need.

"Merchants: Save your scarce merchandise for veterans. Your other customers will gladly wait."

### Ready Dates for Television Sets

The following firms have set dates and price ranges for postwar television receivers, according to the Television Broadcasters Association:

- Belmont (Raytheon) July, \$150.
- RCA, early Summer, \$150-\$200.
- GE, early Summer, \$300.
- DuMont, early Summer.
- Viewtone, May, \$100.
- Farnsworth, Aug. or Sept., \$200 up.
- Emerson, September, \$200.
- Lear, Autumn.
- Sentinel, Latter Quarter '46, \$150.
- Stromberg-Carlson, Autumn.
- Electronics Corp., Latter '46.
- Philco (sets will be ready in '46).
- U.S. Tele Corp., June, \$250 up.

### Lear's Ad Director



Named for the post of director of advertising and public relations for Lear, Inc., is Jean H. DuBuque, formerly a Lt. Col. in the AAF. His duties cover all Lear divisions including home and aircraft radios plus mechanical products.

# Sensational

...in high fidelity reproduction  
...in trade acceptance!

THE

# WALCO "400" SERIES PLAYBACK NEEDLES

Volume sales...greater profits...  
are in the palm of your hand!



There's a reason why more leading manufacturers entrust the performance of their record players depend on a great name in needles... for tonal fidelity... smoothness... and longer service! That's why your trade depends on WALCO... the phono needle that is standard equipment with the "big leaguers"—MAGNAVOX, GENERAL ELECTRIC, PACKARD-BELL, ADMIRAL, MOTOROLA,

SEARS (SILVERTONE), SCOTT, PHILCO, HALICRAFTERS, HOFFMAN, etc. And manufacturer acceptance of WALCO needles is only one of many hard-hitting sales features that reduce dealer effort... stimulate sales demand... get repeat sales month after month. Backed by consistent, intensified national advertising you are "in" with WALCO! Stock or re-order today. Address inquiries to Electrovox Co., Inc., 31 Fulton St., Newark 2, N. J.

## WALCO

NOW IN THESE BEAUTIFUL, NEW PLASTIC CONTAINERS

WALCO "400"  
FLOATING JEWEL \$250

WALCO "400"  
RUBY JEWEL \$200

WALCO "400"  
PRECIOUS METAL \$150

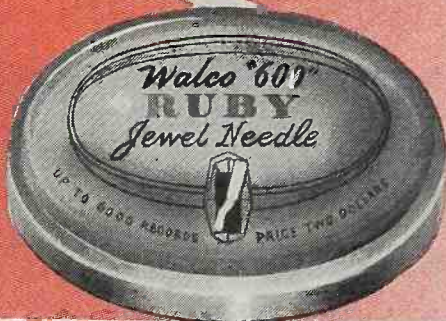

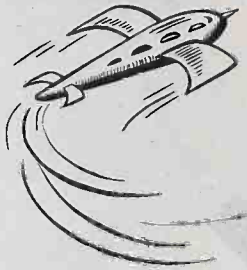

## We Don't Promise You A Trip To The Moon -- But Jobbers

We do promise that you will see on exhibit a line of inter-communication, **NOW BEING DELIVERED**, that is simply out of this world for completeness, beauty of styling and finish, ease and efficiency of operation, and sound economy.

**Booth 121**

Be sure to ask for a copy of the new Talk-A-Phone catalogue . . . just off the press.

. . . headquarters for inter-communication, and you are invited to make it **YOUR** headquarters while attending the show.

AL SCHAAR  
Sales Manager

# Talk-A-Phone Mfg. Co.

1512 So. Pulaski Rd. Chicago 23, Ill.

# AMERICAN CAPACITORS



For dependable, unfailing capacitor performance rely on "AMERICAN."



A hearty welcome awaits convention visitors at the AMERICAN BOOTH

SPECIFICATION SHEETS ON REQUEST

ALL STANDARD TYPES • PRECISION ENGINEERED FOR DEPENDABILITY

## AMERICAN CONDENSER CO.

4410 NO. RAVENSWOOD AVE. • CHICAGO 40, ILL.

## Povlsen Vice-President Maguire Industries

The new vice-president and general manager of Maguire Industries, Inc., is Paul K. Povlsen, according to word from Russell Maguire, president of the firm. The new official, who comes to Maguire



Paul K. Povlsen

from the J. I. Case Co., Racine, Wis., will be in charge of all manufacturing operations of the company. Maguire has units at Bridgeport and Stamford, Conn., Chicago and Mt. Carmel, Ill., Cleveland, and Jamaica, N. Y.

Mr. Povlsen had previously been associated with Bell telephone companies, the Calco Chemical Co., and the Diehl Mfg. Co.

## Motorola's Regional Sales Heads

Released from active duty in the Signal Corps, Lt. Col. Vernon A. Kamin has been announced by Motorola as the regional sales manager for the New York area. He's a sales expert who previously worked with Sears Roebuck, Corona Radio, and Goodyear Tire & Rubber Co.

New appointment by the Galvin Mfg. Corp. in the Detroit and Cincinnati area is that of W. H. "Lefty" Kelley, as regional sales manager. Mr. Kelley comes to Motorola with over 20 years merchandising experience with Apex, Kelvinator, Leonard and others.

Another new regional sales manager for Motorola is J. M. Tuttle, for the West Coast and Inter-Mountain area. Mr. Tuttle has been with RCA since 1928, before he became a Navy officer in 1944.

John Paul Jones is back at his post as district representative for Motorola in the southern California area. His association with Galvin started 6 years ago.

## Steadman Toastmaster Rep

Announcement that Frederick W. Steadman Jr. has been appointed Toastmaster representative in the New England area, was made by Arthur S. Miller, eastern sales manager, domestic appliance department, Toastmaster Products div., McGraw Electric Co., Elgin, Ill. Mr. Steadman will make his headquarters in Boston.



How to make  
FRIENDS and PROFITS  
with  
**SIMPLON**  
RADIO

Reg. U. S. Pat. Off.

RADIO ENJOYMENT AT ITS BEST

## *A First-Team*

## *Product of a Quality-Conscious Organization*

Because we're decidedly quality-conscious about what goes into Simplon Radios, we're building our distributor and dealer set-up on the basis of careful selection. First, because we want the kind of outlets we'll be glad to be in business with over the long haul. Second, because we want to assure adequate profit potentials to the Simplon franchise holders in any given territory or locality.

So, if you're interested in a better-than-average radio in the popular price class to give you better-than-average profits—the kind of radio that will make and *keep* friends for you—then we can go to town together.

### **The Quick Facts About Simplon Radio**

**THE SET**—A handsome table model of outstanding good looks, craftsmanship and quality.

**THE MAKER**—Industrial Electronic Corporation—specializing in equipment of high precision.

### **Sales Policy Geared to Worth-while Profits**

—Our price line-up assures better-than-average profits per set. Our Franchise Plan is geared to selective distribution to assure consistently profitable business for every Simplon Franchise holder. (Conversely, only Simplon Franchise holders will be supplied with Simplon radios.)

### **Prompt Action May Avoid Disappointment**

Whether you're interested in a distributorship or a dealer franchise, we suggest prompt inquiry to avoid the possibility of disappointment. A note on your letterhead will bring a prompt reply—and full details of what Simplon Radio offers in terms of continuing good business as well as immediate profits.

**INDUSTRIAL ELECTRONIC CORPORATION**

505 Court Street • Brooklyn 31, New York

**Order from LAKE!  
You'll Make No Mistake!**

**RADIO CABINETS & PARTS**



**Now Available!**

**Postwar  
2 Post  
RECORD-  
CHANGER**

With luxurious brown leatherette portable case, 15" L x 15" W x 10" D. Latest electronic developments make this modern

record-changer the finest on the market today!  
List price—\$49.95 Dealer's net—\$29.97

**DE LUXE RECORD-CHANGER AND AMPLIFIER CASE**

De luxe changer case with ample room for amplifier. Overall dimensions: 20" L x 16" W x 10" H. Sturdily built of 5/8" plywood, deluxe brass hardware throughout. Inside dimensions: 15 1/2" L x 14 3/4" W x 9 1/2" H. Net price.....\$12.95



**De Luxe  
PHONO  
CABINET**

Covered in luxurious, genuine brown leatherette, has deluxe brass hardware throughout, made completely of plywood with brown plastic handle, has padded top and bottom. Motor board 14" x 14 1/2". Overall dimensions 16" L x 15" W x 8" H. Your special net price.....\$8.95

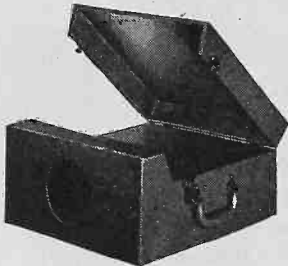

Portable Phono-graph case in brown leatherette covering. Inside dimensions 17 1/2" long, 13" wide, 7 1/2" high. Has blank motor board and opening for speaker. As illustrated at left, specially priced at.. \$7.95

Also blank table cabinets of walnut veneer in the following sizes, with speaker opening on left front side: (\*Note: \*7 has center speaker grille)

- #1 — 8 1/4" L x 5 1/2" H x 4" D \$1.95
- #2 — 10 1/4" L x 6 3/8" H x 5" D \$2.75
- #3 — 13 1/2" L x 7 7/8" H x 6 1/4" D \$3.25
- #7 — 10 1/4" L x 7" H x 5 1/2" D \$2.50

\*Speaker Opening in center of front side. All types of radio cabinets and parts are available at Lake's Lower prices. A large stock is listed in our catalog.



**SERVICEMEN—RETAILERS**  
Join our customer list today.

Dept. B

Write for our NEW 12 page, illustrated, elaborate catalog!

**Lake Radio Sales Co.**  
615 W. Randolph Street  
Chicago 6, Ill.

**New Name  
for Trav-Ler**

Trav-Ler Karenola Radio & Television Corp., Chicago, has changed its name to "Trav-Ler Radio Corp.," according to word from Joe Friedman, president.

The change is in line, Mr. Friedman states, with Trav-Ler's program of "streamlining and unifying the company's entire organizational set-up; it will conform with the name of the new West Coast Trav-Ler plant, known as the Trav-Ler Radio Corp. of California."

**Hamilton Names Jobbers**

W. A. Friedrich, sales director, home appliance div., Hamilton Mfg. Co., Two Rivers, Wis., announce 54 additional distributors of the Hamilton automatic clothes dryers throughout the nation:

B. H. Spinney Co., Albany, N. Y.; Alford's Wholesale, Albuquerque, N. Mex.; Joseph M. Zamoiski Co., Baltimore, Md.; Steel City Supply Co., Inc., Birmingham, Ala.; W. Bergman Co., Inc., Buffalo 3, N. Y.; Northwest Supply Co., Butte, Montana; Cannon Distributing Co., Charleston, S. Car.; Tri-State Supply Co., Chattanooga 2, Tenn.; The Sampson Co., Chicago 16, Ill.; Strong, Carlisle & Hammond Co., Cleveland 13, Ohio; Luethi & Welch, Inc., Columbus 15, Ohio; Radio City Distributing Co., Dallas 2, Texas; The Auto Equipment Co., Denver, Colo.; Schneiderhahn's, Inc., Des Moines, Iowa; Peninsular Distributing Co., Detroit 7, Mich.; Allied Appliance Distributors, Evansville, Ind.; Fargo Glass & Paint Co., Fargo, N. Dak.; Buhl Sons Co., Grand Rapids 2, Mich.; Northwest Supply Co., Great Falls, Montana; Northwest Supply Co., Helena, Montana; The Gibson Company, Indianapolis, Ind.; The Southern Wholesalers, Jackson, Miss.; Mayflower Sales Co., Kansas City, Mo.; Maytag-Atlantic Co., Inc., Long Island City 1, N. Y.; Sues-Young Co., Los Angeles 15, Cal.; Bomar Manufacturing Co., Louisville, Ky.; Shobe, Inc., Memphis 3, Tenn.; Roth Appliance Distributors, Milwaukee 4, Wis.; Forster Distributing Co., Minneapolis 3, Minn.; Gambill Distributing Co., Nashville 3, Tenn.; Woodward-Wight Co., New Orleans 9, La.; Wm. Mee Co., Oklahoma City, Okla.; Major Appliance Co., Omaha 8, Neb.; Pierce-Phelps, Inc., Phila., Pa.; Gordon E. Wilkins, Inc., Phoenix, Ariz.; J. A. Williams Co., Pittsburgh, Pa.; F. B. Connelly Co. of Oregon, Portland 9, Ore.; Erskin-Healy, Inc., Rochester, N. Y.; Mayflower Sales Co., St. Louis, Mo.; Gordon E. Wilkins, Inc., Salt Lake City, Utah; California Electric Supply Co., San Francisco 3, Cal.; Broome Distributing Co., Scranton, Pa.; F. B. Connelly Co., Seattle 9, Wash.; Duncelman-Paco Co., Shreveport, La.; Andrews & Medema, Inc., South Bend 4, Ind.; Columbia Electric & Mfg. Co., Spokane 8, Wash.; B. H. Spinney Co., Springfield, Mass.; B. H. Spinney Co., Syracuse, N. Y.; Gulf Appliance Distributors, Inc., Tampa 2, Fla.; Columbia Wholesalers, Inc., Washington, D. C.; Mayflower Sales Co., Wichita 12, Kan.; York Supply Co., Cincinnati, Ohio; York Supply Co., Dayton 2, Ohio; Forster Distributing Co., Minneapolis 3, Minn.

**"TAB"**

THAT'S A BUY

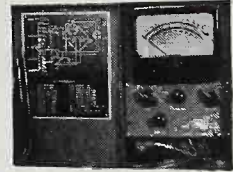

**ELECTRONIC VOLT-OHMMETER BRAND NEW U. S. ARMY TYPE 1-107-F PRECISION UNIT.** Rugged design housed steel case 6"x9 1/4"x4 1/8" leather carrying handle. Contains Simpson 4" highly damped 400 microamp Alnico meter. Clear visible scale large numerals easily readable at all points. All voltage ranges ten megohms sensitivity; reads 0-3 volts in .05 v steps; 0-10 volts in 2 v steps; 0-30 volts in 5 v steps; 0-100 volts in 2 v steps; 0-300 volts in 5 v steps—OHMS Rx1 from .02 to 1000 ohms; Rx10 from 2 to 1000Ω; Rx100 from 20 to 100000Ω; Rx1000 from 200 to 1 megΩ; Rx10000 from 2000 to 10 megΩ (center scale is 10) Unit complete with 3 test leads; batteries and instructions. Cost gov't \$65. "TAB" special \$29.70 Additional V.T.V.M. Octal tube 1 LE 3/SP Sig C \$1.15. \* \* \* \* \*

**COMPLETE NEW W.E. OSCILLOSCOPE** 5 inch made by Western Electric for U. S. Army type BC412. Cost gov't over \$2000. Contains power supplies 115 v 60 cy; amplifiers and controls for Vertical and Horizontal position. Focus intensity, Sensitivity, Spread, Sweep (fixed freq.) with new Tubes 5BP4, 879, 5T4, Six 6L6, Two 6SJ7, 6AC7, 6H6. Easily adapted to laboratory Radio service work or television. Completely housed heavy steel case. Exceptional "TAB" price \$65. Ship. wt cased 200 lbs. Tested guaranteed new.

\$1 Min. orders FOB. N.Y.C. Add Postage all orders and 25% deposit. Whitehall 3-3557. Send for catalog 300. Don't wait, rush orders as quantities are limited.

"TAB", Dept. RR5  
Six Church Street, New York 6, N. Y.

**Introducing —**

the  
**"RADIO SERVICE  
STANDARD  
RATE BOOK"**

A manual designed for the  
Radio Service Dealer

- to assist him in determining and quoting prices for his work
- as a convenient guide for ordering replacement parts
- outlining step-by-step general servicing procedures

**Includes:**

- Radio Tube Prices
- Radio Parts Prices
- Crystal Cartridge Digest
- Registry of Electronic Manufacturers
- Auto Radio Installation and Service
- Price Formula for Repairs of Radio Equipment
- General Servicing Procedures for Radios and Record Changers

**Price: \$1.00 per copy**

Available at  
your radio parts jobber

**OELRICH PUBLICATIONS**  
1627 South Keeler Avenue  
Chicago 23, Illinois

## Commercial Credit Enlarges Facilities

The opening of 18 additional operating offices in 14 states and Canada has been announced by Commercial Credit Corp., Baltimore.

"Prompt and efficient local service for our dealer customers is the keynote of our expansion," said E. C. Wareheim, executive vice-president. "We are adding week after week new totals to the network of local operating offices. With this expansion expected to continue this means that in the period ahead, when all indications point to a rapid upswing in the production and financing of articles usually purchased on time, our dealer customers whether they are located in large cities or small communities can count on maximum service from Commercial Credit."

Managers and locations of the additional regions and offices are: E. A. Howell, Jacksonville (region), Fla.; Earl G. Miller, Indianapolis (region), Ind.; J. H. Miller, St. Louis (region), Mo.; William K. Robinson, Chester, Pa.; S. Laverne Elliott, Vincennes, Ind.; J. B. Lee, High Point, N. C.; George F. Kidwell, Monroe, La.; G. O. Snowden, Daytona Beach, Fla.; Robert T. Williams, Trenton, N. J.; William S. Pettit, Des Moines, Iowa; John Frank, Danville, Ill.; William J. Vann, Fayetteville, N. C.; Harold R. Timmell, Billings, Mont.; F. J. Neale, Saskatoon, Saskatchewan; J. A. Searight, Edmonton, Alberta; James W. Kiesle, New Albany, Ind.; E. J. Brulotte, Quebec, Ontario; Harold L. Hanson, Missoula, Mont.; Don L. Smith, Boise, Idaho, John E. McLeod, Lewiston, Me.

Mr. Howell, Earl G. Miller, and J. H. Miller are new appointees in their regional posts. All three are vice-presidents of the firm.

## JFD Sockettes for New Miniature Tubes

The availability of miniature tube types is stressed by JFD Manufacturing in announcing an additional line of Sockette radio tube adapters for miniatures. Miniature tubes with the characteristics of hard-to-get standard types which may be replaced, include: 6AT6, 6AU6, 6BA6, 6BE6, 12AT6, 12BA6, 12BE6, 35W4, and 50B5. These replace, in order, the 6SQ7, 6SH7, 6SG7, 6SA7, 12SQ7, 12SG7, 12SA7, 33Z5-GT/G, and 50L6-GT. Information on the full adapter line may be obtained from JFD Manufacturing Co., 4117 Ft. Hamilton Pkwy, Brooklyn, N. Y. Ask for Adapted Form 502.

## Bell & Howell Adds 2 Plants

The elaborate 2¼-million dollar Lincolnwood plant on McCormick Rd., Chicago, has been purchased by the Bell & Howell Co., from the Reconstruction Finance Corp. The firm is also building another plant in the area, which makes a total of 5 plants in the Chicago area. The company also has office and factory facilities in Hollywood, Washington and New York.

Where stability  
takes top priority...

# SNYDER

Antennas

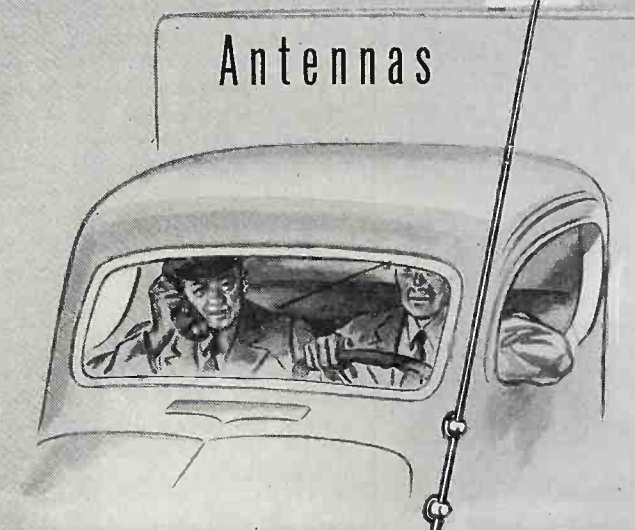

**SNYDER MFG. CO.**  
PHILADELPHIA

**MANUFACTURERS... START TO FINISH**



**MANUFACTURERS OF RADIO, ELECTRICAL  
AND ELECTRONIC COMPONENTS**

# VOKAR

*Corporation*

**7300 HURON RIVER DRIVE • DEXTER, MICHIGAN**

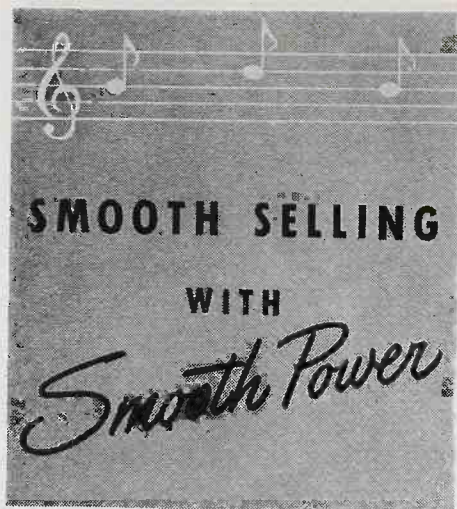

• The fine performance of General Industries *Smooth Power* motors will bring smooth selling for your new designs of phonographs, recorders and record-changers. Any motor you select from the comprehensive GI line will make quick and permanent friends with its smooth-as-velvet operation, quietness and uniform speed. So, for smooth selling and smooth performance, standardize on *Smooth Power*.



The General Industries Company  
DEPT. M • ELYRIA, OHIO

### Bigger Plans for Music Trade Show & Convention

Brisk plans are going forward for the big 1946 Trade Show and Convention of the National Association of Music Merchants, to be staged for four days, July 15-18, at the Palmer House in Chicago. Essentially a "working" convention, the first peace-time get-together of the group in five years, the highlights are "keynote" luncheon on July 15; merchandising clinics on the 16th and 18th; a sales training forum on the 17th, and a final industry banquet on the evening of the 18th.

Much interest centers around the exhibits of merchandise. There will be four sections of the hotel jammed with the latest musical products—the Exhibit Hall, the Club Floor, and the 7th and 8th floors. These exhibits will be open from 10 a.m. to 6 p.m. daily except on the 17th, when they will be closed until noon for industry association meetings.

NAMM urges guests to make hotel reservations at the earliest possible date, either at the Palmer House or other Chicago hotels. Definite plans for an expanded industry will be made at the convention, and the attendance is expected to be exceptional. The first election of the NAMM board of directors under new by-laws will take place.

Meanwhile, NAMM's activity for National Music Week, May 5 to 12, continues with the mailing to merchants of the new 1946 Music Week Kit. A new Music Week Manual is included, so that dealers can do their best job locally on all aspects of the celebration. Sets of three Music Week newspaper mats are available at 38c.

Headquarters of NAMM are at 28 E. Jackson Blvd., Chicago 4, Ill.

### To Handle Meck

The Sacramento Electric & Supply Co., Sacramento, Cal., and the Nebraska Radio Distributing Co., Lincoln, Neb., have been named distributors for John Meck radio products.

### In Sparton Post



N. H. (Terry) Terwilliger has been appointed sales promotion and advertising manager of the radio and appliance division of Sparks-Withington Co., Jackson, Mich. In radio 20 years, he was a well known figure in Zenith promotions, which he handled for 10 years.

## LIBERTY RADIO KITS

**6 Tube "Super Het" Radio Kit**  
Complete Including Attractive Walnut Cabinet  
Your Cost **\$16.95**  
Less Tubes

Diagram Furnished

ALL PARTS MOUNTED—Uses one 25L6, one 25Z6, one 6SQ7, one 6SK7, two 6SJ7's or one 50L6, one 35Z5, two 12SJ7's, one 12SQ7, one 12SK7.

**5 Tube "Super Het" Radio Kit**  
Your Cost **\$13.95**  
Less Tubes  
Complete Including Attractive Brown Bakelite Cabinet  
Diagram Furnished

ALL PARTS MOUNTED—Uses one 25L6, one 25Z6, one 6SQ7, one 6SK7, one 6SA7 or one 12SA7, one 12SQ7, one 50L6, one 35Z5, one 12SK7.

10% Deposit — Balance C.O.D.

**LIBERTY SALES CO., INC.**  
115 WEST BROADWAY • NEW YORK 13, N. Y.

## R-L CONDENSERS GUARANTEED FOR ONE YEAR

### ELECTROLYTIC

Assortment of 25 electrolytic condensers consisting of 3 each—8, 16, 20, 30, 40, Dual 16, 20, and 2 each 30, and 30x20 MFD. 150 volts.

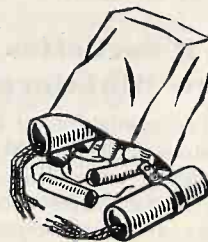

25 CONDENSERS ASSORTED...\$5.85



### PAPER

Assortment of 50 paper condensers consisting of 5 each, .001, .002, .005, .01, .02, .03, .04, .05, .06, .1 MFD. 600 volts.

50 CONDENSERS ASSORTED...\$3.29

Write for Free 1946 Parts Catalog



731 West Washington Boulevard  
Dept. R CHICAGO 6, ILLINOIS

**NEED WIRE NOW**  
for Radio, Electrical and  
Communication Applications?  
**Columbia HAS IT!**

**CONVENTION SPECIALS!**

- EXTRA FLEXIBLE ANTENNA Per 1000 ft. WIRE for AC-DC sets..... \$2.95 (3000 ft. spools)
- 2 Conductor - 19 Ga. Solid T/C Rubber covered, Twisted Pair.... \$6.50
- 2 Conductor Geon Plastic jacket; flame, oil and water-resistant, 20-Ga., Solid Copper ..... 11.95
- 2 Conductor, twisted, with tough rubber jacket, small OD suitable for intercom, etc. .... 9.85

**NOTICE: Our new address.**

We have just moved into our own new, larger quarters to better serve the industry. Come in and see our complete stock of electrical insulated wire and cord sets for radios and appliances.

**COLUMBIA WIRE & SUPPLY CO.**  
5740 ELSTON AVE., CHICAGO 30, ILLINOIS

**LAST MINUTE SPECIALS**

- Iron Cord Sets, 6 ft. fine quality G. E. wire with plugs....\$0.42 each
- Extension Cord Sets, 7 ft., with 3-way cube tap..... .41 each
- Hand Juice Press, beautiful colors..... 3.75 each
- Penetray Heat Lamp (sold in lots of 12 only).....White 1.04 each
- Penetray Heat Lamp (sold in lots of 12 only).....Ruby 2.40 each

**ELECTRIC COFFEE MAKER SET**

Consists of a beautiful Electric Coffee Maker Stove, 8 Cup Glass Coffee Maker, Attachment for Grilling, also Attachment for Making Toast .....\$6.85 each

(O.P.A. Retail Price.....\$9.98 each)

- Compact, exceptionally high grain, hum-free 3-tube AC-DC Phono amplifier (less tubes).....\$4.50
- 5" Jensen speaker and output transformer.....\$3.75

**ALL PURPOSE ELECTRICAL TESTER**

For checking electrical appliances and radios (net) .....\$6.00 each (resale price—\$9.95)

Write for illustrated literature featuring other merchandise. 2% discount for payment with order, otherwise shipped C.O.D. net.

**Sheffield Radio & Appliance Co., Inc.**  
916 W. Belmont Avenue Dept. A Chicago 14, Illinois

**NO TEDIOUS HAND TURNING!**

That's  
What  
SELLS  
It

**KASSON Electric Bar-B-Q MEAT TURNER**

NEW ELECTRIC Meat Turner revolves three times a minute without droppery of hand turning. Meats barbecued evenly, effortlessly. Equipped with 50 feet of cord, ELECTRIC BAR-B-Q is sturdy, all-metal—won't tip over. Operates on house current (110 Volts AC). Height and width adjustable. Extra, short set of uprights included for use in indoor fireplaces. Holders for drip pan permit basting with natural juices.



Distributors, Dealers: Write or wire for literature and discounts on this tested, fast-selling product. Immediate Delivery.

List Price \$39.50 F.O.B. New York

GENERAL DIE & STAMPING CO., 263 Mott St., New York 12, N. Y.

**IMMEDIATE DELIVERY ON THESE FAST SELLING, QUICK PROFIT ITEMS!**

- ★ CAR ANTENNAS
- ★ COMPLETE SET KITS
- ★ METAL RADIO STAMPINGS
- ★ DIAL EQUIPMENT
- ★ PHONO AMPLIFIER UNITS

A fast moving AC-DC, 5 tube superhet receiver kit, 5" P.M. speaker. Includes all parts! Chassis is sub-assembled with sockets, shielded coils and gang condenser in place, ready to wire. Complete to the last detail including resistors, condensers, hardware and even solder. With or without tubes less cabinet. Covers standard broadcast band, excellent tone, sharp tuning. Furnished with detailed diagrams and instructions... anyone can assemble in hour.

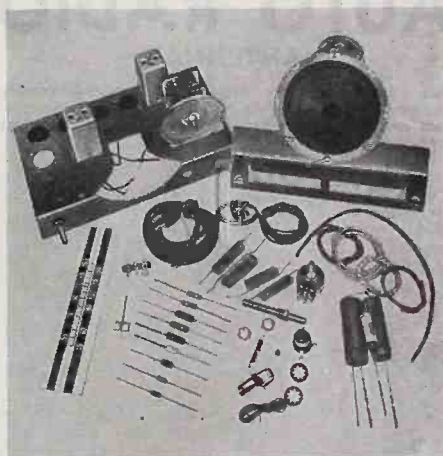

Radio manufacturers and distributors! Investigate the LAMCO complete line of metal stampings — chassis, dial pulleys, pointers, brackets, plates, shafts. Quick delivery guaranteed. Finest workmanship throughout. Besides an unusual line of standard parts, LAMCO can supply special items to your specification.

★ MANUFACTURERS ALSO OF LAMCO RADIOS AND PRIVATE NAME BRAND SETS

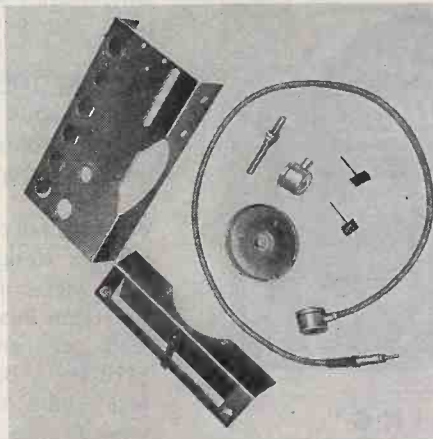

**CAR ANTENNAS**

- ★ SEAMLESS BRASS TUBING
- ★ HEAVY CHROMIUM PLATING
- ★ BAKELITE INSULATION
- ★ DOUBLE SHIELDED LEAD-IN

Besides these important features, LAMCO car antennas have special inserts that prevent vibration, rattle and jamming of sections. Beveled edges on each section prevent weathering on inside of tube. Supplied in 4 types to meet all requirements.

No.	SECTIONS	LENGTH	TYPE
LS 66 A3	3	66"	Side Cowl Standard
LS 72 A3	3	72"	Side Cowl Deluxe
LS 96 A4	4	96"	Side Cowl Deluxe
LS 110 A4	4	110"	Side Cowl Deluxe

**LAMCO**

**LA MAGNA MFG. CO., INC.**

TEL. RUTHERFORD 2-8128, 8604  
51 CLINTON PLACE EAST RUTHERFORD, N. J.

*Spirling*  
ON

**ANTENNAE**

is like  
"STERLING" on Silver

Only "SPIRLING" has it!!  
New!!! PERMA-TENSION\* telescoping

**AUTO RADIO  
ANTENNAE**

Our advance design guarantees unconditionally, the perfect telescoping, proper drainage and perfect contact, thus assuring highest radio reception

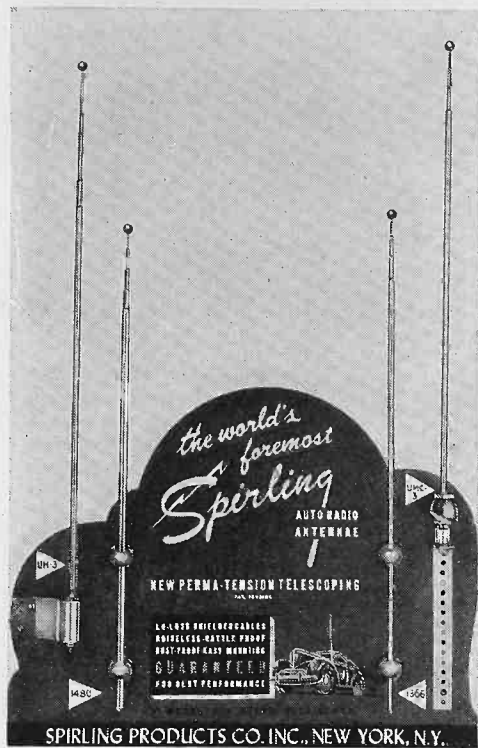

"SPIRLING"  
**PHONO MOTORS**

(heavy duty)

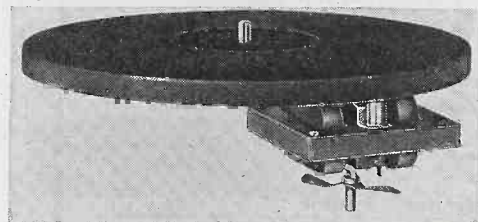

Featuring New!!!  
PERMA-TENSION\*  
(Balanced Stability Operation)

Visit us at the  
**RADIO PARTS SHOW**  
Stevens Hotel, Chicago, May 13-16  
Booth 10

**SPIRLING PRODUCTS CO.**

60-62-64 Grand Street,  
New York 13, N. Y.

\*Patents pending

**20 Years Ago**

From the May, 1926, issue  
of Radio Retailing

**HOT-WEATHER SALES**—Summer reception of good programs now an established fact.

**INSTALLMENT SELLING**—Time payment business shows only one per cent loss.

**COOPERATIVE EFFORT**—(Editorial) Industry jobs await cooperative action in radio (1) Administration, (2) The Laboratories, (3) Production, (4) Publicity and Advertising, (5) Distribution, (6) Retailing, (7) Broadcasting.

**SIDELINES FOR SUMMER**—Athletic goods, musical instruments, electric iceboxes, fans, cameras, auto accessories.

**FROM WASHINGTON**—Proposals are made for a special commission, entirely outside the Dept. of Commerce, to assign wavelengths to broadcasting stations.

**TALK OF THE TRADE**—Federated Radio Trade Associations complete organization in Chicago; thirteen groups send delegates.

**WHAT'S NEW**—Wicker-covered speaker designed to harmonize with wicker furniture for \$35 by American Bosch; six-tube receiver with only one dial control, for \$110 by J. B. Ferguson; new detector tube for \$5, by RCA; five-tube double-range neutrodyne receiver for \$145, by F. A. D. Andrea.

**New Cabinet Said to  
Cut Prices 20%**

Announcements from Admiral Corporation's President Ross D. Siragusa say that "final development of our specially designed plastic radio-phonograph cabinet is bound to affect the price structure of the industry."

Mr. Siragusa said that "the cabinet, which is Admiral's exclusive property, will be used to market a table model radio-phonograph that will cost the retail buyer approximately 20 per cent less than the identical instrument, also made by Admiral, in a wood veneer cabinet." The entire saving occurs, he said, in the existing price differential between plastic and wood veneer. Volume production of the new cabinet already has begun.



Use space in the  
music industry's leading  
dealer publication to tie-in with  
your own July promotion.

*Note well...*

**MUSIC INDUSTRY'S  
SHOW Number**

*of*  
**RADIO & Television  
RETAILING**

*and New*  
**RECORD Section**

*Coming in July*

**Closing Date—June 5**

**CALDWELL-CLEMENTS, INC.**  
480 LEXINGTON AVE., NEW YORK 17, N. Y.

# McGEE'S LATEST BARGAINS!

## 2-VOLT ARMY POWER SUPPLY FOR WALKIE-TALKIE

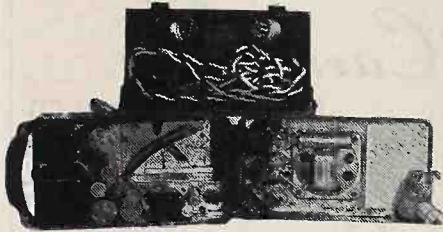

Just full of usable replacement parts. Handy metal case with hinged lid. 4" PM Speaker with three oz. of Alnico-5 magnet. Has two 7-prong 2-volt sync. vibrators as used in G.E. self-charging portable radio; also two 6-volt, four prong, non-sync. vibrators. Ideal for regular replacement use. Three 2500 mfd., 3-volt filters. Also a multitude of condensers, resistors and other small parts. Two unit selenium rectifiers. Spare parts box with heavy duty A-leads and battery clips. Has two relays, one of which is a 10,000 ohm, 4-mill. plate type relay. This unit no doubt cost the government nearly \$100. Complete Manual with each unit. New, factory packed.  
**Price complete** .....\$9.95  
**LESS the four vibrators** .....\$5.95

## 2-VOLT STORAGE BATTERY

For replacement use in the G.E. self charging Portable Radio. Electrolyte included but shipped separately. Shipped dry.  
 Each .....\$4.95

**GENUINE RCA METAL 6L6 TUBES**—Only 1000 to sell. Very special .....99¢  
 500 M Volume Control With Switch .....59¢

**TUBULAR ELECTROLYTICS GUARANTEED 1-Y**  
 16 mfd 150 V 24¢      40-30mfd 150 V 49¢  
 30 mfd 150 V 29¢      8mfd 450 V 28¢  
 40 mfd 150 V 35¢      16mfd 450 V 49¢  
 20-20mfd 150 V 39¢      8-8mfd 450 V 49¢

**PERMEABILITY TUNING UNIT**—A hot item for the set builder. Slug tuned antenna and oscillator all mounted on small bracket with 1/4" shaft. 180° rotation mounts just like a condenser gang. Just remember, all the other coils you need are the 456KC 1Fs. Slug tuner less dial .....\$1.98  
 With dial drive and esch plate .....\$2.98

Remit 20% With Order — Balance Will Be Sent C.O.D. All Items Listed Are in Stock.

## PHONO MOTOR CRYSTAL PICK UP AND CABINET — ONLY \$11.95 — A RED HOT VALUE

Newest phono motor and turntable. Latest fan-cooled-tru 78 rpm motor. Astatic low pressure crystal pick up. Cabinet is deep enough for 5" speaker and small amplifier or radio. Offered in two styles. Type A as shown with speaker hole in center or type R with with speaker hole on the left leaving room on the right side for radio dial. Top of cabinet is cut for motor and pick up.

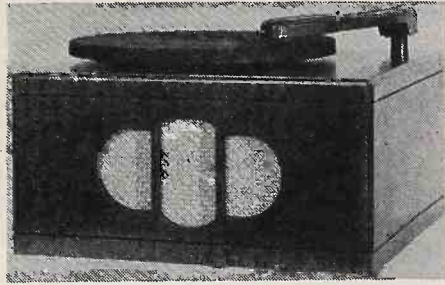

## RECORD CHANGERS—WE HAVE 'EM

Latest construction single post type with light weight crystal pick up. Individually factory packed. We can ship now. Only (each) .....\$17.95

## PHONO. OSCILLATOR \$3.69

Tunes over full broadcast band. Compact size. Made on bracket type chassis for easy mount'g. Complete with tubes.

## REPLACEMENT VIBRATOR UNITS

We furnish you just the inside unit less the can. Has leads and small enough to fit any case. All are brand new. You save as much as \$3.00 by using these units. A hot item for the service man. Standard Sync Unit .....\$1.69  
 Standard 4 prong vibrators.....\$1.49  
 Standard 6 prong Sync .....\$1.98  
 Standard 7 prong 2 volt Sync as used by GE.....\$1.98

## TUBES AND ADAPTERS TO REPLACE NUMBERS STILL SCARCE AT ABOUT PRICE OF TUBES

1R5 & Adapter to 1A7 .99¢      1L4 & Adapter to 1A5 .69¢  
 1S5 & Adapter to 1H5 .69¢      3S4 & Adapter to 3Q5 .69¢  
 1T4 & Adapter to 1N5 .69¢      3S4 & Adapter to 1Q5 .69¢

## "NEW 1946 INTER-COMM SETS" Beam Power Output and Newest Alnico 5 Speakers

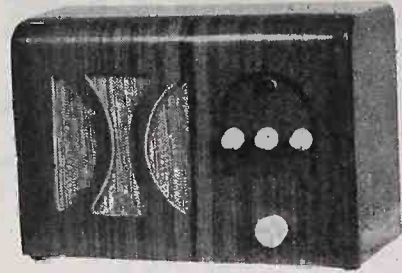

Selective control panel enables operator to communicate with one to four sub-stations, individually or two at once. Designed for 3 wire circuit enabling sub-stations to call in at any time. Three gain stages assure plenty of volume even on remote installations.

**MODEL EX 4 tube MASTER, complete (net)**... \$16.95  
**SUB-STATION, small metal cased Alnico 5 speaker with call-in switch (net)**.....\$2.95

Type 1619 tube, which is a 2 1/2 Volt 6L6, makes perfect substitute for 47-45 or 2A3.  
 1619 and adapter for 47.....79¢  
 1619 and adapter for 45 or 2A3.....79¢

## CARTONED AND UNCARTONED NEW 1ST QUALITY TUBES

6K7	6SK7	6SA7	6J5	12SH7
6H6	6SJ7	6J7	6SH7	12SQ7
6F6	6SQ7	6C5	6SQ7	12SJ7
6K6gt	6SD7	6V6gt	6D6	6C6

Very special at 54¢ each

## 6 1/2" PM SPEAKER

Has new type supermagnet, with 3 1/2 oz. of Alnico-5 magnet. Ideal for Auto Radio and general replacement use .....\$2.95  
 5" 10Z Alnico-5 .....\$1.79

Sure Carbon button hand mike with switch.  
 Cost \$10 net .....\$2.95

## U. S. ARMY 5" SCOPE

5" Scope was made by Western Electric in OD army metal case. Easily converted to a Test Scope. Complete with tubes including 5" scope tube. Cost easily \$200. Priced at.....\$49.95

**McGEE RADIO & ELEC., 1225 McGee St., Kansas City, Mo.**

## IMMEDIATE DELIVERY! DIRECT FROM STOCK

# 2A4G TUBES

also types 2050, 2051, 866-A, 884  
and other popular types

## CHATHAM ELECTRONICS

473 Washington St., Newark 2, N. J.  
Telephone MArket 2-1892

## W. BOLCON COMPANY Wholesalers Distributors

Radios—Supplies—Accessories  
Electrical Appliances

Send orders NOW for Alliance and General Industries Phonograph Motors

Standard 4 Prong Vibrators—Your cost \$1.77—  
Fully Guaranteed

251 Bedford Street      Fall River, Mass.

## WANTED—RADIO and ELECTRICAL BUYER

A group of Ohio Jewelry Stores need an experienced radio buyer and merchandise man. Must have experience, ability and knowledge of Radio lines and Electrical items. If you can fill this position, write all details in letter, stating age, experience and salary desired. E. R. Isroff, The Shaw Rogers Co., 113 S. Main St., Akron, Ohio.



Extremely convenient test oscillator for all radio servicing; alignment  
 ● Self powered ● Range from 700 cycles audio to over 600 megacycles u.h.f. ● Output from zero to 125v. ● Used by Signal Corps. Write for information.

## GENERAL TEST EQUIPMENT CO.

38 Argyle Park      Buffalo 9, N. Y.



**COMPLETE NEW LINE**

"Way out front" with the most outstanding line of antennas. Besides critical engineering, Camco Antennas are also "Easy to look at" because they are superbly designed in true modern taste.

An antenna for every type of installation . . . and all have this in common—rattle proof, Admiralty brass, rustproof, smart styling and handsomely packaged.

Multi-colored dealer sales display helps sell Camco antennas. Write for complete line and prices.



**CAMBURN, Inc.**  
32-40 57th St. Woodside, N. Y.

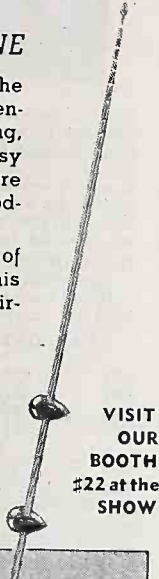

VISIT  
OUR  
BOOTH  
#22 at the  
SHOW

**ROEHR  
DISTRIBUTING  
COMPANY**

*St. Louis' Radio  
Mail Order House*

**TUBES  
TRANSFORMERS  
CONDENSERS  
RESISTORS  
SPEAKERS  
MIKES  
ANTENNAS, ETC.**

*Distributors for  
BELL SOUND EQUIPMENT  
and  
TEMPLE RADIOS*

*Write for our list of tubes  
ST. LOUIS 3, MO.*

**Coming Conventions of  
Interest to Dealers**

- May 12-17: Housewares Show, Atlantic City Auditorium, Atlantic City, N. J.
- May 13-16: Radio Parts & Electronic Equipment Show, Stevens Hotel, Chicago
- May 15-17: Electrical Manufacturers Representatives Club of New England, Mechanics Building, Boston
- May 16-17: American Marketing Ass'n., Spring Convention, Hotel Statler, Boston
- May 23-June 2: Mid-America Exposition, Cleveland, O.
- June 16: Father's Day
- July 8-20: Furniture Show, Summer Market, American Furniture Mart, Chicago
- July 15-18: National Association of Music Merchants (NAMM), Trade Show, Palmer House, Chicago
- July 22: New York Lamp Show, Hotel New Yorker, New York City
- July 29-Aug. 3: Summer Furniture Market, Los Angeles Furniture Mart, Los Angeles
- Oct. 10-11: Television Broadcasters Association (TBA), First Postwar Television Conference, Waldorf Astoria, New York City
- Oct. 28-Nov. 1: Refrigeration Equipment Manufacturers Association, All-Industry Show, Public Auditorium, Cleveland
- Oct. 29-Nov. 1: Fourth All-Industry Refrigeration & Air-Conditioning Exposition, Cleveland Public Auditorium, Cleveland, O.
- Jan. 6-18: Furniture Show, Winter Market, Furniture Mart, Chicago

**Hotpoint Personalized  
Sales Training Program**

A "personalized field training" program, for "selective dealers," aimed at ultimately reaching 20,000 retail appliance salesmen, has been launched by Edison General Electric (Hotpoint) Appliance Co. Four "regional training teams" each directed by a training specialist from company headquarters will conduct clinics across the nation, according to Ward R. Schafer, vice-president in charge of sales. Cooperating with the headquarters personnel will be the key personnel from regional sales offices and sales heads of the company's distributors.

Officials said that the salesmen's meetings will be made up of small groups, possibly less than 20 men, each with clinical and discussion class work opening the sessions and actual operation on appliances under home economists following.

**Ward Expands  
Antenna Lines**

Ward Products Corp., Cleveland, Ohio, makers of aerials for car and home, have now developed a complete line of specialized antennas for amateur, AM, FM, —television, marine, police and fire emergency communications, forestry and many other uses.

*Hearing Aid  
Carriers*  
**SMARTLY STYLED**

By

*Corré*



Wearers of Corré Hearing Aid Carriers are assured of clear, comfortable hearing. . . .

Write today for information on these and other features of Hearing Aid Carriers by Corré. They are styled for Women . . . Men . . . Boys and Girls and are priced for even the strictest budget.

**CORRE CARRIERS**  
62 E. Madison Chicago 2, Ill.

**VIBRALOC Loudspeaker Baffles**

Built to an Acoustic Standard  
. . . and priced accordingly . . .

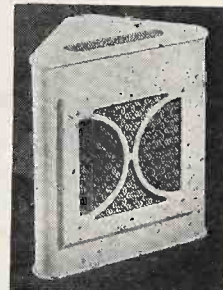

**STREAMLINE  
Corner Cabinet**  
Size 18" x 20" x 10"  
For 8"-10"-12"  
Speakers  
Heavy Plastic  
Construction  
Brown or Ivory  
Baked Wrinkle  
Varnish Finish  
Model 12KS  
List Price. \$17.50

**SUPERTONE  
Wall Baffles**

Size  
17" x 20" x 12" x 8"  
For 8"-10"-12"  
Speakers

Heavy Plastic  
Construction  
Brown or Ivory  
Baked Wrinkle  
Varnish Finish  
Model 1215WS  
List Price. \$17.50

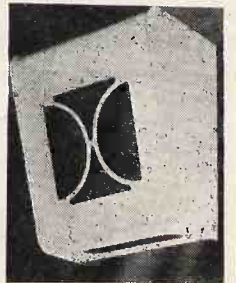

Same as above . . . unfinished \$15.00 List  
Order Direct or Through Your Jobber  
CATALOG UPON REQUEST

**JOBBER:** We can make Immediate Delivery

**VIBRALOC**  
MANUFACTURING CO  
SAN FRANCISCO 10, CALIF  
3597 Mission Street, San Francisco, Calif.



# INDEX To Advertisers

MAY, 1946

	Page		Page
Admiral Corp. ....	71	National Die Casting Co. ....	78
Aerovox Corp. ....	32	National Union Radio Corp. ....	31
Alliance Mfg. Co. ....	154	Newcomb Audio Products Co. ....	134
American Condenser Co. ....	158	Noblitt-Sparks Industries, Inc. ....	133
American Magazine ....	86	Oelrich Publications ....	160
American Phenolic Corp. ....	95	Ohmite Mfg. Co. ....	24
Amperite Co. ....	152	Olson Radio Warehouse ....	134
Astatic Corp. ....	22	Philco, Inc. ....	59
Atlas Sound Corp. ....	140	Philtone Electronics Co., Inc. ....	148
Automatic Radio Mfg. Co., Inc. ....	20, 21	Premier Crystal Laboratories, Inc. ....	107
Aviola Radio Corp. ....	113	Presto Recording Corp. ....	115
Bendix Radio Div., Bendix Aviation Corp. ....	15	Quam-Nichols Co. ....	167
Bogen Co., Inc., David ....	144	Radio Corp. of America	
Bolcon Co., W. ....	165	RCA Victor Div. ....	84, 85
Caldwell-Clements, Inc. ....	164	Tube Div. ....	83
Camburn, Inc. ....	166	Radio Dealers Supply Co. ....	142
Centralab ....	135	Rauland Corp. ....	150
Chatham Electronics ....	165	Raytheon Mfg. Co. ....	152
Chicago Tribune ....	14	Rexon, Inc. ....	25
Clarostat Mfg. Co., Inc. ....	128	Rider Publisher Inc., John F. ....	136
Collier's ....	28, 29	R-L Electronic Corp. ....	162
Columbia Wire & Supply Co. ....	163	Roehr Distributing Co. ....	166
Commercial Credit Co. ....	79	Saturday Evening Post ....	18, 19
Concord Radio Corp. ....	106	Seeburg Corp., J. P. ....	Cover 3
Cornell-Dubilier Electric Corp. ....	149	Shaw-Rogers Co. ....	165
Cornish Wire Co., Inc. ....	124	Sheffield Radio & Appliance Co., Inc. ....	163
Corre Carriers ....	166	Shur-Antenna-Mount, Inc. ....	142
Disc Company of America ....	136	Simpson Electric Co. ....	110, 111
Duotone Co. ....	130	Simpson Mfg. Co., Inc., Mark ....	132
Electro Products Laboratories ....	146	Snyder Mfg. Co. ....	161
Electronic Corp. of America ....	17	Solar Capacitor Sales Corp. ....	5
Electrovox Co., Inc. ....	157	Sonora Products, Inc. ....	33
Emerson Radio & Phonograph Corp. ....	97	Sparks-Withington Co. ....	123
Estate Stove Co. ....	81	Spirling Products Co. ....	164
Fada Radio & Electric Co., Inc. ....	27	Sprague Products Co. ....	26
Fischer, Inc., Carl ....	118	Standard Transformer Corp. ....	114
Franklin Co., L. K. ....	62	Steelman Radio Corp. ....	138
Galvin Mfg. Corp. ....	Cover 4	Stewart-Warner Corp. ....	109
Garod Radio Corp. ....	3	Stromberg-Carlson Co. ....	34
General Die & Stamping Co. ....	163	Supreme Instruments Corp. ....	140
General Electric Co. ....	7, 11	Swain Nelson Mfg. Co. ....	156
General Industries Co. ....	162	Sylvania Electric Products, Inc. ....	12, 13
General Test Equipment Co. ....	165	Tab ....	160
Gibson Refrigerator Co. ....	73	Talk-A-Phone Mfg. Co. ....	158
Graybar Electric Co. ....	76, 77	Tele-tone Radio Corp. ....	143
Hamilton Radio Corp. ....	119	Telicon Corp. ....	137
Harold Co. ....	142	Templetone Radio Mfg. Corp. ....	151
Hearst Advertising Service ....	10	Triplett Electrical Instrument Co. ....	102, 103
Howard Radio Co. ....	131	Tung-Sol Lamp Works, Inc. ....	139
Hyttron Radio & Electronics Corp. ....	127	Turner Co. ....	129
Industrial Electronic Corp. ....	159	Union Radio Corp. ....	152
International Resistance Co. ....	145	Utah Radio Products	
Jackson Electrical Instrument Co. ....	126	Div. International Detrola Corp. ....	147
Jensen Industries, Inc. ....	148	Vaco Products Co. ....	146
Jensen Radio Mfg. Co. ....	30	Vetrod Corp. ....	150
Jesse Co. ....	130	Vibracloc Mfg. Co. ....	166
J. F. D. Mfg. Co. ....	6	Vokar Corp. ....	161
Kwikheat Div. Sound Equipment Corp. ....	144	Ward Leonard Electric Co. ....	154
Lake Radio Sales Co. ....	160	Warwick Mfg. Corp. ....	101
La Magna Mfg. Co., Inc. ....	163	Waterman Products Co. ....	120
Lear, Inc. ....	153	Waters Conley Co. ....	16
Liberty Sales Co., Inc. ....	162	Webster Chicago Corp. ....	99
McGee Radio & Electric Co. ....	165	Weller Mfg. Co. ....	156
Maguire Industries, Inc. ....	8, 9	Westinghouse Electric Corp. ....	168
Majestic Radio & Television Corp. ....	105	Weston Electrical Instrument Corp. ....	2
Mallory & Co., Inc., P. R. ....	Cover 2	Wilcox-Gay Corp. ....	125
Meissner Mfg. Div. Maguire Industries, Inc. ....	117	Woodall Co., Inc., W. P. ....	121
Merit Coil & Transformer Corp. ....	4	Zenith Radio Corp. ....	23
Minerva Corp. of America ....	141		
Mustron Co. ....	155		

While every precaution is taken to insure accuracy, we cannot guarantee against the possibility of an occasional change or omission in the preparation of this index.

# QUAM

the speaker that's  
**2 STEPS AHEAD**

with

*Adjust-A-Cone*

and Alnico 5

You can always depend on Quam for the most advanced speaker design. The new Quam Speakers are not one, but two steps ahead. First, all Quam P. M. Speakers use Alnico 5, the magic magnet metal, that provides better performance with greatly reduced weight and size. Second, there's the new Adjust-A-Cone speaker construction, a revolutionary new development that permits precise centering of the voice coil on every Quam Speaker before it leaves the factory, and assures trouble free sales for distributors and dealers. For tops in speaker performance and design—look to Quam.

VISIT OUR EXHIBIT  
• BOOTH 82 •  
CHICAGO RADIO SHOW



QUAM-NICHOLS COMPANY

33rd Place at Cottage Grove  
Chicago 16, Illinois

## THE REVOLUTIONARY NEW WESTINGHOUSE DUO

It's a radio-phonograph with automatic record changer . . . but you can lift out the radio and play it anywhere. The hottest sales feature of 1946!

### The Amazing PLENTI-POWER CIRCUIT

This exclusive feature gives a low-priced Westinghouse 7-tube set more undistorted output than most 12-tube sets had prewar. *Anyone* can hear the difference . . . *everybody* likes it. It means sales to the millions who want 12-tube performance on a 7-tube budget.

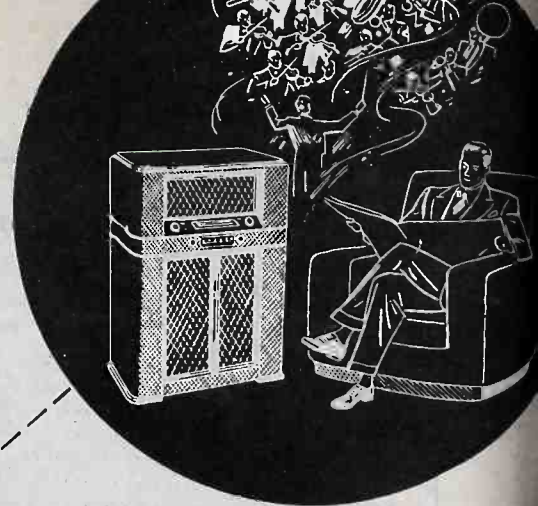

### A POWER-HOUSE IN A JEWEL CASE!

Never before has such performance been packed into a set of this size. You'll have to hear it to believe it!

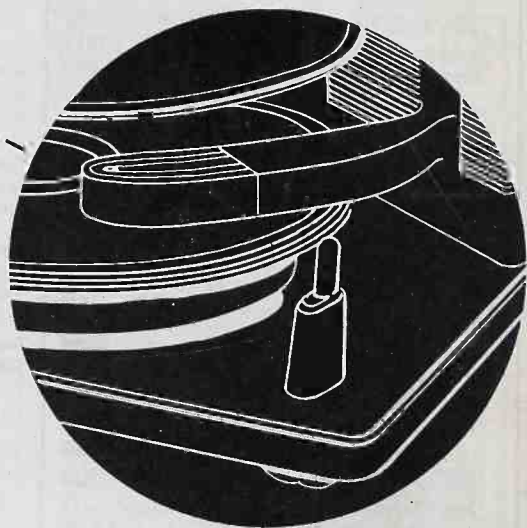

### A completely new AUTOMATIC RECORD CHANGER

Single-button control! No changeover levers to push! No complicated operating instructions.

When you want to operate the tone arm by hand, do so . . . no danger of throwing the automatic mechanism out of adjustment. After the last record is played the tone arm returns to rest and the turntable shuts off automatically.

# NEW IDEAS

*That sell radios*

more proof that you  
can depend on  
**WESTINGHOUSE RADIO**  
for originality

For more information call your Westinghouse Distributor or write Home Radio Division, Westinghouse Electric Corporation, Sunbury, Pa.

### THE EAR-LEVEL SPEAKER

Something new you can demonstrate. The sound originates at the *most natural level* for listening enjoyment. No acoustical loss or distortion from the carpet or floor.



### 6 TO 10 TIMES AS MUCH RECORD STORAGE SPACE

In most of the new radio-phonographs, Westinghouse has made the entire cabinet width available for record storage space . . . 6 to 10 times as much as prewar cabinets of the same size . . . a real selling feature for people with record libraries.

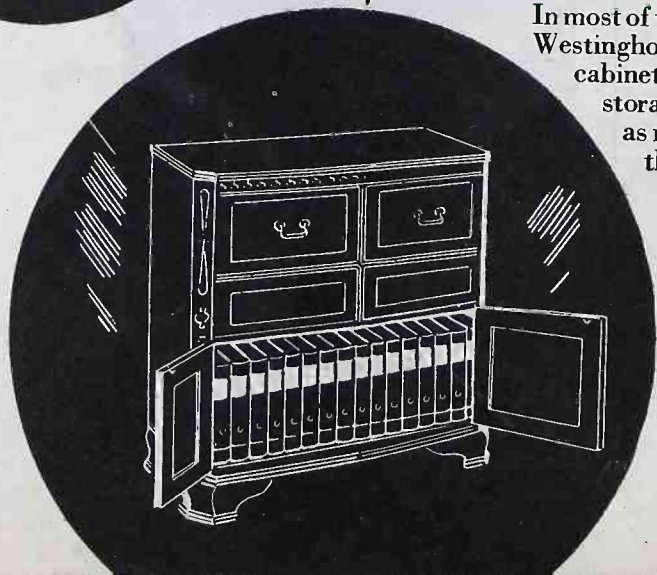

RADIO'S FIRST NAME IS

# Westinghouse

Radio

Television