

# **RADIO** *Retailing* **TODAY**

## **RADIO'S GIFTS TO THE NATION**

- ★ Sixty Million Receivers Kept in Repair
- ★ Complete Coverage for Wartime Appeals
- ★ All-Out Conversion of Radio Factories
- ★ "Alerts" for Civilian Defense Systems
- ★ Instant News from the Fighting Fronts
- ★ Great Music and Drama to Build Morale

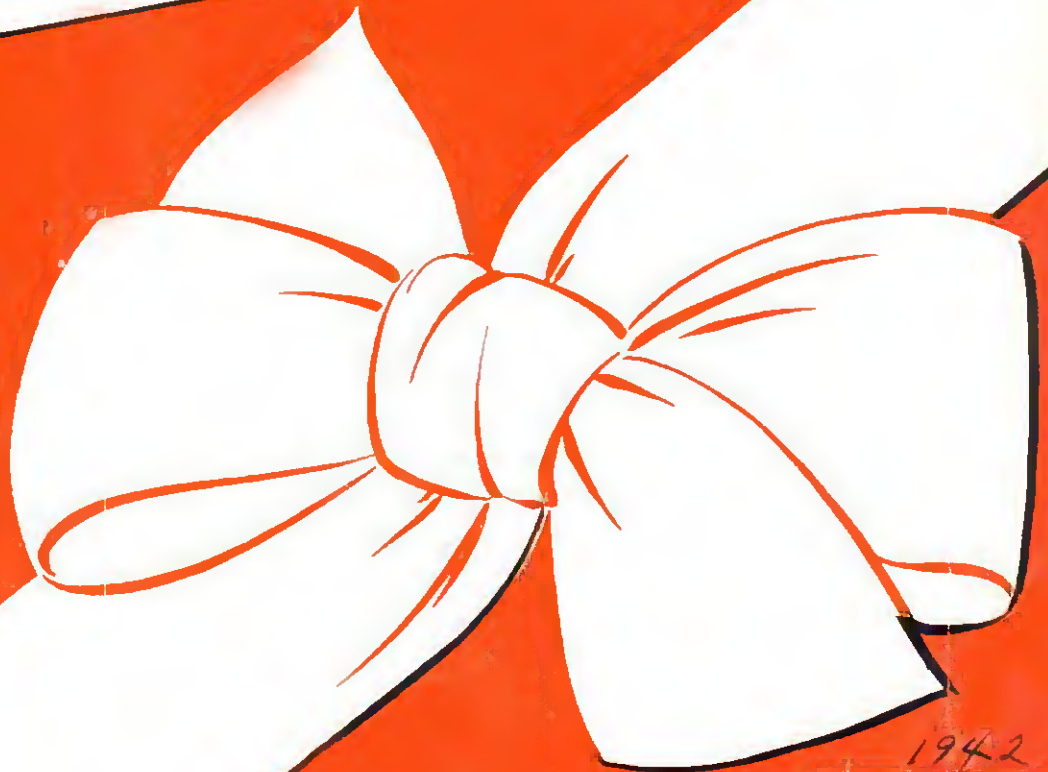



## A Book Worth Owning...



Have you a few well-read and well-beloved books in your library that you wouldn't part with at any price? We suggest you add another . . . because once you've read even a few chapters, you'll agree with hundreds of radio servicemen, engineers, amateurs . . . the new MYE TECHNICAL MANUAL is a book worth owning.

Many hundreds of copies of this book are being distributed to military radio instructors . . . in training centers of the Army, Navy and Marine Corps, including the Air Forces. Once you glance through this list of chapter headings, you'll understand why.

- 1 Loud Speakers and Their Use
- 2 Superheterodyne First Detectors and Oscillators
- 3 Half-Wave and Voltage Doubler Power Supplies
- 4 Vibrator and Vibrator Power Supplies
- 5 Phono-Radio Service Data
- 6 Automatic Tuning—operation and adjustment
- 7 Frequency Modulation
- 8 Television—suggestions for the postwar boom
- 9 Capacitors—how to overcome wartime shortages
- 10 Practical Radio Noise Suppression
- 11 Vacuum Tube Voltmeters
- 12 Useful Servicing Information
- 13 Receiving Tube Characteristics—of all American tube types

Just one suggestion. We know you'll want a copy of this manual eventually. It contains 392 pages of information as down-to-earth as a soldering iron, as indispensable as a voltmeter. It's beautifully bound,

with hard cloth covers. It's worth far more than its price, \$2.00 net to servicemen.

But the supply for civilian use is limited. It will pay you, in the time, effort and money this book can save you *now*, to waste no time in going to your Mallory Distributor to reserve a copy. Order your MYE TECHNICAL MANUAL today!

P. R. MALLORY & CO., Inc., INDIANAPOLIS, INDIANA  
Cable—PELMALLO

**P. R. MALLORY & CO. Inc.**

# MALLORY

Approved Precision Products

# Admiral RADIO

FOR 1942 . . . TO VICTORY!

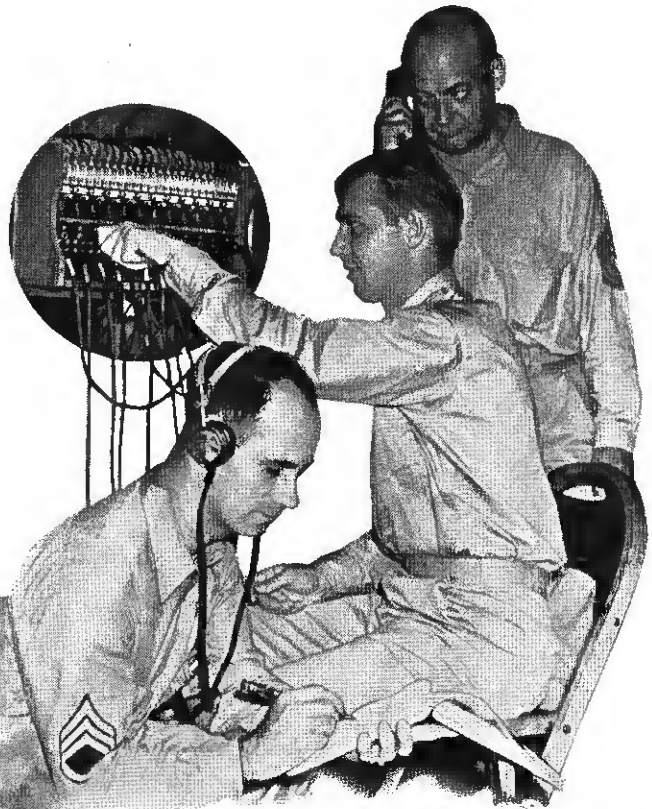

Crisp, curt commands of a squadron commander somewhere over Europe . . . the rapid-fire report of an advance scout on Guadalcanal . . . those are the voices that will be heard over the radio equipment now pouring from the Admiral assembly lines. Both great Admiral plants, which once turned out Admiral Radios and Admiral Radio-Phonograph Combinations with automatic record changers, are now engaged exclusively in the production of Radio Communication Equipment for our armed forces.

## LISTEN TO YOUR RADIO PROGRAM!

**TUNE IN . . . 2:30-2:55 p.m.** New York time, Sunday afternoons. Admiral Radio presents "World News Today" over the Columbia Network . . . with direct short wave reports from the leading news centers of the world. Listen! This is **your** radio program . . . you'll hear frequent messages such as "take care of the radio set you now own. The makers of Admiral Radios appreciate the tremendous responsibility of radio on the home front. Your Admiral dealer will gladly service your radio regardless of make. Call on him! His skill and courtesy is yours for the asking."

## CONTINENTAL RADIO AND TELEVISION CORPORATION

3800 W. CORTLAND ST.  
CHICAGO, U. S. A.

*Photographs courtesy Signal Corps, U. S. Army.*



*this Christmas... it's music*

**I**n these days of War, music has become doubly precious. Without any doubt, it will be one of the favorite gifts this Christmastime. That, of course, means that dealers all across the country will be stormed by customers.

Columbia's Christmas Campaign is built on that premise, is built around the theme "This Christmas . . . It's Music".

Our Gift List is specially culled from the complete Catalog. More than two hundred best-selling items are included. To them will go our peak production.

Our promotion revolves around that Gift List and what we will do this Christmas to back up our dealers far exceeds and excels anything our Company has done in the past.

For example: There will be double spreads in full color in the nation's leading magazines. There will be national radio—our Masterworks of Music program. Dealer newspaper ads in all sizes are in Distributors' hands now and liberal cooperative funds are available. There's a special Christmas Gift Catalog and display material galore—everything, in fact, that you need to make your store a real gift headquarters.

If you haven't yet contacted your Columbia Distributor for full details . . . do it today.

**COLUMBIA**  **RECORDS**

## CAMPAIGN LINEUP

### The Merchandise:

More than 200 items of every type of music, appealing to every taste, are represented on Columbia's Christmas Gift List, included in the special Gift Catalog. These items will be given peak production for the holidays.

### National Magazines:

Double-page, full-color spreads in THE NEW YORKER, December 5; TIME, December 7; LIFE, December 14; NEWSWEEK, December 14. More than 30,000,000 Christmas gift buyers will see these magazines.

### Radio:

Over 70 stations, Columbia's "Masterworks of Music" programs will help develop the Christmas theme.

### Dealer Ads:

Newspaper ads of all sizes include listings of best-selling Christmas merchandise smartly styled in attractive layouts. Ask your Columbia Distributor for details of these cooperative ads.

### Christmas Gift Catalog:

Brand new, handsomely designed, and it's free! Includes entire gift list, more than 200 gift suggestions for Dad, Mother, Sister, Brother, Sweetheart, Serious Music Lover, Christmas music.

### Composer Books:

Books on the lives and recorded music of six of the greatest composers, written by famous critics with forewords by leading artists. Merchandiser also available for display of all six books.

### "Music, Maestro, Please":

Booklet on Columbia's best-selling illustrated albums, indexed by type of music with full-color reproductions of album covers.

### Display Material:

This year's display material encompasses every type of merchandising and advertising. Colorful posters; a banner two feet by six feet; a six-color mounted Christmas display; five beautiful counter cards, and two hangers are among the pieces available.

### Album Merchandiser:

Here's a beautiful merchandiser with space for two ten-inch and two twelve-inch sets. Illustrated albums are perfectly displayed with Christmas gift theme tie-in.

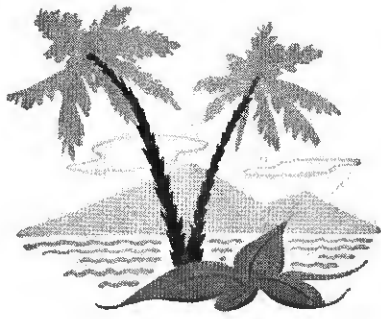

HERE



THERE

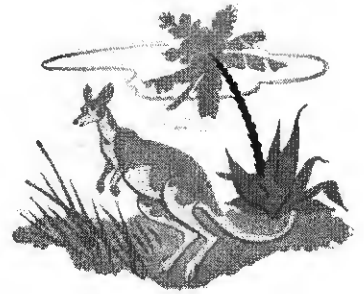

-- *and* EVERYWHERE

Ken-Rad Radio Tubes follow the flag in fighting equipment—from the palm-tipped atolls of the Pacific to the Quonset huts of Iceland to barracks in the land of the kangaroo.

We are making more tubes than ever before in our history, but the armed forces are using almost our entire output. However, there are some tubes available for civilian use, and there may be more. If you can't find Ken-Rad Tubes remember that most of our production is at the front fighting for you in planes, tanks and naval craft.

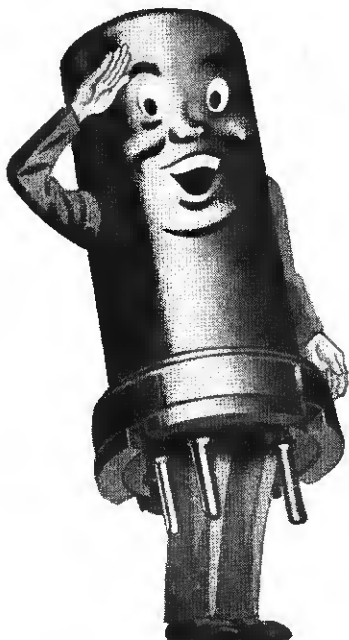

**KEN-RAD TUBE & LAMP CORPORATION**  
Owensboro, Kentucky

**KEN-RAD**  
RADIO TUBES

In over 200 newspapers from coast to coast, PHILCO made this report to your customers of the past and future.



## Battle Flags for Philco Soldiers of Production

AMONG the far-flung manufacturing facilities of Philco Corporation, devoted 100% to the manufacture of war equipment, four Army-Navy "E" Flags now fly from the Philco plants. And each of their soldiers of production wears the official Army-Navy "E" Pin as a badge of honor for "distinguished service to America".

On four separate occasions . . . in Philadelphia, Pa.; Trenton, N. J.; Sandusky, Ohio and Chicago, Ill. . . distinguished officers of the Army and Navy have presented the Army-Navy Production Award

to the men and women of Philco for, in the words of the Under Secretary of War, "accomplishing today what yesterday seemed impossible".

Of course, Philco is proud of its soldiers of production who have turned their knowledge and their skill so effectively to the service of the nation: In the manufacture of intricate communications equipment, powerful radios for tanks, airplanes and ships, artillery fuzes, shells and storage batteries, Philco's war production activities serve every branch of

our fighting forces, on land, at sea and in the air.

The Army-Navy "E" Flags that now fly above the Philco plants are battle flags for Philco soldiers of production. For they realize that if America's might is to strike the decisive blow for Victory, what they have done today must be but an inspiration for greater deeds tomorrow. In this spirit, Philco soldiers of production have made their pledge:

"More—Better—Sooner!"  
**Buy War Bonds and Stamps**

PHILCO CORPORATION

During November, this announcement was published in the nation's newspapers. It is a report to *your customers* of what the men and women who produced over 17 million Philco products are doing for the duration.

This is *your* advertising as well as Philco advertising. For in its achievements for war, Philco sees promise of thrilling new products for peace . . . and new opportunities for Philco dealers everywhere.

PHILCO CORPORATION



*"Still Doing Business  
at the Same Old Stands"*



## SERVICEMEN

... your Distributor can  
**STILL** Supply you with

# Centralab

## MIDGET RADIOHM REPLACEMENTS

Fortunately . . . your distributor  
can still supply you with Midget  
Radiohms for replacements.

The smooth wall-type resistor for  
which Centralab Radiohms are  
famous will keep that now-precious  
radio in good working condition.

Stick to **OLD MAN CENTRALAB**  
for Replacements . . . and always  
specify "CENTRALAB".

**RADIOHMS • FIXED RESISTORS  
• FIXED AND VARIABLE  
CERAMIC CAPACITORS  
• SELECTOR SWITCHES**

**CENTRALAB:** Div. of Globe-Union Inc., Milwaukee, Wis.



# YOU'RE WAY AHEAD OF THE ACTION IN THE U.S. ARMY SIGNAL CORPS



• Some day American voices will rock the Imperial Palace in Tokyo and cause the defenses of Berlin to tremble. They will be the voices of U. S. Army radio men, relaying commands for the final attack. Will yours be one of them?

**I**N THIS fast-moving war, words are weapons. Split-second communications are vital to the timing and teamwork that win battles. As one of Uncle Sam's radio soldiers, you not only see action—you help to guide and direct it!

In Army communications, your opportunities for heroic service are limitless. At the same time, you receive training and experience that will be invaluable for a successful after-the-war career. You learn how to assemble, install and operate the most modern radio transmitters, receivers, "Walkie-Talkies," "Electronic Sentries" and scores of other closely guarded secret devices—pioneers of future industries—which combine today to knit the whole Army into one hard-fighting unit.

Any man, physically fit, from 18 to 44, inclusive, may enlist. Licensed radio operators and radio, telegraph and telephone workers may enlist for active duty at once. They may advance rapidly up to \$138 a month, plus board, shelter and uniforms, as they earn higher technical ratings.

Men of 18 and 19 may choose enlistment in the Signal Corps without any previous training or experience.

Those without qualifying experience, who enroll full time, may enter the Signal Corps Enlisted Reserve for training with pay. Graduate Electrical Engineers may apply for immediate commissions in the Signal Corps.

Civilians over 16 years of age may attend a Signal Corps School, and will be paid not less than \$1020 per year for full-time training and future service with the Signal Corps. Apply U. S. Employment Bureau or U. S. Civil Service.

**"KEEP 'EM FLYING!"**



## U.S. ARMY RECRUITING AND INDUCTION SERVICE

Visit or write the nearest U. S. Army Recruiting and Induction Station or write to: "The Commanding General," of the Service Command nearest you, or Procurement Branch, AE-2, A.G.O., Washington, D. C.

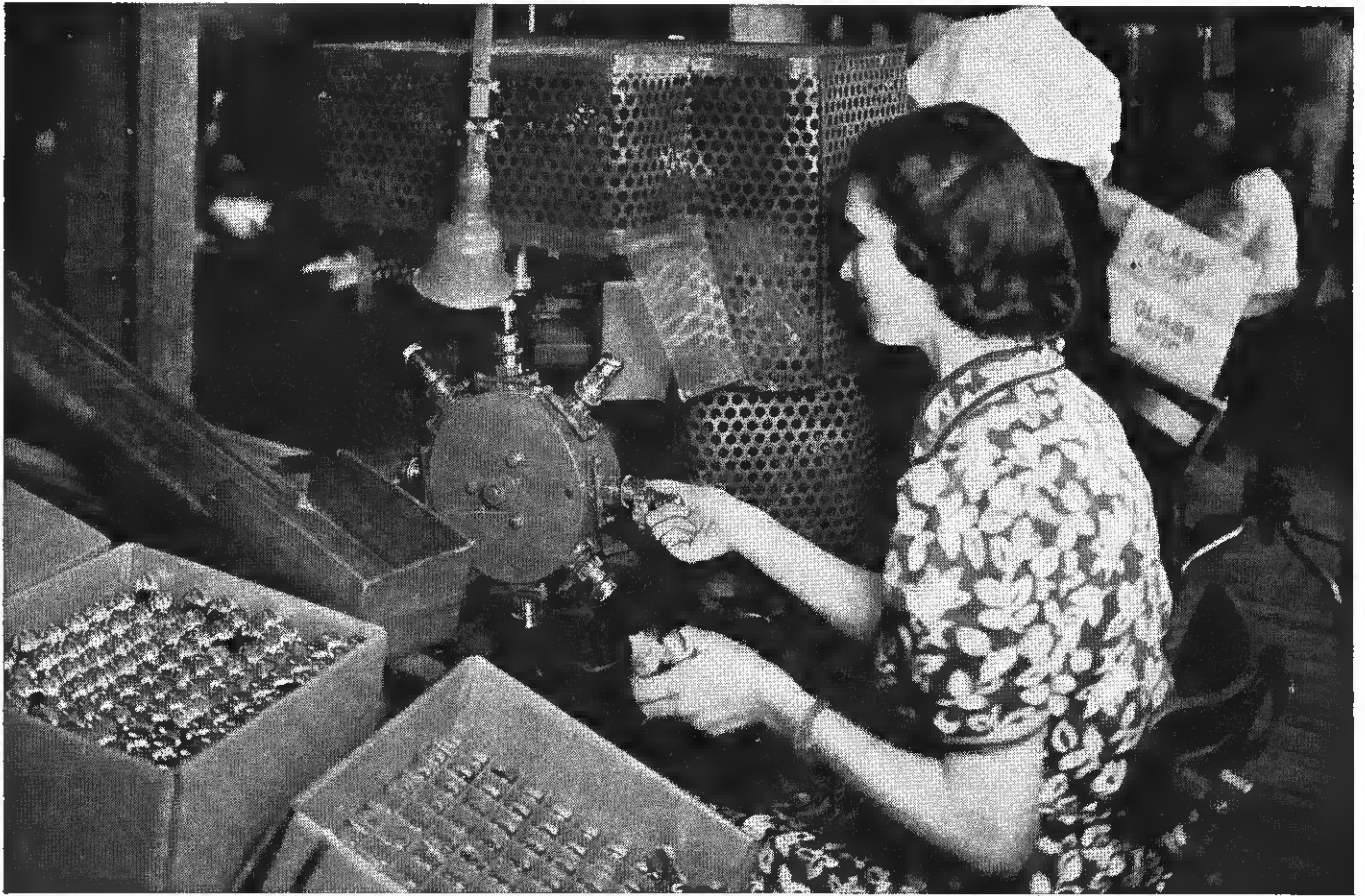

## AWARD FOR EXCELLENCE

**H**ERE you see Sylvania Tubes stepping up to receive their final credential for excellence — the Sylvania trade-mark. Only tubes that pass test after test and come out on top receive it.

We know these tubes are going to get tough, responsible work to do. They might serve the crew of a giant bomber, pitch and toss in a tank over desert sands or do any of 1,001 military tasks where tubes must "take it."



This is why we expect our testing staff to be cranks — why we make it their responsibility to maintain a standard of quality that is the highest anywhere known.

And as we work to perfect our products and our processes for wartime production, we are broadening a background that will serve us well when again we can concentrate all our means on making new products for the purposes of peace.

# SYLVANIA ELECTRIC PRODUCTS INC.

Formerly Hygrade Sylvania Corporation  
Emporium, Pa.

*Incandescent Lamps, Fluorescent Lamps and Fixtures, Radio Tubes and Electronic Devices*

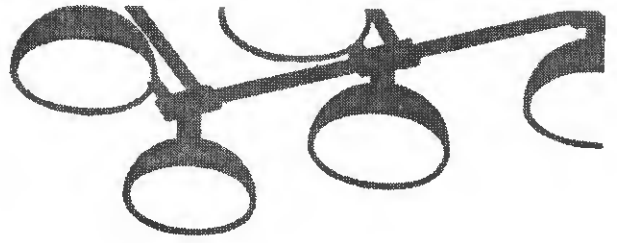
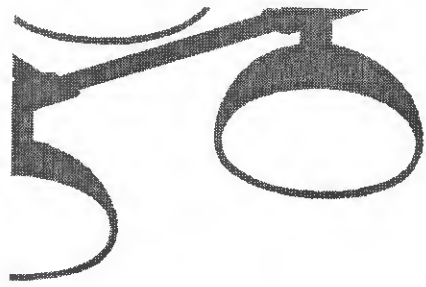

## YOUR FUTURE - IN PICTURES

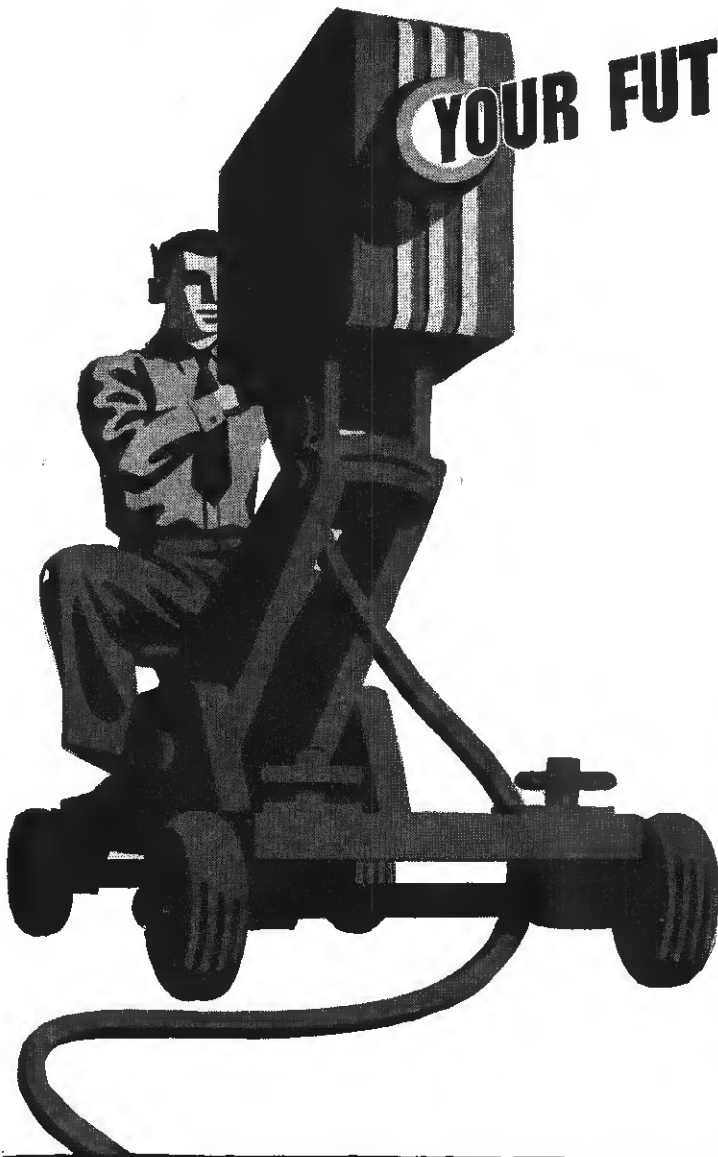

# FARNSWORTH TELEVISION

**T**HE future of the radio business is already deeply involved in pictures — *the magic pictures of the television screen.*

### **BIG MONEY IN TELEVISION**

Informed people expect television to be the country's next great industry, duplicating the success of the automobile business after the last war.

As a leading manufacturer, Farnsworth recognizes its responsibility to today's radio dealers, who will be the television dealers of tomorrow. We can't make sets today — our whole output is precision equipment for the armed forces . . . but we can build a ready and enthusiastic market — a nationwide demand for television that will carry today's radio dealers into this great new field.

### **ADVERTISING BUILDS THE MARKET**

Farnsworth advertising carries the exciting story of television to all America, arousing interest, stimulating desire for sets, creating demand that the trade must fill tomorrow.

As it did for the automobile, the radio, the electric refrigerator and other outstanding successes, advertising is opening the market for television, laying the foundation for business and for new jobs for countless thousands.

For tomorrow's dealers, Farnsworth Television promises a future as bright as television's own!

●  
**YOU HAVE** probably seen Farnsworth Television ads in the magazines. If not, see October 19 *Life* and *Newsweek*, October 10 *New Yorker* and *Business Week*, October *Fortune*, October 5 *Time*, October 2 *U. S. News*.

FARNSWORTH TELEVISION & RADIO CORPORATION, FORT WAYNE, INDIANA. MANUFACTURERS OF RADIO AND TELEVISION TRANSMITTERS AND RECEIVERS; AIRCRAFT RADIO EQUIPMENT; THE FARNSWORTH DISSECTOR TUBE; THE CAPEHART, THE CAPEHART-PANAMUSE, AND THE FARNSWORTH PHONOGRAPH-RADIOS.

# FOR VICTORY TODAY AND SOUND BUSINESS TOMORROW

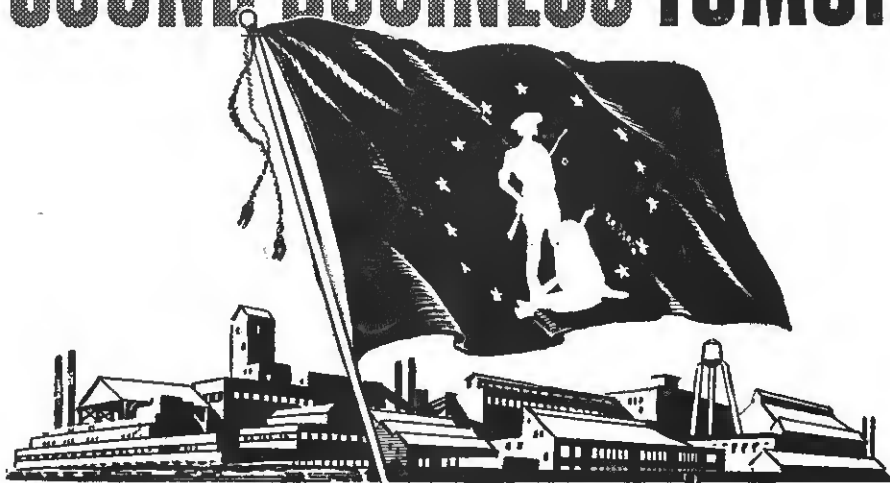

## *Get This Flag Flying Now!*

This War Savings Flag which flies today over companies, large and small, all across the land means *business*. It means, first, that 10% of the company's gross pay roll is being invested in War Bonds by the workers voluntarily.

It also means that the employees of all these companies are doing their part for Victory . . . by helping to buy the guns, tanks, and planes that America and her allies *must* have to win.

It means that billions of dollars are being diverted from "bidding" for the constantly shrinking stock of goods available, thus putting a brake on inflation. And it means that billions of dollars will be held in readiness for post-war readjustment.

Think what 10% of the national income, saved in War Bonds now, month after month, can buy when the war ends!

For Victory today . . . and prosperity *tomorrow*, keep the War Bond Pay-roll Savings Plan rolling in *your* firm. Get that flag flying now! Your State War Savings Staff Administrator will gladly explain how you may do so.

If your firm has not already installed the Pay-roll Savings Plan, *now is the time to do so*. For full details, plus samples of result-getting literature and promotional helps, write or wire: War Savings Staff, Section F, Treasury Department, 709 Twelfth Street NW., Washington, D. C.



Save With  
**War Savings Bonds**

This Space Is a Contribution to America's All-Out War Program by

**RADIO Retailing TODAY**

**"B for Bessie coming in at 1,000 . . ."**

**. . . B for Bessie coming in at 1,000 feet. Can't see a thing through this soup. What are your orders?"**

A bomber pilot, returning through a storm from a successful mission, phones his field for help in landing. He is depending upon his communications to see him through . . . safely.

Our armed forces all over the world are depending upon Raytheon tubes . . . and Raytheons are coming through!

Service men and dealers everywhere know the dependable qualities of Raytheon tubes

## **RAYTHEON**

**PRODUCTION CORPORATION**

NEWTON, MASS.

LOS ANGELES

CHICAGO

NEW YORK

ATLANTA

**RAYTHEON**  
**RADIO TUBES**



DEVOTED TO RESEARCH AND THE MANUFACTURE OF TUBES FOR THE NEW ERA OF ELECTRONICS

**JOE KRAUSS**, one of Ische Bros.' three expert repair men, hunts for a short circuit. His work is sped by the excellent testing equipment of Ische Bros.' shop. In addition to the three regular service men, Gordon Ische reports that he is also spending an increasing amount of time at the repair bench these days.



**"Sure, we're working harder—  
but we're holding our own..."**

**Gordon Ische tells how  
Ische Bros., Milwaukee, Wis., are using  
their heads to stay in business.**

"We were as much startled as anybody," says Gordon Ische, President of Ische Bros., "when the limitation order on radio parts went through. But luckily we weren't caught napping.

"We've always kept accurate sales records and have replaced stocks before they were depleted. And we had on hand a good inventory of parts for emergencies.

"To stretch this inventory as far as possible, we are making repairs whenever we can without new parts. This means re-using and servicing materials at hand. I'm spending more time on repairs myself, and my three service men are always busy.

"Our complete working and testing equipment is a life-saver, though, and keeps our deliveries reasonably prompt.

"Today, our operation is concentrated more in the shop than before. In order to save gas and tires on delivery trucks, we're encouraging customers to bring their sets into our shop.

"From our remaining stock of new receivers we are

getting maximum return by selling for full list price, and limiting allowances (if any at all) to the price we can get on a quick, clean resale.

"We know that people depend on their radios to keep them informed — so we're doing our best to 'keep 'em listening!'"

IN RADIOS, TELEPHONES, SOUND SYSTEMS . . . THERE IS NOTHING  
FINER THAN A

**STROMBERG-CARLSON**

ROCHESTER, NEW YORK



**BY SELLING AT LIST PRICE** and holding down the trade-in allowance, Ische Bros. are getting maximum return from their remaining stock of fine radios.

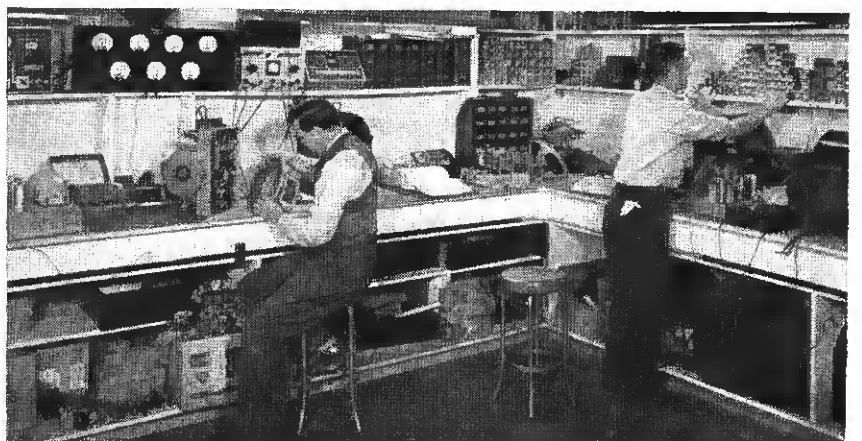

**ISCHE BROS.'** repair shop is handy to work in. The equipment is complete and modern. Their inventory of parts is good — and they stretch it by re-using and re-servicing old parts whenever possible. Here Joe Krauss inspects a speaker unit while Orvall Myers checks stock.

480 LEXINGTON AVE.  
NEW YORK, N. Y.

# RADIO *Retailing* TODAY

O. H. CALDWELL, EDITOR  
M. CLEMENTS, PUBLISHER

Including Radio and Television Retailing

## **Home-Radio Repairs Must Wait on Military Needs**

The situation in home radios is getting increasingly critical. Shortages are beginning to be felt—in tubes, parts, batteries, and even some sets.

Every individual radio man is going to be called upon to exercise all his ingenuity and resourcefulness to keep existing radios in operation. Already the radio executives of the War Production Board at Washington are indicating that sets may gradually be reduced to *one* per home! Last week Frank McIntosh, in charge of civilian radio, even suggested that radio listeners may well be cautioned to begin such self-rationing *at once!* He pointedly advised that householders with several sets make use of only one receiver, right now—so that when *that* set becomes inoperative, the other sets in the house will be available for listening.

In this crisis before us, radio men must remember that they are broadcasting's only personal contact with the public. It becomes their responsibility, therefore, to explain to radio users the vital facts of the present situation, and to prepare the public for restrictions to come.

The Government at Washington is sympathetic with

the widest use of radio that is possible under war conditions. President Roosevelt, himself, and Chairman Fly of the FCC, have both shown that they want everything to be done to perpetuate radio listening.

Actually the whole problem of radio supplies is in the hands of the group pictured on this page. They are experienced radio men, led by an indefatigable worker, Ray Ellis, who labors early and late with the single purpose of seeing that Uncle Sam gets the radio equipment vitally needed for the vast war machine.

These radio experts of the War Production Board have studied our problem exhaustively. They know the true facts about materials available, critical shortages, and the gigantic demands of the armed services. They are squarely facing the issue that confronts radio. And it is the duty of every radio dealer, every distributor and every serviceman to back them up. This means that civilian radio men must conserve materials, use old parts, turn in unusable materials, and buy only as needed—no hoarding. This is the lesson for all of us to heed, until the war is won.

O. H. CALDWELL, *Editor*

### **Back Up These Radio Men of the U. S. War Production Board!**

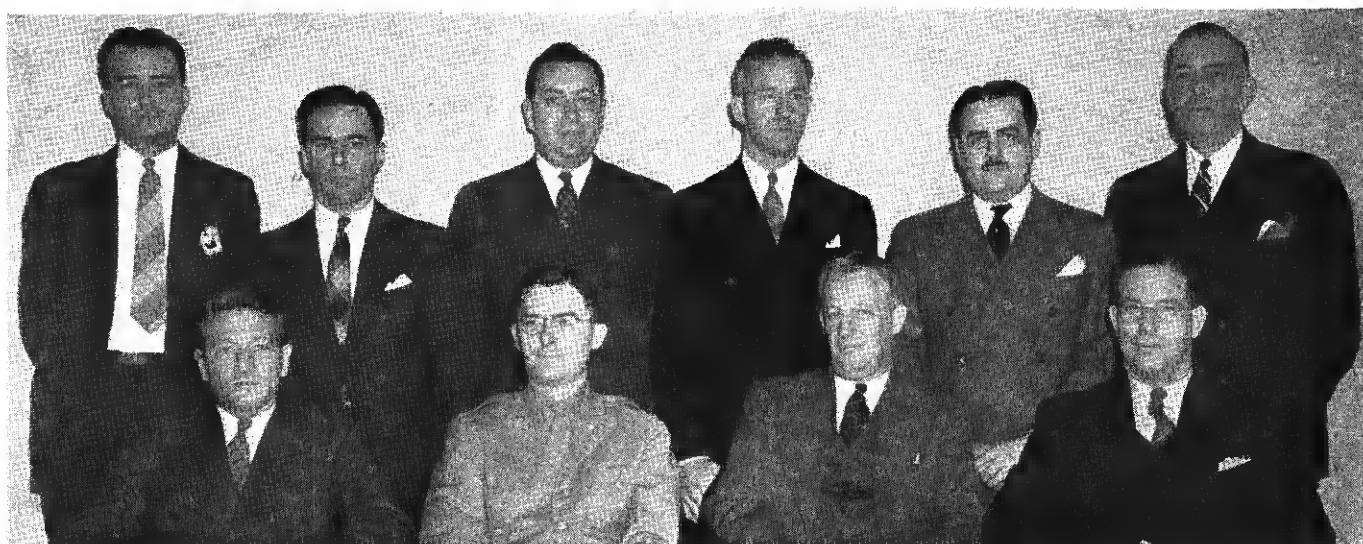

Standing—Marvin Hobbs, electronics; M. E. Whitney, plant facilities; G. E. Miller; Frank H. McIntosh, civilian radio; Sidney K. Wolf, components; Frank S. Hornung, priorities. Seated—M. J. Lowenstein, critical materials; Capt. William A. Gray, tubes; John S. Timmons, chief Radio Branch; Ray C. Ellis, Deputy Director WPB.



Ewing Galloway

Clouds of "snow" have proved to be an effective (and inexpensive) display device for Christmas windows.

# CHRISTMAS SELLING

• Back in 1939, when the flame of war broke over Europe, the radio-dealer and radio serviceman experienced a flood of business which nearly swamped him.

A year ago, when the Jap swooped unannounced out of the skies on Pearl Harbor, the radio business surged ahead again and reached new highs.

But today—the radio industry has been called “to the colors”—and sales have “nose-dived.”

No longer do the great factories

produce radios for homes. You know that.

But also, no longer do people even want to buy radios, as they once did.

That is a fact—whether you realize it or not—and a mighty important factor, too.

There are many reasons why this is so—which need not be analyzed here.

It is sufficient to know, and be guided by, the simple fact that radio no longer has the sales appeal it did only a short year ago.

## Obvious Solution

The answer, to radio men, should be obvious. You must concentrate your efforts on radio-service. Merchandise your Service Department.

Use your ingenuity to get more service-work. Replace your servicemen with more service-women, if necessary, and make more service profit.

But you must also look for, and take on, other lines of merchandise, if you expect to remain a retailer. That is no longer an opinion—it’s a fact.

Now, what can you sell this Christmas—and next year?

Plenty.

This Christmas you can sell the remaining radios you have, if you really try.

And records are good, for Christmas as well as all the year. Many an enterprising dealer is “going to town” with recordings, too.

## Serve the Armed Forces

There are thousands of messages, recorded by the trainees in the great camps scattered all over the country, to be sent to the sweethearts, wives, mothers, brothers, back home.

And recorded messages from the loved ones and friends at home, to the soldier far away—it works both ways and has some interesting possibilities for retailers with some imagination.

At least for the duration, the sale of equipment and gifts to men in the Armed Forces, holds real merchandising opportunities.

This means articles which are designed expressly for the hard usage, and the limited space, of a soldier’s kit.

Not the crested, colored baubles so often seen.

The practical, useful articles which

## Holiday Leaders

Games and Toys

Recorded Greetings

Remaining Radios

Gifts for Fighting Men

Popular and Classical Records



make the soldier's life a bit more pleasant are the type for which there is a ready sale in every village and city in the country.

### **Opportunity in "Home Recreation"**

And then there is, too, an inviting opportunity in adult games and hobby items.

More and more people are going to spend more and more time in their homes than for several generations. They must be amused and entertained.

Games of all kinds, appropriate for adults, and older children, will be in greater demand than for many years.

Beside this new demand, the "home recreation" boom of the "terrible thirties" will pale into insignificance. Smart dealers know this.

Alert retailers are already beginning to ride the wave.

Children's toys, too, present year-round merchandising opportunities of real importance.

Mothers and fathers, knowing their youngsters are young but once, will

never cease buying toys, no matter what they may do without themselves.

Many a radio dealer will do well to study the possibility of toys for one of these days every user of his toys, and buyer too, will be eager to buy one of these new, streamlined FM-television-world-wide radios, which will capture the public's buying fancy after the war.

Radio men must think of all the ways of keeping their business going this Christmas, and next year.

### **Building Future Radio Prospects**

But the radio business should not be forgotten. It's not dead.

One day, when this war will have been won, as it will be in the not too distant future, there will be a radio, an electronic industry, the like of which we have never seen before

And radio men of today must plan—and fight—to be in the radio business then.

In the meantime, keep your eyes open to present day realities. Don't



## **IN A WAR**



hang on to old methods, old merchandise, too long.

Be alert, alive, to the changing times, and the buying habits of a people who are changing their living and playing habits.

There is no set rule you can follow, no single road that leads but to success.

There are few problems of the radio dealer which cannot be solved by enterprise, ingenuity and hard work.

Not by the methods of two, or five, or ten years ago. But by methods and practices geared to today's conditions.

Retail sales this Christmas will surpass anything this country has ever seen before. But this will not be true of radio sales—or household appliance sales or automobile sales.

If you want to stay in retailing—apply the age old retailing maxim—

"Stock what the most people want to buy—at a price they are willing to pay."

**That records rate high with soldiers is seen in this photo from Camp Roberts, Calif. The camp won the combination in Glenn Miller's "Moonlight Serenade" radio song contest.**

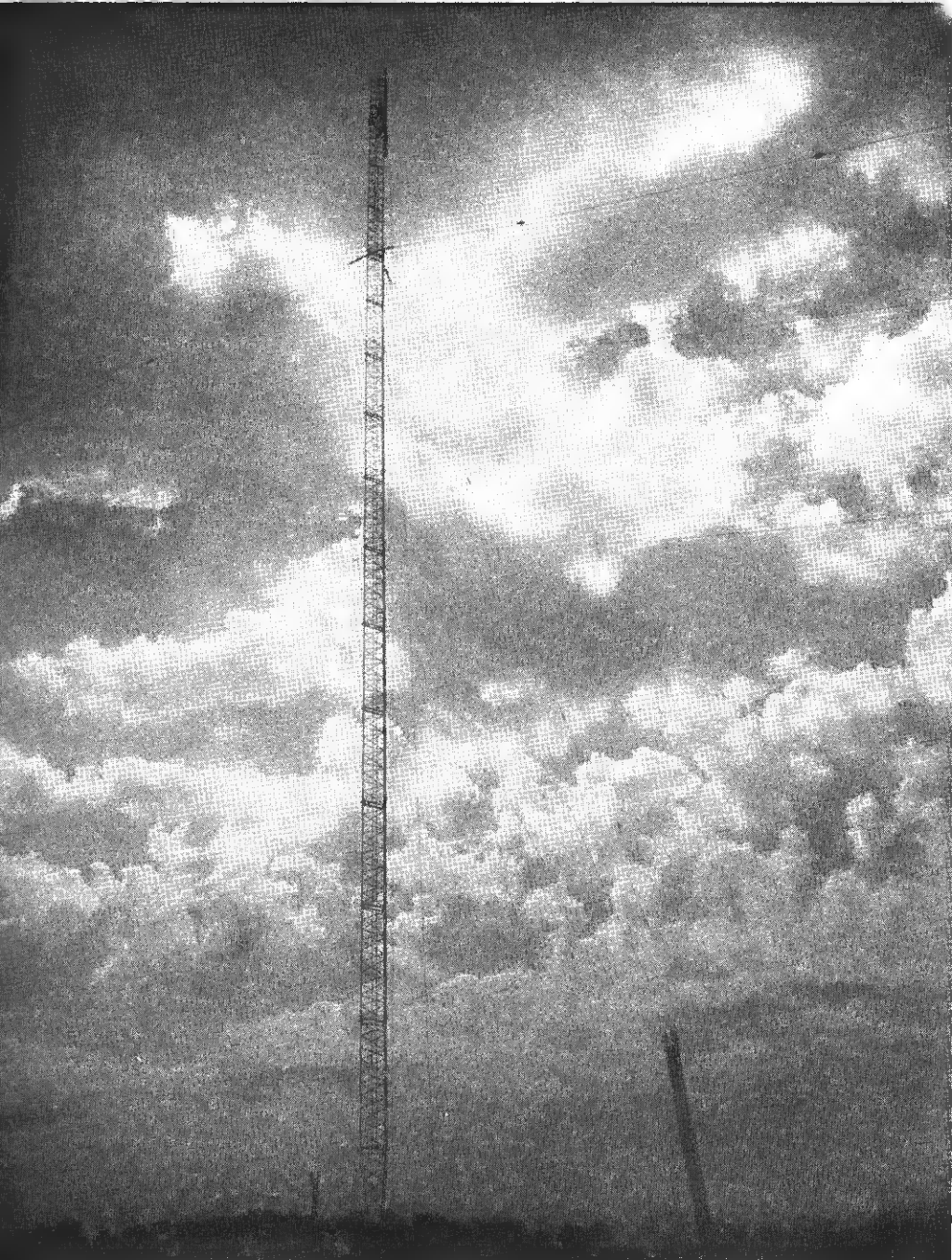

**Broadcasters to Help  
in New All-Industry  
Plan to Keep Civilian  
Receivers in Repair.  
Stations to Advise Pub-  
lic on Shortage of Man-  
power in Servicing**

## **SILVER LINING for**

• The radio industry has now launched a definite, organized, all-inclusive effort to keep civilian radio sets working.

Essentially the job is to help existing servicemen to stay in business, to train new people where needed, and to facilitate the flow of necessary replacement parts. The new plan to get this task done is carefully planned, industry-wide, and sustained.

A new Service Bureau of the Radio Manufacturers Association is being organized for the purpose of developing and conducting this all-industry program to keep civilian sets go-

ing. The Bureau activity will include work on the supplies of replacement parts, as well as the matter of servicing personnel. An experienced manager for the RMA project will be engaged, and the Bureau will work with broadcasting and all other interests concerned, to provide both manpower and materials for wartime radio reception.

### **Real Help**

The action was taken at the annual Fall RMA directors meeting, held in New York City. Formation of the Service Bureau was authorized after

a report by chairman M. J. Schinke of the RMA Service Committee. Programs for training new servicemen will be considered, and a simple text book covering radio servicing fundamentals was recommended.

### **On the Air**

The National Association of Broadcasters stepped into the picture immediately and recommended to all U. S. stations that they cooperate with the new program. Spot broadcasts were outlined, suggesting that listeners *take* their sets to the serviceman. NAB pointed out that "the manpower

situation in the servicing field is such that the first 'must' is to change people's habits . . . from sending for a serviceman to taking their own sets to him."

The vital facts of the radio servicing business today were outlined as follows:

(1) WPB will arrange for parts and materials for repair and maintenance of receiving sets. An industry committee has completed the standardization of component parts and materials. This is on the authority of Frank McIntosh, Chief, Civilian Radio Section, Radio and Radar Branch, WPB.

This is important because many servicemen are quitting because they believe mistakenly that parts will not be available. This assurance should keep men in business.

#### **Draft Status**

(2) Radio servicemen are eligible for consideration for occupational deferment because radio repairmen are included in the list of essential occupations issued by Selective Service in Occupational Bulletin No. 27.

For local trade groups, it might be wise to call a meeting on this subject of deferment because RMA is in no position to do so yet. Key radio jobbers could do this. It is always necessary to make out a case for the local draft board and local radio men need guidance and information.

(3) Servicemen should realize that they are vitally needed and are per-

vicemen's position in the statement of Elmer Davis, Office of War Information Director, who stated at a Senate Hearing:

#### **For Emergency Messages**

"This office has a direct and vital concern with the maintenance of the radio coverage of this country. It is one of the most important media for the conveyance of war information in general to the people, and may become of still greater importance when there is occasion for an emergency message from the national leadership."

A typical announcement to be made

by stations, to help the serviceman immediately is this:

"Your radio set means more to you than ever before. It's truly the magic box which entertains, bolsters morale and brings you the news from the ends of the world . . . morning, noon and night. Keep your set in good repair. Help your serviceman do his job by bringing your set to him. Don't ask him to call . . . he hasn't the time to come after your set and fix it too. Thousands of radio servicemen have joined the colors and the work they did must done by the men who are left. When you bring your set to the

**Stanley Michaels, radio servicing expert of Irvington, N. J., on the job keeping home sets in repair as well as doing special work on equipment for local war plants.**

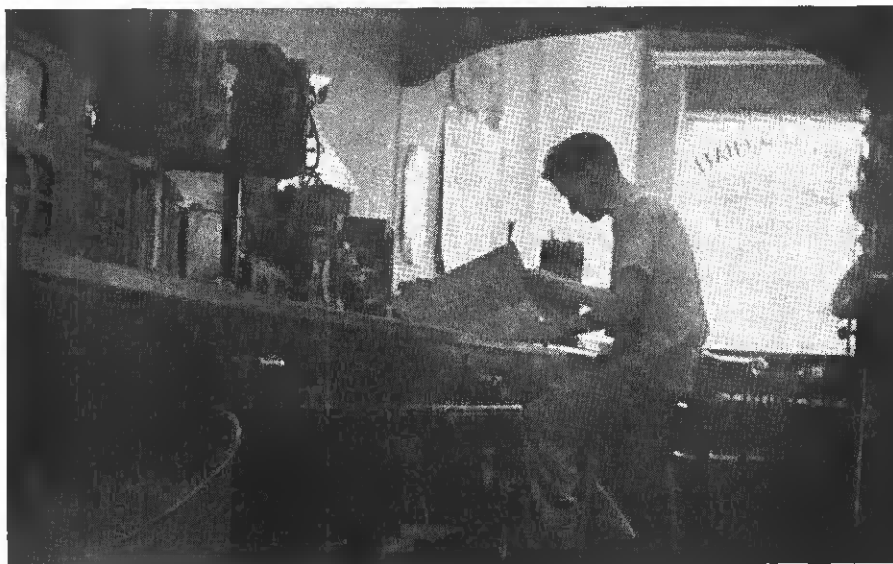

# **Radio Servicemen**

forming an important duty, essential to the war effort, by maintaining the nation's home receivers.

For additional support of radio servicemen in building a case for their local draft board a quotation by William B. Lewis, Chief, Radio Bureau, Office of War Information, who voices the government viewpoint, should be helpful. This is it:

"The maintenance of radio as an essential industry, so classified by the Manpower Commission, is of utmost importance to the prosecution of the war."

Then there is support for the ser-

---

### **Repairman's Duty**

Clean up all old replacement parts, get them in use or in scrap.

Emphasize time-saving methods and equipment.

Cooperate with local stations to explain local shortages.

---

repairman he has more time to spend at the bench repairing radio sets. Bring it in and keep listening."

Other suggested announcements say that of course the idea of *taking* sets to servicemen is new and different, but "so is the rationing in tires, oil, sugar and coffee rationing . . . by bringing the set in for repairs you and your neighbors will be able to hear the news, government messages, music and entertainment without interruption."

Local servicemen can cooperate with this part of the campaign by publicizing any key people of the community who *bring in* their radios for repair.

# DIATHERMY—Troubles

**Short-wave Induction Heating—Both Therapeutic and Industrial—Offers Increasing Challenge to Radio Servicemen**

• Heat induced by short-wave radio is now being used by industry to harden gears and shells, to cement plywood and veneers, to attach soles and heels to shoes, to treat silk, and to dry tobacco and other products.

Heat so generated by short-wave and ultra-short-wave induction is thus applied successfully in many phases of modern life, but probably one of the most important of these uses is in the treatment of the human body's ills.

Shortly after the discovery of the penetrating forces of electrical waves, it became evident that such waves generate heat as soon as they find conducting paths when penetrating a given body, or object.

## Spark-gap Units

The first machines built for this purpose of generating electrical waves for heating, were the so-called "diathermy" apparatus. The term meaning to "heat through" is misleading: these machines produced chiefly surface heat. But at the time they were given their name, scientists expected too much of them.

## Servicing Jobs

Replacing Tubes

Filtering Noise

Analyzing Interference

General Maintenance

Such diathermy apparatus employs one or more spark-gaps, depending upon output and wavelength desired. The first machines of this type with one, two or three spark gaps, generated wavelengths of 72, 50, 36 and 24 meters. When it became apparent that these rather long wavelengths did not permit sufficient penetration, engineers developed diathermy apparatus with 12 spark gaps; finally, machines generating 9-meter waves were built with rows of spark gaps.

But, these machines were not only of cumbersome size, their output in watts in the short and ultra-short wave band was insufficient; the input, too high relative to the low output, constituted an enormous waste of electrical energy.

Furthermore, and this is of utmost importance, the waveband generated by spark gaps fluctuates, is not of a continuous uniform frequency. Every time a spark "jumps," the desired wavelength is generated at the outset, but as the power of the spark decreases, waves of longer length are also produced. In addition, the spark-gap-wave-band consists of a multitude of impulses following each other in succession. Therefore, wavebands from spark-gap generators are neither continuous nor pure.

## Continuous-wave Machines

These considerations have made the manufacturers look for something to replace the spark gap, and they have found the solution quite naturally in electronic tubes. The even flow of oscillations from the tube guarantees

## Health Via High Frequencies

Therapeutic diathermy—example of modern equipment using oscillating tubes for producing a high-frequency field which generates localized heat in human tissues.

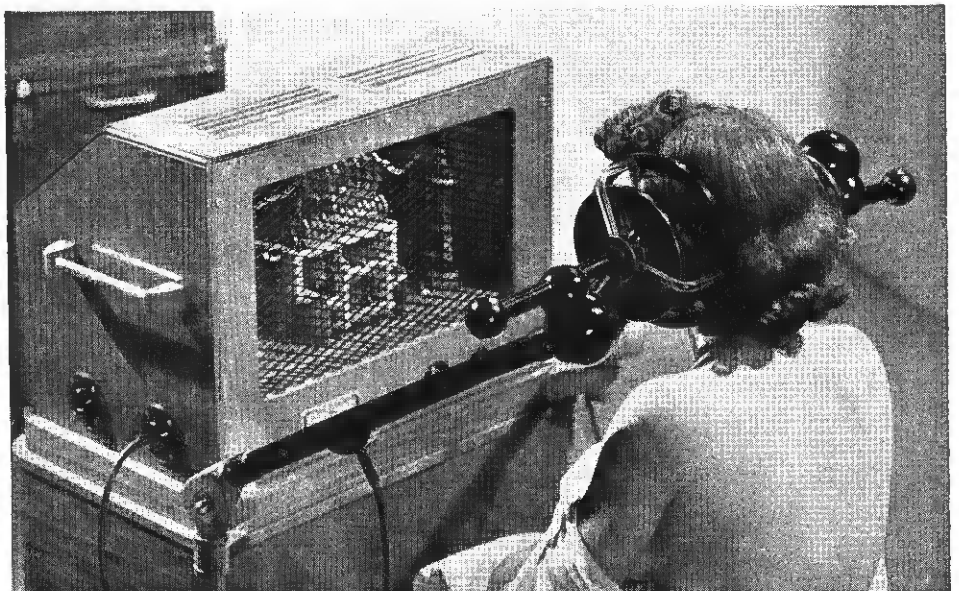

# and Opportunities

an even and pure waveband, and the innate electric economy of the electronic tube—no waste of energy through heat as in spark gaps—has resulted in machines generating short and ultra-short waves with a normal and adequate ratio of input to output.

## Short Waves for Penetration

The shorter the wavelength, the better the penetration of a given body, or object. Having come to this conclusion empirically, and having found a logical explanation for it, the diathermy industry during the past few years has built predominantly 6-meter machines; those generating 12, 14 or 24 meters are used only where deep penetration is either not needed or not indicated.

All short and ultra-short wave diathermy generators are constructed upon this principle: an electric field is generated between two electrodes, the object person or limb to be heated is placed between them, the machine is tuned in, i.e., brought into resonance, and heat will be generated within the object there where the waves, passing through it, induce local currents.

## Localized Heating

The therapeutic value of short and ultra-short wave generators in producing localized heat is well known. The two most important medical applications are: (1) heating certain parts within the body to aid blood

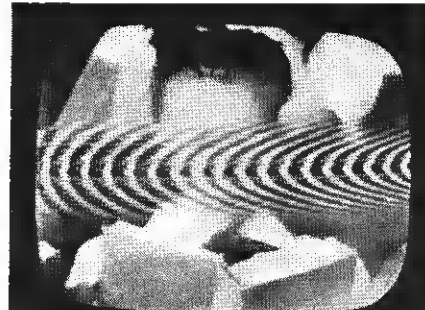

Two examples showing how diathermy radiations interfere with television picture.

circulation, and (2) generating a high over-all body temperature, the effective fever treatment for syphilis.

## More Applications on the Way

In industry, the heating qualities of short and ultra-short waves have already found and will find more and more use as special generators for special industrial purposes are being developed. Wherever heat is to be produced internally between covers, these generators will be of immense usefulness—be it within a cask as in the drying of tobacco, or to heat and “set” cement to glue together two or more sheets of plywood, another already patented process.

In short, wherever heat is to be applied *within* a given object—no matter for what purpose—but where it is of advantage not to heat the surface, short and ultra-short waves are indicated.

Of course, waves radiated by such diathermy generators interfere with

short-wave radio and television. The electric field generated between the two electrodes will also heat metal; therefore, problems arise when certain measurements of objects heated are to be made with instruments using magnets or containing metal. In many instances, shielding against electric leakage is the solution. In others, compromises will be necessary, as for instance in the case of taking the temperature of a patient during a short-wave fever treatment, when either alcohol thermometers must be used, or the generator must be switched off before taking the temperature.

## Work for Servicemen

It is of special interest to local service men that short and ultra-short-wave generators use the same types of tubes as radio transmitters. And as the importance of heat application and generation *within* an object by means of short and ultra-short waves becomes more generally used, the demand for electronic servicing will be increased.

10 CYCLES	180	1000	15 KILOCYCLES	60	500	10 MEGACYCLES
ANNEALING, HEATING TO LOW TEMPERATURES	PREHEATING, ANNEALING, HEATING MAGNETIC METALS	PRINCIPAL BAND FOR COMMERCIAL HEATING, MELTING, HEAT-TREATING WITH ROTATING GENERATORS	SMALL SCALE HEATING, MELTING, HEAT-TREATING	PRINCIPAL BAND FOR COMMERCIAL ELECTRONIC INDUCTION HEATING OF METALS	SURFACE HEATING OF METALS, HIGH-FREQUENCY ELECTROSTATIC HEATING, THERAPEUTICS	
ALTERNATORS. MOTOR GENERATORS			ELECTRONIC GENERATORS OR SPARK GAP CONVERTERS		ELECTRONIC GENERATORS	

## THE INDUCTION HEATING FREQUENCY SPECTRUM

# DISC BOOM

• The traffic in recorded messages, as the most modern and most interesting way for civilians to exchange sentiments with the men in the military training centers, is expected to reach a peak this Christmas. Radio dealers will find that the idea has picked up greatly since last year. Now's the time to get a recording booth under way.

There's no need to worry about whether the men in the Services will have a machine on which to play the messages from home. For in this regard, the USO has again been promptly helpful in supplying what the trainees need. The organization now has some 1,000 clubs in the U. S., and at each of these centers there are from one to three record-players for the men to use. These instruments, in addition to those which are privately owned, and those which are available elsewhere, add up to an impressive total.

Below is shown the busy retailer's recording booth described at right.



Girls at the Wilcox-Gay Corp. factory make a habit of recording messages for their men-in-service. The men can answer via recorders in USO centers.

Observations in the trade are that (1) there are plenty of blanks still available for Christmas, (2) The recordings are particularly popular in family groups where youngsters are involved, (3) There is something about wartime sentiment which makes a spoken greeting highly appreciated, and (4) Men in the Services have been "exposed" to the personal-recording vogue to such an extent that they are decidedly record-conscious.

## Store Scores With Recording Booth

A sizable number of the Christmas greetings which go this year to the men in the Armed Forces will be in the form of personally recorded discs. The vogue is gathering speed, as they are quick to tell you at the Franklin Simon store in New York City, where a new recording booth has been opened in connection with the store's "Gift Barracks."

This store does not regularly sell records or recorders, and so started from scratch on this idea. It was introduced via a newspaper ad and a display window, and now the folks are trooping in and making records at the rate of 25 to 50 every day.

## Department Is Worth Expanding

After the booth had been operating for three weeks, and the public had shown a real interest in recording messages for soldiers and sailors, the store managers planned to expand the department to handle pre-Christmas rushes next month.

This store supplies a mailing service for the 6 in. records, and charges 35c per side, on which a customer may record for about two minutes. The blanks in this case are made by Recordise Corp., 395 Broadway, New York City.

It has been noted that this idea has been used widely by family groups, and that youngsters very often figure in the recording. It was found also that customers particularly appreciate privacy while making records.

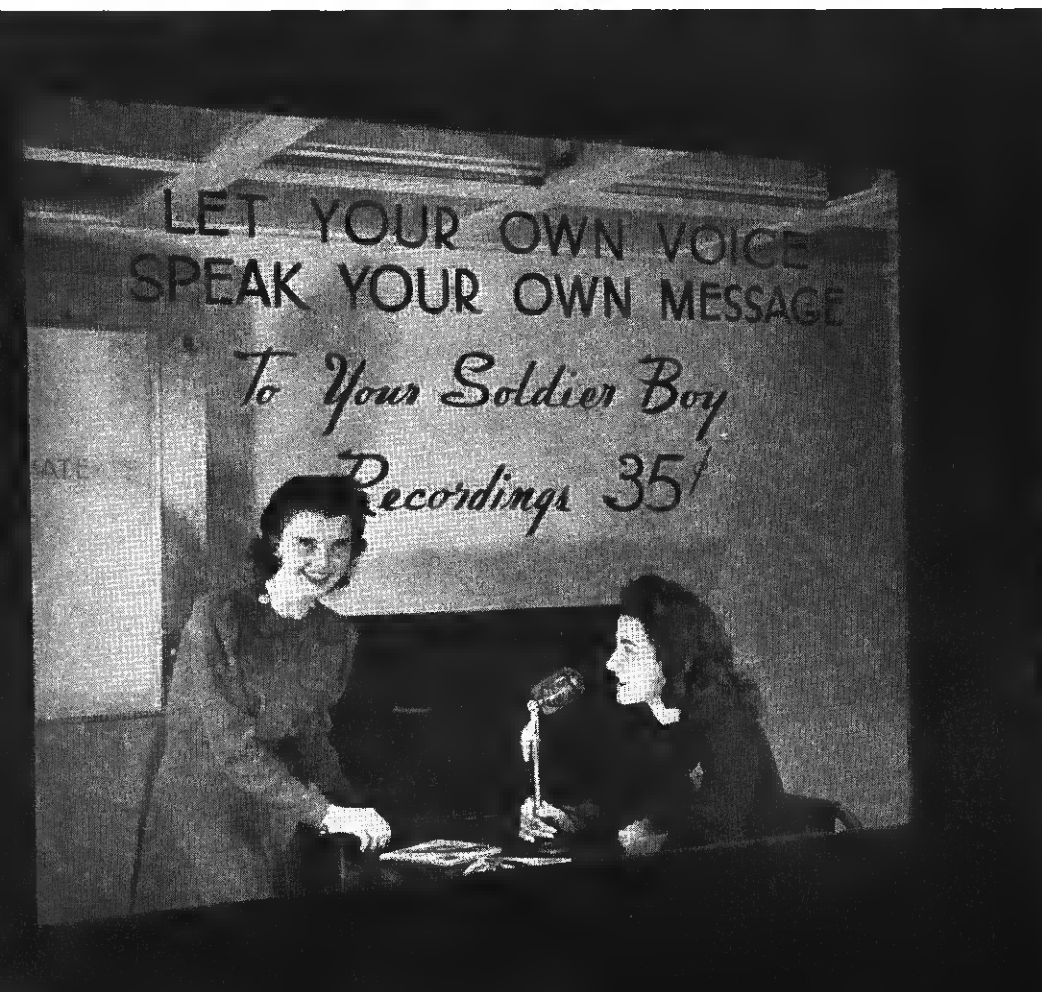

# "share your RECORDIO 'til Victory"

## That's the Theme of Wilcox-Gay's New National Campaign in LIFE Magazine

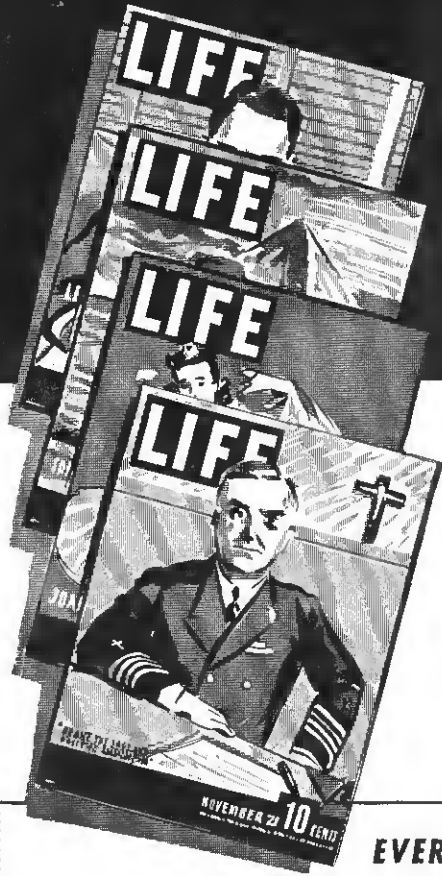

Wilcox-Gay's new campaign will be announced in the November 16 issue of LIFE magazine. Twenty million people will see how they can "keep 'em smiling" by sending cheerful recordings to the men-in-service. Wilcox-Gay will follow up this announcement ad with a carefully timed program in LIFE to keep this campaign active.

IT'S A POWERFUL, DRAMATIC PROGRAM DIRECTED AT ONE OF OUR MOST IMPORTANT WAR EFFORTS—MORALE AT HOME AND IN OUR FIGHTING FORCES. The men-in-service have proper facilities to make recordings so it is our patriotic duty to provide these same facilities for their loved ones back home. Wilcox-Gay knows that every dealer will do his part.

**Your Local WILCOX-GAY Distributor  
Will Tell You About This Program**

**EVERY RADIO DEALER CAN SERVE—AND PROFIT**

Wilcox-Gay's "Share your Recordio 'til Victory" campaign will sell discs and recorder accessories. Wilcox-Gay has designed a special colorful mailing envelope for mailing recordings to the men-in-service. THIS CAMPAIGN PROMISES PLENTY OF ACTIVITY!

**TO ALL RADIO DEALERS:**

*Here are three important steps to take:*

1. Check your inventory of recording discs. Replenish your stock through your distributor.
2. Order your supply of special patriotic disc-mailing envelopes from your distributor.
3. Identify your store with this campaign. THIS IS YOUR OPPORTUNITY TO CAPITALIZE ON WILCOX-GAY'S TIMELY PROMOTION.

**DEALERS WHO DO NOT REGULARLY STOCK DISCS.**

Wilcox-Gay offers a special 10-disc package.

This package contains ten 6½" discs, ten patriotic mailing envelopes, one window poster and one attractive counter disc display.

This package is priced at \$1 net.

SEND YOUR DOLLAR TO WILCOX-GAY CORPORATION, CHARLOTTE, MICHIGAN. IMMEDIATE DELIVERY.

# WILCOX-GAY CORPORATION

CHARLOTTE, MICHIGAN

PRODUCING FOR WAR ★ PLANNING FOR PEACE





# RECORDS FOR

• Beginning now, a retailer of records can do a lot to help serenade the country into a Victory mood. With gift records.

People want the discs and they have the money to buy them. And the general feeling is that they will want recordings even more this Christmas, a year after Pearl Harbor. Thus, the holiday situation is full of opportunities for the dealer. It's a great chance to improve a retailing situation that may otherwise be jammed with merchandise shortages, emergency limitations, wartime regulations and high costs of doing business.

Some of the hard-boiled record experts are saying that recorded Christmas music comes under the head of "escape" entertainment that many people are searching for these days. They believe that the Yuletide carols and hymns are the brand of music

which fills the wartime need exactly, particularly because a war Christmas is naturally a sentimental one. They point out that the simple and solemn values of holiday music have been broken up by the requirements of the Armed Forces.

On the other hand, it has been noted that defense workers in their off-duty hours have so far demonstrated a real liking for music of the gay kind. Of course this applies mostly to the younger set, whose "swing shift" sessions around juke boxes are a national fixture.

### General Demand

Whatever the conclusion as to musical preferences, the fact remains that the U. S. appetite for discs is a vigorous and healthy affair, and that a wartime Christmas will mean a new peak in demand.

This may be a time to sell those slower-moving records on the shelves which were not precisely "in the swim" during past months, but which have merit and need some extra attention to make their value known to customers. This may work out profitably while the demand is so high, and supplies are on the short side.

The dealer should remember, too, that while he is filling this exceptional holiday demand for discs, he has a chance to make new contacts and to create new musical tastes that will benefit him after Christmas. It is important to handle the holiday business so that the customers will be coming back in 1943 after more records and accessories.

The retailer should also keep in mind that this nation is now composed of stay-at-homes—people who are ex-

tremely short of gasoline and tires. They need home entertainment suitable for entire families, and they need a lot of it.

What's doing in record promotion for the Christmas season is reviewed herewith and it can be seen that prompt dealer action is indicated. The work already done at headquarters on holiday selling is big-time and it's effective; alert merchandisers will see unusual benefits.

In the big Christmas promotion campaign for Columbia records, a number of innovations and war-style ideas show up. Starting with the fact that, for the ears of a fighting nation, recorded music is "more precious than ever," Columbia concentrates on 200 gift items for the holidays and blankets the trade with a strong and colorful series of sales aids which will continue to be valuable in their effect after Christmas.

Coming from Columbia are banners 2 ft. by 6 ft., jumbo posters in 5 colors, a special theme display, a

At the left is a colorful theme display featuring "Joe, the Snowman," in 5 colors. Below, a new album merchandiser with room for 4 gift sets.

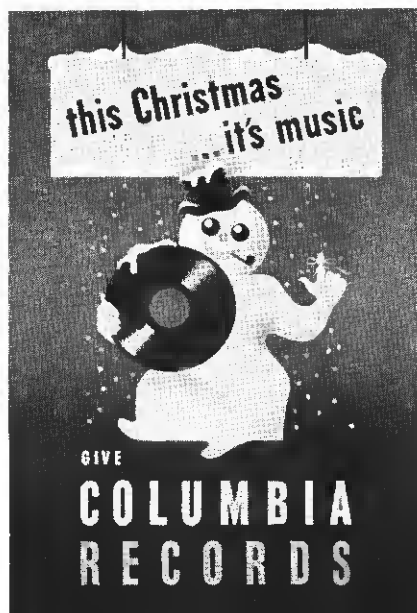



# CHRISTMAS

gift catalog, hangers, counter cards, an album merchandiser, mailers, a musical book promotion, ad reprints and a gift catalog. The latter is a special job with the gift selections listed, and specific suggestions made for various members of the family.

Supporting the campaign is a big drive in national magazines, on the radio, and in newspapers. The ad space has been doubled for the period Dec. 5th to Dec. 14th, and the broadcasting (Masterworks) includes 72 stations for programs from Thanksgiving to Christmas. And cooperative advertising for newspapers reaches a new peak.

Elaborate promotion kits have been sent to distributors and special mailings to dealers, so that the "This Christmas . . . It's Music" theme can be promptly caught up by record men in the field.

RCA Victor has started its holiday activities with an impressive string of sales-makers available to retailers, both for use in their stores and windows and to use in getting the Christmas 1942 recorded music idea out into the homes of customers.



Preliminary emphasis at Victor is on carols, hymns, oratorios, etc., and recorded favorites to be played at the Yule season. For instance under "Christmas Music America Loves Best" the records are classified on one colorful hanger as (1) As Great Artists Sing Them, (2) As Great Artists Play Them, (3) The Famous Trinity Choir, (4) Christmas Bells and Chimes and (5) Christmas Music

All set for holiday business is the new store above, opened by Castellanos-Molina Music Shops, New York City. It's an investment in the future of records, run by manager Tony Contreras and designed by co-proprietor Herman Diaz. The store has the newest in lighting, listening-booth convenience, record storage and general styling.

Below are two holiday displays ready for dealers, an album gift unit at left, and a 3-unit patriotic job at right. (Continued on the following page)

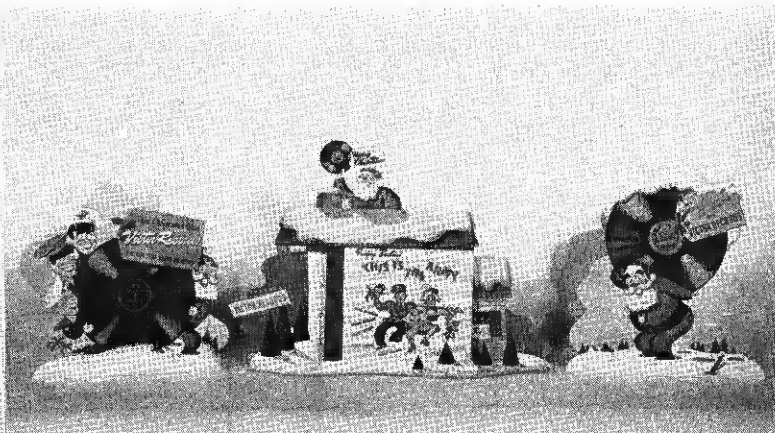

## RECORDS FOR CHRISTMAS

(Continued from preceding page)

Albums. Besides plenty of promotion for gift records for the youngsters.

The company points out that "record dealers who want to get the jump on the coming avalanche of sales in Christmas music will consider their shelves with critical eyes and fill up the empty places promptly . . . the only time in 1942 when you can sell records of specific Christmas subject matter is right now!"

Victor also has a big window display featuring albums in a sleigh, a 3-unit display also for windows, a gift guide, a brochure on favorite music and a folder on gift records for children, to start with.

The radio feature "Music You Want" reaches coast-to-coast audiences regularly, in addition to Victor's large-scale promotion efforts in other media.

### Decca Drive

To start shortly after the Thanksgiving holidays, is an intensive Christmas sales campaign for Decca records, described by the company as "the most vigorous Christmas promotion drive in the history of the company."

### Library Style

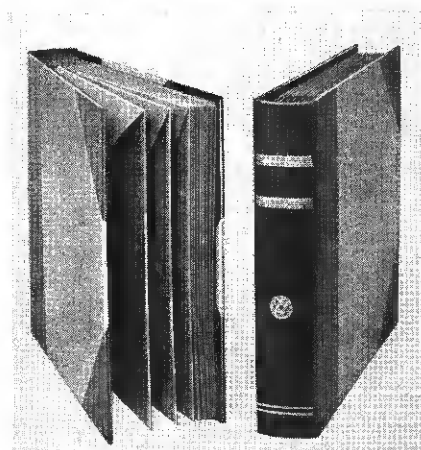

Above is the "Library Edition" record album which is the newest addition to the lines offered by Peerless Album Co., Inc., 38-42 W. 21st St., New York City. It's a gold-embossed job, with rounded wood back and the Protecto-Flap feature. It was described on page 53 of the October issue of *Radio Retailing Today*, but the photo used then was one showing the Peerless Gothic-design album, rather than the "Library" unit.

## The Morgan Manner



Russ Morgan, the popular band leader, is shown here as factory guest of Permo Products Co., Chicago. He accepted the invitation of Permo's Gene Steffens to see how long-life phonograph needles are made, and commented on "so much work and science needed to make the tiny needles."

Full-page, four-color ads in the December issues of leading magazines (*Life*, *Sat. Eve Post*, *Time*, etc.) are the heart of the campaign. Broad-sides built around this advertising, carrying full-color reproductions of the ads, suitable for use as store displays will help dealers to focus the pulling power of the Decca campaign on individual stores which tie in with it. In addition, a series of four-color store posters, featuring Decca Records, album sets, children's records and artists, tied in with seasonal themes will be distributed free to dealers.

### Just Holiday Releases

In order to meet the demand for Christmas "standards" and recently-released popular records—notably Bing Crosby's "White Christmas" and "Silent Night," the Crosby-Astaire "Holiday Inn" album, Herbert Marshall's "Count of Monte Cristo," Ronald Colman's "A Christmas Carol" and others of equally heavy demand—Decca will not release any new records until 1943, and will concentrate a high percentage of its production on the records featured in this advertising and promotion.

## "Share-Your-Recordio-'Til-Victory"

The Wilcox-Gay Corp., Charlotte, Mich., has launched a new type of service program for its product, Recordio.

Since Pearl Harbor the demand for recording facilities has been increasing. Throughout the nation, in service organizations such as USO, Recordios have been pressed into service. Since Wilcox-Gay ceased consumer manufacturing, it has been a problem to meet the demands of such worthy organizations. "Our biggest headache," states W. L. Hasemeier, W-G sales head, "is to find private owners who will loan their equipment."

### Neighborly Plan

A careful survey of this situation suggested the idea behind the new program. In many neighborhoods there are one or more recorders and in those same neighborhoods are families who have men in the service. This circumstance provides the basis for Wilcox-Gay's "Share-your-Recordio 'til-Victory" campaign. National ads will urge that persons owning recorders share them with their friends and neighbors. Wilcox-Gay discs packaged in a handy mailing envelope will be available in retail stores throughout the country. Some dealers have further facilitated the plan by setting up registration bureaus in cooperation with local clubs and organizations. The bureau lists owners of recorders who are willing to loan their equipment for short periods to responsible groups for the benefit of service men and their families.

The firm has no equipment to sell but feels it a pleasant duty to sponsor this idea for the boys in uniform.



Warren Hasemeier of Wilcox-Gay.

# INVESTMENT

# \$ 7.77

# YOUR PROFIT

# \$ 9.48



**HERE'S THE DEAL IN A NUT-SHELL!**

QUANTITY	ITEM	RETAIL VALUE
14 Packages	Filterpoint Needles @ 25c	\$ 3.50
7 Packages	Duo Chrome Needles @ 25c	1.75
7 Packages	Lifetone Needles (4,000 Play) @ \$1.50	10.50
		<b>\$15.75</b>
	<b>FREE!</b> 1 LIFETONE NEEDLE	1.50
	<b>Total Value</b>	<b>\$17.25</b>

**Your COST \$7.77 • Your PROFIT \$9.48**

## MR. JOBBER!

Stock up on the hottest needle deal ever offered to the trade. Duotone's "Lucky 7" is priced to give both you and your dealers a very handsome profit. Here is a priority free item, available immediately. Mailing pieces and return cards supplied free with each order for deals. Write for information today. Don't wait!

## JOBBER SALESMEN!

The "Lucky 7" deal is lucky for you too. Sell the deal ... get a Stetson free! Ask your boss for the details.

## A Profit-Making Promotion If There Ever Was One!

Yes, here is the Duotone "Lucky 7" Deal—The hottest needle offer of the year . . . a money-in-the-pocket operation that is going like wildfire from coast to coast. It's a fast turnover deal, complete from smash counter displays to long profit. Duotone's fastest selling items . . . Lifetone, Filter Point and Chrome Needles are wrapped up in the "Lucky 7" display package that gives you a profit of \$9.48 on a \$7.77 investment. The Duotone policy of liberal dealer discounts makes more money for you again! Don't wait. This is a limited offer and will be withdrawn as soon as allotted quantities are gone. Order from your Duotone jobber immediately or send us the coupon.

### MAIL COUPON NOW

DUOTONE, INC. Dept. R.  
799 Broadway, New York City

Rush Me....."Lucky 7" Deals at \$7.77 each.

My Jobber's Name.....

City & State.....

NAME.....

STREET.....

CITY..... STATE.....

# DUOTONE CO. 799 BROADWAY NEW YORK CITY

# The Sound of War



The sound track of Daldone Radio Service Labs, Newark, N. J., is a familiar unit at war-time events in New Jersey. Daldone reports doing 40% of the naval launchings, state celebrations, parades, etc., in the state, using University Labs equipment.

• At the outset, Britain at war thought that public address was a peace-time luxury. But at least one radio man, R. G. Jones of the Morden district in London, thought otherwise. Mr. Jones had built the first P.A. van to be seen on the British highways in 1926, and had left radio retailing to concentrate on public address.

Then in the days when salvage and the need for saving used material was little known by the public and was only just being considered by the authorities, Mr. Jones took his van to a residential street in Morden, London. He was accompanied by a doubtful Borough engineer.

"Britain needs your scrap and rubbish," came the call from the loudspeakers, and this was followed by a vigorous appeal for local residents to look in spare rooms and attics to see what could be salvaged for the munitions factories.

## 130 Outfits Used

After a few minutes, people began to pour out, bearing a motley mass of material that soon formed a great pile on the sidewalk. Papers and books, cycle frames and garden tools, children's broken toys and cardboard boxes and a hundred other different things were carried out by the suburban householders.

That incident with its results was repeated in every street that the van visited. The success of the appeal brought a visit from Mr. Judd, Britain's publicity chief in the Ministry

department concerned with salvage and since that day Mr. Jones has been busy with 130 public address outfits helping to win the war.

Calls for special savings efforts to invest in Britain's War Savings Fund to buy battleships, airplanes and tanks have been made at great open air meetings using his equipment. Relaxation and recreation for war workers has been provided by lunch hour band concerts on the steps of St. Paul's Cathedral. Thousands of volunteers have answered the appeal for blood donors broadcast by the speakers on his vans. One van is kept ready, day and night, at the service of the Ministry of Information so that in case of any emergency instructions can be given to the inhabitants on an area. Another van with speakers having a four to five mile range has helped in training men of the Home Guard—Britain's part time Army—in field exercises.

## Morale Job

Those are just a few of the ways in which Mr. Jones is today proving in Britain the worth of public address in aiding the war effort.

Over and above these, he has just completed his greatest task this summer. This job involved working 126 hours a week for more than a month and on more than one occasion handling 16 jobs in one day.

This was no less than the task of giving everyone of London's six to seven millions a chance to spend a happy holiday without going away. Due to the need for cutting down passenger travel on the railroads this season so that the locomotives could be used for hauling freight and the lines left clear for military traffic, the

Government planned a "Holidays at Home" campaign. They could not bring the sea to the city, but they planned to turn every open space into a play center, sports garden, theatre and music center. It was the task of Mr. Jones to insure that radio amplification made all these things available to the open air crowds.

## Talk of the Town

In Hyde Park, where Mr. Churchill spoke to the crowds at one of the big reviews; at Trafalgar Square where military bands played; at Lincoln's Inn, once the retreat of lawyers, where concert parties wise-cracked; and at Southwark Gardens, where Shakespeare's plays were given, only a few hundred yards from the site of theatres where he had once played; and at swimming galas, parks and open air dances throughout London, Mr. Jones' speakers brought entertainment to the thousands of London war workers who stayed at home. They stayed firstly because of the Government's appeal, and secondly, because of the amazing feast of gaiety and entertainment that only P.A. could bring them.

## Records Enlisted

Now Mr. Jones is planning a new activity to reinforce the appeal of public address. He has always concentrated on microphone technique when making appeals for special war efforts such as salvage, savings, fuel economy and so on. But his voice has only been able to travel with one van—until he started making gramophone records of such appeals.

"The advantage is that such appeals can be rehearsed, and studied to get the maximum effect and then can be recorded and issued out to as many vans as are being used at one time. Previously we had to use scripts and often it was difficult to get men who combined the qualities of reliable driving with operating and microphone technique. There is always the risk of a mistake with a script."

Owing to the shortage of blank discs, Mr. Jones is experimenting with cellulose type-sprays in the hope of being able to fill up the grooves of old records and use them again.

---

**How a British Dealer  
Used Public Address  
Equipment at Crucial  
Period in London**

---



# *Loud Speaker Maker for the Armed Forces*

*"Engineer a loud speaker for battleships!"*

*"Engineer a loud speaker to go in training tanks!"*

*"Engineer a loud speaker for submarines!"*

*"Engineer a loud speaker for command cars!"*

*"Engineer a loud speaker for landing barges!"*

*Those are just a few of the instructions Jensen has received since America decided to make war its business. Unsurpassed design and production facilities have made Jensen "Loud speaker maker for the armed forces."*

*In addition to the great honor, it is invaluable experience.*

**RADIO**  **Jensen**  
MANUFACTURING COMPANY  
6601 South Laramie, Chicago

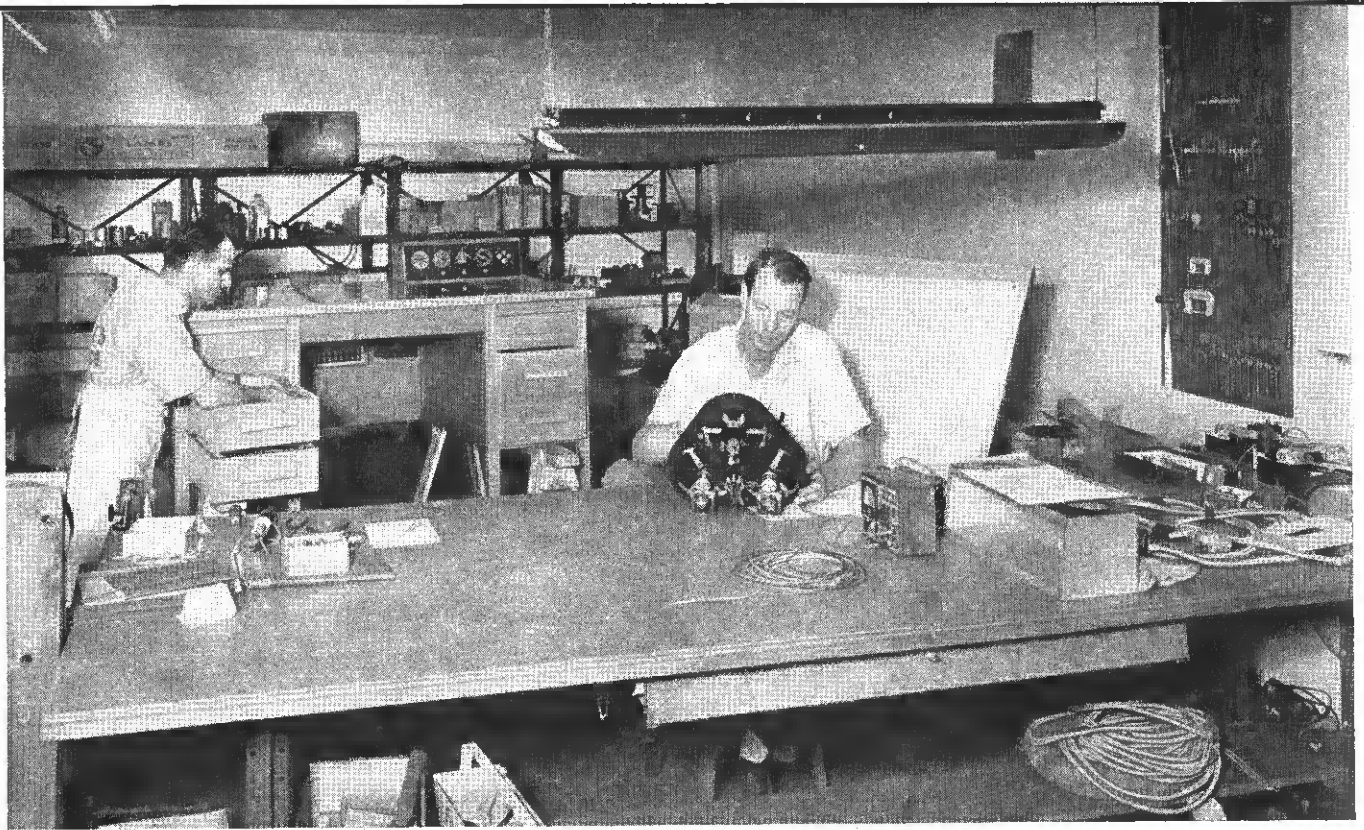

A pair of servicemen, Roy Siler, left, and Frank Babb, are shown in the shop of the Moore Equipment Co., Dayton, at work on secret equipment for the Armed Forces. Such vital jobs confront these servicemen daily, besides the rush of home repair work, but they're eager to make a direct contribution to the war effort by working on military units.

# Ohio Servicemen On War Jobs

Below, left, is William Weller of Standard Radio Parts Co., Dayton, at the business end of a big paging system he built for a local war plant. It's another way servicemen help the war effort. The RCA unit was designed by Ray Stotts, now a first lieut. in the Air Corps.

Below, right, is service expert Lester Grant, also of Moore Equipment Co., aboard an Air Corps repair trailer. He's doing special test work on a two-way radio—typical of the military jobs which mean that Moore servicemen work overtime. Such work shows that radio servicemen have big Victory jobs to do as civilians.

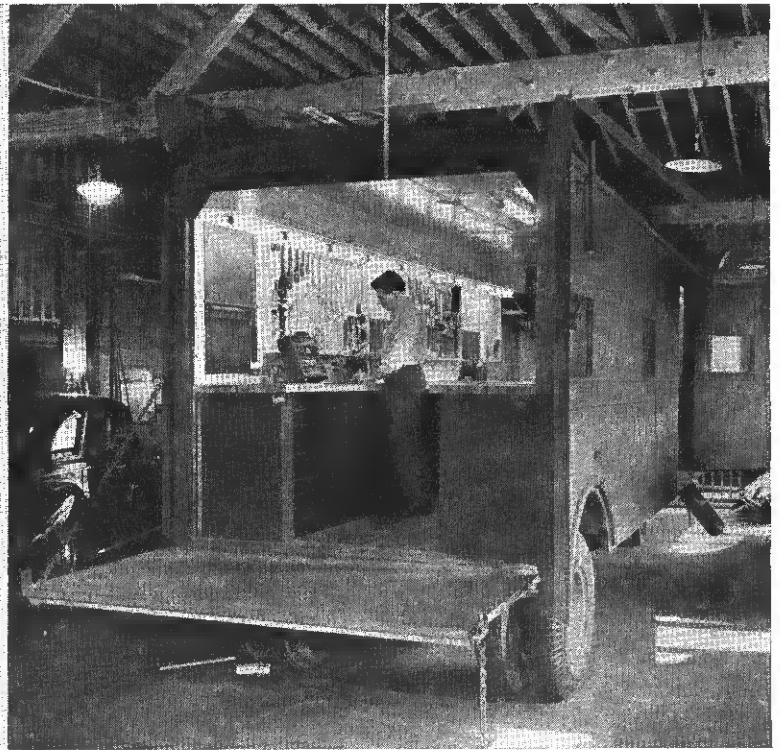

# On Merit Alone-

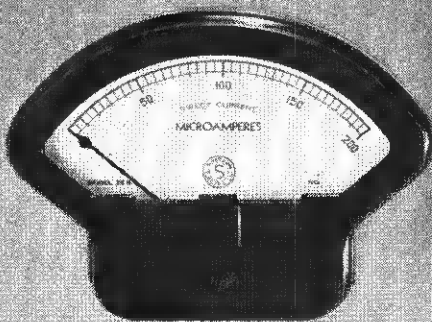
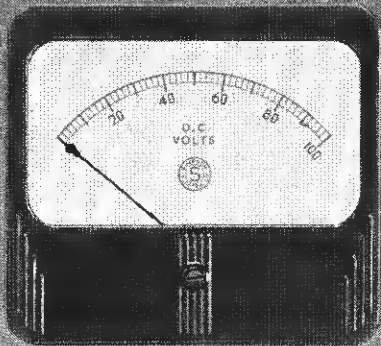
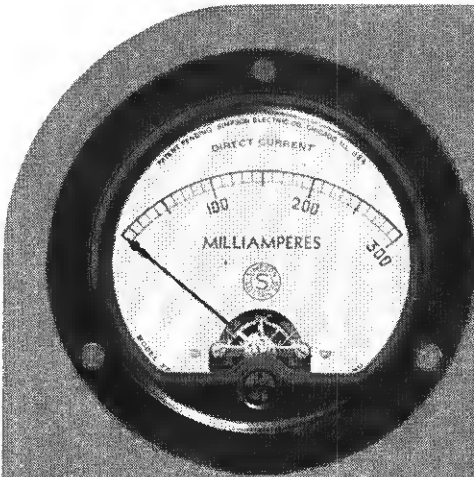
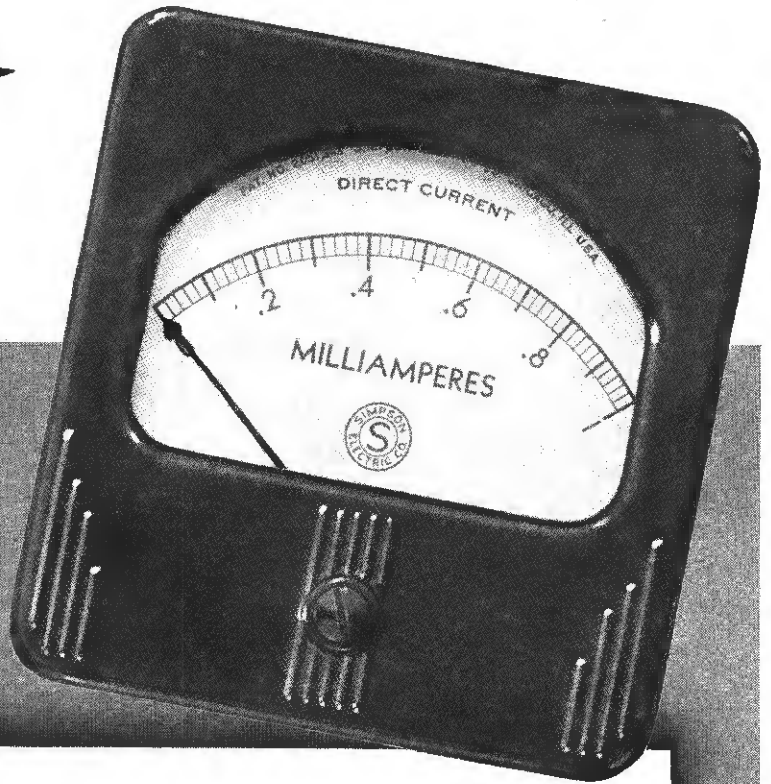

THE name Simpson is a distinguished one in the design and manufacture of electrical instruments. It stands for know-how, and skill, learned through long years of experience.

But people don't buy *names* today; they buy *products*. And that's the real reason why Simpson Instruments have skyrocketed to success so rapidly.

Born of experience that reaches way back into the history of electrical instruments, they offer such important betterments as a full bridge type movement with soft iron pole pieces. Men who know instruments know that such a movement is inherently more accurate and rugged. As produced by Simpson, this finer design achieves its finest expression . . . with all the economies of standardization and straight-line production.

If your need for instruments is vital enough to give you the right to buy, it is vital enough to rate the best. To those who have learned to measure instruments on merit alone, that means Simpson.

**SIMPSON ELECTRIC COMPANY**  
5208-18 Kinzie St., Chicago, Ill.

All Popular  
Styles, Sizes, Ranges

# Simpson

INSTRUMENTS THAT STAY ACCURATE

### MODEL 260 High Sensitivity Tester

- A typical example of Simpson leadership. Ranges to 5000 volts, both AC and DC, at 20,000 ohms per volt DC, and 1000 ohms per volt AC. Current readings from 1 microampere to 500 milliamperes. Resistance readings from 1/2 ohm to 10 meg-ohms. Five decibel ranges, -10 to +52 DB.

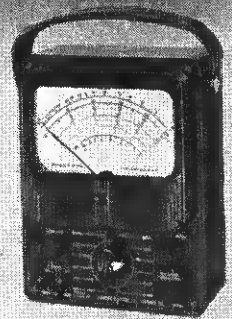

# Government Regulation of Radio Inventories

• Government regulation of radio stocks is definitely on the way. The latest announcement on this from the War Production Board is that formal control of finished consumers' supplies in the hands of wholesalers, retailers and manufacturers throughout the U. S. is scheduled for the near future.

The statement from Washington is that "the order now being drafted will require the achievement of normal inventories by the early part of 1943 . . . the system will require each merchant to maintain the same relationship of his stock to sales which he had on the average in comparable quarters 1939-40-41. Forms giving the details for arriving at "normal inventories" are being made available. In these announcements, WPB does not reveal whether smaller dealers will be exempt from the regulation but earlier indications were that remaining radio stocks of the average dealer would not be large enough to be affected directly by the ruling. However, in the equalizing and balancing of all radio supplies in the hands of distributors and dealers, a kind of distribution may take place which would affect the interests of everybody in the business. In spite of the fact that in general the trade is currently concerned with shortages, rather than with overstocks.

## Immediate Need

The current condition of inventories was investigated by a special Wholesale and Retail Inventory Policy Committee, and reported to Joseph L. Weiner, Deputy Director of the Office of Civilian Supply, WPB. The findings showed "that the tendency toward inequitable distribution of inventories among merchants is sufficiently pronounced to require prompt adoption of a control program."

The report said that an equitable distribution of inventories will help keep in existence thousands of small community stores necessary to supply the needs of suburban and rural communities, especially those in which

## Things to Come?

A new order issued by Canadian authorities has "frozen" all retailing activity by putting a stop to all expansion, new enterprises, new lines, and new services on the part of dealers.

Canadian dealers are thus prohibited from adding any new merchandise which they may have been considering as wartime "substitutes."

war plants are now located. It was stated that the control program is also desirable in connection with any future rationing programs. It was pointed out that a rationing plan could hardly be successful unless the existing supply of the rationed article is distributed among merchants in proportion to the amounts of its which will be bought by their customers.

An earlier recommendation that a system of quarterly reports from the regulated merchants be used to begin

with, was rejected by Donald Nelson, who favors a program that is more direct and formal. Mr. Nelson believes that the carefully-considered order now being drafted will get the job done more effectively.

## Anti-Inflation Measure

It is believed that the new control plan will aid in cutting down the inflationary effects which naturally arise from scarcities of goods. These effects include speculative buying, "black markets," and decreases in the normal regulatory forces of competition which results when competitors cannot get merchandise.

Influencing the shape of the final order will be the recommendations of the reporting committee that the ruling should be simple, inexpensive to administer, and in conformity with the usual accounting practice. Other suggestions were that the order should (1) Be applied by lines of merchandise or by departments, (2) Flexible enough to allow for seasonal fluctuations and changing conditions, (3) Orderly in its provision for liquidation of excess stocks.



"Think you can handle this radio?"





## PREFERRED BY THE HOME FRONT'S COMMUNICATION ENGINEERS

IT IS necessary to keep the receivers in millions of homes and offices operating to get war news—maintain a vital link in air and other civilian defense activities. Home front communication engineers prefer Utah products for this vital work. Experience has taught them that the Utah trademark assures dependability and customer satisfaction. They know it protects their reputation for high quality and sound value.

UTAH VIBRATORS—Outstanding design and advanced engineering have maintained their leadership. The Utah line provides exact replacements for every vibrator requirement.

UTAH SPEAKERS meet practically every radio receiver and sound equipment

need in these industries. A balanced line, Utah Speakers provide ruggedness and adequate power handling capacity.

UTAH TRANSFORMERS are fully guaranteed. They have absolute insulation—which prevents breaking down, even under high humidity and severe atmospheric conditions.

UTAH CARTER PARTS include Vitreous Enamel Resistors, Wire Wound Controls, Plugs, Jacks, Switches, etc. Satisfactory performance is assured in every Utah point in the circuit. UTAH RADIO PRODUCTS COMPANY, 810 Orleans St., Chicago, Ill. In Argentina: Radio Products Co., S. R. L., Buenos Aires. Cable Address: UTARADIO, Chicago. In Canada: Utah Products (Canada) Ltd., 560 King Street, West, Toronto.

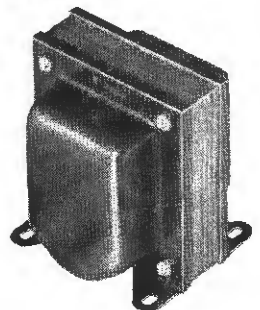
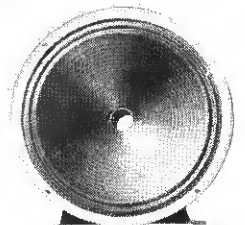

# S P E A K E R S

VIBRATORS • TRANSFORMERS • UTAH-CARTER PARTS

# Staying in Business

## Everything from Flashlights to Tractors

A number of radio manufacturers are energetically helping their dealers and distributors to locate new lines to sell. Much of the new merchandise is completely non-related to radio, but the factories are anxious to be helpful and to give radio outlets some chance of staying in business. Zenith Radio Corp. has been very active in this respect, and has served as a clearing house for its distributors, in exchanging information on new lines, where they are available, etc.

The latest list of new products which various Zenith distributors have taken on, is as follows:

Records	Sporting Goods
Games	Electric Heaters
Linoleum	Woodworking Tools
Cameras	Kitchen Cabinets
Mattresses	Small Appliances
Fans	Breakfast Furniture
Glassware	Refrigerator Parts
Stokers	Sewing Machines
Clocks	Cooling Equipment
Furniture	Water Softeners
Sinks	Ice Refrigerators
Faint	Frozen Food Lockers
Furnaces	Fluorescent Lighting
Carpeting	Lubricating Oil
Dishes	Floor & Table Lamps
Phonographs	Fire Extinguishers
Flashlights	Piston Rings
Sweepers	Coffee Makers
Fertilizer	Kerosene Stoves
Coal Stoves	Hand Tractors
Nested Chairs	Record Cabinets
Gas Stoves	Stirrup Pumps
Sun Lamps	Electric Razors
Ironing Pads	Space Heating

## War Agencies You Should Know

The School of Retailing of New York University has issued a list of "War Agencies Affecting Retailing," as a reminder to dealers that there are, within the Office of Emergency Management—Office of the President—quite a number of wartime control centers in Washington with which retailers should be familiar.

The list, which outlines the way in which each agency affects the retailer, is as follows:

*Office of Economic Stabilization.* Formulates and develops a comprehensive national policy relating to the control of civilian purchasing power, prices, rent, wages, rationing, subsidies, and all related matters. James F. Byrne, Director.

*Office of Price Administration* regulates retailing through price control and rationing. Leon Henderson, Administrator.

*War Production Board.* Division of Civilian Supply sets up regulations to conserve supply and administers such inventory controls as are deemed necessary. Through its priority system, the WPB also restricts the materials available for goods to be sold at retail. Leon Henderson, Director.

*Office of Civilian Defense.* Draws up regulations for business establishments covering air-raid defense. James M. Landis, Director.

## Washington Heads

*National War Labor Board.* By means of mediation or arbitration settles labor disputes that might directly or indirectly interfere with the War Effort. William H. Davis, Chairman.

*Office of Defense Transportation.* Restricts retail deliveries and pickups and aids in developing cooperative delivery systems. Joseph B. Eastman, Director.

*Selective Service System.* Taps retail manpower and sets up responsibilities for reemployment. General Lewis B. Hershey, Director.

*War Manpower Commission.* Allocates civilians to essential industries. May eventually control retail personnel, Paul V. McNutt, Administrator.

## War Stamp Xmas Cards Ready to Sell

A series of War Stamp Christmas Cards, approved by the Treasury Dept., are now available to retailers from The Greeting Card Industry, Inc., 200 Fifth Ave., New York City. This organization represents a majority of the greeting card manufacturers of the country, and by offering these lively and novel cards to all dealers, makes an important contribution to America's Victory program.

The cards sell for 5c each, and contain either a stamp album, or an envelope which the addressee is encouraged to fill with stamps. Short patriotic greetings are so worded that at least one stamp must be enclosed by the sender.

Dealers may order lots of the eight different designs of cards, or they may get the self-displaying container, ready for counter use, which holds 100 cards and envelopes. This assortment includes, besides the big red-white-and-blue display, a colorful window streamer and counter card.

## Putting the Screws on That Terrible Trio



In a Philadelphia parade, this float by Philco Corp. drew heavy applause as an expression of how radio war production plants feel about their job in beating the enemy.

**ARE**

# Coils

**YOUR  
PROBLEM?**

**F**or many years Meissner Coils have been the accepted standard by engineers who insist upon high quality performance . . . Meissner precision coil construction never varies . . . they are the best that engineering research and modern production methods can make.

When you specify a Meissner Coil you have the assurance of long, trouble-free operating life backed by a name that is synonymous with precision-built products.

Coils illustrated and described represent only a few of the complete Meissner Coil line.

*See your nearest Meissner distributor today.*

**Meissner**  
MT. CARMEL, ILLINOIS

**"PRECISION-BUILT PRODUCTS"**

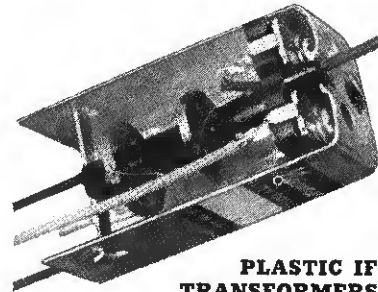

**PLASTIC IF  
TRANSFORMERS**

The most popular replacement types. Compact in size, 1 1/4" square, 2 1/2" high. Available in all frequencies from 175 kc. to 456 kc. List price \$1.10 each.

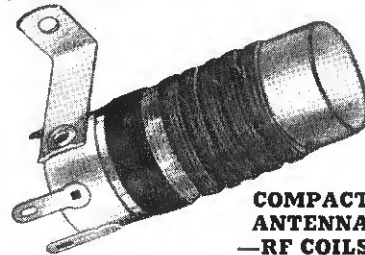

**COMPACT  
ANTENNA  
—RF COILS**

Ideal units for replacement in compact midget or auto Radio sets. Coils wound on form 5/8" in diameter, 1 3/4" long. List price, either type, Antenna or RF, 50c each.

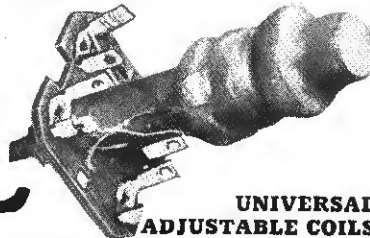

**UNIVERSAL  
ADJUSTABLE COILS**

Adjustable—Inductance Ferrocart (Iron Core) coils will replace the broadcast band coils in practically any receiver. 3 types available, Antenna, RF, Oscillator. List price \$1.38.

# NINETEENTH BOARD of DIRECTORS R.M.A. 1942-43



E.A. NICHOLAS J.J. NANCE H.E. OSMUN RAY F. SPARROW RAY H. HANSON M.F. BALCOM JAMES P. QUAM A.H. GARDNER H.C. BONFIG JAMES T. BUCKLEY



ROY BURLEW E. ALSCHULER OCTAVE BLAKE W.R.G. BAKER PAUL V. GALVIN A.S. WELLS BEN ABRAMS R.C. COSGROVE W.P. HILLIARD



DAVID T. SCHULTZ JAMES C. DALEY ERNEST SEARING JOHN W. VAN ALLEN BOND GEDDES LESLIE F. MUTER J.J. KAHN G.W. THOMPSON P.S. BILLINGS L.L. KELSEY

Above is the roster of key men of the Radio Manufacturers Association, many of whom are serving in wartime advisory capacities in Washington. Chief concern of RMA is now to bring radio war production to absolute peak. Membership is the biggest since 1931; there are now 150 members compared with 109 a year ago. The organization recently launched a new Service Bureau as part of an all-industry plan (see pages 16-17) to provide manpower and replacement parts to keep as many civilian sets in repair as possible after war requirements are filled.

## COURT ALLOWS DEALER TO CANCEL LEASE

More information on the legal position of a radio dealer who may want to cancel his lease contract because of wartime shortages, is seen in a decision by the New York Supreme Court, Monroe County. The action was that of Schwartz vs. The American Auto Supply Co., wherein the former brought suit for store rental, based on a three years' lease dating from March 10, 1940.

(An earlier discussion of a dealer's rights in such cases is to be found in the June issue of RADIO RETAILING TODAY, under the title "Your Lease" on page 26.)

### Tenant's Sales Stopped by Gov't. Regulations

The Schwartz lease contained the provision: "premises to be used for the sale of tires, radios, washing machines and refrigerators." The tenant's answer to the complaint was that the sale of these articles has been prohibited by the United States Government's priority order and the tenant had been evicted from the premises. The Court denied the landlord's mo-

tion for judgment on the pleadings, for the following reasons:

The landlord contended that the lease did not restrict the use of the premises by the tenant to the sale of tires, radios, washing machines and refrigerators, because it did not say that it should be devoted to these purposes exclusively, and that the insertion of the word "only" would be necessary to accomplish that result.

### Special Equity

The court said that if the intention had been to allow the stores to be used in any legal manner that the tenant might desire "there would have been no object in mentioning that they were to be devoted to the purposes above stated. The premises could have been used for these purposes or any other lawful business. The clause is presumed to have been inserted to serve some object, and hence must be interpreted to mean that the purposes stated are exclusive. The restriction by the landlord of the use of these stores for the purposes stated created a special equity in favor of the tenant. If the tenant were to be held to its covenant to pay the rent, then the premises must remain idle because they can be utilized for

no other purpose by the tenant without violating the lease. On the other hand, if the lease is cancelled, they can be used by the landlord for any lawful purpose."

### Partial Close-Outs Not Covered

The court expressly did not decide whether the result would be different if some but not all of the types of merchandise and appliances described in the lease were forbidden to be sold, or if the sale of some or all of them was permitted but in reduced quantities; nor what different effect would be produced by a lease for a long term.

If the government orders do not go as far as forbidding all sales of types of machinery and appliances described in the lease, the effect of any variance will be considered when the action is tried.

So far, cases involving radio merchandise are rare, and no reports have been made on the status of radio servicing in this situation. Radio men may meanwhile get valuable guidance by watching any new court decisions that may be made concerning retailers and servicers in other fields where supplies have been drastically cut by war needs.

# Prediction!

TO KEEP THE



NAME ALIVE  
—AND HELP  
YOU

**1917 WAR**  
RUN BY  
TELEPHONE

**1942 WAR**  
RUN BY  
RADIO

For Instance...

... the patriot forces of Yugoslavia continue to fight. Over its secret radio Gen. Mikhailovitch's headquarters announced the fall of Dombrova after the killing, wounding or capturing of over 3,000 Axis troops. (news item)

... importance of radio in this war is emphasized by the army establishment of radio mechanic and operator schools in Stevens Congress Hotels at Chicago. It is reported that capacity will be about 15,000 men taking 14 weeks training. (news item)

**Interesting!**

Watch for radio use in the war news — you'll find it in the air — on the ground — and at home!

Without radio, the movement of war would still be anchored by telephone lines—the physical hazards of the courier and visual signals.

Now war moves swiftly over the whole face of the earth—instaneous radio communication thru the ether instead of over copper wires has blasted the barriers of space and time.

So today all our radio production centers on war use.

But what of tomorrow—what effect will this have upon the future—after victory? One thing is certain—it will revolutionize and speed the great new future form of transportation.

Radio has never been universally necessary in transportation before. In automobiles—on trains—it has been a great aid but not an essential.

But today for the future, in that great new universal transportation that is forming itself—the airplane—radio is essential as the engine itself.

And—mark this well—airplanes and radio are two of the four great industries destined to lead this country back to business normalcy after the peace is won.

Zenith's leadership in the radio industry has been established by a constant achievement of "firsts." Repeatedly, ideas "branded new" when Zenith first introduced them, later became essential on all radios. And that same "forward thinking" of engineers and factory and organization now concentrates on war production of the time we know—radio—exclusively. We are progressing—we learn every day—and this new experience will inevitably reflect itself when Zenith again produces for peace.

—a Zenith Radio Dealer near you is giving reliable service on all radios—regardless of make—**ZENITH RADIO CORPORATION—CHICAGO**

**ZENITH RADIO**  
"LONG DISTANCE"  
RADIO PRODUCTS EXCLUSIVELY—  
WORLD'S LEADING MANUFACTURER  
U. S. WAR BONDS & STAMPS **NOW**

Running Frequently in a Long List of National Magazines

## RADIO . . . . One of Four Great Industries to Lead Us Back to Peacetime Business Normalcy

ZENITH predicts for the post-war radio industry an important future.

One of the many Zenith National advertisements now appearing . . . shown at left . . . will tell you why.

And because Zenith . . . in war as in peace . . . builds what it knows best—Radio . . . and *nothing but radio* . . . now for the country's armed forces, Zenith is concentrating on radio research—contributing much and learning much that will establish a new record of "firsts" for the future of Zenith Dealers.

We are proud to be producing for Victory—proud to be a part of the great industrial force which manufactures war material for our armed forces—doing all we can to hasten the day when peace will come.

Zenith's proven advertising strategy, used so successfully in establishing deserved supremacy for Zenith Portables, calls for hard-hitting, moderate sized space, run with rapid frequency and aimed toward large circulations in a diversified list of periodicals.

Advertisements similar to the one reproduced at the left will help keep the Zenith name alive before the American public.

**ZENITH RADIO CORPORATION**  
CHICAGO

# New Products

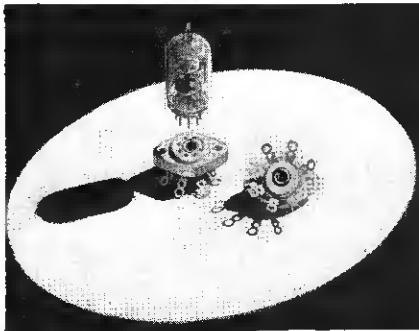

**JOHNSON "VIKING" MINIATURE SOCKET**, No. 267, featuring government grade G steatite insulation. Silver-plated, phosphor bronze contacts are self-aligning. Orientation of contacts for minimum capacity effect and center shield for grounding to chassis. Steatite insulation is glazed top and sides and bottom wax impregnated. Lists at 50c. E. F. Johnson Co., Waseca, Minn.—RRT.

**GENERAL CEMENT RADIO CHEMICAL LABORATORY** contains 20 large 2 oz. bottles of chemicals and cements for all kinds of radio repairs, speakers, coils, contacts, dials, controls, etc., put up in a permanent rack stand which may be placed on bench or hung up on the wall. List price, \$8.17, dealers net, \$4.90. General Cement Mfg. Co., Rockford, Ill.—RRT.

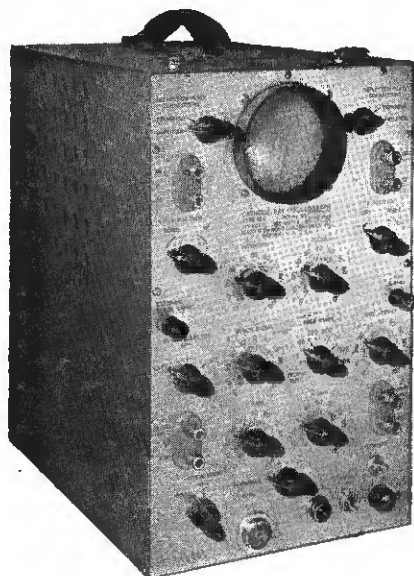

**DU MONT TYPE 224 OSCILLOGRAPH** with greatly extended frequency range, more versatility in the handling of applied signals and special pickup means whereby input capacitance is reduced and stray pickup eliminated. Outstanding feature is Y-axis or vertical deflection response from 20 c.p.s. to 2 million cycles. X-axis or horizontal deflection from 10 c.p.s. to 100 kc. Weighs 49 lbs. and measures 14 $\frac{1}{8}$  in. x 8 $\frac{3}{8}$  in. x 15 $\frac{1}{8}$  in. Operates on 115 v., 60 cycles. Allen B. DuMont Labs., Inc., 2 Main Ave., Passaic, N. J.—RRT.

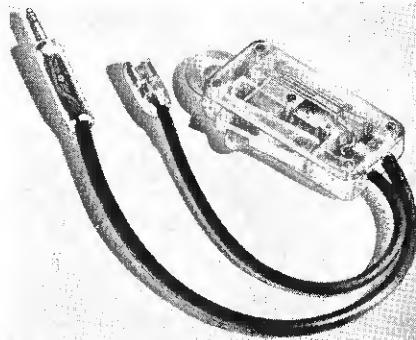

**AMERICAN RADIO HDWE. PHONE-SWITCH**, SW-141, is a double circuit microphone switch designed to permit easy on and off switching. 4 15/32 in. x 3/4 in. x 1 1/4 in. Constructed of Tenite II. Heavily nickel plated with Bakelite insulation. Mounted on sturdy brass brackets, phosphor bronze blades. American Radio Hardware Co., 476 Broadway, New York, N. Y.—RRT.

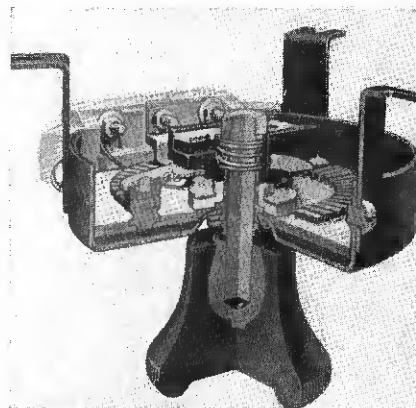

**WARD LEONARD 69 RHEOSTATS**, made of pressed steel are 4 in. in diameter with about 43 steps of control and are rated for 100 w. Feature balanced contact arm, "dead" shaft construction, copper graphite contact shoes and front or back-of-board mounting in single and multiple assemblies. Ward Leonard Elec. Co., Mt. Vernon, N. Y.—RRT.

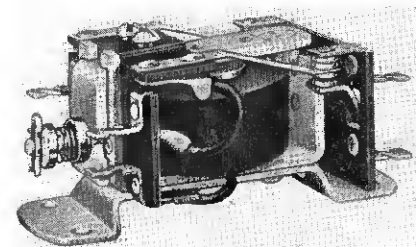

**WARD LEONARD 104 RELAYS**, small, compact remote control units, adapted to applications within their ratings where space is limited. Available for operation on AC and DC circuits. Open type, front connected solder type terminals, double pole, double throw, silver-to-silver con-

tacts. The contacts are rated: 4 amps up to 24 v. AC or DC and 4 amps AC; 1 amp DC from 25 to 115 v. Vibration resistant up to 10 times gravity in the energized position. Overall height from base to armature—1 1/4 in. Ward Leonard Elec. Co., Mt. Vernon, N. Y.—RRT.

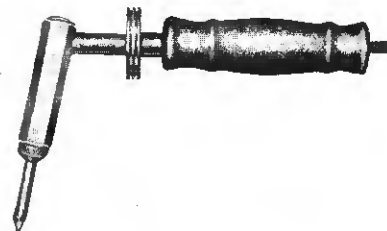

**HEXACON HATCHET TYPE SOLDERING IRON**, made up in wattages of 80, 100, 150, 175, and 200. Tip sizes 3/8 in., 1/2 in. and 5/8 in. Plug tip type with replaceable elements and tips. Principal advantage is that it gives better balance on certain soldering operations and decreases operator fatigue. Range in price from \$8 to \$11.50. Hexacon Elec. Co., 161 W. Clay Ave., Roselle Park, N. J.—RRT.

**CARTER MAGMOTOR**, the smallest and lightest weight permanent magnet dynamo made. 100 w. model weighs only 4 3/4 lbs. Designed for police radio receivers, small aircraft transmitters, portable life saving devices and field communication equipment. Special brushes insure over 5000 hrs. service. Also available as an AC or DC generator. Carter Motor Co., 1608 Milwaukee Ave., Chicago, Ill.—RRT.

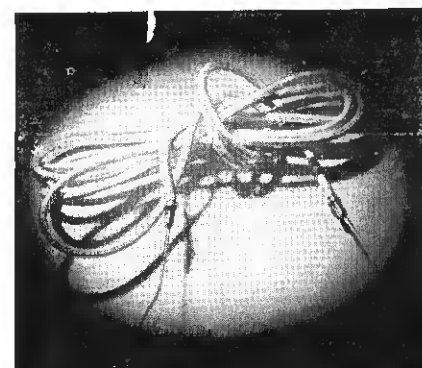

**CLAROSTAT GLASOHM HEATING ELEMENT**, a glass-insulated flexible unit available in lengths of from a few inches to several feet—particularly useful in very limited space. Resistance wire is wound on a fibre-glass core and protected by a fibre-glass braided covering. Can be readily bent. May be provided with any type terminals. Wattage ratings from 1 to 4 w. per body inch depending on the application. Operating temperatures up to 750° F. Clarostat Mfg. Co., Inc., 285-7 N. 6th St., Brooklyn, N. Y.—RRT.



PREFERRED  
*for*  
PERFORMANCE



**RESISTORS**

**WHY?** . . . Results of a nation-wide survey conducted by a wholly independent research organization disclosed that Executives and Engineers in the electronic industries *overwhelmingly prefer* IRC resistors. In voting them "superior" by a plurality of more than two to one, these specific reasons were cited—

**BECAUSE** . . . *IRC offers "best product" and "most complete line."*



*IRC flies the flag of the  
Army-Navy Production Award  
for "High Achievement"*

**INTERNATIONAL RESISTANCE COMPANY**

401 N. BROAD STREET • PHILADELPHIA

# Power Supplies For Portables

## How to Put Battery-less Portables Back into Operation with a Power Line Supply Unit

• The recent government order stopping the manufacture of the batteries normally used for portable receivers leaves some of the older types that were not designed for three way operation to either be stored on a closet shelf for the duration, or to be equipped with a power line supply by the serviceman.

Most of the battery-only type of portables used four tubes in a conventional superhet circuit. The tubes in these sets were generally connected in parallel and required a 1.5 volt battery and a current drain 200 to 250 ma. depending on the type of audio output tube used.

In Fig. 1A a typical parallel filament portable circuit is shown with the conventional AVC system.

### Power Units Available

Several manufacturers offer power line units for use with these portables. The units are designed to fit into the battery compartment of the set. The power from these units is connected to conventional battery sockets so than the cables in the set need only be plugged into the proper socket. These units will offer a quick solution to the problem of putting these sets back into service.

A list of the manufacturers of these power line battery units will be found on page 60 of the Radio Yearbook (March 1942 issue of Radio Retailing Today).

Due to many material shortages it may not be possible to obtain these power units in all cases. If this is the condition, the serviceman can build a unit to do the job.

There are several important problems to consider in the design of such a power unit. In most cases it will be out of the question to consider a rectifier system which can deliver 200-250 ma. at 1.4 volts. A single 80 tube (or 5U4G, 5V4G, etc.) could be used with the plates tied together for half-wave operation at this high value of current. The tube could work directly from the 115-volt line. The problem with this arrangement lies in the filtering of such a high current at such a low voltage. Several hundred microfarads of capacity would be required as well as either a very heavy choke (should be capable of passing 300 ma. or more) or a filter resistor of about 500 ohms. This resistor should be rated at 50 watts or more.

### Convert to Series

Such heavy current parts are expensive and difficult to obtain in these times. Some service shops may have some oldtime copper oxide rectifiers and associated equipment from the early "A" eliminators. This apparatus, if not too large may be used to supply the current for the tube filaments.

A better method which involves more

work but gives a lighter weight and less expensive power unit is that of rewiring the filaments in a series rather than parallel circuit. By connecting the tubes in series, the total current drain need only be 50 ma. and the filament voltage will be 6 to 7.5 (for a four-tube circuit) depending upon the type of output tube used.

This reduction of filament current drain means that the smaller rectifier tubes can be used and the filter parts—capacity and resistance need not be as large.

The rewiring of the filaments into a series circuit involves a few points which should be observed. There is a definite order in which the tubes should be wired. The second detector, usually a 1H5, should be wired as the first tube in the string starting at the negative end. The next tube should be the converter, then the IF tube, and last the output tube which will then connect to the positive terminal of the filament power unit. This connection sequence is shown in Fig. 1B.

### By-passing Methods

The tubes are wired in this order to reduce the possibilities of hum modulation in the high gain tubes. Tubes that are several volts above ground in the filament string should be low gain tubes in order not to cause hum modulation from the rectified filament current. Tubes wired in series must have same current rating.

The next factor to be considered in the rewiring of the tube filaments is the grid return circuit of each tube. With parallel filament circuits, the A-circuit was common to all tubes and the necessary by-passing was connected back to this common lead. The bottom end of the grid circuits of all tubes except those getting AVC voltage also were connected to the A-lead. With the series arrangement, the grid returns and all other by-passing for each tube must be done to the negative filament side of the same tube. The screen grid by-pass condenser of, say the IF tube, must be returned to the negative side of the filament of the IF tube. This by-passing back within a circuit to the negative filament lead is important since each tube has a different voltage reference to "ground" and if the grid returns for each tube are not made to the same tube, the grid bias will be upset.

These bias returns are shown in

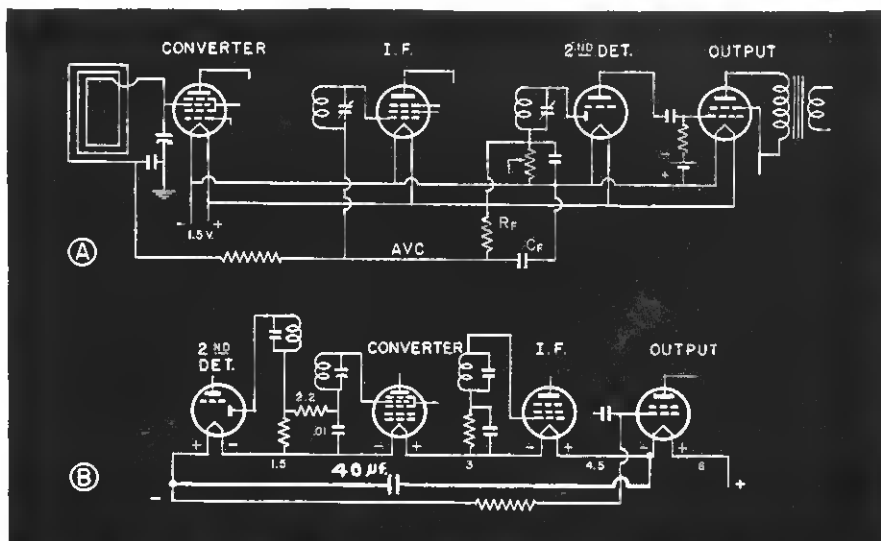

Fig. 1—Typical parallel and series filament arrangement for portables. In rewiring, additional 40 mfd. capacitor is required as shown. See text for notes on grid returns.



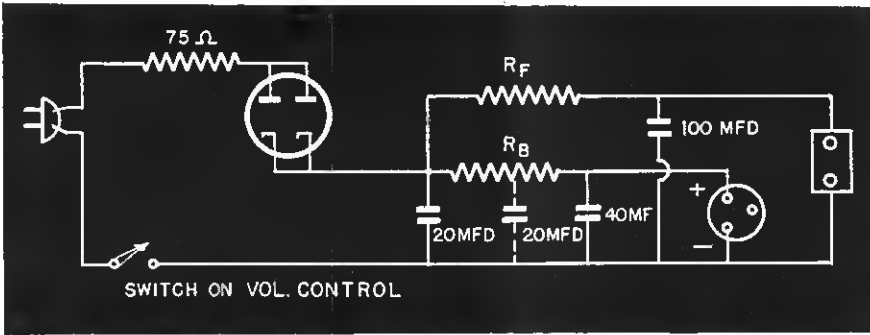

Fig. 2—Half-wave power unit for replacing batteries. Values of filter resistors are discussed in text. Battery-type outlet sockets are used.

Fig. 1B. Notice that the second detector tube is connected so that the diode plate, which is near the negative side of the filament, will have its load resistor returned to the side of the filament connected to the negative side of the converter filament. This is done in order to allow the AVC voltage to be applied to the converter grid without upsetting the grid bias conditions of that tube.

The AVC is usually not applied to the IF tube of these circuits since the 1N5 (most common type) does not have good super control features. Notice in Fig. 1B the IF tube grid is returned to its own filament through a resistor which is usually about 1 to 5 megohms and this is by-passed by 0.01 mfd. capacitor usually. The large value of this resistor give a automatic grid-leak type of bias on large signals. Where only one tube is to receive AVC voltage, it should be one of the tubes early in the circuit such as an RF or converter stage.

**Series Filtering**

The last audio tube in the parallel filament type of circuit usually obtains its bias from the drop across a resistor in series with the B-lead. In the series type of circuit, the bias can be obtained by making the grid return of this last audio tube back to the A- end of the string. The output tube then uses the 4.5 volts drop across the filaments of the other tubes as its bias.

In addition to the precautions to be taken with grid returns and by-passing in the series filament circuit, a large filter condenser will be require to by-pass the audio component of the plate and screen current of the last audio stage around the filaments of the other tubes in the string. This capacitor should be about 40 mfd. rated at about 25 volts. Connect it from the negative side of the output tube filament back to the negative side of the A supply. This capacitor is shown in Fig. 1B.

The actual construction of the power supply will be determined by

the physical layout of the chassis and cabinet. The power supply will consist of a rectifier tube, necessary filter resistors and capacitors, outlet sockets, and power cord. In the absence of small metal chassis on which to assemble the half-wave power supply, a small wood breadboard type of construction can be used. Small blocks of 5-ply wood serve nicely.

**Power Circuit**

The circuit for the power supply is a matter of choice. Fig. 2 shows a

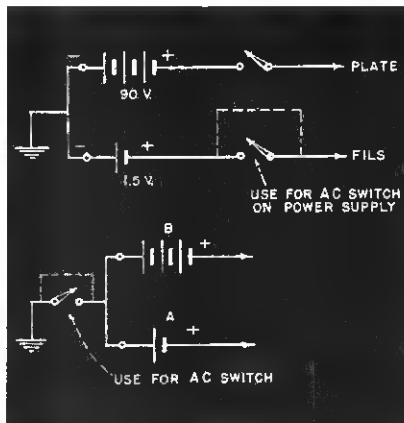

Fig. 3—Common switching circuits that can be rewired to serve as off-on for new power supply.

typical unit. The rectifier tube can be almost any of the high voltage filament tubes that will handle the necessary rectified current. The total current drain of the four tube set will be 50 ma. for the filaments and about 12 ma. for the plates of the tubes—a total of 62. The rectified should be able to handle a minimum of 75 ma. average rectified current. The 117Z6GT is a convenient tube to use as it will not require a voltage dropping resistor for its filament. The 117L/M7GT rectified section can also be used when the 117Z6GT is not available. In the absence of these tubes, the more common 25Z5, 35Z5, and similar rectifiers may be used

equally well by putting in the proper line resistor.

The filter circuit of the supply will consist of a resistance capacity network. The plate current is filtered by one set of condensers and resistors and the filament current by another. Since the usual plate voltage used on these portable circuits is 90 volts, it is best to design the power supply to deliver the same potential. This can be accomplished by selecting the proper size of filter resistor  $R_b$ . With the half-wave supply, and an input capacity of about 30 mfd., there will be approximately 105 DC volts on the cathode (with respect to grounded side of line). This refers to a supply using a minimum series impedance in ohms, as shown in Fig. 2. This resistor should be used in all cases to protect the rectifier tube and set.

With the B output to be 90 volts, the drop across the filter resistor will be 105 volts—90 volts or 15 volts. If the plate current drain of the set is 12 ma, the resistor  $R_b$  should equal 15 volts/0.012 or 1250 ohms. The power lost in this resistor will be  $15^2/1250$  or 0.18 watts. A two watt resistor should be used. For other values of plate drain calculate the correct resistance and power rating.

**Filament Filtering**

The series dropping resistor  $R_f$  for the filament circuit is determined in a similar manner. The voltage drop will be 105—6 or 99 volts.  $R_f$  is 99 volts/0.050A. or 1980 ohms. This is assuming that the tubes are all 1.4 volt, 50 ma. filaments. If the output tube is a 3 volt unit, the  $R_f$  will be 105—7.5/0.050 or 1950 ohms. The power rating of these resistors should be at least 10 watts. Use a sliding tap resistor for exact adjustment.

Even though the filament circuit voltage is only 6 to 7.5 volts, the filter condensers in this section of the supply should be rated at 150 volts DC. If one of the tube filaments should open or the filament circuit be disconnected when the supply was on, the voltage across the last filter condenser would rise to 105 volts and quickly destroy an filter unit rated at less than this voltage.

**Hum Control**

In wiring the power unit, use outlet sockets with the same connection arrangement as employed on the batteries used in the set. The battery cables may then be plugged in directly. The power cord should be wired to the normal set switch. Fig. 3 shows the more common battery off-on circuits. One of the circuits formerly switched can be jumped together and the switch used to turn the power unit off and on.

# SERVICE NOTES

## Service Instructions on Emerson GA, GA1 Chassis

Four models, GA439, GA441, GA1-439 and GA1-441 use the circuit shown in the accompanying diagram. This 6-tube set will be found using 7H7 tube in place of the 6SG7, a 7A7 in place of the 6SK7, and a 7B6 in place of the 6SQ7. These loctal tube sets have the same circuit as the one shown.

The first IF transformer is mounted on top of the deck next to the loop antenna and the trimmers are available through the top of the can. The second IF transformer is mounted next to the 25L6 power tube. The trimmers for the antenna and loop are located on the tuning gang condenser. The front section is the oscillator and the rear tunes the loop. The wave trap is mounted below the deck.

### RF-IF Alignment

To align the IF end of the set, tune the gang condenser to high frequency

end of the dial and feed a 455 kc. signal into the grid of the 6SA7 tube through a 0.01 mfd. capacitor. Adjust the IF transformers for maximum output. The wave trap is adjusted by feeding a 455 kc. signal into the antenna post of the set and adjusting the trap capacitor for minimum response.

### Use Loop

To align the RF end of the set, feed a 1400 kc. signal into the set with the dial set for 1400 kc. Use a loop of wire about one foot in diameter for the radiating loop on the generator and keep it about 12 inches from the loop in the set. Adjust the oscillator trimmer for peak output and then the antenna trimmer.

If the loop has been replaced or repaired, it may require tracking with the oscillator. Set the dial and generator to 600 kc. and move a portion of the outer turn on the loop to either side of the center of the winding until maximum response is obtained. Repeat the trimmer adjustment at 1400 kc.

## Service Shortcuts

Zenith 8S463: Squeal when volume control is beyond middle position is normally due to open 16 Mfd. condenser No. C23 and not due to the volume control being worn.

Zenith 7S487: Set plays weakly. Look for shorted .05 condenser from B+ return of second I.F. to ground.

Zenith 10S589: Phono arm does not finish complete cycle due to improper adjustment. Turn clutch adjusting screw D.P. one half turn.

Zenith 8S443: Local stations received very strong but distant stations weak, look for a partial short of .05 condenser by-passing screen of 1232 R. F. tube.

Silvertone 4462: Set plays intermittently. All tubes test ok voltage is ok. Change 6B5.

## Stromberg Begins Special Promotion

A. F. Schifino, manager of Sound system division of Stromberg-Carlson, has announced the beginning of an intensive promotion on the theme of straight line communication.

"Tell It To Sweeny" is the title of a new booklet showing how the average war plant can save money through the use of "straight line communication" instead of using only the telephone.

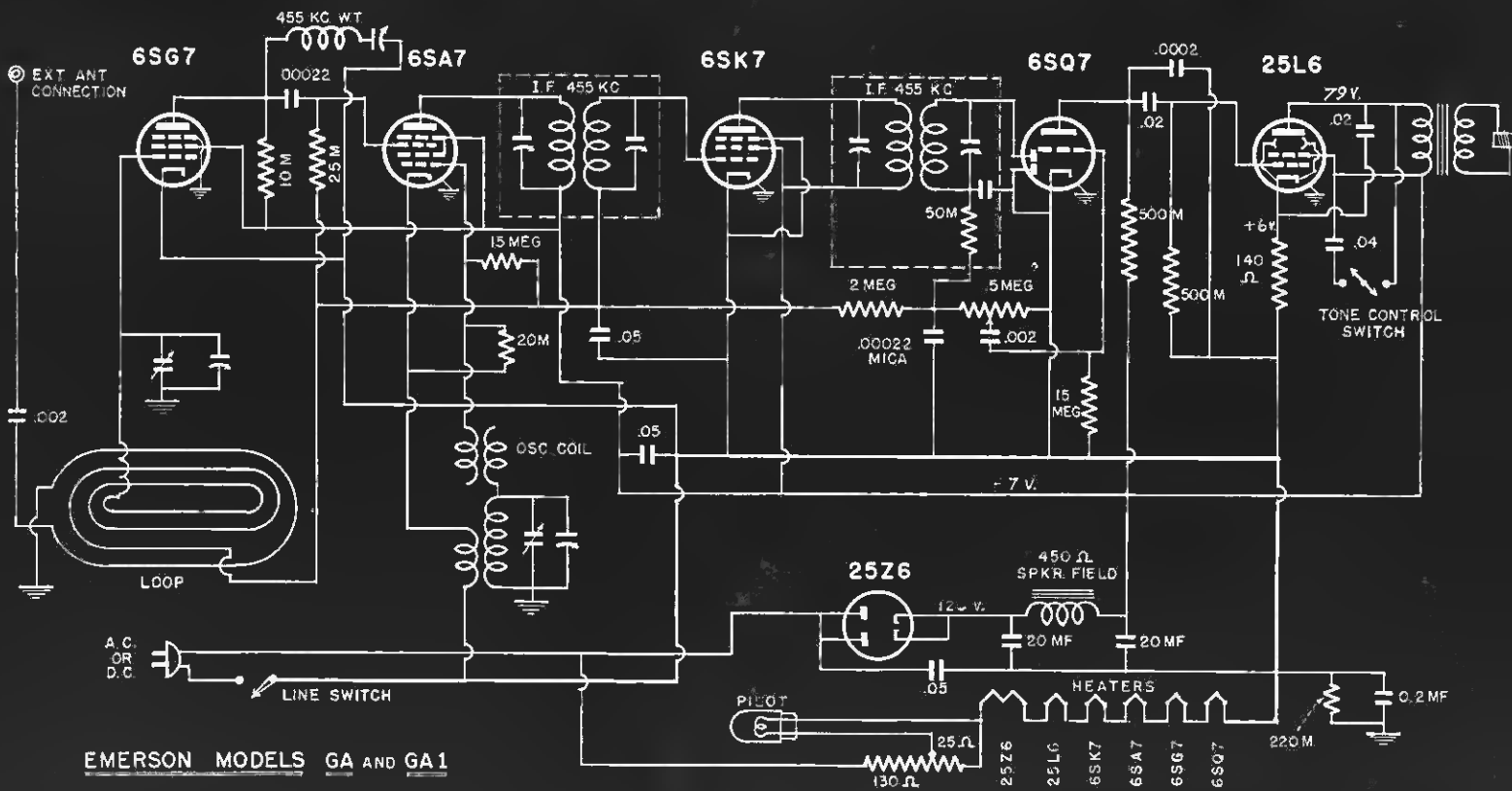

EMERSON MODELS GA AND GA1

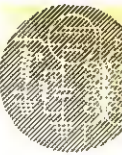

# A PART-IAL

Answer  
to

# Today's Repair Problems

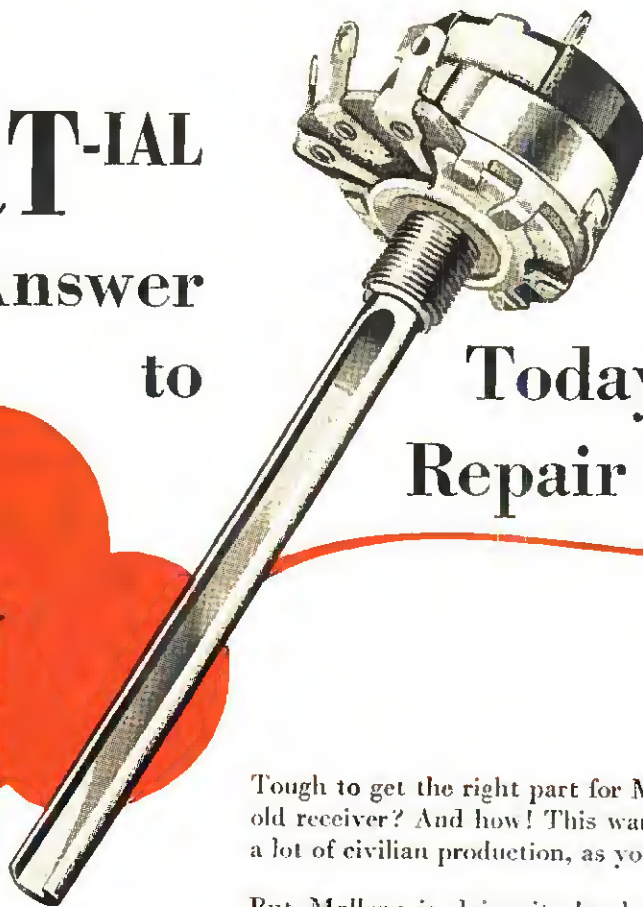

Tough to get the right part for Mr. Blank's blankety-blank old receiver? And how! This war is so total, it's "shorted" a lot of civilian production, as you know.

But Mallory is doing its level best to help you in your important wartime job... of keeping 'em listening! One development started by Mallory many years ago... a program of *standardization* of radio parts, to make them adaptable to many different receiver models... can sure make your job easier.

You'll simplify your parts problems if you ask for standardized Mallory volume controls, condensers, resistors and other components. Here's why:

1. With interchangeable parts, you can keep your inventory at a minimum.
2. A single standardized part will often do the job in any one of a dozen or more different types of receivers.

Even with standardized and interchangeable parts, it still takes ingenuity... and *information*... to make repairs accurately on the wide variety of sets you probably have to service. If you're like thousands of successful servicemen, you'll get the practical information you need from the latest "MYE", the Mallory Radio Service Encyclopedia.

And if you want a specific, detailed answer to some extra-tough problem, don't hesitate to ask us for help. Mallory radio engineers are at your service. Just write our Application Engineering Section, Wholesale Division.

**P. R. MALLORY & CO., Inc.**  
INDIANAPOLIS      INDIANA

Cable—PELMALLO

P. R. MALLORY & CO. Inc.

# MALLORY

Approved Precision Products

# SERVICE NOTES

## FM-Phono Combination Service Notes

The Espey model 2162 and 2160 is sold under the trade name Lexington. This 16-tube chassis is shown in the accompanying diagram. Model 2160 does not have push-buttons, otherwise the circuits are the same.

The set has three bands, 42-50 mc. FM, 9.35-9.9 mc. SW., and 550-1600 kc. The 7H7 RF stage is fixed tuned on the SW band as is the 6SA7 converter circuit. These circuits are peaked to the center of the band and only the oscillator is tuned over the actual dial range on the SW channel. The series band spread system is used to cover this range with the high gang tuning capacity. The main tuning condenser has three separate low capacity stator sections for tuning the FM band. The RF, converter and oscillator are all tuned on FM.

### Twin Limiters

The converter delivers the IF signal into the FM and AM IF transformers which are connected in series. The secondaries, also in series, deliver the signal to the 7H7 first IF tube. The AM output of this tube is coupled to a 6SQ7 second detector. The triode section of this tube is unused. The

FM output is delivered to a second 7H7 IF tube and then into two 6SJ7 limiter tubes. These limiters are operated with fixed screen voltage from dividers. The output of the last limiter feeds the 6H6 discriminator.

### Tube Set-up

The FM, AM or phono input is selected with switch 5A and introduced into the 6J5 tone control tube. The output of the 6J5 is fed to one-half of the 6C8 twin triode where the phase of the audio is reversed and fed back to the cathode circuit of the 6J5 through the bass and treble controls which regulate the gain of the tube at the various frequencies. The audio from the 6C8 is introduced into the second half of the 6C8 acting as a straight amplifier. A separate chassis contains the phase inverter and power output amplifiers also the power supply. Feedback is used in the final amplifier. A 2 meg resistor feeds some of the output back into the plate circuit of the phase inverters.

The two AM intermediate frequency transformers are aligned at 455 kc. in a conventional manner. The IF for FM is 4.3 mc. These transformers may be aligned by any of the standard systems.

The push-button station selector

works in the oscillator and converter grid circuits only. All circuits are selected on a single 6 deck switch. The A sections are on the front of the switch and B at the back. The band-indicating pilot lamps are controlled by deck 3A.

## THINKING AHEAD ON WARTIME SERVICING

The all-important question as to what servicemen will be left on the civilian scene to take care of home receivers, if and when the replacement parts become adequately available, is now very much on the minds of the key men in the industry.

One of the experts, J. J. Kahn of Standard Transformer Corp., Chicago, who has been prominent in helping to frame wartime regulations for the industry, has analyzed the new situation and has shaped up a number of suggestions. Highlights of Mr. Kahn's proposals are presented herewith.

Obviously, our Administration and the various divisions of the government consider home radio receiving sets an essential part of our war program. Efforts have been constantly made to clarify the problems in procuring materials for the further maintenance of those radio sets.

The present program of filling in the PDIX form on the part of the jobber will serve to acquaint the War

(Continued on page 44)

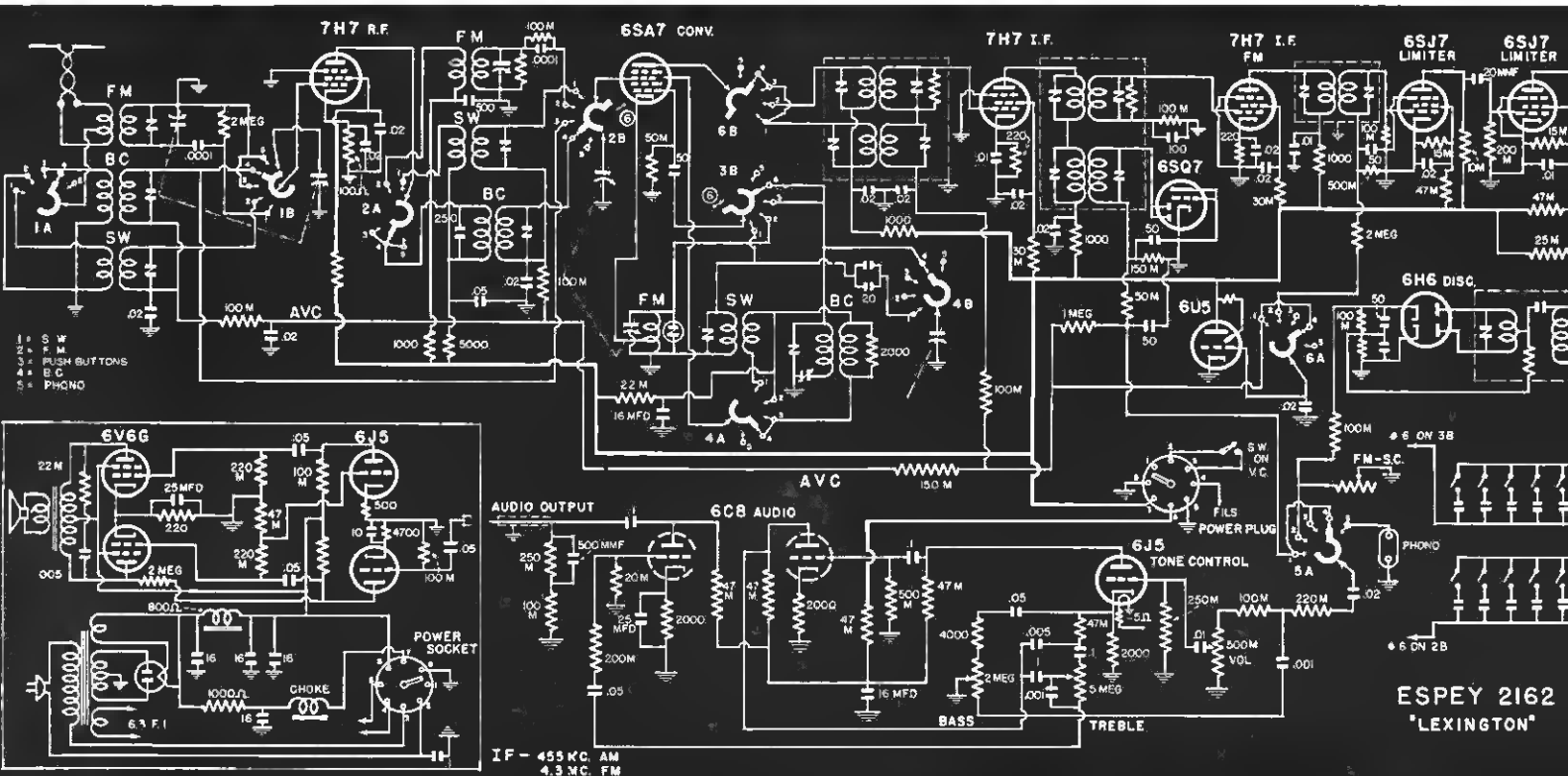



# PRACTICAL RADIO INFORMATION

**Including Frequency Modulation—Television, etc.**

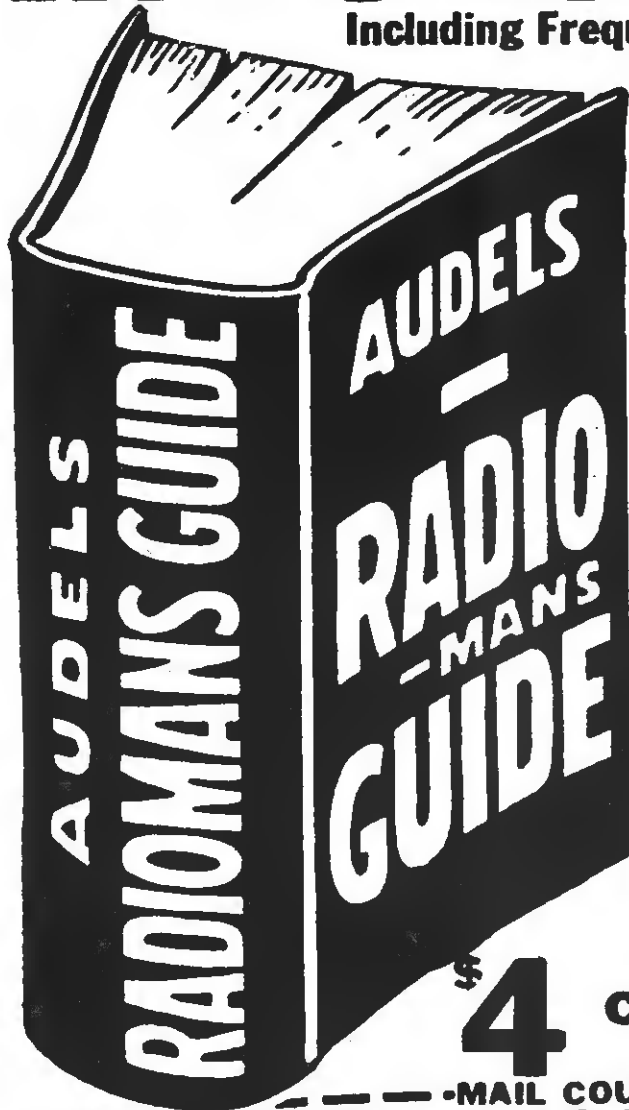

Inside Information for all Servicemen—Aircraft Pilots, Students.

**772 PAGES, 400 DIAGRAMS**

is complete—gives Authentic Principles & Practices in Construction, Operation, Service & Repairs. Covers clearly and concisely Radio fundamentals—Ohm's Law—Physics of sound as related to radio science—Measuring instruments—Power supply—Resistors—Inductors—Condensers—Transformers and examples—Broadcasting stations—Radio Telephony—Receivers—Diagrams—Construction—Control systems—Loud speakers—Antennas—Auto Radio—Phonograph pickups—Public Address Systems—Aircraft & Marine Radio—Radio Compass—Beacons—Automatic Radio Alarms—Short Wave—Coil Calculations—Testing—Cathode ray oscillographs—Static Elimination—Trouble Pointers—Underwriter's standards—Units & tables. REVIEW QUESTIONS—Ready Reference Index.

**COMPLETE • PAY \$1 A MO.**

To get this practical information in handy form—Fill in and

—MAIL COUPON TODAY—

**AUDEL, Publishers; 49 West 23rd St., New York**  
 Mail AUDELS NEW RADIOMAN'S GUIDE for free examination. If O. K. I will send you \$1 in 7 days; then remit \$1 monthly until \$4 is paid. Otherwise I will return it.

Name .....

Address .....

Occupation .....

Reference .....

R. T. D'

## Thinking Ahead on Wartime Servicing

(Continued from page 42)

Production Board with the exact status of the inventories replacement parts, and will provide the vehicle upon which the radio section of the War Production Board may present to the various material sections and requests for allocations of materials to produce the much talked about 'Victory Lines' of replacement parts or components.

Suppose that as of today or tomorrow this allocation program was approved by the various departments within WPB. What next? When I ask what next, I am pondering over the problem of manpower to properly utilize these parts and get them into the inoperative home receiving sets.

Very bluntly, the continued requests of the Army Air Force for radio men, the Signal Corps campaigns to enlist radio servicemen, the Navy's enlistments of qualified radio men, as well as the draft have fallen short of their quotas and as well have left our radio serviceman's market pretty well depleted of qualified men.

### Time Is Precious

This presents the problem of correlating all the facts, material, and manpower into one unified program

## Tube Expert



H. J. Mandernach has been appointed sales manager of the replacement tube section of General Electric's radio, television and electronic dept. His offices are at Bridgeport, Conn.

so that the proper servicing may be accomplished. There are several ways in which this could be done. One would be to have the public service or utility companies handle the servicing of home receivers. My thought, however, is that for the duration of the war a mobilization of servicemen,

dealers, and radio parts jobbers, might answer our problem and keep the servicing of sets in the field where it belongs.

The writer is of the opinion that time saving primarily is the essence of defeating this difficulty. Experience teaches that the average radio set can be actually repaired in a matter of a few moments. The greater portion of time against which charges are made is the time spent in analyzing the trouble and energy spent in making the call, and, if necessary, the transporting back and forth of that particular receiver to the serviceman's shop.

Our first problem, then, is to save that delivery time. My plan would call for the set user to bring his radio set into the dealer or serviceman's place of business and after it has been repaired to pick it up. This might even mean that 'Mr. John Q. Public' might have to take his chassis out of a console cabinet, unless it were in large combination installations, but during war times, I don't think that he could object to this. Today, if a person wants a receiver to play he must be made to realize that some discomfort and some effort and energy must be expended, to save the serviceman's time.

The second problem would be the establishing of these collection agencies to which the public might bring

(Continued on page 46)

## How Adolph Schickelgruber Builds a Radio

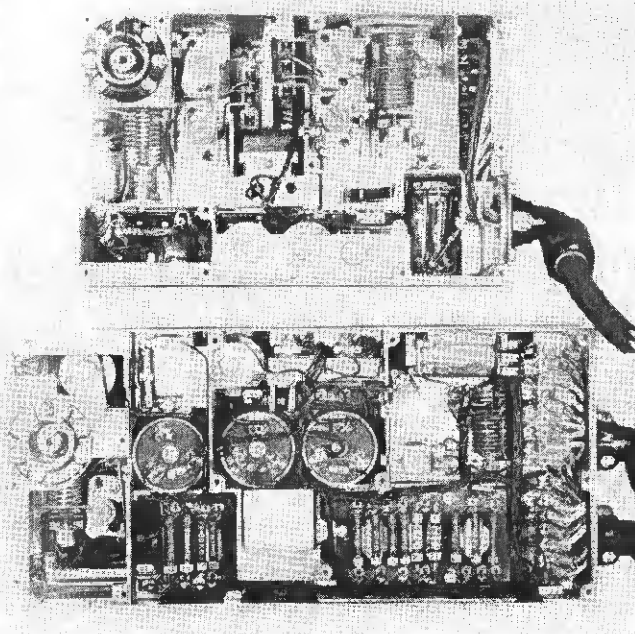

Pictures shown here are representative of German military radio apparatus. The photos were made available through the courtesy of Frederick S. Barton of the British Air Commission at Washington. The rugged construction, good quality of materials and compact layout, were interesting features pointed out by Mr. Barton, who infers that current German military radio equipment is of relatively old design, probably

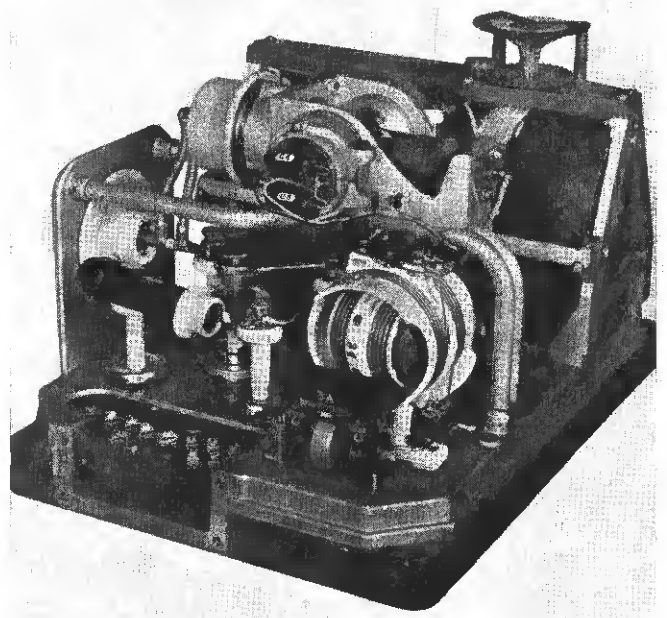

about 1935. He comments also that the equipment seems very heavy and cumbersome. At left is the F.U.G.-10 direction finder and marker beacon receivers for the blind approach system. At right is a top view of the F.U.G.-10 tuning unit, with old style variometer for matching the antenna. See also page 46.

*When Space is at a Premium*

**TRIPLETT**

*Thin Line*

**INSTRUMENTS**

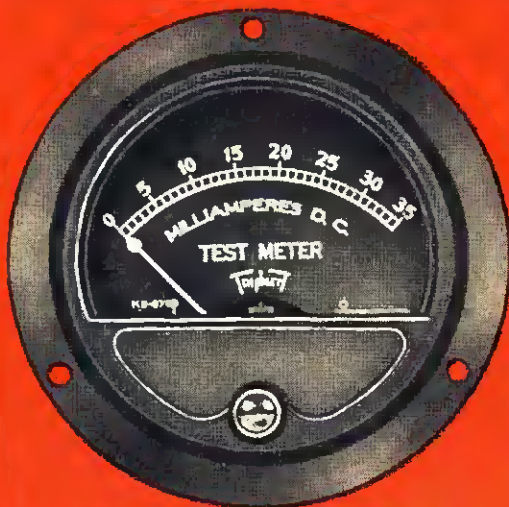

Full size of Instrument. Note deep shroud for glass protection—and "Quick-Look" Scale.

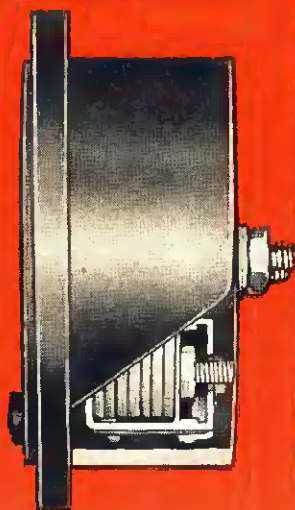

This molded case contains full size Triplet Mechanism. Rugged Construction—Compact Convenience.

**THIS IS THE INSIDE STORY**

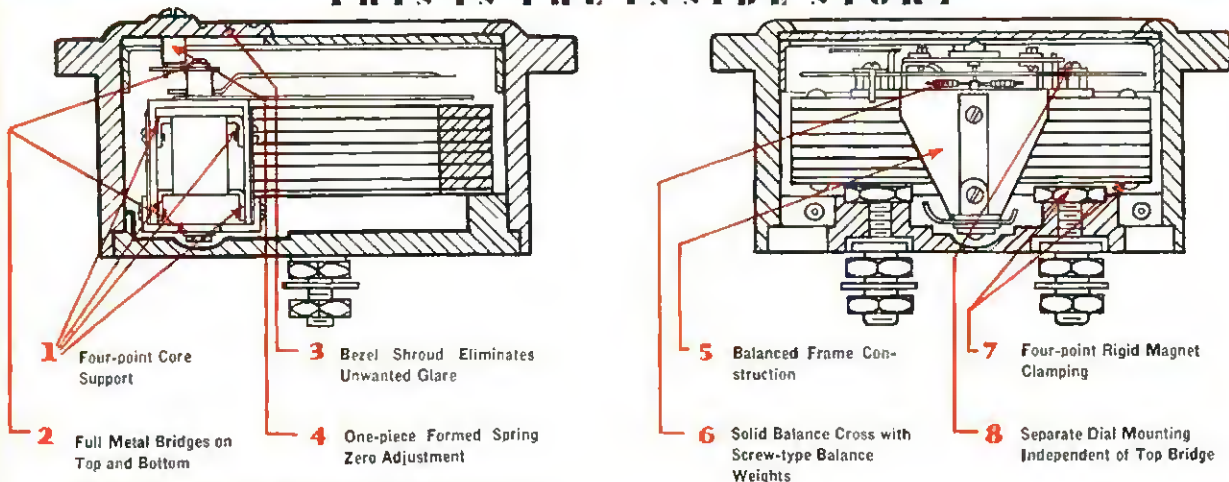

Thin-Line Instruments also have Standard Large Coil Triplet Movements, furnished with Osmium pivots for special requirements. All these features make for greater rigidity under vibration; greater permanence of calibration; greater user satisfaction.

**TRIPLET**  
*Thin-Line*

memo

FOR CIRCULATION TO...

Triplet Thin-Line Instruments meet rigid requirements for dependable performance. Though occupying minimum space they are *not* miniatures. Mechanisms are standard size with emphasis on excellent performance over long periods. Standardized installation. Made in three styles of cases — Molded, Metal Wide Rim and Metal Narrow Rim.

Triplet Thin-Line Instruments, available for many industrial applications, can be depended upon for precision performance in limited space. For full details write for "Triplet Thin-Line Bulletin".

**THE TRIPLET ELECTRICAL INSTRUMENT CO., BLUFFTON, OHIO, U. S. A.**

PLEASE INSERT INITIALS OF YOUR EXECUTIVES

✓

### Wartime Servicing

(Continued from page 44)

their sets. We know the average serviceman who has a shop is so busy these days that it may take some time to get around to actually perform some operations on the receiver. These servicemen or individual shops should effect a mobilization and concentration of the remaining technical skill into an organization such as the local parts jobber wherein all service work could be done by these consolidated servicemen. The service dealer's store would then act as the media through which the receiver was delivered by the public and then turned over in quantities to this master servicing organization. By having the actual servicing done within the parts jobber's establishment, it would salvage the time generally required by the average serviceman to run down and pick up one specific type of tube or one or two other miscellaneous parts that would go into the service work for that particular day. Bear in mind that in order to expedite manpower, time is the one element that can be saved.

When these sets are delivered to the master service organization or the

parts jobber, it would then be turned over to a master diagnostician who could in most instances tell within a few minutes just what is the difficulty. But if diagnosis is extra difficult, the set could then be turned over to one man that would be termed in the vernacular as a "piddler," the kind of an individual who has enough patience and knowledge to sit down and trace out the circuit and find out just what is wrong. Upon completion of the job, the radio service dealer would then pick up the sets to be taken back to his store or the user could pick them up at the master servicing establishment.

### Scrap Angle

The above suggested plan would also facilitate the reclamation or salvaging of used and defective parts. The Radio Section of WPB has asked that some plan be presented to effect the most general salvaging of such defective units, and if the above plan were accepted as a standard practice for the duration, the salvaging of materials would be thus effected in the most important link in the chain of returning those strategic materials to the melting pot. The question of salvaging is to develop directly in

proportion to the proximity of our receiving material allocations and must, therefore, be considered as one of the salient elements of the above plan.

Many jobbers throughout the country have already been affected by the shortages reviewed here. Many jobbers have already converted to a plan coinciding in principle with the above-mentioned outline in cities such as Pittsburg, Penna; Moline, Illinois; Denver, Colorado; Oakland, California; and Long Beach, California. In the middle West, two other distributors have written their servicemen accounts obtaining their reactions to a plan very similar in nature and outlining to them the necessity of action being taken promptly. It would be well, therefore, that the parts distributing groups consider this phase as an industry problem.

As time goes on our service problem is going to become increasingly acute and if we expect materials to be freed by the cooperation of WPB, we must also find some way of "unfreezing" the manpower so that these materials may be used advantageously.

Let us try to think ahead of the manpower problem in radio service and have our own program well established.

### More of Adolph's Ideas on Radio Design

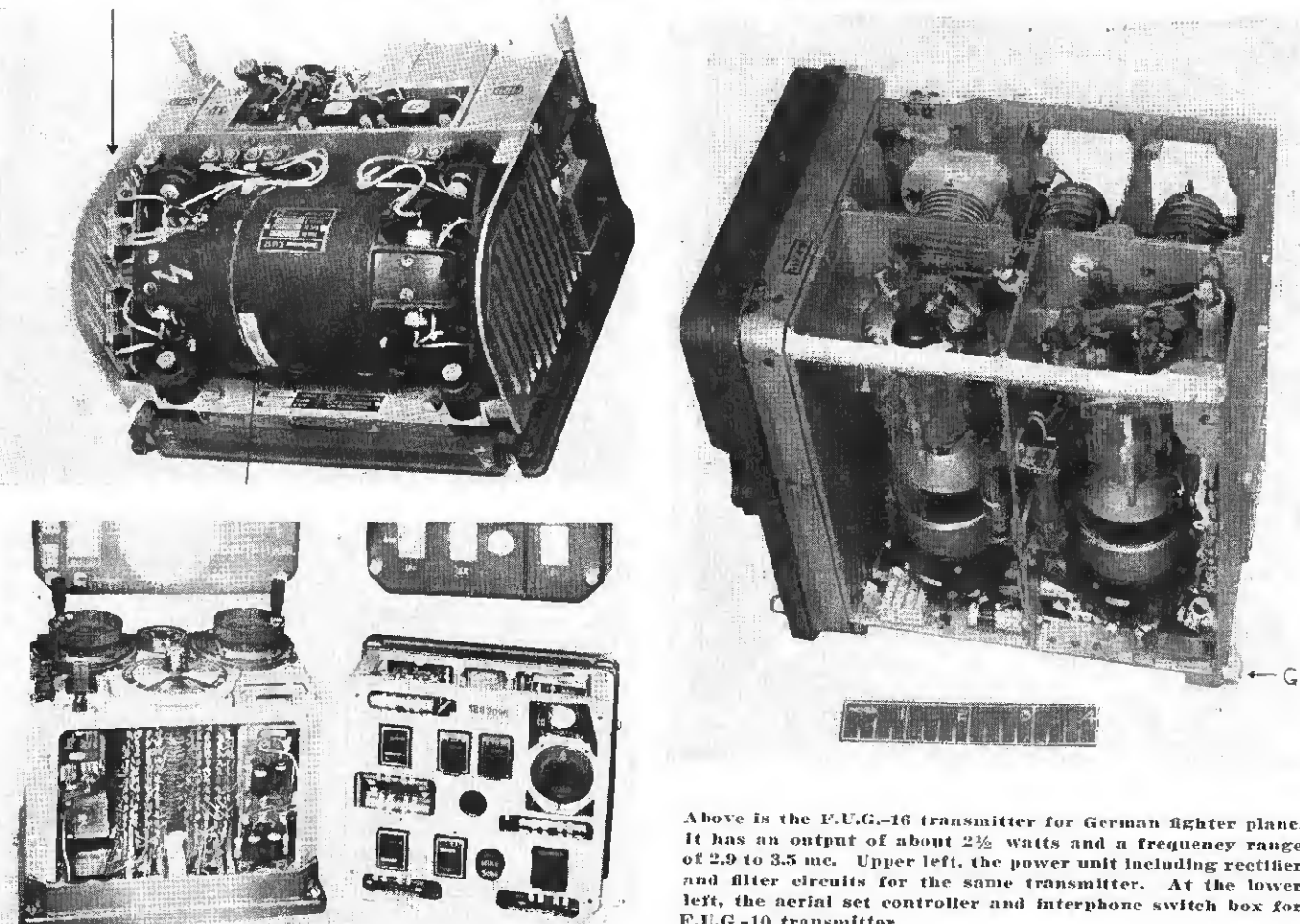

Above is the F.U.G.-16 transmitter for German fighter plane. It has an output of about 2½ watts and a frequency range of 2.9 to 3.5 mc. Upper left, the power unit including rectifier and filter circuits for the same transmitter. At the lower left, the aerial set controller and interphone switch box for F.U.G.-10 transmitter.





**GE Sends Customers to Shops with Plaque**

Starting on Dec. 1, radio network audiences will be urged to take their radio repair jobs to stores displaying the General Electric Radio Service Pledge Plaque. Frazier Hunt, celebrated news analyst, will give this advice on a 51-station network, plus 8 FM stations, and thus will bring the attention of millions to GE's wartime authorized shops.

The plaque, which is an eye-catching job 29 in. by 19 in. for counter or wall, comes to dealers (along with other free identifying display material) who pledge to (1) Give expert and efficient service, (2) Charge fair prices and itemize all bills, and (3) Guarantee the work. Other qualifications are: a. The service account must be set-up to render efficient radio service. In order to do this, he necessarily must possess modern test and repair equipment. b. He must be qualified to render satisfactory service on all makes and types of radios and radio-phonograph combinations. c. He must stock an adequate supply of standard radio parts, including genuine General Electric parts, and d. Since he will be listed under the sign of the G-E Electronic Radio Tube, and/or will display the Pledge Plaque, he must stock G-E Electronic Tubes for use in his service work.

Those who qualify can show the Plaque in their stores and also will be listed under GE's Classified Telephone Book Headings in towns over 50,000. The public will be told to refer to these telephone directories, in the GE broadcasts and in ads in national magazines. In towns under 50,000, dealers may still get the Plaque if they qualify under the plan.

**New Resistor Color Code Chart Ready**

Now available free to radio servicemen is a new Color Code Resistor Card, issued by Sylvania Electric Products, Inc. The card is in handy pocket size, and gives full data on A, B, C and D color markings, RMA standard. It is offered at a time when wartime conditions require many revisions in circuits, and resistor values are needed frequently.

The cards come from Sylvania jobbers, or by writing directly to *Sylvania News*, Emporium, Pa.

**Zenith Director Named Civilian Aide**

Irving R. Allen, member of the board of directors of Zenith Radio Corp., has been appointed as Civilian Aide to the Secretary of War for the State of Illinois, for a four year period.

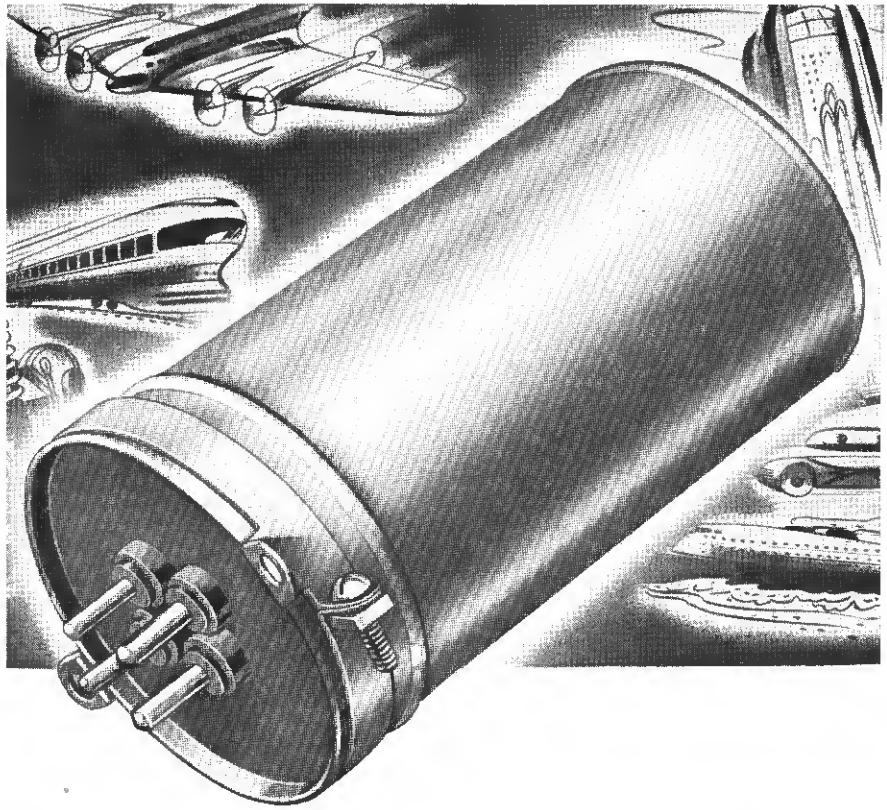

*The Shape of*  
**THINGS TO COME...**

● Simply a plug-in capacitor. True. The fact that Aerovox spent months perfecting the corrosion-proof base is beside the point here. Likewise that such capacitors—in the electrolytic, wax-filled and oil-filled types—are standard in vital wartime equipment.

The vital point is that this capacitor symbolizes "The shape of things to come." The plug-in feature denotes ready checkup and replacement. That in turn signifies continuous, gruelling, accelerated-wear service that wears out the best capacitors in months instead of in years under usual operating conditions. Just as the demountable rim wheel marked the transition of the automobile

from Sunday pleasure rides to everyday essential transportation, so this plug-in capacitor spells an infinitely expanded usage of radio technique, radio components, radio man-power.

Our first job is to win the war. Aerovox is now concentrated on just that. And while tens of thousands of radio men are engaged in waging this war, gaining invaluable training and experience and, indeed, compressing decades of normal progress into as many years, so we at Aerovox are helping lay the foundation for greatly expanded radio and electronic opportunities in the coming days of peace. Thus "the shape of things to come."

*Ask Our Jobber...*

- Ask for your free subscription to the monthly *Aerovox Research Worker*, in order to keep abreast of radio and electronic developments. Ask for copy of the new "Victory" catalog. Or write us direct.

NEW BEDFORD, MASS.,  
U. S. A.  
Sales Offices in All  
Principal Cities

# AEROVOX

CORPORATION

In Canada  
AEROVOX CANADA LTD.  
Hamilton, Ont.  
EXPORT: 100 Varick St., N. Y.  
Cable 'ARLAB'

# Service Needs Selling

Texas repairman finds a follow-up method that works

Paid service calls, reasoned W. J. Inman, owner of Inman Radio Shop, 2005 Pacific Avenue, Dallas, are the success secret of any radio retailer, especially so since December 7 and the subsequent scarcity of new sets to sell.

"While the service end of our business has assumed greater importance than ever," said Inman, "I realized, in making plans to develop it, that the one-time customer wouldn't help me in building my business; radios like all other mechanical accessories to man's comfort and convenience, require periodical checking and repair so I proposed to do it all for every customer I secured—not just the first time but every time they needed a radio man."

## Following Up Jobs

A clever follow-up letter is the principal means of keeping his customers happy and coming back to him when in need of radio work. The letter, of a form nature, but individually typed, calls attention to the fact that Inman serviced the customer's radio (type given) on a certain date some six to eight weeks previous. Then it reads: "This is not just a courtesy letter for we are enlisting your aid in keeping our service the finest obtainable. You can help us do this by calling R-3633 if this set is not operating to your entire satisfaction." It closes with a



Here's the type of follow-up letter used last year and still giving Mr. Inman good results.

request for the owner's cooperation and a desire to serve him again.

"We keep an accurate file on all service calls," declared Inman, "and the secretary spends whatever time is necessary each day to write and get out letters addressed to those names in the back file from six to seven or eight weeks back. We vary the exact time due to the type of job indicated on the file card."

While the letter is an inquiry regarding the operation of the set and indicates another service call will, if necessary, be made without charge, its real purpose is to keep in close touch with the radio owner. If a response comes in asking for a service call to check up on the work performed the first time, Inman sends a man on it who does conscientiously check the former work and, if necessary, adjusts it satisfactorily. However, the repeat call usually brings to light an actual need for other work or parts, Inman points out, thus making it a profitable one.

## Rechecks and Sales

"We don't try to sell the owner something every time we call at his home," Inman asserted. "I realize that the general public, usually ignorant of what makes a radio function, is suspicious of any attempt to honestly improve his set's functioning so I instruct my men to be especially careful in how they tell an owner that additional work or parts or both are needed to make his radio work properly. Usually, if the owner is agreeable, we take the time to demonstrate how much better the radio works with the suggested new parts in it; of course, if the set has stopped completely and needs a trip into the shop, there is no argument about it in the owner's mind."

## Equipped for Wartime Business

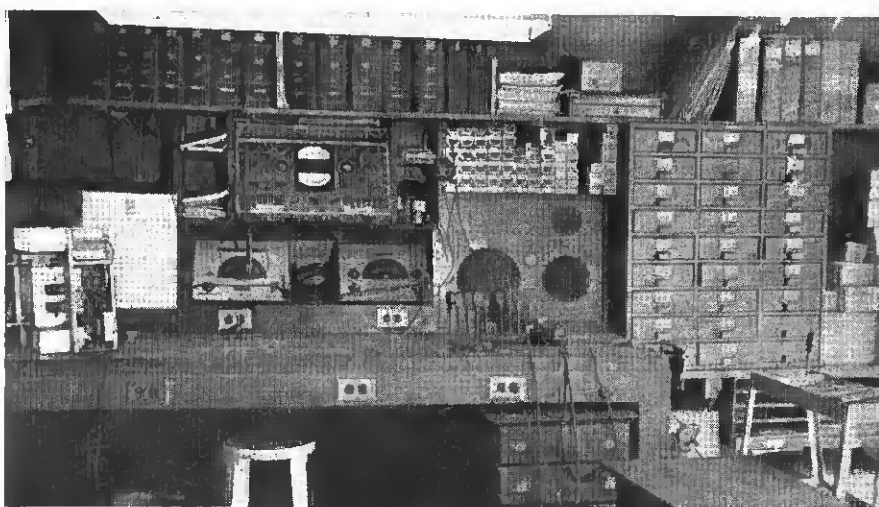

A section of the service bench of LeRoy Sherman, Carthage, N. Y., repairman, where plenty of older sets are showing up because Carthage folks can't buy new ones.

## The Charts Hit the Spot

Editor, Radio Retailing Today:

Some time ago, RADIO TODAY published a chart showing the allocation of all the radio channels. This chart was printed in color, and you also printed a piano keyboard showing the audible frequency range.

Since becoming a radio instructor here I have searched high and low among the old copies of your magazine for said chart. But to no avail. It would be one of the best training aids along this line I have seen.

Is there any possibility of obtaining several copies of said chart, or could you tell me where I could buy perhaps an even larger size?

Sgt. Chaney,  
H. Q. Battery, 89th Division,  
Camp Carson, Colo.



## New Booklets

Aerovox Corp., New Bedford, Mass. has issued three "Research Workers" bulletins on "Taking Complete A.F. Amplifier Data," "Amplitude Modulation" and "High Efficiency R.F. Amplifiers," respectively.

Folder F from E. F. Johnson Co., Waseca, Minn. describes and illustrates the new No. 267 Viking steatite insulated socket for miniature tubes. For information on the complete Viking products line, write for Catalog 967F.

Ward Leonard Bulletin 69, gives specification, illustrations and diagrams of 4 in. pressed steel rheostats. Can be obtained without charge from Ward Leonard Elec. Co., Mt. Vernon, N. Y.

JFD Mfg. Co., 4111 Ft. Hamilton Pkwy, Brooklyn, N. Y. have issued a revised price list showing items requiring preference rating and those that can be ordered freely.

Westinghouse Elec'l. & Mfg. Co. has prepared a booklet to help men and women employees wind up their civilian affairs before entering the service. Topics discussed include installment purchases, insurance, allowances for dependents, income taxes, mortgages, rent, voting and post-war status. This booklet R-1032A will be sent on request.

"Looking Ahead with Kelvinator"—a new 24-page colored brochure is being released to all appliance retailers to acquaint them with the war production program undertaken by Nash-Kelvinator Corp. and also the company's wartime position, philosophy and policies.

### Raytheon Sales Office Transferred

A. E. Akeroyd, manager of Replacement Sales for Raytheon, reports that this department has been transferred from New York to the factory at 55 Chapel St., Newton, Mass.

It is felt that better handling of various inquiries relative to replacement and transmitting tube shipments can be extended from that point.

**Buy U. S.  
War Bonds  
and Stamps**



## TURNER Microphones Give Crystal-Clear Reproduction

Where intelligible communications are a must, Turner Microphones will do the job, clearly and concisely. Constructed to withstand heavy duty under all acoustic and climatic conditions, you can be SURE with a Turner. Each Turner Microphone is given an individual sound pressure test over the entire audio band before leaving the factory — your assurance of complete satisfaction.

### TURNER NO. 101 CAROID CUTS OUT BACKGROUND NOISE

The 2-element generator offers true cardioid characteristics, with the best features of both dynamic and velocity. Highly sensitive to sounds originating in front of the mike, it's dead in the rear. Available in Standard, De Luxe and Broadcast models.

IF YOU HAVE A PRIORITY RATING, we can help you select the Turner Microphone best suited to your needs. Ask, too, for information on how to make your present Turner mike and equipment give you longer, better service.

FREE Write for NEW Turner Microphone Catalog and Service Manual

Crystals Licensed Under Patents of the Brush Development Co.

**THE TURNER CO.**  
950 17th St. N.E., Cedar Rapids, Iowa



### TURNER U9-S OFFERS 4 IMPEDANCES

A twist of the switch gives you 50-200-500 ohms or hi-impedance. U9-S is a ruggedly constructed dynamic that does the job of 4 mikes. Adjustable to semi- or non-directional operation, with a level of -52DB at hi-impedance. Response free from peaks and holes from 40 to 9000 cycles.

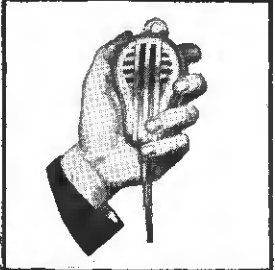

### TURNER HAND HAS LOW FEEDBACK

In either dynamic or crystal, Hand-D gives exceptionally clear voice reproduction without blasting from close speaking. Feedback is surprisingly low. Fits the hand, can be mounted on standard desk or floor stand or hung by hook. Positive contact slide switch permits push-to-talk operation.



### TURNER L-40-3H FREES BOTH HANDS

Here's the unit for all call systems, police cars, sports announcing. "Third Hand" holds the special L-40 mike close to the mouth, giving tremendous volume without feedback. Third Hand is light in weight and gooseneck adjusts to any position. A low-cost efficient unit.

# OHMITE

Resistance Units

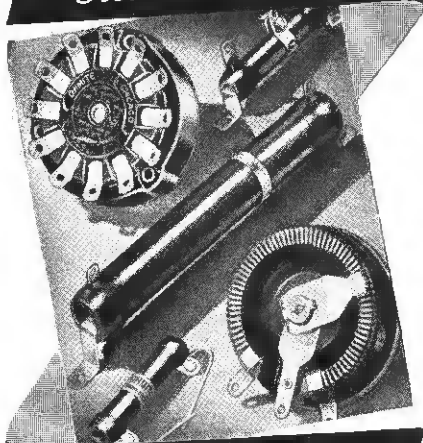

are built for long trouble-free service

Send for FREE Ohmite Stock-Unit Catalog No. 18. Very handy for quick reference.



The extras built into Ohmite Resistance Units make them electrically and physically fit for the toughest service. That is why you find these rugged units so widely used everywhere—in planes, tanks and ships—in communications and electronic equipment—in research and production—in training centers and industrial plants. It's well worth remembering, when you build original equipment or make vital replacements—today and tomorrow.



Send 10c for handy Ohmite Ohm's Law Calculator. Helps you figure ohms, watts, volts, amperes—quickly, easily.

OHMITE MANUFACTURING COMPANY  
4872 Flourney Street, Chicago, U. S. A.



## Wartime Service Program by Zenith

After an exhaustive national inventory of radio service facilities and a survey of the key geographic points in which "backbone" radio service stations should be maintained for the war years, the Wartime Service Plan of the Zenith Radio Corp. has been set in operation throughout the U. S.

Service shops, to qualify for appointment as Authorized Stations, were required to fill these qualifications:

- (1) A good reputation for fair and ethical dealings in their community,
- (2) A proper organization of trained personnel,
- (3) Adequate test equipment,
- (4) A willingness to use the factory's original replacement parts and tubes,
- (5) A definite plan for securing business through proper advertising and promotion,
- (6) A systematic, well organized physical set-up for efficient fast handling of repairs, and
- (7) A willingness to service sets for Zenith radio owners and those dealers not possessing servicing facilities.

Indicating the scope of this plan, the kit materials sent to each Authorized Station includes all of these: identification window transfer, Zenith service shop notes, service and parts operating manual, displays for window and counters, handbills, inside authorization sign, newspaper ad mats, direct mail post cards, tube price lists, tube characteristic booklet, tube wall chart, and consumer giveaway booklets on "Wartime Care for Your Radio."

### Millions Covered

To be credited for "this impressive answer to a wartime problem troubling radio dealer and radio owner alike" are the Zenith executives J. J. Nance, O. E. Wolf, H. W. Blakeslee, Frank Smolek and N. H. Terwilliger.

The company estimated that the average radio owner had his set serviced once every three years, and went on to say that "the average service fee is \$4 and on that basis about 16,000,000 sets went in for repairs in 1941 and realized a gross income of some \$64,000,000 for retailers. This



Above picture shows what materials are available in the Zenith Service Kit. Below is the company's suggestion as to how a serviceman's bench may be set up. Approximate cost is \$397, including bench.

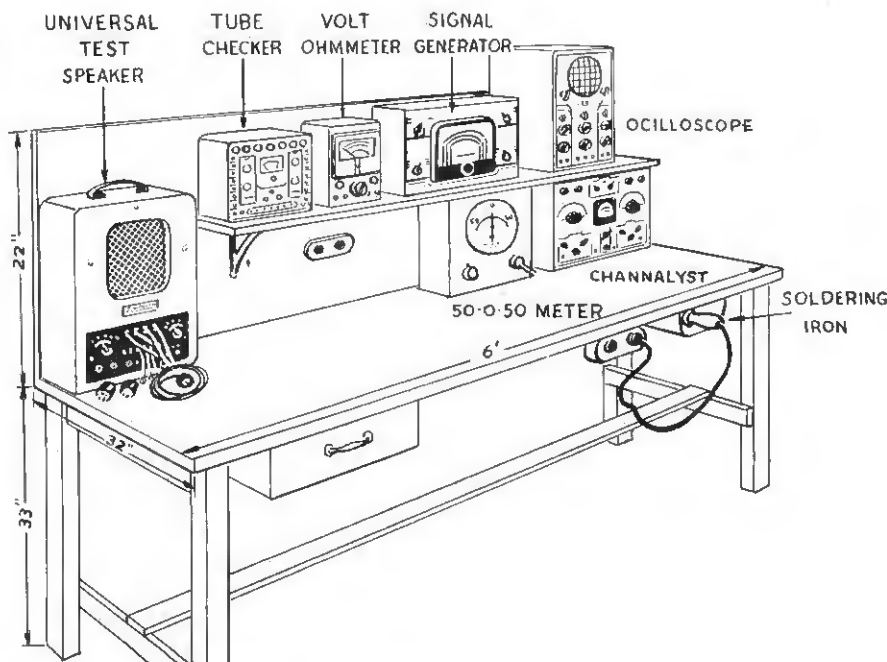



year it is expected that 20,000,000 to 22,000,000 sets will need servicing, thus upping gross income to \$80,000,000 or \$88,000,000. Zenith wants its dealers to be in a position to get their proper share of this business."

**Radio Pioneers Reward Outgoing Officers**

At the latest meeting of the Radio Pioneers of Southern California held at the Mayfair Hotel, Los Angeles, George Tivy, outgoing president, was presented with the traditional gold ring, bearing the Radio Pioneers insignia. Carl Stone is the new president.

Jack Perlmuth, outgoing secretary, was presented with a handsome desk ornament for the work he did for the Pioneers as secretary during the past five years. Mr. Perlmuth is now a vice-pres. and Garratt Arnold is secretary.

At the same meeting it was decided to hold the Annual Christmas Hi-Jinks this year, as usual, in the latter part of December.

**Fourth Plant for Cornell-Dubilier**



Octave Blake of Cornell-Dubilier

The opening of a new Cornell-Dubilier plant for the manufacture of capacitors, which was equipped, staffed and placed in operation in record time, is announced by Octave Blake, president. It has been financed completely by the company and without government assistance, and is expected to relieve some of the pressure under which the other three C-D production units have been working, to supply the needs of the industry and the armed forces.

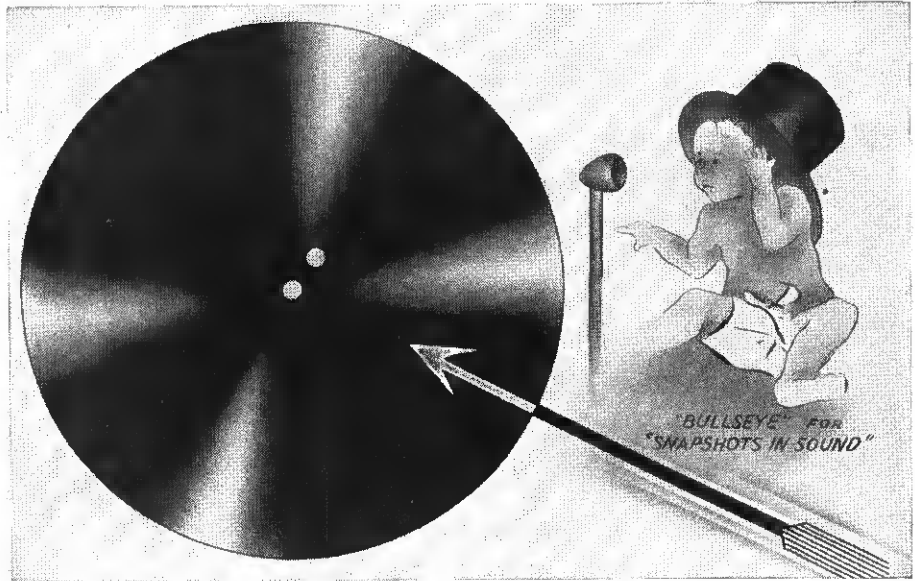

**"Record Making" Sales with new GOULD-TEX Instantaneous Recording Blanks**

Since steel base blanks may no longer be secured, our GOULD-TEX line is being presented through our regular Recordisc distributors. GOULD-TEX blanks employ an improved surface coating on a newly developed, non-priority composition base, the approximate thickness of ordinary phonograph records. These new Recordiscs possess inherent reproduction qualities comparable to any of the former steel base blanks.

Consumer promotion and the consistent performance of our products have built favorable acceptance for Recordisc—and now that we can deliver our regular bond base and these new GOULD-TEX blanks in quantity, "Record Making" sales should bring you welcome profits.



Recordisc "Snapshots in Sound" are available at your local distributor . . . for immediate delivery.

Dealer promotions can feature new mailing cartons for 6½ inch bond base or GOULD-TEX blanks. Requiring only 1½ cents postage, these cartons will send recordings safely . . . anywhere. They are available printed with provision for addressing and return address. Prices on application.

**THE RECORDISC CORP.**

395 BROADWAY  
NEW YORK, N. Y.



Cable Address  
**RECORDISC**  
NEW YORK, N. Y.



# RUSH VIA AIR

Messages must go through. And it's a far cry from the carrier pigeon to two-way radio communication equipment.

## Electro-Voice MICROPHONES

engineered to withstand the rough usages of modern warfare, are important factors in the maintenance of essential communication facilities.

**ELECTRO-VOICE MFG. CO., Inc.**  
 1239 SOUTH BEND AVENUE SOUTH BEND, INDIANA  
 Export Office: 100 VARICK STREET, NEW YORK, N. Y.

### Tube Shortage Is Acute

Tabulations taken in the "national tube inventory" organized by the National Electronic Distributors Association showed "a surprising shortage of tubes." After reports from 350 jobbers and two of the biggest mail order chains had been added up, the total turned out to be less than three million tubes, about one-third of which were "shelf warmers."

The tube count was headed up by George Barbey of NEDA, who is working overtime with officials at Washington in helping to get the shortage straightened out. The War Production Board subsequently asked NEDA to submit a special tube application form but action on the form was held up because officials were considering a change in the PD-1X application form instead.

WPB also asked NEDA to furnish additional information on the PD-1X applications for tubes. The new policy at Washington was to allot a definite number of tubes of each type. Also, because the A-1-j priority assigned on recent PD-1X applications will not release certain types of tubes, WPB planned to assign different priorities for the different types. NEDA described this as very close to rationing.

Meanwhile, NEDA has sent to jobbers complete recommendations for using PD-1X, and advises distributors to stick to these. Mr. Barbey is also continuing his work of making detailed interpretations of other new orders coming out of Washington, and will continue to send advice to jobbers in bulletin form as quickly as the fast-changing picture can be analyzed.

### U. S. Treasury "Bull's Eye" for Walsco

A "Bull's Eye" flag now waves over the plant of the Walter L. Schott Co., Beverly Hills, Calif., presented by the U. S. Treasury Dept., as a reward for 100 per cent of their employees buying War Bonds through the Payroll Allotment Plan.

Not only is 10 per cent of the employees regular pay deducted and converted into War Bonds, but through a unique plan requested by the employees, an excess of up to 25 per cent of all overtime pay checks also goes toward buying War Bonds.

### Insuline Moves

The Insuline Corp. of America has acquired a large modern factory at 36-02 35th Avenue in L. I. City, N. Y.

The vastly enlarged space and facilities put this company in a position to cooperate more closely with governmental departments and prime contractors in the manufacture of electronic and aircraft products.



**PEERLESS ALBUM**

*different!*



## The PROTECTO-FLAP Line by PEERLESS

Uniquely designed, Peerless Albums offer SO much more to the consumer that sales resistance is at a minimum. Ask about the regular Protecto-Flap (not shown), the DeLuxe Library Edition (right, top), and the Protectoview (right, lower), all with the exclusive crashproof Protecto-Flap.



**PEERLESS ALBUM CO., Inc.**  
 38-42 West 21st Street New York City



**Receiver Promotion Head**



R. E. Burrows has been placed in charge of sales promotion for the receiver division of the radio, television and electronic department of General Electric. Bridgeport, Conn., is his headquarters.

**Sylvania Promotions Earn National Award**

Dealers and servicemen who have noticed the wartime themes used by Sylvania Electric Products, Inc., in its promotional items and direct mail pieces made available to the trade, will be interested to know that Sylvania has received an award for this work. The Direct Mail Advertising Association has named the tube manufacturer as one of the 50 direct mail leaders of the U. S. for the past year.

Such promotions as blackout buttons, a First Aid index, and posters and cards for selling War Bonds and Stamps have been issued by Sylvania to dealers and servicemen. The award for the campaign was made to Henry C. L. Johnson, advertising manager.

**Upstate NEDA Chapter Elects**

At a meeting of the N. Y. Upstate Chapter of the National Electronic Distributors Association, at Syracuse, N. Y., election of officers for 1942-43 was held, and Anthony Dybowski elected president. Annette Kater was named secretary-treasurer.

Those present were: A. C. Stallman, J. Scott Burdin, Paul F. Loveless and Earl Stebbins, all of Stallman of Ithaca; Oscar Miller, Radio Equip Co., Buffalo; A. J. Dybowski, R. G. Clements, Dymac, Inc., Buffalo; G. C. LeRay, Joe Marsey, Beaucaire, Inc., Rochester; Jerry Kropt, Ed Masline, Masline Radio Parts, Rochester; M. E. Schifino, A. D. Lamphier, Annette Kater, Rochester Supply Co., Rochester; W. E. Berndt, Syracuse; P.

Vaeth Elec. Co., Utica; John L. Sullivan, Syracuse Radio Supply Co., Syracuse; Harold Dare, Dare's Radio Service, Auburn; Stewart W. Smith, Syracuse; B. N. Green, Federal Radio Supply Co., Binghamton; George C. Isham, Sylvania, Rodman; George D. Barbey, Reading, Pa.

**Three to be Honored at Annual Dinner**

A trio of pioneers in radio's industry-wide philanthropic activity will be honored at the annual dinner of the Radio, Refrigerator & Allied Indus-

tries Division of the New York and Brooklyn Federations of Jewish Charities, it has been announced by Ben Gross, chairman of the division. Mr. Gross is head of Gross Distributors, Inc. of New York. The dinner will be held at the Hotel Commodore on Thursday, December 3, at 6:30 p.m.

The three men are Henry Benjamin, of Davega-City Radio, Inc.; Max Kassover, of Vim Radio & Sporting Goods Stores, Inc.; and Jules Smith of Davega-City Radio, Inc. Regularly, the dinner is a \$100-a-ticket affair, but this year's event will be an exception, as Mr. Gross points out that "this is not a year for parties."

**"ALL-OUT"  
TO HELP WIN  
THE WAR**

Today, the 36-years of skill and experience that pioneered and developed the "QUANTITY-plus-QUALITY" manufacture of BRACH products, are directed exclusively toward serving our armed forces on their road to Victory.

**ANTENNAS & RADIO PARTS  
BRACH  
100% WAR PRODUCTION**

**L. S. BRACH MFG. CORP.**  
World's Oldest and Largest Manufacturers of Radio Aerial Systems  
55-65 DICKERSON STREET • NEWARK, N. J.



# NO RESTRICTIONS ON SALES OF RECORDING DISCS TO COMMERCIAL USERS

As a radio parts distributor, you can still get your regular supplies of Presto Recording Discs on an A-3 preference rating using the PD1X application form.

Distributors are not restricted in their sales and may transfer recording discs without preference ratings. The purchase of cutting and playing needles requires no preference rating.

Good wartime items for you,



immediate shipment, quick turnover, active demand. Renew your stock today.

**PRESTO**  
RECORDING CORP.  
242 WEST 55th ST. N.Y.

In Other Cities, Phone . . . ATLANTA, Jack. 4372 • BOSTON, Bel. 4510  
CHICAGO, Mar. 4240 • CLEVELAND, Me. 1565 • DALLAS, 37093 • DENVER, Ch. 4277 • DETROIT, Univ. 1-0180 • HOLLYWOOD, Hil. 9133 • KANSAS CITY, Vic. 4631 • MINNEAPOLIS, Atlantic 4216 • MONTREAL, Mar. 6368  
TORONTO, Hud. 0333 • PHILADELPHIA, Penny. 0542 • ROCHESTER, Cul. 5548 • SAN FRANCISCO, Su. 8854 • SEATTLE, Sen. 2560  
WASHINGTON, D. C., Shep. 4003

World's Largest Manufacturers of Instantaneous Sound Recording Equipment and Discs

## MORE THAN 11 "HASH MARKS"

. . . and we have earned them the hard way too, majoring in electrical research throught our 47 years . . . Thordarson engineers have always been ahead of new developments . . . that is why you will find, both in military and civilian use, engineers specifying Thordarson transformers for that vital job where unfailing performance is paramount.

Submit your transformer problems to Thordarson Engineers . . . they know how to solve them.

**THORDARSON**  
ELECTRIC MFG. CO.  
500 WEST HURON ST., CHICAGO, ILLINOIS



*Transformer Specialists Since 1895*

### Don Mitchell to Head Sylvania Sales



Don G. Mitchell

Don G. Mitchell, widely known sales expert, has been named by Sylvania Electric Products Inc., as vice president in charge of sales, according to word from the Sylvania executive vice president, W. E. Poor. The office is a new one at Sylvania; it has been established to plan and direct the merchandising and distribution of all the firm's products.

Mr. Mitchell previously held a similar post with the Pepsi-Cola Co., directing sales during the period of its remarkable growth. Prior to that, he had been with the American Can Co.

Sylvania's production is now almost 100 per cent war work, but it is expected that the wartime products will open up large new consumer fields after the war.

### Another Way to Help Victory

In current bulletins sent out to the trade, General Electric presents "an opportunity to you GE radio dealers and servicemen to help America's war effort and you own future." The suggestion is that radio men should contact "any young man who wants to prepare himself for a future in Electronics," and advise him that there is no better opportunity for training than in the Signal Corps of the United States Army.

It is pointed out that the radio industry now helps the Signal Corps to get the men it needs, the ranks of trained men will be a big asset to developing the industry after the war.

The bulletin is accompanied by a reprint of the striking GE ad which is headed "Men Wanted for the Signal Corps of the U. S. Army!"





*Announcing . . . January Issue*

# **RADIO INDUSTRY AT WAR REPORT NUMBER**

SO much publicity has been given to the steel, machine tool, automotive, aircraft and other industries, telling of their part in the war effort, that it is doubtful if the radio trade realizes the big and vital job done by its own manufacturers—electronic and radio.

This story, one of the truly great chapters of the war record, will be featured in the January issue of RADIO RETAILING TODAY.

Keeping within the bounds of censorship yet giving a vivid picture of radio at war, Caldwell-Clements will inventory and illustrate the war activities of companies that are normally engaged in peacetime radio production—sets, tubes, components and parts.

### ***A Double Tie-in for Manufacturers***

- 1—"Tell all" about *your* war contribution in larger space, using special copy and pictures.
- 2—Take advantage of the extra circulation of this issue by sending us complete lists of your distributors, branch managers, Reps, etc. in order that we may send them copies of this Radio Industry at War Report Number.

Despite great interest on the part of the government, the radio industry and the trade, the various phases of radio war production (Army, Navy, Air Corps, War Production Board, OPA, etc.) have never been brought together in a single issue of any publication. Therefore, copies of the January Report Number will be sent to high ranking officials of the Signal Corps, the Navy Bureau of Ships, the War Production Board and many other branches of the government.

A special staff of editors is at work in the field assembling the material from government sources and key plants.

These articles will furnish a broad background for your individual story. Be sure to tell it with adequate space and with emphasis on pictorial presentation.

**CALDWELL-CLEMENTS, INC.**

480 Lexington Avenue, New York  
Telephone Plaza 3-1340

201 North Wells Street, Chicago  
Telephone Randolph 9225

*Publishers of*



Member, Audit Bureau of Circulations

## How to Get the Best Service from Your **SHURE** Microphone

Are you intimately acquainted with your Microphone? Shure Brothers have prepared an interesting four color booklet, called "Long Live Your Microphone". There are sixteen pages of valuable information about Crystal, Dynamic and Carbon Microphones. "Pointers" on Feedback, Cable, Plugs, Service and other practical matters. This data is based on statistics gathered in the Shure Service Department.

One of these booklets will tell you how to keep your Microphone in "fighting trim".

Bulletin 173R

**SHURE BROTHERS**  
Designers and Manufacturers of  
Microphones and Acoustic Devices  
225 West Huron Street, Chicago, Illinois

Send for this **FREE** Booklet



### Fourth Award to Philco Plants

Flying above the plant of the Simplex Radio Div. of Philco Corp., Sandusky, Ohio, is the Army-Navy "E" flag which was presented with appropriate ceremonies by Colonel John H. Gardner, director, Signal Corps Aircraft Signal Service, Wright Field, Dayton, Ohio, and accepted by Fleming Johnson, plant manager.

President James T. Buckley also announced the award of the "E" flag to the Chicago Div. for outstanding achievement in war production. Formal presentation will be made by Army and Navy officials at special ceremonies.

The company's Storage Battery Division at Trenton, N. J., also received the Army-Navy flag recently, coinciding with Philco's 50th anniversary celebration.

Rear Admiral Wat T. Cluverius, USN, made the Trenton presentation to M. W. Heinritz, general manager, George Demp and Max Hart, oldest Philco employees. It was witnessed by Army & Navy officials, a color guard from Ft. Dix and 1,000 employees and friends.

Originally established in 1892 to manufacture storage batteries, Philco celebrated its 50th birthday converted 100 per cent to war work. It is producing communications equipment for tanks, airplanes and ships, shells, fuzes and heavy-duty storage batteries.

### Twenty Year Club Started

Erskine-Healy, Inc., Rochester, N. Y., electrical appliance distributors, have inaugurated a "Twenty Year Service Club" with a dinner party at the local Hotel Hayward. The entire organization and friends, fifty of them, were guests of Donald Erskine, President, W. P. Ward, Vice President and Mr. Ray F. Healy, Secretary and Treasurer.

Members of the Twenty Year Club are George J. Braun, Anthony L. Scheible and Kenyon Raby. Next year three more members will be eligible for the Club.

### Westinghouse "Merchandising" Gets New Name

The "Merchandising" division of Westinghouse Elec. & Mfg. Co. has been renamed "Electric Appliance" division, according to an announcement by J. H. Ashbaugh, manager.

The change has been made because the new name better describes the manufacturing facilities at both Mansfield, Ohio, and Springfield, Mass., plants, and when peacetime production is resumed after the war, the name will suggest the kind of business carried on—that of building electrical appliances to meet future needs.

## WHEN YOU MAKE UP NEXT YEAR'S SCHEDULE

*remember*

THESE TWO

## DIRECTORIES

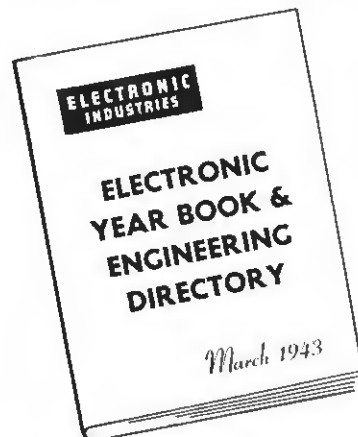

**R**EACHING the responsible electronic engineers, executives and production heads in all radio-electronic manufacturing plants; all communications services and all known users of industrial electronic equipment.

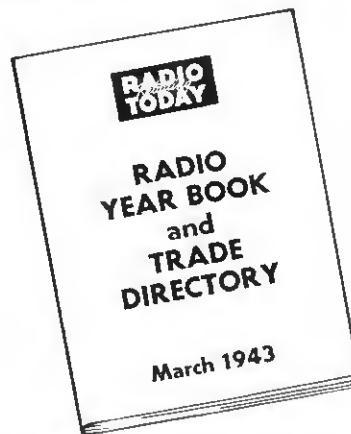

**B**LANKETING the parts and radio jobbers, home and auto radio servicemen, representatives, sound specialists, radio buyers of department stores, radio-music merchants and other key dealers.

### COMPLETE COVERAGE WITHOUT DUPLICATION

**CALDWELL-CLEMENTS, Inc.**  
480 Lexington Avenue, New York  
Telephone PLaza 3-1340

201 N. WELLS STREET CHICAGO  
Telephone Randolph 9225

### Experts Named for Electronics Expediting Agency

Frederick R. Lack, former Western Electric radio head, has been appointed to a newly created position as Director of the Army-Navy Electronics Expediting Agency.

Mr. Lack will work under Lieutenant General Brehon G. Somervell, of the Army Services of Supply, and Vice Admiral Samuel M. Robinson in charge of the Navy Department's procurement and production. He will coordinate and supervise all Army and Navy activities in production expediting of communications and radio. Major General Roger B. Colton, Chief of the Signal Supply Services, and Captain Jennings Dow in charge of the Radio and Sound Branch of the Bureau of Ships, will cooperate with Mr. Lack as associate directors.

Major General Colton has named four experts as technical consultants to his staff—RMA president Paul V. Galvin of Motorola; D. H. O'Brien of Graybar Electric; E. W. Ritter of Corning Glass; and Dr. L. M. Hull of Aircraft Radio Corp.

### Michigan NEDA in War Meeting

A highly successful meeting of the Michigan Chapter of National Electronic Distributors Assn. was held Nov. 3 at the Detroit Leland Hotel.

PD-IX procedures were discussed, along with arrangements for swapping merchandise between members where one was short on one product and had plenty of another.

A resolution was passed approving a plan to turn in old parts (for scrap) when new ones were purchased.

Present officers were unanimously re-elected for the coming year—George Wedemeyer, Regional Director; C. T. Ferguson, Chairman; and "Molly" Williams, secretary.

Those present included: C. T. Ferguson, Ferguson Radio Supply Co.; Don Norton & Molly Williams, Radio Specialties Co.; Mr. Smith, M. N. Duffy Co. all of Detroit; Al Rissi, Rissi Bros., Detroit & Grand Rapids; C. E. Philpot, Radio Tube Merchandising Co., Flint; Harold King, Wholesale Electronic Parts, Pontiac; Gordon Fulton, Fulton Radio Supply, Jackson; Floyd Reason, Electric Prods. Sales, and Mr. Offenbauer, Offenbauer Co., both of Lansing; George Wedemeyer, Wedemeyer Radio Co., Ann Arbor and Battle Creek.

### Rep Finishes Off a Decade of Sales

Fred Ellinger, of the Ellinger Sales Co., Chicago, celebrated last month 10 years as sales representative for Aero-vox condensers. Mr. Ellinger's territory includes parts of Wisconsin, Illi-

nois, Indiana, Iowa and Nebraska, where he has a wide acquaintance among jobbers, set manufacturers and users of industrial condensers. He and his brother Bill, who is also a rep, are constant travellers in the area, as they are strong believers in the "personal contact" method of selling.

### Krautter in New Ad Post

It has been announced by William Z. Burkhart, president of Stockton, West,

Burkhart, Inc., a Cincinnati advertising agency, that L. Martin Krautter has been appointed Vice President and Account Executive.

Mr. Krautter formerly was manager of advertising and sales promotion for the Crosley Corp., and previously had 10 years experience in creative and executive posts in the advertising business. He has served on the advertising committee of the Radio Mfrs. Association, the refrigeration section of the National Electrical Mfrs. Association, and the Modern Kitchen Bureau.

# We're Helping You Sell Bellone RIGHT NOW!

Join In!

HELP THE WAR EFFORT...  
HELP YOUR PROFIT BALANCE!

**Keep Telephone Lines Clear**  
*Communicate Directly with Other Departments!*

There's no need to tie up your overworked telephone lines when you have a Bellone in your office. In an instant you can be in touch with your subordinates or co-workers—talk with them as though they were sitting face-to-face with you—without the wasted time of a two-way intercom. Flip a switch, and you have opened a direct line to the person you need to talk to. There are no delays, no messages to send for, no waiting up others.

A wide variety of installations is possible with standard Bellone equipment. You may have one, two, or three units in use at any one time. You may have one unit in use at any one time. You may have one unit in use at any one time.

A complete Bellone system can be installed quickly and inexpensively. Get complete information today!

**BELL SOUND SYSTEMS, INC.**  
1186 ESSEX AVENUE  
COLUMBUS, OHIO

AN AID TO VICTORY PRODUCTION

BELL SOUND SYSTEMS

Right now . . . on the pages of leading industrial and managerial publications . . . are appearing BELlone ads telling *your* sales story to *your* customers. Live, interested prospects are produced by these ads—prospects who make the most profitable buyers. These are the executives and department heads of firms straining to meet war-time production schedules, firms which will welcome the time-saving aid that BELlone can give. Most important, these are the buyers with priorities *enabling them to purchase BELlone equipment now.*

We're doing our best to help you fill your orders as quickly as possible. We've built a new plant that nearly doubles our productive capacity and are working extra hours at top-speed.

All this makes the present, *today*, the time to go after increased business. Write us at once asking for details. We're working with you.

BELL SOUND SYSTEMS, Inc.

1186 ESSEX AVE. COLUMBUS, OHIO

### Sylvania Plants Receive "E" Award

Rear Admiral Chas. W. Fisher, Director of Shore Establishments, U.S.N., has made the presentation of the Army-Navy "E" flag to Sylvania Electric Products, Inc., Emporium, Pa. employees and plants.

President B. G. Erskine received the flag and an employee representative was awarded the token "E" pin from Col. W. S. Diener, C.O., Central Office Penna. District, Internal Security Board.

Master of Ceremonies, Quentin Reynolds, introduced the guests and notables, which included Lieut. Gen. J. T. McNarney, Deputy Chief of Staff, U. S. Army, who gave a tribute to Sylvania and Emporium.

In the announcement of the award by Hon. James Forrestal, Under Secretary of the Navy, the employees and plants were congratulated for their fine achievement in war production work and "for making a record which has been made only to be broken."

### Bendix Elects Secy-Treas

W. J. Reuscher has been appointed Secretary-Treasurer of Bendix Home Appliances, Inc., South Bend, Ind., announced J. S. Sayre, president of

### Pentode Load Lines

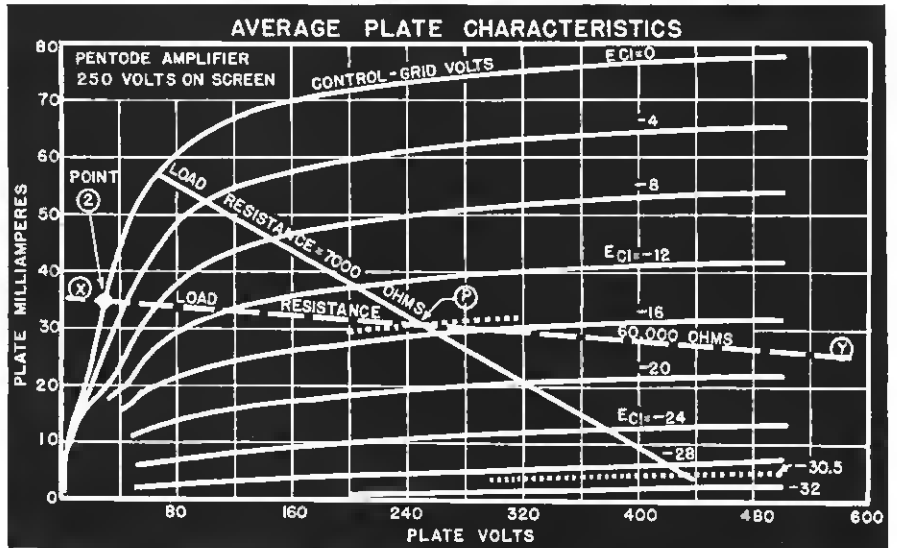

Correct load resistance is very important in pentode amplifiers. Line drawn for 7,000 ohms is correct value on diagram shown. The proper load resistance is the one which gives equal plate current swings above and below average value when grid voltage is varied equal amounts above and below the bias value.

### Bitter Corp. in Bigger Quarters

Limited production of the record-merchandising units made by A. Bitter Construction Corp. is now under way at the company's big new quarters at 721 E. 133rd St., New York City. The firm, which manufactures the "Record Bar" as well as record racks, self-service units and album racks, now owns the new site and plans future expansion using the newest and most efficient production equipment.

Production of the patented Bitter Record Bar was stopped in June, and production of the other "sales-builders" has been behind the demand, although the latter are still being made in very limited quantities.

At the new quarters, research is being vigorously continued, so that after the war, "the record dealers of the nation will be furnished with an even better line of Bitter equipment."

### RCA Export Chief Takes Army Course

J. Myles Regottaz, RCA Victor export manager, Camden, N. J., has accepted an invitation to attend a 4-week orientation course in Army organization and procedure at the Command and General Staff school, Fort Leavenworth, Kansas.

The course is designed to enable a select group of civilians to understand more fully the conditions under which the Army operates. And through Mr. Regottaz, RCA will better understand problems underlying Army requirements for military equipment.

### Eicor Expands

Eicor, Inc., makers of Dynamotors, D.C. motors, converters, etc., have moved to bigger quarters in the new DFC building at 1501 Congress St., Chicago.

**CHICAGO, ILL.**

**Jobber Sales Record**  
 FIRM: R. W. Neill Co.  
 OWNER: Robert W. Neill  
 SALES LAST 12 MONTHS:  
*900% increase*  
 WITH  
**AMPLICALL**  
 INTERCOMMUNICATION AND PAGING SYSTEMS



**Robert W. Neill**

Think of it—in these times—a jobber who increased his sales over 900%! Instead of resigning himself to a diminishing field, R. W. Neill of Chicago "rolled up his sleeves," went to work, and built up a bigger business than ever on the newly developed need for Inter-Com., Paging and PA Systems among war plants. Neill's 268 AMPLICALL installations ranging from 60 watt factory to 1600 watt ordnance plant jobs in the last 12 months gives the alert jobber an idea of what can be done now! Write us today for full details of the Rauland FB Distributing Plan.

• Electroneering is our business •

**THE RAULAND CORPORATION**  
 (Rauland-Webster Sound Division)  
 1245 NORTH KNOX AVENUE  
 CHICAGO



**RADIO SOUND COMMUNICATIONS**



**Club Chairman**



The new chairman of the Sales Managers' Club, Eastern Division, is Charley Golenpaul of Aerovox. A well known veteran in radio parts circles, Mr. Golenpaul started the Club in 1935 and was chairman until 1937. Now a careful student of wartime radio conditions, he plans lively meetings for the Sales Managers.

**Bendix Appliances Resumes Promotion**

An advertising campaign consisting of half-page ads in leading consumer magazines, has been opened by Bendix Appliances, Inc., South Bend, Ind., and will show the Bendix Home Laundry in a war-time setting.

The company is now converted 100 per cent to war production and in this campaign adopts the phrase "Out to War—Back Later." A key part of the campaign is the Bendix move to mail a helpful wartime booklet to every Home Laundry owner.

**Western Spring Market Coming**

Of general interest to retailers and jobbers seeking new lines, will be the 1942 Western Spring Market, to be held at the Western Merchandise Mart in San Francisco Feb. 1 to 6. It will be an exhibiton of home furnishings, showing available merchandise in furniture, floor coverings, draperies, linens and domestics, gifts and housewares.

**Buy U. S. War Bonds and Stamps**



★ **"Sure, I'd Rather Have Roast Beef" ★**

... but if it's a question of who it goes to—me or a boy at the front—**Brother, I'll eat fish and like it."**

★ People are accepting with ever-increasing good-grace each day's new war-born inconvenience—WHEN they know the reason for it.

★ If you explain to your customers how war needs are taking all new radio parts—how you have licked a tough situation to get their sets into operation *without* those parts—they'll be satisfied with performance that's a "little less than perfect."

★ Improvising repairs, however, may require your eliminating certain stages, substituting for specific resistors, condensers, sockets, etc. It may require that you transfer certain materials from one part of a set to another. But one thing it is always *certain* to require is a knowledge of exactly what is *inside* the set.

★ That's where Rider Manuals help you out—quickly. They save you hours otherwise wasted "guessing out" defects and experimenting with "possible" methods of improvising repairs. They lead you right to the cause of the trouble and furnish the facts that enable you to turn out a big volume of work in spite of material and labor shortages.

★ So, reach for one of your thirteen Rider Manuals when you begin every job. Today, it's good sense and good citizenship to work with the greatest possible efficiency.

RIDER MANUALS  
 Volumes XIII to VII.....\$11.00 each  
 Volumes VI to III..... 8.25 each  
 Volumes I to V, Abridged.....\$12.50  
 Automatic Record Changers and Recorders.. 6.00

OTHER RIDER BOOKS YOU NEED  
 The Cathode Ray Tube at Work.....\$3.00  
 Frequency Modulation..... 1.50  
 Servicing by Signal Tracing..... 3.00  
 Meter at Work..... 1.50  
 Oscillator at Work..... 2.00  
 Vacuum Tube Voltmeters..... 2.00  
 AFC Systems..... 1.25

★ HOUR-A-DAY-WITH-RIDER SERIES—on "Alternating Currents in Radio Receiver"—on "Resonance & Alignment"—on "Automatic Volume Control"—on "D-C Voltage Distribution." 90c each

★ JUST OUT!  
 A-C CALCULATION CHARTS—Two to five times as fast as a slide rule—and more fool-proof. All direct reading—operative over a frequency range of from 10 cycles to 1000 megacycles. 160 Pages—2 colors—9 1/2 x 12 inches—\$7.50.

★ FOR EARLY PUBLICATION  
 Inside the Vacuum Tube—complete elementary explanation of fundamentals of vacuum tubes.

★ **John F. Rider Publisher, Inc.**  
 404 Fourth Avenue - New York City  
 Export Division: Rocke-International Electric Corp.  
 100 Varick St., New York City Cable: ARLAB

★ **YOU NEED ALL THIRTEEN RIDER MANUALS TO "CARRY ON"** ★

**STANCOR TRANSFORMERS**

USED BY MOST SERVICEMEN . . . MOST!



**STANDARD TRANSFORMER CORPORATION**  
 1500 NORTH HALSTED STREET . . . CHICAGO

**Today  
POLYMET  
is a  
WAR INDUSTRY**

**FOR VICTORY BUY  
UNITED STATES SAVINGS BONDS  
AND STAMPS**

Much of our production goes to contractors directly engaged in communication installations for the army and navy. At the same time, we are making every effort to serve the growing civilian demand for POLYMET.

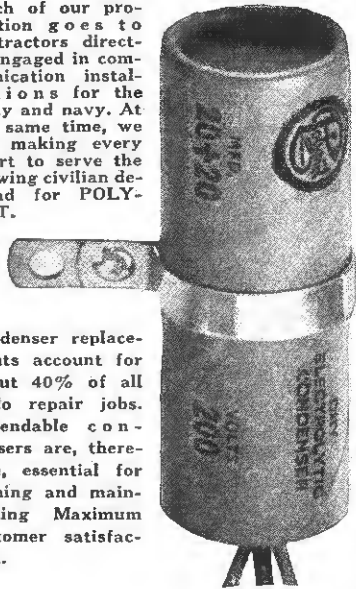

Condenser replacements account for about 40% of all radio repair jobs. Dependable condensers are, therefore, essential for gaining and maintaining Maximum customer satisfaction.

**PROTECT that 40%**

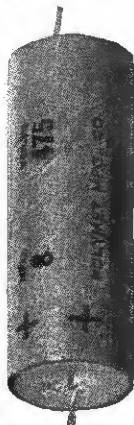

NOW, more than ever, the jobber and service man must recognize the growing demand for POLYMET.

**CONTINUOUS  
DEPENDABLE  
SERVICE**

For 21 years POLYMET ELECTROLYTIC and BY-PASS CONDENSERS have improved quality and service. New researches under the necessity of war requirements are placing POLYMET even further ahead in its field. We're conserving vital materials by limiting sizes to those most universally used. These serve practically every need.

Complete listing of available types and prices will be forwarded upon request.



**POLYMET  
CONDENSER CO.**

699 EAST 135th ST.,  
NEW YORK, N. Y.

**Two-Way Auto Radio  
Development**

After the war, the use of new two-way radios may be common among U. S. motorists.

This is foreseen for millions of drivers by Delmar G. Roos, chief engineer for Willys-Overland Motors, who has outlined results of his company's development of a mass-production technique which enables combat vehicles to send and receive short wave messages without interference.

The development, described as "radio spark suppression," has been in use for the past six months on tanks, Jeeps and half-tracks, Mr. Roos said, and has proved itself especially invaluable when the vehicles are traveling in convoy or close battle formation. Previously, he continued, it was impossible for them to transmit and pick up dispatches on certain short wave bands due to sparks and static generated by the electrical equipment in their gasoline engines.

**Special Work on Static**

In overcoming the problem, Mr. Roos explained, Willys engineers, in close cooperation with the U. S. Signal Corps, designed special filters, suppressors and grounding materials, which eliminated the static without impairing engine efficiency.

He said the company's Jeep assembly lines were then utilized in perfecting a technique to "spark suppress" motorized weapons in mass production. Materials and installation methods were standardized and special testing booths, containing short wave radios, were constructed in sufficient numbers to permit immediate checking of each Jeep as it was driven from the assembly line.

Mr. Roos predicted that the new spark suppression method, in addition to its possible use in the post-war automobile, will greatly affect the future of radio and television since it makes hundreds of wave bands available which were previously useless.

**Buy U. S. War**

**Bonds and Stamps**

*Quality above all.*



**CAPACITORS**

- DRY ELECTROLYTICS
- WET ELECTROLYTICS
- PAPER CAPACITORS
- MICA CAPACITORS
- "ELIM-O-STAT" SUPPRESSORS
- CAPACITOR ANALYZERS

**SOLAR MFG. CORP.**  
Rayonne, New Jersey

**PUBLIC ELECTS  
RECO~~T~~TON  
phoneneedles**

	YES	NO
BRILLIANT PERFORMANCE	<input checked="" type="checkbox"/>	<input type="checkbox"/>
HIGH FIDELITY	<input checked="" type="checkbox"/>	<input type="checkbox"/>
SURFACE NOISE	<input type="checkbox"/>	<input checked="" type="checkbox"/>
SWEDISH STEEL ALLOY	<input checked="" type="checkbox"/>	<input type="checkbox"/>
HIGH POLISH	<input checked="" type="checkbox"/>	<input type="checkbox"/>
HARMFUL FRICTION	<input type="checkbox"/>	<input checked="" type="checkbox"/>
MULTIPLAY	<input checked="" type="checkbox"/>	<input type="checkbox"/>
PERMANENT	<input checked="" type="checkbox"/>	<input type="checkbox"/>
FOR RECORD CHANGERS	<input checked="" type="checkbox"/>	<input type="checkbox"/>
ROUNDED POINTS	<input checked="" type="checkbox"/>	<input type="checkbox"/>
NEEDLE SCRATCH	<input type="checkbox"/>	<input checked="" type="checkbox"/>
HIGH PERFECTION	<input checked="" type="checkbox"/>	<input type="checkbox"/>
IMITATED	<input checked="" type="checkbox"/>	<input type="checkbox"/>
EQUALLED	<input type="checkbox"/>	<input checked="" type="checkbox"/>
INCREASED RECORD LIFE	<input checked="" type="checkbox"/>	<input type="checkbox"/>

Is it strange, then, that dealers like the big Recoton profits and permanent repeat sales?

**RECO~~T~~TON  
phoneneedles**  
**GENTLE AS A CAT'S PAW!**  
*sold everywhere*

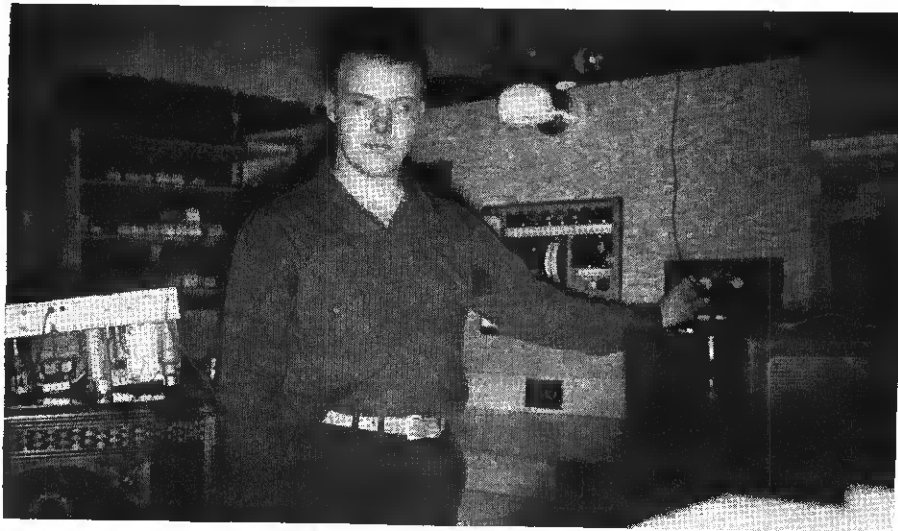

One of Idaho's best known servicemen at his bench in the town of Preston.

## Blind, Serviceman Keeps 'Em Working

One of Southeastern Idaho's most competent radio repairmen is Von Peterson, 22, who has been blind since birth, but whom is well known to nearly every radio set owner in the entire corner of his state.

Von operates his own radio repair shop on Preston, Idaho's, main street, and conducts all his own business—including typing of letters, making of orders, unpacking and placing on shelves of new merchandise, etc. Only rarely does he require the services of a proxy, perhaps someone to read meter figures.

Operating in a small shop, Von, during October, had an average of 40 sets (15 consoles and 25 table models) in his shop every day.

He fixes the town juke boxes, and he made entirely by hand (cabinet and all) the phonograph used by the local music store on which they daily demonstrate classical and popular records. The high school music department entrusts to his care their finest microphones and loudspeakers when repairs are needed.

### Many Activities

Von is a member of an eastern Idaho association for the advancement of the blind, and is chairman of the ways and means committee. The organization is only a few months old, he and some other progressive blind boys having started a new one because the old one in another part of the state was "too slow and couldn't seem to get things done."

His hobbies are phonograph records and playing the piano. In his private record collection he has hundreds of classical and popular numbers and he enjoys every evening listening to them. During the day, while fixing sets and tuning in on various stations, he figures out the bands and songs he likes and has developed a very sharp ear for music.

Von has just begun taking piano lessons by ear and learning the principles of chord structure and harmony. He has a complete ham station which he used nightly until the war.

Von personally assembled the set,

made all necessary connections and put up the aerial, and can send international code at over 35 words a minute.

## Southern Plant Converted

Harold Davis, of the Radolite Mfg. Co., fluorescent lighting specialists of Jackson, Miss., reports that his plant has been turned into an ammunition box factory. Radolite has finished several government contracts and is now starting on a new contract for \$50,000. Mr. Davis himself is applying for a commission in the Signal Corps, but has set up an organization at Jackson to carry on the Radolite work.

**Screaming to an Attack!**

A new war eagle soars above our troops today—replacing Old Abe, of Civil War fame. Superiority of our air force over the enemies' best has been demonstrated over every far-flung battle-front of this war.

This superiority is evidence of the vital need for fast and accurate communications. Two-way radio enables our pilots to function with team-work, affords them the visibility and warnings of their fellow-fliers.

Home-front communications are important, too. "America-at-home" remains the best-informed nation in the world. Thousands of radios powered with Burgess batteries bring day-to-day's happenings from every battle-front.

**BURGESS BATTERY COMPANY**

FREEMONT ILLINOIS

INVEST TODAY TO PROTECT TOMORROW

Buy War Bonds Regularly

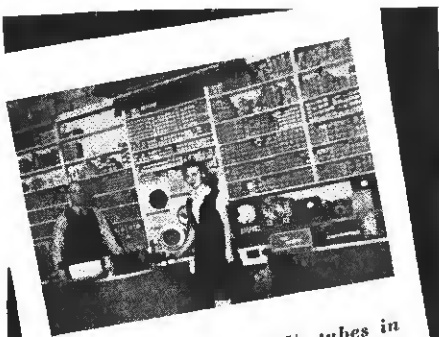

"My dad and I use N.U. tubes in our shop—we found them to be the best quality available and recommend N.U. tubes to all radio men."

June Johnson  
ROY'S RADIO SERVICE  
Ferndale, Mich.

WHERE YOU FIND  
**NATIONAL UNION**  
YOU FIND BETTER  
**RADIO SERVICE**

**PREMIUM**  
*Quality*  
**TUBES**



**BATTERIES**



**CONDENSERS**

also *SAV-A-SHAFT* Volume Controls, Transmitting tubes, panel lamps, cathode ray tubes, exciter lamps, sound equipment, photo electric cells, sound accessories, dry batteries, flashlight bulbs.

NATIONAL UNION invites . . .

All radio service dealers to enjoy the benefits of the N. U. Shop Equipment Plan. The latest in tube testers and test equipment are available to you . . .

More than 60,000 completed deals prove the success of this plan. Investigate now

Ask Your N. U. Distributor or Write



**NATIONAL UNION**  
**RADIO Corp.**  
57 STATE ST., NEWARK, N. J.

**"E" Flag Goes to Clarostat**

Another manufacturer in the field of radio to be awarded the Army-Navy "E" for excellence in production is Clarostat Mfg. Co., Inc., Brooklyn, N. Y., who received the coveted banner from Major H. R. Battley of the Army Air Force at elaborate ceremonies.

Clarostat had enlisted in war production long before Pearl Harbor, and is a specialist in supplying needed components to the Air Force. Normally the firm makes resistors, controls and resistance devices for radio, electrical and allied fields.

John J. Mucher, Clarostat president, accepted the "E" flag, and Samuel Nastri, union head, accepted the emblem pins for the employee group. Austin Lescarboura, advertising director, was master of ceremonies for the several hundred guests, officials and employees.

The inspection routine practiced in the Clarostat plant has won the rare recognition of an "A" classification granted by the Eastern Procurement District Army Air Force.

This means that Clarostat's own inspectors, having demonstrated a high degree of quality control, are now entrusted with full responsibility of meeting all requirements as established. The Air Corps inspectors can now confine their activities to general supervision of the inspection system and final approval, and stamping of completed assemblies.

**Business Ace**



Eric A. Johnston, whose interests include a radio distributing business (Columbia Electric & Mfg. Co.) in Spokane, Wash., is one jobber who has distinguished himself internationally as a business leader. He's president of the United States Chamber of Commerce and has been widely acclaimed for his work on post-war business plans.

**A "LAB" to fit your pocket**

*Readrite*  
**RANGER**

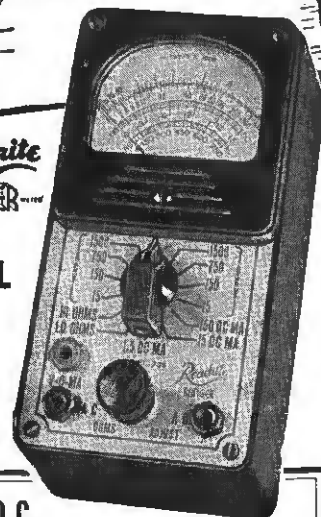

**MODEL 739**

**\$10.89**

Dealer Net Price

**A.C. D.C. VOLT-OHM-MILLIAMMETER**

Pocket Volt-Ohm-Milliammeter with Selector Switch Molded Case. . . . Precision 3-Inch Meter with 2 Genuine Sapphire Jewel Bearings. AC and DC Volts 0-15-150-750-1500; DC MA. 0-1-15-15-150; High and Low Ohm Scales. . . . Dealer Net Price, including all accessories, \$10.89. MODEL 738 . . . DC Pocket Volt-Ohm-Milliammeter. Dealer Net Price. . . . \$8.25

**WRITE FOR CATALOG**

SECTION 717 COLLEGE DRIVE

**READRITE METER WORKS, Bluffton, Ohio**

**AVAILABLE . . .**

**3 DEALERSHIPS**

**1 DISTRIBUTORSHIP**

on nationally advertised product with high WPB priority

Here is unusual opportunity to enter rapidly expanding industry as exclusive representative of the pioneer company (or as a salesman for expanding dealers). Continued production . . . gas and tires for salesmen assured by high priorities. Product, with peace-time permanency, is advertised in Saturday Eve. Post and Rotogravure campaigns. Industry's sales gaining 15 to 34% per year. Saturation still less than 16%. Unusually high profit margins. Only small investment required. In writing for further details and personal appointment give complete facts on age, education, experience, draft status, character references. Write this progressive manufacturer c/o Batten, Barton, Durstine & Osborn, 36th Floor, Palmolive Building, Chicago, Ill.





**Describes War Pace**



Commander E. F. McDonald, Jr., president of Zenith Radio Corp., in a new statement to the company's dealers and distributors, reports on the pace of Zenith's war production work. Pointing out that his firm was always geared to meet stiff competition in a fast-moving business, Commander McDonald said that "the Army and Navy communications branches are setting a terrific pace, but we are meeting it, and in many cases suggesting changes in advance of demands."

**Simplifying Radio Parts for Emergency**

Simplification and standardization of radio parts is bound to come out of the present war experience. Already an extensive simplification program is underway on parts and components for military radio. The number of items and variations is being carefully cut, to the end of simplifying manufacture and saving materials, while making the remaining items more useful than before.

A corresponding simplification program is now being launched with respect to repair parts for home radios, and will cover tubes, transformers, condensers, chokes, volume controls and resistors. Greatly reducing the number of items which must be made and stocked, the move if properly handled, should be warmly welcomed by the radio trade.

Directed by the Radio Branch of the War Production Board, civilian activity will head up through the American Standards Association.

**STANISLAUS WIDGIT MAKES IT CONVINCING**

"See here, guy," said Orbitz Hammer, as he led Serviceman Stanislaus Widgit into the living room. "I sent for you to fix my radio and you'll do it right here, see—not back in your shop. I want to watch you work and know what I'm payin' for. Just try to gyp me and I'll bust you right smack on the beezee, see?"

Good as his word, giant Orbitz Hammer then proceeded to tower menacingly over little Stanislaus as the latter went to work on the ailing radio. Luckily, however, the trouble was easy to locate—a dead section in a big, old-fashioned 8-8 mfd. dual cardboard dry electrolytic condenser.

After removing the old condenser, Stanislaus produced a dual 8-mfd. Sprague Atom from his kit and started to make the replacement.

"Hey," bellowed Orbitz Hammer, looking at the old condenser. "You ain't taking a big thing like this out of my radio and puttin' a little peanut in its place. Put in a big one or I'll smack ya, see?"

"But," protested Stanislaus softly, "this little one is a Sprague Atom. It's even better than the old one."

Bulking head and shoulders over little Stanislaus, Orbitz Hammer shook a huge fist under the serviceman's nose.

"Put in a big one, I tell ya, before I forget myself and put another gyp outta commission for a couple of months, see?"

"But . . ." protested Stanislaus again.

Orbitz Hammer roared wildly. His big fist described a wide arc terminating in the general direction of Stanislaus' "beezee." But neither the



beezee nor any other portion of Stanislaus' anatomy was there to receive it.

Almost at the same instant, something extremely hard and compact crashed into Orbitz Hammer's midriff causing him to grunt mightily. Then a small but surprisingly strong arm encircled his head, and he was flipped jauntily through the air to land with a crash on an end table, which collapsed beneath his huge bulk. When he finally came to, he realized that Stanislaus had carried him bodily to the davenport, propped a pillow under his

aching head and then flipped the entire contents of a vase—flowers, water and all—over his face to revive him.

"Now just take it easy, big boy," Stanislaus was saying softly. "Just lie there quietly while I pick up my stuff and get out of this firetrap before I really get mad and hurt you."

"But," protested Orbitz Hammer weakly, "you came here to fix my radio, see?"

"Uh huh," said little Stanislaus, "and I hope I ended by proving that good goods often come in small packages. Or shall I shove a few of these little condensers down your throat just to make it doubly convincing?"

"Aw," replied Orbitz Hammer, "I was only kiddin'. All I want is my radio fixed as good as it was before, see?"

"It won't be fixed as good," said Stanislaus. "It'll be fixed better. Sprague Atoms do a man-size job, see?"

And back he went to the radio set.

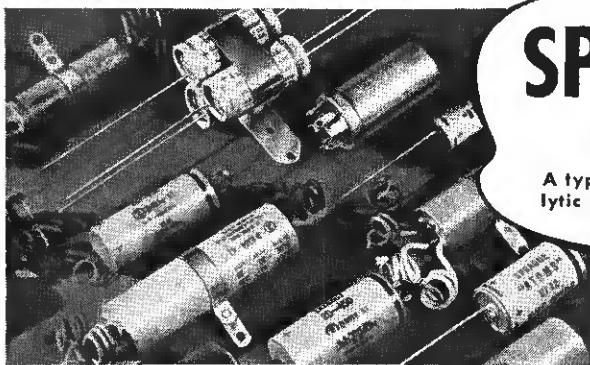

**SPRAGUE ATOMS**

A type for every dry electrolytic need. Use them universally.

**SPRAGUE PRODUCTS CO.**  
North Adams, Mass.

**5000 PLAYS — \$1.00**

A perfect gift for a phonograph owner at any time . . . a Fidelitone DeLuxe Floating Point needle. Its unique Floating Point Construction filters record scratch, gives quieter reproduction. Its precious Permo metal tip gives 5000 plays with kindness to your records. Ask your favorite record dealer for a demonstration and hear the difference for yourself. Permo Products Corporation Chicago, Ill.

Permo Products AID NATIONAL DEFENSE IN Ship Composites

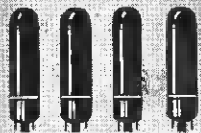

**4 STANDARD TYPES**

of Amperite Regulators replace over 400 types of AC-DC Ballast Tubes now in use.

Amperites are real REGULATORS... have patented Automatic Starting Resistor which prevents initial surge and saves pilot lights. Ask Your Jobber.

**AMPERITE**

THE *Simplest* WAY TO REPLACE

**BALLASTS**

WRITE FOR REPLACEMENT CHART

AMPERITE CO. 561 BROADWAY, NEW YORK, N. Y.

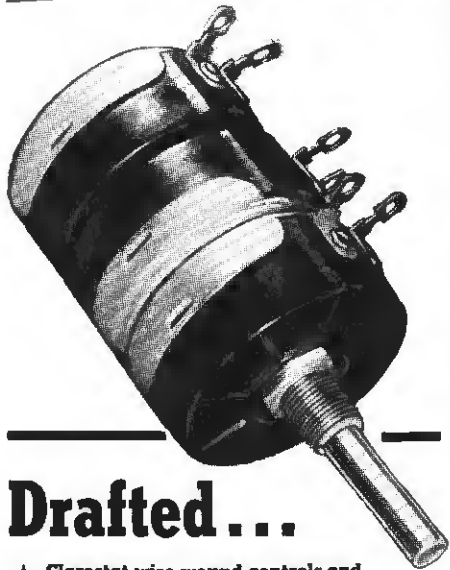

**Drafted...**

★ Clarostat wire-wound controls and power resistors are practically 100% drafted for wartime service. Such products are no longer available for civilian use, except on the very highest priorities. ★ However, Clarostat ingenuity and production capacity have seen to it that essential controls and resistors are still available for servicing home radio sets. Your local Clarostat jobber can help you with your replacement problems.



**"The Representatives" Make News**

The National Publicity Committee Chairman, Ben Joseph, located at 258 Broadway, New York City, reports the following goings-on in the nationwide chapters of The Reps.

New officers were elected by the Buckeye Chapter—Ernest P. Scott, Pres.; E. C. Edwards, V.P., and Wm. E. McFadden, Secy.-Treas.

The New England Chapter recently elected the following: Harrison Reynolds, Chairman; Harry Gerber, Secy.-Treas. Harrison Reynolds and Ernest K. Seyd were designated as delegates to the National Reps.

William Gold, 72 Park Place, New York City, is a new member of the New York Chapter.

**Change Addresses**

G. O. Tanner has moved to 508 Grand Street, Pittsburgh, Pa., and J. P. Kay, formerly of the Southwestern Chapter, has transferred his membership to the Missouri Valley Chapter and is located at 216 E. 10th St., Kansas City.

Another one of the Reps to enter the service is the president of the Dixie Chapter, Henry W. Burwell, who has been commissioned a Captain in the U.S.

Army. (Incidentally, members of the Reps in the armed forces are exempt from dues and are kept in good standing on the roster.)

It was with deep sympathy and regret that the Representatives received the news of the death in an airplane accident of Lt. David Furman of the U.S. Army Air Corps, brother of Nat Furman, member of the New York Chapter—and also of the passing away of P. G. Paylor of the Southwestern Chapter.

The National Publicity Director urges that secretaries of the various chapters send him news items regularly so that news of The Representatives may be included in National releases.

**Gubb Heads Cornell Alumni**

Larry E. Gubb, chairman of the Board of Directors of Philco Corp. has been elected president of the Cornell University Alumni Association. Mr. Gubb was graduated from Cornell in 1916.

He joined Philco in 1921 as a storage battery salesman and worked up to general sales manager, to executive vice president and in August 1941 to his present position on the Board of Directors.



"These wartime batteries are so frightfully weak."

© Punch



We're making only war materials now to hasten the day when we may serve you again with —

# ARVIN Radios

NOBLITT-SPARKS INDUSTRIES, INC., COLUMBUS, INDIANA

Before and After the War Manufacturers of Arvin...

HOME AND CAR RADIOS • HOT WATER CAR HEATERS  
METAL FURNITURE • BATHROOM ELECTRIC HEATERS

## ELECTRONICS ENGINEER

"Large Chicago Manufacturer doing war work needs experienced man for expanding electronics department. B.S. Degree preferred. Man experienced on sound and electronic equipment will be given first consideration. Also A-1 Radio Repairman for production work. These positions are permanent to men who qualify. Please give full particulars—include age, experience and salary expected."

Box 3, c/o Radio Retailing, 201 N. Wells St., Chicago



Every Signal Corps Trainee Needs these 3 Approved "VACO" Drivers

They're being used every day by signal corps men everywhere. Shock-proof, break-proof, chip-proof Ambery handles and narrow straight bits. Other "Vacos" for radio work include: G2 Grip-point Screw-holding and Spin-hex nut drivers.

Jobbers should stock 3 Signal Corps numbers illustrated, immediately. Priority rating preference.



VACO Products Co. 1123 W. WASHINGTON BLVD. CHICAGO, ILL.

### ATTENTION TUBE DISTRIBUTORS

We offer list less 50% for the following tube types, of standard manufacture, individually cartoned. We cannot supply priority rating. Would consider buying your complete stocks at slightly better discount. WIRE us collect if you can furnish over 100 tubes. WRITE us if you have less than 100 for sale. Deposit wired or mailed with each of our orders, balance COD.

1B5/255	6B5	6SQ7 G or GT
2A3	6C6	30
2A4G	6H6 G or GT	45
5U4G	6J5 G or GT	70L7GT
5V4G	6K7 G or GT	76
5Y3G or GT	6L6 G or GT	80
5Z3	6SC7 or GT	2051

W. R. BURTT

308 Orpheum Bldg.

Wichita, Kansas

## Your Last Chance . . .

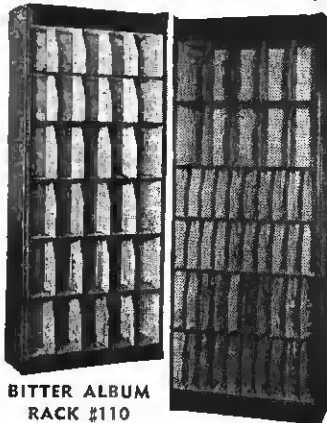

BITTER ALBUM RACK #110

This new album sales stimulator holds about 250 album sets. Same dimensions as the famous Bitter Standard Record Rack (#100) — 2' 10 1/2" long, 7' 2" high, 15" deep; same design; same standard finish — walnut finished birch. May be used interchangeably or together to form attractive unit.

BITTER RECORD RACK #100

This attractive, compact unit holds 500 10", 500 12" records, 75 album sets. Specifications same as #110. No progressive record dealer can afford to do without the big time and space saving features of this famous record rack.

Production on the famous Bitter Record Bar was stopped in June. Now war work makes it imperative to curtail production on these units. This may be your last chance so order your Bitter "Sales Builder" unit today.

★

### BITTER SELF-SERVICE UNIT (below)

For rapid turnover of popular priced stock. Holds 300 records on slanting face, 16 albums on upright face (not pictured). Stocks 500 records or 75 albums in lower section. 58" high. Occupies but 5' of floor space in center aisle or wall position.

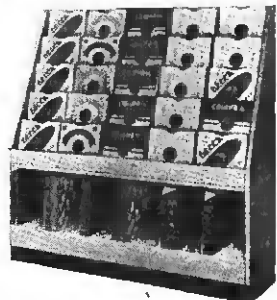

FREE BOOKLET—WRITE NOW!

A. BITTER CONSTRUCTION CORP.  
721 E. 133 STREET • NEW YORK, N. Y.

## GENERAL INDUSTRIES Smooth Power MOTORS

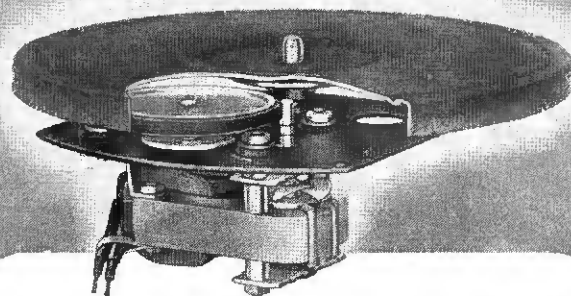

### All Ready for Any Job Ahead

• The wide range in types and sizes of G. I. motors fits them for many applications in war production and makes them available in reasonably short time. For more than thirty years, G. I. small-power motors have been leaders in fields where quiet running and reliability were first requisites. They measure up fully to Government requirements and are furnished only on direct Government orders.



THE GENERAL INDUSTRIES CO.  
Department 15, ELYRIA, OHIO

# FAST, EASY WAY TO CUT HOLES IN RADIO CHASSIS

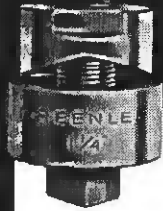

**NO FILING, REAMING, OR TEDIOUS DRILLING**

Here's a handy tool to help the radio worker save many hours of work when cutting holes for sockets, plugs, connectors, and other receptacles in radio chassis. A cap screw is inserted in a small drilled hole, and the punch is easily forced into the die by a few turns of the cap screw with an ordinary wrench. Smooth holes, requiring no filing or reaming, can be cut in metal up to 3/8-inch thick in 1 1/2 minutes or less. Ten punches are available for cutting 3/4, 7/8, 1, 1 1/8, 1-5/32, 1-3/16, 1 1/4, 1 3/8, 1 1/2 and 2 1/4-inch holes. A Greenlee Knockout Cutter is also available for cutting holes up to 3 1/2-inch size for meters. Send for new circular S-114 on Radio Chassis Punches.

SEND FOR FREE COPY GREENLEE CATALOG 33E

**GREENLEE TOOL CO.**

1911 Columbia Ave. Rockford, Illinois

*University*

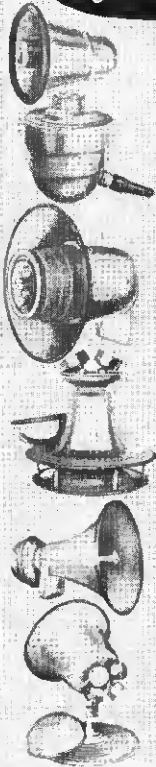

**REFLEX SPEAKERS**  
now the accepted **STANDARD** for all **WAR USE**

**EVERY UNIVERSITY REFLEX**  
the result of years of pioneering research and development

**EVERY HIGH EFFICIENCY SPEAKER**  
in University's extensive line of power speech reproducers has a vital part to play in the WAR program.

**REMEMBER**  
University is now producing many special speakers for the Army, Navy & Signal Corps. Submit your special problem direct to the engineering dept.

UNIVERSITY LABS., 225 VARICK ST., NYC

## Radio Ownership by Rental Values

The 1942 Consumer Analysis of radios in Greater Milwaukee, as compiled by the *Milwaukee Journal* shows that 98.9 per cent of all the families own home radios, 56.5 per cent have 1 set, 37.5 per cent have 2 sets and 6 per cent own three or more. Portable battery-operated radios are owned by 6.2 per cent of the total number of families.

The following figures show ownership of radios by families in various rental groups:

99.7 per cent of renters paying \$50 up per month own plug-in radios, but only 7.8 per cent have battery-operated sets.

99.6 per cent of renters paying \$40 to \$50 per month own plug-in radios, but only 6.8 per cent have battery-operated sets.

98.8 per cent of renters paying \$30 to \$40 per month own plug-in radios, but only 6 per cent have battery-operated sets.

98.2 per cent of renters paying under \$30 per month own plug-in radios, but only 5.4 per cent have battery-operated sets.

## Officer Hutchins



Henry A. Hutchins, general sales manager for National Union Radio Corp., is now a Lieutenant Commander, U. S. Naval Reserve, on active duty. Mr. Hutchins is a familiar figure in radio, and has had previous experience in the Naval Service.

**NOW**

# a really high-powered RADIO ENGINEERING LIBRARY

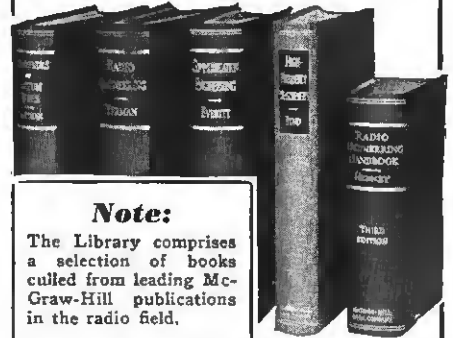

**Note:**

The Library comprises a selection of books culled from leading McGraw-Hill publications in the radio field.

- ▶ especially selected by radio specialists of McGraw-Hill publications
- ▶ to give most complete, dependable coverage of facts needed by all whose fields are grounded on radio fundamentals
- ▶ available at a special price and terms

These books cover circuit phenomena, tube theory, networks, measurements, and other subjects—give specialized treatments of all fields of practical design and application. They are books of recognized position in the literature—books you will refer to and be referred to often. If you are a practical designer, researcher or engineer in any field based on radio, you want these books for the help they give in hundreds of problems throughout the whole field of radio engineering.

**5 volumes, 3559 pages, 2558 illustrations**

Eastman's *Fundamentals of Vacuum Tubes*, 2nd edition

Terman's *Radio Engineering*, 2nd edition

Everitt's *Communication Engineering*, 2nd edition

Hund's *High Frequency Measurements*

Henney's *Radio Engineering Handbook*, 3rd edition

**Special Low Price, Easy Terms**

Special price under this offer less than cost of books bought separately. In addition, you have the privilege of paying in easy installments beginning with \$3.00 in 10 days after receipt of books, and \$3.00 monthly thereafter. Already these books are recognized as standard works that you are bound to require sooner or later. Take advantage of these convenient terms to add them to your library now.

**FOR 10 DAYS' EXAMINATION SEND THIS**

**—ON-APPROVAL COUPON—**

McGraw-Hill Book Co., 330 W. 42 St., N. Y. Send me Radio Engineering Library for 10 days' examination on approval. In 10 days I will send \$3.00 plus few cents postage, and \$3.00 monthly till \$24 is paid, or return books postpaid. (We pay postage on orders accompanied by remittance of first installment.)

Name .....

Address .....

City and State.....

Position .....

Company .....RR-11-42



# INDEX

## To Advertisers

	Page
AEROVOX CORP. ....	47
AMEPRITE CO. ....	64
AUDEL, THEO. & CO. ....	43
BELL SOUND SYSTEMS, INC. ....	57
BITTER CONSTRUCTION CORP., A. ....	65
BRACH, L. S. MFG. CO. ....	53
BURGESS BATTERY CO. ....	61
BURTT, W. R. ....	65
CENTRALAB ....	6
CLAROSTAT MFG. CO. ....	64
COLUMBIA RECORDING CORP. ....	2, 3
CONTINENTAL RADIO & TELEV. CORP. ....	1
DUOTONE ....	25
ELECTRO VOICE MFG. CO., INC. ....	52
FARNSWORTH TELEV. & RADIO CORP. ....	9
GENERAL INDUSTRIES ....	65
GREENLEE TOOL CO. ....	66
HYTRON CORP. ....	Cover IV
INTERNATIONAL RESISTANCE CO. ....	37
JENSEN RADIO MFG. CO. ....	27
KEN-RAD TUBE & LAMP CORP. ....	4
LITTELFUSE, INC. ....	67
MALLORY, P. R. & CO., INC. ....	Cover II, 41
McGRAW-HILL BOOK CO. ....	66
MEISSNER MFG. CO. ....	33
NATIONAL UNION RADIO CORP. ....	62
NOBLITT-SPARKS INDUSTRIES, INC. ....	65
OHMITE MFG. CO. ....	50
PEERLESS ALBUM CO., INC. ....	52
PERMO PRODUCTS CORP. ....	63
PHILCO RADIO & TELEVISION CORP. ....	5
POLYMET CONDENSER CO. ....	60
PRESTO RECORDING CORP. ....	54
RADIO CORP OF AMERICA ....	Cover III
RAULAND CORP. ....	58
RAYTHEON PRODUCTION CORP. ....	11
READRITE METER WORKS ....	62
RECORDISC CORP. ....	51
RECOTON CORP. ....	60
RIDER, JOHN F. ....	59
SHURE BROTHERS ....	56
SIMPSON ELECTRIC CO. ....	29
SNYDER MFG. CO. ....	67
SOLAR MFG. CORP. ....	60
SPRAGUE PRODUCTS CO. ....	63
STANDARD TRANSFORMER CORP. ....	59
STROMBERG CARLSON TELE. MFG. CO. ....	12
SYLVANIA ELECTRIC PRODUCTS INC. ....	8
THORDARSON ELEC. MFG. CO. ....	54
TRIPLETT ELEC. INSTRUMENT CO. ....	45
THE TURNER CO. ....	49
UNIVERSITY LABORATORIES ....	66
U. S. ARMY ....	7
U. S. TREASURY ....	10
UTAH RADIO PRODUCTS CO. ....	31
VACO PRODUCTS ....	65
WILCOX-GAY CORP. ....	21
ZENITH TRADIO CORP. ....	35

While every precaution is taken to insure accuracy, we cannot guarantee against the possibility of an occasional change or omission in the preparation of this index.

## Tuerk Heads Utah Radio Products

The new president of Utah Radio Products Co. Chicago, is Fred R. Tuerk, who has been prominent in Utah affairs for some time. Mr. Tuerk succeeds G. Hamilton Beasley, who is now chairman of the board.

An increasing amount of Mr. Beasley's time is being given to the activities of the Caswell-Runyan Co., which is a wholly-owned subsidiary of Utah. J. W. Caswell of the subsidiary firm has been ill.

The Utah company, manufacturer of speakers, vibrators, transformers, and Utah-Carter parts, emphasizes distribution of its products through recognized jobber channels only. The firm strongly believes that jobber distribution is economically sound, and a stabilizing influence in the industry.

### STATEMENT OF THE OWNERSHIP, MANAGEMENT, CIRCULATION, ETC., REQUIRED BY THE ACTS OF CONGRESS OF AUGUST 24, 1912, AND MARCH 3, 1933

Of RADIO RETAILING TODAY, published monthly at New York, N. Y., for Oct. 1, 1942. State of New York, N. Y., County of New York, N. Y.

Before me, a Notary Public in and for the State and county aforesaid, personally appeared Orestes H. Caldwell, who, having been duly sworn according to law, deposes and says that he is the Editor of RADIO RETAILING TODAY and that the following is, to the best of his knowledge and belief, a true statement of the ownership, management (and if a daily paper, the circulation), etc., of the aforesaid publication for the date shown in the above caption, required by the Act of August 24, 1912, as amended by the Act of March 3, 1933, embodied in section 537, Postal Laws and Regulations, printed on the reverse of this form, to wit:

1. That the names and addresses of the publisher, editor, managing editor, and business managers are: Publisher, M. Clements, 480 Lexington Ave., New York, N. Y. Editor, Orestes H. Caldwell, Catrock Road and Bible St., Cos Cob Conn. Managing Editor, Darrell Bartee, 284 S. Columbus Ave., Mt. Vernon, N. Y. Business Manager, M. H. Newton, 583 W. 215th St., New York, N. Y.

2. That the owner is (If owned by a corporation, its name and address must be stated and also immediately thereunder the names and addresses of stockholders owning or holding one per cent or more of total amount of stock. If not owned by a corporation, the names and addresses of the individual owners must be given. If owned by a firm, company, or other unincorporated concern, its name and address, as well as those of each individual member, must be given.) Caldwell-Clements, Inc., 480 Lexington Avenue, New York, N. Y. Orestes H. Caldwell, Catrock Road and Bible St., Cos Cob, Conn. M. Clements, 480 Lexington Ave., New York, N. Y. McGraw-Hill Publ. Co., 330 W. 42d St., New York, N. Y.

3. That the known bondholders, mortgagees, and other security holders owning or holding 1 per cent or more of total amount of bonds, mortgages, or other securities are: (If there are none, so state.) None.

4. That the two paragraphs next above, giving the names of the owners, stockholders and security holders, if any, contain not only the list of stockholders and security holders as they appear upon the books of the company but also, in cases where the stockholder or security holder appears upon the books of the company as trustee or in any other fiduciary relation, the name of the person or corporation for whom such trustee is acting, is given; also that the said two paragraphs contain statements embracing affiant's full knowledge and belief as to the circumstances and conditions under which stockholders and security holders who do not appear upon the books of the company as trustees, hold stock and securities in a capacity other than that of a bona fide owner; and this affiant has no reason to believe that any other person, association, or corporation has any interest direct or indirect in the said stock, bonds, or other securities than as so stated by him.

(Signed) Orestes H. Caldwell

Sworn to and subscribed before me this 29th day of September, 1942.  
B. M. Phillips

Notary Public Westchester County.  
Notary Public N. Y. County Clerk's No. 442.  
Notary Public N. Y. County Register's No. 4P249.  
(My commission expires March 30, 1944.)  
New York County Commission expires March 30, 1944.

\*Represents minority stock interest which was purchased price for Radio & Television Retailing. Majority stock and control continue in hands of O. H. Caldwell and M. Clements.



**Put a LITTELFUSE IN A VISE**

**TWIST THE CAPS WITH A WRENCH**

You simply can't detach OR EVEN LOOSEN the cap of a **LITTELFUSE**

Grip and turn hard! You may shatter the glass—but the cap will stubbornly stick to its end. Reason: Exclusive Littelfuse Patented Locked Cap Assembly.

Littelfuse Caps with their markings will not be lost in any emergency.

Littelfuse process also waterproofs and hermetically seals filament.

Send for Complete Littelfuse Catalog. Full details on Littelfuses for every instrument purpose. Panels, Mountings, Clips including New Beryllium Copper Clips of remarkable strength and resistance characteristics. Write.

**LITTELFUSE INC.**  
4791 Ravenswood Ave., Chicago, Ill.



# Letters to the Editors

## Radio Repair as Essential Occupation

Editor, *Radio Retailing Today*:

Did you see the list of 92 essential occupations in the communication services given out by National Selective Service headquarters?

There are all kinds of telephone engineers, repair men, telegraph repair men, printers and electrical workers—so far as I can see—no provision whatever for home radio technicians.

I thought you would be interested in checking up on this since I am sure you will agree that radio technicians are just as essential as most of the other occupations listed.

Incidentally, you might be interested to know that my chief technician was able to get a "C" gasoline ration card, about two weeks after we were discussing the difficulty in securing sufficient gasoline for travel. I hope that your efforts at Washington were partly responsible.

A Reader

## California Sets Going Dead

Editor, *Radio Retailing Today*:

We have approximately in this area 300 radios per day going out of order, of which the present crew of men cannot quite keep up two-thirds of this amount on a twelve hour shift. If action through deferment is not forthcoming it is only a matter of time until the broadcasters will have few listeners.

The War Production Board granted through L-183 permission to purchase parts but failed to grant permission to manufacturers to supply them, so we are just as bad off as before. Perhaps it is a matter of "survival of the fittest." It is true the materials used are metal which may be essential to the War Effort but I don't know of anything more essential than morale.

## Radio Audience Depends on Repairmen

If Congressman Joe Doakes wants a listening audience he had better do something about the repair man or he will not have enough listeners to be of any value to him.

May we have your immediate action on this problem, which is perhaps national, but to us is a major catastrophe. Thank you for all past favors. We shall appreciate any help you can give us.

Very sincerely yours,  
Harry E. Ward, Jr.

Radio Technicians' Assn.,  
Long Beach, Calif.

## Serviceman Gets More Gas

Editor, *Radio Retailing Today*:

Your letter received, and a copy of the O.P.A. ruling, which you so kindly enclosed, turned over to my local rationing board.

I was given supplementary gasoline rations when I appeared before the local board on the strength of my own arguments. However, the board members were fully convinced that there were very few floor model sets in use, and therefore, they were not sure that they were completely justified in issuing me the extra gas, which prompted my request to you for help.

Now that they have your figures on floor model sales, and the definition of portable and non-portable radio equip-

ment from a source which they know to be authentic, they feel much better about the matter, and will undoubtedly have more respect, and give better attention to myself, and the other local radio men in our future needs.

Thank you for the prompt attention and considerable trouble which you went to in assisting me.

A Reader

## Repair Job Is a Life-Saver

Following is a letter written to Marvin Struve, radio serviceman of East Ellsworth, Wis., by a customer who is a war worker on a job overseas. Mr. Struve says that "this may show other repairmen, as it did me, how much our work means in these times."

Dear Mr. Struve,

Just a line to let you know that my radio which you overhauled before I left, is working okay. We get the CBS news at 10 every evening, and also got two NY stations, Salt Lake City, Pittsburgh, Cincinnati, and two Canadian stations. We heard Winchell direct last night.

Maybe you don't think this means very much. Well, maybe not to you, but to us who are practically cut off from the rest of the world, it sure is a God-send. But this should mean something to you. Mine is the only radio in camp, thanks to your good repair job, that keeps us connected with the good old USA. You have no idea how much that means to all of us.

Thanks again.  
James Leo Nugent

A.P.O. 3033,  
c/o Postmaster, N. Y.



"I thought maybe you could do something—he refuses to talk."

# UP TO OUR NECK

## BUT NOT OVER OUR HEAD



**HYTRON** is still managing to keep its head "above water." As you know, electronic tubes for this "radio war" are demanded by the armed forces in quantities which tax to the utmost all available productive facilities.

**HYTRON** has been called upon to do a job which has no end. The challenge has been met by expansion, emphasis upon types Hytron is best fitted to make, long-range production planning,—but, primarily, by not taking on more work than can be successfully handled. In this way, assurance can be given to all customers that their tubes will be delivered on time.



**EXPANSION**—Cooperating fully with the Army and the Navy, Hytron is now realizing a plan of expansion to quadruple its size. New high-speed equipment, newly-recruited operators are being correlated by Hytron engineers into a production team at the Newburyport, Mass. plant, even as ever-increasing quantities of tubes are rolling off production lines at the Salem plant.

**PRODUCTION PLANNING** — Far-sighted planning which devotes Herculean efforts to the material procurement obstacle, and to concentration upon fewer, similar types, keeps production lines running smoothly, constantly, with the least possible, time-wasting changeovers.

**SELECTION OF TYPES** — By sticking to its last, by concentrating upon special purpose tubes which for it are "naturals," Hytron is making a maximum contribution toward winning this war. All of its long years of experience in engineering specialized tubes are now at the service of the armed forces and their equipment suppliers.

**HOW YOU CAN HELP**—By placing your orders well in advance, by ordering now the tubes you will need this winter, next year, you can help Hytron to fit your tube needs into its production plan—can assure yourself that you will receive your tubes on schedule.

**HYTRON CORP., Salem and Newburyport, Mass.**

... Manufacturers of Radio Tubes Since 1921 ...

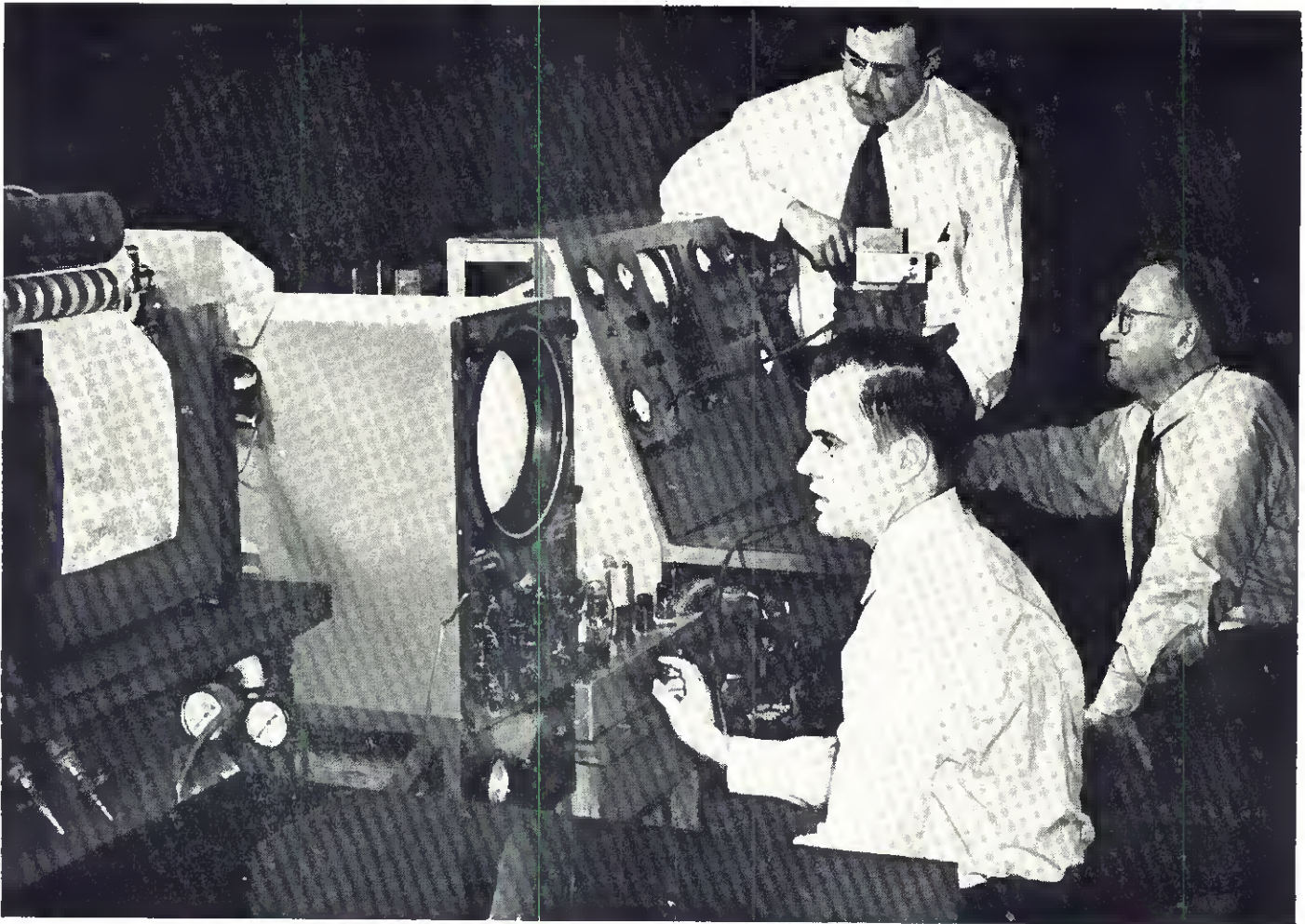

RCA Laboratories Scientists and the new RCA Electron Scanning Microscope. Dr. James Hillier (foreground), Dr. V. K. Zworykin and Richard L. Snyder.

## FROM THREE WONDERS... A FOURTH!

Like a vast, flowing river, the progress of inventive science is fed by many tributary streams . . . streams of earlier research, discovery and invention.

Three such distinct streams converge in the new RCA Electron Scanning Microscope . . . and flow towards the horizons of the future. For this new instrument embodies the principles of television, facsimile, and the electron microscope.

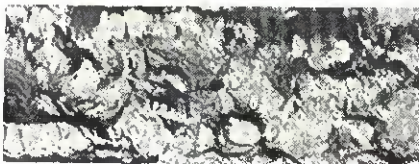

Surface of etched nickel, as seen by the new RCA Electron Scanning Microscope.

Still in the development stage in the RCA Laboratories, this new microscope permits study and analysis of surfaces of opaque objects—even metals. "Scanning" the surface with a beam of electrons, it prints a greatly enlarged picture.

A sheet of metal, smooth as glass to the unaided eye, looks like an airplane view of the Grand Canyon. Every detail of its surface is shown sharp and clear . . . The Electron Scanning Microscope is but one of the many research projects in RCA Laboratories which link the present with the future of Electronics.



BUY U. S. WAR BONDS EVERY PAYDAY

## RCA LABORATORIES

A Service of Radio Corporation of America, RCA Building, New York  
PIONEER IN RADIO, ELECTRONICS, TELEVISION

Other Services of RCA: RCA Manufacturing Co., Inc. • R. C. A. Communications, Inc. • Radiomarine Corporation of America  
National Broadcasting Co., Inc. • Blue Network Co., Inc. • RCA Institutes, Inc.