

OCTOBER 1937

RADIO RETAILING

McGRAW-HILL PUBLISHING COMPANY, INC.

25 CENTS PER COPY

MAN THE GUNS!



Push Ahead to Big-Set Sales with

RCA Victor
OVERSEAS DIAL!

Miles ahead of any other dial on the market! That's the new RCA Victor Overseas Dial—an *exclusive* RCA Victor feature. Makes tuning for short wave stations as easy as for domestic stations. Short-wave bands are spread 50 times wider than on ordinary dials. Separate tuning scales are used for 49, 31, 25 and 19 meter bands. Only the scale in use is lighted. Names of short wave stations are printed right on the dial.

POWERFUL 4-COLOR MAGAZINE
ADVERTISING
Saturday Evening Post and Collier's

STRONG COMMERCIAL
ANNOUNCEMENTS
on Magic Key Radio Program

DRAMATIC LIFE-SIZE WINDOW
AND STORE DISPLAYS

UNIQUE, ATTRACTIVE PREMIUMS

STATION VERIFICATION CARDS
AND MONTHLY SHORT-WAVE
PROGRAM SERVICE—for DX fans.

FORCEFUL NEWSPAPER
ADVERTISING

FOREIGN DIRECT-MAIL
CAMPAIGN
from Paris, London, New York

Man alive—there's a *selling* drive! So, man these mighty sales guns now! Each of them features Overseas Dial—directs customers into your store! Get in this sales push—and march along to a profit victory in October!

SENSATIONAL Short-Wave Tuner the feature of the month! RCA Victor focuses public attention on it with seven outstanding advertising and promotional blasts—all of which will help you make big-set sales, big-time profits!

October is RCA Victor Overseas Dial month! Just look at the seven big selling guns RCA Victor is going to touch off this month and you will see it will pay you—and *plenty*—to feature the sensational Overseas Dial Models 813K and 816K in your store!

RCA Victor

RCA MANUFACTURING CO., Inc., Camden, New Jersey
A Service of the Radio Corporation of America

300 MILLION RCA RADIO TUBES HAVE BEEN BOUGHT BY RADIO USERS... IN TUBES, AS IN RADIO SETS, IT PAYS TO GO RCA ALL THE WAY!

Don't risk the turn of the knob

that turns away customers



Use..

YAXLEY

REPLACEMENT
VOLUME CONTROLS

From a service sales viewpoint, volume controls differ from other radio parts in that the minute your customer turns the knob, he knows the quality of the part that has been installed in his radio.

Don't take chances on inferior controls. Use only quality controls—SILENT controls—and that means Yaxley. Yaxley Controls alone offer the following exclusive features:—

1. "The Roller That Does Not Roll"—the most perfect form of contactor as recognized by leading metallurgical engineers. In addition, the contactor automatically cleans the element of noise-producing dust.

2. Pure Silver Short-outs—assure perfect terminal contact and provide zero signal before switch action.



PATENT APPLIED FOR

3. Silver-to-Silver Contacts—a heavy durable plating of silver is placed on all moving, current carrying parts. Silver oxide is a good conductor—the oxides of copper and brass are not. Although an expensive manufacturing process, Yaxley gives you this to insure permanent quietness and efficiency.

4. Perfected Tapers—mathematically designed. Feather edged tapering of geometric design provides mechanical smoothness and uniform control of receiver volume. Only Yaxley has such a perfect control taper.

These features, plus precision manufacturing and rigid inspection, make Yaxley SILENT Volume Controls leaders of the field. And—remember that Yaxley, with its parent company, P. R. Mallory & Co., Inc., offer the aid of the Mallory-Yaxley Radio Service Encyclopedia, which tells the easy way to make difficult replacements.

Get in touch with your distributor today.

Use
MALLORY
P. R. MALLORY & CO., Inc.
REPLACEMENT
CONDENSERS...VIBRATORS

P. R. MALLORY & CO., Inc.
INDIANAPOLIS INDIANA
CABLE ADDRESS—PELMALLO

Use
YAXLEY
REPLACEMENT
VOLUME CONTROLS

RADIO RETAILING

OCTOBER, 1937

O. FRED. ROST Editor
 W. MacDONALD Managing Editor
 C. A. NUEBLING Technical Editor
 T. H. PURINTON Assistant Editor
 HARRY PHILLIPS Art Director

Tom Blackburn Chicago
 George Tenney San Francisco
 H. S. Knowlton Boston

HOWARD EHRlich
 Executive Vice-President

H. W. MATEER
 Manager

RADIO MONTH	By O. Fred. Rost	9		
DISPLAY	MANAGEMENT	ADVERTISING	SELLING	13
FIGURES		17		
FEET THAT GO UP NEEDN'T COME DOWN	By Tom F. Blackburn	18		
TUNING—YESTERDAY AND TODAY		20		
WHY WAIT 'TIL IT WON'T WORK?		22		
BIGTIME BROADCASTS		24		
TURNOVER	By Russell B. Rich	26		
A WINDOW THAT WON'T WEAR OUT	By I. L. Cochrane	29		
SOUND EQUIPMENT MAKERS		30		
OCTOBER NEWS		33		
PREVIEW OF NEW PRODUCTS		41		
CIRCUITS FOR SERVICERS		55		
AMATEUR NOTES		57		
SOUND SYSTEM CIRCUITS		59		
SHOP SHORTCUTS		61		
TRICKS OF THE TRADE		65		
LETTERS		76		

McGraw-Hill Publishing Company, Inc.

Publication Office
 99-129 North Broadway, Albany, N. Y.
 Editorial and Executive Offices
 330 West 42nd Street, New York, N. Y.

Cable Address: MCGRAWHILL, New York
 Member A.B.P. Member A.B.C.

James H. McGraw, Jr. President
 Howard Ehrlich Executive Vice-President
 James H. McGraw Honorary Chairman
 B. R. Putnam Treasurer
 D. C. McGraw Secretary
 A. W. Morrison Circulation Manager

RADIO RETAILING, October, 1937, Vol. 22, No. 10. Published monthly, price 25c copy. Subscription rates—United States and possessions, Canada, Mexico and Central American countries \$1. All other countries \$2 a year or eight shillings. Printed in U. S. A. Entered as Second Class Matter, September 8, 1936, at Post Office, Albany, N. Y., under the Act of March 3, 1879. Cable address "McGrawhill, New York." Member of A.B.P. Member of A.B.C. Copyright 1937 by McGraw-Hill Publishing Co., Inc., 330 West 42d Street, New York, N. Y.

Branch Offices: 526 North Michigan Ave., Chicago; 383 Mission St., San Francisco; Aldwych House, Aldwych, London W.C. 2; Washington; Philadelphia; Cleveland; Detroit; St. Louis; Boston; Atlanta, Ga.

SALES STATIC . . . "WILL YOU PLEASE EXPLAIN WHAT YOU DO AS YOU GO ALONG"

Suggested by subscriber Harold Gekler



*Here is a Chassis
that's built RIGHT!*



All the parts projecting above the base are protected by this framework. Makes the chassis easy to handle, too, and it can be turned upside-down without harm.

Stromberg-Carlson
..First with
TOTAL SHIELDING
..Now First with
FORTIFIED CHASSIS



Look at this metal base cover that provides an electrical shield as well as mechanical protection. The holes in the bottom allow electrical adjustments to be made on the chassis without removing it from the cabinet.



Live rubber placed between the heavy steel channel-shaped shoes and the reinforced ends of the chassis base make a flexible cushioning that will remain in place at all times.

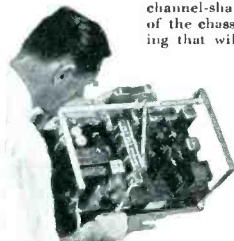

A three point flexible suspension of the tuning condenser, two in front and one in the rear, avoids acoustic coupling effects, thus protecting maximum stability.



These rigid rubber cushion tipped spacer rods, located at the front of the chassis, provide and maintain the correct clearance between the dial and the inside of the cabinet front panel. The chassis cannot be jammed too far forward.



Four large copper colored bolts, ($\frac{1}{4}$ " diameter), fasten the chassis tight against the channel shoes and the cabinet shelf when set is being shipped. These bolts are easy to remove when the receiver is set up for operation.

"The only notable advance in chassis design and construction since Total Shielding was first introduced" is what service engineers everywhere are saying about the new Stromberg-Carlson FORTIFIED CHASSIS. When you first see and examine this new type of chassis you will realize all it can mean to you in reducing service annoyance and in creating satisfied customers.

Stromberg-Carlson Telephone Mfg. Co.,
Rochester, N. Y.

There is nothing finer than a

Stromberg-Carlson

The world's largest Exclusive Radio Tube Manufacturers!

ALL the resources of the vast Raytheon organization are concentrated in the development and production of radio tubes! Raytheon is an organization of *specialists*. All the brains, time and effort are expended toward one end—that you may have better quality, longer-lasting radio tubes. This is the reason for Raytheon's remarkable growth and success.

This unusual policy is responsible for some of the greatest developments in tube design: The universally used auto-set filamentless gaseous rectifier — the OZ4 — is one of the fruits of Raytheon concentration. The Beam-Power output tube is another important Raytheon contribution.

There have been many others since the famous Raytheon "BH" and "BA" tubes years ago which began the era of all-electric receivers.

Raytheon service is comparable to Raytheon quality. There is an outstanding Raytheon jobber in every community to supply you promptly. He stocks the most complete line of tubes made today.

Order Raytheon for greater permanent tube profits!



RAYTHEON

445 Lake Shore Drive, Chicago, Ill. 420 Lexington Ave., New York, N. Y.
585 Howard St., San Francisco, Cal. 55 Chapel Street, Newton, Mass.
415 Peachtree St., N. E., Atlanta, Ga.

FOR BETTER RECEPTION

GET IN ON RCA'S SPECTACULAR FALL CHECK-UP

Now In Full Swing

38 FREE SALES AIDS BRING DEALERS AND SERVICE MEN NEW PROFITS THROUGH RADIO SALES AND APPLIANCE SALES



Get this book of deals from your RCA Tube Distributor—it tells how to get sales aids FREE!

This year RCA helps you cash in on its famous Check-Up by providing 38 exceptional sales aids—every one of which will help you make more money—and every one of which is free. Some of these profit pullers are listed below. Consider the

many new customers they will create for *you*—and then arrange with your RCA tube distributor for those you wish to get. Or, better still, send the replica of the card with tube order to your distributor, telling him what you want.

WITH EACH 25-TUBE PURCHASE—you get 100 unimprinted postcards (Form No. 1337) or 100 Check-Up tags (Form No. 2244)—free.

WITH EACH 40-TUBE PURCHASE—100 prospect cards (Form No. 732)—free.

WITH EACH 60-TUBE PURCHASE—200 leaflets (Form No. 700 or 701) or 500 "Not-at-home" cards (Form No. 317)—free.

WITH EACH 70-TUBE PURCHASE—100 imprinted envelopes and Check-Up letters (Form No. 1311)—or 40 log books (Form No. 913-S)—free.

These are only a few of the 38 deals available to you. The book of deals shown on this page contains a complete listing together with full infor-

mation. Get yours from your RCA tube distributor today—and prepare to march along with the Check-Up to new profits this fall!

Please ship the following RCA Tubes—C.O.D.: Open Account.....:

Type	Quantity	Type	Quantity
24A			
26			
27			
35			
45			
47			
71A			
80			

In accordance with the Special RCA Free Promotional Material offer (effective Sept. 1, to Nov. 1) please ship in return for the tubes ordered in excess of 50 (amount required for telephone listing) the sales promotional items indicated below, using name and address shown under "Telephone Qualifications" for imprint information

Form # Form #

Form # Form #

"TELEPHONE QUALIFICATIONS"

Service Work regularly done..... No. years.....

From Store or Home..... Service Notes used.....

Equipment Owned—Checker Oscillator
Oscillograph Output Meter

Name of Firm or Business

City Telephone

Form 2245

Note to Distributor—After order has been filled send card to RCA District Office so eligibility for Telephone Listing can be determined



Radio Tubes

RCA Mfg. Co., Inc., Camden, N. J. • A Service of Radio Corporation of America

NOW! 9-TUBE WITH ELECTRIC TOUCH-O-MATIC TUNING

Admiral CONSOLE

**PRICED
\$25 TO \$35
BELOW
COMPETITION**



TOUCH A BUTTON— IN COMES YOUR STATION

● Swift . . . simple . . . foolproof! That's Admiral "Touch-O-Matic" Tuning! Controlled by a midget electric motor, the dial pointer travels directly to the station desired . . . does not waste time wandering to the end of the scale and back again. Nor is there any "jamming" when several buttons are depressed simultaneously.

Stations Readily Assigned

Each push button has a corresponding station adjuster located on an easily accessible drum at rear of chassis. The station is first tuned in by hand the usual way. The proper station adjuster is then slid into position as indicated by a special pilot light. Positive hair line adjustment is quickly made.

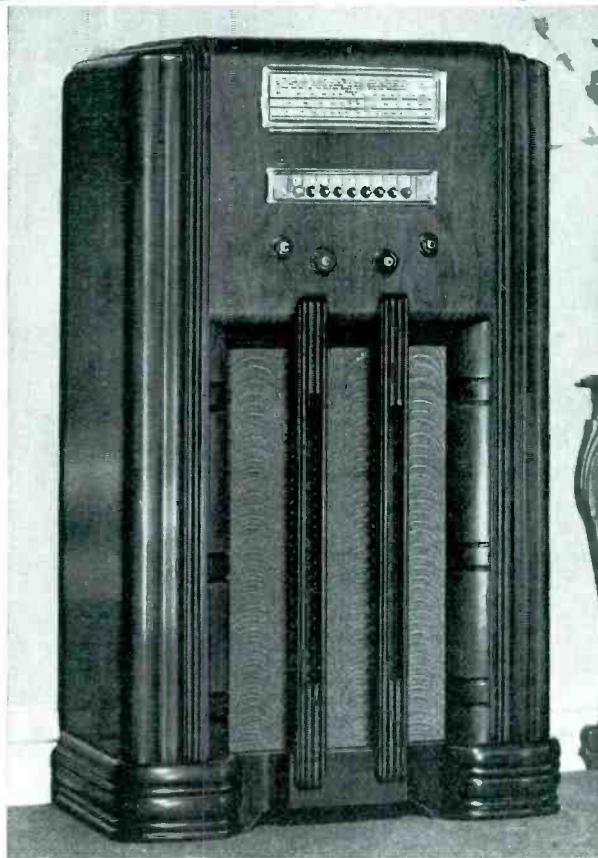

● SAY GOODBYE TO BACK BENDERS



with *Admiral* TILT-TUNING

● The original "tilt-tuning" radios . . . introduced by Admiral over a year ago. Standing or sitting, the tilted dial is tuned in a jiffy. Easy on the back, kind to the eyes. Although others have copied the "tilt-tuning" principle, none can duplicate the streamlined beauty of the patented curved front panel. Admiral alone combines "tilt-tuning" convenience with smart, artistic cabinet styling.

.. YET ALLOWS YOU
AN EXTRA GENEROUS
DISCOUNT. *Ask your jobber!*

● Again Admiral steps ahead of the field with a smashing value! Compare the price! Compare the features! This new 9-tube AC Admiral Console has everything including electric "Touch-O-Matic" Tuning. Has tuning range of 550 to 18,100 KC, 12" auditorium electro-dynamic speaker, push-pull output, high fidelity bass amplifier, etc. An outstanding value that will make 'em stop! look! Listen! And buy!

Note: Admiral "Tilt-Tuners" are fully protected by patents. All models RCA, Hazeltine and Latour licensed.

**MAIL COUPON
FOR FREE
CATALOG**



Just sign, tear out and mail to
CONTINENTAL RADIO &
TELEVISION CORPORATION
325 W. Huron Street, Chicago, Illinois

Name

Address

Grunow

THERMENE

REFRIGERATION

the revolutionary new development in food preservation . . . soon to be displayed by your Grunow Distributor . . . will be

Competitive with
ELECTRIC REFRIGERATION

IN *Initial Price*
IN *Ice Production*
IN *Operating Costs*
IN *Sales Features*

CHILLED BY

THE FREEZING

FLAME

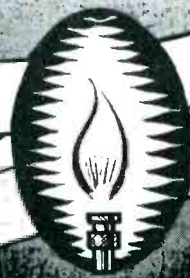

GENERAL HOUSEHOLD UTILITIES CO.
CHICAGO, ILLINOIS

A TOUCHDOWN!



Sentinel *wins with*

RAD-O-FONE!

WHAT IS RAD-O-FONE?
 The most sensational radio development in years—Exclusive with Sentinel! RAD-O-FONE provides the equivalent of TWO radios—radio in one location, second speaker in another location—and a control system that allows two-way conversation between the two!

CITY RADIO from \$21⁹⁵ to \$99⁹⁵!
FARM RADIO from \$26⁹⁵ to \$89⁹⁵!

SMASHING THROUGH TO NEW HIGH SCORES IN SALES AND PROFITS!

It's new—more spectacular than a 50-yard forward pass—with sales punch that has more power than a 250-pound full back crashing the line!

RAD-O-FONE takes Sentinel clear out of the "entertainment only" class—it adds new utility to radio—and eliminates price competition. There's nothing else like it—only Sentinel can offer this exciting new feature—the greatest sales closer you've ever had.

RAD-O-FONE makes a spectacular demonstration, it's something new to talk about and sell, an irresistible plus value added to the already value packed Sentinel line of AC and Farm sets.

Put this unbeatable team to work for you—Sentinel with RAD-O-FONE will crash through for your biggest year in sales and profits! Mail the coupon today!

MAIL THIS COUPON NOW!

SENTINEL RADIO CORPORATION
 2222 Diversey Pkwy. Dept. RRO, Chicago, Ill.
 Please rush me complete details of Sentinel 1938 Line and RAD-O-FONE.

Name

Address

Sentinel

THE DOUBLE PURPOSE RADIO



The BIG 1938 Radio Feature

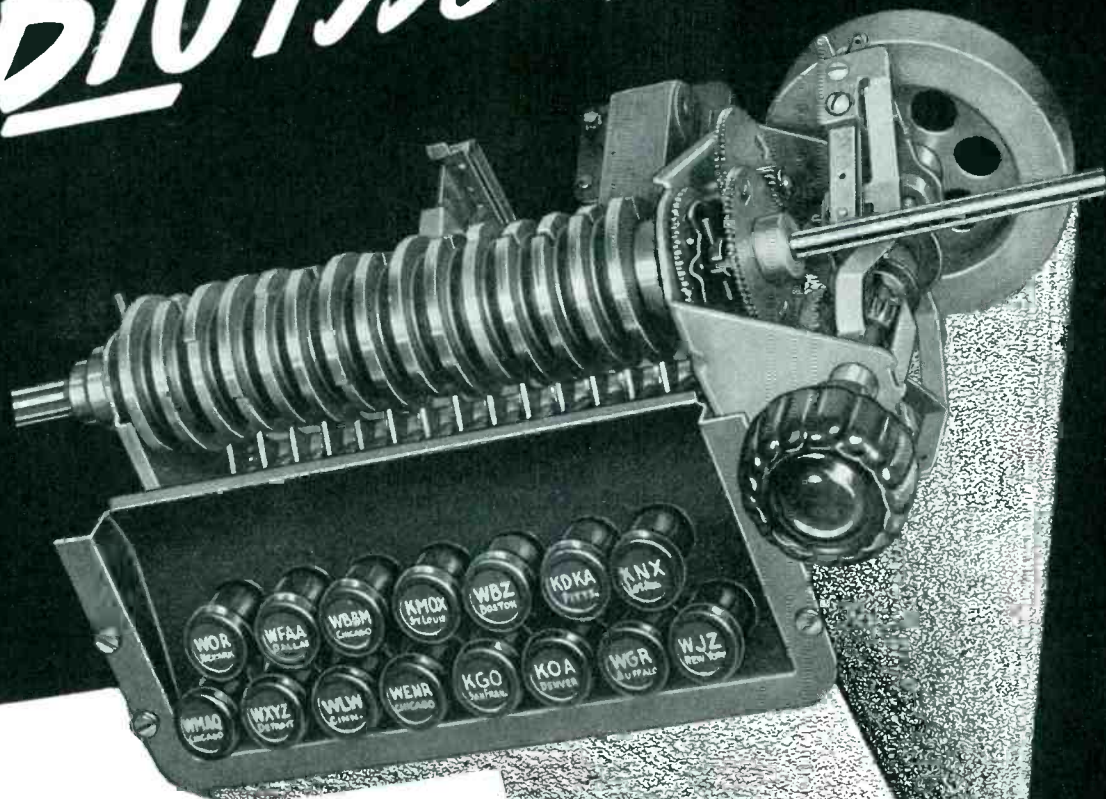

It's the season's sensation—the feature dealers are cheering for—and it's smashing sales records because nothing competition offers can match all its advantages!

- It's faster! . . . goes direct to the station in a split second!
- It's more flexible! . . . takes any 15 stations, in any order!
- It's easier to set up or re-set! . . . adjusts from the front without tools!
- It's foolproof! . . . no hand switching, nothing to forget!
- And it's so accurate it could be used without A. F. C.!

. . . AND that's only part of the story! . . .

- Exclusive Stewart-Warner-C.I.T. Sales Finance Plans open doors that competitors can't get into.
- Coast-to-Coast broadcasts by Horace Heidt's famous Alemite Brigadiers are selling for you now.
- Complete advertising and merchandising plans are really clicking the country over.
- A range of models that satisfies every demand in style, and that blankets every price level.

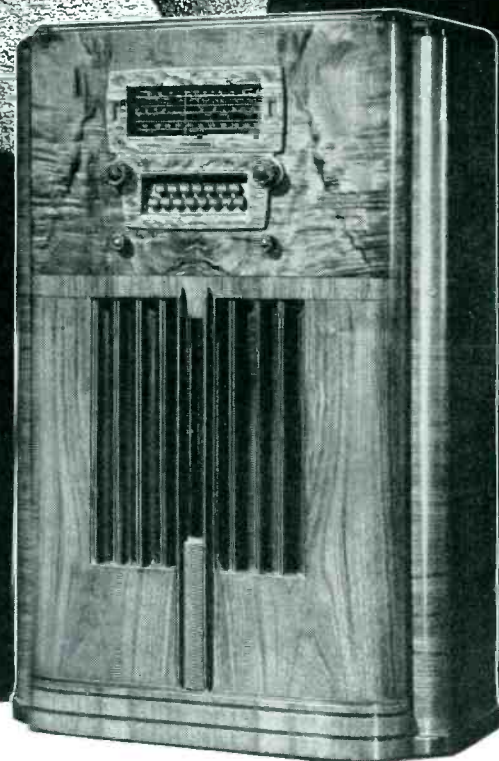

STEWART-WARNER MAGIC KEYBOARD

The RADIO MONTH

Show Opening its doors just as we go to press, a few days too late in the month to permit a complete report in this issue, is the much-heralded New York Radio Parts Show staged by Radio Parts Manufacturers National Trade Show, Inc.

With exhibits moving into the mammoth Port Authority Building indicat-



ing the expenditure of much thought, time and money by cooperating manufacturers, the Victoria Hotel already beginning to feel the pressure of out-of-town registrations, the success of the Show seems assured.

We're hard at work setting up our own booth, oiling the candid-camera for a new foray among the bigshots of the business.

Trade-In Turmoil A little dealer sues a big department store for allowing a customer \$81 on a radio set purchased for \$7.98 one year before. A retail radio association official attacks

a legislator recommending "reasonable allowances" to be left to the discretion of individual dealers, insists instead upon "fixed maximums" to be exceeded by none. (*Radio Retailing* contributed a Blue Book prepared along these lines in June) A nationally respected watchdog of advertising ethics conducts a country-wide survey, finds manufacturer and dealer opinion split between reasonable allowances and fixed maximums.

All this turmoil arises out of the industry's growing consciousness that Fair Trade Laws designed primarily to stop price-cutting are developing teeth, and that price maintenance without trade-in allowance control is very much of a farce. No high bench has handed down a completely clarifying decision to date, and interpretation from state to state may vary widely. So the trade will have to struggle along with the weapons in hand yet awhile.

City Special Suggested several years ago by a member of our staff who built an experimental model was a radio receiver tuned by the mere pressing of buttons. This dream has now become reality. And yet it seems that some manufacturer willing to gamble with an admittedly radical idea might with profit go even farther.

Why not one model equipped with push-buttons only and no dial at all? The type of dial commonly seen today to some extent counteracts the sales appeal of push-button simplicity. Advertised as a "city special," such a set might, furthermore, incorporate reproduction quality not readily obtainable in models which must not only pick up distant stations but also have sufficient selectivity to separate them. Omission of shortwaves might conceivably reduce the price of such a set to a very attractive level.

Phonograph combinations, particularly, seem especially susceptible to such treatment, assuming that many people who buy such machines want quality rather than dx, simplicity of appearance and control rather than flexibility.

That's Cooperation From Oklahoma City, Okla., comes the report that eight wholesalers in the hardware, electrical, drug and food fields have joined forces, for the purpose of promoting the interests of the wholesalers as such and that of certain products in each line.

They have contracted for a series of broadcasts over WKY, and the programs are to be designed so that each contributor will get an even break.

The plan deserves the consideration of radio wholesalers and dealers, particularly of those who are located in remote areas. What is more obvious than to use the radio for building consumer sales of radios.

Education Through passage of the Interior Department's appropriation bill the sum of \$1,298,000 becomes available for training of youths and others in merchandising and all of the various phases of retailing.

Under the George-Deen Act, which authorizes this project, the funds supplied by the government must be supplemented by state or local contributions. Participating states must have a state Board of Vocational Education. Evening and part-time day classes may be provided. Courses will be given in accounting, advertising, management, personnel, commodities and other subjects that will enlarge the knowledge, understanding and judgment of the workers in distributing occupations.

If carried through as planned and continued in future, independent retailers will profit greatly through this effort. Eventually they will be able to hire more useful and better trained assistants, competition should become more intelligent, price-cutting and profit-less selling should decrease.

EDITOR

What's in a NAME?

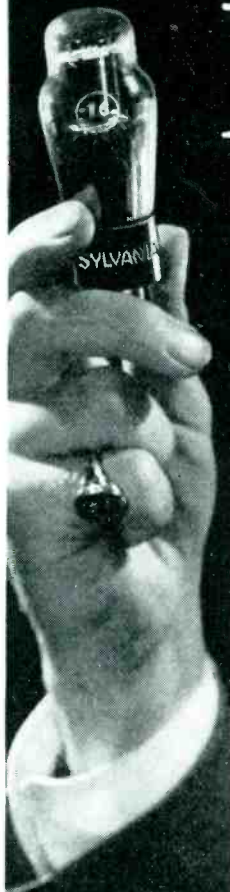

IN THE NAME SYLVANIA THERE'S PERFORMANCE PRESTIGE AND PROFIT **FOR YOU!**

It is performance—*nothing else*—that has placed Sylvania in the high position it occupies today. Not merely technical performance, but *sales performance* as well.

The public knows that the Sylvania name on a tube means thousands of hours of fine, dependable service. The radio trade has taken this sort of performance as a matter of course. For you, the name Sylvania means reputation and profit, all along the line, right down through the trade channels to the retailer's cash-register.

What's in a name? Wherever the name is Sylvania—profit is your answer. Hygrade Sylvania Corporation, Emporium, Pa.

SYLVANIA

THE SET-TESTED RADIO TUBE

A Sensation



Another HOWARD *First*
that points the way to Profits

America now demands automatic tuning. There are console models galore of this type and competition is keen. In the table model field, however, it's a different story. Wide awake dealers and distributors can have this rich, untouched market practically to themselves by acting quickly.

HOWARD has a new model that is a *natural* for your table model trade. Eliminates dialing completely—Tunes any eight stations on the broadcast and police bands by merely pushing a button—Station selection quickly and easily changed by anyone without removing chassis from cabinet—Six tubes with tuning eye—AVC—Dynamic Speaker—Tone Control—Copper Plated Chassis—Beautiful two-position cabinet that looks equally attractive as top-tuner or horizontal. Howard quality throughout.

Since everyone appreciates the convenience of automatic tuning and 95% of them never listen to more than eight stations anyway, this radio at its price will go over with a bang! Remember though, the quicker you get going with it the greater your reward will be, so do something about it right away. If you haven't time to write, *wire!*

WIRE OR WRITE FOR DETAILS ON THIS AND 18
OTHER OUTSTANDING NEW HOWARD MODELS

*Dealers' and Distributors'
interests fully protected—
Ask for either proposition*

HOWARD RADIO CO.
1731-5 BELMONT AVENUE · CHICAGO

HERE'S
AUTO-
MATIC
TUNING
AT LESS
THAN 40
\$ \$ \$ \$
RETAIL



Farmers Everywhere
Enthusiastic Over the *New*

Start-Charger
THE BRIGGS & STRATTON COMPANY
WASHER-MOTOR

ELECTRIC CRANKING . . . WASHING . . . BATTERY CHARGING

No farm equipment in years has caused so much favorable attention. Farmers and their wives are flocking to stores where they can see demonstrations of gasoline driven farm washers equipped with the new Briggs & Stratton Start-Charger Washer Motor. . . . Are you getting your share of all this *new* business? Think what this new motor does! It's self starting like a motor car. And it charges radio and other storage batteries—while doing the washing. No wonder farmers are even discarding their old washers and buying the new Start-Charger Models.

Share in the extra profits that the Start-Charger Motor is bringing so many dealers—get in touch with your washer manufacturer immediately.

BRIGGS & STRATTON CORP.
Milwaukee, Wis.
U. S. A.

Most of your rural customers will not have Hi-Line Service for many years. Why pass up this business when you can make plenty of sales now on Start-Charger gasoline washers. Each month, in state or national farm papers, Briggs & Stratton are telling farmers to see you for a demonstration.

4
CYCLE

BRIGGS & STRATTON
MILWAUKEE, WIS. U. S. A.

GASOLINE
MOTORS

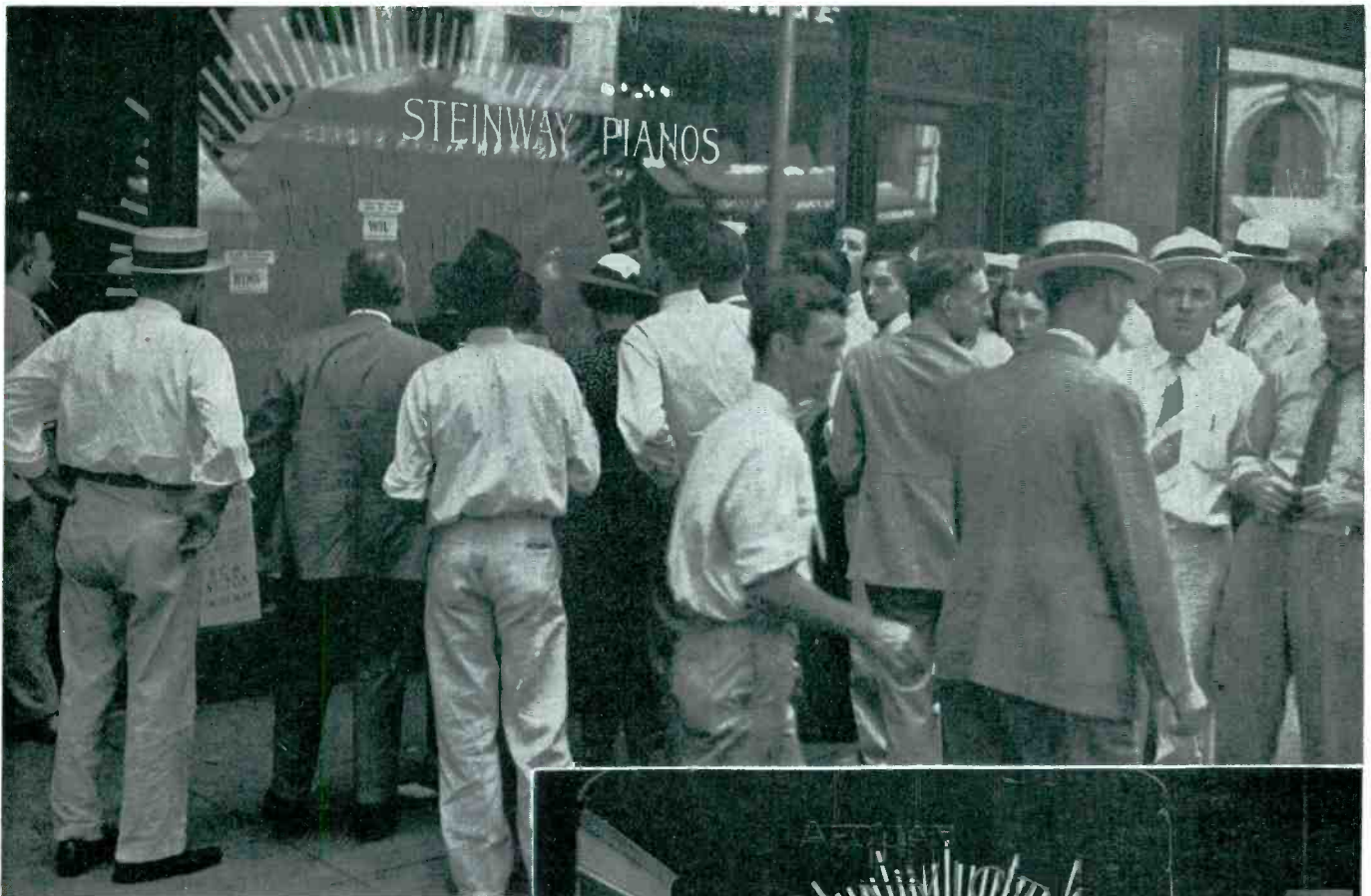

Mystery In Missouri

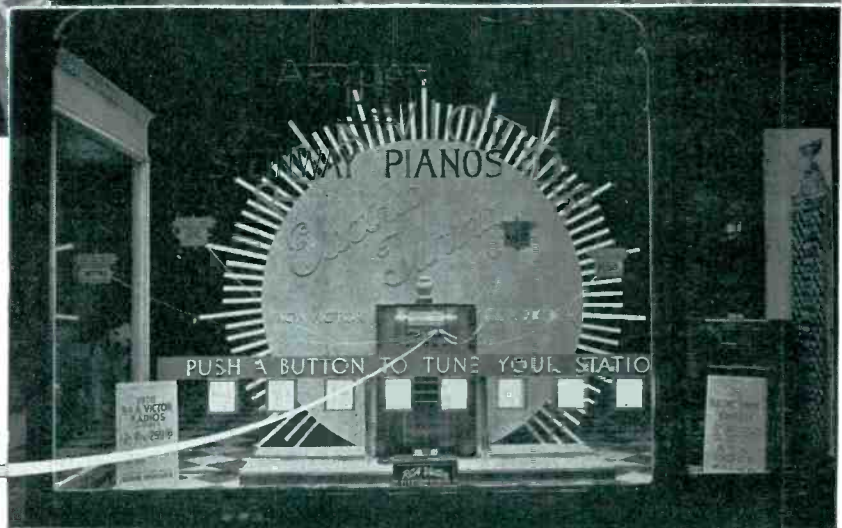

PLACE YOUR HAND
HERE TO TUNE

WIL

ST. LOUIS—Crowds congregated on the sidewalk before Aeolian's store, intrigued by the novelty of electric tuning and a mysterious mechanism which enabled it to be operated through a plate-glass window from the street when Bob Ferree of Interstate Supply . . . egged on by RCA factoryman Fred Pitzer . . . designed, built and installed a clever capacity-relay controlled display. (Complete circuit details on page 61).

To the inner surface of the window, head-high, four 4 by 6-inch cards bearing the call letters of local stations and the words "Place Hand Here to Tune" were glued. Fastened to the back of the cards (and concealed even from inside the store by cardboard backing making a "sandwich" of the metal) were 3½ by 5-inch strips of tinfoil, from which 40-gauge enameled wire, virtually invisible against the black background, ran to the relay unit hidden behind the set.

People (5,000 in 3 days) placed

their hands on the cards, watched the lighted "overseas" dial four feet from their eyes move mysteriously across to the station selected, heard the program over a sound system piping it to the street. Demonstrating this newest of radio features to themselves, many later entered the store, either to ask about the receiver itself or to solve the mystery of how it was controlled through a plate-glass window.

Materials cost \$50 . . . cheap, when the timeliness and effectiveness of the stunt is considered.



UP, DOWN, UP AGAIN—Celebrating a quarter-century of record promotion, Milwaukee's Adele Holtz discovers sales ideas that held the game's head above water during the low-point brought about by radio's sudden rise now produce real profit as the demand for discs resumes

Expert Talks Records

MILWAUKEE—To Adele Holtz, 25 years in the record business, the last 23 with Taylor Electric, the origination of promotional ideas that sell discs is second-nature. Here are a few she considers her best:

Organized a record club, meeting monthly at her own home. Invited music critics, music lovers of all kinds, and gave affair social aspect by serving refreshments. Analyzed recordings of the month, then played key numbers while guests concentrated as they would in a theatre.

Hired women to go from house-to-house, leaving packages of six records of universal appeal on approval overnight where they found reproducing ma-

chines, calling back next day to pick up or sell.

Advertised "Hidden Treasures", featuring recordings of little known numbers that appeared to have broad sales possibilities. In one instance built up a waltz in this manner from almost complete stagnation to a "first".

Originated the idea of demonstrating a new radio-phono combination to every

radio prospect entering the store, developed many new record enthusiasts as a direct result.

Sent a weekly letter listing "Lucky Strike" Hit Parade leaders of the past week, with their position and recording numbers, to all record buyers.

Delivered 25 lectures before Wisconsin clubs during the recent tour of the Philadelphia Symphony Orchestra.

Advantages of a record business, says Miss Holtz, are these:

1. A perfect demonstration, regardless of store location or weather conditions.
2. Elimination of most competition.
3. Development of much higher unit sales.
4. Repeat record business from people sold combinations.

RETOUCHING TO RADIO—

Harvey B. Sutcliffe of Cleveland can prove that radio speeds up production in his photographic studio, has used four Crosley's in his business for 8 years. The sets may be turned off from switches at all telephones



Windows That Work

- 1 SELLS ANTENNAS — For the brothers Zaenglein of Rochester's Hicksons this display moves Stromberg-Carlson antennas with 50 per cent of all sets sold, when they are sold. And an additional 25 per cent buy later
- 2 STIMULATES REPLACEMENT — R. F. Adair, of Long Beach, California's Stricklin's, focussed attention on obsolete radios by offering prizes for the oldest Grebes, putting winners in his window along with new models
- 3 SMALL SPACE CONCENTRATION — Detroit's Peoples Outfitting with little display room for splurging, concentrated on one fast-selling Kadette model, introduced a snow man to add seasonal interest
- 4 LARGE SPACE DIVERSIFICATION — New York's Wurlitzer, with room to burn, showed nearly the whole Emerson line, played up phonograph records and recording, as well, to swell already good store traffic



BALL GAME A LA 1937 — To home-field games played by the Cleveland "Indians" with dyed-in-the-wool fan Rev. Percy M. Kendall goes a Crosley portable radio. He sees each play, listens to expert comment pumped into the air by the broadcasters' leading sports announcers, keeps tabs on scores of distant clubs too

Rent, Not Time

BELOIT, WIS.—L. B. Yagla has worked out a contract under which a purchaser signs a *rental* rather than a time payment agreement, paying so much a month until the entire amount is received. Much like purchase agreements used by office equipment firms, this contract, according to Yagla, is an effective sales inducement for a dealer handling his own paper. The contract (paragraphing omitted to save space here) reads as follows:

Beloit, Wis.....193..... I hereby acknowledge delivery to me of the following: _____ For the use of said appliance I hereby agree to pay as rental to said L. B. Yagla, his successors or assigns, the sum ofDollars (\$.....) as follows: Dollars (\$.....) in hand, and Dollars (\$.....) on theday of each month until the entire rental has been paid. It is understood that whenever the entire rental above provided for, and.....cents per month carrying charge has been paid, the said appliance shall become my property. I further agree as follows: That the said appliance is to remain your property with full title, ownership and right of possession remaining in you until the rental above specified has been paid. In the event of non-payment of any of said rental in the manner above specified, or of the sale or encumbrance of said appliance, or the removal thereof from.....(City)(State) without your written consent, you shall have the right to immediately take possession of the same with or without legal process, wherever the same may be found, and to retain the rental payments theretofore made by me hereunder. To keep the said appliance in good condition and repair, and to be responsible for any loss or destruction thereof by fire, theft or other casualty. It is further understood that no other agreements, verbal or written, express or implied, shall limit or qualify the terms of this contract. This contract shall not be binding on you until approved by an officer of your company. Witness Signed.....(Seal) Approved..... 193.... Per.....



SOUND GOES TO SEA — At Atlantic City, RCA engineers demonstrate a new speaker capable of throwing its voice more than a mile out over the water to bathers, boats. For control of large beach areas sound is a "natural"

Service Sales Campaign

CHICAGO—From J. P. Kennedy, sales manager for Triumph Manufacturing, comes the following service sales campaign suggestion:

Map out a thousand homes within a suitable radius of your shop and test out a consistent plan of advertising. Over 90 per cent of them have some kind of radio.

Start the campaign with a letter, telling about the fine quality of the present programs available from distant cities, which in all probability very few of them are getting, and wind up with a description of your service facilities *and the offer of a free log book if they'll send back a return postcard inclosed with the letter.*

The card should contain a request for the inspection of their radio, which they can check. Follow it within thirty days with a blotter, listing a dozen or so regular programs from other cities, giving the time and dial setting and a brief note about the need of your service if they can't get these programs.

A month later, follow up again with a letter giving standard rates for specific services to their radio and a return postcard on which they may check the service desired.



SECOND-SET SOLICITATION—Salesman Cliff Barrett of Detroit's J. L. Hudson's, shows how the labeling of all table models "Personal Radios," grouping in a corner display playing up this idea, moves merchandise

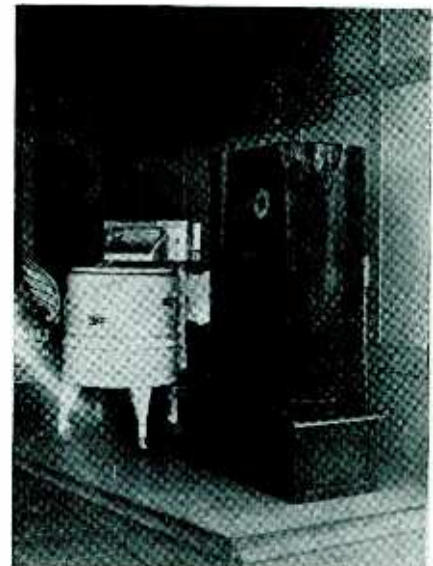

GLASSLESS WINDOW—Shoppers can see, hear and touch the radios and appliances in the F. K. Cox store out in Pomona, California. For Cox has deliberately removed the glass, says people who step into the "window" can be approached by a salesman just as if they had entered the store

SEVEN MONTHS' RADIO EXPORTS

	RECEIVING SETS		RECEIVING TUBES		COMPONENTS Mtrs. Val.	LOUD SPEAKERS		CESSORIES Mfr. Val.
	Number	Mtrs. Val.	Number	Mtrs. Val.		Number	Mtrs. Val.	
Jan.-July 1937	383,139	\$9,459,227	6,573,318	\$2,533,906	34,269,173	279,749	5568,513	\$674,057
Jan.-July 1936	327,456	8,159,114	4,709,794	1,992,116	2,983,252	181,600	382,068	308,247
Jan.-July 1935	309,289	8,184,793	3,622,452	1,573,556	2,441,963	109,079	258,141	376,158
Jan.-July 1934	339,345	8,335,310	3,848,868	1,940,085	2,427,075	67,812	184,740	341,161

F I G U R E S

RETAIL SALES UP

Daily average sales of general merchandise in small towns and rural areas for August were 3 per cent higher in dollar volume than for August 1936. Sales increased 8 per cent over July, somewhat less than the usual seasonal amount, however, according to the Department of Commerce.

Total sales of general merchandise for the first 8 months of 1937 were 11½ per cent above a similar period of 1936, says this same data source, making a preliminary estimate.

RADIO IS TOPS

Listening to the radio tops the list as women's most popular evening-leisure-hour diversion. This welcome fact was uncovered by a survey sponsored by *True Story Magazine*, whose publishers wanted an answer to the question, "What do people do with their evenings?"

Results as reported by *Tide* showed that among women the biggest vote for any single evening diversion was for the radio, with 45 per cent giving it preference. Next came reading, conversing, taking a walk, going to the movies—in that order.

Among the men reading was tops (42%) with radio a close second (35%) and conversation, studying, home work, the movies and taking a walk following in that order.

That's pretty good news for the radio dealers.

FACTORY FIGURES

Belmont reports that in the eight months ending August 31 sales totalled \$3,698,124, the best for any similar period in the history of the company. It compared with \$2,381,204 in the first eight months of 1936 and represents a gain of 55.2 per cent. August sales amounted to \$740,901 against \$600,000 in August 1936, an increase of 23.4 per cent.

WIRED FARM HOMES*

STATE	JUNE 30, 1937
Total U. S.	1,138,335
Maine	18,594
New Hampshire	11,456
Vermont	8,762
Massachusetts	21,258
Rhode Island	3,739
Connecticut	19,340
Total New England	83,148
New York	83,567
New Jersey	17,858
Pennsylvania	80,035
Total Middle Atlantic	181,460
Ohio	87,918
Indiana	48,345
Illinois	45,004
Michigan	74,273
Wisconsin	50,057
Total East North Central	305,497
Minnesota	16,047
Iowa	37,622
Missouri	23,256
North Dakota	2,390
South Dakota	3,245
Nebraska	11,329
Kansas	17,364
Total West North Central	111,253
Delaware	2,651
Maryland	
District of Columbia	14,505
Virginia	21,262
West Virginia	9,729
North Carolina	29,546
South Carolina	13,921
Georgia	15,505
Florida	7,603
Total South Atlantic	114,713
Kentucky	10,157
Tennessee	21,540
Alabama	17,994
Mississippi	6,369
Total East South Central	56,060
Arkansas	5,965
Louisiana	7,243
Oklahoma	6,451
Texas	27,418
Total West South Central	47,077
Montana	3,703
Idaho	20,555
Wyoming	1,547
Colorado	9,264
New Mexico	2,071
Arizona	6,475
Utah	14,365
Nevada	1,271
Total Mountain	69,251
Washington	45,685
Oregon	26,916
California	107,275
Total Pacific	179,876

* Total national gain since January 1, 1937.....9.15%

REFRIGERATORS REGISTER GAINS

STATE	% INCREASE *
Total U. S.	18.32%
Maine	—0.1%
New Hampshire	—17.13%
Vermont	18.53%
Massachusetts	17.63%
Rhode Island	17.46%
Connecticut	31.23%
Total New England	18.02%
New York	20.01%
New Jersey	8.23%
Pennsylvania	26.58%
Total Middle Atlantic	20.42%
Ohio	34.13%
Indiana	19.92%
Illinois	26.52%
Michigan	27.33%
Wisconsin	40.17%
Total East North Central	29.04%
Minnesota	52.55%
Iowa	19.36%
Missouri	10.91%
North Dakota	5.46%
South Dakota	—12.16%
Nebraska	—6.44%
Kansas	11.99%
Total West North Central	14.26%
Delaware	35.62%
Maryland	20.46%
District of Columbia	—20%
Virginia	17.16%
West Virginia	10.04%
North Carolina	30.57%
South Carolina	31.80%
Georgia	21.57%
Florida	19.97%
Total South Atlantic	20.36%
Kentucky	18.84%
Tennessee	20.27%
Alabama	15.18%
Mississippi	15.24%
Total East South Central	18.02%
Arkansas	7.47%
Louisiana	12.44%
Oklahoma	10.28%
Texas	11.91%
Total West South Central	11.30%
Montana	—4.6%
Idaho	—7.02%
Wyoming	16.68%
Colorado	2.11%
New Mexico	14.00%
Arizona	8.50%
Utah	—5.76%
Nevada	19.47%
Total Mountain	7.61%
Washington	—1.22%
Oregon	—20.14%
California	9.9%
Total Pacific	—1.71%

* First 6 months of 1937 compared with same period in 1936

FEET THAT GO UP

CHAIRSIDE RADIO, already exerting an important influence on listener-hours, also goes hand-in-hand with new "conversational group" interior decoration idea

By Tom F. Blackburn

OUTSIDE of cartoonists kidding people who have to stand up all the way home on street cars, there hasn't been a great deal of attention paid dogs and the way one has to humor them.

"Foot troubles?" you say. "What have they got to do with a respectable family magazine like *Radio Retailing*?"

Well, Mister, when you have a pen poised in hand about to order a lot of stock, or when you are planning a bunch of promotion, it is a mighty important time to take a quick stop-look-see at the foot question. For feet play a tremendous part in the growing popularity of armchair radio.

A year ago only one manufacturer had an armchair model. Today they all have them, from two to twenty-nine models. That's growth. You ask: "Is this a fad or a solid trend?"

Trend, Not Fad

Armchair radio, like Caesar's Gaul, is divided into three parts—appeal to human habits, appeal to interior decoration ideas, and its influence on listening. First of all we thought we would start at the bottom of the matter and work up.

So we set out to discover why the human animal tended to bog down in a big chair, making it necessary that the radio be brought to his side. Say what you will, there's something darn funny when a man or woman won't walk five feet to connect with the world's finest entertainment.

We talked to a man who has made a pile of money catering to foot troubles. "Don't quote me—I'm a

physician," he said, "And there's no actuarial data to back me up, but judging by our sales over twenty years, you will find the 128,000,000 inhabitants of our United States are affected this way—

64,000,000 have corns
12,800,000 have callouses
19,200,000 have bunions
38,400,000 have fallen arches
96,000,000 have athlete's foot.

"The corns and the fallen arches are the trouble-makers," said our anonymous friend. "When a man or woman with these pets has been on his feet all day, he topples over as easily as a beer bottle. Once he gets a chance to sit down, he wouldn't give a nickel to witness the second arrival of Kingdom Come."

As Bob Burns' Uncle Poo puts it, "An inch is a lot of room when your beak is under water." That eight feet of floor space between the big chair and the radio dial is too much room—even for a fellow with a boarding house reach.

Fits As Furniture

Probably some of the rapid bloom in popularity of the armchair set can be traced indirectly to the fall in size of the American family. With an average of 3.4 persons per family today, the average poppas and mommas do not need so much room. Indeed, the newlyweds generally start out with two or three rooms, and if no blessed events arrive, they frequently carry on in these sized apartments.

Twenty-five years ago it was hard to find a flat with less than six rooms.

Today that's the exception and the small one is the rule. Go into anything designed in the last ten years, and you will discover, the moment you enter the door that you are all over the place. Arches, open corridors, doors have cut down the amount of wall space tremendously.

Now a console in the middle of the room, its back open, looks as funny as an old maid with her slip showing. With less wall space, and with interior decorators and magazines like *House and Garden* and *House Beautiful* boogie the idea of stringing things

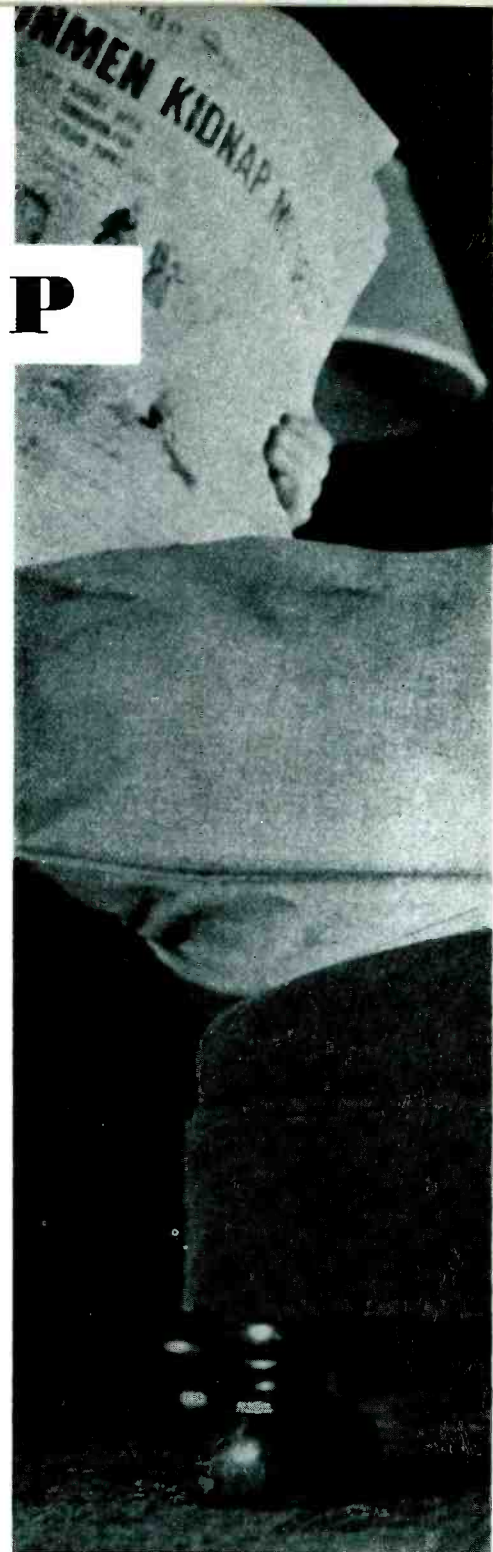

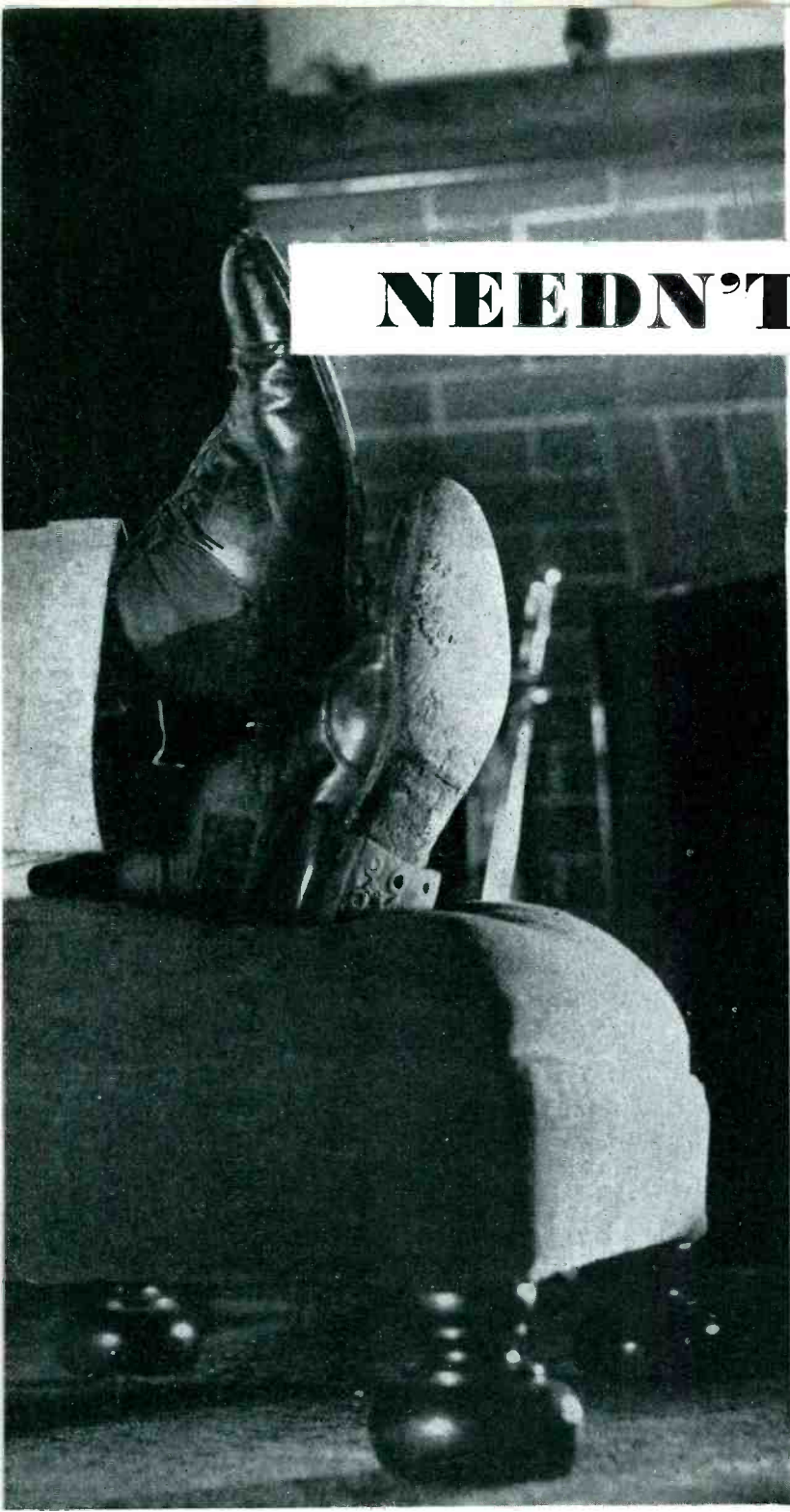

NEEDN'T COME DOWN

1. Convenience in tuning
2. Women want a change in radio design
3. Armchair radios do double duty
4. They lend themselves better to groupings
5. They fit into present day apartments with so many doors better.

Increase Radio Use

Now comes the time to consider the third angle of our study—what change will armchair radio make in our enjoyment of radio. After all, in the long run, it is enjoyment that causes the public to kick in for these little bagatelles.

First of all the utilities will be glad to know that armchair models are likely to be on more time and use more juice—simply by being handy to switch on. According to the Columbia Broadcasting System, listening time per family has increased from 4.1 hours a day in 1932 to 5.1 in 1936. With the trend upward, ease of tuning will undoubtedly cause the family to enjoy their set more frequently.

If you have seen the metered audience survey, made by Robert F. Elder machines in Boston, it is obvious there is a good deal of dial-twisting going on. Audiences range on one station from 5.8% to 22.6%, from 17.5% to 37% on another.

The obvious answer is, the closer the hand is to the dial, the more frequently stations will be changed. The job of pleasing all sexes and ages is an endless one. Columbia shows we have a group of listeners today like this:

WINTER

	<i>Morn- ing</i>	<i>After- noon</i>	<i>Eve- ning</i>
Men, over 18	25%	24%	34.3%
Men, under 18	12.5%	12%	12.5%
Women, over 18	50%	48%	43.7%
Women under 18	12.5%	16%	9.4%

So, it is obvious that the radio with the specialized appeal is coming in. There's a model for the kitchen, one for the automobile, one for the kid's room. The armchair model is built for the old man, who limps home each night tired and footsore. The fact that it happens to appeal to the interior decorator's new scheme of things and fits into modern apartments is just so much lagniappe.

along the edges of the room, it is much tougher for the console to fit into the scheme of things.

These experts at dressing up a room to look pretty had a word for their idea. They called the new arrangement of furniture, "conversational groups." It was based on the fact that human animals like to pop down close to one another for their chatter or cup of tea. Coffee tables, sofas, chairs, all were placed so that any folks that tumbled into them would find themselves looking into one another's eyes.

"An armchair radio does double duty," one of the housefurnishing experts at Marshall Fields said. "You can only put a vase or a clock on a console. On the armchair set you can drop books, cigarettes, ashtrays, magazines, sewing, cocktails or anything—even play a round of cards. You can rearrange your furniture frequently, which you can't do so well with a console."

Rosalie Flank, who experts on such things over at the world-famous Furniture Mart, sums up the case for the armchair radio in this way:

TUNING Yesterday

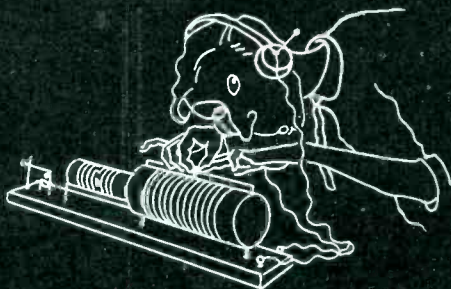

1921 CRYSTAL—Adjusting the "cat's whisker", setting the sliders was a critical, complicated business requiring both skill and patience

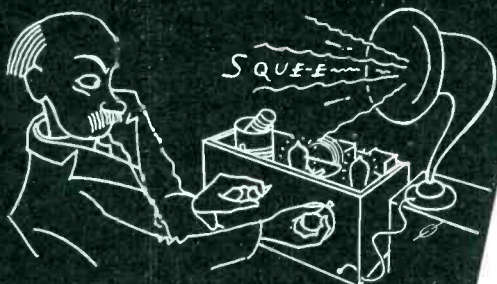

1923 REGENERATIVE— Manipulating the "tickler" to give maximum volume and sharpness, without squealing, was a ticklish and tortuous job

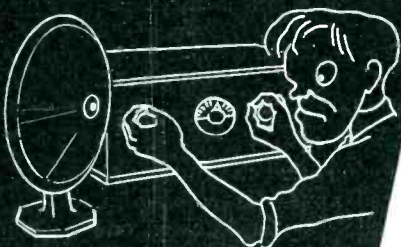

1925 THREE DIAL
— Synchronizing controls was no cinch, even when these "tracked" fairly close together on major broadcast stations

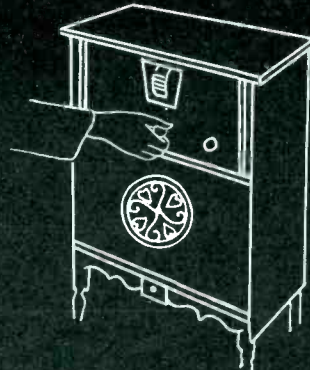

1927 ONE KNOB—Simplicity was later improved by substituting kilocycles for arbitrary dial numbers, including visual indicators

and TODAY

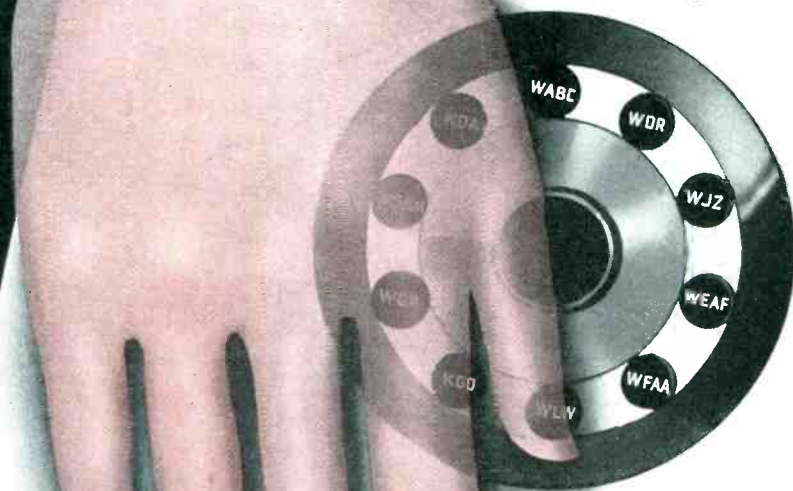

1938 Automatic — Easy as pointing, easier than dialing a telephone number, as fast as you can think what program you want there it is!

**RADIO
RETAILING**

A Single, Simple Motion Brings In Your Favorite Station On a Modern Radio

KADETTE LEADS

IN LEADING CITIES

From Canada to the Gulf—from the Atlantic to the Pacific—the country's largest retailers acknowledge Kadette as radio's fastest selling line.

In every major city these sensational Kadettes are bringing the public into dealers' stores.

The amazing value of Kadette's 10 tube model for only \$19.95 is bringing dealers the greatest floor traffic of any radio ever produced.

From every corner of the country evidence continues to pour in that these 1938 Kadettes are the "hottest" line of the year. And there's a good reason—they're backed with as wide-awake and complete promotional plans as you have ever seen!

Are you profiting by one of radio's biggest opportunities? Get in touch with your jobber NOW.

A FEW CONSISTENT ADVERTISERS OF KADETTE RADIOS

DAVEGA-CITY RADIO CO.	New York City	DENTON, COTTIER & DANIELS	Buffalo, N. Y.	MARSHALL FIELD CO.	Chicago, Ill.
R. H. WHITE CO.	Boston, Mass.	C. E. CHAPPELL & SONS	Syracuse, N. Y.	ED SCHUSTER & CO.	Milwaukee, Wisc.
DENHOLM & MCKAY	Worcester, Mass.	THE HIGBEE CO.	Cleveland, Ohio	JOHNSON & HILL CO.	Wisconsin Rapids, Wisc.
HOMER FITTS CO.	Barre, Vt.	NEWMAN-STERN CO.	Cleveland, Ohio	DAVIDSON-BOUTELL CO.	Minneapolis, Minn.
AGEL-CORMAN FURN. CO.	Burlington, Vt.	RIKE-KUMLER CO.	Dayton, Ohio	DAYTON CO.	Minneapolis, Minn.
WHITNEY'S	Albany, N. Y.	LEED'S, INC.	Cincinnati, Ohio	R. N. CARDOZO & BROS.	St. Paul, Minn.
LUCKEY-PLATT CO.	Poughkeepsie, N. Y.	ELDER & JOHNSTON CO.	Dayton, Ohio	FAMOUS-BARR CO.	St. Louis, Mo.
STERN & CO.	Philadelphia, Pa.	BING CO.	Cleveland, Ohio	HARTMAN'S	Dubuque, Iowa
GEORGE'S RADIO CO.	Washington, D. C.	BEAR FURN. CO.	Akron, Ohio	DAVIDSON'S	Des Moines, Iowa
RALEIGH FURN. CO.	Raleigh, N. C.	HADLEY FURN. CO.	Fort Wayne, Ind.	DENVER DRY GOODS CO.	Denver, Colo.
RABB-SMITH CO.	Greensboro, N. C.	WILLIAM H. BLOCK CO.	Indianapolis, Ind.	COAST RADIO CO.	Seattle, Wash.
J. B. FVEY & CO.	Charlotte, N. C.	PEARSON CO.	Indianapolis, Ind.	HOPPER-KELLY CO.	Seattle, Wash.
BOCOCK-STROUD CO.	Winston-Salem, N. C.	J. L. HUDSON CO.	Detroit, Mich.	THE HUB	Marshfield, Oregon
PHOENIX FURN. CO.	Columbia, S. C.	PEOPLE'S OUTFITTING CO.	Detroit, Mich.	SCHWABACHER-FREY CO.	Los Angeles, Calif.
BURDINES	Miami, Fla.	WIEBOLDT STORES	Chicago, Ill.	JENKINS MUSIC CO.	Kansas City, Mo.
DAVISON-PAXON CO.	Atlanta, Ga.	CHARLES T. WILT CO.	Chicago, Ill.	GIMBEL'S	Pittsburgh, Pa.
KILGORE FURN. CO.	Birmingham, Ala.				
LOWENSTEIN'S	Memphis, Tenn.				
DALTON'S	Baton Rouge, La.				
LAWRENCE FURN. CO.	New Orleans, La.				
TITCHE GOETTINGER	Dallas, Texas				
STAR FURN. CO.	Houston, Texas				
LITTLE PAL	Houston, Texas				
McCURDY'S	Rochester, N. Y.				

INTERNATIONAL RADIO CORPORATION
354 WILLIAMS STREET, ANN ARBOR, MICHIGAN

KADETTE
THE WORLD'S BEST VALUE

WHY WAIT 'til it



IRRISOME to servicemen, and to manufacturers who sell \$11,000,000 worth of radio parts yearly is the fact that nearly all owners wait until disaster takes place before they spend a nickel for repairs.

Important, because 15 per cent of the country's radios are buzzing, whistling, humming, hoarse-voiced, unsatisfactory, and approaching that stage where they go blotto.

This, right at a time when the big money programs of the air are coming on—the million dollar entertainment and sports that make one want to glue his ear to the old loud speaker. The season approaches when comics like Jack Benny and Fred Allen cavort and the symphonies are lushest.

"What's to be done?", the large parts makers ask. "The average fellow is like the fellow who locks the stable after his horse is stolen."

Take a tip from the automobile business if you think nothing can be done. Look over other fields of endeavor if you believe that the average man has to get a kick in the pants before he will take action.

Listen to what Wallace Meyer, a streamline copy writer for Weed chain advertising, did. Meyer saw that it was too late to consider as a customer a guy whose car had started to slip on the ice—he was more of a candidate for a hospital. He observed that most people had to blunder into trouble before they would buy chains. He knew that

any man who has had the daylight's scared out of him didn't want it to happen again. Whereupon, Wallace Meyer hit upon the expedient of running this simple newspaper advertisement:

**Weather prediction: Icy tomorrow
Get your Weed chains now**

This copy was released to newspapers whenever weather predictions were right. It had the tremendous power of being timely and sold barrels and boxes of chains to people who didn't desire trouble.

The Stewart-Warner Corporation cashed in last spring on a similar warning. The Alemite division knew that no motorist wants an overheated car. Therefore they sounded

WON'T WORK?

Job crying for cooperative effort by servicemen and parts makers is education of public to avoid set failures as big programs start by checkup in early fall

a warning as spring was coming on, to change to summer lubricants. The suggestion was enough.

As this is written, the leaves are beginning to swirl down. Right now in the hands of the billboard firms are posters that say, "Warning—Put in your anti-freeze solutions now." The makers of Prestone have built up a tremendous gallonage out of a mixture that was totally unknown to the public a few years ago. Thanks to billboards, advertisements in the papers, and radio announcements, very few cylinder blocks are frozen these days.

Car owners have been successfully taught to get their automobiles ready for changes of season. They have their spark plugs cleaned, their brakes tested, their oil changed, all

before something actually happens.

Radios are possessed by the same mass market that owns automobiles. The organizations that sell the public on the idea of getting service in advance of disaster are not the automobile makers, but rather the group that compares to the servicemen and parts manufacturers in the radio field. They are the ones who profit by seeing that the cars give satisfactory service. They discovered it is a smart idea to tell the public to get going before something happens.

The fall and winter nights, with the world's top entertainment on the air are approaching. The radio parts manufacturers have the advantage of the automobile people in that they know when these big events are going to occur. In the automobile field

they have to wait for the freaks of the weather man. But they have found that the channels that get out newspaper, magazine, radio and poster advertising are unusually smooth functioning. Able to blazon a warning to act before a storm breaks. The same facilities can serve radio equally well.

Warning advertising benefits everybody in the automobile business. When an owner is tipped off to change oil, to change lubrication, to buy chains, his prompt action tinkles the cash registers of everybody in the field. The poster put up in a dealers window helps sell every brand in that particular shop.

Remember this: Anywhere from 15 to 20 per cent of the radios in this country are buzzing, humming, hoarse-voiced and verging on incoherence. A lot of owners are tolerating them when they need only a prod to take action and get them fixed up. That action will be based on the desire to have things shipshape when some big program comes along. If servicemen and parts manufacturers really want to hit when the iron is hot, that is the angle that will turn the trick.

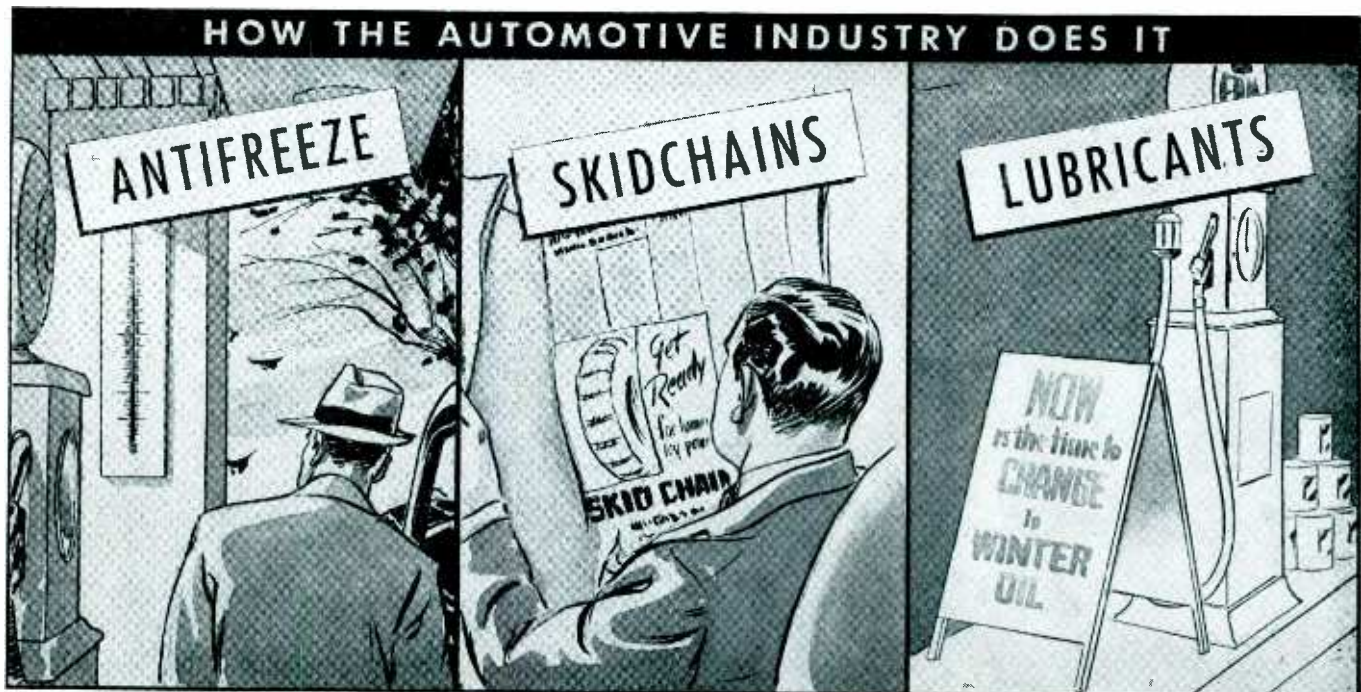

Thermometers in every service station remind drivers temperature is going down

Newspaper ads insidiously tell readers it will be "icy on the roads tomorrow"

Signs call attention to seasonal change and the need for lighter oils



EMERGENCY—When infantile paralysis broke out in Chicago not owning a good radio was equivalent to playing "hookey." For school opening was postponed two weeks, teachers took the air, taught pupils listening in at home



NOVELTY—Tickling the fancy of the younger generation is an innovation introduced by Stewart-Warner's Horace Heidt. The King Sisters produce an unusual rhythm effect with cocktail shakers full of BB shot

BIG TIME BROADCASTS

Fall Programs Have What It Takes



Feuding with a dummy...
W. C. FIELDS



Blonde bombshell...
ALICE FAYE

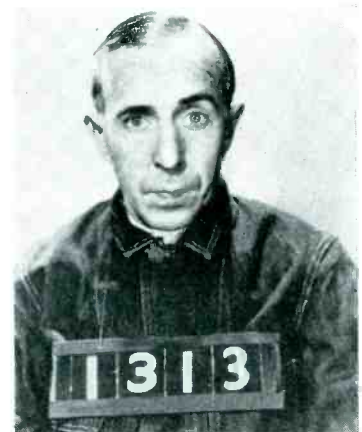

Doubly lucky...
CHARLES BUTTERWORTH

NAMES—From Hollywood come stellar performances by screen stars such as these. Programs originating in the West Coast movie Mecca continue to intrigue the nation



● PHANTOM ACE MODEL 568 DW—5 tubes—two-tone ivory and mahogany.

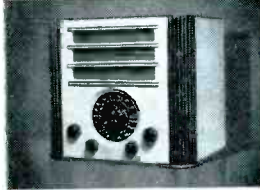

● PHANTOM PAL MODEL 518 DW—5 tubes—two-tone ivory and mahogany.

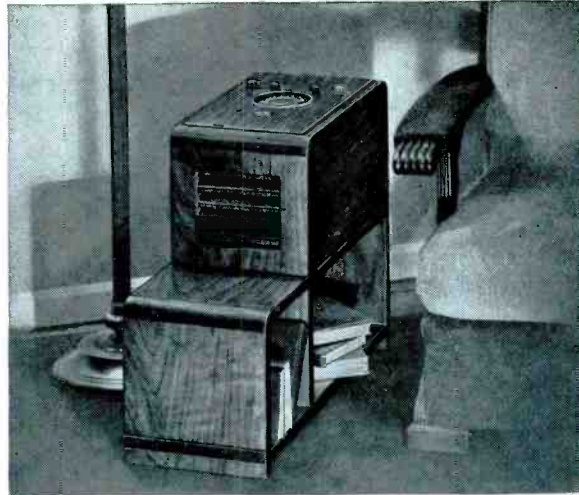

● PHANTOM GRAD MODEL 638 CS—a lovely 6-tube chairside radio with built-in shelves for books and magazines. An exceptional value.

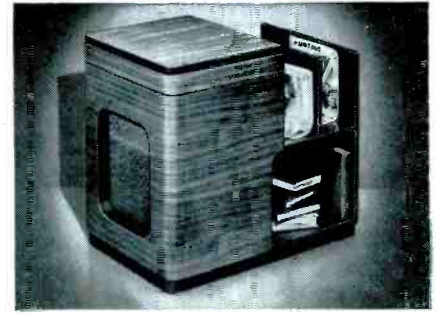

● PHANTOM DEB MODEL 838 CS—8-tube chairside set. Fold-over top hides controls.

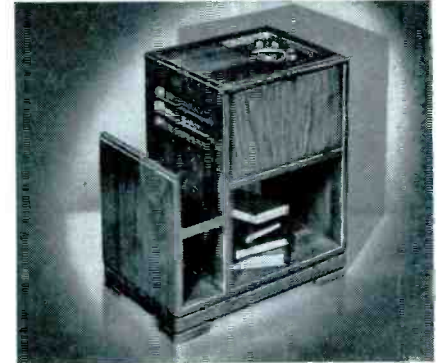

● PHANTOM MATE MODEL 528 CS—5-tube chairside radio at a low price.



● PHANTOM VOGUE MODEL 848 CS—8-tube chairside combination radio-phonograph.

● PHANTOM PRESIDENT MODEL 828 AT—8 tubes with automatic stop-light station tuning. Also Phantom Beauty Model 828A without automatic tuning.

Smart Style Additions
 TO THE 1938 LINE OF
ARVIN RADIOS

With these smart new additions to the line, Arvin now offers more than 30 models, featuring styling that appeals and better radio reception with the Phantom Filter Circuit—two fundamental qualities that sell radios. Of course, Arvin has automatic tuning and all the other features you've heard so much about—but Arvin offers, in addition, better-looking and better-performing radios at most attractive prices.

NOBLITT-SPARKS INDUSTRIES, INC. • COLUMBUS, INDIANA

● PHANTOM PRINCESS MODEL 838 AT—8 tubes with automatic stop-light tuning.

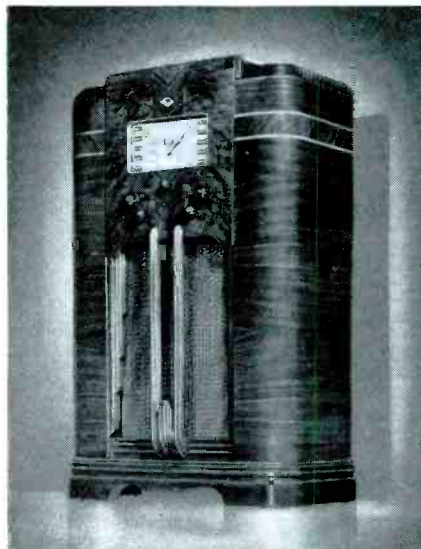

● PHANTOM FAWN MODEL 638—6-tube console at a modest cost.



TIME ... Its effect on a typical transaction

37 DAYS		50 DAYS	
\$ 100 SALE	\$ 100	
-62 COST OF GOODS SOLD	-62	
<u>\$ 38</u> GROSS PROFIT	<u>\$ 38</u>	
-15 DIRECT SELLING EXPENSE	-15	
<u>\$ 23</u> SELLING PROFIT	<u>\$ 23</u>	
-17 OPERATING EXPENSES	-23	
<u>\$ 6</u> NET PROFIT	<u>\$ 0</u>	

T U R N O V E R

UNLIKE department stores and retail chains, many independent dealers with administrative attention focused on sales totals are prone to give little or no attention to the element of time in its relation to the movement of merchandise. In the delusion of wide profit margins and normal sales volume it is natural to assume that all sales made above cost result in a profit. If the independent dealer could go behind the scenes with his large competitors he would see the fallacy of this belief reflected in the emphasis placed on stock turnover.

With an investment frequently too small, the independent must use his capital with higher efficiency than does his large competitors. The way to increase turnover for more profit is not to reduce price but to concentrate investment on fast moving goods and eliminate stock whose sales do not measure up to a profitable standard. It follows then that a standard should be set, all units within the inventory to be measured in the light of this standard.

To illustrate a business just within the satisfactory class has been typified. The proprietor has an investment of \$5,000, new merchandise

By Russell B. Rich

sales amount to \$40,000 annually. The proprietor takes the regular commission on sales that he makes and in addition must have an annual income in the form of net profit from the sales end of the business of \$2,400 to justify its existence. For the sake of simplicity in this example sales of service, together with costs and expenses chargeable to this operation, have been eliminated.

The average inventory for the year is found to be as follows:

Inventories		At Cost	At Retail
January	1	\$1,900	\$3,065
March	31	2,900	4,677
June	30	2,600	4,193
September	30	3,100	5,000
December	31	2,000	3,226
Average		2,500	4,032

In the Statement of Profit and loss below under "Actual" is the sales operating history for the year.

STATEMENT OF PROFIT AND LOSS

	Actual	Per cent Sales	Minimum Standard
Sales.....	\$40,000	100	\$29,565
Less: Cost of goods sold.....	24,800	62	18,330
Gross profit.....	\$15,200	38	\$11,235
Deduct direct selling expenses:			
Overallowances on			
trade-ins..... \$2,000		5	\$1,478
Commissions..... 3,600		9	2,661
Reserve for servicing 400		1	296
Total.....	6,000	15	4,435
Selling profit.....	\$9,200	23	\$6,800
Operating expenses.....	6,800	17	6,800
Net profit.....	\$2,400	6	\$ 0

Under direct selling expenses "Overallowances on trade-ins" represents price concessions made in the form of allowances on trade-ins in excess of their actual value—resale value less cost of repairs and replacements needed to put them in shape for resale.

Service reserve is a provision out of sales to cover subsequent costs of possible service work that may have to be done without charge in ac-

37 days with cost of goods sold and direct selling expenses remaining at the same percentage of sales.

So far the inventory has been taken as a whole and we have been dealing with averages. Within the inventory certain articles have turned 15 or 18 times, others only 5 or 6 times. However, it would seem that an item selling on a gross margin of 38 per cent about once in 37 days has been satisfactory from the standpoint of profits. The Unit Sales Analysis below (left hand column—37 days) shows what actually happens when an article priced at \$100, costing \$62 with direct selling expenses of 15 per cent of sales is sold on the 37th day after receipt. Annual overhead of \$6,800 amounts to \$18.63 per day. Therefore, the overhead absorbed by this item is the portion of average inventory at cost that it represents multi-

—in other words the number of sales necessary to break even on the item.

Alongside the Statement of Profit and Loss—Actual, figures reflecting a Minimum Standard have been arrived at in this way: Eliminating a net profit, the selling profit of \$6,800 is required to cover overhead which will fluctuate very little with sales volume. Direct selling expenses and cost of goods sold will be the same percentages of sales. Therefore sales amounting to \$29,565, resulting in gross profit of \$11,235 are needed to cover all expenses without anything left over.

In reaching the sales total of \$29,565 with an average inventory of \$2,500 at cost, stock must turn 7.33 times per year at a gross profit of 38 per cent or once in about 50 days. Any article not up to this standard is absorbing too much overhead and



Dealers having small investments must use their capital with even greater efficiency than department stores and chains

plied by the daily cost of overhead and again, by the number of days in inventory or

$$62/2500 \times \$18.63 \times 37 = \$17$$

	37 Days	50 Days
Sale	\$100	\$100
Cost of goods sold	62	62
Gross profit	\$ 38	\$ 38
Less: direct selling expenses	15	15
Selling profit	\$ 23	\$ 23
Less: Operating expenses	17	23
Net profit	\$ 6	\$ 0

Setting a Minimum Standard

However, this stock turn of 9.92 times is a standard average that must be maintained or exceeded. Somewhere below it is a minimum that must be found and applied as a test for each item of inventory. Presume this minimum to be the number of turns per year that will show no loss after applying overhead to each sale

in consequence is being handled at a merchandising loss.

In the Unit Sales Analysis (right hand column—50 days) may be seen the application of overhead on this basis.

$$62/2500 \times \$18.63 \times 50 = \$23$$

Effect of Special Discounts

So far the principle has applied only to goods selling on a gross profit margin of 38 per cent, the ratio of sales as a whole. However the inventory contains items that produce a greater or less margin than the average due to varying discounts and to selling prices set at variance with list prices. A \$100 sale costing \$50—a gross profit of \$50—less selling costs of \$15 would be

$\frac{50}{2500} \times \$18.63 = \3.726 per day, selling profit — \$35. $\div \$3.726 = 94$ days or, more simply:

$$\frac{35}{\left(\frac{50}{2500} \times 18.63\right)} = 94$$

representing a turnover of 3.88 times annually as a minimum. Inversely, a

(Please turn to page 53)

cordance with service policies and sales guarantees.

Determining Overhead Per Day

To arrive at the stock turnover divide the sales amounting to \$40,000 by the average inventory at retail—\$4,032 = 9.92 turns per year, or once in about 37 days. (The same result may be had by dividing cost of sales—\$24,800 by average inventory at cost—\$2,500). This means that to cover operating overhead chargeable against merchandise sales and show a net profit from sales of \$2,400 an average inventory at cost of \$2,500 must average a complete turn every

Green Pastures this winter FOR YOU



MILLIONS OF LIVE PROSPECTS TODAY

A nation-wide survey by Radio Retailing reveals this startling fact—

"If the government's ambitious 8-year rural electrification plan is carried out, 1945 will still find more than 4,000,000 farms without this service."

This map (see legend at right) shows the enormous potential in farm radio business open to you—regardless of what progress has been made in "high-line" development.

KEY . . . shows areas energized or construction started.

Crash this fertile market at a real profit with the new Willard Radio Batteries

Are you ready for what promises to be the biggest year for battery-receiver sales in radio history? If you're in a position to "cash in" with a good line of farm radios, remember this—the quality of the reception in a 2 or 6 volt set can be no better than the INSIDE quality of its batteries.

Don't gamble your reputation on inferior batteries! Don't risk losing good customers. Your customers will be better satisfied and you'll make a better profit selling Willards.

Designed and built especially for radio use, these Willard Radio Batteries last longer, perform better and cost less to own. In them you'll find the same dependability that make Willard Automotive Batteries first choice among the millions of American car owners.

And Willard has a special "Radio Dealer Proposition" that makes it easy and profitable to add these popular-priced batteries to your radio lines—plus a "cracker-jack" merchandising plan that really moves 'em.

For your reputation's sake, for profit's sake, tear out and mail the coupon today.

FREE Information—Make More Profits

WILLARD STORAGE BATTERY CO., CLEVELAND, OHIO
If it means more profit to me, I want the details of your SPECIAL proposition on radio batteries.

Name _____

Address _____

City _____

State _____

Willard

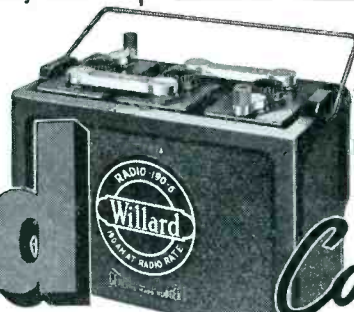

Radio Batteries

Cost less to own

... BECAUSE THEY LAST LONGER AND PERFORM BETTER

A WINDOW THAT WON'T WEAR OUT

By I. L. Cochrane

1 THE FINISHED DISPLAY

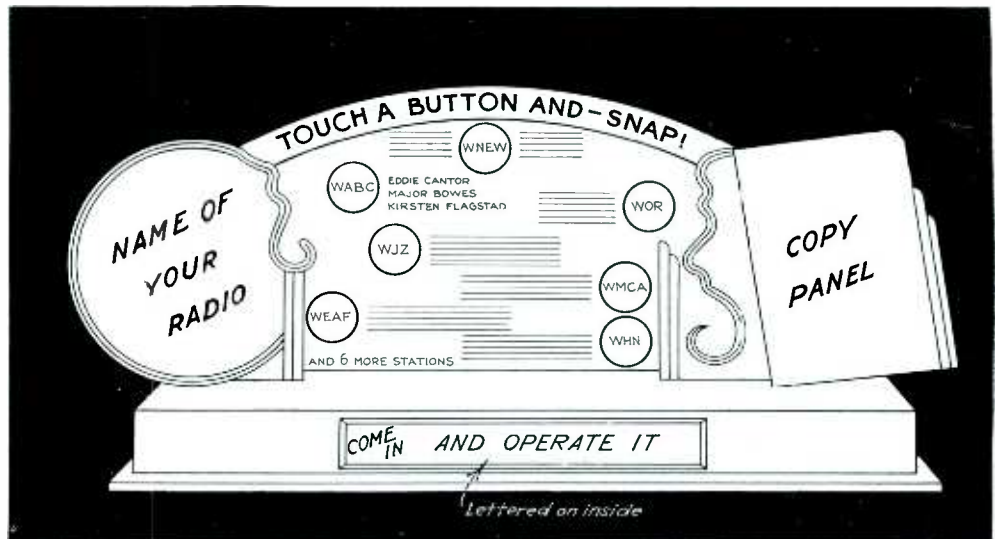

2 CENTER SECTION DETAILS

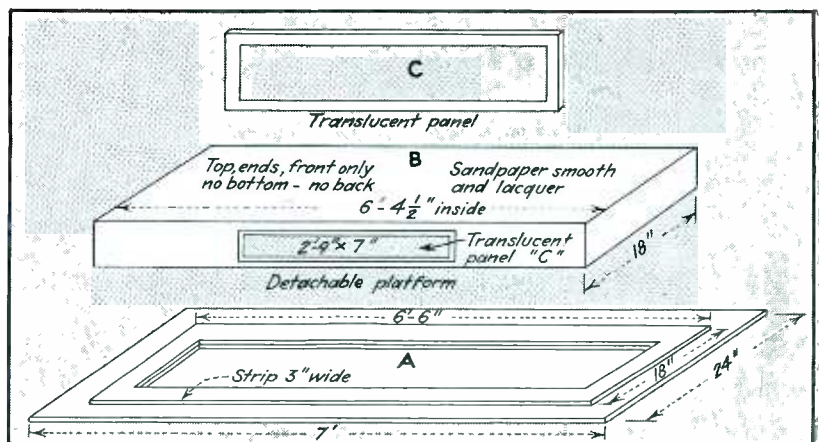
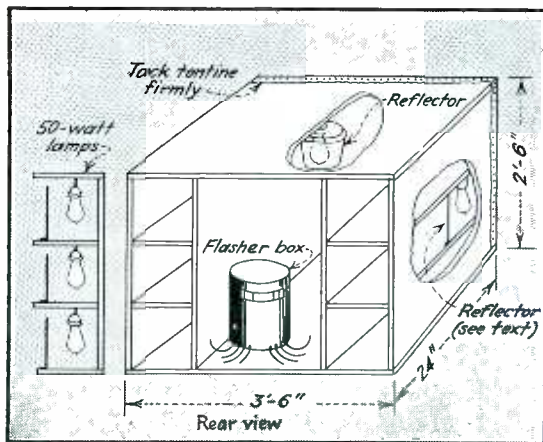

The display described costs no more than \$30 to build. In articles to follow the author will tell how it may be varied and adapted to other types of merchandise, at slight additional cost, providing a novel and effective motion window throughout an entire season.

NOW we have automatic tuning. This new lazy man's aid has something fascinating about it which can be readily dramatized in a radio store window. One might say that automatic tuning was made to be sold in this manner. To any display man, and to most dealers, the pulling power of the setup described in the following paragraphs will be obvious.

Shown finished in illustration 1, it

will be seen the display consists of four separate units, three show sections and a base. Flash! The disc marked WEAF lights up. Two seconds on and then out again. Then WOR, and so on until the whole series of stations has been covered. Finally, the translucent panel in the base lights up. Then the station series is repeated all over again.

The two end show pieces are decorated cardboard cutouts. Manufacturers' lithographs may, of course, be substituted for these. If a poster of a young lady pressing tuning buttons, for example, is available, colored ribbons might be run from each of the painted buttons under her fingers to the lighted circles of the display. An

(Please turn to page 52)

3 BASE CONSTRUCTION

4 THE FLASHER UNIT



AND THEIR PRODUCTS

MANUFACTURER'S NAME AND ADDRESS	P. A. System		Int. Comm.		Pickup Tuntable Com	Mikes					Horns — Baffles	Recording Blanks	P. A. Amplifiers	Record Changers	Pick-ups		Spkra.		Recording Mach.		
	Portable	Fixed	Mobile	Wireless		Cable-Connected	Crystal	Dynamic	Carbon	Velocity					Condenser	Crystal	Magnetic	P M Dyn		Dynamic	Magnetic
Intercall Systems, Inc., Fifth & Norwood, P. O. Box 615, Dayton, Ohio.																					
International Business Machines Corp., 270 Broadway, New York, N. Y.																					
Jefferson Elec. Co., Hellwood, Ill.																					
Jenkins & Adair, 3333 Belmont Ave., Chicago, Ill.																					
Jensen Radio Mfg. Co., 6601 S. Laramie Ave., Chicago, Ill.																					
Kreisler Communication, Inc., 250 W. 57th St., New York, N. Y.																					
Lansing Mfg. Co., Los Angeles, Calif.																					
La Salle Radio Corp., 140 Washington St., New York City																					
Leotone Radio Inc., 63 Dey St., New York, N. Y.																					
Lifetime Corp., 1012 Madison Ave., Toledo, Ohio																					
Lipman Eng. Co., 415 Van Braam St., Pittsburgh, Pa.																					
Fred M. Link, 125 W. 17th St., New York, N. Y.																					
Magnavox Co., 2131 Ruefer Road, Fort Wayne, Ind.																					
Marcophonie, Inc., 679 Madison Ave., New York, N. Y.																					
Melophone Corp., 714 University Ave., Rochester, N. Y.																					
Miles Reproducer Co., 812 Broadway, New York, N. Y.																					
Mirror Record Corp., 58 W. 25th St., New York, N. Y.																					
Morlen Electric Co., Inc., 60 W. 15th St., New York, N. Y.																					
Operadio Mfg. Co., St. Charles, Ill.																					
Ottawa Radio Co., 308 W. Lafayette St., Ottawa, Ill.																					
Oxford Tartak Radio Corp., 915 W. Van Buren St., Chicago, Ill.																					
Pierce Airo, Inc., 510 Sixth Ave., New York City																					
Pacent Eng. Corp., 79 Madison Ave., New York, N. Y.																					
Paekard Elec. Ft. Wayne, Ind.																					
Philco Radio & Tel. Corp., Philadelphia, Pa.																					
Pictur-Fone Co., 212 W. North St., Lima, Ohio																					
Piezoelectric Labs., 612 Rockland Ave., New Dorp., N. Y.																					
Pilgrim Elec. Corp., 44 W. 18th St., New York City																					
Portomatic Corp., 1013 Madison Ave., New York, N. Y.																					
Presto Recording Corp., 139 W. 19th St., New York, N. Y.																					
Proctor & Co., 17 W. 60th St., New York, N. Y.																					
Public-Ad. Inc., 2015 E. 65th St., Cleveland, Ohio																					
Quam-Nichols Co., Cottage Grove Ave. & 33rd Place, Chicago, Ill.																					
Racon Elec. Co., 52 E. 19th St., New York, N. Y.																					
Radio Amplifier Labs., 59 Walker St., New York, N. Y.																					
Radio Receptor Co., 251 W. 19th St., New York, N. Y.																					
Radio Speakers, Inc., 1338 S. Mich. Ave., Chicago, Ill.																					
Radiofone Corp., 136 West 22nd St., New York, N. Y.																					
Radiotone Recording Co., 6103 Melrose Ave., Hollywood, Calif.																					
Rauland Corp., 3341 Belmont Ave., Chicago, Ill.																					
RCA Mfg. Co., Inc., Front and Cooper Sts., Camden, N. J.																					
Recording Equipment Mfg. Co., 6611 Sunset Blvd., Hollywood, Calif.																					
Regal Amplifier Mfg. Corp., 14 W. 17 St., New York, N. Y.																					
Remler Co., Ltd., 2101 Bryant St., San Francisco, Calif.																					
Rola Co., 2570 E. Superior Ave., Cleveland, Ohio																					
Segelsound, Inc., Gardner, Mass.																					
Setchell-Carlson Co., Inc., 2233 University St., St. Paul, Minn.																					
Shure Bros Co., Inc., 225 W. Huron St., Chicago, Ill.																					
Simplex Elec. Co., 100 Fifth Ave., New York, N. Y.																					
Samors Electric Phonograph Co., Inc., 160 Varick St., New York, N. Y.																					
Sound Products, 704 N. Curson Ave., Hollywood, Calif.																					
Sound Systems, Inc., 6545 Carnegie Ave., Cleveland, Ohio																					
Speedway Mfg. Co., 1834 S. 52nd Ave., Cicero, Ill.																					
Stromberg Carlson Tel. Mfg. Co., Rochester, N. Y.																					
Sundt Eng. Co., 4238 Lincoln Ave., Chicago, Ill.																					
Tech Laboratories, 703 Newark Ave., Jersey City, N. J.																					
Techna Corp., 926 Howard St., San Francisco, Cal.																					
L. H. Terpening, 220 E. 23rd St., New York, N. Y.																					
Toledo Sound Equip. Labs., 1215 Jackson Ave., Toledo, Ohio																					
Transducer Corp., 30 Rockefeller Plaza, New York, N. Y.																					
Transstone Corp., 14 W. 45th St., New York, N. Y.																					
Transformer Corp. of America, 69 Wooster St., New York City																					
Turner Co., Cedar Rapids, Iowa																					
Unit Reproducers Mfg. Co., 999 E. Main St., Rochester, N. Y.																					
United Reproducers, Springfield, Ohio																					
United Scientific Labs, Inc., 510 8th Ave., New York, N. Y.																					
United Sound Eng. Co., 2229 University Ave., St. Paul, Inc.																					
United Sound Products, 818 W. North Ave., Chicago, Ill.																					
Universal Microphone Co., Inglewood, Calif.																					
Upco Eng. Labs., Inc., 254 Canal St., New York, N. Y.																					
Vibro-Master Co., 29 W. 57th St., New York, N. Y.																					
Utah Radio Products Co., 820 Orleans St., Chicago, Ill.																					
Victory Speakers, Inc., 7131 E. 14th St., Oakland, Calif.																					
Webster - Chicago, 5622 Bloomingdale St., Chicago, Ill.																					
Webster Elec. Co., Racine, Wis.																					
Western Elec. Co., 195 Broadway, New York, N. Y.																					
Wright DeCoster, Inc., 2233 University Ave., St. Paul, Minn.																					

A BEST SELLER AMONG RADIO DEALERS!

The new—pocket size

“RADIO TRADE-IN ALLOWANCE BLUE BOOK”

to

- end the bickering and trouble over a fair trade-in price and to
- help radio dealers make a decent net profit on set sales!

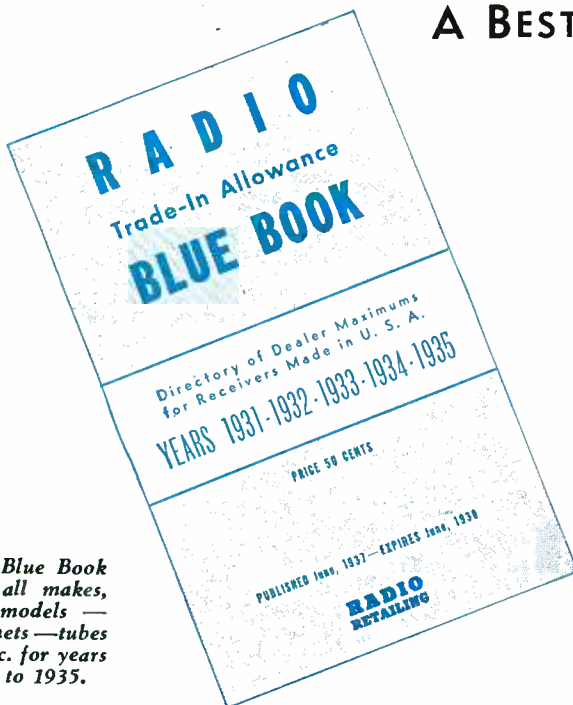

The Blue Book lists all makes, and models — cabinets — tubes — etc. for years 1931 to 1935.

Radio Dealers can use this handy "Trade-In Blue Book" to

- end the wrangling over the proper "trade-in" allowance on an old radio set.
- establish a basis for appraising old receivers so that a legitimate net profit is obtained on the new set sale.
- give official appearance to the "trade-in" allowance quoted the customer.
- to offset competitive allowances which are out of line with a just valuation.
- refer to in front of customer and show that the figure the dealer quotes is in excess of the suggested allowance for any set.

ORDER YOUR COPIES TODAY

Do "trade-ins" make your store a battle ground? Every radio dealer has to face the problem of appraising "trade-in" sets on which too generous an allowance wipes out the net profit from the sale of a new receiver and too small an allowance drives the customer to a competitor's store.

To help dealer's arrive at a just "trade-in" allowance figure, Radio Retailing has published the first authentic, comprehensive directory of "trade-in" maximum allowances ever compiled for radio receivers made in this country from 1931 to 1935. This un-paralleled data appeared in Radio Retailing's June issue but the immediate demand for it was so wide spread that the entire directory was reprinted in a handy, pocket-size book and is now offered to the trade at a nominal price.

Every radio dealer should have this book on his counter and in the hands of his salesmen. It can be used to drive home to the customer a semi-official "trade-in" figure which is fair to the dealer and will insure a legitimate profit on the sale of any receiver. An investment of 50c in the **TRADE-IN ALLOWANCE BLUE BOOK** may save you hundreds of dollars in the course of the year and eliminate most of the headaches arising from lengthy arguments with your customers.

Order a copy of the "Radio Trade-in Allowance Blue Book" for your store today and you'll be surprised at its value as a year around selling aid. Simply attach the coupon to your letterhead and mail it with the fee.

**SINGLE COPIES
50c Each**

Quantity Rates as Follows:

- 25-99 Copies—40c each
- 100-499 Copies—35c each
- More than 500 Copies—25c each

All Orders for Less than 10 Copies Must Be Accompanied by Full Remittance in Currency, Check or Money Order

USE THIS HANDY COUPON TO ORDER YOUR COPIES TODAY

RADIO RETAILING
330 W. 42nd St., New York, N. Y.

Gentlemen:

Attached is \$.....for which you are to send mecopies of the handy, pocket-size "RADIO TRADE-IN ALLOWANCE BLUE BOOK" by return mail, postage pre-paid.

Remittance Must Accompany This Order

Name

Firm

Street

City State.....

RR10-37

October

NEWS

Servicers Spike Consumer Sales

Use purchase orders making jobbers liable for any losses due to extension of discounts outside trade

MINNEAPOLIS—The Radio Service Dealers Association of this city has adopted a standard purchase order form on which members order sets, parts and other equipment from jobbers. On the bottom of each form is the following, under the heading: "Terms of Purchase."

The acceptance of this order constitutes approval of the following terms of purchase by the jobber:

1. That the jobber agrees to comply with the Minnesota Unfair Trade Practices Act, Laws 1937, Chapter 116 and the Minnesota Fair Trade Act, Laws 1937, Chapter 117.
2. That the jobber specifically agrees to sell the above items at less than the manufacturer's list prices only to bonafide retailers of this kind of merchandise.
3. That the jobber will use every means at his command to impartially protect all his dealers against the violation of the manufacturer's list prices.
4. That the jobber hereby agrees to honor industrial purchase orders intended for employees purchases as strictly consumer buying entitled to the manufacturer's list prices only.
5. If the above terms of purchase are not acceptable to the jobber, this order must be cancelled and the dealer immediately notified.
6. That the dealer placing this order is entitled to collect damages equivalent to the

dealer discount plus costs of prosecution if injured by violation of these terms.

This new plan went into effect June 15 and to date no jobber has refused to accept orders so filed. Before printing up the forms copies were submitted to the Minnesota State Attorney General's office by a committee and a verbal opinion rendered that there was no objection to the plan and no reason why the Association should not advocate it. The Association is, however, in no way involved as each purchase order becomes a separate legal contract between the dealer and the jobber.

M. R. Iverson is president of the Association, and H. H. Cory secretary.

Fada-New Jersey Formed

ELIZABETH, N. J.—Fada Radio of New Jersey is a new distributing organization formed here by interests backed by Anthony and Frank Larco. Located at 1115 Elizabeth Avenue, this new organization will serve dealers throughout the state, with the exception of those in the lapover territory adjoining Pennsylvania, handled by the Rumsey Electric Company of Philadelphia.

While the new organization, which will



CLARION'S KELLY—A Chicago girl, *Dorothy Kelly*, Clarion Corp's new sales promotion manager, spent seven years in the Panama Canal Zone, majored in Journalism at Northwestern University, studied English three years at the University of California, took a course in design and illustration at Chicago Academy of Fine Arts, has written copy on everything from teapots to tractors for a large chain, knows both the wholesale and retail specialty appliance business



FARALLONE NO MORE LONELY—To the hitherto lonely Farallone Island lighthouse and direction finder station, 32 miles off San Francisco, comes a new RCA console, along with equally essential food supplies

take over servicing as well as merchandising activities, represents no capital affiliate of the Fada Radio and Electric Company of Long Island City, N. Y., its nearness to the factory, according to officers, will permit service tantamount to what would be available were the factory itself to organize a new distributing company.

Fair Trade For UniveX

NEW YORK—F. G. Klock, sales manager for the Universal Camera Corporation, maker of the UniveX movie outfits, advises this company is now operating under Fair Trade Laws in 42 states where such legislation has been enacted, maintaining prices rigidly in these states.

Bendix Washer Shown

Unveiled to trade at company's first convention Sept. 23.

SOUTH BEND—Priced at a figure which will allow for a trade-in and a substantial commission to specialty men, the Bendix washer made its bow at the first convention of Bendix Home Appliances, Inc., here September 23.

Seventy-five distributors and their men, assembled from coast-to-coast, saw at first hand a machine which many of them had bought sight unseen. Realizing that he was presenting the unusual, sales manager Judd S. Sayre of Bendix marshalled his story as carefully as a lawyer before the bar. F. K. Hanlin of Underwriters' Laboratories vouched for Bendix washer construction. Carl Smelzer of Lever Brothers, soap makers, testified to its efficiency and economical soap consumption. Katharine Fisher of Good Housekeeping magazine declared that the machine came through with flying colors on their tests, and awarded the star of approval.

President D. O. Scott stated that the patent situation was satisfactory, and that the firm did not intend to license other makers.

W. H. Leininger, advertising manager, new from the automobile field, presented probably the most elaborate promotion program in the washer field.

Emerson EHFA Approved

WASHINGTON—The Electric Home and Farm Authority has just approved an arrangement with the Emerson Radio & Phonograph Corporation of New York whereby the Authority will cooperate with public utilities in financing the sale of Emerson receivers to consumers located on their lines.

Radiotron Plant Expansion

HARRISON, N. J.—RCA Radiotron is shortly to start construction of a new factory building here, at an estimated cost of between \$750,000 and \$1,000,000, according to Mayor Frederick J. Gas-



BENDIX EXECS—Judd S. Sayre, sales manager, and Vincent Bendix, meet distributor A. A. Schneiderrhahn of Des Moines



AD MAN—W. H. Leininger, advertising manager, put on a promotional show in the automobile manner

sert. Much of this additional space, it is understood, will eventually be devoted to the manufacture and storage of television tubes.

Consolidated's Sharp

CHICAGO—Sam Sharp, well-known to the middle-west for his activities in the capacitor business, is now with Consolidated Wire & Associated Corporations, handling manufacturers' sales of Red Head condensers.

New Service Group Formed

Seeks affiliation of local organizations now functioning without central coordination unit

CHICAGO—Radio Service Men of America, Inc., is the name chosen by a new association with national ambitions, just formed here. Joe Marty of Room 1533, Monadnock Block, is busy contacting local organizations in its behalf, has already covered much ground in the East and Middle West, with the active assistance of the Sales Managers Club and a number of manufacturers.

The new national organization will, according to Marty, be run entirely by service men, functioning as a central source for the gathering and dissemination of information concerning developments in the radio field. It will, in this way, serve as liaison between manufacturers and individual local service organizations. Improving and promoting the welfare of servicemen will be another major objective.

Three Lucky Winners

NEW YORK—More than 2,000 participated in a competition staged by Transformer Corporation of America in behalf of Clarion amplifiers at the June Parts Show in Chicago. Winners, just announced, include Charles C. Tyler, chief electrician of the Chicago Grand Opera House, Arthur G. Mohaupt, service manager for Chicago's Devon Laboratories and W. M. Emery, radio service engineer from Coon Rapids, Iowa, prizes being awarded in this order.

Detrola Hires Two

DETROIT—Otto Heilmann and Earl F. Bryant, formerly with American Bosch, have joined Detrola, Heilmann as district manager in the St. Louis, Missouri territory and Bryant as district manager in the Denver, Colorado territory. Both are already well known to the trade in the territories they will manage.



RMA'S BOARD—Here's the Radio Manufacturers Association board of directors for 1937-1938

LONDON—Birds-eye of this season's very successful radio show held at Olympia



CHAIRSIDE — H.M.V. introduced this novel set, serving also as a bookcase, glass-topped table. The entire cabinet may be revolved



QUEEN—Chosen to represent "The Spirit of Radio", Miss *Elmina Humphreys*.

Jim Joins Norge

DETROIT—Paul Zimmerman, for 25 years with General Electric, a director of both G. E. Supply and G. E. Contracts, has joined Norge as general sales manager. John H. Knapp steps up to the position of assistant to president Howard E. Blood.

Four To Majestic

CHICAGO—Majestic Radio and Television has appointed F. S. Dahl to its sales staff, covering upper New York State under divisional sales manager Edward Fairchild. Fred Toole will cover Alabama and Georgia and the lower half of South Carolina under the supervision of divisional sales manager Herzog. Russell Fryburg has been appointed district supervisor of northwestern states embracing Oregon, Washington and parts of Utah and Montana, with headquarters at Portland. Parker Randall has been appointed to the territory comprising the eastern half of Iowa, under Frank Hawley, divisional sales manager.

May License Servicemen

DECATUR, ILL.—Radio servicemen operating here will join the ranks of businesses licensed and regulated by city ordinance if a proposal coming from a newly formed organization of 40 is approved by members of the city council.

Promotion of fair trade practices and weeding out of inefficient members of the craft are the chief purposes of the organization, according to Claude C. Nickerson of 742 North Main, who acted as spokesman.

Two New Wilcox-Gay Execs

CHARLOTTE, MICH.—C. M. Wilcox, president of the Wilcox-Gay Corporation, announces two appointments to the executive personnel of the company: Baynon Skinner as manager of the export division and Carl Clum in charge of advertising and sales promotion. The latter has been identified with national advertising agencies for the past fourteen years.

Stromberg In Fall Drive

Features Labyrinth in 11-day effort. Makes C.I.T. limited recourse finance plan available

ROCHESTER—In the eleven days between October 12 and 23 Stromberg-Carlson, with the help of its dealers, drives to make more people conscious of the tone quality permitted by its "Labyrinth" feature.

Advertising and store display material inviting the consumer to inspect modern models incorporating such design is going forward to the trade, is to be backed up by company advertising in consumer papers and national magazines. One of the most novel display pieces now going forward is a giant telegram in which Stromberg itself invites radio-minded consumers to see the sets in the store of a franchised dealer. This is to be used as the central piece of a window trim. Still another novelty is a Labyrinth puzzle-piece. Parts of the puzzle will be given to people entering stores and requesting them.

Simultaneously with the Labyrinth drive Edwin C. Roworth, treasurer of the firm, announces that Stromberg-Carlson has signed with C.I.T. to further extend the credit services already available to dealers. Under the new agreement dealers can now use the C.I.T. limited recourse plan as well as the wholesale and full recourse plans.

For Specialty Salesmanagers

NEW YORK—Fresh from the pen of James Maratta is a new, 93 page book (Council For The Improvement of Specialty Selling, Inc., 185 Madison Ave., \$2.50) entitled "How to Find and Train and Supervise Specialty Salesmen."

Written in the simple and forceful manner of an experienced sales manager who knows the language of his potential readers, the book contains the following interesting chapters: How to find specialty salesmen. . . How sales tools increase volume and profits. . . Teaching salesmen selling-sense. . . How to conduct group interviews. . . Will men work better for salaries or commissions? . . . The value of contests and prizes. . . Seven rules for supervising a local organization. . . Successful ways to find business. . . How to use sales literature.

Gooding Unveils Sparton

WILMINGTON—F. R. Gooding Company, local distributor for Sparton, held a meeting for Del-Mar-Va Peninsula dealers September 23, introduced E. T. H. Hutchinson and Peter J. Lynch from the factory to the trade. At a Monte Carlo party which followed Claud N. Cahall of Harrington, Delaware, won a Sparton set; Harry Peach of Wilmington collected a Hammond clock; J. Croft earned a set of Voss rinse tubs; Geo. McMahon, Jr. got a Sparton horn and L. Downward won a Birnbach aerial kit.

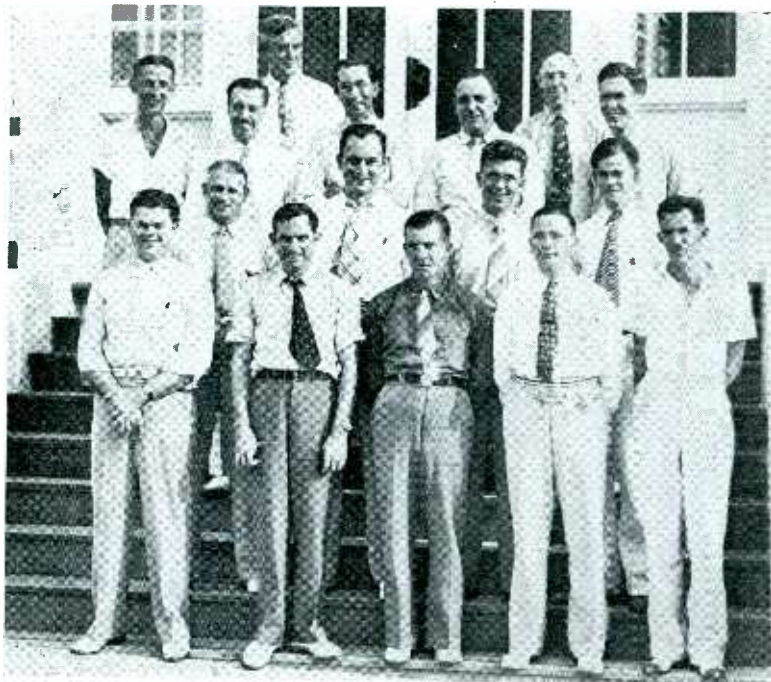

FAMOUS FLORIDA FACES—Snapped at a Daytona Beach sales conference, left to right in front row: Thurow Radio's L. H. Harrell, F. F. Frick, Jimmy Stanford, Bill Jaudon, T. M. Bates. Middle row: Thurow's V. W. Thomas, Sylvania's R. P. Almy, Thurow's Herbert Brown, Andrew Magnuson. Back row: Sylvania's J. T. Fuwiler, Thurow's W. L. Oben-
heim, C. E. Morgan, H. M. Carpenter, C. C. Campbell



115 FROM JERSEY—Krich-Radisco, Newark distributor, bus-rode these dealers to Camden to see new RCA merchandise go through the mill. In lower photo, front row, left to right: Dave Dumont, Krich-Radisco Trenton district manager; H. S. Maraniss, in charge of RCA's record advertising; Lou Roth, factory's New York rep; Glad Henderson; Tom Joyce, RCA's ad manager and Earl Pullen, the distributor's sales manager

RCA Service Meeting Schedule

Stages demonstrations in 73 cities during November

CAMDEN—From service manager E. C. Cahill of RCA Manufacturing Company comes the following schedule of service meetings to be held in cooperation with wholesale distributors during the month of November. Featured will be discussions of latest development in sound, alignment of modern receivers with band-spread shortwave tuning, volume expansion, compression and inverse feedback:

City	Date	City	Date
Albany, N. Y.	11/9	Louisville, Ky.	11/4
Atlanta, Ga.	11/16	Madison, Wis.	11/2
Baltimore, Md.	11/18	Memphis, Tenn.	11/12
Birmingham, Ala.	11/9	Miami, Fla.	11/23
Boston, Mass.	11/9	Milwaukee, Wis.	11/4
Bridgeport, Conn.	11/2	Minneapolis, Minn.	11/9
Buffalo, N. Y.	11/23	Nashville, Tenn.	11/4
Burlington, Vt.	11/4	New Orleans, La.	11/23
Cedar Rapids, Ia.	11/12	Oakland, Cal.	11/16
Charlotte, N. C.	11/2	Oklahoma City, Okla.	11/12
Chicago, Ill.	11/9	Omaha, Neb.	11/18
Cincinnati, Ohio	11/9	Peoria, Ill.	11/16
Cleveland, Ohio	11/4	Pittsburgh, Pa.	11/9
Columbus, Ohio	11/9	Portland, Ore.	11/16
Dallas, Texas	11/30	Providence, R. I.	11/16
Davenport, Ia.	11/18	Richmond, Va.	11/9
Denver, Colo.	11/16	Roanoke, Va.	11/5
Des Moines, Ia.	11/16	Saginaw, Mich.	11/4
Detroit, Mich.	11/9	St. Louis, Mo.	11/30
Elmira, N. Y.	11/18	Salt Lake City, Utah.	11/23
Erie, Pa.	11/2	San Antonio, Tex.	11/23
Escanaba, Mich.	11/4	San Diego, Cal.	11/16
Evansville, Ind.	11/2	San Francisco, Cal.	11/18
Fargo, N. D.	11/16	Seattle, Wash.	11/23
Grand Rapids, Mich.	11/12	Shreveport, La.	11/16
Hartford, Conn.	11/4	Sioux Falls, S. D.	11/19
Houston, Tex.	11/19	Spokane, Wash.	11/19
Huntington, W. Va.	11/4	Springfield, Mo.	11/2
Indianapolis, Ind.	11/12	Syracuse, N. Y.	11/16
Jackson, Miss.	11/16	Tampa, Fla.	11/30
Jacksonville, Fla.	11/19	Toledo, Ohio	11/12
Kansas City, Mo.	11/23	Tulsa, Okla.	11/9
Knoxville, Tenn.	11/2	Washington, D. C.	11/16
Lincoln, Neb.	11/9	Wich, W. Va.	11/2
Little Rock, Ark.	11/9	Wheeling, W. Va.	11/12
Long Beach, Cal.	11/23	Wichita, Kans.	11/4
Los Angeles, Cal.	11/18		

Fairchild Moves

NEW YORK—From R. H. Lasche, manager of the Fairchild Aerial Camera Corporation's sound equipment division, comes last minute news that the entire Fairchild plant will be moved from Woodside, Long Island to 8806 Van Wyck Boulevard, Jamaica, Long Island, on October 9.

The new factory, modern in every detail, contains thousands of square feet more floor space, will provide greatly increased manufacturing facilities.

RCA Ups Five

CAMDEN—L. W. Teegarden, formerly eastern division manager for RCA Manufacturing Company, has been placed in charge of radio tube sales to wholesale distributors. M. F. Blakeslee, formerly manager of the Chicago district, has been appointed manager of the eastern division with headquarters at the factory. Richard A. Graver, former manager of the Cleveland district, has been made manager of the Chicago district. A. G. Kemp, former package goods sales rep in Cleveland, has been made manager of the Cleveland district. E. J. Rising, formerly manager of the San Francisco district, has been appointed manager of the Los Angeles district, replacing E. W. Isenhower, resigned.

ONE GOOD SALE . . .



DESERVES ANOTHER

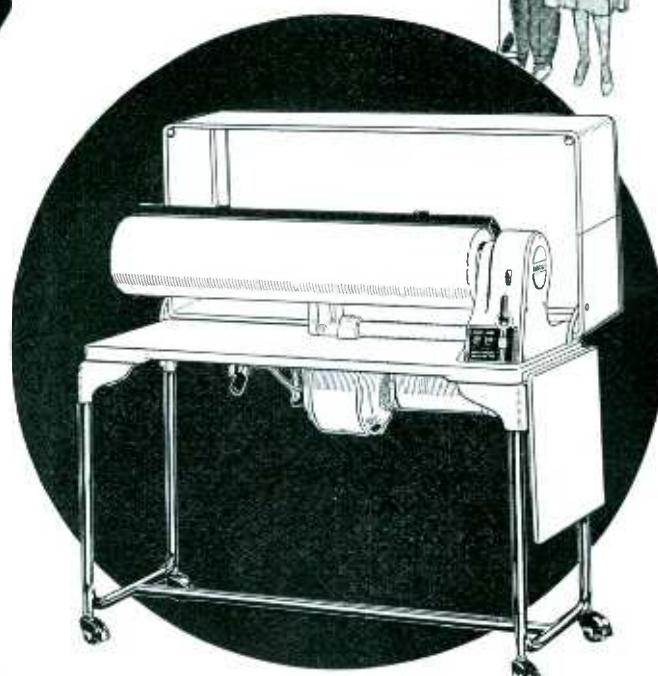

NORGE AUTOBUILT WASHERS . . .

with their extra-value convenience features, refrigerator-porcelain tubs with steam-sealed covers, clothes-saving pressure-indicator wringers, sealed-in-oil Autobuilt transmissions—bring in prospects that are anxious to be sold. But when a demonstration closes the sale, it's really just the beginning . . .

NORGE DUOTROL IRONERS . . .

are the natural companions to the Norge washers. A satisfied washer owner is the finest prospect you can find for a Norge Duotrol Ironer. Talk about the double thermostatic heat controls on the scratch-proof, chromium-plated shoe, the movable knee-control, heat trap dome, porcelain table-top covers . . . and you'll make another sale.

AND ANOTHER...



NORGE ROLLATOR REFRIGERATION

Three lines—each one the outstanding leader in its price class. Each a genuine *Rollator* refrigerator. Most Low-Temp and Deluxe models have 12 different *flexible* interior arrangements—instantly changed, exclusively Norge.

AND ANOTHER...



NORGE CONCENTRATOR RANGES

Both gas and electric models lead in exclusive features, beauty, performance. The natural sales appeal of these ranges plus the desire of Norge owners to make their homes completely Norge give dealers an unequalled opportunity for range sales.

INVESTIGATE

the Norge proposition today. Get in touch with your nearest distributor or write direct. Liberal finance plans make it easy to be a Norge dealer. A smashing sales promotion and advertising campaign is helping dealers break all-time sales records. Don't miss this opportunity to make money with Norge.

NORGE DIVISION Borg-Warner Corporation
606-670 E. Woodbridge St., Detroit, Mich.

NORGE

Plus Value Home Appliances

ROLLATOR REFRIGERATION (Domestic and Commercial) • GAS AND ELECTRIC RANGES
WASHERS AND IRONERS • WHIRLATOR OIL BURNERS • GAS BURNERS • FINE-AIR
FURNACES • COAL STOKERS • AIR CONDITIONING • CIRCULATOR ROOM HEATERS



THE REAL McCANNE—Radio salesman **Lee McCanne** of Stromberg-Carlson, with son **Roy**, spends a week-end at Canandaigua Lake

Predicts Good Southern Season

Says record cotton crop, fair prices will boost console sales

CHICAGO—Good business, particularly in console receivers and especially those automatically tuned, is predicted by J. H. Clippinger, vice-president in charge of sales for Continental Radio & Television Corporation, returning from the South.

Visited in Clippinger's travels were Dallas Radio of Dallas, Texas; Straus Bodenheimer of Houston; and McLendon Electric of Waco. About the latter he comments: "After hearing about Jess McLendon's expert marksmanship in connection with doves on a telephone wire I expect Jess to 'bag' some real business this season."

GE's Clinic, November 8-9

CLEVELAND—The sixth annual merchandising clinic on electric home appliances, including radio, sponsored by General Electric Company, will be held here at Nela Park, November 8 and 9. More than 200 top executives of furniture and department stores are expected to attend.

Details of the two-day program are being arranged by A. M. Sweeney, refrigeration sales manager; A. L. Pierce of the merchandising division and Carl J. Ballus, in charge of department and furniture store activities for the company's specially appliance sales division.

Export Expert Shifts

WOODSIDE, N. Y.—Frank A. D. Andrea, president of Andrea Radio Corporation, has appointed John J. Whyte as export manager. Whyte was formerly manager of the electrical division of American Steel Export, active New York firm.

NEW REPS AND DISTRIBUTORS

MOTOROLA—United Electric Supply of Salt Lake now has both home and car lines in Utah, southern Idaho, eastern Nevada, western Wyoming and southwestern Oregon. Electro-Pliance Company of Milwaukee has home and car sets for all of Wisconsin.

HOWARD—J. H. Weymouth, a native Texan well known for his activity in behalf of a number parts manufacturers and for his association with several well known appliances houses, has been appointed district sales manager for Texas and western Louisiana.

EMERSON—Dakota Harness & Hardware of Fargo, N. D. has the entire state and counties in western Minnesota.

GREBE—Contacting distributors for this line are: Ben Levenson of 370



NEW STANCORMAN—**C. L. Pugh**, Standard Transformer's new sales promotion manager, has been in radio since 1923, was radio parts manager for Hughes-Peters of Columbus, later sold tubes and parts for RCA in midwest and managed Detroit's Radio Distributing parts department

McKee Place, Pittsburgh; Carl Main of 199 N. Washington St. Delaware, Ohio; Ken Waite of 99 Bowdoin St., Newton Highlands, Mass.; B. W. Glassman, 235 Ward Parkway, Kansas City, Mo.; R. H. Cupples, 324 First Ave., Minneapolis; C. H. Mansfield, 810 West 6th St., Los Angeles and H. J. Lenicheck, 2868 Birch St., Denver.

KADETTE—Cloud Brothers of South Bend, Ind. is the latest distributor appointment by International Radio Corporation.

STROMBERG-CARLSON—For northwest Iowa and northern and eastern Nebraska, Warren Electric of Sioux City, Iowa.

ADMIRAL—Shepard Electric of Baltimore and Romar Radio Philadelphia have both taken on this radio line made by Continental Radio and Television.

WILCOX-GAY—New distributors are: W-W Electric, Springfield, Ohio; Radio Accessories, Orlando, Fla.; Radio & Sound Service, Inc., Knoxville; Northwest Radio Labs., Shelby, Mont.; Thompson Radio, Zanesville, Ohio; Radio Electric Service, Harvey, N. Dakota.

GATES—Norman B. Neely of Hollywood, California has this line exclusive for the state.

MAJOR APPLIANCES—W. D. Rowlands, now president at resignation of H. E. Markland, former executive vice-president and sales manager. George Gray, Jacksonville, former district sales manager for Leonard, distributor for Kelvinator in middle west, now appointed general sales manager. Herb Brennen, former vice-president of Gross-Brtnnen, New York, in full charge of radio division.

TRIAD—Merton Dobbs of Portland appointed factory representative covering northwest territory; James C. Pope, Jr., Minneapolis, to cover Minnesota, North and South Dakota and western Wisconsin.

MISSION BELL—Les Logan Co., San Francisco appointed representative of northern California.

CLIMAX MACHINERY—New agents: Federal Distributing Co., 2004 Grand Ave., Kansas City, Mo.; Old Faithful Heater Co., 1220 S. Michigan Ave., Chicago, Ill.; Gambell Distributing Co., Nashville, Knoxville and Chattanooga, Tenn.; Machine Tool and Supply Co., 215 E. Second St., Tulsa, Okla.; Orient Air Conditioning and Commercial Refrigerating Co., 223 Orient Ave., Jersey City, N. J.; A. A. Uhalt, 1705 Orange St., Dallas, Texas.



HARD WORK NETS RESULTS—**Bob Wuerfel**, chief engineer for Kadette, and **Jack Scanlan** of Muter, pack into the "Soo" district with the help of a guide . . . come out with some samples



ASSISTS ELLISON—*Henry C. L. Johnson*, Hygrade-Sylvania's new assistant advertising and sales promotion manager under Paul S. Ellison, comes to New York from Thordarson of Chicago

Crossley To Belden

CHICAGO — Alfred Crossley, well known radio engineer, has been retained by the Belden Manufacturing Company as special consultant; will help this company refine antenna systems and transmission lines.

Wholesale In Boston

BOSTON—Wholesale Radio Service Company, Inc., main office at New York, has opened a branch here at 110 Federal Street.



SHAKES HANDS WITH ANGEL—*C. L. Parris*, president of Parris-Dunn, climbs a Hy-Tower to shake hands with dealer *Aaron Angel* of St. Francis, Kansas. It's probably as near, Parris himself remarks, as he'll ever get to heaven

LATEST DEALER HELPS

SLIDES, SHOWPIECE, CATALOG

—*Stromberg-Carlson* has just released an illuminated, action showpiece boosting the Labyrinth. Clear notes are shown moving from the front of the speaker while distorted notes pass into the device and disappear.

"Fidelity New to Radio" is the name of a new slide-film synchronized with sound. Lasts 15 minutes, is suitable for use by dealers and distributors in training salesmen. Comes for commercial or domestic turnables. Booklet giving highlights of film also available.

A complete, new catalog of parts, tools and accessories lists all standard replacements for Stromberg radios including 1938 models.

RECORDS, TUNING—*RCA Victor* announces a giant record made of cardboard and plugging popular dance-band recordings. First of a monthly series just out.

A doorway display just brought out provides a mounting for the electric tuning remote unit made by this company. Built-inspeaker permits the control box to be used in connection with an actual set inside the store or in the window.

SCREWS, WASHERS — *Shakeproof Lock Washer Company* is now putting out a sheet called "Shakeproof Engineer." First issue contains dope on new thread-cutting screw, detailed information on entire lock-washer line.

HAMANUAL — *Standard Transformer Corporation* October 1 released its new "Hamanual," a combination amateur catalog and construction manual. Contains 16 new transmitter circuits ranging from 5 watts to 1 kw. input, specifications on entire Stancor transformer line.

DEMONSTRATOR — *Galvin Manufacturing Corporation* is now supplying distributor's salesmen with a complete Motorola electric push-button network tuning unit in a neat carrying case. It can be set up on a counter, works just like the unit in a complete set.

TRANSFORMERS — *Kenyon Transformer Company* announces replacement line catalog R-2. Features new, double-shelled transformers and replacement types.

BLANC DISCS—*Mirror Record Corporation* announces a new price schedule on blank discs for recording purposes, prints new prices in a catalog just off the presses.

TROUBLE-SHOOTER — *Radio & Technical Publishing Company* has a special combination counter and wall display stand made to hold six Home-Radio "Gadgets" and six Auto-Radio "Gadgets," service aids printed in quick reference form.

CONDENSERS — *The Cornell-Dubilier Electric Corp.*, releases just as we go to press new catalog 151A, containing a complete listing of all capacitor types made, together with their characteristics and list prices. Given particular attention are condenser types in heavy demand at the present time.

INSTRUMENTS—*Supreme Instruments Corp.* has a new two-color broadside showing the newest available radio service test instruments. Described in detail in this concern's set testers, analyzers, signal generators, multimeters, frequency-modulators and both 2-inch and 3-inch oscilloscopes.

SPEAKER-MIKES — *Wright-DeCoster* offers a new booklet describing its entire line of devices designed to serve in intercommunicating systems as combination speakers and microphones. These range all the way from heavy-duty units designed for high power systems down to small units used in home-type systems. Circuit diagrams for their use are included.

BALLASTS—*The Muter Company* announces a new catalog describing its complete line of ballast tubes, including a cross-referenced list of typical sets in which these are used.

CONTROLS — *International Resistance Co.* releases the most comprehensive volume control replacement guide it has ever published. Containing more than 200 pages of reference material, the booklet lists virtually every receiver made up to the present date, contains in addition much technical information of value to servicemen, including handy calculation charts and graphs.

ANTENNAS—*Technical Appliance Corp.* gives complete details relative to the theory, installation and operation of a new master antenna system, in a pamphlet just published. Particularly interesting are suggestions regarding the surveying of premises for such installations and estimating hints.

TRANSFORMERS — *Thordarson Electric Mfg. Co.* is doing some justified bragging about its new replacement transformer encyclopedia. Included is complete data about power transformers, input transformers, output transformers and chokes. Information published, according to the company, covers 98.9 per cent of Rider's seven volumes.

INTER-COMMUNICATORS — *Operadio Manufacturing Co.* describes its entire line of inter-communicator devices in a new catalog sheet, gives all details including prices.

SOUND—*RCA Manufacturing Company's* commercial sound section has a new 36-page catalog listing more than 100 commercial sound products. It includes

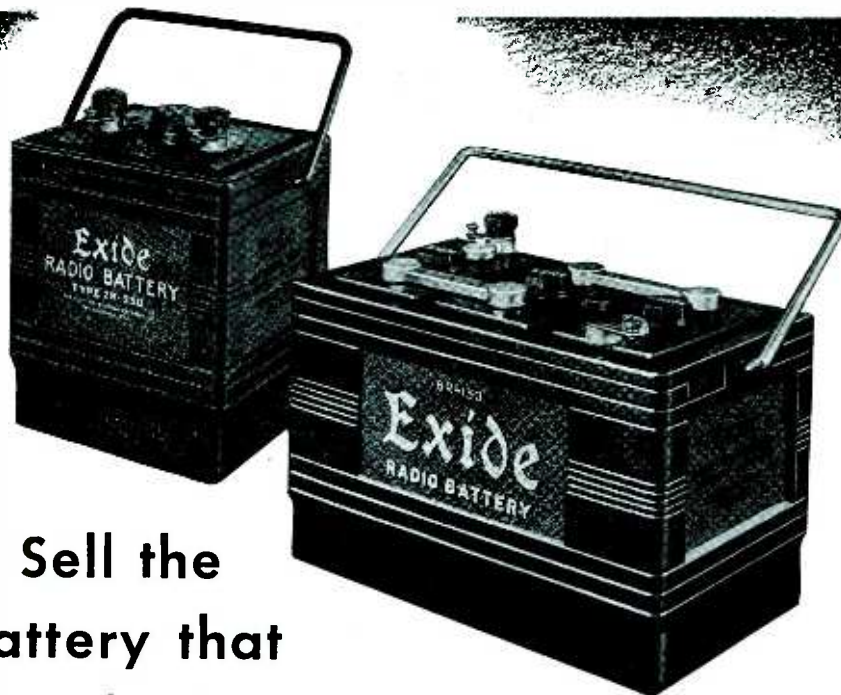

Sell the battery that broadcasting stations depend on

DON'T let your customers down. They have confidence in your merchandise . . . that's why they deal with you. From the earliest days of radio, Exide Batteries have been used in every branch of the industry. And today, many of the leading broadcasting stations depend on Exides to help keep their programs on the air.

Make certain your customers get the good reception they hope for . . . sell an Exide with each battery-operated set. Exides are especially designed radio batteries, built for long life and full power. They not only build customer satisfaction, but *profit*, for they are priced competitively, and subject to the regular radio trade discount.

The Exide line is outstanding. Puts you in a favorable position on battery quality, completeness of line and price. There are 2-volt and 6-volt Exides in various capacities, as well as 6-volt batteries for wind-driven chargers and generators. Mail the coupon today for complete details.

EXIDE RADIO BATTERIES			
CAPACITIES			
Type	R.M.A. 100-hr. Rate Amp. Hrs.	Approximate OPERATING HOURS	Price, Each Consumer
2R-105	105	210 at .5 Amp. Drain	\$4.95
2R-160	160	320 at .5 Amp. Drain	6.95
2R-230	230	460 at .5 Amp. Drain	8.95
6R-100	100	50 at 2 Amp. Drain	11.10
6R-150	150	75 at 2 Amp. Drain	19.95

Other types and sizes described in folder.

THE ELECTRIC STORAGE BATTERY CO., Philadelphia
The World's Largest Manufacturers of Storage Batteries for Every Purpose
 Exide Batteries of Canada, Limited, Toronto

Exide RADIO BATTERIES

THE ELECTRIC STORAGE BATTERY CO.
 1906 W. Allegheny Ave., Philadelphia

Please send me new free Exide Radio Folder, giving complete details on the Exide Radio Battery Proposition, Dealer Price Sheet, and name of Exide Wholesaler near me.

NAME _____

NAME OF FIRM _____

ADDRESS _____

inter-office communication systems, new portable and fixed sound apparatus, new amplifiers, speakers, microphones, and accessory equipment. A special feature is a cross-reference table showing desirable combinations for specific jobs.

RURAL ELECTRIFICATION ADMINISTRATION High Line Construction Contracts Awarded by the REA since the last issue of RADIO RETAILING

- ALABAMA**—Baldwin County Elec. Membership Corp., Bay Minette, 211 miles; Cherokee County Elec. Memb. Corp., Center, 169 miles.
- ARKANSAS**—Arkansas Power & Light Co., Conway, Pope and Yell, 117 miles; Independence, Izard, Sharp, White and Jackson, 116 miles; Boone, Marion, Newton and Searcy, 127 miles; Grant, Hot Spring, Garland, Clark, Saline, 142 miles.
- GEORGIA**—Irwin County Rural Elec. Assn., Ocilla, 200 customers; Satilla Rural Elec. Memb. Corp., Alma, 460 miles.
- IDAHO**—Northern Idaho Rural Elec. Rehab'n Assn., Sandpoint, 103 miles.
- ILLINOIS**—Eastern Ill. Power Coop., Watseka, 250 customers.
- INDIANA**—Jay County Rural Elec. Memb. Corp., Portland, 150 miles; Rush County Rural Elec. Memb. Corp., Rushville, 250 miles; Jackson County Rural Elec. Memb. Corp., Seymour, 245 miles.
- MAINE**—Kingman Power Co., Kingman, 75 customers.
- MICHIGAN**—Ontonagon, 113 miles; Charlevoix, 455 miles.
- MINNESOTA**—P.I.C.K. Coop. Elec. Assn., Brahan, 40 customers; Dakota County Elec. Coop., Farmington, 205 miles; Scott County Coop. Elec. Assn., 163 miles; Crow Wing Coop. P & L Co., Brainerd, 210 miles; Douglas County Coop. L & P Assn., Alexandria, 212 miles; Anoka County Coop. L & P Assn., Anoka, 100 customers; Lake Region Coop. Elec. Assn., Fergus Falls, 100 customers; Goodhue County Coop. Elec'n Assn., Zumbrota, 399 miles; Central Minn. Coop. Power Assn., Redwood Falls, 70 miles.
- MISSISSIPPI**—Southwest Miss. Elec. Power Assn., Lorman, 208 miles; Coahoma Elec. Power Assn., Clarksdale, 81 miles.
- MISSOURI**—Howard County Elec. Coop. Assn., Fayette, 177 miles; Mo. Rural Elec. Coop. Assn., Palmyra, 320 miles.
- NEBRASKA**—Howard County Rural Public Power District, St. Paul, 392; Polk County Rural Public Power District, 50 customers.
- NEVADA**—Clark County, 94 miles.
- NORTH DAKOTA**—Baker Elec. Coop., Baker, 12 miles.
- OHIO**—South Central Rural Elec. Coop., Lancaster, 105 miles; Union Rural Elec. Coop. Marysville, 376 miles.
- OKLAHOMA**—Caddo County Elec. Coop., Albert, 70 customers; Oklahoma Inter-County Elec. Coop., Norman, 150 customers; Red River Valley Rural Elec. Co., Thackerville, 300 customers.
- OREGON**—Umatilla Elec. Coop. Assn., Hermiston, 150 customers.
- PENNSYLVANIA**—Tri-County Rural Elec. Coop. Assn., Mansfield Borough, 200 customers; S. W. Central Rural Elec. Coop. Assn., Indiana, 250 customers; Claverack Coop. Assn., Towanda, 163 miles.
- SOUTH CAROLINA**—York County, 100 miles; S. C. State Rural Elec'n. Authority, 300 miles.
- SOUTH DAKOTA**—Union County Rural Power Co., Elk Point, 197 miles; Lincoln-Union Elec. Co., Alcester, 100 customers.
- TEXAS**—Hidalgo, Willacy and Cameron Counties, 807 miles.
- VIRGINIA**—Nelson, Rockbridge, Amherst, Appomattox, Albermarle Counties, 129 miles; Northern Neck Electric Coop., Warsaw, 140 miles; Southside Elec. Coop., 100 customers.
- WEST VIRGINIA**—Harrison Rural Elec'n. Assn., Clarksburg, 196 miles.
- WISCONSIN**—Pierce-Pepin Elec. Coop., Ellsworth, 319 miles; Columbus Rural Elec. Coop., Columbus, 305 miles.
- WYOMING**—Lower Valley Power & Light, Inc., Freedom, 20 customers.

PREVIEW of NEW PRODUCTS

AMERICAN COMMUN'S

American Communications Corp.,
1650 Broadway, New York, N. Y.

CODE READER—All-wave listeners and DX'ers now have a new field of exploration opened up for them with the Code Reader; transforms code signals into a visual record on a specially treated tape which anyone can decode; may also be used by beginners to acquire speed and accuracy; easily installed; \$20, less tubes.

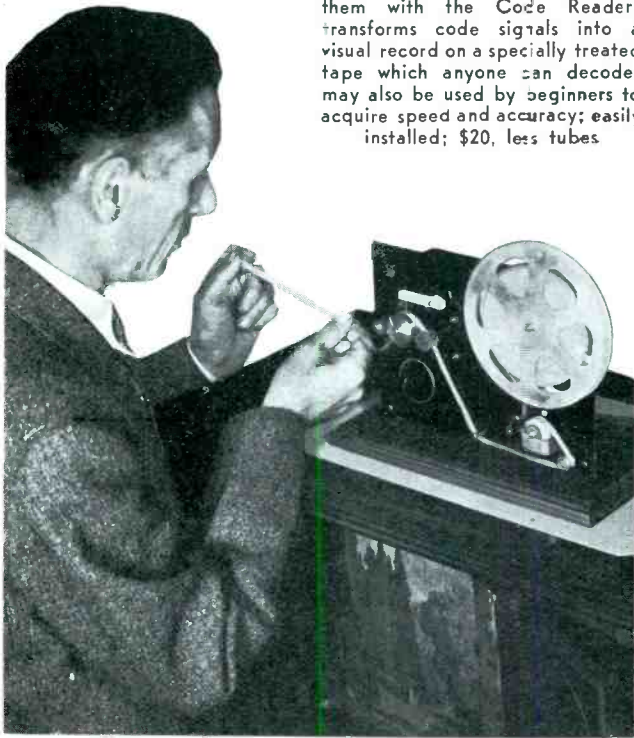

GENERAL ELECTRIC

General Electric Co.,
Bridgeport, Conn.



MODEL F-96—Features touch tuning; because the action is instantaneous the set is silent while touch tuning between stations; automatic frequency; tone monitor circuit; 12 in. speaker; modern wrap-around type cabinet; 4 other consoles also announced

MODEL F-51—Housed in a plastic cabinet of striking modern design; 6½ in. dynamic speaker; tone monitor circuit; 5 tubes; lists around \$30; Model F-40, 4 tubes, plastic cabinet, is about \$20; three other table sets, both ac and ac-dc

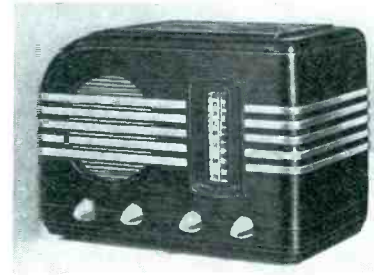

ARVIN

Noblitt Sparks Industries, Inc.,
Columbus, Ind.



ARVIN PHANTOM KING MODEL 1427—Walnut console with automatic touch tuning; choice of 10 stations by simply pushing a button; double Phantom Filter circuit; 14 tubes; two speaker units—one 12 in. bass and one 6 in. treble; electric eye station focus

ARVIN GRAD MODEL 638CS—One of several new models that combine chairside convenience and smart cabinet-craft; Phantom Filter circuit in a 6 tube chassis; electric eye station focus

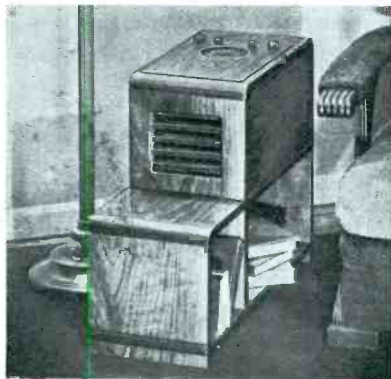

ANDREA

Andrea Radio Corp.,
48-02 48th Ave., Woodside, N. Y.



MODEL 2-D-5—Selected American walnut cabinet; 5 tubes; 535-1720 and 2050-7000 kc.; 8 tuned circuits; dual avc; full vision illuminated dial; scale calibrated in meters and kc; extra easy logging scale; electro dynamic speaker; dimensions 8¾ x 14½ x 6½ in.; \$19.95

MODEL 2-D-8—Inclined panel for easier tuning; 8 tubes; 13 tuned circuits; tunable rf stage on all bands; phono and remote speaker connections; triple anti-fading control; beam power Class A output; 16.4-52.6 and 187.5-585 meters; "Mystic Ray" tuning; Gyroscopic station finder; \$72.95



GENERAL ELECTRIC

General Electric Co.
Schenectady, N. Y.



AUTOMATIC TIMER FOR PUBLIC SPEAKERS—Device automatically flashes a warning to speaker two minutes before he is to finish his address; when this period has elapsed the word "Finis" is flashed as a reminder and a low chime notifies him his speaking time has ended; also adaptable to radio station use

TRAV-LER

Trav-Ler Radio & Tel. Corp.
1028 W. Van Buren St., Chicago, Ill.

MODEL 527 — Travel-Matic automatic tuning with split second action; five tubes; 540-2620 kc; tone control and full avc; 6 in. electro-dynamic speaker; ac; walnut cabinet highly polished and hand rubbed; \$29.95

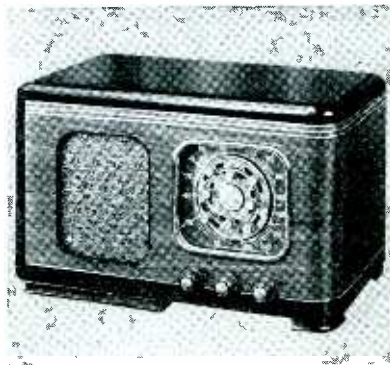

GREBE

Grebe Mfg. Co., Inc.
119 Fourth Ave., New York, N. Y.

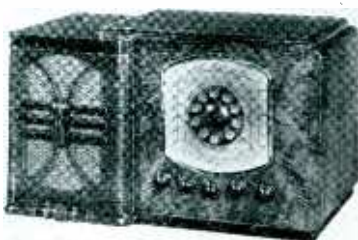

MODEL 309-L — Nine tubes; three bands; 10-button automatic tuning; 8 in. speaker; ac; 3 bands—16-55.5, 83.3-214 and 193-560 meters; \$83.50; also available without automatic tuning

CROSLLEY

Crosley Radio Corp.
Cincinnati, Ohio

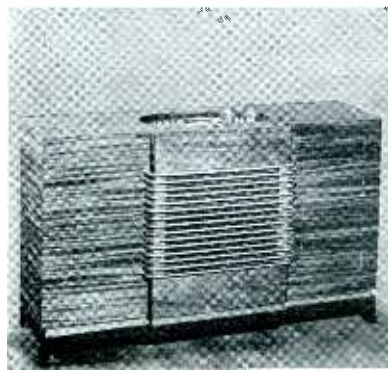

PRESTOTUNE 12 — The massive cabinet with sloping panel, designed by Walter Dorwin Teague, is a brilliant adaptation of the modern vogue; Prestotune motor tuning with push buttons; remote control also available; 12 tubes; two other Prestotune models also ready

ADMIRAL

Continental Radio & Tel. Corp.
325 W. Huron St., Chicago, Ill.

ADMIRAL CONSOLE — Full sized 41 in. console with eight-station push button automatic tuning; vertical dial

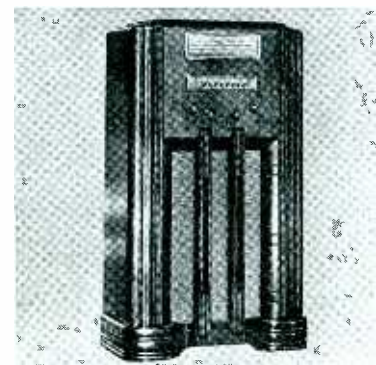

TELETALK

Webster Electric Co.
Racine, Wis.

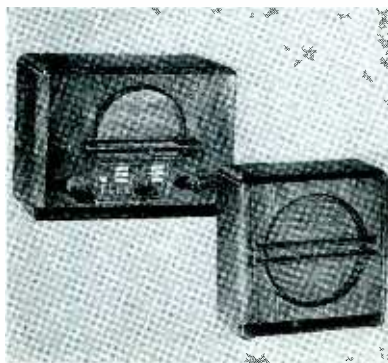

MODEL 105 INTER-COMMUNICATOR — Loudspeaker system for office, factory or home where intercommunication between one point and one to five remote points is desired either as a group or individually; master station is selective; cabinet of solid walnut; master station, \$39.50; speakers, \$9.50

FERGUSON

Ferguson Radio & Television Co., Inc.
745 Broadway, New York, N. Y.

MODEL 214 — Sloping panel for easier tuning; American and foreign stations; electric eye tuning; inlaid cabinet of bent walnut; 14 tubes; ac-dc; \$39.95



CENTRAL-CALL

Central Communication Devices, Inc.
140 W. 22nd St., New York, N. Y.

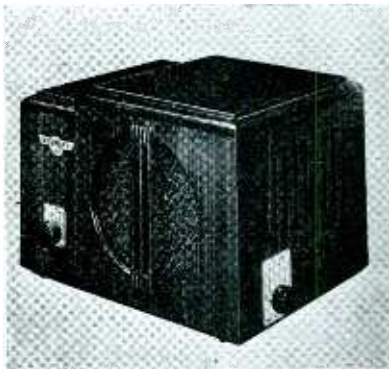

INTER OFFICE SYSTEM—No delays or interruptions as talk-listen switch has been eliminated; simultaneous conversation can be carried on privately between master and any one of the substations; so completely selective no interference or cross talk from other substations

MASTER AND SUBSTATION — Illustrated above is the master station and to the right is the substation; both may be plugged in anywhere without special wiring; metal-glass tubes and 6 in. speaker; 5-ply walnut cabinets with piano finish

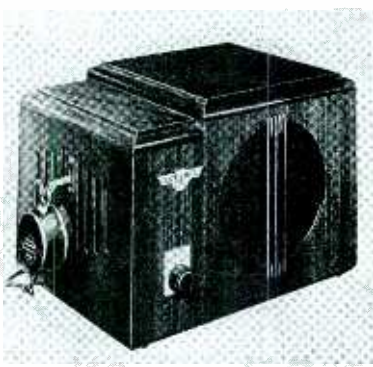

LAFAYETTE

Wholesale Radio Service Co., Inc.
100 Sixth Ave., New York, N. Y.



TOUCH TUNING MODEL B-44—Electric touch tuning; 8 buttons; 13 tubes; 13.7-570 meters; "beam power" push-pull output tubes; r.f. pre-selection; high fidelity switch control; automatic audio compensation; 12 in. speaker; moderne console

EMERSON

Emerson Radio and Phonograph Corp.
111 Eighth Ave., New York, N. Y.



AB-182 CONSOLE—14 tubes; high fidelity; 16 to 555 meters; 15 in. dynamic speaker; 15 watts output; full range volume expansion with Symphonizer; phonograph pick up terminal; hand rubbed figured walnut cabinet, \$89.95

RCA VICTOR

RCA Mfg. Co.,
Camden, N. J.

RCA VICTOR-PHONES—Two intercommunicating call systems—one wired and the other wireless; larger includes a master unit feeding into 5 remotely operated units; complete privacy between stations calling; master unit, \$39.95; remote units, \$12.50 each; the wireless system costs \$76.50 per pair of units



FREED EISEMANN

Freed Mfg. Co. Inc.
44 W. 18th St., New York, N. Y.

MODEL 27 D—12 tubes; ac-dc; 3 bands; electric eye tuning; full avc; automatic telegraph code interference eliminator; hand polished walnut veneer cabinet; \$49.95; also available with 7 tubes for ac operation; \$49.95

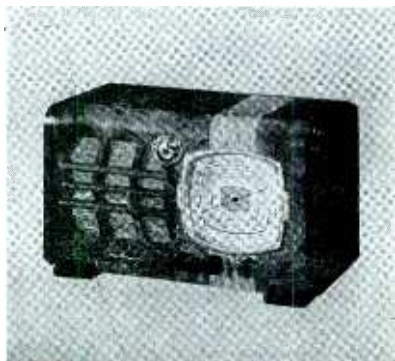

VOCAGRAPH

Electronic Design Corp.
164 N. May St., Chicago, Ill.



SERIES 30 AMPLIFIERS—"Hushed Power" features in a new low price line; three basic chassis, 30 watts, \$66.50; 18 watts, \$49.50; 10 watts, \$32.90; complete systems and fully portable units are also offered

OPERADIO

Operadio Mfg. Co.
St. Charles, Ill.

INTERCOMMUNICATING SYSTEM—A paging and intercommunicating system all in one; any one or all outlying stations may be called; use of one, two or three master stations possible; number of outlying stations unlimited; outlying stations may call master; three models; volume control on master station; 8-15 watts output

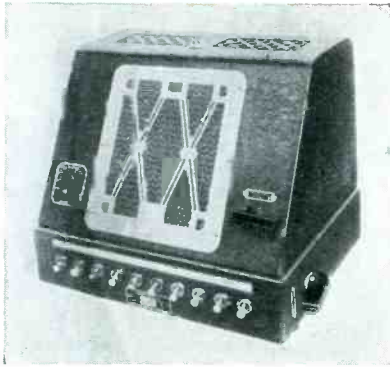

SHURE

Shure Brothers
225 W. Huron St., Chicago, Ill.



85A MICROPHONE—Crystal sound-cell mike; non-directional; sound cell is designed so that mechanical resonances are well above the operating frequency range; output level is approximately 18 db below that of typical diaphragm types, statement reads; high fidelity

ELECTRO-ACOUSTIC

Electro-Acoustic Products Co.
Fort Wayne, Ind.

AP-1832 B SOUND SYSTEM—18 watt system; complete with carrying case, 2 Magnavox 10 in. electrodynamic speakers, crystal microphone with adjustable studio floor stand; amplifier has inputs for two crystal or velocity microphones and high impedance phonograph; outputs for two electrodynamic speakers and 2 to 12 p.m. dynamics



BOGEN

David Bogen Co., Inc.
663 Broadway, New York, N. Y.

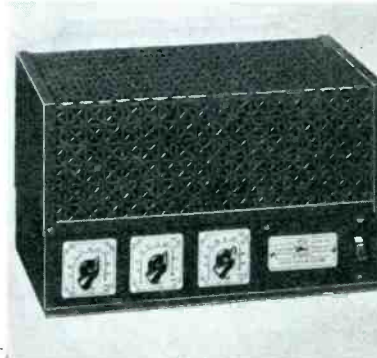

C12-15 AMPLIFIER—For either 110 ac or 6 v. storage battery operation; mike and phono input channels; duo-stage electron mixing between both channels; universal output for various speakers; 12 watts output on 6 v.; 15 watts on 110 ac; phonograph motor has special winding which operates on 6 v. dc and 12 v. ac

PARRIS-DUNN HY-TOWER

Becomes No. 1 Charger Over Night



Photo shows the chargers leaving the production line at the rate of 1 per minute—all packed and ready to start their journey to every state in the union and to 86 foreign countries

1.—Over Night—the Hy-Tower Charger is being custom-built for 40 of the leading radio manufacturers and merchandisers.

2.—Over Night—the Hy-Tower has been given over \$200,000.00 worth of national and international advertising by us and our associates in leading farm and trade papers, pamphlets and folders, radio broadcasts and at fairs throughout the country.

3.—Over Night—the Hy-Tower program has placed vast quantities of cooperative advertising material in the hands of leading radio distributors, offering a substantial profit to their dealers, as well as a \$12 saving to the farmer.

4.—Over Night—the Hy-Tower's two outstanding features have won for it universal acclaim: The "slip the wind" governing principle eliminates propeller breakage and generator burn-outs and relieves the tower of 640 lbs. of strain in high winds, while the extra high tower assures up to 25% greater efficiency.

5.—Over Night—the Hy-Tower, having met the rigid tests of leading radio engineers, distributors and dealers, as well as the farmer himself, has become the undisputed leader in its field.

Backed by Parris-Dunn with over 20 years manufacturing experience and recognized as true pioneers in the wind electric field, the Hy-Tower charger is a proven machine, matchless in quality, performance and service—Truly the World's No. 1 Charger.

Take advantage of these facts. Boost and sell the Charger recommended by your radio manufacturer. Tie up with their advertising and get the full benefit of the Cooperative Set-Up. Write your jobber for details of our plan. Or write direct to the factory.

PARRIS-DUNN CORPORATION

WORLD'S LARGEST EXCLUSIVE MANUFACTURERS OF
6-VOLT WIND-DRIVEN BATTERY CHARGERS

Clarinda

Iowa, U. S. A.

IRC

International Resistance Co.
401 N. Broad St., Philadelphia, Pa.

SPECIAL REPLACE- MENT CONTROLS —

By the elimination of sliding, metal-to-metal contact in volume controls one of the most common causes of noise is eliminated; known as the Silent Spiral Connector; supplied on all new special replacement controls listing at \$1.50 and upward (not on the standard types)

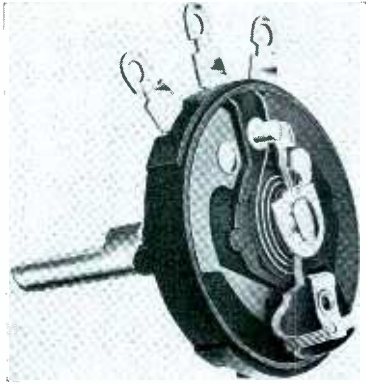

EBY

H. H. Eby, Inc.
2066 Hunting Park Ave., Philadelphia, Pa.



**ADJUSTABLE AUTO
AERIAL —** Extends above car roof just the required distance for best reception in city or country and disappears when not in use; adjustable from driver's seat, even with car in motion; consists of single flexible rod of hard spring brass; resilient so it will not be injured by striking obstacles

CENTRALAB

Centralab
900 E. Keefe Ave., Milwaukee, Wis.

AUTO RADIO VOL- UME CONTROLS —

Universal auto-radio replacement control made especially for this purpose; available with or without switch in resistance values of 1/4, 1/2, 1 and 2 megohms; all are tapped for tone compensation (the tap can be omitted if desired)

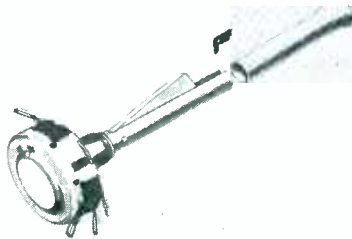

AEROVOX

Aerovox Corp.
70 Washington St., Brooklyn, N. Y.



CAPACITORS — Handy high voltage, compact, oil-filled capacitors in round cans, arranged for inverted mounting in limited space; the section of selected linen paper and foil, bathed in oil, is hermetically sealed in the aluminum can; 600, 1000 and 1500 volts dc working; capacities, 0.5 to 4 mfd.

RETAIL PRICE \$27.50

Something Really New
the
WILCOX-GAY
Wal-Radio for
WALL OR
CHAIRSIDE

WITH NEW WOODEN CASES OF WALNUT OR MAPLE

Hang on the wall as simply as a picture—this thin, streamlined, rich toned radio is the perfect model for compact homes. Also for offices, dens, bedrooms, etc. New in application and principle, it opens fresh merchandising opportunities.

Be the first in your community to feature these remarkably convenient and practical receivers. Gain added sales and customer interest.

Ask your distributor or
write us today

WILCOX-GAY CORP.

Charlotte, Mich. U. S. A.

With this chairside stand, the Wal-Radio is converted into an armchair model with room for favorite books and ash tray. One set, two uses.

**Complete
\$29.95**



RCA

RCA Mfg. Co.
Camden, N. J.

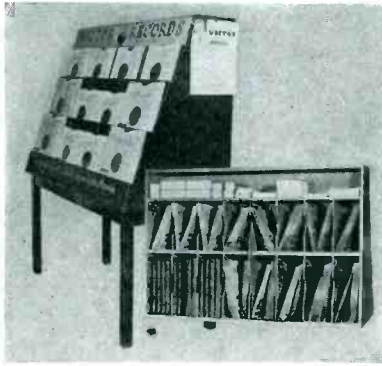

RECORD DISPLAY— Provides compact unit which conserves space yet provides an effective display; titles and wrappers plainly in view; storage shelves behind the display for about 600 records; additional space, too, for needles, catalogues, accessories and supplements

WRIGHT-DE COSTER

Wright-DeCoster, Inc.
2233 University Ave., St. Paul, Minn



NOKOIL MULTI-TEST SPEAKER—Tests all ac and dc radios; requires no field excitation and allows easy checking of auto and battery sets; all leads are brought out to the selector switches so that any desired setting may be had instantly; steel carrying case with suede finish; \$36

TRIUMPH

Triumph Mfg. Co.
4017 W. Lake St., Chicago, Ill.

350 MULTIRANGE METER — Five times greater sensitivity than ordinary meters is claimed for this new model; the small drain of the meter — often less than 50 micro-amperes — permits accurate determination of voltage; two styles, one with 3 in. square meter, \$19.95, the other with 4 1/2 in. rectangular meter, \$24.95

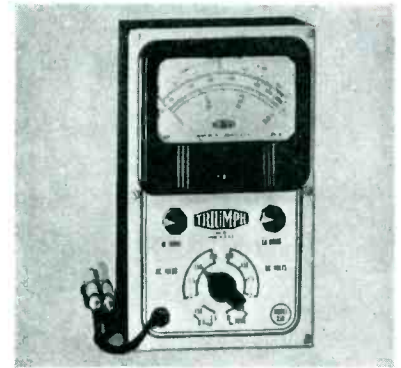

TACO

Technical Appliance Corp.
17 E. 16th St., New York, N. Y.

ANTENNA SYSTEMS IN KIT FORM—Antenna systems for every purse and purpose in handy kit form; Model 400, \$3.75; 510, \$4.50; 210 for localities notoriously poor; master system for apartment houses, hotels and store demonstration purposes



For the first time! **Complete RCA ANTENNA**

FOR ONLY \$3.95

Here's a performance ace—at a price everyone can afford! Tell your customers about it!

HERE'S the new RCA 395 Antenna System! Comes completely assembled and soldered. Kit contains 2 20-ft. antenna wire coils, 2 strain insulators, 1 45-ft. transmission line, 1 junction box, 1 receiver coupling unit, 2 coupling unit links, 2 nail-on knob insulators, 1 ground clamp and 1 instruction sheet. Stock No. 395. List price only \$3.95.

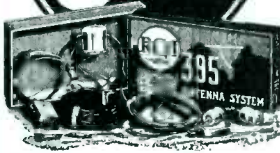

CHECK THESE FEATURES!
Factory-assembled—no soldering
Easily installed—40-ft. span
Wide frequency range—140 to 23,000 kilocycles
Doublet type—efficient pickup
For use with all receivers

RCA Parts FOR PROFIT
RCA Manufacturing Co., Inc., Camden, N. J.
A Service of Radio Corporation of America

ALWAYS — INSIST ON WARD AERIALS
FOR MAXIMUM EFFICIENCY, STREAMLINED BEAUTY



CORONATION
MODEL C.O. \$2.45

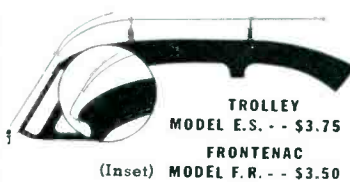

TROLLEY
MODEL E.S. -- \$3.75
FRONTENAC
(Inset) MODEL F.R. -- \$3.50



MAINLINER
MODEL M.L. \$2.95

PROMPT DELIVERIES GUARANTEED
WRITE FOR CATALOG TODAY

The WARD PRODUCTS Corp.
WARD BUILDING CLEVELAND, OHIO

"RED HEADS"



● **SERVICE MEN PREFER**
"RED HEAD" CONDENSERS
THEY'RE DEPENDABLE

YES!

—and, economical too. Use them on all your replacements. They can be depended upon for quality and service —and their lower price makes your dollar go farther.

CONSOLIDATED WIRE AND ASSOCIATED CORPORATIONS
512 So. Peoria Street
Chicago :: :: Illinois

AMPERITE

Amperite Corp.
561 Broadway, New York, N. Y.

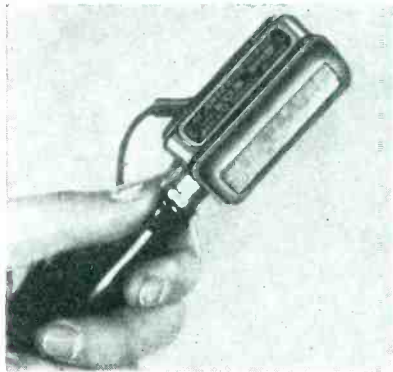

HAND - I - MIKE — In spite of its small size it has a flat response from 60 to 7500 cps and an output only 3 db below the standard size velocity; complete with output transformer of either the high or low impedance type; may also be used as a desk mike or on a floor stand; head is 2 1/4 x 1 x 1 1/8 in.; weight 5 1/2 oz.; moulded rubber case; \$22

UTAH

Utah Radio Products Co.
812 Orleans St., Chicago, Ill.

25 WATT CW TRANSMITTER KIT — Comes in a professionally styled ventilated cabinet in black crystalline finish, 11 1/4 x 12 x 7 in.; crystal control; latest type 6L6 harmonic oscillator; all band performance on only two crystals; self-contained power supply; one coil change per band; \$15.95



MAGNET-O-SIGNS

Magnet-O-Signs Corp.
180 N. Wacker Drive, Chicago, Ill.



MAGNET-O-TYPE — For making professional looking window and show cards easily and quickly; letters are molded of plastic materials with small permanent magnets imbedded in their undersurfaces so they adhere firmly; as no slois, pins or adhesive are needed letters may be arranged in any form; silver, black or red lacquer

ROTO RANGER

Simpson Electric Co.
5216 W. Kinzie St., Chicago, Ill.

SET TESTER — Incorporates the "Roto Ranger" which consists of a rotating drum (containing 12 independent scales) geared to a 12-position range selector switch so that the proper scale automatically comes into view to correspond with the position assumed by the switch; resistance of 10,000 ohms per volt d. c.



WRITE TODAY FOR COMPLETE INFORMATION ON THE MOST VALUABLE FRANCHISE IN RADIO!

Majestic
MIGHTY MONARCH OF THE AIR!
for 1938

— THE LINE OF AUTOMATIC RADIOS —

PROVIDES LIVE-WIRE RADIO DEALERS WITH . . .

. . . A complete line—consoles, chair-side and table models!

. . . A price range to fit every merchandising plan!

. . . Powerful merchandising advantages!

. . . Advanced features that satisfy every consumer demand!

Act Promptly!

MAJESTIC RADIO & TELEVISION CORP.

2600 West 50th Street

Chicago

Cable Address: "Majestic—Chicago"

TOBE

Tobe Deutschmann Corp.
Canton, Mass.

CONDENSER BRIDGE AND ANALYZER—Laboratory type; provides quick and accurate means of testing condensers and resistors; a.c. bridge circuit utilizes electronic eye as balance indicator; pre-amplifier stage ahead of electronic eye and use of a gain control in preamplifier stage



MUTER

Muter Co.
1255 So. Michigan Ave., Chicago, Ill.



BALLAST TUBE—Used as standard equipment by many leading set manufacturers and now available to servicemen for replacement; in addition there are units to replace other types; kit containing tubes which occur with the greatest frequency also available; all tubes list at 80¢

UNIVERSAL

Universal Microphone Co.
Inglewood, Calif.

MICROPHONES — A new line of crystal microphones, manufactured under patent of the Brush Development Company, is announced; illustrated is the crystal stand model



VAC-O-GRIP

Vac-O-Grip Co.
2023 Detroit Ave., Toledo, Ohio



P. A. CARRIERS—Designed to hold p.a. equipment on car tops; held by vacuum supplied through connection to the vacuum system of the auto; can be used on coupes, coaches or sedans; sizes to accommodate one, two or four speakers; \$12.80, \$14.40, \$17 and \$24

Kleenette

BY HORTON

The New Personal Washer

\$10⁰⁰



FOR midweek washings; for laundering fine fabrics; for dyeing and tinting; for sterilizing and bleaching; for dry cleaning (in non inflammable fluid) *here is the modern wonder of washing machine development.*

Every woman wants Kleenette the instant she sees what amazing help it gives her. No more "dunking" filmy garments in the basin—no more "wash bowl hands."

Right now, Mr. Dealer, get the whole story of the big sales possibilities in this new Horton development. Write or wire at once.

HORTON MFG. CO., 9001 Osage St., FORT WAYNE, IND.

HORTON WASHERS-IRONERS SINCE 1871



Standard glass types,
6 Series and genuine
all-metal radio tubes

Ken-Rad Radio Tubes

Dependable performance always

Write for our complete dealer sales plan

KEN-RAD TUBE & LAMP CORPORATION, INC., OWENSBORO, KY.
Also mfrs. of Ken-Rad Incandescent Electric Lamps

Janette Rotary Converters



The original D.C. to A.C. converters with all wave filters developed exclusively for radio and sound apparatus.

CAPACITIES: 35 to 3250 watts.
6, 12, 32, 115 and 230 volts
D.C. to 110 or 220 volts, 1 phase,
60 cycle A.C.

Insist on a Janette
Ask For Bulletin No. 12-25

Janette Manufacturing Company
556-558 West Monroe Street Chicago, Ill. U. S. A.
BOSTON - NEW YORK - PHILADELPHIA - CLEVELAND - MILWAUKEE - LOS ANGELES
DETROIT - SEATTLE

PORTABLE POWER PLANTS Within the Reach of EVERYONE

New "CUB" Type "LB" Plants

- 6 Volts, 100 Watts
- Rope-Pull Starter
- Battery Ignition

\$39.95
F. O. B.
Chicago

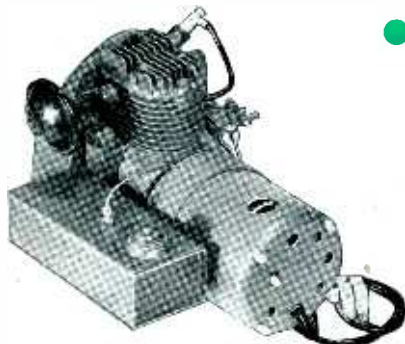

- 6 or 12 Volts, 200 Watts
- Push-Button Starter
- Battery Ignition

\$44.95
F. O. B.
Chicago

PIONEER now furnishes these remarkable plants at an amazingly low list price. The engine is the same as those used on the popular plants shown on the reverse side, with the exception that the small current for the ignition is taken from the storage battery. For installations where engines of this type are satisfactory, the type LB plants have no equal.

Type		Output	Weight	Price	Code
LB6C	For use with 6-volt batteries—rope-pull starter.....	100 watts	44 lbs.	\$39.95	Feggo
LB6X	For use with 6-volt batteries—push-button starter.....	200 watts	49 lbs.	44.95	Feign
LB12X	For use with 12-volt batteries—push-button starter.....	200 watts	49 lbs.	44.95	Felon

Furnished with carrying handle. Wooden base \$1.00 additional to list price.

Standard Model with High Tension Magneto

- Low First Cost
- Economical to Operate
 - 6, 12, 32 and 110 Volt
 - 5/8 H.P., 4 Cycle, 1 Cyl. Engine
 - Push Button Starting
 - Sturdy Construction

The standard "Baby Jumbo" illustrated on the reverse side is furnished with magneto ignition, assuring easy starting and perfect performance under any circumstances. Note the unusual compactness of design—it will fit into a tiny nook measuring only 11" high, 10" wide, and 15 3/4" long. The complete unit, with base attached, weighs only 49 pounds. A convenient carrying handle makes it easily portable, adding to its many useful advantages. Thousands of these plants now giving satisfactory service is your assurance that they are properly designed and constructed. List Price—L6

\$49.95
F. O. B.
Chicago

TYPE		OUTPUT	WEIGHT	PRICE	CODE
L6	For use with 6-volt batteries.....	150 watts	46 lbs.	\$49.95	Fable
L6M	For use with 6-volt batteries (Marine Type).....	150 watts	49 lbs.	55.00	Fanny
L6X	For use with 6-volt batteries.....	200 watts	49 lbs.	55.00	False
L6XM	For use with 6-volt batteries (Marine Type).....	200 watts	52 lbs.	59.95	Fatal
L12	For use with 12-volt batteries.....	150 watts	46 lbs.	55.00	Facer
L12X	For use with 12-volt batteries.....	250 watts	49 lbs.	59.95	Famed
L12XM	For use with 12-volt batteries (Marine Type).....	250 watts	52 lbs.	64.45	Favor
L32	For use with 32-volt batteries.....	250 watts	49 lbs.	59.95	Faint
L32R	For operation of 32-volt lights or DC appliances without batteries.....	250 watts	49 lbs.	59.95	Fairy
L110	For operation of 110-volt lights or DC appliances without batteries.....	250 watts	49 lbs.	59.95	Faker

Wooden base and carrying handle furnished on Marine Type units. If wanted on other types add \$2.00 to list price.



Marine Type

ESPECIALLY designed for marine duty. Use it to supply power for lights and radio while docked or at anchor. Avoid unnecessary and expensive operation of main engines to keep batteries charged. Furnished with pulley for the operation of pumps and other equipment. Complete with carrying handle and wooden mounting base. Prices start at.....

\$55.00
F. O. B.
Chicago

Prices slightly higher in West and South.

GUARANTEE

The Pioneer Gas-Electric plants are guaranteed against defective workmanship and material for a period of ninety days after delivery. Unsatisfactory units will be repaired or replaced without charge if returned to the factory prepaid.

PIONEER GEN-E-MOTOR CORPORATION

466 W. SUPERIOR STREET . . . CHICAGO, U. S. A.

Pioneer

BABY JUMBO

Gas-Electric Power Plants

with
Push Button Starting

for

- **Farms**
- **Boats**
- **Camps**
- **Trailers**
- **Contractors**
- Roadside
Stands**
- and Everywhere**

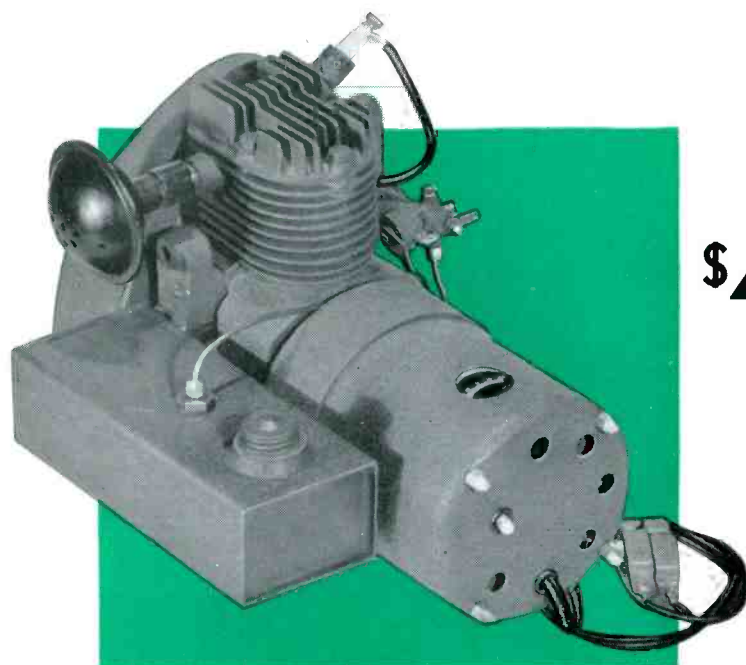

Type L6 with Magneto Ignition

LIST
\$49.95
F. O. B.
Chicago

For the first time, any one can enjoy the convenience and comfort of electricity—and he doesn't have to be a master mechanic to do it. This energetic little "plant" is extremely simple in design. It's sturdily built for long life under heavy-duty service. The complete unit is easily moved about—it weighs only 46 lbs. It will furnish current for a lighting system, charge batteries, run electrically-driven tools, and operate the washing machine, cream separator, water pumps, and other belt-driven machines.

SPECIFICATIONS

ENGINE: "L" head, vertical, air cooled, $\frac{5}{8}$ h.p., 4 cycle, single cylinder. Develops rated output at 2400 R.P.M. Crank shaft runs on ball bearings. Three piston rings. One quart fuel tank. Equipped with fly-ball type governor. Suction feed carburetor. Splash lubrication.

FUEL CONSUMPTION: Fifteen hours on one gallon at 150 watts. Oil consumption, 2 ounces in 10 hours.

GENERATOR: Self-excited, two pole for highest efficiency. Armature mounted directly on crankshaft, outer end supported in oil-less self aligning bearing. Surplus oil for 1000 hours' operation. Easily removable cover provides ready inspection of commutator, brushes, and bearings.

STARTING: A touch of the push button automatically starts the motor, with current provided by the storage battery. An emergency rope-pull starter is also provided.

ACCESSORIES: All plants for use with storage batteries are furnished complete with ammeter, cutout relay, leads, and battery clips. Simply fill with gas and oil, connect with battery, press the starter button, and it goes to work.

FEATURING

- Extreme versatility—plenty of electric current for lights, motors and tools—charging of batteries—plenty of power for V-belt drive of pumps and other equipment.
- Light-weight—only 49 lbs.—easily carried about with permanently attached handle.
- Especially designed for this application—not a converted unit. Quality workmanship; best of materials; simple—rugged design. The most compact unit on the market. Overall dimensions only 11" wide x 10" high x $15\frac{3}{4}$ " long. An added advantage where space is at a premium.
- Surprisingly low prices.

See Table on Reverse Side
for Complete Ratings

Other Pioneer Products — Dynamotors — Gen-E-Motors — Rotary Converters

For Amplifying and P. A. Systems

PIONEER Model H Gen-E-Motor

A Reliable, low-priced Power Supply Unit with filter for Amplifiers,
P. A. Systems, Portable Transmitters and
Sound Trucks

Unusually efficient, compact, and completely enclosed in a sturdy metal case, this inexpensive PIONEER Model H Gen-E-Motor is enthusiastically endorsed by many of the leading operators and manufacturers of amplifiers and sound equipment. The Standard Model H is a 6-volt DC unit, and can be obtained for 12 and 32-volt operation (by adding 10% to the prices listed below). For 110-volt input add 15% to list prices.

Sizes: 5 3/4" x 5 7/8" x 3 5/8"; weight 9 lbs.

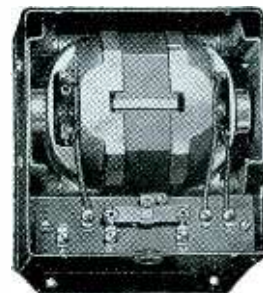

MODEL H

Code	No.	Volts	Output M.A.	Battery Drain	List Price
Basic	7565	265	75	7.75	\$34.00
Baste	7300	300	100	9.5	37.50

A special filter for high gain sensitive amplifiers, recently developed by PIONEER Engineers, is available—add \$3.00 to list price.



MODEL HW

PIONEER HW Gen-E-Motor Without Filter

A compact unit for Manufacturers

Where space is at a premium, use this PIONEER Model HW (without Filter)!
Finer performance, higher quality, and superior service without constant attention
and adjustment make this unit ideal for use by manufacturers or amateurs. Dimen-
sions: 5 7/8" x 4 3/8" x 3".

Code	No.	Volts	Output M.A.	Battery Drain	List Price
Baker	HW 265	265	75	7.75	\$27.50
Badge	HW 300	300	100	9.5	30.00

PIONEER "B" Eliminators for Battery Radios

Operates from any 32 volt farm lighting system.

Plugs into regular 32-volt light socket—connects directly to old battery leads
of battery operated receiver without rewiring. These PIONEER Gen-E-Motor
"B" Eliminators are equipped with built-in filter units. They will operate
from any 32-volt farm lighting system—and have a maximum output of 180
volts. Taps are provided for intermediate voltages.



32 VOLTS				
Code	No.	Volts	Intermediate Tap	Retail Price
Cabin	3280-AT	180	22 1/2, 45, 67 1/2, 90, 135	\$27.50
Cadet	3280-A	180	90 Volts	25.00
Camel	3235-A	135	67 1/2 Volts	25.00
Canal	7320	300	(100 Mills output)	44.00
FOR 6 VOLTS FOR FARM USE				
Candy	6280-AT	180	22 1/2, 45, 67 1/2, 90, 135	\$27.50
Canoe	6280-A	180	90 Volts	25.00
Cargo	6235-A	135	67 1/2 Volts	25.00

All of the above units are equipped with 8 foot
cord, plug and switch ready for use. Shipping weight
9 lbs.

PRICES SLIGHTLY HIGHER IN WEST AND SOUTH

PIONEER GEN-E-MOTOR CORPORATION
466 W. SUPERIOR STREET - - - CHICAGO, U. S. A.

Pioneer

GEN-E-MOTORS

High Voltage "Red Top" B Power Supply With Filter

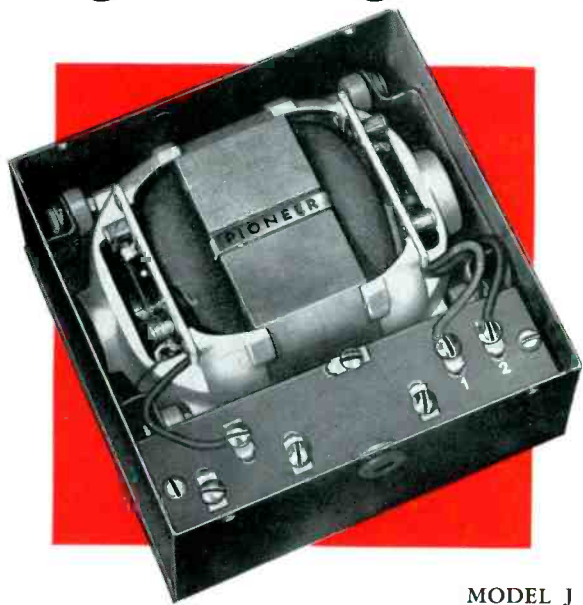

MODEL J

Code	No.	Output Volts	M.A.	Battery Drain	List Price
Baggy	5135-A	135	30	1.80	\$19.50
Balmy	5180-A	180	30	2.50	19.50
Balsa	5200-A	200	40	3.15	19.50
Bandy	5225	225	50	4.3	19.50
Banjo	5250	250	50	4.7	19.50

The above units may be furnished with intermediate tap for 50% additional. Add "T" to code word. Shipping weight 7¼ lbs.

For long life, dependability, and trouble-free service use this Pioneer Gen-E-Motor! It's recognized as the best form of power unit available for obtaining the high voltage needed for radio tube plates, where storage batteries or other sources of DC current are used to supply input current.

Complete with built-in filter—this compact, efficient Pioneer Gen-E-Motor needs no attention or adjustment! The two ball bearings, sealed in grease, will keep the dynamically balanced armature running smoothly without re-lubrication during the entire life of the unit. The Pioneer Gen-E-Motor—floating on rubber mountings—is ABSOLUTELY FREE from vibration! It's quickly and easily installed. The sturdy dust-proof metal case protects the unit from damage. SIZE WITH STANDARD FILTER, 27/8" x 5 1/8" x 5 1/8"; price \$19.50. See table opposite for complete listing of models.

With special short wave filter, for use with 5-meter transceivers, etc.—\$27.50 complete—size 5 3/8" x 7 3/8" x 2 7/8".

Any of these units can be furnished for operation on 12 volts by adding 10% to list price.

Every PIONEER Gen-E-Motor is unconditionally guaranteed.

Model JW-Gen-E-Motor Without Filter

The PIONEER Model JW Power Supply unit—identical with the GEN-E-MOTOR shown above without the filter—is ideal as an integral part of original equipment where the filter is included in the apparatus. Many manufacturers are using this PIONEER JW Gen-E-Motor because it is a compact, reliable unit that will stand up under rough usage without requiring constant attention and adjustment.

It is also being used with remarkable success to replace vibrators in auto radio receivers—as it can be easily installed usually within the set itself. It is excellent for this service because it is extremely compact (4 1/8" x 5 1/2" x 2 7/8") and can be used without circuit alterations—complete instructions included.

The PIONEER Model JW supplies a uniform voltage output, eliminating noisy or weak reception. Use this sturdy, dependable PIONEER Power Supply unit to replace vibrators—and GUARANTEE trouble-free service to your customers.

We guarantee all PIONEER Gen-E-Motors in accordance with R.M.A. standards to operate absolutely noiselessly without adjustment, oiling, or servicing.

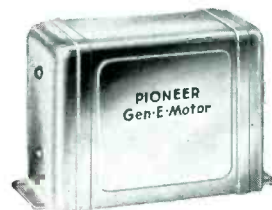

MODEL JW

Code	No.	Output Volts	M.A.	Battery Drain	List Price
Abate	JW-18	180	30	2.5	\$14.50
Abbey	JW-20	200	40	3.15	14.50
Abhor	JW-25	225	50	4.3	14.50
Abide	JW-50	250	50	4.7	14.50

FOR 32 VOLT RADIOS

About	JW-32	210	45	.7	18.00
-------	-------	-----	----	----	-------

Shipping weight, each 6 lbs.

AUDIO DEVELOPMENT

Audio Development Co., 4347 France Ave. South, Minneapolis, Minn.

PRE-AMPLIFIER — Has facilities for mixing four low-level microphones with a separate gain control for each; standard fidelity model for p.a. work and high fidelity model for radio station use; ac operated; other models as well as amplifiers for 110 and 6 v. dc operation also made

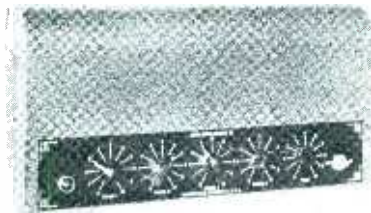

EDDY

Eddy System
143-26 183rd St., Springfield Gardens, N. Y.



RADIO SERVICE FORMS — Padded repair and estimate forms; blue or black ink; carbon sheets; may be obtained with or without imprint; pads of 100, 1000, 2500; repair orders, \$1 for 100, no imprint; estimate forms, 75¢ for 100; larger quantities proportionately lower

AMPLITONE

Amplitone Products Co.
152 Washington St., New York, N. Y.

AMPLIFIER — Convertible electioneering amplifier; 26 watts output; built-in 6 v. genemotor and 110 v. ac power supplies; overall gain 115 db; no ac hum or genemotor ripple with gain control wide open, it is claimed; output matches any voice coils or line; \$36.50, less tubes

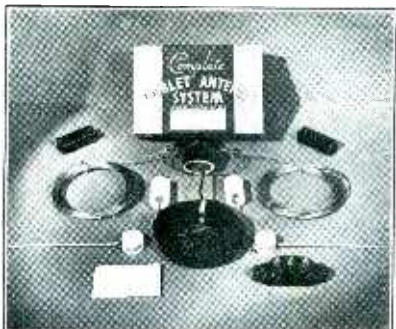
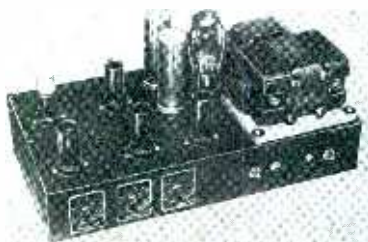

NEW ANTENNA BATTING 1000% No Slump This Season!

Completely assembled ready to install. New type top coupler housing. No. 6066. List Price \$3.25. Send for complete information.

Sold Through Distributors Only. Send for complete information.
RIVARD WIRE AND CABLE CORP.
1014 Madison Avenue Toledo, Ohio

THE 1938 CHALLENGER LINE of

The Greatest Line in Grebe's 25 Year History!



In its long history of radio manufacturing, Grebe has given the trade many outstanding lines. But, nothing like the present one! Pictures and words cannot do it justice. Modern to the minute in styling and features, the new line gives you everything that a winning line should have. No experiments or tricky innovations; no disappointed customers. Every Grebe owner is a Grebe salesman. Every Grebe set will uphold your name and ours.

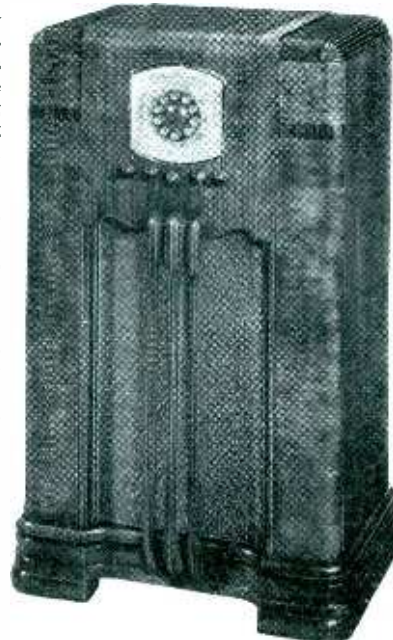

MODEL 3016-4 AUTOMATIC. 16 tube A.C. superheterodyne with automatic tuning. 3 Bands 13-41 meters, 40-130 meters and 173-555 meters. Tunes American, foreign, amateur, aviation and ships at sea. Handsome walnut cabinet, size: 45 inches x 28 inches x 16 1/4 inches.

Get the Grebe Line NOW, Before it is too late!

Distributors and dealers are urged to wire or write for full details of the line. Learn all about Grebe's liberal dealer policy, liberal discounts, and the exclusive franchise that protects every dealer, giving him the full benefit of his effort. Find out about the Grebe cooperative plan of local advertising.

THE LINE IS COMPLETE



Model 206-L. 6 tube A.C. Superhet 2 bands covering 17 to 53 and 173 to 555 meters. Cabinet in Walnut or Ivory trimmed with Gold. Size 10 1/4 inches x 16 3/4 inches x 8 3/4 inches.

Over 50 models, from 5-tube compacts to 16-tube automatic combinations. AC — AC-DC — Battery sets. Radio phonograph combinations. 1 to 5 band short-wave and broadcast sets, some including European long-wave.

GREBE MANUFACTURING COMPANY, INC.
119 FOURTH AVENUE, NEW YORK, U. S. A.

MAIL COUPON TODAY

GREBE MANUFACTURING COMPANY, INC.
119 Fourth Avenue, New York, U.S.A.
Send full details of 1938 Challenger Line.

Name
Street
City State
I am Dealer Distributor

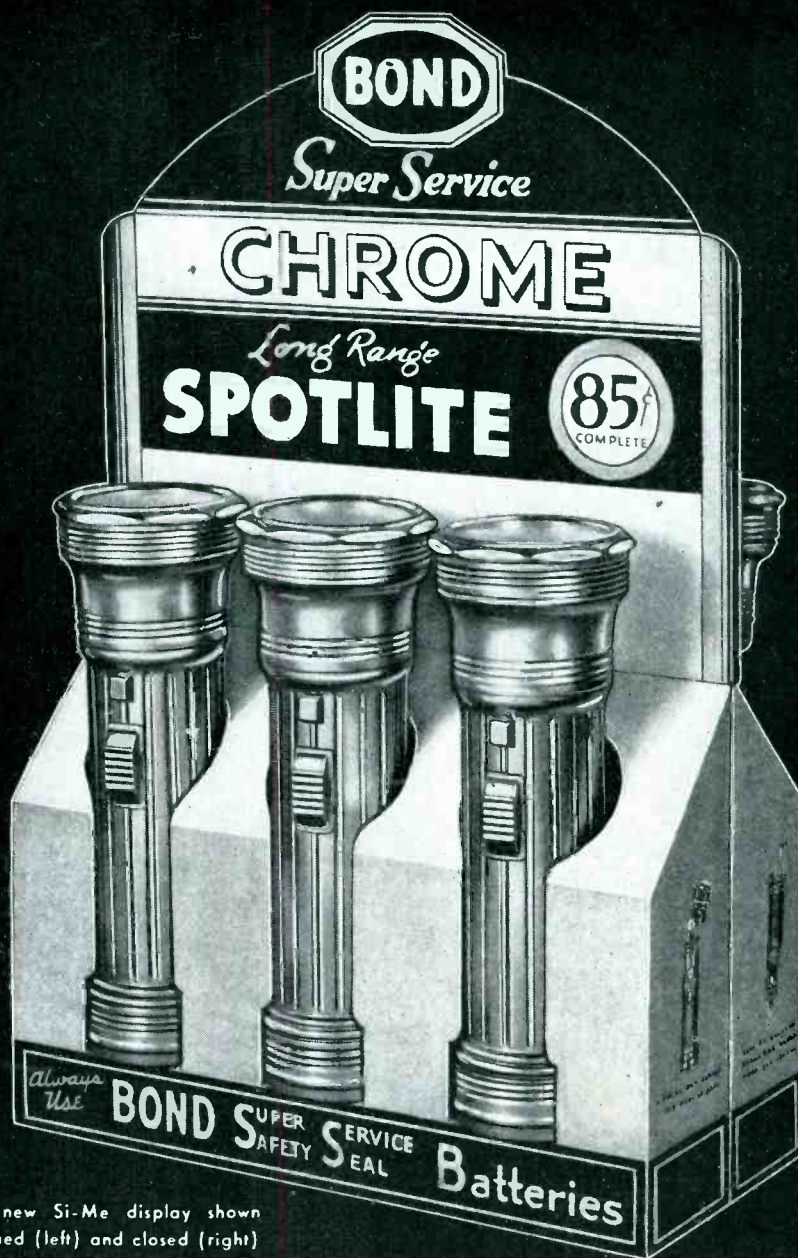

The new Si-Me display shown opened (left) and closed (right)

GRAND VALUE • GOOD PROFIT • UNIQUE DISPLAY

READY for you in Deal #82—truly a **GRAND VALUE**. Here are 6 heavily chrome-plated, thick gauge seamless brass cases. Cases equipped with candle-lite feature, 3-position safety lock switch and bulb shock absorber—in fact, every practical improvement usually found in \$1.25 flashlights. Your retail price 85¢ each, complete with batteries. Deal includes 48 Bond Super-Service Mono-cells and **FREE Si-Me display**. Total Retail Value \$8.70....Your Cost \$5.66....*Your Profit 35%*.

SI-ME twin display packages sell more flashlights in half the counter space. These twin packages are hinged in the middle. They open wide to display 6 lights to the front, or they swing back-to-back to display 3 lights front and 3 lights rear. Displays are delivered completely set up, as shown above.

Closed, open or at any angle, Si-Me twin displays get attention and show off these chrome spotlights, full length, superbly for getting sales.

Ask your Jobber's Salesman for full details

BOND ELECTRIC CORPORATION

NEW HAVEN, CONN.

CHICAGO, ILL.

SAN FRANCISCO, CAL.

RADIO GIMBAL

William A. Thomas Co.
321 Caroline St., Neenah, Wis.

CHASSIS CRADLE — Holds radio chassis in any position for speedy servicing; specially designed brakes hold chassis securely whether with straight sides or sides that are rolled over; also holds power supplies or amplifiers; \$7.50; a cradle of more simplified design but similar in construction is \$4.35

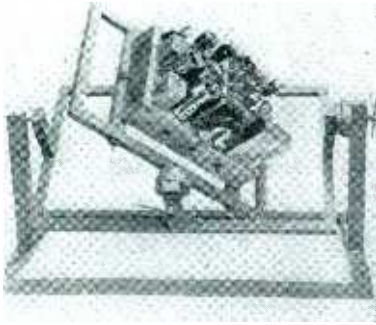

McELROY

T. R. McElroy
175 Congress St., Boston, Mass.

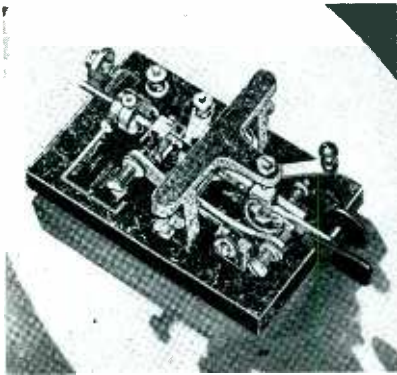

MAC KEY — A key, identical to that used by Ted McElroy, champion telegrapher, is now available to all code operators; two models, deluxe, \$9.50 net and standard, \$7.50 net; incorporates McElroy's ideas on weight, balance, size of contacts, spring tension, bearing pins, etc.

RCA

RCA Mfg. Co.
Camden, N. J.

50 WATT AMPLIFIER — Class "A" amplifier with built-in expander and suppressor circuits to enhance musical reproduction and prevent blasting and overloading in large-scale p.a. and sound reinforcement installations; consists of two units—a voltage amplifier of the high-gain type and power amplifier; \$260

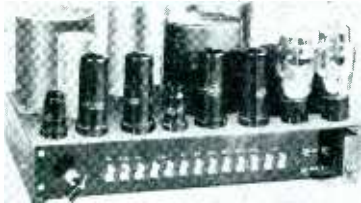

TURNER

Turner Co.
Cedar Rapids, Iowa

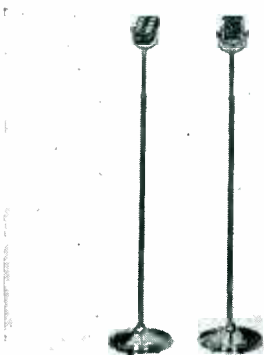

DB-50 CRYSTAL MIKE — Ideal for p.a. systems, stage work and dance band setups; the "Equal-Level" interior is coil suspended thus allowing the microphone to be handled while in use without creating noise; semi-directional when mounted upright and non-directional when tilted back in its saddle; \$34.75



NOT in years has there been such a heavy demand for wire in connection with the Serviceman's business. You have noticed it—we have noticed it.

With Public Address going like a prairie blaze and Radio a seething hotbed of activity which promises to be sustained, you will be needing **GOOD WIRE**.

CORWICO Wires are scientifically produced to do their job 100%. Antenna Systems, P-A Cables, Hook-up Wires—"made by engineers for engineers." Use **CORWICO** on your next contract.



NOISE-MASTER
ALL-WAVE ANTENNA

Eliminates "Man-Made" Static on Broadcast as well as Short Waves

LICENSED by Amy, Aceves & King, engineered with traditional **CORWICO** care, this masterly aerial system fits every set and every location. Filters out nuisance noises caused by electrical devices. Improves reception generally—widely endorsed by Service men.

No. 14 (illustrated above) **\$6.75 list**

FOR broadcast and shortwave frequencies; designed to eliminate "man-made" static and afford better reception. Two to 6 sets can be operated at the same time with an additional lower transformer for each added unit. Other "Noise-Master" units available.

WRITE FOR INFORMATION.

CORWICO Wire Catalog available to Service men.
Distribution is exclusively through Jobbers.

CORNISH WIRE CO., Inc.

30 Church Street  New York, N. Y.

A WINDOW THAT WON'T WEAR OUT

(Continued from page 29)

electric fan might be concealed, blowing the ribbons and adding additional motion. Perhaps in this case it might be found desirable to dispense with the left cutout entirely.

The side panels, if both are used, stand in the positions shown, and are secured to the center panel and base by means of glued and tacked "L" cardboard strips. The cut-outs require no particular explanation. A blow-up of a descriptive ad, (with a touch of surrounding color) from the manufacturers' advertising department might be mounted where copy is specified, for example. Likewise, it is often desirable to cut out the principal section of a litho and mount it on the left-hand circular piece. Thus the manufacturer provides nearly all the copy.

Of course, the center section is the really important one—from it we get our greatest amount of interest and advertising value. Each of the seven translucent openings flash on, haphazardly, one at a time. Following each of these lighted openings are the names of several radio stars who are heard

on that particular station. In that way not only is automatic tuning featured, but we are also bringing to mind what many people really buy in a radio—their favorite stars.

Illustration 2 gives construction details regarding the center section, and requires very little amplification. However, be sure to use Dupont Tontine shade cloth which may be purchased in department stores or through art supply shops. Tontine shade cloth yields the best effect both day and night. Further, it may be decorated with any kind of paint or lacquer; and later, the paint or lacquer may be removed with whatever kind of solvent is suitable. Then we have blank space for another display.

The wooden frame shown in Illustration 2 is very simple and requires no particular skill to build. The box is constructed from three-quarter inch boards. The reflectors may be made of tin, painted white on the inside. The interior of each lamp shelf should also be painted white. The seven double wire cable leads to the flasher box.

After this frame has been made and lamps and sockets set in, cover the front with a sheet of process board in which holes have been cut for the light to shine through. When the process board has been nailed on the front of the frame, then stretch and tack around the edges the Tontine shade cloth. Now, the front is ready to be decorated with a dark background, and light contrasting design and lettering. Of course, the space over the holes in the process board is blank with the exception of the letters of the six leading radio stations which are most usually received in your city. Paint the station letters black.

The two end cut-outs cover the side edges of the center box. A cut-out arc of cardboard is attached to the top, covering the top raw edge. On this arc is lettered the radio maker's favorite slogan, or an other important phrase or sentence.

Since we have finished describing the three major display pieces, it will be seen by referring to Illustration 3 that the base section is a job

Another **PROFIT ITEM** for Radio Retailers . . .



THE SKY PILOT WORLD-TIME CLOCK

Revolutionary!
Years Ahead!

THREE CLOCKS IN ONE

Center Dial revolves with hour hand. Modernistic design of brushed brass. Actual size: 5 1/4" high, 4 3/4" wide. Convex crystal. Indicates minutes—quarter hours.

ELECTRIC MODEL for 110-120 Volt, 60 cycle, A.C. current. LIST PRICE \$5.95.

Spring wound model with same features, same case—LIST PRICE \$4.95.

A regular time piece with A.M. and P.M. divided dial. A world time piece instantly indicating time in all 24 zones. International clock with A.M. and P.M. 24 hour dial.

Can be Set at ANY of the World's 24 Time Zones.

Available in 12" models with illuminating reflectors for commercial use and advertising displays.

Distributors and dealers write for literature

THE SKY PILOT ORGANIZATION
PEARL RIVER, NEW YORK, U. S. A.

Noise-Free Store Demonstrations Make Sales Easier

ALL radio sets will perform at their best from a single antenna when connected to a
BRACH PURATONE MULTIPLEX ANTENNA SYSTEM
(Which Includes Low-Loss Giant Killer Cable)

Permanently Efficient. Equally Effective in Homes Where More Than
One Radio Is Hooked Up to a Single Antenna

LICENSED UNDER PATENTS OF AMY, ACEVES & KING

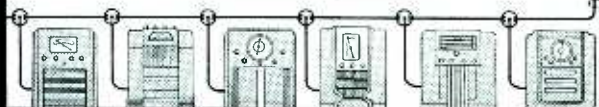

L. S. BRACH Mfg. Corp.

Newark, N. J.



Est. 1906

EVERY HOME and EVERY
OFFICE is a PROSPECT for the

Clean Air

A Year Round MONEY MAKER for
Appliance Dealers and Distributors

Here's an electrical appliance your salesmen can
SELL—in large numbers because there is nothing
to compete with it—and the field is practically
unlimited. Clean Air washes, humidifies,
circulates, heats, deodorizes the air. Removes
dust, smoke, odors and pollen. Can be carried
from room to room. Costs little to operate.
Send coupon today for details about the
Clean Air franchise. Liberal discounts.

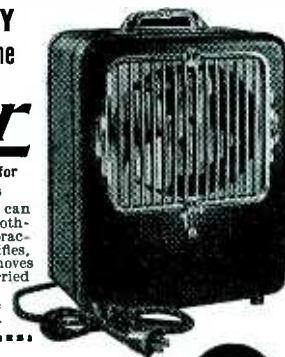

CONTINENTAL MOTORS CORP.
12816 E. Jefferson Ave., Detroit, Michigan.

Send details about Clean Air Franchise.

Name
Address
City and State

ONLY
\$18.95

of simple carpentry. Part "C" is framed of lumber strips, fastened together with corrugated nails, and has a strip of Tontine shade cloth stretched over it and tacked around the edges or brought around to the back and tacked there. This translucent panel is placed behind the opening in the front section of the base. It should be made a little larger than the opening and, when lettered, a nail or screw at each end will hold it in position. Behind it a socket and lamp is placed, connected with the flasher box. See that no light leaks around the edges of "C". As all the stations are flashed on one after another this panel lights up, emphasizing whatever important message has been lettered on it. "B" fits over "A" and need not be nailed to it.

No mention has been made of color scheme. That will depend upon the taste of the showcard writer or displayman who does the sign job. The base should be thoroughly smooth, as lacquer over bumps and hollows yields a sad appearance. Some will prefer to build "B" (Illustration 3) in the form of a frame, cover sides and end with smooth

masonite, and moulding corners to hide nail heads.

Naturally, the base section will be used many times again. With drapes of cloth, paper and other decorative schemes, this base can be made to emphasize radio sets standing on it, as well as other arrangements. Also, store the center flashing section; you will probably find use for that again in the near future.

The compact, enclosed eight-point flasher box shown in Illustration 4 is attached to the bottom of the center section, as shown in Illustration 2. Lead wires to positions behind the station "windows," suspend cord and socket and insert lamps for the seven "windows." The eighth lead illuminates the front base panel.

If used on D.C., especially near the power house or converting station, put a lamp in series with the power line. Made by Betts & Betts, 551 West 52nd Street, New York City. List price, \$7.50.

TURNOVER

(Continued from page 27)

\$100 sale costing \$75—a gross profit of \$25 less selling costs of \$15 would be

$\frac{75}{2500} \times 18.63 = \5.589 per day selling profit — \$10. ÷ \$5.589 = 18 days or

$$\frac{10}{\left(\frac{75}{2500} \times 18.63\right)} = 18$$

representing a minimum turnover of 20 times annually.

Therefore it appears that a conservative setting for turnover minimum would be 7.33 in the case of items grossing 38 per cent. with variations in accordance with other ratios as described above.

Having determined the base, the inventory record can be marked with the established standard in each case and the selection of merchandise for stock and purchasing be guided by this yardstick. Some few articles of no great value can be stocked safely although below standard but the tying up of any significant sum of capital in this way should be guarded against. There is little justification for purchasing any large units or wide lines of small merchandise that do not sell up to the minimum frequency once the base has been set.

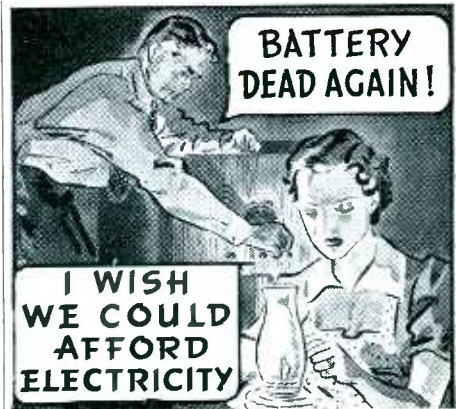

Now—IT'S EASY AND PROFITABLE TO SELL THESE FOLKS

People who won't spend the money for a big light plant and a bank of batteries, buy TINY TIM like hotcakes when you show them how it operates 8 to 13 electric lights and the radio, all with a single 6 volt battery.

The TINY TIM dealer in Elk, Washington sold 220 in a month!

No competition. Only TINY TIM has the Controlled Voltage Generator and the Automatic Shut-Off, for safe, economical, convenient operation. **NATIONALLY ADVERTISED** and guaranteed by *Continental Motors!* Models as low as \$45. No coupon deals—you make a **FULL PROFIT** on every sale!

Get started NOW! We'll send complete details on a COMPLETE line of battery chargers you can sell—and SHOW YOU HOW TO SELL THEM! Mail the coupon TODAY!

Tiny Tim Controlled Voltage BATTERY CHARGERS

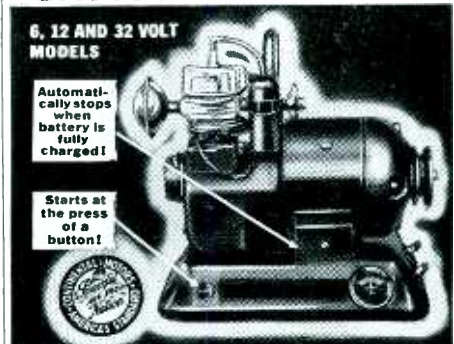

POWERED BY THE FAMOUS

Continental

Red Seal Engine

CONTINENTAL MOTORS CORP., Dept. RR-10
DETROIT, MICHIGAN RUSH TINY TIM LITERATURE FREE!

Name
Address

MAIL THIS COUPON TODAY!

To Servicemen and Dealers

DO YOU KNOW THAT

TRIAD

Manufactures Over 100 Types

of Glass and Metal

BALLAST TUBES

(Resistor Units)

Which are Available Thru Your Jobber—for Increasing Replacement Business

Also a Complete Line of Radio Receiving Tubes

WRITE FOR PARTICULARS

A Profitable Line to Handle

TRIAD
MANUFACTURING COMPANY
INCORPORATED
PAWTUCKET RHODE ISLAND

The Quality Name in Radio

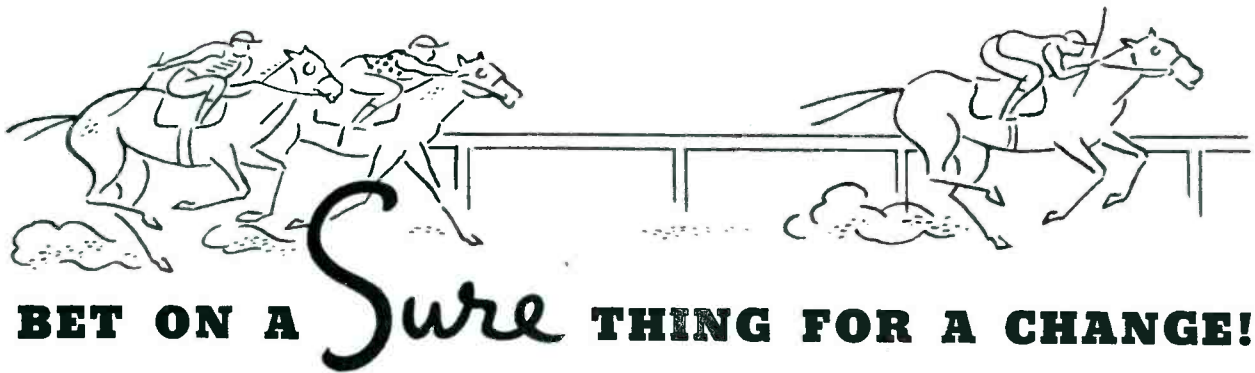

BET ON A *Sure* THING FOR A CHANGE!

Here's the *surest* sure thing that ever put profits in a radio dealer's bank account...the Tung-Sol Consignment Plan.

You don't pay a nickel for Tung-Sol Tubes until they're sold—and the profits are safely in your hands.

No money tied up in shelf-stock. No headaches from slow-moving numbers. Fast selling, nationally advertised Tung-Sol Tubes, placed in your custody with no cash investment. All that is necessary is to meet *Tung-Sol's* qualifi-

cations as a responsible dealer. And mind you—the price is **NO HIGHER** than you pay for any recognized brand. Our ability to finance consignment costs you nothing.

More than 8,000 Tung-Sol dealers are salting away substantial profits without risking a penny. How's *that* for a sure thing?

Write today to learn whether you can qualify for a Tung-Sol Consignment franchise in your neighborhood.



TUNG-SOL
Jone-flow Radio Tubes

TUNG-SOL LAMP WORKS, INC.
 Radio Tube Division
 General Office: Newark, N. J.

SALES OFFICES: Atlanta, Boston,
 Chicago, Charlotte, Dallas, Detroit,
 Kansas City, Los Angeles, New York.
 General Office, Newark, N. J.

*Silent Spiral
Connector...*



NO SLIDE

NO FRICTION

NO NOISE

*5-Finger
"Knee Action"
Contact*



AMAZINGLY

SMOOTH...

PERMANENTLY

QUIET

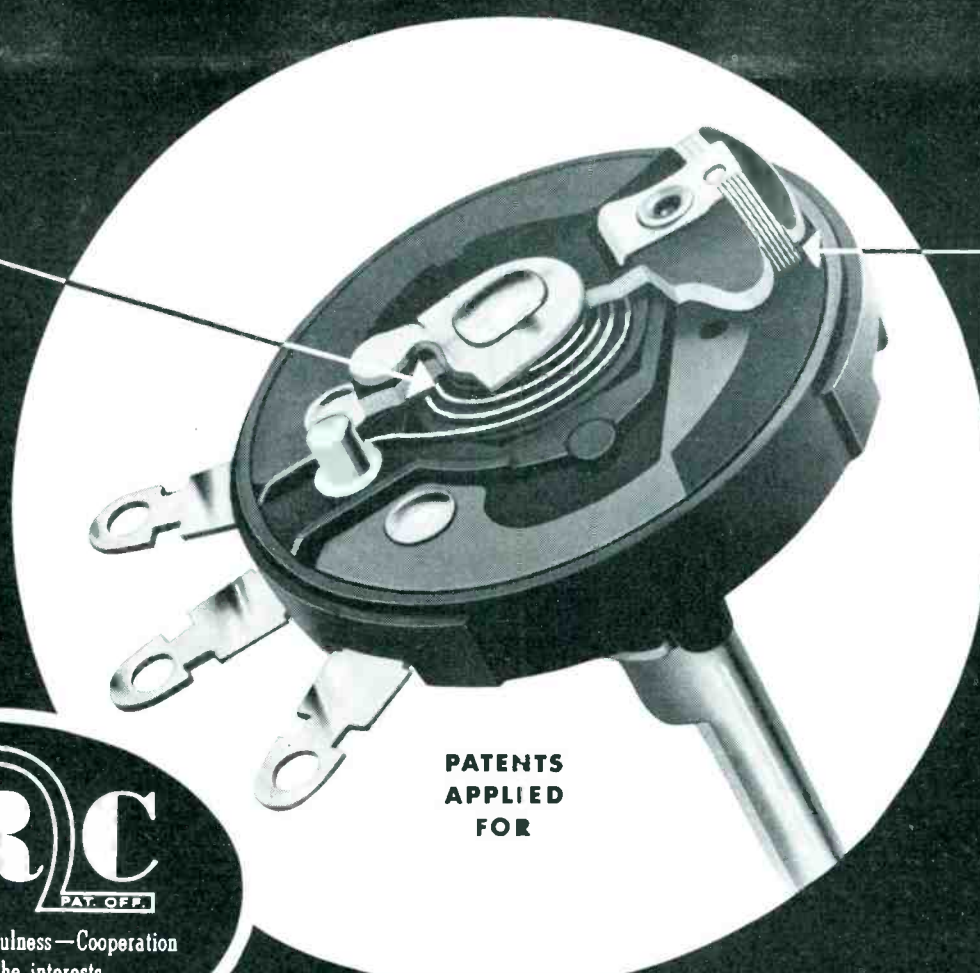

PATENTS
APPLIED
FOR



SPECIAL REPLACEMENT
Metallized **CONTROLS**
with the New SILENT SPIRAL CONNECTOR
plus 5-Finger "KNEE ACTION" ELEMENT CONTACT

Out goes noise at the two most critical points in any control!
Sliding, metal-to-metal contact—the most common cause of control noise—is definitely eliminated by the latest IRC engineering triumph, the Silent Spiral Connector. Because it provides positive, continuous electrical connection between the center terminal and volume adjustment arm, there is no chance for noise to originate. With element noise also eliminated by the famous IRC 5-Finger "Knee Action" Silent Element Contact, you have double assurance of the smoothest, most reliable controls you've ever used—controls that are quiet and stay quiet!

Silent Spiral Connector available only on IRC Special Replacement Controls... designated in Guide with prefix "J"
5-Finger "Knee Action" Element Contact supplied on all IRC Controls.

FREE GUIDE
The most complete guide ever offered. Contains more than 200 pages listing IRC Standard and Special Replacement Controls for practically every receiver.



INTERNATIONAL RESISTANCE COMPANY
401 NORTH BROAD STREET, PHILADELPHIA, PA.

Factories or Licensees in Canada, England, France, Germany, Italy, Denmark and Australia
MAKERS OF RESISTANCE UNITS OF MORE TYPES, IN MORE SHAPES, FOR MORE APPLICATIONS THAN ANY OTHER MANUFACTURER IN THE WORLD

AMATEUR NOTES

922 a vacuum type phototube by RCA similar to the 921. Light-response characteristics for this tube are practically linear for light inputs up to 1 lumen, provided the anode voltage is relatively high and the load resistance relatively low.

Maximum ratings and characteristics are:
 Anode-Supply Voltage (D. C. or Peak A. C.).....250 Volts
 Anode Current.....30 Microamperes
 Ambient Temperature.....50 Degrees C.
 Sensitivity.....20 Microamp./lumen
 Load Resistance:
 For 250 volt anode-supply voltage 1 min. Megohm

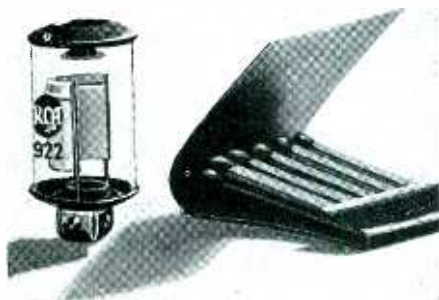

923 gaseous type phototube, standard bulb, similar mechanically and electrically to the 918, but has shorter over-all length.

Characteristics are:
 Anode-Supply Voltage (D. C. or Peak A. C.).....90 Volts
 Anode Current.....20 Microamperes
 Ambient Temperature.....50 Degrees C.
 Sensitivity: At 0 cycles.....100 Microamp./lumen
 Gas Amplification Factor.....Not over 10
 Load Resistance:
 With anode-supply voltage of 90 volts
 For currents { greater than 2 microamp. 4 min. megohms
 less than 2 microamp. . . 1 min. megohm
 With anode-supply voltage of 75 volts
 For currents less than 3.5 microamp. 0 megohm

High Gain Phase Inverter

From RCA comes the following circuit. A 6F5 as a phase inverter following a 6H6 detector supplies sufficient gain to drive a pair of 6F6 or 6L6 tubes in pushpull.

The novel part of the circuit is that part of the rectified signal from the detector flows through cathode resistor of the 6F5. The voltage developed by the procedure drives one grid of the output tubes. Coupling to this stage is made through a 0.1 mfd condenser.

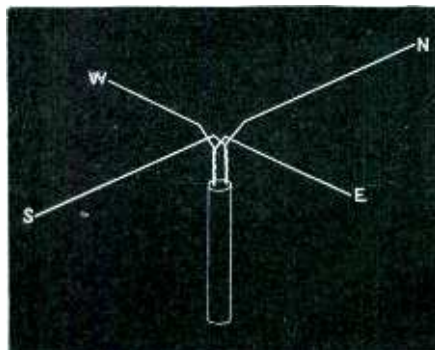
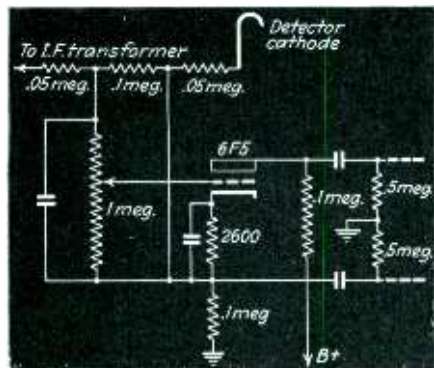

Phase Rotated Antenna

The desirable features of directional antennas are known to every one. For amateur work, a simple yet effective antenna, whose directivity can be changed, has been developed by Taco. By rotating a switch in the shack, changing the phase relation of the antenna net work, signals can be increased in the desired direction by approximately two R points.

The principles involved are shown in the following sketch. Two V doublet antennas are arranged at right angles to each other. Since a half-wave antenna receives or radiates at right angles to the plane of the antenna, the field strength pattern resembles the illustration. The low impedance feeders

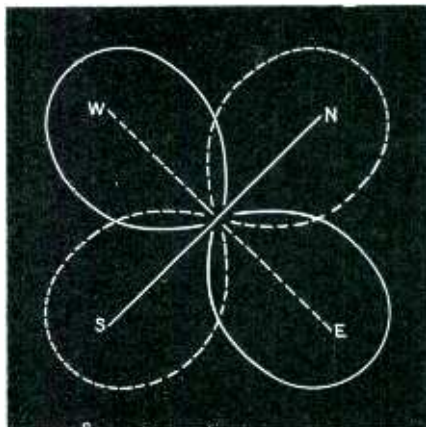

(four wires in all) are connected to a switching system at the receiver end whereby any combination of the antennas may be chosen. By choosing the feeders connected to the antenna running north and south, directivity is obtained in the E-W position. There are many combinations made possible by this switch. Thus, a full range of directivity results.

New Tubes

833—A high power transmitting triode by RCA of new design. Features are: minimum amount of insulation within the tube, low internal lead in-

ductances and high plate efficiency at moderate voltages. A bulb of unusual shape provides desirable mechanical and electrical characteristics.

Class C Telephony Characteristics are:
 Filament Voltage (a.c. or d.c.).....10 volts
 Filament Current.....10 amps.
 Plate Voltage.....2,500 volts
 Plate Current.....335 ma.
 Grid Voltage.....300 volts
 Grid Current......75 ma.
 Driving Power.....30 watts
 Power Output.....635 watts
 Amplification Factor......35
 Grid-Plate Capacity......63 uuf

I. F. Transfilter

Similar to a quartz crystal filter for increasing the selectivity of an i.f. stage, the transfilter by Brush is particularly useful for phone reception. Full selectivity of a quartz crystal handicaps

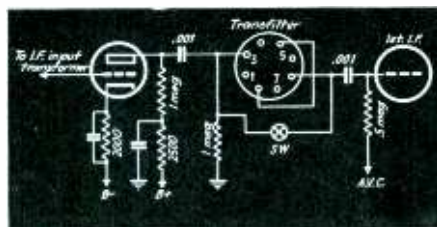

phone reception by destroying the high frequency side bands. The transfilter on the other hand, provides a maximum amount of selectivity for intelligibility of modulated signals.

The outward appearance of the unit resembles a metal tube, and the octal base makes it convenient to use an octal socket as a receptacle.

The actual transfilter element consists of a steel bar whose length determines the frequency at which the filter will operate. On this bar are mounted 4 small Rochelle Salt Crystal plates. They are connected in pairs and constitute the input and output circuits. The steel bar is common to both circuits. The name "transfilter" is derived from the design and principle of operation. That is, the intermediate frequency voltage impressed upon the input crystal plates excite the steel bar into longitudinal vibrations. These vibrations in turn excite the output plates, and the signal voltage is applied to the following stage.

It is a known fact that with a quartz filter at least two stages of i.f. are necessary. With the new filter, a single conventional i.f., followed by a low gain triode, is sufficient. Connections for this are shown in the diagram.

The triode and transfilter are connected between the secondary of the first i.f. transformer and first i.f. tube. The switch SW is connected directly across the input and output of the filter. With the switch open, the filter is in operation. Closing the switch shorts out the filter.



Model 430

Positively Checks All Type Radio Tubes According to Latest Recommendation of tube Engineers.

IMPROVED UP-TO-THE-MINUTE 1937-38 TUBE TESTER

Only
\$18.00
for this TUBE TESTER

- Has Line Voltage Adjustment
- Has Leakage and Short Test
- Uses Triplett Direct Reading Instrument (GOOD-BAD Scale)

Five flush type sockets provide for all tubes. The tester operation is very simple and indicates condition of the tube for dealer and customer on Direct Reading (GOOD-BAD) colored scale of Triplett instrument. Will also test for inter-element shorts and leakages. Complete in attractive, sturdy, quartered-oak case. Sloping etched panel of silver and black. Suitable for portable or counter use.

DEALER PRICE..... **\$19.80**
Model 431 same as 430 except has Readrite (GOOD-BAD) Meter.

DEALER PRICE..... **\$15.90**
A MODIFIED EMISSION TYPE TESTER . . . APPROVED CIRCUIT

Readrite
TESTERS **RANGER** METERS

READRITE METER WORKS
1020 College Drive, Bluffton, Ohio

Please send me more information on Model 430; Model 431; Model 557; Model 740; Model 640-740; I am also interested in.....

Name

Address

City..... State.....



Model 557
\$18.90

Direct Reading Signal Generator

Model 557 Direct Reading Signal Generator uses plug-in type coils. Five frequency bands are covered from 110 to 20,000 K.C., all fundamentals. Completely shielded for static and magnetic fields. Attenuation and stability are outstanding features. Strong signals both modulated and unmodulated are furnished.

Volt-Ohm-Milliammeter

Model 740 Volt-Ohm-Milliammeter has 3" Square Triplett Precision Instrument. Scale readings: 10-50-250-500-1000 A.C. and D.C. Volts at 1000 Ohms per Volt (D.C. Accuracy 2%; A.C. 5%); 1-10-50-250 D.C., M.A.; 0-3000 low ohms; High Ohms to 250,000 at 1 1/2 Volts.

Model 740
\$19.50



Combination Volt-Ohm-Milliammeter and Free Point Tester

Precision built throughout, Readrite-Ranger Radio Testers need no apology from the highest class servicing shops. In fact, you will find them using these rugged testers on calls because they have been particularly designed to withstand rough field work. Ask your jobber to show you today's values in precision radio testers.

Model 640-740 \$28.35



SOUND SYSTEMS CIRCUITS

Remote Volume—Mixer Control

A new idea in sound amplifiers allows the operator of a sound system to control gain and mixing at a distance. Built into a new RCA amplifier it permits these adjustments to be made up to 2,000 feet from the amplifier. Chance of hum pickup or feedback are prevented due to the special circuit design.

Referring to the schematic, a dual input stage is used in the amplifier, one of which is illustrated. The 1612 tube in this stage is a low microphonic pre-amplifier type. The volume control is in the cathode circuit, regulating the bias on this tube. Since the control is not in the signal circuits, remote control may be accomplished at any distance from the amplifier. The change-over to remote control is done simply by plugging the remote control cable into an 8 contact socket on the front panel and turning the standard volume control all the way "off". This causes a switch to remove the standard control from the circuit.

Since the control of both pre-amplifiers is adjusted at the remote box by separate potentiometers, signals may be mixed also; providing of course, that the separate signals are connected to the individual preamplifiers.

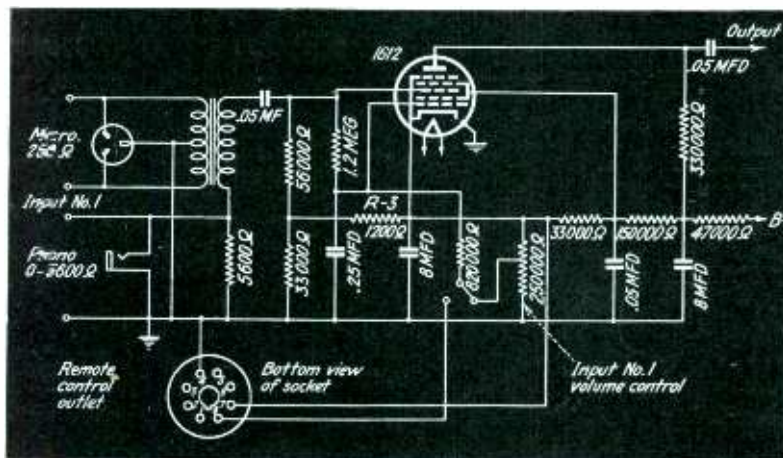

shown herewith. Experiments have been carried further to prove that usual methods of phase inversion, either by cathode and plate connection to the driver tube, or feedback from the opposite tube in a pushpull output stage still leave much to be desired.

The circuit shown employs a 6C8G as first amplifier stage and a 6J5G to obtain phase inversion. The individual grids of the 6C8G are paralleled, the plates are arranged at opposite ends of the plate load resistor. In this way the upper plate is permitted to feed a signal to the upper 6F6G grid through a .01 mfd. condenser.

The lower plate of the 6C8G has a tapped plate load resistor in its circuit. From this tap the 6J5G inverter tube obtains signal voltage. Since the signal present in the plate circuit of a tube is always 180 degrees out of phase with the grid signal, the output voltage of this tube is in correct phase relation to drive the lower 6F6G. The coupling between these tubes is a .01 mfd. condenser.

Frequency response of this circuit is essentially flat. Excellent high frequency response is obtained. The output voltage falls slowly at the very low frequencies.

Class B Automatic Bias System

Since heavy grid current and large plate current fluctuations are customary in Class B. amplifiers the usual methods of automatic bias are unsuitable. The voltage across a resistor in the cathode circuit would vary considerably with these changes. Hence, bias is usually

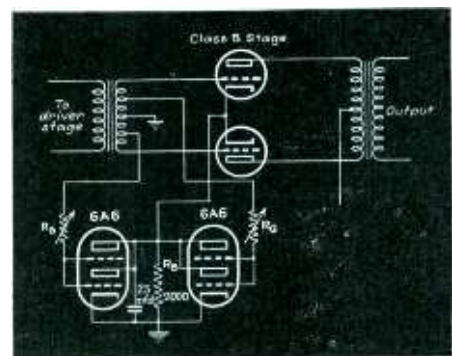

obtained from batteries or special power supplies. In a novel amplifier by Jefferson, all these disadvantages are overcome. Bias voltage is obtained from a cathode resistor, across which is connected a regulator vacuum tube network.

As illustrated, the circuit is conventional except for the 6A6 regulator tubes and the special input transformer. If a signal was applied to the grids of the Class B stage without the regulator tubes in the circuit, plate current changes would likewise cause a change in the voltage drop across R_b . This would result in serious distortion and low output from the amplifier.

With the regulator tubes in place, and a signal applied, signal voltage is present on the 6A6 grids as well as the Class B stage. The 6A6 grids, driven positive, lower the plate resistance of these tubes. Since these are in parallel with the cathode bias resistor, the effect is to lower the effective cathode resistance.

Improved Phase Inverter

With the advent of high power output stages using small tubes in push-pull circuits, phase inverters have become increasingly popular. The simplest phase inverter is a centertapped audio transformer or choke. However, tests by Sylvania have shown such a circuit to be inferior in power output, gain distortion and fidelity to the circuit

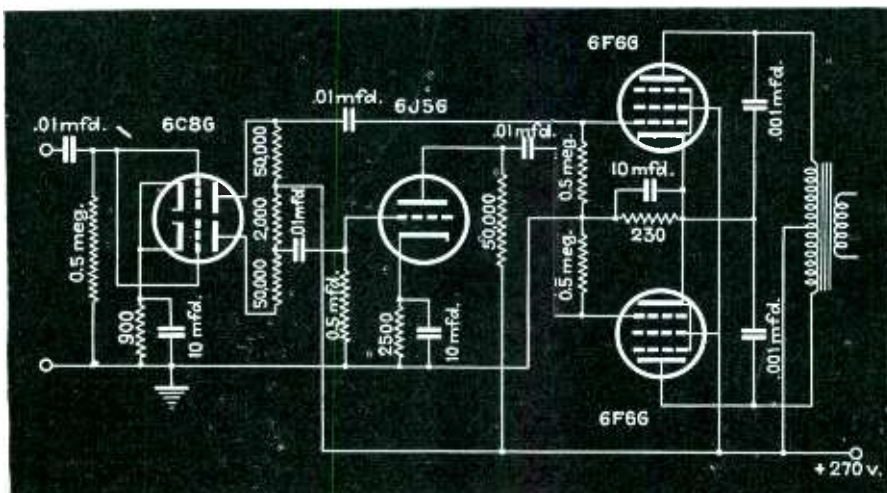

YOU PROFIT *Two* WAYS WITH THE NEW ARCTURUS EQUIPMENT DEAL!

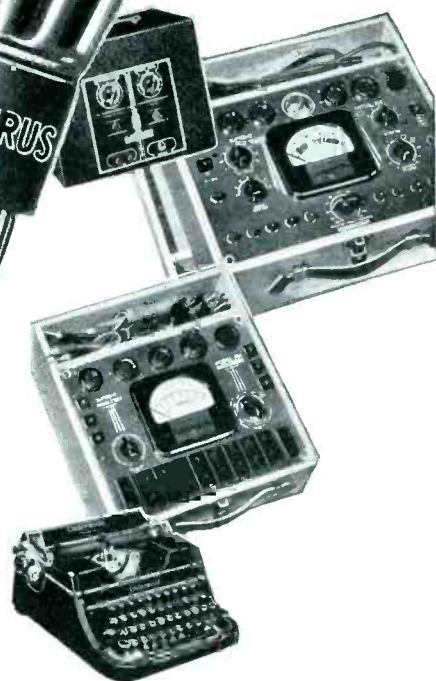
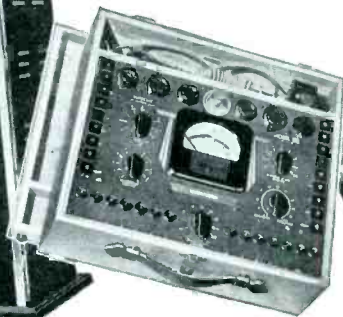

★ **HIGHEST GRADE STANDARD EQUIPMENT** . . . *Quick Delivery* . . .
Amazingly Low Down Payment

★ **THE WORLD'S BEST ENGINEERED TUBES** *At Standard List Prices*

"An equipment deal that stands head and shoulders above any other!" . . .

"The fairest deal I have ever seen." . . .

Thus run trade comments as every mail brings enthusiastic letters from radio men who know a good thing when they see it — who recognize in the new Arcturus Equipment Deal an unexcelled opportunity to get needed shop equipment under the most favorable terms — and, at the same time, feature radio's finest, best engineered tubes in all their work.

TRY IT—YOU CAN'T LOSE!

The ARCTURUS offer includes a long list of high quality, standard shop equipment. Small monthly tube requirements make it unnecessary for you to "oversell" yourself on tubes. Furthermore, ARCTURUS actually *helps you sell* with the finest line of dealer helps on the market today. ARCTURUS tube quality, plus the exceptionally easy terms, make this deal a sure winner! The only way you can possibly lose is by not taking full advantage of it!

MAIL THIS COUPON
for DETAILS 

Arcturus
Radio Tube
Co., Newark,
New Jersey.

Gentlemen:

Send complete details of your new Equipment Deal.

I am a Dealer

I am a Serviceman

Name _____

Address _____

City _____

State _____

My Jobber is _____

RR-2

ARCTURUS

**INDEPENDENT TUBES FOR DEALERS WHO
DO THEIR OWN INDEPENDENT THINKING**

25,000 OHMS PER VOLT

Model 1200-E Volt-Ohm Milliammeter

**MODEL 1200-E
DEALER PRICE
\$31.17**

- Resistance Readings to 40 Megohms
- Separate A.C. and D.C. Instruments in Tilting Twin Case; Accuracy of Each Within 2%
- For All Radio Measurements Not Requiring a No Current Draw Vacuum Tube Voltmeter

TRIPLET MASTER VOLT-OHM-MILLIAMMETER, EASILY IDENTIFIED BY THE EXCLUSIVE TILTING TWIN INSTRUMENT, IS BY ALL ODDS THE OVERWHELMING FAVORITE BECAUSE IT IS THE MOST PRACTICAL (It Offers the Most for the Money).

Model 1200-E offers a new order of precision testing with 25,000 Ohms per Volt. Modern radio sets that require delicate balancing can be easily and quickly adjusted.

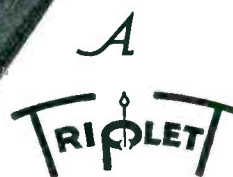
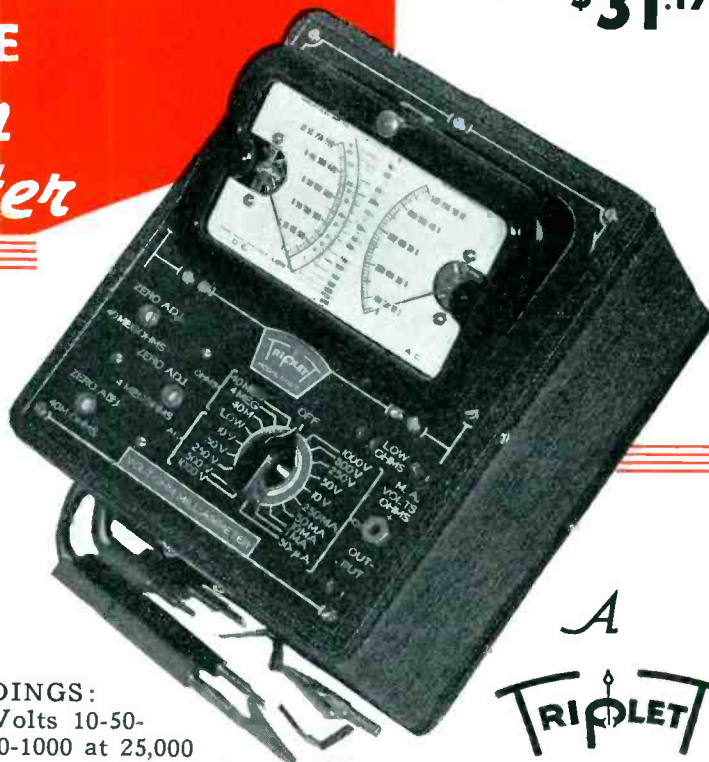

MASTER UNIT

A TRIPLET MASTER UNIT one of a series of co-related single unit testers made in standard sizes, the most economical method yet devised for completely equipping the all-around radio service shop with high quality instruments. Catalog gives complete information regarding other Triplet Volt-Ohm-Milliammeters.

READINGS:
D.C. Volts 10-50-250-500-1000 at 25,000 Ohms per Volt. A.C. Volts 10-50-250-500-1000. 50 D.C. Microamperes; 1-10-50-250 Milliamperes; Resistance 1/4-1000 Low Ohms, Backup Circuit; 0-40,000 Ohms; 4 and 40 Megohms.

New

LABORATORY TEST BENCH PANEL

As Shown Contains:

- 1210-A Tube Tester
- 1232 Signal Generator
- 1209-A A.C. Voltmeter
- 1209-D Volt-Ohm-Milliammeter

OTHER LABORATORY MODELS

Model 1402 with compartments for any two DeLuxe Testers; Model 1403 with accommodations for any two Master Units and one DeLuxe Tester.

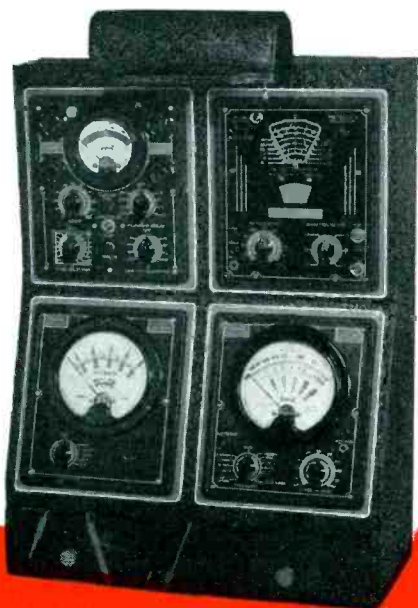

**MODEL 1404
DEALER PRICE \$95.50**
(complete less lamp)

THE TRIPLET ELECTRICAL INSTRUMENT CO.
2010 Harman Ave., Bluffton, Ohio

Please send me more information on Triplet Model 1200-E: _____ Model 1404.

Name _____
Address _____
City _____ State _____

**For More Information
SEE YOUR JOBBER
OR MAIL COUPON TODAY**

SHORTCUTS

Distortion in Small Speakers

By S. C. Ross

A number of auto sets have come into the shop with speaker distortion for which there was no way of adjusting the voice coil; either because the spider is inaccessible or a piece of material is glued from the cone to the center magnet.

To loosen this center, adjust and re-glue, is not practical. The best method is to tap lightly with a small hammer on the back flange, to which the pole unit is attached, until no further distortion is audible. This should be done with the radio in operation and the speaker attached to its baffle. Otherwise, the adjustment will not be satisfactory when replaced, for it will have a tendency to throw the voice coil out of line when bolted, due to the exceptionally small tolerance allowed.

For best results, while tapping, use a weak signal and listen closely to the high frequencies.

Oscillation Troubles With the 1D7G

By H. D. Hooton

Although the characteristics of the new 1D7G "octal" type converter tube, as given in the manufacturer's tube manuals, correspond to those of the older 1A6, there has been a great deal of trouble with the 1D7Gs which was never encountered with the older tubes. Perhaps the most common difficulty is total or partial lack of oscillation over the tuning range when this type of tube is replaced. In some extreme cases it has been found that out of twelve or fifteen tubes only two or three could be made to oscillate without revamping the oscillator circuit of the receiver.

In most instances where the 1D7G does not operate satisfactorily, the 1C7G may be substituted without difficulty. If this is not practical or desirable, the oscillator circuit usually must be revamped. Remove the usual 50,000 ohm grid leak and substitute various higher resistance values, checking for smooth oscillation at both ends of the tuning scale. Be careful not to make the grid leak of too high value; if the leak is higher than 100,000 ohms the set may be very noisy, or howl due to oscillator self-modulation may be encountered when operating the dial over the high-

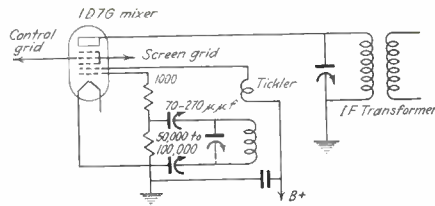

frequency portion of the scale. However, if the leak must be high in order to produce oscillations at the *low-frequency end of the scale*, the value of the oscillator grid condenser will have to be changed or adjusted to a point where the modulation no longer takes place. Perhaps the most convenient method of making this critical adjustment is to substitute a standard padding condenser of about 70-220 mmfd. rating

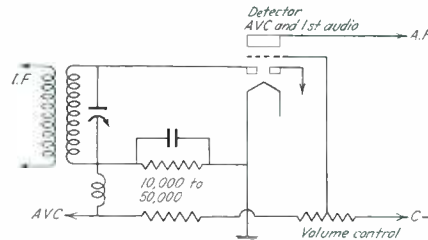

for the usual mica fixed condenser. Incidentally, the insertion of a small ($\frac{1}{4}$ watt) non-inductive resistor of about 1,000 ohms value in the oscillator grid circuit as shown in Fig. 1, will sometimes improve both the stability and oscillation of the 1D7G when the receiver is designed to cover the broadcast band only.

Output Meter from Tube Tester

By James A. Nash

The copper oxide rectifier in an out-moded tube tester can be put to many uses. A half-wave affair was extracted from a Jewell checker pattern 538. It lends itself admirably as an output indicator when connected across a voice coil.

A sensitive voltmeter is used in conjunction with the rectifier. In a few minutes it can be built into any voltmeter. Simply connect it in series with a 1 milliamperer movement. It provides good sensitivity even on weak signals. If the meter dial is calibrated it may be used to measure a.c. voltages.

Eliminating R.F. Oscillation

By R. S. Henderson

Many of the low-cost radio receivers, especially those of the tuned-radio-frequency type have no shielding whatever in the R.F. circuits and are, therefore, very likely to oscillate after making changes in the set or replacing the tubes. A simple method of getting rid of oscillation in sets of this type is to place one or two short-circuited turns of insulated wire around the offending coil and move it up or down until the difficulty is eliminated. The short-circuited coil should not be grounded.



SERVICING SOUND—And other equipment is the topic of a new series of "Technaural" lecture-meetings to be given during November by E. C. Cahill (left), RCA Service Manager, and W. L. Rothenberger, Manager RCA Commercial Sound Section.

A TREASURE TROVE

Of Free Equipment For
Radio Service Men Who Buy
**NATIONAL UNION
TUBES**



ASK
YOUR JOBBER
TO SHOW YOU
THIS
GREAT 1938
FREE EQUIPMENT
CATALOG!

80 Big Pages!
More Than
100 Pieces
of— **FREE EQUIPMENT!**

Through National Union's help radio service dealers everywhere have been able to set up better equipped shops to do better work; also to obtain sales helps that produce more customers. National Union has constantly put the latest advances in scientific equipment as well as modern selling aids within reach of the service dealer. The National Union Deal calls for a dealer deposit which is rebated when the specified number of tubes have been purchased. Over 70,000 completed deals. Every service dealer should investigate.

**NATIONAL UNION RADIO
TUBE QUALITY HAS BEEN
PROVED IN THE FIELD**

**THE ROAD TO
BETTER BUSINESS**

NATIONAL UNION

1. Full guarantee on highest quality radio tubes.
2. Cut price business not solicited.
3. Price Protection.
4. N. U. jobber stocks are complete. No hunting for odd types.
5. Timely business building aids.

NATIONAL UNION RADIO CORPORATION RR-1037
570 Lexington Ave., New York, N. Y.

I am interested in the following equipment Name.....
..... Address.....
..... City..... State.....

All Radiart Vibrators Get Rhythm

- "They don't mean a thing if they ain't got that swing."
- Unless vibrators are correctly designed so that in the proper circuit they immediately break into a full swing and continue to act that way through minimum starting voltage, they will arc, burn and sputter on starting. Don't risk a poor vibrator spoiling a good set.
- Play safe—insist on Exact Duplicate Radiart Vibrators from your dependable Radiart Jobber.

Quiet, Insulated, and Reliable RESISTORS

CONTINENTAL CARBON bakelite insulated resistors are impervious to moisture, conveniently small and noiseless in high gain circuits. They are recommended for use in compact amplifiers and radios.



M3, 2"x13/16", 3 Watt, \$.30
M1, 1"x9/32", 1 Watt, .20
M1/2, 5/8"x7/32", 1/2 Watt, .17



CONTINENTAL CARBON ceramic insulated resistors have withstood the tests of time in actual service. Where space permits, ceramic insulated resistors are recommended for the utmost in stability and long life. In close tolerance applications, these resistors are the choice of leading test instrument manufacturers of precision equipment and meters.

H5, 3"x9/16", 5 Watt, \$.50
E2, 2"x3/8", 3 Watt, .30
D2, 1 1/4"x1/4", 1 Watt, .20
G4, 1"x1/4", 1/2 Watt, .17

Send for Bulletins 104B, 105, 103A, and 101A

CONTINENTAL CARBON Inc.

13902 Lorain Ave., Cleveland, Ohio
Also Toronto, Canada

TRICKS

AC-DC MIDGETS

Oscillation . . . Most oscillation troubles in this type set can be reduced by slightly increasing the bypass from detector plate to chassis. The tone is usually improved by this change.

AC-DC SETS

Considerable increase in sensitivity results when the antenna coil is moved up closer to the secondary winding. Of course this means readjusting the balancing condenser on the first section of the tuning gang.

AIRLINE 62-72

Dead, no voltage on screens. . . . Open field coil, screen voltage supplied through field. As this set has two speakers it may be made to operate by bridging field (red and yellow wires) with 10 watt 10,000 ohm resistor.

AIRLINE 62-89

Insensitive . . . Last i.f. transformer defective. Replace with part #P5127; other transformers unsatisfactory.

AIRLINE 62-103

Weak, low volume . . . shorted or open screen bypass or open screen resistor. Inoperative . . . open 415 ohm flexible wire-wound resistor, shorted screen bypass on 6D6 r.f. and det. stages.

AIRLINE 62-307

Intermittent, noisy . . . replace 1 meg volume control part #101-46. Oscillator dead . . . replace mica condenser from grid of 6C5 oscillator to coil terminal.

APEX 46

Distortion at low volume. . . . This trouble can be overcome by replacing the old control and connecting in a slightly different fashion. The old control is simply a series resistor in the cathode circuits of the 24 tubes. For proper replacement connect one end of a 10,000 ohm tapered control to the antenna lead, the other end to the cathodes of the 24s through a 250 ohm resistor. The center arm should be connected to ground. The open circuit in the wire wound resistor where the old control was connected should be bridged with a jumper.

ATWATER KENT 944

Weak, sensitivity control has no effect . . . look for open 1 megohm resistor connected from the 4 mfd. filter to the grid of 57 tube.

ARVIN 18

Distortion, low volume when jarred . . . replace .05 mfd. 160 volt condenser mounted through chassis near power pack, connected between volume control and resistor on end of i.f. transformer. This is part C-60 in the schematic.

ARVIN 62

Noisy when tuning dial is rotated. . . . Solder bottom arm on planetary drive system to bracket at front end of condenser gang.

AUTO RADIOS

It is common practice to jam the remote control tuning cable as tight as possible into the set fitting. This can result in microphonics, oscillation and erratic operation as the tuning condenser is then mechanically connected to ground.

Set the cable just far enough into the sleeve to properly mesh with the tuning condenser. This procedure will allow the condenser to float, as originally intended.

CROSLLEY 170

Oscillation, reception only when finger is placed on grid of first 58 tube . . . look for opening in r.f. oscillator coil located in back of band switch.

GE 105

Weak, no colorama tuning. . . . Replace 5Z4 rectifier.

GRUNOW 48

Distortion which shows up after 5 to 10 minutes of operation . . . replace .02 mfd. coupling condenser part #29567.

GRUNOW 500

Although not shown in the factory diagrams some of these sets have a hum bucking coil in the speaker. When a set has no plate voltage check the speaker windings as sometimes a flash occurs between the field and this winding, destroying the leads to the field coil.

KOLSTER 70

Some of these sets have a 1 mfd. 400 volt condenser across the filter choke. If set does not have this condenser the tone and volume can be improved by adding one.



STEPPING UP FAST—Starting with little capital just a short time ago, Pompton Lakes (N.J.) Radio Service is now proud owner of over \$250 worth of test equipment, averages \$100 a month for replacement parts and \$150 for tubes

IT'S IN HERE, O. M.!

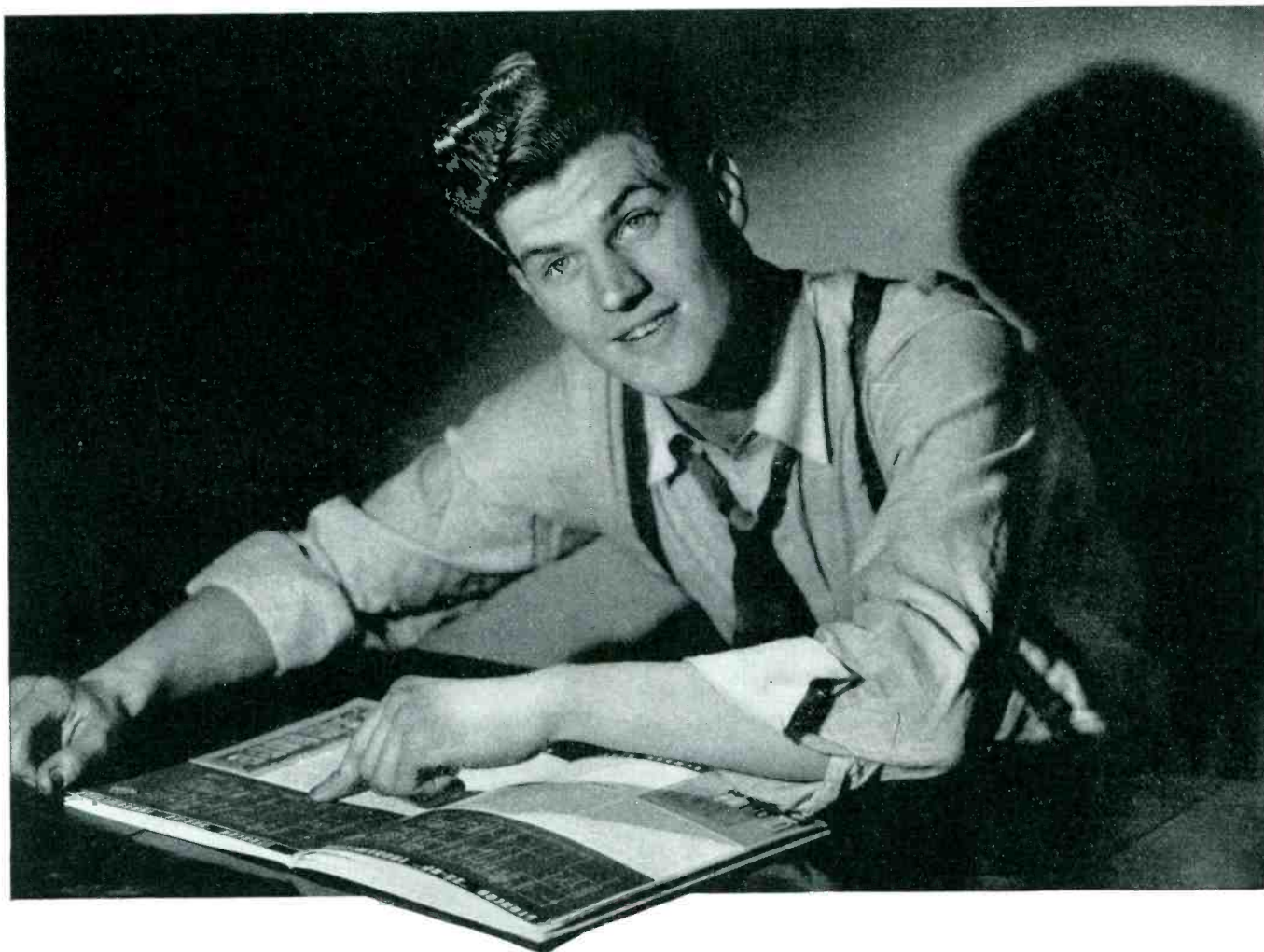

The **STANCOR**
HAMANUAL

New . . . complete . . . practical! 16 complete circuits from microphone to antenna post . . . transformers for *all* tubes. . . . Don't build or re-build until you have seen the Stancor Hamanual. . . . It has all the latest dope!

Ask Your Jobber for Your Copy!

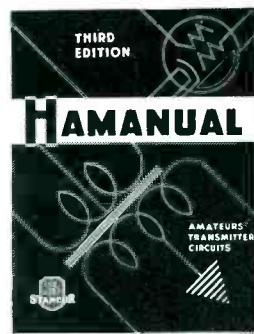

STANDARD TRANSFORMER CORPORATION

850 BLACKHAWK STREET CHICAGO

TRICKS

MAJESTIC 66

Fading, vibrator refuses to function, pilot light still lights. . . . Examine fuse holder for corrosion.

PHILCO 18

The tone control condenser shorting is frequently the cause of a dead set.

PHILCO 47

Intermittent reception, frequent burn-out of tubes and pilot lights . . . short between chassis and pilot light bracket behind shadow tuning meter.

PHILCO 610

Oscillator whenever volume control is touched . . . check 41 output plate condenser for open. This condenser is connected in series with tone control condenser, is located in tone control housing.

PHILCO 630

High pitched whistle with the volume control about $\frac{3}{4}$ on, disappears when control is turned in either direction. . . . Look for open condenser (part #30-4042 connected from plate of 42 to B minus.

RCA M109

Dead from 550 to 900 k.c., weak on remaining portion of dial . . . Open 100 ohm resistor in antenna filter. This resistor along with a choke and condenser are contained in a small metal can located at a point where the antenna enters the chassis. Remove can and replace resistor.

RADIOLA 17, 50

Unstable . . . screw loose on terminal board making poor contact. Tighten all screws.

MILLIONS IN USE  MEANS GOOD WORK

SELL MORE COMBINATIONS

INSTALL General Industries Flyer Motors. When your sets are switched from radio to phonograph, the superior performance of famous Flyers will do a real selling job. High-fidelity reproduction, from uniform speed regardless of variations in record drag. Superior basic design. Precision built. Dependable for long trouble-free service.

The **GENERAL INDUSTRIES CO.**

3737 Taylor St.,
Elyria, Ohio



Flyer Motors are priced so low that customers are surprised to find combinations in such a convenient price range. Order test samples now. Be sure to specify whether AC or DC and give exact voltage and frequency of current you use.



SEALED IN GLASS!

● Now you can cure chronic condenser trouble forever! Keep your customers happy—use GLASSMIKE, the glass-walled condenser, and eliminate profit-eating call-backs! It's new, different, absolutely impervious to moisture, guaranteed for a year, and costs no more than an ordinary condenser.

Ask your jobber for Glassmike, and write today for illustrated descriptive circular.

ASK YOUR JOBBER FOR "GLASSMIKE"

CONDENSER PRODUCTS CO.
1369 NORTH BRANCH STREET
CHICAGO • ILLINOIS



FLASHING SIGNALS!
EAR PHONE!
NOISE TEST!

FLASHES a brilliant red signal for a bad tube—amber signal for a weak tube—and green signal for a good tube. Signals are translucent ivory until you press the button. The customer listens to the noise test through a permanently attached earphone. Shorted or leaky tubes cause intense glow, spreading lengthwise in long glass cylinder. Makes test of grid control. Fast and simple to operate.

Crystalline Metal Case

Lustrous Chrome Panel—Steel Slide for Chart.

NET PRICE TO DEALERS \$54.00

ON DEMONSTRATION AT YOUR JOBBER'S

THE RADIOTECHNIC LABORATORY
1334 SHERMAN AVE., EVANSTON, ILL.

A Complete Line of
Tube Test  Equipment

SEE YOUR JOBBER

RADIOTECHNIC

NEW HEIGHTS!

FOR ten years radio testing equipment had just gone along . . . then it was suddenly revolutionized by the Simpson line.

New designs . . . new standards of workmanship . . . new heights of accuracy, of stamina, of practical, on-the-job useability—that is what hundreds of servicemen have discovered in Simpson Instruments.

See them at your jobber's—and your next servicing equipment will be Simpson.

SIMPSON ELECTRIC CO.
5216 Kinzie Street, Chicago, Ill.

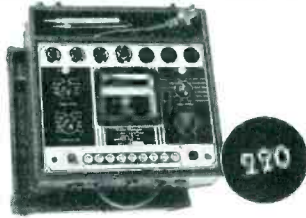

Model 220 Roto-Ranger Tube and Set Tester

The fastest selling instrument in its price class. Roto-Ranger feature places twelve separate scales at your finger tips. Has latest tube testing circuit—filament return selector—separate resistance scales of 0-100-100,000 ohms, and 100 megohms. Three D. C. scales 8-300-1000 volts (2500 ohms per volt).
Net price **\$62.75**
Time price: \$12.50 down and six \$9.60 payments.



Model 201-202 Roto-Ranger Volt-Ohm Milliammeter

Convenient Roto-Ranger gives following ranges: Model 201 (D.C.) Ohms, 0-20-200-2,000-20,000-200,000-20 megohms; Microamps, 0-200; Milliamps 0-10-150; Volts, 0-8-300-1,000. Model 202 (A.C. and D.C.) A. C. volts, 0-8-130-1,000; D. C. volts 0-8-300-1,000; D. C. Milliamps, 0-1-8-130; Ohms, 0-100-0-50,000-2 megohms.
Net prices: Model 201 **\$32.50**
Model 202 **\$35.75**
(Sold on deferred payments)



Model 215 A.C.-D.C. Volt-Ohm Milliammeter

5000 Ohms Per Volt
The small instrument with the big, easy-to-read dial. 0-2.5-10-50-250-1000 volts, A.C. or D. C. 0-10-100-500 Mils. 0-250 Microamps. 0-4,000-400,000 ohms. 0-4 megohms. Five decibel ranges—12 to + 55.
Net price **\$25.75**



Model 205 Volt-Ohm Milliammeter

5000 Ohms Per Volt
Pocket size but highest quality. Highest resistance ranges ever provided in an instrument of this size—0,2000-200,000 ohms-2 megohms; Volts 0-10-50-250-1,000 (D. C. only); Milliamps, 0-10-500.
Net price **\$13.25**



The New "Anal-O-Scope"

Ingenious time-saver for use with any set tester or Volt-Ohm-Milliammeter. Just select card corresponding to tube under test, place it on Anal-O-Scope and you have complete picture of elements and connection while tests are being made. Combines cord and plug analysis with "Free Point" method. Ask for interesting facts.



Model 210 All-Wave Signal Generator

The last word in signal generators. Ask for description and prices.

SIMPSON

Instruments that **STAY ACCURATE**

ASK YOUR JOBBER

MAIL THIS COUPON TODAY

Simpson Electric Co., 5216 Kinzie St., Chicago

Send facts covering items checked

- Model 220 Model 201-202 Model 215
 Model 205 Model 210 Anal-O-Scope

Name _____

Address _____

City _____

State _____

NOT "JUST ANOTHER" VOLUME

A GREAT STEP

toward the *Perfect Manual*

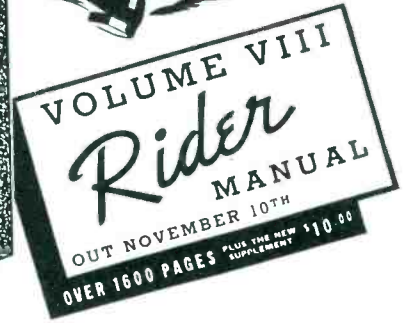
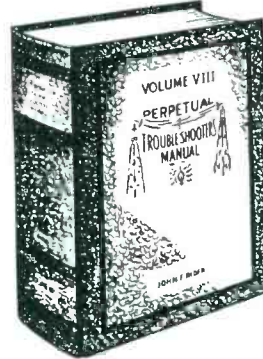

Enthusiastic ordering even before it was published, that is the story of Volume VIII, out November 10th. Jobbers ordered heavily merely from a description of its contents. They visualized the value of the "plus" services which it offered to servicemen.

ORDER TODAY FROM YOUR JOBBER

VOLUME VIII IN TWO SECTIONS

1. **MANUAL:** Over 1600 pages giving complete circuit information on 1937-38 models of over a hundred manufacturers.
2. **INDEX:** Of about 118 pages makes it easy to quickly find the data in all eight Rider Manuals.
3. **"HOW IT WORKS":** A separate section giving a description of the Technical Features of new sets, such as A. F. C.—motorized tuning, etc.

YOU NEED ALL 8 Rider MANUALS

JOHN F. RIDER, Publisher, 1440 BROADWAY, NEW YORK CITY

Geared!

CLAROSTAT SERVICE MANUAL

SEND for your copy of new manual, backed by complete line of CLAROSTAT exact-duplicate replacements stocked by your jobber.

CLAROSTAT Manufacturing Co., Inc.

285-287 NORTH SIXTH STREET
BROOKLYN, NEW YORK, U.S.A.

• OFFICES IN PRINCIPAL CITIES •

TRICKS

SILVERTONE 1390, 1400, 1402, 1404, 1406

Dead, weak, distorted signals on powerful locals . . . Check bypass block mounted in can next to 27 tube. Detector plate bypass section (.1 mfd) is usually at fault. Replace with higher voltage unit. Check 1000 ohm resistor in plate circuit of some tube for overload caused by short.

SILVERTONE 1640

Motorboating . . . check .2 mfd screen bypass for open.

TRUETONE 6K

Crackling, vibrator and ignition quiet. . . . Antenna transformer shield can ungrounded. This condition may be remedied by removing chassis and inserting a phosphor bronze spring between the coil can and chassis bracket with a long-nose pliers. Most stores handling this set have these springs on hand.

SPARTON 870

Noisy . . . terminal board on side of power unit for connection of external choke breaking down. Replace with new terminal.

STEWART-WARNER, 3040-3049

Oscillation when tuned to weak stations or between stations can be removed by connecting a ground to the receiver.

If a ground is not available oscillation can be prevented by connecting a .01 mfd. buffer condenser from one side of the power line to chassis. In connecting the condenser, first solder one side to the chassis. Touch the other lead to one terminal of the line cord and note whether the hum increases. If the hum increases touch the condenser to the other line cord terminal. This will usually be the line cord terminal which connects to the off-on switch. Solder the condenser in this position.

TWO VOLT FARM SETS WITH WIND CHARGERS

Burned out tubes. . . . It is imperative that a good connection is made at the battery with the filament leads. Ordinary battery clips often make poor contact to battery. If wind charged is connected to same clips, voltage from the wind charger is sufficiently high to burn out tubes when battery is disconnected.

Replace clips with auto battery clamps and solder all connections securely.

Reproduction of WEBSTER-CHICAGO Ad In Leading Entertainment Papers



"I said, 'I don't think you need that trumpet, grandpappy—they've got a WEBSTER-CHICAGO Sound System'."

FOR A BIGGER HAND USE BETTER SOUND

ALL PURPOSE SOUND SYSTEM

For Both 6 Volt D.C. and 110 Volt A.C. Operation

Being battery or AC operated, Model MP-530 has the advantage of being usable anywhere; indoor or outdoor, auto, trailer or boat.

It is built rugged and compact of the very best materials and carries the recommended R.M.A. guarantee.

All necessary parts are included, the phonograph turntable being an integral part of amplifier cabinet.

If your show sounds thin and tinny, try a new Webster-Chicago system. . . . Models for all purposes and all purses.

30 WATTS OUTPUT
Will handle audiences to 10,000 people

WEBSTER-CHICAGO



Model 530 Includes:

- Plug-in Power Pack for either 6 Volt DC or 110 Volt AC operation.
- Hand Type Crystal Microphone.
- Phonograph and High Fidelity Pickup Built into Amplifier.
- Two Heavy Duty P.M. Speakers.
- Mixes Microphone and Phonograph; Tone Control also incorporated.
- Economically Priced.

Webster-Chicago, Section S-12, 5622 Bloomingdale Ave., Chicago, Ill.

Without information on Catalog.
Name . . .
Address . . .
City . . .

All Inquiries Referred Directly to the Trade

WEBSTER-CHICAGO SOUND EQUIPMENT MAKES MORE MONEY FOR DEALERS. Direct Advertising creates direct leads and excellent sales promotion material makes it easy for dealer to solicit.

WEBSTER-CHICAGO . . . The Complete Line of Public Address Systems, Sound Equipment and Accessories . . . Popular Priced Leaders in the Sound Field for Over 12 Years!

For Complete Catalog or Other Information Address Section 0-8

WEBSTER-CHICAGO
5622 Bloomingdale Ave. CHICAGO, ILL.

now! RAZOR-EDGE SHADOW TUNING-

-in an amazing new **SUPREME** SIGNAL GENERATOR!

Supreme's newest contribution to radio science—the new 581 Signal Generator! Full of the outstanding precision features found only in laboratory types selling as high as \$600! Over 8 feet of actual scale length! New razor-edge shadow tuning eliminates all possibility of Parallax error!

Includes an all-wave R. F. oscillator—125 K. C. to 60 MC; a 400 cycle modulating oscillator, a beat frequency audio frequency oscillator, an electronic frequency modulator or "wobulator", and dozens of other exclusive, outstanding Supreme features. Complete with four tubes, shielded dummy antenna, calibrated screen for 3" C. R. tube and accessories. Dimensions: 14"x10⁵/₈"x6³/₄".



● (ABOVE) MODEL 581 Signal Generator—Dealer's Net Wholesale Cash Price, \$54.95. On S. I. C. Payment Plan: \$6.00 Cash and 10 monthly payments of \$5.44.

SOLD ON SUPREME S. I. C. TERMS—THE WORLD'S EASIEST INSTALLMENT TERMS. WRITE FOR LITERATURE DESCRIBING COMPLETE SUPREME LINE.

SUPREME INSTRUMENTS CORP.

GREENWOOD, MISSISSIPPI, U. S. A.

EXPORT DEPT., ASSOCIATED EXPORTERS CO., 145 W. 45th STREET, NEW YORK CITY, CABLE ADDRESS: LOPREH, NEW YORK

"PINCO" THE ONLY COMPLETE GAS-O-LECTRIC POWER PLANT LINE



RED TOP COMBINATION A.C.-D.C. POWER PLANT



GOLD CROWN HEAVY DUTY POWER PLANT

Cash in on this Market

Here is an exclusive dealer-jobber line of portable electric light, power and battery-charging plants, priced for quick sale and big profit. "PINCO" combination AC-DC and DC RED TOP and GOLD CROWN heavy duty power plants are a necessity for millions of farms, homes, industrials, etc., where "city" electricity is not available. Provide instant power for lights, radios, electrical equipment and appliances. Now is the time to cash in on this waiting market. Write for literature and discounts.

One Line for Every Requirement

"PINCO"—the only complete power plant line! Full price range; 100 to 2000 watts; alternating or direct current; air or water cooled; remote control; filter and ignition shielding; push button starting.

PIONEER GEN-E-MOTOR CORPORATION
Dept. No. R-1J, 466 West Superior Street, Chicago, Illinois

Please send me complete information on:

"RED TOP" "GOLD CROWN" Converters Dynamotors

Name

Address

City..... State.....



New 15th Anniversary Edition 32-page catalog just issued.

Lists largest variety of condensers yet offered.

Also essential resistors.

Improved listing facilitates selecting condenser by type, voltage, capacity.

Many new items added to line.

Also 8 pages of exact-duplicate replacement condenser listings.

Ask local jobber for a copy. Or write us direct.



Get Your Copy ...



TRICKS

UNITED MOTORS 4037

Weak or inoperative . . . this trouble can often be traced to shorted turns on the primary of the vibrator transformer. Primary winding consists of 4 layers of heavy wire, can easily be rewound. Check secondary for short also before attempting any repair.

Also check buffer condenser and r.f. filter condensers for shorts or leaks.



NEW PRESTO
SOUND RECORDER
RETAILS AT **\$149**

Distribute some literature on this new instrument.

You will be surprised at the interest in home recording among your own customers.

A supply of 3½" by 6½" folders will be sent you free upon request.

PRESTO
RECORDING CORPORATION
137 West 19th Street, New York, N.Y.

ZENITH 1937 MODELS

On the 8, 10 and 12 tube model 1937 Zenith sets, difficulty is sometimes encountered getting optimum tracking over all bands. Generally the B band is the one giving the most trouble, and as this is the key band around which all the fundamental calibrations of the other bands are obtained, its importance in the alignment procedure is obvious.

The fault lies in the shifting of the inductance in the tapped first detector coil. The consequent mismatching of the inductive-capacitive design results in the shifting of the peak resonant condition for optimum alignment of the circuit. In other words, due to the poor matching of inductances as a result of this shift, a resonance peak could not be obtained in the R.F. tuned circuits.

However, the remedy for this is rather easily obtained. It has been found that shifting the small fixed mica condenser marked C1 in the diagram, ordinarily connected in the grid circuit of the antenna coil secondary, over to the first detector coil circuit in the identical position, the matching of the coils becomes closer and a consequent improvement in sensitivity is obtained. The capacity of this condenser is 5 mmfds.

CINAUDAGRAPH
Speaker

CINAUDAGRAPH
Magic Magnet Speakers

—extensively utilized by all leading radio receiver and P. A. equipment manufacturers—are available in a complete range of sizes from 5½ to 18 inches, to meet your every radio requirement.

If you demand utmost dependability and fidelity of reproduction from your equipment—in-sist on Cinaudagraph P. M. speakers. Carried in stock by all progressive distributors. Free descriptive literature on request.

CINAUDAGRAPH
CORPORATION
Speaker Division • Stamford, Conn.

THEY'RE SWITCHING TO C-D!

JOBBERS everywhere in every state of the Union tell us that "QUALITY and PROFIT" conscious servicers are switching to C-D's. These smart servicers are taking advantage of the new highs in performance and dependability that C-D electrolytics are now establishing on the most difficult jobs.

No matter what the radio circuit . . . there's a rugged, dependable C-D condenser designed for it. The use of C-D in servicing men's PROFITS . . . SATISFIED CUSTOMERS . . . PEACE OF MIND.

FOR A BETTER YEAR
SWITCH TO C-D

Ca.alog 151A describing in detail the entire C-D line of capacitors available on request.

World's Oldest and Largest Exclusive Manufacturer of Capacitors

MICA DYKANOI PAPER WET & DRY ELECTROLYTICS

CORNELL-DUBILIER ELECTRIC CORP.
1019 Hamilton Blvd. Plainfield, N. J.

CORNELL-DUBILIER ELECTRIC CORP.
South Plainfield, New Jersey

Don't sell **NEW** parts
for **OLD** Speakers!

MORE CREDIT TO YOU
—MORE PROFIT, TOO
WHEN YOU RECOMMEND A NEW

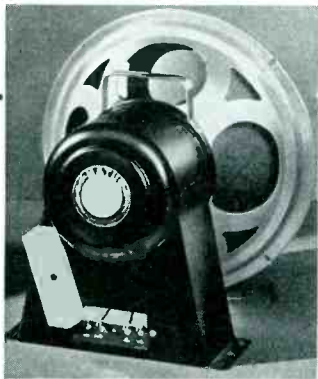

Don't risk customer good-will by selling new parts for old speakers! Even at the factory, parts must be carefully matched for each individual speaker. It's a delicate job—and requires special equipment. A new

UTAH speaker brings a new thrill to set owners—more credit to you, and more profit too! And you can always get the correctly engineered replacement speaker for the job from UTAH. Write for speaker catalog. Address Dept. RR-10.



UTAH VIBRATORS

- ▼ LAST LONGER
- ▼ WORK BETTER
- ▼ COST NO MORE

The 1937 UTAH Vibrator is the finest and toughest ever made—gruelling tests PROVE IT! Exclusive UTAH design and construction mean "no comebacks" for you. And remember, over a million sets are factory equipped with UTAH Vibrators. Here is the vibrator that has earned customer preference—the vibrator easiest and most profitable for you to sell. Order your's today!

UTAH RADIO PRODUCTS CO.
CHICAGO, U. S. A.

TORONTO BUENOS AIRES
ONTARIO, CANADA (UCOA RADIO PRODUCTS CO.)

"16 YEARS OF LEADERSHIP"

Look for the Name **MUELLER**
WHEN YOU BUY YOUR CLIPS



Made to Last Longer
THE ONLY COMPLETE LINE

8 Different Sizes—Copper—Steel—Insulated and Uninsulated
Send for FREE SAMPLES and Catalog 780

Mueller Electric Co.

Clip Makers for 29 Years
1583 E. 31st St., Cleveland, Ohio

FUNCTIONAL DESIGN

"V" Series Velocity Microphones



The smooth trim lines and screen housing are more than just style. They contribute to the top performance that typifies the "V" Series. No side-wall reflection. No resonance.

Priced from \$25 to \$75 list.
Write for catalog. See your jobber.

ELECTRO-VOICE MFG. CO.

328 E. Colfax Avenue, South Bend, Ind.

Export Office: 100 Varick Street, New York City

SHORT WAVE CONVERTERS FOR CAR RADIOS



Model 600

Can be attached to any car radio. Has on and off switch. Does not affect the reception on the standard broadcast bands. MODEL 600—covers 49, 31, 25, 20, 19 and 16 meter bands. Designed for reception of American and Foreign short wave broadcast. Especially adapted to use in tropical countries and the more remote parts of the world. Distance range 5000 to 10000 miles. A very attractive unit. List Price \$24.95
MODEL 300—covers 6000 to 20000 kilocycles. Has variable condenser with illuminated dial. List \$19.95
For Use of Police and Other Law Enforcement Officers

MODEL 100—police converter with fixed condenser. Covers 1500 to 2000 kilocycles. List Price \$11.95
MODEL 200—police converter with variable condenser and illuminated dial. Covers 1500 to 5500 kilocycles. List Price \$17.95
MODEL 500—police converter with two metal tubes, variable condenser and illuminated dial. Very sensitive. Exceptional distance range. List Price \$21.95
Jobbers and dealers wanted **ABC RADIO LABORATORIES** 3334 N. New Jersey St., Indianapolis, Indiana, U.S.A.



announces a complete line of

TRANSMITTING CAPACITORS

OIL — PAPER
and

MICA TYPES

Write for Complete Catalog

SOLAR MANUFACTURING CORP.
599-601 Broadway, New York, N. Y.

TRICKS

SPARTON MODELS

Dial does not track . . . remove chassis from cabinet, set dial pointer to correct setting. Pointer is merely pressed on shaft and works loose from vibration.

ZENITH 420

Rapid motorboating, no reception . . . open 500 mmf. condenser across plate and cathode of the 56 second detector.

ZENITH 1937 MODELS

Electric tuning service adjustments:

Make sure that nothing is obstructing the free action of either the belt, the pulley, or the drive shaft, such as wires or component parts.

Check the band change shaft for clearance on the 9-12-15 tube models. The die cast bracket through which the brass drive shaft for the motor travels can be centered properly by loosening the two Parker-Kalon screws which hold the bracket to the front of the dial assembly. After centering the above mentioned die cast bracket retighten the two Parker-Kalon screws.

Check the $\frac{1}{8}$ nut at the rear of chassis in this manner; loosen the nut, permit the motor to run and retighten the $\frac{1}{8}$ nut while in operation. This will allow the front and rear bearings to align themselves properly.

Check for ample clearance between the dial gang drive pulley and the mounting nut for the bearing through the front of the chassis approximately $\frac{1}{8}$ " clearance. Brass drive shaft should also have ample clearance at rear of chassis between collar mounted on motor switch.

The large drive pulley mounted on the rear of the brass shaft should be in line with the small pulley which will be found mounted on the motor armature. Alignment can be accomplished by loosening the two set screws and sliding the large pulley either backward or forward on the brass shaft.

The tension of the drive belt for the motor can be adjusted by loosening the two hexagon bolts found at the rear of the chassis and holding the motor assembly. The motor assembly should be moved in the elongated holes until the drive belt has a snug tension but not too tight an action. Then retighten the hexagon mounting bolts.

If the drive mechanism has a tendency to slip when using the large manual knob check for a loose spring clutch. All adjustments to the clutch should be made very carefully. The mechanism being essentially the same as in 1937. Adjustments are made by turning the screw mounted through the blue steel clutch spring found at the front of the brass drive shaft mechanism. By running the screw in, the action will be tightened, and by running the screw out, the action will be loosened, but in all cases only one or two complete turns should be necessary.

All bearings, dial mechanism and gears of the gang should be lubricated approximately once a year. If at any time it is necessary to change the electric eye tube, care should be taken not to place the tube too far forward as this will cause a strain to be placed on the dial pan causing friction at the center hub of the gang shaft and the motor assembly will not operate freely.

CLARION 60

Inoperative or noisy . . . check for open in input audio transformer. This is a special transformer and must be replaced with original unit for original tone qualities. Resistance coupling may be substituted.

GE M-81, RCA 143

For a gradual loss of pep and volume on this set be suspicious of the grid resistor and filter network on the 56 tube amplifier stage. Changing of the condenser will work wonders in some cases. (There are two models of this set—information applies to model with divided or two resistor grid network.)

GE F-107

For intermittent operation of this set check the pilot light socket and bracket assembly for shorts.

GE F-107

Unsatisfactory operation of the automatic tuner unit on some of the earlier models is caused by a slipping drive belt. A small hole drilled through the back corner of the motor base plate and a tapped hole into the chassis will enable a small screw and spring to be used as a belt tightening unit to secure the proper tension.

HUDSON TERRAPLANE SETS

When installing auto sets in this car an annoying intermittent buzz is often present while the motor is running. Motor noises are carried and radiated by the gas line. A condenser from the gas line to chassis would not remove the trouble.

A satisfactory solution is to ground the gas tank as a fabric insulates it from the hanger. An easy way to do this is to wrap a piece of copper braid around the insulating fabric and clamp the tank back in position.

MOTOROLA 78

Poor tone . . . check the voice coil and field to see if these connections have been reversed. This causes the voice coil to become charred. If such is the case replace cone and voice coil.

PHILCO 14

No control of tone . . . test 37 first audio in tube tester and by substitution. In many cases this tube is at fault and not the tone control.

SPARTON 600

Motorboating. . . Check the bias resistor on the 183 output tubes. The resistance should be 1,250 ohms but changes to 700 ohms often a few minutes operation. Replace with a wire wound unit.

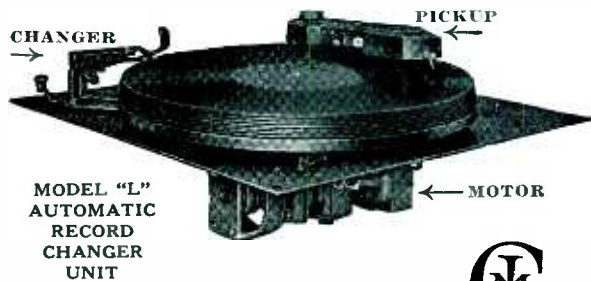

When Writing Your Order

Be sure to specify exact voltage and frequency of current for your test samples. Changer shown above automatically changes eight 10" records or seven 12". Model "K" changes eight 10" and plays 12" records changed by hand.



GO STRONG ON AUTOMATICS WITH LOW-COST CHANGER UNITS

STRONGER every day, the trend to combination radio-phonographs shows up in great shape—with good profits—wherever General Industries record changer units are in the picture. They bring automatic playing down to where average people can afford it. Yet they perform up with the high-priced changers . . . Sell more radio-phonographs equipped for automatic playing. Install General Industries changer units. Dependable for fine service and plenty of it. Easily installed at low cost.

The **GENERAL INDUSTRIES CO.** 3737 Taylor St., Elyria, Ohio

INDEX TO ADVERTISERS

October, 1937

	Page		Page		Page
ABC RADIO LABORATORIES, INC. (Short-Wave Converters)	72	HYGRADE-SYLVANIA CORP. (Tubes)	10	SENTINEL RADIO CORP. (Farm Radio Sets)	7
AEROVOX CORP. (Condensers)	68	INTERNATIONAL RADIO CORP. (Radio Sets)	21	SIMPSON ELECTRIC CO. (Service Instruments)	70
ARCTURUS RADIO TUBE CO. (Tubes)	60	INTERNATIONAL RESISTANCE CO. (Resistors)	56	SKY PILOT ORGANIZATION (Radio Clocks)	52
BOND ELECTRIC CORPORATION (Batteries)	50	JANETTE MANUFACTURING CO. (Rotary Converters)	48	SOLAR MANUFACTURING CO. (Condensers)	72
BRACH MFG. CO., L. S. (Antenna Systems)	52	KEN-RAD CORP. (Tubes)	48	STANDARD TRANSFORMERS CO. (Transformers)	66
BRIGGS & STRATTON CORP. (Gas Engines & Generators)	12	MAJESTIC RADIO & TELEVISION CORP. (Radio Sets)	47	STEWART-WARNER (Radio Sets)	8
CINAUDAGRAPH CORP. (Sound Equipment)	71	MALLORY & CO., INC., P. R. (Replacement Parts & Power Packs)	72	STROMBERG CARLSON TELE. MFG. CO. (Radio Sets)	2
CLAROSTAT MFG. CO. (Volume Controls)	68	MUELLER ELECTRIC CO. (Wire Clips)	72	SUPREME INSTRUMENT CORP. (Test Equipment)	70
CONDENSER PRODUCTS CO. (Replacement Condensers)	63	NATIONAL UNION RADIO CORP. (Radio Tubes)	64	TRIAD MANUFACTURING CO. (Tubes)	53
CONSOLIDATED WIRE & ASSOC. CORPS. (Condensers)	46	NOBLITT-SPARKS INDUSTRIES, INC. (Radio Sets)	25	TRIPLETT ELECTRICAL INSTRUMENT CO. (Test Equipment)	62
CONTINENTAL CARBON CO. (Resistors)	64	NORGE DIVISION, BORG-WARNER CORP. (Refrigerators)	37	TRIUMPH MFG. CO. (Test Equipment)	89
CONTINENTAL MOTORS CORP. (Electric Heaters, Battery Chargers)	52, 53	PARRIS-DUNN CORP. (Wind-Electric Chargers)	44	TUNGSOL RADIO TUBES, INC. (Tubes)	54
CONTINENTAL RADIO & TELEVISION CORP. (Radio Sets)	5	PIONEER GEN-E-MOTOR CORP. (Electric Plants)	68	UTAH RADIO PRODUCTS CO. (Vibrators)	72
CORNELL-DUBILIER CORP. (Condensers)	71	PRESTO RECORDING CORP. (Recorders and Discs)	71	WARD PRODUCTS CO. (Auto-Radio Antennas)	46
CORNISH WIRE CO. (Antennas)	51	RADIART CORPORATION. (Vibrators)	64	WEBSTER-CHICAGO (Sound Equipment)	69
CROSLEY RADIO CORP. (Radio Sets) Inside Back Cover		RADIO RETAILING. (Trade-In Allowance Blue Book)	32	WILCOX-GAY CORPORATION. (Radio Sets)	45
ELECTRIC STORAGE BATTERY CO. (Storage Batteries)	40	RADIO-TECHNIC LABORATORIES. (Testing Instruments)	63	WILLARD STORAGE BATTERY CO. (Storage Batteries)	28
ELECTRO-VOICE MFG. CO. (Microphones)	72	RAYTHEON PRODUCTION CORP. (Tubes)	3		
GENERAL ELECTRIC CO. (Radio Sets)	Back Cover	RCA MANUFACTURING CO., RA-DIOTRON DIV. (Tubes)	4	SEARCHLIGHT SECTION	
GENERAL HOUSEHOLD UTILITIES CO. (Radio Sets & Refrigerators)	50	RCA MANUFACTURING CO., SET DIVISION (Radio Sets) Front Cover		<i>Classified Advertising</i>	
GENERAL INDUSTRIES CO. (Phono. Motors, Record Changers)	67, 73	READRITE METER WORKS. (Test Equipment)	58	Classification	Page
GREBE MFG. CO., INC. (Radio Sets)	49	REMLER CO., LTD. (Inter-Communicating Systems)	54	CATALOGS	75
HORTON MFG. CO. (Electric Washers)	48	RIDER, JOHN F. (Service Manuals)	68	RADIO STOCKS	
HOWARD RADIO CO. (Radio Sets)	11			Allied Radio Co.	75

Although Radio Retailing takes every precaution to insure accuracy, we cannot assume responsibility for an occasional change or omission in the above index.

McGraw-Hill Publishing Company, Inc. Publication Office: 99-129 North Broadway, Albany, N. Y. Editorial and Executive Offices: 330 West 42d Street, New York, N. Y. Branch Offices: 520 North Michigan Avenue, Chicago; 883 Mission Street, San Francisco; Aldwych House, Aldwych, London, W. C. 2; Washington; Philadelphia; Cleveland; Detroit; St. Louis; Boston; Atlanta, Ga.

FACTORY CLOSEOUT OF RADIO TUBES

TYPES			
1A8	6B7	35	57
1C6	6C6	41	59
2A3	6D6	42	75
2A8	6F7	43	77
2A7	10	46	78
2B7	12Z3	49	82
6Z3	24	49	85
6A6	32	55	89
6A7	34	56	99V
			99X

R. C. A. licensed new unbranded, fully tested and guaranteed. Quantities Limited—Order Now

Orders under 50 tubes, you pay postage. Orders 50 tubes and over, we pay postage.
Order in quantities of 50 tubes and get 5 tubes (our selection)—FREE.

A total net worth in excess of \$10,000.00 assures the responsibility and reliability of this offer.

Orders \$10 and over, 20% with order balance C. O. D.

Special discounts allowed to quantity purchasers

No order less than (\$1.00) one dollar will be accepted

While they last 20c each

S. R. Co. 66 Lexington Ave., Passaic, N. J.

OVER 10,000 PARTS FOR VACUUM CLEANERS AND WASHING MACHINES

24-HOUR SERVICE!
Attach this "Ad" to Your Inquiry and Receive Complete Catalog
Manufacturers Factory Representatives
MIDWEST APPLIANCE PARTS CO.
2722 W. Division St. CHICAGO, ILL.

SELLING OPPORTUNITIES OFFERED—WANTED

Selling Agencies—Sales Executives
Salesmen—Additional Lines

OPPORTUNITY OFFERED

NATIONALLY known radio manufacturer offers exceptional opportunity to sales representatives or salesmen of proven ability and with dealer following. Write fully, stating present connection and past experience. 9th floor, 430 N. Michigan Avenue, Chicago, Ill.

DISTRIBUTORS!

Nationally known radio manufacturer has territories open for established distributors. Write fully.

9th floor, 430 N. Michigan Ave.
Chicago, Ill.

"SEARCHLIGHT" ADVERTISING RATES

UNDISPLAYED RATE:
15 cents a word, minimum charge \$3.00.
Positions Wanted (full or part-time salaried employment only), 1/2 the above rates, payable in advance.

Proposals, 50 cents a line an insertion.

DISPLAYED—RATE PER INCH:
1 inch \$8.00
2 to 3 inches 7.80 an inch
4 to 7 inches 7.60 an inch

Rates for large spaces, or yearly rates, on request.
An advertising inch is measured vertically on one column, 3 columns—30 inches—to a page.

COPY FOR NEW ADS. MUST BE RECEIVED BY NOV. 1st FOR THE NOVEMBER ISSUE

Quick-Touch DIAL 1938 KNIGHT 5 TUBE SUPERHET



Only \$1325

A Real Leader!

Here's a new set that's perfect for a price-leader! An amazing performer with latest features. New Quick-Touch Dial!—tunes 12 stations in 12 seconds! R.C.A. and Hazeltine licensed 5 Tube A.C. Superhet circuit, 4 1/2" full-vision dial, Tone control, A.V.C., etc. Gets police calls. Priced low to sell. See this set and 64 other new 1938 KNIGHT "Extra-Value" Radios in ALLIED'S new 1938 Catalog—just out. Investigate this great line of radio profit-makers today!

New RADIO SUPPLY GUIDE Just Out!

Write for the new 1938 ALLIED Radio Catalog—your Complete Buying Guide. 164 pages packed with Everything in Radio! Over 12,000 parts, latest test equipment, new KNIGHT Integrated Sound Systems, books, tools, etc. All standard lines at prices that mean more value—more profit for you. Send coupon now!



ALLIED RADIO CORP.
Dept. 18K-8, 833 W. Jackson Blvd.
Chicago, Ill.
 Send your FREE new 1938 Radio Catalog.
Name
Address
City State

\$500,000 GENUINE MAJESTIC-GRIGSBY GRUNOW REFRIGERATOR & RADIO PARTS. 2000 REFRIG. UNITS GUARANTEED 18 MONTHS. SEND FOR PRICE LIST. G & G GENUINE MAJESTIC REFRIGERATOR & RADIO PARTS SERVICE 5801 W. DICKENS AVE. CHICAGO, ILL.

STOP SEARCHING! HERE IS YOUR "GUIDE"

SEND FOR YOUR COPY NOW!

LOWEST PRICES

The New 1938 Radolek Radio Profit Guide contains complete showings of Radio Repair Parts, Radio Receivers, Public Address Amplifiers, Speakers, Microphones, Service Test Instruments, Radio Technical Books, Special Radio Tools. Leading Standard Brands! Everything you will ever need in the Radio Business all at Lowest Prices. You save money at Radolek!

GUARANTEED QUALITY

Every item you get from Radolek is guaranteed. It must be right or we make it right. Standard merchandise produced by leading Manufacturers with Radolek's guarantee added!

FASTEST SERVICE

Everything in Radio promptly when you want it—and exactly what you want. Radolek's efficient organization backed by a huge stock of standard guaranteed quality merchandise insures you the fastest service in the Radio business. Twenty-five Thousand Servicemen customers depend on Radolek service and benefit by Radolek's LOWEST PRICES. Send Now for your copy of the Radolek Radio Profit Guide. It will help you make money.



AUTO RADIO HEADQUARTERS

EVERYTHING IN AUTO RADIO—at the right Prices
Universal control heads . . . Dash mounting adapted Kits . . . Every type auto aerial . . . Cables and fittings . . . Complete vibrator guide . . . Everything you need . . . Ready for prompt shipment.

RADOLEK

601 W. Randolph St., Dept. A-12, CHICAGO

Send me the 1938 Radolek Radio Profit Guide Free.

Name

Address

Serviceman? Dealer? Experimenter?

Rely on Radolek for "Everything in Radio"

LETTERS

Same Old Grief

I have just cut an ad out of "Successful Farming," a western farm publication. I don't know what this radio game is coming to for in this ad a well-known wholesale mail order distributor advertises sets bearing its own brand and, in addition, offers to send consumers complete catalogs.

I wish you would call to their attention the fact that all radio servicemen will have to cut them out as a source of parts supply if they mail their catalogs to everyone.

HIGH FALLS, N. Y. VICTOR G. PURCELL

Checks With Jacoby

I heartily agree with W. A. Jacoby of Detroit in his letter published in the September issue relative to the fact that the broadcasters of the Hollywood and West Coast programs are "letting us down."

Chain programs over local high power stations are notorious in spurious noises that I believe can be blamed on the wire transmission system, or point of origin, when the program originates on the West Coast. Chain programs originating in New York do not have all these "plops" and scratches.

It looks like to me that the broadcasters have let a very weak chain link get into their end of the high fidelity chain. I wonder how long it will take them to get it out?

GAFFNEY, S. C. ALFRED J. BLANTON
Sound-Radio Service Co.

For Permanent Plates

There is one way in which the radio manufacturers could help the serviceman very much and that is by placing on the chassis of every receiver they make so that it cannot be removed a plate bearing the company name, address, watts consumed and voltage requirements.

This is done by just a few companies now. The majority just put the name on the dial plate, or the cabinet, where it is easily removed. This makes it difficult to identify the set for replacing parts and checking the circuit if alterations have been made in it.

KNIGHTSTOWN, IND. MARION L. RHODES

Brickbat

I have just received my copy of September *Radio Retailing* and I think you spoiled one of your best pages with one sentence. I refer to page 28, "Why Good Servicemen Charge for Inspection".

Your point is well taken in regards to his time and gasoline but why spoil it by stating that "The inspection fee is cancelled if a charge is made for repairs." The time and money for gasoline is spent just the same, so why not make the repair charges extra?

CHICAGO STEPHEN D. MUFFITT
Mobile Radio Service

Far be it from us to take a single nickel out of the average serviceman's pocket. These pages of "Sales Ammunition" are published, in fact, to help the trade make more money. We do feel, however, that some concessions are necessary in order to sell either merchandise or time and that this one will do more good than harm if intelligently applied. Anyway, you will note that it is at the bottom of the page, which is complete without it. And you have a pair of scissors.

And Bouquets

Your magazine is commendable for its efforts to close the gap between big, successful enterprises and small, struggling men in the radio industry. By lending a hand to the weak without impeding the progress of the strong, you are performing a service of inestimable value to all concerned.

This is evident by your recognition of the importance of such articles as that on radio service cost accounting by Russell B. Rich, in your August issue.

SPRINGFIELD GARDENS, N. Y.
RADIO TECHNICIAN

Then you'll like the new story by Rich entitled: "Turnover," in this number.

I hope you will continue providing a postcard in each issue so that subscribers can obtain literature on new products without too much work. It's easy to take the attitude that if a person wants information badly enough he will write an individual letter to each manufacturer. But somehow it doesn't work out that way.

GLENDAL, CALIF. RORT. W. K. SMITH
Warner Brothers

We do describe dealer helps regularly and you will find a column about them in the

News section this month. Postcard pages seem desirable only during the seasons when new lines are being introduced. We intend to continue them periodically but cannot promise this service every month.

Wants More Dope

I have read with interest your article in the September issue of *Radio Retailing* entitled, "Today's Trade-In Market".

You, no doubt, have information on this problem as it applies specifically to automobile radio.

In talking with many dealers, it seems apparent that trade-ins have become more general during the past season on automobile radios than formerly.

If you do not have this information at the present time, I might suggest a subsequent article along that line.

CHICAGO R. F. WEINIG
Zenith Radio Corp.

Sorry, but the information we have from the survey you mention does not segregate auto-radio. It's an extremely interesting angle, however, and we'll follow your suggestion, conducting a follow-up survey sometime in the near future.

Working On It

Do you know, or could you find out and publish some information in the near future showing the number of radios and also the number of service organizations per state? Can do?

NORFOLK, VA. ERNEST L. EMERY

Each January we publish all the data we can develop relative to set sales. And at least once a year, generally June, we publish complete specifications of lines. Your suggestion relative to service organizations is a good one. We'll tackle this job shortly but it will take time to make such a list complete. Meanwhile, names and addresses of service organizations will be welcomed. Secretaries please note.

Competition

My sales next season will be modest indeed because of the competition here. In our town of three thousand there are thirteen concerns selling radios. Two are branches from out of town, one competing with me on a particular line we both handle. Then there are three large chains, two people selling sets from their homes, three auto-garages, a restaurant, a liquor store, several furniture shops, appliance outlets. Also, catalogs flood this area.

EDGERTON, WIS. FRANK BROWN

TEST YOUR BUSINESS KNOWLEDGE

- | | | |
|--|------------------------------|-----------------------------|
| Can a push-button tuned radio be operated by window shoppers through plate glass?..... | Yes <input type="checkbox"/> | No <input type="checkbox"/> |
| Is the sale of electric refrigerators steadily going down?..... | Yes <input type="checkbox"/> | No <input type="checkbox"/> |
| Can the sale of a radio in 23 days spell profit and sale of the same set in 50 days spell loss?..... | Yes <input type="checkbox"/> | No <input type="checkbox"/> |
| Has the automotive industry ever been able to sell accessories and repairs before these were needed?.. | Yes <input type="checkbox"/> | No <input type="checkbox"/> |
| Can "self-bias" be used in a class-B audio amplifier?..... | Yes <input type="checkbox"/> | No <input type="checkbox"/> |

Answers Appear Elsewhere In This Issue

THE STANDOUT VALUES

IN RADIO FOR 1938

the new **CROSLEY** all-star super radios



MODEL 1117—11 tubes; 3 bands, 525-22,000 Kc. continuous; American and Foreign reception; octal base tubes; Push-pull pentode output; broad automatic volume control; continuously variable tone control; IRIS tuning indicator; power supply noise filter; 10" electro-dynamic speaker with plug-in cable; 3-dimensional Mirro-Dial; 8 watts output. Handsome striped walnut cabinet. Dimensions: 40" high, 24 $\frac{1}{4}$ " wide, 13" deep.

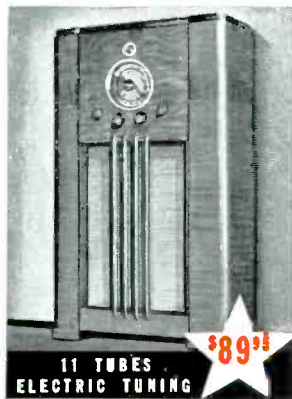

MODEL 1127—11 tubes; 3 bands, 525-22,000 Kc. continuous; Dynatrol Electric Tuning; 10" electro-dynamic speaker; 3-dimensional Mirro-Dial; IRIS tuning indicator; 10 watts output; hand rubbed walnut cabinet. Dimensions: 40" high, 24 $\frac{1}{4}$ " wide, 12 $\frac{5}{8}$ " deep.



MODEL 617—6 tubes; 2 bands, 535-1725 Kc. and 5800-18,300 Kc.; Dynatrol Electric Tuning; 8" electro-dynamic speaker; receives American and Foreign broadcasts; 3-dimensional Mirro-Dial; handsome chairside type cabinet. Dimensions: 20" high, 19 $\frac{3}{4}$ " wide, 10 $\frac{7}{8}$ " deep.



MODEL 637-A—6 tubes; 2 bands, 535-1725 Kc. and 5800-18,300 Kc.; 6" electro-dynamic speaker; Mirro-Dial; 4 watts output. Dimensions: 8 $\frac{3}{8}$ " high, 14 $\frac{3}{8}$ " wide, 6 $\frac{1}{8}$ " deep. MODEL C647-A operates on both AC and DC current; ballast tubes; same cabinet as Model 637-A.



MODEL 567-M—5 tubes; illuminated Mirro-Dial; automatic volume control; American and Foreign reception. Black wrinkle finish chairside type cabinet with Chinese Red bakelite top and red feet. Available also in brown wrinkle finish—Model 567-N, and walnut grained finish—Model 567-P.

THE CROSLEY FIVER—"The World's Greatest Radio Value"; 5 tubes, American and Foreign reception; Mirro-Dial; electro-dynamic speaker; automatic volume control. Cabinet dimensions: 12 $\frac{1}{2}$ " high, 10 $\frac{7}{8}$ " wide, 6 $\frac{1}{8}$ " deep.



MODEL 817—8 octal base tubes; 3 bands, 525-22,000 Kc. continuous; 8" electro-dynamic speaker; 3-dimensional Mirro-Dial; 5 watts output. Walnut veneered cabinet with gold-finished escutcheons and grille bars. Dimensions: 10 $\frac{1}{4}$ " high, 16 $\frac{7}{8}$ " wide, 7 $\frac{3}{8}$ " deep.

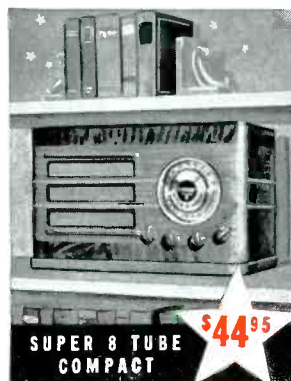

CROSLEY FIVER ROAMIO—5-tube Superheterodyne automobile receiver; octal base tubes; full automatic volume control; exceptional volume; illuminated Mirro-Dial; ONE PIECE INSTALLATION; low battery drain; plug-in connections for both battery and antenna.



THE CROSLEY RADIO CORPORATION, Cincinnati

POWEL CROSLEY, Jr., President

(Prices slightly higher in South and West)

Home of "the Nation's Station"—WLW—500,000 watts—70 on your dial

*General Electric Scores
with Radio's Biggest Hit*

TOUCH TUNING

at a sensational low price



*Press a button
...that's all*

**THE BIGGEST
RADIO DOLLAR VALUE
OF THE YEAR**

NOT 149⁹⁵

NOT 139⁹⁵

NOT 129⁹⁵

but

?? ??

Get the good news from your local G-E Radio Distributor on the sensational price announcement.

MODEL F-96

GENERAL ELECTRIC scores another great radio scoop G-E Touch Tuning, the most important radio improvement of the year, is now offered at a price within reach of every home.

Year customers can purchase a G-E Touch Tuning Radio for no more than they would pay for a good conventional hand-dialed Radio.

No more dialing! No dials to twist, twirl, or swish. The new G-E puts an end to fumbling with knobs. You press a button—that's all! And instantly, silently, and automatically, the program comes in tuned to hairline precision.

The biggest radio dollar value of the year TOUCH-TUNING—Press a button that's all—plus these outstanding features:

New Multi-vision Louver Dial with Visual Volume and Tone Indicators... The amazing new G-E Tone Monitor... Silent Tuning... Automatic Frequency Control... Automatic Volume Control... Custom-craft Cabinet.

G-E RADIO IS EASY TO SELL BECAUSE THE PUBLIC IS SOLD ON



*The
New
1938*



GENERAL ELECTRIC

RADIO

APPLIANCE AND MERCHANDISE DEPARTMENT, GENERAL ELECTRIC COMPANY, BRIDGEPORT, CONNECTICUT