

MARCH, 1937

RADIO RETAILING

McGRAW-HILL PUBLISHING COMPANY, INC.

25 CENTS PER COPY

Out the Window with Guesswork!



NO MORE incomplete data; no more worrying about inaccuracy; no more frenzied hunting for information you can't find; no more experimenting at your own expense; no more advice to buy from manufacturers long since out of business; no more cross listings that double cross your

thinking. No more—
But what's the use! It's just a case of no more guesswork, no more time wasting when you get your copy of the new—

MALLORY-YAXLEY Radio Service Encyclopedia

Here for the first time—under one cover—is concise, complete, authoritative information on *all* repairing of *all* sets. Chuck-full of notes on tricky installations—*all* the references anyone can need—conveniently and simply arranged.

Thousands of servicemen who have bought their copies say "the book is a life saver"—the finest help they have ever had. They are tickled to death with this "All in One" Book—all the information on Circuits—Schematics, I. F. Peak Frequencies, Transformer Circuits, Condensers, Volume Controls, Vibrators and Tubes—in *one* book, on *one* page, on *one* line for any receiving set.

We have prepared this Encyclopedia for you. Your Mallory-Yaxley distributor has your copy ready for you to examine. Your share of the cost is a trifle. Buy the book—if in a week it does not pay its way, if you would part with it for twice what you paid for it—return the book and get your money back. But act today; the edition is limited.

P. R. MALLORY & CO., Inc.
INDIANAPOLIS INDIANA
Cable Address—PELMALLO

Use
MALLORY
REPLACEMENT
CONDENSERS... VIBRATORS

Use
YAXLEY
REPLACEMENT
VOLUME CONTROLS

Over 200 pages of fact information, bound in waterproof, washable cloth and printed on paper that stands the gaff—it is a permanent working reference.

AN OPEN LETTER

*to all who sell 2 or 6
volt radio sets*

Dear Mr. Radio Dealer:

Because it takes more than just a storage battery to provide satisfactory power for a radio, we have designed a complete line of Willard Radio Batteries for 2 and 6-volt sets.

In case you haven't received complete information on these new Willards, mail the coupon and we will send you the whole story by return mail.

Of course you're interested in new profits—and the good will of your set owners. So why not do something about it right away! Fill out and mail the coupon.

Very truly yours,
WILLARD STORAGE BATTERY CO.



THROW NEW LIGHT ON YOUR PROFIT PICTURE
MAIL THE COUPON TODAY!

WILLARD STORAGE BATTERY COMPANY
CLEVELAND, OHIO

Send me complete details on the new Willard Radio Batteries at once.

FIRM _____

NAME _____

ADDRESS _____

Willard RADIO BATTERIES

cost less to own

... BECAUSE THEY LAST LONGER AND PERFORM BETTER

RADIO RETAILING

MARCH, 1937

O. FRED ROST, Editor
 W. MacDONALD, Managing Editor
 C. A. NUEBLING, Technical Editor
 T. H. PURINTON, Assistant Editor
 HARRY PHILLIPS, Art Director

•
 RAY V. SUTLIFFE, Consulting Editor

•
 Tom Blackburn, Chicago
 George Tenney, San Francisco
 H. S. Knowlton, Boston

•
 HOWARD EHRlich, Vice-President
 H. W. MATEER, Manager

McGraw-Hill Publishing Company, Inc.

Publication Office
 99-129 North Broadway, Albany, N. Y.
 Editorial and Executive Offices
 330 West 42nd Street, New York, N. Y.

Cable Address: MCGRAWHILL, New York
 Member A.B.P. Member A.B.C.

James H. McGraw, Jr. Chairman
 Malcolm Muir President
 James H. McGraw Honorary Chairman
 Howard Ehrlich Vice-President
 B. R. Putnam Treasurer
 D. C. McGraw Secretary

RADIO RETAILING, March, 1937, Vol. 22, No. 3. Published monthly, price 25c copy. Subscription rates United States and Central and South American countries \$1. All other countries \$2 a year or eight shillings. Printed in U. S. A. Entered as Second Class Matter, September 8, 1936, at Post Office, Albany, N. Y., under the Act of March 3, 1879. Cable address: "McGraw-Hill, New York." Member of A.B.P. Member of A.B.C. Copyright 1937 by McGraw-Hill Publishing Co., Inc., 330 West 42d Street, New York, N. Y.

Branch Offices: 520 North Michigan Ave., Chicago; 883 Mission St., San Francisco; Aldwych House, Aldwych, London, W.C. 2; Washington; Philadelphia; Cleveland; Detroit; St. Louis; Boston; Atlanta, Ga.

AUTO RADIO AND THE CAR MAKERS.....	7
THE RADIO MONTH.....By O. Fred. Rost	13
AUTO RADIO PROHIBITION LAW SHELVED.....	14
FIGURES	17
SELLING UP CAN GO TOO FAR.....By Ben Abrams	18
NEW AUTO RADIO DESIGN IDEAS.....By Oliver G. Ayer	20
DISPLAY—MANAGEMENT—ADVERTISING—SELLING	24
THIS PLAN SOLD 210 REFRIGERATORS.....By Greg L. Myers	28
HOW TO CANVASS FOR SERVICE.....By Jim Kirk	30
AUTOMOBILE AERIALS	33
AUTO RADIO SPECIFICATIONS.....	34
NEWS	37
PREVIEW OF NEW PRODUCTS.....	49
CIRCUITS	65
1937 IGNITION CIRCUITS.....	71
SHOP SHORTCUTS	77
TRICKS OF THE TRADE.....	81
LETTERS	88

SALES STATIC "\$69,507 WHY THAT'S THE LIST PRICE!"

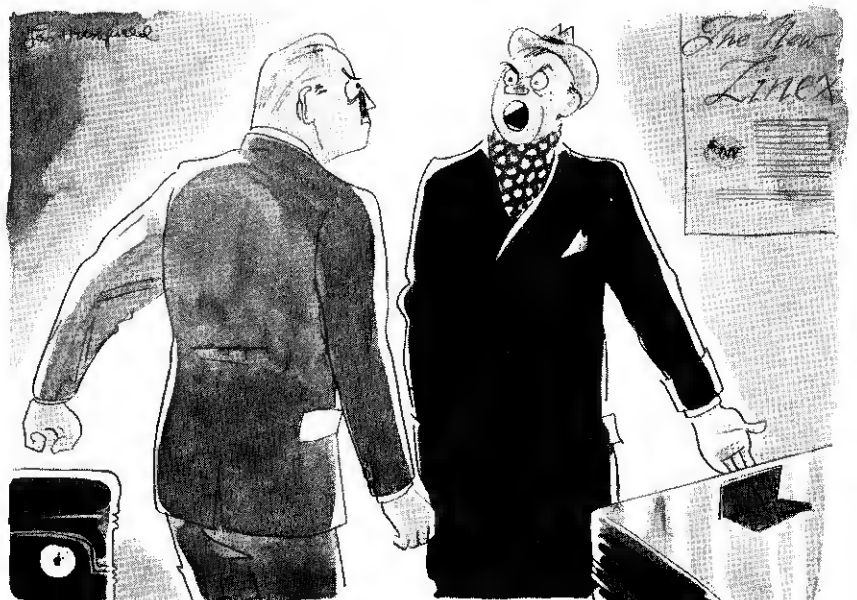

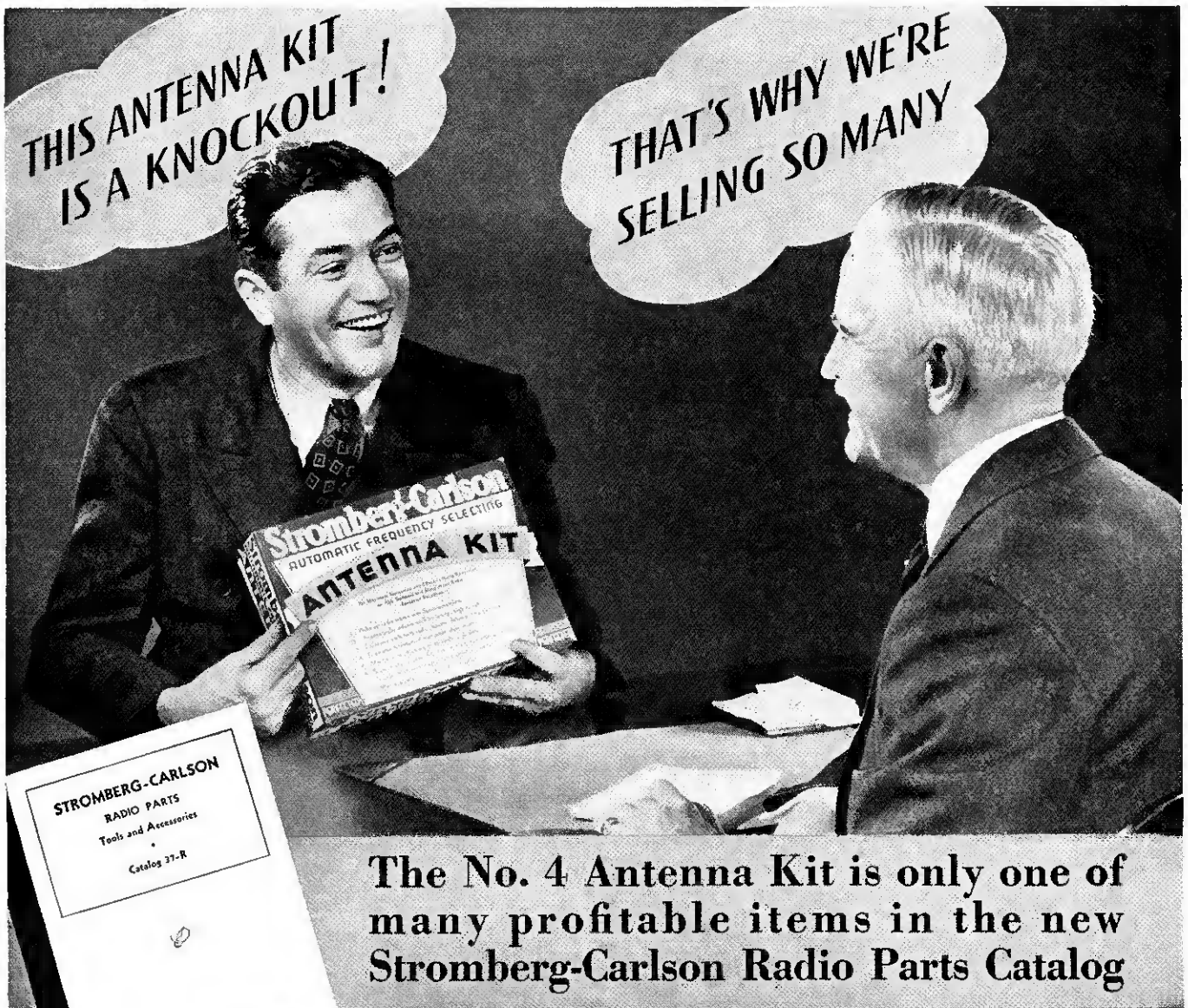

The No. 4 Antenna Kit is only one of many profitable items in the new Stromberg-Carlson Radio Parts Catalog

This new catalog will prove invaluable to both dealer and service man. In addition to describing Stromberg-Carlson products, tools and supplies it lists replacement parts, with prices, for Stromberg-Carlson radio and switchboard equipment.

Sales of Stromberg-Carlson Antenna Kits are booming. Super-sensitive, efficiently eliminating man-made static, effective on all makes of radios, this advanced antenna system not only creates satisfied customers but also increases the net profit on each sale.

Stromberg-Carlson offers you this and many other profitable items in the No. 37-R Parts Catalog. Among them:— a complete, packaged Voice Paging System; a Tri-Focal Tuning Eye Kit and a line of Extension Speakers for every purpose. Send for the new 50-page catalog today. Use the coupon on this page.

"There is Nothing Finer Than a Stromberg-Carlson"

The complete line of Stromberg-Carlson radios range in price from \$51.95 to \$1050. Models with the exclusive Stromberg-Carlson Labyrinth from \$149.50. (All prices slightly higher in Southeastern States and West of the Mississippi.)

STROMBERG-CARLSON TELEPHONE MFG. CO., ROCHESTER, N. Y.

STROMBERG-CARLSON TELEPHONE MFG. CO.
153 Carlson Road, Rochester, N. Y.
Send me the new Stromberg-Carlson Radio Parts Catalog.

Name _____
Street _____
City _____ State _____

Stromberg-Carlson



Emerson

"RE-CREATES THE ARTIST



Radio

IN YOUR HOME"



"Silent Salesmen" Sell the Sets

Dealers Everywhere are Building Auto Radio and Home Set Business with these Dynamic Helps. Ask for Details NOW

Spotlighting the outstanding features and values of the two new Emerson Auto Radios and Emerson Home Sets, these two powerful displays are attracting customers in hundreds of dealers' stores.

Ask your local Emerson distributor how YOU can put them to work in YOUR business—WITHOUT COST TO YOU. Get the facts about the COMPLETE Emerson line: Compacts, Table Models, Consoles, Auto Radio, Combination Radio-Phonographs, Portable Sets, Battery Radio. List prices from \$14.95 to \$149.95.

Or—if you prefer



Write or Wire Direct

EMERSON RADIO AND PHONOGRAPH CORPORATION

World's Largest Maker of Small Radios

Emerson
Radio and
Television

NEW YORK, N. Y.

Exclusive!

. . . The Crosley SHELVADOR Alone
Offers This EXTRA USABLE SPACE

Make This Startling Visible Demonstration



Thus Proving -

THIS MUCH MORE

EXCLUSIVELY IN THE CROSLY SHELVADOR

The Crosley Shelvador offers the buyer more usable food storage space than any other electric refrigerator on the market . . . and you can prove it conclusively right on your sales floor!

In the illustrations above showing this dramatic demonstration, the whole tableful of food—48 pieces in all—is placed first in an ordinary refrigerator, filling up all the normally used shelf area. Then all this food is transferred to the Shelvador, which takes every piece of it without excessive crowding.

What more powerful and convincing sales argument can be offered for any refrigerator than such a demonstration! . . . particularly when it is backed by:
1. MORE BEAUTY; 2. MORE CONVENIENCE; 3. MORE ECONOMY; 4. MORE ACCESSIBILITY

and offers such selling features as the sensational Electrosaver, the Stora-drawer, new tilting shelves, special removable shelf section, spacious Crosley Crisper, Built-in Thermometer, 18-point temperature control, and a dozen others.

It's going to be tougher than ever to sell against the Crosley Shelvador in 1937 . . . and easier than ever to sell the Shelvador. Alert dealers who know refrigerator value and are familiar with public demand are enrolling under the Crosley banner and assuring themselves of the greatest year in their history with—THIS MUCH MORE EXCLUSIVELY IN THE CROSLY SHELVADOR. See your Crosley Distributor for complete details of the Crosley Franchise.

THE CROSLY RADIO CORPORATION, Cincinnati - POWEL CROSLY, Jr., President

Home of "the Nation's Station"—WLW—70 on your dial

THE CROSLY SHELVADOR . . . Patented, Exclusive Feature

THE CROSLY SHELVAHOR FOR 1937

MORE BEAUTY • MORE ECONOMY • MORE CONVENIENCE • MORE USABLE SPACE • MORE ACCESSIBILITY

"THIS MUCH MORE" EXCLUSIVELY IN A CROSLY SHELVAHOR

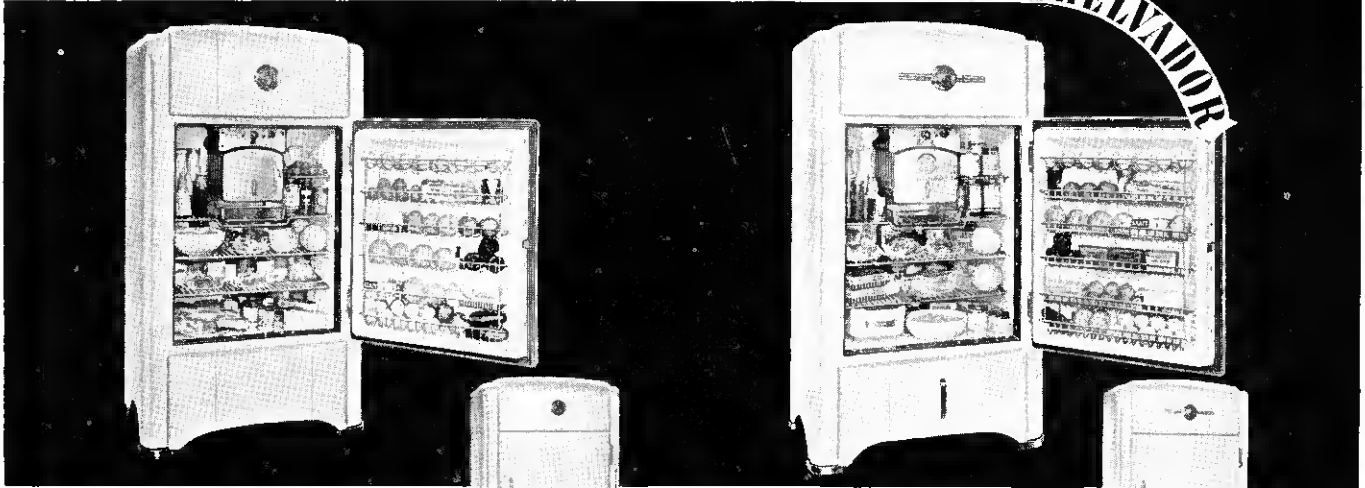

MODEL HB5-71—Food storage capacity 7.1 cubic feet (N. E. M. A. Rating), total shelf area 16.77 square feet, 6 shallow and 1 deep ice cube trays with a total capacity of 168 ice cubes in one freezing. Features include: Shelvador, New Hermetic Unit Model T-5 with large double-section Still Air Condenser, Float Valve, Freon F-12 Refrigerant, 18-Point Temperature Control, Built-In Thermometer, Hinged Shelf, Chromium-Plated dull finish door to Fast Freeze Cube Compartment, Porcelain Interior with Acid-Resisting Porcelain Bottom, beautiful Dulux Exterior, Chrome finish hardware. Automatic Interior Light. Quick-acting Ice-Tray Release. Dimensions: 58 $\frac{3}{4}$ " high, 33 $\frac{1}{4}$ " wide, 29 $\frac{3}{8}$ " deep.

MODEL HB3-71—Same as above excepting Standard Q3 type Compressor Unit.

DELUXE MODEL HL5-71—Net capacity 7.1 cubic feet (N. E. M. A. Rating), shelf area 16.77 square feet, 7 ice cube trays with a total capacity of 168 ice cubes. Features include: Shelvador, new Electrosaver Hermetic Unit Model T-5 with large Double-section Still Air Condenser, 18-point Temperature Control, Built-In Thermometer, 5 all Flat Wire Shelves, 2 Hinged Shelves, Bottom Shelf has Removable Section, bright Chrome Satin Finish Door to Fast Freeze Cube Compartment, 3 Crosley Shelf Jars and Covers, 6 Red Bechtware Dessert Cups, Crosley Crisper, Storage-drawer, Porcelain Interior with acid-resisting porcelain bottom, brilliant white Dulux Exterior, bright Chrome hardware with Blue Inlay, Automatic Interior Light. Quick-acting Ice Tray Release. Dimensions: 58 $\frac{3}{4}$ " high, 33 $\frac{1}{4}$ " wide, 29 $\frac{3}{8}$ " deep.

Other Standard Series HB Shelvador models available: Model HB1-30, 3.0 cu. ft.; Model HB1-31, 3.16 cu. ft.; Model HB1-36, 3.6 cu. ft.; Model HB1-41, 4.1 cu. ft.; Model HB1-50, 5.07 cu. ft.; Model HB1-60, 6.0 cu. ft. All HB models also available with Standard Q3 type Compressor Unit.



Other De Luxe Shelvador Models available: Model HL5-43, 4.3 cu. ft.; model HL5-50, 5.03 cu. ft.; Model HL5-61, 6.1 cu. ft. All De Luxe Shelvador Models have the Crosley ELECTROSAVER, the sensational T-5 Hermetic Unit with Double-Section Still Air Condenser.



Red Bechtware Cups— for quick freezing of salads and desserts.

Storage-drawer — non-refrigerated compartment for storing bulky foods.

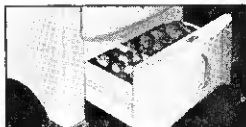

CROSLY ELECTROSAVER FEATURED IN DELUXE MODELS...

Summed up in one word, "ELECTROSAVER", all the years of earnest study, superior engineering skill and tireless experimentation combine to bring worthwhile savings to every Shelvador user. The new Crosley T5 Hermetic Unit is a marvel of efficiency and its exceptional operating economy, its long life and quiet dependable performance, represent the highest possible value in electric refrigeration today assuring enthusiastic customer satisfaction.

Removable bottom shelf section to accommodate roasts, turkeys, etc.

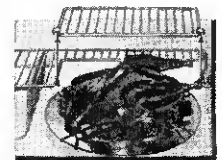

Key-type, quick-acting ice tray release.

Tilting shelves to permit greater storage of tall articles.

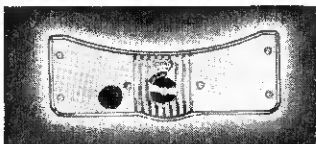

18-Point Temperature Control. Radio-type illuminated dial provides faster or slower freezing speeds as desired.

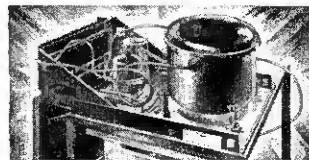

These features distinguish the Crosley Electrosaver: Non-toxic Freon refrigerant . . . economical high side float expansion system . . . high reserve capacity, resulting in shorter running time, faster freezing and greater ice-making capacity.

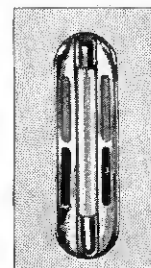

Built-In Thermometer—gives visible proof of safety zone food compartment temperatures.

of the CROSLY ELECTRIC REFRIGERATOR

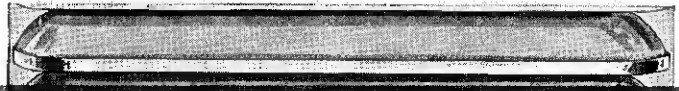

THE *Motorola* ACOUSTINATOR

IS BRINGING FLOCKS OF CAR OWNERS IN TO BUY!

Your Enthusiastic Customers Are Saying:

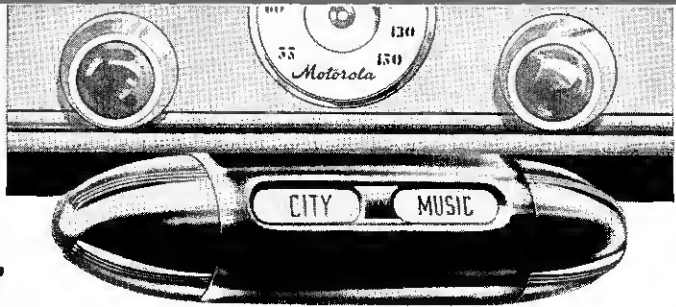

The NEW "PERSONAL PREFERENCE SELECTOR" IS TODAY'S BIGGEST AUTO RADIO FEATURE

PRICED LOW AS
\$29.95

MODEL "35" THE CHALLENGER
NEW LOW PRICE--BIG VALUE
6 Tubes - 3-Gang Tuning Condenser
List, \$29.95

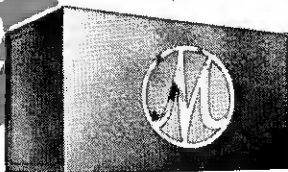

Never before has there been such a wave of enthusiasm among car radio buyers. Motorists itch to get their fingers on the knobs and direct their own radio programs. This "stand-out" ACOUSTINATOR feature permits car owners to emphasize at will either the Music, Voice or Bass of the programs they listen to. And they can accommodate Motorola to their location—whether in the Country, City or alongside Street Cars, insuring extreme useable sensitivity without noise, crashes and crackles. CASH IN NOW ON MOTOROLA!

FEATURES THAT HELP YOU SELL!

- EXACTLY MATCHES DASH OF ALL CARS
- NEW "E-Z" CONTROLS
- "ADAPTO" BROAD RANGE ANTENNA SYSTEM
- REVERSIBLE-PHASE "MAGIC ELIMINODE"

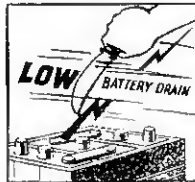

FEATURES THAT HELP YOU SELL!

- ACOUSTINATOR Personal Preference Selector
- LOW BATTERY DRAIN
- PERMANENT MAGNET DYNAMIC SPEAKERS
- ORTHO-ACOUSTIC SEPARATE SPEAKERS

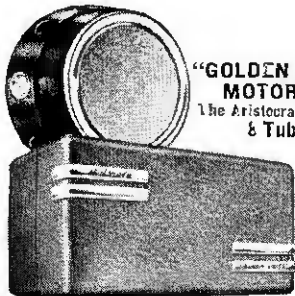

"GOLDEN VOICE" MOTOROLA
The Aristocrat of Radio & Tubes

8" Permanent Magnet Dynamic Speaker
LOW BATTERY DRAIN
ACOUSTINATOR EQUIPPED
List, \$69.50

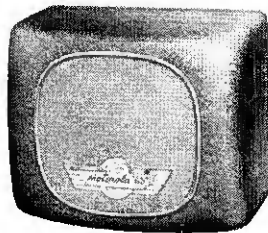

Model "85" ACOUSTINATOR EQUIPPED
LOW BATTERY DRAIN
6 Tubes—8" Electro Dynamic Speaker
List, \$49.95

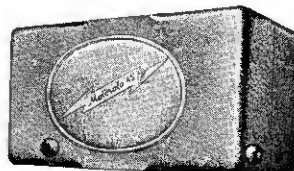

Model "45" REMARKABLE PERFORMANCE
6 Tubes—6" Electro Dynamic Speaker
Local-Distance Switch and Tone Control
List, \$39.95

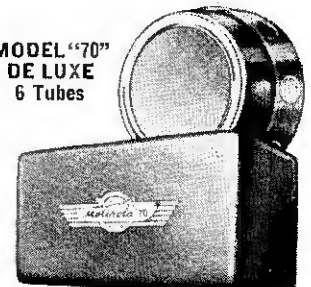

MODEL "70" DE LUXE
6 Tubes

8" Permanent Magnet Dynamic Speaker
LOW BATTERY DRAIN
ACOUSTINATOR EQUIPPED
List, \$54.95

NEW—DIFFERENT—BETTER

Motorola Home Radio

Product of the same engineering staff that has kept Motorola Car Radio far ahead in PERFORMANCE and VALUE for seven years.

READY IN MAY

Motorola is backed by 1937's most outstanding Merchandising and Advertising Program, designed to make your selling easier and your profits greater. Tie in with Motorola for your biggest auto radio year.

GALVIN MFG. CORPORATION
847 WEST HARRISON STREET, CHICAGO, ILLINOIS

RADIO RETAILING

MARCH, 1937

O. FRED. ROST, Editor

AUTO RADIO and the CAR MAKERS

RADIO DEALERS, DISTRIBUTORS and manufacturers of nationally advertised automobile radio sets are losing a substantial volume of business annually through the arbitrary and dictatorial policies of certain automobile manufacturers.

These car manufacturers are forcing their dealers to buy whatever radio set the factory has decided to standardize on, in arbitrarily dictated and often burdensome quantities. The car dealer has no choice of brand. Nor is he permitted to bargain direct with suppliers. Instead, he must pay the car manufacturer the demanded price, which is generally more than what would be paid for the same or a comparable set if he were free to buy it locally through regularly established radio distributors.

The only reason why car dealers have not become vocal in protesting against this practice is that they are afraid to lose their automobile agency franchise. There have been cases where dealers did protest or actually bought and installed radios locally in order to meet their customers' preferences. Those dealers found that their subsequent relationship with the car manufacturers included incidents which demonstrated clearly that they were being punished and decided that it would be better to get back on the band wagon, take what radios the car maker shipped them, pay whatever price was charged and keep quiet.

Car makers are getting bolder in the practice and some are threatening to ship radios with all cars.

★ ★ ★

FOR THE RADIO INDUSTRY THE prolonged continuance of this practice will have the following effect:

1. Local radio distributors and dealers will lose opportunity to sell and install auto-radios

in direct proportion to the speed with which the existing 20 million cars without radio are replaced with new factory-radio equipped cars, excepting only business which comes from owners of old cars.

2. Manufacturers of nationally advertised auto-radios will find their sales through distributors shrinking. They will be forced to battle with car manufacturers on a price basis for equipment contracts and will finally find themselves entirely at the mercy of car manufacturers. Their once well-known brand no longer will be a factor in a field that rightfully belongs to them.

★ ★ ★

THOSE WHO ARE INCLINED TO consider this forecast as the forebodings of a dyspeptic need only consider the records of once famous and nationally known manufacturers of carburetors, ignition equipment, horns and speedometers, of which only a handful have preserved their individual existence while the balance have become mere departments or divisions of some car maker or have failed.

Such process of obliteration may have been economically justified where the products involved were actually a necessary and indispensable unit of the operating mechanism of a modern automobile.

It cannot be justified on this basis in the case of the automobile radio.

The radio industry can boast of nationally advertised brands that are as widely and as favorably known as are any that are associated with the automobile industry. The public acceptance and goodwill enjoyed by radio manufacturers are assets which should not be subject to eventual destruction through the arbitrary tactics of car manufacturers.

In the car... as in the home... it's RCA ALL THE WAY!

Only RCA Victor Auto Radios have *Magic Voice!*

**LOOK AT THESE SALES MAKING
DISPLAYS FOR YOUR STORE!**

An example of the selling help RCA Victor gives you!
Highly attractive Three-Unit display showing sets, speakers, controls—A forceful, silent salesman!



(left) Single-unit display, has controls at top; set, speaker mounted on sheet music of "Merrily We Roll Along."

(right) Escutcheon Plate display demonstrating various types of "Custom-controls." Generous space behind front wall of display for storing boxed controls.

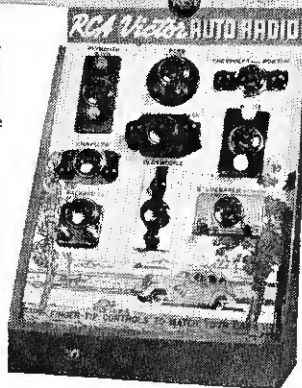

RCA Victor Auto Radio Features!

Finger-Tip Controls to match all cars. (Tone control and Sensitivity control conveniently located on control head.)—Full-vision, non-glare illuminated dial... 16 to 1 tuning drive—easier control... RCA Metal Tubes... Powertron Vibration—eliminates rectifier tube... Automatic Volume Control... Magnetite Core transformers for permanent circuit alignment... 9 watts output... Dynamic speakers... 2 audio amplification stages... No spark plug suppressors necessary, and many other fine features.

Outstanding performance features, plus store sales helps, plus national advertising, plus RCA ALL THE WAY, equal MORE PROFITABLE SALES FOR YOU!

RCA Victor makes it easy for you to cash in on auto radios this year! Its 1937 models are packed with powerful selling features, led by the Magic Voice, famous from coast to coast as the creator of finer tone.

In addition to the many quality features to help you sell, RCA Victor will make your job easier and more lucrative with compelling magazine advertising in *The Saturday Evening Post* and *Collier's*. The RCA ALL THE WAY story will build more sales and volume for you. A vigorous merchandising plan—the sales-inspiring store displays shown on this page—all will do their share. 1937 is going to be auto radio's biggest year. Cash in with RCA Victor!

RCA presents "The Magic Key of RCA" every Sunday, 2 to 3 p. m., E. S. T. on NBC Blue Network

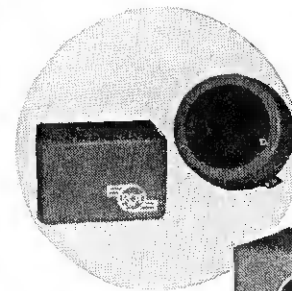

• RCA Victor Magic Voice Model 67M-2... 8-inch Magic Voice speaker, 6 tubes and Powertron, 9w. output, 2 audio stages. Tone control, local-distant switch on control panel.

• (at right) RCA Victor Model 67M... 6 tubes, 3½ watts output. Outstanding performance at low price.

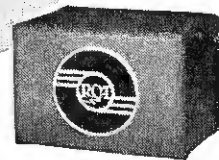

**RCA Victor
AUTO RADIO**

RCA Mfg. Co., Inc., Camden, N. J.
A Service of the Radio Corporation of America

DEALER PREFERRED!

That's the Story Behind the New 1937

FADA MOTOSET

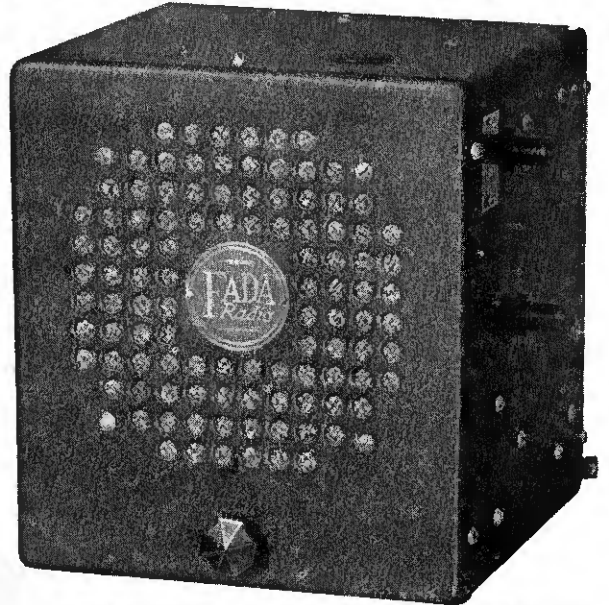

FADA MOTOSSET 267: 6 TUBE SUPERHETERODYNE with 6" SELF CONTAINED DYNAMIC SPEAKER \$42.95
Cabinet Size: 8½" long - 7¾" wide - 7½" high. Brown Shrivel Finish. Will easily fit beneath the dash of all cars and can be installed to give satisfaction with a minimum of special installation precautions.

FADA MOTOSSET 267SD: 6 TUBE SUPERHETERODYNE WITH 8" EXTERNAL DYNAMIC SPEAKER . \$49.95
Cabinet Size: 8½" long - 7¾" wide - 7½" high. Brown Shrivel Finish. Easily installed. The finest performing and tone quality receiver regardless of price or claim.

Two other models, 267SF with special Ford "header" Dynamic Speaker and 267SG with special "header" speaker for G. M. cars complete the Fada line. Both models list for \$44.95

AVAILABLE WITH TWIN SPEAKER ASSEMBLY

Chassis Features that Guarantee Performance

- 6 TUBE SUPERHETERODYNE
- 9 TUBE PERFORMANCE
- NO SPARK PLUG SUPPRESSORS
- FREQUENCY RANGE 535-1620 KC
- 3 GANG CONDENSER
- 6 TUNED CIRCUITS
- AUTOMATIC VOLUME CONTROL
- I. F. FREQUENCY 175 KC
- ILLUMINATED AIRPLANE DIAL
- RUBBER MOUNTED TUNING CONDENSER
- CONTINUOUS TONE CONTROL
- DIODE DETECTION
- 4 WATT POWER OUTPUT
- LOW BATTERY DRAIN
- ELECTROSTATICALLY SHIELDED
- MICRO-SENSITIVITY
- SUPER SELECTIVITY
- EASE OF INSTALLATION

MATCHED PANEL EQUIPMENT

1937 Fada Motoset Under Dash Mountings and controls to match instrument panel of all cars are distinctive for their harmonious designs. Obtainable for all models from 1934 to 1937.

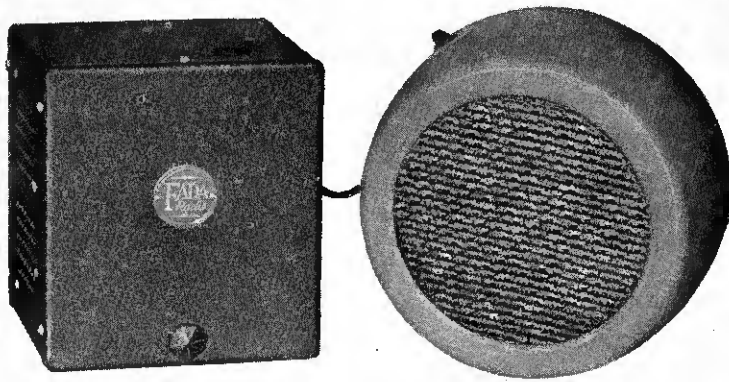
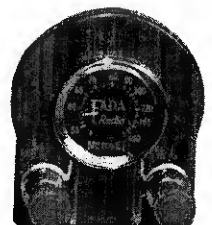

Preferred because the new Fada Motoset line for 1937 has eliminated many of the undesirable features that has made the selling of automobile radios an unprofitable pastime for the dealer . . . Preferred because Fada has not reduced list prices at the expense of the dealer's regular margin of profit . . . Preferred because Fada has not built a vast assortment of models to add to the dealer's inventory investment . . . Preferred because Fada list prices are in the price range of the greatest buying demand . . . Preferred because they have been built to deliver service-free performance and stay sold . . . Preferred because the motorist will prefer the Fada Motoset when he listens to its superb unmatched tone quality. From every angle, in buying and selling, you too will prefer the new Fada Motoset line for 1937.

Investigate the Fada dealer proposition for 1937 . . . liberal discounts on all models . . . attractive demonstration displays . . . sales producing promotions . . . co-operative advertising . . . everything to make 1937 a banner automobile radio year for the dealer.

FADA RADIO & ELECTRIC COMPANY
LONG ISLAND CITY, N. Y.

FASTER FREEZING

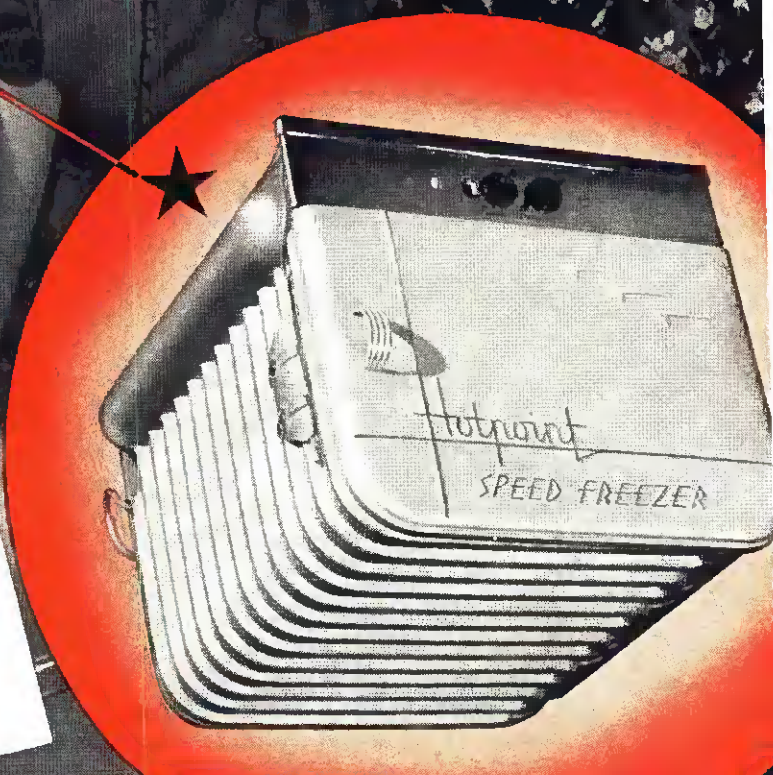

★ **THE NEW HOTPOINT SPEED FREEZER**
 The most amazing advancement in electric refrigeration. Keeps food safer. Freezes ice and desserts faster at lower cost than ever. Sanitary, stainless steel construction throughout. Balanced freezing control holds temperature at exactly the right point—always.

WHY *Hotpoint* IS THE BUY OF THE YEAR!

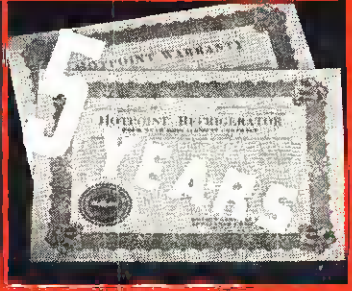
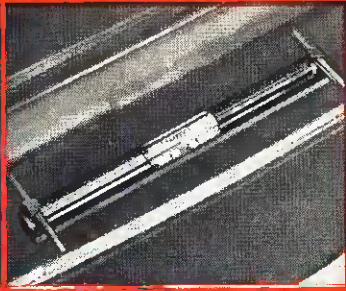
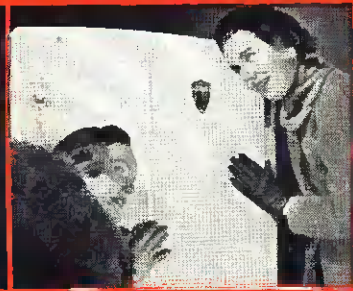

*Lower Prices
 Easy Terms*

● You can pay for a Hotpoint out of savings. New low prices.



Streamlined

Quiet as the purr of a kitten.

Ever-visible safety cage door.

5 years performance protection.

at Lower Cost!

New Speed Freezer Makes Hotpoint Refrigerator America's No.1 Buy!

This two-page advertisement appears in

THE SATURDAY EVENING POST

From top to bottom the new Hotpoint Refrigerator topples old traditions to give an entirely new standard of refrigerator values!

It is demanded faster freezing, greater economy. Hotpoint answers with the Speed-Freezer powered by the Vacuum-Sealed Thriftmaster. These two amazing advancements give you ice and frozen desserts at thrilling speed.

The secret of Hotpoint's remarkable freezing speed is a new method of dissipating heat. In effect it is like the supercharge on an automobile engine. Power is stepped up—fuel consumption reduced.

Hotpoint keeps your food safer—fresh always in the constant cold of a gently flowing blanket of chilled air. When you want ice quickly, you get it. Frozen desserts may be speedily prepared—in time to add a festive touch to a meal when unexpected guests arrive. And Hotpoint pays big dividends in family health—saves much, costs little—actually pays for itself.

Hotpoint's sensational performance and economy are matched by the enduring beauty of its lifetime all-steel cabinets. Touch a finger to the chromium door latch and behold the

gorgeous flood-lighted interior. Adjustable gliding shelves bring all food within reach instantly. Corners of the stain-resisting porcelain liner are rounded for easy cleaning.

There's a nipping shelf that swings back to admit full bottles. A special device releases ice trays easily. And a flexible rubber tray is provided for handy use when a few cubes are wanted.

Say goodbye to the inconvenience, uncertainty, spillage and high cost of old-fashioned refrigeration. See your Hotpoint dealer today. He'll be glad to show you the model you need—explain how you may own it for a trifling cash outlay. Three complete lines to choose from.

EDISON GENERAL ELECTRIC APPLIANCE CO., INC.
5680 W. Taylor St., Chicago, Ill.



Above: The Deluxe line includes 5 refrigerators.



POWERED BY THE VACUUM SEALED THRIFTMASTER

Hotpoint's Thriftmaster (at right) is permanently vacuum sealed, for longer life. This trouble-free cold-making mechanism is highly efficient—converts a mere "trickle" of electricity into abundant freezing power. Actually five cent's worth of current now makes twice as much cold as ever before. The Thriftmaster carries five years' performance protection.

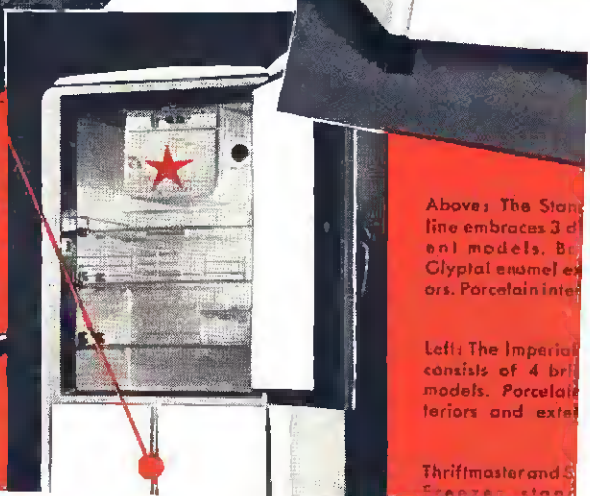

Above: The Standard line embraces 3 different models. Br. Crystal enamel exteriors. Porcelain interiors.

Left: The Imperial consists of 4 brilliant models. Porcelain interiors and exteriors.

Thriftmaster and Speed-Freezer stand

Hotpoint

REFRIGERATOR

WHEN you sell gasoline powered equipment — farm washing machines, small farm tools, battery chargers, etc. — there is nothing so vitally important as the gasoline motor itself.

If the motor runs — and runs economically and free from trouble for years and years — customer kick-backs are unknown. If the motor falls down, then gone are your profits — in comes an unknown quantity of ill will that makes future sales harder and harder to get.

Briggs & Stratton 4 Cycle Motors on the equipment you sell are a sure way to eliminate grief and profit gamble. Twenty years of small gasoline motor experience — over three-quarters of a million in daily use — and their enviable world-wide reputation for dependable, unflinching performance — protect you.

You and your customers also have the backing of a responsible factory-supervised nation-wide service organization — that today is servicing Briggs & Stratton Motors bought many years ago — just like they will be doing a score of years from now.

And, always working for you is the biggest thing of all in retail selling — a consumer acceptance unrivaled in the 4 cycle gasoline motor field — when you say, "It's powered by Briggs & Stratton."

Equipment powered by Briggs & Stratton is easier to sell — and the profits stay in your cash drawer.

BRIGGS & STRATTON CORP., MILWAUKEE, WIS., U. S. A.

4
CYCLE

BRIGGS & STRATTON

GASOLINE
MOTORS

THE RADIO MONTH

NEW MODELS

Our travels have taken us to many radio set factories and, without exception, we found the price and style trends of new models the top topic of discussion. Manufacturers are in a quandary. They are experiencing steadily mounting labor costs while prices on raw materials and parts are creeping higher and higher. They know that somehow they must get more for equivalent values and yet they fear to abandon certain popular unit prices because the public has shown a peculiar preference for buying at those figures.

The solution is likely to be found in trimming down on the chassis costs so as to be able to maintain previous list prices and when the new models are announced we will find previous 7-tube sets reduced to a 6-tube job, former 11-tube units struggling along with only 9 tubes, with their economy and greater simplicity emphasized at presumably no sacrifice in tone quality or volume.

ANTI-RADIO

Last month on this page we urged watching the law mills in the 43 states where legislatures are in session, warned of possible new laws that might hurt the radio dealers. Before that issue went to press we heard that Idaho had started to legislate auto radios off the road. The strenuous and costly efforts that resulted in defeat of the Idaho measure are reported in this issue.

Now the State of Washington is not merely proposing to prohibit automobile radios but it wants to create a State Board of Radio Censors and impose a $\frac{1}{2}$ of 1% so-called "service charge" on income derived from local advertisers and a 2% "occupation tax" on the total business of local broadcasting stations.

Wherever such injurious laws are proposed radio dealers and distributors are urged to organize at once a state-

wide protest campaign and arrange to bombard members of the legislature with telegrams and letters of protest. Public hearings should be demanded. Broadcasting stations should tell the story to the public and ask for help in defeating such measures. *Radio Retailing* will be on the firing line wherever necessary. Write the editor when you hear of proposed laws that would harm the radio industry without helping the public.

20TH FAIR TRADE LAW

The avalanche of Fair Trade Laws is sweeping on. As we go to press, the signing of such a bill by the governor of Indiana makes that state the twentieth to put a Fair Trade law on its statute book. In several other states such bills have passed either one or both houses of the legislature and in no case are any vetoes expected when such bills reach the respective governors.

Radio dealers are urged to keep themselves posted on progress of this type of legislation because wherever manufacturers will create the necessary set-up to operate under such state Fair Trade laws, the independent radio dealer will benefit.

WATCH CHAIR-SIDE JOBS

Several prominent set makers have shown us hand-made samples of chair-side radio sets that may or may not be included in their new line when they announce it in June. One or two of those samples still belonged in the mongrel class where they could be considered neither a practical radio unit nor a useful piece of furniture. Others showed careful planning with the view of having the unit qualify definitely as a high class utility in the home with the radio receiving set built to enhance rather than detract from its value.

Obviously, the designers are willing

to explore new fields which might lead to a model that would find wide public acceptance and eventually put the "obsolete" tag on present-day consoles. Some engineers express the belief that automatic tuning devices will help put over a good chair-side model and then the sales department cold shoulders that idea with the warning "that'll make the price too high."

In any event, the Zenith-McDonald "Keep Them Dissatisfied" yarn—in our October issue has caused action.

PHONEY PHILANTHROPY?

Latest wrinkle among distributors is to offer dealers 5 cents apiece for every old tube salesman are permitted to break . . . provided a new tube is purchased for each one smashed. One set jobber, too, sends his men out equipped with fire-axes as well as brief-cases, instructs them to offer the dealer from three to five dollars for every trade-in whacked in the solar-plexus.

Ideas of this kind, in all probability, will spread rapidly and while they may conceivably spring from a laudable and high-minded inclination on the part of jobbers to remove used merchandise from the market there is some suspicion that their real purpose might be the offering of an additional, though carefully concealed, discount to dealers who buy in the right places.



EDITOR



THE MAN WHO LIKES TO DRIVE FAST

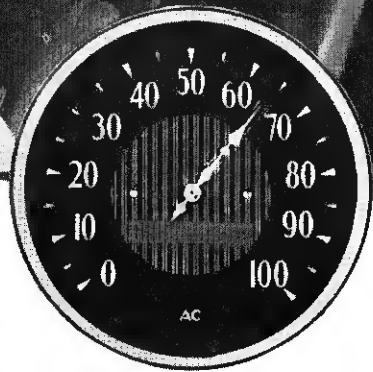

AUTO-RADIO PROHIBITION

INDEPENDENT radio retailers, aided by other radio interests, scored a smashing victory in the "Battle of Boise" February 18 when, by timely action and organized co-operation, they caused the defeat of legislation which would have made the use of automobile radios in the state of Idaho a misdemeanor punishable by fine or imprisonment.

In Idaho there are approximately 100,000 motor vehicles without radio. That vast market for merchandise and labor was very nearly killed by a sweeping anti-auto radio bill introduced by Senator R. E. Whitten. Local radio interests became excited because this meant the loss of thousands of dollars worth of potential business. And national radio interests became alarmed when the bill

was actually passed by the Senate and sent to the House for approval for such legislation could, obviously, start a regular epidemic of similar legislative assaults in other states.

RMA and "RR" Lead Fight

The House hearing was scheduled for 4 p.m. on February 18. Long before that hour arrived the halls of the State Capitol thronged with radio

men. Because of the size of the crowd the original plan of holding the hearing in a committee room had to be altered and it was decided to simply let the House take a recess, have its members remain in their seats and hold the hearing right before them in the chamber so that the whole floor and the visitor's gallery would be available for those interested.

At the appointed time Troy D.

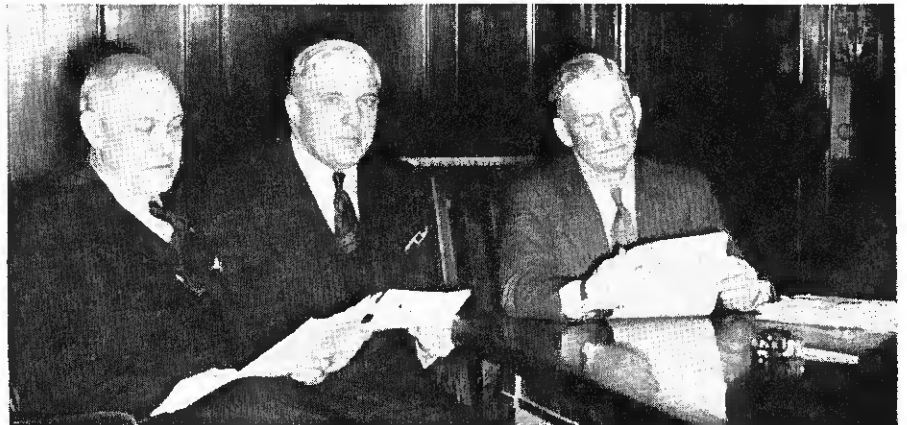



. . . DRIVES SLOWER

WHEN HE LISTENS

LAW SHELVED

Idaho House Committee Votes Against Bill Passed By Senate When Industry Representatives Testify That Sets in Cars Actually Promote Road Safety

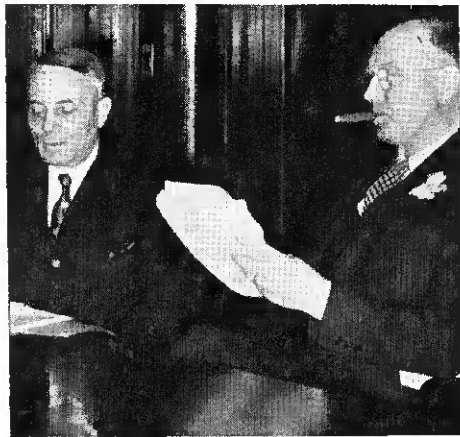

TRUCE BEFORE FIGHT—Meeting informally before the House hearing, leaders in the fight against the bill and its sponsor discuss floor procedure. Left to right: Robert Bailey, Chairman of the Idaho House Committee on State Affairs; O. Fred. Rost, Editor of *Radio Retailing*; Troy B. Smith, Speaker of the House; Bond Geddes, executive secretary and general manager of the RMA and the prohibition law's sponsor, Senator R. E. Whitten

Smith, Speaker of the House, surrendered the gavel to Representative Robert Bailey, Chairman of the House Committee on State Affairs. The battle was on.

First in the radio industry's assault on the proposed bill were the broadcasters, ably led by "Smiling" Phillips, manager of Boise's station KIDO. His protests were supported by station managers from Nampa and Idaho Falls.

Next came individual radio dealers and distributors who pointed out that the bill had no justification, that it did not meet a public demand and, in fact, reacted unfavorably on the public and hurt business interests of the state too.

Then the chairman introduced O.

Fred. Rost, editor of *Radio Retailing*, who had come from New York to defend the radio dealer's interests from a national as well as a local viewpoint. Mr. Rost presented a brief in which he exposed some of the fallacies of the proposed measure, demonstrated the absence of any need for it, showed that its provisions ran contrary to the Constitution of the United States and finally stressed the value of radio as a modern automobile accessory promoting both pleasure and safety. He also pointed out its importance to radio dealers of Idaho and then went on to quote from numerous telegrams and letters received from Idaho dealers and distributors.

One dealer quoted called the bill



POINTS TO PET PEEVE—Senator R. E. Whitten, who sponsored the anti-auto radio bill, got it passed by the Senate only to go down to defeat in the House

“one of the worst we have to contend with”, pleaded for strenuous effort to defeat it. A prominent distributor stated that he had “thought this bill too ridiculous to be taken seriously until we heard that it had been passed by the Senate.” Another said that it was most vigorously opposed by the entire trade and stated that he had sent many telegrams to this effect to legislators.

Whitten's Support Crumbles

Senator Whitten, the bill's sponsor, was then heard in its defense. While he brought out numerous theoretical arguments he was unable to produce factual evidence sufficiently conclusive to counteract facts presented by opponents.

Bond Geddes of Washington, executive vice-president and general manager of the Radio Manufacturers Association, followed Whitten and summarized the high spots of an 18-page brief which he had prepared and which constituted such a powerful barrage of factual and statistical evidence to prove that the law was unnecessary and harmful that any remaining proponents of the bill apparently decided to fold their tents and silently steal away.

After Mr. Geddes finished speaking no voice was heard in the bill's support.

During the proceedings one humorously inclined member of the House suggested that Mr. Whitten

might accept an amendment which would also make it a misdemeanor for anyone riding in an automobile to “scratch an itch”.

The applause which swept the House and galleries on one or two occasions when the opposition scored particularly vital points was excellent indication that, aside from the stubborn resistances offered by the sponsor of the bill, the sentiment of the audience was overwhelmingly against it. Therefore, when the hearing was finally concluded important members of the Legislature did not hesitate to say that it had been, in their opinion, successfully stopped through the effective presentation made by radio interests.

This opinion was substantiated when, on February 25 *Radio Retailing* received the following telegram from Speaker Troy B. Smith: “Senate Bill 72 Whittens Radio Bill Pigeon Holed in Sifting Committee *Result Will Be Death.*”

Following the conclusion of the hearing numerous dealers and distributors, who had come to Boise to take part in the proceedings, went to the Hotel Boise to extend the appreciation of the trade to Messrs. Geddes and Rost for having organized such effective protest against the bill.

One large distributor remarked: “We would have been sunk without you.” Another said: “That d— bill would have gone through if you hadn't organized the fight.” Still another said: “There was nobody out here who could have organized that kind of a fight.”

Until this Idaho assault on auto-radio occurred the few attempts in other states to legislate it out of existence were nipped in the bud without great difficulty by presentation of factual data and proof that no need for such legal restriction existed. Either the sponsor of the bill withdrew it or the law-making body in which it originated voted it down.

It was, however, not so in Idaho. There the bill was introduced by Senator Whitten on January 28 and just eight days later the Senate *passed* it, then shunted it over to the House of Representatives for consideration. At that point local legislative dopesters freely predicted that, being a freak bill, and apparently unopposed, it would probably pass the House and become law.

When this news was flashed over the wires two branches of the radio industry decided to organize a fight to stop the measure from being enacted into law. The Radio Manufacturers Association authorized its executive vice-president to leave no stone unturned. He not only mobilized the manufacturing branch of the radio industry but also enlisted the support of the automobile industry through five important trade associations in this field. A veritable bombardment of telegrams and letters was sent by manufacturers to Idaho legislators in protest against the measure.

This done, Mr. Geddes moved the battle-front right into Idaho by telegraphing important state officials

(Please turn to page 46)



BATTLE-GROUND—Here's a shot of the Idaho state capitol at Boise, where the fight eventually resulting in shelving of the bill raged

FIGURES

RADIO RETAILING'S MONTHLY BUSINESS BAROMETER

PARTS SURVEY REVISION

Since publication of our preliminary report in February showing the number of parts of various types used per 1,000 sets repaired additional dealers have sent in figures. Last month the survey was based on reports from 32 dealers repairing 9,541 sets. Since then 15 additional dealers have reported, raising the total number of dealers to 47 and the total number of sets to 11,493.

Up substantially over the original estimate are by-pass condensers. Use of other parts sold in quantities placing them near the head of the list with respect to industry importance remains essentially the same as originally indicated.

APPLIANCE PREDICTION

From J. R. Bohnen, secretary of the American Washing Machine Manufacturer's Association, comes the prediction that domestic washer and ironer sales should pass the 2,000,000 mark for the first time during 1937. One million were sold in 1929.

Bohnen bases his advance estimate on the fact that January washer sales totaled 121,754 as against 93,532 in December while ironer shipments were 15,857 as compared with 14,777.

Conversion of basement space, planning of utility rooms and dual-purpose service quarters in new construction is considered one major reason for the gain.

FACTORY FIGURES

The annual report of the *Hygrade Sylvania Corporation*, issued February 10, shows that net income for 1936 was \$1,034,736, an increase of 33 per cent over 1935. Current assets are indicated as \$5,119,596, or 4.8 times current liabilities. A 29 per cent sales increase over 1935 was reported, from \$7,913,989 to \$10,234,322.

January *Norge* sales, covering all products made by this company, totalled

43,065 units, a 47.6 per cent increase compared with January 1935. Howard E. Blood, president of the Norge Division of Borg-Warner, advises that refrigerators jumped 75.9 per cent, washers 37.8 per cent, ironers 173.5 per cent, commercial refrigeration 107.6 per cent, kitchen ranges 21.9 per cent, oil-burners 121 per cent and furnaces 361.5 per cent.

CANADIAN SALES

Sales of Canadian radio manufacturers totaled 242,456 sets valued at \$21,861,128, according to reports of the Canadian RMA. In 1935 sales were 190,248 receivers valued at \$18,062,853.

Of the 1936 total 168,353 sets valued at \$16,818,821 were a.c. models; 61,127 valued at \$4,268,137 were battery jobs and 12,976 valued at \$774,170 were automobile receivers.

Production projected for the first quarter of 1937, ending March 31, is 26,093 receivers, including 17,452 a.c., 5,416 battery and 3,225 automobile types.

COST OF LIVING

The cost of living, according to the National Industrial Conference Board, increased slightly less than one per cent from December to January. It was 3.6 per cent higher than a year ago and 21.2 per cent higher than in April, 1933, the depression low-point.

Here's the way the Board records changes during the month indicated: Food, up 2 per cent; housing, up 0.5 per cent; clothing, up 0.3 per cent; fuel and light, down 0.2 per cent; sundries, up 0.5 per cent. Total, up 0.9 per cent.

NBC RECORDS GAIN

NBC network revenue for January soared 32 per cent above the corresponding month last year, a total of \$3,541,999, making the month the highest in the history of the company for any January.

REPLACEMENT PARTS USED

(Per 1000 Sets Repaired)

BY-PASS CONDENSERS
RESISTORS
FILTER CONDENSERS
VOLUME AND TONE CONTROLS
AUDIO TRANSFORMERS
VIBRATORS
RF AND IF COILS
SPEAKER CONES
POWER TRANSFORMERS
SPEAKERS
LINE SWITCHES
FILTER CHOKES

Second report. See accompanying text.

Daytime weekday revenue rose 94 per cent in the same period, topping all previous January records, too. And Sunday daytime revenue topped January, 1935 by 78 per cent.

SETS WITH SHORTWAVES

Of the a.c. receivers sold in Canada during 1936, government figures show that 22 per cent tuned only in the standard broadcast band, or in the standard broadcast band plus police and an upper amateur channel. 18 per cent included one short-wave band. 60 per cent were of the multi-band type.

Of the battery receivers sold, 56 per cent tuned in the standard broadcast band, or the standard broadcast band plus police and an upper amateur channel. 28 per cent included one short-wave band. 16 per cent were of the multi-band type.

AIR CONDITIONING UP

Installed cost of equipment sold by the members of the Air Conditioning Manufacturers' Association in January totalled \$7,152,000 compared to \$2,271,000 in January, 1936, according to William B. Henderson, executive vice-president.

This increase of 215 per cent is due partly, Henderson states, to early buying to escape the oversold condition of the industry such as was experienced last summer and partly to increased advertising and promotion.

SELLING-UP CAN GO TOO FAR

Small sets have a natural market. Hiding them away in a corner is poor business because they frequently provide reception where otherwise no set would be used

s a y s

Ben Abrams

President, Emerson Radio and Phonograph Corp.

THE idea of using popular prices as the bridge from mass production to mass sales is an old one and has found able exponents in many of the large consumer goods industries. Wm. L. Douglas built up a fortune with his \$3.50 shoes. The Richman Bros. have done likewise with their \$22.50 suits. Henry Ford has become both famous and famously rich via his popular priced car, and, as far as the radio business is concerned, many oldtimers vote for Ben Abrams, president of Emerson Radio and Phonograph Corp. as the banner-bearer for popular priced radios.

However, any discussion of this proposition with Ben himself will quickly uncover the fact that his banner-bearing proclivities are subject to certain very definite qualifications, and if those can't be included in the specifications, then friend Ben doesn't want to carry the banner. And as those qualifications reach right down to the fundamental differences between good and bad merchandising, their recognition is perhaps the chief reason why Ben Abrams has been such a successful merchandiser.

Fact is that when Mr. Abrams talks of popular prices on radio sets he thinks of the "popular" part of the price structure being definitely limited to such price range as will prevent any serious sacrifice of quality for the sake of meeting any particular price bracket. He does not merely want the price to be "popular" but insists that the merchandise—in this case the radio set—must

be popular with the public who buys.

Says Mr. Abrams: "Our designers, engineers, suppliers, cabinet-makers and factory workers know that I expect every set our factory turns out to meet three basic requirements. These are:

"1. Style that is either ahead of or abreast with current trends;

"2. Tone that will meet the preference of at least 90 per cent of the radio-buying public;

"3. Efficiency that begins at the tuning-dial and follows right through the whole of every model.

"I feel that those points must be kept in mind constantly if the sets that we send out to our distributors and dealers are going to prove popular with the public."

However, it is only when the discussion is brought around to the subject of "small" radio sets that Mr. Abrams really begins to unlimber his conversational talent because he is

certainly star booster for small sets and is able to advance numerous reasons why radio dealers should pay more attention to selling small sets.

And when Mr. Abrams talks about small sets, he does so with full knowledge that many dealers try to make every customer buy the highest-priced set they can possibly be induced to take. In so doing, so he contends, they actually lose many sales and also miss the opportunity for long-term sales building.

Fill Definite Dealer Need

Mr. Abrams recalls that according to *Radio Retailing's* annual statistical number the small or table models accounted for 54 per cent of all home receivers sold in 1936 and contends that this fact demonstrates that small radios have gained wide public acceptance. He thinks that dealers have only begun to cash in on this trend.

Pointing out that chains and de-

Some Small Set Advantages:

- 1. They call for the lowest stock investment**
- 2. They favor more rapid turnover**
- 3. They make lively advertising features**
- 4. They whet the appetite for several sets per home**



Ben Abrams

This is the sixth in a series of interviews with important industry executives by O. FRED. ROST

a shelf or on top of something else but, rather, shown independently against a practical, attractive background where a full range of models can be displayed and demonstrated side by side.

The interviewer found that Mr. Abrams is a great stickler for good display and that he does not merely talk about but actually does something about improving dealers' methods of store displays. After a new line of sets is finally completed and put into production, Mr. Abrams immediately begins to play around with various designs for display stands, backgrounds or complete "silent salesman" exhibition stands until he finds something that will do the new sets justice and almost automatically force the dealer to place them on a suitable and advantageous display."

Makes Consoles, Too

Despite the fact that Mr. Abrams' company produces a full line of consoles as well as table models, the latter are closest to Mr. Abrams' heart, and he never ceases to extol the advantages he sees in them.

In closing the interview Mr. Abrams said: "The point I am particularly anxious to impress upon every independent radio dealer is that there is a distinct market for small radios and that I am convinced that *that market cannot be switched to consoles* regardless of any price consideration.

"Therefore, in my opinion any dealer who ignores that fact or tries to skirt around it, is really bucking an irresistible trend."

partment stores push small sets with definite objectives in mind, Mr. Abrams continued:

"I believe that independent dealers will make more profits and sell more of all types and sizes of radio sets if they will give small sets the proper place in their selling program.

"These are some of the advantages that I can name offhand:

"1. Small sets call for the lowest stock investment;

"2. They favor more rapid turnover and by providing more frequent sales frequently give greater total profits on invested capital;

"3. They make lively advertising features and spectacular displays;

"4. They provide radio reception where otherwise none would be used and whet the appetite for one, two or three extra sets in homes or offices."

Continuing, Mr. Abrams came back to the price proposition:

"Dealers should remember also

that a small radio does not necessarily mean low price.

"For instance here is a line that has models ranging from \$14.95 upward. It includes at \$44.95 both a table model and a console and the performance of those two models is about the same. Yet the table model at \$44.95 far outsold the console at the same price and in fact, that \$44.95 table model was the second best seller in a line which included 30 different models.

"This being a fact I cannot help but feel that no dealer cashes in to the fullest extent on his sales opportunities unless he carries a complete assortment of table models to suit every purse, perhaps ranging in price up to \$75.

"And he should not simply carry them, but actively promote their sale through proper display and advertising. His windows should show them and on the inside of the store they should not be tucked away on

NEW DESIGN IDEAS AID TRADE AS CAR SET SEASON OPENS

Rod antennas, interchangeable controls, simplified tuning, streamline design seen as highspot sales features

By **Oliver G. Ayer**

Sales Manager, Mac-Adams Equipment Co., Inc.

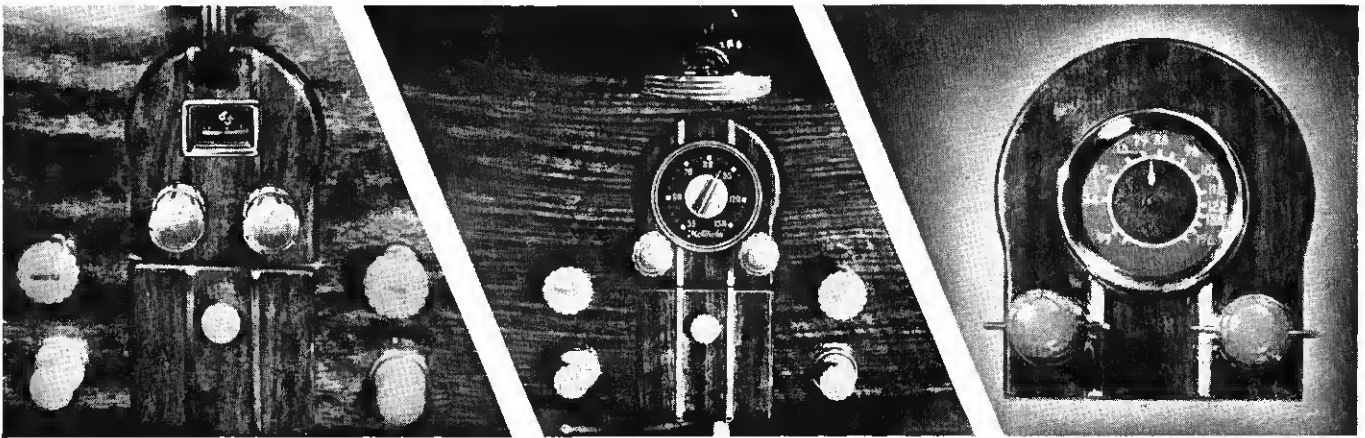

THE outstanding trend in auto radio design for 1937 is the swing back to roof aerials. That old standby of good reception has found a new lease on life. But today it is a vastly different and improved roof aerial, in keeping with the modern technique of turret top construction and all metal automobile bodies.

New pickup devices are rods of glistening stainless steel or chrome plate, generally supported on molded bakelite insulators. They conform to the general contour of the roof and enhance the effect of speed and flash in every line. Due to their unique position on the car, they solve several installation problems at once. Such new antennas have

excellent signal gathering properties, and are usually free from motor noises. Wheel and brake static are gone forever. Installation, while tricky, is not difficult, and much time is saved which would otherwise be consumed in cleaning up motor noise and parasitic disturbances.

There are several general types: One starts at the top center of the windshield and follows back along the center of the top to the rear window. The lead-in is attached through a hole back of the header and brought down behind the windshield moulding. The second is a modified "fish-pole," which extends straight up from the top center of the windshield. The third combines a horizontal section, which extends

half the length of the car, together with a short vertical section, which starts at the cowl ventilator and meets the forward end of the other section above the top center of the windshield. The lead-in is brought in back of the cowl ventilator. All are fastened to the car top either by special bakelite bushings through the roof, by sheet metal screws through bakelite bushings or large rubber suction cups cemented on with a special waterproof cement. Cement, while waterproof, is usually soluble in gasoline. Car makers may, we hear, finish off both ends of roof antenna rods running the length of the car with neat medallions identifying the make of set installed. This they think, would be good advertising and would



ABOVE

DISPLAYS THAT SELL—Here are two typical 1937 demonstrator boards that not only simplify the handling of stock but permit the customer to tune in right in the store. Both are conveniently mounted on wheels

not detract from car appearance.

A well-shielded lead-in is imperative with roof aerials. Great care must be exercised in obtaining a good solid ground on the shield where the aerial lead enters the top of the car.

"bones" and "skis", have been improved by coating them with rubber to assure good insulating quality, and are frequently fitted with "knee action" brackets which facilitate installation.

A certain car manufacturer has provided for the insulation of 1937 car running boards to be used as aerials and the necessary parts to accomplish this are available in a complete package. Good judgment must be used when planning to use

Then there are the fish-pole and the buggy-whip types, which may be mounted on the rear bumper or on a door hinge. These, too, are excellent collectors.

Running board aerials, "trom-

LEFT

CHOICE FOR HENRY—To match the dash cutout provided by Ford control panels are offered by many set makers. Here are three, all for the one car. Equal variety is available to purchasers of other popular cars

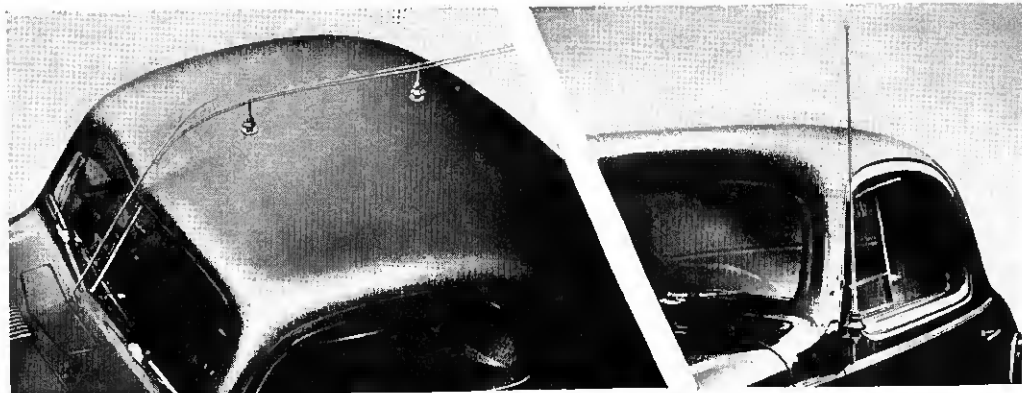

RIGHT

GAINING PUBLIC ACCEPTANCE—Over the initial hurdle of radically different appearance, antennas like these mounted on cowl and windshield, hugging the top silhouette or fastened on door-hinge or bumper, install quickly, increase pickup, reduce noise

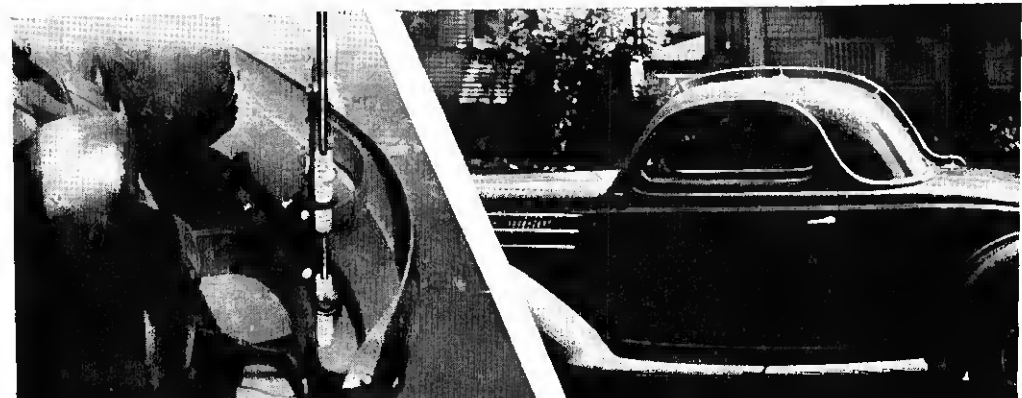

a collector provided by a car maker in connection with sets not marketed specifically for use in these cars. The aerial used on this year's Ford, for example, works well with the special antenna transformer and input circuit of the Ford set. The writer has found it rather unsatisfactory when used with any other receiver, as it is quite short and not suited to many input circuits.

Most of the new receivers use series-fed antenna circuits, which must be accurately adjusted to the aerial. It is not exactly new to include the antenna capacity in the first resonant circuit. Designers have, however, reduced the range of this adjustment to obtain better sensitivity. Therefore, some care must be taken to see that the actual capacity of the antenna is brought within the range of this adjustment. Several values of antenna series condensers are available for this purpose. They are properly shielded and fitted with bayonet connectors. This makes it quite easy to test a new installation and when properly set up it can then be left that way. One rod antenna maker supplies as part of his accessory a variable inductance which, mounted on the dash, loads all sets properly.

The sensitivity of most of the new receivers has, incidentally, been stepped up considerably. This will materially cut down fading in areas of weak signal strength. However, greater care must be exercised in removing the last trace of motor noise between stations, as it will

become quite annoying when the strength of the incoming signal drops off.

"Standardization" seems to be the slogan adopted by most manufacturers this year for custom-built controls, which is a step in the right direction. Most all of the popular sets use one type of control, which simplifies inventory problems considerably. The escutcheon plates for various cars are fitted with a celluloid window which contains the set manufacturer's trade-mark and the dial scale. These windows can often be switched from plate to plate and used interchangeably, thereby allowing the dealer to fit a large variety of sets into almost any car with a rather small stock of plates. The fundamental mechanical parts of this control were used last year by a few manufacturers, and proved very satisfactory. It is positive and smooth in operation, trouble free and simple to install.

Two manufacturers are using a new type control which is adaptable to a majority of cars. The dial pointer is driven by a worm gear and a flexible cable, and a special escutcheon is provided for each car.

Still another has a control which is all contained in the escutcheon plate, and mounts on the face of the instrument panel with a thumb screw. It is very flat and compact.

There are, also, special aeroplane and drum type controls in some of the lines to take care of peculiar arrangements of certain instrument panels.

Permanent magnet dynamic speakers are being used by many manufacturers in place of electro dynamics to reduce the drain on the already overloaded car battery. This means a saving of between one and two amperes.

An innovation in custom-built sets this year is used by one manufacturer. The speaker and control are mounted in one end of the receiver chassis. This end butts against a special grille on the instrument panel. The rest of the set extends back and is fastened to the bulkhead.

The signal-seeking circuit better known as automatic frequency control has invaded the car set field in an eight-tube de luxe chassis. This set will undoubtedly be very easy to tune while driving and should eliminate many complaints of fading from users who do not ordinarily take time to dial accurately.

Another innovation in tuning is a system of push-buttons which automatically tunes in several predetermined stations. Telephone-type dialing is undoubtedly in the immediate offing.

Electro-statically shielded antenna coupling units seen in several models materially improve signal-to-noise ratio.

There is, we note, a definite tendency among set makers to put more promotional steam behind features used in the past but not played up to the consumer. Tone controls and sensitivity controls have been made more prominent by placing them on the control head as supplementary knobs or by placing them in separate, illuminated control units generally mounted on the lower edge of the dash. New names for these features have been coined in order to make them more easily saleable.

Extended audio range and greater undistorted output make new receivers more acceptable to the discriminating listener. The judicious use of various optional speaker combinations allows for some very pleasing accoustical effects. For instance, the combination of a large bulkhead speaker and a header type properly matched to the output of the set, adds a certain amount of auditory "perspective" and gives a fullness to music even at low volume levels. The use of beam-power tubes, too, has contributed toward a reduction of distortion.

1937 auto-radio receivers, in many cases, rival the reception and tone "color" of consoles in medium price brackets.

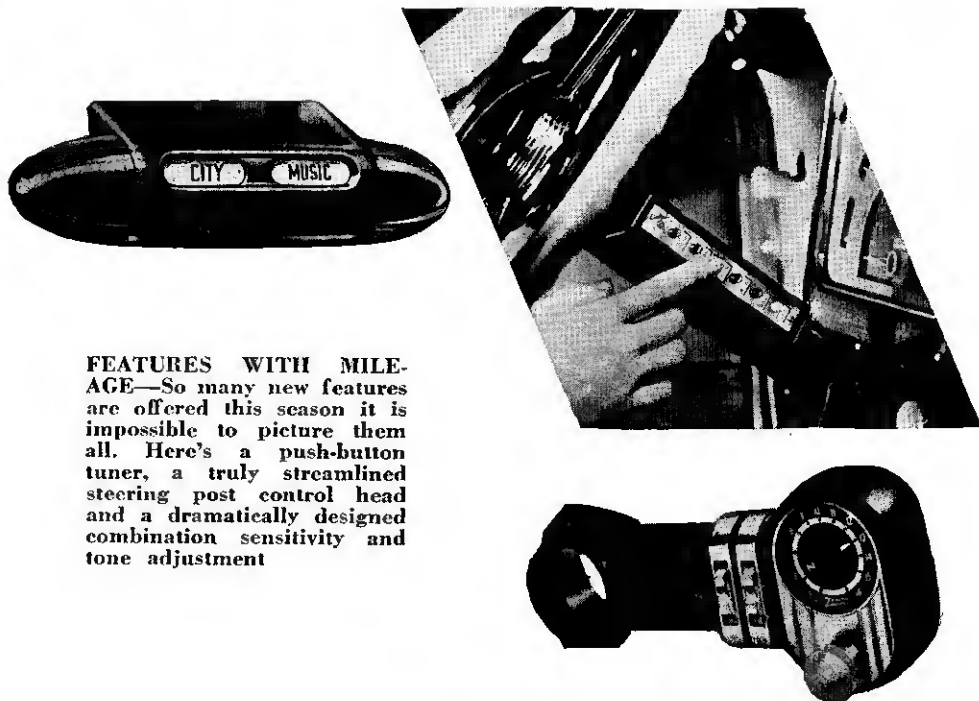

FEATURES WITH MILE-AGE—So many new features are offered this season it is impossible to picture them all. Here's a push-button tuner, a truly streamlined steering post control head and a dramatically designed combination sensitivity and tone adjustment

THE NEW KADETTE EQUAFONIC



Pioneers

AMAZING NEW PRINCIPLE OF Sound Projection!

Equafonic

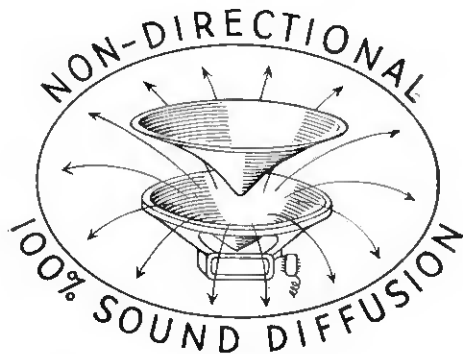

Uniform sound distribution is accomplished by vertically projecting sound waves to a horizontal and expanding plane—equal in amount or intensity in all directions.

Utilizing this new principle of sound projection is accomplished through the use of a sound auxiliary cone and baffle as illustrated above.

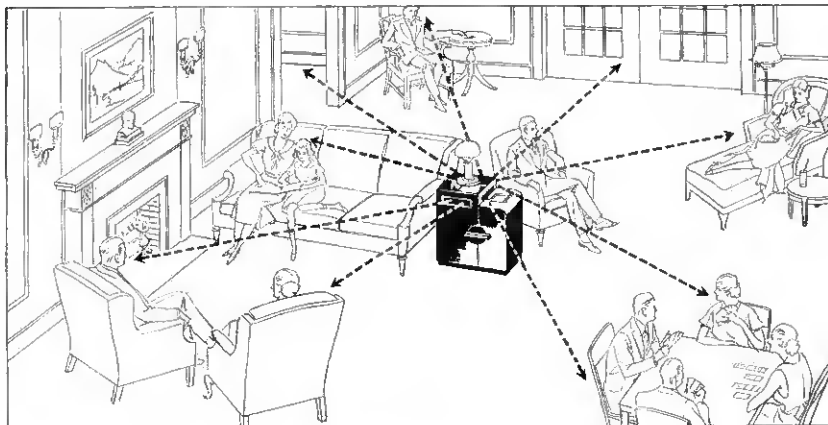

**CLUB MODEL with
COCKTAIL SERVICE**

\$ **49**⁹⁵

COMPLETE

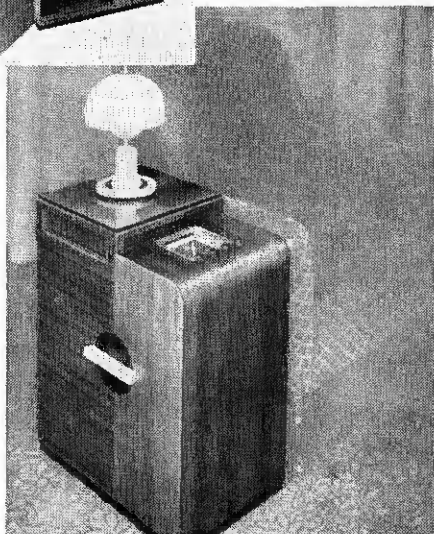
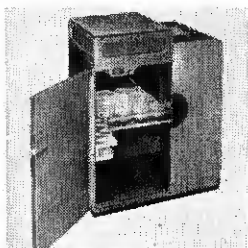

PUTS RADIO IN THE CENTER OF THE (HOME) STAGE

Again Kadette startles the radio world! This time it is the introduction of a brand new principle of sound projection—a principle destined to vastly improve radio reception—revolutionize radio styling and design—create a new place for radio in the home—step up the demand for higher priced models—and increase unit profits for the dealer!

In the new Equafonic Radio the sound waves are projected in all directions, thus assuring clearer and more uniform reception throughout the room. Listeners no longer need to sit "in front" of the radio to hear and enjoy the program.

The new Equafonic takes the radio away

from the wall and places it in the center of the room where it becomes a more useful and attractive piece of furniture. The cabinet itself is of modernistic Club Model design with a cocktail service compartment.

The chassis equipment is the most advanced AC 6-tube design covering both standard broadcast and European bands—540 to 1850 kilocycles (555 to 162 meters) and 5300 to 17,500 kilocycles (56.5 to 17 meters).

Focus your selling effort on this new type radio and watch the sales roll up and profits pile in.

INTERNATIONAL RADIO CORPORATION
531 WILLIAMS STREET, ANN ARBOR, MICHIGAN



Shopping Survey Stimulates Salespeople

MILWAUKEE—Says W. H. Roth, salesmanager for the Radio Specialties Company:

"On November 23, last, the following bulletin was mailed to 50 of our dealers employing approximately 150 salesmen:

ATTENTION

Weekly Cash Awards

For Milwaukee Retail Radio Salesmen Who Know their Merchandise—five (5) \$5 awards . . . each week until Xmas

In a recent city-wide shopping survey, we have learned that Milwaukee radio salesmen in general are failing to bring to the attention of the customer vital selling points which are furnished them by every radio distributor and manufacturer. We believe a great amount of good can be accomplished for the radio industry if this situation can be improved.

Price cutting and profitless trades can, in our opinion, be greatly minimized if more intelligent salesmanship is applied. Therefore, to encourage the retail radio salesman to study and utilize the splendid selling material available to him, we will contribute the above mentioned awards for this most worthy cause.

Cover the selling points of your product thoroughly to every prospect you talk to. One of these prospects may be an employee of ours who will write up a complete report of your presentation. The five best and most complete reports received each week from now until Christmas will be awarded \$5.00 each.

To help you in your radio sales presentation, we are enclosing with this letter a bulletin outlining the salient features of our product. A radio sales presentation would obviously not be complete without full coverage of these great new features. Read this bulletin carefully.

Specialty Stores Best

"The fifty dealers were made up of department stores, music houses, sporting-goods stores, hardware, furniture and specialty radio and appliance dealers. All were shopped weekly by several professional shoppers, for five successive weeks. These shoppers sub-

mitted daily written reports to the distributor.

"Reports . . . and this will be interesting to many . . . showed that 80 per cent of the salespeople failed in varying degrees from 'poor' to 'terrible.' Lack of knowledge, lack of personality and indifference played a big part in this heavy percentage. Included in the 20 per cent group, or approximately 30 salesmen, were several borderline cases that just merely qualified.

"It is interesting to note that the so-called specialty radio and appliance dealers made the best showing but only in instances where the proprietor or sole trader worked as his own salesman, or where the salesman had been trained by this type of tutor. The other extreme was developed in the ranks of this same type of dealer where the element of personal supervision or leadership was lacking."

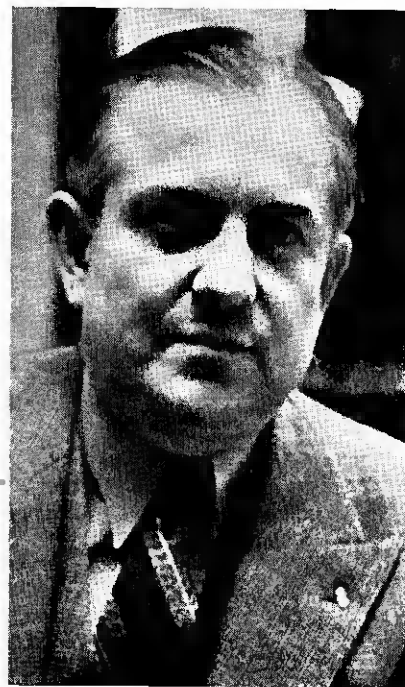

CAPITALIZED IDEA—Like other distributors, W. H. Roth frequently encountered sloppy selling while making the rounds of retail stores. Unlike others, he did something about it, simultaneously improving his own and dealer volume

Cooking Schools Sell Radio

ST. LOUIS—Community cooking schools rate high with the Bigalte Electric Company as a producer of radio as well as electrical appliance business. Four in one month (October, 1936) produced more than 2,000 home economic statistical cards on which women were asked to indicate by a cross what, "My Next Modern Home Appliance Will Be."

Ninety per cent of the 2,000 cards had a cross mark in front of one or more appliance. The greatest number of women checked off an electric range, and the next highest number a new radio.

The schools were sponsored by distributors and food manufacturers, participated in by all electric appliance dealers of the neighborhood. Two dealer salesmen were introduced to the audience at each of two sessions.

The cards have since been classified

by streets for the use of the firm's salesmen. Anywhere from three to five streets are lumped into a salesman's district. They are then filed by districts. After a salesman makes a call on the prospect he enters the details on the card. The street classification of prospects eliminates lost motion and the possibility of more than one salesman calling on the same housewife. This materially reduces later selling expense.

Based on sales in the first month resulting from the use of home economic statistics obtained at the schools, the sales accruing for the first 12 months will be 15 per cent.

Salesmanager J. D. Vinyard comments as follows: "You do get to the one you are trying to sell with these modern home appliance cards. Our first radio sale from the use of this card method was a \$200 set."

Tuning-Talk

Sidetracks Price

JANESVILLE, WIS.—Most important detail of a home demonstration, thinks Les Adams, is to personally show each and every member of the family exactly how the set must be tuned for best results. Once people get their hands on the controls and feel that they know something about how the receiver should be operated, they relegate price to the background, he believes, and become much easier to sell.

Adams frequently goes as far as to instruct members as a family in a group, then call them forward one at a time to prove they have understood. This permits him to remain in the home for some time without appearing to be hanging around for his money. And the "strangeness" of feeling between salesman and customer wears off due to the fact that they talk about the set itself rather than the details of the sale.

Les depends almost wholly for his



FRONT—An attractive store front and an interior that backs it up is necessary to impress the consumer with the concern's reliability, says Les Adams, even though most sales are actually closed in the home

business upon the success of home demonstrations. These are not urged upon people who appear to be cold prospects but the staff concentrates on the business of digging up customers

who can be interested in new radios to the point of asking for a demonstration without being urged.

About 80 per cent of all radios demonstrated in homes are sold.

Rates Ad Methods

JACKSON, MISS.—C. L. Smith, owner of a radio shop bearing his name, rates advertising methods applicable to his business as follows:

For Sales: 1st...Handbills, 2nd... one-cent postcards, 3rd...display newspaper space. Considered poor are telephone directories, want-ads, church bulletins, lodge bulletins and posters.

For Service: 1st...One-cent post cards, 2nd...want-ads, 3rd...telephone directories. Considered poor are newspaper displays, handbills, bulletins.

Smith, who has been in the business since 1922 and started his own full-fledged shop in 1933, says he has checked results against cost carefully over a period of years. He maintains an average inventory of around \$1,000, turns it 10 times per year, carries his own notes on time-payments, discounts all bills and buys repair parts in quantity where extra discounts are available.

"BUILT-IN" BATTERIES—Two rural customers, pictured in a "still" from a National Carbon Company sales movie, are impressed by the fact that all batteries in a new receiver are contained within its console cabinet.



DOUBLE-DUTY DOG—E. F. Droop & Sons, Washington, cleverly aided flood sufferers and at the same time publicized RCA-Victor sets by hanging a coin box on "Nipper's" nose, shoving a Red Cross flag behind his ear

REPAIRS

RADIO SERVICE

Send for our specially designed Service Car and watch in comfort while we work.



TUBES

L & M RADIO COMPANY
1206 West Jefferson Blvd.
Los Angeles, California

Phone RUpublic 8139

POSTCARD TRAILER AD—This picture postcard, mailed to prospects by L & M Radio of Los Angeles, brings invitations to demonstrate at the door. This concern started with service alone, was forced to take on a line of sets to avoid turning down sales opportunities

What Trade-Ins Bring as Junk

KNIGHTSTOWN, IND.—Furnishing facts and figures on a subject about which there has been much speculation, reader Richard Wagoner writes as follows:

"Every radio dealer at some time finds he has a number of antiquated trade-ins that represent a dead loss in addition to taking up valuable space. To clear these out and make room for more salable merchandise, yet realize a profit on such sets, I have evolved the following plan of wrecking them.

"Many of the cabinets are walnut or similar wood which can be sold to a furniture repair man, or anyone owning a home wood-working shop for the wood that can be salvaged. The hinged lid on some cabinets is just the right size for a coffee table while some of the smaller table model cabinets can be made into attractive hassocks.

"There is a good deal of metal in these old sets that can be sold to a junk dealer for more than you would think. A few cabinets are aluminum (such as the Eveready Model 2), also variable condensers and their shields, the 'goose neck' on some horn speakers, some coil shields and numerous other small parts. Coil shields are about all the copper you will find, but some old auto-radios are inclosed in a copper case. Many variable condensers and pulleys are brass, also the control heads of some old auto sets are cast brass. Some variable condenser mountings and shields are white metal, which can also be readily sold.

"I keep a few of the parts I might need. Those I don't want I put in a junk box and find that schoolboys building one and two tube sets are glad to give a quarter for a quantity of them.

"Some of the tubes are good and can be used in reconditioning trade-ins to be sold. Many of the speakers can be installed as extension speakers, for which there is constant demand in my territory and, no doubt, in others.

"Here is an account of the cash realized from the breakup and sale of three battery sets, one old auto set and

an ancient electric set recently torn down:

4 cabinets sold to furniture repair man	\$.50
13 1/4 lbs. of copper @ 8¢	1.06
5 1/2 lbs. of aluminum @ 12¢	.66
4 1/2 lbs. of brass @ 6¢	.27
3 boxes of parts @ 50¢	1.50
2 speakers installed as extensions @ \$4.	8.00
TOTAL	\$11.99

"This averages about \$2.40 a set, to say nothing of parts, good tubes and pilot light bulbs salvaged for use in other trade-ins still considered salable. Cabinets were of the table-type. Console cabinets would be worth more."

Two Unit Combination

ASHLAND, MASS.—A novel method of increasing dollar volume per customer, which apparently can be extended to many lines of specialty selling, is reported by the Warren Telechron Company.

One of this company's more imaginative dealers reports that he has obtained 80% acceptance from buyers of his radios for an additional sale under the following plan: One of the dealer's fastest selling sets retails for \$57.00 complete. The dealer, however, changes the price of the set to \$66.95 and includes Telechron's radio timer clock as part of the "complete" sale.

Whenever prospects asked for a home demonstration of the radio set the dealer delivers the receiver *plus* the timer, which is left on top the radio with a brief leaflet and instruction tag. Eighty per cent of the buyers of the radio also took the clock!

125,000 CLOCKS—When Los Angeles tapped in on new electric lines from Boulder Dam the required change from 50 to 60-cycle caused no upset in the operation of radios for these have sufficient frequency tolerance. Not so with synchronous clocks, however. The power company hired 75 men to change these over free for users, bought 50,000 Warren Telechron rotors for installation where adjustments proved difficult. Here's one corner of the test room

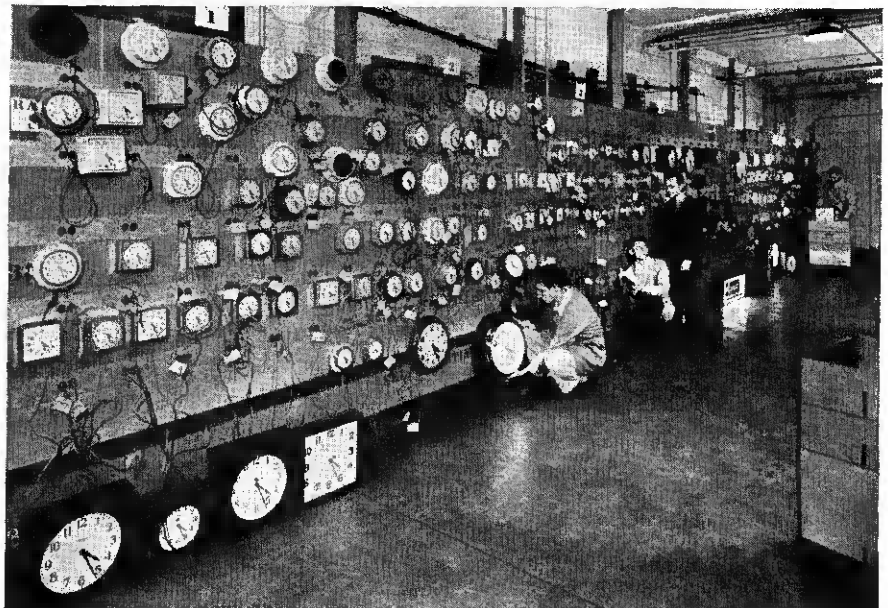

WE'LL TELL THE WORLD . . .

STARTING
APRIL 5th

STEWART-WARNER

HAS "MORE FEATURES FOR YOUR MONEY"



THAT'S right! On April 5th, Horace Heidt and his nationally famous Brigadiers start their coast-to-coast broadcasts selling *your* prospects all the advantages of the new 1937 Stewart-Warner refrigerators. And when they start selling, things happen! This is one of America's most popular radio orchestras, with millions of fans—hundreds right around your store. They'll make actual sales for *you*.

More Features for Your Money Make Selling Easy! 32 features that really make sense—with 6 that are absolutely *exclusive*—are already more than doubling last year's record-breaking sales figures. Dealers everywhere are cashing in right now on . . .

SAV-A-STEP Vapor Sealed Cabinet
SLID-A-TRAY Reversible Evaporator Door
16-Point Lighted Freezing Control
Slo-Cycle Twin Cylinder Compressor

New Floor Plan and Finance Plan Get Quick Action! With the exclusive Stewart-Warner-C. I. T. Floor Plan you can buy now—have a full floor showing—get many extra sales—without paying a penny for financing! And under the exclusive Stewart-Warner retail finance plan, you can advertise "NO MONEY DOWN—3 Years to Pay" and get all *your* money from the sale at once!

Learn now how much more Stewart-Warner offers you—in selling features, financing service and merchandising helps. Talk to your Stewart-Warner distributor now.

STEWART-WARNER

CHICAGO, ILLINOIS

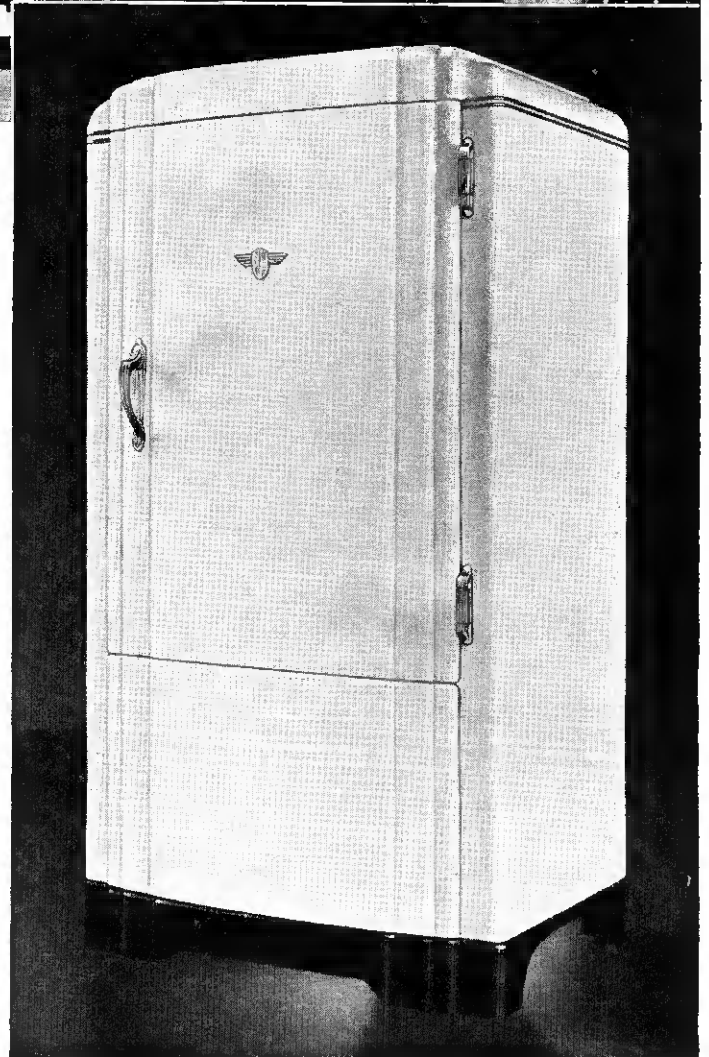

This Plan Sold

210 REFRIGERATORS

For A Radio Dealer

FREE
To users of
ICE BOXES ONLY
Electric Refrigerators, Ice Chests

TRIPLE PLATE CHROMIUM
ICE BOWL for cracked ice—
with handle, glass insert and
ice tongs.

An addition to any home—
beautiful to use on any table
when serving iced drinks.

Nothing to buy—no
strings to this offer.
Just mail the coupon
below for this special
gift.

MAIL THIS COUPON
Address: BOX 231 - X, Star Office.
Please send me the Ice Bowl Free, as advertised in The Star—

Name _____
Address _____
City _____

1 THIS NEWSPAPER AD unearthed ice-box owners

AROUND this time of the year the dealer who handles refrigeration begins to wonder about a number of things. Among them are: how much shall he spend for advertising, how many units can he sell and how many salesmen shall he put on in order to get enough real "coverage" of his territory. But, most important of all, how shall he locate real prospects for his salesforce in the shortest time and at the least expense.

He already knows from experience that cold canvassing at its best is a slow, tedious and expensive method. With business on the upgrade it is difficult to secure men to do this sort of work and it frequently fails due to the turnover of men.

Newspaper advertising usually requires a large monetary outlay and is in competition with Utilities and Department Stores who have large budgets for this purpose and whose line-age rate is often one-half that of the

Produced 2,000 genuine prospects in 10 days . . . Cost 75c per prospect . . . Units averaged \$140 . . . Kept 3 salesmen busy from April through September

independent retailer. The small merchant is at a distinct disadvantage. The returns are too meagre as a direct result of such advertising and unless you are prepared to charge off a large part of such outlays to institutional publicity it would be safer to concentrate efforts elsewhere.

After a number of weeks of thinking, head scratching and just plain guessing, a large retail radio and refrigerator dealer in an eastern city of 500,000 put the following plan into operation in the spring of 1936.

Something Really Free

Proceeding on the theory that everyone, especially women, is anxious to get something for nothing, this dealer decided to run a "blind" ad in two local newspapers, offering a free gift to "owners of ice-boxes only." This ad had no clue to the advertiser but used a box number at the newspaper office. It was decided to use a display ad of not less than 250 lines in each insertion. A coupon was attached for name and address.

The free gift was inspired by the suggestion of numerous manufacturers' representatives that some cheap knick-knack or gimcrack costing about 10c be offered to everyone who came in to see their new lines. Such items as drain-pipe brushes and drip-pans were suggested by them. After some thought it was realized that a great number of people might come in, look around and walk out with a trinket. Most of them would, however, be reluctant to leave their names and addresses and if they all came in a rush how could each one be interviewed properly? On the other hand

By **Greg L. Myers**

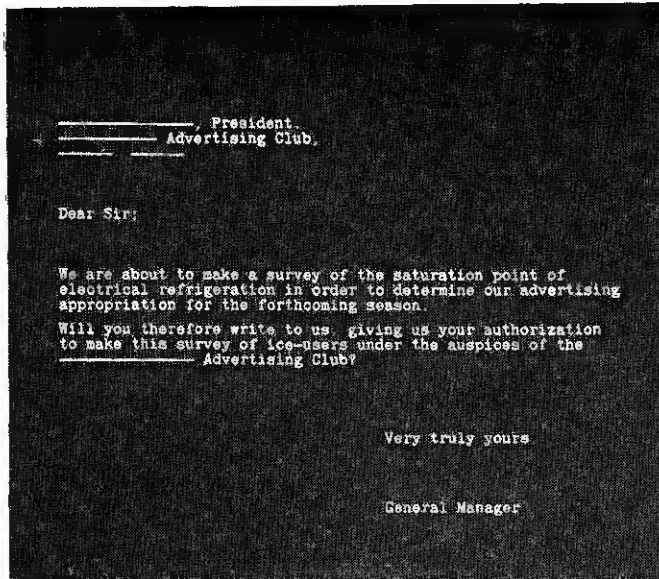

2 THIS LETTER SECURED authority for a "saturation survey"

Name _____	Address _____
Occupation _____	How long? _____
Salary _____	Rental _____
Owner or Tenant _____	Employed by _____
Children _____	Address _____
Rooms _____	Age of Ice-Box _____
Would you like to own a refrigerator? _____	

3 THIS QUESTIONNAIRE was taken door-to-door by college men

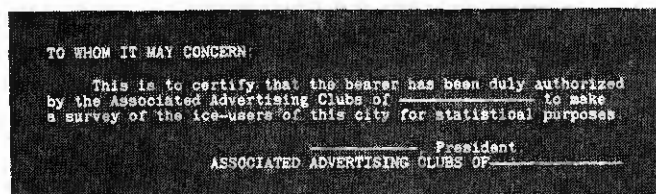

4 THIS CERTIFICATE got the surveyors into homes

5 SALESMEN DELIVERING THE ICE-BOWLS DID THE REST

many people, the thoughtful kind, might feel that there was a catch somewhere and certainly would not spend 10c carfare and waste two hours to go downtown merely to secure a trinket worth about a dime.

After a great deal of search an article was selected which was being extensively advertised in the local papers at \$1.98 and which could be purchased for 45c each in quantities of 500. This was an ice-bowl and tongs. Finished in chromium with

a glass insert, it made a very pretentious appearance. A line drawing was made and the accompanying ad made up.

Backed Up By Survey

The next step was to secure authorization to make a survey of ice-box owners under the auspices of some recognized, semi-official organization. Accordingly, the illustrated letter was sent to the local advertising club,

After personally explaining the purpose to the president of the club, his authorization was received. This letter, on the letterhead of the advertising club, was photostated and fifty copies printed. Its text is reproduced here.

At this point a number of excellent retouched photos of the ice-bowl and tongs were made. They were about the same size as the letterhead of the advertising club. In addition a third form was created. It was a questionnaire bearing thirteen questions. The text of this questionnaire is also reproduced.

This form when answered contained all the information needed by a salesman to really go to work on a prospect. He could decide in advance just what his approach should be and how large a box to suggest to the purchaser. It also gave a line on the credit possibilities of the prospect. Now it only remained necessary to get these questionnaires filled out.

College Boys Rang Doorbells

Next, contact was established with the Personnel Directors of three large local colleges. Each was requested to furnish ten young men who had experience in census or survey work. It was learned that there are many such men who had been used by R. L. Polk & Co. whose business it is to make many such surveys. Therefore the colleges were entirely familiar with such requests and agreed to furnish these young men at once and vouch for their responsibility.

After consulting with the Dean of Men it was decided to pay these young men 10c for each completed questionnaire and five cents for every call where the prospect did not have an ice box or was not qualified for the free gift. They were required to work from 4:30 to 7:30 p.m., at which hours it was felt the head of the house would be home for dinner.

At the rate of 20 completed calls per evening the average man would earn about two dollars. For such part time work this sum is considered more than fair. On the following

(Please turn to page 62)

HOW TO CANVASS FOR SERVICE

By Jim Kirk

CANVASSING is one effective method of increasing business that any radio merchant can use. It is especially an ace in the hole for the small independent man who cannot afford to rely on an advantageous location or extensive advertising; cannot afford to sit back and wait for business to come to him. I have heard many men object to canvassing. They said results were poor, that it was expensive because so much time was wasted in useless calls they could not get enough business to pay for shoe leather.

I'll take up reasons why some men have been disappointed with canvassing and point out how I have overcome these difficulties. My methods have made money for me. They have made warm friends and boosters whom I would have otherwise never known.

For One-Man Shops

First, the small independent man will tell me that he can't canvass because he hasn't a partner.

Who will answer the phone while he is out canvassing? He can't afford to hire some one. A stunt I have worked is to hand customers a government postcard addressed to me, with a serial number stamped on it. Customers are notoriously lazy and you want to make it as easy for them as possible. Tell them to merely drop the card in the mail—that's all. You have a record of their name corresponding to the number on the card. They will drop these cards in the mail when something goes wrong with their radio, and you can hunt up the list and rush out to their home.



WRITES THE AUTHOR—

If you said to everyone:

"You don't need your radio fixed, do yuh?"

Some would still reply:

"Sure I do, come in."

Most failures occur because the serviceman says to himself:

"I'm afraid there is no one home, I hope"

Some customers will even write an appointment time on the card or tell you what's wrong with their radio.

Of course, there are poor locations for canvassing and if you happen to be in one and do not want to move, I'd suggest you find the nearest good canvassing territory and start your work there, although you will have more luck if you are located in a good territory.

Poor territory for canvassing is hilly country, sparsely populated or one with too many apartment houses. You will become tired climbing steps in hilly country and so can not make

many calls. Neither can you make so many in sparsely settled country. Apartment houses make it harder for the beginner to canvass as they require special technique. Apartments do have the advantage of concentrating many customers in a small space, however.

Cards Won't Do Your Work

You want to hand your card to every person you talk to but it is plain waste to stick the cards under doors if people are not at home. Some men scatter their cards everywhere and find their printing bill is larger

(Please turn to page 61)

YOUR COMPETITOR

isn't such a bad guy!



Get to Know Him... Get Him to Tell You About Sylvania!

● You've heard us talk a lot about Sylvania tubes in the last few years. We'd like to have you get your information first-hand for a change.

Do this for us the next time you get a chance, will you? Call on that nearest competitor of yours who

handles Sylvania tubes. Get the whole story straight from him! He'll tell you he likes to do business with Sylvania... that the men who represent them are square shooters, looking out for *his* interests first of all. He'll probably mention the fair list prices, too and the chances are he'll tell you how

little trouble he has now with kick-backs and rejects. Get to know this man. He has a story that will mean dollars and cents to you!

Or *we* will be glad to tell you the story and send you free technical and sales helps. Write to the Hygrade Sylvania Corporation, Emporium, Pa.

SYLVANIA

THE SET-TESTED RADIO TUBE

HOWARD

GREEN HOWARD DIAMOND

1937 RECEIVERS

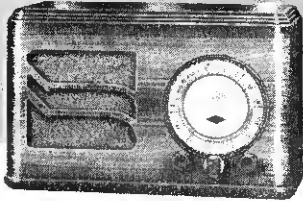

MODEL 256—Five-tube A.C. superheterodyne, 6½" Dynamic speaker, 4½" gold dial. Two bands—(540-1700 KC) (2-6.5 MC). Automatic volume control. Beautiful striped Walnut cabinet.

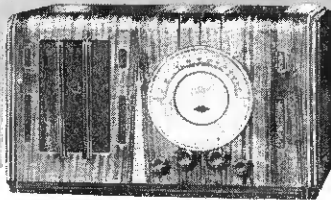

MODEL 266-T—Six-tube 3 band A.C. superheterodyne covering all frequencies from 540 kilocycles to 18 megacycles, 4½" gold dial with gold escutcheon, 3 gang bar type condenser, pre-selector stage in the Broadcast band, automatic volume control. Exceptionally smart cabinet design of striped Walnut.

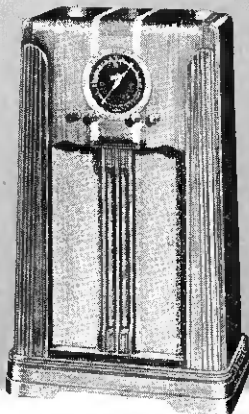

MODEL 218—Eleven-tube 3 band A.C. superheterodyne. Large 6" 3 color dial, three bands—from 540 to 18,000 kilocycles. Electric tuning eye built in dial, variable tone control, automatic volume control, three gang rubber floated tuning condenser, push-pull output, two I.F. stages and R.F. stage, tone control, big 12" Dynamic speaker, hand rubbed roll top cabinet, built of the finest Walnut veneers, tapered sides.

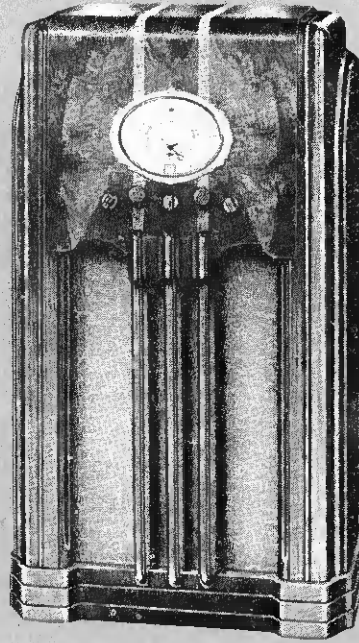

MODEL 214—Fourteen-tube 3 band superheterodyne. Complete frequency coverage from 540 kilocycles to 18,000 kilocycles. Push-pull beam power output, 15" speaker, large gold dial edge lighted glass scale with built-in tuning eye and band indicator. MANUAL BASS-BOOST CONTROL. Beautiful Walnut cabinet.

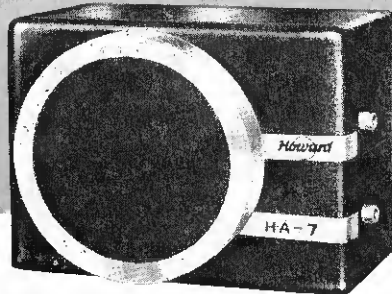

MODEL HA-7—Six-tube superheterodyne auto receiver, 100% ignition filtering, including antenna circuit 3½ watts power output. 6½" Dynamic speaker.
MODEL HA-9—Same as Model HA-7 except has separate 8" Permanent Magnet Dynamic speaker.

Many more outstanding models attractively priced—styled to sell—with performance and HOWARD quality—are offered in the 1937 Green Diamond series. Including a complete line of 2 and 6 volt table and console models for the farm.

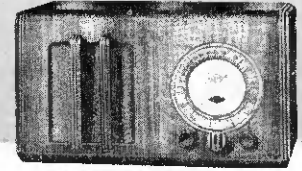

MODEL 259-T—Seven-tube superheterodyne A.C.-D.C. 2 watts power output, 6½" Dynamic speaker, 4½" gold dial. Two bands—(550-1700 KC) (2-6.5 MC). Automatic volume control. Cabinet of striped Walnut, imported Red Birch inlay, piano finish.

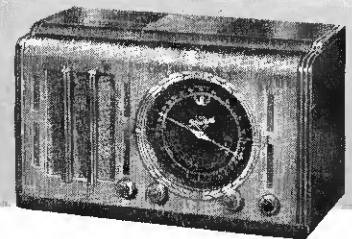

MODEL 268-T—Seven-tube 3 band A.C. superheterodyne; complete frequency coverage from 540 kilocycles to 18 megacycles 6½" three color dial with electric-eye built into dial. 3½ watts undistorted power output, 3 gang tuning condenser, variable tone control, 6½" Dynamic speaker. The most beautiful table cabinet in America—something entirely new in design that will appeal at first glance, built of highest grade striped Walnut and incorporating the new "double roll" top.

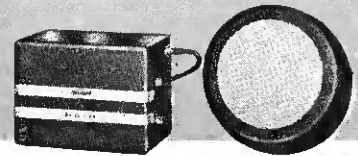

MODEL HA-8—Eight-tube superheterodyne auto receiver with separate 8" Permanent Magnet Dynamic speaker, 8 watts output.

INTERESTED DISTRIBUTORS WIRE OR WRITE FOR COMPLETE DETAILS AT ONCE

HOWARD RADIO CO.

1735 BELMONT AVE., CHICAGO, ILL.

AUTOMOBILE AERIALS

There Are Types for Every Car and Every Radio



**RADIO
RETAILING**

1937 AUTO RADIO

Model	Price (List)	Dimensions (Chassis)	Number of Speakers	Built-in Speaker, Type, Size	Ext. Speaker, Type, Size	Remote Control	Rectifier (Syn. or Tube)	Tubes (Number and Types)	Battery Drain (Amps.)	Output (Watts)	Inter-Freq. (K.C.)
Automatic Radio Mfg. Co., Inc., 122 Brookline Ave., Boston, Mass.											
M10	10½x6½x4½	1	5" El. Dyn.	No	Tube	6A7, 6D6, 75, 41, 84	4	1.75	456
M20	10x6x4	1	5" El. Dyn.	No	Tube	6A7, 78, 75, 41, 84	4	1.75	456
M30	10x6x4	1	5" El. Dyn.	No	Tube	6A7, 78, 75, 41, 84, 6E5	4.5	1.75	456
M60	10½x6½x4½	1	5" El. Dyn.	No	Tube	2-6D6, 6A7, 6Q7G, 41, 84	4.5	2.0	456
M67	10½x6½x4½	1	5" El. Dyn.	No	Tube	2-6D6, 6A7, 6Q7G, 41, 84, 6E5	5.0	2.0	456
M70	8½x7x6½	1	6½" El. Dyn.	Yes	Tube	2-6D6, 6A7, 6Q7G, 6B5, 0Z4	6.0	3.0	456
M80	8½x7x6½	*	6½" El. Dyn.	0½" P.M. Dyn.	Yes	Tube	2-6D6, 6A7, 6Q7G, 2-6B5, 76, 0Z4	7.0	7.0	456
* 2 optional.											
Belmont Radio Corp., 1257 Fullerton Ave., Chicago, Ill.											
661	\$29.95	0½x7½x9½	1	5"	Yes	Tube	6A8G, 6D7G, 6F6G, 6X5G, 2-6K7G	0.2	3	465
667	\$39.95	6½x7½x9½	1 or 2	6" El. Dyn.	5¼" P.M. or 8" El. Dyn.	Yes	Tube	6A8G, 6K7, 6Q7, 6F6, 6X5G	7.2	5	262.5
880	\$69.95	0½x7½x9½	1	8" El. Dyn.	Yes	Tube	6Q6, 6A7, 85, 2-76, 6A6, 84, 2-6D6	8.5	8	465
Continental Radio & Tel. Corp., 325 West Huron St., Chicago, Ill.— "Admiral"											
66*	\$35.95	8½x7½x7	1	6" El. Dyn.	Yes	Tube	6A7, 75, 41, 84, 2-6D6	7	3	175
77*	49.95	8½x7½x8	1	6½" El. Dyn.	Yes	Tube	6D6, 6A7, 6K7, 6H6, 6C5, 6V6G, 84	7	4½	175
78*	54.95	8½x7½x7½	1	8" P. M. Dyn.	Yes	Tube	6D6, 6A7, 6K7, 6H6, 6C5, 6V6G, 84	6	4½	175
88*	59.95	8½x7½x7½	1	8" P. M. Dyn.	Yes	Tube	0Z4, 6D6, 6A7, 6K7, 6R7, 6C5, 2-6V6G	8½	7	175
* Touch-O-Matic push button tuning available on all sets.											
Corona Radio & Television Corp., 420 No. Sacramento Blvd., Chicago, Ill.											
223	\$42.50	7½x8½x6½	1	6½ El. Dyn.	Yes	Tube	6W5, 2-6K7, 6A8, 6Q7, 6AB6	6	4	...
Crosley Radio Corp., Cincinnati, O.— "Roamio"											
A-177	\$59.50	7x10x6½	1	8" El. Dyn.	Yes	Syn.	2-6K7G, 6A8G, 6R7, 2-6V6G, 6W5G	8	9	262
A-167	39.95	7x10x6½	1	6½ El. Dyn.	Yes	Syn.	2-6K7G, 6A8G, 6B8G, 6N6G, 6X5G	7	5	262
Detrola Radio Corp., 3630 W. Fort St., Detroit, Mich.—											
.....	6½x7½x9½	1	5" El. Dyn.	Yes	Tube	6D6, 78, 75, 76, 42, 84	6	3	456
.....	6½x7x9	1	6" P.M. Dyn.	Yes	Tube	2-78, 6A7, 75, 6AB6, 0Z4	5	3.5	456
.....	7x8x9½	1	6" P.M. Dyn.	6" P.M. Dyn.	Yes	Tube	2-78, 6A7, 6R7, 2-6V6, 0Z4	7	8.5	456
Emerson Radio & Phonograph Corp., 111 Eighth Ave., New York, N. Y.											
U-154	\$39.95	6½x9½x6½	1	5" El. Dyn.	Yes	Tube	6A7, 2-6D6, 76, 41, 84	5.6	3	262
V-155	59.95	8½x8½x7½	1	8" El. Dyn.	Yes	Tube	6A7, 6D6, 6B7, 2-76, 2-41, 84	6.6	5	262
Fada Radio and Electric Co., 30-20 Thomson Ave., Long Island City, N. Y.— "Motocel"											
267	\$42.95	7½x8½x7½	1	6" El. Dyn.	Yes	Tube	2-78, 6A7, 75, 41, 84	5.6	4	456
267SD	49.95	7½x8½x7½	1	8" El. Dyn.	Yes	Tube	2-78, 6A7, 75, 41, 84	5.6	4	456
267SF	42.95	7½x8½x7½	1	5½" El. Dyn.	Yes	Tube	2-78, 6A7, 75, 41, 84	5.6	4	456
267SG	44.95	7½x8½x7½	1	5½" El. Dyn.	Yes	Tube	2-78, 6A7, 75, 41, 84	5.6	4	456
Firestone Tire & Rubber Co., Akron, Ohio											
1781	\$39.95	5½x7½x10	1	8" El. Dyn.	Yes	Tube	6J7, 2-6K7, 6Q7, 6F6, 6X5	7.5	3.2	262
Galvin Mfg., Corp., 847 W. Harrison St., Chicago, Ill.— "Motorola"											
35	\$29.95	10½x6x7	1	5" El. Dyn.	Tube	2-78, 6A7, 75, 41, 84	5.75	3	262
45	39.95	10½x6x7	1	6" El. Dyn.	Tube	2-78, 6A7, 75, 41, 84,	6	4	262
65	49.95	10½x8½x6½	1	8" El. Dyn.	Tube	2-78, 6A7, 75, 6AB6G, 0Z4	6.25	5	262
DeLuxe70	54.95	10½x6x6½	1	8" P.M. Dyn.	Tube	2-78, 6A7, 75, 42, 0Z4	5.5	6	262
Golden Voice	69.50	11½x6x6½	1	8" P.M. Dyn.	Tube	2-6K7G, 6A8G, 6C5G, 6H6G, 37, 6N7G, 0Z4	7.2	13	262
G.Voice spec.	74.50	11½x6x6½	1	10" P.M. Dyn.	Tube	2-6K7G, 6A8G, 6C5G, 6H6G, 37, 6N7G, 0Z4	7.2	13	262
General Electric Co., Bridgeport, Conn.											
FA-60	\$39.95	9x8x7½	1	6½" El. Dyn.	Yes	Syn.	2-6K7, 6A8, 6H6, 6F5, 6F6	7.75	4	175
FA-61	49.95	9x8x7½	1	6½" El. Dyn.	Yes	Syn.	2-6K7, 6A8, 6H6, 6F5, 6F6	7.75	4	175
FA-80	64.95	9x8x7½	1	6½" El. Dyn.	Yes	Syn.	2-6K7, 6A8, 6C5, 6H6, 6R7, 6C5, 6N7	8.5	7	175
Gilfillan Bros., Inc., 1815 Venice Blvd., Los Angeles, Calif.											
67	10½x7½x7½	1	6½" El. Dyn.	Yes	Tube	2-6K7G, 6A8G, 6Q7G, 6K6G, 84	6	3	252½
67R	10½x7½x7½	1	6½" El. Dyn.	Yes	Tube	2-6K7G, 6A8G, 6Q7G, 6K6G, 84	6	3	252½
77	10½x7½x7½	1	6½" El. Dyn.	Yes	Tube	2-6K7G, 6A8G, 84, 6H6G, 6F5G, 6F6G	6	4	252½
87	10½x7½x7½	1	8" El. Dyn.	Yes	Tube	2-6K7G, 6A8G, 6Q7G, 6C5G, 2-6K6G, 84	6.5	7	252½
Herbert H. Horn Radio Mfg. Co., 1201 South Olive St., Los Angeles, Calif.— "Tiffany Tone"											
557	\$39.95	6x7x10½	1	5½" El. Dyn.	Yes	Tube	6A8G, 6K7G, 75, 6F6G, 6X5G	5½	3	465
Howard Radio Co., 1735 Belmont Ave., Chicago, Ill.											
HA-7	\$42.95	6½x7½x9½	1 or 2	6½" El. Dyn.	Yes	Tube	2-6K7G, 6A8G, 6Q7G, 6AB6G, 0Z4	7	4	262
HA-8	64.50	5½x7½x9½	1 or 2	8" P.M. Dyn.	Yes	Tube	2-6K7G, 6A8G, 6Q7G, 6C5G, 2-6AB6G, 0Z4	7.25	8	262
HA-9	49.95	5½x7½x9½	1 or 2	8" P.M. Dyn.	Yes	Tube	2-6K7G, 6A8G, 6Q7G, 6AB6G, 0Z4	5.5	4	262
Karadio Corp., 750 Washington Ave., Minneapolis, Minn.											
75	1	6" El. Dyn.	Tube	6A7, 6D6, 75, 42, 84	5.8	2.25	456
76	1	6" El. Dyn.	Tube	2-6K7, 6A8G, 75, 6F6G, 84	6.4	3.0	456
77	1	6" El. Dyn.	Tube	2-6K7G, 6A8G, 75, 2-41, 84	6.8	4.5	456
78	1	8" El. Dyn.	Tube	2-6K7G, 6A8G, 75, 2-41, 84	6.8	4.5	456
787*	1	6" El. Dyn.	Tube	6D6, 6A7, 6F7, 75, 2-41, 0Z4G	6.4	4.8	450
55P†	1	6" El. Dyn.	Tube	2-78, 77, 75, 41, 84	6.4	2.5	456
* Sheriff model. † Police model.											

SPECIFICATIONS

Model	Price (List)	Dimensions (Chassis)	Number of Speakers	Built-in Speaker (Type, Size)	Ext. Speaker (Type, Size)	Remote Control	Rectifier (Syn. or Tube)	Tubes (Number and Types)	Battery Drain (Amps.)	Output (Watts)	Inter-Freq. (K.C.)
Laurehk Radio Mfg., Co., Adrian, Mich.— "Laurehk-Musique"											
A-37			1	6" El. Dyn.		Yes	Tube		5.5	4.0	175
Mission Bell Radio Mfg., Co., Inc., 831-833 Venice Blvd., Los Angeles, Calif.											
3716		8½x8½x6½	1	6" El. Dyn.		Yes	Tube	6A7, 78, 76, 6D6, 41, 84	6	3	465
3718		8½x8½x6½	1	6" El. Dyn.		Yes	Tube	6A8, 2-6K7, 6H6, 6C5, 6V6G, 84	7	4	262
3718*		8½x8½x6½	1			Yes	Tube	6A8, 2-6K7, 6H6, 6C5, 6V6G, 84	7	4	262
* Deluxe.											
Noblitt Sparks Industries, Inc., Columbus, Ind.— "Arvin"											
19	\$39.95	8½x8½x6½	1	6" El. Dyn.	5" to 8" El. Dyn.	Yes	Tube	2-78, 6A7, 75, 41, 84	6.1	3.5	170
29	49.95	8½x8½x6½	1	8" El. Dyn.	5" to 8" El. Dyn.	Yes	Tube	2-6K7G, 6A8G, 6Q7G, 6V6G, 6X5G	6.7	4.5	170
39	59.95	8½x8½x6½	1		8" El. Dyn.	Yes	Tube	2-6K7G, 6A8G, 6Q7G, 6C5G, 6N7G, 0Z4	7.2	9.0	170
Northland Radio Mfg., 2482 University Ave., St. Paul, Minn.— "Kartone"											
66A	\$29.95		1	5" El. Dyn.		Yes	Tube	6A7, 6D6, 75, 42, 84	5	3	456
Pacific Radio Corp., 844 W. Adams St., Chicago, Ill.											
H6	\$43.25	6½x8x9½	2	6" El. Dyn.	6" or 8" P.M. Dyn.	Yes	Tube	6A7, 6D6, 6Q7, 42, 6D6, 0Z4	3.5	262
H7	49.95	6½x8x9½	2	6" El. Dyn.	6" or 8" P.M. Dyn.	Yes	Tube	2-6K7, 6L7, 6Q7, 6C5, 6F6, 0Z4	4.0	262
Pierce-Airo, Inc., 510 Sixth Ave., New York, N. Y.— "De Wald"											
527		5x6x11	1	5"		No	Tube	6A7, 6D6, 75, 84, 41	6	3.3	456
517		6x5x11	1	5"		No	Tube	6A7, 6D6, 75, 84, 41	6	3.0	456
617		7x10x8	1	6"		Yes	Tube	2-6D6, 6A7, 75, 41, 84	6.25	3.3	175
702		7x10x8	1	6"		Yes	Tube	2-6D6, 6A7, 75, 41, 76, 84	6.30	4.0	175
RCA Mfg., Co., Camden, N. J.											
67M	\$42.95	7x7½x10	1	5½" El. Dyn.		Yes	Tube	6D6, 6A8, 6K7, 6B7, 42, 84	7.3	3.5	260
67M1	53.95	7x7½x10	1	6½" El. Dyn.	*	Yes	Syn.	6D6, 6A8, 6K7, 85, 6C5, 6A6	7.5	9	260
67M2	61.95	7x7½x10	1		8" El. Dyn.*	Yes	Syn.	6D6, 6A8, 6K7, 85, 6C5, 6A6	7.5	9	260
67M3	69.95	7x7½x10	2		8" El. Dyn.*	Yes	Syn.	6D6, 6A8, 6K7, 85, 6C5, 6A6	9.0	9	260
* Five inch El. Dyn. Header Speaker optional.											
Simplex Radio Co., Sandusky, Ohio.											
Q	\$39.95	8½x6½x6½	1	5" El. Dyn.		No	Tube	6K7, 6A8, 6N6, 0Z4, 75, 78	4.5	2.5	456
Transitone Automobile Radio Corp., Tioga and "C" Sts., Philadelphia, Pa.— "Philco"											
826	\$39.95	9x8½x6½	1	6" El. Dyn.		Yes	Tube	2-78, 6A7, 75, 41, 84	260
827	49.95	9x8½x6½	1	6" El. Dyn.		Yes	Tube	2-78, 6A7, 75, 41, 84	260
827K	54.95	9x8½x6½	1		9" El. Dyn.	Yes	Tube	2-78, 6A7, 75, 41, 84	260
828	54.95	9x8½x6½	1	6" El. Dyn.		Yes	Tube	2-78, 6A7, 75, 2-41, 84	260
828K	59.95	9x8½x6½	1		9" El. Dyn.	Yes	Tube	2-78, 6A7, 85, 2-41, 84	260
Trav-Ler Radio & Telev. Corp., 1036 W. Van Buren St., Chicago, Ill.											
660	\$39.95	6x7½x8½	1	6½" El. Dyn.		Yes	Tube	2-78, 6A7, 75, 41, 0Z4	3.2	262.5
601	49.95	6x7½x8½	1	6½" El. Dyn.		Yes	Tube	6A8G, 6H6, 6F5G, 6V6G, 0Z4, 2-6K7G	4.25	262.5
770	59.95	6x7½x8½	1		8" P.M. Dyn.	Yes	Tube	6A8G, 6H6, 6F5G, 6V6G, 0Z4, 2-6K7G	4.25	262.5
Troy Radio Mfg., Co., 1144 So. Olive St., Los Angeles, Calif.											
86	\$37.50	7x7x11	1	5" El. Dyn.		Yes	Tube	2-6K7G, 6A8G, 6Q7G, 6AB6G, 84	5.5	2.5	465
58	29.95	7x7x11	1	5" El. Dyn.		Yes	Tube	6A7, 6D6, 75, 41, 84	5.25	2.5	465
United American Bosch Corp., Springfield, Mass.— "American-Bosch"											
536B	\$39.95	9½"dia.x7½"H	1	6" Dyn.		Yes	Tube	6A7, 78, 75, 42, 84	6.5	4.0	456
636	49.95	9½"dia.x7½"H	1	6" Dyn.		Yes	Tube	2-77, 78, 75, 42, 84	6.5	4.0	175
637	54.95	9½"dia.x7½"H	1	5" Dyn.	5" Dyn.	Yes	Tube	2-77, 78, 75, 42, 84	6.5	4.0	175
736	59.95	8½x8½x6½	1	6" Dyn.		Yes	Tube	6A8, 2-6K7, 6H6, 6F5, 6F6, 0Z4	6.5	4.0	175
737	64.95	8½x8½x6½	1	5" Dyn.	5" Dyn.	Yes	Tube	6A8, 2-6K7, 6H6, 6F5, 6F6, 0Z4	6.5	4.0	175
738	67.95	8½x8½x6½	1	8" Dyn.	8" Dyn.	Yes	Tube	6A8, 2-6K7, 6H6, 6F5, 6F6, 0Z4	6.5	4.0	175
838	76.95	8½x8½x6½	1	10" Dyn.	10" Dyn.	Yes	Tube	6A8, 2-6K7, 6H6, 6F5, 2-6F6, 0Z4	7.5	8	175
United Motors Service, 3044 W. Grand Blvd., Detroit, Mich.— "Delco"											
R-640	\$39.95	7x8½x7½	1	5½" El. Dyn.		Yes	Tube	6Q7G, 2-6K7G, 6A8G, 6X5G, 6F6G	6.8	4	262
R-641	49.50	7x8½x7½	1	6" El. Dyn.		Yes	Tube	6Q7G, 2-6K7G, 6A8G, 6X5G, 6V6G	6.8	5	262
R-642	51.90	6x7½x10½	1	8" El. Dyn.		Yes	Tube	6J7, 2-6K7, 6Q7, 6X5, 6F6	7.0	5	262
R-643	53.50	7x8½x7½	1			Yes	Tube	6Q7G, 2-6K7G, 6A8G, 6X5G, 6V6G	7.2	5	262
R-644	65.95	9½x8½x6½			Yes	Tube	2-6K7G, 6A8G, 2-6R7G, 2-6V6G, 0Z4G	8.5	9.5	262
Wells-Gardner & Co., 2701 N. Kildare Ave., Chicago, Ill.— "Wells-Gardner," "Arcadia"											
6C1		8½x7½x6½	1	5½" Dyn.		Yes	Tube	84, 75, 41, 6C6, 2-6D6	6	3	175
6J		10½x7½x6½	1	6" Dyn.		Yes	Syn.	2-6K7, 6J7, 6B7, 41, 6A6	8	6	175
Zenith Radio Corp., 3620 Iron St., Chicago, Ill.											
5M191	\$29.95	7x9½x7½	1	El. Dyn.		Yes	Tube	6A8, 6K7, 6Q7, 6F6, 0Z4	5.5	3.2	456
6M192	39.95	7x9½x7½	1	El. Dyn.		Yes	Tube	2-6K7, 6A8, 6Q7, 6F6, 0Z4	6.95	4.0	252½
6M193	49.95	7x9½x7½	1	El. Dyn.		Yes	Tube	2-6K7, 6A8, 6Q7, 6F6, 0Z4	6.95	4.0	252½
6M194	49.95	7x9½x6½	1		El. Dyn.	Yes	Tube	2-6K7, 6A8, 6Q7, 6F6, 0Z4	6.95	4.0	252½
8M195	69.50	7x9½x7½	1		El. Dyn.	Yes	Tube	2-6K7, 6A8, 6H6, 2-6C5, 6N7G, 6X5	9.2	9.0	252½
Zephyr Radio Co., 13139 Hamillon, Detroit, Mich.											
2M7	49.50	7x8x10	1	6" El. Dyn.		Yes	Tube	2-6K7, 6A8, 6Q7, 6F6, 0Z4	5	3	456

**THIS SERVICE TRUCK FREE!
WITH BUILT-IN LOUD-SPEAKER SYSTEM!**

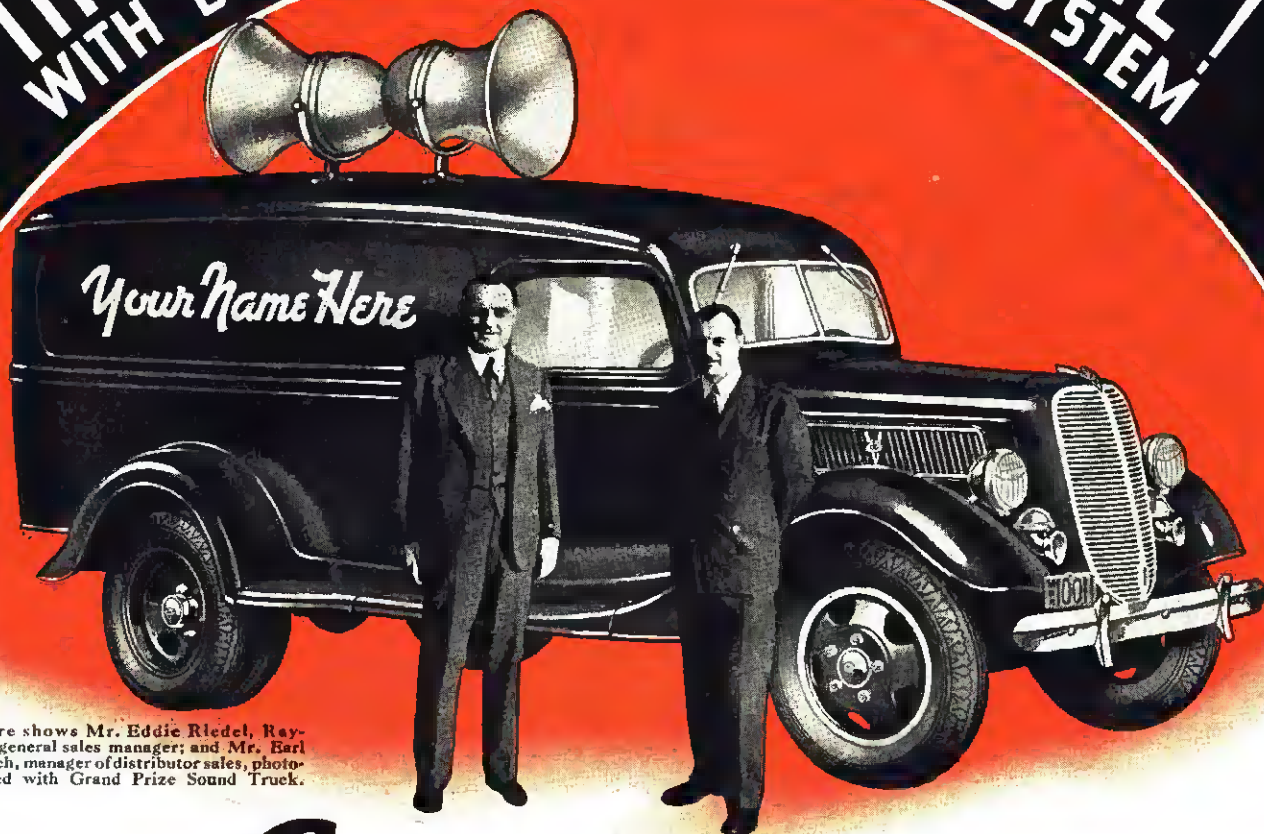

Picture shows Mr. Eddie Riedel, Raytheon general sales manager; and Mr. Earl Dietrich, manager of distributor sales, photographed with Grand Prize Sound Truck.

WE ARE *Giving It Away!*

ALSO 500 OTHER FREE PRIZES

It's the easiest contest ever! Just answer a simple question—an answer that every serviceman or dealer gives to his customers two or three times a week. It may win for you this new V-8 service truck with a complete built-in sound system—or \$600 Cash! In addition, the first prize winner's name and photograph will appear six weeks after the contest in our advertisement in the Saturday Evening Post! There are 500 other prizes you will find equally desirable! Learn about the Raytheon Contest today! Ask your jobber!

RAYTHEON

RAYTHEON PRODUCTION CORPORATION

420 Lexington Ave., New York, N. Y.
55 Chapel Street, Newton, Mass.

445 Lake Shore Drive, Chicago, Illinois
555 Howard Street, San Francisco, Cal.
415 Peachtree St., N. E., Atlanta, Ga.

RAYTHEON IS THE MOST COMPLETE LINE - ALL TYPES OF GLASS, OCTAL BASE, METAL, RESISTANCE AND AMATEUR TRANSMITTER TUBES

NEWS

PEOPLE • PRODUCTS • PLANS

MUSIC WEEK TO BE CELEBRATED IN MAY

Sarnoff, Chairman, Sets Opening Date for First Sunday of Month

NEW YORK—For the fourteenth consecutive year the first Sunday of May will usher in National Music Week, it was announced February 28 by the National Music Week Committee.

In keeping with its annual purpose to concentrate its activities in developing some phase of American music culture, this week will be dedicated to a cause indicated by the slogan: "Foster Local Music Talent".

"Most amateur musicians fail to continue their musical education because of the few opportunities offered them in their local communities to make use of their talents," says David Sarnoff, committee chairman. "Opportunities to use their talent locally will be offered during National Music Week."

HOWARD SPRINGS NEW LINE

CHICAGO—Under the same ownership which started the company and has not changed during the fifteen years of its existence, the Howard Radio Company is offering the famous "Green Diamond" line of radio receivers on a 100 per cent distributor set-up.

The most modern manufacturing methods known have been incorporated in the

making of each set, according to Joseph F. Riley, general manager, and Howard C. Briggs, sales manager.

Models are, we understand, available in every price class and the line is topped by the new fourteen-tube de luxe console.

NEW CROSLY BUILDING

CINCINNATI—Work was started Wednesday, February 24, to clear away the debris of Crosley Radio Corporation's Building K, destroyed by fire on January 24. As soon as this clearing job is completed a new building will be erected on the same site.

To be 500 feet long and 100 feet wide, one story high, this new building will be used for shipping and storing radios, refrigerators and washing machines; will cost \$100,000.

ABRAMS UPS HAST AGAIN

NEW YORK—Nate Hast, who has been climbing the Emerson ladder at a great rate, steps up another rung. Ben Abrams has just made him national sales manager.



NEW ARCTURUS KINGPIN—Clarence A. Earl, most widely known in the industry for his early efforts in behalf of Earl Radio, Freshman and Fredd-Eisemann, returns to an active radio post as president of the Arcturus Radio Tube Company.



READY FOR BANNER YEAR—Ira J. Owen, president of Utah Radio Products, looks over a newly installed cost accounting system. Out in the plant several departments have been re-equipped with ultra-modern automatic machinery and the lab has installed testing apparatus second to none in the parts business.

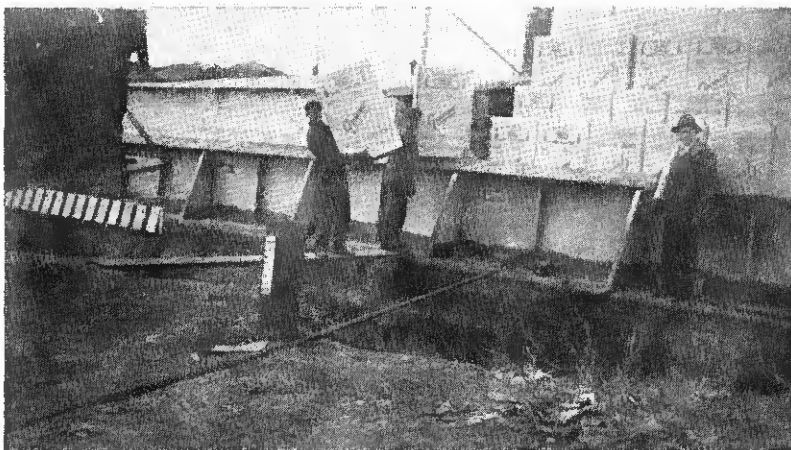

FOILING THE FLOOD—By barge from the Owensboro factory, then by truck to Marion, Indiana, for delivery to jobbers, went these new style 755 Grunow refrigerator cabinets at the height of the recent flood. Bill Grunow went great lengths to avoid delivery holdups.

Kelvinator goes on the air

March 6TH!

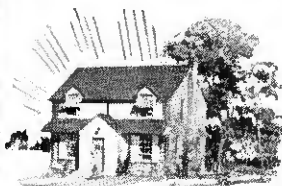

A NEW KELVIN HOME

The first prize in Kelvinator's Big Radio Contest will be a Kelvin Home, complete with year-round air conditioning, electric or gas range, electric refrigerator, constant hot water, electric laundry equipment. The last word in modern living!

★
Half-hour Program
SATURDAY EVENINGS AT 8:00 E.S.T.
COAST TO COAST HOOK-UP OF
55 STATIONS ON THE COLUMBIA CHAIN
TWO BIG CONTESTS
FIRST PRIZE—A KELVIN HOME
AND MORE THAN A THOUSAND OTHER PRIZES
INCLUDING NASH CARS • REFRIGERATORS
• ELECTRIC AND GAS RANGES •
WASHING MACHINES • ELECTRIC
IRONERS • AND CASH



A NASH AUTOMOBILE

Included in the other prizes will be completely equipped Nash cars—one of the country's finest and most beautiful automobiles. Big, roomy, perfectly appointed automobiles, that anyone would be proud to win and drive.

A program built to produce FLOOR TRAFFIC

Kelvinator will not only have a thrilling program that will appeal instantly to everyone, but will have two big contests that will bring people in great numbers to the stores of Kelvinator dealers.

The contests are fascinating and yet so simple that anyone can enter with a real chance of winning. There is nothing to buy—no tiresome essays to write, but every contestant must visit a Kelvinator dealer in order to secure entry blanks and rules of the contests. This means Floor Traffic

for Kelvinator dealers—and because of the nature of the contests, it will mean floor traffic composed of men and women who will be anxious to learn all they can about Kelvinator appliances for their homes.

And this radio campaign with its Two Big Contests is only one of the many sales promotion features of the 1937 Program. Only one of the things which is going to make 1937 the greatest year in history for Kelvinator dealers and salesmen.

KELVINATOR • DIVISION OF NASH-KELVINATOR CORPORATION
DETROIT, MICHIGAN

Kelvinator

ELECTRIC REFRIGERATORS • RANGES • WASHING MACHINES • IRONERS • AIR CONDITIONING EQUIPMENT



35-YEARS IN INSTRUMENTS— Here's *R. L. Triplett*, the man who lends his name to all those fancy meters, celebrating his 35th year in the business

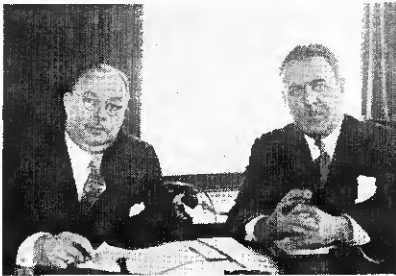

SERIOUS SYLVANIAMEN — C. W. "Bill" Shaw (left) and Paul S. Ellison of Hygrade-Sylvania face the camera, neither cracking a smile. Bill is now general sales manager and Paul is manager of renewal sales as well as advertising and promotion



L'TATRO GM—Ray Wortmann, formerly of Galvin, who has just been appointed general sales manager for L'Tatro of Decorah, Iowa

PARTS SHOW BOOTHS GOING FAST

Exhibit Will Be One Third Larger Than Planned.
Raw Material Makers Entering

CHICAGO—Sell out of 130 booths, all that can be accommodated, is predicted for the Radio Parts Manufacturing National Trade Show to be held at the Stevens June 10-13, according to Arthur Moss, secretary of the show corporation. Entry of many raw materials suppliers is one of the things that has made it necessary to provide 30 per cent more booths than originally planned.

Jobbers, representatives and servicemen on the West Coast are planning to attend the Chicago exhibit in force, according to Ralph Hill, chairman of the western division of the Sales Managers Club, who reports great interest.

PIONEER PUSHES RED-TOP UNITS

CHICAGO—Two new leaflets designed to help dealers sell "Red-Top" Gas-O-Lectric power plants have just been prepared by the Pioneer Gen-E-Motor Corporation. One, designed for the dealer himself, gives full technical details and prices. The other, small enough to be distributed to the consumer through the mails, does a text selling job which should pave the way for many actual retail sales.

IRC EXPANDS PLANT

PHILADELPHIA—An increase of approximately 25 per cent in manufacturing space is reported by the International Resistance Company. All production space and executive offices are still on one floor, but it is now one block long in the spacious Terminal Commerce Building.

Both president Ernest Searing and general manager Fred D. Williams are optimistic regarding the radio industry's outlook for 1937; expect a banner year for IRC resistors.

TARTAK BUYS PREMIER

CHICAGO—Paul H. Tartak, president of Oxford-Tartak Radio Corporation, has just acquired the controlling interest in Premier Products, Incorporated. The plant has been removed from 1800 Grace St. to 915 West Van Buren.

C. R. Bluzat, president of Premier and before that vice-president in charge of engineering and production for Standard Transformer, becomes mid-western sales manager of Oxford-Tartak.

NEW SOLAR SERVICE CATALOG

NEW YORK—A new, complete condenser catalog designed for easy reading and reference has just been published by the Solar Manufacturing Corporation of

599 Broadway. Designated as catalog number 8-S, this new reference book for the serviceman devotes two full pages to each type of condenser. Each type is illustrated by both a photograph and a diagram.

Unusually large type makes this booklet particularly easy to read.

Horning To Elliott-Lewis

PHILADELPHIA—Frank Horning, president of the Southern Jersey Electrical Association, formerly associated with the Samson Electric Company of Chicago, Stix-Baer and Fuller of St. Louis and, more recently, Philadelphia rep. for RCA, has been appointed sales manager of the newly-established Elliott-Lewis Electrical Company radio division.

This division will serve General Electric radio dealers throughout the Philadelphia, Wilmington, Trenton and Atlantic City areas.

CLAROSTAT EXPANDS

BROOKLYN, N. Y.—The Clarostat Mfg. Co., Inc., has increased its plant space by 25 per cent. New machinery installed within the last two weeks, plus additional personnel, was needed to meet an expanding volume of business.

Coombs-Rooney Formed

BROOKLYN, N. Y.—A new company which will be active particularly in the South and Central American export markets has been formed by Robert L. Coombs and Edward J. Rooney. Coombs sails on or about March 20 on a selling trip.



SPARTON ONCE-OVER — E. T. Hutchinson, sales manager of the Sparks-Withington Company, looks over a classy model



WITH TWO OF THE GREATEST NATURAL SALES APPEALS SINCE THE FIRST ROLLATOR REFRIGERATOR

1- *Low-Temp* ROLLATOR REFRIGERATION
2- *NEW Flexible* INTERIOR ARRANGEMENT

For 1937, Norge again sets the pace with the greatest advances in home refrigeration since the introduction of the Rollator—the new Norge **LOW-TEMP** Rollator Refrigerator and ingenious new flexible interior arrangement in both *Low-Temp* and *Deluxe* models.

Straight through the line—right down to the “price” models—Norge has greater value to sell, greater value to demonstrate. Norge dealers enjoy two advantages—sensational public acceptance of the name Norge and continuous product leadership.

The Norge 1937 advertising and sales promotion program is the greatest in Norge history. Get full details of the Norge proposition from your nearest Norge distributor. Liberal finance plans make it *easy* to be a Norge dealer.

NORGE DIVISION Borg-Warner Corp., Detroit, Michigan

See THE DIFFERENCE!
Sell THE DIFFERENCE!
Pocket THE DIFFERENCE!



ROLLATOR REFRIGERATION (Domestic and Commercial) • GAS AND ELECTRIC RANGES
 WASHERS AND IRONERS • WHIRLATOR OIL BURNERS • GAS BURNERS • FINE-AIR
 FURNACES • COAL STOKERS • AIR CONDITIONING • CIRCULATOR ROOM HEATERS

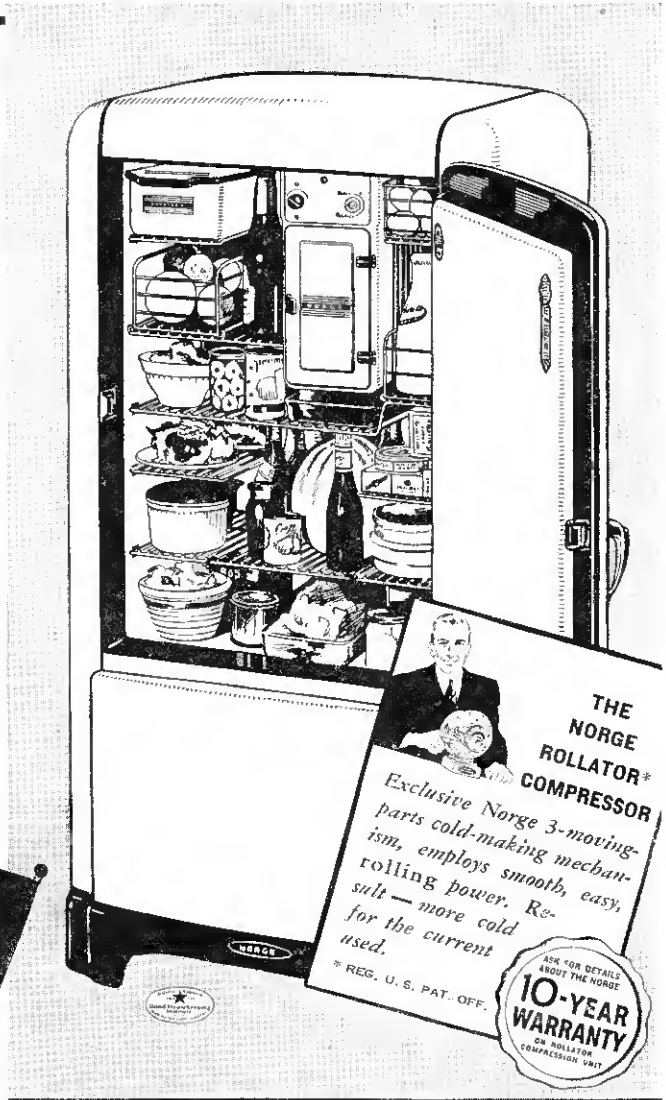

THE NORGE ROLLATOR* COMPRESSOR
 Exclusive Norge 3-moving-parts cold-making mechanism, employs smooth, easy-rolling power. Result—more cold used.
 * REG. U. S. PAT. OFF.
10-YEAR WARRANTY
 ON ROLLATOR COMPRESSOR UNIT

WINCHARGER ANNOUNCES NEW DEALER POLICY

Offers Trade Unit With \$25 List and \$10 Gross Profit. Continues \$15 Coupon Plan Designed To Aid Set Sales Too

SIoux CITY—The Wincharger Corporation will, beginning this month, sell its DeLuxe 6-volt unit through dealers at a retail price of \$25. Interviewed, the company stated that it will also continue its coupon plan under which purchasers of certain new receivers may obtain the device for \$15, at no direct profit to the dealer.

The coupon plan, under which the company has until this month sold exclusively, makes it possible for the trade to use the charger as a means of increasing set business. Said W. W. Watts, sales and advertising manager: "It is anticipated that many dealers will make radio sales to customers who come in to buy a Wincharger at \$25, as the \$10 saving on the price when the unit is purchased together with a new set is an extra sales argument of no small importance."

Continental Appoints Weisburgh

CHICAGO—Herbert Weisburgh, formerly sales manager for Universal Cooler, has been appointed district representative in the New England territory for the Continental Radio & Television Corp., manufacturer of "Admiral" home radios, auto-radios and the newly announced automatic tuning device called "Touch-O-Matic."

Ross Siragusa, president of Continental, announced on his return from a recent trip east that the "Touch-O-Matic" idea was getting excellent dealer reception. J. H. Klippinger, vice-president in charge of sales, says Admiral radios are now on the Commercial Credit acceptance list.

RAY, WANSLOW UPPED

BRIDGEPORT—Fred A. Ray has just been made district radio sales manager for General Electric's Cleveland territory, which includes Ohio, northern Kentucky and eastern Indiana.

F. B. Wanslow, for the past fourteen years RCA-Radiotron district sales manager in the New York and Philadelphia areas, has been made G-E district radio specialist in the Baltimore and Washington territories.

SERVEL BUYS 100 TRAILERS

EVANSVILLE—One hundred Dodge coupes and Aerocar trailers are being put into operation by Servel, Inc., serving as showrooms-on-wheels for the promotion of Electrolux kerosene refrigerators.

The trailers have seating facilities for dealers and prospective customers and are equipped with both radio and sound equipment. They will be used to promote sales both to dealers and consumers in rural areas.



BRENGLE, THE ORIGINAL—Pistols are a nice hobby and handy to have around says C. T. Brengle. His smile reassured our photographer

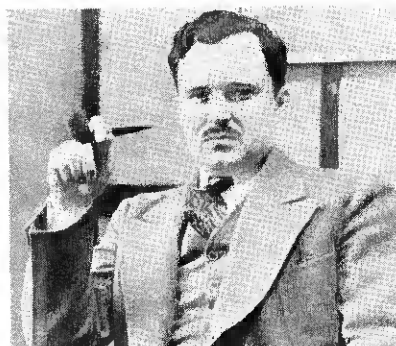

CLOUGH-BRENGLE EXEC—Here's John Meck, who knows his test equipment, deep in thought

RCA MAKES NEW SALES APPOINTMENTS

CAMDEN—From Vance C. Woodcox, sales manager of field operations, comes the following announcement relative to appointments and new assignments in the RCA Victor sales organization:

E. W. Butler, formerly manager of the Pittsburgh district, has been placed in charge of phonograph sales, under Paul C. Richardson, at Camden. George R. Ewald, formerly engaged in special merchandising activities at the plant, has been appointed manager at Pittsburgh.

M. F. Blakeslee, formerly manager of the Atlanta district, has been shifted in the same capacity to Chicago, replacing F. H. Larrabee, resigned. F. M. Bewsher, formerly manager of the New Orleans district, replaces him in Atlanta.

The company's district offices located heretofore in New Orleans have been shifted to Memphis, Tenn. Norman Bass, of the Cincinnati district, has been made district manager of the Memphis office. D. E. Neiswander, formerly assigned to the Detroit district, has been appointed manager of the Cincinnati district.

W. F. Huntington, formerly sales representative in the Cleveland district, has been assigned to the Atlanta district and will be stationed in Florida, succeeding J. R. Slocum, deceased.

George L. Malsed, formerly Minneapolis sales representative, has been assigned to Dallas. And Gay White has resigned as sales representative of the Dallas district to join RCA Victor's new wholesale distributor in that city, the Radio City Distributing Corporation.

Aerovox Appoints Backer

SEATTLE—James J. Backer of 109 Bell St. has been appointed sales representative for the northwestern territory by the Aerovox Corporation; will contact jobbers.



YOU'VE GOT SOMETHING THERE, BOYS—Shown going over the salient points of Thordarson's new "Multi-Match" line of modulation transformers are (left to right, Lorin C. Collins, Henry Johnson, advertising manager, and Charles P. Cushway, sales manager

LEONARD ECONOMY

See how little it costs to operate
a 1937 LEONARD ELECTRIC

This LEONARD ELECTRIC REFRIGERATOR HAS BEEN OPERATING THE NUMBER OF DAYS INDICATED ON THIS TELECRON CLOCK . . .

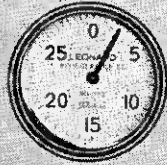

This DUNCAN REGISTERING METER SHOWS HOW LITTLE IT HAS COST IN ELECTRICITY TO RUN THIS LEONARD (Figured at 3¢ per Kilo-watt hour base rate)

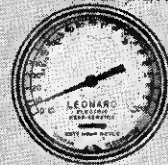

HERE'S HOW LEONARD DEALERS ARE TELLING AN

Economy Story
THAT REALLY
Convinces the Buyer!

Every prospect is interested in economical operation—and every electric refrigerator claims to be economical.

But look how Leonard dealers back up this claim. Into the cabinet being demonstrated is plugged the above Economy Indicator. One dial shows the number of days the Leonard has been operating. The other shows the cost of the electric current consumed. There's proof of economy. And it Convinces buyers.

It is only one of the many things which 1937 Leonard dealers have in addition to a refrigerator that practically sells itself on sight. It's one of the many reasons why Leonard Sales are breaking all records.

LEONARD REFRIGERATOR, Division of Nash-Kelvinator Corp.
Detroit, Michigan



Leonard's Master Dial—the year's most outstanding refrigeration development—leads a list of convenience features that never fail to get instant acceptance for this sensational more-for-the-money refrigerator.

LEONARD ELECTRIC WITH THE *Master Dial*

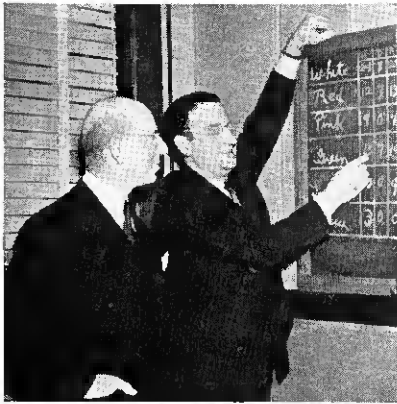

MAX AND MAX MOVE—Max Landay (left) and Max Hegleman of the Capital City Distributing Corp., Albany, set up the all-important sales chart on the walls of the firm's new home at 33 Orange St.



STREET-CORNER CONFAB—Here (left to right) is *Burton Browne* of Ford, Brown & Mathews; *Eddie Riedel*, Raytheon general sales manager and *Earl Dietrich*, Raytheon jobber sales manager, conferring about something or other out in the cold on a Chicago street corner

TAYLOR OPENS WAREHOUSE

ATLANTA—On March 15 Morris F. Taylor, manufacturers representative, opens a warehouse at 440 West Peachtree St., N. W. at which a complete stock of merchandise will be carried.

A. S. Hardy, former assistant manager of the Federated Purchaser's branch in this city, will be in charge. Southern salesman Smith will make his headquarters at the warehouse henceforward.

ZENITH NOW MOVING TO MAMMOTH NEW PLANT

Will Make Own Cabinets, Steel Chassis Frames. Building Takes Up Four Blocks

CHICAGO—As we go to press, machinery of the Zenith Radio Corporation is being moved into a mammoth new plant extending four city blocks along Dickens Avenue and described by Hugh Robertson, vice-president and treasurer in charge of changeover plans as the largest all-on-one-floor radio plant in the world.

Capable of producing 10,500 radio sets every eight hours, or nearly 22 per minute, this new plant permits Zenith to fabricate its own steel chassis frames and various other metal parts for home, farm, boat, trailer and automobile radios. It contains, also, complete facilities for manufacturing cabinets. Zenith has not operated a woodworking plant since 1933 and Commander E. F. McDonald, Jr., president, explains that this step has been taken to protect the company against uncertainty in cabinet delivery from outside sources.



JENSEN'S AMATEUR PHOTOGRAPHER — When *Tom White* is not up to his neck in loud-speakers he drives his family nuts shooting them with a camera worth more than the average man's automobile

JOBBER APPOINTMENTS

ADMIRAL—For metropolitan New York and northern New Jersey: *Dale Parts, Inc.*, now at 25 Warren St. and out of the parts business entirely.

EMERSON—In Savannah: *Graybar Electric*; In Jacksonville: *Graybar Electric*; In Atlanta: *Graybar Electric*; In New York: *Emerson-New York, Inc.*; In Newark: *Emerson-New Jersey, Inc.*

RCA-VICTOR—For the Fort Worth-Dallas territory: *Radio City Distributing Company*, newly formed outfit headed by John Donovan and sales-directed by Gay White.

STEWART-WARNER—Both radio and refrigeration. At Cincinnati: *The Dietz Distributing Co.*; in Cleveland territory with branch at Columbus: *The Kane Company*; For the south-central territory of Texas: *The Alemite Company* of San Antonio; for the central Indiana territory: *The Indiana Distributing Company*, of Indianapolis.



BACHELOR NO MORE—RR's candid-camera gets last look at *Ed May*, advertising major domo of Electrical Research Labs., in the single state. He's just married, beat it for a Florida honeymoon

WOR CELEBRATES 15th YEAR

New York—On February 22, radio station WOR, Bamberger Broadcasting Service, celebrated its 15th year of operation.

Second to go on the air in the metropolitan district, a leader in the recent development of the Mutual Broadcasting System as a coast-to-coast network, WOR was originally operated from the toy department of L. Bamberger's department store at Newark. The first transmitter was a 250-watt DeForest set.

J. R. Poppele prepared the first transmitter for its initial broadcast and has continued as chief engineer of the station ever since. Power was increased to 500-watts in 1922; to 5,000-watts in 1927 and to 50,000-watts in 1935.

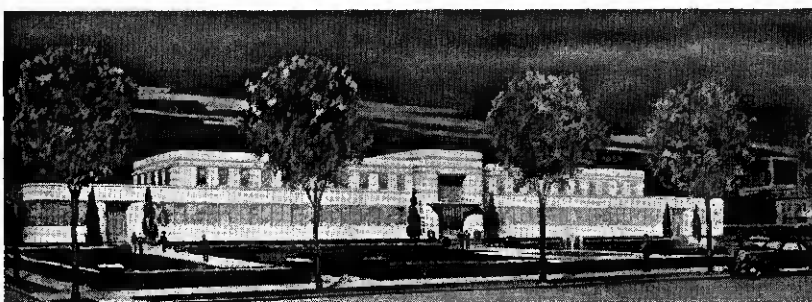

MOTOROLA'S NEW HOME—Designed along ultra-modern lines inspired by buildings at the Chicago World's Fair, this new plant now under construction for the Galvin Mfg. Corp. at 4545 Augusta Blvd. will be ready for occupancy April 1



...ALL

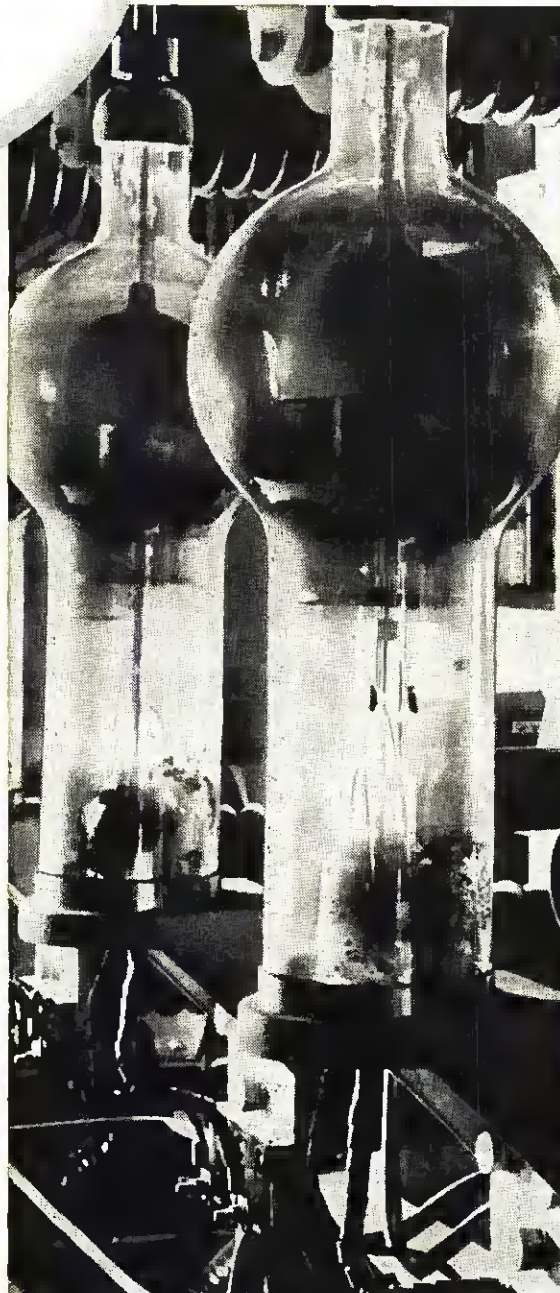

RCA owns and operates NBC, which brings to you scores of outstanding programs.

RCA equipment from microphones to power tubes is used by leading stations.

RCA only company that designs a complete radio system—from microphone to receiver.

RADIO CORPORATION OF AMERICA

THE WAY!

"RCA ALL THE WAY" is *more* than a slogan. It's a statement of fact that means much...to the radio consumer's satisfaction and pleasure...to the dealer's sales and profits. That RCA makes *everything* in radio from the microphone in the studio to the loudspeaker in the home is important. Only RCA is actively engaged in *every* phase of radio. When you buy or sell an RCA product, you can be sure it is soundly engineered by men skilled in all fields of radio... men who have given the benefits of their wide knowledge of every division of the industry to each individual RCA product they design.

RCA IS ACTIVE IN EVERY PHASE OF RADIO

RCA Communications, Inc.... Swift radiotelegraph service between 11 American cities and 45 foreign countries—plus rapid transfer service to all world points.

Radiomarine Corp. of America... Ship-to-ship and ship-to-shore radio communication.

National Broadcasting Co., Inc.... Coast-to-coast radio broadcasting service on Red and Blue networks.

RCA Institutes, Inc.... Technical radio educational service, classroom and correspondence courses.

RCA Manufacturing Co., Inc.... Makers of everything in radio, from microphone in studio to loudspeaker in home. It is this complete experience that attaches a quality meaning to the slogan:

RCA ALL THE WAY!

RCA MANUFACTURING CO., INC.

RCA INSTITUTES, INC.

RCA COMMUNICATIONS, INC.

RADIOMARINE CORP. OF AMERICA

NATIONAL BROADCASTING CO., INC.

Listen to "The Magic Key" every Sunday, 2 to 3 P. M., E. S. T. on NBC Blue Network

AMERICA • *Radio City* • NEW YORK

BRITISH ADOPT NEW TELEVISION STANDARD

Marconi-E.M.I. System Similar to American Method Wins
Out Over Baird in Series of Tests

NEW YORK—From London comes the news that the British Television Advisory Committee has decided to standardize on the Marconi-E.M.I. system "substantially unaltered" until the end of 1938. This is particularly interesting since the adopted system is much similar to that recently decided upon in the United States.

This decision ends a trial period during which transmissions were made on alternate weeks by Baird Television, Ltd. and Marconi-E.M.I., both from the British Broadcasting Corporation's high-power transmitter located in the Alexandria Palace, North London.

The Marconi-E.M.I. system provides a 405 line picture with interlaced scanning to give a picture frequency of 50 per second. Baird's was a 240 line straight scanning system with a picture frequency of 25 per second. Over 1,000 combined vision and sound receivers are already in the hands of the British public but, fortunately, these were provided with switches to accommodate either transmission system.

Two one-hour programs are given daily by BBC but a third "floating" hour is to be inaugurated shortly. This time will be devoted exclusively to outside pickups.

There /s A Santa Claus!

Proving that big-business is not without a soul, Pierce-Airo, Inc., announces that it will replace without charge all DeWald radios destroyed in distributor-dealer stocks by the recent floods.

Key Sales Gets Webster-Racine

TULSA, OKLA.—The Kay Sales Company, of this city, has been appointed district sales representative for the Webster Electric Company, of Racine, covering the states of Oklahoma, Arkansas and the extreme western section of Tennessee, including Memphis.

Camber Gets Automatic

NEW YORK—"Marty" Camber has been appointed metropolitan representative for the Automatic Winding Co., Inc., of

Newark, manufacturer of r.f. coils, chokes, air trimmers and padders.

He retains his representation of Mica-mold products.

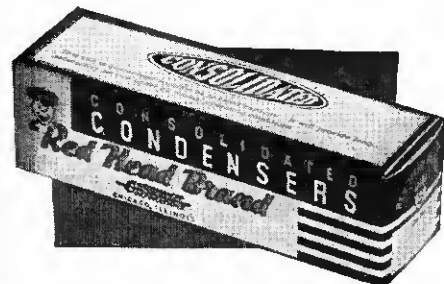

CLASSY, MODERN PACKAGE
—Printed on colored stock and varnished, this new package for Consolidated "Red Head" condensers combines sales appeal and dignity

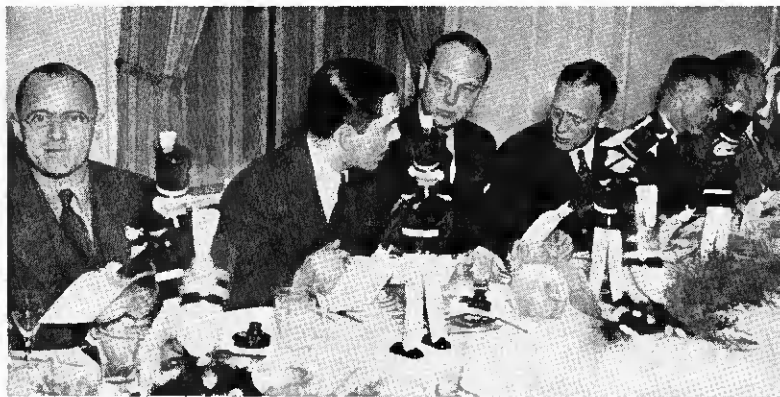

G. E. DINNER HONORS WILSON—Celebrating C. M. Wilson's appointment as sales manager of the General Electric radio division, distributors and dealers of the Atlantic district throw a party at Philadelphia's Ben Franklin Hotel. Here (left to right) are: Charles Tuttle of Elliott-Lewis Electrical Company, W. P. (Bill) Saunders, successor to Wilson as Atlantic district radio sales manager; "Woody" himself; A. C. (Al) Sanger, G. E. appliance sales manager for the Atlantic district; W. R. C. Baker, managing engineer and E. H. Vogel, manager of the G. E. radio division

ANTI-AUTO RADIO LAW SHELVED

(Continued from page 16)

and the police chiefs of every large town in the state for an expression of opinion on the need for such a law and a statement as to whether at any time any auto accidents had been traced to the use of a receiver in a car. The answers received, without exception, denied that radios had ever been found responsible for accidents and the reading of these telegrams at the public heading constituted a most impressive and formidable weapon for the opposition.

Meanwhile, *Radio Retailing* had decided that it should undertake the job of organizing the dealer-distributor branch of the industry because

no national or state organization existed through which the interests of this group could be coordinated. The Editor sent a 100-word telegram to Idaho radio dealers and distributors, calling their attention to the danger, requesting that they send telegrams or letters of protest to their legislators, asking them also to meet him, if possible, in Boise preceding the hearing.

Telegrams of protest were also sent to the legislators and then the Editor began the 2,800 mile trek from New York to Boise. Arriving there, time was arranged for a ¼-hour broadcast over KIDO, during which time it was pointed out to radio listeners that an attempt was being

made to interfere with their constitutional rights. Listeners were urged to attend the February 18 hearing. Radio and auto dealers were simultaneously urged to put in an appearance.

Meetings with local dealers, with legislators, with out-of-town distributors, with radio servicemen followed.

Despite the limited amount of time occasioned by sudden passage of the bill by the Senate and the subsequently quick hearing by the House the effectiveness of manufacturer-distributor-dealer-publisher cooperation was such that this first serious threat against auto-radio was swept aside and the prohibition law shelved.

NOW ANY FAMILY ANYWHERE IS A PROSPECT FOR SERVEL ELECTROLUX

This Modern, *Different* Refrigerator can be run on either Gas, Bottled Gas or Kerosene

TODAY, the popularity of Servel Electrolux is sweeping the country—bringing profits to dealers everywhere. This different refrigerator is now enjoyed by nearly a million families. From Park Avenue to the most isolated farm, it is famous for permanent silence and continued low operating cost.

Owners are enthusiastic about Servel Electrolux because it's the refrigerator that has no moving parts in its freezing system. Nothing to wear, nothing to make a noise, nothing to become inefficient.

To the dealer, all this is important. For it means that he is selling a product with *exclusive* advantages. A product with *proved performance*. A product that's being bought by more and more people every year because they know it will give lasting satisfaction.

In 1937, Servel Electrolux is supporting dealers with the greatest advertising program in its history. Dramatic, sales-compelling messages—32,000,000 a month—are being read by every type of prospect in your community.

Here's a big chance. No matter where you are located, there's money to be made with Servel Electrolux.

In cities and towns, this different refrigerator operates on gas. For farm homes and other dwellings beyond gas and power lines, it runs on either kerosene or bottled gas.

There are several dealer franchises still open. Write at once for information. Servel, Inc., Servel Electrolux Sales Division, Evansville, Indiana.

PROFITABLE DEALERSHIPS
STILL OPEN . . . WRITE FOR
INFORMATION

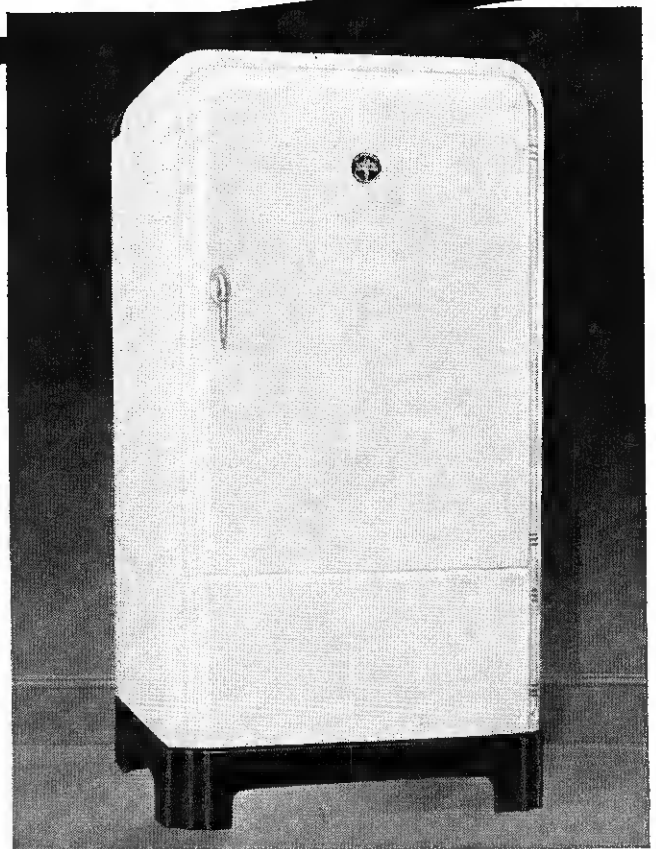

THESE EXCLUSIVE SELLING POINTS ARE YOUR STAR SALESMEN

- Permanent Silence
- Lasting Efficiency
- Finest Modern Beauty
- No Moving Parts To Wear
- Continued Low Running Cost
- Every Worthwhile Convenience



A new idea! Something different! For the first time in its history, *Electrical Merchandising* presents an issue edited and designed for the architect, builder and home owner—the users of electrical appliances. By creating the desire for COMPLETE electrical homes in the minds of home-builders, *Electrical Merchandising*, in its May number, opens up a wonderful opportunity for power companies, electrical contractors, wholesalers and appliance dealers to increase energy consumption, wiring service and appliance sales. This entire number *sells the electrical home idea*—forcibly—graphically—practically. Plan now to use it in your selling campaigns this year.

A Practical Selling Manual for Electrical Contractors Appliance Dealers and Power Companies!

THE completely electrified home represents from \$500 to \$700 MORE in appliance sales over and above the average purchase of appliances. This means business to the appliance dealer and distributor. The wiring services in the complete electrical home mean from \$50 to \$100 ADDITIONAL business for the contractor. Each completely wired home means an energy consumption of 5,000 kw. hrs. annually—valuable residential customers for the power company. When you consider that there will be approximately 425,000 new homes built in the U.S. in 1937—every one a potential customer for complete home electrification—you can readily see that there is a lot of sweet business awaiting only an intelligent and aggressive campaign by dealers, contractors and utilities.

The "Electrical Home" Number of *Electrical Merchandising* (May issue, priced at \$1.50 a copy)

gives you your own model "HOME-IN-PRINT" which you can take to your customers and sell them the idea of low-cost comfort and convenience through the use of more electrical appliances. More than that, there will be facts and figures in this and succeeding issues of *Electrical Merchandising* PROVING that the cost of such appliances will be self-liquidating in the money they save for the home owner.

More than 100 interesting pages will put over the "electrical-home" idea in a way that will make this important number a selling manual that will build PROFITS for every electrical dealer, contractor, wholesaler and power company. It is a factual guide to more business, presented in a way that wins immediate attention from your customers. It's different—it's new—it's usable. Be sure you have a copy for your own use and order extra copies for your salesmen and preferred customers.

Use this handy coupon to order May Number or enter your subscription

Save Money by Entering a Subscription

Any business selling electrical appliances will save money by entering a subscription to *Electrical Merchandising* at \$2 a year. By ordering now, you receive the big May "Electrical Home" Number—priced alone at \$1.50 a copy—as part of your subscription AT NO EXTRA COST.

**MAIL YOUR ORDER
TODAY.**

ELECTRICAL MERCHANDISING—330 W 42nd St., New York, N. Y.

- Attached is \$2 for which enter my subscription to ELECTRICAL MERCHANDISING for 1 year including the special "Electrical Home" May number.
- Attached is \$1.50 for which send me one copy of the special May "Electrical Home" issue of ELECTRICAL MERCHANDISING.

Name Position

Street

City State

Firm Name

RR-3-37

—PAYMENT MUST ACCOMPANY THIS ORDER—

Above rates apply only in U. S., Canada, Mexico, Central and South America.

PREVIEW of NEW PRODUCTS

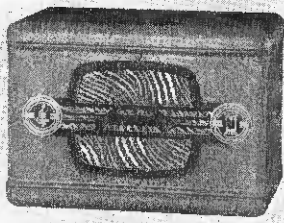

EMERSON

Emerson Radio & Phonograph Corp.,
111 Eighth Ave.,
New York, N. Y.

Models: 1937 auto radios.
Description: Model U-154, 6 tubes, superhet, single unit, voice-music control, special antenna coupling system increases step-up three to six times, low frequency antenna trimmer, 6½x9½x6½.
Model V-155, 8 tubes, superhet, external speaker, improved quiet a.v.c., continuously variable tone control, special antenna coupling system increases step-up five to ten times; low frequency antenna trimmer: 8½x8½x7½.
An 8-inch electrodynamic speaker for cowl panel mounting and remote controls for all cars also available.

Prices: U-154 \$39.95; V-155 \$59.95. — *Radio Retailing*, March, 1937.

ARVIN

Noblitt Sparks Industries, Inc.,
Columbus, Ind.

Models: 1937 auto-radios.
Description: Three models: each may be combined with any Arvin speaker and control to fit every car — hence the trade name "Tailor Fit". All units are packed separately so the dealer may make up any combination quickly and easily.
Model 19, 6 tubes; 29, 6 tubes; 39, 7 tubes, takes external speaker only.
Prices: Chassis only, Model 19, \$30.95; 29, \$38.95; 39, \$43.95. Matching panel controls, \$6.25; overhead speakers, \$4.75; 8 in. separate case speaker, \$9.75; in-the-set speakers (for 19 and 29) \$2.75 and \$4.75. — *Radio Retailing*, March, 1937.

HOWARD

Howard Radio Co.,
1731 Belmont Ave.,
Chicago, Ill.

Models: HA-8, HA-7, HA-9.
Description: HA-8, 8 tubes, push-pull 6AB6G in output with phase inverter; tuning condenser of all cut section type enabling a high secondary inductance antenna coil to be used; first section of spark filters are built against outer shell to eliminate "chassis pick-up" difficulties; separate 8 in. speaker.
Equipped, as are all Howard auto sets, with permanent alignment card which permits alignment without control head or special fixtures.
Model HA-7, 6 tubes, built-in speaker; HA-9, 6 tubes; separate p.m. 8 in. speaker. — *Radio Retailing*, March, 1937.



GENERAL ELECTRIC

General Electric Co.,
Bridgeport, Conn.

Models: Auto-radios.
Description: FA-80, 8 metal tubes; automatic frequency control; 540-1600 kc.; compensating a.v.c.; antenna circuit-matching system.
FA-61, 6 metal tubes; 540-1600 kc.; a.v.c.; antenna circuit-matching system, 2 point tone control.
FA-60, has all features of FA-61 except two-point tone control.
Prices: FA-80, \$64.95; FA-61, \$49.95; FA-60, \$39.95. — *Radio Retailing*, March, 1937.

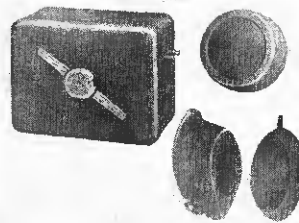
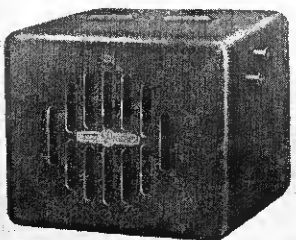

CROSLLEY

Crosley Radio Corp.,
Cincinnati, Ohio

Models: "Roamio" auto sets.
Description: Model A-177, 7 tubes, deluxe; two units; 7 tuned circuits; new a.v.c.; automatic setting of dial logging; special header speaker for GM cars and also another ear level speaker for all other cars for use instead of under cowl speaker; continuously variable tone control; music-speech switch.
Model A-167, 6 tubes; single unit; special noise reducing a.v.c. including also an automatic volume control on audio system.
Customer built controls to match all cars and three antennas also available. — *Radio Retailing*, March, 1937.

DELCO

United Motors Service
3044 W. Grand Blvd.,
Detroit, Mich.

Models: 1937 auto-radios.
Description: Models R-640, and R-641, 6 tubes, single



unit; R-642, 6 metal tubes, single unit; R-643, 6 tubes, two unit with header, dash or instrument panel speaker; R-644, 8 tubes, dash, header or instrument panel speaker.
All sets have Delco synchro-tuning, tone control, antenna adjustment, a.v.c. and suede finish. Models R-642 and R-644 have automatic bass and treble compensation. — *Radio Retailing*, March, 1937.

MOTOROLA

Galvin Mfg. Corp.,
847 W. Harrison St.,
Chicago, Ill.

Models: 1937 auto radios.
Description: A personal preference selector — the Acoustinator — featured. Two choices, city and music.
Models 35 and 45, 6 tubes, Magic Eliminode, Adapto broad range antenna system; Model 65, 6 tubes, Acoustinator; Model 70 DeLuxe, 6 tubes, Acoustinator, Ortho-Acoustic adjustable chamber speaker; Golden Voice, 8 tubes, Acoustinator, oversized 8 in. speaker.
Prices: 35, \$29.95; 45, \$39.95; 65, \$49.95; 70, \$54.95; Golden Voice, \$69.50. — *Radio Retailing*, March, 1937.

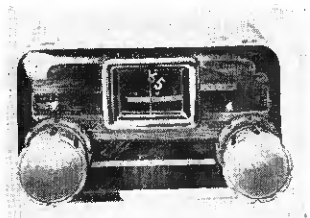

UNIVERSAL

Universal Controls, Inc.,
2107-40th Ave.,
Long Island City, N. Y.

Device: Remote control units for auto radios.
Description: Pre-assembled; easily installed; control head is a single compact unit ready for immediate installation in the dashboard opening without assembly work, cutting or filing of the panel.
Made to fit all cars and car radios, finished to match the dashboard of the original car equipment. Plates and knobs may be obtained separately or together with control head.
A small supply of control heads and a representative assortment of escutcheon plates permit the dealer to handle any re-installation job. — *Radio Retailing*, March, 1937.

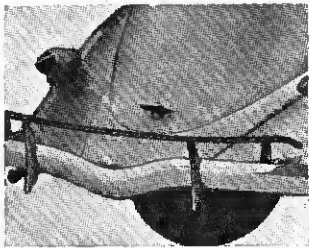

SUPEROD

American Radio Hardware Co., Inc., 476 Broadway
New York, N. Y.

Device: Auto radio antenna.

Description: For mounting along the rear bumper of the car instead of in the usual upright position. The two brackets furnished are so constructed that the antenna is removed from the shielding effect of the surrounding body of the car. The antenna itself consists of a $\frac{1}{8}$ in. diameter copper tubing finished in chrome. Easily installed. — *Radio Retailing*, March, 1937.

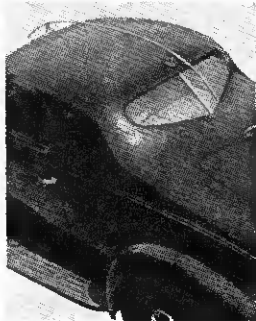

WEDGE

Wedge Mfg. Co., 2334 S. Michigan Ave., Chicago, Ill.

Device: Auto aerial.

Description: For turret top cars; shipped straight; shapes easily to contour of auto top; chromium like finish; comes complete with lead-in, vacuum cup posts, etc.

Price: \$3.85 for sedans or coupes.—*Radio Retailing*, March, 1937.

WARD

Ward Products Co.,
Ward Building,
Cleveland, Ohio

Device: Auto-radio aerials.

Description: Ten new models for 1937 including the "Tur-rette" which requires no drilling in top

of car; "Stratosphere" and "All-Range" for car-top installation; "Flex-Rod" hinge aerial, no drilling; "Long Range Twins," running board type. Type and style to fit any installation. — *Radio Retailing*, March, 1937.

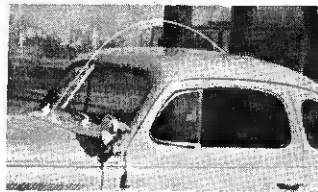

MAGIC ROD

Radio Electric Service,
Saginaw, Mich.

Device: Auto aerial.

Description: Can be held down to car roof with a chromium plated "stream-liner" or left up because it is so flexible it will not break. Cut shows aerial bolted at back of car.—*Radio Retailing*, March, 1937.

AMERICAN-BOSCH

United American Bosch Corp.,
Springfield, Mass.

Model: 678 console.

Description: 12-tube high fidelity Automatic Maestro, with visible Centromatic unit; three wave bands (525 to 18,500 kc.)

The increasing demand for "personal tuning" is recognized by the use of six operating controls—volume control, wave change switch, station selector with two speeds, volume control and off-and-on switch, high fidelity and treble control, automatic frequency demonstrating control. The latter enables the dealer to shut the automatic frequency feature on or off while demonstrating.

Price: \$139.50.—*Radio Retailing*, March, 1937.

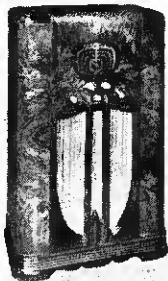

RCA VICTOR

RCA Mfg. Co., Camden, N. J.

Model: Portable Victrola.

Description: Deluxe model; smartly finished carrying case covered with a mar-resistant, durable fabric; improved tone arm and concealed horn; highly polished brass used on all fittings as well as the sound chamber opening for contrast; compartment in the lid accommodates a number of 12-in. records.

Price: \$24.50.—*Radio Retailing*, March, 1937.

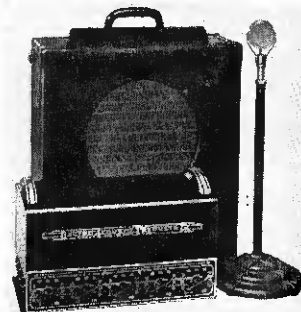

ELECTRO ACOUSTIC

Electro-Acoustic Products Co.,
Et. Wayne, Ind.

Device: 30-watt amplifier.

Description: High gain 30 watt beam power amplifier with provision for mixing three crystal or three velocity microphones and high impedance phono turntable; low hum level; five controls for mixing, fading and tone; master gain control for controlling multi-circuit programs.

Amplifier supplies field for two 13,000 ohm electro dynamic speakers or one 5,000 ohm heavy duty dynamic but the speaker fields are not part of the filter circuit and the amplifier does not require fields for operation. This makes possible the use of as many as 32 permanent magnet speakers.

Price: \$87.50, less tubes.—*Radio Retailing*, March, 1937.

GRUNOW

General Household Utilities Corp., 2650 N. Crawford Ave., Chicago, Ill.

Models: 1937 radios.

Description: 3 table sets and 6 consoles.

Table sets—Model 366, 5 tubes, 540-4000 kc.; 590, 5 tubes, a.c.-d.c., broadcast and police bands; 654, upright, 6 tubes, standard, police, amateur, foreign.

Consoles—Model 755, 7 tubes, electric eye, 12 in. speaker; 1191, 11 metal tubes, 540-18,000 kc.,

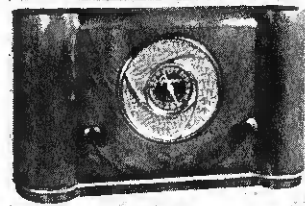

super-chassis, push-pull high fidelity audio system, clock type dial, automatic antenna tuning; 1193, 11 tubes, super-chassis, 540-18,000 kc., electric eye, fidelity control; 1291, 12 tubes, Teledial tuning, metal tubes, 540-18,000 kc.; 1297, 12 metal tubes, 540-18,000 kc., Teledial, "beam" type power tube; 1541, 15 metal tubes, 540-70,000 kc., high fidelity, Teledial, triple speakers. —*Radio Retailing*, March, 1937.

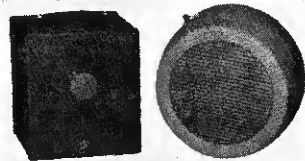

FADA

Fada Radio & Elec. Co.,
Long Island City, N. Y.

Models: 1937 "Motosets."

Description: Model 267, 6 tubes, 6 in. in-the-set speaker, 535-1620 kc.; filtering in the antenna and battery leads eliminates need for suppressors; tone control; antenna circuit may be adjusted to properly track with any antenna.

Model 267SD, dual unit; 6 tubes; external 8 in. speaker.

Models 267SG and 267SF, 6 tubes, intended for header speaker installation.

Prices: 267, \$42.95; 267SD, \$49.95; 267SG and 267SF, \$44.95.—*Radio Retailing*, March, 1937.

To Champion Jobbers' and Dealers' PROFITS



Want to keep abreast of Sound?

Then ask to be put on our list to receive "THE SOUND ADVISOR" — a monthly publication sent with our compliments. Address Dept. R. R. 3.

. . . has always been the policy from which we have never deviated. We offer not only a substantial profit to jobbers and dealers, but so conduct our business that you actually *make* those profits.

OPERADIO does not enter into competition with jobbers and dealers by selling direct to the consumer. Neither do we countenance, directly or indirectly, the practice of competing unfairly with our established outlets by selling *everyone* and *anyone* who can purchase our equipment and pay for it.

To maintain a policy which allows for protected profit taking . . . to pass by the business of those who operate against our established jobber-dealer setup . . . to refuse the business of the "price chiseler" . . . those are the principles to which we subscribe.

Mr. Jobber and Mr. Dealer . . . we submit that when you sell OPERADIO Sound and Public Address Equipment you make more money because you are dealing with a company who does not sell all comers at your expense.

★ **A NEW LINE?** . . . Operadio does not obsolete jobbers' and dealers' stocks by bringing out a new line periodically. To be sure, progress demands that we give you the benefit of new developments as they are proved practical and saleable. Such new developments will be announced shortly.

OPERADIO

MANUFACTURING COMPANY ST. CHARLES ILLINOIS

A NAME LONG KNOWN FOR FAIR DEALING AND QUALITY IN SOUND AND PUBLIC ADDRESS EQUIPMENT

Build Farm Battery Business with **GLOBE!**

A COMPLETE LINE for EVERY RADIO and Light Requirement

Thousands of people who live away from "Power lines" will buy radios and light plants this year. And each must purchase one or more batteries.

The new Globe radio and light batteries offer dealers an unusual opportunity to build a profitable and lasting battery business. There is a Globe high efficiency battery to meet every power and light requirement.

When you sell Globe you sell a complete line of radio, light and automotive type batteries, with 8 factories and 6 warehouses reaching from coast to coast ready to make immediate delivery. Globe national advertising carries the Globe story to millions of your prospects.

Send for new Bulletin 87-A to learn all of the facts about Globe Radio and Light Batteries. Just clip the coupon.

GLOBE-UNION INC., Milwaukee, Wisconsin



No. 35—6-Volt Radio "A" Battery.

No. 25—2-Volt Radio "A" Battery.

Glass Jar Cell with Ball-type indicator.

GLOBE-UNION INC., Milwaukee, Wisconsin
Rush Bulletin 87-A and full details
about Globe radio and light batteries.

Firm Name.....
Street.....
City and State.....
Individual..... RR-1



**2 - VOLT
6 - VOLT
GLASS JAR
BATTERIES
FOR RADIO
AND LIGHTS**

for
**Farm Homes
Summer Cottages
Camp Trailers
Freight Trailers
Boats and Yachts
Tenders
Filling Stations
Garages
Stores**



TRANSFONE

*Transfone Corp. of America,
14 W. 45th St., New York,
N. Y.*

Device: Two-way communication system.

Description: No wiring; plugs into the electric socket; portable; strict privacy; operates on 110-120 volt d.c. or 110-118 volt, 25-60 cycle a.c. Also available for 220 volts, 32 volt diesel powered private installations, farm lighting systems.

The unit is self-contained in a walnut cabinet 11x6½x7½.

Special multiple installations also available.—*Radio Retailing*, March, 1937.

OPERADIO

*Operadio Mfg. Co.,
St. Charles, Ill.*

Device: Type A intercommunicating system.

Description: Complete, two way system; speech may originate at either position; clear tone; 6 in. p.m. dynamic speaker; absolute privacy—no "listening in"; steel construction; fine-grained black baked stipple finish trimmed with chromium bands.

Price: \$75, including two units, tubes and 10 ft. power cord.—*Radio Retailing*, March, 1937.

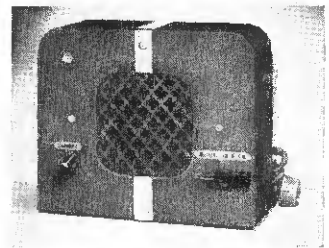

TRIUMPH

*Triumph Mfg. Co., 4017
W. Lake St., Chicago, Ill.*

Model: 120 Signal Generator.

Description: Will attenuate a signal to absolute zero without r.f. leakage, thus permitting accurate sensitivity measurements, it is claimed; direct reading; 115 volt 50-60 cycle a.c. operated; maximum output signal strength has been increased to 200,000 microvolts to provide for automatic frequency control service work; frequency range, 100 kc. to 27 mc. on direct calibrated harmonics.

Price: \$23.95—*Radio Retailing*, March, 1937.

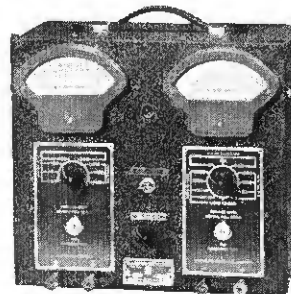

CLOUGH BRENGLE

*Clough Brengle Co., 2815 W.
19th St. Chicago, Ill.*

Device: Model 95 analyzer.

Description: Unusually complete array of a.c. and d.c. voltage ranges; direct reading capacity scales to cover all values from .00025 to 16 mfd.; resistance ranges allow accurate measurement of values from ½ ohm to 20 megohms; built-in power supply; two 4½ in. fan-type meters. Simplification of meter scales and switching mechanism is featured. Both portable and 10 in. relay rack mounting types.—*Radio Retailing*, March, 1937.

ATR

*American Tel. & Radio Co.,
1916 University Ave.,
St. Paul, Minn.*

Device: Replacement vibrators.

Description: Complete line for auto and farm radios; feature longer life, improved performance, precision construction and lower prices.—*Radio Retailing*, March, 1937.

LIGHTNING-FAST SALES

The Phantom Filter

NEW AND EXCLUSIVE DEVELOPMENT IN

ARVIN

TAILOR-FIT

Car Radio

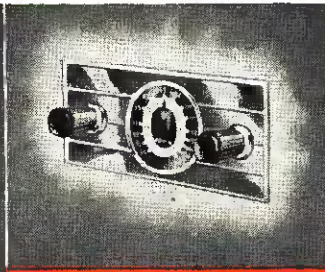

Three powerful radios, two 6-tube sets and a super 7-tube model, with matching panel or universal controls and overhead, separate case or in-the-set speakers. Complete set prices as low as

\$39⁹⁵
LIST

● There's lightning fast sales action in the new Arvin Car Radios, simply because they perform so well . . . when folks hear 'em play they exclaim, "I never heard such a hot performin' car set."

It's all due to the many Arvin engineering achievements headed by the sensational Phantom Filter—a "booster station" that steps up power and brings in more stations, more clearly. The Automatic Eliminoise, Geographical Compensator and Permatune Transform-

ers are other exclusive features that contribute to the brilliant performance of the new Arvins.

Arvin backs you up with a complete line-up of action-getting sales helps, free to registered dealers, and powerful nation-wide consumer advertising. Ask your jobber about the Arvin Floor Plan Deal.

NOBLITT-SPARKS INDUSTRIES, Inc., *Columbus, Indiana*
Also makers of Arvin Radios for the home and Arvin Hot Water Car Heaters

ASK YOUR JOBBER ABOUT THE NEW ARVIN FLOOR PLAN DEAL

MAGNAVOX

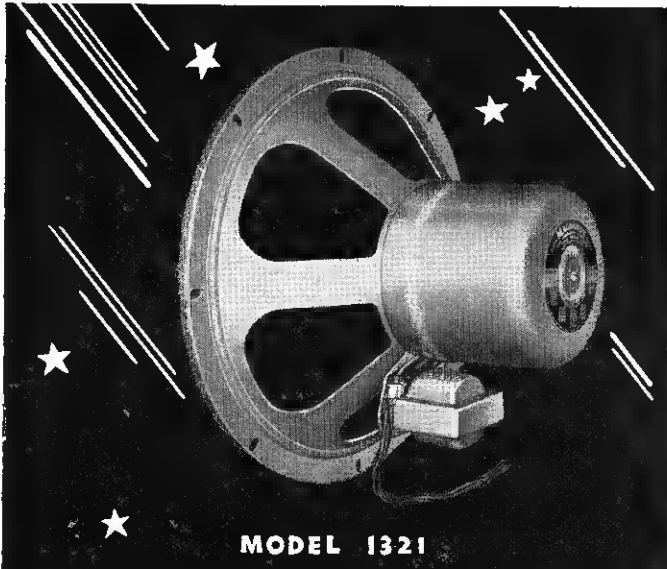

MODEL 1321



THE **NEW** STAR IN THE P.A. SPEAKER WORLD!

THE SPEAKER is the heart of a sound system. Here's a 12" electro-dynamic speaker that not only has an extended low and high frequency range, but is exceptionally flat and smooth in response—giving clarity of voice without any metallic sound. Clean, well defined bass and unusually smooth treble—it's the end of your search for really natural reproduction!

A COMPLETE NEW LINE OF SOUND EQUIPMENT

Electro-Acoustic Products Company offers a distributor line of high quality equipment which tops them all for value. New features—new professional appearance—new performance standards! The entire line presents unusual profit possibilities. Investigate it now.

MODEL
2321
PERMANENT
MAGNET
SPEAKER

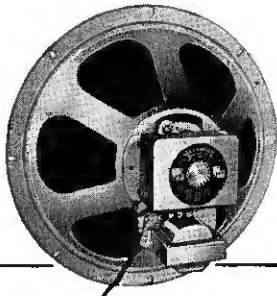

FEATURES
ALNICO
"MARVEL
METAL"
MAGNETS

This speaker has been selected in competition with P. M. speakers of every make and price by Columbia Broadcasting System for the new studios of their western key station—WBBM, Chicago

WRITE TODAY FOR COMPLETE NEW CATALOG
ELECTRO-ACOUSTIC PRODUCTS COMPANY

Subsidiary of The Magnavox Company • Fort Wayne, Indiana

Janette Rotary Converters

The original D.C. to A.C. converters with all wave filters developed exclusively for radio and sound apparatus.

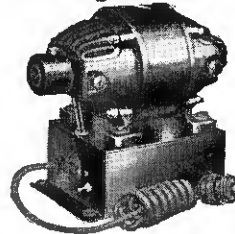

CAPACITIES:

35 to 3250 watts.
6, 12, 32, 115 and 230 volts
D.C. to 110 or 220 volts, 1 phase,
60 cycle A.C.

Insist on a Janette

Ask For Bulletin No. 13-26

Janette Manufacturing Company

555 W. Monroe Street, Chicago, Ill., U. S. A.
New York — Boston — Philadelphia — Los Angeles — Milwaukee

COMPLETE ELECTRIC PLANTS

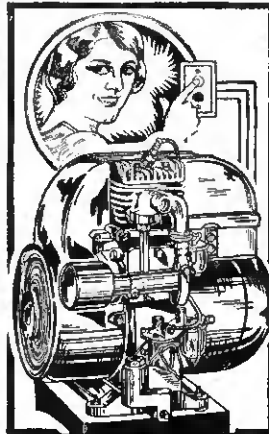

ONAN ALTERNATING CURRENT GENERATING PLANTS operate on gasoline and furnish current for running AC RADIOS, Household Appliances, Motors. The right sizes for Portable Installations, Trailers, Public Address Work, Demonstrating Car Equipment, Talking Moving Pictures, X-Ray—anywhere electricity must be provided.

Sizes 350 Watts and Up
LIGHT and PORTABLE. Complete ready to run. Rubber mountings, flexible exhaust pipe and extra silent muffler available. Shipment from stock. Also 32 volt, Direct Current Models.
Gasoline, Gas or Oil Burning types in larger sizes. Write for details.

D. W. ONAN & SONS
435 Royalston Ave. Minneapolis, Minn.

QUALITY PLUS !!!



ATR

REPLACEMENT

VIBRATORS

for AUTO and FARM RADIOS
A COMPLETE LINE

featuring

- Longer Life
- Improved Performance
- Precision Construction
- Lower Prices



Backed by more than Six Years of Experience in
Vibrator Design and Research, Development
and Manufacturing.

Insist on ATR VIBRATORS — The Best by Test

Mail the coupon TODAY for your FREE copy of the ATR VIBRATOR GUIDE along with the name of your nearest ATR Jobber.

AMERICAN TELEVISION & RADIO CO.

St. Paul, Minnesota, U. S. A. Cable Address: "Likex" New York

Manufacturers of DC-AC Invertors, A Battery Eliminator, Battery Chargers and Invertor Vibrators

American Television and Radio Co.
St. Paul, Minn.

Gentlemen:

Please send my FREE copy of the ATR Vibrator Guide and the name of my nearest ATR Jobber.

Name

Address

City

State

Check here Jobber Dealer Serviceman

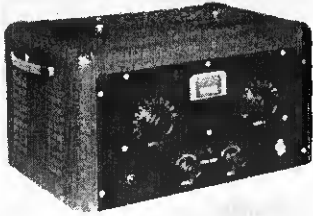

WEBSTER-CHICAGO

Webster Co., 3825 W. Lake St., Chicago, Ill.

Models: Amplifier.
Description: 30-watt amplifier with dual adjustable frequency characteristic—one control is low frequency compensator, another control is the high frequency compensator. Two input controls permit the use of two low level microphones such as crystal, velotron or velocity.—*Radio Retailing*, March, 1937.



PRESTO

Presto Recording Corp.,
 139 W. 19th St.,
 New York, N. Y.

Device: Recording equipment.

Description: Instantaneous and faithful disc recording of sound in permanent form for immediate reproduction; especially useful in schools, colleges, and studios or in the home.

Several models and types to meet all requirements. — *Radio Retailing*, March, 1937.

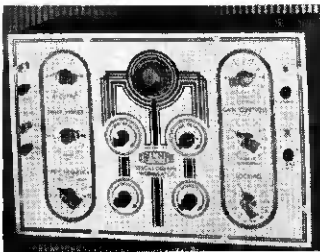

TRIUMPH

Triumph Mfg. Co., 4017 W. Lake St., Chicago, Ill.

Device: Model 77 oscillograph-wobbulator.

Description: Uses 913 tube and thyatron linear sweep with horizontal and vertical amplifiers combined with an adjustable electronic wobbulator which may be varied to sweep any band width from 0 to 55kc.; portable steel case, 13 1/2 x 9 1/2 x 8 in.

Price: \$49.95, net.—*Radio Retailing*, March, 1937.

PIONEER RED TOP

Pioneer Gen-E-Motor Corp.,
 464 W. Superior St.,
 Chicago, Ill.

Device: Power plant.
Description: Combination ac and dc Gas-O-Lectric power plant; keeps batteries charged and provides ample electricity for

ac or dc appliances such as radios, small electric tools. Pulley furnished to drive washer, pump, separator, etc., by means of a "V" belt; push button starting; Johnson motor.—*Radio Retailing*, March, 1937.

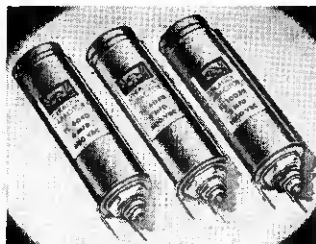

CORNELL DUBILIER

Cornell-Dubilier Corp.,
 South Plainfield, N. J.

Device: Type TL Dykanol capacitors.

Description: Combine the dependable characteristics of the bulkier types with the compactness and assembly simplicity of can-type electrolytics. Ideal for use where reduced size, weight and cost is desired in conjunction with extremely high voltage ratings and negligible power factor.—*Radio Retailing*, March, 1937.

ALL 6L6G's ARE *not* alike!

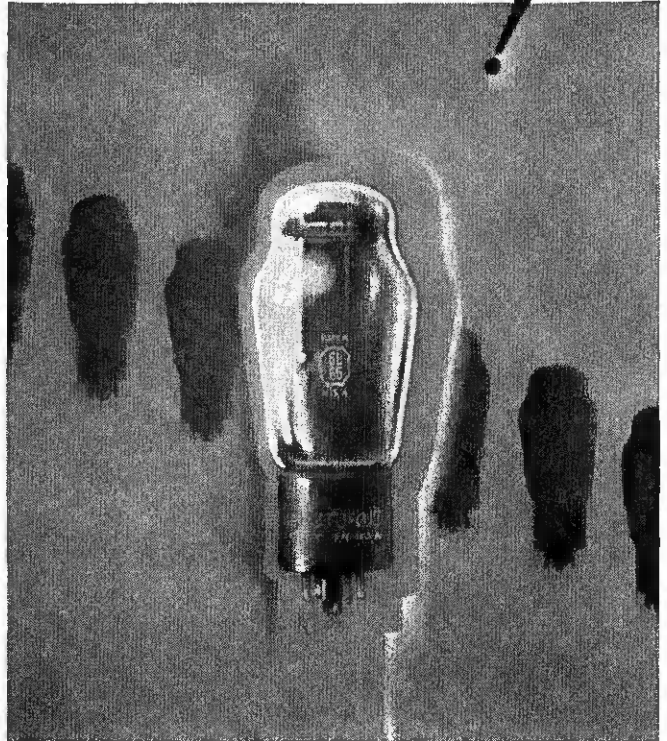

HERE'S why the Arcturus 6L6G tube is recognized as being individual by both radio technicians and amateurs. . . .

Months of painstaking research in the Arcturus laboratory have developed a unique testing method which assures exceptionally low grid current for every 6L6G with an absolute minimum of distortion. Every tube is *individually measured* for power output and resulting sensitivity. Two separate noise tests (the last one in an actual radio receiver) bring truly remarkable freedom from noise while the excellent emission life assures maximum power output over a longer period of time.

Guarding and insuring Arcturus efficiency are 137 separate tests and checks that every tube must pass before being shipped. No wonder then, they have earned the reputation. . . .

The Quality Tube Of The Industry

ARCTURUS RADIO TUBE COMPANY
 NEWARK, NEW JERSEY

ARCTURUS

INDEPENDENT TUBES FOR DEALERS WHO DO THEIR OWN INDEPENDENT THINKING

Now—
a
high-
powered

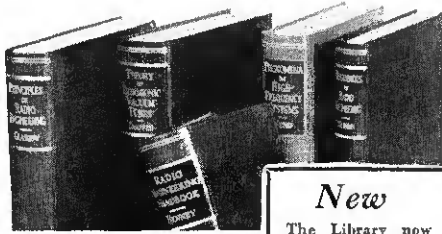

RADIO ENGINEERING LIBRARY

—especially selected by radio specialists of McGraw-Hill publications

—to give most complete, dependable coverage of facts needed by all whose fields are grounded on radio fundamentals

—available at a special price and terms.

THESE books cover circuit phenomena, tube theory, networks, measurements, and other subjects—give specialized treatment of all fields of practical design and application. They are books of recognized position in the literature—books you will refer to and be referred to often. If you are a researcher or experimenter—if your interest in radio is deep-set and based on a real desire to go further in this field—you want these books for the help they give in hundreds of problems throughout the whole field of radio engineering.

5 volumes, 3064 pages, 2000 illustrations

1. Glasgow's PRINCIPLES OF RADIO ENGINEERING
2. Terman's MEASUREMENTS IN RADIO ENGINEERING
3. Chaffee's THEORY OF THERMONIC VACUUM TUBES
4. Hund's PHENOMENA IN HIGH-FREQUENCY MEASUREMENTS
5. Henney's RADIO ENGINEERING HANDBOOK

Special Low Price and Easy Terms

Bought singly, the five volumes comprising this library would cost you \$26.00. Under this offer you save \$2.50 and, in addition, have the privilege of paying in easy installments beginning with \$2.50, 10 days after receipt of the books, and \$3.00 monthly thereafter. Already these books are recognized as standard works that you are bound to require sooner or later. Take advantage of these convenient terms to add them to your library now.

McGRAW-HILL ON-APPROVAL COUPON

SEND THIS ON-APPROVAL COUPON
McGRAW-HILL BOOK COMPANY, INC.
330 West 42d Street, New York, N. Y.

Send me Radio Engineering Library 5 vols., for 10 days' examination on approval. In 10 days I will send \$2.50, plus few cents postage, and \$3.00 monthly till \$23.50 is paid, or return books postpaid. (We pay postage on orders accompanied by remittance of first installment.)

Name

Address

City and State.....

Position

Company R.R. 3-37

(Books sent on approval in U. S. and Canada only.)

New

The Library now comprises a revised selection of books culled from latest McGraw-Hill publications in the radio field.

HIGH FIDELITY

is the trend



AR 43—\$75.00



BR 2S—\$37.50

• Brush sound cell construction is a "natural" for high fidelity. Faithful response over a wide frequency range is an inherent feature.

• When Brush microphones are rated as being flat in response, for a given frequency range, they ARE FLAT—No mechanical or electrical compensation is necessary.

• These facts have been realized and hundreds of sound cell mikes are being used for sound level analysis and calibration purposes—Plus the thousands in "P. A." and broadcast applications.

Technical Data on Request

The **BRUSH**
Development Co.

3314 PERKINS AVENUE,
CLEVELAND, OHIO

Here's an ALLIGATOR

You Can Keep for 

a Pet Around Your Own Shop

Send for him—he's FREE. You can dress him in a rubber insulator and he's absolutely harmless! Mueller Alligator Clips are trained to crawl into any kind of a hole and bite hard.

WRITE FOR CATALOG 679 AND FREE SAMPLES

Mueller Clips are Stocked by Jobbers Everywhere

Mueller Electric Co.

1583 East 31st Street, Cleveland, Ohio

10
NEW
WARD

AUTO AERIALS

FOR 1937

SEND FOR CATALOG TODAY

The **WARD PRODUCTS Corp.**

WARD BUILDING CLEVELAND, OHIO
IN CANADA: ATLAS RADIO CORP., TORONTO, ONTARIO
FOREIGN: LINCOLN EXPORT CO., NEW YORK, N. Y.

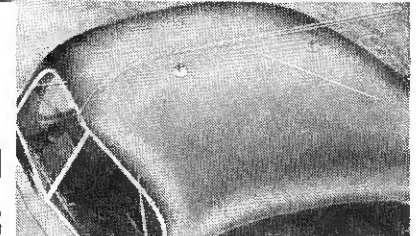

MODEL I. A.—The "Tur-rette"—Maximum Efficiency. One of the new 1937 top aerials featured by WARD. NO DRILLING IN TOP

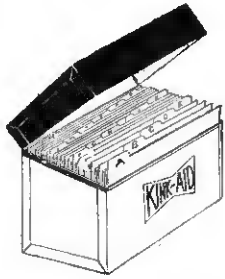

KINK AIDS

Akrad Products Co.,
362 Wooster Ave.,
Akron, Ohio

Device: Collection of service kinks.

Description: Revised, 1937 edition of service kinks, each representing a completed service job; covers 3,500 different models; clearly printed on wear-resisting cards, indexed by set name and model number and filed in an enameled steel filing case.

Owners of 1936 edition may purchase supplement for that edition for 35c.

Price: \$1.95.—*Radio Retailing*, March, 1937.

NORWEST

Norwest Radio Labs., 3450 Fullerton Ave., Chicago, Ill.

Device: Auto aerials.

Description: "Streamline"—polished metal molding forming a rod shaped to the car top, rubber vacuum cup standoffs; special antenna for Ford, Chevrolet and Plymouth; "Magic Triangle," mounts on front of steel top with vacuum cups, apex of triangle points to the front; "Resonator," a variable matching device to match all low capacity antennas to most radios using series feed antenna connection.

For home radios Norwest makes the "Tapestenna," an indoor aerial combined with a decorative tapestry, 20x38 in. Can be hung on wall or placed on top of the radio.—*Radio Retailing*, March 1937.

SPRAGUE

Sprague Products Co.,
North Adams, Mass.

Device: Condenser replacements.

Description: Three universal replacement condensers, adaptable to any type of mounting. With only a few of these new

condensers the serviceman can easily obtain needed capacity combinations or single sections.

Type BT-100 is a rectangular unit having three 8 mfd. sections and two 5 mfd. sections at 25 volts.

Type ST-10 is the same condenser in a round cardboard casing with mounting lugs.

BT-1 has three 150-volt sections, 5-10-25 mfd.—*Radio Retailing*, March 1937.

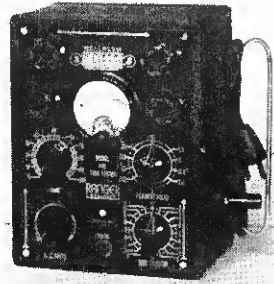

RANGER EXAMINER

Readrite Meter Works
Bluffton, Ohio

Model: 440 tube tester.

Description. Tests any type tube for value, shorts and inter-element leakages under actual load conditions; emission type circuit; direct reading Good-Bad scale; shadow-graph a.c. meter for line voltage adjustment.

Price: \$18.—*Radio Retailing*, March, 1937.

KRAEUTER

Krauter & Co., Newark, N. J.
Device: Kwi-Kut concrete

drill.

Description: A new improved concrete drill which cuts around the circumference of the hole; cannot wedge or bind and expels chips automatically; works about 50 per cent faster than ordinary drills; available in assorted sizes.

Krauter also makes an offset screw driver in three sizes—4½, 6 and 8 in.

Prices: Drills, 35c to \$1; screw drivers, 40c, 50c.—*Radio Retailing*, March, 1937.

NEW "MIKE"

*Streamlined in
Performance and Price*



\$26⁵⁰
LIST PRICE
Less Stand

Small in size, yet providing superb performance, this new RCA Microphone, offers many features for greater efficiency!

Quality Features That Mean Extra Value

Triple Chromium finish • Small size—light weight

Good tone quality—high sensitivity

No external excitation or power required

Rugged construction—insensitive to mechanical vibration

Unaffected by change in temperature, humidity, or barometric pressure

May be operated at distances up to 1,000 feet from amplifier

Excellent for close talking • Minimum response to wind

Practically non-directional when faced vertically

New Alnico magnet—retains magnetism indefinitely

Get your copy of the RCA Commercial Sound Catalog from your RCA Commercial Sound Distributor or write direct to Camden.



Commercial Sound

To centralize responsibility make your sound system RCA ALL THE WAY from microphone to loudspeaker.

RCA MANUFACTURING CO., INC., CAMDEN, N. J.

A Service of the Radio Corporation of America

Freed-Eisemann

FAMOUS SINCE BROADCASTING BEGAN

ANNOUNCES A SENSATIONAL NEW LOW PRICED SPRING LINE

With These Features

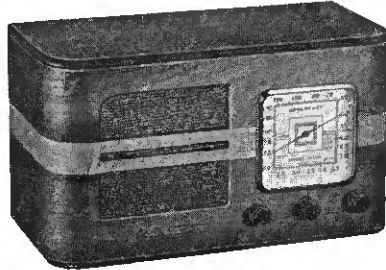

Distinctive Eye Appeal Well Known Name
Competitively Priced Excellent Performance
Good Profit Margin

FREED-EISEMANN Radio meets all these requirements 100%
Model 28 (shown above)—6 tube AC/DC Superheterodyne—has foreign short wave band—gets police, aircraft, amateur, and standard broadcasting. Model 98, similar to above except 5 tube set for use on AC current.

Join the increasing list of FREED-EISEMANN boosters. Write for full information—Sets are priced from \$14.95 to \$49.95.

FREED MANUFACTURING CO., INC.
44 West 18th Street New York, N. Y.

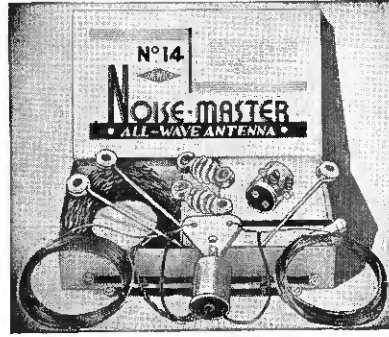

The deadly
enemy of
"man-made"
static



• A. A. & K. licensed. Impalpable foe of nuisance noises caused by electrical appliances near the radio set. No. 14, illustrated, lists at \$6.75. Other units



at various prices. In any location, NOISE-MASTER proves effective on broadcast as well as shortwave bands. Send for complete information.

CORNISH WIRE CO., Inc. • 30 Church St., N. Y. City

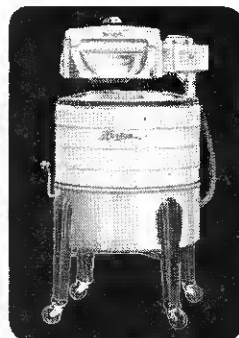

HORTON

WE'RE TELLING
THE WORLD!

• The sensational news about Horton Klean-Zoning is being carried to your prospects in one of the broadest advertising campaigns (including 17 national magazines) ever put behind home laundry equipment.

To cash in on the consumer interest and demand identify your store definitely as Horton headquarters in your community—use Horton sales promotion helps—and follow every lead to the limit!

Horton has created the biggest news in the home laundry industry with Klean-Zoning Washers and Beauty-Aid Ironers. Get in on the big push now and watch your sales and profits mount. Ask your Distributor, or write

HORTON MFG. CO., 306 OSAGE ST. FORT WAYNE, INDIANA

HORTON WASHERS—IRONERS Since 1871

The Perfect Aerial FOR STEEL TOP CARS

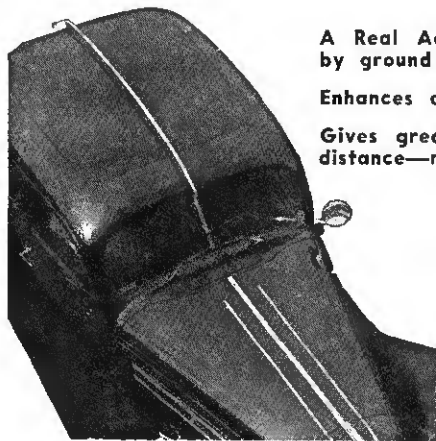

A Real Aerial—not affected by ground conditions

Enhances car appearance

Gives greater volume—more distance—reduces noise

Easy to install—

No holes to drill

Sold by
Jobbers
\$3.85

LIST

A long, broad aerial of copper bearing alloy for high efficiency—polished finish, die-formed like decorative body trim, mounted on top of rubber vacuum posts, for snappy appearance—that's the Auto-Top Aerial.

Over-the-top mounting reduces ignition noise, eliminates wheel static, and makes pick-up independent of ground conditions—affords efficient, quiet reception any time, any place.

Rubber vacuum posts are easy to install—no holes to drill. Shipped straight—no kinks. Not affected by rain, mud, ice or snow.

The keen streamlined appearance and efficient trouble-free performance of Auto-Top Aerials are the answer to steel top aerial problems. Ask your jobber or write us for complete information.

WEDGE MANUFACTURING CO.
2342 S. Michigan Ave. Chicago, Ill.



UNIVERSAL MODEL "W"

The Microphone of a Thousand Uses
—for small address installations, inter communicating systems, detective devices, ordering phones, etc. etc.—A Perfected Watch Model Microphone—full, clear speech reproduction—Light—Compact—Sensitive.

Special Prices to Assemblers and Manufacturers in Quantities.

UNIVERSAL MICROPHONE CO., Ltd.
424 Warren Lane Inglewood, California

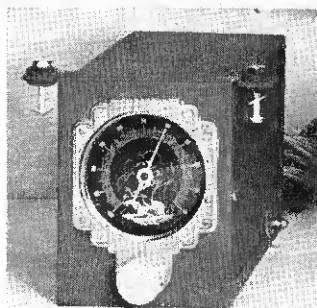

SHORT WAVE CONVERTERS FOR CAR RADIOS

Can be attached to any car radio. Has on and off switch. Does not affect the reception on the standard broadcast bands. MODEL 600—covers 49, 31, 25, 20, 19 and 16 meter bands. Designed for reception of American and Foreign short wave broadcast. Especially adapted to use in tropical countries and the more remote parts of the world. Distance range 5000 to 10000 miles. A very attractive unit. List Price \$24.95

For Use of Police and Other Law Enforcement Officers

MODEL 100—police converter with fixed condenser. Covers 1500 to 2600 kilocycles. List Price \$11.95

MODEL 200—police converter with variable condenser and illuminated dial. Covers 1500 to 5500 kilocycles. List Price \$17.95

MODEL 500—police converter with two metal tubes, variable condenser and illuminated dial. Very sensitive. Exceptional distance range. List Price \$21.95.

Jobbers and dealers wanted **ABC RADIO LABORATORIES** 3334 N. New Jersey St., Indianapolis, Indiana, U.S.A.

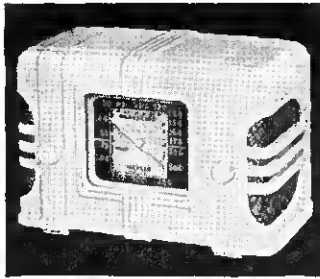

GREBE

Grebe Mfg. Co., Inc., 119 Fourth Ave., New York, N. Y.

Models: Colored radio.

Description: 6 tubes, a.c.-d.c., superheterodyne, comes in a variety of colors, molded cabinet.—*Radio Retailing*, March, 1937.

CLOUGH BRENGLE

Clough-Brengle Co., 2815 W. 19th St., Chicago, Ill.

Devices: Cathode ray oscillograph; R-F signal generator.

Description: Cathode ray oscillograph: except for physical size and screen area identical to the larger model CRA; built-in linear sweep; type 913 tube; separate high sensitivity amplifier for both horizontal and vertical inputs, and beam centering controls on the front panel. 8 $\frac{1}{2}$ x8 $\frac{1}{2}$ x9 $\frac{1}{8}$ in.

Model OC-A r.f. signal generator: each band hand calibrated to a guaranteed frequency accuracy of $\frac{1}{2}$ of 1%; dial length of 25 in. per band; new dual stepless attenuators for both r-f and a-f output voltages; single output switch for instant selection of unmodulated r.f., modulation r.f., and pure sine-wave 400-cycle audio all available at the same output jack.—*Radio Retailing*, March, 1937.

CLAROSTAT

Clarostat Mfg. Co., Inc., 288 N. 6th St., Brooklyn, N. Y.

Device: Metal-tube resistor replacement kit.

Description: A general utility kit of twelve of the most representative units.—*Radio Retailing*, March, 1937.

KADETTE

International Radio Corp., Ann Arbor, Mich.

Model: "Equafonic" arm-chair radio.

Description: New method of sound projection is utilized—the speaker cone is mounted horizontally, immediately above this cone is a special baffle, designed to computed acoustical curves, which bends the sound waves and projects them in all directions. Grilles are located on all four sides. An additional feature is the inclusion of a cocktail service within the cabinet.—*Radio Retailing*, March, 1937.

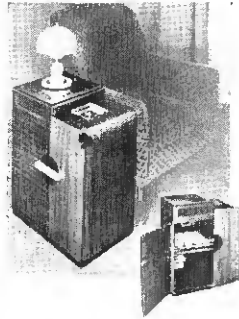

THORDARSON

Thordarson Elec. Mfg. Co. 500 W. Huron St., Chicago, Ill.

Device: Multi-Match modulation transformers.

Description: This new plug-in type of connector has great value in matching tubes and output quickly and accurately. By using the table supplied, any tube or tubes of the rated wattage of the transformer may be properly and instantly connected without soldering.

Multiple contact plate permits use of 12 jack-plug connections designed to match various tube impedances and outputs so they can satisfy tube requirements up to 500 watts.—*Radio Retailing*, March, 1937.

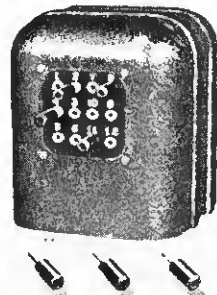

YOU NEED THIS GREATEST OF ALL SELLING AIDS!

EPCO STORAGE BATTERY ELIMINATOR

For Perfect Demonstration of Auto and other D.C. Radios



\$19.75

As Illustrated Variable Voltage List Price

Provides 6 volt-10 amps, filtered D.C. from 110 volt A.C. Assures instant, adjustable current at minimum power consumption. Ends forever the messy battery-charging nuisance. Also efficient as battery-charger.



ELECTROPAK

Supplies rectified D.C. for operating relays, solenoids and remote controls. Voltage ranges from 6 to 24 volts, rated at 2 to 15 amps. Operates on 110 volt A.C.

ADAPTOPAK

Operates A.C. radios in D.C. districts and 110 volt A.C. radios in autos and trailers.

ELECTRICAL PRODUCTS CO.

6537 RUSSELL AVENUE

DETROIT, MICHIGAN

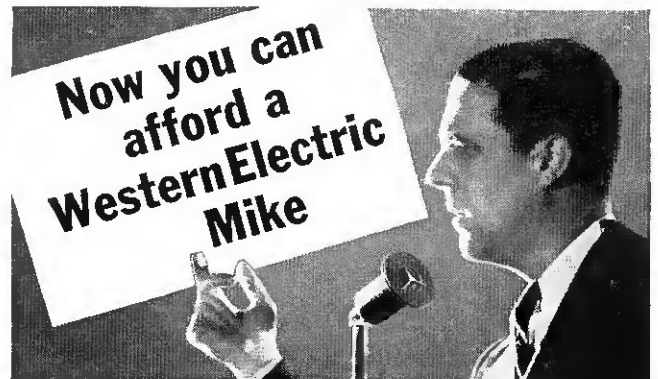

Its low price will surprise you!

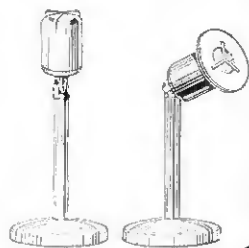

Non-directional and (at right) directional

Western Electric's newest mike—the "Salt-shaker"—was designed by Bell Telephone Laboratories especially for public address and remote pick-up broadcasting. Like the famous "8-ball," it's a 2-in-1 mike: (1) non-directional (2) directional, when you put on the acoustic baffle. It assures "good broadcast quality."

Western Electric

Distributed by GRAYBAR Electric Co. In Canada: Northern Electric Co., Ltd.

GRAYBAR ELECTRIC CO., Graybar Bldg., New York.

Please send bulletin describing the new Western Electric 633A microphone.

Name

Address

City State

RADIO DEALERS

RADIO SERVICEMEN



Get this new radio book

FREE

Explains just how to spot and repair over 700 set troubles.

Saves your time! Saves your money!

Time-Saving Information

Certain radio sets develop trouble peculiar to their particular type of circuit. Each month "Tricks of the Trade" explains how to locate and fix specific set failures. The following are examples of the curl, practical way Radio Retailing offers this vital information to you.

BREMER-TULLY, BRUNS-WICK 58

Bad volume control . . . Often due to fibre projecting too high, causing rotor arm to miss. Push fibre down before replacing control.

CLARION 60, 61

Set dead or very scratchy . . . Look for failure of special audio input transformer primary. Replace with same device or substitute resistance coupling. Tone will suffer if ordinary transformer is used for replacement due to special characteristics of original.

CROSBY 143

Neon pilot lights when set switch is in OFF position . . . Replace leaky 8 mike, 150 volt condenser.

MOTOROLA 77

Poor tone . . . Check to see if voice-coil or field wires have been reversed. This causes voice-coil form to become blackened and charred inside due to heat. If swollen, discolored appearance is noted replace.

RCA 120

Operates at low volume on strong signals. Intermittently comes up to good volume. Check .05 condenser between center terminal of volume control and control grid lead of 2B7 second detector.

Every issue of Radio Retailing will bring you more of these "Tricks". File them and in a short time with this FREE book you'll have a service manual of un-equalled value.

HERE at last is a trouble-shooting guide that will ring the bell with every serviceman and dealer in the radio game. It contains no useless description, no theories, no amateur data. Every single one of its 56-pages is packed with practical, hard-bitten "how" information that can be used profitably on your service jobs every day in the year. "Tricks of the Trade" is a service book that is different. Once you get your copy you won't part with it for a minute. This one book contains:

704 tested ways of finding and fixing the troubles in specific set circuits.

157 tube socket diagrams showing the connections for that many tubes.

Reference charts showing—the cost of electricity used in operating various appliances—the correct and incorrect way to install radio aerials—reception spectrum—etc.

• Every one of these "tricks" (see typical examples in column to left) were volunteered by

active radio men from their own experiences. Why spend hours testing and re-testing a balky set, when with this book, you can put your finger on the most probable cause of the trouble in a few seconds.

• These "Tricks" will show you how to spot a lot of troubles that won't show up in any test equipment. If you value your time and are interested in saving yourself a lot of headaches—get a copy of "Tricks of the Trade"—today. **IT IS FREE TO YOU** if you accept this offer now.

How to Get This Book FREE

Fill in and return the order blank below with the subscription fee to cover one year of Radio Retailing for \$1 or three years for \$2 and you receive this new book—FREE—as our gift.

The book is not for sale separately. No credit orders can be accepted. Don't delay. They won't last long. Mail your order—NOW.

Mail this coupon and payment—Today!

FREE-BOOK SUBSCRIPTION ORDER FORM

PRESENT SUBSCRIBERS NOTICE

Present subscribers may obtain a copy of this FREE book by renewing their present subscription. Regardless of when your present subscription expires, you must send in another FREE-paid renewal order. Your subscription will be extended for additional time without duplication. No previous renewal orders count. We must show a matching order for every book sent out. Mail in your order and payment today. This offer only applies to U. S. and possessions, Canada, Mexico and Central and South America. All other countries add 50c to rate to cover postage charges on book.

All books are sent out by express to insure safe delivery. There is a small handling charge of 15c—added to the express-charge upon delivery of the book. If you prefer book sent prepaid, add 15c to the subscription fee at time of ordering.

O. K. Attached is \$2 for a 3 year subscription to Radio Retailing. With this order I am to get a FREE copy of the 56-page service book—"Tricks of the Trade". I'll pay the expressman 15c for delivery charges. Send the book at once. Check here if this is renewal order.

Name..... Position.....

Street

City..... State.....

Our Main Business Is.....

Check here and remit \$1 if you wish only one year subscription PLUS FREE book.

No orders accepted without payment attached

RADIO RETAILING
330 West 42nd Street
New York, N. Y.

*Pin
\$1 or \$2
Here*

HOW TO CANVASS

(Continued from page 30)

than it should be and that prejudices them toward canvassing.

Some are so timid they are actually glad to escape an interview and hopefully leave their card. They say to themselves, "I'm afraid there is no one at home here, I hope."

They put all advertising cards that are left on their own door-step into the waste-basket pronto but they have the childish faith that somehow customers will save the card they leave.

For cards that will tie in with your canvass and tell the customers how complete your testing equipment is, a good scheme is to arrange your test equipment as impressively as possible and have a professional photographer make a print for a cut.

If you do not care to feature this, you might put your own photo on the cards with a sketch of your radio experience. Mention your studies and research in keeping up to date.

Do Small Area Thoroughly

Many failures are due to lack of system and to this end do not fail to carry a note book while canvassing and be sure to make a notation for every bell you ring. Either "not

home" or "left card" or any special notes such as "Call Friday."

Put down the customer's exact reaction to your canvassing and you will soon see what objection is used most frequently. These records will be very valuable to you.

I can not stress too strongly the importance of this note book.

Too many men are not thorough enough. They forget people who are not at home at first call and thus may overlook their best prospects.

Do not try to take in a large amount of ground but go over the territory with a fine tooth comb. Let your motto be to attempt to meet everybody in a small area. Call back several times because the more people you meet, the greater your chances will be.

Do not become discouraged. Most customers do not resent being solicited. On the contrary, they admire your spunk and initiative. Time and again they have told me that they certainly thought I had the right idea in calling in the home instead of sitting with folded hands waiting for business.

The law of averages will give you some business if you canvass no matter how lousy a salesman you are.

Remember that because it is true and will encourage you.

Take an extreme example: If you persistently went from door to door and asked, (mind you, I am not advising this!): "You don't need yore radio fixed, do yuh?" and kept at it—some day some customer would say, "Sure I do! I was just thinking of sending for a service man!"

Once Inside, You'll Sell

You will get turn-downs. Some places they will say, "We don't want nuthin," before you get a chance to open your mouth. Enter what the customer says in the note book. Later, study your approach and attempt to improve it with an eye to getting invited in. If you are invited in, you may almost congratulate yourself on making another customer.

I do not believe I have ever failed either to sell something right then and there or at least build future business in every instance where I was invited in. So, if you receive a discourteous turn down at one house—the very next place may be a customer who will allow you to repair his radio and boost you to all his friends.

You never know. You can't tell by the looks of the house outside.

CHALLENGER—I

**BRIGHT! COLORFUL!
TONEFUL! PROFITABLE!**

**A Champion
in its Class**

This 6-tube AC-DC Superhetrodyne Receiver is unequalled in eye-appeal, remarkable in performance. Equipped with the new Duo-Power Tube... delivers 2 watts output. Power never before attained in so small a receiver. Moulded Cabinet—a variety of distinctive colors to choose from. The Challenger-I will sell itself on sight!

GREBE manufacturers radio receivers of all voltages, all wave bands, especially designed to meet all climatic conditions anywhere. Over 40 distinctive models!

Some exclusive territories are still available. Write or cable for details on this model—and on the complete GREBE line of deluxe radios.

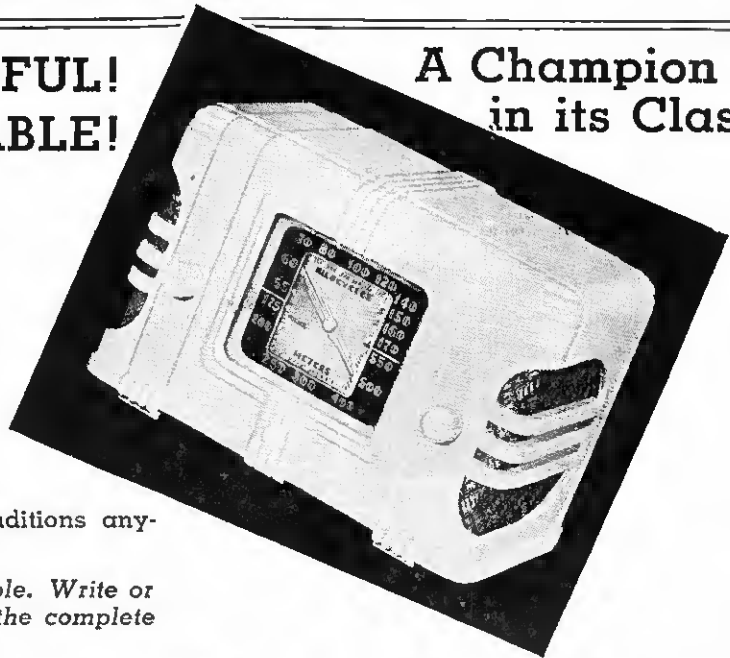

GREBE MANUFACTURING Co., Inc.

119 FOURTH AVENUE, NEW YORK, U.S.A. CABLE ADDRESS, AHGREBE, NEW YORK

THIS PLAN SOLD 210 REFRIGERATORS

(Continued from page 29)

day thirty young men assembled at the office. They were instructed as follows:

"You young men are being employed to take a census of all ice-users in this city. Large display ads are to be run in two local papers. These ads will have a return coupon attached. These coupons will be turned over to you. They will be sorted and grouped so that each group will be from one neighborhood. This means that all your calls will be in a small area, making it possible

for you to cover a large number of people quickly.

"You will be furnished with a large picture of the free gift which we intend to give to all eligible applicants for their trouble in answering the questions on our questionnaire. You will be equipped with a letter which will identify you as being engaged on an official survey. You are not to say that you are being employed by this firm. Your approach will be as follows:

"When the party opens the door in

response to your ring, display your letter of identification and say, 'We are engaged in a census of the ice users of this city, Madam (Mister) Doe, and in response to the coupon which you sent to the newspaper, I've called to get the necessary information. For your co-operation you are to receive a beautiful ice-bowl such as this (displaying picture) at no cost to you. Merely answering a few questions qualifies you. May I come in?'

"When you enter proceed at once toward the kitchen, explaining that you must examine the ice-box for name, age, etc. On the way in get out the pad of forms and allow the party to hold the photo of the bowl while you fill in the answers. Then say, 'Thank you, the ice-bowl will be delivered in a few days.'

"Make your visit as brief as possible and try to get every question answered. Should the party refuse to permit you to enter and see the ice-box you say, 'Madam, it is necessary that I see the ice-box so that you may qualify as an actual ice-user.' If the party has an electric or gas refrigerator, or is a roomer or transient dweller, he is to be told he is not eligible to receive the gift. People who refuse to give any information are to be told the same.

"Now remember boys, you are on your honor. We expect you to return here each day with the previous days completed forms. We will pay you daily for all work. Should later investigation show that you have falsely filled out the papers instead of really making the calls, we shall lodge a complaint with the Dean of Men.

"The forms which you turn in will be turned over to our regular sales-force who will use them as a prospect list of people who are in the market for an electric refrigerator. As an added inducement to do your best we will pay the sum of \$1 per sale to each man whose questionnaire results in the sale of a refrigerator the first week. Should you interview a party who expresses a desire to buy a refrigerator at once and this information is brought in personally and results in an immediate sale, \$3 will be paid.

Ice Broken For Salesmen

The young men expressed themselves as being satisfied with the proposition and were told to report five days later. The following day the ads were run and within twenty-four hours results appeared.

WE ARE Giving Away THESE CHECKS TO BE SPENT IN YOUR STORE

• Our enormous consumer advertising sells thousands of DUN-CHARGERS to farmers every month. With each one we enclose a check for \$2.50 to apply on the purchase price of a selected list of nationally known battery radios.

NATIONALLY ADVERTISED to 11,015,716 FARMS every month

MAIL THIS COUPON!

PARRIS-DUNN CORP.
Dept. 30, Clarinda, Iowa

Send list of radios on which I can accept these \$2.50 checks.

I now handle.....make radios.

Name.....

Address.....

DUN-CHARGER

Approved by **PHILCO**

10 FEET TALL

On the first day over 1,000 coupons were received and by the fourth day over 2,500 were listed. For several days they kept coming in until over 3,000 coupons were accumulated. Then some boys were set to work to assort them into groups according to addresses so the survey crew could best visit them.

When the survey crew arrived on the fifth day there were waiting and ready for them enough calls to last for at least 10 days.

Astonishing as it may seem, a final recap indicated that 2,000 of the families were bona fide possibilities. The balance were either users of electric and gas refrigerators or roomers. For one reason or another, they were not considered suitable prospects. These amounted to about 500. But—here they were with around 2,000 prospects located in ten days in a city of 500,000 population.

Allowing 15 calls per day per salesman it would require at least 45 working days to contact every one of these prospects. Imagine that. Fifteen live prospects per day for a refrigerator salesman. No canvassing, no door-bell ringing and no waiting in the showroom for one or two prospects per day.

The salesmen were given the questionnaires after they had been studied by the salesmanager and went into the field fully armed with complete information concerning the prospect and bearing the free gift. The standard approach was something like this:

"Madam, as a reward for your trouble in answering a few questions may we present you with this beautiful gift?" This usually gave him an immediate entry for who does not welcome a bearer of gifts? After opening the gift box in the living room of a home the salesman went into his sales talk.

"I notice that you still use ice when a modern electric refrigerator is cheaper and more sanitary in the long run." Having so many facts concerning the prospect at their command salesmen were able to use the children or some other factor when appealing to the prospect to buy. They already knew the purchasing power of the prospect and many other potent, sales-compelling facts. Many of these prospects were "push-overs" for aggressive salesmen.

Cost Bearable

Many sales were made as a result of red-hot tips brought in by the survey crew in the first few days. These

were closed by a salesman and a supervisor rushing right out to strike while the iron was hot. And the total cost? Here it is.

The Two Advertisements	\$375
The Survey Crew	300
2,000 Ice Bowls @ 45c.	900
Miscellaneous Expenses, Printing etc.	50
Total	\$1,525

The cost was about 75c per prospect. And as a result of this campaign 210 refrigerators with an average unit of sale of \$140 were sold

and enough live prospects were obtained to keep the entire outside salesforce busy from April to September.

In the opinion of the author a time limit of 10 days should have been set for responses. This would force in the maximum number of inquiries quickly and eliminate the possibility of stragglers requesting gifts months later. And the offer should have been limited to residents of a given area to eliminate the necessity for turning down inquiries from points too distant for salesmen to handle due to the out of town circulation of the newspaper chosen.

The **GIANT**
SKYSCRAPER
DUN-CHARGER

10 FEET TALL!
Only \$1500 NET

"The Higher the Tower the Greater the Power"—and the greater the sales appeal, also! The **DUN-CHARGER** is almost **TWICE** the size of the ordinary wind charger and 27% more efficient! The special extra heavy-duty generator is built from all new parts—permanently oil sealed bearings. Foolproof. The perfect **plus value** to use in closing battery radio sales.

Most prominent set manufacturers inclose coupons in their battery models entitling farmers to buy a **DUN-CHARGER** direct from the factory. You get the sales benefit and have no handling.

Order a **DUN-CHARGER** demonstrator and get **ALL** the battery set business.

Approved by
PHILCO

MAIL THIS COUPON!

PARRIS-DUNN CORP.
Dept. 30, Clarinda, Iowa

Send list of radios on which I can accept these \$2.50 checks.

I handle make radios.

Name

Address

MODEL
1200-A
DEALER
PRICE \$21.67

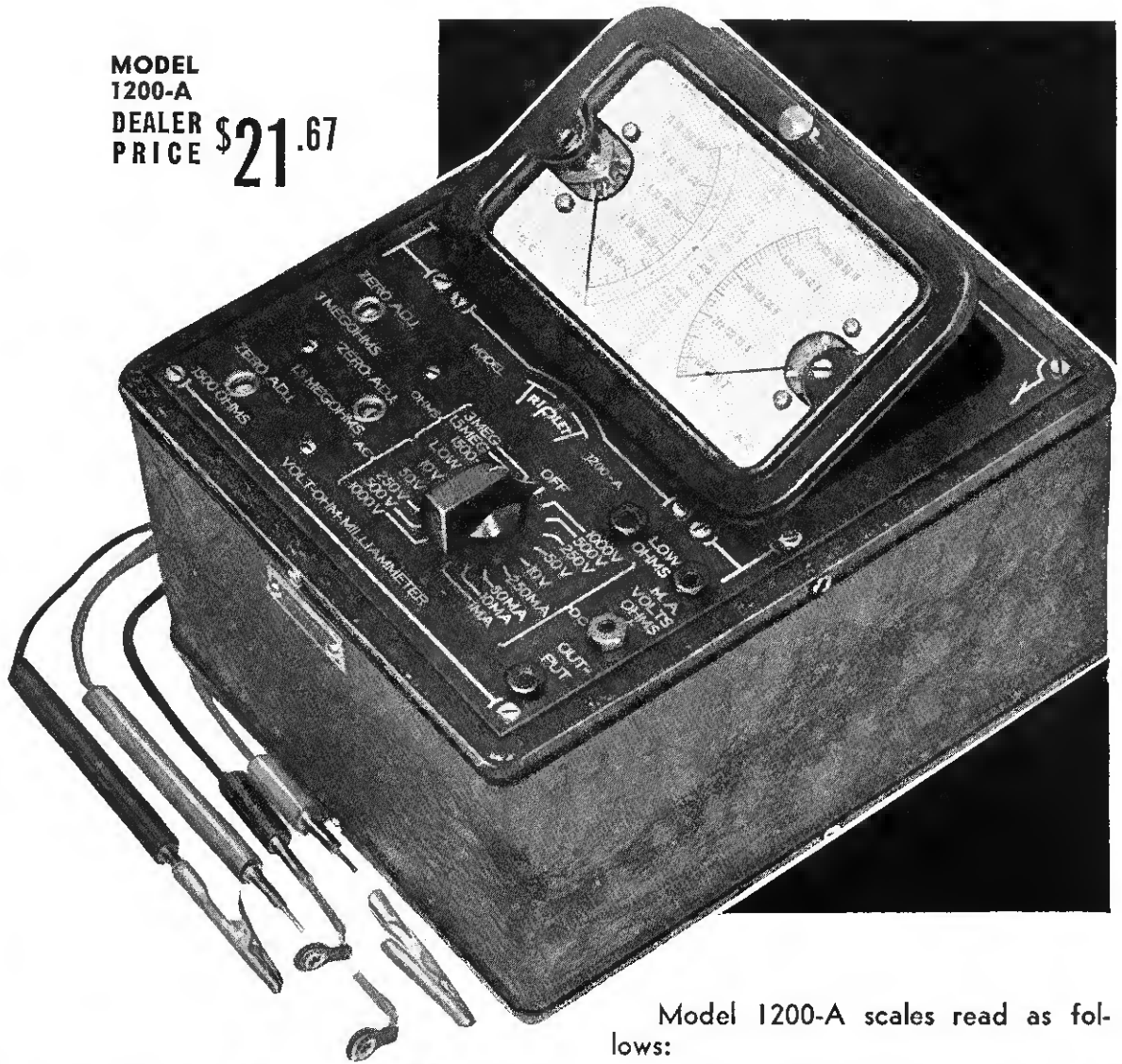

**TODAY'S MOST POPULAR
VOLT-OHM-MILLIAMMETER
USED FOR RADIO SERVICING**

- Separate A.C. and D.C. Instrument Movements
- Tilting Feature for More Accurate Readings
- 2% Accuracy—Both A.C. and D.C.
- Ohm Scales Separately Adjusted to Zero
- Low Loss Switch (Contact Error on Milliamperes Less than 1/2%)
(No Contact Error on Voltage Measurements)
- Metal Case with Black Wrinkle Finish

SEE YOUR JOBBER ● ● ●

Model 1200-A scales read as follows:

D.C. 10-50-250-500-1000 volts at 2,000 ohms per volt; 1-10-50-250 M.A.; Low ohms backup circuit .5 to 500; 1500 Ohms, 1.5 and 3 Megohms, A.C. 10-50-250-500-1000 volts. Contains 22½ and 1½ volt batteries.

Net Price to Dealers \$21.67

A TRIPLETT MASTER UNIT

One of a series of co-related single unit testers; made in standard sizes; the most economical method yet devised for completely equipping the all-around radio service shop with high quality instruments.

WRITE FOR CATALOG

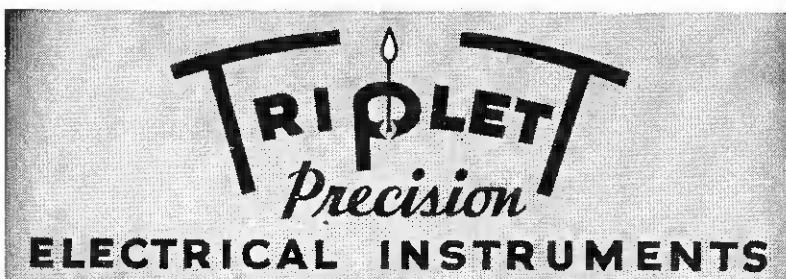

THE TRIPLETT ELECTRICAL INSTRUMENT CO.
205 Harmon Ave., Bluffton, Ohio
Without obligation please send me more information on
___ Model 1200-A
___ I am also interested in _____
Name _____
Address _____
City _____ State _____

SERVICE

DESIGN • REPAIRS • INSTALLATION

NEW CIRCUITS

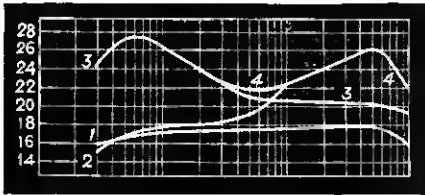

Adjustable Amplifier Fidelity

In many sound installations the acoustic conditions of the auditorium or hall are such that the tone emanating from the loud speakers is unnatural. Under one set of conditions a sound system may sound boomy, while the same equipment in another location appears to be high pitched.

To overcome this problem in its simplest form, Webster-Chicago engineers have designed a new amplifier with an adjustable frequency response. Either the bass or the high frequency end can be accentuated or attenuated at will, with the result that maximum performance can be obtained under any set of conditions.

Previously, the most common trouble was excessive low frequency response. Sound men have frequently undertaken the job of altering the response characteristics of their equipment to accommodate it to a specific installation. This not only takes a great deal of time but is expensive as well.

In the new amplifier there are two controls for adjusting the frequency response. Turning one control increases the low frequency response, while advancing the other control increases the high frequency end. In the diagram, curve 1 was taken with both controls off. Curve 2 is with the treble control full on. Curve 3 is with the bass control full on, while curve 4 is with both controls at maximum.

Pickup Connection Methods

From G.E. comes these diagrams for attaching phonograph connections to sets without such provisions.

A high impedance pickup is used in

all circuits, either a crystal or a high impedance magnetic type. It is important that all audio leads be short. Where these leads are necessarily long they should be shielded and the shield grounded. The changeover switch should be as near the audio circuit as possible and its leads also shielded.

Fig. 1 is the circuit to be used with

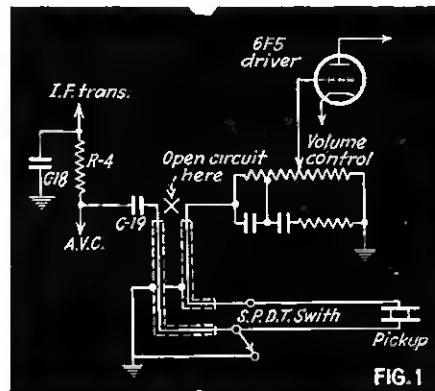

models E-61, 62, 68. The lead is broken between the second detector and 6F5 driver and fed to the phono pickup. By throwing the switch to one position, the detector is shorted and the pickup feeds the signal to the grid of the 6F5. Throwing the switch the other way shorts the pickup and closes the broken circuit.

Both tone and volume control will be effective when records are played. If needle scratch is noticeable, the tone

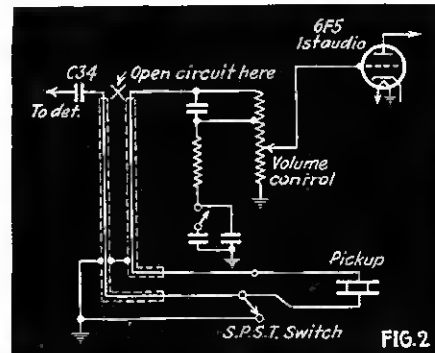

circuit may be set to attenuate the higher frequencies. This will practically eliminate all the background hiss.

For models E-81, 91, 95, 101, 105, 106, the circuit in Fig. 2 should be fol-

LOOK FORWARD . . .

Replacement Parts Used.....	17
New Auto Radio Design.....	20
What Junk Parts Are Worth.....	26
How to Canvass for Service.....	30
Automobile Aerials.....	33
Auto Radio Specifications.....	34

lowed. The procedure is identical to the previous mentioned model. Fig. 3 is for model E-155.

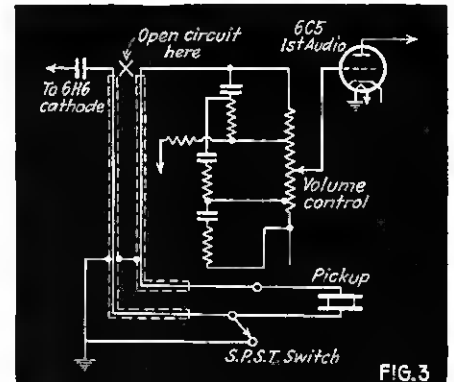

I.F.R.F. Wave Trap

Two tuned circuits comprise the new universal wave trap by Meissner, Interference on an i.f. channel and also the broadcast band can be suppressed with this single unit.

Maximum results are obtained through the use of high "Q" iron core coils. Tests have shown, with an average size antenna the strength of an interfering signal either at 456 kc. or in the broadcast and low frequency police band are reduced approximately 175%, the equivalent of 40 db. A signal 200 kc. or more off resonance is not attenuated appreciably.

In the broadcast section the range of

*"I can use These
Controls with*
CONFIDENCE!"

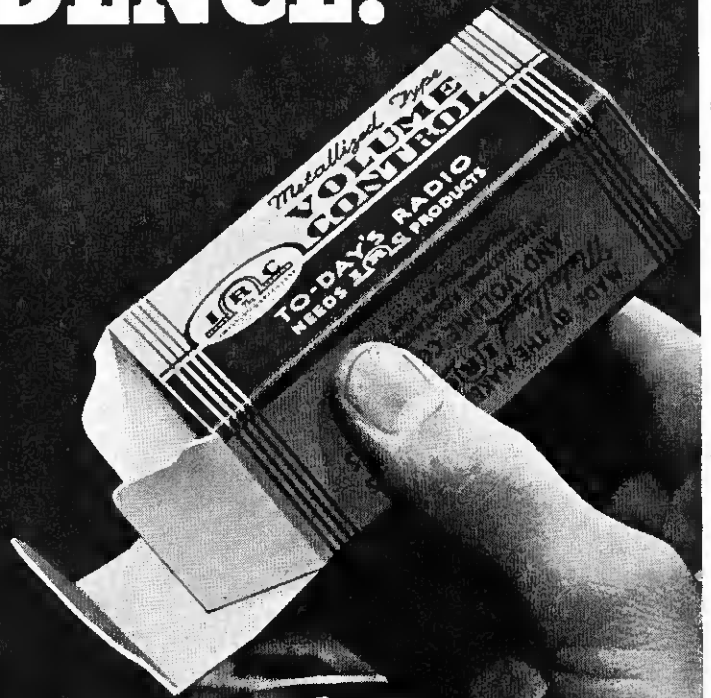
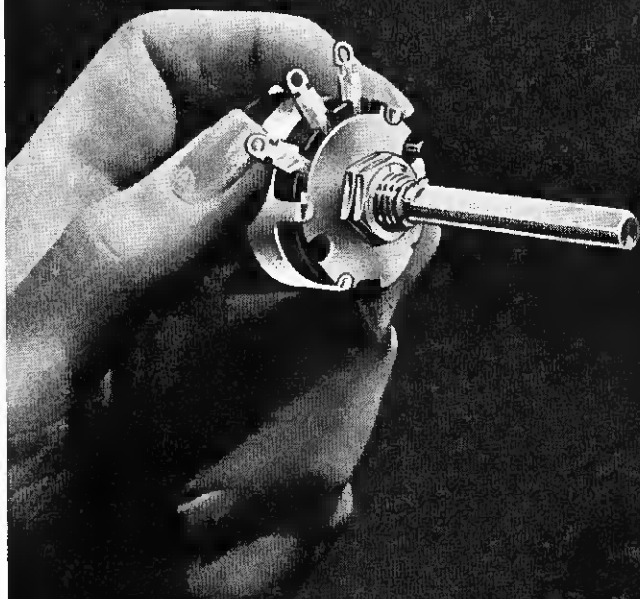

Metallized
**VOLUME
CONTROL**

**• PERMANENT • QUIET •
• RUGGED •**

LOOK IN RIDER'S MANUAL (Index to Volume 7) for complete IRC Volume Control Replacement Guide.

HANDY POCKET-SIZE GUIDE FREE to bonafide servicemen upon request to IRC jobbers.

INTERNATIONAL RESISTANCE COMPANY

401 NORTH BROAD STREET, PHILADELPHIA, PA.

Factories or Licensees in Canada, England, France, Germany, Italy, Denmark and Australia

MAKERS OF RESISTANCE UNITS OF MORE TYPES, IN MORE SHAPES, FOR
MORE APPLICATIONS THAN ANY OTHER MANUFACTURER IN THE WORLD

coverage is from 700 to 1720 kc., the i.f. trap tunes from 400 to 700 kc. Both sections can be adjusted from the outside of the unit.

Each section may be used singly for its particular type of interference, or together when both types of interfering signals are present.

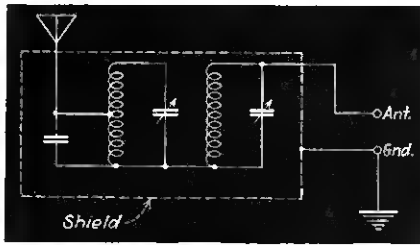

6L6 Low Current Operation

A 6L6 can furnish high power output at low distortion, because of its high plate-circuit efficiency, low screen dissipation, and ability to handle high plate currents. These features distinguish the 6L6 from previous output-tube types. However, high plate-current operation of the 6L6 is not essential for good plate-circuit efficiency. A bulletin by RCA discusses the characteristics of the new 250-volt operating conditions for the 6L6 in which the bias on the 6L6 is adjusted to produce the same cathode current as a 6F6.

An ideal operating condition for an output tube is obtained when the electrode voltages do not vary with power output. This ideal condition cannot be met in practice because some plate, screen, and bias regulation is always present. However, it is desirable to know the ideal operating characteristics of a tube in order to compare actual performance with ideal performance and to know what can be expected from a tube under the most favorable operating conditions.

A test on the operation of a single 6L6 at low cathode current was conducted in a radio receiver of average design. The audio amplifier originally consisted of a 6F5 resistance-coupled to a 6F6. Each a-f tube was self-

biased; each self-bias resistor was bypassed with a 12 mfd electrolytic condenser. Curves of distortion, rms input signal to the 6F5, and cathode current of the 6F6 vs. power output were taken. A 6L6 was substituted for the 6F6 and the bias resistor of the output tube was changed from 410 ohms to 515 ohms. The distortion, input signal, and cathode-current curves were repeated for this tube type. The data for the 6L6 and 6F6 are shown in Fig. 1.

In this average receiver, more than 4 watts can be obtained from either tube type. The cathode currents of both tube types for the same power output are very nearly equal. Because more output without grid current can be obtained from a 6L6 than from a 6F6, the output of the 6L6 contains less high-order distortion, even though the total-distortion characteristics of both tube types are nearly alike.

In push-pull operation with fixed bias

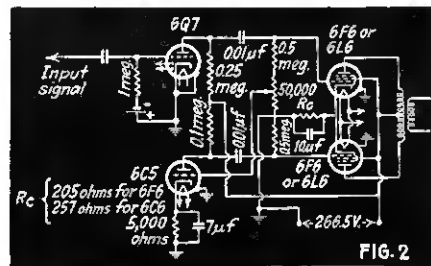

14 watts can be obtained from two 6L6 tubes when zero power supply regulation is obtainable. However, this power output value cannot be realized when the power supply has regulation and the

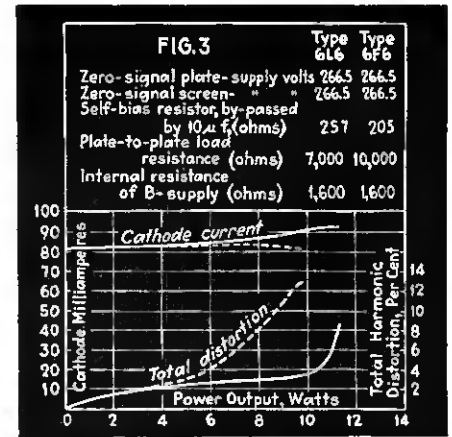

control-grid voltage is obtained from a self-bias resistor. Therefore, it is desirable to know what can be obtained under representative conditions. At the grid-current point, over 11 watts at 2 per cent distortion can be obtained.

A final test on the push-pull operation of the type 6L6 tube at reduced cathode current was conducted in a receiver. The a-f amplifier section of this receiver is shown schematically in Fig. 2. The output of a two-tube phase inverter feeds two type 6F6's connected in push-pull. The output tubes are self-biased, the cathode resistor is by-passed with a 10 mfd condenser, and the internal resistance of the power supply is 1600 ohms. A 420-cycle test signal was introduced at the grid of the 6Q7. Output voltage was measured across the primary of the receiver's output transformer, values are shown in Fig. 3.

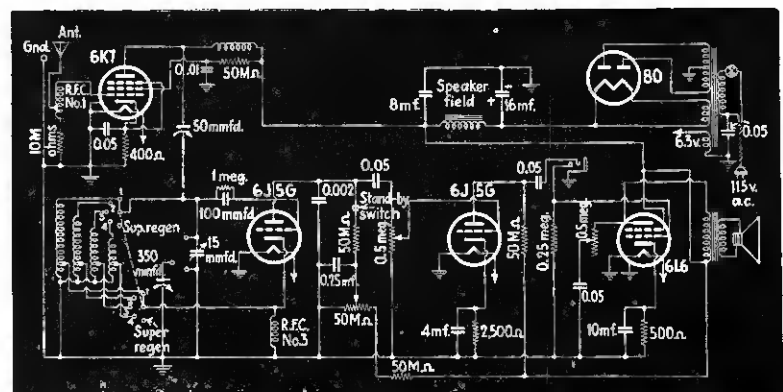

Regenerative-Superregenerative Receiver

A unique receiver covering a range from 550 to 5 meters has been designed by Raco engineers. The most interesting feature is its dual detector. On frequencies up to 22 m.c. it operates as a true regenerative receiver, while on 10 and 5 meters it becomes a super regenerator.

A 6K7 untuned r.f. stage precedes this unusual detector; the antenna feeds this tube through a tapped r.f. choke. A system of band switch coils in the detector stage permit selection of the desired frequency. Four coil covering broadcast and short waves can be switched in or out. When ultra high

frequency reception is desired the band switch is tuned to a neutral position. Coils for 10, 7½ or 5 meters can then be plugged into a special receptacle. This procedure allows greater efficiency by shortening tuned circuit leads.

Regeneration is accomplished in two ways. As a regenerative detector, sufficient feedback is obtained by tapping the cathode of the detector on the grid coil. On the higher frequencies, feedback takes place by the presence of a choke in the cathode lead. This is accomplished by providing an impedance common to both plate and grid circuits, permitting oscillation to take place.

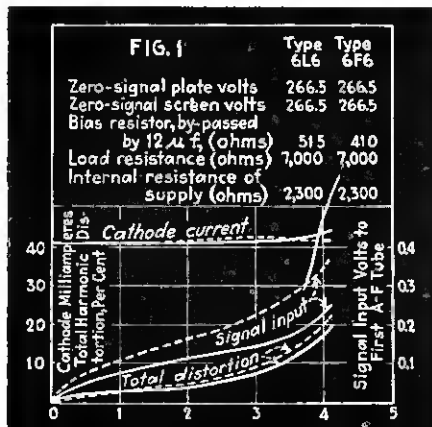

Low Pass Noise Filter

In the antenna circuit of the new RCA auto radio will be found a novel interference filter.

As shown in the diagram below the device is of the wave trap type but performs a different function than the usual trap. Most noises commonly en-

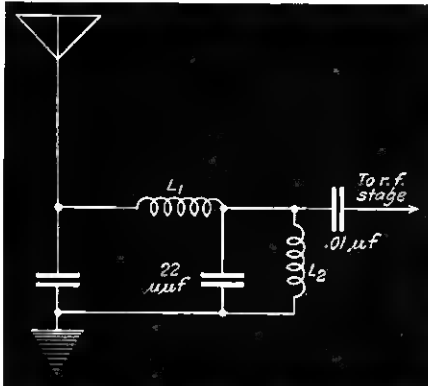

countered in auto installations are of the high frequency type. It is true that the majority of radiations that are set up produce very broad signals. However the maximum energy is produced on frequencies considerably higher than the broadcast band. Frequencies in the ultra short wave spectrum are not uncommon.

In this filter a combination of inductance and capacity are so connected in a low pass filter that only frequencies

lower than 1600 k.c. are permitted to flow through to the antenna coil. Any signal higher than this frequency will be attenuated while signals on the broadcast band are not affected. In addition, inductance L2 is for the purpose of shunting out power line hum pickup.

New Tubes

1G5G. A two volt output pentode by Sylvania. Characteristics are:

Filament Voltage	2.0 Volts
Filament Current	0.12 Ampere
Plate Voltage	90 Volts Max.
Screen Voltage	90 Volts Max.
Grid Voltage	-6 Volts
Plate Current	8.5 Ma.
Screen Current	2.7 Ma.
Plate Resistance	135,000 Ohms
Mutual Conductance	1,500 umhos
Amplification Factor	200
Load Resistance	8,500 Ohms
Power Output	300 Mw.
Total Harmonic Distortion	9 Per Cent

6V7G. A duodiode triode by Sylvania with ratings and characteristics identical to the 85. Heater current is .3 amps.

CLASS A AMPLIFIER (Triode Unit)				
Heater Voltage	6.3	6.3	6.3	Volts
Plate Voltage	135	180	250	Volts
Grid Voltage	-10.5	-13.5	-20.0	Volts
Plate Current	3.7	6.0	8.0	Ma.
Plate Resistance	11000	8500	7500	Ohms
Mutual Conductance	750	975	1100	umhos
Amplification Factor	8.3	8.3	8.3	
Load Resistance	25000	20000	20000	Ohms
Power Output	75	160	350	Mw.

6C8G. A double-triode amplifier tube by Ken-Rad and Sylvania having a low heater current and is designed to make possible the use of specialized circuits such as the phase inverter and infinite-impedance director in automobile receivers. Individual pin connections are used for each element including the two cathodes and a number of other circuit applications are thus made possible. The individual triodes have a relatively high amplification factor and sufficient amplification is possible that a push-pull output stage can be driven with one 6C8G as a phase inverter.

CLASS A AMPLIFIER—ONE TRIODE

Heater Voltage	6.3
Heater Current	3
Plate Voltage	250
Grid Voltage	-4.5
Plate Current	3.1
Plate Resistance	26,000
Mutual Conductance	1,450
Amplification Factor	38

TYPICAL PHASE INVERTER OPERATION

Plate Supply Voltage	250	250
Grid Voltage	-3.0	-3.0
Plate Current Per Triode	1.7	1.0
Plate Load Resistor	50,000	100,000
Grid Return Resistance of Following Tubes	100,000	500,000
Voltage Amplification	45	48
Maximum Output Voltage (RMS)	60	80
Self-Biasing Resistor	900	1,500

5T4. A full wave high vacuum rectifier comparable to the 5Z3. Characteristics are for condenser input to filter.

Filament Voltage (A.C.)	5.0 volts
Filament Current	2.0 amperes
A-C Plate Voltage Per Plate (RMS)	450 max. volts
Peak Inverse Voltage	1250 max. volts
D-C Output Current	250 max. milliamperes

NEWLY IMPROVED!

Model T-37 SIGNAL GENERATOR

Complete . . only **\$12⁴⁰**

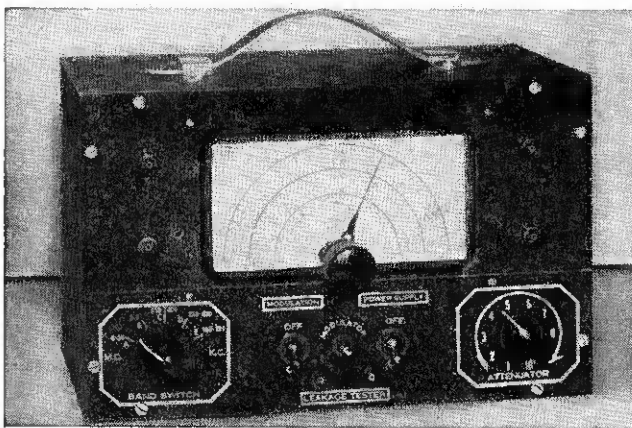

- 110 Volts A.C. or D.C.
- 100 kc.—22 megacycles all on fundamentals.
- Dial is direct reading in frequencies.
- R.F. output may be taken from a high impedance or a low impedance post, with attenuation present for either.
- Separate audio output at 2 amplitude levels, so that tone may be used for checking public address systems, audio amplifiers in receivers, and speech amplifiers in transmitters.
- Two extra posts on front panel enable leakage tests. Condensers may be checked for leakage, so may tubes, and other normally high resistance currents, otherwise difficult to test.

Model T-37 All-Wave Signal Generator, wired, in shielded cabinet with carrying handle and calibrated, tested; complete with 2 Tubes & Neon Tube. **\$12.40**
Instructions (shipping weight 7 lbs).....

SUPERIOR INSTRUMENTS COMPANY

136 LIBERTY STREET

NEW YORK, N. Y., Dept. M

Doing a world-wide job....

little giant



COMPACT Dry Electrolytic CAPACITORS

So small... efficient... completely equalling standard sizes in dependability! All usual capacities; two ratings, 450 v.w. and 200 v.w. You won't believe your eyes!

SOLAR MFG. CORP.

599-601 Broadway, New York, N. Y.

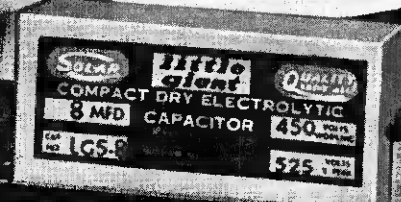
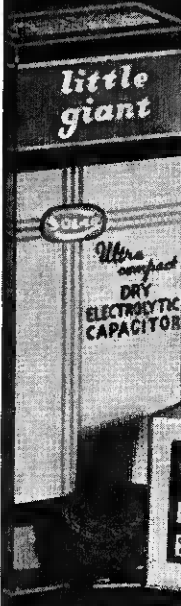

Descriptive literature upon request.

Let Us keep your INVENTORY!

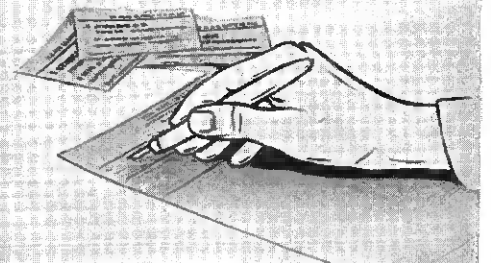
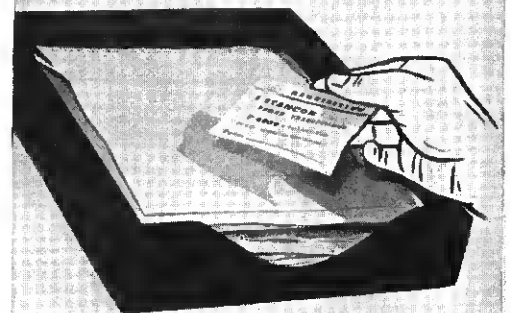
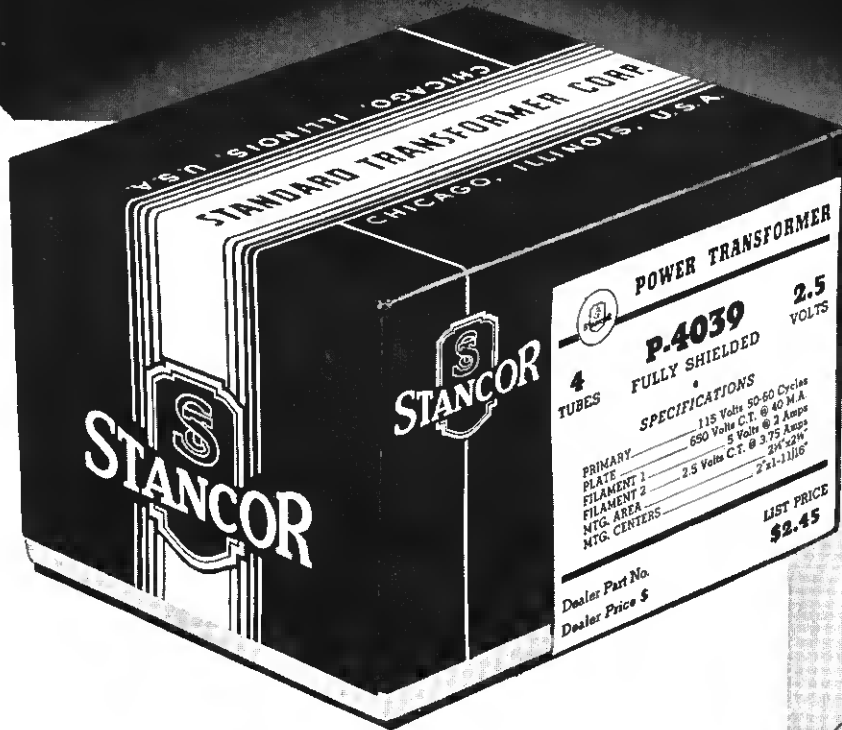

for your Convenience

Stancor makes it possible to throw the "want book" in the discard. There need be no more shortage in your transformer stock. . . and no troublesome inventory routine to keep track of what is on the shelves.

The new Stancor label does the trick. Use it as a stock check and you'll never need to say, "Sorry, but we're just out."

**S T A N D A R D
T R A N S F O R M E R
C O R P O R A T I O N**

850 BLACKHAWK ST. • CHICAGO, ILL.

NEW SUPREME OSCILLOSCOPES



ONLY \$2995
 \$4.00 CASH
 \$4.13 MONTHLY FOR 7 MONTHS

Offering

MORE VALUE FOR LESS MONEY THAN EVER BEFORE!

Model 535 SENIOR Oscilloscope

9 EXCLUSIVE FEATURES!

1. RETURN SWEEP ELIMINATOR for completely removing high frequency linear sweep return!
2. SELECTIVE RETURN SWEEP ELIMINATOR for inclusion or rejection of power supply frequency return sweep!
3. SNAP-LOCK SYNCHRONIZER for positive interlock between linear time base and incoming signal—Range 15 cycles to over 500 k.c./l
4. SEPARATOUGH MASTERPOT allows separate control of two potentiometers from one shaft protrusion—Grouping of controls eliminates groping for controls!
5. ANTIQUE BRONZE PANEL
6. SMALL SIZE and LIGHT WEIGHT!
7. MINIMUM number of PANEL KNOBS control MAXIMUM number of INSTRUMENT FUNCTIONS!
8. "POWER ON" INDICATOR lamp.
9. FLEXIBILITY OF CONTROL FUNCTIONS!

SOLD BY YOUR PARTS JOBBER ON SUPREME S I C EASY TERMS

VISIT THE SUPREME INSTRUMENTS DISPLAY AT BOOTH 51 AND 52 AT THE NATIONAL TRADE SHOW, STEVENS HOTEL, CHICAGO

SUPREME INSTRUMENTS CORPORATION
 Greenwood, Mississippi



ONLY \$2995
 \$4.00 CASH
 \$4.13 MONTHLY FOR 7 MONTHS

Model 530 JUNIOR Oscilloscope

7 EXCLUSIVE FEATURES!

1. SELECTIVE RETURN SWEEP ELIMINATOR for inclusion or rejection of power supply frequency return sweep!
2. SEPARATOUGH MASTERPOT allows separate control of two potentiometers from one shaft protrusion on the panel!
3. ANTIQUE BRONZE PANEL
4. LIGHT WEIGHT and SMALL SIZE!
5. MAXIMUM FUNCTIONS with MINIMUM number of PANEL KNOBS!
6. "POWER ON" INDICATOR lamp!
7. FLEXIBILITY OF CONTROL FUNCTIONS!

SPECIAL INSTALLMENT TERMS ON SIGNAL GENERATOR-OSCILLOSCOPE COMBINATION

Write for Descriptive Folder

SOLD BY YOUR PARTS JOBBER ON SUPREME S I C EASY TERMS

VISIT THE SUPREME INSTRUMENTS DISPLAY AT BOOTH 51 AND 52 AT THE NATIONAL TRADE SHOW, STEVENS HOTEL, CHICAGO

SUPREME INSTRUMENTS CORPORATION
 Greenwood, Mississippi

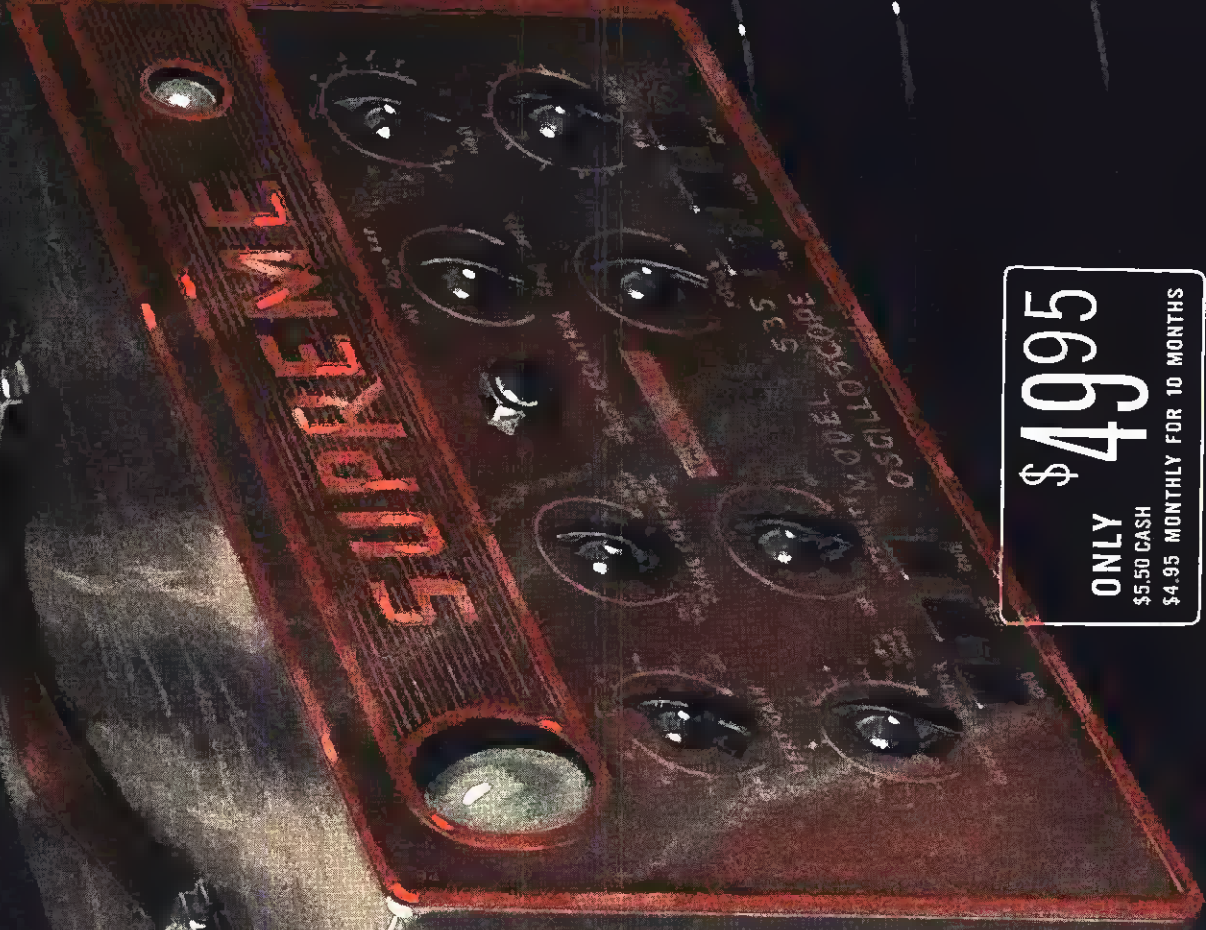

ONLY \$4995
 \$5.50 CASH
 \$4.95 MONTHLY FOR 10 MONTHS

1937 AUTO IGNITION CIRCUITS

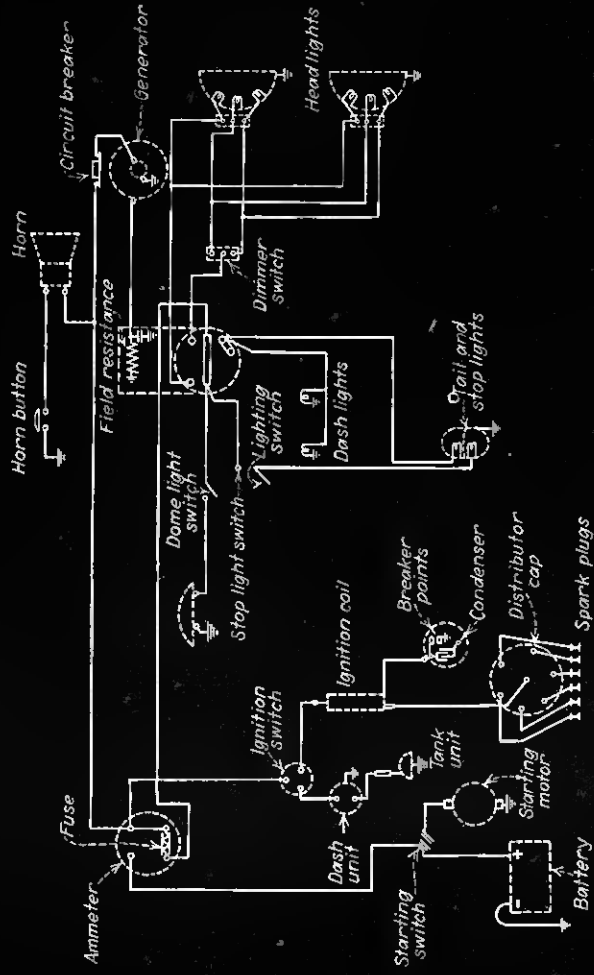

Chevrolet

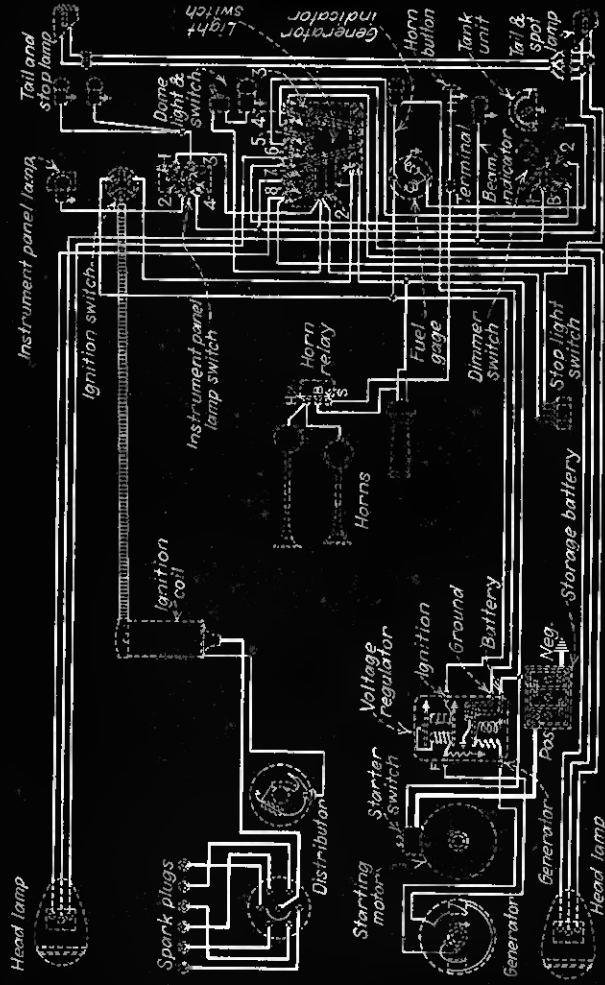

Pontiac 6

RADIO RETAILING

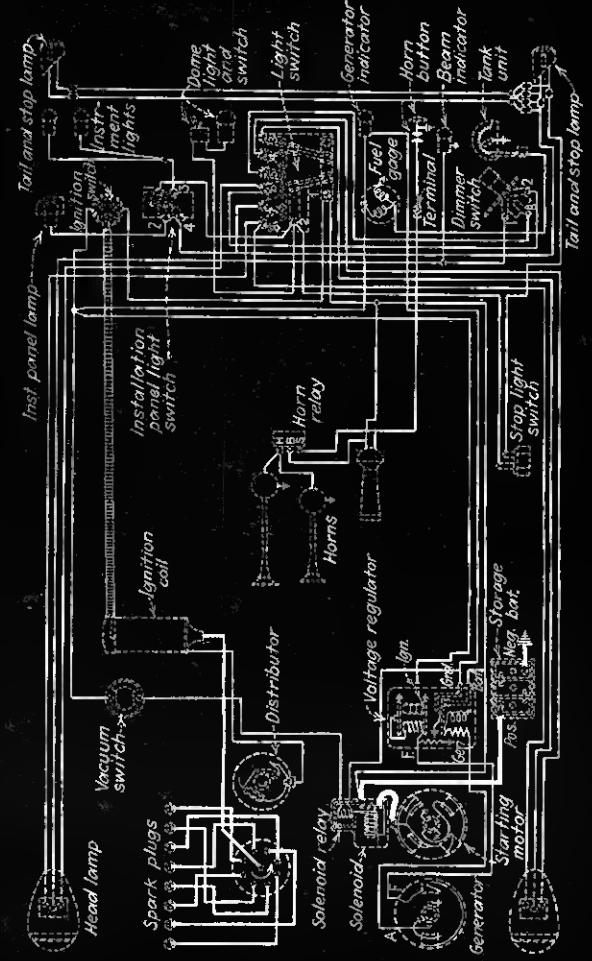

Pontiac 8

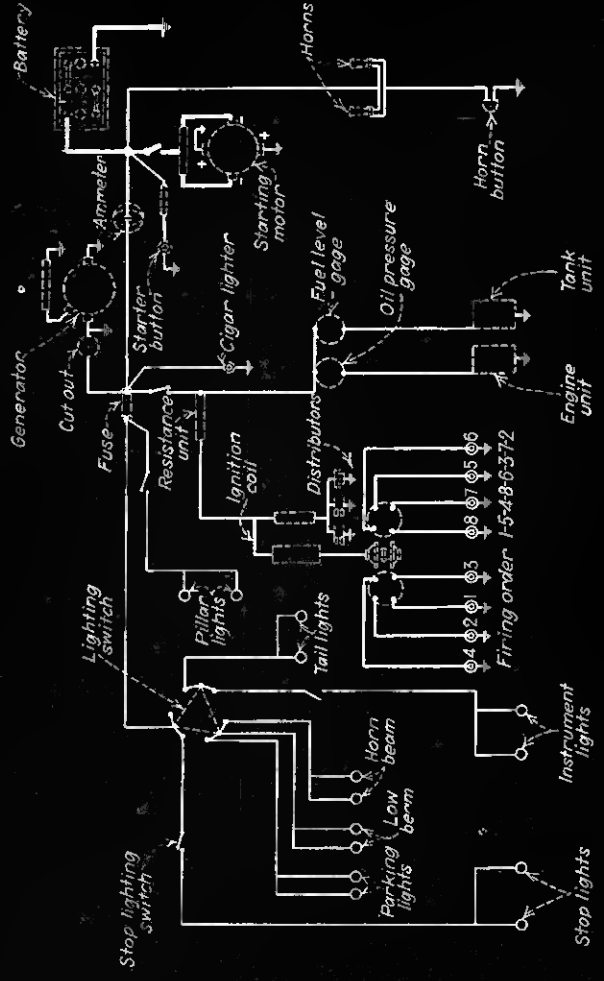

Ford 85 - Ford 60

THOUSANDS HAVE SELECTED THIS TUBE TESTER

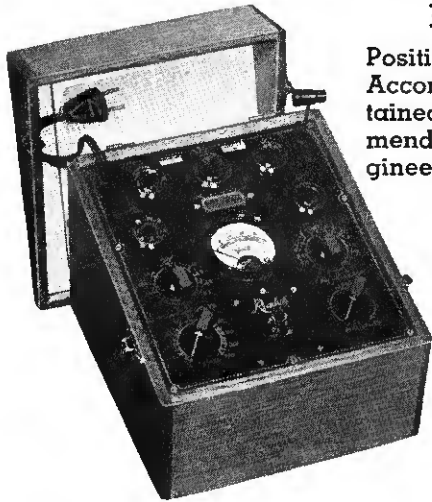

MODEL 430

Positively Checks Tubes According to Data Contained in Latest Recommendation of Tube Engineers.

ONLY
\$18.00
DEALER PRICE

- Tests All Type Radio Tubes
- Has Line Voltage Adjustment
- Has Leakage and Short Test
- Uses Triplett Direct Reading Instrument (GOOD-BAD Scale)

*MODEL 430 is an up-to-the-minute 1937 Tube Tester. Five flush type sockets accommodate all radio tubes. The tester operation is very simple and indicates condition of the tube for both dealer and customer on Direct Reading GOOD-BAD colored scale of Triplett instrument. Will also test for inter-element shorts and leakages. Complete in attractive, sturdy, quartered-oak case. Sloping panel of silver and black. Suitable for portable and counter use.

Dealer Price\$18.00

Model 431 same as 430 except has Readrite (GOOD-BAD) meter.
Dealer Price\$14.40

See Your Jobber — Write for Catalogue



READRITE METER WORKS
320 College Dr., Bluffton, Ohio

Without obligation please send me.....More information on Readrite Model 430.I am also interested in.....

Name

Address

City..... State.....

CAN
Take it!

EXCLUSIVE UTAH FEATURES MEAN LONGER LIFE—HIGHER EFFICIENCY

When you install a UTAH Vibrator—no other serviceman can do a better job. You have given your customer longest vibrator life, freedom from set interference, and peak efficiency.

UTAH Vibrators are TOUGH! We've proved it by gruelling tests. Manufacturers know it too. That's why UTAH Vibrators are original equipment in more than a million sets. And the 1937 UTAH Vibrator is the finest and toughest we've ever made.

Use UTAH Vibrators on your replacement jobs. Prove to yourself they work better, last longer—but cost no more.

Your jobber has UTAH Vibrators for all radios.

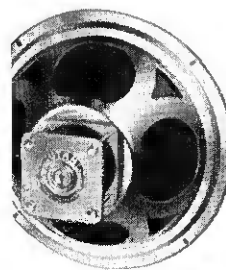

THE NEW UTAH P.M. *Dynamic* SPEAKER

brings "better than new" performance to sets using this type of speaker.

UTAH has designed a new Permanent Magnet speaker that sets a new high in performance and long-time efficiency. Ideal for multiple speaker installations. Twenty-two models available in all standard sizes from five to fourteen inches.

Hear them at your jobber's—or write for details.

UTAH RADIO PRODUCTS CO.
CHICAGO, U. S. A.

TORONTO BUENOS AIRES
ONTARIO, CANADA (UCOA RADIO PRODUCTS CO.)

"15 YEARS OF LEADERSHIP"

1937 AUTO IGNITION CIRCUITS

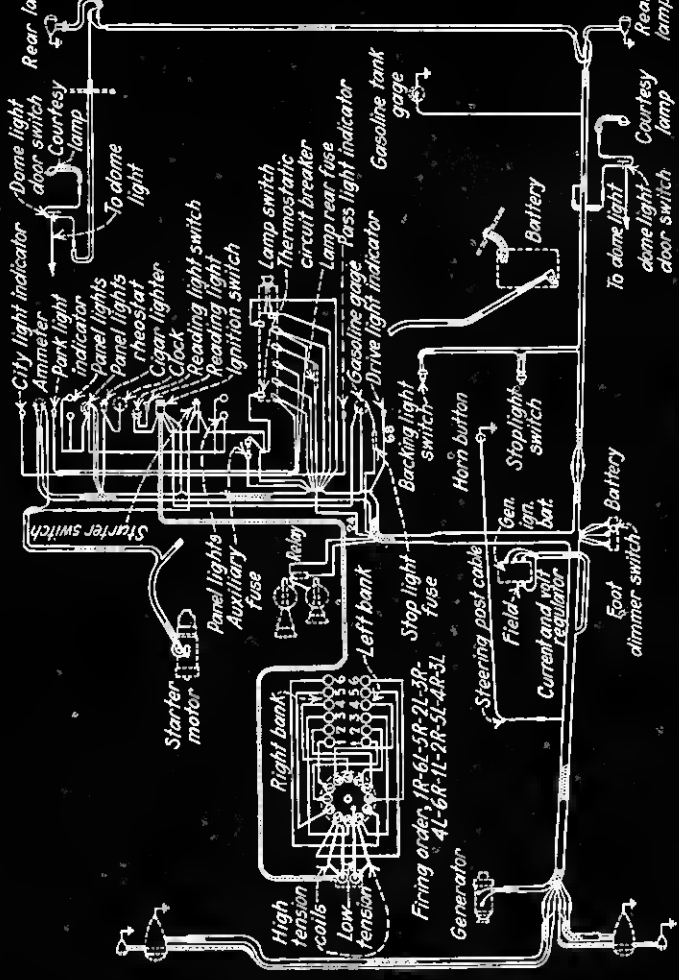

Packard Twelve

RADIO RETAILING

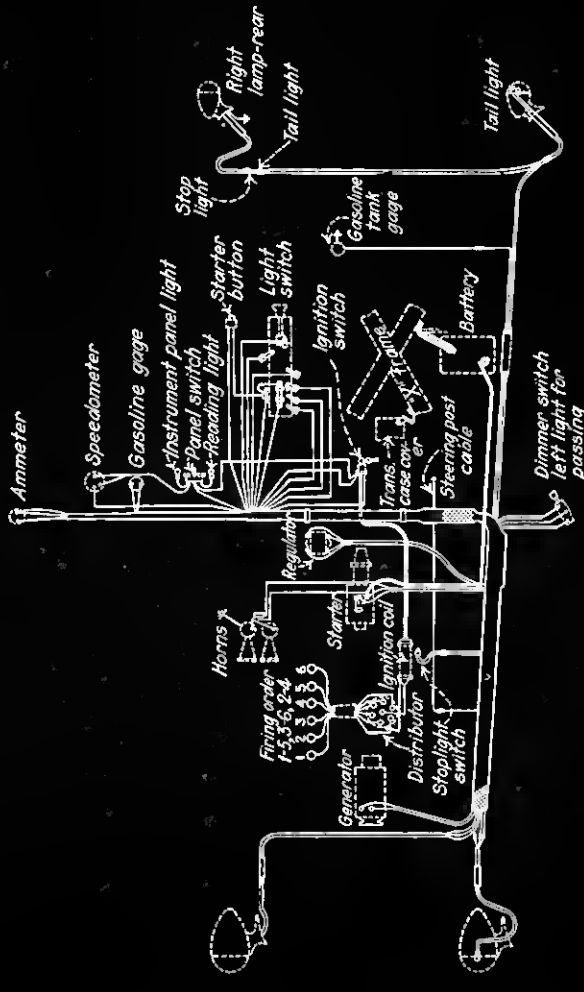

Packard Six

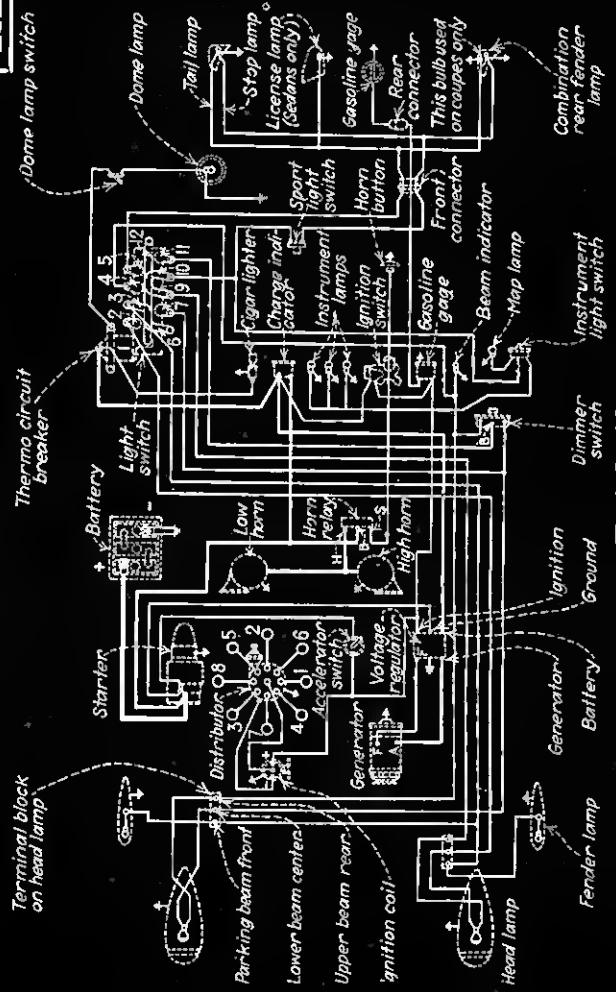

Buick 40

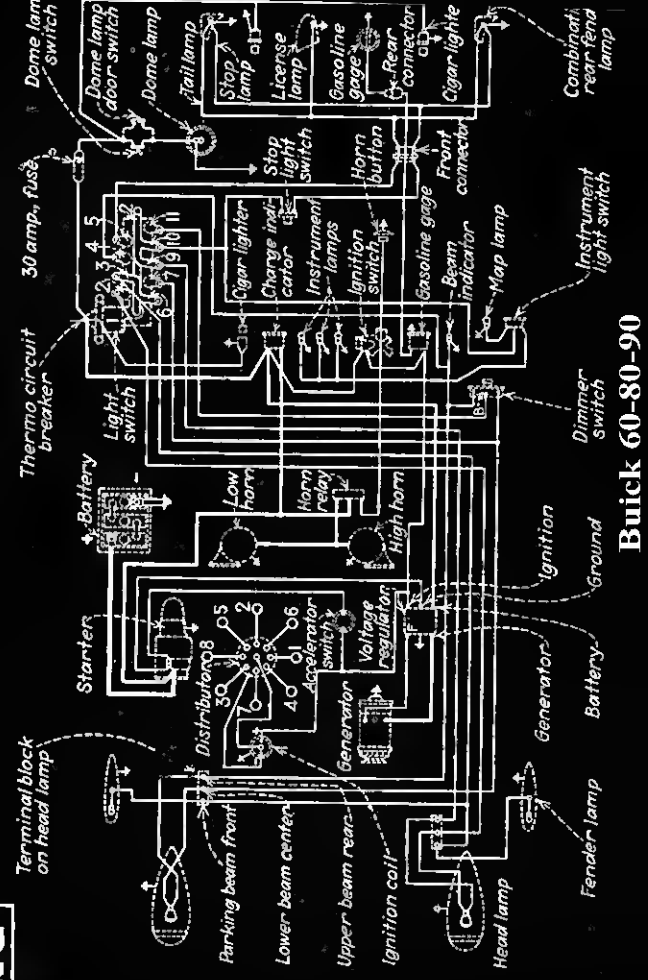

Buick 60-80-90

Don't try to **GUESS**
a radio set into balance!

It's so easy
with this new
Series 3710
\$49²⁵ complete

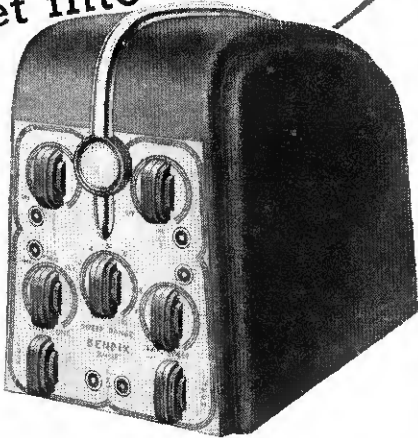

BENDIX-DAYRAD SCOPE

Make your balancing tests swiftly and surely. You'll get the most out of a receiver in the least possible time with this new Bendix-DayRad Scope. At its low, big-production-price, it's a splendid investment for any radio service department.

Here's What You Can Do With It

1. The alignment of radio receivers. (Built-in amplifiers to adjust for the sensitivity of the receiver).
2. The measuring of peak voltage A.C. with or without amplifiers.
3. The measuring of audio quality in audio amplifiers, thereby locating causes of distortion.
4. The measuring of modulation, percentage of transmitters, or oscillators.
5. Checking phase shifts in various devices.
6. Modulation percentages of received signals by phase shift method.
7. Testing of auto radio vibrators.
8. The adjustment of transmitters.

Brief Specifications:

The Series 3710 has complete controls for adjustment of tube and spot, namely intensity, focus, horizontal, and vertical spot controls. The intensity control is equipped with the AC power switch.

Vertical and horizontal gain controls have switches for connecting the binding posts directly to the ray tube or through the amplifiers.

Maximum peak voltage applied to the binding post input must not exceed 400 volts. Both amplifiers substantially flat in frequency response from 15 to 100,000 cycles.

The sweep frequency range is continuously variable from 15 cycles to a maximum of 20,000 cycles, and is linear through its entire range.

The sweep frequency step control is variable in ten steps.

The variable sweep control provides a means of interpolation between the frequency ranges.

The synchronization control provides a means of locking in step the sweep tube with the voltage supplied externally to be viewed. This control has three positions, internal lock, line frequency lock and external lock.

Cabinet is 6 1/4" wide, 8 1/4" high, 10 1/4" long. The handle for carrying is the trim at the top of the case and it is concealed when not in use.

The instrument operates on 110 volts 50 or 60 cycles. 25 cycles at a slightly higher price. Weight complete approximately 15 lbs.

Price complete is \$49.25.

Send Coupon below for new Bendix-DayRad catalog

—SEND THIS COUPON NOW!—

BENDIX PRODUCTS CORPORATION, Bendix-DayRad Dept.
(Subsidiary of Bendix Aviation Corporation)
456 Bendix Drive, South Bend, Indiana

Please send full details of the Bendix-DayRad System of Radio Service, including data on Time Payment arrangements, for above, and other Bendix-DayRad units

Name

Address

City State

My Distributor's Name

"ASK ANY MECHANIC"

he'll
tell
you

REPAIRMEN WHO
KNOW THEIR
STUFF KNOW
KRAEUTER TOOLS
ARE "TOPS"



The more you know about tools, the quicker you will appreciate the superiority of the Kraeuter Line.

No. 4601 — ELECTRICIANS' DIAGONAL CUTTING PLIERS made especially for close cutting. Forged from special plier steel and precisely fitted for exact work. Sizes 4 1/2" to 7 1/2".

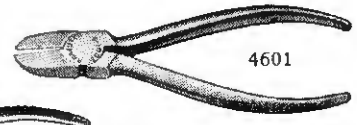

No. 1661 — ELECTRICIANS' HEAVY DUTY PLIERS. Just the thing for general wiring work. Strongly constructed with sturdy wire cutters. 4" to 8" sizes.

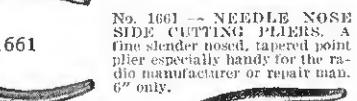

No. 1831 — ELECTRICIANS' HEAVY DUTY PLIERS. Just the thing for general wiring work. Strongly constructed with sturdy wire cutters. 4" to 8" sizes.



KRAEUTER Pliers save time — do the job better. There's a model for every purpose. For further information write Kraeuter & Co., Dept. "R".

KRAEUTER & CO., Newark, N. J.
(Pronounced KROY-TER)

Manufacturers of Highest Quality Pliers and Tools Since 1860

2,199 IDEAS!

—on how to build a record volume of business in 1937. Practical two-fisted money-making sales ideas, ad. specimens, promotion methods. You get them all in this one big book—the first and only one of its kind!

RADIO BUSINESS Promotion and Management

By A. A. Ghirardi and T. S. Ruggles

SELLING — How to get leads and prospects. Market analysis. How to get people into your store. Inside and outside selling. Selling talks. Sales resistances and how to break them down. Business contacts.

ADVERTISING — How to plan your promotional program. Costs. How to write your advertising. Tested appeals. How to get action. Preparation and production. Displays. Direct Mail. Newspaper and other forms of advertising. Publicity. Merchandising. Contests. Follow-ups.

CLIP and MAIL Today
Radio & Technical Publ. Co.

BUSINESS METHODS — Management data. Bookkeeping and accounting. Collections. Sales and service forms and records. House policies.

Applies to sale of sets, servicing, Auto Radio, P. A. work, home appliances, etc.

**Over 400 Pages
Over 200 Illus.**

Dent. RR-37
45 Astor Pl., New York
Please send me free circular BB.

Name

Address

Free Circular

1937 AUTO IGNITION CIRCUITS

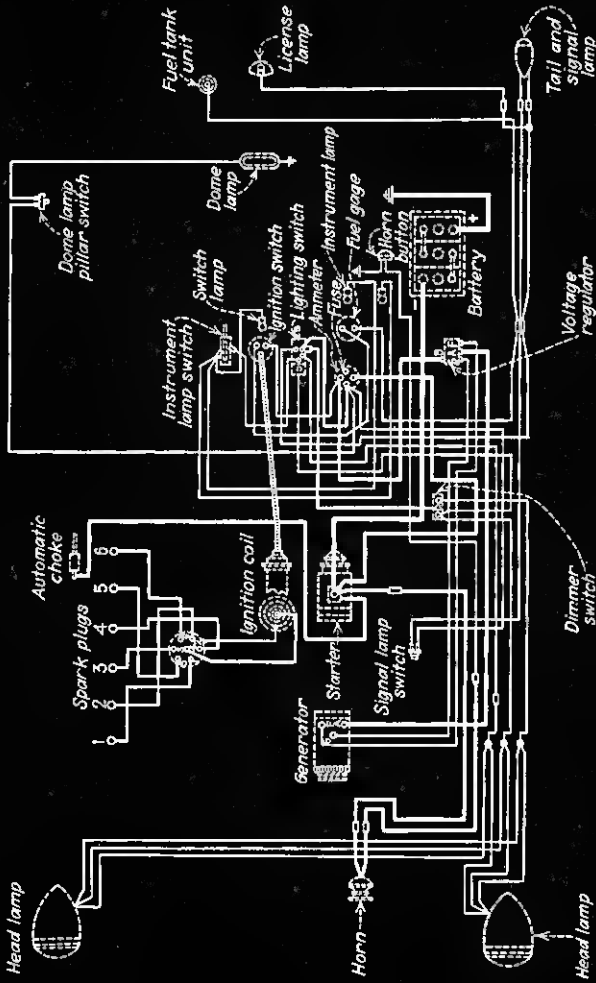

Dodge 6

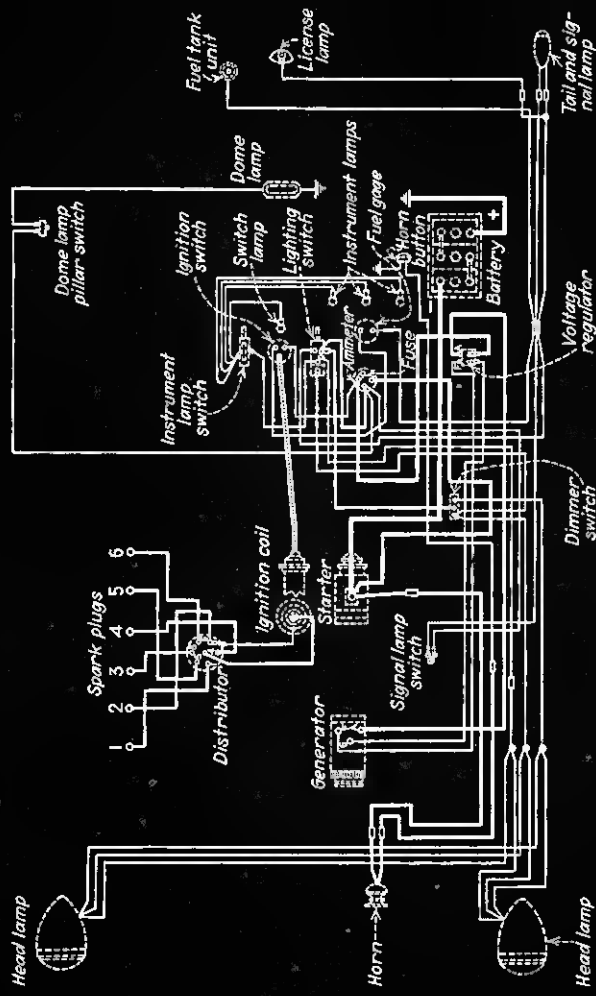

Plymouth Deluxe

RADIO RETAILING

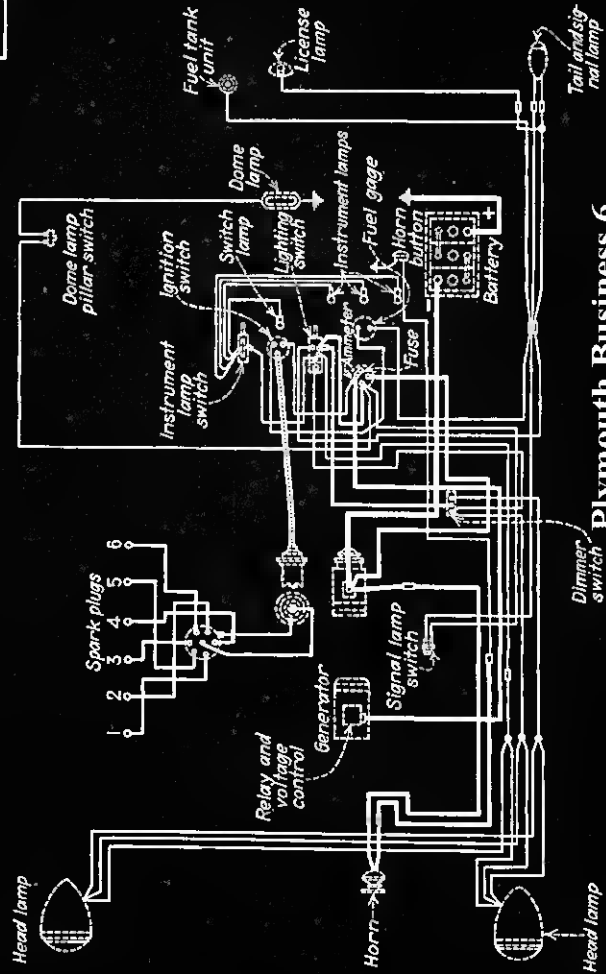

Plymouth Business 6

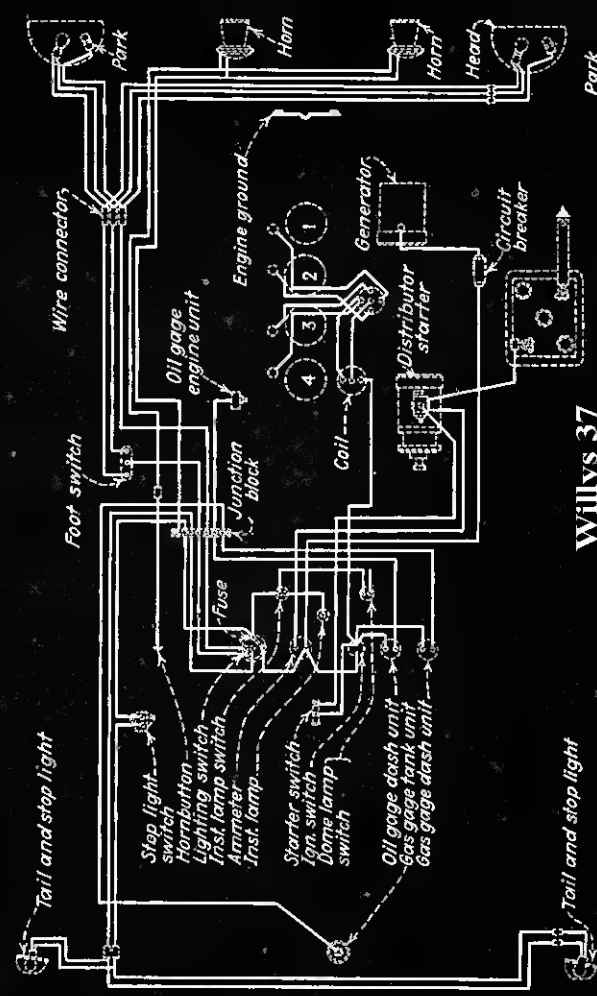

Willys 37

DEALERS... Equip Your Sound Trucks with the All-Purpose

CAN BE USED FOR:

Rentals or Sales. As Portable or for Fixed Location. Outdoors or Indoors. Automobile, Truck or Ship Work—6 Volt Operation if Power Line Not Available. Small or Large Audiences.

SOUND SYSTEM for 6 Volt D.C. or 110 Volt A.C.

A sound system that can be used anywhere. For any size audience to 10,000. Has all the latest refinements including tone control, crystal microphone, two heavy duty permanent magnet speakers. All units especially designed with large factor of safety to insure satisfaction under all conditions. System is complete with all accessories including phonograph turntable.

30 WATTS OUTPUT

Amplifier delivers 30 watts undistorted output. It is a new design using beam type tubes and housed in attractive steel case with japanned finish. Uses 5 tubes on 6 Volt DC and 6 tubes on 110 Volt AC.

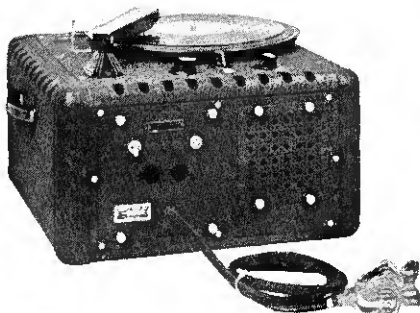

MODEL 530

Note phonograph turntable is built into amplifier.

Latest type crystal microphone.



Improved high efficiency Permanent Magnet Speakers.

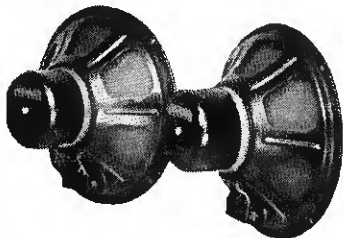

• FULLY LICENSED

• STRICT DEALER POLICY

• TIME PAYMENT PLAN

For more information, send coupon. Learn all about Webster-Chicago's fast selling merchandise and the money-making possibilities for the Sound Specialist. Get new 1937 Catalog.

SALES PROMOTION HELPS

Webster-Chicago Dealer Helps are showing dealers the enormous possibilities now present in the sound market. The single All-Purpose system is all you need stock at the start.

Webster-Chicago manufactures a complete line of Public Address Equipment and Sound Accessories including

New AMPLICALL INTER-OFFICE COMMUNICATION SYSTEM

WEBSTER - CHICAGO

WEBSTER-CHICAGO, Section M-8, 3825 W. Lake St., Chicago, Ill.

..... Please send me complete information on the All-Purpose Sound System.

..... Please send me New 1937 Catalog.

Name

Address

City State

5000 OHM CONTINENTAL Carbon Spark SUPPRESSORS

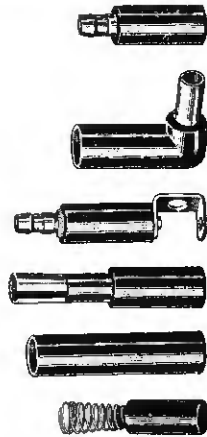

Out where the test begins—out where stations are few and far between, your car radio needs all the sensitivity its circuit will permit. CONTINENTAL Carbon's new 5000-ohm low-voltage-coefficient spark suppressors effectively squelch ignition interference, thus releasing the avc circuit and the full sensitivity of your set.

Make this test—tune in a distant station while driving on a country road at 30 to 50 miles per hour. Shut off your ignition and note if the radio reception is better. If it is better with the motor shut off, you need CONTINENTAL suppressors.

For spark plug suppression select S27, S20A, or S21, in 5000-ohm resistance. Use T13 or T11 for the distributor in 10,000 ohms; T17 for Ford V-8 distributors. Available from leading radio jobbers.

CONTINENTAL CARBON Inc.

13902 LORAIN AVE., CLEVELAND, OHIO

(Toronto, Canada)

Please send booklet on Interference, 10 cents enclosed.

Name

Address

City Jobber

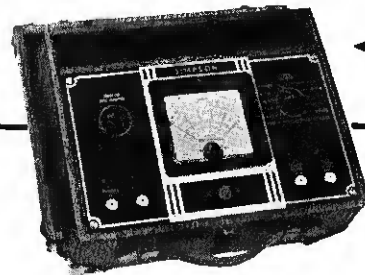

← **FREE**

New Simpson Set Tester No. 250 (20,000 ohms per volt) with purchase of 650 National Union Tubes over 2-year period and dealer deposit of \$21.00 for immediate delivery of tester.

FREE Simpson Instruments To National Union Servicemen

By special arrangement, the Simpson line of testers is now obtainable FREE with special deals on

NATIONAL UNION TUBES

... a complete line of highest quality tubes in glass, metal and G-type. Note special offers at right (good only in the United States). ... Coupon will bring further details. Ask your jobber for new booklet, "Your Pocket-Book ... What About It."



Other National Union Offers

(On Tube Purchases Over 2-Year Period)

Simpson Set Tester No. 225 (10,000 ohms per volt)—with 500 tubes; deposit \$15.00.

Simpson Roto-Ranger Tube Tester No. 220 — with 950 tubes; deposit \$33.00.

Simpson A11-Wave Signal Generator No. 210 (AC)—with 800 tubes; deposit \$28.00.

Simpson Roto-Ranger Volt-Ohm-Milliammeter No. 201— with 500 tubes; deposit \$15.00.

Simpson Roto-Ranger Volt-Ohm-Milliammeter No. 202— with 550 tubes; deposit \$17.00.

NATIONAL UNION RADIO CORPORATION
570 Lexington Avenue, New York City RR-337

Tell me how to get Simpson Testing Instruments and other FREE equipment.

Name

Address

City State

Non-Linear Ohmmeter

By T. Ryall

While working for a radio dealer, I chanced upon an old Cunningham Tube Checker, which had been purchased in 1930 on a "tube deal." It looked somewhat like an upright piano with tube sockets for keys. Because this tester

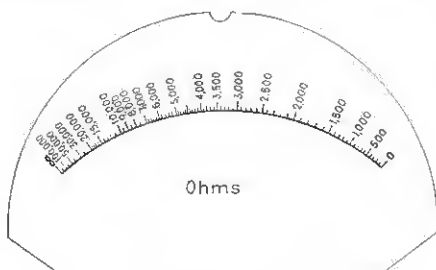

Fig. 1

was so widely purchased I feel that this information will appeal to many dealer servicemen. The checker had become obsolete, but it was felt that its destiny should be more than a mere "prop," useful in impressing the customers.

The meter, a Weston 57 type, was removed from the checker and opened. Inside the case was mounted a thermocouple which made the meter action sluggish. This was removed and the terminal leads wired directly to the

D'Arsonval movement. The meter was then calibrated, at half scale deflection the movement took 300 microamps and at full scale 1.1 mil. In other words the meter was more sensitive at low currents than at high. Being non-linear the meter would not make a satisfactory voltmeter or ammeter. What could it be used for?

If we consider the usual series ohmmeter, its scale divisions are far apart at the upper end of the scale (low ohms) and congested at the lower end (high ohms). Inspiration! let's use this meter for an ohmmeter. Using a General Radio decade box for R_x the meter was calibrated and the result is shown in Fig. 1. The scale divisions are largest at approximately 1800 ohms and decrease in both directions. The

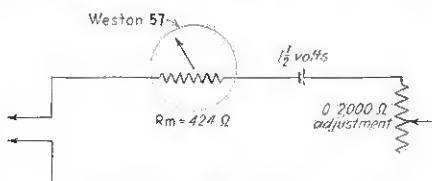

Fig. 2

spacing between divisions is much greater than the usual ohmmeter, accurate definition up to 100,000 ohms is possible. The circuit is shown in Fig. 2.

Finding Intermittents

By G. E. Towers

A very good stunt in locating intermittents is to send a very strong R.F. signal into the antenna circuit, and then tapping on tubes, condensers, resistors, and connections to locate the trouble. This is done with a rubber hammer, with an unmodulated signal. Any defective part will supply the necessary modulation when tapped with the mallet.

Loose shields, poor socket contacts, bad volume controls, bad resistors, noisy tubes, defective condensers; any part that is not working properly but cannot be found with a voltage test, or by tube tester, will show up by this method. It is much quicker than waiting for the set to "act up" on a signal. Besides the intermittent action is not masked by music or speech and is heard directly in the speaker.

Cathode Ray Exploring Coil

By Paul E. Grivet

A very handy accessory for the cathode-ray oscillograph is a good

P-A Control

Here's the new Series CIA CLAROSTAT Constant-Impedance Attenuator.

- Handles up to 25 watts, continuously, safely, at any setting.
- Linear up to 45 decibels, in steps of 3 decibels.
- Compensated ladder type network maintains constant input and output impedances.
- Infinite attenuation at end position.
- 4 1/4" long, 3 1/4" dia. Single-hole mounting. Optional speaker field switch. \$15.00 list.

Write for DATA . . .
You will want to know the details of this remarkable control for public-address system speakers. Literature sent on request

CLAROSTAT
MANUFACTURING CO.
Incorporated
285 North Sixth St.
Brooklyn, N. Y.

ROYAL TYPEWRITER

FREE To National Union Servicemen

National Union and the Royal Typewriter Co. have negotiated a plan to provide free typewriters to National Union servicemen . . . A choice of either the Royal DeLuxe model (shown here) or the Royal Model O may be had with—

NATIONAL UNION TUBES

—purchased over a two year period as follows:
1,000 tubes plus \$35.00 dealer deposit secures the DeLuxe model typewriter . . . Purchase of 850 tubes, plus \$29.00 dealer deposit gets the Model O machine . . . This is at the rate of only 16 to 19 tubes a week, purchased on the 2-year period—depending on model . . . Deposit assures immediate delivery of typewriter . . . Offer good only in U. S.

Send coupon below for further details

NATIONAL UNION RADIO CORPORATION
570 Lexington Avenue, New York City RR337

Tell me how to get Royal Typewriter and other equipment FREE.

Name

Address

City..... State.....

Ask your jobber for new booklet, "Your Pocket Book --What About It."



National Union offers a complete line of radio tubes in glass, metal and G-types—the outstanding favorites in the radio service profession.

Money IN THE BANK...
NOT ON THE SHELF



That's only one of the advantages of the TUNG-SOL CONSIGNMENT PLAN. No outlay for an adequate stock of these high quality tubes. No repeated investments to keep that stock up to the minute. Sell—collect your profit—then remit the cost price. That's "velvet"—for you!

Tung-Sol performance means repeated, full-profit sales. There are still desirable locations for the appointment of reputable dealers..who can qualify. Write for name of your nearest Tung-Sol wholesaler.

TUNG-SOL

Tone-flow radio Tubes.

TUNG-SOL LAMP WORKS, INC.
Radio Tube Division

Sales Offices: Atlanta, Boston, Charlotte, Chicago, Dallas, Detroit, Kansas City, Los Angeles, New York. General Office: Newark, N.J.

Brand New and "A Cinch to Sell"
BELfone
CALL REPLY SYSTEMS

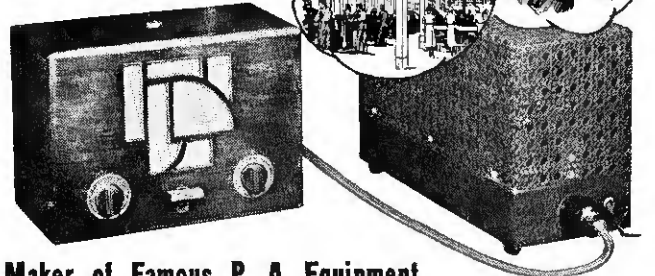

Maker of Famous P. A. Equipment
Opens new fields for Profit!

Here's another BELfone. It's new! It's powerful! Distinctly designed to replace old fashioned call systems... buzzers... gongs... whistles. And every large business needs a call system! But BELfone not only "calls", it is a REPLY system as well. Merely press a key and besides locating your party, BELfone enables

you to converse with him. This model BELfone has ample power for covering large areas and for any number of stations. It has many distinct features—is easy to install — is highly flexible — is free from care — and is a low cost system. A time saver that is a new money maker for you. Write for details.

JOBBERS
Write for full details on this modern money-maker as well as Bell's line of P. A. Equipment.

BELL Sound Systems, Inc.
65 E. GOODALE ST.
Columbus, Ohio
EXPORT OFFICE, 308 WEST WASHINGTON STREET, CHICAGO, ILL.

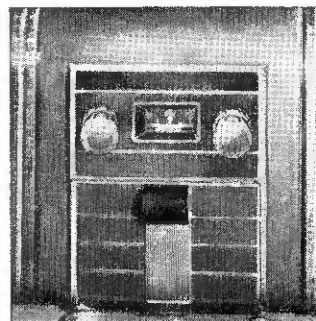

INSTALLATION IN 1937 CHEVROLET

PRE-Assembled CONTROLS FOR ALL CAR MODELS

UNIVERSALS give you something new in remote controls—a complete, single unit already assembled for immediate installation in the dash. One control head to fit all car radios—a complete line of Escutcheon Plates to match the instrument panels of all car models (1937, 1936, 1935). You can save on stock and save on time with UNIVERSALS—it's the profit line for 1937! Mail the coupon today for full details.

UNIVERSAL'S ADVANTAGES

- PRE-ASSEMBLED. No loose parts. Automatic dial adjustment.
 - No cutting of dash. No visible screws.
 - Escutcheon Plates to match all instrument panels. Color-matched knobs.
 - Minimum stock for maximum coverage of installations.
- Patented

Universal CONTROLS, INC.

21-07 40th Ave., Dept. B,
Long Island City, N. Y.

DISTRIBUTORS:
A request will bring our representative with the complete story.

Please send without obligation your descriptive Bulletin 37-B1 about the new, patented UNIVERSAL CONTROLS.

Name

Address



grade A.F. transformer, preferably one uncased and equipped with binding posts, from which the I laminations have all been removed and all the E laminations turned the same way with the open part of the E away from the terminals. The case is cut down so that the open end of the E laminations are flush with the case. The primary and secondary are connected in series and the unit is complete.

If it is inconvenient to connect the oscillograph across a push-pull output then this unit may be placed against the output transformer and the signal will be seen upon the screen. If hum is being traced as the magnetic flux flows through the chassis, this unit may be placed against any transformer or any part of the chassis and the relative amount of hum flux determined and indication as to the effectiveness of various methods of elimination noted upon the screen. Too, best placement of A.F. transformers may be determined quickly in building up P.A. amplifiers or in making modernization changes in sets to decrease the hum pickup of A.F. components.

If a set is completely dead, this unit may be placed against each A.F. component to determine how far the signal gets through the A.F. system (supposing that the voltages and tubes in the set are normal of course). If the signal goes all the way to the output transformer, then there is an open

voice coil or open secondary in the O.P. transformer. Determine if the two windings of the transformer are in series by reversing one set of terminals. The highest signal pickup shown upon the screen is the correct one. A good method of preventing the coil from coming out is to solder a piece of old dial band to the case across the open end of the E of the laminations. This makes a handy gadget.

Another accessory which may prove of great benefit is something of the same order as that just described but instead of E laminations, C laminations are used with the coil on one leg of the C. This may be used for determining the angle necessary to set an A.F. component for minimum hum pickup or in determining the direction of equal magnetic potential in the chassis so that this may be accomplished.

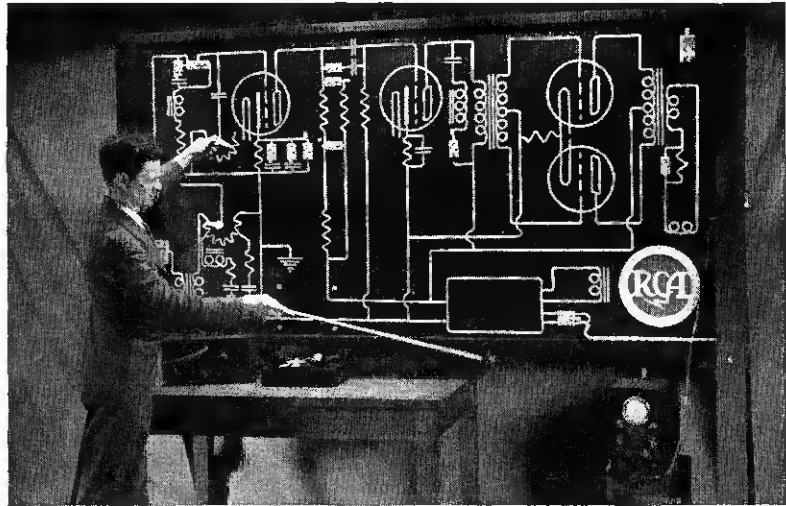

IT COMES OUT HERE—With the aid of this unique board, RCA service engineers are able to demonstrate at the new series of service meetings both visually and audibly a variety of conditions pertaining to audio circuits. The real circuits are wired behind the board. The effect of circuit changes can be heard in the speaker concealed behind the monogram.

AUTO-RADIO Condensers



- ★ AEROVOX auto-radio noise-suppressing units are built better than is deemed necessary.
- ★ That's why they permit super-sensitive auto radio to operate at maximum sensitivity and volume, with minimum background noise.
- ★ Of special construction to meet severest conditions of high temperature, extreme mechanical vibration and exposure to weather.
- ★ Generator units, dome-light filters, ammeter by-pass units, oil-filled vibrator condensers, etc.
- ★ Typical of the completeness and the quality of the AEROVOX LINE.

Write for latest catalog. Lists all types of auto-radio condensers as well as every other type of essential unit. Sample copy of Research Worker included.

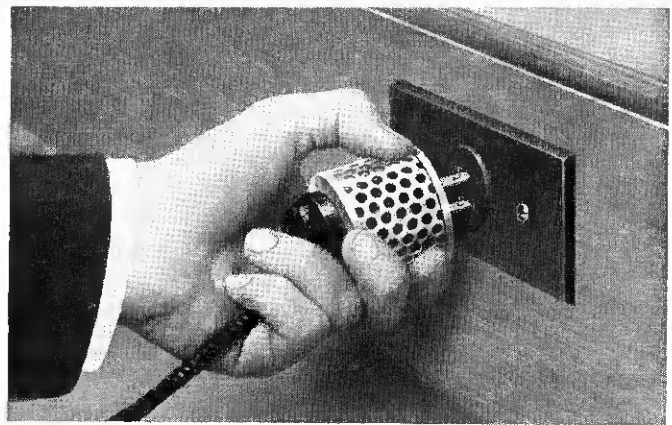

VITROHM Line Voltage Reducer PROTECTS THE SET FROM OVER VOLTAGE

The way line voltage is being stepped up it is no wonder that you are getting kicks because resistors, condensers and tubes are burning up. You can not only answer embarrassing questions but can turn them into profit by offering the kicker this inexpensive unit that brings too high voltage down to safe limits. Write today for folder No. 1480 and prices.



WARD LEONARD ELECTRIC CO.
35 SOUTH STREET, MOUNT VERNON, N. Y.

Please send me Folder No. 1480.

Name

Street

City State

Jobber

20,000 OHMS PER VOLT!

A new HIGH in Sensitivity and Value

At 20 000 ohms per volt, this new Simpson Set Tester is the most remarkable value ever offered to the service man. Negligible current consumption means accurate D. C. voltage readings of 2.5—10—50—250—1000. Same ranges for A. C. at 1000 ohms per volt. Current readings from 1 microamp to 500 milliamps. Accurate resistance readings as low as 1 ohm up to 40 megohms. Ask for new circular covering wide range of tests.

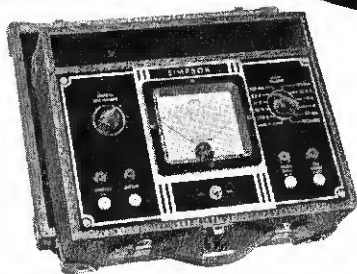

Model 250 (20,000 ohms per volt model)—Net Price... **\$38.50**

Time price: \$8.00 down and 6 monthly payments of \$5.85 each

Model 225 (10,000 ohms per volt model)—Net Price... **\$29.50**

Time price: \$6.00 down and 6 monthly payments of \$4.50 each

Illuminated Dial Tube Tester

Checks all tubes under individual load conditions utilizing latest authoritative circuit. Tube quality shown on illuminated scale. Separate scales for "Diodes" and 0-100 percentage scale for matching tubes. Spare sockets provide for future tube changes. Has neon-tube short check. A beautiful instrument that boosts tube sales.

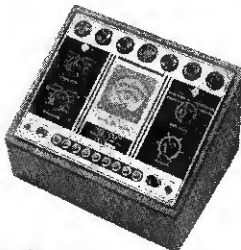

Model 222 Tube Tester—Counter or portable type—Net Price... **\$39.50**

Time price: \$8.00 down and 6 monthly payments of \$6.20 each

"Roto-Ranger" Tube and Set Tester

"Roto-Ranger" feature places twelve distinct scales at finger tips. Utilizes latest tube testing circuit. Has filament return selector. Tests all types condensers on separate scales. Has separate resistance scales of 100 ohms, 100,000 ohms, 100 megohms. Three D. C. scales of 8—300—1000 Volts. (2500 Ohms per Volt.)

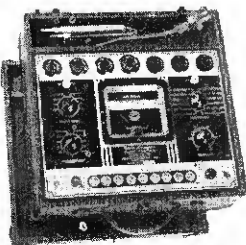

Model 220—Net Price... **\$57.00**

Time Price: \$11.40 down and 6 monthly payments of \$8.75 each

"Roto-Ranger" Volt-Ohm Milliammeter

Incorporates Simpson "Roto-Ranger" feature with twelve separate scales covering all ranges for practical servicing. Model 201 with D. C. ranges only: Net Price... **\$29.50**

Time Price: \$6.00 down and 6 monthly payments of \$4.50 each

Model 202 (A. C.-D. C. type): Net Price **\$32.50**

Time Price: \$6.50 down and 6 monthly payments of \$5.00 each

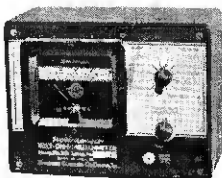

SOLD ON DEFERRED PAYMENTS

SIMPSON
RADIO INSTRUMENTS
AND SERVICE EQUIPMENT

ASK YOUR JOBBER

COUPON BRINGS FACTS

Simpson Electric Co., 5216 Kinzie St., Chicago

Send bulletin describing models checked.

No. 250 No. 225 No. 222 No. 220 No. 201 No. 202

Send deferred payment application.

Name _____

Address _____

TRIAD

THE CHOICE OF SERVICEMEN BECAUSE THEY ARE USED BY LEADING SET MANUFACTURERS.

TRIAD MANUFACTURING CO.

PAWTUCKET INC. RHODE ISLAND
THE QUALITY NAME IN RADIO TUBES

Electronic REPLACEMENT Vibrators ... and CONVERTERS



Electronic products have the quality and stamina required of highly efficient power supplies. The line is complete.

World's Largest Exclusive Manufacturer Vibrators and Vibrator Power Supplies

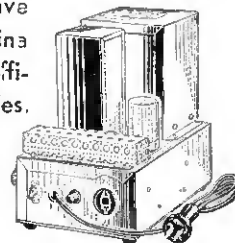

ELECTRONIC LABORATORIES, INC.
Dept. RR337, Indianapolis, Ind.

Meissner Dual Universal WAVE-TRAP



- ELIMINATES
- Blanketing by Powerful, Nearby Broadcasting Stations
 - Cross-modulation
 - Long-wave Signals
 - Code Interference
 - Broad Tuning
 - I.F. Interference

DEALERS:—You can boost your profits and save service calls by selling this unit with every set sale. Keep our dealer display card where your trade and salesman cannot miss it!

Sold by All Leading Jobbers

MEISSNER MFG. CO.
Mt. Carmel, Illinois

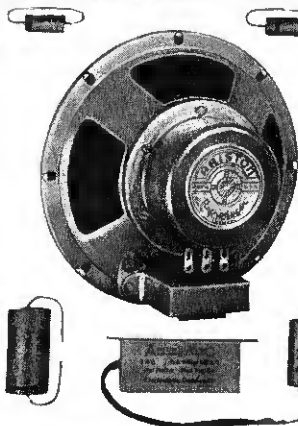

ARISTON

electrolytic and permanent-magnet dynamic speakers, electrolytic condensers, and by-pass condensers are of uniformly high quality—and are made to give consistently satisfactory service.

Order from your jobber or write us for catalog and detailed information.

ARISTON MFG. CO.
4049 W. Diversey Avenue,
CHICAGO, ILLINOIS

AIRLINE T.R.F.

Poor tone . . . connect a 10,000 ohm resistor across primary of p.p. input. Also .02 mfd from plate terminal of primary to one side of secondary.

AIRLINE 1955

Intermittent . . . replace .01 mfd. coupling condenser between oscillator plate and grid. This condition can be checked by testing for oscillator signal.

AIR MASTER A.C., D.C.

Distortion on low volume after heating . . . Replace .01 condenser from screen of 6C6. Check 43 tube, sometimes this tube is responsible for mushy tone even though it tests O.K.

A.K. 275

Bad hum . . . Connect a lead from common ground point to chassis. This set does not use the chassis as a ground return, consequently stray currents picked up in the shields and chassis are carried around to all parts of the circuit.

A.K.

Flat ribbon drives can be replaced with phosphor bronze dial cable. Solder cable to pin on pulley that originally went through belt.

BRUNSWICK 15

Noisy, changes volume . . . replace 35,000 ohm screen grid resistor.

BRUNSWICK 15

Oscillation . . . open .1 mfd. condenser across speaker socket. This condenser in condenser pack, green leads.

CROSLEY 30S, 31S, 33S, 34S

Apparent shorted coupling condenser . . . Check socket prongs to ground. Chassis socket holes sometimes are too small to clear prongs.

CROSLEY 72AF

Oscillator will not track . . . replace mica condenser connected across oscillator trimmer. Condenser open or making poor contact.

CROSLEY 610

Fading, hum . . . loose rivet on filament centertap resistor. Remove resistor and clamp rivet tighter in vise.

G. E. A-67

Poor tone and distortion . . . change output grid resistor from 500,000 to 150,000 ohms.

KADETTE 1200, 2200

Distortion on strong locals . . . no a.v.c. is incorporated in original wiring causing first detector to overload. Insert .0001 mmf condenser between grid of this tube and condenser gang. Also connect 2 meg. resistor from grid to ground and 1 meg. from grid back to i.f. transformer side of second detector load resistor. This procedure will supply an a.v.c. voltage to first detector.

MAJESTIC 15

Irregular volume, dead spots . . . replace G51 tube with '24 and ground cathode.

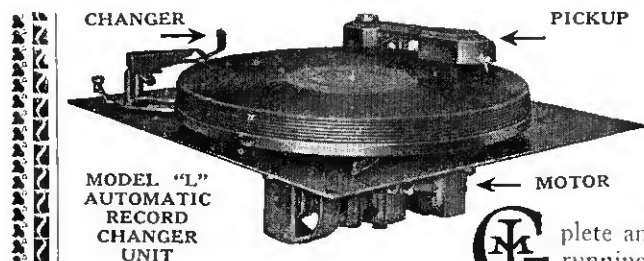

Order Test Samples NOW!

Model "L" plays and changes EIGHT 10-in. or SEVEN 12-in. records. Model "K" plays EIGHT 10-in. records; plays 12-in. records changed by hand . . . When ordering be sure to specify exact voltage and frequency of current you use.

Automatic Playing Sells Combinations

Offer your customers automatic playing radio phonographs at prices they want to pay. Equip with General Industries ready-assembled record changing units. Complete and ready for easy, inexpensive installation. Silent, smooth-running, accurate, self-starting two-speed motor, including turntable. Instantly adjustable at 33 1/3 or 78 R.P.M. Latest flat-type, flexible, balanced pickup. Simple, reliable changer mechanism. Precision-built throughout, assuring long service without repairs.

Send for FREE Trial Package of TRUETONE Needles

The GENERAL INDUSTRIES CO. 3737 TAYLOR ST., ELYRIA, OHIO

FOR CONDENSER SATISFACTION DEMAND

RED HEADS

CONSOLIDATED CORPORATION
CHICAGO • ILLINOIS, U. S. A.

ALL TYPES FROM YOUR DEALER

FOX SOUND EQUIPMENT

The choice of radio engineers. Sells on demonstration and stays sold because it "stays on the job," rendering long satisfactory service.

- Fox One-Piece Metal Diaphragm
- Fox Electro Dynamic Unit
- Fox Aluminum Trumpet Horns
- Fox B-5 Universal Baffle Type Horn
- Fox Low Level Speaker

Write for catalog sheets and prices on complete line. It points the way to greater profits.

FOX SOUND EQUIPMENT CORP.
3121 Monroe St. Toledo, Ohio



As business paper publishers for over fifty years, McGraw-Hill is uniquely equipped to offer complete, authoritative direct mail coverage of industry's major markets. Extreme accuracy is maintained (guaranteed to 98%) and thorough careful analysis of markets, complete classification of companies and personnel, etc., the widest possible selections are available. Send for handy reference folder "Hundreds of Thousands of Reasons Why" which describes how McGraw-Hill Lists are built and maintained.

What Fields Do You Want to Reach?

- Aviation
- Bus & Electric Railways
- Civil Engineering and Construction

- Administrative Executives
- Electrical Dealers & Wholesalers
- Mill Supply Houses
- Power Services
- Product Engineering & Design
- Production and Maintenance
- Radio Dealers & Wholesalers
- Radio Engineering & Design

For further details, selections from above basic classifications, counts, prices, etc., or estimates on special lists . . . ask any representative or write to



Complete Lists Covering Industry's Major Markets

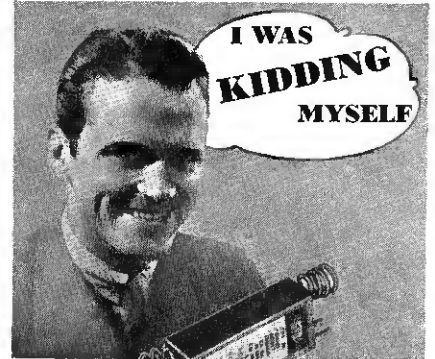

Now I standardize on C-D condensers

"There was a time when I would watch pennies! But the couple of pennies I "saved" by using low quality replacement parts for servicing proved mighty expensive. Disgruntled customers . . . free repeat calls . . . loss of goodwill . . . these are only a few of the results of my "savings."

Today I use only the finest replacement parts that money can buy. I have found that I keep my customers longer, get a good portion of my business through recommendations and I don't lose money on free repeat calls.

Yessir! I standardize on Cornell-Dubilier condensers. They're the "tops." I don't kid myself any longer—I know that the best is the cheapest in the end.

FOR MORE THAN TWENTY-SEVEN YEARS CORNELL-DUBILIER HAS BEEN THE WORLD'S LARGEST EXCLUSIVE MANUFACTURER OF CONDENSERS.

Send for complete catalog No. 137A today!

MICA — DYKANOL — WET & DRY ELECTROLYTIC PAPER

CORNELL-DUBILIER CORPORATION
1019 Hamilton Blvd. So. Plainfield, N. J.



A TRIUMPH

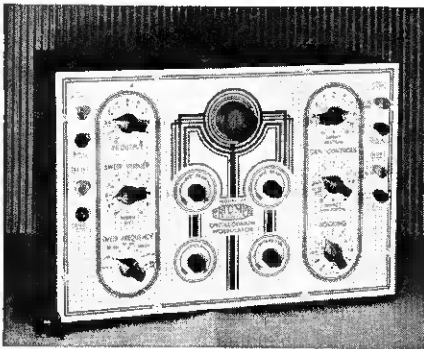

Cathode Ray OSCILLOGRAPH WOBBLATOR

Model 77
2 Instruments FOR the cost of 1

Model 77 combines in one instrument both an electronic Wobbulator and a 913 Oscillograph. A linear sweep, synchronous locking, horizontal and vertical amplifiers and full beam controls are also included. The combination permits visual alignment of r.f. and i.f. tuned stages, flat topping, and adjustments of AFC and AVC circuit constants.

Model 77 used without the Wobbulator, may be employed to locate audio distortion, the cause of intermittent reception and measure audio gain. It will identify auto vibrator trouble with absolute certainty. Functions of a vacuum tube voltmeter may be performed with this versatile Oscillograph such as measuring transformer ratios, hum voltage, power factor and capacity of condensers, percentage of modulation and phase relationships. Any Signal Generator may be used with the Model 77 Oscillograph and Wobbulator.

Model 77 is supplied complete with its six tubes in a portable carrying case, 13 3/4" x 9 1/2" x 8" deep. Wt. 13 lbs. Finished in ivory and black with red pointer knobs and universal, colored binding posts, the Model 77 presents a strikingly attractive appearance. Instructions and circuit diagram available on request.



Triumph Instruments Cost Less

- Model 820 1" Oscillograph with 15 to 35,000 cycle linear sweep, dual amplifiers, synchronous locking, and 4 beam controls, your best buy — **\$39.95**
- Model 800 3" Oscillograph with 15 to 50,000 cycle linear sweep, dual amplifiers, synchronous locking, and 4 beam controls, Lab. style, only **\$63.60**
- Model 180 Electronic Sweep test oscillator for use with any type oscillograph. Copied but unbeatable, Triumph Wobbulator— **\$46.00**
- Model 120A Signal Generator Direct reading dial, calibrated micro-volt attenuation, no leakage, 100 kc to 75 mc on fundamentals, 30% Mod. **\$29.95**
- Model 420L New Standardized Tester checks all types of tubes, makes hot leakage, and performance tests. Accurate, reliable, simple. **\$29.95**
- Model 300 Multirange Meter official 1000 ohm per volt factory standard, 6 ac-dc volt ranges, 3 ohm and 2m.a. ranges, portable, handy. **\$15.95**
- Model 310 Volt-ohmmeter for knock about service, 2 ohm and 3 volt ranges at 1000 ohms per volt. **\$7.85**

TRIUMPH MFG. CO.

4013 W. Lake Chicago, Ill.
Please send catalog and FREE data on "How to Operate An Oscillograph."
Name Address
City State

MAJESTIC 380

Low volume, hum . . . check G57 AS and G58AS tubes. These tubes cannot be replaced with G57S or G58S. The "AS" series are 6.3 volts at .4 amp. filaments.

PHILCO TRANSITONE 5, 10

No voltage, vibrator tubes and filter check o.k. . . . replace .01 mfd. condenser connected between plates of 84 tube.

PHILCO 19-89

Intermittent, returns to normal when line switch is cut on and off . . . re-solder oscillator cathode bypass condenser. Poor joint causing intermittent.

PHILCO 45

Low volume during warmup, then increases . . . replace wave trap.

PHILCO 60

Motorboating . . . cut green lead from bypass can to trimmer condenser. Connect 0.1 mfd. 600 volt condenser from trimmer to ground.

PHILCO 80

Loose rotor on condenser gang . . . Remove assembly and take off rear bearing plate. Center punch the depression on this plate so that it protrudes further against shaft. If plates are out of line when the unit is assembled they can be realigned by loosening set screws holding them to shaft.

PHILCO 89B

Low volume and noisy . . . defective second I.F. transformer. This unit will check o.k. on voltage test.

PHILCO 116

Intermittent oscillation over entire dial . . . replace 10,000 ohm resistor in voltage divider section. To test, turn volume up full, tune off station and tap resistor, listen for crackle. This resistor is diagram #96 part #3524.

PHILCO 623

Low volume . . . replace '30 second detector even though original tube tests O.K. Grounding the grid of the '34 through a 1 meg. resistor will also increase volume.

PHILCO T-11

Boomy tone . . . replace 0.1 m.f.d. tone control condenser with .01 m.f.d.

RADIOLA 50, 80

Distortion . . . replace 110,000 ohm resistor from B plus to cathode of second detector. This resistor decreases in value and supplies excess bias voltage to this tube.

RCA 233

Ballast tubes burn out quickly . . . replace ballast with 125 watt house lamp. This is a 32 volt set and will receive the correct filament voltage when the 125 watt lamp is substituted for ballast.

RCA-VICTOR C11-1

Set changes volume badly when speech-music control is varied . . . Install new capacitor pack. This pack is on the front of the chassis and connects to both volume and speech-music controls.

RCA M101, M104, M108, M109

Noisy . . . Replace leads from stators of condenser gang to grid caps.

IT'S *Easy* TO SELL!

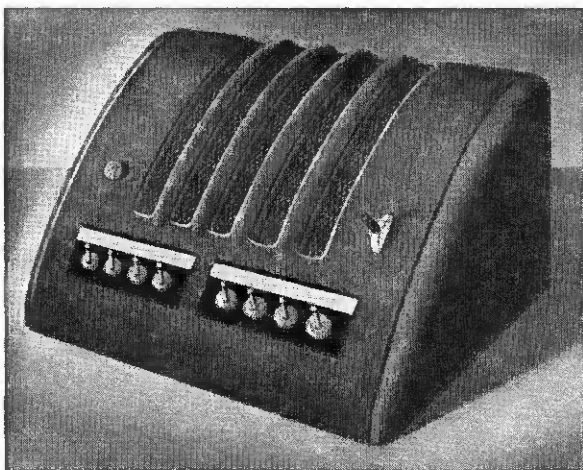

● HERE'S the Techna-Talk Intercommunicating or call system that will increase your profits and please customers. Installation is simple—no special engineering necessary to meet ordinary conditions. Easily adapted to either selective or non-selective systems serving two to eleven stations. Write or wire for details on this business builder. Some exclusive sales territories still open.

TECHNA Corporation
926 Howard Street San Francisco, Calif.

TRYING TO GET BY WITH ONLY SIX RIDER MANUALS "I SAVED" TEN DOLLARS—BUT



It is poor "economy" which prompts a serviceman to try and "get by" without a complete set of seven Rider Manuals. For the profit from only one additional tube sale a week, your set of Rider Manuals can be kept up-to-date.

YOU NEED ALL SEVEN VOLUMES

RIDER MANUALS
NOW IN SEVEN VOLUMES

- Vol. VII—1600 PAGES—\$10.00—Covering 1936-37
- Vol. VI . . . \$7.50—1935-36
- Vol. V . . . \$7.50—1934-35
- Vol. IV . . . \$7.50—1933-34
- Vol. III . . . \$7.50—1932-33
- Vol. II . . . \$6.50—1931-32
- Vol. I . . . \$7.50—1920-31

OTHER RIDER BOOKS THAT SHOULD BE IN YOUR LIBRARY

SERVICING SUPERHETS
Revised edition just published shows how to make superheterodyne repairs quickly. 288 pp., \$1.00

CATHODE-RAY TUBE AT WORK—Complete, practical, written for servicemen. Information on Oscillograph, etc. \$2.50 335 pp. 450 ill.

- "AN HOUR A DAY WITH RIDER" BOOKS
- ON AUTOMATIC VOLUME CONTROL will speed up your AVC work. 96 pp.—65 ill.—hard cover—60c
- ON RESONANCE & ALIGNMENT. You need this! 96 pp.—48 ill.—hard cover—60c
- ON D-C VOLTAGE DISTRIBUTION IN RADIO RECEIVERS. How d-c voltages are led to tube elements, etc. 96 pp.—69 ill.—hard cover—60c
- ON ALTERNATING CURRENTS IN RADIO RECEIVERS—Out in March—60c

ALIGNING PHILCO RECEIVERS—New! Authentic instructions for aligning ANY of the 8,000,000 Philcos. Over 160 pp. Only . . . \$1.00

JOHN F. RIDER, Publisher, 1440 Broadway, N. Y. C.

the New
RED TOP
 GAS-O-LECTRIC
 POWER PLANTS

**YOUR CUSTOMERS
 Want ELECTRICITY**

Here is an exclusive dealer-jobber line of portable light plants priced for quick sales and big profits. The new RED TOP!

A necessity on millions of farms, trailers and wherever "city" electricity is not available. Provides instant power for electric lights, radios, electrical equipment and appliances. Combination A.C. and D.C. or D.C. only. Liberal discounts assure long profits. Mail coupon for information at once.

COMBINATION A. C. — D. C. PLANTS

In one plant—both 110-V., A.C., 300 watts for lighting, household appliances, small electric tools, pumps, etc.; and up to 325 watts D.C., for charging 6, 12, and 32-V., batteries. Prices from \$89.95 up, F.O.B. Chicago. Push button starter.

PIONEER GEN-E-MOTOR CORPORATION, CHICAGO, ILLINOIS

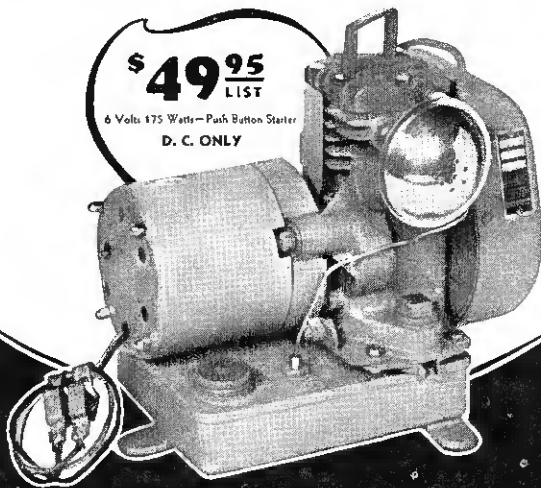

\$49.95
 LIST

6 Volts 175 Watts—Push Button Starter
 D. C. ONLY

Go **RED TOP!**
 THE COMPLETE EXCLUSIVE DEALER-JOBBER LINE

PIONEER GEN-E-MOTOR CORPORATION
 Dept. R-1C 466 West Superior Street, Chicago, Illinois
 Please send me complete information on the new RED TOP
 Gas-O-Lectric Plants.

NAME.....
 ADDRESS.....
 CITY..... STATE.....

MAIL COUPON NOW!

BROWN DEVIL WIRE WOUND
 RESISTORS



*Built to
 Stand Up*
says Bill Fruit

Brown Devils make ideal replacement resistors. They are built exactly like the big OHMITE industrial units . . . wound on a porcelain core and covered with the specially developed vitreous enamel which insures evenly spaced winding. That's why they eliminate profitless "call-backs".

Tinned lead wires make for easy installation. 10 and 20 watt sizes; resistance values through 100,000 ohms. Ask your jobber or get Catalog 16—FREE!

OHMITE

MANUFACTURING CO.

4845 Flournoy St., Chicago, Ill.



MANUFACTURERS
 OF
 RHEOSTATS,
 RESISTORS AND
 TAPSWITCHES

The **RADIO**
STETHOSCOPE
 ONLY ONE OF 15 **R-T-L** FEATURES

At right—Portable Tester. Compartment for tools, tubes and repair parts. Overall size of case, 5" x 12" x 17". R-T-L Counter Tester Models also available.

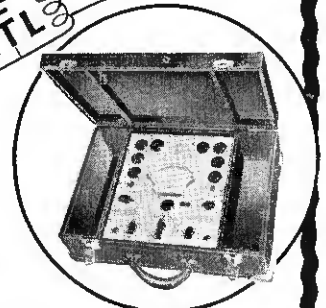

THE RADIO TUBE "STETHOSCOPE", an R-T-L feature, provides an audible check on tube noises caused by loose elements and intermittent shorts. Let your customer listen to the earphone while you watch the neon. He hears the noise while you see it. Easily the hit of the year in advance tube selling. Just one of fifteen R-T-L advantages!

ASK
 for
 FOLDER

The Radiotechnic Laboratory

1328 SHERMAN AVE. Dept. RT. EVANSTON, ILL.



A Complete Line of
 Tube Test **R-T-L** Equipment

SEE
 YOUR
 JOBBER

RADIOTECHNIC



"Have You Seen
the
3 NEW SPRAGUE
UNIVERSAL
REPLACEMENTS?"

SPRAGUE

The Standard of Condenser Quality

"With these handy new Sprague Universal Replacement Condensers you are ready for quick, accurate service on hundreds of different radios:

TYPE BT-100 . . . (Rectangular Type—8 leads) has three 8 mfd. sections (8-8-8, 200 volts) also two 5 mfd. sections (5-5, 25 volts). Gives you many needed combinations such as 8-16; 12-16; 10-16; 5-20, etc., etc. 5 mfd. sections may be used as single 10 mfd. List Price \$2.50, Net \$1.50.

TYPE ST-10—Same as BT-100 except in rectangular cardboard casing with mounting lugs. List Price \$2.50, Net \$1.50.

TYPE BT-1 . . . Three sections (5-10-25 mfd. all 150 volts) six leads give you any needed combinations of these capacities. List Price \$1.95, Net \$1.17. See them at your jobbers—Write for Catalog

SPRAGUE PRODUCTS CO., North Adams, Mass.

SUCCESSFUL in
PERFORMANCE.. DESIGN..
CONSTRUCTION.. SALES..
say leading P.R. men

AMPERITE VELOCITY

ACHIEVES
UNIQUE RECORD
IN ACTUAL USE



Featuring . . .

1. Output increased 6 DB.
2. Triple shielded—against all RF or magnetic fields, entirely eliminating hum pickup.
3. Eliminates feedback troubles.
4. Excellent for close talking and distant pickup.
5. Acoustically designed to eliminate any possibility of cavity resonance.
6. Fitted with switch and cable clamp.

NEW! MODELS RBHn (High Impedance); RBMn (200 ohms), with Cable Connector and Switch—

\$42.00 LIST

NEW! MODELS RBSn, RSHn, streamline; slightly lower output and frequency range than above, with switch only—

\$32.00 LIST

Models RAL (200 ohms); RAH (2000 ohms). Built to Amperite standards: No peaks. Flat response. Triple shielded. Shock absorber. Swivel bracket—

\$22.00 LIST

Finishes: All microphones have the new standard Gunmetal Finish, Available in Chrome, extra. \$1.00 List.

FREE: WINDOW DECAL, advertising your SOUND SERVICE. Four-color design, 5 1/4 x 9 3/4. Write for it now.

AMPERITE Co. Cable Address: Alkern, New York
561 BROADWAY NEW YORK

AMPERITE Velocity MICROPHONE

RCA VICTOR 15K

Magic eye inoperative, lights up but does not close . . . movable arm of tuning tube control shorting to metal cover. Due to the design of this control the clearance at this point is very small when the arm is put under tension. Take control apart and bend arm so it clears.

RCA-VICTOR R50, R55, RAE59

Distortion and lack of volume . . . Check primary of interstage transformer. The winding with the yellow lead opens up. Disconnect the yellow lead from the number 5 terminal on the 8-terminal strip of powerpack. Continuity test will probably show open or high resistance.

STEWART WARNER R-116X

Weak and distorted . . . Shorted 0.1 mfd. condenser between positive terminals of electrolytic condensers shorting speaker field. Replace with 600 volt unit.

STEWART WARNER R 149

Hum on stations . . . connect 6K7 and 6J7 screen grids together. Remove .01 mfd. condenser and 110,000 ohm resistor connected to i.f. circuit.

U. S. 24

Volume control ineffective on strong signals . . . Replace control with good left hand tapered 5000 ohms carbon control and reverse center and high leads. In the original the antenna went to center arm.

WESTINGHOUSE WR24

Noisy, when walking across floor or bumping the set . . . Socket prongs lose their tension and fail to make good contact with tube pins.

ZENITH 50

Loud hum, all parts and tubes check O.K. . . . Connect a .25 meg. resistor between grids of second audio stage.

ZENITH 12U158-159

Distortion at low volume . . . replace 1 watt 400 ohm cathode resistor on 6F6 with 5 watt wire-wound unit. Check cathode bypass condenser for leakage.

No reception on lowest wave band . . . untwist grid lead wires from screw on gang condenser. Realign, using .0001 mfd. mica condenser from oscillator to antenna.

Weak reception, high noise level . . . check r.f. alignment, also fixed condenser grouped around volume control.

"Sure! . . . and do
you know Sprague
has the biggest list of
EXACT DUPLICATE
REPLACEMENTS?"

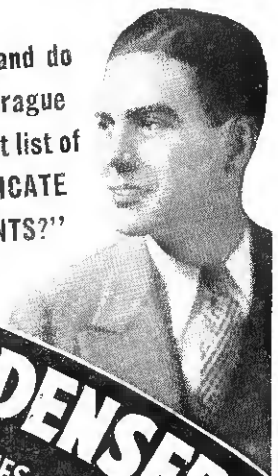

CONDENSERS

USE SPRAGUES . . . and Note the Difference

"If you were to visit us here in North Adams you'd be amazed at the thousands of condenser types we are making regularly. As a matter of fact, there is hardly a radio receiver manufactured of any size who isn't using Sprague Condensers today. That's why our list of exact duplicate condenser replacements is so amazingly large—why you can call on us for any condenser you'll ever need in radio amateur or service replacement work. Round, square, dry or wet, special shapes, special mounting, unusual types no matter what your requirements, we can supply 'em. Try Sprague First!"

Sincerely, *Henry Kalkul*
Sales Manager,

SPRAGUE PRODUCTS CO., North Adams, Mass.

"BULLET" DYNAMIC MICROPHONES

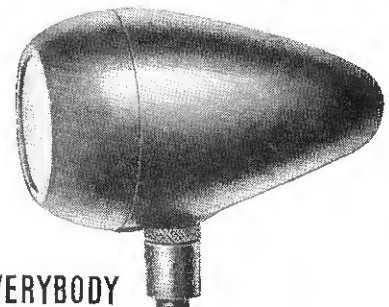

EVERYBODY
WANTS ONE . . . EVERYBODY
CAN AFFORD ONE!

The All-Purpose "Bullet" Dynamic Microphone is sweeping the 1937 market.

T. R. 3—New Model "Bullet" . . . smaller than TR 2 but with relatively the same characteristics. List price, any impedance . . . \$24.50.

T. R. 2—Standard Model "Bullet" . . . the ultimate in dynamic microphone performance. List price, any impedance . . . \$39.50.

Write for circular "T" and technical data

TRANSDUCER CORPORATION

30 Rockefeller Plaza
New York, New York

INDEX TO ADVERTISERS

MARCH, 1937

	Page		Page		Page
ABC RADIO LABORATORIES (Short-Wave Converters)	58	HORTON MFG. CO. (Washers and Ironers)	58	SOLAR MFG. CO. (Condensers)	69
AEROVOX CORP. (Condensers)	79	HOWARD RADIO CORP. (Radio Sets)	32	SPRAGUE PRODUCTS CO. (Condensers)	85
AMERICAN TELEVISION & RADIO CO. (Vibrators)	54	HYGRADE SYLVANIA CORP. (Radio Tubes)	31	STANDARD TRANSFORMER CORP. (Transformers)	68
AMPERITE CO., INC. (Microphones)	85	INTERNATIONAL RADIO CORP. (Radio Sets)	23	STEWART-WARNER (Refrigerators)	27
ARCTURUS RADIO TUBE CO. (Radio Tubes)	55	INTERNATIONAL RESISTANCE CO. (Volume Controls)	66	STROMBERG CARLSON TELE. MFG. CO. (Radio Sets)	2
ARISTON MFG. CO. (Replacement Speakers)	80	JANETTE MFG. CO. (Rotary Converters)	54	SUPERIOR INSTRUMENTS CO. (Service Instruments)	69
BELL SOUND SYSTEMS, INC. (P. A. Equipment)	78	KRAEUTER & CO. (Tools)	74	SUPREME INSTR. CORP. (Radio Test Equipment)	70
BENDIX PROD. CORP. (Testing Equip.)	74	KELVINATOR CORP. (Refrigerators)	38	TECHNA CORP. (Sound Systems)	83
BRIGGS & STRATTON CORP. (Battery Chargers)	12	LEONARD ELECTRIC CO. (Refrigerators)	42	TRANSDUCER CORP. (Microphones)	85
BRUSH DEVELOPMENT CO. (Microphones)	56	MALLORY & CO., INC., P. R. Front Cover (Volume Control)		TRIAD MFG. CO. (Radio Tubes)	80
CLAROSTAT MFG. CO. (Volume Control)	77	McGRAW-HILL BOOK CO. (Technical Books)	56	TRIPLETT ELEC'I INSTR. CO. (Elect. Instruments)	64
CONSOLIDATED WIRE CORP. (Condensers)	81	MEISNER ELECTRIC CO. (Wave Traps)	80	TRIUMPH MFG. CO. (Service Instruments)	82
CONTINENTAL CARBON CO., INC. (Filters)	76	MUELLER ELECTRIC CO. (Wire Clips)	56	TUNGSOIL RADIO TUBES, INC. (Radio Tubes)	78
CORNELL DUBILIER CORP. (Condensers)	82	NATIONAL UNION RADIO CORP. (Service Instruments)	76, 77	UNIVERSAL CONTROLS, INC. (Remote Control)	78
CORNISH WIRE CO. (Antennas)	58	NOBLITT-SPARKS IND., INC. (Auto-Radios)	53	UNIVERSAL MICROPHONE CO. (Recording Equipment)	58
CROSLEY RADIO CORP. Inside Back Cover (Radio Sets)		NORGE DIVISION, BORG-WARNER (Refrigerators)	40	UTAH RADIO PROD. CO. (Replacement Speakers)	72
CROSLEY RADIO CORP. (Refrigerators)	4-5	OHMITE MFG. CO. (Resistors)	84	WARD-LEONARD ELEC. CO. (Replacement Parts)	79
EDISON G. E. APPLIANCE CO. (Refrigerators)	10, 11	ONAN, D. W. (Electric Plants)	54	WARD PRODUCTS CO. (Auto Antennas)	56
ELECTRICAL PRODUCTS CO. (Battery Eliminators)	59	OPERADIO MFG. CO. (Sound Systems)	51	WEBSTER-CHICAGO (Sound Equipment)	76
ELECTRICAL MERCHANDISING (Publication)	48	PARRIS-DUNN CORP. (Wind Electric Plants)	62, 63	WEDGE MFG. CO. (Car Antennas)	58
ELECTRO-ACOUSTIC PROD. CO. (Sound Systems)	54	PIONEER GEN-E-MOTOR CORP. (Wind-Electric Chargers)	84	WESTERN ELECTRIC CO. (Microphones)	59
ELECTRONIC LABORATORIES	80	RADIO & TECH. PUBL. CO. (Service Manuals)	74	WILLARD STORAGE BATTERY CO. (Storage Batteries) Inside Front Cover	
EMERSON RADIO & TELEVISION CORP. (Radio Sets)	3	RADIO CORP. OF AMERICA (Sound Engineering)	44, 45		
FADA RADIO & ELEC. CO.	9	RADIO TECHNIC LABS. (Instruments)	84		
FOX SOUND EQUIP. CO. (Sound Equipment)	81	RAYTHEON PRODUCTION CORP. (Radio Tubes)	36		
FREED MFG. CO. (Radio Sets)	58	R C A MFG. CO. (Radio Sets)	8		
GALVIN MFG. CO. (Auto Radio Sets)	6	R C A MFG. CO. (Commercial Sound)	57		
GENERAL ELECTRIC CO. Back Cover (Radio Sets)		READRITE METER WORKS (Tube Testers)	72		
GENERAL INDUSTRIES CORP. (Phonograph Motors)	81	RIDER, JOHN F. (Service Manuals)	83		
GREBE MFG. CO. (Radio Sets)	61	SERVEL, INC., ELECTROLUX DIV. (Refrigerators)	47		
GLOBE-UNION, INC. (Batteries)	52	SIMPSON ELECTRIC CO. (Service Instruments)	80		

SEARCHLIGHT SECTION

(Classified Advertising)

Classification	Page
CATALOGS	87
SERVICEMEN'S SPECIALTY Akrad Products Co.	87
RADIO STOCKS	
Allied Radio Corp.	87
Apparatus Design Co.	87
Dymac Radio	87
Radolek Co.	87

McGRAW-HILL PUBLISHING COMPANY, INC. Publication Office: 99-129 North Broadway, Albany, N. Y. Editorial and Executive Offices: 330 West 42d Street, New York, N. Y. Branch Offices: 520 North Michigan Avenue, Chicago; 833 Mission Street, San Francisco; Aldwych House, Aldwych, London, W. C. 2; Washington; Philadelphia; Cleveland; Detroit; St. Louis; Boston; Atlanta, Ga.

SEARCHLIGHT SECTION

EMPLOYMENT and BUSINESS OPPORTUNITIES—SURPLUS STOCKS—DISCONTINUED MODELS

UNDISPLAYED—RATE PER WORD:

Positions Vacant and all other classifications, 15 cents a word, minimum charge \$3.00.

Positions Wanted (full or part-time salaried employment only) 1/2 the above rates, payable in advance.

(See ¶ on Box Numbers.)

Proposals, 50 cents a line an insertion.

INFORMATION:

Box Numbers in care of our New York, Chicago and San Francisco offices count 10 words additional in undisplayed ads. Replies forwarded without extra charge.

Discount of 10% if one payment is made in advance for four consecutive insertions of undisplayed ads (not including proposals).

DISPLAYED—RATE PER INCH:

1 inch \$8.00
2 to 3 inches..... 7.50 per inch
4 to 7 inches..... 7.00 per inch
Rates for larger spaces, or yearly rates, on request.

An advertising inch is measured vertically on one column, 3 columns—30 inches—to a page. Radio Retailing

The Leading
RADIO
PARTS and EQUIPMENT DEALER
in Buffalo, N. Y.
is
DYMAC RADIO 216 E. Genesee St.
Phone: CL 2080

YOU ARE ONE

of more than 20,000 readers of RADIO RETAILING.

Your problems of selling radio sets, accessories and other home merchandise—whether business or individual—are duplicated with other readers, but—

Still OTHER readers can provide the solution of your problem IF THEY KNOW WHAT IT IS!

Tell them! Here!

Through classified advertising in the Searchlight Section of RADIO RETAILING—your business paper and theirs.

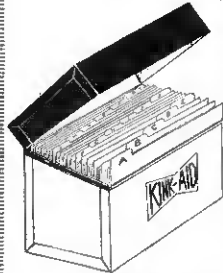

SERVICEMEN

More than 3000 filed and indexed service kinks to repair those hard-to-fix home and auto radios. Just pull out the card corresponding to the name and model of the set you are repairing, and there you have listed the service troubles found in that radio and how to fix them.

NEW, REVISED KINK-AIDS

- Filled by set name and model number
- Printed on 250 wear-resisting cards
- Enameled steel cabinet, bench size, free
- Supplements issued quarterly

Send postpaid for only..... \$1.95

Note: Holders of last year's edition may purchase up-to-date supplement for 35c

FREE: Send for Bulletin RR-3 and sample cards

Jobbers: Write for attractive proposition

AKRAD PRODUCTS COMPANY
362 Wooster Ave. Akron, Ohio

1937 TUBES Every Confidence and Unameter TUBE TESTER

can be brought up to date for 1937 octal base and metal tubes by either adapters, Kits, Socket Units or factory re-vamp jobs at very reasonable rates. From \$2.00 up. You cannot obtain proper test data for the new tubes from any source other than this factory. Send for **FREE SERVICE FOLDER** No. 152 which describes fully the requirements to bring every model up to date. Tell your friends who own one of the thousands of Confidence or Unameter testers.

APPARATUS DESIGN CO.
Little Rock, Arkansas

Owned and operated by J. R. Williams & Sons

Newest Radio Developments

**MONTHS
AHEAD!**

in **ALLIED'S**
New Spring Catalog

Write for the new Spring 1937 **ALLIED** Radio Catalog—156 pages packed with interest for every Dealer, Serviceman and Sound Specialist—

Everything in Radio that's new, important—months ahead! More than 10,000 exact duplicate and replacement parts; 53 new Knight Radios, featuring latest console, auto, portable, plastic, and phonograph combination models with Automatic Dialing, Touch-O-Matic Tuning, AFC, Tone Expansion, etc.; Public Address Systems; newest Test Instruments; latest Amateur Transmitting and Receiving gear; dozens of set-builders' kits; books, tools, etc. This great book is loaded with tremendous sales opportunities—send for your **FREE** copy today!

10,000 PARTS



Send for **FREE**
CATALOG

You're always sure of huge stocks, fastest service and lowest prices when you order from the new **ALLIED** Catalog—Radio's Leading Supply Guide!

ALLIED RADIO Corp.

833 W. Jackson Blvd., Dept. 18-C
Chicago, Ill.

Send me your new Spring 1937 **ALLIED** Catalog.

Name

Address

City..... State.....



STOP SEARCHING! HERE IS YOUR "GUIDE"

Don't Grope Around In The Dark...

Send For This New Radio Buying Guide Today!

Here is the solution to all your radio supply problems... Here is your key to the fastest service... Lowest Prices... and the largest stock of Radio Repair Parts in the world! This Radolek new 1937 Radio "Profit Guide" is the most complete Radio Parts Catalog ever published... over 160 pages... bringing to you over 10,000 individual Repair Parts... hundreds of new items... a complete new selection of Radio Receivers, Amplifiers, Tubes, Tools, Books and Instruments... Everything you need... always in stock... ready for prompt shipment... at the right prices.

YOU NEED THIS BIG CATALOG!

It's FREE! Send this coupon NOW! Radolek endeavors to restrict circulation of the Profit Guide to those actively engaged in the Radio business. Please enclose your business card or letterhead.



RADOLEK

601 W. Randolph St., Dept. A-5, CHICAGO

Name

Address

Serviceman? Dealer? Experimenter?

FASTEST SERVICE

COMPLETE STOCKS

LOWEST PRICES

Rely on Radolek for "Everything in Radio"

Small Town Distribution

Manufacturers, distributors and dealers are greatly in hopes the year 1937 will reap them a large gross business with a nice fat net profit. Why not? The depression is turning that long looked for corner, there is better and more attractive merchandise to sell, and above all, Mr. and Mrs. Public seem to be in a buying mood.

In spite of the fact that the trade is shouting from store top to house top, "better times" I ask the question: "is the small town dealer doomed?" That is a question about 60% of all small town radio and electrical dealers are asking. They are well aware of the answer unless the distributor and manufacturer also becomes interested in the answer to this question.

The key is distribution, that little matter of who can buy from who at wholesale. Let's take an example:

I have in mind a small town of about 1,000 or 1,500 population. Let's say it has a radio and electrical store meeting all requirements of a good dealer. The radio business is fair, the service business fair, the electrical business very poor. There are a lot of radios sold every year in this community, there are a good number of refrigerators, electric washers, etc. sold each year, also, but the dealer sells few. Who sells the rest?

The druggist and his family and relatives buy every electrical item including radio at cost, the hardware dealer likewise. All filling-stations have the same privilege, not to mention a host of others. The dealer talks to his distributor. His distributor advises him that he has given him protection of the radio and electrical merchandise he sells. That's very true, but there are at least a dozen other distributors who sell in this territory, and of whom this dealer does not buy. They can't sell the dealer (he can't possibly handle every line offered) so to produce sales they sell any merchant in town. This is what will eventually kill the small town dealer.

CLAY CENTER, NEB. ROGER H. HERTEL

Tried "Home Rolling"

I have just been reading the last page of your January number. I always read the last page first.

I was quite interested in what Gerald Evans has to say about building your own sets to meet competition as I had a similar idea a few years ago. At that time one of the catalog houses offered a kit for building an eight-tube receiver at a price which looked quite attractive but when I figured the price of the cabinet, tubes, speaker and other accessories I found that the materials would cost me more than I had been paying for a nationally advertised ten-tube set with two speakers.

Then, too, I have never been able to learn how such home-built sets get by

the patent rights. If I could build up sets at a cost which would make it possible for me to sell them at a small profit it would at least give me a pleasant occupation to fill up the dead spots. I am still looking for someone to tell me how it is done.

RICHFIELD SPRINGS, N. Y.

ARTHUR RISLEY

England Speaks

On page 30 of your January 1937 issue you raise the question: "Who was the originator of trailer publicity, selling and display?"

I am open to correction, but I believe the idea originated in England, and was first employed in the introduction of Motorola car radio, by one of the first exponents of car radio in this country, Mr. St. John Chesney, who, I think, is now in U.S.A.

It was through the introductory medium of this particular trailer that about four years ago I acquired my first car radio. That same individual, I believe, first devised the di-pole type of aerial, and employed it, flexibly mounted, for use in open cars.

BALHAM, LONDON, ENGLAND R. BARLOW

Canton, Mass.

Will you kindly send this letter on to the Tobe Deutschmann Company, whose address or advertisement we do not see in February *Radio Retailing*?

We read with interest Mr. Metcalf's article on "Beware Half-Truths About Noise" in the above issue and would like to have more information about the utility interference investigator. We have a good many noise troubles in this town and would like to interest the local power company in getting one.

At the present time they use an auto radio for noise pick-up, which is generally unsatisfactory, particularly as the auto is generally in another part of the district when needed.

SARASOTA, FLA.

C. A. SERVICE, JR.
Service Radio Co.

Flowers for Waller

Your article in the January issue of *Radio Retailing* on the construction of an oscillograph using the 913 tube is one of the finest constructional articles that I have ever come across.

I have constructed this unit, using a slightly different panel layout to accommodate a metal cabinet that I had on hand but the same basic circuit. It works excellent.

I could not refrain from writing to con-

pliment you on this article. Let's have more like it.

GLENFIELD, PENNA.

PAUL TERRY

Comm. Receivers Again

In answer to the letter concerning inability to get satisfactory trade discounts on communication receivers, written in the January issue by R. G. Peele, I wish to say the same thing. I have tried to get into this business but wholesalers and distributors sell communication receivers to anybody at 40 per cent off.

It makes it hard for a radio dealer to make a go of the business when the consumer frequently buys as cheaply.

BRISTOL, CONN.

C. E. HEMENWAY

Ass'n Uses Page

The Phoenix Chapter of the Radio Service Association of Arizona, at a regular meeting, instructed me, as their secretary, to write a letter expressing our appreciation of your page in the November, 1936 *Radio Retailing*: "Why Good Service Can't Be Cheap."

We also took the liberty of reprinting it in our monthly bulletin.

PHOENIX

KENNETH SLOAN

Radio Service Ass'n of Arizona

We are, indeed, glad to have this statement of approval from your Association as it is our sincere desire to publish material that is of practical value to the trade and comment of this kind steers our efforts in the right direction.

EDITOR

Files Each Copy

I have taken your *Radio Retailing* magazine since March 1935 and I find it to be one of the best publications of its kind.

I file these magazines by the year, twelve issues, in my library for future reference on technical data.

I wonder if you could supply me with the two editions of January and February 1935 to complete my files for the year.

N. LITTLE ROCK, ARK.

O. L. HAWLEY

In this case we can supply the two copies requested. This is not true of all issues as many have been completely exhausted.

EDITOR

Reads Every Page

I have just received your latest issue of *Radio Retailing*, a magazine I have been receiving since its first issue and which I think contains the best all around information that is available today.

I start from the first page and read everything from cover to cover.

WASHINGTON

ANTHONY J. ZUGEL

CROSLLEY Brings the Finest HOME RADIO RECEPTION TO THE MOTOR CAR

WITH THESE 2 NEW 1937

CROSLLEY ROAMIO

AUTOMOBILE RECEIVERS



CROSLLEY ROAMIO A-177

In these new 1937 Roamio models Crosley brings automobile radio performance to a new peak of perfection with reception and tone quality that equals that of the finest home radio. This and many other advanced engineering improvements, together with the newly-designed modern cases and custom-built remote controls that match the dash of every modern car, make the Crosley Roamio unquestionably the finest auto radio ever built. 1937 promises to be a record breaking year for car radio sales, and dealers who stock and sell the Crosley Roamio will get the biggest share of this profitable business. See these new Roamio models at your Crosley Distributor's and arrange with him to place them on your sales floor.

Seven tube De Luxe automobile receiver . . . Two unit Superheterodyne with 9 tube effectiveness . . . No spark plug suppressors . . . Seven tuned circuits . . . New automatic volume control . . . Automatic setting of dial logging . . . Three gang tuning condenser . . . Remote control with airplane-type dial to match the dash of all cars, or steering column chrome plated tear drop type control . . . 1 microvolt sensitivity . . . 9 watts output . . . 3" moving coil dynamic speaker with special pressure relief in car giving performance equivalent to large home radio cabinet. Accessories: Special header speaker to mount in GM cars and also another car-level speaker for all other cars for use instead of under-cowl type. A continuously variable tone control and a music-speech switch are also included in the remote control.

CROSLLEY ROAMIO A-167

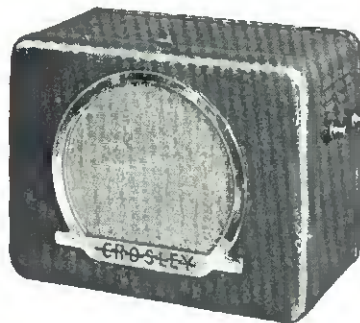

Six tube Superheterodyne . . . single unit automobile receiver with eight tube effectiveness . . . No spark plug suppressors necessary . . . Seven tuned circuits . . . Full wave interruptor type vibrator . . . Special noise reducing automatic volume control on audio system to prevent blasting . . . Automatic setting of dial logging . . . Three gang tuning condenser . . . Full 6 1/2" moving coil dynamic speaker . . . Custom-built remote control with illuminated airplane-type dial to match the dash of all cars . . . or steering column control of chrome plated tear drop type . . . 2 microvolt sensitivity . . . 5 watts output.

. . . WITH CUSTOM-BUILT CONTROLS TO MATCH ANY CAR



Ford



Plymouth



Hudson



Packard



Studebaker



Chrysler

THE CROSLLEY RADIO CORPORATION - CINCINNATI

POWEL CROSLLEY, JR., President

Home of "the Nation's Station"—WLW—70 on your dial

You're **THERE** *with a Crosley Radio*



WATCH THE PROFITS ROLL IN WITH G-E AUTO RADIO

Today, only 4 out of every 23 automobiles on the road are equipped with auto radio—19 million cars without auto radio. What a market! No wonder auto radio dealers are enthusiastic about this year's unequalled opportunity to win new sales and increased profits.

Once Again - - - General Electric leads the auto radio parade. This time with the most complete auto radio program in G-E Auto Radio history. It puts G-E Radio dealers on the fast lane to auto radio sales and profits.

Only GENERAL ELECTRIC OFFERS YOU ALL THESE SALES-MAKING ADVANTAGES

- 1 The ONLY Auto Radio with Automatic Frequency Control—a real contribution to simplified tuning and safe driving.
- 2 A complete Auto Radio line in 3 new models—each a sales leader in its price bracket.
- 3 Dominating Performance . . . Metal Tubes . . . Greater Power.
- 4 "Custom-Built" Instrument Panel Controls for all makes of cars.
- 5 Complete line of Auto Antennas—a new source of business and profits.
- 6 Powerful Sales Promotion Helps.
 Demonstration Stand . . . Folders . . . Wall Charts . . . Banners . . .
 Handbills . . . Auto Door-Handle Hangers! Everything you need for
EASY STARTING and a quick **GETAWAY** to volume sales.

Ask your G-E Radio Distributor—or return the coupon—for full particulars about General Electric **MERCHANDISING DEAL**. It contains **FOUR** of the new G-E Auto Radio **MODELS** plus a complete **SALES PROMOTION SERVICE**. Get set for a record run in sales and profits in General Electric's greatest Auto Radio year.

GENERAL ELECTRIC

Auto Radio

Section R-323
 General Electric Company,
 Radio Division, Bridgeport, Conn.

Please send me complete information about
 the G-E AUTO RADIO 1937 Merchandising Deal.

Name

Firm

Address

City State