

# RADIO RETAILLING

McGRAW-HILL PUBLISHING COMPANY, INC.

25 CENTS PER COPY

*Spotting the features*

THAT HELP YOU MOVE  
RCA VICTOR RADIOS FASTER!



## Number 1

### RCA VICTOR'S MAGIC VOICE

During the past six months, the Magic Voice has proved to thousands that it has removed the last serious obstacle to complete naturalness of music and voice in radio. For the Magic Voice ends "boom", directs all sound forward through the loud speaker. Its completely closed chamber contains five organ-like pipes which eliminate all undesirable tone and which control back waves. This results in increase of low frequency range. The size and position of the pipes in the sound chamber were determined by mathematical calculation after hundreds of laboratory tests. The Magic Voice has given radio a completely new tonal quality. It extends musical range, gives brilliant expression to programs found by RCA Victor's Magic Brain, tuned by the Magic Eye, made more sensitive by RCA Metal Tubes. RCA Victor has spent huge sums of money promoting the Magic Voice—in newspaper and magazine advertising—on the air—with national contests. So keep the Magic Voice in mind. Remember its qualities shown above. Talk about them—and profit!



### THESE 24 EXCLUSIVE RCA VICTOR FEATURES ALSO MEAN FEWER "FIRST YEAR", NON-PROFIT SERVICINGS

Magic Voice; Magic Brain; Magic Eye; Metal Tubes; Worldwide Reception; Super-Fidelity Speakers; Higher Fidelity Tone System; Duo-plane Speaker Mountings; Tone Compensation; Dynamic Expansion; Microtone Control; Music Speech Control; Beam Power Amplifiers; Antenna

Wave Traps; Built-in Antenna Couplers; Automatic Volume Control; Permanent Adjustment; Stabilized Oscillator Circuit; Rubber Floated Chassis and Condensers; Selector Dial; Band Spreaders; Edge Lighted Dial; Record Player Connections; Magnificent Cabinets.

RCA Victor believes the best way to sell *more* radios *faster* . . . to reap richer profit rewards . . . is to offer *extra* quality at moderate cost.

For this reason, RCA Victor urges dealers to become familiar with its 24 great features for finer performance. *Proofs* of quality construction, they are convincing because they are actual *facts*. If you will acquaint yourself with these *extra* RCA Victor qualities . . . *show* these features to your prospects . . . *talk* features to them—you'll move your RCA Victor radios *faster*, *easier* and with more profitable results.

This is the first of a series of advertisements designed to bring you closer to RCA Victor's radio features. Each will "spot" a definite feature—tell you its advantages, so you may do the same when selling direct to a customer. Study this information . . . keep it handy . . . use it . . . to your advantage!



## RCA Victor

RCA MANUFACTURING CO., INC.

Camden, New Jersey

*A Service of the Radio Corporation of America*

### RCA ALL THE WAY

Most broadcasting equipment is built by the Radio Corporation of America. Most power on the air is RCA installed. The newest RCA Victor sets keep the thread of RCA quality unbroken from the microphone to you. They bring you reception to match the fidelity with which RCA equipment and NBC engineering put programs on the air.



**IT** is waiting for you at your Mallory-Yaxley distributor. The biggest help you've ever had—and the easiest to use!

Here's the "All in One" Book for you—all the "Dope". In one book, on one page, on one line, you find the answer for any servicing problem for *any* radio set. When we say "any", we mean "any"—any of over 12,000 different models. All the information on—

Schematics—Circuits    I. F. Peak Frequencies    Volume Controls  
 Condensers    Vibrators    Tubes    Transformer Circuits

## MALLORY-YAXLEY Radio Service Encyclopedia



*Over 200 pages of exact information. Bound in water-proof, washable cloth and printed on paper that stands the gaff... it is a permanent working reference.*

It's practical—educational. For the first time, accurate, detailed instructions are given on the thousands of receivers that ordinarily are headaches to the most experienced Service engineers. No need now to worry about the tough ones. This book always gives the correct answer. What's that worth to you? Boy, the sky is the limit.

Get it and you will discard all the jumbled mass of incomplete and often inaccurate data that now clutters up your desk. What a life saver in time and energy! There's just no limit to its value to your business.

We have prepared this Encyclopedia for you. Your Mallory-Yaxley distributor has your copy ready for you to examine. Your share of the cost is a trifle. Buy the book—if in a week it does not pay its way, if you would part with it for twice what you paid for it—return the book and get your money back. But act today; the edition is limited.

Use  
**P. R. MALLORY & CO., Inc.**  
**MALLORY**  
 REPLACEMENT  
 CONDENSERS... VIBRATORS

**P. R. MALLORY & CO., Inc.**  
 INDIANAPOLIS    INDIANA  
 Cable Address—PELMALLO

Use  
**YAXLEY**  
 REPLACEMENT  
 VOLUME CONTROLS

# RADIO RETAILING

FEBRUARY, 1937

## In This Issue

O. FRED. ROST..... Editor  
 W. MacDONALD.. Managing Editor  
 C. A. NUEBLING.. Technical Editor  
 T. H. PURINTON... Assistant Editor  
 HARRY PHILLIPS..... Art Director

RAY V. SUTLIFFE.. Consulting Editor

Tom Blackburn            George Tenney  
 Chicago                    San Francisco  
 H. S. Knowlton  
 Boston

HOWARD EHRLICH.. Vice-President  
 H. W. MATEER..... Manager

### McGRAW-HILL PUBLISHING COMPANY, INC.

Publication Office  
 99-129 North Broadway, Albany, N. Y.  
 Editorial and Executive Offices  
 330 West 42nd Street, New York, N. Y.

Cable Address: MCGRAWHILL, New York  
 Member A.B.P. Member A.B.C.

James H. McGraw, Jr.....Chairman  
 Malcolm Muir.....President  
 James H. McGraw.....Honorary Chairman  
 Howard Ehrlich.....Vice-President  
 B. R. Putnam.....Treasurer  
 D. C. McGraw.....Secretary

RADIO RETAILING, February, 1937, Vol. 22, No. 2. Published monthly, price 25c copy. Subscription rates—United States and Central and South American countries \$1. All other countries \$2 a year or eight shillings. Printed in U. S. A. Entered as Second Class Matter, September 3, 1936, at Post Office, Albany, N. Y., under the Act of March 3, 1879. Cable address "McGrawhill, New York." Member of A.B.P. Member of A.B.C. Copyright 1937 by McGraw-Hill Publishing Co., Inc., 330 West 42d Street, New York, N. Y.

Branch Offices: 520 North Michigan Ave., Chicago; 885 Mission St., San Francisco; Aldwych House, Aldwych, London, W.C. 2; Washington: Philadelphia; Cleveland; Detroit; St. Louis; Boston; Atlanta, Ga.

CHAINS OF SALES.....	9
THE RADIO MONTH.....	By O. Fred. Rost 11
QUESTION: WHAT IS UNFAIR TRADE PRACTICE?.....	By Howard Barman 12
FIGURES .....	15
AFTER THE RADIO—SELL APPLIANCES.....	By Powel Crosley, Jr. 16
DISPLAY—MANAGEMENT—ADVERTISING—SELLING .....	18
OPERA ON THE AIR.....	22
MOTION WINDOW SELLS TONE.....	By I. L. Cochrane 24
HOW TO ESTIMATE ON MASTER ANTENNA SYSTEMS.....	26
FOILING THE FLOATER.....	By Charles Phillips 28
NEWS .....	31
FACTS ABOUT NEW BATTERY RADIOS.....	41
PREVIEW OF NEW RADIO PRODUCTS.....	44
RADIO RETAILING'S SPRING APPLIANCE REVIEW.....	59
CIRCUITS .....	73
METERS: WHERE TO PUT THEM.....	81
BWARE HALF-TRUTHS ABOUT NOISE.....	By C. W. Metcalf 83
SHOP SHORTCUTS .....	89
TRICKS OF THE TRADE.....	95
LETTERS .....	100

### SALES STATIC

"HOW MUCH IS THE \$59.50 PHOENIX RADIO?"



IT'S A 12-MONTH  
RADIO SEASON WITH  
STROMBERG-CARLSON

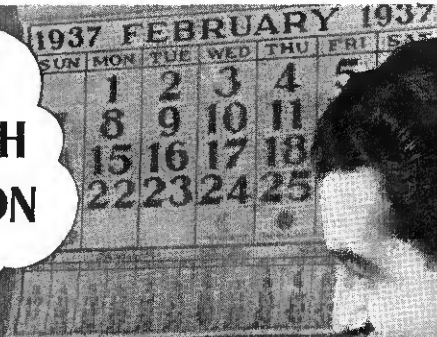

*Labyrinth* RADIOS PROVE BIG SELLERS  
ALL THROUGH THE YEAR!

There is no "off season" for sales of Stromberg-Carlson Labyrinth Radio. Prospects buy, regardless of the month, when their own ears tell them how completely Labyrinth Radio outmodes all previous radio reproduction.

The prospect for a big unit of sale like Labyrinth Radio can, and will, buy whenever he makes up his mind. He is not so greatly influenced by seasonal trends as is the low price buyer.

Radios are used every day. Programs are on the air every hour. Your Labyrinth Radio prospect can be sold at any time.

Labyrinth Radio has proved that for the customer and for the radio dealer, "There is Nothing Finer Than a Stromberg-Carlson."

The complete line of Stromberg-Carlsons range in price from \$51.95 to \$985. Labyrinth models from \$149.50. (All prices slightly higher in Southeastern States and West of the Mississippi.)

STROMBERG-CARLSON TELEPHONE MFG. CO., ROCHESTER, N. Y.

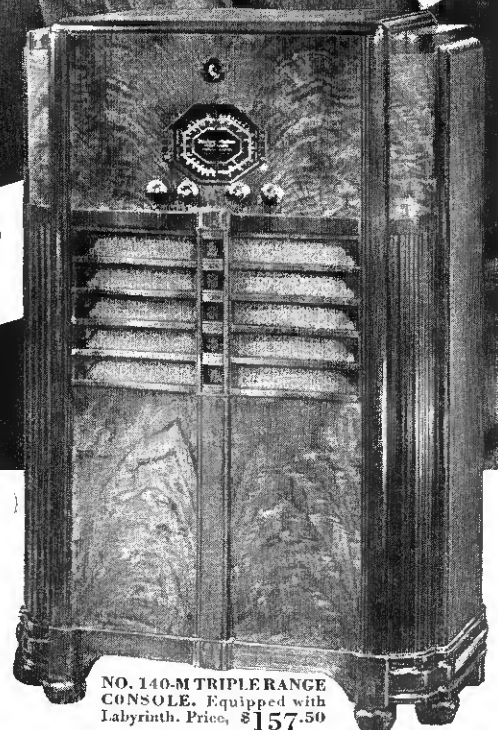

NO. 140-M TRIPLE RANGE CONSOLE. Equipped with Labyrinth. Price, \$157.50

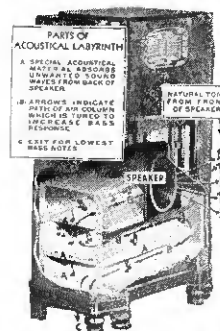

PARTS OF ACOUSTICAL LABYRINTH  
A. SPECIAL ACOUSTICAL MATERIAL ASSORBS UNWANTED SOUND WAVES FROM BACK OF SPEAKER  
B. ARROWS INDICATE PATH OF AIR COLUMN WHICH IS FORCED TO RESONATE IN BACK  
C. SLOT FOR LOWEST BASS NOTES

### Labyrinth RADIO

The long, winding passageway of the Acoustical Labyrinth takes the place of the usual box-like cavity in the cabinet which is the source of the exaggerated boom in low tones. It gives you deeper bass notes, with a new fidelity and increases the volume capacity and accuracy of the loud speaker. Shown in No. 145-L Radio.

NO. 130-J TRIPLE RANGE TREASURE CHEST. Price . . . \$87.50

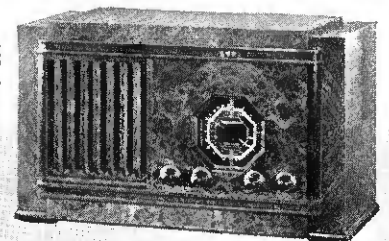

# Stromberg-Carlson

**W**hat 1937 Refrigerator will carry an authoritative "Seal of Approval" to assure purchasers of faster freezing, uniform shelf temperature, food odor prevention and greater ice-cube capacity?

**W**hat 1937 Refrigerator scientifically eliminates all food odors from its cabinet interior and prevents contamination due to odor absorption?

**W**hat 1937 Refrigerator will offer a doubled ice-cube capacity of 16 pounds of ice (168 cubes) even in lowest-priced models?

**W**hat 1937 Refrigerator has the new Econo-Phase Vacuum Freezing Unit to increase its efficiency, economy and overload capacity?

**W**hat 1937 Refrigerator will have handy shelves that can be lifted out for easy cleaning, and for use as trays?

**W**hat 1937 Refrigerator will establish new style in deluxe cabinet design with one piece cabinet and Duo-Seal doors?

(PLEASE TURN TO PAGE 69)

# A Two-Way

**NOW!**  
**KADETTE**  
**RADIO**  
**TUBES!**

The Cream of the Tube  
Market Merchandised  
under the Famous Kadette Name

Kadette comes forward with the soundest idea in tube selling!

Everyone in the radio business is well aware that even the best of tube manufacturers produce certain "peak-Performers."

In the many years International has been building radios, it has had the opportunity to know exactly which tubes show the highest performance factors.

Now it has taken the pick of the tube market—the best several major tube manufacturers can produce. These tubes have been selected on the basis of

quality, performance and long life. They are, literally, "the cream of the tube crop."

Effective at once, you can stock a complete line of Kadette Tubes at a surprisingly nominal investment—at the regular trade discount.

Here's the long looked-for answer to a tube line you can boost—for customer satisfaction and profit.

Kadette plans to put a real merchandising program behind these tubes.

Look into the unusually liberal arrangements for stocking Kadette Tubes. See your jobber—or write direct to the factory for complete information.

**I N T E R N A T I O N A L R A D I O C O R P O R A T I O N**

527 Williams St. • Ann Arbor, Michigan

# Announcement

**KADETTE**  
*NOW- RADIOS*  
**"BELL-TESTED"**

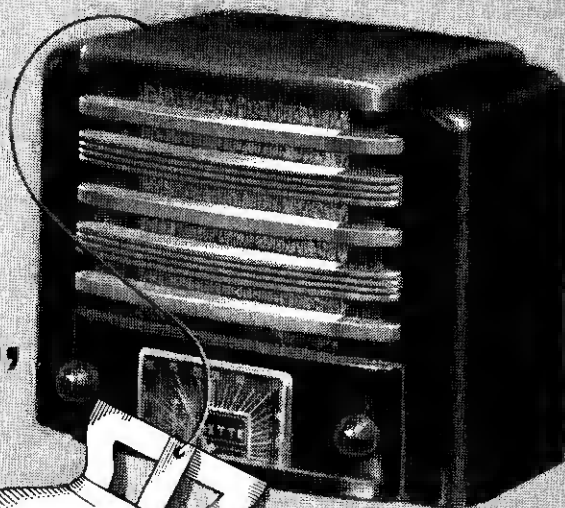

For the First Time an  
Authoritative Standard  
of Radio Tone Quality

Kadette has pioneered many of radio's most significant advancements—the first AC-DC radio—the Compact—the use of plastics in radio cabinets—the use of multiple colors and many other sales-making ideas.

Now, Kadette brings to radio the first authentic standard by which tonal quality can be truly measured—Bell-Testing.

Down through the centuries, the pure, ringing melody of the bell has been acknowledged the purest musical note known. Today, every Kadette must reproduce the delicately shaded note of the bell with uncompromising fidelity—constituting, unquestionably, the most exacting comparison of tone quality known to science.

#### A "MERCHANDISING" FEATURE

The silver and blue bell tag on every Kadette Radio is a hall-mark of tonal excellence and an exclusive Kadette feature.

It will make Kadette Radios mean more to every buyer—and easier to sell for every dealer.

Make "Bell-Tested" Kadette Radios your sales leaders. Stock a complete line. Give them prominent display and they'll be the top profit producer for you as they are for dealers all over the country.

**I N T E R N A T I O N A L R A D I O C O R P O R A T I O N**

527 Williams St. • Ann Arbor, Michigan

# Admiral

1<sup>ST</sup> with  
\$89<sup>95</sup>  
PLUS  
INSTALLATION



JUST *touch* THE BUTTONS —  
TOUCH-O-MATIC TUNING  
does the rest!

Housed in a compact, metal cased unit measuring only 4½" x 4¼" x 2½" and attached to the side of the radio is the mechanism that does the work. Easy to install on any car radio . . . old or new . . . sturdily built, its very simplicity assures years of dependable operation.

The control mechanism is shown actual size. Streamlined, handsomely faced with chromium, it becomes a striking addition to the most luxurious car. "Windows" provide spaces for call letters of stations selected. Note: Touch-O-Matic tuning is optional equipment with all Admiral Auto Radios.

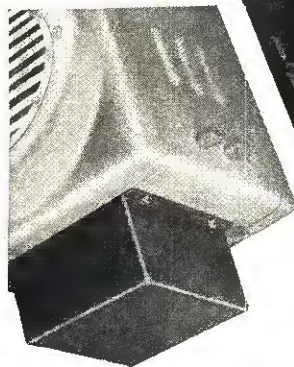

(PATENT APPLIED FOR)



## NEW 4-IN-2 DASH CONTROL PLATES MATCH ALL CARS

Each Admiral Auto Radio comes complete with smart-looking dash control to match any car for tuning stations not controlled by touch-o-matic tuning. The 7 and 8-tube models have the new "4-in-2" dash control plates. Admiral has put all the controls in the dash where they are within easy reach.

1. On-and-off switch with volume control
2. Variable tone control
3. Station selector
4. Local-distance switch

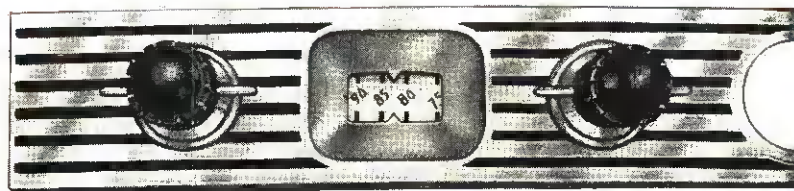



# AMERICA'S *Smartest* **AUTO RADIOS** **TOUCH-O-MATIC**

## *Tuning!*

Safety first . . . keep your eye on the road! Now . . . just touch a button . . . and presto! . . . in comes one of your favorite radio stations clear as a bell. As quick and simple as switching on an electric light . . . that's touch-o-matic tuning. An exclusive Admiral feature. Mail coupon below for full details.

**Continental Radio & Television Corp.**  
 325 W. Huron St., Chicago, Ill.

Model 77 Admiral 7 tube auto radio with 6 5/8" self-contained dynamic speaker.



Model 66 Admiral 6 tube auto radio with 6" self-contained dynamic speaker. May also be adapted for installation with speaker in "header" in 1937 Fords.

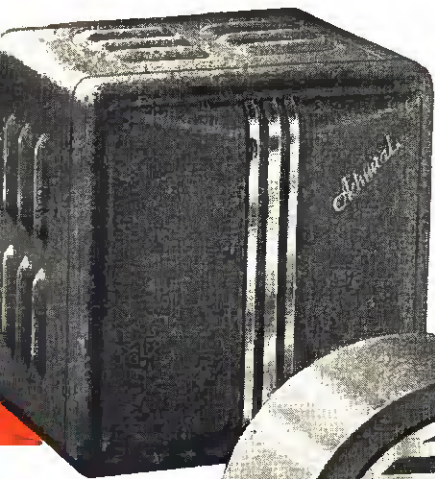

*Packed with Features*

that's what you find in *all* Admiral Auto Radios. Powerful superhet circuit operates entirely from 6V car battery with lowest drain. 10 KC selectivity. Variable tone control. Iron core antenna gives 1/4 MV sensitivity and increases antenna "pick-up" 2 to 7 times over other car radios. Gives daytime reception in any locality. Heavy duty, high-fidelity dynamic and permanent magnet type speaker. Each model complete with dash-matching control. Touch-O-Matic tuning optional.



Model 78 (7 tubes) and Model 88 (8 tubes) with external 8" permanent magnet dynamic speaker for installation in any position below dash.

Admiral Auto Radios  
 As Low as

**\$ 35.95**

Complete with Dash Control to Match Any Car! (Full Discounts!)

### GET THE FACTS

Continental Radio & Television Corp.  
 325 W. Huron St., Chicago

Gentlemen: Please send full details about Touch-O-Matic Tuning and your 1937 line of Admiral Auto Radios.

Name \_\_\_\_\_

Address \_\_\_\_\_

City \_\_\_\_\_ State \_\_\_\_\_

# Motorola

THE 1937 FEATURE HIT!



"GOLDEN VOICE"  
MOTOROLA  
The Aristocrat  
of Radio  
6 Tubes  
List, \$69.50

8-Inch Permanent Magnet Dynamic Speaker  
LOW BATTERY DRAIN  
ACOUSTINATOR EQUIPPED

MODEL "70"  
DE LUXE  
6 Tubes  
List, \$54.95



8-Inch Permanent Magnet Dynamic Speaker  
LOW BATTERY DRAIN  
ACOUSTINATOR EQUIPPED

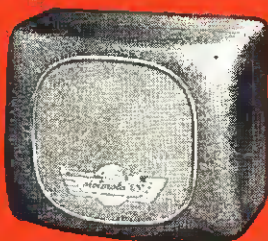

MODEL "65" ACOUSTINATOR EQUIPPED  
LOW BATTERY DRAIN  
6 Tubes—Powerful 6" Electro Dynamic Speaker  
List, \$49.95



MODEL "45" REMARKABLE PERFORMANCE  
6 Tubes—Powerful 6" Electro Dynamic Speaker  
List, \$39.95



MODEL "35" THE CHALLENGER—List, \$29.95  
NEW LOW PRICES—BIG VALUE  
6 Tubes—3-Gang Tuning Condenser

## New Revolutionary Features

THAT MAKE MOTOROLA THE OUTSTANDING CAR RADIO FOR 1937...YOUR TRADE WILL THRILL TO THE EXCLUSIVE NEW

# "ACOUSTINATOR"

PERSONAL PREFERENCE SELECTOR

Motorola again heads the parade with five outstanding FEATURE models... Each representing value leadership in its price class... Priced lower than ever before in Motorola's history. Take advantage of the remarkable sales and profit possibilities of this "stand-out" FEATURE merchandise. FEATURES you can easily demonstrate... FEATURES your customers can see and hear! Write for full information and prices.

**NEW LOW PRICES**

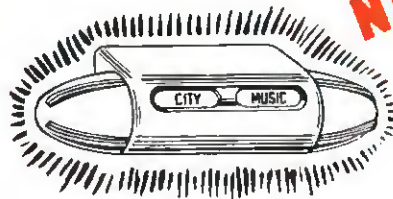

### ENJOY NEW THRILLS

Be Your Own Program Director  
Interpret Every Broadcast  
to Your Individual Taste

With the thrilling new ACOUSTINATOR, you can dial programs far and near, accommodating the sensitivity of your Motorola to your location, insuring distinct, noise-free reception.

And as you ride you can interpret programs to suit your fancy... (VOICE) "spotlighting" your favorite speaker or soloist—or (MUSIC) enjoying balanced musical programs—or (BASS) emphasizing the mighty, deep bass instruments.

Backed by Powerful National and Point-of-Purchase Advertising

### MATCHES ALL CARS—"ADAPTO" ANTENNA SYSTEM

{ In May, we will introduce a complete line of home radios. Write for complete details regarding this new Motorola profit-making opportunity. }

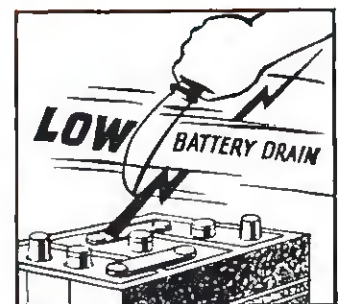

LOW BATTERY DRAIN—Due to the use of Permanent Magnet Dynamic Speakers, Cold Cathode Tubes, Class "B" Audio System, New Design Power Transformers, and New Circuit Developments, the Battery Drain has been reduced as much as 25% in some models... Added Efficiency... New Economy of Operation. An outstanding Motorola feature.

**GALVIN MFG. CORPORATION**  
847 WEST HARRISON STREET, CHICAGO, ILLINOIS

---

# RADIO RETAILING

FEBRUARY, 1937

O. FRED. ROST, Editor

## CHAINS OF SALES

RADIO RETAILERS HAVE LEARNED much about the technique of building goodwill among their customers but they still have much to learn about the art of turning goodwill into better profits.

Retailers in all lines occupy a unique and in many respects enviable position. While they do not make the goods they sell, they maintain the one and only free channel through which those goods can reach their market. This means that in the radio industry the radio dealer stands as the one indispensable link between the consuming public and those vast manufacturing enterprises in which radio goods are made.

★ ★ ★

THOSE MANUFACTURERS CAN PROTECT their investment, income and profit only if they supply the type of satisfactory merchandise that will build up in the minds of the consuming public a positive attitude of goodwill toward their trade mark or brand, but—since the public rarely ever sees or meets the manufacturer that sense of friendliness and goodwill finds its focus in the retailer who sold the goods.

★ ★ ★

THE RESULTING BONDS of confidence and goodwill are accentuated if the dealer supports the primary sale with satisfactory service and thereafter they may be expanded so as to apply to whatever other services or mer-

chandise the dealer may offer to his trade, provided he knows how to cultivate his opportunity.

That is the point at which many radio dealers have faltered. Too often the first sale to any customer has been the last and only sale when in fact it should have been merely the first link in a whole chain of sales.

★ ★ ★

ANY HOME THAT CAN BOAST of a radio set affords opportunities for selling other radios and accessories. Increasing popularity of shortwave reception is creating demand for up-to-date receivers. Many householders are potential buyers of a second, third or fourth radio set because wide differences in the ages of listeners obviously creates wide variations in the type of program preferred and often causes family quarrels which multiple equipment would prevent.

There is a vast assortment of major electrical appliances of which one or several lines can be sold quite properly by radio dealers. Already many of the most successful radio retailers are equally successful in retailing refrigerators, washing machines and similar items.

Thus there is manifold opportunity for wide-awake dealers to capitalize the goodwill of their customers through intelligently coordinated sales effort. This will result in effectively forging to the first sale a chain of other sales and its companion—a chain of profits.

**T**HE "name" Briggs & Stratton represents a valuable asset to the dealer selling washers, battery set radios, garden tractors, and other small farm equipment.

Over 750,000 of these dependable 4-cycle gasoline motors are running today—all over America's rural routes. Some of them are 10–15, even 20 years old . . . still giving trouble-free service . . . starting quickly on cold days . . . using the minimum of gasoline on all days.

Naturally, such service has "sold" these  $\frac{3}{4}$  million users on their Briggs & Stratton Motors. So are other millions of their neighbors who have heard about them.

Capitalize on this ready acceptance—your sales will come easier—by offering only equipment powered by Briggs & Stratton.

BRIGGS & STRATTON CORP. MILWAUKEE, WIS. U. S. A.



## THE RADIO MONTH

### WATCH OUT

This is another one of those years when in addition to Congress the legislative mills of 43 states will be grinding away for weeks and months. Every law-making body is searching hungrily for new sources of income with which to meet the mounting cost of government. New taxes, licensing plans, other indirect burdens on business will be proposed.

Often such new imposts have a more serious effect on one industry than on another, and therefore it behooves every member of the radio industry to watch out for dangerous or discriminatory legislation of all types. *Radio Retailing* will welcome letters giving full details of proposed laws or new restrictions and will cooperate wherever such action is necessary to the protection of the broad interests of the entire industry.

### THE CO-OP BUGABOO

From confidential sources in Washington comes the report that the White House enthusiasm for producer and consumer cooperative business enterprises is definitely on the wane. Last spring the professional boosters for broad governmental legislative and financial support of the co-op movement were receiving much encouragement in certain official quarters. Their hopes rose highest when the President appointed a special commission of inquiry that was charged with making a study of co-ops in Europe.

The commission had its European outing, returned in October, but since then has found it impossible to agree on any specific recommendations. In all probability its forthcoming report will simply record their observations. Furthermore, it is said that the President has reached the conclusion that co-ops of the European pattern do not fit into the American scheme of things.

So it appears that co-ops will have to

make their own way, without the benefit of governmental fertilization—which is exactly what individual business enterprises have had to do since time immemorial.

### THE MINIMUM

We found ourselves with extra time in one of the large Mid-Western cities and our desire to pick up some news led us to scanning the classified telephone directory. There, under the heading "Radio Manufacturers" we found a single name, impressive, important sounding, printed in heavy type, and one not shown on any national list. It looked promising. We dialed the number. The male voice that answered sounded business-like. No, the president of the company was out. To gain a measure of its size we inquired as to the number of men working in the plant. The answer came back, "one." We thought that our question had been misunderstood, so repeated it. "That's right," said the bright boy at the other end of the wire, "We've got just one worker here and that's me."

### FLOOD

There may have been more disastrous floods in the past but there has been none, of which detailed and accurate news reached the world so promptly as of that which is still raging as we go to press. At no time were people, living in potential flood areas, kept so constantly posted as to progress of the waters and received more ample warnings when danger threatened. At no time have relief agencies been organized so quickly and appeals for relief funds and materials found more instantaneous response.

Radio made much of that possible. Not the most exhaustive investigation could uncover more than fragmentary details of radio's contributions in this

emergency. Even at this time a history of dramatic incidents, occurrences and rescues in which radio was a factor would fill a book.

The Radio industry is proud of the operators, amateurs, broadcasters and all those who worked unselfishly and untiringly often under almost unsurmountable difficulties to establish or maintain communication during the disaster.

### PLUGS

Henry Ford has raised his voice in protest against the widespread practice of broadcasters to inject chain break or "spot" announcements either before or after the fully paid-for Ford broadcasts. For instance when Mr. Ford buys one-half hour on the air, he wants to have the full 30 minutes and not a minute less, because the station might use it to shoot some entirely unrelated "spot" advertisement for some other advertiser—at so much per word. That's a reasonable request. But, Mr. Ford objects also to having those "spot" items precede or follow his program even if they are made on time taken from adjoining advertising or sustaining programs.

Now it remains for Mr. Ford to object to having advertisements of others shown on adjoining pages of a magazine or showrooms featuring other cars in the same block with one of his own.



EDITOR

# QUESTION:

## WHAT IS UNFAIR

**Activity of St. Louis  
Retail Furniture Dealers  
Association, once lauded  
by NRA, now con-  
demned by FTC**

**Individual effort must  
now be substituted for  
group action against  
wholesale-retailing, dis-  
counts for cash, "spiffs"**

**By Howard Barman**

*NEWS ITEM: (Jan. 9)—The Federal Trade Commission has ordered the Retail Furniture Dealers Association of St. Louis, Mo., its officers and 36 merchant members, including those in East St. Louis, Ill., to cease and desist from certain unfair trade practices in the interstate sale of furniture and allied products, including electric refrigerators and radios.*

**I**N the release quoted, the following practices are among those held to have tended toward the creation of a monopoly in certain respondent members and to have restrained competition and increased the cost of furniture and other allied products to the consumer:

Requiring retail furniture dealers to impose a separate, uniform carrying charge on instalment accounts to consumers. Concerted action against sales made by manufacturers and distributors to employees of large companies outside the radio field or to their own employees except where these buy for their own use. Insistence against sale of merchandise by manufacturers or distributors to dealers outside the St. Louis area where re-sale in this area is contemplated.

Other Association policies condemned by the FTC were: Group action against donation of merchandise to retailers by manufacturers and placing of manufacturer or distributor employees upon retail sales floors for the purpose of influencing prospective purchasers.

### *Association Men Talk*

Interested primarily in the instalment finance charge and industrial selling phase of the situation, *Radio Retailing* assigned to this reporter the task of interviewing Association men.

From Gail B. Ussery, secretary,

the following statement was obtained:

"As a group, we did launch a campaign to reduce industrial selling in January, 1934. This was done by pointing out the evils of the practice to wholesalers who accepted such business and in some instances even solicited it and by telling owners of large industrial plants how fostering of employee cooperatives disrupted the local market. Our methods were similar to those used in Milwaukee and described in your November issue.

"We discontinued this activity following the death of NRA in May, 1935, however. And dealer action against sale of merchandise on time, without carrying charges, has never been an Association activity. It is possible that certain of our members may, as individuals, have intimated to distributors that they would not look too kindly upon merchandise sold to retailers advertising 'no carrying charge'.

"It is my opinion, furthermore, that while the Association can not now work in this direction, effort to straighten out disruptive merchandising practices, and particularly industrial discount selling, will probably continue as individual policy of dealers both within and outside the group. *For industrial selling increases as business improves. During depressions money is tight and the consumer must take advantage of credit offered by legitimate dealers. In good times the consumer has cash with which to buy at a discount through his employer.*"

Says Joseph Manne, president of the Association:

"Refrigerators are being sold here on three-year terms. You can't make a profit on the sale of merchandise in this manner unless there is a carrying charge. Individually, as head of Manne Brothers Furniture Company, I will recommend, as in the past, a

# TRADE PRACTICE ?



AS BUSINESS GETS BETTER . . . . INDUSTRIAL DISCOUNTS GROW WORSE

. . . for the consumer then has cash  
with which to command fancy price-cuts



JOSEPH MANNE, president of the Association, who . . . "as an individual will continue to recommend carrying charges . . ."

## SPEAK ONLY FOR THEMSELVES

JOSEPH HELLRUNG, treasurer of the Association, who . . . "as individual will continue to oppose industrial discounts . . ."



separate carrying charge. It is the proper way to do business."

Indicative again of the St. Louis trade's intention of continuing action, but on an individual basis, is this statement from Joseph Hellrung, treasurer of the Association and president of Hellrung & Grimm H. F. Co.:

"If merchandise is priced at its true cash price the retailer selling on time must charge something for deferred payments or lose the cost of this financing. If the price of the article is fixed high enough to sell it on the deferred payment plan without adding anything, then the cash purchaser is paying an unjustly higher price and is discriminated against.

"Regarding industrial discounts: When an industrial concern permits its employees to buy through its purchasing department that concern is tampering with and retarding business recovery. Retail stores carry the burden of displaying merchandise and advertising it into public acceptance and will be gradually forced out of business if by-passed."

### Dealer Opinion Varies

Branching out, away from Association officials and into the ranks of furniture, radio and appliance dealers inactive in the organization and in some instances not members at all, *Radio Retailing's* reporter next interviewed men known to be antagonistic to any activity designed to standardize carrying charges.

Said the owner of a large furniture house located in East St. Louis, industrial town across the Mississippi, concerning his continued radio programs and newspaper advertisements featuring "no carrying charges":

"We do not and will not inflate advertised prices of either radios or refrigerators by adding a carrying charge on time-payment accounts. The increased business obtained through this method of advertising more than compensates us for the actual additional financing cost."

Still another furniture dealer in this same town across the river informs us that: "If a consumer walks into the store, asks the price of a radio and asks how much he will be charged for carrying the account a year he will be told that we give him the regular cash price, without any extra charge."

Carrying charges should be included in the manufacturer's adver-

tised price, thinks Erwin Loewenstein of the Loew Company, in nearby University City. States this radio and home appliance man: "If the buyer wants to pay cash then he should be allowed his discount. The consumer objects to carrying charges being added on time purchases. One dealer charges 6 per cent and another 8 per cent, with the result that the customer is confused. When a customer learns he can get a good discount for cash he'll often pay cash, or make a substantial down-payment."

Opinions favorable to standard carrying charges and individual activity against industrial selling were the rule rather than the exception.

Said Arnold Wick of the Wick Electric Company: "Dealers will have to take some kind of action to protect their interests. I sometimes think that the dealer who doesn't have a salesman out on the street is the smart man. Discount buying is encouraging more dealers to engage in chiseling."

A dealer selling air-conditioners, appliances and radio, who asks that his name be withheld, remarked when interviewed: "It is high time that some distributors here cease antagonizing their retail outlets by selling direct to the consumer. This has broken down the friendly spirit between dealers and distributors and has thrown many specialty salesmen out of work. Dealers learn too often after they have interested a customer in a new radio to the point of buying that the sale actually went through wholesale channels."

Another: "Price-cutting on merchandise and advertising it less carrying charge is so detrimental to the dealer's welfare that distributors selling outlets with such policies should be reminded that these practices will eventually lose them more sales than they are worth by inducing other dealers to drop the line."

Commented the sales manager of an appliance distributing company: "I wish it was possible for radio and appliance dealers in St. Louis to form an Association such as the one covering the furniture field and then find a way to legally take an open stand against selling at wholesale. We, as distributors, would then have something to tell large industrial plant purchasing agents when they asked for discounts. It would give us a legitimate alibi."

When the Furniture Association's campaign against industrial selling

(Please turn to page 70)



# FIGURES

## RADIO RETAILING'S MONTHLY BUSINESS BAROMETER

### NBC PROGRAMS ANALYZED

The National Broadcasting Company's programs were made up as follows during the year just passed:

	% of Total Hours	% Against 1935
Music .....	63.4	+10.0
Literature .....	13.3	+ 9.4
Talks .....	6.9	+14.4
Novelty .....	4.5	+15.1
Children's .....	3.7	+ 3.5
Current Topics ..	2.9	+ 2.9
Special Events ..	2.1	+39.9
Women's .....	1.3	— 6.3
Religion .....	1.3	+13.1
Reports .....	0.6	+22.2

While popular music absorbed 65.7 per cent of the time given to music of all types, in which division a 10 per cent increase over 1935 was recorded, serious music was actually given 21.4 per cent more time during 1936 while popular increased only 4.9 per cent.

### AIR-CONDITIONING FORECAST

William B. Henderson, executive vice-president of the Air Conditioning Manufacturers' Association, predicts that the installed cost of equipment manufactured by member companies will reach at least \$85,000,000 in 1937, a 60 per cent increase over 1936.

This estimate is based on the fact

that Association members already have one-third of their 1937 capacity in both summer and year-round equipment already sold or being figured by engineers and the fact that the final quarter of 1936, the biggest in the industry's history, showed substantial increases over earlier months.

### PARTS SURVEY SOURCES

One month ago we asked dealers with repair shops and independent servicemen for a record of the number of radio receivers repaired in any period on which data was available, plus a detailed list of the replacement parts actually used in these jobs.

While the report appearing in the accompanying box is preliminary and will obviously gain in accuracy if we succeed in obtaining an appreciable number of additional reports it is our feeling that it is near the facts, for a total of 32 shops, reporting on 9,541 sets, is here represented.

Service managers and men who have obligingly contributed to this study so far represent a fair, though small, cross-section of the business by type of outlet. Included are reports from men who fix a mere handful of sets per month and others who turn out as many as 300 in a similar period.

REPLACEMENT PARTS USED	
(Per 1000 Sets Repaired)	
BY-PASS CONDENSERS . . . . .	290
RESISTORS . . . . .	220
FILTER CONDENSERS . . . . .	160
VOLUME AND TONE CONTROLS . . . . .	140
AUDIO TRANSFORMERS . . . . .	40
VIBRATORS . . . . .	26
RF AND IF COILS . . . . .	20
SPEAKER CONES . . . . .	18
POWER TRANSFORMERS . . . . .	13
SPEAKERS . . . . .	7
LINE SWITCHES . . . . .	4
FILTER CHOKES . . . . .	3

Preliminary report. See accompanying text.

Records coming to us from small towns in New England, Texas, Indiana, California as well as larger cities such as Chicago and Philadelphia cover periods ranging from the last two weeks to all of 1936.

No attempt has been made to subdivide reports by type of outlet and it may be that this will be impossible even when all returns are in. It is obvious, therefore, that the figure shown on an item like Vibrators, while essentially correct insofar as the run-of-the-mill radio shop is concerned, might be low for shops specializing in auto-radio.

Because figures relating to the relationship between sets repaired and required parts stock are almost nonexistent it is our belief that this study, original with *Radio Retailing*, will be useful to dealers and servicemen who wish to safeguard against either under or overstocking. The number of sets likely to be repaired in a given period is generally susceptible to close estimate. Use of the factors developed by this survey, against such estimates, throws light on probable part requirements.

Servicemen are urged to forward more reports for inclusion in this study. Simply advise what parts you used for actual repairs in any given period and then tell us how many sets were repaired in that same period, including those on which just adjustments were made as well as those in which parts were installed. Individual reports will be kept strictly confidential.

### WHAT SET MAKERS PAID THE GOVERNMENT

RMA's Tabulation of Excise Taxes Collected by the U. S. Treasury from Home Radio Manufacturers

(Auto-Radios Excluded)

	1936	1935
January	\$601,144.68	\$398,177.40
February	423,673.38	193,467.30
March	336,043.04	350,334.03
April	321,006.84	253,066.45
May	220,750.43	291,536.71
June	422,696.37	199,885.37
July	595,713.31	146,320.19
August	495,792.96	319,331.10
September	682,952.35	339,382.47
October	869,136.57	643,440.02
November	639,630.11	571,479.61
December	906,358.41	730,002.69
<b>TOTAL</b>	<b>\$6,514,898.45</b>	<b>\$4,436,423.34</b>

This represents a tax collection increase of 46.9%

# AFTER THE RADIO - SELL

**Most falsely pleasant and least profitable is that relaxed feeling which comes after a retail sale has been made. It should immediately raise the question: "What can I sell them next?"**

says

**Powel Crosley, Jr.**

*President, Crosley Radio Corporation*

**P**ROFIT or Loss—which one of the two shows up in the statement at the end of each month of operation? That's the thing that interests Powel Crosley, Jr., as president of the Crosley Radio Corporation, and that's what he says should interest every radio dealer.

Mr. Crosley found early in his career as a radio manufacturer that the seasonal ups and downs in set sales are hard to level out through the year. Still he hated to see his hard earned profits, made during the good months, endangered by possible losses during the "off" season.

So he proceeded to add other products that could be sold while radio sales were less active and figured that those, together with radio, would keep his sales organization and dealers on their toes *twelve months of the year*, would help to keep sales at more uniform levels *twelve months of the year*, would enable him to show a profit *in each of the twelve months of the year*.

Having proved the theory absolutely sound in practice, as far as a manufacturer is concerned, Mr. Crosley was asked to give some good reasons why a dealer should consider to do likewise.

Here is what he answered:

"It is my firm conviction that the dealer's ultimate success depends to a great extent upon eliminating seasonal concentrated sales effort with consequent spotty sales and spotty profits as well as physical and sales relaxation.

"A dealer's business often can be made more successful when it does not depend upon the sale of just one appliance but instead offers a complete line of allied appliances. I think that diversification is necessary if there are to be none or only slight seasonal sales drops."

The fact that Mr. Crosley feels quite strongly on this matter of leveling the sales curve was demonstrated, when he continued:

"In my opinion a business can be more profitable if it is consistent in maintaining a sales curve that is reasonably straight throughout the year and this I believe is more readily possible if the selling of radio sets is combined with that of allied products such as refrigerators, washing machines, ironers and other major appliances.

### **Keep Instalment Buyers Coming**

"One of the most falsely pleasant and least profitable sensations is that relaxed feeling which comes after a retail sale has been made, particularly if the sale was difficult to close. It seems to me that the closing of one retail sale should not end in relaxation of effort but immediately should raise the question, 'What can I sell them next?' and then set in motion a new flow of sales effort that has as its objective the sale of some allied product.

"Of course if that is to happen the dealer must have learned to recognize two factors that are vitally important to the success of his busi-

ness, to his steady progress and greater profits. These are:

"1. The importance, the advantages, in fact the necessity of handling allied products;

"2. The strange psychology that instalment buyers always want to buy."

Convinced that these two points cannot be overemphasized, Mr. Crosley continued:

"It is my belief that after every retail sale the first and most fruitful question that a dealer or salesman should ask himself is, 'How can I keep that customer constantly aware that through my store every radio and electrical appliance need can be satisfied, or how can I keep that buyer of a radio set from going elsewhere for a refrigerator, washer, ironer, etc.'

"And the fact that many people buy radio sets on the instalment plan can be made to pay dealers rich dividends if they make up their mind to cash in on it.

"Instalment buyers always are buying; they do not want to be out of debt. If they buy a radio from a certain dealer they will be more ready to buy other major appliance needs from the same dealer provided he is in position to serve them.

"If that is the case the dealer should start working on the next sale as soon as the first has been closed satisfactorily.

"In that follow-up work the dealer can use one or several of the usual methods, personal calls, tele-

# APPLIANCES

**THE NAMEPLATE** on a Crosley product is not merely a trade-mark but the sign of a personality, that of Powel Crosley, Jr.

Fourteen years ago he, personally, put his own name on the first batch of radio sets and ever since he, personally, has tested and approved every new model, every new product.

Still, Powel Crosley, Jr. finds time to play but he likes to play with lots of action. Three fast airplanes (he is one of the country's pioneer private pilots), a yacht, a game-farm, horses, dogs, keep him busy when he plays at other than business.

And his business includes plenty of play because he owns the Cincinnati "Reds", National League baseball team, and Crosley Park, their home grounds.

This is the fifth in a series of interviews with important industry executives by O. FRED. ROST

phone contacts or direct mail but the important thing is to keep constantly at it.

"If no additional sales have been made and only a few instalments remain to be paid, then is the time to stage a concentrated sales drive so as to sell some other item and thereby keep the customer on the books as an active instalment buyer because this is always an advantage in making future sales.

"In other words, there is every reason why the retail sales of radio and major electrical appliances can be logically combined and this holds

true even if a dealer has only limited resources, because today, with the convenient and liberal floor plans which manufacturers offer, even the smallest dealer can stock a complete line of major appliances."

### *Trade-Marked Products Help*

Of course, Mr. Crosley had a great deal more to say on a subject so close to his heart. He reminisced, quoted many personal experiences where the first sale became the first link in a veritable chain of sales of allied products.



In closing the interview, Mr. Crosley said,

"I have just one more comment to make concerning what I believe to be essential factors in a successful and profitable dealer's business.

"The dealer's reputation for reliability, his good will, is a large share of his stock in trade and no dealer can afford to sell merchandise which will in any way jeopardize it. Going a step farther, the merchandise is no more reliable than the company or the trade name behind it but when a dealer sells merchandise to his customer, he not only sells the name of the manufacturer but his own name as well.

"Nationally advertised, trade-marked radios and appliances are the dealer's best insurance that his good will always will be maintained.

"I know of no better way for a dealer to thrive and prosper than through handling only radio and allied products that are trademarked and, of course, he should always remember that the closing of one sale should mark the beginning of effort that will bring another order."

## Merchandising, Minus Kid Gloves



**LOW RENT**—\$125 per month for this store. Location is no bargain but there is space for display at low overhead

**NO INTERIOR SWANK**—Stock variety, quantity, fits the clientele better than trappings

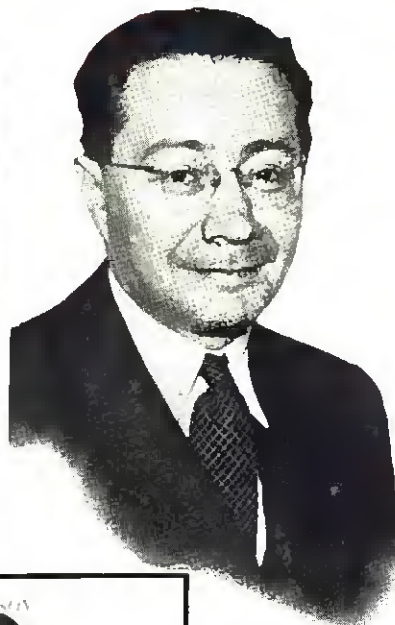

### CHECKBOOK BUYER

— Isidore Jacobson. Cash - on - the - barrel brings him bargain automobile alcohol, appliances, radios. Leaders priced near cost attract 90 per cent of his trade

**CREDIT HAWK**— Bill Kahn discourages poor-pay prospects by quoting prohibitive down-payments, limits terms to 18-month maximum

PEORIA—That cake recipe methods of apportioning one's mark-up to get business cannot be followed blindly by all radio dealers is the opinion of Harry Alter, veteran Chicago distributor. What you do depends on where you are and what you are.

Among those who apparently upset the orthodox apple cart in their merchandising methods is Jay's Inc., of Peoria, Illinois. With a location that most radio dealers would term poor, without the plush trappings of Mrs. Astor's horse, and lacking the acceptance of any of Peoria's great store names, Isidore Jacobson has, nevertheless, pushed his way up to one of the tidiest radio businesses in the town in thirteen years.

Here's how this dealer, representing a rarely spotlighted type, does it:

Rent: \$125 a month, according to William S. Kahn, his sales manager (exclusive of new garage, in try-out



**STEP-UP SYSTEM**—Leaders are advertised but this is the type of set most frequently sold. Without step-up salesmanship Jay's would crash



# ADVERTISING ..... SELLING .....

stage). Advertising: 2,791 inches of advertising for first ten months of 1936, against 2,414 used by his closest rival.

**Attraction:** Something at cost, like automobile alcohol, to bring the people in. Jay's likes to buy up distress merchandise, or even good second hand stuff, so always to have something on the floor that is an astonishingly good buy. Jacobson tries to have something that shades the prices of mail-order department stores. Ninety per cent of the store's trade comes from floor traffic.

"The psychology of low prices gets traffic," Mr. Kahn declares. "Very little merchandise is nailed down. We'd rather pass on our bargains and depend on our skill in stepping up sales."

**Display:** Like the fish house that advertised "If it walks or swims, we have it," Jay's carries a lavish stock of many makes of radio.

**Stepup:** "My name is Kahn? Yours?" In carefulness of introduction Kahn obtains prospect's name, passes it on to girl. Over private line, firm obtains credit rating as deal goes on. If prospect turns out to be no good, he is discouraged by high-down payment. If good, he gets \$5 to \$10 down payment offer, plus monthly payments up to twelve months. Nothing goes over eighteen months.

Kahn follows the brutal technique of informing his prospects that a cheap bargain isn't much good, and inquires how many years service they expect to get out of it. You know when you buy a used car you are buying the other fellow's grief, he points out, and this holds true with a bargain.

**Service:** Some eleven men are kept busy. Jay's realized early that department stores and larger radio outlets did not like to be bothered with service, hence accent was placed here. While department makes a small profit, the real value comes from leads it originates and it would be worthwhile as advertising. Men work on salary.

**Buying:** Isidore Jacobson believes in going to market frequently. He likes to shop with a checkbook in hand. For one thing it gives him a chance to see many things he can sell, and cash on the nail gets the best prices. Store sometimes follows dress shop technique of selling two articles for the price of one.

**Other wrinkles:** Jay's contracts carry a wage assignment in them. Jay's underseil performance of a radio—uses *Radio Retailing's* list of "Things No Radio Can Do." (RR Dec., 1935) Jay's welcome all newcomers to Peoria with special literature.

## Telephone Technique Earns Salary

ST. LOUIS—Working from 9 o'clock in the morning until 4:45 in the evening, Miss A. Murdock, telephone solicitor for the Schweig-Engel Corp., unearths an average of 15 radio service orders a week through 10 months of the year. In July and August service orders average eight a week. Solicitation is omitted on Saturdays.

The conversation may swing to

spaces for type of ticket, model and make of merchandise sold or serviced, date of transaction and amount of payment.

"The solicitor goes through the files containing 20,000 accounts, refers to the date column on the envelope and if it shows "no call" from the customer within a year she will attempt to reach her over the telephone."



**MEET MISS MURDOCK**—She sells radio service, by 'phone, from 9 to 4:45

babies, household budgets or cooking but it is brought back to "how is your radio," shop facilities and trained service men.

Miss Murdock works strictly on a salary. Schweig-Engel employed its first telephone business getter 10 years ago and ever since has employed a girl with a "telephone voice" for this work.

Says Sam Singer, manager of the firm's radio department:

"We may not get an order today but maybe in six months or a year we do. And the service order gives our men a chance to get into the home and talk about a new radio if one is needed.

"We use a service record envelope (illustrated) in which the customer's delivery, service, shop and order tickets are filed. On the envelope's face are

**ON THE RECORD**—As a list for calls names of old customers are used. The envelope illustrated (brown manila) bears dates of previous sales. Within (white) are individual reports

Delivery-Shop Conversation File in DELIVERY, DEPTAGE SERVICE, SHOP & ORDER TICKETS

NAME *Proctor, L. W.*

ADDRESS *566 2 1/2* Phone No. *2-2044*

New Address *4539 Lindell* Phone No. *2-2044*

REMARKS

Ticket No.	Type of Plan	Model and Make of Merchandise	Date	Amount
27280	Plan	Harold	5/26/36	9.75
6464	Plan	Harold	5/16/36	9.69
6785	Plan		3/4	
7471	Plan		3/4	
43167	Plan			
43677	Plan			
43730	Plan			
71183	Plan			
10387	Plan			
11330	Plan			

**SCHWEIG-ENGEL CORPORATION**  
6924 DELAWARE BOULEVARD  
ST. LOUIS, MO.  
The most scientific Radio Service in St. Louis.

Model of Merch. \_\_\_\_\_  
Date of Sale \_\_\_\_\_  
Date of Service \_\_\_\_\_  
Date of Shop \_\_\_\_\_

Service Order No. \_\_\_\_\_  
Shop Order No. \_\_\_\_\_  
Delivery Ticket No. \_\_\_\_\_

**SERVICE REPORT**

Customer's Name *L. W. Proctor*  
Address *566 2 1/2 Lindell*  
Phone No. *2-2044*

Material *Harold*  
Cost *9.75*

Work done by *Proctor*  
Charge *Proctor*  
Name *L. W. Proctor*  
Address *566 2 1/2 Lindell*  
Phone No. *2-2044*

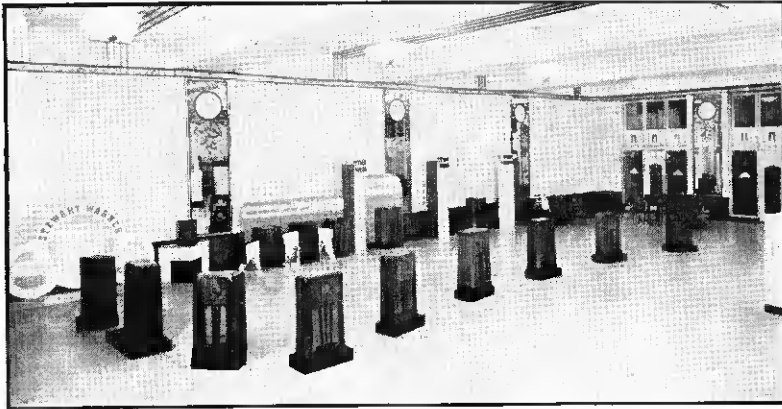

**EXPANSIVE AND EXPENSIVE —** Radio and refrigerator displays in the new showrooms of *Stewart-Warner Distributors Company, Chicago*, radiate class. In merchandising as in publishing "white-space" proves effective

## Sliding-Scale Commissions

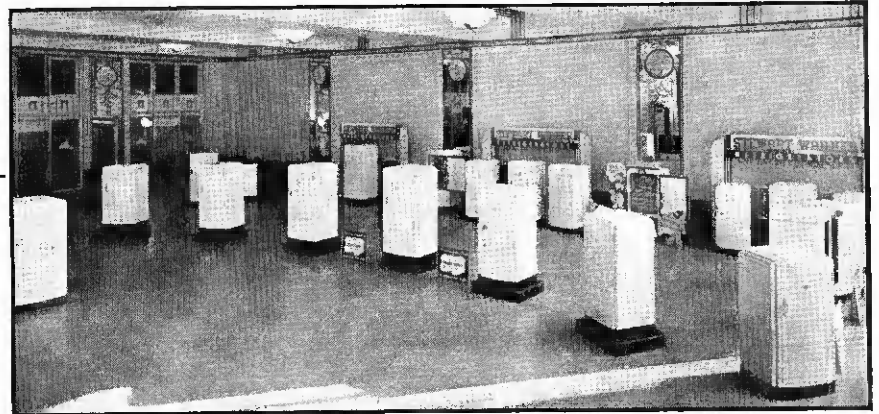

ST. LOUIS—Rate of commissions to salesmen of the Stix, Baer & Fuller Co., department store, will be based on a sliding-scale in 1937. Moreover, a higher rate of commission will be paid for radio sales made in the field than those closed on the floor.

Says J. P. Heshion, manager of the store's radio department:

"We have arranged a commission schedule on a sliding scale, ranging from 3 per cent in the lowest bracket to 10 per cent in the highest bracket, as an added inducement to the men to sell better radios.

"Radio sales have been divided into four price brackets. The first one is up to \$40; the second ranges from \$40 to \$75; the third is \$75 to \$120, and the fourth \$120 and up.

"We'll pay a bonus of  $\frac{1}{2}$  of 1 per cent on all sales made by a salesman who completes the year with us. We have set a quota of \$30,000 for each salesman and will pay a bonus of \$150 next Christmas to the men who reach this figure. We sell the better price merchandise and our men should average a commission rate of 8 per cent.

"A quota was set up for 1937 that

makes it necessary for us to go out and make more sales on the outside. Even though the upward business swing would give us a natural increase of 20 to 25 per cent, this would still be short of our quota and so our salesmen will put in three days in the field per week doing direct contact work."

The differential in commissions on radios sold on the floor and those in the field ranges from 1 to 2 per cent in the three upper price brackets of the company's schedule. For example, the salesman who sells a \$200 set in the field will earn \$4 more.

**UTILITY STOPS LINE NOISE —** Power Companies go to great lengths to stop radio noise . . . if it is their fault. Niddrie-Foss of Hempstead, N. Y. (Radio and auto accessories) reported trouble to Long Island Lighting. Joseph Foster of the latter company installed Tobe Filterettes in the lighting circuit, put up a noise-reducing antenna and effected almost total elimination of racket due to corona and charging current to the pin on adjacent 66,000 and 23,000 volt high-tension transmission feeders

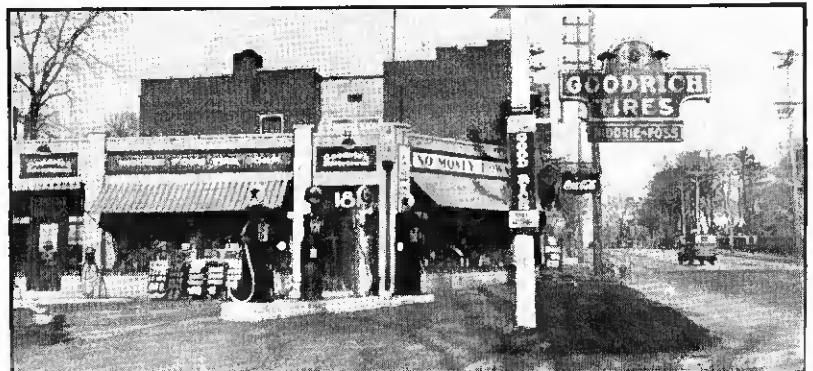

# NEW

## COLORADIO SERIES

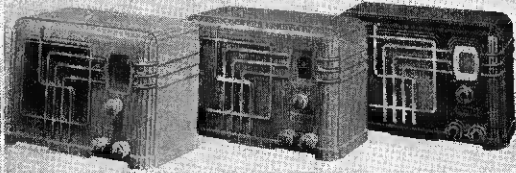

### SERIES 254 FOR AC CURRENT 5 TUBE SUPERHETERODYNE FEATURING METAL TUBES AND BEAM POWER TUBE

*The Most Powerful Small Set Made*

**CHASSIS FEATURES:** 7 tube performance; Illuminated airplane dial calibrated in KC; Frequency range 535 to 1750 KC; Beam power output tube; Automatic overload control; Built-in antenna; I. F. Frequency 456 KC; Acoustically fitted dynamic speaker; Operates on 115 volts, 60 cycles, AC.

254W: WALNUT BAKELITE CABINET	\$22.95
254D: BLACK BAKELITE WITH CHROMIUM	24.95
254V: PURE IVORY CABINET	24.95
254R: PURE CHINESE RED CABINET	24.95
254BG: BLACK BAKELITE AND GOLD	24.95
254G: IVORY AND GOLD	26.95
254RG: CHINESE RED WITH GOLD	26.95

*Prices include full tube equipment*

MODEL 254T IN WALNUT WOOD CABINET WITH IDENTICAL CHASSIS FEATURES . . . \$24.95

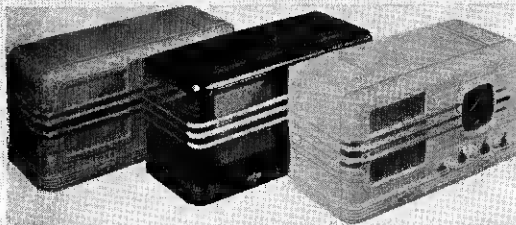

### FADA BATTERY COLORADIO FOR THE FARM

#### SERIES 242 - 4 TUBE SUPERHETERODYNE OPERATES FROM 2 VOLT AIR CELL

**CHASSIS FEATURES:** 8 tube performance; 9 tuned circuits; Tunes American, Short Wave and Police Broadcasts; Frequency range 535-1750 KC and 2.2-6.9 MC; Illuminated airplane dial calibrated in KC and MC; Tone control; Phono-jack; Rubber mounted tuning condensers; 6 in. permanent magnet dynamic speaker; I. F. Frequency 456 KC; Automatic volume control; Air cell drain only .4 amps.

242W: WALNUT BAKELITE CABINET	\$31.50
242D: BLACK BAKELITE AND CHROMIUM	36.50
242V: PURE IVORY CABINET	36.50
242R: PURE CHINESE RED CABINET	36.50
242BG: BLACK BAKELITE AND GOLD	36.50
242RG: CHINESE RED AND GOLD	41.50
242G: IVORY AND GOLD	41.50

*Prices include full tube equipment*

#### SERIES 246 - 4 TUBE SUPERHETERODYNE OPERATES FROM 6 VOLT STORAGE BATTERY

**CHASSIS FEATURES:** Identical with Series 242 excepting special built-in "B" Eliminator and synchronous vibrator for power supply from 6 volt storage battery. Drain, only 1.45 amps.

246W: WALNUT BAKELITE CABINET	\$36.50
246D: BLACK BAKELITE CABINET	41.50
246V: PURE IVORY CABINET	41.50
246R: PURE CHINESE RED CABINET	41.50
246BG: BLACK BAKELITE AND GOLD	41.50
246RG: CHINESE RED AND GOLD	46.50
246G: IVORY AND GOLD	46.50

*Prices include full tube equipment*

Both Series obtainable in Walnut Wood Cabinets, Compact & Console Models.

# FOR 12 PROFITABLE MONTHS IN 1937

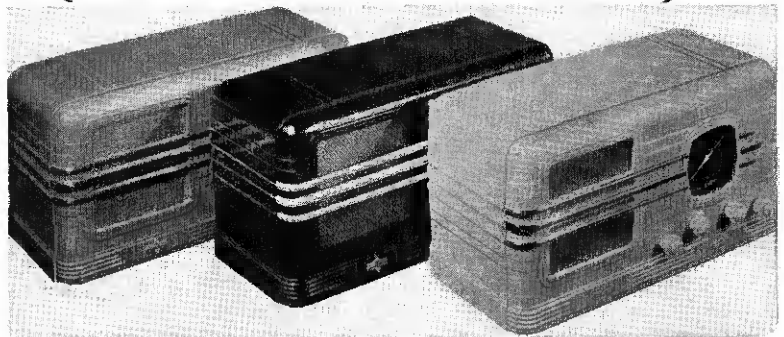

### FEATURED IN 7 DISTINCTIVE SERIES IN 8 MAGNIFICENT COLOR COMBINATIONS

and priced as low as **\$19<sup>99</sup>** complete

One of the oldest and surest devices used to command attention is the appeal of color. Color glorifies . . . Color is stimulating to the eye . . . Color creates the desire to buy. The appeal of color proves a strong selling ally because it is a "plus" feature. Color in radio is not new . . . but Coloradio by Fada is! Every Coloradio series possesses not only the appeal of color but also the new "Streamline" cabinet designs which blend with the majestic color combinations. No other small set line combines so many selling features to offer the consumer . . . Color . . . Streamline . . . Design . . . Performance . . . Value.

#### ATTRACTIVE COLORADIO DISPLAY NOW AVAILABLE

A new display designed for the new Fada Coloradio Series is available to all dealers.

#### SUEDE ZIPPER CARRYING CASES FOR ALL MODELS

Suede Zipper carrying bags for every Coloradio series are featured for as little as \$2.50

**FADA RADIO & ELECTRIC COMPANY**  
LONG ISLAND CITY, N. Y.

# OPERA ON THE AIR



**MICROPHONE TECHNIQUE** — Kirsten Flagstad and Lauritz Melchior rehearse a dramatic scene from "Lohengrin." Interesting is the fact that the footlight mike shown here is of special design for Wagnerian operas

**CANDID CAMERA** goes backstage for *Radio Retailing* during rehearsals. "Met" officials work with NBC experts to insure perfect transmission of RCA-Victor's sponsored Saturday broadcasts

**MAESTRO & MANAGER** — Edward Johnson, general manager of the Metropolitan Opera Association (left) watches intently while composer-conductor Richard Hageman directs production of his new work "Caponacchi", presented for the first time in America shortly after this picture was taken



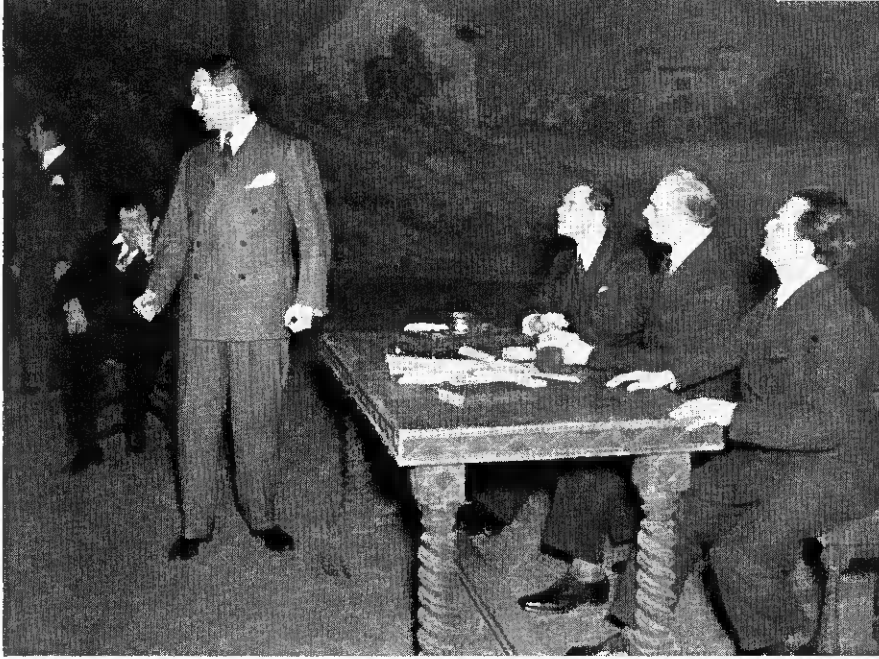

**DRAMA IN DEVELOPMENT** — Lawrence Tibbett sings one of the “Caponsacchi” arias while other stars—sans stage costumes—listen



**BETWEEN THE ACTS** — Marcia Davenport (daughter of the once-famous Alma Gluck) runs through comment notes while Milton Cross, music announcer, looks on



**ENSEMBLE SCENE** — Chamlee struggles—melodiously and physically—to escape his captors in the “Caponsacchi” courtyard episode



**BEAUTY IN ACTION**— Mario Chamlee—in street clothes, collar loosened—carries Helen Jepson onstage

**SIMPLE PICKUP SYSTEM** — High in the proscenium arch are suspended microphones. These, plus those shown in the footlights, do the entire “Met” job. There are no additional units in the wings or elsewhere to impede free movement of performers

**FINGERS THAT TALK**— With his right hand this radio engineer follows the musical score. With his left he directs a nearby operator adjusting gain

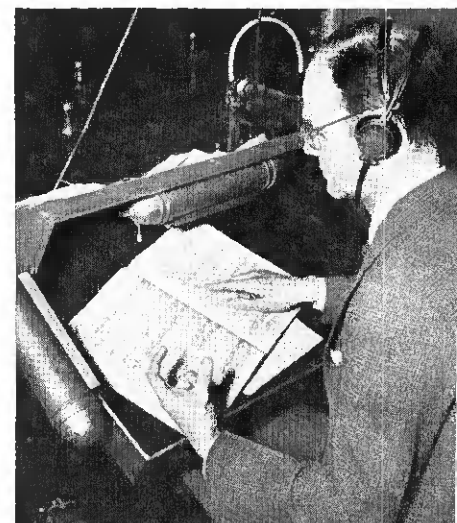
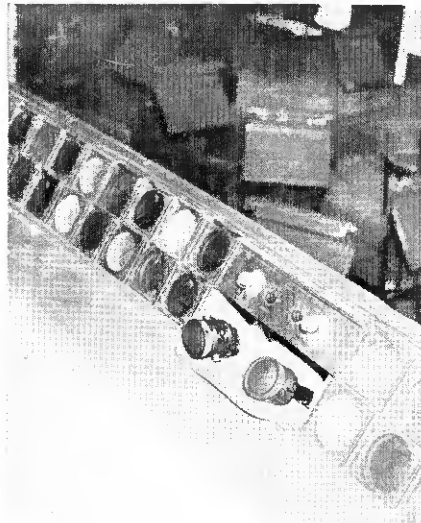
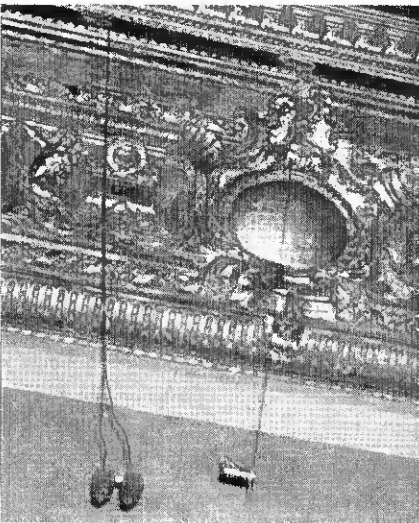

# MOTION WINDOW SELLS TONE

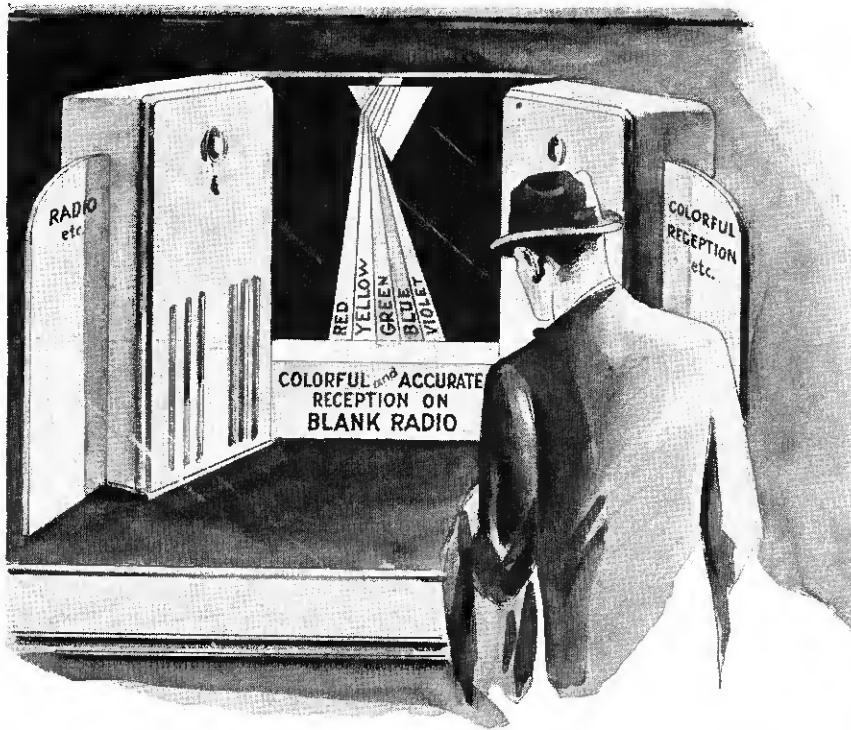

By

I. L. Cochrane

**T**HE word "color" has two meanings in every-day life. First, we think of color as relating to red, blue, green, violet, etc. Again, we are accustomed to hearing the word applied to a clear, harmonious blend of sound overtones.

The word "colorful" immediately suggests drama, beauty and the very best in artistic expression, both visible

and audible. Hence our effort, in the form of an action display, to catch the popular ideas of the word "colorful" and translate them into colorful selling thoughts for a console.

The illustrated display has plenty of color, but color derived from artificial light will not fight daylight. Therefore, in order to make this display as good in day as at night, the method of a leading department store is suggested. When that store shows a display with artificial light as an essential element opaque drapes are hung from the window top to about six feet above sidewalk level, and another drape up from the bottom to about four feet, six inches above the sidewalk. Thus, both the short and tall may easily see through the open space, but enough daylight is kept out to give the artificial light colors flashing through the open space a chance. The combination of masked window (which in itself is novel) and vivid moving colors flashing through the open space seems to attract more attention than any other window display, when it is used for the first time.

When a prospective customer looks through the open space in the window what does he see? Two consoles (on sale) placed at acute angles, form a semi-shadow box for the colorful motion display between them. The face of the display backdrop is painted dull black, except the slanting streak

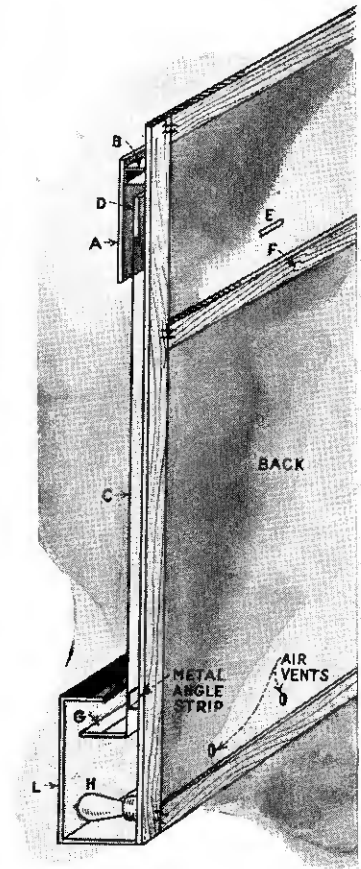

**DIAGRAM 1**—On the front of the wooden frame, which should be the same height as its accompanying consoles, is mounted a sheet of process board painted dull black. The triangle "A" represents the prism, held firmly by cardboard box-holder "B". Swinging pendulum "C" has at the top a pocket "D" to receive looped wire rod "N" from motor, as shown in diagram 2. "E" is slot in back-drop through which rod "N" passes. Bolt motor to cross brace "F". "G" is the metal mask and "H" the lamps. Shadow box holding lamps is "L."

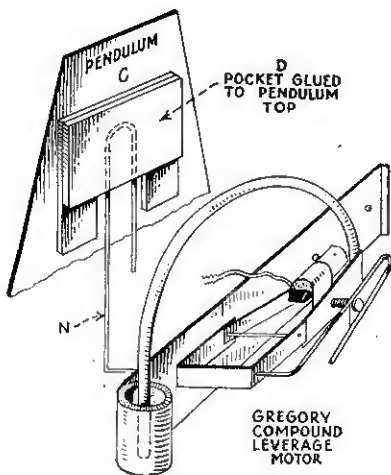

**DIAGRAM 2**—Gregory compound leverage motor is attached to cross bar "F" of diagram 1. Pocket "D" is glued to the rear top of pendulum "C", the motor and pendulum being connected by wire rod "N", which makes the pendulum swing and also supports it. This motor is made by Gregory Motors, 159 E. 34th St. New York, and lists at \$4

of white at the top, and the imitation "prism", or white triangle. As the white light hits the "prism" it is broken into five primary colors, which continue in broadening bands downward to the bottom of the swinging

(Please turn to page 70)

# 5 POPULAR PRICED MODELS



**THE CHAMPION**  
Model R-644

8 Glass Tubes—Octal Base. Large Super-Dynamic Dash Speaker.  
**List Price**..... \$65.95  
*(For dual speakers, use overhead or instrument panel speaker. List price, \$71.95)*

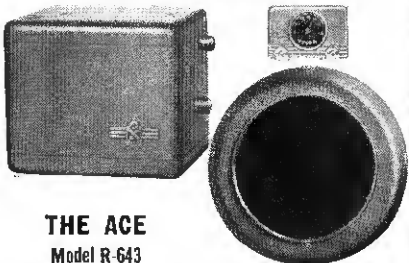

**THE ACE**  
Model R-643

6 Glass Tubes—Octal Base. Header Panel or Dash Speaker.  
**List Price**..... \$53.50

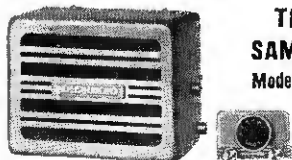

**THE SAMSON**  
Model R-642

6 All-Metal Tubes—8" Speaker. New Streamlined Case. Adaptable to All Cars.  
**List Price**..... \$51.50

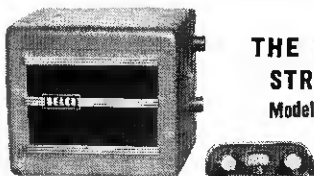

**THE BLUE STREAK**  
Model R-641

6 Glass Tubes—Octal Base. Superb Tone. Outstanding Value at a Popular Price.  
**List Price**..... \$49.50

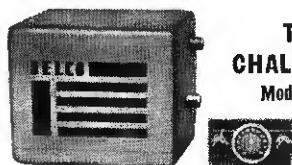

**THE CHALLENGER**  
Model R-640

6 Glass Tubes—Octal Base. Modernistic Grille. Real Station-Getter at a Low Price.  
**List Price**..... \$39.95

# Delco

OFFERS for 1937

A New and Complete Line of

## AUTO RADIOS

with

## CUSTOM-BUILT CONTROLS FOR ALL CARS

Built in one of the largest auto radio plants in the world—backed by one of the greatest names in the automotive industry—these complete new Delco Auto Radios offer dealers a great opportunity for more sales—greater profits. There are five models, with more power—bigger speakers—more tubes—wonderful tone . . . everything new, modern, up-to-date—the finest line of auto radios on the market, in every sense of the word.

### CUSTOM-BUILT CONTROLS FOR ALL CARS

With this line of popular-priced auto radios you can match the dash of any make of car—1937, 1936, 1935. For quick action, write, phone or wire your nearest United Motors Distributor or Branch for full particulars.

#### LOOK AT THESE FEATURES!

Smart, Modern, Suede Finish.  
Continuous Variable-Tone Control Mounted on Control Panel.  
Automatic Bass and Treble Compensation.  
6V6G Beam Power Tube.  
Metal Tubes.  
Glass Tubes—Octal Base.  
High Gain Iron Core Coils.  
More Tuned Circuits.  
Motor Noise Eliminator.

Robot-Controlled Syncro-Tuning.  
Full-Vision Dials.  
Easy to Install and Service.

#### COMPLETE MERCHANDISING PLAN

Including Cooperative Newspaper, Direct Mail Advertising, Display Stands, Banners and Other Merchandising Helps.

# UNITED MOTORS SERVICE

3044 WEST GRAND BOULEVARD DETROIT, MICHIGAN



**BEFORE AND AFTER**—Mystic mazes such as the one shown at the left will one day be banned by law . . . To be superseded by efficient, safe installations such as the one at the right

## HOW TO ESTIMATE ON

**APARTMENT HOUSE OWNERS** are now exhibiting keen interest because: **Roof repairs account for 9 per cent of their overhead . . . Competitors are making effective use of new installations when renting to short-wave listeners . . . Equipment banishes costly feuds between desirable tenants for the best aerial locations . . . Eliminates a prolific source of liability suits**

**By The Engineering Department**

*Technical Appliance Corporation*

**○**MITTING preliminary discussion concerning the market possibilities of modern master antenna systems capable of operating many receivers of both the broadcast and allwave variety, we go immediately into installation details around which accurate estimates revolve.

It is our impression that inability to estimate properly the cost of such installations among retail radio men

is at present the chief deterrent to sales. For salability is, every day, becoming more obvious.

### **Supports Must Be Figured**

The master antenna system begins with the aerial. Simple dipoles or doublets must be swung high and clear of surrounding structures. Advantage is taken of water towers, elevator-shaft houses and other super-structures, for the supports.

Otherwise, iron pipe masts are required.

Permanency is the keynote of such an installation. The sloppy workmanship that has characterized antenna jobs of the past has no place here.

Typical of the durable character of a master antenna installation is the recommended iron pipe mast. For the necessary strength, at least 1½" galvanized pipe, capped at top for protection against weather, should be used. Pipe and fittings should be galvanized. The pipe is preferably in a single length up to 15 ft. tall, and is supported by an elbow and by tees. Such a mast generally requires no guy wires, but if they should be required, the wires must be broken up by strain insulators into lengths not over 6 ft. each. Wooden masts may be employed on lower buildings but are often prohibited by building codes on high buildings. The weight and wind resistance of sleet-covered aerial wires must not be overlooked.

By careful planning, the number of masts is kept to a minimum.

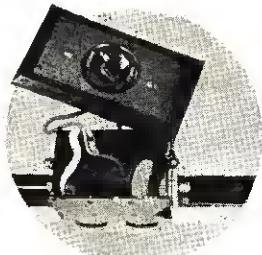

**ATTENTION TO DETAIL.**— Here's the way a transmission line can be made inconspicuous, running down the side of a large apartment house. Close-up: Note use of flat copper ground-strip to flashing, protected by angle-iron

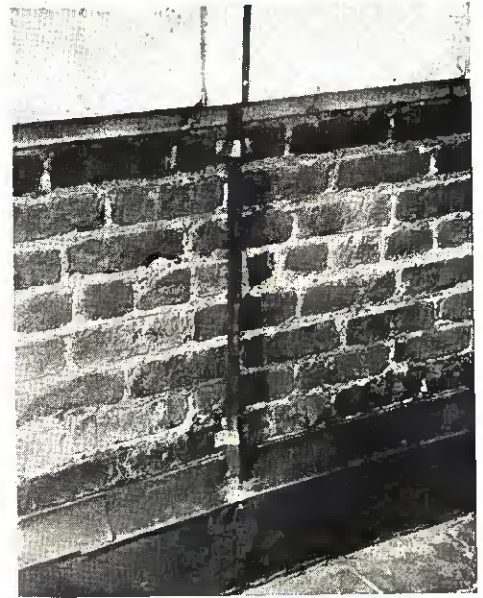

**FOR OLD OR NEW** — (top to bottom)  
Typical conduit wiring job . . . Typical BX job . . . Typical knob and tube job

# MASTER ANTENNA SYSTEMS

Super-structures serve to hold one end of an aerial. A single mast may serve to support one or two aerials. Considerable saving in masts and downlead lengths may be effected by proper layout of the job.

Once the masts and other supports are available, the aerials are strung up. There is generally a transfer unit in each doublet aerial, separating the two sections and connecting with the downlead cable or transmission line. The twisted-pair transmission line first connects with an approved type lightning arrestor, and then goes down to the various outlets in the building. A good ground connection is secured for the lightning arrestor, preferably the steel framework of the building, nearby copper flashing, or a pipe known to go to ground.

### Exposed Wiring Job

From this point on, the nature of the installation depends on whether it is an exposed-wiring or a concealed-wiring job. Most installations are of the former category, (Please turn to page 43)

SUGGESTED COST ESTIMATE FORM					
MATERIAL					
	No. Used	Unit Cost	Total Cost		
Foundation Kits					
Couplers					
Transmission Line (ft.)					
Mast Assemblies					
Porcelain Knobs					
Solid Wire					
Miscellaneous					
LABOR					
	Man-Hours Per Operation (A)	Cost Per Man-Hour (B)	Cost Per Operation (C) A x B	Units Used (D)	Total Cost (C x D)
Handling of Material					
Mounting of Masts					
Erection of Aerials					
Mounting Lightning Arrestors					
Embedding Wires					
Mounting Knobs					
Installing Couplers					
Testing					
<b>GRAND TOTAL.....</b>					<b>\$</b>

# FOILING THE "FLOATER"

These facts concerning *fidelity bonds* will be particularly interesting to outside-selling organizations hiring large crews of commission salesmen

By Charles Phillips

HE wanted to work on straight commission—10 per cent. All he wanted was names of people who had money and who were interested in buying a radio.

Occasionally that kind of a salesman applies for a job—no haggling about drawing account or salary, just straight commission. We engaged him on the strength of his face and his aggressive sales attitude. He had four of our biggest sets out on demonstration in two days—good prospects too, rating A-1 through the retail credit bureau. His reports were excellent—the prospects were good and prompt sales seemed imminent.

Our next report was that four customers had sales receipts for their radios and our man was missing with \$180 cash—

*It happened to us, it could happen to you!*

You can't depend on an "honest" face, you can't always check references in time, all you can do is to buy protection—dishonesty insurance; *fidelity bonds* is the official name for it.

Files of surety companies show the average age of embezzlers to be 34 years, their term of employment ten years and one month. They average seven years and three months before starting to steal and get by an average of three years and one month before being discovered.

## Individual or Group

Dishonesty insurance may be written in several different forms; 1st, by *individual* bond on each employee;

2nd, by a single bond called a *schedule* on which new employees may be added from time to time with a proportional adjustment of the premium; 3rd by a *blanket bond* on all employees and officers. All new employees are automatically added to a blanket bond without extra insurance premium obligations.

The premium on a blanket bond is determined by the number and class of employees at anniversary date of the bond. The type of dishonesty protection best suited to your particular business may be determined after a frank discussion with your insurance agent.

Dishonesty insurance covers only losses suffered through acts of the employees covered by the insurance. It does not, for example, cover claims which a customer may make against a salesman or serviceman for loss of property—direct criminal action by the customer against the individual is the only recourse for such claims.

## Reduces Shrinkage

What about small inventory losses? The tubes and parts which show a shrinkage that is not accounted for on the books are not covered by a fidelity bond, unless proof of theft by a bonded employee is obtainable and then **only in the amount which it can be proved was stolen by him.**

Bonding employees cuts petty lar-

## CAUSES of LOSSES

Fictitious Payments

Cash Rebates

Juggling Accounts

"Borrowing"

Unauthorized Expenditures

"Forgetting" Sales

Padding Expenses

Connivance

"Trying Out" Sets

Filching Parts

Absconding

Fraudulent Contracts

ceny to a negligible amount. Each individual fills out the detailed information on the bonding company's regular investigation form which discloses his past employment, the names of his relatives, business and social friends. The bonding company investigates these references free of charge and advises the employer if certain individuals constitute a greater risk than they care to assume. The psychological effect of filling out the form is a great deterrent to employees with dishonest tendencies.

## Several Kinds

All dishonesty insurance is not the same.

Read a sample policy carefully before you buy. Some obsolete forms require that you prosecute the embezzler before you are able to collect. Others deduct all of the salvage recovered even though the loss be far greater than the bond! When you buy fidelity bonds, make certain that you are obtaining protection against any dishonesty or criminal act of your employees including fraud, forgery, theft, misapplication and misappropriation.

# PARRIS-DUNN LAUNCHES SENSATIONAL *New* DUN-CHARGER COOPERATIVE MERCHANDISING PLAN

## DEALERS—Build Your Battery Radio Sales With this Amazing New Merchandising Plan

When you tie in with the powerful new merchandising plan of the Skyscraper Dun-Charger, you are assuring yourself of all the opportunities offered by the greatest sales plan ever conceived. A plan that actually creates radio prospects and gives them a check for \$2.50 to apply on the purchase of a farm radio. It then automatically makes each purchaser a salesman for you and Parris-Dunn pays their wages.

### REVOLUTIONARY IN DESIGN

The new DeLuxe Skyscraper Dun-Charger with its 10 foot installation in many cases puts the propeller above the eddy currents and broken wind stream increasing its efficiency as much as 30% over low mounted chargers. The exclusive Dunn governing device controls propeller speed perfectly even in violent windstorms and the positive elimination of broken blades as the propellers tilt back and slip the wind. All governing devices are kept off the blades so that the propeller is light and free to operate in the lightest winds.

### HOW THE NEW MERCHANDISING PLAN WORKS

Dealers may order any quantity of Dun-Chargers without special order blanks at \$15.00 net cash F.O.B. the factory.

Radio Manufacturers cooperating with us will coupon their radios. The dealer, if he so desires, can use the



### FEATURING UNMATCHED QUALITY IN

1. Propeller — Dunn's stronger and more efficient.
2. Speed Control — Dunn's positive automatic — patented and exclusive.
3. Generator — Extra Heavy Duty Wind-Electric, with oil sealed bearings.
4. Collector ring — lifetime, foolproof.
5. Turntable — ball bearing.
6. Propeller Shut-off-pull back type making brakes unnecessary and obsolete.
7. Tower — Heavy reinforced steel, double height.
8. Instrument Panel — new, completely wired.

coupon as a premium to give the buyer of his radio the opportunity to purchase a Dun-Charger direct from our factory for \$15.00.

If charger is delivered by the dealer with a 6-volt radio, we suggest a delivery price from \$17.50 to \$19.50. An installation charge of \$5.00 to \$15.00 should be made.

### DUN-CHARGER PAYS FARMERS FROM \$1.00 TO \$25.00 FOR BUYING YOUR RADIO

Packed with each Dun-Charger are 25 special order blanks which the purchaser hands to friends and neighbors, these blanks entitling the holders to buy a Dun-Charger at \$17.50 F.O.B. factory. For his work, Parris-Dunn will mail him a check of \$1.00 for every order received bearing his name.

### DUN-CHARGER PAYS EVERY FARMER \$2.50 TO APPLY ON PURCHASE OF RADIO, AT YOUR STORE

Every one who buys a Dun-Charger direct from our factory at \$17.50 will be given a check for \$2.50 to be applied on the purchase of a new 6-volt radio. This check will be redeemed in cash by Parris-Dunn Corporation when accepted and certified by any store selling a radio manufactured by a company couponing and recommending the Dun-Charger. A list of these manufacturers will be supplied to all holders of the \$2.50 checks.

### PARRIS-DUNN MERCHANDISING PLAN BACKED BY NATIONAL AND STATE FARM PAPER ADVERTISING CAMPAIGN

Every month Eleven Million ads are appearing in National and State farm papers telling the farmer how he can receive a Dun-Charger FREE. Dealer helps — folders, letters, new leads to prospects in your community and local newspaper ads featuring your radio and Dun-Charger — are supplied all dealers selling one of the radios whose manufacturers are cooperating with us on this plan.

Here is an amazing opportunity to skyrocket your 6-volt farm radio sales with the greatest cooperative merchandising plan ever devised. Get your display model today and take advantage of the peak of the farm radio selling season.

Mail Coupon Today for Details!

**IT'S A LEADER  
A CLOSER  
COOPERATIVE  
MONEY-MAKER  
COLOSSAL**

Parris-Dunn Corporation,  
Clarinda, Iowa

I think this is a real merchandising plan and I would like to see the radio we are now handling packed at factory with Dun-Charger coupon.

Make of radio handled.....

Name ..... City.....

County ..... State.....

Please send further details on the Parris-Dunn Cooperative Merchandising plan.

I am enclosing..... for which please send me.....  
Skyscraper Dun-Charger including high tower, according to your special money back guarantee test offer.

Prices and Merchandising Plan good only in U.S.A.

# ANNOUNCING

## The New 1937

# ZENITH

LONG DISTANCE  
AUTO RADIO

Called "America's Safest" by Traffic Experts

## FEATURING THE FIRST FINE SET



AS LOW AS  
\$29<sup>95</sup>

### SPECIFICATIONS

Exceptional sensitivity—really amazing. Distortionless, clear reception. Big Black Dial. "Guardian reminder" prevents leaving set turned on. One-bolt, four-way installation position—Zenith Monogram always upright. Choice of steering post or custom dash-panel safety control. Finest type 5" electro-dynamic speaker; 5 meta-glass tubes; superhet. circuit; rubber cushioned condenser; no spark-plug suppressors. Available for full season.

**A**N OUTSTANDING new line—typically Zenith in performance and value—headed by this \$29.95 set that leads in price yet makes no sacrifice of quality.

Just as Zenith dealers broke all records last year on the home sets, so you will find this auto radio line a smash-hit—your big profit-maker for 1937. This line's got *everything!* Attractive discounts that assure fine profits—powerful display and

promotion material—outstanding Zenith performance with features galore, superb tone, astonishing power—complete provision for one-bolt, plug-in-connection installation—aerials of all types—custom panels for all cars.

Ready for delivery NOW! Ask your distributor, or write us direct.

ZENITH RADIO CORPORATION, CHICAGO, ILLINOIS

**A COMPLETE LINE FROM \$29.95 TO \$69.50**  
COMPLETE SELECTION CUSTOM PANEL PLATES FOR ALL CARS



# NEWS

PEOPLE • PRODUCTS • PLANS

## RMA OPPOSES SET EXHIBITS, OK'S PARTS

Goes On Record Against Receiver Display At Both Trade And Public Shows. Endorses Parts Makers Shows Scheduled For Chicago, New York

CHICAGO—Exhibition of receiving sets in trade shows and public shows, by set manufacturers or distributors, is not helpful to business and is not approved, according to a show policy determined by the Radio Manufacturers' Association board of directors at its meeting here January 13. RMA set manufacturers are being requested to refrain from such exhibitions and also to request their distributors not to participate in such shows.

Formal endorsement of parts shows to be run by Radio Parts Manufacturers Trade Shows, Inc., at the Hotel Stevens, Chicago, June 10-13 and in New York October 1-3 was voted by RMA at this same meeting. It was arranged, also, to hold the annual RMA membership meetings and convention at the Stevens on June 8-9, immediately preceding the first of these parts shows.

### PARTS SHOW BOOTHS GO FAST

CHICAGO—A goal of 100 booths set by the management of the Radio Parts Manufacturers National Trade Show for its first exhibition at the Stevens Hotel, June 10 to 12, has already been attained, according to S. N. Shure, president of the Shure Corporation.

It now appears that the facilities of the Exhibition Hall where the show is to be staged may be inadequate to accommodate all applicants.

### Battery Exchange Plan Inaugurated

PHILADELPHIA—Under a plan just launched by the Philco Radio and Television Corporation dealers may provide the consumer with a freshly-charged stock storage battery when his battery becomes discharged. The service costs \$1.

The plan was "officially" adopted after its highly successful use by a small town dealer who was able thereby to build up a remunerative battery set business.

It was found, on test, says Philco, that one additional battery for dealer stock of each four put out with radios was sufficient reserve.

### GRUNOW UPS DAVIN

CHICAGO—Bill Grunow of the General Household Utilities Company has announced appointment of J. J. Davin to the position of assistant to the president, in full charge of sales promotion.

Davin has been associated with Grunow for the past 10 years. One of his first assignments is to release an official house organ to 15,000 dealers.

### WILLIAMS BUYS APPARATUS DESIGN

LITTLE ROCK—J. R. Williams, designer of "Confidence" and "Unimeter" tube testers, has purchased the Apparatus Design Company and will carry on its business with the aid of his sons, who have helped him design equipment.



**NEW GRUNOW EXEC**—Here's a shot of Harry Alter, taken three short weeks ago when he was still distributing Grunow merchandise. Harry's now with the General Household Utilities Company itself . . . and as director of sales

During the coming year activities will be confined to modernizing the thousands of testers put into the field by this company in the past. A new line is in process of development.



**MESSRS. PARRIS & DUNN**—Hard at work on wind-driven chargers at Clarinda, Iowa, are C. L. Parris (left) and W. C. Dunn, who joined forces a short time ago as reported in our December issue

## ILLINOIS DEALERS HARNESS FAIR TRADE LAW

### Association Questions Distributors Concerning Franchise Plans For Year

CHICAGO—No grass is growing under the feet of the Illinois Radio & Electrical Dealers Association, now that the clouds have been rolled away by the Supreme Court decision on the state's Fair Trade Act. Some thirty-two appliance distributors have been asked to consider franchising their retail outlets under the terms of the act.

Asks George W. Rockwood, executive secretary:

"1. What lines handled by you will be sold under a dealer franchise plan under the Fair Trade Act provisions?"

2. After what date will this franchise be in effect?"

3. In lines so resale priced, will there still be for sale in Illinois items in your line not sold under franchise as to resale prices?"

The association suggests the following:

1. Not to sell, deliver, consign, rent, lend or otherwise transfer merchandise, whether actually in possession or otherwise, to any firm that has not been franchised for resale.

2. To notify in writing all franchised dealers of any reduction in resale prices at least ten days in advance.

3. To check at intervals on dealers, and investigate complaints.

4. Consider any dealer to have violated resale price agreement if, without authorization he: (1) Reduces prices directly, (2) allows excessive trade-ins, (3) gives merchandise as premiums to boost other merchandise sales, (4) gives rebate or cash discount.

5. Not to sell products covered by the Fair Trade Law to organizations selling in violation.

6. Cut off sales to violating dealers, and repurchase the merchandise as provided by the act.

### New C.I.T. Office

MORRISTOWN, N. J.—The C.I.T. Corporation has opened a new office here at 10 Park Place, placed it under the wing of K. R. Manville, formerly in the Perth Amboy office, assisted by C. F. Gilbert, formerly of the Newark office.

### Ken-Rad Weathers Flood

NEW YORK—A report received from the Ken-Rad Tube and Lamp Corporation at Owensboro, Kentucky, February 3 states that flood conditions had not at that time seriously interfered with manufacturing activities.

The Ohio reached alarming stages several times in this vicinity, however, and railroad facilities were cut off. To meet this emergency a barge was chartered and put in service between Owensboro and Evansville for shipment of needed ma-

terials. Outgoing shipments went over the same route.

Mail service, as well as long-distance telephone and telegraph, was not operating normally but this communication deficiency was made up without great trouble via shortwave radio.

### FCC Asked for Protected 455 Kc. I.F.

WASHINGTON—Assignment of 455 Kc. as a protected intermediate frequency standard for the radio industry has been requested of the Federal Communications Commission. Chief engineer T. A. M. Craven presided over an FCC meeting at which this proposal was submitted by the Radio Manufacturers Association January 18.



**TO GALVIN FROM RCA**—For the past five years advertising and sales promotion manager of RCA's radio and phonograph divisions, *Walter H. Stellner* goes with Motorola as assistant sales manager, household division

## RADIO PLAYS DRAMATIC PART

### IN FLOODS



**EMERGENCY STATION**—A police announcer, tired, worn, directs Louisville rescue work over a hastily set up rig driven by a portable generator



**THE DANGER ZONE**—Foster Brooks of WHAS climbs a Louisville 'phone pole with his boots on to give his ultra-high frequency pack transmitter the benefit of height while Pete Monroe of CBS waits on "land"

## CROSLY PRODUCTION AND SHIPMENTS RESUMED

**Main Radio and Refrigerator Plant Intact. Rex and Truscon Companies, Supplying Shelvador Cabinets and Dies for Some Time, Take Over Assembly Formerly Handled in Burned Building K**

CINCINNATI—Powel Crosley, Jr., president of the Crosley Radio Corporation, returned here January 26 as the flood started to recede and, after a survey of the plant, issued a statement to *Radio Retailing* to the effect that the main factory and sources of supply for the manu-

outside sources are set up to take over the entire cabinet assembly job formerly done in Building K.

Shortly before the flood engulfed Cincinnati, Crosley held the largest and most successful distributor convention in its history. 150 distributors attended the



**FOOD BEFORE THE FLOOD**—(Left) Charles Bowers and Henry Roth of Wheeling, Harold Goldstein and Harry M. Sadler of Pittsburgh, eat the Crosley spread. (Right) David Slobodien, Harold Bergman and Fred Goldberg discuss the new refrigerator over a cup of Java

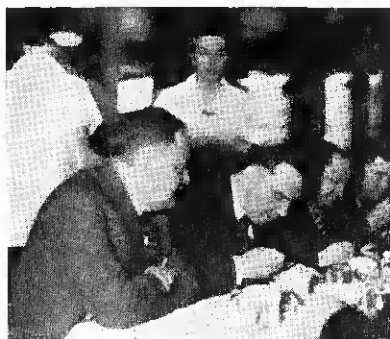

**DISTRIBUTORS AT DINNER**—(Left) C. B. Savage of Ft. Worth, Lewis M. Crosley of the company, Hymen Reader of Houston, Lee Bird polish off desert served by Rosemary Bador. (Right) Hugh C. Green, Oscar Maurer and Howard Brewer, all of Indianapolis

facture of both radios and refrigerators remain intact and that if there are no further serious rains it will be possible to resume operations in full in two weeks.

The main Crosley plant at Colerain and Arlington Streets, an 8-story building, suffered only water damage on the first floor. It was, however, threatened by fire from ignited gasoline floating on the flood water, January 24, and Building K, across the street, was completely destroyed. Building K handled refrigerator cabinet assembly. Fortunately, however, Crosley has never undertaken to manufacture all its refrigerator cabinets, Rex Manufacturing Company, of Connersville, Ind., building some and the Truscon Steel Company, of Cleveland, making dies for certain of the cabinet parts. These two

meetings in the studios of WLW. In what he called a "new deal," Powel Crosley, Jr., personally introduced two radically new lines of Shelvador electric refrigerators for 1937, a standard and a deluxe line. Outstanding among more than a score of innovations and improvements is a new hermetically sealed mechanical unit called the Electro-Saver, that has greatly increased freezing speed and lowered current consumption, in addition to enlarging ice-making capacity. Cabinets have been re-styled, further improving the lines of the 1936 models. Many new convenience features have been introduced.

Another innovation that created great interest was one model which incorporates a five-tube superheterodyne radio in the refrigerator, the first refrigerator ever to

be equipped with a radio. The radio is concealed in the upper part of the refrigerator and only a small dial is visible.

## FCC GETS BROADCAST REPORT

WASHINGTON—General power increases in broadcasting, a fundamental recommendation made by the RMA, featured a report to the FCC on January 12 by its engineering department. The report, growing out of the Commission's hearings last October at which data prepared by Bond Geddes and L. F. C. Horle was presented, recommended the following:

Minimum power of 50 K.W. on clear channel stations, together with general power increases for other stations at the discretion of the Commission.

Reduction in the number of clear channels from the present 40 to 25.

Retention of 10 K.C. channel separation system.

Opening of the 1510-1600 Kc. band for regular broadcast service under three alternative plans providing for from 40 to 500 additional stations.

It was deemed inadvisable at present to specify standards of receiver selectivity and postponement of consideration of receiver fidelity standards was also recommended.

## ROCHESTER SERVICEMEN MEET

ROCHESTER—The Association of Radio Service Men held its first meeting of the new year here January 11.

Committee reports reflected optimism for the coming year. William Bellor arranged the entertainment. Chairman Bert Lewis read a letter from the FCC asking the association's opinion as to whether it thought increased station powers would aid or injure reception in the area. Their answer indicated they believed it would aid reception.

George Driscoll spoke on broadcast service.

## PR SMA HONORED

PHILADELPHIA — The Philadelphia Radio Service Men's Association has been honored by a request from the Philadelphia Board of Education to cooperate by supplying information pertaining to accepted standards of workmanship, tools, test equipment and supplies in the radio service field.

The Board of Education contemplates introduction of a radio course in its new vocational schools this Autumn.

## New G.M. For World

BOSTON—Dan E. Baumbaugh, former merchandise manager of The May Company, Cleveland, has been made general manager for World Radio, operating 34 retail chain stores in New England.



**ANOTHER STANCOR ASSET**—Everett E. Gramer has been appointed vice-president in charge of engineering and production for the Standard Transformer Corporation, according to Jerome J. Kahn, president



**BELMONT THROWS PARTY**—And Sidney Freshman looks at a still wet photo of the company's employees in their best bibs and tuckers



**PIONEER-MAN LIKES ELEPHANTS**—Dave Bright of Gen-E-Motor fame keeps a flock of them on his desk for luck, bronze ones

**Four New Men For F, M**

INDIANAPOLIS—J. H. Hopwood, R. E. Eshman, W. H. Hayward and D. B. Keller have been appointed special representatives for the Home Appliance Division of Fairbanks, Morse & Company, according to W. Paul Jones, general manager of this division.

**ELECTRO-ACOUSTIC SPRINGS NEW POLICY**

To Market Complete Sound Line Through Distributors-Dealers. Includes Special Magnavox Speakers.

FORT WAYNE—Electro-Acoustic Products Company, subsidiary of the Magnavox Company, has just announced a new manufacturing and sales policy of interest to radio and radio parts distributors and dealers who recognize the possibilities for profitable volume in the popular price public address market. Hitherto active in the custom-built field, this company has now developed and is marketing through a distributor-dealer setup, a complete, diversified line of packaged sound equipment.

The engineering personnel has perfected this new line in conformity with the long established policy of producing only a quality product. It covers all requirements of sound reinforcement and distribution. Portable systems, emphasizing distinctive appearance together with wide-range repro-

duction, range in power output from 6 to 30 watts. Replacement amplifiers for all applications are offered, together with accessory equipment.

An outstanding feature is the new line of Magnavox speakers, developed and made available expressly for public address requirements. This is the first time in a number of years that Magnavox speakers have been made available for general public address work.

Electro-Acoustic manufactures under license agreements involving patents of the Magnavox Company, Electrical Research Products Company, Western Electric Company, American Telephone and Telegraph Company, and all sub-license rights these companies now or hereafter acquire from other sources.

**MALLORY-YAXLEY RADIO ENCYCLOPEDIA CLICKS**

Control, Condenser, Vibrator Data On 12,000 Receivers Shown In Novel, Practical Style. Rapid Reference Charts Of Every Description Included

NEW YORK—Understood to have cost \$75,000 to compile and print, reported already ordered to the tune of 20,000 copies with half of the company's distributors yet to be heard from, the long-heralded Mallory-Yaxley Radio Service Encyclopedia published by P. R. Mallory & Co., Inc., Indianapolis parts manufacturer, comes to us for review just in time to make press-schedule.

Available solely through Mallory-Yaxley distributors (\$2.50 list, \$1.50 to servicemen) this 8 1/2 by 11 1/2-inch, 224-page book bound within a hard, washable cover represents, without question, the greatest single reference work ever prepared for servicemen by a parts maker.

Backbone of the Encyclopedia is its 99-page section listing 12,000 radio receiver models of all known makes together with their tube lineup and I. F. peaks. And this is only the beginning. For the tabulation shows, also, the type of controls (including switches where these are integral), by-pass and filter condensers and the type of vibrator (where one is used) in each of the models listed.

While no complete receiver circuit diagrams are included, a clever method of keying each individual model of the 12,000 permits the serviceman to clearly identify the method of control, condenser and vibrator connection used in each set by referring to "blown-up" diagrams covering just these vital circuit points.

Transformer connections, covering replacement parts in which Mallory-Yaxley has little personal interest, are likewise indicated. This same broadness of viewpoint calculated to make the Encyclopedia

indispensable to the serviceman also leads its publishers to include a wealth of additional data dealing with new circuits such as automatic frequency control, resistors, antennas, tubes and set alignment.

High in interest and practical value, too, are the many full page charts such as those showing tube socket connections from both top and bottom, actual socket voltages in receivers of standard design, methods of rapidly calculating inductance, capacity and resistance values required for specific jobs.

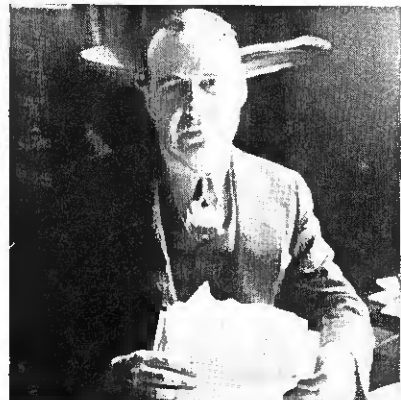

**ZENITH'S AD WIZARD**—Many of the unsigned promotional masterpieces received by the trade recently are the handiwork of E. G. Herrmann, advertising manager



# CAN YOU USE \$600 CASH?

ALL YOU HAVE TO DO IS ANSWER A QUESTION. YOU KNOW THE ANSWER NOW—YOU TELL IT TO A CUSTOMER TWO OR THREE TIMES A WEEK. YOUR CHOICE OF EITHER \$600 CASH OR A NEW V-8 SERVICE TRUCK WITH A COMPLETE BUILT-IN SOUND SYSTEM IS THE FIRST PRIZE. THERE ARE 500 OTHER PRIZES!

**ASK YOUR JOBBER**

# RAYTHEON

**RAYTHEON PRODUCTION CORPORATION**

420 Lexington Ave., New York, N.Y.

55 Chapel Street, Newton, Mass.

445 Lake Shore Drive, Chicago, Illinois

555 Howard Street, San Francisco, Cal.

415 Peachtree St., N. E., Atlanta, Ga.

RAYTHEON IS THE MOST COMPLETE LINE—ALL TYPES OF GLASS, OCTAL BASE, METAL, RESISTANCE AND AMATEUR TRANSMITTER TUBES

## KELVINATOR UNVEILS 1937 LINE

DETROIT — Nash-Kelvinator didn't borrow the Sherwin-Williams paint sign, "We cover the earth," for use at their Detroit convention, January 6-7, but when the procession of products ended, it looked as if Kelvinator's line about completely covered the major appliance market.

Higher, wider and shallower are the sixteen 1937 Kelvinator refrigerators, to

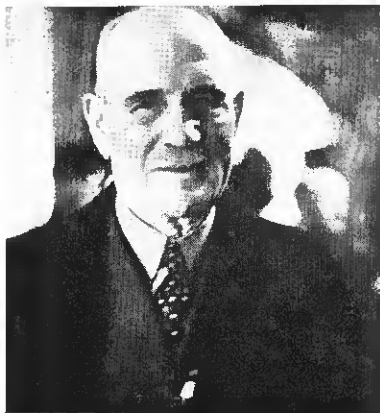

**MEET NASH**—C. W. Nash himself, Chairman of the Board. He was a major Detroit drawing-card

permit fuller use of shelf room. Advertising message hammers home the increased "plus" power. Four separate lines are offered, from 3.16 to 16.79 cubic feet. Although chromium hardware is standard, it may be obtained with choice of black, yellow, tomato red, lettuce green, medium blue or snow white trim at slight additional cost, M. S. Bandoli, director of domestic refrigeration sales, declared.

That the electric range is at the place refrigeration stood in 1927, Pierre Miles, sales manager, range and water heater division, told the twenty-five hundred dis-



**BROADCAST HARBINGER** — Sam C. Mitchell told distributors Kelvinator would soon have a hot spot on the air

tributors and utility men who assembled in the Wilson Theater.

"Note how only 8% of the business in ranges was done by dealers in 1932," he said. "Look at how 35% was done by them in 1936. We are on the eve of general acceptance of range and water heaters."

Home economics schools will be held about the country this year instead of Detroit, Miss Frances Weedman, director of home economics, told the audience. H. W. (Hoke) Newell of the advertising agency, showed how the Kelvinator story had been condensed to a couple of nutshells, "plus" power and "coasting" being the theme. Aimed at the less than \$2,000 a year income group, copy features 90¢ a week financing. A free Kelvin home book, and coupon blanks for the Kelvinator contest insures floor traffic, Newell pointed out. Sam C. Mitchell, director of advertising and sales promotion, broke the news that Kelvinator was going on the radio, with free homes as prizes to the contest.

E. L. Sylvester, director of public re-



**FIRST AND LAST**—H. W. Burritt was first on Kelvinator's convention platform. And he polished it off with the last speech too

lations, told the story of the much talked about Kelvin home. W. A. Saylor, promotion man, trotted out a new Kelvinator sign and dealer store trims.

V. J. McIntyre, sales manager, laundry equipment division, showed the crowd the new line which includes four washers, a two-tub model and a spinner, as well as ironers.

Probably the distributors and utility men who journeyed to Detroit were as much interested in meeting the personality of C. W. Nash, automobile tycoon, who has recently become a member of the major appliance industry, as in anything else. Mr. Nash told of his belief in the future of air conditioning and

assisted by President G. W. Mason, tried to meet everyone present.

General talks were made by Vice President H. W. Burritt, in charge of sales, and other Kelvinator executives.

### EMERSON DEALERS MEET

NEW YORK—At a dinner in the Hotel New Yorker January 25, President Ben Abrams, of the Emerson Radio & Phonograph Corporation, announced formation of a new distributing organization for the metropolitan territory, to be known as Emerson New York, Inc. More than 700 dealers heard Louis Abrams named president of this new distributing organization. Lillian Guth is treasurer and credit manager; Harold Karlsruher, sales manager. Headquarters will be at 111 Eighth Avenue.

During the session formation of Emerson New Jersey was also announced. This new organization will distribute Emerson products in the state after which it is named.

Several new automobile radios were shown and Ben Abrams revealed, during his discussion of these, that Emerson sales in the New York area totaled \$6,000,000 last year. Forty thousand units were observed by retailers in the territory during December alone, he said.

### SHURE GETS XTAL LICENSE

CHICAGO—Shure Brothers, manufacturer of microphones and acoustic devices, has just been licensed by the Brush Development Company for the manufacture of piezo-electric reproducers.

Engineers are engaged in the further development of Rochelle salt crystal devices for use in microphones, vibration pickups and record reproducers.

### TUNG-SOL EXECS MEET

CHICAGO—A meeting of the executives and branch manager of the Tung-Sol Lamp Works, Inc., Radio Tube Division, was held at the Hotel Sherman December 9-13. According to Clyde Bohner, vice-president, every branch reported a substantial increase in sales for 1936.

The company's new factory, now completed, is in full production, turning out tubes for sale under the Consignment Selling Plan which functioned so well during the season past.

### RMA Fights Luxury Tax

OKLAHOMA CITY—In Oklahoma a "luxury" tax bill has been introduced proposing a 10 per cent sales tax on a large number of articles, including radio, refrigerators, automobiles, musical instruments, sporting goods, cosmetics and broadcasting. Opposition to the proposed levy was organized immediately by RMA, for elimination of radio from the bill.

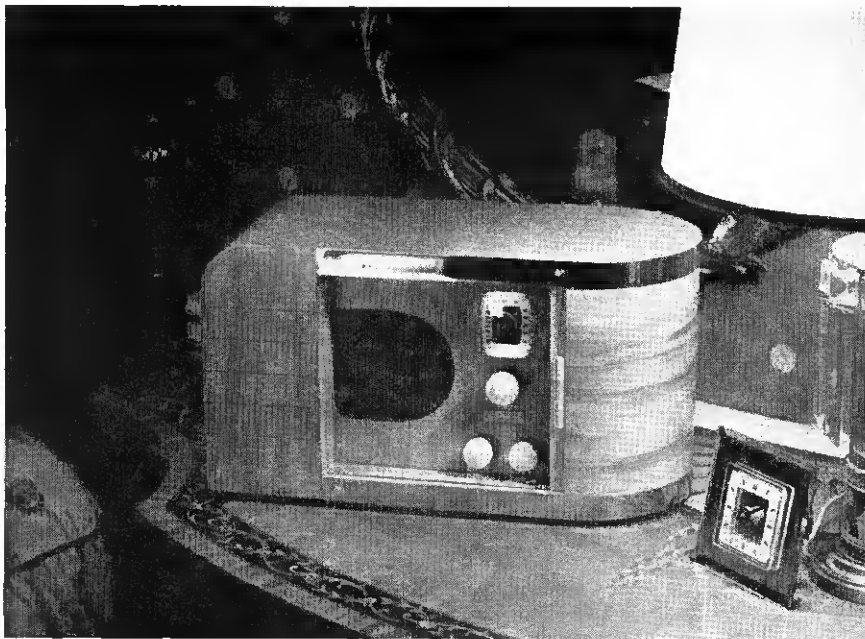

This is the  
**DICTOGRAPH**

*Silent!*  
**RADIO**

**WITH THE ACOUSTICON MYSTIC EAR**  
*... an Outstanding Sales Opportunity!*

• When you feature the Dictograph Silent Radio, you start from scratch. *Everyone* is a prospect, radio-owners as well as non-owners—for this radio is absolutely non-competitive compared with all the conventional loudspeaking sets on the market. The Dictograph Silent Radio puts into your hands a brand new sales argument, growing out of its ability to make listening either a personal experience or a group experience at the turn of a switch. Dealers who have appreciated this fact are reaping a harvest of sales; you should be one of them.

Realize, please, that the Acousticon Mystic Ear is not an earphone or a miniature speaker. It is a newly patented device that employs the tonal fork principle in which 60% of all sound is heard through bone conduction. No other set can achieve the same result—because no other set can include the Mystic Ear. Get the facts about this astonishing set that is revolutionizing the radio industry. Learn how it can build *your* income.

*Return the coupon today.*

**DICTOGRAPH PRODUCTS COMPANY, INC.**  
Executive Offices: 580 Fifth Avenue, New York, N. Y.

The words "Silent" and "Acousticon Mystic Ear" are trade marks;  
U. S. Pats. 101,980 and 1,630,028; other patents pending.

Don't confuse the Acousticon Mystic Ear with an Earphone or a Miniature Loudspeaker.



*The Tuning Fork.*  
... Strike it! Hold it in the ear! Little or no sound is emitted.

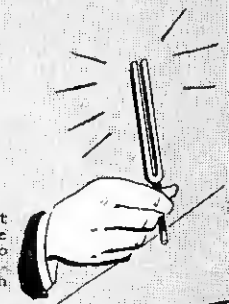

*But press it against a table and the table is put into resonance—vibrates—gives forth a musical note.*



*The Acousticon Mystic Ear functions on the tonal fork principle. Hold it in your hand—hardly a sound.*

*But put the Mystic Ear behind a pillow, lean your head against the pillow—and you hear! Remember—60% of that sound is heard through bone-conduction, inaudible to others even a few feet away.*

**Dictograph Products Co., Inc.,**  
580 Fifth Avenue, New York

Please send me further information concerning your Dictograph Silent Radio proposal. RR-1

NAME \_\_\_\_\_

ADDRESS \_\_\_\_\_

CITY \_\_\_\_\_

STATE \_\_\_\_\_

I am a retailer ;

I am a wholesaler

## GENERAL HOUSEHOLD SHOW HELD

CHICAGO—What Grunow will do in 1937 was revealed to 400 distributors and department store buyers assembled in the Stevens Hotel January 6 and 7 for the General Household Utility Company's radio and refrigeration sales convention.

"We're lined up to produce both radios and refrigerators at a price that will attract buyers," President W. C. Grunow said. "In addition, we have increased our advertising appropriation decidedly and promise that the potential market for the line will be well cultivated."

Additions have been made to both lines. Three new radios—a 5-tube AC-DC model at \$29.95; a 6-tube table model with foreign reception at \$39.95; and a 7-tube console with foreign reception at \$59.95. The refrigerator line includes six models ranging from 5 ft. to 8-ft. in size, all containing several improvements, and priced from \$149.50 up.

A large share of the advertising appropriation will be spent cooperatively, with an adequate magazine, billboard and radio campaign of national proportions.

### New Jersey Branch for G-E

NEWARK—The General Electric Company has just opened a radio distributing branch here. The General Electric Supply Corp., which has handled radio distribution up to this time, will concentrate on Hotpoint refrigeration, home laundry equipment and G.E. appliances and electrical materials.

Walter T. Ferry will be directly in charge of the new office at 98-108 Frelinghuysen Ave., as sales manager for northern New Jersey. D. W. May, district radio sales manager, will spend much of his time at the new office. He presided over a celebration dinner tendered radio dealers at the Essex House January 21.

### Eshman Joins Fairbanks, Morse

INDIANAPOLIS—R. I. Eshman, well-known in the refrigeration industry, has just joined the Home Appliance Division of Fairbanks, Morse & Company as a special representative. He reports to W. Paul Jones, general manager.

### IRSM Election Held

FORT WAYNE—The Fort Wayne, Indiana chapter of the Institute of Radio Service Men has elected the following officers for 1937: Chairman, Robert Stone; Vice-chairman, Harold Ramon; Secretary-treasurer, Edward Moennig.

Committeemen appointed include Henry Schryver, Fred Pembleton, Marcellus Miller, T. R. Eiler.

### Dakota Radio Expands

YANKTON, S. D.—The recently organized Dakota Radio Corporation has purchased the wholesale distributing business of the Dakota Radio Service Company. The executive personnel is as follows: R. A. Bowyer, Jr., president; M. J. Kramar, vice-president and G. H. Ellerman, secretary-treasurer.

The Corporation will conduct a general wholesale radio and appliance business and is, at present, looking for a line of electric refrigerators.

### G.E. Advances Cameron

NELA PARK—Ralph C. Cameron, for some time in charge of department store activities on General Electric kitchen appliances, has been made manager of the department store sales division and will henceforward be responsible also for laundry equipment, radios and smaller home appliances sold through both department and furniture stores.



**BACK ON WESTON JOB—**  
**E. Jenkins, laid up for the first few weeks of January with appendicitis, is back on the job but still wobbly**

### KEN-RAD SALESMEN CONFAB

OWENSBORO—The district sales representatives of the Ken-Rad Tube & Lamp Corporation attended a sales meeting here recently. C. J. Hollatz, vice-president and general manager, congratulated the men on the records for the year, particularly results obtained in the replacement radio tube field.

"Bud" Mathews, sales manager, and A. O. Perlitz, sales promotion manager, outlined sales plans for 1937. These were enthusiastically received.

### Leonard Distributors Place Heavy Orders

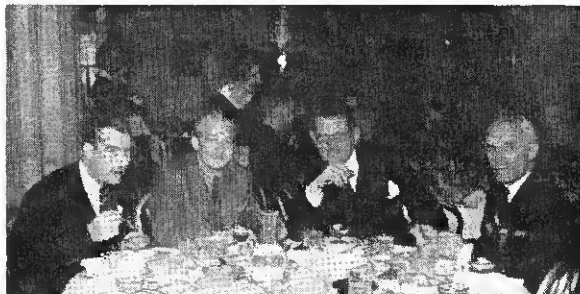

Members of the Colen-Gruhn Co., New York distributor attending Leonard's December 10 convention (left to right): H. A. Dutton, B. D. Colen, C. R. Wagner and E. F. Donnelly



More Leonard conventioners: R. F. Downing, Newark branch of E. B. Latham; G. Strellinger, assistant to Leonard vice-president; B. T. Roe, district manager



From Toledo (left to right): Earl Ziems, P. J. Hooker, J. J. Manor, J. L. Berry, G. E. Flora and Perry White, all of the Electric Range & Equipment Co.



# SELL MORE RADIOS

## WINCHARGER

IN THE FARM MARKET WITH

### GENUINE DELUXE MODEL 37

HERE ARE A FEW OF THE EXTRAS YOU GET AT NO EXTRA COST WHEN YOU TIE UP WITH WINCHARGER!

1. NATIONAL ADVERTISING CAMPAIGN—with circulation running into the millions! Powerful consumer messages that forcefully point out the advantages of the new 6-volt farm radios and urge the consumer to come into your store for a demonstration. You see at the right two of the ads which are appearing right now in the biggest national farm magazines.
2. FOLLOW-UP PLAN that keeps on furnishing you with live prospects in your community. We send our literature with your name printed on it to these prospects, to draw them into your store and make it easy for you to SELL them.
3. YOUR RADIO MANUFACTURER carries the Wincharger story in his advertising. To get the most out of your manufacturer's advertising and our big co-operative campaign, you must use WINCHARGER.

#### WHY EXPERIMENT?

There are ten times as many genuine Winchargers in use as all other makes combined. More than 300,000 people are now enjoying finest modern radio reception through Wincharger—in every state in the Union—and in over 100 foreign countries.

These leading radio manufacturers know the difference. They insist on genuine Winchargers for best performance:

- |                  |                   |
|------------------|-------------------|
| Admiral          | Patterson         |
| Arvin            | Philco            |
| Belmont          | RCA-Victor        |
| Crosley          | Sentinel          |
| Emerson          | Spartan           |
| Fada             | Stewart-Warner    |
| Fairbanks-Morse  | Stromberg-Carlson |
| General Electric | United American   |
| Grunow           | Bosch             |
| Kadette          | Westinghouse      |
| L'Atro           | Zenith            |

#### SPECIAL TEST OFFER To Authorized Dealers

If you are an authorized dealer for one of the radios listed above, we want you to make this test: Order a genuine Wincharger, using the coupon at right. Compare it with any other charger on the market. Stand it alongside competing makes on your floor, and LET YOUR CUSTOMERS DECIDE which one gives the most for the money! If they fail to choose Wincharger, return it to us and GET YOUR MONEY BACK!

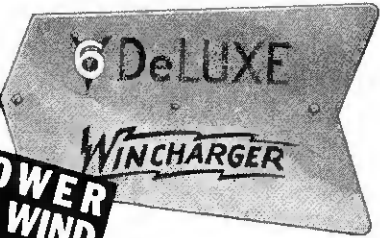

**FREE POWER FROM THE WIND**  
Operating Cost  
**LESS THAN 50¢ A YEAR**

**NO OTHER WIND-DRIVEN GENERATOR CAN OFFER ALL THESE FEATURES!**

- 1—Famous Albers Airfoil Propeller, pronounced 20% to 50% more efficient by leading radio manufacturers. Proved by conclusive wind tunnel tests.
- 2—Copper Tips and Copper Sheathing, with 3 coats of weatherproof varnish, prevent propeller damage from weather.
- 3—Positive Acting Auto-Type Brake. When you stop Wincharger, it stays stopped. No complicated tip-up devices or swinging tail vanes.
- 4—Sturdy Ball Bearing Turntable. Easy turning.
- 5—Double-Brush Collector

**PLAY YOUR RADIO TEN HOURS A DAY**

**YOUR NAME AND ADDRESS PRINTED HERE**

We send this folder to your prospects, with your name printed on it.

- Ring gets all the electricity. No loss due to using iron tower for one conductor—very important at 6 volts.
- 6—Heavy Four-Leg Angle-Iron Tower of 1/4" x 1" x 1" rails. Costs more than sheet steel, and worth it!
- 7—Instrument Panel comes complete with ammeter showing charge and discharge. Positive-acting relay cuts battery off when propeller speed drops too low.
- 8—Famous Wincharger Generator—weighs 24 pounds. Made by world's largest generator manufacturer specially for Wincharger use. Not an auto generator. Uses third-brush principle to prevent excessive charging rate. Oil-sealed bearings never need oiling. Air cooled for increased efficiency.
- 9—Condenser to eliminate radio interference.
- 10—Patented Speed Governor operates by centrifugal force, the only recognized method for controlling speed. Acts as flywheel to maintain constant output in any wind up to 20 m.p.h. In high wind, flaps swing out, spilling air away from propeller. Safe in a hurricane!
- 11—Special Fins on Governor Arms aid in starting at low wind velocity, give extra efficiency.
- 12—Extra Braces on Tower Feet.

#### WINCHARGER CORPORATION, Sioux City, Iowa

World's Largest Makers of Wind-Driven Generating Machinery

WINCHARGER CORPORATION, Sioux City, Iowa RR-2-27

I am an authorized.....(state make).....radio dealer.

My distributor is.....(distributor's name).....

Distributor's City.....

I enclose \$15.00 for a Genuine Wincharger, according to your MONEY BACK SPECIAL TEST OFFER. Please ship it at once.

Name.....

Address.....City.....State.....

(\$15.00 price applies only in U. S.)

# *Sylvania can take you* **OVER THE TOP!..**



## ***Sell Sylvania and Watch Your Profits Hit a New High!***

● Is your tube business going over the top with a bang? Are you getting your share of the repeat business, the pleased customers and the profits that go to the dealer who sells Sylvania?

Ask the man who profits with

Sylvania...he'll tell you how it's done. No kick-backs...because Sylvania tubes have gone through *eighty separate tests* for your protection. Fair list prices and the kind of technical and sales helps that are designed to make better business for you! It pays to sell

Sylvania...because Sylvania plays ball with you every inch of the way!

You owe it to yourself and your business to find out about Sylvania NOW! For complete sales and technical information write to the Hygrade Sylvania Corporation, Emporium, Pa.

# **SYLVANIA**

---

***THE SET-TESTED RADIO TUBE***

---

# Things You Will Want To Know About NEW BATTERY RADIOS



**WEATHER REPORTS** are available hourly on many new models due to the inclusion of extended bands



**"ONE SHOT" CONNECTORS** on modern "B" batteries eliminate possibility of wrong connections



**WORLD-WIDE RECEPTION** is available on new sets equipped for short-wave tuning

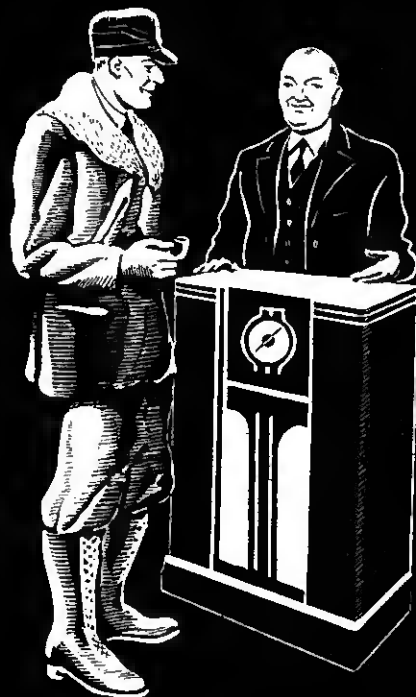

**WIND-CHARGERS** and small gasoline chargers now re-charge storage batteries, easily, cheaply, at home



**LIGHTED DIALS** make tuning much easier in dimly lighted rooms

## MORE ADVANTAGES

Batteries and wiring are completely concealed within cabinets, styled to rival big-city models

Tone quality is equal to that of the best electric models, thanks to new permanent magnet dynamic speakers

Volume is ample for even distant stations due to the use of new, efficient power tubes

Prices are down because manufacturers are at last getting sufficient business to make quantity production savings



**BATTERIES NOW LAST** many months with a minimum of attention because modern tubes use little electricity

For Better Performance, Lower Operating Cost  
Greater Convenience and Modern Appearance

**RADIO  
RETAILING**

**REPUTATION  
INSURANCE**  
...for YOU and  
the sets you sell!

*Introducing*

**Willard**

**RADIO BATTERIES**



Designed to provide a smooth, trouble-free power supply for every type of 6-volt or 2-volt radio set, Willard Radio Batteries are made right and priced right.

**Why risk your reputation on doubtful batteries when . . . WILLARDS COST LESS TO OWN.**

To insure customer satisfaction, equip the sets you sell with Willard Radio Batteries.

Write or wire for details of the special proposition open to Radio Dealers on this NEW line.

**WILLARD STORAGE BATTERY COMPANY**  
Cleveland • Los Angeles • Toronto, Canada

**Willards**

*cost less  
to own*

## HOW TO ESTIMATE ON MASTER ANTENNA SYSTEMS

(Continued from page 27)

and fall well within the capabilities of the skilled radio service man. The work is by no means formidable, but rather an elaboration of the better kind of aerial installations.

In the exposed-wiring job, the transmission line, dark or light, for the downlead is run up and down the building wall, being anchored in place by knobs or other convenient means. The transmission line is tapped at each apartment level for connection with the outlet. The twisted-pair leads of the outlet are neatly spliced to the bared pair of the transmission cable, then soldered and finally taped and varnished to guard against moisture. The outlet leads pass through a hole in the window casing, afterwards sealed with suitable mastic, and connect with the exposed type outlet mounted on the inside window sill or nearby baseboard. Wiring is of the simplest sort in this type of installation which is favored not only for existing buildings but frequently for new structures as well, because of low cost.

Even though the wiring is exposed, every effort must be made to protect the transmission cable against damage and to effect a neat installation. Where the transmission line must cross a terrace, for example, between penthouse and roof parapet, the cable is run along terrace partitions or fences if same exist. Lead-covered wire may sometimes be used. In the case of a tiled terrace, the expansion joint is raked out, the cable laid therein, and the job finally sealed. Where a transmission line crosses a parapet, the mortar joint is likewise chipped out to take the cable which is then sealed in place. If the cable rests on a masonry coping, that portion may generally be covered with a length of copper tubing to afford protection against abrasion.

### Concealed-Wiring Job

In new structures, the job must sometimes be entirely concealed. The downlead cable enters the building through a suitable pipe or conduit near the aerial, and then runs through conduit or BX to the outlet boxes. If local authorities permit, the wiring may even be of the knob-

and-tube variety, with the cable strung along studding and passing through studs and floors by means of porcelain tubes.

If the decision be conduit or BX, we might as well frankly admit that the job is pretty much in the realm of the electrical contractor. The radio service man can still handle the aerial installation, and also the wiring and testing of the outlets, but the inside wiring proper had best be handled by the electrical contractor or at least sponsored by him.

Of course the downlead or transmission line must be run along through conduit or BX. It must be kept away from power wiring, to avoid possible interference. The line is tapped for each outlet which consists of a special coupler that fits in a standard outlet box. A single Gem box serves nicely for a plain radio outlet, fitted with a polarized receptacle and face plate or binding posts. Sometimes a combination radio and power outlet is preferred, in which case a 4-in. square box is employed, with the outlet coupler separated from the power receptacle by means of a metal shield.

### Color-Coded Connections

It is really difficult to go wrong on the connections of a well designed master antenna system. One simply connects red with red and black with black, all the way through. Each outlet may be tested immediately after connections have been made with the transmission cable, by means of a typical midget receiver of modest sensitivity. No other testing necessary.

### Separate Filter Estimate

Because of its lofty and efficient aerial, the master antenna system delivers a good signal to every set. However, because of the extensive transmission-line wiring throughout the building or along side walls, the system is naturally subject to whatever serious inductive interference or so-called man-made static that may be present.

Thus electric elevators with their motors and relays, electric motor appliances, bells and buzzers, automatic telephones and other equip-

ment may set up a veritable noise barrage through which even strong signals can hardly survive. Hence the preliminary survey must take into consideration the existing background noises which will have to be reduced, if not eliminated, if a satisfactory installation is to result. Generally it is safer not to include noise elimination work in the bid for the master antenna system proper, but to consider that phase as a separate job.

Suitable filters are available which take care of the simplest or the most stubborn cases of radio interference. Along with the master antenna system installation, therefore, goes the supplementary job of cleaning up background noises.

### The Initial Survey

As with the usual wiring job, the first step in a contemplated master antenna system installation is the preliminary survey. The building is checked for floor plans, locations of radio outlets, available superstructure supports and required masts, stringing of aerial wires, running of transmission lines along walls and through walls as the case may be, and other essential details.

Standardized components and materials available at known list prices and trade discounts eliminate all possible gamble in estimating material costs. Labor costs may be readily figured because of the simplicity of the installation work. Estimates, therefore, are easily and safely arrived at.

Both for estimating purposes and layout, one determines the number and location of the radio outlets. In the usual apartment building, for instance, the living room is the customary location for the outlet. With the help of a floor plan, it is easy to locate the most convenient placement of the transmission line. This in turn determines the placement of masts and the direction of and arrangement of aerials.

For general guidance, the cost items presented in the accompanying table may be used in estimating any proposed installation. These are the major materials and labor costs, such as incidentals as tape, screws, nails, clamps, etc., not being included.

# PREVIEW of NEW PRODUCTS

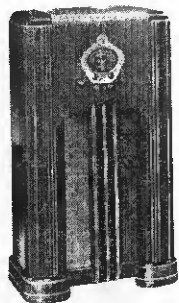

**MAJESTIC**

*Majestic Radio & Tel. Corp.,  
600 W. Adams St.,  
Chicago, Ill.*

**Models:** 620 and 800 consoles.

**Description:** Model 620-540-1750 and 2250-7100 kc.; avc; 8-in. electrodynamic speaker; attractive glass dial illuminated from both edge and gold background; 36½x22x11 in.

Model 800, ac-dc console, magic eye, beam output power tube.—*Radio Retailing*, February, 1937.



**TELETALK**

*Webster Electric Company,  
Racine, Wis.*

**Model:** Enlarged line of Teletalk intercommunicating systems.

**Description:** Fully selective and master station models available, as well as confidential models, affording privacy in conversation. Full selective up to ten stations permits several simultaneous conversations without interference.

Separate volume control at each station and exceptional tone fidelity.

Completely self-contained; no extra parts or separate microphone; simply plugs into the light socket.—*Radio Retailing*, February, 1937.

## STROMBERG-CARLSON

*Stromberg Carlson Tel. Mfg. Co., Rochester, N. Y.*

**Models:** 145-SP, 140-M, 130-J.

**Description:** Model 145-SP Labyrinth type high fidelity radio and automatic phonograph; 530-18,000 kc. chassis similar to the 145-P; deluxe index type dial; trifocal tuning indicator, volume and fidelity indicators, micrometer

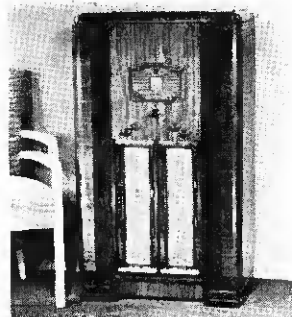

sub-dial and indexed selectorlite station dial are all grouped in one attractive unit; 10 tubes.

Model 140M console has metal tubes; equipped with the Acoustical Labyrinth; high fidelity type radio; 540-3500 kc. and 5600-18,000 kc.; Trifocal tuning indicator; automatic sensitivity control.

Model 130-J, horizontal table model; uses metal tubes; same tuning ranges as 140-M; full vision airplane type dial with edge-lighting; automatic sensitivity control; trifocal tuning indicator; 8 tubes.—*Radio Retailing*, February, 1937.

## RCA RADIOTRON

*RCA Radiotron Div., RCA Mfg. Co., Inc.,  
Harrison, N. J.*

**Model:** RCA-806.

**Description:** Air-cooled transmitting triode designed to operate as an r.f. power amplifier with high plate-circuit efficiency and with maximum rating input at frequencies as high as 30 mc. Also useful as a Class B modulator.—*Radio Retailing*, February, 1937.

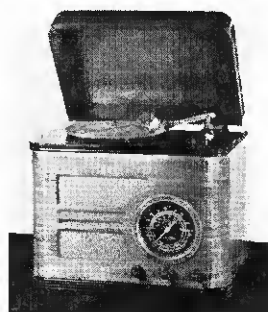

**TROY**

*Troy Radio Mfg. Co.,  
1142 So. Olive St.,  
Los Angeles, Calif.*

**Model:** 75PC Phono-radio combination.

**Description:** 5-tube superheterodyne; Webster self-starting motor; new RCA curved pickup; centralized station listed dial; plays 12 in. records.

**Price:** \$44.50.—*Radio Retailing*, February, 1937.

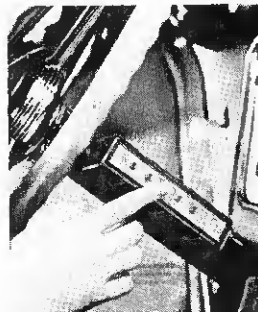

**CONTINENTAL**

*Continental Radio & Tel. Corp., 325 W. Huron St.,  
Chicago, Ill.*

**Models:** 1937 line of Admiral auto radios.

**Description:** "Touch-O-Matic Tuning" is featured. This is a streamlined attachment for automatic tuning of 5 favorite stations by simply touching a button. Other stations are tuned in the regular way. This compact metal case unit measures 4½x4½x2½ in. and can be installed on the steering gear. May be used with any make of car set.

Model 66, 6 tubes, 6-in. self-contained speaker; Model 77, 7 tubes, 6½-in. self-contained speaker; Model 78, 7 tubes, 8-in. heavy duty permanent magnet dynamic external speaker; Model 88, 8

tubes, 8-in. external speaker.

No spark plug suppressors needed; 10 kc. selectivity; variable tone control; complete filtering of all car noises; iron core antenna coils; self-adjusting to roof, whip, running board or under-car aerial.—*Radio Retailing*, February, 1937.

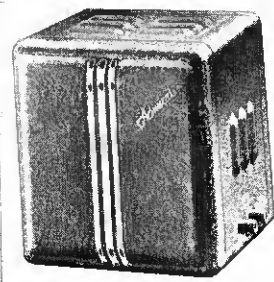

**FADA**

*Fada Radio & Electric Co.,  
Long Island City, N. Y.*

**Model:** Two and six volt sets in color.

**Description:** Engineered to give high sensitivity with 4 tubes so performance will be high but battery drain low. 8½x16½x7½ in. deep. Made in the two volt air cell and 6v. storage battery types. Black and chromium, ivory, Chinese red, black and gold, Chinese red and gold, ivory and gold.

**Prices:** Two volt series, \$36.50-\$41.50; six volts, \$41.50-\$46.50. Zipper bag, \$3.75.—*Radio Retailing*, February, 1937.

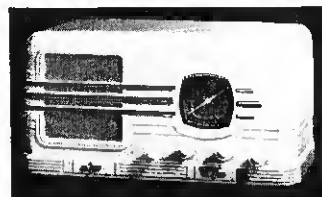

**ARCTURUS**

*Arcturus Radio Tube Co.,  
Newark, N. J.*

**Model:** Improved 25Z5 rectifier tube.

**Description:** "Flash-overs"; open cathode tabs, slow heating, shorts, filament burn outs, etc., reduced to a minimum, it is claimed.—*Radio Retailing*, February, 1937.



## MOTOROLA

Galvin Manufacturing Corp.,  
847 West Harrison St.,  
Chicago, Ill.

**Models:** 1937 line of auto radios.

**Description:** The "Acoustinator" is featured this year. It is a personal preference selector with two choices — city and music. With this the sensitivity of the set may be adjusted to the location, eliminating static from street cars, etc., during city reception. Available on Models 65, 70 and Golden Voice.

Model 35, 6 tubes, Magic Eliminode, Adapto broad range antenna system.

Model 45, 6 tubes, 6-in. speaker, Adapto antenna system, Magic Eliminode.

Model 65, Acoustinator, 6 tubes, 8-in. speaker, uses cold cathode rectifier and new 6AB6G booster power output tube.

Model 70, De Luxe, Acoustinator, 6 tubes, Or-

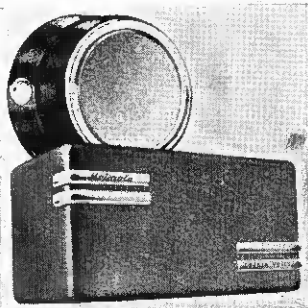

tho-Acoustic adjustable tone chamber speaker.

Golden Voice, 8 tubes, oversized 8-in. speaker, Acoustinator, Ortho-Acoustic adjustable tone chamber speaker.

**Prices:** 35, \$29.95; 45, \$39.95; 65, \$49.95; 70 De Luxe, \$54.95; Golden Voice, \$69.50.—*Radio Retailing*, February, 1937.

## PARRIS-DUNN

Parris-Dunn Corporation,  
Clarinda, Ia.

**Model:** Deluxe Skyscraper model "Duncharger."

**Description:** Incorporates the Dunn governing prin-

ciple of automatically shifting the wind charger propeller during high winds, eliminating propeller damage. Designed for a ten foot installation, replacing the original six-foot installation. The new high tower gives increased power and can be more efficiently installed to operate above obstructions.

Other styles and sizes also included in line.—*Radio Retailing*, February, 1937.

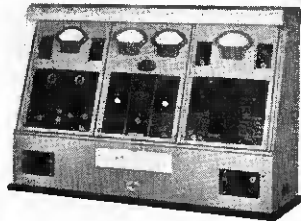

## UNITED MOTORS

United Motors Service, Inc.,  
3044 West Grand Blvd.,  
Detroit, Mich.

**Model:** Model 652 Radio service panel.

**Description:** Divided into three sections containing all the testing instruments necessary to locate and correct trouble in any automobile or home receiver. Output meter calibrated in both watts and volts; signal generator covers fundamental frequencies of 100 kc. to 30 mc. The signal generator is guaranteed to within an accuracy of  $\frac{1}{2}$  of 1% at all frequencies.

For testing voltage and current on car sets, a volt ammeter is permanently connected to the battery supply reading up to 10 volts or 20 amp. Car radio vibrators may be tested without removal from the receiver. Size 22 $\frac{1}{2}$ x11x35 in.

**Price:** \$259.50.—*Radio Retailing*, February, 1937.

## SPRAGUE

Sprague Products Co.,  
N. Adams, Mass.

**Device:** Aluminum can dry electrolytics.

**Description:** New small size in capacities of 4, 8, 8-8 and 8-8-8 mfd. Known as type PLS and rated at 525 volts.—*Radio Retailing*, February, 1937.

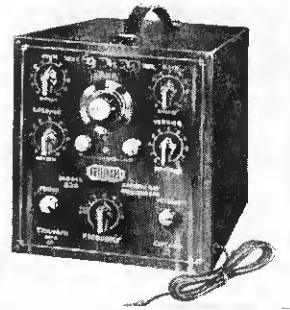

## TRIUMPH

Triumph Mfg. Co., 4017 W.  
Lake St., Chicago, Ill.

**Device:** 820 midget oscillograph.

**Description:** Combines both horizontal and vertical amplifiers in one tube, a 6A6; an 885 thyratron provides a saw-toothed linear sweep for the customary horizontal trace on the 913 cathode ray tube; an 80 rectifier furnishes all d.c. voltages. Despite its small size, it will do all that the big 3 in. tubes were expected to accomplish except for the size of the image, it is claimed. Sweep frequencies from 20-20,000 with a vernier control for adjustment between steps; synchronous locking control to lock any desired trace in position for photographing.—*Radio Retailing*, February, 1937.

## RCA

RCA Mfg. Co., Inc.,  
Camden, N. J.

**Devices:** No. 151 cathode ray oscillograph; No. 150 oscillator.

**Description:** Oscillograph—uses RCA 913 cathode ray tube; high sensitivity, 1.75 volts, (rms) for full scale deflection; vertical and horizontal amplifiers; linear timing axis; small spot diameter, sharp focus.

Oscillator — Variable electronic sweep, 1-40 kc.; wide frequency range, 90 to 32,000 kc.; internal 400 cycle or external amplitude modulation; large 4 in. dial; 3 step attenuator plus continuously variable control.

**Prices:** Oscillograph, \$47.50; oscillator, \$64.50; both net prices complete with tubes.—*Radio Retailing*, February, 1937.

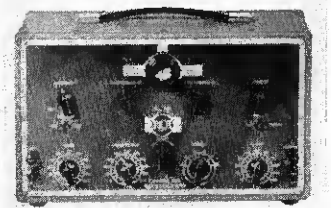

## SKY-RANGER

Universal Products Corp.,  
306 Park Ave., Rockford, Ill.

**Device:** Indoor antenna.

**Description:** Pendant type to hang inside cabinet, 2x5 in., operates on both short and long waves, easy to install.

Consists of an inductance winding and means for connecting same to the receiving set, also a distributed capacity coupling to ground throughout the length of said winding.—*Radio Retailing*, February, 1937.

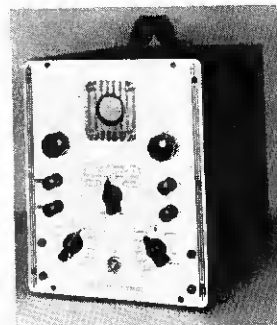

## BURTON ROGERS

Burton-Rogers Co., 755 Boylston St., Boston, Mass.

**Device:** Oscilloscope.

**Description:** Uses 913 cathode ray tube; 1 in. screen; built-in amplifier for vertical plates and built-in 60 cycle sweep; frequency range of vertical amplifier 20-100,000 cycles.

**Price:** \$29.95 complete.—*Radio Retailing*, February, 1937.



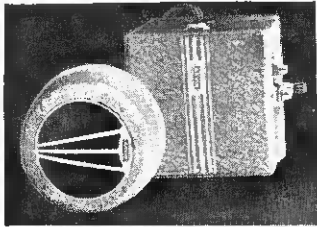

## ARVIN

*Noblitt Sparks Industries, Inc.,  
Columbus, Ind.*

**Models:** 1937 "Tailor Fit" auto-radios.

**Description:** Three models. Each may be combined with any Arvin speaker and control to fit every car—hence the trade name "Tailor Fit." Forty-seven matching panels and 12 types of speakers to choose from; also special panel type speaker for 1937 Buick and Oldsmobile. All units are packed separately so the dealer may make up any combination quickly and easily.

Highlights of the line include: Automatic Elim-

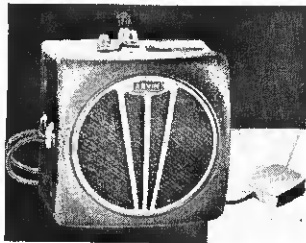

noise which eliminates use of spark plug suppressors; Phantom Filter to boost signal strength and reduce objectionable noise; Permatone i.f. transformers which are permanently balanced; Geographical Compensator to increase or decrease sensitivity as desired.

Arvin also offers a full line of antennas listing at from \$2 to \$4.

Model 19, 6 tubes; 29, 6 tubes; 39 De Luxe, 7 tubes, takes external speaker only.

**Prices:** Chassis only, Model 19, \$30.95; 29, \$38.95; 39, \$43.95. Matching panel controls, \$6.25; overhead speakers, \$4.75; 8 in. separate case speaker, \$9.75; in-the-set speakers (for 19 and 29) \$2.75 and \$4.75.—*Radio Retailing*, February, 1937.

## TURNER

*Turner Co., Cedar Rapids,  
Iowa*

**Model:** Melody-X system.

**Description:** Unique microphone especially designed to aid musicians to amplify tone and volume. The microphone is mounted on the instrument by means of a small vacuum cup of soft rubber and coupled to an amplifier. Has frequency characteristics for both music and voice, thus giving the musician a convenient means for vocalizing or making announcements. May be used on any stringed or wind instrument.

**Price:** \$85, complete.—*Radio Retailing*, February, 1937.



## CROSLEY

*Crosley Radio Corp.,  
Cincinnati, Ohio*

**Device:** Doublet antenna.

**Description:** It is so designed as to be practically equally efficient in reception of radio signals from all directions, it is said. Designed to receive signals with the greatest possible strength and at the same time eliminate to the greatest degree static, noises and similar interferences.—*Radio Retailing*, February, 1937.

## ACTONE

*H. W. Acton Co., 370 Seventh  
Ave., New York, N. Y.*

**Device:** Phonograph needles.

**Description:** All steel needle; 100% shadowgraphed for minutest imperfections; used in broadcasting stations which demand that a needle remain perfect throughout a 15-minute transcription. For general or professional use.—*Radio Retailing*, February, 1937.

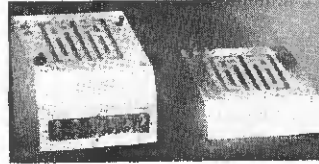

## VOCAPHONE

*Miles Reproducer Co., Inc.,  
112 W. 14th St., New  
York, N. Y.*

**Device:** Loud speaker switchboard calling system.

**Description:** Designed on the "cash register idea" equipped with buzzer and annunciator system and a complete switchboard enabling the master station to talk to one or all (up to 6 substations) at one time. Easy to install as each substation plugs into a special terminal box included with the master station. Substations may be added at any time.

A portable "Privaphone" for one or two way private communication is also made.—*Radio Retailing*, February, 1937.

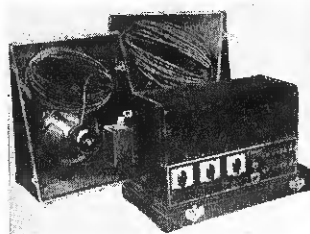

## CLARION

*Transformer Corp. of America,  
69 Wooster St.,  
New York, N. Y.*

**Device:** C55 portable sound system.

**Description:** Specially designed for orchestras, radio stars on tour and others performing in large theatres and ball-rooms.

Output 25 watts; 35 watts peak. Provisions for mixing, fading, etc.

The system includes microphones, floor stand, two 12-in. electrodynamic speakers and a metal tube amplifier employing seven all-metal tubes and one glass tube. Housed in two black leatherette carrying cases.

**Price:** \$169.—*Radio Retailing*, February, 1937.

## CAL-FON

*Universal Microphone Co.,  
Inglewood, Calif.*

**Model:** Inter-communicating microphone telephone.

**Description:** Housing contains transformer and trans-former so any number of phones may be used on one circuit by coding rings. Black and mahogany finishes standard. Available in colors in quantities at slight additional charge.

Adaptable for use in trailers for communication between trailer and driver's compartment.—*Radio Retailing*, February, 1937.

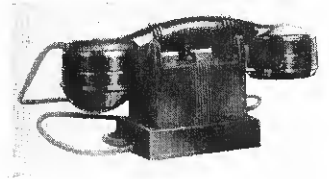

## BRUSH

*Brush Development Co.,  
Cleveland, Ohio*

**Model:** 3 in. spherical crystal sound cell microphone.

**Description:** Output level.—60 db. (zero reference = 1 volt per dyne per sq. cm.). Higher sensitivity characteristic makes this microphone ideal for public address or broadcast applications where longer leads are required with a minimum loss of output.

A companion microphone (AR-2S6P) has a slightly lower output but has the advantage of still longer leads as a high impedance microphone. Can be supplied with a transformer for operation into low impedance equipment (50 and 200 ohms).—*Radio Retailing*, February, 1937.

## WINDEX

*Ward Products Corp., 2135  
Superior Ave., Cleveland,  
Ohio*

**Device:** Window aerial.

**Description:** Fastens to the window-sill; plated; rust resistant; extends to 8 ft.; may be used on all waves. Features the Ward moulded power house type insulation.—*Radio Retailing*, February, 1937.





**THE NEW ELECTRO-ACOUSTIC  
30-WATT HIGH FIDELITY SYSTEM!**

TYPICAL OF THE MOST MODERN AND COMPLETE LOW PRICED LINE.

HERE'S APPEARANCE, PERFORMANCE, PORTABILITY, BEYOND ANYTHING BUILT TODAY.

New Class "A" "beam" power amplifier full 30 watts output—high fidelity range. Five controls. Inputs for three ribbon velocity or three crystal microphones and high impedance phonograph. More than sufficient gain for any modern high impedance microphone at distance pickup. Outputs for two electro-dynamic speakers and one to sixteen permanent magnet dynamic speakers.

**LOOK WHAT YOU GET  
FOR \$189.50 (LIST PRICE)**

NEW MAGNAVOX 12" electro-dynamic speaker—expressly developed for high fidelity P.A. requirements—flat frequency response plus heavy duty construction. Complete with 35 ft. rubber covered cable and plug.

LATEST TYPE high efficiency curvilinear diaphragm crystal microphone. Rugged—compact—"moisture sealed." True wide range performance and highest output level ever attained in a diaphragm type crystal. Complete with all-purpose take-down floor stand featuring the new Electro-Acoustic "friction lock" height adjustment—25 ft. connecting cable and plug.

DUAL PURPOSE. Thirty Watt streamlined amplifier complete with tubes and chrome trimmed modernistic cover and dials of exclusive design. Tremendous undistorted power makes it ideal for use wherever large crowds gather. Equally useful for smaller locations which require perfect speech and music reproduction and maximum flexibility of operation.

DE LUXE CARRYING CASE. Handsome design. Custom construction.

**OTHER SYSTEMS FROM \$59.50 UP**

*Current jobber and dealer discounts apply on list prices. Electro-Acoustic Systems are fully licensed.*

# HERE'S NEWS!

**ELECTRO-ACOUSTIC PRODUCTS COMPANY  
— MAGNAVOX SUBSIDIARY — INVADES THE  
LOW PRICED PUBLIC ADDRESS FIELD  
WITH HIGH FIDELITY EQUIPMENT.**

DISTRIBUTORS! This is your opportunity for real profits in the year 'round P.A. market.

SUCCESS over a long period in the field of large custom-built systems has established the name Electro-Acoustic as the symbol of highest quality sound equipment.

MILLIONS have heard and enjoyed perfect distribution of speech and music by Electro-Acoustic installations in nationally known institutions and expositions. Consumer demand means quick turnover profits to you.

ELECTRO-ACOUSTIC equipment is NOW available to you at prices LOWER than you are asked to pay for hastily assembled products of inferior grade.

**A MODERN PLANT IN THE CENTER  
OF AMERICA**

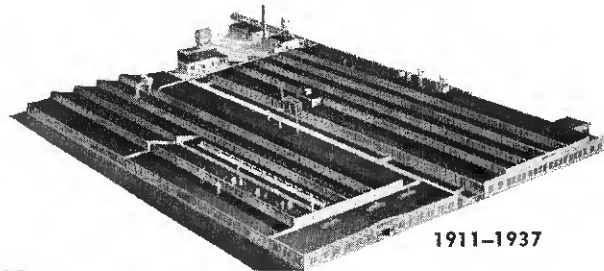

**HERE'S A  
SOURCE OF SUPPLY YOU CAN DEPEND UPON!**

The pioneer manufacturer of sound reproducing apparatus—combining a quarter century of leadership with the finest engineering and production facilities in the industry.

A COMPLETE NEW LINE of matched, advanced design equipment for every portable and permanent P.A. requirement—amplifiers, a new line of dynamic and permanent magnet speakers especially engineered and developed for P.A. work, and other accessories.

Let us show you and your dealers the key to profitable year 'round sales of sound equipment that stays sold.

**WRITE OR WIRE TODAY FOR CATALOG AND DETAILS!**

**ELECTRO - ACOUSTIC PRODUCTS COMPANY**

SUBSIDIARY OF THE MAGNAVOX COMPANY • FORT WAYNE • INDIANA

**RADIO DEALERS**

**RADIO SERVICEMEN**



Get this new radio book

**FREE**

Explains just how to spot and repair over 700 set troubles.

**Saves your time! Saves your money!**

**Time-Saving Information**

Certain radio sets develop troubles peculiar to their particular type of circuit. Each month "Tricks of the Trade" explains how to locate and fix specific set failures. The following are examples of the curt, practical way Radio Retailing offers this vital information to you.

**BREMER-TULLY, BRUNS-WICK 58**

Bad volume control . . . Often due to fibre projecting too high, causing rotor arm to miss. Push fibre down before replacing control.

**CLARION 60, 61**

Set dead or very scratchy . . . Look for failure of special audio input transformer primary. Replace with same device or substitute resistance coupling. Tone will suffer if ordinary transformer is used for replacement due to special characteristics of original.

**CRDSLEY 143**

Neon pilot lights when set switch is in OFF position . . . Replace leaky 8 mks. 150 volt condenser.

**MOTOROLA 77**

Poor tone . . . Check to see if voice-coil or fluid wires have been reversed. This causes voice-coil form to become blackened and charred inside due to heat. If swollen, discolored appearance is noted replace.

**ROA 120**

Operates at low volume on strong signals, intermittently comes up to good volume . . . Check .05 condenser between center terminal of volume control and control grid lead of 217 second detector.

Every issue of Radio Retailing will bring you more of these "Tricks". File them and in a short time with this FREE book you'll have a service manual of un-equalled value.

**H**ERE at last is a trouble-shooting guide that will ring the bell with every serviceman and dealer in the radio game. It contains no useless description, no theories, no amateur data. Every single one of its 56-pages is packed with practical, hard-bitten "how" information that can be used profitably on your service jobs every day in the year. "Tricks of the Trade" is a service book that is different. Once you get your copy you won't part with it for a minute. This one book contains:

704 tested ways of finding and fixing the troubles in specific set circuits.

157 tube socket diagrams showing the connections for that many tubes.

Reference charts showing—the cost of electricity used in operating various appliances—the correct and incorrect way to install radio aerials—reception spectrum—etc.

Every one of these "tricks" (see typical examples in column to left) were volunteered by

active radio men from their own experiences. Why spend hours testing and re-testing a balky set, when with this book, you can put your finger on the most probable cause of the trouble in a few seconds.

These "Tricks" will show you how to spot a lot of troubles that won't show up in any test equipment. If you value your time and are interested in saving yourself a lot of headaches—get a copy of "Tricks of the Trade"—today. IT IS FREE TO YOU if you accept this offer now.

**How to Get This Book FREE**

Fill in and return the order blank below with the subscription fee to cover one year of Radio Retailing for \$1 or three years for \$2 and you receive this new book—FREE—as our gift.

The book is not for sale separately. No credit orders can be accepted. Don't delay. They won't last long. Mail your order—NOW.

*Mail this coupon and payment—Today!*

**FREE-BOOK SUBSCRIPTION ORDER FORM**

**PRESENT SUBSCRIBERS NOTICE**

Present subscribers may obtain a copy of this FREE book by renewing their present subscription. Regardless of when your present subscription expires, you must send in another PRE-Paid renewal order. Your subscription will be extended for additional time without duplication. No previous renewal orders count. We must show a matching order for every book sent out. Mail in your order and payment today. This offer only applies to U. S. and possessions, Canada, Mexico and Central and South America. All other countries add 50c to rate to cover postage charges on book.

All books are sent out by express to insure safe delivery. There is a small handling charge of 15c—payable to the expressman upon delivery of the book. If you prefer book sent prepaid, add 15c to the subscription fee at time of ordering.

**O. K.** Attached is \$2 for a 3 year subscription to Radio Retailing. With this order I am to get a FREE copy of the 56-page service book—"Tricks of the Trade". I'll pay the expressman 15c for delivery charges. Send the book at once. Check here  if this is renewal order.

Name..... Position.....  
Street.....  
City..... State.....  
Our Main Business Is.....

Check here and remit \$1 if you wish only one year subscription PLUS FREE book.

**No orders accepted without payment attached**

RADIO RETAILING  
330 West 42nd Street  
New York, N. Y.

*This offer void after May 1st, 1937*

*Pin  
\$1 or \$2  
Here*

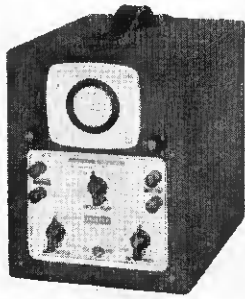

## JACKSON

*Jackson Electrical Instrument Co., Dayton, Ohio*

**Device:** Model 521 cathode ray oscillograph.

**Description:** Employs new type 913 cathode ray tube which has high brilliance screen; self-contained amplifier for the vertical deflecting plate permits excellent sensitivity for radio testing and servicing; approximate input sensitivity to both the horizontal and vertical plates, 40 volts per inch (rms). However, with the vertical amplifier turned on, the vertical sensitivity may be adjusted to as high as 1.0 volts (rms) per inch.

Special duplex chart is mounted directly in front of the cathode ray tube. This screen is printed on transparent material and has one calibration directly in frequency (kc. off resonance). Another simple cross-section calibration also printed on the screen.

**Price:** \$29.50, complete.—*Radio Retailing*, February, 1937.

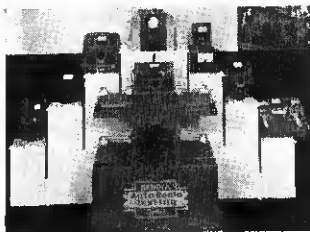

## BENDIX-DAYRAD

*DayRad Corp., Subsidiary of Bendix Products Corp., Dayton, Ohio*

**Model:** Auto-radio testing equipment.

**Description:** A complete line of devices for inspecting and servicing car radios and ignition systems.—*Radio Retailing*, February, 1937.

## AUDAK

*Audak Co., 500 Fifth Ave., New York, N. Y.*

**Device:** Micromatic pickups, AT-21, AT-26.

**Description:** For twelve inch and transcription records (18 in.) respectively. Give wide range response and have a smooth and rising characteristic at the low end—beginning at 300 cycles and gradually increasing to 10 db. at 70 cycles, correctly compensating for the attenuation in recording at the low end. Above 300 cycles it is substantially flat.

**Prices:** \$55 and \$75.—*Radio Retailing*, February, 1937.



## TARSO

*Consolidated Lithographing Corp., 1013 Grand St., Brooklyn, N. Y.*

**Device:** Decorative woods for radio cabinets.

**Description:** Photographic reproduction in natural colors of the finest veneers, inlays and special designs. This reproduction is transferred to birch plywood by means of a special process. Will not shrink, blister, nor peel and may be ordered in panels of the exact size and shape required. Eleven stock designs; panels of special design to order.—*Radio Retailing*, February, 1937.

## RECTOPACS

*The B-I. Electric Mfg. Co., 19th & Washington Ave., St. Louis, Mo.*

**Device:** Coin machine Rectopacs.

**Description:** Eliminate the inconvenience and expense of changing batteries; require no further attention after installation; sizes are so arranged that they will operate coin devices economically and without waste of power. Available for every purpose in standard types and also designed for special requirements.—*Radio Retailing*, February, 1937.

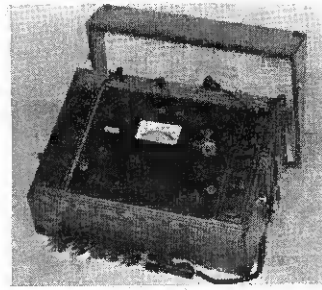

## TRIPLETT

*Triplett Electrical Instrument Co., Bluffton, Ohio*

**Device:** Model 1504 multi-purpose tester.

**Description:** Combines in one instrument the equivalent of eleven separate units; checks any type tube for worth, Neon short test, separate diode test, metered paper condenser test, electrolytic condenser leakage test, d.c. voltmeter, d.c. milliammeter, a.c. voltmeter, ohmmeter, decibel meter, free point tester. For portable or counter use.

**Price:** \$56.67, net to dealer.—*Radio Retailing*, February, 1937.

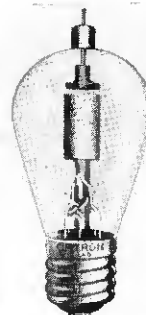

## CETRON

*Continental Electric Co., Geneva, Ill.*

**Device:** Mercury rectifier charger bulb.

**Description:** New and different type of filament designed for long life; guaranteed life, 2,000 hours; universal cap connection permits use of Fahstock clip or any other type that may be convenient. Filament volts, 2; filament amperes, 13; output, 6 amperes; inverse peak voltage, 300 volts. Designed for use in battery chargers or any other device where rectified alternating current is desired.

**Price:** \$6.—*Radio Retailing*, February, 1937.

## SPELL-O-LIGHT

*Besbee Products Corp. Subsidiary of Heinemann Electric Co., Trenton, N. J.*

**Device:** Advertising sign.

**Description:** Spells out any advertising message, letter by letter, by syllables, by words or complete phrases, at any speed; comprises any number of metal box units electrically and mechanically coupled merely by pushing them together. No wiring required other than plugging the attachment cord into an outlet. No motors used; no clockwork, no elaborate mechanism. Changeable message; adjustable timing and sequence; choice of colors and arrangement.—*Radio Retailing*, February, 1937.

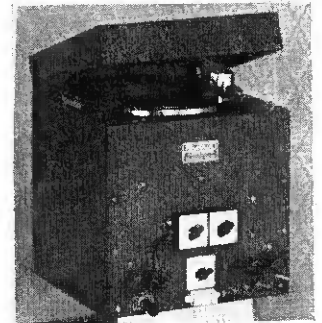

## RADOLEK

*Radolek Co., 601 W. Randolph St., Chicago, Ill.*

**Model:** Amplifier-phonograph combination.

**Description:** Combination 20-watt amplifier, phonograph turntable, 6 volt d.c. and 110 volt a.c. power supply all contained in one covered portable case. Completely electrically operated including phonograph motor.

Amplifier incorporates a high-gain circuit which permits use of a crystal, velocity or carbon mike. Dual channel input for mike and phonograph or radio with separate volume control for each input. Complete mixing and fading system built-in. The two volume controls are installed in a detachable remote control head that may be mounted at a distance. Adjustable legs permit unit to be placed on driver's seat. Draws only 12 amps. from a 6 volt storage battery.—*Radio Retailing*, February, 1937.



## **SOUND ENGINEERING**

Rising 70 stories above New York's sidewalks, the massive RCA Building houses the nerve-center of RCA's services in communications . . . broadcasting . . . reception—the pyramids of radio. Overlooking the towers of midtown Manhattan, this huge structure rises 850 feet and has a gross area of 2,192,000 sq. ft. It stands as a mighty symbol of radio's advance.



**RADIO CORPORATION**

# Broadcasting Headquarters!

**R**ADIO has made neighbors, good neighbors, of all America—and the world. And the Radio Corporation of America is proud to have played an important part in creating this widespread spirit of fellowship. RCA has done this through the National Broadcasting Company—one of its services—whose two network systems, comprising 116 stations, spread across the United States from Maine to California—from Canada to Texas—across the Pacific to Honolulu.

Broadcasting Headquarters are located in splendid Radio City. Here are NBC's modern, acoustically perfect studios, where many of radio's most famous programs originate. Built specifically for broadcasting, these 22 studios incorporate the latest advances in design, sound-proofing, acoustics and technical facilities. They make possible better program transmission, assuring better home reception.

RCA supplies the world with service in *every* branch of radio. Its varied services have earned unlimited public confidence. The world knows the RCA trademark as a magic key to quality . . . so it buys "RCA ALL THE WAY." And dealers who feature this organization's products do a more profitable business. They know it pays to be associated with Radio's Leader—pioneer in the engineering of sound—pioneer that some day will give the world radio *sight!*

---

RCA MANUFACTURING CO., INC. • RCA COMMUNICATIONS, INC.  
NATIONAL BROADCASTING CO. • RCA INSTITUTES, INC.  
RADIOMARINE CORPORATION OF AMERICA

*RCA presents the Metropolitan Opera every Saturday afternoon. And "Magic Key of RCA" every Sunday 2 to 3 P. M., E. S. T. Both on NBC Blue Network.*

## OF AMERICA • Radio City • NEW YORK

EVERYTHING IN RADIO FOR SERVICE IN COMMUNICATIONS . . . BROADCASTING . . . RECEPTION



"ONLY NBC was there!"

*Outstanding broadcasts of 1936 heard only over NBC networks*

From Zeppelin "Hindenburg"  
First broadcast from "S. S. Queen Mary" during her trial run

Rose Bowl Football Game, 1937

Salzburg Music Festival

Harvard Tercentenary

Metropolitan Opera

Louis-Schmeling Fight

America's Town Meeting

Cardinal Hayes at NBC

Federal Radio Project  
(4 programs)

Boston Symphony Orchestra

In 1937, "NBC will be there," serving the public with a feast of outstanding broadcasts.

# FREE

A NEW ILLUSTRATED  
BOOK EVERY ONE  
INTERESTED IN  
RADIO SHOULD OWN



It tells, and shows, how batteries are made, how they should be used to best advantage, what you should expect from them. It contains performance curves, charts and helpful technical information. Profusely illustrated. If you want to be "up" on the latest in battery-operated sets, get this book. There's dope in it every radio man will want.

SEND US THE COUPON  
WE'LL SEND YOU THE BOOK



NATIONAL CARBON COMPANY, INC.  
P. O. Box 600, Grand Central Station  
New York, N. Y.

Please send me free of charge the new book, "The Inside Story of Radio Batteries."

Name \_\_\_\_\_

Address \_\_\_\_\_

RR-2

## Janette Rotary Converters

The original D.C. to A.C. converters with all wave filters developed exclusively for radio and sound apparatus.

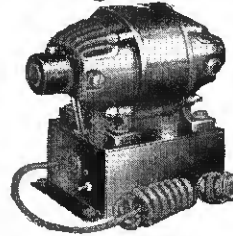

CAPACITIES:  
35 to 3250 watts.  
6, 12, 32, 115 and 230 volts  
D.C. to 110 or 220 volts, 1 phase,  
60 cycle A.C.

Insist on a Janette  
Ask For Bulletin No. 13-26

Janette Manufacturing Company

555 W. Monroe Street, Chicago, Ill., U. S. A.  
New York — Boston — Philadelphia — Los Angeles — Milwaukee



Standard glass types,  
G Series and genuine  
all-metal radio tubes

## Ken-Rad Radio Tubes

Dependable performance always

Write for our complete  
dealer sales plan

KEN-RAD TUBE & LAMP CORPORATION, INC., OWENSBORO, KY.  
Also mfrs. of Ken-Rad Incandescent Electric Lamps

71,300,875 ADVERTISEMENTS TO  
YOUR PROSPECTS ABOUT

## HORTON Washers and Ironers



National advertising in 17 leading publications will carry the forceful sales story of Horton's exclusive sales features to your prospects, during 1937, Mr. Dealer. Aggressive sales promotion cooperation will enable every Horton dealer to cash in on this campaign. Write now for details of the most valuable franchise in the washing machine industry.

HORTON MANUFACTURING CO.  
206 OSAGE ST., FORT WAYNE, IND.

## FOR DEMONSTRATION OF AUTO AND OTHER D.C. RADIOS



**Epeco** STORAGE BATTERY  
ELIMINATOR

**\$19.75**  
As Illustrated  
Variable Voltage  
List Price

Provides 6 volt-10 amps. filtered D.C. from 110 volt A.C. Assures instant, adjustable current at minimum power consumption. Ends forever the messy battery-charging nuisance. Also efficient as battery-charger.

**\$15.75**  
Model B  
6 volt-5 amps.  
Fixed Voltage

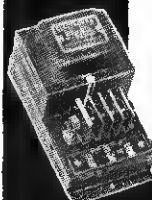

**ELECTROPAK**

Supplies rectified D.C. for operating relays, solenoids and remote controls. Voltage ranges from 6 to 24 volts, rated at 2 to 15 amps. Operates on 110 volt A.C.

**ADAPTOPAK**

Operates A.C. radios in D.C. districts and 110 volt A.C. radios in autos and trailers.

**ELECTRICAL PRODUCTS CO.**

6537 RUSSELL STREET · DETROIT, MICH.

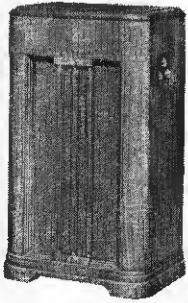

### ELECTRO-ACOUSTIC

*Electric-Acoustic Products Co.,  
Ft. Wayne, Ind.*

**Device:** Magnavox Symphony console record player.

**Description:** Incorporates a new type amplifier using metal beam power tubes; two special 12 in. double cone speakers; output, 25 watts; separate controls for volume, bass and treble; uniform sound distribution; free of amplifier distortion and speaker "peaks"; self-starting, constant speed, governor-controlled motor.

Also available with automatic record changing mechanism to handle 8 records, either 10 or 12 in. size.

A complete line of record playing instruments, including a radio attachment, a portable and a table model, also available.

**Prices:** Console, \$110; automatic, \$175.—*Radio Retailing*, February, 1937.

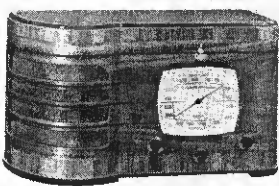

### EMERSON

*Emerson Radio & Phonograph Corp., 111—8th Ave.,  
New York City*

**Models:** R-156 "Miracle 5," R-153, R-158.

**Description:** Model R-156, 5 tubes, a.c., superheterodyne, 75-550 meters, Micro-selector; Gemloid indirectly lighted dial; 6 in. speaker; upright cabinet.

Model R-153 same technical features, presents a

new thought in design, a cello-shaped cabinet, (see cut).

Model R-158, also same technical features, compact cabinet of striped oriental wood with ebonized ends and base.

**Prices:** R-156, \$19.95; R-153, \$26.95; R-158, \$29.95.—*Radio Retailing*, February, 1937.

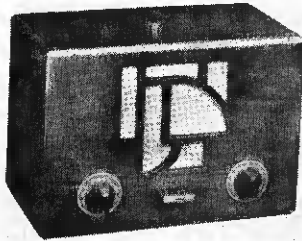

### BELFONE

*Bell Sound Systems, Inc.,  
Columbus, Ohio*

**Device:** Inter-communication system.

**Description:** A new and improved system providing wider range of applications. Two-direction voice communication between two or more stations; through ability to be used in connection with loud-speakers it can also be employed as a call system; rotary type selector switch; "treadle" type "send-receive" switch; combination volume control and "on-off" switch and a control for controlling volume of outlying speaker stations.

Amplifier and combination microphone speaker encased in walnut finished cabinet, 9½x7x5¼ in.—*Radio Retailing*, February, 1937.

### GENERAL CEMENT

*General Cement Mfg. Co.,  
611 Lincoln Ave.,  
Rockford, Ill.*

**Model:** "Ruf-Koat" wrinkle finish varnish.

**Description:** Available in black and colors; requires no baking; may be easily applied with a brush or sprayed. Special colors available in gallon lots.

**Price:** Black, ½ pt., 35c.; brown or green, 45c. Undercoat for use on porous materials ½ pt., 35c.—*Radio Retailing*, February, 1937.

# ANNOUNCING



## THE NEW SHURE ZEPHYR

BALANCED-TRACKING CRYSTAL RECORD REPRODUCER

**T**HE Shure ZEPHYR is not just another pickup—it's entirely new—utterly different! Basically new design features now bring you more accurate, more life-like reproduction of the recorded original... decidedly longer record life... and new, beautiful, aero-stream design in black bakelite molded... at low cost.

Built-in "Balanced-Tracking," provided by the new exclusive Shure "needle-tilt" principle, keeps the needle practically tangent to and centered in the record groove at all times—thus materially reducing record wear. Here, for the first time, low-tracking error has been achieved in combination with new modern "streamline" design!

And these features, too, are important!... ★ "Ultra" wide-range response—corrects for deficiencies in recording characteristics ★ Full-floating double precision ball-bearing pivot ★ Double moisture-proof, fully electrostatically-shielded crystal ★ Mechanically "shock-proof" critically damped moving system ★ Special "high-lift" arm for convenient needle-changing.

List Price..... \$12

See your Jobber for complete information or write for Bulletin 142R today!

*Licensed under patents of the Brush Development Company  
Shure Patents Pending*

**SHURE** *Cable Address: SHUREMICRO*  
**MICROPHONES**  
SHURE BROTHERS • MICROPHONE HEADQUARTERS  
225 WEST HURON STREET • CHICAGO, U. S. A.

# SMASHING RADIO VALUES

1937 MODELS

## FAMOUS PERVAL RADIOS SELLING AT UNHEARD OF PRICES

ONE LOW PRICE for one or many sets, plus our BUY for CASH—SELL for CASH Policy enables us to supply you with the finest quality radio sets at the lowest possible prices.

LOOK AT THESE VALUES

### FOUR TUBE RCA LICENSED

RADIO SET  
ONLY

**\$4.95**

List Price \$13.95

MODEL 51—4 tube AC-DC, self contained aerial, large three color illuminated airplane dial, magnetic speaker. Dimensions: 10x6 $\frac{3}{4}$ x4 $\frac{1}{2}$  in. Weight: 5 $\frac{1}{2}$  lbs.

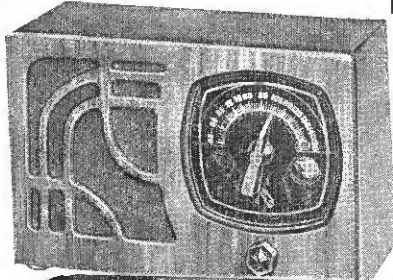

#### MODEL 52

—5 tube AC-DC, dynamic speaker, airplane dial, 2 bands, 70-200 meters and 200-550 meters, standard broadcast, police, amateurs, and aviation. Dimensions: 7 $\frac{1}{2}$ x-9x6 in. Weight 8 $\frac{1}{2}$  lbs.

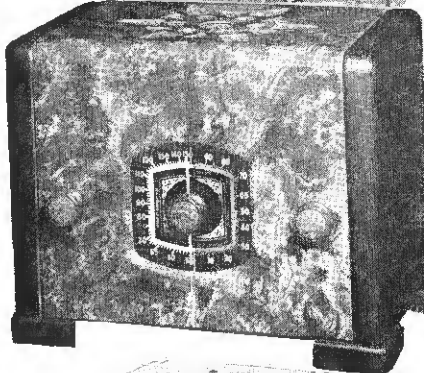

List Price \$16.95

Net to  
YOU **\$7.95**

#### MODEL 581

—5 tube AC-DC, dynamic speaker, big scan airplane dial, 2 bands, 70-200 meters and 200-500 meters, standard broadcast, police, amateurs and aviation. Dimensions: 9 $\frac{3}{4}$ x-8x6 $\frac{1}{2}$  in. Weight: 9 lbs.

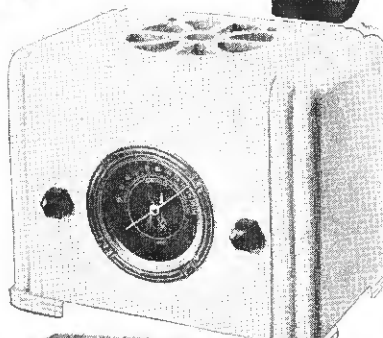

List Price \$19.95

Net to  
YOU **\$9.85**

#### MODEL 741

—7 tube AC-DC, 3 band superhet standard broadcast, American and foreign, short-wave, amateur, police, ships at sea, aircraft, electric eye, tuning range 18-55, 60-175, 175-550 meters; 6 $\frac{1}{2}$  in. dynamic speaker, 5 color jumbo aero dial, A.V.C. Dimensions: 16x-9 $\frac{3}{4}$ x7 $\frac{1}{2}$  in. Weight: 16 lbs.

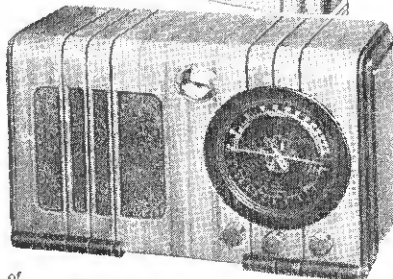

List Price \$37.50

Net to  
YOU **\$15.75**

You may order one or more of each of the above sets on our money-back guarantee, including carrying charges both ways, if they do not satisfy you . . . . . OR

Drop us a postcard today for complete information on 32 Radio Bargains, including consoles and farm radios. All of our sets are RCA licensed . . . . . every one a LEADER! Our low overhead enables us to furnish you with quality Radio Sets at prices which enable you to meet the competition of quantity buyers and mail order houses. Owing to the large demand for our quality radio sets, we reserve the right to limit quantities.

**PERVAL  
RADIO & TELEVISION COMPANY**

140 N. Dearborn St.

Dept. 10

Chicago, Ill.

## COMPLETE ELECTRIC PLANTS

ONAN ALTERNATING CURRENT GENERATING PLANTS operate on gasoline and furnish current for running AC RADIOS, Household Appliances, Motors. The right sizes for Portable Installations, Trailers, Public Address Work, Demonstrating Car Equipment, Talking Moving Pictures, X-Ray—anywhere electricity must be provided.

Sizes 350 Watts and Up

LIGHT and PORTABLE. Complete ready to run. Rubber mountings, flexible exhaust pipe and extra silent muffler available. Shipment from stock. Also 32 volt, Direct Current Models. Gasoline, Gas or Oil Burning types in larger sizes. Write for details.

D. W. ONAN & SONS

434 Royalston Ave. Minneapolis, Minn.

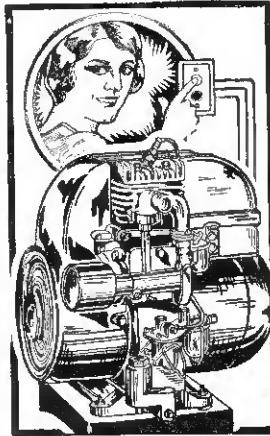

## Here's an ALLIGATOR

You Can Keep for 

a Pet Around Your Own Shop

Send for him—he's FREE. You can dress him in a rubber insulator and he's absolutely harmless! Mueller Alligator Clips are trained to crawl into any kind of a hole and bite hard.

WRITE FOR CATALOG 679 AND FREE SAMPLES

Mueller Clips are Stocked by Jobbers Everywhere

*Mueller Electric Co.*

1583 East 31st Street, Cleveland, Ohio

For Better Soldering  
Rubyfluid Paste or  
Rosin Core Solder



Ruby Fluid Paste will not corrode or give off objectionable fumes, does not harden in container. Ruby-fluid Solder is 40-60 mixture of tin and lead. 14 gauge, self-fluxing. Flows smoothly and evenly when heat is applied, does not sputter.

Write for  
Free Sample

THE RUBY CHEMICAL CO.  
69 McDowell St., Columbus, Ohio

**Rubyfluid**

**10 NEW  
WARD**

**AUTO AERIALS**

FOR 1937

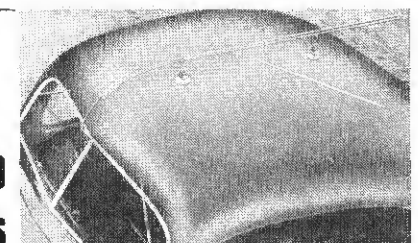

MODEL T. A.—The "Tur-rette"—Maximum Efficiency. One of the new 1937 top aerials featured by WARD. NO DRILLING IN TOP

SEND FOR CATALOG TODAY

**The WARD PRODUCTS Corp.**

WARD BUILDING CLEVELAND, OHIO

IN CANADA: ATLAS RADIO CORP., TORONTO, ONTARIO

FOREIGN: LINCOLN EXPORT CO. NEW YORK, N. Y.





## SHURE

Shure Bros., 225 W. Huron St., Chicago, Ill.

**Device:** "Zephyr" crystal record pickup.

**Description:** First of a series of improved crystal phono-record reproducers; tone arm and base are streamlined in black Bakelite molded. Ultra wide-range frequency response to 10,000 cycles, and the new built-in "needle-tilt" method of reducing "tracking error" are among the technical features.

Illustrated is Model

99A. 10½ in. long over-all and equipped with a special hinge mechanism which allows the head to be lifted high above the turntable for convenient needle changing.—*Radio Retailing*, February, 1937.

## PHILCO

Philco Radio & Television Co., Philadelphia, Pa.

**Model:** 1412 "trailer" radio.

**Description:** 6-tube super-het, operates from either 6-volts d.c. or 110-volts a.c. Similar in many respects to the auto-radio deluxe sets.

Receiver proper is housed in a steel container, plated to prevent rust, and given an exterior black wrinkle finish.—*Radio Retailing*, February, 1937.

# SHOWROOM TRAILERS



## COVERED WAGON

Covered Wagon Co., Mount Clemens, Mich.

**Models:** Showroom trailers.

**Description:** Three standard models available as complete units, or, the shell (chassis and body) may be purchased with the interior built to specifications. Electrically-welded, automotive trailer chassis combined with a new steel body material known as Shermanite.—*Radio Retailing*, February, 1937.

## PIERCE ARROW

Pierce-Arrow Motor Corp., Buffalo, N. Y.

**Models:** Showroom trailers.

**Description:** All metal unit built specifically for commercial purposes, ample room for shelves, display

cases, etc. Electrical connections are located at points of convenience; outlets for both 6-8 volt and 110-volt output. All lights are wired for both circuits and provision is made for installation of radios that will operate on either voltage by the flip of a switch. Three models.—*Radio Retailing*, February, 1937.

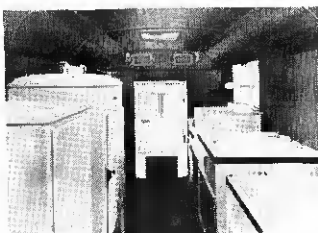

## FEDERAL

Federal Motor Truck Co., Detroit, Mich.

**Models:** Commercial trailers.

**Description:** Six types rating in load capacity from 1,000 to 2,000 lb. or more, engineered for rated loads. Any interior will be built to specifications.—*Radio Retailing*, February, 1937.



# RCA TEST EQUIPMENT

.. at prices every service engineer can afford

This new Test Equipment offers many new features. Designed by RCA engineers to make your job simpler, faster and more precisely efficient. Ideal for visual alignment, vibrator testing, checking modulation, distortion and all other general oscillographic applications.

Check the features! Consider how helpful this equipment can be to you. Then get it and put it to work!

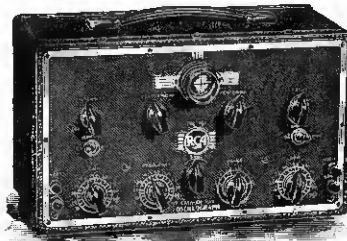

**NEW**  
RCA CATHODE RAY  
OSCILLOGRAPH  
NET PRICE \$4750  
STOCK NO. 151

### FEATURES

- 1 COMPLETE oscillograph using new RCA-913 Cathode Ray Tube—ready for every service application.
- 2 High Sensitivity—1.75 volts (RMS) for full-scale deflection.
- 3 Vertical and horizontal amplifiers—Individual gain controls—Flat 30-10,000 cycles.
- 4 Linear Timing Axis—Range 30-10,000 cycles.
- 5 Small spot diameter, sharp focus—Individual centering controls on front panel.
- 6 Removable light shield—Excludes room light and gives intense image. Calibration screen provided.
- 7 A-C operated—Input power, 50 watts.
- 8 Ruggedly built—Snap-out leather handle—Symmetrical appearance for use with new Test Oscillator. New two-tone gray, wrinkle finish with highly polished nickel silver etched panel.

**NEW**  
RCA ELECTRONIC  
SWEEP TEST OSCILLATOR  
NET PRICE \$6450  
STOCK NO. 150

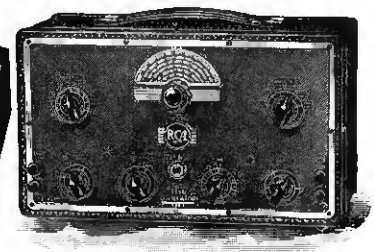

### FEATURES

- 1 Variable electronic sweep (no moving parts)—1 to 40 kcs.—at any R-F or I-F frequency—Sweep rate, 120 times per second—eliminates screen flicker—air trimmers for all bands.
- 2 No amplitude modulation with frequency modulation. Horizontal sweep frequency linear across screen.
- 3 Wide frequency range—90 kcs. to 32,000 kcs.—fundamental frequencies—400 cycle internal modulation—JACK FOR EXTERNAL MODULATION.
- 4 Large direct reading dial—4 inches diameter—indirect illumination—two vernier ratios, 2:1 and 5:1.
- 5 High r-f output—0.25 volts at all frequencies—negligible leakage—three-step attenuator plus continuously variable control.



**Parts FOR PROFIT**

RCA Manufacturing Co., Inc., Camden, N. J.  
A Service of the Radio Corporation of America

# The NEW TRAV-LER

## AUTO RADIO

..... Has 5 Features  
You'll Especially Like:



Model 601

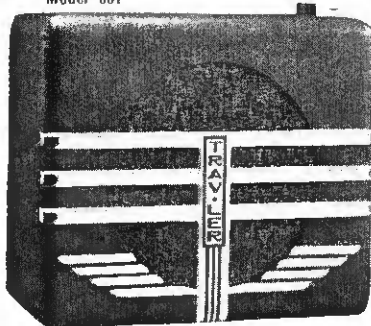

**1 SUPPRESSORLESS . . .** Special trav-ler designed high frequency filtering system automatically eliminates all motor and ignition interference.

**2 GREATER SENSITIVITY . . .** Under 1 microvolt . . . Uses latest type iron core coils.

**3 CUSTOM BUILT PANELS . . .** For all type 1937 and 1936 cars.

**4 ATTRACTIVE HOUSING . . .** Color is metallic gray with chromium plated front grille and red lettering.

**5 PLUG-IN SOCKET FOR EXTRA SPEAKER . . .** for easy installation of auxiliary overhead or underdash speaker—if desired.

Trav-ler Model 601 is a newly designed 7 tube superhetrodyne with single hole mounting for easy installation. The set is equipped with six and one-half inch high fidelity heavy duty curvilinear speaker . . . three gang ball bearing rubber mounted variable condenser. Power Output 4.25 Watts, undistorted.

Complete, ready for installation . . . **List Price. . .\$49.95**

### Something New in Home Radio

. . . A new design in cabinet and dial . . . smart . . . pleasing . . . sure to appeal . . . This set will sell itself in appearance, performance and price.

**List Price . . . . . \$18.95**

5 Tubes — AC-DC — TRF — 5 1/2" i.n. Dynamic Speaker. Tuning Range 520 KC — 1730 KC. Two gang ball bearing variable condenser. 11 tube sets available for 220 V. operation and European wave band.

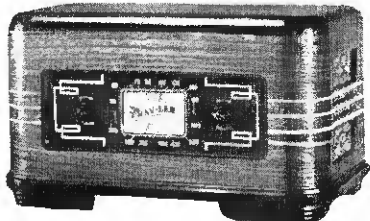

SEE  
**TRAV-LER  
DISPLAY**  
Automotive  
Accessory  
Show

Room 661-A  
Hotel Stevens  
Chicago  
Feb. 13-17  
Room 440-A  
Hotel Edison,  
New York City,  
Feb. 28-Mar. 5

## NOTICE TO DEALERS

Big  
Money Making  
Possibilities  
in  
Trav-ler Radio.  
Why not send  
coupon now?

Trav-ler Radio & Television Corp'n.  
1036 W. Van Buren St., Chicago, Ill.  
Cable Address: Travl Chicago

Without obligation please send me complete catalog and details of your dealer plan.

Name .....

Address .....

City ..... State .....



The deadly  
enemy of  
"man-made"  
static !

• A. A. & K. Licensed. In-  
placable foe of nuisance  
noises caused by electrical  
appliances near the radio  
set. No. 14, illustrated,  
lists at \$6.75. Other units  
available in any location,  
proves effective on broadcast  
as well as shortwave bands.  
Send for complete information.



CORNISH WIRE CO., Inc. • 30 Church St., N. Y. City

## THE MOST FLEXIBLE

### Pocket Multitester You Can Buy

Dependable Model 408-602 Detachable  
Combination AC-DC Tester

THE ONLY POCKET-SIZE MULTITESTER HAVING

- AC volts 1-5-50-500-1,000; DC 5-50-500-1,000
- 2,000 ohm per volt sensitivity • 3 range self-contained ohmmeter 1,000,000-50,000-500 ohms • 17 meters in 1 • No test leads required for balancing • 550 Micro-amp; 5 amp; 5-50-500 mills • Low ohm reads 5 ohms at center scale 1/10 ohm for 1st 10 division—low current drain



AND  
only  
**\$13.90**  
complete

Available separately: DC multitester  
408, \$9.95; AC converter 602, \$3.95  
Write to Dept. R for catalog

**RADIO CITY PRODUCTS CO.**  
88 Park Place, New York City

## SENSATIONAL NEWS

### ATR

REPLACEMENT

### VIBRATORS

for AUTO and FARM RADIOS  
A COMPLETE LINE

featuring

- Longer Life
- Improved Performance
- Precision Construction
- Lower Prices



Backed by more than Six Years of Experience in  
Vibrator Design and Research, Development  
and Manufacturing.

Insist on ATR VIBRATORS — The Best by Test

Mail the coupon TODAY for your FREE copy of the ATR VIBRATOR GUIDE along with the name of your nearest ATR Jobber.

### AMERICAN TELEVISION & RADIO CO.

St. Paul, Minnesota, U. S. A. Cable Address: "Likex" New York

Manufacturers of DC-AC Invertors, A Battery Elimina-  
tors, Battery Chargers and Invertor Vibrators

Pin Coupon to Your Letter Head  
American Television and Radio Co.  
St. Paul, Minn.

Gentlemen:  
Please send my FREE copy of the ATR Vibrator Guide and  
the name of my nearest ATR Jobber.

Name .....

Address .....

City ..... State .....

Check here  Jobber  Dealer  Serviceman

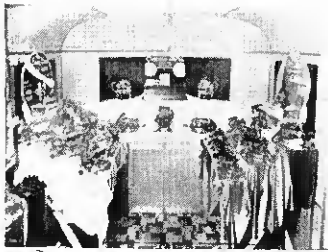

### SILVER DOME

*Silver Dome, Inc., 50 Endicott St., Detroit, Mich.*

**Models:** Commercial trailers.

**Description:** Models 18 and 20 are built for use with caster type third wheel which practically eliminates all weight from the power car and reduces wear and tear on the rear tires, rear springs, etc. to a minimum. Interiors to suit any particular business. — *Radio Retailing*, February, 1937.

### KOZY COACH

*Kozy-Coach Co., Kalamazoo, Mich.*

**Model:** Commercial trailers.

**Description:** Parking leg enables the owner to park the coach anywhere and to move it around easily for handy parking without attaching to the car; built-in jack raises and lowers the coach for coupling to car. Illustrated is an 18-ft. commercial shell. — *Radio Retailing*, February, 1937.

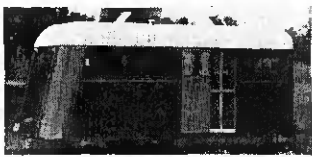

### VAGABOND

*Vagabond Coach Mfg. Co., New Hudson, Mich.*

**Model:** Sales trailers.

**Description:** Four standard sizes; ball and socket coupler with locking caps; dual wiring system—6 and 110 volt; signal buzzer to driver's compartment; radio aerial; built in trunk. Complete sleeping kit available at a nominal cost. — *Radio Retailing*, February, 1937.

### AUTO CRUISER

*Auto Cruiser Sales Corp., 4401 York Road, Baltimore, Md.*

**Model:** Commercial trailers.

**Description:** Sturdily constructed of light, yet strong, material; interior arranged to meet the needs of any business; all-steel chassis; improved jack wheels, rear storage compartment. — *Radio Retailing*, February, 1937.

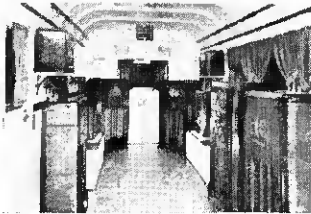

### YORK

*Split-Coach Motor Corp., York, Pa.*

**Model:** Trailers.

**Description:** New type body construction provides greater strength and less weight; junior and senior models; special steel screw-type landing legs adjustable with handle regulator and hinged to chassis; body finished in special coated leatherette. — *Radio Retailing*, February, 1937.

### STANDARD TRAILER

*Standard Trailer Co., Cambridge Springs, Pa.*

**Model:** Commercial trailers.

**Description:** Wired for 110-volt lights, as well as 6-volt lights from the battery. Designed to give maximum amount of room inside. — *Radio Retailing*, February, 1937.

### CANTRELL

*J. H. Cantrell & Co., Huntington, N. Y.*

**Models:** Trailers.

**Description:** Streamlined; electric brakes; ball and socket coupling; electric welded steel chassis; can be outfitted for use by radio and electrical dealers. — *Radio Retailing*, February, 1937.

# OPERADIO QUALITY COSTS YOU NO MORE

The name OPERADIO has always meant good sound equipment . . . high-grade dependable merchandise, reasonably priced.

That means dollars and cents to you . . . a good profit, quick turnover, and no costly calling back on the customer to fix equipment that has broken down. When you buy sound or P.A. equipment BUY

## OPERADIO UNIT-MATCHED EQUIPMENT

All equipment is "unit-matched" to insure a fine, well-rounded performance; and each piece is marked with the name "OPERADIO" . . . your guarantee of the best sound equipment that money can buy at a price no more than the ordinary.

The Operadio line is unequalled for completeness . . . including public address systems, speakers, amplifiers, paging systems, microphones, all component parts and accessories. Especially popular and profitable is the

### Model 111 Amplifier Paging System

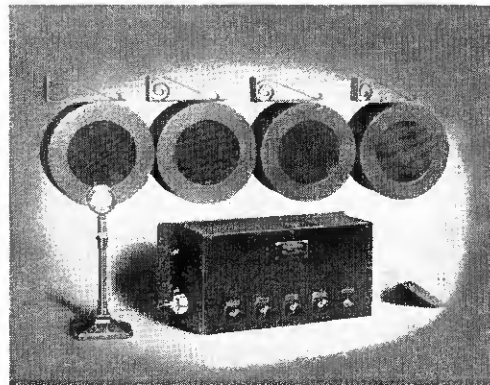

A complete paging system for factories, hotels, public buildings, theatre dressing rooms and similar places. This system is equipped to use up to 12 speakers and comes complete with contact crystal microphone mounted on a beautiful stand, a special amplifier with its tubes which mounts on the wall at some convenient place near the microphone, a foot switch for use when talking, and a complement of 4 permanent magnet dynamic speakers in attractive steel wall cabinet.

Send in your name to receive catalogs and a free copy of THE SOUND ADVISOR. Address Dept. RR.

**OPERADIO MANUFACTURING COMPANY**  
St. Charles, Illinois

# Again NORGE LEADS



IN  
**LOW TEMP**

*Rollator  
Refrigeration*

YOU HAVE A  
FUNDAMENTAL  
IMPROVEMENT TO  
SELL

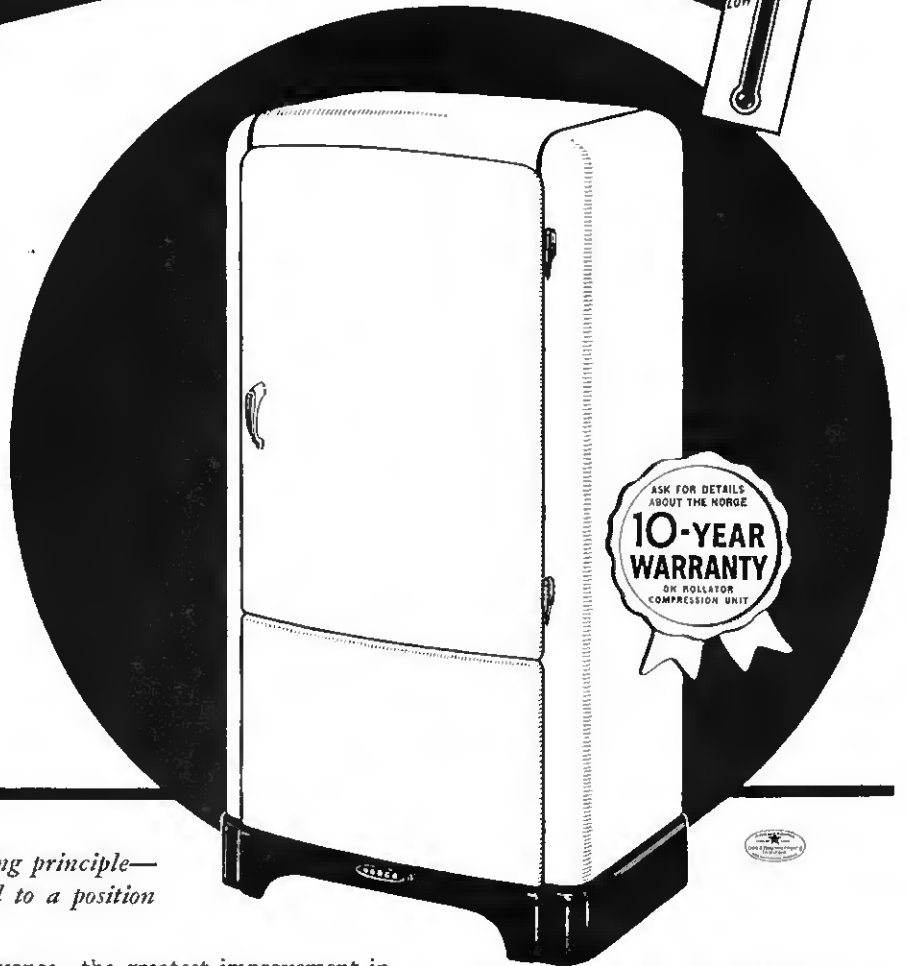

*THE introduction of a new engineering principle—the Rollator—started Norge on the road to a position of leadership.*

Today, Norge introduces *another* advance—the greatest improvement in home food preservation since the introduction of the Rollator. The new Low-Temp Rollator Refrigerator—like the Rollator itself—is a *fundamental* advance. It will keep foods **PRIME FRESH** from 2 to 5 times longer with no increase in current consumption. Temperatures up to 20 per cent *lower* are maintained, together with humidity high enough to allow foods to retain natural moisture.

*That's something to talk about*—something to sell. Especially since the new Low-Temp Norge has all the important features of style, convenience—every practical *use* advantage that has been proved sound.

Get all the facts about Norge Low-Temp Rollator Refrigeration—the aggressive advertising and promotion program behind it. Liberal finance plans make it easy to be a Norge dealer. Write for details.

**NORGE DIVISION** Borg-Warner Corp., 606-670 E. Woodbridge St., Detroit, Mich.

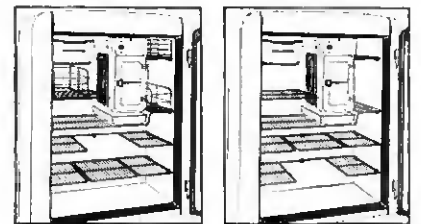

2 of the 9 New  
*Flexible Interior Arrangements*

*Any woman can see at once the advantages of this new feature—an extremely easy method of adapting the shelves to meet ever-changing storage requirements. As many as nine different arrangements are possible in most models.*

ROLLATOR REFRIGERATION  
(Domestic and Commercial)

GAS AND ELECTRIC RANGES

WASHERS AND IRONERS

WHIRLATOR OIL BURNERS

# NORGE

## *Rollator Refrigeration*

REG. U. S. PAT. OFF.

GAS BURNERS

FINE-AIR FURNACES

COAL STOKERS

AIR CONDITIONING

R-1 CIRCULATOR ROOM HEATERS

**RADIO RETAILING'S**

*Spring  
Appliance  
Review*



Postage  
Will Be Paid  
by  
Addressee

No  
Postage Stamp  
Necessary  
If Mailed in the  
United States

**BUSINESS REPLY CARD**

FIRST CLASS PERMIT NO. 64, SEC. 510 P. L. & R. NEW YORK, N. Y.

**RADIO RETAILING**

330 WEST 42nd STREET

30th Floor

NEW YORK, N. Y.

**A Section Devoted to  
New Electrical Equip-  
ment Suitable for Sale**

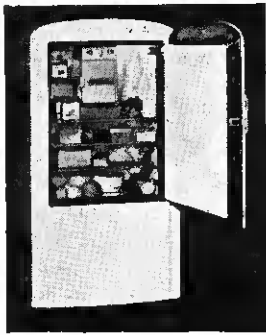

**UNIVERSAL COOLER**

**1** *Universal Cooler Corp.*

**Models:** Refrigerators.  
**Description:** Down-draft "double" cooling provides extra circulation of low temperature air within the cabinet keeping the moist air in circulation instead of removing it. This brings about a more uniform food preservation temperature. Baked lacquer exterior finish, safety zone thermometer, special defrost setting.—*Radio Retailing*, February, 1937.

**NORGE**

**2** *Norge Div., Borg-Warner Corp.*

**Models:** Refrigerators, electric ranges, washers, ironers.  
**Description:** Two "Low-Temp" refrigerators — maintain temperatures under 40° instead of the usual 50°; Rollator compressor. A gasoline-electric Rollator refrigerator for rural homes also made.  
 Five models make up

the de luxe series; two come in mother-of-pearl, tan or green; have dairy rack, egg basket and sliding utility basket. Two models in the standard line and one sink type.

Electric ranges — 6 models; all but one available with red, green or black hardware.

"Auto-Built" washers—6 models; three available either with electric or gasoline motors.

"Duotrol" ironers — 7 models. Double open-end

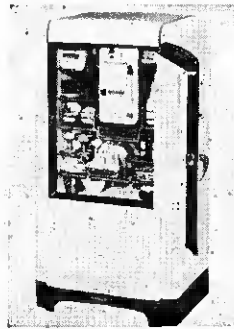

roll, two speeds, two roll controls, two heating units, two thermostats, two or more pressure tensions. The portable press-ironer may be hung on a closet hook.—*Radio Retailing*, February, 1937.

**MARION**

**3** *Rutenber Electric Co.*

**Model:** 442 electric range.  
**Description:** Full size range of all porcelain enamel; well cooker; large utility drawer; closed units. Equipped with timer outlet.  
**Price:** \$122.50.—*Radio Retailing*, February, 1937.



**THOR**

**4** *Hurley Machine Co.*

**Model:** Washers; ironers.  
**Description:** Washers: "Gentle Hand" washer eliminates friction and rubbing so that lingerie can be safely laundered. Super-agitator; free-rolling wringer; seven models.  
 Ironers: "Fold-A-Way" model; Stowaway model which takes up only 1 sq. ft. of floor space and four table models.—*Radio Retailing*, February, 1937.

**GENERAL ELECTRIC**

**5** *General Electric Co.*

**Models:** Heating pads.  
**Description:** Soft eiderdown covers in a choice of pastel shades. Each is equipped with a conveniently located three-heat switch, two non-radio interfering thermostats, and a 10-ft. cord set. Overall dimensions, 12x15 in. A slip-on rubberized waterproof cover is furnished with one model.  
**Prices:** \$3.95 and \$4.95.—*Radio Retailing*, February, 1937.

**APEX**

**6** *Apex Electric Mfg. Co.*

**Models:** Washers, ironers, cleaners.  
**Description:** Washers—double dasher for gentle handling of all materials; adjustable pressure selector on wringer; Lovell wringer rolls; ten models.  
 Ironers — both table tops and open models included; five models.  
 Cleaners — three full size and two hand cleaners.—*Radio Retailing*, February, 1937.



**HORTON**

**7** *Horton Mfg. Co.*

**Models:** Washers, ironers.  
**Description:** Washers — specially designed wringer gear head harmonizes with washer; Kleen-Zoning; six models.  
 Ironers—four models, one may be attached to wringer post of any Horton washer; two open models and one with all-metal cover.—*Radio Retailing*, February, 1937.

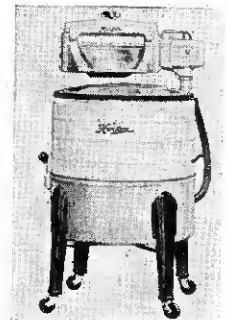

**HAAG VORTEX**

**8** *Haag Brothers Co.*

**Models:** Washers, ironers.  
**Description:** Washers — multi-flush agitator, safety wringer with mechanical hand, 5 models.  
 Ironers — two models, double thermostatic control, knee and finger-tip control, 6x26 in. heavily padded roll.—*Radio Retailing*, February, 1937.

**CIRCLE NUMBERS-SIGN-AND MAIL**

**RADIO RETAILING**  
 330 West 42nd Street  
 New York, N. Y.

**FEBRUARY**

Gentlemen: . . . We are interested in knowing more about the literature and products identified by the numbers circled below:

1	2	3	4	5	6	7	8	9	10	11	12	13	14	15	16	17	18	19	20
21	22	23	24	25	26	27	28	29	30	31	32	33	34	35	36	37	38	39	40
41	42	43	44	45	46	47	48												

SIGNED \_\_\_\_\_ TITLE \_\_\_\_\_

COMPANY \_\_\_\_\_



GIBSON

9 Gibson Refrigerator Co.

Models: Refrigerators.

Description: 4, 5, 6 and 7 ft. models in standard group; 5, 6, 7 and 8 ft. models in the Custom Built group. Freez'r shelf in all models but the 4-ft. standard. A new feature is the swinging shelf. —Radio Retailing, February, 1937.

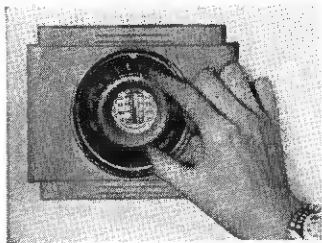

LEONARD

10 Leonard Refrigerator Co.

Models: Refrigerators.

Description: Master Dial gives the housekeeper positive temperature control at all times. Len-A-Dor foot pedal is retained. 11 models, three in porcelain and eight in permalain. —Radio Retailing, February, 1937.

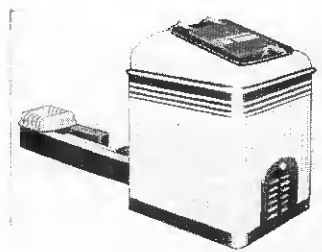

FIRETENDER

11 Holcomb & Hoke

Device: Stokers.

Description: 300-lb. capacity hopper is so designed that no mechanical coal agitator is necessary; slope of hopper side pre-

vents "arching" of coal; oil flow drive unit; automatic throwout. —Radio Retailing, February, 1937.

YORK

12 York Ice Mach'y. Corp.

Model: Portable air conditioner.

Description: Housed in a walnut cabinet with a

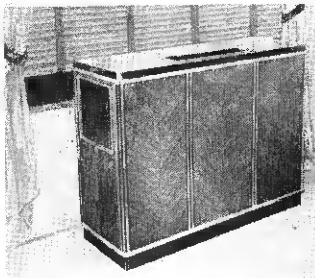

black metal base which conceals the casters. Three sizes. Truly portable; requires no plumbing or piping of any kind; simple to install with one electrical connection, adjustable to window size. Uses outdoor air as a condenser medium for removing the heat from the room. —Radio Retailing, February, 1937.

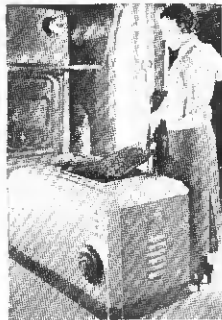

WHITING

13 Whiting Corporation

Models: Stokers.

Description: Encased in smart colorful modern cabinets; may be easily attached to warm air furnaces or steam, hot water and vapor boilers. Available in capacities of 20 and 40 lb. of bituminous coal per hour. A 60 and 90 lb. capacity model also available for large residences and small apartment buildings as well as two commercial models. —Radio Retailing, February, 1937.

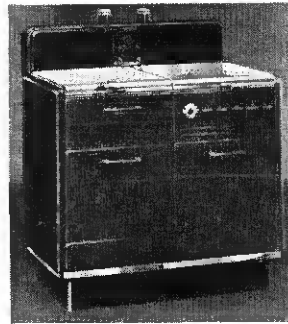

ESTATE

14 Estate Stove Co.

Models: Electric ranges.

Description: Five models including Black Beauty, an extremely modernistic model in black, with deluxe mantle back, time control, Monel metal top covers, waist high, drawer type broiler; three leg-type models and one with the cabinet base. Two may be equipped with electric cooker at extra charge. —Radio Retailing, February, 1937.

PROCTOR

15 Proctor & Schwartz Electric Co.

Model: Roast-or-Grille.

Description: Broiler in lid makes it a portable range in itself; broiling, grilling, toasting and top-browning can be done in addition to roasting, baking, boiling, steaming and frying. The self-cleaning grille is a separate element with its own terminals. Cooks complete meals for six to ten persons. —Radio Retailing, February, 1937.

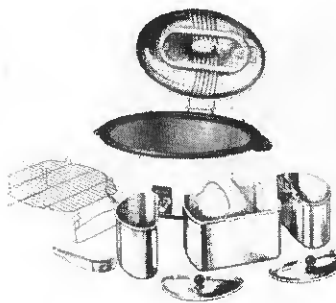

DELCO

16 Delco Appliance Div. General Motor Sales Corp.

Models: Fans.

Description: "Aircirculator"—three bladed fan; two-speed control; two

sizes, 24 and 30 in. blade; four types of mounting—floor pedestal, counter wall or ceiling; a.c. and d.c. models.

Three oscillating Northeast fans; 8-, 10- and 12-in. blade sizes.—Radio Retailing, February, 1937.



ABC

17 Altorfer Bros. Co.

Models: Washers, ironers.

Description: Three electric models and a farm washer in two sizes.

Three ironers are also included in the new line. —Radio Retailing, February, 1937.

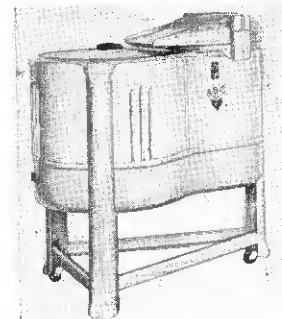

WESTINGHOUSE

18 Westinghouse Elec.

Models: Ranges.

Description: Tailored to specifications demanded by housewives; ten models; Corox units, "Economizer" speed unit.—Radio Retailing, February, 1937.

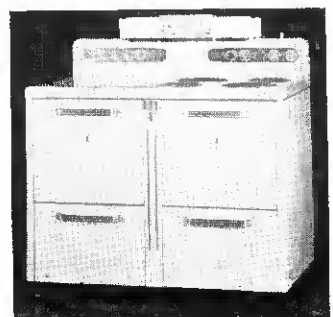

**Hotpoint**  
THE NAME EVERYBODY KNOWS

*offers* **3**



### **3 NEW LINES** **HOTPOINT DE LUXE LINE**

Five popular models in the Hotpoint De Luxe line, all with gleaming baked Glyptal finish. All the features and style that a prospect could possibly want. Speed Freezer powered by the vacuum-sealed Thriftmaster is standard equipment on all Hotpoint Refrigerators.



### **HOTPOINT IMPERIAL LINE**

Four popular models in the Imperial line, America's finest refrigerators, all in enduring porcelain enamel inside and out. Beautifully styled, attractively priced, and built to keep your customers boosting for you. The Imperial line has powerful sales appeal. It offers a host of extra features that convert lookers into buyers.



### **HOTPOINT STANDARD LINE**

Three fast-selling models in baked Glyptal finish, porcelain interior. Dependability, long life and beauty in a line that does credit to the famous reputation which Hotpoint enjoys for full value. See this line and note the profit possibilities offered by its big value.

**Hotpoint**

**REFRIGERATOR**



# NEW REFRIGERATOR LINES POWERFUL SALES FEATURES

## 3 GREAT FEATURES

**H**OTPOINT gives you a quick selling, profit building refrigerator line with plenty of easy-to-demonstrate features and plus values.

Beauty that sells on sight; lifetime all-steel cabinets; gliding shelves; ever-visible food safety gauge; are a few of the plus features. Read about the 3 Powerful New Sales Features of the new Hotpoint Refrigerators.

Then get the sensational Hotpoint story before you start your 1937 campaign. Call or write the Hotpoint distributor in your territory. Ride with Hotpoint in 1937.

**Speed Freezer**  
Ice and desserts frozen faster than ever! Foods kept safe and crispy fresh in a gently floating blanket of frosty air—air held at constant chill, regardless of freezing speed, by Hotpoint's precisely balanced freezing control.



## NATIONAL ADVERTISING EVERY MONTH DURING THE SELLING SEASON

Double pages in color and full pages featuring the Hotpoint refrigerator exclusively will appear in Saturday Evening Post and Collier's. Beginning in March this advertising will appear every month throughout the selling season.

**VACUUM SEALED Thriftmaster**  
Delivers more power at lower cost. Tests prove that the Hotpoint Vacuum Sealed Thriftmaster is one of the most efficient mechanisms ever produced. Almost by magic a mere trickle of electricity is transformed into an abundance of freezing power. 5¢ worth of electricity makes twice as much cold as it did formerly.



## STREAMLINED SALES PLANS

Fast-acting direct mail pieces, dramatic window displays, newspaper mats, powerful outdoor posters.

## SALES FEATURES THAT GET THE ORDER

Look over the Hotpoint line. Count up the plus-value sales features that make the prospect want to sign the order. Get in touch with your Hotpoint distributor now.

**EDISON GENERAL ELECTRIC APPLIANCE CO., INC.**  
5680 West Taylor Street, Chicago, Illinois

**5-YEAR PROTECTION PLAN**  
The new Hotpoint line of refrigerators is backed by a 5-year protection plan. It is another strong sales feature which stresses the care-free performance of the Vacuum Sealed Thriftmaster. See the 1937 line of sales-winning Hotpoint Refrigerators.



RIDE WITH

**Hotpoint**

IN 1937

Edison General Electric Appliance Co., Inc.  
5680 W. Taylor Street, Chicago, Ill.

Please send me full information, prices and sales plan on the new line of Hotpoint Refrigerators.

Name \_\_\_\_\_

Address \_\_\_\_\_

City \_\_\_\_\_

State \_\_\_\_\_



## VOSS

19 *Voss Bros. Mfg. Co.*

**Models:** Washers, ironers.

**Description:** Washers — agitator floats and automatically adjusts itself to proper washing position; electrically protected safety guard wringer; four models.

Ironer—finger tip or knee control; cabinet cover may be had at small additional cost. — *Radio Retailing*, February, 1937.

## BARTON

20 *Barton Corp.*

**Models:** Washers.

**Description:** A patented convoluted tub provides the Barton patented water action. The convolutions concentrate the water—shoot it back through the clothes in 15 jets of cleansing suds; six models.

**Prices:** \$39.95 to \$89.95. — *Radio Retailing*, February, 1937.

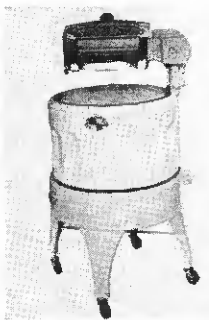

## AUTOMATIC

21 *Automatic Washer Co.*

**Models:** Washers; ironers.

**Description:** Duo-Disc agitator, Magic Button safety wringer, Stokes ballbearing patented transmission; five models; also two gas-engine

washers for farm homes.

**Ironers**—Two models, finger-tip and knee control, chromium shoe.

**Prices:** Washers, \$49.95 to \$94.95; ironers, \$59.95 and \$79.95. — *Radio Retailing*, February, 1937.

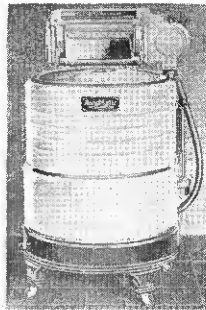

## MAGIC MAID

22 *Fitzgerald Mfg. Co.*

**Model:** No. 777 iron.

**Description:** Automatic, fast heating, medium weight, chrome finish with one-piece "easy heel action" support.

**Price:** \$3.95.—*Radio Retailing*, February, 1937.

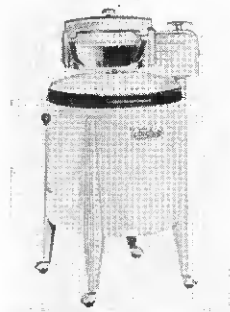

## WOODROW

23 *Woodrow Washer Co.*

**Models:** Washers.

**Description:** Five electric and gasoline engine models. Model 792, illustrated, is an insulated tub washer with white porcelain tub, 10 or 23 lb. capacity. — *Radio Retailing*, February, 1937.

## MELLO-CHIME

24 *Mello Chime & Signal Co.*

**Models:** Door chimes.

**Description:** Musical chimes to replace door bells. Models G, H and J operate on present door bell current; easily installed. Model F de luxe

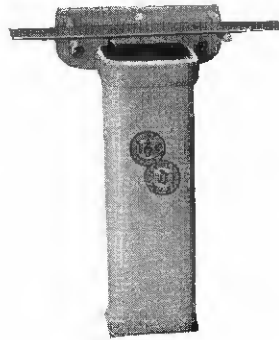

serves both front and rear doors.

**Prices:** Model G, \$1; H, \$1.95; J, \$3.75; F, in lettuce green, \$6; ivory \$7.—Two-door adapter, \$1.—*Radio Retailing*, February, 1937.

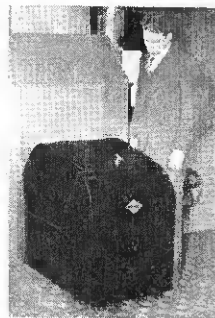

## CADILLAC

27 *Clements Mfg. Co.*

**Models:** Vacuum cleaners.

**Description:** Three full size and one hand cleaner. All large models have electric light, super-suction power through 8 blade fan and large motor; gentle beating-cleaning action.—*Radio Retailing*, February, 1937.

## WILL-BURT

25 *Will-Burt Company*

**Models:** Stokers.

**Description:** Eleven models with capacities ranging from 15-350 lb. of coal an hour; automatic air control; may be installed in any type of heating plant. — *Radio Retailing*, February, 1937.

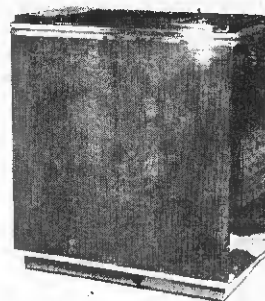

## KAUFFMAN

26 *Kauffman Air Conditioning Corp.*

**Model:** Air conditioners.

**Description:** Illustrated model is entirely auto-

matic; compact cabinet, mounted on casters so it can be moved; no plumbing or drain connection necessary. Cools, dehumidifies, filters and circulates air. Freon refrigerant.

Other models available. — *Radio Retailing*, February, 1937.

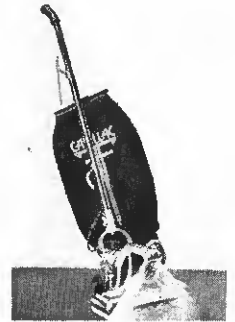

## GENERAL ELECTRIC

28 *General Electric Co.*

**Models:** Washers; ironers.

**Description:** Illustrated is the "Quiet" washer, AW-27P, 9 lb. capacity, new type Activator, "Monotrol" wringer. Many other styles and sizes also available.

**Ironers**—Two portable flat-plate ironers and a rotary ironer with table top or in console cabinet.—*Radio Retailing*, February, 1937.

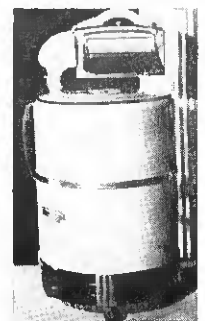

# STEWART-WARNER

## YOUR *Best Bet* FOR 1937

### FOR 4 BIG REASONS

#### ✓ More Features for Your Money

Thirty-two exciting sales features—with 6 absolutely *exclusive* headliners topping the list—give new convenience, new economy and dependability, new beauty! These are the qualities your customers will gladly spend money for. But they're only one of four reasons why the 1937 Stewart-Warner is already smashing sales records.

#### ✓ Exclusive New Finance Plan

Now you can feature "NO MONEY DOWN" terms without tying up your capital. A special, exclusive Stewart-Warner - C. I. T. 100% Advance finance plan means that every sale is a *cash sale* for you! Think what that means in terms of extra sales and freedom from worries.

#### ✓ Exclusive New Floor Plan

This new plan—the best in the industry—developed by Stewart-Warner solely for Stewart-Warner dealers, lets you buy now—install a complete floor showing—and not pay a cent for finance charges! It means *more* sales and easier sales and saves you money.

#### ✓ A Super-Power Merchandising Plan

Your fourth ace is the hardest-hitting merchandising program in Stewart-Warner history—far more powerful than the record-breaking year of 1936. Horace Heidt and his famous Brigadiers head the list with broadcasts over a coast-to-coast Columbia network. And everything else you need to bring customers in—and *sell 'em*—is included. Get the whole story from your Stewart-Warner distributor at once.

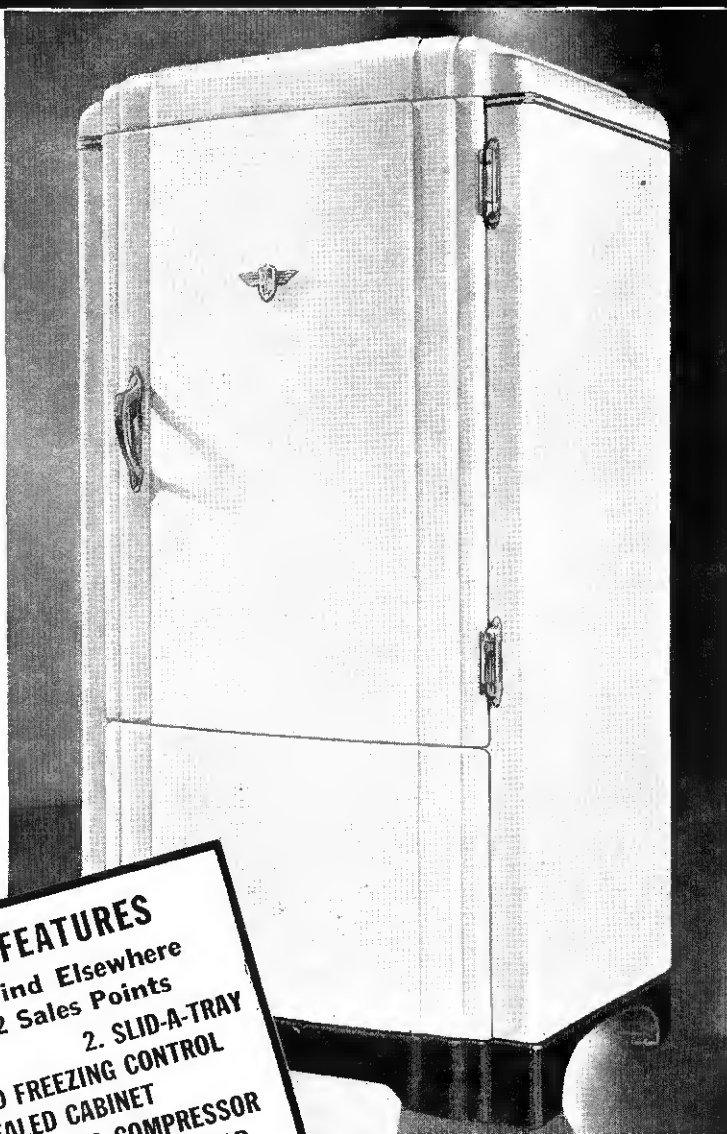

- 6 EXCLUSIVE FEATURES**  
That You Can't Find Elsewhere  
Head a List of 32 Sales Points
1. SAV-A-STEP
  2. SLID-A-TRAY
  3. 16-POINT LIGHTED FREEZING CONTROL
  4. VAPOR SEALED CABINET
  5. SLO-CYCLE TWIN CYLINDER COMPRESSOR
  6. REVERSIBLE FREEZING CHAMBER DOOR

**STEWART-WARNER**  
CHICAGO, ILLINOIS

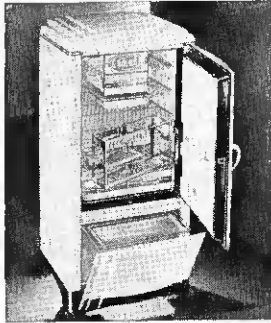

### STEWART WARNER

29 Stewart Warner Corp.

Models: Refrigerators.

Description: Three Master and 8 DeLuxe models; exterior of cabinets has been restyled; improved Sav-A-Step; automatic Slid-A-Tray; 16 point cold control; reversible evaporator door; touches of color on interior of DeLuxe models.—*Radio Retailing*, February, 1937.

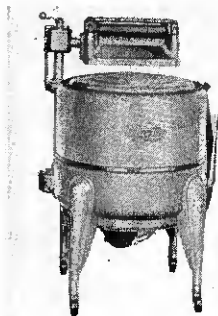

### MAYTAG

30 Maytag Company

Models: Washers, ironers.

Description: Washers—Gyrator principle of washing, sediment trap, divided frame wringer. Gasoline Multi-Motor available on any washer for use in non-electrified districts.

Ironers—Knee and finger tip controls, cork padded ironer roll, table top cabinet.—*Radio Retailing*, February, 1937.

### 1900

31 1900 Corporation

Models: Washers.

Description: Classic and Master models. Classic—

holds 21 gal. of water to washing line, massive safety wringer; oversize "Surgilator" cleanser; large capacity.

Master—oversize capacity, finished in dawn gray or in white at small extra cost.—*Radio Retailing*, February, 1937.

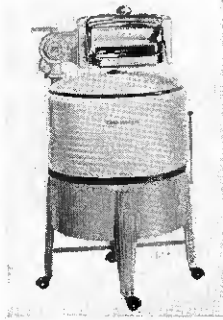

### ONE MINUTE

32 Ont Minute Washer Co.

Models: Washers.

Description: Five electric models, each available with Briggs & Stratton engine if desired; bottom aluminum agitator with full height wings; streamlined design.—*Radio Retailing*, February, 1937.

### GENERAL ELECTRIC

33 General Electric Co.

Model: Electric Sink.

Description: Combines an electric washer and the G-E "Disposal."

Washes dishes, glasses, silver, pots and pans, and dries them; and disposes of food waste down the drain right at the sink.

Available in various models to fit any requirements for the home.—*Radio Retailing*, February, 1937.



### COMBUSTIONEER

34 Combustioneer Div., Steel Product Engineering Co.

Model: Automatic coal burner.

Description: Automatic "respirator" accurately regulates the amount of air admitted; when coal and air meet in the "breathing fuel bed" the result is scientific combustion of both carbon and volatile gases. Quickly installed in any furnace or heating system.—*Radio Retailing*, February, 1937.



### CROSLY

35 Crosley Radio Corp.

Models: Savamaid washers and ironer.

Description: Spc-dry washer—does all the washing, bluing, rinsing and pre-iron drying automatically—all within the machine itself. Several models, all available with gas engine assembly for non-electrified areas.

Ironer—handles everything from laciest frills to heaviest garments.—*Radio Retailing*, February, 1937.

### SERVEL ELECTROLUX

36 Servel, Inc.

Model: Gas refrigerators.

Description: Six models; cabinets finished in New-tone: porcelain crisper,

egg basket, fruit and vegetable basket, special desert tray which may also be used to freeze cubes.—*Radio Retailing*, February, 1937.

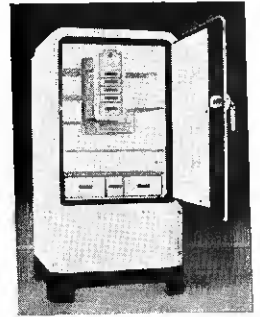

### HOTPOINT

37 Edison General Elec. Appliance Co.

Models: Three Standard, 5 De Luxe and 4 Imperial flat top refrigerators.

Description: Sliding shelves in all but 3 and 4 cu.ft. and 5, 6, 7 cu.ft. specials; aluminum and rubber ice trays; hermetically sealed units; stainless steel Super-Freezer; glass dishes, water bottles, egg and fruit baskets in large De Luxe and Imperial models. Standard and De Luxe models have Glyptal exteriors; Imperial models, porcelain exteriors.—*Radio Retailing*, February, 1937.

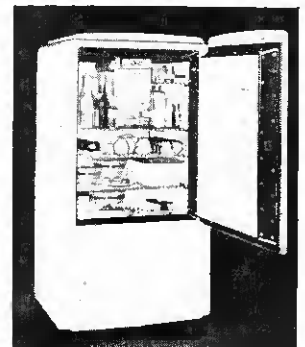

### WAYNE

38 Wayne Oil Burner Corp.

Models: Oil burner.

Descriptions: "Mistoil" oil burner, takes its name from the fact that 33 parts of air are mixed with one part of oil to form a hazy mist that burns in suspension. Available for hot water, steam or vapor heating.—*Radio Retailing*, February, 1937.

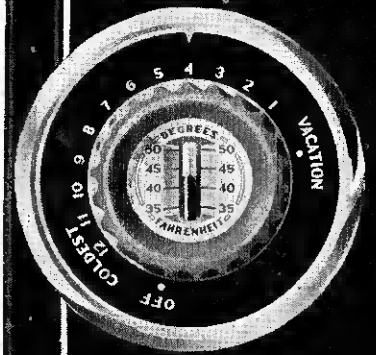

*Just look at it!*

Is it any wonder that dealers say . . .  
"It's the greatest 'self-seller' on the  
market . . . and the program back of  
it gets them in front of a Leonard."

# LEONARD

## REFRIGERATOR

WITH THE

*Master Dial*

LEONARD, DIVISION OF NASH-KELVINATOR CORPORATION • DETROIT, MICHIGAN

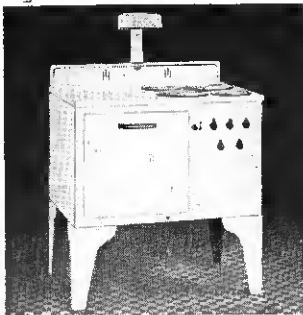

### STANDARD

#### 39 Standard Electric Stove

**Models:** Electric ranges.  
**Description:** Sizes to meet every requirement from the smallest home to the largest hotel. Most models are available in both the cabinet and leg types. Combination coal and electric range also made.—*Radio Retailing*, February, 1937.

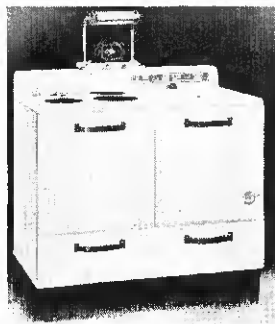

### KELVINATOR

#### 40 Kelvinator Corp

**Models:** Electric ranges.  
**Description:** Seven models; some furnished with automatic timer and minute meter, while this equipment may be had at a slight additional cost on all other models. Both flush-type base and leg models are made.—*Radio Retailing*, February, 1937.

### SUPERFEX

#### 41 Perfection Stove Co.

**Models:** Oil burning refrigerator and range.  
**Description:** Refrigerator: Made especially for homes beyond gas, electric light lines. Three simple burners form the "power plant"; only about two hours of burning operation required

to make sufficient refrigeration for 24 hours or more. Condenser is completely self-contained and requires no water.

Perfection also has a cabinet type oil range of modern lines to match the refrigerator. *Radio Retailing*, February, 1937.



### HEXCEL

#### 42 Hexel Radaitor Co.

**Model:** Humidifier.  
**Description:** Table type; motorless; for 110 volt a.c. or d.c.; evaporates 1½ pt. water per hour; capacity 2½ gal. water; automatic shut-off; true vapor type.  
**Price:** \$27.95.—*Radio Retailing*, February, 1937.



### ZEPH-O-LATOR

#### 43 Century Eng. Corp.

**Model:** Air conditioning unit.  
**Description:** Condensed type of furnace in which the distribution of heat is as nearly perfect as possible and eliminates the necessity of baffling in order to deliver uniform temperatures at the bonnet. The combustion chamber is of the removable drawer type.—*Radio Retailing*, February, 1937.

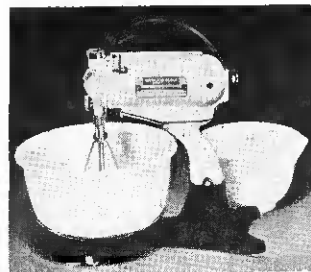

### HAMILTON BEACH

#### 44 Hamilton Beach Co.

**Model:** "D" food mixer.  
**Description:** Can be set at exact speed required for each individual mixing job; double guarded feeders, easily removed in one piece; bowl control feature assures thorough mixing; radio interference eliminator; a.c.-d.c.—*Radio Retailing*, February, 1937.

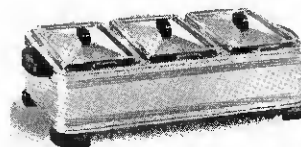

### UNIVERSAL

#### 45 Landers, Frary & Clark

**Model:** Buffet food server.  
**Description:** Three heat-resisting removable glass containers are enclosed within the server. Each dish holds 3 pt. Body and covers of brass, plated with brilliant chromium. Universal also makes toasters, irons, waffle irons, percolators.—*Radio Retailing*, February, 1937.



### EVERHOT

#### 46 Swartzbaugh Mfg. Co.

**Model:** Automatic roaster.  
**Description:** Designed for easy cooking. A complete meal can be cooked in one operation. Thermostatic control automatically regu-

lates temperature, meat bastes itself. Capacity: serves from 4 to 20 persons.

**Price:** \$18.95.—*Radio Retailing*, February, 1937.

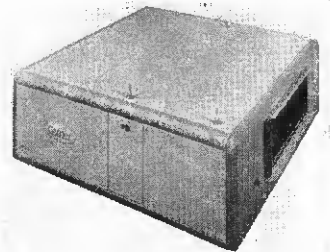

### CARRIER

#### 47 Carrier Corporation

**Model:** Home air conditioning.  
**Description:** A small unit especially designed for winter or year round air conditioning; suspends from the ceiling. Following combinations: humidifying only; humidifying - cooling; heating-humidifying; and, heating-humidifying-cooling-dehumidifying in one unit.—*Radio Retailing*, February, 1937.



### GENERAL ELECTRIC

#### 48 General Electric Co.

**Model:** Electric Comforter.  
**Description:** A light bed covering takes the place of heavy blankets. Gently heated by means of low voltage wires with special water proof insulation. Unique feature is the control which automatically varies the amount of heat to the blanket as the temperature in the bedroom changes. An attractive control box houses the transformer, as well as the control unit which consists of an adjustable thermostatic blade and heating coil.  
**Price:** \$65.—*Radio Retailing*, February, 1937.

(CONTINUED FROM PAGE 3)

# HERE'S THE GREAT BIG BEAUTIFUL NEW Grunow FOR 1937 AIR-CONDITIONED REFRIGERATION FOR EVERYONE!

WITH THE  
**AMAZING NEW "AERATOR"**  
(STOPS THAT ODOR)  
THE **ECONO-PHASE VACUUM UNIT**  
AND THE **HANDY SERV-SHELF**

**THE "SEAL OF APPROVAL"  
ON EVERY BOX**  
To Assure Purchasers of Faster  
Freezing . . . Uniform Shelf Temperature  
. . . Food Odor Prevention . . . and  
Double Ice-Cube Capacity

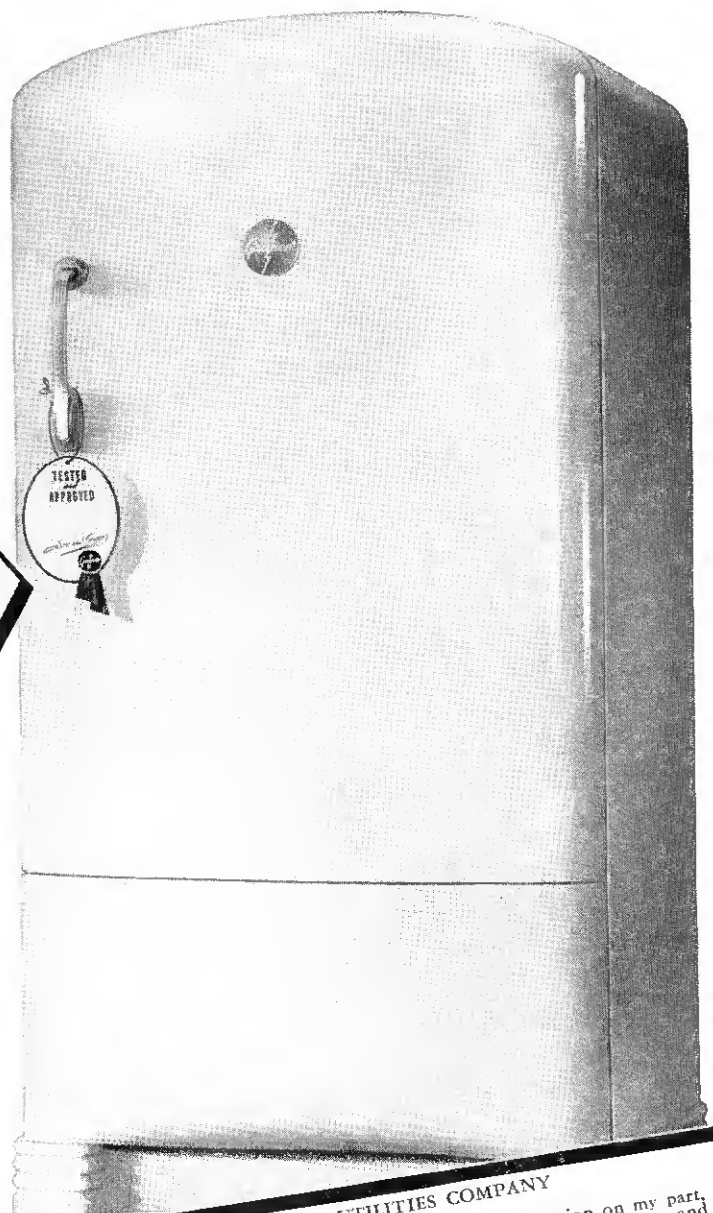

★ Here it is . . . the refrigerator with the **SELL!** The great big new beautiful Grunow Refrigerator for 1937. Enthusiastic dealers everywhere say that here is another merchandising *natural* . . . with the same kind of sales "IT" that made **TELEDIAL** the 1937 sensation of the radio industry. And why not? Look at all the performance features that can really be *demonstrated!* . . . Faster freezing! . . . Double ice-cube capacity (168 cubes) even in lowest priced models! . . . The amazing new **AERATOR** that sweeps the interior clean of all food odors! . . . The marvelous **Catrene Econo-Phase Vacuum Freezing Unit!** . . . And new cabinet styles by Walker, the ace of industrial designers! Then there's a brand new finance plan . . . a new factory service plan . . . and the most unusual advertising campaign ever put behind the merchandising of a mechanical refrigerator! Get full details today by mailing the coupon, or by wire!

**GENERAL HOUSEHOLD UTILITIES COMPANY**  
**CHICAGO, ILLINOIS      MARION, INDIANA**

*Manufacturers of Grunow Carrene Refrigerator • Grunow Household Radios • Grunow Automobile Radios*

**Ask About the New  
GRUNOW LOW-COST FINANCE PLAN!**

**MAIL THIS COUPON NOW!**

**GENERAL HOUSEHOLD UTILITIES COMPANY**  
2680 N. Pulaski Rd., Chicago, Illinois  
Gentlemen:—Please send **AT ONCE**, with no obligation on my part, complete information about the 1937 Grunow Refrigerator Line, and put me in touch with my nearest Grunow Distributor.

Name.....  
Store Name.....  
Address.....  
City..... State.....

was in full-swing abuses declined to a point where it was believed complete clearing up of the situation must soon follow. But trouble is again becoming serious, as indicated by the following comment obtained from St. Louis dealers while making the rounds of the city's radio, appliance and furniture stores:

From Sam Singer of Schweig-Engel: "We lost two radio sales yesterday because one buyer said he could buy a set we had on display at 40 per cent off and the other told us outright that we couldn't meet the price he could get on a set which we had previously demonstrated to him."

Another dealer interviewed said: "One of our salesmen has a relative working for a large local shoe manufacturer. The relative wanted to buy a radio and was invited to the store to look over the line. He came, selected a set, but then informed our man that he could buy it cheaper

through his own purchasing agent."

A downtown merchant remarked: "People still come into the store, ask to be shown a radio or refrigerator and then ask for literature or some number identifying the model. When our men ask for the name and address this information is refused. Or a fictitious address is given. Obviously, these people are using us for demonstrations and then buying at cut prices elsewhere."

Experiences of this same kind are so common at the Famous-Barr department store that Art Graeff, sales manager of the radio department, gives customers who ask for identification only part of the model number.

That the St. Louis trade is in a dangerous frame of mind is indicated by the following outspoken statement by a dealer who practically lives on industrial business: "I sell at 10 per cent above wholesale price

to purchasing departments of local plants. There are a few repossessions. But the employee knows that his bill must be paid so long as he continues working for the plant. We need no collector, therefore. Nor do we have to carry a large floor display. Many people who buy in this manner will make their selections from photographs. We don't have to worry about a sales organization. The purchasing agent is the salesman and so we save 10 per cent in commissions."

Definitely known is the fact that at least one wholesale house is actually soliciting business from local factories. They use salesmen who contact purchasing agents and are in direct competition with their own dealers.

Present signs, thinks *Radio Retailing's* reporter, point to increased industrial selling in St. Louis and adjacent towns.

MOTION WINDOW SELLS TONE (Continued from page 24)

pendulum. These five primary colors are continuously changing shades.

The continuous change of color tone is the result of the metal mask ("G" in diagram No. 1) passing to and fro over the four colored lamps in the shadow box. These lamps are red, blue, white and green. As each lamp is shut off by the metal mask passing over it, the color shading of the pendulum is, therefore, continuously changing.

While the diagrams and text underneath briefly explain construction of the center-piece, a few points should be emphasized. Be sure to bolt a strip of thin angle metal to the bottom of the pendulum with five or six bolts, washers on both sides. The angle strip is to avoid warping of the pendulum by heat rising from the lamps. However, the heat will not be serious if two-inch holes are cut alongside each lamp socket to create a current of air. Note also that the pendulum is entirely supported by the wire extension leading from the motor. This wire extension is a part of the motor. Further, that the swinging pendulum extends into the shadow box, keeping the attached metal mask out of sight, as well as the bolt heads of the angle strip. The motor suggested has a very short swing, and so the pendulum

likewise has a short swing—which is all the space allows.

An effective touch is to paint the five stripes, after the words "Visible Rays" on the left-hand panel, in the same colors as the pendulum, but in this sequence, beginning at the top; violet, blue, green, yellow and red. Violet being the shortest wave-length and red the longest.

No measurements are given, but the height of the center display frame should be the same as the consoles—and all other parts in proportion, as shown in the layout illustration and diagram No. 1.

Copy for the right-hand panel reads as follows:

**COLORFUL RECEPTION**  
A Prism Yields Only Fundamental Colors but the Rainbow is a Glorious Harmony of Color.

The Indifferent Radio Set (like the Prism) Brings to You Mainly the Flat Fundamental Tones, but . . .

The **BLANK RADIO**  
The Rainbow of Radio, Brings to You the Full Colorful and Precise Range of Voice and Instrument.

Copy for the left-hand panel is:

**RADIO**  
Color and Light  
Are All Varying Electro-Magnetic  
Wave Lengths.

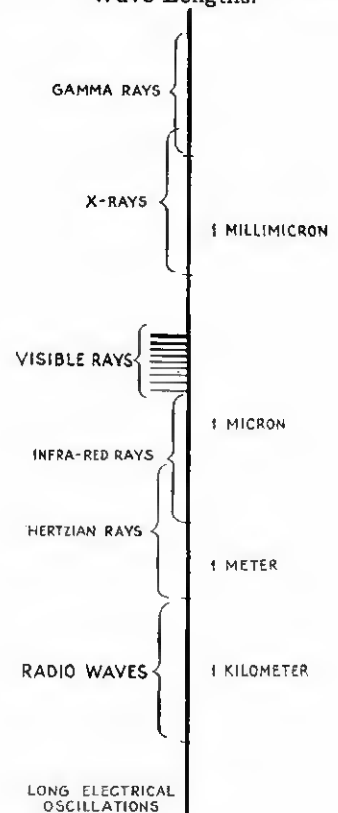

(1 MILLIMICRON = 1 BILLIONTH OF 1 METER)



HERE'S ANOTHER ENDORSEMENT OF

# **Kelvinator's**

## **great 1937 program!**

**ORDERS FOR KELVINATOR REFRIGERATORS IN 1937 HAVE  
ALREADY SHATTERED ALL PREVIOUS RECORDS!**

**THE FINEST LINE  
OF REFRIGERATORS  
KELVINATOR  
HAS EVER BUILT**



That's how the field organization feels about the great Kelvinator programs for 1937.

Right down the line—distributors, dealers and salesmen—are more enthusiastic than they have ever been before at the start of a selling season. They are enthusiastic about the new product, the advertising, the promotion, and the selling story.

And they voiced this enthusiasm with *orders*—orders far in excess of those ever turned in, in previous years, following the announcement of a program.

KELVINATOR, *Division of Nash-Kelvinator Corp., Detroit*

**PROMOTION  
THAT GUARANTEES  
FLOOR TRAFFIC**

**THE LARGEST NATIONAL  
ADVERTISING  
CAMPAIGN IN  
KELVINATOR'S HISTORY**

**COAST-TO-COAST  
RADIO  
CAMPAIGN**

**THE MOST CONVINCING  
SELLING STORY EVER  
PUT BEHIND  
A REFRIGERATOR**

*1937 will be the greatest year in history for*  
**Kelvinator Dealers**

JUST AS SCIENCE HAS ADDED YEARS TO THE LIFE OF MAN...

# ARCTURUS

*has added hours of*  
DEPENDABLE, TROUBLE-FREE SERVICE

to **25Z5's**

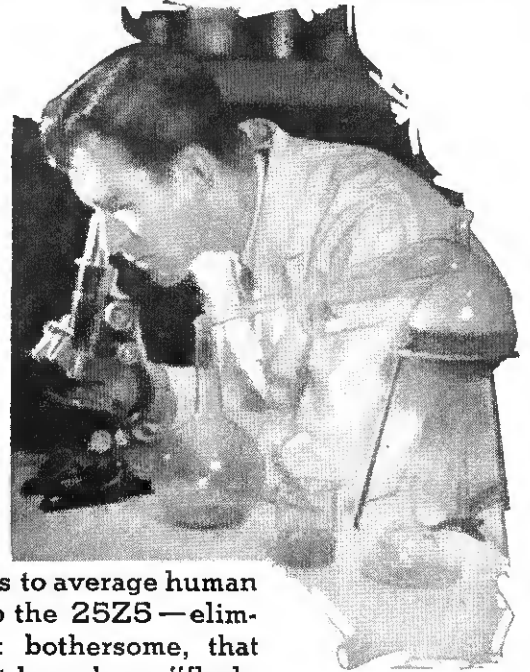

Just as scientists have added many years to average human life, so have Arcturus engineers built up the 25Z5—eliminating all the troubles, sporadic but bothersome, that seemed inherent in this tube. Prevalent have been “flash-overs”; open cathode tabs caused by overloads; slow-heating; shorts with resultant blown filter condensers; filament failures in excess of normal.

The new Arcturus 25Z5 protects users from these troubles. A high margin of safety built into these tubes, makes this 25Z5 outperform\* and outlast ordinary tubes and withstand abuse.

Start using them today—on EVERY job! Keep customers satisfied. Protect your reputation by selling only the “quality” tube—Arcturus.

ARCTURUS RADIO TUBE CO., NEWARK, N. J., U. S. A.

**\*HERE'S THE PROOF! . . .**

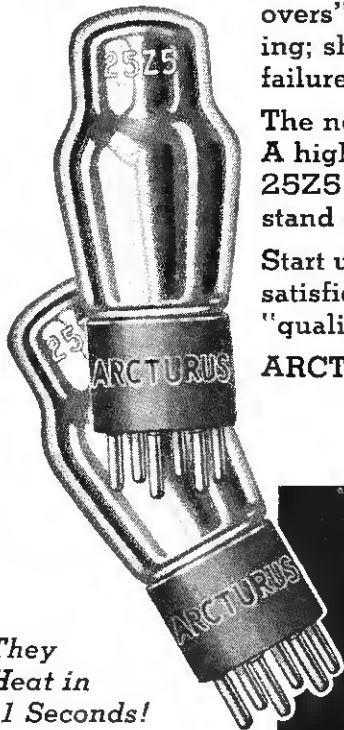

*They  
Heat in  
11 Seconds!*

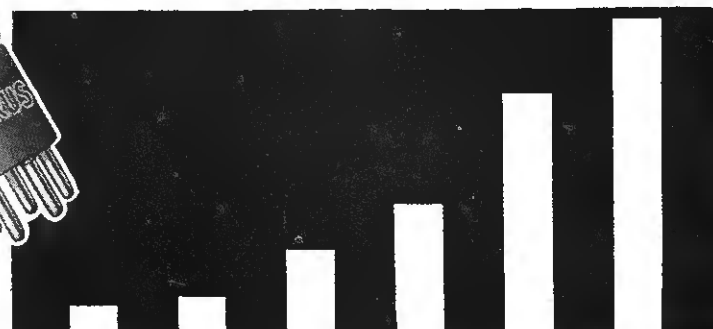

MFR. A      MFR. B      MFR. C      MFR. D      MFR. E      ARCTURUS 25Z5

There is no ordinary way to test 25Z5's effectively. You've got to treat them rough—just as they are treated in actual use. Shoot overload after overload into them. Snap them on and off constantly. Let 'em burn for many hours at a stretch.

Under such an extremely severe test the Arcturus 25Z5 Tubes came through with results indicated in the accompanying graph—having an effective operating life considerably in excess of five leading competitive makes of tubes, the average life of which is also indicated in the graph!

# ARCTURUS

**INDEPENDENT TUBES FOR DEALERS WHO DO THEIR OWN INDEPENDENT THINKING**

# SERVICE

DESIGN • REPAIRS • INSTALLATION

## New Circuits

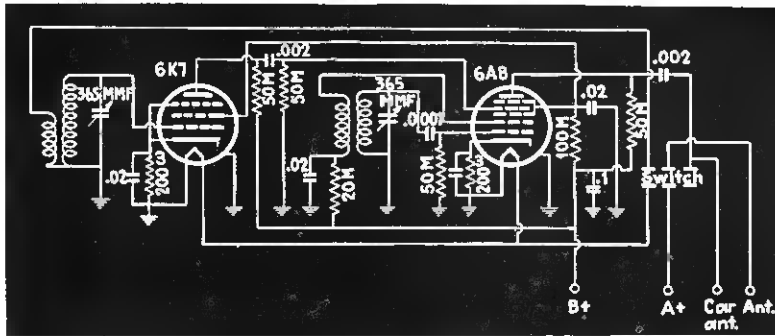

### Auto S. W. Converter

Any automobile radio can be made to receive short wave signals with the addition of a converter by A.B.C. Laboratories.

The unit works on the superhet principle. A 6K7 r.f. stage supplies the necessary signal to a 6A8 mixer which in turn uses the present receiver as a 600 kc. i.f. system.

Four connections are necessary, the car antenna is disconnected from the receiver and connected to the antenna post on the converter. The antenna lead of the receiver is then connected to the output of converter. The two additional terminals, A+ and B+ are taken from the receiver's power supply. A switch is provided so that the unit may be cut out when standard broadcast reception is desired.

The converter may be had in either of two frequency ranges. Model 500 covers from 1600 to 6000 kc. and is suitable for police, airway and amateur use. Long distance reception up to 12,000 miles is possible from model 600 whose frequency range covers from 6,000 to 18,000 kc.

Amperite has recently developed a ballast tube with a thermostat, so connected that only 70 volts is allowed to reach the set during the warm-up period. When all tubes are thoroughly heated the thermostat closes, supplying the set with full voltage.

Provisions for either one or two pilot

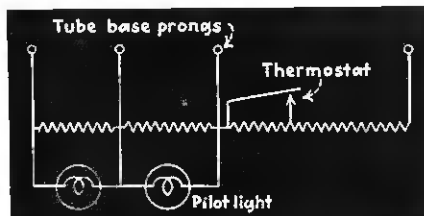

light voltages is also incorporated. Fig. 1 shows the resistance network and also the thermostat.

Another feature of this tube is its ability to supply a constant voltage to the filament, even though voltage variations from 90 to 130 volts are encountered. In addition, four models of these ballasts will take care of approximately 90% of all ac-dc replacements.

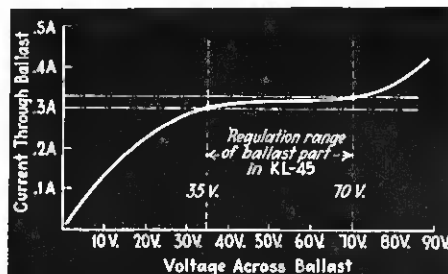

### Thermostatic Ballast

Pilot light burn out and tube damage often result when ac-dc receivers are turned on. This is due to the low cold resistance of the seriesed filaments.

### Resistance Coupling Design

Difficulties from motorboating are often experienced when a high-gain multi-stage audio amplifier of conventional design obtains B-supply voltage from a single power-supply unit. These difficulties are usually due to interstage coupling through a common impedance in the power unit. Customary expedients to prevent motorboating include the use of very large filter condensers and several power-supply units. However, as outlined by a recent RCA bulletin, the gain of an audio amplifier of low frequencies can be reduced to such levels that the effects of feedback through a power unit of conventional design are greatly reduced.

The use of a series screen resistor and a self-bias resistor offers several advantages over fixed-voltage operation. The effects of possible tube differences are minimized; operation over a wide range of plate-supply voltages without appreciable change in gain is feasible; and the low frequency at which the amplifier cuts off is easily changed. Fixed-bias or fixed-screen-voltage operation increases the tendency of an amplifier to motorboat and decreases the compensating action of the remaining series resistors.

The values of resistors and condensers were determined as follows. A

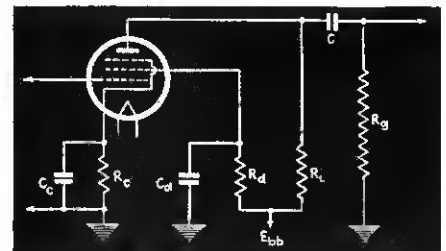

cathode-ray oscillograph was connected to show the relation between output voltage and input voltage (dynamic characteristic) of a single stage resistance-coupled amplifier. From previous experience, it is known that in an a-f amplifier employing pentode-type tubes the output voltage is substantially flat from a frequency above the cut-off frequency ( $f_c$ ) and below

★ Acclaimed . . . for Its True Amplification Test



**GIVE ALL TUBES  
A  
COMPLETE TEST**

**P.O.E. TUBE TESTER**  
POWER OUTPUT EMISSION

**SIMULATING  
SET OPERATING  
CONDITIONS**

**MODEL 1503**  
DEALER PRICE **\$46.67**

**MADE IN THREE MODELS**

**MODEL 1502**

P.O.E. Tube Tester has Shadow Graph Line Voltage Indicator. Neon Inter-element Short Test is made while tube is hot. Complete in Quartered Oak Case. DEALER PRICE.....

**\$36.67**

**MODEL 1504**

same as 1503 but also combines Free Point Tester. DEALER PRICE.....

**\$56.67**

**MODEL 1503**

combines with the P.O.E. Tube Tester separate Universal Volt-Ohm-Milliammeter, Condenser Tester and Decibel Meter. Housed in same Quartered Oak Case as the Model 1502. DEALER PRICE.....

**\$46.67**

**SEE YOUR JOBBER  
WRITE FOR CATALOG**

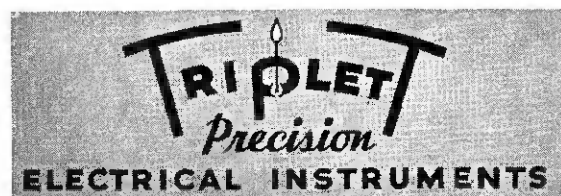

THE TRIPLET ELECTRICAL INSTRUMENT CO.  
202 Harmon Ave., Bluffton, Ohio

Please send me more information on.....Model 1502; .....Model 1503;  
.....Model 1504. ....I am also interested in.....

Name .....

Address .....

City..... State.....

some higher frequency ( $f_2$ ). It is also known that the value of the parallel combination of  $R_L$  and  $R_s$  determines to some extent the value of  $(f_2)$ . The following approximate values of  $(f_2)$  obtain for the recommended values of  $R_L$  when normal circuit and tube capacitances are present.

$R_L$ megohm.	$f_2$ cycles
0.1	20,000
0.25	10,000
0.5	5,000

For given values of  $R_L$  and  $R_G$ , the magnitude of  $R_c$ ,  $R_d$ , and the input signal were adjusted until kinks just appeared at the extremities of the dynamic characteristic at the grid-current point. Under these conditions, the tube operates at the center of its dynamic characteristic, which is nearly linear throughout the operating range. Therefore, maximum output at minimum distortion is obtained. The values  $C_c$ ,  $C_d$  and  $C$  were then determined. Very large capacitances were used in the positions indicated by  $C_c$ ,  $C_d$ , and

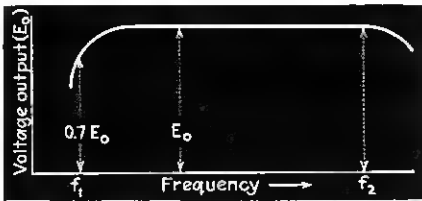

$C$ . The value of each was reduced, in turn, until the output voltage at 100 cycles is approximately  $0.7 E_o$  where  $E_o$  is the output voltage at some higher frequency which is less than  $f_2$ .

The combination of condenser and resistor values suggested for triodes causes a 20 per cent drop in output voltage per stage at 100 cycles. A similar cut-off characteristic at any other low frequency ( $f_1$ ) can be obtained by multiplying the capacitance values shown by  $100/f_1$ . As with pentodes, the use of self-bias reduces the effects of possible tube differences and permits operation over a wide range of plate-supply voltages without appreciable change in gain. The regulating action of a self-biased triode amplifier is not as good as that of a pentode amplifier having series screen and self-bias resistors, because the regulating action of a screen is not available in a triode.

When therefore a good high-frequency response from a triode amplifier is desired, low- $\mu$  tubes and low values of plate and grid resistors should be used.

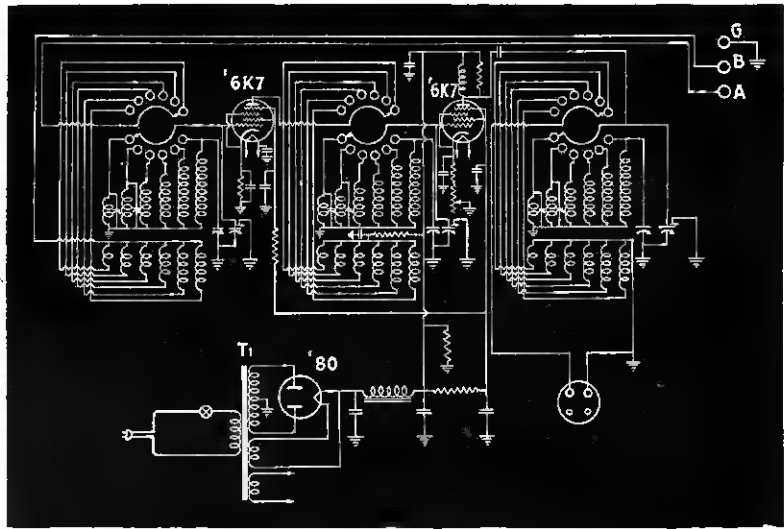
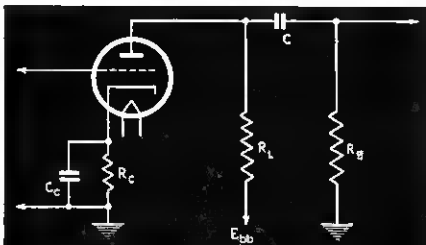

### Signal Intensifier

The new radio frequency preamplifier by RME provides an overall gain of 12 to 1 and an image rejection ratio of greater than 20,000.

Five tuned circuits comprise the two stage r.f. unit. A 6K7 in the first stage is coupled to a second 6K7 which in turn feeds to a low impedance output winding. The desired gain is controlled by a potentiometer in the cathode circuit of the second 6K7. Thus the signal ratio from the unit can be varied from 1 to 1 to a maximum of 12 to 1.

Frequency coverage is from 9 to 540 meters. All inductances are band switched, eliminating the necessity for plug in coils. The dial is calibrated directly in kc. in manner similar to the RME receivers.

Input is either high or low impedance. Three connections are provided: ground, 250 ohms for a doublet, or a high impedance winding for a Marconi single wire antenna. Output is standard low impedance and feeds directly into any receiver designed to be operated on a doublet. If it was desired to work into a high impedance input, an r.f. transformer could be used to increase the impedance ratio.

A single '80 serves as a rectifier to the self contained power supply. A switch on the panel allows the unit to be cut out of the circuit at any time, in which case the antenna is automatically connected to the antenna terminal of the receiver.

rectifier much similar to the standard auto radio supply. The a.c. generated in the vibrator transformer is rectified by an 84 tube. The resultant voltage is then filtered by a 4 mfd. input condenser, a choke and an 8 m.f.d. unit on the output.

If it is desired to operate the receiver from 110 v.a.c., the procedure is slightly different. Line voltage is impressed across the primary of the transformer  $T_1$  and the control switch thrown to A.C. The voltage thus generated in one secondary of this transformer feeds through to half of the primary of  $T_2$ . This voltage is of such value to give approximately the same secondary voltage as was supplied by the vibrator unit.

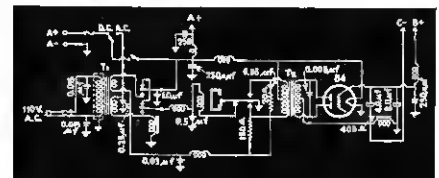

### Infinite Baffle Construction

The desire for greater fidelity reception has led a Jensen engineer to discover the peri-dynamic and bass reflex principles of speaker baffles. In a peri-dynamic baffle, the entire speaker is inclosed in an acoustically treated box only the front of the speaker is left open. This gives the equivalent of an extremely large baffle, resulting in improved low frequency response. No cabinet resonance is observed since the inside of the box is lined, deadens all reflections.

The bass-reflex system consists of ports in the back of the speaker cabinet, so proportioned that they are approximately resonant in the extreme low frequency range. These openings are directly related to the cubic con-

### Universal Receiver

A portable receiver for automobile or 110 v.a.c. has recently been designed by Philco. The dual purpose power supply unit combines two commonly used principles.

When operated on 6 v., the voltage from a storage battery feeds a vibrator-

# Webster Electric

## A COMPLETE LINE OF Teletalk SYSTEMS

Webster Electric is the first to announce a complete line of TELE-TALK SYSTEMS—the finest quality line of inter-communicating systems available to alert jobbers and progressive dealers!

With this complete line, the market for Teletalk systems is expanded to a degree where the intensive promotion of Teletalk is a big paying proposition for you.

Look over the models shown on the opposite page. With this range of models, dealers have units of sale that run from \$75.00 to \$525.00—a unit of sale sufficient to warrant the close

attention of any aggressive selling organization.

Teletalk systems are easy to sell. They sell themselves on demonstration and trial. Equip your men to sell on this basis and they will sell nine out of ten prospects. Write for the interesting booklet, "How and Where to Sell Teletalk." It will be sent upon request.

*Webster Electric Sound Systems are licensed by agreement with Electrical Research Products, Inc., under patents owned by Western Electric Company, Inc., and American Telephone and Telegraph Company.*



**WEBSTER ELECTRIC COMPANY**  
**RACINE • WISCONSIN**

ESTABLISHED 1909

Export Department: 100 Varick Street  
New York, N. Y.



# WEBSTER ELECTRIC

# Announces

Write—right now for complete details regarding these new systems. Teletalk is now available in models that will meet commercial, industrial, or professional requirements. All models are enclosed in hand-rubbed walnut cabinets. Watch for additional announcements.

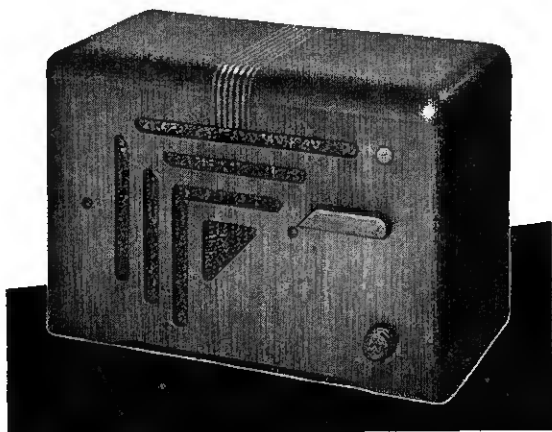

## NON-SELECTIVE TELETALK

● This model can be used up to and including six stations. It is ideal for small businesses, individual departments, between executive and secretary, doctors and dentists, etc.

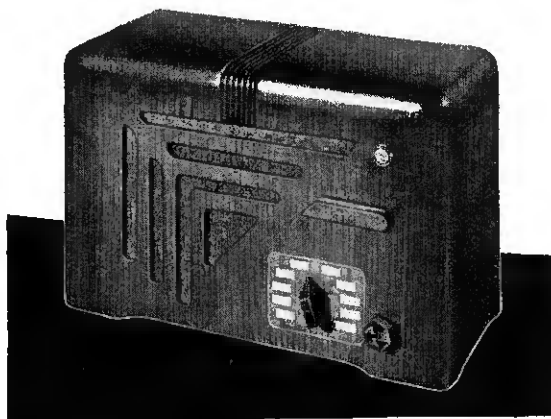

## SELECTIVE TELETALK

● Permits you to select the individual to whom you wish to speak. Business offices, clubs, hotels, manufacturing plants—all have serious need for this Selective Teletalk.

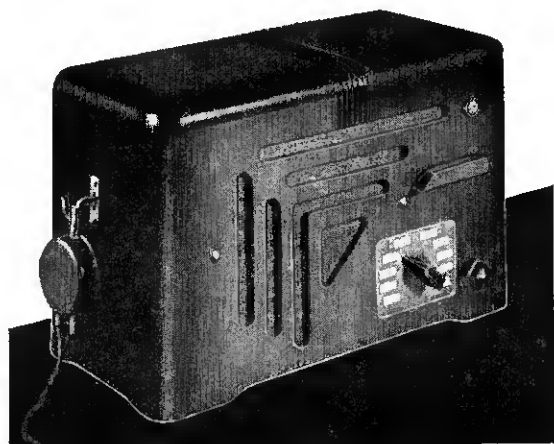

## CONFIDENTIAL TELETALK

● For the chief executive, credit manager, bank teller, employment manager—this Confidential Teletalk is just the thing. When ear-phone is used, hook-switch automatically silences speaker.

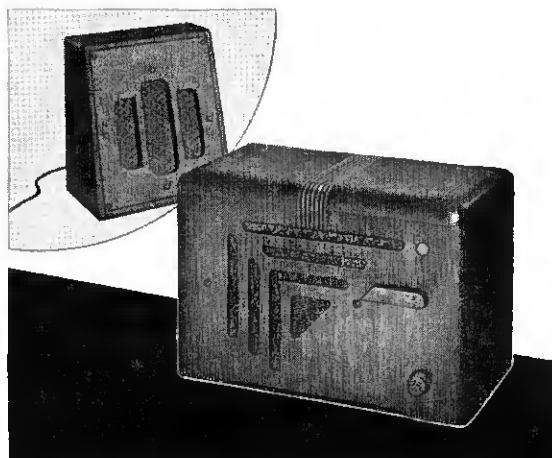

## MASTER STATION TELETALK

● Ideal for telephone operator who must constantly locate department heads. Paging baffle may be used for talk-back, thus making it an ideal unit for hospitals, clinics, sanitariums, etc.

# TELETALK SYSTEMS

**"THE HANDIEST TOOL  
BUILT FOR *experienced*  
SERVICEMEN"**

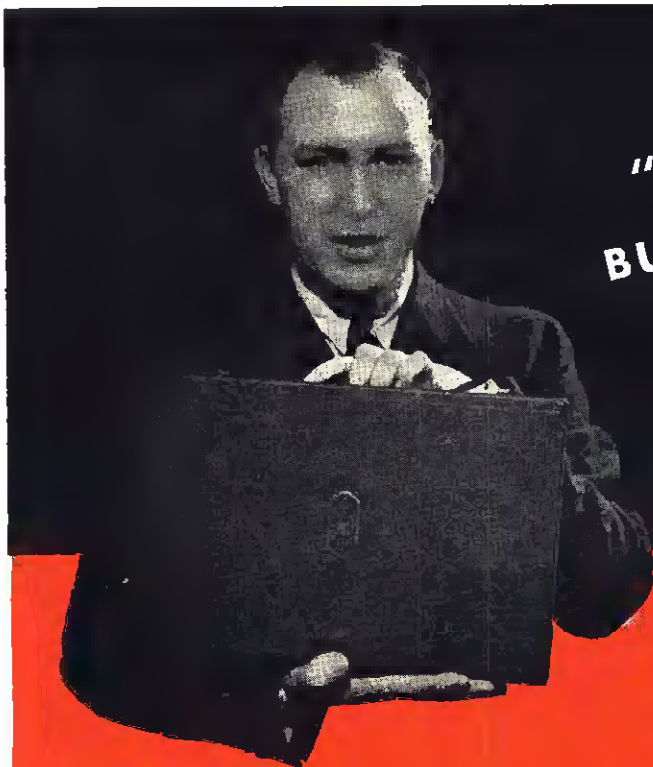

**THE WESTON  
CHECKMASTER**

**\$45<sup>00</sup>  
NET**

TO DEALERS IN U. S. A.



It's the experienced servicemen who have gone for the Model 771 Checkmaster in a big way. This was to be expected . . . for we built Model 771 to give the serviceman everything he needs for trouble shooting and estimating in one compact, easy-to-carry case. He has *all* this in the Checkmaster . . . providing as it does for a thorough check of tubes, as well as for checking continuity, resistances and voltages. In addition, it has a spare compartment for tubes or tools. This means *time saved* in answering emergency calls . . . for he need carry only this one, compact and complete Checkmaster for quickly getting at the root of the trouble.

But to make the Checkmaster even more useful, it has been strikingly designed and finished for counter use as well . . . making it the handiest, most versatile tool any serviceman can own. Inexpensive, too. And the name it bears is the best guarantee of instrument dependability and long life. Be sure to see the Checkmaster at your jobber's, or return the coupon for complete information.

**FEATURES:**

**INGENIOUS WESTON SWITCHING CIRCUIT ACCOMMODATES TESTING OF TUBES WITH WANDERING FILAMENTS**

Wired for testing latest tubes.

Neon short check while tubes are hot.

Cathode leakage test of **CORRECT DESIGN**.

Individual tests on elements of diodes.

Voltage ranges for point-to-point testing.

High and low resistance ranges for continuity testing with built-in filtered power supply.

Actual condenser leakage measurements—all types of high and low voltage condensers—read in ohms on meter scales.

All readings on one legible, open-scale meter . . . the famous WESTON rectangular 301.

Positive line voltage control.

Weston Electrical Instrument Corp., 581 Frelinghuysen Ave., Newark, N. J. . . Rush me bulletin on the Checkmaster and other Radio Instruments.

NAME.....

ADDRESS.....

CITY..... STATE.....



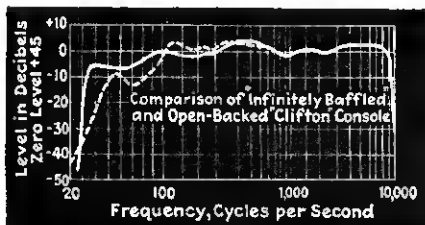

tent of the cabinet resulting in reversal of phase of back radiation. Thus this back radiation appears in phase with direct or front radiation, reinforcing it in a beneficial manner.

The new McMurdo Silver receivers use both these principles. The curve shows the comparison between this type of baffle and the usual open back type. A considerable increase in low frequency response is the result.

### Sensitive Photo Cell

Operating without external power, a photo cell has been developed by G.E. that delivers up to 150 microamperes to a sensitive relay or vacuum tube control device.

The element in the cell consists of a layer of selenium deposited on the surface of a steel plate, 1.7 in. by 0.9 in. by 0.065 in. The active area is approximately 1.1 sq.in. Over this layer of selenium, two transparent layers of conducting metal are deposited; this makes up the negative terminal of the cell. This double metallic layer is a special feature in this light-sensitive cell, and is directly responsible for its high degree of sensitivity.

Two strips of metal are sprayed on the surface of the cell for electrical connection to the negative terminal, and also on the back for connection to the positive terminal. This sprayed metallic coating also serves as an excellent resistant to corrosion. With the exception of the electrical contacts, the entire cell is covered with a transparent protective coating. The cell is mounted in a textolite case with a glass window for admitting the light.

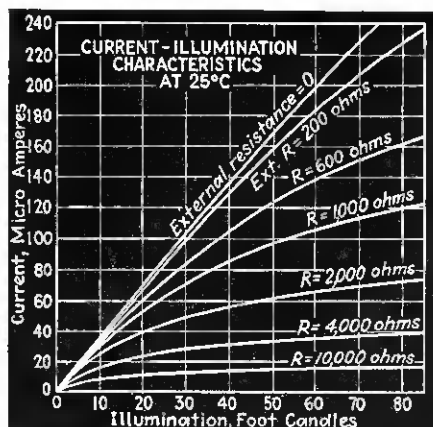

### Speaker Vibrator Tester

A new instrument by United Motors Service provides for speaker and vibrator servicing.

Voice coil impedances from 1½ to 15 ohms and plate loads of 2500, 4000, 5000, 7500, 10,000, and 15,000 can be accurately matched. Any receiver under test can be fed into this network and a comparative check on fidelity and output obtained.

A rheostat on the upper right hand side of the panel regulates the voltage

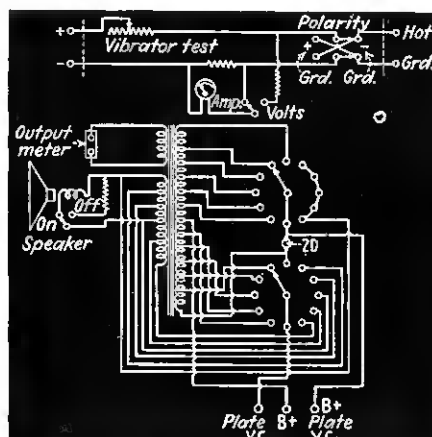

for testing auto radios and checking the starting voltage of the vibrator. A good vibrator will start at less than 5 volts. Rectified d.c. voltage from the vibrator can be checked at the receiver by means of test leads from the d.c. meter.

A switch is provided for cutting the voltage off and on, so as to check the vibrator starting action. Another switch permits the reversal of polarity of the voltage to the set.

### New Tubes

**6A5C.** A heater type power amplifier triode similar to a 6A3 and 6B4G.

#### Operating Conditions and Characteristics

##### Class A Amplifier

Heater Voltage.....	6.3 Volts
Heater Current.....	0.6 Amp.
Plate Voltage.....	250 Volts
Grid Voltage.....	-45 Volts
Plate Current.....	60 Ma.
Plate Resistance.....	800 Ohms
Mutual Conductance.....	5250 umhos
Amplification Factor.....	4.2
Load Resistance.....	2500 Ohms
Power Output (With 5% 2nd Harmonic).....	3.75 Watts

##### Push-Pull Class AB Amplifier

	Fixed Bias	Self-Bias
Power Output.....	15	10 Watts
Total Harmonic Distortion.....	2.5	5 Per Cent

**6Y7G.** A Class "B" power amplifier having ratings and characteristics identical to a type 79.

#### Operating Conditions and Characteristics

Heater Voltage.....	6.3	6.3 Volts
Heater Current.....	0.6	0.6 Amp.
Plate Voltage.....	180	250
Grid Voltage.....	0	0 Volts
Plate Current (no signal).....	7.5	10.5 Ma.
Load Resistance (plate to plate).....	7000	14000 Ohms
Power Output.....	5.5	8.0 Watts

## AMATEUR NOTES

**Modulation Monitor**—A visual means of checking percentage modulation of a transmitter is provided in an instrument by Triplet.

A '76 tube connected as a diode rectifies the carrier wave. This voltage is then passed on to a copper oxide rectifier, which in turn rectifies the audio signal.

In operation, a pickup coil is connected between the antenna and ground posts. This coil is then adjusted to absorb sufficient energy from the transmitter so as to bring the 0-1 milliammeter in the plate circuit of the 76 to exactly half scale. If modulation is now applied to the transmitter, the audio voltage that is rectified by the copper oxide rectifier will actuate the 0-200 microammeter and indicate percentage modulation directly.

In addition, any deflection of the carrier level meter, while the transmitter is being modulated, will indicate carrier shift.

Two tip jacks provide a method for aural monitoring of the signal.

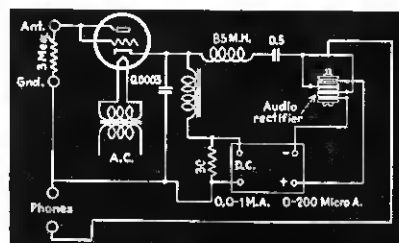

**806.** A high power triode by RCA. Plate connection is brought out through the top of the bulb, the grid lead is through the side. Maximum rating up to 30 megacycles. Filament power is 5 volts at 10 amperes. Maximum Class "C" conditions are:

Plate Input.....	600 max. watts
Plate Dissipation.....	150 max. watts
Typical Operation:	
D-C Plate Voltage.....	2000 2500 3000 volts
D-C Grid Voltage.....	-400 -500 -600 volts
Peak R-F Grid Voltage.....	640 755 870 volts
D-C Plate Current.....	195 195 195 milliamperes
D-C Grid Current (Approx.).....	25 25 25 milliamperes
Driving Power (Approx.).....	15 17 20 watts
Power Output (Approx.).....	280 370 450 watts

**250TH** Class "C" output from a single tube is 750 watts. In a class "B" audio amplifier, 1,180 watts can be obtained.

### CHARACTERISTICS

Filament Voltage.....	5 to 5.1 volts
Filament Current.....	10.5 amperes
Amplification Factor.....	32
Grid-plate capacity.....	3.3 mmfds.
Grid-filament capacity.....	3.5 mmfds.
Plate-filament capacity.....	3 mmfds.
Maximum plate voltage.....	3000
Maximum plate current.....	350 milliamperes
Maximum grid current.....	65 milliamperes
Plate dissipation.....	250 watts

# Of Interest to Readers and Advertisers: Next Month—

in the March issue, Radio Retailing will present its annual automobile radio issue. Some of the features will include:

1. 1937 Auto-radio specifications.
2. Photographs and descriptions of the new auto radio models.
3. Descriptions of the new auto radio antennas.
4. Auto-radio service kinks.
5. An analysis of auto-radio installation methods.
6. ADVERTISING OF LEADING AUTO RADIO, ANTENNA AND ALLIED EQUIPMENT MANUFACTURERS.

## Auto Radio Sales Have Increased Each Year as Follows:—

Year	Units	Dollar Volume (Retail)	Average Retail Price
1930 .....	34,000	\$3,000,000	\$88
1931 .....	108,000	5,940,000	55
1932 .....	143,000	7,150,000	50
1933 .....	724,000	28,598,000	39
1934 .....	780,000	28,000,000	36
1935 .....	1,125,000	54,562,500	48*
1936 .....	1,412,000	69,188,000	49*
1937 .....	Looks very optimistic—and don't forget the sales of some 100,000 auto trailers will help auto radio sales.		

\* Includes tubes.

And in addition to these editorial features, the March issue will include all the regular editorial departments, editorials, news, preview of new products, service, sales ammunition-charts, industry figures, etc.

DO NOT MISS THE MARCH ISSUE. FINAL ADVERTISING FORMS CLOSE MAR. 5

## RADIO RETAILING

A McGraw-Hill Publication • Member A B C and A B P • 330 West 42nd Street, New York City

Now in its 13th year of publishing service to the radio industry.

# METERS: WHERE TO PUT THEM

This diagram is intended to refresh the memory of users with regard to fundamental practice. A diode-pentode was chosen for illustration since its elements permit broad analysis of meter placement in virtually all tube circuits

Because modern testing equipment is designed to conserve the harassed serviceman's thinking-time there is always danger that the individual meters comprising such instruments may not be used to best advantage . . .

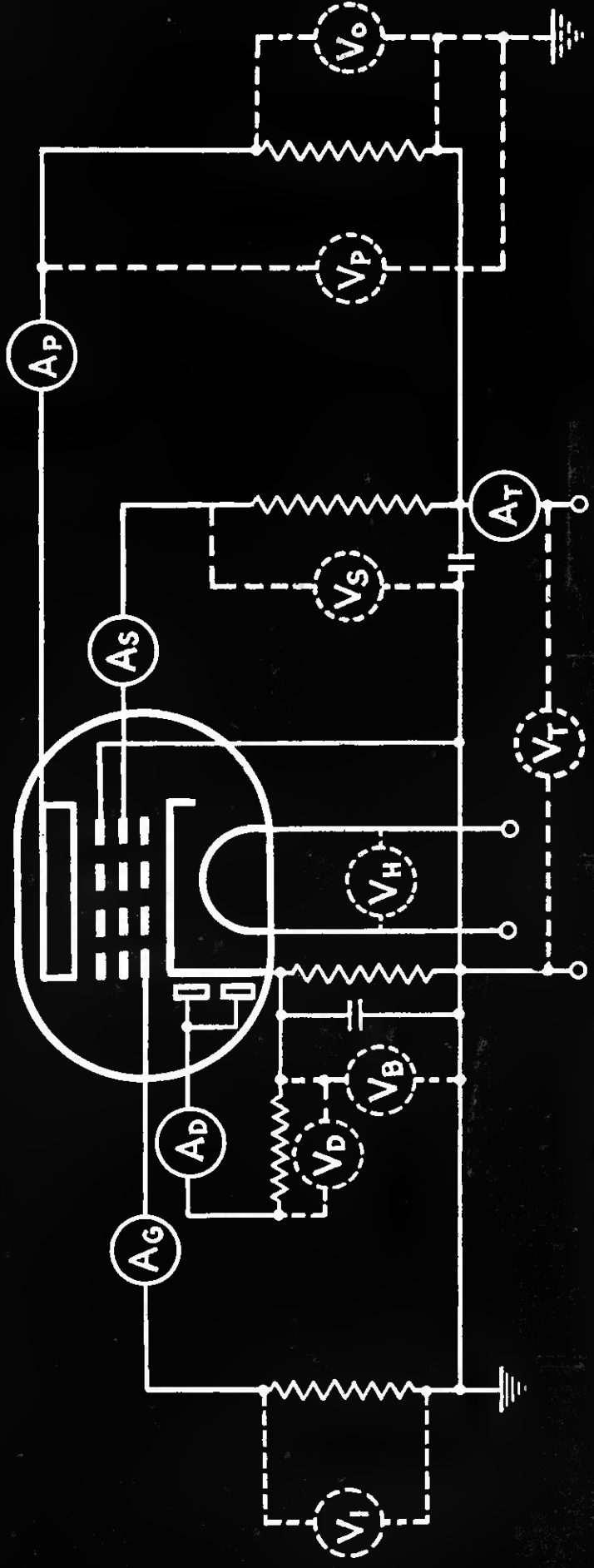

## VOLTAGE MEASUREMENTS

- \* V B (Grid Bias) High resistance voltmeter (0-10-50)
- \* V D (Diode Voltage) High-resistance voltmeter or v.t.v.m. (0-1-5)
- V H (Heater Voltage) Low scale of a.c. voltmeter (0-10-25)
- V I (Signal Voltage) Output meter or v.t.v.m.
- V O (Output Voltage) Output meter or v.t.v.m.
- \* V P (Plate Voltage) High resistance voltmeter (0-250-500)
- \* V S (Screen Voltage) High-resistance voltmeter (0-100-500)

## CURRENT MEASUREMENTS

- A D (Rectified Current) Microammeter or low-range ma. (0-0.05-1.0)
- A G (Grid Current) Microammeter or low-range ma. (0-0.05-1.0)
- A P (Plate Current) Milliammeter (0-5-100)
- A S (Screen Current) Low-range d.c. milliammeter (0-1-10)
- A T (Total Current) Low-range d.c. milliammeter (0-1-10)

\* Actual voltages slightly higher than meter reading, accuracy dependent upon resistance of instrument

**RADIO  
REPAIRING**

RADIO SERVICE SHOP

**SUPREME** Testing  
*Using Instruments*



WRITE FOR DETAILS

*Designed by* SUPREME INSTRUMENTS CORP. GREENWOOD, MISSISSIPPI

# Beware Half-Truths About Noise

By C. W. Metcalf

Tobe Deutschmann Corporation

**M**OST of the headaches that have resulted from efforts to clear radio interference are the direct outcome of too much trust in half-truths which cannot be wholly disregarded, yet cannot be relied on for guidance. Let's look at some of the common beliefs about what causes radio interference, and see if we can separate the true from the false.

## Noisy Equipment

A wholly fallacious belief is that only defective apparatus can produce radio interference. The proportion of truth to untruth is great in this case.

Because motors of the type used on three phase circuits and for driving washing machines, oil burners, or electric refrigerators do not depend for their operation upon the making and breaking of electrical circuits, they should not cause radio interference. Radio noise from motors of this type is an indication of trouble which should be rectified. So it is evident

that there is a slight basis of fact for the belief that interference indicates defective apparatus.

The more important fact, however, is that about 60 per cent of all the interference heard in broadcast receivers

### DO YOU KNOW THAT—

**Loop antennas on noise-finding apparatus frequently point the wrong way?**

**Spark-suppressors sometimes actually increase racket-radiation?**

**Motors need not spark to create serious interference?**

**Leaky power-line transformers are almost non-existent?**

**Pickup through a receiver's power connection is comparatively rare?**

**Electrical apparatus is not necessarily defective just because it generates noise?**

**Simple condenser filters across an offending appliance are generally wasted effort?**

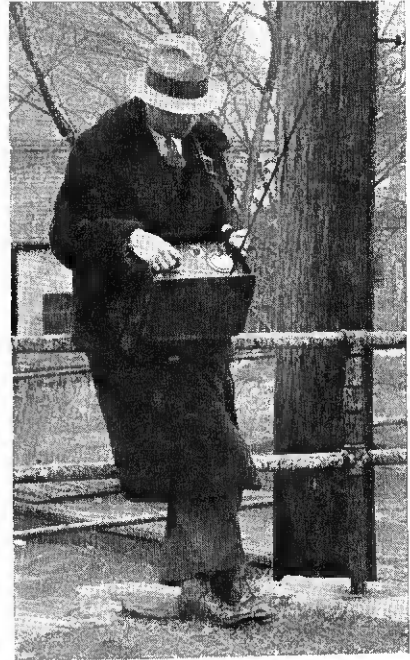

Utility interference investigator using portable noise and fault locator with non-directional rod antenna. The instrument shown is standard equipment with over 500 power companies.

originates at the brushes of small series wound motors used for operating common household appliances. This interference is not an indication of poor contact, worn brushes, pitted commutator, or any other motor trouble, but is a perfectly normal result of the rapid making and breaking of an electrical circuit. Sanding the commutator or otherwise adjusting the motor will not overcome the disturbance because it is inherent in the operation of the device. Consequently, no time should be wasted in attempting to make adjustments.

## Leaks

The oldest of all misconceptions is that much radio noise can be traced to a leaky transformer. True, interference is sometimes localized at an electrical power distribution transformer such as shown in Fig. 1, but loose connections rather than leaks are generally responsible for the disturbance. One reason for the prevalence of the belief in leaky transformers is that there was formerly in common use a type of primary cut-out that tended to develop loose contacts after being in service for some time. These loose contacts, being in relatively high potential circuits, produced really serious interference. Obviously this noise was not originating in the transformer although the transformer got the blame.

The number of actually "leaky" transformers could be counted on the fingers of one hand. You may be very sure that any condition of power leakage in a distribution transformer will soon make itself known by interrupting elec-

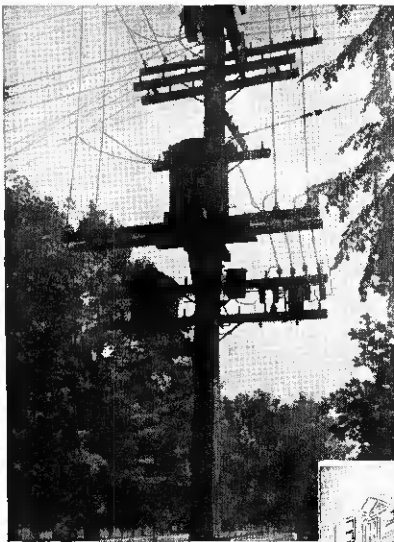

Do not look here for interference because modern methods of line maintenance assure freedom of power transformers from radio noise sources.

Diagram showing how noise that travels on power lines reaches the radio thru its aerial and lead-in.

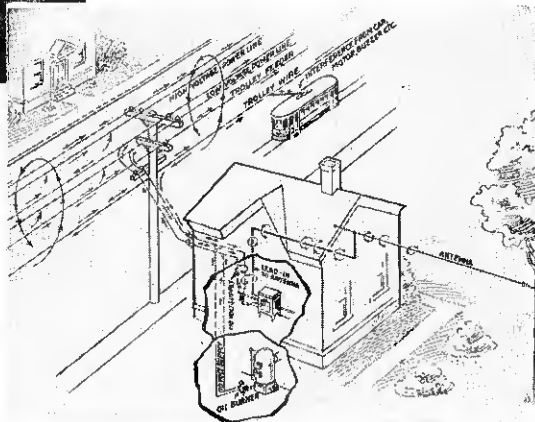

tric service, and the transformer will be replaced and not allowed to drip static all over the radio listener. So the truth is, you can forget about leaky transformers as long as the electric service is sufficiently reliable to keep the radio playing.

### Sparking Contacts

Even though there seems to be a great deal of sparking at the brushes of a motor it must not be assumed that this is responsible for radio noise. Experience has shown that a commutating type motor may operate with absolutely no visible sparking and yet create enough interference to blanket a wide area.

A similar condition also prevails as regards such contact making devices as sign flashers and traffic control units. In many cases, the addition of spark suppressing devices results in intensification of the interference despite the fact that the sparking is reduced so as to be invisible. So don't be misled by the prevailing fiction that sparking or apparatus defects may always be blamed for interference.

### Filters

So far as the layman is concerned, the belief that radio interference reaches the receiver through its connection to the power line has been re-

sponsible for more misspent money than any other one belief. Street fakirs have reaped a golden harvest from the sale of "line filters" containing beach sand, scrap condensers, and other worthless material. So it is more than ever important for the reputable dealer or service man to have positive knowledge about so called "line noise."

It is true that, with the advent of the a.c. operated receiver, interference became much more noticeable, but increased receiver sensitivity rather than connection of the receiver to the power line was responsible for the higher apparent noise level. Any service man who will analyze a modern receiver circuit will see just how little likelihood there is of interference on the power line reaching any portion of the circuit which may be affected by man-made static. In fact, deliberate attempts to introduce interference through the power supply line have proved that the average receiver operated at maximum sensitivity does not respond to noise voltages of less than 200 microvolts. Noise voltages of this magnitude are not commonly encountered, and when they are, it is usually in locations where powerful local stations lay down a signal that allows the receiver to be used at much less than full sensitivity. Consequently, it should be evident that the power line connection is not the most important means by which interference

may enter the radio, and that most attempts to cure noise by installing so-called power line filters have little effect.

The truth of the matter is that interference which is present on practically all electrical wiring circuits reaches the radio by way of the antenna or lead-in wire (Fig. 2) as a result of inductive or capacitive pickup from the power supply line. The common use of indoor aerials and unshielded lead-in wires, particularly in buildings whose electrical circuits are not carried in metal conduit, is responsible for a high percentage of existing noisy reception. Thus it is important for every radio dealer to insure the performance of new receivers by providing a modern noise reducing aerial system which will minimize the amount of interference introduced to the radio by way of its antenna and lead-in.

### Filter The Source

Another belief that gets the serviceman into trouble, and causes the radio listener to doubt the value of his service is that interference can be stopped by connecting a condenser to the interfering apparatus or across the line. There are rare instances in which a condenser connected across the power supply line to an appliance provides the necessary interference attenuation.

# Announcing TWO NEW P.A. UNITS



## 60 Watt 6L6 Amplifier by THORDARSON

The Thordarson 6L6 amplifier delivers powerful, brilliant tones at full rated output. 4 beam power 6L6's are used in push pull parallel, eliminating grid current and permitting simple driver requirements at 60 watts output. Performance improved by greater gain and frequency response. Wave distortion at minimum. Tube life increased. Power supply regulation effect reduced by decreased plate current fluctuation. Carefully engineered, perfectly designed and powered by Thordarson transformers including Tru-Fidelity.

NOTE: Radio men everywhere acknowledge these two new P. A. units the finest they have heard. Both of these amplifiers available completely wired or in "Build-it-yourself" style with "Foundation Units."

## Now Tru-Fidelity Speaks!

Clear audio reproduction—a marvel of modern transformer and amplifier design. You be the judge! Hear the Thordarson Tru-Fidelity P. A. unit in operation. Delivers absolute linear and distortion free audio power at 10 watt output. Ideal as a recording amplifier—speech amplifier for broadcast purposes—general P. A. or sound reproduction work where moderate output levels are sufficient, and quality reproduction is most essential.

ASK YOUR SUPPLIER FOR BULLETIN SD 269. Lists prices, circuit diagrams, and descriptions of units, or write factory direct using coupon. Get your copy today — FREE.

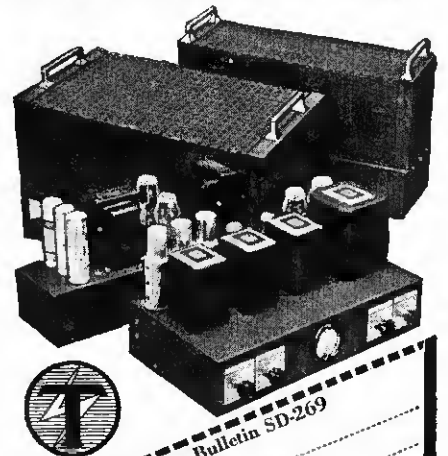

**THORDARSON ELECTRIC MFG. CO.**  
500 W. HURON ST., CHICAGO, ILL.

Please send me Bulletin SD-269  
Dept. Name Address City State

# MISTER JOBBER AND DEALER HERE'S YOUR OPPORTUNITY!

LIST  
\$49.95

F.O.B. Chicago  
6-volt 175 watts  
Push button starter  
D. C. ONLY



*the New*  
**RED TOP**  
GAS-O-LECTRIC  
POWER PLANTS

Dealers! Jobbers! Send now for discounts and full details on the new RED TOP Gas-O-Lectric Power Plants. This is your own exclusive line . . . priced for quick sales and big profits.

Millions of farms, trailers, industrials and others clamor for this economical means of charging batteries and producing electricity to operate radios, lights, electrical equipment and appliances, etc. The RED TOP Line fills the bill. Here are some of its outstanding

features: *Combination A. C. and D. C. or D. C. only, fuel tank base, light weight, portable, low-cost operation.* Go RED TOP in 1937! Our complete merchandising plan, sales helps, literature, etc., will help you put it over. Mail the coupon immediately for full details.

**COMBINATION A. C.-D. C. PLANTS**

In one plant—both 110-volts A. C. 300 watts; and 6, 12, or 32-volts D. C. up to 350 watts, for battery charging Generator mounted on engine. Prices from \$89.95 up, F. O. B. Chicago. The coupon will bring complete detail

**PIONEER GEN-E-MOTOR CORPORATION  
CHICAGO, ILL**

*Go* **RED TOP!**  
**IN 1937!**  
THE COMPLETE EXCLUSIVE DEALER-JOBBER LINE

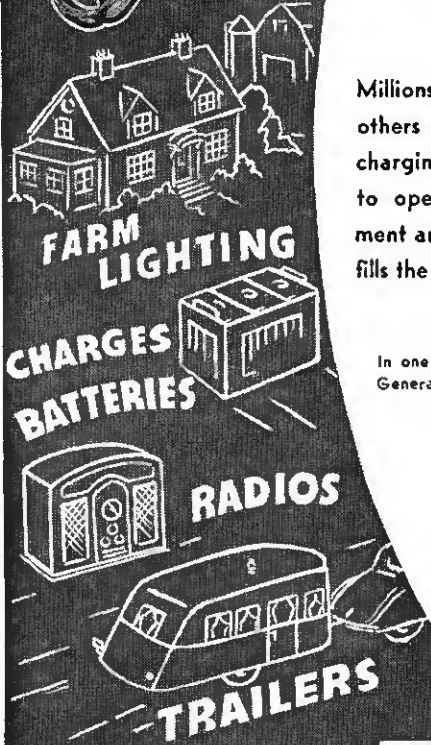

*Mail  
Coupon  
Now!*

PIONEER GEN-E-MOTOR CORPORATION

Dept. No. R-1B, 466 West Superior Street, Chicago, Illinois.

Please send at once information and discounts on RED TOP Gas-O-Lectric Power Plants.

NAME \_\_\_\_\_

ADDRESS \_\_\_\_\_

CITY \_\_\_\_\_ STATE \_\_\_\_\_

TYPE OF BUSINESS \_\_\_\_\_

*You need this*  
**BENDIX-DAYRAD**  
 TESTING EQUIPMENT  
*to successfully handle  
 radio service!*

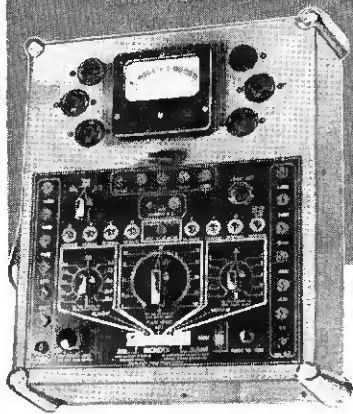

Combination Unit (Series 200) with stand **\$104<sup>50</sup>**

For quick inspection of either household or auto radio sets, the popular Bendix-DayRad Series 200 Combination Testing Unit provides utmost flexibility and accuracy. More than two hundred types of tubes may be tested, including the new metal, Octal "G" and "MG" types. Operation on 110-Volt A.C., 60-cycles.

The Portable Service Stand pictured (and included in the price) provides a splendid means of merchandising tubes. There is ample drawer space for tube and supply storage. It may be wheeled on its rubber-tired casters, up close to a car or a set to be tested.

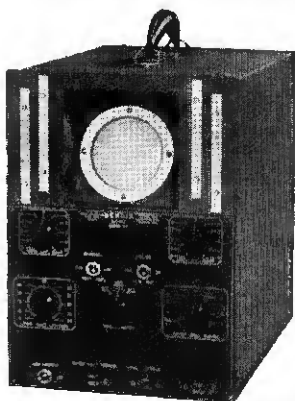

**CATHODE RAY  
 OSCILLOGRAPH**

Essential to the accurate aligning and balancing of modern radio sets. For adjusting auto and household radio receivers as well as transmitter sets. The extreme precision inherent in this splendid instrument makes it an invaluable aid in all critical radio circuit balancing work.

**\$85**

SEND THIS COUPON NOW!

**BENDIX PRODUCTS CORPORATION, Bendix-DayRad Dept.**  
 (Subsidiary of Bendix Aviation Corporation)  
 456 Bendix Drive, South Bend, Indiana

Please send full details of the Bendix-DayRad System of Radio Service, including data on Time Payment arrangements, for above, and other Bendix-DayRad units

Name .....

Address .....

City ..... State .....

Nature of Business .....

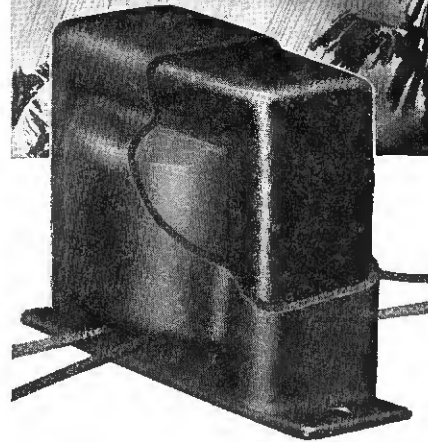

**Sealed  
 Against  
 Moisture**

**Plastic-Sealed Audio and  
 Output Transformers and Chokes**

● Here is what an east coast Virginia radio parts dealer says:—"On close inspection of the Hermetically Sealed transformer, we find that there could be no better transformer built for this location. We are located on the Virginia Peninsula which is almost surrounded by salt water. This salt atmosphere penetrates the best of transformers not coated. The Jefferson in our estimation tops them all."

● Many have found the Jefferson Plastic-Sealed Transformers have answered their requirements . . . Sealed in their tough elastic non-brittle jacket, the windings are completely protected.

Listings below allow you to make your selection—your radio parts jobber can supply you . . . JEFFERSON ELECTRIC COMPANY, Bellwood (Suburb of Chicago), Illinois. Canadian Factory: 535 College St., Toronto, Ontario.

**SELECT  
 FROM LIST  
 BELOW**

ASK YOUR RADIO PARTS JOBBER

**JEFFERSON Radio Transformers**

AUDIO TRANSFORMERS			
CAT. NO.	SIZE	PRICE	
467-501	1 to 2 Audio 2-7/8 x 1-5/8 x 1-7/8"	\$1.25	
467-502	1 to 2 P. P. Input 2-7/8 x 1-5/8 x 1-7/8"	1.30	
467-503	1 to 3 Audio 3-1/4 x 1-7/8 x 2-1/8"	1.50	
467-504	1 to 3 P. P. Input 3-1/4 x 1-7/8 x 2-1/8"	1.60	

OUTPUT TRANSFORMERS			
for Single or P. P. Output Tubes—71A, 45, 33, 42, 47, etc.			
467-509	2 Watt-7000-4/6 Ohms 2-7/8 x 1-5/8 x 1-7/8"	\$1.20	
467-510	3-1/2 Watt-7000-6/8 Ohms 3-1/4 x 1-7/8 x 2-1/8"	1.35	

CHOKES			
Small filter and plate chokes			
466-(590)	20 Hen.-50MA.-425 Ohms 3-1/4 x 1-7/8 x 2-1/8"	\$1.50	
466-(540)	250 Hen.-10MA.-5000 Ohms 2-7/8 x 2 x 2-1/2"	1.30	



It's dollars to doughnuts, however, that the use of a condenser in this manner will be wasted effort, for the experience of interference specialists indicates that only in a small fraction of 1 per cent of the cases can satisfactory results be secured in this manner.

The truth in regard to the elimination of interference at its source is, that whatever apparatus is used to stop noise it must embody the correct electrical and radio frequency characteristics to balance with the electrical and radio characteristics of the appliance and the power supply line. According to studies made in the laboratory, the interference produced by an electrical appliance is distributed in a complex manner, and as there are so many variables affecting the intensity of the interference that fixed rules easily followed by the serviceman are difficult to formulate. It may safely be said, however, that the interference attenuation secured through the use of condensers is generally limited to an extremely narrow band of frequencies and depends to a considerable extent upon the ability of the serviceman to install the correct value of capacitance in close proximity to the point at which the noise originates.

Before the popularity of the all-wave receiver, considerable success was reported in the elimination of interference through the use of condensers

alone, but with increased receiver sensitivities and the addition of the short-wave feature, capacitive type filters have been found generally unsatisfactory. This does not mean that interference cannot be eliminated, but simply indicates the necessity for installation of interference suppressing devices

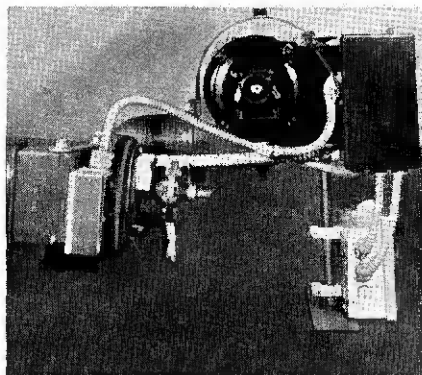

A correctly balanced combination of inductance and capacitance, assembled in accordance with established standards for safe electric wiring practice, quells interference from electrically ignited oil burners. Underwriters' Lab. approval is essential for devices used with oil burners.

which incorporate the necessary values of inductance to provide effective interference elimination over a wide band of frequencies, (Fig. 3). Such units are commercially available at prices

commensurate with their value and are being found of vital importance in the sale of radio receivers and in the utilization of commercial radio equipment.

### Trouble Shooting

Despite the fact that the locations at which radio interference may be expected to arise are fairly well known to all radio service men, the need is sometimes felt for a means of determining the exact source of some particular type of interference.

Since the directional loop has proved a false prophet, the interference investigators for electric power companies (who undoubtedly have had more experience in this field than any other group) have adopted a vertical, non-directional antenna for use in connection with their interference locating instruments. This antenna has the advantage of greater response to the vertical polarization of interference waves and is free from the misleading characteristics of the loop. It also enables the noise investigator to secure closer coupling to the power lines on which interference travels, and to identify with greater accuracy the exact point at which interference has maximum intensity. When such an antenna is used with a correctly designed interference locating instrument (Fig. 4), interference sources can be located with maximum facility and accuracy.

# HERE'S THE WAY YOU CAN OWN A NEW C-B OSCILLOGRAPH FREE!

Linear Sweep Circuit  
Dual Amplifiers

Synchronizing Circuit  
Beam Centering Control  
Five Tubes

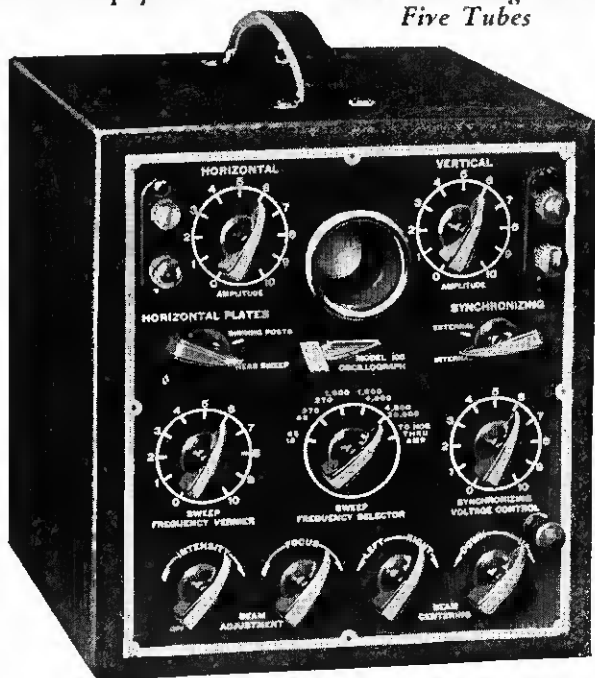

## SPECIAL LIMITED OFFER

Don't miss this chance to own a fine new oscillograph. Act quickly! Until March 31st you deposit only \$20.00 and agree to buy less than 8 National Union tubes per week for two years. You get the instrument immediately. After your purchase the required number of tubes YOUR DEPOSIT IS REFUNDED as a merchandise credit. After March 31st the deposit goes up to \$28.00, so SAVE \$8.00, ACT TODAY! Here's an instrument you need . . . let National Union give it to you.

### ACT QUICKLY—BEFORE MAR. 31!

← This fine instrument would cost you \$48.90. Get it free the easy N. U. way.

National Union means more than radio tubes. National Union means MORE service business, BETTER service business AT A PROFIT



NATIONAL UNION RADIO CORP.,  
570 Lexington Ave., New York, N. Y.

Rush name of nearest N. U. jobber and send data on SPECIAL C-B OFFER.

Name.....

Street.....

City.....State.....

SEE YOUR JOBBER OR MAIL COUPON TODAY

RR 237

# COMPARE THIS ACCURACY AGAINST THE FIELD



Direct Reading  
Signal Generator  
Model 557

EXCLUSIVE RANGER-  
EXAMINER  
DEVELOPMENT

DEALER PRICE **\$18.00**

- \* GUARANTEED ACCURACY
- 1% — 110 to 3000 K.C.
- 2% — for higher frequencies
- Range — 110 to 20,000 K.C.

This amazing accuracy has been made possible by an exclusive Ranger-Examiner development. Each individual coil is separately calibrated by an exclusive method of peaking with trimmer condensers.

Model 557 All Wave Direct Reading Signal Generator uses plug-in type coils. Five frequency bands are covered from 110 to 20,000 K.C.—all fundamentals. Completely shielded for static and magnetic fields. Attenuation and stability are outstanding features. Strong signals both modulated and unmodulated are furnished.

Supplied in attractive Black Leatherette Case. Silver and Black Panel. Dealer Price.....\$18.00

Other Ranger-Examiner Models include Tube Testers, Volt-Ohm-Milliammeters, Free Point Testers, etc., both in single units and in Money Saving Combinations.

See Your Jobber Write for Catalog



## FREE Booklet

"101 Radio Troubles and Their Cures." Lists 101 most frequent radio troubles, how to detect and how to cure. Nothing like it before. Greatly simplifies every day service work. Send coupon now.

READRITE MOTOR WORKS  
220 College Dr., Bluffton, Ohio

Without obligation please send me your free booklet—"101 Radio Troubles and Their Cures," with complete Ranger-Examiner Catalog.

I am particularly interested in Ranger-Examiner Model .....

Name .....

Address .....

City ..... State .....

# O.K. SAY RADIO MANUFACTURERS! REPLACE WITH



## Original Equipment In More than 3,000,000 Radios

Don't gamble with ordinary parts when there is a UTAH precisely engineered for the job.

The radio industry has depended upon UTAH for 15 years. They know each UTAH part is an opportunity to deliver extraordinary performance—without paying a premium price.

In making your job easier and more profitable, UTAH goes another step—your inventory is simplified. With just a small investment in UTAH parts, you can establish a reputation for prompt service, with tailor-made parts.

UTAH speakers, ever since broadcasting began, have been building good will—a reputation on which you can capitalize with but a small investment. With the UTAH line you can service ANY make and model of radio receiver.

UTAH Vibrators... UTAH is responsible for practically every major improvement on vibrators. Instead of 90 auto vibrators, UTAH jobbers do a perfect job with only 24—just one example of your savings with UTAH.

Check over the UTAH parts below. Be sure of customer good will and maximum profits.

Standardize on UTAH!

- Vibrators
- Transformers
- Chokes
- Volume Controls
- Tone Controls
- Speakers
- Resistors
- Plugs
- Jacks
- Jack Switches
- Push Button Switches

## UTAH RADIO PRODUCTS CO. CHICAGO, U. S. A.

TORONTO BUENOS AIRES  
ONTARIO, CANADA (UCOA RADIO PRODUCTS CO.)

"15 YEARS OF LEADERSHIP"

**Volume Control Repair**

By B. S. Seymour

Noisy volume controls can sometimes be easily repaired if they are not burned. Pull the shaft forward and wrap a few turns of stiff wire around the shaft behind the washer that is clamped in the groove. This method puts more pressure on the wiper contact and provides a more positive connection. In most cases the repair is completely effective.

**Socket-to-Chassis Tester**

By Al Beers

The sketches show a system I have just rigged up for speeding up the customary socket-to-chassis resistance tests. Using one power supply, the resistance of four different circuits may be measured simultaneously on four separate meters.

The switching unit to accommodate the four meters is shown at "A". The analyzer cable is shown at "B". The 6A7 socket under test is shown at

"C". The equivalent circuit of the system used is illustrated at "D".

Note from "D" that it is simply a parallel circuit containing four branches, a 1 ma. meter connected in each circuit to measure current flowing in that circuit. Now, if the four shorting switches are closed the four meters will read full scale. As the meters have a calibrated scale in ohms, when shorting switches are open the value in ohms of resistors in negative leg is registered. This procedure is the equivalent of making the actual tests.

Say a socket-to-chassis test on a 6A7 is desired. You can get it in 10 seconds flat with this system as follows. The unit is naturally already connected to the power supply. The adjustment rheostat is a 100 ohm, 25 watt unit connected in one leg of power transformer primary. All that needs to be done is connect cable, select desired ohms range on switch 1, set switch 2 on position 1. A test lead connects between negative pinjack on unit and chassis. Close shorting switches, close line switch. Adjust meters to full scale, open shorting switches. Meter 1 gives screen-grid. Meter 2 gives plate. Meter 3 one heater leg. Meter four the other heater leg. Now, flip

switch 2 to position 2 and meter 1 gives cathode, meter two gives control grid, meter 3 oscillator grid and meter 4 anode grid.

Suppose you are testing four prong tube sockets such as the 80, 2A3 or 45. Connect four-prong adapter on analyzer cable. Switch 2 in position 1, then simply insert an analyzer plug in each four-prong socket and the complete test is registered right there as control-grid, plate, heater, heater. Testing metal tubes is identically the same except that the test lead from negative pinjack to chassis is not needed. The "S" prong of octal adapter connects to S stud on cable plug. Then the S phone tip of cable goes to negative pinjack of unit.

Testing a 27 socket. Switch 2 in position 1 will give control-grid, plate, heater, heater. Switch 2 in position 2 gives K on meter 1. Close shorting switch of meters 2, 3 and 4 to keep current normal and prevent voltage rising.

A 24 socket: Switch 2 in position 1 gives screen, plate, heater, heater. Switch 2 in position 2 gives cathode, control grid on meters 1 and 2. Short out meters 3 and 4.

A 78 socket: Switch 2 in position 1

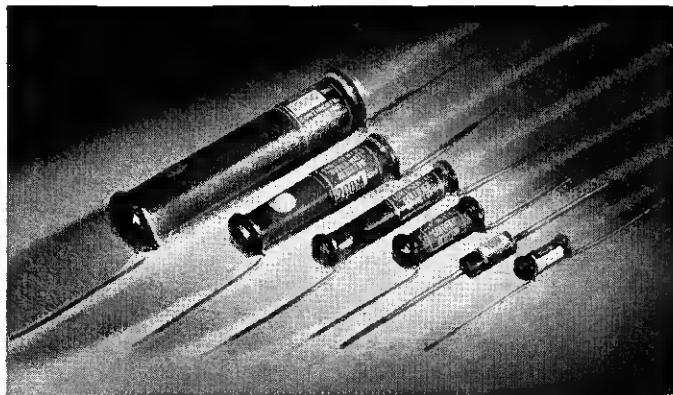

**Second from the right—**

lies CONTINENTAL Carbon's new M-5 bakelite insulated 500 milli-watt straight-line resistor; quiet, moisture-proof, easy to handle, not deteriorated by soldering iron temperatures, small and yet every bit as dependable within its rating as the large ceramic insulated resistors pioneered by CONTINENTAL over four years ago! You'll need the M-5 for auto set repairs. Now stocked in all standard values. List price, 17c. See your jobber for net prices.



MFS1, the Master Filternoys Selector, is a handy salesman for CONTINENTAL Filternoys suppressors! Indicates the correct method of blocking 90% of the ordinary forms of man-made interference. List price, complete..... \$11.25

**CONTINENTAL CARBON Inc.**

13902 Lorain Ave., Cleveland, Ohio Toronto, Canada  
Send 10c for your copy of "Handy Pocket Data on Radio Interference"

**BELphone INTER-COMMUNICATING SYSTEM**



**New! SENSATIONAL!**



Nothing on the market to equal it! Improved in every respect. Tone fidelity that will amaze you. More attractive design. New, convenient "treadle" talking switch. Integral ten station selector switch. Arranged for any desired multiple station hook-up for desk-to-desk communication or, with loudspeakers, for two-way talking when 30' to 40' from the equipment. Replaces call systems and house-phones. Saves time and steps — economy that appeals to every business. Sells upon demonstration.

Write For Full Details On This Modern Money-Maker

Mr. Jobber, you'll be interested too!

**BELL Sound Systems, Inc.**  
65 EAST GOODALE STREET  
EXPORT OFFICE, 308 WEST WASHINGTON STREET, CHICAGO, ILL.

# HAILED BY "SOUND DEALERS" THE HIT OF THE SEASON

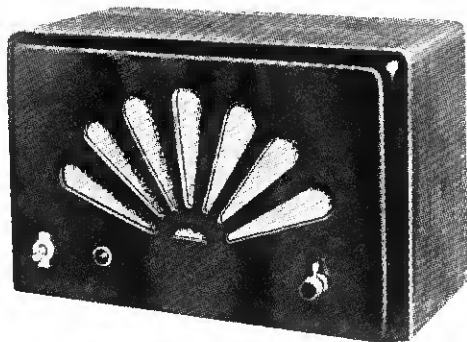

TYPE OC-2

HUMLESS  
BEAUTIFUL CABINETS  
VERY SENSITIVE  
EXCELLENT TONE

## WEBSTER-CHICAGO'S NEW INTER-OFFICE COMMUNICATION SYSTEMS

**TYPE OC-2** is the two station system. Operates on either A.C. or D.C. 110 volts. System consists of two amplifier units, each being housed in an attractive cabinet with ebony finish. Separate volume control for adjusting to any degree of loudness. Unit is very sensitive and ordinary conversation can be picked up across the desk. Free from hum or noise, and conversation is entirely private.

**TYPE OCM** is the multiple system for any number of stations up to ten. A selector switch permits picking any station for private conversation. Housed in identical cabinet to Type OC-2, and has the same features of construction, including operation on either A.C. or D.C. 110 Volt.

### SPECIAL DEALER SALES HELPS

This looks like the big money maker of 1937 for aggressive Radio dealers. Webster-Chicago has prepared an attractive mailing piece that will help open doors for you. Don't miss this opportunity. Get started now. Write for full information.

### WEBSTER-CHICAGO

Manufactures a complete line of sound equipment and accessories including factory call systems, school systems, theatre equipment, etc.

- STRICT DEALER POLICY
- FULLY LICENSED
- TIME PAYMENT PLAN

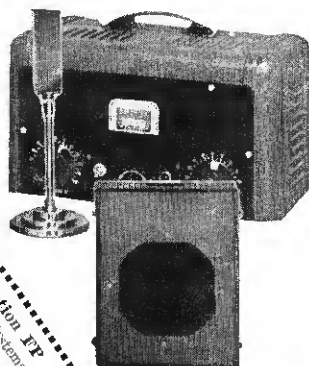

**SEND COUPON NOW**  
Please send me more information on Inter-Office Communication Systems.  
I am also interested in  
Name \_\_\_\_\_  
Address \_\_\_\_\_  
City \_\_\_\_\_  
State \_\_\_\_\_



## New OHMITE POWER LINE CHOKES

"Just the thing  
to cure R. F.  
Interference"

says Bill Frit

"Many's the time I've wished for a unit like this to keep interference from a near-by transmitter out of a customer's receiver."

Z-20, 5 ampere chokes may be installed at the receiver with the usual by-pass condensers to serve as a filter for high frequency currents. Z-21 and Z-22, 10 and 20 ampere chokes are suitable for installation at transmitters or other high frequency apparatus to prevent R. F. Currents from going out over the power line. For further information ask your jobber, or write for Bulletin 105 — FREE.

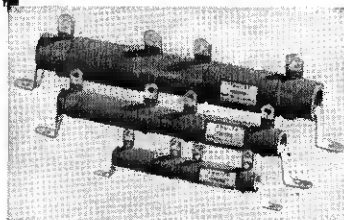

## OHMITE MANUFACTURING CO.

4845 Flournoy St., Chicago, Ill.

Manufacturers of Resistors, Rheostats and Tapswitches

## Don't Take Unnecessary Chances Trying to "Get by" Without

the  
*Complete*

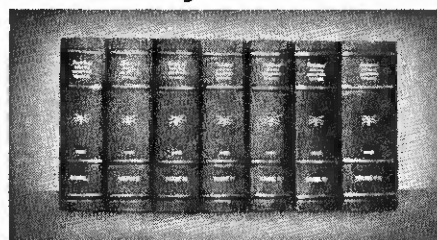

set  
of

## RIDER MANUALS NOW IN SEVEN VOLUMES

Volume	Price	Covering
I	\$7.50	1920-31
II	6.50	1931-32
III	7.50	1932-33
IV	7.50	1933-34
V	7.50	1934-35
VI	7.50	1935-36
Vol. VII—1600 Pgs.—		
\$10—Covering		1936-37

Why take chances of creating dissatisfied customers—losing money on a job—wasting valuable time—when the complete set of seven Rider Manuals gives all the necessary service information you need, when you need it—at a cost of only a few cents a day.

Stop taking chances—Fill in Your set of Rider Manuals Today at Your Jobber's.

**JOHN F. RIDER, Publisher**  
1440 Broadway, New York City

AND  
OTHER  
RIDER BOOKS  
THAT SHOULD  
BE IN YOUR  
LIBRARY

The Cathode-Ray Tube at Work—Complete, practical information on oscillographs, etc. 336 pgs. 450 illus. ....\$2.50

Hour a Day with Rider on Automatic Volume Control—Will speed up your AVC work. 98 pgs. 65 illus. Hard cover...60c

Hour a Day with Rider on DC Voltage Distribution in Radio Receivers—How DC voltages are led to tube elements, etc. 98 pgs. 69 illus.; hard cover...60c

Hour a Day with Rider on Resonance & Alignment—You need this! 96 pgs. 48 illus. Hard cover; only .....60c

Servicing Superheterodynes—Make repairs on constantly changing superhets at profitable speed. 288 pgs....\$1.00

Servicing Receivers by Means of Resistance Measurement—Tells how to use Ohmmeter. 203 pgs. 83 illus....\$1.00

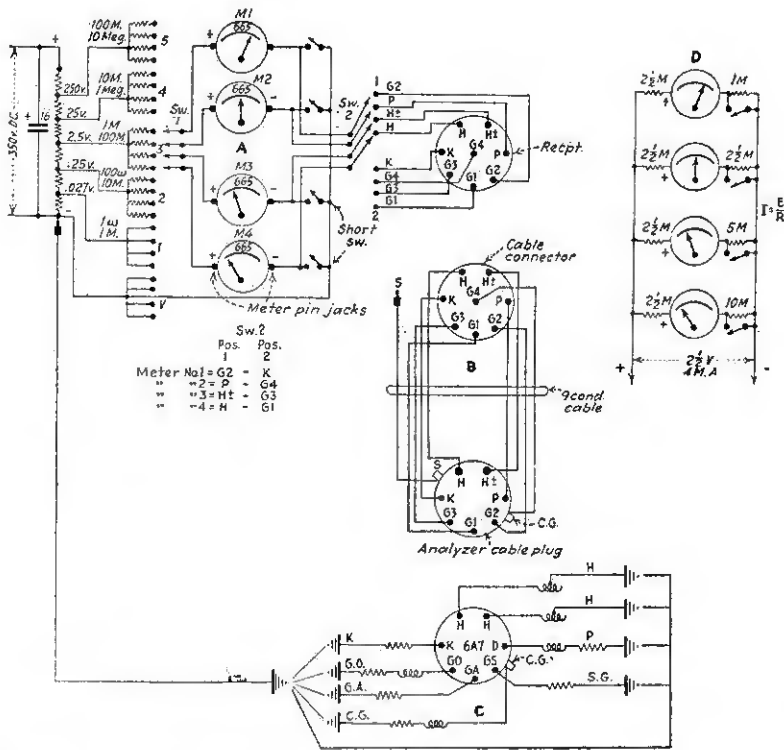

gives screen, plate, heater, heater. Switch 2 in position 2 gives cathode, control grid and G<sub>2</sub>. Short out meter 4.

From the above it is seen that any circuit can be double-checked by simply shorting out the three unused meters, adjusting the remaining one to full scale and then checking the circuit exactly as when using a single ohmmeter. It is important that each set of four calibrating resistors for each range be within 1 per cent of accuracy rating. Unit "A" is mounted on a Bakelite panel 6 x 4 x 3/16 and is self explanatory. My meters are Weston 301's but I put 665 scales on them. The ohmmeter scale on the 665 reads 2,500 ohms at half scale deflection. The 301 reads 4,500 ohms at half scale.

The ideal way to do the job would be to use 8 meters but I only had 1 ma. movements and find the system plenty fast.

A socket-to-chassis voltage test can be made with the unit also. Simply polarize your meters properly when you hook them up. Then set switch 1 on position "V". If meters have reversing switches it is a cinch. Why have three good meters idle and in use only for socket-to-chassis resistance tests when all may be used?

In making a test on a complete chassis get all four prong sockets first, then the fives, then the sixes, then the sevens, etc. Make your tests with switch 2 in position 1 on all sockets first, then switch 2 in position 2.

The system may appear confusing to

some. However, a simple way to picture it is to say that two 5-volt meters are paralleled across 2½ volts, each meter reading 2½ volts or half scale. This is merely a parallel circuit with two branch circuits of 5,000 ohms each. With a 1 ma. meter measuring the current flow in each circuit. It's all simple Ohm's Law.

## Noisy Tuning

By Merrill Lindley

A great deal of receiver noise can be removed by thoroughly grounding the dial assembly and tuning condenser.

Since manufacturers have been using one side of the heater at ground potential it is necessary that the pilot light bracket have a solid ground return. It is a good idea to run a separate lead to the chassis from the ground side of the pilot light bracket. In stubborn cases, it sometimes is necessary to ground all the moving parts of the dial assembly.

## Chassis Holder

By S. S. Balsam

For chassis that will not rest upside down on the work bench, the following holder has been devised.

Four ¼ in. holes are drilled in the center of bench to form a one foot square. A ¼ in. brass rod about 10 in. long is inserted in each hole with a collar and set screw to keep it from passing completely through. When a set is placed over these rods and the required height adjusted, the set may be held in any position or height above the bench.

# NEW — a low cost C-B Oscillograph MODEL 105

with Linear Sweep, Dual Amplifiers, etc.

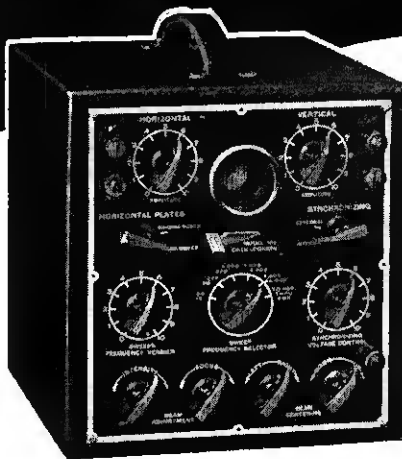

### You Need Every One of These Exclusive Features

Uses the new Type 913 one-inch Cathode-ray tube and provides every feature of the most expensive oscillographs, such as: Linear Sweep with synchronizing circuit using the Type 885 Thyatron; separate High Gain Amplifiers for horizontal and vertical plates; Beam Centering Controls; and adjustable light shield for Cathode-ray tube screen.

Compact, easily portable — yet the most complete instrument ever offered using the Type 913 tube. Not one of these features can be omitted without so limiting the utility of the oscillograph that any saving is wasted by limited performance. Write for bulletin describing this instrument in detail.

Complete with five tubes, net cash **\$48<sup>90</sup>**  
Pay-As-You-Earn. \$5.50 down

### Oscillators for Use with MODEL 105

This instrument now makes it possible for you to secure complete Cathode-ray Receiver Servicing equipment for only \$9.50 down (MODELS 81-A and 105). Designed for use with either the MODEL OM-A Frequency Modulated Oscillator or the MODEL 81-A Frequency Modulator, to produce calibrated selectivity curve images by single or double trace method.

### The CLOUGH-BRENGLE CO.

2819 W. 19th St., Chicago, U.S.A.

Send at once full description of the new MODEL 105 Cathode-ray oscillograph and time payment order blank.

Name \_\_\_\_\_  
Address \_\_\_\_\_

See Your Jobber Today — Or Use This Coupon



every sale is  
"VELVET"

With the TUNG-SOL CONSIGNMENT PLAN, your money is not on the shelf. Only after sales are made and profits taken do you remit. You're on "velvet" all the way through.

A complete line of high quality radio tubes of nation-wide proved performance—an adequate stock without repeated investment to keep it so—a selective plan of distribution that gives you "elbow room" and full profit. Put it all together and you have the Tung-Sol selling plan. There are still desirable locations for the appointment of reputable dealers . . . who can qualify. Write for the name of your nearest Tung-Sol wholesaler.

# TUNG-SOL

Tone-flow radio Tubes

TUNG-SOL LAMP WORKS, INC.  
Radio Tube Division

Sales Offices: Atlanta, Boston, Charlotte, Chicago, Dallas, Detroit, Kansas City, Los Angeles, New York. General Office: Newark, N. J

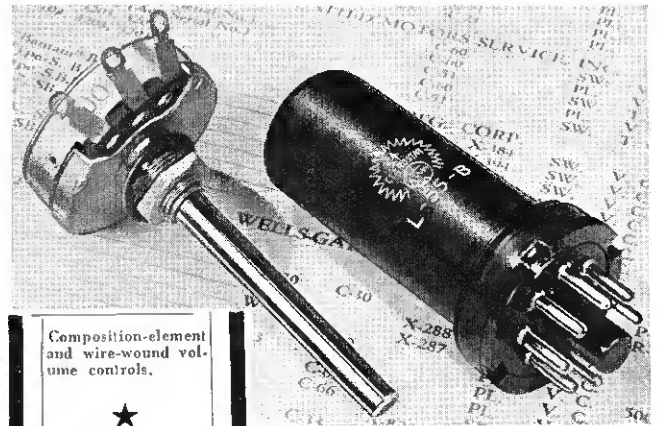

Composition-element and wire-wound volume controls.



Backed by manual that specifies exact units - -



Metal-tube voltage dropping resistors for all needs.



Handled by jobbers who believe in representative stocks for prompt servicing.

## Fitted to the Job!

Whether volume control or voltage-dropping resistor, CLAROSTAT offers an exact-duplicate unit. • There's a perfectly matched volume control replacement for every set. • Likewise a metal-tube resistor where needed. • This completeness means the saving of time, money and trouble.

**Free DATA:** Handy resistor - tube chart and volume-control replacement bulletin sent on request. Meanwhile, see your local Clarostat jobber.

**CLAROSTAT** *Manufacturing Co. Inc.*  
285-287 NORTH SIXTH STREET  
BROOKLYN, NEW YORK, U.S.A.  
• OFFICES IN PRINCIPAL CITIES •

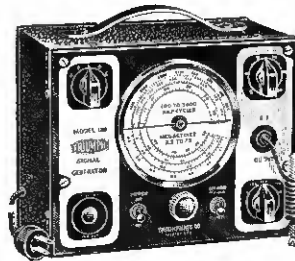

**SAVE**  
\$10 to \$25

**No drip-pan needed!**  
Triumph Model 120 does not leak r.f. to ruin sensitivity measurements!

On a new Signal Generator! Triumph Model 120 is a precision Generator guaranteed to be better than any similar unit offered under \$50!!! Money back 10 day free trial.

## TRIUMPH—factory to you net prices

- Signal Generator, No. 120, 100 kc to 75 mc, a.f. mod. optional, dual uv attenuator, list \$53.00..... **\$23<sup>95</sup>**
- Tube Tester, latest model No. 420, checks each element of 150 types for all possible faults! ..... **23<sup>95</sup>**
- Cathode-Ray Oscillograph, 3" and electronic Webbulator, the easiest C-R to operate. Special..... **100<sup>00</sup>**
- Multi-Range Meter, ac-dc volts, ohms, mills at 1000 ohms per volt. 3 1/2" round meter, now only..... **15<sup>95</sup>**

No extra charge for export packing, F.O.B. Chicago

**TRIUMPH MEG. CO.**  
4017 W. Lake, Dept. Chicago, Ill., Cable Triumco  
Please send complete catalog of instruments.

Name \_\_\_\_\_  
Address \_\_\_\_\_  
City \_\_\_\_\_ State \_\_\_\_\_

## Battery Clamp

By S. I. Ray

With the popularity of portable radios, it often becomes a problem to hold the batteries stationary. In some cases tubes or the batteries themselves are damaged by transit.

To overcome this, drill two small holes through the cabinet on each side of the battery. Then by inserting long machine screws through the holes and through a short piece of light angle brass over the battery the loose unit can be clamped down firmly. Wing nuts on the ends of the screws will facilitate removing the units when it is necessary to replace them.

of the planetary mechanism becoming loosened and too much or not enough tension applied to the friction band.

It is best to remove the planetary unit from the dial. With a screw driver or pointed instrument, turn the plate to the right until the slow speed knob is fairly hard to turn with the tension screw loose. If the plate appears to be likely to work out again, it may be anchored in place by a drop of solder along one edge. Replace the mechanism on the dial and tighten the screw in the friction band.

## Salvaging Slotted Toggle Switches

By E. P. Waldo

Many of the older volume controls removed for replacement have slotted toggle switches which may be salvaged for future use.

Clean the slot, preferably by filing. Wrap a small piece of tape around the toggle almost to the top of the ball to keep solder from running out the side of the slot. Put a drop of soldering acid or flux in the slot and then fill it with solder. Remove tape and file smooth. By wrapping a piece of sandpaper and holding while rotating switch a smooth factory finish will be imparted.

## Repairing Name Plates

By D. H. Beech

Name plates, especially those that are held in place by the mounting nut of some control, are likely to become bent during handling or transportation and therefore may give the radio set or amplifier a "second-hand" appearance. To straighten these plates and make them lie flat against the panel, simply place the plate face down on the end of a cylinder, such as a piece of tubing or a tube base, and press down the center until the plate has a slightly convex shape. Replace on the panel and tighten the nut. The convex shape holds the plate perfectly flat and the appearance is "good as new."

## Repairing Planetary Dials

By H. D. Hooton

Many of the new receivers are using dials of the band-spread and two-speed types. A great deal of trouble has been encountered with these dials, especially the two-speed variety. Most of the complaints have been that the slow-speed knob has refused to function or that back-lash is encountered when using this control. An examination usually shows that the trouble is caused by the screw-end plate at the rear

## Grid Cap Repair

By Americus Molinara

Quite often the caps of screen grid tubes work loose, and if not repaired they usually break off.

Loose caps can easily be repaired by applying a small amount of Ambroid cement or any similar adhesive. Allow to dry from 12 to 24 hours for a firm and permanent job.

## Use Phonograph Motors That Suit MUSIC-MINDED CUSTOMERS

Let the most critical purchasers of radio-phonographs guide your choice. Whether selecting a symphony or the latest dance tune, it will be given the highest quality presentation by a General Industries two-speed FLYER motor. Accurate speed, precisely maintained, regardless of changing record drag and the weight of your pickup. Self-lubricating laminated bakelite gears and long over-size bearings assure absolutely smooth silent operation. Two speeds . . . 33 1/3 or 78 R.P.M., instantly changed by simple shift lever. Self enclosed. Easily installed. Low cost.

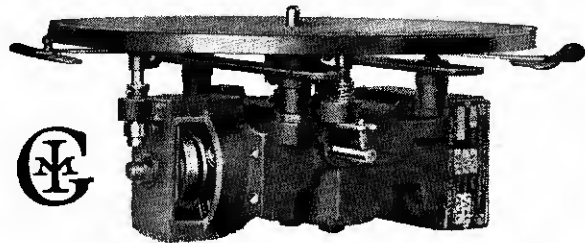

Order test samples TODAY. Be sure to specify whether AC or DC, also exact voltage and frequency of current you use.

**The GENERAL INDUSTRIES CO.**

3737 TAYLOR STREET, ELYRIA, OHIO

## 110 VOLTS AC ANYWHERE

With Katolight Jr. Complete light plant for \$49.95.

Electricity at price anyone can afford. Dealers you can sell the Katolight Jr. Each plant sold creates lifetime user for lamps, motors, wiring, Radio and appliances.

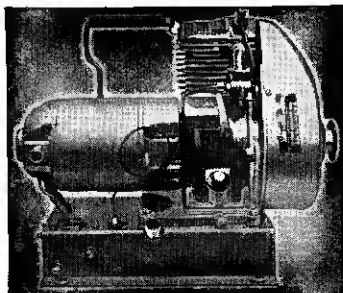

6 V. 150 watt.....\$49.95  
12 V. 200 watt..... 59.95  
32 V. 300 watt..... 72.00  
110 V. 300 watt A. C. 87.50  
110 V. 350 watt, A. C.  
Self-cranking ..... 98.00

Ask about 450, 550, 750 and 1000 watt complete plants made by mfs. of AC & DC Plants, Diesel Plants, Generators, Rotary Converters.

**Kato Engineering Co.**  
Mankato, Minn., U. S. A.

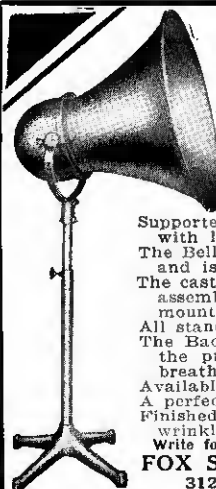

## A 4-STAR SENSATION

★ ★ ★ ★

The New Fox B-5  
Universal Baffle Type Horn

Overall depth 27". Bell diameter 29".  
Quality construction.  
Completely universal in directional characteristics.

Supported by a sturdy adjustable cradle complete with lock screw adjustment. The Bell is made of FOX special alloy horn material and is correctly designed for utmost output. The cast aluminum throat collar reinforces the entire assembly, forming a perfect foundation for speaker mounting and cradle. All standard 12-inch speakers can be used. The Back Cover is of heavy horn material and has the proper air by-pass so that the speaker can breathe, thus eliminating distortion. Available complete with adjustable stand. A perfect combination for indoor or outdoor work. Finished in standard aluminum gloss or Fox special wrinkle.

Write for catalog sheets and prices.  
**FOX SOUND EQUIPMENT CORP.**  
3120 Monroe Street, Toledo, Ohio

# 20,000 OHMS PER VOLT!

## A new HIGH in Sensitivity and Value

At 20,000 ohms per volt, this new Simpson Set Tester is the most remarkable value ever offered to the service man. Negligible current consumption means accurate D. C. voltage readings of 2.5—10—50—250—1000. Same ranges for A. C. at 1000 ohms per volt. Current readings from 1 microamp to 500 milliamps. Accurate resistance readings as low as 1 ohm up to 40 megohms. Ask for new circular covering wide range of tests.

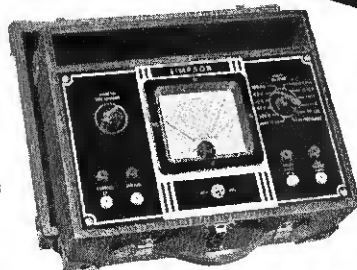

Model 250 (20,000 ohms per volt model)—Net Price... **\$38.50**  
 Time price: \$8.00 down and 6 monthly payments of \$5.85 each  
 Model 225 (10,000 ohms per volt model)—Net Price... **\$29.50**  
 Time price: \$6.00 down and 6 monthly payments of \$4.50 each

## Illuminated Dial Tube Tester

Checks all tubes under individual load conditions utilizing latest authoritative circuit. Tube quality shown on illuminated scale. Separate scales for "Diodes" and 0-100 percentage scale for matching tubes. Spare sockets provide for future tube changes. Has neon-tube short check. A beautiful instrument that boosts tube sales.

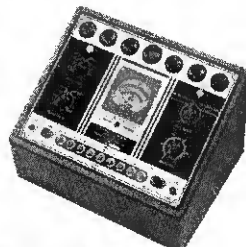

Model 222 Tube Tester—Counter or portable type—Net Price... **\$39.50**  
 Time price: \$8.00 down and 6 monthly payments of \$6.20 each

## "Roto-Ranger" Tube and Set Tester

"Roto-Ranger" feature places twelve distinct scales at finger tips. Utilizes latest tube testing circuit. Has filament return selector. Tests all types condensers on separate scales. Has separate resistance scales of 100 ohms, 100,000 ohms, 100 megohms. Three D. C. scales of 8—300—1000 Volts. (2500 Ohms per Volt.)

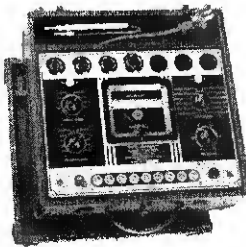

Model 220—Net Price... **\$57.00**  
 Time Price: \$11.40 down and 6 monthly payments of \$8.75 each

## "Roto-Ranger" Volt-Ohm Milliammeter

Incorporates Simpson "Roto-Ranger" feature with twelve separate scales covering all ranges for practical servicing.

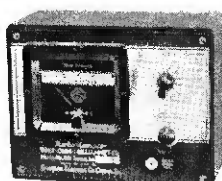

Model 201 with D. C. ranges only: Net Price... **\$29.50**  
 Time Price: \$6.00 down and 6 monthly payments of \$4.50 each  
 Model 202 (A. C.-D. C. type): Net Price **\$32.50**  
 Time Price: \$6.50 down and 6 monthly payments of \$5.00 each

SOLD ON DEFERRED PAYMENTS

**SIMPSON**  
 RADIO INSTRUMENTS  
 AND SERVICE EQUIPMENT

ASK YOUR JOBBER

## COUPON BRINGS FACTS

Simpson Electric Co., 5216 Kinzie St., Chicago  
 Send bulletin describing models checked.  
 No. 250  No. 225  No. 222  No. 220  No. 201  No. 202  
 Send deferred payment application.

Name \_\_\_\_\_  
 Address \_\_\_\_\_

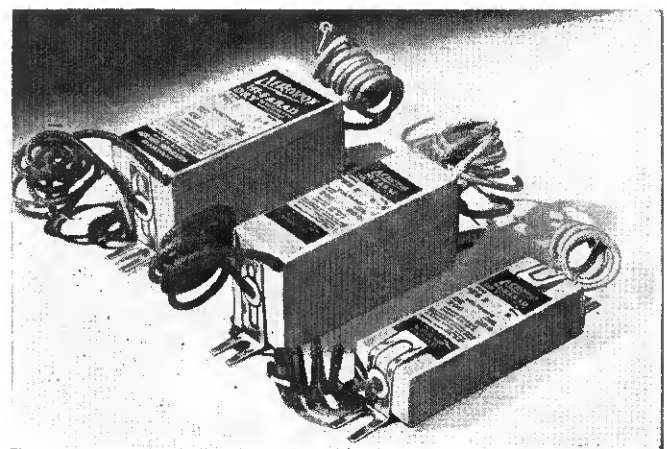

## Handier than Ever!

...with ADJUSTIMOUNT feature



For those hurryup service jobs.  
 \* Mounted singly, in pairs or in threes. Flat or upright. Swivel flange.  
 \* Minimum bulk due to latest electrolytic technique.  
 \* In 200 and 450 v. working. Popular capacities. Single, dual and triple sections.

AEROVOX PBS Cardboard-Case Electrolytics—handiest units in common use—are made still handier with the NEW Adjustimount Flange feature. • Metal flanges match any mounting hole spacing. • Units mounted individually or stacked. • Fit anywhere.

Send for CATALOG...  
 Covers the MOST COMPLETE line of condensers as well as resistors. Also copy of Research Worker.



## What's Radio Retailing Say?

If you read it in RADIO RETAILING it is true—and timely.



That goes for both the editorial and the advertising contents of this, the radio industry's recognized leading publication!

## RADIO RETAILING

330 W. 42d St., New York, N. Y.

**FOR CONDENSER SATISFACTION DEMAND**

**RED HEADS**  
 CONSOLIDATED CONDENSERS  
 Red Head Brand  
 CONSOLIDATED WIRE AND COPPER CORPORATIONS  
 CHICAGO • ILLINOIS, U. S. A.

ALL TYPES FROM YOUR DEALER



## TRICKS OF THE TRADE

### CLARION AC 51

Low volume, low voltage . . . Check 1 mfd. condenser across 900 ohm output bias resistor for short.

### COLONIAL 600A

Intermittent . . . replace solid grid lead of 6A7 with flexible wire.

### CROSLEY 41S

Noisy and distortion at high volume . . . replace 440 resistor under chassis. Check first r.f. coil for intermittent short.

### CROSLEY 706

Fuse blows . . . replace fiber bushings on field supply.

Voltage divider gets extremely hot . . . replace .5 mfd. condenser from center arm.

Noisy tuning . . . burrs on stator tuning plates. Can be cleaned off with long sharp knife blade.

Dial light flickers, noisy . . . replace A.C. switch.

Poor tone, volume increases when one output tube is removed . . . Small wires on "F" type speaker unit broken.

### EMERSON 30 AW, 33 AW, 250 AW, 321 AW, 350 AW

Motorboating, intermittent . . . Replace .01 mfd. coupling condenser on grid of 43. Also change  $\frac{1}{4}$  meg. grid resistor to 100,000 ohms.

### G.E. E81, E86

Loud background noise . . . Change cathode resistor of 6K7 first i.f. to 25000 ohms.

### G.E. E91, E95, E101, E105, E106, R155

High noise level . . . break cathode connection of 6K7 first i.f. and bias through 10,000 ohm half watt resistor. Bypass with .05 mfd. condenser.

### GREBE S.K.4

Low volume . . . Check aligning condenser at extreme right of tuning gang for high resistance leak. Distortion at low volume is caused by .25 meg. resistor from c.t. of p.p. input changing value.

### GRUNOW 1191, 1291

Set dead but tuning eye operates . . . Check for open 205 ohm 6F6 cathode bias resistor.

For high pitched tone check speaker terminal strip. One lead from output transformer broken.

### RADIO RETAILING, FEBRUARY, 1937

### GRUNOW 1291

Part of dial dead . . . dial shorting one lug of volume control.

### LYRIC 450

Weak, insensitive . . . Corrosion at lugs of first r.f. coil. Clean lugs and leads and resolder.

### LYRIC L6RT, 454A

Short waves dead except for 19 meter band . . . do not touch padders on oscillator. Replace 2 mfd. 350 v. condenser as this unit has lost capacity. To check, bridge the new capacitor across the old unit.

### MAJESTIC 9P3

Detector plate choke frequently opens . . . Can be replaced with a 25,000 ohm, 1-watt resistor.

### MAJESTIC 130A

Fading . . . Defective .04 condenser bypassing 500-ohm resistor between secondary of last r.f. transformer and chassis. Located under tuning condensers, accessible by removing tuning condenser shield. The resistor is inside the r.f. coil.

### MAJESTIC 500

Motorboating when tuned off resonance . . . Replace .25 mfd. bypass on 6A7 and 6F7 cathodes. Condensers are in one container of four .25 mfd., one .03 mfd. and one .06 mfd. capacitors.

### MOTOROLA 50

High background at low frequency end . . . shorted antenna series padder. Metallic shavings between segments cut through mica.

### PHILCO 54

Fading, motorboating, dead on part of dial . . . replace coupling condenser, 51000 and 5000 ohm resistor of oscillator circuit.

### PHILCO 70

Hum on stations near the center of the band . . . Look for trouble in the condensers seriesed across the power transformer primary.

### PHILCO 87

Hum control ineffective . . . shorted twin .25 mfd. condensers across 1 $\frac{1}{2}$  volt filament. Replace condensers, set hum control. Condensers are in long can on front of chassis.



IS IT *Maximum PROFITS and Utmost* CUSTOMER SATISFACTION YOU'RE LOOKING FOR? IF SO . . .

*Standardize with Cornell-Dubilier*

Seldom, if ever, do new and startling improvements in the field of scientific research come overnight. They are, rather, the fruit of patient, painstaking effort. Likewise, the building of a reputation is a slow, tortuous process. Here at Cornell-Dubilier, we are ever conscious of our obligation to the radio and electrical industries, and of the ideals of the founders of this great organization, established more than twenty-seven years ago!

Your every condenser requirement can be filled, promptly and efficiently. For more profits EDUCATE your customers on the value of C-D condensers.

**WORLD'S LARGEST EXCLUSIVE MANUFACTURERS OF CONDENSERS.**

**PAPER—MICA—DYKANOL  
—WET AND DRY ELECTROLYTIC**

*Complete descriptive catalog material free on request!*

CORNELL-DUBILIER CORP.

1019 Hamilton Blvd.

So. Plainfield, N. J.

**CORNELL-DUBILIER**

**"ASK ANY MECHANIC"**  
*he'll tell you*

**KRAEUTER  
 PLIERS ARE  
 THE FINEST  
 MONEY CAN  
 BUY**



From start to finish nothing but perfect workmanship and the best materials go into the production of Kraeuter Tools. Every Kraeuter Plier is individually tested for strength and cutting ability on testing machines designed and developed by us. Pliers below are shown in Highly Polished Supreme Kraeuter Finish. Also furnished in Kraeuter's black Industrial Finish.

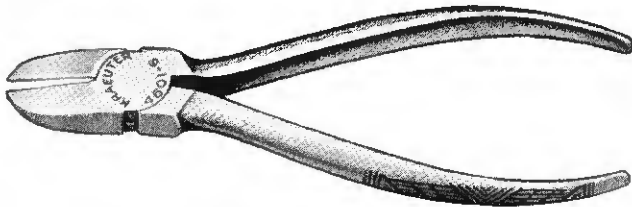

No. 4601 **ELECTRICIANS' DIAGONAL CUTTING PLIERS** made especially for close cutting. Forged from special plier steel and precisely fitted for exact work. Made in sizes from 4½" to 7½".

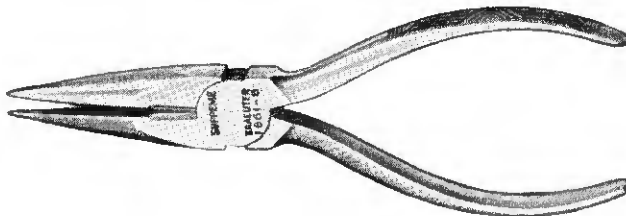

No. 1661. 6" **NEEDLE NOSE SIDE CUTTING PLIERS**. A fine slender nosed, tapered point plier especially handy for the radio manufacturer or repair man.

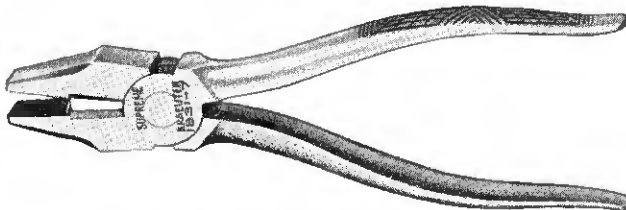

No. 1831 **ELECTRICIANS' HEAVY DUTY PLIERS**. Just the thing for general wiring work. Strongly constructed with sturdy wire cutters. Made in sizes from 4" to 8".

KRAEUTER Pliers save time—do the job better. There's a model for every purpose. For further information write Dept. "R":

**KRAEUTER & CO.**  
 (Pronounced KROY-TER)  
**NEWARK, N. J.**

*Manufacturers of Highest Quality Pliers and Tools Since 1860*

**MILLION**

**UP-TO-DATE TUBE TESTERS  
 ASK YOUR JOBBER OR  
 WRITE FOR INFORMATION**



Model  
 CN  
**\$9.95**  
 net



Model TM .....\$18.95 net  
 Model TV — with Analyzer  
 Scales and Illuminated  
 Meter .....\$26.95 net  
**MILLION RADIO AND TELEVISION LABORATORIES**  
 379 W. SUPERIOR ST., CHICAGO, ILL.



**CAPACITOR  
 ANALYZER**

Your eyes and the **MAGIC TUBE** see all, know all, quick as a wink! Capacity, power factor, leakage resistance, read directly on the panel! Write for literature.

*Jobbers in  
 All Leading Cities*

**SOLAR MFG.  
 CORP.**

599-601 Bway., N.Y. City

**2,199  
 IDEAS!**

In this one big book you'll get 2,199 money-making ideas, plans and methods that have already been tested and proved sound, practical and successful. The first and only book of its kind!

**RADIO BUSINESS**  
*Promotion and Management*

*By A. A. Chirardi and T. S. Ruggles*

**SELLING**—How to get leads and prospects. Market analysis. How to get people into your store. Inside and outside selling. Selling talks. Sales resistances and how to break them down. Business contacts.

**ADVERTISING**—How to plan your promotional program. Costs. How to write your advertising. Tested appeals. How to get action. Preparation and production. Displays. Direct Mail. Newspaper and other forms of advertising. Publicity. Merchandising. Contests. Follow-ups.

**BUSINESS METHODS**—Management data. Bookkeeping and accounting. Collections. Sales and service forms and records. House policies.

*Applies to sale of sets, servicing, Auto Radio, P. A. work, home appliances, etc.*

Over 400 Pages

Over 200 Illus.

**CLIP and MAIL**

*Today* Radio & Technical Publ. Co.

45 Astor Pl., New York Dept. RR-27

Please send me free circular 111.

Name .....

Address .....

*Free Circular*

### PHILCO 111, 111A, 211, 211A

Low volume, all voltages check . . . Change  $\frac{1}{2}$  meg. resistor (#44) in plate circuit of '27 detector.

### RADIOLA 17, 18, 50

Repeated breaking of condenser drive cable . . . Due to scraping of cable on edge of drum. Install new cable, rotate control knob fully in one direction and then the other several times. If scraping is noted remove dial scale from drum and file edges to assure better clearance. When replacing scale put it slightly off center, more toward the edge of the drum on which no filing has been done.

### RADIOLA 18 D.C.

No plate voltage . . . Open 1,000 ohm plate resistor located in power unit. Connect a 20-watt, 1,000 ohm replacement from binding post 7 to binding post 9 for permanent repair without necessity of removing and replacing chassis.

### RADIOLA 80

No control of volume . . . Open 18,000 ohm resistor in screen grid circuit of 1st r.f. Check 14,300 ohm and 110,000 ohm resistors in same circuit before installing replacement as new unit will burn out again if these have dropped materially in value.

### SILVERTONE 1570

Weak . . . Look for corrosion around control grid of second detector where it goes through hole in chassis; slip spaghetti over lead to insulate from chassis. May be further pepped up by substituting almost any 175 k.c. 4 lead I.F. transformer for resistance first and second I.F. network. Leave 20M resistor previously used as a filter with the addition of a .1 mfd. paper tubular to bypass this resistor or the increased gain will cause motorboating.

### SILVERTONE 1802A, 1803A, 1807

No reception at high frequency end. . . . Open 2 mfd. tubular cond. from oscillator coil to ground. Set dead. . . . Check open 17M and 32M ohm sections of Candohm voltage divider.

### SILVERTONE 1824-1830

Weak or dead . . . check 4 mfd. cond. from 78 screens to ground. Also check tuning meter for open. Wave change switch dirty; clean with alcohol and small brush.

### SILVERTONE 1926

Code interference. Repeak at 445 k.c. (originally 480). Retrim the two padding condensers mounted on gang at 1500 kc., also repad 600 k.c. trimmer while rocking selector knob.

### STEWART WARNER R147

Station hum . . . replace .1 mfd. screen bypass on 6A8 with .5 mfd. unit.

### STROMBERG-CARLSON 846A

Whistling and motorboating . . . Frequently caused by defective 10-ohm center tapping variable rheostat across filament winding of detector tube. Wire on this rheostat takes solder so carefully solder wire ends to lugs and center lug to case of rheostat.

### US 10

Overloading . . . Check 200,000-ohm resistor in plate circuit of a.v.c. tube, also condenser from plate of this tube to cathode. Erratic reception . . . Examine resistance strip mounted tight against side of cardboard electrolytic upon which the a.v.c. circuit resistors are mounted. There is often sufficient leakage between the resistance strip and the condenser to cause trouble. Insulate with cardboard.

### WURLITZER SUPERHETS

Noisy . . . I.F. coils wound with 6 strand litz, failure of one strand won't show up on ohmmeter but increases R.F. resistance. Cut leads, fray and scrap each strand separately and resolder.

**SUCCESSFUL PERFORMANCE UNDER SEVERE CONDITIONS**

**AMPERITE VELOCITY**

**ACHIEVES UNIQUE RECORD IN ACTUAL USE**



### SUCCESSFUL

in performance: "A magnificent instrument . . . Despite the climate here, results are marvelous and could not be bettered, I am sure". D. Hopkins, Raffles Hotel, Singapore.

### SUCCESSFUL

in design: "Your streamline mike is going over big with our trade. Congratulations on its fine design and performance". R. Ruben, Saugus, Mass.

### SUCCESSFUL

in construction: "We believe no other mike could take the punishment it has and still give such excellent reproduction". Johnston P.A. Service, Oneonta, N. Y.

### SUCCESSFUL

in sales: "The finest type microphone that I ever used . . . Please duplicate my order". Ridley's P.A. Systems, Inc., Tulsa, Okla.

### FEATURES:

1. Output increased 6 DB.
2. Triple shielded—entirely eliminating hum pickup.
3. Eliminates feedback troubles.
4. Excellent for close talking and distant pickup.
5. Acoustically designed to eliminate any possibility of cavity resonance.
6. Fitted with switch and cable clamp.

MODELS RBHn (High Impedance); RBMn (200 ohms) . . . \$42.00 LIST

NEW! Models RBSn, RSHn; streamline; slightly lower output and frequency range than above. . . . \$32.90 LIST

Models RAL (200 ohms); RAH (2000 ohms). Built to Amperite standards; No peaks. Flat response. Triple shielded. Shock absorber. Swivel bracket. . . . \$22.00 LIST

Finishes: All microphones have the new standard Gunmetal Finish. Available in Chrome, extra, \$1.00 List.

FREE: WINDOW DECAL, advertising your SOUND SERVICE. Four-color design, 5 1/4 x 9 1/4. Write for it now.

AMPERITE Co. Cable Address: Alkon, New York 581 BROADWAY, N. Y.

**AMPERITE** Velocity **MICROPHONE**

## Cashing in on HOME RADIO WIRING



- TACO Master Antenna System means one aerial serving up to 25 set outlets.
- Ideal for apartment house, hotel, hospital, club or even private dwelling.
- An all-wave, noiseless, high-efficiency system at cost within reach of any building owner.
- Neat. Easily installed. Exposed or concealed wiring.
- Handy foundation kit. As many outlets as needed. Complete instructions. Engineering collaboration. A neat profit is assured on every job!

**Free MANUAL!** Just issued. New edition. Describes surveying, estimating, installation, testing, etc. Ask your jobber for your copy or write us.



**TECHNICAL APPLIANCE CORP.**  
Pioneers in Noiseless Antenna Systems  
17 E. 16th St., New York City

# INDEX TO ADVERTISERS

FEBRUARY, 1937

	Page		Page		Page
AEROVOX CORP. ....	94	JEFFERSON ELEC. CO. ....	86	SHURE BROTHERS .....	53
(Condensers)		(Transformers)		(Microphones)	
AMPERITE CO. ....	97	KATO ENG. CO. ....	93	SIMPSON ELEC. CO. ....	94
(Microphones)		(Electric Plant)		(Sound Equipment)	
AMERICAN TELEVISION & RADIO CO. ....	56	KELVINATOR CORPORATION .....	71	SOLAR MFG. CO. ....	96
(Vibrators)		(Refrigerators)		(Condensers)	
ARCTURUS RADIO TUBE CO. ....	72	KEN-RAD CORP. ....	52	STEWART-WARNER .....	65
(Radio Tubes)		(Radio Tubes)		(Refrigerators)	
BELL SOUND SYSTEMS, INC. ....	89	KREUTER & CO. ....	96	STROMBERG CARLSON TELE. MFG. CO. ....	2
(P. A. Equipment)		(Tools)		(Radio Sets)	
BENDIX PROD. CORP. ....	86	LEONARD ELECTRIC CO. ....	67	SUPREME INSTR. CORP. ....	82
(Testing Equip.)		(Refrigerators)		(Radio Test Equipment)	
BRIGGS & STRATTON CORP. ....	10	MALLORY & CO., INC., P. R. (Volume Control) Inside Front Cover		TECHNICAL APPLIANCE CO. ....	97
(Battery Chargers)		MILLION RADIO & TELEVISION CORP. ....	96	(Antenna Systems)	
CLAROSTAT MFG. CO. ....	92	MUELLER ELECTRIC CO. ....	54	THORDARSON ELEC. MFG. CO. ....	84
(Volume Control)		(Wire Clips)		(Transformers)	
CLOUGH-BREngle CO., THE. ....	91	NATIONAL CARBON CO. ....	52	TRAV-LER RADIO & TEL. CORP. ....	56
CONSOLIDATED WIRE CORP. ....	94	(Radio Batteries)		(Radio Sets)	
(Condensers)		NATIONAL UNION RADIO CORP. .	87	TRIPLET ELEC'L INSTR. CO. ....	74
CONTINENTAL CARBON CO., INC. 89		(Service Instruments)		(Elec. Instruments)	
(Filters)		NOBLETT-SPARKS IND., INC. (Radio Sets) Inside Back Cover		TRIUMPH MFG. CO. ....	92
CORNELL DUBILIER CORP. ....	95	(Radio Sets) Inside Back Cover		(Test Equipment)	
(Condensers)		NORGE DIVISION, BORG-WARNER. 58		TUNGSOLO RADIO TUBES, INC. ....	92
CONTINENTAL RADIO & TEL. CORP. 6&7		(Refrigerators)		(Radio Tubes)	
(Radio Sets)		OHMITE MFG. CO. ....	90	UTAH RADIO PRODUCTS, INC. ....	88
CORNISH WIRE CO. ....	56	(Resistors)		(Transformers)	
(Antennas)		ONAN, D. W., & SONS. ....	54	UNITED MOTORS SERVICE, INC. ....	25
DICTOGRAPH PRODUCTS CO., INC. 37		(Electric Plants)		(Radio Sets)	
(Radio Sets)		OPERADIO MFG. CO. ....	57	WARD PRODUCTS CO. ....	54
EDISON G. E. APPLIANCE CO. .... 62, 63		(Radio Sets)		(Auto Antennas)	
(Refrigerators)		PARRIS-DUNN CORP. ....	29	WEBSTER-CHICAGO .....	90
ELECTRO-ACOUSTIC PRODUCTS CO. 47		(Wind Electric Plants)		(Sound Equipment)	
ELECTRICAL PRODUCTS CO. ....	52	PER WAL RADIO & TEL. CO. ....	54	WESTON ELEC'L INSTRU. CORP. ....	78
(Battery Eliminators)		(Radio Sets)		(Instruments)	
FADA RADIO & ELEC. CO. ....	21	PIONEER GEN-E-MOTOR CORP. ....	85	WILLARD STORAGE BATTERY CO. ....	42
(Radio Sets)		(Electric Plants)		(Storage Batteries)	
FOX SOUND EQUIP. CO. ....	93	RADIO CITY PRODUCTS CO. ....	56	WINCHARGER CORP. ....	39
(Sound Equipment)		(Test Equipment)		(Wind Elec. Plants)	
GALVIN MFG. CO. ....	8	RADIO & TECH. PUBL. CO. ....	96	ZENITH RADIO CORP. ....	30
(Auto Radio Sets)		(Service Manuals)		(Radio Sets)	
GENERAL ELECTRIC CO. .... Back Cover		RADIO CORP. OF AMERICA. .... 50, 51			
(Radio Sets)		(Sound Engineering)			
GENERAL HOUSEHOLD UTILITIES CO. .... 3, 69		RAYTHEON PRODUCTION CORP. ... 35			
(Refrigerators)		(Radio Tubes)			
GENERAL INDUSTRIES CORP. ....	93	R C A MFG. CO. .... Front Cover			
(Phonograph Motors)		(Radio Sets)			
HORTON MFG. CO. ....	52	R C A MFG. CO. .... 55			
(Washers and Ironers)		(Test Equipment)			
HYGRADE SYLVANIA CORP. ....	40	READRITE METER WORKS. ....	88		
(Radio Tubes)		(Tube Testers)			
INTERNATIONAL RADIO CORP. .... 4 & 5		RIDER, JOHN F. ....	90		
(Radio Sets)		(Service Manuals)			
JANETTE MFG. CO. ....	52	RUBY CHEMICAL CO. ....	54		
(Rotary Converters)		(Service Cement)			

## SEARCHLIGHT SECTION (Classified Advertising)

Classification	Page
BOOKS	
McGraw-Hill Book Co. ....	99
CATALOGS .....	99
SERVICEMEN'S SPECIALTY	
Akrad Products Co. ....	97
RADIO STOCKS	
Allied Radio Corp. ....	99
Apparatus Design Co. ....	97
Radolek Co. ....	99

McGRAW-HILL PUBLISHING COMPANY, INC. Publication Office: 99-129 North Broadway, Albany, N. Y. Editorial and Executive Offices: 330 West 42d Street, New York, N. Y. Branch Offices: 520 North Michigan Avenue, Chicago; 883 Mission Street, San Francisco; Aldwych House, Aldwych, London, W. C. 2; Washington; Philadelphia; Cleveland; Detroit; St. Louis; Boston; Atlanta, Ga.

**NOW**- how to repair and re-wind all types of motors . . .  
**ELECTRIC MOTOR REPAIR LIBRARY**

4 volumes, \$10.00, payable in easy monthly installments

THIS set of books should be on the shelf of every man who ever has to touch a motor for purposes of repairing it or changing it to meet different operating conditions. In shop language and with practical shop methods, it covers every step in stripping, rewinding and connecting a.c. and d.c. motors of all kinds.

**How to change motors for different operating conditions**

Here is all the information you need in order to determine what changes various types of motors permit; to lay out new windings for specified service conditions; and to handle every step in the work with satisfactory results.

Covers all types of motors, from those used in small household and commercial appliances of all kinds, to mining and railway motors. Explains principles underlying the different types of windings; gives definite instructions for doing the various rewinding jobs. Also gives many data, tables and diagrams constantly needed by the repair man, including data difficult to get from any other sources.



**Low price—easy terms—10 days' examination on approval**

Bought separately the books in this Library would cost you \$11. By using this coupon you need pay only \$2.00 in 10 days and \$2.00 monthly until the special price of \$10.00 is paid. In addition, we give you 10 days in which to examine the books. Send no money; simply fill in and mail the coupon now; let us know your answer after you have seen the books.

McGraw-Hill Book Co., Inc., 330 W. 42nd St., N. Y. C.

Send Electric Motor Repair Library for 10 days' examination on approval. In 10 days I will send \$2.00, plus few cents postage, and \$2.00 monthly for four months, or return books postpaid. (We pay postage on orders accompanied by remittance of first installment.)

Name .....  
Address .....  
City and State .....  
Position .....  
Company ..... R. R. 2-37

**SEARCHLIGHT SECTION**

EMPLOYMENT AND BUSINESS  
"OPPORTUNITIES"

PARTS—DISCONTINUED MODELS  
SURPLUS STOCK

See last issue for advertising rates

**38 Amazing RADIOS**



1937 Knight Radios offer you unbeatable profit-making opportunities! Sensational new features include giant 11-in. Magna-Span Dials and super-dynamic Vita-Tone Speakers. Unmatched performance, at amazingly low prices. 38 models, 5-19 tubes, as low as \$8.45!

**10,000 Service Parts**

You can fill every service need from the ALLIED Catalog—at lowest prices. Lists over 10,000 exact duplicate and replacement parts, complete test equipment, tools, books, etc. You save time, trouble and money on every purchase by ordering from ALLIED.

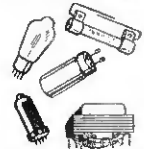

**Send For CATALOG**

FREE



This great 152-page Catalog also shows a vast sound systems, amateur gear, kits, Huripower units and Windchargers, etc. Whatever you need, you'll always find it in the ALLIED Catalog at the lowest prices.

**ALLIED RADIO**

ALLIED RADIO CORPORATION Dept. 18-B  
833 W. Jackson Blvd., Chicago, Ill.

Send us your new 1937 Catalog (Free).

Name .....  
Address .....  
City .....

**1937 TUBES**  
Every Confidence and Unameter  
**TUBE TESTER**

can be brought up to date for 1937 octal base and metal tubes by either adapters, Kits, Socket Units or factory re-ramp jobs at very reasonable rates. From \$2.00 up. You cannot obtain proper test data for the new tubes from any source other than this factory. Send for FREE SERVICE FOLDER No. 152 which describes fully the requirements to bring every model up to date. Tell your friends who own one of the thousands of Confidence or Unameter testers.

**APPARATUS DESIGN CO.**  
Little Rock, Arkansas

Owned and operated by J. R. Williams & Sons

**New "SEARCHLIGHT" Advertisements**

must be received by March 3rd to appear in the March issue

Address copy to the  
Departmental Advertising Staff  
Radio Retailing

330 West 42d St., New York City

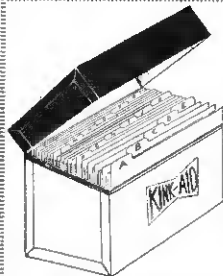

**SERVICEMEN**

The 1937 enlarged edition of KINK-AIDS encyclopedia is ready.

**KINK-AIDS**

Now embraces over 3000 symptoms and successful repairs for hundreds of home and auto radios.

**NEW, REVISED KINK-AIDS**

- Filled by set name and model number
- Clearly printed on wear-resisting cards
- ENAMELED steel cabinet, bench size
- Supplements issued quarterly

At your jobbers or postpaid, .....\$1.95

Note: Holders of last year's edition may purchase complete supplement for 35c

**FREE:** Send for Bulletin RR-2 and sample cards

Jobbers: Write for attractive proposition

**AKRAD PRODUCTS COMPANY**

362 Wooster Ave. Akron, Ohio



**STOP SEARCHING!**

HERE IS YOUR "GUIDE"

**Don't Grope Around In The Dark . . .**

**Send For This New Radio Buying Guide Today!**

Here is the solution to all your radio supply problems . . . Here is your key to the fastest service . . . Lowest Prices . . . and the largest stock of Radio Repair Parts in the world! This Radolek new 1937 Radio "Profit Guide" is the most complete Radio Parts Catalog ever published . . . over 160 pages . . . bringing to you over 10,000 individual Repair Parts . . . hundreds of new items . . . a complete new selection of Radio Receivers, Amplifiers, Tubes, Tools, Books and Instruments . . . Everything you need . . . always in stock . . . ready for prompt shipment . . . at the right prices.

**YOU NEED THIS BIG CATALOG!**

It's FREE! Send this coupon NOW! Radolek endeavors to restrict circulation of the Profit Guide to those actively engaged in the Radio business. Please enclose your business card or letterhead.



**FASTEST SERVICE**

**COMPLETE STOCKS**

**LOWEST PRICES**

**Rely on Radolek for "Everything in Radio"**

**RADOLEK**

601 W. Randolph St., Dept. A-4, CHICAGO

Name .....

Address .....

Serviceman?  Dealer?  Experimenter?

## Second-Hand Set Shuffle

I am writing this in the hope that through publicity in *Radio Retailing* we dealers may be able to nip in the bud what might turn into an evil of great proportions.

A certain chain store and mail-order house here has been selling their used radios to brokers, or peddlers. These fellows re-sell them from little stores in poor neighborhoods. But one of them came to us the other day and offered us 10 trades at an extremely attractive price. He says he can get 35 more.

What I am afraid of is that if these fellows get a toe-hold they will quickly ruin the used set market and also the market for inexpensive new receivers. Some of us here are attempting to lick the problem by buying up trades ourselves at prices higher than the peddlers will pay. We get first choice.

At first thought, some dealers think they are getting off easy when they dump used stuff through peddlers. In the end they get stung as their own business is injured.

DUBUQUE, IOWA

FRED C. EVEN

We hung out a storm-warning in regard to this trend on pages 16 and 17 of the February, 1936 number, just one year ago. Read the article entitled "Second-Hand Radio Store Trend Grows."

EDITOR

## Exponent of the Axe

It is well known that there are many small companies continuing to make parts and tubes as replacements for sets after the original manufacturers have folded. I think all these companies should stop making parts for obsolete sets and just make parts for sets made in the past 7 years or so.

This will force owners of obsolete sets to junk them and buy new. While there are other sides to the question I believe they are few and far between.

CORAOPOLIS, PENN. ANTHONY PASATERI

Other sides to the question? This is putting it mildly. It would be lovely to wipe out really obsolete stuff in one fell swoop but, doggone it, sometimes manufacturers make good money selling parts for such sets. So what would you suggest be done about it?

EDITOR

## There Aren't Any

Radio manufacturers have a way of making things that if they knew how servicemen felt about them and also the attitude of the customer they would perhaps have done the job differently.

We had a radio of a reputable manufacturer come in for repair because the speaker did not sound right. We found that the voice-coil was rubbing against the pole-piece. But there was no way to re-center the speaker as it was all welded

together, never to be taken apart. Imagine how the customer felt when we told him the speaker of his new set had to be returned to the factory.

Here's another: A 6-volt mantel set was hooked up for demonstration the other day, black lead connected to the battery minus and red to the plus. The vibrator just hummed and nothing else happened. The leads were reversed, while the customer fidgeted and the set played. The assemblers must have been color-blind!

It is just too bad when manufacturers feel that they have a product that never needs to be serviced.

WILLMAR, MINN. LLOYD V. STENBERG

## Br-r-r-r!

If I were a dictator there would be many changes.

Every commodity bought and sold would have one unit price, and only one, regardless of whether the customer took one unit or a million. It would be all for one and one for all. As things now stand small business is out. One party can now buy at half the price that another has to pay, with the result that one party can sell on credit cheaper than the other can buy wholesale for cash.

No first class dictator would stand for anything like that.

I'd set up an accounting system, presided over by a public executioner paid on a strict commission basis. The heads in the basket would determine his days pay.

BERWYN, PENNA. PADRAIC LAGAN

## Export Agony

Until and unless American manufacturers send out to India both technical and businessmen (or one man possessing both qualities) there can be no unity of progress among the various export distributors here.

The undersigned is giving his opinion for what it is worth solely with the idea of being some help to American manufacturers and with no idea of teaching them their own business:

1. It is his considered opinion that American manufacturers should all agree in fixing a golden figure and thus arrive at the *Nett* retail selling price in the export market, by multiplying the dollar price with this golden figure according to currency.

2. All distributors in the export market should have a clause in their agreement that no discount is to be given to retail customers whether they buy one set or a dozen sets (Those who have a dealer's license are to be classed as dealers).

3. Maximum discount of 25 per cent only should be allowed to sub-agents appointed by the distributors; all the sub-agents should also be prohibited from selling at anything below the fixed price.

4. The distributor should be given an adequate margin of profit for his investment and undertaking to stock sets for local distribution in his territory which will leave him at least a *Nett* profit of 25 per cent after deducting all overhead charges including adver-

tising, free servicing, etc., unless the manufacturers open out Bonded Warehouses for distributors to draw on and not carry stocks.

5. That manufacturers make a binding agreement of at least five years minimum period with the distributors whom they find satisfactory after a trial period which can be mutually arranged.

BOMBAY, INDIA

D. R. D. WADIA

*The Automobile Co., Ltd.*

## More Notes On Noise

Your articles on Noise have been read with great interest. However, you seem to overlook entirely one of the fundamental causes for these conditions. I refer to the many small broadcasters who have for some reason or other persuaded the FCC to allow them to place their transmitters right in the center of the most thickly populated metropolitan areas.

Result: Inherent blanketing, cross modulation, squeals, whistles, etc. Under these conditions customers with even good modern sets, wave-traps and gadgets are able to *minimize* the annoyance only at considerable cost and inconvenience.

ASTORIA, N. Y. EDMUND MCD. BENDHEIM

In answer to Mr. H. M. Goldhoff's letter in your December issue of *Radio Retailing* it seems to me that Mr. H. M. Goldhoff is a newcomer to radio when he says that radio manufacturers have done practically nothing to eliminate electrical interference.

Let me advise Mr. H. M. Goldhoff that there are many manufacturers burning candles trying to eliminate man-made static which can be eliminated at the source in most cases but when trying to eliminate this static at the set itself the animal assumed a different color.

Does Mr. H. M. Goldhoff know that a 10-cent blinker such as used on Christmas-tree lights causes interference 60 feet away? As for car sets, let me advise that great improvement has been made in new models as against those of several years ago with respect to noise pickup.

JAMAICA, N. Y. WILLIAM RAZIN

I have read with extreme interest your article "Noise Is Costing Us Money," in the October number.

The writer is service manager for the above firm and for the past eight years has made a careful study of noise filter systems and noise-reducing antennas. We employ a truck service that handles a large amount of aerial and line filter work that is done in this city. I have attempted at various times to encourage a plan somewhat similar to that outlined in your article, but could not obtain sufficient lasting interest from others.

TORONTO, ONT.

K. C. BRIDGES

*W. H. Tait Radio Products*

# Amazing ARVIN Achievements

## VASTLY IMPROVE CAR RADIO

● You'll make more car radio sales and profits than you ever thought possible with the new Arvins. They achieve what your customers get on the finest home set. The Arvin Phantom Filter is only one of the many exclusive Arvin developments. It's a remarkable "booster station" that doubles the number of stations you get—filters out noise and vastly improves performance. With the Phantom Filter and its magic helpers, you have a new brilliance and clarity of tone undreamed of in car radio. See your jobber for full details.

**NOBLITT-SPARKS INDUSTRIES, INC., COLUMBUS, INDIANA**  
*Also makers of Arvin Rhythm Radios for homes and Arvin Hot Water Car Heaters*

...ASK YOUR  
JOBBER ABOUT  
THE ARVIN  
FLOOR PLAN DEAL



● Tailor-Fit Overhead Speakers, In-the-Set or Separate Case Speakers with beautiful deep tone. Matching panel controls and universal controls for all cars.

# Tailor-Fit ARVIN

Car Radio  
WITH THE  
Phantom Filter



3 new Tailor-Fit Radios—2 marvelous 6-tube sets and a 7-tube super-deluxe radio. Wide choice of control and speaker equipment. Complete set prices as low as

**\$39.95**  
LIST

ONLY  
ARVIN HAS  
The Phantom  
Filter

ONLY  
ARVIN HAS  
The Automatic  
Eliminoise

ONLY  
ARVIN HAS  
Permatune  
Transformers

ONLY  
ARVIN HAS THE  
Geographical  
Compensator  
and Other New Features

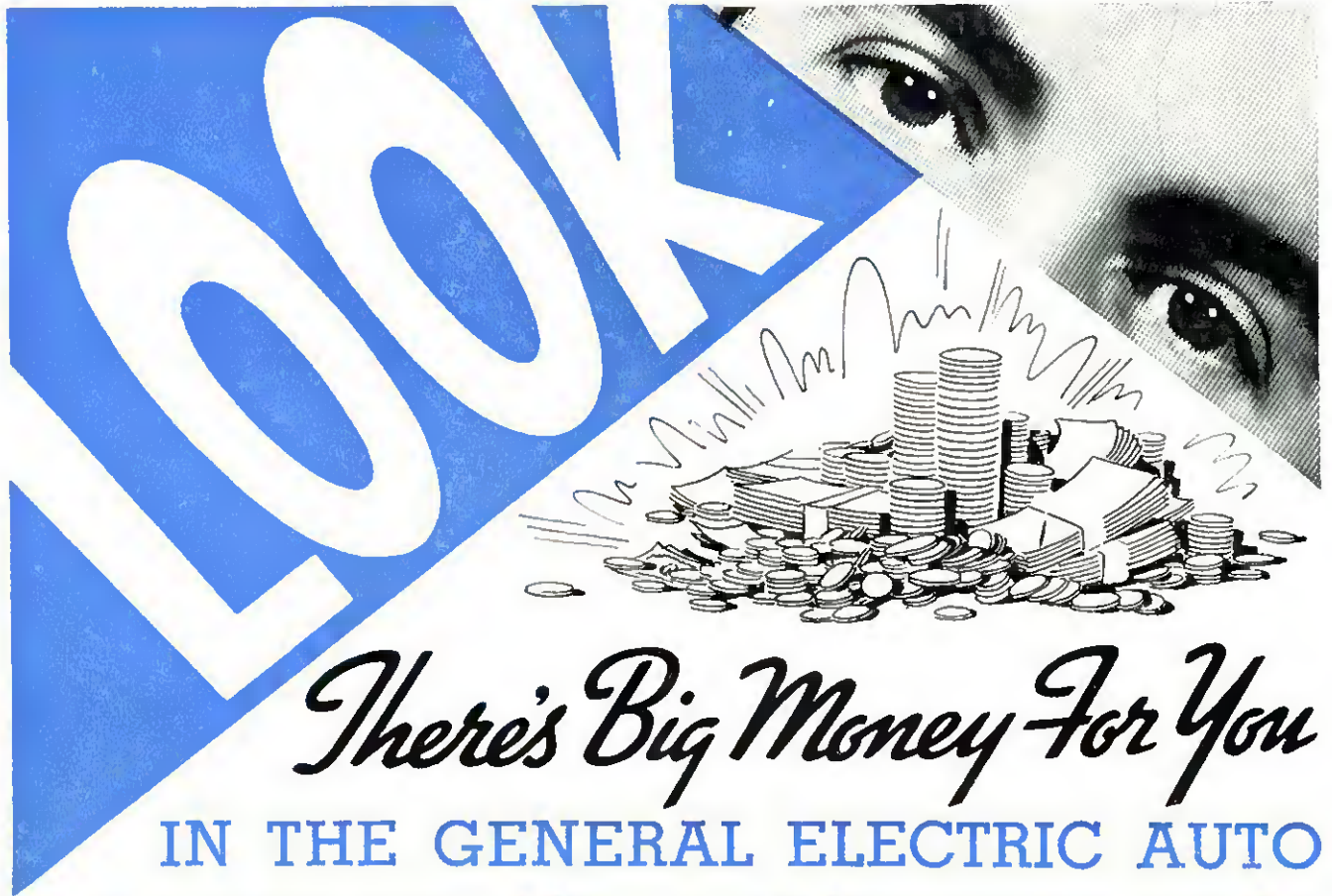

*There's Big Money For You*  
**IN THE GENERAL ELECTRIC AUTO  
 RADIO 1937 MERCHANDISING DEAL**

A package of FOUR new, modern, sensational G-E AUTO RADIO MODELS, **plus** a big assortment of SALES PROMOTION SELLING AIDS, **plus** a sensible purchase plan on custom-built mounting plates. Together, they comprise the G-E Auto Radio MERCHANDISING DEAL. Right at the beginning of the season, you get everything you need to sweep the auto radio market at a profit.

JUST **LOOK** AT THIS ASSORTMENT OF MODELS

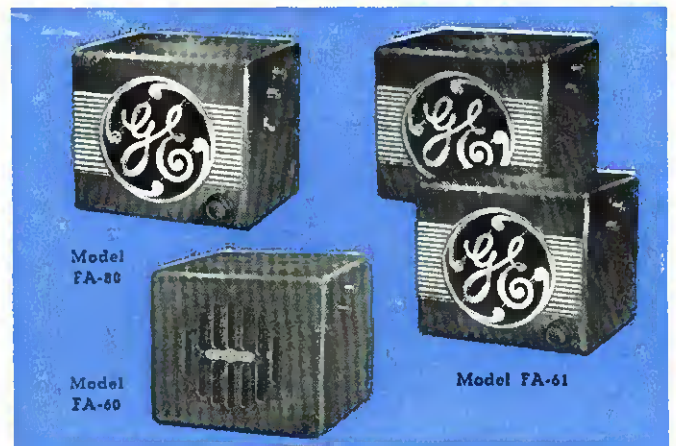

AND **LOOK** OVER THIS LIST  
 OF SALES PROMOTION MATERIALS

- \*Demonstration-Display Stand
- \*Truck and Store Banners
- \*Wall Chart
- \*Auto Door-handle Hangers
- \*Handbills
- \*Window Streamers
- \*"Saftee" Auto Reflectors
- \*Full-line Folders.

GENERAL ELECTRIC GIVES YOU

- \*Fast Turnover
  - \*Small Initial Investment
  - \*"Spotlight" Selling Features
  - \*"Custom-built" Controls for Instrument Panel Installation
  - \*Leadership in Design and Performance
  - \*The FIRST Auto Radio with AFC
  - \*A model in each of the three major price-class brackets.
- Ask your G-E Radio Distributor for details of the General Electric AUTO RADIO 1937 MERCHANDISING DEAL.

  
**GENERAL  
 ELECTRIC**  
**AUTO RADIO**  
 APPLIANCE AND MERCHANDISE DEPARTMENT.  
 GENERAL ELECTRIC CO., BRIDGEPORT, CONN.