

APRIL, 1935

RADIO RETAILING

INCLUDING
SERVICE
AND
INSTALLATION
SECTION

HOME ENTERTAINMENT MERCHANDISING

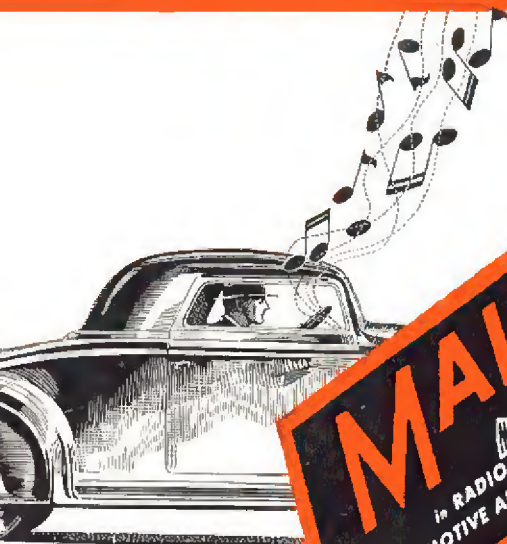

Now!

MALLORY

REPLACEMENT VIBRATORS

are available for **Every Auto Radio**
and... at no greater cost than
ordinary vibrators

Every Radio Service Man
should be a member of the
Institute of Radio Service Men



in RADIO, ELECTRICAL,
AUTOMOTIVE AND INDUSTRIAL FIELD
© P. R. M. Co.

Mallory Vibrators are the standard. Over half the automotive radio sets in operation are equipped with Vibrators made by Mallory. Mallory has led the way to better and more efficient auto radio performance—Mallory continues to pioneer each new development.

Now Mallory has Replacement Vibrators available for every set in every make and model.

As the vibrator is the unit in the radio set that naturally is subject to the most wear, vibrator service becomes increasingly important. Just as Mallory equipped auto radio sets give the finest performance, so Mallory Replacement Vibrators will give the greatest satisfaction.

Use Mallory Vibrators. Order from your jobber today.

P. R. MALLORY & CO., Inc.
INDIANAPOLIS INDIANA

2 ARVIN SPECIALS

COMPLETE THE LINE OF 5 FINE MODELS \$37.95 TO \$64.95

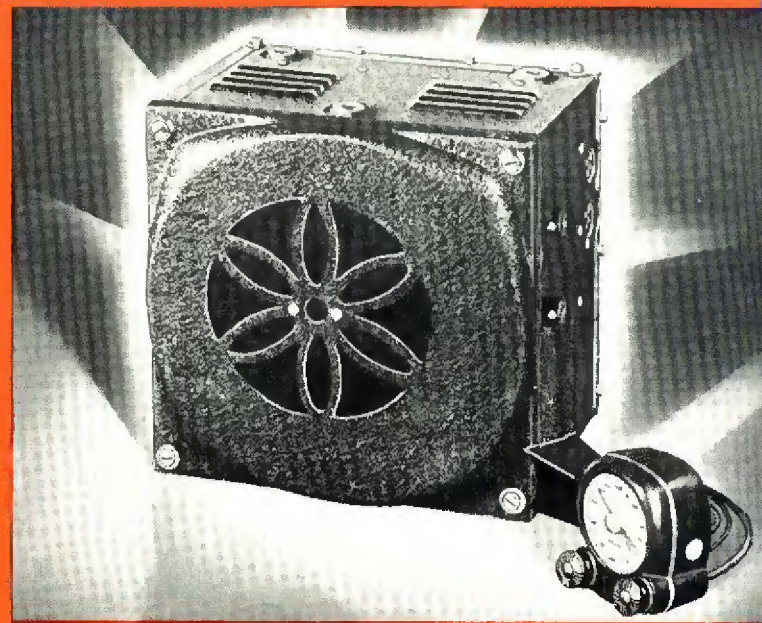
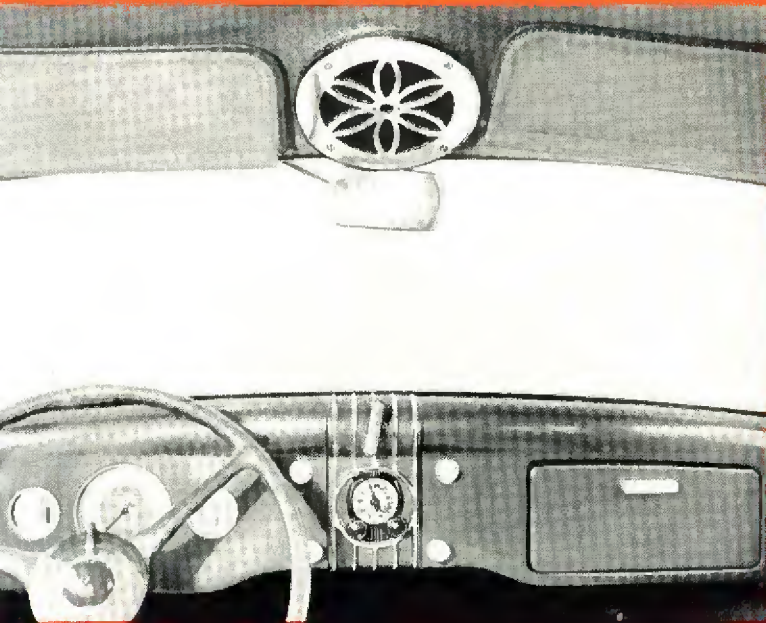

NEW ARVIN SPECIAL MODEL 17-A

Tailor-Made for 1935 Fords. A powerful 6-tube superheterodyne with overhead speaker that installs above the windshield. Remote control with airplane type dial clamps in the ash tray opening and matches the instrument panel of the deluxe Ford perfectly. All the new Arvins fit beautifully in the 1935 Fords—but this model is custom-built for them. Furnished complete with eight spark plug suppressors. **\$44.95 list**

NEW ARVIN SPECIAL MODEL 7

For All Makes of Cars. A 5-tube superheterodyne with automatic volume control built in—tone control—local and distance switch—airplane type remote control dial for steering column or instrument panel—and many Arvin engineering achievements that simplify installation and service. The car radio for those who want the magnificent performance of an Arvin at the lowest possible price. **\$37.95 list**

And Arvin Selling Support is as Complete and Powerful as the New Arvin Line, Including:

- The most beautiful and impressive consumer advertising campaign in the history of car radio—full-color “bleed pages” in The Saturday Evening Post—and a practical working plan that links the trade with Arvin advertising and builds a profitable volume of business for Arvin dealers.
- An all-inclusive lineup of selling helps for Arvin dealers—a wide variety of effective displays—tie-up newspaper advertisements, mailing cards and circulars—and a complete sales manual—in fact, everything you need to cash in on the big Arvin business-building plans.
- And a strictly jobber-dealer distribution policy assures progressive independent dealers the profit

they deserve on a line that leads right up to additional profits on Arvin Car Heaters. See your jobber now for full information on the complete Arvin Car Radio line and selling program behind it.

NOBLETT-SPARKS INDUSTRIES, Inc., Columbus, Indiana
ALSO MAKERS OF ARVIN HOT WATER CAR HEATERS

ARVIN
THE MAGNIFICENT
Car Radio

3 NEW AUTO RADIOS

by **ZENITH**

to give the prospect the price and performance he wants

"THIS RADIO IS A HONEY," writes Seattle Distributor

"I have just returned from . . . a town 100 miles north of Seattle and before leaving had Zenith Model 666 installed in my car. It is not my habit to make wild and extravagant claims for any radio instrument but, frankly, this is a honey.

"I was able to play about 15 different stations during the bright daylight and double that many coming home at night. . . . We are planning to equip all our salesmen's cars with these sets . . ."

SEATTLE HARDWARE CO.
by Arn Allen, Jr.
Manager Electrical Division

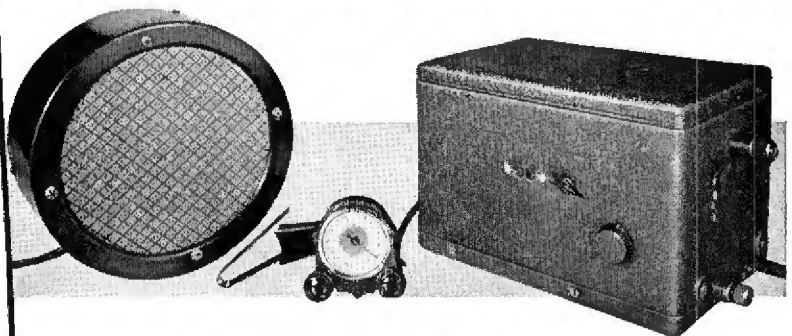

ZENITH MODEL 668 6-tube superheterodyne — \$51.95. 8-inch separate dynamic speaker.

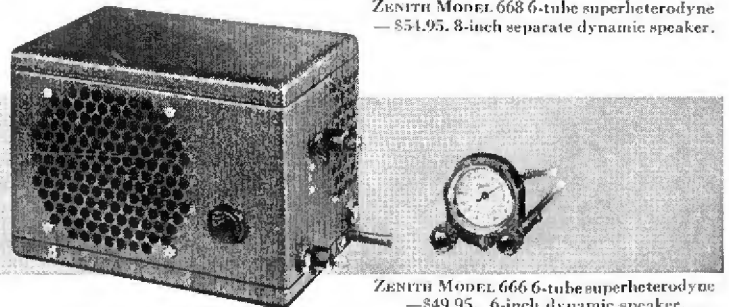

ZENITH MODEL 666 6-tube superheterodyne — \$49.95. 6-inch dynamic speaker.

Triple Filtered for Finer Reception Unexcelled in Tone and Selectivity

These three new Zenith Auto Radio Models now come in 5 and 6 tube sets priced from \$39.95 to \$54.95—a price and performance to fit any prospect, any pocketbook. Triple filtered to screen out the noises caused by auto ignition, power lines, trolleys, signs, etc. The greatest power and volume you've ever heard in any auto radio. They have a superheterodyne all-electric circuit that places a minimum drain on batteries. No special parts or accessories are required. You can install a Zenith Auto Radio quickly and without trouble. Check up on these sales features Zenith offers you: (1) Triple Filtering (2) wide price range (3) easy installation (4) a widely advertised name! Your distributor will give you all details on these 3 models. Write him!

Prices slightly higher west of Rockies (subject to change without notice)

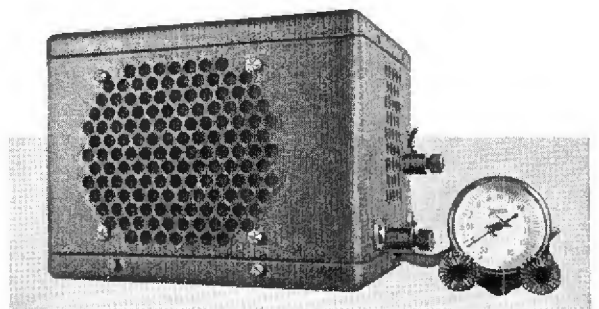

ZENITH MODEL 664 5-tube superheterodyne — \$39.95 f. o. b. factory. 6-inch dynamic speaker.



ZENITH RADIO CORPORATION, 3620 Iron St., Chicago, Ill.

MAIL THIS COUPON TODAY!

ZENITH RADIO CORPORATION
3620 Iron Street, Chicago, Illinois
Gentlemen: Please send complete details on your three new Zenith Auto Radios.

Name.....
Address.....
City..... State.....



"Now I see why the tone is so **NATURAL** *"*

Whenever a product is head and shoulders above competition, there is a reason. In the No. Seventy High Fidelity, the Acoustical Labyrinth, an exclusive Stromberg-Carlson development, makes possible, for the first time in a cabinet model radio, reproduction of deep bass tones without "boom". Never before has perfect reproduction of all sound from 50 to 7500 cycles been offered in a radio for the home. Only in a laboratory with a very large flat baffle has such tone quality hitherto been achieved.

Besides the ACOUSTICAL LABYRINTH, these Stromberg-Carlsons use Two Speakers—Bass and Treble—of large Dynamic Range, fed through a Dividing Network; Sound Spreading Vanes and a Broad Speaker Opening in the cabinet front for Wide Angle Sound Diffusion.

Stromberg-Carlson High Fidelity instruments are ALL-WAVE, covering every wave band from 520 to 23000 kc. Te-lek-tor Remote Control may be added.

Stromberg-Carlsons range in price from \$69.50 to \$935. (East of Rockies).

STROMBERG-CARLSON TELEPHONE MFG. CO.
ROCHESTER, NEW YORK



No. 70 All-Wave, High Fidelity, Te-lek-tor type.
Price, \$ 149.5. (East of Rockies).

Stromberg-Carlson



Overwhelming SALES PUNCH



**The AUTO RADIO
that does NOT cut
Motor Efficiency**

New Fairbanks-Morse Auto Radio Has *No Spark Plug Suppressors*

New Single Hole Mounting—New Aeroplane Glo-Lite Dial
—New Fingertip Tone Control—New Type Automatic
Volume Control—New Duplex Antenna Connection

• Stop and think what a tremendous selling advantage the Fairbanks-Morse Auto Radio has.

Thousands of motorists object to spark plug suppressors. These astute car owners know that suppressors cut down motor efficiency—cripple car performance—waste gasoline—reduce speed—cause loss of power.

F-M engineers have a new and better way of eliminating spark plug interference. This new method in no way cuts down motor efficiency, yet it ends spark plug roar

just as effectively as suppressors do.

Fairbanks-Morse Auto Radios also offer you every other worthwhile radio feature, including full-throated resonant tone quality typical of the best console receivers. And they pay a generous profit.

Write today for franchise details on the radio with the strength of 105 years of business integrity behind it. Fairbanks-Morse Home Appliance, Inc., 430 South Green Street, Chicago.

Cable Address: FAIRMORSE, CHICAGO

FAIRBANKS-MORSE

REFRIGERATORS - WASHING MACHINES - IRONERS



105 YEARS OF PROGRESS IN PRECISION MANUFACTURING

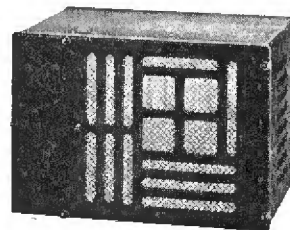

MODEL C6. 6 tubes—very sensitive and selective with good tone quality, sturdy case. Single hole mounting and duplex antenna connection make it easy to install.

\$42.95

Western prices slightly higher

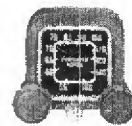
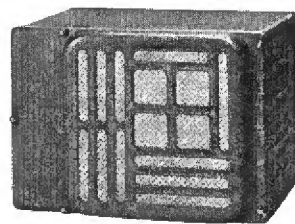

MODEL 64. 6 tubes—3 watts output—6" dynamic speaker. Newly designed rattle-proof case with single hole mounting can be mounted on end or back. Plug-in connections, easily installed.—

\$49.95

Western prices slightly higher

MODEL 74. 7 tubes—6 watts output—separate large 8" dynamic speaker. The sturdy, rattle-proof case can be mounted on end or back with the new single hole mounting. Convenient plug-in connections. Quick, easy installation.—

\$64.50

Western prices slightly higher

Auto Radio

SANITY

Arcturus Radio Tubes are built for performance . . . and are worthy of a quality price.

Yet they are sold to jobbers, dealers and service-men at competitive prices.

Arcturus asks no increase, but the quality list price gives dealers and service-men a greater profit.

To those interested in maintaining a stable business, write for complete details. Arcturus Radio Tube Company, Newark, N. J.

ARCTURUS
R A D I O T U B E S



Model "6-A"
—Six-Tube

No Spark Plug Suppressors Required

Single Unit Superheterodyne Set . . . Non-synchronous Vibrator . . . Automatic Volume Control . . . Tone Control . . . Dynamic Speaker . . . 3-gang Condenser . . . Operates on all cars, including "steel tops." Low battery drain . . . Attractive black case. Only 3 mounting bolts. Easy to install and service.

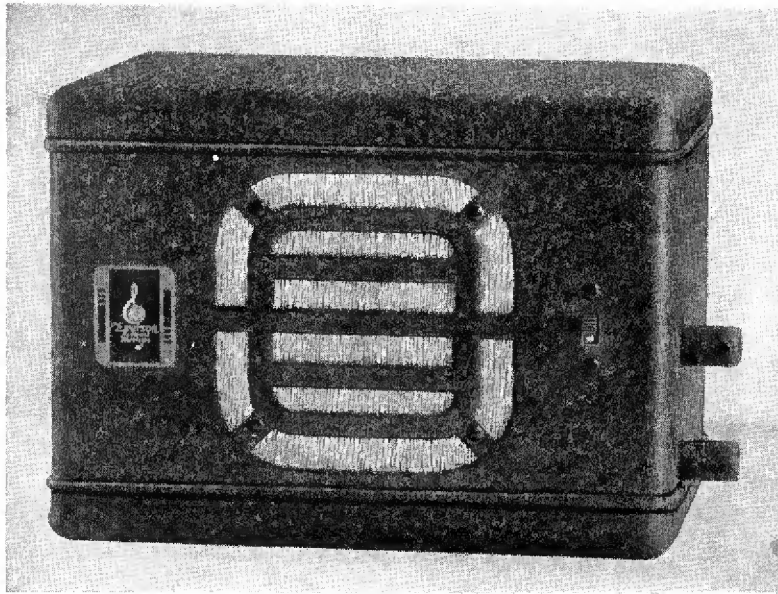

LIST PRICE

\$39⁹⁵

with RCA Radiotrons

Emerson AUTO Radio

Has Introduced New Features . . . New Values . . . New Profit Opportunities
With Powerful Sales Helps for Distributors and Dealers

Never before has Auto Radio been given such exhaustive study and provided with as many practical features. Installation improvements, construction advances and performance superiorities are all combined at prices which defy comparison. The elimination of spark plug suppressors, the new modern styling and general adaptability to all automobiles are but a few of the many advantages of these sets.

Never before has EMERSON been so well equipped to serve the interests of distributors and dealers. Attractive portable demonstration displays, literature, newspaper mats, field cooperation—the entire merchandising set-up makes this the most desirable Auto Radio proposition in the industry. (NOTE: Prices listed here are subject to upward revision. Write or wire for details now.)

De Luxe Model

New Plug-In Type—
Full-Wave

Synchronous Vibrator

Equivalent of SEVEN-Tube Set

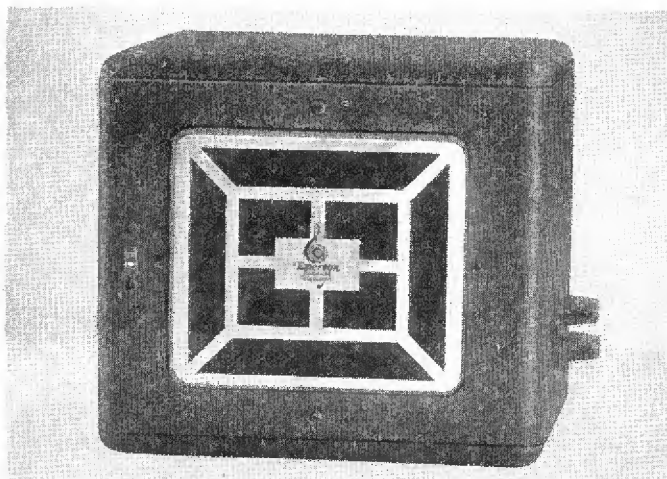

New Die-Cast Housing

Latest Development in Construction. Free From Rattles and Microphonism. Only Auto Radio of its Kind

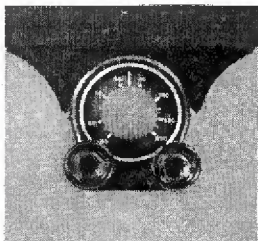

CHOICE OF MOUNTING

Steering Post, on Instrument Panel or Beneath Lower Edge of Panel
Indirectly illuminated remote control—free from back-lash and play—furnished with two brackets for steering post or lower edge of panel.

No Spark Plug Suppressors · Automatic Volume Control · Tone Control · 3-Gang Condenser · 6-inch Dynamic Speaker

By all odds, the **FINEST** Auto Radio ever produced. Single-Unit Superheterodyne five-tube set—new plug-in type full-wave **SYNCHRONOUS** Vibrator—equivalent of SEVEN Tubes . . . Die-cast case with chromium grille . . . Only two holes required for mounting. Complete with R.C.A. Radiotrons.

LIST PRICE **\$44⁵⁰**

(NOTE: Mounting Kit and complete instructions accompany each set.)

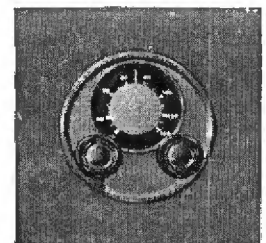

Special Mounting Plates

For Instrument Panels of Popular Makes of Cars

Special mounting plates can be furnished for such cars as Chrysler, De Soto, Dodge, Plymouth, Ford. Details on request.

ANNOUNCEMENT
to
TUNG-SOL RETAIL AGENTS

Recent price and policy developments in the Radio tube industry indicate that a period of panicky competition is to be expected. Tung-Sol Radio Tubes, Inc. will continue to maintain its retail partners in a position to resourcefully meet competition.

As in the past, no losses on inventory will be absorbed by Tung-Sol retailers.

**The Tung-Sol time tested consignment plan,
pioneered four years ago, continues unchanged.**

More than a quarter of a century of selling through independent dealers has enabled us to appreciate and consider their problems. Accordingly, Tung-Sol has conducted its tube business on consistent basic policies.

We believe that in this way the best interests of our retail partners and the industry can be served.

TUNG-SOL RADIO TUBES, INC., NEWARK, N. J.

ATLANTA · BOSTON · CHARLOTTE · CLEVELAND · CHICAGO
DALLAS · DETROIT · KANSAS CITY · LOS ANGELES · NEW YORK

Independent dealers, qualified to become Tung-Sol retail partners are invited to write for the name of their nearest distributor.

1920
The First
Fada Radio
was built

FADA Radio

1935
Over 1,000,000
Fada Radio
Owners

Announcing Two New

SUMMER

The New 5 Tube
**SUPER
FADALETTE**

19⁹⁹

Profit **SENSATIONS**

Two New Fada
Radios Designed
And Priced To
Create More
Summer Sales

The New Fada
**6 TUBE
MOTOSSET**

49⁹⁵

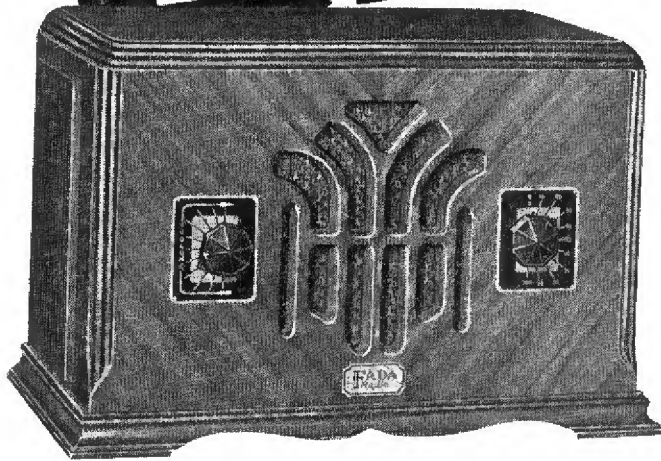

**BIG SET PERFORMANCE
BIG SET EYE VALUE
BIG SET TONE QUALITY**

Model 155: 5 tube superheterodyne with actual 7 tube performance; AC-DC 110 Volt 40-60 cycles; Tuning Range 540-1750 K. C. Dual illuminated dials; Self Contained aerial; Automatic Overload Control; Full Dynamic Speaker of exceptionally fine Tone Quality; High Output for Volume without distortion; Cabinet made from fine grain walnut with high lustre finish; Complete with genuine RCA Radiotrons.

**10 TUBE PERFORMANCE
YEARS AHEAD IN DESIGN
PRICED RIGHT FOR PROFITS**

Model 166: 6 tube superheterodyne, delayed automatic volume control, three gang shock mounted condenser; variable tone control, plug in vibrator unit; Three piece housing facilitates installation and service; Illuminated aeroplane dial; Remote Control on steering wheel or panel; Built-in spark filter eliminates suppressors; Diode detection; Low Battery Drain; 3 Watts Output; 6 Inch Full Dynamic Speaker of superb tone quality; COMPLETE with RCA Radiotrons.

THE FAIRBANKS-MORSE REFRIGERATOR

IS *Going Places!*



Going places! What other refrigerator in the entire history of the industry ever met with such widespread distribution and sales in such short time? What other refrigerator so instantaneously won the approval of distributors and dealers from coast to coast?

Why did these men, old in refrigerator knowledge, look at the Fairbanks-Morse refrigerator and decide so quickly that *this* was the line they would handle this year?

The answer is the CONSERVADOR!—the biggest selling feature built into a refrigerator since home refrigeration began. Franchises are still open for the right type of dealers in some localities. A few opportunities still exist for dealers to ally themselves with one of America's oldest, largest, and most respected manufacturing organizations. Write, phone or wire for complete information and name of nearest distributor. Fairbanks-Morse Home Appliances, Inc., 430 South Green Street, Chicago.

Cable Address: FAIRMORSE, CHICAGO



FAIRBANKS-MORSE

RADIOS-WASHING MACHINES-IRONERS

105 YEARS OF PROGRESS IN PRE



Refrigerators

CISION MANUFACTURING

Round for Sound—
Round for Sales—
and
**NO SPARK PLUG
SUPPRESSORS!**
(in most installations)



• This sparkling round display rivets the eye to this sparkling round car-radio

TWO NEW CAR-RADIOS

MODEL 634
(displayed above)—
10-tube-performance
with 6 high-efficiency tubes **\$52⁹⁵**

MODEL 524
—9-tube-performance
with 5 high-efficiency tubes **\$44⁹⁵**



Western Prices slightly higher

STOP! . . . says this round arresting bull's-eye display!

Look! . . . says the round Vibro-Balanced Design of this new American-Bosch Car-Radio!

Listen! . . . urges the slogan . . . "It's round for sound!"

And when they listen they hear something . . . a triumphant advance in car-radio tone quality. Tone Quality? That's why these sets are round! . . . Round to conform to a recognized principle in acoustical design—Vibro-Balance. This principle is introduced here for the first time in any car-radio. There's never been anything like it in car-radio before.

And there's never been anything like this display stand! It's a "honey." A rich aluminum background . . . a striking ribbon of red. It's a bull's-eye that stops you 50 feet away.

Hear these new car-radios! See this new counter stand! Phone your nearest American-Bosch distributor; or wire headquarters for literature, discounts, and full description of such sales-compelling features as Anchored Construction, Elimination of spark plug suppressors, Panel Mounting Control, new exclusive Tone Control, etc.—features that are making American-Bosch Police-Proven Car-Radio the Number One choice of dealers and car owners for 1935.

UNITED AMERICAN BOSCH CORP., Springfield, Mass., New York, Chicago, Detroit

The makers of American-Bosch products have always taken pride in creating, designing, building and selling products superior to those commonly in use. Proven leaders in their fields, these products are built up to a high standard of quality and not down to a price.



A FAIR DEAL TO ALL..

RAYTHEON'S New Price Plan effective April 1st, 1935 is built upon this keystone: "A Fair Deal to All"—consumer, dealer, service man and jobber. Its need was never more acute—a sixty-five million dollar replacement tube market slashed during the last five years to twenty-four million dollars—reduced prices and profits—loss of public confidence.

THE AVERAGE list price per tube on January 1st, 1930 was \$2.63; the average price per tube on April 1st, 1935 was \$.80 and no increase in consumer sales. An \$.89 price will sell no more tubes than a \$1.00 price.

RADIO TUBES are service items, not ordinary shelf or counter merchandise; tubes must be tested and installed; purchasers require information and advice, service questions arise; and for all this work the trade must be fairly compensated.

RAYTHEON'S new selling plan was built after weighing these factors; it incorporates the answer the trade is seeking and includes the only tube distinctly different in design—4-Pillar Construction—unexcelled quality, consumer acceptance and competitive trade prices—not price-slashing lures, but profit-building list prices. All 4-Pillar Tubes bear the Raytheon name; the story is easy to tell—the 4-Pillars are plainly visible to the consumer. Reputable dealers and service men everywhere recommend, endorse and sell them.

Ask your Jobber for complete details of Raytheon's plan, or use the coupon.

RAYTHEON PRODUCTION CORPORATION

30 East 42nd Street
New York

55 Chapel Street
Newton, Mass.

445 Lake Shore Drive
Chicago

555 Howard Street
San Francisco

RAYTHEON PRODUCTION CORPORATION,
Dept. A-5, 30 E. 42nd Street, New York:
Please send Detail New Price Plan Display Material
NAME _____
ADDRESS _____
CITY _____

FOUR PILLAR

RAYTHEON

RADIO TUBES

ATWATER KENT RADIO

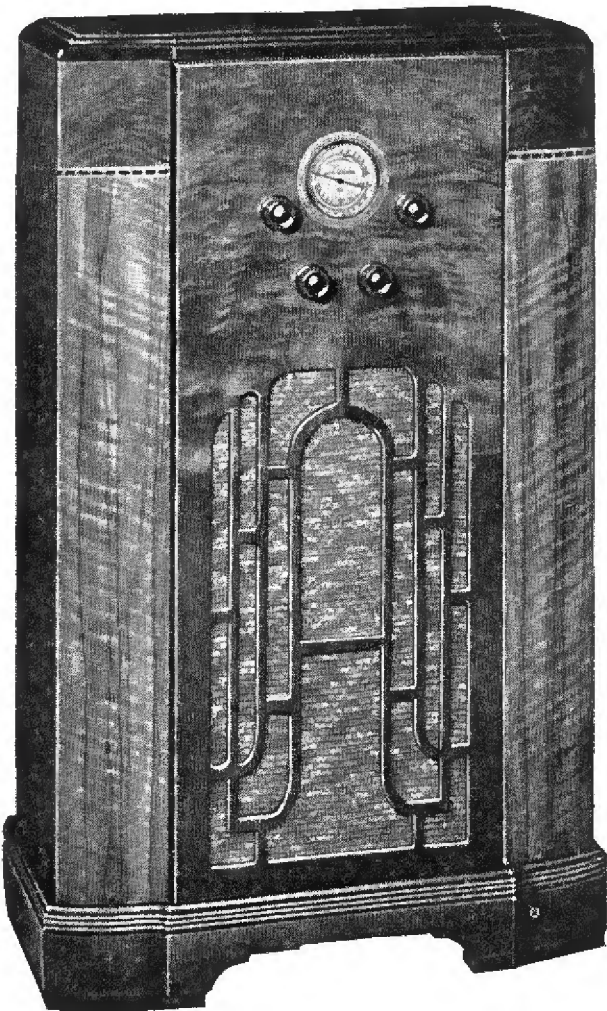

MODEL 475B—Five-tube A. C. Console—three-band tuning with regular broadcasts from 540 to 1600 kilocycles, all police broadcasts from 1600 to 4800 kilocycles and principal International short-wave broadcasts from 5300 to 16,000 kilocycles—new, smooth-operating two-speed tuning—excellent sensitivity and selectivity—illuminated airplane-type dial—three-point tone control—distinctive cabinet with butt walnut instrument panel and figured Oriental walnut pilasters.. F.O.B. **\$59.75** factory

• The profit sheets of thousands of radio dealers are repeating this year what they say every year: "Atwater Kent sales are profit sales. No rejects. No comebacks. No service bills. No lost customers. Every Atwater Kent means sure profits to you."

NEW MOTOR CAR RADIO MODEL 776
Six tubes. Three-gang condenser. Automatic volume control. Six-inch dynamic speaker. Shielded vibrator. One-bolt mounting. Pure tone. **\$49.90**
Rugged construction. F.O.B. Factory . .

MODEL 854—Four-tube A.C. Compact—two position tone control—vernier station selector permits exact tuning—four tuned circuits—illuminated dial—sensitivity control—large, powerful dynamicspeaker—tuning range 540 to 1720 kilocycles, which includes standard broadcasts and some police broadcasts. The cabinet is of rich butt walnut and figured American walnut with attractive inlay. **\$27.50** F.O.B. factory

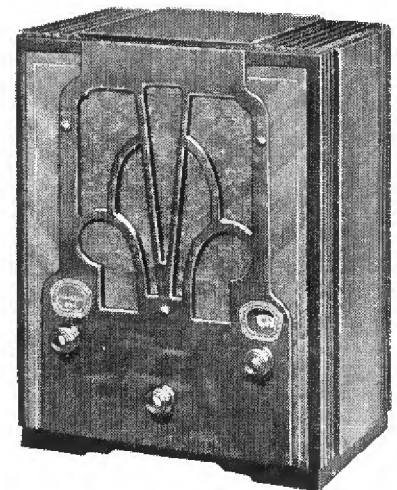

Prices subject to change without notice.

**Such Spectacular Values
As These 3 Typical 1935 Grunows
Plus Exclusive**

SUPER-SAFE CARRENE

ARE
KEEPING

Grunow

AT THE HEAD
OF THE PARADE

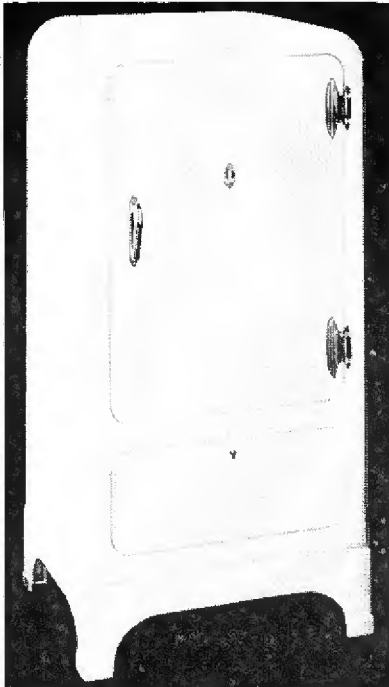

★GRUNOW MODEL 67 D—A big De Luxe refrigerator with 6.7 cu. ft. food capacity, 14.3 sq. ft. shelf area, 160 ice cubes. Has ice tray release, automatic light, and all other Grunow De Luxe features.

\$200 F.O.B. Factory—Federal tax paid

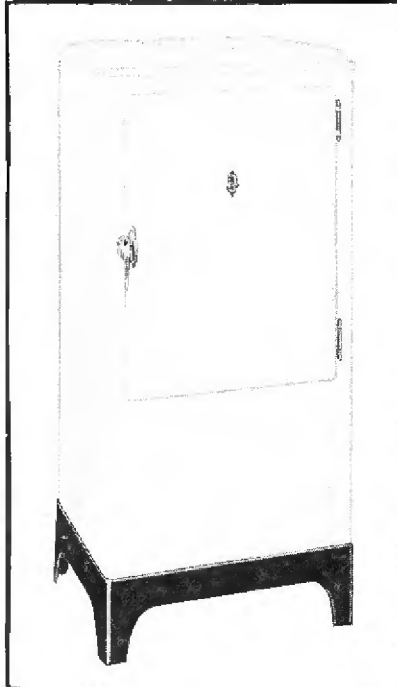

★GRUNOW MODEL 60 S—Large enough for a good-sized family! Almost 6 cubic feet of capacity—10.5 square feet shelf area. Automatic interior light and many other features.

\$155 F.O.B. Factory—Federal tax paid

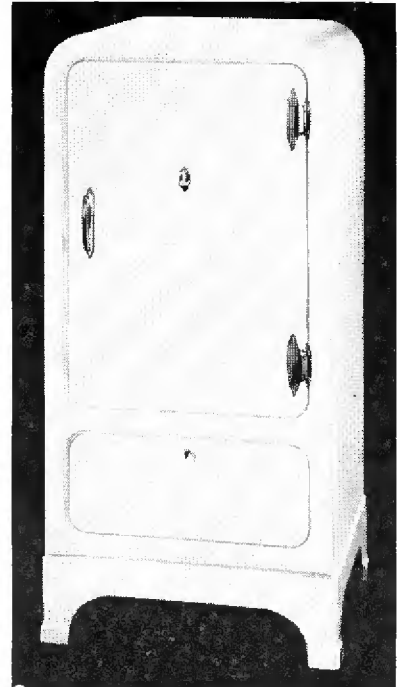

★GRUNOW MODEL 82 D—A huge, spacious De Luxe model with 8.2 cu. ft. capacity, almost 16 sq. ft. shelf area, 192 ice cubes. Ice tray release, new push-or-pull latch and all other De Luxe features.

\$230 F.O.B. Factory—Federal tax paid

Other Grunows of super-quality at equally low list prices to suit every family's needs

FLASH! Grunow refrigerators are advertised consistently every other week in full page space in the Saturday Evening Post

GENERAL HOUSEHOLD UTILITIES COMPANY
2650 North Crawford Avenue, Chicago, Illinois

Only DELCO AUTO RADIO

SYNCRO TUNING

Antenna automatically synchronized with aerial

has

UNIVERSAL CONTROL

One control dial with special mounting plates for all cars

FOUR MODELS

For every price range —completely cover the market

WARRANTY

That covers both parts and labor

-backed

ADVERTISING

50-50 newspaper and direct mail

BY A MERCHANDISING PLAN THAT SELLS!

These are only a few of the many outstanding features of these revolutionary new radios. And that's not all—they are backed by a merchandising plan that will make sales a certainty. Direct mail—large demonstrating display stand—counter display stand—large cloth display

banner for outdoor or indoor use—free newspaper advertising mats and window streamers—every thing you really need! Mail the coupon NOW and get complete details on these amazing new Delco auto radios and the liberal, comprehensive merchandising plan that sells them.

UNITED MOTORS SERVICE

General Offices
Detroit, Michigan

UNITED MOTORS SERVICE, 3044 West Grand Boulevard, Detroit, Mich. Please send your complete Merchandising Plan on the new Delco Auto Radios.

Name _____

Address _____



★ From the New York Musical Comedy, "Anything Goes"

Let the "Magic Brain" put zip into your auto radio sales

Over 22,000,000 cars are now ready for the "Magic Brain" on the road—a golden summer market. Let RCA Victor help you get your share of this rich sales opportunity. The "Magic Brain" is sweeping the country! And RCA Victor's great new money-making line of auto radios is built on the famous "Magic Brain" principle—the most complete line of auto radios... for every car and every purse... from \$44.95 to \$74.95 f.o.b. Camden, N. J. ... outstanding in value and performance... with remarkable tone beauty, tuning ease and freedom from ignition noises.

Every RCA "Magic Brain" auto radio has the new streamline control unit—the most modern and attractive unit in auto radio design... as well as the exclusive RCA Victor ignition noise-filter which guards against spark-plug interference, and the "POWERTRON", a special RCA Victor power device which gives *extra tube* reception at no extra cost.

Get ready now to boost your warm weather profits!

A new development... RCA Victor's new DI-POLE antenna for "turret-top" cars. Easily installed under the running board!

An RCA Victor Auto Radio from \$39.95 to \$74.95 (F.O.B. Camden, N. J.)



RCA VICTOR

AUTO RADIO

RCA VICTOR, A UNIT OF RADIO CORPORATION OF AMERICA... THE WORLD'S LARGEST RADIO ORGANIZATION. OTHER UNITS: NATIONAL BROADCASTING CO., INC. ... R.C.A. COMMUNICATIONS, INC. ... RCA RADIO-TRON ... RADIOMARINE CORPORATION OF AMERICA

Model M-101, The "Magic Brain" on the road... with streamline control unit. Sensational radio performance. Only **\$44.95** f.o.b. Camden, N. J.

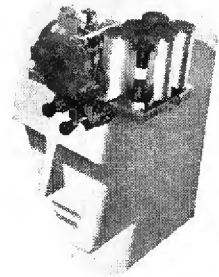

The "Magic Brain" acts like the human brain—concentrates entire set on the station you select—brings higher fidelity tone, more stations, easier tuning, freedom from noise.

A fast selling living-room set. Model 243—"Magic Brain" Console Grand Radio. Tuning range from 140 to 410 and from 540 to 18,000 k. c., which includes U. S. Gov't. weather forecasts, standard domestic broadcasts, police, aircraft, amateur signals and foreign reception. 10" dynamic speaker, airplane dial, automatic anti-fade volume control. Two-toned hand-rubbed walnut. Complete with RCA micro-sensitive radio tubes. **\$119.50** f.o.b. Camden, N. J. (Prices subject to change without notice.)



RADIO RETAILING

O. H. CALDWELL
Editor

HOWARD EHRLICH
Vice-President

H. W. MATEER
Manager

RAY V. SUTLIFFE
Managing Editor

W. W. MacDONALD
Associate Editor

T. H. PURINTON
Assistant Editor

HARRY PHILLIPS
Art Director

PAUL WOOTON
Washington

APRIL 1935

VOL. 20

NO. 4

TUBE TURMOIL

29,000,000 replacement tubes sold last year. Ten million of these retailed at prices well under established lists.

One hundred and forty private brand tubes available for public purchase at from 19 cents up. A preponderant majority of tube manufacturers, large as well as small, supplying this market and quoting retailers the equivalent of jobbers' discounts.

Wholesalers, dealers, servicemen buying from the lowest bidder regardless of any obligations which they may have incurred to feature some other brand.

And a few tube makers committed to a policy of conservative dealer and jobber discounts and the maintenance of advertised prices.

This unbalanced situation just couldn't continue. The inevitable has happened. April 1, RCA tube consignment contracts were rescinded—and a lower "competitive price policy" now prevails. RCA has filed new schedules and the other tube concerns have done likewise. A majority of the latter, however, are from six to 20 cents higher on certain tube types.

Out of this welter of price schedule filings and re-filings it would appear that the average reductions on the active movers is 15 per cent and that those types priced at 59 and 69 cents will account for approximately 45 per cent of "demand" tubes.

SO much for past history. What of the near future? Are we about to enter a period of intensified turmoil in the tube industry? For the present such would appear to be the case.

Will this latest explosion seriously injure the tube business of the alert independent retailer? We think not. For those dealers and servicemen who possess the

necessary business sagacity will still sell many tubes at profitable markups. And in this they will be aided by more than one far-seeing tube manufacturer.

WHETHER or not the average radio man can now increase his tube sales sufficiently to return a greater net profit than heretofore is a matter of wide differences of opinion. Certain seasoned tube makers predict an increase in the swing toward the cut price houses. Others contend, however, that the small merchant will find himself in a better competitive position than before—and able to sell more tubes per customer.

It is unfortunate that this latest tube war had to happen. As *Radio Retailing* repeatedly has stated, the public is not—or was not—tube price conscious, the majority of dealers and servicers want *higher* not lower prices and can get their asking price.

WHILE, at this late date, no purpose is served by any attempts to fix the blame, it is of interest that it is now generally admitted that practically every tube maker had a finger in the pie. "We simply don't know how to get together and play ball," to quote a well known sales manager.

And so the fight is on—and no favors asked. But out of it may come, we earnestly hope, a blanketing of the "inside" price advantage which the price specialists not only have enjoyed but have been encouraged to pursue due to these many special deal practices.



MANAGING EDITOR

Getting
Ready



Now's the time

to buy that

AUTO-RADIO

the Old Bus

for the Road?

SPRING is in the air. Roads are clear and Lake Pocahokus beckons. Out with the touch-up brush. Down to the garage for the season's overhaul. For soon the old bus will be rolling along over the roads to the land of "Sunday drivers."

No need to do without your radio while you ride. Now's the time to turn your car into a veritable home with an auto-set.

Reception as good as you get right in your favorite easy chair. No fading. No crackling. No extra batteries or accessories to worry about.

Installations take less than an hour and the "fixings" harmonize with the dashboard of your car . . . all at new low prices.

Now's the time to buy that AUTO-RADIO.

TO "DISCOURAGED" DEALERS

Today, as never before, we are suffering from the onslaught of the mail order houses . . . How can we sell against this competition? . . . What protection are the setmakers going to give us?

The above, in substance, is the gist of a letter received from a radio dealer in West Virginia. Published in the February issue of *Radio Retailing*, it invoked a widespread response; mostly of a sympathetic nature.

Elsewhere in this issue we print some of these replies. One, signed "A Discouraged Dealer," plumbs the depths. But do not fail to read also Mr. Cloyd's rebuttal.

Defending the practice of selling to nationally known catalog and chain store houses, a leading set manufacturer advances this argument: "By taking this type of business we can build up production to a point where our dealers obtain far more attractive values, which are considerably more competitive to mail order and chain stores' prices than if our production was based only upon supplying the demand of regular jobber-dealer outlets."

To those manufacturers in a position to do so, *Radio Retailing* suggests consideration of the feasibility of producing one or more "pursuit" models—receivers de-

signed and priced specifically to enable dealers to meet this so-called "direct-from-manufacturer-to-user" competition.

It is not easy to meet entirely the tactics of Sears, Ward and others. In many instances, however, it can be done. The dealer is not without responsibility in this matter. To those of our readers, therefore, who want to take off their coats and go to work we throw out the following thoughts:

1. The dealer has a far better chance to accumulate customer lists and to "use the user" than the mail order chains.

2. Independents are better able to select, train and supervise salesmen.

3. On price the chain has the edge—but is not able to "trade up" to a better item as is the local merchant.

4. Local dealer has every advantage when it comes to rendering maintenance service.

5. The sentiment of the community normally is for the independent local man.

6. In local social-business activities the town merchant can skate rings around the chains.

COLD—BUT VERY MUCH ALIVE

Dealers who have dismissed cold canvassing as an impractical idea should consider the following experience of the Home Radio Company, Milwaukee, Wisconsin:

House-to-house introductory calls put this firm in the success class within a two-year period.

Today its outside representatives are averaging nine set sales for every 100 cold calls. True, many of these are replacements—"but business we would miss entirely if we didn't go out and grope for it."

Home Radio now has a mailing list—"with all the facts on each card"—second to none in its section of the city.

"Times have changed," declares Sales Manager Alfred Wilson. "New earning power has suddenly blossomed forth in families heretofore regarded as hopeless prospects."

Lastly, the new all-wave models supply the final justification for this all-coverage, personal call method of selling.

"Now it pays," says Mr. Wilson.

Tube Makers Define Contestants in Latest Price Battle

The advent of April 1 marked the greatest upset the tube industry has yet experienced. We have interviewed practically every tube manufacturer. Contemplated policies to meet these new conditions vary. Without exception the top executives would like to go on a basis of higher list prices and reasonable discounts but claim that the sharp shooters would still lurk in the woods and take pot shots at those holding the umbrellas, to mix our metaphors.

We urge our dealer and jobber readers not to be too hasty or severe in their judgments or criticism. No one manufacturer is to blame. The spirit to work out this problem on a sane basis still persists. For the present let the retailer "carry on" and make the best of a perplexing situation.

Following are exclusive interview statements to "Radio Retailing":

"RCA Forced Off Consignment and Into Present Policies"

*E. T. Cunningham, President
RCA MANUFACTURING CO., INC.*

"What would you do, Mr. Sutcliffe, if you were in our position? Quite frankly our dealers and jobbers were not producing the volume necessary to make practical the continuance of our tube consignment plan—a plan whose primary purpose was the maintenance of higher list prices which they had requested. After giving this plan a fair trial it was increasingly evident that we must place our dealers and jobbers in a position to meet competitive tactics."

"I am inclined to agree with you," I replied, "that possibly your consignment plan made you vulnerable without adequate partner support; that the thing to do was to switch the bid to some other suit, but I question the wisdom of again lowering prices."

To this Mr. Cunningham responded, "This move was made having in mind the welfare of the dealer and the serviceman. Due to the increasing prevalence of cut price tube offers our retail agents reported it more and more difficult to obtain their proportionate share of the tube business in their territory. By reducing list prices we hope to narrow the retail differential which has existed between tubes offered for sale by cut price specialists and our own retailers. Thus the latter now should be able to get more of this business to which they are justly entitled. The decision to price certain tubes at 'odd cents' figures (59c., 69c., 89c., 99c.) illustrates this point. To the consumer these list prices will appear more competitive, quality considered, with those tube prices

they have been accustomed to seeing featured in the advertising of mail order concerns and other cut price stores."

We then pointed out the probability that such a move would likely result in immediate offerings of all types of tubes, including Radiotrons, at even lower bargain prices.

"Possibly," said Mr. Cunningham, "but every effort will be made to keep our discounts within reason so as to discourage this practice and it will be our objective, as before stated, to keep our dealers on such a competitive basis that they will be able to obtain a greater proportion of the business than they have in the past.

"Stabilizing the tube price market evidently is contrary to 'human nature,' at least during depression times. It has merely resulted in increasing 'cross fire' in which radio consigned stocks were looked upon as a convenience and not as an obligation nor an opportunity to build a profitable business.

"Under the new plan a 20 per cent volume increase in replacement tube sales will return a slightly greater net dollars profit than under the old one—and that extra volume the live merchandiser should obtain because he can get a greater share of tube business and should be able to persuade more customers to buy more tubes.

"In justice to RCA I think it should be pointed out that my company does not manufacture private brands nor does it sell 'seconds.' Neither have we indulged in making inside private deals. RCA will continue these policies and will make every attempt to strengthen the competitive position of the dealer and service man."

"Will Maintain Present Consignment Policies in Every Respect"

*H. W. Harper, President
TUNG-SOL RADIO TUBES, INC.*

Since the first rumors of impending price cuts began to trickle through the trade, we have received numerous letters and telegrams from our retailers deploring any such reductions and recommending that Tung-Sol stick to its present price schedule or even increase it.

Much as my company would like to do this, after mature deliberation Tung-Sol believes that it will be in the best interest of its distributors and dealers to meet the new list price schedules. However, and in every respect, our consignment policies will remain entirely as now established. The present schedule of discounts therefore will not be altered. Neither will the Tung-Sol tubes be priced at "odd cents" (retail) but will take the next higher even number figure. We make only one

Their New Policies

Interviewed by "Radio Retailing"

brand of tube—and that tube is trade marked Tung-Sol.

After the present hysterical condition is passed and the resultant situation can be more clearly appraised, Tung-Sol will increase list prices if it appears to be mutually advantageous.

"For Higher Lists and Decent Profit Margins"

D. T. Schultz, Vice President
RAYTHEON PRODUCTION CORP.

In our opinion, dealers generally are very much dissatisfied with these continual slashes of list prices on tubes which have reduced their gross dollar volume and net profits. The enthusiasm of dealers directly controls their sales effort. Raytheon believes that retailers are entitled to a fair margin of profit and that this can be obtained only through higher, not lower, list prices.

Accordingly, and based upon the intrinsic value of the article offered for sale, our lists will range from 6c. to 10c. higher than those recently announced by the RCA Manufacturing Company.

"We Will Continue Our 'Higher List Price' Policy"

H. A. Hutchins, Vice President
NATIONAL UNION RADIO CORP.

In the belief that radio tube prices were being depressed to levels economically unsound from the viewpoint of the dealer, distributor and manufacturer, about two years ago we raised list prices of National Union tubes ten cents per tube above the general level of the industry.

The radio trade expressed its appreciation of this leadership by returning a substantial increase in the volume of National Union tube sales.

In the present chaotic condition of the radio tube industry National Union will continue to maintain for dealers and distributors the highest possible margin of profit. It will continue to maintain its high standards of quality and will follow its established "higher list price" policy and constantly seek through constructive merchandising activities a means of leading upward to a sane price structure and fair profits for the trade.

"Price Situation Deplorable"

Roy Burlew, Vice President
THE KEN RAD CORPORATION

I can only say that the price situation at present obtaining in the tube industry is a most deplorable one. It is unfortunate that it should appear necessary to market such a highly technical line solely on the basis of price, leaving the manufacturer, jobber and dealer without much chance of profit.

"Believe Higher List Prices Needed Under Present Conditions"

B. G. Erskine, President
HYGRADE SYLVANIA CORP.

Hygrade Sylvania Corporation is definitely *not* in sympathy with the lowered list prices recently announced to the radio industry.

To properly take care of the constantly increasing complexity of modern radio receivers, thousands of dealers and service men have made substantial investments in technical training and equipment. In so doing, they have lifted the sale of a radio tube entirely out of the category of convenience merchandise, sold on short margins of profit and too often at cut prices.

The set manufacturing section of the industry has made definite and admirable strides in making available to the public a type of radio receiver which is not equalled anywhere else in the world. The good will which the public now has toward these manufacturers will be torn down if the standards of dealer and service men groups are not maintained.

Rather than lower list prices for radio tubes, it is our sincere belief that higher list prices are required under present conditions.

What is the simplest way of bringing together the set owner and the radio dealer and service man? The answer is—thru service contacts. The intelligent dealer will recognize this and will aggressively push the service side of his business. But it is not reasonable to expect that selling thru service will receive the proper attention unless it is profitable in its own right.

We have always believed in profitable operation for the wholesaler and the retailer, and we see nothing in the present situation to make us alter this policy.

(For further statements and other tube news please turn to pages 32 and 33.)

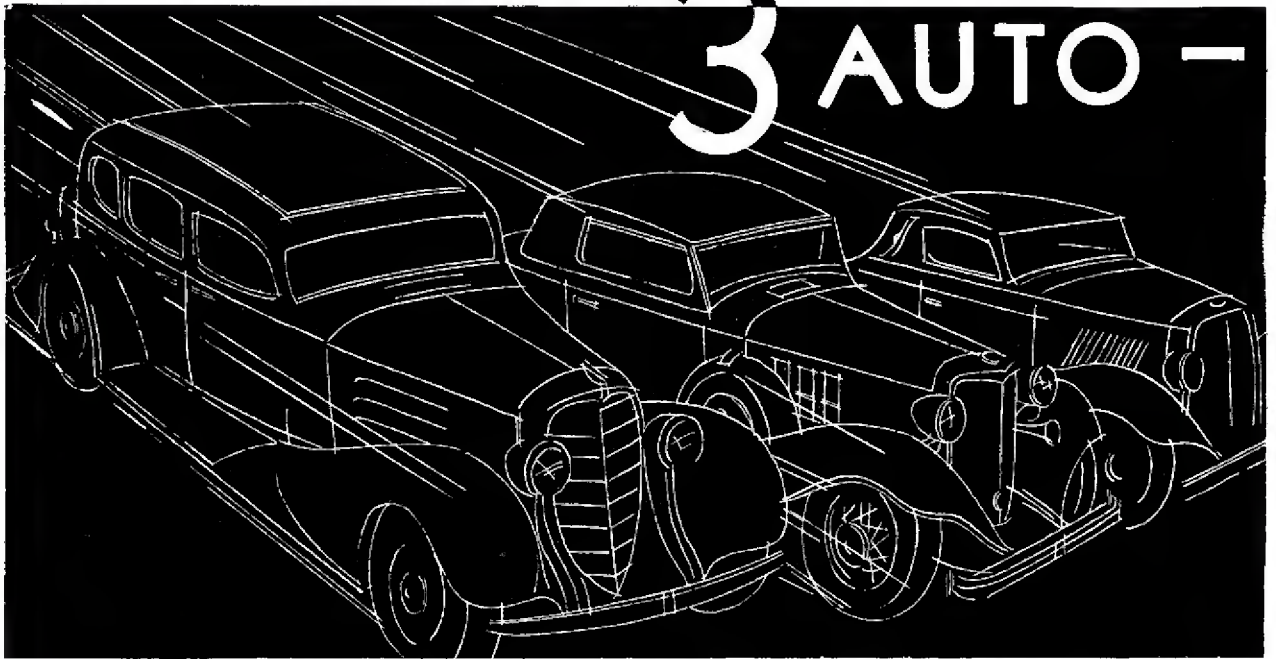

SELLS THE INSTALLATION TO LICK THE AUTO-RADIO "CHISELER"

Henry's, Inc., radio dealer at 376 High Street, Newark, New Jersey, has sold 204 auto-radios at full list within the past 12 months, despite keen cut-price competition in the local territory, which includes New York City. How? By selling the installation rather than the set.

"We are making money because we convince auto-radio prospects that they do not save money by purchasing a price-cut set if the dealer who sells them the set cuts corners on installation in order to do it. A sign in our showroom carries the gist of our sales talks:

'Buying a high-grade auto-radio is no assurance that it will give high-grade service. Buy a high-grade auto-radio where it receives high-grade installation. We sell both.'

"This type of appeal is effective when dealing with car owners who have been quoted by price-cutters, or who want us to chisel. We explain that any dealer can cut price if he takes the difference out of the installation. But the purchaser eventually suffers as the set cannot possibly perform as well as it would with a good job and costly adjustments and repairs, to say nothing of inconvenience, are certain to follow.

"This argument lacks punch when selling home sets, but seems to be convincing when selling auto-radios."

TRY THIS TIE-UP WITH CAR DEALERS

The automobile boys, no slouches at selling, have developed a hot new idea for boosting auto-radio sales to purchasers of new cars. Here's the story:

When a man buys a car and signs his John Henry on the dotted line the salesman says: "You ought to have a radio for your new car. Let us install one before we make delivery. Don't pay for it. Simply use it while you are breaking the car in. We will loan it to you at our own risk. When you come in for your 500-mile adjustment we'll sell it to you or take it out if you decide

you don't want to keep it. No argument, no obligation."

Read what three car-dealers who have tried the plan say about it:

"In the first month we put 28 sets out with new cars on trial. Twenty-four of them were sold when the customers came back for 500-mile adjustment." . . . H. M. Smith Company, Paterson, N. J.

"Last year we sold only 18 auto-radios. In the first six weeks of this year, using the trial plan, we sold 30." . . . Brown Chevrolet, Inc., White Plains, N. Y.

"We find the easiest way to merchandise radios is to install them in new cars at the time of delivery on the basis of a free trial to 500-mile adjustment. About 90 per cent of these installations remain sold. In the case of a cash purchase we offer to refund the money at the end of 30 days trial if the set is not wanted." . . . The Cochrane Chevrolet Company, Bridgeport, Conn.

How can a radio dealer use this plan? Tie up with local car salesrooms and use it "as is." Not all such salesrooms have their own radio. And not all of them want to be bothered with the installation phase of the business.

TUBE "ENDURANCE CONTEST" AIDS SALES

"There have been all kinds of endurance tests," says Benjamin Swayne, manager of The Hub Piano Company of Baltimore, "but never to my knowledge a radio tube endurance contest. I put a tube in the center of my window between two new boxes, which put over the idea that the tube itself had been taken from one of the boxes and was brand new. Then I connected the filament to the secondary of a small transformer, hooked the primary up to the 110 line and let it burn.

"A display card was placed beneath the tube, reading:

ENDURANCE CONTEST
How Long Will This High Efficiency Tube
Continue to Burn?

It started Thursday, March 19th, at 9 a.m. It has been burning to date Hours.

"The hour space was equipped with slots into which

RADIO *Sales Ideas*

Others on Tubes and Window Displays

a new card, bringing the time up to date each day could be inserted.

"The idea created a lot of attention and people came into the store to talk about it, so we decided to award a complete kit of tubes to the person estimating the total life of the tube most accurately. Small paper slips reading as follows were handed out to inquirers:

	<i>Hours</i>	<i>Minutes</i>	<i>Seconds</i>
I estimate the High Efficiency			
Tube will burn continually.....
Name:			
Address:			
I own a	radio (year and make)		
It has	tubes (type and number)		
Positively no estimates will be accepted unless deposited at the store. Do not mail.			

"Store traffic increased materially as a result and we soon had an excellent mailing list for solicitation on tube and set business."

into the instrument panel, attracts considerable attention. The improved tone of modern receivers, comparable with that of home models, is stressed when playing the sets.

"Most furniture stores shy away from auto-radio, as it involves more installation trouble than home models. We feel that the relatively light credit losses associated with this business more than compensate for this. Because it is much easier to check the credit of a man with a car, which he generally purchases through a finance company, reverts run less than 3 per cent of sales."

AN EGGS-ELLENT DISPLAY

The Radio Shop of Newark, N. J., injected a touch of magic into its Easter window. The background showed 50 eggs, quivering in the air, seemingly without support. Shoppers craned their necks in vain. The trick fooled them. How was it done?

The displayman extracted the yolk and albumen from the eggs and strung them, lengthwise and equidistances apart, on five long, black threads with drops of glue at the perforations. He enclosed the window with an all-black background and suspended threads of 10 eggs from sticks behind an overhanging crepe paper valance. The black background renders the black threads invisible. A small electric fan behind the background valance kept the eggs quivering while the gazers gaped.

Eggs-ellent motion also is injected into this window by slowly revolving a pyramid of eggs on the top of a phonograph turntable. This pyramid of white cardboard was completely covered with eggs, one standing on top of the other and a lone egg perched on the apex.

What prevented them from falling off? Simple. A few drops of glue at the intersections of the pointed ends. To make the trick most effective white eggs and white underlining must be used.



8 x 3 FT. DISPLAY INCREASES AUTO-RADIO SALES 50 PER CENT

"Fifty per cent of our auto-radio sales," says A. T. Erickson, radio buyer for Powers Furniture Company of Portland, Oregon, "are credited to an 8x3 ft. display placed in the center aisle of our main floor, directly in front of the elevators. Four different models are set up on supporting boards, complete right down to the steering wheel. Prospects literally stumble over them when walking through the store and may tune in for their own demonstration.

"We are now playing up the airplane dial both in this display and in our windows. A complete dashboard, showing how modern receivers may be 'blended' right

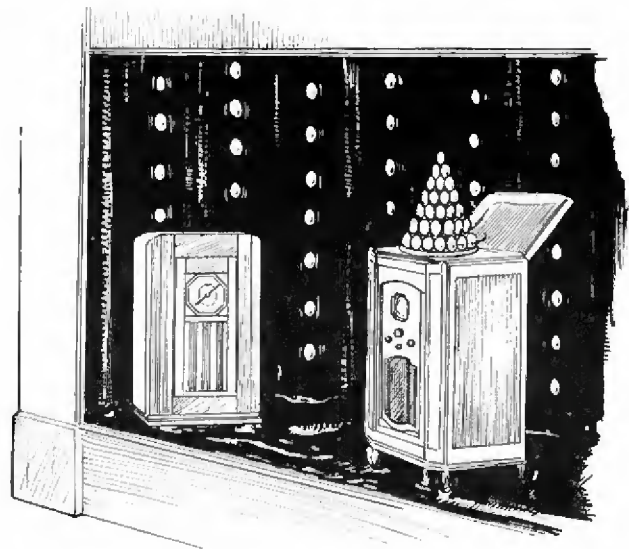



NATIONAL RECOVERY ACT

It has been the declared policy of the Congress and of the President to remove obstructions to the free flow of commerce which tend to diminish the amount thereof, to provide for the general welfare by promoting the organization of industry for the purpose of co-operative action among trade groups; to induce and maintain united action of labor and management under adequate governmental sanction and supervision, and to eliminate unfair competitive practices.

This policy of the Congress has been placed in effect by the National Recovery Act which provides for the formation of Codes of Fair Competition upon application to the President. After the President shall have approved any such Code, the provisions of such Code shall be the standards of fair competition for such trade or industry, or subdivision thereof.

RADIO WHOLESALING CODE

The Supplementary Code of Fair Competition for the Radio Wholesaling Trade is one of the Codes approved in the manner prescribed by the National Recovery Act, and therefore is the instrument through which it is decided that the policy Congress has accomplished, in the Radio Wholesaling Trade.

To give you a brief insight into the administration of the Code and the Code features, this Bulletin is published.

The Code is administered through District Agencies which are branches of the Divisional Code Authority, its objective the administration of the Radio Wholesaling Code. Certain practices are prohibited by the Code: inaccurate advertising, false billing, inaccurate labelling, inaccurate reference to competitors, threats of rates, bribing employees, interference with another's contracts, coercion, protection to dealers.

In respect to the following subjects-- **NO MEMBER OF THE TRADE SHALL**

Protection to Dealers discriminate directly or indirectly between dealers in service prices extended; quantity discounts are not prohibited.

Terms and Cash Discounts offer terms or cash discounts more favorable than those offered to the general public, or less than 10 days from the date of the shipment date, or less than 10 days to receive credit.

Consignment A bulletin, explaining the provisions of the Code, was mailed to the 49 radio jobbers in northern California—and to their salesmen and dealers

EDITOR'S NOTE: Despite the incomplete functioning of the authorized Radio Wholesalers Code of Fair Practices, this instrument, in many trading areas, has served useful purposes and has justified the considerable amount of effort which went into its making. For example:

Distributors and dealers can now lawfully meet together and discuss frankly the price situation.

Limitations as to the sale of "spiffs" are enforceable.

The character of retail advertising is subjected to lawful control and has undergone a revision for the better since the Code was adopted.

Terms may be agreed upon. In many communities they are being enforced to the mutual betterment of every radio dealer in that territory.

Lastly, credit losses have been materially decreased.

The following is an outstanding example of the successful adaptation of the Radio Wholesalers Code:

THE Radio Wholesaling Code is a supplement to the Code of Fair Competition for the Distributing Trades. With this dual arrangement, we have the broad provisions of the basic Code applying to all wholesale operations as well as the more direct and specific provisions of the Supplemental Code which relate only to the Radio Wholesale Trade. With these two instruments as a guide and foundation of fact, we find that the Radio Wholesaling Industry can well govern itself and be a very material aid in effectuating the policies of the Recovery Act.

In this government of itself, the radio wholesaling trade finds one of the most important tenants of the Code (Article 4, Section 2) rendering a service not to itself, but to the dealers of radio. This provision is called "Protection to Dealers" and declares that "Members of the trade shall not discriminate, directly or indirectly, between dealers in services rendered or in discounts or net prices extended; . . ."

This simply means that all dealers must be accorded the same service and offered the same price, and an additional clause to the above mentioned section adds "provided that nothing herein shall prohibit quantity discounts." This latter phrase permits of the reward of additional discount for

RWA Code

a Boon to

San Francisco Jobbers

By Stanley M. Johnson

volume purchases which, of course, in view of the section referred to in the above paragraph, cannot be anticipated but must be earned.

Of course, all of the Code provisions relating to unfair trade practices as well as other matters are not very effective, or of no effect at all, unless the Code furnishes some method of control over the situation. This control lies in Article 4, Section 3, "Filing of Price Schedules." This section is optional to each trading area and provides that:

"Should any District Agency find that a two-thirds majority of all members of the trade in its district desire to file their Price Schedules, the District Agency shall require all of the members of the trade operating in its district to file with it their schedules of prices, discounts, terms and all allowances . . . and . . . to . . . make such schedules available to all members of the trade and other parties."

The members of the trade in this area immediately availed themselves of the optional feature just cited and thereby gave effectiveness to the "protection to dealers" clause. Every member of the trade had available all of the details of every other members' offer to dealers. A situation more idealistic can not be imagined.

In a good many instances, I dare say that an examination of these schedules was a liberal education to members of the trade. Here was the first evidence of the cooperation which the Code offered to its members in industry.

Here too, in these filed schedules, was the basis of all investigation of complaint. A committee of review inspected each of the schedules for possible code variations, and if the schedule needed clarification, correction or amplification so that it would be a clear record of that member's offer to dealers, such variation was called to his attention and in most cases corrected without further comment.

These schedules of price filings are not a control of price as each member of the trade prepares his own schedule, paying attention only to that Code provision relative to selling below cost, which latter requires special permission from the District Agency as provided for in the Code.

It might be said the filing of prices is a gentlemen's agreement between members of the trade, and to further clinch the agreement each member files the prices to which he agrees. It is an unfair trade practice to sell or offer for sale goods at prices other than those which are on file. However, he may change his prices merely by so informing the District Agency with an amended or revised schedule.

The two provisions of the Code just discussed, form the bulwark of the enforcement structure. Without them it would be a very different and difficult job.

An Effective Instrument for Correcting

Filing of Prices Benefits

The filing of prices serves also another very important function. It is doubtful whether the framers of the Code had this additional feature in mind. By the filing of prices, the Code was brought to the immediate attention of the members of the trade. They immediately and continuously felt its presence as that something that necessitated compliance for an infraction of the rules. A laxness in reporting price changes, immediately brought a complaint from someone. With such a set-up no one could ignore or forget the Code provisions for very long.

There is one other feature that holds a very prominent place in continuity of Code enforcement and that is the "Terms" clause.

The terms in our trading area are briefly "cash discount two per cent, tenth prox." Prior to the advent of the Code, remittances were received at all times of the month with the cash discount taken. Now there is very little or no difficulty. Remittances must be received showing a post-mark not later than the tenth at midnight or the discount is charged back. The Credit Managers' Association has cooperated wonderfully in this respect and with such a spirit any problems are very quickly solved. Remittances and all collections have been speeded up until it is no longer a problem.

We have now presented two or three provisions which have been most beneficial and which have through each month of Code existence reminded the Distributor that there is such an instrument as the Code.

Entire Trade Invited to Meetings

To further bring about cooperation, the District Agency held meetings to which the entire trade was invited. Various Code problems were presented and discussed. Members of the local NRA were invited also, and they gave enlightening information on the workings of the Codes and methods of enforcement. Also several meetings were held with groups interested in different phases of the radio business, such as sets and parts.

These meetings developed a feeling of cooperation, which in the early days of the Code was tremendously helpful.

In our own meetings of the District Agency we had a splendid group of very keenly interested members. Their interest was manifest by the manner in which each kept his personal file on Code Bulletins and pertinent information. It was like a school of instruction, with each member carrying with him his file on the Code. Discussions were hearty and full of news disseminated from all branches of the trade. Without such an interested group and their enthusiasm, we would not have gone very far.

Now then with the foregoing instruments in our possession, that is, "Protection to Dealers," the "filing of prices," the "cash discount" clause, coupled with a membership of District Agency officials who were interested keenly in applying the Code to fit the needs of the situation, there could not be much doubt as to the outcome. The result is a very fair measure of success.

Bulletins Sent Out—Complaints Encouraged

In carrying out its program of information the District Agency sent out a number of Bulletins, in addition to those required by the Divisional Code Authority. Still another Bulletin was prepared for sales personnel giving an outline of the Code provisions and requirements. This was most appropriate as it seemed that sales personnel in their contact with dealers should be able to quote the Code provisions with some degree of accuracy.

Complaints were encouraged from anyone who felt that he had a justifiable matter for our attention. In this man-



STANLEY M. JOHNSON

Secretary, Divisional Code Authority for Radio Wholesaling Trade, San Francisco District

ner a great deal of information was received and it was surprising to note the results in accomplishments in a rather roundabout way, for most of the complaints received were without substantial foundation in fact—yet the mere denial of an alleged practice was in most cases a sufficient warning that the members of the trade were watchful and that one had better amend questionable practices.

Then there are other clauses which tend to make the radio Code more effective. They are, the consignment provision and its attendant differential; the "Dropped Line" provision which seems to have put a brake, at least, on the dumping of merchandise and its consequent demoralizing influence; the limit on participation in cooperative advertising and the rules of fair advertising. All of these are very important.

In any industry, which it is acknowledged by all concerned was in the terrible state of demoralization as far as trade practices are concerned, even the smallest measure of improvement should be welcomed by all the trade—a chance for that industry to sum up all of its faults and conjure with them. Given an instrument with which to be guided, that industry will go as far in its corrective procedure as the ability of those in it will permit.

Our supplementary Code is not a perfect instrument by any stretch of the imagination, nor does it go far to correct all of the evils of the industry, but any improvement over the chaotic conditions prevailing in the years prior to the advent of the Code is a step in the direction of making the radio wholesaling industry a business venture.

There are many things we hope to have clarified for more effective enforcement and for the betterment of the radio wholesaling business, principally the clarification of the situation of the manufacturer with a sales policy of coincidental selling to dealers, but that in itself is a long story.

I have tried to present in the foregoing, a brief summary of the provisions of the Code that lend themselves to enforcement and through such enforcement, bring out the beneficial features which in the long run must bring an advancement of profit as well as a higher and cleaner plane of competition.

Trade Malpractices How to Use It

THE RADIO
DEPARTMENT
On the main floor



THE MAN

Andrew Meiklejohn: Piano, radio, electrical appliance merchant

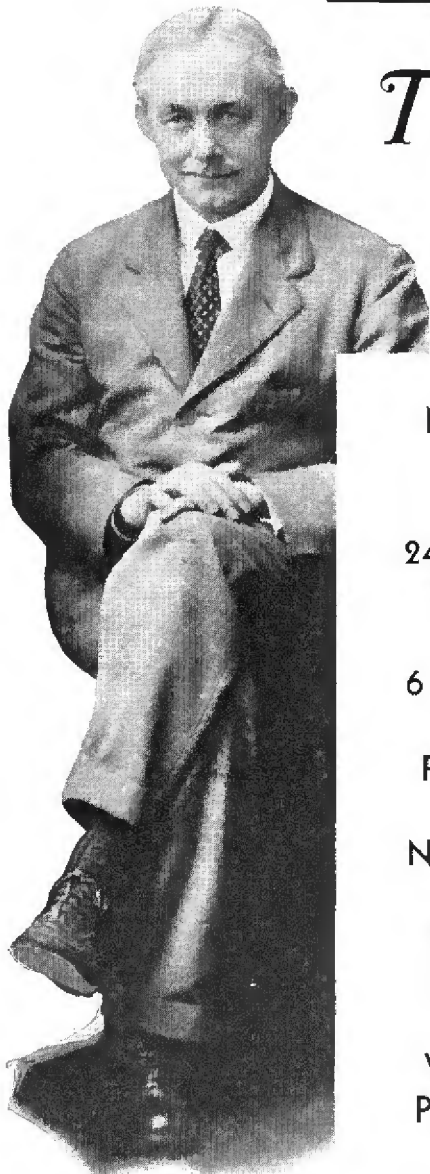

The Meiklejohn

UP IN shrewd, hard-headed New England, where few merchants detour from concrete-paved, four-lane roads of conventional merchandising procedure, white-haired and successful Andrew Meiklejohn is celebrating his 50th business anniversary with an experiment in credit selling.

"Nothing down . . . 24 months to pay . . . 6 per cent interest per year . . . No additional finance charge." This is the plan he offers prospective purchasers of pianos, band instruments, radios, refrigerators, washers and heating appliances. Not new among furniture and credit jewelry stores. But certainly an innovation for an old-line, high-class specialty dealer.

Cast your eye over this schedule of cash and credit prices:

Nothing
Down
•
24 Months
To Pay
•
6 Per Cent
Interest
Per Year
•
No Addi-
tional
Finance
Charge
•
Weekly
Payments

"Norge" Model	Retail Price	Weekly Payment	Number Months	Interest	Lease Price
E231	\$83.50	\$1.75	12	2.60	\$86.10
E425	119.50	1.05	26	8.35	127.85
E425	119.50	1.25	25	7.40	126.90
L519	156.50	1.75	24	8.80	165.30
P519	181.50	2.00	24	10.80	192.30
L621	189.50	2.00	25	11.75	201.25
P621	219.50	2.25	26	13.65	233.15
L720	224.50	2.50	24	12.75	237.25
P720	259.50	3.00	23	14.70	274.20
L804	269.50	3.00	24	15.40	284.90
P804	299.50	3.00	27	19.25	318.75
P953	329.50	3.50	25	20.40	349.90
P1117	379.50	4.00	25	23.50	403.00

Compare the interest charges with your own. It's a good gamble that yours are nearly double Meiklejohn's. For not only does he limit the extra cost of credit-sold merchandise to 6 per cent per annum, but this interest rate is charged only on the *unpaid* balance. Thus, the

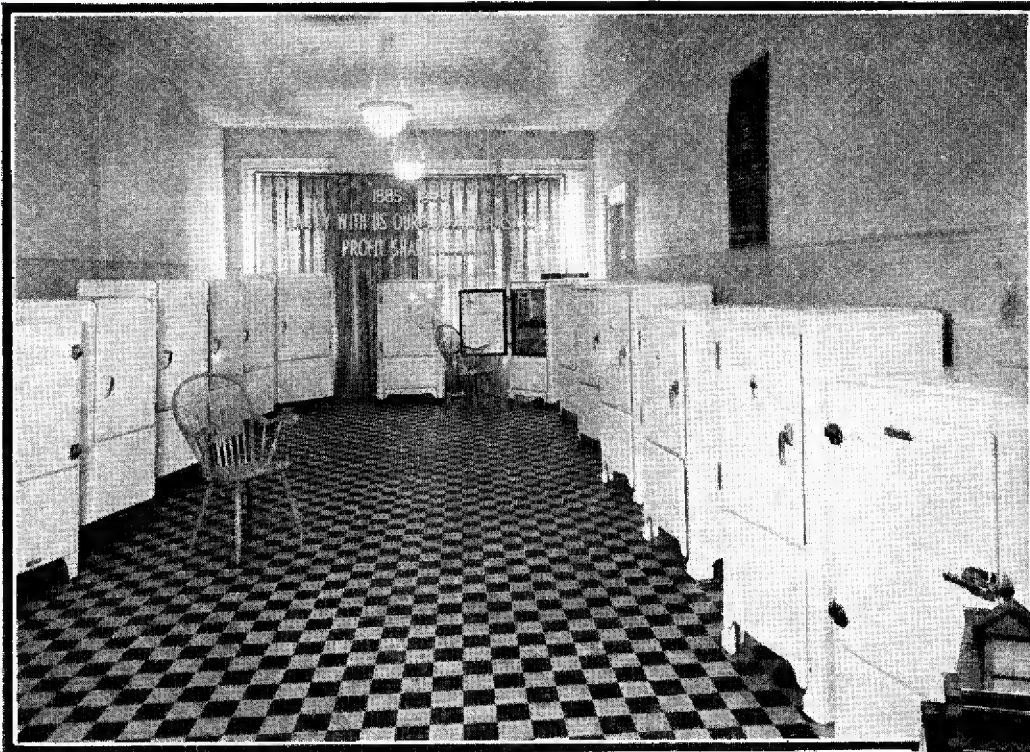

THE
REFRIGERATION
DEPARTMENT

Off by itself

THE
STORE

A landmark in
Providence, Rhode
Island, since 1885

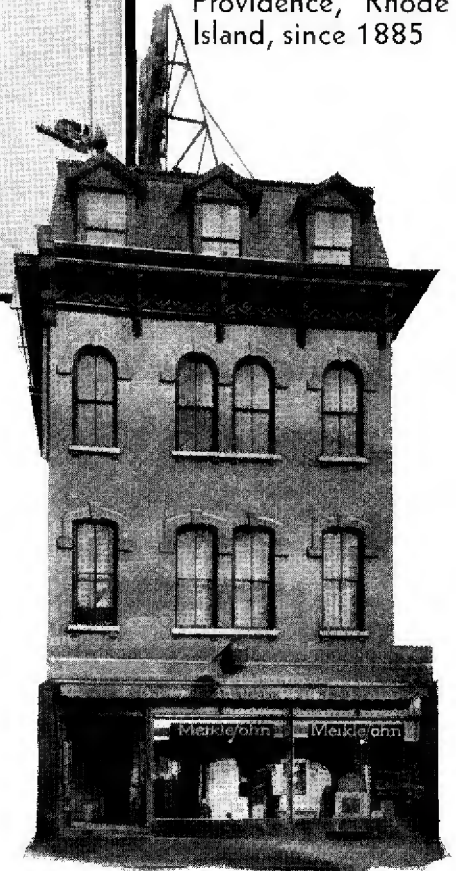

Plan of credit selling

annual interest charge is even less than 6 per cent on the retail list. For the actual balance due decreases after each payment. For convenience, interest is averaged over the life of the contract and the customer pays a fixed charge each week instead of a relatively large sum at the beginning and a small fee at the end.

VOLUME UP 22 PER CENT

Obviously, the plan is a deliberate bid for the patronage of working classes, an attempt to increase volume without pyramiding sales costs. To attract new business its advantages must be shouted from the housetops. This is effectively done through heavy newspaper advertising carrying the following theme:

"All instruments, regardless of price, are offered on the Meiklejohn Profit-Sharing Plan. No payment down and weekly payments so liberal as to meet the need of the small wage-earner. This is the new note in credit selling which may well hold the key to our nationwide business recovery."

Business is up in Providence, but Meiklejohn attributes a 22 per cent sales gain since January largely to the pulling power of the plan. Here's his reasoning:

"The meter-plan of refrigerator selling has, we understand, increased volume as much as 200 per cent in some localities. In our estimation the success of this 'piggy-bank' idea is due almost entirely to the elimination of down-payment and long terms. Certainly the necessity of feeding coins into the maw of a machine in order to maintain operating current is a constant annoyance to the customer. And the regular opening of the banks by the

dealer is a costly collection routine. So we've 'lifted' the no-down-payment idea, used it in our own. And we have gone the meter-plan one better by eliminating what to our mind are excessive carrying charges, making it possible for people to buy on credit without paying too great a premium for the privilege.

"Six per cent is enough to make on a loan, isn't it? We can borrow money at this interest rate or better. Why should the customer finance our business? That's our job. It seems to us that credit selling and so-called financing charges just don't 'jell.' Time payments are designed to place merchandise within the reach of people with jobs but not much cash. High financing charges penalize this class, which can stand it least, too heavily and when the cash price of an article is compared with the contract price the severity of the penalty scares them away, defeating the very purpose of credit selling—volume.

"We are content to make the same gross profit on a credit sale as on a cash sale, charging just sufficient interest to cover our own extra borrowing costs. The

By W. MacDonald

extra volume has raised our gross business to a point where fixed overhead is amply covered for the first time since the beginning of the depression. Naturally, it is necessary to be in a position to finance a credit business of this sort. Time-payment selling is, for that matter, not good for any dealer who must rely upon a finance company for funds.

"We use our own money to swing the bulk of the business, borrow some on the paper from our bank and give some overflow business to a finance company. Where the bank or finance company holds the paper we guarantee it, taking the entire credit risk ourselves and so reduce the interest rate charged. In all cases we make our own collections.

"Compare this system with the usual dealer-finance company tie-up. You will find that the elimination of a fancy carrying charge is not so radical a concession as it seems at first glance. *For where a finance company supports a credit business and takes all the risk most of the finance charge goes to them and not to the dealer.* The customer pays plenty and the dealer profits little."

CREDIT LOSSES NO HIGHER

With the inauguration of the Profit-Sharing Plan Meiklejohn switched to weekly payments. He attributes to this system a credit business history which is no less satisfactory than it was before the plan went into effect.

"When working with so little a margin of safety for credit losses and financing our own sales," states Meiklejohn, "it is necessary not only to examine prospective accounts with extreme care before delivering merchandise, but also to keep payments up to date. Weekly instead of monthly payments facilitate this and we consider them an absolutely essential part of our program.

"Customers are told in plain language that in order to participate in our economical Profit-Sharing Plan it is necessary for them to meet payments 'on the nose,' and that no extensions can be given. (We do, on occasion extend this courtesy, of course.) Most of them pay at the store. Paid weekly, the amounts due seem smaller than when paid every 30 days and, consequently, they are materially easier to collect. But the most important feature of weekly payments is the fact that no account falls more than a week behind without us knowing it.

"We have a particularly elaborate record system of all credit accounts. The cards are gone over every Saturday, after the close of business and first thing Monday morning overdue accounts are sent form letters or called on the phone and, in cases which seem to warrant closer attention, visited by a collection man. Less than 5 per cent of our accounts require personal collection, but it is worthwhile in certain instances.

"Despite the fact that customers pay weekly our books are kept on a monthly basis. Thus, an account which is in arrears a week or two is not necessarily a bad account, as there is four weeks of grace between the 52-week year and the 12-month year. About 40 per cent of our accounts are in arrears a few dollars, figured on the weekly basis. Practically none of them are in arrears when their accounts are considered on the monthly basis. Thirty-five per cent are paid up to date. The remaining 25 per cent is actually paid slightly in advance. Customers frequently pay a few dollars extra when coming to the store to clean up their indebtedness in advance of the contract period. The payments due are so small that this is made easy. Most dealers who sell on a monthly credit business know that when an account gets in arrears the sum due is so substantial that it is frequently carried on from

month to month and appears as a stumbling block at the time the contract is ready to be closed. This almost never happens with our weekly plan.

"Cash business is made sufficiently attractive by the elimination of the 6 per cent interest charge. Down payments on credit sales are encouraged by pointing out to the customer the fact that interest is charged only on the unpaid balance. Interest is not, of course, charged on the down payment. This is so effective that fully 80 per cent of our credit business is effected with a down payment of some sort, despite the fact that we will sell quite as readily without such a payment if the customer's credit is AAA-1. Where the interest charge is less than \$2 we waive it and sell on time at the cash price. This applies, for example, to inexpensive midget radios.

"Our business is widely diversified and yet the plan is working out satisfactorily for all departments. It is true that it has only been in operation for 3 months, but we feel confident that it will continue to operate satisfactorily, bringing in sufficient additional credit business to more than pay its way. Here is how our business breaks down:

Refrigerators, Washers, Heating Appliances.....	30%
Pianos.....	30
Radio.....	25
Band Instruments.....	10
Records.....	5

"Our store is completely departmentalized, a 'manager' presiding over each of the departments listed. Depending upon the season and state of business these heads may have one or more salesmen working under their direction. All employees, however, are privileged to sell any of our merchandise, but are primarily concerned with their own field, receiving a bonus on all business under their wing when pre-set quotas are exceeded. Outside selling is an important part of the operation.

"Department heads are uniformly enthusiastic about the new Profit-Sharing Plan. It could not, of course, be successfully employed by a 'borax' dealer or out-of-town managed chain. Undoubtedly our reputation for straight shooting, built up over a period of 50 years, has helped put it over. For Providence people know that our offer is genuine and not for the purpose of 'switching.'"

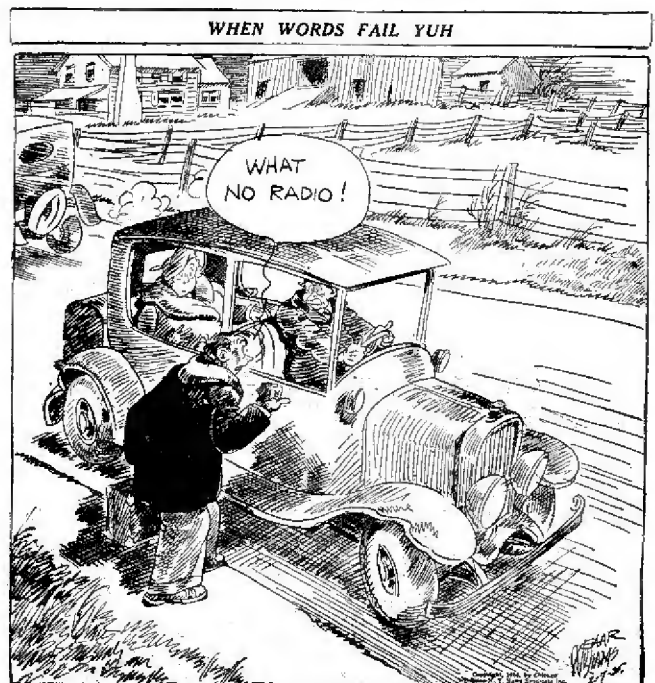

Courtesy Chicago Tribune

This sketch of the prospect's grounds secures an audience where straight cold canvass would fail. The original antenna here was beautifully placed to pick up the maximum of noise.

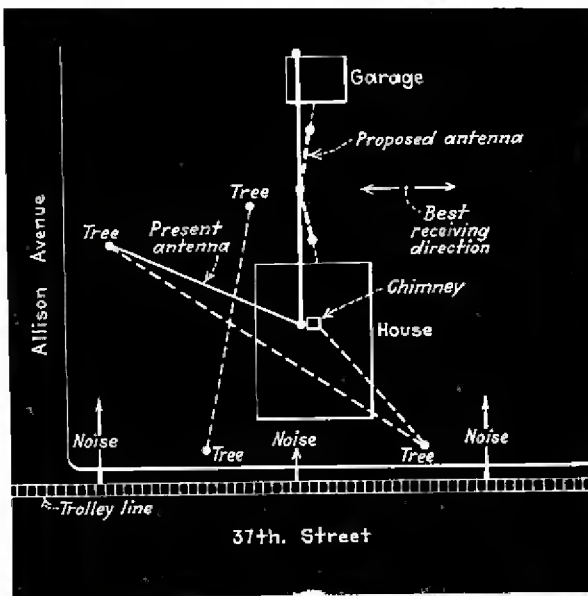

The Antenna Sells the Set

Thomas Electric, of Des Moines, surveys home layout, submits antenna plan, tests with new all-wave receiver and sells both. Ratio of demonstrations to sales jumps from 30 to 90%

By Daniel Ladd

THE ratio of all-wave radio sales to demonstrations had long been unsatisfactory to the Thomas Electric Company, of Des Moines, Iowa. Less than 30 per cent of the sets taken out on trial "stuck," according to salesmanager O. R. Haptonstahl.

Too many people, it seemed, believed all-wave reception a much simpler matter than it really is and wherever noise existed rapidly became disillusioned. Prospects almost never had noise-reducing antennas and it was too expensive to erect them on trial. Haptonstahl reasoned that this situation might be the chief cause of failure.

He decided, therefore, to sell noise-reducing antennas first and all-wave sets second. And in working out a method of attack he uncovered a plan which has since proven to be an excellent means of taking the sting

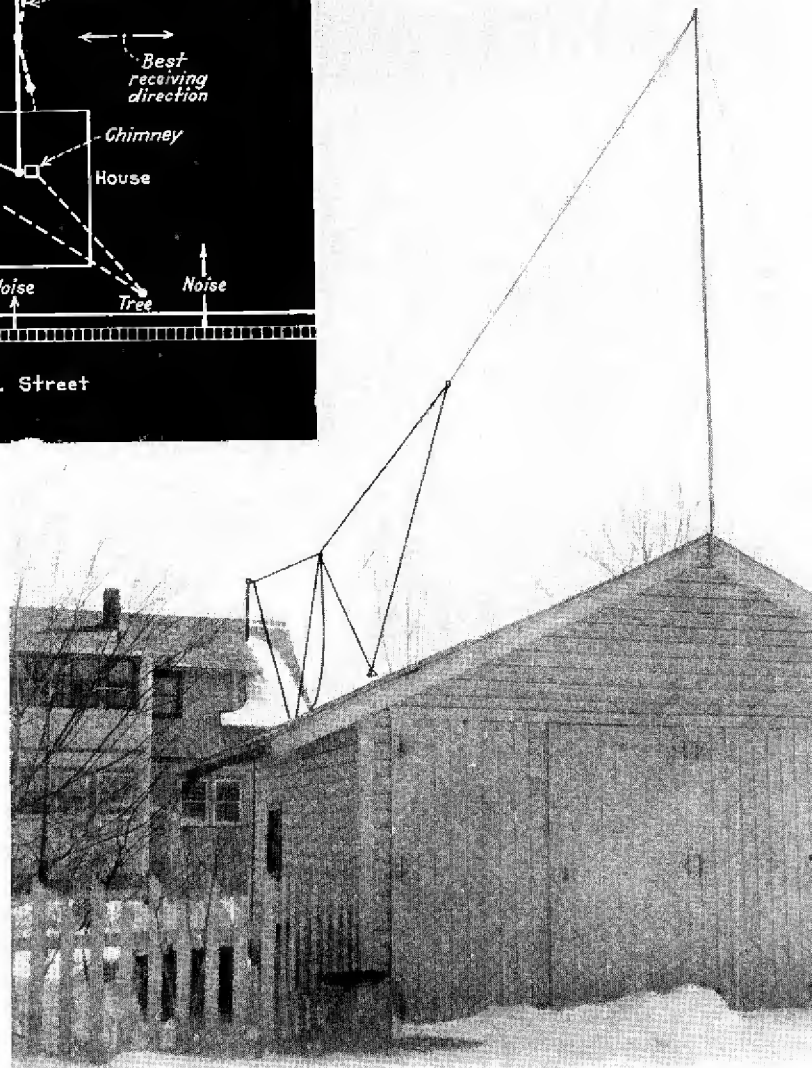

Here is the finished job, high, rugged and carefully located for best reception and minimum noise pick-up on the old broadcast-band receiver or the new allwave "test" set.

out of the cold canvass. Not only does he now demonstrate all-wave sets on proper antennas but a special antenna approach is successfully used to stimulate initial interest in new receivers.

SURVEYS HOMES

A list of professional and business men with above-the-average credit rating was compiled. "Hap" then sent one of his servicemen out to look over their property and return to the shop with a rough sketch of it plus a suggested location for a special antenna. Car lines, pole transformers, noisy motors and other obvious interference producers are indicated on the sketch as are trees, chimneys and possible supports.

From this rough sketch Hap draws a neat, detailed plan. His salesman takes this plan and calls on the home owner "cold" to explain the undoubted need for such an antenna system. He generally secures an interview where the unprepared man would fail simply because the prospect is intrigued by the close study which has been made of his house and grounds.

Sales effort is confined to upper classes and no attempt is made to sell a new set. The solicitor talks antennas only. Antenna jobs are secured from this type of pros-

(Please turn to page 40)

Straight from the Shoulder

Direct Mail Has Us Down

EDITOR, RADIO RETAILING,—

I wish to add my voice to an article appearing in February number of *Radio Retailing* concerning the sale of "private brand" radio receivers by chain stores and mail order houses.

I have been repairing radio for many years, also selling a few now and then. My work is mostly on battery sets on farms and in small towns. At the present time there are a growing number of chain stores opening up in every small town near here, selling hardware, radios, batteries and auto supplies. They have their own "private brand" receivers, which are manufactured by one of the nationally known radio companies. They sell these sets at practically the wholesale dealer's cost of a "standard brand" receiver. They have their own brand of batteries and tubes also at the same low prices.

I believe I am safe in saying that at the present time these chain stores and the mail order firms are putting out 75 per cent of all radio sold here. They are not bad sets either. It seems that anybody with a little money and a sales outlet can have their own "private brand" receivers. The dealer selling "standard" sets cannot meet this competition.

I cannot understand why the manufacturer is allowed to put out sets in this manner. They should be compelled to sell to regular dealers as cheap as to the chain store. Or else manufacturers of "standard brands" should give their dealers a larger discount with permission to cut prices if necessary. The dealer in high priced radio hasn't a chance in these "depression days." And there still is depression in the small towns and farms.

Things are looking better, though, and there will be millions of battery-operated sets sold in the next few years.

I would like to see you start something that would give the ordinary man a chance to do a little business.

Ernest Barker,
Bradford, Ill.

EDITOR, RADIO RETAILING,—

On page 18, February issue, you get right down to the real trouble in the retail radio game.

I want to add my experience to these letters. For several years I have handled a well known line exclusively, believing their story and their ads that they "dominated" the market.

Over two years ago I started to harp on the necessity of putting out a cheaper battery set. I got about as far with this as a snow ball in the lower regions, and all the time my chain store and mail order competitors were selling sets.

I lost over half of the sales last fall to outside competition because my so-called "big" company either could or would not produce a set selling within \$20 of my competitors. I did the advertising, created the

demand, got the customers radio-conscious. They came to town and bought of the chain boys. The conversation with me was short and sweet, usually two phrases "How much?" and "Too much."

The old bunk of "quality" fails to register with me any more as I have noticed that I do fully as much running and free trouble shooting on the high priced and well advertised line as my competitors do on their product.

Frank Riese,
Bloomington, Wis.

EDITOR, RADIO RETAILING,—

I am writing to you out of a dire need in this section [Vermont, mostly rural] for advice and comfort and cooperation in some way. Something has got to be done or I can't stay in business any longer!

The February issue of *Radio Retailing*, page 18, partly illustrates our troubles up here. I need not enlarge further except to say that two mail order houses have this rural section flooded with their big annual catalogs and then besides they issue special supplements and bulletins many times a year so that it is about as hard to sell any kind of radio or radio product and compete with them as it is to fly without wings.

But on top of that all the (Blank) Corp. of Chicago sends its "wholesale" catalogs to a number of ordinary people right here in Waterbury. The thing has been spreading till many local citizens are buying tubes, parts and even radios at wholesale prices!

I thought that since the NRA all this funny business had to be stopped. Well, it's got to be here or I go out of business and I don't know what to go to for I have studied servicing many years.

Now your staff must get together and organize with all forces possible to do something.

A discouraged Dealer.

EDITOR, RADIO RETAILING,—

Referring to page 18 of the February issue I wish to say that insofar as the catalog houses are concerned there is an answer but I defy anyone to make the average purchaser believe it till too late to do anyone any good. If anyone doubts this let him try to get repair parts for any of these sets and see what happens.

A while ago a farmer brought me a set put out by Montgomery-Ward, a ten tube set which had all the ear marks, leg bands, etc.—everything but the name plate—of a well known set. He complained that at times the set worked well and at other times it just squeaked. He insisted that the trouble was all in the switch. I found three 34 tubes and two 30's that were simply too dead to bury although he insisted that he had used them only about a month. I replaced these and could find nothing more wrong. Took it home and connected it up. It was one of the sweetest sets I ever saw both in tone and performance.

A few weeks later it came back again

with the claim that it worked properly only a few hours after I left. This time I found two more tubes dead, an a.f. transformer and a r.f. transformer open. The input transformer I had in stock but the only way out so far as I could see was to order a new r.f. transformer. I sent this order to Albany, they sent it on to the Chicago house which in turn sent it to the factory. The goods came back around the circle. In a month I got the transformer.

After this was installed the set worked but not as it should. I may have missed the trouble on my first test or this may have happened during the delay; however I found the grid coil of the oscillation transformer open so the only thing was to go back after one. This time it took six weeks. Then I found the cause of a lot of the trouble. The A, B and C current all went through the On and Off switch. The C contact sometimes failed to connect, thus allowing the tubes to overload.

From now on and until something changes, Shears Sawbuck and Monkey Ward can sell all the sets they wish for all I care, more power to them. For my part I am, so far as possible, stocking a line of independent parts which will take care of the average case of trouble in these sets and one good repair job will make me more profit than they made on the original sale.

Arthur Risley,
Richfield Springs, N. Y.

"Not So!" Says Mr. Cloyd

In answer to page 18 February *Retailing*, I have been a subscriber to *Retailing* for last 6 years and it is the best radio magazine published today. I have been in Radio business since 1924.

It amuses me to read the pitiful tales of some radio dealers. I get a kick out of them. Wake up, Mr. Independent Radio Dealer, shake off the cobwebs, get the old spring in the step. Your chance was never better than today. I am situated in a town of 5,000 in San Luis Valley. Started here in July, 1934, sold 117 sets from July 10 to Jan. 1, 1935; sold 20 sets in January; have sold 21 sets to date in February.

Here's an angle in our favor—we have the chain stores whipped on batteries, thanks to National Carbon Co. They are the independent dealers' best friend, just reduced battery prices—and the chain stores can't get them.

I can sell new battery sets in competition with any chain store, dollar for dollar, with better parts. So why sit down and cry about something that doesn't exist.

Carry the two catalogs of the chain stores mentioned, check price for price, take set out of cabinet, check part for part; it is all in your favor. I worked for 6 years in a large chain store. I know what I am talking about. I am getting all the battery business that used to go to the chain stores from the Valley. Wake up and get going.

W. J. Cloyd,
Cloyd's Radio Shop,
Alamosa, Cal.

1935 AUTO RADIO

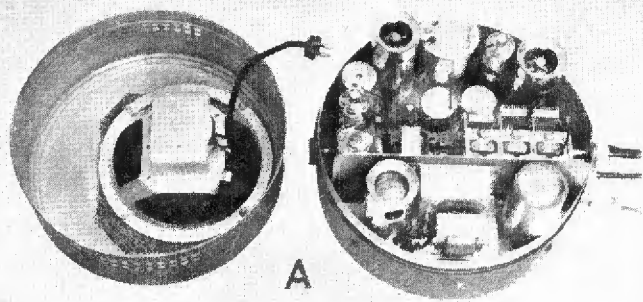

A

A
Circular chassis assembly has many advantages, says American Bosch

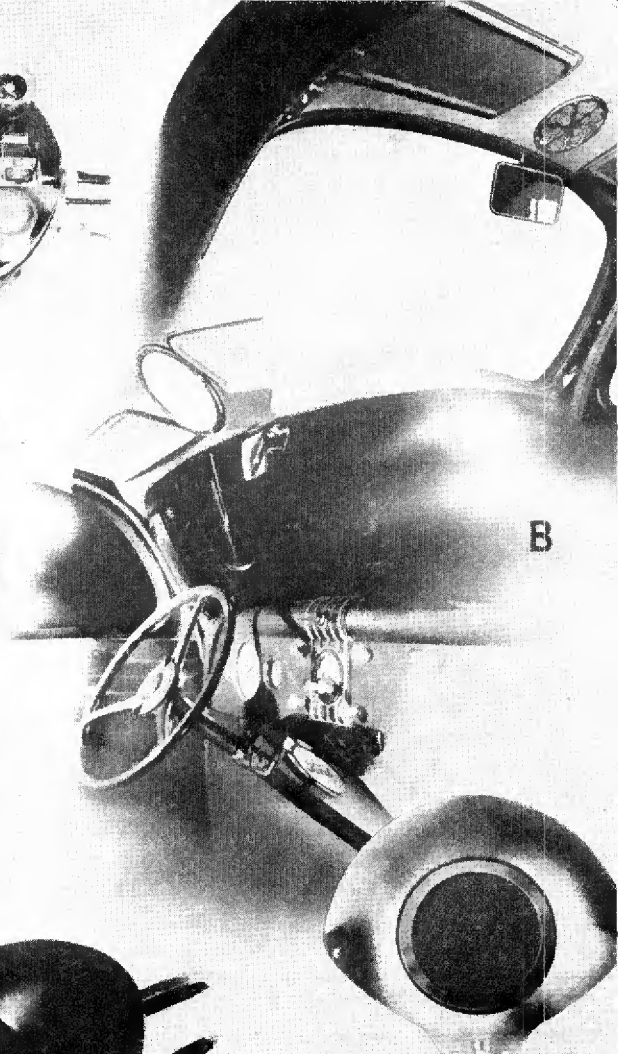

B

B
Locating the speaker flush in the header board, above the windshield, is a new development this year

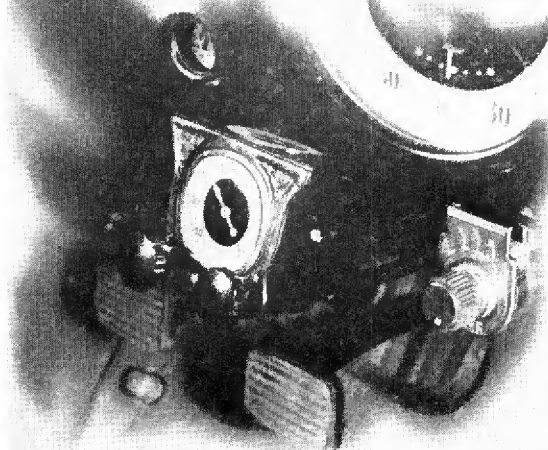

C

C
Control mounted on lower edge of dash

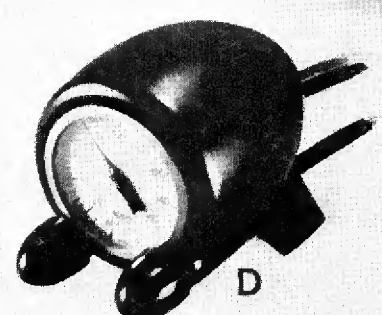

D

D
Bullet type, streamline controls are popular

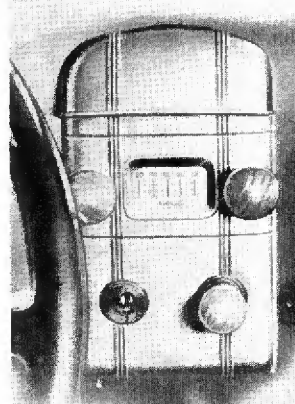

E

E
Two kinds of dash mountings—with horizontal dial tuning

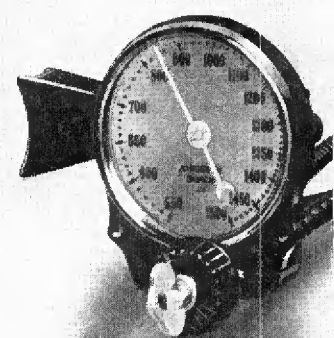
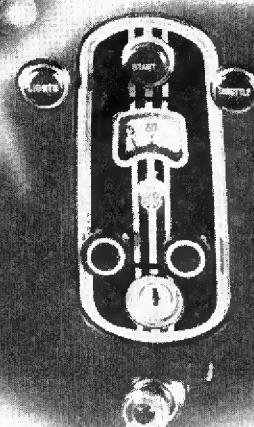

F

F
Airplane dials still predominate

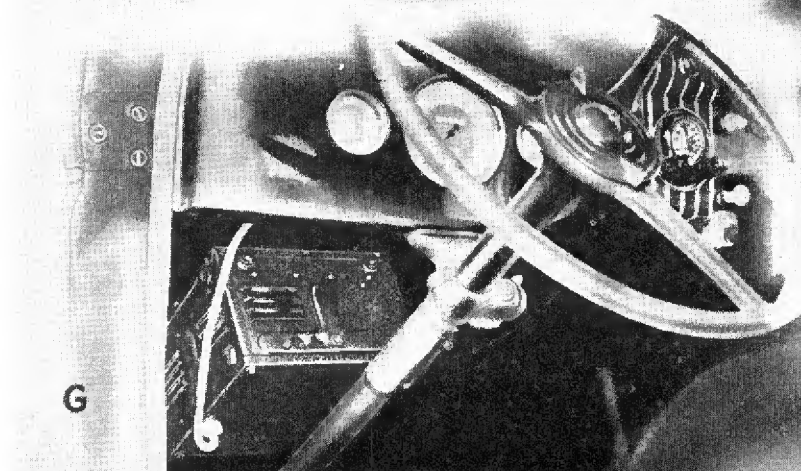

G

G
Out of the way, yet accessible. Arvin installation in the new Ford

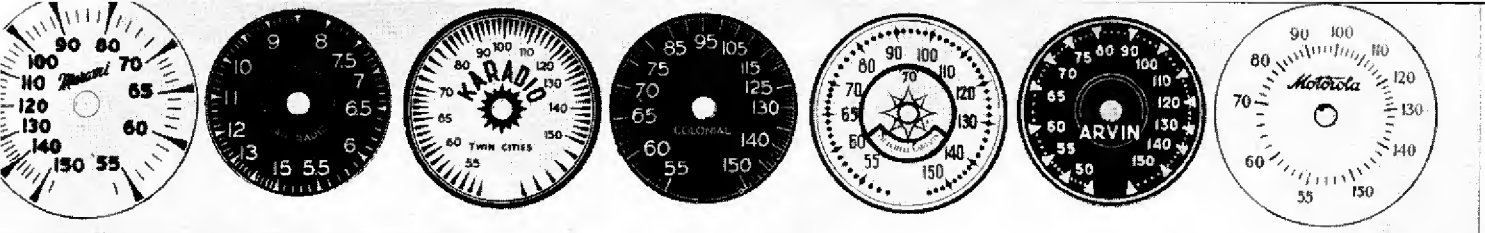

AUTO-RADIO SPECIFICATIONS

Trade Name	Model (Name or Number)	Price (with tubes, less inst'n)	Dimensions Chassis	Speaker	Remote Control?	Separate Speaker?	Eliminator (Type)	Tubes (Number and Type)	Battery Drain (Amps.)
Atwater Kent Mfg. Co., Philadelphia, Pa.	Atwater Kent 776	\$49.90	6½x6½x12	6" diam.	Yes	No	Vibrator	6D6, 6A7, 6D6, 85, 41, 84	6
Automatic Radio Mfg. Co., Inc., 112 Canal St., Boston, Mass.	Automatic; Tom Thumb Junior	\$29.90	8x7x9	Yes	Yes	Vibrator	77, 77, 78, 37, 41, 84	5
	Automatic; Tom Thumb Senior	49.50	8x7x9	Yes	Yes	Vibrator	75, 78, 6A7, 41, 84, 78	5
Belmont Radio Corp., 1257 Fullerton St., Chicago, Ill.	Belmont-Freshman 580	6½x7x9½	Yes	No	Vibrator	6A7, 6D6, 75, 42, 84	5
	Belmont-Freshman 670A	6½x7x9½	Yes	No	Vibrator	6D6, 6C6, 75, 42, 84, 6D6	5.5
	Belmont-Freshman 880	7x7½x9½	Yes	Yes	Vibrator	6D6, 6A7, 6A6, 84, 78, 85, 6D6, 76	7.5
Colonial Radio Corp., Buffalo, N. Y.	Chevrolet 601574	8½x7x8	6" diam.	Yes	Header	Vibrator	6F7, 6A7, 6B7, 41	6
	Oldsmobile 405057	8½x7x8	6½" diam.	Yes	Header	Vibrator	6F7, 6A7, 6B7, 41	6.2
	Oldsmobile 405062	8½x7x8	8" diam.	Yes	Yes	Vibrator	6F7, 6A7, 6B7, 41	6.2
	Oldsmobile	8½x7x8	Yes	No	Vibrator	6F7, 6A7, 6B7, 41	6
	Sears 1864	9x6½x8	Yes	No	Genemotor	78, 6A7, 78, 75, 41	6
Commonwealth Radio Mfg. Co., 1225 N. Paulina St., Chicago, Ill.	Com-Rad A-66	\$39.75	7x7x10	Yes	No	Vibrator	6D6, 6A7, 6D6, 75, 41, 84	4.5
Crosley Radio Corp., Cincinnati, Ohio.	Roamto 4A1	\$36.95	6½x6x10	No	No	Vibrator	6F7, 6B7, 6D6, 42	5.6
	Roamto 5A3	47.50	7½x7½x10½	No	No	Vibrator	2-78, 6F7, 6B7, 42	5.8
Custom Built Radio Co., 4453 Whittier Blvd., Los Angeles, Cal.	Crown 6A	\$39.50	7x11x7½	Yes	No	Vibrator	6A7, 6B7, 41, 6D6, 6D6, 84	7
Demco Radio Corp., Wheeling, W. Va.	D66*	\$59.50	12½x7½x8	Yes	No	Vibrator	78, 78, 77, 75, 41, 84	5.5
	D88	79.50	13½x7½x8	10½" diam.	Yes	Yes	Vibrator	78, 78, 77, 85, 76, 6A4, 6A4, 84	7.5
*Made in special models for Fords.									
Detrola Radio Corp., 3630 W. Fort St., Detroit, Mich.	Detrola	\$45.00	7½x9½x6½	6½" diam.	Yes	42, 6A7, 75, 84, 42
Electrical Research Laboratories, 2222 Diversey Blvd., Chicago, Ill.	Erla 10M	\$39.95	7x7x8½	5" diam.	Yes	No	Vibrator	6A7, 6D6, 6B7, 41, 84	6
	Erla 7M	49.95	9½x8½x6½	6" diam.	Yes	No	Vibrator	41, 75, 84, 6D6, 6A7, 6D6	7
El Rey Radio Mfg. Corp., 8408 S. Broadway, Los Angeles, Cal.	C	\$29.95	9½x6½x6½	Yes	No	Vibrator	6F7, 6D6, 75, 41, 84	5
Emerson Radio & Phonograph Corp., 111 Eighth Ave., New York City, N. Y.	Emerson 5A	\$44.50	8½x5½x8	Yes	No	Vibrator	42, 78, 6A7, 78, 85	6
	Emerson 6A	39.95	6½x6½x9½	Yes	No	Vibrator	78, 6A7, 78, 85, 41, 84	6
Fada Radio & Elec. Co., Long Island City, N. Y.	Fada 166*	\$49.95	9½" diam. x 7½" high	Yes	No	Vibrator	73, 6A7, 78, 75, 41, 84	6.5
*Circular shape.									
Fairbanks-Morse Home Appliance, Inc., 430 S. Green St., Chicago, Ill.	Fairbanks-Morse 64	\$49.95	9½x7½x6½	Yes	No	Vibrator	6D6, 6D6, 6A7, 75, 42, 84	6
	Fairbanks-Morse 74	64.50	9½x7½x6½	9" diam.	Yes	Yes	Vibrator	6D6, 6D6, 6A7, 85, 41, 6A6, 84	6.6
Federated Purchaser, Inc., 25 Park Place, New York City, N. Y.	Acratone 40	\$49.75	7½x10½x7½	Yes	No	Vibrator	6D6, 6A7, 6D6, 75, 41, 84	5.4
	Acratone 49	33.25	10x7x6½	Yes	No	Vibrator	6A7, 6D6, 6B7, 41, 84	4.9
	Acratone 51	39.75	10x7x6½	Yes	No	Vibrator	6D6, 6A7, 6D6, 75, 41, 84	5.4
Fischer-Smith, 1401 Station St., W. Englewood, N. J.	FS42	\$19.50	7x7x4	8x8x8	No	Yes	Vibrator	44, 44, 77, 41	5
	FS62	39.50	8x7x7	Yes	No	Vibrator	78, 6F7, 78, 75, 42	7
	FS71	49.50	8x7x7	8x8x5	Yes	Yes	Vibrator	78, 6F7, 78, 85, 42, 42	9
Fordson Radio Mfg. Corp., 4181 Oakman Blvd., Detroit, Mich.	Fordson T	\$45.00	11½x7½x6½	Yes	No	Vibrator	75, 6D6, 6D6, 6A7, 42, V6	2
Galvin Mfg. Co., 847 W. Harrison St., Chicago, Ill.	Motorola 100	\$64.50	6½x8½x9½	8" diam.	Yes	Yes	Vibrator	78, 77, 78, 85, 76, LA, LA, 84	7
	Motorola 75	47.50	8½x7½x8½	Yes	Yes	Vibrator	78, 77, 78, 75, 41, 84	6
	Motorola 57	37.95	7½x7½x7½	Yes	Yes	Vibrator	77, 78, 75, 41, 84	5
Special models in all numbers for Fords using header speaker. Special models in all numbers for General Motors cars designed for undercar aerial.									
General Electric Co., Bridgeport, Conn.	General Electric D50	\$44.95	9x6½x6	Yes	No	Vibrator	6D6, 6A7, 6D6, 6B7, 41	5.5
	General Electric D51	49.95	9x6½x6	Yes	No	Vibrator	6D6, 6A7, 6D6, 6B7, 41	5.5
	General Electric D52	57.95	6½x6x7	6½x6x7	Yes	Yes	Vibrator	6D6, 6A7, 6D6, 6B7, 41	5.5
	General Electric D72	74.95	Yes	Yes	Vibrator	6D6, 6A7, 6D6, 6B7, 41, 79, 84	7
Gibellan Bros., Inc., 1815 Venice Blvd., Los Angeles, Cal.	Gibellan 700	\$55.00	6½x8½x8½	7" diam.	Yes	Yes	Vibrator	77, 77, 78, 85, 76, 42, 84	4
Halson Radio Mfg. Corp., 120 E. 16th St., New York City, N. Y.	199	\$39.50	9x7½x6½	Yes	No	Vibrator	6A7, 76, 6D6, 75, 42, 6Z4	5.8

Trade Name	Model (Name or Number)	Price (with tubes, less inst'n)	Dimensions Chassis	Speaker	Remote Control?	Separate Speaker?	Eliminator (Type)	Tubes (Number and Type)	Battery Drain (Amps.)
Herbert H. Horn Co., Tiffanytone	12th & Olive Sts., Los Angeles, Cal. 335	\$29.90	9½x7x7	9" diam.	Yes	Yes	Vibrator	6A7, 6D6, 75, 43, 84	5
Howard Radio Co., Superhighwayman HA-3	1731 Belmont Ave., Chicago, Ill.	\$49.95 39.95	7½x9½x7½ 7½x9½x7½		Yes Yes	No No	Vibrator Vibrator	6D6, 6A7, 6D6, 75, 41, 84 6A7, 6D6, 75, 41, 84	5.5 5
International Radio Corp., †Combination home and auto. *Adapter.	Ann Arbor, Mich. 90 Duplex†	\$36.50	8½x6½x3½				Vibrator*	6D6, 6C6, 75, 12A7	4
Karadio Corp., Karadio 150 Karadio 160 Karadio 180	50 Eleventh Ave., N. E., Minneapolis, Minn.	\$39.50 49.50 59.50	11x7x5½ 10" diam. x 8" 9½x9½x7½		Yes Yes Yes	No No No	Vibrator Vibrator Vibrator	41, 75, 84, 6A7, 6D6 41, 75, 78, 6A7, 84 41, 75, 77, 78, 6F7, 84	4½ 4 5½
Mission Bell Radio Mfg. & Dist. Co., Mission Bell 14 Mission Bell 11	1453 Venice Blvd., Los Angeles, Cal.	\$37.50 49.50	9½x7½x7 9½x7½x7		Yes Yes	No No	Vibrator Vibrator	84, 41, 78, 6F7, 75 84, 41, 6F7, 75, 78, 78	5.25 5.5
Noblett Sparks Industries, Inc., Arvin Arvin Ford Spec. 17A Arvin 17 Arvin 27 Arvin 37	Columbus, Ind.	\$37.95 44.95 44.95 54.95 64.95	8½x8½x6½ 8½x8½x6½ 8½x8½x6½ 8½x8½x6½ 8½x8½x6½	2 7/8x7x7 4½x8½x8½	Yes Yes Yes Yes Yes	No Yes No No Yes	Vibrator Vibrator Vibrator Vibrator Vibrator	6A7, 6B7, 6F7, 41, 84 78, 78, 6A7, 75, 41, 84 78, 78, 6A7, 75, 41, 84 78, 78, 6A7, 75, 41, 84 78, 6A7, 6B7, 84, 76, 76, 41, 41	5 6.5 6.5 8 8.25
Phileo Radio & Television Co., Phileo-Transitone 805 Phileo-Transitone 806 Phileo-Transitone 807 Phileo-Transitone 808	Philadelphia, Pa.	\$42.95 49.95 59.95 75.00	7x7 7/8x10½ 7x7 7/8x10½ 7x7 7/8x10½ 7x7 7/8x10½		Yes Yes Yes Yes	No No No Yes	Vibrator Vibrator Vibrator Vibrator	6A7, 78, 75, 41, 84 6A7, 78, 78, 75, 41, 84 6A7, 77, 78, 75, 76, 6A6, 84 6A7, 77, 78, 75, 76, 6A6, 84	5.4 5.8 7 7
Pierce Airo Inc., DeWald Motortone 605	510 Sixth Ave., New York City, N. Y.	\$64.95	7½x8x7		Yes	No	Vibrator	6D6, 6D6, 6A7, 75, 41, 84	5
RCA Mfg. Co., Inc., RCA Victor 101 RCA Victor 104 RCA Victor 108 RCA Victor 109	Camden, N. J.	\$44.95 49.95 57.95 74.95	9½x9x6½ 9½x9x6½ 9½x6½x6½ 7½x6½x7	9x3½ diam. 8½x8½x5½	Yes Yes Yes Yes	No No Yes Yes	Powertron Powertron Powertron Powertron	6D6, 6A7, 6D6, 6B7, 41 6D6, 6A7, 6D6, 6B7, 41 6D6, 6A7, 6D6, 6B7, 41 6D6, 6A7, 6D6, 6B7, 6A6, 76, 84
Remler Co., Ltd., Remler 36	2101 Bryant St., San Francisco, Calif.	\$59.50	11x7x7		Yes	No	Generator	6D6, 6C6, 76, 6D6, 75, 41	6.5
Republic Industries, Sky Hawk	Ashland, Ohio. 321	\$44.90	10x7½x6½	6" diam.	Yes	No	Vibrator	78, 78, 75, 77, 84, 41	5
Sentinel Mfg. Co., Sentinel 10M Sentinel 7M	2222 Diversey Blvd., Chicago, Ill.	\$39.95 49.95	7x7x8½ 9½x8½x6½	5" diam. 6" diam.	Yes Yes	No No	Vibrator Vibrator	6A7, 6D6, 6B7, 41, 84 75, 84, 6D6, 6A7, 6D6, 41	6 7
Simplex Radio Co., Simplex T	Sandusky, Ohio	\$37.75	9½x5½x6½	6½" cone	Yes	No	Vibrator	6D6, 6A7, 75, 6D6, 42	4
Sparks Withington Co., Details on new line not available as we go to press.	Jackson, Mich.								
Stewart Warner Corp., Stewart Warner R1311	1836 Diversey Parkway, Chicago, Ill.		10x7½x7½		Yes	No	Vibrator	78, 78, 75, 41, 84, 77	6.5
United American Bosch Corp., American-Bosch 634A* American-Bosch 524A* *Circular shape.	Springfield, Mass.	\$52.95 44.95	9½" diam. x 7½" high 9½" diam. x 7½" high		Yes Yes	No No	Vibrator Vibrator	77, 77, 78, 75, 42, 84 6A7, 78, 75, 42, 84	6.2 6
United Motors Service, Inc., Deleo 629 Deleo 626 Deleo 627 Deleo 628 *Installation included.	3044 W. Grand Blvd., Detroit, Mich.	\$42.50* 49.50* 57.50* 67.50*	7½x7½x8½ 7½x7½x8½ 7½x7½x8½ 7½x7½x8½		Yes Yes Yes Yes	No No Yes Yes	Vibrator Vibrator Vibrator Vibrator	6F7, 6B7, 6D6, 42 6D6, 6D6, 6A7, 6B7, 42 6D6, 6A7, 6B7, 6E6, 6E6 6D6, 6D6, 6D6, 6A7, 85, 6A6
Wells Gardner & Co., Wells Gardner 25Y1 Wells Gardner 26S1	2701 N. Kildare Ave., Chicago, Ill.		12x9x4 10x7x7		No Yes	No No	Vibrator Vibrator	6C6, 6D6, 6D6, 41, 75 75, 6C6, 6D6, 6D6, 41, 84	5.2 5.8
Westinghouse Electric Supply Co., Westinghouse WR500 Westinghouse WR501	150 Varick St., New York City, N. Y.	\$52.95 44.95	9½ diam. x 7½ 6½x6½x9½		Yes Yes	No No	Vibrator Vibrator	77, 77, 78, 75, 42, 84 78, 6A7, 78, 85, 41, 84	6.5 6
Wholesale Radio Service, Lafayette AM20 Lafayette C60 Lafayette L30 Lafayette B62	100 Sixth Ave., New York City, N. Y.		10½x7½x6½ 10x6½x7 12x8x4		Yes Yes Yes No	No No No No	Vibrator Vibrator Vibrator Vibrator	78, 77, 78, 75, 41, 84 6D6, 6A7, 6D6, 75, 41, 84 78, 77, 78, 75, 41, 84 6D6, 6C6, 6D6, 75, 41
Wilcox-Gay Corp., Road Mate 4B6	Charlotte, Mich.	\$44.90	10x7½x6½	6" diam.	Yes	No	Vibrator	78, 78, 77, 75, 84, 41	5
Zenith Radio Corp., Zenith 664 Zenith 666 Zenith 668	3620 Iron St., Chicago, Ill.	\$39.95 49.95 54.95	9x6½x7 9½x6½x6½ 9½x6½x6½	6" diam. 6" diam. 8" diam.	Yes Yes Yes	No No Yes	Vibrator Vibrator Vibrator	6A7, 6D6, 75, 41, 6Z4 6D6, 6C6, 6D6, 75, 42, 81 6D6, 6C6, 6D6, 75, 42, 6Z4	6 6 6

Courtesy - D. J. Anson.

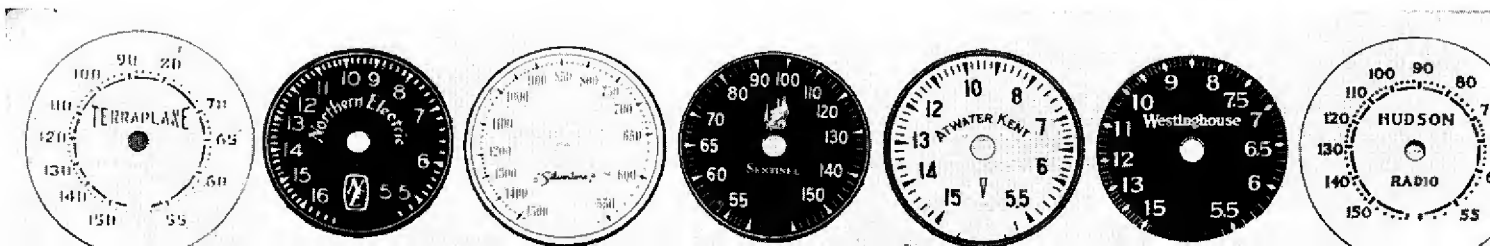

NEWS OF THE MONTH

TUBE PRICES IN ANOTHER TAIL SPIN

Radiotron-Cunningham Agency Consignment Plan Withdrawn as of April 1—The Battle Rages

RCA's hat is in the ring! Freeing itself of the restrictions imposed by the terms of its agency consignment plan, instituted less than a year ago, the RCA Manufacturing Company, announces a return to its former policy of outright selling, at the same time, April first, filing new tube price schedules. These new schedules, distinguished by a prevalence of "odd cent" markings, average, for the tubes in active demand, about 15 per cent lower than formerly. Of a total of 75 tube types, 47 are thus listed. These range as follows: 3 at 59 cents, 10 at 69 cents, 14 at 89 cents and 20 at 99 cents.

Dealers discounts will be slightly more liberal than under consignment—especially for the present as RCA is offering a special added bonus to those who wish to buy in their present consignment stocks—on the new, lower list price basis.

Other Companies 5 to 20 Cents Higher Than New RCA Schedule

As might be expected the other tube makers are reducing prices—but are not meeting RCA. For the first time in history a majority of the new lists range from 5 to 20 cents higher.

National Union will continue its well-known policy of a 10 per cent higher list—but with free premiums and service "helps" thrown in to balance the scales.

Tung Sol sticks to its consignment guns—will make no alteration in its distribution set-up, which has proven very successful, but will lower lists slightly in line with the present trend.

Arcturus, guided by the returns from a recent survey indicating an overwhelming desire on the part of the retail trade for higher prices, will act accordingly. Its lists will be above the others.

Hygrade Sylvania is adding 11 cents to the "odd cents" group and pricing the others 10 cents over the accompanying table.

Raytheon tops the 59, 69 and 99 tubes by a 6-cent margin and the others are topped a dime.

Ken Rad, it is understood, will meet the prices as set forth in the table here shown, while Philco is under some of these items and even or above on others.

The above reflects the rapidly changing picture as of April 1. Rumors of further cuts are in the air, but, in view of the price stand being taken by quite a number of manufacturers, such a move hardly seems politic or necessary.

Arcturus Will Hold to a Quality Tube Price Basis

Officials of the Arcturus Radio Tube Company, Newark, N. J., when interviewed by the managing editor of this magazine last week, expressed the conviction that a radio tube is a highly technical product and that this continued decrease in prices cannot continue without sacrificing standards of high

RCA NEW LIST PRICES

Type	List Price	Type	List Price	Type	List Price
00A	\$1.25	81	\$.89	84A	\$1.50
01A	.59	82	.99	84	1.25
1	1.25	43	.99	85	.99
1A	.89	15	.69	89	.99
10	2.00	16	.99	999	.99
11	1.25	17	.89	999	.99
12	1.25	18	2.50	1A6	1.25
112A	.69	19	.99	2A3	1.25
19	.99	30	2.50	2A5	.99
20	.99	53	1.25	2A6	.99
22	1.25	55	.99	2A7	1.25
24A	.89	56	.69	6A4	1.25
26	.59	57	.89	6A8	1.25
27	.69	58	.89	6A2	1.25
30	.69	59	1.25	2B7	1.25
31	.69	71A	.69	6B7	1.25
32	1.25	75	.99	1C6	1.50
33	.99	76	.69	6C6	.99
35	1.25	77	.99	6D6	.89
35	.89	78	.99	6F7	1.50
36	.89	79	1.25	5Z5	.89
37	.69	80	.59	18Z3	.99
38	.89	81	2.00	23Z5	.99
39-41	.89	82	.89	874	1.90
40	.69	83	.89	876	6.70
				886	6.75

quality. "The public is more interested in a quality service than in petty savings," it was stated. "Furthermore, the servicing of such a delicate article should be in the hands of dealers and service men skilled to do this work. The radio tube, therefore, should not be merchandised as a cut rate item. If this service is to be rendered by experienced men they must be adequately recompensed."

Philco Tube Policies Unchanged

Philco will continue without any major change in either its distribution or discount schedule on replacement tubes. Philco feels that stability is necessary in the replacement tube business both from the manufacturers' and dealers' standpoint. "As this has been our aim in the past, we see no reason why there should be any change in this well established policy," writes this concern under date of April 2.

Public Shows Will Not be Sponsored by RMA

A general policy regarding public radio and electrical shows was adopted unanimously by the RMA board of directors at their meeting, March 22, at New York City. Under this general policy the RMA will not sponsor, approve or support any public radio and electrical show in New York or any other city. While strictly "local" radio shows are not disapproved, it is felt that RMA sponsorship of any show carries with it a national character, attracts distributors and dealers, and the result is that sales before the show period are retarded with a resultant loss of business. The RMA Board's policy is advisory to members but leaves each company free to take such action as it may desire regarding show exhibits.

Regarding the proposed "national electrical and radio exposition" at the Grand Central Palace in New York City next September, under the general policy detailed above the RMA Board rejected a proposal received from the Electrical Association of New York for RMA sponsorship. The board took similar action with respect to tentative plans for a radio show at Madison Square Garden and none will be held this year at the Garden.

RMA Convention June 11-12

The Eleventh Annual Convention and Membership Meeting of the RMA will be held June 11-12, at the Stevens Hotel in Chicago, according to plans adopted by the RMA board of directors at their New York meeting, March 22. Paul B. Klugh of Chicago will again be chairman of the convention and entertainment committee. Details of the program for the convention at which new officers and directors will be elected and other important business transacted, will be announced later.

New Visual Sound Products Department Created by RCA

The creation of a new visual sound products department, headed by John K. West, is announced by the RCA Mfg. Company. This department will handle sales activities in connection with 16-mm. sound-on-film amateur motion picture cameras and projectors.

Branch offices for the promotion and sales of visual sound projects have been established in New York, Chicago and Hollywood.

Wiltbank Heads Eby Sales

In line with an aggressive program of expansion in the radio parts field, Charles N. Wiltbank has been appointed sales manager of Hugh H. Eby, Inc., Philadelphia.

GE DESIGNS LINE OF 10 METAL-SHELL TUBES—TO BE USED IN NEW FALL LINE

RCA To Manufacture—Radically Different Bases

Prohibit Replacement Use—Prices Not Yet Determined

On April 1, *Radio Retailing* was invited to the "House of Magic" showroom in New York by radio sales promotion manager J. W. McIver to see a line of 10 new metal-shelled tubes designed by the General Electric Company, manufactured by RCA. Ira J. Kaar, chief radio design engineer, and Bill White, engineer of the vacuum tube department, described the new "bottles" which, we understand, will be seen in GE's fall line of receivers and, probably, in sets offered by several competitive companies.

The new tubes use a drawn steel envelope instead of the usual glass. This shell is brought out to a base pin for grounding. (Later, if fire underwriters can be appeased, it may be used as the anode.) Elements are very much like those used in existing tube types but inasmuch as leads are brought through individual glass beads fused in an inner base it is possible to avoid converging in a "pinch" seal. This permits all elements to be brought down closer to the base and the metal shell is much closer to the elements, reducing size on both dimensions. Comparison of metal-shelled tube sizes and existing glass types may be made in the photograph. The new designs, it is claimed, will be more efficient, particularly at high-frequencies, because of the shorter leads involved and the closer shielding achievable.

Bases are entirely different, consisting of as many as eight extremely small prongs symmetrically grouped around a center insulated prong equipped with a lug to insure proper orientation. All prongs are of the same diameter and it is likely that one standard socket will be used for all types, the position of the lug on the central pin alone determining pin position. Where tubes have less than 8 pins the same bases will be used, unnecessary pins simply being omitted. It will be seen from this that the new types are not meant for replacing existing glass-enveloped types. It would be possible to equip with replacement type bases, of course, but this is not at present contemplated.

The 10 types to be seen in fall receivers will include tubes having indi-

rectly heated cathodes and characteristics similar to existing types as well as several new designs, such as a duodiode, $\frac{3}{8}$ inch high above the base, and an improved pentagrid converter. Heat, it is explained, radiates quite as readily from the metal shell as from glass, especially since the shell is painted black. Power tubes will be just about as hot to the touch as those in use.

Prices have not yet been determined but it seems likely to the Editors that they will be somewhat higher than at present, at least until volume demand permits manufacturing economies due to quantity production. Eventually they may be produced even cheaper as assembly is much more mechanical and breakage in transit will, unquestionably, be reduced to a negligible factor. Eventual prices are, nevertheless, a matter for conjecture.

Assembly is much different than that of older types. A small "header" punched out of metal and not unlike the top of a small tin-can in appearance is drilled to receive the leads. Leads are threaded in extremely small glass beads which are, in turn, fitted within small metal eyelets. The eyelets are impressed into the header holes and by fusing and brazing leads, beads, eyelets and header become one.

The elements structure is built up right on the header. Then the metal shell, which fits quite closely, is dropped over the assembly and welded in place. A small steel tube in the center of the header permits the tube to be exhausted

while a gas-jet flame heats the shell to expel gas. (Glass tubes are bombarded" indirectly by radio frequency to heat the internal elements while exhausting.) Then the tube is pinched and sealed and the base affixed. The type number is cut right into the shell.

Naturally, one can't see the tubes light. Kaar points out that few tube failures are due to burned out heaters anyway and that this is no disadvantage. The new GE receivers, he advises, will use the metal-shelled tubes exclusively . . . with the exception of the pilot light!

Philco Urges Caution in Use of New Metal Tube

Dr. Walter E. Holland, vice-president in charge of engineering for Philco, has released the following statement on radio tubes:

"My company urges the radio industry in its own and the public's interest to proceed cautiously in the introduction of all metal tubes in view of the utter failure of the metal vacuum tube in England where, under the name of Catkin, it was introduced two years ago and discarded in favor of glass by the entire industry after one season's sad experience. Whether the tube envelope is metal or glass is not important. It is the inside of the tube that counts.

"The introduction of metal as a shield in radio sets is not an innovation. Metal shields have been and are used in all good radios to separate tubes and circuits from each other."

"Not So!" Say GE Engineers

Engineers and research scientists of the General Electric Company, replying to the warning issued by Dr. Holland, Philco technician, relative to the reliability of GE's new metal shelled tubes, point out that the American tube differs materially from the European "Catkin product." In the RCA-GE product the metal casing serves only as a shield whereas the metal envelope of the foreign tube was designed to serve also as one of the active elements and therefore is more critical in its functions.

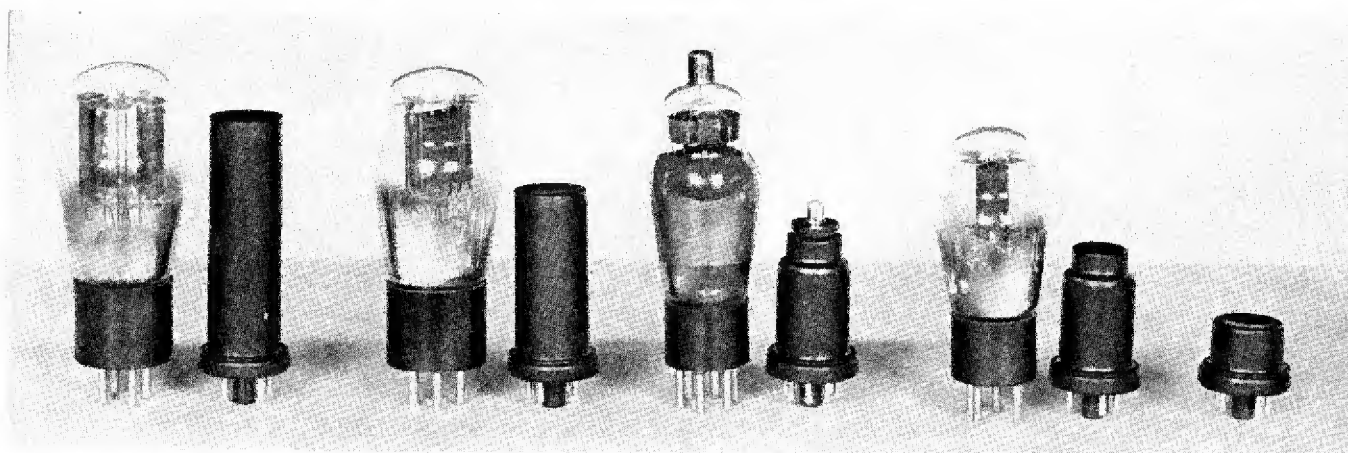

Five of the "iron" tubes to be used by GE and others in fall set production. Left to right: Conventional rectifier and its armored counterpart; triode power tube and a bullet-proof duplicate; r.f. pentode and hard-shell brother;

common triode and the new baby; duo-diode, $\frac{3}{8}$ inch high above the base. Elements are full size in all types, space being saved by the method of construction rather than by using miniature parts.

CANADIAN RMA SPONSORS TWO PLANS TO HELP DEALERS' SPRING SELLING

A nationwide, two-fold plan to stimulate radio business is being sponsored by the Radio Manufacturers' Association of Canada according to the "Radio Trade-Builder." It consists of two parts—first the RMA Spring Prize Plan for dealers' salesmen; second, the Radio Explorers' Club of Canada in which both salesmen and consumers may take part.

Under the Spring Prize Plan, for every \$100 worth of merchandise the salesman sells, he is credited with ten points which have a definite merchandise prize value. Each manufacturer has prepared a special list of the models in his line which are included in the plan offer. This contest started Feb. 15 and will end on May 15.

The second part consists of a Radio Explorers' Club. The salesman who wishes to become a member must certify that he has tuned in and listened to a program from at least one foreign shortwave station, sending

all information such as call letters, country, frequency, time and details of program to the RMA, who then mails a verification card with an international stamp to the station reported. At the same time the Association sends the salesman a finely designed and executed pin which he may wear. Membership in the Club is held "airtight" and all requirements must be fully met before the application is considered. Radio owners may become members by sending verification cards from three foreign stations.

The plan also provides special publicity for dealers in that set owners who have qualified for membership in the Club are directed by the RMA of Canada to loan their verification cards to the local dealer from whom they bought their set. It is anticipated that these cards will be used by dealers as the basis for a special window display.

short wave stations when atmospheric static makes long distance broadcast reception impossible. It means spring and summer sales to the radio dealer."

Stromberg Ups Haubrich

A. M. Haubrich has been appointed manager of Stromberg-Carlson's Chicago office, succeeding Carl W. Schafer, who died January 16. Haubrich has been with S-C since 1901.

RR NOMINATES for membership in its PRIME MOVERS CLUB



W. C. Braun

To qualify for membership in our "Prime Movers Club" one must have contributed, in an altruistic sense, to the advancement of the industry he represents. Personal service is not enough.

W. C. Braun, president of Radolek, Chicago, is just such a man. Credited with being largely responsible for the organization of the Association of Radio Parts Distributors—which group he heads and ably represented last month at the IRSM convention in Chicago—Bill Braun didn't let it go at that. Last June, at the Radio Wholesalers Association convention, he sprang into the breach and presided at the parts jobbers group meeting; now represents them in his capacity as a director of the RWA.

Bringing the picture up to date, Mr. Braun's latest move is the purchase of the entire parts stock of the Harry Alter Company—which should make him the head of just about the largest parts house in the Middle West.

Braun believes in protecting the dealer by not soliciting business direct from the consumer—a good creed in any man's language.

NEWS of the STATIONS

April 1, WBBM, Chicago, jumped to 50,000 watts, double its former power. This station carries Columbia net programs for the Lake Michigan area. Station KFAB, Omaha-Lincoln (synchronized with WBBM during evening hours) also doubled its power on the same date, now broadcasting with 10,000 watts.



ver; WOW, Omaha; WTCN, Minneapolis and KMBC, Kansas City. This transmitter is designed to deliver 5 kw. of unmodulated carrier to the antenna and to effect 100 per cent modulation of the carrier corresponding to peak power outputs of 20 kw.

Why do radio programs sometimes fade, distort or mush—including those from local stations; what is meant by high fidelity, wide band transmission; how may a user obtain the most satisfaction from his set? These questions are answered in a pamphlet prepared by the Engineering Department of a large broadcasting system.

To get this information, write the Editor of "Radio Retailing."

Stromberg-Carlson Anticipates Lively Spring Season

This year, according to a prominent official of the Stromberg-Carlson Company, indications are that radio dealers will continue their winter concentration on radios well into the summer months. "This is so," he states, "because now, with short wave transmission so greatly improved and with sensitive receivers, which reproduce both short wave and standard wave with natural tone, radio has a year-round appeal.

"Short wave antenna becomes not only stronger, but more important as the days grow longer. It means good summertime reception of both American and foreign

Guy S. Felt Dies

Word has been received of the death of Guy S. Felt, vice-president of Hygrade Sylvania Corp., on March 8, after a short illness. Mr. Felt was one of the most prominent figures in the incandescent lamp and radio tube industry. He had been associated with B. G. Erskine for 16 years and was an important factor in originating and carrying out the business policies of the company.

The trend toward directional or "pattern" antennas has now been definitely established. The illustration shows what can be accomplished in distances when a station knows what it wants and goes after it. Of course you know that WOR is now a 50,000 watter.

The following stations have recently installed Western Electric new type 5 kw. broadcasting systems: KFRC, San Francisco; KHJ, Los Angeles; WSPD, Toledo; WJAS, Pittsburgh; KLZ, Den-

1704 ATTEND CHICAGO IRSM SHOW

Attendance Tops '34 By 500—Exhibit Huge Success

The Institute of Radio Servicemen staged its annual Chicago Convention and Radio Trade Show at the Hotel Sherman, March 22, 23, 24. Exhibits maintained by 77 manufacturers, jobbers, representatives, attracted an attendance of 1704, an increase of 500 over last year. Fully 400 jobbers and manufacturers' representatives were on deck, indicating that the show was considered of general trade importance even outside the service industry. Jobbers from as far away as Texas and California were present.

Exhibitors expressed complete satisfaction with the attendance and its quality, reported that they were amazed at the diversification of visitors from retail, wholesale and manufacturing branches of the industry.

Exhibit-checking time was interspersed with technical, association business and sales educational sessions which were heavily attended. Speakers were: E. C. Arnold of the IRSM; Ellis McFarland, Chicago Association of Commerce; F. P. Stevens; Dr. Wolff, of RCA; C. C. Aiken of the same company; L. O. Gorder; Kendall Clough of Clough-Brengle, Bob Anderson of Tobe Deutschmann; P. J. Burrill of Hickok; D. E. Johnson of Dayrad; Fred Pizer of RCA; J. T. Keeney of Readrite; F. E. Wenger of Triplett; R. M. Krueger of Earl Webber; C. G. Miller of Weston; C. G. Pyle of Hygrade-Sylvania; Walter Jones of the same company; E. H. Wavering of Motorola; R. D. Wright of Pioneer Gen-E-Motor; A. J. Farkas of American Bosch; J. P. Kennedy, contributing editor to *Radio Retailing*. Also Hugh Eby, James B. Durham, Arthur Lynch, Charles Herbst of RCA and William J. Gaynor of Technical Appliance.

Sessions were held by the parts distributors, the Radio Wholesalers Association (W. C. Braun, of Radolek, presiding) and by the RMA Service Section, J. N. Golten, of Stewart Warner, presiding.

Heard at the Chicago show: "What this country needs is a good five cent tube."

Fred D. Williams Joins IRC



Fred D. Williams

The appointment of Fred D. Williams as vice-president and general manager of the International Resistance Company, Philadelphia, has been announced by president Ernest Searing. Mr. Williams needs no introduction to the radio trade. Prominently identified with the industry since its earliest days, he brings to IRC an unusually broad knowledge of all branches of the business with special emphasis on manufacturing and distribution in both the original equipment and replacement parts fields. As president of the Radio Manufacturers Association for two consecutive terms, Mr. Williams was a leader in various moves for stabilization and betterment. He is now treasurer of that organization.

Mr. Williams' association with IRC comes as a logical move in line with



"Doc" ARNOLD (Rochester) who, as 1935 President, presided at IRSM Convention sessions

that company's program of expansion on IRC resistors and volume controls as well as on other developments to be announced in the near future.

North and South Servicemen Plan Local Conventions

The Northwest Radio Servicemen's Association is sponsoring a servicemen's convention in Minneapolis, May 5-7, at the West Hotel. This convention is for servicemen of Minnesota, North and South Dakota, Iowa and the northwestern part of Wisconsin.

The following program will start at 1:30 p.m., May 5, immediately following the Mid-American ARRL Amateur convention which is being held in the same hotel the two preceding days. On Monday evening there will be a banquet followed by an important national speaker and then a stag.

Montgomery, Ala., is the city chosen for the Southern District convention of the Radio Servicemen's Association to be held June 17-20, inclusive. P. F. Metzler, of Birmingham, is president.

S. B. Levaur with Zenith

The appointment of S. B. Levaur, well known among refrigeration and radio dealers and distributors as eastern representative for Zenith is announced by E. A. Tracey, vice-president.

Mr. Levaur, formerly with RCA-Victor, more recently actively engaged in the merchandising of refrigeration. He will headquarter in Philadelphia.

DEALER HELPS

The title, "Service Men's Guide" tells the story of what to expect in Thordarson's new booklet, No. 342A. Write to: Thordarson Electric Mfg. Co. 500 W. Huron St., Chicago, Ill.

Preparation of a new auto-radio service and replacement manual has been completed and this splendid booklet, which contains schematic charts of more than 200 popular automobile radio receivers, will be sent upon request to:

P. R. Mallory & Co., Inc.
Indianapolis, Ind.

Something new in service manuals, "Voltage Tables for Radio Receivers," is the latest publication of:

F. L. Sprayberry,
2548 University Place, N.W.
Washington, D. C.

Bound in durable fabrikoid in the handy 8½ x 11 in. size. \$2.

Electrad introduces five new products in its catalogue just off the press. For example, volume controls, resistors and a new 150 watt rheostat. The address is:

Electrad, Inc.
175 Varick St.,
New York City.

A folder describing its new 19-tube receiver with technical information is now available from the:

Howard Radio Company,
1731 Belmont Ave.
Chicago, Ill.

Data on the loss characteristics of insulators is included in a new catalogue of analyzer plugs, adapters, connectors and shortwave condensers issued by:

Alden Products Co.
715 Center St.
Brockton, Mass.

Lenz Catalogue

The March issue of *Radio Retailing*, page 31, stated that the Lenz Electric Mfg. Co., 1751 N. Western Ave., Chicago, would mail its latest manual free. We are informed that there is a charge of 12c. to cover mailing.

Hendrickson GM for Midland



E. J. Hendrickson

E. J. (Joe) Hendrickson has been appointed general manager of the Midland Radio Company, Cleveland, distributors of Sparton radios and refrigerators. He succeeds Warren Cox, who recently resigned.

Mr. Hendrickson is widely known in the radio industry having started in 1923 as sales representative for the Radio Corp. of America in the upper New York State territory. He later was radio merchandise manager for General Electric, Bridgeport.

All-Wave Makes Radio of Utilitarian Value Says Richardson

Inspired by increases in radio sales in January, February and March, instead of the customary declines, Howard E. Richardson, assistant to Powel Crosley, Jr., president, Crosley Radio Corp., urges that dealers do not let down on the home market for sets this spring.

"Many of our jobbers have told me that business is holding up so well that added stock commitments have been necessary. Beck & Gregg, for example, report radio sales for February way ahead of last year and also over those of January," states Mr. Richardson.

"Radio's expansion into the realm of foreign, police, amateur, aviation—and even weather—not only has added new interest for the listener but has, in many instances, made of his set a business instrument. Those who travel by ship or air are now keenly alert to aviation and weather broadcasts. The same applies to the man of world-wide affairs—who follows the foreign news broadcasts avidly. Yes, all-wave reception has put radio into the utilitarian class.

"These factors are carrying radio beyond its former seasonal limitations—making it a necessary instrument in the life of practically every citizen."

J. J. Bressler With S. O. S.

Julius J. Bressler, formerly of Federated Purchaser and WNYC, has left the p.a. field for the flickers. He is now connected with the S. O. S. Corporation and will welcome any inquiries from radio men interested in the motion picture equipment field. Address Bressler at S. O. S., 1600 Broadway, New York.

Pilot at India's First Show

"Radio is already a factor in the education and enlightenment of natives of India," according to an account of the popular interest displayed in India's

first radio show. The all-wave sets developed by the Pilot Radio Corporation occupied an outstanding place.

Chevrolet Campaigns Auto-Radio

Did a radio manufacturer write the accompanying? No! As a matter of fact it is a page from a "pep talk" chart prepared by an auto-maker—Chevrolet.

Chevrolet already has started boosting motor car radio in a series of di-

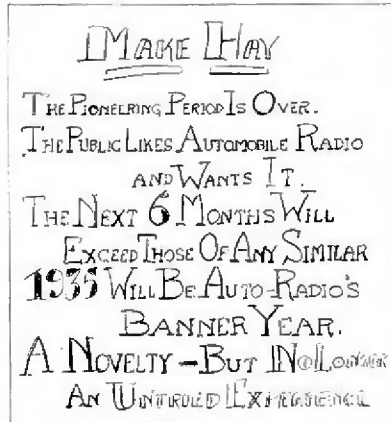

visional meetings for its dealers and salesmen. Its accessory-promotion men are telling auto dealers that it takes the sale of only seven car radios to equal the gross profit on the sale of a Chevrolet. This is what one of our very largest automobile makers thinks of the prospects for auto-radio this year.

Let the radio dealer, whose main line this spring should be radio, take a tip from this motor car concern.

Pittsburgh Servicemen Publish Monthly Bulletin, "Amplifier"

The growth and activities of local organizations of servicemen has been a noteworthy feature of the past 12 months. Indicative of this trend is the receipt of the March issue of *The Amplifier* published monthly by the Radio Servicemen's Association of Pittsburgh, Pa. An orchid to editor William Iriam, who is doing a mighty fine job with this 18-page publication.

J. H. Crump, Texas, Makes a Bid for Farm Business



This very fine radio booth was installed by the J. H. Crump Company, Fort Worth, Texas, at the Southwestern Exposition and Stock Show, March 16-24. "A 100 per cent coverage medium for reaching farmers," writes Jack Bates, who represents Electrical Research Laboratories in the Pan Handle State.

Emerson Presents A-R Models During "Open House" Week

A highly successful introductory showing of its new line of auto-radio models was conducted March 12 to 15 by the Emerson Radio and Phonograph Corporation at its New York showroom. Open House was maintained from 5 p.m. to 11:45 p.m. during which hours hundreds of dealers inspected the new models on display. For technical specifications see New Merchandise department.

President Ben Abrams, recently returned from an extensive trans-continental business trip, was on hand each evening. This affair also served as the introductory party for Nate Hast, new eastern sales manager.

Mann and Levinson to Distribute "All American" Sets

All American Products Corp. is the name of a new radio jobbing firm with headquarters at 800 W. Washington Blvd., Chicago. Phillip Mann, president, states that the company will specialize in assisting dealers and service men in their sales promotional work. Also, it will feature a line of radio receivers installed manufactured especially for All American and carrying the All American name. Louis Levinson, vice president, was associated for eleven years with the Triangle Electric, Chicago.

Philco Meets RCA 'Odd Cent' Prices in Majority of Types

APRIL 4—AS WE GO TO PRESS the following schedule of new prices, on tubes distributed by the Philco Radio & Television Corporation, reaches our desk:

PHILCO, APRIL 1, TUBE LISTS						
	59¢	69¢	79¢	89¢	99¢	\$1.25 \$1.50
01A	27	30	2	5	32	6
26	45	31	4	9	34	10
	56	37	12A	19	55	14
	71A	40	24A	33	59	15
	80		35-51	42	79	17
			36	43	84	48
			38	46	1A6	50
			39-44	49	2A5	81
			41	55	2A7	1B2B
			47	75	2B7	1B3
			57	77	6A4	4B5
			58	78	6A6	1G6
			76	85	6A7	6F7
			82	89	6B7	12A5
			85	X99	22	12A7
			1A1	2A5		
			1C1	2A6		
			1V	6C6		
			5Z3	12Z3		
			6D6	25Z5		

Analysis discloses that, in 10.8 per cent of the tube types mutually listed, Philco tops RCA 10 or 20 cents. In 6.1 per cent, Philco is under RCA by 50 cents or \$1. These latter tubes (types 10, 50, 48 and 81) are three power amplifiers and one rectifier.

The other tubes where price differences occur are as follows: type 80—RCA 59c., Philco 69c.; types 30, 31, 37, 40—RCA 69c., Philco 79c.; types 12A and 76—RCA 69c., Philco 89c. Otherwise Philco's and RCA's new lows match—including the 'odd cent' as well as the \$1.25 items.



WHY CONSIGNMENT FAILED

The Agency System is the only legal means by which a manufacturer can control trade re-sale and consumer prices on his product. It is primarily a means of establishing the ideal in orderly marketing with price as a competitive weapon removed.

Our attempt to accomplish the above objective in the badly disorganized radio market could not succeed without aggressive, active, loyal support from the trade. The majority of our wholesalers and dealers did not give us this kind of support. Competitive manufacturers and their distributing organizations short-sightedly intensified their price selling, thus aggravating market conditions and making it impossible for RCA Radiotron alone to carry the burden of stabilizing and limiting price competition.

Stabilized price marketing very evidently went contrary to "human nature" in the radio business and during a severe depression. Sales effort by Agents decreased. Many of our Wholesale Agents, finding their sales effort limited to stimulating the activity of their served dealers only, took on other brands to be sold at greater discounts to Radiotron Agents served by competitive jobbers. As this "cross fire" spread, Dealer-Agent volume decreased. Radiotron consigned stocks were looked on as a convenience and not as an obligation and an opportunity. This was a short-sighted policy but was sound "human nature" in the present state of the radio business.

Most of our wholesalers distribute radio receivers. Their set dealers and Radiotron Agency appointments did not coincide, further aggravating jobber-dealer relations and weakening sales effort on our tubes.

Consigned stocks and Agency selling were more expensive for us to handle and many of our wholesalers felt similarly. A market stressing low prices requires low-cost operation.

The Agency System—to be kept in legally approved form—requires considerable "red tape," with resulting inflexibility. Competitive radio tube conditions require speed, quick action and therefore the utmost flexibility.

Many classes and types of retailers sell tubes. We found it impossible to construct Agency Contracts that would appeal to the great variety of competitive dealers that dominate the tube business.

Much more could be said on "Why Consignment Failed." But need more be said?

PRESIDENT, RCA MANUFACTURING CO., INC.

NEW AUTO-RADIO MERCHANDISE

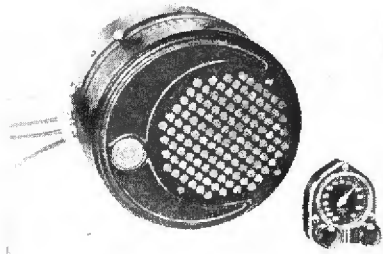

American Bosch "Round"
Auto-Radios

A new line of car-radios that "look different and sound different" and are built "round for sound" is being shipped from the factory of the United American Bosch Corp., Springfield, Mass. Based on the principle that a curved or cylindrical shape guards musical tones against unwanted vibrations and distortions and enables the sound to travel continuously without being broken up.

The new sets for 1935 include Model 634, a 6 tube set at \$52.95 and Model 524, a 5 tube set at \$44.95. The former has a new type of tone control which sustains volume regardless of whether higher or lower pitch is emphasized, the announcement says. Each has an improved "spark noise trap" to cut ignition noises to a minimum.—*Radio Retailing*, April, 1935.

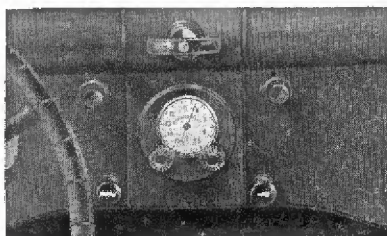

A K 776 Auto-Radio

Dash mounting in the ash receiver opening of most cars is possible with the latest car set of the Atwater Kent Mfg. Co., Philadelphia, Pa. An opening 2½x2 7/16 in. will accommodate the control. Mounting plate furnished at slight additional charge. The easy accessibility of the 1934 line with one bolt mounting has been retained.

This is a 6 tube set listing at \$49.90.—*Radio Retailing*, April, 1935.

Kadette "Duplex" Radio
for Home and Car

The International Radio Corp., Ann Arbor, Mich., offers a new Kadette "Duplex" set which may be used both in the car and in the home. It is easily carried from room to room or to the car as it weighs but 6½ lb.

The original installation of the auto-adaptor-socket is easily made in a few minutes by clipping one wire to the ammeter. After that, to use the set in the car the a.c. cord is plugged in. No switches or cables are needed. The circuit employs four tubes: 6D6, 6C6, 75, 12A7 and the cabinet is a two tone mahogany bakelite measuring 8½x6½x3½ in. The 6-volt auto-adaptor-socket measures 6x5x2½ in. List price complete is \$36.50.—*Radio Retailing*, April, 1935.

RCA Victor Auto-Radios

The Magic Brain principles which have been featured in the home radios of the RCA Mfg. Co., Inc., Camden, N. J., have been applied to its auto-radios.

These sets have a streamlined control unit and incorporate the new Powertron unit using a new full-wave synchronous rectifier, plug-in type. A special ignition noise filter makes it unnecessary to employ spark plug suppressors in most new cars.

Model M-101 listing at \$44.95 is a 5-tube, single unit receiver. Tuning range, 540 to 1600 kc.

Model M-104, similar in general characteristics but with improved performance, is \$49.95.

Model M-108 is a two unit receiver utilizing the same chassis. Tuning range, 540-1600 kc. \$57.95.

Model M-109 is a two unit, 7-tube job with the power supply unit mounted in the speaker case, permitting a smaller, more convenient installation of the chassis.

As with other RCA-Victor auto-radios, if dash mounting of the control head is desired it can be accomplished easily by the use of a special bracket, at a slight extra cost.—*Radio Retailing*, April, 1935.

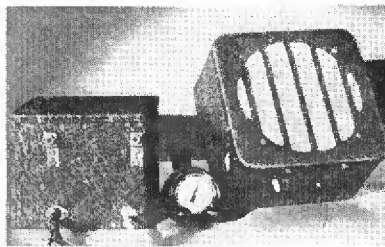

Philco Auto-Radios

Three single unit and one double unit auto-radios make up the new line of Philco Radio & Television Co., Philadelphia, Pa.

Model 805 is a 5-tube all-in-one set with universal mounting. The price is \$42.95. As with all Philco auto-radios, this is the price installed to car aerial.

Model 806 is a 6-tube single unit receiver at \$49.95.

Model 807, also a single unit, takes seven tubes. Combines features of Model 806 with still greater sensitivity and selectivity and better fidelity. \$59.95.

Model 808 is the de luxe set of the line and is a two unit model that fits any car. Has newly designed large electrodynamic speaker. \$75.

These Philco radios have a modernistically designed control unit which fits on the steering column or instrument panel. They are designed to operate on either under car or roof aerials and will fit any car.—*Radio Retailing*, April, 1935.

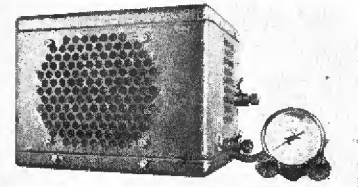
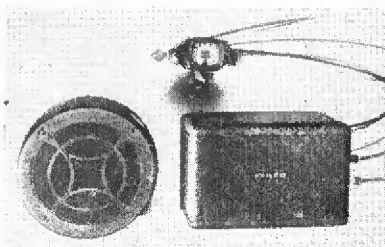

Zenith Auto-Radios
664 and 668

In addition to its Model 666 auto-radio announced last month, the Zenith Radio Corp., 3620 Iron St., Chicago, has brought out Models 664 and 668.

Model 664, illustrated, is a 5-tube set with 6 in. speaker. One unit construction. Tuning range: 535-1600 kc. Spark plug suppressors are not necessary, the release states.

Model 668 takes 5 tubes and has an 8 in. separate speaker. Same tuning range as Model 664. No spark plug suppressors needed.—*Radio Retailing*, April, 1935.

G.E. Auto-Radios

Model D-51 of the General Electric Co., Bridgeport, Conn., is a single unit set. The three-bolt mounting permits the set to be quickly installed in any of the three positions. A synchronous vibration rectifier of the plug-in type takes the place of a rectifier tube and provides regulation of set voltage under varying conditions of battery voltage. \$49.95.

Model D-52 is a double unit set with separate speaker and employing the same chassis as the Model D-51. The separate speaker is designed for overhead installation if desired. \$57.95.

Model D-72 is a de luxe set of the line and it is of two-unit design. By means of a new antenna circuit filter, the ratio of background noise to signal is greatly reduced. This set has seven tubes and streamlined remote control units. \$74.95.—*Radio Retailing*, April, 1935.



Triplett Shunts for Auto-Radio Servicing

The shunts for auto-radio servicing made by the Triplett Electrical Instrument Co., Bluffton, Ohio, are designed for severe service and made from heavy strips of shunt material mounted on pin jack tips, which are plugged directly into tester jacks. Equipped with binding posts.

Shunts Nos. 1115 and 1215 (capacity 15 amp.) are used to detect power pack and vibrator troubles.

Shunts Nos. 1118 and 1218 (capacity 30 amp.) are used to set the generator at the correct value in order to prevent the battery running down and the generator burning out when installing auto radios.—*Radio Retailing*, April, 1935.

Arvin Auto-Radios

Three new special Arvin car radios have been announced by Noblitt-Sparks Industries, Inc., Columbus, Ind., to complete the 1935 line of six models in a price range from \$37.95 to \$64.95.

Three special models are included: an especially designed model tailored for new Fords; a 6-tube set for installation in the new Chevrolets, Oldsmobiles, Pontiacs and other popular makes of cars, and a low-priced 5-tube super for all makes of cars.

Model 17-A, custom-built for the new Fords, features an overhead speaker that mounts above the windshield between the sun shields. The speaker is finished to harmonize with the interior. Six-tubes. \$44.95.

Model 17-B, also features an overhead speaker and is designed for installation in the Chevrolets, Oldsmobiles, Pontiacs and other new cars. Six-tubes. \$44.95.

The third new model is a 5-tube super-heterodyne of the all-in-one type and the retail price is \$37.95.—*Radio Retailing*, April, 1935.

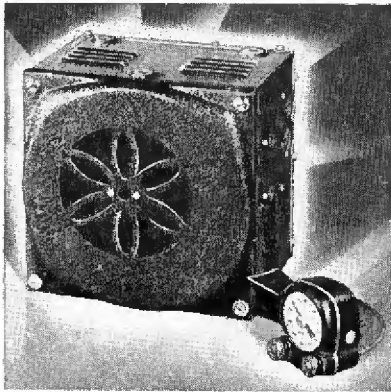

Emerson Auto-Radios

Two attractive auto radio sets, overcoming the use of spark plug suppressors and incorporating several new advances in construction are being shipped by the Emerson Radio & Phonograph Co., 111 Eighth Avenue, New York City. Model 5-A, is a five-tube superheterodyne using two dual-purpose tubes. It is a one-unit job and only two holes are required for mounting. \$44.50.

Model 6-A is a six-tube super using two dual-purpose tubes and listing at \$39.95. The power supply comes from the battery, an arrangement made efficient and noiseless through the use of a new plug-in non-synchronous (non-rectifying) type of vibrator used in conjunction with an 84 full-wave thermionic rectifier. This is a single unit job.

The chassis of both sets are what is termed "fortified" — that is, protected against road shocks, moisture, heat, cold and dust.—*Radio Retailing*, April, 1935.

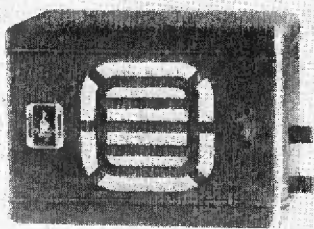

Battery Eliminator for Demonstrating Auto-Radios

For demonstrating automobile radio sets in the store the Schauer Machine Co., 905 Broadway, Cincinnati, Ohio, has brought out a 6-volt, 6-amp. automobile radio battery eliminator, Type AR 8006. This device is operated from 110 volts, 50-cycle current. The direct current output is thoroughly filtered and it is claimed that it will operate any of the standard makes of auto sets without hum.

The assembly consists of a rectifying element of the copper oxide type, a trans-

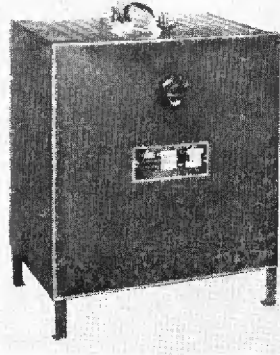

former with insulated primary and secondary windings, the latter with taps connected to a multipoint switch for varying the d.c. output.

The entire assembly is housed in an attractive black crystalline finish metal case measuring 10x10x8 in., arranged for wall or shelf mounting. The energy consumption at maximum load is less than 75 watts.—*Radio Retailing*, April, 1935.

Fairbanks-Morse Car Sets

Illustrated Model 74 motor car set made by Fairbanks-Morse Home Appliances, Inc., 430 S. Green St., Chicago, may be had with ash tray mounting at no extra charge for Ford, Dodge, DeSoto, Plymouth and Chrysler cars. This set has new type a.v.c., new duplex antenna connection, 7 tubes and separate 8 in. speaker. \$64.50.

Model 64 is a single unit, 6 tube receiver listing at \$49.95.—*Radio Retailing*, April, 1935.

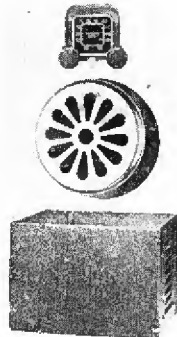

Mallory Replacement Vibrators

Announcement is made by P. R. Mallory & Co., Inc., Indianapolis, Ind., of a complete replacement vibrator line at new low prices. It is said that all replacement vibrator requirements can now be met with the new Mallory line. Such sets as the Air-line, Belmont, Bosch, G.E., Motorola, RCA-Victor, Stromberg-Carlson, Emerson, Fairbanks-Morse, Philco, Sparton, Stewart-Warner, Zenith, as well as those used in the Buick, Oldsmobile, Pontiac, Chevrolet, Ford and Terraplane cars are included in the long list.—*Radio Retailing*, April, 1935.



Bone-Air Conduction Oscillator for the Hard of Hearing

The invention of the Lieber Bone-Air Conduction Oscillator opens up a new field for radio dealers, jobbers, etc. While it is made especially for the hard of hearing, it has many other uses which makes it of unusual interest.

This device consists of a small, light weight electro-magnetic oscillator which, when pressed against the bones of the forehead, back of the head, neck, etc., enables the deaf to listen to the radio. Attaches to any receiver by a plug-in jack and has a volume control.

It has many other practical uses. For example, it may be placed under a pillow and clear reception is obtained, making it suitable for hospital use. May be used any place where earphones are employed, without fear of ear blasting.

This oscillator is made by the Sonotone Corp., 19 W. 44th St., New York City. While no definite list has yet been established, it will be moderately priced.—*Radio Retailing*, April, 1935.

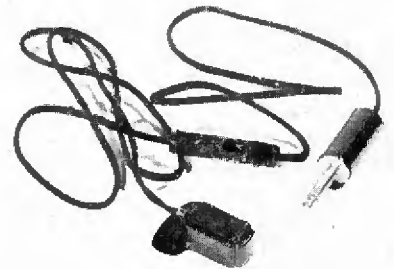

Supreme "385 Automatic" Tester

The "385 Automatic" tester is presented by Supreme Instruments Corp., Greenwood, Mississippi. Built on an entirely new principle, this instrument is automatic in its diagnosis. In addition to retaining the popular features of the 333 de luxe analyzers and 85 tube testers, it has two separate ohm-meters,—one with a low range of 0-200 ohms, the lowest division of which is 1/4 ohm and the other with intermediate ranges of 0-2,000-20,000-200,000 ohms and high ranges of 0-2,000,000-20,000,000 ohms.

One of the most interesting features is the improved condenser tester with six direct reading capacity ranges, neon condenser leakage test for non-electrolytics indicating leakages, shorts and opens plus an English reading electrolytic condenser tester, the first of its kind, Supreme states.—*Radio Retailing*, April, 1935.

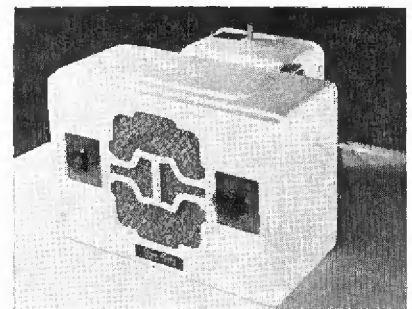

Leonard "Recipe Radio" and Coin Meter

Convinced that the meter plan of merchandising electric refrigerators increases sales, the Leonard Refrigerator Co., Detroit, Mich., has gone one step farther with its "Radio Len-O-Meter" plan through which Leonard outlets are given a combination kitchen "recipe radio" and coin meter.

This combination is tamper proof and constructed so that the coin which keeps the refrigerator operating also provides current for the radio. The radio (4 tubes and built-in antenna) is finished in white and almost entirely conceals the meter.—*Radio Retailing*, April, 1935.

MAKE MORE CALLS

and

BIGGER PROFITS

with this new
NO. 720



Readrite Tester

HERE is the tester that every serviceman needs for properly servicing radio receivers. The new Readrite No. 720 Tester enables you to make more calls per day at less cost per call—and make bigger profits because of its speed, its accuracy and its dependability.

The new No. 720 unit operates *faster . . . more efficiently* and with *less manipulation*.

It tests all resistances, continuities, voltages, current and capacities from the set socket by the reliable point-to-point method. And it is built to withstand severe field service.

Two highly developed Vane-type AC and DC meters are incorporated into this new tester. They are simple in design and dependably accurate. The DC scales are 15, 150, 300 and 600 volts, 15-150 milliamperes. AC scales 10, 25, 150 and 750 volts.

Your Jobber Can Supply You . . .

With the Readrite No. 720 Tester at Dealer's net price of only \$15.00. Write direct for literature to

READRITE METER WORKS

159 College Ave.

Bluffton, Ohio

MAIL COUPON FOR CATALOG

Readrite Meter Works
159 College Avenue, Bluffton, Ohio
Send me catalog on Readrite No. 720 Tester and folder proving Readrite leadership.

Name

Address

City State

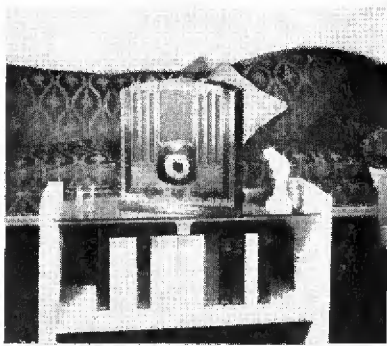

RCA Victor Radios

A new series of five moderately priced home instruments have been announced by the RCA Mfg. Co., Camden, N. J.

Model 119, the smallest in the new line, is a 5-tube table model covering domestic and police bands and housed in an attractive chest-type cabinet. \$29.95.

Model 117 is a 5-tube, two band table model which provides full police band coverage and the important 49-meter foreign entertainment band. It also covers the 80-meter amateur and the day and night aviation services. \$39.95.

Console Model 214 has the same technical features but uses an 8-in. speaker and is housed in a down-to-the-floor console. \$47.95.

Model 125 is a 6-tube, two band table model providing complete domestic band coverage, 1600 to 1720 kc. police band in addition to the foreign entertainment bands on 49, 31, 25, 19 and 16 meters. \$52.95.

Model 225 has all the features of the above set together with a 10-in. dynamic speaker. It is housed in a console grand cabinet and lists at \$67.95.—*Radio Retailing*, April, 1934.

Pilot 100 Series Sets

Pilot Radio Corp., Long Island City, N. Y., is producing a new receiver, the 100 Series, to cover 16 to 52.6 meters and 178.5 to 550 meters.

The five-tube circuit takes a 6A7, 6D6, 72, 42, and 80. There is also a d.c. model. A phonograph jack is standard equipment.

In addition, for sale in Europe only, there is a broadcast and highband model, covering 178.5 to 550 meters and 739 to 2,142 meters.—*Radio Retailing*, April, 1935.

G.E. Radios

Five new home type sets, including two consoles and three table models with cabinets of modern design are announced as additions to the spring line of the General Electric Co., Bridgeport, Conn.

Console Model M-655 is housed in a neo-classic console and incorporates a 6-tube broadcast and short-wave circuit. The tuning range covers 540 to 1720 kc. and 5400

to 18,000 kc. including the important short-wave bands of 49, 31, 25, 19 and 16 meters. \$67.95.

Console Model M-55 is a 5-tube set in a small floor type cabinet. In addition to the standard 540 to 1720 band it receives calls between 2250 and 6850 kc. \$47.95.

Model M-62 is a 6-tube receiver in a semi-cathedral table type cabinet. It is a two-band set covering 540 to 1720 and 5400 to 18,000 kc. \$52.95.

Model M-52 is also a semi-cathedral model. It has five tubes and receives standard broadcasts, police calls and experimental broadcasts and some amateur transmissions. \$29.95.

Model M-50 is a 5-tube American and shortwave radio in a modern-appearing table type cabinet. \$39.95.—*Radio Retailing*, April, 1935.



Acorn Tube Socket

A specially designed socket for use with the Acorn tubes is available from the Alden Products Co., 715 Center St., Brockton, Mass. In keeping with the necessity of holding losses to an extreme minimum, use has been made of the Na-Ald Vitron material.

The base is made flat for ease in holding down the heater by-pass condenser plates. A post is provided which makes it impossible to incorrectly place the tube in the socket. The list price of this socket, No. 4953V, is \$1.50.—*Radio Retailing*, April, 1935.

Weston Test Oscillator

A new test oscillator, specifically designed to meet the servicing requirements of all-wave radio sets, has been brought out by the Weston Electrical Instrument Corp., Newark, N. J. It has a frequency range from 100 kc. to 22 mc. and a special attenuator system which makes possible an approximate output of one microvolt. This is a factor of increasing importance as it permits alignment of receivers equipped with automatic volume control below the a.v.c. level. Constant output over the wide frequency range is provided by means of six individual coils, which are plugged into a doubly shielded compartment for operation on each of six frequency bands.

Output of this Model 692 oscillator may

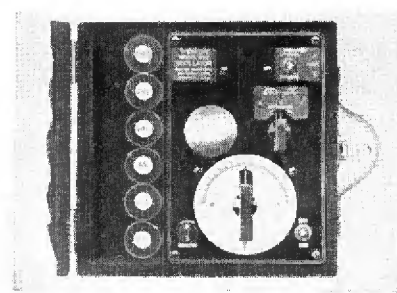

Crosley Koldrink

An electric bottle cooler to sell for \$99.50, installed and including one year's service, is announced by the Crosley Radio Corp., Cincinnati, Ohio. It is completely automatic and requires no attention. Capacity 125 12 oz. bottles or 152 6 oz. bottles. It is sufficiently high to hold 24- to 32-oz. bottles upright. Outside dimensions 44½x25½x37 in.—*Radio Retailing*, April, 1935.

Norge Refrigerators

The 1935 Norge Rollator refrigerator line consists fundamentally of eight models in eight sizes. Introduction of color in certain models and an optional porcelain, or the new Norgloss lacquer exterior in others, provides a variation of 18 models altogether.

In the Economy series there is one model and in the De Luxe series there are 10 white models in six sizes and two models in three colors. In addition there is a chest type model known as the Norgette.

The classic lines of the Norge cabinet with rounded corners and top have not been changed. A set of accessory dishes is also available. Norge Corp., Detroit, Mich.—*Radio Retailing*, April, 1935.

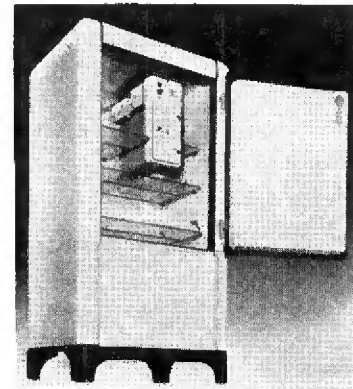

The Antenna Sells the Set (Continued from page 27)

pect and a charge of between \$15 and \$18 seems to be satisfactory to them.

When the antenna has been installed Hap delivers a new all-wave receiver. This, he explains, is the company's method of testing the antenna installation. The salesman tunes in numerous foreign stations in the presence of the prospect and in most instances is asked to leave it for a day or two, with the result that not only is the antenna itself sold but the market for new receivers is automatically developed.

All-wave set demonstrations, which formerly produced only 30 per cent in sales, now have built up to 90 per cent. The success of the plan is particularly apparent where the home has children who are intrigued by foreign reception.

When a receiver is left for trial, at the suggestion of the antenna purchaser, the salesman also leaves circulars describing its operation, stating the price and other details. Tuning instructions are printed in these leaflets and are explained before the salesman leaves.

When soliciting antenna business, for which the "personalized" sketch is an excellent entree, it has also been found helpful to show a mimeographed detail drawing of the recommended antenna, including necessary poles, guy wires and overall excellence of the contemplated installation. This makes it seem well worth the money.

Hap recommends the scheme highly for developing business among upper-class prospects. "Let the antenna sell the set."

Supreme Presents

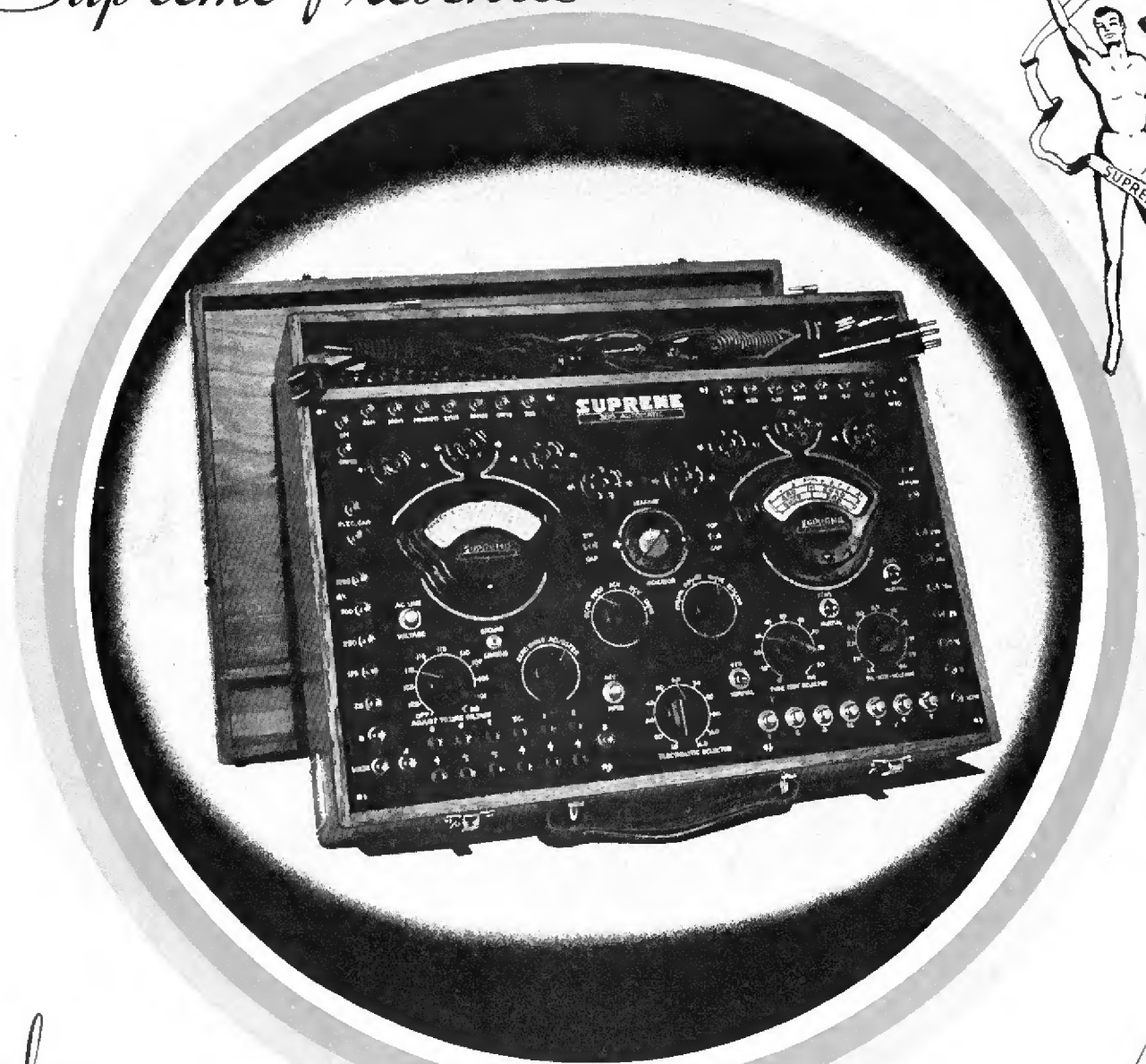

the

385 AUTOMATIC!

Presenting the Supreme "385 Automatic" - - marking another Supreme trail-blazing achievement - - "UNI-CONSTRUCTION." Go to your jobber to see the "385 Automatic" and prepare yourself to expect not only a new standard of value made possible by uni-construction, but an instrument sure to revolutionize radio service procedure. Built on an entirely new principle the "385 Automatic" is the most complete, easiest handled, and the fastest instrument ever built - - - AUTOMATIC in its diagnosis.

In addition to retaining the many popular features of the famous 333 DeLuxe Analyzers and 85 Tube Testers, the "385 Automatic" has PLUS features such as two separate ohmmeters. One with a low range of 0/200 ohms the lowest division of which is 1/4 ohm. The other with intermediate ranges of 0/2,000/20,000/200,000 ohms and high ranges of 0/2,000,000/20,000,000 ohms. All with self-contained power supply.

One of the most interesting of the new Supreme developments in the "385 Automatic" is the improved condenser tester with six direct reading capacity ranges, neon condenser leakage test for non-electrolytics indicating leakages, shorts and opens PLUS THE FIRST ENGLISH READING ELECTROLYTIC CONDENSER TESTER. Just set the "condenser selector" to the value of the condenser to be tested and the meter will read directly in terms of "GOOD" or "BAD." Condensers will read in the "BAD" area when leakage is more than 1 milliampere per mfd.

Here is something actually NEW. See your jobber and write today for the complete descriptive booklet "385 Automatic." See for yourself how Supreme inventive Engineering and Supreme uni-construction make possible the finest radio service instrument in the world at a price so pleasantly interesting.

SUPREME INSTRUMENTS CORPORATION

523 Supreme Bldg.

Greenwood, Mississippi

Export Dept., Associated Exporters Co., 1457 Broadway, New York City. Cable Address, LOPREH, New York

SERVICE SECTION

Conducted by
W. MacDonald

Including
Installation Data

CIRCUITS of the MONTH

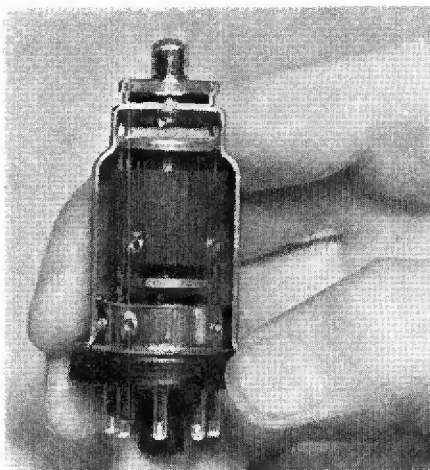

Iron Tubes

Iron tubes, long the dream of the man who discovered to his sorrow that glass ones would not "bounce," are at last a reality. RCA is now making triodes, tetrodes and pentodes and will eventually have a complete line.

The photo shows a pentode *one-half actual size*. The metal shell is evacuated, the only glass employed in construction being small beads in the inner base, used to seal leads airtight. Prongs, and there can be up to 8, are equidistant and all one size. A central insulating shaft is used, proper placing of a small lug on this member insuring correct positioning of each tube type.

The metal envelope, contrary to expectations, is not used as a plate, but is at cathode potential. It will be insulated to some extent, probably coated.

Allwave Oscillator

Weston has a new allwave oscillator, Model 692, which is interesting not only from the standpoint of circuit design but also because of its mechanical construction, particularly the rather complete shielding.

To obtain a low minimum signal, necessary for a.v.c. circuit alignment, and still have a strong maximum signal available, a complete outside shield of brass and copper is used. In addition

a low r.f. field is obtained inside the case by using plug in coils which are inserted in a completely shielded individual compartment. The unit is thus doubly shielded against radiation.

Use of individual coils also permits the signal to be kept at a nearly constant voltage over the entire range. The turns ratio between grid and pick up coil of each individual plug in is adjusted to keep output uniform.

The attenuator circuit, which is individually shielded, is of especial interest. It is of the "L" pad type reflecting a constant impedance from the output circuit back on the oscillator coil. Changes in attenuator setting do not, therefore, affect the oscillator frequency. A constant impedance of 200 ohms is maintained at the output pin jacks. This is equal to or greater than that of the average antenna and provides a means of alignment without upsetting the first tuned circuit of the receiver when changing the attenuator setting. All attenuation is accomplished ahead of this output resistance so it is unnecessary to short circuit the output posts to drop the signal to a low value.

A separate modulator tube is used to provide a fixed per centage of modulation, about 50 per cent, on all bands. This also provides a high impedance input for external modulation. The impedance at the input jacks is $\frac{1}{2}$ megohm, working directly into the grid of the modulator, which, with the panel modulation control switch in the external position, is converted into an amplifier. The 400 cycle internal modulation is cut out and if the unit is not externally modulated it may be used with the switch in this position as a pure, unmodulated r.f. oscillator.

The range covered is from 100 kc. to 22 mc., in six steps, all bands overlapping. Maximum signal on the i.f. bands is approximately .2 volt. A maximum of .1 volt is available on all other bands and the stray field outside the oscillator is below $\frac{1}{2}$ microvolt at all frequencies, according to the manufacturer. Battery operation is intended, to eliminate possibility of signal feedback into the receiver through the common power line and to avoid frequency fluctuation with line voltage changes.

Note the heavy lines in the diagram,

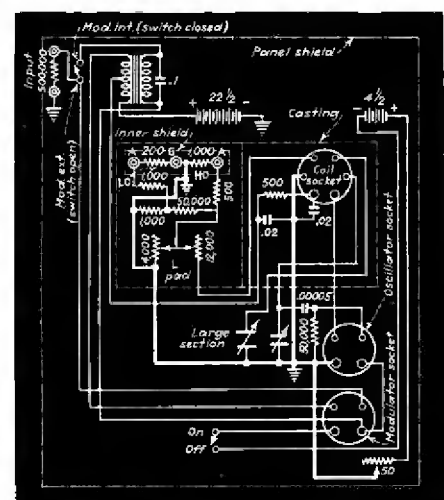

indicating the grounding circuit designed to keep circulating currents in the shields themselves at a minimum.

Shortwave Super Has Monitor, Crystal Filter, Electrical Bandsread

The Hallicrafters' new "Super-Sky-rider," a 7-tube superhet tuning from 13.5 to 240 meters (equipped for 10 meter or broadcast band at slight extra cost) has a number of circuit features which will interest shortwave fans and transmitting amateurs.

The job is, for example, equipped with an unusual type of send-receive switch which permits it to be silenced with respect to outside signals while transmitting. With the switch in this position the set serves as a monitor, permitting the operator to listen to his own transmission.

The first circuit diagram shows how this is done. Switches A and B, simultaneously operated, are shown in the "send" position. The position of A removes plate voltage from the r.f. pre-selector stage, hence outside signals are not received. The position of B removes

10 points of OSCILLATOR difference

—OF VITAL INTEREST TO YOU!

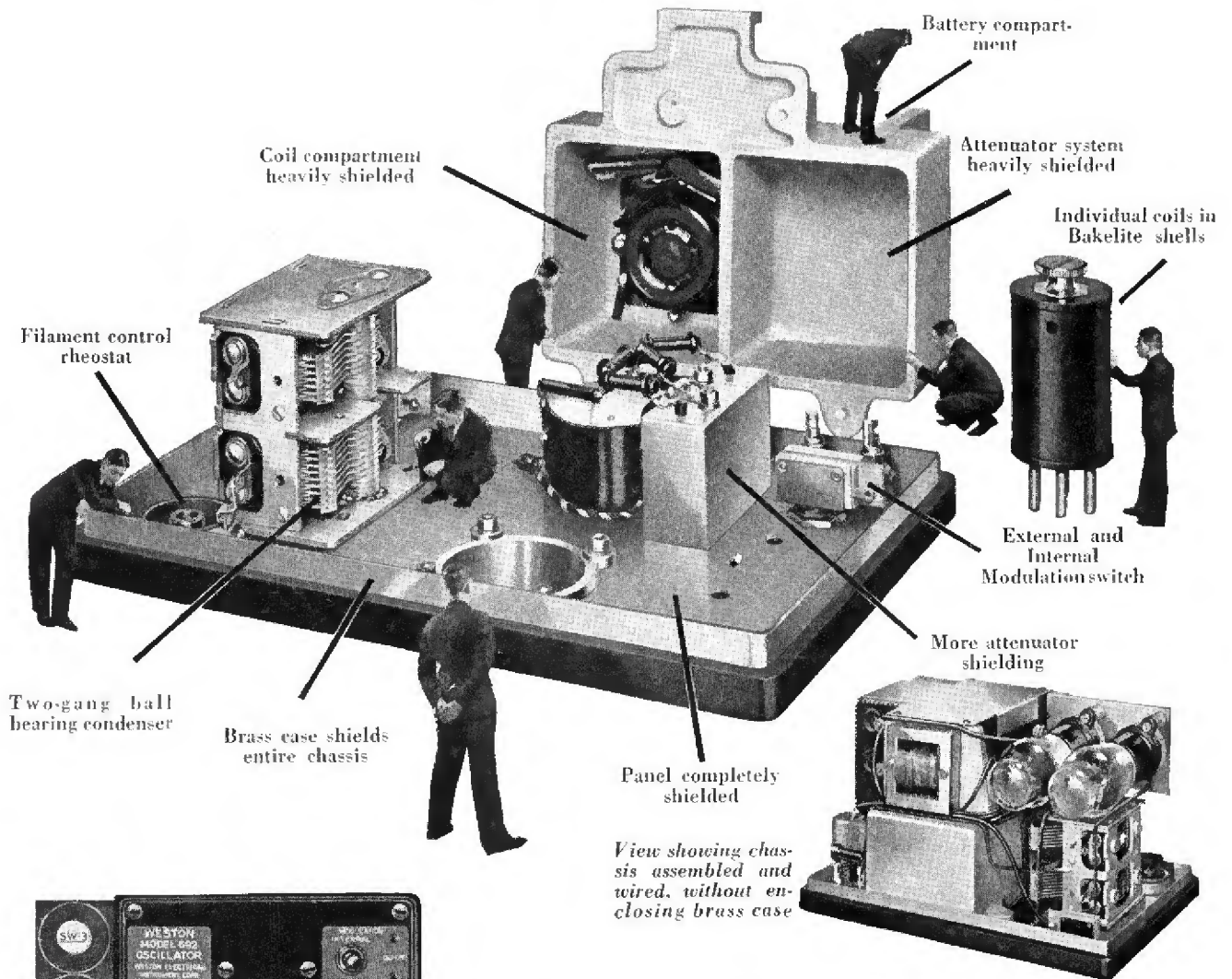

Compare this Weston Model 692 All-Wave Oscillator . . . in all details of design and construction . . . part for part . . . with any the market affords. Note particularly that each part in Model 692 has been carefully designed for its special purpose. You'll agree that here is an oscillator you can safely stake your reputation on . . . that will enable you to do accurate servicing on all modern receivers. See Model 692 at your jobber's, or write for descriptive bulletin . . . Weston Electrical Instrument Corporation, 581 Frelinghuysen Avenue, Newark, New Jersey.

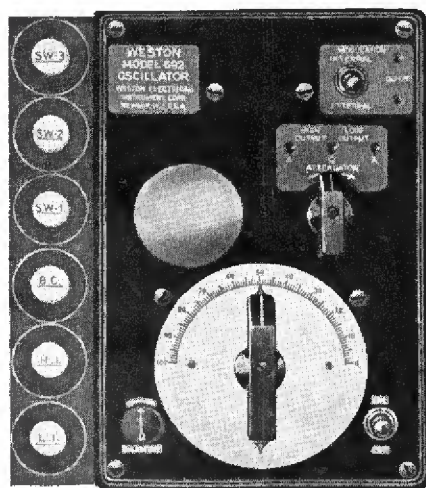

THE WESTON ALL-WAVE OSCILLATOR

WESTON 
Radio Instruments

SERVICE SECTION

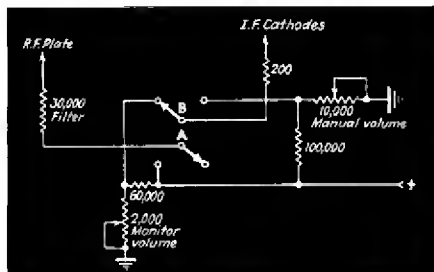

the 10,000 ohm manual volume control from the i.f. grid return circuit and instead substitutes the 2,000 ohm monitor control in series with a 200 ohm fixed resistor between i.f. cathodes and ground. The monitor control is screwdriver adjusted so that the i.f. stages become sensitive enough to permit pick-up of the transmitter at any preferred volume level.

A quartz crystal filter ground to the exact intermediate is available as an extra. The holder is included in all models. With the switch in the "off"

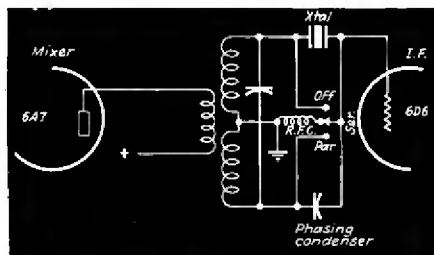

position the crystal holder is shorted and the i.f. secondary is simply a balanced bridge circuit. The phasing condenser, controlled from the panel, is adjusted for maximum signal. When the crystal switch is in the "series" position signals must be exactly resonant with the frequency of the crystal to pass through it to the first i.f. stage, hence the receiver is extremely sharp. It is too sharp, in fact, to use in this position on phone stations hence the series position is employed only when tuning in code signals. By slightly detuning the phasing condenser one sideband may be cut, giving the receiver a single-signal characteristic.

With the crystal in the parallel position it acts as a shunt resonant circuit in parallel with the tuned i.f. transformer secondary. This gives results approximating band-pass in the i.f. This position is useful when tuning in phone stations where there is severe adjacent channel interference. The phasing condenser is shorted out.

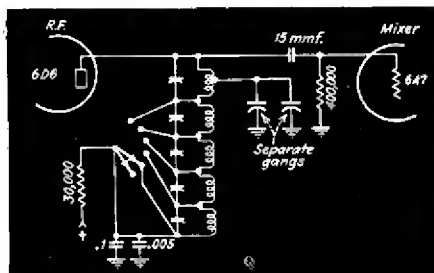

Electrical bandspread is achieved by the use of two separate three-gang tuning condensers. This is clearly shown in the accompanying diagram of the tuning equipment between the r.f. stage and the mixer. Each coil is individually trimmed and it will be noted that the switching shorts out the coil next to the one in use to avoid possibility of dead spots. Primary coils are dispensed with by using capacity coupling between stages. Thus there can be no dead spots introduced by resonant primaries.

Semi-Fixed Bias, Resonant Output Filter

Here is the output system of GE's "Bandmaster" M107 and M106 (1935 production), in which we find two circuit features not often seen.

The triode section of the 85 second detector-first a.f. tube (not diagrammed) is semi-fixed biased by tapping the control grid return to the junction between two resistors connected in series with the negative pack lead, in parallel with a resistor of 220 ohms which carries most of the supply current. This latter resistor provides semi-fixed bias for the final 42's, the grid-return lead from the final stage input transformer secondary running to the negative side of this resistor. Inasmuch as plate current for all tubes flows through this resistor voltage drop across it remains fairly con-

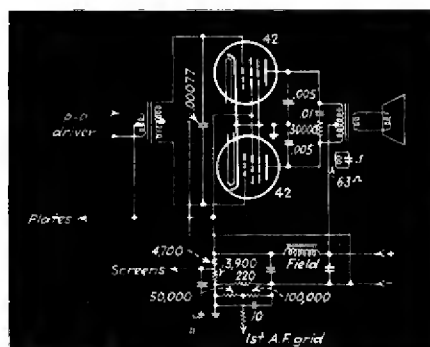

stant irrespective of variations in the final amplifier's plate current.

The driver stage, consisting of a pair of 76's in push-pull, is cathode biased. Screen voltages for r.f. tubes is obtained by tapping between the 4700 ohm and 3900 ohm bleeder combination shown.

The second "kink" is the inclusion of a coil tuned by a .1 mike condenser in the output transformer assembly. This coil-condenser combination is tuned to resonance just outside the high-frequency end of the audio response bandwidth, adding to the very sharp high-frequency cut off of the entire audio system to reduce reproduction of any existing inter-channel high-frequency interference.

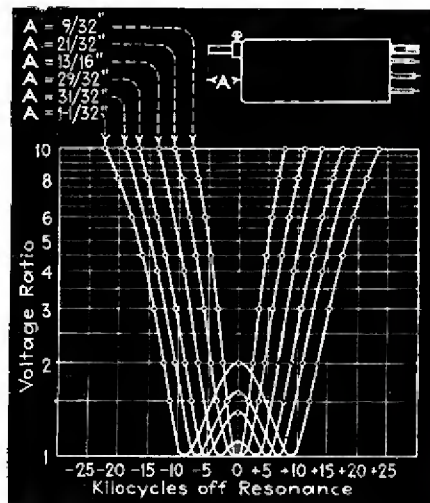
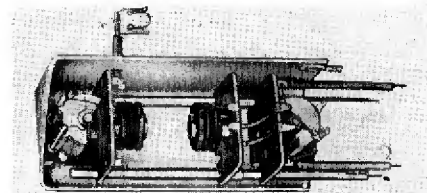

I. F. Transformer With Variable Coupling

Hammarlund's long-heralded i.f. transformer with variable coupling between air-tuned primary and air-tuned secondary is shown in cross section in the accompanying photo. The curves are supplied by the maker and indicate band acceptance at various mutual inductance settings. We are told that mutual may be changed within the limits noted without materially affecting other circuit constants, such as resonance at a given frequency, for example.

The curves are for one single transformer. A one stage amplifier would use two, an input and an output, so that the overall selectivity curve of such a stage would be calculated by squaring the ordinates of the graph. The voltage ratio marked 10 would thus become 100. 5 would become 25 etc. Similarly, for a two stage i.f. amplifier three transformers would be used and the 10 ratio would become 1,000 and so on.

When several i.f. stages are used in cascade two variable i.f. transformers and one fixed type is recommended for wide band acceptance. The coupling of the fixed transformer is in this case adjusted to level off the "notch" obtained when two variable units are closely coupled. Where extremely sharp tuning is desired at the possible expense of fidelity all transformers may be of the variable type.

The mutual inductance of the transformers used may be adjusted and then locked in place. Or it may be made adjustable from the front panel by a suitable mechanical control arrangement, a stop being provided in this case to avoid over-coupling and the resulting "notch."

HI-FORMATION ELECTROLYTICS

A complete range of electrolytic capacitors at voltages from 25 to 500 volts.

A new type electrolytic condenser has been discovered!

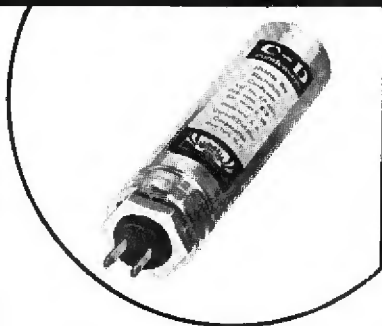

EP 9808 . . . \$1.60 LIST PRICE
YOUR COST \$.96

Unheard of low leakage characteristics. High voltage safety factor. Exceptionally low power factor.

As usual, Cornell-Dubilier has pioneered in this latest laboratory development. Now available at new low prices.

Have you received your latest copy of the No. 128 catalog?

CORNELL-DUBILIER
CORPORATION

4399 BRONX BOULEVARD • NEW YORK

Service Dealers!

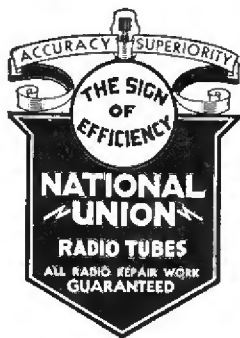

DO you know that this emblem stands for a bigger, better business for you? Do you know of all the shop equipment National Union gives you, has given to thousands of your fellow service experts everywhere? Do you know about National Union business building helps and plans? Do you know why National Union means a more profitable radio service business? You can't afford not to find out all about National Union tubes and why they are sold by more service men than any other make. Find out! Send the coupon!

National Union Radio Corporation of N. Y.,
570 Lexington Ave., N. Y. C.

Send me your free book "Merchandising Radio Service" and tell me about free shop equipment.

Name.....
Street.....
City..... State.....
R. R. 4-35



Mail the Coupon Now!

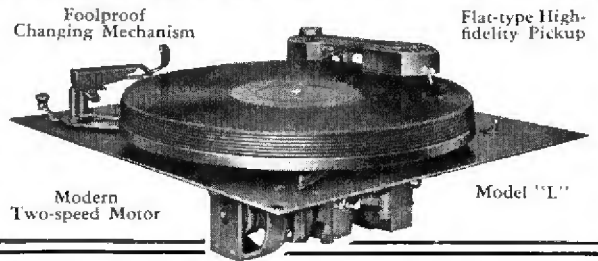

Add Automatic Record playing at VERY LITTLE EXPENSE

Make a test installation. See how compact these new General Industries Automatic Record Changer units are. How easy to install. How simplified in construction—no intricate working parts. How smoothly, quietly, efficiently they operate. See the superior materials and workmanship.

Then consider this unit's surprising low price—and the big upturn in sales of phonograph records. You'll see the big sales possibilities for cabinet and portable installations. "G. I." Automatic units come in two types. Model "L" plays and changes eight 10-inch or seven 12-inch records. Model "K" plays and changes eight 10-inch records and plays 12-inch records manually. Both units repeat last record. And both units are instantly adjustable for either 78 or 33 1/3 r.p.m. records. Made for all commercial AC and DC voltages and frequencies, also universal motor for AC-DC, and 6 volt DC for sound trucks.

Each unit combines two-speed motor, turntable, flat-type pickup, and automatic changer. Ready to install practically without labor. Attractive bronze finish harmonizes with any type cabinet or case.

Immediate deliveries. Order sample TODAY.

The **GENERAL INDUSTRIES CO.**

3537 Taylor Street, Elyria, Ohio

Also Manufacturers of Electric and Spring Phonograph Motors and Truetone Needles.

Modernize Your One Milliampere Meter with—



New Semi-Precision Meter Multiplier Resistors made by CONTINENTAL CARBON INC.

Study this modern circuit! You can rebuild your 1 milliampere into a seven range high resistance voltmeter and a dual scale ohmmeter, using the New CONTINENTAL CARBON Volt-Ohmmeter Kit for Weston 302 and Jewell 88, 444, 408, 409, 54, 199, 133, 133A, 210, 538, 137, 137A meters. Kit consists of 9 fixed resistors with close tolerance limits, paper dial scales and a length of resistance wire. List \$3.60.

Switch, batteries, and potentiometer are standard items available from CONTINENTAL CARBON Distributors. Jobbers, order your stock now! Get extra copies of Bulletin 102!

RESISTOR ENGINEERING BULLETIN 102 FREE!

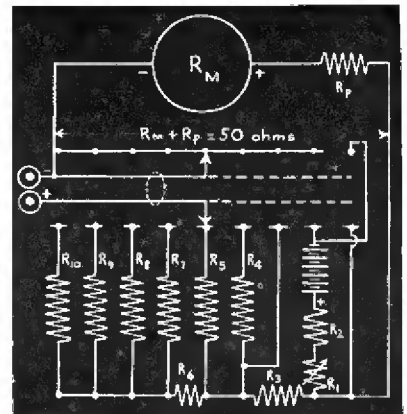

CONTINENTAL CARBON Inc.

13902 Lorain Ave., Cleveland, Ohio

Toronto, Canada

INSTALLATION AND SERVICE TIPS ON MODERN AUTO-RADIOS AND 1935 CARS

Antennas for turret-top models . . . Noise elimination for the more sensitive sets . . . New voltage - controlled generators . . . Supply filtering and shielding

By M. B. McCULLOUGH

Mac-Adams Auto & Radio Equipment Co.

THE last year has brought so many improvements in the design and construction of automobile radios and accessories that the problems of installation and ignition interference elimination have been greatly simplified. Car manufacturers have also assisted in this respect by the relocation of ignition parts and the grouping together of control rods and wires. Many of these improvements have, however, introduced new problems.

The purpose of this article is to describe some of the new developments that affect both the radio and the car in which it is installed.

Ignition and Noise Elimination

Although practically all of the new auto radios now being manufactured are more efficiently shielded and filtered than they were a year or more ago, sensitivity has also been materially increased and they are more susceptible to objectionable noises generated in the car. Generally, noises are prevented from entering the set through the chassis and "A" line by the use of effective shielding and an "A" circuit filter. Some sets even now, however, do not employ such a filter. In cases where "chassis pickup" is prevalent, the installation of a good "A" filter inside the set will usually remedy the trouble.

With properly designed sets, where no trouble is encountered with "chassis pickup," it is necessary that proper precautions be taken to prevent noises from entering the set through the antenna lead-in or the antenna itself. These precautions, although not new, have become more important because of increased sensitivity. Even with the antenna filters or other systems that have been incorporated in the new sets, it is necessary to eliminate noise pickup by the antenna or lead-in.

To accomplish this, it is very important to carefully shield the antenna lead-in to a point outside the field of disturbance and properly ground this shield in one or more places. Extreme care should be taken to be sure the shielding is complete and continuous where the connection is made between the lead-in from the set and the lead from the aerial; also that a good high

frequency bond is made to a grounded member of the car. Many cases will be found where the instrument panel and other parts of the car that are apparently grounded do not actually make a high frequency ground and consequently require additional bonding to the frame or dash. In some cases where the antenna lead-in comes down the windshield post, it is necessary to move the lead-in back to one of the door posts to remove it outside the disturbance field. The installation of a good dome light filter or condenser in the dome light circuit is usually required to prevent noise radiation direct to the antenna.

Additional sources of noise other than that originating in the ignition system, are found in electrical gauges, such as electric oil pressure gauge, electric thermo gauges,

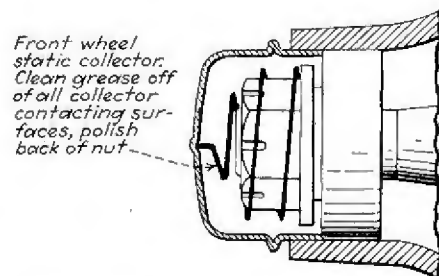

Front wheel static-collector detail. In this instance the collector was included by the car maker

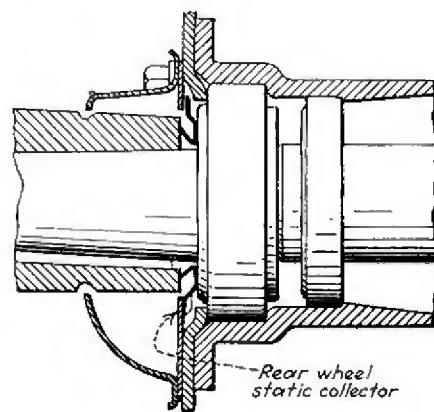

Rear wheel static-collector. Also factory included. The brush-collector system can be readily duplicated by installation stations on cars not so designed

electric gas gauges, etc. Application of a condenser at the source of the disturbance will remedy this trouble. Static generated by the friction between the brake drums and brake shoes when the car is in motion is sometimes strong enough to create objectionable noise. This is overcome by installing static collectors on the wheels. Figures 1 and 2 show typical static collectors for front and rear wheels respectively. Some cars are now being factory equipped with these collectors.

Antennas

The problem of furnishing a good antenna for auto radios has changed with the advent of all-steel tops. Heretofore, a

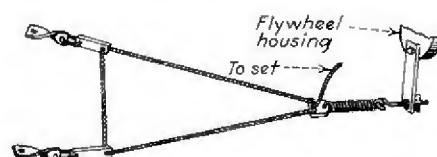

Triangular cable under-car antenna, one possible answer to the turret-top

roof antenna was recognized as being the best and fulfilled all requirements satisfactorily. The car with an all-steel or "turret" top does not permit the use of a roof antenna so it becomes a necessity to use an under car antenna.

The conventional running board antenna used in the past, leaves much to be desired, first, in respect to operating efficiency and second, in respect to mechanical construction. The cable or triangular type antenna as shown in figure 3, offers a better solution from both a mechanical and efficiency standpoint.

Many improvements are now being made in under car antennas, such as the new Flex-o-strip antenna shown in figure 4 and the new Dipole antenna shown in figure 5. The Dipole Antenna is broadly resonant to a frequency of approximately seven meters at which most of the troublesome ignition interference occurs. The result is that for interference frequencies, it acts as a tuned trap circuit while for broadcast frequencies, it acts as a

NOISE CURES

Bothered by background noise complaints? That's easy. Just sell them those handy AEROVOX noise filters . . . over the counter or through service calls. Here they are:

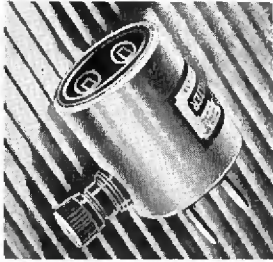

Type IN-25 Interference Filter . . . plugs into outlet; wall plate screws hold and ground; takes noisy-appliance plug; blocks man-made static from getting into house wiring and causing trouble aplenty. Neat. Efficient. Necessary. Only \$1.75 list!

Also **Type IN-26 Interference Filter** . . . male and female plug inserted between noisy-appliance plug and outlet; for devices with long extension cords such as vacuum cleaners; binding post for ground. Only \$2.25 list!

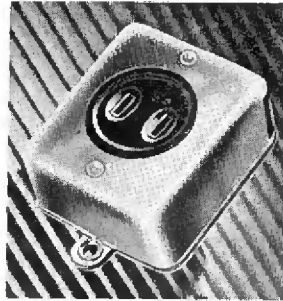

Get the Facts! Your local jobber can show you the Aerovox line and give you the sales story. Or write for 1935 catalog and free copy of Research Worker. Remember, Aerovox means more quality for less money.



AEROVOX
CORPORATION
74 Washington St. : : Brooklyn, N. Y.



WET AND DRY ELECTROLYTIC PAPER AND MICA CONDENSERS

RECOGNIZED FOR SUPERIOR QUALITY IN ALL CLIMATES THE WORLD OVER

SOLD BY LEADING JOBBERS EVERYWHERE

SOLAR MFG. CORP.
599 BROADWAY
NEW YORK

BEST BY TEST!

ASK FOR CATALOG OF EXTREMELY COMPACT TYPES HANDY FOR SERVICE

CANDOHMS

STANDARD EQUIPMENT IN LEADING SETS

WIRE WOUND RESISTORS



TEN MILLION IN USE

Send Today for New Complete Catalog and Free Resistance Calculation Tables

THE MUTER COMPANY
1255 South Michigan Ave., Chicago



Rider's MANUALS

Might just as well try to move a piano on a kiddie-car as try to do a 100% radio servicing job without RIDER'S Manuals. Richer, fuller, more accurate than any similar manuals, RIDER'S alone enable you to handle any and all the tough problems that come your way today. No other manuals contain so many manufacturers, models, I-F peaks, chassis views, voltage data . . . and there's none so permanent . . . that you can use YEAR AFTER YEAR! RIDER'S Manuals are BEST for EVERY service man!

<p><i>Out in April</i> The CATHODE RAY TUBE AT WORK 320 pages 6x9 \$2.50 postpaid</p> <p>Up-to-the-minute data, revealing all the ins and outs of building cathode equipment and utilizing it to maximum advantage. No service man should be without it.</p>	<table border="0"> <tr> <td>Vol. I</td> <td>1000 pages</td> <td>\$7.50</td> </tr> <tr> <td>Vol. II</td> <td>800 pages</td> <td>6.50</td> </tr> <tr> <td>Vol. III</td> <td>1070 pages</td> <td>7.50</td> </tr> <tr> <td>Vol. IV</td> <td>1060 pages</td> <td>7.50</td> </tr> <tr> <td>Vol. V</td> <td>1200 pages</td> <td>7.50</td> </tr> </table> <p>RIDER'S SPECIALIZED AUTO RADIO MANUAL, Vol. II. About 350 pages, nearly 70 manufacturers covered, no duplication 'twixt this and Vol. I. Contains more real data than any similar volume; even better than Vol. I!</p> <table border="0"> <tr> <td>Vol. I 350 pages</td> <td>Vol. II 350 pages</td> </tr> <tr> <td>\$3.50</td> <td>\$3.50</td> </tr> </table>	Vol. I	1000 pages	\$7.50	Vol. II	800 pages	6.50	Vol. III	1070 pages	7.50	Vol. IV	1060 pages	7.50	Vol. V	1200 pages	7.50	Vol. I 350 pages	Vol. II 350 pages	\$3.50	\$3.50
Vol. I	1000 pages	\$7.50																		
Vol. II	800 pages	6.50																		
Vol. III	1070 pages	7.50																		
Vol. IV	1060 pages	7.50																		
Vol. V	1200 pages	7.50																		
Vol. I 350 pages	Vol. II 350 pages																			
\$3.50	\$3.50																			

FREE "SUCCESSFUL SERVICING," our 8-page monthly house organ, with valuable data pertaining to RIDER'S Manuals, should be reaching you regularly. Be sure that you are on our list!

JOHN F. RIDER, Publisher
1440 Broadway, New York City

FACTS
You should know about
Condensers

WE PROVE IT!

FREE!

You owe it to yourself to write today for a copy of this BOOKLET.

Just what does the Power Factor rating really mean in the condensers you buy?
 . . . What is the truth and the whole truth about leakage claims—capacity and voltage ratings?
 As serviceman or amateur, how can you be SURE you are getting the most filtering, the best performance for the least money?
 These and many other bothersome condenser questions are clearly explained in our new free booklet illustrated above. It will show you that we not only claim Sprague condensers are best—but explain exactly how we PROVE it! Write for a copy. SPRAGUE PRODUCTS CO., North Adams, Mass.

SPRAGUE CONDENSERS

MADE RIGHT  PRICED RIGHT

SERVICE SECTION

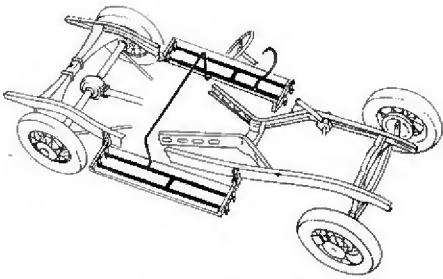

Another type of under-car collector. Note the use of two units, one under each running-board.

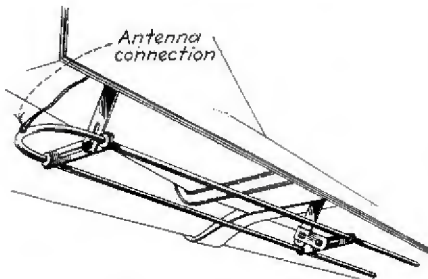

Still another antenna type, a di-pole. Ignition noise in the vicinity of 7-meters is "trapped" out by this system, which acts as a capacity pick-up device at higher wavelengths

regular capacity antenna. Two running board antennas of special construction to fit the car are being used by most car manufacturers of steel top cars as part of their custom built radio equipment.

The use of under car antennas on some of the new cars, increases the work involved in eliminating noise because the noise level is usually stronger along the bottom of the car than it is near the roof. On these cars, it may be necessary to bond the brake rods, torque-tube, etc. The use of a condenser at the stop-light switch has often been found necessary to kill the radiation along the light wires that run under the floor.

Generator and Battery

The addition of an auto radio together with other electrical accessories now commonly used in automobiles, places a heavy drain on the car generator and battery. The problem of keeping the battery properly charged is a very important one to the car owner. The standard generator and battery supplied with the car is adequate to take care of normal starting, lighting and ignition requirements. In placing additional loads on these units, care must be exercised that they are not overloaded.

The practice of stepping up the generator charging rate when a radio is installed without referring to the generator specifications to find out the maximum safe output, has resulted in many generator failures. Using the car ammeter to regulate the charging rate is also dangerous as these ammeters are not accurate. To properly set the charging rate of a car generator, both a good ammeter and good voltmeter should be used. The genera-

tor specifications always give the maximum current output at a specified voltage which usually simulates the voltage conditions with a fully charged battery. With a partially charged battery, the output voltage will be low and a resistance should be inserted in the charging circuit to bring the output voltage up to normal so a safe setting of the charging rate can be made.

The majority of generators in passenger cars have third brush regulation. Changing the position of the third brush, varies the peak current output of the generator. When the third brush is moved in the direction of armature rotation, the output is increased and when moved in the opposite direction, the output is decreased. The output setting should be made with the generator at normal operating temperature and the battery in a fully charged condition if possible. All output settings should be within the safe maximum limits given for the particular unit. When the generator is cold, the output will be somewhat higher than after it becomes warm. Also at speeds beyond the maximum output range, the output will be reduced or will taper off due to the action of the third brush. When the battery is low the maximum output will also be lower than when the battery is fully charged.

Most of the cars prior to the 1934 models, do not have sufficient generator capacity to take care of the added current demands when special electrical accessories are installed. To remedy this condition, a new high capacity generator was brought out last year. This generator is shown in figure 6 while figure 7 shows a comparison of the output with a typical standard equipment generator for cars prior to 1934. Many of the 1934 and 1935 cars are being factory equipped with larger capacity generators and also some external means of regulating the generator output to more nearly conform to driving requirements.

There are three general methods of regulating the charging rate or output of generators now being used which will be described briefly. First—*Third Brush Regulation*. This is the conventional method used on practically all passenger cars up to 1934 and is well known. Second—*Lamp Load Control*. This method consists of inserting a resistance in series with the field circuit which is shorted out when the lamp load is turned on, thus increasing the output, or splitting the generator field and connecting the lamp load in series with one winding so when the lamp load is turned on, the generator output is increased. Third—*Voltage Control*. This method consists of controlling the output of the generator by means of a voltage regulator and is described more in detail as it is being more extensively used on new cars.

The voltage regulator limits the generator voltage and tapers down the charging rate as the battery counter-voltage rises on charge. A high voltage condition in a car's electrical circuit exists mainly because of the high voltage obtained at the battery terminals under certain conditions of charge. In other words, the voltage obtained at the battery is, without other means of voltage control, the governing

factor. Third brush generators have a characteristic of reducing the charging rate when the battery is low and as the battery approaches a fully charged condition, the increase in battery voltage increases the charging rate. It is readily apparent from this statement that a generator functions inversely to the actual requirement of the battery. What is wanted, is a high charging rate when the battery is low and a low charging rate when the battery is fully charged.

High voltage results in poor distributor contact life, decreased bulb life, damage to the battery due to overcharging and possibly damage to the generator armature and field windings. The voltage regulator will not increase the capacity of a generator as this is dependent upon the original design, but it will increase the efficiency of the generator and charge the battery under the constant potential system which has been advocated by leading battery manufacturers.

Accessories

There are several automobile radio accessories which the installation station can handle as additional profit items, such as locks for locking the chassis to the dash, "A" switch locks for sets not equipped with a locking arrangement, special instrument panel plates for mounting the control unit in the instrument panel, etc. The most important accessory item from a performance standpoint, is probably the ignition filter. The one we use is a low resistance, inductance type unit. There are two types of filters now available, the individual filter, one of which should be used on each spark plug and one in the distributor head, and the master filter, a later development, this one unit being used to replace all suppressors.

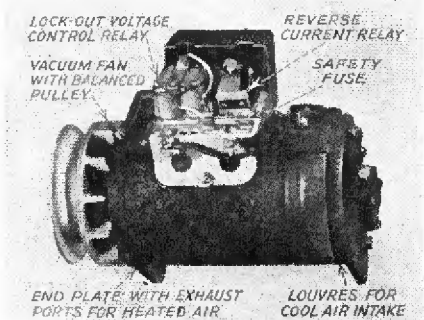

Typical heavy-duty replacement generator, especially useful in older cars equipped with generators incapable of running accessories

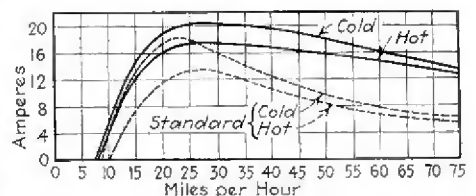

Comparison of the replacement generator's output with standard, typical generators used in 1933 cars

17-Watt
Portable
Address
System
That
Enables
You
to

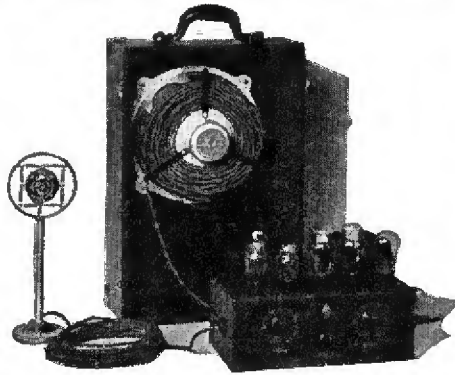

REACH OUT FOR MORE BUSINESS—Here's the Way!

*We Want More
Radio Dealers and
Sound Men*

*to represent the
Webster - Chicago
Line of Sound
Equipment. It is
reasonably priced
and profitable.
Write us!*

WITH its ready portability and its powerful 17-Watt amplifier, this Webster-Chicago unit is ideal for orchestras, lectures, athletic fields, etc.

The Webster-Chicago Line includes—Address Systems (portable, public, mobile types)—Microphones—Speakers—Amplifiers—Pre-Amplifiers—Mixing Panels—Rack and Panel Equipment—etc.

—all profitable items for Radio Dealers and Sound Men. Write for details today!

THE WEBSTER COMPANY
3829 W. Lake St., CHICAGO, ILL.

SEALED AGAINST MOISTURE!

Special sealing compound effectively prevents the entrance of moisture in

Metal end piece for fast solder iron heat radiation. Prevents "OPENS"

Protruding rolled wax-cardboard edges for protection



TOBE
Tubular
Condensers

TOBE DEUTSCHMANN CORPORATION

TOBE DEUTSCHMANN CORPORATION
CANTON, MASSACHUSETTS

FREE BATTERY CHARGING

LET THE WIND DO IT!

AND LIGHTING

• Farm surveys show that thousands of 6-volt battery radios are not in use because of "dead" batteries. The Zephyr Charger solves this problem. Also lights three to five rooms. Starts charging in low wind. Efficient. Strongly built. Mechanically perfect. Sells fast. Big opportunity for dealers.

• WRITE TODAY for complete details on our dealer proposition. Territories going fast. Send name at once to:

ZEPHYR CHARGER

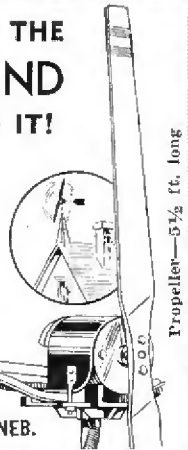

Propeller—5½ ft. long

ZEPHYR POWER CO., 11TH & DODGE, OMAHA, NEB.

Free AUTO-RADIO POWER SUPPLY SERVICE MANUAL

HOW to service an Auto-Radio so that you can GUARANTEE the job and make money on it! The thing that gives you the most trouble—power supply—is thoroughly covered in this manual. It is invaluable. Get your FREE copy before the supply is exhausted and before the summer season starts!

TEAR OUT THIS AD, pin it to your letterhead (or write your name and address in the margin) and mail it together with 12c. in stamps to cover costs of postage, addressing, mailing, etc.

ORIGINAL PIONEER GEN-E-MOTOR CORP.

458F W. SUPERIOR ST., CHICAGO, U.S.A.

See our announcement to the Auto-Radio owner in the March 23, SATURDAY EVENING POST

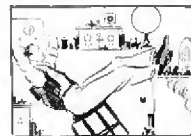

This servicing racket ain't what she used to be!

No sir—gone are those days when you could sit back in the shop and take things easy. Competition has done for that—competition and the fact that you really have to be a top-notch radio technician in order to service the receiving sets of 1935. You've got to know all the latest servicing methods, have the most up-to-date equipment, get all the latest dope.

Now—for the first time—in one place—you can get all you need to know about radio servicing as it is practiced today by the most advanced servicing organizations in the country. This remarkable source of information is Ghirardi and Freed's MODERN RADIO SERVICING and its handy supplement, FIELD SERVICE DATA.

No theoretical guesswork here. No bunk. Just plain, practical, tried and tested dope—over 1200 pages full, with hundreds of illustrations.

Don't you think it's high time you started to make some real money out of this business? This book will show you how to do it—in the quickest, easiest way!

Send for the free circular now.
MODERN RADIO SERVICING —\$4.00.
FIELD SERVICE DATA SUPPL. —\$4.50.

Combination Offer:
BOTH BOOKS (if purchased together) \$5.90 postpaid

TO Radio & Technical Publishing Co. 45 Astor Place, N. Y. Dept. RR-4

MODERN RADIO SERVICING

By A. A. GHIRARDI and B. M. FREED

FREE CIRCULAR

MAIL TODAY
Please send your FREE CIRCULAR
Name
Address

SHOP SHORTCUTS

NOTES ON THE KIRK GRID-DIP OSCILLATOR

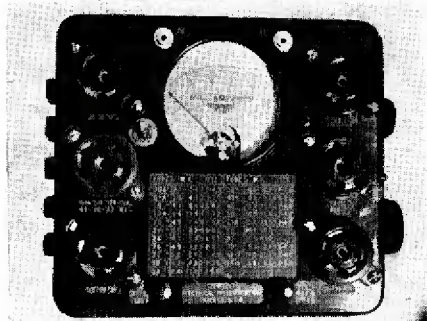

Re-Vamped 209 Tester

By Carl F. Mathisen

The old, familiar Jewell 209 tube tester can be made over to test modern tubes at small expense, with a neon short-checker included in the design to make it especially practical. A large part of modern tube failures are due to shorts and leakages.

Drill out the original sockets so as to make $1\frac{1}{8}$ in. holes for mounting new composite sockets. The upper left-hand one (right on the diagram) is wired to take care of common types such as the 24A, 26, 27, 32, 34, 45, 56, 57, 58, 71A, 80 and others with similar base connections. This socket accommodates more than $\frac{1}{3}$ of types encountered and about 75 per cent of our sales.

The other two sockets on the left side have only the filament contacts permanently connected in the test circuit, the rest of the contacts being connected to tip jacks mounted on this same side so that testing circuits may be patched by using jumper cords. The 47 and 25Z5 tubes are the only ones among the common types which must be patched in this manner.

The lower right-hand socket is connected for testing the 41, 42, 43 and 2A5 types and the second plate of the 80 and other full-wave rectifiers. The filament voltage selector switch is mounted on the right side below this socket. An additional tap should be brought out from the transformer to give 6.3 volts. The proper voltage for 12, 14 and 25 volt tubes is secured by a power cord resistor and a resistance mounted within the tester. A 2,000 ohm resistance and a switch are put in the plate circuit to provide an additional load for low resistance tubes such as the 25Z5, which, together with the meter, might otherwise be damaged.

The two upper sockets on the right side (still referring to the picture, the diagram being just the opposite) are for short checking. The $\frac{1}{4}$ watt neon lamp is mounted below the panel between these sockets and the meter. The short checking switch, which is mounted directly below these sockets on the right side, may be made from a double-deck

switch by removing one of the regular contact arms and substituting a fan cut from sheet metal. Possibly it might also be made from a single deck switch by adding a fan. It will be seen from the circuit drawing that this switch serves to connect one tube element at a time to one side of the line and all the rest to the other side. The neon lamp will normally light on one side only. Light on both sides indicates short or leakage.

In making up a chart of directions for testing those tubes which require the use of tip jacks and jumper cords it is simpler to indicate the connections by diagrams as shown by the samples in the drawing rather than by assigning numbers to the jacks and listing these.

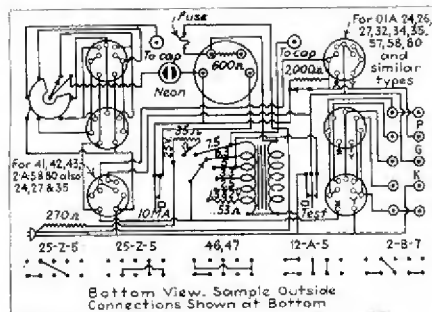

The readings engraved on the face of the tester should still hold true with the altered tester, since the fundamental circuit is not changed.

Intermittent Reception

By James E. Conway, Jr.

Intermittent reception is unquestionably the most difficult kind of trouble to locate.

I use a simple test which actually forces the trouble to occur. The set is placed on the bench, upside down so that the "works" are fully visible, antenna and speaker connected and a station tuned in. With the receiver operating at normal volume a 4 to 8 microfarad paper condenser having no leakage is connected to the chassis and a single test prod.

The test prod is touched momentarily to the high voltage lead from the pack and charges up. The test prod is then touched to the suspected resistor or condenser and the sudden jolt of discharged voltage invariably shows up the defect if there is one.

This same test may be effectively applied to coils and connections and tube defects which do not show up in a checker are frequently unearthed by touching the prod to the control grid circuit. Naturally, it is necessary to recharge the condenser after each test.

In the February issue an article written by Jim Kirk of 3919 Opal, Oakland, California, described the construction and use of a grid-dip oscillator. Coil and condenser sizes were deliberately omitted as the author assumed servicemen would prefer to use tuning gangs already on hand, necessitating the "hand-tailoring" of coils.

We have since received many letters asking for the exact size of Kirk's coils and tuning condensers, with details on the proper location of taps. Here's the dope:

"The variable coupling condenser should be small, not more than 20 mmfd. maximum capacity. The two-gang tuning condenser used in my case was taken from a Stewart-Warner SW700 battery receiver but any gang having a maximum capacity of 350 mmfd. per section will do.

"The lowest frequency i.f. coil is bank-wound to get as much inductance as possible in small space, consists of 12 banks, 36 turns per bank or 432 turns of No. 26 dsc wire on a $1\frac{1}{2}$ in. diameter form. Length of winding 2 in.

"The high frequency i.f. coil has 6 banks, 36 turns per bank or 216 turns of No. 26 dsc on a $1\frac{1}{4}$ in. diameter form. Length of winding 1 in.

"The broadcast coil is 70 turns of No. 30 enamelled, close-wound on a 1 in. diameter form. Length of winding $\frac{5}{8}$ in.

"The first shortwave coil is 30 turns of No. 26 dsc wound on a 1 in. form, turns spaced the diameter of the wire.

"The second shortwave coil is 15 turns of number 18 bare wire wound on air, spaced the diameter of the wire and braced with celluloid ribs. Form, 1 in. in diameter.

"All coils were exactly center-tapped. Experiments showed that this was not only the easiest position to find, but the best.

Improvements

"I have since improved the instrument. It is not necessary in the new design to shield the coils. Neither need they be placed at angles, although it would not hurt to do so. A three-section inductance switch has been substituted for the double deck originally used. The movable arm on the extra section is grounded.

"Hook the coils up as described and run the condenser over the scale, one range at a time. If you get a dip, ground temporarily with a piece of wire one coil grid lead at a time, noting the effect. The right connection will cause the dip to fade out of the picture. Hook that one to the proper switch contact point permanently.

"You will find no dips on the two i.f.

SERVICE SECTION

coils. In the broadcast range you will find one dip, caused by the lowest i.f. coil. And in the lowest frequency shortwave coil you will find a dip caused by the highest i.f. coil. The other shortwave coils may have dips. These can be traced down and eliminated as outlined above.

"Since I had to add a new switch anyway I got a three section, six point style and added another shortwave coil, extending the instrument's range. The new coil consists of $7\frac{1}{2}$ turns of No. 18 bare wire wound on air and braced with cellophoid. It is 1 in. in diameter.

"Since my article appeared in the SERVICE SECTION of *Radio Retailing* a number of your readers have written asking if I would make up the coils. The answer is, for a modest fee . . . and how!

TRICKS of the TRADE

AIRLINE 62-76. To improve bass response and avoid overloading of paralleled 47's . . . Change resistor in plate circuit of 57 first a.f. stage from 50,000 to 25,000 ohms. This will probably make set screech when volume is full on and tone control is in treble position, so shunt a condenser of from .005 to .01 capacity (a .006 is usually best) from the variable arm of the manual tone control potentiometer to the high potential end of this same potentiometer.

AIRLINE 62-68. Intermittent reception . . . Due to periodic opening of 3,200 ohm candohm resistor furnishing cathode and suppressor grid bias to the 57 first detector-oscillator. Replace with 1 watt unit.

AK 246. Bad audio howl as volume control is advanced with tone control in low position . . . Generally due to defective volume control. Replace.

ARVIN 25. Set completely dead . . . Check for shorted tone control. This is a tapped condenser type. Intermittent reception . . . Replace dual .015 mfd. antenna coupling condenser. No reception, vibrator sounds weak . . . Check for shorted dual .02 condenser used as a buffer across power transformer secondary.

BRUNSWICK 11, 12, 16, 17, 18, 24, 25, 33. Poor volume or entirely inoperative . . . All models use a screen supply resistor of 14,000 ohms, 2 watts, followed by a $\frac{1}{3}$ watt, 5,000 ohm unit in the case of the 24 oscillator and another $\frac{1}{3}$ watt, 5,000 ohm resistor as a bleeder to ground. These resistors commonly become charred and their values drop to as little as 500 ohms, or they burn out

entirely. Replace them with a 15,000 ohm, 2 watt and two 5,000 ohm, $\frac{1}{2}$ or 1 watt units. No control of volume although control itself tests ok . . . Look for grounded grid returns in r.f., mixer and i.f. stages. These frequently short to hold-down clamps, cutting out a.v.c. and manual control action. (I.F. 175 kc.)

CROSLEY 124-1. Fading and intermittent reception . . . Generally due to high leakage in one of the four .1 condensers located in condenser block No. W22412. Also check the two .25 mfd. units and the .5 mike in block No. W23736 for high leakage. (IF 175 kc.)

EARL 31, 32. Replacement dial assembly . . . Where an original replacement cannot be obtained, and it rarely can be, substitute a Philco 90 dial assembly. The only change in construction necessary is the filing off of five rivets holding the dial scale of both units, fitting the Earl scale to the Philco mechanism.

GE S42. Noisy, or cuts out when jarred . . . Before removing chassis try removing 35 i.f. tube and 24 first detector and tightening bolt between them. It works loose quite often and inasmuch as it holds the oscillator coil in place and provides a ground for this coil trouble may be this alone.

MAJESTIC 55. Fading and intermittent reception . . . Usually due to high leakage condensers in block, located on outside of chassis, near speaker. Also check tubular condensers for opens as some have loose ends that cause noise when switch is first turned on.

MAJESTIC 90. Set plays for about an hour then fades in volume, though stations are still heard weakly . . . Look for partially shorted r.f. 5 mike condenser located at front of chassis, with chassis upside down, on left side.

MAJESTIC 15. Operates satisfactory only at certain positions of the dial . . . Try changing first detector-oscillator cathode resistor to 5,000 ohms, instead of the original 10,000. The tube is probably overbiased.

PHILCO 90. Intermittent reception . . . Generally due to trouble in coupling condensers between first and second 27's or between second and third 27's, or between third 27 and 47 final amplifier. The first one is hard to test and it is best to insert a new one and try the receiver.

PHILCO 18. Shadow indicator extremely wide and no signal . . . Voltages are usually all ok in this condition

and the trouble is probably shorted trimmers. Bend plates up and insert larger insulating washers.

RCA RAE59. Flat tone quality when used close to high-powered local stations . . . Trouble is in a.v.c. action. Over control is exerted. Look for 500,000 ohm resistor from plate of a.v.c. tube to ground. Open the ground end and insert a 300,000 ohm resistor in series, replacing the ground connection. Now release the r.f. and i.f. leads from the plate of the a.v.c. tube and place them at the junction of the two resistors, by-passing this junction to ground with a $\frac{1}{2}$ mfd. condenser.

RCA 110. Tracking condenser shown on circuit diagram as number C-31 appears to be missing . . . This condenser has a minimum of 15 and a maximum of 70 mmf. Try inserting one small enough to be placed between oscillator coil and chassis. Adjustment to about 50 mmf. will give maximum deflection at 600 kc. while rocking tuning condenser. Sensitivity will be uniform over entire dial. Apparently this condenser is occasionally omitted through error in production.

SPARTON 14. Intermittent reception, operation restored by jarring cabinet . . . This is a common trouble which may be attributed generally to a single cause in these models. The wire running from the intermediate transformer to the 58 looses some of its insulation where it passes under the shield-can. The short is very difficult to actually see and may be guarded against with a short length of spaghetti on the lead.

SPARTON 930, 931. Replacing 483 power tubes with 45's . . . The usual method is to rewire the filaments in series to reduce voltage from 5 to $2\frac{1}{2}$. This usually results in hum. A better method is outlined here: Remove the bias resistor from the center lead of the power transformer. Transfer one of the filament wires from the outer tap to which it is normally connected to the center-tap. Remove the old hum balancing potentiometer and install a 20 ohm center-tapped resistor across the filament circuit. Connect the opened end of the bias resistor to the midpoint.

Wanted: Appliance Data

Our "sister" paper, "Electrical Merchandising," now publishes an appliance service section.

Have you any data on the adjustment or repair of household refrigerators, washers, cleaners, oil-burners or minor appliances?

Send them in to the Service Editor, "Electrical Merchandising," 330 West 42nd Street, New York City.

"Merch" will pay for all accepted items, just as we do, of course.

**"BELIEVE ME, IT PAYS TO SELL
QUALITY PRODUCTS AT FULL"
 LIST PRICES**



This Service Man knows what he's talking about . . . read what he actually said:

● "I've got good customers. I've got a reputation to live up to. That's why I can't afford to sell anything but first-rate merchandise . . . products I'm not afraid to stand back of and recommend to my customers.

"Besides, it actually *pays* to sell the *best*. That's why I always recommend Sylvania tubes. They're as good as any made . . . stand up under long service, and I *keep* my customers when I sell them Sylvania tubes.

"I've got another reason for pushing Sylvania's, too. I make a real profit when I sell Sylvania tubes because I get the full list price. Sylvania doesn't seem to franchise outlets that sell any other way, and believe me, in my business, that's important to me."

Would you like to know more about why more and more dealers and distributors are swinging to Sylvania's? Information on Sylvania's sales policies and the extra profit that is yours will be sent on request. Hygrade Sylvania Corporation . . . Emporium, Penna.

SYLVANIA

THE SET-TESTED RADIO TUBE

SEARCHLIGHT SECTION

EMPLOYMENT and BUSINESS OPPORTUNITIES—SURPLUS STOCKS—DISCONTINUED MODELS

UNDISPLAYED—RATE PER WORD:
Positions Wanted (full or part-time salaried employment only), 10 cents a word, minimum \$2.00 an insertion, payable in advance. (See ¶ on Box Numbers.)
Positions Vacant and all other classifications, 15 cents a word, minimum charge \$3.00.
Proposals, 40 cents a line an insertion.

INFORMATION:
 Box numbers in care of our New York, Chicago and San Francisco offices count 10 words additional in undisplayed ads. Replies forwarded without extra charge. Discount of 10% if one payment is made in advance for four consecutive insertions of undisplayed ads (not including proposals).

DISPLAYED—RATE PER INCH:
 1 inch \$8.00
 2 to 3 inches..... 7.80 per inch
 4 to 7 inches..... 7.60 per inch
Rates for larger spaces, or yearly rates, on request.
 An advertising inch is measured vertically on one column, 3 columns—30 inches—to a page. Radio Retailing

SPECIAL NOTICE:

TO THE RADIO INDUSTRY

Advertising in connection with legitimate offers of surplus stocks and discontinued models of radio merchandise is acceptable in this section of "Radio Retailing."

Extreme care will be exercised by the publishers to prevent the use of advertising in the Searchlight Section to encourage price cutting on current models of merchandise or equipment. Nor will advertising which invites violation of the dealer's contract with the manufacturer be acceptable.

All merchandise offered in the Searchlight Section must be accurately and fully described and must be available on order.

AGENTS WANTED BIG PROFITS

THEATRE EQUIPMENT

New - Used - Rebuilt



Projectors, Screens, Soundheads, Amplifiers, Chairs, Portable Projectors, Arc Lamps, Rectifiers and Generators.

REPAIRING AT LOWEST RATES

S. O. S. CORP., 1600 Broadway, New York
S. O. S. Buys Equipment at Highest Prices

"We have had splendid results from Aviation advertising and have sold five or six planes recently directly through your magazine."

If there is anything you want—

or something you don't want that other readers of this paper can supply—or use—advertise in the

Searchlight Section

"We have had many inquiries and several sales from the first advertisement, and are receiving mail every day in response to the second ad."

NEW 92-PAGE RADIO CATALOG

Containing the greatest array of PUBLIC ADDRESS EQUIPMENT ever assembled between two covers. If you are in the sound equipment field or intend to go into it, you will find this catalog indispensable. SEND FOR YOUR COPY TO-DAY.

WHOLESALE MERCHANDISERS, Inc.
 626 Broadway, Dept. R, New York City

GENUINE GREBE PARTS

In Stock for all Grebe Sets built prior to 1933. Use only Genuine Grebe Parts in servicing these sets to maintain the original high standard of performance for which they were noted.

Write for Parts Price List
C. I. VERMILYE
 (Former General Factory Manager of A. H. Grebe & Co., Inc.)
 137-30 Jamaica Ave. Jamaica, N. Y.

The **NEW** 1935 148 Page **RADOLEK CATALOG** Ready Now!

Hundreds of New Items!

RADOLEK'S Revised 1935 Radio Profit Guide contains all the new items recently brought out by leading manufacturers. This big book is a complete radio encyclopedia—accurate descriptions of thousands of radio parts, test instruments, tools, amplifiers, and receivers!

Valuable Information!

Diagrams, charts, illustrations! The Profit Guide is more than any ordinary catalog—it is a valuable reference book combining information with product data in such a way as to actually help you in securing more business and in doing your work more rapidly.

Sharp Price Reductions!

Lower prices than you have seen in several years! Take advantage of the hundreds of Specials and genuine bargains offered in this, the most complete Radio Servicemen's Profit Guide ever published.

If you have not ordered recently—

Send for this latest 1935 Profit Guide on your business stationery. RADOLEK restricts distribution to active and legitimate Radio Accounts.
RADOLEK CO., 605 W. Randolph St., CHICAGO, ILLINOIS

RADIO SERVICING

Residence course, 6 months modern methods, new courses, special work on service equipment, superheterodyne servicing; instruction on public address systems, photo cell and cathode ray tubes included. Other courses obtainable: Radio Engineering—9 months; Marine Radio—6 months; Morse telegraphy—6 months. School est. 1874. All expenses low. Catalog free.

Dodge's Institute, 12th St., Valparaiso, Ind.

MICROPHONE REPAIRS

Any make or model completely rebuilt—Missing parts replaced. Replated if desired. Guaranteed equal or better than new. Large size: \$6.50. Medium: \$3.00. Small: \$3.00. Single button: \$1.50.

ELECTRO-VOICE MFG. CO., Inc.
 328 E. Colfax Avenue, South Bend, Ind.

Service men!

RADIO CATALOG FREE

Just out—the new 1935 Spring and Summer ALLIED Catalog. Devoted 100% to Radio. A real Double-Value Book listing the highest quality Standard Radio Lines at less than so-called "bargain" prices. Features thousands of exact duplicate replacement parts for all makes of receivers—all leading lines of test instruments, tools, etc. Offers new profit-making ideas in Sound Equipment, Phonograph Modernization, All-Wave Antenna Installations, etc. Service Engineers and Dealers—it's wise to consult this new ALLIED Catalog before you buy. It will bring you bigger profits and help you give better service. Send for this valuable FREE Catalog now. Address Dept. SE.

ALLIED RADIO CORPORATION
 833 W. JACKSON BLVD., CHICAGO, ILL.

Meets the demand for a quality combination of Radio and Bar.

\$99.50 up—complete with glassware, etc. A money-maker. Can be supplied without chassis. Dealers please write for details.

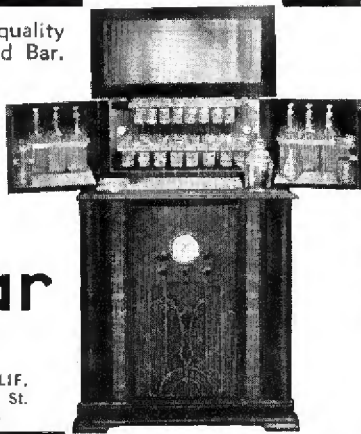

Radiobar

RADIOBAR COMPANY OF AMERICA

7100 McKinley Ave., LOS ANGELES, CALIF.
New York Office: 13 East 47th St.
Cable Address: LIKEX, New York



Ken-Rad Radio Tubes

DEPENDABLE LONG LIFE

Ken-Rad Radio Tubes are made to give clear, dependable reception. They satisfy customers and build good will for dealers. Write for full information.

THE KEN-RAD CORPORATION, Inc., Owensboro, Ky.
Division of The Ken-Rad Tube and Lamp Corporation
Also Mfrs. of Ken-Rad Incandescent Electric Lamps

6-VOLT RADIO SALES ARE SUCCESSFUL with WINCHARGER

There is no doubt about it—Wincharger will make your 6-Volt radio sales successful and profitable—satisfactory to both dealer and buyer. Wincharger once and for all removes that heretofore insurmountable sales argument: run-down batteries and the frequent necessity of taking them to town for re-charging. Wincharger Standard enables the 6-Volt radio owner to use his radio night and day and keeps his battery fully charged without operating cost.

The 6-Volt Direct Drive Wincharger Standard is a compact, sturdily built, wind-driven battery charger, designed with sufficient output to charge at one time 2 Heavy Duty 6-volt radio or car batteries. Operates in surprisingly low wind speed due to the Albers Airfoil propeller and specially built generator. Easy to install. Built as a complete unit at an outstandingly low price and offers a good margin of profit to the dealer.

The Wincharger De Luxe

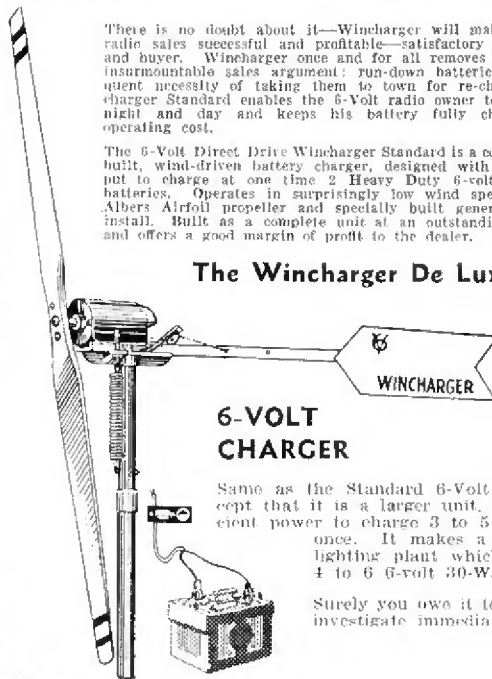

6-VOLT CHARGER

Same as the Standard 6-Volt charger except that it is a larger unit, having sufficient power to charge 3 to 5 batteries at once. It makes a small home lighting plant which will carry 4 to 6 6-volt 30-Watt lamps.

Surely you owe it to yourself to investigate immediately.

WINCHARGER CORP.,
2702 HAWKEYE DRIVE,
SIOUX CITY, IOWA

COMPLETE ELECTRIC PLANTS

ONAN ALTERNATING CURRENT ELECTRIC PLANTS furnish the same current as supplied by power lines—110 volt, 60 cycles, A.C.

OPERATES A.C. RADIO, PUBLIC ADDRESS AND SOUND CAR EQUIPMENT

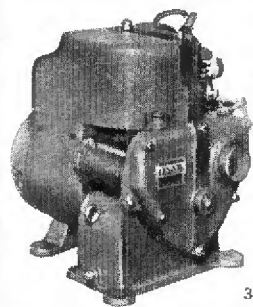

For all Household and Commercial Purposes. Runs Washing Machine, Water Pump, Refrigerator, A.C. Motors.

SIZES 350 TO 50,000 WATTS

Operate on Gasoline, Gas or Distillate. No battery used except to start engine. Ideal for places remote from electric service. Battery Plants also available in similar sizes.

High-grade, inexpensive ONAN PLANTS offer opportunity for sales of Plants, Radios, Wiring and Appliances. Write for details.

D. W. ONAN & SONS
380 Royalston Ave. Minneapolis, Minn.

DAYRAD

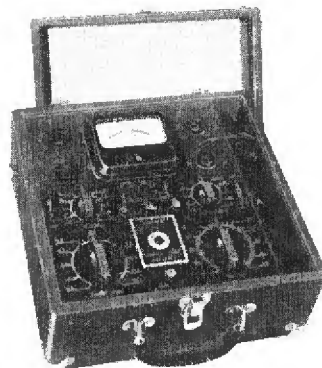

ANNOUNCES a
COMPLETE
NEW LINE OF
TUBE
TESTERS

with Leakage Test 20
Times more Sensitive

Two-thirds of all tube replacements is caused by leaks and shorts in tubes. This is your BIG MARKET. Now the DAYRAD Tri-Test Tube Checker multiplies that market by providing a super-sensitive check. Tube faults that you have missed before are clearly revealed and tube sales increase proportionately! A simple, efficient and precise tester for either portable or store use.

ALSO! NEW SIGNAL GENERATOR
60 to 60,000 KC. (5 METERS)

WRITE! For the new DAYRAD CATALOG OF RADIO SERVICE INSTRUMENTS illustrating and explaining the complete new line. Do it today.

The RADIO PRODUCTS Co.
125 SUNRISE PLACE
DAYTON, OHIO.



CORWICO "NOISE-MASTER" ANTENNA

Goodbye, "man-made" static! For clear, pure NATURAL reception on both broadcast and short-wave bands. "NOISE-MASTER" makes every radio a better radio. Service men, INVESTIGATE!

• "TRAVEL FIRST CLASS," our new folder, sent free . . . write for your copy at once.

CORNISH WIRE CO.
30 Church St.,
N. Y. City

CONTENTS, APRIL, 1935

Copyright, 1935, by McGraw-Hill Publishing Company, Inc.

Tube Turmoil By Ray V. Sutcliffe 15
Getting the Old Bus Ready for the Road 16
To a Discouraged Dealer 17
Tube Makers Define Policies 18
Auto-Radio Sales Ideas 20
Making the RWA Code Work 22
The Meiklejohn Plan By W. W. MacDonald 24
The Antenna Sells the Set By Daniel Ladd 27
Straight from the Shoulder 28
Auto-Radio Pictorial 29
Auto-Radio Specifications 30
Tube News 32
News of the Month 34
New Auto-Radios 38
Other New Products 39

SERVICE SECTION

Circuits of the Month 43
1935 Auto-Radio Tips By M. B. McCullough 47
Shop Shortcuts 51
Tricks of the Trade 52

INDEX TO ADVERTISERS

This index is published as a convenience to the reader. Every care is taken to make it accurate, but *Radio Retailing* assumes no responsibility for errors or omissions.

	Page		Page
Aerovox Corp.	48	Raytheon Products Co.	10
Arcturus Radio Tube Co.	4	RCA Victor (Sets)	14
Atwater Kent Mfg. Co.	11	RCA Radiotron (Tubes)	37
Continental Carbon, Inc.	46	Readrite Meter Works	40
Cornell Dubilier Corp.	46	Rider, John F.	48
Cornish Wire Co.	55	Solar Mfg. Corp.	48
Crosley Radio Corp.		Sprague Products Co.	48
	Inside Back Cover	Stromberg Carlson Tele. Mfg. Co.	2
Deutschmann Corp., Tobe.	50	Supreme Instrument Corp.	42
Emerson Radio & Phono. Corp.	5	Thordarson Elec. & Mfg. Co.	56
Fada Radio & Elec. Co.	7	Tungsol Radio Tubes, Inc.	6
Fairbanks-Morse Home App., Inc.	3-8	United American Bosch Corp.	9
General Electric Co. (Radio)		United Motors Service	13
	Back Cover	Webster Co., The	50
General Household Util. Co.	12	Weston Electrical Instr. Co.	44
General Industries Co.	46	Wincharger Corp.	55
Hygrade Sylvania Corp.	53	Zenith Radio Corp.	1
Ken-Rad Corp.	55	Zephyr Power Co.	50
Mallory & Co., P. R.	Front Cover		
Muter Co., The	48		
National Union Radio Corp.	46		
Noblitt-Sparks Industries, Inc.			
	Inside Front Cover		
Onan & Sons, D. W.	55		
Pioneer Gen-E Motor Corp.	50		
Radiobar Co. of America	55		
Radio Products Co.	55		
Radio & Technical Pub. Co.	50		

SEARCHLIGHT SECTION

Classification	Page
AGENTS WANTED	54
CATALOGS	54
EDUCATIONAL COURSES	54
REPAIRING	54
RADIO STOCKS	
Allied Radio Corp.	54
Radolek Co.	54
Vermilye, C. I.	54
Electro-Voice Mfg. Co., Inc.	54
S. O. S. Corp.	54
Wholesale Merchandisers, Inc.	54

McGraw-Hill Publishing Company, Inc., 330 West 42d Street, New York, N. Y. Branch offices: 524 North Michigan Ave., Chicago; 883 Mission St., San Francisco; Aldwych House, Aldwych, London, W. C. 2; Washington; Philadelphia; Cleveland; Detroit; St. Louis; Boston; Greenville, S. C. James H. McGraw, Chairman of the Board; Malcolm Muir, President; James H. McGraw, Jr., Vice-President and Treasurer; Mason Britton, Vice-President; H. C. Parmelee, Vice-President; Harold W. McGraw, Vice-President; B. B. Putnam, Secretary. Member A.B.P. Member A.B.C. Printed in U. S. A.

Printed by The Schweitzer Press, N. Y.

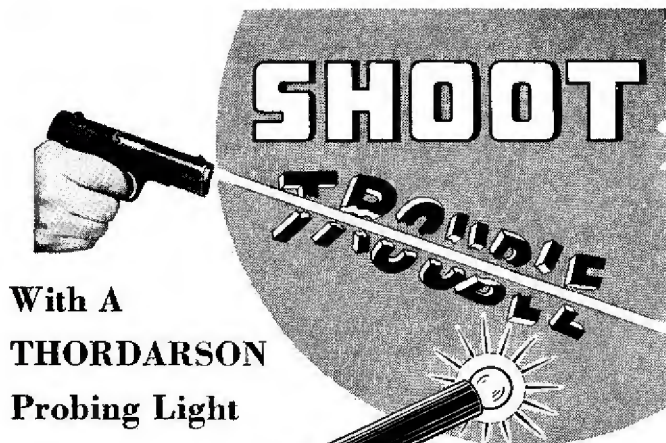

With A
THORDARSON
 Probing Light

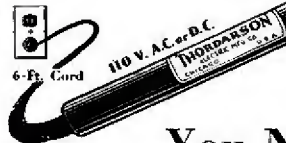

Have Plenty
 of Light Where
 You Need it and When
 You Want it! . . .

Fountain Pen Size! Six volt Pilot Light operated from 115 volt A.C. or D.C. Line! A dependable batteryless light for your workshop, garage, or radio service calls.

At all **THORDARSON** Distributors

List Price \$1.50

★ ★ ★ ★ ★

The Servicemen's Guide

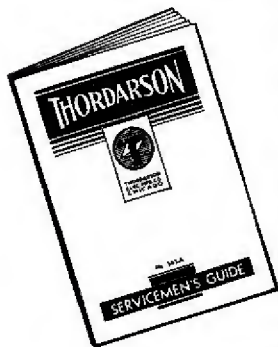

Valuable Technical Data, Charts, Diagrams, Tables, Plans, and Trade Secrets never before published!

How to Build it Information: For a Condenser-Capacity-Leakage Tester; an Output Indicator; and several other useful items.

Circuits of Audio Systems with relative Db. gain. An easy method of calculating Db. gain.

Tables for selecting the proper output transformer! How to Survey and Replan your Radio Business! These are only a few of the high lights from the Servicemen's Guide. It is not a catalog—no merchandise is listed for sale in it. Price 10c.

Send for Your Copy Today!

THORDARSON ELECTRIC MFG. CO.,
 500 W. Huron St., Dept. K, Chicago, Ill.

Please send me the following new THORDARSON literature:

- THORDARSON Servicemen's Guide—No. 342-A Price 10c postpaid (Catalog 341-A included Free.)
- THORDARSON Transformer Manual—No. 340-A (includes the Servicemen's Guide with the Sound Amplifier Manual and Transmitter Guide bound in heavy covers.) Price 50c postpaid.



Name

Address

City

State

**ONLY CROSLLEY DEALERS
CAN PROFIT by**

This much more in a
SHELVADOR

EXCLUSIVELY IN
CROSLLEY
ELECTRIC REFRIGERATORS

As poetry, not so hot. But as a selling *idea* there's a world of meaning and of profit in the simple rhyme—"This much more in a Shelvador." To this let us add—"and twice as easy to find."

There is no argument so convincing as a *record*. And the record shows that the Shelvador feature has been most productive single sales factor in recent electric refrigeration history. During 1934 the Crosley Shelvador Electric Refrigerator showed the greatest sales growth in the entire field. And 1935 will far exceed 1934. That's not guess-work. It's a certainty, already partially established. During January Shelvador sales were 360% ahead of the same month in 1934. Gains of 200% and more are common. Some dealers report a 1000% increase.

The Shelvador—with its greatly increased usable space—has lifted the Crosley Electric Refrigerator out of competition. Crosley quality—established and proved by hundreds of thousands of satisfied users—has received national recognition. Crosley value is even more aptly illustrated in these models than ever before.

As for you—if you are not now selling the Crosley Line—let the success of others be your guide. The more you look into this matter, the more you'll find that you cannot afford NOT to handle Crosley.

* * *

All 1935 models have the Shelvador feature, flat bar shelves, no-stop defrosting control, new-designed chromium-plated hardware, porcelain interior. Shelvador and Tri-Shelvador models have in addition: Automatic interior light, ventilated front. All Tri-Shelvador models add to these features: Shelvatray, Shelvabasket, Storabin and self-closing ice-tray chamber door.

Prices in Florida, Texas, Rocky Mountain states and west, slightly higher.

THE CROSLLEY RADIO CORPORATION
CINCINNATI

POWER CROSLLEY, Jr., President.

(Pioneer Manufacturers of Radio Receiving Sets)

Home of WLW—the world's most powerful broadcasting station.



2 TABLE SHELVADORS

TABLE SHELVADOR

FR-20—2 cu. ft. NET Capacity. Semi-hermetic Rotary Compressor. Dimensions: 36" high, 29 1/2" wide, 25" deep. (Shown at left) **\$79.50**

TABLE SHELVADOR

FR-30—3.1 cu. ft. NET Capacity. Rotary Compressor. Same dimensions as FR-20 **\$94.50**

4 SHELVADOR MODELS

SHELVADOR MODEL FA-40

4.00 cu. ft. NET Capacity. 8.0 sq. ft. shelf area. 2 ice trays—42 cubes. Dimensions: 52 1/2" high, 29 1/2" wide, 25 1/2" deep. **\$112.50**

SHELVADOR MODEL FA-60

6 cu. ft. NET Capacity. 13.5 sq. ft. shelf area. 3 ice trays—63 cubes—one double-depth tray. Dimensions: 56 1/2" high, 30 1/2" wide, 25 1/2" deep. **\$149.50**

SHELVADOR MODEL FA-50

5 cu. ft. NET Capacity. 11.3 sq. ft. shelf area. 2 ice trays—42 cubes—one double-depth tray. Dimensions: 56 1/2" high, 29 1/2" wide, 24 1/2" deep. (Shown at left) **\$129.50**

SHELVADOR MODEL FA-70

7.08 cu. ft. NET Capacity. 14.9 sq. ft. shelf area. 4 ice trays—84 cubes—one double-depth tray. Dimensions: 57 1/2" high, 32 1/2" wide, 25 1/2" deep. **\$169.50**

3 TRI-SHELVADOR MODELS

Models FA-50, FA-60, FA-70, and all Tri-Shelvador Models also available with porcelain exterior at slight extra cost.

TRI-SHELVADOR MODEL F-55

5.51 cu. ft. NET Capacity. 11.6 sq. ft. shelf area. 3 ice trays—63 cubes—one double-depth tray. Dimensions: 57 1/2" high, 29" wide, 24 1/2" deep. **\$164.50**

TRI-SHELVADOR MODEL F-43

4.3 cu. ft. NET Capacity. 9.15 sq. ft. shelf area. 2 ice trays—42 cubes—one double-depth tray. Dimensions: 56-9/16" high, 29 1/2" wide, 25 1/2" deep. **\$139.50**

TRI-SHELVADOR MODEL F-70

7.08 cu. ft. NET Capacity. 14.9 sq. ft. shelf area. 4 ice trays—84 cubes—one double-depth tray. Dimensions: 57 1/2" high, 32 1/2" wide, 25 1/2" deep. (Shown at left) **\$189.50**



ALL PRICES INCLUDE DELIVERY..INSTALLATION..ONE YEAR FREE SERVICE

This *New* G-E AUTO RADIO Sells Itself

WHILE YOU
POCKET
THE
PROFIT



5 TUBES
\$44.95

It's the *newest* G-E Auto Radio. A real five-tube set—five *working* tubes. A synchronous vibrator rectifier is used, eliminating a rectifier tube. Model D-50 carries the prestige of the General Electric name—and the *salability* that goes with it. And it's priced so you can sell it for only \$44.95, and make a good profit, too.

We feel fully justified in saying Model D-50 will sell itself while you pocket the profit.

Glance at some of its other features. Real lowering of background noise in relation to signal. Simplified elimination of motor noise—many cars will not require spark-plug suppressors. Only 5.5 amp. current drain, because of design improvements and elimination of the rectifier tube. Improved tone quality, with full response, particularly on low frequencies. Improved 6-inch electro-dynamic speaker, with great sensitivity and large out-

put. Three-bolt mounting — flexible enough for practically every make of car. Maximum sensitivity and selectivity.

Model D-50 fills out the G-E Auto Radio line to perfection. It is a low-priced leader *par excellence!* For further information on Model D-50 or the Approved Installation Station plan, ask your G-E Distributor, or write to the address below.

Section R-114, Merchandise Department,
General Electric Co., Bridgeport, Conn.

G-E Auto Radio Approved Installation Stations, from coast to coast, handle installation and service for G-E Auto Radio Dealers.

In these stations, G-E Auto Radios are installed by experts; serviced for 90 days. Satisfactory performance is guaranteed by certificate.

GENERAL ELECTRIC

AUTO RADIO

MERCHANDISE DEPARTMENT, GENERAL ELECTRIC COMPANY, BRIDGEPORT, CONNECTICUT