

Radio Retailing

The Business Magazine of the Radio Industry

*a New
development!*

Freshman EQUAPHASE

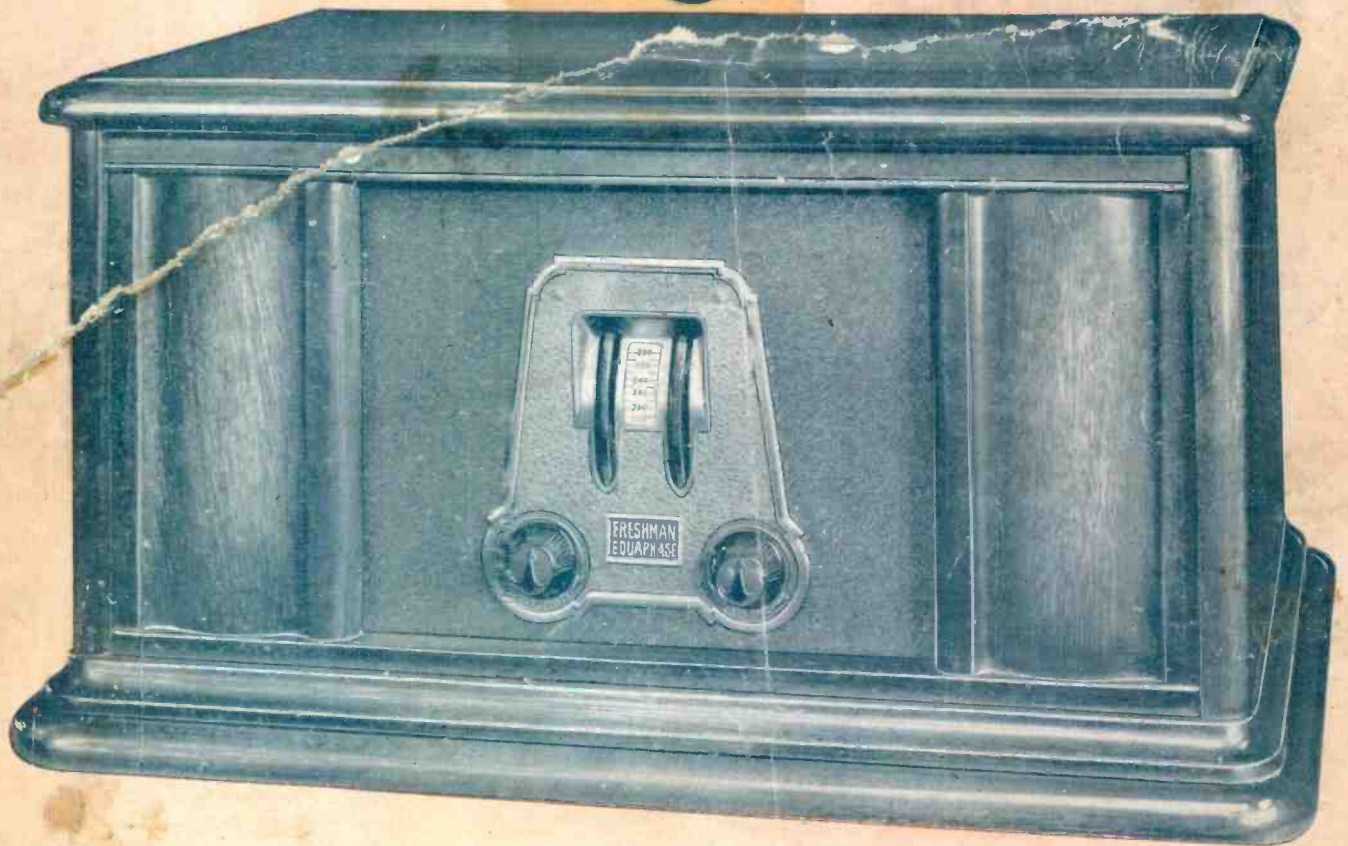

An entirely new principle of stabilization
and these features:

- 1: Four tuned circuits
- 2: Single drive—one control
- 3: Full floating tube shelf
- 4: Drum type illuminated dial—calibrated in wavelengths
- 5: Solid Mahogany cabinet—artistically highlighted

\$70

A Freshman development—licensed under patents;
RCA—General Electric Co.,—Westinghouse
Electric & Mfg. Co. and American Tel. & Tel. Co.



With
Cunningham
 RADIO TUBES
 in every socket

any good radio receiver can deliver its utmost in tone quality

Dealers everywhere will be interested in the Cunningham merchandising and sales helps now ready for the radio season of 1927. The illustration above shows a suggested window trim using the entire set of 6 Cunningham displays made in full color lithography. These can also be used separately for counter displays.

In selling Cunningham Radio Tubes as equipment for every socket in every set that leaves your store, you have insured customer satisfaction and customer satisfaction is your greatest asset.

Twenty different types—
 all in the Orange and Blue carton.

E. T. CUNNINGHAM, INC.
 CHICAGO

NEW YORK

SAN FRANCISCO

EARL WHITEHORNE,
Contributing Editor
S. J. RYAN,
Merchandising Counsellor
L. E. MOFFATT,
Associate Editor
H. S. KNOWLTON, Boston
PAUL WOOTON, Washington

Radio Retailing

The Business Magazine of the Radio Industry

WILLIAM C. ALLEY
Managing Editor

RAY V. SUTLIFF, Chicago
Western Editor
HENRY W. BAUKAT,
Technical Editor
OVID RISO,
Assistant Editor
C. GRUNSKY, San Francisco

Table of Contents September, 1927

The Principles of Fall Buying	57
Turning Failure Into Success	58
Make Service Your Stepping Stones to Sales	62
Are We on the Verge of New Developments in Radio Reception?	65
Details of Radio Day Window Contest	67
The Big Fight—Let It Work for You	68
Selling Methods that Net 13 Per Cent	70
Forewarned by Radio!	72
Radio Today Deserves a Beautiful Setting	77
Why Radio Dealers Should Merchandise Attractive Cabinets	78
How One Dealer Capitalized the Dempsey-Sharkey Fight	84
Practical Service Methods	85
News of the Month Pictorially Told	87
"Know Your Lines"	88
New Radio Products Announced This Month	90
What the Trade Is Talking About	95
News of Jobbers and Distributors	99
Specifications of Radio Receivers for 1927-28	100
Specifications of Speakers for 1927-28	105
Sell Selected Parts, Not Cut-Price Bargains	109
Previewing the New Circuits	111
Manufacturers and Markets	113

"For These Few Words Our Thanks—"

THE true value of a magazine can best be expressed by its readers. The editors appreciate keenly the many letters received from our friends of the radio trade and take this means of thanking you for your comments.

Here's what a few of you have said:

"We are all students in the study of the proper merchandising of radio and I know of no one who is doing more to assist in the schooling than *Radio Retailing* and its editors."
W. C. MILLER,
Butler's Music Co., Kansas City, Kan.

"Permit me to compliment you on the June issue of *Radio Retailing*. It is complete with valuable information to the radio retailer and has suggestions and ideas that should greatly help him in the business this Fall."

ROBERT N. WATKIN,
Will A. Watkin Co., Dallas, Texas,
Formerly president of the National Assn. of Music Merchants.

"We are great readers of *Radio Retailing*—the only dealer's magazine worth a darn."
C. E. AMMEN,
1333 S. Carrollton Ave., New Orleans, La.

"Couldn't get along without *Radio Retailing*. The best trade paper I take."
O. D. INGALL,
Radiophon Radio Supplies, Nantucket, Mass.

"In our five years' experience in this industry we have yet to find a publication that gives the dealer as much interesting information and advance data as *Radio Retailing*. We have derived great benefit by putting into practice several of your sales helps. There is hardly a topic pertaining to this field that is overlooked by your publication. It certainly is a credit to the industry. We trust you'll carry on your good work and our conclusion is that a dealer is asleep who doesn't benefit by your publication."

M. WEIDHORN,
Electra Radio Service, 1133 Broadway, Brooklyn, N. Y.

Radio Retailing is a great help to the retailer. It gives new ideas that certainly help to sell sets and parts.
THORNTON G. LAKE,
Lake Charles, La.

"I read an article in *Radio Retailing*, 'Checking Up the Town for Equipment' and to my surprise I went out and sold a raft of equipment. One accomplishment was seven Majestic "B" Eliminators last Friday afternoon and Saturday morning, seven hours."
A. C. WEFELMEYER,
24 Forty-first St., Astoria, N. Y.

"But It Takes a Little Rain with the Sunshine..."

"Trade magazines are not worth a real business man's time to read. Take it in the Wall Paper, Music and here it is in your Radio, never once have I saw an instructive and educative, worth while article."

"I admit there is not enough brains in the radio world, the right class of men aren't in the business. Well so long, boys, kindest regards."

Yours as ever, off of Trade Journals,
Evans and Son, Kokomo, Ind.

My, oh my, that spoils our whole afternoon.

Member Audit Bureau of Circulations

Circulation of This Issue, 30,000 Copies

McGraw-Hill Publishing Company, Inc., Tenth Ave. at 36th St., New York, N. Y.

New York District Office, 285 Madison Ave.

JAMES H. MCGRAW, President
JAMES H. MCGRAW, JR., Vice-Pres. and Treas.
MALCOLM MUIR, Vice-President
EDWARD J. MEHRN, Vice-President
MABON BRITTON, Vice-President
EDGAR KOBAK, Vice-President
C. H. THOMPSON, Secretary

Electrical World Electrical West Ingenieria Internacional
Industrial Engineer Engineering and Mining Journal
Chemical & Metallurgical Engineering American Machinist
Electrical Merchandising Power Electric Railway Journal
Bus Transportation Engineering News-Record
Coal Age Coal Age News Construction Methods
Copyright, 1927, by McGraw-Hill Publishing Company, Inc.
Cable Address: "Machinist, N. Y."
Annual subscription rate is \$2 in United States and Canada.

WASHINGTON, National Press Bldg.
CHICAGO, 7 South Dearborn St.
PHILADELPHIA, 1600 Arch St.
CLEVELAND, Guardian Bldg.
ST. LOUIS, Bell Telephone Bldg.
SAN FRANCISCO, 883 Mission Street
LONDON, E. C., 8 Boulevard St.

The Greatest Stromberg-Carlson Line

A.C. Receivers for operating direct from 60 cycle house lighting circuit; Universally Powered Receivers for operating in all other areas.

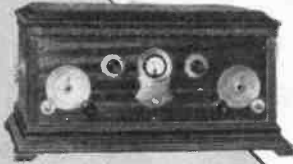

No. 633 Stromberg-Carlson A.C. Receiver Price, with Audio-Power Unit and 9 R.C.A. Tubes—but without Cone Speaker or Loop. East of Rockies \$355; Rockies and West \$380.

No. 601 Stromberg-Carlson, Universally Powered Receiver, similar cabinet. Price, less accessories—East of Rockies \$215; Rockies and West \$240.

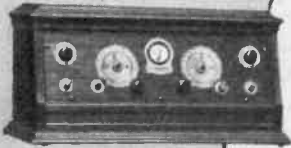

No. 523 A.C. Receiver. Price, with Audio-Power Unit and 8 R.C.A. Tubes but without Cone Speaker; East of Rockies \$195; Rockies and West \$215.

No. 502 Universally Powered Receiver, similar cabinet. Price, less accessories; East of Rockies \$180; Rockies and West \$192.50.



No. 744 A.C. Receiver Radio and Phonograph combination. Incorporates an electric phonograph having magnetic pick-up for reproducing records through audio system of Receiver and the Cone-Speaker. Price, including Cone Speaker, Loop, Socket-Power Unit and 11 R.C.A. Tubes, East of Rockies \$1245; Rockies and West \$1299.

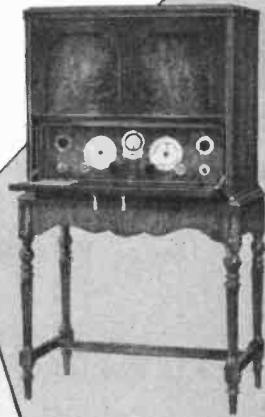

No. 524 A.C. Receiver. Price, with Audio-Power Unit and 8 R.C.A. Tubes—but without Cone Speaker; East of Rockies \$425; Rockies and West \$455.

No. 502 Universally Powered Receiver, similar cabinet. Price, less accessories, East of Rockies \$290; Rockies and West \$315.



No. 734 A.C. Receiver. Price with Socket-Power Unit and 11 R.C.A. Tubes—but not including Cone Speaker or Envelope Loop, East of Rockies \$755; Rockies and West \$795.



No. 10 Cone-Speaker. A 12-inch seamless Cone Speaker built with thin apex and thicker edge for even sound-producing qualities. Reproduces below 60-cycle fundamental tones. Designed only for highest grade Receivers. Price, East of Rockies \$40; Rockies and West \$44.

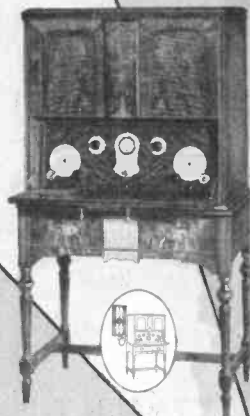

No. 634 A.C. Receiver. Price, with Audio-Power Unit and 9 R.C.A. Tubes but without Cone-Speaker or Loop, East of Rockies \$505; Rockies and West \$545.

No. 602 Universally Powered Receiver, similar cabinet. Price, less accessories, East of Rockies \$330; Rockies and West \$360.

SIX NEW A.C. STROMBERG-CARLSONS satisfy the demand for all direct light socket operation wherever 105-125 volt, 50-60 cycle alternating current is available. Four Universally Powered Stromberg-Carlsons give indirect A.C. operation with "B" eliminator and Unipower; or complete D.C. operation with batteries where house current is unavailable or unsuitable.

The Stromberg-Carlson line contains Receivers which offer loop or antenna pick-up in Treasure Chest or Console models; Receivers with single or dual station selectors; Rec-

ivers which give radio reproduction of phonograph records.

Every Stromberg-Carlson irrespective of current supply uses inexpensive, long-lived, D.C. type tubes of proved efficiency offering no limit on tone quality.

The wide range of Stromberg-Carlson prices, plus the protection and profit possible under the new Stromberg-Carlson financing plan permits more sales with safety.

Stromberg-Carlson's complete patent protection on every item of their radio installations and their guarantee not to reduce prices, assures "permanent value"

STROMBERG-CARLSON TELEPHONE MFG. CO., ROCHESTER, N. Y.

Stromberg-Carlson

Makers of voice transmission and voice reception apparatus for more than thirty years.

This year, make it Grebe for Profit

QUICK sales, customer satisfaction, minimum service, full profit. An ideal set-up with Grebe batting .998 per cent.

Tie up to Grebe this year and you'll make *real* profits—and no apologies to customers.

The Synchronphase Seven—the newest and best receiver Grebe has ever put out. As usual, full of exclusive Grebe developments that make sales easy and satisfaction sure. Wonderfully attractive, too, with its real French marquetry inlay panel in butt-grain walnut.

And *The Synchronphase Five*—dependable—and also with special Grebe features that always move this set quickly.

To complete the Grebe line:—The new *Grebe Natural Speaker* for true reproduction; and *Grebe Socket Powers* for dependable "A", "B", and "C" power supply.

You'll miss a lot if you fail to learn full details about this wonderful new Grebe line.

Booklet RR gives the facts. Send for it

A. H. Grebe & Co., Inc. 109 W. 57th St., New York City
Factory: Richmond Hill, N. Y.
Western Branch: 443 South San Pedro St., Los Angeles, Calif.
The oldest exclusive radio manufacturer



Grebe Natural Speaker
\$35



Grebe Synchronphase Seven
\$135

The

GREBE

TRADE MARK REG. U.S. PAT. OFF.

SYNCHROPHASE

TRADE MARK REG. U.S. PAT. OFF.

RADIO



Grebe Socket Powers

- Type 128—"A" Supply—\$60
- Type 671—"B" and "C" Supply with cable—(less tube) \$50
- Type 671-B—"B" and "C" Supply—with binding posts—(less tube) \$50



CONE SPEAKER

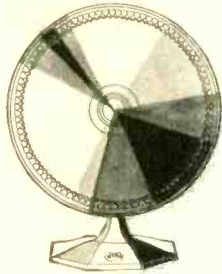

\$10⁰⁰

PIANO SPEAKER

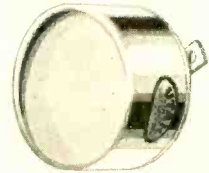

Makes a Radio
Reproducer
out of any piano
\$10⁰⁰

UTAH No.30 SPEAKER



Size-Height 18"
Weight 15 lbs.
\$30⁰⁰

UTAH No16 DRUM SPEAKER

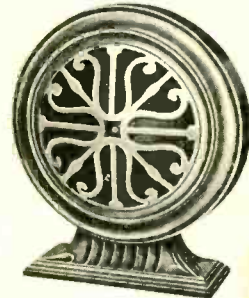

16"high-13"wide
4½"deep-Weight 10 lbs.
\$16⁰⁰

Utah Radio Products Company, 1615 South Michigan Avenue, Chicago.

The Newest Ideas..

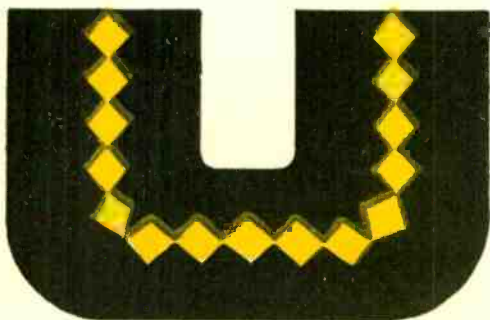

SUPERFLEX

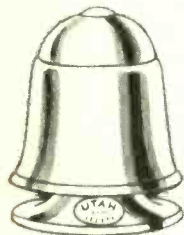

New
1927 Model
\$10⁰⁰

UTAH STANDARD

\$22⁵⁰

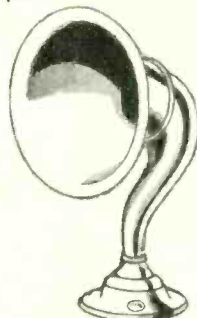

Utah Junior
\$12⁵⁰

UTAH SCREEN SPEAKER

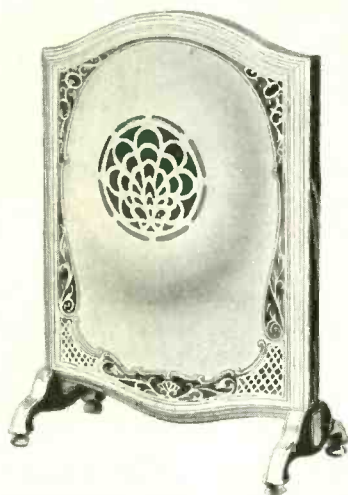

\$100⁰⁰

10ft. air column
40" high x 28" wide
x 12" deep.

Utah Radio Products Company, 1615 South Michigan Avenue, Chicago.

the most Complete Line

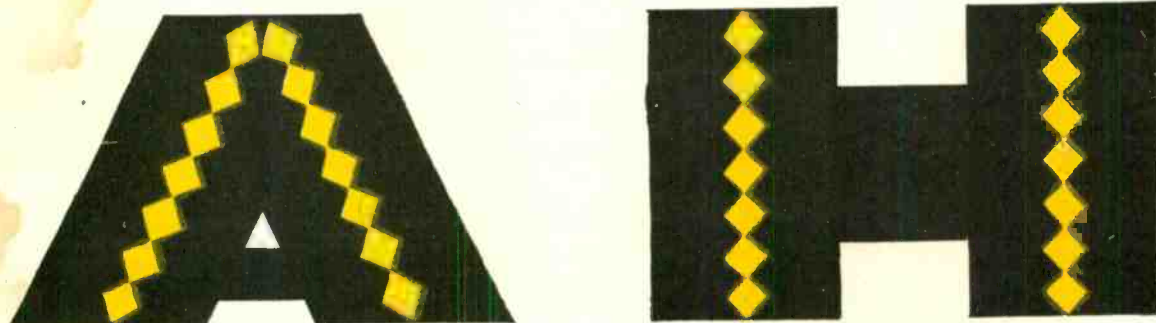

The Sleeper ELECTRIC RADIO

Has a Brilliant
Record of Six
Months of
Success—
Thousands in
Use Without
Service
Complaints

Time—the only acid test of any new product—has already proved to hundreds of dealers that Sleeper electric sets not only sell easily, but they stay sold, protecting profits from excessive service.

With everybody demanding electric sets, dealers realize that actual delivery means everything now and infinitely more so if delivery has back of it months of successful field experience in all parts of the country.

You need not wait for electric sets promised for later this year when you can cash in today on the proven Sleeper sets available now.

Complete New Line of both A.C. and D.C. Types

Includes the popular priced type 64 Scout table model at \$160.00, the exquisite new polychrome Console at \$175.00, as illustrated above, the Heppelwhite Scout Console at \$235.00 and the Imperial Console at \$265.00. All models furnished for either D.C. or 110 volt 60 cycle A.C. as required.

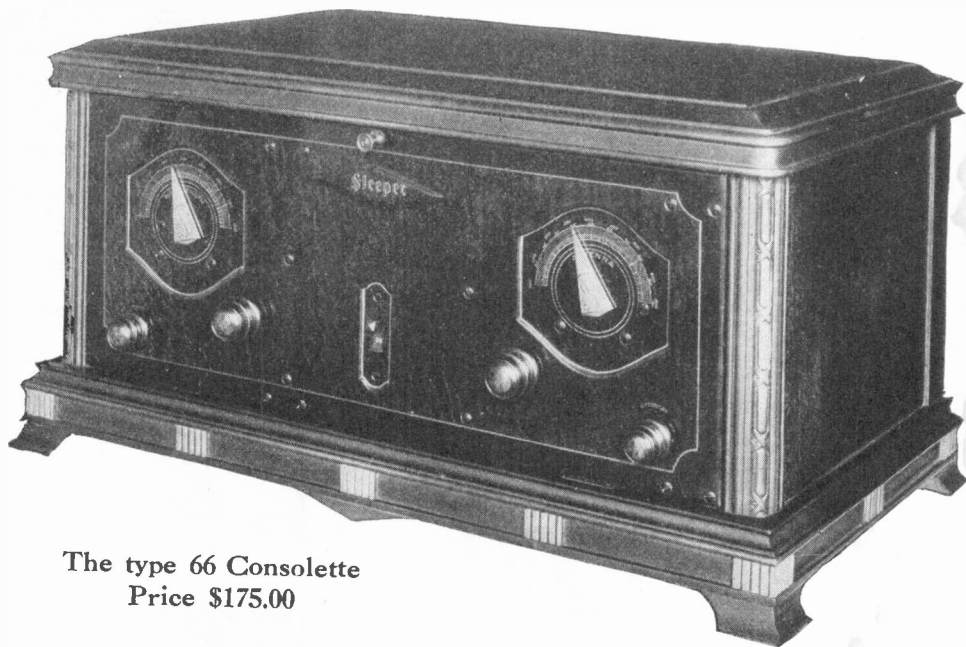

The type 66 Console
Price \$175.00

These are the big features that sell Sleeper Electric Sets:

- First:* Incredible tone quality. Flawless and clear over the entire musical range of frequencies.
- Second:* No batteries, no power devices to hook up, and no technical knowledge needed to install or operate.
- Third:* Standard tubes of proven merit always available anywhere.
- Fourth:* Genuine distinction of design and appearance—good engineering easily recognizable.
- Fifth:* Obvious good value for the price asked.
- Sixth:* Made and guaranteed by one of the oldest Companies in Radio—nationally known since 1920.

Write today for full story on Sleeper franchise.

Visit our Booth at the Radio World's Fair

SLEEPER RADIO & MFG. CORPORATION

GORDON C. SLEEPER, *President*

464 Washington Avenue, Long Island City, N. Y.



Tower Adventurer

\$9⁵⁰

SLIGHTLY
HIGHER IN
THE WEST

YO, HO, HO! headin' for buried treasure unknown lands the Tower Adventurer exemplifies a genuine sailing ship of early days that will at once appeal to lovers of ship models. The full-rigged galleon finished in old ivory is cast integral with the protecting ornamental frame. The large 17" free-edge cone is driven by the identical armature-type unit as the higher priced models with a tone quality and volume as delightful as exceptional.

Ask Your Jobber or Write Us!

TOWER MFG. CORP. 122 Brookline Ave., Boston, Mass.
MORE THAN TWO MILLION TOWER PRODUCTS NOW IN USE

*PRICES ON
CASTLE CONE
AND
PIRATE SHIP
SLIGHTLY HIGHER
IN THE WEST



MODEL "28," \$17.50

PIRATE SHIP, \$7.95*

CASTLE CONE, \$9.50*

NEW IMPROVED
MEISTERSINGER, \$15

Now Sell the only *Time-tested*

**ELECTRIC
RADIO**

*at America's
LOWEST PRICE!*

\$100



\$100

With Tubes, \$120.75

Licensed by R. C. A.—
only for Radio amateur, experi-
mental and broadcast reception

THE
HI-BOY
CONSOLE
\$165
TABLE MODEL
WITH SPEAKER
\$135

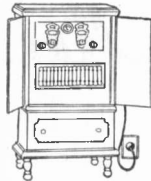

STEINITE for 1927-28 offers the oldest electric set at a price that *simply eliminates competition*. It has power in abundance. Rich, pure tone. The ability to pull in the far stations. Two table models, one with and one without speaker, and a smart hi-boy console, all in genuine solid Philippine mahogany, meets the whole range of public demand . . . *that simplifies your stock problem!* The only time-tested set available to you, it is also the simplest—completely self-contained—using standard tubes—with no outside attachments, no acids, no water! STEINITE will be backed by strong national advertising. The STEINITE franchise is too valuable—too vital—for you to lose—write for our proposition today!

A Year Ahead!

Thousands of STEINITE ELECTRIC sets
have been in use for more than a year!

Steinite

STEINITE RADIO COMPANY
506 SOUTH WABASH AVE., CHICAGO

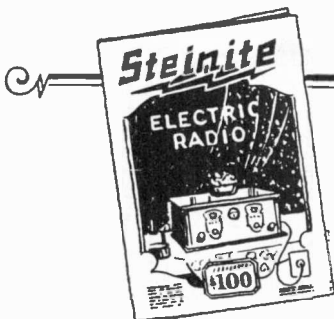

The STEINITE PROPOSITION is Ready—*Write for it!*

STEINITE offers a sound, well-rounded proposition to dealers. It presents the possibilities of a line that offers Electric Radio at a price that most people can afford. It has been put into a circular which you should have—write for it today! There is a STEINITE jobber in your territory, ready to serve you—his name will be sent on request.

SEE THE STEINITE AT THE RADIO WORLD'S
FAIR IN NEW YORK, SEPTEMBER 19-27

What This Speaker

WILL NOT DO

- Will Not Rattle
- Will Not Burn Out
- Will Not Warp
- Will Not Sag
- Will Not Lose Volume
- Will Not Get Complaints

WILL DO

- Will Take Voltage
- Will Give Volume
- Will Give Quality Tone
- Will Register All Notes
- Will Give Clear Speech
- Will Give Satisfaction

Order a Sample Today!

100% GUARANTEE WITH EVERY SPEAKER

RETAIL
\$ 28.50
 PRICE



SLIGHTLY
 HIGHER
 IN THE WEST

Melofonic  **Radio Speaker**

Progressive Musical Instrument Corp.

319 Sixth Avenue, New York City

Steps to Bigger



B and DEMCO Automatic Power

OPERATES on ALTERNATING or Interchangeable on 25-40-50 and 60 Cycles

ELIMINATES A-B AND C

Automatic — Efficient — Silent — Permanent
Fully Covered by Patents

NO

**BATTERIES
TUBES
ACIDS
PASTE**

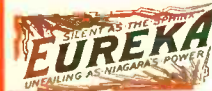

B

DEMCO Automatic Dry Charger

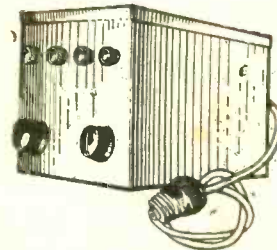

Eureka B battery eliminator made to operate from 110 volts A.C. or 110 volts D.C. Delivers 145 volts at 50 M.A. drain. Housed in a beautiful metal Duco finished case with bakelite panel. No rectifying tubes, no acid, no paste. Guaranteed to operate any set of ten tubes or less.

Fixed voltages of 22, 45, 67, 90, 145 and 4½-9 volt C bias, volts are available.

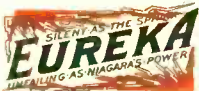

Universal B

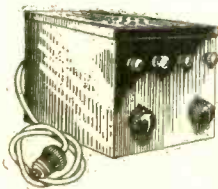

Eureka B battery eliminator. Made to operate from 110 volts A.C. or 110 volts D.C. Delivers 135 volts at 50 M.A. drain. Housed in a beautiful metal Duco finished case with bakelite panel.

No rectifying tubes, no acids, no paste.

Guaranteed to operate any set of ten tubes or less.

Fixed voltages of 22, 45, 67, 90 and 135 are available.

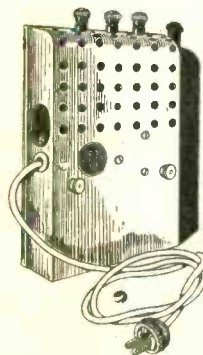

Demco Type D automatic dry charger. When attached to A battery, makes automatic socket power. Eliminator and charger automatically controlled by radio set switch.

Encased in a beautiful Japan case—weight four pounds. No tubes, liquids nor paste—nothing to replace — practically indestructible. Charging rate 1½ tapered to ½ amperes.

Our engineers are prepared to furnish special types to manufacturers

Ask Your

Dooley Electrical Manu

Business—

Units Electrify All Radio

DIRECT CURRENT

BATTERIES

DEMCO A, B & C

Battery eliminators

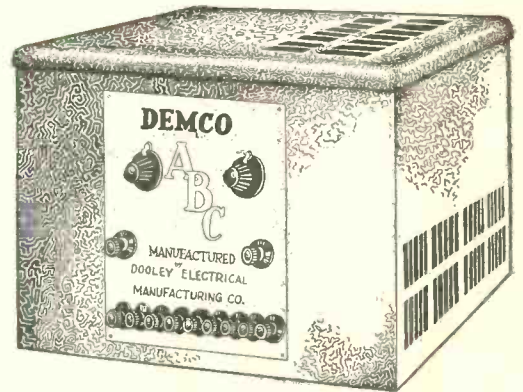

These are straight ABC eliminators. No tubes, trickle charger, acids or batteries of any description. Demco ABC De Luxe. Operates on 110 A.C. or D.C. 25 to 60 cycles. Delivers 2 1/2 amperes filtered current at 6 volts D.C. 135 volts plate supply. Demco ABC De Luxe No. 4. Model 4 operates at 4 volts and 2 amperes for sets using 199 tubes. (Other specifications same as above.) Demco ABC Master—operates on 110 volts, 25 to 60 cycles A.C. only. Delivers 2 1/2 amperes filtered A supply at 6 volts D.C. Delivers 180 volts at 75 M.A. drain plate supply, and 4 1/2, 9, 27 and 45 negative C bias. Specially designed for sets using 171 tubes.

DEMCO Dry A
Battery eliminators

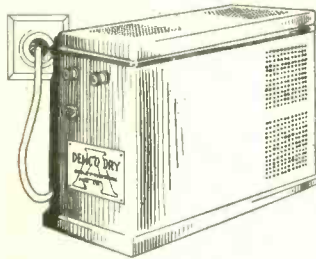

Contains no batteries, tubes, acids or trickle chargers of any description. Guaranteed to deliver 2 1/2 amperes filtered A supply, free from any hum or distortion, at 6 volts D.C. Automatically disconnects power supply from eliminator and A unit by operation of set switch. The rectifying element in this unit is of the permanent dry type—no replacements necessary—practically indestructible. Permanent A power—will last a lifetime.



B-C Dreadnaught

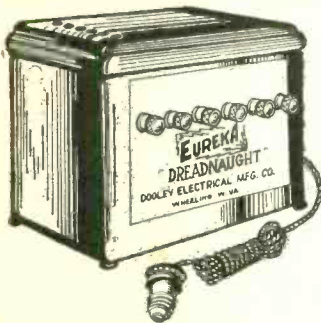

The super B and C current supply will deliver 75 M.A. at 190 volts continuous service, and 150 M.A. is available for instantaneous drain without drop in plate voltage. Fixed voltages available, 22, 45, 97, 90, 185, 180 and 4 1/2, 9, 27, 45 volts C bias. This unit is specially designed for sets using ten tubes or less with 171 power tube.

eliminate your loud speaker on powerful or low notes which has been so common in present-day eliminators, due to their failure to maintain a steady flow of current when called on for an excessive drain. These socket powers will perform satisfactorily where no other eliminators could be used, as they operate on alternating or direct current, 110 volts, 25 to 60 cycles without any changes. **Your rural communities and foreign fields are thus opened for you.**

By an entirely new principle of power supply, patented by us, we have produced socket powers that cannot motorboat on any set nor blast or fluctuate your loud speaker on powerful or low notes which has been so common in present-day eliminators, due to their failure to maintain a steady flow of current when called on for an excessive drain.

These socket powers will perform satisfactorily where no other

Jobber or Write Today for Sample

Manufacturing Co., Wheeling, West Virginia

DOOLEY ELECTRICAL MFG. CO.
Wheeling, West Va.

Send me information regarding socket powers.

DEALER DISTRIBUTORS

Name

Address

City State



How many radio sales are ruined because of junk accessories?



A Straight-from-the-Shoulder Talk

By A. T. HAUGH

IT'S a funny thing how closely radio has paralleled the automobile industry in its development. And it's strange too how little we have all learned from the automotive folks, to help us in this radio business.

Take, for instance, the matter of accessories. Here's a report on one New York situation: "A servicing organization in New York handling repairs for dealers and individual set owners with more than four thousand customers on its books, informed the writer that sixty-five per cent of their repair work is the result of careless merchandising on the part of retail dealers. Fifty per cent . . . are the direct result of unsuitable and inadequate accessories or their improper installation."

The report goes on to say: "Dealers, as a rule, concentrate on selling the prospect the highest-priced receiver he can be led to buy and then try to keep the total down by equipping the receiver with second

rate accessories. No Automobile Dealer would think of selling an expensive chassis and delivering it with a soap-box for a body and second hand tires so as to keep the cost within the limitations of the customer's pocket-book. But fifty per cent of the radio receivers are marketed with just that policy. The receiving set is no better than its tubes, power supply and loud-speaker. The sooner the dealer learns to sell radio reception and not radio

receivers, the sooner will radio's reputation for reliability and satisfaction rise."

Those are not my words! They come from Edgar Felix, writer in Advertising & Selling. But they express sane sentiments which every dealer should follow.

I suggest you get a sample of our PEERLESS Reproducer, try it against any speaker you have ever sold. Convince yourself that it gets the low notes that old-type speakers miss. Convince yourself that it will sell radio sets and improve your installment collections. Your jobber can supply a sample. Meantime, write us for Peerless Portfolio, giving the proposition. I'll see that you get a prompt answer.



UNITED RADIO
CORPORATION

Makers of
The Peerless Reproducer

15-C Caledonia Avenue
ROCHESTER, N. Y.



"... where known requirements meet known performance!
A service that builds laminated Bakelite around your
production and service problems, rather than attempting
to fit your needs to a "stock" quality... That is Phenolite!"

"punching stock"

We were invited by one of the really great Radio set manufacturers of the world to co-operate with their engineers in the development of a punching stock that would give a thoroughly satisfactory performance under every condition of production and service.

For fourteen months these experiments were carried on—in our own laboratories and shops; and under actual production conditions in their own plant... Scores of formulae were developed—and tested out. And each test uncovered some little detail that called for further development.

And then—we hit it!... A punching stock that meets every test that the experience and ingenuity of the world's greatest radio production engineers could suggest. A punching stock that, to quote their Chief Engineer, "is far and above anything we have ever seen—or ever hoped to see!"

Let us tell you more about Phenolite Engineering Service—where *known requirements meet known performance*. And more about what we are doing to reduce production costs and increase service quality in the Radio Industry...
And more about Punching Stock!

NATIONAL VULCANIZED FIBRE CO.
Wilmington, Del., U. S. A.

New York Pittsburgh Baltimore Greenville Chicago Boston
Cleveland Rochester Portland Philadelphia St. Louis
New Haven Toronto San Francisco Seattle Los Angeles
Detroit Milwaukee Birmingham Paris London Sydney

PHENOLITE
Reg. U.S. Pat. Off.
Laminated BAKELITE
SHEETS : RODS : TUBES : SPECIAL SHAPES

The NEW Thermi

[Ther-MY-odyne]

REMOTE RADIO

*Only device
for operating
from your*

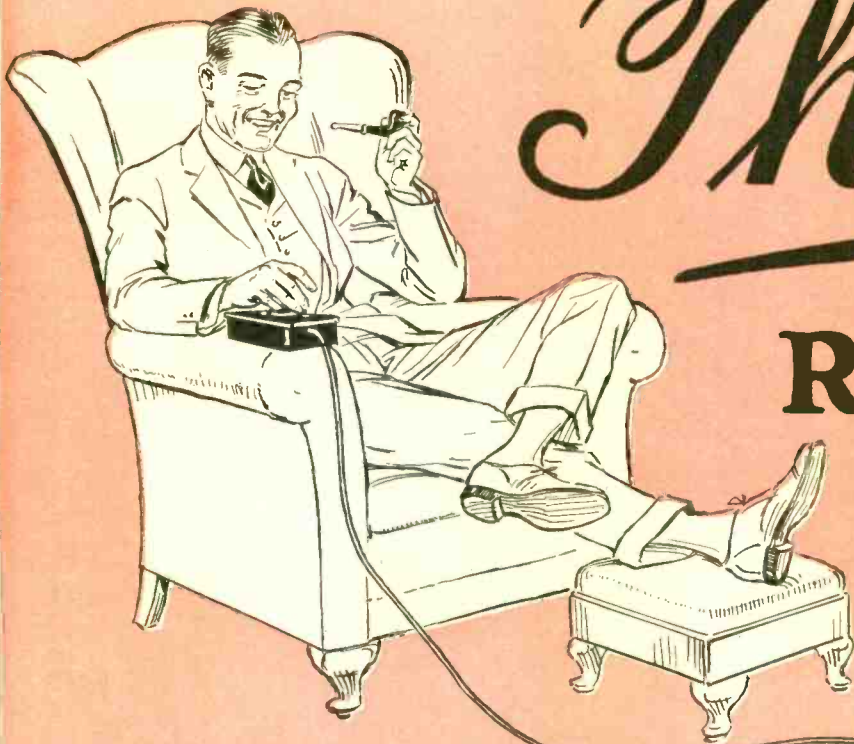

THERMIODYNE GUARANTEE

All Thermiodyne and Algonquin Radio Products are manufactured entirely within our own factories. Every step from selection of raw materials to final test and inspection is carefully supervised, thereby attaining a degree of efficiency impossible to obtain in purely assembled products. Every product manufactured by us guaranteed free from defect in material and workmanship.

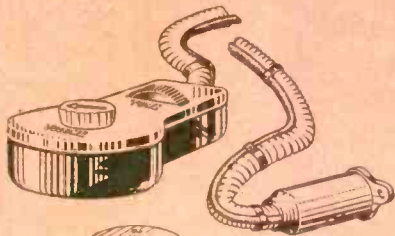

(PAT. APP. FOR)

Mechanical Remote Control Unit, \$18.00
West of Rockies, \$19.80

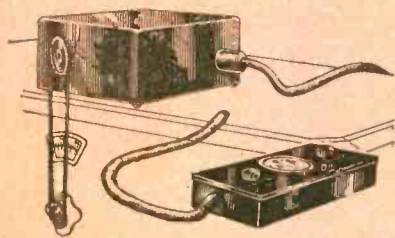

(PAT. APP. FOR)

Electrical Remote Control Unit, \$60.00
West of Rockies, \$66.00

THE New Thermiodyne Remote Control Radio Tuning Unit is a scientific development introduced by Thermiodyne engineers, enabling the set owner to install his set where he chooses and operate it from his easy chair placed wherever he likes—thus banishing forever the annoyance of having to get up every few minutes to tune your set or make some minor adjustment.

Does everything necessary to operate a radio receiver at maximum efficiency: turns it "on" or "off", tunes from one station to another, regulates volume—swiftly, surely—and with no more effort than it takes to wind a watch.

Made in two models; mechanical unit which controls the set within the radius of a six-foot flexible rotating cable; electrical unit which permits the set to be installed anywhere—living room, attic, or closet—and controlled by wire from any room in the house. If desired, every room can be wired with outlets for plugging in both Remote Control Unit and Loud Speaker.

Either model may easily be attached to any Master Control Thermiodyne or other single dial receiver by simply removing old dial and substituting adapter plate supplied. Easily attached in a few minutes. No cutting or tools required. The electrical unit may be installed on top or at either end of cabinet, or within a console.



ALGONQUIN

Leo Potter,

245 FIFTH AVENUE

Thermodyne

"Trade Mark, Reg. U.S. Pat. Off."

CONTROL

TUNING UNIT

*on the market
your radio set
easy chair*

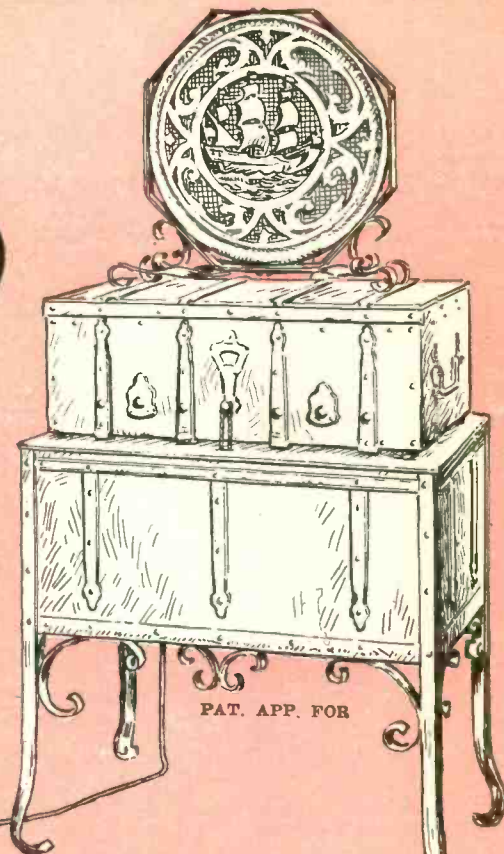

PAT. APP. FOR

Thermodyne TA7 Receiver

Unexcelled in power, selectivity, distance and quality of tone by any other receiver, regardless of cost or number of tubes!

All-metal cabinet of XV Century Spanish Chest design, affords individual, double and total shielding against both internal and external electrical interference. Seven tubes. All tuning by one Master Control. Three instead of the usual two stages, before detector, for distance, and three stages of audio frequency furnishing wonderful quality and loud speaker volume.

The Console is of the same XV Century period design and polychrome gold stipple finish as TA7 Receiver, made entirely of metal, and rigidly constructed. Ample room for all accessories.

Thermodyne Speaker is of full-floating cone type brought to the highest point of perfection. Electro-magnetic unit, with direct drive to 18-inch cone, extremely sensitive and exact to highest degree. Designed and finished as a companion-piece to Thermodyne TA7 and Console.

Thermodyne WT7 Receiver

Identical in circuit design and interior construction with Thermodyne TA7—equally wonderful in performance—but less elaborate in cabinet and priced accordingly. Dollar for dollar this seven tube receiver is outstanding radio value—beyond comparison with any other receiver now offered. All-metal cabinet, finished in walnut, affords individual, double and total shielding against external and internal electrical interference.

Thermodyne TA7 Receiver

De Luxe XV Century Spanish Chest ensemble. Three pieces complete without accessories, and not including the New Thermodyne Remote Control, \$250. Priced separately as follows:

Thermodyne TA7 Receiver.....\$180
XV Century Spanish Chest Console..... 40

Thermodyne Speaker . 30

(West of Rockies add 10%)

Algonquin

SPEAKER
\$15.00

Popular priced but ranks with speakers costing much more in quality of output. Full floating, moisture-proof, 18-inch, adjustable fabric cone—not paper. Exceptionally fine electro magnetic unit of improved design. Art metal scroll and ship model design finished in polychrome gold stipple. Price, \$15.00; West of Rockies, \$17.00.



Pat. app. for

Thermodyne

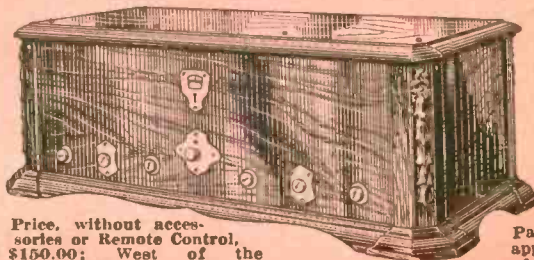

Price, without accessories or Remote Control, \$150.00; West of the Rockies, \$165.00.

Pat. app. for

ELECTRIC CO., Inc.

President

NEW YORK CITY

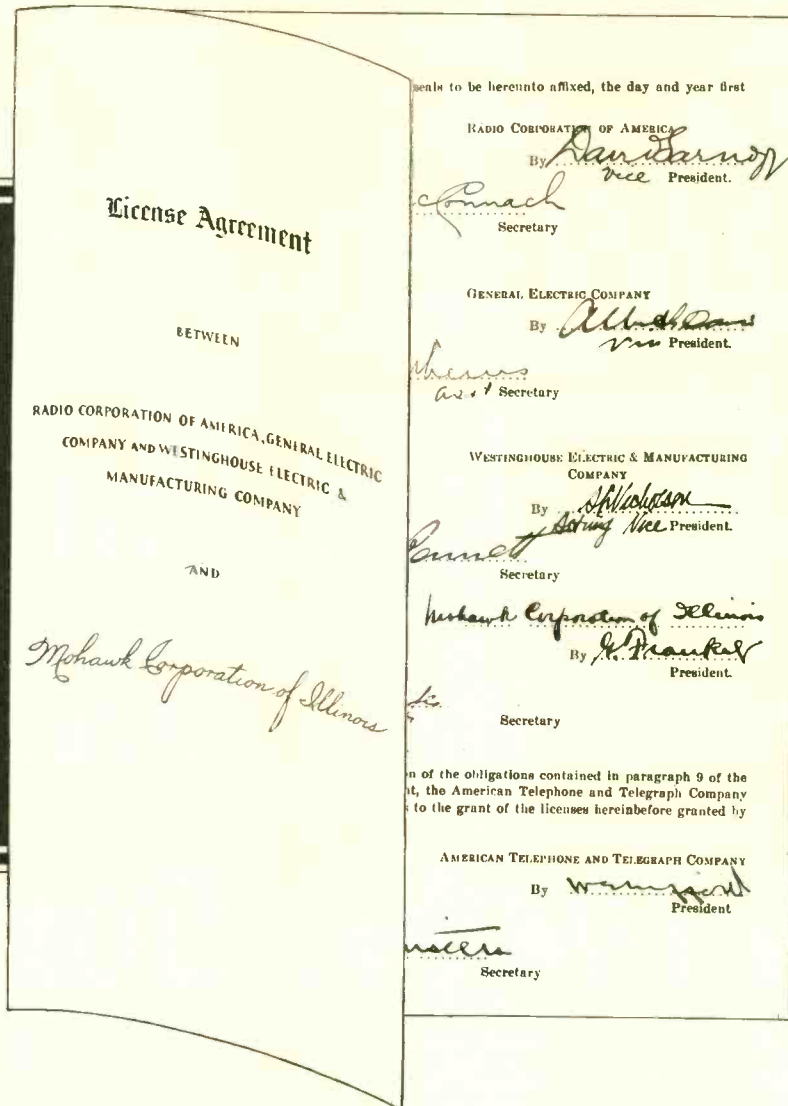

These signatures behind your Mohawk franchise

put one more huge *selling and protective* advantage in the Mohawk dealer's hands—for Mohawk is now licensed under RADIO CORPORATION OF AMERICA, GENERAL ELECTRIC COMPANY and WESTINGHOUSE ELECTRIC & MANUFACTURING COMPANY patents.

This important step, the signing of this license agreement, removes the last atom of sales resistance from the Mohawk dealer's path.

You are protected, your customers are protected.

Nothing but clear sailing and bigger business ahead. You have the line, you have the price

range—from \$67.50 to \$275—and NOW AC electrically operated sets—built in the famous Mohawk interchangeable drawer unit, adapted to all models, at only \$110 additional. Nothing more to buy—and full protection. Enabling us to concentrate on *Building them Better—Pricing them Lower—Selling them Faster.*

Be sure to see the Mohawk Exhibit at the Fourth Annual Radio World's Fair, New Madison Square Garden, New York, Sept. 19 to 24. Write today concerning Mohawk franchise.

Mohawk
 One Dial Radio

MOHAWK CORPORATION OF ILLINOIS
 Established 1920
 Independently organized 1924
 CHICAGO

28⁵⁰/₁₀

28⁵⁰/₁₀

28⁵⁰/₁₀

28⁵⁰/₁₀

28⁵⁰/₁₀

28⁵⁰/₁₀

28⁵⁰/₁₀

28⁵⁰/₁₀

28⁵⁰/₁₀

28⁵⁰/₁₀

The
First Quality
'B' Socket Power
*made and priced
for the Millions*



Sterling
"B" POWER UNIT

**GENUINE RAYTHEON
TUBE EQUIPPED**



Your greatest opportunity for Big Socket Power Profits

MADE for the millions . . . priced for the millions . . . the Raytheon-equipped Sterling Model R-81 presents brand new sales opportunities found in no other Power Unit.

Lowest Priced Raytheon Model

At \$28.50 complete, it is the lowest priced genuine Raytheon-equipped Socket Power on the market today. Life tests have proved beyond question, that the Raytheon BH Tube [125 mils—300 volts] holds its voltage. The Raytheon "Seal of Approval" is every dealer's guarantee of permanency. Add to this the advantages of Sterling quality and low price.

Operates up to 8 Tubes

R-81 incorporates the Sterling feature of perfected voltage regulation enabling it to provide exact "B" current for the big

majority of radio sets using up to 8 tubes including power tube. Thus you can cater to an ever widening range of set owners on a minimum stock.

Advertising

The big drive back of Sterling Socket Powers is about to open. On the following page are reproduced a few of the advertisements shortly to appear in newspapers and magazines. Window cards, counter cards, folders, will do their share in "bringing home the bacon" for you dealers. Make up your mind to be in on this nation-wide sales drive.

R-81 is the "B" Power for the 3-tube customer. It is the "B" Power for the 8-tube buyer. It is the "B" Power for 90% of all radio owners. Get in touch with your jobber or write us direct.

THE STERLING MANUFACTURING COMPANY
2831 Prospect Avenue . . . Cleveland, Ohio



Sterling "B"

21 Years Electrical Experience

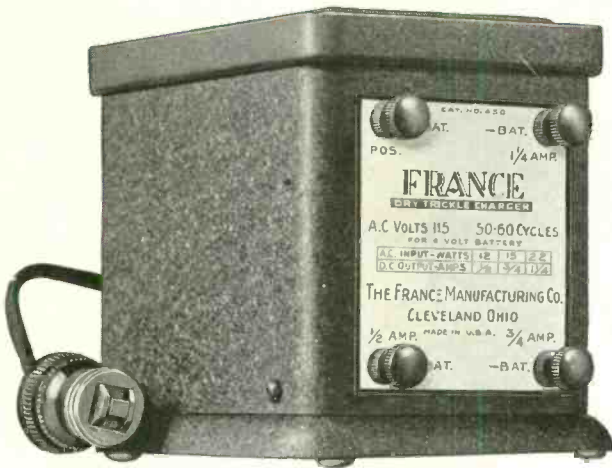

(France Dry Trickle Charger without relay switch)

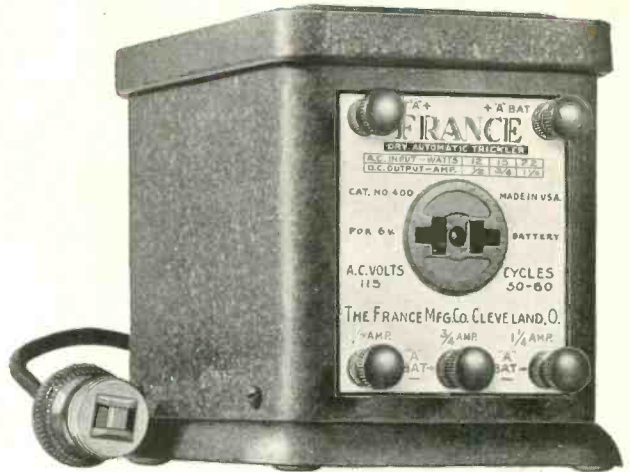

(France Dry Automatic Trickler with relay switch)

Three Speeds—Dry—Proved Two Models

THERE ARE THOUSANDS—yes millions—of battery-operated sets today, whose owners are dissatisfied with Wet Trickle Charging. They want something better—something that once installed, its existence may be forgotten. Here it is.

The France three-rate Dry Trickler delivers $\frac{1}{2}$, $\frac{3}{4}$ and $1\frac{1}{4}$ amperes—ample input to meet demands on any set.

No bulbs, no liquids, no noise, no moving parts—a dry disc rectifier.

Your opportunity this season for replacements and new business is tremendous.

Only a trickler complete in itself—designed, built and balanced as its individual characteristics demand, assures this and the utmost economy in current consumption.

First, last and always the France Dry Trickler gives complete satisfaction.

Selling the set owner the France, is selling him service—and lots of it. Dealers and jobbers recognize this—they realize that the France builds good-will—it instills confidence—it brings customers back again and again for other merchandise. Write us.

<p>DRY TRICKLE CHARGER 110-115 Volts 50-60 Cycle Model LIST PRICE \$13.50 25-30 Cycle Model \$1.50 additional</p>

<p>DRY AUTOMATIC TRICKLER 110-115 Volts 50-60 Cycle Model LIST PRICE \$17.50 25-30 Cycle Model \$1.50 additional</p>
--

THE FRANCE MANUFACTURING COMPANY, 10326 Berea Rd., Cleveland, Ohio
Since 1913 manufacturers of highest grade battery charging equipment

FRANCIE

Each of the **S-H** Products

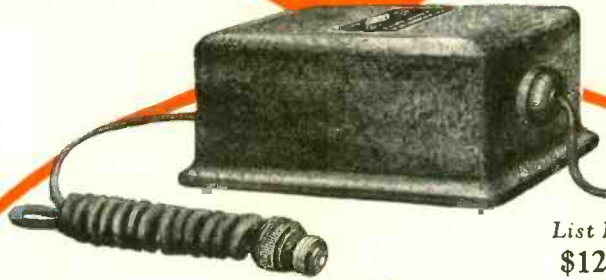

List Price
\$12.50

S-H

Automatic Dry "A" Power Unit

Internal automatic control charges "A" Battery the instant the switch on receiving set is turned off and cuts off house current when the set is in operation. Stops charging when set is fully charged. Controls "B" Eliminator if used. Hums, noises, tubes and liquids are all eliminated. No possibility of a reverse current flowing back through the charge and causing battery to run down. Full Wave Unit—operating at 1/4 ampere rate, 110 volt—60 cycle.

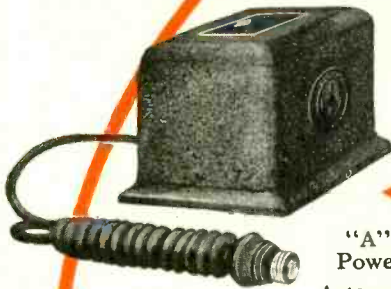

List Price
4.00

S-H

"A" and "B" Power Control

Automatically controls any trickle charger and "B" Eliminator. Trickle Charger starts as soon as radio set switch is turned off. Prevents reverse current flowing back and causing battery to run down.



List Price
\$2.50 to \$4.00
Per Pkg.

S-H

AERO Complete Outdoor Aerial Kit

Why buy your aerial equipment in pieces and be bothered with duplicate book accounts, short ends, left overs and finally no profit when you can get it packaged ready to sell in attractive over-the-counter cartons.

S-H

Safeguard Lightning Arrester

A lightning arrester of exceptionally fine construction. Approved by the Underwriter's Laboratories for both indoor and outdoor use. Made of Bakelite with a Bakelite protective petticoat.

List Price
\$1.00



S-H

AERO

Light Socket Antenna

Of interest to those people who live in apartments. The S-H Light Socket Antenna keeps down static and interference.

List Price
\$1.00



S-H

Lead-in Lightning Arrester

The only combination lead-in and lightning arrester on the market. It eliminates four troublesome connections. Wonderful sales possibilities.

List Price 60c



S-H

AERO

Complete Indoor Aerial Kit

Put up in cartons like the popular outdoor kit. Contains 100 ft. of insulated aerial cord and 12 special tacks for easy installation.

List Price
60c
Per Pkg.



Dealers From Coast to Coast Find Them Profitable

WHEN you offer any of these S-H items to a customer you can do so with the feeling that you are rendering him a service—that he will be more than satisfied with the results and always look to you as headquarters for reliable merchandise.

We are proud of the conscientious workmanship that goes into our products and we are gratified to see it build up good-will for our jobber and dealer friends everywhere.

SWAN-HAVERSTICK, Inc., Trenton, N. J.

Has Unique Features

**While Set is on
Current is off**

The switch on your set does it all!

The S-H Dry "A" Power Unit is automatic in action—INTERNALLY automatic! All you have to do is to hook it up to your set—"A" Battery—and "B" Eliminator, if you use one—then let this unit take care of your power supply.

It keeps your battery charged—never over-charged. It prevents the possibility of a reverse current flowing back and causing the battery to run down. It keeps out the hums and noises which ordinarily filter through house current.

The S-H Power Unit operates without tubes or acids—so it is really and truly "trouble-proof", 110 volt—60 cycle.

Your dealer, no doubt, carries it. If not, write us direct.

Guaranteed to cut out all hums

SH

Automatic "A" Power Unit

Full Wave
3/4 Ampere Rate

Price
\$12.50

SWAN-HAVERSTICK, Inc. - TRENTON, N. J.

"AERO" Complete Aerial Kit

contains just the right items for a perfect aerial. It makes possible increased Distance, Volume and Clearness. Install one today. Kits from \$2.50 to \$4.00.

One of Our Saturday Evening Post Advertisements

THIS is but one of several ads which we are running this fall in The Saturday Evening Post to acquaint a large audience with both our new and old products. Last year's consumer advertising created such a hearty response that we decided to continue on an even larger scale.

You might just as well profit by the demand. Have S-H Products on hand when they come in. See your Jobber about them at the first opportunity

SWAN-HAVERSTICK, Inc., Trenton, N. J.

FADA Radio

The FADA "Special"

Think of it! Harmonated Reception to retail at a moderate price. This amazing achievement of Fada engineering puts in your hands the most astounding value and performance the industry has ever offered — AT ANYWHERE NEAR ITS PRICE. Of course, they are Fada-designed and Fada-built. And you know what that means in workmanship.

Here, gentlemen, is THE profit-maker of them all. Hear it—NOW.

F. A. D. ANDREA, Inc., Long Island City, N. Y.

Licensed under Hazeltine Corp. patents, Latour Corp. patents, Radio Corp. of America patents, General Electric Company patents, Westinghouse Electric and Manufacturing Company patents, American Telegraph and Telephone Company patents—Licensed only for Radio amateur, experimental and broadcast reception.

The Fada "Special"

6 tube—3 radio frequency stages—detector—2 audio amplification stages. Individual stage shielding. Equalized amplification.

\$95.00

The Fada 17" Cone

17-in. free-floating cone—permanent Parkerized magnet. Cone of Grecian design. Antique bronze finished trifoot.

\$25.00

Prices slightly higher west of the Rockies

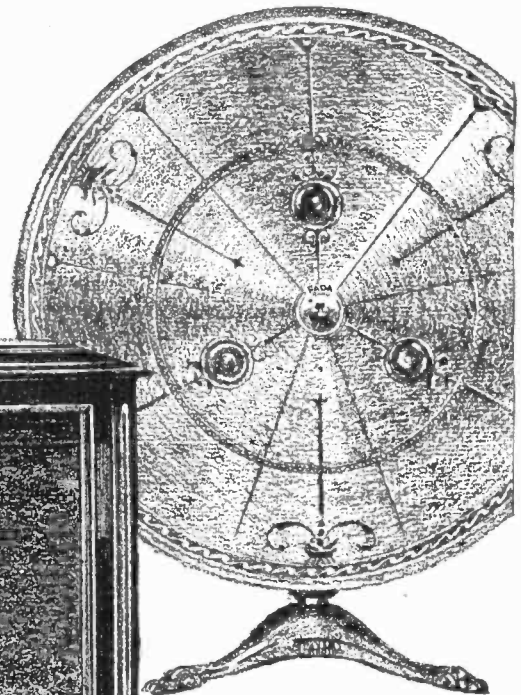
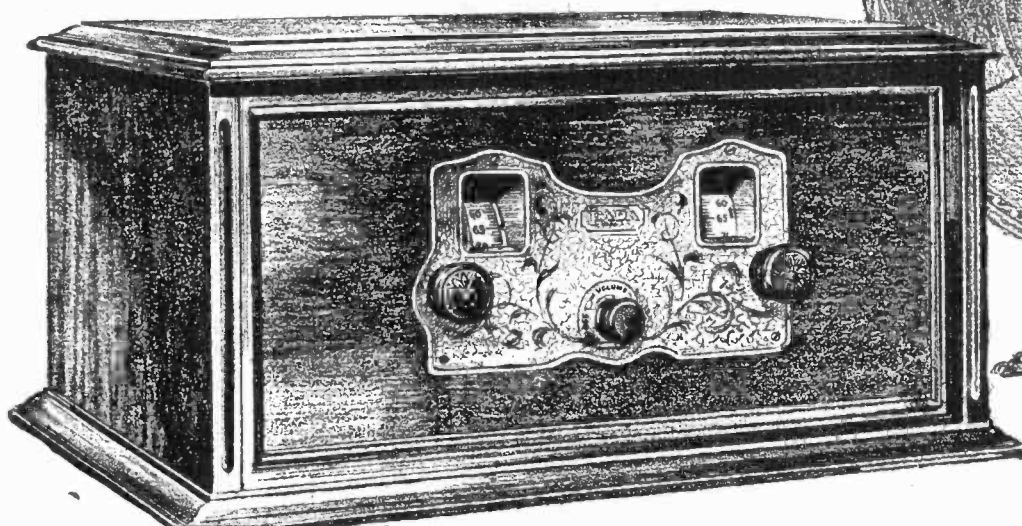



Enduring
BEAUTY
in RADIO

THERE is an opportunity now for dealers to offer, along with a radio receiver that is scientifically correct, a piece of beautiful furniture, handsomely executed, designed to be a permanent addition to the home.

The Splitdorf Radio Corporation, in a selection of beautiful authentic period furniture models of radio receivers, has created the first line to meet the requirements of the buyer who today prefers a radio instrument that combines lasting decorative value with superb musical qualities.

12 models. List prices from \$45 to \$800.
Prices apply only east of the Rockies

THE ABBEY—Patterned after an Old World jewel case. Devoid of metal trimmings. Done in deep antique walnut, with carved ornament. Equipped with the new Splitdorf Single Dial Receiver, employing four tuned circuits. List price, without accessories, \$100. Splitdorf Period Cone Tone, \$35.

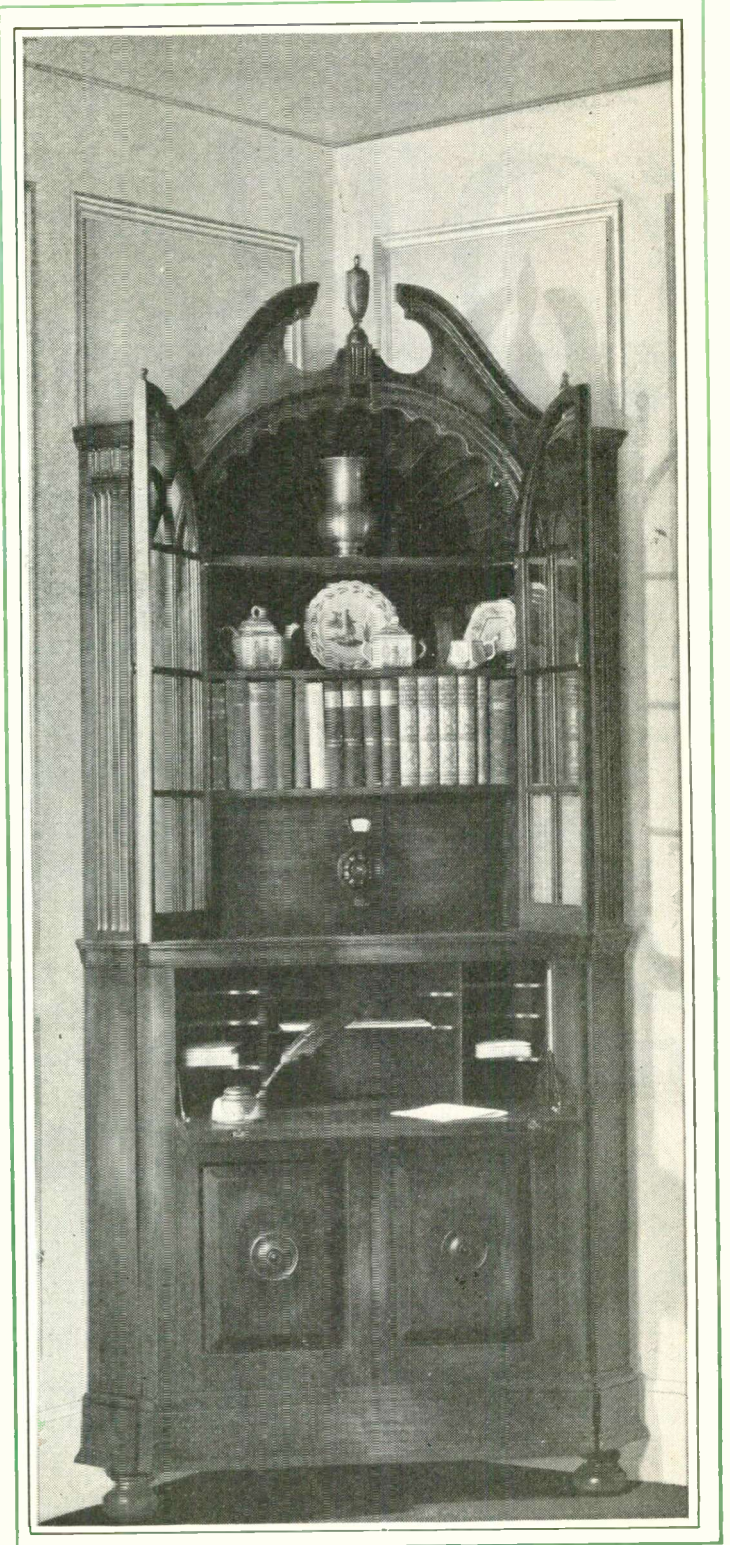
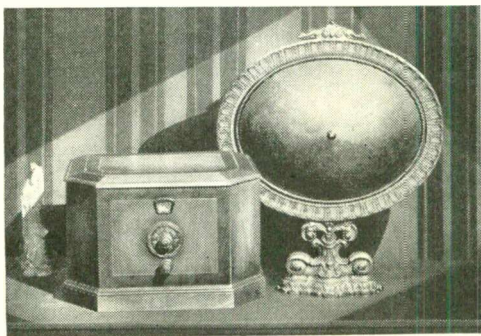

Cabinets designed under the personal direction of Mr. Noel S. Dunbar

THE WINTHROP—An early American corner secretary. Radio receiver, writing desk and bookcase combined. Equipped with the famous Splitdorf Single Dial 6-tube Radio Receiver, loud-speaker, and the Splitdorf socket power plant or, at option, the Splitdorf Electric Receiver (A. C. operated). The power plant is located in the compartment below the desk. List price with Socket Power, \$600.

SPLITDORF *Radio* CORPORATION

Subsidiary of Splitdorf-Bethlehem Electrical Company

NEWARK



NEW JERSEY

“O, What Music!”



Masterpieces in Appearance

Apex Cabinets in both console and table models, offer exceptional beauty in line and materials, and craftsmanship without a peer. Specially designed for 1927-28 Apex Radio Receivers and built by the Plymouth Radio & Phonograph Co., of Plymouth, Wisconsin

Masters of Radio Performance

The Apex line of Radio Receivers for 1927-28 presents something absolutely new and different. The circuit has nothing in common with any other now in use — it is the only New radio circuit developed in 5 years.



TECHNIDYNE

The Only

NEW

Radio Circuit

in

5 Years!

The Apex Troubadour Model, shown above, is typical of the splendid achievement expressed by every set in this up-to-the-minute Radio Line. Simplicity, beauty and dependable performance make these Receivers unique in lifelong satisfaction. Faithfully reproduced entertainment — brought into the home through a medium itself surpassingly beautiful.

The dealer who handles Apex has everything in his favor — a superior product and an absolutely square deal from its manufacturer. The Apex franchise is a valuable one — if you want it in your vicinity prompt action is necessary.

APEX ELECTRIC MFG. COMPANY

1420 West 59th St., Chicago, U. S. A.

Be Sure To See The Complete Line of APEX RADIO RECEIVERS at the RADIO WORLD'S FAIR New York — September 19-24 Booth 7, Section "H"

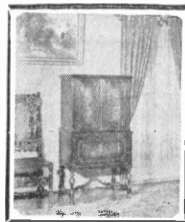

Apex Troubadour — 9 tube Technidyne, High-boy Model internal loop operated Complete with cone speaker

\$295

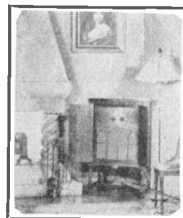

Apex Minstrel — 7 tube Technidyne, Low Boy Model — antenna operated. Complete with cone speaker

\$225

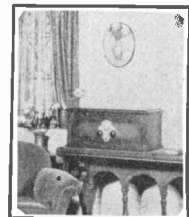

Apex Corsair — 7 tube Technidyne, Table Model — antenna operated. Price, without accessories

\$170

The Apex Price Range — \$80 up, covers 75% of the market

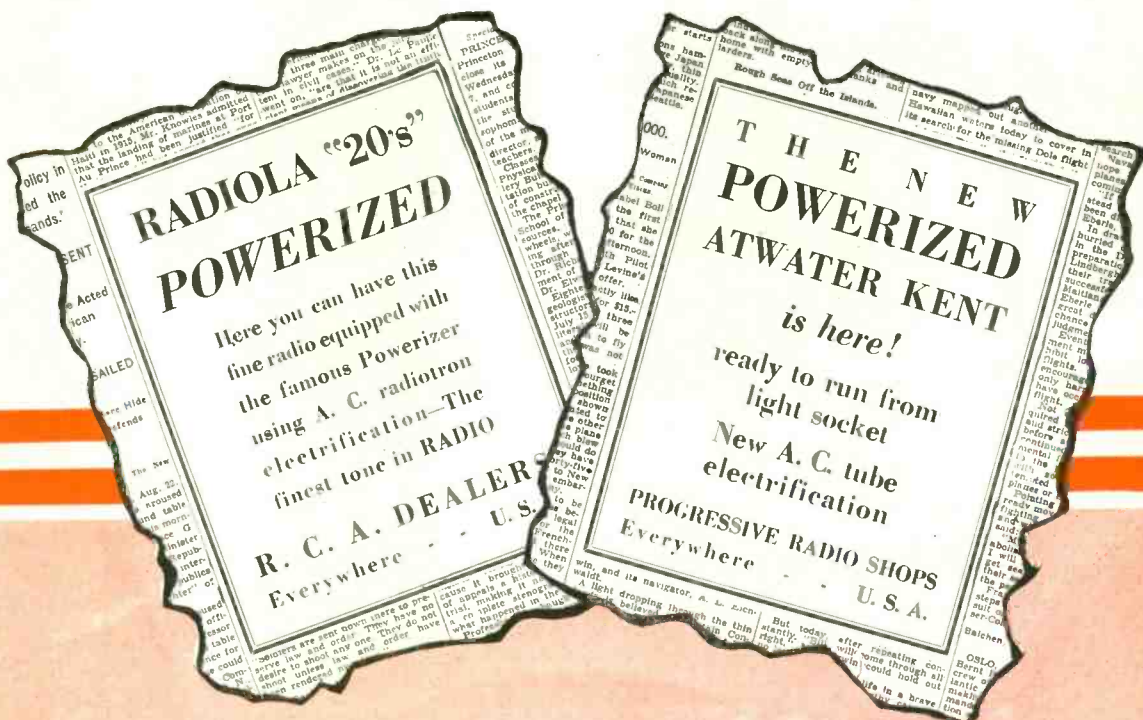

Dealers Who Feature Electric Sets Will Get the Business

Now you can sell every set with A.C. Radiotron electrification—

This season the business will go to the dealer who runs ads like the above — everyone wants an electric set. Leading Atwater Kent distributors realize this and are offering their dealers sets already equipped with Powerizers. This perfected system of electrification achieves remarkable tone quality and reproduces deep bass tones with amazing richness.

Powerizer makes every set a DeLuxe Electric Model . . .

No matter what your leading set may be — R. C. A., Sonora, Stromberg-Carlson — you can make it a true electric model. The Powerizer does not convert A. C. current into D. C. — instead the alternating current flows smoothly into the A. C. Radio-

trons inset, the only practical scientific method of electrification.

Make YOUR store Powerizer headquarters . . .

The Powerizer will not only give you no competition, by enabling you to sell all electric sets, but also it offers a wide field in profitable business from all those who want to electrify last year's sets. Think of the thousands of Radiola "20's" and others now in use.

Send for Brochure . . .

Write for "Real A B C socket power — giving the world's finest tone" and other literature telling how new A. C. Radiotrons are used in power application, with complete instructions for installation.

RADIO RECEPTOR COMPANY, Inc.
106 7th Avenue, NEW YORK, N. Y.

LICENSED BY RADIO CORPORATION OF AMERICA and Associated Companies

A. K. Model for Atwater Kent—
List without tubes, \$60.00.
Radiotrons UX-280 and UX-210, \$14.00

Radiola "20" Model—List
without tubes, \$59.00. Radiotrons UX-280 and UX-210, \$14.00



Universal Model—for majority
of 6-tube RFL and Neutrodyne
circuits. Without tubes,
\$60.00. Radiotrons UX-280
and UX-210, \$14.00

Hear it at our Hotel Astor exhibit during Radio Show week

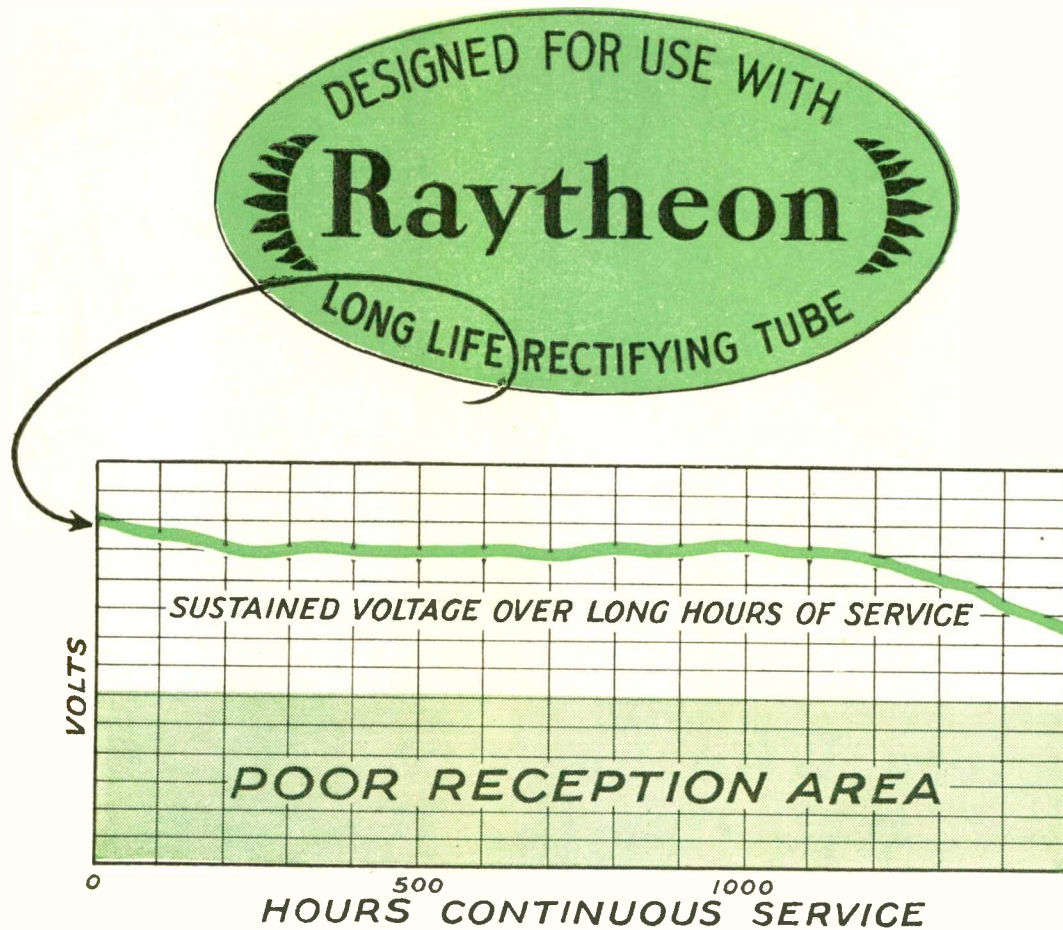

Raytheon Long Life and what it means to you

IN the above chart you see the performance of any Raytheon BH rectifying tube during a standard test of life and voltage output. Note that it starts at the required voltage output and *maintains* for its full life that constant flow of smooth, silent power so necessary to perfect reception night after night, month after month. All Raytheon tubes are alike in this respect—for Raytheon maintains the most careful control over every manufacturing process. No wonder the performance of Raytheon equipped power units is so highly satisfactory to their owners!

For the dealer, this dependability means confidence in the unit so equipped, the absence of profit-eating "service charges" and the certainty of future sales when the tubes have outlived their guarantee.

Nearly a million Raytheon-equipped power units now in use testify to the desirability of a rectifying tube that can *maintain* full power for the greatest number of hours.

Raytheon
THE HEART OF RELIABLE RADIO POWER



Make it a point to call the purchaser's attention to this mark of reliable light-socket power units. Due to Raytheon's national advertising the green Seal of Approval is a "talking point" of great value. And—only those manufacturers whose power units have been fully tested and approved by the Raytheon Research Laboratories are entitled to use Raytheon Long Life Rectifying Tubes and this mark in connection with their products.

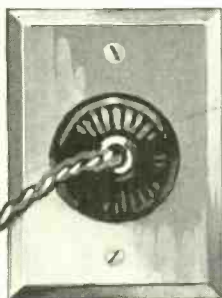

FROM a radio merchant's standpoint, the most satisfactory merchandise is that which sells—not at the most profit, but at the highest *net* profit throughout the year. In the case of battery eliminators—many sell for less than Raytheon-approved units, and others at a higher profit, but none, absolutely none, sell with as little sales resistance and maintain themselves with as little attention as those units which bear the Raytheon green Seal of Approval. The number of these approved units, too, allows your clientele the widest choice in type and price—for more than 40 manufacturers have national distribution on one or more Raytheon equipped power units.

**RAYTHEON MANUFACTURING COMPANY
CAMBRIDGE, MASS.**

TYPE BH

The improved rectifier for heavy duty power service. Designed to supply B-power to standard sets and A-B-C-power to receivers using 199 tubes in series.

Rating: 125 m.a. at 300 V.
List Price \$4.50

TYPE A

A simple, compact, unbreakable metal cartridge of revolutionary principle and design. Type A is the efficient rectifier for battery chargers and A-power units.

Rating: 2½ amps.
List Price \$4.50

TYPE BA

This remarkable tube is designed for power units which completely eliminate all batteries, chargers and outside power accessories. A-B-C Units employing Type BA are now on the market.

Rating: 350 m.a. at 250 V.
List Price \$7.50

TYPE R

The voltage regulator tube designed to maintain constant voltage output from B-power units regardless of fluctuating line and load conditions.

Rating: 90 V. 60 m.a.





Play with a Winner

Line Up with BASCO !

THE Basco all-star line of radio power units and the Basco selling organization are getting set for the big 1927-28 radio power championship campaign.

Every detail of the entire selling program has been worked out and carefully rehearsed. Basco dealers and distributors know their "signals" and "stunt plays". And down here at Milwaukee the Basco "coach" is on the job every minute, watching every play, ready with reserve "players" if any point in the present line-up shows weakness.

Newspaper advertising, direct mail advertising, window display material, authorized dealer signs, dealer hook-up materials—these and other selling helps will be used to the best advantage. And back of it all is a line of radio power units second to none!

There's still a place in the Basco line-up for a few more live, aggressive dealers — fellows who will *play the game* and stay with it! These dealers will receive enthusiastic sales support all along the line.

Eighteen years of precision-manufacturing experience and complete engineering and production facilities are your assurance of a thoroughly satisfactory product.

Ask your jobber about the Basco line of radio power units and the selling program behind it! Get lined up now with the Basco line-up!

BRIGGS & STRATTON CORPORATION
MILWAUKEE, WISCONSIN



Get one of these attractive signs for your store. It is the mark of super-quality radio power — and dependable service. It will be featured in all Basco newspaper advertising this Fall. It identifies Basco dealers with Basco advertising.



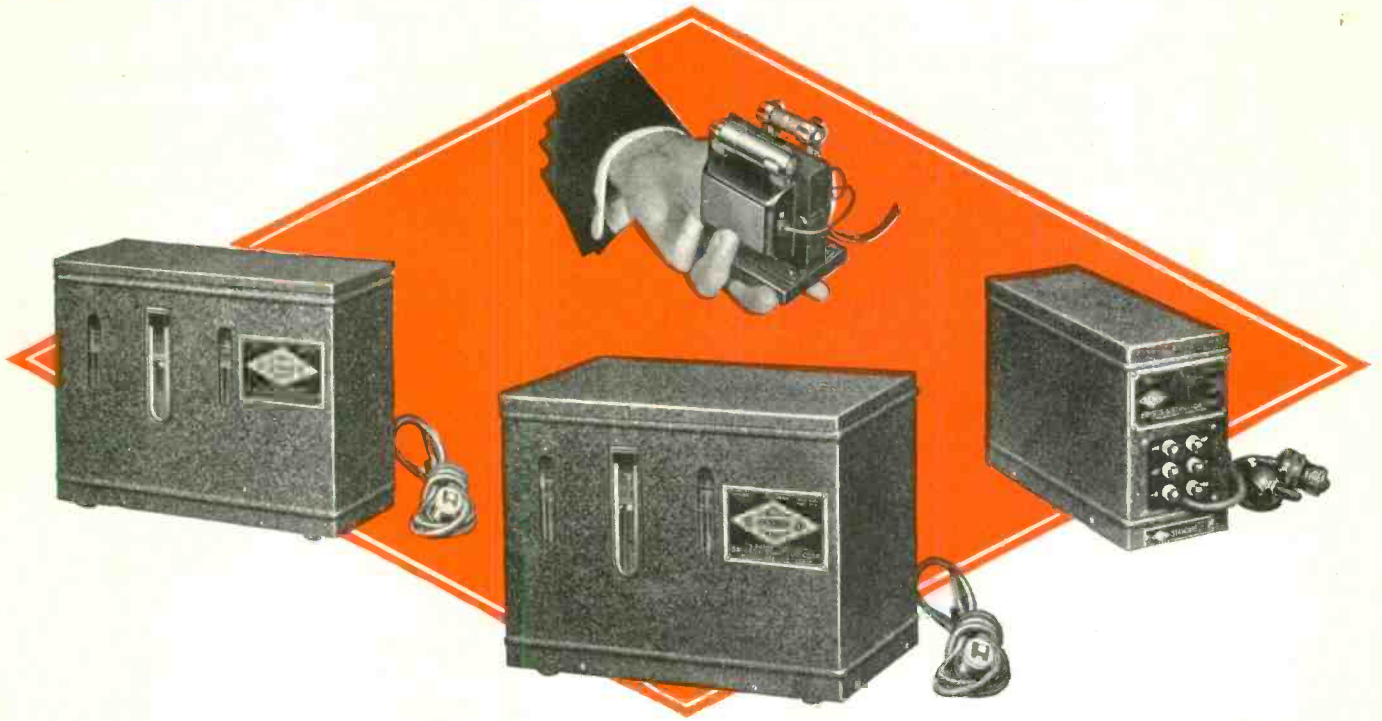

Here's the **BASCO** Line!

THE Basco line of super-quality radio power units has been developed to provide the radio owner with that measure of convenience and operating efficiency which he demands and expects.

BASCO "AB" UNIT

Provides complete "A" and "B" power supply. Is entirely automatic in operation. Employs 45-ampere-hour Exide glass-jar "A" battery, equipped with Basco-built automatic charging device, using Raytheon 2½ ampere rectifying element. Operates without trickle charge. Line power is disconnected from battery during radio power — protection against "line noises" and hum. "B" power supply of 50 milliamperes at 185 volts. Will handle any power tubes. Exclusive hook-up improves radio reception. Entire unit contained in compact, crystalline-lacquered steel case. Radio switch controls entire operation.

BASCO "A" UNIT

This is the same unit, contained in an individual case, as the "A" power supply of the "AB" Unit. It provides battery-smooth, peak-charge power at all times. Battery charges only during idle radio periods. Basco-built automatic switch controls operation — turns on charger as needed, and disconnects charging unit from power line when battery has reached peak charge. No trickle charge. No bulb. Uses Raytheon 2½ ampere charging element. Neat, compact, crystalline lacquered steel case.

BASCO "B" UNIT

Replaces all "B" batteries. This unit is the same as the "B" power supply of the Basco "AB" Unit. Its exclusive hook-up provides extra storage capacity in filter circuit that reproduces highest pitched treble notes or deepest bass with the greatest naturalness. Has output of 50 milliamperes at 185 volts. Adjustable to all power tubes. Variable intermediate voltage control. Uses Raytheon rectifying bulb. Crystalline lacquered steel case fits almost any radio cabinet.

BASCO CHARGER

One of the smallest chargers made. Has no moving parts. Absolutely silent in operation. Uses 2½ ampere Raytheon rectifying cartridge. Employs initial charge of 2½ amperes, tapering down to 1¼ or 1½ amperes as battery nears peak charge. Keeps battery in best condition and prolongs its life. Very economical in operation—uses only 40 watts. Ideal for charging automobile batteries, as well as radio batteries.

The Basco line will enable you to meet every radio power need of your most discriminating customers, with the most satisfaction for them, and the most profit for you!

BRIGGS & STRATTON CORPORATION
MILWAUKEE, WISCONSIN

Radio Power Units



PERRYMAN RADIO TUBES

Any one of these
four reasons
is sufficient!

1. No tubes made by anybody, anywhere deliver better performance than Perryman Tubes. You can prove this yourself.
2. All your competitors do not have Perryman Tubes. You control sales, repeat business and good will.
3. Perryman Tubes cost you less than other tubes of equal merit and you do not have to cut the price to sell them.
4. You have no replacement worries. We guarantee that your customer gets immediate satisfaction at our expense, not at yours.

*The Perryman Exhibit at the New York Show will be in
Booth 5, Section DD.*

Write for complete information on new Perryman AC Tubes,
volume discounts and dealer cooperation.

PERRYMAN ELECTRIC COMPANY, INC.
33 WEST 60TH ST., NEW YORK



PERRYMAN RADIO TUBES
A Complete Line of Standard Equipment for every Radio Purpose





Gold Seals cover the whole range of requirements for successful selling - every detail worked out to make business for the Jobber and Dealer.

Quality line of tubes - each perfected for its purpose. Made in Gold Seal's own plant, America's largest for tubes only.

Effective national and local advertising, dealer displays and selling aids - a policy that holds the friendship of the Trade and the Public.

Registered Trade Mark, symbolic of the sturdy dependability of Gold Seal Radio Tubes

Gold Seal Radio Tubes

ALL STANDARD TYPES

GOLD SEAL ELECTRICAL CO. INCORPORATED

250 PARK AVENUE, NEW YORK

Jobbers - some valuable territory still open. Write for details of our attractive proposition.



Type GSX-171
High power tubes for use in last stage of audio amplification give increased volume. *List price \$4.50*



Type GSX-213 - Rectifier tube, designed to accomplish full wave rectification of alternating current (a. c.) to direct current (d. c.) *List price \$5.00*



Type GSX-201a
The popular general purpose type, for amplifier or detector. Long life and high efficiency. *List price \$1.75*



Make a Good Receiver Better

The Tubes of Longer Life!

—are released to the trade and the public ONLY after they have been proven perfect by exacting tests.

Now We Announce

CEC

A.C. Tubes

for Best Results in A.C. Receivers

TYPE M. 26

TYPE N. 27

Write for particulars.

General Purpose Tubes
Special Purpose Tubes
Power Tubes

Filament Type Rectifiers
Gas Filled Rectifiers
A. C. Tubes



C. E. Mfg. Co., Inc., Providence, R. I.

Largest Exclusive Tube Makers in the World

THE RIGHT TUBE *for the* RIGHT SOCKET



Means you render

**A Better
Tube Service**
—at a richer margin
of PROFIT

Sonatronic offers dealers the selling leverage of the World's Largest Radio Tube Line—plus a substantially greater profit margin. In addition, Sonatronic's policy of progress brings you the newest tubes, standard quality, a strong guarantee and consistent national advertising. Ask your jobber for the Sonatronic proposition which gives you remarkable opportunities for volume business

Among the newest Sonatronics are those advanced developments—the SH 85 No Filament Rectifying Tube... the new half-wave rectifying tube, type 281... The complete line includes Power Detectors and Amplifiers, Dry Cell Rectifying and Hi-Mu Tubes... and the standard X-201-A



This Sonatronic label identifies a tube line which has become an accepted standard with the radio public

SONATRON

SONATRON TUBE COMPANY

NEWARK, N. J. 108 West Lake St., CHICAGO 16 Hudson St., NEW YORK CITY
320 Lafayette Building, DETROIT WINDSOR, ONT., CAN.

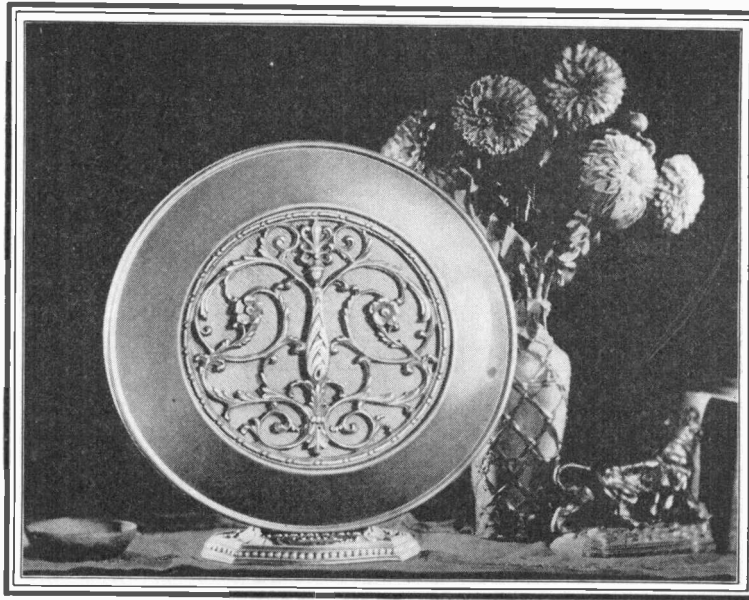

Model 10 Vogue Speaker is attractive in appearance. The air column (over 30 inches) is of special design patented by Richard T. Davis, Inc. Beautifully finished with grille and base of carved art work touched with gold highlights. Size 20 inches high, base 10½ inches long, 7½ inches wide.
List price \$26

Vogue—the only speaker that beautifies the home

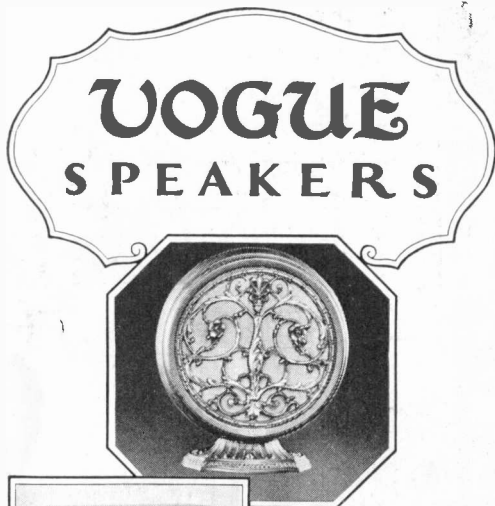

NEVER before has the radio market known a speaker that combines true beauty with natural tone reproduction. Today the outstanding product of real beauty in any radio dealer's display is the Vogue Speaker. It catches the eye of the American woman, who furnishes the American home, and the ear of her husband, who pays for it.

Vogue Speakers give distinctive charm to any room, blend with any color scheme, fit into any plan of interior decoration. Brown walnut crackle finishes and carved grilles and bases, embossed with gold, "sell" the woman who wants a radio, but who won't let an unattractive speaker break up the harmony of her living room. Deft internal construction, exclusively Vogue, insures the natural tones all men demand.

Ask the dealer who handles Vogue Speakers. He'll tell you what Vogue beauty does to build instant sales. He'll tell you his customers eye the Vogue Speaker with instant approval, hear it with spellbound interest and smile when you mention its price.

Get acquainted with Vogue Speakers at once and cash in on their rising popularity. For further information address

RICHARD T. DAVIS, Inc., 5252 Broadway, Chicago



Model 12 New Vogue Speaker is a compact cone type instrument employing entirely new acoustical principles which give it all the advantages of the horn type, yet retain the fullness of tone so essential for faithful reproduction. Rich antique finish in dark brown crackle with grilles and base highlighted with gold. Size 17 inches high, 5¼ inches wide, base 10½ inches long, 7¼ inches wide.

List price \$30

Ortholian Model Cabinet type Speaker is finished in shaded walnut and dark trim with beautifully carved grille and legs. This type speaker contains a horn having an air column over 8 feet long. Ample space is available for radio batteries. This speaker has immediate acceptance. Dimensions 48 inches high, 14 inches deep, 22 inches wide. Can be equipped with cone if desired.

List price \$55

Prices slightly higher west of the Rockies

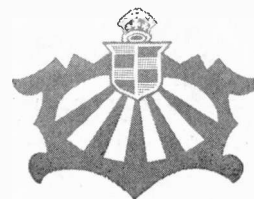

A new Model No. 8 cone type Speaker of advance design selling for \$19.50 will be offered for distribution October 1st.



Model 35 Desk

A wonderful combination of luxury and utility at a price. With Atwater Kent Receiver Model 35 and built-in Speaking Unit. Advertised Retail Price \$110.

Model E30 Desk

The ultimate in musical instruments. This unique cabinet incorporates Atwater Kent Model 30 Receiver and Model E. Speaker. Retailing at nationally advertised retail price \$140.



Model 33 Desk

This design is similar to Model 35, except that it incorporates the chassis of an Atwater Kent Model 30 Receiver. Advertised Retail Price...\$120

During 1926 Atwater Kent Dealers sold many thousands of Red Lion Cabinets with little effort and much profit. And this without a line of advertising.

This season, Red Lion Cabinets will have back of them the strongest kind of national magazine and newspaper publicity.

The beautiful, highly practical and attractively priced Desk Type Cabinet is made only by Red Lion and sold only with Atwater Kent Radios. It will pay you to feature Red Lions.

RED LION CABINET COMPANY, Red Lion, Pa.

Red Lion Cabinets



H. T. ROBERTS
PRESIDENT

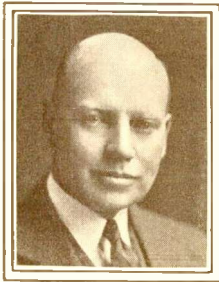

A. J. KENDRICK
GENERAL SALES MGR.

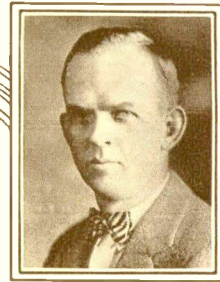

C. T. MCKELVY
MGR. OF
SALES PROMOTION

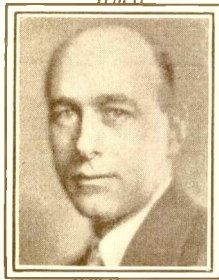

C. D. MACKINNON
EASTERN SALES MGR.

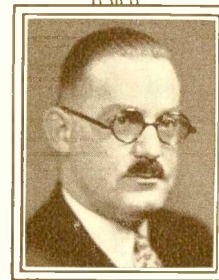

D. J. PIERI
CHIEF ENGINEER

BRINGING REAL PROFIT TO YOU

As you well know, net profit is the life of all business. To enjoy a healthy net, two things are necessary. Quality merchandise, which sells quickly, and a margin of profit ample enough to afford a real net profit. Products presented by the H. T. Roberts Co. will absolutely bring real profit to both Jobbers and Dealers!

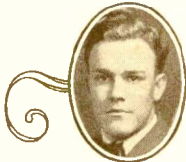

J. L. WOODS
SPECIAL REP.



M. E. SAMUELS
SPECIAL REP.



J. K. ROSE
SERVICE DEPT. MGR.



DONALD MACKENZIE
VIRGINIA DISTRICT COL.
DELAWARE MARYLAND
SOUTHERN PART N. JERSEY



P. R. HAWLEY
EASTERN OHIO WEST VIRGINIA
PENNSYLVANIA



HARRY SCHOENWALD
ILLINOIS

THE Roberts Organization is composed of experts in radio cabinet construction and merchandising. Men you have known for years in a friendly and business way. A group who, perhaps, more fully appreciate the problems of this trade than any other single organization ever assembled in the industry.

Understanding your needs, they have for months worked, planned, and developed a line of radio cabinets which will sell readily and bring you a real cash net profit. In so doing, they have secured the exclusive backing of manufacturing plants with assets in excess of \$20,000,000.

Today, through selected Jobbers, they present to the trade a line of radio cabinets which in price and all-around excellence, is beyond comparison with any on the market. And through Crosley Jobbers exclusively they offer the beautiful Crosley Approved Consoles.

Jobbers and Manufacturers, interested in radio cabinets, will find it mighty worth-while to address us. And we will appreciate the privilege of submitting our plan and catalog to you.



ORVILLE G. WHITE
NEBRASKA IOWA
THE DAKOTAS



B. J. KOLLROS
IND. KEN. TENN.
WESTERN OHIO

DEALERS—Our next announcement will introduce the most startling radio-musical product ever shown in this industry. Watch for it—or better, write for pre-information.



L. H. RAGSDALE
MO. ARK. OKLA. KAN.



G. R. DUNGAN
WISCONSIN MINNESOTA
NORTHERN MICHIGAN

H.T. ROBERTS CO.

Chicago Office
914 So. Michigan
Avenue
Chicago, Illinois

New York
Office
33 W. 42nd St.
Suite 1536 N.Y.C.

Selling Exclusively to Crosley
Distributors Crosley Approved Consoles
Manufactured by
SHOWERS BROTHERS COMPANY
THE WOLF MFG. INDUSTRIES

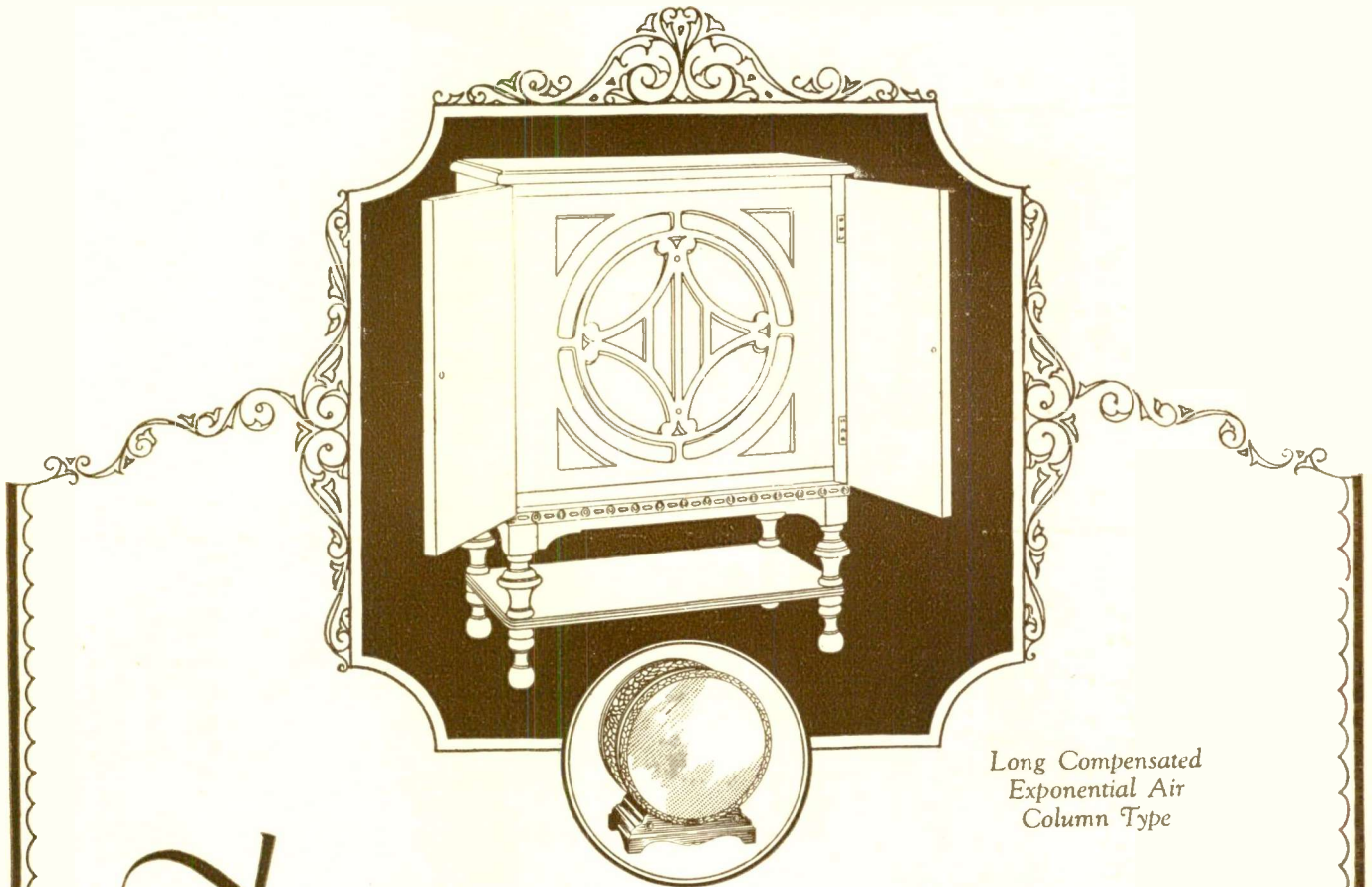

Long Compensated
Exponential Air
Column Type

The **TEMPLE SPEAKER** *improves the tone quality of ANY radio set*

The Temple Speaker is not just "another speaker" for you to sell. To the contrary it is truly a musical instrument that *sells itself*.

Wherever the Temple is heard its audience is more than enthusiastic—it marvels—for no one believed that such reproduction of tone was possible.

Listen to the Temple once. That's the way your customers buy speakers and that's the way you *should* buy them.

Here is a speaker that is worthy in every way of your most enthusiastic support. It will add many more dollars to your profit sheet this fall.

Rigid sales policy backed by extensive advertising campaign.

13 inch priced at	\$29.00
18 inch priced at	48.50
Console Model priced at . . .	65.00

West of the Rockies	\$32.00
West of the Rockies	55.00
West of the Rockies	75.00

TEMPLE, INC., 213 S. Peoria St., Chicago

Sales Offices in All Principal Cities

LEADERS IN SPEAKER DESIGN

Announcing— the new Console Model

Borkman Velvet Radio Speakers



No. 25 Console
List Price, \$70.00

THIS beautiful new Velvet Speaker, No. 25, which lists at \$70.00, will find instant favor with the discriminating radio enthusiast. It has a deep, full-throated tone, and the walnut case is indeed a thing of beauty. Equipped with a nine foot air column horn and special, double-stylus, balanced diaphragm Borkman Velvet Unit.

We also announce the new No. 27 and 30 model console speakers, with amply large

set compartments. These will be available in the open and closed styles. The first showing will occur at the Radio World's Fair in New York, and they will be shown later at the 6th Annual Chicago Radio Show. Be sure to see them.

Correspondence is invited regarding these new models and the other popular Velvet Speakers, some of which are illustrated below. Inquiries should be directed to the General Sales Office in Chicago.

Velvet

Reg. U. S. Pat. Off.

Radio Speakers

See them at
Radio World's Fair
New York
Space 9-FF



No. 21 Jewel Case
List Price, \$40.00

See them at
6th Annual Radio Show
Chicago
Space 1-T

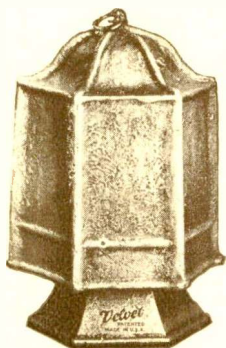

No. 9 Reflex Lantern
List Price, \$12.50

Manufactured by
BORKMAN RADIO CORP.
Salt Lake City, Utah

General Sales Office
230 East Ohio Street
Chicago



No. 18 Coniform
List Price \$25.00

The Newcombe-Hawley Drum Speaker is a compact reproducer of exceptional quality and volume.



The Newcombe-Hawley Drum Speaker is ruggedly constructed throughout and beautifully finished.

Newcombe-Hawley Radio Reproducers

A superlative series of radio reproducers, so outstanding in tone quality and volume that they have established a new standard of radio program re-creation. Every Newcombe-Hawley demonstration has amazed and delighted the most critical audience.

The remarkable Newcombe-Hawley tone chamber (86 inches long in the console models shown below) is the secret of this exceptional performance. You should investigate the Newcombe-Hawley line. It is a prestige-builder and profit-maker.

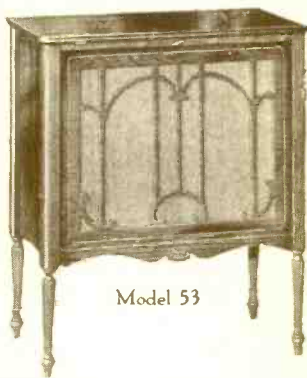

Model 53

A Wide Selection of Console Models

There is a Newcombe-Hawley Console Reproducer, with the 86-inch tone chamber, for every purpose. Model 53 is the most compact form. Model 55 has room for power units or battery installations, and Model 56 is equipped with doors to cover the tone chamber grill. Other models, with room to install radio receiving sets, are included in the line.



Model 55

Send for latest catalog with complete description of all models.



MAIL THE COUPON



Model 56

Newcombe-Hawley, Inc.,
201 First Ave., N., St. Charles, Illinois
Please send us full information about the
Newcombe-Hawley line.

Name.....

Address.....

Newcombe-Hawley console cabinets are made of finest 5-ply genuine walnut.

BEAUTIFUL CABINETS THAT SELL



Super-Excellent Radio Desk

finished with beautiful Butt Walnut matched panels mounted on gracefully shaped, solid walnut frames. Swinging door for cone speaker up to 21 1/4 in. high. Ample room for accessories.



Super-Excellent cabinet on Super-Excellent Speaker Console—Here is a real piece of Radio Furniture which for its beauty of lines, its beauty of finish and smart appointments has never been equalled.



Super-Excellent Cabinet on Super-Excellent Battery Console—To appreciate its real value and attractiveness, you should see this number.

The Ehlert line includes 23 models in various sizes to accommodate advertised receivers with panels up to 9x30-in. Complete stock in Chicago warehouse ready for immediate shipment.

Send for complete illustrated Catalogue.

Ehlert

RADIO FURNITURE COMPANY

2468 Lincoln Avenue, Chicago, Illinois



“QUALITY” CABINETS for Every Type of Receiver

You will appreciate the value of a high quality cabinet in assisting the sale of a receiver when you see the excellence of our new line of Speaker Cabinets. Manufactured from number one grade of striped American walnut, and finished in duo-tone lacquer. They have large Orthophonic type loud speaker horns built into the space below the receiver space, and there is ample room for all batteries or power units.

In addition to those illustrated, we build lower priced cabinets without doors, and cabinets similar to the No. 70R with feet like those on the type 80R. In every cabinet from the smallest to the largest, the workmanship and quality of material is the very best obtainable. They are in keeping with the finest set that will be mounted in them.

No. 70R 18 in. deep, 26 in. wide and 41 in. high. Equipped with large orthophonic speaker horn just below the set compartment.



No. 80R 17 1/2 in. deep, 30 1/2 in. wide, 31 1/4 in. high. Will accommodate large battery or eliminators. Has large orthophonic horn built in.

ART NOVELTY COMPANY

Builders of Quality Furniture
GOSHEN, IND.

DEALERS say:

"It clinches the sale, to say
Cabinet Work by ADLER-ROYAL"

ADLER-ROYAL



RADIO
CABINETS

CONSIDER the Woman!

Not as "radio" does she buy radio, but as FURNITURE. It must enhance the ensemble of the home *first*. The merchant who takes advantage of this fact sells the most Radio and is mentioned most often and pleasantly by Milady to her women friends. *That helps sales.*

No other accessory to radio will win her preference and praise so quickly as "Cabinet Work by Adler-Royal." *Give your dealers this very definite sales advantage.*

*Special
to Radio
Distributors
and Dealers*

A new line of exceptionally beautiful stock models by a nationally famous designer are now available to you at surprisingly moderate prices. Write today for photographs.

*Special
to Radio
Manufacturers*

We specialize in designing and executing exclusive cabinets for Radio Set Manufacturers. Write us about your needs.

ADLER
Manufacturing Co.
Incorporated
LOUISVILLE THE HOME OF
ADLER-ROYAL
RADIO
CABINETS KENTUCKY



NEW RADIOLA FURNITURE

Watson town again leads in offering a complete line of Tables and Consoles for the popular New Radiolas.

for
Radiola
16

Beautiful
Solid
Mahogany
Desk

*Ventilated
compartment for
Batteries or
Eliminators*

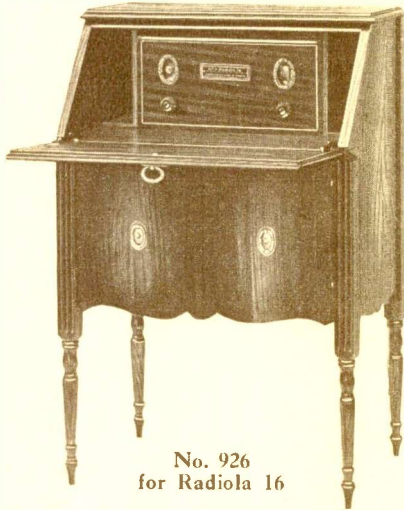

No. 926
for Radiola 16

Let our furniture work for you
It will help sell sets

See us at Radio World's Fair
Madison Square Garden, New York
City, Sept. 19-24. Booths Y-2-3.

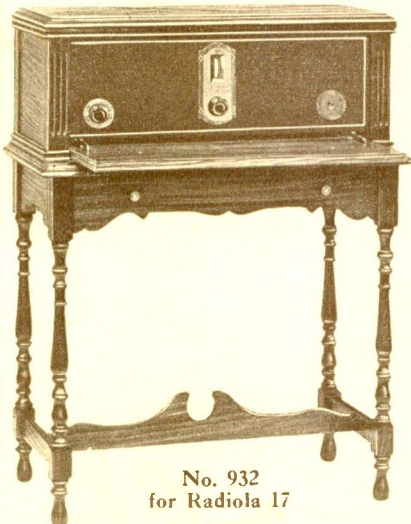

No. 932
for Radiola 17

for
Radiola
17

A most dignified setting for a Radiola that will have universal demand. Solid mahogany at it's best.

Radiolas

*Write for Our Complete Catalogue
and Prices*

Watson town Table & Furniture Co.
Watson town, Pa.
Makers of Fine Furniture Since 1893

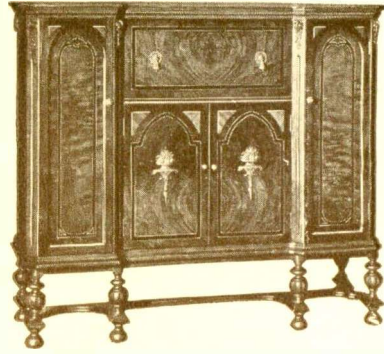

*A Masterful Creation
the product of old craftsmen*

That rare combination of delightful beauty, matchless quality and superb craftsmanship that arrests a discriminating radio public is a distinctive characteristic of Pierson Radio Furniture.

Pierson Craftsmanship is well known to the Radio Industry. Any dealer may sponsor the "Pierson Name Plate" with the certainty that he is offering America's foremost line of Radio Furniture.

New Catalogue A, Now Ready.
Over 40 Models Available.

THE PIERSON COMPANY
ROCKFORD, ILL.

Cabinetry and tone combined

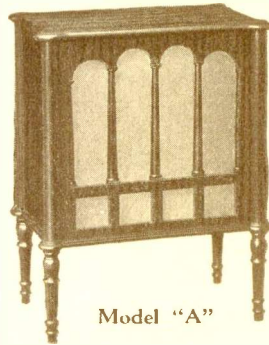

Model "A"

Artistic — graceful — luxuriously beautiful, this cabinet houses the 75-in. air column Aston-Cathedral horn with its superlative tone-reproducing qualities—the horn that has won instant favor.

Dimensions are—width, 23-in., depth, 15½-in., height, 30 in. Made of selected genuine Walnut Plywood, finished in rich Chestnut brown.

Price, complete with unit and \$59.50
20 feet of cord. I.o.b. Chicago

STANDARD PIANO BENCH MFG. CO.
1221-27 West Lake St., Chicago

Mr. Dealer -
More Sales - More Profit

If You Buy From
MIDLAND WHOLESALE CO.
5116 Ravenswood Ave., Chicago, Ill.

Distributors of all standard and nationally advertised radio, electrical and hardware merchandise.

Lowest Wholesale Prices
RADIO
Electrical Supplies

Write for THIS FREE BOOK

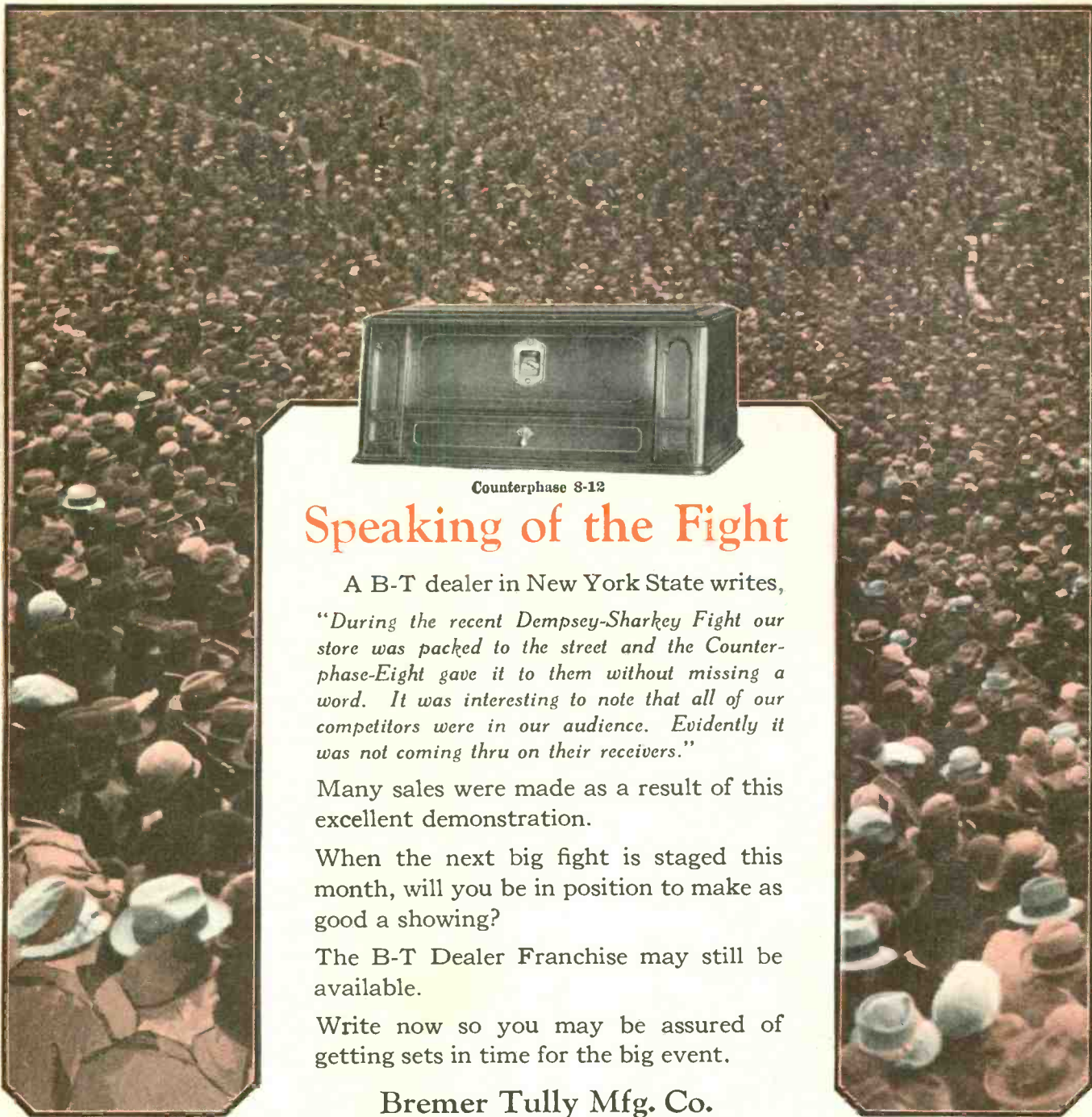

Counterphase 8-12

Speaking of the Fight

A B-T dealer in New York State writes, "During the recent Dempsey-Sharkey Fight our store was packed to the street and the Counterphase-Eight gave it to them without missing a word. It was interesting to note that all of our competitors were in our audience. Evidently it was not coming thru on their receivers."

Many sales were made as a result of this excellent demonstration.

When the next big fight is staged this month, will you be in position to make as good a showing?

The B-T Dealer Franchise may still be available.

Write now so you may be assured of getting sets in time for the big event.

Bremer Tully Mfg. Co.

520 S. Canal St., Chicago, Ill.

Comprising the B-T Line are five Counterphase Receiver models ranging in price from \$110.00 to \$295.00.—An efficient B-Power Unit and a wonderful new speaker.

Counterphase Receivers are covered by numerous Bremer Tully patents and licensed by RCA and affiliated companies



Counterphase 8-16



Counterphase 6-37



AMPLION—"the line"



AMPLION
Colonial Cone
AC12-----\$35.00
14" x 14" x 9"

A handsome two-tone mahogany cabinet with a fine piano finish.

New cone assembly with the famous Amplion unit.

The efficiency of this compact little model is due to its unusual construction and design. The cabinet itself acts as a sound board and resonating chamber, which produces a natural tone of singular sweetness.

Other Amplion's
from \$12.00 to \$145.00

Ever since broadcasting began, the name "Amplion" has been supreme in sound-reproducing devices

AMPLION quality is an accepted standard the world over—due to the famous tone quality of every Amplion model.

Each model is designed by a recognized artist—the cabinet work is of the highest order of craftsmanship. *Amplion pleases the eye as well as the ear.*

Our new illustrated booklet is now ready. Write for a copy.

THE AMPLION CORPORATION OF AMERICA
531-535 West 37th Street, New York City, U. S. A.
The Amplion Corporation of Canada Limited

THIS is the second of the Amplion series of art studies on the new Amplion line.

Amplion national advertising carries the atmosphere of Amplion quality and beauty, and is a strong contribution towards breaking down sales resistance.

An Amplion demonstration usually means a sale. Amplion tone quality—which is secured by means of best materials, highest type of workmanship, backed by 40 years of engineering experience, means customer's satisfaction.

AMPLION

THE AMPLION CORPORATION
531-535 West 37th

with least resistance”



Colonial Cone
AC 12 List \$35.00

Handsome two-tone mahogany cabinet, 14" x 14" x 7", piano finish. New Amplion balanced armature unit with straight bar magnets of finest English Tungsten steel.

These models are
now being featured
in national advertising

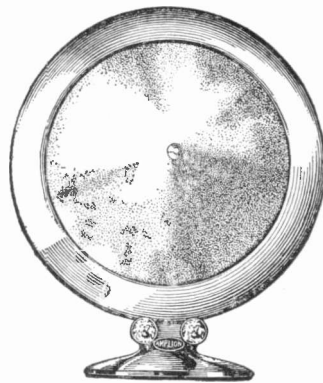

Lion Cone
AC 21 List \$25.00

14" shaded bronze finish Cone mounted on an 18" walnut sound board. Height 20½" including bronze moiré base. New balanced armature unit with straight bar magnets of the finest grade English Tungsten steel.

Other Amplion Models
from \$12.00 to \$145.00

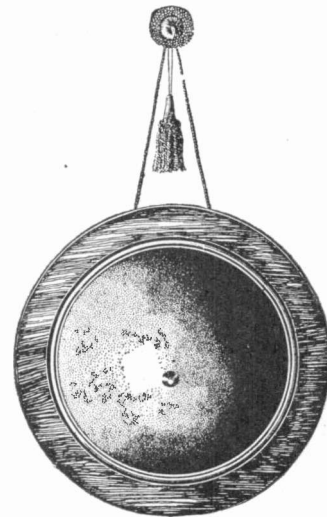

Amplion Mural
AC 24 List \$25.00

Same as the Lion—but for wall decoration. Equipped with brown silk picture cord and tassel. 20 ft. connecting cord.

THESE models are selected for current national advertising for their quick turn-over and sales volume building possibilities in the early part of the season. The handsome line-cuts shown above are valuable for dealers to tie up their local advertising with this national drive. Consumer literature is also ready upon application.

ATION of AMERICA
Street, New York



AUDITED AMPLIFICATION
HAS ELIMINATED ALL OF THE GUESS-WORK
FROM THE RADIO.

THE SUPERIOR SENSITIVITY, RANGE
AND TONE-QUALITY
OF ALL ERLA SETS ARE CHARTED AND
MADE CLEARLY APPARENT
BY AUDITED AMPLIFICATION.
DEALERS WHO MUST HAVE THE BEST
WILL WRITE FOR PARTICULARS.

ERLA



MADE BY ELECTRICAL RESEARCH LABORATORIES, CHICAGO

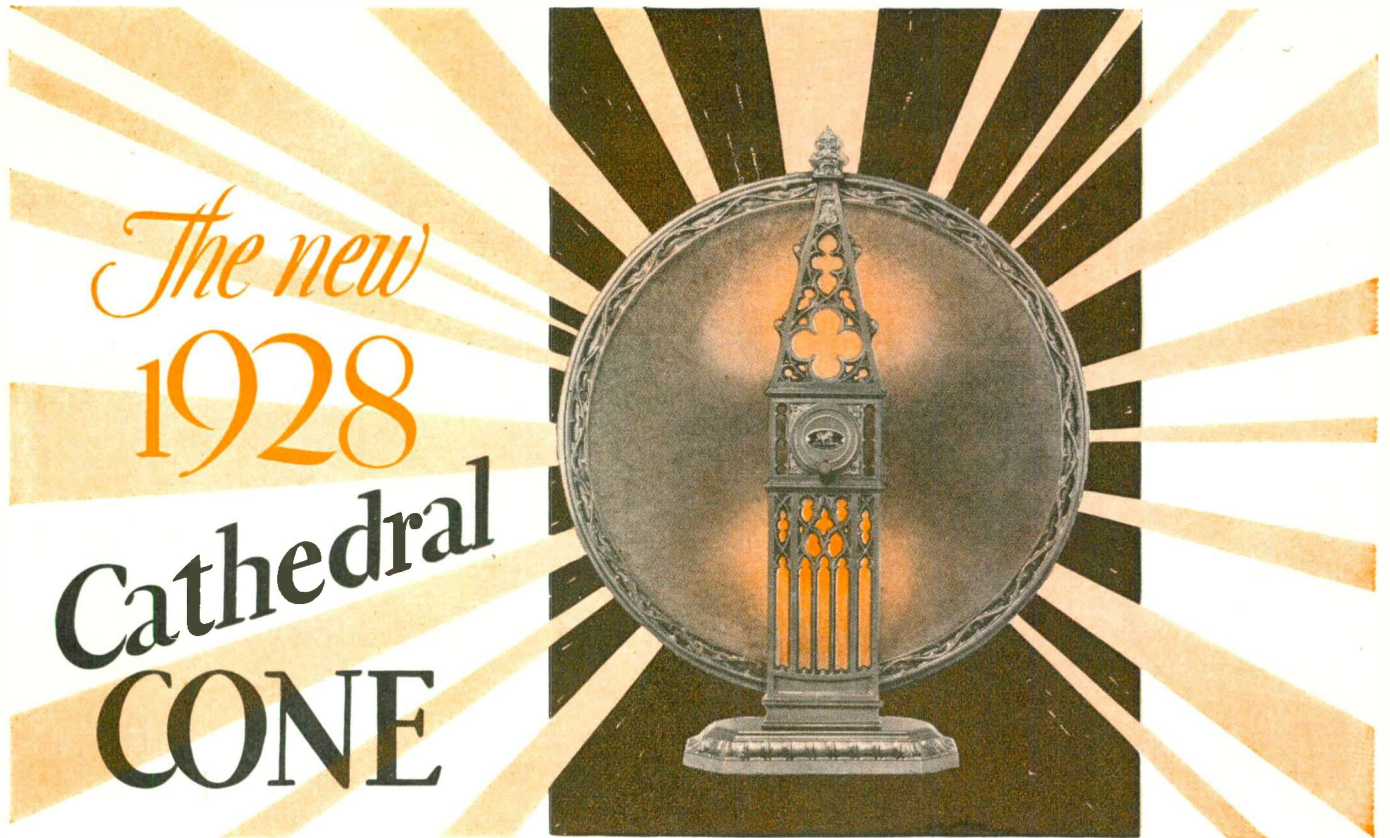

Gold or Polychrome Finish

Illuminated

—with the same Unexcelled Performance—
PLUS added Selling Advantages—

[Licensed under
 Lektophone Patents]

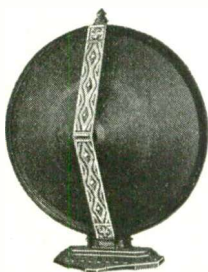

Rear View

A **LITTLE** thing, but a big sales booster. All 1928 Pathe Cones will be equipped with this all metal guard to protect the cone point. Prevents damage in shipping and handling, eliminates repairs and returns. You can capitalize on this feature. Your past experience will make you appreciate this point.

Now the pioneers in radio acoustics since the beginning of broadcasting offer new selling advantages to aid you in displaying and selling the artistically beautiful Cathedral Cone.

In tone and reproduction the Cathedral Cone has been long accepted as the standard. It is still the leader—the bass notes come out clearly—the soprano tones are reproduced without blasting.

The new added lighting feature not only sells the Cathedral on sight but as a wonderful window display works for you night and day. The illuminated feature with its soft lamplike glow enhances the true beauty and decorative value of the Cathedral Cone.

Get in the van now. Don't miss the superior advantages of the Cathedral Cone. Order your sample now. For quick action get in touch with your nearest jobber or write to us direct.

- Cathedral Cone (Illuminated).....\$32.50
- Cathedral Cone 30.00
- Grecian Cone 25.00

PATHE PHONOGRAPH AND RADIO CORPORATION
 20 Grand Avenue, Brooklyn, N. Y.



You've noticed the pitchless tops on Ray-O-Vac batteries

Do you know what they stand for?

THESSE tops are the visible evidence of a totally new type of construction that makes Ray-O-Vac batteries last from 10% to 15% longer . . . and Ray-O-Vacs have always been known for their remarkably long life!

With this new construction, each round cell is housed in a square waterproofed compartment. The corners of this compartment allow room for the expansion of whatever electrolyte breaks through the zinc can. In pitch-filled batteries the oozing electrolyte forces its way to the top of the cell, contacts with neighboring cells, and short-circuits.

The new Ray-O-Vac construction does more than eliminate short circuits. It permits all the active elements within each cell to give all their energy in producing current. Practically every particle of electrolyte is used up . . . every ion of the zinc can goes into making volts!

No wonder then, that Ray-O-Vac batteries last longer! They are *built* to do so!

They are batteries that will give your customers the kind of satisfactory service that brings them back to your store. Aren't these the kind of batteries that you had rather sell?

Millions are learning these facts

Every month in *The Saturday Evening Post*

day Evening Post the longer life of Ray-O-Vac batteries is being explained to millions of radio owners in full page color advertisements. Similar pages in color in *The Country Gentleman*, and large space advertisements in the leading newspapers of the country tell the same story.

This advertising is making sales—for Ray-O-Vac dealers and jobbers—all who sell Ray-O-Vac batteries.

Wouldn't you like to handle a line of batteries with the quality points of Ray-O-Vacs to talk about and with the promotional work behind them that is supporting Ray-O-Vacs?

Ask your jobber for information about the line, or write us and get full particulars.

FRENCH BATTERY COMPANY
MADISON, WISCONSIN

Also makers of Ray-O-Vac "A" and "C" radio batteries, Ray-O-Vac flashlights and batteries and Ray-O-Vac ignition batteries.



Look for the full page advertisement like this that appears every month, in colors, in *The Saturday Evening Post*.



It's the Reinforced Construction that makes possible this **UNCONDITIONAL GUARANTEE /**

THE unusual guarantee that accompanies every CRUSADER Radio Tube is not a *chance proposition* built on shallow hope nor is it the unrestrained pride of the manufacturer.

In every CRUSADER Tube, including the 201A and 199 types, the plate, grid and filament are solidly locked together and cannot be jarred out of position in transit or by rough handling.

Microphonic howls are eliminated because it is impossible for the filament to sag and

vibrate; the filament remains taut throughout the entire life of the Tube.

Burdensome replacements are reduced to a negligible factor.

Infinitely longer life, pure tone, greater volume are achieved and a revolutionary guarantee made possible.

Built by a substantial company who thoroughly believes in the jobber and gives the dealers vivid selling support, CRUSADER deserves your immediate consideration.

CRUSADER

RADIO *Guaranteed* TUBES



THE SUNLIGHT LAMP COMPANY

Est. 1922

NEWTON FALLS, OHIO

Investigate the

INVESTIGATE the King Franchise—
Study the Complete Line—Analyze its
Sales Possibilities—Then Compare the Fol-
lowing Advantages with any other Franchise.

1. Complete Patent Protection¹
2. Actual Franchise Protection
3. Beautiful Cabinet Designs
4. Unmatched Quality of Performance
5. Correct Range of Prices
6. Solid Financial Responsibility
7. Effective Advertising Program
8. Attractive Merchandising Helps
9. Working Sales Service Plan

If you will honestly compare these advantages—point by point—you will find that your real opportunity to build a safe, profitable and lasting Radio business is by getting a King Franchise.

Drop us a postal card or a note and we will immediately send you the name of our distributor.

King Manufacturing Corporation
Buffalo, New York

Prices Slightly Higher West of Rocky Mountains.

SELECTIVITY
TONE



The Baronet

A six tube tuned radio frequency table model. Single dial station selector with separate vernier adjustment. Beautiful Gothic design cabinet. Rugged mechanical construction. Price without accessories, \$70.



The Crusades

A six tube completely shielded table model with single dial station selector. (Same chassis as "Chevalier".) Handsome cabinet, two tone finish. Unusually attractive panel to match cabinet. Price without accessories, \$115.

King Franchise

DISTANCE
VOLUME



The Chancellor

A six tube completely shielded Console Model with single dial station selector and built-in seven inch Peerless Cone Reproducer. Beauty, character and adaptability have been combined to an unusual degree in this model. Ample space for batteries, etc. Price without accessories \$190.00.



The Chevalier

A completely shielded six tube receiver with single dial station selector. Beautiful Burl Walnut High Boy cabinet. Most beautiful design and value on the market at its price. Built-in, seven inch Peerless reproducer with space for batteries, etc. Price without accessories, \$210.



The Viking

A six tube tuned radio frequency console model. Single dial station selector with separate vernier adjustment, stabilized circuit, two stages radio frequency, detector, three stages audio. Attractive blended cabinet with built-in speaker and space for batteries, etc. Price without accessories, \$140.



KING RADIO



NO one knows better than you, Mr. Radio Merchant, where lie the *real* profits in retailing radio. No one need tell you what class of merchandise has contributed most to the success of *your* business. You know. You knew *last* season. Yet, may we ask, are you taking advantage of this invaluable knowledge? ¶ Once again a new radio season is on its way and once again the radio dealer is beset by the tempting, low prices of imitative, inferior products rich in pre-season promises of volume selling. And in no item is this more pronounced than in radio speakers. ¶ "Just as good as Farrand" has been a favorite competitive slogan ever since the first Farrand Speaker established the supremacy of the cone-type reproducer. Imitations continue to follow in its wake. And, while many of them *look* good, how many of them "make good"? You probably

don't have to look further than your own shelves for the answer. And of those remaining unsold, how many, if any, are still worth what you paid for them? Which, among them, has not suffered the ravages of ruthless price-cutting? ¶ Backed by an unswerving policy of dealer protection, the Farrand Speaker stands alone today, as it has from the very beginning not only in point of sales leadership, but also in price maintenance commanding the same full price, insuring the same full retail profit that it did three years ago. ¶ Follow the lead of thousands of other progressive radio retailers, and *concentrate* on Farrand. It means maximum profits at the beginning

of a season, and between seasons one hundred cents on the dollar, whenever you *buy*, whenever you *sell*! Farrand Manufacturing Co., Inc., Long Island City, N. Y.

100 CENTS ON THE DOLLAR

Whenever you **BUY**
Whenever you **SELL**

- and NOW
the *New*
OVALL
Farrand
A greater-than-ever
Farrand Speaker

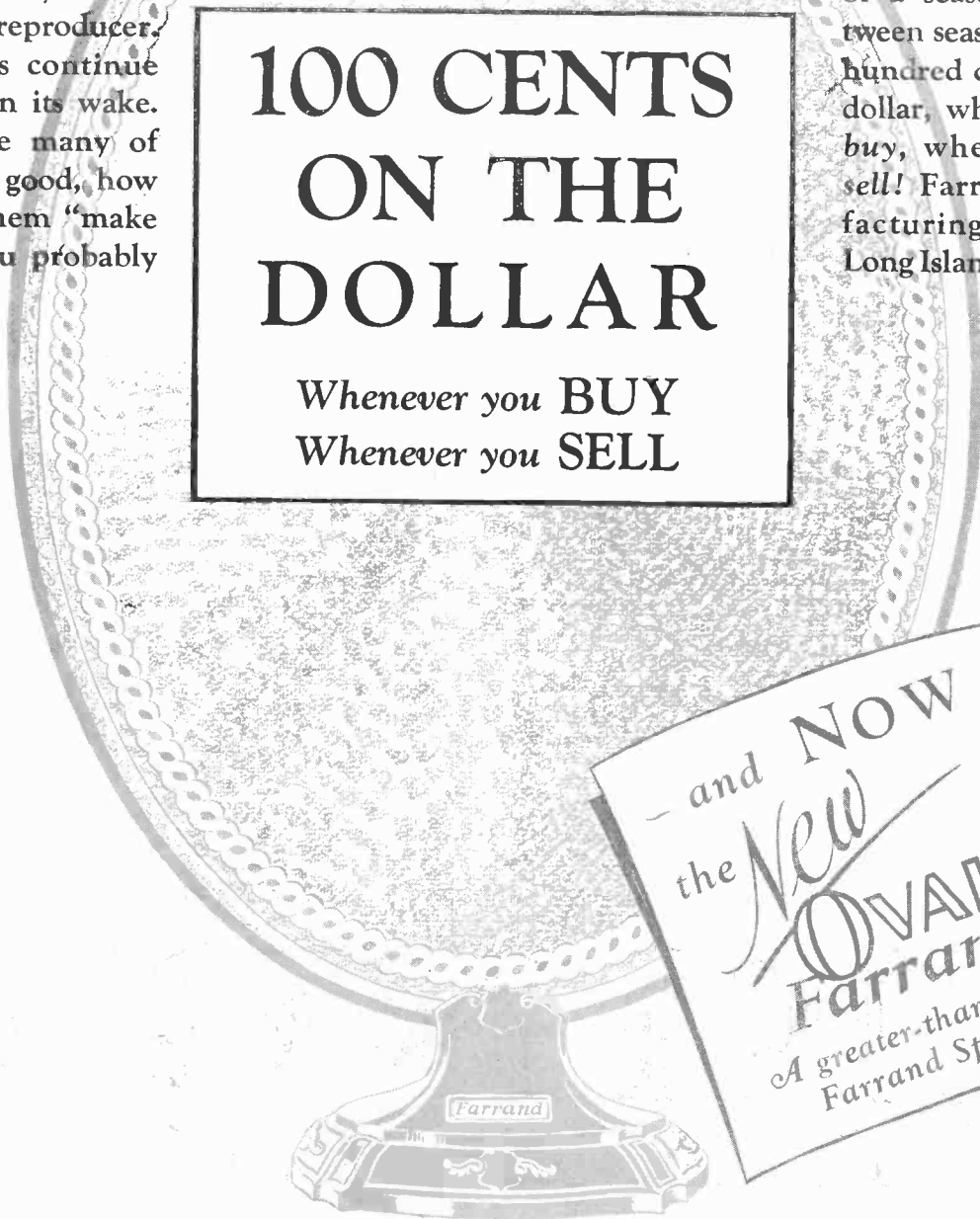

ATWATER KENT RADIO

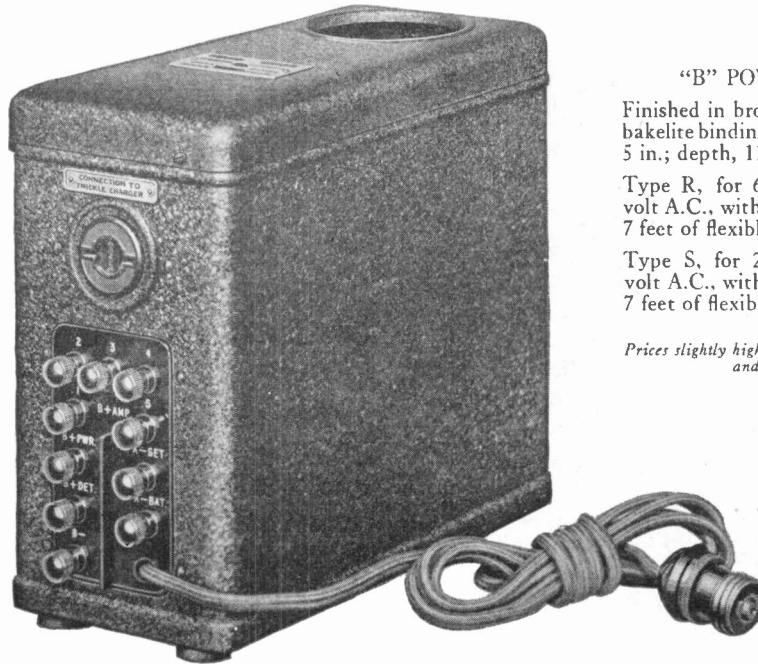

"B" POWER UNIT

Finished in brown crystalline with bakelite binding post panel. Length, 5 in.; depth, 11 in.; height, 9 in.

Type R, for 60-cycle 110 to 115 volt A.C., with rectifying tube and 7 feet of flexible cable \$50

Type S, for 25-cycle 110 to 115 volt A.C., with rectifying tube and 7 feet of flexible cable \$55

Prices slightly higher from the Rockies West, and in Canada

ANNOUNCING

The Atwater Kent "B" Power Unit

THE Atwater Kent "B" Power Unit delivers up to 135 volts and is designed for use with any model of Atwater Kent Receiving Set or other make consuming not more than 40 milliamperes.

Operation is entirely automatic, due to a special built-in relay actuated by the power supply switch located on the receiving set. If a charger is used (it should be of the trickle type) provision is also made for connecting the "A" battery and charger to the "B" Power Unit, in which case the relay also automatically starts and stops the charger.

A special rectifying tube is included as part of this equipment.

This Atwater Kent "B" Power Unit insures true and even tone quality. No adjustment is needed for differing voltages, as fluctuation is compensated for by transformer and circuit design. It is therefore trouble-proof and fool-proof. Dealers will find it is the kind they can install and forget.

Write for illustrated booklet telling the complete story of Atwater Kent Radio.

ATWATER KENT RADIO



POSTERS

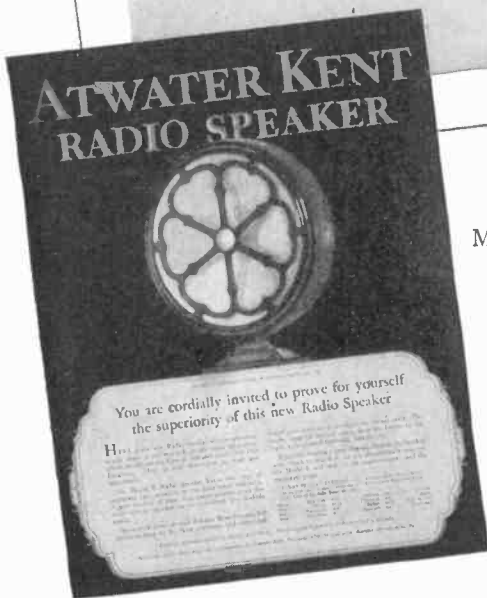

MAGAZINES



NEWSPAPERS

Perfection—Prestige—Profit

THIS new Radio Speaker—Model E—is being introduced this month to millions of people in the United States and Canada. It is being advertised in the MAGAZINES on the long list used by the Atwater Kent Manufacturing Company, in NEWSPAPERS reaching every city and town, on POSTERS in the 300 greatest centers of travel.

For every Atwater Kent dealer the Model E Radio Speaker means perfection, prestige and profit.

Write for illustrated booklet of Atwater Kent Radio.

ONE Dial Receivers Licensed Under U. S. Patent No. 1,014,002

ATWATER KENT MANUFACTURING CO., A. Atwater Kent, President, 4733 WISSAHICKON AVE., PHILADELPHIA, PA.

The Principles of FALL BUYING

SEPTEMBER is the "last-minute" time for the dealer in buying radio for the Fall season. Retailers who have not yet completed their lines will have to make their decisions this month.

Seeking to find out if there were any "rules of procedure" that might be followed, the editors asked James C. Blinn, manager of the radio department of the Denver Dry Goods Company, Denver, Col., on what basis he judged new lines. From his opinions on the subject, the following thoughts were gleaned:

1. Is it an item that will increase sales at no sacrifice to lines already in stock?
2. Is it so much better than some present line that a present line should be discontinued to make room for it?
3. Is it in public demand or will the demand have to be created?
4. Will it be a permanent item, or "here today, gone tomorrow?"
5. How it is priced in comparison to competitive lines?

"Buy strictly on these lines," Mr. Blinn said, "and do not hesitate to say 'No' if it won't stand the test."

S. J. RYAN, merchandising counsellor of *Radio Retailing*, also advances some sound common sense regarding buying radio this Fall.

"First of all," declares Mr. Ryan, "I would carefully inform myself as to what effect the new light socket sets will have (a) upon those

who have not purchased radio to date, and (b) will they stimulate a demand that will call for a large number of trade-ins?

"I would determine definitely a trade-in policy that will at least permit me to handle trade-in merchandise without a loss and, if possible, at an assured profit, in order to be able to handle sales of the new sets to those of my customers who now own battery sets.

"Next I would tackle the comparatively easy problem of deciding what are the best lines in the long run, in both AC and battery-operated receivers. By that I mean the largest *initial* profit is not always the largest *ultimate* profit. Numerous instances have occurred where price-cutting, excessive drop in cost, frequent changes in models, and similar occurrences, have made it impossible for dealers to operate at a fair profit. Those sets which are generally accepted as standard by the public are naturally the easiest to sell and consequently, as a rule, the cheapest to sell.

"I would go to the Public Library, get out the files of the newspaper for the last year, and study the radio advertising that had been done in my locality. I would study the records of my purchases and sales for the preceding year and I would study the experiences of fellow dealers that have appeared in *Radio Retailing*.

"All of the above seem to be generalities, but they are the generalities which must be taken into consideration, and intelligent application of them to any specific business is necessary."

Turning FAILURE



This dealer saw disaster staring him in the face—how he met the situation, licked it and started his business on the upgrade is the substance of this unusually dramatic story

BUSINESS came to the "Williams Radio Company" from the very start. "In fact that was the chief cause of most of my troubles—too much business," declares "L. A. Williams," sole owner of this now prosperous concern located in a midwestern city of 43,000 persons. The identity, both of Mr. "Williams" and his home city, is concealed by request.

This young man, of limited experience but unbounded enthusiasm, opened his store to the public in January, 1926. The first six months, despite seasonal conditions, his gross sales were \$18,600—taken, as his first business statement discloses, at an alarming cost. Then he called a halt. He took stock of himself and of what it was really all about. He took a week to learn from experience and successful radio dealers, just how they did it. In brief, he reshaped his entire plans and policies.

Twelve months after this reformation was effected, he had reduced an accounts payable item of \$16,700 to less than half that

amount. He had built an annual business of \$47,000, increased the ratio of stock turns to sales six times and turned a book loss of 2.6 per cent into a net profit, from July, 1926, to July, 1927, of 6½ per cent.

A proper appreciation of Williams' achievement is not possible without a knowledge of his mistakes as he now views them. The outstanding ones, he declares, were too liberal terms and overstocking.

"I started in by featuring a down payment of only ten dollars," he says. "This was too low. It attracted an irresponsible class of buyers that caused me unlimited trouble and ex-

pense. It created a book business of close to \$8,000 for the first two months I was open, fifteen per cent of which has since been charged to experience. But the greatest harm it did was in giving me a distorted view of true values. In my enthusiasm, I soon became the world's greatest boob buyer. I thought that I ought to stock every set or accessory that was asked for or advocated by the scores of salesmen who soon began to call on me. Result—at the end of the first six months, a merchandise inventory of \$16,400. Total gross sales, for the same period, were \$18,600, of which \$7,683 was still outstanding on July 1, 1926. Liabilities at that time were \$15,663.

The third difficulty was the natural result of this loose selling and buying policy—heavy servicing expense. Unreasonable customers looking for excuses to hold up payments and diversity of lines meant many free service trips and generally unsatisfactory results due to the multiplicity of details the service man was expected to master.

To Our Jobber Readers:

One of the chief factors in Williams' "right about face" movement was the new relationship which he established with one of his jobber friends. There is, therefore, much of interest and of profit in this article for the many jobbers who read this magazine

Into SUCCESS



"Of course, there were many small mistakes which I committed, but as I now see it, they likewise, were due in great measure to the two cardinal errors—loose buying and loose selling. I spent more than I should for institutional advertising. Generalized too much in my copy. Because of the rapid increase in my stock inventory, I am positive I lost unduly through my inability to keep track of things. 'Shrinkage' I think it is called. I formed the habit of buying in large quantities for the sake of the extra five or seven per cent and would order from firms located many hundreds of miles away. By July, 1926, this practice had 'frozen' my liquid assets and I realized that I was in a bad way."

Right at this critical moment, when the demands of the creditors were becoming more insistent and Williams was pretty well discouraged, "came," as they say in the movies, "the dawn." Sunrise, in this instance, appeared in the form of a bright young salesman—a representative of one of the many jobbing houses from which Williams was buying. In a burst of confidence, our friend poured out his tale of woe.

"What you need is a fresh start on another track. Why not take a week off and get far enough away from these business details so that you can obtain an entirely new perspective?" suggested this emissary who, it will be readily granted, was something more than just an order-taker. "Jump in my car and let's call on ten or a dozen of my most successful

dealers. It can't do any harm and might prove to be time well spent all around."

The net results of this suggestion were far-reaching; highly profitable for the salesman and his live wire clients, as well as for Mr. Williams. Fourteen dealers were interviewed in five days. Williams would be introduced by the jobber's representative as a radio dealer, who was anxious to swap experiences with brother retailers. He was given his opportunity to find out "how they did it" while the salesman talked with the clerk and looked over the stock. It is worthy of note that the salesman and his dealer friend were everywhere most cordially received and that the former wrote 30 per cent more business that week than he had expected to obtain at that time of the year. Williams states also that practically every successful merchant read thoroughly at least one radio trade magazine.

"My presence seemed to put everyone on a friendlier basis," he further explained. The dealers appeared to appreciate the fact that here was a jobber who was actually trying to help a dealer make money. All of them were keenly interested in the purpose of my mission. A number expressed a desire to make a similar pilgrimage and three made definite arrangements with my friend to accompany him for four days each during his next tour of the territory.

"That there is much merit in this plan is apparent also from the fact that during the past year, five dealers on whom we called have visited me for a like reason. I have continued by correspondence the friendships established during my 'tour' with ten of the dealers I met. We frequently exchange ideas by mail. There is no reason why we should not do this, as we handle the same lines and are far enough apart to be non-competitive.

"Need I add," Williams continued, "that it would take considerable pres-

sure to pry me loose from this particular jobber."

Returning to his home town full of fight and armed with a new set of weapons with which to continue his battle for a business existence, Williams lost no time in putting his new ideas into practice. He killed immediately the old slogan "Ten Dollars Down." He continued to grant

tention on reducing my seven lines of sets to three."

The handicap of a heavy stock inventory in July had been apparent to Williams even before he left on his investigative tour. His dealer friends were generally in agreement on most of their major suggestions. They were emphatic as well on this point. "Clean up that surplus stock by all means," they said, "and do it quickly."

Williams was able to accomplish this objective without running costly sales because he concentrated his selling effort on his unnecessary lines and closed them out one at a time. Before the middle of November, 1926, he had cleaned up four of the seven lines which had graced his floor in mid-summer. The three lines which he retained were selected because their operating principles were dissimilar, they were well and favorably known locally, they carried a wide price range and they possessed eye and ear appeal.

"My new selling policy was to find the manufacturer or circuit favored by the prospect, then to talk that one line. One disadvantage of switching in the middle of a sale is that it is necessary to take time to sell the prospect on another manufacturer and another circuit. This wastes time and energy."

Indebtedness was reduced because buying ceased temporarily while sales volume for August and September was well sustained. Creditors were

told frankly that new policies, which a personal investigation showed to be sound, were in effect and were given specific reasons for believing that a little more patience would be rewarded by a settlement of 100 cents on the dollar.

When Williams did resume his buying he concentrated on three nearby distributing houses. He ceased to buy in large quantities for the sake of an apparent extra five or ten per cent, or to pay heavy transportation charges on goods shipped from distant points.

How Williams Staged His Comeback

Old Policies

New Policies

—PAYMENTS—

<i>\$10 down and a year to pay</i>	<i>At least 20% down and balance within 9 months</i>
--	--

—STOCK—

<i>Seven different lines of receivers</i>	<i>Concentration on three lines</i>
---	---

—ADVERTISING—

<i>General radio appeal</i>	<i>Personalized "buy-it- from-me" selling</i>
-----------------------------	---

—SALES—

<i>No particular sales appeal</i>	<i>Featured "electrify your set" idea</i>
---------------------------------------	---

—OUTSIDE SELLING—

<i>No outside campaign</i>	<i>Hired special sales- men to push "home selling."</i>
----------------------------	---

—MANAGEMENT—

<i>No system</i>	<i>Two hours daily for planning work</i>
------------------	--

terms but based them on the customer's ability to pay. It is now a matter of pride with this concern to see how much it can obtain as the initial payment. This is never less than 20 per cent of the total purchase price. Whereas Williams frequently permitted the terms of payment to run as long as a year, they are now held to nine months.

"But the big problem that faced me on my return," he says, "was that of reducing stock and satisfying my creditors. I discontinued practically all buying and concentrated my at-

An itemized expense sheet is not submitted with this article because Williams' difficulties were not due to petty leaks but to unsound policies. Having withdrawn that offer which had attracted unprofitable customers and having cleaned up the stock situation, this seeker-after-truth next sought to build for volume.

While Williams reduced his advertising appropriation thirty per cent, his new "copy" actually began to pull people to his store and jingle the telephone bell. He ran a series of heart-to-heart "talks" that were widely read and favorably commented upon. One of these advertisements, on the household department page, appeared weekly. It always carried the general heading "Single Column Radio Talks by Williams." Its messages were presented in understandable language. They were read because they contained much of real interest to the majority of the paper's readers. Plain statements of fact on such subjects as aeri-als, eliminators, types of sets, noise and kindred subjects soon created an invaluable reputation for Williams and registered his store in the public mind.

Naturally the quest for more and better business quickly lead to selling in the home. Williams met this challenge to better salesmanship by hiring an old appliance salesman who was given a commission of fourteen per cent and who specialized on following leads to their source and closing sales in the home. The Williams Radio Company closed 35 per cent of the last fiscal year's \$47,000 gross business in the home.

"Electrify Your Set," a phrase of no particular technical exactitude, but which hit the popular fancy, was the slogan under which our friend pushed the sale of socket power devices. "I no-

ted that most of the live dealers I talked to had some distinctive way of featuring themselves with the public," he declares. "The business value of a simple phrase such as "Column Talks" or "Electrify Your Set" is surprising."

The last, and perhaps the most fundamental change Williams made was in the personal habits he had

formed in conducting his business.

"I realized the need for systematic thinking and now devote the two best hours in the day, from seven to nine each morning, to these tasks, generally in the order in which they are enumerated: a review of yesterday's happenings, planning the day's work for myself and my clerks, examination of the record of sales and of past due accounts, opening the mail, writing advertising copy.

"This habit of getting on the job bright and early has toned up the morale of the entire organization. It is now a rare occurrence for a day to pass that something in the way of a definite suggestion, a plan or a constructive criticism does not come to me because I have a specific time when I sit down and dwell upon these matters before the confusion of the day's petty details surround me.

"The Williams Radio Company is not yet entirely out of the woods but it is so near the edge that I can heartily recommend the course which I have pursued to any other radio dealer who finds himself in a predicament similar to that which faced me in the dark days of July, nineteen twenty-six."

THE moral of this story, if there is any, would seem to lie in the fact that Williams was a good enough business man to realize the value of translating his business to black and white figures, in the form of the Financial and Profit and Loss Statements reproduced on these pages. From them he realized his financial condition was not all it should be, and he sought ways and means of correcting it.

It is not beyond the ability of any dealer who finds himself on the skids to do just what Williams did. Stop, analyze, the situation, and devise its remedy.

Financial Statement

WILLIAMS RADIO COMPANY

Issued at End of First Six Months in Business

CURRENT ASSETS

Cash	\$324
Accounts receivable* ..	6,530
Merchandise inventory** (at list) ..	16,400
	<hr/>
	\$23,254

LIABILITIES

Accounts payable	\$15,663
------------------	----------

FIXED ASSETS

Store, office and delivery equipment (at present net worth)	2,600	Capital investment	5,000
	<hr/>	Surplus	5,191
	\$25,854		<hr/>
			\$25,854

PROFIT AND LOSS STATEMENT

Sales for the first six months	\$18,600
Cost of goods sold	11,160
	<hr/>
Gross Margin	\$7,440
Expenses	
Selling and operation	\$5,580
Servicing	1,187
Bad debts and shrinkage	1,153
	<hr/>
	\$7,920
Net loss	\$480 (2.6 per cent)

*Estimated collectible value. Actual total accounts receivable on books \$7,683.

**At full list prices, NOT at actual prices obtainable.

NOTE the disproportionate size of the merchandise inventory to gross sales. At this rate Williams would turn his stock but 2.2 times per annum. He started with a capital of but \$5,000. This was immediately tied up in stock and equipment. Cash reserve (\$324) is too low.

Gross margin is entirely satisfactory but servicing, bad debts and "shrinkage" expenses must be reduced if this man is to remain in business.

Williams financial statement, issued twelve months after the one which appears above, reveals, markedly, the result of his ability to detect the danger points and to correct them. It showed: cash in bank \$849; accounts receivable \$7,450; merchandise inventory \$3,893. Liabilities were reduced from \$15,663 to \$8,140. Sales for that fiscal year were \$47,200. Gross margin (\$17,936) was two per cent less than during the period when he was buying for price and not for profit, but he showed an actual net profit of 6.5 per cent because he had reduced selling and operation costs to 31.5 per cent as against the first six months record of 42.6 per cent.

Make SERVICE

Your service department should be made a sales department, Griffin says—Every service call should result in sales of additional apparatus

By JOHN W.
President, Haynes-

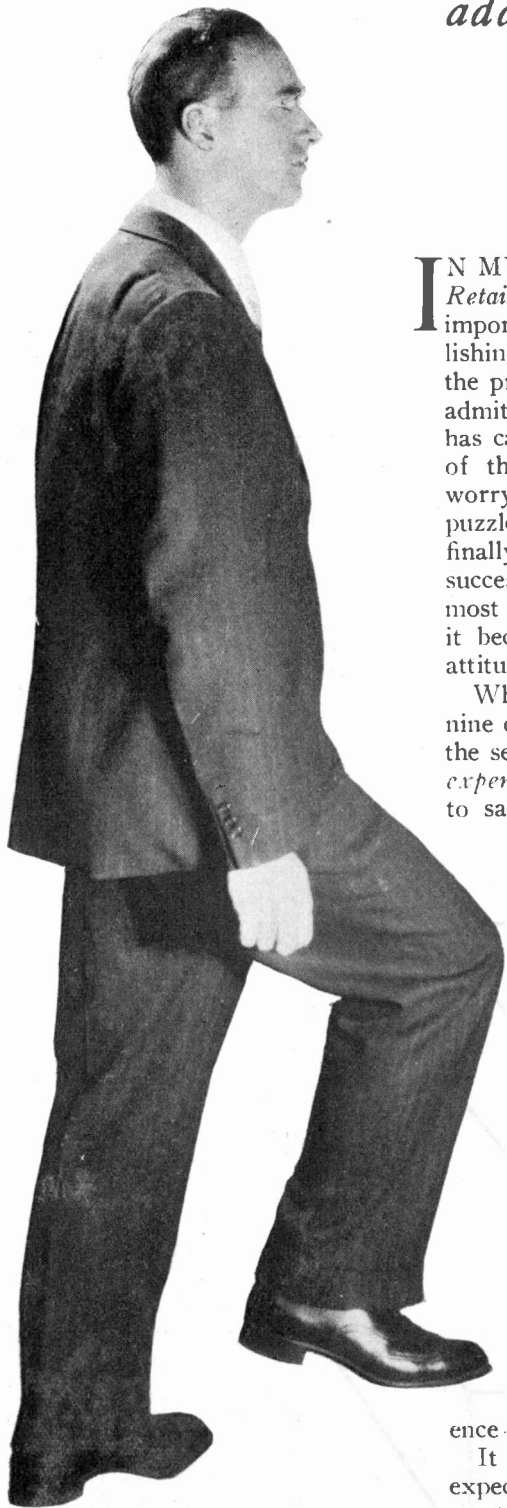

IN MY two previous articles in *Radio Retailing* I touched lightly upon the importance of service and of establishing a definite service policy for the present radio season. It must be admitted that the problem of service has caused many a dealer long hours of thought, and more than a little worry. After having worked on the puzzle myself for several years and finally solved it with a degree of success, I am inclined to think that most of us have so much trouble with it because we start with the wrong attitude toward the whole thing.

What I mean is simply this—that nine out of ten radio dealers consider the service department as a *necessary expense*, rather than as an accessory to sales. It is a department which must be run, but one which they would like to throw out of the store if they dared to. There is no getting around the fact that any radio store which sells any quantity of sets must maintain some kind of an installation and maintenance service. The dealer is right in regarding his service men as an absolute necessity. But he is wrong, I believe, in looking upon the service end of his business primarily as an expense and a drain upon his gross profits. Experience has proved it otherwise.

It is a little too much, perhaps, to expect that the service department of most radio stores can operate at any great profit. But as I see the situa-

tion now, there is certainly no reason why this end of the business should run at a loss. I am going to draw from my own experience to give you a concrete example which will help to show what can be done in the way of giving service without calling upon other departments of the store to help foot the bills.

For the last two years at Haynes-Griffin we have been working to make our service department self-sustaining. We have calls for about every sort of radio service it is possible to think of. The work of the department includes installing new sets, remodelling old ones, replacing batteries and tubes, putting in extension cords for speakers, hooking up socket power units and trickle chargers, and trouble shooting of all kinds. We have all of the many demands for free service which other stores have, and possibly a few more every month.

In one way our store is similar to stores in smaller cities in that we have a large number of steady buyers rather than selling to transient trade which buys once and doesn't come in the store again for years after, if ever. Competition, particularly in the matter of free service, is keen. To sell a certain customer a set, we are all apt to extend our usual term of free service much longer than we can afford to.

HOWEVER, the fact remains that even if the service department of any store fails to make money, there is no reason why it should not break even or show but a very slight loss.

All very well and good, you say, but if it shows a real loss, what are you going to do about it? We've

Your Stepping Stones to SALES

GRIFFIN
Griffin, Inc.

got to give the service to sell the sets and it costs us so much to do it. The income is only so much. That means a definite loss that represents a real drain on our gross profits. What can be done to reduce the loss?

Two years of intensive work on the service problem has given me something approaching a satisfactory solution. And I might say that even yet I am not satisfied.

For such value as it may be to other dealers, I am going to set down here the exact results of our two-year struggle with this service problem, showing what we did wrong the first year, with the resulting loss, and how we corrected these difficulties in a large measure the second year.

As expense against the service department is charged, first of all, the salaries of the service manager and his clerical assistant. Then there is the rent and incidental upkeep of a separate warehouse, where sets are unpacked and prepared for installation, and equipped with the proper accessories. At this warehouse we keep a stock clerk and a furniture refinisher, whose salaries are also charged to service. Then there are, of course, the actual service men themselves, working on the outside, the number required varying with the season of the year. In addition to salaries they have certain expenses covering carfares, overtime, meals, etc. And last, but not least expensive, the service department must bear the cost of upkeep, depreciation and running expense of four service automobiles.

To offset this long list of necessary expenses the service department is credited, in the way of income, with all installation fees when the same is charged to the customer over and above what he pays for the merchandise itself; for such service calls as our customers are charged for at a given rate per hour, and finally, such additional fees as are paid us for overtime work, extra traveling expense, and incidental items.

Last year our service expense was roughly divided as follows, considering our total expense as 100 per cent:

Executive control (service manager and clerical assistant)...	22.7%
Inside men (service stock clerk, refinisher, inside mechanics and testers)	20.6%
Warehouse expense	7.6%
Salaries, outside service men...	29.3%
Traveling expenses, overtime, etc.	3.8%
Automobiles	16.0%

Considering our total revenue as 100 per cent, our service department income was derived from the following sources:

Income from installation fees...	63.0%
----------------------------------	-------

Two years ago, Griffin's service department operated at a loss. He changed the policies and last year showed a small profit.

"But still I'm not satisfied that my service department cannot be made to pay more," he states. What he is going to do next and how he's going to do it should prove extremely interesting to every retailer.

Income from service costs.....	28.8%
Miscellaneous revenue	3.2%

It is to be noted that the above figures are for last year, when we operated under improved conditions, and showed a small profit. Figures for two years ago are not available in such detail, and in view of subsequent changes, would not be particularly illuminating, if offered.

THE principles upon which we operated our service department two years ago—and showed a loss—were in general as follows:

A week's free trial on any set sold and no charge for installation if set was returned or exchanged for another.

A charge of \$10 for installation on all sets sold.

Six months unqualified free service after installation, regardless of cause of complaint.

Service calls after expiration of free service period at the rate of \$1.50 per hour, charging only for the time our man was actually at the home of the customer.

A sincere attempt on our part to visit the customer's home at the time most convenient to him, involving much overtime and night work at no extra cost to the customer.

No refusals of calls for service work, notwithstanding that we were convinced that many of our so-called customers were service cranks and undoubtedly imposing on us.

Frequently our installation charge was waived on special sale sets, offering the bait of free installation as an attraction to buy.

Aerial material was included as part of the installation fee.

After one year of this policy our books were balanced and we found the results of the policy just set forth to be that our service expenses had been slightly more than double our service department

ment income. In other words, our service department ran many thousands of dollars behind and materially reduced our margin of gross revenue.

THE next year many reforms and changes were instituted:

Our week's free trial was continued but our usual installation fee was collected even if the set was returned, and an additional fee charged if the set was changed.

Our installation fee was increased to \$15 on sets installed outside the city.

Our period of free service was reduced from six months to thirty days. Most real defects develop in the first few weeks, and no longer were we obliged to give free service on run down batteries and similar matters.

Our charge for service work was increased from \$1.50 to \$2 per hour, with a minimum charge of \$2 for all calls, time charged for including traveling time to the customer's home.

Except in cases of the utmost importance we constantly declined to make definite appointments other than to promise either the morning or afternoon of a given day. This change alone more than doubled the work turned in by each service man. Night work was charged for at double rates, and proved to be seldom necessary.

A definite refusal on our part to accept further service work from customers who had proved unreasonable in their demands.

Not one set was installed by us unless installation was paid for, regardless of the fact that frequently only an inside loop was

required. We maintain this policy religiously, whether the set sold retails at \$50 or \$1,500.

When an outside aerial was required we made an additional charge of \$3.50 for aerial material.

As a result of the year we showed an increase in set sales of just short of 30 per cent over the previous year, indicating certainly that our strengthened service policy had not cost us business. Our total service cost was 18 per cent higher than the year previous, but our total income from service work exceeded our total cost by about \$600. This, you will recall, is contrasted with a loss of several thousand dollars for the year before.

In March, 1927, we handled more than twice as many requests for service as in the same month a year previous. This year 78 per cent of these calls were charged to the customer at our regular rate, whereas a year ago, we were able to charge for only about one-third of all the calls made.

This complete shift in our service policy was not easy to make, and we had many difficulties and prejudices to overcome. I ascribe our success more than anything else to the fact

that once we had decided what should be done, we stuck to our policy through thick and thin. Early in the season we had a written guarantee prepared, telling the customer in very plain words just what this policy was and just what we would and would not do. No set was accepted by our service department for installation until the salesman had provided the service manager with our customer's signature indicating that he had been furnished with our written guarantee.

I have related the facts here written to some dealers personally, and they have expressed some amazement at our ability to attain what they have styled the ideal in service; namely, a service department that actually pays its own way.

IAM not, however, at all satisfied that we have plumbed the depths of what service can be made, and the real function it should play in the conduct of a radio store. This year, we will try out a new plan. Definitely, *we are going to make our service department produce sales.*

I am inclined to think that most of us scoff at the opportunities which service calls present to us. At least a half a dozen house-to-house canvassers call each week at a customer's home and can't get an audience, much less admission. Probably more than a dozen direct-mail selling pieces come to the same home every week and are thrown in the waste basket, most of them unopened. Through his service department the radio dealer is literally invited to enter these same homes and stay as long as is necessary. Any door-to-door canvasser knows that once the entrance is made the sale is half completed.

THE service department of a radio store should be looked upon as a definite and reliable part of the sales force. The service man has a select group of prospects to work on; he has a group which has shown its interest in radio by already investing money in it. The service man has an intimate knowledge of what's new in radio. He knows what to recommend and sell to correct the faults common to radio reception. But what is most important—he has access to the prospective buyer.

There are many other possibilities in connection with selling through the service department. Almost every store will have its own particular line of approach which best suits its organization and personnel. At Haynes-Griffin this fall we are

Please turn to Page 76

This guarantee is valid only on radio sets installed and used in metropolitan New York and immediate suburbs

CONDITIONS OF SALE: No. 420

This Guarantee Tells You What You Are Entitled to from Haynes-Griffin

Please Save It

In order to avoid misunderstanding, salesmen are required to call the attention of the radio purchaser to the following conditions of sale and guarantee. The attached coupon to be signed by the customer is merely our salesman's receipt that he has furnished you with a copy of this guarantee.

1 You are entitled to

ONE WEEK'S FREE TRIAL

on the receiving set and accessories selected. Within one week after purchase, the set may be returned to us either for cash refund, credit or replacement by some other set, at your option. This trial privilege applies to all sets, regardless of make or price.

Obviously, however, it is impossible for us to allow credit or refund on any charges made by us for labor covering installation by us, or for material used in erecting an aerial. This is the sole exception to our unqualified offer of one week's free trial.

2 Following the period of One Week's Free Trial we continue to guarantee radio sets furnished by us to be free from defects in material and workmanship.

If any defects develop within the set manufacturer's guarantee period, provided the merchandise has not been tampered with, we

agree to repair the set satisfactorily or at our option to replace it with another of the same make.

3 For thirty days following purchase, our service department is at your disposal without charge.

Upon request an experienced radio repair man will call at your home to correct any defects which become manifest, or make such adjustments as are sometimes necessary, due to peculiar local receiving conditions. This Free Service at your home does not include service on breakage or defects due to care-

lessness or abuse of the set or accessories by the customer.

The above mentioned Free Service for thirty days is extended, of course, only on such sets as were originally installed by our own service department.

4 All service calls or inspection made at your own home after thirty days from purchase are charged for at the rate of \$2.00 per hour, including traveling time.

We are unable to make any exceptions to this rule regardless of circumstances, and all guarantees furnished by us are subject to this provision. Replacements or repairs necessary under our

general guarantee as outlined in Paragraph Two are made free only on the basis that the material in question is brought to the store from which purchased, and not called for or delivered by us.

Service guarantee issued by Haynes-Griffin which eliminates all confusion in the customer's mind as to what he will get in the way of service.

Are We on the Verge of

New Developments

in Radio Reception?



*Dr. Frederick K. Vreeland**

Frederick K. Vreeland, independent inventor, who made the super-heterodyne circuit possible, says the old order always gives way to new methods—believes improvements are coming

WHAT are the possibilities of developing new methods of radio reception? Are brand new circuits possible—circuits entirely different from, and independent of, those in use at the present time? Are new discoveries in the methods of radio receiving imminent?

Knowing that the radio industry is vitally interested in these questions, the editors set out to learn if it were possible to find the answers.

We proceeded on the assumption that, as new circuits have been developed from time to time in the past, therefore it is logical to assume that new, patentable circuits will be developed in the future.

We remembered that Prof. Pupin once said that basic invention was rare—that the mathematician-physicist rather than the laboratorian on the development side, would be responsible for new progress in the radio art.

We browsed around first in our own files, seeking to discover whether some practical light could be thrown on the subject by actual developments in recent years. Finding nothing of very great importance there, nothing

By WILLIAM C. ALLEY

that could be construed as recent practice, we turned our attention to the old electrical history files of the McGraw Book Company, in the belief that possibly some theorist, delving into the mysteries of the art, might furnish a clue that would aid in answering the questions that were uppermost in our minds.

After many hours of searching, and reading thoroughly the books we could find on the theory of electricity as applied to wireless, we came across one that looked exceedingly interesting. Its title was "Maxwell's Theory and Wireless Telegraphy," and it was published in 1904 by the McGraw Book Company. It was claimed to be the first American treatise on this subject and was written at a time when merely a handful of scientists theorized learnedly about "ether in the air," and radio as a popular industry was unknown.

In its pages were predicted many things concerning radio, unheard of then except in theory, which are today, standards of practice in radio telephony.

The author put Maxwell's abstruse mathematical theory into words of one syllable, gave a clear explanation of how radio waves travel, and showed the difference between the free waves of Hertz and the grounded waves of Marconi—the very thing the short-wave enthusiasts are wrestling with today. He discussed the mysterious effect of daylight on radio transmission and showed that it is due to ionization of the upper air under the influence of the ultra-violet rays of the sun—the explanation which we now know to be correct. (This is believed to be the first publication of this theory in print.)

He showed how much better it was to receive by ear with a telephone than to tinker with the coherers and relays that were then almost universal, and described the Electrolytic Detector, which every operator of pre-crystal days will remember. He analyzed the weak points of the spark system of radio, then the accepted thing, pointed out the enormous advantages of continuous waves—if a way could be found to produce them—and pointed the way by forecasting the regenerative oscil-

*Frederick King Vreeland, M.E., A.M., Sc.D., scientist and physicist, has a long list of achievements in radio invention to his credit. He has won the degrees of M.E. and Sc.D. at Stevens Institute of Technology (1895), and A.M. at Columbia University, (1909). He is a Fellow of the American Institute of Electrical Engineers, Institute of Radio Engineers, American Association for the Advancement of Science;

member of Tau Beta Pi, Sigma Xi, New York Academy of Sciences, Franklin Institute of Philadelphia. His long list of patents include the electrolytic detector, Jan. 24, 1905; sine-wave oscillator, Aug. 28, 1906; "beats" receiver, the basis of the heterodyne and super-heterodyne circuits, Sept. 11, 1917, and June 30, 1925, applications filed Jan. 2, 1907; and other important electrical and radio patents.

lator, which is the rock foundation of present day radio. Tradition says that he got the clue by watching the intermittent fountain in Union Square in New York City.

The author of this interesting pioneer volume on radio was Frederick K. Vreeland.

The name awoke, at first, only a dim recollection of an old-timer in wireless telegraphy; somehow in the records, this name appears with Marconi, DeForest, Armstrong, Alexander, Pupin and others who have become identified through the years with the development of radio as it is today.

Then, the full significance of the name flashed into mind. It was Frederick K. Vreeland, we remembered, who invented and patented the "beats system" of radio reception, or, in other words put the heterodyne into the super-heterodyne circuit, who actually made the regenerative oscillator that was predicted in the book mentioned above, and in 1906 obtained the "beats" patent that covers every broadcasting station and tube transmitter of the present day; and who has licensed the Radio Corporation of America for its use.

Here we thought, is the ideal man to answer those questions we had in mind about new circuits. Editors have a habit of asking questions. In fact, if there were no editors, the question and answer business would probably die out completely. We asked David Sarnoff a few questions last month about the Radio Corporation and its patent policies, and he answered them, we thought, very fairly and honestly.

WE DECIDED to risk a journey out to Dr. Vreeland's laboratory in the Electrical Engineering Building at Stevens Institute of Technology and see what a real old-time radio inventor had to say about the patent situation in the radio industry.

We had previously asked a few questions and learned that Dr. Vreeland is one of the few recognized authorities in the technique of radio who maintains an independent laboratory. He prefers to play a lone hand and has never become affiliated with any one company. His laboratory at the University adjoins the historic laboratory of Professor Hazeltine, where the neutrodyne principle was developed.

We discovered that he patented the electrolytic detector in 1905, the Sine-wave oscillator in 1906, the "Beats" or super-heterodyne circuit in 1917 and 1925, the carrier wave multiplex system in 1916 and 1917, which permits the sending of a number of non-interfering signals over the same wire, and other important inventions.

We found Dr. Vreeland on the verge of departing for his camp in the Adirondacks, with his mind more on the delights of a mountain vacation than on radio patents. But we

"A CONSPICUOUS feature of popular radio progress is the prevalence of fads and fashions," says Dr. Vreeland in this article. "The fashion of today seems to be the only thing worth considering. Tomorrow, this is discarded and another fashion takes its place."

Is this true of present methods of radio reception? Will new circuits arise to take the place of those in use today?

started asking our questions anyway.

"Dr. Vreeland," we began, "you're an independent inventor, aren't you? You understand the situation concerning patents in the radio industry, don't you? And, as an independent inventor, will you answer a few questions about radio patents?"

"Now, just a minute," he answered. "Not so fast, please. You're putting me in a rather delicate position. I am in fact independent, not being associated with any commercial radio manufacturer. I have enjoyed in the past, and I desire earnestly to retain friendly relations with both sides of the controversy. The delicacy of my position is increased by the fact that some of the major parties in the controversy are licensees under certain of my basic patents."

"Well, now Dr. Vreeland," we began again, in our best attorney-for-the-prosecution manner, "you read those articles and editorials about radio patents in our August issue, did you not?"

"Yes, I did," Dr. Vreeland answered. "Your editorial, the one headed 'Patents and Progress,' you will remember, impressed me by its fair and impartial analysis of the present situation and by its wise forecast of the future. . . . Mr. Alley, I'm going to answer your questions

and I shall try to be as fair and impartial as you have been."

"Thanks," we said modestly. "All right—here's our first question: 'Are the independent manufacturers justified in condemning the Radio Corporation of America for not licensing every applicant?'"

"As you yourself pointed out last month," Dr. Vreeland answered, "no one can deny the principle of law which gives an inventor the right to enjoy an equitable monopoly of his invention. But when a situation arises that puts in the hands of a single power, a group of patents that appear to dominate an entire industry, vitally affecting the interests of many parties representing an investment of untold millions of dollars, the owner of this monopoly carries on his shoulders a responsibility involving difficult problems of ethics and far-reaching economic consequences. I cannot attempt to solve these problems and that is one question on which I am glad I do not have to make the decision."

"But, Dr. Vreeland," we said, "since the independents have contributed so much in recent years to the commercial progress of radio and the development of the radio frequency circuit, aren't they entitled to some consideration?"

"It is an old saying, Mr. Alley, that necessity is the mother of invention, and to-day the independents are clearly face-to-face with a dire necessity. If a thing *must* be done, it can be done—and if it can be done, *someone will come along and do it.*"

HAS anyone done it yet, Dr. Vreeland?"

"Yes, I believe so," was the startling answer. "In the present instance, invention has already anticipated necessity. A conspicuous feature of popular radio progress is the prevalence of fads and fashions. The fashion of today seems to be the only thing worth considering, for the time being. Tomorrow this is discarded, and another fashion takes its place. Sometimes we think today's fashion is the ultimate and essential end. Tomorrow we learn that it is far from being the ultimate and is not really essential. While the crowd is following popular fads there are always a few pioneers who do not follow the beaten track, but work quietly in their laboratories, blazing new trails

(Please turn to page 76)

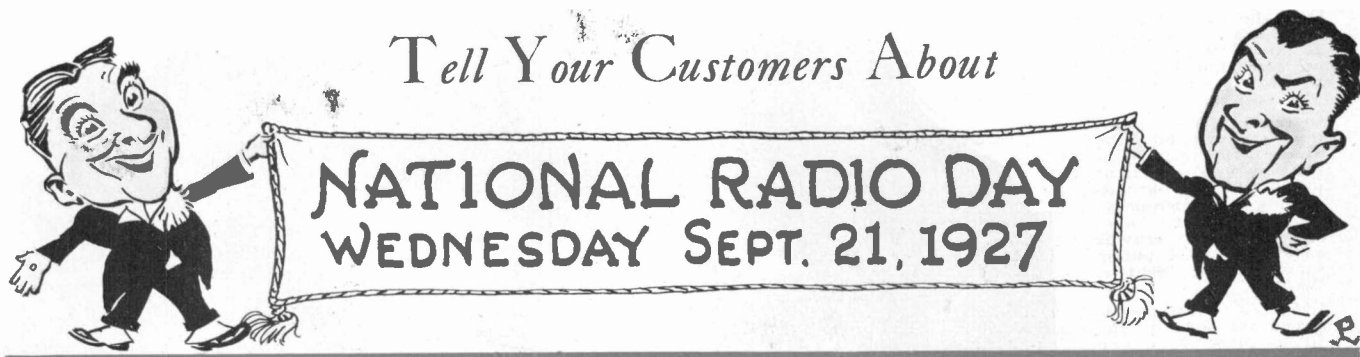

Window Displays

Will HELP

Try for One of the Seven Prizes in "Radio Retailing's"
\$100 Window Display Contest

THE radio industry's first National Radio Day has been set by the Fourth Annual Radio Industries Banquet Committee for Sept. 21.

The entire week of Sept. 19 to 24, which is Radio World's Fair Week in New York, will lend itself to exploitation. Programs of great interest will be broad-

cast throughout the entire week from Madison Square Garden, New York, where the Radio World's Fair will be held; the program from the Radio Industries Banquet, always of outstanding public interest, will be broadcast the evening of National Radio Day, the 21st; and the Dempsey-Tunney championship bout is scheduled for Thursday evening, the 22nd.

Details of the Contest

Any retailer who sells radio is eligible to compete.

The window must display, prominently, the words "National Radio Day, Wednesday, September 21st."

A photograph of the window must be in *Radio Retailing's* office on or before October 1st, 1927.

The name and address of the dealer must be written on the back of the photo.

Entries should be addressed to the Window Display Editor, *Radio Retailing*, 36th Street and Tenth Avenue, New York City.

The envelope should contain a piece of cardboard to prevent creasing or cracking the photograph.

Seven prizes for the best displays will be awarded as follows: first prize, \$50; second, \$25; and five prizes of \$5 each. In addition, any entries that do not win prizes, but are deemed worthy of publication, will be paid for at the rate of \$3.

NATIONAL RADIO DAY can be made the subject of many striking window displays from now until the 21st. To further the preparation of such windows, *Radio Retailing* is offering its readers \$100 in prizes for the best displays featuring National Radio Day.

Tell It to Them Through
Window Displays—

Feature the
National Radio Day Idea—

Get In on
Radio Retailing's Contest

On the evening of Thursday, September 22, the Dempsey-Tunney championship bout will be broadcast. Merchandise it.

On the opposite page, top, is shown how the Sunset Electric Company secured excellent publicity by broadcasting the Dempsey-Sharkey fight last July, to the crowds assembled in a public square at Seattle, Wash.

Center, a typical newspaper ad, used by the Bryn Mawr Radio Shop, Chicago, Ill., to advertise the big bout via radio.

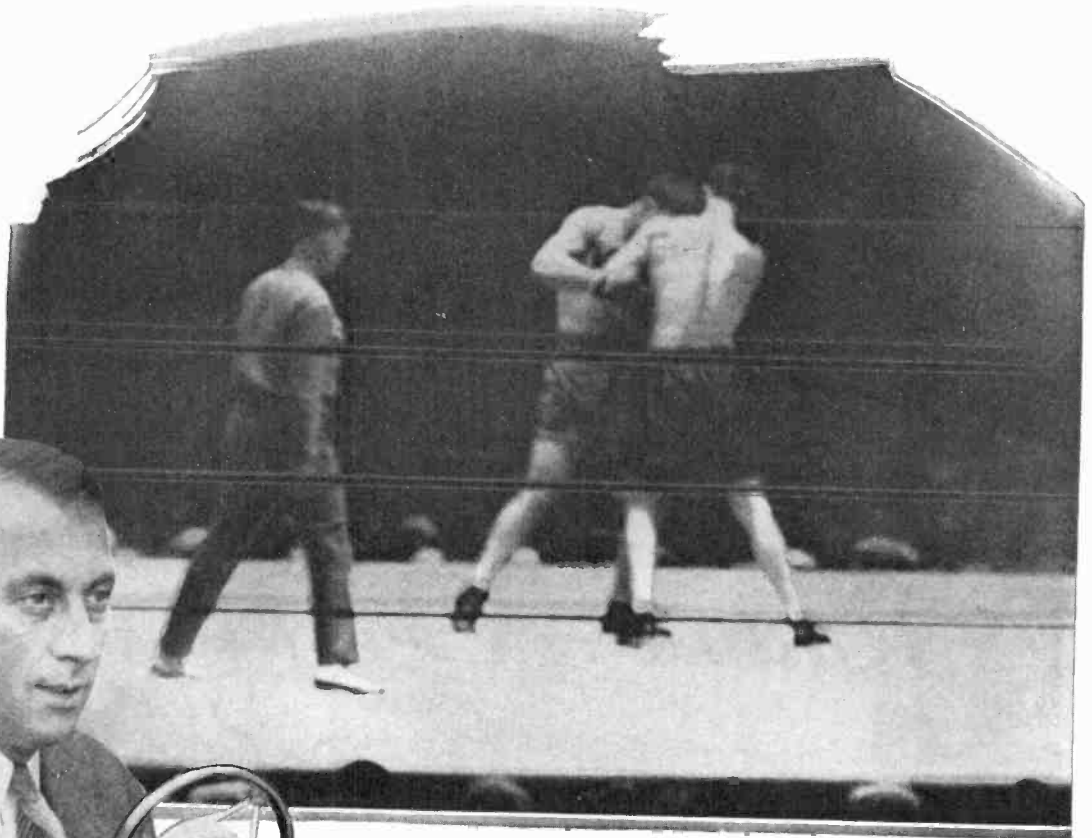

Graham MacNamee broadcasting the Dempsey-Sharkey fight.

The BIG *Let It* Work

A CHAMPIONSHIP bout is generally admitted to be one of the most powerful stimulators of public interest in radio. Dealers everywhere report a mad scramble for last-minute servicing, for new batteries and tubes and even for complete receiving outfits, just prior to a championship affair.

Let's prepare this time to cash in 100 per cent on this month's Tunney-Dempsey fistic argument by "starting something" a week or ten days in advance of the actual encounter. You will not only materially increase the total sales, but you will ease up the last-minute peak load.

Start your advance publicity now for the Dempsey-Tunney fight—September 22—and you won't have to turn cash customers away at the last minute. How dealers merchandised the Dempsey-Sharkey bout

A number of radio dealers took time by the forelock when Dempsey and Sharkey fought it out and were highly pleased with the business which resulted. Irving Zuelke, Appleton, Wis., started his newspaper

copy a full week before the "Manassa Mauler" staged his comeback. "Only Six More Days Before the Big Fight" ran the first heading. The following day the advertisement was worded "Only Five More Days Before the Big Fight." This copy idea was continued right up to the day of the fight.

Zuelke not only had a radio speaker in operation in front of his store that night but saw to it also that the local newspaper and the Elk's Club were provided with the proper receiving apparatus. Each set carried a card reading, "This radio set furnished by courtesy of Irving Zuelke."



FIGHT

For You

Get Ready Via Radio
**Dempsey and
 Sharkey Fight**
JULY 21
BRYN MAWR
Music & Radio Shop
 2102 East 71st Street
 Near Clyde
 Fairfax 3379

An oil cloth sign, fastened on the back of the delivery automobile of the Bryn Mawr Music and Radio Shop, Chicago, Ill., brought definite "fight" business to its store in a steady stream for two weeks preceding the July 21 encounter, according to Ed. Walsh, its owner. It read:

Dempsey-Sharkey Bout—July 21
 Expert Service

Is Your Radio OK?

BRYN MAWR MUSIC AND RADIO SHOP
 Tel. Fairfax 2379

"I was unable to take care of at least sixty per cent of the business that poured in on me the day of the

Dempsey-Firpo fight but, due to these precautionary measures, I handled a seventy per cent increase this year without difficulty," he declares.

"Scoop your competitors," advised the Sterling Radio Company, Kansas City, Mo., in a pre-fight letter to its dealers. It suggested the following methods:

1. A "fight special" window poster.
2. Loan of a set and several speakers to the local theater together with a slide reading: "This radio service furnished through courtesy of the Blank Radio Company."
3. Get the theater to advertise this special attraction for a week in ad-

vance and to give proper credit in its copy to the radio dealer.

4. Place handbills nightly in parked automobiles.

5. Telephone or write your best customers and offer to inspect their sets without charge if they will give you a tip on a fight fan who could use a little attention from a radio man.

Don't miss this golden opportunity to register your store as a radio headquarters because of the lack of just a little foresight. The experience of alert dealers proves that advance promotional efforts will double the fight business.



Selling

That

13

Here's a dealer who considers his business a PUBLIC SERVICE and sells on that basis

Dealers Who Have Made Radio Pay—No. 9

“THERE is only one thing a radio dealer sells, and that is service—servicing the set will give to its owner, and service the dealer will give to the set.”

We are quoting Gordon Ische of 4709 Center Street, Milwaukee, Wis., a dealer with five years' experience in radio. A man who, from July, 1926, to July, 1927, grossed \$46,000 in sets and accessories and cleared 13 per cent net exclusive of his own salary.

This dealer specializes in both kinds of service: He talks what radio will do—and demonstrates it on quality sets to quality folks in a quality neighborhood; and he follows this up by a specific and sales-producing service policy.

Until July, 1926, it was a one-man struggle to make both ends meet—then he got down to business. From then on he adopted *fixed policies*. They were—and are:

Sales: Feature tonal quality and the wealth of interesting programs available.

Feature the reliability of the sets.

Service: Grant a 90-day free service guarantee. After that give extremely moderate flat rate charges.

This service policy means that the purchaser will *know* in

By RAY V. SUTLIFFE

advance exactly what it will cost him for servicing. He knows, for example, that it cannot cost him more than \$2 for labor, even when it is necessary to bring the set to the store for attention. The flat-rate servicing policy has attracted and held countless customers for the Ische Brothers Radio Shop.

Those, in brief, are the policies. How do they work out in actual practice?

WELL LOCATED STORE

The concern is located in one of the best residential districts of Mil-

Ische Makes a Net Profit of 13 Per Cent on Selling Service Because:

He handles only the best makes.

Stresses the reliability of the sets.

Gives a 90-day free service guarantee.

Features a \$1 flat-rate service charge thereafter.

In short—because he SPECIALIZES IN SERVICE.

waukee. It has approximately 90,000 well-to-do persons within a radius of three miles from the store. These people want results in radio and are willing to pay a fair price. Ische therefore, adapted his policy to fit local conditions. He does not stock low-priced sets. He always gets his price—which is the manufacturers' suggested list—or no sale. That, also, has strengthened him with the clientele he serves.

His average sale totals \$240. This means that the goods he carries are of such quality that he is able to give the very best possible demonstration either at the store or in the home, and that nowhere will his prospects hear better reproduction quality.

“When a prospect steps into the store I size him up,” he says, “and ask him frankly what it is about radio that he is particularly interested in. I try to obtain an admission that it is tonal quality. Then I talk tone. I bear down on it, never getting very far from the subject. The majority of my sales include a large separate-unit speaker.

Concerning selling style, he says, “In presenting the higher-priced sets, care should be exercised that there is no apparent attempt to ‘force the sale.’ This is invariably resented. It is

Methods

Net

Per Cent

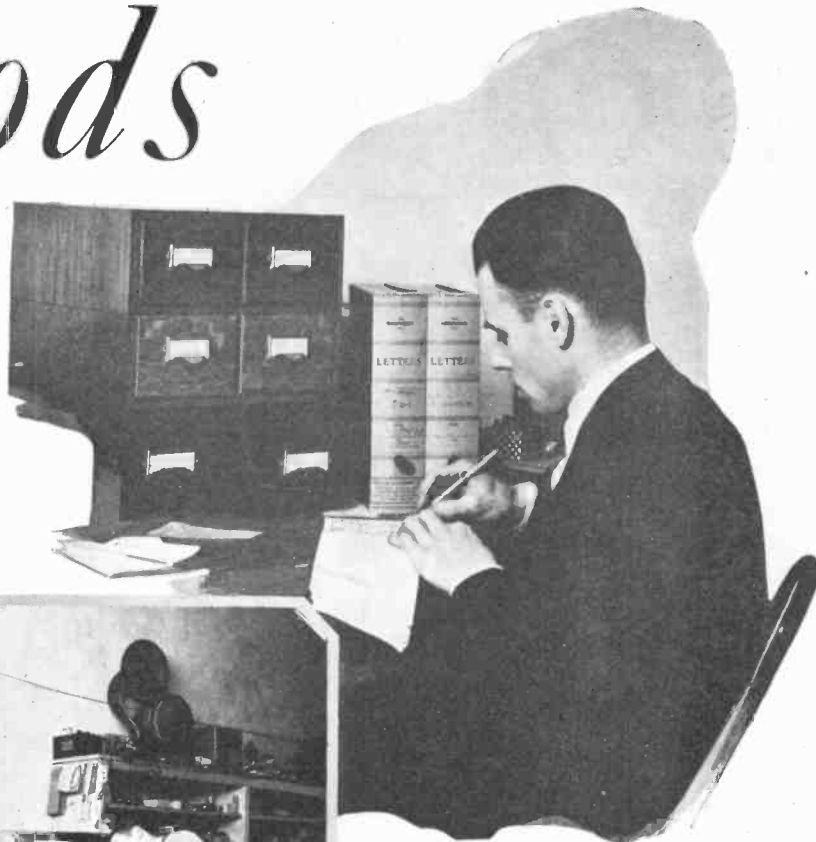

This six-drawer card file contains these records: Salesman's prospects; future calls; general prospects; sales; service pending; service completed.

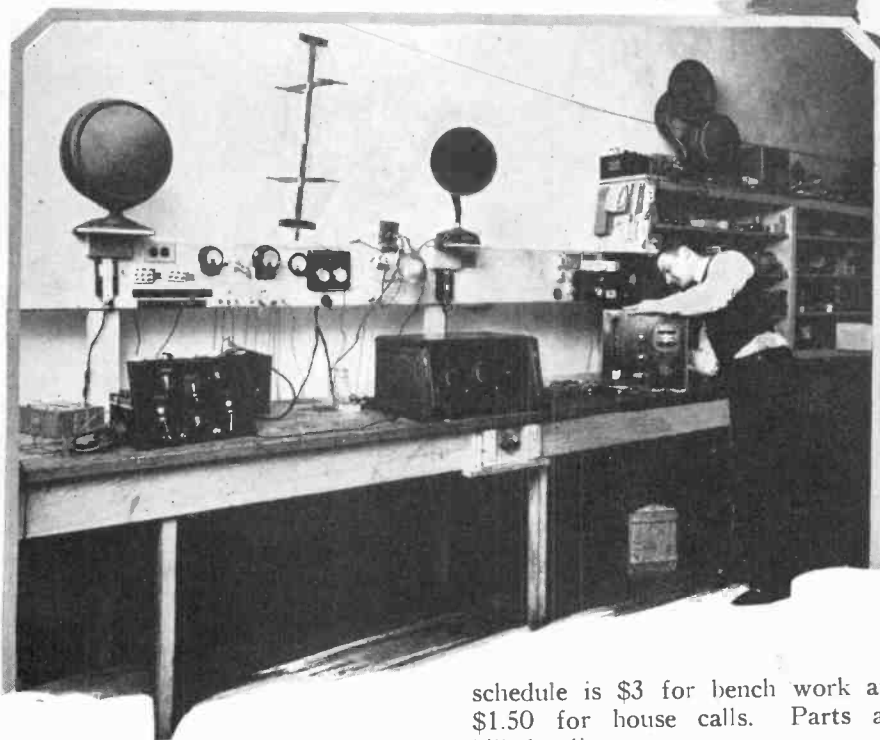

not in good taste with people who are buying an article for entertainment purposes. Such a sale should be conducted rather in a natural atmosphere of easy, good-natured frankness as befits the nature of the product being sold. I have found this attitude very helpful."

BECAUSE this firm gets its price for each installation, it can afford to feature low service rates. At the expiration of the 90-day free service period a flat charge of \$1 per call is made, *regardless of the nature or amount of work performed*. If shop work is necessary the fee is \$1 to get the set and \$1 to return it. For those who purchased sets elsewhere, the

schedule is \$3 for bench work and \$1.50 for house calls. Parts are billed at list.

"I do not lose money on this flat-rate basis. Here's why," says Ische. "Each set is tested and put in perfect shape before it leaves the store. The time required to service a set in the home, therefore, rarely exceeds one hour. My service man can make eight calls a day. These calls will total, at minimum rates, \$8 plus twice as much again in the sale of parts and accessories. Naturally, some jobs take longer, but the average is more than a 'break-even' proposition. This fee sounds exceedingly attractive to the customer but it produces an income during the busy season of over \$250 a month.

"The word-of-mouth advertising that this plan produces accounts, I

am convinced, for 35 per cent of my new set business. What do neighborhood people talk about when they get together? Radio is certainly one of the major subjects discussed. This is what they say in effect—I know for a fact—about Ische Brothers: 'The set I bought from that firm is as good as any I have heard (because I sell no cheap lines whatsoever) and his service is prompt and ridiculously inexpensive.'

"This word-of-mouth advertising is invaluable to the neighborhood dealer. It means that I spent but \$700 for paid advertising during the past twelve months and yet from October to February I sold, on the average, a set a day."

Despite the fact that Ische did a \$46,000 business, he seldom ties up more than \$3,000 in stock at any one time. One or two sets of each type is all he requires. Local jobbers with one-day delivery do the rest. This means that the set the customer sees and hears on the salesroom floor is the set he gets. It also means low depreciation losses.

Up to September, 1926, his business
(Please turn to Page 97)

FOREWARNED

Editor's Note: Ernest J. Downing runs a prosperous fruit farm four miles west of New Madison, Ohio. What he thinks about the commercial value of radio to the farmer is here told in his own language.



RADIO'S first big dividend to the Downing family was a saving of 20 per cent of the apple crop; a saving sufficient to pay for the set many times over. And this is only one incident in a distinguished record of dollar saving and dollar making performances which has made Ernest J. Downing consider his purchase of a radio set the wisest and most profitable investment he ever made.

Radio became a member of the Downing household last December. It was purchased to entertain a member of the family, confined by illness to the monotony of a fruit farm

home. Valuable as that humanitarian service is, even more important is its utility in bringing in weather reports and market information. Each morning at nine finds the receiver tuned to WLS, Chicago, and each evening at the same hour to KDKA, Pittsburgh, for the information which is the guiding hand on the Downing farm.

THE first and the most valuable contribution made was a weather forecast which came through WLS last spring. It is a splendid example of what radio can do for any farmer, whatever his specialty, if he intelligently takes advantage of the information which it makes available to him.

"It was the time for applying spray to apple trees," explained Mr. Downing. "The first day a very high wind was blowing, making the job of spraying next to impossible. And so it was with the next day and with the next. Without radio, we would have postponed spraying from day to day until the few days in which this all important first spray can be applied effectively would have slipped by. But the radio forecast saved us. It said 'continued high winds followed by a considerable period of rain.' The spray, to be effective, must be applied before rain comes. So, forewarned by radio, we undertook the job in spite of the unfavorable conditions. We made a thorough and painstaking job of it.

"It did continue to blow and then



By Radio!

rained just as predicted. We certainly would have missed the spray had it not been for the radio. Though there is no way to determine exactly what we gained, we do know that we had the cleanest, finest apples we ever grew. If that spray saved an extra twenty per cent of the fruit—and it is no more than reasonable to believe that it did—then that one weather tip was worth the price of at least four five-tube radio sets.”

“**H**ERE’S another example: A few months later WLS said, ‘Southwest winds of hurricane force are expected within the next twenty-four hours.’

“This warning came when the apple trees were bending under a tremendous crop of fine fruit. My father and I hurried to the woods and cut props and thoroughly propped the limbs. We paid special attention to the trees on the south and west sides of the orchard. When the

blow came, it broke only a few branches. We had been forewarned again by the trusty radio.

“The cold snap found our apples well covered and protected in the shed. We do not expect blizzards to slip up on us and find us unprepared this winter either.

“Usually we lose some hay-alfalfa by getting it wet. This season we watched the general weather conditions through the eye of the radio and saved every cutting. Not one load was damaged by rain.

“There is always a risk when preparing soil for seeding, of getting rain before planting is made. We use the tractor several hundred hours every summer. By heeding the forecasts we were able to prepare just the area we could plant before rain came. We did not waste one gallon of fuel this year by having to re-work the fields. This item surely paid for the batteries which make the radio talk.

“The weather forecasts are not the only money making service of the radio. The market reports con-

tribute their share of profits, too, even though we do not produce much livestock. Mother has quite a flock of chickens. Every now and then she made an extra few cents a dozen on a shipment of eggs because she sells or holds them according to market forecasts. In the course of a year, these extra dollars mount up to a tidy sum, another radio dividend.

“**A**LL the Downings are enthusiastic about radio. It pays us to like it. It has come to this farm to stay. And so it would to every farm, if only every farmer knew what it could do for him. But it takes more than just a radio; you have to use the information it brings you to get the fullest advantage from it. We’ve made it a matter of habit to use our radio. It’s a valued member of the family, working for us early and late.

“Nor can we overlook the entertainment it brings; the new cheer which makes life on the farm a joy. In winter, when we have the least to do, the radio works the best. Programs come in from all parts of the country. And in summer, it does the work of a crackerjack hired hand by the aid of its weather reports and market information. We wouldn’t be without a radio on this farm because we couldn’t get along without one any more.”

The new complete line of Radiolas

—led by two custom-built models of the famous tone-perfect Super-Heterodyne



RCA Radiola 10-A—The most popular model in the line. Complete with Radiola and Loudspeaker. \$100.00



RCA Radiola 10-A—The most popular model in the line. Complete with Radiola and Loudspeaker. \$100.00



RCA Radiola 10-A—The most popular model in the line. Complete with Radiola and Loudspeaker. \$100.00



RCA Radiola 10-A—The most popular model in the line. Complete with Radiola and Loudspeaker. \$100.00



RCA Radiola 10-A—The most popular model in the line. Complete with Radiola and Loudspeaker. \$100.00



RCA Radiola 10-A—The most popular model in the line. Complete with Radiola and Loudspeaker. \$100.00

All the available resources of the General Electric and Westinghouse companies in cooperation with the RCA Research Laboratories, have been placed at the service of the radio designer to produce a radio set as well as possible in perfecting radio reception and sound broadcasting.

To meet the demand for the best cabinet sets, RCA offers a limited number of custom-built models, using the famous Super-Heterodyne principle, universally acknowledged as the standard in radio design.

These sets are available in two designs, one accepting the famous RCA Loudspeaker 100 and the other the remarkable new RCA Loudspeaker 100-A.

The new complete line of Radiolas now available includes sets for all methods of operation and all requirements of location. These sets are designed to give the best performance in the studio for the maximum pleasure in the studio.

Every appearance of a complete set is accompanied by the RCA Authorized Dealer for a definite service order.

These Radiolas are the product of the same engineers who have been designed to be representative of the performance in the studio for the maximum pleasure in the studio.

RADIO CORPORATION OF AMERICA
New York - Chicago - San Francisco

RCA Radiola

Big space in newspapers and magazines will be used to advertise RCA products during the last four months of the year. This is the greatest advertising campaign in the history of radio.

RCA Announces a new complete line of Radiolas

—for all methods of operation
—for all requirements of location



RCA Radiola 10-A—The most popular model in the line. Complete with Radiola and Loudspeaker. \$100.00



RCA Radiola 10-A—The most popular model in the line. Complete with Radiola and Loudspeaker. \$100.00



RCA Radiola 10-A—The most popular model in the line. Complete with Radiola and Loudspeaker. \$100.00



RCA Radiola 10-A—The most popular model in the line. Complete with Radiola and Loudspeaker. \$100.00



RCA Radiola 10-A—The most popular model in the line. Complete with Radiola and Loudspeaker. \$100.00

FROM the Research Laboratories of Radio Corporation of America, Westinghouse and General Electric have come these RCA Radiolas and Loudspeakers—the greatest achievements of the radio art.

These tried, tested and perfected receiving sets are individually adapted to the different methods of operation, as well as to the exacting requirements of different locations.

RCA Radiolas set the standard for radio because of their unrivaled perfection of tone and simplicity of operation. They are designed by the same engineers who planned the leading high-power broadcasting stations. They are the finest radio sets that have been chosen for exclusive use by Victor and Brunswick in their latest instruments.

Included in the new Radiola line are dry battery sets, storage battery sets, and, of course, the sets that operate directly from the electric light circuit.

You haven't really heard radio until you have listened to a Radiola and RCA Loudspeaker.

Ask any RCA Authorized Dealer for a definite service order.

These Radiolas are the product of the same engineers who have been designed to be representative of the performance in the studio for the maximum pleasure in the studio.

RADIO CORPORATION OF AMERICA
New York - Chicago - San Francisco

RCA Radiola

The new RCA Radiolas never before so perfect in tone so simple to operate so attractively priced

—led by two custom-built models of the famous tone-perfect Super-Heterodyne

—for all methods of operation
—for all requirements of location

—for all methods of operation
—for all requirements of location

—for all methods of operation
—for all requirements of location

—for all methods of operation
—for all requirements of location

—for all methods of operation
—for all requirements of location

—for all methods of operation
—for all requirements of location

—for all methods of operation
—for all requirements of location

—for all methods of operation
—for all requirements of location

—for all methods of operation
—for all requirements of location

—for all methods of operation
—for all requirements of location

—for all methods of operation
—for all requirements of location

—for all methods of operation
—for all requirements of location

—for all methods of operation
—for all requirements of location

—for all methods of operation
—for all requirements of location

—for all methods of operation
—for all requirements of location

—for all methods of operation
—for all requirements of location

—for all methods of operation
—for all requirements of location

—for all methods of operation
—for all requirements of location

—for all methods of operation
—for all requirements of location

—for all methods of operation
—for all requirements of location

—for all methods of operation
—for all requirements of location

—for all methods of operation
—for all requirements of location

—for all methods of operation
—for all requirements of location

—for all methods of operation
—for all requirements of location

—for all methods of operation
—for all requirements of location

—for all methods of operation
—for all requirements of location

—for all methods of operation
—for all requirements of location

—for all methods of operation
—for all requirements of location

—for all methods of operation
—for all requirements of location

—for all methods of operation
—for all requirements of location

—for all methods of operation
—for all requirements of location

—for all methods of operation
—for all requirements of location

—for all methods of operation
—for all requirements of location

—for all methods of operation
—for all requirements of location

—for all methods of operation
—for all requirements of location

—for all methods of operation
—for all requirements of location

—for all methods of operation
—for all requirements of location

—for all methods of operation
—for all requirements of location

—for all methods of operation
—for all requirements of location

—for all methods of operation
—for all requirements of location

—for all methods of operation
—for all requirements of location

—for all methods of operation
—for all requirements of location

—for all methods of operation
—for all requirements of location

—for all methods of operation
—for all requirements of location

—for all methods of operation
—for all requirements of location

—for all methods of operation
—for all requirements of location

—for all methods of operation
—for all requirements of location

—for all methods of operation
—for all requirements of location

—for all methods of operation
—for all requirements of location

—for all methods of operation
—for all requirements of location

—for all methods of operation
—for all requirements of location

—for all methods of operation
—for all requirements of location

—for all methods of operation
—for all requirements of location

—for all methods of operation
—for all requirements of location

—for all methods of operation
—for all requirements of location

—for all methods of operation
—for all requirements of location

—for all methods of operation
—for all requirements of location

—for all methods of operation
—for all requirements of location

—for all methods of operation
—for all requirements of location

—for all methods of operation
—for all requirements of location

—for all methods of operation
—for all requirements of location

—for all methods of operation
—for all requirements of location

—for all methods of operation
—for all requirements of location

—for all methods of operation
—for all requirements of location

—for all methods of operation
—for all requirements of location

—for all methods of operation
—for all requirements of location

—for all methods of operation
—for all requirements of location

—for all methods of operation
—for all requirements of location

—for all methods of operation
—for all requirements of location

—for all methods of operation
—for all requirements of location

—for all methods of operation
—for all requirements of location

—for all methods of operation
—for all requirements of location

—for all methods of operation
—for all requirements of location

—for all methods of operation
—for all requirements of location

—for all methods of operation
—for all requirements of location

—for all methods of operation
—for all requirements of location

—for all methods of operation
—for all requirements of location

—for all methods of operation
—for all requirements of location

—for all methods of operation
—for all requirements of location

—for all methods of operation
—for all requirements of location

—for all methods of operation
—for all requirements of location

—for all methods of operation
—for all requirements of location

—for all methods of operation
—for all requirements of location

—for all methods of operation
—for all requirements of location

—for all methods of operation
—for all requirements of location

—for all methods of operation
—for all requirements of location

—for all methods of operation
—for all requirements of location

—for all methods of operation
—for all requirements of location

—for all methods of operation
—for all requirements of location

—for all methods of operation
—for all requirements of location

—for all methods of operation
—for all requirements of location

—for all methods of operation
—for all requirements of location

—for all methods of operation
—for all requirements of location

—for all methods of operation
—for all requirements of location

—for all methods of operation
—for all requirements of location

—for all methods of operation
—for all requirements of location

—for all methods of operation
—for all requirements of location

—for all methods of operation
—for all requirements of location

—for all methods of operation
—for all requirements of location

—for all methods of operation
—for all requirements of location

—for all methods of operation
—for all requirements of location

—for all methods of operation
—for all requirements of location

—for all methods of operation
—for all requirements of location

—for all methods of operation
—for all requirements of location

—for all methods of operation
—for all requirements of location

—for all methods of operation
—for all requirements of location

—for all methods of operation
—for all requirements of location

—for all methods of operation
—for all requirements of location

Double page color announcement:
COLEMAN'S SEPTEMBER 17
LIBERTY SEPTEMBER 10
LITERARY DIGEST SEPTEMBER 10
SATURDAY EVENING POST SEPTEMBER 17

Alternating Current or Direct Current Built-In or Separate Loudspeaker Outdoor Aerial or Indoor Loop Storage Battery or Dry Battery

SOCKET POWER OPERATED

from \$69.50 to \$895

BATTERY OPERATED



RCA RADIOLA 32—A special custom-built combination of the famous RCA 8-tube Super-Heterodyne with Loudspeaker 104—the two finest radio instruments ever designed. Operated directly from the electric light circuit—either A.C. or D.C.
Complete with Radiotrons \$895



RCA RADIOLA 17—Operates directly from the electric light circuit without batteries or battery eliminators. This year's outstanding achievement in the radio art. Employs the new RCA alternating current tubes. Tuned with one knob.
Less accessories \$130.00
With Radiotrons \$157.50



RCA LOUDSPEAKER 104—When used with Radiola 28, provides a perfection and volume of tone production that has been a sensation ever since it was introduced.
RCA Loudspeaker 104 (A.C.) \$275
RCA Loudspeaker 104 (D.C.) \$310



RCA RADIOLA 23—For the many who prefer receiver and loudspeaker in separate cabinets, the 23-104 combination is the standard of comparison in the radio art.
Radiola 28, with Radiotrons \$260
A.C. Package for adapting Radiola 28 for A.C. operation with RCA Loudspeaker 104 \$35



RCA RADIOLA 30-A—Custom-Built—A de luxe instrument, employing the same perfected Super-Heterodyne circuit as Radiola 32, but using the new Loudspeaker 100-A. Operated directly from electric light circuit—either A. C. or D. C.
Complete with Radiotrons \$495

THE new, complete line of Radiolas, backed by the greatest advertising campaign ever launched by RCA gives the RCA Authorized Dealer the answer to every buyer's requirements.

These tried, tested and perfected instruments, from the laboratories of RCA, Westinghouse and General Electric, enable the dealer to meet every trade demand under one nationally known trade-mark.

Dealers can best assure themselves of their share of the big Fall business by placing their orders with distributors now.



RCA LOUDSPEAKER 100-A—This refinement of the popular model 100 embodies improvements in construction which give greater sensitivity and ability to handle greater volume \$35.00



RCA RADIOLA 20—The biggest value in radio. Many times as selective as the average antenna set. A battery operated set that can readily be adapted to A. C. operation.
Less accessories \$78.00
With Radiotrons \$89.50



RCA RADIOLA 16—The widest musical range ever achieved with one-dial control. A storage battery set of great compactness. For selectivity, sensitivity and tone quality, it sets a new standard for receivers in its price class. By use of socket power devices, it can be adapted for A.C. operation.
Less accessories \$69.50
With Radiotrons \$82.75



RCA RADIOLA 28—The famous receiving set that brought a new meaning to radio in thousands of American homes. Employs the tried, tested and perfected RCA 6-tube Super-Heterodyne circuit.
With Radiotrons \$260

RCA Radiola

RADIO CORPORATION OF AMERICA ~ NEW YORK ~ CHICAGO ~ SAN FRANCISCO

Make Service Your Stepping Stones to Sales

(Continued from page 54)

expanding on our present system, and instituting what we term our first annual service survey. We are putting into actual practice the "check up every set in town" plan which has been recommended by *Radio Retailing* for many months.

We are starting the ball rolling by writing to everyone who has purchased a set from us, asking them to allow us to inspect their radio set. There will be no charge whatever. The customer is told that we wish to make the inspection simply to bring our records up-to-date as to the condition of his equipment and as to what results and satisfaction he is getting.

A few days or a week later the service man calls at the customer's residence. He inspects the receiver and accessories, and fills out the Service Inspection Report, a copy of which is reproduced with this article. While the form to be filled out has been boiled down to a single mimeographed sheet, I think it will contain considerable information; in fact, just about everything we want to know about the condition of the set, the accessories, as well as whether the customer is satisfied with it.

WHEN the survey is completed, we shall have in our possession accurate, first hand information on nearly 2,000 separate customers. These reports will be carefully read, analyzed and classified. They will be used as the basis of an extensive selling campaign through our service department.

To sum up, then, I believe that the first and most important step for every dealer is to put his service department on a definite pay-its-own-way basis, determining this only on the receipts from services rendered as distinguished from such merchandise as may be sold through the service department. We have done it, thousands of other dealers have done likewise.

But this is not the end of the road by any means. Over and above this, a service department must be made and can be made the chief adjunct to sales. Service men are the shock troops of radio selling. They are constantly in the front line trenches and are daily reaching prospects that no inside salesman ever sees. Make them do their stuff. They will not only pay their own way, but pay yours, too.

New Radio Developments

(Continued from page 66)

into still richer territory. The old order of things must always give place to a new and better way."

"Am I to understand, Doctor, that a 'new and better way,' as you say, has already been developed?"

Dr. Vreeland gazed thoughtfully out the window. "It must be a beautiful day in the Adirondacks," he said.

"Oh, I see," we murmured. "Yes, it must be." . . .

"IN the present situation, as I have already said," Dr. Vreeland went on, kindly, "invention has al-

ready anticipated necessity. It is now known that the principle of 'geometric tuning' is not necessary to the operation of a successful radio frequency amplifier. It is also known that a radio frequency amplifier may be so constructed as to eliminate the principal feed-back couplings, and to make capacity neutralization or balancing unnecessary. It is known as well that amplifier tubes, even high power tubes, may be operated with perfect articulation without a 'C' battery, and with distinct advantages.

"It is well known to radio engineers that faithful reproduction of tone requires the receiver to reproduce, not only the carrier frequency of the waves, but also the full sidebands, embracing a frequency range in the transmitted wave of something between ten and twenty kilocycles. It is also known that a receiver tuned by resonance does not do this. A tuned circuit responds well to a certain single frequency, less well or not at all to other frequencies. It is not the carrier frequency, but the sidebands that give the tone to music and the articulation to a voice. If the

tuning system has reasonable selectivity the sidebands, are seriously trimmed and the tone is distorted.

"It is now known that these defects are not necessary but that we can in fact receive, with full intensity, the entire frequency band of the modulated wave with a sharp cut-off for frequencies outside the band, so that faithful tone reproduction is achieved, from the deepest bass to the shrillest sibilants, without any loss but rather with a gain in selectivity. And these things are accomplished without the use of the patented features now in controversy.

"I feel certain therefore that the present situation need not be the cause of bitterness or acrimonious criticism of a monopoly, for the monopoly does not exist in fact."

Dr. Vreeland would say no more, but his words had given us plenty of food for thought.

SERVICE INSPECTION REPORT	
Inspector _____	Date _____
Customer's Name _____	
Address _____	
Make of Set _____	Model No. _____
Make of Loud Speaker _____	Current (AC or DC) _____
Make of "A" Battery _____	Age _____ Condition _____
Make and Type of Charger _____	
"B" Batteries _____ Condition _____	
Make of Tubes _____ Kind of Power Tube _____	
Condition of Tubes _____	
Type of Aerial _____ Inside () _____ Outside () _____ Loop () _____	
Does Aerial Need Overhauling? _____	
How Many Hours A Day Is Set Used? _____	
Who In Family Uses Set Most? _____	
Would Remote Speaker Be Appreciated? _____	
Has Customer Any Complaint About Selectivity _____ Volume _____	
Quality _____ Noise _____ Charger _____ Life of B Batteries _____	
Has Customer A Phonograph? _____ State Kind _____	
Does Customer Buy Records? _____	
Will Customer Give Names of Other Prospective Customers? _____	

Is Customer Friendly Toward Haynes-Griffin? _____	
What Would You Suggest To Improve Set _____	

Can Customer Be Sold New Set? _____ What Kind? _____	
Can Customer Be Sold Any New Equipment? _____ What? _____	
Remarks: _____	

Report cards Haynes-Griffin's service men must fill out

Radio TODAY Deserves

a Beautiful Setting



CONTRAST the new way, above, with the old way, at the right, and you will see why a cabinet should be sold with every receiver.



Every Radio Home Should

What It Means
to the

DEALER

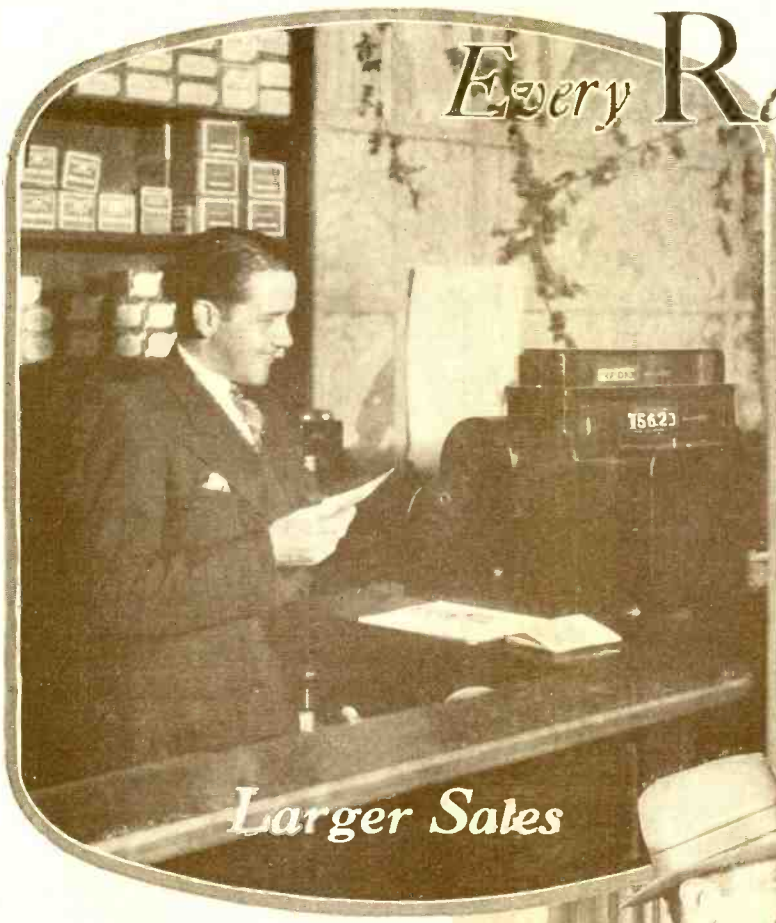

Larger Sales

ARCHITECTS are striving for beauty when they design home interiors. Owners are striving for beauty when they furnish and decorate their homes. Radio should harmonize with its surroundings.

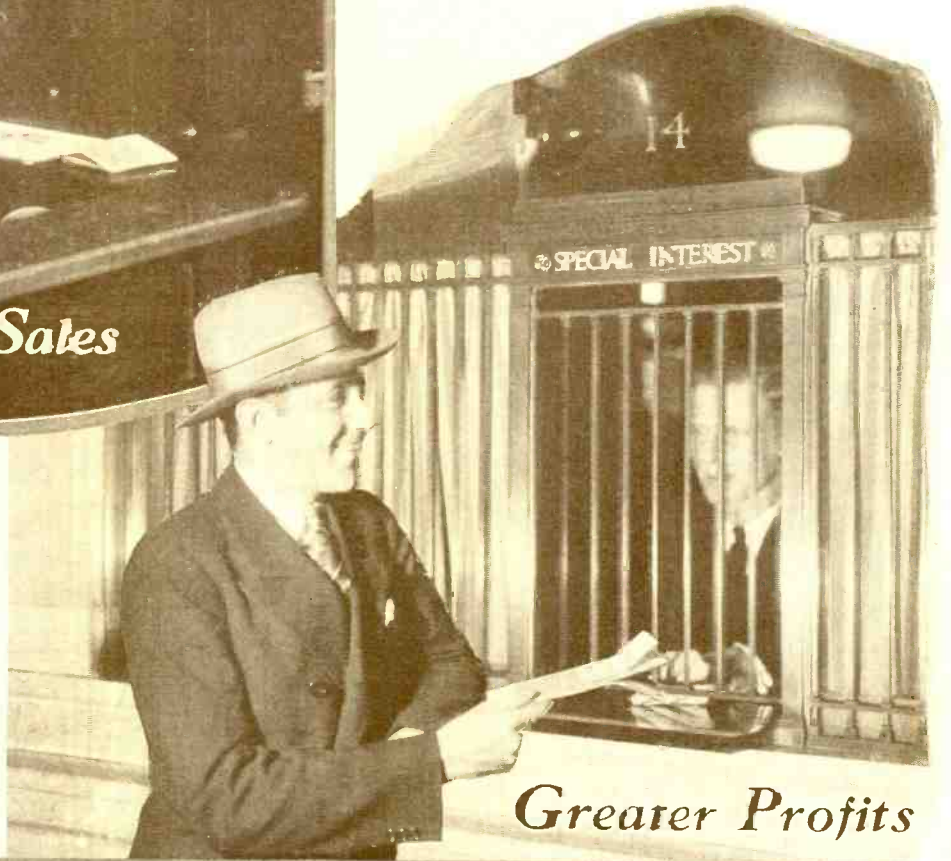

Greater Profits

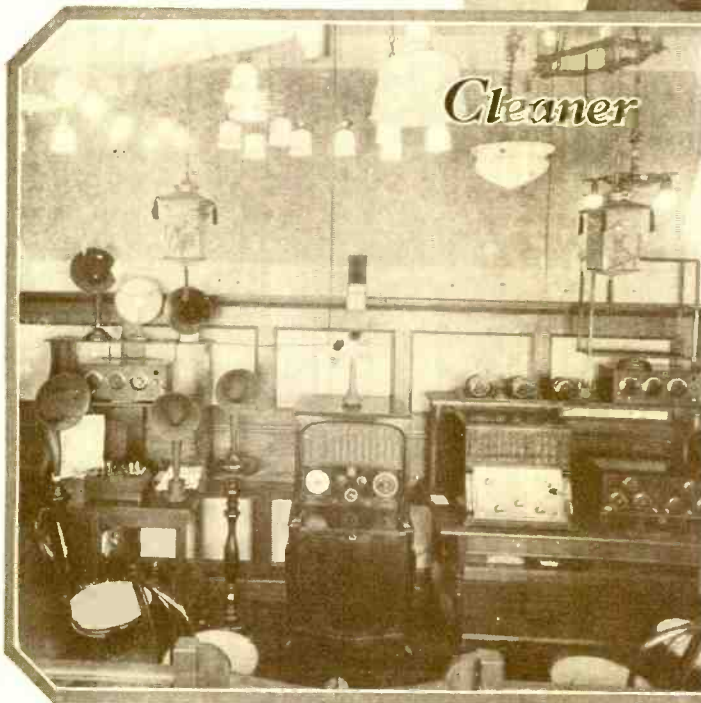

Cleaner



Merchandising

Have An Attractive Cabinet

What It Means
to the
CUSTOMER



Convenience



Beauty



Pride

THE man who owns a radio set likes to show it off to his friends. The receiver should be attractive enough in appearance to make his "pride of ownership" justified.

Set Your Business Sails in the Favorable Wind of Radio Master Popularity

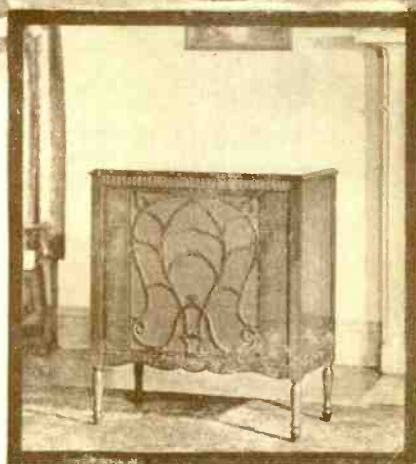
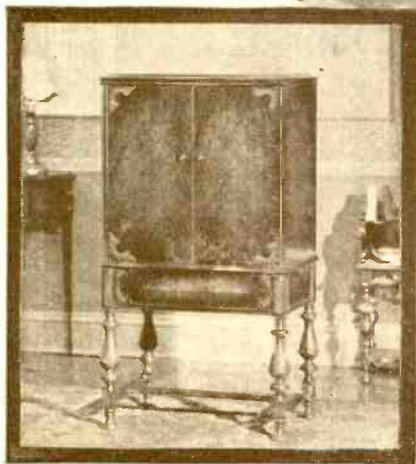
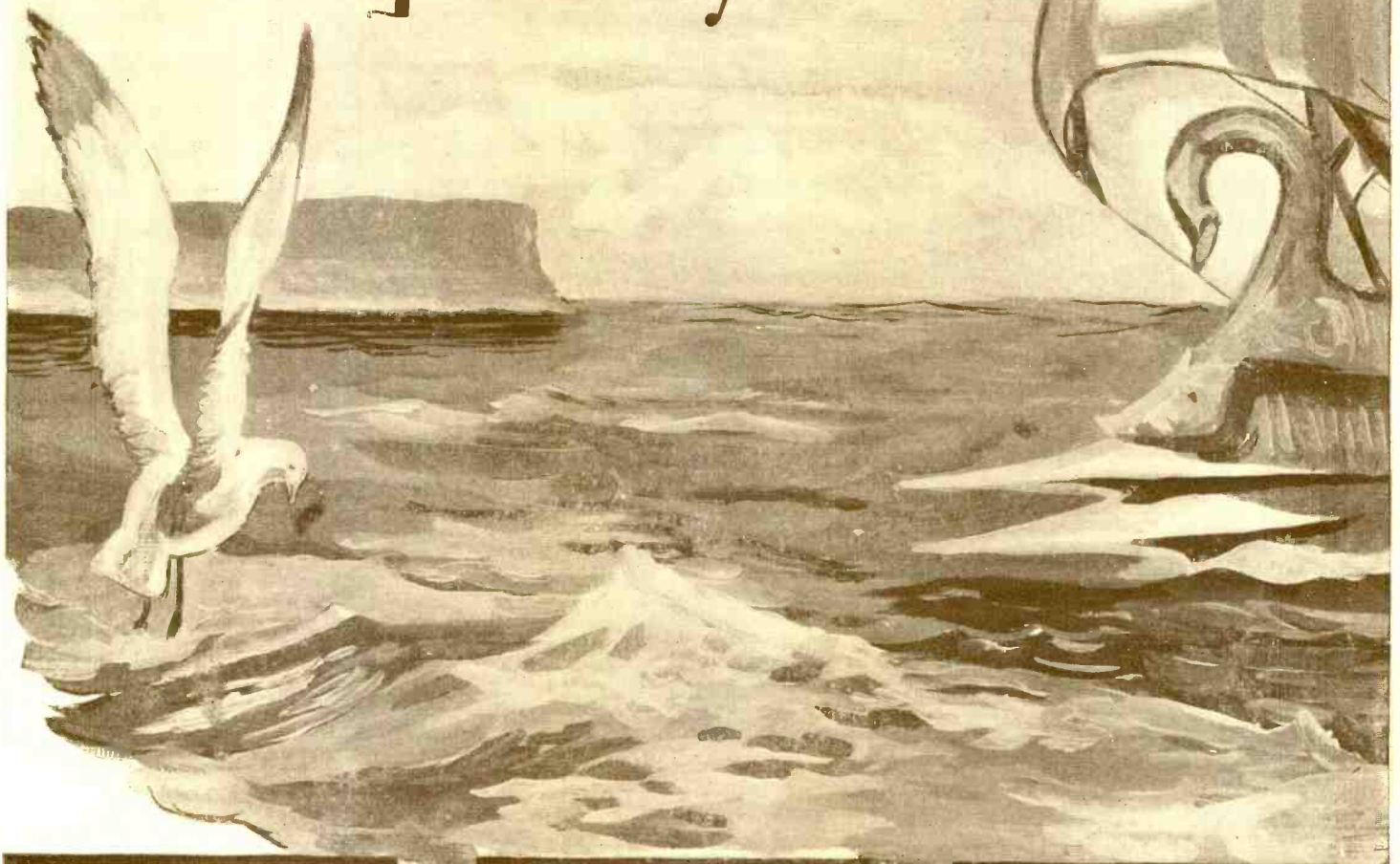



THE sheer excellence, the winsome beauty of Radio Master Cabinets sowed the seeds of their popularity.

The ease with which radio sets may be installed in them, their convenience and long life, brought fruit in the form of unusual consumer acceptance.

When you tie up with Radio Master Cabinets, you set your sales in a favorable wind to waft your ship to the bigger and better business year waiting.

With the new line, Radio Master offers you everything a customer can desire.

—Models containing 84-in. horn made popular by phonographic developments—models which conceal set, batteries and wiring—simple models—lavish models—we offer them all.

All made in our own cabinet factory by master craftsmen, who do each job as though their reputation depended upon it.

THE RADIO MASTER CORPORATION

One Of The Ward Industries
BAY CITY, MICH.

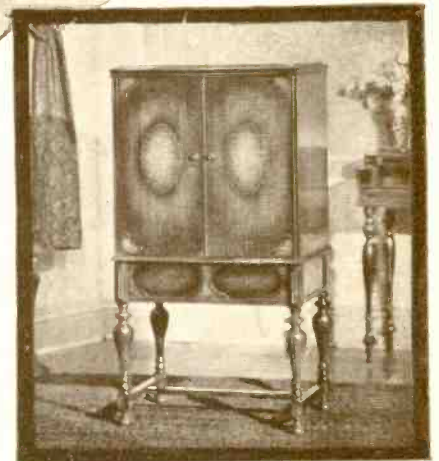
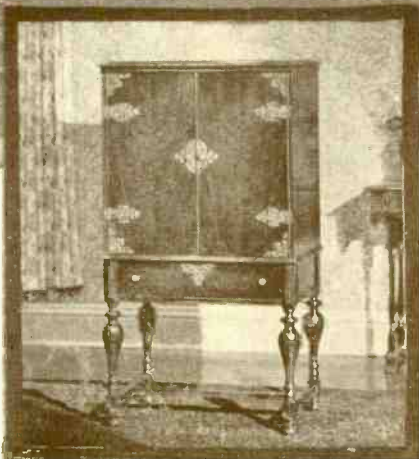

Balkite has pioneered



Balkite "AB" *Contains no battery.* A complete unit, replacing both "A" and "B" batteries and supplying "A" and "B" current directly from the light socket. Operates only while the set is in use. Turn it on and the set operates. Turn it off and you're through. Two models: "AB" 6-135, 135 volts "B" current, \$59.50. ("AB" 6-135R, for 25-40 cycle current, \$69.50.) "AB" 6-180, 180 volts "B" current, \$67.50.

Balkite "A"

Contains no battery. The same as Balkite "AB" above, but for the "A" circuit only. Will serve wherever 6-volt "A" batteries are now in use. Not a battery and charger but a perfected light socket "A" power supply. One of the most remarkable developments in the entire radio field. Price \$32.50.

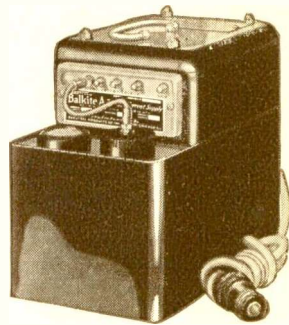

Balkite "B"

Has the longest life in radio. The accepted tried and proved light socket "B" power supply. Has probably the longest life of any device in radio. The new "B"-135 and "B"-180 include new improvements making their condenser capacity far greater than usually found in any commercial "B" power supply. Three models: "B"-W, 67-90 volts, \$22.50; "B"-135, 135 volts, \$32.50. ("B"-135R, for 25-40 cycles, \$37.50.) "B"-180, 180-volts, \$39.50. Balkite now costs no more than the ordinary "B" eliminator.



Balkite Chargers

Standard for "A" batteries. The standard charger for radio "A" batteries. Noiseless. Can be used during reception. Prices drastically reduced. Model "J," rates 2.5 and .5 amperes, for both rapid and trickle charging, \$17.50. (Model "J"-R, 25-40 cycle current, \$19.50.) Model "N" Trickle Charger, rate .5 and .8 amperes, \$9.50. (Model "N"-R, for 25-40 cycle current, \$11.00.) Model "K" Trickle Charger, the most popular of all chargers, \$7.50.



⌘ *Prices are slightly higher West of the Rockies and in Canada* ⌘

FANSTEEL PRODUCTS CO., INC., NORTH CHICAGO, ILL.

Balkite

Radio Power Units

but not at the expense of the public or the radio trade

FIRST noiseless battery charging. Then successful light socket "B" power. Then trickle charging. And today, most important of all, Balkite "AB," replacing both "A" and "B" batteries and supplying radio power from the light socket. The great improvements in radio power have been made by Balkite.

This pioneering has been important. Yet alone it would never have made Balkite one of the best known names in radio—nor have made Balkite the leader in the radio power field.

Balkite has become the leader because over a period of years Balkite has built a record of performance at the hands of its owners unequalled in radio. Because with 2,000,000 units in the field Balkite has a record of freedom from trouble seldom equalled even in the oldest and most soundly established industries. Because Balkite Radio Power Units last longer than any other devices in radio. Because Balkite is today synonymous with quality.

Balkite has pioneered. But not at the expense of the public, nor of the radio trade. Balkite owners have been satisfied owners; Balkite dealers have always made money. No Balkite product has ever failed to be a best seller.

The famous Balkite electrolytic principle

Balkite success has been based on the Balkite principle of electrolytic rectification. This principle is so reliable that it is today standard on the signal systems of most American as well as European and Oriental railroads. It is the principle that has enabled Balkite to do away in rectifying current with tubes and their uncertain output. It is this principle that accounts for Balkite long-life, that makes Balkite radio power units permanent pieces of equipment.

Don't gamble with untried devices

Time was when one radio device looked as good as another. And every device sold that later turned out to be a failure cost the radio dealer money. Today there is no longer any need for gambling with your own or your customer's money—you need no longer sell experiments. Balkite—the tried and reliable—offers you a complete line, to serve all requirements, at the lowest prices in Balkite history, backed by one of the largest advertising campaigns in radio. Concentrate on Balkite and make money.

FANSTEEL PRODUCTS CO., INC., NORTH CHICAGO, ILL.

Balkite

Radio Power Units

DEMPSEY VS. SHARKEY

*How One Dealer
Merchandises
Bouts via Radio*

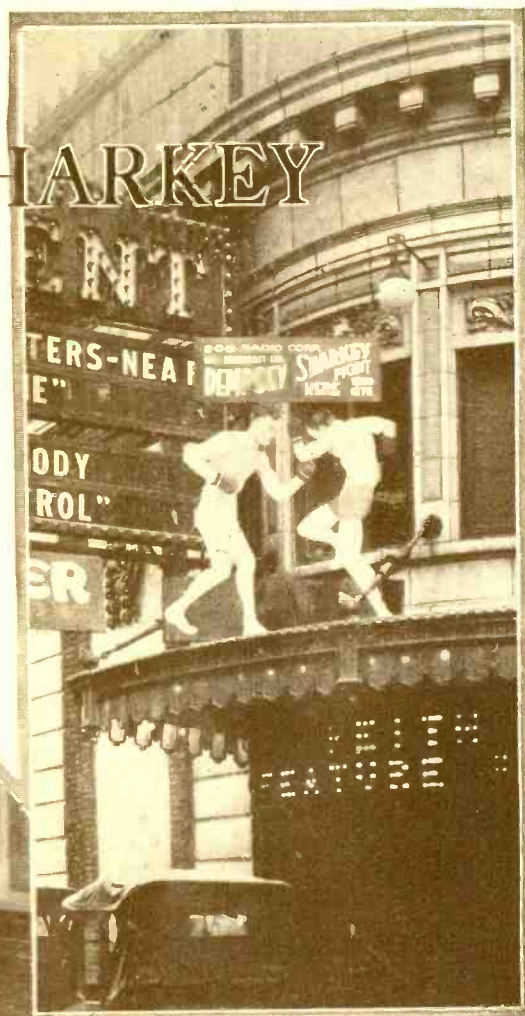

The S. O. S. Radio Company, Paterson, N. J., co-operated with a local theater in broadcasting the radio report of the Dempsey-Sharkey fight from the stage of the theater. How it was done is shown on this page. The Dempsey-Tunney fight September 22 affords other dealers the same promotional opportunity.

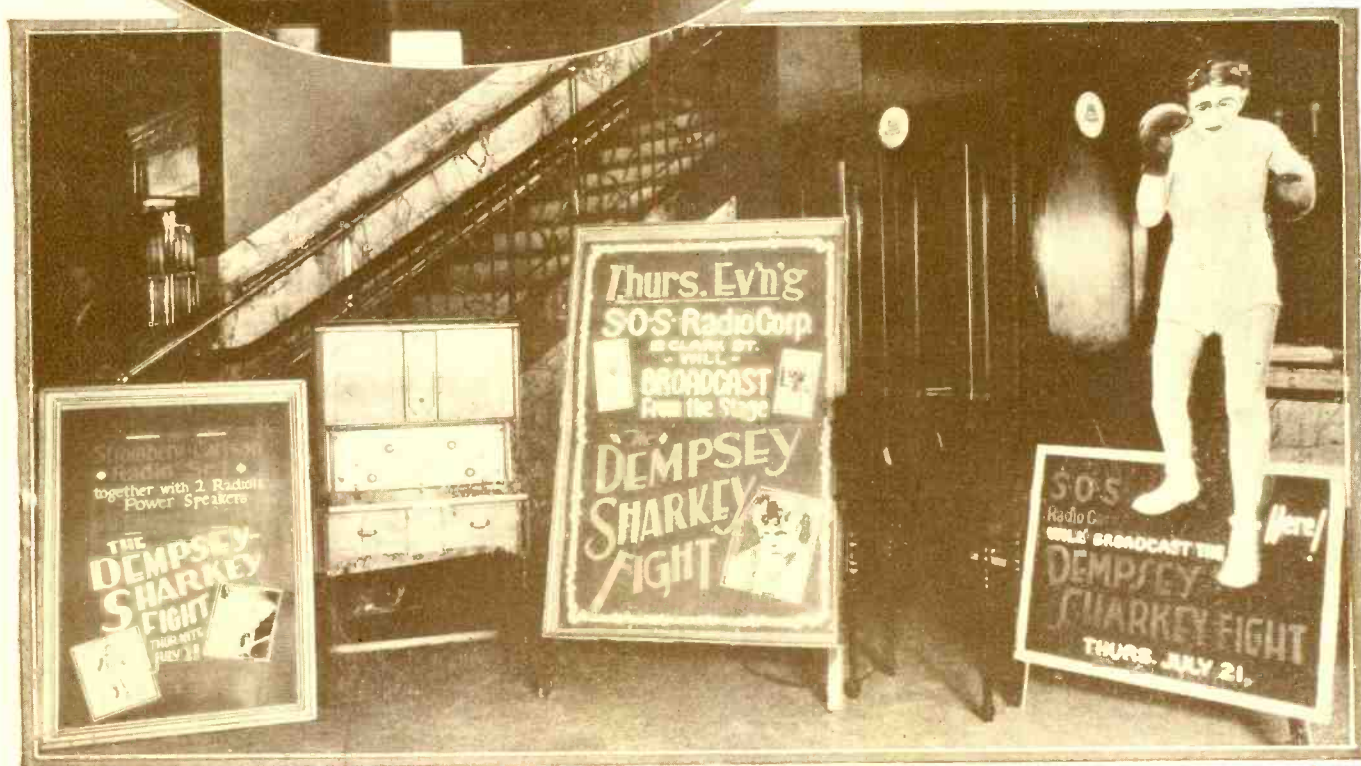
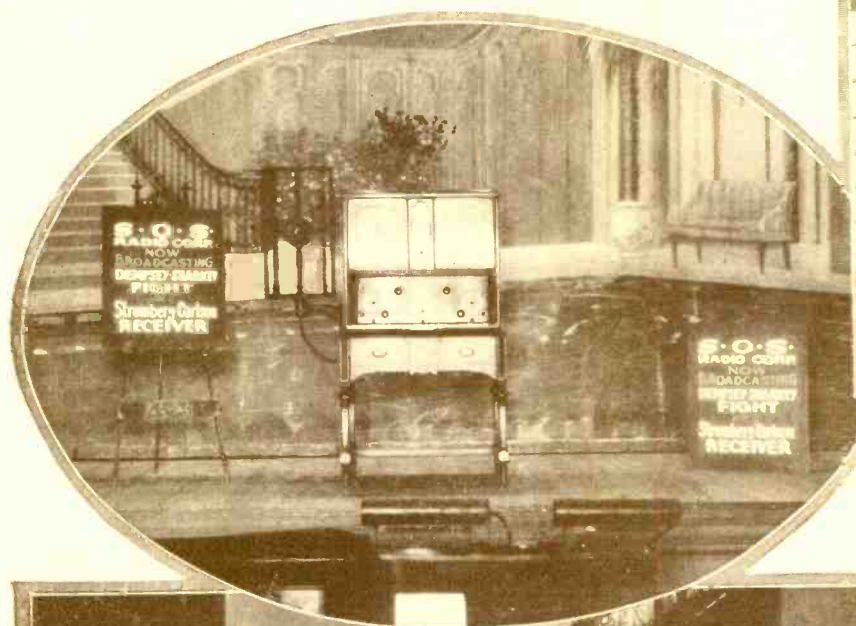

Practical SERVICE Methods

Soldering Connections to a Paper Condenser

Faulty soldering will destroy or permanently weaken a paper condenser very quickly. Acid soldering flux or paste should never be used as the slightest trace of acid may result in chemical action which will weaken the condenser. Condensers should not be allowed to become too hot from the soldering iron and they should also be kept cool and well ventilated while in operation. They should not be operated at a heat beyond 110 deg. F. as the leakage mounts rapidly with the increase in temperature and this in turn reduces the resistance and therefore, passes more current through the condenser. A little precaution will prevent many breakdowns.

Set Dead at Certain Places on the Dial

Whenever the signals cut out or the set goes dead, at a certain place or at various places on the dial after it is rotated it is probably because the plates of one or more of the tuning condensers are touching at these particular spots. This may be only a loose connection which sometimes shows up on a very strong signal. The way to remedy this is to find the exact spot where the plates are touching and which plates they are—usually one of the rotary plates—and then with a small piece of sharpened wood or some insulating material bend the plate, so that it is in its normal position in the center between two stator plates.

The Antenna

An indoor antenna is usually satisfactory for local stations and eliminates much static and interference. It also gives greater selectivity than an outdoor antenna. However, an outdoor antenna gives range and volume and therefore should be used for getting distant stations.

If the antenna is only a few feet above the roof of the building, the height of the building has little effect. It is therefore advisable that the antenna should be as high above the roof as possible. All connections out-

Conducted by
H. W. BAUKAT
Technical Editor

side the house should be soldered to prevent corrosion. The lead-in wire should make as direct a line as possible from the antenna to the set.

If the total length of the antenna and the lead-in wire from the antenna to the set is greater than 100 feet the selectivity of the set may be diminished. Loop antennæ can only be used with sets which are designed for them.

Interfering Hum Caused by Loose Light Socket

A rather difficult source of interference to find was recently discovered in a loose electric light plug contact by a service man. He was called to the home of a set owner who complained that a low frequency hum would frequently be emitted from the loud speaker. A thorough inspection was made of all the electrical equipment in the house, condensers were put across the electric fans and other devices were employed and yet the interference persisted. The discovery was entirely by accident. The customer had just purchased

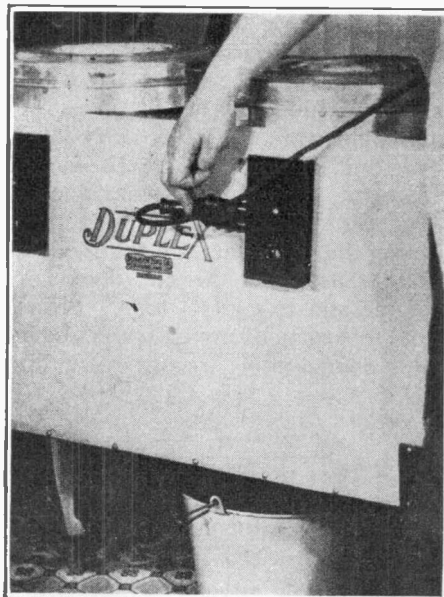

A loose contact in the plug connecting to this fireless cooker caused radio interference that was hard to find.

an electric washing machine from the dealer, who also sold the radio set. The service man had called to instruct the housewife to operate the machine. It so happened that food was being prepared in the electric fireless cooker, located in the kitchen. Suddenly the hum was heard, not from the radio or any part of it, for that was in another section of the house, but right there in the kitchen.

The connecting plug shown in the illustration, on the 110-volt line, that connects on the thermostat switch, had become loose through constant use. This caused a little arc to be set up at intervals through vibration. Tightening the connection plug of course eliminated the trouble. Small things like this cause much radio interference every day, and although they take but a moment to correct it is sometimes necessary to spend hours in locating them.

Oscillation Control for R. F. Stages

When the radio frequency stages of a receiver oscillate the simplest and most effective method of controlling the oscillations seems to be that of using a small neutralizing condenser and a variable high resistance in series across grid and plate of the r.f. tube. The variable high resistance should have a range of from practically zero to several megohms if possible, and with a relatively fine adjustment despite the great range.

Voltage Drop of Gaseous Rectifiers

The Raytheon "B" type of rectifier tube has a voltage drop of 120 at full load of 60 milliamperes. The "BH" type has a voltage drop of 90 at a full load of 85 milliamperes.

Profitable to Use Tube Tester

"It is always preferable to test tubes with a regular tube tester instead of in the set," says a Fada Radio service bulletin.

"A defective tube inserted in a set will sometimes cause considerable damage, as it will short circuit

Chalk in File Enables Faster Work

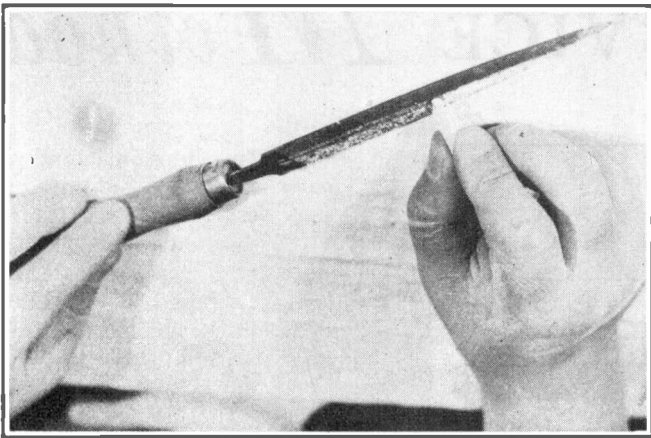

Filing Bakelite and other material often results in the filling up of the file so that the cutting edge slides uselessly over the work. Solder is the worst offender. Rubbing chalk in the file, as shown, before the work is commenced, will prevent this filling up.

and possibly burn out coils or resistances:

"Tube testers can be purchased through jobbers from about \$10 up and many dealers have found it to their advantage to maintain and advertise a free testing service for any tube brought in. This leads to more business, for the public is still under the impression that if a tube lights it is O. K. This, of course, is not true, as a tube may light and still be defective. By maintaining this testing service, the dealer, of course, makes sales on tubes to replace defective ones, as well as other accessories.

"One of the first things you should do if a customer is complaining about tubes is to request that the tubes be brought in for testing and a regular tube tester is essential for this work."

What a Filter Condenser Does

It is well to know the functions of the main condenser in the ordinary filter system of power units so that when trouble occurs the fault may more easily be found.

There are three filter condensers in the usual two-section filter system. The first condenser, or that nearest the rectifier, does not have much influence on the hum or smoothing of the output current. It is intended rather to maintain the output at a fairly fixed voltage, despite the fluctuating current drain. It serves for the regulation of the rectifier.

The second condenser controls the degree of hum, and any increase in the capacity of this condenser, within reasonable limits, reduces the hum in conjunction with the proper choke coils.

The third condenser controls the tone quality at full volume, because it acts as the virtual electrical fly-wheel of the B-Unit by providing an

ample reserve of energy to meet the unusual drains, particularly the deep, bass notes, placed on the B-supply. This condenser should be as large as possible, say even up to 8 mfd. capacity. The usual manufactured B-unit can be materially improved by placing additional condensers, say 4 to 6 mfd. in capacity, across the minus B and plus maximum B terminals, in building up the last condenser in the filter system for the best tone quality.

Testing Station Hook-up Easy on B Batteries

Technical Editor, *Radio Retailing*:

The wiring diagram, published in a recent issue, and submitted by the Main Auto Supply Company, Ft. Wayne, Ind., of a miniature sending station hook-up for testing and demonstration purposes, is good, but I think I have worked out a better one. The circuit enclosed herewith takes very little B current, about 7 milliamps., and gives remarkable volume with two 216-A Western Electric tubes. In fact, I found it advisable to introduce a 100-1,000 ohm variable resistance across the secondary of the modulation transformer to cut down my volume and to control tone. Before I did this some of my customers heard my phonograph record grinding

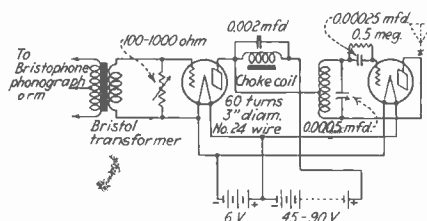

Wiring diagram of a miniature sending station hook-up for testing and demonstrations.

away and rushed in here all excited. Thought they were getting KMOX, St. Louis.

I would suggest to your readers that they use wooden needles in the Bristophone. They give a much pleasanter tone—eliminate the harsh, metallic sounds.

I put my testing outfit in the automobile when going out on a job, leave it in the parked car in front of the house, and, when ready for the reception test or demonstration, start the record going. I am almost always able to convince the customer that the set is O. K. and has good tonal qualities when I use this method of testing.

Yours appreciatively,

A. P. Ross, Jr.

Washington, Mo.

Improving the Old Speaker

Rattling in a passé speaker having no adjustable diaphragm, granting that the receiver and A and B batteries are in good condition, often presents a problem. A fixed condenser of almost any capacity, placed in series with one of the speaker leads, preferably the positive, will smooth out the reproduction and eliminate speaker noises.

Temporary Antenna

Darkness or perhaps inclement weather prevents a service man from erecting an antenna when installing a new radio set for the inconsiderate customer having a party of friends to entertain. A satisfactory temporary antenna may be made by running the lead wire to the bedspring of the nearest bed; also, letting the wire hang suspended from a window makes a good temporary aerial.

Protect Clothing

Battery acid is sulphuric acid. It is one of the most destructive elements to cotton, silks, woollens, and other fabrics. Its action is slow and deadly, and is usually not noticed until, in cleaning, a piece simply drops out of the garment. A man working around his radio set need only touch his finger, wet with acid, on his own suit, or on the furniture covering or the light dress of a feminine member of the household, to insure the appearance of a hole.

Radio dealers would be performing a real service to their customers if they would urge them to take ordinary precautions against letting the acid come in direct contact with their clothing.

News and Views of RADIO

RADIO BEACON GUIDED HONOLULU FLIERS

The radio beacon station erected at Presidio, Cal., which, by sending out a continuous "beam" guided the fliers to their destination.



WAVE OF HAND STARTS STEEL MILLS BY RADIO

One of the last acts of the late Judge Elbert H. Cary, was to start the huge mills of the electrified Homestead plant near Pittsburgh with a wave of his hand towards the sensitive Knowles grid-glow tube. This set in motion, via radio, the huge new electrical mills situated miles away.



"SILENT NORTH" NO LONGER SILENT

Members of a survey party and their assistants sent by the Canadian National Railways into far northern Canada listening to a broadcast program. (Left.)



BROADCASTING THE PRINCE'S SPEECH OF PEACE

H. R. H. the Prince of Wales speaking at the opening of the International Peace Bridge at Niagara Falls. (Below.)



WESTERN STAGES INSTALL RADIO SETS

These modern auto buses fitted up with lavatory, buffet, parlor, smoking, observation and baggage compartments have now added radio for the entertainment of their passengers. (Above.)

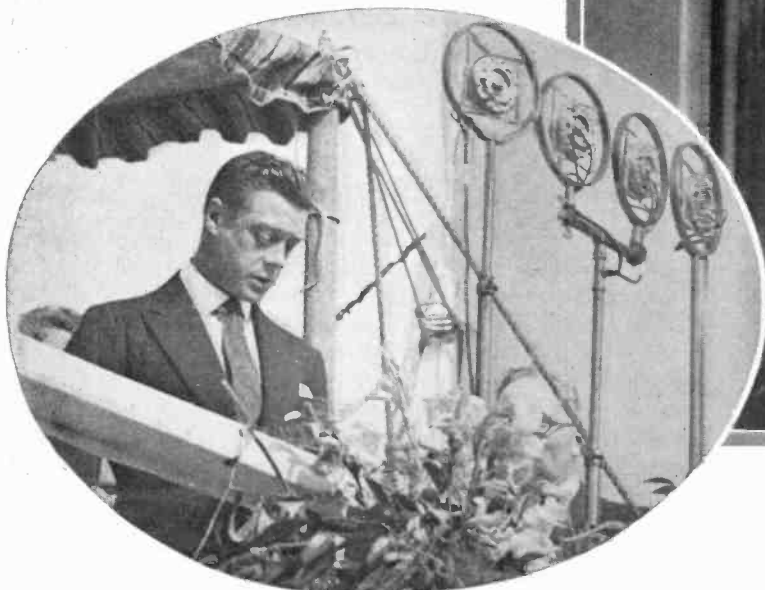

Radio Retailing

A McGraw-Hill Publication

September, 1927

Vol. 6, No. 3

Know Your Merchandise

"**K**NOW your merchandise as well as your competitor's," is a business axiom that might well be put to work by radio retailers this Fall.

Dealers frequently change the lines they handle. Manufacturers are constantly making changes in their own lines. The dealer, to sell radio successfully, must keep up with the procession. Otherwise, he'll find himself slipping.

Axiom No. 1—Study your own lines and learn them thoroughly. Be able to point out their strong features, defend their weaknesses.

Axiom No. 2—Know your competitor's lines. Comparisons are odious, but *know* why your line is better than your competitors. You will then find yourself much more able to answer your customers' questions intelligently.

* * *

Two Consecutive Gala Nights

TWO of the biggest radio broadcasting events of the year are, by a lucky chance, scheduled to fall on consecutive nights. The Fourth Annual Radio Industries Banquet will be held Wednesday evening, September 21. The *following night*, Thursday, Dempsey and Tunney swap fistic compliments. Here, then, is a wonderful opportunity to hold a two-day reception.

Advertise these consecutive events. Announce that there will be a special showing of 1928 model sets and accessories both evenings. Dress up the store and its windows. Hold open house those two nights.

Here is an unusual opportunity for two consecutive gala nights of promotional efforts. Don't pass it up.

* * *

Help Your Outside Salesmen

IT IS a well-known fact in the electrical appliance industry that a large majority of those specialty dealers who operate outside salesmen profitably, plan their men's work. The employer sees that his men are supplied with live leads. He requires that they report at stated intervals the result of each call. He runs sales contests; holds "pep" and experience meetings, takes them by the hand and shows them how to sell, by actual example. He breaks down the resistance at the front door by advertising in the local newspaper the high character of his salesmen and the interesting nature of their mission.

Recently a radio dealer obtained gratifying results with his outside force of salesmen, largely because he employed similar inspirational policies.

Front door selling is not a pleasant task, neither is it an easy one, but experience has shown that in the case of certain devices which the public does not look upon

"KNOW YOUR and Your

as necessities, the so-called "resale" plan is the only one whereby volume business is obtainable. The men on the firing line who wage this arduous battle require, and deserve, every ounce of support the boss can give them.

* * *

Urge Your Customers to Attend the Radio Shows

THE radio shows held every year are accomplishing a great mission in helping to popularize radio. The public should be urged to attend the local show each year. The more people who attend these shows, the greater results, in the way of sales, will be obtained by the manufacturers who exhibit and the dealers who buy their products.

Dealers can help by displaying window posters advertising the shows, many of which are being supplied by the show management, particularly the New York and Chicago shows; also by urging their customers, in every way possible, to attend the shows.

Manufacturers can help by including in their newspaper advertisements an invitation to inspect the product personally at the show.

* * *

Another Stabilizing Influence

THE formal declaration of trade practices, adopted by the Radio Manufacturers Association and published in this issue, contains much that should benefit the industry. It is a common sense presentation of principles that are basically sound.

The manner in which the radio industry, through organized effort, is classifying and clarifying its many problems is decidedly encouraging and will go a long way toward placing the manufacturing and merchandising of radio on an economically sound and permanent basis.

* * *

"Service With a Smile"

WE FOUND the above heading in a manufacturer's bulletin the other day. These four words mean so much to every dealer that it is worth while to emphasize them. Servicing with a smile creates the most valuable asset in any business—satisfied customers. The lack of "smile" will surely bring dissatisfaction. Nor is it meant that the service man should stand before a mirror before he starts out in the morning, assume a certain facile expression and keep it during the whole day. A smile is something that cannot be reduced to a formula. It consists of many parts, among which are words, tone of voice, manner, gesture and facial expression. It is one of the intangible tools with which to build success.



What's New in Radio and

This editorial section is prepared purely as a news service, to keep readers of "Radio Retailing" informed of new products.

Eight-Tube Table Receiver

The Workrite Manufacturing Company, 1812 E. Thirtieth Street, Cleveland, Ohio, is manufacturing the illustrated table type receiver incorporating an 8-tube circuit which includes 1 power tube. This set is merchandised by the Zinke Company, 1323 So. Michigan Blvd., Chicago, Ill. Control is obtained by a single drum dial illuminated from the inside and calibrated in kilocycles. According to the manufacturer the special audio-frequency amplification system incorporated in the set produces very fine tone quality and great volume. The cabinet is of walnut with a burl maple panel. The intended retail price of the receiver alone is \$160, and with the table, as illustrated, \$205.—*Radio Retailing*, September, 1927.

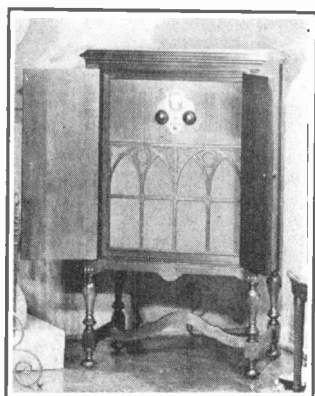
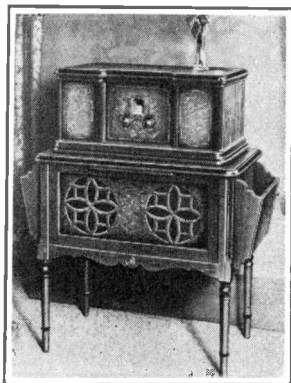

Seven-Tube Console with Built-in Cone Speaker

The Apex Electric Mfg. Co. of 1410 West 59th St., Chicago, Ill., is making the illustrated 7-tube console receiving set, known as "The Minstrel." The circuit includes four stages of radio-frequency amplification, a detector and two stages of audio-frequency amplification. The master station-finder control actuates the single drum dial. There is also a volume control knob, as well as an on-and-off battery switch. The cabinet is of 5-ply selected walnut, with a 3-coat lacquer finish, high-lighted and rubbed. A cone speaker is built-in at the bottom and covered with grill work. The intended retail price without accessories is \$225. This is made up as follows: \$62.50 for the cabinet; \$17.50 for speaker and \$145 for the chassis.—*Radio Retailing*, September, 1927.

circuit. Practically the set may be installed anywhere in any dwelling or upon its premises, and the unit placed in any room in the house, wherever most convenient. Twelve feet of wiring is furnished with the control and extensions may be purchased as desired. Operation of the dial in both directions is effected by a small motor controlled by a switch and rheostat in the unit bed plate. Volume is handled as in the case of the mechanical control. The size of this electrical unit, which can be placed on top or at either end of the cabinet, or, by a simple cut-out operation, within a console, is no larger than the average man's hand.—*Radio Retailing*, September, 1927.



One-Dial, Six-Tube Receiver

The illustrated "Pawnee Consolette" receiving set made by the Mohawk Corporation of Illinois, 2220 Diversey at Logan Blvd., Chicago, Ill. is one of the many new models made by this company. A rich walnut is used, hand rubbed with a duo-tone piano finish. The front panel is removable. Overall dimensions 38 1/2 in. x 19 1/2 in. x 13 1/2 in. For battery operation, less accessories, intended retail price is \$85. All models for electric operation are furnished with Kellogg a.c. tubes. Other models are the "Iroquois" console—\$120; the "Cortes" console—\$185; the "Seminole Spanish Vargueno" console—\$245; the "Hiawatha" console—\$150; and the "Cherokee" table cabinet—\$65. Also the "Chippewa" at \$110. These receivers use six tubes and have one-dial control. For a.c. operation of all models add \$100 to list price.—*Radio Retailing*, September, 1927.

Six-Tube Single Control Receiver

Compactness is an outstanding characteristic of the "Abbey," a six tube receiver made by the Spiltford Radio Corporation, 392 High St., Newark, N. J. The receiver employs four tuned circuits in three straight stages of tuned radio-frequency amplification with a variometer in the antenna stage. By this arrangement it is said that there are assured more selectivity, greater sensitivity and the use of various lengths of antenna with equal, maximum efficiency. An aluminum shield is placed on top of the deck through which the tubes protrude with the variometer fully shielded. The intended retail price is \$100.—*Radio Retailing*, September, 1927.

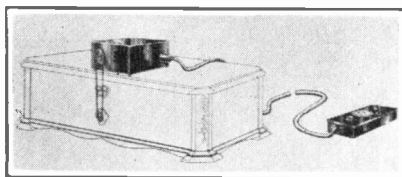

Remote Control Radio Tuning Unit

The Algonquin Electric Company, Inc., 245 Fifth Avenue, New York City, presents a novel device in two forms, mechanical and electrical, by which radio reception may be controlled in wave-length indication, tuning and volume, at a distance from the receiving instrument. Both forms of the device are easily attachable to any single control receiving set with a removable dial. The mechanical remote control unit is comprised essentially of a six-foot flexible operating cable. One end of this cable is attached to the dial shaft of the set by an adapter plate, as furnished and the other end is attached to a thumb wheel embedded in a unit, by means of which the flexible cable is rotated and the dial in turn operated, thus bringing in and cutting out any series of stations at will. Volume is controlled by a rheostat installed in the bed plate and connected by wire with the corresponding set terminal.

The electrical remote control unit can be operated, theoretically, at any remote distance from the set, however great, if installed on a perfectly closed electrical

Cone Reproducer

The Bremer-Tulley Mfg. Co., 520 Canal St., Chicago, Ill., has placed a new speaker on the market. The mechanism consists of a double-acting balanced armature actuating a floating-edge six-inch cone. Air circulation is prevented by the cabinet design, thereby avoiding harmful wave interference and giving faithful reproduction. With all of the advantages of the larger cone, the enclosed design affords additional protection against damage, as well as being pleasing and ornamental in appearance. The speaker cases are of mahogany, beautifully finished. A lyre motif suggestive of music is carried out. Height of speaker, 12 in., width 10 in. Shipping weight approximately 14 lb. Price \$35.—*Radio Retailing*, September, 1927.

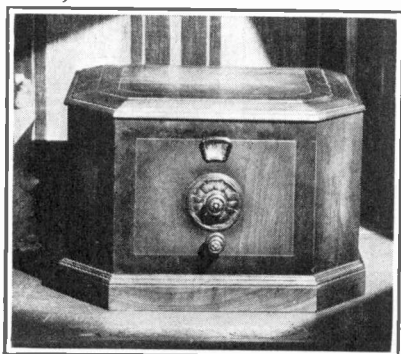

Where to Buy It

News of the latest products
gathered by the editors



All announcements appearing on these pages are published without advertising considerations of any kind whatsoever.

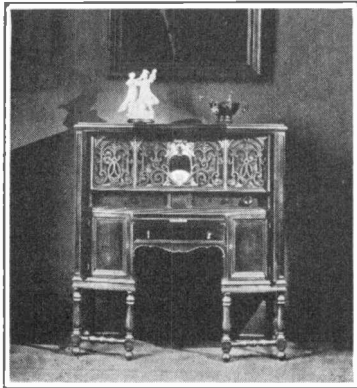

Ten-Tube De Luxe Receiver

The Zenith Radio Corporation, 332 So. Michigan Avenue, Chicago, Ill. makes the illustrated De Luxe English model radio receiver. This conveys a dignity with an abundance of characteristic interest of the chaste, severe lines known to this particular class of exclusive furniture. This model is single control, containing a specially constructed Zenith circuit. It covers a wave band of some 105 to 550 meters, and is equipped with two built-in speakers and illuminated dials.—*Radio Retailing*, September, 1927.

three separate secondary windings each of which has a center tap. The $1\frac{1}{2}$ volt secondary is of sufficient capacity to take care of eight UX-226 tubes all in parallel. The $2\frac{1}{2}$ volt winding is large enough to take care of three UY 227 tubes in parallel. The five volt secondary is sufficient for two UX 171 tubes in parallel. Between the primary winding and the secondary there is a copper ground shield, from which is brought out a connection grounded to the clamping frame and core. The intended retail price is \$12.

Type PF-281 is a power transformer designed for use with the new UX-281 rectifying tube. This transformer contains a 750-volt plate winding with a tap for 550 volts, thus enabling it to be used with a 216-B rectifying tube. It also has a metal ground shield over the primary and is designed for use on 110 volt, 50 or 60 cycle current. This transformer has five secondary windings each insulated from the others and from the primary. They are as follows:

One 750 volt winding with a 550 volt tap and a current capacity of 110 milliamp.; two 8 volt center-tapped filament windings, one for the rectifying tube and the other for the power tube; one $1\frac{1}{2}$ volt center-tapped winding capable of supplying current for the filaments of 6 to 8 type UX-226 a-c tubes; and one $2\frac{1}{2}$ volt center-tapped winding designed to supply heater current to two or three UY-227 A C detector tubes. The intended retail price is \$25.—*Radio Retailing*, September, 1927.

Decorative Cone Speakers

The Tower Manufacturing Co., Boston, Mass., has developed a line of decorative cone speakers of which is illustrated the "Castle" model. It is a picturesque, mediæval castle with embattled turrets cast in relief and finished in two-tone bronze. A new type armature unit drives a 17 in. free-edge cone, protected by a metal rim. The overall height is 19 in. and the intended retail price is \$9.50. The "Meister-singer" model is so designed that it may have its base detached for hanging on the wall. The design includes a supporting eyelet and a 15-foot cord for this purpose. The free-edge cone of this model is protected by a rich mahogany frame of wood. Intended retail price is \$15 and the overall height is 22 in. The "Adventurer" model is a ship model having an overall height of 18 in. The intended retail price is \$9.50. Model "28" is a drum type with an elaborate heraldic grill covering the front. This model has an overall height of 16 in. and the intended retail price is \$17.50. The remaining model, the "Pirate Ship," is a 14-in. cone of which the intended retail price is \$7.95.—*Radio Retailing*, September, 1927.

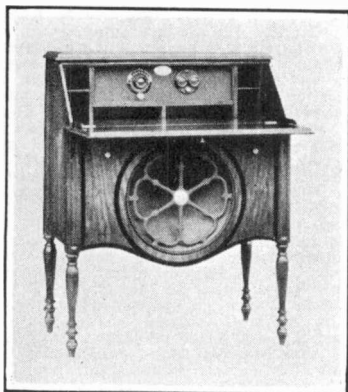

Radio Furniture

The Red Lion Cabinet Company, Red Lion, Pa., is making the illustrated desk model, equipped with a built-in Atwater Kent speaker unit and designed for use with an Atwater Kent Model 35 set. Its overall dimensions are 17 in. by 30 in. by 37 in. high. The intended retail price without set or speaker is \$40. Complete with set and speaker \$110. This company is concentrating on furniture built exclusively for Atwater Kent's models.—*Radio Retailing*, September, 1927.

Transformers for New A-C Tubes

The American Transformer Company, 178 Emmett Street, Newark, N. J., has just placed on the market two new transformers designed for use with the a-c tubes. The first, type H-67 is designed for operation on 50 or 60 cycle circuits and the primary has taps for 100, 110, 115 and 120 volts. There are

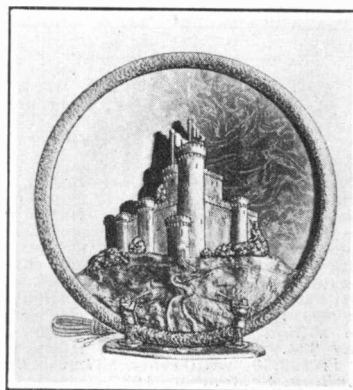

Consoles For Crosley

Crosley distributors are now announcing an entirely new line of art furniture cabinets to their trade. Each model is specially built to afford immediate installation of the various Crosley receivers, and is fully equipped with a Musicone. The Approved Consoles are being supplied exclusively to Crosley jobbers by the H. T. Roberts Company, Chicago, Ill. The Console Model 400 is finished in walnut veneer. Complete with 12-in. set compartment. Height 40 in., width 24 in., depth 14 in. This cabinet is ready for quick installation of the Bandbox.

Model 405 is finished in selected walnut veneer, with burl walnut veneer doors. Complete with 10-in. set compartment. Height 43 in., width 24 in., depth 15 in.

The Model 410 illustrated is a De-Luxe Console, finished in selected walnut veneer, with burl walnut veneer doors. Complete with 20-in. combined set and speaker compartment. Height 50 in., width 28 in., depth 16 in. Prepared for quick installation of Crosley receivers.—*Radio Retailing*, September, 1927.

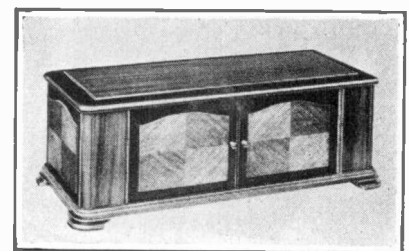

Seven-Tube One-Dial Receiver

The Browning-Drake Corporation, Cambridge, Mass., has placed on the market a seven tube one-dial control receiver known as Model 7-A. It has a single-control illuminated drum-dial which is said by the maker to have exceptionally powerful driving mechanism and an action which operate without the slightest trace of backlash. The dial is illuminated from the center of the drum which gives a very pleasing effect as the light glows through the dial. All important parts are completely shielded in sections. The cabinet is of two-tone mahogany or walnut as desired. It measures 30 in. long, 15 in. deep, and 11 in. high. A console base is available for this model and when the base and the receiver cabinet are joined they appear as a single piece of furniture. The intended retail price, (without tubes,) is \$145, with console base, \$185.—*Radio Retailing*, September, 1927.

What's New in Radio and Where to Buy It

Antenna and Lead-In Connector

The Ajax Electric Specialty Company, 1926 Chestnut St., St. Louis, Mo., is making the "Ajax" antenna and lead-in connector. This holds two No. 14 wires with tight contacts. Use of this connector eliminates soldering and it is not necessary to cut the antenna wire in order to connect the lead-in wire to it. It is made of pure copper, having heavy brass screws and set nut. Intended retail price is \$1.10.—*Radio Retailing*, September, 1927.



A-Power Unit

A new A-power unit using the Raytheon cartridge is being made by the Valley Electric Co., 4515 Shaw Avenue, St. Louis, Mo. Provision has been made in this unit for the use of an additional cartridge when operating sets using seven tubes or more. A receptacle is provided at the back of this unit for plugging in the B-power supply which is placed under control of a switch on the A-power supply. Intended retail price \$39.50.—*Radio Retailing* September, 1927.



Fixed Resistances

The "Kroblak" fixed resistances made by C. E. Mountford, 465 Greenwich Street, New York City, are being made in standard sizes for B-socket power devices and designed to carry 20 watts. This is an increase of 10-watts in capacity over the old style. The intended retail price of the 20-watt type is 50c. above the price of the 10-watt type.—*Radio Retailing*, September, 1927.

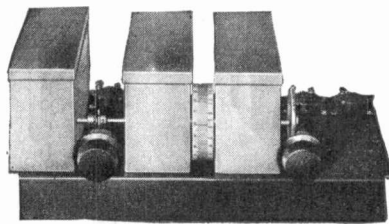
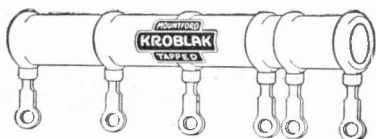

Six-Tube Shielded Chassis

A six-tube completely shielded chassis is being placed on the market by the Audiola Radio Company, 430 South Green St., Chicago, Ill. The chassis is of the single control type. The dial is illuminated and reads in kilocycles. Volume is controlled by means of a 100,000 ohm variable resistance in which the filament switch is incorporated. Complete shielding is given to each individual circuit including the condenser, coil and tube. Thordarson transformers are used for audio-frequency amplification.—*Radio Retailing*, September, 1927.

A and B-Power Units

The Fansteel Products Co., Inc., North Chicago, Ill., recently placed on the market several new types of A and B power units. Model 6, which is an A unit having a rated output of 6 volts, 2 amp., operates on 110-volt 60-cycle current, and has an intended retail price of \$35. Model 6-135 is an AB unit which has a rated output of 6 volts, 2 amp. A current and 135 volts at 40 milliamp. B current. This also operates on 110 volt, 60-cycle current and has an intended retail price of approximately \$75. Model 6-180 is an AB unit with a rated output of 6 volts, 2 amp. and 180 volts at 55 milliamp. and is also designed for 110 volt, 60-cycle operation. The intended retail price is \$75. Another model is B-180, has an output of 55 milliamps. at 180 volts and the intended retail price is \$39.50. Model B-135 has an output of 40 milliamp. at 135 volts, and the intended retail price is \$32.50. Model B-W for sets using 5 tubes or less. Intended retail price \$22.50. This model can also be had for 25-40-cycle operation.—*Radio Retailing*, September, 1927.

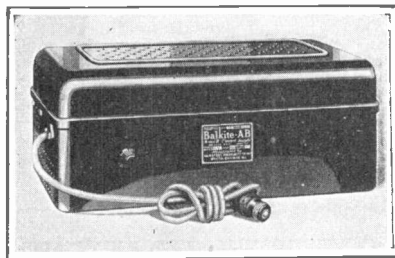

A-Power Unit with Dry Rectifier

The Vesta Battery Corporation, 210 Indiana Avenue, Chicago, Ill., now manufactures an A-power unit which utilizes a dry rectifier. This rectifier is made under the Vertrex patent. A switch provides a high charging rate of 1½ amp. and a low rate of ½ amp. The unit may be had with or without an automatic relay. The 4-volt, 50 ampere size without relay retails at \$28, with relay \$33. The 6-volt size, without relay is \$32.50, with relay \$37.50.—*Radio Retailing*, September, 1927.

Rectifying and Receiving Tubes

The C. E. Manufacturing Co. Inc., 702 Eddy St., Providence, R. I., recently placed on the market two new types of rectifying tubes; also two types of receiving tubes. The first, D-½, corresponds to the 216 B-type rectifier and is a half-wave rectifier. It has a 7.5 volt filament drawing 1.25 amp. A voltage of 550 a.c. may be used and d.c. milliamp. output will be 65. The intended retail price is \$7.50.

The D-1 corresponds with the 213 type and is a full wave rectifier. Filament voltage 5, filament ampere 2, a.c. volts 220, d.c. milliamp. 65. Intended retail price \$5.

Type K is a radio frequency tube with a 5-volt, quarter amp. filament, UX base and will take a plate voltage of 67 to 140. L-10 corresponds to the 210 type and has a 7½ volt, 1½ amp. filament, and will take 425 volts on the plate. UX base. Intended retail price \$9.—*Radio Retailing*, September, 1927.

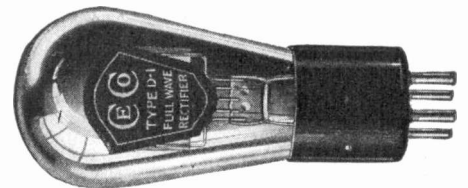

New Line of Variable Resistances

Herbert H. Frost, Inc., 160 N. LaSalle St., Chicago, Ill., has placed on the market a new line of variable resistances, some to be used as rheostats with or without filament switch and others as potentiometers. Either metal or bakelite frames may be had. Series 1,700 metal frame rheostats range from 2 ohm—2.5 amp. to 75 ohm—.06 amp. with an intended retail price of \$.75 each. Series 1,800, Bakelite frames, have the same range of values with an intended retail price of \$1. S 1700 series, metal frame rheostats with the filament switch incorporated, range in resistance and current value the same as the above, the intended retail price in this case being \$1.10. Series S 1800, Bakelite frame rheostats, with filament switch have the same values with an intended retail price of \$1.35. For higher resistances, series 1880, equipped with 2 terminals, has values ranging from 2,000 ohms to 500,000 ohms with an intended retail price of \$1.75. Series 1890, equipped with 3 terminals has the same range of values and the same retail price. These resistances are equipped with a filament switch and retail for \$2.10.—*Radio Retailing*, September, 1927.



Latest Products Gathered by the Editors

Combination Switch and Metal Rheostat

A combination switch and air cooled metal rheostat with one hole mounting is being made by the DeJur Products Co., 199 Lafayette Street, N. Y. It is sturdy and efficient and the metal frame will not bend or warp, according to the manufacturer. It can be furnished in any ohmage of 2 to 50. Intended retail price is \$1.—*Radio Retailing*, September, 1927.

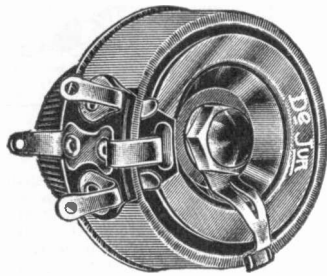

Midget Jacks

In compact receivers where space is at a premium the Pilot midget jack commends itself because it requires the minimum of room. This is made by the Pilot Manufacturing Company, 323 Berry Street, Brooklyn, N. Y. According to the manufacturer positive contact is assured at all times by a high tension spring with silver contact surface. Another feature of the midget jack is that two distinct uses are combined in the one unit—a jack for ear-phone open circuit in addition to a jack for regular speaker output.—*Radio Retailing*, September, 1927.

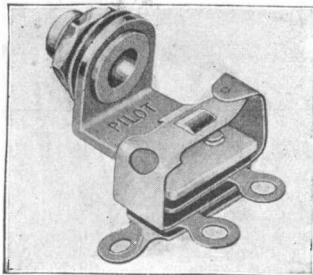

Automatic Molded Bakelite Plugs

The illustrated automatic molded bakelite plug is being made by Herbert H. Frost, Inc., 160 N. LaSalle St., Chicago, Ill. These may be had for either single or double connection. The single automatic plug retails for 50c. and a double automatic plug for 75c.—*Radio Retailing*, September, 1927.

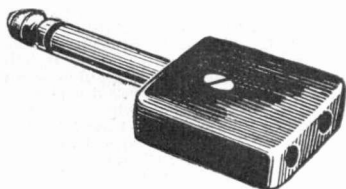

Radio Retailing, September, 1927

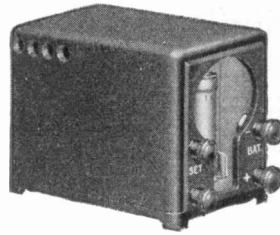

Automatic A-Battery Charger

The "Charg-A-Matic" is the latest type of battery charger to be made by the Johnson Motor Products Company, 308 North Sheldon Street, Chicago, Ill. When properly connected with the light socket and the battery it automatically charges the battery to 6.9 volts and shuts off. When the battery drops to 5.9 volts it automatically turns on again. The charging rate is from 1 to 1 1/2 amps. The intended retail price is \$13.75.—*Radio Retailing*, September, 1927.



Pedestal Type Speaker

The illustrated "True Tone" speaker, made by Yahr-Lange, Inc., Milwaukee, Wis., is of cast aluminum construction and has a tone column which, according to the manufacturer, is so divided as to segregate high and low notes. A special unit is used which will successfully handle up to 200 volts. The intended retail price is \$35.—*Radio Retailing*, September, 1927.

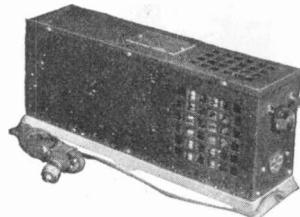

A-Power Supply Unit

An A-power supply unit incorporating a dry rectifier is being made by the Triple-A-Specialty Co., 312 S. Hamilton Ave., Chicago, Ill. It is designed for 110 volt, 60 cycle operation and comes in two 6-volt sizes, one for 2 amp. output, the other for 3 amp. output, with intended retail prices of \$39.50 and \$43.50 respectively. A 4-volt 1/2 amp. size has an intended retail price of \$39.50.—*Radio Retailing*, September, 1927.

Automatic Charger

The Apco Manufacturing Company of Providence, R. I. has placed on the market a new automatic charger. Full wave rectification is accomplished by means of a dry, copper oxide rectifier. This charger is for the use with the regular six volt storage batteries. Once it is properly connected no further attention has to be given it by the set owner as it will charge the battery when needed and turn off when the battery is fully charged.—*Radio Retailing*, September, 1927.

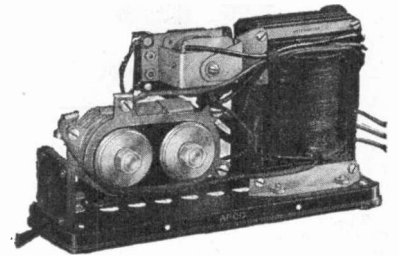

B-C-Power Unit

The illustrated power unit is the latest development of the Triple-A-Specialty Co., 312 S. Hamilton Ave., Chicago, Ill. It is equipped with wire wound resistances made so that they can be adjusted for any particular type of set the unit is used with, all adjustments being made within the unit. It is designed for operation on 110 volt, 60 cycle current and has an output of 40 milliamp. at 180 volts. The detector voltage is 20 to 60, intermediate 60 to 90, amplifier 90 to 112 and full power 135 to 180. C-battery voltage of 0 to 45 volt is also furnished. Overall dimensions 10 1/2-in. x 5 1/2-in. x 6 1/2-in. Intended retail price \$45.—*Radio Retailing*, September, 1927.

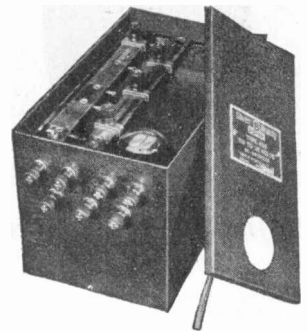

Cage Antenna

The Supertron Manufacturing Company, Hoboken, N. J., has brought out a cage antenna, which it is claimed makes tuning sharper. It is constructed of 100 feet of copper stranded wire enamel covered, which is mounted on moulded Bakelite. It is thoroughly insulated, and absolutely weatherproof. It can be mounted on a roof top, a window ledge, against a wall or on the running board of a car. A universal bracket makes it adaptable to any position. Total weight, 9 lb. Intended retail price, complete, \$10.—*Radio Retailing*, September, 1927.



What's New in Radio and Where to Buy It

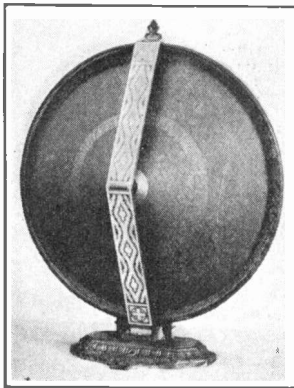

Illuminated Cone Speaker

The Pathe Phonograph & Radio Corp., 20 Grand Avenue, Brooklyn, N. Y., has just placed on the market the "Illuminated Cathedral" cone speaker. It is equipped with two lights which operate on house current, one of which is red and the other orange. The illuminated cone produces a soft glow like a lamp and adds greatly to its decorative value in a room. Another feature is the metal guard which protects the cone point and prevents damage in shipping. This is shown in the illustration which is the rear of the cone. The speaker may be had in either a gold or polychrome finish. Intended retail price of the illuminated cone is \$35 complete.—*Radio Retailing*, September, 1927.

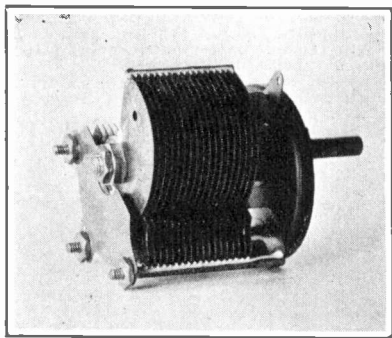

Adjustable Variable Condenser

The Armo Radio Laboratories, 1666 Tarleton Street, Los Angeles, Calif., has placed on the market an extremely small variable condenser so designed that the maximum, minimum and middle capacities may be altered to exactly match the capacity of other condensers with which it may be ganged. No special tools are required to make these adjustments. The condenser may be used singly or in a gang. Rigid spacing and secure suspension by means of rods and solder are features claimed by the manufacturer. It is made in 35 capacities ranging from .00015 to .0005 mfd.—*Radio Retailing*, September, 1927.

Electric Receivers

The Sleeper Radio and Manufacturing Corporation of Long Island City, New York, has added direct current operation to its full line of receiving sets. This company has recently added to its line of electric table models, two consoles, one the "Scout" console which retails at \$235 and the other the "Imperial" console, which retails at \$265.—*Radio Retailing*, September, 1927.

Six-Tube Shielded Receiver

The Crosley Radio Corporation, Cincinnati, O., has placed on the market what is known as the "Bandbox" model. This is a small 6-tube receiver inclosed in a brown frosted-crystalline finish metal cabinet, with bronze escutcheon. It is completely shielded and mounted independently in the metal box in which it is inclosed. By releasing four screws the chassis can be taken from the metal box and mounted in any type of furniture that may be desired. The intended retail price of this model is \$55. Included in the new line this year are three improved musicones, one of which is constructed like a tilt-top table and finished to harmonize with the Bandbox set. It stands 3 feet high and the intended retail price is \$27.50. The 16-inch super musicone has an intended retail price of \$12.75, and the 12-inch ultra musicone has an intended retail price of \$9.75.—*Radio Retailing*, September, 1927.

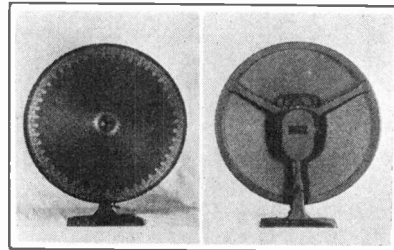

Cone Speakers

The Trimm Radio Manufacturing Company, 847 West Harrison Street, Chicago, Ill., has put on the market two new cone speakers. Both of these speakers are equipped with balanced armature units, which are non-adjustable. The cones may be removed from the base and hung on the wall. The larger size, which is 17 in. in diameter, is known as the Concerto Grande No. 38, and has an intended retail price of \$16. The other, which is 14 in. in diameter, is called Concerto No. 28, and retails at \$10.—*Radio Retailing*, September, 1927.

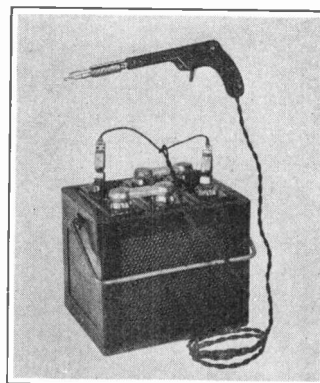

Six-Volt Soldering Iron

The H. A. Wagg Manufacturing Company, Wapello, Iowa, is making a soldering iron to operate from a six-volt storage battery. It is arranged with a pistol grip and trigger, making it very easy to operate. It heats instantly when the trigger is pulled. It is furnished complete with clips and cords and the intended retail price is \$2.45.—*Radio Retailing*, September, 1927.

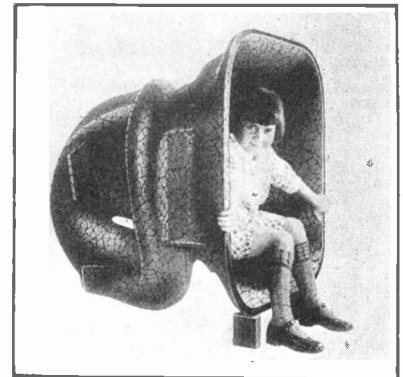

Giant Speaker

A giant speaker is being made by Temple, Inc., 213 South Peoria Street, Chicago, Ill. It weighs 180 pounds and has an air column of ten feet, with a bell of three feet. A specially constructed unit is used to actuate the air column. This speaker is the largest of the family of similar speakers made by the company. The others made are: No. 13 standard, a 13-inch drum with an intended retail price of \$29; No. 18 speaker, an 18 in. drum with an intended retail price of \$48.50 and console model No. 65 in a walnut-finished cabinet of Spanish design. This model measures 32 in. from the floor, with a top of 14½ in. x 24 in. It contains the same tone chamber as No. 18 senior and has an intended retail price of \$65.—*Radio Retailing*, September, 1927.

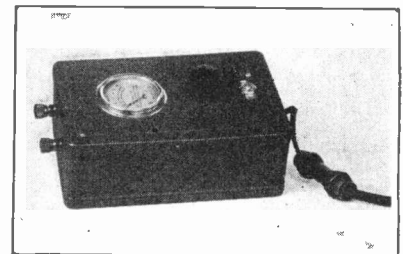

A-Battery Supply From 32-Volt Source

A device for obtaining A-battery current from a 32-volt farm lighting system is being manufactured by the National Distributing Corporation, 309 Fifth Avenue, New York City. The cord of the device is connected to the lamp socket, thereby drawing current from the entire unit of batteries instead of utilizing a few cells as is generally the case.

The cord is of a special resistance type which reduces the voltage to approximately that desired, while in the box is located a voltmeter and a Bradley ohm, by means of which the correct voltage may be adjusted more closely. Binding posts are conveniently located at the top for connection to the filament terminals of the set. A switch is also provided for turning the current on and off.

Various sizes of resistance cords can be had. They are manufactured in steps of ½ amp., each one having distinguishing colors. A small fixed condenser is also furnished with the unit and it should be inserted in the ground lead of the radio set. This is to prevent damage in case one side of the farm lighting system is grounded. This device should fill a long-felt need in rural districts.

The unit is contained in a maroon, crystalline-finished, metal box 7 in. long, 4 in. wide, 3 in. deep, and has an intended retail price of \$15, which includes one 10-ft. cord of any desired rating.—*Radio Retailing*, September, 1927.

What the Trade is Talking About

Chains Will Broadcast Banquet Program

Over \$16,500 will be spent to entertain 2,000 guests at the Fourth Annual Radio Industries Banquet, to be held the evening of National Radio Day, Wednesday, September 21st, at the Hotel Astor, New York City.

The program will be of unusual calibre, as is testified by the fact that the chains of the National Broadcasting Company, and the new Columbia system, will co-operate with scores of independent stations in broadcasting the program through the largest station hook-up achieved up to date.

The banquet is sponsored each year by 22 leading radio trade organizations.

The members of the Federal Radio Commission will be guests of honor at the banquet, and Admiral W. H. G. Bullard, chairman of the Commission, will be one of the speakers.

Atwater Kent Signs RCA License Agreement

The Atwater Kent Manufacturing Company, Philadelphia, Pa., is the latest addition to the circle of licensees under the radio patents controlled by the Radio Corporation of America and affiliated companies.

Although the Atwater Kent Company had filed an appeal from the District Court decision it lost in July to the Radio Corporation, officials of the company decided to cease litigation and take out a license under the RCA patents. The arrangements were completed by David Sarnoff, vice-president of the Radio Corporation, and A. Atwater Kent, president of the Atwater Kent Company.

Lower Manhattan Dealers to Hold Jubilee

A "Downtown Radio Jubilee" will be held among the radio retailers of Cortlandt Street and Greenwich Street, New York City during the week of September 6-10. It is the plan to decorate the outside and inside of the various stores besides stringing flags of all colors and sizes and thousands of electric lights across the streets.

As an added feature a beauty contest will be run, open to any non-professional beauty between the ages of 16 to 22, for the purpose of selecting "Miss Downtown Radio," who will represent this section as candidate for the title of "Miss Radio Queen" for the coming New York Radio Show at Madison Square Garden.

The following committees are in charge of the jubilee:

Executive Committee—Dudley H. Cohen, Harry De Jur, Emanuel Modell, Jack Weber and Leonard C. Welling.

Publicity—Larry Nixon.

Finance Committee—Jules Smith, Chairman, Joseph Frank, Max Kassover, Claude Levin, Arthur Mirofsky, Abe Nadel, Lewis Rose and Morris Zobel.

Reception Committee—Robert Robbins, Chairman, Gustave Kraus, Wm. G. Malada, Phil Masters, and David Schloss.

Program Committee—Milton Kraus,

Chairman, Samuel Kavesh, Samuel Nadel, Jack Newmark, Eddie Rosenbaum and Henry Walker.

Advertising—Sternfield Godley.
Official Photographer—Harold Stein.
The treasurer is Leonard C. Welling.

Music Trades Convention

The Fourth Annual Convention of the Western Music Trade Association, comprising the music houses of Arizona, Nevada, California, Oregon, Washington, Utah, Idaho, Montana and British Columbia was held at the St. Francis Hotel in San Francisco, July 11 to 14. Wednesday, July 13, was set aside as radio day and at this session J. W. Laughlin, managing director of KPO spoke on the importance to the radio dealers of good broadcasting. R. J. Heffner, Pacific Telephone & Telegraph Company, San Francisco, spoke on electricity in music.

Other speakers at this session were B. E. Martin, Palo Alto; Wm. H. Cross, Oakland; Lorren L. Ryder, San Francisco and R. E. Smiley, assistant sales manager of Atwater Kent Company. In the evening a program entitled "A Night by Candlelight" was tendered by A. Atwater Kent, at which Ernest Ingold acted as toastmaster.

National Association of Broadcasters to Convene

Plans for the Fifth Annual Convention of the National Association of Broadcasters to be held during the week of September 19 at the Hotel Astor, New York City, are announced as follows:

MONDAY, SEPT. 19

1 p.m.—Luncheon meeting of the Board of Directors.

2 p.m.—Committee Meetings.

TUESDAY, SEPT. 20

10 a.m. to 5 p.m.—General Session, to be addressed by authorities on Radio Legislation; Musical Copyright; Field of Broadcasting in Sales Promotion and Merchandising.

8 p.m.—The Convention will be given over to a social meeting of all station owners and members of their staffs attending. One of the high lights will be exhibition of

a motion picture film depicting the history of Radio Legislation, which was taken by one of the members of the staff which was stationed in Washington during the past session of Congress.

WEDNESDAY, SEPT. 21

10 a.m.—Election of Officers and Business Session.

1 p.m.—Luncheon and joint business meeting of the Boards of Directors of the N.A.B. and R.M.A.

2:30 p.m.—Continuation of Business Session.

Details of the program are being arranged by L. S. Baker, executive vice-president of the Association.

Five Manufacturers Merge to Solve Patent Troubles

Five of the leading radio manufacturers have effected an amalgamation under a parent company to be known as the United States Electric Corporation. The parent company has been licensed under all radio receiving set patents owned by the Radio Corporation of America and affiliated companies.

The manufacturers composing the new group are as follows:

Apex Electric Manufacturing Company, Chicago, Ill., O. G. Nelson, president; C. D. Boyd, vice-president; J. Prince, secretary.

Sentinel Manufacturing Company, Chicago, Ill., J. T. Beatty, president (chairman of the board, Inland Steel Co., Chicago); R. J. Beatty, vice-president.

Indiana Electric Manufacturing Company, Marion, Ind., Arthur E. Case, president; Robert J. Spencer, Jr., treasurer, (president, Marion Insulating Wire Co.).

Slagle Radio Company, Fort Wayne, Ind., L. S. Slagle, president; P. K. Romey, vice-president; W. L. Swindler, secretary.

The Workrite Manufacturing Company, Cleveland, Ohio, V. H. Meyer, president and treasurer.

The officers of the United States Electric Corp. were elected as follows: Allen G. Messick, president; Carl D. Boyd, first vice-president; P. K. Romey, secretary, and John Beatty, treasurer.

Directors are A. E. Case, V. H. Meyer, L. S. Slagle.

Pittsburgh A-K Convention at the William Penn Hotel



The 1927-28 Atwater Kent season was formally opened in the Pittsburgh territory with the third annual convention of Atwater Kent dealers held at the William Penn Hotel by the Esenbe Company, distributors for that district. A. A. Buehn,

president of the Esenbe Company, welcomed the dealers, while H. M. Swartz, treasurer, and Charles Weisser and P. A. Ware of the Atwater Kent company added words of wisdom on how to make the coming season the best yet.

St. Louis Radio Trade Show of National Character

Manufacturer and trade names only will designate the exhibits at the Southwest National Radio Exposition to be held in St. Louis, September 19-24. This ruling by the show committee and directors of the St. Louis Radio Trades Association was made to give the impression of a national trade show, and while one-third of the exhibits are direct factory displays the consumer is given the impression that all exhibits are direct. The splendid co-operation of the St. Louis Jobbers who buy exhibit space for the lines they represent is making this condition possible.

On Wednesday, September 21, National Radio Day will be featured. On listeners day, Saturday, September 24th, Radio Commissioner, Henry Bellows, will be the guest of honor and address the show visitors and invisible audience.

Murdock Gets RCA License

Wm. J. Murdock Company has signed a license agreement with the Radio Corporation of America which gives the manufacturers of Murdock Radio full right to manufacture under one hundred and forty or more radio patents held and controlled by the Radio Corporation of America, the General Electric Co., the Westinghouse Electric & Mfg. Co., and the American Telephone and Telegraph Co.

This license also includes the right to manufacture under the patents controlled by the Hazeltine Corporation and the Latour Corporation.

Vreeland Wins Patent Interference Suit

Frederick K. Vreeland, Montclair, N. J., was awarded priority over Michael I. Pupin, New York City, in a patent interference case decided last month by the U. S. Patent Office.

The patent in question concerned a method for elimination of stray impulses, or static, which find their way into the receiving set along with the incoming signals.

It was shown that Vreeland was the first to develop the system in question and so was awarded priority. Vreeland's invention was patented May 19, 1925, while Pupin's patent was granted June 16, 1925.

Braid Electric Co. Holds A-K Dealer Convention

The third annual Atwater Kent conference for dealers of Tennessee and Kentucky was held at the Andrew Jackson Hotel, Nashville, Tenn., August 15-16, under the auspices of the Braid Electric Co., A-K distributors. More than 300 dealers were present.

The convention was officially opened with an address of greetings by W. W. Gambill, president Braid Electric Co., who was followed by W. W. Gambill, Jr., sales manager, on the sales policy for 1927-28. J. F. McCoy, assistant sales manager; E. L. Hollingsworth, district manager, and Jas. H. McKee, convention manager, all represented Atwater Kent in addresses, while J. S. Dagney and W. G. Coleman represented Pooley and Red Lion Cabinets respectively. Rodney Morrison, Jr., At-

In Europe

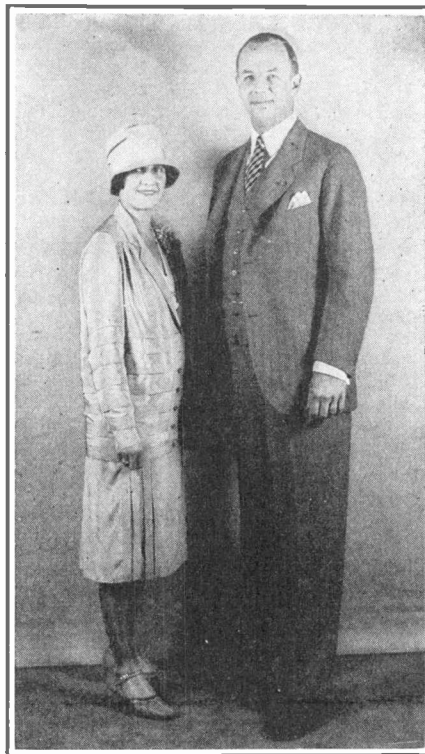

Major Herbert H. Frost and Mrs. Frost sailed August 6 on the S. S. Majestic on a hurried trip to France and England where Major Frost is viewing exhibits for the Radio World's Fair to be held in Madison Square Garden, New York City, Sept. 19-24. Major Frost is former president of the Radio Manufacturers' Association and the present sales manager of E. T. Cunningham. They will return early in September.

lanta district manager of the National Carbon Co.; Marshall Adams, merchandising manager of Westinghouse; Gordon C. Rowley, manager, Radiotron Division, R.C.A., and L. Callender, of the Philadelphia Storage Battery Co., all gave addresses during the two-day program.

Northwest Show in New Minneapolis Auditorium

The Sixth Annual Northwest Radio and Electrical Show will be held in the new three-million-dollar Minneapolis auditorium September 26 to October 1 inclusive. This convention building is one of the finest of its kind in America.

Among the nationally-known radio artists engaged for this occasion are such stellar lights as Mary Lewis, youthful prima donna of the Metropolitan Opera Company; Allen McQuhae, the Irish tenor; the Smith Brothers (Trade and Mark) and the Ray-o-vac Twins.

This year's show will be held under the auspices of the Northwest Radio Show, Inc., Minneapolis, Minn.

Arborphone Licensed under Loftin-White Patents

Precision Products Company has been licensed under Loftin-White patents. Of the seven sets in the new Arborphone line,

four will use those circuits. These four will be known as models 25, 253, 252 and 255 De Luxe. The latter is a combination power radio and phonograph.

Coinciding with these new developments the company has employed William Ingles to handle the new merchandising and advertising plan on Arborphone. Mr. Ingles, formerly with *Radio Retailing* and Thomas A. Edison, Inc., will be responsible for Arborphone advertising and sales promotion work.

Philco Will Double Contest Prizes

The Philadelphia Storage Battery Company, Philadelphia, Pa., has announced it will double the prizes in *Radio Retailing's* National Radio Day window display contest, for any Philco dealer who wins a prize.

If a Philco dealer wins a prize, the Philco Company will send him double the amount of the prize, in addition to the prize offered by this publication. Details of the contest appear on page 67.

New Haven Boosting Radio Show

"The largest radio show in New England outside of Boston," is the slogan of the New Haven, Conn., Radio Show to be held at the Arena, September 26-29. E. E. Hulbert, sales manager of the Southern New England Electric Company is taking charge of the show, and a large musical program has been arranged. Graham McNamee and Milton Cross of the National Broadcasting Company have been obtained and will be in full charge of the broadcasting features which will be broadcast by Station WDRC New Haven, and WTIC Hartford.

Federal-Brandes Takes RCA License

Federal-Brandes, Inc., 200 Mt. Pleasant Ave., Newark, N. J., makers of Kolster Radio, announce that an agreement has been reached with the Radio Corporation of America and its associated companies under which Federal-Brandes, Inc., is licensed to manufacture under patents held by the Radio Corporation group.

Northern Ohio Association Is Incorporated

The Northern Ohio Radio Trade Association of Cleveland has been incorporated with an authorized capital of 500 shares of stock, no par value, designated to hold annual radio shows and exhibits for the display of radio sets, supplies and devices. The incorporators are Elmer Glaser, S. J. Brenza, C. J. Halfinger.

Indianapolis Radio Show is Cancelled

Plans for the Third Annual Indianapolis Radio Exposition of the Broadcast Listeners' Association, which was to have been held during the first week of October this year, have been cancelled and will be held in abeyance until 1928.

300 at Conference in Nashville, Tenn.

Three hundred men of the radio industry, men prominent from a national standpoint, engineers, service men and dealers from Southern Kentucky, Tennessee, Alabama and parts of Georgia, gathered in Nashville, July 2 as the guests of Buford Brothers, radio distributors.

During the day Powell Crosley, Jr., head of the radio corporation which bears his name, Arthur Haugh, formerly president of the Radio Manufacturers' Association, Rodney Morris of the National Carbon Co., W. L. Morley, chief engineer of the King Radio Co., M. Y. Brocket, sales manager of Buford Brothers, and Jack Lins, assistant general sales manager of the Crosley Corporation, talked over the problems confronting the radio dealers and offered suggestions for their solution.

The conference was terminated by a banquet which Mr. Haugh and Mr. Morley addressed.



"Are You There?"

The most unique long distance interview in the history of journalism took place August 23 when Major Herbert H. Frost, chairman of the show committee of the Radio Manufacturers' Association, speaking from the Hotel Metropole, London, England, was interviewed via international radio telephone by a group of radio trade magazine editors at the home of G. Clayton Irwin, in New York City. Major Frost reported there was intense interest throughout England in the Radio World's Fair to be held the week of September 19 at New Madison Square Garden, New York—admission 50c (You're welcome, Mr. Irwin.) The bill for the call was \$275 and although Mr. Irwin suffered a severe heart attack immediately thereafter, he is now resting comfortably on 117 columns of publicity.

THE COLUMBIA BROADCASTING SYSTEM will inaugurate its chain programs on Sunday, September 18, according to Major J. Andrew White, director of operations. The new chain has stations in many leading cities.

STEINITE LABORATORIES COMPANY, 506 South Wabash Ave., Chicago, Ill., manufacturer of Steinite receivers, has entered into a license agreement with the Radio Corporation of America and its associated companies including General Electric Company, Westinghouse Electric & Mfg. Company and the American Telephone and Telegraph Company.

MOHAWK CORPORATION of Illinois, Diverssey at Logan Blvd., Chicago, Ill., manufacturer of Mohawk receivers, has received the R.C.A. license which gives Mohawk full access to and use of the patents under control of R.C.A., the General Electric Company, the Westinghouse Electric & Manufacturing Co., and the American Telephone & Telegraph Company. Mohawk is the sole owner of the Chamberlain patent, and is also licensed under the Hogan patent. Gustave Frankel, president of the Mohawk Corporation, made the announcement.

Kentucky Dealers Hold Fada Conference

Peaslee-Gaulbert Company, Louisville, Ky., southern distributors of Fada Radios, recently held a convention for their dealers at the Andrew Jackson Hotel, at which the Fada line was demonstrated. In addition, the Nashville Battery Company, also representatives of Fada, demonstrated the Willard and Philco batteries with the new model Fada set.

Selling Methods that Net 13 Per Cent

(Continued from page 71)

ness was a one-man job. Ische alone sold and serviced \$18,000 worth of radio from October, 1925, to September, 1926. His total overhead during this period was less than 20 per cent of his gross sales. This materially reduced his average overhead, and increased the net profit for that fiscal year. By September, 1926, his policy had brought such an influx of calls that he added a part-time salesman and a service expert. These he trained himself so that they would carry on the high standards he had established.

"The so-called 'summer slump' is a good thing. It gives the prospective buyer as well as the dealer a necessary breathing spell," Mr. Ische informs us.

This July and August he called on all set owners, inspecting their equipment without charge. "Every owner gets one free service call in the summer," is one of Ische's slogans. "This slogan and his service policy—a \$1 flat service charge—are so stressed at the time the sale is made that every customer knows them by heart," he states.

Ische is not worried about losing money in the summer. His rent is \$75 a month. His other expenses, including salaries, do not exceed \$300.

"Accessory business and set sales, to those purchasers who have been waiting, and preparation for the early Fall prospect by canvassing, keep me quite busy. Cut prices or side lines may be necessary in other districts, but in a territory such as this one, my experience has been that high-class service will produce better results."

Iowa Distributor Holds Crosley Meeting



The heavy rain prevented all the Crosley dealers in Iowa from attending the dealer meeting held by the Standard Battery & Electric Co., Waterloo, Iowa, but it stopped in time to enable those present to have their picture taken. R. P. Crawley, district manager, and L. A. Kellogg, sales promo-

tion manager, represented the Crosley Radio Corp., while F. A. Byrnes and E. G. Johnson represented the Willard line and C. P. Lorenzen represented the Burgess line. After the banquet everyone attended the Dempsey-Sharkey fight by means of a Crosley Band Box.

Radio-Music Exposition for Milwaukee

The Wisconsin Radio Trade Association plans to broaden the scope of its show activities this fall by admitting, as exhibitors, members of the music industry in Milwaukee and surrounding towns.

Its affair will be called "The Fifth Radio-Music Exposition" and will be held Oct. 4-9 in the Auditorium Building. A radio trade convention will be held on the mornings of Oct. 6 and 7.

Amplion Stockholders Elect New Board

At a meeting of the stockholders of the Amplion Corporation of America, held at 280 Madison Avenue, New York City, on July 1, the following directors were elected: Leslie Laurence, chairman; S. B. Trainer, president; W. H. Lynas, vice-president; J. N. Trainer, treasurer; A. W. Harris, chief engineer; L. L. Spencer, general sales manager; and P. N. Gray.

The Amplion Corporation has recently

moved its offices and factory from 280 Madison Avenue to 531 West Thirty-seventh Street, New York City. David H. Moss superintended the installation. At a sales conference during the week of July 25, three new members were added to the sales staff. They are W. L. Lown, recently associated with the Daven Corporation; Carl J. Main, formerly with the A. H. Grebe Company; and J. J. DeBona, formerly general sales manager of the Homer P. Snyder Manufacturing Company. H. G. Hillebrand and F. W. Piper continue in their old posts.

WEAF's new 50-kilowatt broadcasting station at Bellmore, Long Island, N. Y., will start operating sometime during the month of September according to an announcement by the National Broadcasting Company. The studios will remain at 195 Broadway, New York City, and the programs will be relayed by telephone wire to the transmitting plant. The change in location of the aerial, together with the increased power, is expected to provide fine reception of WEAf throughout the entire east.

Radio World's Fair Opens Sept. 19th

All arrangements have been completed for the fourth annual Radio World's Fair to be held the week of September 19th at New Madison Square Garden, New York City. Window posters advertising Radio World's Fair Week have been mailed by G. Clayton Irwin, Jr., general manager of the show, to all dealers in the Metropolitan area and they are urged to use the posters in their windows.

Those exhibiting at the show, as of Aug. 25, are as follows:

Abox Company, Chicago, Ill.
A. C. Dayton Company, Dayton, Ohio.
Acme Apparatus Company, Cambridge, Mass.
Acme Wire Co., New Haven, Conn.
Advance Battery Corp., Brooklyn, N. Y.
Aero Products, Inc., Chicago, Ill.
Aerovox Wireless Corp., Brooklyn, N. Y.
Algonquin Elec. Co., New York City.
All-American Radio Corp., Chicago, Ill.
Allen Bradley Co., Milwaukee, Wis.
Aluminum Co. of America, Edgewater, N. J.
American Bosch Magneto Corp., Springfield, Mass.
American Elec. Co., Inc., Chicago, Ill.
American Mechanical Lab., Brooklyn, N. Y.
Amplion Corp. of America, New York City.
Amrad Corporation, Medford Hillside, Mass.
Apex Elec. Mfg. Co., Chicago, Ill.
Arco Battery & Plate Co., Fort Wayne, Ind.
Arcturus Radio Co., Newark, N. J.
Argus Radio Company, New York City.
Aristocrat Corp., New York City.
Atwater Kent Mfg. Co., Philadelphia, Pa.
Bakelite Corporation, New York City.
Nathaniel Baldwin, Inc., New York City.
Balsa Wood Company, Inc., New York City.
Batteryless Radio Corp., New York City.
Belden Mfg. Co., Chicago, Ill.
Best Mfg. Co., Newark, N. J.
Bodine Electric Co., Chicago, Ill.
Borkman Radio Corp., Chicago, Ill.
Boy Scouts of America.
L. S. Brach Mfg. Co., Newark, N. J.
Bremer-Tully Mfg. Co., Chicago, Ill.
Briggs-Stratton Corp., Milwaukee, Wis.
Bright Star Battery Co., Inc., Hoboken, N. J.
Brooklyn Metal Stamping Corp., Brooklyn, N. Y.
Browning-Drake Corp., Cambridge, Mass.
Burgess Battery Co., Chicago, Ill.
Burt Bros., Inc., Philadelphia, Pa.
Cable Supply Company, New York City.
Camfield Radio Mfg. Co., Chicago, Ill.
The Allen D. Cardwell Mfg. Corp., Brooklyn, N. Y.
Carter Mfg. Co., Cleveland, Ohio.
Carter Radio Co., Chicago, Ill.
C-E Mfg. Co., Providence, R. I.
The Celeron Company, Bridgeport, Pa.
Central Radio Laboratories, Milwaukee, Wis.
Chicago Solder Company, Chicago, Ill.
Citizens Radio Call Book, Chicago, Ill.
Colonial Radio Corp., New York City.
Commercial Metal Works, New York City.
Consolidated Battery Co., Philadelphia, Pa.
Corbett Cabinet Mfg. Co., St. Mary's, Pa.
Cornell Elec. Mfg. Corp., Long Island City.
Cornish Wire Co., New York City.
Crosley Radio Corp., Cincinnati, Ohio.
Crown Phonograph, Inc., New York City.
E. T. Cunningham, Inc., New York City.
Davis, Inc., R. T., Chicago, Ill.
Day-Fan Elec. Co., New York City.
DeForrest Radio Corp., Jersey City, N. J.
Diamond Elec. Spec. Corp., Newark, N. J.
Diamond T Radio Mfgs., South Bend, Ind.
Dodd, Mead & Co., Inc., New York City.
Dongan Elec. Mfgs., Detroit, Mich.
Dry Storage Battery Co., Philadelphia, Pa.
Dubilier Condenser Corp., New York City.
Eagle Charger Corp., Philadelphia, Pa.
Electrad, Inc., New York City.
Electric Storage Battery Co., Philadelphia, Pa.
Electrical Research Lab., Chicago, Ill.
Elkon Works, Inc., Weehawken, N. J.
Empire Elec. Prod. Co., New York City.
Engineers Service Co., New York City.
Evening Telegram, New York City.
Experimenter Publishing Co., New York City.
Fansteel Products, New York City.
Farrand Mfg. Co., Inc., Long Island City.
Federal-Brandes, Inc., Newark, N. J.
Federal Radio Corp., Buffalo, N. Y.
Fergus Co., Newark, N. J.
J. B. Ferguson, Inc., New York City.
Ferranti, Inc., New York City.
Formica Insulation Co., New York City.
Freed-Elsemann Radio Corp., Brooklyn, N. Y.
French Battery Co., New York City.
Chas. Freshman Co., Inc., New York City.

(Please turn to page 192)

Radio Shows and Conventions

September 4-10: Fifth Annual National Radio Exposition, Ambassador Auditorium, Los Angeles, Cal.

September 6-10: The Canadian Exhibition Company, Third Annual Winnipeg Radio Show, Royal Alexandra Hotel, Winnipeg, Man., Can.

September 6-10: Greater Vancouver Radio Trades Association, Westminster, B. C., Can.

September 10 - 16: Buffalo Radio Show, Broadway Auditorium, Buffalo, N. Y.

September 12-17: Philadelphia Radio Rodeo, Commercial Museum, Philadelphia, Pa.

September 12-17: Penna. Electrical Contractors Assn., Electrical and Radio Show, Erie, Pa.

September 14-18: Oregon Radio Trades Association, Portland, Oregon.

September 19-22: Richmond Radio Show, Richmond, Va.

September 19-24: Radio World's Fair, New Madison Square Garden, New York City.

September 19-24: Third Annual Southwest National Radio Show, Coliseum, St. Louis, Mo.

September 19-24: Rochester Radio Trades, Inc., Third Annual Rochester Radio Show, Convention Hall, Rochester, N. Y.

September 21: Annual Radio Industries Banquet, Hotel Astor, New York City.

September 22-25: Oregon Radio Trades Association, Spokane, Washington.

September 26-October 1: Seventh Annual Boston Exposition, Mechanics Hall, Boston, Mass.

September 26-October 1: Sixth Annual Northwest Radio Show, Minneapolis Auditorium, Minneapolis, Minn.

September 26-October 1: The Canadian Exhibition Company, Fourth Annual Montreal Radio Show, Windsor Hotel, Montreal, Canada.

September 26-October 1: Radio and Electrical Exposition, Convention Hall, Kansas City, Mo.

October 3-8: Salt Lake City Radio Show, Salt Lake City, Utah.

October 3-8: Pittsburgh Radio Show, Duquesne Gardens, Pittsburgh, Pa.

October 4-9: Fifth Wisconsin Radio-Music Exposition, Civic Auditorium, Milwaukee, Wis.

October 10-16: Sixth Annual Radio Show, Coliseum, Chicago, Ill.

October 24-27: National Electrical Manufacturers Association, Apparatus Division, Briarcliff, N. Y.

October 24-29: New Orleans Radio Show, New Orleans "States" Building, New Orleans, La.

October 24-30: Detroit Radio Show and Michigan State Radio Gathering, Convention Hall, Detroit, Michigan.

November 8-13: Third Annual Radio Show, Municipal Auditorium, Cleveland, Ohio.

News of Jobbers and Distributors

USL Holds Convention at Niagara Falls

The USL Corporation, Niagara Falls, N. Y., held their Annual Sales Convention at that place August 8-9 inclusive. More than 300 USL distributors were present. The two days were devoted to business sessions, luncheons and banquets and various scenic tours around Niagara Falls. Service, sales and advertising plans for USL Batteries and USL radio equipment were developed in the business sessions.

It was an occasion, also, for awarding the prizes in the recent three month national USL sales contest, the winners of the contest being: Birmingham Battery & Electric Co., Birmingham, Ala.; R. C. Clapp Co., Knoxville, Tenn.; and Florida Battery Service, Tampa, Fla.

Ohio Arborphone Jobber Holds Dealer Meeting

The Wagner Hardware Company, Mansfield, Ohio, entertained more than a hundred Arborphone dealers at a special display meeting and banquet at the Mansfield-Leland Hotel, July 16th. George Stelts, vice-president and general manager of Wagner Hardware Co. opened the meeting.

C. T. Anderson and Paul Smith explained the Loftin-White Circuit of the Arborphone receivers while W. K. Jackson, sales manager, talked on sales possibilities. William Ingles, advertising and sales promotion manager, explained the Arborphone merchandising plan and Mr. Wagner closed the meeting with a short talk.

WM. H. BRIMBERRY, for the past ten years a departmental head of the Carter Electric Co., Atlanta, Ga., has joined the Capital Electric Company, 7 Auburn Ave., of that city, as vice-president. Mr. Brimberry is associated with Frank F. McGaughey, formerly vice-president of the Carter Electric Company, and now head of the new venture. Mr. Brimberry is also chairman of the board of directors of the Atlanta Radio Trade Association and was general chairman of the Cities Radio Exhibition Committee last year.

SPLITDORF RADIO CORPORATION, Newark, N. J., has appointed the following new jobbers to handle the distribution of Splitdorf Radio products in the metropolitan territory: Auto Hardware and Equipment Co., 245 West 55th Street, New York City; Plaza Music Company, 10 West 20th Street, New York City. These appointments were announced by Frank T. Adler of Splitdorf's New York office. The following jobbers have represented the company heretofore and have renewed their contracts for the 1927-1928 season: Bergman Hardware Co., 97 E. Eagle Street, Buffalo, N. Y.; Lockner Bros., 420 Columbia Street, Utica, N. Y.; Walters' Rubber Co., Jericho Turnpike and Old Country Road, Mineola, L. I., N. Y.

FREED-EISEMANN RADIO CORPORATION, Junius Street and Liberty Avenue, Brooklyn, N. Y., has appointed a new distributor, the Superior Lamp & Auto Equipment Co., 152 West 52nd Street, New York City, which will operate in Manhattan and

Bronx. This concern maintains an office at Newark, N. J., which also has been appointed distributor to operate in northern New Jersey.

The Wholesale Radio Equipment Company, 115 Leonard St., New York City, also with a branch in Newark, N. J., at 37 William Street, will continue to serve Freed-Eisemann dealers in the same territories.

Boetticher & Kellogg Company, Evansville, Indiana, and Grinnell Bros., 1447 First Street, Detroit, Mich., have been appointed as distributors in their respective territories.

BUCKINGHAM RADIO CORP., 17 East Austin Ave., Chicago, Ill., has recently appointed the following distributors: Wm. Dutton & Sons Company, Hastings, Neb.; Western Radio & Auto Supply Co., Cedar Rapids, Ia.; Prusia Hardware Co., Fort Dodge, Ia.; Electric Lamp & Supply Co., St. Louis, Mo.; United Factories, Cleveland, Ohio; C-L Radio Company, Dayton, Ohio; Finke Furniture Company, Evansville, Ind.; and the Louis Model Company, Boston, Mass. The announcement was made by R. T. Anderson, sales manager of the Buckingham Radio Corporation.

PLAZA MUSIC COMPANY, manufacturer and distributor of musical merchandise, 10 W. 20th Street, New York City, has entered into the distribution of radio products. The company has taken the Splitdorf line and a fine line of radio console cabinets as its major items and expects to add tubes, speakers, eliminators and other radio units.

THE FRIEDMAN-SNYDER COMPANY has opened new offices at 9 Park Place, New York City. This company represents the H. H. Eby Manufacturing Company, the Mayolian Corporation, the Kurz-Kash Company, the Wizard Company and the Langbein-Kaufman Radio Co.

THE FROMAR COMPANY, radio jobber, Harrisburg, Pa., was host at the third annual assembly of its dealers, June 21, at the Colonial Country Club, Harrisburg, Pa. Troy B. Wildermuth, president of the company, welcomed the dealers. Two business sessions were held during the day, and were followed by a dinner and an entertainment in the evening.

THE ZINKE COMPANY, 1323 Michigan Boulevard, Chicago, Ill., distributors of radio and electrical equipment, has recently published a book, under the title, "Sales—At What Cost," of interest to manufacturers and jobbers with sales problems. A copy of the book will be sent free upon request from an executive of a concern with sales problems.

THE F. D. PITTS COMPANY, Boston, Mass., has been appointed distributor of the complete Kellogg radio line for the New England territory. A. H. Holke of the Kellogg sales force is co-operating with the sales force of the Pitts company, and lining up representation of Kellogg in the New England States.

VENUS RADIO CORP., distributors, New York City, has moved its offices and general stock rooms from 135 Liberty Street to 142 Liberty Street.

West Virginia Distributor Holds A-K Convention

The Third Annual Atwater Kent Dealers Convention of the Williams Hardware Company, was recently held at the Waldo Hotel, Clarksburg, W. Va., under the direction of John McGuigan, district manager for Atwater Kent. D. B. Williams, of the Williams Hardware Company welcomed the dealers and was followed by W. W. Huffman with talks on furniture—Pooley, Red Lion and Conner cabinets.

Atwater Kent advertising was covered by Charles Weiser, while Merchandising and Sales Promotion Plans were presented by F. A. Delano. Miss Mae B. Colombo of Philadelphia gave a talk on radio in the schools and selling radio to women. The Atwater Kent line for 1927-28 was presented to the dealers.

JONES-BEACH Co., Inc., 307 North Seventh Street, Philadelphia, Pa., has been appointed distributor for that territory by the Splitdorf Radio Corporation. The connection was made by A. A. Sinclair, special representative of Splitdorf for the Philadelphia territory.

SYLVANIA PRODUCTS COMPANY, INC., Emporium, Pa., has appointed the Wiedenbach-Brown Company, Inc., 26 East Twenty-second Street, and the Import and Distributing Company, 156 Chambers Street, both in New York City, as its distributors in the Metropolitan District.

FEDERAL-BRANDES, INC., has appointed Musical Products Distributing Co., Inc., 22 W. 19th St., New York City, as a jobber of Kolster radio sets, speakers and power units. The territory to be covered will include New York City, the lower Hudson Valley, Long Island and northern New Jersey.

BREMER-TULLY MANUFACTURING COMPANY, Chicago, Ill., has appointed two new distributors, one in the East and one in the South. They are Freeman, King and Co., Ithaca, N. Y., and Harbison-Cathright Co., Louisville, Ky.

SLEEPER RADIO & MFG. CORP., Long Island City, N. Y., has appointed the Willis Company of Canton, Ohio, and the Akron Parts Co. of Akron, Ohio, as distributors to serve the dealers in the eastern counties of the state.

THE LINCOLN MOTOR SALES COMPANY, Baltimore, Md., the Minot Supply Company, Minot, N. D., and the Churchill Drug Company, Cedar Rapids, Iowa, have been appointed Crosley distributors in their respective territories.

DOUBLEDAY-HILL ELECTRIC COMPANY, Washington, D. C., has been appointed distributor of F. A. D. Andrea, Inc. The company will cover Maryland, Virginia, and North Carolina, as well as Washington, D. C.

THE CAHALL-DICKELL DISTRIBUTING COMPANY, 672 N. Broad Street, Philadelphia, Pa., has been appointed one of the F. A. D. Andrea, Inc., distributors in the Philadelphia territory.

Complete Specifications of

For the Season

Name and Address of Manufacturer	Trade Name and Model Number	List Price	A. C. or Battery Operated	Style of Cabinet	Is Speaker Built-In? If So, what Type	Stages of R. F.	Stages of A. F.	Type of Tubes Used
A-C Dayton Co. 308 E. First St. Dayton, Ohio	A-C Dayton XL-25	\$85.00	Battery	Standard	No	2	2	201-A
	XL-60	135.00	Battery	Standard	No	3	2	201-A
	XL-25	149.00	Battery	Console	Horn	2	2	201-A
	XL-70	165.00	Battery	Standard	No	4	2	201-A
	XL-25	252.00	Battery	Console Grand	Exclusive A-C*	2	2	201-A
*Duophonic. †Duophonic	XL-60	285.00	Battery	Console Grand	A-C Dayton†	3	2	201-A
	XL-70	315.00	Battery	Console Grand	A-C Dayton†	4	2	201-A
Adroit Tool Co., N. Y. C.	Adrola—All Electric	230.00	A.C., D.C.	Table	No			5-201-A
Algonquin Electric Co., Inc. 245 Fifth Ave., N. Y. C.	Thermodyne WT-7	150.00	Battery	Table	No	3	3	201-A
	Thermodyne TA-7	250.00	Battery	Table	No	3	3	201-A
All-American Radio Corp. 4201 Belmont Ave. Chicago, Ill.	All-American 44	70.00	Battery	Table	No	3	2	5-UX-201-A, 1-UX-171
	55	125.00	Battery	Hiboy	Cone	3	2	5-UX-201-A, 1-UX-171
	80	135.00	A.C.	Table Cabinet	No	2	2	4-UX-199, 1-UX-112
	90	145.00	A.C.	Table Cabinet	No	2	2	4-UX-199, 1-UX-112
	77	150.00	A.C.	Table Cabinet	No	3	2	4-UX-226, 1-UX-171, 1-UY-227
	Duet	160.00	A.C.	Table Cabinet	No	2	3	5-UX-199, 1-UX-112
	115	170.00	A.C.	Hiboy	No	2	2	4-UX-199, 1-UX-112
	66	200.00	Battery	Console	Cone	3	2	5-UX-201-A, 1-UX-171
	88	210.00	A.C.	Hiboy	Cone	3	2	4-UX-226, 1-UX-171, 1-UY-227
	Sextet	220.00	A.C.	Hiboy	Cone	2	3	5-UX-199, 1-UX-112
	Forte	270.00	A.C.	Table Cabinet	No	4	2	5-UX-226, 1-UY-227, 1-UX-171
	99	285.00	A.C.	Console	Cone	3	2	4-UX-226, 1-UX-171, 1-UY-227
	Lorraine	360.00	A.C.	Hiboy	Cone	4	2	5-UX-226, 1-UY-227, 1-UX-171
Sovereign	460.00	A.C.	Console	Hawley (Ortho.)	4	2	5-UX-226, 1-UY-227, 1-UX-171	
American Bosch Magneto Corp., Springfield, Mass.	Bosch 66		Battery	Table	No	3	2	201-A, 112 or 171
	76		Battery	Console	Cone	3	2	201-A, 112 or 171
	57		Battery	Console	Cone	4	2	201-A, 112 or 171
Amrad Corp. Medford Hillside Massachusetts	Warwick DC-6	138.00	Battery	Compact	No	3	2	5-201-A, 1-UX-171 or 112
	Windsor DC-7	195.00	Battery	Compact	No	4	2	6-201-A, 1-UX-171 or 112
	Berwick DC-6	195.00	Battery	Console	RCA-100A	3	2	5-201-A, 1-UX-171 or 112
	Hastings DC-7	295.00	Battery	Console	RCA 100A	4	2	6-201-A, 1-UX-171 or 112
	Warwick AC-6	238.00	A.C.	Compact	No	3	2	4-UX-226 & 1-UY-227, 1-UX-171 or 112
	Windsor AC-7	295.00	A.C.	Compact	No	4	2	5-UX-226 & 1-UY-227, 1-UX-171 or 112
	Hastings AC-6	295.00	A.C.	Console	RCA 100A	3	2	4-UX-226 & 1-UY-227, 1-UX-171 or 112
Hastings AC-7	395.00	A.C.	Console	RCA 100A	4	2	5-UX-226 & 1-UY-227, 1-UX-171 or 112	
Andrea, F. A. D. Inc. Jackson Ave. Orchard and Queen Sts. L. I. City, N. Y.	Fada special 265-A	95.00	Battery	Table	No	3	2	301-A, 201-A, 371, 171
	Fada 7 475-A	185.00	Battery	Table	No	4	2	301-A, 201-A, 371, 171
	Fada 7 S.F. 45.75	285.00	Battery	Console	No	4	2	301-A, 201-A, 371, 171
	Fada 8 480-B	300.00	Battery	Table	No	4	3	301-A, 201-A, 371, 171
	Fada 8 S.F. 50.80	400.00	Battery	Console	No	4	3	301-A, 201-A, 371, 171
Anylite Electric Co. 1418 Wall St. Ft. Wayne, Ind.	King Cole 6	75.00	Battery	Table	No	1	4	201-A and 112-A
	7	92.50	Battery	Table	No	3	3	201-A and 112-A
	8	115.00	Battery	Table	No	4	3	201-A and 112-A
	7	175.00	Battery	Console	Newcombe-Hawley	3	3	201-A and 112-A
	8	200.00	Battery	Console	Newcombe-Hawley	4	3	201-A and 112-A
Note—All prices without power supply units. Add \$75 for these.								
Apex Electric Mfg. Co. 1410 W. 59th St. Chicago, Ill.	Apex Lyric	80.00	Battery	Table	No	2	3	200-A, 201-A, 171
	Milan	135.00	Battery	Console	Cone	2	3	200-A, 201-A, 171
	Corsair	170.00	Battery	Table	No	4	2	200-A, 201-A, 171
	Minstrel	225.00	Battery	Console	Cone	4	2	200-A, 201-A, 171
	Troubadour	295.00	Battery	Console	Cone	6	2	200-A, 201-A, 171
Argus Radio Corp. 257 W. 17th St. New York City	Argus Electric B-125	125.00	A.C.	Table	No	3	2	5-UX-199, 1-112 power
	B-195	195.00	A.C.	Table	No	3	2	5-UX-199, 1-210
	B-295	295.00	A.C.	Console	Horn*	3	2	5-UX-199, 1-210
	B-395	395.00	A.C.	Console	Newcombe-Hawley†	3	2	5-UX-199, 1-210
	A-25	195.00	A.C.	Table	No	3	3	5-UX-199, 1-UX-171, 1-201-A
	No. 375	295.00	A.C.	Console	Horn*	3	3	5-UX-199, 1-UX-171, 1-201-A
*with Baldwin Unit. †Horn with Baldwin Unit.								
Atwater Kent Mfg., Co. Philadelphia, Pa.	Atwater Kent 35	65.00	Battery	Table	No	3	2	201-A
	30	80.00	Battery	Table	No	3	2	201-A
	33	90.00	Battery	Table	No	3	2	201-A
	32	110.00	Battery	Table	No	4	2	201-A
	50	150.00	Battery	Table	No	4	2	201-A
Audiola Radio Co. 430 So. Green St. Chicago, Ill.	Audiola 6-T	75.00	Battery	Table	None	3	2	201-A, 200-A, 112
	8-T	125.00	Battery	Table	None	4	3	201-A, 200-A, 112
	6-C	175.00	Battery	Console	Newcombe-Hawley	3	2	201-A, 200-A, 112
	8-C	225.00	Battery	Console	Newcombe-Hawley	4	3	201-A, 200-A, 112
	6-B	225.00	Battery	Baby Grand*	Temple	3	2	201-A, 200-A, 112
	8-B	275.00	Battery	Baby Grand*	Temple	4	3	201-A, 200-A, 112
*Console								
Bosworth Electric Mfg. Co. Main & Lexington Ave. Northwood, Cincinnati, O.	Bosworth B-6	75.00	Battery	Table	No	2	2	201-A and 171
	B-3	100.00	Battery	Table	No	3	2	201-A and 171
	B-5	165.00	A.C.	Table	Ro	2	2	CX-326, C-327, UX-171
	B-7	250.00	A.C.	Console	Peerless Cone	3	2	CX-326, C-327, UX-210
Bremer-Tulley Mfg., Co. 520 S. Canal St. Chicago, Ill.	Counterphase†6-6-35	110.00	Battery	Table	No	4	2	201-A, 112
	6-6-22	140.00	Battery	Table	No	*4	2	201-A, 112
	†6-6-37	165.00	Battery	Table	No	4	2	201-A, 112
	8-8-12	215.00	Battery	Table	No	*5	3	201-A, 112
	†8-8-16	295.00	Battery	Table	No	*5	3	201-A, 112
	*Uses B.T. rejector stage. †May also be had in model using new A.C. tubes. Prices later.							
Bronx Radio Equip. Co. New York City	Breco 12	120.00	Battery	Hiboy	No	2	2	201-A
Brooklyn Radio Lab. 4320—16th Ave. Brooklyn, N. Y.	B. R. L. Royal 6	62.00	Battery	Table	No	2	3	201-A
	Miniature	65.00	Battery	Portable	Horn	3	3	199
	Royal 6-E	650.00	A.C.	Console	1 cone, 1 horn	2	3	199, 120
	Grand 8-C	800.00	A.C.	Console	1 cone, 1 horn	4	4	201-A, 171

Radio Receiving Sets

of 1927-1928

Name and Address of Manufacturer	Trade Name and Model Number	List Price	A. C. or Battery Operated	Style of Cabinet	Is Speaker Built-In? If So, What Type?	Stages of R. F.	Stages of A. F.	Type of Tubes Used	
Browning-Drake Corp. 110 Brookline St. Cambridge, Mass.	Browning-Drake 5-R	\$95.00	Battery	Table	No	1	3	201-A	
	6-A	105.00	Battery	Table	No	1	3	201-A	
	7-A	140.00	Battery	Table	No	2	3	201-A	
Buckingham Radio Corp. 25 E. Austin Ave. Chicago, Ill.	Buckingham 1	*	Battery	Table	No	3	2	200, 201, 112	
	2	*	Battery	Console	Horn	3	2	200, 201, 112	
	5	*	Battery	Orthophonic	48, 55 in. tone†	3	2	200, 201, 112	
	18	*	Battery	Console	55 in. tone chamber	3	2	200, 201, 112	
	20	*	Battery	Orthophonic	84 in. tone chamber	3	2	200, 210, 112	
*Price not ready. †Cabinet.									
Bush & Lane Piano Co. Holland, Mich	Bush & Lane 1	80.00	Battery	Table		2	3	201-A	
	1-C	102.50	Battery	Consolette		2	3	201-A	
	4	130.00	Battery	Table		4	2	201-A	
	7	170.00	A.C.	Table		2	2	McCullough	
	6	175.00	A.C.	Table		3	2	McCullough	
	4-C	195.00	Battery	Console		4	2	201-A	
3-C	205.00	Battery	Console		2	3	201-A		
6-C	275.00	A.C.	Console Grand		Yes Yes 8-ft. horn	3	2	McCullough	
Clearstone Radio Co. 1731 Central Ave. Cincinnati, Ohio	Clearstone Standard 110	145.00	A.C.	Table	No	2	2	Kellogg-McCullough	
	110 Compact	165.00	A.C.	Table	No	2	2	Kellogg-McCullough	
	110-T Standard	180.00	A.C.	Set and Table	No	2	2	Kellogg-McCullough	
	Mayflower Compact	200.00	A.C.	Table	Cona	2	2	Kellogg-McCullough	
	110-C Standard	270.00	A.C.	Console	Horn	2	2	Kellogg-McCullough	
	Senator Console	295.00	A.C.	Console	Cone	2	2	Kellogg-McCullough	
	Congressional	345.00	A.C.	Console	Horn	2	2	Kellogg-McCullough	
Crescent Radio Mfg., Co. 1026-2nd Ave. So. Minneapolis, Minn.	Crescentyne M-6	65.00	Battery	Table	No	2	3	201-A	
	C-6	80.00	Battery	Table	No	2	3	201-A	
	K-6	90.00	Battery	Table	No	2	3	201-A	
	K-16	150.00	Battery	Console	Horn, wood, any unit	2	3	201-A	
	M-28	190.00	Battery	Console	Horn, Temple drum	2	3	201-A	
	K-28	200.00	Battery	Console	Horn, Temple drum	2	3	201-A	
Crosley Radio Corp. Cincinnati, Ohio	Bandbox 601	55.00	Battery	Table	No	3	2	5-UX-201-A, 1-UX-171	
	602	65.00*	A.C.	Table	No	3	2	4-UX-226, 1-UY-227, 1-UX-171	
*Without accessories or supply unit.									
Day-Fan Electric Co. Dayton, Ohio	Day-Fan Jr.—5142	65.00	Battery	Table	No	3	2	201-A	
	Day-Fan 6—5140	110.00	Battery	Table	No	3	2	201-A	
	Day-Fan 6—5146	115.00	*	Table	No	3	2	201-A and spec.	
	Day-Fan 6—5145	115.00	A.C.	Table	No	3	2	Kellogg	
	Day-Fan 6—5145	115.00	Battery	Table	No	3	3	201-A	
	Day-Fan 7—5124	115.00	Battery	Table	No	3	2	201-A and spec.	
	Day-Fan 6-D.C.—5152	115.00	110 v. D.C.	Table	No	3	2	201-A and spec.	
	Day-Fan 6-D.C.—5153	115.00	32 v. D.C.	Table	No	3	2	201-A and spec.	
	Day-Cee 6-A.C.—5143	140.00	A.C.	Table	Horn	3	2	Kellogg	
	Day-Craft 5-A.C.—5148	155.00	A.C.	Table	Horn	2	2	Kellogg	
	Day-Royal 6A.C.—5144	195.00	A.C.	Console	Horn	3	2	Kellogg	
	Day-Mar 6-A.C.—5158	220.00	A.C.	Console	Horn	3	2	Kellogg	
	*Motor Generator—5508		80.00	110 v. A.C. To be used with	5146 set.				
	Diamond T Radio Mfrs. South Bend, Ind.	Super Special	65.00	Battery	Table	No	3	3	201-A
Diamond Special		75.00	Battery	Table	Yes	3	2	201-A	
Baby Grand		110.00	Battery	Console	Yes	3	2	201-A	
Chief		150.00	Battery	Console	Yes	3	3	201-A	
Above set for A.C. operation with McCullough type tubes Above set for A.C. operation is equipped with 6-201-A tubes 1 power tube and A-B-C- Power unit. Price \$250.									
DuBois-Leach Radio Service Co., East Orange, N. J.	DuBois 6	60.00	Battery	Table	No	2	3	201-A	
	Unitrola	75.00	Battery	Table	No	3	2	201-A	
Electrical Research Labs. 2500 Cottage Grove Ave. Chicago, Ill.	Erla Monodie RFL								
	S-50, C-12	65.00	Battery	Table	No	2	2	201-A, 200-A, 112 or 171	
	S-51, C-12	75.00	Battery	Table	No	3	2	201-A, 200-A, 112 or 171	
	Erla Single Six S-52, C-53	90.00	Battery	Table	No	3	2	201-A, 200-A, 112 or 171	
	Erla Monodie RFL								
	S-50, C-50	115.00	Battery	Console	Horn, Erla Unit	2	2	201-A, 200-A, 112 or 171	
	S-51, C-22	125.00	Battery	Console	Horn, Erla Unit	3	2	201-A, 200-A, 112 or 171	
	S-51, C-51	135.00	Battery	Console	Horn, Erla Unit	3	2	201-A, 200-A, 112 or 171	
	Erla Single Six S-52, C-52	170.00	Battery	Console	Horn, Erla Unit	3	2	201-A, 200-A, 112 or 171	
	Erla Super Seven S-61, C-60	175.00	Battery	Table	No	4	2	201-A, 200-A, 112 or 171	
	S-61, C-61	255.00	Battery	Console	Horn, Erla Unit	4	2	201-A, 200-A, 112 or 171	
S-61, C-62	295.00	Battery	Console	Horn, Erla Unit	4	2	201-A, 200-A, 112 or 171		
All receivers wired for power tube operation.									
Federal-Brandes, Inc. 200 Mt. Pleasant Ave. Newark, N. J.	Kolster 6-D	80.00	Battery		No	3	2	201-A	
	7-A	125.00	Battery		No	4	2	201-A	
	7-B	140.00	Battery		No	4	2	201-A	
	6-G	165.00	Battery		Cone	3	2	201-A	
	8-A	185.00	Battery		Cone	4	3	201-A	
	8-B	235.00	Battery		Cone	4	3	201-A	
	6-H	265.00	Battery		Power cone	3	2	201-A	
	8-C	375.00	Battery		Cone	4	3	201-A	
Federal Radio Corp. Buffalo, New York	D 10	100.00	Battery	Table	No	2	2	UX-201-A	
	E 10	165.00	Battery	Table	No	3	2	UX-201-A	
	D 10-60	185.00	A.C.	Table	No	2	2	UX-201-A	
	D 40	200.00	Battery	Console	Yes	4	2	UX-201-A	
	F 10	250.00	Battery	Table	No	2	2	UX-201-A	
	E 10-60	275.00	A.C.	Table	No	3	2	UX-201-A	
	D 40-60	285.00	A.C.	Console	Yes	3	2	UX-201-A	
	E 40	350.00	Battery	Console	Yes	4	2	UX-201-A	
	F 10-60	360.00	A.C.	Table	No	4	2	UX-201-A	
	F 40	450.00	Battery	Console	Yes	3	2	UX-201-A	
	E 45-60	460.00	A.C.	Console	Yes	4	2	UX-201-A	
	F 45-60	600.00	A.C.	Console	Yes	4	2	UX-201-A	
	Oxford 60	775.00	A.C.	Console	Yes	4	2	UX-201-A	
	Louvain 60	900.00	A.C.	Console	Yes	4	2	UX-201-A	
	Mandarin 60	1125.00	A.C.	Console	Yes	4	2	UX-201-A	
	Milan 60	1225.00	A.C.	Console	Yes	4	2	UX-201-A	

Receiving Set Specifications—Season 1927-1928 (Continued)

Name and Address of Manufacturer	Trade Name and Model Number	List Price	A. C. or Battery Operated	Style of Cabinet	Is Speaker Built-In? If So, What Type	Stages of R. F.	Stages of A. F.	Type of Tubes Used
Ferguson, Inc., J. B. 3542-41st St. Long Island City, N. Y.	Ferguson 12	\$75.00	Battery	Table	No	2	3	112-UX, 201-A, 301-A 112-UX, 201-A, 301-A 112-UX, 201-A, 301-A 5-McCullough and 171 112-UX, 201-A, 301-A
	10	110.00	Battery	Table	No	2	3	
	12	145.00	Battery	Consolette	Cone	2	3	
	18	195.00	A.C.	Table	No	3	2	
	14	235.00	Battery	Table	No	6	3	
Filter-Flex Radio Corp. 724 W. Vernon Ave. Los Angeles, Cal.	Filter-Flex	98.50	A.C.	Table	Utah Unit	1	2	199 199 199
	Filter-Flex	125.00	A.C.	Desk Console	Utah Unit	1	2	
	Filter-Flex	150.00	A.C.	Hiboy	Utah Unit	1	2	
Freed-Eisemann Radio Corp., Brooklyn, N. Y.	Freed-Eisemann NR-8	90.00	Battery	Table	No	3	2	201-A, 171 201-A, 171 201-A, 171 201-A, 171 201-A, 171 201-A, 171 201-A, 171
	NR-9	100.00	Battery	Table	No	3	2	
	411	100.00	A.C.	Table	No	3	2	
	NR-11	125.00	A.C.	Table	No	3	2	
	NR-66	125.00	Battery	Table	No	3	2	
	NR-77	175.00	Battery	Table	No	4	2	
	800	300.00	Battery	Table	No	4	2	
Freshman Co., Inc., Chas. 240 W. 40th St., New York City	Equaphase F		Battery	Various		3	2	RCA RCA
	Equaphase G		A.C.	Various		3	2	
Freshman Co., Inc., Chas. 240 W. 40th St. New York, N. Y.	Freshman 7-AC-2	54.50	A.C.	Table	No	3	2	A.C. A.C. A.C. A.C. A.C. A.C. A.C. A.C. A.C. A.C. A.C. A.C. A.C.
	7-F-2	54.50	Battery	Table	No	3	2	
	F-1	70.00	Battery	Table	No	3	2	
	G-1	70.00	A.C.	Table	No	3	2	
	7-F-3	87.50	Battery	Console	Freshman Cone	3	2	
	2-F-5	109.50	Battery	Console	Freshman Cone	3	2	
	F-2	110.00	Battery	Console	Freshman Cone	3	2	
	7-F-4	120.00	Battery	Console	Freshman Cone	3	2	
	7-AC-3	153.00	A.C.	Console	Freshman Cone	3	2	
	F-4	161.00	Battery	Console	Freshman Cone	3	2	
	G-2	175.00	A.C.	Console	Freshman Cone	3	2	
	7-AC-5	175.00	A.C.	Console	Freshman Cone	3	2	
	F-5	185.00	Battery	Console	Freshman Cone	3	2	
	7-AC-4	185.00	A.C.	Console	Freshman Cone	3	2	
	G-3	200.00	A.C.	Console	Freshman Cone	3	2	
G-4	225.00	A.C.	Console	Freshman Cone	3	2		
G-5	250.00	A.C.	Console	Freshman Cone	3	2		
.....	350.00	A.C.	Console	Freshman Cone	3	2		
Gossard Radio & Wire Co. Belvidere, Ill.	Gossard 527	55.00	Battery	Table	No	3	2	201-A 201-A 201-A 201-A 201-A 201-A 201-A 201-A 201-A
	627	65.00	Battery	Table	No	4	2	
	527-S	70.00	Battery	Table	Comp. Wood	3	2	
	627-S	80.00	Battery	Table	Comp. Wood	4	2	
	527-C	125.00	Battery	Console	Comp. Wood	3	2	
	627-C	175.00	Battery	Console	Comp. Wood	4	2	
	727-C	275.00	Battery	Console	Comp. Wood	4	3	
	727-C	275.00	Battery	Console	Comp. Wood	5	2	
	727-E	400.00	Battery	Console	Comp. Wood	5	2	
*Built in A-B-C power unit.								
Grebe & Co., Inc., A. H. New York City	Synchrophase 5 MU-1	95.00	Battery	Table	No	2	2	4-201-A, 1-171 6-201-A, 1-171
	7	135.00	Battery	Table	No	4	2	
Guthrie Co., Inc. Elyria, Ohio	Nightingale E-6-2	40.00		Table	No	2	3	Any type except 200 Any type except 200 Any type except 200
	S-6-1	60.00		Chassis only	No	2	3	
	A-8-1	75.00		Chassis only	No	3	4	
Haddaway Mfg., Co. Los Angeles, Cal.	Haddaway A.C.-6	162.00	A.C.	Console	Cone	2	3	5-199, 1-201-A
Harmon & Sons Co., H. W. Grove City, Pa.	Harmonson 5-C	100.00	Battery	Table	Kellogg Horn & Unit	1	3	201-A, 200-A Hi-Mu, 112, 171
	Unitrol	150.00	Battery	Table	No	2	3	
Harold Herbert, Inc. 40th Ave. and 23rd St. Long Island City, N. Y. *Push-pull amplification is used.	Herbert Lectro 120	120.00	A.C.†	Table	No	2	2	4-199, 1-171 4-199, 2-171 4-199, 2-171
	200*	200.00	A.C.†	Table	No			
	275*	275.00	A.C.†	Table	No			
	†Built in A-B-C power supply			Console	No			
Hartman Elec. Mfg. Co. Mansfield, Ohio	Hartman	65.00	Battery	Compact	No	3	2	201-A 201-A 201-A 201-A
	Hartman	95.00	Battery	Junior Upright	No	3	2	
	Hartman	120.00	Battery	Senior Upright	Yes	3	2	
	Hartman	120.00	Battery	Sheraton	Yes	3	2	
Harvey Mfg. Co., F. C. Muncie, Ind.	Melody 527	39.50	Battery	Chassis		2	2	201-A 201-A 201-A
	627	49.50	Battery	Chassis		3	2	
	727	200.00	Battery	Console		3	3	
Homer Products, Inc. 3542-41st St. Long Island City, N. Y.	Homer	80.00	Battery	Chassis only	No			
	Homer	95.00	Battery	Table	No			
	Senior	150.00	Battery	Table	No			
Howard Radio Co. 451 E. Ohio St. Chicago, Ill.	Howard	135.00	Both	Desk Console	No	3	2	UX-226, UY-227, UX-201-A UX-226, UY-227, UX-201-A UX-226, UY-227, UX-201-A UX-226, UY-227, UX-201-A UX-226, UY-227, UX-201-A UX-226, UY-227, UX-201-A
	Howard	165.00	Both	Console	Yes	3	2	
	Howard	290.00	Both	Desk Console	No	3	2	
	Howard	325.00	Both	Console	Yes	3	2	
	Howard	375.00	Both	Table	No	3	3	
	Howard	675.00	Both	Console	Yes	3	3	
Hyatt Electric Corp. Chicago, Ill.	Hyatt Portable A	95.00	Battery	Leatherette	Baritone	3	2	CX-299
Imperial Radio Co. Union City, Ind.	Le Pilote T-6	85.00	Battery	Table	No	3	2	201-A, 112 or 171 201-A, 112 or 171
	C-6	140.00	Battery	Console	86 in. molded horn	3	2	
Imperial Radio Corp. 21-31 Ottawa Ave., N. W. Grand Rapids, Mich.	Michigan 5	40.00	Battery	Table	No	2	2	201-A 201-A 201-A 201-A 201-A
	6	50.00	Battery	Table	No	2	3	
	6	75.00	Battery	Console	Cone	2	3	
	6	150.00	Battery	Console	Temple	2	3	
*Built in A-B-C power unit.								
Indiana Mfg. & Electric Co. Marion, Ind.	Case 60-A	65.00	Battery	Table	No	3	2	201-A 201-A 201-A 201-A 201-A 201-A 201-A 201-A 201-A 201-A
	61-A	85.00	Battery	Table	No	3	2	
	61-C	135.00	Battery	Hiboy Console	Horn	3	2	
	62-B	185.00	A.C.	Table	No	3	2	
	90-A	225.00	Battery	Table	No	6	2	
	62-C	235.00	A.C.	Hiboy Console	Horn	3	2	
	92-A	350.00	A.C.	Table	No	6	2	
	90-C	350.00	Battery	Console	Newcombe - Hawley	6	2	
	92-C	475.00	A.C.	Console	Newcombe - Hawley	6	2	

Receiving Set Specifications—Season 1927-1928 (Continued)

Name and Address of Manufacturer	Trade Name and Model Number	List Price	A. C. or Battery Operated	Style of Cabinet	Is Speaker Built-In? If So, What Type?	Stages of R. F.	Stages of A. F.	Type of Tubes Used	
Jones Motroia Sales Co. 370 Gerard Ave. New York City	Jos. W. Jones J-621	\$45.00	Battery		No	2	3	201-A	
	J-625	45.00	Battery		No	2	3	201-A	
	J-600	60.00	Battery		No	2	3	201-A	
Jones Radio Co. Brooklyn, N. Y.	Harmonic 29	100.00	Battery		No	1	3	201-A	
Keystone Radio Labs., Inc. 129 No. Jefferson St. Chicago, Ill.	Keystone 126	60.00	Battery	Chassis	No	3	2	200-A, 201-A, 171-A	
	226	60.00	Battery	Table	No	2	2	200-A, 201-A, 171-A	
	3-D-6	60.00	Battery	Table	No	3	2	200-A, 201-A, 171-A	
	126	70.00	Battery	Table	No	3	2	171-A, 200-A, 201-A	
	126-C	97.50	Battery	Console	Yes	3	2	171-A, 200-A, 201-A	
126-A	150.00	Battery	A.C.	Console	Yes	3	2	A.C.	
King Mfg., Corp. Buffalo, N. Y.	Baronet 80	70.00	Battery	Table	No	2	3	201-A	
	Crusader 81	115.00	Battery	Table	No	2	3	201-A	
	Viking 80-H	140.00	Battery	Console	Horn	2	3	201-A	
	Chevalier 81-H	210.00	Battery	Console	Cone	2	3	201-A	
	Commander 71	220.00	Battery	Table	No	3	2	201-A	
Kings Radio Corp. St. Louis, Mo.	Kings RF-5	40.00	Battery	Table		2	2	201-A	
	RF-5-C	75.00	Battery	Console	Cone	2	3	201-A	
Krantz & Sell Co. Honesdale, Pa.	Wayne 4-1	50.00	Battery		No	2	1	201-A	
	4-2	55.00	Battery		No	2	1	201-A	
	Daisy 4	65.00	Battery		No	2	1	201-A	
	Superior 3	95.00	Battery		No	2	1	201-A	
	DeLuxe 5	125.00	Battery		No	2	1	201-A	
Langbein-Kaufman Radio Co., 62 Franklin St. New Haven, Conn.	Elkay Jr.-6	80.00	Battery	Table	No	2	3	200-A, 201-A	
	Jr.-7	92.50	Battery	Table	No	3	3	200-A, 201-A	
	Sr.-6	125.00	Battery	Table	No	2	3	200-A, 201-A, 112 McCullough	
	Sr.-6-E		Battery	Table	No	2	3		
Leutz Inc., C. R. 6th and Washington Ave. Long Island City, N. Y.	Universal Plio 6	59.00	Battery		No	2	3	Any	
	Transoceanic 7	150.00	Battery		No	4	4	Any	
	Silver Ghost 9	650.00	Battery		No	4	4	Any	
Lone Wolf Radio Corp. Chicago, Ill.	Lone Wolf Portable	85.00	Battery	Fabrikoid	Reflex	3	2	UX-199	
Martí Elec. Radio Co., Inc. 22 Central Ave. West Orange, N. J.	Martí TA-2	235.00	A.C.	Table	No	2	3	McCullough	
	TA-10	250.00	A.C.	Table	No	2	3	1-UX-210, 5-McCullough	
	DC-2	275.00	A.C.	Desk	No	2	3	McCullough	
	DC-10	290.00	A.C.	Desk	No	2	3	1-UX-210, 5-McCullough	
	CS-2	325.00	A.C.	Console	Newcombe - Hawley	2	3	McCullough	
	CS-10	350.00	A.C.	Console	Newcombe - Hawley	2	3	1-UX-210, 5-McCullough	
Murdock Co., Wm. J. 347 Washington Ave. Chelsea, Mass.	Murdock 350	52.50	Battery	Table	No	2	2	201-A	
	65	65.00	Battery	Table	No	3	3	201-A	
	75	75.00	Battery	Table	No	3	3	201-A	
Mu-Rad Labs., Inc. Asbury Park, N. J.	Super-Six T	98.00	Battery	Table	No	2	3	4-UX-201-A, 1-UX-200-A, 1-UX-171	
	SC	172.00	Battery	Console	No	2	3	4-UX-201-A, 1-UX-200-A, 1-UX-171	
	SE	265.00	Battery	Console	No	2	3	4-UX-201-A, 1-UX-200-A, 1-UX-171	
*Built in A.B.C. power supply.									
Natr Radio Corp. St. Louis, Mo.	Slocumb Resonator N	150.00	Battery	Consolette		3	3	201-A	
Operadio Mfg. Co. 700 E. 40th St., Chicago, Ill.	Operadio 7 Note—With A-B-power unit, \$190.75 complete.	146.50	Battery	Portable	Yes	3	3	201-A	
Pfanstiehl Radio Co. Waukegan, Ill.	Junior 28	65.00	Battery	Table	No	3	2	201-A	
	Overtone 30	105.00	Battery	Table	No	3	2	201-A	
	32	150.00	Battery	Table	No	3	3	201-A	
	302	185.00	Battery	Console	Horn	3	2	201-A	
	322	250.00	Battery	Secretary*	Cone	3	3	201-A	
*Console.									
Porter, Frank R. Washington, D. C.	Coriola 7	75.00	Battery		No	3	3	201-A	
	Superior 25	150.00	Battery	Library Table	No	3	3	201-A	
Precision Products Co. 321 S. Main St. Ann Arbor, Mich.	Arborphone 27	65.00	Battery	Table	No	2	2	199, 201-A, 112, 171	
	271	99.50	Battery	Console	Arborcone	2	2	199, 201-A, 112, 171	
	272	125.00	Battery	Console	Arborcone	2	2	199, 102-A, 112, 171	
	25	125.00	Battery	Table	No	3	2	199, 201-A, 112, 171	
	252	185.00	Battery	Table	Arborcone	3	2	199, 201-A, 112, 171	
	253	250.00	Battery	Table	Peerless	3	2	199, 201-A, 112, 171	
	255†	600.00	Battery	Table	Power Arborcone†	3	2	199, 201-A, 112, 171	
†Combination radio and electric phonograph. *Built-in A-B-C-power supply. †(special type).									
Premier Electric Co. Chicago, Ill.	Premier 6 in line	50.00	Battery	Chassis only		3	2	112, 200, 301-A	
Premier Radio Corp. Defiance, Ohio	30	75.00	Battery	Table	No	2	4	201-A	
	40	100.00	Battery	Table	No	2	4	201-A	
	50-B	350.00	Battery	Console	8 ft horn	2	4	201-A	
	50	375.00	Battery	Console	8 ft horn	2	4		
*Built-in A-B-C-power supply.									
Q. T. Radio Products Co. Nutley, N. J.	Evening Hour E.H.-7	225.00	A.C.	Console	No	3	3	A.C.	
Radio Corp. of America 233 Broadway New York City	Radiola 16	69.50*	Battery	Table	No	3	2	UX-201-A, UX-112	
	20	78.00*	Battery	Table	No	2	2	UX-199, UX-120	
	17	130.00*	A.C.	Table	No	3	2	UX-226, UY-227, UX-171	
	28	260.00†	Battery	Floor	No	†	2	UX-199, UX-120	
	30-A	495.00†	A.C.	Floor	100-A type cone	†	2	UX-199, UX-171	
	30-A (D.C.)	495.00†	D.C.	Floor	100-A type cone	†	2	UX-199, UX-171-A (4)	
	28 and 104	570.00†	A.C.	Floor	Cone in 104 cabinet	†	2	UX-199, UX-210	
	28 and 104-D.C.	605.00†	D.C.	Floor	Cone in 104 cabinet	†	2	UX-199, UX-171-A (4)	
	32	895.00†	A.C.	Floor	104 type cone	†	2	UX-199, UX-210	
	32 (D.C.)	895.00†	D.C.	Floor	104 type cone	†	2	UX-199, UX-171-A (4)	
	*Less tubes. †With tubes. †1 R.F., 2 I.F.								
	Radio Products Corp. 3816 N. 28th St. Birmingham, Ala.	Superflex A-4	80.00	Battery	Table	No	1	2	201-A
B		90.00	Battery	Portable	Horn	1	2	199	
C		139.50	Battery	Console	Cone	1	2	201-A	

Receiving Set Specifications—Season 1927-1928 (Continued)

Name and Address of Manufacturer	Trade Name and Model Number	List Price	A. C. or Battery Operated	Style of Cabinet	Is Speaker Built-In If So, What Type?	Stages of R. F.	Stages of A. F.	Type of Tubes Used	
Ranger Coil Co. West Davenport, N. Y.	Ranger R-6-28	\$70.00	Battery		Ranger	3	2		
	R-7-28	80.00	Battery		Ranger	3	3		
	R-8-28	125.00	Battery		Ranger	4	3		
Ray Isler Radio Co. 1021 Park Ave. Rochester, N. Y.	Ray Isler 55	275.00	A.C.	Table	No	2	2	Marathon	
	Note—Complete with all tubes.	375.00	A.C.	Console	Cone	2	2	Marathon	
Rich Mfg., Co., Geo. H. S. E. Cor. 18th and Dauphin Sts., Philadelphia, Pa.	Custom Built 6-S	110.00	Battery	Table	No	2	3	201-A, 200-A, 112	
	6	110.00	Battery	Table	No	3	3	201-A, 200-A, 112	
	7	125.00	Battery	Table	No	3	2	2001-A, 200-A, 112	
	EP-6-S	300.00	*	Console	Horn	2	3	201-A, 200-A, 171	
	EP-6	300.00	*	Console	Horn	3	2	201-A, 200-A, 171	
	EP-7	325.00	*	Console	Horn	3	3	201-A, 200-A, 171	
*Built-in A-B-C power supply.									
Both-Downs Mfg., Co. Saint Paul, Minn.	Orpheus H	60.00	Battery	Table	No	1	3	201-A	
	25	75.00	Battery	Table	No	1	3	201-A	
	C	95.00	Battery	Console	Horn	1	3	201-A	
	A	120.00	Battery	Console	Horn	1	3	201-A	
	30	140.00	Battery	Console	Horn	1	3	201-A	
	40	240.00	Battery	Console	Horn	1	3	201-A	
Shamrock Mfg., Co. 196 Waverly Place Newark, N. J.	Shamrock A	75.00	Battery	Table		2	3	301-A, 340	
	B	98.50	Battery	Console		2	3	301-A, 430	
	C	150.00	Battery	Console	84 in. horn	2	3	301-A, 340	
	BL	185.00	A.C.	Console		2	3	McCullough	
	CL	250.00	A.C.	Console	84 in. horn	2	3	McCullough	
Simplex Radio Co. Main and Rector St. Philadelphia, Pa.	Simplex SR-9	64.00	Battery	Table	No	2	2	201-A	
	SR-10	70.00	Battery	Table	No	2	2	201-A	
	SR-11	70.00	Battery	Table	No	3	2	201-A	
	Console SR-11	95.00	Battery	Table	Air column	3	2	201-A	
	Console SR-10	95.00	Battery	Table	Air column	2	2	201-A	
	Console SR-9	95.00	Battery	Table	Air column	2	2	201-A	
	Console SR-11	145.00	Battery	Console	Cone	3	2	201-A	
	Console SR-10	145.00	Battery	Console	Cone	2	2	201-A	
	Console SR-9	145.00	Battery	Console	Cone	2	2	201-A	
	*All the above models supplied for Direct Current at same prices and supplied for 25 cycle A.C. operation for \$20 extra per model. Have built-in A-B-C-power supply.								
	Simplex Radio Co. Sandusky, O.	Simplex Electric B	250.00	A.C.	Console	No	2	3	Kellogg
Complete with all accessories.									
Slagle Radio Co., Inc. 1232 Maumee Ave. Fort Wayne, Ind. *Prices not available.	Slagle A	*	Battery	Table	Horn			201-A	
	B	*	Battery	Console	Horn			201-A	
	C	*	Battery	Console	Horn			201-A	
Sleeper Radio & Mfg. Corp. 463 Washington Ave. Long Island City, N. Y.	Sleeper Electric								
	Scout 64	160.00	*	Table	No	2	2	4-UX or CX-199, 1-UX or CX-171	
	Serenader 65	175.00	*	Table	Horn	2	2	4-UX or CX-199, 1-UX or CX-171	
	Scout Console 66	175.00	*	Table	No	2	2	4-UX or CX-199, 1-UX or CX-171	
	Scout Console 67	235.00	*	Console	No	2	2	4-UX or CX-199, 1-UX or CX-171	
	Imperial Console 68	265.00	*	Console	No	2	2	4-UX or CX-199, 1-UX or CX-171	
	Monotrol 69	350.00	*	Console	No	2	2	4-UX or CX-199, 1-UX or CX-171	
	Electric Chassis 5 tube	148.00	*	Chassis only		2	2	4-UX or CX-199, 1-UX or CX-171	
	6 tube	240.00	*	Chassis only		3	2	4-UX or CX-199, 1-UX or CX-171	
	*All the above models supplied for Direct Current at same prices and supplied for 25 cycle A.C. operation for \$20 extra per model. Have built-in A-B-C-power supply.								
Sparks-Withington Co. Jackson, Mich.	Sparton Electric								
	6-15	68.00	Battery	Table	No				
	6-26	88.00	Battery	Table	No				
	62 Electric	188.00	A.C.	Table	No				
	63 Electric	215.00	A.C.	Table	No				
A.C.-7 Console	375.00	A.C.	Console	Cone					
Splitdorf Radio Corp. Newark, N. J.	Splitdorf R-560	45.00	Battery	Table	No	2	2	201-A, 112	
	RV-580	60.00	Battery	Table	No	2	2	201-A, 171	
	RV-695	75.00	Battery	Table	No	3	2	201-A, 171	
	Abbey	100.00	Battery	Table	No	3	2	201-A, 171	
	Concerto	112.00	Battery	Console	No	3	2	201-A, 112	
	Virtuoso	127.50	Battery	Console	Yes	2	2	201-A, 171	
	Maestro	170.00	Battery	Console	Yes	3	2	201-A, 171	
	Intermezzo	173.50	Battery	Console	Yes	3	2	201-A, 171	
	Warwick	275.00	Battery	Console	Yes	3	2	201-A, 171	
	Lorenzo	350.00	Battery	Console	Yes	3	2	201-A, 171	
	Winthrop	600.00	Battery	Console	Yes	3	2	201-A, 171	
	Buckingham	800.00	Battery	Console	Yes	3	2	201-A, 171	
	Stromberg-Carlson Tel. Mfg. Co. 1060 University Ave. Rochester, N. Y.	Stromberg-Carlson 501	180.00	Battery	Table	No	2	2	UX-201-A, UX-171
601-B		225.00	Battery	Table	No	3	2	UX-201-A, UX-171	
502		290.00	Battery	Console	No	2	2	UX-201-A, UX-171	
602-B		330.00	Battery	Console	No	3	2	UX-201-A, UX-171	
744		1245.00	*	Console	No	3	2	UX-201-A, UX-210	
*Built-in A-B-C power supply.									
Sun Mfg., Co. Louisville, Ky.	"Sun" 27-A	75.00	Battery	Table		2	2	UX-200, UX-201	
	27-B	80.00	Battery	Table		2	2	UX-200, UX-201	
Terminal Electric Co. 685-11th Av. New York City *Complete with all tubes	"Powerola" C-3	115.00	D.C.	Table	No	2	2	201-A	
	6-150	155.00*	A.C.	Table	No	2	2	A.C.	
	C-3	165.00	A.C., D.C.	Table	No	2	2	201-A	
Tidmarsh's Radio Supply Elwood, Ind.	T-R-S Super-4	85.00	Battery	Console	Cone	3	3	UX-CX 201-A	
	Note—Complete with built-in A-B-C power supply \$150.								
Traveler Mfg., Corp. Chicago, Ill.	Traveler Portable	65.00*	Battery	Portable	Baldwin-rival	2	2	UV-199	
	*Stripped.								
U-Flex Mfg., Co. Philadelphia, Pa.	U-Flex	125.00	*	Table		2	2	301-A	
	*Built-in A-B-C power supply.								
United Engineering Co. Lansing, Mich.	United Lansing 90-28	90.00	Battery	Table	No	3	2		
	160-28	160.00	Battery	Console	96 in. horn	3	2		
	225-28	225.00	Battery	Console	96 in. horn	3	2		
	275-28	275.00	A.C.	Console	96 in. horn	3	2		
	205-28	285.00	A.C.	Table	No	3	2	5-Kellogg, 1-Kellogg power tube	
	340-28	340.00	A.C.	Aristocrat *	96 in. horn	3	2	5-Kellogg, 1-Kellogg power tube	
*Console.									
United Radio X Mfg., Co. Gary, Ind. *Built-in A-B-C power supply.	Majestic	185.00	*	Table	No				
	Majestic Grand	295.00	*	Console	Horn				

Receiving Set Specifications—Season 1927-1928 (Concluded)

Name and Address of Manufacturer	Trade Name and Model Number	List Price	A. C. or Battery Operated	Style of Cabinet	Is Speaker Built-In If So, What Type?	Stages of R. F.	Stages of A. F.	Type of Tubes Used
United Scientific Labs. New York City	Pierce-Airo B	\$45.00	Battery		No	2	3	201-A
USL Radio, Inc. Niagara Falls, N. Y.	USL Receiver DC-6	69.50	Battery	Table	No	3*	2	201-A
	DC-6		Battery	Console	Orthophonic horn	3	2	201-A
	DC-7	90.00	Battery	Table	No	3	3	201-A
	DC-7		Battery	Console	Orthophonic horn	3	3	201-A
	AC-7	95.00	A.C.	Table	No	3	3	Arcturus
	AC-7		A.C.	Console	Orthophonic horn	3	3	Arcturus
Valley Electric Co. St. Louis, Mo.	Valleytone 52	85.00	Battery	Table	No	4	2	201-A, 200-A, 171
	71	95.00	Battery	Table	No	4	2	201-A, 200-A, 171
Walbert Mfg., Co. 1000 Fullerton Ave. Chicago, Ill.	Walbert Isofarad 47-T	180.00	Battery	Table	No	3	3	201-A
	26	215.00	A.C.	Table	No	2	3	Kellogg
	26-PT	250.00	A.C.	Table	No	2	3	Kellogg
Wellston Radio Corp. 1479 Hodiamont St. Louis, Mo.	Ford Radio Marvel	50.00	Battery	Table	No	3	2	4-201-A, 1-300-A, 1-112
	Wonder	50.00	A.C.	Table	No	3	2	Ford A.C. tubes
	F.R.-8	150.00	Battery	Table	No	4	3	6-201-A, 1-300 A, 1-171
	F.R.A.-8	150.00	A.C.	Table	No	4	3	Ford A.C. tubes
	F.R.C.-8	225.00	A.C.	Console	Utah	4	3	Ford A.C. tubes
Welty & Co., Wm. A. Chicago, Ill.	Welty's W-6	125.00	Battery	Console	No	3	2	201-A
	A.C.-7	175.00	A.C.	Console	No	3	3	Marathon
Witherbee Co., Inc., T. S. New York City	Shielded Knight 665	65.00	Battery	Table	No	3	2	201-A
WorkRite Mfg. Co. 1812 30th St. Cleveland, Ohio	WorkRite 17	95.00	Battery	Table	No	2	2	6-201
	26	160.00	Battery	Console	Cone	2	2	
	37	160.00	Battery	Table	No	4	3	8-201 or 7-201 and 112
Wright De Coster, Inc. St. Paul, Mich. *Built-in A-B-C power supply.	Wright De Coster 7	165.00	Battery	Table	No	3	3	1-UX-120, 6-UX-199
	7-A	185.00		Table	No	3	3	1-UX-120, 6-UX-199

Specifications of Speakers—Season 1927-1928

Name and Address of Manufacturer	Trade Name and Model Number	List Price	Type	Style	Diameter of Cone in Inches	Length of Horn and Diameter of Bell	Is Filter Included	Composition of Cone or Horn
Acme Apparatus Co. 37 Osborn St. Cambridge, Mass.	Acme K-1	\$25.00	Cone	Table	13			Special paper
	K-2	38.00	Cone	Cabinet	13			Special paper
	K-3	14.50	Cone	Table	11			Special paper
Ajax Electric Specialty Co. 1926 Chestnut St., St. Louis, Mo.	Ajax-Marveltone	13.50	Air-column	Cabinet		24-10	No	Rubber
Algonquin Electric Co., Inc. 245 5th Ave., New York City	Algonquin-A	15.00	Cone	Table	18			Impregnated
	Algonquin-B	15.00	Cone	Table	18			Fabric, moisture proof
All-American Radio Corp. 4201 Belmont Ave., Chicago, Ill.	All-American	25.00	Cone	Mantel clock	12		Yes	Specially prepared paper
American Electric Co., Inc. State and 64th Sts., Chicago, Ill.	Burns-227	22.50	Cone	Table type	8		Yes	
Amplion Corp. of America 531 W. 37th St., New York City	Amplion AR-35	12.00	Unit	Phonograph			No	
	AC-21	25.00	Cone	Table	13½		No	Burtex
	AC-24	25.00	Cone	Wall	13½		No	Burtex
	AC-12	35.00	Cone	Table cabinet	11½		No	Burtex
	AR-19	42.50	Horn			14½ Bell	No	Metal and rubber
	AA-18	50.00	Air column	Table		48	No	Cloth composition
	AC-27	67.50	Cone	Table cabinet	16½		No	Burtex
	AC-30	97.50	Cone	Floor cabinet	16½		No	Burtex
	AC-15	145.00	Cone	Floor cabinet	16½		No	Burtex
Andrea, F. A. D., Inc. Jackson Ave., Orchard & Queen Sts. Long Island City, N. Y.	Fada 315-A	25.00	Cone	Table	17		No	Special paper
	415-B	35.00	Cone	Table	22		No	Special paper
	W-15-B	35.00	Cone	Wall	22		No	Special paper
	425-B	50.00	Cone	Pedestal	22		No	Special paper
Armstrong Co. 1501 E. 55th St., Chicago, Ill.	Armstrong A	35.00	Air-column	Cabinet		20-7x8½	No	*
	B	8	Air-column	†		48-8x8½	No	
	C		Air-column			60-12x12½	No	
*Composition neck wood tone chamber with sounding board. †For use by console mfgs. and electric phonographs.								
Blood Tone Arm Co. 28th and Garfield Sts. Bay City, Mich.	Radio Master 39	65.00	Air-column	Cabinet		86	No	Newcombe-Hawley
	48	90.00	Air-column	Cabinet		86	No	Newcombe-Hawley
	49	110.00	Air-column	Cabinet		86	No	Newcombe-Hawley
Cannon & Miller Co., Inc. Springwater, N. Y.	Cannon-Ball 2	9.00	Cone	Table	16		No	Paper
	6	9.00	Cone (Kit)	Wall	36		No	Paper
	5	12.50	Cone	Table	16		No	Paper
	3	15.00	Cone	Table	16		No	Paper
	4	20.00	Cone	Pedestal	16		No	Paper
Carls, M. J., 1929 S. Los Angeles St., Los Angeles, Calif.	Golden Bear 100	*	Air-column	Cabinet		13-3x6	No	Wood and wood fibre
	200	*	Air-column	Cabinet		18-5x8	No	Wood and wood fibre
	300	*	Air-column	Cabinet		23-6x9	No	Wood and wood fibre
	500	*	Air-column	Cabinet		30-6x7	No	Wood and wood fibre
	600	*	Air-column	Cabinet		48-8x12	No	Wood and wood fibre
	800	*	Air-column	Cabinet		100-14½x14½	No	Wood and wood fibre
* Quoted on application to mfgs.								
Claravox, Inc. 3115 W. Tusce St., Canton, O.	Claravox S-4	35.00	Air-column	Table			Yes	Special composition
Cook Radio Corp. 500 South Bentalou St., Baltimore, Md.	Cook Super-Dynamic CP	50.00	Air-column power	Panel		7 ft. 14	No	Racon Reinforced fabric
	CF	75.00	Air-column power	Panel		9 ft. 18x24	No	Racon reinforced fabric
	CFPC	200.00	Air-column power	Floor Console		9 ft. 18x24	Yes	Racon reinforced fabric

Speaker Specifications—Season 1927-1928 (Continued)

Name and Address of Manufacturer	Trade Name and Model Number	List Price	Type	Style	Diameter of Cone in Inches	Length of Horn and Diameter of Bell	Is Filter Included	Composition of Cone or Horn
Crosley Radio Corp. Cincinnati, O.	Musicone Ultra	\$9.75	Cone	Table	12		No	Special grade paper
	Musicone Super	12.75	Cone	Table	16		No	Special grade paper
	Musicone Tilt Table	27.50	Cone	Pedestal	12		No	Special grade paper
Davis, Richard T., Inc. 5252 Broadway, Chicago, Ill.	Vogue 8	19.50	Cone	Table	7½	30x12½	No	Compressed wood
	10	26.00	Air-column	Table	7½		No	
	12	30.00	Cone	Table		30x12½	No	Compressed wood
	13	40.00	Air-column	Pedestal		96x19½x23"	No	Composition
Farrand Mfg. Co., Inc. Long Island City, N. Y.	Farrand 20	16.50	Cone	Table	19x13		No	Treated paper
	24	32.50	Cone	Table	24x17		No	Treated paper
Federal-Brandes, Inc. 200 Mt. Pleasant Ave., Newark, N. J.	Brandes 1500	25.00	Cone	Cabinet	10x6½		Yes	Paper
	1600		Cone	Cabinet	9½		No	Paper
	Kolster 5600	175.00	Power Cone	Cabinet	9½		No	Paper
Federal Radio Corp., Buffalo, N. Y.	Ortho-sonic S40	125.00	Air-column	Floor Cabinet		72x19x24	No	Wood pulp
Fergus Co. 235 Elizabeth Ave., Newark, N. J.	Mozart-Radiocieve	14.00	Cone	Wall	36		No	Paper
	Mozart-Radiocieve	18.00	Cone	Wall	36		No	Paper
Freed-Eisemann Radio Corp. Junius Street and Liberty Ave., Brooklyn, N. Y.	Freed-Eisemann 147	20.00	Cone	Table	15		No	
Freshman, Chas. Co. 240 W. 40th St., New York City	Freshman Master Speaker	10.00	Reflex Tone	Table	5x7	14	No	Bakelite
	Freshman Cone Speaker	27.50	Cone	Table	9		No	Wood and paper
	Freshman Power Speaker	65.00	Cone	Table	9		Yes	Wood and paper
Heinemann Electric Co. 1730 No. 5 St., Philadelphia, Pa.	Sensory-88	19.50	Cone	Drum	11½			
Jodra Mfg. Co., 510 Virginia St., Seattle, Wash.	Enchanter S	23.50	Cone	Table	14½		No	Paper
	Enchanter G	25.00	Cone	Table	13		No	Paper
	Enchanter H	32.50	Cone	Table	14½		No	Paper
	Sylfan F	32.50	Cone	Table	15		No	Paper
Kellogg Switchboard & Supply Co. 1066 W. Adams St., Chicago, Ill.	Symphony 554	14.50	Air-column	Table		38x15	No	Wood pulp
	Symphony 558	15.50	Air-column	Table			No	Wood pulp
	Kellogg 557	20.00	Air-column	Cabinet		38x8x12	No	Wood pulp
	Kellogg 559	25.00	Air-column			43x12½x16	No	Composition plaster
	Kellogg 560	65.00	Air-column	Cabinet		43x12½x16	No	Composition plaster
Kirkman Engineering Corp. 484 Broome St., New York City	K-E A-18	18.00	Air-column	Table		27x14	No	Hard rubber
	K-F R-25	25.00	Air-column	Table		27x14	No	Aluminum
Leaf-Burkhard Radio Elec. Corp. 158 Greene St., New York City	Leaf-Burkhard C16	16.50	Cone	Table	18		No	Alhambria Paper
Liberty Metal Prod. Co., Berea, O.	Liberty	22.50	Air-column			21x15	No	Rubber
Manhattan Elec. Supply Co. 17 Park Place, New York City	Manhattan "Symphonic" 2556B	35.00	Air-column			36	No	
Newcombe-Hawley, Inc. St. Charles, Ill.	Newcombe-Hawley Drum	32.00	Air-column	Table		60	No	Special acoustical fiber
	Newcombe-Hawley 53	5.00	Air-column	Table		86	No	Special acoustical fiber
	Newcombe-Hawley 55	75.00	Air-column	Table		86	No	Special acoustical fiber
	Newcombe-Hawley 56	85.00	Air-column	Table		86	No	Special acoustical fiber
	Newcombe-Hawley 57	125.00	Air-column	Table		86	No	Special acoustical fiber
	Newcombe-Hawley 58	125.00	Air-column	Table		86	No	Special acoustical fiber
Onell Mfg. Co., 715 Palisade Ave. West New York, N. J.	Junior	8.50	Cone	Table	14		No	
	The Onell	12.75	Cone	Table	17½		No	
Operadio Mfg. Co. 700 E. 40th St., Chicago, Ill.	Operadio Bloc-Type Junior	15.00	Air-column	Table		30x8	No	Monolithic Stonite
	Operadio Bloc-Type Senior	25.00	Air-column	Table		54x14	No	Stonite and die-cast metal
	Operadio Deluxe	80.00	Air-column	Cabinet		84½	No	Stonite and wood
Pacent Radio Corp. 91-7th Ave., New York City	Pacent	22.50	Cone	Table	17		No	
	Pacent	35.00	Cone	Cabinet			No	
Pathe Phonograph & Radio Corp. 20 Grand Ave., Brooklyn, N. Y.	Grecian G	25.00	Cone		15		No	
	Cathedral C	30.00	Cone		18½		No	
	Cathedral C. I.	32.50	Cone		18½		No	
Porter, Frank B. 1370 Vermont Ave., Washington, D. C.	Magic Picture 5	25.00	Air-column	Table and Wall		32x4x10	Yes	Composition and wood
	Alladdin Lamp 2	35.00	Air-column	Table		16x6	Yes	Black walnut
	Floral Vase 4	40.00	Air-column	Table		18x7	Yes	Opal glass
	Choral Cabinet 3	50.00	Air-column	Table		8x9x12	Yes	Composition and leather
	Enchanted Cup 6	75.00	Air-column	Table		18x8	Yes	Silver and Gold
Radio Corporation of America 233 Broadway, New York City	Radiola Loud Speaker 100-A	35.00	Cone	Table	7		Yes	Paper
	Radiola Loud Speaker 104	275.00	Power Cone	Cabinet	6		No	Paper
	Radiola Loud Speaker 104-10C	310.00	Power Cone	Cabinet	6		No	Paper
Rola Co. 45th and Hollis St., Oakland, Calif.	Rola Cone Speaker 10	28.50	Cone	Table	8½		Yes	Paper
	Rola Cone Speaker 12	32.50	Cone	Pedestal	8½		Yes	Paper
	Rola Cone Speaker 15	45.00	Cone	Table	8½		Yes	Paper
	Rola Cone Speaker 20	85.00	Cone	Floor Screen	8½		Yes	Paper
	Rola Cone Speaker 25	135.00	Air-column	Console		72x12x24	Yes	Paper
Sandar Corp. Long Island City, N. Y.	Sandar 21	16.50	Cone	Table	15		No	Paper
	Sandar 25	27.50	Cone	Table	17		No	Paper
Shield Speaker Co. Lebanon, Pa.	Shield Mural	30.00	Cone	Wall	29x18½		No	Special paper
	Shield Harmony	37.50	Cone	Pedestal	29x18½		No	Special Paper
	Shield Intrinsic	47.50	Cone	Pedestal	57x21		No	Special paper
Stevens & Co., Inc. 46 E. Houston St., New York City	Stevens A27	18.50	Cone	Table	14½		No	Burtex
	B27	25.00	Cone	Table and Wall	17½		No	Burtex
	CT27	35.00	Cone	Table	17½		Yes	Burtex
	W.T.27	45.00	Cone	Wall	19		Yes	Burtex
	P.T.27	65.00	Cone	Pedestal	19		Yes	Burtax
Splitdorf Radio Corp. 160 Summit St., Newark, N. J.	Splitdorf Tone Cone	35.00	Cone	Table	18		No	Burtex

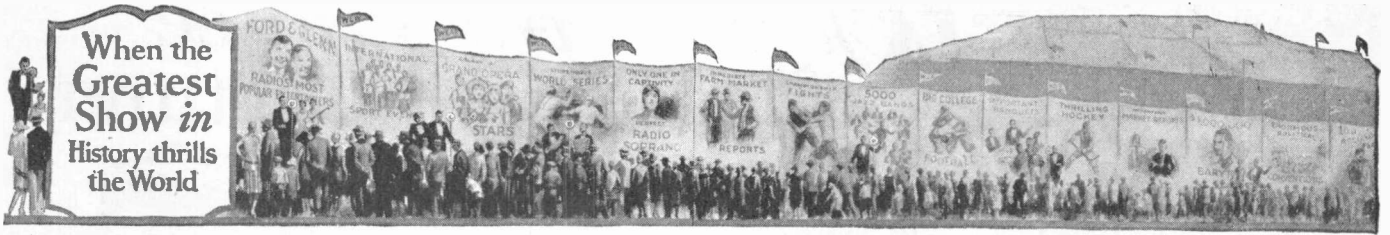

"....You're there with a Crosley"



\$35



\$85

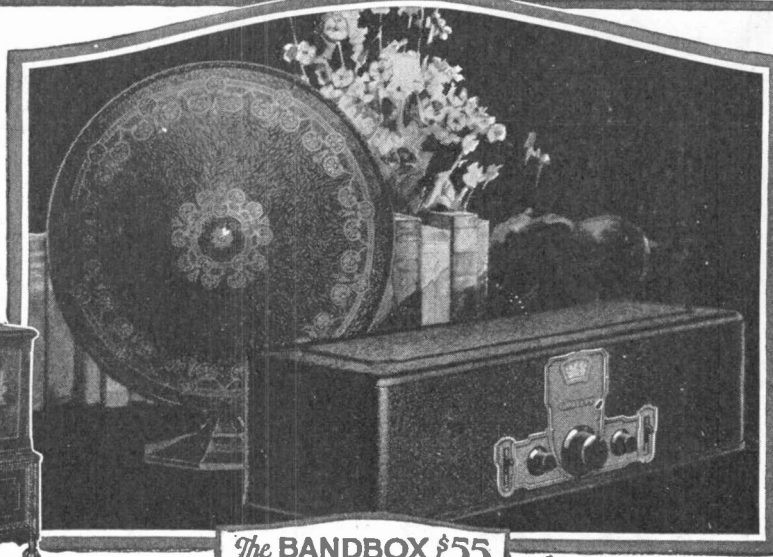

The BANDBOX \$55
A 6 tube Receiver
Brown frosted Crystaline finish—
Bronze Escutcheon.

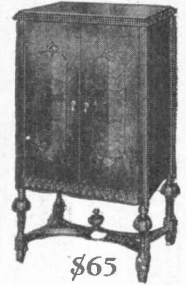

\$65

These approved cabinets have been selected by Powell Crosley, Jr., as ideal consoles, acoustically and mechanically, for the installation of the Crosley "BANDBOX." Genuine Musicones built in. Crosley Dealers secure them from their jobbers through

H. T. ROBERTS CO.,
914 S. Michigan Ave.,
Chicago, Ill.

Sales Agents for
Approved Console
Factories:

SHOWERS BROTHERS
COMPANY
THE WOLF MFG.
INDUSTRIES

A tremendous Crosley radio achievement 1927-28

RECENT court decisions which clarified the ratio patent situation have paved the way for still greater Crosley triumphs. Now—completely available to Crosley—and amplifying Crosley supremacy in fullest measure, are the enormous resources, great discoveries and ideas embodied in patents of

- 1—The Crosley Radio Corporation.
- 2—The Radio Corp. of America.
- 3—The Westinghouse Co.
- 4—The General Electric Co.
- 5—The American Telephone & Telegraph Co.
- 6—The Hazeltine Corporation.
- 7—The Latour Corporation.

under which Crosley is now licensed to manufacture.

Here are the seven big things which represent radio's greatest advancement, brought together by Crosley and combined with the experience, mass production method and leadership of the Crosley organization. No wonder a waiting radio world pronounces the "Bandbox" at the unprecedented price of \$55, Crosley's paramount achievement.

The Bandbox is Shielded

Radio coils are surrounded by magnetic fields similar in every respect to the magnetic field around the earth that moves the needle of a compass, but around radio coils these fields make nuisances of themselves by feeding back on each other. Heretofore it has been customary to make inefficient coils with inefficient fields to prevent such feeding back. The Crosley Bandbox incorporates copper shields around each coil to prevent such feeding back. The coils consequently can be made and are very much more efficient. The amplification of the receiver is, therefore, much higher—the sensitivity is greatly increased. Condensers are also completely shielded from each other in separate metal compartments. Hitherto, only high priced sets have enjoyed this super radio advantage.

There Is No Oscillation

The Bandbox employs completely balanced or neutralized radio fre-

quency stages to prevent oscillation, instead of the common form of lossier method. More costly, to be sure, but extremely necessary in achieving such results as are obtained by this marvel of radio reception.

For Sharpness—The Acuminators

"Bandbox" acuminators enable "fishers" for distant stations to bring them in loud and clear. As powerful telescopes magnify distant scenes, acuminators increase the volume of far-away signals so they seem like local programs.

Volume Control

This is another big "Bandbox" feature which permits full brass band power for those who want their dance notes strong and loud. For others, it cuts volume down to a soft and gentle murmur, without distortion.

Illuminated Dial

A Master Station Selector has an illuminated dial for easy reading in

shadowy corners. A single knob permits full tuning for ordinary reception of local, nearby and super-powered stations.

Installation Simplified

A woven cable, containing vari-colored rubber covered leads makes installation and hook-up easy for the veriest novice. No waiting for the radio service man, should the batteries be changed.

Easily Adopted to Consoles

Simply remove screws in escutcheon and in base of set. Lift off metal case. Chassis now stands ready for installation in console cabinet. Opening in console cabinet permits control shafts to protrude. Escutcheon screws in place and—Presto! the console radio is complete.

For A.C. Operation a special Bandbox is available at \$65, wired especially for use with the Crosley Power Converter at \$60. This special Bandbox utilizes the new R.C.A. A.C. tubes which have made the operation of radio receivers direct from house current so simple, efficient and dependable. The first



IMPROVED MUSICONES

Although Musicones improve the reception of any radio set, they are perfect affinities in finish, beauty and reproductive effectiveness for Crosley Radios. A new model built in the form of a Colonial Tilt-Table with brown mahogany finish, stands 3 feet high. Price \$27.50.
16-inch Super Musicone (As pictured with Bandbox) \$12.75
12-Inch Ultra Musicone \$9.75

three tubes employed in the A.C. model are UX226. These go into the radio frequency sockets. The detector tube is UY 227, with indirectly heated emitter. Another UX226 is used in the first audio stage. Raw A.C. current heats the filament of all UX226 tubes. Power tube UX 171 is in the last audio socket. This makes the "dog houses" rumble sonorously and the bass drums deeply boom.

The Power Converter

The power converter which smooths the alternating current is a marvel of engineering ingenuity. Only half the size of an ordinary "A" storage battery, it supplies the required A, B, and C currents, without hum. Finished in brown frosted crystal-line.

There are models for 25 and 60 cycle current. A snap switch shuts down the set and power converter completely.

Price of Power Converter—\$60

You owe it to yourself to see the "Bandbox" and listen to its remarkable performance. If you cannot easily locate the nearest Crosley dealer, his name and address will be supplied on request. Write Dept. 130

CROSLEY RADIO

Crosley Radio is licensed only for Radio Amateur, Experimental and Broadcast Reception



Crosley recommends the use of five 301-A Radiotrons and one UX171 power tube, or Cunningham equivalents which are furnished at stand-



ard tube prices, with each Bandbox. While Radiotron UX-171 is 150-volt tube, it gives a superior performance for 135-volt "B" batteries.

THE CROSLEY RADIO CORPORATION

Powell Crosley, Jr., Pres.

CINCINNATI, O.

Prices slightly higher west of the Rocky Mountains

Always the first choice
of leading manufacturers

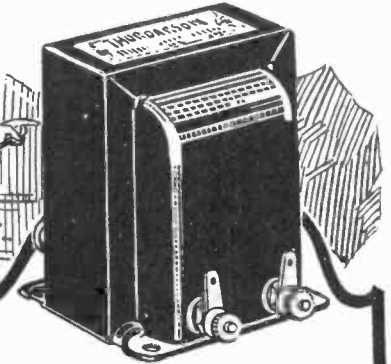

THORDARSON TRANSFORMERS

FEDERAL, Freed-Eisemann, Howard, Kennedy, Murad, Murdock, Pfanstiehl, Prestolite, Radiodyne, Sparton, Valley, Willard, Zenith. These outstanding trade names are representative of the highest degree of radio workmanship and performance.

All specify Thordarson transformers as best in keeping with the high standards of performance maintained in their receivers and power units.

No wonder then, that the home constructor likewise is so insistent in his demand for Thordarson apparatus.

Cash in now on this popularity. Why waste time trying to sell unrecognized goods when there is a Thordarson transformer for every radio need.

If you would give your customers good musical reproduction sell *Thordarson Transformers*.

THORDARSON ELECTRIC MANUFACTURING CO.
Transformer specialists since 1895
WORLD'S OLDEST AND LARGEST EXCLUSIVE TRANSFORMER MAKERS
Chicago, U.S.A.

3565

MAIL THIS COUPON

R-200 AMPLIFYING TRANSFORMERS, \$8.00

STANDARD AMPLIFYING TRANSFORMER

2:1 ratio, \$5.00
3½:1 ratio, \$4.00
6:1 ratio, \$4.50

SPEAKER COUPLING TRANSFORMER

R-76, \$6.00

OUTPUT CHOKE

R-196, \$5.00

POWER PUSH PULL TRANSFORMER AND CHOKE

T-2408 Input Transformer, \$8.00
T-2420 Output Choke, \$8.00

AUTOFORMER IMPEDANCE

R-190, \$5.00

POWER COMPACTS (for power amplifiers)

R-171, \$15.00 R-210, \$20.00

130 M. A. FULL WAVE RECTIFIER

T-2098 (Transformer) \$20.00
T-2099 (Double Choke) \$14.00

R. C. A. A. C. TUBE SUPPLY TRANSFORMER

T-2445, \$10.00

McCULLOUGH A. C. TUBE SUPPLY TRANSFORMER

T-2504, \$7.50

VAN HORNE A. C. TUBE SUPPLY TRANSFORMER

T-2370, \$5.00

Thordarson Electric Mfg. Co., Dept. M
500 W. Huron Street
Chicago, Ill.

Gentlemen:

We would appreciate receiving information on your complete line of audio and power supply transformers for the fall and winter season.

Jobber

Dealer

Name.....

Street.....

Town..... State.....

Merchandising Radio Parts



A Section of *Radio Retailing*

September, 1927

Sell Selected Parts— Not Cut-Price Bargains

ANYONE who believes the sale of parts has passed out of the picture should pay a visit to the shop of the B. S. M. Radio Company, 1309 Filbert Street, Philadelphia, Pa. Parts account for 80 per cent of the business, according to E. H. Middleton, owner of the company.

Asked what were the factors that built up a business almost exclusively on parts, Middleton said, "selling parts as parts, not as cut-price bargains."

"Times have changed," Middleton continued. "Whereas in the past dealers could sell almost anything in the way of parts, nowadays we must concentrate on popular parts of recognized quality. The miscellaneous junk that used to sell like wildfire is dead. It has been replaced by high grade, quality products—in many cases, selected and matched parts only are demanded by the customer."

"A large part of the success of the B. S. M. Radio Company can be traced to our policy of handling only parts which

we tested and found satisfactory, and of having them in stock when our customers want them.

"Of course, there is not the trade in parts today that there was two or three years ago," Middleton went on. "The trade has not yet recovered from the deluge of indiscriminate parts, good, bad and indifferent, that was thrust upon it. But it is surprising the large portion of radio fans who are still interested, and always will be, in buying parts and building their own sets. Perhaps more surprising still, the number is increasing every day.

"The manufacturer was as much at fault, if not more so, than the retailer in the price cutting of his parts. He sold them to all kinds of retailers and in many cases to combines of retailers who got together and pooled their money for greater purchasing power, thus enabling them to buy at ridiculously large discounts. Many of the manufacturers were foolish enough to sell to these interests and had only them-

selves to blame when they found that those very merchandising methods precluded the possibility of an established trade with the great number of average substantial retailers. Of course, it must be recognized that a great deal of the price cutting was made possible through the purchasing of the stock of bankrupt companies, but after all the manufacturer only made matters worse and in my opinion actually caused more harm as a whole than did the dumping of bankrupt stocks on the market.

"HOWEVER, these conditions, strange as it may seem, have worked for the good of the industry generally, because they have automatically reacted upon the questionable manufacturers, and today most of them are gone, whereas, yesterday, we had questionable or unscientific parts manufactured by unstable manufacturers who very often were out of business before their wares were off our shelves.

"It is no longer a case of carrying every type of rheostat and socket on the market, but rather a case of carrying a few selected instruments and having plenty of room to sell them. What I mean by that is that the customer today comes in to select his parts, not merely to buy them. We spread the circuits out on the counter and go over them together, choosing the best instruments for each particular circuit or even parts of a circuit. Consequently, we need less shelf room and more counter space, and this month I am tearing out and arranging to extend my store further back in anticipation of greater business this fall and winter.

"One might think that the parts business is mostly a matter of replacement or even alteration of sets in design from year to year, but I do not find it so," Mr. Middleton continued. "In fact, I am quite sure from the very nature of the sales that the major portion of the parts which I sell go into new sets.

"Customers of today ask for such things as matched radio-frequency transformers and condensers, and parts for power supply units, and filter circuits. This class of parts, of course, requires more care and skill in selecting and installing them.

"This peculiar condition has given rise to



The B. S. M. Radio Co., Philadelphia, Pa., features the new circuits as they appear and devotes its window displays to the parts which it recommends for the circuits.

What Kind of Voice Has *Your* Loud Speaker?

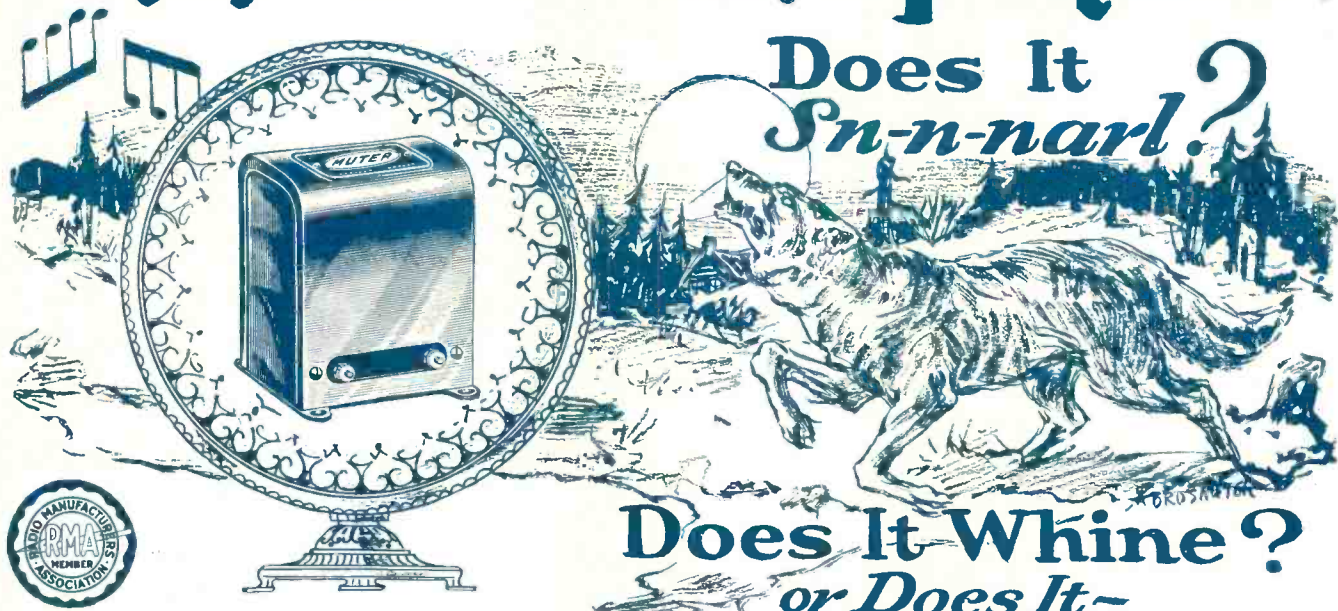

Register Clear, Natural *Human* Tones? **The Muter Clarifier**

(New Output Transformer)

will astonish and delight you by immediate, almost unbelievable improvement in reception. In nine cases out of ten that weak, distorted voice issuing from the speaker Unit is suffering paralysis from high "B" voltage. The clarifier protects Speaker coils from this shattering current, assuring longer life as well as strong, full tone, clarity and volume. If your speaker is one of the great majority that fail to respond properly to the output of the set—you need a Muter Clarifier. It's the **only** thing that will remedy the cause. Easily attached in a few seconds without disturbing set. Try out to your own satisfaction on our liberal guarantee—you won't recognize your set!

A Sensational Seller

Beginning next month with the above advertisement a unique campaign will be launched in all the leading consumer Radio Publications. This campaign brings out in a different and sensational way the real appeal of a device that fills an order-pulling need. The device is sensational—the campaign is sensational and the enthusiastic

reception of the Clarifier amply forecasts sensational sales. This great little instrument is only one item in the Muter complete Quality Popular Priced Line—all backed by consistent and extensive advertising. Ask your Jobber for Dealer prices on the Attractive Muter Line; and send coupon today for comprehensive Muter Catalog.



Dependable Products

Send coupon for complete catalog.

Leslie F. Muter Co.

76th and Greenwood Ave., Dept. 6038-M
CHICAGO, ILL., U. S. A.

Use This Coupon!

LESLIE F. MUTER CO.,
76th & Greenwood Ave.,
Dept. 6038-M, Chicago, Ill.

Send at once catalog of complete Muter Line.

Name

Address

City

State

Jobber's Name

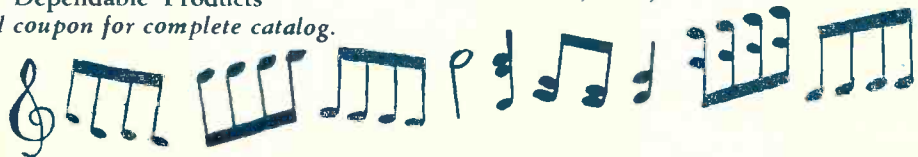

Pre-viewing the New Circuits



Readers of the October fan magazines will build these circuits. Have you the necessary parts on hand?

Complete constructional details for this set are contained in an article by Zeh Bouck appearing in the September issue of *Popular Radio*.

This set is an exceptionally satisfactory receiver that embodies the principle of high- μ amplification in both the radio-frequency and the audio-frequency amplifier and although single control is employed, the tuning of the receiver is very sharp.

Tested out in the Popular Radio Laboratory and in various other parts of New York and Chicago, the set proved to be adequately selective for tuning through the locals and bringing in distant stations with plenty of volume and without interference.

Resistance in the high-frequency and the low-frequency amplifier, gives reproduction of excellent quality using a UX-171 type valve in the last stage, either a UX-112 type of valve or a UX-201-a type of valve in the second stage and either a UX-240 or a UX-201-a type of valve in the first stage.

The front panel and the sub-panel are furnished cut to size and completely drilled. Holes are also provided for everything.

The Aero Receiver

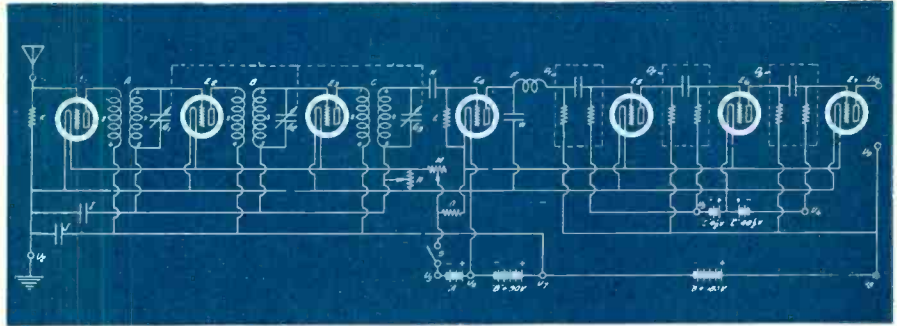

A, B and C—Tuned radio-frequency coils.
 D1, D2 and D3—Resistance-coupled amplifier kit.
 E1, E2, E3, E5, E6 and E7—Tubes and sockets.
 E4—Detector tube and floating socket.
 F—Choke coil.
 G1, G2 and G3—Triple variable condenser, each section .0005 mfd.
 H—.00025 mfd. fixed condenser.

I and J—.5 mfd. by-pass condenser.
 K—Antenna tuning resistor.
 L—5 megohm grid leak.
 M—6 ohm rheostat.
 N—200 ohm potentiometer.
 O—Filament resistor.
 S—Battery switch.
 U1, U2, U3, U4, U5, U6, U7, U8, U9 and U10—Binding posts.
 W—.001 mfd. fixed condenser.
 Drum dial.
 Front panel.

THE circuit illustrated is for a set designed by Kendall Clough, Director, Research Laboratories of Chicago. It is designed to cover all wave lengths between 15 and 550 meters. The theoretical phases of the receiver were discussed in the September issue of *Radio News* and in the October issue appears the complete constructional details.

The main feature of the set is high quality of reproduction, an unusual characteristic for this type of receiver.

In order to cover the desired wave lengths, special plug-in coils are used. The wave length ranges for these coils as given by the manufacturer are as follows: No. 1, 15 to 35 meters; No. 2, 32 to 68 meters; No. 3, 57 to 133 meters. Larger coils may be had that will cover the 125 to 250 and 235 to 550 meter bands, thus making possible reception on the broadcast band without difficulty.

All the parts used in this diagram are standard except the radio-frequency choke and the grid leak and condenser. A 2:1 audio-frequency transformer shunted by an .0001 mfd. condenser, replaces the conventional grid leak and condenser.

The Radio News Short-Wave Broadcast Receiver

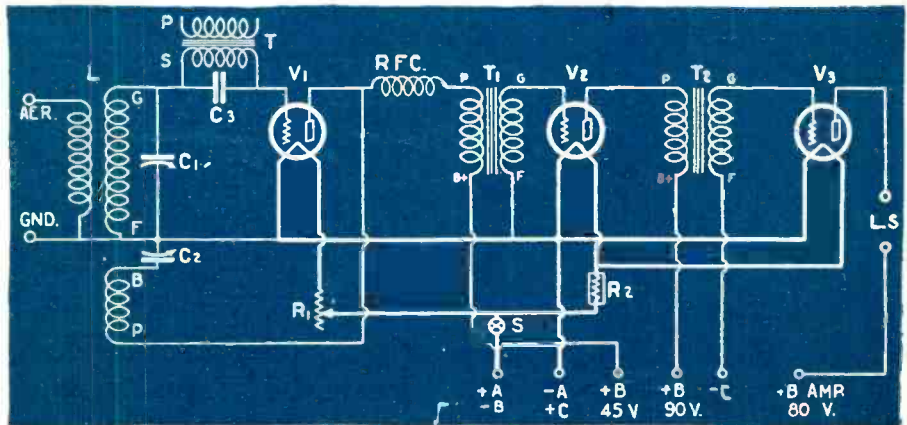

XL—Set of Aero plug-in coils.
 C1—.00014 mfd. s.l.f. variable condenser.
 C2—.00025 mfd. s.l.f. variable condenser.
 C3—.0001 mfd. grid condenser.
 V1, V2 and V3—UX type sockets and tubes.

R1—20 ohm rheostat.
 R2—Automatic filament rheostat.
 RFC—Radio frequency choke.
 T, T1 and T2—2:1 ratio audio-frequency transformers.
 S—Filament switch.
 2 Vernier type dials.
 2 Tip jacks, 8 binding posts.

a form of business from which the B. S. M. Radio Co. is also deriving considerable profit. A great number of its customers are the business men from the business district of Philadelphia in which it is located. They can well afford to pay for first-class instruments and they invariably are willing to pay the cost of selected and matched instruments. A great many of them even arrange to have their sets designed and laid out and in many cases assembled after their own ideas.

"In order to accommodate them a good supply of sheet metal, hard rubber and Bakelite raw products and wire, as well as

other sundries used in building a radio set, are kept on hand, and sufficient machinery is also maintained in the workshop in the back of the store to do any necessary work involved in the construction of a set.

"Considering all these things, it would seem safe to say that, if the parts dealer today is willing to go after the business and particularly stress the part of the business of selecting the instruments and to help a customer choose the proper circuit and follow it up with service—just the same as is done in selling manufactured sets—that he need not fear the sale of parts will disappear."

Milwaukee Dealer Jobs Parts Exclusively

Something new in the radio jobbing line is the recent establishment of the Radio Parts Company at 4th and State Streets, Milwaukee, Wis., by J. R. Brown, formerly in charge of the Accessory Department of the Badger Radio Company. This store, which is the only exclusive parts jobber in this district, is making arrangements with a number of jobbers to take care of all parts for them, where they have no parts department of their own.

Sell Allen-Bradley Perfect Radio Devices

Bradleyunit-A

PERFECT FIXED RESISTOR

Unaffected by temperature, moisture or atmospheric changes. Does not age or change in resistance.



A solid-molded fixed resistor, baked under high pressure, and accurately calibrated. Can be soldered without affecting accuracy of unit.

RADIO RESISTORS — Fixed or Variable

The market for fixed and variable resistors is tremendous. For resistance-coupling, plate voltage control, input-voltage regulation, and innumerable other applications, there is a steady demand for reliable, well-known resistors.

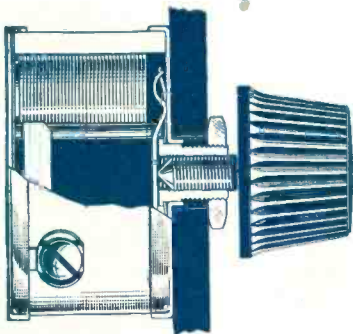

Bradleyohm-E

PERFECT VARIABLE RESISTOR

Made in several ranges and capacities. Used by leading B-Eliminator manufacturers for plate-voltage control. Merchandised in distinctive checkered cartons.

Radio dealers, alive to the sales possibilities of radio resistors, are increasing their stocks for the coming season.

Get all the facts about Allen-Bradley radio resistors from your nearest jobber, or write, today, for latest literature.

ALLEN-BRADLEY CO.
489 Clinton Street
Milwaukee, Wisconsin

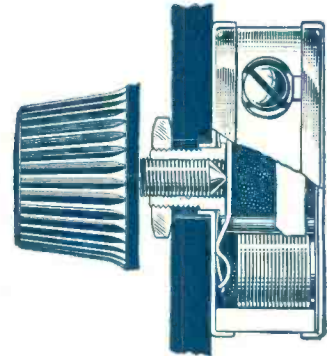

Bradleystat

PERFECT FILAMENT CONTROL

The outstanding filament rheostat on the market. Noiseless, perfect regulation of filament current.

Allen-Bradley

PERFECT RADIO RESISTORS

MANUFACTURERS and MARKETS

*Devoted to the Problems
of the Manufacturer in
the Design and Distribu-
tion of Radio Apparatus*

A Section of *Radio Retailing*

September, 1927

Co-operative or National Advertising

Which Has the Greatest Sales Influence?

A VITAL question, and often a troublesome one for manufacturers planning the advertising appropriation, is that of deciding in what proportion money should be expended in national magazines and in co-operative local newspaper campaigns. Each method has firm supporters and each has scored effectively.

The principal argument in behalf of national magazines is that they stimulate consumer interest in the product generally. Local newspaper advertising, on the other hand, sends the interested consumer directly to his dealer, while national advertising leaves upon the consumer the burden of finding the particular dealer at his trading center who handles the nationally advertised product.

Those seeking to stimulate broader distribution with the aid of national magazines are often in doubt as to the efficiency of the method. Retail dealers have expressed to the editors many times the opinion that the same expenditure in local newspapers, with the name and address of the dealer prominently displayed, is a more effective and less wasteful method of increasing retail sales.

Radio Retailing's staff has questioned hundreds of dealers in all parts of the country as to their preferences regarding general consumer versus local co-operative advertising. There is no doubt about the widespread preference for the local co-operative campaign. The dealer feels the manufacturer's interest in his selling problems when the two join forces to stimulate their mutual business. General national advertising is impressive, but oftentimes the dealer is hardly conscious of the fact that it benefits him. Not so with co-operative advertising; it bears the dealer's signature and sends the interested prospect to the dealer's store.

Another advantage of the co-operative system is that the manufacturer can concentrate his advertising dollars where he has the most active and effective local outlets. The co-operative advertiser knows that every bit of interest aroused by local campaigns is capitalized because the dealer is established and ready to sell the consumer who reads the advertisement.

However, certain criticisms of co-operative campaigns have been reported by *Radio Retailing's* observers. Some manufacturers, who appreciate the effectiveness of the co-operative campaign, have been too active in selling it to the dealer. In cities where many outlets distribute the same

line, the individual dealer's signature is too insignificantly submerged with the signatures of his competitors to make him feel that he is getting his money's worth. The most popular and, at the same time, most effective individual co-operative advertisement is the one in which the dealer pays half the cost and the manufacturer the other. There is no room, with such an advertisement, for the feeling that a rival dealer, whose name appears near the head of a long list of local merchants, derives most of the benefit. Its entire influence is exerted in behalf of a single dealer.

National advertising through mediums of great circulation has a definite advantage in that it requires no special organization to handle the details of placing it. But the efficiency of co-operative advertising and its value in stimulating the dealer to push a particular line seems to overshadow any additional work entailed.

Manufacturers Form New Association

Early in August a number of radio manufacturers organized the Radio Protective Association, with headquarters in Chicago at 134 So. La Salle Street.

Representatives of about thirty manufacturers took the initial steps in the formation of this organization by obtaining a charter of incorporation from the Secretary of State of Illinois. This charter declared the purpose of the association to be "to promote the progress of science and the useful arts in so far as they apply to radio and to preserve the freedom of said science and useful arts."

The following were named as the original board of directors: Harvey Cory, Neutrowound Radio Manufacturing Company, Homewood, Ill.; Fred S. Armstrong, Vesta Battery Company, Chicago, Ill.; R. W. Augustine, Joy-Kelsey Corporation, Chicago, Ill.; Allen G. Messick, Indiana Manufacturing and Electric Company, Marion, Ind.; Harry Sparks, Sparks-Withington Company, Jackson, Mich. Oswald F. Schuette of Chicago was elected executive secretary.

R.M.A. Compiling Patent Information

The Committee on Patents of the Radio Manufacturers' Association, Inc., 32 West Randolph Street, Chicago, Ill., has issued

a folder giving the introduction and index to the compendium of patent information which is being compiled for the association.

This compendium is being published in two sections. The first section, covering the listing on United States patents affecting the radio industry, and comprising over 300 pages, is ready for printing, and the second section, dealing with suits relating to these patents, is expected to be completed within the next two or three months.

A complete copy of the first section is in the hands of the Patent Committee, who will be glad to have members examine it and offer suggestions as to the most useful form in which to print it for distribution. A copy of the folder describing the compendium is available upon request to the committee mentioned above.

Atwater Kent Gets Patents on One-Dial Sets

An excellent example illustrative of the present tendency towards simplification of broadcast receivers is offered by the one-dial sets made by the Atwater Kent Manufacturing Company. The United States Patent Office has just issued patents numbered 1,639,414 and 1,639,042 covering this and other Atwater Kent features. These patents, in conjunction with a license under Hogan Patent Number 1,014,002, cover the one-dial construction put out by the Atwater Kent Company.

New N.E.M.A. Standards

A suggested standard for future design covering the color of vacuum tube sockets has been adopted by the Radio Division of the National Electrical Manufacturers' Association. The suggested standard reads: "The colors for vacuum tube sockets in receiving sets shall be as follows: For general purpose tubes, dark red; for special detector tubes, green; for audio power tubes, orange." This suggested standard to govern future design and enable rapid identification of sockets in all sets was adopted in July, 1927.

The third edition of the NEMA Handbook, now available includes a number of standards covering the proper construction of socket power devices which have been formulated into standards by the Radio Division from the Underwriters' requirements. Among them is this new standard: "Current-carrying parts of the tube sockets in a socket-power device shall be

SM

Profits Plus!

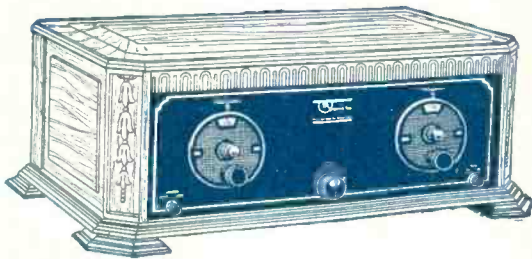

The New Shielded Six Is Ready!

The Improved Shielded Six is ready, the very latest model of this excellent receiver which has over a year of successful and satisfying performance to its credit. The Improved model has vastly increased selectivity, greater distance getting ability, and the same fine tone that has made almost every builder say of the original "That's the finest set I've ever heard!"

This year the Six offers the additional possibilities of push-pull amplification with 210 tubes for the man who wants the utmost. All in all, the Six deserves the reputation as the finest tuned R. F. kit you can build.

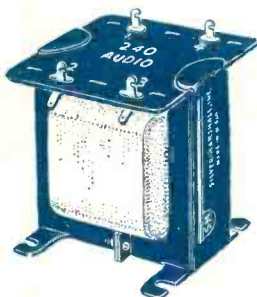

Two smaller sized audio transformers are offered for replacement work in older sets wherever price and size is a consideration. Type 240 audio transformer is equal or superior to the majority of high-grade audio transformers but does not reproduce frequencies below 80 cycles to the same extent as does the famous 220. Due to their small size these transformers are ideal for replacement in receivers like the Atwater Kent—they will fit in almost any of the older receivers and once installed will work wonders in tone quality improvement, customer satisfaction, and simultaneous tube and battery sales. Price, 240 audio transformers, \$6.00. 241 output transformer, \$5.00.

PROFITS plus—as a phrase it sounds fine, as an entry in your bank book there's nothing like it. And extra profits—half again what your looking forward to for 1927-28, maybe twice as much—are within your grasp, ready for the taking.

The way to make them is by specializing in custom-built radio receivers and accessories. Here's how. Instead of selling a customer an ordinary \$125 or \$150 dealer factory-built set of questionable tone quality, DX ability and material value, give your customer double value by selling him a custom-built Shielded Six, in a cabinet to suit his taste and purse. The Shielded Six kit costs you \$95.00 less regular discount, your service man puts it together in three hours of an evening, and you sell the receiver complete with a beautiful cabinet for \$130 to \$145. You make a far larger profit than you could on a factory-built set, and you give your customer a set that can't be equalled for tone, appearance and performance for less than \$250 to \$300 in factory built models. Repeat sales are yours, for you're given a bigger value than your competitor with greater customer satisfaction, and too, you've opened up the way for later sales of power amplifying equipment and other accessories.

It's just the same with the new Silver-Marshall Unipacs—combination lightsocket power amplifiers and B power supplies that you can build and sell for from \$74.00 to \$93.25. There's a tremendous market opening up on these amplifiers, for besides delivering the finest tone of any commercial equipment, they will electrify your customers old phonographs at a cost far below that of standard electric phonographs, and with better results.

And so it is with Silver-Marshall transformers—there's a replacement sale in every old set in use if you're on the job to put in a pair of S-M audio transformers for your older customers.

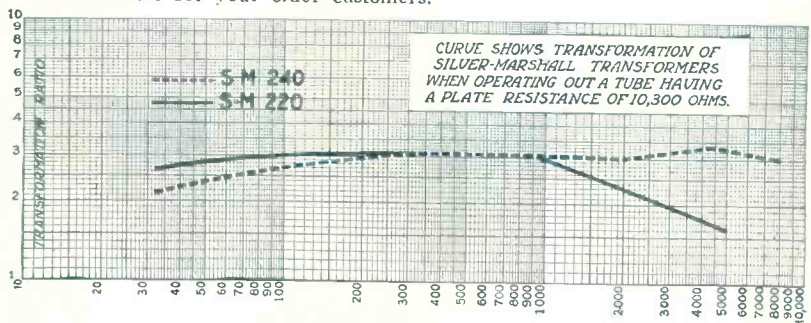

87% At 30 Cycles!

At 30 cycles, an S-M audio transformer in a standard amplifier circuit gives 87% of the amplification obtained at 1000 cycles, while its curve is substantially flat from 100 to 1000 cycles. Above 2000 cycles, the curve for a single stage falls off gradually, while in a standard two stage amplifier circuit the curve is substantially flat up to 5000 cycles above which frequency it falls off rapidly to keep static, heterodyne squeals and "set noise" at a minimum.

These are facts—they demonstrate why S-M audios are the choice in over half the new 1927-28 designs, why they are used in countless broadcasting stations. That is why they are sold on a money back guarantee, to give your customers more satisfactory quality than they've ever heard before—that's what makes S-M 220's and 221's the best replacement proposition in the field. S-M 220 audio transformer \$8.00, 221 output transformer \$7.50, or with cord and tip jacks, No. 222, \$8.00.

Silver-Marshall, Inc.
870 West Jackson Blvd.
Chicago, Ill.

Please send me full information on all of the new S-M developments.

Name

Address

Silver-Marshall, Inc.

870 West Jackson Blvd., Chicago, U. S. A.

enclosed although the device may be so designed that tubes may be replaced without opening the case."

The new edition of the NEMA Radio Standards Handbook shows a drawing of the connections for a five pin vacuum tube, giving the important dimensions of the base also. The designation of the pins in such base is declared as follows:

"In a triode employing a heating element insulated from the cathode, it shall be standard to designate the heater pins by H, the cathode pin by K, the grid pin by G, and the plate pin by P. The use of the word filament to refer to the heater of this type of tube is not approved."

R.M.A. Adopts Code of Ethics

By unanimous vote, the members of the Radio Manufacturers' Association present at the June 17 meeting in the Stevens Hotel during the Trade Show, approved the following "Code of Ethics." This code was submitted by E. N. Rauland, president of the All-American Radio Corporation and chairman of the R. M. A. Fair-Trade Practice Committee. It is here reproduced in its entirety with the exception of clause 14, which relates to the manner in which grievances shall be presented to the committee. This code, according to reports, has been well received by the membership at large and by those jobbers and dealers who have commented on it.

RADIO MANUFACTURERS ASSOCIATION, INC.

Code of Ethics

1. Statistics

Knowledge—thorough and specific—and unceasing study of the facts and forces affecting this industry are essential to lasting individual success, and the members of this association should co-operate in the collection and dissemination of facts relating to the industry, for the benefit of all.

2. Standards

The standardization of parts, manufacturing methods, terminology, rating and types are of great assistance to the industry and to the public and the members of this association pledge themselves to make all reasonable efforts toward this end, provided, however, that attempts to standardize should not be pressed to such a point as to discourage or limit the development of the industry.

3. Mutual Relations

Recognizing that the radio industry will benefit by the existence of harmonious and friendly relations between its members, no member of this association shall make statements or take action calculated to injure, directly or indirectly, the business reputation, product, or personal standing of a competitor.

4. Duty to the Public

The nature of the radio industry is such that there is a well-defined duty and obligation to the public. Their interest demands that the members of this association use every honorable means to uphold the dignity and honor of this industry, to raise its standards, and to extend its usefulness.

5. Piracy of Design

A company gaining an advantage by reason of superiority in designing skill, electrical or mechanical, is under no obligation to share such advantage with other companies. Such a company cannot, however, expect to retain exclusive use and benefit of unpatentable features of construction; but specific construction and designs of one company should not be appropriated by its competitors.

6. Piracy of Appearance

The duplication in color, description or designation of product or package which would tend to deceive the buyer or the public, that in purchasing the imitation they were getting the original article, is a form of unfair competition which this association condemns in the strongest terms.

7. Production Costs

Realizing that only through exact knowledge of the cost of production can the manufacturer sell on a fair margin of profit, this association specifically urges every member to adopt an intelligent check on their business operations, and to know accurately the cost of management, production, and distribution of their product. This association distinctly leaves to the determination of each member, however, all questions of selling prices, labor, hours, and wages, and avows its position in such matters to be that of the strictest observance of the law.

8. Advertising

Advertising should at all times be fair and honest. It is not discreditable to become enthusiastic in print, but to criticize a competitor, directly or indirectly, in a paid advertisement or to convey to the public your opinion of your competitor or his products, or to include statements in advertising which through actual misrepresentation, through ambiguity or through incompleteness are likely to be misleading to the public is unjust to competitors, and should not be permitted.

9. Subsidizing Buyers' Representatives

We are opposed to any manufacturer offering in any way special compensation of any type or kind as an inducement to the individual who acts as buyer for his employer.

10. Jobbers Catalogs

We discountenance the furnishing by the manufacturer of inserts for jobbers' trade catalogs without charging for same at full cost, or the making of any allowance upon the part of manufacturers to the jobber for illustrating the manufacturer's goods in such catalogs.

11. Cash Discounts

A cash discount is given in return for payment within a specified time after shipment. The terms given should be adhered to or the transaction ceases to be of the nature intended.

12. Returned Goods

We recommend the following as standard practice with reference to return of goods where orders have been correctly filled:

A. The customer should be required to obtain consent of the manufacturer before returning such goods for credit.

B. The goods thus returned may be credited subject to a service and rehandling charge including the shipping expense.

C. Such returned goods may be sold as new goods, if in salable condition.

13. Guarantees

We disprove of any unreasonable guarantee believing such to be detrimental to the manufacturer and to the industry. Apparatus should be guaranteed free from defects in material and workmanship, for a reasonable time, but this should not apply to apparatus which has been subjected to misuse, neglect, or accident. Defective material should be repaired or replaced at the option of the manufacturer upon the return of the same, transportation charges prepaid.

New Radio Patents

ISSUED JULY 5, 1927

- 1,634,407. Harry A. Douglas, Bronson, Mich. Contact Carrier.
 1,634,625. Martin Nystrom, Chicago, Ill. Assignor to The Brunswick-Balke-Clender Company, Wilmington, Del. Station-Selector Dial for Radio Receiving Sets.
 1,634,896. Lloyd B. Cogswell, West Springfield, Mass. Radio Apparatus.
 1,634,930. Carl P. Brockway, Toledo, Ohio, Assignor to The Arcturus Radio Co., Harrison, N. J. Variable Condenser.
 1,634,962. Rudolph Sachtler, Brooklyn, N. Y. Radio Receiving System.
 1,635,151. Edward E. Clement, Washington, D. C., Assignor to Edward F. Colladay, Washington, D. C. Radio Distributing System.
 1,635,152. Edward E. Clement, Washington, D. C., Assignor to Edward F. Colladay, Washington, D. C. Radio Broadcast Selecting and Distributing System.
 1,635,153. Edward E. Clement, Washington, D. C., Assignor to Edward F. Colladay, Washington, D. C. Subdivided Service System of Radio Broadcast Distribution.

- 1,635,154. Edward E. Clement, Washington, D. C., Assignor to Edward F. Colladay, Washington, D. C. Radio Service Metering System.
 1,635,155. Edward E. Clement, Washington, D. C., Assignor to Edward F. Colladay, Washington, D. C. Radio Service Metering System.
 1,635,156. Edward E. Clement, Washington, D. C., Assignor to Edward F. Colladay, Washington, D. C. Radio Broadcast Distributing System.
 1,635,157. Edward E. Clement, Washington, D. C., Assignor to Edward F. Colladay, Washington, D. C. Radio Broadcast Distributing System.
 1,635,158. Edward E. Clement, Washington, D. C., Assignor to Edward F. Colladay, Washington, D. C. Radio Broadcast Distributing System.

JULY 12, 1927

- Design 73,043. Ferdinand Kulhawy, Guttenberg, N. J. Radio Apparatus Multiple Dial.
 1,635,316. Charles Elsler, Newark, N. J. Machine for Making Radio Tube and Lamp Parts.
 1,635,324. Charles Francis Jenkins, Washington, D. C. Web Message Radio.
 1,635,459. Paul A. Chamberlain, Chicago, Ill., Assignor to Mohawk Electric Corporation, Chicago, Ill. Radio Condenser.

JULY 19, 1927

- 1,635,990. John O. Gargan, Brooklyn, N. Y., Assignor to Western Electric Company, Incorporated, New York, N. Y. Electrostatic Condenser.
 1,636,146. Franklin Mohr, East Orange, N. J., Assignor to Western Electric Company, Incorporated, New York, N. Y. Control of Electric Waves.
 1,636,233. Henry J. Kasch, Dayton, Ohio, Assignor to The Kurz-Kasch Company, South Broadway, near Dayton, Ohio. Vernier Dial.
 1,636,328. Louis B. Sauer, Western Springs, Ill., Assignor to Kellogg Switchboard and Supply Company, Chicago, Ill. Condenser.
 1,636,362. Edward Alfred Graham, Brockley, London, England. Maria Graham and Alfred Graham, Executors. Telephone Receiver with Detachable Sound Amplifier.
 1,636,503. Herbert Grove Dorsey, Gloucester, Mass., Assignor to Submarine Signal Company, Portland, Me. Variable Condenser.
 1,636,570. Frederick A. Kolster, Palo Alto, Calif., Assignor to Federal Telegraph Company, San Francisco, Calif. Radio Receiving Apparatus.

JULY 26, 1927

- 1,636,699. Lloyd V. Lewis, Edgewood, Borough, Pa., Assignor to The Union Switch & Signal Company, Swissvale, Pa. Amplifying Apparatus.
 1,636,713. George C. Reier, Brooklyn, N. Y., Assignor to American Telephone & Telegraph Company, Electrical Wave Filter.
 1,636,716. Carl Scrabie, Urbana, Ohio. Combination Recorder and Reproducer of Sound.
 1,636,737. Eginhard Dietze, Brooklyn, N. Y., Assignor to American Telephone & Telegraph Company, Electrical Wave Filter.
 1,636,765. Alfred S. Curtis, East Orange, N. J., Assignor to Western Electric Company, Incorporated, New York, N. Y. Wave-Transmission System and Apparatus.
 1,636,940. Theodore Lindenberg, Columbus, Ohio. Reproducer for Radio Receiving Apparatus.
 1,637,015. Bruce Thomas Umsted and Edward Nathaniel Harris, Jackson, Tenn. Said Harris, assignor of forty-five one hundredths to John H. Johnson & Sons, Jackson, Tenn. Current Rectifying and Controlling System.
 1,637,046. Edward W. Kellogg, Schenectady, N. Y., Assignor to General Electric Company. Radio Receiving System.
 1,637,051. Frederick W. Renwick, Camden, N. J. Dial for Radio Apparatus.
 1,637,058. Paul F. Shuey, Pittsburgh, Pa. Radio System.
 1,637,084. Guadalupe Mendez, Dawson, N. Mex. Radio Tube Socket.
 1,637,119. Frederick A. Kolster and Sigurd A. Sollie, Palo Alto, Calif., Assignor to Federal Telegraph Company, San Francisco, Calif. Electromagnetic Sound Reproducer.
 1,637,233. Karl Schmidt, Berlin-Sudende, Germany, Assignor to C. Lorenz Aktiengesellschaft, Berlin-Tempelhof, Germany. Means for Frequency Multiplication.
 1,637,310. John Hays Hammond, Jr., Gloucester, Mass. Transmission System for Radiant Energy.

WANTED!

Live Dealers Active Jobbers

POWER equipment and receiver kits for alternating current operation will be an important factor in jobber and dealer sales during the coming radio season.

Good resistors and rheostats are essential to the successful operation of these devices.

Ward Leonard Electric Co. has built apparatus employing resistance for more than 35 years.

The Vitrohm (vitreous enamelled) Resistor and Rheostat represents the experience gained during this time.

Ward Leonard Electric Co. wants a number of well-rated dealers and jobbers to aid in meeting the demand for Vitrohm Radio Resistors and Rheostats. To those dealers and jobbers who are located in territories not as yet covered, Ward-Leonard offers these sales-aids.

1. A complete line of resistors and rheostats which are proven in performance.
2. The use of a well equipped laboratory and the aid of competent engineers for the development of special apparatus.
3. Dealer and jobber protection on unfair competition. The number and type of dealers in each territory is strictly limited.
4. An advertising campaign which will include more than 40 full page advertisements in national radio publications.
5. A generous plan for cooperative dealer and jobber advertising in local newspapers.
6. Publicity in newspapers and magazines which will tell a real "story."
7. Dealer and jobber protection on defective material. If a Vitrohm Resistor or Rheostat fails in service which is within its rating, Ward Leonard replaces it without question.
8. The assurance and satisfaction which comes from knowing that in selling Vitrohm Radio Resistors and Rheostats you are selling a product that "stays sold." 35 years experience is a good guarantee to you of service and responsibility.

Vitrohm Resistors and Rheostats are adopted as standard by most of the large radio manufacturers for use in their power equipment to be sold this coming season. An aggressive advertising and sales campaign addressed to the parts-buying public will force *their* recognition of the worth of Vitrohm Radio Products.



If you plan to make money in the parts business next season, write today for our complete proposition. Large territories are still open but only a limited number of dealers and jobbers can be accepted in each district. The coupon at the bottom of this page is for your convenience.

Ward Leonard Electric Company

37-41 South Street,

Mount Vernon, N. Y.

Name

Address

Send Information

Dealer

Jobber

Dealer-Jobber

Speaker Specifications—Season 1927-1928 (Concluded)

(From Page 106)

Name and Address of Manufacturer	Trade Name and Model Number	List Price	Type	Style	Diameter of Cone in Inches	Length of Horn and Diameter of Bell	Is Filter Included	Composition of Cone or Horn
Stromberg-Carlson Tel. Mfg. Co. 1060 University Ave., Rochester, N. Y.	Stromberg-Carlson	7	Cone	Wall	15			Treated paper Treated paper Acoustic fiber
		5	Cone	Pedestal	15			
		11	Cone	Wall	21			
		10	Cone	Pedestal	21			
Teletone Corp. of America 3rd St. and Van Alst Ave., Long Island City, N. Y.	Teletone 68	70	Cone	Table	12½		No	Paper Cone Paper Cone
		70	Cone	Table	12½		No	
Timmons Radio Products Corp. Germantown, Philadelphia, Pa.	Concert Grand	30.00	Cone	Table and Wall	25x22½		No	Paper
Tower Mfg. Corp. 122 Brookline Ave. Boston, Mass.	Tower-Spitfire Tower-Pirate Tower-Castle Tower-Adventurer Tower-Meistersinger Tower-Meistersinger Tower-28	4.95	Air-column	Table	14	20x10	No	Fibre Paper
		7.95	Cone	Table				
		9.50	Cone	Table	17	26x14	No	Paper Paper
		9.50	Cone	Table				
		15.00	Air-column	Table	15	26x14	No	Aluminum Paper
		15.00	Cone	Table				
		17.50	Cone	Table	10		No	Paper
Trimm Radio Mfg. Co. 847 W. Harrison St. Chicago, Ill.	Homespeaker-25 Concerto-28 Concerto Grande-38 Entertainer-90 Concert-80 Rex-80	10.00	Air-column	Table	14	18x12	No	Rubber Paper
		10.00	Cone	Table				
		16.00	Cone	Table	17	21x12	No	Paper Rubber
		17.50	Air-column	Table				
		25.00	Air-column	Table	23x15	23x15	No	Rubber Rubber
		25.00	Air-column	Table				
Unger Doll & Toy Co. 270-4th Ave., Milwaukee, Wis.	Unger Speaker-A	12.00	Air-column	Table		25x14	Yes	Aluminum and laminite
United Radio Corp. 15 Caledonia Ave., Rochester, N. Y.	Peerless-7A	35.00	Cone	Table	7		Yes	Paper
Victor Radio Corp. 4321 N. Western Ave., Chicago, Ill.	Operetta Drum	20.00		Table	12		No	Aluminum
Vitalitone Radio Corp. 88 University Place New York City	Vitalitone Wall 36 in. Conquer Ship T-20 Santa Maria Ship Dream Castle	12.00	Cone	Wall	36		No	Paper Paper Paper Paper Paper
		12.50	Cone	Table	16½		No	
		15.00	Cone	Table	20		No	
		15.00	Cone	Table	17½		No	
		25.00	Cone	Table	22½		No	
Welty & Co., William A. 36 S. State St., Chicago, Ill.	Welty's "Babyola"*-M Reproducer-B "Babyola"-C Reproducer-A Cone Speaker-Con	14.00	Air-column	Cabinet	36	4½x7½x9 24x15 5x8x10 24x15	No	Solid wood Wood fibre and metal Solid wood Wood fibre and metal Prepared paper
		18.75	Air-column	Horn				
		18.75	Air-column	Cabinet				
		25.00	Air-column	Horn				
		35.00	Cone	Wall or pedestal				
*Special for manufacturers of portable sets.								
Wright-DeCoster, Inc. 1466 Selby Ave., Saint Paul, Minn.	Radograph	125.00	Cone	Cabinet	19		No	

What the Trade is Talking About (Continued from Page 99)

Rules for International Radio Sought

Co-ordination of the international use of radio may be expected to be established by the International Radiotelegraphic Conference to be held in Washington beginning October 3. The object of the conference, according to Mr. Hoover, who is chairman of the American delegation, is to assign wave bands to the different types of radio services employed internationally so that interference will be reduced.

More than 50 nations, including practically all of the nations of Europe, will send delegations to the conference. No date of adjournment has been set, the plan being to continue the conference until all of the work is completed.

Postal and Federal in Agreement

The Postal Telegraph Company has entered into a 20-year contract with the Federal Telegraph Company whereby the Postal Company agrees to purchase the land and marine telegraph system developed by the Federal Company.

Federal-Brandes, Inc., radio manufacturer, is a subsidiary of the Federal Telegraph Company. The terms of the contract also require the Postal Company to purchase its radio, wired radio and television

equipment, as well as its telephone receiving apparatus from the Federal Company.

FRANK A. D. ANDREA, president of F. A. D. Andrea, Inc., recently moved his plant from 1581 Jerome Ave., New York City, to Jackson Ave., Orchard and Queens St., Long Island City, N. Y., and has made several changes within the organization.

W. J. ROCHE, formerly managing director of Fada Radio, Ltd., of London, has been appointed manager of Fada Radio, Inc., of Illinois, and is now stationed in Chicago. A branch of Fada Radio, Inc., at Illinois is operated in Kansas City, Mo., over which Mr. Roche also has jurisdiction. J. H. Thomas, succeeds Mr. Roche as manager of the London factory branch.

KEN-RAD CORPORATION, INC., Owensboro, Ky., is offering an elaborate variety of advertising helps for National Radio Improvement Week, October 1-8 inclusive. These helps are in the form of window strips, announcement letters, counter mailing folders, and counter and window display holders for their merchandise. Most of these advertising helps are free to all dealers and jobbers and the others are charged for at a nominal price.

EDGAR K. JAMES, formerly manager of the manufacturers' sales division of the Pacent Radio Corporation, and also eastern sales manager of the Freed-Eisemann Corporation, has opened an office as manu-

facturers' representative, at Room 510, 1123 Broadway, New York City. He plans to represent several radio lines in the Metropolitan territory and is in the market for additional radio lines.

Radio Show at Richmond

Many new features will be included in Richmond's 1927 Radio Show to be held four days, commencing September 19, under the auspices of the Richmond Radio Dealers' Club, at Richmond, Va.

The show committee is composed of, H. R. Perkinson, Tower-Binford Electric Company; H. G. Duval of B. T. Crump Company; F. L. Sheilor, the Holloday Company; Robert Frayser, Howell Brothers; B. H. Hoffman, Hoffman and Goodman; Pete Christian, of Hicks and Christian; J. R. Price, of Price Brothers; R. L. Harrison of Carter & Cook; and E. W. Bugg of Dabney & Bugg.

Mr. Bugg is president of the Richmond Radio Dealers' Club. Other officers are: Robert Frayser, vice-president; B. H. Hoffman, treasurer, and J. A. Steere, secretary.

THE UNIVERSAL ELECTRIC LAMP COMPANY, 843 Broad Street, Newark, N. J., manufacturer of Buck tubes, has moved its sales organization to 26 Treat Place, Newark.

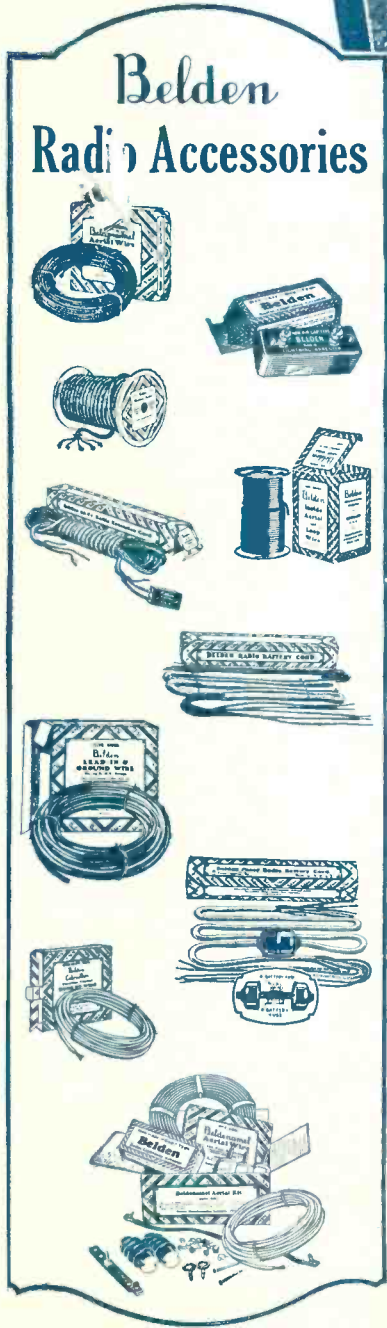

**Belden
Radio Accessories**

**Belden Radio Advertising
Reaches Over 7,000,000 Readers!**

The combined circulation of the above influential publications, all of which will carry Belden advertising this year, is 3,807,375. Figuring an average of two readers per magazine, this means that Belden advertisements will reach 7,614,750 readers.

This extensive publicity assures rapid turnover for the complete Belden line of proven radio accessories. Now is the time to prepare for the fall radio business. Place your order with your jobber today for a complete Belden stock. Prepare to capture your share of the business created by Belden extensive advertising.

BELDEN MANUFACTURING COMPANY

2308-A S. Western Avenue

Chicago, Illinois

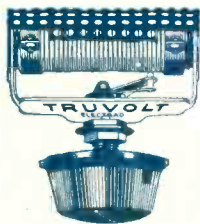

It's
a
Winner!

TRUVOLT

An All-Wire Variable Voltage Control

B-Eliminators and socket power are coming into general use. Take advantage of this, dealers—stock and sell Truvolt, the new wire variable voltage control for power devices.

Truvolt is superior in that it is kept cool like an air-cooled motor—a fact that is being played up in Truvolt advertisements and write-ups in the big radio publications.

Every fan, using house current will buy Truvolt to perfect their power devices because of its many superior features:

- 1—Greater radiation area keeping it cool on principle of Lindbergh's air cooled motor.
- 2—Permanent accuracy and long life due to no deterioration from high temperatures.
- 3—Made entirely of wire; potentiometer control; positive electrical contact.
- 4—Nichrome wire resistance with 30 exact readings of resistance.

Eight stock types with resistances up to 50,000 ohms. All rated at 25 watts. List \$3.50.

Also full line of fixed wire resistances.

*Write for descriptive circular
and full information*

Dept. 15A, 175 Varick Street, New York

"This Is An Eliminator Year"

ELECTRAD

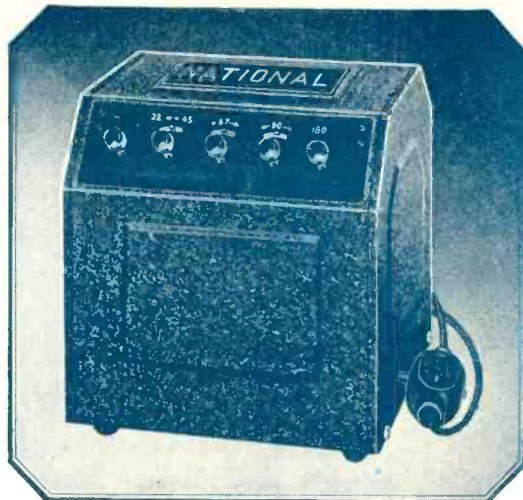

AN ENTIRELY NEW AND UNIQUE HEAVY DUTY BETTER—B

Supplies detector voltages from 22 to 45, adjustable; R. F. voltages from 50 to 75; A. F. voltages from 90 to 135. Power tube voltage 180; fixed tubes and by-pass condensers are protected against excessive and harmful voltages.

An Exclusive Feature
DESIGNED FOR LASTING
SERVICE WITH LIBERAL
FACTORS OF SAFETY

A STRICTLY HEAVY- DUTY POWER UNIT

Output rating is 70 mills at 180 volts. Uses R.C.A. UX-280 or Cunningham CX-380 Rectron. Licensed under patents of Radio Corporation of America and Associated Companies. For 105-115 Volts, 50-60 cycles A.C. List price with cord, switch and plug; \$40.00. Rectifier Tube \$5.00.

Write National Co. Inc.,
W. A. Ready, Pres., Malden,
Mass. for new Bulletin R.

NATIONAL - B

Type 7180

A "B" That's Built for Service

*At Booth 5-Sect. F. F. New York Radio World's Fair
Booth 94 and 95 Boston Show*



"BRAIDITE"

A new hook-up wire
that is selling fast



Braidite is the neatest looking and fastest working hook-up wire on the market. To make a soldered connection, it is not necessary with Braidite, to strip back the insulation. The braid is simply pushed back while the soldering is done and then replaced, thus making the neatest possible connection. Made in red, green, yellow, brown and black. 25 ft. of one color with solid copper core, list price per carton, 30c. 25 ft. of one color with stranded copper core, list price per carton, 35c.

(Order a sample carton, today)
See the Cornish Wire Display
at New York Radio Show,
Booth 17, Sec. CC.

DEALERS, JOBBERS
AND MANUFACTURERS
Write or wire today for complete
catalog and discounts.

"Cornico" Products
Antenna Wire
(Solid, Stranded and
Braided)
Complete Aerial Kits
Magnet Wire
Battery Cable
Bus Bar Wire
Hook-Up Wire
Lead-in Wire
Annunciator Wire
Loop Aerial Wire
Litz Wire
Flexible Wire

CORNISH WIRE COMPANY

30 CHURCH STREET, NEW YORK CITY

BOSTON 90 Federal St.	CHICAGO 326 W. Madison St.	KANSAS CITY 208 Baltimore Bldg.
SAN FRANCISCO 585 Mission Street	LOS ANGELES 224 East 18th Street	

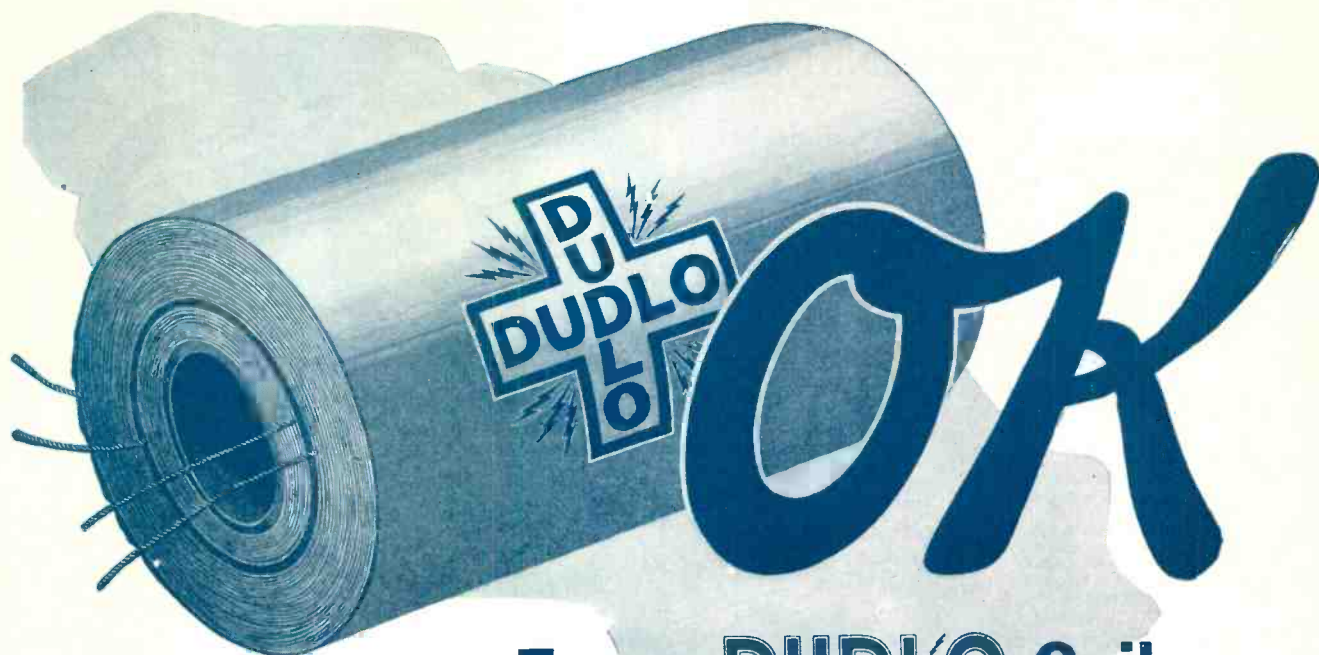

**Every DUDLO Coil
must be O. K. in every respect**

—number of turns

—no short circuits

—dimensions

—resistance

—output

Complete satisfaction is assured to Dudlo customers because each individual coil is thoroughly tested and accurately checked in every way possible.

Dudlo coils must be up to specifications. There is no passing mark short of perfection.

Here in the world's coil headquarters has been developed the most complete testing apparatus in the industry. Special methods and equipment have been developed that would be impossible with any but the largest volume.

Unlimited volume, deliveries on schedule and exact adherence to specifications make Dudlo the logical source of supply for magnet wire and windings.

DUDLO

DUDLO MANUFACTURING CORPORATION, FORT WAYNE, INDIANA
 56 EARL STREET NEWARK, N. J. 160 NORTH LA SALLE STREET CHICAGO, ILL. 4153 BINGHAM AVE. ST. LOUIS, MO. 274 BRANNAN ST. SAN FRANCISCO, CALIFORNIA

BEE CEE CONDENSERS

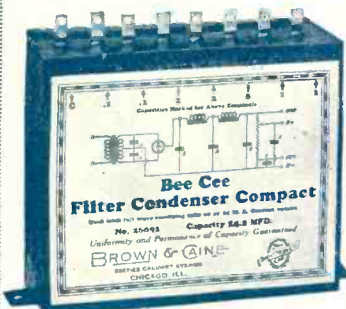

Filter Condenser Compacts

The Bee Cee line of condenser filter compacts is complete. Each unit is especially designed for a specific type of rectification capacities and location of condensers in each compact together with installation chart are shown complete on each label. Each compact is packed in a mailing carton.

We are equipped to produce in quantities any type of paper condenser, or any combination of capacities, for any working voltage up to 1,250 volts, D.C. We will produce condensers to meet any specified requirement, or be pleased to quote upon receipt of blue prints for any manufacturer's requirements.

You can't go wrong with Bee Cee.

BROWN & AINE
ESTABLISHED 1911

2317-19-21 CALUMET AVENUE
CHICAGO

Branch Offices:
Denver
Kansas City

Los Angeles
Portland

Atlanta
Cleveland

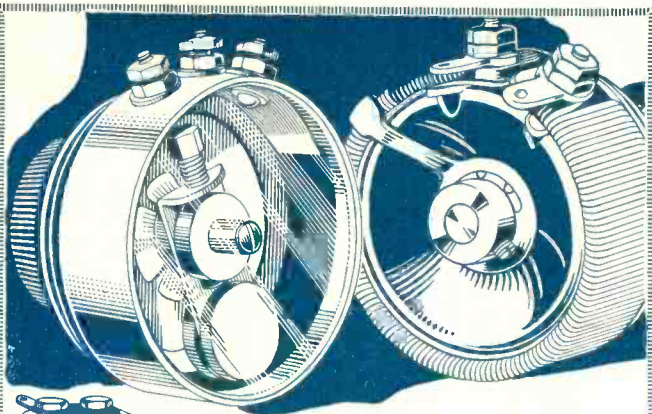

FROST-RADIO DE LUXE APPARATUS IN UNIVERSAL DEMAND

Professional and amateur set builders as well as scores of leading set manufacturers have been quick to realize the superb quality of Frost-Radio De Luxe items. They could see at a glance wherein they excelled other apparatus in fine finish, better design and more careful workmanship. Supplied in a complete line of Rheostats, Potentiometers, Variable High Resistances and Fixed Resistances. Write us today for complete information about this fast selling apparatus.

HERBERT H. FROST, INC.
Main Offices and Factory
ELKHART, IND.

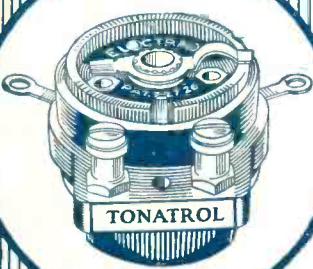

Exclusively Licensed by
Technidyne Corporation
under U. S. Patent No.
1593658, July 27, 1926.

**They
Sell
Fast!**

"TONATROL" A True Tone and Volume Control

Another Electrad product is cutting a wide sales swath. Everywhere the demand for "Tonatrols" is big and increasing rapidly.

"Tonatrol" controls volume smoothly from a whisper to full volume. Very easily installed and built of genuine bakelite to last.

Are you prepared to deliver to your customers this profitable item? If not, place your order now.

Tonatrol—Standard Volume Control. List \$1.50
Tonatrol—Type W. S. (with filament switch attached). List \$2.00.

For full information, write
Dept. 84B, 175 Varick Street, New York, N. Y.

ELECTRAD

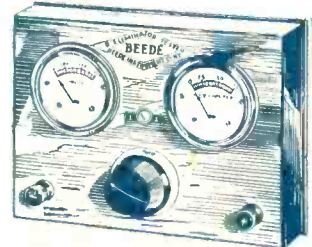

Absolutely Essential New Beede "Service" Type "B" Eliminator Tester

Needed by every Jobber and Dealer Service Man. Nothing like it! Compact Accurate Volt and Milliampere readings. Switch enables you to disconnect Milliammeter so that it can be used separately for testing set load. Backed by usual Beede Guarantee. A Precision instrument at \$12⁰⁰_{List}

There's a Beede Meter For Every Battery Need

Ask your jobber or write for our new catalog.

**BEEDE ELECTRICAL
INSTRUMENT CO.**

136 Liberty St., New York

BEEDE METERS

Faradon means quality to your customers—

Amateurs, fans and discerning dealers know that the name Faradon can be found on the fixed condensers sold in quality shops.

The acceptance of Faradon Capacitors by the largest set manufacturers is the most convincing reason why they should be on your counters.

For kit and replacement business stock Faradon. You can then assure your customers that they are getting fixed condenser quality and reliability which is the result of twenty years' manufacturing skill and experience.

Your usual jobber can supply you. Or write us direct for full information and prices.

WIRELESS SPECIALTY
APPARATUS CO.

Jamaica Plain
Boston, Mass., U. S. A.

Est. 1907



Faradon

Electrostatic condensers for all purposes

EBY

NEW

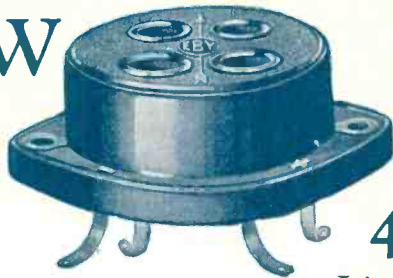

40c
List Price

The Last Word in Sockets

The New EBY Socket is *new* in every sense of the word. Not an old socket improved to avoid becoming obsolete—but a *new* design that keeps pace with the latest achievements in tube manufacture and radio reception.

The New EBY Socket has three big features:

1. *Contact*
A 3-point wiping spring contact the full length of the prong—the prongs are completely enclosed and *can't* spread.
2. *Appearance*
Beautifully moulded in phenolic material with new stipple finish. *Top exactly same size as tube base.* Small beautiful and completely contained.
3. *Unique Design*
One universal model—one stock—one price.

BAKELITE Mounting

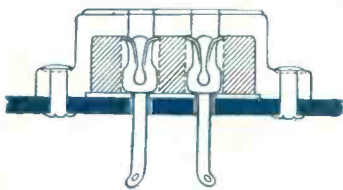

By drilling six holes in a Bakelite panel, subpanel wiring is possible with the new EBY Socket, although the socket is mounted on top of the panel. Easy subpanel mountings on Bakelite or metal. For wood the contact prongs bend over and are wired on top of panel.



EBY Binding Posts are specified in nearly all popular circuits and come packed in complete sets for those circuits. Inbuilt quality with *non-removable* tops—nationally advertised at a list price of 15c. It will pay you to standardize on EBY Binding Posts.

The
H. H. EBY Manufacturing Co., Inc.
4710 Stenton Ave., Philadelphia, Pa.

Selling Big!

These new additions to the fast-selling AERO line are going big. You are sure to have a big demand for these items during the coming season, so make it a point to acquaint yourself with the many features of the improved Universal Coils, Chokes, Transmitter Kits and Foundation Units.



The Improved AERO Universal Coil

At last—a true universal coil that is adaptable to any type of radio receiver under all conditions of usage. These improved inductances are suitable for any straight tuned radio frequency circuit—both bridge and loss balanced, and are easily and ideally adaptable to 3, 4, 5, 6, and 7 tube sets and circuits. The improved Aero universal coils can be used with all types of tubes—201-A, 199, 112, and the new 240 and A.C. Tubes, and are offered in the following kits:

Kit	List Price
Kit of 4 Coils (for improved Aero-Dyne 6).....	\$15.00
Kit of 3 Coils (for Aero 7).....	12.00
Kit of 2 Coils (for Aero 4).....	9.50
3 Circuit Tuner.....	5.50
Antenna Coupler.....	4.50
Wave Trap Unit.....	4.00

All coils are furnished for use with either .0005 or .00035 condensers if desired.

New AERO Choke Coils

AERO Choke 60

Modern circuits of high sensitivity demand the use of radio frequency chokes in certain parts of the circuit. The Aero Choke-60 is designed to have a uniform choking action over a wide range of wave lengths, including Broadcast bands and Amateur Short Wave bands as well. Many chokes employed on short waves have an unpleasant characteristic of showing so-called "holes" in the tuning range, which is present also on the broadcast band but in a minor degree. These faults are corrected in the Aero Choke-60. Price..... \$1.50



AERO Choke 248

The Aero Choke 248 is especially designed for operation in Aero Transmitter kits 2040K, 4080K, and 9018K, and other circuits. Aero Choke 248 presents a high impedance or choking action over the usual amateur wave lengths. It is wound with a conductor sufficiently liberal to handle transmitters up to 100 Watts. Price..... \$1.50



A New AERO Transmitter Kit



The new key 9080 Aero interchangeable kit has a range of 90 to 180 meters. The kit includes two mounting bases and two Aero choke 248 coils, and is designed for use in the Aero transmitter with Key 2040 kit and key 4080 kit. All kits use the same mounting bases and choke coils. Price..... \$12.00

A New Service

We are now able to supply Foundation Unit for all Standard Aero kits, drilled and engraved on Westinghouse Micarta, for the convenience of home set builders. Prices and discounts on these Foundation Units will be furnished on request.



AERO PRODUCTS, INC.

Dept. 117

1772 Wilson Ave., Chicago, Ill.

ACME Celatsite Battery Cable

IN HANDSOME BROWN RAYON

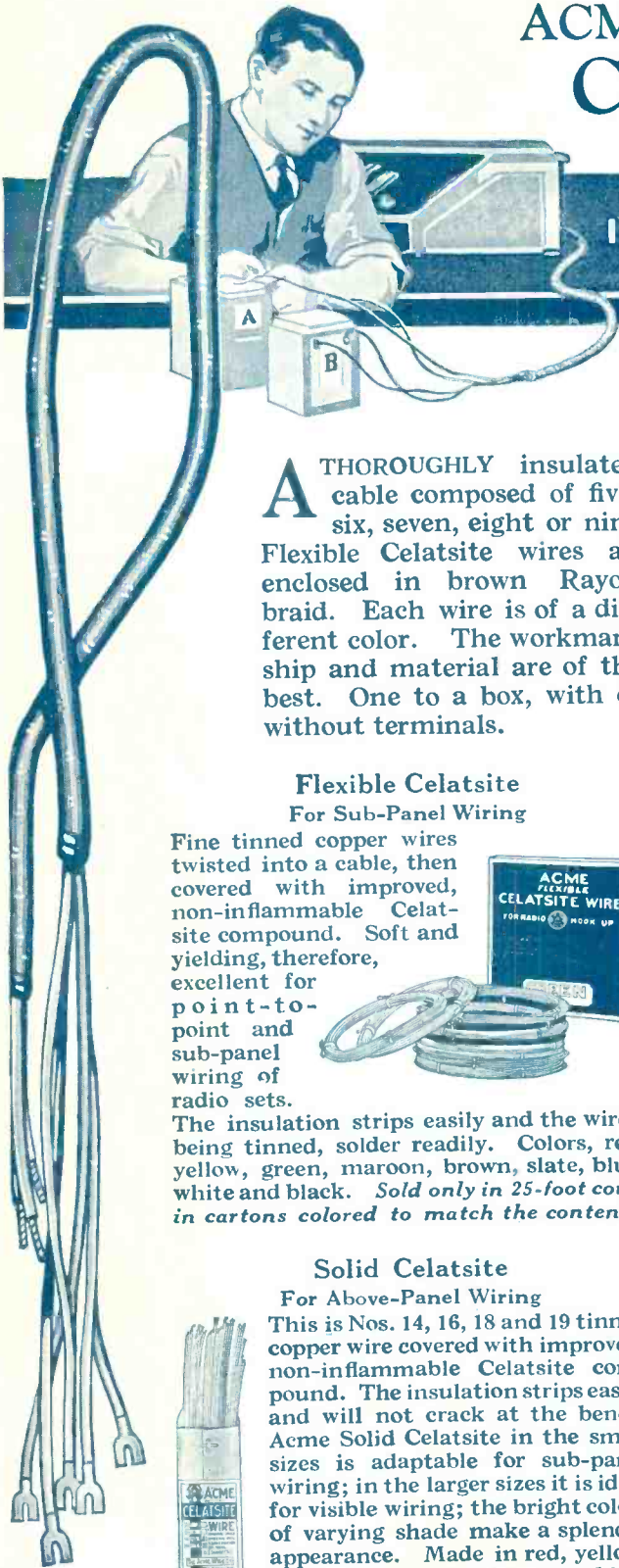

A THOROUGHLY insulated cable composed of five, six, seven, eight or nine Flexible Celatsite wires all enclosed in brown Rayon braid. Each wire is of a different color. The workmanship and material are of the best. One to a box, with or without terminals.

Flexible Celatsite For Sub-Panel Wiring

Fine tinned copper wires twisted into a cable, then covered with improved, non-inflammable Celatsite compound. Soft and yielding, therefore, excellent for point-to-point and sub-panel wiring of radio sets.

The insulation strips easily and the wires, being tinned, solder readily. Colors, red, yellow, green, maroon, brown, slate, blue, white and black. Sold only in 25-foot coils, in cartons colored to match the contents.

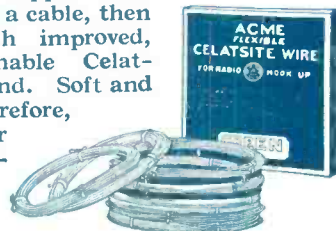

Solid Celatsite

For Above-Panel Wiring

This is Nos. 14, 16, 18 and 19 tinned copper wire covered with improved, non-inflammable Celatsite compound. The insulation strips easily and will not crack at the bends. Acme Solid Celatsite in the small sizes is adaptable for sub-panel wiring; in the larger sizes it is ideal for visible wiring; the bright colors of varying shade make a splendid appearance. Made in red, yellow, green, maroon, brown, slate, blue, white and black; 30 inch lengths, single or assorted colors.



Acme Stranded Enameled Antenna



Made of seven strands of copper wire thoroughly enameled, then twisted into a firm cable. This type of antenna resists corrosion and presents maximum surface to the incoming wave, thus greatly improving the signals. Made in size to

equal Nos. 14 and 16 solid enameled antenna wire. (We also make solid and stranded bare, and stranded tinned antenna.)

Acme Loop Antenna

No wire but the best should be sold for loops. Acme Loop Antenna Wire is composed of sixty strands of No. 38 bare copper wire, to give it flexibility, and five strands of No. 36 phosphor-bronze wire, to prevent stretching. Green or brown cotton next to the wire, and an outer covering of green or brown silk, result in splendid insulation and a very pleasing appearance. In convenient spools.

Acme Spaghetti

Acme Spaghetti is oil, moisture and acid proof, and highly dielectric; the choice of manufacturers of the most delicate electrical instruments. In 30-inch lengths, for wire sizes from 12 to 18. Nine bright colors: red, yellow, green, maroon, brown, slate, blue, white and black. (We also make tinned bus bar, round and square, in 2 and 2½-ft. lengths.)

Dealers--Write Dept. E for catalog inserts showing the full line

THE ACME WIRE CO.

Main Office and Works, NEW HAVEN, CONN.

Branches at

New York, 52 Vanderbilt Ave. Chicago, 427 West Erie St. Cleveland, Guardian Bldg.

ACME WIRE

For greater certainty in radio circuits

These Midget Condensers fit in *anywhere*

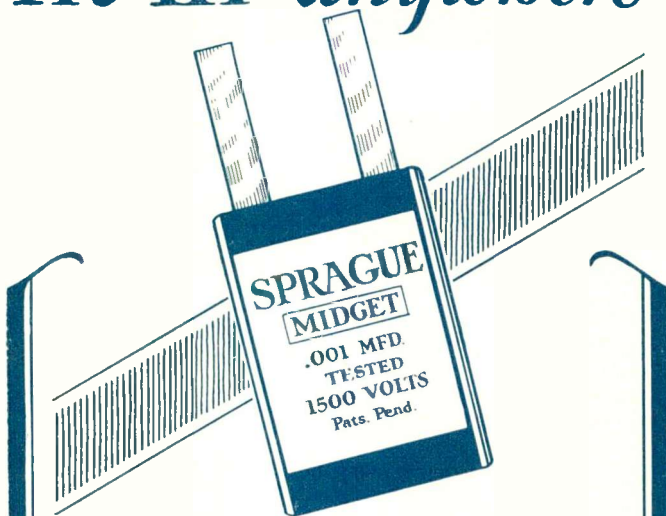

There is good reason for set-builders calling SPRAGUE MIDGETS the easiest-to-wire condensers. They fit into circuits almost anywhere and in altogether new and simpler wiring arrangements.

Soldering difficulties of paraffin treated condensers are removed in Sprague's. Their specially pre-soldered lugs make for quick, easy, and solid soldered contacts. Due to their light weight, no support other than that furnished by these contacts is necessary.

The flexible lug feature of SPRAGUE MIDGETS allows an almost unlimited variety of hook-ups. With new lightness and compactness in addition, SPRAGUE'S bring heretofore unheard of wiring facilities.

SPRAGUE SPECIALTIES COMPANY
QUINCY, MASSACHUSETTS

SPRAGUE MIDGET CONDENSERS



IGRAD Means Quality

When selecting By-pass Condensers economy of space and convenience of mounting are important and desirable items if they can be obtained in a condenser possessing superior electrical characteristics.

They are now to be had in the IGRAD "C" type, made up in $\frac{1}{4}$, $\frac{1}{2}$ and 1 MF capacities. They are of the usual superior IGRAD quality, having high insulation resistance, high conductivity and very non-inductive.

Write for our catalog describing the IGRAD line.

Igrad Condenser & Mfg. Co.
26 Avenue D, Rochester, N. Y.

See us at the Radio World's Fair, Madison Square Garden, Sept. 19-24, Section DD-12.

DeJUR RESISTANCE SPECIALISTS

MANUFACTURERS OF ELECTRICAL AND RADIO RHEOSTATS, CONTROLLERS AND REGULATORS SINCE 1912.

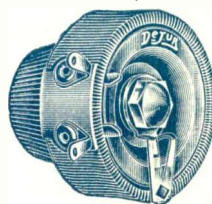

ALL-METAL AIR COOLED RHEOSTAT
Bakelite arrow pointer knob, one-hole mount. No noticeable temperature rise at constant co-efficient of conductivity.

Furnished any ohmage 6 to 50.

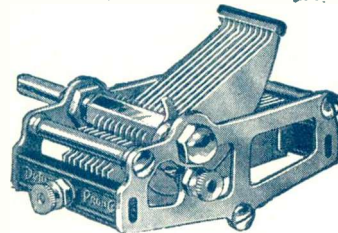

CONDENSERS
Single—Double—Triple Types
In All Capacities

Moulded Bakelite insulation outside electrostatic field suspends stator plates which bear only on one point. Condenser frame grounded to rotor, eliminates all hand capacity. End plates of brass, finished in highly polished nickel. Small phase angle difference; low minimum capacity.

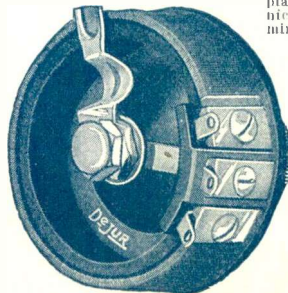

POWER RHEOSTAT
For Socket Power Sets

Designed for a large current carrying capacity. Large Bakelite base $2\frac{3}{4}$ inches in diameter. Single-hole mount. Contact arm rides smoothly over surface of resistance. Soldering lugs supplied for convenient connections. Made in 2, 3, 4, 6, 10, 50, 100, 200, 400, 1000, 2000 ohms.

TO DEALERS AND JOBBERS
Write for new catalog of complete 1927-28 Line.

TO MANUFACTURERS

The De Jur Products Company is the largest manufacturer of rheostats and resistances made to special specifications. Let us figure on your requirements.

DeJUR PRODUCTS Co.
199 LAFAYETTE STREET, NEW YORK CITY

1915 — 1927



As each new radio year approaches General Radio can be counted on to be in the lead with new devices of proven quality keeping pace with the latest engineering practice.

Have you received our fall catalog? If not, send for Bulletin No. 928-K.

General Radio Company
30 State Street, Cambridge, Massachusetts.

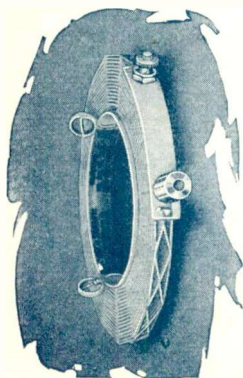

Set Manufacturers!

Standards of radio reception are becoming higher with each new year. 1927 models must be an improvement over those of 1926, and they will be.

Correct coils are vital to good reception. We specialize in such coils. We are producing regularly the most advanced types, built with the famous "Diamond weave" construction.

Write us concerning your own requirements. We are prepared to furnish better coils for the new sets.

THE F. W. SICKLES COMPANY
140 Union St., Springfield, Mass.

SICKLES DIAMOND-WEAVE
COILS

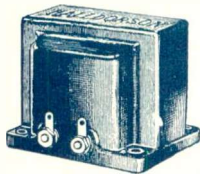

Rich tone quality

in a transformer of normal size and price is secured in the Halldorson Overtone through a special core design of highest efficiency.

Set manufacturers, write for prices and samples.

The Halldorson Company
4745 N. Western Av., Chicago

Halldorson
Audio
Overtone *Transformer*



CONDENSER TISSUES

Prevent Breakdowns of Most Vulnerable Radio Parts

B Eliminators impose severe service on Filter Condensers. The success of Radio reception depends upon the strength and select quality of the Tissue Paper used to insulate the strips of foil in the Condensers.

Leading manufacturers of Condensers have by practical tests demonstrated the superiority of DEXSTAR CONDENSER TISSUES. The DEXSTAR TISSUES are made of rag stock, closely formed, free from pinholes and conducting particles. They possess extra strength and high di-electric properties.

To avoid customer complaints and troublesome servicing, Radio Jobbers and Dealers should make sure that all Condensers handled are made up with DEXSTAR TISSUES. Radio equipment is no better than its weakest link. DEXSTAR CONDENSER TISSUES add strength and long life to weak Radio Condensers.

Samples of DEXSTAR TISSUES for Condenser use will be gladly sent for inspection by Dealers or Manufacturers.

C. H. DEXTER & SONS, Inc.
Makers of Highest Grade Thin Papers
Windsor Locks, Conn.

Let your "fans" try out this new transformer

So remarkably fine are the results obtained with this new series that you can offer them on a trial basis. Every user will pass the good word along.

MANY sets deliver a clear signal from the detector tube only to distort it in amplifying. Type M assures volume with true amplification of all tones.



MODERN Type M Transformers

High inductance, large core and wire sizes. (weight approx. 3½ lbs. each) and careful proportioning of windings assure uniform amplification over entire broadcast range. No harmonics or over amplified high notes. Type M Transformers truly establish a new standard of perfection in audio amplification. 1st and 2nd Stage \$8.50 Each; Output \$8.00; Push-Pull \$10.00 Each.



MODERN "B" Compact (Proven Dependable)

Sell this "B" unit with the assurance of satisfaction. No service — no returns. Modern "B"

Compact went through the past season with practically no complaints. It will serve your trade as well.

Ample capacity for all modern sets, plenty of power tube voltage. Made for use with Raytheon Type B tube which is not included. Price \$26.50.

Ask for detailed information on these two fast selling lines.

The Modern Electric Mfg. Co.
Toledo, Ohio



Such Leadership must be deserved!

Durham Resistors and Powerohms, adopted by leading set manufacturers, are the FIRST choice in all successful circuits where constant quality is the ultimate consideration.

International Resistance Co., Dept. J, 2½ So. 20th St., Phila.

DURHAM
METALLIZED
RESISTORS & POWEROHMS

DEPENDABLE COIL SERVICE for Radio Manufacturers

Battery Charger Coils
Eliminator Chokes and
Transformer Coils
Coils for Loudspeakers
Audio Transformers and
Impedance Amplifiers
Honeycomb Inductances

Send us your specifications for our quotation and shipping date. Service prompt.



UNIVERSAL WINDING CO.
PROVIDENCE, R.I.

STEWART-WARNER

Matched-Unit RADIO

Table Cabinet Model 325. Six tubes. Single dial vernier control. Cabinet of selected walnut veneer richly finished. Price, \$80.00. West of Rockies, \$82.00.

Stewart-Warner Reproducer Model 42C. Extremely compact. Has new perfected unit. Finished in gold bronze. Price, \$17.50. West of Rockies, \$18.25.



DeLuxe Console Model 710. Exquisite cabinet of solid walnut, and specially selected burl'd walnut veneer. Six tubes. Single dial control. Fully shielded. Price \$259. West of Rockies, \$263.50.



DeLuxe Table Cabinet Model 505. Fully shielded chassis. Solid walnut and selected walnut veneer cabinet. Six tubes. Single dial vernier control. Price, \$125.00. West of Rockies, \$128.00.



Compact Console Model 320. Six tubes. Single dial vernier control. Selected walnut veneer cabinet with lustrous finish. Price, \$125.00. West of Rockies, \$130.00.



Stewart-Warner Tube Models 701-AX, 10-A, and 501-AX. Price, \$1.75.

Consider These Facts, Mr. Dealer

If you hold the Stewart-Warner franchise, you are served by one Distributor only. This man handles the Stewart-Warner line exclusively. He has one paramount aim—to insure your success—for your success is his success. Your problems are his problems. You represent his sole asset in the radio business. To protect his own interests, he will give you the most earnest advice and help in the sale, installation and servicing of our line. He will guard you completely against "next-door" competition and price cutting. In view of these facts, is it surprising that Stewart-Warner Dealers—almost without exception—are showing a worth-while profit? These facts are worthy of your consideration. Further details may be obtained, without obligation, by mailing the coupon.

STEWART-WARNER
SPEEDMETER
CORPORATION
Chicago, U. S. A.

Radio Sales Department: Please send me complete details of your proposition showing how I can make more money selling Stewart-Warner Radio. I understand this does not obligate me in the least.

Name.....
Street.....
City..... State.....



Table Cabinet Model 300. For those who prefer three dials. Metal panel and sides. Walnut top. Five tubes. Price, \$50.00. West of Rockies, \$52.50.



Stewart-Warner Reproducer Model 42C. Newly perfected unit insures wonderful reproduction of all tones. Finished in gold bronze. Price, \$25.00. West of Rockies, \$26.50.



Watch the Sales Mount!



Ten individual boxes, with instructions included, are packed in an attractive carton to be used for a counter display. The 5-day money-back trial works to your advantage.

\$1.50 sales, carrying a sweet profit, are going to be plentiful this radio season for the dealer who sells Dubilier Light Socket Aerials. Dubilier advertising in the leading radio magazines and in a big list of newspapers is showing countless set owners what a neat, efficient aerial looks like.

"Just connect it to the set and plug into the nearest light-socket" sounds mighty good to the man who hates the trouble and appearance of crazy poles and sagging wires atop his home. You don't have to tell him that the Dubilier Light Socket Aerial reduces static and interference, and does away entirely with the lightning hazard—our advertising does that job for you. Your move is to put the Dubilier display carton on a counter near the door and watch it empty itself at \$1.50 per sale. Write us if your jobber can't supply you.

Dubilier

LIGHT-SOCKET AERIAL

GENERAL RADIO

Raytheon



THORDARSON

SAMSON

Power-Unit Builders Want the APPROVED Condenser Block



The Accurate Metaleak

A small item of large importance in the performance of any set. So why not sell only the best? Dubilier Metaleaks are accurate to within 5 points of their rated resistance and absolutely noiseless in operation. Interchangeable with any tubular leak on all standard mountings.

List Prices

20,000 to 200,000 ohms, 75c
.25 to 5 meg. ohms, 50c

These blocks have been tested and approved by leading engineers and manufacturers. There is a type especially designed for—

THORDARDSON R 171 POWER COMPACT
THORDARDSON R 210 POWER COMPACT
AMERTRAN POWER PACK
RAYTHEON AND QRS 60 AND 85 M.A. B-ELIMINATORS
ABC PACKS FOR RAYTHEON 350 BA AND QRS 400 M.A. TUBES
LIGHT SOCKET POWER DEVICES USING TYPE 213, 216, 280 AND 281 THERMIONIC TUBES

Dubilier condenser blocks are recommended by all, on account of their rugged construction and unusually high factors of safety.

A Consistent Favorite

For years the Dubilier Micadon has been known as the "Standard Fixed Condenser of Radio," due to its dependable ratings and remarkably long life. In its new shape and moulded bakelite case, the micadon is a better condenser than ever, and admirably adapted to the modern trend of set building.

TERMINALS ADAPTED TO EITHER SCREWED OR SOLDERED CONNECTIONS

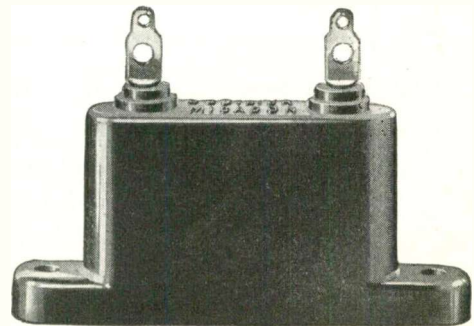

Retail Prices 45c to \$1.50

DUBILIER CONDENSER CORPORATION - 4377 BRONX BLVD., NEW YORK

Dubilier

CONDENSERS

45 VOLTS
30 CELLS
\$4.50

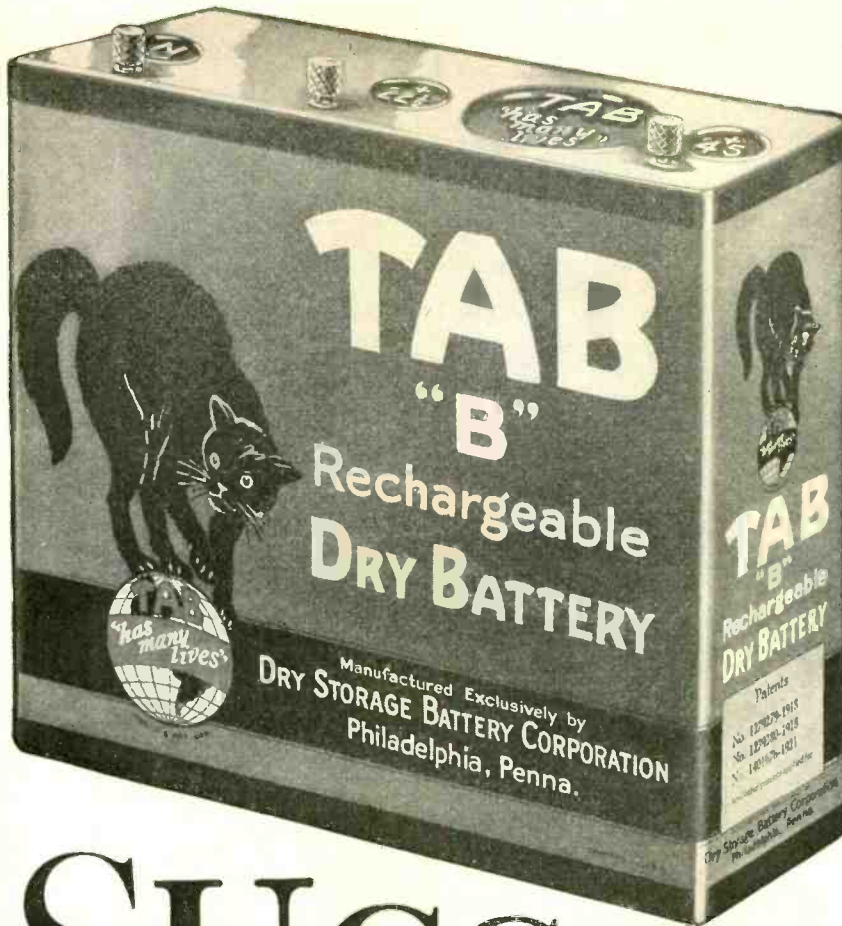

TAB "A"
1½ Volt Dry Cell

for Radio—Ignition, and All General Purposes,—has the same remarkable recharging features as the TAB "B" Battery. Especially adapted and particularly economical for use on Radiolas.

Write for literature and prices.



SUCCESS!

TAB Rechargeable Dry Batteries Have Passed the Experimental Stage

TAB Rechargeable Dry Batteries are no longer an experiment. They are here to stay. The best proof we have is a stack of orders which keeps our plant running full capacity.

TAB batteries are in a field by themselves—the *only* dry batteries expressly designed for recharging purposes and protected by patents dating back to 1918. They have been tested in the laboratory—tried in the living room—and accepted on merit.

The sales possibilities are unlimited! The profits are greater than on other batteries! Now is the time to make arrangements for your requirements. Ask your jobber or write to us for prices and discounts.

Patented and Manufactured by

DRY STORAGE BATTERY CORPORATION, 3860 Coral Street, Philadelphia, Pa.

TAB—the Rechargeable Dry "B" Battery

Sentinel

the FIRST and ONLY Complete Line of

RADIO POWER UNITS

NEARLY a quarter of a million dollars were spent in perfecting Sentinel Power Units before they were ever offered to the radioworld. An enormous plant, representing an investment of over \$500,000, is now busy meeting the steadily increasing demand for Sentinel products. This demand is due to two things



Unrivalled Quality Backed by Predominating Advertising

See Us
Booth 3
Section S
Mezzanine
NEW YORK
RADIO
SHOW
September
19 to 24

Within the month thousands of new radio receivers will be sold. Every set using three or more tubes should be equipped with Sentinel power units for greatest efficiency. Sentinel newspaper advertising in the leading cities throughout the country will prove a tremendous influence. Only Sentinel Jobbers and Dealers will secure the full benefits and profits of this advertising. If you are not handling Sentinel Radio Power Units you are letting a real money-making opportunity get by. Don't do it. Write today for our co-operative sales-building and merchandising plan. Sentinel products are sold only through legitimate Jobber-to-Dealer channels.

Sentinel "DRY-A" and Sentinel "DRY-ABC"

are absolutely new units operating without batteries, direct from house current. No acids—no refilling—no bother. Prices slightly higher.



The Sentinel A-B-C Completely Automatic Unit combines the Automatic "A" and Automatic B-C Power Unit into one compact, efficient master unit. The price is \$79.50 complete. (Metered Beverly Model \$98.50.)

SENTINEL MANUFACTURING COMPANY
9705 Cottage Grove Avenue :: :: Chicago, U. S. A.



With "A" Battery and Charger (other than the Trickle type) Sentinel Automatic Control Unit makes "A" power supply completely automatic. Price \$15.00



The Sentinel Automatic Control and Charger with good "A" Battery makes the "A" power supply permanently and completely automatic. Price \$29.50

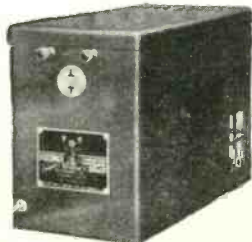

The Sentinel Completely Automatic "A" Power Unit provides control, charger and a 4 or 6-volt battery all in one compact case. Note Trickle Charger. Price \$40.00



The Sentinel B-C Power Unit furnishes both B and C voltage for any set, regardless of the number of tubes—80 mil. at 180 volts. Price \$44.50



The Sentinel B-C Beverly model combines completely automatic power with meter which gives control of all plate voltages. Price \$65.00

BOSCH

Two new models have been added to the group of Bosch Radio Receivers—they are receivers you can sell at popular prices making Bosch Radio the desirable radio line of the season.

The Model 46 is a compact six tube receiver but 16" long with electrically lighted single tuning dial. It has the famous Bosch tonal quality. It lists at \$68.50.

The Model 87 is a seven tube table model of unusual beauty with which an outside antenna or loop is not necessary. Single electrically lighted dial, armored and shielded with great power and Bosch tonal quality, the Model 87 lists at \$195.00.

All the new Bosch Receivers are "transportation proof" allowing deliveries to customers with the original factory settings—life-like reception, far reaching, satisfactory,—without adjustment.

The Bosch Radio line is complete—four six tube models, two seven tube models—"A" power unit—"B" power unit—two loud speakers and phonographic pick up.

For dealers who are in business to stay we have something of interest—a dealer and merchandising policy that is fair and fully supported. Write us in confidence about yourself, business standing, financial strength, your plans, and we will explain our plans.

AMERICAN BOSCH MAGNETO CORPORATION

MAIN OFFICE AND WORKS: SPRINGFIELD, MASSACHUSETTS

BRANCHES: NEW YORK CHICAGO DETROIT SAN FRANCISCO

Bosch Radio Receivers are licensed only for Radio Amateur Experimental and Broadcast Reception. They are manufactured under patent applications of American Bosch Magneto Corp and are licensed under patent applications and patents of Radio Corp. of America and under applications of Radio Frequency Laboratories, Inc.



Model 46—"Little Six," 6 tube, single station selector, table type, vibration proof aluminum chassis. \$68.50

RADIO

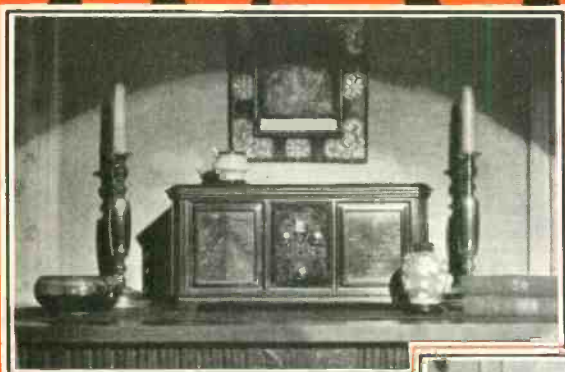

Model 87—Seven tube, single station selector, table type, loop operated, wired for battery or socket power \$195.

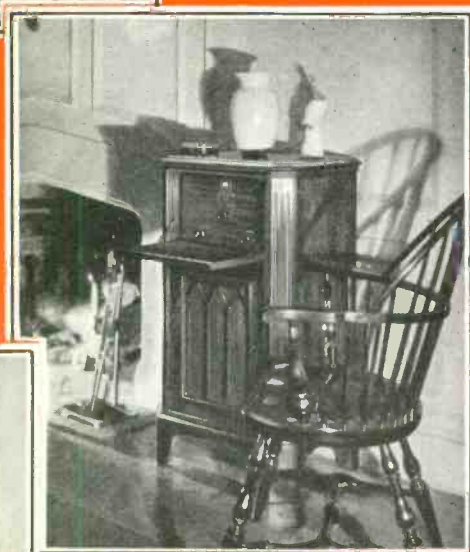

Model 76—Six tubes, single station selector, cabinet type, wired for battery or socket power—
with built-in speaker. \$195.
Without built-in speaker. \$175.



Model 66—Six tube, single station selector, table type, wired for battery or socket power operation . . . \$340.



Model 57—Seven tubes, single station selector, cabinet type, concealed loop, built-in reproducer wired for battery or socket power operation . . . \$340.

BOSCH RADIO THE COMPLETE DEALER LINE

Model 57—Seven-tube Receiver, Single Dial, cabinet type, loop operated—built-in reproducer—wired for battery or socket power operation \$340.00

Model 76—Six-tube Receiver, Single Dial, cabinet type—wired for battery or socket power. With built-in speaker \$195.00
Without the built-in speaker \$175.00

Model 87—Seven tube Receiver, Single Dial, table type, wired for battery or socket power \$195.00

Model 66—Six-tube Receiver, Single Dial, table type, wired for battery or socket power . . . \$99.50

Model 46 "Little Six"—Six tube Receiver, Single Dial, table type, vibration proof aluminum chassis . . . \$68.50

Ambotone Reproducer—Cone Type, Table Reproducer with years of recognition for its perfect tonal reproduction . . . \$27.50

Nobattery—"A"—An ideal socket power device, supplying "A" current for all sets up to ten tubes—no acids, no moving parts, no hum, no trouble, no heating delay. . . . \$58.00

Nobattery "B" Famous Bosch Nobattery for supplying "B" Power for all sets up to ten tubes—no acids, no hum, long lived \$42.00

Recreator—a truly successful three unit device for providing electric reproduction of phonograph records—utilizes any style phonograph and reproduces through a radio receiver and loud speaker . . . \$20.00

—and the fastest
seller represents
the greatest
profit—



WORLD'S *fastest selling* SPEAKER

This claim for
MUSICONES is based on
actual facts and figures
gained from authentic
sources.

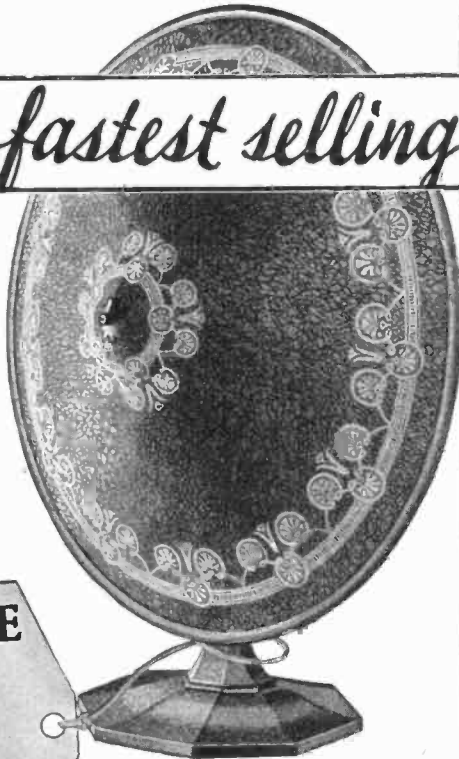

12 in. Ultra MUSICONE
\$9⁷⁵
16 in. Super Musicone \$12⁷⁵

Prices slightly higher
West of the Rocky Mts.

Write Dept. 130, for descriptive literature

The CROSLEY RADIO CORPORATION
Cincinnati, Ohio

Powel Crosley



Jr., President

CROSLEY MUSICONE

Every result has an actuating force—a definite reason for final consummation.

Musicone superiority is a result that has behind it real and tangible cause for the flood of profit enjoyed by Musicone dealers.

*The reasons are in the
MUSICONE itself—*

—in the patented Crosley actuating unit which has demonstrated its tremendous capacity for magnified reproduction in more sales than any other loud speaker on the market.

—in the special Crosley magnet coil coating which keeps Musicones constantly efficient in any climate.

—in the Bakelite, instead of cardboard, bobbins which prevent retention of moisture.

—in the higher voltage capacity which results in louder, finer tones.

—in the simplicity of armature adjustment.

—in the new metallurgical discovery which increases vibrations 10 times over other types, resulting in an amazing range of tone capacities from the piccolo shrill to the booming of the deepest bass.

—in the all around virtues which have made MUSICONES the most widely imitated—but still unequalled—radio accessory brought out.

VESTA 30th ANNIVERSARY

Wet or Dry? Here They Are—

The Vesta Line is Complete for Every Radio Demand!

With the Vesta Line of Radio Power Units you can satisfy every desire of your trade. More money will be spent for radio power units this season than for any other radio product. One customer prefers a certain type, while the next customer wishes another type.

In the Vesta Saturday Evening Post half-page reproduced herewith you will note how this condition is easily met—with Vesta Units.

The power of this quality name—with the completeness of the line—is the most valuable combination a radio dealer can find with which to build volume of business.

Let us send you complete details and name of the Vesta Central Distributor near you.

VESTA BATTERY CORPORATION
2100 Indiana Avenue
CHICAGO, U. S. A.

VESTA

QUALITY RADIO UNITS

VESTA BATTERY CORPORATION
2100 Indiana Avenue, Chicago, Ill.

Please send me your folders on Vest Radio Products

particularly the one about

Name _____

Address _____

City _____

State _____

R. R.
9-27

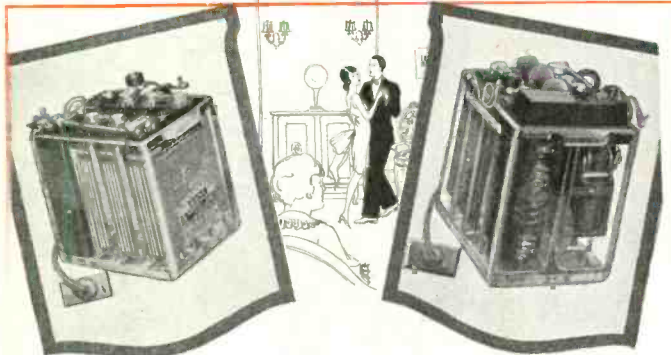

VESTA RADIO "A" UNIT
BALKITE RECTIFIER

VESTA RADIO "A" UNIT
VERTREX RECTIFIER

of Great Value to Every Radio Owner

You may now have Vesta BUILT-IN-GLASS, Radio "A" Socket Power Units with either wet or dry rectifiers.

As pictured above, the Dry Rectifier is of the Vertrex type, built in with either a 4 or 6 volt battery and hydrometer.

The wet Rectifier is Balkite, built in a glass case, with either a 4 or 6 volt battery and hydrometer.

These two combinations present the utmost in radio "A" Power—to please radio owners who prefer either the wet or dry rectifier type of chargers.

These units have a high and low charging switch which provides a rate of charge for sets of all sizes under variable operating conditions.

They are supplied with or without automatic relay (as desired) which automatically cuts off the current going to the battery when set is in operation and turns on the current when set is turned off.

Ask your radio dealer to show you this complete Socket Power "A" Unit—BUILT-IN-GLASS—with everything visible. A clean, compact, reliable source of "A" power that will insure greater enjoyment from your set.

Prices range from \$28 without the relay to \$37.50 with relay in either 6 volt or 4 volt, 50 ampere units

VESTA BATTERY CORPORATION
2100 Indiana Avenue
CHICAGO, ILL.

VESTA

QUALITY RADIO UNITS

MAKERS OF VESTA AUTO-RADIO BATTERIES FOR 30 YEARS



VESTA DRY TRICKLE CHARGER
Socket Power, without relay \$17.50. (Licensed U.S. Patent Serial No. 1611653).



NEW "B" UNIT
Socket power with automatic relay. 40 mls, 180 volts, \$39.50; 60 mls, 180 volts, \$44.50.



COMPLETE "A-B" UNIT
Socket power (dry rectifier) automatic relay. 40 mls, 180 volts, \$72.00; 60 mls, 180 volts, \$77.00.

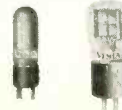

Complete line of Vesta Non-Microphonic Tubes for every radio purpose, the height of quality.

Sept. 10
Saturday
Evening
Post

1/2-page

Another 1/2-page will appear in Liberty, Sept. 17—Sat. Eve. Post Sept. 24—and on thru the season—with a full page Oct. 22.

Also half-pages thru the season in Liberty, Country Gentleman and Successful Farming.

Vesta Advertising is designed to direct business to Vesta Dealers





Selling-power!

These dealer helps mean selling-power. Use them! Use them because they wire you up with the Kolster advertising-and-selling-voltage,

—which is hundreds of thousands of dollars strong,

—and will do the maximum amount of good to the dealer who lets the passer-by know that here are the Kolster Radios which he has been reading so much about in the

newspapers. These three sales-helps, (1) The Large Window Display in full colors, (2) The Demonstration Window Strip and (3) The Authorized Dealer Sign, have been sent to all Kolster authorized dealers. If you have not received yours please let us know.

If you are not a Kolster dealer you will find information of great interest to you on the opposite page.



Kolster

Real news for radio buyers!

The authorized Kolster dealer has real news for radio buyers and prospective buyers.

We do not refer to the extraordinary naturalness of the tone of Kolster Radio, which in itself is astonishing news to everyone who has not heard it,

—and which, in Kolster 6D selling at \$89.50, represents an overwhelming plus-value over all competition,

—but we do refer to the *Kolster Power Cone Reproducer*.

The market for power cone reproducers has hardly been scratched and the news of the Kolster Power Cone Reproducer at \$175 is a magnet that will pull people into the store.

We in the radio industry should never get so close to our business as to forget that there are many people in every community who are behind us in radio knowledge. The Kolster Power Cone Reproducer is amazing news to millions.

The Kolster Line

There are eight Kolster models: three six tube sets, two seven tube sets and three eight tube sets. The price range is from \$89.50 to \$375.

If you have not yet received the Kolster Dealer Advertising Book please notify us. Mats and cuts of very attractive advertisements are available upon request.

There are still profitable Kolster franchises open which give you the right to display the Authorized Kolster Dealer Sign, as below. Fill in the coupon and let us tell you where.



The Kolster Power Cone Reproducer is contained in a walnut cabinet with cathedral grill. It gives literally the finest reproduction obtainable. Built-in "B" power unit supplies plate voltage to any commercial receiver. Twenty foot cable supplied with each reproducer.

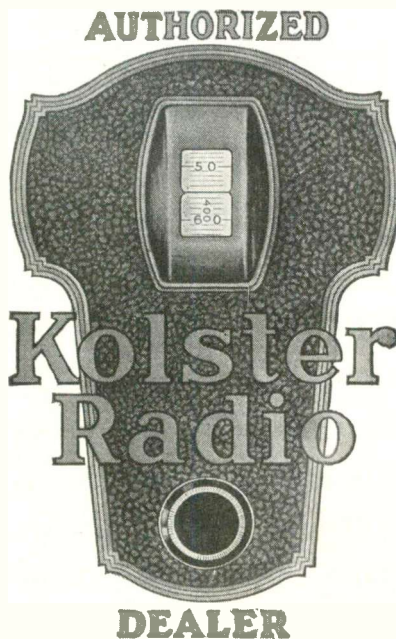

Radio

FEDERAL-BRANDES, Inc.
Newark, New Jersey

Please send me information regarding
the 1927-1928 Kolster proposition.

Name _____

Street _____

City _____ State _____

KINGSTON



For Perfect Reception

THE KINGSTON B CURRENT SUPPLY UNIT insures everything Radio has to give—rich, full tone, clearness, perfect reception always! This unit met last year with unprecedented success, and this year it will attain a new high record in sales and satisfaction. Make the Kingston the leader of your fall and winter business.

KOKOMO ELECTRIC COMPANY
Kokomo, Indiana

PRICES

Type 2, for 110-120 Volt AC 50 or 60 Cycle Current, \$35.00.

For receiving sets having not more than eight tubes and not having type UX171 power tube or equivalent.

Type 2A, for 110-120 Volt AC 50 or 60 Cycle Current, \$42.50.

For all sets using type UX171 power tube or equivalent and for all large sets having nine or more tubes.

Type 2C, for 110-120 Volt AC 25, 30 or 40 cycle current, \$47.50.

Prices include type BH Raytheon tube.

Any of these models will be furnished with an automatic control switch built in the unit for \$2.50 additional. With this the B unit is automatically switched on or off when switch on the radio set panel is turned.

What the KINGSTON is

THE KINGSTON will maintain the radio set always at its perfection peak. It contains no acid or solution, operates without vibration or noise and will not heat. There are provided three different voltage terminals, each adjustable over a wide range, making possible any desired voltage from 5 to 200. A fourth variable voltage may be easily had, if desired, by connecting a separate variable resistor to one of the terminals. The primary or main current supply is controlled by a rheostat, making it possible to reduce the current entering the unit to the amount actually required for any individual set, thus protecting the set against overload.

Handsomely finished in satin black. Size: nine inches long, 5¼ inches wide, 8¼ inches high. The Raytheon 85 milliamperere type BH tube is used as rectifier. Fully guaranteed.



**BUILT TO EXCEL
NOT UNDERSELL**

A remarkable success built on sheer quality and merit

IN the performance of Universal Socket Power Units there is no element of luck or of chance. Every detail is carefully worked out and results are absolutely assured.

Scrupulous care in designing, building and testing them has met with its just reward—an extraordinary success, a nation-wide recognition of merit. Sales, in a volume which taxes our capacity, have proved beyond all doubt that the trade knows and appreciates dependability and quality in radio accessories. The whole country is buying Universal.

There are three Universal Socket Power Units available:

The "A" unit is a dependable source of "A" power equipped with Dry Plate Rectifier controlled by set switch. Has "B" Plug-in.

The "B-C" unit delivers 40 mils at 180 volts. Ideal for 171 power tube operation. Guaranteed delivery of proper voltages to each tube, as specified by set manufacturer. Seven taps—two for "C" voltages and all variable, due to the use of wire wound resistances throughout. Improved filter circuit. Designed for use with Raytheon BH-85 mil long-life rectifying tube. Raytheon approved. Operates perfectly on every set manufactured. Will sell readily and stay sold.

The "A-B-C" Socket Power Unit is a combination of the "A" and "B-C" units, all contained in one case and with set switch control.

The cases of all units are unusually attractive and are finished in brown cracked lacquer.

If you are not already familiar with the details and specifications of these exceptional units, we should be glad to send you descriptive literature and prices. Without the slightest obligation, of course. Drop us a line.

UNIVERSAL BATTERY COMPANY

3453 South LaSalle Street - Chicago, Illinois

Batteries for Every Purse and Purpose
AUTOMOBILE - RADIO - FARMLIGHT
Parts for all makes of Batteries
SHOP EQUIPMENT

UNIVERSAL BATTERIES

Here is a
 "NEW and BETTER VOICE"
 for RADIO

Read What
 Hudson-Ross, Inc., Chi-
 cago Say About the
 Quam Speaker

"You may be interested to know that, as a result of our several tests, the organization is *unanimous* in recommending the Quam Speaker as being a thoroughly quality article and competitive to speakers of other makes that are from \$10 to \$12 higher."

(Signed) Hudson-Ross, Inc.
 Robt. Himmel, Pres.



Retails
 at
 \$17.50

The QUAM LOUD SPEAKER

Embodying the New "STRETCHED-REED" Principle

The Quam Loud Speaker introduces a new and startling improvement in Loud Speaker construction. Instead of a floating reed secured at only one end, the Quam Speaker has a *Stretched Reed*—like the human vocal chords. The result is amazingly superior to any you have heard before.

- It gives a much wider range of accurate tone reproduction.
- It picks up and reproduces the highest tones of the violin as faithfully and fully as the deepest tones of the pipe organ.
- It has unmatched range—and *gives you all*.
- It is free from "blasting."

Matchless Quality—Striking Beauty
 and Popularly Priced at \$17.50

A product of a factory that has been supplying parts to America's greatest radio manufacturers for a number of years. Exceptionally permanent construction—requires no adjustment at any time. It is a beautiful, lasting, marvelous "New Voice for Radio."

*Write for descriptive circular and dealers' discounts,
 or better still, order one for personal trial.*

QUAM RADIO CORPORATION

9718 Cottage Grove Ave.
 CHICAGO, ILL.

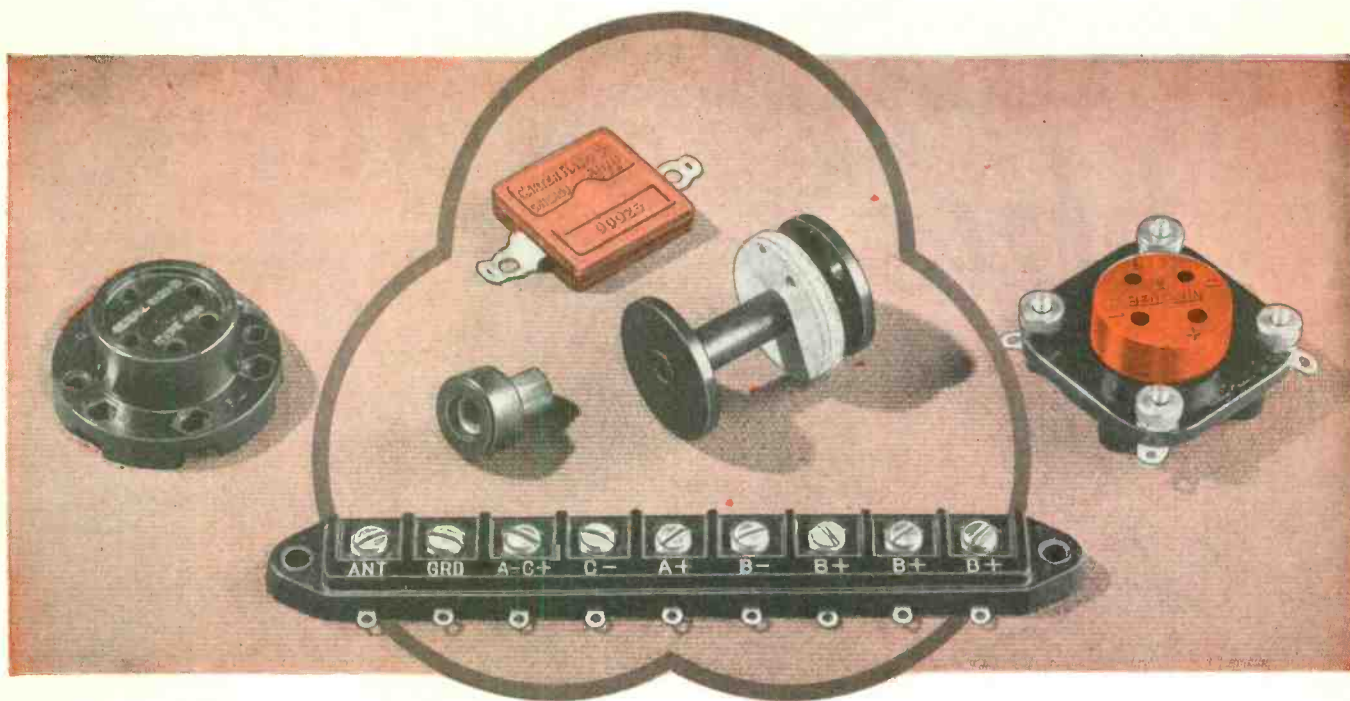

Four reasons why it pays you to sell Bakelite Molded parts

BAKELITE Molded possesses high insulation value and radio parts made of it cause no trouble because of faulty insulation.

Bakelite Molded is strong, so there is slight chance of loss through breakage in handling or in service.

Bakelite Molded is handsome in color and finish, so it creates a

favorable first impression in the mind of your customer.

Bakelite Molded is durable and loses none of its insulation value, strength, color or finish through time, exposure or long service.

Because of these facts it always pays the dealer to make sure that Bakelite Molded is used in the radiosets and parts that he handles.

Write for Booklet No. 39

BAKELITE CORPORATION

247 Park Ave., New York, N. Y. Chicago Office, 635 W. 22nd St.
BAKELITE CORPORATION OF CANADA, LTD., 163 Dufferin Street, Toronto, Ontario

BAKELITE

REGISTERED

U. S. PAT. OFF.



THE MATERIAL OF A THOUSAND USES

"The registered Trade Mark and Symbol shown above may be used only on products made from materials manufactured by Bakelite Corporation. Under the capital "B" is the numerical sign for infinity, or unlimited quantity. It symbolizes the infinite number of present and future uses of Bakelite Corporation's products."

POPULARITY *plus*

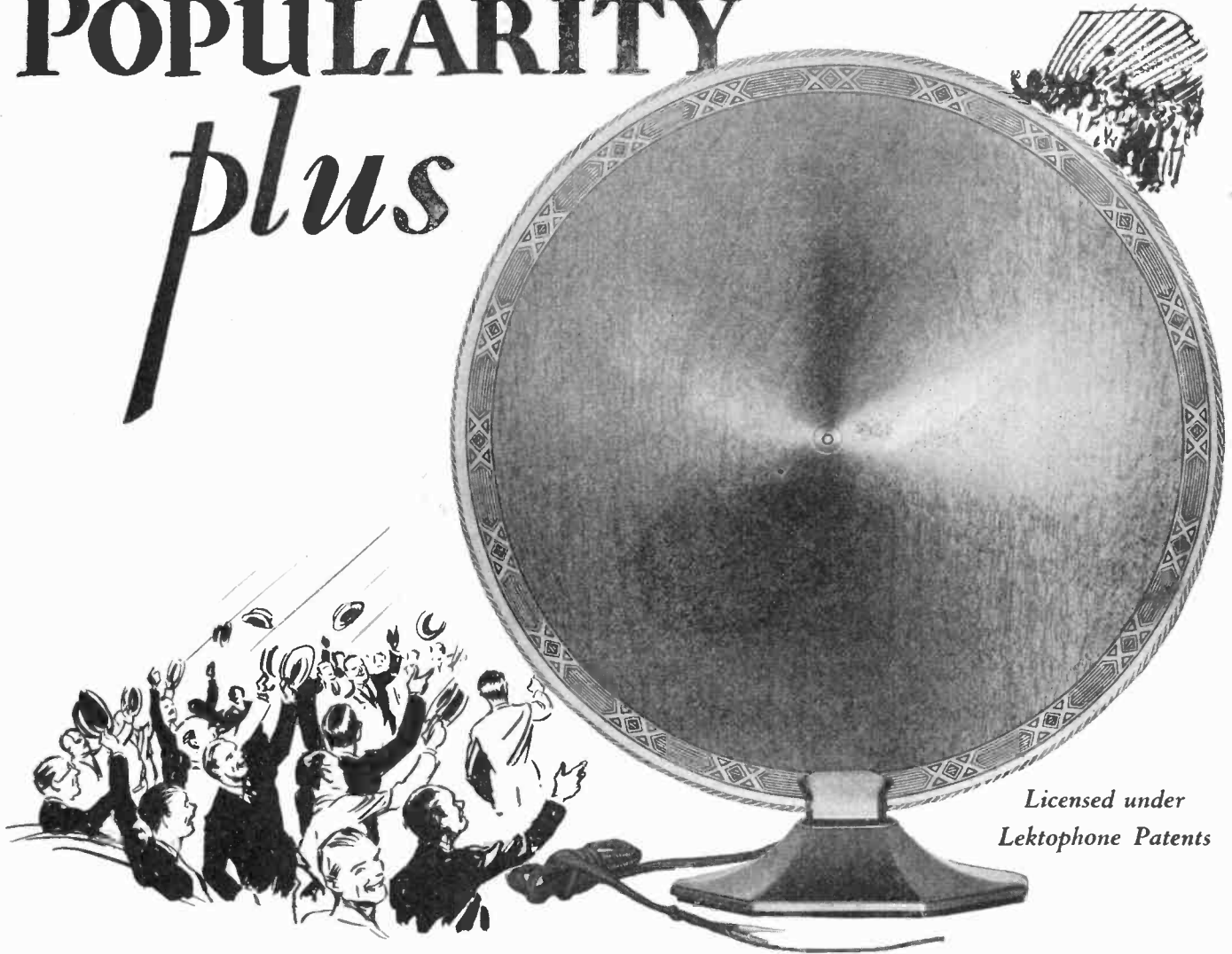

Licensed under
Lektophone Patents

EVER since its introduction the Sandar Speaker has been immensely popular, both with fans and dealers.

Marking a new refinement in radio reception, Sandar caught on immediately, and the demand for it has been steadily on the increase.

Add to its perfect performance and pleasing appearance its notably low price, \$27.50—the lowest of any speaker of its size—and

you have ample reasons why Sandar has been such a sensational success.

Now there is a Junior model also, retailing at \$16.50, which has already registered strongly with those who recognize high quality at a low price.

The opportunity is still yours to share in the profits and prosperity that go with a Sandar franchise—write TODAY for terms and full information.

SANDAR S P E A K E R

SENIOR Model \$27⁵⁰
(No. 25)

West of the Rockies \$30⁰⁰

JUNIOR Model \$16⁵⁰
(No. 21)

West of the Rockies \$17⁷⁵

SANDAR CORPORATION, Crescent Plaza Building, Long Island City, New York

*Dollars for
Day-Fan Distributors
and Dealers!*

Day-Fan

RADIO RECEIVERS

Licensed under RCA Patents

**A Year Ahead Again
in Battery Elimination
and Tone Quality**

Nationally Advertised

Send This →

R.R.3

Day-Fan Electric Co., Dayton, Ohio.

You may send me information regarding the

New line of Day-Fan Radio Receivers

Distributor territory Dealer territory

Name

Address

The Most Spectacular Since the Advent

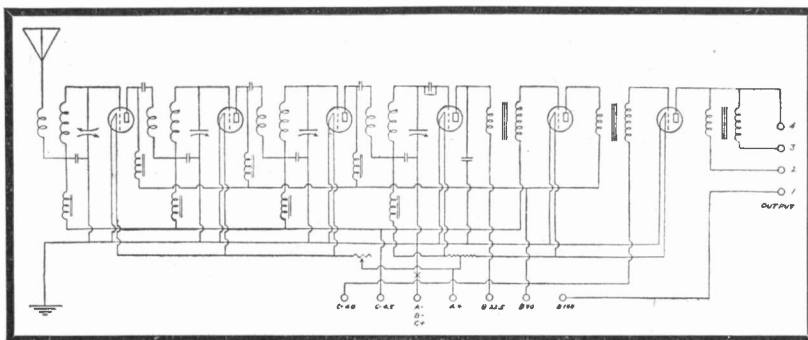

—this—
↓

Arborphone engineers took this complicated wiring diagram and so thoroughly simplified it in laying it out that, in the finished product, it looks like—

—and this—
↓

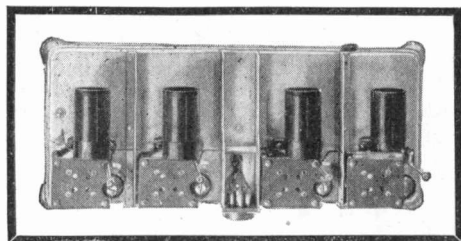

Chassis base. A marvel of simplicity, balance, and accessibility.

—and this—
↓

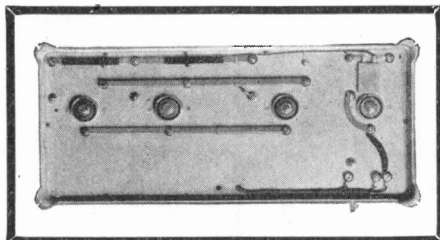

Underneath view of chassis base, showing the elemental simplicity of the wiring, highly important to performance and service.

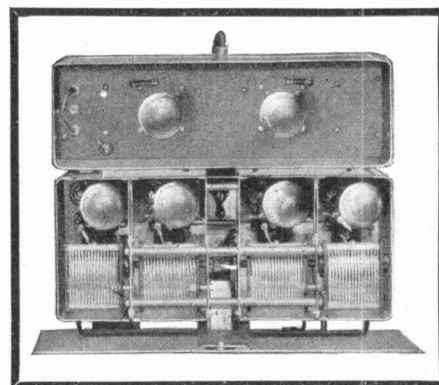

The compact, double shielded chassis. Another feature is the output transformer in the audio, which may be switched in or out for best results with all speakers.

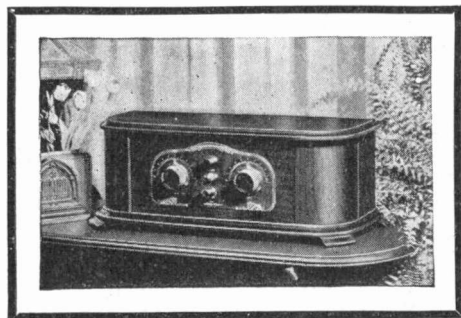

Model 27
A table model of unique design and beautiful dark finish, hand rubbed to a soft, satiny appearance.

Extracts From Magazines and Newspapers

Robert H. Marriott, Past President, Institute of Radio Engineers—
... a really new circuit, which is attracting the attention of the technical world.

New York Sun Radio Data Sheet—
... the nearest approach we have had to exact engineering applied to radio.

Radio News, March, 1927—
... bids fair to become the outstanding circuit of 1927.

Radio World, August 21, 1926—
... the system neutralizes independent of tube capacity.

Science and Invention, April, 1927—
The tuning is miraculously sharp...

ARBOR

Accomplishment of Broadcasting

Thus the Loftin-White circuit as used in the Model 25 Series Arborphone is described by leading engineers and publications

When the now famous Loftin-White circuit was made public only a year ago, technical experts and radio publications were outspoken in their praise. Paper after paper printed long articles describing it and telling of the wonderful results that could be accomplished.

Now Arborphone, maintaining its leadership in engineering advancement, has simplified the Loftin-White construction and made it

commercially practicable. Engineers who have seen the layout of the Model 25 Series Arborphone have pronounced it a marvel of engineering and have congratulated us upon our contribution to the industry. Those who have heard it have been unreserved in their praise.

Dealers and jobbers will do well to seriously consider this in choosing their line for this year. With a receiver that has been so highly recommended in theory and in performance, that accomplishes things impossible to equal by any other arrangement, and with the thoroughly proven Arborphone Merchandising Plan—a plan so successful that the dealer himself has to hold it in check, once it gets under way—with all these advantages Arborphone dealers are going to have the most profitable year ever known. Write to us now.

**Precision Products
Company**
Ann Arbor, Michigan

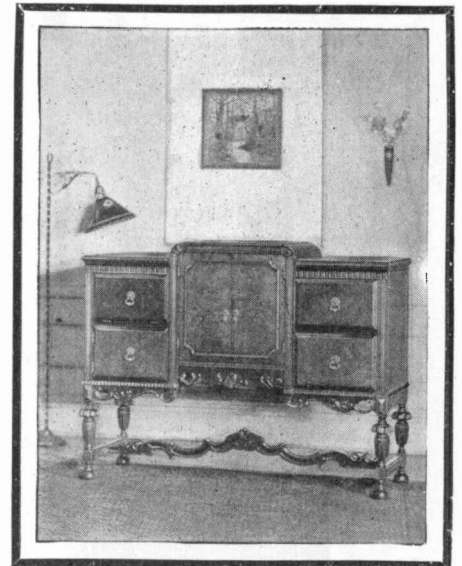

Model 255 De Luxe
Combination radio and electric phonograph. Six tube Loftin-White chassis. Full A. C. operation.



Model 252

A dignified small console with the mark of real craftsmanship upon it. Either the five tube chassis or the six tube Loftin-White chassis may be had with it.

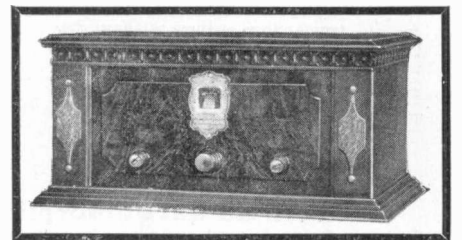

Model 25

Called by many the handsomest table model on the market. Six tube Loftin-White chassis.

PHONE

INSTANTLY! YOU KNOW IT IS BETTER

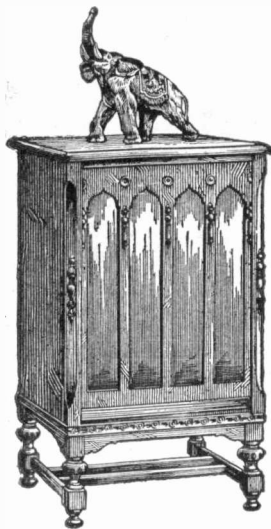
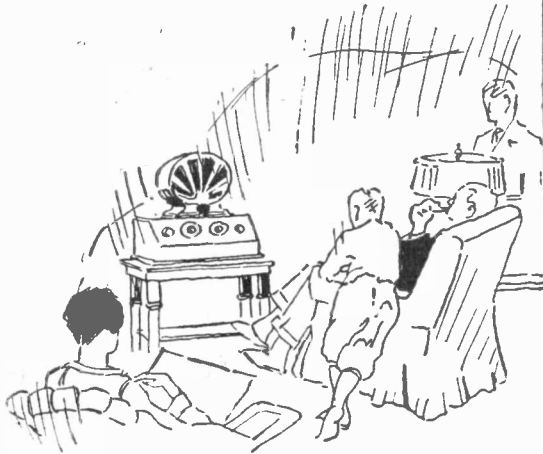

DeLuxe Model
(Patents Pending)

The largest edition of the Operadio line. Has an 84 inch air column. Tone chamber weighs 36 pounds—capacity for handling tremendous volume without distortion. Not affected by weather—safely used with power amplification. Beautiful cabinet—stump walnut quarter matched veneer.

Price \$80.00

Prices Slightly Higher West of the Rockies and in Canada

notes, no wave absorption. Tones are all there—true, clear—with their original fascinating charm.

You can test the Operadio Speaker for yourself. You will say it is better instantly! Write or wire for details of the profitable dealer plan. At these prices, your profit is certain.

Manufactured by
OPERADIO MFG. CO.
705 East 40th Street
Chicago, Ill.

Sales Dept.
THE ZINKE CO.
1325 South Michigan Avenue
Chicago, Ill.



Stonite foils the thieves that would steal the music from Radio!...

WAVE absorption and distortion cannot destroy the charm of music from your radio if your speaker is an Operadio Bloc Speaker. Clear at a whisper—rich and rounded though the volume of a brass band is coming through the air. Every instrument in its place—every note pleasing!

Stonite, a new inert material from which the tone chamber of the Operadio Speaker is cast en bloc, makes such recreation possible. Its monolithic structure cannot vibrate, consequently no false

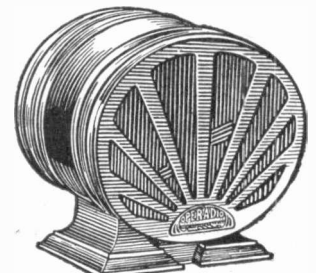

(Patents Pending)

Senior Model

Its weight is its greatest asset—absolutely prohibits vibration and distortion. Fifty-four inch air column.

Price \$25.00

Junior Model

Unusual volume and tone quality though small size. Thirty inch exponential air column. Both models beautifully finished in gold and brown—leatherized.

Price \$15.00

OPERADIO
BLOC TYPE SPEAKERS

Coming - Almost Here - Coming

National Radio Improv'ment Week

Oct. 1st
to
Oct. 8th

WHY ARCHATRONS MEAN BETTER RADIO

*It's the Arch
in Archatrons*



UX-201-A

Complete degasification is the secret of Archatron superiority. It lengthens filament life and promotes free flow of electrons which result in longer distance, more stations, greater selectivity and better volume. Starting at top efficiency Archatrons continue to render maximum service with maximum uniformity up to the very end of filament life. The unusual characteristics of Archatron Radio Tubes are expressed in the new Archatron guarantee of complete satisfaction, longer life for any one tube and better radio reception from any complete set of Archatrons—or money refunded to purchaser. Send for a trial set of Archatrons today. Full credit if your most critical test does not prove them better radio tubes. You are the judge.

Are You Prepared?

National Radio Improv'ment Week, conducted under the auspices of the Ken-Rad Corporation, is an impartial, unselfish movement to promote radio improvements on the part of radio owners when they should be made—at the start of the radio season. This gives longer, better, more substantial and less expensive radio to the public, decreases servicing expense and promotes sales for the radio dealer. It is designed to help accomplish in one movement what the trade may devote the entire season to doing, with less result.

Irrespective of whether a dealer stocks Archatrons he will be accorded the privilege of sharing in the results of the movement to the extent of the selling helps prepared for non-co-operative trade.

Of course, the Ken-Rad Corporation trusts that after the foregoing explanation of Archatrons you will understand the tremendous import of such a super radio tube and give your patrons the benefit of their indisputable value.

Little time remains. You should have all your material for National Radio Improv'ment Week NOW. Send for it today. An order for Archatrons is not necessary. Complete details on receipt of wire or special delivery.



The Ken-Rad Corporation, Inc.
National Radio Improv'ment Week Division
Owensboro, Kentucky

SIMPLY PIN THIS COUPON TO YOUR LETTER-HEAD
THE KEN-RAD CORPORATION, INC.
Owensboro, Kentucky.

Please send us full particulars about National Radio Improv'ment Week, your co-operative offer, free selling helps and Archatron Radio Tubes.

"Get all from the air there is on the air"

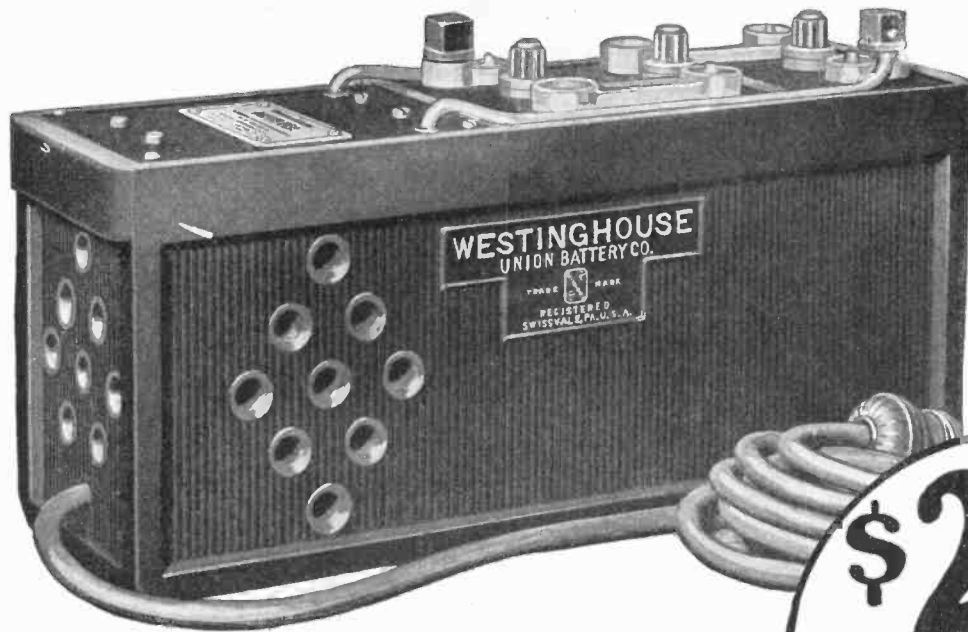

\$20
Retail
Price

*Slightly higher west
of the rockies*

This New WESTINGHOUSE "A" SOCKETPOWER meets low-price competition!

IF you've ever had a customer walk out of your store in search of a "more reasonably priced" "A" power unit, here is good news for you. The new "A" Socketpower, backed

by the fame of the name Westinghouse, built of the best, in the traditional Westinghouse painstaking way, yet selling for only \$20, retail, is your best answer to all low-price competition.

This is the unit to sell for small sets, plugs right into the light socket, and in reach of thousands who can't afford more expensive and larger "A" power units.

The WESTINGHOUSE "A" AUTOPOWER

A new model of the finest "A" power unit ever built by Westinghouse. Full 40 amp. hour battery of high reserve capacity, a low and high charging rate, and a "booster" for quick action. No hum, no glare.



A special built-in socket for attaching "B" eliminator, making the set entirely operated from the set switch. Sell "A" Auto-power with "B" eliminators or dry cells for better reception and complete customer satisfaction.

WESTINGHOUSE UNION BATTERY CO.
Pittsburgh, Pennsylvania.

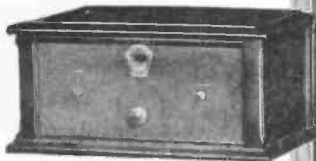

Model 6-15
Battery Operated
This also illustrates the
AC 6-15 Electric Model

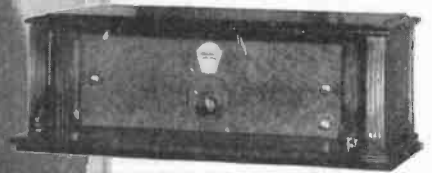

Model 6-26
Battery Operated

Sparton Electric AC-7
Console (without batteries
of any kind) is shown in
center illustration

NOT Limited to Higher Priced Field !!

The market for Sparton Radio is not limited to the higher priced field. Sparton instruments priced as low as \$68 enable dealers to present models suited to every purse.

As the public learns that

there is no price premium on Sparton craftsmanship and Sparton tone, Sparton sales mount to even more amazing heights . . . An inquiry will bring you an eye-opening story.

THE SPARKS-WITHINGTON COMPANY

Pioneers of Light Socket Radios without batteries of any kind

JACKSON, MICHIGAN, U. S. A.

SPARTON RADIO

"The Pathfinder of the Air"



A Big Improvement over "A" Batteries

The WHITE "A" SOCKET POWER UNIT is not a substitute for "A" Batteries. It is vastly superior to batteries—more dependable—more efficient—more economical. Requires no batteries of any character—no trickle charger. Never charged. Never discharged. Gives even, constant, unflinching current—without slightest noise. Always ready for constant and continued use. Not affected by disuse. Trouble proof. On when "on" and off when "off". Induces full clear-toned reception. Costs practically nothing to

operate. Moderate in price. Quickly pays for itself by abolishing expense of battery charging. Designed for standard 6 volt sets from 1 to 9 tubes. Compact—convenient. The most satisfactory and scientific "A" current supply. Saves money—time and trouble. Attractive in appearance. Housed in substantial 20 gauge metal cabinet—handsomely finished in sage-green Duco. Liberal dealer discounts. Desirable franchises now available. Particulars on request.

White "A" Socket Power is licensed by Andrews-Hammond Corporation under Andrews Condenser and other Andrews-Hammond patent applications.

White
"A" SOCKET POWER UNIT

Our complete line of "A", "B" and "A-B" power units gives a wide, active range of sales.

Julian M. White Manufacturing Co., Sioux City, Iowa

The foundation of a radio business



The Sign of the
Designated Federal Retailer

This sign, displayed by all Federal designated retailers, will swing you into line for the obvious and permanent benefits of this, the most promising of all profit combinations in the radio field.

✓ Institutional Stability

Sets, A C and Battery
Operated

All-inclusive
price range

The Only
Ortho-sonic Radio

Distinctive Beauty
of Cabinets

Nationally
Advertised

Don't build yours on shifting sands!

Industrial history repeats itself! What took place in the automobile field is just as surely taking place right now in the field of radio. Only the fit will survive. Only the few will several years hence be rolling up profits, paying dividends on past as well as present effort, and making the game worth while.

So why not line up with a "stayer"? Why not do it now? And remember, no line of radio in the world provides you with a safer, more solid foundation on which to build for the future than does FEDERAL.

"Why do the builders of the famous Federal Ortho-sonic enjoy their enviable position of leadership today?" asks a prominent western Federal wholesaler in a letter to his trade. "Because," he goes on to say, "prior to the time when transmission and reception of voice and music through the air was found possible, Federal had already and for twenty-three years, been

building equipment for electrical communication"

And this is your answer, too, Mr. Radio Retailer. Here is a line backed by an old and established organization of electrical communication specialists who have been in business for years, whose products are of recognized quality, who are pouring into their radio production the results of years of successful experience, and who now in addition to the most remarkably line of radio in America give you such a combination of sales-and-profit advantages as to have made the FEDERAL designation the most valuable business asset of hundreds of the largest and most reputable retail operators in the field. Nor if you can secure it will this designation cost you a nickel extra to operate.

Don't wait. We can't begin to tell you all the wonderful and desirable things about FEDERAL here. Get in touch with your wholesaler today for all the facts. Or write us direct.

FEDERAL RADIO CORPORATION, Buffalo, N. Y.
(Division of The Federal Telephone Manufacturing Corp.)

Operating Broadcast Station WGR at Buffalo

ORTHO-SONIC*

Reg. U. S. Pat. Off.

Federal Radio

Licensed under patents owned and/or controlled by Radio Corporation of America.

*Federal's fundamental exclusive development making possible Ortho-sonic reproduction is patented under U. S. Letters Patent No. 1,582,470.

THE IMPROVED UNIPOWER

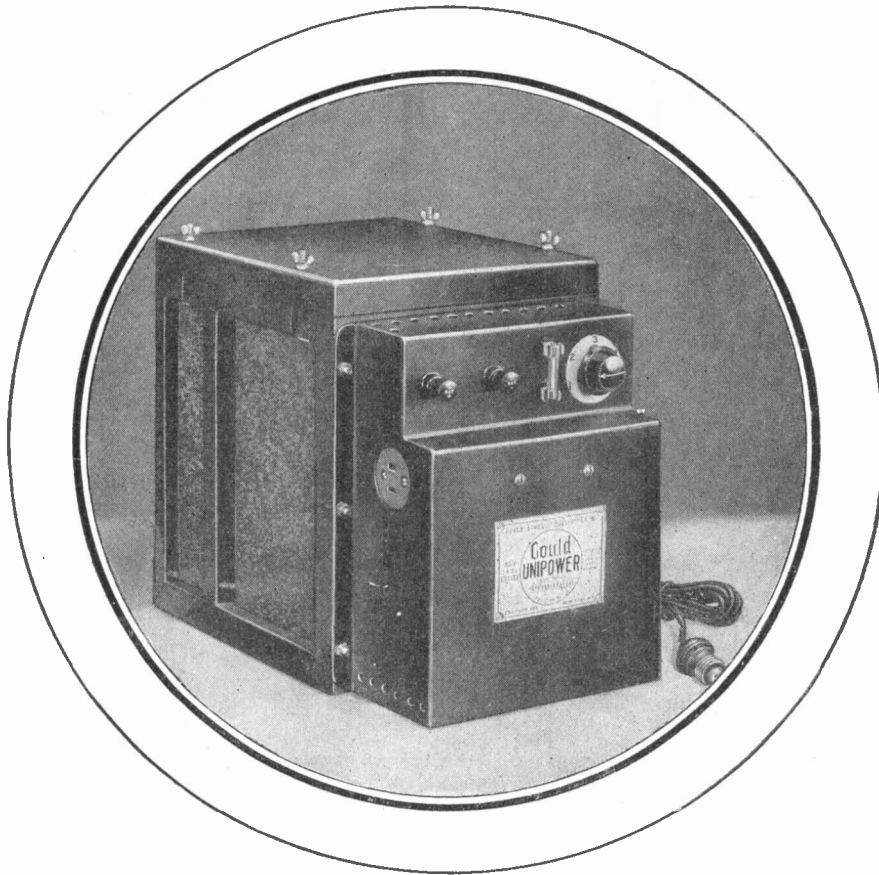

Gould Kathanode Construction leads all radio "A" power improvements

THE design of the new improved Gould Unipower embodies the best points of design in all previous models. To this has been added the most striking advance in battery construction for two decades. This new construction is known as the Gould Kathanode assembly. It is a principle first developed by Gould for submarine batteries. With the Kathanode battery element the new Gould Unipower has greatly increased life, care is simplified, and service costs are practically eliminated.

Gould Storage Battery Co., Inc., 250 Park Ave., N. Y. C.

*Ask to see the finest Unipower Gould
ever built and write for new low prices.*

The new
IMPROVED

Unipower

A GOULD PRODUCT

Kellogg

A.C.

*The First Radio using
A.C. Tubes throughout
including a Power Tube*

And

Kellogg D.C. Sets

**to Answer the Demand for
Kellogg Quality at Popular Prices**



Kellogg is fully awake to the demand for high quality radio reception at a minimum price. So that Kellogg dealers may supply that demand we offer Kellogg D.C. sets in 5- and 6-tube models to retail at \$75.00 up. ALL have the Kellogg exclusive system of Inductive Tuning. ALL are built with the same engineering skill that Kellogg has been building into its telephone equipment for the last 30 years. The time is growing short. If you are not yet assured of the Kellogg franchise, NOW is the time to act. Write or Wire!

KELLOGG SWITCHBOARD & SUPPLY COMPANY

Member R.M.A. and N.E.M.A.

Dept. 54-76

CHICAGO

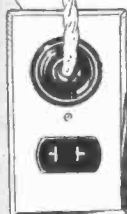

makes them want to buy!

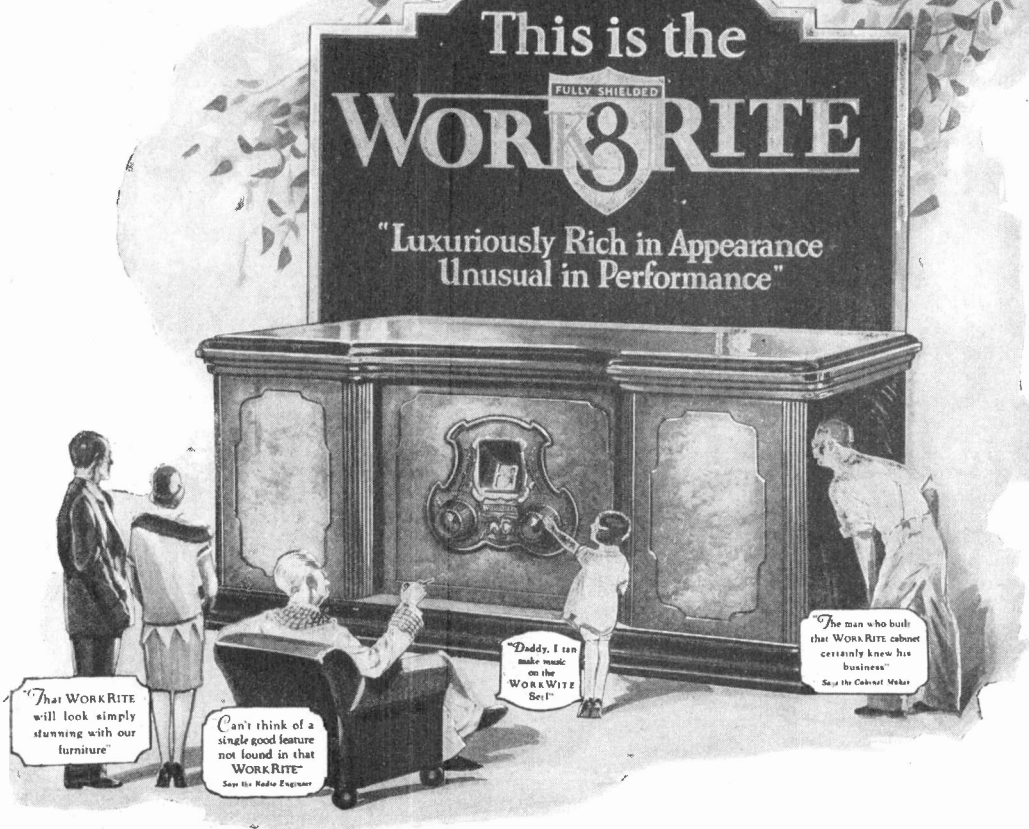

This beautiful new **WORKRITE**
Window Display
as different as the Workrite itself

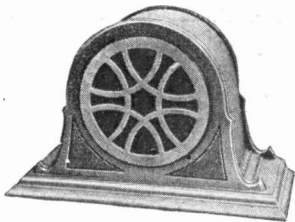

WorkRite Cone Speaker

This beautiful cone speaker has exceptional efficiency, great volume and wide tone range due to its double magnet and balanced armature which gives greater undistorted volume with less input energy than single magnet types. The cabinet is of walnut finish.
Price \$32.00

WorkRite Silver Mast Antenna

A jointed aluminum antenna that can be quickly erected and occupies small space. More effective than 95% of the antennas in use today.
Price \$12.50

WorkRite dealers are facing a most prosperous season—they are handling an outstanding line of radio receivers and products and they are being supplied with sales helps that are as different as the WorkRite Receivers themselves; witness this five piece window display.

WorkRite 37—the model illustrated—is an 8-tube receiver having all metal chassis, complete copper shielding, single illuminated dial control, loop or antenna oper-

ated and a host of other features that place it among the best receivers on the market. And the price is only \$160.00.

There are two 6-tube models—one a table receiver and the other a console model that are just as efficient and as attractive, price considered, as the Model 37. They complete a line that offers a remarkable opportunity for profits.

Wire or write for complete information.



Manufactured by
The WorkRite Mfg. Co.,
1812 East 30th St.,
Cleveland, Ohio

Canadian Factory: Workrite
Radio, Ltd., Branford, Ontario

Sales Department
The Zinke Company,
1323 So. Michigan Blvd.
Chicago, Ill.

Licensed under R.C.A., Hazeltine and La Tour Patents

Its Beauty Attracts— Its Performance Sells

THE new EFFARSEE ART PANEL ANTENNAE, with the appearance of a wonderfully attractive rare old tapestry, not only sells itself but is a mighty force in aiding you to sell radios where an outside antenna would be difficult or impossible to install. Thousands of homes would now have radios were it not for the problems of the antenna. EFFARSEE solves these aerial problems—many more prospects can be sold because this exquisite panel, that adorns even the most handsomely furnished home, will appeal to all the members of a family.

And it is a real antenna. Cuts down static, gives better tone in reception, removes the need of rigging up an outside aerial, is not affected by dampness and is far more powerful than a bulky loop. Being of large capacity, but a tuned aerial of low natural period, EFFARSEE can not help but be selective. More stations can be logged because more easily separated, *without losing your volume.*

Both "THE NYMPH" (as per illustration) and "THE FAUN" sell at \$9.50 complete with silk cord hanger, *giving a good profit for the dealer.* They sell fast, and will sell big this season, not only to new set buyers but to the owners of old sets who want more selectivity and less static. The non-decorative type selling at \$2.50 and \$4.00, that have been acclaimed for performance all over the world for the past four seasons, will be continued without change.

Write or wire today for folders and full information or get in touch with your jobber regarding our line at once.

The
Fishwick Radio Co.
Cincinnati Ohio

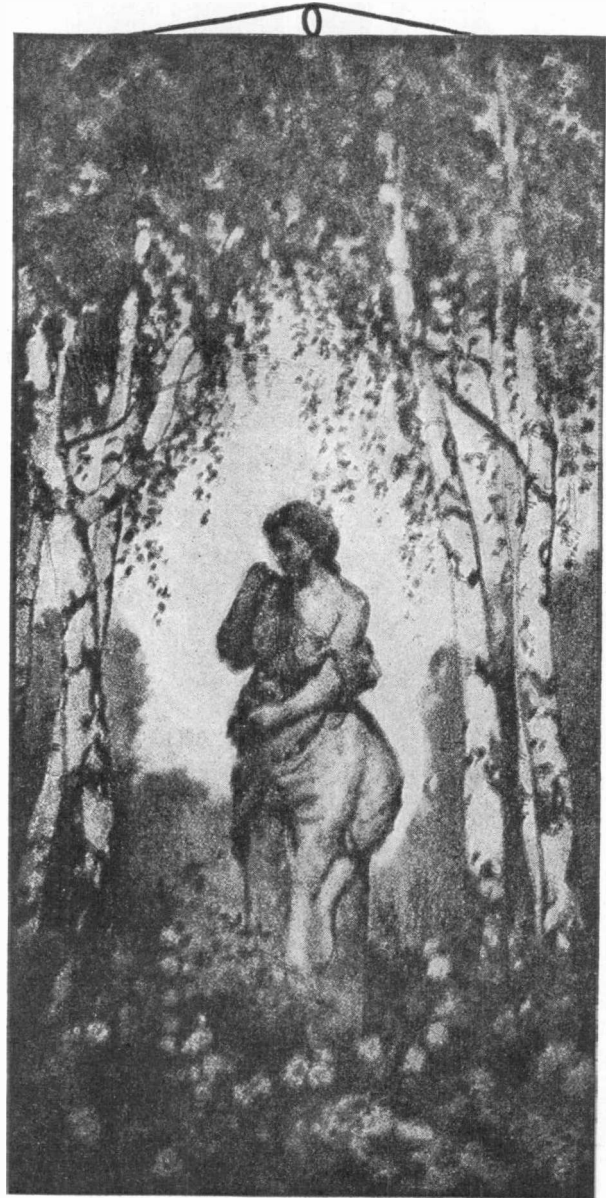

FISHWICK RADIO CO.,
S.E. Cor. Elm and Central Parkway, Cincinnati, Ohio
Please send me at once further details about "Effarsee" Antennae.

Name

Street

City

State

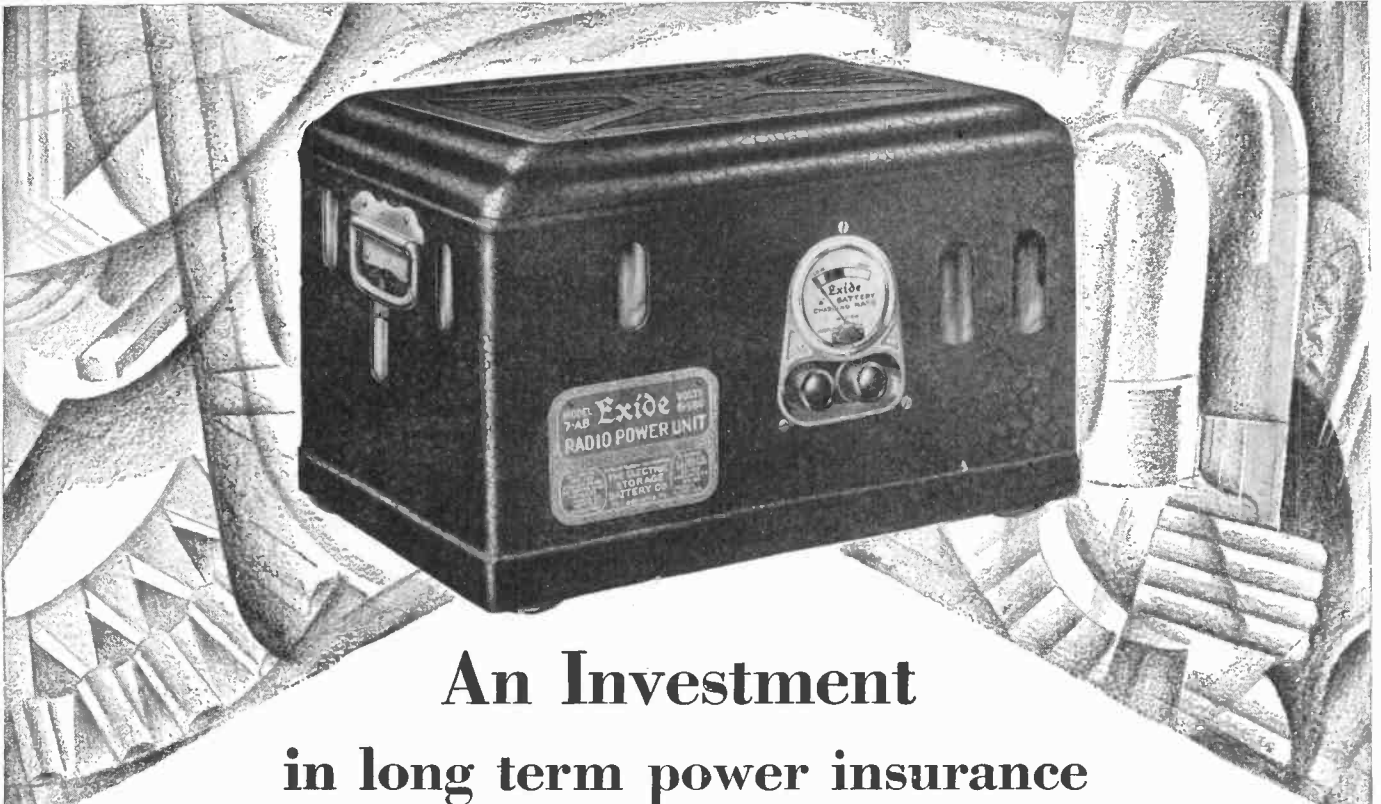

An Investment in long term power insurance

This dependable Unit insures ample
"A" and "B" power for any set

THINK how a customer will sit up and take notice when you say to him, "You don't have to bother about your 'A' and 'B' power supply any more. The new Exide Super 'AB' Power Unit has virtually unlimited range for home use, and takes care of your power requirements automatically."

Then show him how this ingenious device can be used for any size set from three tubes to ten tubes; how the Unit has almost unlimited reserve power; how it will provide smooth and noiseless "A" and "B" power for one hour or many hours a week.

Like any other unit he simply connects it to his set, plugs it into his light socket, and leaves it there. But with the Exide "AB" Unit, he has full automatic control of the power supply from the set switch, and the Unit requires practically no attention.

There are big profits waiting for the progressive dealer who starts pushing the Exide "AB" Power Unit now. It is being featured in our national advertising, and is creating a sensation in the radio field.

Don't take a chance on losing sales. Let us know how many "AB" Power Units you can use.



Exide Standard "A" Power Unit with trickle charger—in 6-volt and 4-volt sizes.



Standard Exide 6-volt "A" Battery—also 4-volt sizes. Rugged—built in one-piece case.



Master Control Switch for use with "A" Power Unit.



Exide 24-volt "B" Battery in glass cells. 6000-milliamperes capacity. Also made in 48-volt sizes.

Exide at the
Radio World's Fair

Don't miss the Exide exhibit in Booth 7, Section C, at the Fourth Annual Radio World's Fair—to be held in the New Madison Square Garden, New York City, Sept. 19—24 inclusive.

Exide

RADIO BATTERIES

THE ELECTRIC STORAGE BATTERY COMPANY, Philadelphia
Exide Batteries of Canada, Limited, Toronto

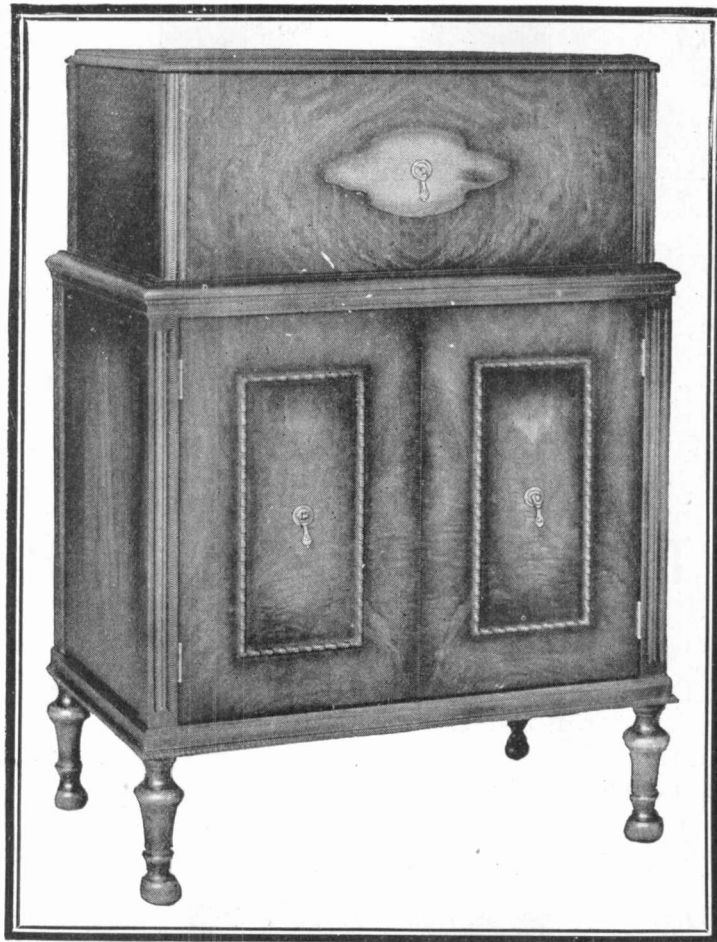

THIS SLAGLE QUALITY PROFITS YOU

THE current Slagle models are designed and built with this single purpose: to provide the most satisfactory performance possible today. . . There are thousands of people who will gladly pay a good price for such a receiver, and every factor of engineering, of material, of workmanship has been utilized to make these sets conform to that standard.

A few of the outstanding features which produce such quality are: selectivity which almost splits a wave-length meter, full natural tone values in *every* register; accurately controlled volume from a whisper in the smallest room to a mountain of sound that fills an auditorium, pure and undistorted in either case; cast aluminum chassis and full shielding; A and B socket power; single-dial control; Ferranti audio transformers; Hammarlund condensers; 7, 9 and 10 tube models with outstandingly beautiful cabinet work.

The most rigid tests on any reasonable comparative basis invited. We are willing to stake our reputation on the results your own eyes and ears will detect from the standpoint of performance, appearance and value. Let us show you how you can turn Slagle quality to your own account.

SLAGLE RADIO COMPANY, Fort Wayne, Indiana

Builders of Radio Receivers Since 1911

Slagle Radio

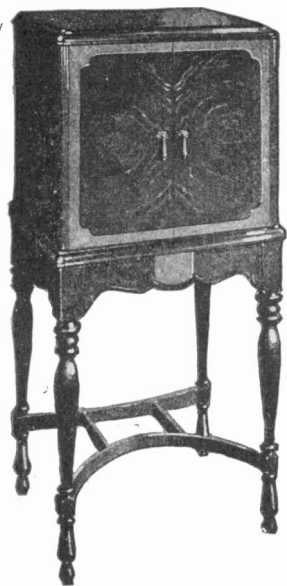

The Lincoln
\$175.00 to \$195.00
For Battery or A.C. Operation

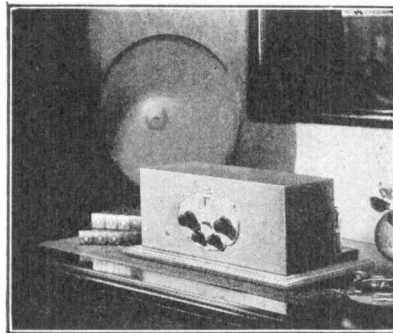

The Congress
Metal Cabinet \$80.00
Walnut Cabinet, \$95
For Battery or A.C. Operation

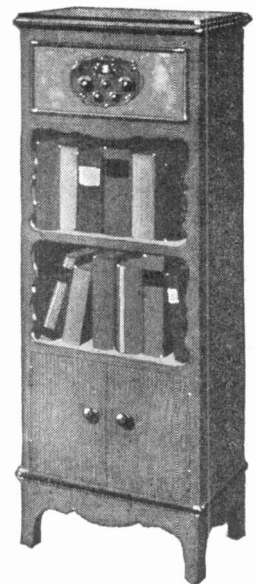

The Monroe
\$125.00 to \$135.00
For Battery or A.C. Operation.

PARAGON SELLS DIRECT-TO-DEALER Exclusively

THE Paragon Direct-to-Dealer policy has been adopted for two important reasons: 1. To protect the dealer and insure for him full profits and close co-operation. 2. To give the public the best there is in radio at a price no higher than is asked for inferior merchandise.

One Chassis—Many Models

The Paragon "Six," while built in several models, has a standard chassis—for there is but one Paragon Circuit and one Paragon amplifying unit. The \$80.00 Congress Model gives the same razor-edge selectivity, the same tone-perfection, the same great volume, as the \$195.00 Lincoln Model.

Double Impedance Amplification

The Paragon "Six" exclusively features a new and patented audio system known as Tuned Resonant Double Impedance Amplification. A system that insures quadruple volume without distortion and reproduces sound with a fidelity to the original lifelike enough to satisfy even the most critical ear.

A.C. or Battery Operated

Paragon engineers have taken into full account the increasing popularity of A.C. operation and the Paragon "Six" can be obtained in all Models, (1) for battery or eliminator operation, (2) for operation with A.C. Tubes, or (3) for operation with the Paragon A.B.C. power Box.

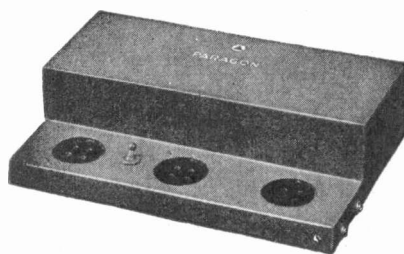

Tuned Resonant Double Impedance Amplifier

For set builders. Modernizes old sets. Complete with Output Filter, \$30.00



A.B.C. Socket Power

No expense has been spared to equip this unit with the proper condensers and chokes in order to convert the raw A.C. into the proper A. B. C values for quality reception. Complete A. B. C unit, \$125.00
Special A.C. Tube Unit, \$75.00

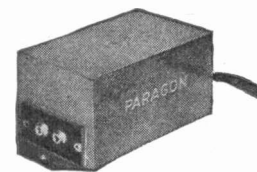

Output Filter

Protects the loud speaker and improves reception. \$5.00

The Paragon Plan

Write, today, for the Paragon Direct-to-Dealer Plan which explains in detail the full Paragon Line, liberal discounts and terms offered responsible dealers who qualify to tie-up for 1928 with one of the great names in Radio.

At the
Show
Booth 7

The PARAGON SIX

PARAGON ELECTRIC CORPORATION

General Offices and Factory

Upper Montclair

New Jersey

At the
Show
Booth 7

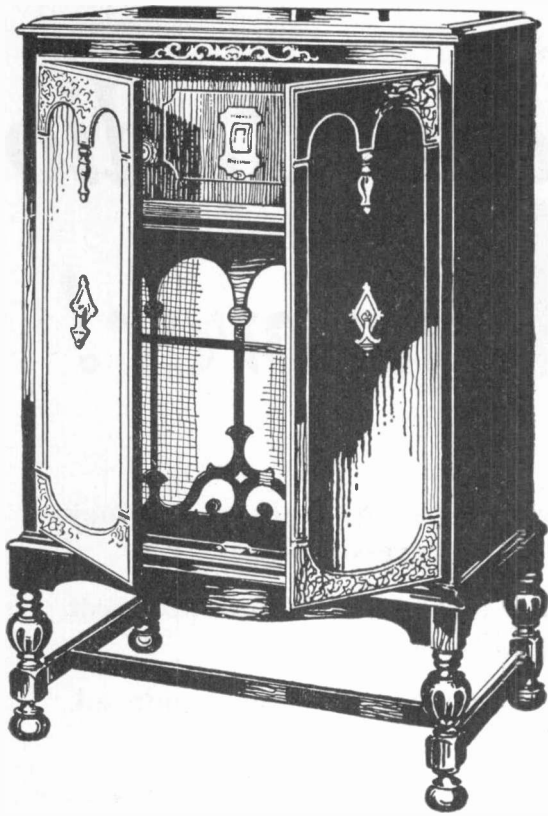

Above is illustrated the Royal Series Neutrodyne "Hastings" Console, 7 tubes, single dial control, completely shielded. Equipped with latest AC tubes for lamp socket operation.

AMRAD SETS ARE DISTINCTIVE!

1. Single dial control.
2. Complete shielding.
3. Exclusive tone filter.
4. Illuminated dials.
5. Extremely selective.
6. Dial calibrated with wave lengths.
7. 6 and 7-tube models in Compact and Console types.
8. The prices range from \$138 to \$395.
9. Fully protected by R. C. A., LaTour and Hazeltine patents and licenses.
10. Amrad electrical models use genuine AC tubes, are of latest design, and are now being delivered to dealers.
11. All Amrad Sets may be operated by either a loop or antenna.
12. Cabinets are of rare artistic beauty.
13. And a tone quality of exquisite richness and purity.

At the New York Show

The point of highest interest will be AC Radio Sets, operated with newest R.C.A. tubes, requiring no batteries and giving perfect tone quality. *There will be few of them!*

AMRAD ELECTRICAL MODELS

displayed at the New York Show in space 3, Sec. N, are genuine lamp socket sets, using the latest AC tubes, perfected by the engineers of six great laboratories—and are now in full production! Amrad models are NOT makeshift electric sets. We earnestly invite your critical comparison of these AMRAD electric models with other lines that may be on exhibition.

A full line of AMRAD 6-tube and 7-tube models will be on display in space 3, Sec. N, New York Radio Show, September 19th to 24th.

Royal
Series

AMRAD

NEUTRODYNE

THE AMRAD
CORPORATION
Medford Hillside,
Mass.

Amrad sets are manufactured under license contract between Radio Corporation of America and Crosley Radio Corporation. Licensed under Hazeltine and LaTour patents issued and pending, for radio amateurs, experimental and broadcast reception.

6 questions about Radio —and 1 answer!



Now—10 Tube Electric Radio

The ten tube *Electric Zenith* is the first receiver of this type to be produced on the commercial scale. An instrument of remarkable tone quality, range and selectivity. Entirely electric in operation with power speaker—no batteries, loops or antennae. Here, again, Zenith is first—and Zenith dealers will share in the reward that goes to the leader.

Licensed only for radio amateur, experimental and broadcast reception

Western United States prices slightly higher

- 1 Who is the manufacturer that has uniformly made money for his dealers the last four successive seasons?
- 2 Who is the manufacturer that is the largest producer in the world of high quality radio?
- 3 Who is the manufacturer that has *never* overproduced, *never* dumped, *never* slashed prices?
- 4 Who is the manufacturer that makes a complete line—3 circuits—6, 8 and 10 tubes—loop or loopless—battery or electric—16 models—meeting all pocketbooks, \$100 to \$2500?
- 5 Who is the manufacturer that gives you protection—makes it worth while for you to sell?
- 6 Who is the manufacturer whose franchise is acknowledged the most valuable in radio?

THE ANSWER IN EVERY CASE IS ZENITH
The record of Zenith relations with the radio dealer is clear and impressive. It is open to any dealer who wishes to investigate it.

\$100 to \$2500

ZENITH
TRADE MARK REG.
→LONG DISTANCE←
TRADE MARK REG. **RADIO**

3620 IRON STREET, CHICAGO

WORLD'S LARGEST MANUFACTURERS OF HIGH GRADE RADIO

AUTOMATIC EAGLE SOCKET POWER UNITS

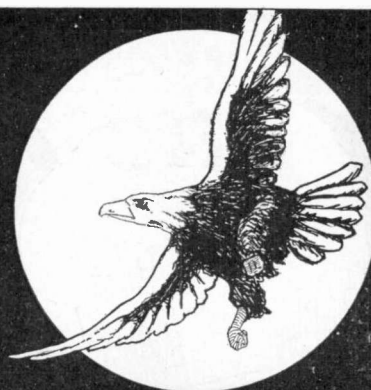

THE POWER BEHIND THE RADIO

Eagle Dry-Disk Battery Charger

Bone dry—no tubes, no acids.

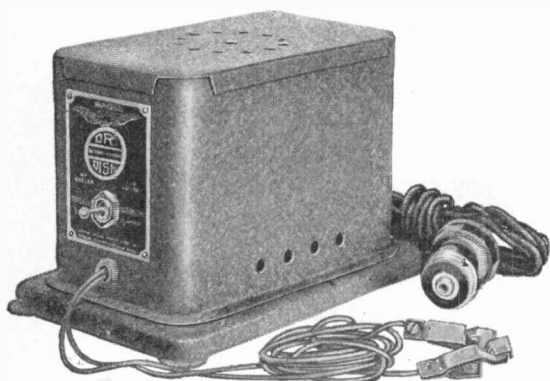

One-half ampere trickle rate, one and one-half ampere high rate. Absolutely cool and quiet in operation. Guaranteed for one year. Coupled with Eagle Automatic "B" Socket Power forms economical "A" and "B" power supply, automatically controlled from radio set.

Size: $7\frac{1}{4}'' \times 4\frac{3}{4}'' \times 4\frac{3}{4}''$. Price \$15.00 complete.

Eagle "B" Socket Power Units

Eagle "B" Socket Power—Type 135

Will operate up to eight tube set. Delivers 150 volts at 40 mils. Ample binding post connections. Variable voltage controls. Automatic relay built in each unit with flush receptacle in rear to attach trickle charger. Requires one Raytheon "B-H" tube. Size $4\frac{3}{4}'' \times 9\frac{5}{16}'' \times 7''$. Price \$28.00.

Eagle "B" Socket Power—Type 180

Will operate any set irrespective of number of tubes. Delivers 180 volts at 60 mils. Will deliver 240 volts at 30 mils. Three variable voltage controls. Ample binding post connections. Automatic relay built in each unit with flush receptacle in rear to attach trickle charger. Requires one Raytheon "B-H" tube. Size $5\frac{1}{16}'' \times 9\frac{1}{4}'' \times 8\frac{1}{2}''$. Price \$37.50.



Approved by Raytheon

Eagle "A" and "B" Radio-Powr Unit

Not a trickle charger combination, but a powerful "A" and "B" supply for multiple tube sets. Fully automatic. "A" supply up to 3 amperes at 6 volts. "B" supply 180 volts at 60 mils. Variable to accommodate all sets. Absolutely quiet and cool in operation. Fits into any ordinary size console cabinet. Extremely compact.

Size $16'' \times 8'' \times 8''$. Price \$79.50

Prices of eliminators and "A & B" Radio-Powr do not include tubes.

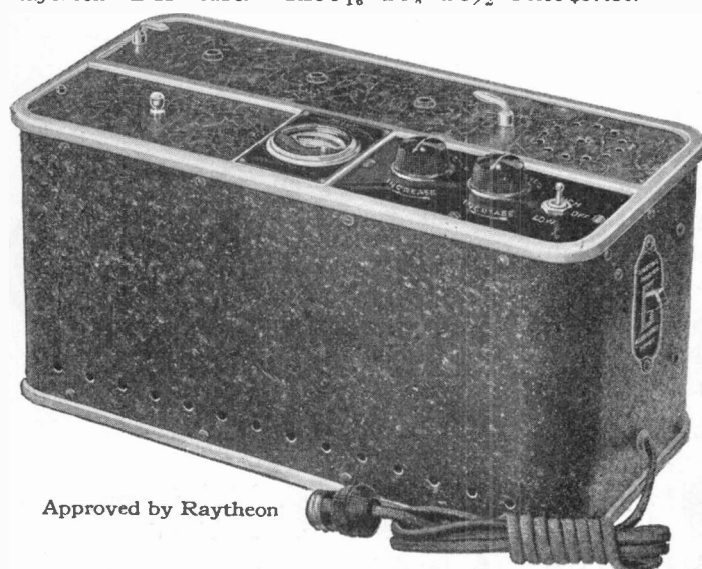

Approved by Raytheon

Write for catalog sheets, folders, electros, etc.

EAGLE CHARGER CORPORATION
121 North 8th Street, Philadelphia, Pa.

See us at the Radio World Fair, Booth EE-3, New York, September 19 to 24

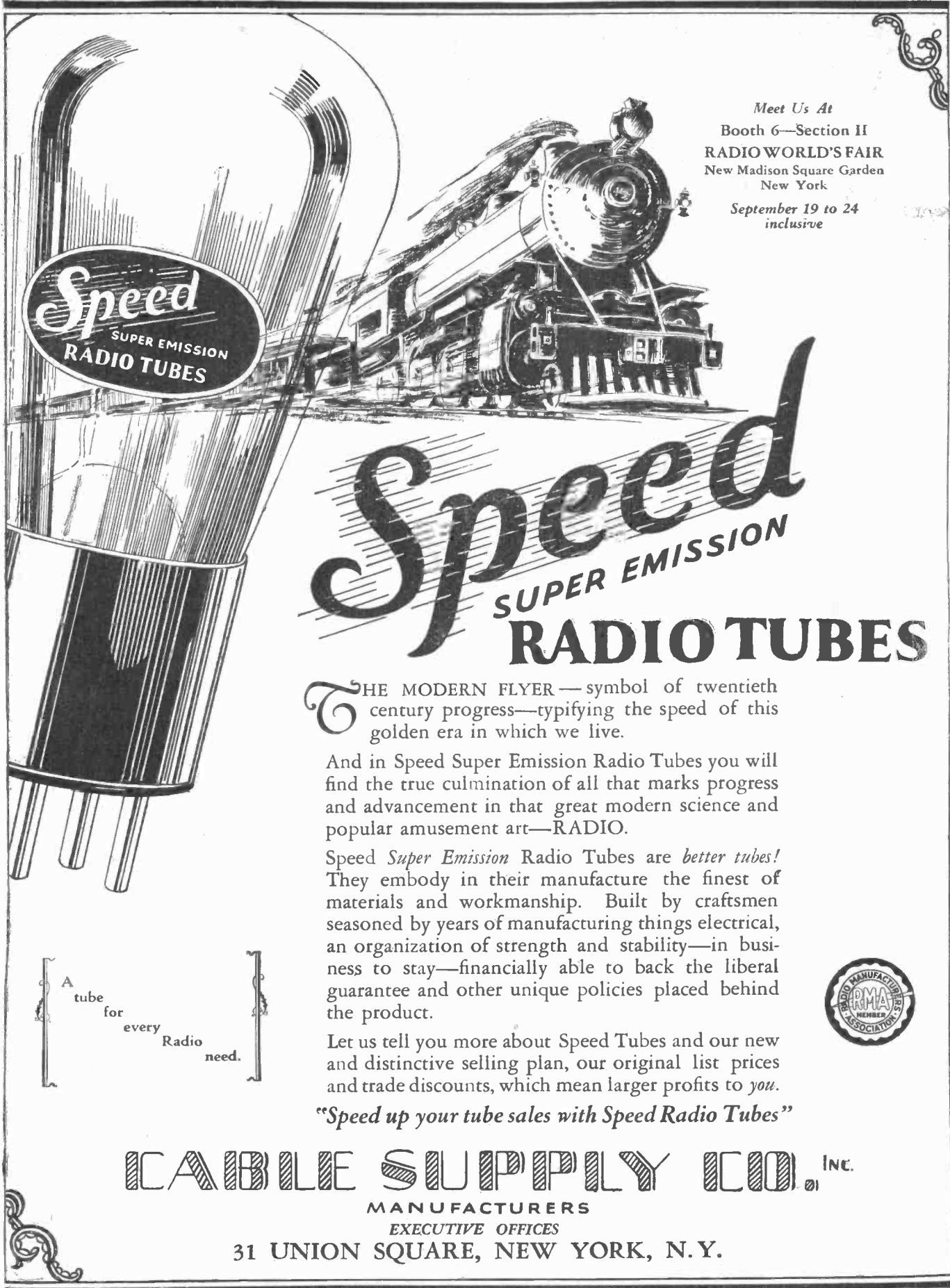

Meet Us At
 Booth 6—Section II
RADIO WORLD'S FAIR
 New Madison Square Garden
 New York
 September 19 to 24
 inclusive

Speed
 SUPER EMISSION
 RADIO TUBES

Speed
 SUPER EMISSION
RADIO TUBES

THE MODERN FLYER—symbol of twentieth century progress—typifying the speed of this golden era in which we live.

And in Speed Super Emission Radio Tubes you will find the true culmination of all that marks progress and advancement in that great modern science and popular amusement art—RADIO.

Speed *Super Emission* Radio Tubes are *better tubes!* They embody in their manufacture the finest of materials and workmanship. Built by craftsmen seasoned by years of manufacturing things electrical, an organization of strength and stability—in business to stay—financially able to back the liberal guarantee and other unique policies placed behind the product.

Let us tell you more about Speed Tubes and our new and distinctive selling plan, our original list prices and trade discounts, which mean larger profits to you.

"Speed up your tube sales with Speed Radio Tubes"

A tube for every Radio need.



WIRE CABLE SUPPLY CO., INC.

MANUFACTURERS
 EXECUTIVE OFFICES

31 UNION SQUARE, NEW YORK, N. Y.



Sure to Sell This Season

The new APCO Automatic "A" Battery Charger with the Westinghouse Rectox unit will be one of the biggest sellers because:

1. It makes a perfect "A" Power Socket supply out of any good storage battery.
2. Apco national advertising and complete dealers' sales helps are pushing this item to the limit.

Advance orders indicate that we will be oversold; so it will be well to place your order now.

Jobbers are ready to supply you, or we will send you a sample on approval if your jobber has not received his stock.

APCO AUTOMATIC "A" BATTERY CHARGER With Westinghouse Rectox Unit

APCO-MOSSBERG CORPORATION
ATTLEBORO MASSACHUSETTS

It's the Finer Tones That Sell **TRIMM** Cones

No. 28
Concerto
14 in. Diameter
A Speaker
Sensation
at
\$10.00

West of Rockies, \$10.75
Canada, \$13.50

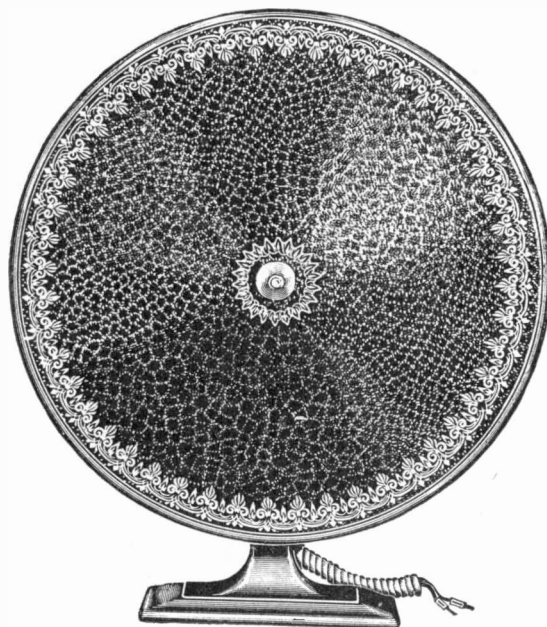

No. 38
**Concerto
Grande**
17 in. Diameter
A Quality
Reproducer
at a
Medium Price
\$16.00

West of Rockies, \$16.75
Canada, \$22.00

Rattle of snare drum, blare of bugle, deep throated note of mighty organ or shrill piping of the flute—you get them all, in all their naturalness with the new Trimm Cones.

The low notes as well as the high with great fidelity. A speaker you will be proud to sell—a speaker that will give maximum customer satisfaction.

Built on the balanced armature principle.

Particularly well adapted to operation with semi-power and power tubes. Will take the higher voltages and maximum amplification without distortion or blasting.

Edge of cone is fully protected. Unit ruggedly built, of ample proportions, and all parts are rust-proofed before assembly.

Unit is equipped with handy handle, a great convenience in moving the cone about.

Trimm also makes the well-known and popular line of Horns, Headsets and Units:

Trimm Concert, \$25.00
Trimm Entertainer, \$17.50
Trimm Home Speaker, \$10.00
Trimm Dependable Headsets, \$4.00
Trimm Professional Headsets, \$5.50
Trimm Units, for Horns, \$8.50; for Cones, \$6.00 and \$9.00
Trimm Giant Phonodapter, \$10.00
Trimm Little Wonder Phonodapter, \$4.50

Trimm Cones are Packed in a Special Wire-Bound Wooden Container, assuring transportation and delivery in perfect condition.

TRIMM
RADIO MANUFACTURING
COMPANY
847 W. Harrison St.
CHICAGO
U.S.A.
ESTABLISHED 1922

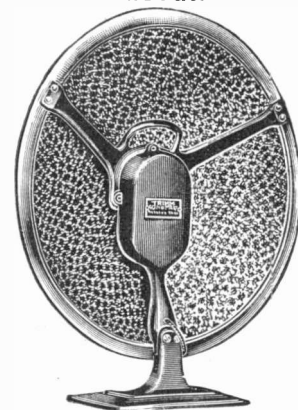

Rear View, With Handy Handle

The "Know" Public Demands

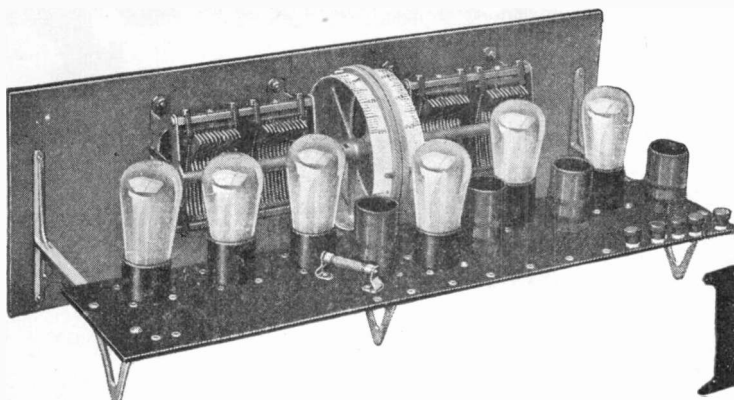

6ⁱⁿ LINE 2ⁱⁿ ONE PREMIER

ONE DIAL

The exclusive PREMIER feature—One dial to meet popular demand—Instantly convertible to Two-Dial for extreme selectivity.

DEALERS: Get in line now to make this your biggest radio year.

PREMIER offers you Exclusive Franchise, "No quota" contracts, advertising and sales assistance, Free Trial.

Features and Specifications

- 1. Two-in-One Tuning Drum or Dial**—Convertible from single to two drum tuner in 30 seconds—no wiring changed.
- 2. One Control**—Battery and loud speaker volume.
- 3. Hook-Up**—Tuned radio frequency, 3 radio, detector and two transformer coupled audio.
- 4. Light Socket Operation**—Takes all standard A, B and C Power Packs.
- 5. PREMIER "Split Meter" Condenser**—Latest approved type giving extreme selectivity.
- 6. Bakelite Sub-base**—Carries all wiring and apparatus rigidly mounted on steel supports.
- 7. Steel Front Mounting Panel**—Furnished with natural wood facing of beautiful walnut or mahogany. Very dressy and finished in appearance.
- 8. PREMIER Radio Frequency Transformers**—"Navy type" operating at greatest efficiency with "Split Meter" Condenser.
- 9. Power Tube and Special Detector**—Provision for use of both if desired.
- 10. Cable Connections to Spring Jacks**—Cable can be connected for complete wiring in 10 seconds.
- 11. Aerial or Loop**—Provision is made for use of either.
- 12. Chassis is Self Contained**—Very rigid steel front panel carries all moving parts assuring permanence of adjustment and uniformity of operation.
- 13. Tone Quality**—Positively unsurpassed by any set.



One of the many console model cabinets available to Premier dealers.

Exclusive Cabinet Designs

Buyers are demanding radio sets that are different—cabinets that will express their own taste and individuality. Up to now only makers of the very highest priced sets attempted to meet this demand, but now under PREMIER'S plan every franchise dealer is given a big selection of fine cabinets to choose from which enables him to meet this demand at attractive selling prices and at a much larger profit to himself.

Low, flat price

on one or more chassis or on complete sets. "No quota" contract.

We have specialized in the manufacture of electrical devices and equipment for the past 22 years. We manufacture all parts of PREMIER chassis from the raw material. Write today for our liberal proposition and our new radio merchandising plan.

PREMIER ELECTRIC COMPANY

EST. 1905—AND MANUFACTURERS EVER SINCE

Dept. 224, 3800 Ravenswood Ave., Chicago, Illinois

Canadian Distributor: Premier Electric Company, Ltd., London, Ontario

AUDIOLA

It's the Chassis that Counts

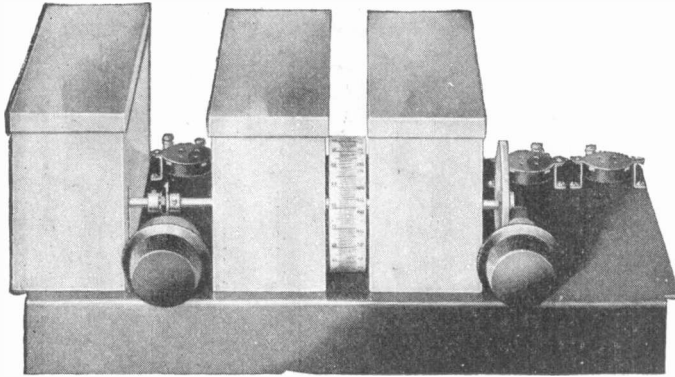

Therefore—
Sell the Chassis

THE big thing in Radio is the chassis—we realized this long ago—we built a chassis thru engineering skill that today, in performance, exceeds the most enthusiastic expectations.

Set in cabinets of great beauty the Audiola Chassis makes a line offering greatest selling possibilities.

Complete sales cooperation thru our advertising program. Write now for details.

A Complete Line distributed Thru Recognized Jobbers.

Audiola sets, both six and eight tube models, are of the single control type with all tuned circuits individually shielded. Two knobs on the front panel comprise all the controls—a Steering Wheel and a Throttle—the Steering Wheel to select the station you want and the Throttle to control the volume. Thordarson transformer audio amplification is used in all models.

Cabinets

Stage Shielded Six—\$75.00
Stage Shielded Eight—\$125.00

Baby Grand

Stage Shielded Six \$225.00
Stage Shielded Eight—\$275.00



Stage Shielded Six Console—\$175.00
Stage Shielded Eight Console—\$225.00

AUDIOLA RADIO CO.

430 So. Green St.
CHICAGO

What ACME IS DOING NOW



The ACME A & B Socket Power Unit Means Real Reception

—thru its ability to give a strong flow of constant, dependable A & B Power.

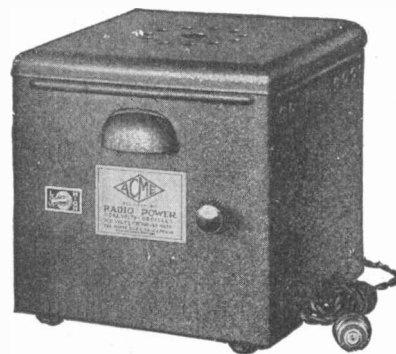

Type AB-1-R

Capacity 40 mills, at 150 volts for 6 and 8 tube sets and Radiolas. Lists, complete ready to operate
\$67.50

East of the Rockies

Type AB-2-R

Capacity 60 mills, at 180 volts. Recommended for any number of tubes. Lists, complete ready to operate
\$72.50

East of the Rockies

Consider these Acme Features that will help make easy sales for you.

This Unit (either Type) is compact. It's quiet, efficient, and exceptionally attractive in design.

ACME Products are popular with the Public because they are known to give long satisfactory service.

They are nationally advertised and sold thru leading Jobbers everywhere.

Send today for our new Sales Plan complete with Dealer's Helps and cash in on Acme's universal popularity.

Factory Representatives in Leading Cities.

COUPON

Send me your latest literature with complete information on the new Acme Line.

Name

Address



Est. since 1917
10 years' successful manufacturing experience.

THE ACME ELECTRIC and MANUFACTURING COMPANY.

1435 Hamilton Avenue

Cleveland, Ohio

The "Power"
A B and C

Socket Power Unit
(NO BATTERIES)

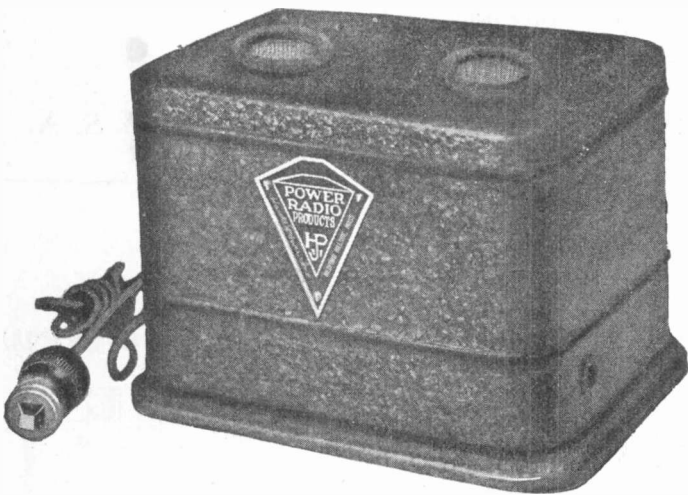

\$47⁵⁰

Including
R.C.A. Tube
Ask your Jobber

THIS Unit manufactured by Harold J. Power, Inc. delivers 50 mils at 180 volts "B" Current and provides the necessary A. C. voltages for operation of the new A. C. tubes. Mr. Power has embodied in this unit every feature which his many years of experience shows are necessary in a radio device for permanent operation. The dealer's opportunity to capitalize on this pioneer's radio experience is yours.

Licensed under patents owned and/or controlled by the Radio Corporation of America

Harold J. Power, Inc.

Medford, Mass.

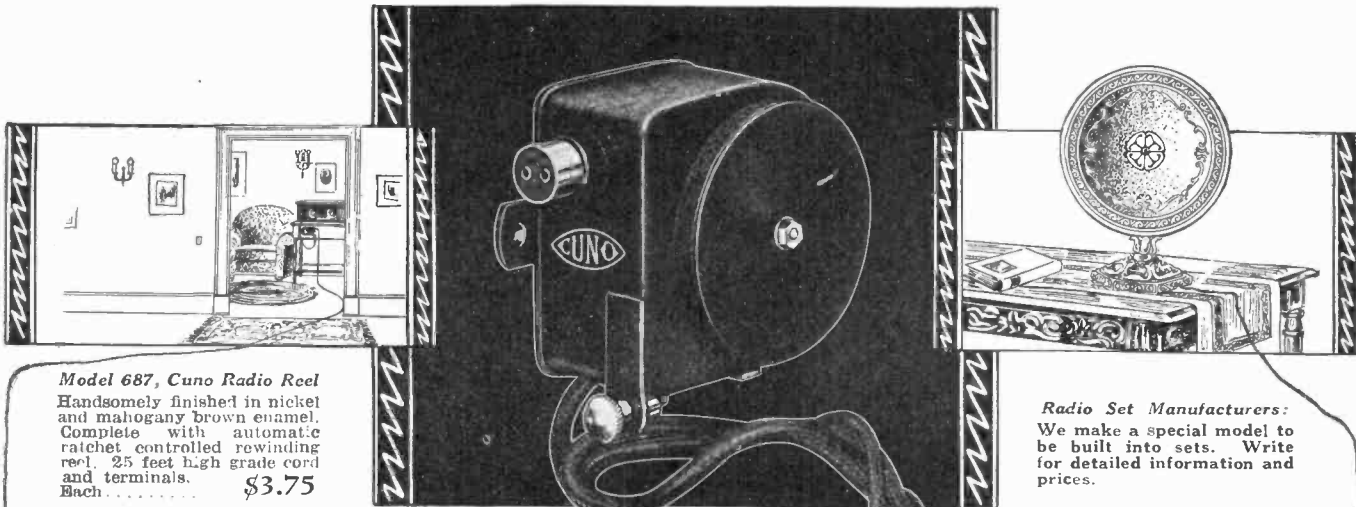

Model 687, Cuno Radio Reel
 Handsomely finished in nickel and mahogany brown enamel. Complete with automatic ratchet controlled rewinding reel. 25 feet high grade cord and terminals.
 Each \$3.75

Radio Set Manufacturers:
 We make a special model to be built into sets. Write for detailed information and prices.

6,600,000 Possible Sales!

That's the estimated number of receiving sets in use. Every owner of a set *should* have a Radio Reel. It's simple, yet reliable. It's easily attached, with two screws, to cabinet, table or set itself. By connecting between loud speaker jack and horn, the loud speaker, or an additional loud speaker can be moved to another part of

the same room, into the kitchen or out on the porch. The cord is kept free from kinks and tangles when in use and out of the way and protected when not in use. You can profit by the sure appeal to every set owner. Handsome display card packed in each carton containing six reels in attractive individual boxes.

Place your order with your jobber today, or write us for prices and detailed information.

The Cuno Engineering Corp.



Meriden, Conn., U. S. A.

Radio Retailing, September

You'll Profit More with the New



The new CASE GLORITONE offers radio dealers not just another radio set—but radio's greatest development. A set built for those wanting a real musical instrument that reproduces every tone of the voice and music scale faultlessly at a whisper or with room-filling volume. Such a set is quite naturally housed in a cabinet that represents the cabinet maker's highest art.

The CASE Line for 1927-28

offers a set for every class of buyer: A popular priced line of six-tube battery operated sets as low as \$65; a line of full power-operated AC tube sets as low as \$185; and the "90" line of nine-tube loop operated GLORITONE sets, either battery or full power-operated sets, appealing to those of the most exacting requirements . . . This line of time proven sets is backed by five years of successful sales and performance records, and a merchandising plan that offers jobber and dealer greater profits. Some valuable territory still open. Write for full details.

The CASE GLORITONE CONSOLE

Nine-tube—loop operated—single illuminated tuning control—self interstage shielded—self shielded loop—full sustained quality of tones over complete scale—artistic walnut cabinet designed by Mowitz of Philadelphia—full throated concert speaker. **\$350**

Power Set—Same as above but complete with AC tubes ready to plug in light socket. Licensed under Technidyne patents. **\$475**

INDIANA MFG. & ELECTRIC CO.

Marion, Indiana

Radio Sets, Automatic Chargers and Accessories

General Electric Battery Chargers

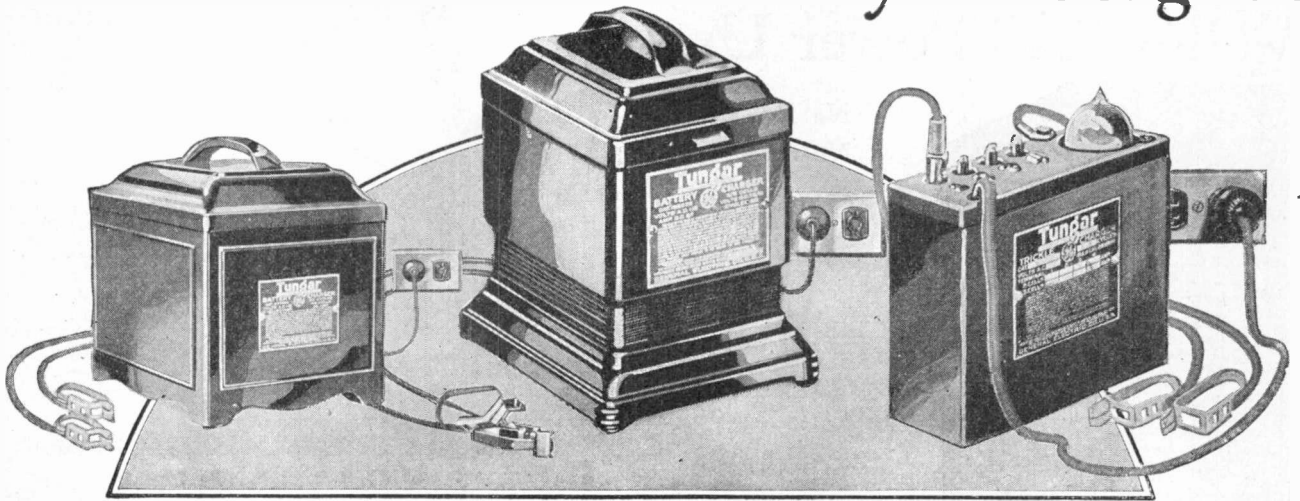

Push these profit-makers with the 3 Punch Plan

The new low prices on General Electric Battery Chargers (Tungar) make them easier than ever for you to sell—\$14 for the 2-ampere—\$24 for the 5-ampere and \$10 for the trickle charger.

A million of them now in use—convincing proof of their popularity.

The popular 2-ampere Tungar gives both trickle and boost charging rates.

And we have a big new 3-PUNCH PLAN to help you cash in on General Electric Battery Charger advertising.

Prepare for October—General Electric Battery Charger month—by sending in the coupon for full details of the 3-PUNCH PLAN. Send it now!

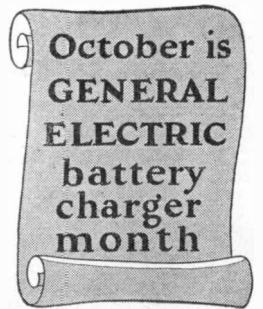

Mail this coupon ↘



Tungar—a registered trademark—is found only on the genuine. Look for it on the name plate.

Merchandise Department,
General Electric Company,
Bridgeport, Connecticut.

Gentlemen:

Please send me full details of your 3-PUNCH PLAN for dealers.

Please send me the name of the nearest distributor of General Electric Battery Chargers.

GENERAL ELECTRIC

MERCHANDISE DEPARTMENT ~ GENERAL ELECTRIC COMPANY ~ BRIDGEPORT, CONNECTICUT

The New Valley "A" Power Unit



**No Batteries
No Charging**
List price \$39.50
f.o.b. St. Louis

Here is the unit which now makes it possible to completely electrify any set. The Valley "A" Power Unit eliminates the 6-volt storage battery by replacing both the "A" battery and a charger. This unit contains no batteries, tubes or moving parts; it makes no hum or noise. To install, simply connect up the Valley "A" Power Unit in place of the storage battery. If a "B" Power Unit is used, plug it into the back of the "A" Power Unit and you have a completely electrified set without disturbing your set or making any changes in it. Use your present tubes and you will get excellent results.

The Valley "A" Power Unit consumes current from the light socket only when the set is in use. One switch on the Valley "A" Power Unit turns on both "A" and "B" Power, so it is not necessary to use the switch on your set.

The results obtained with the Valley "A" Power Unit are much more satisfactory than when a storage battery is used. There is always an even flow of full strength current which gives clear, powerful reception at all times.

The Valley "A" Power Unit comes in a handsome black enamel, satin finish case, complete with cord and plug.

List price \$39.50—f.o.b. St. Louis

Valley Automatic Charger

Combines the desirable features of all other types of chargers. Thanks to the Raytheon Element and Valley engineering ingenuity, this automatic charger has in its favor every factor for making it one of the biggest and most popular selling items on the radio market in 1937-28.

Charges at either 1½ or 2¼ amperes, controlled by a HIGH and LOW plug under the lid. Equipped with B Power supply receptacle and start and stop toggle switch. Equipped with automatic B power relay switch and battery charger control so that set and all accessories can be operated from the switch of your receiving set. We recommend it as far superior to trickle chargers.

Designed to charge 6-volt A batteries. Small, compact, black enameled case, satin finish. Comes complete with cord, plug, leads and clips.

List price, \$16.50—f.o.b. St. Louis.



Valley "B" Power Unit

Model 40—Designed for use with radio receivers of 5 and 6 tubes or less. Supplies all B current necessary including extra B voltage and C voltage required when a UX-171 power tube is used.

The tube supplied with this unit is the standard Raytheon Type BH tube which is ideal for this service.

Built compactly in black enameled case with C tap, detector and intermediate controls, and binding posts on front panel.

List price, \$37.50
(including Raytheon Tube)
f.o.b. St. Louis



(Model 60—The big Valley B Power Unit for all radio receivers up to 12-tube sets, lists at \$50.00 including Raytheon Tube.)

Valley Electric

Write the factory or the nearest office for further details, discounts, dealer helps, etc. VALLEY ELECTRIC CO., Radio Division, 4515 Shaw Avenue, St. Louis, Mo.

District Offices: Boston, Chicago, Cleveland, Detroit, Indianapolis, Kansas City, Minneapolis, New York, Philadelphia, Pittsburgh, San Francisco

Don't Miss the Biggest Show on Earth

BUCK TUBES Are The Best Performers

They Receive Royal welcome everywhere—
DEALERS all over the country are profiting thru their sales of **BUCK TUBES**.

Types—201A—199
—12— List price \$1.00 or One Buck.
Detectors and Powers.
Types—200A—112
—171
List price \$2.00 or Two Bucks.
A few good territories still open for Distributors.

UNIVERSAL ELECTRIC LAMP CO.
Newark, N. J.

Free—Latest radio log with every tube. Also a new line of attractive window displays.

CLIP TIME OFF WIRING JOBS BY USING

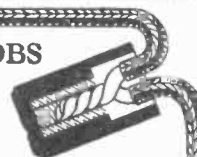
WIRE NUTS

Approved by the Underwriter Lab.
Cartons of 100—Standard Package 1000

For Free Working Samples Sign Below and Mail

Name _____
Address _____

COLT'S PAT. FIRE ARMS MFG. CO., HARTFORD, CONN.



List Price
\$1.00

Listed by Board of Fire Underwriters

"Cash in"

on the

ELECTRAD

Lamp Socket Antenna

Due to its superior features, the Electrad Lamp Socket Antenna is an easy-selling and profitable item.

This antenna makes every electrical outlet a neat, efficient aerial. It takes no current, does away with unsightly wiring, and is absolutely **SAFE**. Tested at 2500 Volts A.C.

Add this item to your stock, Mr. Dealer and "cash in" on the demand.

Write for full information

Dept. 85, 175 Varick Street, New York, N. Y.

ELECTRAD

Entertainment in ANY room of the house with THE HYATT PORTABLE

If you have a standard radio, it belongs to the family. If you have a Hyatt Portable, it belongs to you. Take it to any room—to your office—on trips, etc. When you travel, it provides entertainment en route, and at your destination it is still on the job.

The Hyatt Portable is a complete, self-contained unit, possessing the ideal characteristics of selectivity and tone quality. It is a receiver that practically eliminates static, reproducing the programs you like to hear clearly and with pleasing volume.

6 tubes—Single Dial—Loop Aerial—
Built-in Loud Speaker.



High grade two-tone brown leatherette case with nickel trimmings. Beautifully embossed loop panel in gold relief. 28 lbs., completely equipped.

\$95 without accessories



A New Model

Cash in on these possibilities with the Hyatt. Demonstrations result in sales. If your jobber cannot supply you with details, get in touch with us.

Try it and you'll buy it—Hyatt.



“If I had a retail radio business,

I'd tell my customers about the Improved Reliable Automatic Power Control Switch. It has so many advantages and so controls set operation that no set owner should be without it. This one sells at a startlingly low price and sells fast.”

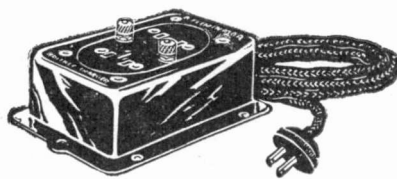

The low price of Reliable Relay Switches, from \$2.00 to \$3.50, gives dealers a decided advantage in competitive figuring on set installations. Every dealer knows that a Reliable Switch installation materially reduces his service calls.

The Reliable Switch prevents depleted filament current by keeping the Trickle Charger working every minute the set is not in use. Protects B Eliminator by preventing overload when Eliminator is not in use.

If your shelves by chance, are bare of this radio necessity, or if you haven't seen this switch, fill out the coupon below and mail it now, before the season gets into full swing.

The Reliable Parts Manufacturing Co.
Wellington, Ohio

RELIABLE Automatic Power Control Switch

THE RELIABLE PARTS MFG.
COMPANY
Wellington, Ohio

Please send me more complete information, dealers' prices, etc., on the relay switch you describe.

Name _____

Address _____

Name of Jobber _____

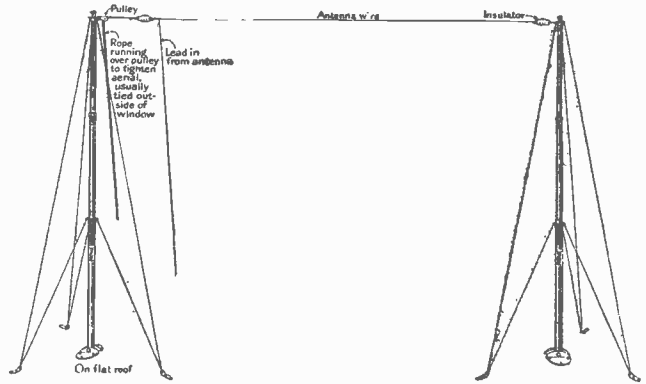

Easier, Simpler, Better Aerial Support

The adjustable Premax steel mast helps sell sets and keeps the customer satisfied with his radio because of its better reception.

7 and 10 foot masts telescope into convenient 4 foot sections. Easy to stock, easy to erect. Light but strong. Neat and attractive. Rust-proof, durable and priced lower than a good wooden pole.

Their convenience, economy and practical features are readily appreciated by dealer and customer alike. Write today for sample mast complete with guy wire, pulley and anchors.

**NIAGARA METAL
STAMPING CORP.**

Dept. RR-4

Niagara Falls, New York



10 ft. 3 section
Premax Mast No. M10

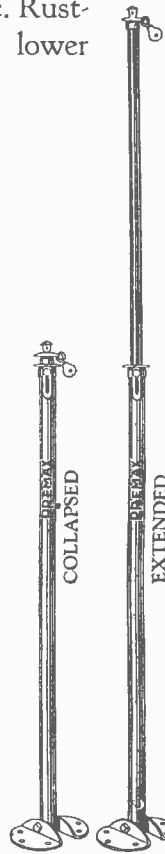

7 ft. 2 section
Premax Mast No. M7

Now!
 Plug In-and Tune In

A Real Electric Radio Set!

Three Year Guarantee

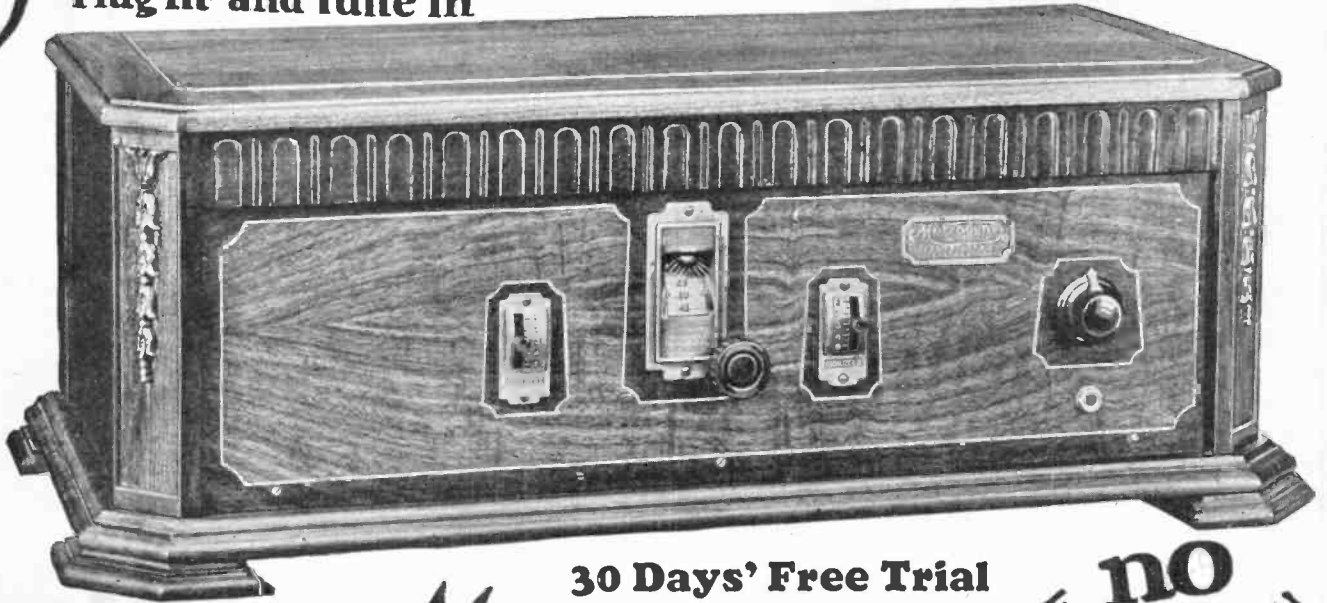

30 Days' Free Trial

Metrodyne
 ALL ELECTRIC RADIO

7 Tubes—Single Dial Set

100% Electric. Insert plug in socket—press switch button—and "it's on." The set illustrated above is the Metrodyne table model, single dial, 7-tube batteryless radio. Solid Walnut Cabinet, size 28x13x10, beautiful two-tone effect, handsome gilt metal trimmings. Made of the very highest quality low-loss parts. Has electrically lighted dial—easy to log stations, even in the dark. Excellent tone—wonderful volume.

Do not confuse the Metrodyne All-Electric radio with ordinary light socket sets, because the Metrodyne is truly an all-electric radio—consumes less than 2c. worth of electricity a day. Comes to you direct from the factory. We are so confident that you will be delighted with this wonderful, easy-to-operate batteryless radio that we offer to ship it to you for thirty days' free trial—you to be the judge.

no
~~A-Batteries~~
~~B-Batteries~~
~~C-Batteries~~
~~Eliminators~~
~~Chargers~~
~~Acids~~



Gorgeous Console ALL-ELECTRIC RADIO

Genuine walnut cabinet, in beautiful, two-tone finish. Built-in genuine Metrodyne large size speaker. Brings in programs with great volume, reproducing the entire range from the lowest to the highest notes with remarkable clearness and distinction. All metal parts finished in old gold. Wonderful electric radio, in a cabinet that will beautify the appearance of any home.



Height 5 ft. The Cone Speaker is 22 inches in diameter. The ornamental wrought iron stand is finished in old gold and beautifully Polychromed.

\$25

The New Metrodyne
 Most Wonderful Loud Speaker in the World

The scientific construction of the New Metrodyne has been recently perfected. Never before has such a remarkable loud speaker been sold at such a low price! The Metrodyne is not merely a horn—not just a loud speaker—but rather—a faithful reproducer of the broadcast programs, whether it be the soft, sweet notes of the mezzo-soprano or the thunderous crashes of the military band.

True radio reception has been made possible through the advent of the new Metrodyne. Now you can hear and enjoy the songs and music rendered by the world's greatest artists. The soft, lilting notes of the piccolo, the deep bass tones of the pipe organ—in fact, the entire range of instruments and of the human voice are reproduced with all the faithfulness of the original broadcast sound.

Dealers! Metrodyne All Electric and battery sets, Metrodyne Loud Speakers and Power Units offer you opportunities for big profit. Write for catalog.



\$18

Double cone design artistically decorated. Heavy ornamental base. Height 24 1/2 inches, diameter 22 inches.

METRO ELECTRIC COMPANY

2165 N. California Ave., Dept. 506, Chicago, Illinois

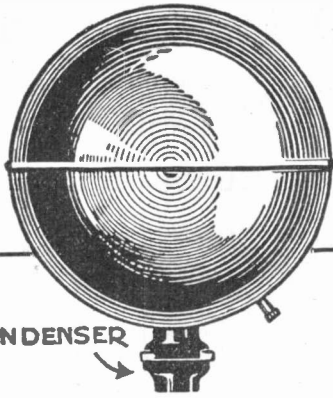

"Super Ball" Antenna

Add this profitable item to your line this Fall! Every owner of a radio set, every purchaser of a new radio is a prospect! Replace inefficient, corroded wire aerials and limited-reception loop aerials with the Super-Ball Antenna. Improves radio reception—is non-directional, gives greater selectivity, receives all wave lengths, helps to minimize static, clarifies tone, is attractive in appearance (10-inch aluminum alloy ball with built-in condenser), sheds ice and snow, is easy to install—and *pays you a good profit!* Lists at \$10.00. Backed by our 30-day unqualified guarantee.

Super-Ball Antenna Kit

Contains all materials necessary for complete installation of Super-Ball Antenna, including improved ground clamp, with full directions. List price, complete, \$4.50

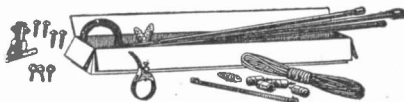

—and a revolutionary SUPER-SPEAKER!

It remained for the Super-Ball Antenna engineers to develop the Yar True-Tone Speaker—a speaker that is unlike all other speakers! Designed on scientific acoustic principles, combining a 27-inch tone column, distributing chamber and divisional tone chamber with cast aluminum construction, this speaker establishes a new standard of speaker performance! Equipped with 20 feet of power cord. Beautiful in design, attractively finished. Price, \$35.00.

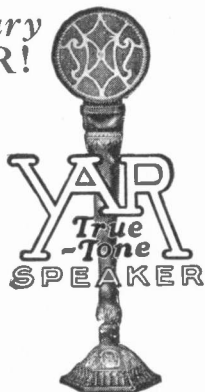

Ask your jobber about these Yar products and write us for detailed descriptive information. The Super-Ball Antenna and Yar Speaker will be supported by an extensive advertising and merchandising program this Fall.

YAHR-LANGE

MILWAUKEE

INCORPORATED

WISCONSIN

Notice to the Trade

Battery Eliminators, Power Amplifiers and Power Operated Sets now being offered for sale embody the application of one or more of the following United States Patents, controlled by the undersigned, viz.:—

1,455,141 May 15, 1923

1,606,212 Nov. 9, 1926

1,635,117 July 5, 1927

In addition this Company now has pending many patent applications covering improvements for the operation of radio receiving sets from power lines, means for similarly operating power amplifiers and loud speakers and battery eliminators for use with radio sets.

The following are licensed under one or more of the above patents, according to the nature of the device produced or used, viz.:—

Willard Storage Battery Co.

Fansteel Products Co., Inc. (Manufacturers of Balkite)

Federal Brandes, Inc. (Manufacturers of Kolster-Brandes Receivers, Power Amplifiers, Power Horns and Battery Eliminators)

Philadelphia Storage Battery Co. (Manufacturers of Philco)

Argus Radio Corporation

J. S. Timmons, Inc.

Grigsby-Grunow-Hinds Co. (Manufacturers of Majestic)

U. S. Government.

Practically all battery eliminators and radio sets operated from alternating current presently on the market infringe in one or more particulars, some or all of the foregoing patents.

Infringers will be prosecuted and all unauthorized manufacturers are warned to cease the manufacture, sale or distribution of articles which wholly or partly infringe upon any of these patents.

The distribution and sale of infringing devices renders the seller thereof separately liable to suit for injunction and accounting for damages. Unauthorized apparatus can be readily identified by the notice of one or more of the foregoing patents, conspicuously marked thereon.

DUBILIER CONDENSER CORPORATION

4377 Bronx Boulevard
New York, N. Y.

The OUTSTANDING



**"A"
BATTERY**

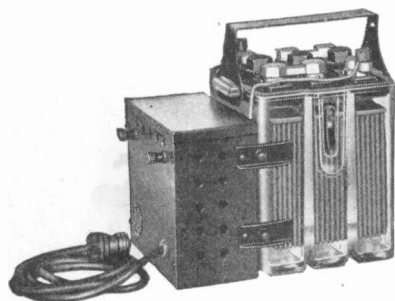
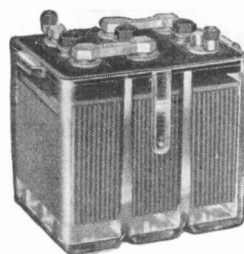

**POWER
UNIT**

"B" ELIMINATOR

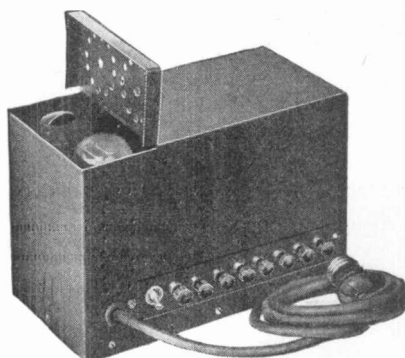
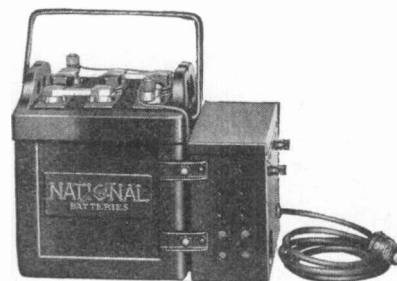

of the season is the

NATIONAL

Radio engineers and testing laboratories endorse them, radio users demand them—because National has combined simplicity of operation, compact, fool proof design, and long, carefree service with remarkably low prices.

"A" and "B" Power

A New National development—not bulky or clumsy, a combination of the National "B" Eliminator with any National Power Unit, easy to stock and a "self-seller" if there ever was one.

This season offers greater opportunities than ever before to National jobbers and dealers. There is still time to have National insure your radio profits. Wire or write for full details of the National franchise.

See Our Exhibit at the

**FOURTH ANNUAL RADIO
WORLD'S FAIR**
New Madison Square Garden, New York
September 19th to the 24th, inclusive
Booth No. 2, Section G.G.

**SIXTH ANNUAL CHICAGO
RADIO SHOW**
Coliseum, Chicago
October 10th to the 16th, inclusive
Booth No. 20, Section H.H.

NATIONAL LEAD BATTERY CO.

General Offices, St. Paul, Minn.

Factories: St. Paul, Chicago, Kansas City, Los Angeles

Branches: New York City, Dallas, Oakland, Atlanta, Portland (Ore.), Baltimore, St. Louis, Seattle, Cincinnati

Crowe

Metal Panels Cable Markers Escutcheons and Name Plates

Metal Panels

Made of brass, bronze, or steel, formed or flat, to meet every requirement of the radio manufacturer. Processed in walnut, mahogany or burlled walnut

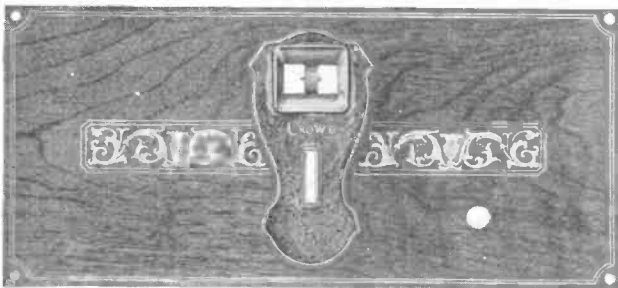

finishes, in combination with etched or lithographed designs. Escutcheons embossed directly on panel, if required.

Escutcheons and Name Plates

Produced in a wide variety of beautiful finishes, etched and embossed, with formed or drawn windows or openings for tuning drums and controls. Expert die makers and adequate facilities for executing intricate designs at reasonable cost.

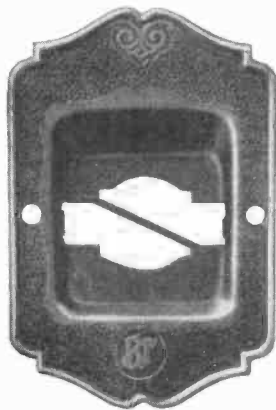

Cable Markers

This marker has been designed primarily to meet the requirements of receiving set makers. Fits snugly to cable. Particularly adapted to "bunched" leads, or when cables must be drawn through slots or holes. Markings etched in legible black characters. Stocked in all standard markings or made to order when special markings are needed in quantities.

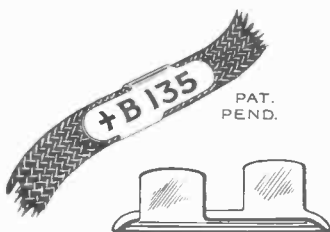

**CROWE NAME PLATE &
MANUFACTURING CO.**

1740 Grace Street, Chicago, Ill.

Televocal Quality Tubes Win the Fans

Because of the TELEVOCAL SUPPORT which prevents "shorting" and microphonic noises—a feature that fans recognize instantly—Televocal Quality Tubes are a profitable and fast-moving item. The special boxes permitting the tubes to be tested in the containers are also a convenient selling aid. We manufacture a complete line of Televocal Tubes in all standard types.

Dealers, Order Through Your Jobber



Televocal Corp'n
Televocal Building,
Dept. E1, 588 12th St.,
West New York, N. J.

**TELEVOCAL
QUALITY
TUBES**

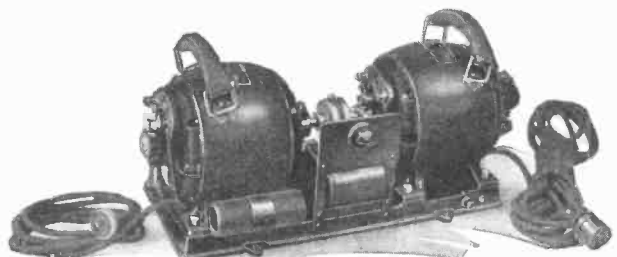

BODINE D. C. TO A. C. CONVERTER

For Operating Alternating Current Radio Sets and Devices on Direct Current Supply

Dealers located in D. C. districts can demonstrate A. C. radio sets and devices with perfect reception by using the new Bodine Radio Motor-Generator Set pictured above. A built in filter system absolutely eliminates all noise. Can be operated as close to set as desired. No complicated wiring necessary—just plug into radio set and D. C. socket. Capacity 250 watts, ample for the largest radio and phonographic combinations.

Write for Description and Price.

BODINE ELECTRIC COMPANY, 2242 W. Ohio St., Chicago, Ill.

RADIO AT WHOLESALE

WRITE for my Big 1928 Radio Catalog—just off the press. Thousands of nationally advertised items listed. All the LATEST IN RADIOS and equipment. It's a regular encyclopedia on Radio. *FREE Log and Call Book* and Catalog. Get your copy today. Send postcard now!

American Auto & Radio Mfg. Co.
Dept. 753, American Radio Bldg.
Kansas City, Mo.





Note complete shielding of coils, condensers, transformers and wiring. Most rigidly built chassis on market. All metal, re-enforced. Beautiful metal panel 7" x 18". Illuminated dial, graduated in kilocycles and degrees, moves horizontally. No oscillation.

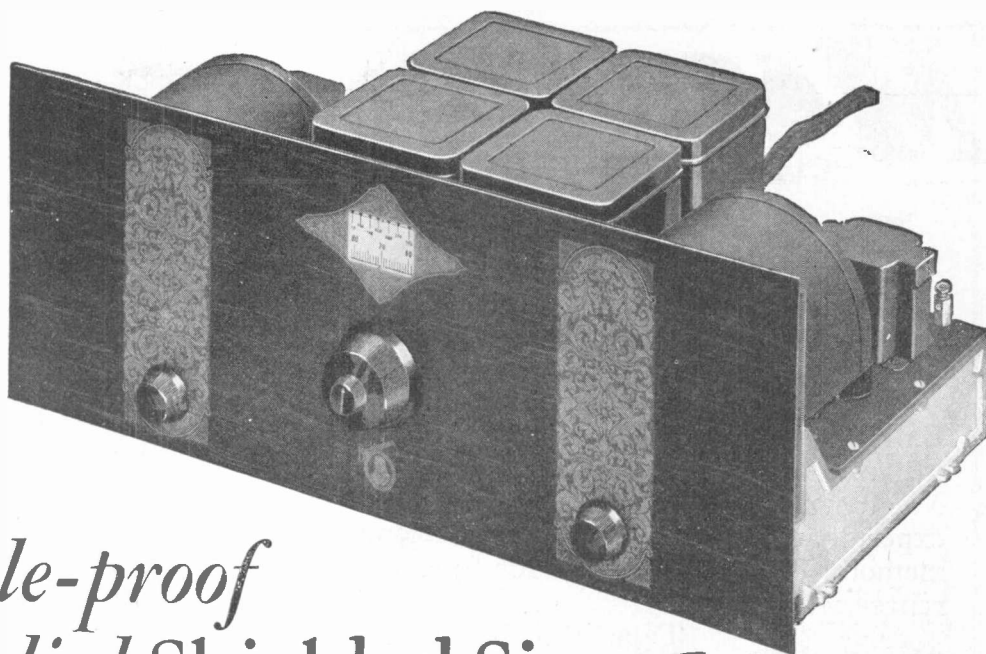

The trouble-proof one dial Shielded Six — Guaranteed

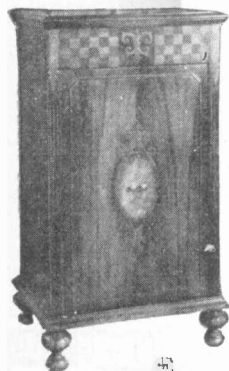

Buckingham Perfect Orthophonic, Model 20. Built of rare imported woods, strikingly finished. Built-in 34 in. tone chamber, Utah unit.

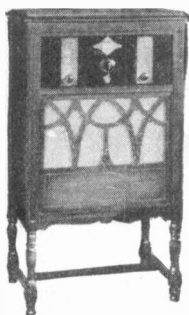

Buckingham Semi-Hiboy Console Model 2. Genuine walnut plywood, beautifully finished.

WHEN the season is at its height, you want sets to arrive in 100% perfect condition—ready for you to deliver with confidence that they will work as promised and stay sold without "servicing."

The new Buckingham All-Metal Chassis insures this. It is the most rigidly built chassis on the market—re-enforced—with every part completely protected. It ships without damage.

For selectivity, tone, volume, distance and ease of operation, the new Buckingham Shielded Six will thoroughly please even your "fussiest" buyers—giving anything that no other radio can offer.

All parts scientifically matched before and after assembly. They are highest quality. They bear famous names. The coils, for example, outperformed 200 other types in a recent official laboratory test.

The one-dial enclosed control, a Buckingham invention, cannot

back-lash, will not get out of order. Small vernier permits fine tuning, giving 3 dial accuracy.

Three stages of powerful distance amplification, detector (in cushion socket) and two audio stages deliver equal volume without oscillation from 200 to 550 meters. Positive replacement guarantee.

The beauty of the Buckingham instantly strikes the eye. The panel is rich and dignified. The shielded chassis "looks like a million dollars"—and performs the same way.

The "eye-appeal" is completed by handsome cabinets—from fine table consoles to gorgeous Orthophonic-type consoles.

Perfect, trouble-proof performance plus distinctive appearance—at low prices, with provision for a "long" profit to yourself! The Buckingham Dealer Franchise will give you a most decided edge on competition. Send coupon today for full particulars.

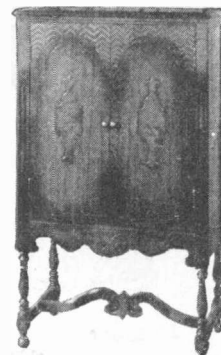

Buckingham Perfect Console, Model 18. Beautiful woods, delightfully contrasted. Built-in 52 in. tone chamber, Utah unit.

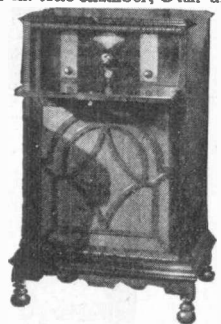

Buckingham Orthophonic Junior, Model 5. Built-in 48 in. tone chamber, Utah unit.

BUCKINGHAM RADIO CORPORATION
C H I C A G O

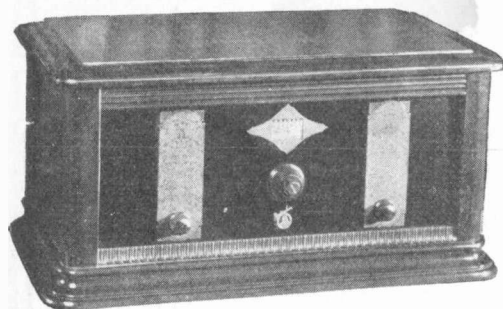

Solid walnut, matched burl sides and top, beautiful lacquer finish. Full nickel piano hinged top with stop. A real piece of fine furniture, guaranteed to ship without damage and not to warp or blemish in use.



RE M I N D E R

Write
BUCKINGHAM RADIO CORPORATION,
DEPT. 1309
General Offices: 25 East Austin Ave., Chicago

Without obligation, you may send your catalog illustrating the complete line of Buckingham console cabinets—also particulars of the Buckingham Dealer Franchise.

Firm.....
Individual.....
Address.....
City..... State.....

MAGNAVOX

electro dynamic

Power Cone Speakers

Built under exclusive patents on electro dynamic principle made famous by Magnavox. Recognized by technical experts and music critics as the one method of construction for perfect reproduction.

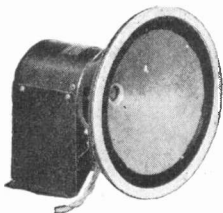

R-4 Unit



Beverly

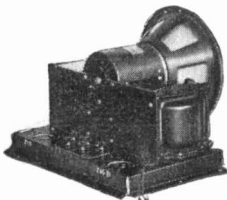

R-51 Unit



Lobby Cabinet

Type R-4 has 6-volt 1/2-ampere field. Type R-5 for A.C. radio or phonograph circuits using field as the choke in filter pack. Unit designed for easy installation in radio and phonograph cabinets. List prices: R-4, \$50; R-5, \$55.

Beverly cabinet speaker complete with R-4 unit, cords, switch, \$75. Requires 6-volt A battery for power supply.

Type R-51 unit is R-5 with built-in power amplifier and rectifier using one 216 and one 210 tube. List \$120. Easily installed in your radio or phonograph cabinets.

Lobby cabinet speaker, complete with R-51 unit, cords, etc. \$165.

These speakers and units are being nationally advertised and are selling extensively. You should know about this advanced development in radio.

Send at once for special bulletins about electro-dynamic and permanent magnet type speakers and units—also name of nearest Magnavox distributor.

The Magnavox Co., Oakland, Calif.
Chicago Sales Office: 1315 So. Michigan Avenue



Radio dealers recommend and use the

ekko Ground Clamp

because it eliminates the high percentage of radio troubles due to faulty ground

Imperfect ground contacts are responsible for a high percentage of all radio troubles. The ekko Clamp eliminates these troubles by insuring perfect contact. Radio dealers know this. That is why they include an ekko Clamp with radio set installations and instruct their service crews to use it in replacing old faulty grounds.

The hardened steel points of the ekko Clamp bite through paint, rust, dirt, corrosion or any other insulation. Its positive contact insures full signal strength. Easy to use. Ground wire screws to Clamp. Clamp attaches to nearest pipe by a turn of the screw. Non-corrosive, permanent. Finished in white nickel. Fits 1/4 to 1 1/4 inch pipe. At your dealer's.

25¢



Radio Dealers:

The ekko Clamp is supplied in lots of ten in an attractive counter display that helps you sell this most popular of all ground clamps.

THE EKKO COMPANY

111 West Monroe Street, Chicago, Ill.

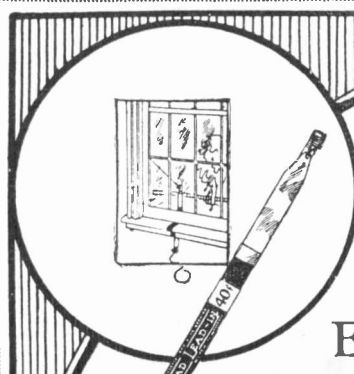

Why the Fans Want
ELECTRAD

CERTIFIED LEAD-INS
LIST PRICE 40c.

- 1—Bends any shape to fit around corners and under locked windows.
- 2—Improves reception by stopping losses and short circuits.
- 3—Triple-ply insulation full 10 inches long covered with waterproof webbing.
- 4—One-piece copper strip heavily tinned to prevent corrosion.
- 5—Riveted and soldered connections.

Stock and sell the ELECTRAD Certified Lead-In—it satisfies!

Write for full information.

Dept. 86, 175 Varick Street, New York, N. Y.

ELECTRAD

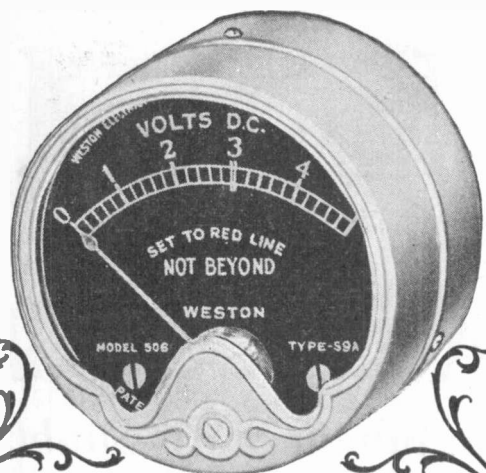

IN KEEPING WITH THE
CHARM OF THE FINEST SET

This little instrument with its green gold finish and black dial with gold markings will richly adorn even the most expensive cabinet.

Unusual accuracy and other typical Weston features augment this attractive design, but its great value, however, is its aid to better reception and the service it renders in extending the useful life of tubes and batteries.

It is intended for use with dry cell operated sets equipped with voltmeter pin-jacks—inexpensive, too, so that every set should have one. Accurate for a life-time and this mark is your guarantee of highest quality.



STANDARD THE WORLD OVER
WESTON
Pioneers since 1888



Dealers should stock this Model 506 Pin-Jack Voltmeter in time for a profitable season's business. Advertising in Radio magazines of set owner circulation during the fall and winter is sure to create a wide demand. The price is right and for quality and accuracy no similar instrument can compare with it. Put this down in your jobber-book for early delivery.

WESTON ELECTRICAL INSTRUMENT CORP.
25 Weston Avenue Newark, N. J.

ADJUSTS UPRIGHT WITH ANY PIN-JACK ARRANGEMENT

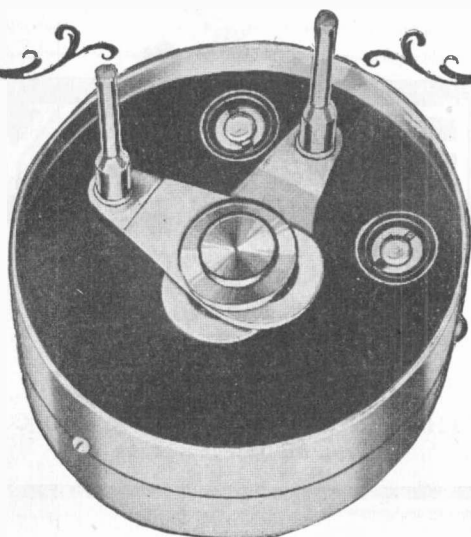

"This year it's the
ACCUSTI-CONE

the famous original 3 ft. Giant
Double Cone Speaker Kit"

Because of its

"Unequaled Tone Quality"



Must be seen to be appreciated.
Order now or write Dept Z.R. for catalog.

List Price
\$12.50

Stand \$2.50
Extra

"Accusti-Cone" means prompt and plentiful sales, because the "Accusti-Cone" satisfies the customer.

Dealers be sure now to get your share of these sales and enjoy your full profit by selling "Accusti-Cone," the speaker-kit that is in great demand.

EACH KIT CONSISTS OF:—

- | | |
|--|----------------------------|
| 1 Special Accusti-Cone Unit, adjustable. | Accusti-Cone Cement. |
| 2 Sheets genuine Fon-O-Tex. | Inside Metal Unit Support. |
| Alhambra Low Frequency Paper, circular cut, decorated and ready to cement. | Apex Fittings. |
| One laminated Back Baffle Ring. | 1 Phone Connecting Cord. |
| One wooden Mounting Base for Unit. | 1 Metal Handle. |
| | 1 4" Reinforcement. |
| | Screws, Bolts, etc. |
| | Full Instructions. |

24 IN KIT \$11.00

The "Accusti-Cone" operating mechanism is most powerful and adjustable to any receiver. Guaranteed to take 500 volts. Truly equal to any speaker selling today up to \$75.

Accusti-Cone sold through recognized wholesale channels. Inquiries from reliable distributors will receive prompt attention.

ACCUSTI-CONE LABORATORIES
11 N. 7th St. Philadelphia, Pa.

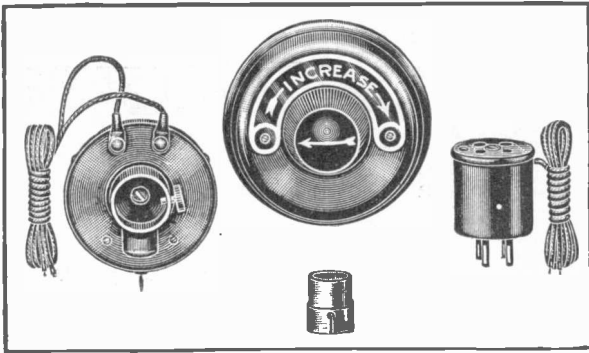

Via-Rad

ELECTRIC PHONOGRAPH REPRODUCER

Via-Rad is a proven B.M.S. product that can be quickly attached, without tools, to any phonograph to change the phonograph into a radio operated instrument of unsurpassed quality for the true and life-like reproduction of voice and music.

The Via-Rad set consists of the following units as shown above—one electric phonograph reproducer to replace the phonograph sound box, one Via-Tector which fits into the detector socket of the radio set and one Via-Trol which regulates the reproduction from a mere whisper to the loudest volume.

Big Field for Sales and Profits

Every owner of a phonograph is a prospect for a Via-Rad. Simply give a demonstration and four out of five prospects buy. It surpasses any other electric pick-up for quality and value.

List price of \$10
Via-Rad set complete.....

Write or wire today for complete particulars and discounts.

See the Via-Rad and Complete Line of B.M.S. Radio Parts at New York Radio Show, Booth 7, Section CC.

BROOKLYN METAL STAMPING CORP.
718-728 Atlantic Avenue, Brooklyn, N. Y.

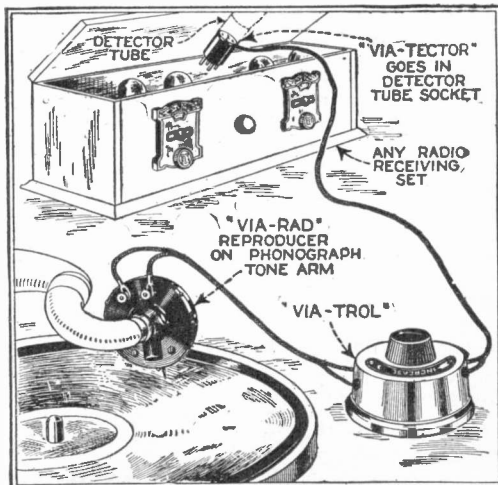

This illustration shows the connections of the Via-Rad and the simplicity of the entire arrangement.

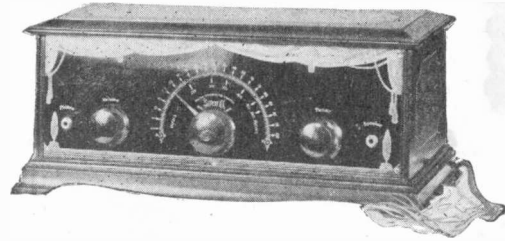

Ah! . . . look!

an inbuilt Static Snubber!

Pat. Pdg.

- | | |
|-------------|--------------------------|
| Clarity | Beauty |
| Selectivity | Price—\$80 up |
| Distance | Attractive Discount |
| Volume | Exclusive Territory |
| Easy Tuning | Co-operative Advertising |

Test Sample—secure YOUR territory

SUPERFLEX

Pat. 8/17/27 No. 52913

RADIO PRODUCTS CORP., INC.
3816 N. 28th St., Birmingham, Ala.

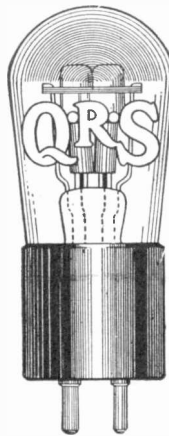

For Your "B" Battery Eliminator
Ask Your Dealer for Guaranteed

Q · R · S

Trade Mark Registered
Gaseous

Rectifier Tubes

Are Better

- | | |
|---------------------------|---|
| 60 Milliamperes
\$4.50 | 400 Milliamperes
With Ionizer
300 Volts for A, B and C
Eliminators with
Charts and Diagrams
\$7.00 |
| 85 Milliamperes
\$4.50 | |

Manufactured by the Q · R · S Company
MUSIC CHICAGO

Established 1906. References: Dun, Bradstreet or any bank anywhere

ELKAY

TRADE MARK REG.

RADIO PRODUCTS

Equalizers, Suppressors, Drum Dials
Battery and Electric Sets

Write for Catalog

THE LANGBEIN-KAUFMAN RADIO CO.
Dept. M, New Haven, Conn.

CYCLONIC!

That Expresses the Trade's Opinion on the Success of the

New Cleartone

JOBBERS and dealers who have investigated the new Cleartone *Electric* Radio Receiver have been unstinting in their enthusiasm.

It was *proved* a dependable A. C. electric powered set in thousands of American homes last season. It is therefore not an experiment.

Its cabinet designs are as distinctive as its electrical construction. Beauty, charm and dignity expressed in solid mahogany and walnut.

And in addition, a real big appealing feature to the trade is the "retail" style and commanding size of the newspaper advertising campaign. All these advertisements clinch the reader's favorable opinion and they will run in *YOUR* territory.

Write Today. Let us tell you about this fast seller and its merchandising plan.

THE CLEARSTONE RADIO CO.
Division of The Cincinnati Time Recorder Co.,
Cincinnati, Ohio

The New Cleartone

Electric Radio Receiver

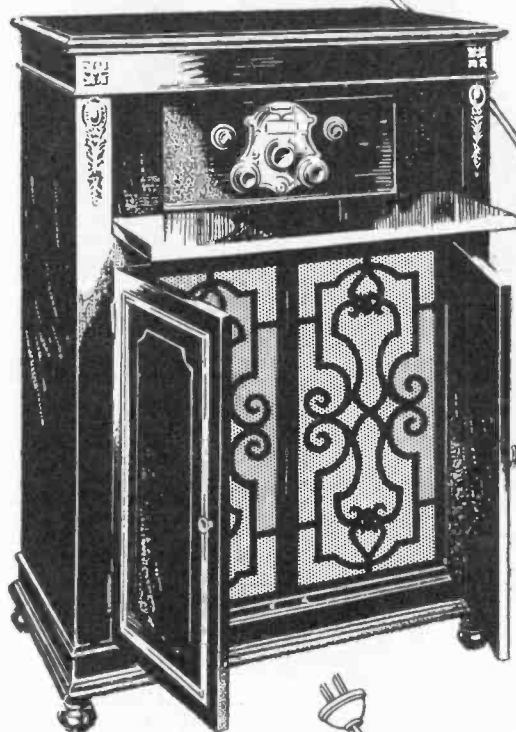

The CLEARSTONE "CONGRESSIONAL"
List \$375.00

The ultimate in radio and furniture design. Built-in loudspeaker. Price, complete with tubes, ready to attach.]

Other Models

- The "SENATOR" \$325
- The "MAYFLOWER" \$250
- "110 COMPACT" \$195

30 Years of Craftsmanship

For thirty years the master craftsmen of The Cincinnati Time Recorder Co. (of which The Clearstone Radio Company is a division), have been responsible for distinguished cabinets for hall clocks and time recorders. These master craftsmen are the builders of the New CLEARSTONE Electric Radio Receiver.

The **SONOCHORDE** Junior

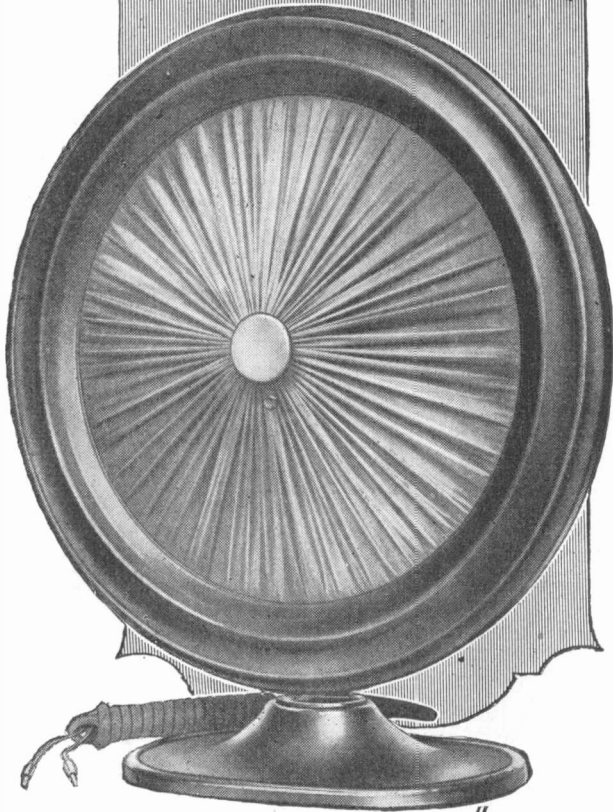

Now you can offer your trade all the quality—all the exclusive features of the wonderful—**\$15** SONOCHORDE Cone Speaker at the nominal price of \$15.00. SONOCHORDE Junior, only slightly less decorative than the regular model, is bound to be one of the fastest selling Cone Speakers ever manufactured. The protected back practically guarantees SONOCHORDE being trouble-proof. The silk front wins instant approval with both men and women alike and the marvelous tone quality simply carries the listener away with rapture. Learn more of these wonderful Cone Speakers today.

Write for details, circulars, etc.

BOUDETTE MFG. CO.
Chelsea, Mass.
Dept. C.

Model A—2 larger, more decorative, with fuller volume, operates successfully on all receivers, including power sets.



\$25

We Are **DELIVERING**
Our Customers Are **PLEASED!**
GENERAL INSTRUMENT
66 99
PERMANENT

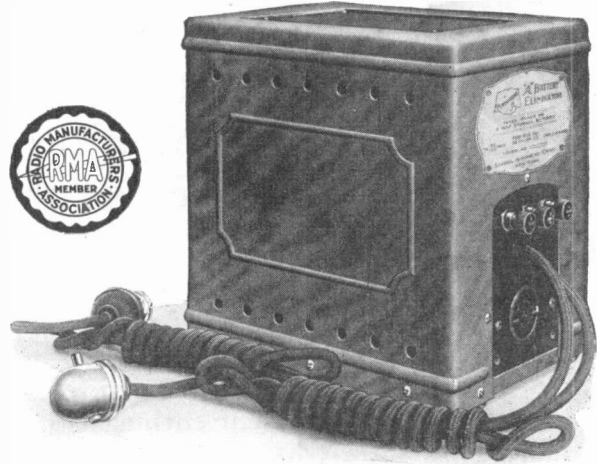

Eliminator

THE PERMANENT "A" is a GENUINE eliminator. It does NOT employ a trickle charger or a storage battery in any disguise whatsoever. The fact that no power is delivered to radio receiver when main line is cut off proves this beyond a doubt. Make this test and convince yourself.

The PERMANENT "A" has no tubes. There is no acid to spill. No AC hum on any set. This instrument is the first unit to successfully supply "A" filter current without causing any disturbance in the radio receiving set. There is no rewiring whatever required. Simply connect the PERMANENT "A" the same as you would connect your storage battery.

Requires no dealer service. Every PERMANENT "A" sale will make a permanent customer. Write or wire TODAY for further details.

PERMANENT "A" Eliminator: Delivers 2—2½ amperes. Operates on 110 volts A.C., 60 cycles. Consumes only between 50 and 60 watts at maximum load. Size 8¼ inches high, 6 inches wide and 8½ inches long. Weighs approximately 21 lbs.

List Price
\$39.50

The PERMANENT "B" Eliminator is housed in a container the same size and finish as the PERMANENT "A". This PERMANENT "B" will deliver 180 volts at 60 mils. Suitable for any set. Lists for \$42.50.

GENERAL INSTRUMENT CORP.
477 Broadway, New York City

"That EXTRA 10%"

Thousands of radio dealers know the cost of doing business (dealers' overhead expense) is 35% to 40%, yet the customary dealer discount on standard sets is only 40%.

FREED EISEMANN RADIO

recognizes the dealer's need for a *larger gross profit*... The Freed-Eisemann distributor has a plan by which 40% and 10% discount on sets is available to you. That *extra 10%* may mean the difference between profit and loss at the end of the year.

EXTRA PROFITS

Proved by Hundreds of Letters Like This

"I made 9½% on my sales last year. If I handled any of the other nationally advertised standard sets that give only 40%, I would have done a year's business without any profit. That extra 10% is a life-saver to the dealer. This year I'm going exclusive on the Freed-Eisemann line. The new Electric is a WOW!"

PERFORMANCE

Proved by Hundreds of Letters Like This

A dealer in Warsaw, Wisc., writes the Interstate Sales Co., his distributor—"We have never before been able to get Chicago or Minneapolis on any set in the morning and we have practically all of them. We are getting both every day on the NR-9. I have tried out the other models in the line and feel we really have got something big this year".

—and Freed-Eisemann Radio is Patent Protected!

Licensed under Latour, Hazeltine-Neutrodyne and Radio Corp. of America Patents

FREED-EISEMANN RADIO CORP., Junius Street and Liberty Avenue, BROOKLYN, NEW YORK

ARCO—ARCO—ARCO—ARCO

Here's the line hundreds of dealers asked about... and bought!

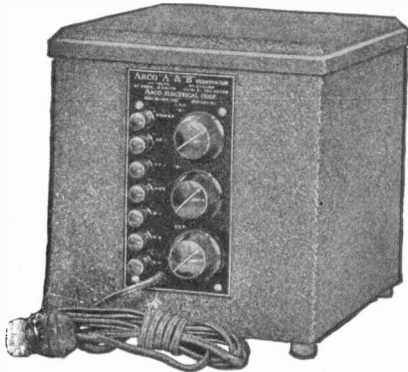

Arco "AB" Power. Just plug in and forget it. 2 1-2 amp. at 6 V and 80 M. A. at 180 V. Complete \$67.00

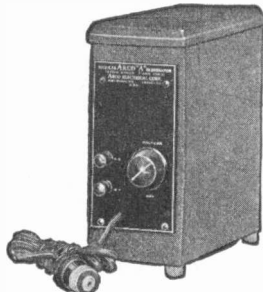

Arco A Power 2 1-2 amp. at 6 V. \$37.00

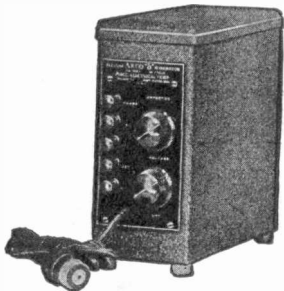

Arco "B" Eliminator. 50 Mil. Amp. at 180 V. Complete \$32.50

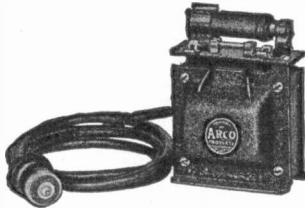

Hi-Rate Charger No. 6. 2 1-2 amp. \$11.50.—5 amp. \$18.00



Arco "A" Power. 60 amp. battery with 2 1-2 amp. charger, automatic control. Complete \$33.00 to \$37.00

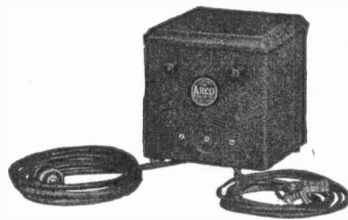

Hi-Rate Charger [HRC1] Automatic cutout—attach to your present "A" battery and you have a power unit. 2 1-2 Amp. \$18.50—5 Amp. \$25.00

Prices slightly higher West of Rockies and in Canada.

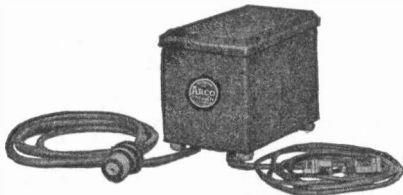

Hi-Rate Charger [HRC3] same as HRC 1 except less automatic cutout. 2 1-2 amp. \$12.50—5 amp. \$19.50

ARCO ELECTRICAL CORP.
825 BARR STREET, FORT WAYNE, INDIANA

Please send me details on Arco
Send me miniature catalog []

Name _____

Address _____

City _____ State _____

ARCO—ARCO—ARCO—ARCO



Overall Dimensions 18 in. x 31 1/2 in.

Available in three attractive designs.

Type P.1.

Baritone Picture Cones Radio's Latest Utility

Beautiful oil paintings on genuine velvet. Add to this a mellow-toned Baritone Cone Speaker, and you will readily appreciate the unusual value in these Baritone Picture Cones.

The cone speaker and unit are efficient on all pitches. You hear rounded notes throughout the entire audible range, and the speaker and unit are so mounted that not only does the sound deflect from the wall, but actually comes through the picture.

9 IN. BOX CONE

Especially designed to fit in consoles. Is a marvel. Must be heard to be appreciated.

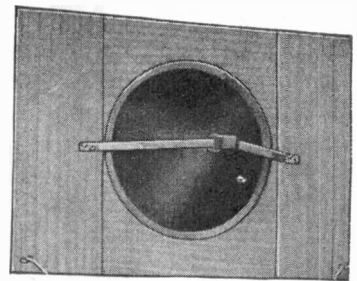

The many applications of the new box cone with its excellent reproducing qualities has caused wide comment throughout the trade. Write for complete specifications.

All Baritone Speakers offer genuine and natural radio reception with perfect amplification over the entire audible range.

BARITONE MFG. CO.
844 W. Jackson Blvd., Chicago, Ill.

BARITONE

An Astounding DIFFERENCE
in Sharper Tuning and Clarity beyond belief—
until your own Ears
PROVE IT!

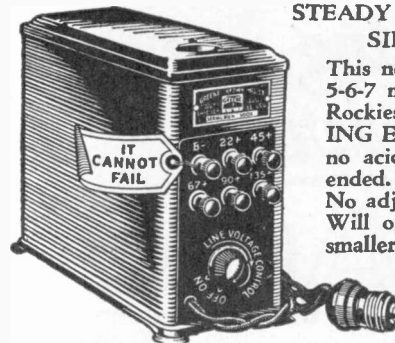

STEADY AS A RIVER'S CURRENT
SILENT AS A SUNSET

This new, complete GREENE "B" 5-6-7 model lists at \$27.50 east of Rockies, including Tube. **NOTHING ELSE TO BUY.** No liquids, no acids. All battery annoyances ended. Brings results unequalled. No adjustments—all voltages fixed. Will operate all sets of 7-tubes or smaller. Any set-owner can connect it. Never needs servicing. Insured against short-circuiting.

Millions wait

to Compare... **ACCLAIM**... and Demand
this "finest-of-all" Radio **POWERS**

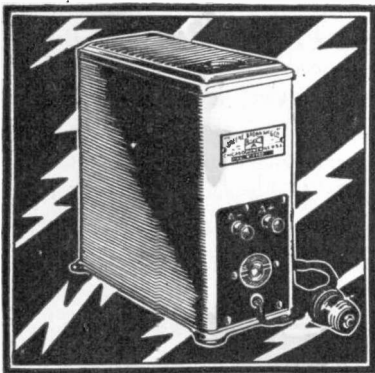

Radio "A" Power

.....*Simplified!*

Practical in design. Unfailing in performance.

A 2½ ampere, 6-volt unit for all sets up to 10 tubes. All advantages of super-battery power with all troubles banished. Superior to any other "A" power now available. Entirely Automatic. List, east of Rockies \$30.00. Complete.

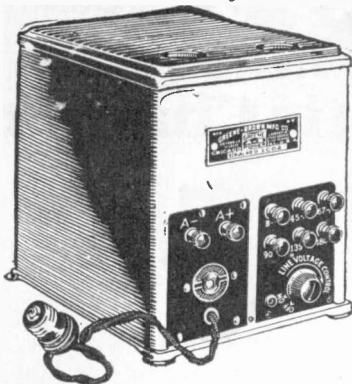

"AB" ALL-IN-ONE

An incomparable combination of the GREENE "A" and "B" Hi-Power units in one case, for all sets up to 10 tubes. Automatic, controlled, by receiving-set switch. Sold complete with tube. List east of Rockies, \$60.00.

PROBABLY never before, has any industry witnessed a change in dealer and public preference more phenomenal than accorded this new, low-priced GREENE-BROWN line, since first exhibited at the RMA Trade Show in June.

In this greatest-of-all radio selling seasons our new enlarged plant production is keyed up to the highest peak in our history—working day and night to meet an unprecedented demand—a demand that week after week shows greater gains.

Sales leadership was inevitable for the GREENE-BROWN line this year. No dealer fully acquainted with the wants of his set-owner customers, will fail to provide this "better than batteries" satisfaction; the unfailing service and the supreme advanced engineering principles which enable GREENE-BROWN Power Units to outperform so many

higher-priced devices. Words cannot adequately describe such performance. Utterly *beyond comparison*, provable in any test.

Here is an *entirely* FOOL-PROOF line for battery-less Radio—an "A" and "B" model for every set. Here are scientific, yet highly *simplified* devices for *over-the-counter* selling. Any qualified dealer, by concentrating on the GREENE-BROWN line with enthusiastic support can profit *richly*. No servicing necessary. The sale *completes* the deal.

Dealer outlets in all territories will be limited. Before too late, write now, or **WIRE** for selling franchise, and names of nearby jobbers.

SOLD WITH AN ABSOLUTE
GUARANTEE

GREENE
POWER AB UNITS
Better than Batteries

Get the FACTS

Greene-Brown Mfg. Co. (Dept. E3)
5100 Ravenswood Ave., Chicago, U. S. A.
Please send full description of GREENE Units.

Name

Address

PIN COUPON TO YOUR LETTERHEAD

The New Complete
GREENE "B" Hi-Power
For heavy-duty 10-tube sets.
List, east of Rockies \$30.



The BROWN "B"
SUPER-POWER \$33.50
For all extra-sensitive sets
up to 12 tubes. Formerly
\$39.50.



TOMORROW'S RADIO POWER FOR TODAY'S ENJOYMENT

Announcing Harvard ELECTRAPOWER

Radio Power Units and Battery Eliminators

The most sensational proven successes of the field of Radio Power devices are the Harvard Power Units and the Harvard Battery Eliminators, the best devices to be obtained at ANY price—and yet sold at an EXTREMELY MODERATE PRICE.

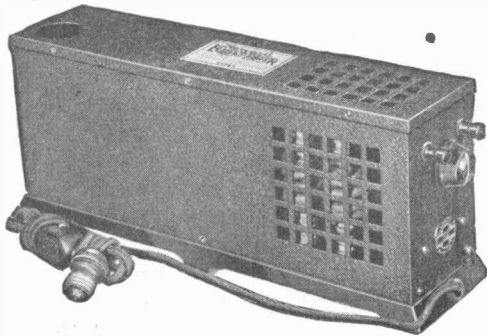

HARVARD Battery Eliminator

Types C, D and E—"A" Battery Eliminator
Type ABC—"A", "B" and "C" Battery Eliminator

Quiet, constant, power. No bulbs; no acid. No batteries of any description, paste, jellied or otherwise. Operates direct from light socket—only uses current when set is in use.

Type "C" List \$39.50

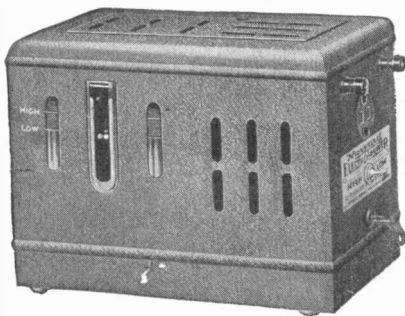

HARVARD Automatic Power Unit

Complete and unfailing "A" supply for Radio Sets of any size. Operates direct from light socket. No tubes; no moving parts; no trouble; absolutely silent. Contains specially designed glass cased battery.

Type R \$28.50

THESE HARVARD products give Radio results that will astound you upon demonstration. And at their extremely low prices they can be featured extensively.

Let us send you full information.

AMERICAN STORAGE BATTERY CO.
339 A Street,
Boston, Mass.

Makers of the famous

HARVARD STORAGE BATTERIES



\$8.00

The HANDY Full Automatic Switch

The Handy Separate Potential and Series Relay offers you something to sell to those who already have an "A" battery and charger and "B" power unit. By means of the switch, "A" and "B" power is placed under automatic control. It automatically connects charger to battery when radio filament switch is turned off and automatically disconnects charger when full "A" battery strength is reached or filament switch is turned on. Also automatically turns "B" power unit on and off as set is turned on or off. Big seller with nearly all set owners or prospects.

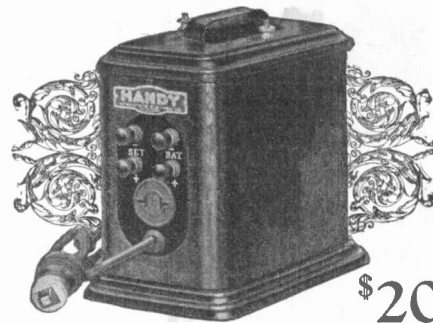

\$20.00 COMPLETE

The HANDY Automatic Charger

Here is a charger having the automatic features made possible by the switch illustrated and described above. Employs either Tungar or Raytheon Type Rectifier. Charges at 2 to 2½ ampere rate. Effective and dependable—a charger you can safely recommend. In its new green Krakle case, the Handy is an accessory whose beauty is only rivalled by its ability to furnish dependable automatic charging service. Ask your jobber about the Handy line. Write now for descriptive literature, prices and discount to the trade.

INTERSTATE ELECTRIC COMPANY
4351 Duncan Ave. St. Louis, Mo.

Before We Attempt to Enter Your Store Balsa Wood Has Something to Say



One of the attractive
Lata Balsa Reproducer
designs.

THE last remaining obstacle to perfect radio reproduction has been removed by the use of the Lata Balsa reproducer which uses as a diaphragm a wide expanse of carefully selected and treated Lata Balsa Wood.

Through a fortunate coincidence which has been elaborated upon by designers of the Balsa Wood Reproducer Corporation, the appearance of this reproducer, a model of which is illustrated, is such as to make it a real work of art and an adornment which fits into the furnishing scheme of any tasteful home.

The remarkable, non-resonant characteristics of the Balsa diaphragm, its ability to reproduce any frequency in the musical scale and its attractive appearance and decorative possibilities are rapidly gaining for this speaker a wide acceptance among radio and acoustical experts.

DEALERS

Lata Balsa Reproducers are so new both in operating principle and especially appearance that a marked demand has been created over night.

We are opening up your territory for distribution of speakers.

For detailed information write to either the Balsa Wood Reproducer Corporation or to Arthur H. Lynch, Inc.

Balsa Wood Reproducer Corp.

331 Madison Ave., N. Y. C.

Sole Distributor

ARTHUR H. LYNCH, INC., General Motors Bldg., 1775 BROADWAY, N. Y. C.

TIP TABLE CONE SPEAKER *Model 70*

is Furniture as well

MODEL 70 shown at right, is the new Teletone Tip Table Cone Speaker. It stands out not only as a new Teletone, but as an astonishing advance in cone speaker designing and reproduction. As shown in the illustration, it is a speaker which can be sold as furniture as well.

Its highly finished two-tone mahogany case is especially rich. The mahogany table top on which the speaker is mounted is 18 inches in diameter, thus permitting its use as a decorative end or lamp table. Bridge with music beneath the finger tips is one of the many powerful selling features that you can develop for this speaker. The cone is so mounted as to use the entire wooden casing and table top as a sounding board.



Model 70 is furniture as well and plays perfectly in table position.

List Price, \$40.00

Tip Table Cone Speaker Model 70, packed in individual corrugated containers, net weight 9½ pounds, shipping weight 20 pounds each. Equipped with a twenty foot cord.

TELETONE CORPORATION OF AMERICA
Third St. & Van Alst Ave., LONG ISLAND CITY, N. Y.



For Better Service

Use Jewell radio service equipment if you want your service to be better and more satisfying to your customers.

The Jewell Pattern No. 117 is the most complete service set on the market. Your service men equipped with Jewell Radio Service Sets are prepared to test batteries, charging rates, circuits, transformers (audio, radio and power), tubes, A and B battery eliminators, condensers, resistances, in fact they can make any test required by a radio set or its accessories.

It contains: A four scale high resistance B eliminator type voltmeter, a three scale milliammeter, a universal type tube tester with tube adapter, a compartment for complete set of A, B and C test batteries, a complete set of phone tipped test leads, a drawer for tools, spare parts, etc., all in a handy, two part carrying case.



*Pattern No. 117
Radio Service Set*

Enterprising dealers everywhere are giving dignified and reliable service with Jewell Radio Service Sets.

Write for our special form No. 1117 which describes this set in detail.

Jewell Electrical Instrument Co.

1650 Walnut St., Chicago

"27 Years Making Good Instruments"

Restored Enchantment

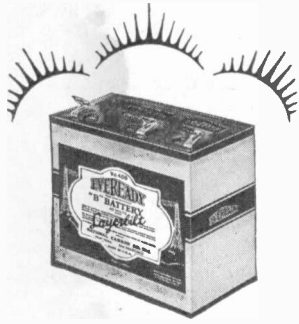

This is the Eveready Layerbilt that gives Battery Power for the longest time and the least money

AT A throw of a switch and a turn of a dial a radio program comes in. It is clear. It is true. It is natural. The listener thanks the powers of nature that have once more brought quiet to the distant reaches of the radio-swept air. He is grateful to the broadcasters whose programs were never so enjoyable, so enchanting. He calls down blessings upon the authority that has allotted to each station its proper place. And if he has bought a new set of "B" batteries to make the most out of radio's newest and most glorious season, he will thank the dealer who recommended them to him.

For there is no doubt of it—radio is better with Battery Power. And never was radio so worthy of the perfection of reception that batteries, and batteries alone, make possible. Today more than ever, the radio user needs what batteries give—pure DC, Direct Current, electricity that flows smoothly, quietly, noiselessly. When such is the current that operates a receiver, the listener is unconscious of its mechanism, for he does not hear it humming, buzzing, crackling. The enchantment of the program is complete.



Radio is better with Battery Power

Batteries themselves have improved, as has radio. Today they are so perfect, and so long-lasting, as to be equal to the demands of the modern receiver. Power your customers' sets with the Eveready Layerbilt "B" Battery No. 486. This is the battery whose unique, exclusive construction makes it last longer than any other Eveready. This is the battery that makes your radio power business trouble-free, profitable, and a builder of goodwill. Order from your jobber.

NATIONAL CARBON CO., INC.  New York—San Francisco
Atlanta Chicago Kansas City

Unit of Union Carbide and Carbon Corporation

Tuesday night is Eveready Hour Night—8 P. M., Eastern Standard Time

WEAF—New York	WGR—Buffalo	WGN—Chicago	WRC—Washington
WJAR—Providence	WCAE—Pittsburgh	WOC—Davenport	WGY—Schenectady
WEEL—Boston	WSAI—Cincinnati	WCCO—{ Minneapolis	WHAS—Louisville
WDAF—Kansas City	WTAM—Cleveland	{ St. Paul	WSB—Atlanta
WFI—Philadelphia	WWJ—Detroit	KSD—St. Louis	WSM—Nashville
		WMC—Memphis	

Pacific Coast Stations—9 P. M., Pacific Standard Time

KPO—KCO—San Francisco	KFI—Los Angeles
KFOA—KOMO—Seattle	KCW—Portland

Have you heard the new Victor record by the Eveready Hour Group—orchestra and singers—in Middleton's Down South Overture and Dvořák's Goin' Home?

EVEREADY
Radio Batteries
—they sell faster



A B-7
for 6 or 4 volt sets

WEBSTER
PAT. PEND.
TRADE **BONE-DRI** MARK

**A, B and C
Socket Power Units
Raytheon Equipped**

*Automatically controlled from Radio
Receiver "on" and "off" switch*



A-7
for 6 or 4 olt sets

"Little Giant B-C"

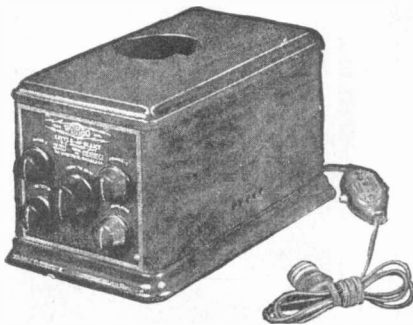

Webster "Bone-Dri" units completely electrify any radio receiver to operate from the light socket *without any revolutionary* rebuilding of sets. The users need only to throw away the batteries—the trouble and expense—and put in a "Bone-Dri" unit. New receivers can be sold easier with "Bone-Dri" socket-power.

Radio Dealer

Remember! to get your share (or more) of the enormous demand for socket-power units *from now on*—you'll need a ready supply of the "Bone-Dri" units. It's one safe bet in the radio game.

If your jobber will not supply you the Webster "Bone-Dri," don't take a substitute, but write or wire us for name of nearest distributor and free booklet "How to Eliminate the Batteries."

THE WEBSTER COMPANY

848 Blackhawk, Chicago, Ill.

Super B



World's Fair Exhibitors

(Continued from page 98)

H. H. Frost, Inc., Chicago, Ill.

Gem Tube Company, New York City.
General Radio Co., Cambridge, Mass.
Gold Seal Elec. Co., New York City.
Gould Storage Battery Co., New York City.
A. H. Grebe & Co., Inc., Richmond Hill, N. Y.
Grigsby-Grunow-Hinds, Chicago, Ill.
Grimes Radio Engineering Co., Grasmere, Staten Island.

Hammarlund Mfg. Company, New York City.
Hartford Battery Mfg. Co., New York City.
Harold Herbert, Inc., Long Island City.
Homer Products, Inc., Long Island City.
Hovt Electrical Instrument Works, Boston, Mass.
Hamilton Mfg. Co., New York City.

Igrad Condenser & Mfg. Co., Inc., Rochester, N. Y.
Indiana Mfg. Elec. Co., Marion, Ind.

Jewell Elec. Instrument Co., Chicago, Ill.
Howard B. Jones, Chicago, Ill.

Karas Elec. Company, Chicago, Ill.
Kellogg Switchboard & Supply Co., Chicago, Ill.
King Mfg. Corporation, Buffalo, N. Y.
Kodel Radio Corporation, Cincinnati, O.
Kokomo Elec. Co., Kokomo, Ind.

Arthur H. Lynch, New York City.
Lignole Corp. (Hartzell), Chicago, Ill.
Leutz, Inc., C. R., Long Island City.

The Magnavox Co., Oakland, Calif.
Marco Storage Battery Co., Brooklyn, N. Y.
Marti Elec. Radio Co., W. Orange, N. J.
Martin Copeland Co., Providence, R. I.
Mayolian Radio Corp., Bronx, N. Y.
Metal Devices Corp., Chicago, Ill.
Minerva Radio Co., Chicago, Ill.
Mohawk Corp. of Illinois, Chicago, Ill.
Musical Prod. Co., New York City.

Leslie F. Muter Co., Chicago, Ill.
McGraw-Hill Pub. Co., New York City.

Nassau Radio Co., Inc., Brooklyn, N. Y.
National Carbon Co., Inc., New York City.
National Company, Inc., Boston, Mass.
National Lead Battery Co., St. Paul, Minn.
The N. Y. Herald Tribune, New York City.
Northern Mfg. Co., Newark, N. J.

Oriental Loud Speaker Co., New York City.
Oxidite Battery Company, St. Paul, Minn.

Perry Wire Works, Yonkers, N. Y.
Pacent Elec. Co., Inc., New York City.
Paragon Elec. Corp., Upper Montclair, N. J.
Penn Products, Inc., New York City.
Perrine Quality Prod. Corp., Waltham, Mass.

Perryman Elec. Corp., New York City.
Pfanstiel Radio Company, Waukegan, Ill.
Philadelphia Storage Battery Co., Philadelphia, Pa.
Philmore Mfg. Company, New York City.
Pilot Elec. Mfg. Company, Brooklyn, N. Y.
Plaza Music Co., New York City.
Polynet Mfg. Company, New York City.
The Pooley Company, Philadelphia, Pa.
Potter Mfg. Company, N. Chicago, Ill.

Q. R. S. Music Co., Chicago, Ill.

Radio Corporation of America, New York City.

Radio Dealer, New York City.
Radio Relay League, American.
Radio Retailing, New York City.
Raytheon Mfg. Co., Cambridge, Mass.
Red Lion Cabinet Co., Red Lion, Pa.
Reichmann Co., Chicago, Ill.
R. G. S. Mfg. Co., Inc., Staten Island, N. Y.

Samson Elec. Company, Canton, Mass.
Sander Corporation, Long Island City, N. Y.
Sangamo Elec. Co. (See Ward Leonard.)
Schicklering Prod. Corp., Newark, N. J.
Scovill Mfg. Co., Waterbury, Conn.
Sentinel Mfg. Co., Chicago, Ill.
Shanrock Mfg. Co., Newark, N. J.
Showers Bros. Co., Chicago, Ill.
Silver-Marshall, Inc., Chicago, Ill.
Slagle Radio Co., Ft. Wayne, Ind.
Sonatron Tube Company, New York City.
Sonora Phonograph Co., New York City.
Spaulding Fibre Co., Inc., New York City.
The Sparks-Withington Co., Jackson, Mich.
Splittorf Elec. Co., Newark, N. J.

Steinite Lab., Chicago, Ill.
Stettner Phonograph Corp., New York City.
Stevens & Company, Inc., New York City.
Stewart-Battery Co., Chicago, Ill.
Stewart-Warner Speedometer Corp., Chicago, Ill.
Stromberg-Carlson Telephone Co., Rochester, N. Y.
Sturges Multiple Battery Co., Jamaica, N. Y.

The New York Sun, New York City.
Superior Cabinet Corp., New York City.
Superior Cabinet Co., Muskegon, Mich.
Sylvania Prod. Co., Emporium, Pa.
Sleeper Rad. & Mfg. Co., Long Island City.

Tele vocal Corporation, New York City.
Temple, Inc., Chicago, Ill.
Thordarson Elec. Mfg. Co., Chicago, Ill.
The New York Times, New York City.
Timmons Radio Prod. Corp., Philadelphia, Pa.
Tower Mfg. Corp., Boston, Mass.

United Radio Corp., Rochester, N. Y.
United Scientific Lab. Inc., New York City.
U. S. L. Battery Corp., Niagara Falls, N. Y.
U. S. L. Radio Corp., Niagara Falls, N. Y.
U. S. Army.
Utah Radio Prod. Corp., Chicago, Ill.

Valley Elec. Company, St. Louis, Mo.
Vesta Battery Corp., Chicago, Ill.
Victoreen Radio Co., Cleveland, O.
Vitalitone Radio Corp., New York City.

Walbert Mfg. Company, Chicago, Ill.
Geo. W. Walker Co., Cleveland, Ohio.
Ward-Leonard Co., c/o Ray D. Lillibridge, Inc., New York City.
Watsonstown Table & Furniture Co., Watsonstown, Pa.
The Webster Company, Chicago, Ill.
Westerland Corp., Dobbs Ferry, N. Y.
Westinghouse Elec. & Mfg. Co., East Pittsburgh, Pa.
Weston Elec. Instrument Co., Newark, N. J.
Willard Storage Battery Co., Cleveland, Ohio.
Workrite Mfg. Co., Cleveland, Ohio.
The World, New York City.

Yaxley Mfg. Company, Chicago, Ill.
Yale Elec. Corp., Brooklyn, N. Y.

Zenith Radio Corporation, Chicago, Ill.
Zetka Lab. Inc., Newark, N. J.

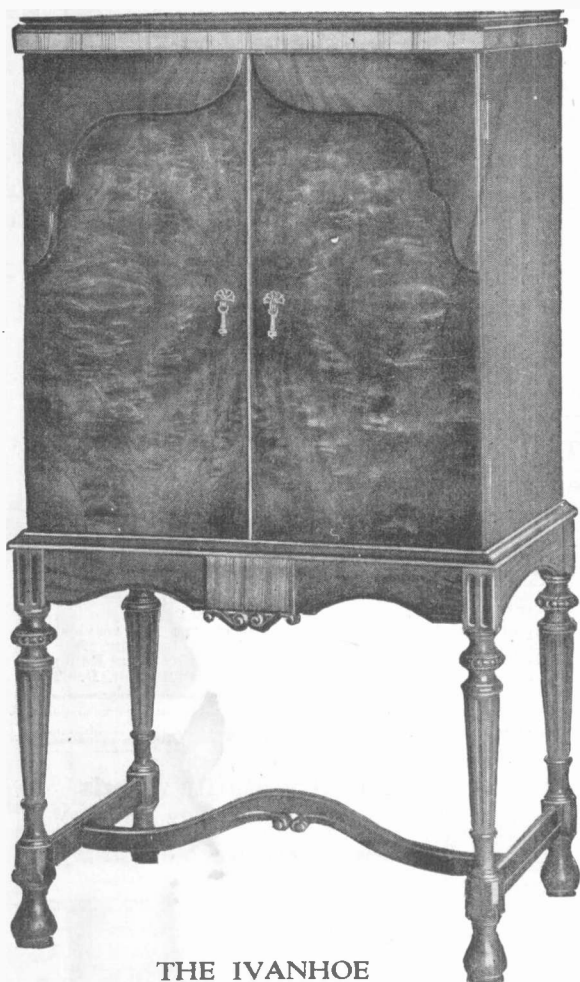

THE IVANHOE

Exclusive McMillan Design. Sides and top striped walnut. Doors of butt walnut, mahogany overlay. Veneered moldings. Built-in speaker. Four-foot air column. Utah Unit. Size of top, 25 $\frac{7}{8}$ in. x 17 $\frac{1}{2}$ in. x 50 in. high. Shipping weight, 117 pounds.

TEN GREAT FEATURES
Here They Are

A. C. Tubes. .Selectivity. .patented circuit. .Built-in power unit. .single dial control. .lower operation cost. .low service costs. .beautiful exclusive cabinets. .special audio transformers. .rigid sub base panel.

McMILLAN
Trade Mark Reg. U. S. Pat. Off.
ELECTRIC

5 MODELS

Prices range from \$170 to \$325

THE McMILLAN RADIO CORPORATION
1421 S. Michigan Av., Chicago, Ill.
We also make a complete line of battery models.

10 GREAT FEATURES
Make this the greatest
Batteryless Receiver

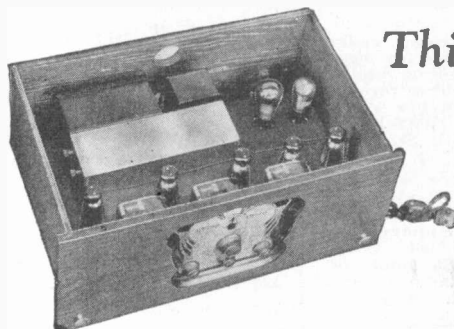

This is all there is to it

Employing A.C. tubes and operating direct from a light socket—the new 10 feature McMillan is a year advanced in design. Write for prices now.

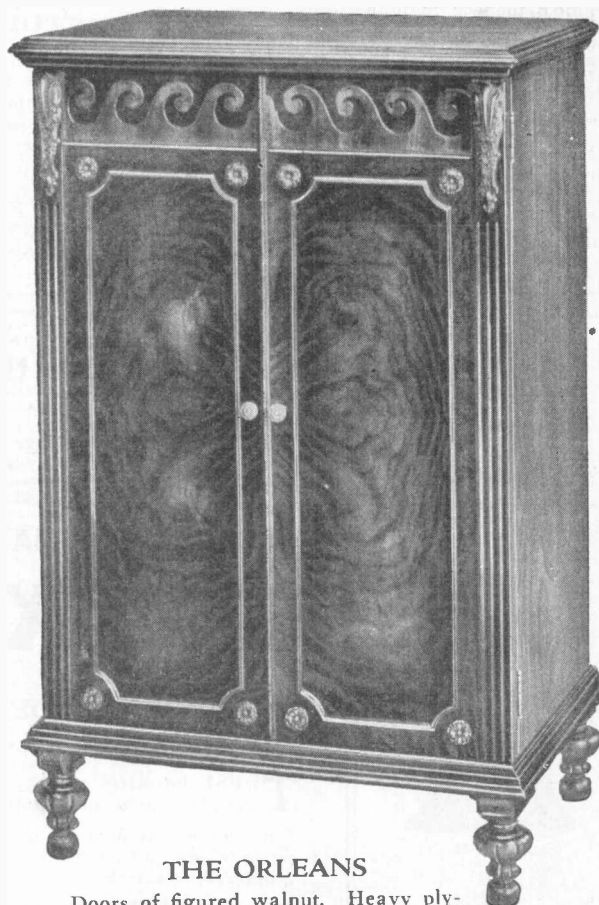

THE ORLEANS

Doors of figured walnut. Heavy plywood construction. Equipped with built-in speaker—Utah Unit. Four-foot air column. Size of top 26 $\frac{1}{2}$ in. x 19 in. x 43 $\frac{1}{2}$ in. high. Shipping weight, 135 pounds.

SEARCHLIGHT SECTION

SURPLUS STOCKS—BUSINESS OPPORTUNITIES

UNDISPLAYED—RATE PER WORD:
 Positions Wanted, 6 cents a word, minimum \$1.25 an insertion, payable in advance.
 Positions Vacant and all other classifications, 10 cents a word, minimum charge \$2.00.
 Proposals, 40 cents a line an insertion.

INFORMATION:
 Box Numbers in care of any of our offices count 10 words additional in undisplayed ads.
 Discount of 10% if one payment is made in advance for four consecutive insertions of undisplayed ads (not including proposals).

DISPLAYED—RATE PER INCH:
 1 to 3 inches.....\$6.65 an inch
 4 to 7 inches..... 6.40 an inch
 8 to 14 inches..... 6.20 an inch
 Rates for larger spaces, or yearly rates, on request.
 An advertising inch is measured vertically on one column, 3 columns—30 inches—a page.

Radio Retailing

POSITIONS WANTED

FORMER high official of the largest radio concern in the world is available for position with strong concern needing intelligent sales or executive help either foreign or domestic service. Over twenty years buying, selling, production. PW-42 Radio Retailing, Tenth Ave. at 36th St., New York.

RADIO manager and buyer. 37 years of age. Five years' experience in buying and selling. At present manager of radio department for large St. Louis house. Prefer to locate in St. Louis or the Middle West. PW-40, Radio Retailing, Bell Telephone Bldg., St. Louis, Mo.

AGENTS WANTED

Good Live Manufacturers' Agents Can secure the very latest receiving sets, part sets, to offer direct to the best retail trade; these sets are made by one of radio's pioneer manufacturers; substantial, clean dealing and only agents answering these same qualifications will be interested; address in confidence, AW-43, Radio Retailing, Tenth Ave. at 36th St., New York.

WIDE AWAKE RADIO MANUFACTURERS' REPRESENTATIVE

In California who gives radio 100 per cent of his time wants to represent a line of receiving sets, speakers, and eliminators. Would like to hear from financially responsible manufacturers who wish to increase their business in this territory. Also maintain technical department.

RA-41, Radio Retailing
 883 Mission St., San Francisco, Cal.

Superior Radio Crystals

World Famous Brands Concert Tested Radio Crystals for Reflex or Crystal Sets

Unconditionally Guaranteed

Discounts furnished upon Request

CALIFORNIA RADIO MINERALS

Harry Grant, Jr.

Successors to K. O. PRODUCTS CO.

904 Oak Grove Ave., Burlingame, California.

Technical Service (Agency)

217 Broadway, New York

RADIO PERSONNEL

EXECUTIVE—ENGINEERING
 PRODUCTION AND SALES

Salesmen—Mfr. Exp..... Open
 Salesmen—Dealer Exp..... Open
 Engr.—Mge. Prod'n..... \$3100
 Engr.—Receiver Devel..... 3100
 Engrs.—Recent—Know Code..... 1500

Your Production Problem Solved

A complete radio receiving set factory is all tooled up and ready to go into immediate production on modern receiving set chassis, and power units, for a responsible manufacturer.

Write your requirements in confidence to:

BO-44, Radio Retailing
 Tenth Ave. at 36th St., N. Y. C.

FREE RADIO EMPLOYMENT SERVICE

Employers in any line of the Radio industry (or in allied industries) should call on our Free Radio Employment Service when additional employees are needed. Thoroughly trained, experienced men supplied anywhere in the U. S. or Canada on 48 hours' notice. No charge for service. Send post card today for our free monthly bulletin. Address National Radio Institute, Dept. R.R., Washington, D. C.

We have cash for Surplus Radio Goods

Write us what you have and lowest cash price.

Dewey Radio Company

148 Summer St., Boston, Mass.

CASH

We want your SURPLUS RADIO STOCK

Send us your list and lowest cash price

EMPIRE RADIO CO.

216 Washington St., Boston, Mass.

CASH

Your Overstock is a Dead Investment—Move it at a Profit !!!

Use the Radio Dealers' Overstock Exchange in Radio Retailing

What have you to turn into cash NOW? Get it into the "Exchange" of the next issue of RADIO RETAILING. The cost will be small.

A REAL SPECIAL OFFER TO DEALERS!

MAGNAVOX CONE SPEAKERS

STANFORD MODEL—Former List, \$35.00 each—Special at \$7.25 each!
 CORNELL MODEL—Former List, \$22.50 each—Special at \$4.75 each!

THESE beautiful speakers must be seen and heard to be really appreciated. They cover the complete tonal scale from 50-10,000 cycles without distortion or snary effects.

They have full floating Cones, (free edge) resiliently mounted to give free movement to the entire Cone, which will stand powerful or weak volume equally well and reproduce with wonderful clarity.

The Stanford Model is constructed of genuine two-toned mahogany. Cornell Model has artistic non-resonant metal finish.

Each speaker, brand new, packed in original factory sealed cartons, five cartons to the shipping container, gross weight of container for Stanford Model, 49 lbs., for Cornell Model, 39 lbs.

TERMS: 20% cash with order, balance C. O. D. F. O. B. New York City.

AMERICAN SALES CO., 21 WARREN ST., NEW YORK CITY

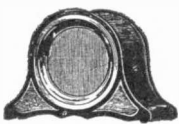

Stanford Model



Cornell Model

Announcing The NEW



Model 99 List Price \$225
Eight other attractive
models ranging in price
from \$70.00 to \$400.00



ALL-AMERICAN

TRADE MARK

ELECTRIC RADIO



Hear the All-American Reproducer with filter system built in and adjustable unit—Compare it with any other at any price. This is a convincing test.

List \$25.00



All-American Socket B Power is compact, efficient and low priced. Delivers up to 180 volts yet small enough to fit any compartment.

Price \$27.50
Raytheon tube extra

Using Radiotron or Cunningham Raw AC Tubes

Power direct from light socket through adjustable power unit supplying correct A, B and C voltages—six tubes. All models available for battery operation if desired.

Now in production and in position to make quick delivery.

Wire for attractive proposition to a limited number of responsible dealers.

[[Licensed under patents of R. C. A., General Electric, Westinghouse, and A. T. & T.]]

ALL-AMERICAN RADIO CORPORATION
4223 Belmont Avenue, Chicago, U. S. A.

All-American Radio, Ltd., Toronto, Canada

Branches

New York	Buffalo	St. Louis	Boise	Seattle	New Orleans
Milwaukee	Denver	Minneapolis	San Francisco	Washington	Portland
Salt Lake City	Pittsburgh	Los Angeles	Boston	Philadelphia	Detroit

BIRNBACH Radio Products

There's a BIRNBACH BATTERY CABLE for EVERY Circuit and PURPOSE

Made of flexible stranded colored rubber insulation for connecting A, B and C Batteries or eliminator to set. Each conductor of separate solid color in accordance with R. M. A. Standards, and assembled with brass lug terminals, soldered, which prevent loose connections. Made in 5, 6, 7, 8, 9, or 10 Wires. Packed in individual cartons.



No.	Wires	Length	Price	No.	Wires	Length	Price
110-5	5	54 inches	\$0.50	114-5	5	10 foot	\$1.25
111-6	6	54 inches	.60	116-6	6	10 foot	1.55
112-7	7	54 inches	.70	117-7	7	10 foot	1.85
113-8	8	54 inches	.85	118-8	8	10 foot	2.15
116-9	9	54 inches	1.00	127-9	9	10 foot	2.45
119-10	10	54 inches	1.15	128-10	10	10 foot	2.75



Birnbach Riga Battery Cable

These Cables are made of flexible stranded conductors for A, B, and C Batteries. Assembled with storage Battery Clips for the A Battery and soldered brass lug terminals.

No.	Wires	Length	Price	No.	Wires	Length	Price
100-5	5	60 inches	\$1.00	150-5	5	10 foot	\$1.60
160-5	5	54 inches	.90	152-6	6	10 foot	1.80
161-6	6	54 inches	1.05	153-7	7	10 foot	2.25
162-7	7	54 inches	1.20	154-8	8	10 foot	2.55
163-8	8	54 inches	1.40	155-9	9	10 foot	2.85
154-9	9	54 inches	1.55	156-10	10	10 foot	3.15
165-10	10	54 inches	1.70				

Birnbach Radio Battery Connectors

These Connectors are made of flexible stranded wire with soldered lug terminals for use in connecting Dry Cell Batteries, B and C Batteries. Packed 25 of each size per carton.

No.	Size	Price
RC 3	3-in. Connectors	each \$0.04
RC 6	6-in. Connectors	each .05
RC 8	8-in. Connectors	each .06
RC12	12-in. Connectors	each .07



Birnbach Loud Speaker Extension Cord Units

You can move your Loud Speaker into any room desired. A BIRNBACH EXTENSION CORD UNIT improves the tone quality when power tubes are used, by placing the Speaker away from the Set. Made in six sizes and furnished complete with Connector. Packed in individual cartons.



No.	Length	Price
108	10 foot, complete	\$0.75
120	20 foot, complete	1.00
121	30 foot, complete	1.40
122	40 foot, complete	1.80
123	50 foot, complete	2.20
124	100 foot, complete	4.20

Birnbach "60" Bakelite 3-Circuit Tuner

This 3-Circuit Tuner is wound on colored Bakelite and will improve any Circuit. A marvel for performance. Use BIRNBACH TUNERS for the best tone quality, long range distance, and volume. For use with .0005 Mfd. Condenser. Tuning range 200 to over 550 meters.

No. 60	Colored Bakelite 3-Circuit Tuner	\$2.00
No. 60	Colored Bakelite Radio Frequency Coil	1.25



Birnbach "180" Bakelite 3-Circuit Tuner

This Tuner is larger in size than our No. 60 and in this form it is the most efficient TUNER ever designed. Distant stations can be tuned in with greater volume and the very best tone quality. For use with .0005 Mfd. Condenser. Tuning range 200 to over 570 meters.

No. 180	BIRNBACH Colored Bakelite 3-Circuit Tuner	\$3.50
No. 180	BIRNBACH Colored Bakelite Radio Frequency Coil	1.50

Birnbach "400" Bakelite Post Strip

A new and convenient strip for sub panel mounting, moulded in Bakelite with 9 characters engraved. Packed in individual cartons.

No. 400	Birnbach Bakelite Post Strip	each \$0.65
---------	------------------------------	-------------



BIRNBACH RADIO CO.
254 West 31st Street, New York City



INDEX TO ADVERTISEMENTS

	Page		Page
Acme Electric & Mfg. Co.	168	Kellogg Swi board & Supply Co.	155
Acme Wire Co.	125	Ken-Rad Corp., Inc.	140
Accusti-Cone Lab's.	181	King Mfg. Corp.	52-53
Adler Mfg. Co.	43	Kokomo Electric Co.	140
Aero Products Co.	124	Langhein-Kaufman Radio Co.	
All American Radio Co.	195	Magnavox Co.	3
Algonquin Elec. Co.	14-15	McMillan Radio Corp.	
Allen-Bradley Co.	112	Metro Electric Co.	
American Auto & Radio Mfg. Co.	178	Midland Wholesale Co.	
American Bosch Magneto Co.	134-135	Modern Elec. Mfg. Co.	128
American Storage Battery Co.	188	Mohawk Corp.	16
Amplion Corp.	46-47	Muter, Leslie F. Co.	110
Amrad Corp.	161	National Co.	120
Andrea, F. A. D.	24	National Carbon Co.	191
Apco Mossberg Mfg. Co.	165	National Vulcanized Fibre Co.	12
Apex Elec. Mfg. Co.	26	National Lead Battery Co.	177
Arco Electrical Corp.	186	Niagara Metal Stamping Co.	174
Art Novelty Co.	42	Newcombe-Hawley, Inc.	41
Atwater Kent Mfg. Co.	55-56	Operadio Mfg. Co.	148
Audiola Radio Co.	168	Paragon Elec. Co.	160
Bakelite Corp.	143	Pathe Phonograph & Radio Co.	49
Balsa Wood Reproducer Corp.	189	Perryman Elec. Co.	32
Baritone Mfg. Co.	186	Pierson Co.	44
Beede Elec. Instrument Co.	122	Positions Wanted	194
Belden Mfg. Co.	119	Power, Inc. H. J.	168
Birnbach Radio Co.	196	Precision Prod. Co.	146-147
Bodine Elec. Co.	178	Premier Elec. Co.	10
Borkman Radio Corp.	40	Progressive Musical Inst. Co.	
Boudette Mfg. Co.	184	Q. R. S. Co.	182
Bremer Tully Mfg. Co.	45	Quan Radio Corp.	142
Brooklyn Metal Stamping Corp.	182	Radio Corp. of America	74-75-Back Cover
Briggs Stratton Corp.	30-31	Radio Master Corp.	80-81 (Pictorial Section)
Brown Caine Co., Inc.	122	Radio Products Corp.	182
Buckingham Radio Corp.	179	Radio Receptor	27
C E Mfg. Co.	34	Raytheon Mfg. Co.	28-29
Clearstone Radio Co.	183	Red Lion Cabinet Co.	37
Cable Supply Co.	164	Reliable Parts Mfg. Co.	174
Colt's Patent Fire Arms Mfg. Co.	172	Roberts Co., H. T.	38
Cornish Wire Co.	120	Sandar Corp.	144
Crowley Radio Corp.	107-136	Searchlight Section	194
Crowley Name Plate & Mfg. Co.	178	Sentinel Mfg. Co.	133
Cunningham, Inc., E. T.	Inside Front Cover	Sickles Co., F. W.	127
Cuno Engineering Corp.	170	Silver Marshall Co.	114
Day Fan Elec. Co.	145	Slagle Radio Co.	159
Dry Storage Battery Co.	132	Sleeper Radio & Mfg. Corp.	8
DeJur Products Co.	126	Sonatron Tube Co.	35
Davis, Richard T. Co.	36	Sparks-Withington Co.	151
Dexter & Sons, Inc., C. H.	127	Spitdorf Radio Corp.	25
Doehler Die Casting Co.	118	Sprague Specialties Co.	126
Dooley Electrical Mfg. Co.	10-11	Standard Piano Bench	44
Dubilier Condenser Corp.	130-131-176	Steinitz Radio Co.	8
Dudlo Mfg. Corp.	121	Sterling Mfg. Co.	17-18-19-20
Eagle Charger Co.	163	Stewart-Warner	129
Eby Mfg. Co., H. H.	124	Stromberg-Carlson Tel. Mfg. Co.	2
Ehler Radio Furniture Co.	42	Sunlight Lamp Co.	51
Ekko Co.	180	Swan Haverstick Co., Inc.	22-23
Electrad, Inc.	120, 122, 172, 180	Sylvania Prod. Co. Inside Back Cover	
Electric Storage Battery Co.	158	Teletone Corp.	190
Electrical Research Laboratories.	48	Televoac Corp.	178
Fansteel Products Co.	(Pictorial Section) 82-83	Temple, Inc.	39
Farrand Mfg. Co.	54	Thordarson Elec. Mfg. Co.	108
Federal-Brandes Corp.	138-139	Tower Mfg. Corp.	7
Federal Radio Corp.	153	Trimm Radio Co.	166
Fishwick Radio Co.	157	United Radio Corp.	12
France Mfg. Co.	21	Universal Battery Co.	141
Freed-Eisemann Radio Co.	185	Universal Elec. Lamp Co.	172
French Battery Co.	50	Universal Winding Co.	128
Freshman Co., Inc., Chas. H.	Front Cover	Utah Radio Prod. Co.	4-5
rost, Inc., Herbert H.	122	Valley Elec. Co.	172
General Electric Co.	171	Vesta Battery Co.	137
General Instrument Corp.	184	Ward Leonard Elec. Co.	116
General Radio Co.	127	Watson Table & Furniture Co.	44
Gold Seal Elec. Co., Inc.	33	Webster Co.	192
Gould Storage Battery Co.	154	Westinghouse Union Battery Co.	150
Grebe & Co., Inc., A. H.	3	Weston Elec. Instrument Co.	181
Greene-Brown Mfg. Co.	187	White Mfg. Co., Julian M.	152
Halldarson Mfg. Co.	127	Wireless Specialty Apparatus Co.	123
Hyatt Elec. Corp.	173	Workrite Mfg. Corp.	156
Igrad Condenser	126	Yahr-Lange, Inc.	176
Indiana Mfg. & Elec. Co.	170	Zenith Radio Co.	162
International Resistance Co.	128		
Interstate Elec. Co.	188		
Jewell Elec. Instrument Co.	190		



*If Your Tube Sales "Could Be Better"
Write at Once for This Effective Display*

**ARE YOU A FAN
TOO?**

Then tune in on Sylvania broadcasting every Wednesday evening at 8.00 P. M. through the WJZ chain of stations. You will hear a mighty fine program, and while you're being entertained remember, too, what this advertising is doing for your Sylvania sales!

TO TIE up with the new Sylvania Carton and our increased advertising program, we have created an exceptionally good-looking display panel which carries five of the most popular types of "The Tube that Never Disappoints."

On your counter or in your window the unique coloring and design of this exhibit will attract the kind of attention that turns lookers into buyers.

To secure the advantage of such a tube-sales booster, all *you* have to do is write us. It is here. No strings attached—anyone can have it who sells Sylvania Tubes—and most good dealers do.

Sylvania



RADIO TUBES

SYLVANIA PRODUCTS COMPANY, EMPORIUM, PA.

**A Radiotron
for every purpose**

- RADIOTRON UX-201-A**
Detector Amplifier
- RADIOTRON UV-199**
Detector Amplifier
- RADIOTRON UX-199**
Detector Amplifier
- RADIOTRON WD-11**
Detector Amplifier
- RADIOTRON WX-12**
Detector Amplifier
- RADIOTRON UX-200**
Detector Only
- RADIOTRON UX-200-A**
Detector Only
- RADIOTRON UX-120**
Power Amplifier Last Audio Stage Only
- RADIOTRON UX-112**
Power Amplifier
- RADIOTRON UX-171**
Power Amplifier Last Audio Stage Only
- RADIOTRON UX-210**
Power Amplifier Oscillator
- RADIOTRON UX-240**
Detector Amplifier for Resistance-coupled Amplification
- RADIOTRON UX-213**
Full-Wave Rectifier
- RADIOTRON UX-216-B**
Half-Wave Rectifier
- RADIOTRON UX-226**
A.C. Filament
- RADIOTRON UV-227**
A.C. Heater
- RADIOTRON UX-280**
Full-Wave Rectifier
- RADIOTRON UX-281**
Half-Wave Rectifier
- RADIOTRON UX-874**
Voltage Regulator Tube
- RADIOTRON UV-878**
Ballast Tube
- RADIOTRON UV-888**
Ballast Tube
- RADIOTRON UV-877**
Protective Tube

The standard by which other vacuum tubes are rated



Look for this mark on every Radiotron

A Radiotron for every purpose
RADIOTRON UX-201-A
Detector Amplifier
RADIOTRON UX-199
Detector Amplifier
RADIOTRON UX-199
Detector Amplifier
RADIOTRON WD-11
Detector Amplifier
RADIOTRON WX-12
Detector Amplifier
RADIOTRON UX-200
Detector Only
RADIOTRON UX-200-A
Detector Only
RADIOTRON UX-120
Power Amplifier Last Audio Stage Only
RADIOTRON UX-112
Power Amplifier
RADIOTRON UX-171
Power Amplifier Last Audio Stage Only
RADIOTRON UX-210
Power Amplifier Oscillator
RADIOTRON UX-240
Detector Amplifier for Resistance-coupled Amplification
RADIOTRON UX-213
Full-Wave Rectifier
RADIOTRON UX-216-B
Half-Wave Rectifier
RADIOTRON UX-226
A.C. Filament
RADIOTRON UV-227
A.C. Heater
RADIOTRON UX-280
Full-Wave Rectifier
RADIOTRON UX-281
Half-Wave Rectifier
RADIOTRON UX-874
Voltage Regulator Tube
RADIOTRON UV-878
Ballast Tube
RADIOTRON UV-888
Ballast Tube
RADIOTRON UV-877
Protective Tube



Look for this mark on every Radiotron



The Radiotron is the standard vacuum tube for laboratory tests throughout the radio industry.

It is significant that in factory and research laboratories the Radiotron is the standard tube in all tests of radio apparatus. And that practically all makers of quality radio sets use the Radiotron in testing sets under construction and in final testing of the finished product. The Radiotron is the joint product of the engineers of RCA, Westinghouse and General Electric.

Don't let your sales fall off.
If your vacuum tubes have been in use for a year and are still giving trouble, they will be replaced by the Radiotron.
To keep your sales up, use Radiotrons in producing efficiency, dependability and long life.



RCA Radiotron

MADE BY THE MAKERS OF THE RADIOLA

RADIO CORPORATION OF AMERICA - NEW YORK CHICAGO SAN FRANCISCO

Eight years of national advertising are behind the RCA Radiotron—which you can figure in terms of compound public interest payable to the Radiotron dealer today and in the years to come. This is a color page appearing in August magazines. There is one every month.

No other item of radio can be compared with RCA Radiotrons on these high points of salability:

- Large sales volume*
- Low stock investment*
- Advanced engineering*
- High margin of profit*
- Steady rate of turnover*
- Assured consumer demand*
- Complete line for every purpose*
- Greatest national advertising campaign*



RADIO CORPORATION OF AMERICA
NEW YORK CHICAGO SAN FRANCISCO

RCA Radiotron

MADE BY THE MAKERS OF THE RADIOLA