

Radio Retailing

The Business Magazine of the Radio Industry

*The Tungar line
is now complete*



TWO AMPERE



FIVE AMPERE

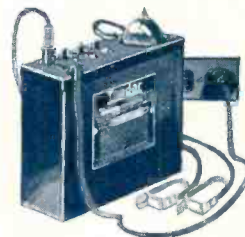

TRICKLE CHARGER

For quick turnover, assured profits and satisfied customers, you should stock and push the entire Tungar line. It is now complete. There is a TUNGAR for all home battery charging requirements.

Tungar

REG. U.S. PAT. OFF.

BATTERY CHARGER

TUNGAR—a registered trade mark—is found only on the genuine. Look for it on the name plate.

GENERAL ELECTRIC

Webster defines "quality" as "distinctive power or capacity, natural superiority in kind, high rank, excellence of character". This definition applies exactly to the in-built quality of Cunningham Radio Tubes. The "distinctive power or capacity" of these tubes is known to millions of radio-owners. "Natural superiority in kind" is maintained and guarded as a Cunningham "buy-word" with the radio public. "High rank, excellence of character" is sold with every Cunningham Radio Tube. The slogan "Since 1915—Standard for all Sets" has created Cunningham prestige that builds for greater and more profitable dealer sales year after year.

Hear the

UTAH

Made in Salt Lake City

Trade Mark Registered

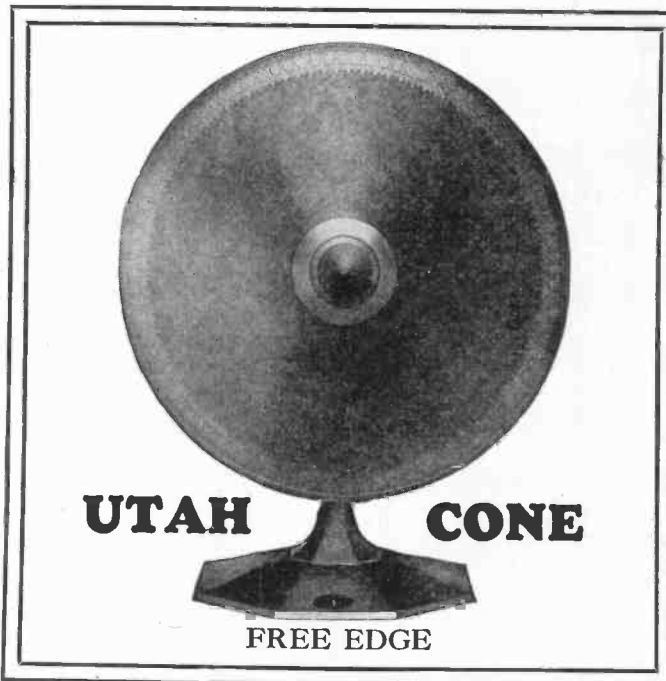

\$16

**UTAH
CONE**

FREE EDGE
17½ in. high

GUARANTEE
Buy a **Utah** and use it for two weeks. Compare its tone with the best the others are able to produce. **If the Utah does not give better reception** return it to your dealer and **he will refund your money.**

See us at the
Chicago
Radio Show

Utah Radio Products Co.

1421 S. Michigan Ave., Chicago

We are manufacturers, not assemblers

The only complete line of speakers on the market



\$10

**UTAH
SUPERFLEX**

REG. U. S. PAT. OFF.

UTAH BOOK



\$19

\$19

Looks like an open book. Finest reproduction.
Size 17½-in. x 13½-in. List \$19.

UTAH STANDARD



The
Speaker
with
the
Golden
Throat

\$22-50

14-in. bell

**UTAH
JUNIOR**

\$12-50

11-in. bell

Noteworthy Additions to Stromberg-Carlson Products



No. 502 Receiver, Art Console. 5-tube; coils shielded; equipped with voltmeter; operates from house current or batteries; space for socket power units or batteries; American Walnut. Price, less accessories but including external Cone Speaker, East of Rockies \$325; Rockies and West \$355.

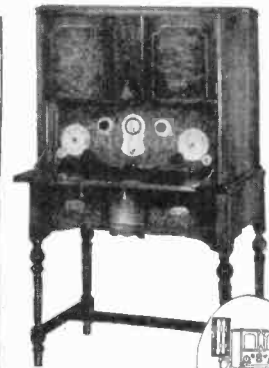

No. 602 Universal Receiver Art Console. 6-tube; totally shielded; dual control; equipped with voltmeter. American Walnut. Price, without accessories or Loop, but including external Cone Speaker, East of Rockies \$365; Rockies and West \$400.

New 5-tube shielded Receivers, supplementing the famous totally shielded "Universal" 6-tube models—together with important accessories—give increased desirability to the Stromberg-Carlson franchise.

These 5-tube Receivers, with their lower price range, will attract additional buyers who seek Stromberg-Carlson excellence, but who do not demand the mighty amplification and range of the 6-tube models.

The Stromberg-Carlson Accessories, built primarily to enable owners to obtain the utmost from their Stromberg-Carlsons, afford dealers the opportunity of augmenting a customer satisfaction which is already without equal.

Stromberg-Carlson Telephone Manufacturing Co.

Rochester, N. Y.

These prices are for the United States.

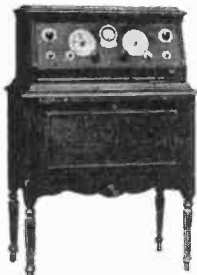

No. 501 Receiver, Treasure Chest. 5-tube; coils shielded; equipped with voltmeter; operates off either house current or batteries; solid Mahogany. Price, less accessories, East of Rockies \$180; Rockies and West \$192.50.

No. 51 Radio Cabinet Table. For use with No. 501 Receiver. Mahogany finish. Price \$54.50; Rockies and West \$67.

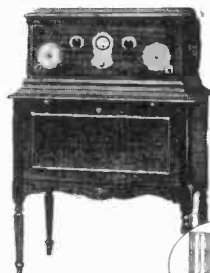

No. 601 Universal Receiver, Treasure Chest. 6-tube; totally shielded; dual control; equipped with voltmeter; solid Mahogany. Operates off either house current or batteries. Price, without accessories or Loop, East of Rockies \$225; Rockies and West \$240.

No. 101 Loop Outfit \$22.50; Rockies and West \$25.

No. 61 Radio Cabinet Table. For use with No. 601 Receiver. Mahogany finish. Price \$56; Rockies and West \$68.50.

Stromberg-Carlson No. 5 Audio Output Transformer. Improves reception and avoids possibility of damaging insulation of loud speaker when power tubes are used. Can be used with any cone speaker. Price, East of Rockies \$8; Rockies and West \$6.55.

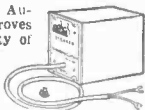

Stromberg-Carlson No. 301 Power Switching Relay. A bridging relay for giving single switch control when sockets power units or external super-power amplifier is used. Price \$11; Rockies and West \$11.75.

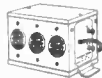

Stromberg-Carlson No. 10 Audio Filter. Eliminates transmitting of rattling noises from overloading tubes to cone speaker. Price, East of Rockies \$3.50; Rockies and West \$3.65.



No. 5-A Cone Speaker. Violin wood soundboard. Price East of Rockies \$35; Rockies and West \$40.

Licensed under Lektrophone patents, 1-271527 and 1271529 Others pending.



The "A" Socket-Power Unit (Gould Unipower, built to Stromberg-Carlson specifications). A reliable source of filament current, operating from house lighting mains. Price East of Rockies \$38; Rockies and West \$43.

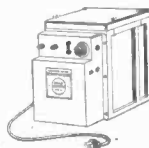

Stromberg-Carlson No. 401 "B" Socket-Power Unit. Eliminates "B" batteries. Designed to meet Underwriters' requirements. Price East of Rockies \$58; Rockies and West \$64.

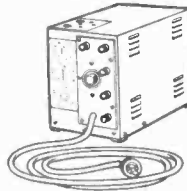

Stromberg-Carlson



Makers of voice transmission and voice reception apparatus for more than thirty years.



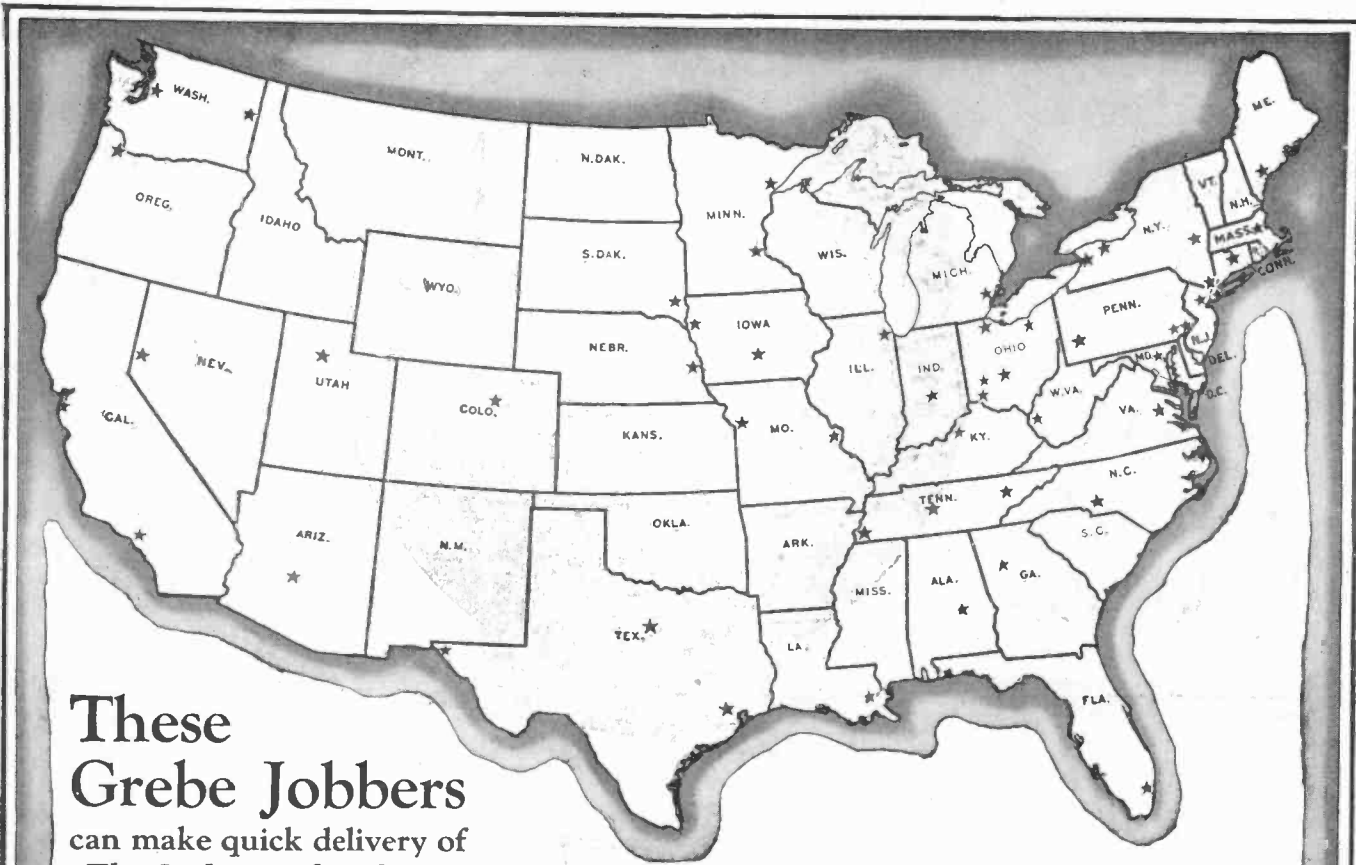

These Grebe Jobbers can make quick delivery of The Grebe Synchronphase

Albany, N. Y.
Esco Electric Supply Co.
461 Broadway

Atlanta, Ga.
The Cooper Tire & Battery Co.
204 Spring Street

Baltimore, Md.
Jos. M. Zamoiski Co.
111 W. Redwood Street

Boston, Mass.
Milhender Electric Supply Co.
617 Atlantic Avenue

Brooklyn, N. Y.
G. J. Seedman Auto. & Radio Co., Inc.
Bedford Ave., at Madison Street

Buffalo, N. Y.
H. B. Alderman, Inc.
69 W. Mohawk Street

Charlotte, N. C.
American Hardware & Equipm't Co.

Chicago, Ill.
Manhattan Elec. Supply Co., Inc.
114 S. Wells Street

Cincinnati, Ohio
The I. J. Cooper Rubber Co.
8th & Main Streets

Cleveland, Ohio
Lokwell Sales & Service
2430 Euclid Avenue

Columbus, Ohio
The I. J. Cooper Rubber Co.

Dallas, Tex.
Radio Equipment Co. of Texas
1319 Young Street

Dayton, Ohio
The I. J. Cooper Rubber Co.

Denver, Colo.
Rocky Mountain Radio Corp.
1512 Broadway

Des Moines, Iowa
Central Automobile Supply Co. Inc.
12th & Mulberry Streets

Detroit, Mich.
Detroit Electric Co.
113 E. Jefferson Avenue

Duluth, Minn.
Kelley-How-Thomson Co.
309 So. 5th Ave., W.

El Paso, Tex.
Western Radio Supply Co.
3661 Douglas Street

Hartford, Conn.
The Hartford Elec. Supply Co.
234 Pearl Street

Houston, Tex.
Bering Cortes Hardware Co.
Prairie Avenue & Millam Street

Huntington, W. Va.
Banks-Miller Supply Co.

Indianapolis, Ind.
The I. J. Cooper Rubber Co.

Kansas City, Mo.
Townley Metal & Hardware Co.
200 Walnut Street

Knoxville, Tenn.
C. M. McClung & Co.
501 W. Jackson Avenue

Lancaster, Pa.
Kirk Johnson & Co., Inc.
16-18 W. King Street

Los Angeles, Cal.
A. H. Grebe & Co., Inc.
443 So. San Pedro Street

Louisville, Ky.
The Cooper Louisville Co., Inc.
242 E. Main Street

Marion, So. Dak.
Hieb Radio Supply Co.
730 Broadway

Memphis, Tenn.
The Clyde Washburn Co.
1055 Union Avenue

Miami, Fla.
Miami Tire Co.
11 N. E. Second Street

Montgomery, Ala.
Johnson Tire & Auto Co.
Cor. Bibb & Lee Streets

Nashville, Tenn.
Braid Electric Co.
910 Broadway

Newark, N. J.
Beller Electric Supply Co.
283 Market Street

New Orleans, La.
Gulf Sales, Inc.
1123 St. Charles Avenue

New York, N. Y.
Universal Radio Co.
355 East 149th Street

Omaha, Nebr.
Lee-Kountze Hardware Co.

Portland, Me.
The Farrar Brown Co., Inc.
492 Forest Avenue

Portland, Ore.
Stubbs Electric Co.
75 6th Street

Phoenix, Ariz.
Nielsen Radio Supply Co.
311 No. Central Avenue

Philadelphia, Pa.
Trilling & Montague,
49 No. 7th Street

Pittsburgh, Pa.
Doubleday-Hill Electric Co.
719 Liberty Avenue

Reno, Nev.
Reno Motor Supply Co.

Richmond, Va.
Benjamin T. Crump Co., Inc.

Rochester, N. Y.
Chapin-Owen Co., Inc.
370 E. Main Street

Salt Lake City, Utah
Inter-Mountain Electric Co.
43-69 E. 4th, So.

San Francisco, Cal.
Weinstock-Nichols Co.
538 Golden Gate Avenue

Seattle, Wash.
Fobes Supply Co.
560 1st Avenue So.

Sioux City, Iowa
Warren Electric Co., Inc.
304 Jackson Street

Spokane, Wash.
Holley-Mason Hdw. Co.

St. Louis, Mo.
Manhattan Elec. Supply Co., Inc.
1106 Pine Street

St. Paul, Minn.
Pioneer Electric Co.
137 E. 5th Street

Toledo, Ohio
The Rollaway Motor Co.

Write for Booklet RR and prices.

A. H. Grebe & Co., Inc., 109 West 57th Street, New York City
Factory: Richmond Hill, N. Y. Western Branch: 443 So. San Pedro St., Los Angeles, Cal.



All Grebe apparatus is covered by patents granted and pending.

THE GREBE SYNCHROPHASE

TRADE MARK REG. U.S. PAT. OFF.



Doctor Hux

This Company owns and operates stations WAHQ and WBOQ

Thousands
in Use!

Every
Owner
A Booster

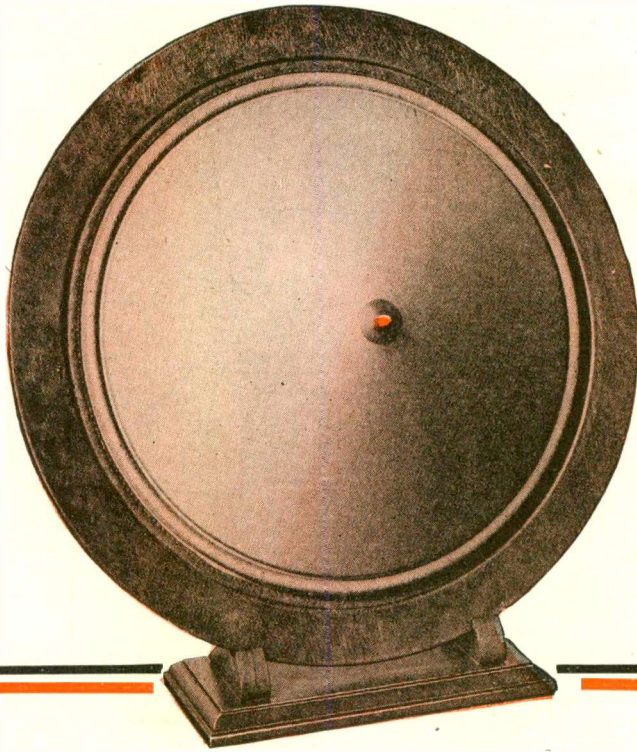

LIST
\$25

Slightly higher in the West

50%
DEALERS
DISCOUNT

TRADE
Melofonic
Radio Speaker
MARK

One after another the long list of Melofonic Dealers is being added to—explainable only by actual performance. Dealers who have been looking for a cone that will give natural reproduction, volume and quality without sacrificing appearance or being prohibitive in price have found it in the Melofonic.

Find out for yourself why every Melofonic owner is a booster—the secret of repeat business. The investment is very small—the profits are surely going to be large. Order just one Melofonic Speaker and you are sure to order many more.

*Melofonic Dealers Are Making Money—
And a Good Reputation*

Progressive Musical Instrument Corp.

319 Sixth Avenue

New York City



\$9.50

The Tower cone

Packed in wooden boxes—no breakage

Pictures can tell you nothing of the exceptional sales possibilities of the Tower Cone—the fastest selling radio speaker on the market. The Tower Cone might well sell for \$35, but scientific design and mass production make possible highest quality at a very low selling price—a non-competitive value.

Line up with Tower and increase your volume of business. Profits will be generous.

*There's a Tower Distributor in Your Territory.
Write Us For His Name.*

TOWER MFG. CORP.
Boston, - - Mass.

-  **Meistersinger**
\$15.20
-  **Scientific**
\$8.50
-  **Little Spitfire**
\$4.95
-  **Phonograph Attachment** \$3.95
-  **Tower Scientific**
\$2.95

Perfected/

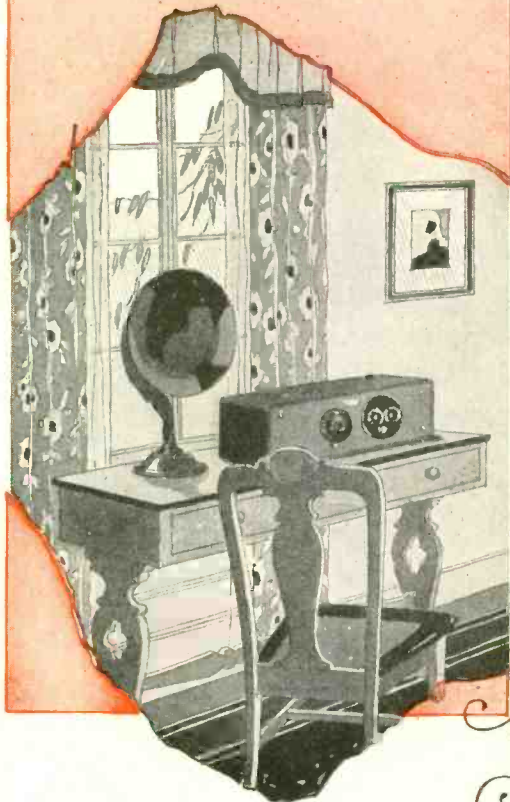
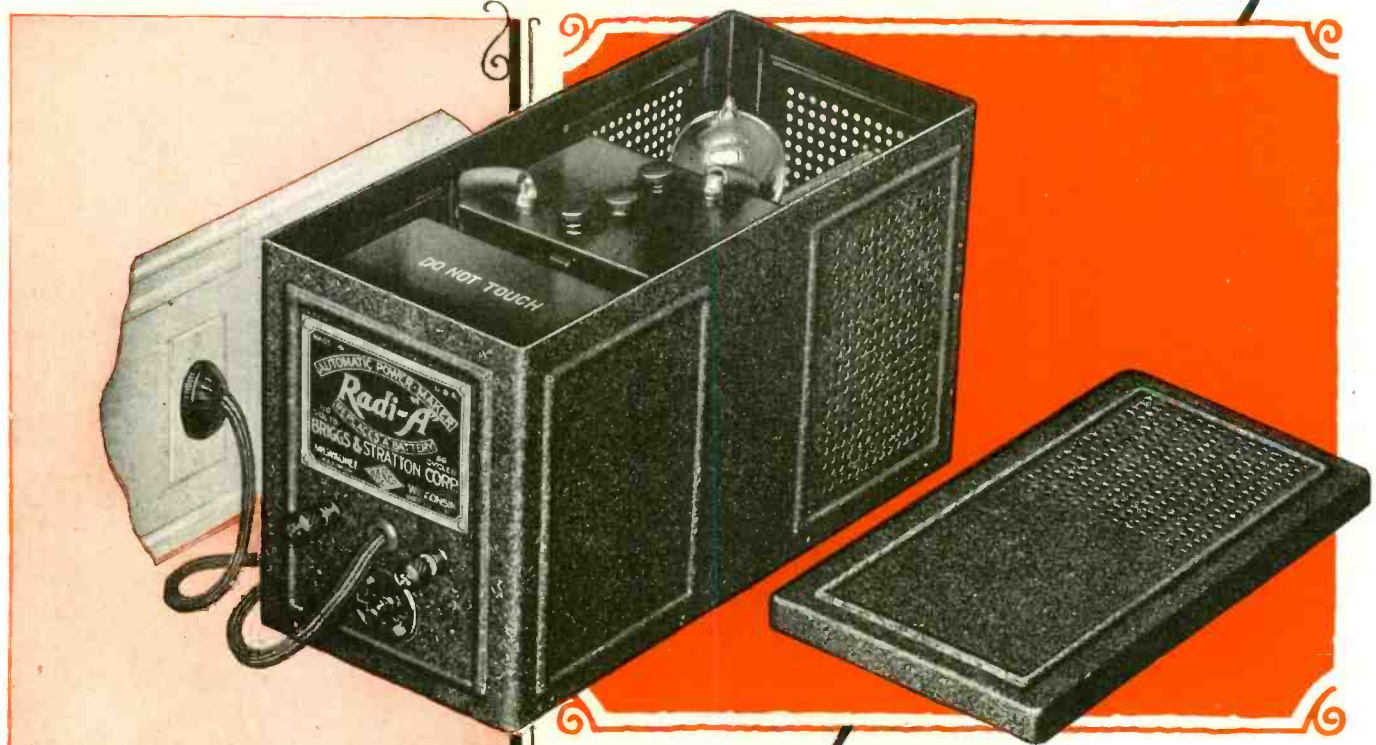

OUT of the chaos of radio experimentation has come a new, *perfected* instrument — Radi-“A”, the “A” Battery’s doubly efficient successor! For more than a year Radi-“A” has been *proving itself* under actual radio reception conditions, with gratifying success — supplying *uniform, humless “A”* current directly from the 110-volt A.C. 50 or 60 cycle household powerline.

Radi-“A” operates with unrippled smoothness and provides a constant, 6-volt current of 2 to 2 3/10 amperes [sufficient for any standard 8-tube set], no matter how long or how often the set is used. *Radio switch automatically controls both Radi-“A” and “B” Eliminator, when one is used.*

Truly Radi-“A” offers the utmost in radio reception and convenience.

Radi-“A”

"A"-POWER from Light Socket Without Battery

RADI-"A" does away with the "A" battery nuisance — one of the chief prejudices held by many people against radio. And it provides a new standard of radio reception — full volume *always!* Radi-"A" will actually increase your sale of "sets" — and net you a better profit per sale.

Every present owner of a radio set has been looking forward to the day when he could replace his "A" battery with a dependable battery-less "light socket" power unit. Radi-"A" meets this want; you can supply the demand!

Your "A" battery service calls can easily be converted into Radi-"A" profit calls. Re-charging jobs can be made Radi-"A" installation jobs. Radi-"A" profits are waiting wherever you turn!

You are naturally going to keep step with radio progress by selling a light-socket "A" power unit that requires no battery. Radi-"A" will fulfill your best expectations both in profits and performance.

Satisfactory Performance Guarantee

We guarantee Radi-"A" to give satisfactory reception, free from hum or distortion, if installed and operated in accordance with our printed instructions. Furthermore, we will repair or replace any Radi-"A" that fails to perform properly, due to defective material or workmanship, within a year. This guarantee does not apply to the Tungar Bulb which is covered by the manufacturer's guarantee.

Write for complete descriptive information and name of the nearest Radi-"A" distributor.

BRIGGS & STRATTON CORPORATION, Milwaukee, Wis.



[See Radi-"A" at the Chicago Radio Show, Section JJ, Booths 2 and 3, South Balcony, Coliseum, Oct. 11 to 17. Radi-"A" was one of the chief objects of interest at the New York Show in September.]

REPLACES "A" BATTERY

Uniform Power-
No Hum or
Distortion
Maximum
Reception
Always

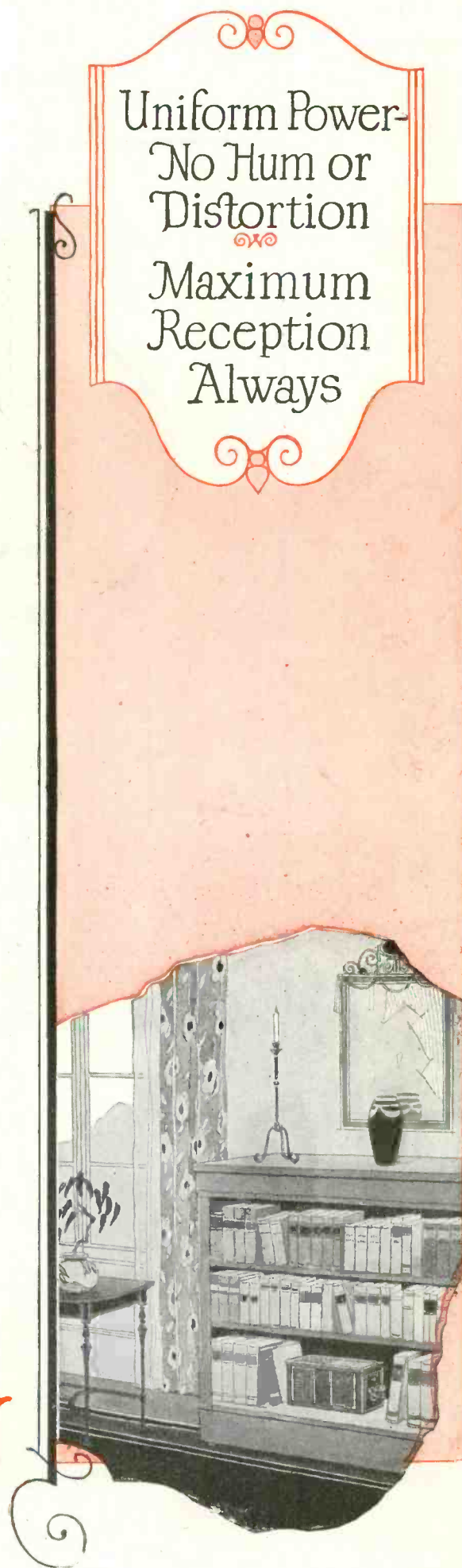

Time



Reg'd U. S. Pat. Off.

OCTOBER-1926						
SUN.	MON.	TUE.	WED.	THU.	FRI.	SAT.
					1	2
3	4	5	6	7	8	9
10	11	12	13	14	15	16
17	18	19	20	21	22	23
24 31	25	26	27	28	29	30

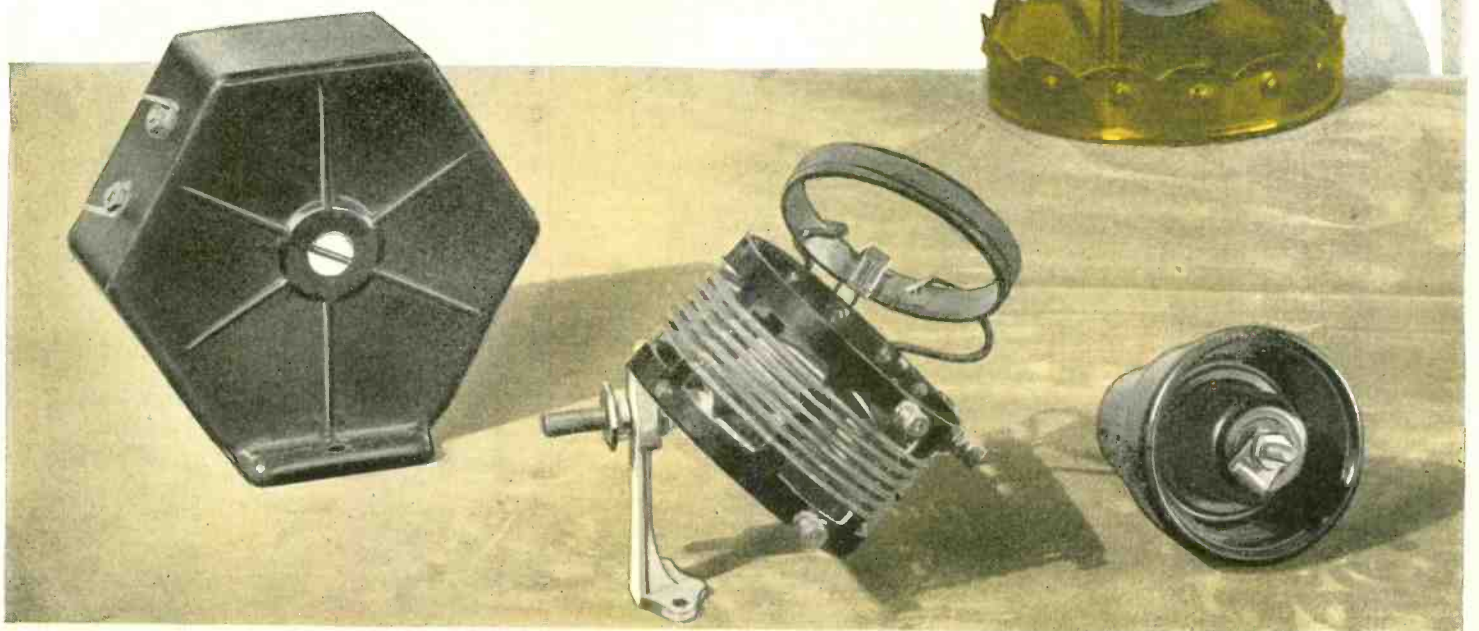

exact's no toll of Bakelite

TIME is relentless in the toll it exacts of many materials— but of Bakelite, which is immune to the ravages of time, it exacts nothing.

The color and lustre of Bakelite are permanent; it does not warp nor become brittle under any variations of temperature or atmosphere; it is not subject to destructive chemical changes. Bakelite does not deteriorate with age.

For these reasons the radio public prefers Bakelite, and radio dealers may sell Bakelite panels, parts and accessories, and Bakelite equipped sets, with the assurance that their customers will never have cause to complain of lost brilliancy, color or strength.

Booklet No. 39 sent upon request.

BAKELITE CORPORATION

247 Park Ave., New York, N. Y. Chicago Office, 636 W. 22d St.
BAKELITE CORP. OF CANADA, LTD., 163 Dufferin St., Toronto, Ont.

BAKELITE

REGISTERED U. S. PAT. OFF.



THE MATERIAL OF A THOUSAND USES

The registered Trade Mark and Symbol shown above may be used only on products made from materials manufactured by Bakelite Corporation. Under the capital "B" is the numerical sign for infinity, or unlimited quantity. It symbolizes the infinite number of present and future uses of Bakelite Corporation's products.



Q·R·S Redtop Radio Tubes *are Better*

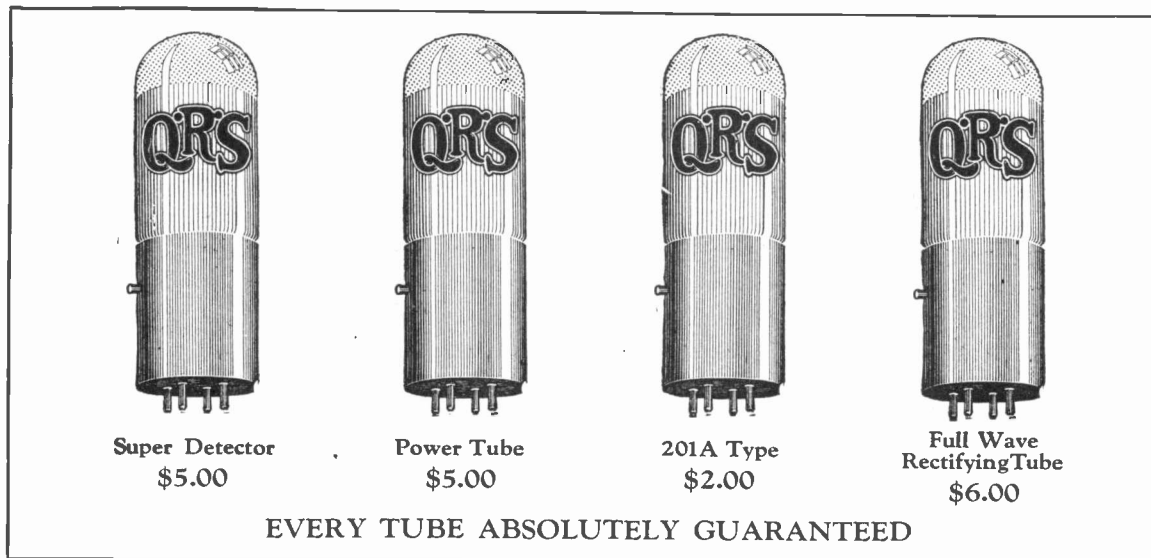

Have You the Mistaken Idea?

Read This and See!

Note the Difference

Two tubes in one bulb—
Consumes no more current

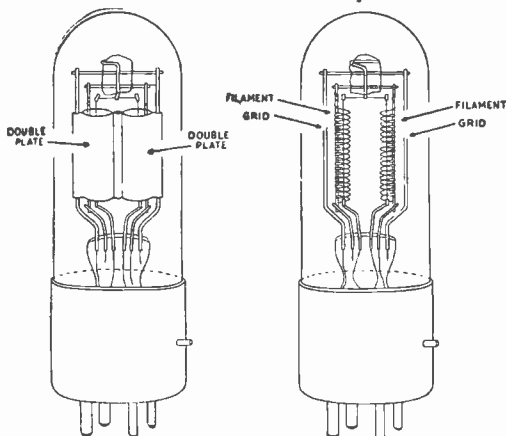

Clearer Reception—Better Tone Quality

*You will never know how good your set is
until you use better tubes*

Many dealers have the mistaken idea that they are not concerned about the financial standing of the manufacturer whose goods they sell.

No retailer can reach the maximum of his profit possibilities unless the financial standing of the manufacturer insures him a continuance of the merchandise on which he builds his trade.

We did not inherit our good will or capital—we started 26 years ago with less than \$35,000 capital. Today we have over Two Million net capital. (See Dun or Bradstreet.)

We do business with over 9000 dealers and our Q·R·S player rolls are in over two million homes. This position could not have been achieved unless our merchandise were right and our policy fair.

Is it not important that the dealer sells a trade mark article nationally advertised, the perpetuation of which is insured not only by the financial standing of the manufacturer but also by the record of growth and good will earned by progressive methods and the maintenance of policies, fair alike to the dealer and the buying public?

The Q·R·S Music Company 306 South Wabash Ave.
Chicago, Illinois

Factories at: CHICAGO NEW YORK SAN FRANCISCO TORONTO, CANADA SYDNEY, AUSTRALIA

Ride in on the Vesta Line

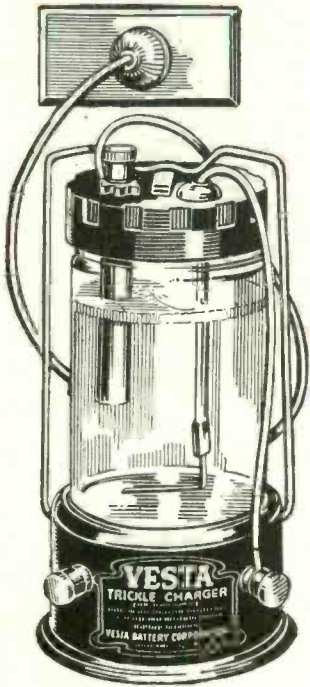

Vesta Trickle Charger
Keeps the "A" Battery fully charged — always

\$10

(Pacific Coast \$10.50)

Now six million Radio owners with two million new Radio owners to be added this season—

Vesta comes out with the very products the Radio public have been hoping for—

These products will sell like "hot cakes" to this great eager throng. "Double our last order." "They're a wonder." "Superior to anything we've had." "Be sure and ship at once." These and a host of other letters from dealers who have already started—and going strong.

Big national advertising campaign — Big newspaper campaign — and many dealer helps—will make Vesta the big seller among Radio products this season.

Get aboard! Ride in on the Vesta Line!

VESTA BATTERY CORPORATION
2100 INDIANA AVE., CHICAGO, U. S. A.

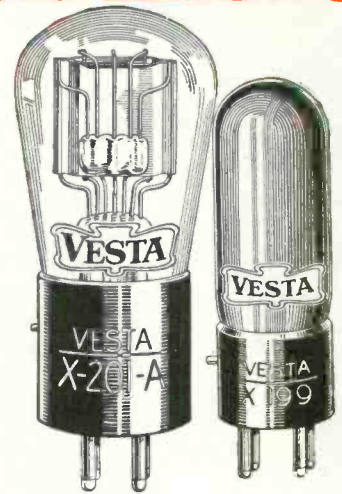

\$2.00 \$2.25
VESTA QUALITY TUBES
A quality that cannot be questioned

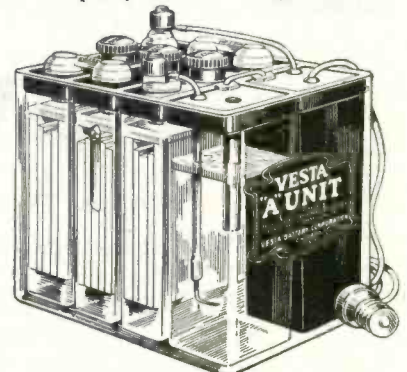

VESTA RADIO "A" UNIT
Three-in-one—"A" Battery, Trickle Charger and Built-in Hydrometer, all in a clear glass case. See solution and water level at a glance.
With 25 amp. Battery, \$25.00
With 50 amp. Battery, \$27.50
(Pacific Coast, add \$1.50)

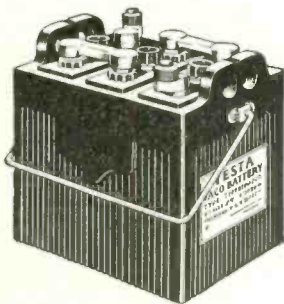

VESTA VACO "A" BATTERY
Dependable — Low Price

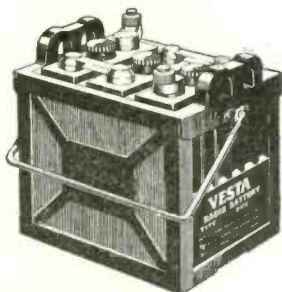

VESTA RADIO "A"
The Highest Quality

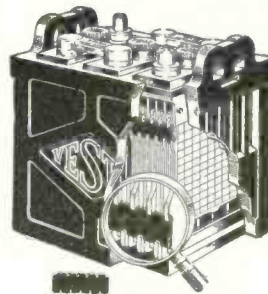

VESTA ISOLATOR
Auto Battery Isolator Construction High Quality

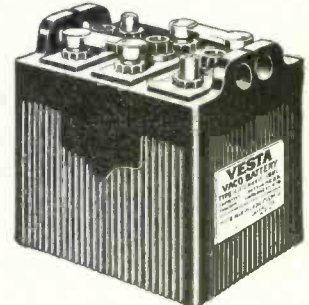

VESTA VACO
Auto Battery Standard Construction Low Price

VESTA

AUTO-RADIO PRODUCTS
Vesta for Vitality

WRITE HERE

VESTA BATTERY CORP., 2100 Indiana Ave., Chicago, Ill. R.R.—Oct.
Please have your Central Distributor near me present the Vesta

Radio Line

Auto Battery Line

Name.....

Address.....

City..... State.....

SEE THE VESTA EXHIBIT AT THE RADIO SHOW—CHICAGO, Oct. 11-17, Booths 32 and 33. Section HH



Niagara Falls—
greatest single
source of un-
failing power
in the world.

POWER

*Ample, abundant power is
the newest demand in radio*

YOUR customers are clamoring for more volume—for more power to operate the newer types of speakers. Ordinary tubes can't handle so much power—they choke up like a flooded carbureter.

Gold Seal high power tubes, GSX-112, GSX-171 and GSX-Hy Mu, have been developed to meet this need. They are fast sellers and mean larger profits for you. *Are you making the most of this opportunity?*

All Gold Seal tubes are made with the exacting care which has made them famous from Coast to Coast in record time—making new friends all the time. You should be sharing in their success.

If not obtainable from your jobber, write us for particulars of our attractive dealer proposition

Gold Seal Radio Tubes

**Jobbers! Some desirable territories still open.
Full Protection. Write for particulars.**

**GOLD SEAL ELECTRICAL CO.
INCORPORATED**

250 PARK AVE., NEW YORK



Type GSX-171
High power tubes
for use in last stage
of audio amplifica-
tion give increased
volume.
Price \$6.00
Look for the red box



Type GSX-112
High power tubes
for use in last stage
of audio amplifica-
tion give increased
volume.
Price \$6.50
Look for the red box



Type GXS-200A
For use as detector
only, giving super-
ior strength on
weak signals—es-
pecially desirable
for distance.
Price \$5.00



Types GSX-201A
and
GS-201A
The popular gen-
eral purpose type,
for amplifier or de-
tector. Long life and
high efficiency.
Price \$2.00
Look for the blue box



Types GSX-199
and
GS-199
For use with dry
cell batteries—ideal
for portable and
other compact re-
ceiving sets.
Price \$2.25
Look for the green box



Type GSX-120
For dry cell opera-
tion used in last
stage of audio im-
plification it in-
creases volume.
Price \$2.50
Look for the red box

All Standard Types

PERMANENCE

*The Pharaohs
Built for the Future*



The Kellogg Franchise Appeals to Dealers Who Also Are Looking for Permanence

SELL a good set, made by a concern that will surely be able to supply more good sets next year and the year after—that is the secret of permanent prosperity in the radio business.

The Permanence of your manufacturing connection is vitally important because a big proportion of your next year's sales should come, at slight sales expense, from the word-of-mouth advertising created by the good sets you put out this year.

Kellogg has an *exceptionally good* radio set—its financial standing, reputation and tremendous investment in Radio are ample assurance of Kellogg's future permanence in the radio field.

The Kellogg line and franchise are proving most attractive to dealers who look to future as well as present profits. If YOU are that kind of a dealer, and your territory is still open, we would like to hear from you.

Kellogg Switchboard & Supply Co.
Dep. 12-J, 1066 West Adams Street, Chicago, Ill.

Kellogg receivers are licensed under application for letters patent of Radio Frequency Laboratories, Inc. (R. F. L.)



Model 507, 6 tube receiver Kellogg's development of the sensational new RFL circuit. The acme of Selectivity and Musical Reproduction.

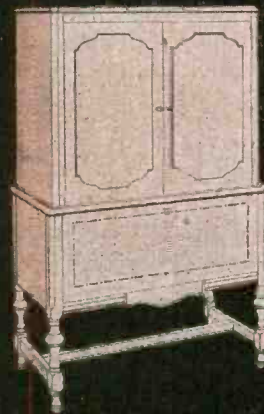

Model 505, the 6 tube Kellogg RFL in a beautiful walnut console, equipped with the Kellogg new, long air column speaker.

KELLOGG Radio
FLAWLESS REPRODUCTION

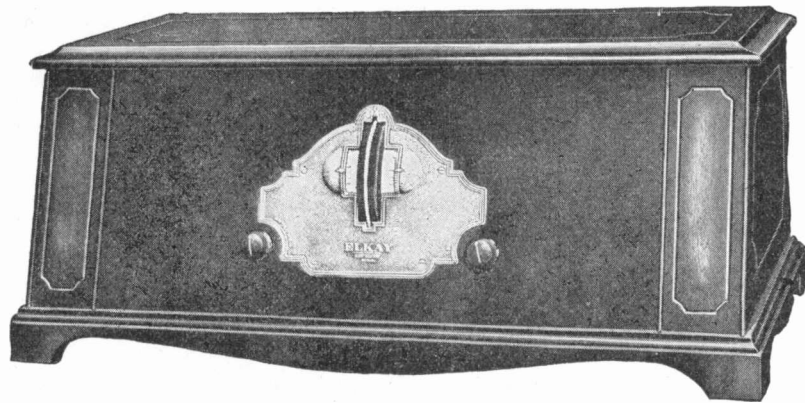

(Licensed Under Patents Granted and Pending)
Six Tubes—\$125 List

THE NEW **ELKAY** RECEIVER

Will Be Up To Date For Years To Come

Some cars get out of style very rapidly. Others, like the famous Rolls-Royce, look right, function right and please their owners for many years . . . a case of far-sighted designing, inspired by close study of the field.

Now, radio designers are looking ahead. The new ELKAY shows this.

Note the advanced panel design, with neat, centralized Uni-Control. Note also the graceful lines of the cabinet. The Elkay will always please the eye.

The circuit embodies the Elkay Tube Equalizer System of interchangeable, automatic rheostats. Any combination of tubes can be used. Owners can change instantly to the newer tubes as they come out, without change of wiring.

The new Donle Truphonic System of Audio Amplification and the Elkay Synauto R. F. are also a part of the circuit . . . giving a wonderfully pure tone and a high, UNIFORM amplification from 200 to 580 meters.

The R. F. stages and the Detector are completely shielded against "strays." Full "Floating" Sockets prevent microphonic howling. All connections are from a common cable, plainly tabbed.

These are all forward-looking improvements that make the Elkay a permanent investment instead

of a passing fancy. They afford the dealer arguments that make sales.

Retail price, \$125, in brown antique Duco finished mahogany.

Elkay Five-Tube Receiver

Compares favorably in appearance, selectivity, volume, distance and tone with receivers at twice its price. One stage R. F., detector, one stage of transformer-coupled amplification and two resistance-coupled amplifiers. Operates smoothly on low or high wave lengths. Has the Elkay Equalizer System, which permits the use of any combination of tubes, and an Elkay (patented) selectivity control. \$80, list.

Elkay Tube Equalizers

Elkay Equalizers replace variable rheostats, delivering correct voltage to any type of tube automatically. To use any combination of tubes in the same set, merely insert an Equalizer of the correct value; there is one for every tube made. 50 cents list; 75 cents mounted.

We protect our trade on an EXCLUSIVE BASIS. The season is close at hand. Orders are coming in briskly. Territories are rapidly being allotted. We urge you to write your jobber today for discounts and territorial franchise. If he does not handle the Elkay line, write us.

THE LANGBEIN-KAUFMAN RADIO CO., Dept. M, 62 Franklin St., New Haven, Conn.

Let us tell you why the **VAN HORNE LINE** will be a Profit Maker for you

YOU as a progressive dealer are directly interested in selling radio tubes that not only are meritorious in producing results for your customers but that produce for you a fair profit on your investment. VAN HORNE radio tubes—because they are so distinctively different are not sold on a price basis—they are bought for the improvement they make in reception.

This means your customers buy VAN HORNE radio tubes on what they will actually accomplish in bettering reception. It gives you an opportunity to ignore price competition and to make the legitimate profit you deserve.



Distinctive—and Therefore Without Competition. A Sales Advantage Meaning Profits.

WHEN you become a VAN HORNE dealer you can at all times offer to your customers the latest improvements in radio tubes. The VAN HORNE line is a progressive one—not just keeping up with the trend of developments but setting the pace. Each tube is backed by an experienced factory organization—guaranteed unconditionally by a reliable company which is headed by a man who is a recognized authority on radio tubes.

Progressive

First ~ a power tube that requires no change in set wiring ~ for clearer volume

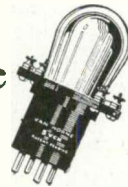

Then ~ the cushion-base 5VAX ~ to absorb vibration and give fullness of tone



Now ~ the 5VD super-sensitive detector ~ for greater distance and volume



At the bottom of the page you will find a coupon—send it today and let us tell you what the VAN HORNE line offers to you.

Don't delay in "lining up" with the most progressive radio tube manufacturer in the field.



Superiority—Not a Claim but a Quality that can be proven by comparison.

The Van Horne Co., Inc.
FRANKLIN, OHIO

THE VAN HORNE CO., Inc.
FRANKLIN, OHIO
Please tell me why the Van Horne line will make profits for me.

Name
Street
City State

Selling an
Educated
Market—
with

Blue Ribbon Receivers

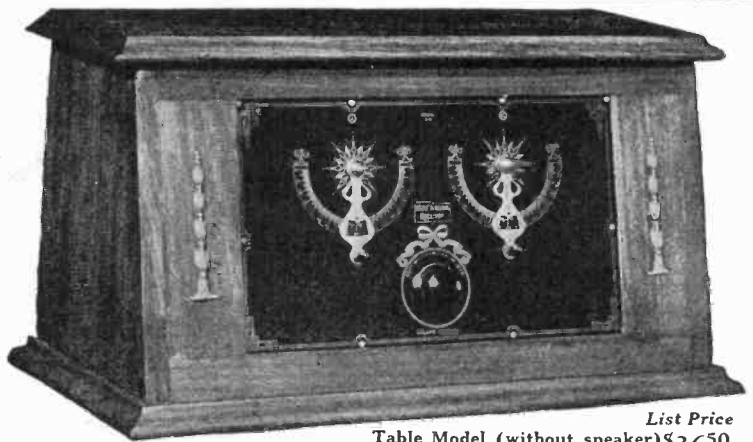

Table Model (without speaker) ^{List Price} \$36⁵⁰



Console
Model

List Price

\$7200

ture of our Console receivers, extreme selectivity under most congested broadcasting conditions, superb summer reception, etc., are also conspicuous selling points that are making these instruments the sensation of all radiodom.

Both construction and performance of Blue Ribbon Receivers are backed by a concern of unassailable repute.

Some territories still open for live, aggressive representation. Send today for full description of models and attractive selling proposition.

In radios today, the public "wants what it WANTS."

Tell any prospect that you have a five-tube set that will match in performance any six-tube instrument produced today, and he will immediately say, "Show me!"

When you can offer him a choice of these three Blue Ribbon models, he is half sold right from the start—and on appearance alone. Then explain Blue Ribbon construction—the entirely new circuit, operating efficiently on dry cell batteries, but *universal* in using storage battery tubes, if preferred.

Blue Ribbon tone quality, due to a distinctly new type of speaker unit, which is an exclusive fea-



Table Model
List Price \$5900

RADIO DIVISION

Chicago Nipple Mfg. Co.

1966 Southport Avenue, Chicago, Ill.

The GRADEON

A NEW MUSICAL ACHIEVEMENT



Sells Three Other Products While Selling Itself

Electrical reproduction! That is the coming thing. The Gradeon is the sensational new instrument that is taking the country by storm. The Gradeon is the instrument that enables phonograph and radio owners to enjoy the superiority of electrical reproduction of phonograph records at a cost of only \$17.50 retail!

*In Your Store—the Gradeon Shows Off Phonographs,
Radio and Records as They Have Never Been Shown Before.*

Attached to the tone arm of any phonograph, the Gradeon carries the sound impulses from the record through the audio tubes of the radio set, amplifies them electrically, picks up all the fine tones usually lost and pours them forth in glorious splendor and volume through your radio loud speaker. Volume

enough for dancing—tone quality surpassing the most expensive instruments.

Leading department stores are already using The Gradeon (1) to demonstrate all new phonograph records, (2) to sell phonographs to radio owners, (3) to sell radio sets to phonograph owners.



*A Package
That Looks
The Quality
That The
Gradeon's
Performance
Proves.*

Orders received at once can be promptly filled by Jobbers

DAVID GRIMES, INC.

151 BAY STREET

JERSEY CITY, N. J.

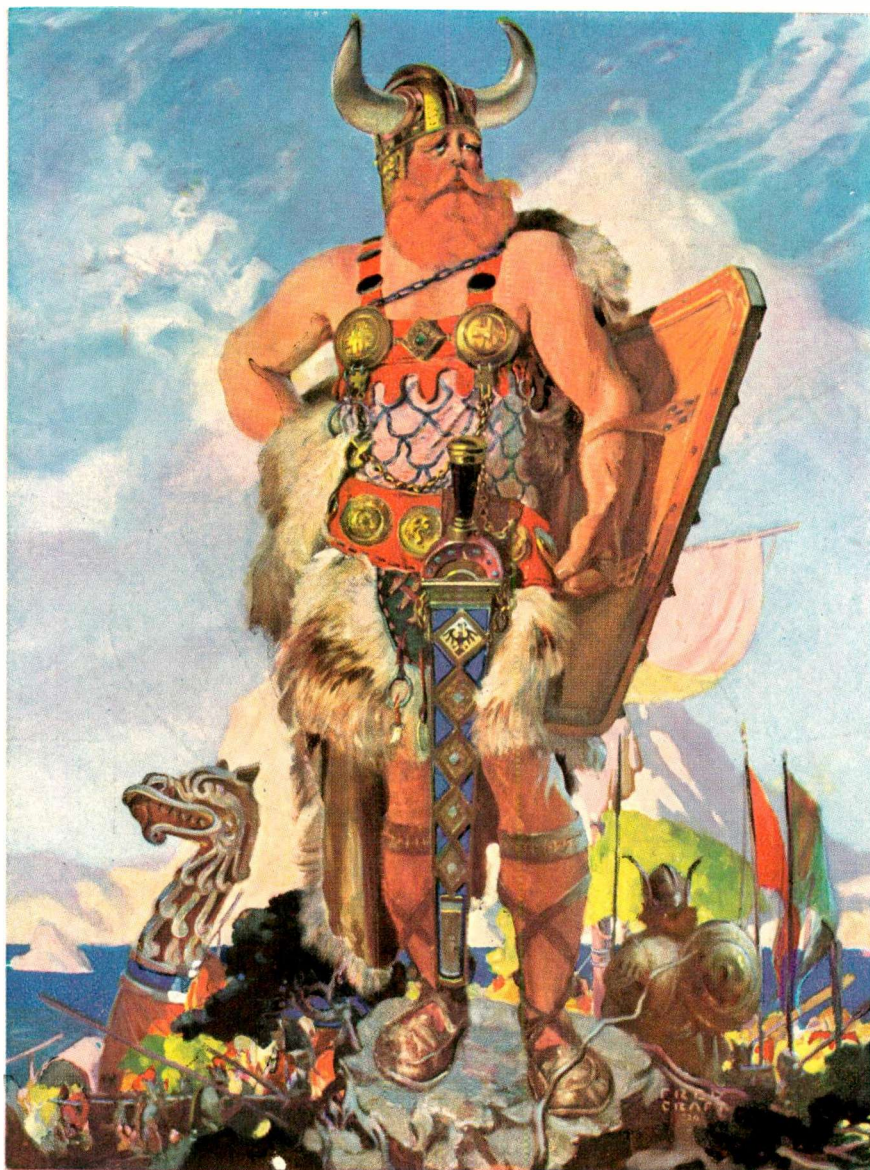

VIKING

At last, with final radio perfection, the time has come to give the most distinguished of all new radio models a distinctive

name of its own, just as new automobile models became worthy of special names when perfection had been finally attained.

Exclusive Dealers Now Being Appointed

DAVID GRIMES, INC.

JERSEY CITY, N. J.

Manufacturers of the Viking Radio and the Viking Imperial. Retail price range, \$79.50 to \$300.
Also producers of "The Gradeon." See opposite side of this page.

STEWART-WARNER

Matched-Unit Radio

Are you hooked up with a winner?

The day of the fly-by-night radio manufacturer and dealer has passed. The day of the solid, substantial, responsible manufacturer and dealer is here!

Convincing proof of this is found in the astonishing growth in the sales of Stewart-Warner Radio—and in the number of applications for Stewart-Warner Protective Franchises which are pouring in every day.

Far-seeing dealers everywhere are realizing the vital importance of "hooking up with a winner" to insure immediate profits and permanent prosperity.

Never before has the Stewart-Warner Protective Franchise been so valuable an asset as today! The Stewart-Warner line has been rounded out by the addition of many new, fast-selling, up-to-the-minute models, including several new six-tube single dial sets and an amazing new reproducer.

Now you can supply all the demands of all your customers from the Stewart-Warner Matched-Unit Line. There's a Stewart-Warner Radio for every taste, every home, every purse.

Right now, with the cream of the selling season just before you, is the time to clinch your Fall and Winter Profits by lining up with Stewart-Warner. Delay will mean lost sales, lost opportunities for making real money. Write today for complete catalog and details regarding a Franchise in your locality.



Reproducer
Model 415
\$30

Beautifully
finished in
antique
bronze

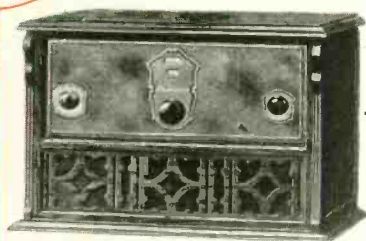
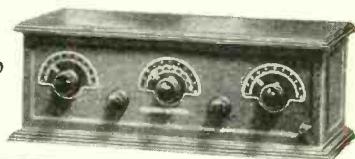

Table Cabinet Model
350—\$110

Model 300
\$65



Console Model
355—\$150



Radio Tube
Model 501 AX
\$2.00

Prices slightly higher
west of Rockies

The new Stewart-Warner Reproducer, shown above, is already creating a sensation from coast to coast. It is a musical marvel! By employing an altogether new principle of electrical sound reproduction, Stewart-Warner has achieved the triumph of eliminating the annoying distortion caused by tones at the "natural period of vibration" of the diaphragm. Radio manufacturers have attempted for years to accomplish this feat, but it remained for Stewart-Warner to do it. Stewart-Warner is in exclusive control of the patents on the device which eliminates this distortion. No other make of reproducer can use it.

The result is clear and faithful rendition of every musical sound, from the lowest to the highest, just as they are broadcast from studio or stage. You will find this new Stewart-Warner Reproducer to be a phenomenally fast seller—and a big profit-maker for yourself.

STEWART-WARNER SPEEDOMETER CORPORATION
1820 DIVERSEY PARKWAY, CHICAGO, U. S. A.

TWELVE MILLION PEOPLE ARE TODAY USING STEWART-WARNER PRODUCTS

The facts

which every radio distributor and dealer should know

PROBABLY no word in the entire radio vocabulary has greater commercial importance than the word "Neutrodyne." So let's get started right with a definition.

The word "Neutrodyne" is a registered trade-mark, owned by the Hazeltine Corporation and applied to a radio receiving set embodying certain patented inventions of Professor L. A. Hazeltine, and manufactured exclusively by fourteen licensed manufacturers.

Every genuine Neutrodyne set carries the Neutrodyne trade-mark. Unless it bears this trade-mark, and unless made by one of the fourteen Hazeltine licensees, a receiving set is not a Neutrodyne.

The birth of the Neutrodyne

Back in 1921, when music and speech began to float through the ether in really appreciable quantities, the receiving sets, so-called, were merely crude adaptations of existing radio telegraph apparatus. Without exception they were cumbersome, complicated and unsatisfactory.

Their chief characteristic was their tendency to become transmitters. Upon the slightest provocation, they filled the surrounding air with squeals, howls and hideous sound until the absolute destruction of broadcasting itself was threatened.

This was the situation in 1921 and early in 1922. And then came the change—the change that marked the first real advance—the first radio receiver designed and constructed to receive broadcast.

Professor L. A. Hazeltine, of Stevens Institute of Technology, an electrical genius who has applied his unusual talents particularly to radio, designed and perfected the Neutrodyne receiver which embodies his radio circuit.

This type of amplifier eliminates regeneration by neutralizing the inherent feed back due to undesirable capacity coupling, thereby giving high selectivity, good tone quality and simple adjustment and preventing squeals, whistles and radiation.

This radio receiver when properly constructed and adjusted could not under any circumstances become a transmitter. It could not howl or squeal. It could not radiate.

In addition, this new receiver was found to possess a higher degree of selectivity than had ever before been obtained. It was extremely sensitive and the quality of its reproduction of sound unusually fine.

Small wonder that the Neutrodyne swept the country. Small wonder that it was widely imitated. Small wonder that all kinds of sets were sold as "neutrodynes."

Organization of the Hazeltine interests

Following the granting of patents to Professor Hazeltine—patents which have successfully stood the test of litigation—the Hazeltine Corporation was formed. This company now owns and controls these patents and inventions, and the Neutrodyne trade-mark.

It manufactures no receiving sets, but has granted

Look for this trade-mark

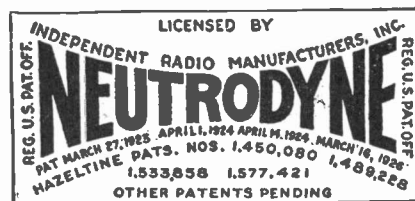

It is your protection against patent infringement liability

HAZELTINE CORPORATION
(Sole owner of "Neutrodyne" patents and trade-marks)

INDEPENDENT RADIO MANUFACTURERS, INCORPORATED
(Exclusive licensee of Hazeltine Corporation)

The next advertisement in this series will explain the service rendered the radio business by the Hazeltine Corporation

about Neutrodyne

an exclusive license to the Independent Radio Manufacturers, Incorporated, which in turn has licensed its fourteen member companies to manufacture Neutrodyne receivers.

The Independent Radio Manufacturers, Incorporated

The fourteen companies, who alone are permitted to use the Hazeltine inventions and to label their receiving sets with the Neutrodyne trade-mark, are these:

THE AMRAD CORPORATION, Medford Hillside, Mass.
 F. A. D. ANDREA, Inc., New York City
 CARLOYD ELECTRIC & RADIO COMPANY, Newark, N. J.
 FREED-EISEMANN RADIO CORPORATION, Brooklyn, N. Y.
 EAGLE RADIO COMPANY, Newark, N. J.
 GAROD CORPORATION, Belleville, N. J.
 GILFILLAN RADIO CORPORATION, Los Angeles, Cal.
 HOWARD RADIO COMPANY, Inc., Chicago, Ill.
 KING-HINNERS RADIO COMPANY, Buffalo, N. Y.
 WM. J. MURDOCK COMPANY, Chelsea, Mass.
 STROMBERG-CARLSON TELEPHONE MFG. CO., Rochester, N. Y.
 R. E. THOMPSON MFG. CO., Jersey City, N. J.
 WARE RADIO CORPORATION, New York City
 THE WORK-RITE MFG. CO., Cleveland, Ohio

How the companies operate

These fourteen manufacturers pay royalties to the Independent Radio Manufacturers, Incorporated, which company turns over this income to the Hazeltine Corporation, less a fixed charge which is set aside to accumulate into a fund. This fund provides the means for prosecuting infringements of "Neutrodyne" patents and trade-marks, whether by manufacturers, wholesalers, retailers or even by the ultimate purchasers of radio receivers. This fund also provides for the defense of distributors and dealers authorized to handle and sell licensed Neutrodyne radio receivers against patent infringement prosecution as far as those receivers are concerned.

Complete protection for Neutrodyne distributors

The value of this arrangement for the protection of the manufacturers, distributors, retailers and

users of Neutrodyne apparatus has already been demonstrated.

"Neutrodyne" distributors when sued have been successfully defended in the courts by the Independent Radio Manufacturers, Incorporated. And the validity of "Neutrodyne" patents and inventions has been upheld by the courts against infringers.

So that today no radio receiving sets or radio apparatus offers the distributor and the dealer a greater degree of safety than Neutrodyne.

It has won its battles in the law courts, just as it has won the hearts of the radio listeners. And it is financially able and more than willing to protect itself and its distributors. Neutrodyne will not only defend itself when attacked—it will lead the attack if its rights are invaded.

Play safe with Neutrodyne

Remembering that distributors, wholesalers, retailers and even consumers are liable under the law, in selling or having in their possession infringing radio apparatus, read the following paragraphs carefully:

The courts have recently ruled that Tuned Radio Frequency Receivers equipped with adjustable means to usefully control regeneration and prevent oscillation, infringe the Armstrong patents.

The courts have also held that receivers employing certain neutralizing schemes infringe the "Neutrodyne" patents.

Ask yourself whether the sets you handle are clear of liability; whether the manufacturers of such sets would be likely to protect you if you were sued.

If you are in doubt about your liability, consult competent legal authority.

Thoughtful, careful, conscientious distributors are today playing safe by handling licensed Neutrodyne apparatus. They have not only found such a policy safe and sound, but highly profitable.

Look for this trade-mark

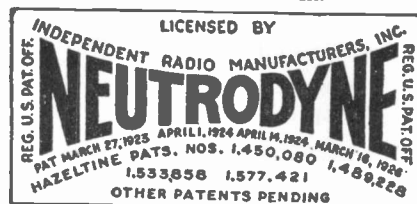

It is your protection against patent infringement liability

HAZELTINE CORPORATION

(Sole owner of "Neutrodyne" patents and trade-marks)

INDEPENDENT RADIO MANUFACTURERS, INCORPORATED

(Exclusive licensee of Hazeltine Corporation)

Keep this important statement and file it for your future reference and guidance

WORKRITE RADIOS WORKRITE

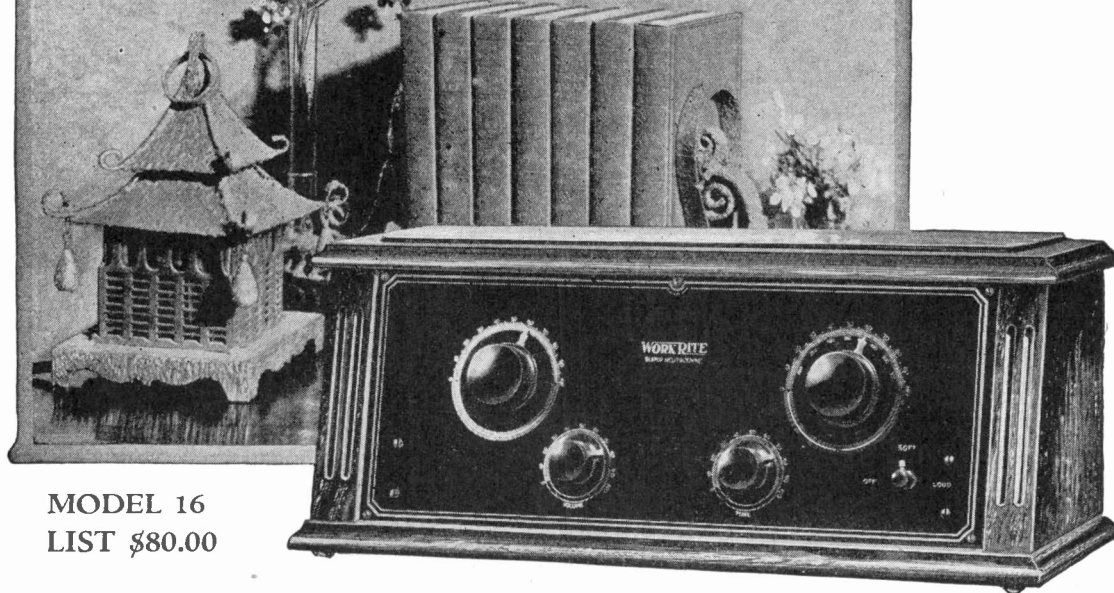

MODEL 16
LIST \$80.00

Real Value for your Customers Real Profits for you!

WorkRite Model 16

6 tube Neutrodyne receiver with new 2 dial control. Straight line broadcast condensers. Beautiful walnut cabinet with panel to match, gold trimmed. Will outperform many sets selling for much higher price. Price, \$80.00.

WorkRite Model 26

The same circuit and control as the Model 16, mounted in a handsome walnut console cabinet. 3-way switch—"Off, Soft, Loud," gives wonderful volume control. 20-in. built-in cone speaker gives deep, full tone. Best value console on the market today. Price, \$145.00.

WorkRite Model 36

6 tube transformer and resistance coupled Neutrodyne circuit. 3-way switch. TWO-IN-ONE dial operates all three condensers from one control. Large built-in cone speaker 24-in. wide. Beautiful walnut cabinet, is a most pleasing piece of furniture. Price, \$210.00.

DEALERS

Some exclusive territory is still available for the WorkRite line. Write for information about your territory.

The day of the fly-by-night set manufacturer is over. The demand for reliable, well known sets has put him out of business. Your customers want a set that is made by a reputable company because they feel more certain of getting full value for their money.

The line of WorkRite Super Neutrodyne Radios is made by a pioneer radio manufacturer and has a standardized circuit,—the Neutrodyne.

Standardized production by experienced workmen has reduced the cost of WorkRite Radios and enables us to quote them at the remarkable prices listed.

Every WorkRite Radio is excellent value because of the wonderful volume, fine tone and easy tuning of the set and the beautiful cabinet in which the set is housed.

These Radios will please your customers because of their performance and high quality. They will make money for you because they are easy to sell and require practically no servicing.

WorkRite dealers are given exclusive franchise. Your territory may be open. Write today.

The WorkRite Manufacturing Co.

1819 E. 30th St., Cleveland, Ohio



Eagle will never compromise its responsibility to the dealer

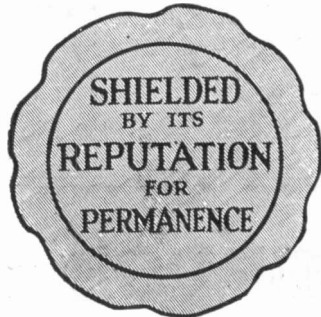

Model K2 Console

More than at any other period in the history of radio, the public is demonstrating its preference for the product backed by an established reputation.

In other words, the public is now reacting to the same situation the dealer has faced.

Eagle has kept faith with its dealers and with the public. It has never permitted itself to be stampeded into manufacturing and merchandising practices which would be injurious to the trade or cause the users of Eagle receivers to lose confidence.

Interest at the New York Radio World's Fair in the new additions to the Eagle line was extraordinary. Dealers who attended and witnessed the interest of the fans went away filled with enthusiasm.

May we send you details of the new things Eagle is doing—and the registered dealer agreement upon which Eagle dealers operate?

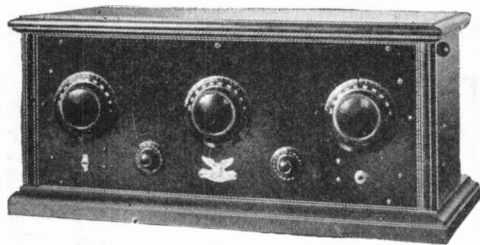

Model M Table Type

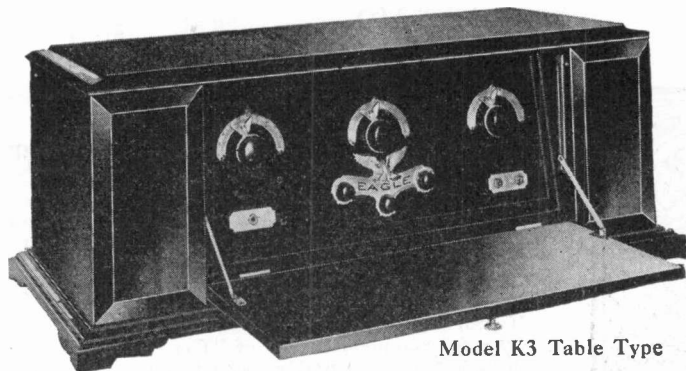

Model K3 Table Type

EAGLE RADIO Co., Boyden Place, Newark, N. J.

Now—2 New Electric Power Garods!
Both marvellously richer in tone, sounding new low notes

GAROD *ELECTRIC* POWER RADIO

YEARS AHEAD!
Startling New Advanced Units of Design!

GAROD-*EA*



Simply—
Plug into
light socket
at cost of ½c
per hour.

No Batteries! No Eliminators!
No Chargers! No Attachments!

*NEW POWER INCREASES TONE RANGE
AND RICHNESS*

POWER is the absolute essential for the deeper and finer tones in radio. And new Garod-EA now reproduces *entirely by electric power!*

Five elements in new Garod-EA contribute to this unparalleled quality of tone. First, the House Current... equivalent in power to 10 "B" Batteries. Special Power Tubes... 100 times more powerful than standard tubes. The Power Unit... that steps up the house current to 450 volts. The Super Audio Transformer that, together with the power tubes which never overload, amplifies tone *without distortion*. Neutrodyne, that silences all "squeals" and guarantees world's finest selectivity.

Price \$310

Only Loud Speaker and Tubes to be added

GAROD-*EC*



—Simply
Plug into
light socket
at cost of ½c
per hour.

No Outside Antennae! No Batteries!
No Loop! No Battery Substitutes!
(unless preferred)

COMPLETELY SHIELDED
ONE-DRUM-DIAL *Tuning Control*
SEVEN TUBES :: ELECTRIC POWER
INDUCTANCE-TUNED
RADIO FREQUENCY TRANSFORMER
(Replacing Variable Condensers)

INSURING —

- 1—Accurate, permanent synchronization of multiple stages.
- 2—Extreme sensitivity and selectivity due to high ratio of inductance to capacitance.

Presented in "The Robin Hood," a fine period chest, made of three rare woods from the forests of Robin Hood.

CUSTOM BUILT BY GAROD LABORATORIES
(Made to Order Only)

Price \$750

Only Loud Speaker and Tubes to be added.



DEALERS' ATTENTION!

Garod-EC illustrated above was one of the outstanding features of the Radio World's Fair at Madison Square Garden, New York, September 13th to 16th. This remarkable achievement represents the very finest receiver that can be built. It is custom-made. Complete details will be sent upon request.

Garod-EA today has put the factory into night and day production.

If your territory is not yet covered by a Garod wholesale representative write us at once for complete details of "The Garod Franchise" which protects exclusive Garod dealers in every desirable way when a territory is allotted. The big thing in radio today is **ELECTRIC POWER**. Get acquainted!

GAROD CORPORATION :: :: :: Belleville, New Jersey

An
Instantaneous
Success

FREED-EISEMANN
CRASTIES
into the accessory market



Model 14—Full Floating Cone Speaker—built on new principles exclusively Freed-Eisemann, to reproduce all frequencies with full sonorous tone and clear definition. Sells immediately by comparison. List price \$25.



MODEL FE60
Trickle Charger
List Price \$12.50



Model 16—"B" and "C" Power Unit—the only power supply with all these features: 1—Gives both B and C supply, 2—Safety! Automatic switch disconnects current when door is open. 3—Absolutely noiseless. List price less tubes \$45.00

Each of these accessories represents years of research. With the new Freed-Eisemann Receivers, they give the utmost in radio performance. Nationally advertised.



Model FE603
"A" Socket Power
List Price \$36.50

NEUTRODYNE

The NEW Models of ... GILFILLAN RADIO



The New Gilfillan Model 20 with Single Dial Control and Shielded Radio Stages.

The above model 20 is operable from light socket with battery eliminators, as well as usual batteries. Plenty of power and highest degree of selectivity, marvelous tone with abundant volume. Rola cone speaker and magnificent hand carved cabinet.

Other new Models are No. 10—A compact, powerful 5-tube table set. Hand carved walnut cabinet; and Models 30 and 40—6-tube copper shielded sets of special design with console or table cabinets and unusual features. Prices range from \$90. to \$350.

Place your order through your jobber for prompt delivery, and write to nearest office for literature.

GILFILLAN BROS. INC.

2525 W. Penn Way
Kansas City, Mo.

1815 Venice Blvd., Los Angeles, Calif.

25 Wilbur Ave.
Long Island City, N. Y.

You have

2

Customers for Radio

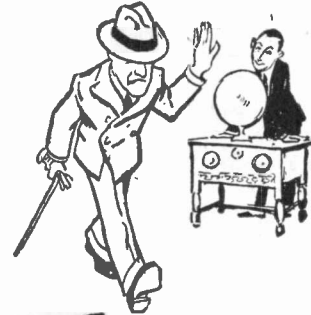

THERE are two kinds of people in the market for radio today. Fada Harmonated Reception will turn them both into customers.

1 There is the man who already owns a set and isn't entirely satisfied. He is in the market for something better, but is rather doubtful about finding it. He trusts to his own ears.

Fada Harmonated Reception is outstandingly superior to ordinary radio. One has but to hear it to recognize this instantly. It makes radio reception a new sensation! It is radio without alibis!

2 There is the fellow who has been waiting for radio to find its feet—he has listened in on other people's sets and has said to himself, "I'll wait until radio is right!"

Fada Harmonated Reception is by far "righter" than any radio ever before offered. Its performance is astoundingly better than anything you have ever heard. It is the radio of tomorrow—here today!

Here's how to get them both



Fada Harmonated Reception, a brand new development in radio engineering, is being demonstrated by the distributors in your territory. Write to us for our Dealer's Proposition.

F. A. D. ANDREA, INC.
1581 Jerome Avenue New York
Manufacturers of TUNED RADIO FREQUENCY Receivers
using the highly efficient NEUTRODYNE principle

Fada Cone Speaker
Table Type
\$35



Fada Neutrodyne Receivers—table and furniture models—8, 6, and 5 tubes from \$85 to \$400. Illustrated is the Fada 8 Console. \$400

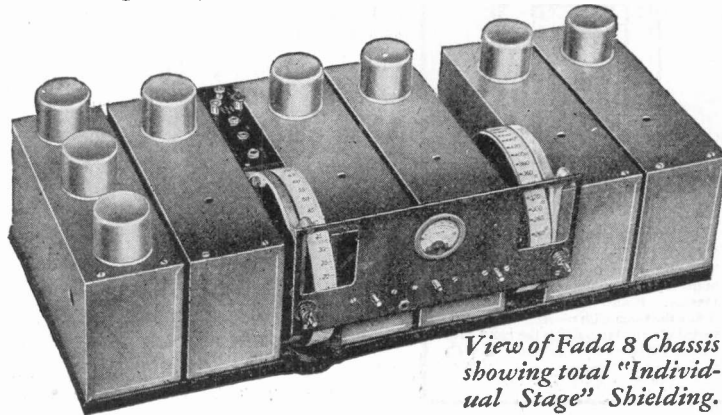

View of Fada 8 Chassis showing total "Individual Stage" Shielding.

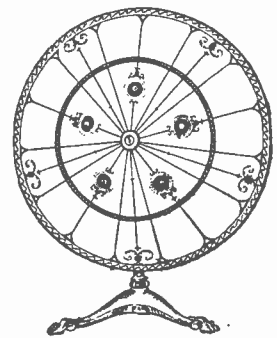

\$29⁰⁰

Console with Cone Loudspeaker Ready for Your Set and Batteries

(West of the Rockies \$35)

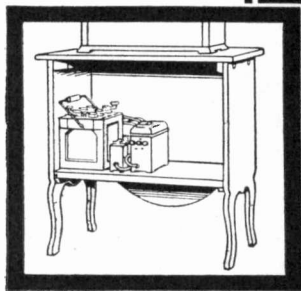

Rear view showing large compartment providing ample space for all batteries, battery charger or battery eliminator. These are entirely concealed from view. The back is open for ventilation of batteries.

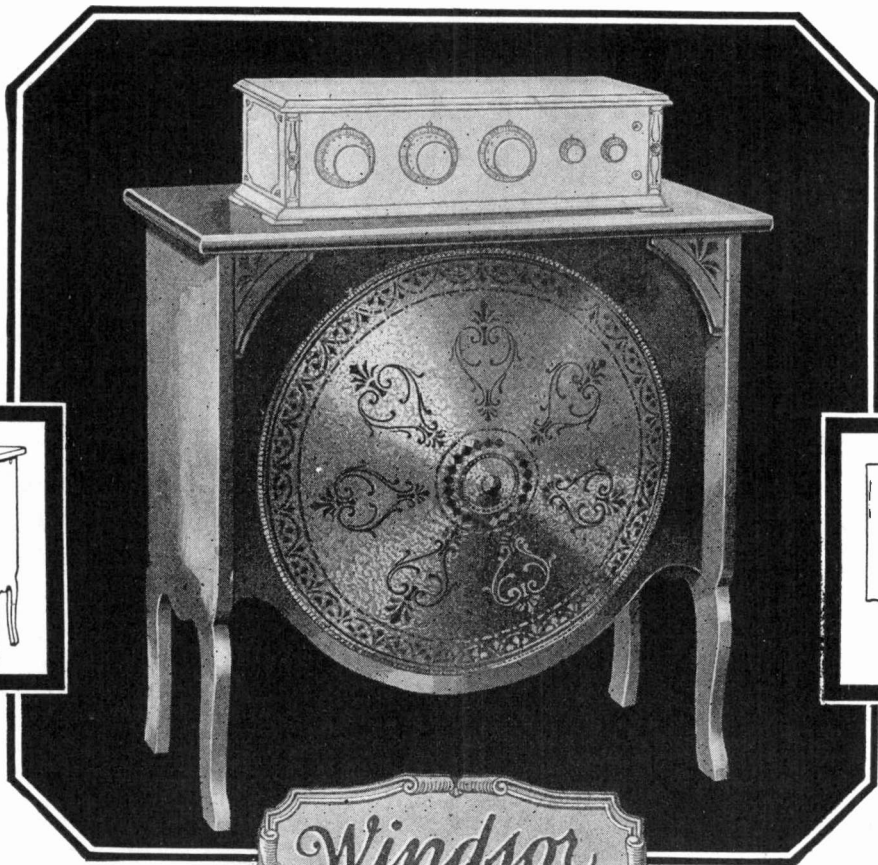

MODEL 200 with 22-inch Cone



MODEL 200 with 22-inch Cone

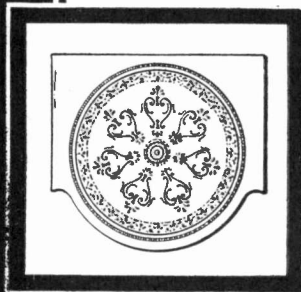

The Cone Loudspeaker, with its Spruce sounding board, is quickly and easily removable, allowing instant access to all batteries, battery eliminator or other equipment and wiring.

A Revelation in Radio Reproduction

AT LAST—a cone loudspeaker that reproduces *all* the tones as they are broadcast. From the deep voiced tuba of an orchestra to the softest note of a vocal solo—*every* tone—*every* sound is reproduced in all its beauty, just as it entered the microphone.

* *

This 22-inch Windsor Cone Loudspeaker, with its spruce sounding board, will reproduce the softest crooning lullaby in a softly lighted room, or the full throated march music of a band in an auditorium—both with perfect fidelity of sound and tone.

* *

The Windsor Cone Loudspeaker Console is the greatest value in the

world of radio. When compared with the average cost of cone-type loudspeakers of even smaller size, the cost of the complete Windsor—cone loudspeaker, spruce sounding board, and console—is amazingly low.

* *

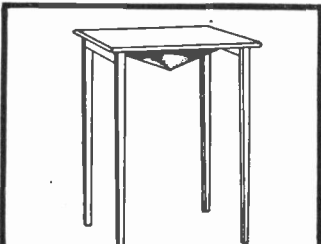

Model 600

With 16-inch Cone (Pat. applied for)
This 20 by 17-inch Cone Loudspeaker Table has suspended from the underside of the top a 16-inch Windsor Cone Loudspeaker. Placed in any part of a room, it fills the room with music just as an inverted electric lamp floods the room with light. Finished in Mahogany \$19 or Walnut. Price
(West of Rockies, \$23.00)

As a piece of furniture, the Windsor Cone Loudspeaker Console is of such manifest high quality and attractive design as to be a welcome addition to any home. Finished in Mahogany or Walnut.

* *

The Windsor Cone and Horn Loudspeakers, combined with attractive pieces of furniture in many models beautifully finished in either walnut or mahogany, offer

recognized radio dealers a remarkable new field for largely increased sales and profits. The retail prices are unusually low for loudspeakers of such outstanding perfection and the attractive furniture with which they are combined serves to enhance the value offered.

* *

Write or wire at once for illustrations and prices covering all models in the Windsor line, together with retail prices and the *unusually liberal trade discounts*. The extensive magazine and newspaper advertising campaign to appear this season will send many radio enthusiasts into your store to see and hear this remarkable new line of cone and horn loudspeakers combined with fine furniture.

Electrical Department

WINDSOR FURNITURE COMPANY
World's Largest Manufacturers and Originators of Loudspeaker Consoles
1420 Carroll Avenue Chicago, Illinois
Los Angeles Branch—917 Maple Avenue

Sylvania

TUBES

"The Better Tube"

There Is A Big Profit In Tubes For The Dealer
 —but there is likewise a world of grief unless care is
 used in selecting the line to be handled.

The dealer should require, and
 has a right to expect—not only a
 perfectly made, positively guaran-
 teed product—but a dependable
 and reliable source of supply that
 will back him to the limit on
 every sale.

Sylvania offers to dealers the
 ideal proposition—a good tube—
 and a maker that believes in his
 product.

Write us today.

"They Never Disappoint"



SYLVANIA PRODUCTS CO.
 EMPORIUM, PENNA.

BOSCH

Item number seven of Bosch Radio Policy states "The Bosch Franchise is a man sized, two fisted opportunity for one merchant in a locality" The new Bosch ARMORED LINE of Balanced Radio substantiates that claim — receiving sets which show a remarkable advancement in radio engineering. Bosch Radio has engineering features which make it the outstanding sales opportunity of the year. Perfected radio and quality furniture are united in the new Amborada — a completely armored and shielded seven tube receiver of unique simplicity. Two controls only — station selector and volume regulator. It has ample space for batteries, charger or power units.

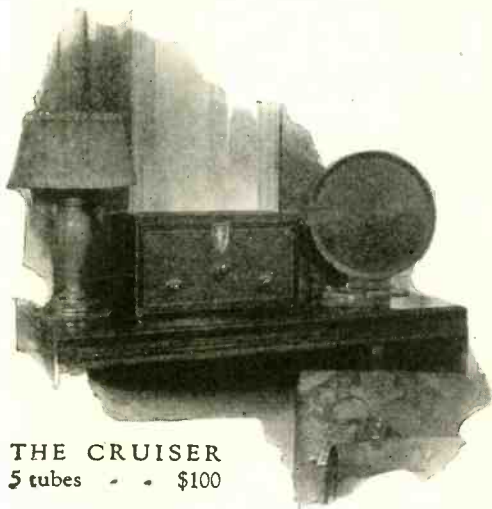

THE CRUISER
5 tubes - - \$100

The Cruiser — a five tube Armored and Shielded set with its "Unified Control" shows great progress in simplified operation. Single station selector for most tuning and two dials for "cruising the air". See for yourself the new operating simplicity, the steel chassis construction, the trouble proof design, the clean cut mechanical appearance and learn the electrical perfection of Bosch Radio.

Are you the man to sell Bosch Radio? Tell us in confidence about yourself—your business, financial strength and experience. We will tell you the direct benefits of the new BOSCH RADIO PLAN.

All prices slightly higher, Colorado and west and in Canada.



The Bosch Nobattery is a power unit to supply B current. Thousands of enthusiastic owners are creating a big market through their voiced satisfaction.

The Bosch Radio Line is a complete dealer's line—popular priced 5, 6 and 7 tube receivers—power units—two reproducers—a full line of accessories and radio furniture designed to build dealer's volume.

The Bosch Ambotone sets a new standard of radio reproduction. Its patented wood cone and art bronze finish makes it sell on appearance as well as on its performance.



RADIO

Armored



THE AMBORADA
7 tubes - - \$310

AMERICAN BOSCH MAGNETO CORPORATION
 MAIN OFFICE AND WORKS: SPRINGFIELD, MASSACHUSETTS
 BRANCHES: NEW YORK CHICAGO DETROIT SAN FRANCISCO
 Manufactured under patent applications of the American Bosch Magneto Corporation and licensed also under applications of the Radio Frequency Laboratories, Inc.

Make Bosworth the line you

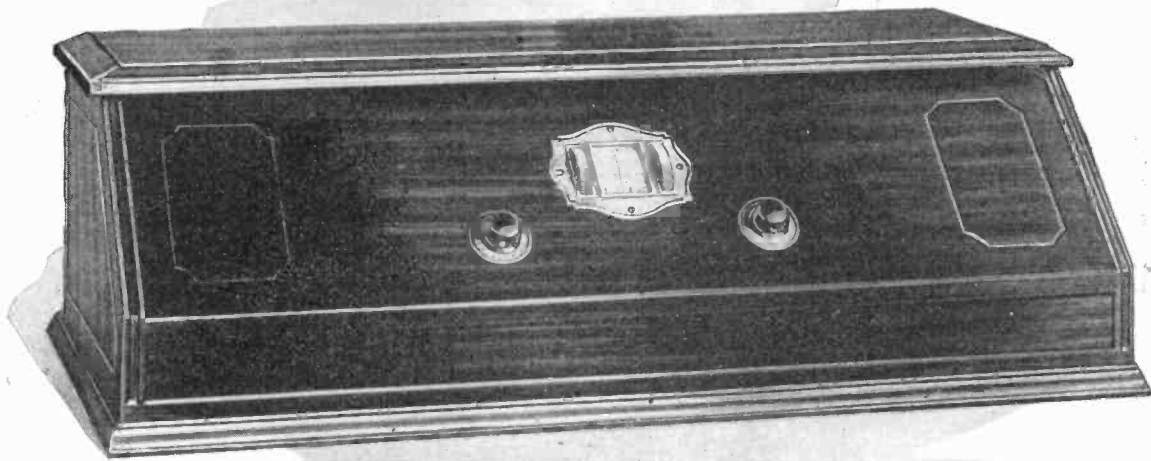

Bosworth Type B-3
Price, east of Rockies \$155.00

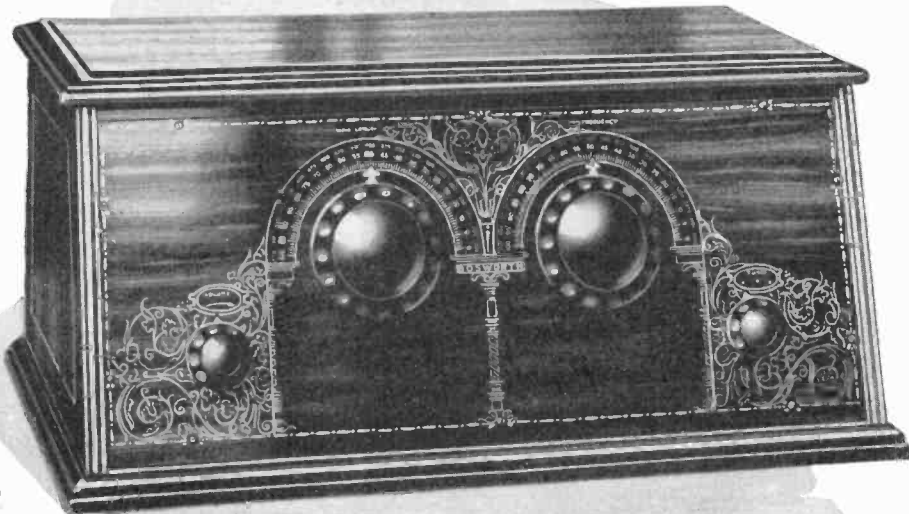

Bosworth Type B-2
Price, east of Rockies \$115.00

Two Great Receivers

Tone quality distinguishes the Bosworth sets. But tone quality is provided in conjunction with matchless performance. The B-3 has three stages of tuned radio frequency (providing great selectivity, and volume on weak or distant stations), detector and two audio. The B-2, the five tube set with two radio, will out-perform many sixes. Both are provided with modern simple control. Both are equipped for power tube.

See the Bosworth Exhibit at the Chicago Radio Show

BOSWORTH GUARANTEE

We guarantee this set to be in perfect condition. We will repair it free of charge, or, at our option, replace it with a new set, if found to be defective - - - within one year from date of purchase

THE BOSWORTH ELECTRIC MFG COMPANY



are really interested in!

*You'll thrill at demonstrating it—
You'll rest easy when it's sold . . .*

If a man can't be enthusiastic over the radio he handles, he ought to get a new line. He ought to get a line that will delight him every time he tunes in. His enthusiasm should be infectious—his pride in the product impressive.

That's one thing the Bosworth does for a dealer, for it makes good unfailingly. By its tone quality, its range, volume and selectivity, Bosworth excites old-timers into ecstasies of admiration. And of course they can sell a thing when they feel that way about it! They can sell Bosworth against any good set.

And dealers who now handle Bosworth keep on feeling enthusiastic, for they find it saves them service costs. They find that the Bosworth guarantee is based on a knowledge that Bosworth sets don't fail.

The performance capacity of Bosworth radio is the result of extraor-

dinary manufacturing methods as well as skillful designing. The General Radio Type 285 transformers in the audio amplifier and the full utilization of side frequencies, achieve a natural and enchanting reproduction. Careful manufacturing and packing safeguard the receiver against derangements in transit or in operation.

This packing method of Bosworth is an important source of jobber and dealer satisfaction. Jobbers do not need to inspect Bosworth sets. They may re-ship them without opening the box. The dealer can bank on delivering all the sets he receives.

Here is merchandise that sells on performance, stays sold and wins you repeat business. Here is radio that needs no servicing. Make Bosworth the line you are really interested in. Get the facts.

See the Bosworth exhibit at the Chicago Radio Show

THE BOSWORTH ELECTRIC MANUFACTURING COMPANY
3754 Montgomery Avenue, Cincinnati, Ohio

Export Office—220 Broadway, New York

**BOSWORTH
RADIO**

Why try to sell
them something else
when they're already
"sold" on Farrand
?

THERE are many cone speakers on the market this season, but the Farrand "arrived" two seasons ago. Half a million radio fans are daily listening to its matchless performance—spreading the message of its superiority to every home that owns a radio, voicing a vast countrywide preference that comes only through time-tested, proven merit. Will you try to sell your customers "something else" or will you feature the speaker they're prepared to buy? There's a Farrand distributor near you. Order NOW.

Farrand Speaker

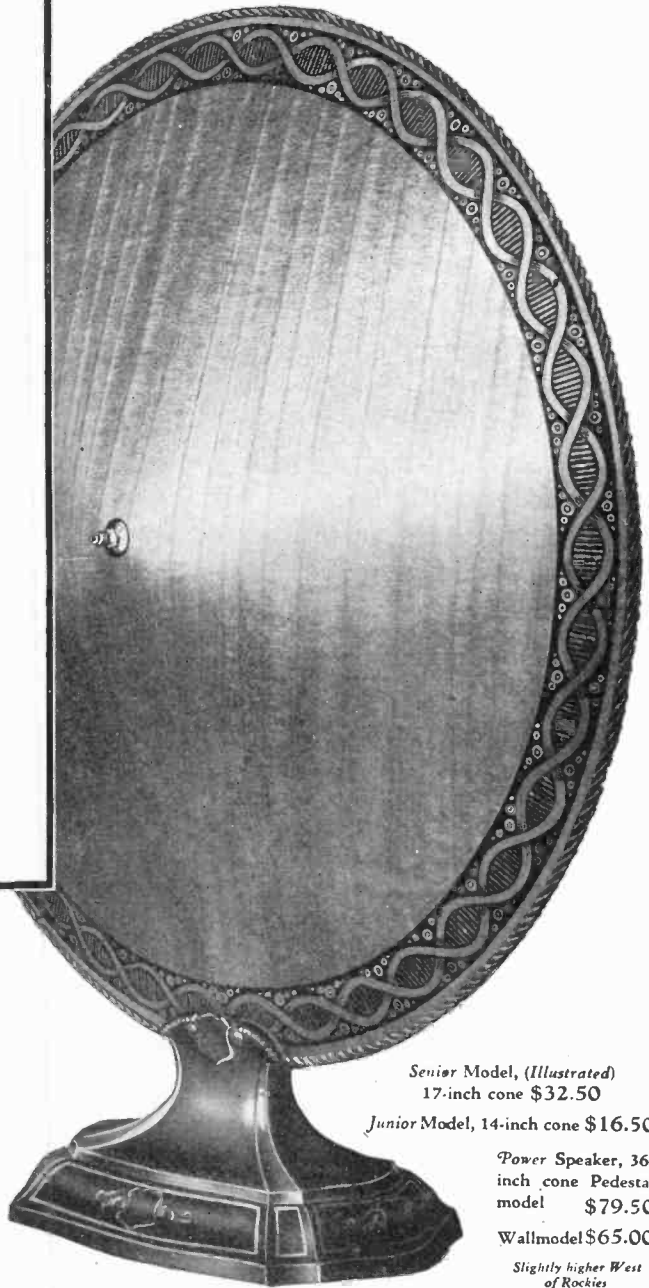

Another

Farrand "hit"!

Another Farrand triumph—a heavy-duty "B" Eliminator that sets a new mark in high voltage capacity. \$48.50, without tube. Combined with Power Amplifier—\$62.50, without tubes.



Senior Model, (Illustrated)

17-inch cone \$32.50

Junior Model, 14-inch cone \$16.50

Power Speaker, 36-inch cone Pedestal model \$79.50

Wall model \$65.00

Slightly higher West of Rockies

FARRAND MFG. CO., Inc., LONG ISLAND CITY, N. Y.

KOLSTER PLAN WELCOMED BY DEALERS EVERYWHERE

OUR offer to let Kolster Radio and Brandes Speakers prove their own superiority has met with great success.

We showed our supreme faith in our products. We made no sensational claims. We simply said, "Satisfy yourself by hearing these instruments."

Progressive dealers everywhere have accepted our offer of a personal demonstration as outlined on the next pages. These wise dealers are giving their customers the results of their comparisons. The opinion is unanimous—Kolster Radio and Brandes Speakers prove their outstanding superiority.

Read
the next three
pages



Dealers everywhere

Asking to hear Kolster Radio

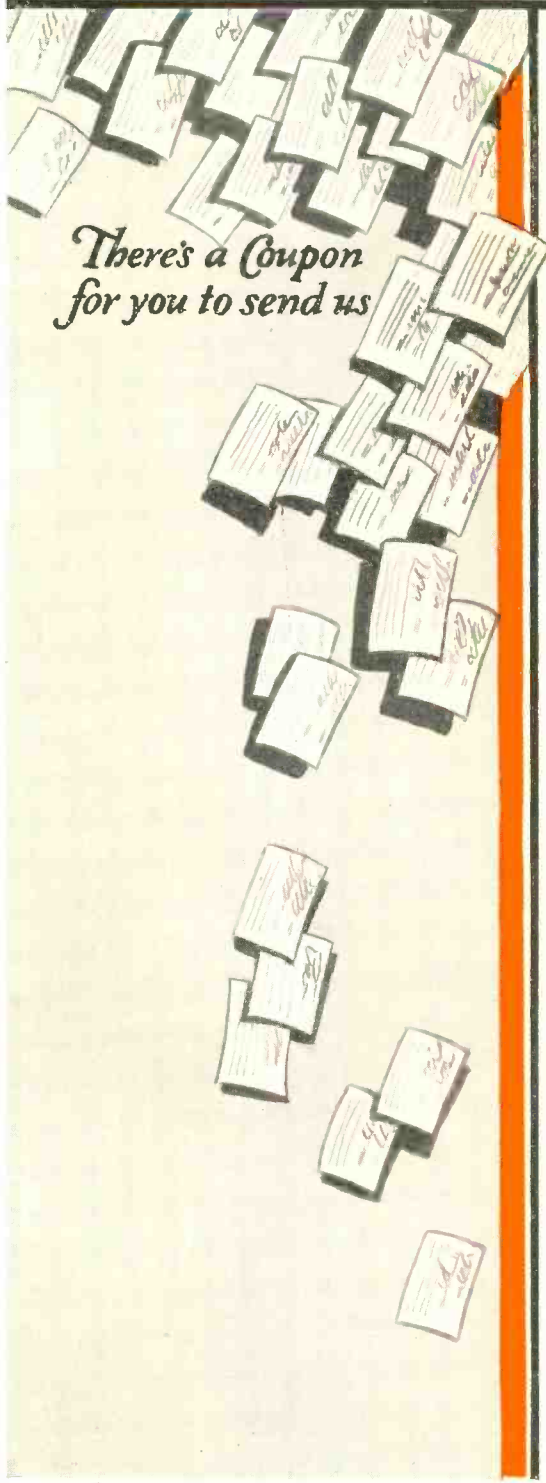

*There's a Coupon
for you to send us*

OUR OFFER

WE don't ask you to read a lot of specifications. We don't make a lot of boisterous claims. For neither you nor we are selling specifications or claims. But we do say, "Have a demonstration on us." Our jobbers are cooperating with us.

All we ask is for you to be open-minded and willing to let a Kolster Radio and Brandes Speaker prove their supremacy. It doesn't cost you a cent. It doesn't obligate you. Your Kolster-Brandes jobber will loan you our instruments for a demonstration in your own store or home. Listen. Operate. Put yourself in the frame of mind of a customer of yours. Compare.

Then you'll see why our confidence is so great. But in case you shouldn't, there's no harm done—you've not committed yourself in the slightest. Our "show me" plan is for careful dealers. We know you've listened to every possible claim. Our job is to show you and we welcome the opportunity.

Almost everyone who hears a Kolster Radio and a Brandes Speaker is instantly enthusiastic.

send in the Coupons *and Brandes Speakers* * * *

Tone!—well, hear for yourself.
Simplicity!—well, operate a
Kolster. Beauty!—have a look.
Workmanship!—lift the lid.
Sensitivity and selectivity!—we
leave them to you.

Price!—lowest, you'll agree, for
such superfine instruments—
which will attract trade, make
quick profit for you and en-
thusiastic customers.

•••••

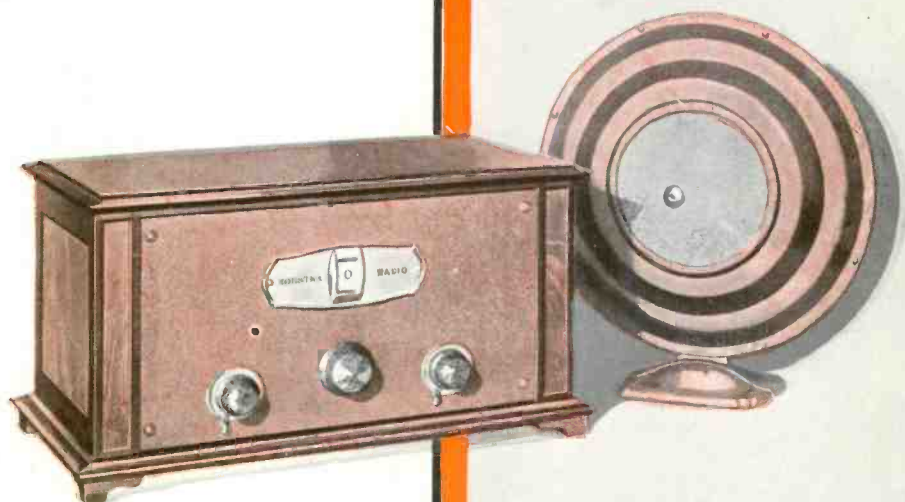

Here's a picture of the Set (6-D)
and Cone you can have for dem-
onstration. They're bound to
be nation-wide favorites.

HOW TO SATISFY YOURSELF FIRST

YOUR Kolster-Brandes jobber will be glad to loan you a Kolster Set and a Brandes Reproducer. Give yourself a comparative demonstration, in your own store or home.

Make our products prove their superiority. Let them prove that they are easy selling—that they present outstanding values for your customers.

All you have to do is to mail us the coupon below. We'll notify your Kolster-Brandes jobber that you'd like to hear a Kolster Set and a Brandes Reproducer. In the meantime we'll send you descriptions and pictures of our entire line. To mail the coupon does not obligate you in the least.

Kolster- Brandes

Woolworth Building
New York, N. Y.

Federal-Brandes, Inc.
Woolworth Building, New York, N. Y.

10

Please arrange a Kolster-Brandes demonstration. It is understood that this does not obligate me.

NAME

STREET

CITY.....STATE.....

THE NEW SHIELDED HAMMARLUND - ROBERTS Hi-Q* RECEIVER

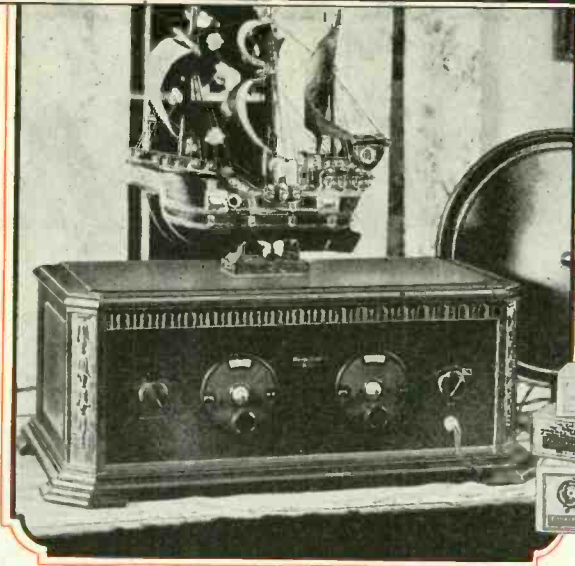

Associate Manufacturers
 These ten nationally known firms supply the 33 perfectly matched parts which constitute the Hammarlund-Roberts Hi-Q Receiver.

- | | |
|----------------------|----------------------------|
| Carter Radio Co. | Benjamin Electric Mfg. Co. |
| Martin-Copeland Co. | Eby Manufacturing Co. |
| Radiall Company | Hammarlund Mfg. Company |
| Samson Electric Co. | Durham Resistors |
| Sangamo Electric Co. | Westinghouse Micarta |



How Much of this
 \$5,000,000 Dealer Profit will You Make?
 (Without stocking new merchandise!)

DON'T lose sight of this very important feature—the Hammarlund-Roberts Hi-Q Receiver uses 33 standard parts, which are nationally advertised, nationally known and are universally accepted as finest quality. If you haven't every item on your shelves you cannot need more than two or three to give you complete parts.

And don't forget that the Hammarlund-Roberts Hi-Q is a thoroughly modern receiver in every respect. The united achievement of ten of America's leading engineers, it incorporates new features which produce astounding results—the power and selectivity of a Super-Heterodyne, an exceptional DX range, absence of oscillation, and tonal qualities which establish new standards.

Over 65,000 novices and amateurs have built the Hammarlund-Roberts. Every one a booster. Dealers selling it have made more than \$2,600,000 in parts and accessories in about 11 months' time. For 1927 sales promise to double!

All you require is two things—a stock of our "How to Build It" books and a number of Hi-Q Foundation Units. Get them from your jobber and put them on display. Our impressive advertising will send you the customers. \$63.05 worth of parts in each sale—accessories extra!



Order this Hi-Q Foundation Unit.

Displaying this unit made over \$2,600,000 for Hammarlund-Roberts dealers in 11 months. Consists of drilled and engraved Micarta panel, drilled Micarta sub panel, two complete shields, extension shaft, two equalizers, fixed resistance, hardware, wire, nuts and screws.

List

\$10.50

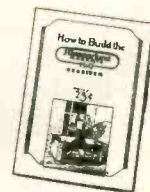

Display This Book.

The most complete Radio Instruction Book ever printed. Circulation now approaching 100,000. Covers every detail of the Hammarlund - Roberts Hi-Q. Fully illustrated nationally advertised.

List

25c



HAMMARLUND-ROBERTS, 1182-J Broadway, New York

*Hi-Q High ratio of reactance to resistance.
 High ratio—great selectivity—loud signals

The Hit

Radio Master



RADIO MASTER COR
One of the
BAY CITY,

of the Show

Cabinets Fit Any Table Set



Radio Master Cabinet Fit Any Table Set

Installation is the work of a few minutes. Pull out radio frame gives easy access to tubes, disappearing arm rest, Plenty of battery space below, speaker horn arranged for your favorite unit above.

Makes a beautiful cabinet type of any table set.

Radio Master Cabinets, displayed at the Chicago and New York Radio Shows, were the outstanding hits of both exhibitions.

Their beautiful cabinet work, splendid, lasting lacquer varnish finish, were an irresistible magnet which drew the eyes of all who came.

The price, and the fact that they made unnecessary the scrapping of beloved table sets, brought crowds of people to the buying pitch.

So it is wherever these splendid cabinets are given adequate display—whether in a show, or in your store.

They are not expensive to sell because they move fast, and the profit per sale is the kind that brings smiles to dealer who handles them.

Radio Master Cabinets present a proposition which no dealer can well afford to dismiss without thorough investigation.

Investigate now—let us show you. These sets are a “home run” in profit. Use the coupon today.

Radio Master Corp. of America
 Bay City, Michigan

Please send me complete information about your Cabinets as advertised in Radio Retailing.

CORPORATION OF AMERICA
Ward Industries
MICHIGAN

FERRANTI



\$12

What does Perfect Reception Through Perfect Through Perfect FERRANTI Are Nearly

The unfailing test

THE musical scale is the only satisfactory measure on which to base a real audio frequency transformer test. This graph shows the full gamut of audible musical and spoken reception. Note the range of the various instruments and of the human voice. Remember that the peculiarities of a voice or an instrument are due to a combination of a low tone called the "fundamental" with higher ones known as "harmonics." Only when the relative values of these are faithfully reproduced can best results in reception be obtained.

The chart also shows the evenness and fullness of amplification extending throughout the range of the organ, cello, flute and the human voice. The unattainably perfect curve would be a straight line. Note how much nearer than any other transformer made the Ferranti approaches this characteristic of perfection. That is why it is called "nearly perfect."

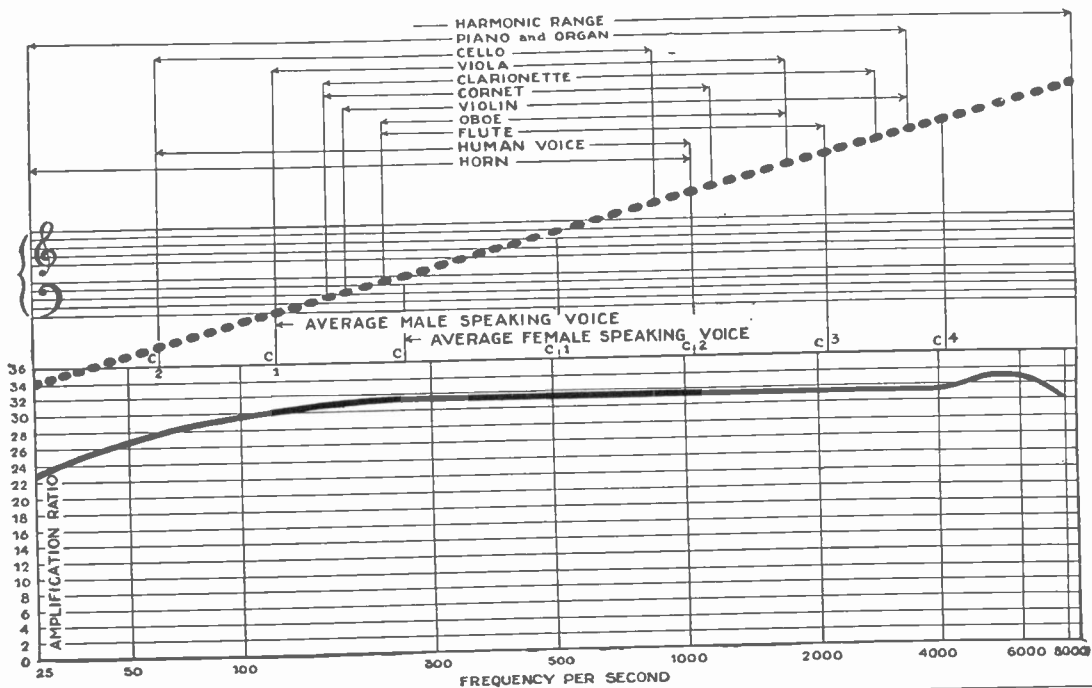

your customer really want?

through Perfect Amplifications.

Transformation.

Transformers! and—

TRANSFORMERS

Perfect

Let's Talk Business

AFTER all, you know as well as anyone that the fellow who really decides how much money you are going to make in radio this season is your customer. No matter how hard you try to sell him, he always reserves the privilege of exercising his judgment on what you say and on the product you offer.

All this is just common sense—but it is the kind of common sense which, if applied properly, makes a dealer successful.

So the real thing for you to determine is what your customer actually wants. Does he buy his parts simply to put them together without real results in reception? Of course not, for his family and his friends, to say nothing of his judgment of himself, would make him a laughing stock if the set he constructed himself did not give fair reception.

If he is a real fan and not a tin horn sport, he will want to get the best parts—particularly those which are most important in good radio receiving.

So we offer you the privilege of selling the Ferranti Audio Frequency Transformer. We call it “nearly perfect” because the curve of its amplification is almost a straight line. No better transformer is available at any price.

To convince yourself, put a Ferranti in one of your sets, taking care to observe the installation directions and note the difference.

These are the sort of results which build good will, which make you enthusiastic about selling Ferranti Transformers, which help you in building large profits.

We are trading through bona fide wholesalers with a minimum quantity shipment of 24.

We are prepared to supply two transformers and two only to any retailer who sends cash with order. If you are interested in handling Ferranti Transformers, please write in immediately and we shall supply you with information in regard to discounts and general company policy.

FERRANTI, INCORPORATED
130 West 42nd Street NEW YORK

A Complete Line of Radio Cable and Harnesses

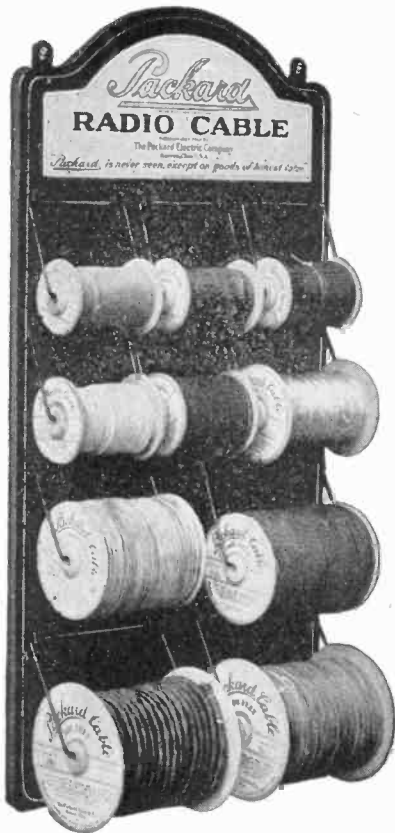
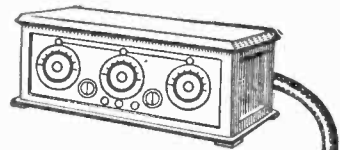

Packard Radio Wiring Harnesses come in neat individual cartons making an attractive shelf package.

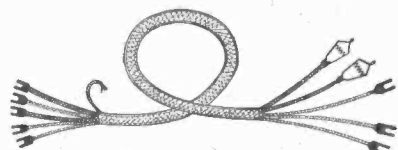

There is a style of Packard Harness for every radio requirement.



Plain rubber-covered wire for "lead in" and inside aerial wiring.



Rubber-covered braided cable for battery circuit wiring. Comes in following colors: white, black, red, green, and brown.



Packard Aerial Wire—full size carefully stranded—strong yet flexible.



Small, very flexible two-conductor cable for extension of speaker circuit.



Multiple Conductor Battery Cable.

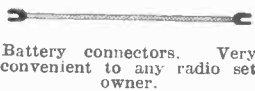
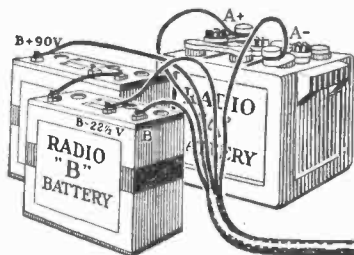

Battery connectors. Very convenient to any radio set owner.

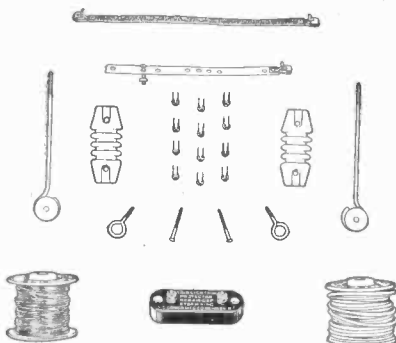

Type A Aerial Ground Kit

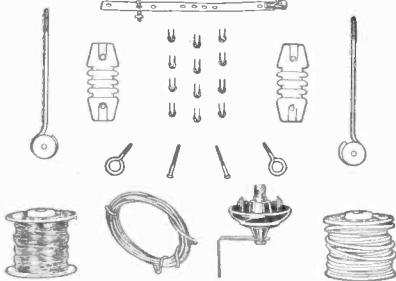

Type B Aerial Ground Kit



Ask Your Jobber's Salesman

DE LUXE ASSORTMENT comes complete—display board and ten spools of cable in one strong box—easy to set up and use. Requires wall space only 36 in. by 18 in. Shipping weight approximately 70 pounds.

THE STANDARD ASSORTMENT (for counter display) comes complete with five spools of cable in a strong carton—easy to set up and use. It is a particularly attractive and useful display.

THE PACKARD ELECTRIC COMPANY

Warren, Ohio

Packard is never seen, except on goods of honest value

THEY SELL AND STAY SOLD

There is a Trimm Reproducer for Every purpose

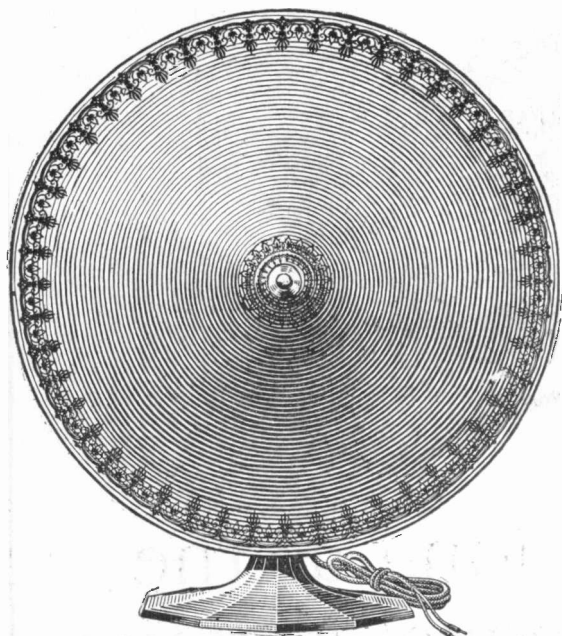

The Trimm Cone, Model 11. A large size, popular priced, instrument which reproduces with absolute fidelity every tone, note, and inflection of voice or instrument, covering the entire scale. It brings to radio the deeper and higher tones. The last word in radio reproduction, 17-inch cone—list **\$16.00.**

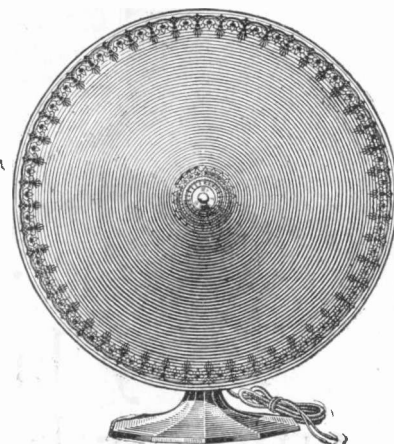

Trimm Cone, Model 7. Same principle as larger models. Meets demand for smaller, lower priced cone. 14 inch cone—list **\$12.00.**

Quick Turnover—The Public Knows Trimm Speakers

For four years Trimm Quality Reproducers have been known to the trade and public to be uniformly and entirely satisfactory—the outstanding value in each type and price class. The new numbers, added to the Trimm line this season, are no exception. Read the letters which follow:

From a letter to a prospective dealer by Charles A. Frazer, Pres., Ross-Frazer Iron Company:

"We handled the Trimm speakers last year with splendid results; in fact, we do not know of a single speaker being returned on account of being unsatisfactory. The line from the lowest priced to the highest is all good and you will make no mistake in selecting any one or more of the models you desire."

This from E. M. Deeter, Pres., E. Mather Co. of Harrisburg, Pa.:

"I enjoy good music and let it go at that. Where it comes from does not particularly interest me. I am interested in the sale of these units so far as our organization is concerned and I know of no reason for anybody desiring anything better than the results I have received in a few hours with the new cone speaker."

This extract from a letter from O. M. Woods, Purchasing Agent Wayne Hardware Co.:

"The Cone Speakers arrived and have met with the approval of our entire organization."

Keen thinking wholesalers are interested in Trimm Reproducers for just one reason—they *sell and stay sold*. Made right and guaranteed for a lifetime. Let us send you full information about the Trimm line, prices, policies, and advertising. *You can make money with Trimm.*

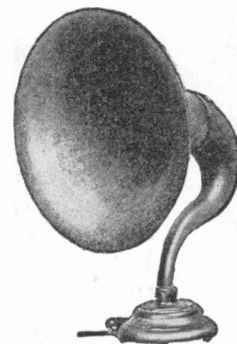

Trimm Concert. The leading high grade horn reproducer, still further refined and improved for this season. No finer Horn Type Radio Reproducer has ever been made. 22 inches high—15 inch bell. **\$25.00.**

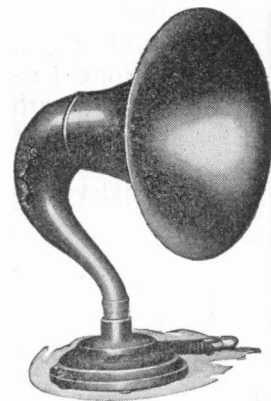

Trimm Homespeaker. The most popular low priced goose neck speaker ever produced. Big volume, fine tone—a thoroughly satisfactory speaker at a wonderful price; 18 inches high, has 12 inch bell. You can make money on this one. **\$10.00.**

TRIMM
 RADIO MANUFACTURING
 COMPANY
 24 So. Clinton St.
 CHICAGO
 U.S.A.

SPEAKERS

- Trimm Cone No. 11...\$16.00
- Trimm Cone No. 7....12.00
- Concert..... 25.00
- Entertainer..... 17.50
- Home Speaker..... 10.00

PHONODAPTERS

- Giant Unit..... 10.00
- Little Wonder..... 4.50

HEADSETS

- Professional..... \$5.50
- Dependable..... 4.40

(Prices slightly higher west of Rockies.)



They last twice as long as the smaller batteries of equal voltage

THAT, boiled down, is the message that Eveready Radio Battery advertising will hammer home, month after month, beginning with October.

It is estimated that fully 80 per cent of all radio receivers sold have four or more tubes. All such sets require Heavy-Duty Batteries, yet many dealers, in their efforts to sell complete a radio outfit—receiver, tubes, "A," "B" and "C" batteries, loud-speaker, etc.—keep the initial cost down by supplying the smaller, less expensive and shorter-lived 45-volt batteries. The heavy drain of 4 or more tube sets exhausts these batteries in a short time and the purchaser becomes dissatisfied—even distrustful.

On the same set and under similar conditions Eveready Heavy-Duty "B" Batteries—either Eveready No. 770 or the even longer-lived No. 486—will last as long as *two* sets of smaller batteries of equal voltage.

You can build up invaluable good-will if you will make it a rule to sell only Eveready Heavy-Duty "B" Batteries for sets with 4 or more tubes with or without power tube.

Eveready Dry "B" Batteries give the pure, noiseless D. C. (direct current) so absolutely essential to pure tone.

Tie up with Eveready advertising. Use Eveready window and store display material and watch sales grow.

Manufactured and guaranteed by

NATIONAL CARBON COMPANY, INC.
New York San Francisco
Atlanta Chicago Kansas City
Canadian National Carbon Co., Limited, Toronto, Ontario

Tuesday night means Eveready Hour—9 P. M., Eastern Standard Time, through the WEAf network stations:

WEAF—New York
WJAR—Providence
WEEI—Boston
WTAG—Worcester
WFI—Philadelphia

WGR—Buffalo
WCAE—Pittsburgh
WSAT—Cincinnati
WTAM—Cleveland
WWJ—Detroit

WGN—Chicago
WOC—Davenport
WCCO—Minneapolis
KSD—St. Paul
WRC—Washington

EVEREADY

Radio Batteries

-they sell faster

POOLEY
RADIO CABINETS
with
ATWATER KENT
RADIO

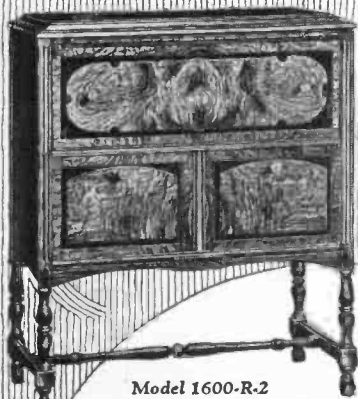

Model 1600-R-2
Finished in Mahogany or Walnut, with built-in Pooley (patented) Floating Horn and Atwater Kent Set. Prices without tubes and batteries, \$175 to \$200.



Model 1700-R-2
Finished in Mahogany or Walnut, with built-in Pooley (patented) Floating Horn and Atwater Kent Set. Prices without tubes and batteries, \$240 to \$320.

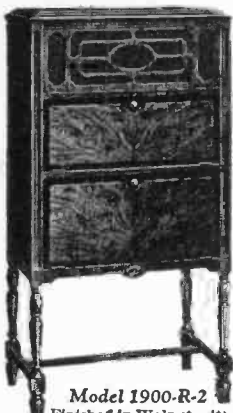

Model 1900-R-2
Finished in Walnut, with built-in Pooley (patented) Floating Horn and Atwater Kent Set. Prices without tubes and batteries, \$135 to \$160.



Model 2000-R-2
"Arm Chair" Model. Finished in Mahogany, with built-in Floating Horn and Atwater Kent Receiving Set. Prices, without tubes and batteries, \$135 to \$160.



Model 1100-R-2
Finished in Mahogany or Walnut, with built-in Pooley (patented) Floating Horn, and Atwater Kent Set. Prices, without tubes and batteries, \$200 to \$280.



Model 1300-R-2D
Finished in Walnut or Mahogany, with built-in Pooley (patented) Floating Horn and Atwater Kent Set. Prices without tubes and batteries, \$225 to \$305.

Pooley Radio Cabinets and Cabinet Speakers

NATIONALLY advertised*—three years on the market—known to millions as quality merchandise—made by a firm 43 years old and in business to stay—approved by Mr. Atwater Kent himself in these words:

"The Pooley Radio Cabinet is approved for Atwater Kent Radio because of the design and quality of Pooley cabinet work and because of the tone qualities of the Pooley built-in floating horn. Both meet the standards we set and maintain for Atwater Kent Receivers and Speakers."

(Signed) A. ATWATER KENT

Beware of imitations—look for the name "Pooley"

THE POOLEY COMPANY

1600 Indiana Avenue Philadelphia, U. S. A.

Prices slightly higher west of the Rockies and in Canada.
Canadian Pooley Radio Cabinets are manufactured by Malcolm & Hill, Ltd., Kitchener, Canada

*Saturday Evening Post—Good Housekeeping—Vogue
Vanity Fair—House & Garden—Country Gentleman

POOLEY
CABINET SPEAKERS
with
ATWATER KENT
UNIT

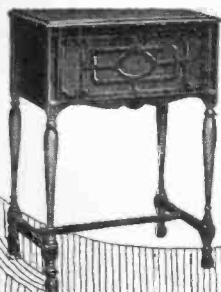

Pooley Cabinet Speaker Model 2100
Finished in Mahogany. Built-in Pooley (patented) Floating Horn with Atwater Kent Reproducing Unit. (Without Battery Compartment). Price \$40.



Pooley Cabinet Speaker Model 1400 (left)
With Battery Compartment. Finished in Mahogany. Built-in Pooley (patented) Floating Horn with Atwater Kent Reproducing Unit. Price \$60.

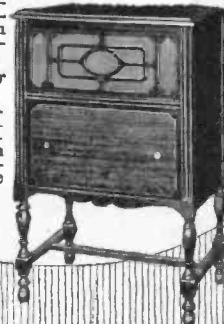

Pooley Cabinet Speaker Model 2200 (lower right)
With Battery Compartment. Finished in Mahogany. Built-in Pooley (patented) Floating Horn with Atwater Kent Reproducing Unit. Price \$50.

ATWATER KENT RADIO

To ATWATER KENT DEALERS

THE ADVERTISEMENT ON the opposite page is reproduced from the "Saturday Evening Post." The "Post" is one of FIFTY-ONE national magazines and farm publications carrying the story of Atwater Kent Radio to *your prospects* this fall.

When you handle this line you know that

- it is backed by the most comprehensive advertising in the country.*
- it is factory-tested 159 times.*
- it works and keeps on working.*
- legitimate service-calls are practically unknown.*
- owners are satisfied.*

Atwater Kent Radio is the Radio people want—and it *stays sold.*

Note: Watch for other advertisements in this "Saturday Evening Post" Series. Make them count for YOU.

ATWATER KENT MANUFACTURING COMPANY

A. Atwater Kent, President

733 WISSAHICKON AVENUE

PHILADELPHIA, PA.

THE SATURDAY EVENING POST

ATWATER KENT RADIO

"IT WORKS!"
SAY THOSE WHO OWN IT

"IT STAYS SOLD!"
SAY THOSE WHO SELL IT

WHEN Atwater Kent Radio leaves our factory in Philadelphia we say to ourselves:

"When this Radio has been shipped across the country and finally installed in someone's home, it's going to work—and keep on working!"

Proof that it does is coming to us from every state in the Union, from Canada and even from across the sea.

The extra months of experiment and testing behind Atwater Kent Radio have not been wasted. The

extra hours of inspection (there are 159 inspections of every Atwater Kent set) have been worth while.

There are no short-cuts in making radio. It's a difficult job, calling for first-rate engineering brains, infinite patience, plenty of resources in money and men and time.

Yet it all counts after a set or speaker gets out there where it has to prove itself.

It counts in the satisfaction of the user. Our dealers tell us that legitimate service-calls for difficulties originating in Atwater Kent Radio Receiving Sets and Speakers are practically unknown. Of course someone's battery runs down occasionally or an aerial gets crossed. People are so used to constant performance from Atwater Kent Radio

that they forget to look for obvious things—like a stalled motorist who starts to call a mechanic and then discovers that his gas tank is empty.

It counts in keeping our dealers from having their legitimate profits melt away in service on needless repairs. Many a merchant who thought he made a lot of money last year by selling a job-lot of sets has found that he actually lost money in service afterwards.

Radio has passed through its fantastic days. People are buying Radio by the reputation of the maker. They know they are buying entertainment, performance, satisfaction.

On this basis and this basis alone we have sold twice as many sets in the past year as we did the year before—and they have stayed sold.

EVERY SUNDAY EVENING—The Atwater Kent Radio Hour brings you the stars of opera and concert, in Radio's finest program. Hear it at 9:15 Eastern Time, 8:15 Central Time, through:

- | | |
|---------------------------------|------------------------|
| WEAF . . . New York | WGN . . . Chicago |
| WEAR . . . Providence | WRI . . . Philadelphia |
| WEEI . . . Boston | WCAE . . . Pittsburgh |
| WRC . . . Washington | WGH . . . Buffalo |
| WBAL . . . Cincinnati | WOC . . . Davenport |
| WYAG . . . Worcester | KSD . . . St. Louis |
| WEAR . . . Cleveland | WWJ . . . Detroit |
| WCCO . . . Minneapolis-St. Paul | |

Prices slightly higher west of the Rockies and in Canada. Write for illustrated booklet of Atwater Kent Radio.

ATWATER KENT MANUFACTURING COMPANY
A. Atwater Kent, President
4703 WISSAHICKON AVENUE, PHILADELPHIA, PA.

Of course you'll want a speaker as good as your set. With an Atwater Kent Radio Speaker you are sure of natural tone and all the volume you wish. Model L, shown at right with its dark brown crystalline finish, \$16.00.



A good set deserves a good speaker—this means nothing less than an Atwater Kent Radio Speaker. It is the standard of good tone everywhere. Model L, shown at left in dark brown crystalline finish, \$21.00. Model G, same design in amber buff and sage green, \$23.00.



Model 28, seven-tube ONE Dial receiver, less tubes and batteries, but with battery cable attached, \$140.00.



Model 30, six-tube ONE Dial receiver, less tubes and batteries, but with battery cable attached, \$85.00.



Model 35, six-tube ONE Dial receiver, shielded cabinet, less tubes and batteries, but with battery cable attached, \$70.00.



Model 39 Compact, five-tube Three Dial receiver, less tubes and batteries, but with battery cable attached, \$80.00.

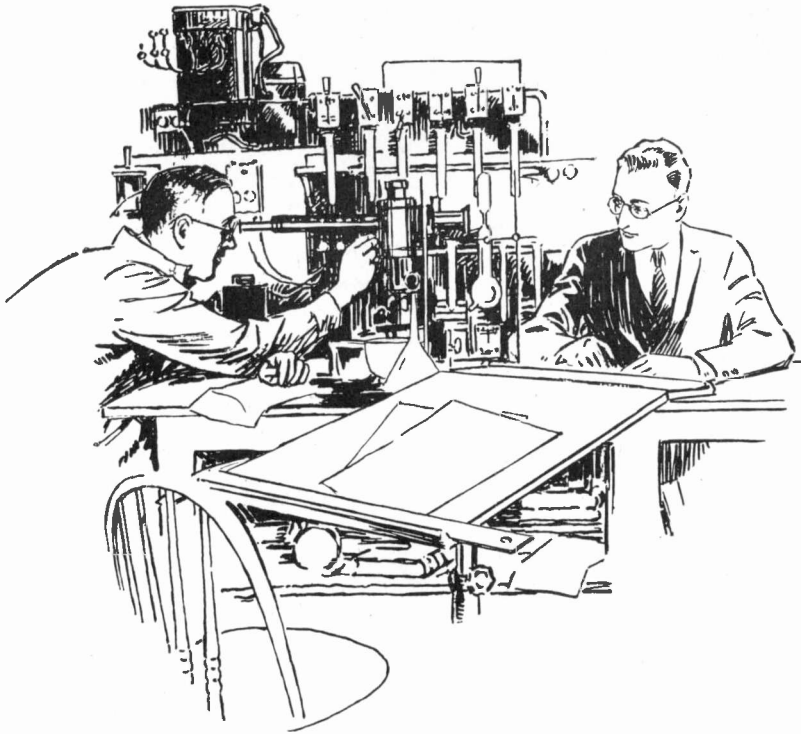

Let us do your worrying



APPROVED BY RAYTHEON

Acme Apparatus Co., Cambridge, Mass.
 All-American Radio Corp., Chicago, Ill.
 American Bosch Magneto Corp., Springfield, Mass.
 American Electric Co., Chicago, Illinois
 Apco Manufacturing Co., Providence, R. I.
 Bremer-Tully Mfg. Co., Chicago, Ill.
 Cornell Electric Mfg. Co., Long Island City, N. Y.
 Electrical Research Labs., Inc., Chicago Ill.
 General Radio Co., Cambridge, Mass.
 Grigsby-Grunow-Hinds Co., Chicago, Ill.
 King Electric Mfg. Co., Buffalo, N. Y.
 Kokomo Electric Co., Kokomo, Indiana
 Mayolian Radio Corp., Bronx, N. Y.
 The Modern Electric Mfg. Co., Toledo, Ohio
 Pathe Phonograph Co., Brooklyn, N. Y.
 Pontico Corp., Pontiac, Michigan
 Sparks-Withington Co., Jackson, Michigan
 A. R. Spartana, Inc., Baltimore, Md.
 The Sterling Mfg. Co., Cleveland, Ohio
 Storad Mfg. Co., Cleveland, Ohio
 J. S. Timmons, Inc., Germantown, Phila., Pa.
 Valley Electric Co., St. Louis, Mo.
 The Webster Co., Chicago, Ill.
 Zenith Radio Corp., Chicago, Ill.
 Dongan Electric Mfg. Co., Detroit, Mich.
 Ford Mica & Radio Corp., New York City
 Jefferson Electric Mfg. Co., Chicago, Ill.
 Thordarson Electric Mfg. Co., Chicago, Ill.

MANY is the time you have made a sale of some piece of equipment, wondering whether it would come back again because of unsatisfactory performance. Many is the time you have hesitated to stock an item, fearing that its manufacturer was not keeping up with the times, and that by another season the product would be out of date. Both of these considerations are vital ones, yet in most cases you must "take a chance" or else spend precious hours in testing and study.

In the case of B-Power Units, Raytheon does your worrying for you. Raytheon Rectifiers are sold only to manufacturers of recognized standing whose complete units have been thoroughly tested and approved in the Raytheon Laboratory. The Raytheon Research Organization, probably the best manned and best equipped of its kind anywhere, is constantly experimenting and working with Raytheon's approved customers, so that their products are the finest and most up to date in the field. If you carry B-Power Units that are Raytheon equipped, you need never worry about the satisfaction which they will give your customers.

Remember too, that it was the introduction of the long life Raytheon Rectifier, Type B, based on the gaseous principles, and giving full wave length rectification, that first made B-Power units really practical. Remember that the new Raytheon Rectifier, Type BH, recently announced, gives power enough to supply current for the filaments of type 199 receiving tubes, connected in series. Remember that the Raytheon Research Organization is always at work on the latest developments of radio power. Both now and in the future, be sure that you are carrying Raytheon-equipped units, and your worries in that direction are over.

**RAYTHEON MANUFACTURING
 COMPANY
 CAMBRIDGE, MASS.**

RAYTHEON
 rectifier

E. E. WHITEHORNE,
Contributing Editor
S. J. RYAN,
Merchandising Counsellor
L. E. MOFFATT,
Associate Editor
H. S. KNOWLTON, *Boston*
PAUL WOOTON, *Washington*

Radio Retailing

The Business Magazine of the Radio Industry

O. H. CALDWELL, *Editor*

WILLIAM C. ALLEY,
Acting Managing Editor
RAY V. SUTLIFFE,
Western Editor, Chicago
H. W. BAUKAT,
Assistant Editor
WILLIAM McDONALD,
Assistant Editor
C. GRUNSKY, *San Francisco*

A Full-Fledged Member of the Audit Bureau of Circulations

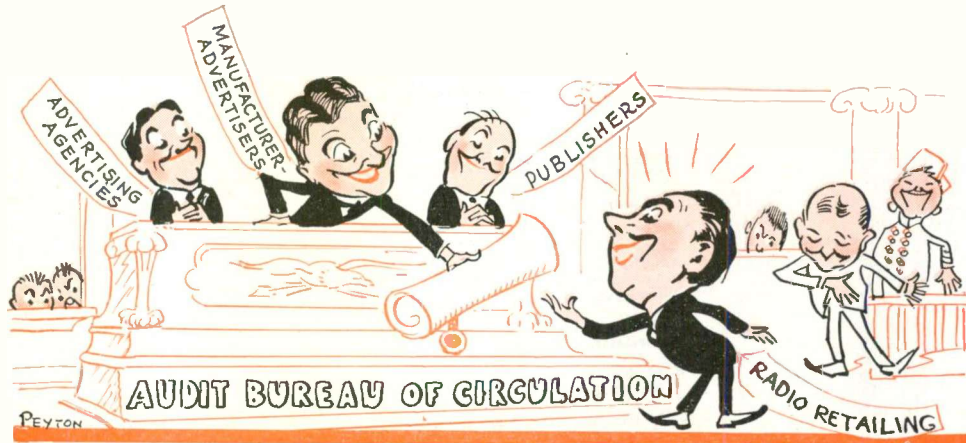

For six months, "Radio Retailing's" application for membership in the Audit Bureau of Circulations has been under advisement by the officials of the Bureau. For six months, therefore, the editorial, advertising and circulation policies of this publication have undergone the closest scrutiny by the manufacturers, advertising agencies and publishers who compose the Bureau.

It is with a very great degree of gratification, therefore, that the McGraw-Hill Publishing Company is able to announce at this time that "Radio Retailing's" application has been accepted and that this magazine is now a full-fledged member of the Audit Bureau of Circulations—the only radio trade magazine that has won this coveted honor.

Table of Contents, October, 1926

The Woman's Influence in Radio Sales	52	How Snappy Dealers Are Selling Parts	72
"Indifference—That Black Beast of Salesmanship"	54	Socket Power Receivers on the Market This Fall	74
"How I Sold Farmer Brown"	58	Barometer of the Market	76
Window Broadcasting Attracts Attention	60	Merchandise Thefts and How to Stop Them	80
"It Pays to Be Ethical"	61	Your Editors Have This to Say	82
Intelligent Direction Makes Field Salesmen Successful	62	For the Service Man	86
Specifications of Radio Cabinets and Circuit Units	65-71	New Merchandise for the Dealer to Sell	90
		What the Trade Is Talking About	98

McGraw-Hill Publishing Company, Inc., Tenth Ave. at 36th St., New York, N. Y.

JAMES H. MCGRAW, President
JAMES H. MCGRAW, JR., Vice-Pres. and Treas.
MALCOLM MUIR, Vice-President
EDWARD J. MEBREN, Vice-President
MASON BRITTON, Vice-President
EDGAR KOBAK, Vice-President
C. H. THOMPSON, Secretary

Electrical World Journal of Electricity Ingenieria Internacional
Industrial Engineer Engineering and Mining Journal
Chemical & Metallurgical Engineering American Machinist
Electrical Merchandising Power Electric Railway Journal
Bus Transportation Coal Age Engineering News-Record
Successful Methods
Copyright, 1926, by McGraw-Hill Publishing Company, Inc.
Cable Address: "Machinist, N. Y."
Annual subscription rate is \$2 in United States and Canada.

WASHINGTON, D. C., Colorado Bldg.
CHICAGO, 7 South Dearborn St.
PHILADELPHIA, 18th and Parkway
CLEVELAND, Guardian Bldg.
ST. LOUIS, 713 Star Bldg.
SAN FRANCISCO, 883 Mission Street
LONDON, E. C. 8, Boulevard St.

How Great is the Influence of

A Typical Answer
to the Questionnaire

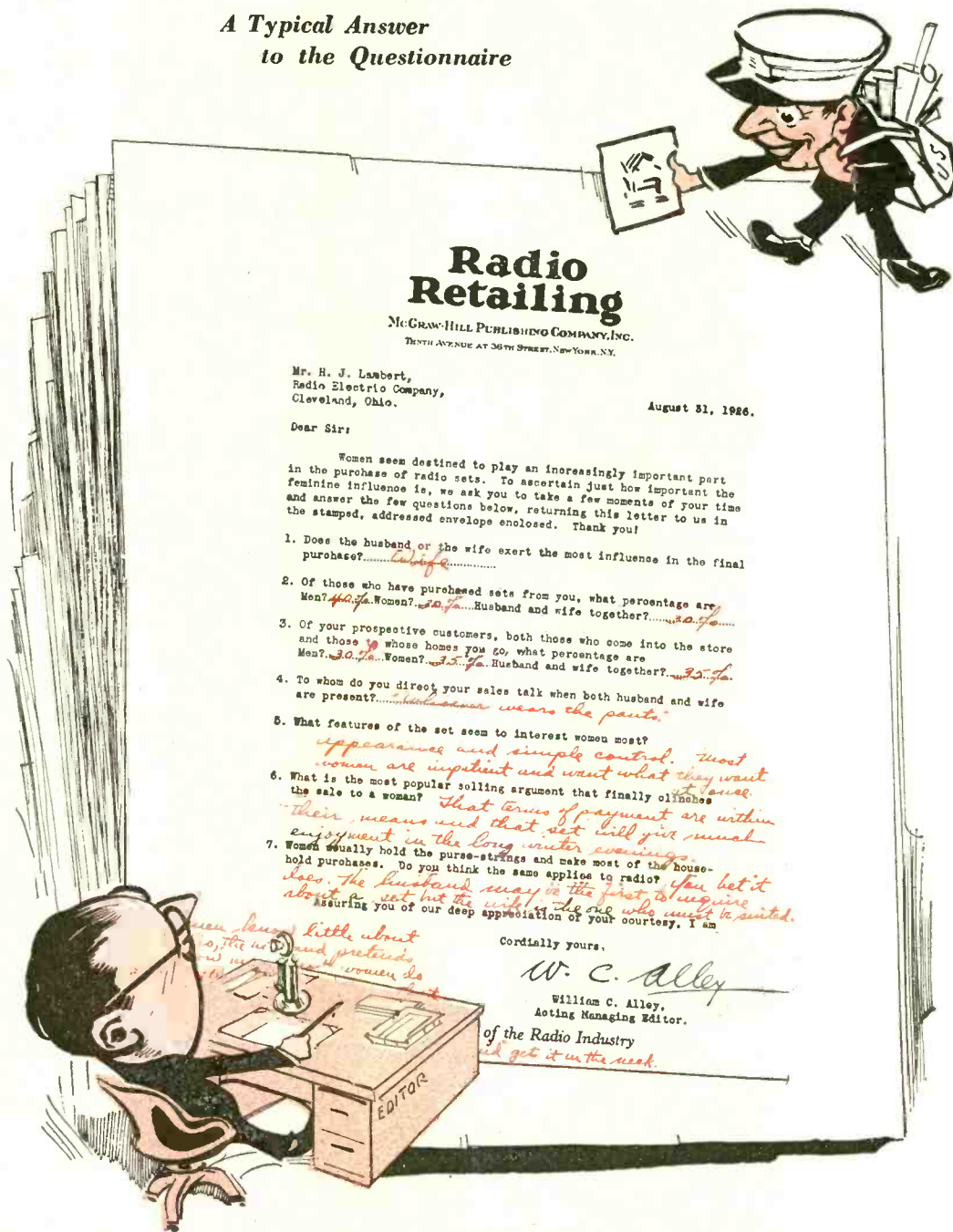

Radio Retailing

McGraw-Hill Publishing Company, Inc.
TENTH AVENUE AT 36TH STREET, NEW YORK, N.Y.

Mr. H. J. Lambert,
Radio Electric Company,
Cleveland, Ohio.

August 31, 1926.

Dear Sir:

Women seem destined to play an increasingly important part in the purchase of radio sets. To ascertain just how important the feminine influence is, we ask you to take a few moments of your time and answer the few questions below, returning this letter to us in the stamped, addressed envelope enclosed. Thank you!

1. Does the husband or the wife exert the most influence in the final purchase?..... *Wife*
2. Of those who have purchased sets from you, what percentage are Men? *40%* Women? *50%* Husband and wife together?..... *30%*
3. Of your prospective customers, both those who come into the store and those whose homes you go, what percentage are Men? *30%* Women? *55%* Husband and wife together?..... *25%*
4. To whom do you direct your sales talk when both husband and wife are present?..... *husband wears the pants*
5. What features of the set seem to interest women most? *appearance and simple control. Most women are impatient and want what they want*
6. What is the most popular selling argument that finally clinches the sale to a woman? *That terms of payment are within their means and that set will give much enjoyment in the long winter evenings*
7. Women usually hold the purse-strings and make most of the household purchases. Do you think the same applies to radio? *Yes. The husband may be the first to inquire about a set but the wife is the one who will be suited.* Assuring you of our deep appreciation of your courtesy, I am

Cordially yours,

W. C. Alley

William C. Alley,
Acting Managing Editor.

of the Radio Industry
id get it in the neck.

Some Radio Wisecracks Brought Out by the Questionnaire

"Find out who wears the pants and sell that one."

"Win the women. Ladies first!"

"Make 'em think it's a bargain. Women are usually close buyers."

"Women may hold the pursestrings but the men still have a lot to say. We're not licked yet."

"Tell the woman it's a much better set than the one next door."

"Women do so little to please a man that the

husband usually makes the choice. But if the set is not satisfactory to her, friend husband gets it in the neck."

"My wife's looking over my shoulder. I don't dare answer your questions."

"Direct the sales talk to both husband and wife—for the sake of peace."

"Women used to hold radio in contempt but now they're coming round."

"Sometimes it's the man and sometimes the woman. Go get 'em both!"

Women in the Purchase of Radio?

Here are the tabulated reports of a letter sent by *Radio Retailing* to 500 dealers asking them a few questions about their women customers

Answering the question, "Does the husband or the wife exert more influence in the final purchase?"

Husband32 per cent
 Wife63 per cent
 50-50 5 per cent

* * *

Answering the question, "To whom do you direct your sales talk when both husband and wife are present?"

Husband14 per cent
 Wife41 per cent
 Both45 per cent

Answering the question, "Of your past customers, what percentage are men? Women? Husband and wife?"

Men49 per cent
 Women19 per cent
 Husband and wife..32 per cent

* * *

Answering the question, "Of your prospective customers, what percentage are men? Women? Husband and wife?"

Men43 per cent
 Women22 per cent
 Husband and wife..35 per cent

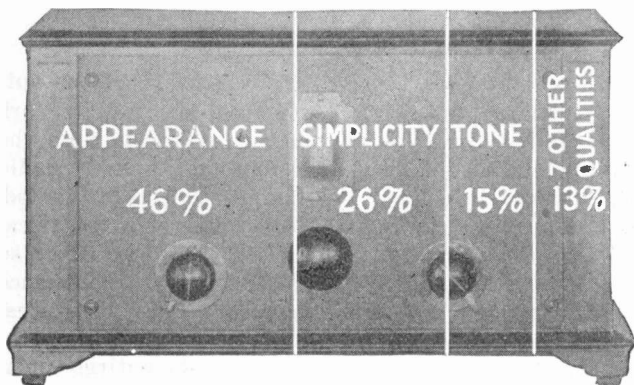

The illustration above tabulates the answers to the question, "What features of the set seem to interest women most?" The seven other qualities women ask for, are neatness, price, reputation, volume, selectivity, number of tubes and "better than the neighbor's."

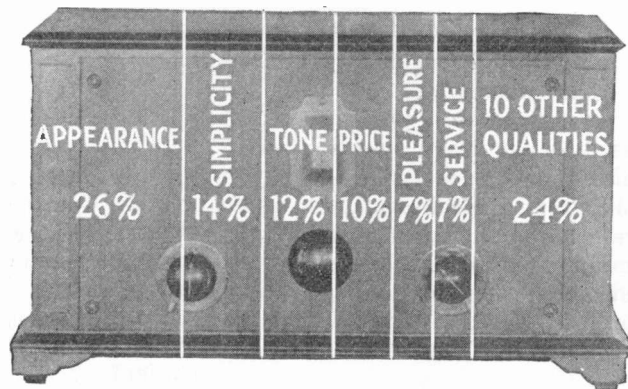

The illustration above tabulates the answers to the question, "What is the sales argument that clinches the sale to a woman?" The ten other arguments include neatness, reputation, easy payments, economy of operation, dealer's recommendation and "household necessity."

Do Dealers Understand the Psychology of Selling to Women?

DO RADIO retailers fully appreciate the great influence the woman of the household exerts in the purchase of radio and do they fully understand the psychology of selling to feminine buyers? Feeling there is much to be said on this subject the editors sent out the questionnaire analyzed on these pages. The answers show that whereas, in the past, women figured in 51 per cent of radio sales, 19 per cent being to women alone, those figures have increased to the point where women now figure in 57 per cent of the transactions, 22 per cent being to women alone. Sixty-three per cent of the dealers answering said that the wife exerts the greater influence in the final purchase but only 41 per cent said they direct their sales talk primarily to the wife. It looks as though some dealers are not concentrating on the one who must be sold—the wife.

Now, as to the degree to which dealers understand feminine psychology—while 46 per cent declare the main feature of the set which most interests the women is the way it

harmonizes with its surroundings, only 26 per cent said this is the final sales argument. This would point out that while the lady of the house is *apparently* interested in the appearance of the set, actually several other factors, particularly the results accomplished by the set, must be brought to her attention before she will buy.

TO ASCERTAIN in just what way dealers are appealing to the feminine influence, *Radio Retailing* selected an average housewife, typical of the American woman, and sent her out to interview a number of radio dealers in an attempt to buy a set. Her story, on the pages immediately following, written by herself, is a great preachment on how NOT to sell radio to women. In almost every case dealers tried to sell her, not a radio set which she wanted, but an article of furniture which she did not want. Read it. Whether you think you understand feminine psychology, or whether you know you do not, it will prove of value to you.

INDIFFERENCE—That BLACK

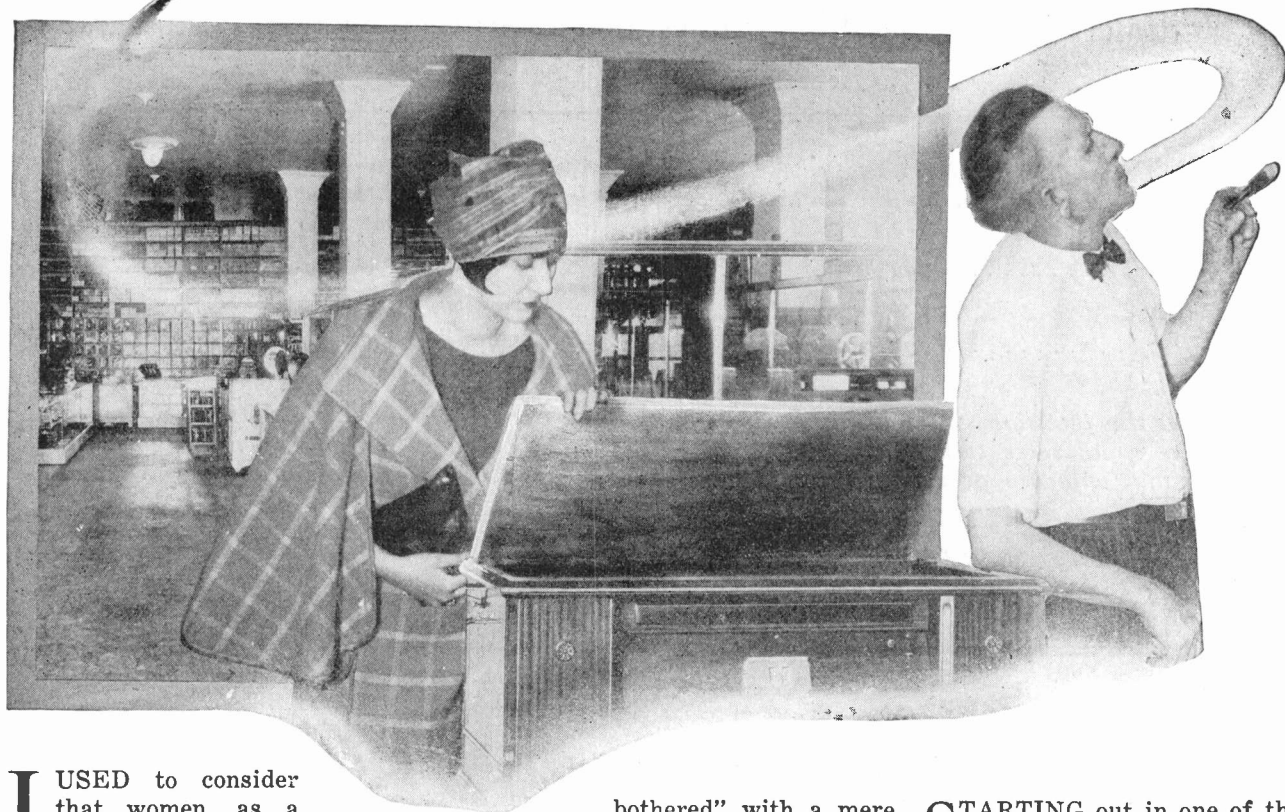

I USED to consider that women, as a group, were possessed of at least average intelligence. But since trying to buy a radio from a dozen dealers in radio I've come to the conclusion that the feminine half of our population is just about one degree lower than morons. That is, in the estimation of the dealers from whom I tried to buy a set.

I wanted to buy a radio set. I visited many stores. I almost urged them to sell me a set. Did they sell me one? They did not!

When I started out on my quest, I knew absolutely nothing at all about radios, except that I had listened to many—good, bad and indifferent. My hope was that I would learn "all about them" and become the proud owner of one at the end of my pilgrimage.

But, alas, I did neither. I know just as little about radio now as I did before and I am still trying to convince several radio salesmen that I can be sold a radio set if they will only sell it to me in the way the ordinary, every-day woman wants to be sold.

Indifference—that black beast of all trades—seemed to hold most of the salesmen in its grip. Or was it merely that they "couldn't be

bothered" with a mere, senseless woman? Not in any case did they rise to meet my feminine intelligence. Courteous, yes, in most instances. But give me credit for an ounce of common sense? One out of a dozen did

Do these men think radios are not within the province of a woman purchaser? Their interest in the sale seemed to be something that I, the prospect, had to evoke, whereas right interest on the part of the salesman is often the open sesame to a woman customer's purchase. The prevalent attitude seemed to be, "Here is a radio—take it or leave it."

Perhaps a man informs himself all about a proposed purchase, before he goes to buy. A woman rarely does. She expects to be told all about it. She has been trained to that through her years of shopping. On major things, a woman starts out knowing little about her intended purchase, and learns through the people who serve her.

On my radio quest, salesmen took everything for granted. Sales talks were always invited—but not always forthcoming. To be specific, I shall detail a few interviews in the "great city," in a smaller city some miles removed, and in nearby towns.

STARTING out in one of the outlying home sections of New York City, it was surprising to note the difficulty of finding a strictly radio shop. In the first store I visited, radios were sold along with electrical goods, and in this one the owner so quickly inspired me with confidence in his knowledge and electrical ability and honesty that the temptation was strong to rely entirely upon his judgment.

"You see I do not carry many sets in stock," he volunteered, "but if you want to look around some place else and find the set you'd like to buy, I'll buy it for you and give you the advantage of half of my commission, as well as install it for you and give you a year's guarantee of service."

This seems to be the method of many of the smaller dealers. This man had his electrical establishment and his reputation in the neighborhood to uphold. He was sincere and honest, made his offer in good faith and inspired confidence. But when I said:

"Well, how will I know how to pick out a good radio?"

"Why, you just pick out one of a number of standard sets, and there you are!" he smiled at me.

It surely sounded simple, so I went on my way, much predisposed to

BEAST of Salesmanship

She wanted to buy a radio set—visited a number of dealers, large and small, in a large town and a small town—was she convinced she should buy one? She was not—let her tell you her story—it might be labeled, "Why Radio Stores Fail"

BY VIRGINIA PICARD

take him at his word, and visited next a store which he recommended to me as having a complete stock where I might pick out the kind I wanted.

In this shop, the salesman did not dilate on radios. It may be that he only awoke in the evenings, for when I asked him about radios, he walked to the back of the store with his hands in his pockets, and seemed to be dreaming of "last night on the back porch" or something equally remote. I stood and waited.

He came forward again, waved his hands to include all the radios in view, and drawled:

"There you are! What kind of a radio do you want?"

"Why, that is what I came to find out. I thought that perhaps you could show me the good points of some special radio set that I might approve."

"Well, here's the furniture," he answered me. "When you decide on the kind of cabinet you want I'll demonstrate it in your home. It all depends on how much you want to spend for your table or cabinet." And he actually showed them to me.

So a hazy idea grew in my mind that radio was somehow bound up with a table or cabinet. I grew uncertain. Then I said:

"Do you never demonstrate here?"

He seemed suddenly to come to life, and replied:

"Oh yes! Come in some evening."

Which reply seemed to include an escort of the masculine gender who might be talked to man to man about this thing.

"Oh! Thank you!" I smiled, as I

Radio Retailing, October, 1926



made my exit, and he deigned to give me a parting smile, the first sign of humanity he had shown. As I reached the door, I turned and asked about a standard make that the electrical man had suggested.

"Oh! I wouldn't recommend that," he replied, "I used to carry it, but I don't handle it now. They changed their policy too often. You would not like it if I sold you a radio, and next week you saw it reduced in price."

"No," I answered, and still more hazy on the subject, departed.

THE next store was not a strictly radio shop. Indeed they seemed hard to find. This one carried phonographs. They were having a special sale on the standard make of radios which the electrician had recommended, and the other dealer had knocked.

Here was a dilemma! Which one was right? For the unsophisticated in radio, I was spending an enlightening day!

In this store the salesman was very affable. He invited me to follow him, and I was led down a white semi-Colonial stair case into what

originally was a cellar, now transformed into a beautiful studio. It was quite a surprise, a pleasant one, and here after being shown much furniture I was enlightened to the extent that radio had become "standardized." Also that "the days of experiment are practically over and if I bought this particular set today, I'd be saving a lot of money." His efforts to please, to close a sale, were in sharp contrast to the indifference of the previous dealer. But I was not convinced as regards radio. The furniture was very beautiful.

(Please turn to next page)

MY NEXT halt was a studio in one of Manhattan's smartest shopping centers, where I was shown with the greatest courtesy the most expensive kind of furniture and—oh yes—radios. This latter came as a surprise by this time. I expressed my desire for something "not so ponderous in furniture, and more simple in exterior" and was then escorted to another salon, and given a special price if I decided on a particular radio "today," which had been used in demonstration, but which would be delivered with "new batteries and tubes, and would be like new." This radio, I was told, comprised the latest improvements in every device and appliance, and it was all enclosed in an exquisite exterior. It seemed the nearest approach to what I might purchase, but the salemen didn't attempt to tell me what it would do! He didn't even try to sell me the radio set which, I had learned by this time, must have been inside that beautiful cabinet.

And when I asked the price, he said, benignly, "Only \$395, special!"

I murmured a dazed, "You're so kind," and exited as gracefully as possible. A good radio set, complete, I had been told, shouldn't cost more than \$150.

But I was beginning to learn a few words in the realm of radio. I was becoming technical. I know now, for instance, that the most essential part of every radio set is the cabinet. Without the cabinet, there can be no radio, of that I am certain. I had almost come to the conclusion that I mustn't buy a radio; that I must buy a cabinet and that somehow there would be a radio inside.

So much for the metropolis. For these visits covered representative districts. Do they consider the woman buyer a moron? The answer is, "Yes!"

FORTUNATELY, I have a different story to tell of places outside of New York City.

A thriving city near the metropolis became the field of my next research, and I'll call it a happy adventure. Woman comes into her own in the smaller places, it seems.

It happened that my first visit here was in a branch store of one of the larger firms that I had called upon in New York. But what a difference of attitude! While they still stressed "furniture," they did speak of the radio and I learned that "tone and

SHE entered a radio store and said to the proprietor, "I want to buy a radio set."

"Sure, look 'em over," he answered, and disappeared into the back of the store.

So she visited half a dozen or so more stores in a vain quest to be sold a radio. With one exception, every salesman fell down miserably in attempting to interest this eager-to-buy feminine purchaser.

beauty" were the things to be looked for in buying a radio, and that "the mechanism was to be depended upon according to the standard make that was bought and the reputable firm that sold it to you."

"That is why you come to us," this salesman smilingly told me. This was rather enlightening, after my wandering around in the labyrinths of furniture.

By devious ways, I came upon a small shop where a "really truly" radio dealer held out. He actually showed me the sets, having little furniture to show.

"A five-tube set is good," he explained, "but of course a six-tube set is better."

"In what way?" I asked.

"Why, you get better tone and volume."

"Does this price you quote, include everything complete, with installation?" I asked.

"Oh! No. That is just the set. You will need the loop, and loud speaker, and batteries and so forth."

Again I was lost.

"Why do you not quote me a price with everything complete?" I asked.

"You see, I do not know enough about radio to ask you for the separate parts."

"That is true," he laughed, and proceeded to show me the sets, the batteries, explaining somewhat of A and B batteries, and how often they would require to be recharged. He also showed me cones and built-in speakers; told me about concealed loops and outside aerials. He talked radio, which was what I had set out to buy—and as a closeup, on reaching prices, said that the kind of table or cabinet selected, would deter-

mine the additional amount of expenditure. He was the first dealer who had not stressed the exterior of his radio, to the submergence of the instrument itself. He seemed to realize that a woman might have some glimmerings of intelligence, and that his radio talk might be understood. He will sell his radios—and to women customers—too.

MY NEXT experience was ideal in every respect, characterized by an interested human courtesy that was not merely an assumption, but the real thing.

"I would like to look at radios," I volunteered, on entering this establishment.

"Certainly, madam. Will you come with me?" this salesman said, leading the way upstairs to a balcony studio.

"Have you decided on any particular set?" he next queried.

"No! I do not know enough about them."

"Oh! I see," he responded, pleasantly, and then proceeded to show me several standard makes, explaining their various points—the controls, tubes, aerials, batteries. He even spoke of eliminators, and transformers, and chargers, explaining somewhat their meanings as related to radio. He demonstrated the radios explaining degrees of tonal quality in each, and stressed the beauty of exterior, in relation to the furnishings of the room, where it was to be placed.

No effort was made to close the sale immediately. He asked for my name and address (the first one who did) and offered to demonstrate in my home. This salesman had an exceptional degree of knowledge in regard to the radios he had for sale, and was not afraid to impart it. I shall be inclined to buy from him.

A CLOSELY similar experience followed in the next visit that I have to recount. A very young salesman served to display his firm's wares in a degree highly satisfactory to a prospective buyer. True interest in the radios themselves, and also in the prospective sale, was remarkably balanced by a regard for the prospect's interest. Nothing seemed to be a trouble. It was his pleasure to serve, and he created a delightful anticipation of owning a radio.

He had enthusiasm coupled with his interest, yet he did not try to persuade or influence my judgment. He emphasized the wonderful pro-

grams one could hear every night, at comparatively little cost. He made me visualize with him. He will no doubt rise high in salesmanship, if he doesn't permit time to endow him with indifference.

In the suburban towns the methods were also that of a pleasant relationship between seller and buyer. Interest, enthusiasm, and a desire to please predominated to a marked degree, in contrast to the city's methods. The salesmen—and I must add, saleswomen, new perhaps in radio, but well informed, and pleasant to deal with—knew their jobs. They talked radio, and furniture was an accessory.

Sparking Condenser Makes Unique Window Feature

A unique "attention attracter" employed by the H. L. Barney Radio Company, 270 Dwight Street, Springfield, Mass., seldom fails to attract a crowd to the store window. It is inexpensively constructed and costs little to keep in operation.

A Ford spark coil furnishes the necessary potential from a radio storage battery and supplies high voltage to a standard variable condenser which is placed on a support in the display window. When the store closes in the evening the storage battery is connected in the manner illustrated and the high voltage is applied to the opposite terminals of the variable condenser immediately causing a break-down of the air dielectric, or insulation between the plates. A series of long blue

flashes or spark discharges jumping from the condenser's rotor to stator plates and vice versa are visible from the other side of the street.

The value of this scheme could be increased by installing the condenser in a dummy receiver, opening the cabinet so that the instrument was visible from the street and conceal-

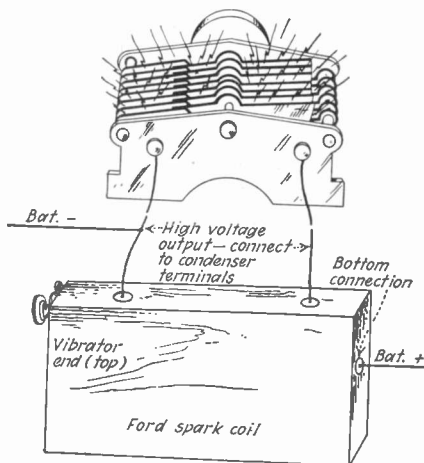

Connections for the attention attracter

ing all wires and the spark coil. This arrangement would tie up excellently with a display of lightning arresters.

Putting Practical Ideas to Practical Uses

"Business has been good this summer and it is that article on selling yearly service contracts, published in the July issue of *Radio Retailing*, that I can thank for it." That's what H. W. Henshaw of the Henshaw Cycle Company writes from Miami, Florida.

Shortly after the service contract idea employed by the Collingwood Radio Company of Toledo, O., was outlined in an article in *Radio Retailing*, Mr. Henshaw saw its possibilities as a sales booster, so he immediately made a "bee-line" for his local printer and duplicated the forms reproduced on our pages.

The service was promptly featured in a large ad in the Sunday edition of a local newspaper, and this was followed by several smaller ones in succeeding dailies.

Less than a month has elapsed since these ads first appeared and Henshaw has sold sixty certificates at ten dollars per. Aside from this actual cash advance, Henshaw tells us that it has boosted his sales of parts and sets greatly by attracting new prospects to the store.

The last paragraph on the card contract form, cancelling the agreement if anyone other than an authorized service man tampers with the set is the only addition to the original form employed by the Collingwood Company.

McNamee's Book Published

Graham McNamee's long-heralded book, "You're on the Air," has made its appearance. It is published in New York by Harper and Brothers. McNamee has secured a fine name for himself as premier announcer of WEAJ, New York, and has succeeded admirably, with the collaboration of Robert Gordon Anderson, in putting his many varied broadcasting experiences down in black and white. The book is most interestingly written and should prove pleasant reading for every radio fan.

No. 424 Name Address Amount Paid \$	QUESTIONNAIRE No. 424	\$10.00	SERVICE CERTIFICATE No. 424
	HENSHAW CYCLE CO. Miami's Most Complete Radio Service 108 W. Flagler St. Phone 6298 Miami, Fla.		HENSHAW CYCLE CO. No. 424 108 W. Flagler St. Phone 6298 Miami, Fla.
Owner's Name		Received from	
Address		Address	
Make of Set..... Type.....		The Sum of..... Dollars (.....)	
When Purchased		for which HENSHAW CYCLE CO. guarantees:	
Make of Speaker Type.....		1. To keep your radio in efficient operating order at all times.	
No. of Tubes..... Type of B. Bat.....		2. A complete inspection of your equipment at least once every 30 days. This inspection includes a thorough test of your set, condition of batteries, tubes, etc.	
Make of Charger..... Type.....		3. Free delivery to your home of all necessary new batteries, tubes, etc.	
Remarks:		4. A 10 per cent reduction from regular price on all new accessories or parts.	
Date..... Salesman.....		5. A flat rate of seventy-five cents for storage battery charging.	
HENSHAW CYCLE CO. Miami's Most Complete Radio Service 108 W. Flagler St. Phone 6298 Miami, Fla.		6. The privilege of calling one of our Service Men any time between 9:00 A.M. and 7:00 P.M. should any trouble develop between the inspection periods.	
		The \$10.00 fee does not cover such work as charging batteries, installing or moving equipment, installing accessories purchased from other dealers, or for repairing equipment damaged by carelessness, mishandling, fire, or lightning.	
		Tampering with the set by anyone other than the Henshaw Service Man automatically nullifies this contract.	
		MAKE ALL CHECKS PAYABLE TO HENSHAW CYCLE CO. This Certificate is void unless signed by an officer and authorized salesman of the Company.	
		Salesman..... GOOD FOR A PERIOD OF 1 YEAR FROM DATE HEREOF	

This 3 1/2 x 9 inch card has pulled the Henshaw Cycle Company through the summer season. The stub at left is retained by the salesman, the questionnaire section filed

as a service record and the contract form is retained by customer. The Henshaw Company duplicated it from article which recently appeared in "Radio Retailing"

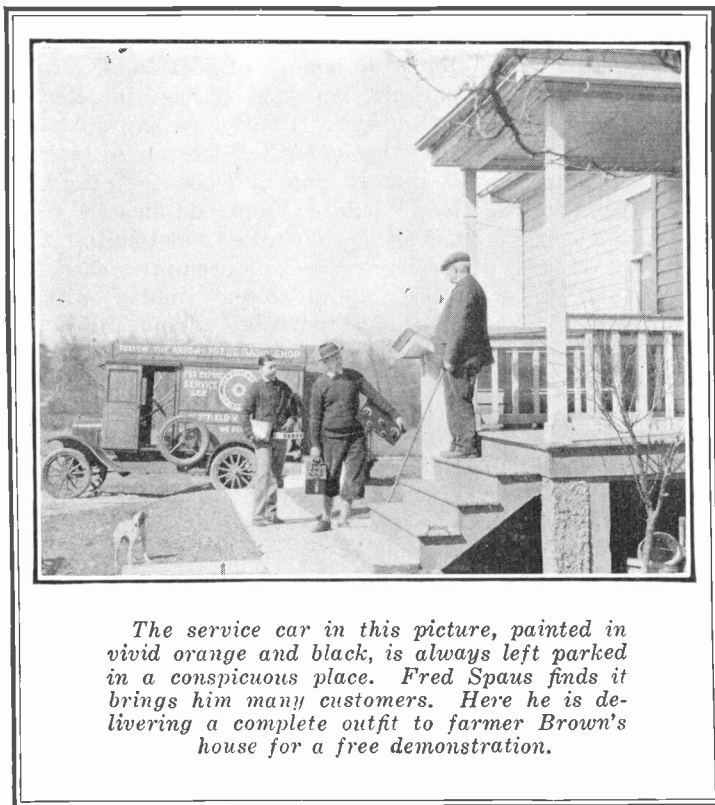

The service car in this picture, painted in vivid orange and black, is always left parked in a conspicuous place. Fred Spaus finds it brings him many customers. Here he is delivering a complete outfit to farmer Brown's house for a free demonstration.

How I Sold Farmer Brown

AS SOON as I hear of anyone that is interested in buying a radio set, I at once get in touch with him and get permission to call and install an antenna and ground and give a home demonstration," says Fred Spaus, owner of Fred's Radio Shop, Westfield, New Jersey. "The antenna is put up with the understanding that it is entirely free of charge and becomes the property of the prospect.

"Take, for instance, this last set that I sold. A customer came into the store one day recently with the information that his friend, Farmer Brown was getting interested in radio. Next day I went out to Brown's farm which is situated about five miles from town, got his permission to put up an antenna and gave him a demonstration.

"You wonder why I went out without delay and erected an antenna before I even had an order? Well, that is part of my selling plan. I give absolutely no demonstrations of the receiving qualities of a radio set in my store. Whenever I find an interested prospect I obtain his permission to put in a complete antenna and ground connection outside his house. This is absolutely free of charge to him. Then I give him a

demonstration right in his home."

"But supposing you do not sell a set to this man," I began.

"That has only happened to me once," Fred broke in, "and in that case it was due solely to the fact that the prospect did not have enough money to buy a radio set at that time. He still has the antenna and ground connection, and will in all probability buy a radio set from me when he is financially able.

"But to return to Farmer Brown.

Selling Radio Sets

by letting the prospect do the demonstrating in his own home is a novel idea. Keep your ear to the ground, as Fred Spaus does, and when you hear of anyone interested in buying a set, get permission to call and give a demonstration.

Most people, especially farmers, are willing to be shown why and how a radio set should be included in their household equipment.

I next installed in Brown's house a cheap 3-tube set complete with batteries. This I told him to try out for a few days, then I would come back and see how he liked it. He was not going to like this cheap set and I knew it, but I wanted to prove to him first that he would not be content with it so that in the future he would have the satisfaction of knowing that he bought the better product.

Leaves Cheap Set First

"Having already mentally determined what type of set he would want, when I went the next time to get his decision on the cheap set I brought with me a 5-tube set. It was as I had figured; he wanted to see something a little better. I connected up the 5-tube outfit and left it for a week.

"When I next called I met a satisfied man and there was no trouble in closing the sale.

"And when you think it over," Fred continued, "why isn't this the most sensible way for a small town dealer to sell radio? Why waste time giving store demonstrations when the set that satisfied the prospect in the store may not be what he wants in his home. I save time by giving this type of home demonstration. Of course I know the majority of people in this community and, therefore, am reasonably sure that

This New Jersey dealer gets radio sets to the farm population of his district by erecting aerial free of charge and selling the farmer a set to go with it. A service car, painted in vivid orange and black, has been his best advertising medium. When parked before the door of a prospect it carries its sales message to everyone in the vicinity, and gives him most of his leads.

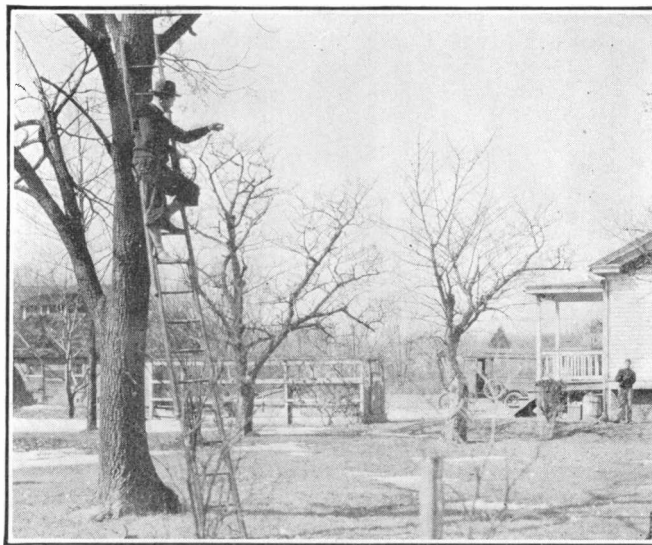

An integral part of Fred's selling plan is the installation of aeriels free of charge. Carrying sectional ladders in his service car saves time and energy in putting up and repairing antennas, especially in the farm community which he serves.

the man is going to buy a radio set of some sort before I start out.

"I further guarantee every set I sell for a period of one year, but only after I have proved its satisfactory operation in the owner's home. Of course, I do not mean that I will not sell a set in the store if a man demands one. But I will not give free service on such a set unless it has been installed and demonstrated according to my methods."

Another feature of the merchandising plan used by Fred is that on any set sold and installed by him, accessories needed by the owner of that set at any time, are the same price, whether the owner buys them in the store or calls Fred up and asks him to deliver them. No charge is made for service or delivery on these accessories as it has been found that the profit on them is sufficient. However, no deliveries will be made where the total purchase is less than 75c.

Has Regular Service Hours

On regular service calls a charge of \$1.50 an hour is made. This servicing is done between the hours of 2:30 p. m. and 10:00 p. m., when the programs from various local stations are best for making tests.

"Where do I get most of my leads? They are direct results of the advertising I get from my service car,"

replied Fred. "One can't miss this car, painted a bright orange with a big wooden arrow on the roof and the inscription "Follow the arrow to Fred's Radio Shop."

Always Leave Car in Conspicuous Place

"Wherever I go," says Fred, "I take particular pains to leave my car in a most conspicuous place. The car itself is a complete little store. Extra parts, accessories, sets, loud speakers, odds and ends and also a sectional ladder long enough to permit working high enough on any tree or house for installing or preparing aerial equipment. Two or three extra fully-charged storage batteries are also in the car at all times so that a man may never lose on an evening's entertainment due to a discharged battery."

By working late in the night with the aid of an amateur, a high school student, Fred is able to give service on every trouble call on the very day it comes in.

During the past 5 years Fred has been in the radio business, he has found his plan works out satisfactorily in every case. The farmer that wants a radio set usually also wants to take his time in making a

selection. Therefore this home demonstration plan is the most logical one.

Fred has discovered also that it is best to demonstrate a cheaper set first, followed up by a more expensive one, so that the customer may determine which is best suited for his purpose and pocketbook. In a small community, it does not pay to force the sale of a high priced article when a less expensive one would do just as well, because talk is cheap and a dissatisfied customer, especially one who thinks he has been taken advantage of, can do much material damage to the dealer.

Dealer Keeps Loudspeaker Operating in Nearby Drug Store

An enterprising radio dealer of Miami Beach, Florida, has installed a loudspeaker in an adjoining drug store, wiring it to a set in his shop. He keeps it operating as continuously as possible on the best programs.

This novel "broadcasting" scheme has attracted considerable attention among the patrons of the drug store and many prospects who would not ordinarily be reached, enter the radio shop to see the "works."

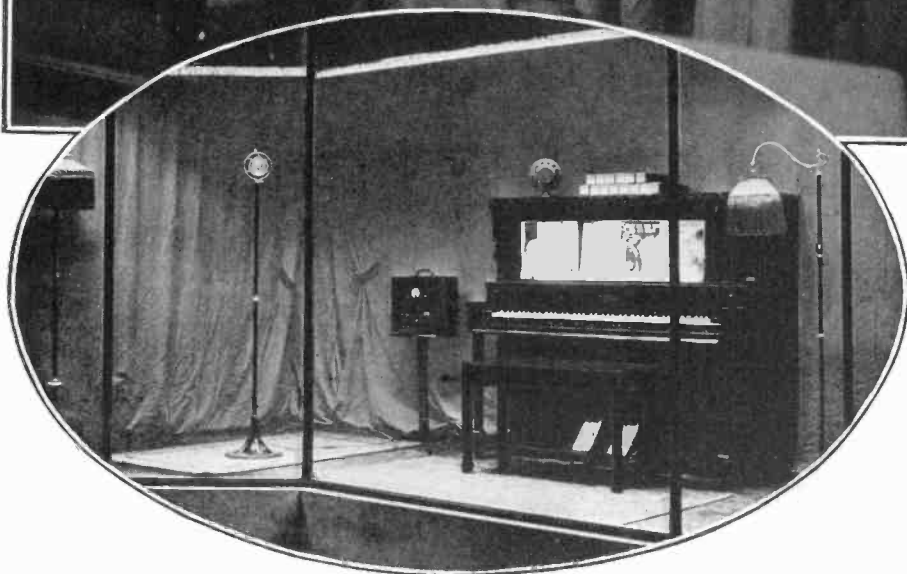

Above: Crowds outside the Kansas Gas & Electric Company's store at Wichita, Kansas, listening to a concert from a miniature broadcasting station set up in a show window. And—

At left: A close-up of the window station, the magnet that drew this fascinated audience. All the apparatus used in a real studio appears in this ingenious display.

"Fake" Window Studio Attracts Attention

There is an indescribable fascination about a broadcasting studio. There is an appeal to the imagination in the thought that one is actually witnessing the birth of sounds, that will be radiated almost to the four corners of the earth.

The Kansas Gas & Electric Company, Wichita, Kan., sensed this fact, and put it to practical use, when it installed a miniature broadcasting studio right in its show window, as shown in the photograph in the oval above. In this studio, which was

called station KCE local talent appeared in a series of concerts.

The picture at the top of the page answers the question—"Did it pull?" A standard "pick-up" microphone is used by the announcer and the artists. A small control panel and a loud speaker, the latter placed outside the window, complete the necessary equipment. Of course, the signals are not actually broadcast, the loud speaker being connected directly to the microphone.

F. H. McCullough, sales manager

for the utility company, has this to say about the operation of Station "KCE": "Everything occurs exactly as though it were a real studio and station. The talent is usually local. This also induces the townspeople to turn out and witness the display.

"Whenever we stage a concert a large crowd gathers and remains until the program is concluded. The radio fraternity in this section of the country, where stations are so remotely located, is always eager to see the actual operation of a studio."

"It Pays to Be Ethical"

How a furniture house conducts its radio business so that "the firm as well as the customer gets a square deal."

OUT in the heart of Illinois, in a trading territory of 30,000 people, there is a merchandiser who sold, from last November to last March, 340 radio sets.

Did this firm specialize in cut prices? It did not.

Did it pile one "sale" on top of another or "pay" the public to buy from it? Not at all.

How then did the Hummer Furniture Company sell over \$35,000 worth of radio apparatus within the short span of five months?

The house of Hummer extracted its full share of radio business from the good people of La Salle and vicinity by just "being ethical," according to Manager H. I. Halpin. In other words, it drafted a set of rules to cover its conception of sound business practices and then proceeded to abide by them.

"By being ethical," states Mr. Halpin, "I mean simply conducting one's business so that the firm as well as the customer gets a square deal."

Hummer's radio department showed a net profit of over eight per cent as of May 1, 1926. Let's examine, therefore, the policies of this member of the "100 per cent markup" class of retailer, as the furniture merchant is sometimes termed.

Reasons for Volume

Hummer's has been selling radio for five years. It has profited by its earlier mistakes. It owns and operates WJBC. The license for this station is four years old. Halpin and his right hand man are both expert radio service men. It goes without saying, therefore, that Hummer's radio department is built on the bedrock of public confidence.

Then there is the little matter of store clientele. People from a dozen smaller places—towns where they still have a bicycle rack in front of the post office—come to La Salle to buy their furniture. Again how could any prospective buyer overlook the dealer whose generous use of newspaper space for radio advertising ran over \$1,200 last year? Hummer also has a large and select list of customers and "fans." This list was circularized three times during the winter.

That a large and reputable estab-

lishment with a reputation of 20 years of fair dealing behind it and a proven mastery of its latest line should dominate the local radio field is not at all surprising. How it makes that eight per cent profit is, however, another question and one of equal interest. "We could never do it," to quote Mr. Halpin, "were it not for our code of business ethics."

Summarized, this code is as follows:

Demonstrations—Will not leave a set "on trial." "This encourages indecision. Our set is without a defender if we leave it. This gives static every opportunity to lick us. On the other hand, we have found that the firmer the stand we take the better the public seems to like it," says Halpin.

Trade-ins—"Have been able to avoid them so far."

Terms—The customary 10 per cent down and 10 months to pay.

Quotations—Price includes complete equipment and installation. Halpin adds \$25 for this latter expense and to cover also a three months' free service agreement.

Claims—"We do not exaggerate and we will not guarantee distance."

Service—"We bow to no one when it comes to rendering expert service."

Stock Maintenance—Halpin's attitude in respect to his stock furnishes an excellent illustration of the practical application of his philosophy of a square deal.

Once a month, every tube, every battery and every other part or accessory subject to deterioration, is inspected. "We scrap those goods that are found unsuited for sale or for demonstration purposes, selling only what we know is perfect."

"We find," concludes Halpin, "that the public is willing to do business on our terms, provided those terms are fair and square and it receives full value for its money."



A striking example of progressive sales promotional effort. The Hummer Furniture Company operates station WJBC in connection with its radio department. Last winter this store moved its studio to the above spacious double window. For the two weeks it was in operation the sidewalks were filled with crowds of interested spectators.

INTELLIGENT DIRECTION Makes

How the Crouch Radio Company, Oneonta, N. Y., developed a \$500 capital into a \$17,000 net worth in less than two years, mainly due to resourceful guidance of its sales staff



“OUR original investment in the radio business was \$500. That was two years ago. Today our assets are \$17,400. We attribute a major part of this growth to our policies with respect to outside selling. The dealer who overlooks this opportunity for increasing sales is passing up 75 per cent of his possible business.”

L. D. Crouch, majority owner of the Crouch Radio Company, Oneonta, N. Y., is authority for the preceding statement. Last year this concern did a business of \$55,000. This year to date (Oct. 1) it has grossed \$33,000.

Since this firm was organized in 1924, it has favored and developed the “house-to-house” canvass as a means of building volume radio

business. Its policies and methods have never been haphazard. On the contrary Crouch is doing a real job in field selling. His men average \$300 a month during the active season. He apparently has solved the problem of labor “turnover,” inasmuch as all five men are now in their third year with the Crouch Radio Company.

“Like Running Our Own Business”

Here’s the answer to a dealer’s prayer—the reason why Crouch can no more lose one of his outside salesmen than Ringling Brothers can lose the fat lady in the side show: “We stick because it’s just like running our own business,” declares Carl Cummings, one of the faithful five. The following remarks, made by Crouch to the writer, shed further light on this subject:

“We pay our men 15 per cent and on top of this they get the \$5 installation charge. This charge does not include the material. Our men can employ our installer if they choose.

In that case we get the \$5. They usually, however, either do the installing themselves or ask someone on the outside to do it for them, paying their own installer by the job.”

“Installation,” according to Crouch, “covers the work of erecting the aerial and making the ground connection. Cummings’s “installer,” for example, is a railroad man who works on a night shift. This gives him most of his daylight hours off. He has, for the past two years, installed for Cummings at a flat rate of \$2 an aerial. All of Crouch’s men have been with him long enough to become thoroughly experienced in connecting the set and instructing the user in its proper manipulation.

“There is a lot of difference whether salesmen work *for* you or *with* you,” says Crouch. “Our men do the latter because we are careful to hire local boys who have other summertime employment. Groff, for example, sells washing machines in the summer. Because of this summer experience he is a better radio

Field Salesmen Successful

By Roy V. Sutcliffe

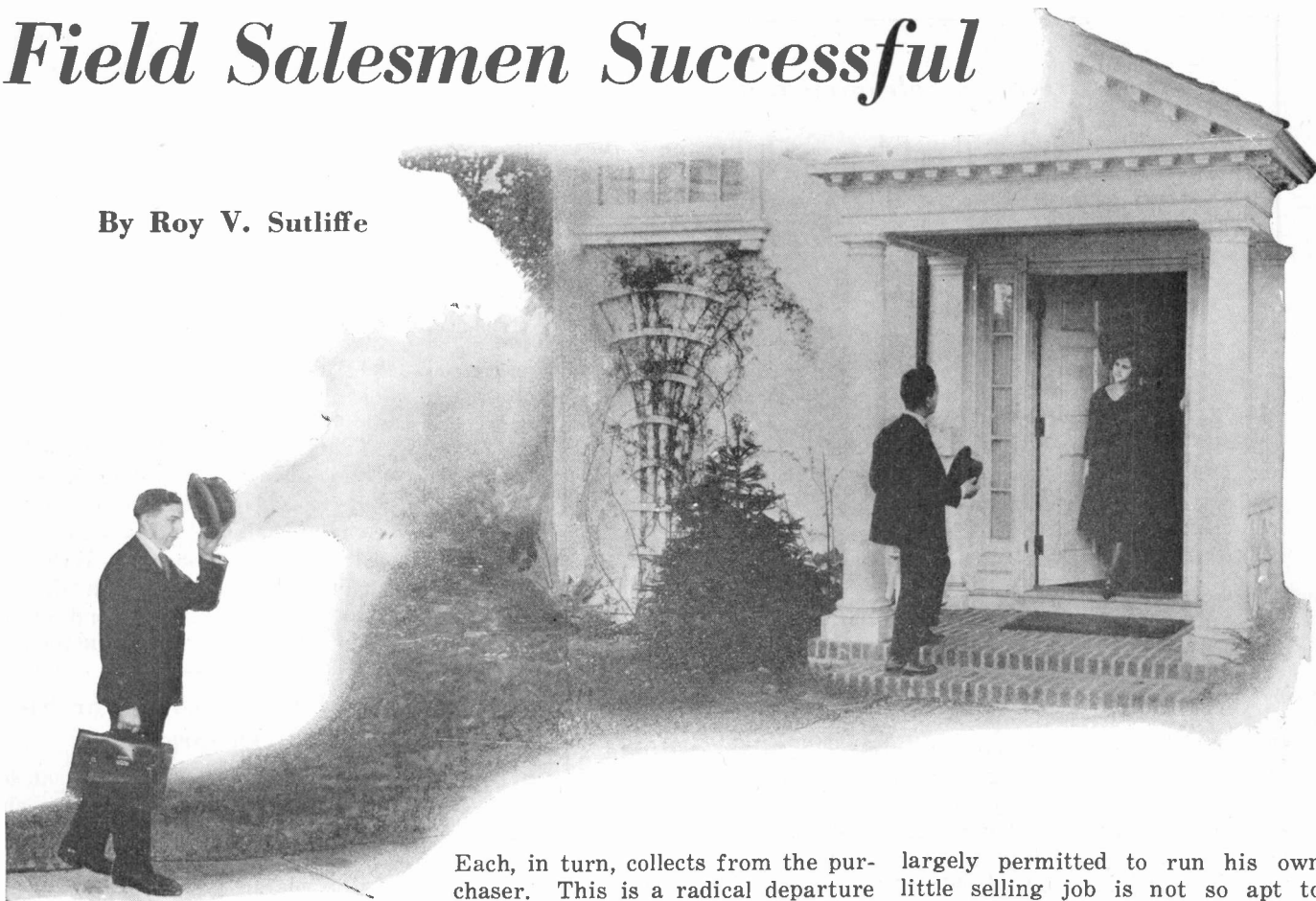

salesman. During that time he digs up many prospects for radio which he closes when he starts to work for us in the fall. Clement sells automobiles in the summer. He has to be good to sell motor cars and this makes him a top-notch radio salesman. Clement is a thorough radio man. He understands how sets are made and knows how to service those he sells. Another of our men, Cummings, holds a regular position with the Delaware & Hudson Railroad Co. He sells the railroad men and lots of them. Cummings does his own servicing after hours. Beside the local salesmen, we have about nine men located in nearby towns who are constantly looking out for radio prospects. These men receive a 5 per cent commission on every sale that is closed. This commission is deducted from the account of salesman to whom the prospect is referred."

Crouch assigns specific territory to each field representative. Thus the salesmen are in a position to build for future sales through the acquaintances they make through this intensive cultivation of a limited district.

Each of the five is billed direct.

Radio Retailing, October, 1926

Each, in turn, collects from the purchaser. This is a radical departure from the accepted practice and is only practical, according to Mr. Crouch, with financially responsible and trusted employees. Where such is the case this plan has the merit of protecting the dealer against credit losses, it cuts his collection costs, it prevents the salesman from selling wobbly prospects and it serves as one more method of putting the outside man "on his own."

"The man who is trusted and

largely permitted to run his own little selling job is not so apt to throw it over or resort to trickery," is the explanation offered by Crouch in defense of this practice. He states that he is able to exercise sufficient control over his accounts because he holds the purse strings and the reserve stock of sets. "These men are making too much sure money to want to cut loose and chance their capital on a business of their own," he adds.

Under the Crouch plan of inde-

"Words from the Lips of Wise Men"

Crouch Says—

"There is a lot of difference whether salesmen work for you or with you. Make them work with you."

"There are men in every community and in every walk of life who can be trained as efficient radio salesmen. Find them."

"Go to the source of business—the home."

"If a dealer is content with store business only he is missing seventy-five per cent of his opportunities."

"We spend \$15 a week on our windows. Don't merely put the radios and parts in for display but make them carry a real sales idea."

"The man who is trusted and largely permitted to run his own little selling job is not so apt to throw it over or resort to trickery."

How Crouch's Salesmen Get the Business

Operating under the following policies, five outside salesmen last year wrote over \$30,000 worth of business for the Crouch Radio Company, Oneonta, N. Y.:

Each salesman is assigned exclusive territory.

Salesmen receive straight commission of 15 per cent.

Pay their own expenses. Are allowed a \$5 instal-

lation fee if they make their own installation, which is generally the case.

Set is billed to salesman, who in turn collects from the customer.

Each salesman must know the technical points of the set he sells and do his own servicing.

Must attend weekly sales meeting.

pendent sales operations each salesman must know how to render ordinary service. For this purpose weekly sales-service meetings are held. Attendance is compulsory. At these meetings selling methods are brushed up, overlapping prospect leads straightened out and, of greatest importance, service technicalities and standard servicing rates are agreed upon. Because of this plan for servicing minor troubles the Crouch Radio Company conducted a \$55,000 business last year with but one expert store service man. This man also found time to wait on store trade and to deliver and install sets sold off the floor.

House-to-house selling is mighty hard work. These men pay their own expenses. In return they are backed up with advertising on four bill boards and in the local newspapers to the extent of 3½ per cent of the total gross sales.

Leads from advertising and from friends who drop in the store or telephone average three per week for each outside man.

"Close and friendly co-operation," that's the way Crouch summed up the reasons for his success with his outside crew. Then he added: "Other dealers can get this extra business also if they will but use due care in the selection and training of their men and then treat them more like partners and less like servants."

The Many Advantages of the Raised Platform

Displaying sets and accessories in the store on a platform three feet wide, twelve feet long and six inches high may seem, at first thought, in-

consequential, but it has many important advantages, according to G. I. Morgan of the Independent Electric Sales Company, Sioux Falls, S. D.

A raised platform attracts attention and adds to the appearance of the store, it can be carpeted and kept clean, it protects the sets from injury, especially from the shoes of careless customers. Moreover, it elevates the product to the eye level, brings the dials within easy reach of the hand and permits the ready display of smaller articles such as batteries and chargers. Show cards also may be placed on this dais without appearing to be too low.

"Such a platform costs about twenty dollars to construct and adds ten times its cost to the appearance of the store," remarks Mr. Morgan.

Applause Cards Increase Store Traffic

J. E. Jenkins, Davenport, Iowa, induces people to come to his store by announcing that he will furnish, without charge, station applause cards and, furthermore, that he will supply the postage for these to any person who wishes to acknowledge a program from local station WOC. The only condition is that the person who wishes to use this service must come in person to the Jenkins Radio Store to obtain the card.

"This has not only increased the volume of my store traffic," he states, "but it has placed me on a very friendly basis with the local broadcasting station so that WOC frequently tips me off when there is going to be anything good on the air. I pass it along to my customers."

Signboard Posters for Store Decoration

The radio dealer is often at loss to find a way to decorate the shop and is confronted in many cases by a large blank wall surface. Many of the manufacturers of radio apparatus are supplying retailers with large posters designed for use on outside signboards. A brilliantly colored poster which is made up in red, brown and white, supplied by a manufacturer for outdoor use, has been hung on a blank wall in the shop of M. M. Griffin, Rockville Centre, N. Y., making an effective background out of what was previously an eyesore.

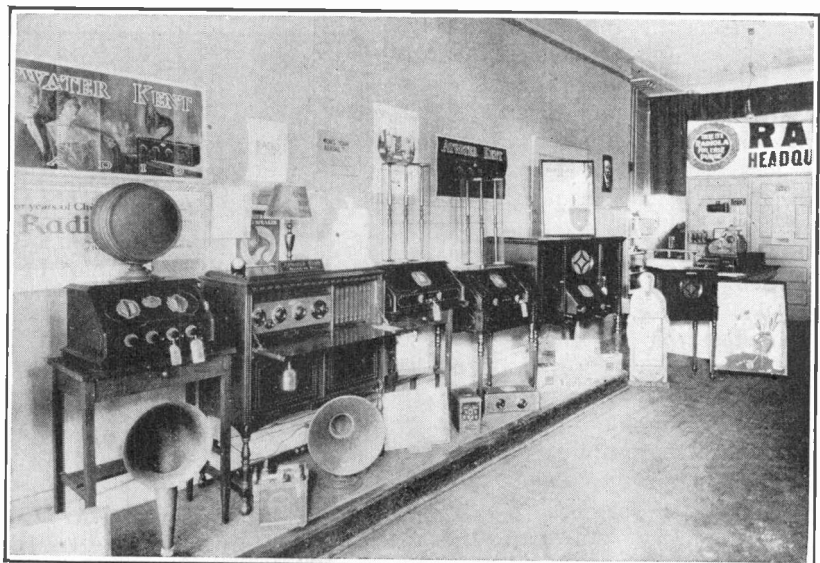

The interior of the Independent Electric Sales Company's store, Sioux Falls, S. D., showing the raised platform for the display of radio sets, accessories and parts

Specifications of Receiving Set Chassis and Cabinets

The following lists have been prepared for those dealers who wish to install standard chassis in cabinets other than furnished by the set manufacturers.

INFORMATION concerning radio products, with the name and address of the manufacturer, is a feature of *Radio Retailing's* editorial service published from time to time as market conditions warrant. This service is wholly for the benefit of readers and is without charge of any kind whatsoever to the manufacturer listed. Forms are mailed out with return envelopes well in advance of these listings and those manufacturers wishing to be represented *must* fill out the forms as indicated and return them

to us within the time specified. It is *Radio Retailing's* desire to make these pages a representative directory of radio products, so that, by following them as they are published, the dealer will always have at hand the information he wants to know about any radio set, reproducer or accessory. For portable receiving sets see the May issue, page 447. For audio frequency transformers see the June issue, pages 574-76. For receiving sets see the July issue, pages 35-46, and the August issue, page 66. For loud speakers,

head sets and phonograph units see the August issue, pages 58-61. For battery chargers, battery eliminators and power units see the September issue, pages 78-81, also page 107. Complete listings of all radio manufacturers and their products appear in the *McGraw-Hill Radio Trade Catalog*, which is published three times a year by the McGraw-Hill Publishing Company, Incorporated.

For specifications of vacuum receiving and rectifying tubes, see the next, the November issue.

Receiving Set Chassis

Name and Address of Manufacturer	Trade Name and Model Number	Price to Dealer	Type of Circuit	No. of Tubes	Stages of R.F.	Stages of A.F.	Type of A.F. (See Note)	No. of Tuning Dials	Overall Dimensions in Inches	Total Weight in Pounds	Equipped to Use 3- or 5-Volt Tubes	Operates on Antenna and Ground or Loop
Able Tool & Engineering Co. 536 W. Elm St., Chicago, Ill.	Atec-5	\$25.00	TRF	5	2	2	Tr	2 & 3	7x18x8	10	5	A & G
	Atec-6	33.00	TRF	6	3	2	Tr	2	7x21x8	12	5	Both
Adroit Tool Co., Inc. 14 Front St., New York City	Adrola-R5P	34.00	TRF	5	2	2	Tr.	3	7x18	8	Both	Both
	Special brand	12 up	TRF	5	2	2	Tr	3	7x18		Both	Both
	Electric Power Chassis for A.C. or D.C.	70.00	TRF	5	2	2	Tr	3	14x18		5	Both
Argus Radio Corp. 257 W. 17 St., New York City	A-250	150.00	TRF	7	3	3	1 Tr, 2 I	2		90	5-199 1-201A 1-171	G only
	A-375	225.00	TRF	7	3	3	1 Tr, 2 I	2		90		
Ambu Engineering Institute 2632 Prairie Ave., Chicago, Ill.	Ambu-5	39.75	TRF	5	2	2	Tr	3	28x7x7½	7½	5	A & G
All-American Radio Corp. Chicago, Ill.	All-American	70.00	TRF	5	2	2	Tr	2	18x9½x8½	15	5	A & G
Amplex Instrument Lab. 88 W. Broadway, N. Y. C.	Amplex "Harmo-Sonic"-34	20.70	TRF	6	2	3	R	2	7x18		5	A & G
	Amplex "Harmo-Sonic"-42	25.50	TRF	6	2	3						
Andrea, Inc., F. A. D. 1581 Jerome Ave., N. Y. City	192S-Neurolette	74.00	Neut.	5	2	2	Tr	3	19½x10½x7½	8½	Both	A & G
	170A-Neut. Unit	95.00	Neut.	5	2	2	Tr	3	22x11x9	12	Both	A & G
	R60-Fada-6 Unit	120.00	Neut.	6	3	2	Tr	2	21½x11x6½	32	5	Both
	R80-Fada-8 Unit	235.00	Neut.	8	4	3	Tr	2	29x12½x8	60	5	Both
Anylite Electric Co. 1418 Wall St., Ft. Wayne, Ind.	King Cole-VI	60.00	RF	6				2	12x19x10½	30	Both	A & G
Apex Electric Mfg. Co. 1410 W. 59 St., Chicago, Ill.	S-5	*	TRF	5	2	2	Tr	3	7x18x8	11	5	A & G
	A-6	*	TRF	6	2	3	I Dual	1	7x18x9	15	5	A & G
	A-5	*	TRF	5	2	2	Tr	1	7x18x8	13	5	A & G
	* Sold only to Distributors, Jobbers or Furniture Mfrs. on contract.											
Audiola Radio Co. 430 S. Green St., Chicago, Ill.	527-T	33.50	TRF	5	2	2	Tr	2	Front panel 7x18 Sub-panel 7x17	7	5	A & G
	627-T	47.00	TRF	6	2	1*	Tr	2	Front panel 7x21 Sub-panel 8x20	10	5	A & G
* And push-pull.												
Automatic Radio Mfg. Co., Inc., 332 A St., Boston, Mass.	"Arc" No. 35	Prices on application	TRF	5	2	2	Tr	3	7x18x7	10	5	A & G
	"Arc" No. 37		TRF	6	2	3	R	3	7x18x7	10	5	A & G
	"Blue Bird" No. 42		TRF	5	2	2	Tr	3	7x18x7	10	5	A & G
	"Blue Bird" No. 45		TRF	5	2	2	Tr	3	7x18x7	10	5	A & G
	"Blue Bird" No. 50		TRF	5	2	2	Tr	3	7x18x7	10	5	A & G
	"Blue Bird" No. 57		TRF	5	2	2	Tr	3	7x18x7	10	5	A & G
Autometal Corp. 311 Falls St. Niagara Falls, N. Y.	Aragain Model E	57.00	TRF	6	2	2	Tr	2	10x12x21	21	5	A & G
	Aragain Model B	72.00	TRF	5	2	2	Tr	3	10x11½x32½	25	5	A & G
	Aragain Model C	90.00	TRF	5	2	2	Tr	3	11½x12x31	32	5	A & G
B & H Radio Prod. Co. San Antonio, Texas	Radioclar	17.50	RF	5	2	2	Tr	3	8x21		3	A & G
	Radioclar	20.00	RF	6	2	3	R	3	8x21		3	A & G
Baird Radio Mfg. Co. 152 Summer St., Boston, Mass.	Baird-Built Browning-Drake	37.50	TRF Reg.	4	1	2	Tr	2	7x21	8	Yes	A & G
Barbly Radio Co. 307 Sixth Ave., N. Y. City	BB5	Not Shielded	TRF	5	2	2	Tr	3	7x18x7	6		A & G
	BB6		TRF	6	2	3	Tr, R	3	7x18x7	6		A & G
	SW5		TRF	5	2	2	Tr	3	7x18x5½	6		A & G
	SW6		TRF	5	2	3	Tr, R	3	7x18x5½	6		A & G
Barty Radio Co. 66 Jamaica Ave. Astoria, L. I., N. Y.	Criterion Deluxe	16.00 to 12.25	TRF	6	2	2	Tr	3	7x18x7	11	Both	A & G
Branston, Inc., Chas. A. Buffalo, N. Y.	Branston Hetrola-R45	33.00	TRF	5	2	2	Tr	2	7x18	9	5	A & G
Brown Radio Mfg. Co. Wilkes-Barre, Pa.	Thorobred CH-88	70.00	TRF	6	2	3	Tr	3	21x12x8	16	5	A & G

Receiving Set Chassis (continued)

Name and Address of Manufacturer	Trade Name and Model Number	Price to Dealer	Type of Circuit	No. of Tubes	Stages of R.F.	Stages of A.F.	Type of A.F. (See Note)	No. of Tuning Dials	Overall Dimensions in Inches	Total Weight in Pounds	Equipped to Use 3- or 5-Volt Tubes	Operates on Antenna and Ground or Loop
Buckeye Elec., Gladwin, Mich.	Aristocrat Baby Five No. 200	55.00	TRF	5	2	2	Tr	3	26	5	5	Both
Cardinola Radio Corp. Indianapolis, Ind.	Cardinola Model 1N Cardinola Model 2N	27.00	TRF	5	1	3	Tr, R	1	14x10x10½	10	5	A & G
		27.00	TRF	5	1	3	Tr, R	1	14x10x10½	10	5	A & G
Crouch Radio Co. 160 Main, Oneonta, N. Y.	Clar-A-Dyne Clar-A-Dyne	36.00	RF	5	2	2	Truphonic Coupler	3	7x18	21	Both Both	A & G A & G
		60.00	RF	6	2	3		3	7x18	23		
DeWitt-La France Co. Cambridge, Mass.	Superadio Model 5	25.20	RF	5	1	3	Tr	2	8x16x9	10	5	A & G
Diamond T Radio Mfrs. South Bend, Ind.	Diamond T	22.50	TRF	6	2	3	Tr	2	7x18x7	12	5	Both
Drexel Radio Mfg. Co. 2351 E. 75th St., Chicago, Ill.	Drexola-4 Drexola-5 Drexola-3 Drexola-8	29.50	TRF	4	1	2	Tr	2	7x18x7		5	A & G
		33.00	TRF	5	2	2	Tr	3	7x18x7		5	A & G
		29.50	Super-Het.	3	2	2	Tr	1	7x18x7		3	Loop Loop
		95.00		8	3	2	Tr	2	7x26x9		5	
Elgin Radio Supply Co. 207 E. Chicago St., Elgin, Ill.	S.R.-27	22.50	Regen.	3		2	Tr	1	15x6x6	5½	Both	Both
Empire Electric Mfg. Co. 25 Juneau Ave. Milwaukee, Wis.	Empire-5 Empire-6 Empire-7	23.00	RF	5	2	2	Tr	3	7x18	12	5	A & G
		25.00	RF	6	2	2	Tr	1	7x18		5	A & G
		100.00	RF	7	3	2	Tr	1	8½x20		5	A & G
Freshman Co., Inc., Chas. 240 W. 40 St., N. Y. C.	Freshman Masterpiece	18.00	TRF	5	2	2	Tr	3	17½x6x7	8½	5	A & G
Gormac Elec. Co. 311 W. 59 St., New York City	Gormac-C3 Gormac-C3	15.00	TRF	5	2	2	Tr	3	7x16x9	10	5	A & G
		15.00	TRF	5	2	2	Tr	2	7x16x9	10	5	A & G
Grebe & Co., Inc., A. H. 109 W. 57 St., New York City	Synchrophase Type Mu-1	84.00	Synchro- phase	5	2	2	Tr	1, 2 or 3	19½x6½x10½	14	5	Both
Guthrie Company, Inc. Grafton, O.	Nightingale-5-35-3 5-38, 50-2 6-40-3 6-44-2	17.50	TRF	5	2	2	Tr	3	7x18x10	13	Both Both Both Both	
		19.25	TRF	5	2	2	Tr	2	7x18x10	13		
		20.00	TRF	6	2	3	Tr	3	7x18x10	13		
		22.00	TRF	6	2	3	Tr	2	7x18x10	13		
Herbert, Inc., Harold 40 Ave., at 23 St. Long Island City, N. Y.	Model 49	15.00	TRF	6	2	2	Tr	3	8½x17½ Front panel 7x18 is recom- mended	5½	Both	A & G
Hall, Charles 1674 Broadway, N. Y. City Note—Double modulated with two outputs operating cone or horn or entirely metal and total magnetic shielded.	Flex-O-Dyne Series 27 DeLux-27	125.00	TRF	8	3	4	(See Note)	2	9x30x9	80	5	Both Both
		1000.00	TRF	12	8	4		2	9x34x14	130	5	
Holland Radio Corp. 316 Knoxville Ave., Peoria, Ill.	Any name Any name	35.00	TRF & Reg.	4	1	2	Tr	2	7x21x6½	10	Both	A & G
		35.00	TRF & Reg.	5	1	3	R	2	7x21x6½	10	5	A & G
Hartman Elec. Mfg. Co. Mansfield, O.		54.00	TRF	6	3	2	Tr	1	5½x15x5	12	Both	A & G
Howard Radio Co. Chicago, Ill.	Model 5 Model 6 Model 7	75.00	Neut.	5	2	2	Tr	3	12½x33½x10½	33	5	Antenna
		120.00	Neut.	6	2	3	Tr, I	3	30½x12x9	50	5	Antenna
		225.00	Neut.	7	3	3	Tr, I	2	30½x15½x11½	70	5	Loop
Industrial Radio Service Saginaw, Mich.	Ultra-Marvel Type 404-N	50.00	TRF	5	2	2	Tr	2	7x18x90		5	A & G
Illinois Radio Engineers Mt. Vernon, Ill.	Illinois (5) Illinois (6)	40.00	TRF	5	2	2	Tr	3	8x7x26	25	5	A & G
		50.00	TRF	6	2	3	Donle	1	12x8x28	34	Both	Both
Irving Radio Corp. Columbus, O.	Irving		TRF	5	2	2		3	7x7x18	8	5	A & G
Keystone Radio Co. Greenville, Penn.	Classic-5	25.00	TRF	5	2	2	Tr	3	7x18x8	8	Both	A & G
Keystone Radio Laboratories, Inc., 154 Whiting St. Chicago, Ill.	Keystone No. 1 No. 2 No. 3 No. 4 No. 5	18.00	TRF	5	2	2	Tr	3	7x18x8	6½	5	A & G
		21.00	TRF	5	2	2	Tr	3	7x18x8	7	5	A & G
		30.00	TRF	6	2	2	Tr	2	7x18x8	7	5	A & G
		32.00	TRF	6	2	3	Tr	2	7x18x8	8	5	A & G
		34.00	TRF	6	2	3	Tr	2	7x18x8	8½	5	A & G
Leich Electric Co., Genoa, Ill.	IA	52.00	Neut.	5	2	2	Tr	3	8x24x7½	11	Either	A & G
Lone Wolf Radio Corp. 4725 Clifton Ave., Chicago, Ill.	E.L.W. F.L.W.	16.00	TRF	5	2	2	Tr	3	18x7x7		Both Both	A & G A & G
		36.00	TRF	6	2	3	R	1	21x8x8			
Magnavox Co. 2725 E. 14 St., Oakland, Cal. † List price.	T D	175.00	TRF	5	2	2	Tr	1	7½x11½x13½	15	5	A & G
		175.00	TRF	5	2	2	Tr	1	7½x11½x12½	13	5	A & G
Malone-Lemmon Prod., Inc. 52 Vanderbilt Ave. New York City	Model 25 Model 55 Model 56 Model 80 Compact PR-60	36.00	TRF	5	2	2	Tr	3	26x7x8		5	A & G
		33.00	TRF	5	2	2	Tr	3	18x7x8		5	A & G
		54.00	TRF	6	3	2	Tr	2	21x7x10		5	Indoor
		180.00	I	8	4	3	I	2	22x7x14		5	Loop
		65.00	Tr	6	3	2	Tr	2	14x9x3		3	Loop
NOTE—Flat type for phonographs. All types with cable.												
Mastercraft Radio Mfg. Corp. 35 W. 19 St., New York City	Mastercraft-5 Mastercraft-6	12.50	TRF	5	3	2	Tr	3	7x18	5	5	A & G
		13.50	TRF	6	3	3	R	2	7x18	5	5	A & G
Melodian Labs. Independence, Mo.	Melody King Melodian	24.00	TRF	5	2	2	Tr	1	7x18x9	13	Either Either	A & G A & G
		45.00	TRF	5	2	2	Tr	1	7x18x9	15		
Metro Electric Co. Chicago, Ill.	Metrodyne Super-Six Metrodyne Single Dial	29.10	TRF	6	2	3	Tr	3	28	18	5	A & G
		45.00	TRF	7	3	3	Tr	1	28	20	5	A & G
Minerva Radio Co. 154 E. Erie St., Chicago, Ill.	Minerva No. 1	40.50		6	2	3	R	1	7x18 7x21, 7x24	13	5	Both
Mu-Rad Radio Corp. Asbury Park, N. J.	Type A Chassis		TRF	5	2	2	Tr	1	14x12x7½		5	A & G
Mutual Radio Co. Francis Rd., Wellesley, Mass. * Wired for power tube in last stage.	Mutual V. Super-Six Chassis	30.00	TRF & Reg.	5	1	3	Tr, R*	2	7x18x7		5	A & G
		45.00	Super Het.	6	3	2	Tr	2	7x18x7		3	Loop

Receiving Set Chassis (concluded)

Name and Address of Manufacturer	Trade Name and Model Number	Price to Dealer	Type of Circuit	No. of Tubes	Stages of R.F.	Stages of A.F.	Type of A.F. (See Note)	No. of Tuning Dials	Overall Dimensions in Inches	Total Weight in Pounds	Equipped to Use 3- or 5-Volt Tubes	Operates on Antenna and Ground or Loop
No-Battery Radio Co. 682 Beacon St., Boston, Mass.	Mastertone-5	16.50	TRF	5	2	2	Tr	3	7x18	5	Both	A & G
	Mastertone-6	17.75	TRF	6	2	3	R	3	7x18	5	Both	A & G
	Supertone-5	17.85	TRF	5	2	2	Tr	2	7x18	5	Both	A & G
	Supertone-6	19.00	TRF	6	2	2	R	2	7x18	5	Both	A & G
	Supertone DeLuxe	21.50	Spec.	5	2	2	R	2	8x14	5	Both	A & G
Norbert Radio Service Bureau 152 W. 42 St., New York City	Seminole "Super-Five"	18.50	TRF	5	2	2	Tr	3			Both	A & G
	Melodee	20.50	TRF	6	3	3	Tr	3			Both	Both
	Diamodyne	28.50	TRF	5	2	2	Tr	3			Both	A & G
	Melodee Consol-Art	48.50	TRF	6	3	3	Tr	3			Both	Both
	Metro-dyne	66.50	TRF	5	2	2	R	1			Both	Both
Munn-Landon Co. Milwaukee, Wis.	Cascade	60.00	TRF	5	2	2	Tr	2	6x21x10	15	5	A & G
Okay Radio Corp. Brazil, Ind.	Okay R. F. 1	15.00	TRF	5	2	2	Tr	3	7x18x7	15	5	A & G
	Okay R. F. 2	19.00	TRF	5	2	2	Tr	3	7x18x7	15	5	A & G
	Okay R. F. 6	25.00	TRF	6	2	3	Tr	2	7x18x7	15	Both	A & G
Operadio Corp. Chicago, Ill.	Operadio Model-8	26.00	TRF	5	2	2	Tr	2	7x14x9D	8	5	A & G
	Operadio Model-9	40.00	TRF	7	4	2	Tr	1	7x20x11D	20	5	Loop
Orthodyne Radio Mfg. Co., Inc., New York City	Airo-Master Model 27	18.50	TRF	6	2	2	Tr, R	2	7x18x7	10	5	A & G
Penna Radio Mfg. Co. New Castle, Pa.	DeLuxe-5	45.00	TRF	5	2	2	Tr	3	7x21x8	10	Both	A & G
	DeLuxe-6	48.00	TRF	6	2	2	R	1	7x21x8	12	Both	A & G
Perlesz Radio Mfg. Corp. 560 W. Congress St. Chicago, Ill.	Perlesz-7	Net 144.00	RF	7	3	3	Tr	1	18x10x11½	22	5	A & G
	Perlesz-8	180.00	RF	8	3	4	Tr	1	18x10x11½	25	5	A & G
	Perlesz-9	210.00	RF	9	4	4	Tr	1	18x10x11½	26	5	A & G
Ports Mfg. Co. 3305 E. Belmont, Fresno, Calif.	Primco Model C-105	20.00	TRF	5	2	2	Tr	3	7x18x7½	10	5	Both
Premier Electric Company 3800 Ravenswood Ave. Chicago, Ill.	Premier 226-V-5	27.00	TRF	5	2	2	Tr	2	Front panel 7x21x7½ Distance from face to back of sub-base is 7½	15	5	Both
	Premier 326-V-5	27.00	TRF	5	2	2	Tr	3			5	Both
	Premier 226-V-6	30.00	TRF	6	2	2	Tr	2			5	Both
	Premier 326-V-6	30.00	TRF	6	2	2	Tr	3			5	Both
Radio Master Corp. Bay City, Mich.	Type S Chassis	33.00	TRF	5	2	2	Tr	2	7x18		5	A & G
Radio Research Laboratories 1600 Noks St., Hastings, Nebr. †Localized control	Waulok-5	32.50	TRF	5	2	2	Tr & Trufonic	3	7x18x7	6½	5	A & G
	Waulok-6	65.00	TRF	6	2	2		3	7x18x10 or 7x15x10	8½	5	A & G
Rauschenberg, Inc. Greenville, Pa.	Magnatone-5	15.00	TRF	5	2	2	Tr	3	7x18x7½	7	Both	A & G
	Magnatone-5	22.50	TRF	5	2	2	Tr	1	7x18x7½	7½		A & G
Rose Radio Co. Brooklyn, N. Y.	Aurora-2A	18.00	TRF	5	2	2	Tr, I	3	7x18x7	10	5	A & G
Roth Radio, Inc. 16 Hudson St., New York City	Melorad	16.50	TRF	6	2	3	Tr	3	7x18	11	5	A & G
	Melorad	14.50	TRF	5	2	2	Tr	3	7x18	10½	5	A & G
Shamrock Mfg. Co. 196 Waverly Ave. Newark, N. J.	List	70.00	TRF	6	2	3	R	1	5½x11½x12½ 5½x11½x12½ 5½x11½x12½	12	5	A & G
	Model "A"	70.00	TRF	6	2	3	R	1		12	5	A & G
	Model "C"	70.00	TRF	6	2	3	R	1		12	5	A & G
Simplex Radio Co. Sandusky, O.	Simplex-6-A	66.00	TRF	6	2	3	Tr	1	Front panel 7½x15½x9 Sub-panel length-17	9½	5	A & G
Sparks-Withington Co. Jackson, Mich.	Sparton 5-15	163.00	TRF	5	2	2	Tr	3	14x15x22½	28	5	A & G
	Sparton 5-26	183.00	TRF	5	2	2	Tr	3	14x17x29½	40	5	A & G
	Sparton Console	135.00	TRF	5	2	2	Tr	3	12½x27½x43½	90	5	A & G
	Sparton Console	175.00	TRF	5	2	2	Tr	3			5	A & G
† List Price.												
Stanrad Corp. 427 E. 76 St., New York City	Standard-5	On application	TRF	5	2	2	Tr	3	7x18	12	Both	A & G
Tidmarsh's Radio Supply Elwood, Ind.	T-R-S Selec-Tone	35.00		4		3	Tr	1	7x18	8		Both
Tilman Radio Corp. Largo, Ind.	Tilman	15.75	TRF	5	2	2	Tr	3	7½x7½x18	10	5	A & G
U-S-L Radio, Inc. Niagara Falls, N. Y. NOTE—Last 2 tubes in parallel.	U-S-L Broadcast Receptor Type UA-6	45.00	TRF	6	2	2	Tr	2	21x12x10	16	5	A & G
Twitchell Co., S. A. Minneapolis, Minn. NOTE—The Super is regenerative and has a plate glass panel.	Twitchell-C5	15.00	RF & Reg. Super Het.	5	2	2	Tr	3	7x18x5	7	5	A & G
	Twitchell-L2	65.00	RF & Reg. Super Het.	8	4	2	Tr	3	10x18x7	18	5	Both
Volotone Mfg. Co. Main and Hart Ave. Minerva, O.	Volotone Model VIII.	75.00	TRF	6	2	3	Tr	1 or 3	7x24x8	15	5	A & G
	Volotone Model X	48.00	TRF	5	2	2	Tr	1 or 3	7x18x8	12	5	A & G
	Volotone Model XI.	28.00	TRF	4	1	2	Tr	2	7x18x7	10	3	A & G
Walbert Mfg. Co. 925 Wrightwood Ave. Chicago, Ill.	Walbert Special Model S36	56.00	Special	6	2	3	R	3	7x18x9	8	5	A & G
	Walbert Isofarad Kit Unwired Assembled Chassis	85.00	Isofarad	5	2	2	I, Tr	3	7x26x9	17	5	A & G
	Model 36	120.00	Isofarad	6	2	3	Double I	3	8x21x14	19	5	A & G
	Model 47	155.00	Isofarad	7	3	3	Double I	4	8x28x14	22	5	A & G
	Model 27	215.00	Isofarad	7	3	3	Double I	2	8x28x16	24	5	A & G
Model 27P	375.00	Isofarad	7	3	3	Double I	2	8x28x16	35	5	Ant. only	
Wells Mfg. Co. Fond du Lac, Wis.	Wells 32		TRF	5	2	2	Tr	2	7x20		5	A & G
	Wells 45		TRF	6	2	3	R	3	7x20		5	A & G
	Wells 27		TRF	6	2	3	R	3	7x20		5	A & G
W-K Electric Co. Kenosha, Wis.	Model 71-S	66.00	TRF	6	3	2	Tr	2	7x21	14	5	A & G

Note—Transformer = Tr. Resistance = R Impedance = I

Cabinets Providing for Panel and Chassis Only

Manufacturer's Name and Address	Trade Name and Number	List Price	Type (Console or Table)	Compartments for Batteries	Loudspeaker Built-in	Loudspeaker Unit Included	Size of Panel That Can Be Accommodated (in Inches)	Overall Dimensions in Inches L. W. H.	Weight in Pounds
American Furniture & Cabinet Co., Inc. 231 Race St., Phila., Pa.	Criterion 103	\$47.00	Console	Yes	Yes	No	14 to 26		
	Criterion 102	53.00	Console	Yes	Yes	No	14 to 26		
	Criterion 101	65.00	Console	Yes	Yes	No	14 to 26		
Bear Furniture Co., G. H. 15 and Green Sts. Allentown, Pa.	2087	100.00	Console	Yes	Yes	No	30x8	35x16x54	
	2122	105.00	Console	Yes	Yes	No	30x8	36x16x56	
	2088	120.00	Console	Yes	Yes	No	30x8	36x16x59	
	2124	120.00	Console	Yes	Yes	No	30x8	36x16x59	
Blandin Phonograph Co., Inc., Racine, Wis.	Blandin Triple A R-20	19.50	Cabinet	No	No	No	Any size from 6x17 to 8x26	32x15½x11	45
	Blandin Triple A R-40	34.50	Battery table	Yes	No	No		32x16½x30½	60
	Blandin Triple A R-41	34.50	Speaker table	Yes	No	No		32x16½x30½	60
	Blandin Triple A R-100	54.00	Console	Yes	No	No		32½x16½x41½	105
	Blandin Triple A R-101	54.00	Console	Yes	No	No		32½x16½x41½	105
Charlotte Furniture Co. Charlotte, Mich.	Charlotte 5	34.00	Console	Yes	No, but can be	No	37x10 or less	38½x13½x39	89
	Charlotte 3	50.00	Console	Yes	No, but can be	No	32x13 or less	36x15x42	103
	Charlotte 2	82.00	Console	Yes	No	No	35x9½ or less	38x21½x37	127
	Charlotte 10	118.00	Console	Yes	Yes	Yes	24x8 or less	36½x15½x41	138
Columbia Mantel Co., Inc. 175 Powers St. Brooklyn, N. Y.	H	50.00	Console	Yes	Yes	No	8x19 top horn	34½x14½x42½	
	D	60.00	Console	Yes	Yes	No	8x20 top horn	36x14x44	
	B	70.00	Console	Yes	Yes	No	8x24	28x15½x46	
	E	72.00	Console	Yes	Yes	No	9x23	32x16½x52	
Corbett Cabinet Mfg. Co. St. Marys, Pa.	Model C	15.00 to 23.00	Table	No	No		7x18 to 2x30	11½x23½x35½	
	Model TV Straight-Model TS. Sloping Front	8.00 to 17.00	Table	No	No		7x18 to 2x30	9½x20½x32½	
Crescent Chair Co. Plymouth, Wis.	200	35.00	Console	Yes	Yes	No	Atwater-Kent No. 20 Compact and No. 30	12x25x40	75
Detroit Woodcraft Corp. 2262 Hendrie Ave. Detroit, Mich.	Model 100-A	22.50	Cabinet	No	No	No	30x7 or less	32½x12½x12½	25
	Model 101-A	22.50	Cabinet	No	No	No	24x7 or less	26½x12½x12½	23
	Model 500	150.00	Console	Yes	Yes	Yes	26x7 or less	37x19½x51	120
Elgin Phonograph & Novelty Co. Union and Chicago Sts. Elgin, Ill.	Elgin Art Model	21.00	Table	No	No	No	7x26	37½x12½x11½	
	Elgin Art Speaker	42.50	Table	No	Yes	Yes	7x26	31½x12½x15	
	Stratford Model R	75.00	Console	Yes	Yes	Yes	28	33x15½x43½	75
	Elite Model O	100.00	Console	Yes	Yes	Yes	30	34½x16½x45½	90
	Compact Model C	100.00	Console	Yes	Yes	Yes	21	25½x15½x48	85
	Sheridan Model X	110.00	Console	Yes	Yes	Yes	30	34½x16½x45½	90
	Newport Model M	115.00	Console	Yes	Yes	Yes	30	34½x16½x45½	90
	DeLuxe Model L	130.00	Console	Yes	Yes	Yes	30	34½x16½x45½	95
	DeLuxe Model K	130.00	Console	Yes	Yes	Yes	30	34½x16½x45½	95
	Peerless Model W	160.00	Console	Yes	Yes	Yes	32	36½x17½x45½	110
Empire United Hat Block Co., Inc., 312 E. 22 St. New York City	Empire 316	30.00	Table	Yes	No	No	7x18 to 9x30 7x18 to 9x30 7x18 to 9x32 7x18 to 10x32	33x15x31½	20
	Empire 360	65.00	Console	Yes	No	No		35x16x41	35
	Empire 365	80.00	Console	Yes	No	No		34x16x42	38
	Empire 370	90.00	Console	Yes	No	No		35x16½x42	42
	Empire 400	140.00	Console	Yes	No	No		35x16x52	50
Federal-Irving Furniture Factories, Inc. New York City † Net price to dealer.	205	†22.50	Console	Yes	Yes	No	9x23	14x27x46	100
	190	†25.00	Console	Yes	Yes	No			
	215	†27.50	Console	Yes	Yes	No			
	225	†32.50	Console	Yes	Yes	No			
Furnas Furniture Co. Indianapolis, Ind.	667	85.00	Console	Yes	Yes	Yes	7x18-7x21	25½x19½x45	110
Ideal Radio Cabinet Co. 281 Vermont St. Blue Island, Ill.	Ideal KFO	65.00	Console	Yes	Yes	Yes	7 to 9 up to 32 long	37x18x43	85
	Ideal KFO	70.00	Console	Yes	Yes	Yes	7 to 9 up to 34 long	39x18x43	90
	Ideal KYW	70.00	Console	Yes	Yes	Yes	7 to 8 up to 32 long	32x18x42	80
	Ideal 201	75.00	Console	Yes	Yes	Yes	7 to 8 up to 30 long	34x18x40	110
	Ideal WGY	80.00	Console	Yes	Yes	Yes	7 to 8 up to 28 long	32x17x52	110
	Ideal 202	90.00	Console	Yes	*	Yes	9x28	34x18x48	120
* No—but space is provided for cone or horn.									
International Equipment 1324 Chestnut St. Kansas City, Mo.	Straightfront Standard	2.75 to 9.75	Table	No	No	No	9 to 40		5½ to 20
	Slant Front Standard	8.00 to 12.50	Table	No	No	No	18 to 30		8 to 15
	Straight Front DeLuxe	10.00 to 15.00	Table	No	No	No	18 to 30		12 to 18
	Slant Front DeLuxe	11.00 to 15.00	Table	No	No	No	18 to 30		12 to 18
	IIRS	9.00	Table	No	No	No	15x9	17½x15½x10½	15
BSH	19.00	Table	Yes	No	No	20x7	36½x11½x9½	25	
	75	25.00	Table	Yes	No	No	24x7	39½x15x11	28
Knickerbocker Talking Machine Co. 831 Broadway New York City	Marie Louise	150.00	Console	Yes	Yes	No	Atwater-Kent No. 20 30 or 32	30½x16½x52½	
	Louis XIV.	250.00	Console	Yes	Yes	No	Atwater-Kent No. 20, 30 or 32 or Stromberg-Carlson 601	32x20x55½	
	Marie Louise	275.00	Console	Yes	Yes	No	A.K. 20, 30 or 32	30½x16½x52½	
	Louis XIV.	350.00	Console	Yes	Yes	No	A.K. 20, 30 or 32	32x20x55½	
	Cardinal Woolsey	400.00	Console	Yes	Yes	No	Stromberg-Carlson 601 A.K. 30, 30, 32, or Stromberg-Carlson 601	35½x19x59	
Lakeside Supply Co. Chicago, Ill.	Celeste	40.00	Console	Yes	Yes	Yes	7x18 (with speaker) 7x28 (without speaker)	31½x14½x37	
Marshall Furniture Co. Henderson, Ky.	Marshall 42	32.00	Console	Yes	As desired	As desired	9½x21	15x36x42	100
Musical Products Distributing Co. 22 W. 19 St. New York City	3035-D	125.00	Console	Yes	Yes	Yes	Atwater-Kent No. 20, 30, 32 and 35 or similar size	28x19x48	
	66	165.00	Console	Yes	Yes	Yes	23½x9	30x19½x54	
	70	195.00	Console	Yes	*Yes	Yes	23½x9	36x19½x58	
* Also space provided for loop installation.	70	295.00	Console	Yes	*Yes	Yes	23½x9	34½x16½x59½	
Natural Voice Talking Machine & Radio Cab. Co., Inc., Oneida, N. Y.	Natural Voice 31	40.00	Console	Yes	Yes	No	7x21	25x16x45	46

Cabinets Providing for Panel and Chassis Only (concluded)

Manufacturers' Name and Address	Trade Name and Model Number	List Price	Type (Console or Table)	Compartment for Batteries (Answer Yes or No)	Loudspeaker Built-in (Answer Yes or No)	Loudspeaker Unit Included (Answer Yes or No)	Size of Panel That Can Be Accommodated (in Inches)	Overall Dimensions in Inches L—W—H	Weight in Pounds	
Newsonic Radio Corp. 307 Sixth Ave., N. Y. C.	Newsonic	59.50	Console	Yes	Yes	Yes	7x18	14x31x37		
Oyen, O. O. 1201 So. 4 St. Minneapolis, Minn.	Oyen Oyen Oyen Oyen Standard Oyen Special	12.00 16.50 17.50 40.00 48.00	Table Table Table Console Console	No No No Yes Yes	No No No No No	No No No No No	7x18 7x24 7x26 7x30 7x30	21½x12x10 28x12x10 30x12x10 34x16x39 34x16x40	12 14 15 62 58	
Note: Consoles equipped with panel size up to 7x30.										
Parkins Phonograph Co. 831 N. Wood St. Chicago, Ill.	Perkins 27 Perkins 24 Perkins 26 Perkins 25	56.00 75.00 77.00 87.00	Console Console Console Console	Yes Yes Yes Yes	Yes Yes Yes Yes	Yes Yes Yes Yes	8x21 33x10 30x10 33x10	45½x26½x16½ 38x42x16 47½x34½x16½ 38x47½x16		
Platter Cabinet Co. North Vernon, Ind.	Platter 93	78.00	Console	Yes	Yes	Yes	7½x21	15x24½x44½	57	
Plaza Music Co. 10 W. 20 St. New York City	Model T-1 T-2 C-47 C-3 C-99	21.00 21.00 32.90 37.80 47.60	Table Table Console Console Console	Yes Yes Yes Yes Yes	Yes No Yes Yes Yes	No No No No No	18x7 or 19x5 19x5 18x7 or 19x5	18x30x36 20x30x36 15½x25x44 16½x34x41½ 14½x28x46	93 82 42 70 48	
Pooley Co.* 1600 Indiana Ave. Philadelphia, Pa.	Model 2020-R-2 2050-R-2 1900-R-2 1600-R-2 1100-R-2 1300-R-2 1700-R-2 1200-R-2	135.00 160.00 135.00 160.00 200.00 280.00 240.00 320.00 390.00	Console Console Upright Console Upright Upright Upright Upright	Yes Yes Yes Yes Yes Yes Yes Yes	Yes Yes Yes Yes Yes Yes Yes Yes	Yes Yes Yes Yes Yes Yes Yes Yes	Equipped with Atwater-Kent Model 20 Compact or Model 30 as desired. Equipped with Atwater-Kent Model 20 Compact, Model 30 or 32, as desired.	22½x17½x31½ 22½x17½x31½ 45½x24½x15 41½x35½x16½ 52½x33x15½ 50½x29½x15½ 50x30x18 56½x36x18	90 90 104 146 173 151 173 203	
*The Pooley Cabinet is made exclusively for the Atwater-Kent Receiving Set and sold with or without the set. Prices given on this list include the receiving set.										
Square Deal Radio and Elec. Co. Fenton, Mich.	Fair Deal I Honest Deal III Square Deal V	5.00 10.50 12.00	Table Table Table	No Yes Yes	No No No			7x18 7x21 7x28	21x12x9½ 25x14x12 40x16x12	
United Cabinet Mfg., Corp. 1421 South Michigan Ave. Chicago, Ill.	602-20 600 603-25 611 610 639-B 614 607 639 641 643AK 645 645AK 649B 649BAK 649 651 651AK 615 659	18.50 22.50 22.50 24.00 27.50 27.50 30.00 35.00 35.00 35.00 35.00 40.00 40.00 40.00 40.00 50.00 50.00 50.00 57.50 65.00	Table Table Table Table Table Console Table Table Table Console Console Console Console Highboy Console Highboy Highboy Highboy Table Highboy	Yes Yes Yes Yes Yes Yes Yes Yes Yes Yes Yes Yes Yes Yes Yes Yes Yes Yes Yes Yes	No No No No No No No No No No No No No No No No No No No No	No No No No No No No No No No No No No No No No No No No No		RCA-20 7x18* RCA-25 7x18 19x32 31½x13½x37 7x18 20 and 30* 7x18 20 and 30* 21x9x10½ 7x18 20 and 30* 21x9x10½ 20 and 30* 30x9x11	22x13½x31 32x15x30 38x18x30 31½x13½x37 32x21x30 32x15x30 7x18 31x13½x37 31x13½x37 31x14½x37 31x14½x37 25½x14x38½ 25½x14x38½ 25½x14x45½ 25½x14x45½ 25½x14x45½ 38x18x30 33½x15½x45½	40 5 5 85 60 65 95 85 70 70 70 75 75 90 90 100 100 100 70 125

Cabinets or Tables Providing for Complete Set Including Original Cabinet

Manufacturers' Name and Address	Trade Name and Number	List Price	Type	Compartment for Batteries	Loudspeaker Horn Built-in	Loudspeaker Unit Included	Size of Set That Can Be Accommodated (in Inches)	Overall Dimensions in Inches L. W. H.	Weight in Pounds
Akerson-Ringstrom Co. 800 Johnson St. Keokuk, Ia.	505K 504K 600K 601K 105K 602K 206K 603K 700K 707K 705K	\$5.75 6.25 6.75 7.25 11.50 12.50 13.50 15.00 15.00 17.50 17.50	Table Table Table Table Table Table Table Table Table Table Table	Shelf Shelf Shelf Shelf Yes Yes Yes Yes Yes Yes Yes	No No No No No No No No No No No	No No No No No No No No No No No	Same size as top Same size as top Same size as top Same size as top Same size as top Same size as top Same size as top Same size as top Same size as top Same size as top Same size as top	30x18x30 30x18x30 36x18x30 36x18x30 30x18x30 36x18x30 36x18x30 32x20x30 30x18x30 32x18x30 38x19x30	75 (2 in crate) 50 55 55 65 55 65 65
Athens Table & Mfg. Co. Athens, Tenn.	565 566 570 571	6.50 6.50 8.50 8.50	Table Table Table Table	No No No No	No No No No	No No No No	18x32 18x32 18x42 18x42	18x32 18x32 18x42 18x42	
Bosworth Electric Mfg. Co. Norwood, O.	One Model	35.00	Table	Yes	No	No	28	30	
Carlson Cabinet Co., Inc. 21 Market St. Jamestown, N. Y.	Table Console Carlson Cabinet 400 Carlson Grand	24.00 26.00 28.00 60.00 85.50	Table Table Table Console Console	Yes Yes Yes Yes Yes	Yes Yes Yes Yes Yes	No No No No No	7x18 7x21 7x24 7x24 8x30	22½x13 25½x13 28½x13 28½x16x51 36x19x49	
Charlotte Furniture Co. Charlotte, Mich.	Charlotte 12 Charlotte 15 Charlotte 5 Charlotte 3 Charlotte 2 Charlotte 10	25.00 27.50 34.00 50.00 82.00 96.00	Table Table Console Console Console Console	No Yes Yes Yes Yes Yes	No No No, but can be No, but can be No No	No No No No No No	35x19 31x19 37x12½x10 32x12x13½ 35x12x9½ 32x14x8H	37x20½x31 33x20½x29 38½x13½x39 36x15x42 38x21½x37 36½x15½x41	50 65 89 103 127 130

Cabinets or Tables Providing for Complete Set Including Original Cabinet (continued)

Manufacturer's Name and Address	Trade Name and Number	List Price	Type (Console or Table)	Compartment for Batteries	Loudspeaker Built-in	Loudspeaker Unit Included	Size of Panel That Can Be Accommodated (in Inches)	Overall Dimensions in Inches L. W. H.	Weight in Pounds
Chicago Phonograph Mfg. Co., 5127 S. State St. Chicago, Ill.	A.B.C.-O	30.00	Console	Yes	Yes	No	7x18—7x21	33½x38	
	H	44.00	Console	Yes	Yes	No	7x21—7x18	45x25x13	
	C	50.00	Console	Yes	Yes	No	10x32		
	D	52.00	Console	Yes	Yes	No	10x32		
	E	55.00	Console	Yes	Yes	No	10x32		
	F	56.00	Console	Yes	Yes	No	10x26		
	G	60.00	Console	Yes	Yes	No	10x26		
Chillicothe Furniture Co. Chillicothe, Mo. Note—Also various table models and specialize on manufacturing special tables and cabinets for manufacturers of sets.	Model 1170	120.00	Console	Yes	Yes	No	32x10	38x18x52	110
	500	20.00	End table	Yes	No	No	12x24	12x24x24	20
Detroit Woodcraft Corp. Detroit, Mich.	Model 200	32.50	Table	Yes	No	No	24x12	36x16x30	40
Elgin Phonograph & Novelty Co., Union and Chicago Sts., Elgin, Ill.	Elgin Table 300	25.00	Table	Yes	No	No	33x15½	33x15½x30	38
	Elgin Table 301	25.00	Table	Yes	No	No	33x15½	33x15½x30	45
	Elgin Battery Cab. 200	31.00	Table	Yes	No	No	33x15½	33x15½x30	45
	Elgin Battery Cab. 201	31.00	Table	Yes	No	No	33x15½	33x15½x30	45
	Elgin Speaker Table 400	40.00	Table	Yes	Yes	Yes	33x15½	33x15½x30	42
Federal-Irving Furniture Factories, Inc., 206 Lexington Ave., New York City Note—To take box from 9x12 to 9x26.	Complete line	22.50 to 100.00	Highboy or Console	Yes	Yes	No	7x18 Note		From 75 to 250
	339 D. G.	42.00	Console	Yes	No	No	10½x12½x32 12x32 on top 12x32 on top 12x32 on top	34x11x43½	125
319 D. G.	Yes			No	No	100			
329 D. G.	Yes			No	No	100			
328 D. G.	Yes			No	No	100			
Ideal Radio Cabinet Co. 281 Vermont St. Blue Island, Ill.	Ideal 102	27.50	Table	Yes	No	No	17x32	33x17x32	40
	Ideal 101	32.00	Table	Yes	No	No	17x32	33x17x32	45
	Ideal 2	45.00	Table	Yes	Yes	Yes	18x38	39x18x32½	45
International Equipment Co., 1324 Chestnut St. Kansas City, Mo.	25 Radiola	15.00	Table	No	No	No		27½x18½x28½	30
	20 Radiola	17.50	Table	Yes	No	No		21½x16½x28	35
	201	22.00	Bat. Table	Yes	No	No		33x18x31	50
	275	27.50	Bat. Table	Yes	No	No		38½x18½x30½	60
	401	40.00	Bat. Table	Yes	No	No		33x18x31	65
	400	50.00	Console	Yes	No	No	28	31x16½x22	30
	601	70.00	Console	Yes	Yes	No	30	35½x15½x42½	100
	701	75.00	Highboy	Yes	Yes	No	30	35½x16½x42½	125
	501	88.00	Art Con.	Yes	Yes	No	28	33x18x53	95
	801	95.00	Highboy	Yes	Yes	Yes	30	35½x16½x46	140
Lauter Co., H. Indianapolis, Ind. *Veneer and gumwood	*801 two-tone walnut		Console	Yes	Yes	No		14x31x46	
	*802 two-tone walnut		Console	Yes	No	14x32½x46			
	*803 high-lighted or Norman Walnut		Console	Yes	No	17x36x41			
Marshall Furniture Co. Henderson, Ky.	Marshall 20	6.00	Table	Shelf	No	No	15x36	15x36x30	50
	Marshall 33	15.00	Table	Yes	No	No	15x36	15x36x30	50
	Marshall 23	20.00	Table	Yes	No	No	20x30	20x30x30	45
Musical Products Distributing Co., Inc. 22 W. 19 St. New York City	Radio-Art Cab. 800 K.D.	19.50	Table	Yes	No	No	17½x32	32x17½x30	
	Radio-Art Cab. 810	30.00	Table	Yes	No	No	20½x33	33x20½x32½	
	Radio-Art Cab. 812	40.00	Table	Yes	No	No	20½x40½	40½x20½x31½	
	Radio-Art Cab. 95	65.00	Console	Yes	No	No	Atwater-Kent No. 20, 30 or 35 or similar size	25x17x42	
	Radio-Art Cab. 2028	95.00	Console	Yes	Yes	Yes	Radiola No. 20, 28 or similar size	28x19x48	
Radio-Art Cab. 3035	95.00	Console	Yes	Yes	Yes	Atwater-Kent No. 20, 30, 32 and 35 or similar size	28x19x48		
Radio-Art Cab. 65	125.00	Console	Yes	Yes	Yes	23½x9 panel size	30x19½x54		
Radio-Art Cab. 2028-D	125.00	Console	Yes	Yes	Yes	Radiola No. 20 or 28 or similar size	28x19x48		
Oyen, O. O. 1201 So. 4 St. Minneapolis, Minn.	Oyen-Standard A gum. im. walnut	22.00	Con. Table	Yes	No	No	32x14	33x14½x30	45
	Oyen-Standard B Genuine walnut	30.00	Con. Table	Yes	No	No	33x14	33x15x30	50
Perkins Phonograph Co. 831 N. Wood St. Chicago, Ill.	Perkins 29	24.00	Table	Yes	No	No	19x33	38x19½x30	
	Perkins 28	37.00	Table	Yes	Yes	Yes	19x33	38x19½x30	
Platter Cabinet Co. North Vernon, Ind.	Platter 93	78.00	Console	Yes	Yes	Yes	7½x21	15x24½x44½	57
Pooley Co. 1600 Indiana Ave. Philadelphia, Pa.	Pooley Cabinet Speaker Model 2100	40.00	Table	No	Yes	Yes	20½x13½	21½x14½x30	34
	Pooley Cabinet Speaker Model 2200	50.00	Table	Yes	Yes	Yes	20½x13½	21½x14½x33	50
	Pooley Cabinet Speaker Model 1400	60.00	Console	Yes	Yes	Yes	28½x10	34x15½x31½	98
Radio Master Corp. of America Bay City, Mich.	No. 18	35.00	Console	Yes	Yes	No	7x18	30x13x38	75
	40	40.00	Table	Yes	Yes	No	Top 15x37	31	55
	41	40.00	Table	Yes	No	No	Top 15½x33	31	55
	19A	69.50	Console	Yes	Yes	No	8x21	23½x13x46	100
	19B	74.50	Console	Yes	Yes	No	8x21	23½x13x46	100
	19D	77.50	Console	Yes	Yes	No	8x21	23½x13x46	100
	19E	77.50	Console	Yes	Yes	No	8x21	23½x13x46	100
	19C	81.50	Console	Yes	Yes	No	8x21	23½x13x46	100
	15	80.00	Console	Yes	Yes	No	8x24	23½x13½x46	100
	22	94.50	Console	Yes	Yes	No	8x24	36x15½x41	120
	16	125.00	Console	Yes	Yes	No	8x23	30½x15x49	140
	210	180.00	Console	Yes	Yes	No	8x32	30x20x49	140
	211	190.00	Console	Yes	Yes	No	11x32	35x20x51	175
	Roth Radio Inc. 16 Hudson St., N. Y. C.	De Luxe Console	40.00	Console	Yes	Yes	No	7x18 or Atwater-Kent Compact	36x16x40

Cabinets or Tables Providing for Complete Set Including Original Cabinet (concluded)

Manufacturers' Name and Address	Trade Name and Model Number	List Price	Type (Table or Console)	Compartment for Batteries	Loudspeaker Horn Built-in	Loudspeaker Unit Included	Size of Set That Can Be Accommodated (in Inches)	Overall Dimensions in Inches L. W. H.	Weight in Pounds
Square Deal Radio & Elec. Co., Fenton, Mich.	Real Deal II.	52.00	Console	Yes	Yes	No	Up to 28	31x16x38	
	Best Deal V.	65.00	Console	Yes	Yes	No	Up to 32	34x17x41½	
Eugene Straus Cabinet Works, Baxter Ave. Station, Louisville, Ky.	A	4.50		No	No	No	18x7	20x9½x8½	
	B	15.00		No	No	No	14x7½	30x12x11	
United Cabinet Mfgs., Corp., 1421 S. Michigan Ave., Chicago, Ill.	659-B	50.00	Console	Yes	No	No	30L-9H-11D	33½x15½x38½	110
	667	85.00	Console	Yes	Yes	Yes	7x18-7x21 Freed-Eise. A-K	25½x19½x44½	120
	665	100.00	Highboy	Yes	Yes	Yes	21x9x10½	25x14½x48	125
	679-B	120.00	Console	Yes	No	No	30x9x11	33½x16x44½	150
	679	135.00	Console	Yes	Yes	Yes	30x9x11	33½x16x30½	165
	685-B	145.00	Console	Yes	No	No	30x9x11	36x17½x38½	165
685	160.00	Console	Yes	Yes	Yes	30x9x11	36x17½x38½	125	
Wasmuth Goodrich Co. Peru, Ind.	5 Hi-Boy	80.00	Console	Yes	Yes	Yes	18½x10 (can be made larger or smaller)	30x15x50	133
	31		Table	Yes	No	No		46x14x30	60
Watsontown Table & Furniture Co. Watsontown, Pa.	916	12.50	Table	Shelf	No	No	18x35	18x35	
	917	14.25	Table	No	No	No	30½x30½	20½x30½x27	
	919	16.75	Table	Yes	No	No	19½x22½	19½x22½x28	
	907	17.25	Table	Yes	No	No	20x30	20x30	
	909	18.00	Table	Yes	No	No	20x30	20x30	
	924	18.50	Table	Yes	No	No	18x22	18x22x30	
	908	20.00	Table	Yes	No	No	20x30	20x30	
	910	20.00	Table	Yes	No	No	18x35	18x35	
	912	21.00	Table	Yes	No	No	18x35	18x35	
	911	22.25	Table	Yes	No	No	18x35	18x35	
	921	22.75	Table	Yes	No	No	18x30	18x30x30	
	913	25.25	Table	Yes	No	No	20x38	20x38	
	915	26.00	Table	Yes	No	No	20x38	20x38	
	922	26.50	Table	Yes	No	No	18x35	18x35x30	
	923	27.50	Table	Yes	No	No	20x38	20x38x30	
	905	27.50	Table	Yes	No	No	26x42	26x42	
906	28.50	Table	Yes	No	No	26x42	26x42		
914	29.00	Table	Yes	No	No	20x38	20x38		
920	30.75	Console	Yes	No	No	13½x29½x13½	18x35x43½		
904	31.75	Table	Yes	No	No	26x42	26x42		
Udell Works 28 St. at Barnes Ave. Indianapolis, Ind.	736	16.00	Table	Yes	No	No	15x30	29x15x30	55
	706	17.00	Table	Yes	No	No	15x30	29x15x30	55
	737	17.50	Table	Yes	No	No	15x36	29x15x36	60
	726	18.00	Table	Yes	No	No	For Radiola 20	30x20½x17½	50
	707	19.00	Table	Yes	No	No	15x36	29x15x36	60
	716	20.00	Table	Yes	No	No	15x30	29x15x30	55
	717	22.00	Table	Yes	No	No	15x36	29x15x36	60
	725	22.00	Table	No	No	No	For Radiola 25	29x20½x29	55
	728	25.00	Table	Yes	No	No	18x30	31x30x18	75
	735	30.00	Table	Yes	Yes	If wanted	18x38	29x38x18	83
	732	33.00	Table	Yes	Yes	If wanted	18x38	29x38x18	75
	727	36.00	Table	Yes	No	No	20½x30½	20½x30½x20½	76
	740	62.00	Console	Yes	Yes	If wanted	6½x23	43x27½x17½	102
	742	64.00	Console	Yes	Yes	If wanted	6½x23	43x27x16½	97
	739	65.00	Console	Yes	Yes	If wanted	9x22	46x27x16	94
	752	67.00	Console	Yes	Yes	If wanted	8x31½	44x34x21	125
	745	75.00	Console	Yes	Yes	If wanted	9x30	45x33x17	125
	719	77.00	Console	Yes	Yes	If wanted	8x32	44x36x19	125
	754	78.00	Console	Yes	Yes	If wanted	8x31½	44x36x19	125
	747	84.00	Console	Yes	Yes	If wanted	8x31½	43x35x19	125
744	85.00	Console	Yes	Yes	If wanted	8x32	44x36x19	125	
746	87.00	Console	Yes	Yes	If wanted	6x25	47½x28x17½	108	
748	90.00	Console	Yes	Yes	If wanted	8x23	63x26½x16	130	
743	99.00	Console	Yes	Yes	If wanted	8x29	44x32½x19	138	
Wilhelm Furniture Co. Sturgis, Mich.	7150	10.00	Console	Yes	No	No	16x32	32x16x30	75
	7110	14.00	Table	No	No	No	18x36	36x18x31	50
	7056	17.00	Console	Yes	No	No	15x34	34x15x30	75
	7091	17.50	Console	Yes	No	No	18x38	38x18x30	75

Delivery Car Used to Arouse Attention

This "radio house" belonging to Al Pechette, Astoria, Long Island, is used for delivery purposes and has been the source of many inquiries and prospects. The unique appearance of the car plus the radio set which it operates makes it a good attention-getter.



Parts Are Still Active—How Live

More than \$75,000,000 worth of radio parts were sold during 1925. Manufacturers and jobbers estimate 1926 sales will nearly equal that figure.

THERE is going to be plenty of parts business this year. Furthermore, it will unquestionably be worth the while of many retailers to go after this market.

Though it is not probable, or even desirable for that matter when the ultimate good of the industry is considered, that the parts business will ever again reach the \$100,000,000 level which it attained during the boom days of 1924, the scientific nature of radio, coupled with the fact that set building is a science well within the reach of the average man's pocketbook, will certainly insure a healthy parts business for years to come.

To the experimentally inclined, which includes the amateur, set building will remain an attraction, regardless of the progress made by manufacturers of complete receivers and accessories.

Four Logical Outlets

It is doubtful, however, if the demand for parts during the coming season will warrant the stocking of such apparatus by every radio dealer. Certain types of retail store are obviously unsuitable for the sale of parts, while others will find this class of merchandise highly profitable.

A survey of the potential parts market, conducted particularly in New England, indicates to the editors of *Radio Retailing* that there are but four logical outlets for this class of merchandise. In the small

town, say, with less than 5,000 population, parts will continue to hold a definite appeal for the small electrical contractor-radio dealer. It is possible for this type of dealer to conduct a profitable parts business in his community without making a large investment, such as would be necessary for the purchase of a complete stock of receivers and accessories.

The chain store, of the Kresge-Woolworth type, selling nationally advertised merchandise and purchasing such apparatus on a large scale at attractive prices, will undoubtedly remain a factor in the sale of radio parts. In many centers, such stores have made severe inroads into the parts business of exclusive radio stores. Their success to date has been due largely to the method of displaying merchandise, price, and the stimulation of interest in set building through the display of circuit diagrams and blue-prints. In the window of such a store circuit diagrams have always been given a prominent place.

In the larger cities, the retailer who features "cut prices" was probably responsible for the sale of parts last year to a greater extent than any other outlet. His sales methods are obvious. Location in the shopping district, "price" ads in local papers and elaborately decorated windows are largely accountable for his volume of business. It is evident that this class of dealer will continue to be a factor in the parts



A Connecticut dealer capitalizes of reception of

business during the entire season.

Yet the fourth and last outlet is perhaps the one upon which the real future of the parts business depends. We refer to the dealer located in a moderately sized town or in a well defined neighborhood, who carries both complete receivers and parts, and has established a reputation for carrying a complete stock of reliable apparatus.

Success Based on Getting All the Parts Business

The success of this so called "legitimate" parts dealer is based on two things: complete stock and thorough technical knowledge. His reputation is such that parts buyers are assured of accurate and authentic information on any set building question; and of obtaining an "odd piece of apparatus" there.

To this type of dealer, chain store and cut price competition has no terrors. Each of the four outlets has an entirely different clientele. The chain store sells inexpensive merchandise where price is a prime consideration, the cut price store in the larger city disposes of its merchandise largely to the "shopper" who is seldom a repeat customer, while the "legitimate" parts dealer retains his customers through service, quality merchandise and good technical advice. He literally gathers his customers from miles around and makes his store the local headquarters for parts.



Daily specials in parts are listed on a blackboard in front of one dealer's store

Dealers Are Getting Their Share

Retailers who have made a success of the parts business in the past outline some ideas that have built up large profits



on acknowledgments distant stations

Thorough Knowledge of Radio Essential

WELL above 15 per cent of the radio business of the Lancaster Electric and Construction Company, of Lancaster, Pa., for instance, is due to the sale of parts. "The company's business during 1925," says J. E. Heiss, its president, "totaled about \$30,000. This figure has been very nearly equalled during the first six months of 1926."

Heiss attributes his success in the sale of parts entirely to the efficiency of his radio department manager who has been actively interested in the technical as well as the merchandising angle of radio for more than ten years, experimenting with amateur transmission and reception shortly after its inception. During this time he has acquired a thorough knowledge of radio fundamentals and is, therefore, in a position to give each parts customer authentic information on all but the most advanced technical subjects.

It has been his experience that the parts customer prefers to buy in the shop which carries a complete line and in which he may get expert and authoritative information regarding the best parts to use and the circuits in which to use them. "Unless the radio dealer knows more than his customer about radio, or employs a man well up on the subject," says Mr. Heiss, "it is doubtful if he can do any appreciable parts business."

Blackboard Features Daily Specials

EACH day, an employee of Eppe's Radio Shop, Philadelphia, chalks the name and price of a popular article on a blackboard which swings over the door of the shop. In cooperation with the store "bargain coun-

ter," specials on sale at attractive prices are listed on this board from time to time.

Radio fans in the vicinity have grown to regard Eppe's sign as a buying oracle. Its variations from day to day are followed eagerly and the store proprietor has found it to be of great help in putting over new items. A miscellaneous array of parts on an open counter also attracts attention. In the chain and department store, this method of permitting the customer to rummage through such a varied collection of parts has been particularly successful. Out of pure curiosity the prospect often runs across an article which he has needed for some time, but neglected to buy.

"Buy the Kit— We Wire it Free"

"BUY a complete receiver kit—and all the accessories from us, and we will wire the set to your order without charge." That's the offer of the B & R Radio Company, Lancaster, Pa. According to B. Rosen, its manager, this method of increasing parts sales is highly profitable. He estimates that a three-tube set can be wired for about \$1. A good man to do this work can be hired in this section for about \$5 per day and is quite capable of wiring five to six such receivers in a day.

"During the first three months, more than 200 kits of receiver parts were sold in my store by this method," says Rosen. "Many prospects for radio receivers are interested in securing a set built to order. It is possible, by this sales method, to supply any type cabinet and to follow any circuit design requested.

"Taking the unit sale into consideration—each sale with accessories running into the neighborhood of \$100—the slight cost of the service is worth while. The customer should be required to place at least a 50 per cent deposit on parts before starting work on an order of this kind."

Acknowledgment of KFI Reception Sells 53 Sets

"SHOW them what others have done with receiver parts bought in your store," is the advice of W. B. Tanner, proprietor of the Radio Store Company, Bridgeport, Conn.

"About six months ago, I built a three-tube receiver with popular three-circuit tuner parts, hooked it up at home and spent several evenings tuning in distant stations. I had exceptional luck during the first week, tuning in several stations on the Pacific coast. KFI promptly verified reception of its program with a written acknowledgment which has since proved a valuable sales aid.

"Since that time, I estimate that I have sold about 53 kits of parts similar to my own merely on the strength of this acknowledgment. Of course I do not stress distant reception as a feature of the set, but without claiming a thing for it, the acknowledgment posted on the wall has a stimulating effect."

Diagram Contest Nets 20 Customers a Week

CAMDEN, N. J., retailer employs an advertising method which has brought into his store regularly each week 15 to 20 prospects, most of whom were later sold receiver parts.

Each Wednesday, a schematic diagram of a popular receiver is printed in the local paper radio section. Each part used in its construction is shown in the diagram, but connections are omitted. A note under the diagram invites all "fans" to solve the problem of its wiring, naming the correct terminals to which each wire is connected and returning it to the shop together with an account of how they would wire the set, wire for wire.

A weekly award of a B battery or some other small accessory is made to the contestant who best describes the wiring process.

(Continued on Page 101)



Another dealer sells parts by offering to wire his customers' sets without charge

Demand for Socket Power Receivers

Engineering improvements and more attractive designs have resulted in an increase of popularity for "batteryless" receivers. The majority of these sets have been made for use with 110 volt, 60 cycle current, some using special A.C. tubes

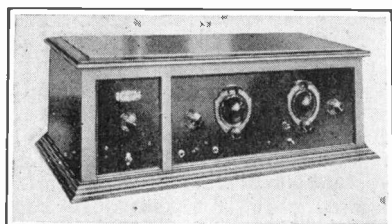

*Cleartone Radio Co.,
Cincinnati (a.c.), \$200*

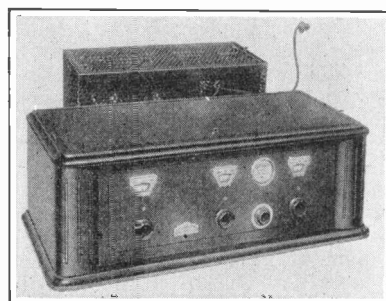

*Amrad Corp., Medford Hillside,
Mass. (a.c.), \$150*

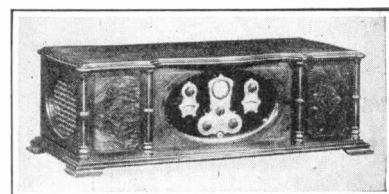

*Argus Radio Corp.,
New York (a.c.), \$250*



*Radio Corp. of America,
New York (a.c.), \$575
Also Radiola 28 with 104
Speaker (a.c.), \$535*

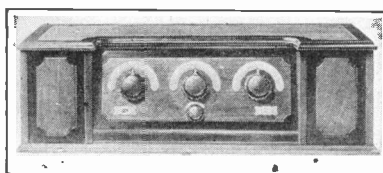

*Harold Herbert, Inc.,
Long Island City, N. Y. (a.c.), \$99.50*

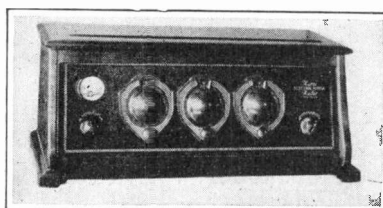

*Martian Mfg. Co., Inc.,
West Orange, N. J. (a.c.), \$175*

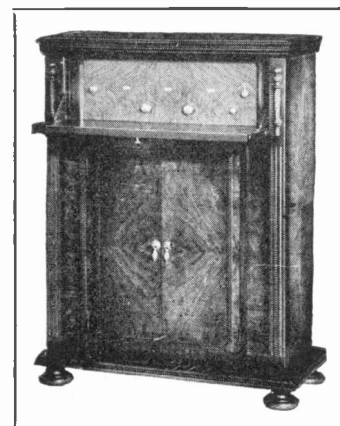

*Sparks-Withington Co.,
Jackson, Mich. (a.c.), \$360*



*Tidmarsh's Radio Supply,
Elwood, Ind. (a.c.), \$250*



*Sovereign Elec. & Mfg. Co.,
Chicago, Ill. (a.c.), \$130*



*Melodyne Radio Co.,
New York (a.c. or d.c.), \$300*

Shows Surprising Strength This Year

Many companies other than those listed here are experimenting with this type of receiver, but represented on these pages are all those of which the editors are aware. They are published without advertising considerations of any kind



*Colonial Radio Corp.,
Long Island City, N. Y. (a.c.), \$225*

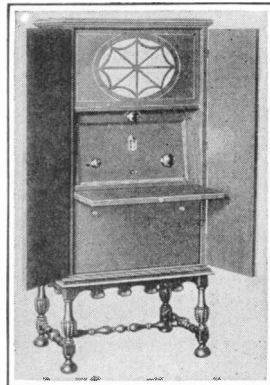

*All-American Radio
Corp., Chicago (a.c.), \$335*

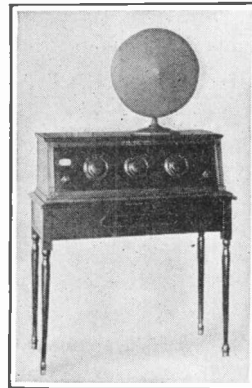

*Garod Corp., Belleville,
N. J. (a.c.), \$310*

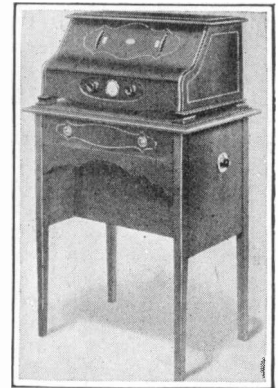

*Wright-DeCoster, Inc.,
St. Paul (a.c.), \$313.75*



*Blair Radio Lab.,
New York (a.c.), \$395*

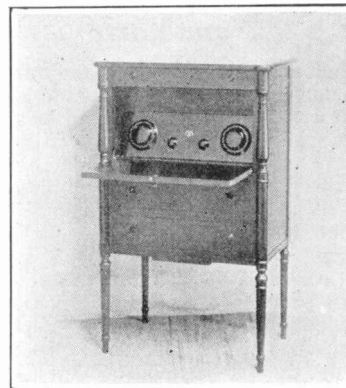

*Nassau Radio Co.,
Brooklyn, N. Y. (a.c.), \$325*



*National Radio Co.,
Forest Lake, Minn. (a.c.), \$250*



*Distantone Radios, Inc.,
Lynbrook, N. Y. (a.c.), \$275*

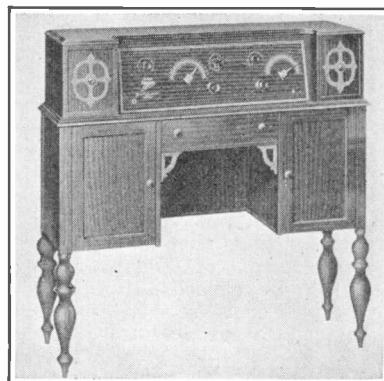

*Zenith Radio Corp.,
Chicago, Ill. (a.c.), \$280*



*Minerva Radio Co.,
Chicago, Ill. (a.c.), \$200*

Radio Retailing's Barometer of the Market

Detroit

Fall radio season here gaining headway right along. Business running over fifty per cent ahead last month and one hundred per cent ahead corresponding period last year. Outlook for October excellent. Socket power sets attracting much attention and distributors report good sales of such models. Public interested and beginning to buy, but cautious. Shoppers want to find out whether they are successful before purchasing. Same is true of A-battery eliminators and while they are welcome as an improvement and many are buying, others are holding back. Shielded sets and simple control are favored. Sales of eliminators, speakers, new power tubes and special detector tubes very good. In sets tendency is toward console models at good prices. New speakers becoming important and many who have owned sets for years are buying new speakers of artistic design at \$35 and more. Return of vacationists, continued prosperity of automobile industry and attractive features of new merchandise are factors that will tend to improve radio business in near future.

Denver

Late August and early September radio sales in Denver territory show unusual increase over previous month as well as over same period last year. Reports from jobbers show increase in wholesale business is fifteen per cent, while dealers' reports would indicate an increase in retail sales of fifty per cent over 1925. Reports of exceptionally heavier sales of accessories, especially tubes, batteries and power units indicate receiving sets are being put into action at least thirty days earlier than a year ago. Sum of all reports including those from dealers in very small towns very gratifying and both wholesale and retail merchants are confident of biggest radio year in history of industry.

St. Louis

Most encouraging feature in past thirty days St. Louis territory has been surprisingly large gain in consumer sales of radio equipment. This is attributed to unusually good reception and improved broadcasting programs. One thing which created more retail sales in St. Louis territory has been play-by-play broadcasting of St. Louis cardinal baseball games by local stations. Prospects of world series here with St. Louis Cardinals participating has made retail radio sales jump 150 per cent. With final season games

played away from St. Louis radio was only means of satisfying pennant-thirsty bugs. Average of thirty thousand listeners lined streets daily before dealer stores where speakers were set up. Healthy listening condition prevails throughout territory and dealers report tremendous business. Consensus indicates power units and eliminators will create most interest this year. Sale of cone speakers exceptional and indications are, cones will establish new mark for speaker sales. Furniture value enters into most sales. Dealers confining themselves to average of two and three standard lines helps in stabilizing retail business. Past month's business surpasses that of same period in 1925 by almost 200 per cent. World series followed immediately by local radio show accounted for unprecedented increase in radio business.

New York

Wholesale trade in Metropolitan district now in full swing. Business fully 40 per cent ahead same period last year and approximately double last month. "Hand-to-mouth" buying seems prevalent this year but notwithstanding this fact business in many instances has reached former December level two full months in advance. Radio World's Fair attended by usual jobbing slump due to absence of salesmen from road, but renewed interest brought about by exhibits is expected to eclipse all records during October. One jobber reports more than 80 per cent of his customers attended. Retail trade gaining headway, though slowed down somewhat during week of show. Keen competition among manufacturers expected this season due to similarity of lines. Exclusive franchises are factor this year. Closed territory for the jobber has permitted many to put over notable jobs. Predicted that more than 75 per cent of manufacturers will either equip sets with power packs next year or will recommend power supply accessories of other concerns. Power apparatus selling so well there is shortage of rectifying tubes used in battery eliminators. Trade looks for fewer lines in demand this year but greatest year yet for lines that do sell.

Announcement of Dempsey-Tunney fight by radio caused retail trade to show decided increase. Sales of tubes and batteries went way up just prior to fight.

San Francisco

Optimistic tone has pervaded radio market in San Francisco during first two weeks September. Radio show

late in August registered largest attendance to date with keen dealer interest. Feeling against show which had been growing in some quarters for past two years has been entirely swept away and there seems to be general agreement that radio buying, both wholesale and retail, has been much stimulated by the display. Both jobbers and dealers express judgment that market is about month early this year. Sales good with marked increase shown over August, in some cases as much as twenty per cent. Compared with September last year, advance is shown varying from slight increase to as much as forty per cent. Activity continues in power accessories, B-battery eliminators leading in sales. Survey at radio show by one jobber indicated public is interested in more expensive sets particularly those with attractive exteriors and simplified operation. Medium priced sets are reported active by department store trade while music field seems to run to more expensive cabinet type. Outlook for coming month appears excellent in every way.

Minneapolis

Radio business in Northwest excellent with every indication that fall and winter sales will exceed anticipated increase of fifty per cent. Great improvement recorded in agricultural conditions with one of largest corn crops on record. Good prices for live stock, poultry and dairy products assure more farm income than last year. Farmers in Minnesota and Dakotas buying more than one half of radio apparatus sold in this territory. Large jobbers who have stock on hand report one hundred per cent more business now than last year, but many jobbers are hampered by slow deliveries on new models causing dealer cancellations and reducing increased sales over last month to about sixty per cent increase. One long established jobber reports 125 per cent increase over last month. Heavy sales began four to six weeks earlier than last year. Large St. Paul retailer conducted own radio show securing 1,000 live prospects in three days and making sales that exceeded all expectations. Country dealers beginning to use own radio show in store with great success. B-eliminators and cone speakers going strong. Demand for higher priced sets very pronounced equalling sale of low priced models in numbers. Factors that will improve business are better deliveries, more advertising in local papers, more and better broadcasting. Northwest radio show last week September attracted dealers from five states and gave a big impetus to sales in Northwest.

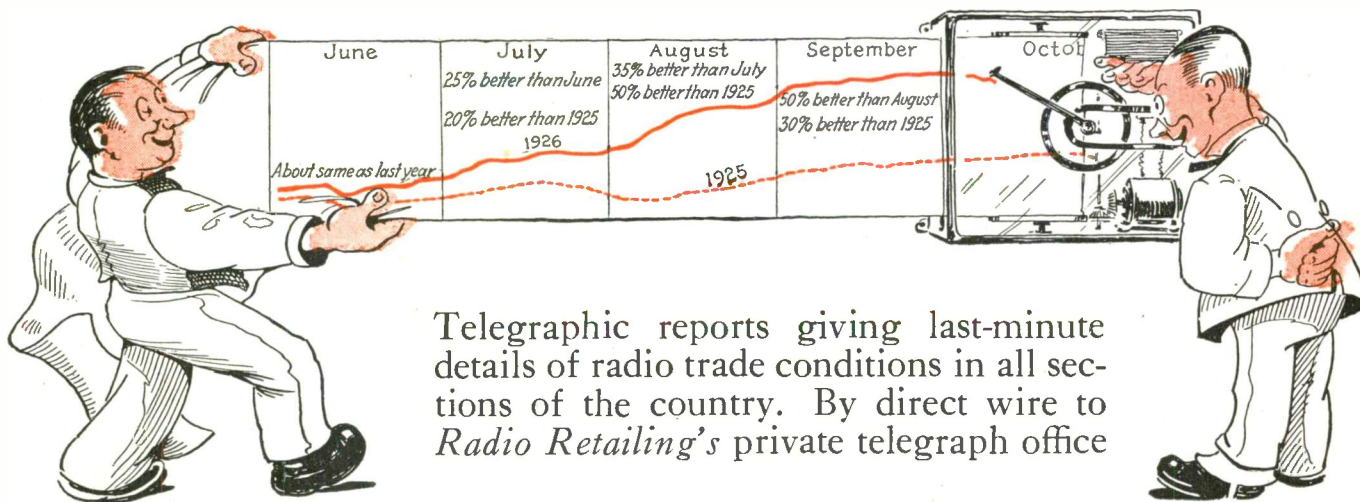

Telegraphic reports giving last-minute details of radio trade conditions in all sections of the country. By direct wire to *Radio Retailing's* private telegraph office

Toronto

National exhibition plus Dominion election started buying wave that augurs biggest radio season here. Farmers have money and are buying. Peculiar feature is that in some cases public demand is ahead of dealers' buying. Retail mail order going strong. Experiencing good demand for standard parts from rural districts. Comparatively few changes in dealer personnel this year, indicating stabilization. Dealers are enthusiastic over broadcasting of elections, shows and sporting events. Gross sales fifty per cent better than August. Change from daylight saving to standard time distinctly improved sales. Everything indicates that owners are using their radios or putting them into shape several jumps ahead of last year. Business at this time averaging thirty per cent better than year ago and this figure is exceeded in cases where extra pressure has been applied. Better times, stabilized government and good weather indicate that October buying will be well up towards peak activity. Rejuvenating effect of new models and devices evident in call for trade-ins. High lights of consumer demand include simple control, batteryless and furniture receivers; eliminators, cone speakers and parts for ballyhoo circuits. Public is more appreciative of tone quality and demands comparative speaker tests. Due to educational campaign and better weather, interference is less and if Canadian wave-lengths are not pirated trouble should decrease in future.

Boston

Radio business brisk. Accessories in active demand. Sets moving in good volume and parts beginning to attract attention. Compared last month, business much better. According to one prominent distributor fifty per cent better in accessory sales and twice volume in set sales. All dealers report quick recovery in set sales beginning last of August. Many brands are behind in deliveries to this district. One jobber reports one hundred unfilled orders to date on medium priced sets. Demand for these at about \$100 very strong compared last year. All concede from fifty to one hundred per cent in-

crease compared with last year. Accessory sales strong and in same ratio. Parts have not yet shown similar momentum but sales are gaining. Next month outlook promising with every indication of heavy sales. Dealers are preparing for this trend by increasing stocks. One well known jobber records twenty-five per cent increase over last year stocks in tubes, batteries, chargers and loud speakers. Similar indications are that dealers also are alive to increasing public activity. Demand for sets is directed toward two types—complete box type at about \$100 account for greatest volume. Higher priced sets averaging about \$300 with console cabinet and built-in speaker come next. Gradual turn to attractive furniture reported throughout trade. Dealers pleased at announcement of broadcasting twenty-four concerts of famous Boston Symphony. Claim this early notice is best boon received in this district and recommend similar program announcements as greatest stimulant to trade.

Atlanta

Coming radio show Atlanta week October 18 has greatly increased interest throughout this territory. Dealers and jobbers exceedingly pleased with demand which is very good and comes much earlier than had been expected. There is every indication of continued early buying by consumer which naturally is reflected in jobbers' sales. Many jobbers report fall stock bought and in warehouses though many dealers have been unwilling to look ahead and stock merchandise in anticipation of consumer demand. August sales compare favorably with last year but only slight increase. Twenty-five per cent increase over July this year. Radio reception materially improved and is responsible in great measure for general optimistic outlook for October. Still little or no interest in parts except for eliminators and power amplifiers which demand grows greater. Factory-built units continue to hold limelight. Sets having six or more tubes demanded especially since good cone speakers are available to reproduce faithfully and withstand power amplification. Dealers are resorting to improved merchandising ideas. Standard and highly adver-

tised merchandise holds top position in the South. That both low and high priced receivers are turning over reveals two distinct classes of trade. Little turnover on medium priced receivers as compared to others. Outlook for improved broadcasting in country at large tends to improve business as whole.

New Orleans

From lethargy in August, radio season in New Orleans has jumped to great activity in September. This was especially felt in renewal of batteries, tubes and repairs. Transformer sales particularly good. A tropical hurricane came out of the Gulf of Mexico August 25th and the following morning there was considerable work on aerials to be done all over lower Louisiana and neighboring gulf states. Number of aerials knocked down however were comparatively few. There was much comment on security of such masts. Some of leading manufacturers have pointed out to retail trade the necessity of placing orders that will practically take care of the season's needs for the reason that demand is expected to exceed supply of sets this year. While this condition is expected to exist only on highest type sets the statement is said to have beneficial effect on all retail orders. Fourth annual radio show of New Orleans will be held week October 11th in Roosevelt Hotel. Retailers are finding increased demand for better sets and more powerful loud speakers. Those reproducers containing power units are selling in considerable volume. More attention is being given cabinets this year and console models are attracting attention of people who have had table models heretofore.

Chicago

Last minute survey confirms prediction September sales will run twenty-five per cent better this territory than year ago. Are fifty per cent heavier than thirty days ago. Exhibitors at South Bend, Indiana, show report orders thirty per cent larger than at last year's show. Tunney fight and World's Series responsible for increased retail activity.

What This Industry Needs

Readers of "Radio Retailing" give their experiences as aids to solving the problems of the dealer

The Outside Salesman Has Prospect All to Himself

BY T. A. HAZLITT

Manager, Brunswick Hall
228 Yonge Street, Toronto, Canada

HOW many dealers today are thinking about outside selling? What is there to it? Will it pay?

I used to wonder, too—so I went out one evening and tried it. Here is what happened. I made nine calls in a first-class residential neighborhood. These resulted in: Two householders who claimed they "could get wholesale prices"; one prospect "out"; one busy with a social engagement; one who "wouldn't talk"; one who already had a good set; one "hard shell," and two definite arrangements for home demonstrations.

It took me four hours that first night. The following evening I made one of my demonstrations and closed the sale. The next night I made the other demonstration and obtained the customer's signature two days later. Total time for the original canvass, the two demonstrations and obtaining both signatures—nine hours.

My gross sales from this effort totaled \$245. When I checked up my net profit I found that I had been repaid for this nine hours of outside work at the rate of a little over five dollars an hour.

It seems to me that this kind of selling is well worth while. I plan to put out two men on "cold canvass" about the middle of next month. My theory runs like this:

Although we have an excellent store trade and a big list of store prospects these people who come into the store are all "shopping around." The chances are that they have already viewed a half-a-dozen sets of other makes, or intend to do so, before deciding. This type of buyer *thinks* he knows how to select a radio set. As a matter of fact he is guided in his final decision by external appearances, a "hunch," the line of a smooth salesman, some chance piece of good reception, or some other influence equally as misleading. Yet what reason has the average man or woman to think that he or she has the special knowledge and training necessary to make him or her a judge of what constitutes a real radio set? None whatsoever.

Now in working up prospects on the outside from "cold canvass" you escape all this time-consuming and costly "dickering." There are lots of people who are just waiting to be sold. Deep down in their hearts they want radio, but they don't know it. They are the

kind of people who think that "next year" will see "something revolutionary"—simply because no one has ever taken the trouble to explain to them that this is not so—and the fundamental reasons why. Then again there is a large class of potential prospects who can afford radio but whose desire has lain dormant—they didn't realize how wonderful, how fascinating, how entertaining, it all was—until some live merchant took the trouble to show them—in their own home.

Don't you see how you as a dealer can control a customer situation of this kind? No pack of other dealers hot on your prospect's trail. He's all yours, by right by discovery. "Findin's keepin's," as the kids say.

Greater Volume of Business through Distributors

BY W. B. FULGHUM

General Sales Manager, Crosley Radio Corporation, Cincinnati

WE DEAL through Jobbers, or Distributors as we prefer to call them, exclusively. We differentiate between Distributors and Jobbers in this way. We should put in the jobbing class, those houses who list Radio receiving sets in voluminous catalogs, and ask their salesmen to take orders for them.

In other words, Radio receiving sets are perhaps one of thousands of other articles listed, and the salesmen having no more knowledge of Radio than they have of the hundreds of other articles for which they are attempting to take orders.

We should class Distributors as those houses which give special study to the distribution of Radio products, have especially trained salesmen who are concentrating on Radio, are doing special promotional work in the interest of Radio generally, and the particular Radio products which they are handling.

We see no reason for changing our policy of marketing our goods through "Distributors."

It is our opinion that it will cost less to operate from Manufacturer to Distributor to Dealer, particularly on a volume of business such as we do, making it necessary to have an extraordinarily large number of Dealers, covering even the smallest trading communities.

Building Radio for the millions as we do, this low-priced Radio must be made accessible to the public in the smaller trading centers. The cost of collect-

ing the accounts of the large number of Dealer outlets which we have, would be excessive.

We are also quite certain that a greater volume of business can be done through Distributors, because we have the benefit of the personal solicitation of hundreds of salesmen in the employ of the Distributors.

The advantages to the retail Dealer are tremendous. First, because he always has a near-by stock of goods to draw upon. Second, because of the close contact, greater credit limits can be extended by his local Distributor than could be done by a far removed Manufacturer. Third, service problems can better be handled by a near-by Distributor than by a Manufacturer, perhaps, hundreds of miles away. Service has always been a big factor in Radio, and the real Distributor is always set up to take care of this problem for the Dealer quickly, and with a minimum transportation charge.

The gist of the thing is that as long as the Manufacturer can have the support of "Distributors" and not "Jobbers" it will be to his advantage and the advantage of his Dealers to continue with this method of distribution; but, on the other hand, if an outlet of real Distributors cannot be obtained, the Manufacturer will be compelled to go direct to the Dealer in order to make certain that his interests are being properly taken care of. The Crosley Radio Corporation has always found it possible to secure reputable distributors.

Decries Unfair Selling Methods

BY W. A. STILLWELL

Big Rapids, Mich.

YOUR publication has been coming to us each month and we read the articles with interest. Now we want to express our thoughts on various topics.

The biggest trouble we see with the radio is the uncertainty of reception and the unjust methods of selling. You talk up a customer and have him all ready to purchase, then a set is installed at the home, and at night you turn it on and it is as far from good as the North Pole is from the South. Let's get down to the main trouble and eliminate this outside interference so that a demonstration is a sure thing.

Then the unfair methods of selling. In some localities, it appears that as soon as a man takes a folder out of your store, all of the dealers have watchdogs so that this can be reported to them. We have been in places where the party had three and more sets in, all from different dealers. Now, if a party goes into a store to purchase a fountain pen, he goes and buys a Parker, a Waterman or a Conklin or some other kind because he knows what he is getting and the dealer will say, "if this model does not suit you, I will be glad to exchange it for you" and the man feels that he has

been treated fine and will trade there again. Isn't this the spirit we want to instil in all customers?

We know of one place where a certain model was installed, using a loop. This party came to us and asked us to place an instrument there to try, which we did, our model having an outside aerial. We made an appointment with him to be there at 7:30 p.m. and when we arrived we found that another dealer had walked in, attached his receiver to our aerial and was demonstrating his receiver. Is this what you would call fair business methods? This man went past the house and saw us putting up the wire and so he went and got a receiver and took it there.

Now, we suggest that we all go a little easy on purchasing, stock up only what can be disposed of in a reasonable time, and wait until 90 per cent of the present shady manufacturers and dealers are out of the list.

We are not able to be judges of the next two or three years, but with the many radio concerns that have gone bankrupt the past 18 months, we know there will be more and their models will be "dumped" on the market, and after a short time, the radio field will be limited to about five manufacturers and their agents.

Few Items Prevent Losses from Overstocking

BY J. E. DONALDSON

President, Federal Radio Corporation, Omaha, Nebr.

I WOULD like to comment on "Know What the Public Wants" in your June issue. The heading of this article states that the phrase "Sorry we're all out of that" should never be heard in a radio store. I believed that once, but in trying to put it into practice I had to stock so many different items that our inventory was burdensome. As the demand changed I found that we would have a few of each item left and that we had \$5,000 worth of merchandise that was not worth shelf room.

I think it is far better to pick a few articles of unquestionable merit and tell the customers when they ask for something else "We are very sorry but we do not handle the particular brand that you desire. We have such and such brand that has proved very satisfactory." Undoubtedly a number of sales will be lost but a much more rapid turnover will be possible and at the end of the year the inventory will be much smaller and the real profits will be larger.

Mr. Ryan further states that 15 per cent of the business will be accessories. It has been our experience that more than 50 per cent of radio business is in this class. With all of the sets out there is bound to be more than 15 per cent spent on such articles as "B" batteries, tubes and other accessories.

There may be 25 per cent combinations sold in the larger cities, but in the smaller towns I venture to say that the combinations will not make up 5 per cent of the total.

I am not writing in the spirit of criticism, but to find out if my experience is similar to other dealers.

Says New Zealand Must Be Sold Direct

BY C. R. RUSSELL

Christchurch, New Zealand.

LIKE all McGraw-Hill magazines *Radio Retailing* is of the highest grade of publications. Your recent article on the "Gyp" dealers was excellent and is a ventilation of a trouble which is causing the trade in general much concern.

While I am on the subject of the commercial side of radio, there is one subject that deserves clearing up: A large proportion of American dealers, manufacturers and jobbers think New Zealand is a part of Australia and do not realize that Australia is 1,500 miles away at the nearest point. The two countries are geographically, politically and in every other way separate countries as are South Africa and New Zealand and we have a customs tariff against all countries including Australia.

Jobbers and dealers here are constantly getting replies from American manufacturers stating that they cannot supply goods as they have an Australian agent, or referring the dealer to this Australian agent. In 99 cases out of 100 the manufacturer gets no order as New Zealand dealers will not order through an Australian agent. New Zealanders are proud of their country and nothing arouses their ire so much as to be called Australians and their country part of Australia.

"Never Put a Set in a Home and Forget It"

BY R. M. AIREY

Tacoma, Wash.

YOUR recent issue of *Radio Retailing* received, and it is certainly filled with interesting articles.

Service counts. Never put a radio into any home and forget about it. Some people are very sensitive about complaining to you, but to their friends they are not, and that's what hurts your business. I give my customers all the service possible. Whenever I am near or within a few blocks of their home I make it a point to stop in and see how things are going, in this way I get new prospects from them.

Whenever I sell a radio to an old couple and they have no one to put up an aerial, and it is not too big a job for one man, I put on my overalls and put it up. What's a few minutes time when you have a satisfied customer?

Upholds the Jobber and His Service

BY A. C. WHITEFIELD

Sales Manager, General Instrument Corporation, New York City

AS A result of reading your article "Is the Jobber a Necessary Link in the Chain of Radio Distribution?" that appeared in the August issue, I am tempted to break into print, much

against my usual reticence and—shall we say?—modesty.

It is hard to understand why there is any question regarding the jobber's status in the field. Understand, I have no quarrel with any manufacturer's policy whether he is sold to the idea of dealing direct with the dealer or like ourselves, definitely committed to jobber distribution.

The real answer to the question about the jobber's existence is so obvious, that I sometimes wonder how there can be any discussion.

His existence was brought about, and his function made important, by the confidence that the dealer he serves bestows upon him. While it may be true, that the jobber would have a hard time, if he could not buy his materials from the manufacturer, he would certainly be much harder up against it, if he were, for a moment, not endorsed by the dealer he serves.

Now, if that is the case, why the question?—economic principles? greater efficiency? lessening of sales resistances? Every one of these points can be answered overwhelmingly in favor of the jobber. Confining business dealings to one organization makes for economy and efficiency.

The steady and remarkable method of such institutions as Butler Brothers, whose service to the dealer and keen capacity for analysis of the dealer's wants have practically made them a clearing house for the numerous clientele they serve, illustrates this.

Can you imagine the resulting chaos for the dealer, set up as he is now, if he had to be served on all items direct by the manufacturer. Any business man with practical common sense will understand how impossible that is.

Here and there some aggressive manufacturer steps out of rank and makes the attempt of direct contact with dealers, but at best, he is far in the minority. But has the dealer received definite material benefit from such practice? What is claimed to be an advantage does not increase his profit since the jobber stands ready to absorb that part of the additional cost which must otherwise be borne by the manufacturer and make his profit out of his ability to pool many items and thereby so decrease his sales cost as to leave him a satisfactory profit. And so the dealer is as content to buy from his legitimate jobber as from the manufacturer, because he makes as much money, receives the same discounts and is well served otherwise.

Should Quote Two Prices

BY J. B. L. DAVIS

Marshall, Mo

I believe the time has arrived when two prices should be quoted on console models—one for the set with battery equipment, the other for the set with eliminator equipment. I think also that manufacturers should list their console models that way in their advertising so that the public may be made aware of the difference. This step would aid prospective customers in deciding the kind of set they want, and would relieve the dealer of unnecessary demonstrations.

Plugging Up the Holes Through Which

Many dealers through lax store methods make thefts of small articles by dishonest clerks and customers easy

THE amount of money and merchandise stolen yearly in the radio industry alone would go a long way toward supplying a large sized community with complete radio outfits.

The owner of a radio business is confronted with a difficult problem in attempting to reduce losses, no matter what they may consist of. By careful manipulation he can cut his tangible losses to a minimum. But those due to theft are intangible and hard to detect.

Dealer Jones, for instance, conducts his establishment under large overhead, sells his wares, with a small margin of profit, and small volume of sales. His books show a loss. A careful investigation reveals that either the overhead must be reduced or the resale prices raised, to stop such loss. On the other hand, suppose that Jones after making these changes still finds that the surplus is on the wrong side of the ledger. He may have every reason to believe that his merchandise is being stolen and yet he may not be able to place his hand on the culprit to stop such loss.

Occur in All Departments

Thievery leaks occur in all departments. The extent of such loss depends upon the lack of protective system covering the departments in question and to the amount of trust imposed on those running them.



Clerks sometimes pocket the proceeds of a cash sale instead of ringing it up on the cash register.



Merchandise should not be left where a dishonest customer can appropriate it when the clerk's back is turned. Small articles should be kept off the counter.

Radio merchandise offers great temptations for thieves. An unscrupulous radio bug selling parts does not think it worth while to pay for a few insignificant grid leaks and flat condensers that he slips into his coat pocket at an opportune moment. He gets these home and finds out that a radio set cannot be built with just a grid leak and a condenser. So taking into consideration the ease with which he got away with these small items, he takes a chance on some larger ones which he smuggles out in a package that he might have brought in with him in the morning. He succeeds in getting this and other merchandise out and begins to think of things on a larger scale. Why not build some sets for his friends and make a little

easy money for himself? Sure, let's go!

The burglar then starts looking for assistance and talks it over with his croney in the shipping department. Having been won over by promises of easy money Bill, the shipping clerk, goes into business with the crook. He has control of all outgoing merchandise as the unwary boss, Jones, places entire confidence in him.

The thief's set-building business however, does not net him returns fast enough, and besides it involves too much labor, so he turns to obtaining factory-made sets. Bill, by this time, has enlisted the truckman's services. Every time a console is shipped, Bill places a small factory set in it, together with enough accessories to equip it. To Boss Jones, making a casual inspection, everything appears to be running smoothly, for he never realizes what is really going on. This condition may continue for months at a time. The picture is not merely imaginative; it is drawn from actual occurrences.

Dishonest Cashiers

Young men in charge of cash registers are responsible, also, for losses. They help themselves to silver and even an occasional greenback. Jones' carelessness in his system of transacting sales enables his cashier to pocket the money after the customer leaves. On one occasion I noticed a clerk fumbling with a bill and

Stock and Profits Leak Out of the Store

A dozen merchandise and help checks by which this pilfering, a prolific source of loss, can be effectively stopped

asked him why he hesitated to ring up the sale. He feigned innocence of any wrong intention, but on investigating at once I saw him throw into a dark corner his handkerchief containing \$11.25 in silver. It was found later that this young man had been in the habit of handing merchandise to his friends in packages that he himself wrapped without getting payment for them.

Another form of larceny is practiced by installers and repair men in the field. These fellows have a habit of reporting false short shipments and volunteer to deliver the missing merchandise to the customers the following day to complete the job. As it is impractical to follow up each and every claim, advantage is sometimes taken of the concern.

Losses, again, are frequently due to failure to check the receiving clerk. A shipment may be fully received as per packing slip of shipper and yet part of such shipment may have never been delivered to the store. Where does this merchandise go to? The answer is simple. The shipping clerk having become very intimate with the truckman had previously arranged to deliver the merchandise to some predetermined place.

How to Prevent Thefts

It is possible to go on illustrating at length such unscrupulous methods, but the dealer will be more interested to know how to prevent such thefts.

First of all, bond all your men. The cost is small, compared to the protection offered. Then use the services of professional shoppers who act as detectives, and watch every move made by the salesmen. They generally work in pairs. One will transact a purchase and the other will detect the actions of the salesmen while the first is leaving the store.

Cash registers should be fully equipped with a control tape so that if any question arises about the amount rung up, there will be a means of checking the sale.

It is not desirable to permit the salesman to handle cash nor is it

Eight Ways to Stop Radio Thefts

- 1—Check all merchandise going out from the shipping room.
- 2—Give every customer a receipt.
- 3—Take frequent inventories.
- 4—See that there is a sales slip for every sale made.
- 5—Lay occasional traps for suspected clerks.
- 6—Check all packages employees carry out.
- 7—See that salesmen ring up every sale.
- 8—Don't tempt dishonest customers by placing merchandise where it can be easily pilfered.

good practice to allow him to pack the merchandise he sells. On such counters where it is necessary for the salesmen to take cash it is advisable that the prices on the merchandise be such that no matter what currency is handed to the salesman, he is compelled to make change. That is why we see such prices as \$0.99, \$0.49, \$1.24, etc.

Do not place too much responsibility on any clerk's shoulders without checking his work from time to time if you do not wish to take big chances. The cautious dealer

should devote much of his time in checking. Do not take too much for granted.

A good rule to follow is not to let one hand know what the other hand is doing. To be explicit, use independent checking.

Be sure always to get customers signatures for all merchandise delivered to them and make the customer understand that he is responsible for any merchandise for which he signs.

Do not permit any merchandise to leave the premises without a requisition of some kind, authorizing such removal. A customer should be given some form of receipt which might be asked for when his sale is in question. All packages should be wrapped before leaving the premises and inspection of all merchandise leaving the shipping room should be made by someone besides the shipping clerk.

Frequent inventory taking will help to minimize merchandise losses. Careful checking should be made on all personal packages brought into and taken out of the premises by employees.

Occasional traps should be laid to test the integrity of the employee. You might request the jobber to over-ship and find out what becomes of the surplus sent in. There are numerous tests of this nature that may reveal much to the dealer. Before hiring your help, carefully investigate your applicant.

By observing such precaution the dealer can effectually reduce the losses due to theft.



The shipping clerk is occasionally in league with a crooked salesman and demands his share of the spoils.

Who Shall Control Radio?

AS BOTH radio legislation bills—the Dill Bill in the Senate and the White Bill in the House—contain practically the same provisions, it remains only to decide whether administration of those provisions shall be vested in an independent commission or in the Department of Commerce. Both bills, it is understood, defend the best interests of radio and the public.

The most important next move, therefore, is to guarantee just and impartial administration of the provisions of the bill after it is passed. This can be done only by vesting radio control in a Government department free from political blemish—in this instance, the Department of Commerce.

The future prosperity of radio hinges on a continuance of its unhindered development. Those who have the best interests of the trade at heart should do the utmost in their power to see that radio control is not placed in a political body as the Dill Bill would provide, but continued in the tried and competent hands that have guided it in the past—the Department of Commerce.

The great flaw in the Dill Bill is the fact that political hangers-on, those seekers of office to whom plums must be issued in return for political favors they have done for the party—will be the ones who will get the places on the commission. The White, or House of Representatives Bill, providing for an advisory commission to the Department of Commerce, will give men within the industry itself a chance to have a say in the administration of their own affairs.

* * *

The Congressional conferees will meet next month and try to agree on a radio bill. So much personal attention from Washington may give this adolescent industry a swelled head!

* * *

There Is Hope for the Future

SEVERAL radio officials have learned a lot of things lately that they didn't know before. One of them is that a group of business men can sit around a conference table and thresh out their differences in a friendly and cordial way.

The recent harmonious conference in New York City between representatives of the two manufacturers' factions—the R.M.A. and the A.M.E.S.—who, until a few weeks ago, were engaged in a ridiculously bitter mud-slinging contest—heralds the dawn of an extremely brilliant future for this industry.

"It's an ill wind that blows nobody good." Impending disaster in the broadcasting situation brought together these two great, important manufacturing groups. Each found out that the other fellow was a regular human being after all. It is earnestly hoped that the co-operative relations thus established continue throughout future years. Many problems and plans for the trade as a whole can be worked out through the combined efforts of these two fine organizations.

Keep Politics Out of the Picture

SENATOR Dill is called a good friend of radio and it is undoubtedly true. He has worked conscientiously and industriously to perfect a good radio bill. But it must be remembered that Senator Dill is a politician first and a friend of radio after that. He wants commission control because it would be good politics for the Senate to have a hand in it. He entirely loses sight of the fact that it is for the best interests of radio and the public to keep politics out of the picture and put radio control into the hands of an administrative department of the United States Government where politics are banned and unbiased decisions guaranteed.

Opposition to commission control broke out at the conclusion of Senator Dill's speech at the recent industry conference when several leaders of the industry took issue with his remarks and voiced regret that Senator Dill had referred to the radio executives and engineers in the Department of Commerce as "clerks." Whether radio control is ultimately to be vested in an independent commission or the Department of Commerce, it will not be administered by clerks, despite what Senator Dill may say to the contrary.

* * *

Anyway, one good clerk in the Department of Commerce is worth five politicians on a commission.

* * *

A Sign of Increasing Stabilization

PROBABLY the point of outstanding interest to the retailer in connection with the Radio World's Fair, held in New York City during the week of September 13, was the noticeable absence of "freak" design and sensational circuits in the receivers offered for the season. The so-called "revolutionary" receivers have again failed to materialize. During the past summer, it is evident, the laboratories of large manufacturers have bent every effort toward the elimination of tuning controls, selectivity through metallic shielding and superior tone quality via better audio amplification systems and improved speakers. One was struck by the similarity of design while passing from the display of one manufacturer to another. In many instances cabinet design was the only divergence. Standardization of models and the almost total absence of "trick" apparatus indicate that the industry has made considerable progress in the past year.

* * *

The season of manufacturer-jobber banquets for their dealers is on full swing. Thus is the poor retailer assured of at least one good meal a year.

* * *

The Parts Business Is Far from Dead

RAMBLING around the Radio Show in New York last month brought to light an astonishing fact, considering that the parts business is supposed to be going down instead of up. This interesting observa-

This to Say—

**Radio
Retailing**
Vol. 4, No. 4

tion was that the displays of the parts manufacturers always had larger crowds of interested observers around them than did the displays of completed receivers.

This may be answered in two ways—first, that the amateur set-builder is still a very important factor, and second, that the man who owns a factory-built set may now be interested in what makes it tick, possibly with a view toward building one himself. Try it out on some of your set owners—most people could use a second set for various reasons—and see if, with your help, they would not be interested in buying the parts and building a set themselves, for use in the car, or on the boat, or for the children.

* * *

Why all this hullabaloo about "The jobber's life is at stake?" The jobber who plays square with his dealers need never worry about his place in the radio picture.

* * *

The Future of Broadcasting Is Not Threatened

THE future of broadcasting, commercial or otherwise, is not threatened, despite a definite attack on ether advertising by magazines devoted to the field of advertising and publishing. There is and will always continue to be high class programs sponsored and paid for by commercial interests. It is well known that some of the most enjoyable and popular programs are being broadcast by advertisers.

Using as a basis for the attack, the very minor amount of confusion caused by several stations jumping their wavelength, an attempt is evidently being made to destroy the value of commercial broadcasting by developing the erroneous hullabaloo about "chaos in the ether" which, at its worst, can cause little or no damage between now and the time when legislation will be enacted.

It is true that there is a small degree of confusion; it is true that it doesn't amount to the proverbial "hill o' beans"; it is true that commercial broadcasting is here to stay; it is true that commercial programs hurt radio unless they are of extremely high type and done inoffensively; it is true that many publishers and advertising men resent the entrance of broadcasting into the field of advertising; it is true that David slew Goliath with a slingshot and it is also true that aerial towers will never be destroyed with pen and paper, no matter how much ink is used in the attempt.

It's the Product that Counts!

AN ARTICLE on the distribution of radio apparatus from manufacturer to consumer, printed recently in this publication leads us again to point out one outstanding fact which gleams through the fog of present merchandising methods. After all, regardless of distribution plans, sales policies or advertising schedules, it is the actual worth of a manufacturer's product which makes for his ultimate success.

* * *

Sell Agricultural Programs to Rural Prospects

MORE than a million farmers, it is estimated, are Uncle Sam's students as the National Radio Farm School of the United States Department of Agriculture opened October 1. A comprehensive program has been approved by Secretary of Agriculture William M. Jardine. It will be broadcast by more than 100 stations.

Here then, is another opportunity for the alert dealer with his hand on the business stimulation throttle, to add another sales argument and added sales impetus to his campaign this fall and winter.

These particular programs will be rich in practical interest to the farmer and his wife and children.

Radio Retailing suggests that you will find in this course the most effective selling tools to use on the rural dweller. The radio department of many newspapers will contain interesting items on these programs and on the progress of this course. Clip them and take them with you on your sales rounds.

Bringing the City to the Farmhouse

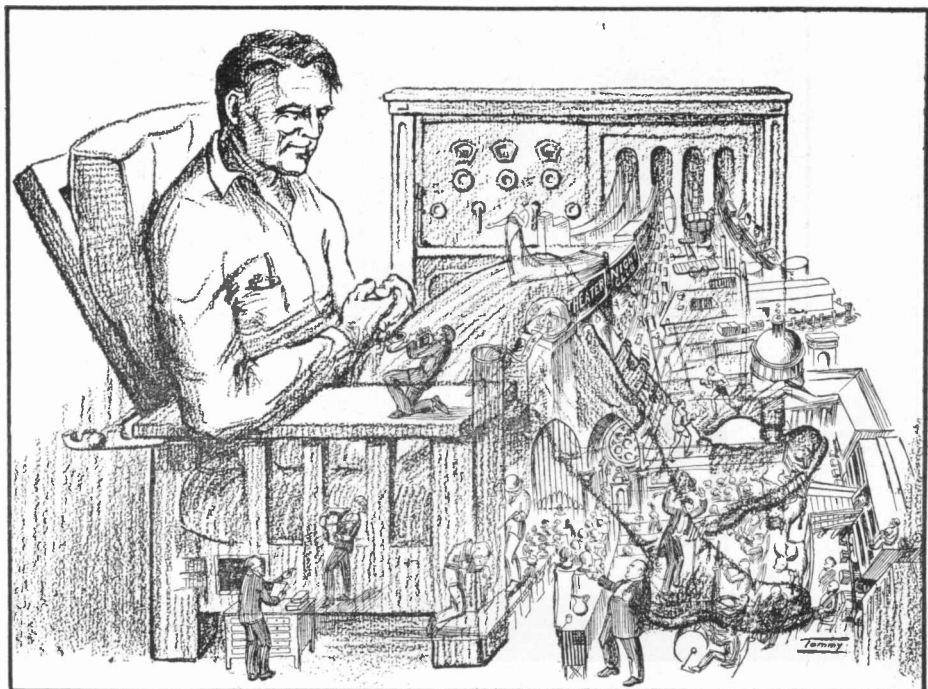

One year ahead

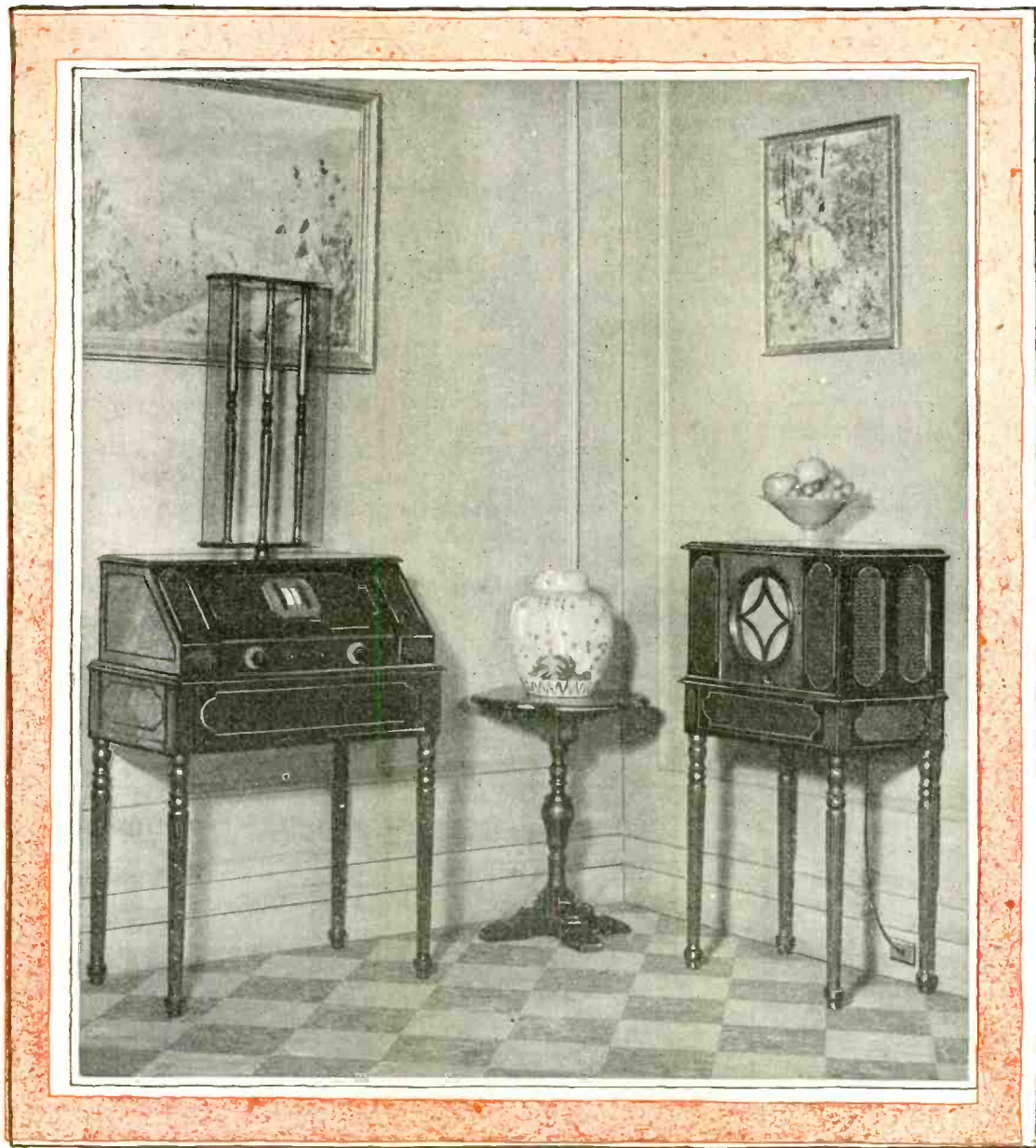

Radiola 28, list price, with Radiotrons, \$260

RCA Loudspeaker 104, list price, complete, \$275

A. C. Package, for adapting Radiola 28 for use with Loudspeaker 104, without batteries, \$35



RCA Radiola

MADE · BY · THE · MAKERS · OF · THE · RADIOTRON

RADIO · CORPORATION · OF · AMERICA · NEW YORK · CHICAGO · SAN FRANCISCO

in all that's new

- NO BATTERIES
- REALISM - *through power*
- NO ANTENNA*
- SINGLE CONTROL
- SEALED CONSTRUCTION*

*Three years ahead!

WHERE others are taking their first trial steps, RCA has had more than a year of experience. In every new advancement of radio, RCA Radiolas have proved themselves *in use*. The laboratories have followed them closely through a year of "road-test" in many thousands of homes—perfecting them steadily. And in this proved and perfected radio you will find sound business with sure profit.

The kind of new product you want to sell and the public wants to buy is the new product that has been *tried, tested and perfected*.



Radiola 30, list price, complete . . . \$575

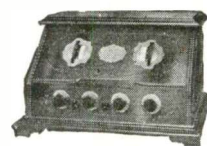

Radiola 20, list price, with Radiotrons, \$115

This sign marks the leading dealer in every community.



RCA Radiola

MADE BY THE MAKERS OF THE RADIOTRON

RADIO CORPORATION OF AMERICA · NEW YORK · CHICAGO · SAN FRANCISCO

For the Service Man

A monthly department of service helps —For practical ideas in 200 words if acceptable for publication two dollars will be paid.

**Conducted by
Henry W. Baukat**

Radio Trade Association Helps Dealers Find Interference

How many small town dealers are able to locate and clear up difficult cases of local interference? Work of this nature requires an expert radio-trician and, as a rule, expensive testing apparatus. This knowledge and equipment is not always available within the ranks of three or four radio merchants in the average country town. It was for this class of radio dealer, therefore, that the Northwest Radio Trade Association of Minneapolis and St. Paul, Minn., arranged to provide the services of its technical "trouble shooter."

The following correspondence which actually took place, tells the story of co-operation between the big city radio organization and the small town dealer and suggests possibilities for other dealers whose business is located in either type of community.

Northwest Radio Trade Association,
Gentlemen:

There is a great deal of interference locally, and I feel confident that it is due to some defective electric line. A few days ago I made arrangements with the lighting company and they shut off the power and the noise ceased. They do not seem to have any facilities to remedy this trouble and I wish to ask you what charge you would make to find this trouble, if you do this kind of work. I am a member of your association.

T. O. BERG RADIO STORE.
Little Falls, Minn.

T. O. Berg,
Little Falls, Minn.
Dear Mr. Berg:

Mr. Sparks, our association interference man, has investigated numerous towns about the territory and has

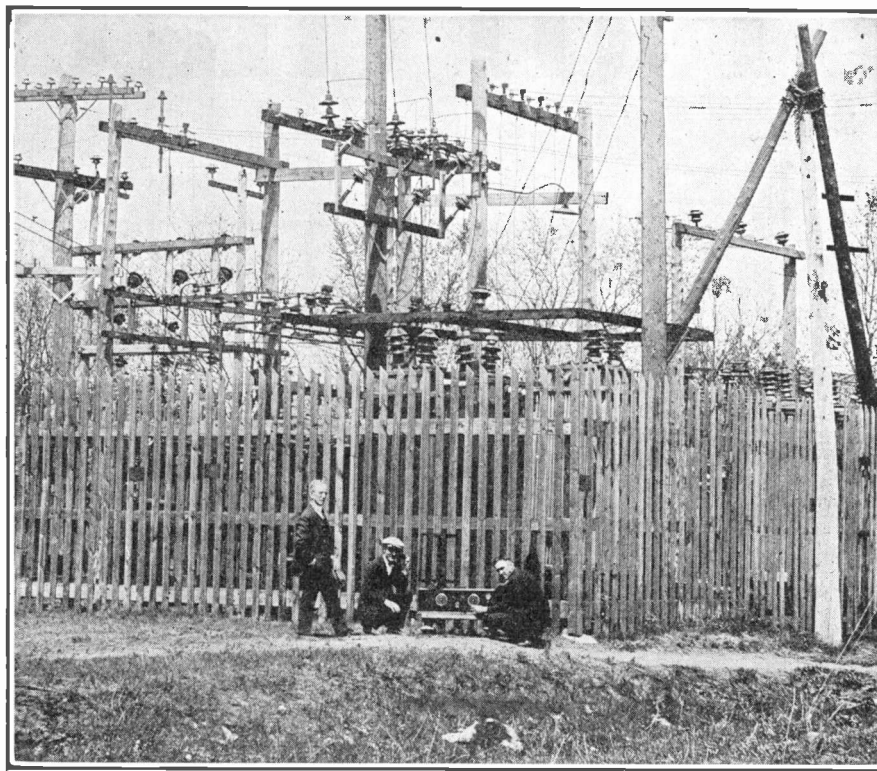

"Radio Wave" Sparks (center) "shooting" trouble for the small town dealer.

cleared up their interference trouble, very effectively.

Mr. Sparks charges at the rate of \$10 per day and his expenses out and back. He is generally able to find the trouble in three or four days time and get it eliminated. In many instances the city council has paid the bill—being glad to do something for the benefit of the radio listeners. In other cases, the power company has paid his expenses and in some cases a collection was taken up among the radio fans.

If you are having bad interference, I would recommend by all means that you send for Mr. Sparks and have him run it down. Your radio reception will be improved and you will naturally sell a great many more radio sets.

NORTHWEST RADIO TRADE
ASSOCIATION.

Northwest Radio Trade Association,
Gentlemen:

Replying to your letter of the 29th, will you kindly send your Mr. Sparks (R.W.) up here Monday, May 10th, to see if he cannot locate and eliminate the interference we are having. I have collected a fund from the dealers for this purpose and the money is now in my hands to be paid to him. I understand his terms are \$10 per day and expenses and that usually he is able to find the trouble and eliminate it in three or four days time.

T. O. BERG RADIO STORE.
Little Falls, Minn.

Sparks explains that the outside cases on which he is called are generally serious ones which affect the entire township and which naturally, therefore, originate from the lighting company's lines, or at least are distributed by them. He states that so far he has always succeeded within two or three days' time in locating the source of these disturbances. In River Falls, Wis., for example, he found that a certain doctor was operating an X-ray machine almost continuously including the evening hours. He instructed the doctor in the method of grounding the patient which would practically do away with radiations from this source. The doctor, however, refused to follow instructions and the city council declared that the operation of this X-ray machine was a public nuisance. The district attorney of River Falls stated that the present law on public nuisances was ample to cover cases of this kind. The doctor was forced to discontinue his X-ray machine during the evening hours.

Mr. Sparks states that the town council or the lighting company frequently volunteered to pay him for

his time in locating the source of interference.

Instructs Dealers

"Radio Wave" Sparks, as he is called all over the territory, always calls the dealers together and gives them complete instructions on locating the commoner causes of local interference disturbances. He also explains the way in which the "bloopers" set may be operated to cause the least disturbance.

The dealers always make more in increased set sales than the cost of Sparks' visit. As soon as the trouble is cleared up, the dealers grab their prospect books and start to work. One dealer sold ten sets within two days from the time the local noises were cleared up.

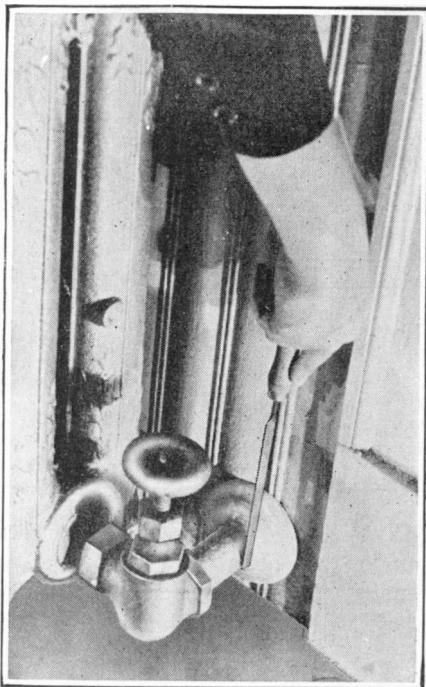

A cabinet rasp used instead of a file makes cleaning pipes for ground connection easy.

Clafin are serviced three times by him without charge. After the third call a charge is made. To obtain the 5 per cent discount mentioned on the card the transaction must be cash at the time of service.

Easy Method for Cleaning Ground Connection Pipe

Aluminum or gold paint on radiators is not a good conductor. The varnish mixed with the powdered metals gets in between the tiny flakes, causing little insulated walls.

If you have a new service man—and in some cases this advice will not be out of place for old timers—caution him to remove this coating. The easiest method is to use a cabinet rasp, as shown in the accompanying illustration. This is much faster than a file, the work being performed in a few quick strokes.

This makes for a clean contact with the metal ground strap, and radio results that keep your customer pleased. Not enough attention is paid to the importance of a good ground. Do the job right.

Year Ticket Increases Service Profit

Free servicing for three months was found by H. M. Clafin, Waterville, Maine, to be a losing proposition. He was frequently called out for service when there was nothing that he could do.

Now, however, he has transformed his servicing into a paying business. A card, a facsimile of which is shown on this page, is sold to set owners for \$10. This entitles the purchaser to a service of one call a month for a period of one year. Each

time a service or inspection call is made the corresponding month is punched at the bottom of the card. In this way there is no chance for an argument as to whether or not the set has been serviced for any particular month. Any one may purchase one of these cards and obtain service, regardless of where he bought the set.

All receiving sets that are sold by

Eleven Ways to Ensure An Efficient Antenna

To ensure a highly efficient antenna system, S. W. Hull, president S. W. Hull & Co., Cleveland, Ohio, recommends that the following details be kept in mind:

1. Over-all length not more than 125 feet.
2. No close approach to trees or buildings.
3. Horizontal part as high as possible.
4. Lead-in away from building.
5. Absence of joints (where possible).
6. As few insulators as possible.
7. Ground wire connected to water pipe.
8. Set close to window where lead-in enters.
9. Wire fairly heavy and rigid.
10. Clean connections and soldered joints throughout.
11. Straight, well secured masts.

A good aërial sometimes entails a lot of trouble, but the effort is worth while. The difference between a good and a poor aërial is most noticeable on distant reception.

A Cause of Interference

Non-receptivity of distant stations in a receiver that should be a good distance-getter, may be caused by having the receiver too close to a radiator or other metallic object.

Radio Service Ticket

Number 1000.

This ticket is your receipt for 12 monthly inspections and service at the time: including minor adjustments, testing batteries and tubes and labor replacing when necessary, this service commencing *June 1st, 1926* and the *first of every month* for one year for which the sum of \$10 is in full.

To John Jones.
1342 Broadway.

Signed Harold M. Clafin,
25 Silver Street,
Tel. 1222-W, Waterville, Maine.

This ticket also entitles the above to a 5 per cent cash discount on any radio material used for replacement, discount taken from regular market price.

Please keep this ticket in or near your set.

.....
Jan. Feb. Mar. Apr. May Jun. Jul. Aug. Sep. Oct. Nov. Dec.

The above ticket used by H. M. Clafin, Waterville, Maine, has turned radio servicing from a losing to a paying proposition. It eliminates dispute and makes the customer more careful in calling for service.

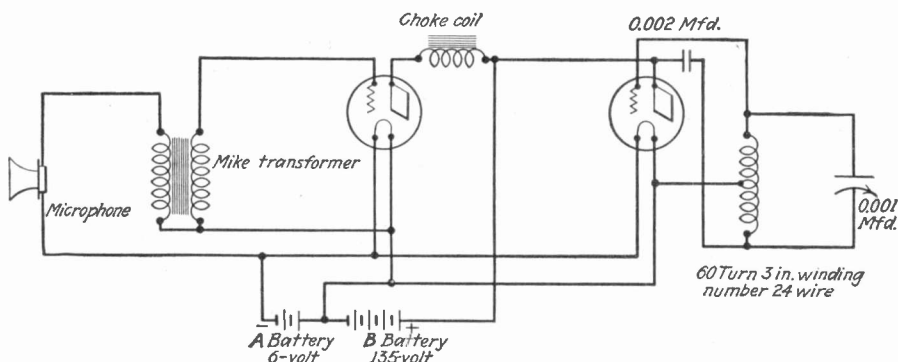

Circuit used by Main Auto Supply Company, Fort Wayne, Ind., by which music from a phonograph is transmitted within the store for testing purposes and also for demonstrations.

Miniature Sending Station Helps in Testing Sets

The Main Auto Supply Company, Fort Wayne, Ind., has a simple but satisfactory method of testing sets. A miniature broadcasting station has been constructed, as shown in the illustration, at the entire expense of \$85.

This little sending station consists of a Bristol loudspeaker tester, an old phonograph, a microphone transformer, two 201-A tubes and an inductance winding, which is tuned by a .001 mfd. variable condenser.

The same six-volt A battery is used to light the filament of the tubes as is used to furnish current for the microphone. Sixty turns of No. 24 wire, on a three-inch solenoid, form the inductance coil. This is tapped at the mid-point.

The input at the microphone is connected to the Bristol speaker tester. This, in turn, is actuated by means of the phonograph.

The set-servicing and repair room is located about fifteen feet from this device. When a service man wishes to give a set a real working test under actual conditions he walks into the "sending room" and starts the phonograph going.

This transmits energy far enough for his testing purposes, but does not radiate to the extent of being a source of interference outside of the store.

Here are the advantages of testing sets by this method: The variable condenser on the transmitting unit permits wavelengths of from 200 to 600 meters to be sent out.

There is no static by use of this equipment and reception is available whenever the service man wants it. This makes possible comparative tests for volume inasmuch as

the sending station always puts music "on the air" at the same intensity.

UX-200-A Detector Tube Cures Trouble

One service man who has been doing a good deal of work out on Long Island had considerable trouble in satisfying a very exacting customer. The receiver which was installed was of the neutralized tuned radio frequency type and did not work properly. It did not seem to have the required kick. Stations could be heard but with not enough volume to suit either the owner or the service man. Various types of aeriels were tried, the ground was changed, the tubes were tested, in fact every trick the mechanic knew was tried out.

The set when taken back to the shop performed perfectly. So it was concluded that the location was causing the trouble, and it was decided to

try out the new type of detector tube. A marked increase of volume was noted immediately. Without any other change, the replacing of a single tube made all the difference in the world. Later a power tube and increased voltage were also used with the set. The use of the latest tubes, according to this service man, is a sure cure for weak receivers.

Power Lines Cause General Interference

Faulty insulators and other power line equipment on a high voltage transmission line carrying 66,000 volts were found to be causing considerable interference to radio fans in western central Oregon.

In its desire to co-operate with the radio fans of that section the power company has appropriated money with which to purchase an auto equipped with a trouble-finding set, and has appointed a radio expert to patrol its lines to locate and eliminate trouble as it occurs.

Check Multi-Point Switches

Multi-point switches very seldom give electrical trouble except when the tension of the contact spring weakens which may cause the high resistance contact. If the shaft of the switch is pig-tailed check the pig tail making certain that it is intact. Check also the soldered connections to the contact points of the switch making sure that the contact connections are firm and clean.

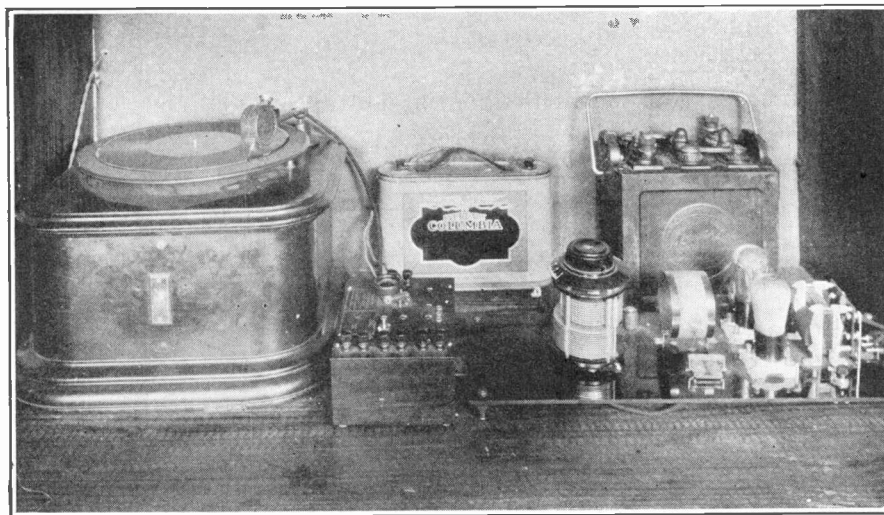

Phonograph music transmitted 15 feet by the above apparatus enables the Main Auto Supply Company, Fort Wayne, Ind., to test sets at any time during the day or night

Camera Glimpses of Radio Events

Radio Expert Loses Life

Charles Clavier (below), the French radio engineer who was killed when Fonck's giant transatlantic airplane was destroyed at the take-off in New York, is shown testing the 150-watt transmitter which was to have kept the plane in touch with land.



West Coast's Radio Show

More than 110,000 persons attended the Third Annual Pacific Radio Exposition, shown at right, held under the auspices of the Pacific Radio Trades Association in the San Francisco auditorium the week of August 21.

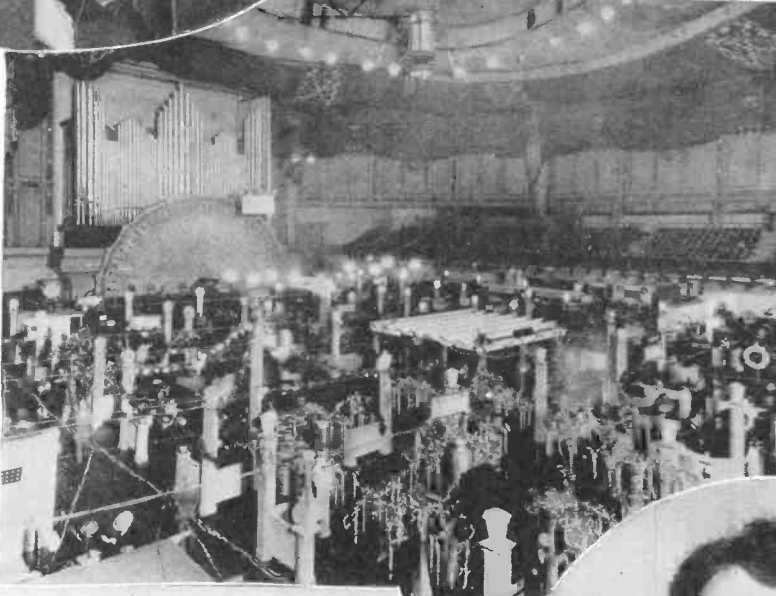

A Transmitter on Wheels

Above — Station 6XBR, portable broadcaster of Warner Brothers Studios, broadcasting a program in Salt Lake City. It is now in the fifth month of its world tour

Studio Built Like Set

Here is the studio of WPAP, located at the Palisades Amusement Park, N. J. The building represents a popular receiving set. The windows are built in the dials.

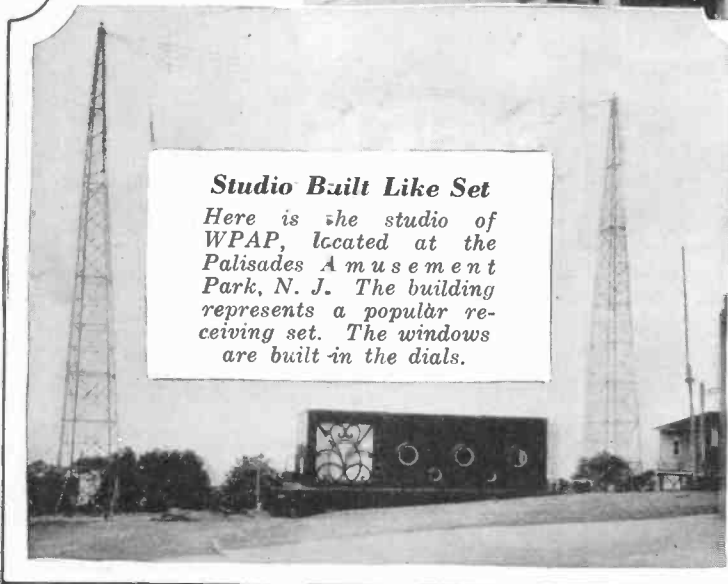

First Lady M. P. Broadcasts

The only speech delivered by Lady Astor on her recent visit to the U. S. was made via radio from a dinner in her honor in New York City.



What's New in Radio and

This editorial section is prepared purely as a news service, to keep readers of "Radio Retailing" informed of new products.

Seven-Tube Receiver Equipped For Loop Reception

Radio Retailing, October, 1926

The S-7 receiver manufactured by the Howard Radio Company, 469 E. Ohio Street, Chicago, Ill., employs three stages of tuned radio frequency neutralized under Hazeltine patents, detector and three stages of combination transformer and impedance audio amplification. Each radio frequency stage is individually shielded with heavy gauge brass, and interlocking condenser control construction permits the use of two illuminated tuning dials. Automatic filament control, on all but the detector and first radio stage, is a feature of the receiver, permitting the use of these controls as volume modifiers. The set is equipped with a loop, which plugs into the cabinet top and tunes from 185 to 575 meters. The upper part of the cabinet is of 14 gauge aluminum finished to represent walnut. The cabinet itself is 15½ in. x 30½ in. x 11½ in. overall, while the panel measures 26 in. x 8 in. Intended retail price, with loop, but without accessories, \$375, F. O. B. Chicago.

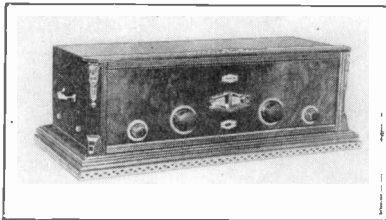

Six-Tube Set and Speaker in Console Cabinet

Radio Retailing, October, 1926

The "American Beauty" console receiver shown in the accompanying illustration is manufactured by the American Auto and Radio Manufacturing Company, Inc., 1416 McGee Street, Kansas City, Mo. The set employs six tubes in a tuned radio frequency circuit and is mounted in a console cabinet which will accommodate either batteries or elimination units. Intended retail price, \$115.

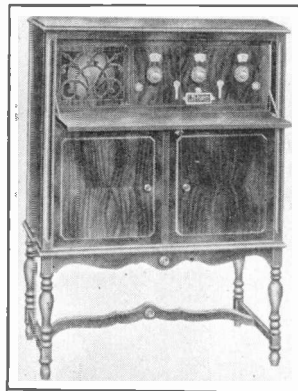
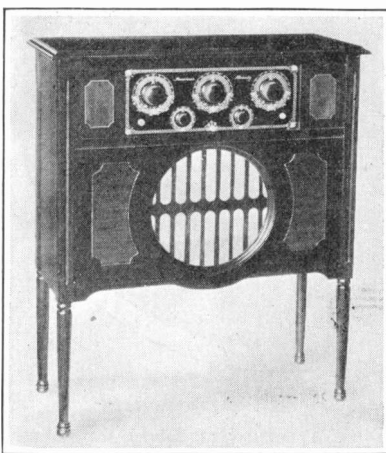

Five-Tube Console Receiver with Built-in Speaker

Radio Retailing, October, 1926

The 6-F 10 "Aristokrat" console receiver, manufactured by the Charles Freshman Company, Inc., 240 West 40th Street, New York City, employs two stages of tuned radio-frequency, self-stabilized, detector and two stages of transformer coupled audio. A power tube may be used in the last audio stage, with the necessary B and C battery voltages and a jack is provided in the first audio stage so that the receiver may be used in conjunction with a power amplifier. Tube sockets are spring suspended, the sub-panel and panel are of metal, all connections are cabled and a cone loudspeaker is built into the cabinet. The cabinet itself is of burled-walnut. The same receiver is available in a mahogany cabinet as type 6-F 9. Space is provided for batteries.

Five-Tube Receiver with Interstage Shielding

Radio Retailing, October, 1926

The Bosch Cruiser, manufactured by the American Bosch Magneto Corporation, Springfield, Mass., employs two stages of tuned radio frequency, shielded in individual sections, detector and two stages of transformer coupled audio. The set is equipped with two controls which may be varied in unison for approximate tuning, then separately for more accurate settings. This receiver is encased in a walnut finished cabinet, which is also used as a front panel and is said to be extremely silent in operation. According to the manufacturer the set cannot be made to squeal or radiate.

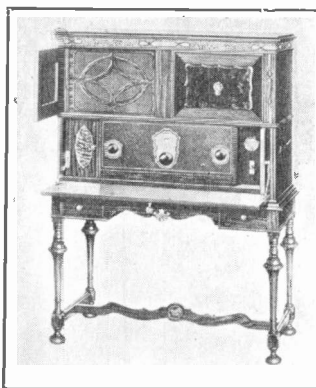

Six-Tube One-Dial Console With Built-in Speaker

Radio Retailing, October, 1926

Model 360 console receiver, manufactured by the Stewart-Warner Speedometer Corporation, 1834 Diversey Parkway, Chicago, Ill., is a six-tube set with single-dial tuning control. It is equipped with space for batteries or an eliminator, a spare drawer for accessories such as log books, etc., a double range voltmeter in a separate compartment and a built-in loudspeaker. The cabinet itself, is of the William and Mary period design, equipped with a hinged front, and is 53½ in. high, 37½ in. wide, 18½ in. deep. Intended retail price, \$400.

Straight Line Frequency Tandem Condenser

Radio Retailing, October, 1926

Amsco Products, Inc., manufactures a tandem condenser in all standard capacities which is said to be particularly suitable for use in connection with single-control super-heterodynes. Rotors are on a single shaft and the condensers, of straight line frequency construction, are said to be matched within one mmfd. Rigid construction insures permanent plate alignment. Intended retail price, .00025 size, \$7.

Wire Wound Resistance Unit

Radio Retailing, October, 1926

For use particularly as voltage regulators in B battery eliminators, the Aerovox Wireless Corporation, 489 Broome Street, New York, manufactures wire wound resistance units capable of carrying 250 milliamps. The units are compact, a resistance of 10,000 ohms being about 4 in. long, and are so constructed that several lengths may be joined and taps brought out as required. The size of the unit depends largely on the resistance required and current specifications.

Where to Buy It

News of Latest Products
Gathered by the Editors

All announcements appearing on these pages are published without advertising considerations of any kind whatsoever.



Seven-Tube Self-Contained Receiver with Speaker

Radio Retailing, October, 1926

The new model 7, manufactured by the Operadio Corporation, 8 South Dearborn Street, Chicago, is a complete self-contained receiver. A directional loop, which may be folded within the cover when not in use, compartments for dry batteries and a concealed loudspeaker with a 24-in. air column make this set one that may be used in the home or as a portable. The entire outfit is 17 in. x 12 in. x 9 in. over all, encased in a substantial cabinet. The circuit consists of one stage of tuned radio frequency, two of untuned, detector, one stage of transformer coupled audio and two of resistance.

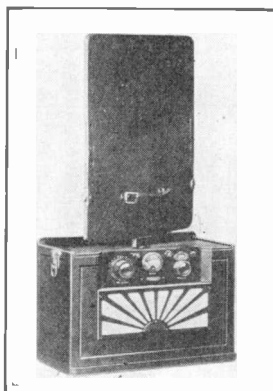

Six-Tube Console Combination

Radio Retailing, October, 1926

The Apex Electric Manufacturing Company, 1410 West 59th Street, Chicago, is marketing the illustrated Model 106 console combination. This combines model No. 6 and model No. 100. The receiver is of the six-tube type having impedance coupling and one dial control. The intended retail price is \$175. Other models are 16, with an intended retail price of \$150, which includes a built-in loud speaker; model 116, with intended retail price of \$210, this is a console model with built-in speaker; model 5, which is a five-tube table receiver, with an intended retail price of \$85; and model 100, which is a console base or table, with an intended retail price of \$60.



Laminated Wood Cone Reproducer

Radio Retailing, October, 1926

The Farrand Manufacturing Company, Incorporated, 11 Court Street, Long Island City, N. Y., is manufacturing the illustrated "Senior" cone type reproducer which is 17 in. in diameter. This reproducer is equipped with an entirely new driving unit and has a walnut laminated wood cone. It stands 22 in. high and would carry a maximum plate voltage of 250 volts. The intended retail price is \$32.50.

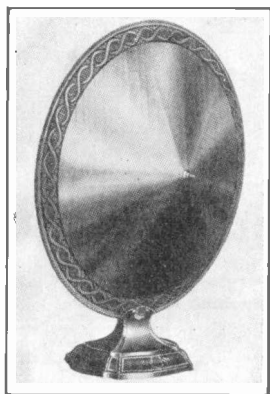

Five-Tube Console Receivers

Radio Retailing, October, 1926

The illustrated "Princess" model is one of the five new console type receivers being made by A. H. Grebe & Company, Inc., 109 West 57th Street, New York. This incorporates the five-tube synchronous receiver. The cabinet is mahogany and has overall dimensions of 24½ in. x 14 in. x 40½ in. It is designed for external speaker use and the intended price is \$220. The "Puritan" model is also of mahogany, designed for external speaker use and overall dimensions of 25 in. x 14½ in. x 39½ in. The intended retail price is \$195. The "Lancaster" is designed for external speaker use and includes a large chamber for the housing of all batteries. The intended retail price is \$260. The "Andalusia" is made to house all batteries and the overall dimensions are 41½ in. x 15½ in. x 41½ in. The intended retail price for the plain finish \$320, with polychrome finish, \$340. The last, the "Renaissance" model is of walnut, elaborately carved. It contains three loud speakers, syn-



chronized, and provision is made for housing all batteries. Overall dimensions are 42½ in. x 21 in. x 50 in. Intended retail price, \$1,400.

Spray and Ventilation Cap for Unipower Cells

Radio Retailing, October, 1926

The Gould Storage Battery Company, Inc., 250 Park Avenue, New York City,

is manufacturing the AC-6 Unipower unit with a new improved ventilation cap for the cells, which prevents spray. The company offers to ship enough caps to each dealer who sold Unipowers last year to permit these installations to be brought up to date. No charge will be made for this service.

Six-Tube, Two-Dial Control Receiver

Radio Retailing, October, 1926

Model 70, "Oriole" receiver, manufactured by the W-K Electric Company, 89 Middle Street, Kenosha, Wisconsin, employs two stages of radio frequency in a circuit which, according to its manufacturer, uses no "lossers" to prevent excess oscillation, thus improving reception. The radio frequency coils are wound of Litz, or insulated stranded wire, and high voltage is excluded from the primaries, which is said to reduce internal noises. Equipped with taps to suit various antennas, and two tuning controls. Intended retail price, \$125.

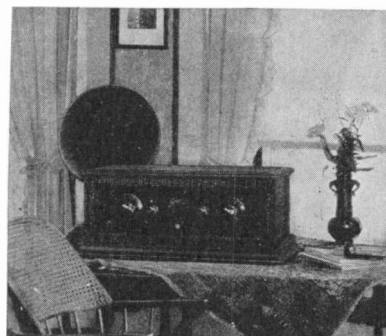

What's New in Radio and Where to Buy It—

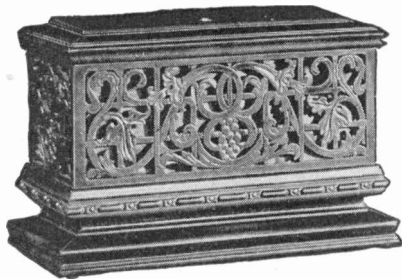

Non-Directional Reproducer in Art Cabinet

Radio Retailing, October, 1926

The "Patrician," a loud speaker manufactured by the Amplion Corporation of America, 280 Madison Avenue, New York City, is the latest development of the company in air-column type reproducers. The model combines the advantages of a long air column with the compactness so necessary in the sale of reproducers, employing a column 48 in. long constructed in such a manner that the speaker is but 80 in. x 12 in. x 9 in. overall. The cabinet work is of carved mahogany and the unit has an intended retail price of \$45.

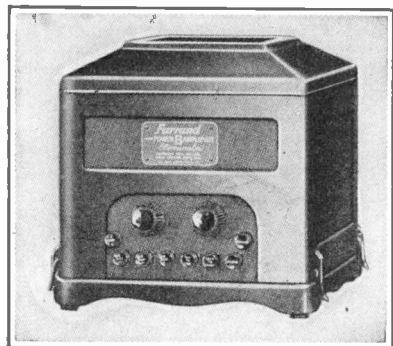

B Eliminator and Power Amplifier for A.C. Use

Radio Retailing, October, 1926

One stage of power amplification and suitable B voltages for the radio receiver is available in the new Farrand Power B Amplifier, made by the Farrand Manufacturing Company, Inc., Long Island, N. Y. The unit employs two half-wave rectifying tubes and one power amplifier, delivering plate voltages up to 400 volts when connected with a 110-volt 60-cycle current supply. Variable resistances provided control the detector and radio frequency plate potentials and the unit when used in connection with a good receiver is said to reproduce exactly the tone and volume of a large orchestra. It is especially designed for use with a cone speaker, though horn types may be used. Encased in a pressed steel case, less tubes, the combination retails at \$62.50.

Dial Light and Cigar Lighter Combination

Radio Retailing, October, 1926

The Starbuck Manufacturing Company, Meriden, Conn., manufactures a combination cigar lighter and panel light for the radio receiver, called the "Dial-Liter." The article is finished in statuary bronze, equipped with a heavily weighted base with cushion feet and is mounted on a swivel support which permits the lamp shade and cigar lighter to be turned in any direction. Intended retail price, with 6 ft. of lamp cord and wall plug, \$10. The lamp itself is also furnished separately for \$5.

Device for Minimizing Station Interference

Radio Retailing, October, 1926

The "Filtrola," manufactured by the All-American Radio Corporation, 4201 Belmont Avenue, Chicago, consists of a rejection and absorption circuit, tuned by means of the two dials shown in the illustration. Use of this device is said to greatly improve the selectivity of a radio receiver. It is connected between the antenna and ground and the radio receiver and employs no tubes or batteries. Furnished in a shielded walnut case with an intended retail price of \$15.

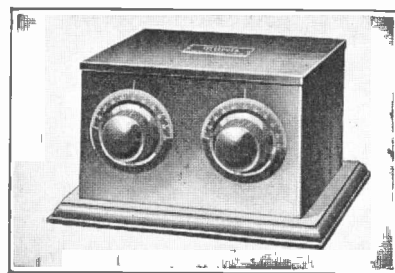

Electrolytic Charger with 2 1/2 Ampere Rate

Radio Retailing, October, 1926

The "Silite Homecharger," manufactured by the Kodol Radio Corporation, Cincinnati, Ohio, employs a metallic glass element which is said to resist battery acid. The charger is designed for use on 110-120 volt a.c. lines 50-60 cycle, but is also obtainable for 25, 30 and 40 cycle use. It is silent in operation, employs no moving parts and is of the automatic regulation type. Equipped with connection clips and cable and plug, mounted in a pressed steel case finished in dark brown enamel, the charger has an intended retail price of \$19.50.

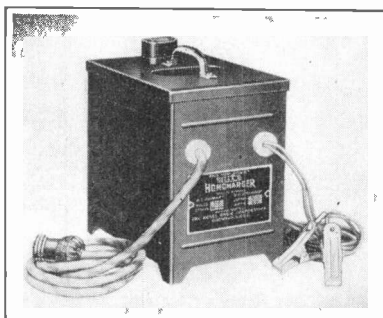

Belden Antenna Kit

Radio Retailing, October, 1926

A complete antenna kit, designed to provide every requirement for a durable outside antenna and ground, is being marketed by the Belden Manufacturing Company, 2300 South Western Ave., Chicago. The kit contains: 100 ft. stranded Beldenametal aerial; 50 ft. lead-in and ground wire; 25 ft. flexible hookup wire; 2 Fedco blue insulators; 3 nail-on knobs; 1 Fahnestock 15 in. lead-in strip; 1 Fahnestock ground clamp; 1 Brach storm king arrester; 2 No. 7 galvanized screw eyes; 2 1 1/4 in. No. 8 rd. hd. iron screws; 12 2-point Blake insulated staples; and 1 instruction sheet. Intended retail price, \$5.00.

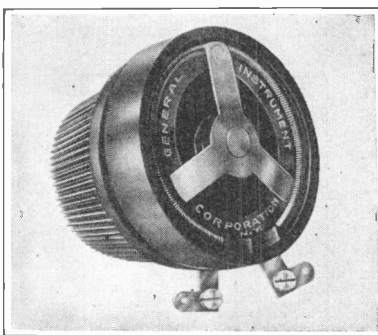

Rheostat with Metal Core

Radio Retailing, October, 1926

A metal core, preventing burn-out of the resistance element by dissipating heat, is the feature of the new Little Giant rheostat manufactured by the General Instrument Corporation, 423 Broome Street, New York City. The core also holds the resistance unit firmly in place, preventing it from introducing noises in the receiving set. The rheostat is small in size and is equipped for single hole mounting. Intended retail price, in values from 6 to 30 ohms, 75c. to 85c.

Hard Rubber Panel with Crackle Surface

Radio Retailing, October, 1926

A new "crackle" finished hard rubber panel, manufactured by the American Hard Rubber Company, 11 Mercer Street, somewhat resembles a coarse-grain high-grade leather, giving a very attractive appearance to the panel, yet preventing finger marks and scratches from showing as on highly polished panels. One side of the panel, known as the Ace, is finished in this new process, the other being the conventional glazed surface. It is made in 1/8 in. thicknesses in all standard sizes in either black or mahogany grain, and may be engraved in the usual manner.

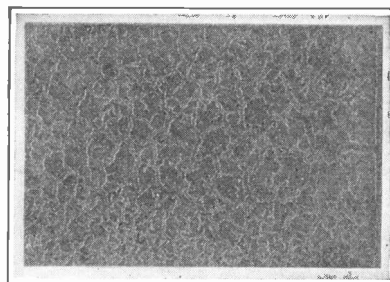

News of Latest Products Gathered by the Editors



B Battery Eliminator

Radio Retailing, October, 1926

The "Popular B," a battery eliminator manufactured by the Webster Company, 3504 East Lake Street, Chicago, Ill., is mounted on a metal base and all wiring is concealed. The eliminator will furnish up to 135 volts with a variable intermediate supply from 20-120 volts and detector voltages from 5 to 75 volts. Full wave-rectification is accomplished by means of a Raytheon tube and voltages are controlled by means of wire wound resistances. Up to 35 milliamp. may be drawn without appreciable voltage drop. Complete with connection cord and plug, fully wired, the intended retail price is \$35.

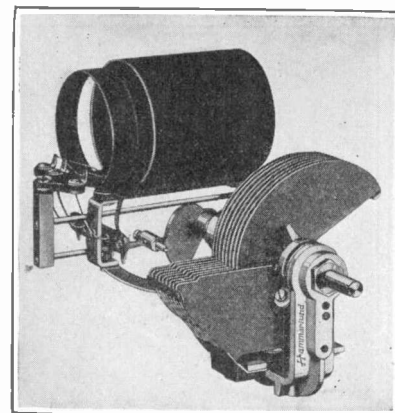

Tuning Unit with Automatic Primary Coupling

Radio Retailing, October, 1926

The "Auto-Coupling" tuning unit, made by the Hammarlund Manufacturing Company, Inc., 424 W. 33rd Street, New York City, consists of a .00035 variable condenser and a tuning coil covering broadcast frequencies. The device is provided with a cam arrangement which mechanically varies the coupling between the primary or plate coil and the secondary as the condenser is varied, thus providing, according to the company, maximum amplification on all frequencies and preventing self-oscillation on low-wavelengths when used as a radio frequency unit. The condenser is of straight line frequency construction, the coils are space wound on celluloid and the entire unit is equipped with a metal shield which encloses the tuning stage, including the tube and its socket. Coils and condensers may be obtained separately. Intended retail price, Midline condenser, \$4.75. Auto-couple coil including cam bracket, \$3.50, Aluminum shield, \$2. The complete assembly lists at \$10.25.

Electrolytic Trickle Charger with Silite Element

Radio Retailing, October, 1926

"Silite," a metallic glass rectifying element which is said successfully to resist the erosive effects of electrolyte used in a battery charger, forms the positive element in a new trickle charger, called the Silite trickle charger, manufactured by the Kodol Radio Corporation, Cincinnati, Ohio. The charger may be connected to the receiver while it is in operation, maintaining a steady predetermined charge rate and is entirely noiseless in operation. The charge rate may be varied from .6 to .75 amp. per hour and can be used in connection with either 4 or 6 volt storage batteries. The unit uses an ordinary battery acid solution and requires no attention other than the addition of distilled water from time to time. It is housed in a compact pressed steel case

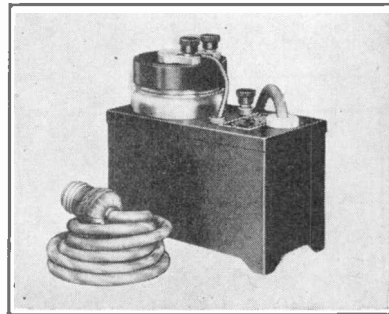

finished in dark brown enamel and comes equipped with an attachment cord and plug. Operates on 110-120 volt, 50-60 cycle lines and is also obtainable for 25, 30 and 40 cycles. Intended retail price, \$10.



Quarter Ampere Detector Tube

Radio Retailing, October, 1926

The "B-6" vacuum tube designed and manufactured by the Donle-Bristol Corporation, Meriden, Conn., is said to greatly increase signal strength and tone quality, especially on distant stations when substituted for the conventional hard type tube as a detector. The tube draws $\frac{1}{4}$ amp. normally, at 5 volts and may be used with plate voltages from 22 $\frac{1}{2}$ to 90. No special circuit changes are necessary, merely plug it into the detector socket and make the proper voltage and grid leak adjustments. Intended retail price, \$5.

B and C Battery Eliminator with Safety Switch

Radio Retailing, October, 1926

A safety switch, mounted on the door of the new Model 16 B and C battery eliminator manufactured by the Freed-Eisemann Radio Corporation, Brooklyn, N. Y., is the feature of the new instrument. This switch automatically cuts off the power supply when the door is opened for access to the interior of the eliminator for any purpose, protecting the user against shock. The unit is equipped to supply B battery voltage up to 135 volts with a tap for detector tubes and also has taps from which 4 $\frac{1}{2}$, 9 and 27 volts are obtainable for use as C battery bias. The high C battery voltage available is especially designed to accommodate the new power tubes. A voltage regulator tube is used to maintain steady plate and bias potentials regardless of the load placed on the eliminator or the line voltage.

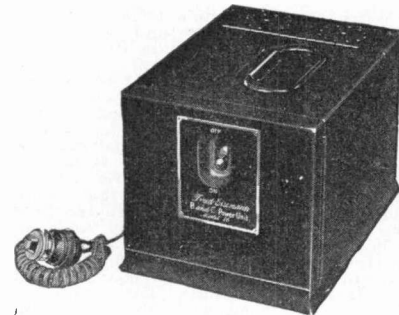

Jewel Case Radio Reproducer

Radio Retailing, October, 1926

A radio reproducer mounted in an ornate Jewel Case is the latest product of the Borkman Radio Corporation, Salt Lake City, Utah. Model 21, illustrated, contains the Velvet unit, designed by the company with two stylus bars, which is said to greatly improve reproduction over the complete range and prevent blasting. The unit is not adjustable, and it is said to be impervious to ordinary moisture.

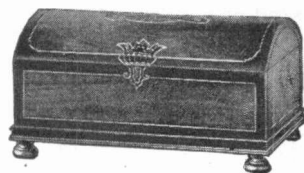

Tube Socket with Low Grid-Plate Capacity

Radio Retailing, October, 1926

The method of construction of the Air-gap vacuum tube socket, shown in the illustration, permits the grid and plate prongs to be separated by an air space. According to the manufacturer, the Air-gap Products Company, 9-13 Campbell Street, Newark, N. J., this construction effectively reduces grid-plate capacity in the socket itself, improving reception. The socket is of Bakelite and the contacts are of phosphor bronze of side-wiping construction. The socket is made in styles to accommodate the UX or the UV type tube base. Intended retail price, UX type, 60c; UV, 75c.

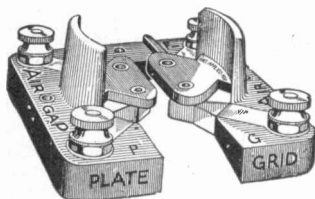

What's New in Radio and Where to Buy It—



Device Uses Radio Speaker and Audio to Play Records

Radio Retailing, October, 1926

The "Bristophon" phonograph reproducer, manufactured by the Bristol Company, Waterbury, Conn., replaces the tone arm and reproducer of a phonograph, substituting electrical pickup and the audio amplification of a radio receiver in its stead. The unit itself consists of an enclosed microphone, a tone arm which automatically shuts off the current when placed upon its hook and leads which are to be connected to the reproducer. A small external battery is necessary though the radio loudspeaker may be used either with or without power amplification. Intended retail price, as illustrated, \$15. According to the manufacturer this unit is capable of delivering volume equal to that of a small orchestra, while retailing exceptional tone qualities. When used in connection with the new electrical process records reproduction is said to equal that of the new type phonographs. A volume control is provided. Intended retail price, \$45.

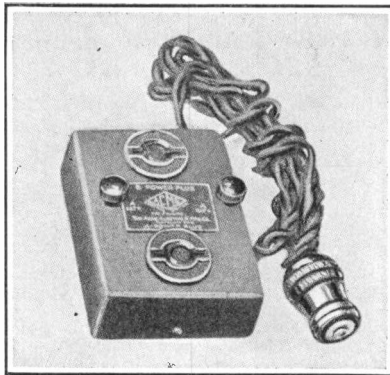

Charger and Eliminator Control Switch

Radio Retailing, October, 1926

When connected to a trickle charger, B battery eliminator and the house light line a new radio control switch manufactured by the Acme Electric & Manufacturing Company, 1438 Hamilton Avenue, Cleveland, O., automatically controls the entire installation. When the receiver is in use the trickle charger is automatically disconnected from the A battery and the B battery eliminator is placed in operation. When the receiver is turned off, the trickle charger is connected with both the light line and the storage battery and the B battery eliminator disconnected from the line and the set. According to the manufacturer, the current consumed by the device is negligible. A connection cable is furnished with the unit. Intended retail price, \$5.

Power Amplifier and B Eliminator Kit

Radio Retailing, October, 1926

The S-M Power Pack kit, manufactured by Silver-Marshall, Inc., 864 West Jackson Boulevard, Chicago, Ill., contains the principal units necessary in the construction of a single-stage power amplifier and B battery eliminator operating from the a.c. electric light lines. The S-M kit consists of a No. 220 audio transformer, a No. 221 output transformer, No. 330 power transformer supplying up to 300 volts, No. 331 Unichoke, No. 332 bank of blocking and filter condensers and two No. 511 tube sockets. The balance of the apparatus, such as the variable resistances, Raytheon tube, power tube, panel, jacks, binding posts, etc., may be secured from other manufacturers.



Oval Cone Speaker

Radio Retailing, October, 1926

Radio Foundation Inc., 25 W. Broadway, N. Y. has introduced the illustrated "Balanced Oval" cone speaker. It is a single cone with an attractive front grill done in old gold. The long axis measures 20 in. and the speaker stands 15 in. high. It has been found that a small cone reproduces high notes only and a large cone the low notes. By using an oval cone equal distribution is obtained. Special brown decorated paper is used. The unit will stand under 450 volts and the intended retail price of this Renaissance model is \$25.

Solenoid Coils Wound on Hard Rubber

Radio Retailing, October, 1926

The Allen D. Cardwell Manufacturing Corporation, 81 Prospect Street, Brooklyn, N. Y., is now making the illustrated single layer solenoid coil which is wound on a hard rubber form. The use of comparatively fine wire reduces the grid-plate, as well as the distributed capacity of the windings. This, according to the manufacturer, decidedly increases the efficiency of the transformer. The terminals are so arranged that the inductors can be used for almost any of the popular circuits. Center taps on the windings allow the tuning of one-half the coil only, to reach shorter wave lengths than can be reached with a whole coil. Overall dimensions are 2 in. x 2 in. x 2 in. When tuned by a condenser of approximately 340 mfd. maximum capacity, these coils cover the entire broadcast wave band. Intended retail price type 196 A, \$1.50. For 2 coils \$2.75 and for a set of 3, \$4.

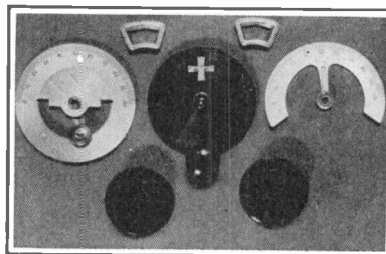
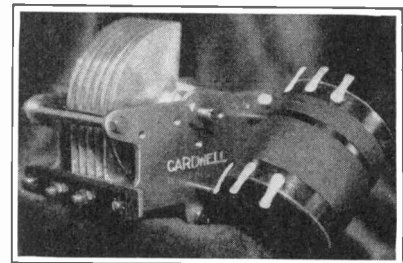

Vernier Dial With 6 to 1 Ratio

Radio Retailing, October, 1926

The "White Cross Dialler," a 360 degree vernier dial with approximately a 6 to 1 tuning ratio, is manufactured by W. F. Loughman, Inc., 161 High Street, Boston. The dial is made of Bakelite with a "rosette" finish. According to the manufacturer, knurled disc and washer construction prevents backlash and insures smooth operation. The scale may be reversed so that it reads either clockwise or counter-clockwise and space is provided for the logging of stations. Intended retail price, \$1.25. Similar dials are available for bakelite construction equipped with metal indicators which may be mounted on the panel. Shielded dials are also available for \$2.

News of Latest Products Gathered by the Editors

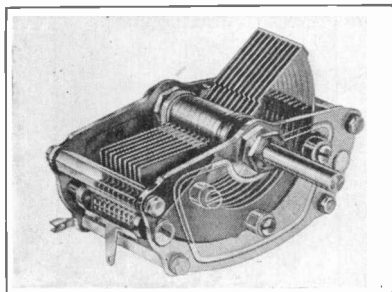

Variable Condenser with Straight-Line Tuning

Radio Retailing, October, 1926

The "Metralign" variable condenser, manufactured by the General Instrument Corporation, 423 Broome Street, New York City, embodies stator design that affords combination straight line frequency, capacity and wavelength tuning characteristics. Ball bearings assure smooth operation of the rotor element and the rugged construction of the unit insures permanent alignment. The condenser is made either in brass or in aluminum. Type 90, the aluminum condenser has an intended retail price of \$3.25 to \$4.50, depending on maximum capacity desired, while type 91, the brass construction job has an intended retail price of from \$4.25 to \$5.50.

Heavy Duty B Battery Eliminator

Radio Retailing, October, 1926

The Farrand B eliminator, manufactured by the Farrand Manufacturing Company, Inc., Long Island City, N. Y., is designed for use with multi-tube receivers and will rectify and filter more than 75 milliamp without perceptible voltage drop. Taps are provided so that detector voltages may be varied from 15 to 70 volts, radio frequency tubes may be given 60 to 100 volts plate potential and last audio stage from 135 volts to 200 volts, sufficient to operate a power tube. One rectifying tube of the UX-213 type is employed in a full-wave circuit utilizing both sides of the a.c. wave. The eliminator operates on 110 volts, 60 cycles and is encased in a bronzed steel case. Intended retail price, less tube, \$48.50.

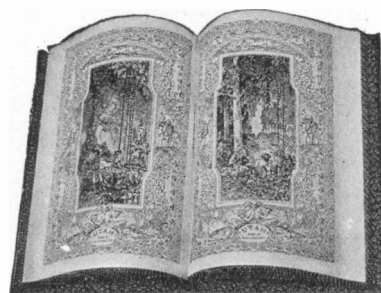
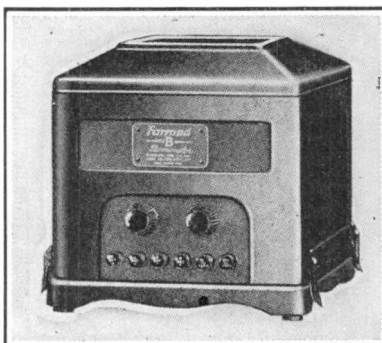

Book Type Loudspeaker

Radio Retailing, October, 1926

The illustrated speaker is the new "book" type unit manufactured by the Utah Radio Products Company of Salt Lake City, Utah. It is designed to represent an open book, its pages finished in gold, the binding in morocco leatherette. The speaker may be placed in an upright position by means of an easel provided or may be suspended on the wall as a picture. A new principle of sound reproduction fits in well with the design, the driving unit being applied to the edge of the curved membrane formed by the open pages. The speaker is 17½ in. long by 13½ in. wide and has an intended retail price of \$19.

B Eliminator with Protective Fuse

Radio Retailing, October, 1926

The "Precision B Power Unit," manufactured by the Precision Electric Manufacturing Corporation, 717 East 9th Street, Los Angeles, Cal., is equipped with a protective fuse which protects the tubes of a radio receiver to which it has been connected if wires are accidentally crossed or excessive voltage applied. The unit does not employ chemicals or tubes in any form, operating from 110-120-volt, 50 or 60-cycle current. Model L supplies voltages up to 90. Model M is equipped with a voltage tap supplying 135-volts at currents sufficient to operate multi-tube receivers. Intended retail price, Model L, \$32.50, Model M, \$35.

Porcelain Socket for U X Type Tubes

Radio Retailing, October, 1926

The Hart & Hegeman Manufacturing Company, 342 Capitol Avenue, Hartford, Conn., is now making the illustrated porcelain socket designed for use with UX type tube and known as W-188. The socket is 2 in. square and is equipped with both binding posts and soldering lugs. The spring contact clips are very sturdy, insuring positive grip at all times. The proper terminal markings are molded in the porcelain which has a glazed finish. In the center is a small rubber insert which prevents the tube from being jammed against the porcelain. Two screws for mounting come with each socket. Intended retail price is 50c. This type of socket may also be had in red bakelite and the intended retail price of this type, known as W-187, is 60c.

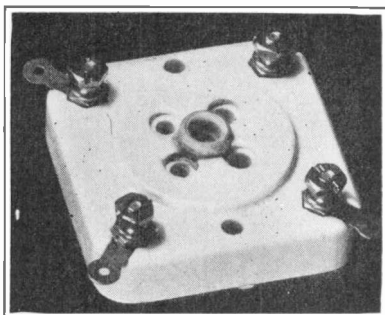

Extension Cord Connector

Radio Retailing, October, 1926

A small extension cord connector, manufactured by the Frank W. Morse Company, 289-291 Congress Street, Boston, Mass., called the "Morse Eureka," is equipped with small tip jacks. Any number of loudspeaker extension cords may be connected in series through the use of these connectors and the speaker may be moved from room to room without unscrewing caps, soldering wires or tightening thumb-screws. The unit is 1½ in. long by ¾ in. wide.

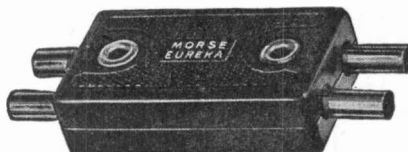

Lamp-Socket Antenna Plug

Radio Retailing, October, 1926

The Leslie F. Muter Company, 76th and Greenwood Avenues, Chicago, manufactures the illustrated plug which is designed to serve as an antenna when inserted in a house lighting socket. The unit is made of moulded Bakelite and does not consume any current. Length 2½ in., with an intended retail price of 60c. packed in individual boxes.

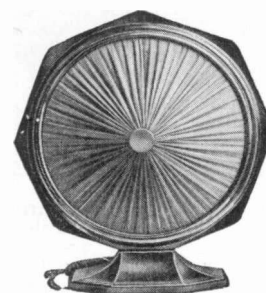
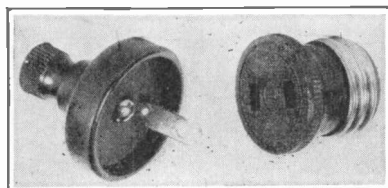

Cone Speaker with Protected Diaphragm

Radio Retailing, October, 1926

An ornamental grille protects the back of the illustrated cone speaker, the "Sonochorde," manufactured by the Boudette Manufacturing Company of Chelsea, Mass., from injury. The cone stands 18 inches high and is 16 inches in diameter. The frame, according to the manufacturer is practically unbreakable and is finished in mahogany. The cone itself is formed of wine-colored silk drawn to the apex and driving arm in attractive folds. The speaker is manufactured in table form, with a piano-lamp pedestal and also as a hanging wall model. Intended retail price, pedestal model \$35; wall model \$25; and table model, as illustrated, \$25.

What's New in Radio and Where to Buy It—



Direct Reading Tube Tester

Radio Retailing, October, 1926

The illustrated direct reading tube tester is designed primarily for use of dealers desirous of testing tubes in quantity, by the Hoyt Electrical Instrument Company, Penacook, N. H. Model 200 is equipped with a galvanometer employing a $4\frac{1}{2}$ in. mirror-backed scale and a direct-reading scale. No computations are necessary. In addition this model is equipped with suitable shunts and resistances so that it may be used for making other tests. The following ranges are available: 0-5 0-50 0-500 milliamp., and 0-5 amp. In the voltmeter scale, 0-10 volts, 2-000 ohms resistance, 0-50 volts, 10,000 ohms resistance, and 0-500 volts with 100,000 ohms resistance. It is equipped with mahogany carrying case.

Moulded Bakelite Vernier Dial

Radio Retailing, October, 1926

The Mydar Radio Company, 9 Campbell Street, Newark, N. J., makers of "Accuratune Products," is manufacturing the illustrated moulded bakelite dial. The dial itself is well proportioned, with embellishments on a matted background. Two windows are provided, one showing a graduated scale divided into units, and the other providing space where stations may be logged. The numbers are raised in black against a silver background. The dial is designed to be equipped with a vernier mechanism which will give a ratio of over 200 to 1 if so desired. The overall dimensions are 4 in. wide and $5\frac{1}{2}$ in. high. Each dial comes complete with all screws necessary for mounting, and also a miniature screw driver.

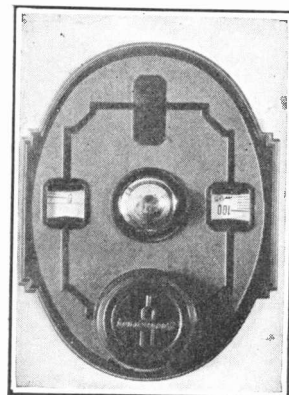

Cone Type Reproducer

Radio Retailing, October, 1926

Illustrated is a cone type reproducer being made by the Plaza Music Company, 10 West 20th Street, New York City. This is $15\frac{1}{2}$ in. in diameter, and has an overall height of 17 in. It is equipped with a special fabric diaphragm which, according to the manufacturer, cannot possibly buckle or warp. It is finished in bronze, and has an intended retail price of \$15.



Cone Speaker with Carved Grille

Radio Retailing, October, 1926

The "Vogue" cone speaker manufactured by Richard T. Davis, Inc., 5252 Broadway, Chicago, Ill., is equipped with a carved grille and is finished in brown crackle trimmed with gold. The speaker, which employs a principal of tone chamber extension said to insure clarity of reproduction, stands 20 in. high. It is equipped with a base $7\frac{1}{2}$ in. wide.

Straight Shank Drills

Radio Retailing, October, 1926

The Morse Twist Drill and Machine Company, New Bedford, Mass., is manufacturing a set of straight shank drills and taps for radio use. The set consists of one drill each of No. 5, 10, 16, 20, 29, 36 and 45 and also one plug tap each No. 4³⁰, 6³⁰, 8³⁰, 10³⁰, 12³⁰, 14³⁰. These are the sizes most needed when building or repairing a radio set. Intended retail price per set is \$2.

A Power Unit

Radio Retailing, October, 1926

The Willard Storage Battery Company, Cleveland, is making an A power unit contained in a single case as shown in the illustration. This incorporates an A battery, a small bulb-type rectifier, which charger is designed for either a 2 amp. or trickle charge, and also so arranged that it can charge storage B batteries. The battery unit is in a glass case and has a capacity of 40 amps. The charging unit is separated from the battery by a double thickness of steel to keep heat from the battery. Switches on the front of the unit are so arranged that the charger works continuously at $\frac{1}{2}$ amp. except when the set is in operation. Three differently colored balls visible through a window in the unit show the condition of the charge of the battery at all times. Both 6- and 4- volt sizes are made, which have the same overall dimensions of $9\frac{1}{2}$ in. x $9\frac{1}{2}$ in. x $9\frac{1}{2}$ in.

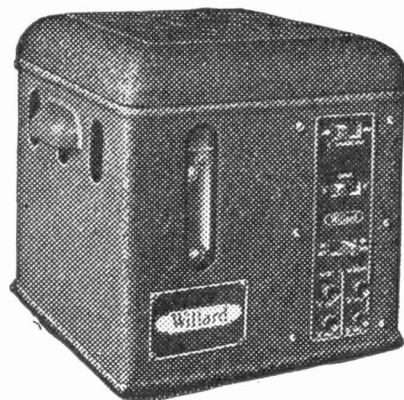

High Mu Tube for Use as Audio Amplifier

Radio Retailing, October, 1926

"G S X Hy-Mu" vacuum tube, manufactured by the Gold Seal Electrical Company, Inc., 250 Park Avenue, New York City, is designed for use as an audio amplifier in connection with resistance coupling. This new tube has an amplification factor of 20 as against 7 or 8 in the ordinary tube, thus, according to the company providing better results with increased volume. Draws $\frac{1}{2}$ amp. at 5 volts. Intended retail price, \$4.

News of Latest Products Gathered by the Editors

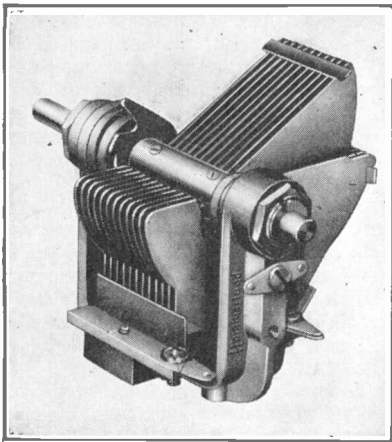

Variable Condenser of New Characteristic

Radio Retailing, October, 1926

The "Midline" condenser is being made by the Hammarlund Manufacturing Company, Inc., 424 West 33d Street, New York. This combines the advantages of the straight line capacity, the straight line wave length and straight line frequency types in one condenser applying their characteristics at the points on dial where they are most valuable. Heavy non-corroding brass plates held in position by tie bars, an exterior brake for holding the rotor in position, one hole mounting with anchoring screw, clock spring pig tail rotor connection, a full ball bearing at one end of the shaft and a ball bearing end thrust at the other, complete the specifications. In addition, a full floating axle has been provided which supports no weight and may be entirely removed in order that a longer axle for connecting several condensers together may be substituted. It requires only 4 in. of panel space when open and is made in the following sizes: .0005, .000375, .00037 mfd., with intended retail prices of \$5.00, \$4.75, and \$4.65.

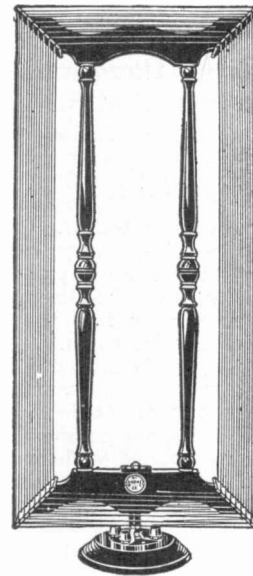

Loop with Walnut Frame

Radio Retailing, October, 1926

A recent addition to the line of radio loops manufactured by the Bodine Electric Company, 2244 W. Ohio St., Chicago, is a De Luxe loop, measuring 12 in. x 26 in. The frame is solid walnut, hand-rubbed. The winding is a braided silk-covered wire wound on bakelite spreaders. A tap is brought out from the center of the winding, and terminals are connected through a three-contact, low-capacity plug and jack to binding posts on the base. This feature permits the jack to be easily removed from the base of the loop, and mounted in the cover of the radio cabinet, so that the loop may be plugged directly into the radio cabinet without connecting wires. Intended retail price, \$12.

Resistive Coupling Amplifier Unit

Radio Retailing, October, 1926

The illustration shows a coupling unit, manufactured by the Amsco Products, Broome & Lafayette Streets, N. Y., for use in resistive coupled audio frequency amplifiers. The binding posts are so placed that the "couplers" are lined up before the sockets, rather than between them. Connections are made to the grid and plate posts of the sockets by soldering directly lug to lug. In addition to the constructional advantage, this arrangement results in the compactness cutting 3 in. from the average panel. *A

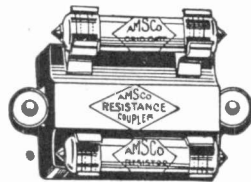

coupling condenser is molded into the bakelite base. Large prongs clip the resistors into a permanent mechanical and electrical contact. The resistive coupler, with the resistors, has an intended retail price of \$2.45.

Air-Cooled Rheostat

Radio Retailing, October, 1926

An efficient low-cost resistance-unit is manufactured by De Jur Products Company, 199 Lafayette Street, New York. It operates without any noticeable temperature rise at constant co-efficient of conductivity. Filament voltage can be built up slowly and held at right point for most efficient operation. Sliding contact arm is adjustable and resistance is exposed on all sides. Bakelite Knob and one hole mount.

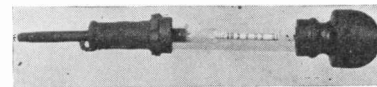
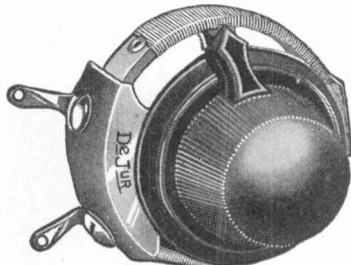

An Unbreakable Hydrometer

Radio Retailing, October, 1926

The Break-Not hydrometer is a product of A. Edelmann & Company, 2332 Logan Blvd., Chicago. It is equipped with a very heavy red para rubber bulb with a large capacity. The float is double tested for accuracy and printed in three colors so that it can easily be read at a distance. Small glass projections prevent the float from sticking to the sides. A large rubber tip protects the float against breakage and the use of very little glass in the main part of the hydrometer eliminates much danger from breakage. The tip is also so constructed that the hydrometer may be hung up on a nail when not in use. Intended retail price \$1.

Automatic Control Switch for Charger and Eliminator

Radio Retailing, October, 1926

The illustrated "Controlit" made by L. S. Brach Manufacturing Company, Newark, N. J., is designed to take care of all switching connections on the trickle charger and B eliminator, throwing the control on the A battery switch in the set itself. All connections are permanent. When the set is turned on, the trickle charger is turned off and the B battery eliminator turned on. Upon turning the set off, the operation is reversed. The switch itself consists of a relay in the A battery circuit which

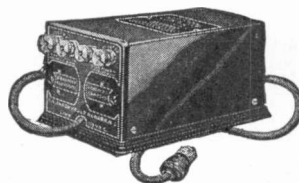

operates two different sets of contacts, one for the B eliminator, the other for the trickle charger. This device, known as Model R-U, may be used on sets employing either four or six volt batteries and has an intended retail price of \$6.

A and B Battery Replacement Fuses

Radio Retailing, October, 1926

Fuses for both A and B-Battery circuits have been placed on the market by the Belden Manufacturing Company, 2300 South Western Ave., Chicago, for use in their Fused Battery Cord. These fuses are so designed that A and B-Battery fuses can not be interchanged.

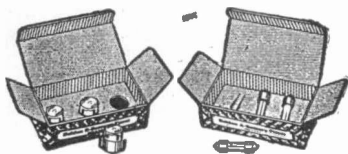

201-A Type Tube with Isolantite Base

Radio Retailing, October, 1926

The SX 201-A vacuum tube manufactured by the Supertron Manufacturing Company, Inc., Hoboken, N. J., is equipped with a base of Isolantite. The tube elements are also supported on a bridge of this material which is said to be electrically and mechanically superior to other insulating substances. The tube is equipped with a UX type base. Filament voltage specified, 5, drawing 1/2 amp. Normal plate voltage, when used as an amplifier, 112 volts. The amplification constant of the tube is about 8.17, plate impedance, 10070 and mutual conductance, 810.4. Intended retail price \$2.

What the Trade Is Talking About

Third Radio Banquet Proves Unprecedented Success

The Third Annual Radio Industries Banquet, held September 15 at the Hotel Astor, New York City, will undoubtedly go down in history as a model for similar events to follow. Over 2000 diners, representing every branch of radio and most of the companies in the trade, filled the grand ballroom of the hotel and overflowed into the balcony and an adjoining ballroom.

Every credit is due the committee for the efficient way the thousands of details connected with the banquet were handled and the even manner in which the program went off without a hitch. General Charles G. Dawes, vice-president of the United States, was the guest of honor and his address was broadcast by 33 stations, the largest hook-up so far accomplished.

Gen. Dawes took advantage of the opportunity thus offered by the vast audience, estimated at 20,000,000, which listened to the banquet, to continue his campaign for a revision of the Senate rules in order to expedite legislation.

The program of entertainment, which was prepared and presented under the supervision of Major J. Andrew White, was one of the most outstanding events since broadcasting began. Not only was it prepared with "ear-value" for the listening audience, but also with "eye-

value" for the audience present in the ballroom. On behalf of the committee, Richard W. Lawrence of New York presented a scroll to Major White extending him the gratitude and appreciation of the committee. Paul B. Klugh, who was toastmaster, also received an appreciation from the committee, in the form of a silver gavel presented by Senator Jimmy Wadsworth of New York.

At the guest table, in addition to Vice-President Dawes, were Owen D. Young, General James G. Harbord, Senator James Wadsworth, A. Atwater Kent, David Sarnoff, Arthur T. Haugh, L. B. F. Raycroft, Major Herbert Frost, Powel Crosley, Jr., John H. Miller, Harry La Mertha, Walter A. Russ, Geo. L. Patterson, Fred Yahr, L. S. Baker, Major Edward Bowes, Earle C. Anthony, U. G. Herrmann, Mrs. Lotta Harrauff, "Mrs. Radio;" Donald B. MacMillan, Major J. Andrew White, Senator C. C. Dill, Paul B. Klugh, toastmaster; A. H. Grebe, Miss Norma D. Smallwood, "Miss America;" E. F. McDonald, Richard W. Lawrence, W. E. Harkness, J. D. R. Freed, H. A. Bellows, Harold J. Wrape, Henry M. Shaw, B. W. Ruark, R. W. DeMott, Irwin Kurtz, D. H. Kelly, A. M. Edwards, J. A. White, L. A. Nixon.

The entertainment included such popular air-stars as Mary Lewis, of the Metropolitan Opera Company, Reinald

Werrenrath, the Happiness Boys, the Victor Salon Orchestra, Sam and Henry, the WEA Combined Opera Companies, Eveready Mixed Quartet, Victor Revelers, Royal Typewriter Orchestra with the Royal Hero and Heroine, Markel's Society Orchestra, Ipana Troubadours, Clicquot Club Eskimos, A. and P. Gypsies, Premier Male Quartet, the Capitol Family with Major Bowes, Vaughn de Leath, Phil Cook, and Ernie Golden and his orchestra. After the entertainment, which lasted six hours, the Clicquot Club Eskimos played music for dancing.

The radio industries banquet each year is conducted by a committee composed of representatives of the following organizations:

National Association of Broadcasters, Radio Manufacturers Association, Radio Section, National Electrical Manufacturers' Association, Federated Radio Trade Associations, Electrical Supply Jobbers Association, Jobbers Radio Association, Independent Radio Manufacturers, Inc., Radio Magazine Publishers Association, Talking Machine and Radio Men, Inc., Northwest Radio Trade Association, Wisconsin Radio Trade Association, Radio Trade Association of Michigan, Saint Louis Trade Association, Electric Club of Chicago, National Radio Trade Association, National Battery Manufacturers Association and Buffalo Radio Trades Association.

"All the Birds and Beasts Were There"—



Two thousand—count 'em—2,000 ladies and gentlemen of the radio industry crowded into the main ballroom of the Hotel Astor, New York City, hung by their teeth from the balcony and overflowed into a second ballroom to attend the third annual Radio Industries banquet held September

15, and witness an entertainment by what was undoubtedly the greatest aggregation of talent ever gathered together under one tent. What with Vice-President Dawes in the chair of honor, the entertainment going on continually on the stage and trying to keep all the bottles under the table,

The banquet committee was composed of the following: Paul B. Klugh, general chairman; Major J. Andrew White, master of ceremonies; Alfred H. Grebe, treasurer, and L. A. Nixon, secretary. It was divided into these sub-committees:

Finance—Powel Crosley, Jr., Chairman, Frank W. Elliott, M. C. Rypinski, Harry Bradley, Richard Gimbel, Frank Reichman, F. M. Rosenfeld, Hugh H. Eby, Townner K. Webster, H. B. Richmond, Laurence Gardner, H. A. Bellows.

Publicity—E. F. McDonald, Chairman, Eric Palmer, Vice-Chairman, Stephen L. Coles, E. L. Bragdon, Leonard Parker, D. H. Kelly, Jack Binns, W. A. Schilling, Fred E. Baer, Byron Foster, William S. Hedges.

Program—David Sarnoff, Chairman, E. E. Schumacher, Chandos M. Sweet, Gerard Chatfield, T. R. Deutsch, Jack Adams, John M. Reddell, Walter G. Douglass, Paul Stacy, Max Landay, R. B. Rose.

Broadcasting—W. E. Harkness, Chairman, C. B. Popenoe, Earle C. Anthony, George Schubel, William H. Heinz, Christie Bohnsack, Ted Nelson, Major N. B. Levinson, J. D. Barnett, George F. George, H. Goldman, B. W. Ruark.

Speakers—Major Herbert H. Frost, Chairman, John Shephard III, Harold J. Wrape, Irwin Kurtz, L. G. Baldwin, Henry M. Shaw, S. B. Trainor, George C. Furness, Paul Godley, A. H. Barsch, N. C. Beerend, F. C. Beekley.

Arrangements—J. D. R. Freed, Chairman, R. W. DeMott, Vice-Chairman, Godefrey Gort, E. N. Rauland, Alfred Bloom, E. C. Raynor, E. M. Squarey,

Walter C. Russ, L. S. Baker, Mark Smith, L. D. McGeedy, E. H. Jaudan.

Seating—A. Atwater Kent, Chairman, L. B. F. Raycroft, Clarence Wheeler, C. C. Colby, George A. Scoville, George L. Patterson, G. P. Scott, Earnest Danielson, C. L. Farrand, A. F. Thatcher, Henry C. Forrester, Mansel Keith.

Tickets—A. T. Haugh, Chairman, U. J. Herrmann, R. M. Canfield, E. C. Ingrahm, Benjamin Gross, Arthur H. Lynch, A. J. Steelman, John W. Griffin, L. J. Rooney, W. C. Howe, J. G. Johnsen, J. L. Owen.

Trade Interests Inaugurate Co-ordinating Committee

The most significant move for the advancement of the radio trade that could possibly be taken at this time was the conference of various trade interests held the morning of September 15 at the Hotel Astor, New York City.

Officials of the National Association of Broadcasters, the Radio Manufacturers' Association, the National Electrical Manufacturers' Association, the Federated Radio Trades Association and the American Radio Relay League, whose relations have not always been of the friendliest, put aside their animosities and got together for the good of the trade.

The outstanding result of this meeting was the formation of the Radio Co-ordinating Committee, composed of representatives of each association, whose duties, as the name implies, will be to co-ordinate the work of the five

associations for the benefit of the trade, particularly in the matter of preventing broadcasting confusion until the passage of legislation. A resolution was adopted to that effect.

Senator Dill, who was present, injected a discordant note into the meeting by making a political address in behalf of his radio bill. The industry's opposition to the political commission control plan was noticeable when several speakers later took issue with Senator Dill's views.

The conference was presided over by Louis B. F. Raycroft, chairman of the Radio Section of the National Electrical Manufacturers' Association. At the executive table also were Arthur T. Haugh, president of the Radio Manufacturers' Association; Harold Wrape, president of the Federated Radio Trades Association; Paul B. Klugh, chairman of the National Association of Broadcasters, and C. T. Stewart, head of the American Radio Relay League.

Radio Bill Conferees to Meet in November

Conferees of the Senate and the House of Representatives are to meet early in November in an effort to adjust differences between radio bills now pending in both houses before the next session, according to an announcement of Representative Scott, Michigan. It is hoped that a compromise measure will be whipped into shape at these conferences so radio legislation may receive the immediate consideration of Congress in December.

—At the Third Radio Industries Banquet



the boys and girls enjoyed a regular three-ring circus. Everybody of importance in the radio industry was there (including ourselves) proving that once a year at least the entire trade can forget their differences and have a good time over a hot dog and a skittle of near beer. As the

tickets were ten dollars per, it insured the attendance of only the aristocracy, all of which you see in the picture above. In the inset, left to right: Major Herbert Frost, Senator James Wadsworth, Vice-president Charles G. Dawes and Mr. Klugh.

Radio World's Fair Draws Record Attendance

The success of the Radio World's Fair, held in Madison Square Garden, New York City, during the week of September 13, under the direction of G. Clayton Irwin, Jr., and U. J. Herrmann, from the standpoint of consumer interest created and its stimulating effect on the trade, has been instrumental in securing an expression of optimistic opinions from men prominent in the industry. If public interest in the show may be taken as a criterion, it is evident that radio is going to be a very profitable business this year, for an attendance record for New York City was hung up during the first few days of the show.

The exhibition occupied two entire floors of the Garden, as well as an immense balcony, with every available exhibit space sold to manufacturers long before the doors opened. Probably the point of greatest interest to retailers who were unable to attend is the fact that, with the possible exception of usual minor developments, the superior design of cabinets this year is the outstanding feature of set design. Radio has taken a decisive step forward this year, out of the mechanical instrument class into that of a utility and a real article of furniture.

The Fifth Annual Chicago Radio Show, to be held at the Coliseum in that city during the week of October 11, is also to be directed by Mr. Herrmann and Mr. Irwin.

Damrosch to Broadcast for Bakelite Company

Walter Damrosch and his New York Symphony orchestra have been engaged by the Fansteel Products Company, manufacturer of Bakelite radio apparatus, to broadcast through a chain of stations operated by the Broadcasting Company of America.

This series of concerts is to begin on October 23 and will be broadcast each Saturday evening at 9 p.m. eastern standard time. Each symphony concert will be preceded by a piano recital by Mr. Damrosch.

W. S. Gould has resigned as president of the Gould Storage Battery Company, Inc., New York City, and pending the election of his successor by the board of directors of the company, K. M. Smith, formerly assistant to the president, has been appointed vice-president in charge of operation and sales.

Radio and Electrical Interests Combine for Atlanta Show

The Atlanta Radio Trades Association and the Atlanta Electrical League have joined forces to put over during the week of October 18 at the City Auditorium the largest consumer exposition the city of Atlanta, Ga., has ever known.

At a meeting of the executives of both these organizations which list practically every concern engaged in the sale of radio or electrical apparatus in Atlanta, W. H. Brimberry, head of the radio department of the Carter Electric Company, was selected as general chairman. With the co-operation of association members, J. C. Martin, president of the Electrical League and S. D. Katz, who presides over the activities of the Radio Association, Mr. Brimberry expects to make the exposition attractive enough to draw more than 25,000 people during the week.

The exposition committee has engaged fully 75 per cent more space than last year and has already disposed of 95 per cent of it. Foster D. Stewart, of Chicago, who staged the 1925 show, will also be on hand to eclipse his former record.

The Sparton Electric Corporation, formerly located at 99 Chambers Street, New York City, has moved to new and larger quarters at 350 West 34th Street. The addition of modern equipment in the new home of the company will greatly facilitate service.

Sylvan Harris, formerly managing editor of *Radio News*, has been appointed head of the radio research department of the Stewart-Warner Speedometer Corporation, Chicago. Mr. Harris is known for his excellent contributions in connection with the operation of variable condensers.

T.M.R.M. Annual Outing Held at Briarcliff

Members of Talking Machine and Radio Men, Inc., an association of New York City retailers, journeyed to Briarcliff Lodge, in Westchester County, September 21, for the annual outing of the association. Several busses left New York City in the morning, arriving at the Lodge in time for lunch. Athletic and aquatic events occupied the afternoon and an elaborate dinner for members and their friends followed by dancing topped the day off pleasantly.

Jones Receivers Again Being Manufactured

The Joseph W. Jones radio receivers are now being manufactured by the Jones-Motrola Sales Company which also makes electric drills, motors and similar articles. The factory is located at 370 Gerard Avenue, Bronx, N. Y., with sales offices at 40 West 25th Street, New York City. The Precision Trading Company of New York City is to be the sales representative in the Metropolitan district, Goodman & Goodman of South Norwalk, Conn., are the New England representatives, and A. Luque & Company, 150 Nassau Street, New York City, will handle the receivers for export. Two models are being placed on the market, one known as the 621 which is in a large cabinet, and the 625 which is of the compact type.

Edward R. Fiske, formerly eastern sales manager for the Waage Electric Company of Chicago, has joined the staff of the C. E. Manufacturing Co., Inc. at 702 Eddy Street, Providence, R. I., as assistant director of sales. Formerly Mr. Fiske was buyer for the radio section of the John Wanamaker Store, New York City. During the World War, he was on active duty in the Radio Communication Department of the U. S. Navy.

The Airgap Products Company, has removed from its plant at 188 N.J.R.R. Avenue, Newark, N. J., and is now located in new and larger quarters at 9-13 Campbell Street of that city.

Federated Radio Trade Association Convenes at Detroit

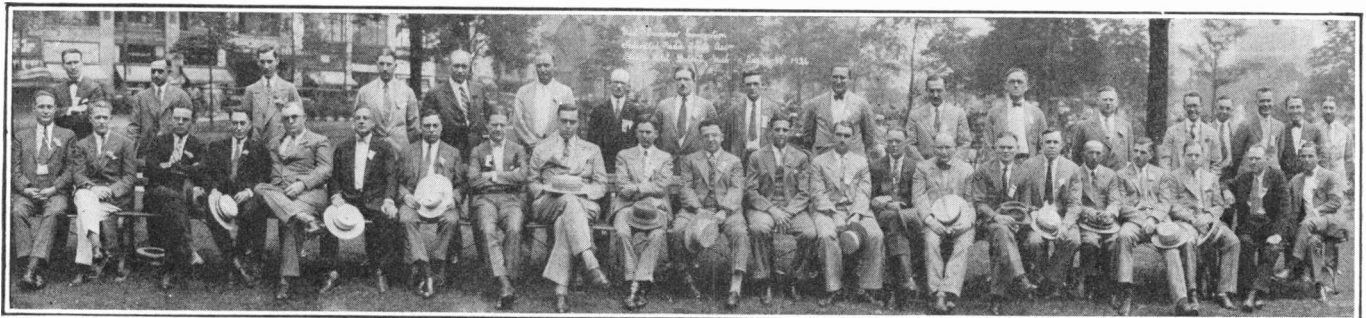

Here you see pictured some of the hundred-odd delegates who attended the August convention of the Federated Radio Trade Association held in Detroit. While several of the photographees were prevailed upon to look pleasant during the picture-taking process, the serious business of the convention so weighed on everyone's mind that expressions of deep concern are far in the majority. The sun was very

strong that day. If you look close enough you will probably find in the above picture the owners of many names that are synonymous with radio progress in the Middle West. The Radio Trade Association of Michigan (Detroit) was host to the visiting guests and showed them the town in 20 private autos. Our hats are off to an organization that stops for nothing short of a freight train, if you get what we mean?

Parts Are Still Active

(Continued from Page 73)

To each of the contestants, this dealer forwards a small printed card, advising that they have a thorough working knowledge of radio and offering a slight commission in view of this proficiency. According to the dealer, each diagram insert yields a harvest of buyers who take advantage of this slight discount. He points out, that many of these prospects were often on the verge of buying receiver parts but had not the confidence to wire it. The merit certificate turned the trick.

The Display's the Thing

BATTERY eliminators are one of few accessories which may be still bought cheaper in kit form than factory made, according to the proprietor of the Whiting Radio Service Company, Bridgeport, Conn.

"More than anything else, a proper display of parts is necessary to promote sales. Few customers can remember the multitude of parts necessary for the construction of such a device, so I combine the demonstration idea, used to sell complete receivers, and a good window display to sell eliminator kits."

Whiting's window is given over to a neat array of eliminator parts, circuit diagrams and complete instructions for building the power unit advertised. A small sign on the pane invites the prospect to come in and listen to one of the eliminators constructed of these parts in operation.

National Broadcasting Co. Formed with WEAF as Nucleus

"In order to provide the best programs available for broadcasting in the United States," the National Broadcasting Company, Inc., has been organized by the Radio Corporation of America, according to a formal statement issued by Owen D. Young and General James G. Harbord of that company. WEAF, the former American Telephone and Telegraph Company station located in New York City and recently purchased by R. C. A., will form the nucleus of the proposed system.

It is not the object of the Radio Corporation, the statement explains, to secure a broadcast monopoly but to place superior programs, necessary for the continued growth of the industry, at the disposal of broadcasting stations run by private interests throughout the country, thus forming a co-operative program chain so that important events may be broadcast simultaneously in all parts of the country. Programs of the new company, available after November 15, will, under the plan be "sold" to other stations forming part of the chain. Competitive groups formed for the purpose of raising programs to a higher plane will be welcomed by the company.

M. H. Aylesworth has been appointed president of the new company and G. F. McClelland will hold the post of vice-president and general manager. Mr. Aylesworth was for many years man-

Radio Shows and Conventions

October 4-9: Pittsburgh Radio Show, Duquesne Gardens, Pittsburgh.

October 4-9: Montreal Radio Show, Windsor Hotel, Montreal, Quebec, Can.

October 11-17: Fifth Annual Chicago Radio Show, Coliseum, Chicago.

October 18-23: Atlanta Radio-Electrical Exposition, City Auditorium, Atlanta, Ga.

October 18-23: Second Southwest National Radio Show and Trade Convention, Coliseum, St. Louis.

October 16-25: Buffalo Radio Show, Broadway Auditorium, Buffalo.

October 25-31: Fifth Annual Detroit Radio Show, Convention Hall, Detroit.

October 25-30: Second Annual Indianapolis Radio Exposition, and Dealers' Convention, State Fair Grounds, Indianapolis, Ind.

October 25-30: Toronto Radio Show, Coliseum, Toronto, Ontario, Can.

October 30-November 6: Third Annual Radio Exposition, 23rd Regiment Armory, Brooklyn.

October 30-November 6: Cleveland Radio Industries Exposition, Public Auditorium, Cleveland.

November 9-13: Fourth Wisconsin Radio Exposition and Trade Convention, Milwaukee Auditorium, Milwaukee.

June 8-13: Radio Manufacturers Convention and Trade Show, Stevens Hotel, Chicago.

aging director of the National Electric Light Association and has had public experience as chairman of the Colorado Public Utilities Commission. He is well known in the electrical industry for his organizing ability. Mr. McClelland will be remembered as former managing director of WEAF.

The National Carbon Company, manufacturer of Eveready batteries, Long Island City, N. Y., has advanced Harry S. Schott, formerly assistant general sales manager to the post of sales director. Mr. Schott has been actively engaged in selling and sales direction in the Eastern states and Canada for the past 25 years.

The Precision Products Company, Ann Arbor, Mich., announces the purchase of the radio division of the Machine Specialty Company of that city. The latter company has been engaged in the manufacture of Arborphone receivers, on contract with the former. The officers of the company are the same as heretofore. R. Verschoor, president, C. H. Dunlap, vice-president, J. E. Royce, treasurer, and M. J. McCarthy, secretary. H. J. Faulkner remains as production manager.

Hugh M. Smith now heads the radio division of the Frank Kiernan Advertising Agency, 41 Maiden Lane, New York City. Mr. Smith has been actively engaged in advertising and merchandising for the past 17 years. Among his notable successes in the radio advertising field are the recent campaigns on Weston instruments and Amperite resistances. Paul S. Weil and C. B. Cabaniss, formerly with the Kiernan company, have joined Albert Frank & Company, 14 Stone Street, New York City.

The Sleeper Radio & Manufacturing Corporation, Long Island City, N. Y., announces the appointment of Robert C. Cameron as service manager in

charge of repairs and replacements and the instruction of all service men in the employ of the company's distributors throughout the country. Mr. Cameron succeeds F. A. Klingenschmitt.

Sales in the midwest territory will in the future be under the supervision of Hugh H. Wilken, district sales manager, who will make his headquarters at 33 West Kinzie Street, Chicago. Mr. Wilken was formerly associated with the California Packing Company.

The Westinghouse Union Battery Company, Swissvale, Pa., has made the following changes in its sales, engineering and executive organization: C. H. Smith, formerly vice-president and general manager has been appointed president and general manager. D. W. Souser becomes assistant to the president, J. K. Ross Duggan, former export manager is now vice-president of sales, J. L. Rupp is promoted from sales manager to vice-president of engineering, and G. B. Cushing, his assistant, to the sales managership.

E. R. Pfaff has been appointed sales engineer and director of publicity for the Carter Radio Company, 300 South Racine Avenue, Chicago, Ill. Mr. Pfaff comes from the engineering department of Silver-Marshall, Inc., where he was employed for the past two years. Previous to this time he was connected with the engineering laboratory of the Western Electric Company.

Paul J. Heuschkel, formerly a member of the Bureau of Exhibitions, New York Edison Company, has been appointed manager of the Radio Bureau of that company with headquarters at the 42nd street office in New York City.

Cheltenham Cabinet Makers, Inc., manufacturer of high grade radio cabinets, has appointed J. Andrew White president. The company maintains plants at Rockford, Ill., and Jamestown, N. Y., and a business office at 36 West 44th Street, New York City.

E. T. Cunningham Receives Ovation

Radio, financial and civic leaders of the Pacific coast and associated western states joined forces in tendering a banquet to E. T. Cunningham, president of E. T. Cunningham, Inc., at the Cliff Hotel, San Francisco, September 14, the eve of his departure for the East. The ovation represented a spontaneous outburst of enthusiasm on the part of various of Mr. Cunningham's friends as a result of his success in the radio field.

Arthur Halloran, president of the Pacific Radio Trade Association headed the general committee in charge of the banquet, while Ernest Ingold, of Ernest Ingold, Inc., acted as toastmaster. The committee, in addition to Mr. Halloran and Mr. Ingold, included: A. B. C. Scull, Don Lippincott, W. E. Darden, Walter Cribbins, Charles Musladin, Clyde Chamblin, Lou Townsend, Robert Eastman, M. W. Sturdevant, W. H. Kemper, L. W. Reyburn, O. E. Huber, W. J. Aschenbrenner, Joe Hobrecht, H. V. Davis, A. Guy, E. C. McLaughlin, H. W. Dickrow, Major Levinson, A. S. Lind, James Ramsey, George R. Murphy, Norris Hill, Eugene McCann, Leo J. Meyberg, Lloyd Hanlon, Hal Berringer, Harry Augur, Ellery Stone, Ernest Danielson, Charles Shively and E. A. Portal.

The Sparks-Withington Company, Jackson, Mich., has erected a three story building adjoining its former plant, to facilitate the production of radio receivers.

Kester S. Lindsay, formerly with the Bryan-Marsh division of the General Electric Company, is now engaged in the sale of Stromberg-Carlson radio apparatus to retailers throughout the state of Connecticut. Mr. Lindsey is well known in this district.

The Radio Institute of America, 362 Broadway, New York City, has added to its curriculum a course in the servicing of radio receivers which is specially intended to educate and train the servicing personnel of dealers and jobbers. The course, which began September 14, embodies practical as well as technical instruction in the repair of radio receivers, loudspeakers, socket-power devices, etc. Special correspondence courses of a similar nature are offered for those who find it impossible to attend the school.

Half of World's Radio Sets in U. S.

There are probably between twelve and fifteen million radio sets in operation throughout the world, according to a survey recently made by the Electrical Equipment Division of the Department of Commerce. Of these, the United States is believed to have over 5,500,000 sets, or nearly half.

Over 500 of the 900 world's broadcasting stations are in the United States. The number in simultaneous operation is considerably less, owing to the divided-time agreements in force. This, however, is not common in foreign countries, where the stations are fewer and the distances between them greater. The wave bands used abroad are also much wider.

E. N. Hurley, Jr., has been appointed president of the Walbert Manufacturing Company, maker of Isofarad receivers, and has concluded arrangements for the establishing of branch offices of the Chicago company in Canada and Australia. Mr. Hurley is a well known figure in electrical and radio circles and was formerly connected with the Hurley Machine Company, manufacturer of the "Thor" electric washer.

Coast Guard Disposes of Spark Transmitters

Spark transmitters used by the vessels of the United States Coast Guard are to be entirely dispensed with before December 1, according to government officials. A contract for 40 vacuum-tube transmitters has been placed with the General Electric Company for completion by this date. Vacuum tube transmitters are also rapidly replacing the older "arc" type in the Navy Department, though lean Naval appropriations make a rapid transfer impossible.

Under normal conditions, the vacuum tube transmitter may be tuned more sharply than the older type apparatus, thus causing much less interference on adjacent wavelengths in the channels of other services. The Coast Guard is the first government department to take this step, due largely to its exhaustive experiments with vacuum-tube transmission between Newfoundland and Washington on a wavelength of 35 meters. Contracts have also been placed for the manufacture of vacuum tube sets to replace older types in coast radio beacons.

Japan Makes Broadcast Appropriations

For the installation of radio broadcast stations in six of its cities and towns, the Japanese government has appropriated 525,187 Yen, the equivalent of about \$242,000, according to U. S. Consul Charles L. DeVault, Taiwan. Work on these projects is about to begin, the report states. All matters connected with the installation and operation of these stations, with the exception of those under the control of the Imperial Navy, will be under the direction of the Bureau of Communications and Transportation of the Taiwan Governor-General. The apparatus used in the erection of these stations is almost exclusively of American make and an increase in market possibilities for broadcast receivers is imminent.

Fargo Dealers Attend Trade Show



"For there are no flies on Fargo" merrily sang these Twin-City salesmen and Dakota dealers just before this picture was taken. Many of these merchants drove eighty miles to get the latest "dope" on advance

styles in radio. This information was given them in a one day radio trade show, staged by the business delegates constituting the second annual radio trade tour of the Northwest Radio Trade Association.

The Grimes Radio Engineering Company, Long Island City, N. Y., which has heretofore confined its activities to radio and electrical research, will shortly engage in the manufacture of shielded receiver kits, embodying the Inverse-Duplex system of reflexing. David Grimes has been elected president of the company and intends to market these new kits, which are equipped with single-dial-control mechanism and attractive aluminum cabinets, through regular trade mediums.

The Amoroso Manufacturing Company, Boston, Mass., is now located in new and larger quarters at 60 India Street. The company is engaged in the manufacture of radio apparatus and electrical equipment and has been obliged to enlarge its quarters owing to an expansion of the business.

The Masterphone Sales Company, Tipton, Indiana, has opened a wholesale and retail radio department equipped with modern apparatus for the demonstration of receivers. Electrical supplies will also be sold in the new store.

News of Jobbers and Distributors

Tower Appoints Five Western Distributors

Gordon C. Bennett, general sales manager of the Tower Manufacturing Corporation, Boston, Mass., has appointed five distributors of Tower radio products in the far west. An extensive sales campaign on the Tower cone speaker and headsets is being planned by the Montana Electric Company, Butte, Mont.; Washington Electric Supply Company, Spokane, Wash.; Illinois Electric Company, Los Angeles, Cal.; Nielson Radio Supply Company, Phoenix, Ariz.; and the Oklahoma Radio & Electric Company, Oklahoma City, Okla.

Upon his return to the east coast office of the company Mr. Bennett remarked upon the comparative absence of cut-price competition and the splendid service facilities of dealers in the west. The organization of efficient retail service forces has become imperative on account of the distance from most manufacturers, according to Mr. Bennett, and is responsible for a healthy trade condition.

The Blair Radio Laboratories, 368 Sixth Avenue, New York City, has appointed the Universal Agencies, of San Francisco and Los Angeles, its exclusive representative for the states of Nevada and California.

The C. W. Smith Company, 1125 Wall Street, Los Angeles, has been appointed exclusive agent for the Walbert Manufacturing Company's products in California. The company also maintains a branch office at 200 Davis Street, San Francisco.



Harrisburg Dealers Migrate to Philly for Day

Led by Troy Wildermuth, president of the Fromar Company, dealers of Harrisburg, Pa., thundered at the gates of the Atwater-Kent plant in Philadelphia after making the trip across the state in special cars engaged for the occasion. Officials of the A. K. com-

pany conducted the retailers on a tour of the plant, later adjourning to the Penn Athletic Club for dinner. No convention is complete without a photo to show to the folks back home, so here it is. Mr. Wildermuth is the gentleman in the center of the photo without a hat.

The Van-Ashe Company, distributor of Bremer-Tully, Ferguson and Bosworth radio apparatus now occupies an entire half-block at 200-210 North 10th Street, St. Louis. At a recent meeting of the board of directors the company's capital stock was increased to a total of \$30,000 fully paid. W. W. Van Sickle is president of the company, G. W. Van Sickle is secretary and treasurer, D. P. Buckley is assistant treasurer, and H. W. Menges is sales manager.

Mid-West Fada Dealers and Jobbers Get Together

Under the direction of Louis J. Chatten, sales manager of F. A. D. Andrea, Inc., sales meetings of wholesalers and retailers throughout the Middle West were arranged to demonstrate the new Fada products to retailers and jobbers salesmen and to outline plans for an intensive campaign.

At Indianapolis, the Gibson Company arranged a gathering of dealers who heard E. M. Glass, radio manager of the company and Mr. Chatten speak. The Beck and Corbitt Company, St. Louis, held a rally several days later at the Coronada Hotel, at which many local dealers were present, and Cummings Brothers of Pontiac, Mich., arranged a convention in Detroit which was attended by more than 75 dealers in the territory. Mr. Chatten visited the Chicago office of his company before returning to New York.

Sign on the Dotted Line, Please!

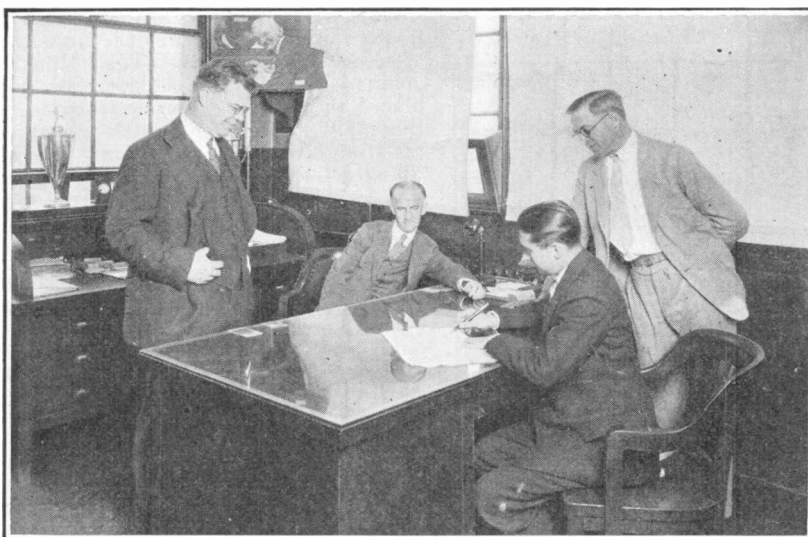

Well may R. W. Porter, sales manager of the Splittorf Electrical Company smile, as he leans over Edward J. Biel, secretary, treasurer and sales manager of the Progressive Musical Instrument Corporation who is signing a contract giving his company exclusive right to distribute Splittorf radio receivers and equipment in the entire

New York metropolitan territory, northern New Jersey and the lower Hudson valley. Looks like a profitable tie-up for both. Left to right: A. Sinclair, field representative of Splittorf in the metropolitan territory, M. W. Bartlett, president and general manager, E. J. Biel of Progressive and R. W. Porter.

Hallock and Watson Drops Store Business

The Hallock & Watson Radio Corporation, manufacturers and distributors, of Portland, Oregon, have discontinued their wholesale and retail store business, and will confine their activities to the manufacture and development of the Halowat line of radio receivers. Fobes Supply Company of Portland will act as their distributors for the state of Oregon, part of Washington, and South Dakota. Other Halowat distributors are the Pacific Telegraph Institute of Spokane, Washington; Electric Appliance Company of San Francisco; and R. Kohara, exporter, of Portland, Oregon.

The company is located at 192 Park Street.

Omaha Jobber Organized

The Interstate Electric & Radio Corporation, wholesaler of radio and electrical apparatus, was recently incorporated under the laws of Nebraska and has secured a lease on a two-story building at 1113 Harney Street, Omaha. The total of \$25,000 capital stock was entirely subscribed for. The officers of the new concern are E. C. Nickerson, president and general manager, formerly manager of the Electric Supply Company of Omaha, W. H. Green, vice-president, H. G. Fricke, vice-president, Ralph J. Nickerson, secretary and H. D. Patterson, treasurer.

The company will distribute Crosley, Cunningham, Ray-O-Vac, Utah, Valley, Kodel, D-G and Belden radio products exclusively on a wholesale basis throughout the district.

The Roller-Smith Company, 233 Broadway, New York City, manufacturer of precision electrical instruments and circuit breakers, has appointed the Robinson Sales Company, Seattle, Wash., as its exclusive agent for the state of Washington and Oregon. The Ashida Engineering Company, Ltd., of Daini, Osaka, Japan, will also handle Roller-Smith instruments in Japan, Korea and Manchuria. The Ashida Company is one of the most prominent concerns of its kind in Japan, and the new connection is expected to increase greatly the company's Japanese business.

The Pausin Engineering Company, 727 Frelinghuysen Avenue, Newark, N. J., distributes its product, the Octacone speaker, in the metropolitan territory through the Royal Eastern Electrical & Radio Company, Twentieth Century Radio Corporation, Knickerbocker Talking Machine Company, Herbert John Radio Corporation and R. H. McMann.

The Federal Radio Corporation, Buffalo, N. Y., has appointed the following wholesalers as distributors of Ortho-sonic radio receivers: Chapman Drug Company, Knoxville, Tenn.; Electric Appliance Company, Dallas, Tex.; Phonograph Company, Cleveland, O.; Radio Supply Company, Inc., Albuquerque, N. M.; Straus-Bodenheimer Company, Houston, Texas.

The Bosworth Electric Manufacturing Company, Cincinnati, Ohio, has appointed L. A. Chambers, 522 South Clinton Street, Chicago, as its representative in this district. A. Hedeman, 80 Federal Street, Boston, will cover the New England territory.

The following distributors have also been selected to job Bosworth products: The Chicago Radio Apparatus Company, Chicago; Hub Cycle & Auto Supply Company, Boston; Van Ashe Radio Company, St. Louis; James L. Elam, Spokane; Dakota Radio Company, Jamestown, N. D.; M. A. Hartley & Company, Northumberland and Gettysburg, Pa.; Larson Hardware Company, Sioux Falls, S. D.; A. A. Doerr Mercantile Company, Larned, Kansas, and the Stanley A. Morsbach Company, Cincinnati.

Lawrence A. Chambers, formerly sales manager of Silver-Marshall, Inc., has formed his own company, which will be known as L. A. Chambers Company, at 522 South Clinton Street, Chicago. This new organization, with Mr. Chambers directing, will act as manufacturers' agent for several western manufacturers of radio equipment.

The Blackman Talking Machine Company, 28 West 23rd Street, New York City, has been appointed a distributor of Fada radio in the Metropolitan territory by F. A. D. Andrea, Inc. The company also distributes R. C. A. tubes.

Chicago Jobber Holds Dealer Meeting

The Illinois Electric Co., Chicago, Ill., recently held its first dealer meeting "in the heart of the territory." This gathering was staged at Peoria, Ill., and was attended by over 65 retailers.

It is the intention of this jobbing house to establish a branch radio service school at Peoria. This will make it possible for service men to obtain a few days intensive training in the fine points of keeping the radio set "in tune."

"The establishing of branch servicing schools within convenient range of a large group of our dealers will facilitate and popularize this very essential part of a jobber's duty to his dealers," states John Duncan, in charge of radio activities for the Illinois Electric Co.

Adolph Friedman, formerly sales manager for the Hartzell Sales Company, has been appointed New York representative for the H. H. Eby Manufacturing Company with offices at 250 Park Avenue, New York City. Mr. Friedman, who at one time represented J. H. Bunnell & Company in New York, Ohio, Pennsylvania and the New England states, also represents the Kurz-Kasch Company of Dayton, Ohio, which maintains an office at the same address. John B. Sanborn, formerly connected with the Cutler-Hammer Company in the Chicago territory, is district manager for the Kurz-Kasch Company.

The Peaslee-Gaubert Company, Louisville, Ky., recently held a convention of its specialty salesmen engaged in the distribution of Fada radio receivers and equipment. L. J. Stutz, district sales manager for F. A. D. Andrea, Inc., addressed the convention, outlining the merchandising plans of his company for the season.

Harger & Blish, Des Moines, Ia., jobber, has just published the first issue of a new house organ. The "Mike," a small 5 in. x 8 in. booklet, has been placed in the mails for delivery to retailers in their section with the object of stimulating sales through the exchange of ideas. The first issue is well illustrated and contains several effective sales editorials written by company officials.

Smythe Sales Service, Inc., 109 Liberty Street, New York City, has been appointed a distributor of "Windham" radio products in the metropolitan district by the manufacturer, the Goyer Company, Willimantic, Conn. The company has distributed radio and electrical products for several years.

W. J. Grimes has been appointed factory representative of the Walbert Manufacturing Company, 925 Wrightwood Avenue, Chicago, Ill., in charge of its northwest territory. Mr. Grimes has resigned his position as manager of the Duluth branch of the Northwestern Electric Equipment Company, St. Paul, Minn.

Kimball H. Stark has joined The Charles Freshman Company as production control Executive.

All Is Well Along the Arkansas



Roy E. Steuber, president of 555 Inc., Little Rock, Ark., engineered this convention of Atwater Kent dealers in the "Bear" state, with the assistance of H. L. Gunn, vice-president in charge of sales, H. T. Stockholm, district manager of the Atwater Kent Manufacturing Company, and A. N. Doty,

district manager of the Pooley Company. More than 150 retailers attended the convention held at the Rainbow Garden, absorbing up to date A-K sales methods outlined by the 555 organization, as well as an elaborate lunch served in the roof garden of the building.

New Dealer Help Material

Aids to greater profits provided by radio manufacturers for their dealers

Grebe Advertising Check Goes Direct to Dealers

Under the new cooperative advertising plan inaugurated by A. H. Grebe & Company, a check for a portion of amount spent exclusively on Grebe advertising copy will be mailed direct to dealer upon receipt of a copy of the advertisement, together with a duplicate bill.

The company makes the provision that all copy must conform with Grebe standards, in order to tie-in with national advertising. Electros and mats of such copy will be furnished without charge. The company will refund to the dealer up to the amounts listed below, on each set stocked. The serial numbers of sets on the floor must accompany advertising bills. MU-1 Synchronphase—\$3; BC 1 Battery Cabinet, 30c.; Chassis, \$2.80; Puritan, \$3.90; Princess, \$4.40; Lancaster, \$5.20; Andalusia, Plain Type, \$6.40; Andalusia, Polychrome Type, \$6.80; and on the Renaissance, \$28.

The Myers Radio Tube Corporation, Cleveland, is supplying retailers of its radio tubes with attractive window and counter cards. In these merchandising aids the Myers Tube is reproduced in white against a red background, showing the external and internal construction of the tube very clearly. The cards measure 12x8 in. and are equipped with cardboard supports. Folders, electros and newspaper mats may also be obtained upon request.

Colored Window Centerpiece



The Hartman Electrical Manufacturing Company, Mansfield, O., is responsible for this attractive three-panel display centerpiece. Made of heavy cardboard, the display is in three colors. The lower part of the center panel and the lettering which appears as grey in the illustration are red, the background of the center panel and the lettering on the two side wings is black, while the words "Syntonized" and "Single-Six" are white.

Radio Retailing, October, 1926

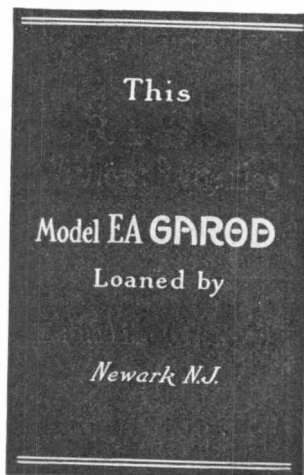

For the Club Demonstration

One of these 14 x 22 inch, easel-backed signs with the dealers imprint is available to each authorized representative of the Garod Radio Corporation for use in connection with demonstrations at clubs and other such organizations, and may be obtained upon application to the local Garod distributor. The card is unobtrusive and adds dignity to the receiver.

The Kodol Radio Corporation, Cincinnati, O., is now distributing copies of its 1926-1927 catalog. This sixty-page pamphlet, printed on highly glazed stock and equipped with a substantial limitation leather cover, contains color illustrations of the various Kodol radio products with complete descriptive matter and prices. Thirty-three pages of the catalog are devoted to descriptions of mailing pieces, counter cards, electrotypes and other dealer help material supplied by the company free of charge. Advertising mats available are reproduced to enable the dealer to select his supply of "hand grenades and small arms."

The Atwater Kent Manufacturing Company, Philadelphia, is in a position to make shipment, direct to dealers, or to retailers via distributors, of the mahogany picture frames designed to display reprints of the company's magazine advertising which will be released shortly.

The Watsontown Table and Furniture Company, Watsontown, Pa., has available a quantity of display cards of a very conservative nature which are suitable for use in identifying radio cabinets and tables manufactured by this company when on display. The cards are 5½ x 8½ inches overall, and are equipped with easel-backs. Raised gold lettering against a black felt facing make these merchandising aids distinctive.

The Geo. F. Dent Radio Company, Bay City, Mich., supplies on request to retailers, copies of its recently released booklet on the trickle charger automatic switch which it manufactures. The device is designed, according to the company, to "take the worry out of radio." So also is this booklet supplied to take the worry out of its installation. The pamphlet is illustrated and an attractive color cover makes it suitable for use as a mailing piece.

The Chappell Machinery Company, wholesale radio distributors of Americus, Ga., has issued a 1926 catalog in which its entire line of apparatus is listed with descriptions and prices.

Distantone Radios, Inc., Lynbrook, N. Y., has issued a small circular illustrating and describing the entire Distantone line of tuned radio frequency receivers.

The Gray and Danielson Manufacturing Company, San Francisco, Cal., is featuring the Remler Infra-Dyne Amplifier in its latest dealer help material, supplying a window poster and a small mailing leaflet. The poster is 8 x 32 inches in size while the direct-mail piece may be placed in a standard 3½ x 6 inch envelope. Both advertising helps are printed in brilliant orange and blue.

The Radiotron Man Arrives

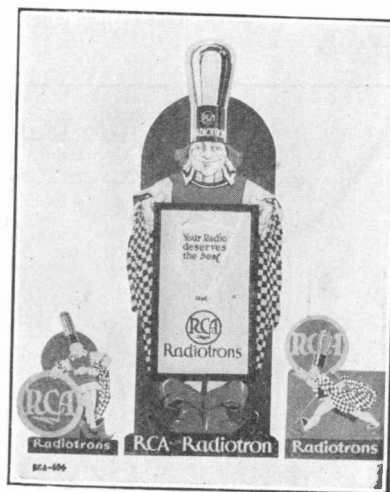

Very shortly, this little gnome will be a familiar figure in all R.C.A. stores. He is quaint and interesting, and each month his replaceable poster delivers a new message about Radiotron tubes. The display, which stands 40 inches high and is painted in eight striking colors, along with twelve posters, a window transparency, 100 price tags, five smaller displays of similar character and a supply of sales booklets, constitutes an attention-attracting window display. The entire lot is obtainable from the manufacturer for \$1.50.

The Pooley Company, 1600 Indiana Avenue, Philadelphia, Pa., supplies a new 8 page catalog, suitable for use as a mailing circular, in which the entire line of Pooley-Atwater Kent cabinet and receiver combinations are illustrated in attractive half-tones. The folder is 9 x 12 inches, equipped with a substantial cover and contains photos of various processes in the manufacturing of cabinets, with list prices.

The Airgap Products Company, 9-13 Campbell Street, Newark, N. J., has developed an effective piece of newspaper copy designed to aid in the sale of its Airgap vacuum tube socket and matrices of this "ad" are now available to dealers without charge.

Diamond T Radio Manufacturers, South Bend, Ind., supplies 12 x 21 inch wall posters, printed in orange and black for use as sales aids. Each poster is devoted to one receiver which the company manufactures and bears a large photographic illustration.

The Day-Fan Electric Company, Dayton, O., offers an interesting sales aid to the radio retailer in its new 4-page leaflet entitled "5 Things You Want." In this leaflet, which is printed in red and black, the company's line of receivers for the coming season are reproduced in a form which makes it highly acceptable as a window display or wall sign in addition to its possibilities as a mailing circular. To convert the leaflet into a display sign it is merely unfolded to its full size—23 x 25 inches—and fastened to the store window or wall by means of adhesive strips.

The Haworth Manufacturing Company, 5119 Plankinton Building, Milwaukee, Wis., has just released a two-page, 6 x 3½ inch, pamphlet describing in detail the Haworth Disk Antenna, which it manufactures. The leaflet is illustrated, contains the intended retail prices of various models and is provided with a blank space in which the dealer's name and address may be inserted.

A Good Display Is Half the Sale of Parts



This reproduction of window and counter display cards upon which articles of merchandise are mounted is an example of the co-operation between the retailer and Electrad, Inc., New York City. The company realizes the value of attractive displays in connection with the sale of small parts.

Showers Brothers Company, 1517 Tribune Tower, Chicago, illustrates its line of console radio receivers in a new 6x9 inch folder printed in color, which is distributed to retailers for use as a merchandising help.

The Priess Radio Corporation, 693 Broadway, New York City, supplies two 8 x 11 inch counter distribution sheets for use as a merchandising aid in connection with the Priess Straight-Eight and Straight-Nine receivers. Loop operation is featured in these sheets which bear photographic illustrations of the receivers described.

The Federal Radio Corporation, Buffalo, N. Y., lists its entire line of new Orthosonic receivers in a new 8-page catalog available as a merchandising aid. The folder is 7 x 5 inches, equipped with an attractive blue cover and contains illustrations of each receiver manufactured in original colors, amid surroundings of a home. Each receiver is well described and the catalog may be used as an advertising piece in direct-mail work.

The Apco Manufacturing Company, Providence, R. I., in a new four-page catalog printed in red and blue, lists its entire line of chargers, battery eliminators and other radio accessories. Each item is adequately described and retail list prices are quoted.

The Sampson Electric Company, Canton, Mass., in a new booklet, which is destined to become the handbook of Sampson dealers according to this manufacturer, covers the subject of tone quality. The causes of distortion and remedies are pointed out in a clear, concise manner, beginning at the microphone in the broadcast studio and running through the entire gamut of transmitting amplifiers to the audio amplification unit of the radio receiver. The booklet contains numerous blueprint diagrams and is available at 25 cents per copy.

The Automatic Radio Manufacturing Company, Inc., Boston, manufacturer of Blue Bird radio receivers, has announced that its 1926-1927 catalog is now available. This six-page booklet contains photographs of the entire line of Blue Bird products with list prices and also reproduced letters of commendation on the performance of these sets received from satisfied owners.

The Reynolds Radio Company, wholesale distributors of radio apparatus, 1534 Glenarm Street, Denver, Colo., has published its latest 28-page catalog in which its full line is illustrated with prices. Complete operating specifications are given on all apparatus listed.

The American Fabric Company, 46 Baker Street, Providence, R. I., supplies battery cables which it manufactures in individual boxes and packed in dozen lots in an orange and black counter display carton, the cover of which when raised forms an attractive background for the merchandise. A diagram showing the use of the cable itself is also printed on the cover.

The Marin-Copeland Company, 101 Sabin Street, Providence, R. I., furnishes a merchandising help in the form of an easel-backed counter card representing a radio receiver in the center of which a Marco tuning dial is attached, making a realistic display. The card is 14 in. x 17 in. and is printed on heavy stock in brown, blue and yellow.

The Apex Electric Manufacturing Company, 1310 West 59th Street, Chicago, supplies as a merchandising aid to retailers, a small folder in which 6x9 inch cards are enclosed, each card containing full information regarding a specific Apex receiver. The cards bear photographic illustrations and full descriptions of the set, with list prices.

A Little Light on the Subject

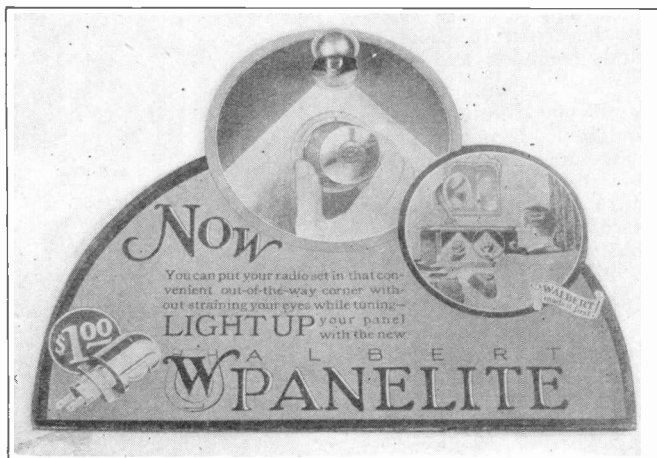

This 7 x 9 inch counter display card is furnished by the Walbert Manufacturing Company, Chicago, Ill., as a merchandising aid in connection with the "Panelite" dial illuminator. It is easel-

backed, finished in orange and black, and is equipped with a mounting hole for one of these instruments. The company also furnishes a new 12 x 15 in. wall card, advertising the Penetrola.

CROSLLEY RADIO
All prices slightly higher west of Rocky Mts.

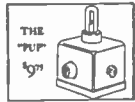

This little double-circuit 1-tube set has made long distance records.



4 tubes. Amazing efficiency. Crescendon equipped!



The 4-29 in portable form.



Five tubes, tuned radio frequency. Two stages non-oscillating radio frequency amplification, Crescendon, two stages audio frequency amplification.



5 tubes, 1-dial control acuminators, Crescendon, power tube adaptability.



5 tubes. True-cascade amplification; non-oscillating and non-radiating.



In solid mahogany console. 6-tube \$60 instrument, Crosley Musicone speaker, ample compartment for batteries.



Double drum station selector Musicone and room for batteries and accessories.



12-inch size, \$12.50. Super Musicone, \$14.75. Musicone Deluxe, \$23.50. Also beautiful Musicone console with room for batteries and accessories, as below.

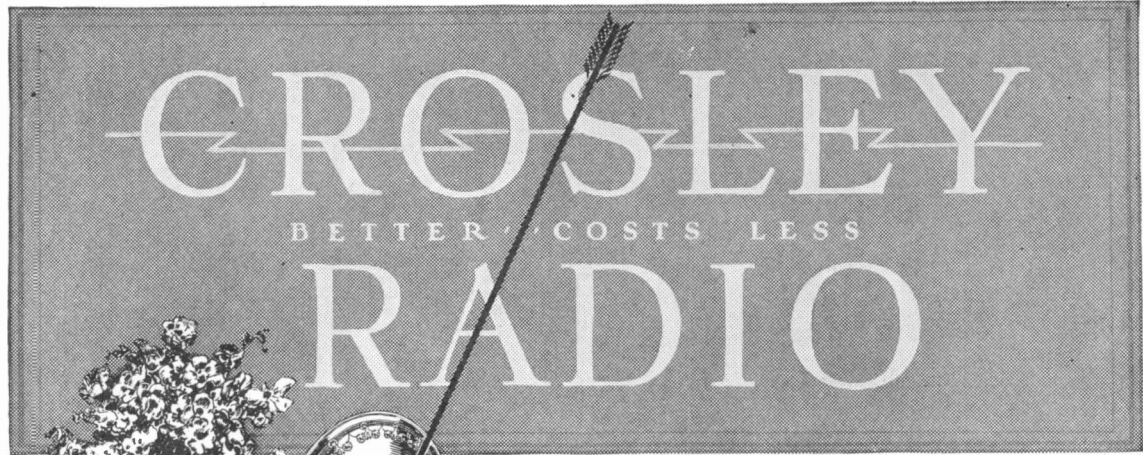

One-Dial Control!

... in this amazing 5-tube set at \$50

Already the new 5-tube Crosley set, at \$50, has met such a tremendous demand as to confirm the prediction that it will replace thousands upon thousands of sets now in use.

Confronted by high prices, many people who desired to replace their old sets have hitherto hesitated to do so. Now... in the new Crosley "5-50" . . . they find the features and qualities they desire, formerly exclusive to very high priced sets . . . available at small investment.

The incomparable joys of Single-Dial Control! Uncanny selectivity, resulting from its metal-shielded chassis and the surpassing efficiency of the Crosley circuit's advanced design! Exquisite volume, thanks to the matchless Crescendon! Crosley Acuminators, power tube adaptability . . . all the attributes of radio at its best . . . for \$50!

In all the Crosley line no instrument represents a greater triumph than this wonderful 5-tube set. Examine the line in full, as illustrated in the marginal column at the left . . . each item a victory for mass production in reducing radio prices. Then see the Crosley line at Crosley dealers . . . including the new "5-50" . . . now on display!

See it . . . hear it. View the refreshing beauty of its solid mahogany cabinet. Operate it yourself. Watch the stations, written in on the graphic dial, parade before you and usher in their programs with unerring accuracy. Sharpen the selection with the Crosley Acuminators. Release inspiring volume by means of the Crescendon.

Know what heights . . . in tone, volume, selectivity and sensitivity . . . radio of moderate price has reached!

One-dial control. You find your station, then write its letters on the graphic dial, locating it once and for all, to turn to whenever your fancy dictates.

The new Crosley all-metal shielded chassis not only aids in producing astounding selectivity, but standardizes manufacture and helps make possible the price of \$50.

\$50

Slightly higher west of the Rockies. Never before, at anywhere near this price, has a radio set possessed all these advantages: 1. Single-dial control with graphic station selector. 2. Metal-shielded chassis, contributing to amazing selectivity and reducing cost. 3. Crescendon control, producing exquisite volume from distant stations. 4. Crosley Acuminators, which sharpen tuning and increase selectivity. 5. Power tube adaptability. 6. Beautiful, solid mahogany cabinet of distinguished design and exquisite two-tone finish.

THE CROSLLEY RADIO CORPORATION, CINCINNATI—POWER CROSLLEY, Jr., President
Crosley manufactures radio receiving sets, which are licensed under Armstrong U. S. Patent No. 1,113,149 or under patent applications of Radio Frequency Laboratories, Inc., and other patents issued and pending. Owning and operating station WLW, first remote control super-power station in America. All prices without accessories.

For Catalogue write Dept. 13

Crosley Features
"CRESCENDON"
When, on ordinary radios, ears must strain to catch a station miles away, a turn of the Crescendon on Crosley radios instantly swells reception to room-fill-

ing volume. An exclusive Crosley feature.
ALL-METAL SHIELDED CHASSIS
This truly great radio achievement, found in several Crosley sets,

furnishes a substantial frame for mounting elements, produces excellent alignment of condensers, shields the units from each other, prevents interstage, improves the stability of the circuit, increases selectivity and saves costs by standardizing this phase of manufacture.

THE SINGLE-DIAL STATION SELECTOR
Nothing in radio equals the joy or the convenience of single dial control. Crosley single drum control enables you to find the stations sought without log book or "tuning"

THE "ACUMINATORS"
Crosley Acuminators provide sharp tuning where reception spreads broadly over dial, easily tune out local and bring in far stations. Ordinarily, once adjusted and they need not be touched again.

USE OF POWER TUBE
Power tube adaptability marks the Crosley "5-50", "5-75" and "RFL" sets. This feature typifies Crosley provision for best radio reception at moderate cost. This feature is in keeping with all that is most progressive.

QUALITY AND BEAUTY IN CABINETS AND CONSOLES

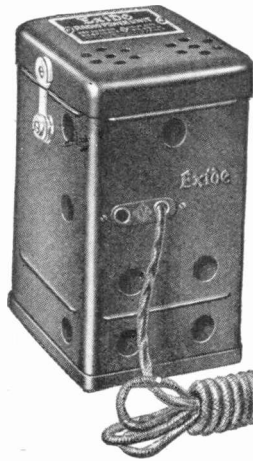

The new Exide Radio Power Unit Model 3A for sets using 4-volt tubes—same construction as 6-volt unit.

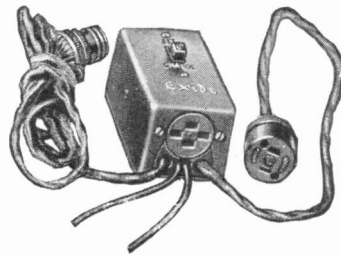

The Master Control Switch for use with new Power Unit. Enables you to place unit out of sight and control both "A" and "B" circuits from set.



The new Exide Radio Power Unit Model 3A for sets using 6-volt tubes. Consists of special Exide Battery and high-rate trickle charger, in mahogany metal case.

Now . . .

plenty of "A" power for even the largest radio sets

This power unit with a separate switch is specially designed to meet the heaviest demands for current

HERE is something that will interest your customers—a source of "A" battery power that will meet even the heaviest current demands.

It is a new type of the Exide Radio Power Unit, comprising an "A" storage battery and charger. It is kept connected at all times with the house current as well as the radio set.

The battery of this new unit is a specially designed Exide with an unusually large current capacity, ample for the newest and largest types of radio sets. The charger is

designed to take in current at a correspondingly high rate, so that the battery can be quickly recharged when the set is not in use.

The Master Control Switch

An outstanding feature of the new Exide Radio Power Unit is the Master Control Switch. This switch is in a separate case, and can be placed at any convenient location. It permits the unit to be placed anywhere—in cellar or closet—yet both

"A" and "B" circuits are controlled at the set.

The new Exide Radio Power Unit comes in two sizes—one for sets with 6-volt tubes; the other for sets with 4-volt tubes. They retail for \$38 and \$28 respectively. The prices are slightly higher west of the Rockies.

The constantly increasing current demands of the new model radio sets are going to make this battery unit very popular. It will be widely advertised, and you should get in your order early so you can deliver promptly.

And be sure you haven't run short on the rest of the Exide line—the "A" and "B" batteries, and the smaller Radio Power Unit with the built-in switch.

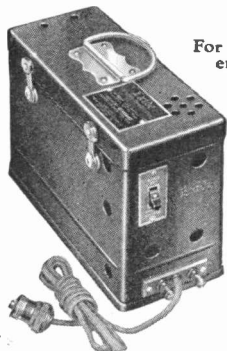

Exide Power Unit Model 2A with built-in control switch. Contains Exide "A" Battery and trickle charger. Operates from light socket or base plug. Two sizes, 6-volt and 4-volt.

For convenient reference, see our page in Radio Trade Catalog.

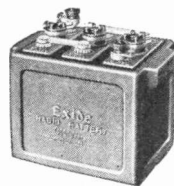

Standard Exide Radio "A" Battery for 6-volt tubes. Rugged. Built in one piece.

Exide

RADIO BATTERIES

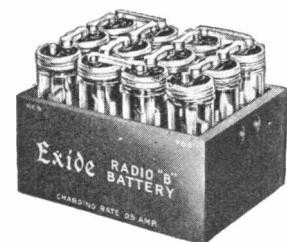

Exide "B" Battery in glass cells. 6000 milliampere hour capacity. Also in 48-volt size.

THE ELECTRIC STORAGE BATTERY COMPANY, Philadelphia
 Exide Batteries of Canada, Limited, 153 Dufferin Street, Toronto

This Advertisement Appears in the Oct. 2nd Issue of the Saturday Evening Post

Time To Change Your Aerial

Good Reception Depends On It!

REGARDLESS of the type, price or make of your radio set its performance depends upon the efficiency of your Aerial.

Soot-covered Wire and Insulators, a leaky Lead-in Wire, an improperly designed Lightning Arrester or a defective Ground Connection may be robbing you of more pleasurable radio hours.

Failure to tune in stations sharply and clearly, inability to get distance and noisy disturbances are some of the warnings that your aerial equipment is worn out.

At the first sign or sound of imperfect reception replace your Aerial with an S-H "Aero" Kit—a complete antenna outfit, designed for quick, neat installations of maximum efficiency.

If not at your dealer's write us

SWAN-HAVERSTICK, Inc.

Trenton, N.J.



S-H "Aero" Kits are available in five different assortments. Prices \$2.50 to \$5.00, depending upon your requirements.



S-H Lightning Arrester, approved by the Underwriters—made of Bakelite, \$1.00.

We are telling millions of radio owners to look to their aerial at the first sign or sound of imperfect reception. You can sell S-H—the complete aerial kit—quickly and profitably with this advertising behind it.

*If your jobber can't supply you,
write us.*

SWAN-HAVERSTICK, Inc.

Trenton, New Jersey

Nationally

S-H

Advertised

FINE-ARTS CONE SPEAKER

Retail
\$15.⁰⁰



Jobbers:— Look into this proposition which is without parallel in quick, satisfactory sales for you.



**Distinctive beauty—
 flawless reproduction!**

The public is instantly attracted by its distinctive beauty—its exceptionally low price—and most important of all—its flawless reproduction.

Fine-Arts Cone Speakers are the result of intensive study in the requisites for good acoustics. They are already an absolute radio success from both the dealer and customer viewpoint.

Frank D. Lewis, international expert in radio

and phonograph acoustics, is the designer—The Plaza Music Company, with its twenty years experience in manufacturing music products, is responsible for its correct manufacture.

Let this Cone Speaker, beautiful in design and superb in tonal qualities, *build* customers and profits for you.

Dealers write now for details and prices. Order samples. Prepare for the big season.

PLAZA MUSIC COMPANY RADIO DIVISION 10 W. 20th ST., NEW YORK

NEW

MUTER

Dependable Products

—for the 1927 Season

Used by leading set builders—
Quality with a Popular Price

If your jobber has not furnished you with the new complete MUTER catalog—we'll be glad to send you one direct.

Write Dept. R. R.

LESLIE F. MUTER CO.

76th and Greenwood Avenue
CHICAGO, U. S. A.



Knife Throw Switches

Moulded Bakelite base—Spring brass contact—Moulded insulated handle.



Single Pole, Double Throw
Base 2 1/4" x 7/8"
Stock No. 2010.....70c list



Double Pole, Double Throw
Base 2 1/4" x 1 3/8"
Stock No. 2020.....\$1.00 list



Triple Pole, Double Throw
Base 2 1/4" x 2"
Stock No. 2030.....\$1.50 list

Five Pole, Double Throw
Base 2 1/4" x 3 1/4"
Stock No. 2050.....\$2.50 list



Antenna Plug
Black moulded Bakelite. 2 1/2" long.
Stock No. 2600.....60c list

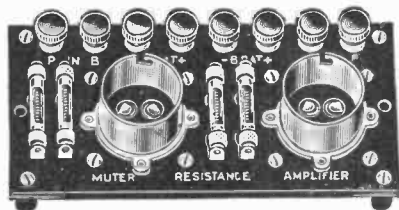

Resistance Amplifiers

Completely wired, ready for installation. Individually packed, with instructions.
Stock No. 1410 (2 stage).....\$6.00 list
Stock No. 1400 (3 stage)..... 8.00 list

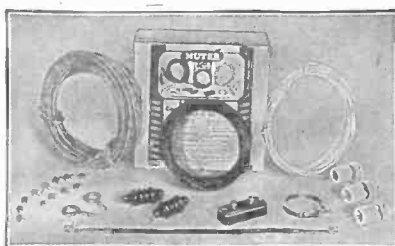

Standard Complete Aerial Kit

Contains all necessary parts to erect. Attractive individual cartons.
Stock No. 250.....\$3.50 list

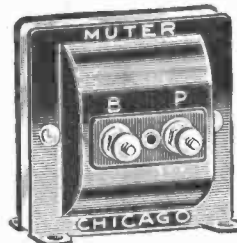

Audio Frequency Transformers

Highly efficient—popular price—fully shielded in an enameled metal case.
Stock No. 1500—
3 1/2 to 1 ratio.....\$2.25 list
Stock No. 1550—
5 to 1 ratio..... 2.50 list



Variable High Resistance

Controls oscillation and regulates quality and volume. Highly nickel plated metal shell with moulded Bakelite knob.
Range 0 to 200,000 Ohms
Stock No. 2120.....\$1.25 list
Range 0 to 500,000 Ohms
Stock No. 2150.....\$1.25 list

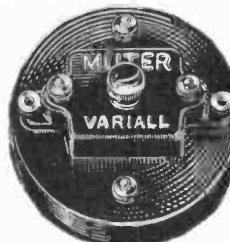

Interference and Static Eliminator

Moulded Bakelite case with insulated adjusting screw.
Stock No. 1800.....\$2.50 list



Variable Condensers

Moulded Bakelite case.
Balancing condenser .000003 to .00005 M. F.
Stock No. 1900.....\$1.00 list
Variable grid condenser .00015 to .0005 M. F.
Stock No. 1950.....\$1.00 list



Fixed Condensers

Highly polished metal end plates with adjustable soldering lugs. Bakelite plates—mica insulation—brass electrodes—gives maximum results.
Used by leading set builders.
All popular sizes—from 30c to 85c list.

Eagle "TRICKLER"

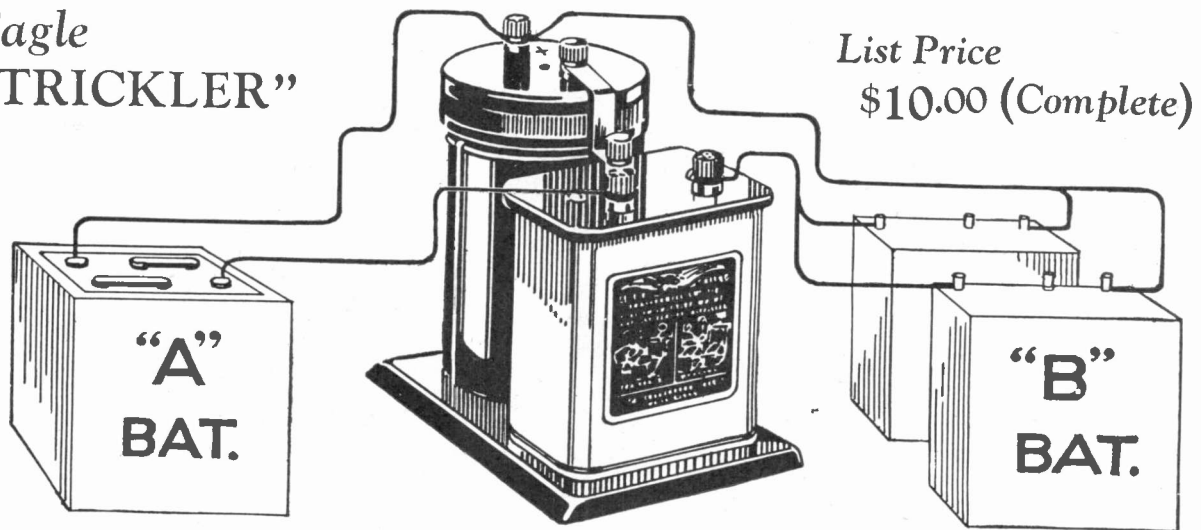

The Trickle Charger that took the New York Radio Show by Storm

Everyone that saw the Eagle "TRICKLER" at the New York Radio Show pronounced it an innovation in the Charger business. This little wonder not only charges an "A" Battery but also will charge any type of storage "B" Battery or TAB rechargeable dry "B" batteries.

This is "trickle year." Take advantage of the special sales features of the Eagle "TRICKLER" and offer your customers the most for their money.

List Price \$10.00—Complete

(Slightly higher West of the Rockies)

Eagle "MASTER" the Charger of the Future

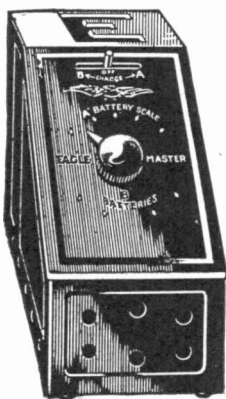

When connected to batteries, Eagle "MASTER" forms a complete power unit. It charges "A" batteries, full or trickle, and at a turn of the switch becomes a charger for "B" batteries with a range from 45 to 135 volts. After Eagle "MASTER" is connected to the batteries and set once, it is never necessary to connect or disconnect any more wires.

You can sell this power unit at a profit and save a lot of time you now spend in unprofitable servicing.

List Price \$25.00

(With Bulb)



If your jobber can't supply you with Eagle Chargers write direct to us.
For Detailed Buying Information see the McGraw-Hill Radio Trade Catalog.

EAGLE CHARGER CORP., 121 N. Eighth St., Philadelphia

EAGLE CHARGERS

There is no Substitute for a Good "B" Battery in Radio

45 VOLTS
30 CELLS
\$4.50

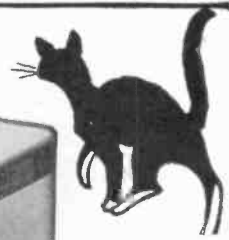
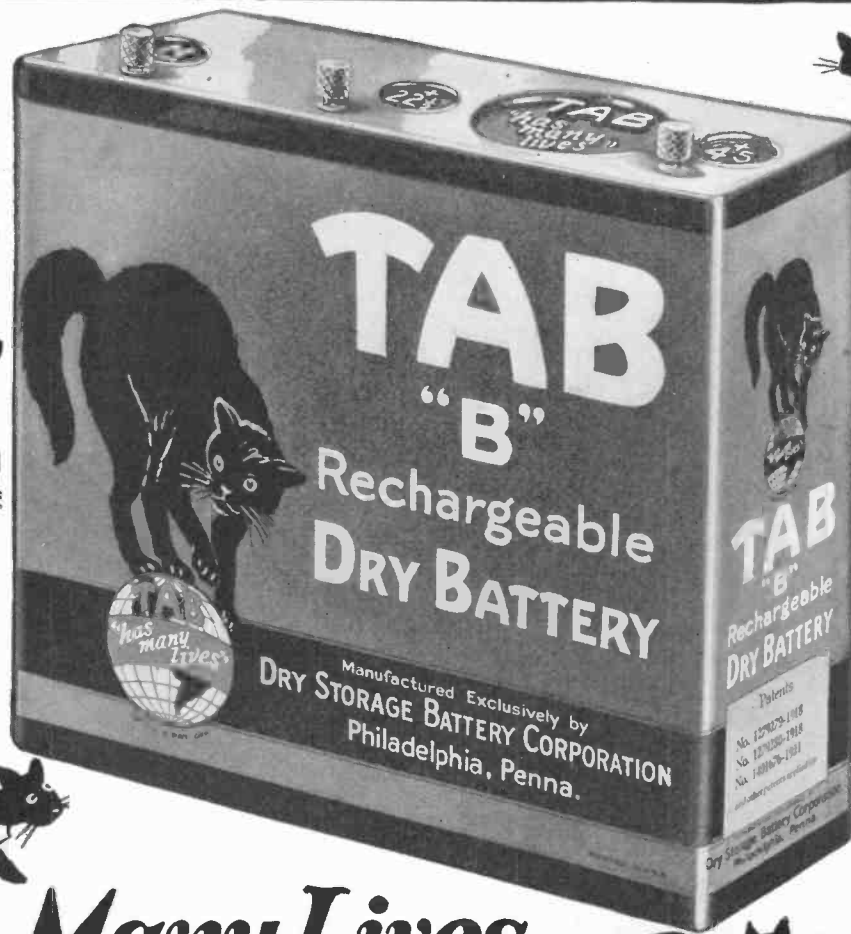

*As Many Lives
as a Cat*

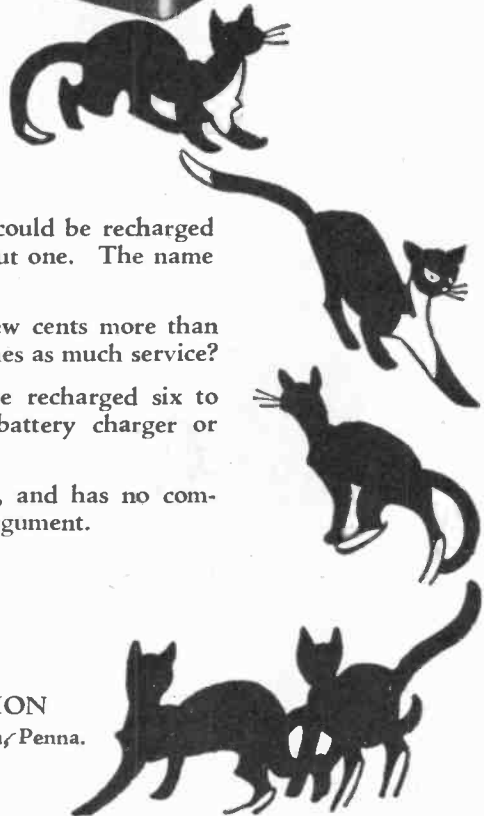

EVER hear of a dry Radio "B" Battery that could be recharged six to eight times? We are telling you about one. The name is TAB.

Can you sell a dry "B" battery that costs a few cents more than the ordinary "B" battery yet gives six to eight times as much service?

TAB Batteries will do this because they can be recharged six to eight times at home with any standard "B" battery charger or chemical rectifier.

TAB is the only rechargeable dry "B" battery, and has no competition. When money talks there can be no argument.

WRITE FOR LITERATURE
AND DISCOUNTS

Manufactured exclusively by
DRY STORAGE BATTERY CORPORATION
213 South Broad Street Philadelphia, Penna.



TAB - *the Rechargeable Dry "B" Battery*

PRECISION
ARBORPHONE
PRODUCTS

ARBORPHONE

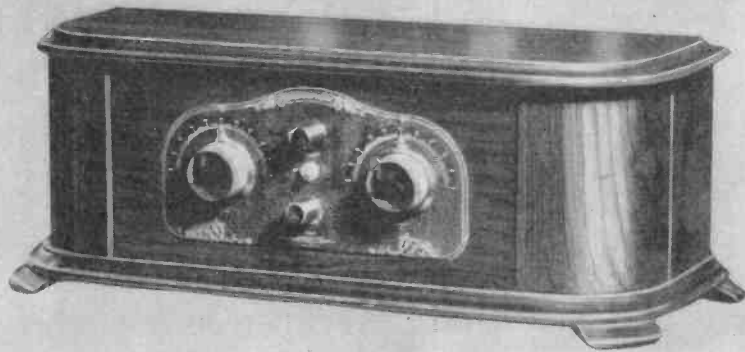

Exquisite beauty of cabinet design is excelled only by superior performance on all wave lengths

\$60⁰⁰

Add \$5 in Rocky Mountain and Pacific Coast States



Write for Catalog

PRECISION PRODUCTS CO.
317 SOUTH MAIN STREET, ANN ARBOR, MICHIGAN

National Factory Representatives
SANFORD BROS.
30 W. Walton Place
CHICAGO ILL.

Our Biggest Improvements —Your Biggest Season



Model 58 \$125
Standard Console

When you can offer Thorola technique and Thorola console style at such a price you dominate the best radio market. All the Thorola betterments are included, in circuit, instruments, speaker, panel and console design.

Model 57 \$60
Standard Cabinet

Thorola Performance!—Popular Price! Radio that is so much better for so much less money that sales records are being smashed with this receiver. 5 tubes with extra power. Duo-Dial control. Positively selective Doughnut Coils. Golden Tone Transformers. Matchless advancement in every feature except the price!

Model 59 \$185
De Luxe Console

Genuine Walnut. Antique, Highlighted finish. Highest art in cabinet, as in reception. The power of the Thorola 5-tube circuit cannot be measured by ordinary standards, because of all the exclusive Thorola features. Cone and horn type speakers, series-connected, in non-directional sound chambers assure the most realistic reception in radio history. Judged by performance and impressiveness the price seems unbelievable.

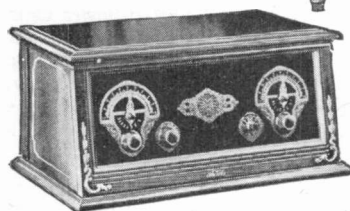

Model 4 \$25, Horn Type Speaker

Today thousands will accept no speaker but this Thorola horn type, with its slender grace and flawless reproduction. You know that the Controlled Mica Diaphragm, Separix and other Thorola developments brought musical recognition to radio. Now Thorola 4 is better than ever, in artistic rendition, and in sales.

For finest possible speaker performance at moderate price the Thorola Junior horn type is supreme \$15.00

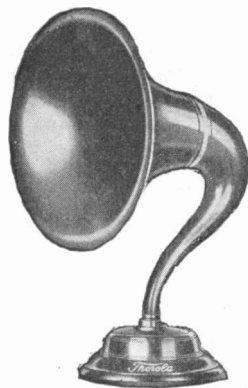

Model 9 \$20
Cone Type Speaker

For the first time the cone type provides artistic reproduction of both high and low notes. Only the Double Range Diaphragm of the Thorola Cone makes it possible. Only Thorola talent produces such advancements. Judged by ear or eye, you outclass competition with this rich, walnut-and-gold cone speaker at this competitive price.



Thorola Doughnut Coils, with their patented indented wiring and true low-loss construction, go far beyond other type theories in improving reception. \$2.00 each (set of 3) \$6.00

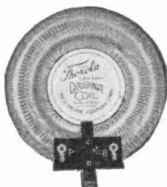

A whole list of things nobody else can talk about puts punch into Thorola sales efforts. And a far higher type of performance, that nobody else can demonstrate so consistently, is the Thorola dealer's unbeatable closer.

Big betterments by Thorola are your biggest assurance of 1927 success. The complete Thorola line of receivers and speakers includes the only receiver with *both* horn and cone type speakers, reproducing every shade of every tone with accuracy never before possible. This de luxe radio, without a de luxe price, out-distances competition for you. Still more moderately priced are the standard Thorola console and cabinet models, all with perfected Duo-Dial Control, Thorola Low-Loss Doughnut Coils, Golden Tone Transformers and other Thorola advancements. You are sure of surpassing performance in each sales classification. You have a price advantage. And your Thorola receivers are the first with *provable* upkeep economy!

When it comes to speakers Thorola strength is overwhelming. There could be nothing better than the famous Thorola 4 with its Controlled Mica Diaphragm and all the superiorities which make it the "pipe organ of speakers". There is also a junior model to open every purse to you. And now comes the Thorola cone-type with Dual-Range diaphragm, the wanted combination of Thorola tonal art and latest speaker style.

Exclusive radio ability, exclusive technical betterments and exclusive furniture designs are bound to build leadership for Thorola stores. Thorola national advertising also works for you. And the exclusive franchise for Thorola receivers is the fairest sort of profit protection. Get in on it now, and get a whole season of Thorola selling power.

REICHMANN COMPANY, 1725 West 74th Street
CHICAGO, U. S. A.
Member R.M.A.

Thorola



Uses only
the
**RAYTHEON
TUBE**

"For reliable
reception"

The finest reputation can be trusted to this Valley-B-Eliminator

Some of the most particular radio dealers in the country have accepted The Valley B Power Unit as a product which they can stand behind and sell to their customers with the assurance that it will give complete satisfaction with any receiving set.

From the standpoint of the dealer nothing could be more important. The retailer of radio equipment who is in business to stay can afford to handle only dependable, tested, satisfaction-sure merchandise. Such is the Valley B Power Unit.

Such indeed are all Valley radio products. The quality and performance of Valley radio units are so easy to demonstrate that as merchandise for resale Valley equipment is the dealer's surest and safest choice.

Will you investigate for yourself? A request to our nearest office will bring a representative without cost or obligation. Send that request by card or letter today.

Valley B Power Unit

The Valley B Power Unit takes the place of B batteries by providing plate voltage from the house lighting circuit for any radio receiving set of 12 tubes or less. Its maximum output is 50 milliamperes at 180 volts. It will supply the plate voltage necessary for a power unit or power tube.

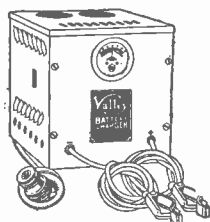

Valley Battery Charger
Twin Bulb Type



Valley Battery Charger
Vibrator Type

We use the Raytheon tube in the Valley B Power Unit because only this tube gives full wave rectification and has no filament to burn out. Also, it is the only rectifying tube for this service which will deliver full current and voltage continuously over a long period of time.

The Valley B Power Unit operates without hum or noise—as silent as dry batteries. Comes complete with Raytheon tube, cord and plug. List price \$40.00 F. O. B. St. Louis.

Valley A Battery Chargers

Twin Bulb Type: Charges at 2½ amperes with one bulb and at 5 amperes with two bulbs. Use of second bulb is optional. Absolutely noiseless. List price \$15.00 without bulbs. Bulbs, \$4.00 each. F. O. B. St. Louis.

Vibrator Type: The pioneer of battery chargers. Nearly a quarter of a million of them are in use. Charges 6-volt batteries at 6 amperes and 12-volt batteries at 3 amperes. List price, \$19.50 complete, F. O. B. St. Louis.

Valleytone Radio Receiver

Valleytone Radio Receiver, Model 52, is a 5-tube tuned radio frequency receiver which employs the exclusive Valley potential balance method of suppressing oscillation and preventing distortion. Two-dial control; antenna control for improving selectivity on crowded lower wave lengths and increasing volume on higher wave lengths; power tube wiring which makes the use of a power tube optional at the desire of the user. List price, \$90.00, F. O. B. St. Louis.

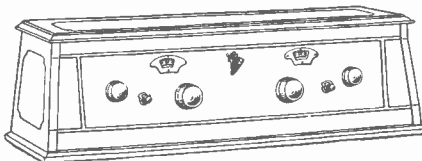

The Valleytone Radio
Receiver
Model 52

VALLEY ELECTRIC CO., St. Louis, Mo.
District Offices: Boston, Chicago, Cleveland, Indianapolis, Kansas City, Minneapolis, New York, Philadelphia, San Francisco.

Valley Electric



No. R-111

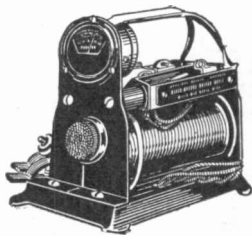

No. 900

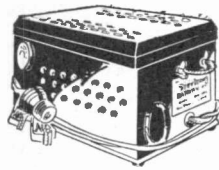

No. R-113

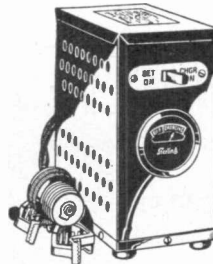

No. R-101



No. 19



*For every individual need
fancy, or purse there is a*

Sterling BATTERY CHARGER or "B" POWER SUPPLY

Radio has advanced to the stage where no single type of battery charger will satisfy every customer. The Sterling line of Chargers and "B" Power Supply Units give dealers a complete line, under one brand name, to suit the individual requirements of set owners and to meet various price demands.

No. R-111 Bulb Type Charger for six volt Radio "A" and up to 96 volt "B" battery charging. So easy to operate that any inexperienced person can use it. No fussing with wires while changing from "A" to "B" battery or vice versa. Equipped with Sterling ammeter. Absolutely noiseless in operation. List price with bulb \$18.00.

No. R-113 Bulb Type Charger, a compact unit equipped with indicator which shows "OR" and "Charging." For six volt "A" batteries only. List price with bulb \$13.50.

No. 900 Vibrating Type. A high-rate charging rectifier for use on Radio "A" or automobile batteries. Equipped with Sterling two-way scale ammeter. Charges at a normal 5 ampere rate which automatically decreases to prevent overcharging. List price \$15.00.

The Sterling Charger was one of the first rectifiers on the market and our new types have more than kept pace with the development of the radio industry. A vibrating-reed type, a bulb type, a trickle type charger and an up-to-the-minute type of battery eliminator . . . Sterling's is indeed a versatile line.

No. R-101 Trickle Charger. This new Sterling continuous charger operating from lighting circuit offers owners of six volt and four volt "A" batteries the utmost in convenience, safety and efficiency, both charging and receiving are controlled from a combination switch in the unit. Equipped with Sterling meter to show that charger is working efficiently. Noiseless in operation; compact enough to fit any compartment that will accommodate three No. 6 dry cells. List price with bulb \$14.00.

No. 19. Combination A. & B. Charger. Vibrating Type, charges "A" Battery at an average rate of 5 amperes and "B" battery at 1/5 ampere. Meter indicates both A and B charging rate. List price \$22.50 (50 to 60 cycle). \$25.00 (25 cycles.)

No. 17.6 Volt "A" Battery Charger. Same as No. 19 except for "A" and auto battery charging only. List price \$18.50 (50 to 60 cycle). \$21.00 (25 cycle).

Sell Sterling
Care-Takers
as
Christmas
Gifts



*Bulb Type
Battery Chargers*

*Vibrating Type
Battery Chargers*

*Bulb Type
Trickle Chargers*

*Meter-Equipped
Tube Reactivators*

*Midget-Model
Tube Reactivators*

*Battery
Eliminators*

*Automatic Control
Switches*

Sell Sterling
Inspectors
as
Christmas
Gifts



Pocket Meters

Panel Meters

Filament Meters

Charge Indicators

Tube Testers

*Universal Tube
Testers*

*Combination
Tube Testers
and Reactivators*



THE STERLING
MANUFACTURING
COMPANY
Cleveland, Ohio

*Electrical
Manufacturers
since 1906*



Retail Price

\$30⁰⁰



This Amazing Test Was a Revelation Even To Us

Twenty-four hours, day after day—since April 1. Seven months of continuous operation in a laboratory. Equal to more than two years of ordinary six-hour-a-day reception. Yet this stock Consolidated "B" Eliminator has not required the slightest care nor attention and is still delivering the same unmatched pureness and strength of tone.

Only Consolidated Contains All These Twelve Big Retail Selling Points:

1. Universal in application; usable on AC and DC, any cycle, without change.
2. Power for any standard set—even the new power tubes; 110 to 115 volts.
3. Retail price—Only \$30.
4. No AC hum; no noise.
5. No costly bulbs to break; refills cost next to nothing.
6. Maintains permanent even tone and resonance.
7. Low in upkeep; uses less current.
8. An adornment to any set or to the furniture of any room.
9. Standard guarantee.
10. Small in size; less cumbersome.
11. Fewer parts; trouble proof.
12. Stops "B" battery cost; pays for itself.

Consolidated "B" Will Double Eliminator Sales and Increase Set Sales

Demonstrate radio reception at its best and you will cash in on maximum set sales to say nothing of extra accessory business. Let the Consolidated "B" Eliminator sell not only itself, on hearing as well as on sight, but any set in your store. Regardless of make, Consolidated brings out the highest possible degree of pure, strong tone.

Makes no difference about the current in your store or your customer's home. The Consolidated "B" Eliminator operates,

without change, on D.C. as well as A.C.—110 to 115 volts at any cycle. Powers any standard set and new power tubes.

More Sales, Less Servicing, When You Carry the Entire Consolidated Line

Say good-bye to servicing. Consolidated offers a fast moving line of virtually trouble proof radio products—the wonderfully advanced Consol 7 tube set and dependable "A" and "B" power to operate the set.

Exclusive features—advanced designs! For example, tone control of Consol "7," universal operation of Consolidated "B" and compactness of Consol "A" power.

Made of best quality material. Built by skilled workmen. Every Consol product is priced to cut down sales resistance.

When you stock the good Consolidated Automobile Battery, the Consolidated Line at once becomes an all-year-round strong profit line.

Write or telegraph today for complete information. Address Dept. R, Philadelphia.

Cut your eliminator stock in half—with Consolidated "B" you need carry only one model. Think of the unlimited market awaiting this universally usable instrument.

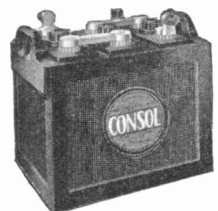

Consol Radio "A" Storage Batteries hold super supply of strong, even "A" power. Same quality as good Consolidated Automobile Batteries. Last longer because of pure materials in unstinted quantity

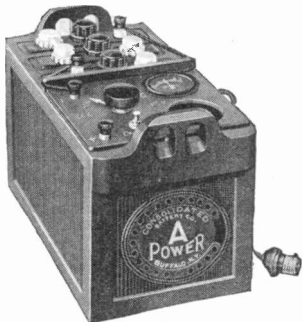

Consol "A" Power Unit retails for \$40. Single, compact unit—from trickle to two ampere change. High capacity battery with standard size plates. Trouble proof.

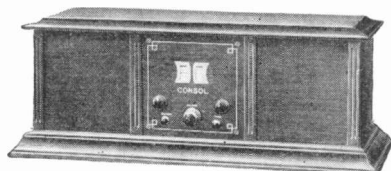

Consol 7-Tube Radio—Retail Price \$95—Contains many new and exclusive features. Tone control. Three stages of radio frequency. Double rectification. Two detector tubes. Shielded transformers and condensers. Panel light over dials. Beautifully designed and finished.

Consol

CONSOLIDATED BATTERY CO., Inc.
NEW YORK PHILADELPHIA BUFFALO

Simplex

RADIO

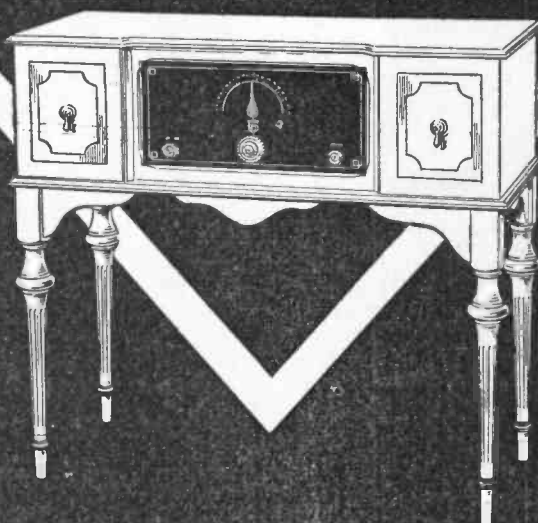

The Consol \$165

THE FIRST **THE BEST**
SINGLE DIAL CONTROL

Originators and pioneers in the single dial Art —
Simplex now offers a New instrument of superlative
quality destined to bring new laurels to its good name.

*A dealer franchise of unusual
attractiveness.*

THE SIMPLEX RADIO COMPANY
Main Office and Works—Sandusky, Ohio

BRANCH OFFICES

Atlanta
Buffalo

Chicago
Detroit

Houston
Indianapolis

Los Angeles
Minneapolis

New York
Omaha

Philadelphia
Portland

St. Louis
St. Paul

Salt Lake
San Francisco

Seattle
Toronto

AMSCO

FOR EXCELLENCE

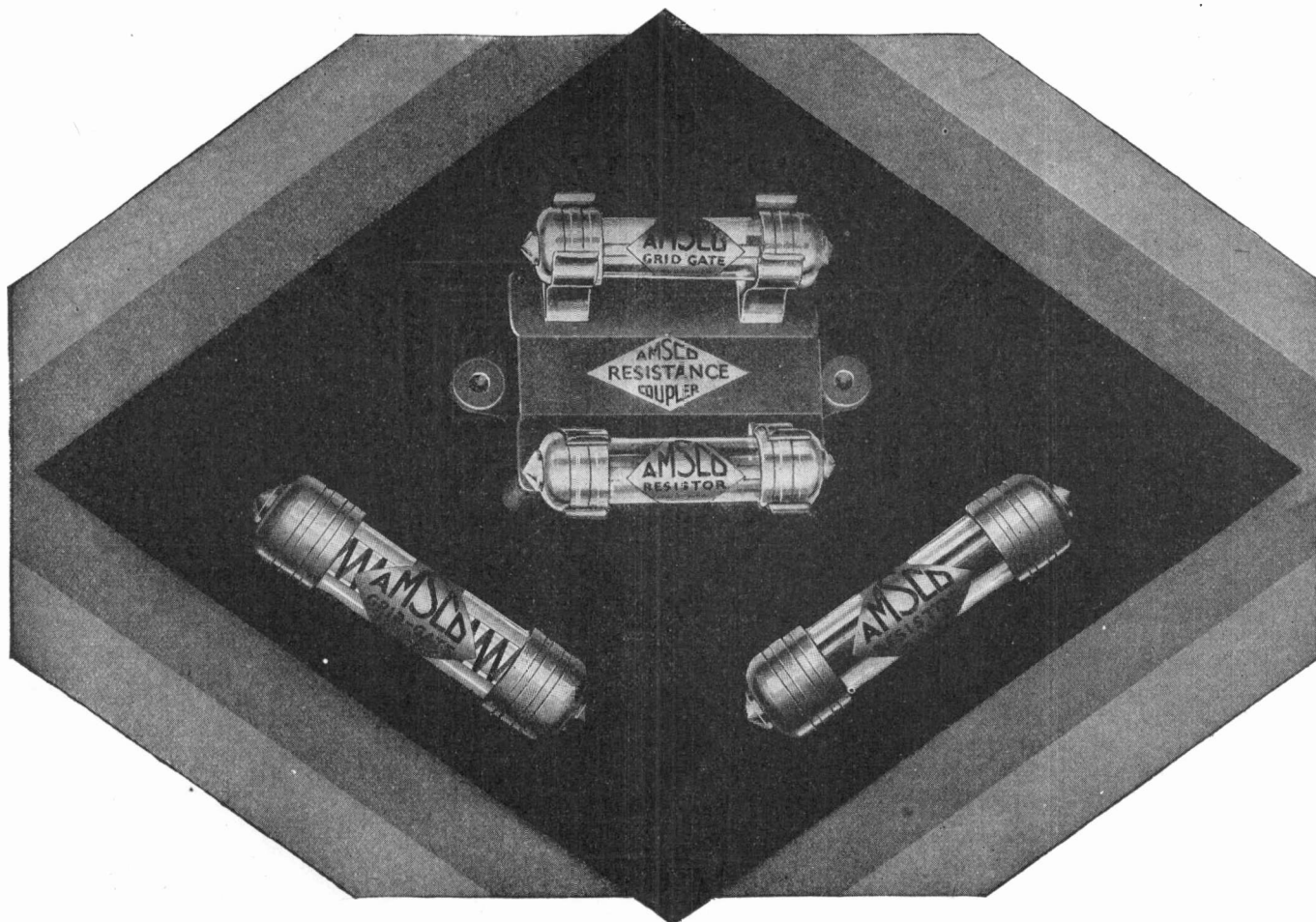

SILENCE, PLEASE!

AMSCO METALOID Grid Gates and Resistors are uniquely silent. There is no thunder in them. They do their work noiselessly—and they give you—*TONE*.

The secret of AMSCO excellence is in the new Metaloid resistance element—*colloidal and unbroken*, superseding crystalline forms, with their jagged, noisy pathway to the current flow.

It pays to insist upon getting AmSCO Metaloid Grid Gates, AmSCO Metaloid Resistors, AmSCO Resistance Coupled Amplifier Units.

AMSCO PRODUCTS, INC., BROOME AND LAFAYETTE STREETS, NEW YORK CITY



Two Profits on Every Sale!

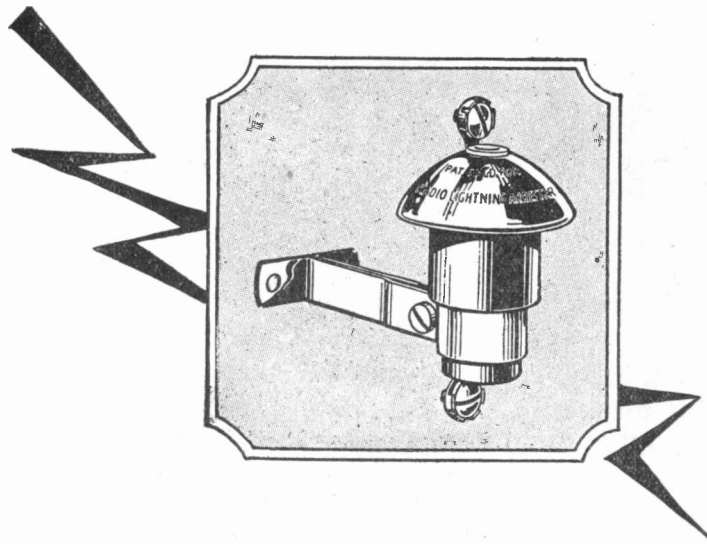

Wirt Radio Lightning Arresters

Air-gap type. Small and neat in appearance. Made of Bakelite and brass. Wide petticoat for ample insulation in wet weather. Bracket for rigid fastening. Lead in connects without cutting wire. Heavy brass screws furnished for mounting. Listed as standard by Underwriters' Laboratories. \$1.00.

Wirt Radio Wall Insulators

Made of brown glazed porcelain. Keep wired at the proper distance from walls and buildings to prevent sagging and leakage. Bracket for rigid fastening. Complete with heavy screws for mounting. 35 cents.

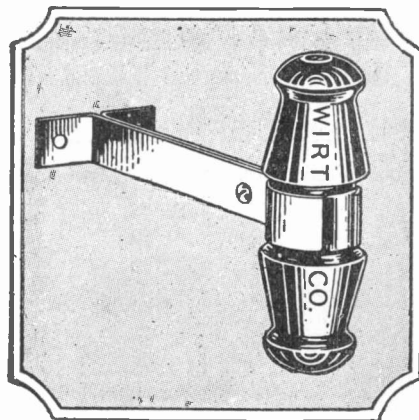

Wirt Radio Wall Insulators and Radio Lightning Arresters sell hand in hand. One sells the other. Show them together. Make two profits on every sale. If you are installing sets, always use Wirt Lightning Arresters and Insulators. They make a neater installation. They help

bring in everything the aerial gets. They give the set a chance to perform its best. They make satisfied customers.

Put a little extra selling effort behind these two winners. There's bigger profit in selling the best. Push these two leaders.

WIRT COMPANY
 PHILADELPHIA, PENNSYLVANIA
Makers of Dim-A-Lite

arrived!

THE Sandar — the new cone Speaker — has *arrived*.

Sandar covers the whole range, it brings out each sound within the scope of the set, unblemished, unaltered, and with full value all along the scale.

Sandar is artistically designed, it appeals to those to whom attractive appearance is as essential as mechanical excellence, AND Sandar is priced lower than any other licensed speaker of its size on the market, it

retails at \$27.50! A remarkably low price for a quality product — a price that is sure to *move Sandars fast*.

Look into the merits of the Sandar Speaker. Sandar is going to register strongly with those who are always in the market for refinements in radio reception.

A forceful, comprehensive advertising campaign is planned to back up and supplement all sales effort on Sandar. Write us for terms and full information.

SANDAR CORPORATION

Crescent Plaza Building, Long Island City, N. Y.

*Licensed under
Lektophone Patents*

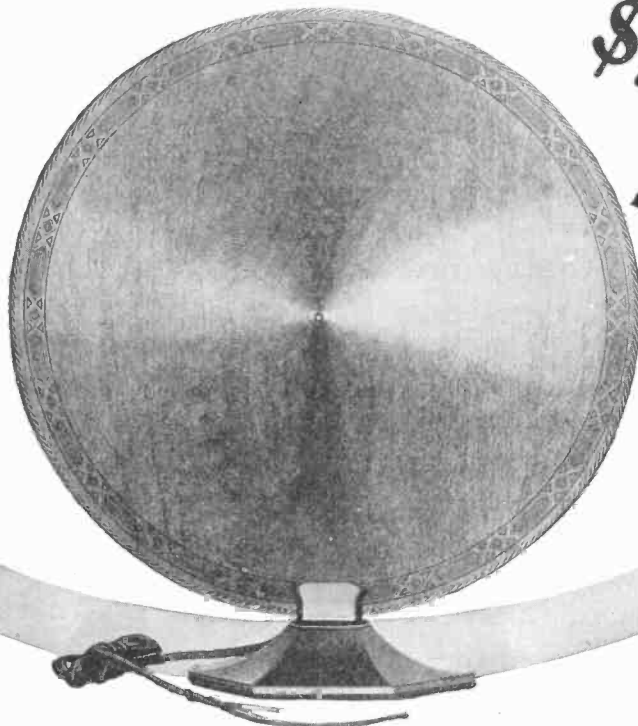

\$27.50

SANDAR SPEAKER

Announcing

Gemco Trutone Speakers

Gemco's entry into the radio field is based on years of experience and scientific investigation in the production of loud speakers.

As a result, Gemco comes into this field with a real contribution to offer—an amazing improvement in loud speaker performance.

Tones from the Gemco are soft and melodious, full and natural, regardless of the amount of volume. A demonstration is little short of a revelation. It convinces even the most doubtful that Gemco's achievement is of the first magnitude and a great advance in radio progress.

Gemco designs are exclusive—not simply to be different, but to carry out Gemco's scientific discoveries of improved reception. All models beautifully finished.

Make Money with Gemco

No increase in your overhead—but a big increase in your profits! Sales are easy with Gemco Trutone Speakers because, at last, they provide what the public has long searched for—a receiver that would lift radio performance to a new and higher plane. Radio enthusiasts throughout America will welcome this great new achievement.

Write today for full information

Gemco Mfg. Co.

727 So. Pierce St.
Milwaukee, Wis.

The GEMCO Trutone Speaker is manufactured and guaranteed by one of the oldest and best known manufacturers of automotive accessories in America.

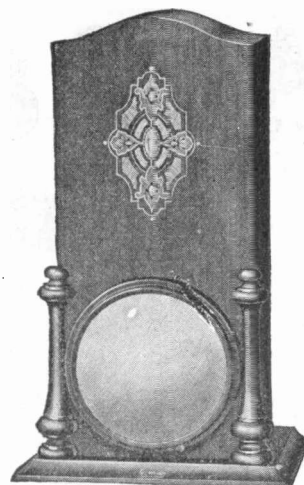

MODEL 26

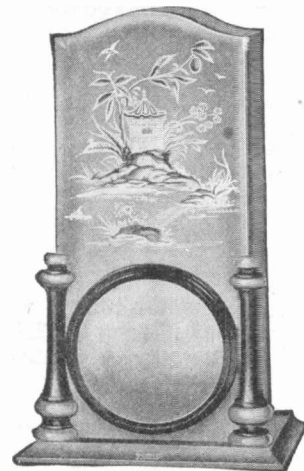

MODEL 26R

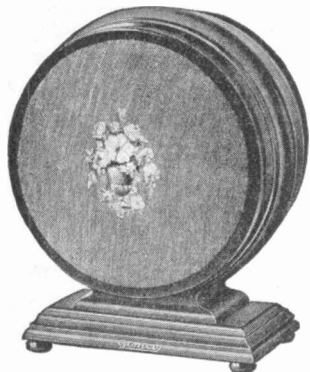

MODEL 25

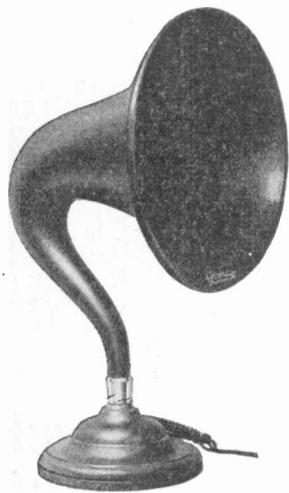

MODEL 27

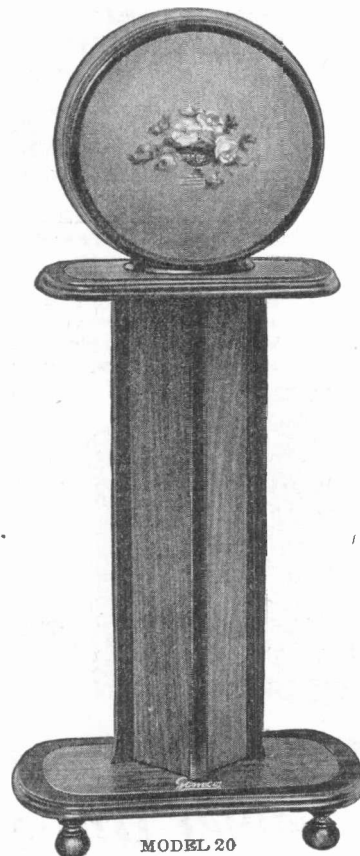

MODEL 20

A·B & C Radio Power from your light socket

SILITE

TRICKLE CHARGER

.6 ampere charging rate. Absolutely noiseless—no bulbs—makes a power unit of your battery.

\$10.00

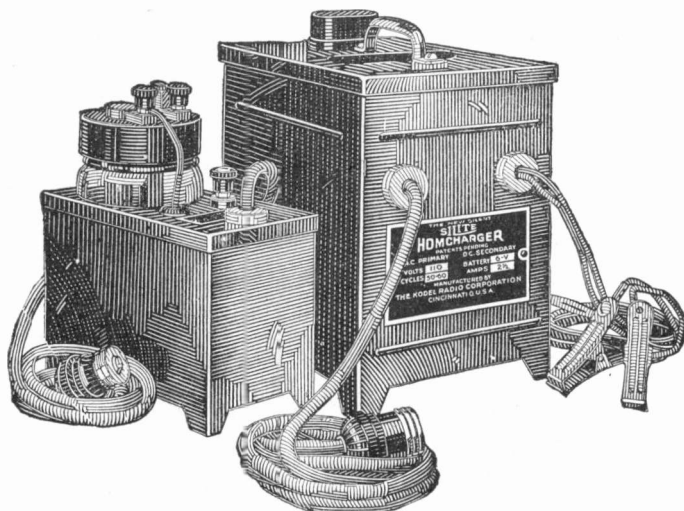

SILITE

HOMCHARGER

Charges at 2½-3 ampere. Absolutely noiseless—no bulbs—can be used while set is operated.

\$19.50

Your battery troubles are over at last! Now ALL radio power is in your light socket, for ALL circuits, A, B, and C.

Silite, the marvelous new metallic glass rectifying element, provides perfect rectification of light socket current into "A" battery power. Leave the Silite Trickle Charger permanently connected to your storage

battery and on charge—then forget battery charging forever. Silite Trickle makes a power unit of your battery—insures constant, never-falling "A" current that operates your set at highest efficiency. For very large sets, where a higher charging rate is necessary, Silite Homcharger is recommended. Either model may be used while the set is operated.

Kodel A&B Transifiers

Kodel A and B Transifiers actually supply all A, B, and C current direct from the light socket—no batteries of any kind are needed. Just plug the Transifiers into the wall socket and turn on your receiver—smooth, uniform A, B, and C power operates your set as it has never operated before. Watch the new life, new pep it gives your set—the longer range, the much greater volume. Transifiers give quiet, noiseless reception that was never

before possible, even with fresh, new batteries.

Vastly different from and superior to the ordinary power units, Transifiers consume electric current only while you operate the set—maintenance cost is much less—it costs less than one-half cent for every hour the set is operated, for all A, B, and C power.

Ask any radio dealer to show you the Silite Chargers and Kodel Transifiers.

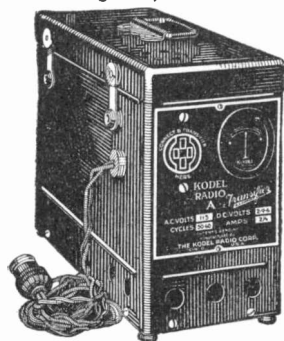

- MODEL 10 "A" TRANSIFIER—Supplies 2, 4, or 6-volt "A" current direct from the light socket. For sets using up to 10 tubes \$42.50
- MODEL 10 "B" TRANSIFIER—22½ to 150 volts "B" current; 4 to 10 volts "C" current for any size set. Operates power tubes \$42.50
- MODEL 61 "B" TRANSIFIER—22½ to 90 volts noiseless "B" power for sets up to 6 tubes. (Bulbs extra) \$28.50

["Behind the Scenes in a Broadcasting Station" an interesting 24-page booklet, will be mailed free on request, together with literature describing Silite Chargers and Kodel Transifiers.]

THE KODEL RADIO CORPORATION

503 E. Pearl St. • Cincinnati, O.
Owners and Operators of Broadcasting Station WKRC

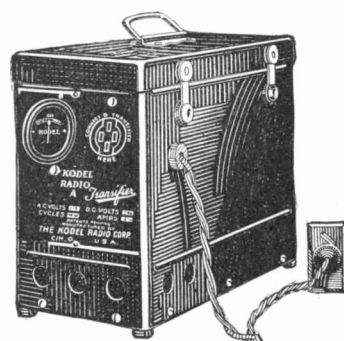

Battery Chargers
Power Units

KODEL

Radio Receivers
Loud Speakers

POWER SPECIALISTS SINCE 1912



Weigh This Offer

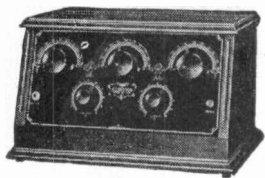

Type XL-20
Standard \$55

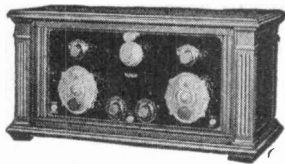

Type XL-30
Standard \$135



Type XL-30
Console \$210

BACKED by national advertising, large resources and 6 years of previous radio success, A-C DAYTON offers *exclusive* territory and *full protection* to qualified dealers.

To these dealers it further offers the most distinctive line of receiving sets in the field of Radio, six models (5 and 6 tube), priced from \$56 to \$255.

These sets are not only superior in appearance, refinements and dollar for dollar value, but they feature, in all 2-dial models, an additional or Second Stage of Tuning, in which the sets perform entirely above the normal standard. In the First Stage you tune as with other high grade receivers; the new controls of the Second Stage are used when ordinary tuning will not meet conditions.

Your territory may yet be open. The big season is just beginning.

Write us immediately for full details.

THE A-C ELECTRICAL MFG. CO.

Dayton, Ohio

Makers of Electrical Devices for More Than 20 Years

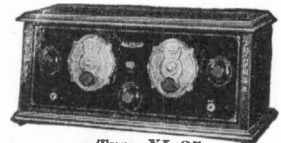

Type XL-25
Standard \$79

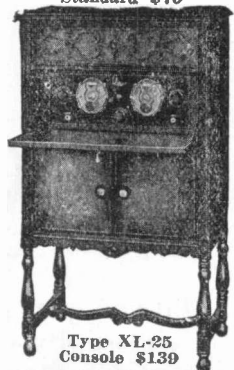

Type XL-25
Console \$139



Type XL-30
Console Grand \$255

A-C DAYTON

RADIO

*All prices slightly higher
Denver and West*

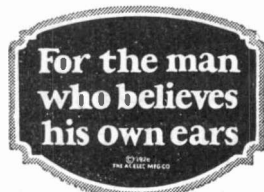

RR-10

The A-C
ELECTRICAL
MFG. CO.
Dayton, Ohio.

Gentlemen: I am interested in your exclusive franchise. Send full details at once.

Name

Address



No Speeches—

Did you ever listen to a spellbinder? He's usually long on talk and short on performance.

In Radio, especially, it's necessary to get down to cold, clear facts—based on *performance alone*.

Test every set you plan to put *your* good name behind, yourself—play with it in different territories and under varying conditions. Then you'll be *sure* that you are giving value to your customers.

Here's a fact about Shamrock that will be readily verified at a trial. *Under the same conditions it will perform as*

just Plain Facts!

well as the best of the high-priced sets. It is by all odds one of the finest values on the market today—it's the perfected *One Dial Set!* Ask us to prove it.

Box model \$95—other models \$130 to \$275—6 tubes—Tuned Radio Frequency—One Dial Control.



SHAMROCK

RADIO SETS

Pioneers in Manufacturing the Perfected One Dial Sets

SHAMROCK MANUFACTURING CO.

Main Office and Factory: 196 WAVERLY AVE., NEWARK, N. J.

Voices that are Human

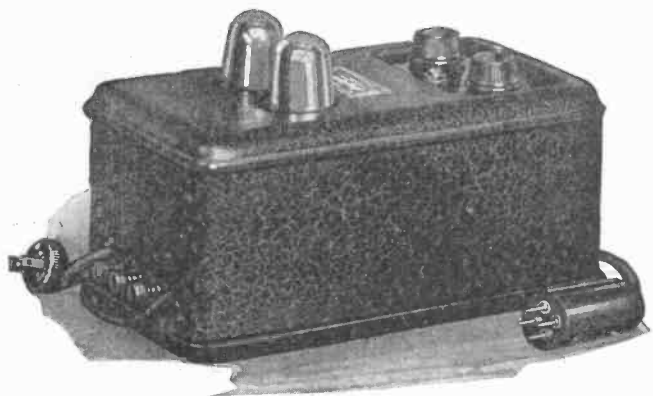

THE Aero B Amplipower can actually turn any average radio set into a true musical instrument. It makes possible the exact reproduction of every shading of tone, both vocal and instrumental. Low D on the base viol booms out just like the original and high C is actually high C. With an Amplipower, voices are really *human*, not merely boxed up reproductions.

The Aero B Amplipower not only makes possible the maximum in tonal quality and volume, but *also* supplies *all* of the "B" current for the radio set. Simply attach it to any set the same as a "B" battery,

If your jobber hasn't Amplipower or Aero B power units in stock, write us for complete details, giving your jobber's name.

remove the last audio tube of the set and insert the Amplipower adapter and the Amplipower is ready for service.

The Amplipower will bring out *music* that you never before heard in radio—music that is *music*, with every note as rich and full as the original when used with a good speaker that is capable of reproducing all the notes of the scale. It is a real profit maker for radio dealers—at the list price of \$65.00 without tubes.

Aero B is also built as a "B" power unit without the high voltage power tube — price \$50.00 complete with tube.

THE GLENN L. MARTIN COMPANY, Radio Division, Cleveland, O.

AERO B
Amplipower

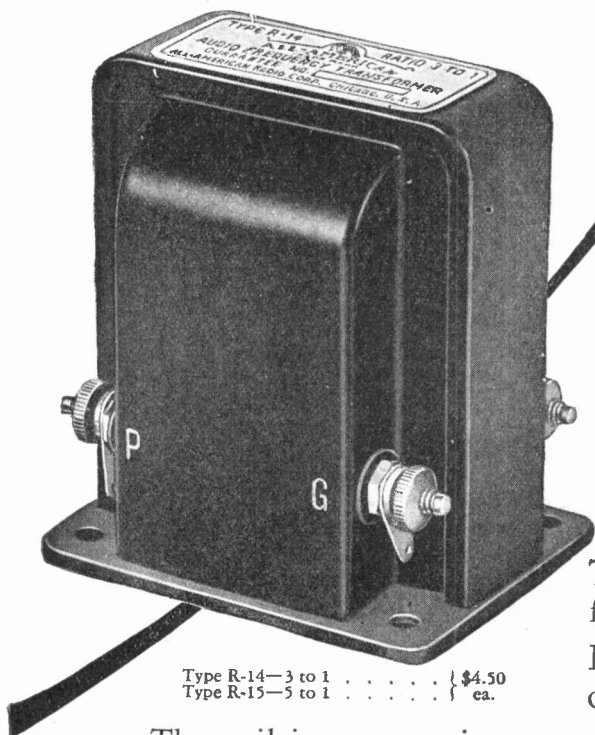

Type R-14—3 to 1 \$4.50
 Type R-15—5 to 1 ea.

New!



ALL-AMERICAN TRADE MARK AUDIO TRANSFORMER

This latest development meets the new demands for compact wiring and longer life—
 Binding Posts are conveniently located for straight or sub-panel wiring—

The coil is vacuum impregnated—

After assembly the shell is filled with special compound and the complete unit hermetically sealed. *A transformer that sets a new standard.*

Tone Quality Is the Keynote

No standards of quality can be higher than those we set for our own products; no inspection is more rigid; no tests more severe.

Each of these All-American Transformers plays its part in determining the quality

of radio reception. Each is designed and made with the same care that goes into the finest receiving sets.

These products have helped to create All-American leadership.

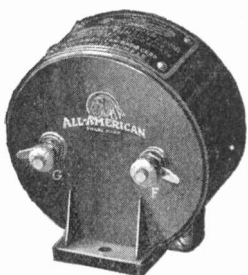

UNIVERSAL COUPLER highly efficient both as antenna coupler and tuned R. F. Transformer

New 1927 Radio Key Book

Everybody who enjoys radio should read it—an interesting 48-page analysis of radio in terms anybody can understand; with complete constructional details of the leading types of circuits. Send 10c in coin or stamps for your copy.

All-American Radio Corporation
 4223 Belmont Avenue CHICAGO

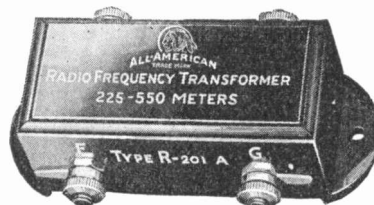

SELF TUNED R. F. TRANSFORMER effectively amplifies all frequencies. Designed to match tube characteristics

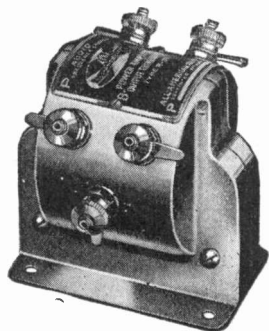

POWER (PUSH-PULL) AMPLIFYING TRANSFORMER, gives power amplification without distortion where excessive volume is demanded

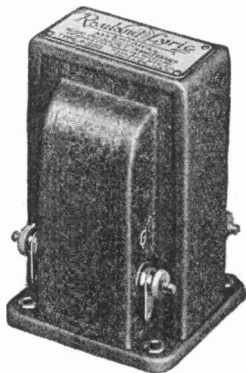

RAULAND-LYRIC An audio Transformer, famous for its perfect tone reproduction—an outstanding product. Made with painstaking thoroughness without regard to cost

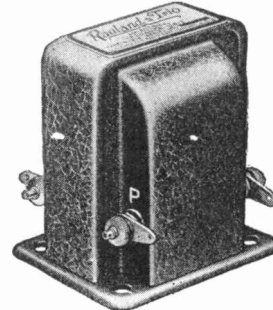

RAULAND-TRIO An inductance, a resistance and a capacity perfectly balanced in one shell—a compact factory-built unit for impedance coupled amplification

3 Bodine Radio Items, that sell fast!

Bodine DeLuxe Radio Loop

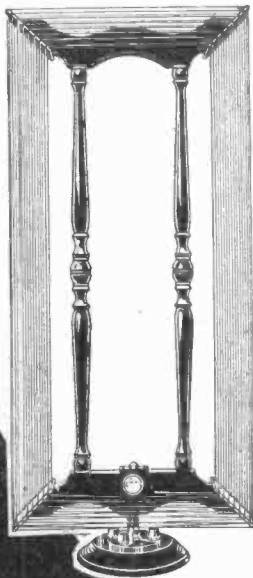

Unusual care has been taken to make this loop outstandingly beautiful so that it harmonizes with the most attractive furniture. The frame is superb, hand-rubbed walnut, beautifully balanced, and the winding is covered with a lustrous silk braid. Bakelite supports the winding, and not only provides good insulation but also enhances the appearance of the loop.

Fine copper wires, stranded with phosphor bronze wires, hardened to prevent stretching, are used for the winding. A three-contact jack mounted on bakelite in the base permits the loop to be rotated continuously without disturbing the connecting wires. If desired, the jack which supports the loop may be mounted in the cover of the set, eliminating exposed connecting wires.

Write for complete data on the well advertised Bodine Line

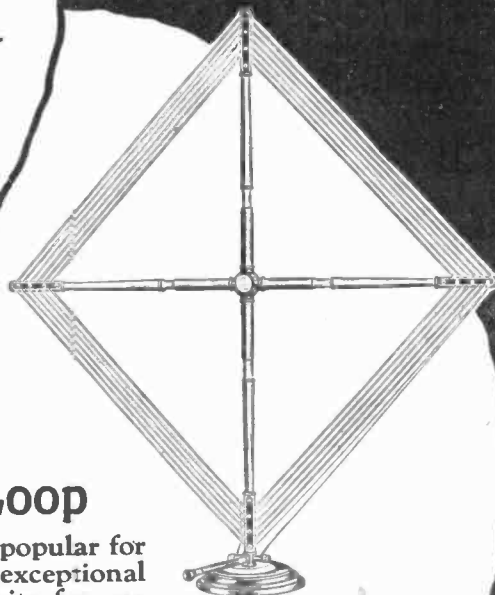

Bodine Folding Loop

This handsome loop is very popular for use in homes, because of its exceptional pick-up. It is a special favorite for use with portable sets. The English Mahogany frame folds until it occupies minimum space, yet, when extended, it provides a large effective area. The basket-weave principle of winding reduces undesirable distributed capacity and increases the effective area. Special non-stretch wire is used so that the loop holds its shape well in service.

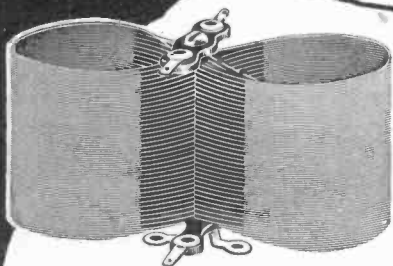

Bodine Twin-Eight R. F. Transformer

New principles of design are embodied in the Bodine Twin-Eight Radio Frequency Transformer. This unique coil combines a very limited magnetic field with tremendously high amplification. The result is unexcelled amplifying capacity with an unusually high degree of selectivity. These coils greatly improve the performance of tuned radio frequency sets and circuits. Sketches and wiring diagrams covering the Bodine Twin-Eight Receiver which utilizes these remarkable coils free on request.

BODINE ELECTRIC COMPANY
2242 West Ohio Street
Chicago, Illinois

Gentlemen: Of course we want to know about the Bodine fast selling radio products. Kindly mail folder covering entire line.

Name

Address

65%

reduction in deadly service costs means far greater profits in set sales

ARE you one of the many radio dealers who frankly admit they are losing money on the sale of complete sets? Are you, like so many others, merely breaking even? What is the *real* reason why so few dealers are making a decent profit?

Many dealers have found out. They tell us that the high cost of servicing is to blame for one of the most discouraging conditions radio has known. When a dealer sells a set he must service it, whether his profit is large or small. The cost of that servicing over a period of months consistently eats huge holes in the profit—often consumes it entirely.

Most of that profit-killing cost is absolutely needless. The majority of the service calls you make—65% to be exact—are caused by the failure of batteries to function properly. If you do away with the cause of battery failure, you automatically eliminate $\frac{2}{3}$ of your service costs. That is precisely how Unipower, radio's pioneer "A"

power unit, is helping hundreds of dealers. By selling Unipower with the complete set, the dealer forestalls "A" battery service calls. And saves his profit from much of the normal cost of servicing.

The customer is glad to have Unipower. It gives him unfaltering power from the light socket and eliminates for him the bother and inconvenience of having you make monthly service calls.

Here then are three profits no dealer can afford to pass up—1: A substantial margin on Unipower itself, for Unipower is distributed only to reliable dealers through responsible jobbers. 2: A definite saving in deadly service bills. 3: A satisfied and thankful customer.

We shall be glad to send you additional information and price lists. Or booklets to help you sell your customers. Send a post card.

The Gould Storage Battery Company, Inc., 250 Park Ave., New York.

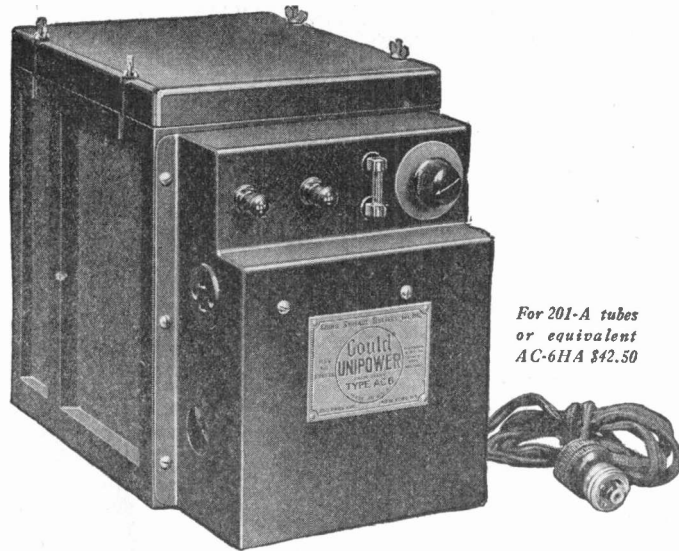

For 201-A tubes
or equivalent
AC-6HA \$42.50

New refinements to a proven principle—the principle of trickle charge plus the indispensable rapid charge found only in Unipower—are present in this new 6-volt Unipower designed to furnish unfailing "A" power to any 201-A tube set. Four trickle rates, operated by a simple dial, enable the user of heavily-worked multi-tube sets to adjust the power to the exact rate necessary to his individual set and hours of use.

Complicated wiring is eliminated—installation is as simple as that of a storage battery. Automatic switching makes possible a power-operated set under one control—no change is necessary in "B" power supply or set wiring.

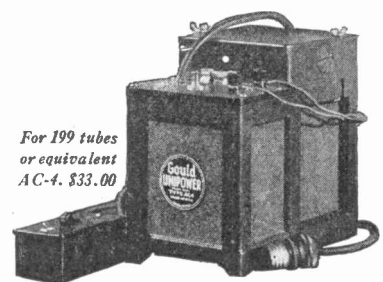

For 199 tubes
or equivalent
AC-4. \$33.00

Unipower contains a Balkite charging unit of Gould design. It operates from alternating current 110-125 volt—60 cycle—special models, 25-50 cycle, at slightly higher prices. Patents pending on all models.

Unipower

A GOULD PRODUCT

RADIO "A" POWER THAT CANNOT FAIL

Selling Better All the Time



When each year surpasses the last, you know there are good reasons. Especially in the radio industry where stability means more! The record shows that CASE sets have been thoroughly proven and found absolutely dependable; that CASE policies are fair and sound; that our prices give the utmost possible values; that our factory facilities—all parts being made in our own plant—insure perfect fitting and matching of all parts, and low service costs for jobbers and dealers.

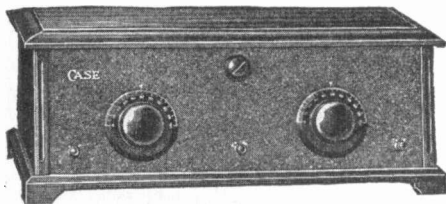

MODEL 60A
6 Tubes, 2 Controls only **\$75.00**
3/4-in. Solid Mahogany Cabinet List

Never freakish, the CASE line is noted for the soundest merchandise it is possible to build, sold honestly and fairly, through reputable jobbers and dealers only. Our merchandising policy includes liberal sales helps and national advertising.

The CASE 1927 line is built around a standard circuit with 6 tubes—noted for remarkable reception, power, clearness and selectivity. These are precision instruments—made for a lifetime of satisfactory service. Volume production and sales—now the largest in our history—enable us to offer the lowest prices ever known on such quality sets.

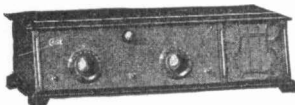

No. 60B, \$100

The CASE franchise in your territory may still be available. Write today and find out—it will pay you well.

INDIANA MFG. & ELECTRIC CO.
 Marion, Indiana



No. 60D, \$170

CASE

RADIO PRODUCTS

See Our Exhibit—Fifth Annual Chicago Radio Show,
 Coliseum, Oct. 11 to 17, inclusive.

Use This!

The complete CASE line of 10 numbers lowers sales resistance by enabling you to give customers what they want. The 4 numbers illustrated herewith typify the rare values in all CASE sets—6 tubes, 2 controls, dials or vernier—perfectly logged and easy to tune. Walnut and mahogany cabinets of carefully selected woods.

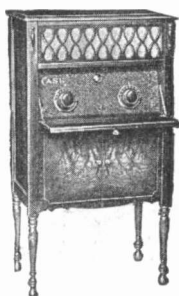

No. 60C, \$125

INDIANA MFG. & ELECTRIC CO.
 530 Case Avenue
 Marion, Indiana

Send complete information regarding the CASE franchise in this territory—without obligation.

Name _____

Address _____

Tell 'Em \$2.00 Buys an Automatic Switch

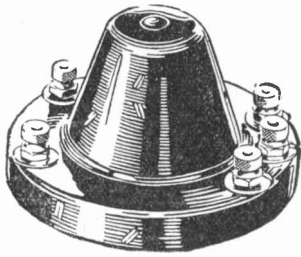

Model 13, list price \$2.00, operates 80 per cent of the existing receiving sets. However, for sets using Type 199 Tubes, Model 14, list price \$2.50, is required.

Your customers will appreciate having you tell them about this positive-acting device which makes the A Battery switch on a receiving set automatically turn on or off, either or both the Trickle Charger and B Eliminator as required.

You can tell them that two dollars is enough to pay for an automatic switch. This one, sold under a money back guarantee, can make the operation of a receiving set fully automatic. No other switch sold at any price can do more.

Your jobber is ready to supply you. Sell one with every Trickle Charger or B Eliminator.

THE RELIABLE PARTS MFG. CO.
2821 Prospect Ave. Cleveland, Ohio

RELIABLE
Automatic
Power Control Switch

A Supremely Fine Instrument
No. 78—\$270



"The Mayfair"

Amazing Selectivity—Delightful Tone—Exceptional Volume!

TWO new home delights! First the joy of a supremely fine bit of furniture craftsmanship—a rarely beautiful console to enhance the beauty of your home.

Second the all surpassing joy of true radio entertainment—all the programs of the air brought in with surprising fidelity and beauty of tone. Amazing selectivity that makes radio enjoyable.

The Trinum Circuit makes Oriole Receivers genuinely satisfying in performance. Built with the precision of a fine watch they bring at last to radio that genuine dependability which you have been hoping for. Ask your dealer to show you.



"The Canterbury"
No. 75—\$150

This pleasing console model will grace any home. The six-tube, two dial Oriole Receiver will bring new joy to Radio for you.

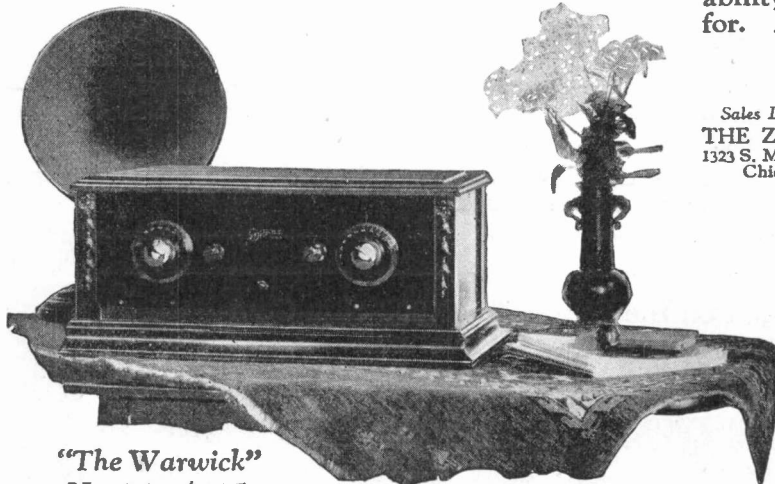

"The Warwick"
No. 71—\$125

A table model of exceptional grace and truly unusual power. Everything that radio can give, at a price in reach of all.

Sales Department
THE ZINKE CO.
1323 S. Michigan Ave.
Chicago, Ill.

Manufactured by
W-K ELECTRIC CO.,
Kenosha, Wis.

ORIOLE
RADIO
RECEIVERS
with the Trinum
Circuit

ELECTRAD

New Model ELECTRAD Royalty Variable High Resistances

For Perfect Control of
Tone and Volume

Note these important exclusive features:

- 1.—Resistance element not exposed to any mechanical operation.
- 2.—Electrical contact made positive by metallic arm on wire-wound strip.
- 3.—The same resistance is always obtained at the same point.
- 4.—Resistance value is under control in process of manufacture and does not change in use.
- 5.—Entire range of resistance is covered with less than a single turn of the knob.
- 6.—There is no mechanical binding and shaft is turned smoothly over entire range.

All ranges dissipate three watts.

A Range for Every Purpose. Type E, \$2.00; all other types, A-L, \$1.50. Canada, \$2.10-\$3.00

Write for free circular

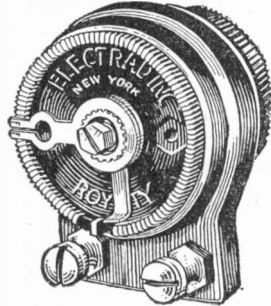

Type G—0 to 10,000 ohms, recommended as a volume control in the L. C. 27.

Licensed by Technidyne Corporation under U. S. Patent 1593685, July 27, 1926.

ELECTRAD Certified Jacks

(Open and closed)

Positive acting spring of phosphor bronze. Sterling Silver contact points. Insulation of hard rubber. Tinned soldering lugs, placed to make good connections easy. Require less than 1 in. behind panel. Certified and guaranteed electrically and mechanically. List, open, 25c. closed, 35c. In Canada, open, 35c, closed, 50c.

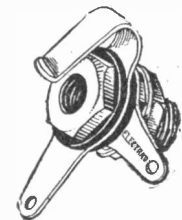
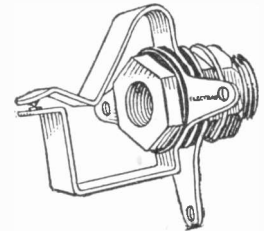

ELECTRAD CERTIFIED LEAD-IN

When you sell a lead-in you might as well sell a good one. Note these points: Triple-ply insulation full 10 inches long, covered with water-proof webbing. One-piece copper strip, heavily tinned to prevent corrosion. Fahnestock clips. All connections riveted and soldered. Fits under locked doors and windows—bends to any shape. List 40c—in Canada, 60c.

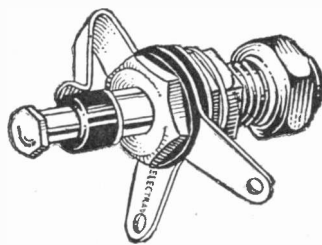
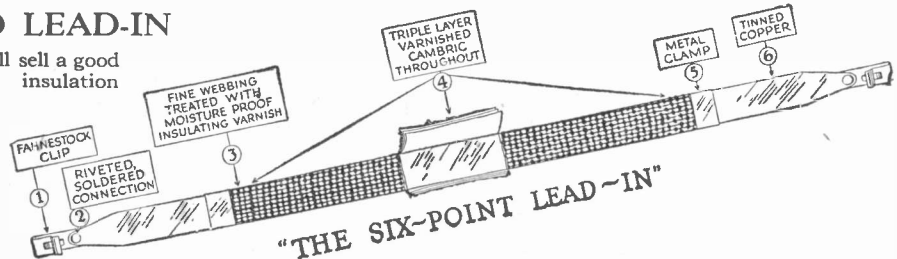

ELECTRAD CERTIFIED SWITCHES

When they're on, they're 100 per cent on; when they're off, they're 100 per cent off. Solid brass construction. Tinned soldering lugs, placed to make good connections easy. Neat design, genuine *Bakelite* knob. Require less than 1 inch behind panel. List 40c—in Canada 60c.

Write for details of our square dealer proposition that helps you sell and protects your profits.

Write for information on the Electrad 500,000-ohm Compensator for perfect control of tone and volume.

428 Broadway, New York City



ELECTRAD

Inc.

The hit of radio!

Radio Retailing

The same rapid development that has marked the radio industry during the past twelve months pertains as well to the growth of the foremost radio sales service, *Radio Retailing*.

The army of readers of *Radio Retailing* grows and grows!

During the past year and a half it has grown not only to the top of its field but by every numerical yardstick far ahead of every other radio-industry publication.

It has the largest radio trade audience ever gathered together as well as the largest paid subscription list.

And the new readers continue to come!

That's because *Radio Retailing* is of incomparable service in assisting the dealer to boost sales and profits. But read on and get other valuable facts.

Radio Retailing is admittedly the foremost authority on the problems of the radio dealer.

Every issue overflows with tried and tested methods for increasing radio sales — just the figures, facts and photographs that you can use right now!

Make sure that you receive a copy of every issue of *Radio Retailing* — fill in and return the coupon on the other side of this page.

Reading *Radio Retailing* is a business-building investment!



Read on 



To help you
get the
business

Radio Retailing will do it!

That *Radio Retailing* is one of the biggest hits in the radio field is putting it mildly!

Radio dealers in every part of the country agree that it's the biggest value for two dollars ever offered in radio!

Dealers everywhere say that there's no service to compare with it in the way it presents methods and systems for running a radio business at a profit.

To keep up-to-date with the endless procession of new ideas and new developments in the vastly diversified field of radio is utterly impossible without using *Radio Retailing*.

To learn of new sales methods, new sets, parts and accessories, new methods of ap-

proach, new display and layout ideas, ideas on advertising, demonstrating and servicing, requires an ever-searching investigating organization.

This is the job *Radio Retailing* is doing for its readers!

Think of such a valuable service for only \$2 a year!

Make sure you receive a copy of *Radio Retailing* every month—keep up-to-the-minute—you'll find it will pay in more ways than one!

To enter your subscription just fill out the coupon below and return to *Radio Retailing* headquarters today.

The cost is only \$2—the biggest value for the money in the whole radio industry!

Don't delay—Fill in and return this coupon now—*Today*

Radio Retailing

Tenth Avenue at 36th St., New York, N. Y.

Send me *Radio Retailing*, the business magazine of the radio industry, which gives the collected ideas, plans and methods of the most successful radio dealers in every part of the country. Start the service with the next issue, please. I'll send the \$2 after I receive your invoice.

NAME

STREET

CITY

NAME OF COMPANY

BESIDES RADIO WE SELL

OCT.

BUILT LIKE A VIOLIN

*Tone first .. Beauty next
 .. make sales easy
 and profits generous*

A human-like throat, fashioned as a violin, to amplify the tone-product of the finest unit ever put into a radiospeaker!

A cabinet job in American mahogany or African walnut—exquisite in the simplicity of its design; beautiful beyond description in the natural grain tracery and finish of its wood!

No radiospeaker, so far, has ever offered this supreme

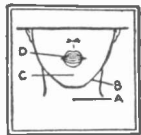
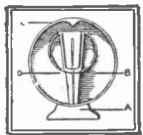
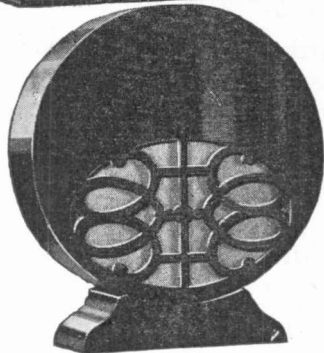
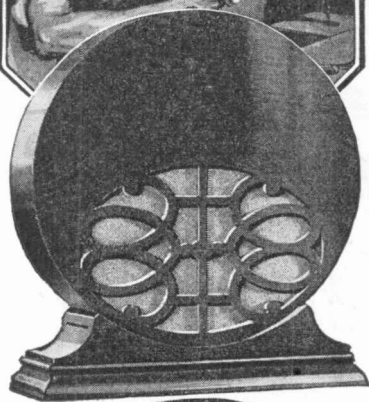

combination . . . a combination which makes it virtually self-selling.

If ever a radio dealer was offered a richer instrument, backed by adequate advertising and offering a comparable assurance for profit, we have never heard of it.

A post card is enough to bring you the entire profit-story.

TELEPHONE CORPORATION
 OF AMERICA
 449-453 West 42nd St.
 New York City

Note that a sound-wave coming from the sound producing unit "A" (the human vocal cords) is amplified through the orifice "B" (the human larynx) until it reaches the conducting area "C" (the back of the throat), whence it is again conducted to the point of greatest amplification "D" (the correctly formed and opened mouth of the singer).

TELEPHONE
Radio speaker

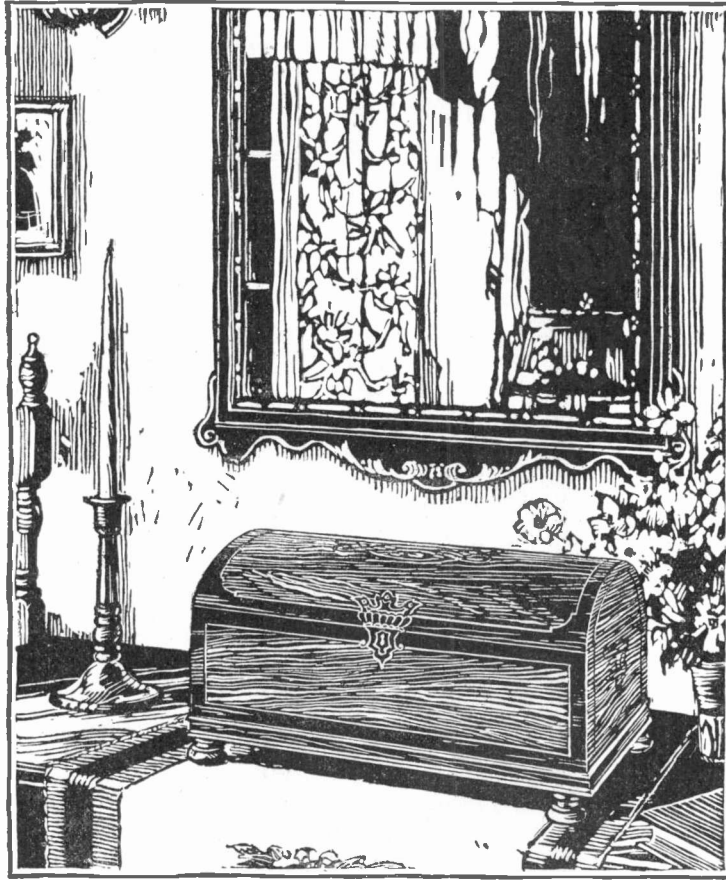

Velvet Radio Speakers

No. 21
"The
Jewel
Case"
\$45

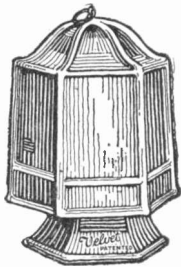

No. 9
"The Lantern"
\$12.50

Such quaint charm to please the eye — and rare power to please the ear! Full and faithful tone recreations of beauty. Priced low.

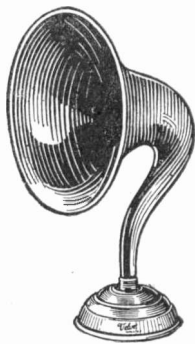

No. 12--\$16.00
No. 15--\$23.50
Borkmanite Horn—
Velvet Double
Stylus Unit



No. 18 ---\$27.50
"The Chinese Cone-Flex"

"Just as if you were there!"

The Ultimate in Radio Recreation

THE trappings of laboratory are gone. In its rich, quiet beauty, the Velvet "Jewel Case" Speaker is at peace in company with your richest furnishings—a rarely precious possession for any home.

For it is not merely beautiful. It is living Radio Recreation itself when it brings in the full round tones of the whole orchestration. Tonal beauty that matches its outward delightful dignity. You must hear it—see it—to fully appreciate the long step ahead which Velvet brings to Radio.

Dealer-Jobber Franchise sales plan unusual—write or wire for details. It will bring you new satisfaction in selling Radio.

Sales Department
THE ZINKE CO.
1323 S. Michigan Ave.
Chicago, Ill.

Manufactured by
THE BORKMAN RADIO CORP.
Salt Lake City, Utah
Kalamazoo, Mich.

With Rare Beauty, Volume, Power!



Complete
automatic
control of
radio sets
on 1 switch
the Set Switch
itself

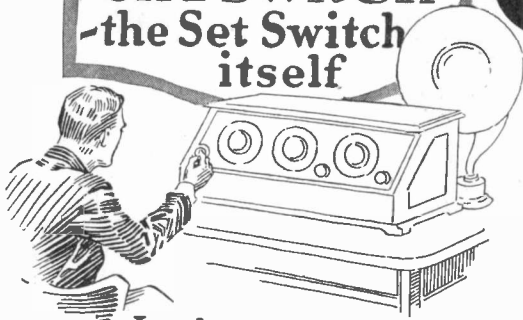

with the **BRACH
CONTROLIT**



*Links any Set with
HOUSE CURRENT*

*The Greatest Invention
since RADIO itself*

Your set switch or rheostat ALONE can now control "B" Battery Substitute and "A" Trickle Charger automatically.

Merely adding a BRACH CONTROLIT makes any set a light power-operated set, eliminating all switches from "B" Battery substitutes and Trickle Chargers.

No added wiring; no alterations to set required.

Anyone can install CONTROLIT, and the power plant can be placed anywhere—in cellar, or closet, or shelf.

Set makers are urging the use of CONTROLIT; radio users will demand it.

Price \$6

★Leading manufacturers of socket-power units have adopted Brach Controlits as standard equipment.



How CONTROLIT Works

When the set switch is turned on the Brach CONTROLIT automatically connects the "B" battery substitute with the 110-volt house lighting circuit obtained from the light socket. When the set switch is turned off the CONTROLIT automatically breaks this circuit thus cutting off the house current from the "B" substitute. At the same time it diverts the house current to the trickle charger which automatically commences to continuously or trickle charge your "A" Battery.

Brach Lightning Arrester

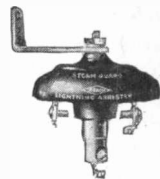

Storm Guard Arrester is made of Bakelite; weather-proof and non-grounding; will stand years of exposure; operates on proven non-air-gap principle; very sensitive; takes off heavy discharges, protecting radio and home. Sold at modest price, **\$1.50.**

All Brach Arresters carry a \$100 Lightning Insurance Guarantee

Shock-Proof Radio Plug

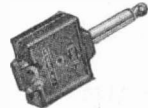

Simplicity itself. Gives perfect electrical contact. Withstands high voltages. No exposed metal parts to shock the user. Easily connected or released. Neat, artistic and inexpensive. **Price 50c.**

Extension Cord Connector



A useful Brach device, in one piece—made of pure Bakelite—indestructible; readily connects speaker or head set cord with extension cord. Enables you to place loud speaker wherever desired. Cord tips grip automatically. **Price 50c.**

Master Aerial Outfit

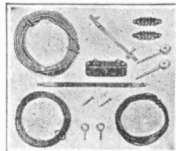

The highest form of aerial obtainable—for those having room to stretch wires outdoors. The set is complete to the last screw and includes Brach Lightning Arrester—all ready for erection.

**Brach Master Aerial - \$3.50
Other Aerials - \$4 to \$5.50**

Brach 20
years
in the
lead
Radio Products

L. S. BRACH MFG. CO., Newark, N. J.

L. S. Brach of Canada, Ltd., Toronto, Can.

a Real One Dial Control in the **Perlesz** TRADE MARK

The Unit Control in the Perlesz Receiver needs no supplementary dials to take care of inefficiency in design or manufacture. Once the compensating condenser has been set, no further adjustments are necessary. Tuning becomes simply a matter of turning one dial to the proper point.

Note the strong, solid construction of the worm drive which governs the movements of the Straight-Line-Frequency Condensers. The worm is designed on a floating bearing principle, supported by a spiral spring which automatically takes up the slightest wear. Back-lash is eliminated.

The Unit Control is only one feature of the Perlesz. Some others are; the gang-mounted condensers with die-cast plates and the all-metal chassis which, by preventing dielectric losses, insures extreme accuracy in tuning.

We have an attractive proposition for distributors and dealers. Write us

PERLESZ RADIO MANUFACTURING CORP.
560 West Congress Street, Chicago

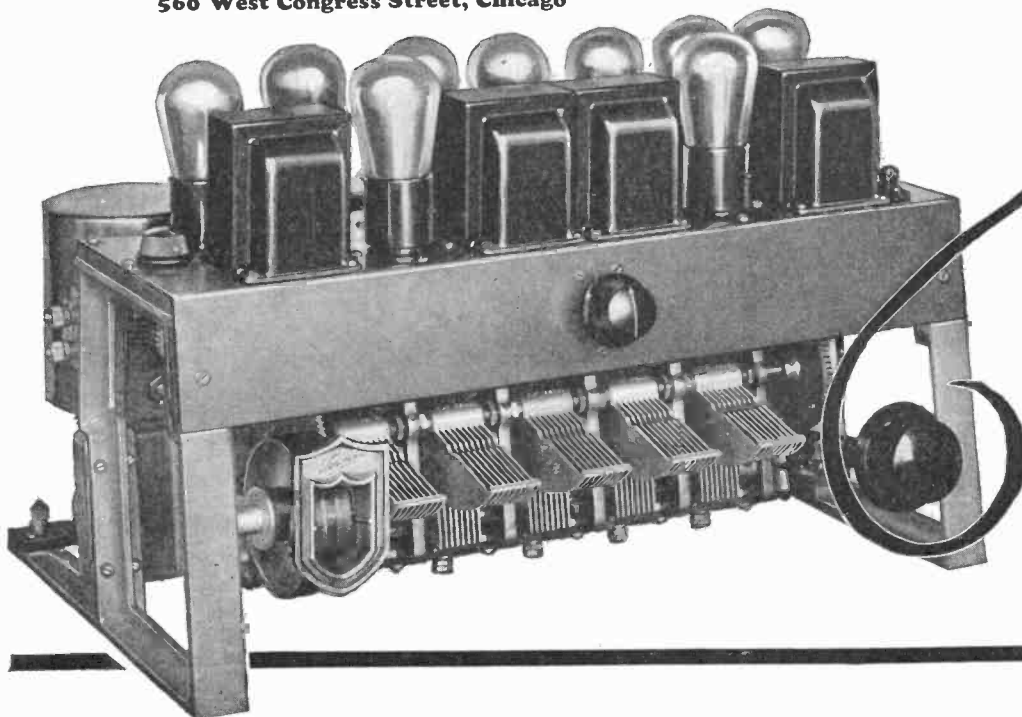

Perlesz receivers are offered in seven, eight and nine tube models in a variety of cabinet styles, for table and semi and full console design. The prices range from \$275 to \$1000

If you want the best!

Pathé CONE SPEAKER

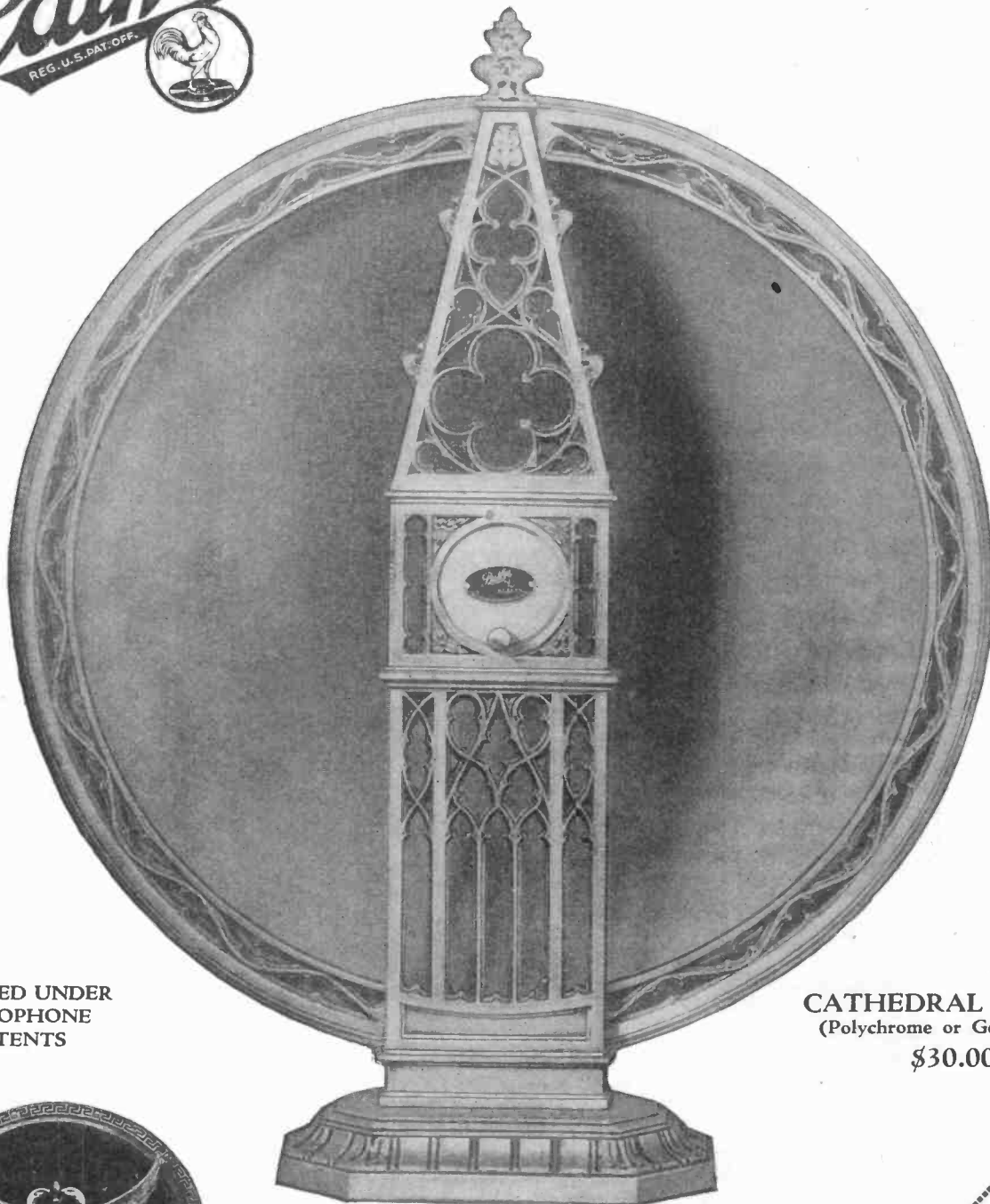

LICENSED UNDER
LEKTOPHONE
PATENTS

CATHEDRAL MODEL
(Polychrome or Gold Finish)
\$30.00



GRECIAN MODEL
\$25.00

To Real Radio Dealers!

Sell a speaker that will stay sold and one made by the original cone speaker manufacturer—one on which the price is upheld and on which you can make a good profit. There are more Pathé Cathedral Speakers being sold now than any other quality speaker in radio.

Sign the coupon and send in an order for one Pathé Cathedral at 40% off. Have it shipped either through your jobber or direct. If it isn't as we represent it, highly satisfactory, you may return it after three days' trial. This will be the quickest way for you to see just what we have and what you can do with it.

We will advise you of nearest jobber to take care of your future orders.

Pathe Phonograph and Radio Corporation
20 Grand Avenue, Brooklyn, New York

**Pathe
Phono.
and Radio
Corporation.**

Gentlemen:
Ship quickest way one
Pathe Cathedral Loud
Speaker at 40% discount.

My jobber is:

Name

Address

My name is

Address

City State.....

BOSCH RADIO

The AMBOTONE REPRODUCER

The Bosch Ambotone gives true tonal reproduction so much desired.

All the bass and every high note is reproduced by the Ambotone with utmost fidelity. The pure tones whether on reduced volume or full power for dancing are accurate. The wood cone gives that mellowness of a wood instrument.

Radio owners who have tried all types of speakers decide upon the Bosch Ambotone as the true reproducer. Its popularity is built upon owner satisfaction. Bosch Ambotone is \$27.50 and the Art Pedestal is \$11.50.

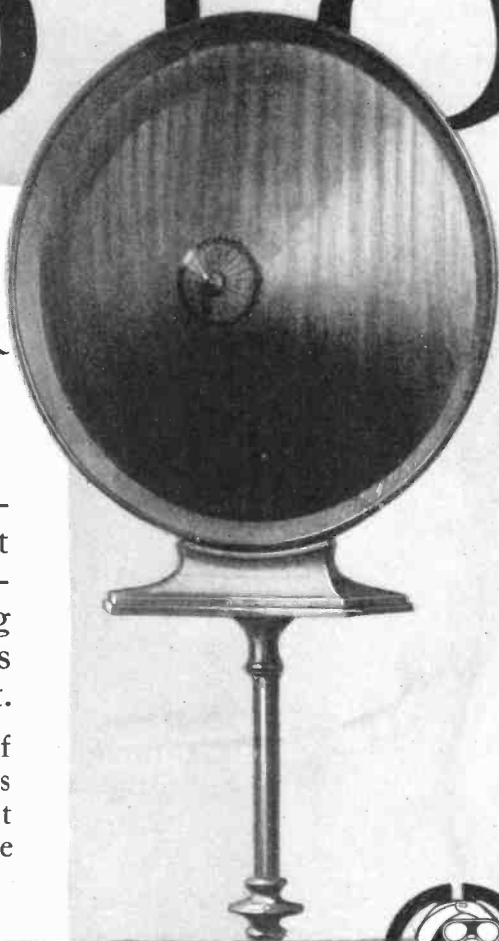

The NOBATTRY "B" POWER UNIT

The Bosch Nobattry provides constant "B" power from the light socket. No acids to spill or renew—no filaments to burn out. The Nobattry is designed to insure personal safety as well as to perform safely. Entirely automatic with no adjustments, it performs without hum on all sets up to 10 tubes. It is an investment for years. It sells on its unusual performance and makes satisfied customers.

Ed. 3 for Alternating Current . . . \$55.00
For Direct Current 42.00
All prices slightly higher, Colorado and West
and in Canada.

AMERICAN BOSCH MAGNETO CORP.
Springfield, Mass. Branches: New York, Chicago, Detroit, San Francisco



Sturdy

\$19⁵⁰
*Slightly higher
 West of the Rockies*

Licensed under Frank E. Miller Patents numbers
 1,190,787, 1,220,669, 1,294,137
 Other patents pending

Octacone is built on the same principles as the most perfect reproducing instrument known to science—the human ear. It has a patented diaphragm, shaped exactly like the ear. The apex of this diaphragm is placed off center—exactly as in the Tympanic Membrane or ear drum. No wonder it's "as accurate as the human ear"!

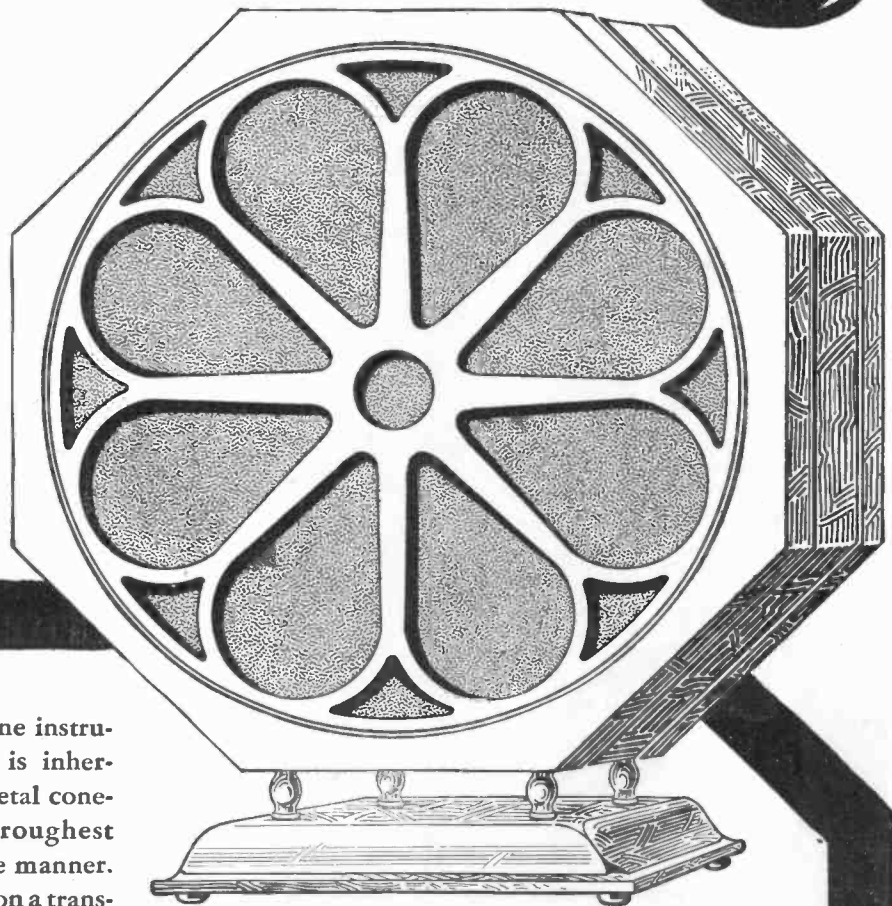

Unlike most fine instruments Octacone is inherently strong. Its metal cone-case will resist the roughest treatment in a remarkable manner. Whether it's bounced about on a trans-continental freight car or bounced on the floor by your customer's most mischievous child—it comes up smiling and singing as well as ever.

Yet Octacone is as sensitive and as accurate as the human ear. It gives a natural-

ness of tone that is truly remarkable. Let Octacone sing your praises to all your customers! Ask your jobber about it—today!

Pausin Engineering Company
 727 Frelinghuysen Ave., Newark, N. J.

OCTACONE
 PAUSIN

MAGNAVOX

SINGLE DIAL Radio

*"One of the three
best franchises
in Radio"*

That's what a national authority on radio sales has said of *Magnavox*. Look how true it is:

Experience—Fifteen years of making radio products. First to produce a loud speaker. First to perfect single dial control.

Stability—Paid 100% in dividends since 1920—more than any other radio company whose stock is listed.

Quality—Only thirty-seven sets returned to factory as defective last year. 400,000 loud speakers made and sold.

Advertising—Radio's first large advertiser. One of three largest in magazines 1922 to 1925. Using more space this fall in the Saturday Evening Post than any other present radio advertiser has ever used during the same period.

Policies—Chief executives have been retailers, wholesalers and manufacturers of radio and musical instruments. Policies based on intimate appreciation of retailers' problems.

Merchandise—Complete line of sets from \$75 to \$260 list (model 10, \$110 list, shown). Three cone speaker models \$22.50 to \$50. (Cornell model, \$22.50 list, shown).

Write at once for full details

THE MAGNAVOX COMPANY

General Office and Factory: Oakland, Calif.

Chicago Sales Office: 1315 S. Michigan Ave.

R. S. Williams & Sons Co., Ltd., Toronto • Distributors for Canada
[not including British Columbia] 24D16© 1926



The Passing of "By-Pass" condensers

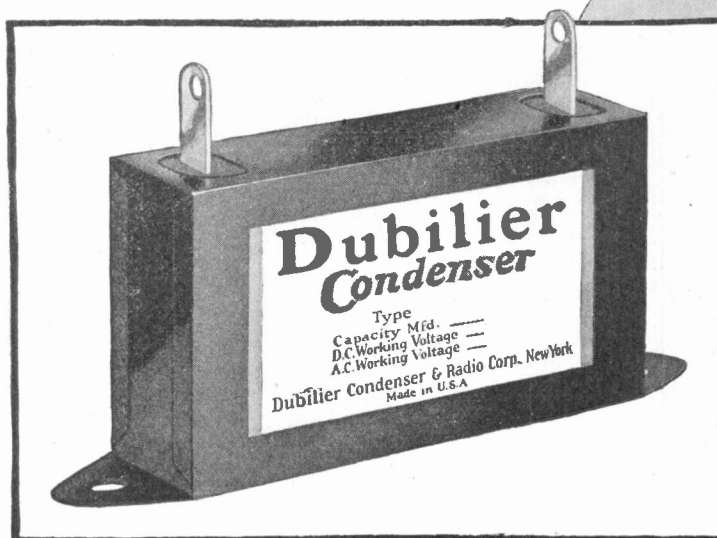

Dubilier Condenser Type
907

Capacities 0.1 to 2.0 mfd.
Price \$.60 to \$1.75.

"By-Pass" was the name originally given to small paper condensers by Dubilier. This name described their functions—such as shunting radio frequency currents around high resistances, and their use in amplifier circuits.

But now the clumsy old "By-Pass" condenser is out of date. The high voltage used in radio today along with sub-panel construction, demand a condenser of higher electrical efficiency and more compact size.

In the new Type 907, Dubilier has made a compact all-purpose condenser with a *working voltage** of 160 volts D. C. With improved soldering lug terminals and mounting feet, Type 907 will give more efficient service in smaller space for every purpose for which the old "By-Pass" type of condenser has been used.

Dealers will find that radio fans are insisting on Dubilier Paper Condensers because of their proven ability to withstand high voltages in continuous operation.

Dubilier

CONDENSER AND RADIO CORPORATION

4377 Bronx Blvd., New York, N. Y.

*Working voltage means more than "test voltage." It is the voltage at which a condenser may be safely used in *continuous operation*.

Allen-Bradley Radio Devices Boost Your Radio Sales and Profits

Allen-Bradley Radio Devices are in greater demand than ever due to the increased publicity given to B-eliminator hookups which require fixed and adjustable resistors. Capitalize on the growing demand for Allen-Bradley Radio Devices by ordering your radio stock now.



The Bradleyunit is being used extensively by B-eliminator manufacturers as standard equipment in their B-eliminators. It is being recommended by leading radio writers as the ideal fixed resistance unit for B-eliminator kits. Send for the latest Allen-Bradley price sheet giving complete details and ratings of Bradleyunits for every application.



The Bradleystat, Bradleyleak, and Bradleyometer are still in great demand by radio fans. The detachable bakelite knob makes installation easy and permits the use of any type of knob or dial. These units are endorsed by leading radio authorities.



The Bradley-Amplifier is a three-tube resistance-coupled amplifier of unexcelled tone quality. For perfect reproduction sell the Bradley-Amplifier.

Endorsed by
PHILCO

PHILCO
BATTERIES
PHILADELPHIA, PENNSYLVANIA

ALLEN-BRADLEY CO.,
Milwaukee, Wisconsin.

July 14, 1926.

The Bradleyohms which we are using in Philco "B" and "AB" Socket Powers for voltage adjustment are very satisfactory.

We have tested many variable resistors but have found no other unit equal to yours. We shall continue to use Bradleyohms in Philco Socket Powers during the coming season.

Yours very truly,
Walter E. Holland
Research Engineer.

The leading manufacturers of B-eliminators have standardized on Bradleyohm-E for their B-eliminators. You can sell them to your trade for B-eliminator kits and make an attractive profit.

Write today for new and revised literature on the Allen-Bradley line. Get in line for bigger radio profits for the coming radio season by ordering your Allen-Bradley Radio Devices now. Don't delay!

ALLEN-BRADLEY CO.

489 Clinton Street . . . Milwaukee, Wis.

Bradleyohm-E

PERFECT VARIABLE RESISTOR

Why experts say the new Erla (RFL) is a year ahead of its time

RADIO is progressing rapidly. Sets called "good" last year suffer in comparison with receivers based on recent discoveries.

Realizing this, Electrical Research Laboratories this year joined forces with the famous Radio Frequency Laboratories of Boonton, N. J., a group of brilliant scientists whose discoveries are so vital that they are changing the whole trend of radio design.

New in principle

Together our engineers and "RFL" have produced a set that combines new and radical principles decidedly in advance of those common today. A set of astounding performance . . . one that authorities pronounce at least a year ahead of its time. A set so solidly built as to be both trouble-proof in performance and transportation-proof.

Banishes regeneration

The outstanding feature of the new Erla (RFL) is that it completely banishes regeneration (blooping, squealing, distortion), one of the greatest causes of radio dissatisfaction.

Other manufacturers have tried to do this. But never succeeded save at sacrifice of volume and distance. In the new Erla (RFL), instead of loss, there is *positive gain in reception*. And, **MOST IMPORTANT**, an ease and certainty of operation that puts the Erla (RFL) in a class by itself as a profit-maker for the dealer!

Four great improvements

Here in detail are the outstanding improvements in the new Erla (RFL):

1. Squeals and howls completely done away with in tuning, *automatically*. No expert manipulation of knobs needed.
2. Radiation — annoying broadcasting of squeals into neighboring antennae eliminated.
3. Harshness and fuzziness of tone—resulting from regeneration, eradicated, and reproduction of sound made *entirely natural and undistorted*.
4. Stations inaudible with most receivers—except when manipulated by experts—now brought in loud and clear *by anyone*. Vastly improved selectivity.

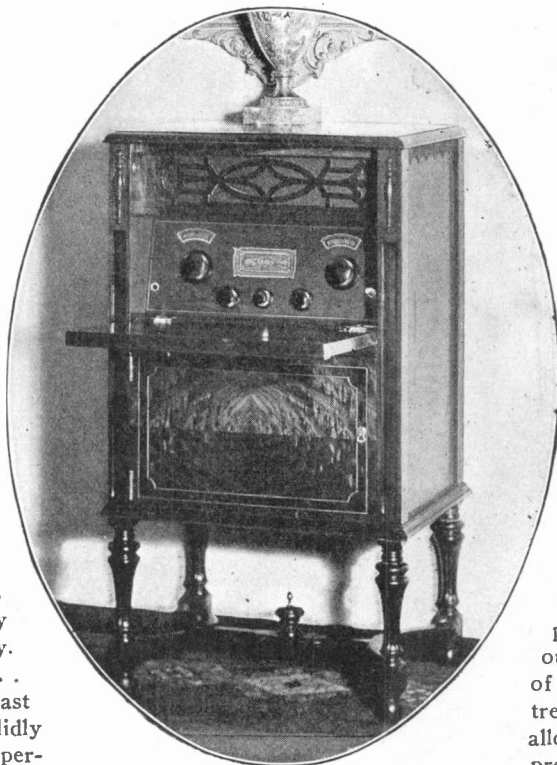

Erla (RFL) Monodic S-50 De Luxe Console
Quartered and matched figured walnut panels. Supreme excellence in materials and construction. Built-in loud speaker.

Radio profits this year depend on these points

- Better tone quality than any yet known
- No squealing
- Better selectivity than has been offered
- EASY MANIPULATION—** makes anyone an expert
- Maximum distance and volume for a given dollar
- More exquisite cabinet work and the utmost in technical efficiency

Beautiful cabinets

To house this extraordinary achievement, Erla has provided strikingly beautiful cabinets. Prices are decidedly less than comparable competitive receivers. We make 95% of all parts of completed receivers within our own plants. This one-profit system of manufacture makes possible extremely low retail prices while still allowing distributor and dealer adequate profit margins.

Greatest profit opportunity

The outstanding performance of this new Erla (RFL) . . . its trouble-proof construction . . . make it the greatest profit opportunity in radio today. Here is a set you can sell with no worries. Send the new Erla (RFL) out in its original package without a fear. It will be found O. K. when unpacked.

Get franchise details

All authorities say this season is going to be a profit-maker for the dealer with the right merchandise. Merchandise that is above what everybody else is offering. So we urge you, sign up with no radio proposition until you have examined the Erla (RFL). Write us today for sales franchise details. The handy coupon will bring you this information without obligation.

Other Erla Profit-makers

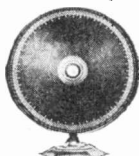

Omnitonic Speaker

Universal in range and pitch. Brings out both low and high notes with absolute fidelity of tone. To list at \$17.50.

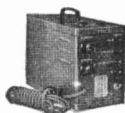

"Big Ten" "B" Unit

A positively *hum-free* "B" unit with a big safety factor. Will handle 10 tubes with perfect results. To retail at \$45.



"Triple-Life" Tubes

Last fully three times as long as other makes. Also greater uniformity. Minimum of 3,000 hours' service at rated voltage. To sell at usual prices.

ERLA

Electrical Research Laboratories,
Dept. M-50, 2500 Cottage Grove Ave., Chicago

Send me full information on your dealer proposition as advertised.

Name.....

Address.....

City.....



WC 15 Jr.
5-Tube—2 Dial \$49.50
Also console at \$85.00

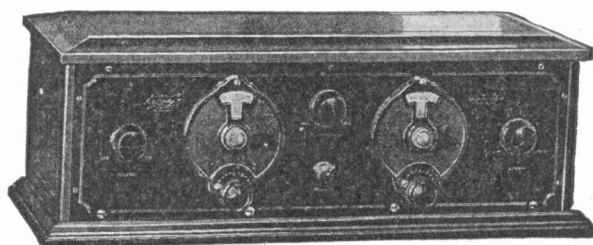

6-Tube—2 Dial WC 19E Compact \$110
Also 6 other Models at \$120; \$125; \$140; \$195;
\$210; and \$485

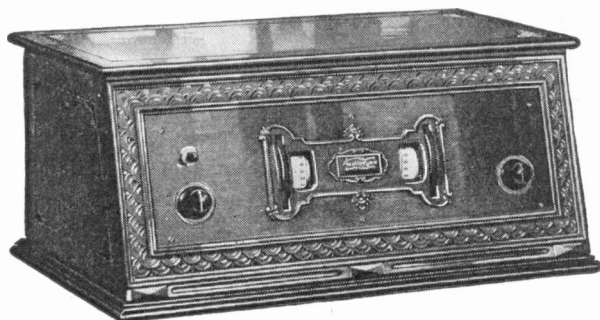

WC 20G Super Radiodyne
9 Tube—2 Dials (3 volt tubes) \$225
Other Models up to \$595



WC 20F Super-Radiodyne
9 Tube—2 Dial (3 volt tubes)
Walnut Console \$320

Radiodyne

A Line You Can Demonstrate in the DAYTIME

Dealers tell us they don't have to wait until night or for favorable conditions to demonstrate, to the entire satisfaction of the customer, the Radiodyne Line. Every day looks alike to the Radiodynes 19 and 20.

Again—A Year Ahead

A DEALER'S POLICY that gives the Dealer Real Protection and a Generous Margin.

SELECTIVITY that cuts through locals like a rapier in cities like New York and Chicago.

VOLUME on Distant Stations that astonishes even experts.

TONE QUALITY that must be heard to be appreciated.

EASY TUNING—only Two Dials yet 5 to 9 tubes.

Ahead—in Dealer Policy

Last year's Radiodyne dealer's policy was a year ahead and its soundness was the talk of the trade. Radiodynes are sold only through jobbers—never direct. They have never been over-produced and are never dumped. Radiodyne dealers have never had to carry the bag.

You can't be too careful about the Line you take on and the responsibility of the company behind it. Write for details of a Merchandising Plan that gives the dealer proper protection and a liberal margin. The Radiodyne Line is going to be a hard line to compete against. Write for name of nearest jobber and details of Plan.

Visit our Exhibit

Chicago Radio Show—Booth No. 3. Section A

WESTERN COIL & ELECTRICAL CO.
RACINE, WIS.

HERE IT IS! THE NEW

Cooper **A** Eliminator



Actually Eliminates the "A" Battery!

Operates Directly from the
Light Socket!

No Battery to Bother with!

No Acids or Liquids to Replace!

Needs No Attention of Any Kind!

Good radio dealers in most cities have the Cooper "A" Battery Eliminator on display now. Price \$87.50 (tubes extra), slightly higher west of the Rockies.

RADIO has been awaiting this day. The storage "A" battery with all its messy watering and charging has at last been totally eliminated as a radio necessity.

The Cooper "A" Battery Eliminator is entirely new in principle. It is unlike anything that has ever been offered the radio public. It actually eliminates the "A" battery with all its objectionable features—it operates directly from the light socket. The Cooper "A" Eliminator requires no attention of any kind—no battery to water or bother with—no acids or liquids to replace—none to spill and ruin costly rugs. It is not a power unit—it employs no trickle charger—it operates only while you operate the receiver. A simple throw of a switch and your current is on—tumble back the switch and the current is off.

The Cooper "A" Eliminator operates on any make or type of receiver using 6-volt tubes—it creates no noise of any kind—it gives you everything that batteries ever gave—and DIRECT from the light socket.

DEALERS—JOBBER

The Cooper "A" Eliminator is the only device of its kind on the market. It has no competition. Limited distribution and full protection to trade outlets insure legitimate dealer and jobber profit. Write for full particulars of our exclusive proposition in your territory.

SEND FOR THIS FREE BOOKLET

We have prepared a very complete illustrated folder describing the Cooper "A" Eliminator in detail. May we send it to you?

THE COOPER CORPORATION

Radio Division—Dept. R

CINCINNATI, OHIO

One of Slagle's Leaders

This 2-dial set wins sales. Perfect control, easy tuning, beautiful appearance, clean, quiet reception, very good value, console or cabinet models. Let us tell you more about it.

**A set is no better
than its accessories
—sell good ones**

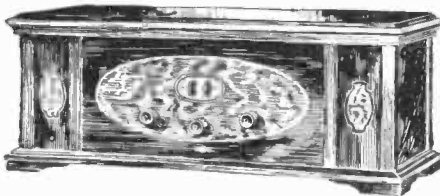

Model XX. Free of noises for which sets are often responsible. Low battery consumption; extreme sensitiveness to signals; sharp, clean tuning; plenty of volume; simple and complete control; full, rich tone values; and beautiful appearance are some of the points this set gives you. It's real value for your money. All elements completely shielded from each other. The highest development in radio receiving sets. Beautiful walnut cabinet with matched burl panels \$130 without accessories.



Model XX
Console
2-Dial Control

Beautiful cabinet work makes this console a delight to the eye as well as the ear. Two-toned walnut with burl panels. Drop front makes convenient room for tuning and logging. Ample space in lower compartments for batteries.

Equipped with Model XX 2-dial control 5-tube receiver described above. \$185 without accessories.

THE Slagle Merchandising Policy is to provide a full line of sets within a range of prices that enables a dealer to fill any order for first-class sets from the one line. The Slagle line gives you a fully representative stock on display with smaller investment; you can concentrate your efforts on a single line and back it to the limit. The guarantee below protects you because it protects your customer.

We shall be glad to send a beautifully illustrated, 4-color sheet, giving details of our line and complete plan of merchandising. Mention the name of jobber from whom you prefer to buy.

SLAGLE RADIO COMPANY
FORT WAYNE, INDIANA

GUARANTEE

Every Slagle Radio Receiver is positively guaranteed against all defects in material or workmanship, and if, upon installation in your home, it does not give thoroughly satisfactory service, your money will be refunded.

TRADE MARK
Slagle Radio

The SONOCHORDE CONE

Push a Speaker That Gives You Prestige Plus Quick Profits

EVERYONE is talking Sonochorde. Once you hear this superlative Cone, nothing else matters. You'll want it.

The new Sonochorde is so far superior to other cone speakers anywhere near its price, that there is absolutely no comparison.

If you don't find it so, we'll return your money.

Responsible Dealers Wanted

BOUDETTE MFG. CO. Chelsea, Mass.

Factory Sales Agents Hastings Electric Sales Co.
42 Binford St., S. Boston, Mass.



Floor Standard Model

A design of unusual distinction. Price with cord \$35.00.



Back View Table Model

Note how the back of all Sonochordes is protected against possible injury. This back is integral with the Duraluminio frame, handsomely finished semi-gloss mahogany.



Wall Model

Equipped with heavy cord and decorative tassel, protected back and all Sonochorde features. Price \$27.00.



\$ 25⁰⁰



Get this sign in your window

Line up for Federal profits at once

You can sell the greater Federal Ortho-sonic line with confidence and build on for the future as well as the present. Designed by Federal engineers—built to Federal's high standards of quality, in Federal factories by Federal craftsmen. You know what that means—*quality*—in sets that won't be "orphaned."

In addition to the exclusive Ortho-sonic principle, we now offer Ortho-sonic radio in variety and price range that eclipses all precedent. Many popular priced models from \$75 to \$400—among them the splendid new D, E and F series—and four custom-built models at \$600 to \$1,000. Altogether a model for every purse and a design for every setting.

Write at once. Get the Federal

proposition. Get the sign in your window. Our big national advertising campaign in magazines and newspapers is reaching millions. Everywhere the thrilling Ortho-sonic tone-test is being demanded. Be prepared to give these tests. Be ready to close these sales.

Read the liberal provisions of the Federal proposition. Profit-making discounts! Adequate protection! National advertising! Powerful resale helps! Red-tape freedom! And, back of it all, the name *Federal*, which is a guaranty of clean-cut business methods.

Get lined up for the big fall and winter trade. Write your wholesaler at once for the Federal proposition. If you don't know the Federal wholesaler serving your section of the country, write us. Let us tell you. NOW!

FEDERAL RADIO CORPORATION, Buffalo, N. Y.

(Division of Federal Telephone and Telegraph Company)

Operating Broadcast Station WGR at Buffalo

Federal

ORTHO-SONIC*

Radio

*The fundamental exclusive circuit making possible Ortho-sonic reproduction is patented under U. S. Letters Patent No. 1,582,470.

Reg. U. S. Pat. Off.

SHOWERS



Can be sold at \$145 complete
Model 556. Top 17" x 24".
Height 50".
MAHOGANY ONLY

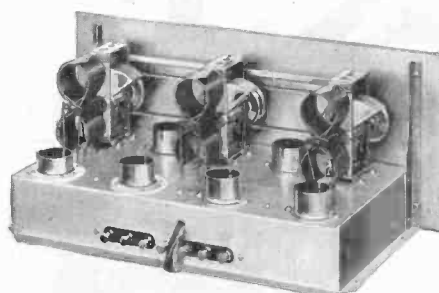

Our dealers are realizing substantial returns on our EXCLUSIVE FRANCHISE. One dealer to a city on a console radio of such advanced design and construction as the Showers, means absolute protection on a line that is bringing in business.



Can be sold at \$135 complete
Model 448. Top 17" x 32".
Height 40".
WALNUT ONLY

These beautiful consoles come to you with our ONE DIAL control, all metal shielded construction receiver, Foley system of amplification and Utah unit. Artistically designed for compactness, yet with more than enough room for all batteries and charger. Harmonize with living room furniture and decoration. Satisfy every demand. Write Chicago office, or wire at our expense today. See our exhibit at the Chicago Radio Show, Coliseum, October 11-17.

SHOWERS BROTHERS COMPANY

Bloomington, Indiana

RADIO DIVISION—914 SOUTH MICHIGAN BOULEVARD—CHICAGO, ILLINOIS

Now a **BALANCED** Cone Speaker!

R. F. I. BALANCED
OVAL CONE SPEAKER

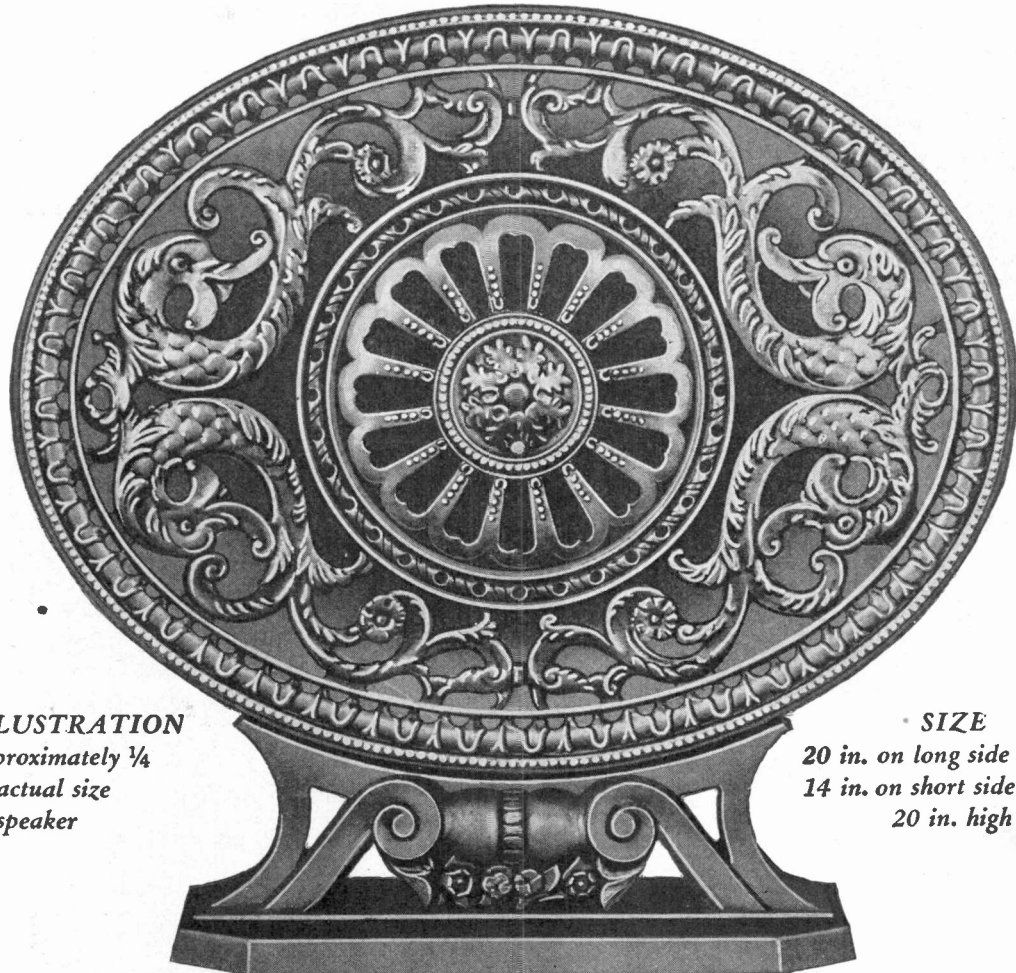

ILLUSTRATION
approximately $\frac{1}{4}$
of actual size
of speaker

SIZE
20 in. on long side of oval
14 in. on short side of oval
20 in. high

AT LAST all the high notes and all the low notes! A small cone gives high notes only. In a large cone, low notes predominate. In the R. F. I. *Balanced* Oval Cone Speaker the long side of the oval stresses the low notes and the short side stresses the high notes, and the two give a *complete balance*. Wonderful volume, clear tone, and all mechanical parts hidden. The insistent demand for more beauty in radio loud speakers is met by the R. F. I. Oval. It is a pure Renaissance reproduction, designed by A. Kimball & Son, New York. Free of all patent infringements, licensed under all the Lektophone patents. Old Gold or Statuary Bronze.

Price \$25.00 - West of the Rockies \$26.50.
Supplied on Approval by your Dealer.

Mr. Jobber or Mr. Dealer: Write or Wire for Agency

RADIO FOUNDATION INCORPORATED
25 WEST BROADWAY NEW YORK



Away with Opinion—Get Facts!

UNBIASED LABORATORY TESTS
PROVE URECO SUPERIORITY

ONE of the leading electrical laboratories of the country recently put a number of the best-known radio tubes on the market into a comparative laboratory test—checked them in all possible scientific ways.

You'll be amazed to read what this scientific report reveals about tubes

The results of this tube test have been put into a report that is thoroughly scientific and yet extremely simple. As a radio dealer you *must* have the information that the report gives. You will be shocked to learn some things you never dreamed of before.

Many dealers, since they read this report, are recommending only URECO tubes in the sets they sell. For in the test URECO came *first*—and dealers all know that any

set gives better satisfaction when equipped with highly efficient tubes.

We'll be glad to send you an exact copy of this report on request. Just fill out and mail the coupon below *today*.

Also, if you are interested, we'd like to tell you about some unusual ways we have of helping URECO dealers on the resale—co-operation that really works.

UNITED RADIO & ELECTRIC CORP.
418-420 Central Avenue
NEWARK, N. J.

UNITED RADIO & ELECTRIC CORP.
Newark, N. J.
Gentlemen:

I am interested in the comparative test given the best-known radio tubes in a leading electrical laboratory recently. Please, without obligation on my part, send me an exact copy of the report made by the laboratory on this test.

Name

Address

City State

PERRYMAN P RADIO TUBES

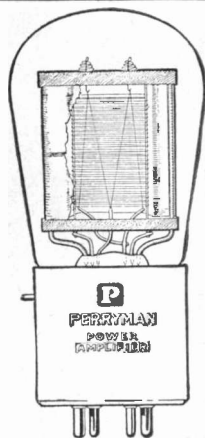

Patented June 22, 1926

Above is the clear glass demonstrating tube showing the patented Perryman Bridge which holds the elements in place at the distance of greatest efficiency. Ordinary jars or jolts do not affect Perryman Tubes. Notice the double filament which distributes the electron emission over the full area of the plate, giving greater capacity without overloading. You can get natural tone for the life of the tube and the life of the tube is exceptionally long.

"Distance without Distortion"

Double Filament! Extra Capacity!

THE filament of Perryman Radio Tubes with the patented Perryman bridge is doubled to form a letter M. This twin construction not only exposes a greater area of filament surface, but it doubles the area of electron emission and increases the capacity of the tube. The real result is a tube that does its appointed work more easily, giving greater volume without distortion. Its longer life is a distinct economy.

Perryman authorized distributors carry ample stocks and can service dealers on sales helps and advertising material. The dealer who anticipates his requirements will greatly assist his distributor in making timely deliveries. This will be a big Perryman year.

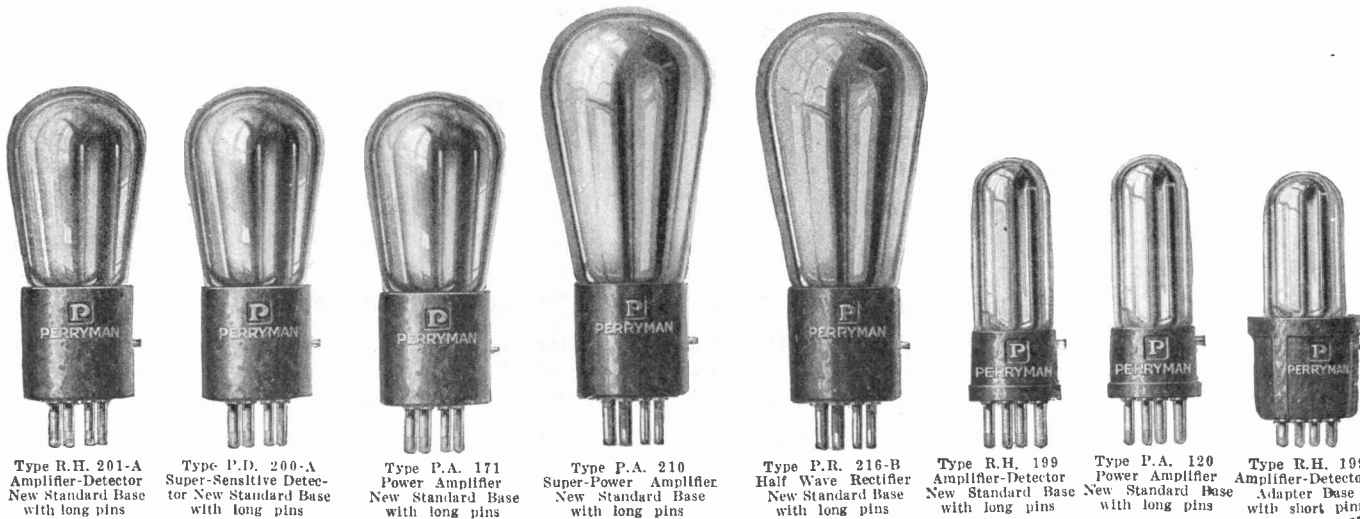

Type R.H. 201-A
Amplifier-Detector
New Standard Base
with long pins

Type P.D. 200-A
Super-Sensitive Detector
New Standard Base
with long pins

Type P.A. 171
Power Amplifier
New Standard Base
with long pins

Type P.A. 210
Super-Power Amplifier
New Standard Base
with long pins

Type P.R. 216-B
Half Wave Rectifier
New Standard Base
with long pins

Type R.H. 199
Amplifier-Detector
New Standard Base
with long pins

Type P.A. 120
Power Amplifier
New Standard Base
with long pins

Type R.H. 199
Amplifier-Detector
Adapter Base
with short pins

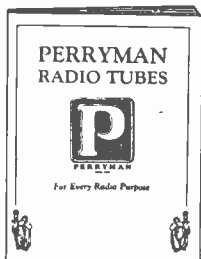

This Perryman catalog "Just off the Press" lists and illustrates the complete line of Perryman Tubes, giving all characteristics, sizes, etc. Send for your copy.

PERRYMAN
ELECTRIC
CO., Inc.

33 West 60th St.,
New York, N. Y.

Dept. RR

Gentlemen: Kindly send me a copy of your latest catalog.

Name

Address

My distributor is

PERRYMAN P ELECTRIC CO., INC.

LABORATORIES AND PLANT
NORTH BERGEN, N. J.



SALES AND EXECUTIVE OFFICES
33 W. 60th ST., N. Y. C.

A Real Opportunity
For Live Dealers!

Stop thief!

Ordinary amplification
is the thief of Tone in
radio music

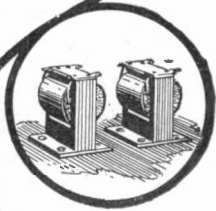
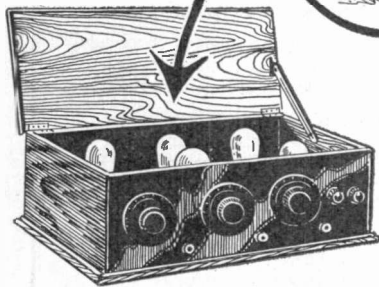

Almost any radio set is a perfect reproducing instrument—that is, up to and including, *the detector tube*. As everyone knows, if you listened with a pair of ear phones to the music from the *detector tube* you would have *perfect reproduction*. If that same quality could only be made to come out of the loudspeaker in great volume, perfect radio enjoyment would be assured.

But it cannot—with ordinary amplification. Too much is blurred, too much is weak, too much is lost altogether.

How can we get this pure detector tone with great volume? Can it be had simply by changing the method of amplification? That depends.

Resistance coupled amplification is better, but many of the high notes are frayed and shattered, and the tone breaks down badly on strong volume.

Large size transformers are also better, but too many weak signals are absorbed. The actuality of the base, and the distinction between one musical instrument and another are lacking.

Impedance Coupling is unstable. It shares most of the faults of resistance coupling, and, like transformers, it absorbs the weak signals.

Electric-light-socket power amplifiers are also better, to be sure. But they operate *after* one of the music-distorting transformers already in the set.

The Truphonic Power Amplifier

An entirely new and different method of amplification has been developed by the eminent radio inventor, Mr. H. P. Donle, and is made by the Alden Manufacturing Company, well known for its Na-Ald quality products. It is called the "Truphonic." Already manufacturers of the higher quality sets are endorsing it, and

adapting it as the finest type of reproduction. The Truphonic Power Amplifier is different from any other method of amplification. But what is most important, the *results* are different. No more need be said than that the Truphonic passes faithfully *all* notes of broadcasted music.

The Truphonic is a small compact instrument (shown below) which when attached in a few minutes to any radio brings through the loudspeaker with great volume *the detector tube music* in all of its perfect tonal quality.

What Does This Mean to You?

The Truphonic will enable you to make a substantial extra profit from your customers who have bought sets from you in the past but who are not buying new sets this year.

You will not only make the extra profit on a \$20 sale plus the extra tube (either 201A or power tube) but you will also make a decided hit with your customers. Order the Truphonic from your jobber and get in on this profitable business as soon as you can get shipment.

For the Set Builder

Truphonic amplification is provided in separate Truphonic couplers for the set builder. Three stages not only give the finest quality of reproduction obtainable but also give considerably more volume than two stages of ordinary transformer amplification. Price \$5.00 per stage.

The Truphonic Output Unit protects the speaker against burning out and demagnetization when power tubes are used. (This output is used of course in the complete Truphonic Power Amplifier described above). Price \$5.00.

The Truphonic Catacomb Assembly is also of great convenience to set builders. A lacquered steel catacomb houses three Truphonic couplers and a Truphonic output unit. A special moulded socket panel with 6 or 7 sockets of special construction which hold either UV-201A or all UX tubes, covers this catacomb. This unit may be arranged in a thousand different ways to meet all the requirements of every circuit and set design. Short direct leads to connected apparatus, with a minimum of soldered connections, with a minimum of apparatus to mount. A six-foot battery cable is included. Price 6 tube \$20, 7 tube \$22.



ALDEN MANUFACTURING CO.
Dept. A19
SPRINGFIELD, MASS.

TRUPHONIC Power Amplifier

\$20

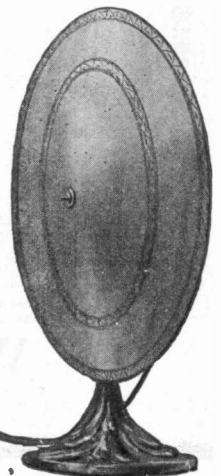
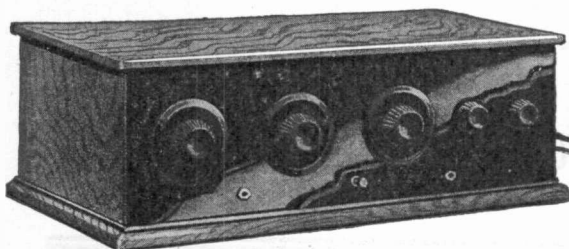

A dealer appeal which has no parallel in radio today—

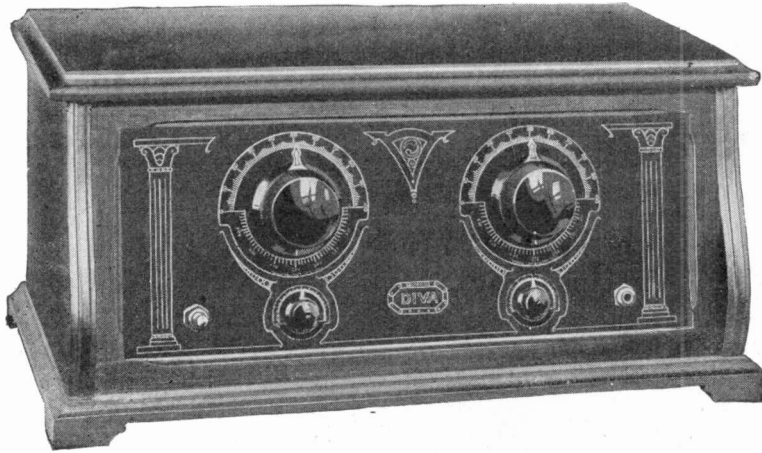
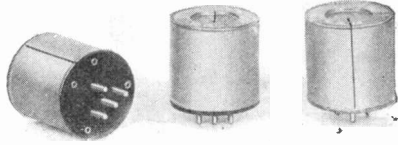

DIVA RADIO CORP. 294 East 137th Street, NEW YORK, N. Y.

Seattle
2817—31st Avenue South
Represented by
Howard B. Thomas

New York
67 West 44th Street
Represented by
Studner & Cumming Co.

St. Louis
915 Olive Street
Represented by
Wood & Anderson Co.

Chicago
28 East Jackson Boulevard
Represented by
Hawthorne & Stemm

Philadelphia
629 Chestnut Street
Represented by
Lyons Radio Sales Co.

Boston
10 High Street
Represented by
Eames Corporation

Last year Diva made the outstanding contribution of the year to the profitable selling of radio—Completely Serviceless Construction.

This season again, Diva takes the initiative in developing a new feature of far reaching importance—

Interchangeable Coils (SHIELDED)

THEY make the set readily adaptable to any peculiar local conditions, and make operation now possible on all wave bands from the amateur range right up through the European.

Jobbers and dealers who handled the Diva line last year made money with it. They not only found a ready sales response to its features, but they found their profits intact at the end of the year.

This year, although double the number of jobbers and dealers are enthusiastically pushing it, practically 100% of last year's dealers are again carrying it.

The model shown is Diva 45. Five tubes. Shielded interchangeable coils. Transformer coupled amplification. (Full tone register.) Power tube connections built in. Cable equipped. LIST \$45.

To jobber and dealer alike, Diva offers a proposition that is different from any other in radio. Write or wire for particulars.

How can the right table help you sell sets?



No. 923—Solid Mahogany, Dull Lacquer Finish, Top 20x38-in., Height 30-in., End Cabinets 9 1/3x15 1/2 x11 1/2-in. high. Doors open 8 1/2-in. wide and full height. Battery cabinet ventilated.

All Watsontown furniture is shipped in plywood cases.

If you can furnish a table that matches the set the prospect wants, you have a double grip on the sale. Watsontown radio furniture is not only made to suit the taste and the purse of the set buyer but to *match* various types of receivers. That idea has proved a big success.

We know how to make good furniture at attractive prices, and we know how to help the dealer *sell*. We have put into effect a number of practices which dealers have found greatly to their advantage in selling.

Write for literature and full particulars.

Watontown Table & Furniture Company
Watontown, Pa.

For All Popular Makes and Circuits of radio receiving sets

*A Constant "B"
Voltage Supply
Unit with Power
Amplification*



TYPE 400
Price
\$ 68.

The **NEW GENERAL RADIO** "B" Eliminator *and* Power Amplifier

Broadcast listeners everywhere are now demanding above all else "B" battery elimination and reception that is NATURAL.

The answer to this demand is the new General Radio Type 400 "B" eliminator and Power Amplifier which is designed to operate with all popular makes and circuits of radio receivers, regardless of whether they may be operated by storage battery or dry cell tubes.

Where A.C. 110 volt (60 cycle) lighting current is available the use of the Type 400 Unit is the most practical and satisfactory method of supplying all necessary "B" voltages. The Power Amplifier in conjunction with the "B" eliminator permits the convenient use of a high power tube in the last audio stage. This overcomes the tendency toward tube overloading and removes the most common cause of distortion in loudspeaker operation.

An outstanding feature of the General Radio Type 400

"B" Power Unit is that it has no variable resistance voltage controls to get out of order and cause noisy reception.

Voltages in this unit are controlled by fixed resistances which are properly designed to make the Type 400 readily adaptable to all average receivers.

Once installed it requires no further alteration and is ready for years of unfailing service.

The Type 400 Unit is designed to use the UX-213 Rectron rectifier tube and UX-171 power tube in the amplifier.

Dealers show this unit to your set owning customers, and you will interest them, demonstrate it and it will sell itself. Why not include a Type 400 unit in every new installation?

Place your initial order with your jobber now and be ready for the big popular demand for plate supply and power amplifier units.

GENERAL RADIO COMPANY, Cambridge, Mass.

GENERAL RADIO

INSTRUMENTS

Behind the Panels of Better Built Sets

Standardyne

Presents

The Receiver with 7 Exclusive Features

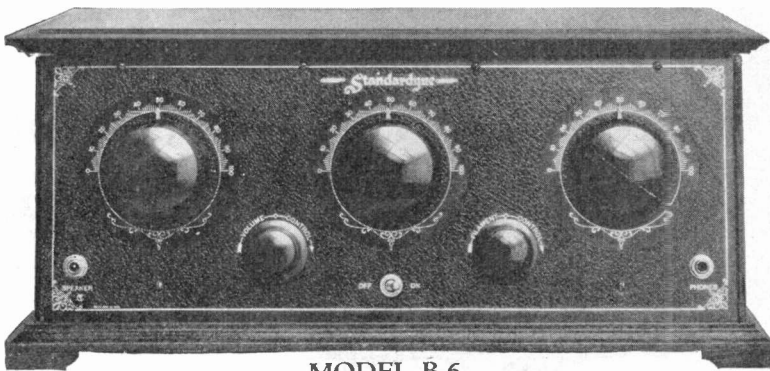

MODEL B-6

The patented Re-acted circuit, prevents distortion.
The patented UX socket, insures perfect contact with any tube.
The patented Philharmonic transformers, insure power without distortion.
Elimination of undependable solder connections by riveting wires to baseboard.
Straight line wave length condensers provide proper spacing without interference.
Etched metal panel serves as a shield for receiver.
Provision for meter on sub-panel, indicating correct voltage for tubes.

MODEL B-6 offers to discriminating buyers of radio a marvelously efficient 6 tube receiver, tuned radio frequency and employing the remarkable Re-acted circuit exclusive with all Standardyne models. Its perfection of performance is matched by the beauty of its appearance. Encased in a finely finished mahogany cabinet with correctly designed sloping front panel, the shining dials of this Standardyne contrast vividly with the gold etched lettering and morocco leather grain which feature its exterior.

List Price, \$45.00

MODEL 600 presents the newest 6 tube Standardyne receiver with tuned radio frequency and exclusive Re-acted circuit in the finest example of the console designer's art. An exquisite cabinet of correct height and smartness, finished in two tone mahogany, this console carries with it an air of distinction and an impression of artisticness achieved only in the finest console radio. With loud speaker and unit and commodious compartments for the necessary accessories, Model 600 will delight the heart of the feminine radio purchaser and fulfill the masculine demand for performance and class.

List Price, \$100.00

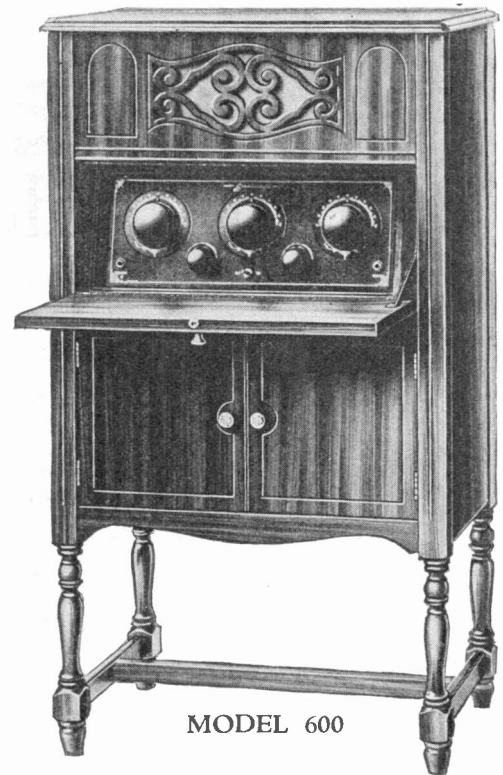

MODEL 600

Standard Radio Corp.,
 Worcester, Mass.
 Please send complete information on Standardyne.

Firm

Address

.....

.....

MANUFACTURED BY
The Standard RADIO CORPORATION
 WORCESTER, MASS.
 ~ USA ~

BEN W. FINK—Vice-President and General Manager



Electrifies the
phonograph and
brings it up to
the minute

*RICHER TONE
GREATER VOLUME*

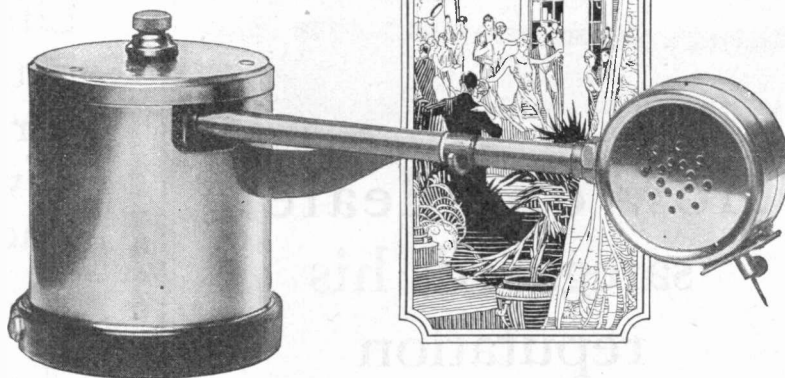

Announcing the **Bristophon**

Model L
Electric Phonograph Amplifier

A new instrument which will operate the old type of phonograph electrically. . . . giving it a tone richer, smoother, and of far greater volume than it ever had before.

It vastly improves the performance of all old records, and, when used to play the new-process electrical record, it brings out all the depth, clarity and tone range of the newer, high-priced phonographs.

The Bristophon operates (1) through the medium of a radio Power Speaker, similar to the R. C. A. 104; (2) with radio amplifier and loud speaker; and (3) with radio loud speaker only.

The remarkable volume possible with the Bristophon makes the old-style phonograph a noble substitute for a small orchestra for dancing. Yet the tone can be regulated to any size of room.

The retail price is \$45.

Your jobber should have the Bristophon.

If not, write us for descriptive folder, explaining it in detail, and we will see that you are afforded a demonstration.

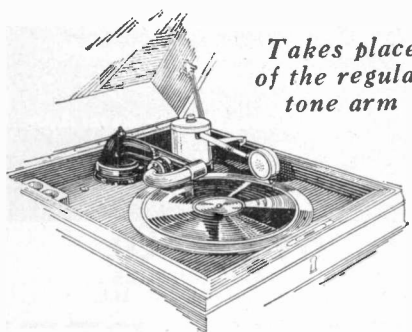

*Takes place
of the regular
tone arm*

THE BRISTOL COMPANY
Waterbury, Conn.



How one dealer safeguards his reputation

ONE of the leading electrical and radio stores in Sacramento, California, wrote us the following letter regarding their business in Prest-O-Lite Radio Batteries:

"We wish to express our satisfaction with results we have obtained from Prest-O-Lite Batteries. We have built up a wide reputation for handling honest radio merchandise and giving good service. Therefore, to deserve and keep that reputation we have always handled the highest quality radio sets and accessories.

"Our sets are priced complete and we always list the Prest-O-Lite Batteries.

"Your battery is good-looking, has rated capacity and carries enough discount to make a decent profit."

The J. C. HOBRECHT COMPANY
(Signed) E. STAATS

Prest-O-Lite Radio Storage Batteries—both "A" and "B"—are made especially for radio use. And behind them is a real merchandising plan and distinctive national advertising.

In addition, our nation-wide distribution, insuring quick deliveries, enables our dealers to operate with a very small capital investment. Write today for our interesting dealer proposition.

THE PREST-O-LITE CO., INC.
INDIANAPOLIS, IND.

New York San Francisco

In Canada: Prest-O-Lite Company of Canada, Ltd., Toronto, Ontario

Prest-O-Lite



CECO

TUBES

You get longer wear OUT of them because Longer Life is built INTO them in the CeCo Factory—the largest in the world devoted exclusively to Radio Tubes.

A Type for Every Radio Need



Type AX
Storage Battery
General Purpose
Price \$2.00



Type BX
Dry Cell
General Purpose
Small Base
Price \$2.00

C. E. Mfg. Co., Inc. Providence, R. I.

Sell Udell Radio Cabinets

A good example of our stock line of Radio Cabinets and Tables is No. 746 illustrated at left.

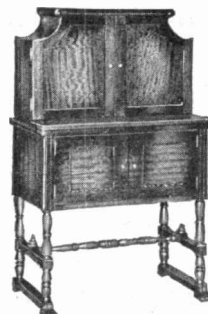

UDELL covers a complete range in design, finish and price. See our permanent displays—spaces 1029-31 American Furniture Mart, Chicago; space 314, New York Furniture Exchange, 206 Lexington Ave. Write for complete catalog R-86 and dealer's discounts.

We also build special Radio Cabinets under contract.

Write your requirements.

THE UDELL WORKS, INC.
28th Street at Barnes Ave.,
INDIANAPOLIS, IND.

ELECTRICAL SUPPLIES — RADIO

For speedy service on guaranteed Radio and Electrical goods, send your orders to Harry Alter. I make it my business to give you Same Day Delivery.



Harry Langer mgr. Order Dept
If you are not on our mailing list write today for our catalogs.

The Harry Alter Co.
ELECTRICAL and RADIO SUPPLIES
Ogden at Carroll Ave. CHICAGO ILL.



Radio's Best Wire

"From the Ground Up"

Jobbers and dealers are invited to write for the new Corwico catalogue, giving full specifications, prices, and discounts for the complete Corwico line.

Manufacturers—Let us quote on your requirements.

See Our Display at Chicago Radio Show, Booth CC6

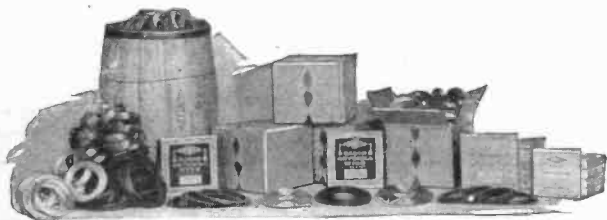

Aerial Wire

Corwico Aerial wires possess large surface areas, high electric conductivity and tensile strength. They are made solid, stranded and braided of plain, tinned and enameled copper wire.



Magnet Wire

Made of the best grade copper wire and insulated of the finest materials obtainable. Each spool contains a single length of wire, neatly wound and suitably labeled. Supplied in single and double cotton, single and double silk and plain enamel.

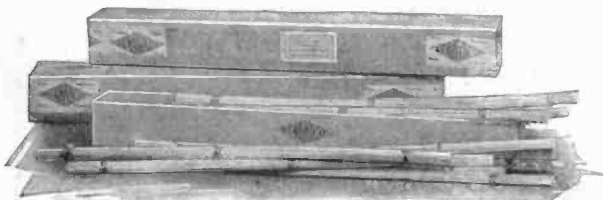

Bus Bar Wire

Made in uniformly straight lengths from either sharp cornered, square tinned or round tinned copper wire. Each 100 lengths bound together. Each 1000 lengths packed in attractive fibre board containers.



"Flexibus"

A flexible insulated multistrand copper hook-up wire. Makes a neat and efficient product for "point to point" and sub-panel wiring. Covered with a varnished cambric flameproof insulation finished in the following colors: red, green, yellow, brown and black.

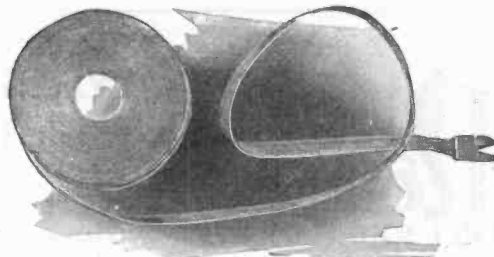

"Echo" Tape

A flexible metallic ribbon antenna especially manufactured for indoor reception. It is as flexible as a fabric tape yet contains as much effective metallic surface as a solid metal strip. For radio installations in apartments, hotels, etc., where outside aerials are impossible. Each 100-foot length in attractive carton.



Battery Cable—Five, Six and Seven Wire

Each conductor insulated in a different color for the purpose of identification and the wires are enclosed in a neat and substantial braid of either cotton or silk. Prevents burning out of tubes, insures good contacts and guarantees neat installation.

BOSTON
80 Federal St.
CHICAGO
337 W. Madison St.

CORNISH WIRE COMPANY
30 CHURCH STREET, NEW YORK CITY

KANSAS CITY
208 Baltimore Bldg.
SAN FRANCISCO
585 Mission Street

Satisfactory hook-ups include



Style T Non-Removable Knobs

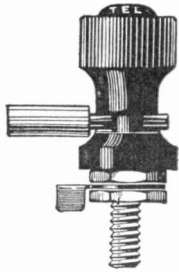

Real Opportunities For Leading Dealers

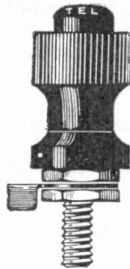

The "Queen" of binding posts. Body turns while knob is stationary, making markings always plainly visible and in line.

Bakelite construction makes them a most practical and neat appearing post of the screw type. Morse Eureka Binding Posts are furnished with any desired marking. *Write for details and prices.*

Manufactured by

FRANK W. MORSE CO.
Boston, Mass.

HARTUNG CLIPS

Continuous Circuit -Bulldog Grip

Get This Display at the Quantity Price!



The clips in this carton come to you at *quantity* prices—just as though you were buying each size in carton lots. Here is a complete assortment of radio clips, and just the right number of each size so you'll have no dead stock.

Order this display carton from your jobber today, or write us direct.

New price reductions now in effect. Send for circular.

C. F. HARTUNG CO.
730 E. 61st St., Los Angeles, Calif.

Music Master

RADIO REPRODUCER

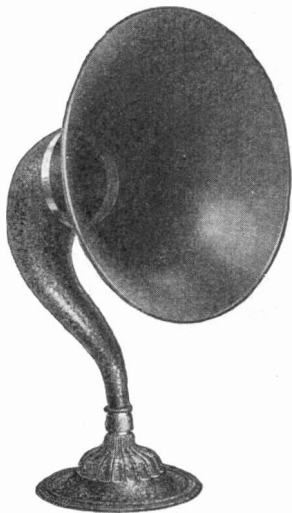

14-in. Mahogany Wood Bell
Cast Aluminum Tone Chamber
The Music Master Reproducing Unit

Music Master Horn Speaker

The Distinct Musical Instrument of Radio
No Mutilation of Tone

Music Master Horn Speaker stands out as the acknowledged amplifying musical instrument of Radio.

Reproduces every tone color with resonance and sustained power unequalled.

The distinguishing feature is the amplifying bell. Made of selected, seasoned wood which insures the rich, mellow sweetness conceived by the old master violin makers.

Before condemning your radio try the Music Master Horn Speaker, acknowledged everywhere as the perfect reproducer.

PRICE COMPLETE **\$22**

Do not accept a Substitute

Music Master Corporation

David S. Ludlum, Trustee,
Betzwood, Pa.
(Port Kennedy P. O.)

NO TIN-CAN *to* CORRODE on this New National Homepower

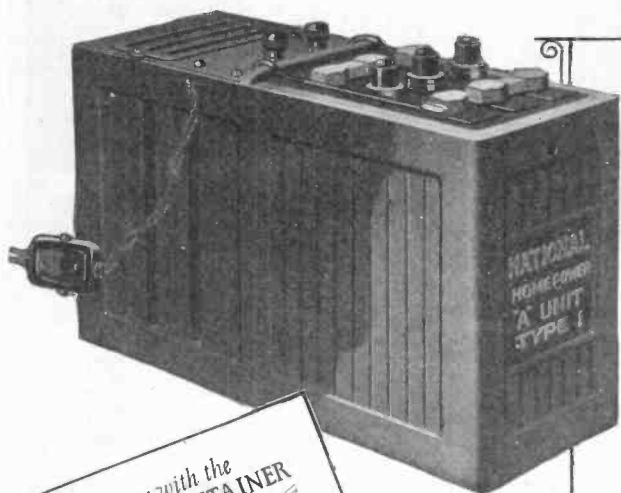

ANOTHER victory for "National" Engineers! A Combination "A" Battery and Charger fitted with a one-piece composition container which is positively impervious to the acids and gasses accumulating during the charging process. No tin cans to be eaten away as in the ordinary charger outfit. Radio users need never again grease the box which holds their charger outfit. It has cost us over \$5,000 to perfect this new non-corrosive and practically non-breakable case; but it is just what the radio world has been waiting for.

Operates via House Current Unfailing "A" Power

Destructive gassing is reduced to a minimum in the National Homepower. Proper control of the charging rate prevents excessive bubbling and the effuion of acid fumes through the radio set. Cabinet and set thus remain unimpaired.

The National Homepower operates from ordinary house current and assures full-powered "A" service every day of the year. Remarkable volume, distance, clarity. And what an economy! The National Homepower saves its first cost within a year. No more recharging expense; no more dry cell renewals!



a strong newspaper series

full page space now running in LIBERTY

9,000,000 Radio Users are reading about the NATIONAL HOMEPOWER

For months to come, leading National Magazines and local newspapers will carry the National Homepower advertising story into the homes of millions of radio users—the type which appreciates every radio improvement. You know what the reaction will be. Sales and more sales for every dealer who stocks National Homepower Units and allies himself with this strong campaign. National Homepower Units are built in three types, making your sales field still more unlimited. The margin of profit on these Units is liberal even though they retail at a remarkably low cost. Write us today before demand finds you unprepared! Let us outline our dealer policies, advertising co-operation, etc., in detail! Be the first in your territory to offer something better than the "tin-can" charger outfit!

NATIONAL LEAD BATTERY CO.
General Offices: St. Paul, Minn.

Factories: St. Paul, Chicago, Kansas City, Los Angeles

Branches:
New York City, Oakland, Atlanta, Portland (Ore.), Baltimore, Dallas

NATIONAL HOMEPOWER RADIO "A" UNITS

TYPE 1
TYPE 2
TYPE 3



New!

**Sell
POWER!**

THE biggest thing in radio this season is the amazing popularity of power tubes. Sonatron has been a remarkable factor in creating and maintaining the power tube demand, and today the Sonatron agency is yielding a golden harvest to thousands of dealers! Sonatron's 25 distinct types of tubes—the world's largest line—is your guarantee of tube leadership. Write today for full information. Sell POWER!

Sonatron dealers are backed by thorough national and local advertising, and intensive dealer co-operation.

SONATRON TUBE CO.
108 W. Lake St., Chicago
16 Hudson St., New York City
320 Lafayette Bldg., Detroit, Mich.
Newark, New Jersey
Windsor, Ont., Canada

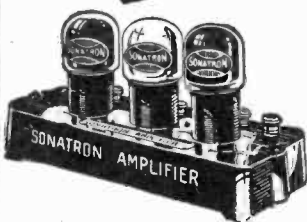

The
**SONATRON
AMPLIFIER**
complete with 3 Red
White and Blue
matched power tubes

The newest Sonatron development—a quick, profitable seller! Every set owner, whether he has a crystal or a 10-tube set, wants it! Write for details.

SONATRON
Nationally Advertisied  Standard Quality
Trade Mark
THE WORLD'S LARGEST TUBE LINE

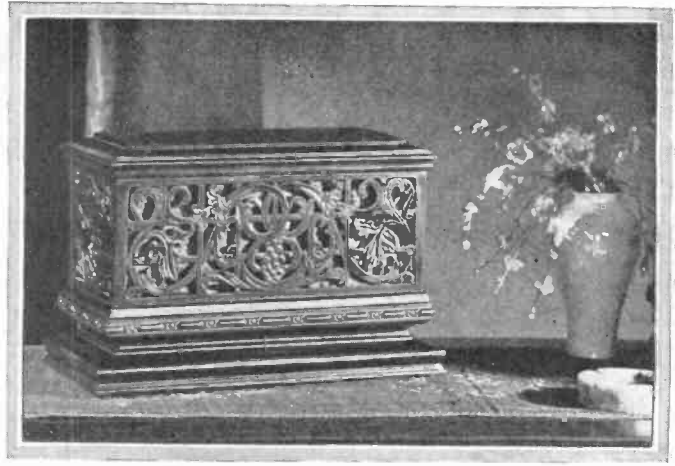

The Luxurious New Amplion Patrician
AA18 List \$45

This is the latest development of the world-famous Amplion air-column type of speaker—sembling a remarkable 46" column, with standard Amplion unit, in a luxurious, richly carved mahogany cabinet, 18" x 12" x 9". Acoustically, the Patrician is non-directional; to the notable Amplion sensitivity and clarity, it adds a new softly diffused mellowness of tone that makes this instrument the choice of the connoisseur, wherever heard.

**National distribution
for 1927 is now established**

National Magazine Advertising, with a circulation of over 4,400,000, commenced in October.

Newspaper Advertising, covering all strategic local territorial points, is now under way.

If not already in line for Amplion, write us at once for name of Jobber in your territory. Profit by this powerful Sales and Advertising Campaign, from the start!

Amplion Prices, \$12 to \$45, cover the most comprehensive range of radio reproducers on the market.

—backed by the absolute guarantee and prestige of the world's oldest makers of sound reproducing instruments.

—freely recognized as unquestionably the greatest sales and profit making line ever offered to the Trade.

THE AMPLION CORPORATION OF AMERICA
Suite E, 280 Madison Avenue, New York City
THE AMPLION CORPORATION OF CANADA Ltd., Toronto



Amplion Cone
AC 12 List \$30

The new Amplion Cone is the result of over two years intensive experimenting—subjected to the most rigid tests and comparisons—by The House of Graham scientists. It is time-perfected—totally different in principle, construction and results from other cone-type speakers. In artistic, two-tone mahogany cabinet, 14" x 14" x 9". A new-season salesleader!



Amplion Dragon
AR 19 List \$42.50

This celebrated Amplion is used as standard by leading radio manufacturers, wherever broadcasting exists. Famous for unequalled sensitivity to even the faintest speech and musical signals—for clarity, naturalness, and amazing volume. Height, 20 1/2"; mahogany-finished paneled flare, 14 1/2" diameter. Hinged base.

DRAGON MODELS

- AR19 Amplion Dragon . . . List \$42.50
- AR111 Amplion Junior . . . List \$24.00
- AR114 Amplion Junior de Luxe . . . List \$27.50
- AR102 Amplion Dragonfly . . . List \$12.00

Phonograph Attachments

- AR35 Amplion Concert Grand List \$20.00
- AR67 Amplion Standard Unit List \$12.00





The Year's High Point in Speaker Values

A rare combination of beauty and efficiency

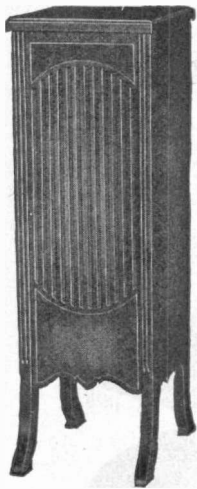

The Orchestrion Pedestal Speaker is 29 inches high and nine inches square. It may be had in either solid walnut or mahogany; also in a variety of lacquer and paint finishes.

Price \$24.50

To the already famous tone quality and radio efficiency of the Horn Type Orchestrion Speaker, has been added the beauty of a finely made, five-ply, sliced Walnut Console Table. It stands 30 inches high, 36 inches long and 15 $\frac{3}{4}$ inches wide. Designed by musical instrument makers, it incorporates the famous ORCHESTRION TONE ARM and unit, so that true tones are reproduced with sweetness and clarity, together with ample volume. Top space is large enough for practically all table-type receiving sets. Priced at \$35.00 the Orchestrion Console type is indeed the greatest value yet offered.

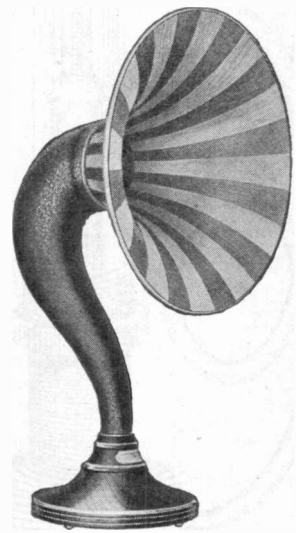

The Horn Type Orchestrion Speaker—known all over the world for Clarity of Tone.

Now priced at \$29.50

The RADIO CABINET CO.

2118 Gale Street, Indianapolis, Ind.

ORCHESTRION

LOUD SPEAKER

ANY HYDROMETER CAN TEST YOUR BATTERY BUT ONLY THE **"BreakNot"** TESTS IT RIGHT! THAT'S WHY YOUR TRADE BUYS IT

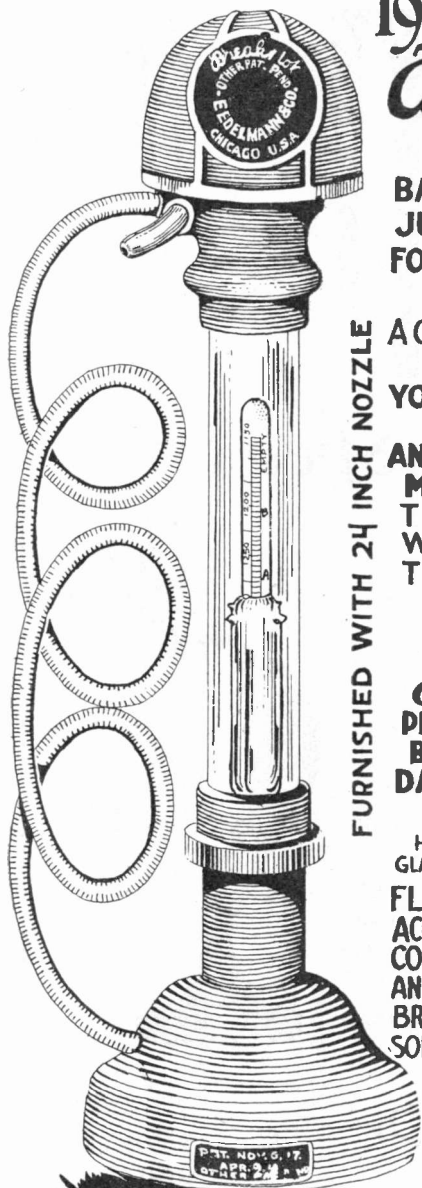

1927 Model **"BreakNot"** RADIO

BATTERY TESTER JUST THE THING FOR RADIO A OR B BATTERIES.

A Child Can Operate It! USE IT ONCE YOU'LL USE NO OTHER SET IT DOWN ANYWHERE WHILE MAKING A TEST. TEST EVERY CELL WITHOUT MOVING THE INSTRUMENT. WILL NOT TIP OVER

PATENTED CONSTRUCTION PROTECTS AGAINST BREAKAGE AND DANGER OF ACID SPILLING.

FURNISHED WITH 24 INCH NOZZLE

HAS ONLY HALF AS MUCH GLASS HAS OTHER HYDROMETERS

FLOAT: GUARANTEED ACCURATE-PRINTED IN COLORS EASY TO READ AND PROTECTED AGAINST BREAKAGE BY PATENTED SOFT RUBBER HOUSING

THE BIGGEST VALUE \$1.00 EVER BOUGHT

Dealers: IF YOU HAVEN'T THE "BreakNot" IN STOCK YOUR LOSING MONEY.

EASY TO SELL

PACKED 10 "BreakNot"s IN COUNTER DISPLAY-ORDER FROM YOUR JOBBER TODAY.

OR WRITE US TO TELL YOU MORE ABOUT THIS RAPID SELLER.

MADE BY **E. EDELMANN & CO.** 2332 LOGAN BLVD. CHICAGO ILLINOIS



Radio Results

WESTON Model 506 "Pin-Jack" Voltmeter with High Range Stand offers a combination to the dealer that will be as profitable to you as to your customer. The voltmeter alone, plugged into the panel of the set, measures filament voltage. When this voltmeter is plugged into the High Range Stand it measures battery voltages up to 160 volts. You know Weston quality. Write us for Bulletin "O."



WESTON ELECTRICAL INSTRUMENT CORPORATION

25 Weston Avenue, Newark, N. J.



STANDARD THE WORLD OVER

WESTON

Pioneers since 1888



Two Things That Spell Bigger SALES

1. The perfection of a new idea in single control radio—a flexible transformer which enables the identical matching of inductances in the assembled receiver instead of using just approximately matched coils. Possessing the exclusive rights to this coil (known as the Flexiformer) we have produced a truly single control, seven tube receiver so superior to anything heretofore known that it is rightfully called the Super Single.

2. We are backing Super Single with a big localized newspaper campaign at *no* expense to either jobber or dealer. This runs over the dealers' names. In addition we provide graphic moving window displays, powerful direct-mail literature and national advertising in radio magazines, and other merchandizing ideas—in all a campaign more detailed and more complete than any heretofore presented in radio.

This combination is bound to produce business—*big* business for radio jobbers and dealers holding the Super Single franchise. This mighty merchandising campaign will be released shortly over dealers' names; we sell our dealers in every ad.

Protected territories are going fast. Write or wire immediately for interesting proposition for jobbers and dealers.

PLYMOUTH RADIO &
PHONOGRAPH CO.

PLYMOUTH

Plymouth,
Wisconsin



the 5 tests of a radio

1 MORE STATIONS (Efficiency Test)

Thirty stations in one revolution of the tuning knob is ordinary performance for this receiver. Range—coast to coast.

2 SIMPLE TUNING (Operation Test)

Just one tuning knob—no verniers. Every station perfectly tuned.

3 TONE QUALITY (Ear Test)

The combination of the Super-Single and the Plymouth Speaker, containing a scientifically designed and constructed wood horn over eight feet in length affords a revelation in reception. Every audible note is faithfully reproduced.

4 APPEARANCE (Eye Test)

Cabinets designed and constructed under the personal supervision of William H. Thommen, well-known designer of America's most beautiful phonograph and radio cabinets.

5 PRICE (Pocketbook Test)

Lower than any set which deserves comparison on a performance basis.

A New Idea in Battery Testers

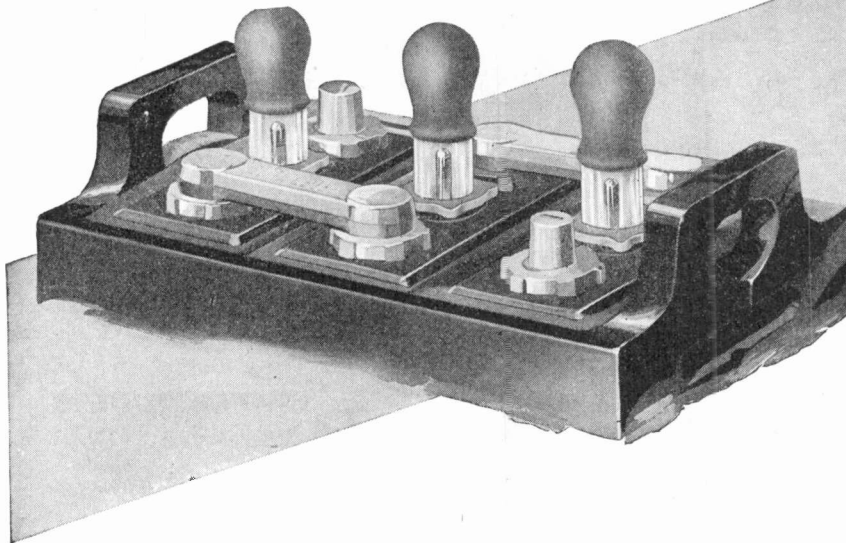

SCRANTON Battery-Cap-Tester

Now Being Nationally Advertised

IN Liberty Magazine, with its more than 1,300,000 readers, the new Scranton Battery-Cap-Testers are being advertised every other week.

This remarkable new tester—which is revolutionary in a number of ways—reduces four operations to one—and that one is the *easiest* one. Screw the three testers into battery vents in place of regular caps, and leave them there permanently. To test battery charge, simply compress bulb and draw solution into barrel. Condition is shown at a glance, for three colored divisions—another special Scranton feature—clearly indicates whether charge is GOOD, FAIR or POOR. Solution returns to cells automatically. No spilling, no breakage, no soiling of clothes or hands.

With this greater convenience and speed of testing there is another important and exclusive feature: *A single pressure of each bulb shows if water is needed.*

In sets of three to retail at \$2.

Prepare for the calls you are sure to get. Order a supply at once.

The Scranton Glass Instrument Co., Inc.
Scranton, Pa.

SCRANTON BATTERY TESTERS

Battery Cap Set of 3,
\$2.00 list

Kantstick
\$1.00 list

Scranton
85c list

Ayanbee
75c list

Sturdy Special
75c list

Sturdy
65c list

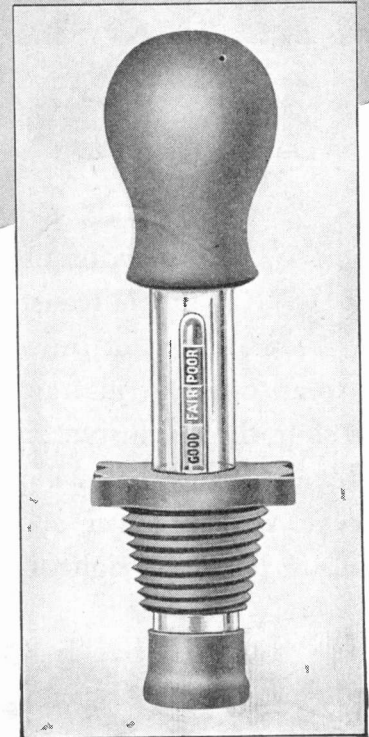

Be Ready for the
Freezing Radiators

All that old uncertainty regarding the amount of anti-freeze solution to pour into the radiator is definitely settled forever for the man who has a

SCRANTON Kantstick Anti-Freeze Tester

Tests accurately *all* accepted anti-freeze solutions. Shows at a glance when the right amount has been added. Pays for itself over and over again in the protection it gives.

You can sell one to every second car owner who enters your store.

In individual cartons to retail at \$1.

The Masterpiece of Masterpieces!



New and Improved **FRESHMAN MASTERPIECE**

THIS "Masterpiece of Masterpieces" startles and surpasses all expectations.

It is the most perfect radio that has ever been designed. It is massive—it is beautiful. It is just what is wanted for the home. For no matter how exquisite the furnishings are, this artistic genuine mahogany upright console will lend additional beauty. And yet it is priced so moderately that almost every family can easily afford to own one.

—the thing that makes it wonderful is its tone quality. The large cone speaker has been designed to exactly match Freshman's new **QUALITY** radio receiver. This special cone speaker easily handles the full power that this new set delivers.

Simplicity

Its ease of operation, with its three distinct controls, allows any novice to tune in the station wanted day after day at the same points on the dials. This efficient means of operation eliminates the overlapping of wave lengths, which assures distinct separation of one broadcasting station from all others.

\$119.⁵⁰
Model 6-F-11

Genuine RCA Radiotrons

are recommended for use with Freshman Masterpiece Receivers.

A special package containing—1 UX-112 power tube, 1 UX-200A detector tube and 3 UX-201A amplifying tubes—matched and tested for the set in which they are shipped, is sold by Authorized Freshman Dealers.

Sold to Authorized Freshman Dealers Only.

CHAS. FRESHMAN CO., Inc. Freshman Building, New York
2626 W. Washington Blvd., Chicago, Ill.

Worlds Greatest Radio!



Steinite

**7-Tube
No-Battery Set**
No Chemical Rectifiers.
Operates from Light Socket
1c hour A. C. Circuit, 100
to 125 V.

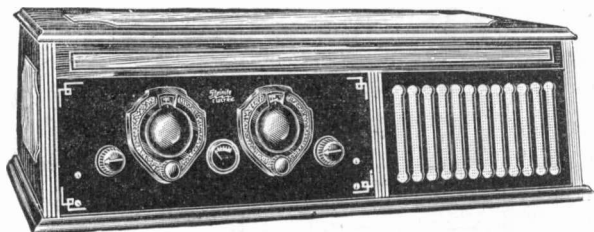

Retail Price
\$125.00

\$15.00 extra
for Table
to Match
(Table Optional)

Solid Mahogany Cabinets
The line carries nice Jobbers and Dealers' discounts from stated retail prices.

Manufacturers of 6-Tube Battery Type T. R. F. Table Model \$45. Console, with built-in Loud Speaker, \$79.50. Steinite Crystal Set \$6. Steinite Crystal 50c. each Steinite Aerial eliminator \$1 Steinite Interference Eliminator \$1
Literature on request.

STEINITE LABORATORIES

Factory: ATCHISON, KANS.
General Sales Offices: 504 So. State St., CHICAGO

ELECTRAD

New!



ELECTRAD

Heavy Duty Metallic Resistor

Specially developed for B eliminators and power supply units.

Special features are:

- 1—High current-carrying capacity.
- 2—Non-inductive. Accurate calibration.
- 3—Low temperature coefficient.
- 4—Resistance element fused to inside of Lavrock tube.
- 5—All standard high resistance sizes.

Technical data furnished on request
List Price **\$1.00**; in Canada \$1.40.

ELECTRAD, INC.

428 Broadway, New York City

ELECTRAD

CAMPBELL Radio "A" Charger

Less input
More output
List \$14.00

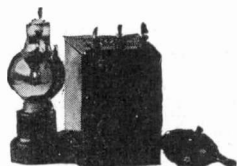

Most
efficient
Charger
manufactured

CAMPBELL MFG. CO.

Lynn, Mass.

Transformer Specialists

"Outsell, Because They Excel"



ALL TYPES

Including NEW

DETECTOR (EX-200A)
**HIGH MU and
Power Amplifier**

*Dealers and Jobbers
Write for Prices and Folder "RR"*

EMPIRE ELECTRICAL PRODUCTS CO.

Sales Office, 132-134 Greene St., New York

Laboratories and Factory, Kearny, N. J.

Also Mfrs. of EMPIRE Cone and Horn Speakers

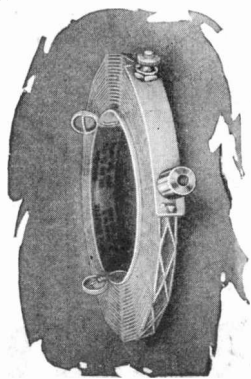

Set Manufacturers!

Standards of radio reception are becoming higher with each new year. 1926 models must be an improvement over those of 1925, and they will be.

Correct coils are vital to good reception. We specialize in such coils. We are producing regularly the most advanced types, built with the famous "Diamond-weave" construction.

Write us concerning your own requirements. We are prepared to furnish better coils for the new sets.

THE F. W. SICKLES COMPANY
140 Union St., Springfield, Mass.

**SICKLES DIAMOND-WEAVE
COILS**

Surplus Stocks Are Easily Disposed of *Through the*

"SEARCHLIGHT SECTION"

"FOR SALE" announcements are carefully read by the trade.

"SEARCHLIGHT" Ads bring prompt and profitable returns.

Just
Plug
In



ARGUS ELECTRIC RADIO

PATENTED MAY 15TH 1923 - OTHER PATENTS PENDING

Not an experiment but an accomplishment of three years' standing

Not an ensemble of A, B and C battery eliminators, trickle chargers, etc., but a *real electric receiver without attachments of any kind.*

Not an apology to the demand of 13,000,000 A.C. wired homes for a truly foolproof, real electric receiver, but an *advance in radio engineering that "Marks an era in Radio as distinct as the discovery of electricity itself."*

Not an advance in radio engineering alone but an *advance in the Science of Acoustics as well;* for the reception attained by the Argus Electric Radio Receiver is so crystal clear and chromatically perfect in tone that it is—well, why attempt to exhaust the adjectives of the dictionary?—it is like being present in the broadcasting studio while the artists are before the microphone.

In justice to yourself ask your jobber for an Argus demonstration.

ARGUS RADIO CORP.
257 WEST 17th STREET., N. Y. C.

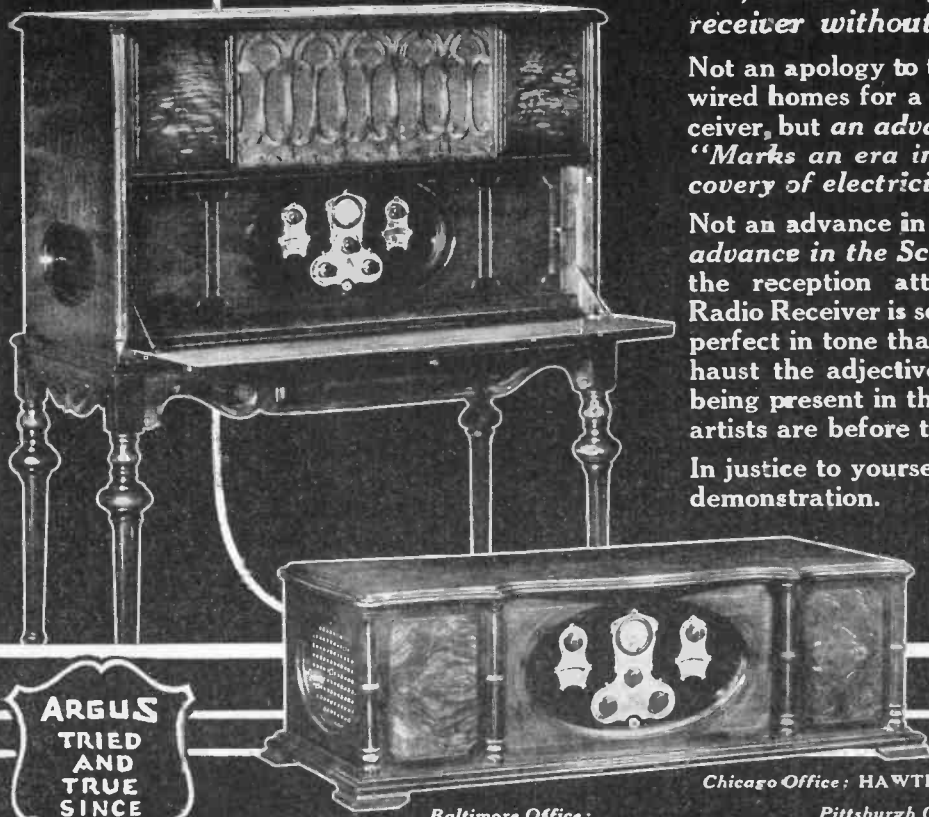

**ARGUS
TRIED
AND
TRUE
SINCE
1923**

Baltimore Office:
**HERMAN A. SMITH, Greenspring Ave. & South Road
Mount Washington**

Chicago Office: **HA WTHORNE & STEMM, 28 East Jackson Boulevard**

Pittsburgh Office:
**W. A. BITTNER
422 First Ave.**

St. Louis Office:
**N. DAVID THOMPSON
308 Central National Bank Bldg.**



Value plus—

Our merchandising plan for the 1926-27 selling season gives you a proposition that should enable you to meet and to beat your competition on the basis of price as well as performance.

In general, we are offering a 5-tube neutrodyne receiver built under one of the original licenses by a concern with a background of years of manufacturing experience—

A superselective receiver of exceptional range, simplicity of tuning and clarity of tone.

Specifically, we present:

5-Tube Neutrodyne; Murdock—C-26; Console Cabinet—Mahogany, with Built-in Speaker.

to List at
\$125⁰⁰

5-Tube Neutrodyne; Murdock—M-26; Table Cabinet—Mahogany Finish, Without Equipment.

to List at

\$60⁰⁰

Write for details now—before our capacity is pledged—to

Wm. J. Murdock Co.
Chelsea, Mass.

STORAD

Radio Power Supply

*Pleases Your Customers—
Increases Your Profits*

Storad Power Supply is constant and reliable. Once a Storad is on the circuit, the customer's worries are over. He has current—lots of it—when he wants it.

Raytheon Tube Type "B" Power Supply is used with all heavy duty units supplying "B" Power. Other standard products used throughout are Tobe Deutchmann Heavy Duty Condensers and Storad Special Transformers and Filters.

100% OVER CAPACITY.—That's why Storad Power Supply will work on any set regardless of size without hum. That's why your customers like Storad's and why you can recommend and sell them with complete confidence.



Type 201

Type 201-B Power Supply and Trickle Charger

Raytheon Tube Type B Power Unit—high capacity, with a bulb type Trickle Charger for Storage A Battery. Operated from one switch which turns off set and "B" Power and turns on Trickle Charger. Four variable controls.

Type 101—"B" Power Supply

Raytheon Tube Type Unit of large capacity. Will operate sets using power tubes on last stage audio. Operates on house lighting circuit. Three variable controls from 180 volts down.

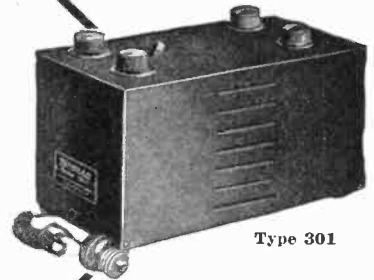

Type 301

Type 701 Trickle Charger

Sufficient capacity for A Batteries used with larger sets. Switch turns on charger when set is turned off. Variable control regulates charging current from 1/2 to 1 amp.

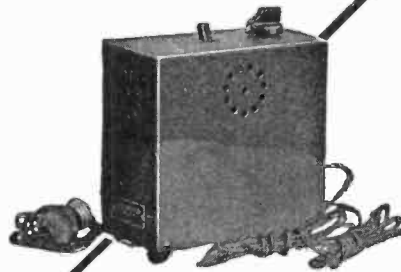

Type 701

The three years of research work and one year of actual tests put on Storads before they were placed on the market, place Storad "B" Power Supply many months in advance of the average eliminator.

Handle the Storad line and increase sales and profits.

Write for information and prices.

The Storad Manufacturing Co.
2413 Detroit Ave., Cleveland, Ohio

First in the field!
 "A" and "B" Battery Elimination!
 Successful - at a price within reach
 of all...

The Best in Radio Today

\$231

with 5 McCullough AC
 Tubes and Rectron 213
 without Loud Speaker

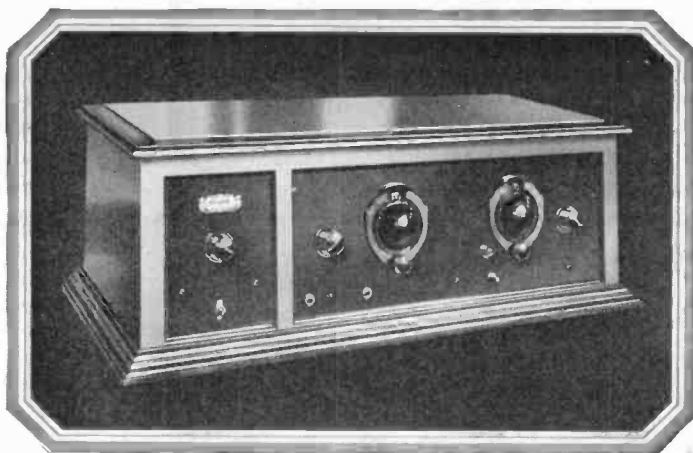

You radio fans who want a set that will eliminate both "A" and "B" Batteries can now have one at a reasonable price. The Cleartone Radio Electric Model 110, operating from the house current and using no fluids or acids, costs only \$231, with 5 McCullough A.C. Tubes and one Rectron—213 without loud speaker.

This remarkable set uses McCullough A.C. Tubes, to abolish the battery problem and they are undoubtedly the greatest achievement in radio today. It has been highly approved by such a great authority as Professor Wilcox of the Armour Institute of Technology of Chicago.

The Cleartone Radio Electric Model 110 is the

result of five years of exclusive radio receiving set manufacturing. Tone quality and volume are exceptional. Two vernier dial controls with the proper degree of selectivity simplify operation. The high quality of workmanship insures a set which will give years of satisfactory service, fully guaranteed by a manufacturer of the highest standing in the radio industry.

DEALERS

Let us tell you how this set will help you do away with losses due to heavy service costs. We have some interesting facts and figures FOR YOU.

The Cleartone Radio Company
 2432 Gilbert Ave., Cincinnati, Ohio

CLEARSTONE *Complete*
 RADIO SETS



TRADE-MARK

FILTER CONDENSERS

are in standard and extensive use by

- Philadelphia Storage Battery Company
- General Radio Company
- National Company, Inc.
- Sterling Manufacturing Company
- Modern Electric Manufacturing Company
- Storad Manufacturing Company
- King Radio Manufacturing Company
- and many others.

What does this mean?

It means, you will have no difficulty in selling TOBE Condensers to the eager purchasers of parts for B-Eliminators for home construction. Filter condensers that meet every rigid requirement of the great companies listed above need no further recommendation.

The TOBE B-BLOCKS comprise in the various combinations, all of the needed filter condensers required for Raytheon, Rectron and other filters. They cost less than the separately cased condensers and save space and wiring.

- Type 760 for Raytheon Type B Tubes.....\$11.00
- Type 761 for Single-Choke Filter Circuits \$9.50
- Type 764 for UX-213 Tubes\$11.00
- Type 765 for Raytheon B. H. Tubes.....\$11.00

(If you are not already a TOBE dealer, write us for price-list RR and name of our nearest jobber.)

Tobe Deutschmann Co.

Manufacturers, Engineers and Importers of
Technical Apparatus
Cambridge, Mass.

MU-RAD Solves Another Dealer Problem!

How many times have you watched prospective customers turn away and murmur "I'll wait for something newer and better"? How many sales have you lost because people don't want to invest money in this year's radio—"next year's will be more up-to-date"—? Mu-Rad has worked out a plan to destroy this sales resistance.

A fixed plan for exchanging old Mu-Rad sets for new yearly models. A plan that will make your cash register hum! This plan and the new Mu-Rad one-dial control receivers are a combination unbeatable in radio history.

Write today for further information Dept. R.

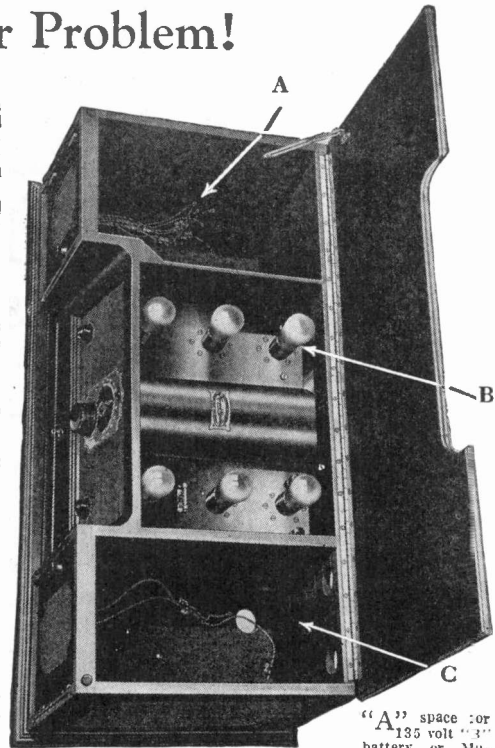

"A" space for 135 volt battery or Mu-Rad B Eliminator.

"B" power tube.

"C" space for "A" battery and Trickle Charger.

MU-RAD Radio Corporation
Asbury Park, New Jersey

KELFORD

THREE STAGE RESISTANCE COUPLED AMPLIFIER, List \$8

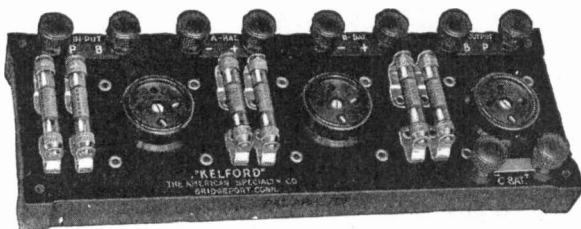

Here's a completely equipped amplifier with a moulded all Bakelite form to list at a moderate price. It's a big seller wherever shown. Stock a few and you will soon reorder.

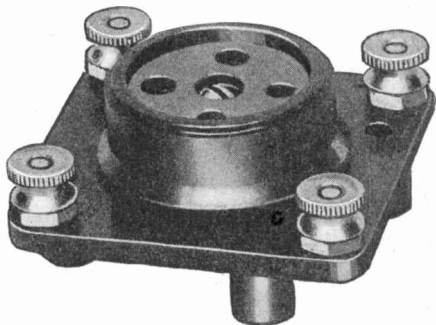

"Cushion" Type Socket No. 190

Designed to take new standard UX type tubes. Will also take tubes with old style bases except UV190. By substituting Kelford "Cushion" type Sockets, tube jars and resulting noises are eliminated. List Price 50c.

Write for catalog giving prices and discounts on the complete Kelford line.

THE AMERICAN SPECIALTY COMPANY
BRIDGEPORT, CONN.

Used and Surplus Equipment

INDIVIDUAL items of used equipment, or surplus new equipment, or complete plants, are disposed of (and found) through advertising in the *Searchlight* Section of this paper.

This is the section which so effectively aided the Government in selling the many millions of dollars worth of surplus material and equipment accumulated during the war without disturbing the market.

"SEARCHLIGHT"



Customers Respond To This Triple Appeal

Premier Model 20 has the triple appeal which makes sales easy.

Its splendid tone appeals to the ear. Artistic cabinets and panels with dignified gold engraving appeal to the eye. Exceptionally low retail price appeals to the purse.

At \$75.00 list, the Premier Model 20 is unquestionably the best proposition of all 7 tube sets. On a 30 foot an-

tenna its range and selectivity enables it to reach far distant stations through powerful locals. Unique combination of resistance and transformer coupled circuit,—all the volume you can use.

Liberal discount. It sells easily and is worth selling. Write for complete information, jobber and dealer discounts, etc.

The Triple
Appeal
for
EAR-EYE
AND PURSE

Premier Radio Corporation

Defiance, Ohio, U. S. A.

"LITTLE GIANT" Rheostat

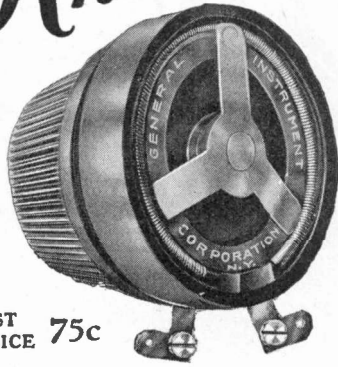

LIST PRICE 75c

"ALL THE NAME IMPLIES"

The only rheostat which definitely eliminates the possibility of burnt out or broken resistance units. Perfect and velvet silent action. Bakelite insulated throughout. One hole mount. 6 to 30 Ohms.

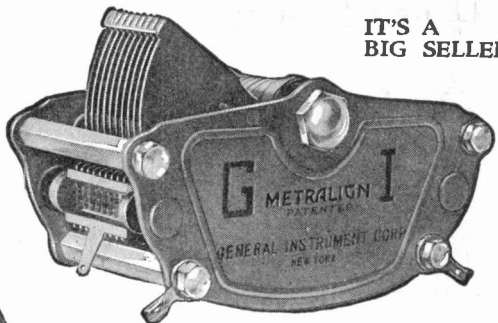

IT'S A BIG SELLER

METRALIGN SLT STRAIGHT LINE TUNING

Because of its outstanding merits and superior performance, backed by a national advertising campaign in radio magazines and newspapers throughout the country. METRALIGN SLT condensers will be one of the season's biggest profit-making items for dealers. Prepare for the coming season's big replacement business. Get in touch with your jobber today. If he cannot supply you, write us direct.

Makes Any Set a New Set—
In 15 Minutes

GENERAL INSTRUMENT CORP.

Makers of "Bureau of Standards" Variable Primary Condensers

477 Broadway,
NEW YORK CITY.

Priced right

Works right

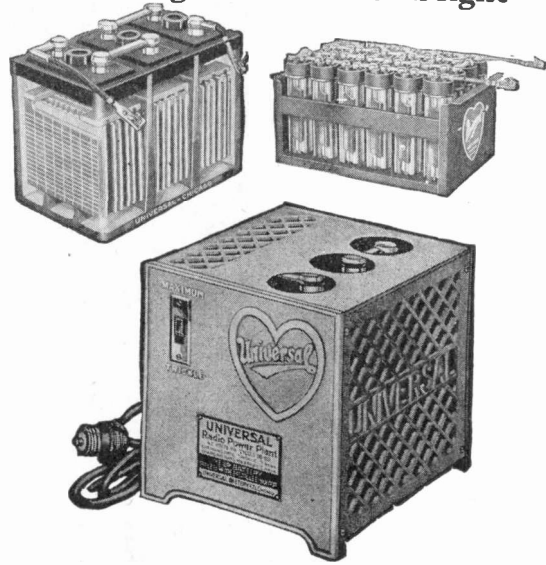

Dealers say this new "A" Power Unit is right!

Right in price, right in appearance, and most important of all, right in performance. You'll be enthusiastic about it, too. Dealers are having a decided success with it, although it has been on the market only a few weeks.

Correctly designed by experts in their work. Made of the best materials and enclosed in an attractive aluminum cabinet. Silent in operation. Can be charged at trickle or 2-ampere rate by merely throwing the switch. Plenty of acid space above the plates. Economical and convenient to use.

It is made up of our own bulb-type charger and our type GCR battery. This battery is also used in our chemical unit "A" Power Plant. (Send for catalog.)

Our new molded-glass "A" Battery comes separately and many dealers report it the finest they have ever handled. It is a fit companion for the long-lived, Universal "A" and "B" radio batteries.

If your battery business isn't fully as, or even a little more satisfactory than any other department of your business, drop us a line and let us tell you how Universal dealers are making *real* money.

See our Exhibit, Chicago Radio Show,
October 11th to 17th, inclusive

UNIVERSAL BATTERY COMPANY

3447 South LaSalle Street • Chicago, Illinois

Batteries for every Purse and Purpose
AUTOMOBILE - RADIO - FARM LIGHT

Parts for all makes of Batteries
SHOP EQUIPMENT

UNIVERSAL BATTERIES

TONE QUALITY, LIKE DISTANCE, NOW LENDS ENCHANTMENT!

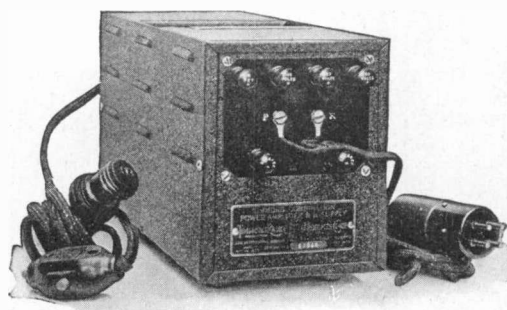

Timmons "Combination" (at left) lists at \$70.00, without tubes. It is a power amplifier and B-eliminator combined. Timmons Power Amplifier (at right) lists at \$45.00, without tubes. Both prices slightly higher west of the Rockies.

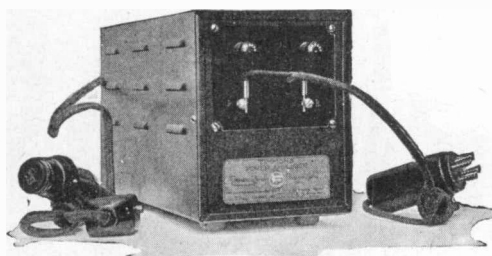

And There's Real Profit In the "Lending"!

A compact, *botherless* package of the truest, most natural tone quality is what you sell in either the two new Timmons power amplifier units shown above. And, for good measure, increased signal strength is included—to be used, when desired, for better "DX!"

Both units furnish the adequate POWER which is indispensable for the most efficient loud speaker operation, and both literally *liberate* the *living* tones any set *receives* but cannot *deliver* without POWER. In addition, the "Combination" is a *permanent* B-eliminator.

The two instruments operate entirely from an ordinary electric socket. Neither requires any auxiliary equipment (except their two tubes, UX 216-B and UX 210) and no changes are required in the wiring of any set.

TESTED AND APPROVED

The following Timmons Products have just been tested and approved by Prof. Collins P. Bliss, in the Russell Sage Research Laboratories of New York University, for Popular Science Institute of Standards:—



Timmons Combination Power Amplifier and "B" Supply
 Timmons Power Amplifier
 Timmons Raytheon Blim (high voltage B-eliminator)



TIMMONS RADIO PRODUCTS CORPORATION
 Germantown, Philadelphia, Pa.

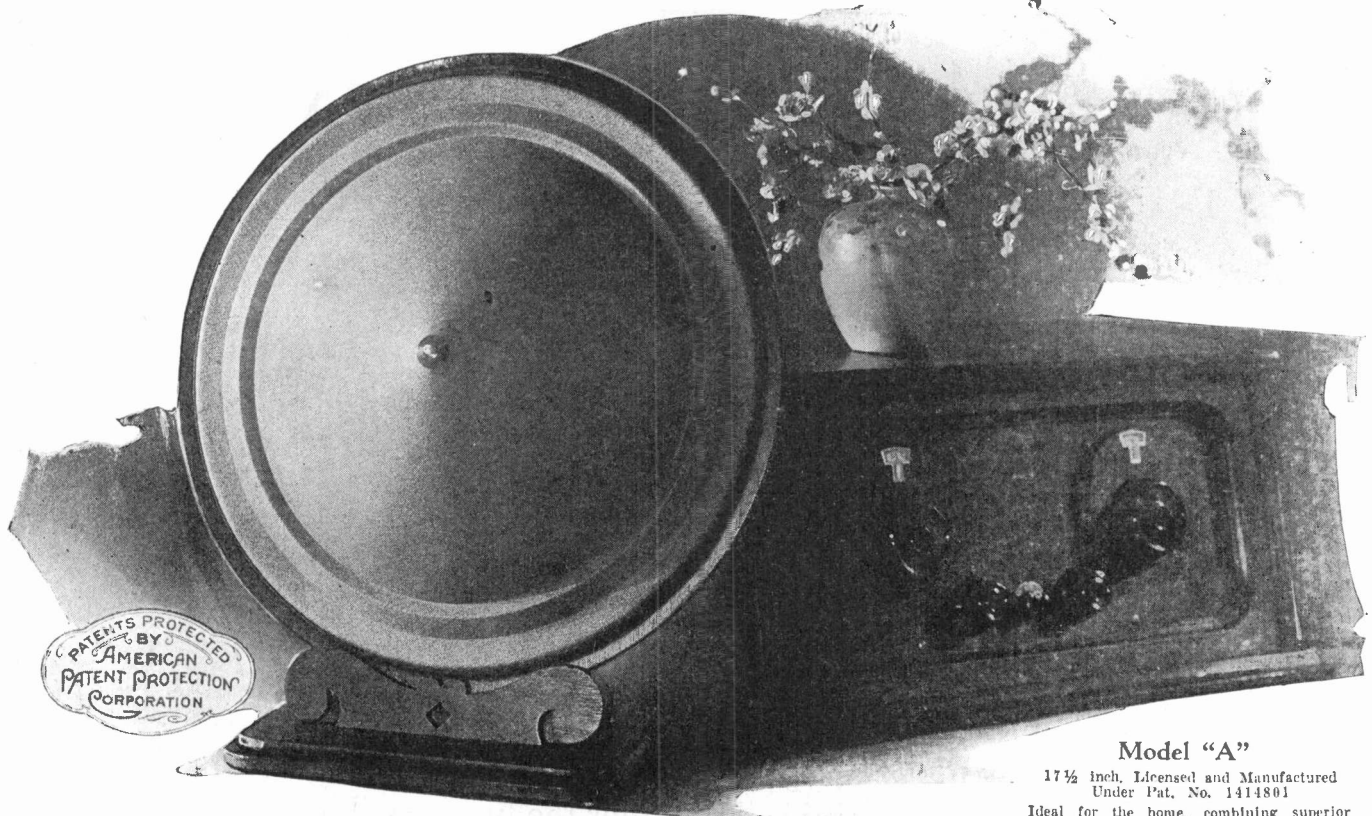

Model "A"

17½ inch. Licensed and Manufactured Under Pat. No. 1414801

Ideal for the home, combining superior tone and volume with decorative elegance. Mahogany sounding board gives rich resonance and power to the tone. Can be used on console, or hung on wall. Complete with easel base and silk hanging cord \$25

What every woman wants in a speaker—

Women cast the deciding vote in 85% of radio equipment purchases. They want decorative as well as technical quality.

Stevens speakers capture their interest on both counts — obvious beauty and adaptability to interior decoration, and superior reproduction quality that is equally apparent.

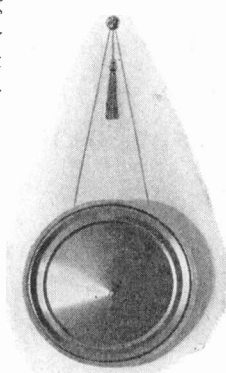

Just show them the Stevens models. Demonstrate their performance in comparison with any others—and the sale is yours.

And there are no come-backs or returns—Stevens Speakers make good from the start. That is why Stevens sales have increased by leaps and bounds. Share in the success of this fast selling line.

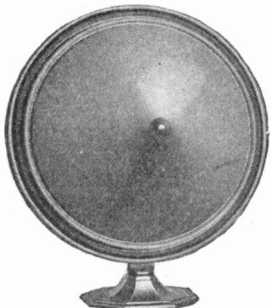

Model "B"

14½ inch

Similar to Model "A" but smaller. Ornamental and highly efficient.

An exclusive device gives all directional effect if desired—

ADJUSTABLE by tilting top as illustrated. Complete.... \$16.50

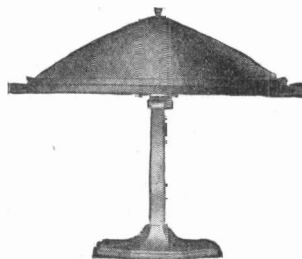

Stevens Speakers Superiority

is based upon the many exclusive features which combine to make perfect radio reproduction.



The unique Stevens diaphragm is made of "Burtex"—a new scientific material which makes possible the *only* seamless diaphragm on the market. It is a fabric base, formed under tension and impregnated so that it is absolutely damp-proof.



The Scientific Curve of Sound Reproduction

Furthermore, it is the *only* diaphragm formed in the famous "Conoidal" shape which, combined with the Stevens "non-freezable" balanced armature unit, affords a greater range of tones and overtones than any other commercial speaker. Hear it and see for yourself why Stevens Speakers SELL!

Stevens Speakers

Stevens & Company, Inc.

46-48 East Houston St.
New York City

POWERIZER PROTECTS



DEALERS' PROFITS

Eliminate Trade-in Losses
Sell

POWERIZER

REG.

Combined
"B" Eliminator and
Power Amplifier

LIST PRICE

~~\$49.50~~
\$49.50

WITHOUT TUBES

Attaches to any set without re-wiring

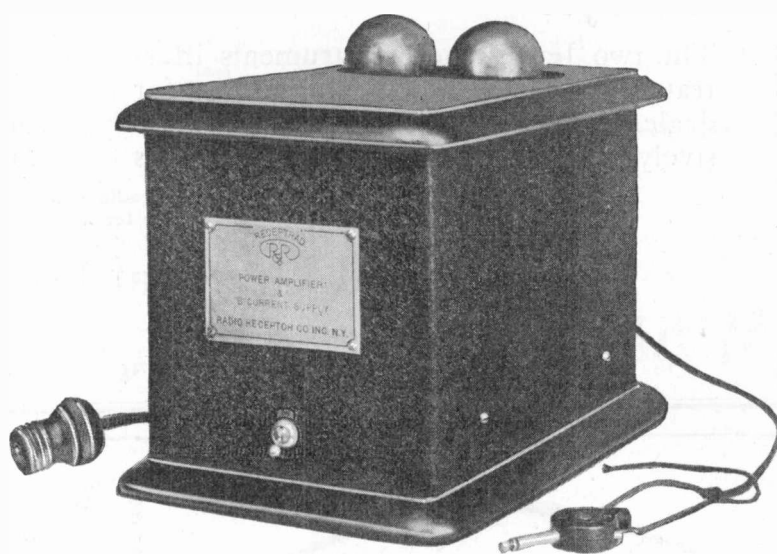

The biggest thing this year in Radio will be Powerizer—Combined "B" Eliminator and Power Amplifier. Everybody wants "B" Battery elimination. Everybody will want the wonderful tone and volume made possible by the Powerizer. Powerizer offers both of these things without re-wiring. Merely attach it to any set. Costs no more than a good "B" Eliminator *alone*. Don't take old sets in trade at a loss in order to give this power amplification offered in some of the new sets.

Modernize the old sets at a profit by selling Powerizer.

Supplies up to 170 volts "B" Power for set, 350 volts for power tube, proper bias eliminating "C" batteries, and "A" voltage for last tube.

At the recent Radio Exhibit at the Hotel Astor in New York City, Powerizers were demonstrated on five different makes of radio sets. Hundreds of visiting dealers and jobbers from all parts of the United States expressed amazement at the marvelous tone qualities and the wealth of volume which even the lowest priced sets produced when hooked up with a Powerizer. You should handle it.

This will be a Powerizer Year. If your jobber cannot supply you
Write, Phone or Wire direct to us.

Radio Receptor Company, Inc.

106 Seventh Ave.

NEW YORK CITY

POWERIZER PROTECTS



DEALERS' PROFITS

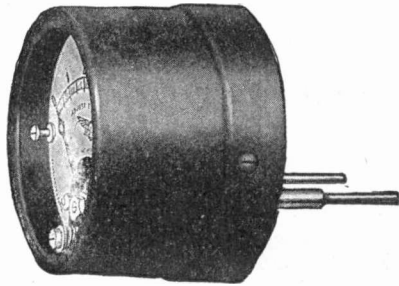

Jewell Tip-Jack
Voltmeter No. 135-A

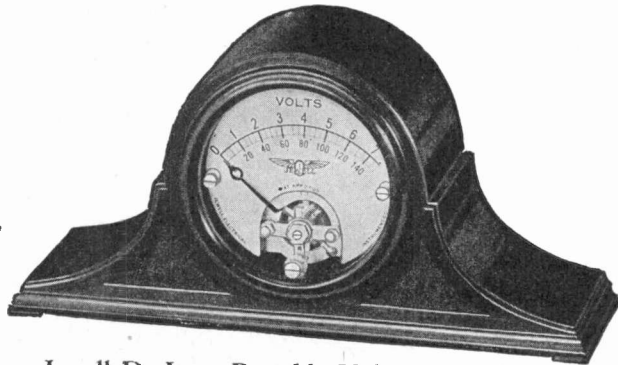

Jewell De Luxe Portable Voltmeter No. 135-C

Profit—

The two Jewell radio instruments illustrated above are real profit makers for dealers. They are being advertised extensively in all the leading radio magazines

—and we have especially attractive two color circulars illustrating each of these instruments, which we supply for dealer distribution through mail and over counter.

Our new thirty-two page radio catalog—No. 15-C is just off the press. Ask your jobber for a supply or write to us.

Jewell Electrical Instrument Co.

1650 Walnut St

Chicago, Illinois

27 Years Making Good Instruments

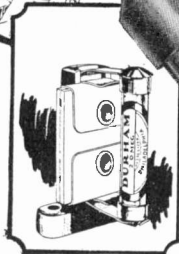
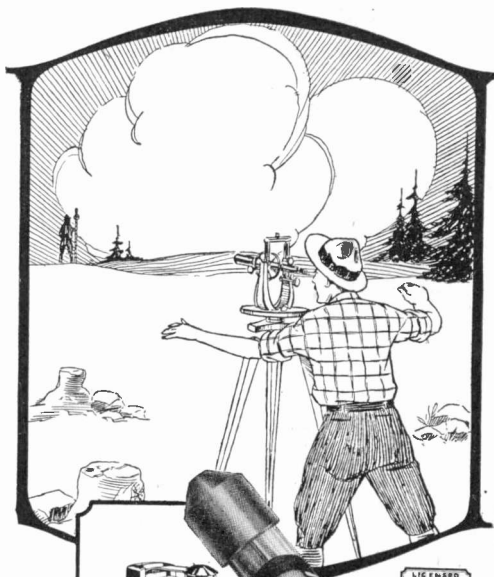

Resistor
Mounting

Single mounting 50c.
For condenser . . 65c.

Precision!

DURHAM Metallized RESISTORS

WHERE accuracy in calculation is vitally necessary to the success of an enterprise, instruments of amazingly precise operation are enlisted in the service of man. Thus the mariner has his compass, the scientist his seismograph, the surveyor his theodolite.

Absolute precision of resistance is found in the operation of the Durham *Metallized* Resistor. Its stamped resistance value is unaffected by atmospheric changes. Good for dealer business because it builds perfect consumer satisfaction.

500 ohms to 10,000 ohms.....	\$1.00
Above 10,000 ohms to .24 meg.....	.75
.25 meg. to 10 me50
Packed 10 to a box, 100 to the carton.	

DURHAM METALLIZED RESISTORS

International Resistance Co.
Dept. J, Perry Building, Philadelphia, Pa.

Oscillations
Absolutely
Eliminated

Hairline
Selec-
tivity

Tuning Is As
Easy As
Winding
Your Watch

Remark-
ably Clear,
Undistorted
Tones

HARTMAN RADIO

Moder-
ate
Prices

Hartman Radio is so vastly superior—so astonishingly different—so immeasurably *greater* than any other receiver on the market that it knows no sales resistance.

We don't like the word "revolutionary." But two new inventions employed in Hartman Radio lift it so far above the ordinary receiver that only "revolutionary" seems to describe its true distinctiveness.

As a dealer in radio, you are naturally interested in one thing above all else—a line you can *easily* sell your customers; a line they, in turn, will gladly recommend to their friends and relatives. Such a line is Hartman Radio!

We want every radio dealer who is not familiar with the Hartman to write for "The Complete Hartman Story"—a booklet fully describing our line and unusual sales policy.

You owe it to yourself and to your customers to *know* Hartman Radio.

THE HARTMAN ELECTRICAL MFG. CO.
Coshocton, O. Mansfield, Ohio Chatham, Ont.

Perfectly
Synton-
ized

Six Tubes
Under
Single
Control

Absolute
Minimum
Service
Required



Regeneration
Eliminated by
L-W Circuit

Hartman
Clover-Leaf
Condenser

Four
Beautiful
Cabinet
Designs

Maximum
Volume and
Distance,
Regardless of
Wave Length

Morse-Eureka
TRADE MARK

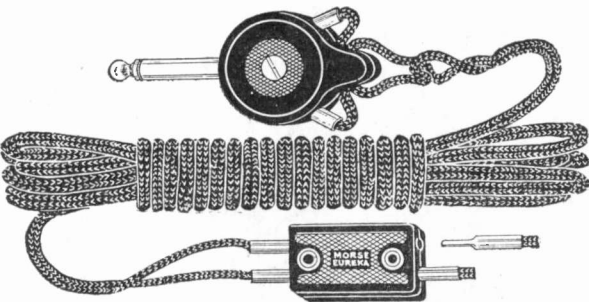

**Extension Cords
for Loud Speakers**

A fast moving product
for live wire dealers

Prices including Plug. Cord and connector attractively packed.

20 ft. long.....	\$1.25
30 ft. long.....	1.50
40 ft. long.....	1.75
50 ft. long.....	2.00

Manufactured by
Frank W. Morse Co.
289 Congress St., Boston, Mass.

\$10 Loud Speaker

You can sell, at \$10, the most satisfactory loud speaker that money can buy—the new, improved Dulce-Tone, the perfected radio-talking-machine-speaker.

Set the talking machine needle in the Dulce-Tone reed, plug in, and you have the full volume, the beautiful clear tone that only Dulce-Tone and a talking machine can give.

THE GENERAL INDUSTRIES COMPANY
Dulce-Tone Division
Formerly named THE GENERAL PHONOGRAPH MFG. Co.
308 Taylor St., Elyria, Ohio



Dulce-Tone

Fully guaranteed to you and your customers. Nationally advertised in the Saturday Evening Post, Literary Digest and Liberty.

Write for sample and dealer's prices.

In Your
HOME, OFFICE, HOTEL



The Talking Book. A Complete Radio. Brings A New Story Each Night. Dealers tell this story to your customers.

Pair of standard Ear Phones, Aerial and Ground Leads, Indoor Antenna. Self contained in attractive book.

Price **\$3.50** Without Phones.
\$6.00 With Phones.

With new Celerundum Rectifying Unit—No batteries required.

We have an attractive and exclusive sales proposition for live dealers and Jobbers.

This Talking Book will make an attractive window display and increase your sales.

THE LISTEN-IN CO., 115 Federal St., Boston, Mass.

Manufacturers:

WHY BUY ADVERTISING SPACE in 10 or more different trade publications when ONE magazine now reaches ALL retailers and wholesalers of radio sets and accessories?

RADIO RETAILING
a McGraw-Hill publication
471 Tenth Avenue, New York City

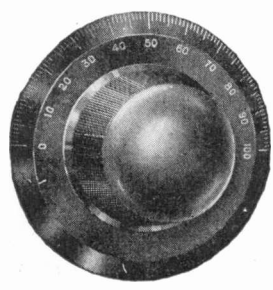

Efficient Service on Model Parts

BAKELITE AND COLD
MOLDED MATERIALS
MADE TO YOUR
SPECIFICATIONS

American Insulator Corp.
52 Vanderbilt Avenue, New York City

Long-Lived Windings

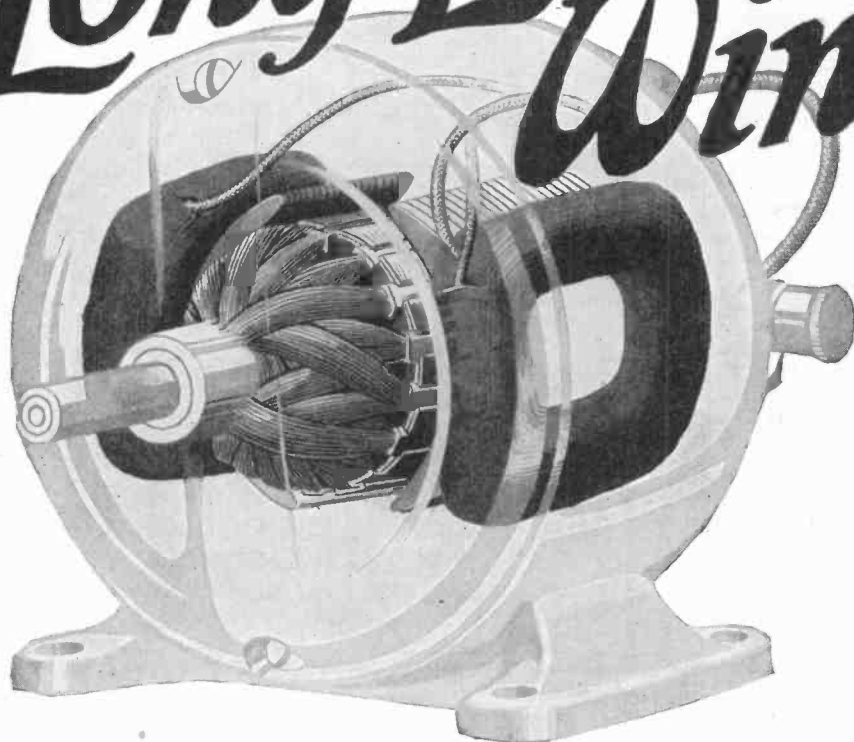

make
Long-Lived
Motors

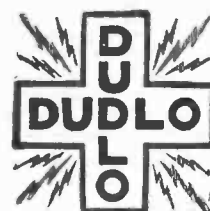

The life of any motor is measured by the durability of its windings. The life of DUDLO Windings is insured through the durability of the wire, particularly the insulation, upon which winding efficiency depends. Manufacturers of fractional horse power motors for all kinds of domestic and industrial equipment will insure the longest possible life for their motors through the use of Dudlo Magnet Wire and Field Coils.

The Dudlo experimental and engineering departments are at the service of any manufacturer, fully and freely, without obligation of any kind.

DUDLO

DUDLO MANUFACTURING CORPORATION, FORT WAYNE, INDIANA

412 Chamber of Commerce Bldg.
NEWARK, N. J.

160 North La Salle Street
CHICAGO, ILL.

4153 Bingham Ave.
ST. LOUIS MO.

274 Brannan St.
SAN FRANCISCO, CALIFORNIA

The HYATT 6-TUBE PORTABLE RADIO RECEIVER

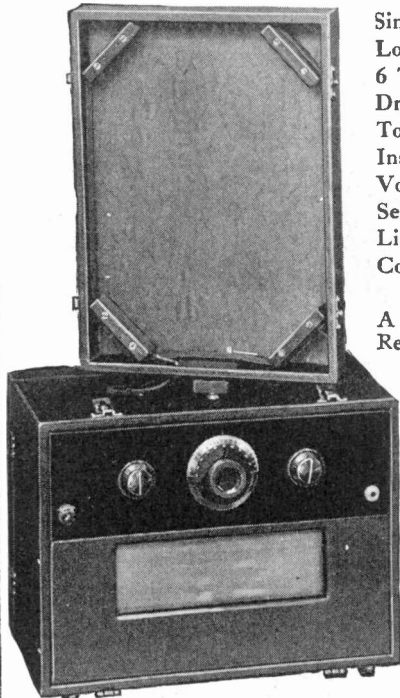

- Single Dial.
- Loop Aerial.
- 6 Tubes.
- Dry Batteries.
- Tone Quality.
- Inside Speaker.
- Volume.
- Selectivity.
- Light Weight.
- Compact.

A real portable Radio Receiver of highest quality, substantial construction, neat appearance, a source of entertainment, and complete in every detail.

LIST PRICE
Fully Equipped
\$95.00 Factory.
West of Rocky Mountains—
\$100.00 Factory.

14½" W. x 11" H. x 9¼" D. Wt. 28½ lb.

Dealers—Correspondence Invited from those Engaged in Radio Resale. Progressive and Wide-Awake Dealers Who Wish to Make a Real Selling Connection, Write at Once. Our Discounts are Liberal. Our Policy Fair.

THE ELECTROPHONE CORPORATION
109 No. Wabash Ave., CHICAGO, ILL.

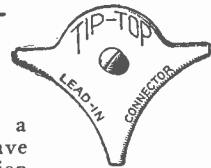

25c

Don't Neglect this Vital Point of Contact!

A FEW spare moments, a screw driver and you have a sure, perfect connection between your aerial and lead-in wire. No noise, no soldering, no loss of "distance" due to swinging aerial or corrosion. Tip-Top cannot work loose.

Eliminates antenna noise

Jobbers and Dealers write us!

JAMES F. DOOLAN MANUFACTURING CORPORATION
36-42 West 47th St., New York

New Harkness Counterflex Models
Better than ever for 1927



Another Winner

The Improved 5 Tube
Single dial tuning

A truly remarkable set, which will do everything the most critical fan could demand. Simplicity itself in operation, the last word in tone quality, volume and selectivity.

Kit, \$47.50 Chassis \$55.00 Set \$62.50
Complete parts and simplified instructions. for use in special cabinet 7x18-in. cabinet, as shown.

These prices are list. Jobbers and Dealers—write for attractive discounts.

FREE—A special 16-page Harkness Book with complete illustrations, diagrams, etc., will be mailed on request.

The Radio Guild, Inc.
241-243 Market St. Newark, N. J.

BEEDE

MIDGET "Swivel Jack" \$2.50

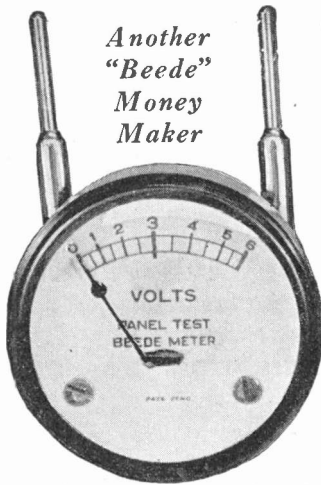

Another "Beede" Money Maker

Here's the newest member of the BEEDE Meter family, shown in ACTUAL SIZE. This Voltmeter is designed so as not to interfere with tuning knobs on SUPERHETS, RADIOLAS or BRUNSWICKS. It is a precision instrument of very high resistance and guaranteed accuracy. Thousands of Radiola and Brunswick owners have been waiting for the "MIDGET". There is a ready market—cash in on it. Buy them—Display them—Advertise them—Order from your jobber NOW.

STANDARD SWIVEL JACK

Made especially to fit jacks in Radiola and Brunswick Superhets. Guaranteed accurate. **\$3.00**

STORAGE BATTERY TESTER

Tests all 3 cells or any single cell. Shows when to charge and when to stop. Guaranteed accurate. **\$1.50**

There's a "BEEDE" Meter for Every Battery Need
Order from your jobber—Liberal Discounts—Catalog on request
BEEDE ELECTRICAL INSTRUMENT CO.

Factory: Penacook, N. H.
N. Y. Sales Office: 136 Liberty St. John L. Madsen, Manager

METERS

DIAMOND T RADIO

Leads the World in Radio Values

"Baby Grand Console" Model

Six tube T.R.F.

Power operated from light socket, list \$99.50

Battery operated, list \$89.50

Volume, selectivity and tone quality for present day conditions.

Note: Two loud speakers built in, both work at same time, one on the higher and one on the lower tone range and all notes whether high or low pitch are perfectly reproduced.

Here are united, in extreme degree, luxury of appearance and luxury in performance.

Our previous offer of sample at factory cost expires Oct. 15th.

DIAMOND T RADIO MFRS.
SOUTH BEND, IND.



This speaker has received the Certificate of Merit from the Radio News Laboratories.



Full
Floating
Diaphragm
Patents Pending

Write for discounts on the new Zeco Loud Speaker and other products.

New! ZECO Loud Speaker
(Reg. U. S. Pat. Office)
\$16.50 List

The ZECO Loud Speaker shown here is a new product from the ZECO Laboratories, where perfection in radio production has attained National recognition. Full floating diaphragm. The unit is made entirely of Bakelite. Zisch Engineering Corp., 39-43 Avenue L, Newark, N. J.

Used and Surplus Equipment

INDIVIDUAL items of used equipment, or surplus new equipment, or complete plants, are disposed of (and found) through advertising in the *Searchlight* Section of this paper.

This is the section which so effectively aided the Government in selling the many millions of dollars worth of surplus material and equipment accumulated during the war without disturbing the market.

"SEARCHLIGHT"

Tilman Leads With This 6-Tube T. R. F. Value

Beauty
Volume
Selectivity
Tone Quality
Speaker Built In

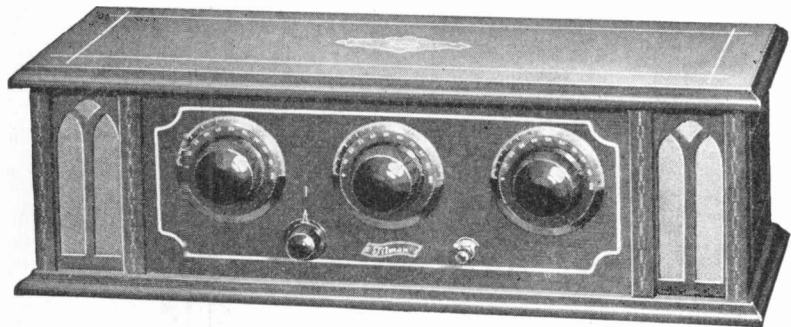

CHALLENGER MODEL, List Price \$49.50

One Sample, \$24.75, Check With Order

One sample to you at our cost. We will profit after you are satisfied.

Return in 10 days if not pleased in every way and we will refund your money immediately. No questions asked. We protect one good dealer in each town so make us prove our quality right now and then talk to us about protection. Mention your favorite jobber when ordering.

TILMAN RADIO CORPORATION
 LAGRO, INDIANA



CAPACITORS For All Purposes

Immediate Deliveries Can Be Made on Over
 200 Standard Types of

F A R A D O N CAPACITORS

Devoting its resources since 1907 to specialized research and development in the Radio field and to the improvement, production and application of electrostatic capacitors, the Wireless Specialty Apparatus Company continues to supply equipment to efficiently take care of operating requirements.

Not until a product has successfully passed exacting final electrical and mechanical tests is it considered worthy of the "FARADON" trade mark and ready for commercial use. Dependable, efficient products are the result.

U. S. Army, U. S. Navy, Bureau of Standards, General Electric Co., Radio Corp of America, Tropical Radio Telegraph Co., Westinghouse Electric & Mfg. Co., and Western Electric Co., are some of the large Faradon users.

Advise for what purpose capacitor equipment is wanted and literature describing such types will be forwarded promptly.

TO SET MANUFACTURERS

We will promptly quote on your requirements upon receipt of detailed data. Complete specifications are requested.

Wireless Specialty Apparatus Company

Established 1907

Jamaica Plain

Boston, Mass., U. S. A.

NEW

BIG MONEY MAKING PLAN FOR RADIO DEALERS

SPEEDS UP SALES MULTIPLIES PROFITS

For the first time, a well known and soundly financed Radio Manufacturer frankly faces the problems of retail selling and offers practical solutions of them.

This soundly practical and highly productive plan is backed by an organization whose ability and integrity have been established by twenty-one years of manufacturing activity.

FOR YOU—The Copyrighted Premier Plan is yours for the asking—no charge—no obligation.

The New Premier Plan strikes right at the heart of the greatest problems facing you as a Radio Dealer to-day. It is literally packed with new ways of attracting trade—of centering keen attention on your store.

FREE SERVICE—that is free.

Liberal cash **TRADE-IN** allowance on old sets.

Learn all about these dealer aids that get right out and hustle in the orders—tested, proven helps that produce more sales and bigger profits. Write for your free copy today.

PREMIER ELECTRIC COMPANY

Manufacturers Since 1905
 3806 RAVENSWOOD AVENUE
 Chicago, Illinois



Premier Electric Company of Canada, Ltd., Exclusive Distributors for Eastern Canada, London, Ontario, Canada

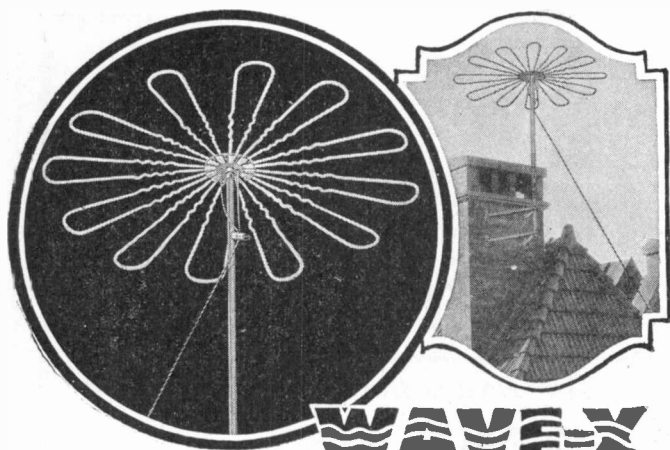

WAVE-X
Condensing
ANTENNA

Gets every wave!

HERE is the new outdoor antenna that is the scientific answer to a real need in radio for efficient aerial equipment. The Wave-X Condensing Antenna is a neat, compact unit composed of twelve graceful looped air-pins or feelers which reach out in all directions to secure and register the faintest radio signal. It has the capacity of a long single wire antenna but takes much less space and is easier to erect.

The Wave-X antenna is non-directional, provides sharper tuning and increases selectivity. It adds to the efficiency of any set and insures uniform reception at all times.

Wave-X fits any roof, chimney or wall. Several can be erected on one roof; only a single upright to erect and the only tools required are a hammer and a screwdriver.

No. 2 Wave-X with 8-foot pole and all accessories ready to install \$12.50. No. 3 for side wall or chimney mounting \$12.50. Complete instructions with each set.

REDI-MAST
FOR AERIALS FITS ANY ROOF INSTANTLY!

A strong hand-turned rock maple pole which gives a quick, convenient method of erecting a dependable antenna. 5 or 8 foot lengths, will fit any roof—carry single or multiple wire antenna. Will carry the heaviest sleet-covered antenna in strong wind without weakening. Neat in appearance. Can be set up or dismantled without danger of causing leaks in roof. Complete set includes three steel guy rods 3/4-in. diameter, adjustable pulley, web irons, roof sockets, anchor pins and full instructions; price, 5 foot mast, each \$3.50; 8 foot mast each \$4.25.

Dealers!

Wave-X Antennas and Redi-Masts are quick sellers everywhere. Write for the special dealer sales plan. Put in a stock of Wave-X Antennas and Redi-Masts now! Be prepared for the biggest radio season.

Write Today

Manufactured by

The **PRESSED METAL MFG. CO.**
WAUKESHA, WISC.

Sales Dept.

The **ZINKE COMPANY**
1323 S. MICHIGAN AVE.
CHICAGO

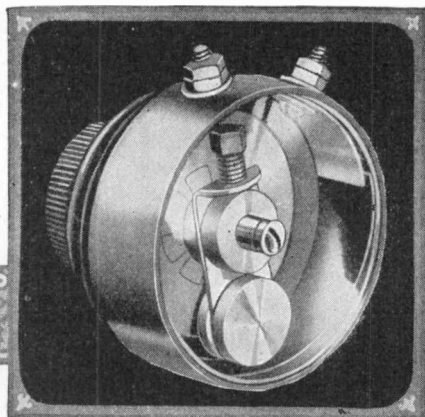

Type

880

The Newest Member of the FROST-RADIO Family

Type 880 and 890 Series Super Variable Resistances

Set builders everywhere have welcomed these new non-inductive high resistance units. They provide the accurate and minute control of electrical currents so necessary in the newer radio circuits. They are smooth and silent in operation. There is no wear nor variation in resistance even after long continued use. Type 880 Series has two terminals and Type 890 three terminals. List Price, both types \$1.25.

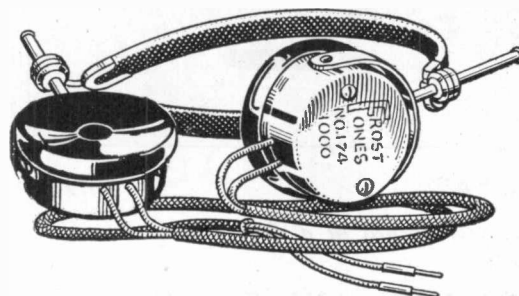

FROST-FONES Lead all others in sales

FROST-FONES are the fastest selling headsets for two reasons: First, because they are made as carefully and precisely as a fine watch. Second, large production permits prices that mean volume sales to you. Get your supply now while delivery is certain. List Prices \$3.00 to \$6.00.

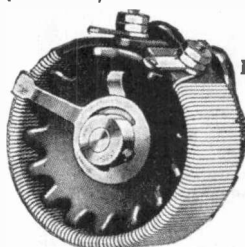

Type 800
FROST-RADIO
Bakelite Frame
Rheostat

Made on a cast frame of genuine Bakelite designed to allow free circulation of air around windings. Has large current carrying capacity and will not over-heat. Operates with a smooth and noiseless action. Supplied in resistances of 2 1/2 to 75 ohms. Price 75c.

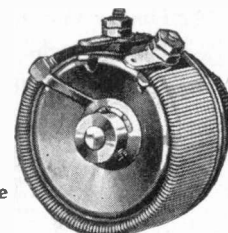

Type 700
FROST-RADIO
Metal Frame
Rheostat

A simple rugged rheostat for little money. Yet it has all the electrical and mechanical qualities of our Type 800 Bakelite Rheostat. Its metal frame cannot warp or bend and the shaft alignment is permanent. Supplied in resistances of 2 1/2 to 75 ohms. Price 50c.



Gem Jac

Gem Jac. A small sturdy jack that projects only 1 inch behind panel. Sterling silver contacts are self-cleaning. Frame is nickel plated brass. Adjustment is permanent. List prices 40c to 50c.



Pan Tab

Pan Tabs. The DeLux radio jacks. Springs are heavier and contacts more positive. Arranged for panel or table mounting. List prices 65c to 90c.

MEMBER
RMA
NEW YORK

Herbert H. Frost, Inc.
160 North LaSalle Street
CHICAGO

MEMBER
RMA
LOS ANGELES

Aerial Kits



Style "A" \$3.50

Attractively packed in a display box, these kits contain:

- 1 Nifty Lead-in. 1 Nifty Ground Clamp.
- 1 Approved Lightning Arrester.
- 100 feet No. 7-22 Tinned Copper Antenna Wire.
- 50 feet (white covered) Lead-in Wire.
- 25 feet Hook-up Wire.
- ★2 Housex Crystal Glass Insulators.
- 3 Nail-it Knobs. 2 Screw Eyes.
- 12 Insulated Staples.



Nifty Ground Clamp (shown at left) requires no tools and is easily adjusted to commonly used pipe. Made of tinned copper and brass. No soldering necessary.

Nifty Lead-in (shown below) completely weatherproof, pliable, and insulated. No holes to bore. Fits easily under window or door tightly closed.



Everything that is necessary for the installation of an efficient aerial and ground system. Easy to install. Easy to buy. Easy to sell.

AMOROSO

MANUFACTURING COMPANY
60 India Street,
Boston, Mass.

*ASK US FOR PRICES ON GLASS INSULATORS

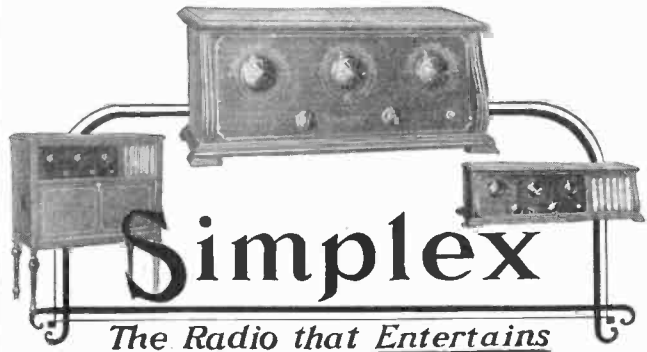

Simplex

The Radio that Entertains

Don't Miss Any Christmas Sales

The signals are set for a busy radio season ahead. Will you have enough receivers? Are your preparations complete? Consider the Simplex. A dust-proof 5-tube tuned radio frequency receiver in a handsome walnut finish cabinet. Appearance takes it home; performance keeps it there.

A complete line of models

	List Price
Simplex SR 9	\$ 65
Simplex Console	95
Simplex Console	125
Simplex Console Grande	185

Write Today for Liberal Dealer Proposition

Chosen by the State of Pennsylvania as representative of radio industry at Sesqui-Centennial, 35 years' experience behind these sets.

Simplex Radio Company
Main and Rector Streets
Philadelphia, Pa.

ACME CELATSITE WIRE

—a tinned, copper bus bar wire with non-inflammable "spaghetti" covering, for hook-ups. 5 colors; 30-inch lengths.

We also offer the highest grade of "spaghetti" tubing for Nos. 10 to 18 wires. 5 colors; 30-inch lengths.

Flexible Celatsite

Flexible, stranded wire for point-to-point and sub-panel wiring. Non-inflammable "spaghetti" covering.

In black, yellow, green, red and brown; a color for each circuit. Put up in 25-foot coils.

Celatsite Battery Cable

—a silk covered cable of vari-colored Flexible Celatsite wires, for connecting batteries to set. Prevents "blowing" of tubes; gives your set an orderly appearance.

Stranded Enameled Antenna

Best outdoor antenna you can buy. 7 strands of enameled copper wire; maximum surface for reception. Prevents corrosion and consequent weak signals.

Dealers Write for Acme Wire Products Folder E

THE ACME WIRE CO. - New Haven, Conn.

ACME WIRE

MAKES BETTER RADIO

KEYSTONE LIGHTNING ARRESTERS

Re-stock for the coming months!

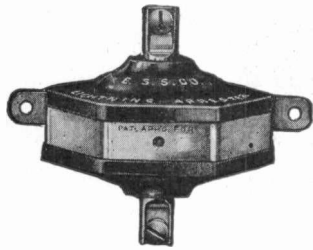

Approved by Underwriters
E-1835
Retail \$1.25 complete
(In Canada \$2.00)

Keep a good supply of Keystone Radio Lightning Arresters on hand to meet the steadily increasing demand created by national advertising.

Made of genuine Bakelite and brass parts, the Keystone Arrester is a quality product having high electrical characteristics.

It is advisable to place your order now.

For Detailed Information see the McGraw-Hill Radio Trade Catalog.

ELECTRIC SERVICE SUPPLIES Co.

50 Church St. New York, N. Y. 17th and Cambria Sts., Philadelphia, Pa. Ill. Merchants' Bk. Bldg. Chicago, Ill.

The Raytheon battery eliminator that offers the most for the money.

MODERN "B" Compact \$30.00

For Sets up to six tubes. Three B+ Taps—Two Variable Voltage Controls.

The Modern Electric Mfg. Co. Toledo, Ohio

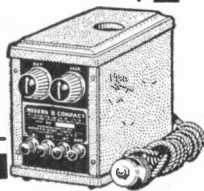

A Record—

Radio Retailing's July 1926 issue shows a 96% gain in advertising over the July 1925. This indicates radio manufacturers' attitude toward its coverage, reader interest and advertising value.

Radio Retailing

The Business Magazine of the Radio Industry
McGraw-Hill Publishing Company, Inc.
473 Tenth Avenue, New York City

Gem Tubes \$1.00

BUILD GOOD WILL and PROFIT

Sell Gem—the Biggest Dollar's Worth in Radio

Gem Tubes need no introduction to the Radio trade or Fans. Gem is the only guaranteed quality tube worth \$2.00 selling for a dollar.

GEM TUBES GUARANTEE SATISFACTION AND STAY SOLD

For greater distance, clear volume and finer tone Gem has proved its power of performance to thousands of radio fans.



V199



X120

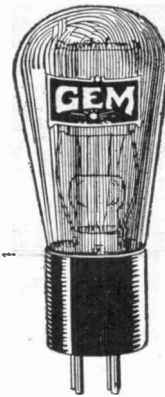

X216B



X201A



X171A

A COMPLETE LINE—

There's a Gem for Every Radio Receiver and Every Radio Need

GEM DOLLAR LINE

X201A	X199
199A	199

GEM POWER TUBES AT POPULAR PRICES

200A	120	112 Adapter
112	171	171 Adapter
216B	210	213
12	120A	202

½ Amp. B Eliminator Tube
1 Amp. B Eliminator Tube

M U—X 29-19-9-Dry Cell
M U—X 30-30-6-Wet Cell

Write for information about our Special Kit that settles Tube problems.

Gem Tubes are nationally advertised and distributed by leading jobbers throughout the country.

Dealers and Jobbers Communicate.

GEM TUBE COMPANY

16 Hudson St., New York City

108 West Lake St., Chicago, Ill.
Lafayette Bldg., Detroit, Mich.

We have a story for the set manufacturer who sees beyond immediate efficiency of his set—

We don't care to do business with the fly-by-night, because we don't want our condensers used in the kind of a set he builds.

But for the manufacturer who builds well, we have something attractive to offer. May we send you particulars?

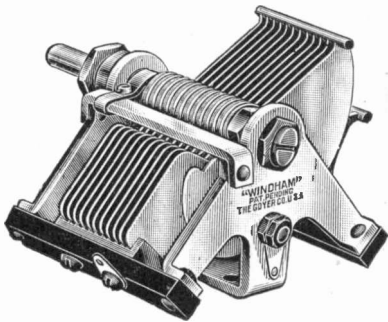

The Goyer Company
Willimantic, Conn.

Business Wants

THE *Searchlight* Section of this paper represents a meeting place for men and concerns who have immediate business "wants" to fill—the section covers

Agencies Wanted
Agents Wanted
Books and Periodicals
Business Opportunities
Civil Service Opportunities
Contracts Wanted
Desk Room for Rent or Wanted
Educational
Employment Agencies
Employment Service
Foreign Business
For Exchange
For Rent
For Sale
Franchises
Labor Bureaus
Miscellaneous Wants

New Industries Wanted
Office Space for Rent or Wanted
Partners Wanted
Patent Attorneys
Patents for Sale
Plants for Sale
Positions Vacant
Positions Wanted
Property for Sale
Representatives Wanted
Salesmen Available
Salesmen Wanted
Spare Time Work Wanted
Sub-Contracts Wanted
Tutoring
Vacation Work Wanted
Work Wanted

"SEARCHLIGHT"

The Tide of Popularity is Rising

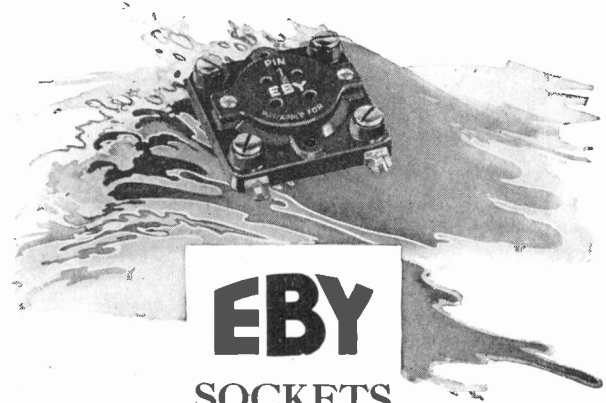

EBY
SOCKETS
Now 50c List

After all, it's only a matter of common sense. Everyone knows that a three point wiping spring contact is the most positive, perfect and scientific contact possible for a socket.

Whenever a tube moves in an EBY socket, the contact tightens and checks the jar. No wabbling, no noises, no losses!

The H. H. Eby Co. is a specialist in *contact*. And whenever you sell a product bearing the name EBY you are sure of honest values, sound merchandising and public confidence.

*Manufacturers
and now Circuit Builders
specify Eby Products*

Most circuit builders know that EBY Binding Posts are specified on eight out of ten manufacturers' sets. That's one reason why EBY products are recommended and specified in the Infradyne, Hammarlund-Roberts, Cockaday, L.C. 27, Browning-Drake, Victoreen, Madison-Moore, Lynch and Varion Power Units and other popular circuits.

Made in 28 different markings—List Price 15c



H. H. EBY MFG. CO.
4710 Stenton Ave.
Philadelphia

MEMBER
RMA



This is
Day-Fan's
 biggest year!
 Always a
 great radio, the
 endorsement by
 the broadcasting
 stations has
 made the whole
 U.S.A. demand

Day-Fan
 Get aboard the
 band wagon!

Day-Fan Electric Co
 Dayton, Ohio.

R.R. Oct.

...this
 is the trend
 of Radio Progress

SHIELDING



ALCOA



TRADE-MARK

Only the genuine
bears this mark

ALUMINUM
RADIO
SHIELDS

The Cockaday LC-27
 uses Alcoa Alumi-
 num Radio Shields.
 Now—another de-
 signer is using them
 — the Varion Re-
 ceiver — marketed in
 kit form by the
 Morison Electric Sup-
 ply Co., Inc. 15 East
 40th St., New York
 City. Write them for
 hook-up and instruc-
 tions, mentioning
 the ALCOA Shield.

SHIELDING of radio receivers is
 the most notable feature of re-
 cent construction. Surprising im-
 provements follow. ¶ Our exhibit of
 Aluminum Radio Shields at the
 Radio Shows created a sensation.
 ¶ Shields remove stray capacity
 and inductive coupling. ¶ They
 permit perfect stabilization.
 ¶ They eliminate interference by
 near-by circuits. ¶ Tuning con-
 trols can be reduced. ¶ Alcoa
 Aluminum Radio Shields are of
 virgin aluminum with the highest
 mass conductivity known.

Use the coupon. Get our new treatise,
 "Aluminum Radio Shields," by Cocka-
 day, Free and our Research Engineers.

ALUMINUM COMPANY OF AMERICA, Pittsburgh, Pa.

ALUMINUM COMPANY OF AMERICA
 Room 2323, Oliver Building, Pittsburgh, Pa.

Gentlemen:
 Please send me special information and a complimentary copy of the booklet
 "Aluminum Radio Shields."

Name

Position

Street City

Are you now selling shields?



Pal Products are quick sellers!



Pal Cone De Luxe

A 14-in. floating Cone with 16-in. resonance chamber, combined with an unusually sensitive and powerful unit. Produces exceptional tonal results. Silk facings in front and back.

List Price, \$19.50

Pal Cone Easel

A 14-in. Cone on easel stand, with provision for wall hanging, if desired. Harmonious in appearance and highly satisfactory in results.

List Price, \$12.50

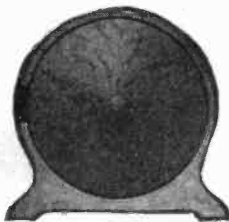

Standard Head Sets

Type A—Over 500,000 in use—satisfaction guaranteed.

List price, \$1.95.

Type B—Heavy duty model — extremely rugged construction.

List price, \$3.50.

Type C—Quality and extreme sensitiveness.

List price, \$5.00.

Electric Soldering Iron

Unconditionally guaranteed on 110 volts a-c or d-c. Length 11-in. Furnished with either $\frac{3}{8}$ or $\frac{1}{4}$ renewable copper tips. Nichrome wound lava element.

List price, \$1.50.

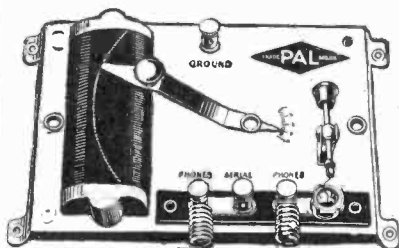
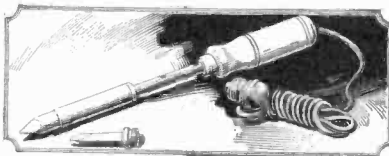

Standard Crystal Receiver

Hundreds of thousands giving unflinching satisfaction. Simple, substantial construction. All working parts in plain sight. Base 7x4½-in.

List price, \$1.50.

Jobbers
Write for
Pal Proposition

Dealers
Write for descriptive matter
and discounts to your jobber
or to us.

PAL RADIO COMPANY, INC.
1204 Summit Ave., Jersey City, N. J.

Priess advertising tells the story of the remarkable new STRAIGHT NINE. It is concentrated in LOCAL territories, where it will do most good.

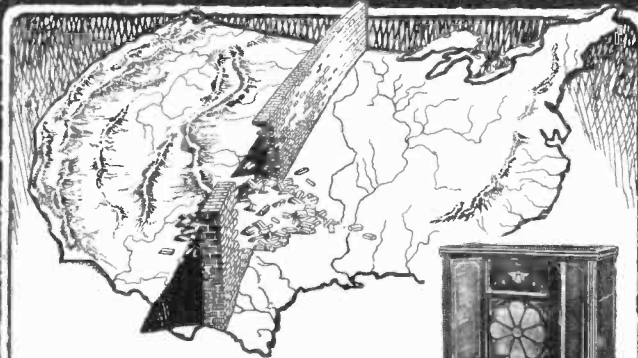

9-tube power smashes the barrier of distance

—remote stations come in with remarkable clarity and volume even when local stations are on



Console \$335

The one set for cities and other congested areas

LOOP OPERATED

NO other commercial set made has such power—or power so easily and simply controlled.

Single dial control. Matchless selectivity. Nine tubes. Tremendous distance. No interference. No background noises. No lightning hazards.

All the RADIO experience of 14 years is back of this new Priess, the best set that radio engineers have ever made and by far the greatest value your money can buy.

In the console there is ample room for all battery equipment.

Do not buy any radio until you have heard the new Priess—**IN YOUR HOME**—a Priess dealer will demonstrate gladly. No obligation to buy. Write for name of nearest dealers. Illustrated leaflet on request.

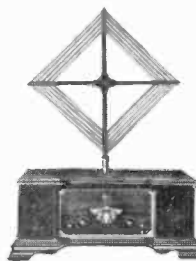

Table Model \$195

Priess
TRADE MARK.

STRAIGHT **9** NINE

"Outstanding radio performance and value on the market today—without exception."

PRIESS RADIO CORPORATION
697 Broadway, New York

Priess dealers are given the fullest protection against price cutting, change in price and change in model. **WRITE** or **WIRE** for distributor **DEMONSTRATION**.

3
OUT OF
4

Will Demand
a
Console

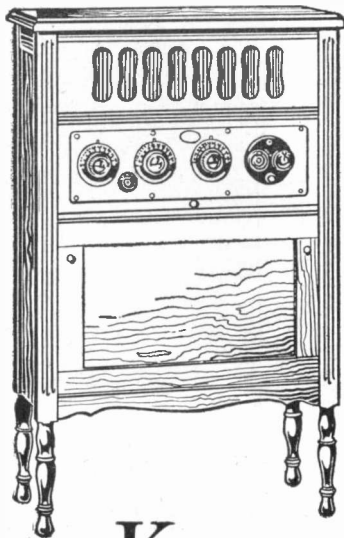

ATWATER-KENT DEALERS

HERE is a beautifully finished Walnut console made especially for the Atwater-Kent Model 30 and Model 20 Receivers. Every owner and purchaser of these sets is a prospective buyer.

This console is 40 inches high, 25 inches wide and 12 inches deep with a wood horn (floating) with a metal tone arm. Exceptionally beautiful in tone and possessing a wide range of pitch. Horn is arranged to take Atwater-Kent or any standard pronograph type of unit.

\$35.00 List. Liberal Discounts to Dealers.
Enter Your Order Today

PLYMOUTH FURNITURE CO.
25 JUNEAU AVE. MILWAUKEE, WIS.

Customers Showing Great Favor for "Baby Grand" Dealers Pleased

The sensation of the day is this New Audiola "Baby Grand." It is the only "Baby Grand" in Radio. Dealers quick to sense its unusual selling possibilities have already reaped profitable returns. It is designed to be placed in the corner of a room where a console properly belongs.



Baby Grand
\$250.00

The Audiola 1927 line of Consoles and Table Type Sets stay sold because of beauty, simplicity of operation, and tonal quality. Every radio dealer who desires to increase his sales volume should turn to Audiola now for his answer. We guarantee never to dump an Audiola set on the market. Audiola sales cooperation is worth having. Get details now.

AUDIOLA RADIO CO.
430 So. Green St. Chicago

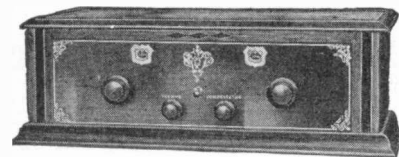
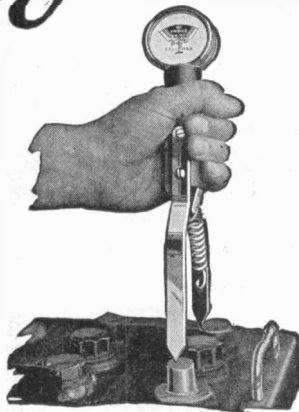

Table Type
No. 627-T-6 tube—\$100.00
No. 526-T-5 tube—\$ 70.00

Console Type
No. 627-C-6 tube—\$185.00
No. 527-C-5 tube—\$120.00

Hoyt
CELLCHEK



The HOYT CELLCHEK is a more accurate, more easily used electrical instrument, for determining the condition of your storage batteries without the withdrawal of a single drop of liquid or danger of damage to rugs, floors and furniture. It tells immediately, cell by cell, whether the battery is down, in fair condition or good condition.

Price \$2.50

If you are not already a HOYT dealer, write us for name of nearest jobber and Radio Meter price-sheet.

BURTON-ROGERS CO., Boston, Mass.
Sale Dept. for Hoyt Electrical Instruments

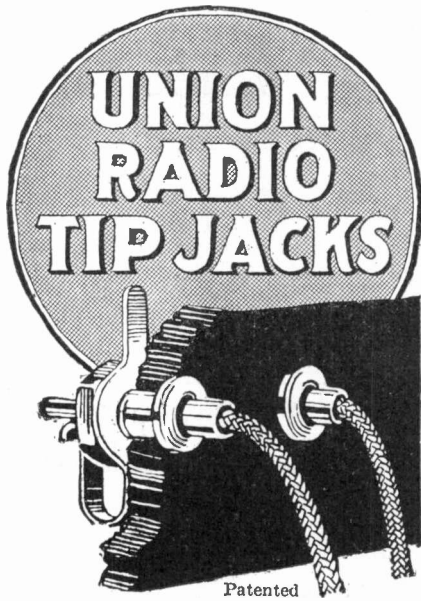

Steady Sellers and Repeaters

MOST set-builders know the convenience and dependability of Union Radio Tip Jacks. They make temporary or permanent connections quickly and easily and with positive electrical contact. No parts to loosen or lose. All parts heavily nickel-plated. Used as standard equipment in many fine sets.

Retail at **25c** a Pair

Firmly grip all wires from No. 11 to No. 24 B & S gauge. Three sizes for all panels. **TYPE A** (Standard) for $\frac{3}{16}$ " to $\frac{1}{4}$ " panels. **TYPE B** (Special) for panels, cabinet walls and partitions from $\frac{5}{16}$ " to $\frac{1}{2}$ " thick. **TYPE C** (Special) for panels up to $\frac{1}{8}$ " thick. Packed in self-selling counter cartons of $\frac{1}{12}$, $\frac{1}{2}$ and 1 gross pairs.



Identification Tags

Hard red fiber ovals, marked with proper identifications of battery connections, such as A-, B-, B67, B90, etc. Prevent shorting battery or blowing tubes. Two holes—will take any wire up to $\frac{1}{8}$ ". Packed 100 in box of one designation only. Retail price \$1.00. Also in set of 9, retail price 10c.

To All Branches of the Trade

Send for illustrated circulars and sample of these fast selling radio products, and details of our attractive proposition.

UNION RADIO CORPORATION
 124 S SUSSEX AVENUE, NEWARK, N.J.
 NEW YORK OFFICE 40 EAST 34TH STREET.

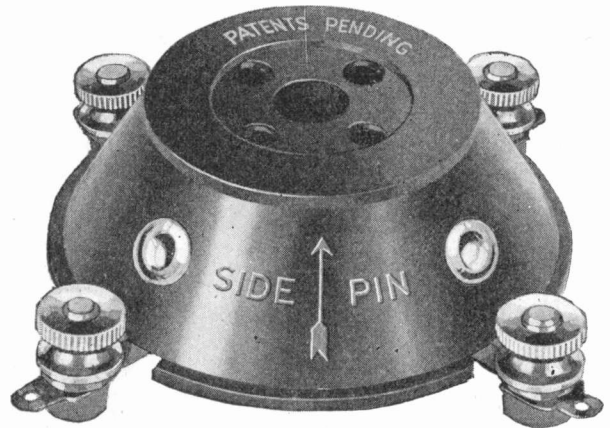

List price, 50c.

The new RISILIO Shock Absorbing SOCKET

The Resilio Socket provides a delicate four-point suspension so that the most minute shocks are perfectly absorbed, thus eliminating objectionable horn noises and prolonging the life of the radio tube.

Absolutely perfect contact is insured. There is no possibility of loss in efficiency after continued use.

Made of Duo-Pressed Bakelite, it is sturdy, attractive.

The four connections are made with either knurled thumb nuts or by soldering.

For set makers we recommend our Special Resilio Socket for under panel wiring. Send for sample.

It fits all standard tubes.

Write for prices and literature

Automatic Molded Products Co.
 280 Passaic St., Newark, N. J.

ARE YOU TAKING ADVANTAGE OF HOMMEL'S DEALERS' SERVICE AND REPAIR DEPARTMENT ?

THE House of Hommel maintains a dealer service unexcelled if even equaled by any other radio jobber. In addition a complete repair and inspection department takes care of all sets needing minor repairs, thus saving the time and trouble of sending them to the factory. Hommel's Catalog No. 27-R will be sent on request.

WHOLESALE EXCLUSIVELY
LUDWIG HOMMEL & CO
 929 PENN AVENUE PITTSBURGH, PA.

A Real Sales Maker

Made of selected genuine Mahy. or Amer. Walnut Plywood. Finished two tone Antique Brown Mahy. or American Walnut. Battery Compartment. High grade Loud Speaker Wood Horn and UTAH LOUD SPEAKER UNIT COMBINED. 30-in. High, 32-in. Wide, 15-in. Deep. Average shipping weight 62 lbs. Price Antique Brown Mahy. \$36.00. Price, Antique Amer. Walnut \$36.75.



Radio Console No. 505

Exclusive United States Sales Representatives
SANFORD BROS.

CHICAGO, ILL.
 30 W. Walton Place

CHATTANOOGA, TENN.
 615 Broad St.
 SAN FRANCISCO, CAL.
 311 Minna St.

SEATTLE, WASH.
 Amer. Bank Bldg.

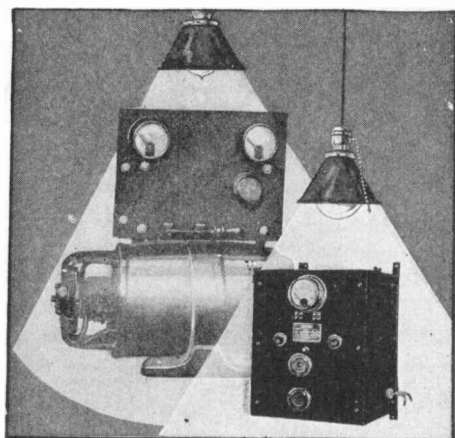

Authorized and Licensed Under HEYER System of Battery Charging and Testing

**Which Gives the Most Light—
A 100 C.P. Carbon Lamp or a 100 C.P.
Modern Nitrogen Bulb**

Both give the same light (100 C. P.) but the carbon bulb consumes TWICE as much energy because much more material is used less efficiently to get the same results.

THE HEYER TWIN SIX 12-HOUR CHARGER

Weight 120 lbs., price \$144 can more than duplicate a 200 ampere motor generator of the same daily capacity weight (600 lbs.) for the same reason. 120 lbs. of electrical machinery can be manufactured, shipped and sold cheaper than the 600 lb. unit. When both do the same work, the lighter unit is undoubtedly more efficient.

This explains the increasing popularity of the TWIN SIX Charger and why in 6 months sales have been greater than all last year.

**CONSOLIDATED
EQUIPMENT CORPORATION**

160 Grand Street, New York, N. Y.

Send for booklet "Speed Up With the Twin Six."

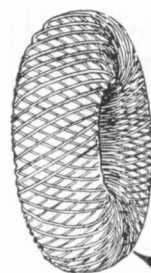

**COILS
for
RADIO**

- Balloon Honeycombs
- Wave Wound Spirals
- Transformer Windings
- Honeycomb Inductances

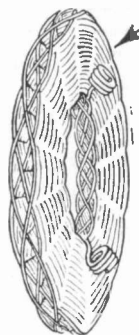

We Wind For The
Manufacturer Only

Universal Winding Co.
PROVIDENCE
R. I.

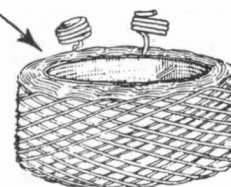
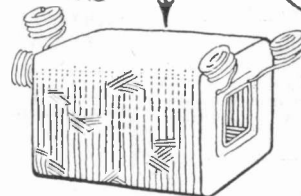

MORE

than the next five combined

RADIO manufacturers spent more money for advertising in the September issue of "Radio Retailing" than they did in the next five trade publications carrying radio advertising *combined!*

Further evidence of the leadership of "Radio Retailing".

Radio Retailing

473 Tenth Ave., New York City

A McGraw-Hill Publication

ABC

SEARCHLIGHT SECTION

SURPLUS STOCKS—BUSINESS OPPORTUNITIES

UNDISPLAYED—RATE PER WORD:
 Positions Wanted, 6 cents a word, minimum \$1.25 an insertion, payable in advance.
 Positions Vacant and all other classifications, 10 cents a word, minimum charge \$2.00.
 Proposals, 40 cents a line an insertion.

INFORMATION:
 Box Numbers in care of any of our offices count 10 words additional in undisplayed ads.
 Discount of 10% if one payment is made in advance for four consecutive insertions of undisplayed ads (not including proposals).

DISPLAYED—RATE PER INCH:
 1 to 3 inches.....\$6.85 an inch
 4 to 7 inches..... 8.40 an inch
 8 to 14 inches..... 6.20 an inch
 Rates for larger spaces, or yearly rates, on request.
 An advertising inch is measured vertically on one column, 3 columns—30 inches—to a page.

Radio Retailing

POSITIONS VACANT

WANTED: Young man with retail store and selling experience in phonograph and radio trade to travel as sales promotion specialist for long established manufacturer in working with and assisting wholesale distributors and retail dealers introducing and applying new patented electrical phonograph reproducer. Must be free for unlimited travel and quick transfers. Highest character references required. Write describing experience, ambition and other qualifications. P-20, Radio Retailing, Tenth Ave. at 36th St., New York.

REPRESENTATIVE AVAILABLE

Manufacturers Agent
 Desires lines in radio and electrical material. Only standard product considered. Quota filled on sets and tubes. New Jersey, Eastern Pa., Baltimore and Washington. Vernon H. Walker, Otis Building, Philadelphia, Pa.

FOR SALE

One Western Electric Power Amplifier
 For sale, with three D, 216 A tubes and model 518 speaker in first-class condition. \$45.00. Wellston Radio Corp., St. Louis, Mo.

Mr. Manufacturer

What have you to offer State Distributor for Michigan. We handle state from Flint. Have Detroit Branch also. Have sold Radio dealers for three years. Can handle good radio line—"A" and "B" eliminator at once.

Box 277, Flint, Mich.

Distributors Wanted for NEW ARMOR BRAND RADIO TUBES

DIFFERENT type of construction makes them equally efficient anywhere in the circuit. Will improve any type of receiver. Have platinum oxide coated filament that actually improves with use. Filament draws only ¼ amps. at 5 volts and is guaranteed absolutely non-microphonic giving louder and clearer signals.
 Worth investigating. Write for sample tube from regular stock, for test purposes.

ARMSTRONG E. & M. CO., Inc.
 351 HALSEY ST., NEWARK, N. J.

Factory Sales

Representatives Wanted

to sell to Radio manufacturers and Jobbers in all principal cities—Rheostats, Sockets, Battery Clips, Lightning Arresters, Insulators, etc., made by an organization well known in the field. Only high class men need apply, able to stand on their record.

AS-21, Radio Retailing
 Tenth Ave. at 36th St., New York City

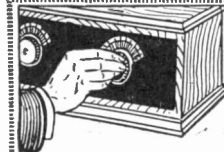

TUNE IN for Big PROFITS!

Dealers jump at this live line of radios and accessories, including Bremer Tully, Balkite, All American, G. E. Tunkar, Thorola, Majestic, Utah, R. C. A. Tubes, nationally advertised parts, batteries, chargers, etc. Send for catalog and attractive dealer's proposition. Exclusive territories to responsible dealers. Wholesale only. Quick sales and splendid profits assured. Don't pass this up. Write today.

NEW ENGLAND MILLS COMPANY
 Distributors of Nationally Advertised Radio Lines
 655 Washington Blvd., Chicago, Ill.
 Dept. 91F

DEALERS WANTED

For Excellent "Tacoma" Radio Crystal

Prices to Retailers c.o.d.: Mounted, \$3.25 per carton of 25 Crystals. Unmounted, \$1.95 per carton of 25 Crystals. Each crystal packed in a separate container. Special prices to wholesalers.

COUSIN TRADING CO., Tacoma, Wash.

W E P A Y Liquidate Your Surplus **C A S H**
RADIO STOCK
 Highest prices paid for surplus radio cabinets, sets and parts. Any quantity.
 What have you to sell?
GENERAL RADIO SET CO.
 74 Cortlandt St., N. Y. C.

Agents—Salesmen Representatives—Selling Opportunities

You can find them all through an ad in the

SEARCHLIGHT SECTION

Your ad here will have the attention of the whole industry and the cost is small

For Every Business Want

"Think SEARCHLIGHT First"

ALPHABETICAL INDEX TO ADVERTISEMENTS

	Page		Page
A			
A-C Electrical Mfg. Co.	125	Freshman Co., Inc., Chas.	169
Acme Wire Co.	188	Frost, Herbert H., Inc.	187
Alden Mfg. Co.	155	G	
All-American Radio Corp.	128	Garod Corp.	24
Allen-Bradley Co.	144	Gemco Mfg. Co.	123
Alter, Harry Co.	160	Gem Tube Co.	189
Aluminum Co. of America.	191	General Electric Co.	Front Cover
American Bosch Magneto Corp. 30-31, 140		General Industries Co.	182
American Insulator Corp.	182	General Instrument Corp.	176
American Specialty Co.	174	General Radio Co.	157
Amoroso Mfg. Co.	188	Gilfillan Bros., Inc.	26
Amplion Corp. of America	164	Gold Seal Electrical Co.	12
Amsco Prod., Inc.	120	Gould Storage Battery Co., Inc.	130
Andrea, F. A. D.	27	Goyer Co., The	190
Apco Mfg. Co.	Inside Back Cover	Grebe, A. H. & Co., Inc.	3
Argus Radio	171	Grimes, David Co.	17-18
Atwater Kent Mfg. Co.	48, 49	H	
Audiola Radio Mfg. Co.	193	Hammarlund-Roberts	39
Automatic Molded Products Co.	194	Hartman Electrical Mfg. Co.	181
B			
Bakelite Corp.	8, 9	Hartung Co., C. F.	162
Beede Electrical Inst. Co.	184	Hazeltine Corp.	20, 21
Benjamin Electric Mfg. Co.	198	Hommel & Co., Ludwig	194
Bodine Electric Co.	129	I	
Borkman Radio Corp.	136	Imperial Radio Corp.	176
Bosworth Elec. Mfg. Co.	32, 33	Indiana Mfg. & Electric Co.	131
Boudette Mfg. Co.	149	International Resistance Co.	180
Brach Mfg. Co., L. S.	137	J	
Briggs & Stratton Corp.	6, 7	Jewell Elec. Instrument Co.	180
Bristol Co., The	159	K	
Burton-Rogers Co.	193	Kellogg Switchboard & Supply Co.	13
C			
C E Mfg. Co.	160	Kodel Radio Corp.	124
Campbell Mfg. Co.	170	L	
Chicago Nipple Mfg. Co.	16	Langbein-Kaufman Radio Co., The	14
Clearstone Radio Co.	173	Listen-In Co.	182
Consolidated Battery Co.	118	M	
Consolidated Equipment Corp.	195	Magnavox Company, The	142
Cooper Corp.	147	Martin Co., Glenn L.	127
Cornish Wire Co.	161	Modern Electric Mfg. Co.	189
Crosley Radio Corp.	107	Morse Co., Frank W.	162, 182
E. T. Cunningham Inc. . Inside Front Cover		Mu-Rad Radio Corp.	174
D			
Day-Fan Electric Co.	191	Murdock, Wm. J., Co.	172
Deutschmann Co., Tobe	174	Music Master Corp.	162
Diamond T Radio Mfgs.	185	Muter Co., Leslie F.	111
Divar Radio Corp.	156	N	
Dry Storage Battery Corp.	113	National Carbon Co., Inc.	46
Dubiller Condenser and Radio Corp.	143	National Lead Battery Co.	163
Dudlo Mfg. Corp.	183	P	
Doolan Mfg. Corp., James F.	184	Packard Electric Co., The	44
E			
Eagle Charger Corp.	112	Pal Radio Co.	192
Eagle Radio Co.	23	Pathe Phonograph & Radio Corp.	139
Eby Mfg. Co., H. H.	190	Pausin Engineering Co.	141
Edelmann & Co., E.	166	Perlesz Radio Mfg. Co.	138
Electric Service Supplies Co.	189	Perryman Elec. Co.	154
Electric Storage Battery Co.	108	Plaza Music Co.	110
Electrical Research Laboratories	145	Plymouth Furniture Co.	193
Electrad Inc.	134, 170	Plymouth Radio & Phono. Co.	167
Electrophone Corp.	184	Pooley Co.	47
Empire Elec. Prod. Co.	170	Positions Wanted	196
F			
Farrand Mfg. Co., Inc.	34	Precision Prod. Co.	114
Federal-Brandes Corp.	35-36-37-38	Q	
Federal Radio Corp.	150	Q.R.S. Music Co., The.	10
Ferranti, Inc.	42-43	R	
Freed-Eisemann Radio Corp.	25	Radio Corp. of America. .84-85-Back Cover	
G			
Pressed Metal Mfg. Co.	187	Radio Cabinet Co.	165
Premier Elec. Co.	186	Radio Foundation, Inc.	152
Premier Radio Corp., The	175	Radio Guild Inc.	184
Prest-O-Lite Co., Inc.	160	Radio Master Corp.	40, 41
Priess Radio Corp.	192	Radio Receptor Co.	179
Progressive Musical Instrument Corp. . .	4	Raytheon Mfg. Co.	50
H			
Reichmann Co.	115	Rellable Parts Mfg. Co., The	132
I			
J			
K			
L			
M			
N			
O			
P			
Q			
R			
S			
T			
U			
V			
W			
X			
Y			
Z			
Zisch Engineering Corp.	185		

None other than high quality radio products can give good steady results—

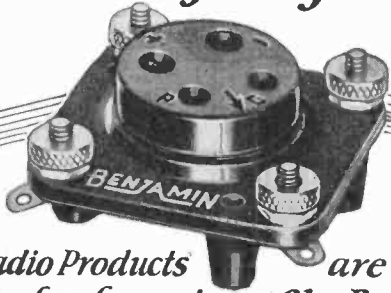

All Benjamin Radio Products are of the same high standard as the far-famed Cle-Ra-Tone Sockets—

The most beautiful or the largest radio set it is possible to produce is helpless with just a little technical flaw in its interior. Thus if you would have clear and consistent radio reception you can not afford to use "bargain" radio parts.

There are just three characteristics which have gained popularity for Benjamin Radio Parts: the best possible quality in material; the highest perfection in technical construction; and absolute permanence in cooperating with other radio parts to give perfect radio reception.

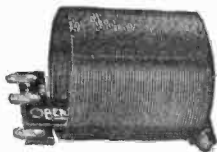

Improved Tuned Radio Frequency Transformers

Proved through exhaustive and comparative tests to be the most efficient coil for modern radio sets. Better in all important features and characteristics. Space wound. Basket weave. Cylindrical. Highest practical air dielectric. Gives wonderful sharpness in tuning, better volume and purer tone.

2 1/4" Diameter Transformer

Compact. Especially desirable for crowded assembly. Eliminates interfering "pickup."

3" Diameter Transformer

Capacity coupling reduced to lowest degree. For use with .00035 Mfd. Condensers.



Push Type Cle-Ra-Tone Sockets

Spring Supported, Shock Absorbing. Stop Tube Noises. Greatest aid to non-noisy operation. Contacts always clean.

Brackets

An aid to simplification in set construction. Supports sub-panel, with room underneath for accessories and wiring. Plain and adjustable.

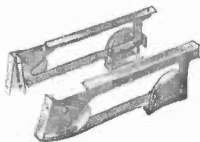

Straight Line Frequency Condensers

No crowding of stations. The broadcast range is spread evenly over the complete dial. Stations come in without interference, and tuning is much easier. Adjustable turning tension. Low loss characteristics give a definite and distinct radio reception. Beautiful in appearance—a credit to the looks and efficiency of any set. Finished in dull silver. Made in 3 sizes:

.00025 Mfd. .00035 Mfd.
.0005 Mfd.

"Lekeless" Transformers

Uniform high inductance, low distributed capacity and low resistance. The external field is so slight that it permits placing coils close together without appreciable interaction.

Battery Switch

Quick, positive, clean-cut make and break. When it's "in" it's "off," eliminating danger of wasteful use of battery.

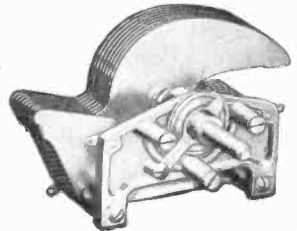

PRIZES FOR RADIO HOOKUPS

A contest for new and original circuits. Write our nearest office for full details.

Benjamin Electric Mfg. Co.

New York:
247 West 17th Street

120-128 S. Sangamon Street
Chicago

San Francisco:
448 Brvant Street

Manufactured in Canada by the Benjamin Electric Mfg. Co. of Canada, Ltd., Toronto, Ontario

Big in Sales - Profits - Results



Model No. 274
APCO Raytheon
Rectodyne "B" Battery
Eliminator—\$35.00



Model No. 266
APCO Rectodyne
"B" Battery Eliminator
\$29.50



Model No. 233
APCO "A" Battery
Trickle Charger—\$8.50



Model No. 289
APCO Wet "B"
Battery Charger—\$4.00

THE familiar warning "The storage battery is low" can never apply when the APCO Full Automatic "A" Battery Converter is used. The "A" battery is automatically kept always at full charge, enabling set owners to enjoy better reception at all times without battery recharge. There is nothing else in the world today like it.

Remember, there are no bulbs to burn out, no arrows to point, no flipping of switches—just complete, automatic "A" power from the lamp socket without trouble and battery starvation.

APCO'S National Advertising is paving the way for easier sales and bigger profits. Every set owner and purchaser is a prospect for APCO products. Wide-awake dealers throughout the country are taking advantage of our direct-to-dealer plan. It protects and assures full profit. APCO Radio products are sold direct only through APCO Franchise Dealers.

Territory is being rapidly allotted. Yours may be open. Write today for our proposition.



Model No. 270
APCO Twin Tube
Double Filament
201-A type—\$2.00.



Model No. 265
APCO "B" Battery Eliminator
Open Kit Model—\$22.50



Model No. 277
APCO "A" Battery
Charger—\$12.50
Prices slightly higher for
Denver and West

APCO MANUFACTURING CO.

Main Office and Factory:
PROVIDENCE, R. I.

New York

Chicago





Sell POWER Radiotrons. They show up well on the profit sheets—and they help you to sell all along the line. The public wants big-volume reception today.



On your shelves they take small space—
— stay a short time.
On your books they show steady year-round
~ ~ ~ profits ~ ~ ~
Radiotrons are the *backbone* of your radio business



Are you using this fellow? For the brightest, best-selling radio window in town, ask your RCA distributor about the complete Radiotron window display.

RADIO CORPORATION OF AMERICA
New York Chicago San Francisco

RCA Radiotron

MADE BY THE MAKERS OF THE RADIOLA