

Radio Retailing

The Business Magazine of the Radio Industry



*“Contacts” That Sell Radio in Summer
A Season of Sound Radio Growth Ahead*

Brandes announces a broader line

Since 1908, Brandes has been specializing in radio acoustics. The high quality of its products has given the company an acknowledged standing throughout the radio world. Its laboratories have been constantly striving to improve the audio circuit of the radio receiving set, which circuit, in the final analysis, determines the quality of the reception. It now gives us much pleasure to announce several important additions to our line.

An audio transformer of outstanding merit.

A large horn type speaker of unusual quality and beauty which we believe will be accepted as the standard of comparison.

A cabinet speaker of harmonious design that will not only satisfy the most aesthetic taste but will give a performance equal to that of the best horn type speaker.

For those who prefer to use the horn of their phonograph, the unit of the cabinet speaker will be available as a phonograph attachment, suitably encased for this application.

Brandes has always set for itself a high standard of distribution policy, constantly endeavoring to make its jobber-dealer franchise more valuable.

This policy will be continued and every effort will be made to improve conditions by carefully selecting distributors and by controlling

production so that the latter keeps pace with, rather than runs ahead of the demand.

The new Brandes price list will be issued as of August 1, 1925, and the Brandes jobbers will be protected thereafter against any price reduction made effective prior to July 1, 1926.

The New Brandes Line

Brandes
Audio Transformer

Brandes
Cabinet Speaker

Brandes
Speaker, Type H

Brandes
Phonograph
Attachment

And These Old Friends

Adjustable
Table-Talker

Superior
Matched Tone
Headsets

Navy Type
Matched Tone
Headsets

Watch for the New
Receiving Sets with

*"Acoustics
By Brandes"*

M. Rypinski.

Vice-President.

Brandes

Experts in Radio Acoustics
Since 1908

Bradleystat

PERFECT FILAMENT CONTROL

The result of more than twenty years' research and experience in the manufacture of graphite disc rheostats for radio, mines, mills, etc.

Use the same Bradleystat for ALL Radio Tubes without changing connections

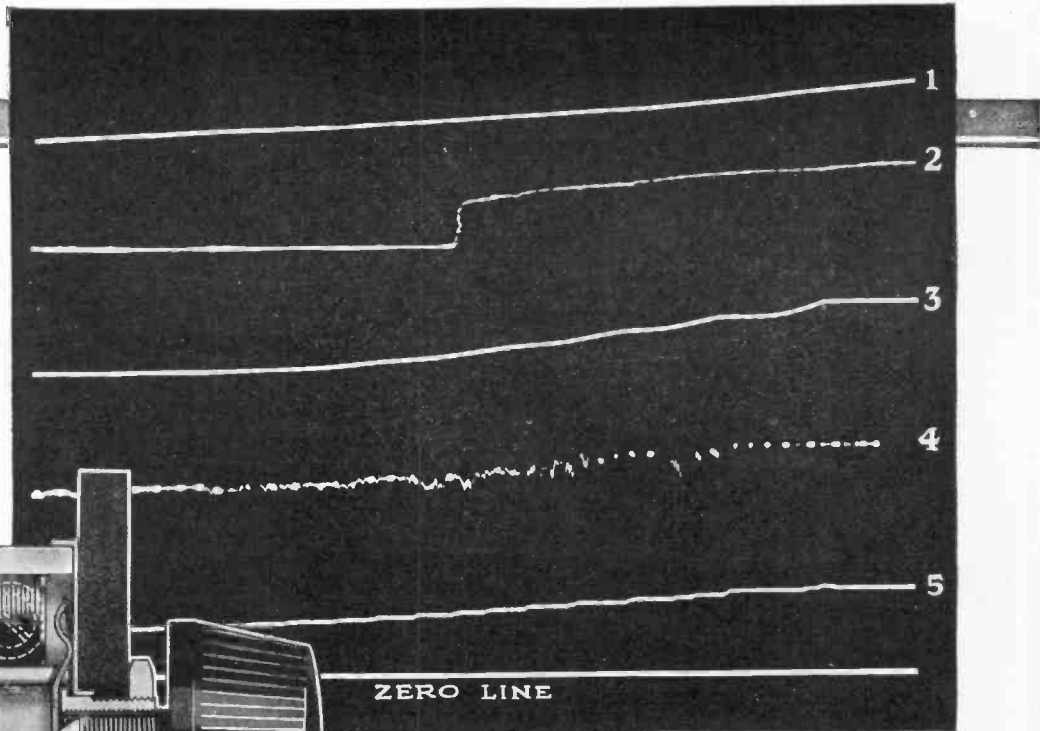
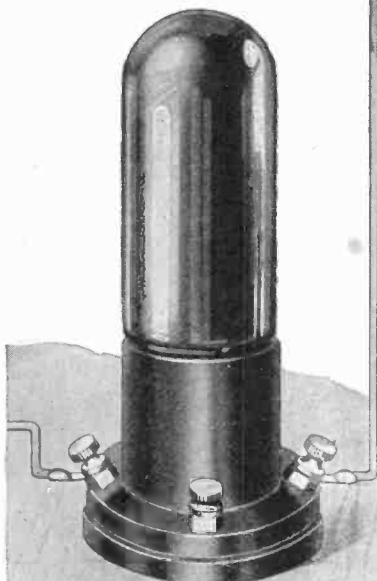

Amazing Performance makes the Bradleystat a big seller!

Radio dealers know that Bradleystat advertising is creating a continuous demand for this exceptional graphite disc rheostat. Real performance, however, keeps the Bradleystat sold and creates repeat business for the Bradleystat dealer.

The above control curves, produced automatically by an electric oscillograph at the University of Wisconsin, show graphically the noisy, scratchy control curves of wire and carbon powder rheostats, Nos. 2, 3, 4, and 5. Compare these with curve No. 1, showing the smooth noiseless control of the Bradleystat, using graphite discs.

It's no wonder every Bradleystat user is a booster. Get your share of this attractive radio business, by getting a Bradleystat stock, to-day!

Mail the Coupon for Latest Data

Allen-Bradley Co.
Electric Controlling Apparatus

489
Clinton
St.



Milwaukee,
Wis.

Mfrs. of graphite disc rheostats for over twenty years.

Allen-Bradley Co.
489 Clinton St., Milwaukee, Wis.
Please send us your latest dealer literature on the Allen-Bradley line of Perfect Radio Devices.

Name.....
Address.....

TYPE 175
 Six Tubes. Special MUSIC MASTER circuit. Built-in MUSIC MASTER Reproducer. Very selective, long distance, splendid tone quality. Solid mahogany cabinet in brown mahogany art satin finish. Price \$175



TYPE 400
 Five Tubes. Special super-selective circuit. Operated either by batteries or special MUSIC MASTER Battery Eliminator on house lighting circuit. Connect with standard bell or cabinet type MUSIC MASTER Reproducer, or with specially designed art model reproducer illustrated. French Spinet Desk cabinet of solid mahogany, beautifully ornamented, in brown mahogany art satin finish. Price \$400

MUSIC MASTER Reproducer Model XIII. Drum Type, Specially designed art model, illustrated. Price \$40



TYPE 60
 Five Tubes. Two stages of radio frequency, detector, and two stages audio frequency. Selective, good volume and distance. Brown mahogany art finish cabinet. Price \$60

Canadian Prices Slightly Higher.

Increase Your Prestige

by handling Quality Radio Merchandise of International Reputation backed by Aggressive National Advertising—

Music Master
 RADIO PRODUCTS

A series of radio receivers equaling in reception the famous MUSIC MASTER quality of reproduction, designed, produced, merchandised and advertised by the self-same organization that made MUSIC MASTER Reproducer

*The Musical Instrument of Radio
 —There IS no Substitute*

You can stress the superior merits of MUSIC MASTER Receivers with absolute confidence in their efficiency, and with an assurance of responsibility for every claim made. Each model is the highest type of artcraft furniture, while scientific designing and technical skill assure the fullest possibilities of Radio Reception.

Ten Models \$50 to \$460

Complete range of models from the neat cabinet type at \$50 to the exquisite Louis XVI design at \$460. In character of design, construction and beauty of finish each set is supreme in its class. In powers of reception and quality of reproduction there IS no comparison.

Unconditionally Guaranteed

Music Master Corporation

Makers and Distributors of High-Grade Radio Apparatus

MUSIC
 RADIO



MODEL VIII
Cabinet Type. Solid mahogany with full floating wood bell Price \$35

Increase Your Profits

by Liberal Margins on Large Sales Volume based on Merchandising Quality and Advertising Co-operation.

MUSIC MASTER RADIO PRODUCTS

Register as a MUSIC MASTER dealer and secure exclusive MUSIC MASTER representation in your sales area. Aggressive merchandising backed by national advertising, now, as always, supports MUSIC MASTER Dealers.

*Superior in Reception: Supreme in Reproduction
Radio's Greatest Merchandise Value*

MUSIC MASTER Radio Receivers are built to win—and hold—the confidence of the growing public interested in radio. Of varied type, in a series of models to meet every price requirement, they provide a quality of reception on a parity with the quality of MUSIC MASTER Reproduction.

Distributed by Authorized Jobbers

Modern merchandising and aggressive national advertising assure Music Master Registered Dealers substantial volume of steady business on attractive terms.

Get in touch with your regular jobber, or write us direct, regarding registration to handle Music Master in your territory.

Sold Only by Registered Dealers

128-130 N. Tenth Street
PHILADELPHIA

Chicago New York Pittsburgh Montreal
Canadian Factory: Kitchener, Ontario

Master PRODUCTS



MUSIC MASTER
Resonant Wood
Insures
Natural
Tone
Quality



MODEL VI
14" solid mahogany wood bell, cast aluminum tone chamber and Standard MUSIC MASTER reproducing unit.
Price \$30

MODEL VII
21" wood bell \$35

MODEL V
Metal Cabinet. Mahogany finish woodbell. Price \$18



MODEL X
Pedestal Type. Solid mahogany. Full floating wood bell in top section. Shaded electric bulb concealed within case reflects a soft, diffused light through silk screen.
Price \$100

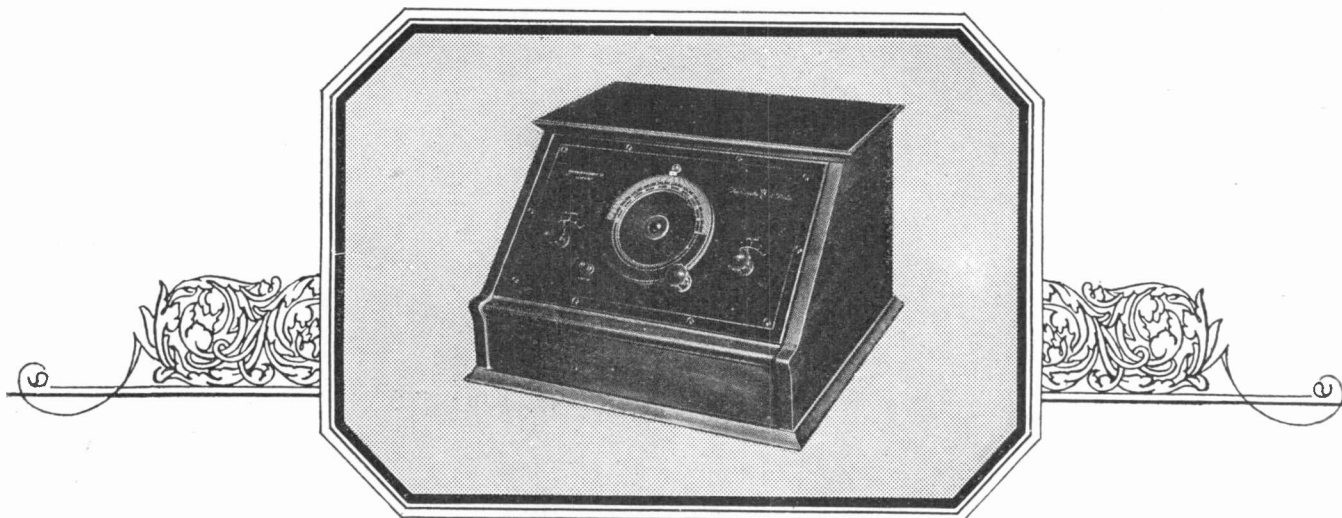

New—MODEL 20—One Dial

Dealers, here is the latest addition to the Kennedy line — the new Model 20. It is a one-dial, 5-tube radio-frequency unit, combining extreme simplicity with accurate tuning of all radio-frequency stages.

The single dial is a special Kennedy development and is so arranged that all stations are uniformly distributed from one end of the scale to the other. It is 5-in. in diameter, and has a positive vernier control. Widely spaced graduations assure easy reading of the dial scale. Two auxiliary control knobs are provided — the slight movement of one compensates for antenna tuning, while the other regulates volume. Model 20 operates satisfactorily on an indoor aerial.

The cabinet is of mahogany, furnished with a beautiful satin finish. Panel slopes at the convenient Kennedy angle — dial markings and engravings are in gold — exposed metal parts in permanent dull black.

Adding Greater Value to the Kennedy Protective Dealer Franchise

The new Model 20 adds still greater value to the Kennedy Protective Dealer Franchise. It rounds out the Kennedy line, affords recognized Kennedy qual-

ity at a moderate price, and gives every present and prospective Kennedy dealer a real incentive to get back of Kennedy receivers.

The Kennedy Line for 1925-26

The additions of Model 20 and the new Kennedy Royal Sixteen (a 5-tube upright cabinet model with built-in reproducing unit and tone chamber) offer you real profit-making possibilities — plus the insurance of a permanent, growing business that the Kennedy Protective Dealer Franchise extends to you.

Write today for full particulars.

K E N N E D Y



Colin B. Kennedy Corporation,
2018 Locust Street, St. Louis, Mo.

You may send particulars of the Kennedy Protective Dealer Franchise and full information on the complete Kennedy line.

Name Address

City State

A \$2,000,000 Experiment in Selling

CONSIDERING itself "different" the Radio industry in the last two years spent \$2,000,000 experimenting with different ways of selling in New York.

Today it has learned what Musical Instrument houses and other New York merchants and manufacturers have known for years.

**When volume of sales are needed, mediums
that sell goods in volume must be used.**

Musical Instrument advertisers for ten years have invested more lineage in the Evening Journal than in any other New York evening newspaper.

Radio manufacturers today—also selling entertainment for homes—have turned so decidedly to the Evening Journal because of its selling power that it now has rushed up to second place among all New York newspapers, with no lineage of undesirable advertisers.

The Evening Journal's selling strength has given it leadership over a period of years among all New York evening newspapers in practically all important classifications:

Local Display	Furniture
Department Stores	Shoes
Musical Instruments	Jewelry
Men's Wear	Beverages
Women's Wear	Candy
Druggist Preparations	

The New York Evening Journal gives Radio manufacturers the largest evening circulation in America. It is bought by 43 out of every 100 people who buy any New York evening newspaper—*more than the next two evening newspapers combined.* This is the most intensive coverage offered by any New York newspaper. *It devotes an entire page every day to Radio.*

The Evening Journal is the strongest and most economical medium for Radio manufacturers to use for entering the New York market at minimum cost and with maximum expectations of success.

The services of a representative thoroughly familiar with the New York Radio market are at your disposal—without obligation.

Write for copy of 288-page "Sales Manual of the New York Market." Sent without cost to sales and advertising executives.

NEW YORK JOURNAL

Largest evening circulation in America—and at 3c a copy

BECAUSE it sells easily and stays sold—because it appeals to the largest of markets—because it yields a profit undiminished by excessive service charges, returns and adjustments—A-C Dayton represents the soundest foundation for future development offered to radio retailers today.

THE A-C ELECTRICAL MFG. CO.
DAYTON, OHIO

THE A-C DAYTON has a story to tell for the 1925-26 season which no dealer who seeks a permanent business in radio can afford not to know about. See that you are fully informed on what A-C Dayton has to offer by sending in your name now.

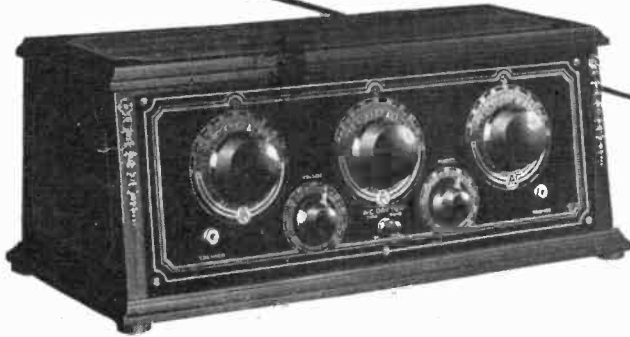

Good Company Pays

For more than twenty years, the A-C Electrical Manufacturing Company has been manufacturing electrical devices of highest quality. During those twenty years, this company has risen to success first of all because it based all sales effort on straightforward relations at all times with its dealers and representatives.

* * *

This established policy has reacted to the definite benefit of A-C Dayton dealers within the past season. A-C Dayton closed last season with its stocks exhausted, its prices firm, and its dealers in healthy condition—results of a demand built by the sheer merit of the A-C Dayton line backed by the sound policies of this old-line company.

* * *

With a new season in prospect, A-C Dayton faces the new year with dealers protected in every way. The product has been improved—not radically, to force a radical cut in prices—not experimentally, to catch a fickle market—but conservatively as sound experience and careful experiment have advised. In short, the A-C Dayton receiver for 1925 will again be the receiver most sought for—the greatest value in actual performance offered to the public.

* * *

To dealers interested in the development of radio as a permanent business, A-C Dayton will have an unusual proposition to offer. Send us your name now, that you may receive the information early.

THE A-C ELECTRICAL
MFG. CO.

R-R-7

DAYTON, OHIO

A-C DAYTON

RADIO

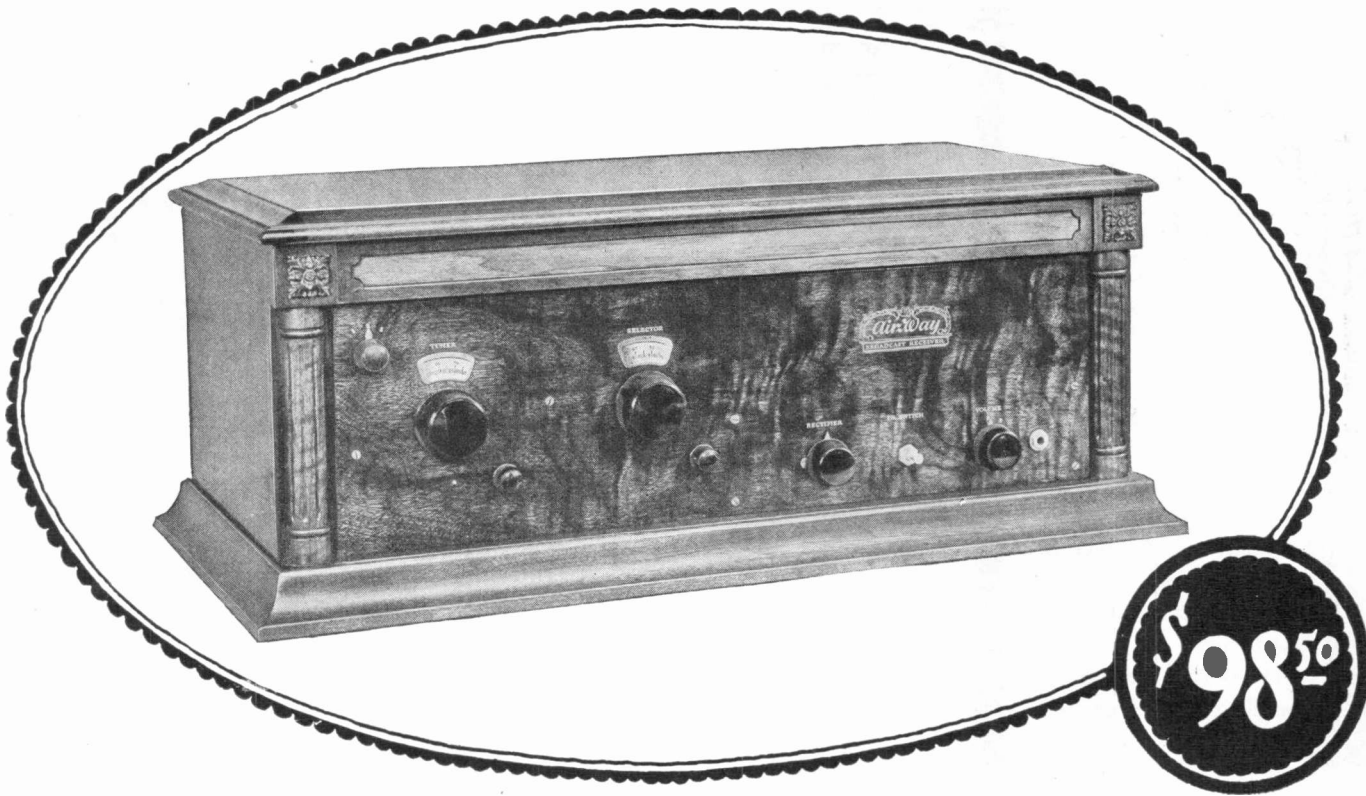

By Any Test You Want To Make -

The new, improved Air-Way today reveals outstanding superiorities which have never before existed, and which do not now exist in any other radio receiver, regardless of price or design.

We will demonstrate the Air-Way in parallel with any other receiver whatsoever, anywhere, at any time, under any conditions, and rest the Air-Way case with the auditors without a word of explanation or argument. You or anybody else can do the same. For among other things the new Air-Way is the first SUCCESSFULLY simplified receptor.

Air-Way tone quality is an unmistakable revelation. Blind tests will prove it.

The new Air-Way gets radio clear out of the "instrument" class by a new, luxurious richness in design and cabinet work.

Air-Way today is building into this set everything dealer and user have desired. And at a price easily within reach of the vast, eager market impatient for real radio entertainment.

The new Air-Way is a tuned radio frequency set with four stages of resistance coupled amplification. It includes many exclusive Air-Way refinements. It meets the universal demand for radio equipment with actual intrinsic worth, and a simplicity that avoids operating and service problems.

You don't know radio until you know Air-Way. Find out today what the new Air-Way offers to dealers everywhere. Modernize, stabilize, and build your radio business for security and permanence. Use the coupon.

Air-Way Electric Appliance Corporation
Toledo, Ohio



Air-Way Electric Appliance Corp., Toledo, Ohio

Please send me data and prices covering the new Air-Way Radio Receivers.

Firm Name

Address

Your Name

The MAN Behind KOLSTER RADIO ~

Kolster Radio was designed by Frederick A. Kolster, Chief Research Engineer of the Federal Telegraph Company and for eight years chief of the Radio Section of the United States Bureau of Standards.

He is the inventor of the Kolster Decremeter, the Kolster Radio Compass and other radio devices used throughout the world.

Kolster is a radio scientist of international reputation. Since 1902 he has made extremely important contributions to radio.

He represented the U. S. Government at the International Radio Convention as technical advisor. At the request of Secretary Hoover he attends all the important radio conferences held in this country.

Kolster's technical genius and wide research experience are now crystallized in a master receiving instrument—establishing new standards in reception and reproduction.

How you can build a permanent, profitable business

Simple business principles
must replace boom practices

You are interested in permanent profits more than quick temporary gain. That is the first consideration of every business man who is successful.

For permanent profits you must have:

- a radio that gives satisfactory service, guaranteed by the maker to the owner*
- a territory which is restricted as to number of dealers so that you can operate unmolested*
- stabilized models at stabilized prices*
- a set widely advertised locally and nationally*
- a strong company, a permanent manufacturer*
- profits which are substantial and certain.*

Then—and only then—are you on the safe, sane road to a growing business with satisfied customers and an assured future.

It is such a relationship which you can have with Kolster Radio.

**KOLSTER
RADIO**



This is a program wise dealers will welcome

—what it means to such men

Kolster policies were primarily created with the sound, progressive dealer in mind as one of the main factors in stabilizing the industry.

We need not review the chaotic condition now existent, nor dwell on over-production, "dumping," "gyps," rapidly changing models and prices.

Kolster policies offer all and more than is outlined on the opposite page.

Kolster Radio means stabilization. Federal engineers, headed by Frederick A. Kolster, are your guarantee against profits lost in obsolete models. Federal executives, headed by Rudolph Spreckels, are your assurance of sound, honest and progressive merchandising policies.

We invite aggressive, forward-thinking dealers to become acquainted with Kolster policies in full. Space here does not permit all the details.

We promise satisfactory profits, protection, stabilization. We enter the new era of sound merchandising which replaces the promotive era.

Serious minded, progressive dealers are invited to mail the coupon which will bring further details without obligation.

The COMPANY Behind KOLSTER RADIO ~

The Federal Telegraph Company which manufactures and markets Kolster Radio, is a California Corporation with its radio factory in Newark, N. J.

It is strongly and ably financed. Mr. Rudolph Spreckels controls the company and is Chairman of the Board. Thus the permanency and stability of Kolster Radio is assured.

The Federal Telegraph Company is the oldest radio company in the United States existing under its original name, and has pioneered some of the most important radio developments in this country.

It introduced CW transmission in the United States and has designed and built the vast majority of the high-powered radio transmitting stations in the world, including the Lafayette Station in France, which is the world's largest.

FEDERAL TELEGRAPH CO.,^{RHT}
Merchandising Division,
Woolworth Building,
New York, N. Y.

I would like to be informed further as to your plans and policies.

Name.....

Street.....

City..... State.....



ALEX. EISEMANN



J.D.R. FREED



A.R. FREED



LEO FREED

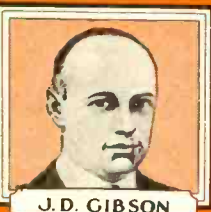

J.D. GIBSON



R.I. MacCLELLAN



J.J. KUSCHER



J.C. CUSHMAN



RAY FARRA



D.N. McPHERSON

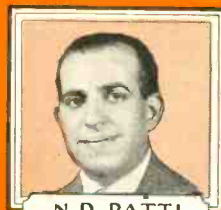

N.D. PATTI



P. STERN



FRED McINTYRE

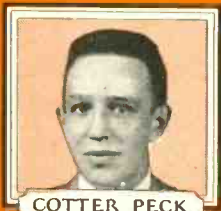

COTTER PECK

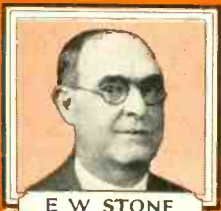

E.W. STONE

These are the MEN

—the executives and department heads of the organization which has proved itself to be, by a wide margin,

the largest and the most successful manufacturer of Neutrodyne Receivers in the World!



Study this circle! The figures given are official.

Freed-Eisemann



H BERMAN



A ZIPSER



E.A. FREED



W. HEINA



D SONKIN

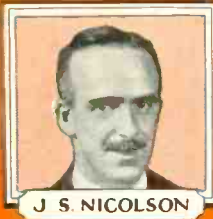

J S NICOLSON

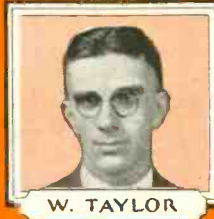

W. TAYLOR

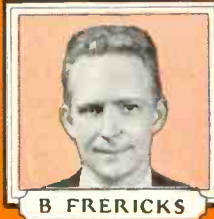

B FRERICKS



M. NAVON

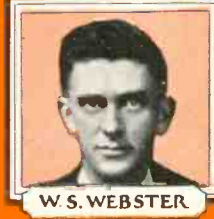

W.S. WEBSTER



H M. PERITZ



O A. MARTINI



M SIEGEL

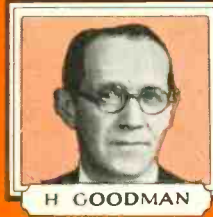

H GOODMAN



E.C. STEVENS



B. TROTT



G. CURTIS

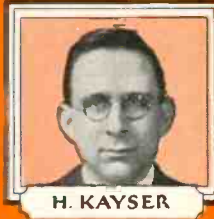

H. KAYSER



R. GRATZNER

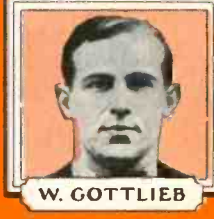

W. GOTTLIEB

These are the MEN

who are solidly behind the new policy of dealer protection which provides:

1. LONGER DISCOUNTS—enabling the dealer to give service and yet make a profit.
2. GUARANTEE AGAINST PRICE REDUCTION, unless the dealer is rebated.
3. EXCLUSIVE TERRITORY—territorial franchise sharply defined and protected.
4. PROTECTION AGAINST MODELS BECOMING OBSOLETE.
5. BINDING CONTRACT direct with manufacturer (through distributor) giving dealer absolute protection.

THE NEW FREED-EISEMANN LINE—five and six tube sets, \$75.00 to \$195.00—is backed by one of the largest advertising campaigns ever put behind Radio.

Write us and one of our executives will reply personally, giving full details.

FREED-EISEMANN RADIO CORPORATION
Manhattan Bridge Plaza, Brooklyn, N.Y.

Freed-Eisemann

PREMIER

A Tone That Could Not Be Improved

With all the rumors of changes and improvements in sets and with all the new sets being brought out it may seem strange that not one has excelled the fine tone quality that has distinguished Premier.

It is further evidence of the correctness of the principle that Premier uses for getting pure, clear tones that overshadow even the unusual distance and sharp selectivity.

Everyone knows that a crystal is the clearest detector. Premier uses the best crystal it is possible to obtain, practically indestructible. Five tubes, reflexed, give four stages of radio and three stages of audio amplification.

Premier is designed especially for volume reception on loop, but operates equally well on aerial, either inside or outside, and can be instantly switched from loop to aerial, or back, with no change in wiring.

Mahogany cabinets, console or table type, are classically plain in design and beautifully finished.

A few minor changes that will improve the appearance and convenience of the sets will appear upon the latest Premiers, but even constant trying has been unable to improve the fine tone.

A demonstration sells a Premier. It does what is claimed for it. The direct to dealer, exclusive franchise sales plan is an unusually profitable one for good dealers. Discounts and full details upon request.



The Premier Radio Corporation.

Defiance, Ohio

Phenolite can be milled, punched, threaded, turned, tapped, sawed, drilled, bored, ground!

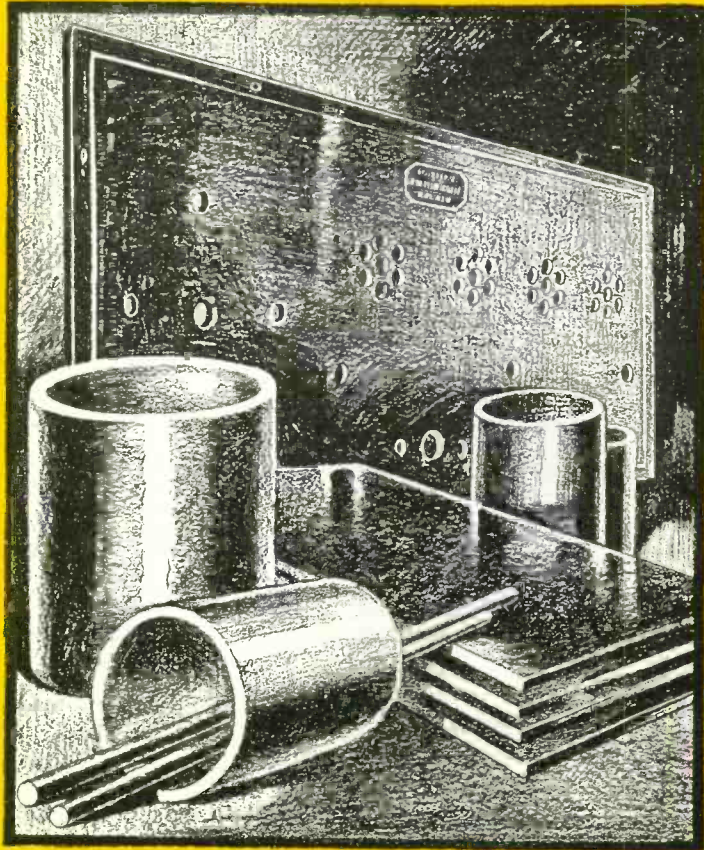

-sell perfected quality!

FOR more than thirty-five years we have been producing laminated insulation materials for use under conditions demanding absolute uniformity—physical and chemical! . . . And now, out of these more than thirty-five years of experience comes Phenolite, laminated Bakelite, built to meet the exact requirements of radio insulation. America's leading manufacturers of radio receiving sets are paying a premium to insure perfect insulation—they are standardizing on Phenolite . . . Your jobber will supply you with panels or tubing of Phenolite . . . Or write us.

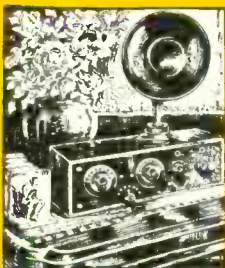

Radio panels and tubes of Phenolite combine perfect insulation with great physical strength and fine machining quality! . . . Phenolite has a dielectric strength of 700 to 1300 volts per 1-1000 of an inch!

National Vulcanized Fibre Co.
PHENOLIC PRODUCTS DIVISION, WILMINGTON, DEL., U. S. A.
We operate six great plants and maintain sales and service offices at New York, Chicago, Boston, Philadelphia, Pittsburgh, Cleveland, Milwaukee, Los Angeles, San Francisco, Detroit, Rochester, Birmingham, Denver, Seattle, Toronto, Greenville, St. Louis, Baltimore.

PHENOLITE

Reg. U.S. Pat. Off.

Laminated BAKELITE

SHEETS : RODS : TUBES : SPECIAL SHAPES

Made by the makers of National Vulcanized Fibre

The New Pooley Models

*To be sure of enough
Cabinets this fall—Act Now!*

TO PUT a Pooley Cabinet through our factory takes months. Production must be started early to make all needed deliveries. Only by knowing what Pooley distributors and dealers will need can we regulate production. That's your problem and ours in a nutshell. Now is the time to act—in your interest as well as ours.

September is only two jumps away. Your Pooley business will begin then—if you are ready. Six months from now the Christmas sales peak will have come and gone.

We prepared the Pooley line three months earlier this year because many far-seeing Pooley dealers said they needed it. Our shipments for July and August retailing are already big and beyond anything in our experience.

Pooley quality cabinets and Atwater Kent receiving sets are an unbeatable combination. The new Pooley line has hit the bull's eye.

See the Pooley distributor in your territory. If you don't know who he is, write us. He'll show you these new models—all of them ready for immediate shipment. To be sure of enough cabinets this fall—Act Now!

Radio Sales Department B
THE POOLEY COMPANY
1602 Indiana Ave. Philadelphia, U. S. A.

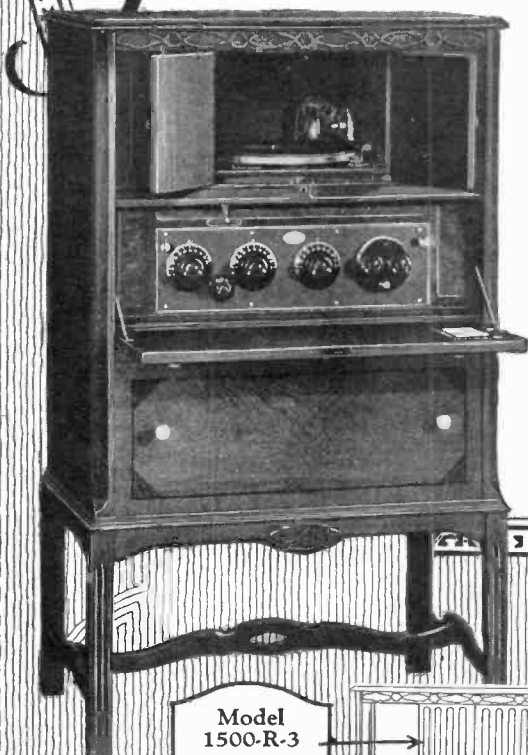

Model 1500-R-3
Sliding grilles and phonograph
Radio in sliding panel
Compartment for batteries
Shelves for record albums

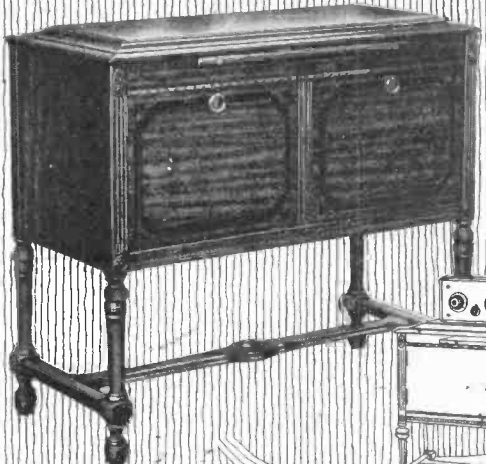
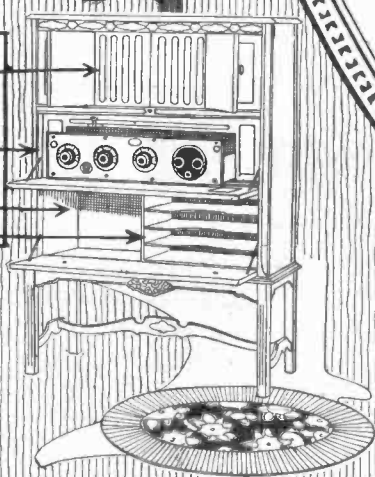

1400
R-1

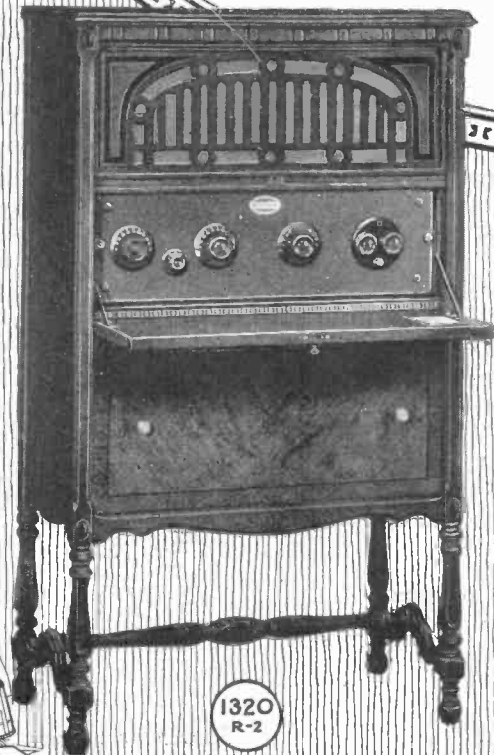
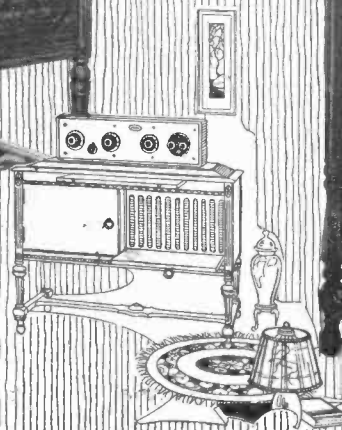

1320
R-2

-Distributors have them

Model 1500-R-3

**THE POOLEY
RADIO-PHONOGRAPH**

Chinese Chippendale Style. Duotone finish, American Walnut or English Brown Mahogany.

Height 50", width 30", depth 18".

Equipped with Atwater Kent 5 tube Model 20 Compact Set; built-in Pooley floating horn; Pooley phonograph in amplifying chamber.

Price complete, less tubes and batteries—

\$295

**Models 1110-R-2 and
1120-R-2**

Stuart Style, Duotone finish, American Walnut or English Brown Mahogany. Height 52½", width 33", depth 15½".

Model 1110-R-2, equipped with Model 10 Atwater Kent 5 tube open receiving set.

Price complete, less tubes and batteries—

\$220

Model 1120-R-2, equipped with Model 20 Atwater Kent 5 tube set. Price complete, less tubes and batteries—

\$225

Model 1320-R-2

Stuart Style. Finished in American Walnut or English Brown Mahogany—special Oriental Burl, Rosewood and Walnut inlays.

Height 50¾", width 29¼", depth 15½".

Equipped with Model 20 Atwater Kent 5 tube set.

Price complete, less tubes and batteries—

\$260

Model 1600-R-2

Italian Style. Duotone finish, American Walnut or English Brown Mahogany.

Height 41½", width 34¼", depth 16½".

Equipped with Atwater Kent 5 tube Model 20 Compact Set.

Price complete, less tubes and batteries—

\$200

Console Model 1400-R-1

Louis XVI Style, Duotone finish, English Brown Mahogany.

Height 31½", width 34", depth 15¾".

Accommodates any Atwater Kent Set. Space for set, 28½" x 10½".

Price, less Set, tubes and batteries—

\$75

Prices slightly higher west of the Rockies and in Canada.



1600
R-2

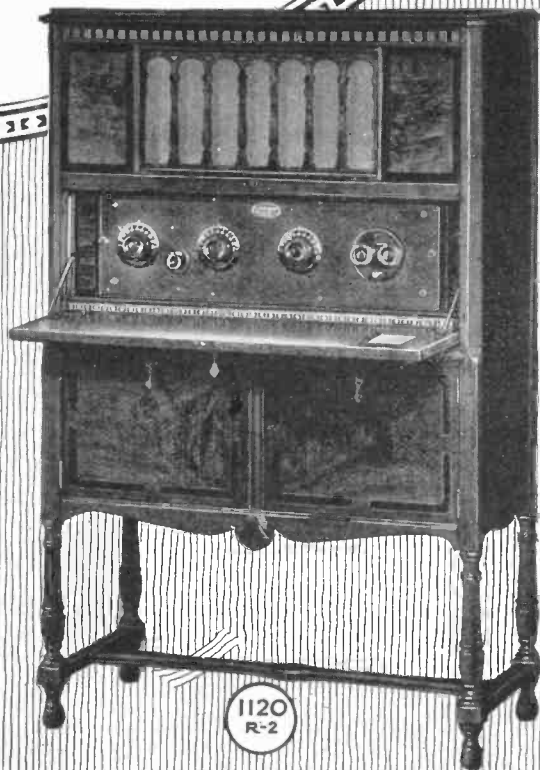
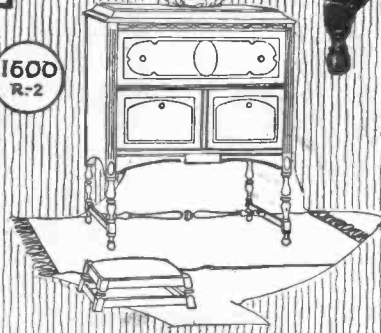

1120
R-2

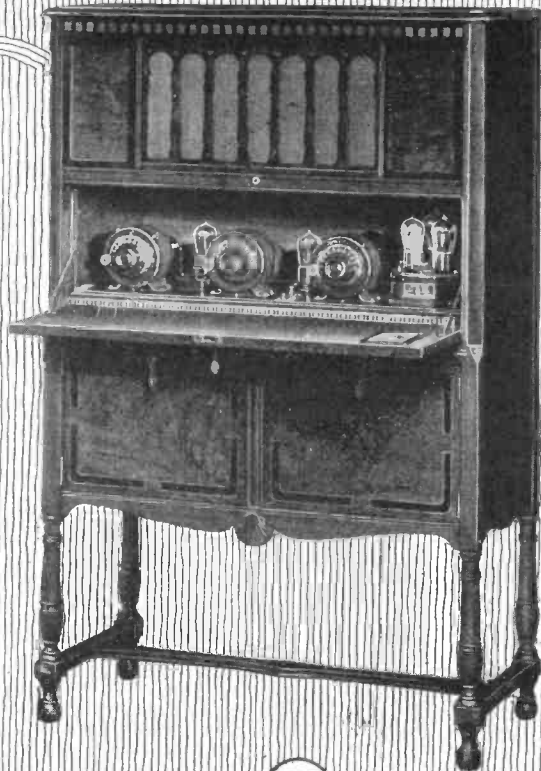

1110
R-2

ATWATER KENT RADIO

Model H, \$22

Model R, \$12

Model L, \$17

Model M, \$28

Model 20 Compact, \$80

Model 19, \$60

Model 20, \$80

Model 24, \$100

Model 10, \$80

Model 12, \$100

Prices slightly higher from the Rockies west, and in Canada

A Stabilized Product— A Stabilized Policy

BUSINESS MEN have confidence in a company whose merchandise does not become obsolete, does not cling to their shelves, is never butchered to make a bargain holiday.

The radio merchant buys Atwater Kent Receiving Sets and Radio Speakers to sell to the public, and does sell them to the public, with strong hands helping him. He expects a legitimate profit, and he gets a legitimate profit.

And very pleasing to him is the knowledge that our Receiving Sets and Radio Speakers are so well constructed, so simple, so durable and so fool-proof that the purchaser is not likely to call him up and say: "That set you sold me won't work."

The Atwater Kent selling organization is protected in its product, and in its territory. And the prices are on the lowlands of popular demand, not on the heights.

That is why every month sees more and more radio business men of the better type endorsing our policy of sound design, painstaking manufacture and fair dealing.

We invite the inquiries of substantial merchants who have been meaning to get behind Radio "when it becomes stabilized."

If you are the right kind of dealer, and have the right kind of store, and are in Radio *to stay*, let's talk it over.

ATWATER KENT MFG. CO.

A. Atwater Kent, President

PHILADELPHIA · PENNSYLVANIA

Our Broadcasting. The concerts of the Atwater Kent Radio Artists are broadcast from these ten high-powered stations from 9 to 10 P.M. on Thursday evenings:

WEAF New York	WFI Philadelphia	WOC Davenport
WJAR Providence	WCAE Pittsburgh	WWJ Detroit
WEEL Boston	WGR Buffalo	WSAI Cincinnati
	WCCO Minneapolis-St. Paul	

J. ANDREW WHITE,
Contributing Editor

S. J. RYAN,
Consulting Editor

E. E. WHITEHORNE,
Contributing Editor

L. E. MOFFATT,
Associate Editor

Radio Retailing

The Business Magazine of the Radio Industry

M. CLEMENTS,
Managing Editor

WILLIAM C. ALLEY,
Associate Editor

H. S. KNOWLTON, Boston

PAUL WOOTON, Washington

C. GRUNSKY, San Francisco

O. H. CALDWELL, Editor

Table of Contents July, 1925

"Nobody Ever Asked Me to Buy a Radio Set"	18
A Season of Sound Growth Ahead	19
Building Business in the Summer	22
"Tuning-In Through the Window"	24
Contacts That Sell Radio in Summer	25
Trained Salesmen Are Best Sellers	27
Music Merchants Hold Convention	29
"Slamming the Summer Slump"	32
Four Policies that Defeated the "Gyp"	33
This Business of Ours	35
Jobbing Margins on Radio	37
Static—How to Minimize It	39
Bringing Tubes Back to Life	41
Overhauling Sets Will Bring Summer Dollars	42
Service Calls Build Sales	46
Tying Up with State and County Fairs	49
What Does the Public Think the Ad Means?	50

Departments

Letters to the Editor	52
The Editors Have This to Say—	54
New Merchandise for the Dealer to Sell	56
What the Trade Is Talking About	64
Dealer Helps the Manufacturers Offer	70

McGRAW-HILL COMPANY, INC.
Tenth Ave. at 36th St., NEW YORK, N. Y.

JAMES H. MCGRAW, President
ARTHUR J. BALDWIN, Vice-President
MALCOLM MUIR, Vice-President
EDWARD J. MERRIN, Vice-President
MASON BRITTON, Vice-President
JAMES H. MCGRAW, JR., V.-P. and Treas.
C. H. THOMPSON, Secretary

WASHINGTON, D. C., Colorado Bldg.
CHICAGO, 7 South Dearborn St.
PHILADELPHIA, Real Estate Trust Bldg.
CLEVELAND, Leader-News Bldg.
ST. LOUIS, 713 Star Bldg.
SAN FRANCISCO, 883 Mission Street
LONDON, E. C., 8 Boulevard St.

Engineering News-Record Electrical World
American Machinist Radio Trade Directory
Power Electric Railway Journal
Journal of Electricity Industrial Engineer
Bus Transportation Ingenieria Internacional
Coal Age Electrical Merchandising
Chemical and Metallurgical Engineering
Engineering and Mining Journal-Press
Copyright, 1925, by McGraw-Hill Co., Inc.
Cable Address: "Machinist, N. Y."
Annual subscription rate is \$2 in United States and Canada.

Paid Circulation Leadership in Six Months

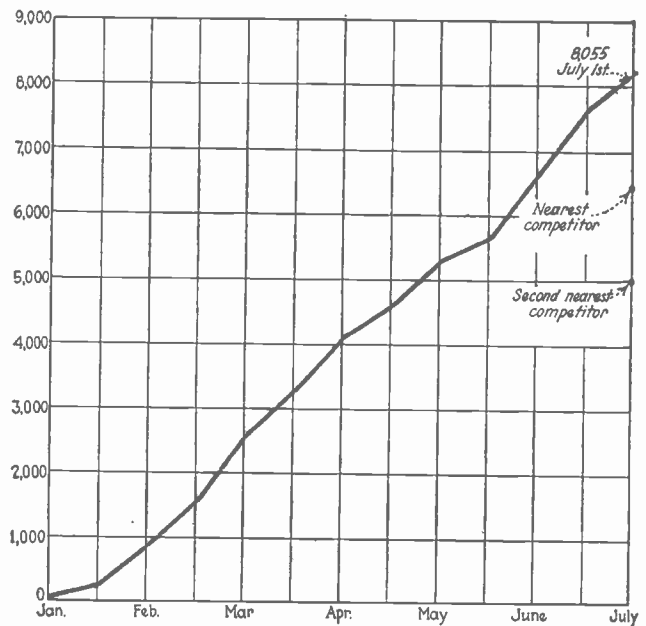

8,055 Paid Subscribers to "Radio Retailing"

NO ONE will purchase a railroad ticket or commodity unless he expects to use it. And likewise, no merchant will subscribe to a business paper in his respective field unless he expects to stick in that line. This is particularly true in radio where the turnover in some cities reaches as high as 40 per cent.

The majority of the radio merchants who fall by the wayside can to a great extent anticipate the length of their business lives, and thus gauge their expenditures accordingly.

Bearing this fact in mind, the editors of *Radio Retailing* feel that no greater tribute to their effort could be had than the 8,055 paid subscriptions which have been rolled up the last six months—all during the "off-season."

This list of readers represents one of the greatest forces in radio merchandising—the better and stable types of merchants who, despite "gypts," "slumps," and "dumping," have made up their minds to stick to their guns and see the situation through.

Radio Retailing welcomes these stickers who are joining our family of readers at the rate of more than 1,000 a month. It's a safe bet that they'll be well up in front when the in-door season returns this fall.



Four out of five passers-by said:

“Nobody Ever Asked Me to Buy a Radio”

A merchandising authority recently made the statement before a radio convention in Philadelphia, that dealers were not making any effort to sell *outside* their stores. *Radio Retailing's* Inquiring Reporter followed up this challenge and went out on a busy thoroughfare and asked five passers-by if they had ever been asked to buy a radio set. The answers, at right, prove his contention, and also prove that the public is interested in radio and wants sets.

Personal visits and telephone calls are two of the best methods of cashing this interest into sales.

WEDNESDAY, JULY 1, 1925

“Radio Retailing’s” Inquiring Reporter

THE QUESTION.

Has any radio dealer ever come to your home and tried to sell you a radio set?

WHERE ASKED.

Fifth Avenue and Forty-second Street, New York City.

ANSWERS.

C. C. H—, Banker: “Not that I know of. Of course, someone may have been around while I was not at home, but if that had happened, I’m sure my wife would have told me about it.”

B. R—, Export Manager: “No, never, and here’s a coincidence: I’ve been thinking about buying a set for a long time, but never got around to it. Sure I’d buy one if somebody put it up in my home and it worked all right.”

J. W—, Printer: “No sir, they have not. Nobody ever tried to sell me a set. I’ve received circulars through the mail, but insofar as I remember they were never followed up by any personal calls. Yes, I’d probably buy one if it was a good, well-known set, and fully installed and everything.”

Mrs. W. F. H—, Housewife: “No, I don’t believe so. No one ever has brought a set up to the door and asked permission to install it and give me a demonstration.”

H. M—, Salesman: “Yes, that’s how I got my set. A radio man telephoned my wife one morning and asked her if he could bring it up and show it to us. So she said all right, bring it along provided it doesn’t cost anything, so when I got home there it was all ready and working. Sure, I bought it.”

test
burne
Clinte
there.
Mr.
In the
the C
said to
line his
of him
“Sher
law. H
came t
that h
estate.
can’t r
it has
is un
goes
Shepl
kin.
to ca
by S
this e
set h
tion.

ot
ad
t,
ht
any
res
ess
or
ie
ed
ve
es
ait
of
ner
ia-
us-
es,
te
ut
ed
ate
city
ght
eal
he
om
Z,
in

Radio Retailing

With Which Is Incorporated *Electrical Retailing*

A Season of Sound Growth Ahead

*Confidence in the Future of Radio Sales Shared by
Leaders in the Industry—Stabilization Coming
—Fall Will Bring Biggest Demand Ever*

With July there comes the "zero hour" of the retail radio selling season. It is a period for "marked time" throughout the trade, but it is also an opportunity for constructive thinking and for getting ready for the business that will come with the Fall.

The radio man can look forward to the radio future with confidence. A market yet barely touched awaits his wares. And the business is becoming more stabilized. Progress will, of course, continue in technical design and construction, but no revolutionary changes which are apt to demoralize the market are in sight. Rather may advances be expected to come through the combination and refinement, and wider acceptance, of principles and devices already well known.

To reflect the spirit of confidence and optimism which prevails in high quarters in the industry, "Radio Retailing" has invited expressions from leaders who see clearly, despite the clouds, the great future ahead for the radio art and the radio trade.—Editors.

Radio Now Repeating History of Other Industries

By JAMES H. MCGRAW
President, McGraw-Hill Company

Radio is here to stay as an important factor in American life,—let there be no mistake about that. Its fundamental soundness and its demand by the public are proven by its rapid growth in sales, in only four years,—to its present retail volume of between \$400,000,000 and \$700,000,000 annually.

Yet so far, only one home in six has a radio set; the other five homes are still prospects waiting to buy. The 6,500,000 farms of the country present probably radio's greatest opportunity for usefulness as a business and cultural instrument,—though only a few hundred thousand radio sets are in use on farms to date.

Such outlines of vast unsaturated markets show the opportunities ahead for radio sales.

A great industry and a competent widely-ramified retail trade must be built to supply this demand. Radio needs stabilization but this will come. Let us not be too impatient with this young giant. Let us have

faith in its future, based upon its miracles accomplished to date.

* * *

In 40 years of active publishing contact with the electrical arts,—of which radio is the youngest offspring,—I have learned the necessity for patience with the growing pains of a youthful industry.

I have watched the beginnings and the early commercial discouragements of the great electric-light industry. I have seen the electric street car become a practical reality after many disappointing trials in the dark years of the late 'eighties. And I have been an observer of the steady growth of electric power transmission, dating back to the pioneer experiments of Tesla and Westinghouse.

The world now knows that the faith of the pioneers in these great fields was justified, for it has seen huge, stable industries built upon the inventions of the engineers.

The same history is being repeated right now with radio, but at a highly accelerated pace in which mere years are substituted for the decades in the growth of the older electrical lines. Today we see radio rapidly stabilizing into a great industry that will serve mankind. We have confidence in the commercial as in the scientific future of this art. And we have faith in the men who are devoting their best thoughts and business fortunes to getting this great commercial job done.

Radio Has Entered Era of Stabilization

By GENERAL J. G. HARBORD
President, Radio Corporation of America

There is no other modern business which offers the romantic appeal of Radio; no other which has so enlisted the interest of millions of intelligent and investigating amateurs; no other so unexplored as this in which every amateur experimenter is a potential Edison, every discoverer a ten thousandth edition of Christopher Columbus; no other in which a toy and a fad has so quickly become a tremendous utility,—an entertainer, an instructor, an informer and a bearer of

international communications,—a necessity to millions,—a luxury to millions more.

I recall no other art or industry which has developed so rapidly in so short a time. Three powerful factors have combined to stimulate this growth:

The almost instantaneous response of an understanding public to its imaginative appeal, by an appreciation of its tremendous possibilities. The contribution by the older related industries of personnel, capital and facilities to promote its development along sound economic lines. The sympathetic support and understanding of its infant difficulties by our Government in Washington.

Its future depends upon its retention of these factors through its demonstrated ability and disposition to serve mankind.

Its precocity and unprecedented rapidity of growth have been penalized by the conditions that always accompany such phenomena. Elements have appeared which have neither lent stability nor supported permanency. The early history of other industries has been repeated in radio through poor merchandise, much stock promotion and foolish investments. These are passing phases, however. Fundamental discoveries made over night are no longer frequent in radio. The industry has entered the era of stabilization. Research laboratories are now developing refinements rather than fundamentals. Distributors and dealers are in a favorable position to wisely select the merchandise which an instructed and discriminating public is demanding. Radio no longer sells itself, and manufacturers, jobbers and dealers are now applying to radio the time-honored methods that in all forms of business create and maintain standards of quality and service. Experience has already shown what those standards must be in radio.

There is no industry today, in my opinion, standing upon firmer ground than radio, provided those who direct its activities keep public service as their aim. Intelligent direction to such a purpose, upon sound lines, will unquestionably continue to command the sympathetic support and encouragement which insure future growth and prosperity. Only those institutions will survive which are willing and able to give a full measure of public service to justify the profit they hope to derive from the industry.

The Present Situation from an Engineer's Viewpoint

By DR. LEE DE FOREST

Although I have not been actively engaged in radio development work for the past three years, my interest in every development of this art, to which I have devoted so many years of my life, has in no wise slackened, and I seek to keep closely in touch with radio engineering progress.

As a result of my survey of conditions which exist today in radio engineering and manufacturing circles, I can see that the future, at least for the succeeding six or eight months, has nothing revolutionary in store for us. Recent developments have been chiefly confined to refinements in circuit design and to artistic betterments. The various standard elements from which the receivers and amplifiers are built have been amply improved in detail and simplified in manufacturing costs, but these same elements, which were essential to radio three years ago, exist today and they will exist

in all the essentials a year from now, and probably for a much longer period.

It may be truthfully said that the "laboratory stage" of the art lies behind us. We are safely in the manufacturing stage, and nine-tenths of the effort of the radio engineers today is devoted to refinements in manufacturing processes and materials and in simplified and more durable designs of the component parts. With this state of affairs the radio dealer can look confidently into the future, unquestionably for the balance of 1925, and can with assurance take the position that the art has now been very well stabilized. He can safely dismiss from his mind the bug-a-boo of "revolutionary changes," complete upset in the line of established products, vague rumors regarding mysterious new and epoch-making inventions about to be revealed to a breathless public. For example we have heard from time to time vague rumors regarding lamp-socket tubes, 110-volt tubes, etc., designed to do away entirely with storage and plate batteries, and to necessitate the junking of millions of dollars worth of apparatus now considered standard. Such rumors can be classed as "bunk." Possibly they were designed with mischievous intent to keep the trade in a state of upset, unrest or disastrous uncertainty. My advice to all dealers is to dismiss without further consideration talk of that sort, and lay plans for the forthcoming season on the basis that the best of what is already on the market will be further standardized, merely improved here and there in detail and made more attractive for the customers.

Changes and Improvements Will Come Slowly

I do not wish to be misunderstood as stating that the art is perfected or that improvements are not needed or do not actually await us. Recently I have seen a demonstration of a device for successfully eliminating A and B batteries. This is a step forward for which every radio user has fervently hoped. One of the greatest drawbacks to more widespread introduction of radio and to longer daily hours of use is the too frequent exhaustion of the storage battery or the plate dry-cells. If an eliminator is brought out which is quite independent of the receiving set, which can be successfully applied to practically any type of tube set, from one to eight tubes, and which will forever do away with the nuisance of recharging storage batteries or replacement of dry cells, such a device is certain to go far towards increasing the popularity and reliability of radio. This being the case, progressive dealers will, I am sure, welcome the advent of such genuine eliminators. For in the long run their wholesale introduction will enormously increase the total actual radio turnover. Innovations of this nature, improved loud speakers, etc., should cause no disturbance to the gradual progress of radio. Such improved merchandise will be genuinely welcome by the trade and public alike.

Unquestionably, an incalculable amount of inferior apparatus, most of it "half-baked," turned out without proper engineering study, has been dumped upon a generous and long-suffering public during the past season. This unfortunate state of affairs has produced the inevitable result, a severe attack of radio indigestion. But I believe we can safely say that this epidemic has now been successfully survived, and that the dealer during the ensuing season, may look forward to a normal and thoroughly healthy state of growth.

Confidence Means More Sales and Greater Profits

By A. ATWATER KENT
President, Atwater Kent Manufacturing Company

Confidence!

Here is one word which, in itself, is the very essence of that Golden Rule upon which all dealings that are good between men are founded. With renewed confidence on the part of all—manufacturers, wholesalers, dealers and public alike—opportunity in the radio business is limitless.

In considering the haphazard policies and indiscriminate merchandising on the part of a certain element to which radio selling has heretofore been subjected, we must remember that we have been engaged in a new business. Precedents were to be made rather than followed. Within a few short years, radio has been placed on a plane of merchandising and distribution along with the automotive, phonograph and other industries which were years and even decades in getting established.

"Those Who Regard the Industry Sanely Will Survive"

Small wonder a few incompetents found their way into the field and the weeding out process has been, mayhap, a rigorous one. Throughout the seeming turmoil and confusion of a few years past, those who have regarded the industry in a sane light rather than as a thing of mushroom growth for sudden and easy riches have done much toward placing radio on a sound and enduring basis. Now we are entering upon another selling season, the keynote of which could not be more apt than *Radio Retailing's* suggestion of renewed confidence.

Personally I shall be happy if, instead of selling only radio sets, we can continue to sell confidence in our organization. That, in itself, will promote the sale of more material than any other method I know, not only for ourselves but for every dealer throughout the country who handles our product. Moreover, these sales will be made in an entirely satisfactory manner wherein all concerned will realize a just profit, and the final consumer receives a radio set that has been built to the best of our ability and which is a sound investment.

"Avoiding Over-Production Will Prevent Indiscriminate Merchandising"

The policy of the Atwater Kent Manufacturing Company will remain unchanged. We have always been exceedingly careful to avoid over-production and results have shown that this is the surest method of preventing indiscriminate merchandising.

We have, ourselves, the utmost confidence in the future of radio and will strive in our every effort to pass this on to others. Radio has grown with astounding rapidity as an industry. If, in some cases, it has suffered from growing pains, these have been only temporary.

With the coming of the fall and winter season, radio will have been carried far toward its establishment on a solid and enduring foundation which will bring its reward to sound business policies and fair merchandising. It will be a confidence well repaid.

Confidence an Essential Requisite

By WALTER L. ECKHARDT
President, Music Master Corporation

"Confidence" hits a very sympathetic cord with us because confidence is a very essential requisite and we have been spending a great deal of time during the past few years building confidence.

That we have the utmost confidence in the future of the industry may be readily seen in the fact that we have projected a production for the 1925-1926 season of 140,000 receiving sets and that the trade is equally as confident is manifested by the fact that we have already received orders from jobbers throughout the country for practically this entire output.

Our policies as presented have evidently struck a sympathetic keynote, and, although daring in the radio business, are quite old to other standard and nationally advertised lines, viz.: limited number of jobbers, restricted and registered dealers, established in a limited number throughout the United States, with assurance to the public against price reductions or liquidation, assurance to the jobber and dealer against shrinkage in investment, and with merchandise unconditionally guaranteed we have all confidence in the future and fully expected to see radio within a reasonable time take its place with the greatest of industries.

"Parasites" Will Disappear

By M. RYPINSKI
Vice-President, C. Brandes, Inc.

Our organization is, as usual, optimistic about the radio outlook so far as those representative manufacturers and distributors are concerned who are endeavoring to serve the industry faithfully, and who are making contributions to the permanent good of the industry, rather than acting the part of a parasite.

The radio parasite, whether he be manufacturer or distributor, is a true parasite. That is, he makes no real contributive effort in the way of constructive activity, and is not concerned whether radio lives or dies, so long as he can derive immediate returns.

The best cure for radio parasitism is the wholesome disinfectant of popular disapproval and non-support.

As time goes on, the public is becoming more and more enlightened as to the destructive effects of the radio parasite, not only on the industry in general, but also as it affects him personally, and we may hope to see, in the not too far distant future, the complete passing of this temporary phase of our industry.

Looking Beyond the Horizon

By CLARENCE E. OGDEN
President, Kodel Radio Corporation

Twenty years ago a group of men who had entered the automobile business expecting everyone to purchase a motor car almost the day after they started in business, gathered together to lament the fact that the automobile business was in terrible shape. It was a novelty, only the rich could ride in motor cars, gasoline

(Continued on page 38)

Building Business in the Summer

This Chicago Radio Shop Uses Complete Stocks, Service in the Home, and "Ask 'em to Buy" as Summer Sales Stimulants



APRIL, so the wise ones said, is not the month to open a radio shop. When Harry Friedman and Jack Herdan opened the Lincoln Radio Shop, Chicago, in April a year ago, they were told there was no chance for them to sell radio before fall; that there was no summer radio business and that they were using pretty poor judgment in opening at the beginning instead of the end of the summer.

But Friedman and Herdan were too busy to pay much attention to the crepe hangers. They had a definite plan to carry through which they expected would produce both immediate business and lay a solid foundation for bigger business in the fall. Which it did.

The plan was simple. They knew that people did not stop using their radio sets simply because it was summer. They also realized that sometimes these sets needed service; and that if they could get into people's homes to service sets they could sell them other radio merchandise at a profit and collect leads for set selling.

Their advertising appeal was built on service. There are a good many thousand mail boxes in the district surrounding the Lincoln Radio Shop. Into these mail boxes went circulars offering expert radio service at a moderate charge. Inspection of the set was offered free. People began to come in and call up and the two partners were kept busy making serv-

ice calls. They soon accumulated a number of customers pleased with the prompt and careful service work and the moderate charges.

When in a home servicing a set, these live radio men always took the opportunity to do a selling job as well. They noted the accessories lacking in the customer's equipment and pointed out what these accessories would do to improve the enjoyment of the set. A free trial was often arranged so the customer could see for himself. This suggestive selling sold chargers, current supply devices and reproducers. Leads were always being picked up for sets and these leads were personally followed and turned into sales.

Summer store sales were also found

to be better than had been anticipated and the chief reason for this was that the customer who wanted something knew he would find it in the stock of this store.

"One of our most frequent experiences," relates Mr. Herdan, "was to have a man come into the store and ask, 'Have you such and such a thing?' naming a particular make of part or accessory. He would ask this in such a tone and manner as to suggest that he did not expect we had it. When we handed him the article right off the shelf, he would remark that he had tried a half dozen other stores who were all out of it.

"Keeping up our stock at the time that many dealers allow theirs to run low, did much to establish our

Accessory Sales Make Summer Profits

THE majority of radio set owners do not own a full equipment of needed accessories. Probably not one in four owns a battery charger. Which means that there is a large and easily reached market for the dealer who will push the chargers and other accessories this summer.

Here is a plan that sold chargers last summer for the Lincoln Radio Shop in Chicago, which kept on selling chargers last winter and which is selling chargers today.

First of all, the customer remarks that the battery needs to be charged. The dealer suggests that instead of

the customer taking the battery out to be charged, that he will send a battery charger to the customer's home and charge the battery there. "How much?"—"Oh, fifty cents."—A lot easier than carting the battery to a charging station and the customer cheerfully agrees.

This is the first step toward a sale—getting the charger into the prospect's home. The prospect gets the idea of the ease and convenience of home-charging his own batteries. Sometimes the dealer takes the charger back but more often he makes the sale after this one demonstration.



shop with many worth while customers. We believe that when a man drops in for something and we haven't got it, the next time this customer needs anything he will be likely to pass up the store that disappointed him. Keeping our stock up has been customer insurance.

"It has not been necessary to have a lot of money tied up in inventory to carry a complete stock. We cut down on the quantity of any one item but keep the number of items up. Instead of buying a dozen at a time we buy a fourth of a dozen and make quick stock replacements from the jobber. This keeps up variety and keeps down investment."

This same customer who has been pleased by finding what he wanted does not get out of this shop without being solicited to buy something

in addition to the purchase he came in to make. As his purchase is being wrapped and his change made he is asked what kind of a set he owns. "Have you seen the new Blank Speaker?" the salesman asks (there are salesmen in this store, not clerks. There is a lot of difference). Maybe the customer has, but anyway he will be glad to talk about it. If he has built his own set and is a construction fan there is a new coil or transformer or other part that is called to his attention. By one means or another the salesman gets a line on the radio equipment owned by the customer and tries to sell him something that will supplement and improve his receiver.

Using Credit as a Sales Stimulant

In a year's time Friedman and Herdan have made the acquaintance of their neighborhood and its people. One selling help that this acquaintance has developed is the intelligent use of credit as a buying stimulant. Not only have sets sold on time payments since this shop was opened but a considerable thirty-day charge account business has been developed in accessories.

Some business man known to be a good credit risk is interested, let us say, in a charger or a new reproducer. He shows all the symptoms of buying, but holds back at the

critical point. Here is where credit comes in to close the sale. "You have your car outside," says the salesman. "Take this charger home with you, I'll send you the bill later." No man was ever yet insulted by being told that his credit was good and this offer to "send the bill later" has closed many profitable sales.

Whenever a service call is made, a battery delivered or called for, in fact, every time a representative of the store has access to a customer's home, he will always note the equipment the customer has and what is needed to make for more perfect reception. The sale of many accessories can be attributed directly to this plan. Moreover, the service man never leaves the store without several tubes and batteries for replacement purposes.

By keeping an accurate record of the names and addresses of all known set owners, the service man is given several "chance" stops to make in the neighborhood of the call he goes out on, with the possibility of selling new tubes or batteries. Very often, set owners need new accessories, but for various reasons have not purchased them. When they are brought right to the door, the sale is made then and there.

True, dealers may think that is "chicken feed." But every extra dollar in the summertime helps pay the rent.



A new way of selling chargers has been devised by Harry Friedman and Jack Herdan, of Chicago. When a customer wants a radio battery charged, the suggestion is always made that the store will be glad to send a charger to the customer's home and charge the battery there, without losing the

use of the set or incurring the expense of a rental. The salesman then takes a charger to the resident and makes a selling talk concerning the ease and convenience of charging batteries in the home. Nine times out of ten the charger is sold, and invariably it stays the second time.

"Tuning-in from the Sidewalk" Draws the Crowds



Curiosity is a universal failing. The reason for the crowd in front of this radio window is that one of the passers-by discovered he could stand on the sidewalk and tune the set in the window to whatever station he pleased. The crowd gathered to find out "how and why." Here's a novel window display that brought into play three fundamental human characteristics—"Look, Listen and Do It Now." A loud speaker peeping out through the transom over the window gave forth the signals from any station the passer-by chose to tune in.

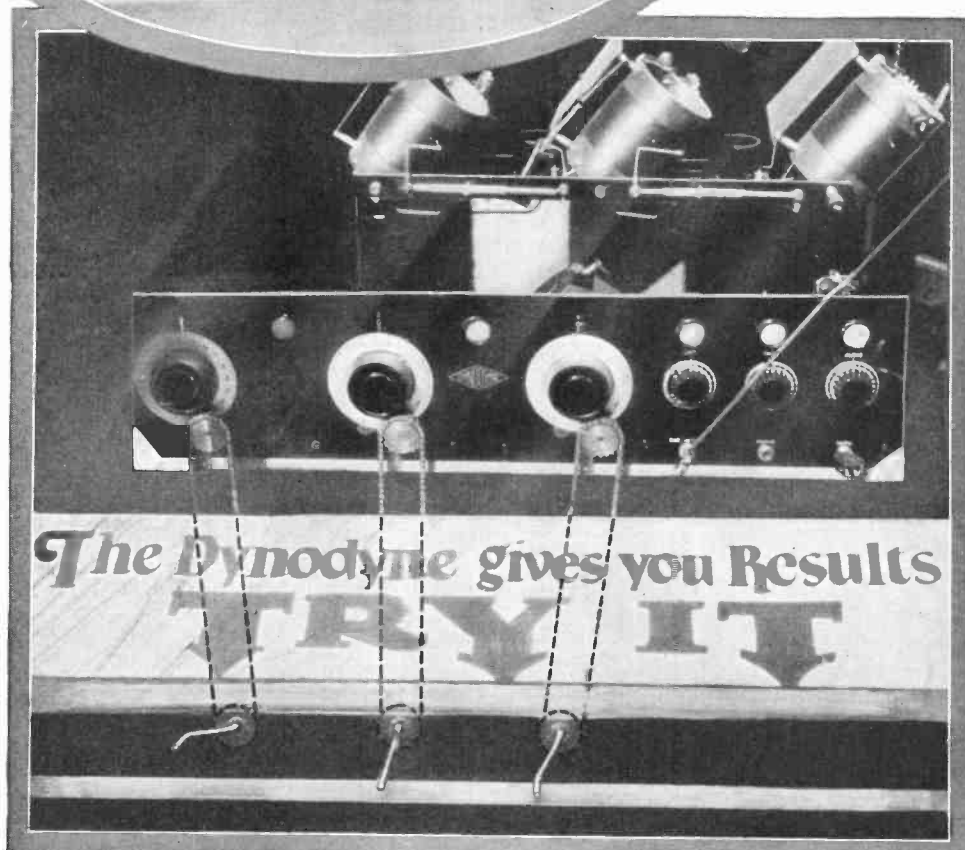

To C. Weber, one of the owners of the Electric Service Engineering Corporation, 105 West Forty-seventh Street, New York City, goes credit for the idea. The mechanism employed consisted of three small handles protruding through the lower wooden framework of the window, each connected by a rod to a gear and chain inside the window, the other end of the chains being connected with gears on the three tuning dials of the set in the window. Thus when the handles outside were turned, the condensers turned also.

Sales, both in parts and sets, jumped twelve per cent, Weber reports. The display took only three and a half hours of Weber's time and three hours of a carpenter's time, at \$1 an hour. The gears and chains cost \$11.50, so that the whole expense amounted to only \$14.50.

Of course, the dial settings of a number of stations were prominently displayed in the window, for the guidance of the tuner-in. The rest of the display consisted of an expert who sat in the window and built sets, each step being explained by means of cards. Also sets in various stages of completion, from the drilled panel alone to its final appearance, formed part of the display.

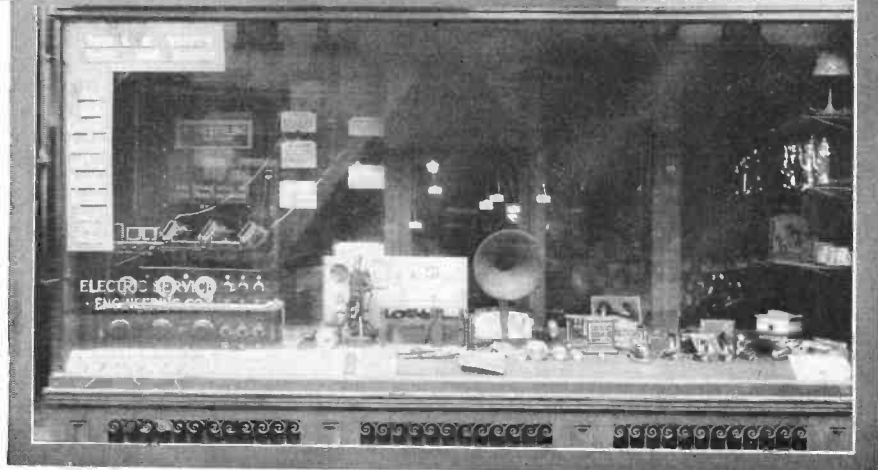

"Contacts" That Sell Radio in Summer

How the Dealer Doing Business in a Small Community
Can Extend His Activities to Win Hot Weather Sales

By GEORGE J. ELTZ, Jr.

General Radio Sales Manager, Manhattan Electrical Supply Company, New York

THE average radio dealer's contact with his customers is a personal contact. In general he is a "community" dealer, and his clientele is limited to the area surrounding his store. By advertising he can increase this area, but unless he has something special to offer, his advertising will still have the greatest effect on those in the area he is best fitted to serve. During the summer the radio dealer has considerable free time which can be used to good advantage.

In rural or suburban districts, as a general rule, residents do not spend the summer months away from home. This is of advantage to the dealer in two ways: His prospective customers for summer or winter sales are always available and as there is no vacation money to be spent in addition to regular expenses the chance of interesting customers is greater.

Personal contact with the customer in selling is always desirable. In no other business perhaps is it as desirable as in radio. Radio sets are still sold largely by word of mouth or upon actual demonstration to the customer. A radio set which

has given satisfaction to one member of a group of friends will do more towards selling sets of the same kind to the others than any amount of advertising. This is personal contact selling of a slightly different nature than the dealer's, but nevertheless of the same general character. Because of the small area which the average dealer covers, the possibility of selling through personal contact with his customer is great. At no time in the year is this personal contact as valuable as when business is naturally poor. The radio dealer who has been located in the same place for any length of time, if he is progressive, has built up a list of good prospects in his territory. If the list is properly compiled it will be divided geographically and the names will be graded according to the financial standing of the prospect.

Get Prospect List from Other Merchants

The dealer who has no such list available may build up a satisfactory one from names obtained from the local butcher, grocer, or other friendly merchant. After the list has been properly arranged the pros-

pects should be called upon personally. Those prospects who head the list from a financial angle should be the first ones given attention. The initial call should be made in the morning and should be designed primarily to interest the woman of the household.

Do not make the mistake of trying to sell the radio set to the woman; instead, sell the idea of the entertainment and instruction possibilities. This is what the woman is interested in—not the number of tubes, the type of circuit, etc. If she appears interested tell her approximately how much the complete set will cost and arrange for a call in the evening when the man of the house is at home, and perhaps a demonstration made. In quoting on a radio set try to find out how much the prospect is willing to invest. Bear in mind that better grade sets invariably are more reliable in operation and finer in appearance than the cheaper sets. Also bear in mind that if the woman of the household can be interested, she will do more towards selling the set than the dealer ever can do.

On this first call it may not be

"Musical Census" Gets Good Prospect List

THE "musical census" idea seems to be gaining rapidly in popularity as a means of getting names and addresses of prospects for the sale of radio sets. Borrowed from the music trades, the "census-taking" consists merely of hiring a few girls of high school age, paying them a nominal salary and sending them out on a house-to-house tour of the residential sections. The girls ascertain if the home is equipped with a radio and use a line of conversation something



like this: "How do you do? I am Miss So-and-So and I am helping to take the musical census of Dashville. Would you mind telling me what sort of musical instruments you have and whether you are interested in radio?"

The girl then puts down the householder's name and address and the musical instruments she owns. In this way it is possible to find out just which homes in town are prospects for radio sets.

advisable to bring a receiver for demonstration. It may be better to size up the prospect, find out the actual degree of interest he has in the purchase of a set, and ascertain exactly how much he can afford to spend. When the dealer is convinced of these points he should arrange for a demonstration. When the receiver is set up, the prospect should be fully but simply instructed in the manner of operation.

After the set has been installed do not make the mistake of continually calling either in person or on the telephone. Permit your customer to operate the receiver himself. If it is a good set, properly installed, he can cause no damage and the fascination of operating it will do more towards selling it than anything the dealer can do or say. Moreover, if the set is left for demonstration over a period of several days, some time during that period, even in the summer months, good distance reception will be possible.

The cost of making these demonstrations is slight. If the prospect is sold the actual set left on demonstration, the cost is zero. Where a special demonstrating set is used, practically the only cost is that of delivery and the trifling cost of the current consumed from the batteries. When it is considered that the possibility of sales through these demonstrations is much greater

than demonstrations in the store where the same expense is incurred, the question of cost is practically negligible.

In making a demonstration in the home, remember that there is nothing quite so discouraging as a demonstration which requires a mess of batteries and wires. Try and bring the receiving set to the home

Get Acquainted with Your Community

by making as many personal contacts with prospective customers as you can possibly make—that's the advice of George J. Eltz, Jr., radio sales manager of the Manhattan Electrical Supply Company, one of the very first pioneers in the retailing of radio.

"Even if the prospect you call on already has a set," says Eltz, "there is always a possibility of selling him new accessories, and, at the same time, you are bringing yourself and your store to his direct attention, so that he will have you in his mind when he makes his next radio purchase."

as nearly complete as possible. The loop type receiving set is particularly good for this purpose.

In making up a list of prospective customers the dealer will invariably include a number of people who already possess satisfactory radio sets. Although sales of sets are unlikely to these people the personal contact when they are called on will be valuable and may lead to a request for servicing their set or to the sale of additional accessories. Because of the improvements which have come about in radio sets during the last few years it may also be possible to interest these customers in new receivers.

Where the prospect appears to be interested in a deal of this character leave the set on demonstration so that he can convince himself that the new set is much better than his old one. There is also a possibility of speaker sales to these customers. In the last two years, speakers have been wonderfully improved. If they have an old speaker show them how much better the new ones are.

Don't Start a "Bell-Ringing" Campaign

If an outside sales campaign is inaugurated, paying salesmen about ten per cent on commission only, it should not be turned into a bell-ringing campaign. The prospects should be selected carefully and approached accordingly. This plan entails considerable work on the part of the dealer, but good results are practically assured. While the percentage of sales made on this plan during the summer months may not be as high as could be desired, nevertheless the foundation is laid for future contacts and sales when the time is more propitious.

The community dealer, particularly in suburban districts, will always have to depend for his sales on his personal contact with his customers. Anything which improves or increases his personal contact is bound in the long run to reflect itself in increased business. The possibility of accessory sales in itself should be interesting when it is considered that accessories, such as speakers, storage battery chargers, etc., frequently are sold at a profit rate considerably higher than complete radio sets.

Get behind a plan of this or a similar character during the summer months and try to make radio business better instead of surrendering to the weather man!

One Half Million Motor Boats Are Waiting for Radio Sets

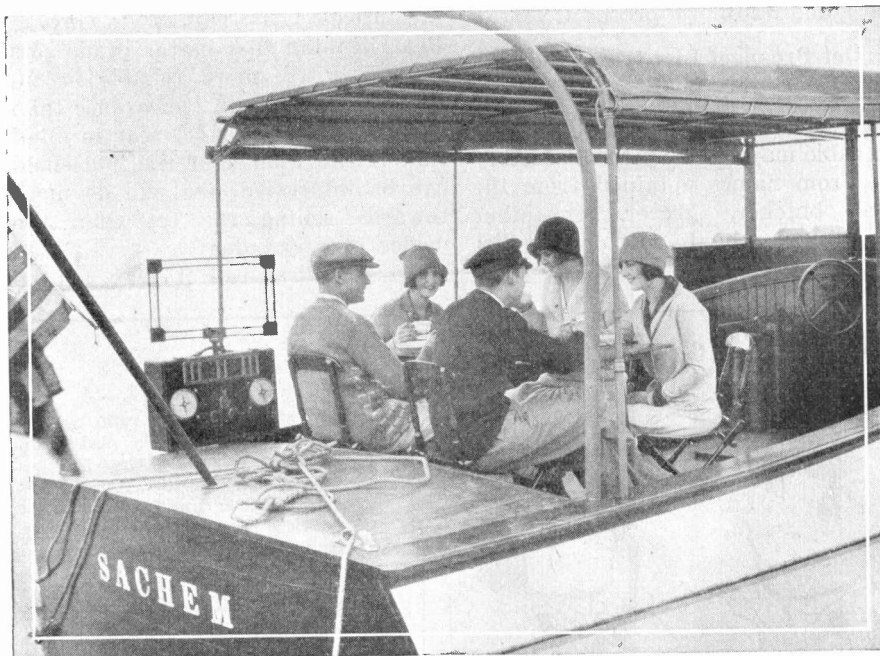

It requires no survey to point out the negligible number of radio sets installed on the 500,000 motor boats in this country. This untouched market is available to thousands of dealers, as one-third of the cities and

towns are on waterways. To reach these prospects, the home-demonstration method must be adopted. Go down to the river or lake, take a set or two with you, and "Ask 'em to buy."

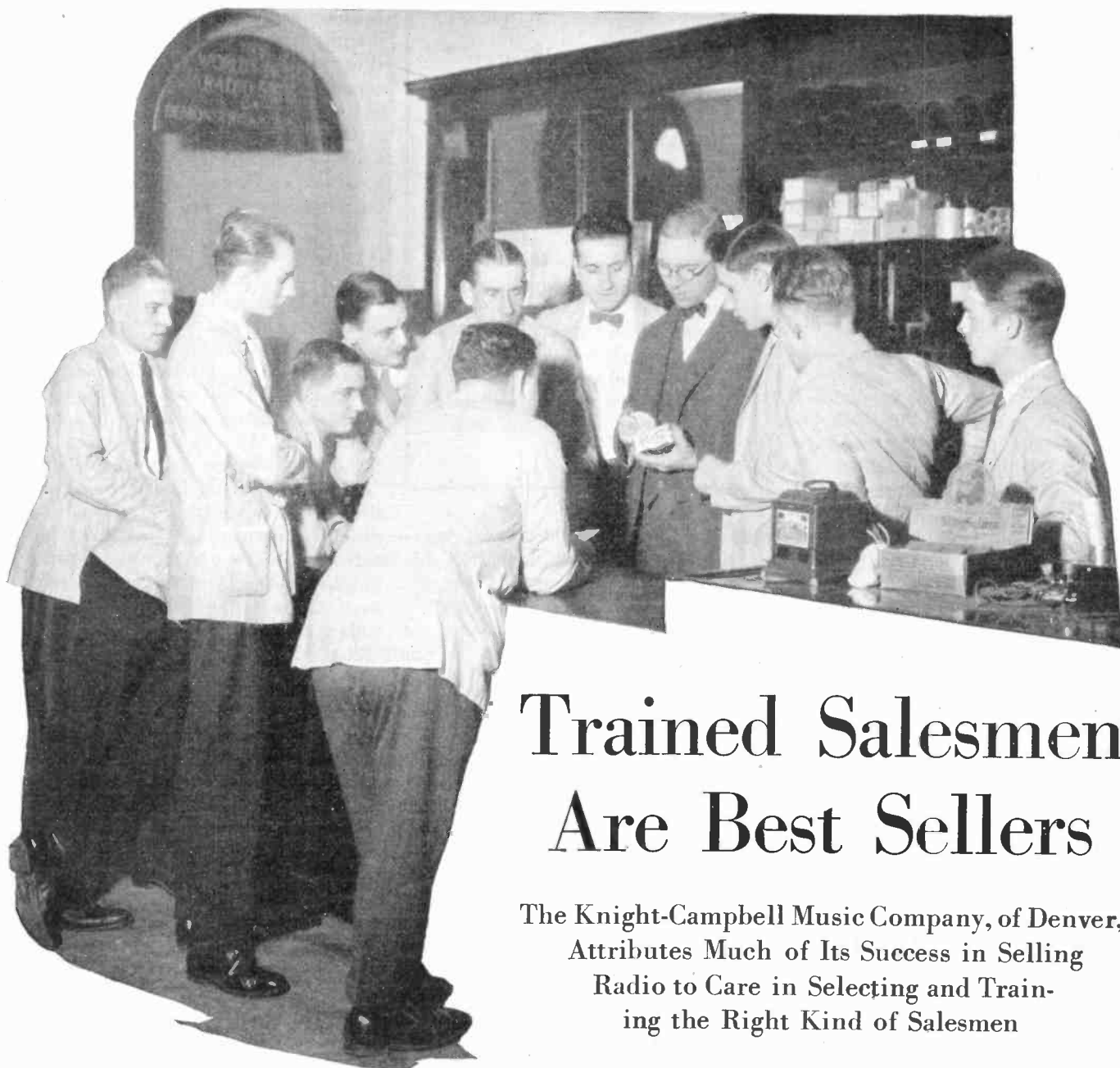

Trained Salesmen Are Best Sellers

The Knight-Campbell Music Company, of Denver,
Attributes Much of Its Success in Selling
Radio to Care in Selecting and Train-
ing the Right Kind of Salesmen

CARE in the selection and training of salesmen has been the outstanding reason for the success of many retail dealers. Particularly in the music and radio trades, where much house-to-house selling is done, an efficient and capable sales staff is a fundamental necessity.

With this realization, the Knight-Campbell Music and Radio Company, of Denver, Colo., has spent much time and money to build a selling staff to which it can point with pride. And the seven men who now comprise the Knight-Campbell radio sales staff are rated among the best salesmen in the Colorado capital.

Each of the men, according to

Photo through the courtesy of Haynes-Griffin, Inc., New York City, and shows A. J. Haynes instructing his sales force. N

George P. Hopkins, manager of the radio department, often hits a \$5,000 monthly gross, as a result not only of their own natural ability in outside selling, but also as a result of the training they received before being allowed to sell radio on a house-to-house basis.

In the hiring of salesmen, advertisements are inserted in the daily papers and all applicants are personally interviewed by Hopkins. Recently, twenty-two men were interviewed before one finally came up to the high standard set by the store.

Upon accepting a salesman, he is given a drawing account of \$125 a month and sales quota of \$1,666 which he must reach. He is paid 7½ per cent commission on all sales.

The salesmen then undergo a course of training under the super-

vision of Hopkins. This covers not only salesmanship, but includes the selling features of the sets to be sold, and a general familiarity with the firm's standing and policies. Each salesman is also required to spend at least one day each week on the floor of the store, and they must hold themselves ready to help out during rush periods. This system of using outside salesmen in the store one day a week, keeps them "on their toes," Hopkins believes, and keeps them in direct touch with the store and its customers.

This works beneficially both ways, as it has been found that his outside experience makes him a better store salesman, and his experience in the store gives him added technique for his outdoor work.

Salesmen are prohibited from ex-

aggerating or misrepresenting radio receivers in any way. Evidence that they have violated this ruling brings immediate dismissal. By misrepresentation is meant any statement about a set which would not be true from the standpoint of the customer, Hopkins points out.

"I have a set in my home," he said, "with which I get New York quite frequently. But someone not so familiar with the set probably could not do so. The fact that I can do it, doesn't give the salesman grounds for telling the customer he can do the same thing.

"We lose some sales, no doubt, by vigorously enforcing this rule, but we make up for it in the reputation we gain for honesty in selling. We look upon radio as a permanent business and are building our radio reputation and clientele on the performance of our sets rather than promises as to what they can do."

Hopkins considers the man trained in selling a better radio salesman than the man trained in the technicalities of radio. He has tried both kinds and has found the non-technical man to be productive of more business.

Radio caused the reorganization of the Knight-Campbell sales methods, Hopkins states. When the firm first began selling radio, a piano salesman

Trained Salesmen

sell more radio than the radio technician, according to the experience of the Knight-Campbell Music Company of Denver.

Seven carefully chosen men, trained as radio salesmen and instructed in the policies of the company, comprise the selling staff and each often hits a \$5,000 monthly gross. Care in selection, and care in training are the two great essentials in building an outside sales staff.

often spent as much as two years selling a high-grade piano. He became an intimate friend of the customer during that time. Radio, on the other hand, is a fast mover and caused speedier methods to be put into practice throughout the store.

Piano salesmen who have been with the store a long time have naturally built up a large personal clientele, consisting of some of the leading social, civic and business lights of the city. On the theory that these people are drawn to the store

to buy radio because of their acquaintance with the piano salesman, these salesmen are given part of the commission, when one of their piano customers buys a set.

Another feature of Knight-Campbell's selling philosophy is service. Free service is given for thirty days on new installations, and a well organized service department keeps three crews busy. Service calls, outside of the free period, are at the rate of \$1.50 an hour, with 75c. the minimum charge.

A well-equipped laboratory is maintained to test sets. No sets are stocked until they spend ten days or two weeks in the laboratory and pass rigid tests. Unless they come up to standard, they are not considered.

There is a strict line of demarcation between the radio and phonograph departments. They are kept entirely separate and while phonographs will be accepted as part payment for a radio set, the customer makes the exchange against the advice of the firm, as it is pointed out that each fulfills a separate and important need.

Radio Retailing's representative was given a parting thought from Hopkins that is worthy of consideration. "The limit in selling radio," he stated, "is determined only by the salesman's ability to sell it."

"Ask 'em to Buy"—and Show 'em Why!

Here's a List of Things to Sell This Summer to the People Who Have Already Purchased Radio Receiving Sets

A head set

This will enable them to bring in stations they could not locate on the speaker alone. A head set will sometimes nearly double the number of stations to be heard.

Dry battery tubes

so that they may take the set away on vacation without having to lug a heavy storage battery along. Include adapters in this if necessary.

Small-size B batteries

In order to make the set light and easily portable.

An extension cord

so that the loud speaker may be carried out on the porch or to any part of the house. A new plug may also be needed with this.

Battery service

if they are going away all summer. You can keep the storage battery charged and in condition.

Extra speakers

for the porch or a small one for the automobile.

A hydrometer

so that the storage batteries may be kept fully charged.

An indoor antenna

to overcome the natural fear of lightning, but don't talk about the danger because there isn't any.

A connecting cord and plug

which may be used when the set is installed in the auto and will permit the auto battery to be used as radio A battery.

A lightning arrestor

as required by the Board of Fire Underwriters.

A loop aerial

for use with the set in the open. Make sure first that the set will work this way.

A lamp socket aerial plug

for use in the home, the summer hotel or boarding house.

Flexible antenna wire

which may be reeled up and used with a portable camping set.

Parts for a portable set

Many of the magazines carry articles on how to make these sets; play these up in your windows and sell the parts, together with a portable case to put it in.

A phonograph attachment

in order to get the best summer reception. Metal horns seem to amplify static more than phonograph horns.

A clock switch

which will turn the radio set on in the morning so that the whole family may get its exercise, and also turn it off at night after the family has gone upstairs.

Distilled water

for the storage battery. It will always evaporate faster in the summer time.

Music Merchants Hold Convention

Spirit of Enthusiasm and Optimism Pervades Chicago
Sessions of Music Industries Chamber of Commerce—
One Meeting Given Over to Study of Radio Problems

CONFIDENCE — confidence in the music trade—confidence in the radio industry—confidence in themselves and the merchandise they sell—that was the keynote during the four days, June 8 to 11, that the National Music Industries Convention was in session at the Drake Hotel, Chicago. It is estimated more than 1,000 representatives of the nation's music and radio trades gathered for the various meetings.

Annual meetings of nearly a dozen trade organizations affiliated with the Music Industries Chamber of Commerce, were held during the convention and it is noteworthy that an atmosphere of enthusiasm and good humor prevailed at every gathering.

Monday noon, June 8, saw the official opening of the convention with a luncheon of the Piano Club of Chicago, presided over by Harry Schoenwald, president of the club. An address of welcome was made by Mayor Dever of Chicago, after which Richard W. Lawrence, president of the Music Industries Chamber of

Commerce, fired the first verbal barrage, outlining the work of the Chamber in the past and what it hopes to accomplish in the future.

Touching upon the troubles of radio during a portion of his speech, Mr. Lawrence declared that four hundred million dollars had been spent on radio with little or no profit for the radio retailer. He made the statement that if the radio industry had studied the lesson the music trade had learned, and had been able to profit thereby, much of the stormy seas would have been sailed in safety.

Most of Tuesday and Wednesday were given over to meetings of the National Association of Music Merchants, opening with a short talk by the president, W. W. Smith, of Toledo, Ohio.

Howard A. Lewis, manager of *Radio Retailing*, was chairman of the Wednesday morning session, which, after an address by Mr. Lewis on radio marketing conditions, was given over to a general discussion from the floor concerning radio.

In radio, we have a business running into millions of dollars, Mr. Lewis said. It has been estimated that our sales for 1924 were \$350,000,000 and, to all intents and purposes, the volume of business will exceed in 1925 that of 1924. One thing is lacking—profits. Without being presumptuous, I will undertake in my small way to divide the proposition into the proper pieces and spread the pieces before you. The first analysis will divide our problems into what might be called external problems and internal problems.

Under external problems I would place first and foremost broadcasting; second, patents and engineering; third, the question of diversified retailers, with which question I also include the problem of the "gyp."

Under internal problems I would make seven classifications based on the order of their importance to the individual retailer: Service, demonstration, seasonability, sources of supply, time payments, outside sales work, trade-ins.

Allow me to discuss each of these ten points in detail and then let me sum up the situation.

1. *Broadcasting*—From the Government's latest list of broadcasting stations there are now at least 145 stations using 500 watts power or over. We have several using up to 5,000 watts.

Radio Problems Discussed by Music Dealers at Chicago

AT THE radio meeting of the Music Industries Chamber of Commerce—part of the recent convention at Chicago—the music and radio dealers who are members of the Chamber of Commerce, were given an opportunity to express freely and frankly their opinions on any question appertaining to radio. Howard A. Lewis, manager of *Radio Retailing*, was chairman of the meeting and delivered the principal address.

Some of the questions brought up, and extracts from the minutes of the dealers who talked on those subjects follow:

LARGER DISCOUNTS

H. V. Beasley (Texarkana): "One of our biggest radio manufacturers is giving the dealer at this time only 35 per cent. How in the world can we do business on that?"

E. A. Francis (Galesburg, Ill.): "I think I voice the sentiment of every good music dealer when I say that the only salvation for us is to have an exclusive franchise. I believe we can make money on radio, but I do agree that we cannot do it on 35 per cent, because we're going to have to take trade-ins."

Mr. Watkins, (Dallas, Texas): "We must have larger discounts. No retail merchant in the music business can make a satisfactory profit on 35 per cent."

"GYPS" AND PROTECTION

Mr. Manning (Augusta, Ga.): "They" (the manufacturer of a set sold by Manning) "sent representatives down to look the situation over, and they found we were doing a great deal of

advertising, and were giving them satisfaction and they protected us in every way. If dealers will buy from manufacturers who will give them protection in that way, I think this gyp matter will be overcome."

G. C. Dailey (Milwaukee): "Get high class merchandise. If you can't get protection from your jobber, take it up direct. Bombard your manufacturer if you are not getting the right protection, and if you are handling their merchandise properly you will be O.K."

SERVICE

Mr. Dailey: "We give three free service calls after the sale is made. After the customer has had three calls he pays \$1.50 an hour with \$1.50 as a minimum charge, even if it's only to replace B batteries."

We are, therefore, approaching the summer of 1925 in a position where our service to the American public is infinitely better than it has ever been before. Also controllable interference from spark type transmitters is being quickly eliminated, thanks to the help of the United States Government and to the co-operation of the British and Canadian Governments. In addition, the industry as a whole is doing much to eliminate the interference that results from various kinds of electrical apparatus. On this point we have the benefit of all the engineering skill of the entire electrical industry.

In reference to uncontrollable interference such as static, the answer is increased power. With the new Government regulations which allow for 2,000-watt stations in our cities and 5,000-watt stations placed in certain specified areas in relation to our cities, we are in a position to crash through static, which makes summer reception not only possible, but practicable. In the past it has not been that static was so powerful, but that our broadcasting stations were so weak.

In addition to all this, we have certain developments on the practical side of broadcasting. We have greatly improved our transmitting apparatus with a decided increase in the skill of the operators. Our better stations, as an example, all have duplicate apparatus and in addition they have a personnel of operators who have worked together long enough to give a smooth-working electrical and mechanical performance.

Experience Will Bring Better Programs

Finally, the programmes which the public is now enjoying represent better talent and better studio skill. We have studio musical directors who correspond to the stage directors of our theatres. These musical directors demand what amounts to dress rehearsals on the part of unknown performers before they are allowed to go on the air. When you add the increased efficiency of the broadcasting directors in bringing to their studios the best-known musical talent, educational features, and news stories, we have today a remarkable service of which the American public should be allowed to get full benefit. The real point is that today we have a quality of programme and an improvement in transmission that makes it possible for radio to be a practical 12-months-a-year household service. At present the American public can enjoy radio with a minimum of discomfort during the period which in the past has always been the radio "bugaboo." I believe that as time goes on additional improvements will be made in the art of broadcasting.

2. Patents and Engineering—The patent situation is in the "lap of the gods." I am sure, however, that out of the welter and strife will come fair, logical, and broad-minded court rulings and business decisions that will give stability and permanence to every branch of the industry.

As for engineering developments, evolution, rather than revolution, will be the order of the day. We will have, and should expect to face logical modifications and refinements in all our radio

apparatus including the matter of filament supply from the house current.

3. Diversified Retailers—To a great extent, the reputable retailer has been in the hands of the manufacturers and the jobbers. Unfortunately, the leading manufacturers up to now have not been able to control their distribution. To the extent that the selection of their distribution passed beyond their control and to the extent that the supply has exceeded the immediate demand we have had chaos.

The manufacturing end of this business is undergoing a house-cleaning. They are gathering together the necessary merchandising brains and adequate capital. You see encouraging signs in the form of sales franchise plans, restrictions of jobbers, and restrictions in the number of dealers. I do not believe that the so-called franchise plan is in itself the "open sesame" to prosperity, but I do see in this development a factor for retail stabilization and selection, providing the retailers will also put their houses in order; to wit, regardless of whether it be music stores, electrical stores, etc., the individual retailer will see in radio a business of specialty merchandising that requires on his part specialty sales methods. To the extent that this is done will there be a retail foundation on which the manufacturers can intelligently build and automatically eliminate and control the undesirable and superfluous retail outlets.

That brings us to the question of the internal problems of selling radio:

Service—First and foremost I include service. Radio apparatus is a highly technical electrical and mechanical device. You music men may call it what you will, but you are dealing with an intricate piece of mechanism, a piece of machinery which, regardless of how carefully it may be engineered and designed, must also be properly manufactured and super-carefully inspected, and even then may get out of gear in transit. Radio must be installed with care and judgment. In addition it must be kept in satisfactory operation if the public is to be profitably served. The music retailer who is going to make a satisfactory profit on his investment in radio merchandise must maintain an adequate service department. This is as necessary to the art as it is to have merchandise to sell.

I see no reason why the service department should not be a profitable part of your business. It has proved so in the automotive field and it has proved so in parts of the electrical field. It requires on the part of the management a true understanding of the relationship of service to sales and then it requires personnel in the service department who can do the work and can do it properly. In addition it requires the courage to charge a fair price for service rendered.

Demonstration—Next in importance I place the question of demonstration. Our experience in the last three years has shown us that you cannot "slot machine" radio and prosper. The only person who can possibly compete in this "slot machine" game is the "gyp." Therefore, the only way to meet this competition is to do what he cannot or will not attempt. It has been pointed

out by many manufacturers and others that the great contribution that the music trade brings to the radio art is their ability to demonstrate. No piece of radio apparatus, I am now referring to sets, should ever leave a store until the purchaser has had an adequate demonstration any more than we would think of selling an automobile without adequately explaining the control and operation of the car.

Seasonability—Third, seasonability. Regardless of what I have said about broadcasting and regardless of the progress made by engineers in overcoming the difficulty of summer reception, the fact remains that radio must compete in the summer with all outdoors. Every form of outdoor sports takes our interest away from indoor occupations and, while the portable set business has an outdoor place in the picture to the average man and woman, his relaxations in the summer time are found in other ways than in listening in on radio programmes. Of course, we have in the summer season things such as sports, news, and political events, and great artists who automatically bring renewed interest to radio, but, during the summer you face a logical period of sales depression in your radio business which must be met as a commercial fact.

Dealer Must Co-operate with Source of Supply

Sources of Supply—Fourth in importance, and closely related to seasonability and the other problems is the question of the sources of supply from which you buy your material. I am not here to make a brief either for direct distribution from manufacturer to retail or from manufacturer to jobber to retail. That problem is dependent upon the retailer's location with reference to the sources of supply and is also dependent upon the lines of merchandise that he may carry and the volume of business which he may do. The real point at issue on source of supply is the question of the adequacy of the plant capacity of the manufacturer, his inspection system, and his ability to take care of the peak load which, by the very nature of the business, is forced upon him. This question of capacity to supply holds for the jobber as well. Upon the shoulders of the retailer rests the need to co-operate with his sources of supply in the anticipation of demand. If we grant that there is a peak in the fall and winter, to maintain a smooth flow of merchandise from raw materials to manufactured product to ultimate user, the retailer must be willing to anticipate his purchases far enough in advance to make possible quantity production to take care of reasonable requirements.

I have no sympathy, personally, with the retailer who rushes into the market at the last minute and demands service from his source of supply and then whines and yaps because he does not receive all of the goods as promptly as he feels his business demands. There must be and should be mutual give and take between the retailer and the manufacturer and his intermediaries on this question of the movement of stock if we are to give the American

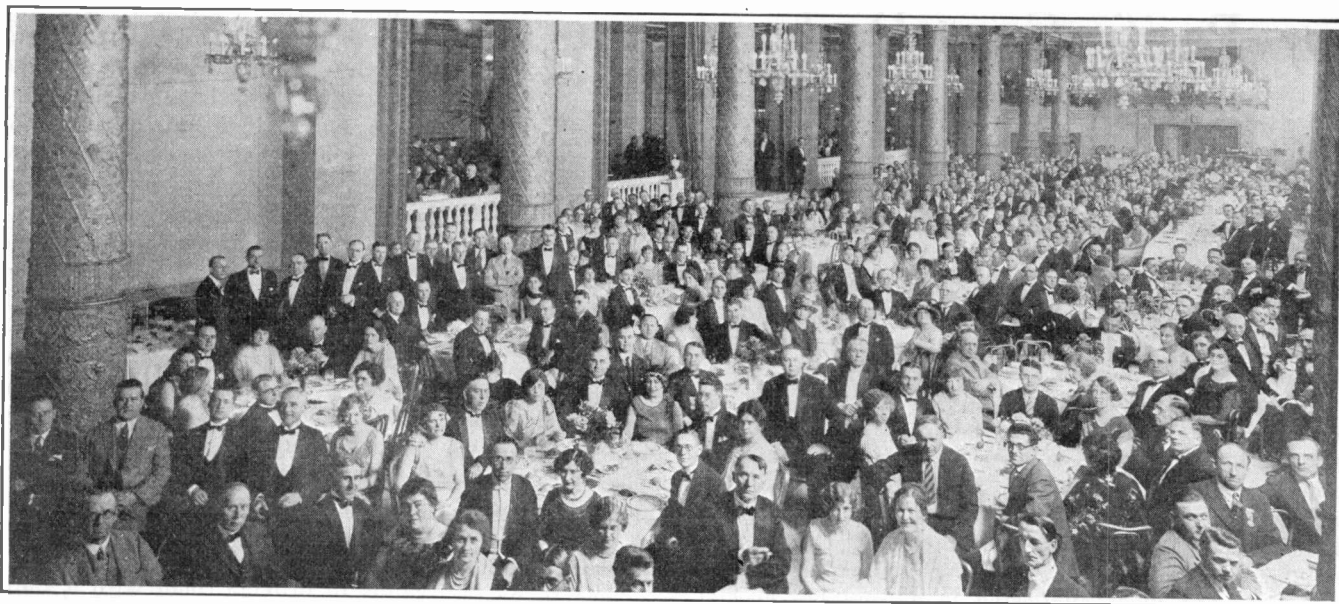

Almost 1,000 members of the Music Industries Chamber of Commerce, many with their families, attended the recent Chicago convention of this body. The highlight of

the social activities of the convention was the banquet held at the Drake Hotel, Wednesday evening, June 10, by the National Association of Music Merchants. The con-

vention was generally considered one of the most successful ever held by the Music Trades. It is planned to have the 1926 convention in New York City.

people what they are entitled to with reference to radio. To sum up, the retailer must use good judgment in the selection of sources of supply that are dependable in terms of the merchandise, both from the electrical and mechanical point of view, in terms of factories that can produce good goods consistently and will give him every assurance of careful consideration no matter what the demand. But in return the manufacturers and the distributors have a right to demand of the retailer a willingness to anticipate his requirements during the peak seasons.

Time Payments—Regardless of the present-day criticism of time payment selling and its relationship to the economic structure of America, it is a practical fact that a household device running over \$100 must be sold on time if volume is desired. The point I wish to make is that time payment selling will be used as a radio merchandising tool and we should begin by following the best practices and the best thinking of the time payment bankers. When they tell us that we should get at least 33½ per cent down and should liquidate the paper in eight months, we should give serious consideration to this recommendation and, when in addition they suggest that any sales made in the off-season should carry with them a larger down payment we should be willing to follow this suggestion also.

Outside Selling Work—I am firm in the opinion that the next real development in radio merchandising will be the intensive use of some form of outside selling. Here is a piece of merchandise that must be demonstrated. After you have "creamed" your market the surest thing to maintain volume is to take your merchandise to the public and make the demonstration in the most convenient place, the home.

They tell me that the most successful salesmen who are today selling radio work a plan whereby they make an appointment with the mistress of

the house in the afternoon and demonstrate the set in the evening. This always means two calls and one demonstration an evening. A salesman who sells radio must have a showman's sense and to the extent that he can size up the family and pick the programme that will fit their individual and collective tastes, to that extent he is a good salesman. If he can do this, 90 per cent of his sales work is done.

You can rightly ask where are we going to get such salesmen, how are we going to train them, and how much are we going to pay them. In asking these questions you are stating the problems that have faced every specialty organization since the year one.

You will get the salesmen where you can find them and you will pay them what the market price demands. This question of hiring and firing and training is a problem of management. It is my opinion that you will have to pay from about 15 per cent to 20 per cent commission. You must pay the market price for good man power and you had better face it now rather than two years from now.

The merchants who are today in the radio business, and who will be in it five years from today, will have reckoned on house-to-house selling and they will also have taken into consideration the problem of "trade-ins."

Trade-ins—Trade-ins are not something to be faced three or five years from now, it is an immediate problem. It took the sewing machine industry fifty years to develop a proper trade-in policy. In less than five years we have distributed 4,000,000 radio sets and in my judgment 2,000,000 of them should be taken in on trade right now. One point of view is to regard the trade-in as a complete loss, or nearly so, and scrap it. It may be possible with adequate service departments to rehabilitate the trade-in sets and to offer them to other possible purchasers who cannot afford to pay the price for new merchandise.

In conclusion, Mr. Lewis expressed the opinion that the trade of selling radio at retail does not belong to the electrical dealer, nor to the music merchant, nor to any one class of retail store. It is an entity in itself, sufficient to itself, and requires specialized merchandising methods.

There followed a lively discussion from the floor, in which it was brought out that music dealers desire a discount of from 40 to 50 per cent on radio products before they can show a reasonable profit from the sale of radio sets.

H. V. Beasley (Texarkana): There is one question I want to ask. How are we going to pay salesmen's commissions and give service on a discount of 35 per cent? One of our biggest radio manufacturers is giving the retail dealer at this time only 35 per cent. How in the world can we do business on that?

E. A. Francis (Galesburg, Ill.): I understood from your speech, Mr. Lewis, that you did not favor the exclusive franchise. I think I voice the sentiment of every good music merchant that the only salvation for us is to have an exclusive franchise. I bought a certain set and inside of three weeks I found in my town of Galesburg nine different businesses handling it. I believe the radio business has come to stay, and I believe that we can make money on it, but I do agree with the first gentleman that we can't do it on 35 per cent.

I do believe that we will have to have a larger percentage because we are going to have to trade-in old musical instruments—I have had four or five chances—and we are going to have to trade-in old radios.

Mr. Watkins (Dallas, Texas): Why on earth should the manufacturers say
(Continued on Page 72)

Pacific Coast Dealers Slam the "Summer Slump"

"Summer Time Is Radio Time" Is Slogan of Dealers' Organization in Effort to Increase Summer Radio Sales

"SUMMER Time is Radio Time" is the slogan recently adopted by 400 radio dealers and others interested in radio, at a meeting held in Portland, Ore. Following along the lines of this battle-cry, the Pacific Radio Trade Association, San Francisco, Cal., has issued a bulletin containing suggestions for dispelling the so-called "summer slump."

One of the ideas suggested is a "radio picnic," sponsored by radio dealers, to be held some day during the summer in a place accessible to automobiles, a prize to be given to everyone who brings a portable radio set.

Some of the things these West Coast dealers decided to do were as follows: Make "Summer Time is Radio Time" well known in the public mind by using it in all newspaper advertisements and window displays; eliminate the word "static" from the radio sales vocabulary; tell the public that higher-powered broadcasting will make summer reception a hundred per cent improved; capitalize the springtime athletic urge by telling them the sporting events and setting up exercises they can get via radio.

Selling portable sets to automobile owners is another plank of vital importance in the West Coast's summer

sales platform. They intend to cooperate with other local dealers for camp and automobile radio window displays, and have agreed to take a portable set with them whenever they go on an auto trip themselves.

For the "radio picnic," elaborate preparations were made. Broadcasting stations co-operated by announcing the event weeks before it was scheduled to occur, and they not only sent out special programs to be received at the party, but loaned some of their artists to furnish the entertainment, which was amplified for the crowd by a public address system.

Boost Service Facilities

These dealers also plan to use the summer months to perfect their service facilities. They will follow up set owners for additional tube, battery and accessory sales. This will keep set owners acquainted with the dealer and will furnish names of the owner's friends for further following up.

New buildings of all types will be watched by the California dealers this summer, and architects and builders will be urged to include wiring for radio in every room, as inaugurated in 1922 by the editor of *Radio Retailing* in his home at Bronxville, N. Y. This smooths the way for the sale of the receiver when the time comes.

Broadcasting stations will be asked to include more entertainment in their programs this summer, the dealers feeling that people want to be entertained during the hot weather and that they can sell more sets on the summer entertainment idea. It was also agreed that the store windows will be kept lighted longer and the store itself open later in the summertime, so as to catch the evening promenaders.

Other markets which will be intensively canvassed this summer include poolrooms, hotels and other places where baseball scores and market reports would be of interest; hospitals and sanitariums for radio outlets at every bedside; appeal to the families of shut-ins and invalids to provide them with a radio receiver; dance halls at remote summer camps, country clubs, etc.

Churches and other organizations which hold lawn fetes will also be canvassed not only for permission to give a demonstration, but for the sale of a set for their clubrooms.

Radio Exports Increase

Shipments of radio apparatus abroad continue to show a marked increase over last year, according to statistics given out by the Electric Equipment Division of the Department of Commerce.

The trend of exports for the first four months of the present year is toward a distinctly upward tendency, foreign sales for that period totalling \$2,720,127 as compared with \$1,222,685 for the same period of 1924.

Exports this April were almost three times last year's. April, 1924, showed \$299,903, while April, 1925, showed exports amounting to \$853,148.

Return Card Used by Southern Radio Dealer to Start Paid "Radio Service"

Dear Sir:—

Get best results regularly from your radio by using our new "RADIO SERVICE." Once a month we will send an expert radiotrician to inspect your set, test all batteries, put water in your storage battery, clean all contacts, and make a thorough report to you as to the condition of your set, letting you know if any parts are worn or needed. Such a service as this will mean better results in receiving, and will keep your RADIO in better condition.

This service, by an expert radio man, will cost you \$1.25 a month. This price does not include repairs or new parts, but it will provide a thorough examination and test of the set, adjusting, and proper care of the batteries.

Yours for better radio.

LOUIS D. RUBIN ELECTRICAL CO.
345 King Street Telephone 708

LOUIS D. RUBIN ELECTRICAL CO.

345 King Street
Charleston, S. C.

Dear Sirs:—

I want you to service my radio set once every month. Have your radiotrician examine and test my set, as you offer, and see that the storage battery is charged and filled with distilled water, and inspect all connections and see that the set is operating properly. I agree to pay you \$1.25 per month for this service.

Yours for better radio,

Address..... Telephone.....

The Louis D. Rubin Electric Company, Charleston, S. C., evidently believes the era of free radio service has passed. Reproduced herewith is a postcard and return card sent out by the Rubin company to all

known radio set owners in Charleston and vicinity, to inaugurate a radio service for the sum of \$1.25 a month. At the left is the card sent out and at the right, attached to it, is the card which the customer re-

turned. The service includes inspection of the set, tightening and cleaning connections, testing tubes and batteries, putting distilled water in storage battery and ascertaining what parts need replacement.



Cut Rate Advertising Doesn't Worry Nicolai—His Own Ads Are Clean and He Keeps Right on Selling Radio

Four Policies That Defeated the "Gyp"

Calumet Electric Shop, Pullman, Ill., Sold \$75,000 Worth of Radio Sets Last Season, Though Surrounded by Cut Rate Stores—Carried but Few Different Makes and Has Exclusive Agency for One Line

SURROUNDED by at least a score of other stores selling radio sets and supplies, the radio department of the Calumet Electric shop of Pullman, Illinois, a suburb of Chicago, sold over \$75,000 worth of radio sets in the last season.

Such a volume of business may be considered good in any locality but where a shop is surrounded by cut rate stores, there are bound to be some good reasons for this store's record.

"I believe there are four chief reasons to account for the success we have had in selling radio sets," asserts the manager of the radio department, George W. Nicolai. "Of course there are many little things that every merchant does that add to his business, but there are four main policies upon which we operate.

"Our first policy is to sell nothing but standard sets, sets that are nationally advertised and known to most radio fans by name. We specialize on one set for which we are exclusive agents in our territory, and carry several others, their prices ranging from \$60 to several hundred. In the last season we have sold 360 of the special-agent sets, and nearly as many high priced sets of another well-known make.

"By carrying only several different makes of sets we have been able to build up a reputation for each which has done much to counteract the 'gyp' stores in the district which sell any kind of a set at cut prices. We have never cut the price of any set, and people, knowing this, have confidence in us. They know that they have to pay no more than anywhere else.

Obtains Many Leads Through "Free Service" Policy

"Our second policy is to install every complete set of three tubes or more that we sell, and give a year's free service on it besides. Some dealers will say that they cannot afford to make free installations and give a year's free service but we have found that there is surprisingly little expense arising from the free servicing and the extra sales and leads obtained from the installations amply pay us for installing the sets we sell.

"We are able to offer a year's free service because we sell nothing but reliable sets. We did have trouble with one make of set, which we thought was perfectly reliable. But we were called out to repair eleven of these sets the first few weeks that

we handled them. Rather than make a bad reputation in the community, we went to every man who had bought one of the sets and either took the set back or exchanged it for another one.

"That is the only trouble we have had, and the policy we pursued in that instance has brought us many new customers and made more satisfied ones. Of course we have many calls to service sets that need only new batteries. Even here we make no charge to the owners of our sets. This may be stretching the year's service guarantee but we lose no money on the service for the profit on the batteries usually pays for the service.

"But the big advantage comes from the sale of supplies such as additional earphones, speakers, console cabinets, and so forth, that we make while putting in the fresh batteries. We find that these people often have been intending to purchase additional apparatus for their sets, and when we get into their homes it is no trouble at all to make the sales. If we did not make a policy of this free service for a year, the buyer might drop into some other store. And most of our customers will buy another set at the

end of a year, so if we keep in touch with them, it will be easier for us to make the new sale.

"Then there are the new sales we make from leads we get while servicing a set. It is safe to say that every person who buys a set from us has at least half a dozen friends who have seen his set, and admired it. While giving free service we usually get the names of these friends. When we sell a set we can always count on that set selling several others."

The third policy of the Calumet Electric shop is its demonstration plan. "We make free installations and leave the set in the prospect's home for three or four days on trial," explained Mr. Nicolai. "Where the sale is not closed we charge only for the aerial equipment used. In obtaining permission to make a trial demonstration, we use the telephone to a great extent. We go over a list of leads every day and call as many as possible over the phone, asking permission to make a trial demonstration, explaining our plan. We have found that after a man has permitted us to make an installation, we seldom have to take the set back to the shop.

Offers Prizes to Set Owners for Other Prospects

"In making a trial demonstration we leave the set in the prospect's house for three or four days. In that length of time he has become in the habit of using the set and depending upon it for his entertainment. Even in trial demonstrations we try to make the installation just as neat as possible, for the prospect

"Carry Fewer Lines of Receivers"

is the advice of George Nicolai, of Pullman, Ill., who is successfully combating the so-called "gyp" stores in his neighborhood. By carrying only several makes, and having the exclusive local agency for one make, Nicolai was able to build public confidence in the sets he sells.

The four policies, to which he attributes his success are:

1. Selling only standard, well-known products
2. A year's free service, resulting in many leads
3. Leaving a set on several days' demonstration
4. Selling receivers on the installment plan

hesitates just that much more to make us take the set down after we have taken so much pains in putting it up."

The Calumet Electric Shop has a plan of getting good leads and of making its customers their salesmen that has been responsible for about half of its sales. To every person who buys a set, it offers a new set of B batteries or an inexpensive piece of apparatus for every lead he gives that results in a sale of a set. Many good leads are obtained in this way. There is a bit of unexplained psychology in men that makes them

work for a small prize, and it is this that gets the good leads for the shop.

"In offering this prize," said Nicolai, "we are in no way making a cut or destroying the regular retail price of our sets. We suggest this plan to any merchant who is bothered by cut rate stores, rather than trying to meet their prices. It has been my observation that every legitimate radio merchant who tries to meet cut rate prices loses in the long run."

The fourth policy of the shop is also a good method of defeating the "gyp." It is installment plan selling. "We have found that even the people of means like to buy on the installment plan," Nicolai continued, "and there is no other way to sell high priced, reliable sets to the man of small means, to whom the 'gyp' makes most of his sales. Cutting prices does nothing toward giving the small-salaried man a chance to buy a good set.

"So to get everybody's trade we have devised three installment plans. In the first we charge no interest. One-fourth of the price is required on purchase, and the remainder is divided into three monthly payments. In the second and third plan we also require one-fourth down but charge interest on the remainder at six per cent. In the second plan the payments are divided into five monthly payments exclusive of the first payment, and in the third plan the remainder is divided into eleven monthly payments.

"By following these four policies strictly we have found that we have little trouble from the 'gyp' radio stores, and are doing a business that we are proud of in every way."

Radio Exposition Planned for Los Angeles

A Radio Exposition is to be held in Los Angeles under the auspices of the Radio Trade Association of Southern California at the Ambassador Auditorium, September 5 to 12. The exposition is to be preceded by a meeting of radio dealers from all sections of the state.

Throughout the week of the event, a program will be held in the Ambassador Theater from 1 to 2:30 in the afternoon. This will be open to dealers and the public alike. The committee in charge of the Exposition consists of Carl A. Stone, Les Tafenback, W. D. Scott, J. A. Hartley, A. G. Farquharson, J. W. Boothe, H. S. Mason, L. J. Smith and G. F. Hall.



George W. Nicolai, manager of the radio department of the Calumet Electric Shop, Pullman, Ill., demonstrates the fine points of a radio coil to one of his customers.

"The legitimate radio dealer who tries to meet the prices of the 'gyp' store is slipping the noose around his own neck," he declares.

This Business of Ours

- ¶ *Why Worry About Seasonal Depressions?*
- ¶ *Bright Prospects for the Fall*
- ¶ *Plan Next Season's Campaign Now*
- ¶ *Comparing This Summer with Last*

A Monthly Department of Retail Radio Comment
By J. ANDREW WHITE

AT A business luncheon a few weeks ago a "that-reminds-me" story occurred to me which I feel inclined to repeat here. The gathering was composed exclusively of members of an electrical supply league and they had just voted to discontinue their regular monthly meetings over the heated period and to resume in September, when the chairman called upon me for the customary after-eating address. Now an introduction quickly following upon an official recess-taking hardly calls for an inspirational speech, and furthermore it appeared that there was nothing to get steamed-up over, anyhow; these fellows were all relaxed and comfortable, smoking placidly and in no apparent hurry to get back to work. It seemed appropriate to tell the story of the man who never could get his mind off the concerns of business.

The story is told in humorous vein; very briefly, its essentials amount to this:

A Hebrew on his death-bed had expressed the wish that all the members of his family be summoned for a last farewell. Through eyes over which the film was already beginning to gather, he looked about and then asked his wife if his youngest daughter, Rachel, was there; she assured him that she was; and then he asked for the next oldest, and so on, through inquiries about the remaining three daughters, each time being given the assurance that they were all standing at the bedside. Then his inquiries turned to the four sons, successively, and tenderly he was told that they, too, individually were in the room. Then came a final inquiry, in a voice growing

fainter and fainter. It was for Grandma, and was she there, too? The grief stricken wife's gentle response was that she was; that they all were present, adding, "Now, Abr'm, don't worry; everybody's here—everybody." Whereupon the weakened old man made one last effort, raised himself on his elbow and hissed: "Dot's it; oy, yoi! everybody's here—who's taking care of the store?"

And as in jest many a true word is spoken, I can't help but think that there's a moral in that light anecdote.

A lot of radio dealers are needlessly concerned about the store, and its fate, all the time, whether it's opportune or obviously just that much wasted effort.

Don't Be Discouraged in the Slow Periods

I dropped in on a neighboring retailer and competitor the other day, for a chat. There was nobody in his store, not a single customer; and he was pretty glum. Business was all shot to pieces, and to hear him tell it, things would never be the same again. Viewed in the light of contrast, I had to agree that the situation was not a happy one, but a large part of his trouble lay in his mournful recollections of crowded counters and filled demonstration rooms a few months back, in comparison with the present dreary waste. Buying had stopped earlier than usual this year, and that was bad enough; but when he compared his daily average sales of last year in the slack season with the corresponding summer days thus far this year—well, there was no ques-

tion about business being on the down grade. I think that his attitude of mind is generally typical of radio retailing.

But suppose we look at the situation a little closer. Last summer we had the advance excitement of a presidential election; we haven't any substitute in broadcasting now for the conventions and speeches that brought us then a very material volume of business. Sales are bound to be less. And last year, too, we didn't have the dumping of sets on the market for a song, which I referred to in last month's article as the destroyer of public confidence that stopped legitimate buying demand short in its tracks.

So the picture is a little different.

The summer of the year before last was more like this one. There was no business, to speak of. But what a season in the Fall!

I see no reason why we can't expect the same thing again.

And it is just possible that many retailers would be better off if they stopped worrying about who is taking care of the store, now, relaxed a bit from the high tension of the difficult season we have gone through and took up a vantage point of freshened perspective for the things that are ahead.

There is nothing in particular to be gloomy about. If the radio retailer is worthy of the name merchant, he has had sufficient foresight to cut down his overhead for the summer months; far fewer salesmen are needed, and a lesser number of service men; and certainly advertising, which is based upon a definite percentage of gross sales, automatically cuts itself down. The

whole idea is to temper efforts with reason; the go-getter spirit is great stuff, but holding expectations that by sheer will power one can offset the influences of a demoralized market in an off season, lead only to gray hairs and disillusionment, as I see it. The industry has had to learn a bitter lesson this year and it is reasonable to expect that the hysterical "dumping" and consequent cutting short of the normal buying season will not soon be repeated. Maybe out of this experience a lesson will be learned. . . .

Look to the Future—Don't Fret About the Present

The point now is, that the outdoor market and supply and accessory renewals have constituted practically the whole of our summer sales possibilities. If these have been covered intelligently and energetically, well, that's that, and the retailer who is clarifying his vision for a look ahead to future prospects is doing his duty by his business far better than the fellow who is fretting about present day unpleasantness and overlooking the reasonable expectation that customers will again come trooping into the store and merchandise and service must meanwhile be made available for their needs.

Now, don't expect me to tell you what to buy. It's a little too early for that, and besides, there is no universal prescription that will cover the needs of small stores and large, scattered all over the country. But I do think it will be very helpful if retailers in general adopt a policy of carrying fewer lines than last season and concentrating sales efforts on merchandise which has gained their full confidence. This is not going to be so very difficult, because fewer announcements of "revolutionary" changes may be expected; then, too, a lot of smarting fingers have already been withdrawn from the pie of quick clean-up manufacturing, and firms that expect to stay in business will be more easily distinguished from the opportunists.

So, looking at the bedrock of things, a vital matter is the condition of business in general. In radio we are selling a luxury, consequently nothing is more important than general prosperity. And, personally, I don't see how pessimism can live in the face of the facts that are plainly evident. Such a basic commodity as steel is reported to be behind the demand in production;

records are being broken in railroad traffic; wheat prices have rebounded sharply; domestic cotton consumption is at the peak; bank clearings are the greatest in our history, and—in the luxury class—automobile selling is so vigorous that many manufacturers are running behind in their deliveries.

Psychology may be a much abused word, but I like it because it stands for nothing more or less than an analytical study of the causes back of a hunch—so psychology it is, of the sales variety, to look upon the summer cessation of sales effort as something of a blessing. You know, we have made an awful ballyhoo about radio, and its romance, and its charm and its unrivalled entertainment values—it's just possible that the public by now is fed up with the constant urge to get aboard. If we let them alone for the summer and ease up on the wig-wagging of their attention away from things that form their accustomed recreation, it is likely that in the Fall the appeal of broadcasting will hold something of the glamour of the return of an old and valued friend.

Two years ago we had a summer cessation; it was for a different

A Birthday Card for "Roxy"

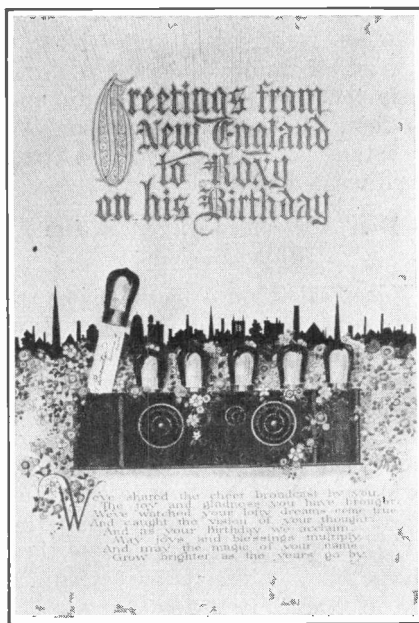

"Roxy," otherwise S. L. Rothafel, a familiar radio broadcasting figure, because of his Sunday evening Capitol Theater programs through WEAF and allied stations, will be the recipient, on his birthday, July 9, of the card reproduced above, as a testimonial to his popularity. "Roxy" inaugurated, and carried through to a successful conclusion, the fund to equip the disabled war veterans' hospitals with radio. The card is the gift of "Roxy's" New England admirers and is hand-colored, measuring 25 x 38 inches. It is in the form of a radio set, and each tube can be pulled out, disclosing the signature of the Governor of each of the New England States.

reason—the manufacturers were trying to catch up—but as I said before, what a season it was when the Fall did come.

Now if all this sounds a little bit like letting everything slide for a while and going off for a good time, that is only a half-truth. Summer may not be a good time for doing, but it is the best time for planning and trying-out. That I really believe this, is disclosed in two instances—fourteen years ago, in July, I launched my first radio magazine; just four years ago we picked the month of July to introduce practical broadcasting of entertainment for the first time to the public. So it wouldn't be consistent for me to recommend to others to stand around and do nothing. Besides, that isn't what I mean at all. The idea is to stop fretting, stop worrying, champ-ing at the bit, or whatever you choose to call it.

Advocates "Fewer Stations and Better Programs"

If nothing else occurs to you to do, take your pen in hand and get busy on the matter of fewer stations and better programs. Mr. Hoover has announced the calling of a radio conference at Washington in the early Fall; and there is no subject to come before that body which could possibly equal in importance that of supplying the entertainment which sells our sets. It is nothing short of the duty of every retailer to unite with the industry in asking for the establishment of a program standard which stations must live up to, or get off the air. There are too many stations now—an even hundred would be plenty—and one of the most effective ways of weeding out those who would never be missed is to make it obligatory upon all stations to supply a program worthy of the tremendous radio audiences.

Never mind about the lack of authority to bring about such a change; if the statutes don't give it now, they can be revised. The main thing is to let them know at Washington that this is something we want done. One sure way to do this, is to write to the Secretary of Commerce and say so. It is the program that sells the sets, and furtherance of commerce is Mr. Hoover's principal job. Aside from which, he is the mentor of radio—a fortunate combination all around for us who are in the retail business.

Will you write? . . . I wonder.

Jobbing Margins on Radio

Wholesalers' Gross Earnings on Sets, Batteries and Chargers, Compared with Jobbers' Margins in Other Lines

AT THE Hot Springs, Va., convention of the Electrical Supply Jobbers' Association, June 4, W. R. Herstein, vice-president of the Wesco Supply Company, electrical jobbers, Memphis, Tenn., presented the accompanying figures, showing the gross earnings by twenty-one electrical wholesalers on various radio items, and comparing these margins with those granted recognized jobbers in non-radio merchandise.

Jobber Number	1	2	3	4	5	6	7	8	9	10	11
Miles from New York	0	200	300	500	600	700	700	700	800	1,000	1,000
Freight included?		No	No	No	No	Yes	Yes	Yes	No	Yes	Yes
Radio Sets, etc	16.6	21.3	18.8	21.3	19.9	21.5	22.0	20.9	21.6	19.7	19.1
Dry Batteries	21.1	18.0	19.7	29.1	17.5	20.	25.	21.4	24.2
B Batteries	20.6	20.1	21.	21.5	24.2
Battery Chargers	19.0	20.2	22.	18.	25.5	21.6

Jobber Number	12	13	14	15	16	17	18	19	20	21	Average
Miles from New York	1,000	1,200	1,200	1,200	1,500	1,500	2,000	2,500	3,000	3,000	Margin
Freight included?	Yes	No	No	Yes	Yes	Yes	Yes	No	Yes	Yes
Radio Sets, etc	20.3	21.6	20.0	18.3	20.1	91.2	20.2	20.0	20.1
Dry Batteries	18.7	27.4	20.0	19.0	19.4	12.5	21.7	21.2	27.7	21.3
B Batteries	20.3	21.3	20.5	19.0	24.2	22.9	21.0	20.6	21.3
Battery Chargers	22.	26.8	17.2	21.6	25.1	21.4	21.7

Jobbers' Margins on Other Merchandise Lines

Wholesale Automotive Equipment		Screen Wire	11.4	Patent Medicines	15
	Margin	Metal Roofing	10.2	Paints	15
Springs	33.3	Wholesale Plumbing		Chemicals	14
Brake Linings	30.5		Margin	Lead and Oil Compounds	10
Motometers	26.8	Cast Iron Soil Pipe and Fittings	25.0	Tobacco	10
Shop Equipment	22.0	Plumbers Brass Goods	22.5	Average Margin	17.2
Spark Plugs	21.5	Wrought Iron and Steel Pipe	21.5	Expenses	16.3
Horns	20.8	Brass Pipe	20.0	Net Earnings	0.9
Chains	18.8	Wholesale Dry Goods			
Bumpers	16.7		Margin		
Average Gross Margin	24.9	Enameled Iron Ware (Bath Tubs, Lavatories and Kitchen Sinks)	18.0	Millinery	25
Operating Expenses	23.4	Cast Iron and Malleable Pipe Fittings	17.5	Queensware	24
Net Earnings	1.5	Brass Pipe Fittings	17.5	Men's Hats	22
		Plumbers Lead Products	17.5	Silks	20
		Cast Iron Heating Boilers	15.0	Dress Goods	20
		Cast Iron Heating Radiators	7.5	Shoes	20
				Notions	20
				Hosiery	18
				Overalls	17
				Carpets and Rugs	16
				Ginghams	15
				Linoleum	14
				Duck	12
				Sheetings	11
				Window Shades	10
				Threads	10
				Average Margin	17.6
				Total Expense	16.6
				Net Earnings	1.0

Wholesale Hardware		Wholesale Drugs	
	Margin		Margin
Pocket Cutlery	25.0	Bulk Goods	25
Flashlights, Batteries, Bulbs	22.5	Fluid Extracts, Elixirs, Tinctures	22
Farm Implements	22.0	Rubber and Bristle Goods	22
Glassware and Queensware	21.9	Stationery	22
Auto Accessories	20.2	Patent Medicines, Non-Secret Formulae	20
Stoves and Ranges	20.1	Candy	20
Tools, Hatchets, Axes	19.0	Soda Fountains and Fixtures	20
Household Specialties, Refrigerators, etc.	18.4	Perfumes and Cosmetics	18
Harness and Saddles	17.9	Glass Bottles	18
Prepared Roofing, Building Paper	15.8		
Cotton Rope and Other Cordage	13.1		

A Season of Sound Growth Ahead

(Continued from page 21)

was limited, the cars were as good as they could be made, there could be no improvements, one car would last a lifetime and all these things being true the automobile industry was on its last legs the first year of its existence—therefore, these men closed up their shops, sold their holdings in motor car companies and started confectioneries, grocery stores or pool rooms.

That is exactly where they should have started and radio dealers and manufacturers who do not look beyond the horizon where hard work, disappointment and sometimes despair confronts them, into the future growth of the radio business, should do exactly the same thing. Only by realizing the importance of steady, substantial expansion, the reliability of the radio industry, the fact that big radio manufacturers have come into being faster than they did in any other known industry, can those people in the radio industry, especially the retailer, see a vision which spells an early retirement, winter in Florida and summer in Maine, a few Cooks' Tours through Europe and a life of peaceful repose—made on radio profits honestly earned by selling an honest line of radio merchandise.

The radio dealers who are now hardest hit ordinarily are handling merchandise backed with little more than a storeroom workshop, forgetting the quality and perfection of the radio product, and looking only at the profit which could be made. These same dealers, were they to identify themselves with a substantial radio corporation, manufacturing guaranteed products, would grow and grow—otherwise they die.

Build Confidence in Parts as Well as in Sets

By H. B. RICHMOND,
Secretary, General Radio Company,
Cambridge, Mass.

In spite of the increased sales during the past radio season most radio dealers have not made anything like the profits they anticipated. Many, on the other hand, have made unusual profits. Why? We all know that it is not the profit on the first few items that counts. When we buy a standard package containing ten instruments we only succeed, in the average case, of covering expenses of all sorts when we sell the first eight or nine. Our profit is the sale of the last one or two. If we give away 10 or 20 per cent discount on each item in our standard package of ten, we must sell all of the ten in order to break even. These conditions apply particularly to the parts business.

When broadcasting first started, the sale of sets was only a small proportion of sales in the radio industry. The people interested in radio were those with electrical and mechanical tendencies who preferred to experiment. What sets that were available were sold at a high price. Many people without electrical tendencies were interested in receiving radio programs. The cost of a set

was prohibitive; they could assemble their own set for a price perhaps one-third of that of a complete set. The influx of these people into the radio industry gave a tremendous stimulus to the parts business. As radio increased in popularity sets were made in ever-increasing quantities so that unit costs were materially reduced until today a person attracted to the novelty of radio reception can purchase a set for as small an amount as he could assemble one himself. Price, therefore, no longer has any appeal.

Today the parts sales must be to those who are interested in experimenting with radio. The American nation is notably a nation of experimenters. There is, accordingly, a host of people interested in experimental work. The total volume of sales, however, can never again be expected to approach the volume of the sale of sets. The problem of the distribution of radio parts must be met by consideration of these changed conditions. In this discussion, accessories have not been considered as radio parts. They go with both the parts and set business.

Unfortunately, during the past season, radio parts have been handled by many dealers that are generally classed as undesirable. They believed there was a profit in radio parts and have taken them on as a sideline to their bakery, shoe shop, or whatever type of business they were engaged in. They found that this would not pay. They cut prices materially to move their merchandise and the general feeling has been that price-cutting is a necessity in the parts business. The better class of dealers want no connection with a business in which price-cutting is prevalent.

Price Is no Longer a Factor

Price-cutting disturbs the entire distribution program. It starts by creating skepticism on the part of the ultimate consumer. He does not understand the reason. It is fortunate that the price appeal is no longer of great importance in the parts business. The user of parts is the experimenter and he is discriminating. A sales policy must, accordingly, be built up on this basis.

* * * * *

The best of merchandise, backed by a house of reputation, cannot be sold if that house should suddenly start on a vacillating policy. A firm policy must be adopted. The distributor wants to know that he can rely on the manufacturer to treat him fairly after he has developed a market for the manufacturer. The dealer, in turn, wants to know that if he has created a consumer demand by displaying the parts in his window, the distributor will not come along and sell another dealer in the next store to him. In the past too many stores and too many brands have taken up all the profits in the radio industry. Present conditions seem to indicate that in the parts business the best effort of distribution is for the manufacturer to select a limited number of distributors and, in turn, have his field representatives see that a limited number of dealers are served by the distributor. The dealer should reciprocate by handling as limited a number of lines as is practical. If the manufacturer is willing to limit his sales to a few distributors and, in turn, to a respective dealer in each community, the dealer must be expected to limit the lines he is handling to the manufacturer giving him exclusive protection.

Static—How to Minimize It

When Your Customers Ask You About Summer Static, Tell Them the Truth—It Does Not Seriously Hinder Warm Weather Reception and Its Interference Can Be Reduced

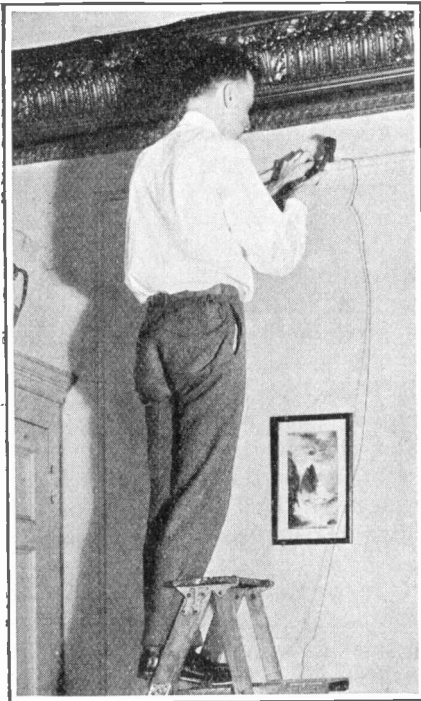

There are three simple ways of reducing the interference of natural static. They are (1) Use an indoor aerial strung along the picture molding—

By EDGAR H. FELIX

YOU never hear a Californian talk about the rainy season; he always refers to his native state as the land of sunshine. Radio dealers try the same kind of dignified evasion with regard to static. But the secret is out; static has received the full benefit of publicity. Most prospects have a more or less hazy notion about it and they cannot be cured by evasion.

The best way to answer inquiries about static is to tell the whole truth about it. Remove from the customer's mind the popular misconceptions regarding static disturbance, which are often exaggerated to the point of discouraging the purchase of the receiving set, by frank admission of the facts and firm exposure of the misconceptions. Only such a course will enable you to win the confidence of the customer so that he will believe all of your statements.

The three principal misconceptions which are current regarding static are as follows:

1. That a radio antenna attracts lightning or accumulated static;
2. That static makes summer reception practically impossible; and
3. That there is no means of minimizing the disturbing effect of static.

Each of these statements is false and can be met with definite refutation. But before discussing the true facts about them, let us agree upon just what static is.

What Is Static?

According to a very generally accepted theory, there is above the atmosphere, many miles above the

to the plate of a huge condenser which has facing it another immense plate, namely the earth. Separating these two plates is a dielectric, consisting of the earth's atmosphere. When this upper layer becomes very highly charged with respect to the earth, there is a strong tendency for the charge to leak through the earth's atmosphere. Humidity helps to weaken the insulating properties of the air. Consequently, when humidity is high, static increases. When the atmosphere is dry and clear, the leakage is small and we do not have much static.

Clouds are good conductive bodies and, being within the electrostatic field of the huge terrestrial condenser, they sometimes accumulate such very large charges that there is a breakdown of the air insulation, accompanied by a blinding flash of lightning.

Since static is energy derived from the sun, just as the light and heat of the earth are derived, we may always expect to have it with us. But it is not really such a formidable



(2) Use a directional loop aerial, adjusting it to the point where the signals are loudest and the static weakest—

earth's surface, a fairly good conductive layer which becomes charged with electricity, presumably by energy radiated from the sun. We are not concerned as to just how and why this conductive layer becomes charged nor in discussing the large amount of supporting evidence which science has collected to support this theory.

If we assume the existence of a conducting layer many miles above the earth, this layer may be likened

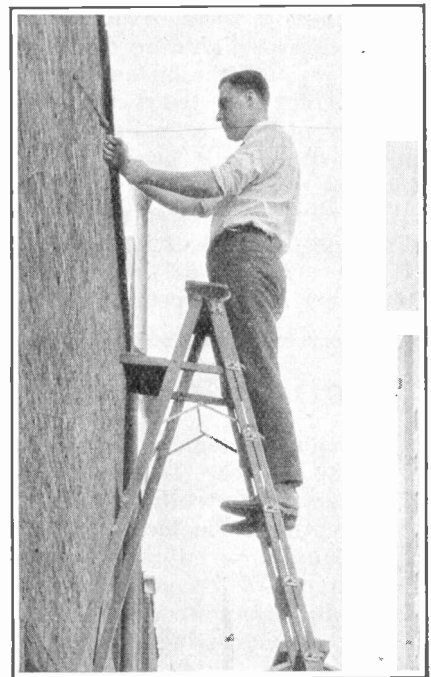

Or (3) Shorten the outdoor antenna to a length best suited to the individual set, and perhaps, change direction of aerial.

enemy to radio as some pessimists would have us believe.

"Is it true that static charges may accumulate in an antenna and cause either shock or fire?" asks a nervous old lady whose ten-year-old grandson has induced her to inquire about a radio set. Give her a real answer. Here are the facts—

Millions of radio sets have been in operation for fully three years without a single casualty or fire attributable to an antenna. This is sufficient evidence of the ridiculousness of this claim. It is true that a large multiple wire antenna which is not grounded may collect a charge during heavy static which may jump a distance of four to six inches to the ground lead. However, with an antenna equipped with a lightning arrester, there is no possibility of the accumulation of such a charge, even if the antenna is not otherwise grounded.

In addition, practically all receiving sets are so designed that the antenna is conductively grounded through a primary inductance so that static charges are instantly passed to the earth without the possibility of accumulation in the antenna system. This protection, coupled with that afforded by a lightning arrester, eliminates all danger from static.

Some nervous temperaments believe that antennas attract lightning. If aerials do that, fire escapes are a still greater source of danger; so are plumbing and heating systems.

It requires a force of billions of volts to cause a lightning discharge to break through the distance of six or seven miles from the clouds to the earth. If an infinitesimal stretch of copper wire, thirty or forty feet above the ground, has any influence on the tremendous force exerted in a lightning discharge, it would be advisable not only to remove your antenna but also all metallic objects

Trees Make Good Summer Aerials

according to a discovery by General Squier, U. S. Army, retired. A nail, driven about three inches into a tree, and connected to the set with insulated wire, reduces static to an appreciable extent and makes reception louder and clearer.

Turn to page 51 and read about General Squier's experiments.

in the vicinity of your home, such as lightning rods, because these, like your antenna, are also grounded. But considering the power of a bolt of lightning, a pound or so of copper has as much influence on its course as a penny whistle upon the flight of a 16-inch shell.

Summer Programs Maintain Winter Standards

When a prospect talks about static as a force which robs him of summer radio, call his attention to the attractiveness of local programs. Program managers of the principal broadcasting stations do not relax their efforts to maintain the same high standard of program value which obtains in the winter months. Static does interfere with comfortable headphone reception, especially from long distance stations, but loud speaker reception from moderate distances is perfectly feasible and enjoyable. There is no more reason for putting the radio set in camphor balls during the summer than there is for carrying an umbrella to work every day of the year, or storing your car for the winter. A radio set with a good program, doing its duty on the piazza during the summer, is a valuable social asset.

Static Does Not Kill Summer Reception

as many customers have been led to believe. Tell your customers the truth about it. Reception from local stations is equally as enjoyable as in winter, DX reception is not wholly eliminated, quality of the broadcasting programs keeps its winter levels, and higher-powered stations will

push the signals through over the natural noises.

Also, tell them that aerials do not attract lightning, they do not store electric charges, and that a shortened aerial, or indoor loop, or using a tree as an antenna, are tried and proven ways of reducing static interference to a minimum.

Static can be minimized by the elimination of very long antennas and through the substitution of a small indoor antenna.

Even better than a small antenna is a loop receiver. But for receivers not adapted to loop reception, a 15 or 20-foot indoor antenna is practically as good. Both these means of picking up ether waves not only minimize the effect of static but also secure much sharper tuning. Also, it has been found that a nail, driven three inches into a tree and connected by insulated wire to your set and used as an aerial, eliminates a great deal of the natural noises.

Summing up, we arrive at three conclusions about static. They are:

1. It is true that static does interfere with long distance headphone reception. But even in summer there are good nights which permit long distance work.

2. It is true that local and moderate distance reception from high power stations is perfectly feasible in summer and that programs offered by large stations are maintained at mid-winter standards throughout the year.

3. It is true that static will be forgotten as the power of broadcasting stations is increased and that the sensitiveness of receivers may then be reduced accordingly, not only minimizing the effect of static but also that of radiating receivers, carrier waves from long distance stations and radiation from power transmission systems.

Sell Through Home Demonstrations

The J. W. Greene Company, Toledo, Ohio one of the largest and oldest music houses in Ohio, has made a rule that salespeople shall not demonstrate a set in the store but must confine the demonstration to the home of the prospect.

Away from the downtown interference the results are always better. The set may be shown, analyzed, and the time for the demonstration decided during the conversation in the store but the actual demonstration is given only in the prospect's home where "sales resistance" is considerably lessened.

In installing the set for the home demonstration, care in erecting the outside aerial will play a big part in obtaining the most satisfactory results.

Bringing Tubes Back to Life

Method Used by Haynes-Griffin to Re-activate Inoperative Tubes—Description of Apparatus Used and Its Cost of Construction

PUBLIC attention has recently been arrested by advertisements of several radio dealers who claimed they could revive vacuum tubes of the "hard" type. Immediately these places were flooded with the questions, "How much does it cost?" "How long will it take?" and "Does it really work?" It does and now tubes are flocking in to these dealers for rejuvenation.

Among the first of such dealers was the Haynes-Griffin Radio Service of New York and Chicago, whose apparatus itself is nothing more than a sixty-cycle step-down transformer, a variable resistance, a number of tube sockets, and a filament volt and ammeter. The sockets are connected

ten or twelve months and finally ceases to operate, will not give the same length of service as a tube only two or three months old.

The filament of the modern vacuum tube of this type is constructed of tungsten, impregnated with thorium, which is apparently the electron-emitting element. Being driven rapidly from the surface of the tungsten by an excess current, it is necessary for the thorium inside the tungsten to seep through to the surface before the tube can function. The older the tube the less thorium remaining for emission and the less the chances are for the tube being rejuvenated.

There is no doubt that such a piece

Additional summer profits are being made by many dealers who were foresighted enough to install a tube rejuvenator.

In response to many inquiries and requests, "Radio Retailing" publishes on this page, wiring diagrams for two types of re-activators, together with instructions for building and operating them.

and only the so-called "hard" tubes can be rejuvenated. The type 200 cannot.

An ideal tube rejuvenator for a large number of tubes, employing from five to ten volts on the filaments, may be constructed easily and supplied directly from the power lines without the use of a transformer. It will be found that fifty tube sockets, one 60-ohm variable resistance capable of carrying two amperes, a 15-volt AC voltmeter, and a one ampere AC ammeter wired as shown in Fig. 1, will renew any number of tubes from 10 to 50 at one time. The desired voltage may be determined by a voltmeter connected directly across the terminals of one socket, and is controlled by the rheostat. The ammeter is not absolutely necessary but is convenient for checking the current. No tube must be removed from a series of sockets until the current is turned off and all the sockets in a series must be filled.

For the dealer who has but a few tubes to re-activate at one time, a five-tube rejuvenator, still more easily constructed, would do. A transformer capable of delivering two amperes at ten volts, a 25-ohm rheostat, and five sockets, wired as in Fig. 2, would be found very satisfactory. In this case as well as the other, the voltmeter would be necessary while the ammeter would not. With this, one, two, three, four, or

(Continued on Page 68)

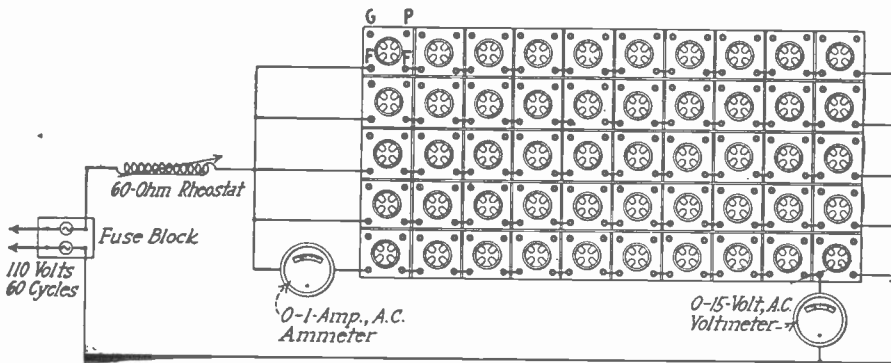

Fig. 1—Wiring Diagram for Fifty-Tube Rejuvenator

either in series or parallel, depending upon the secondary voltage of the step-down transformer. The variable resistance controls the voltage applied to the tube filaments.

The actual methods of different dealers vary to a certain extent. Some maintain that the correct method is to apply from five to seven volts to the tube filaments for a period of twelve hours, while others claim that a sudden impulse of current at ten or twelve volts for a few moments, then a gradual voltage drop until the voltage at the filament is normal, and continued for two to two and one-half hours, is more efficient. However, the average number of tubes that "come back" is not more than fifty per cent.

Those tubes that do function again at their original efficiency will be found to give twenty-five to forty per cent of their original life, although this does not hold true in all cases. A tube that has been used

of apparatus in a retailer's store will increase his business as it brings customers and publicity. Some dealers make a charge of fifty cents for each tube renewed, others make no charge at all but only handle tubes that were purchased at their store. A tube rejuvenator built to accommodate one hundred 201-A tubes may be run twenty-four hours at a cost of approximately eighty-four cents.

Voltages applied to tubes such as the type 199 should be in proportion,

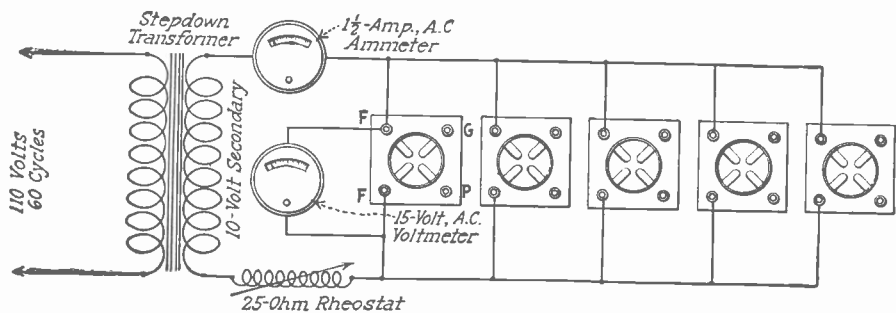
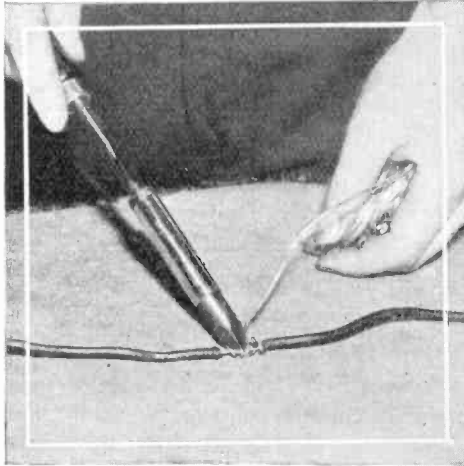

Fig. 2—Wiring Diagram for Five-Tube Rejuvenator

Here's a Profitable Activity for July

Radio Dealers Can Perform a Service of Benefit to Themselves as Well as Their Customers by Putting Into Effect a Campaign to Overhaul Every Radio Receiver



Go over lead-in and ground, tighten clamps and connections and solder where necessary. Test other possible grounds for louder signals.

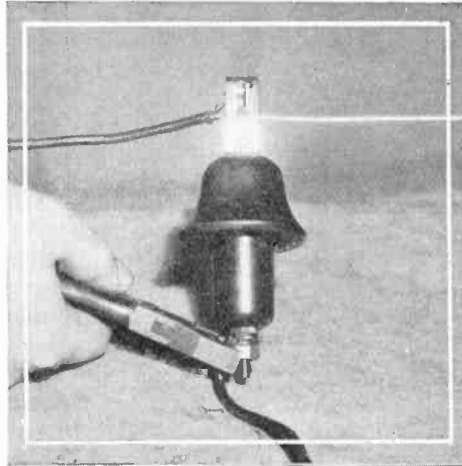

Inspect antenna, insulators, lightning arrester and tighten connections. Use temporary aerial and try it in different directions until reception is best.

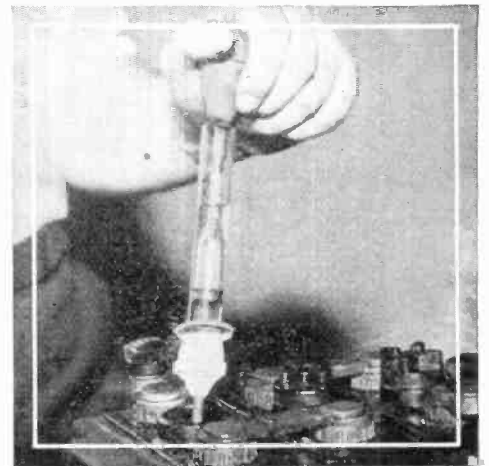

Test and charge storage battery. Fill with distilled water and re-fill with new acid, if necessary. Remove corrosion on poles and clips. Fuse storage battery leads as now required by National Electrical Code.

AUTOMOBILE owners have acquired the habit of taking their cars into auto service stations at regular intervals and having them overhauled. Radio sets that have been functioning six months or more need precisely the same kind of looking over. Get started on the idea now! On this page is a pictorial presentation of the testing, cleaning and servicing every radio set and installation needs to improve summer reception. And on Page 41 are wiring diagrams for tube rejuvenators so that you can perform that function for your customers as well. Practically the entire charge is profit, for the only expense is that of time, and cartage of the set from the home to the store and back.

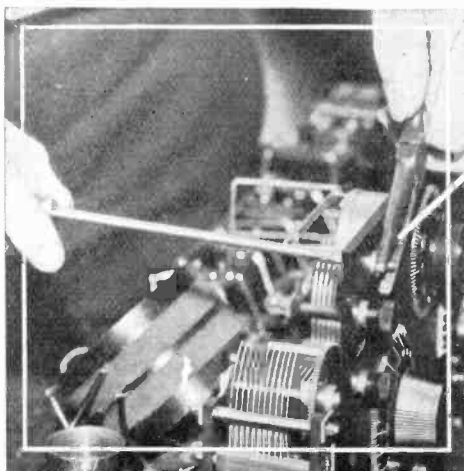
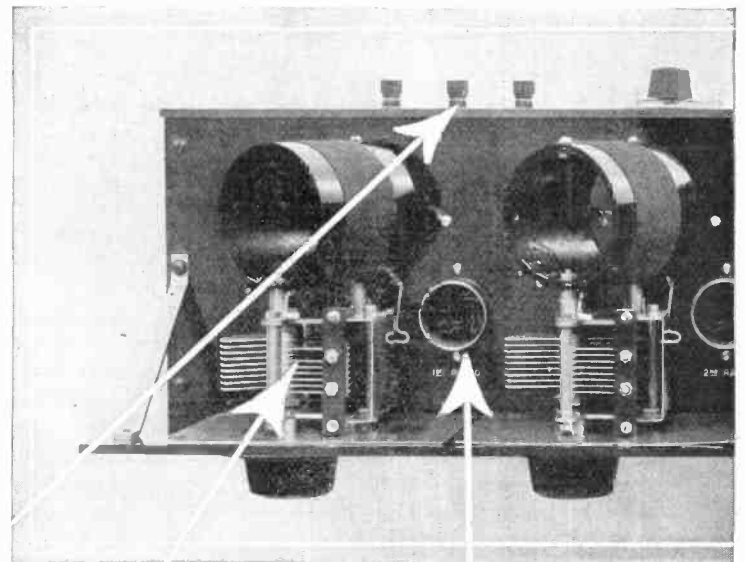

Tighten binding posts and connections and solder all loose or near loose connections. Do all work on the set itself in your own shop.

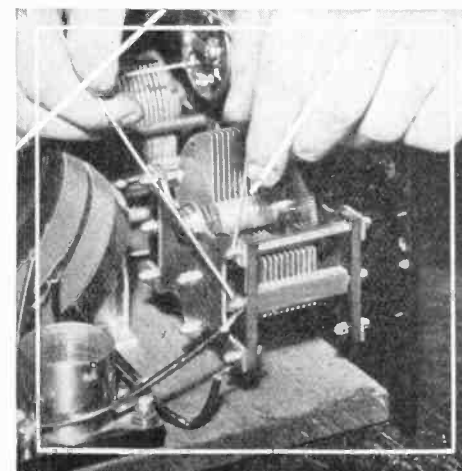

Clean plates of variable condensers. Tighten connections and test with earphones, after closing filament circuit. Cross stator and rotor plates with earphone leads. Click should result.

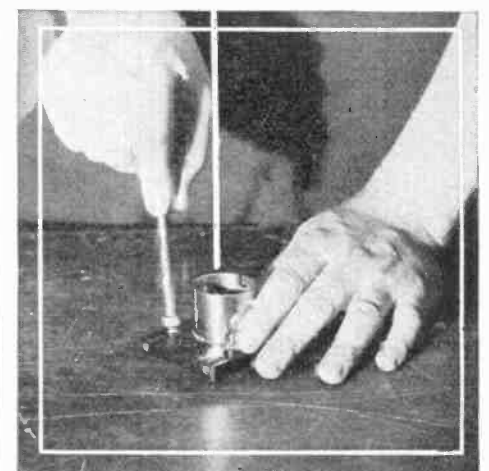

Tighten socket connections, contacts and springs. Make sure tubes fit tightly down on springs.

—Start a Set Overhauling Service

Keep Busy This Summer by Making It Your Business to See That Every Radio Set in Town Is Put Into Perfect Condition by Your Service Man



Test B and C batteries and advise whether they need replacing.

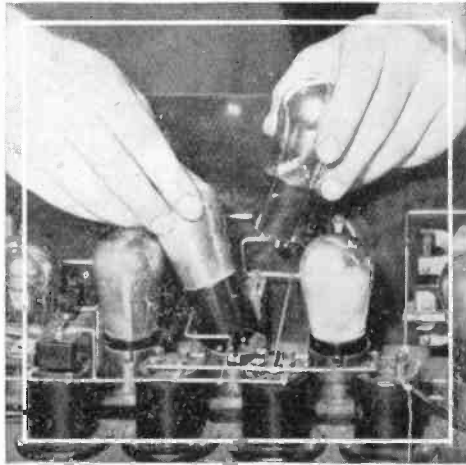

Test tubes by replacing each one in turn with a good tube, if you have no tube tester. Re-activate tubes where possible, charging 50c. each. Insert tube fuse to prevent blowing out.

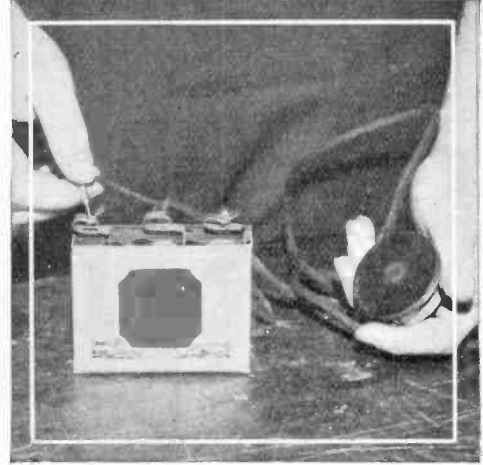

Test loud speaker unit by connecting one lead with C battery. Completing the circuit with the other lead should result in slight click. Test p.ugs.

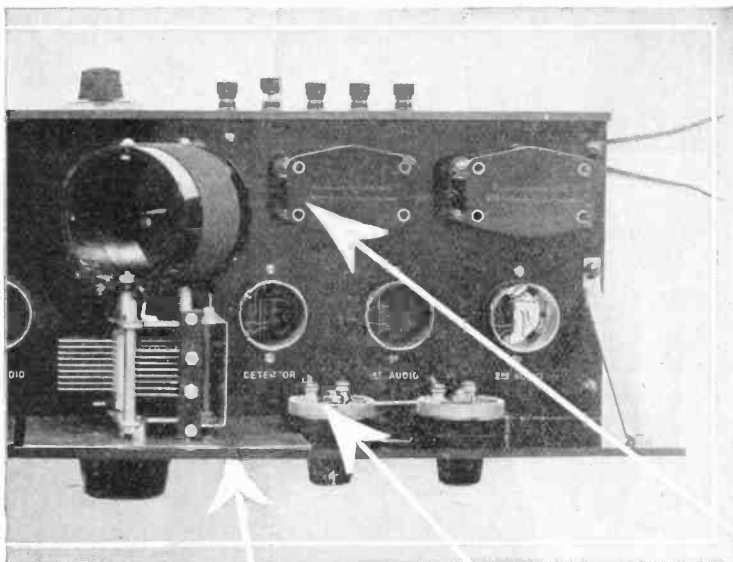

DECIDE on a proper charge for the service—from \$5 to \$7.50, exclusive of the rejuvenation of tubes, but including recharging the storage battery—and advertise it not only in the newspapers, but in your window and store displays as well. Show these pages to your customers and let them see for themselves what their set needs and how you will put the receiver in perfect working condition. Impress upon them that every set, no matter how well it may be functioning, requires specialized attention of this sort at frequent intervals. Several dealers have found it profitable to send out return post cards, explaining the service, to every known set owner as well as their own mailing list.

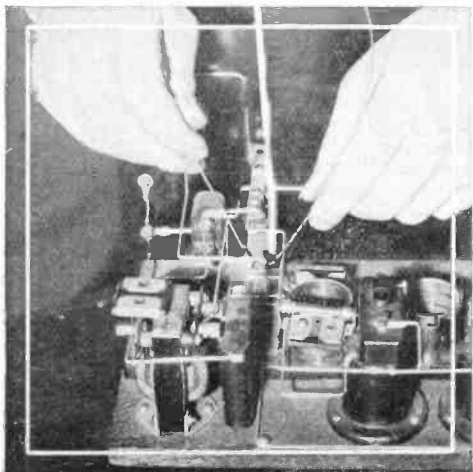

Test B battery circuit by plugging in earphones to jacks, with tubes lit. Good click should result. Make similar test at jack connections with earphone leads.

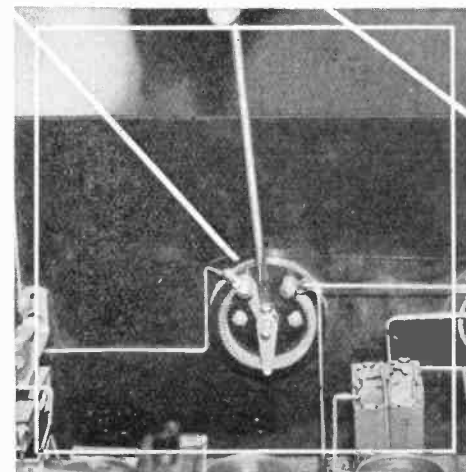

Tighten rheostat connections, making sure that the arm makes a firm contact. Make sure rheostat is of proper resistance for set. Test windings for breaks.

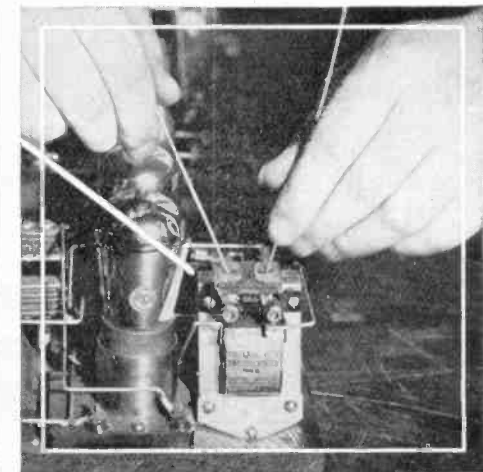

Test transformers by crossing poles with earphone leads. Click should result. Test grid leaks and fixed condensers and see if they are of the right resistance.

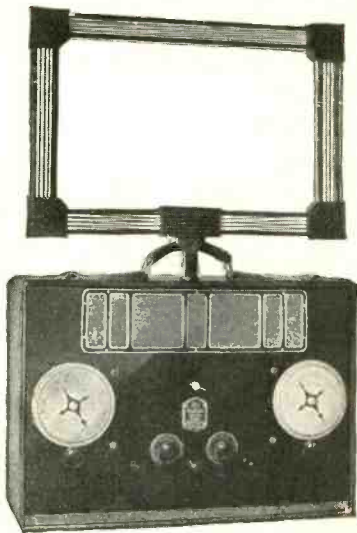
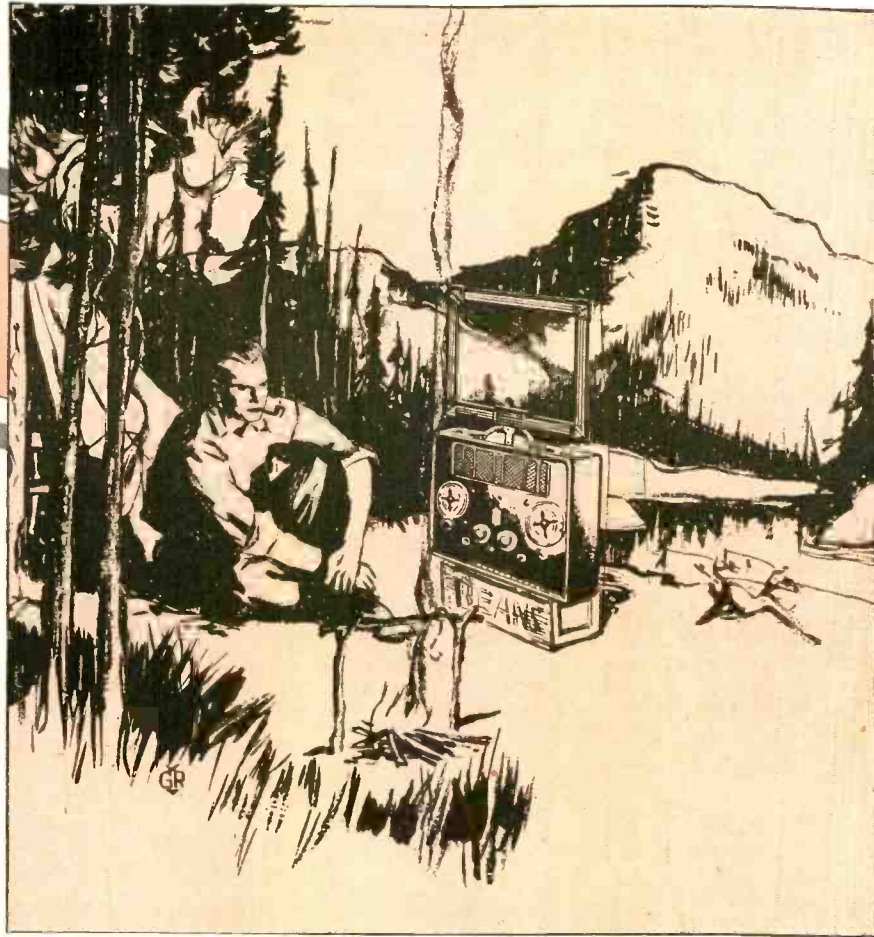

Radiola 24, suitcase model with built-in loudspeaker. With six Radiotrons UV-199 . . . \$195

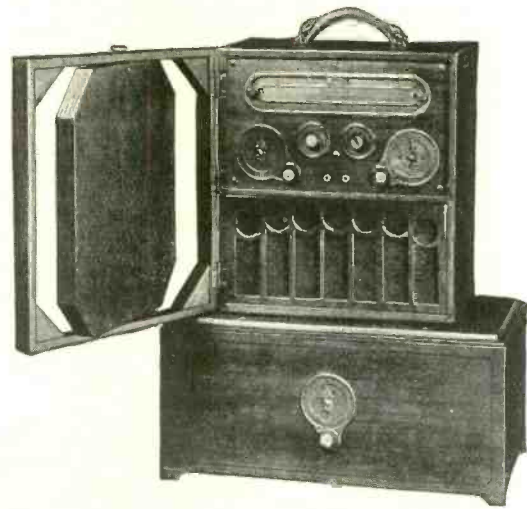

Radiola 26, with its extra battery cabinet for home use. Walnut finish; loudspeaker-built in. With six Radiotrons UV-199 . . . \$225

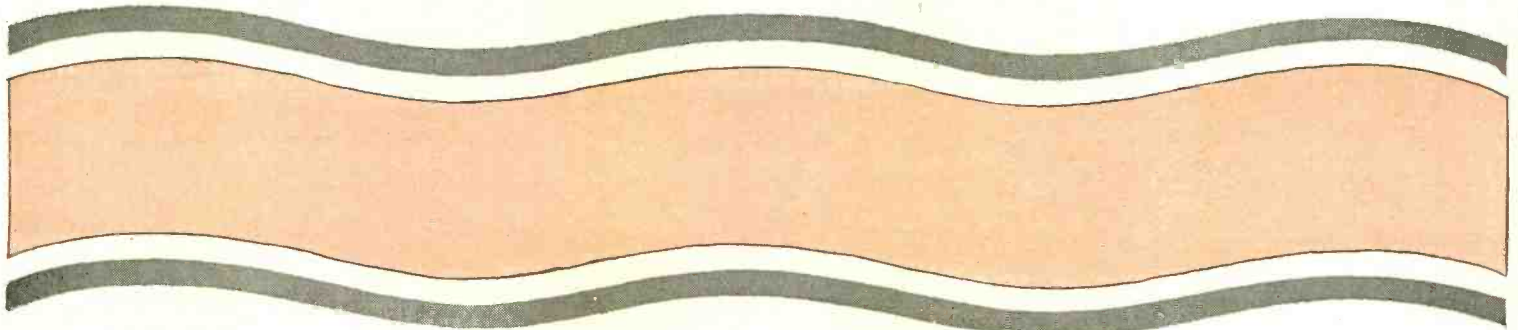

Are you selling this man?

*Thousands everywhere are eager
to buy a Portable Radiola
Super-Heterodyne*

Thousands will buy—if you will sell. With the popularity and the performance-fame of the Radiola “Super-Het,” sales are easy enough—if you go after them. With two completely portable models of the “Super-Het”—with strong backing of advertising for them—and train loads—highway-fulls—of people going off to sea and mountain, there’s big summer business right now for the man who knows it is there and goes out to get it.

Radio Corporation of America

Chicago

New York

San Francisco



Radiola

REG. U.S. PAT. OFF.

AN RCA PRODUCT

Service Calls Build Sales

"Free Monthly Service Calls" Prove Successful in Getting Names of Set Owners' Friends for Future Follow-Up-- Girls Found to Be Sure Way of Interesting Women via Telephone

"SERVICE, more service, additional service and then still more service," is the sales slogan of a radio firm of Los Angeles, Calif., whose identity is omitted by request.

Service is, with this firm which has just opened its third store and which employs fourteen salesmen, the biggest word in the dictionary. In fact it is an extra, added service—service that is over and above and beyond the things expected by the customers—that this concern has built its business.

When a customer makes a purchase of a radio set he is informed that these services are at his free disposal for a year from the date of his purchase:

First—Year's free service on adjustments.

Second—Batteries tested free of charge for a year.

Third—Batteries kept charged, without expense to the customer, for a year.

Fourth—Regular monthly calls on the customer by a service man when the customer can talk over conditions and get free advice and help from the service man.

All this service is of tremendous importance in creating friendship for the firm, but the greatest of all is the fourth service listed—that of regular monthly calls by the service men. The customer considers the calls as being strictly part of the service rendered by the concern. But the concern views them from an entirely different angle—they are considered the best business-building proposition the firm has yet developed.

Service Calls Made by Regular Salesmen

The store salesmen make these monthly calls and when he makes a call he secures the names and addresses of the customer's friends, relatives, neighbors and acquaintances who have come to his house and listened to his set. The salesman makes a note in black and white of these names and addresses for future tips.

In making calls on these new prospects, the salesman introduces

himself by saying that he is the one who sold So-and-So the radio that the prospect has heard. Then the salesman tells about some of the things that the owner of the radio has recently been doing with his set and in this way leads gradually into a sales talk. More sales are made through this method than through all other sales methods combined.

It might be considered likely that customers would tire of the regular monthly calls and would get to the point where they would resent such calls.

This might be the case if it weren't for the fact that the service men make their calls consistently interesting and helpful to the customers. They render worth while service to the customers in more ways than



"Hello, is this Mrs. Brown? This is Miss Smith of the Jones Radio Shop talking. Puccini's opera, 'Madame Butterfly,' is to be sung over the radio this evening and we are wondering if you care to hear it at our expense? If you do, we would be very glad to install a set at your home tonight, at no charge of any kind, and demonstrate how much pleasure a radio set can bring you."



"Yes, this is Mrs. Brown. 'Madame Butterfly?' Why, that's my favorite opera, I'd love to hear it. What time does it start? 8.30? All right, that's quite convenient. Yes, you may bring the set over this afternoon at half past four. The man will return at eight o'clock and let us hear the opera? That is very satisfactory. Good-bye."

one. The salesmen, on starting out each day, are provided by the firm with a list of customers who have recently gotten distant stations and they are given the dial readings for these stations. The salesmen impart this information to the customers and help the customers in getting the same stations and this, of course, is a service that is highly appreciated by every radio user.

Again, the men look over the customers' sets very

carefully and make such adjustments as are necessary.

Also the service men are thoroughly familiar with everything that is being done in the way of broadcasting by stations all over the United States and they impart this information to the users with splendid results in getting the appreciation of the owners and in making them glad to greet the men when they call.

When a prospect comes into the store to hear a set it is pointed out that the location on a busy street is bad for reception and that the best results can't be obtained at the store.



"The best feature of this set, Mrs. Brown, is its simplicity of operation. All that is necessary to receive the program, is to pull this switch and adjust the dials for whatever station you select. It brings the station in immediately. Note the clarity and natural tone of the voice, and the absence of any disturbing noises. Just listen to the absolute fidelity of reproduction. It sounds as though the singer were right here in the room. And the broadcasting of complete operas is only one of the many good things you can hear through the air every evening."



"Mr. Green, please take a set over to Mrs. Brown's at 455 Maplewood Road at half past four this afternoon and install it. Go back at eight o'clock, get everything ready and tune-in station WXYZ at half past eight. Mrs. Brown wants to hear the broadcasting of 'Madame Butterfly.' Be sure to make a good installation so that the demonstration will be as perfect as possible."

Arrangements are then made, in many instances, for putting a set in the prospect's home for demonstration purposes. The set is seldom left for over a single night because a few sales have been lost where longer demonstrations were given.

When sales are made it is either on a cash basis or on a contract basis, with the contract so good that it can be turned over at once to a finance company, thus relieving the retail company of all financial worry.

Girls Make Intensive Telephone Campaign

While service is the foundation on which the radio business of this firm has been built, it is probable that few other radio merchants make such an extensive use of the telephone.

Two girls are employed to do

are called up, the girls say something like this:

"This is the Blank Company, radio dealers. We understand that you might be interested in purchasing a radio receiving set and we called up to ask if you would give us

nothing else permission to make a demonstration other than call in your home at no cost to you."

The girls talk just as long as the other manifests interest and during the course of the talk, find out just how deep the interest of the people is in radio. Reports are then made to the executives of the firm and the leads are distributed to salesmen.

The leads thus secured are watched carefully and the girls are given the right credit for every sale made from a lead secured by them. The girls are given a nominal salary and a commission on every sale made from one of their leads. This makes the girls particularly keen to get good prospects.

It is interesting to know that the girls, in calling up folks in this way, very seldom run across a person who

Use Women to Interest Women

is a sales policy adhered to by this radio dealer of Los Angeles, Cal. Two girls are employed during the day, whose sole duty it is to call up housewives, talk radio to them and interest them in the purchase of a set. Names so secured are then turned over to the salesmen.

Another way of getting prospects, used by this concern, is a "free monthly service call" system on sets they sell, thus keeping the customers' sets in working order. On these calls, names and addresses of interested friends of the customer are secured and prove good leads.

hangs up on them and very seldom find a person who isn't willing to do a considerable amount of talking.

As the majority of places called up are residences, most of the people talked to by the girls are women. The women, it has been found, welcome the phone calls as being interesting breaks in the monotony of the daily housework.

Also, the fact that it is a girl calling, makes the women feel more like being conversational. Undoubtedly, this is one of the reasons why this telephone selling plan has been so successful in building business for this concern.

Women Are Good Prospects

It is, too, the woman of the house who is, quite frequently, the most ardent radio fan. It is the woman who finds life monotonous, it is the woman who has to spend ninety per cent of her time indoors and it isn't surprising that she is anxious for a radio which will give her an added interest in life and make her days more pleasant.

The girls have found that, in selling over the phone to women, it is a big help to emphasize this phase of the radio in their sales talks. Almost every time the girls do emphasize this line, they get a "rise" out of the woman which eventually leads to the securing of a very good prospect.

How a Cincinnati Dealer Uses "Radio Retailing"

With every mail, *Radio Retailing* receives letters of commendation from radio dealers. But here is a letter that is more than a commendation. It is an account of how Louis Rouse, president of the Scientific Electric Company, of Cincinnati, Ohio, has put *Radio Retailing* to work for him and profited thereby.

Mr. Rouse believes *Radio Retailing* is crammed full of sound, practical merchandising helps and suggestions and proves his belief by putting them into actual practice.

"I have not come across a magazine yet that has as much valuable information as *Radio Retailing*," Mr. Rouse reports. "It has increased our income because it has taught us to give our customers better service than we did before and for that reason they are willing to recommend us to others.

"We have used several of your ideas in our business. We have adopted a card index system you published some time ago for keeping track of our customers. We have a service we sell people by the year. We call twice a month and go over their equipment and batteries and if anything needs adjustment we take care of it for the yearly fee. We had such a time keeping track of the people that were next on the list, that

some people would be skipped and then we would hear from them. So, in looking through your magazine I came across a service report form and saw that it was adapted immediately to our business, as we can keep all the information on this card, that is, the kind of set and batteries they have and about what time they will need new ones, etc., and it has worked very successfully up to the present time.

"We have also used your suggestions in regard to selling plans, and are now putting into use a plan taken from your magazine for time payments. We are also trying out a plan where we can rent sets out for nights or weeks or months, and are using your ideas in the April number. And a number of other little ideas have worked wonders for us."

Radio Jobber Solves Local Broadcasting Situation

Realizing that the basis of radio merchandising is good local broadcasting, the Southern Equipment Company, jobbers, of San Antonio, Texas, has undertaken this responsibility for its district. The problem of selling radio, it recognizes, is much more difficult if long-distance reception is all that can be counted upon, particularly in the southern district where static is so bad in the summer months that distant stations can be heard with satisfaction for not more than five months of the year.

For some time this wholesale electric company has operated station WOAI. This has now been advanced to a 5,000-watt station, raising it to the first rank among broadcasting stations throughout the country. The programs offered are distinctive and high class in character. At first volunteer talent was used, but it was found that it was not always possible under this system to maintain an even level of quality in programs. In consequence, the Southern Equipment Company has developed a corps of its own performers who are capable of furnishing an excellent program at all times. When special talent from outside is available, this can be substituted, but the regular company is always ready, thus insuring the best of quality, and an uninterrupted program.

It is felt that the installation of this first-class station will do much toward lessening the local problems of static and the "summer slump" in the Southwest.

How London Displays Parts and Accessories



Selfridge and Company, Ltd., London's great department store, has adopted the "pyramid" idea of displaying radio products, making a loop aerial the apex of the pyramid and two glass show-cases the base. Note the two glass-enclosed sets, one in the center and one at the right, which are mounted on display stands in such a way

that the set revolves, thus enabling customers to view it from every angle. A special demonstration of set-building was also given. The sign, "Listen in on April 28th," refers to a program that was broadcast by the English "National Association of Radio Manufacturers and Traders," of which Selfridge's is a member.

Profiting by the State and County Fairs

MOST of the counties in every State hold annual "county fairs" before the warm weather is over, and while the fairs are in duration, it will prove profitable for radio dealers to co-operate with them in every way possible. There'll be little business in radio while the fair lasts and there's an old saying, "If you can't lick a competitor, work with him."

Leasing space and fitting out a "radio booth" is the best way of tying up with the fair, but if you consider that too expensive, there are other ways of using the fair to get publicity and advertising. One

dealer in a town of 8,000, taking advantage of the crowds which the fair would bring into his town, started a set-building contest, to close simultaneously with the fair.

Prizes were given for the most perfectly-built radio sets, with the following rules:

1. All parts were to be purchased at the dealer's store.
2. All sets were to be finished one week prior to the fair.
3. All sets must be able to receive a distance of 500 miles.
4. Prize winners must allow the dealer to exhibit the sets for a month after the contest.



Before the close of the contest, 250 sets had been entered, the parts for every one having been bought in the dealer's store. In addition, interest was kept up long after the contest, by exhibiting the prize-winning sets, many fans buying parts to build similar sets.

Balloon ascensions are old standbys of many fairs, and here is an idea which dealers may adapt for their own use if the local fair in their community features balloon ascensions. The Schneitter Radio Company, of St. Joseph, Mo., built radio receivers for several of the entrants in the National Balloon Race, held in May, and which started at St. Joseph.

Reports were made as to reception conditions several miles in the air, and were played up in the newspapers, resulting in excellent advertising for the Schneitter Company. Equipping the balloon at the local fair with radio is one way of getting some good publicity.

Above is the booth of a manufacturer at a radio exposition and at the left is the exhibit of the Rose Radio Shop at a recent New Orleans, La., fair.

IF YOU take space at the fair and make an exhibit, here are a few suggestions for the booth:

1. Make your exhibit a model of good lighting.
2. Furnish it with a few good receivers, and comfortable chairs and settees for demonstration purposes.
3. String several headsets along the railing so that passersby may listen in.
4. Attract attention with a set and speaker at work, if permitted.
5. Establish a "question and answer" department for the radio fans.
6. Have it conspicuously displayed that you specialize in home demonstrations at no expense to the prospect.
7. Be sure there is plenty of manufacturers' literature ready to be given out.
8. Have a competent man in charge at all times to answer trouble questions and take names and addresses for home demonstrations.
9. Don't try to display everything in your store; the less crowded the booth is, the better it looks.
10. Remember—"The Voice with the Smile Wins."

What Does the Public Think the Ad Means?

It Is the Reader's Impression and Understanding That
Counts in Building Future Good Will—Regardless
of How Clearly (or Sharply) the Copy Is Worded

By WILLIAM P. GREEN

Associate Director National Vigilance Committee,
Associated Advertising Clubs of the World

IN THE use of advertising, radio does not differ from any other business. The same principles apply, and if radio retailers are to obtain an adequate return on their advertising investment, they must write their copy with a clear understanding of what it is supposed to convey to the reader.

Too much radio advertising is being written only from the standpoint of what it will do for the retailer. Not enough attention is given to the interests of the consumer. In many cases, this is due to the erroneous impression that the only purpose of advertising is to make sales. While this may be the immediate result, the retailer who follows this policy, to the exclusion of every other factor, will lose rather than gain in the long run.

It is a fundamental principle of advertising that the construction placed on copy by the public is a most im-

portant factor in building a business. It makes little difference what the advertiser may think a particular statement means. Likewise, the question of what he wants a statement to mean is equally unimportant. The main question is—what will the public think the statement means?

Good Will, the Greatest Asset

Sales are made on the basis of the meaning conveyed to the reader of the advertising. If merchandise is purchased as one thing, and later the customer discovers that the quality of the material or performance is different from what he was led to expect, the store suffers.

Good will has been described by one business philosopher as a reasonable probability that customers will continue to do business with a store. There can be only one reason for assuming that customers will

do this and that is because they are satisfied with their first transaction. If a man has responded to an advertisement, feels that he received his money's worth, and is perfectly satisfied with the merchandise purchased, then the store has in him a very definite good will investment. He is an asset not only because of the business he, personally, will continue to give the store, but the comments he makes among his friends are as valuable in obtaining additional business as any advertising copy could be. If, on the other hand, the customer is dissatisfied and feels that the merchandise was misrepresented, he is a liability rather than an asset and his comments among friends will tend to send them elsewhere with their business.

Three Questions to Answer

Recognizing the tremendous part played in the successes and failures of retail stores, the National Vigilance Committee and the local Better Business Bureaus, constituting the Truth-in-Advertising movement, are asking advertisers in all lines, including radio, to consider these three questions when preparing advertising copy:

1. What do you know about the goods you are advertising?
2. What do you want the public to believe?
3. What has the public a right to believe from your copy?

Radio offers a good illustration of the probability of misconstruction by the public in the case of claims that are made for distance reception. One of the common terms in radio is "on the air." The statement frequently is seen in radio copy that certain sets will get any station "if it is on the air."

What does this statement mean in

A Type of Ad That May Mislead the Customer

END-OF-THE-SEASON SALE

Radiolas Fada Paragon DeForest D-17

Priess Dayton Eagle

30 per cent to 60 per cent off on the following—

Loud Speakers	Transformers
Phones	Kits
Cabinets	Condensers
Chargers	Coils

Response to this advertisement brought out the fact that on some of the sets listed, no reductions were being made. Yet because of the use of the headline "End of the Season Sale," the reader of the advertising

might well believe that he could buy one of the sets at a reduced price, perhaps only 10 per cent or 15 per cent off, but at least some reduction, because of the great savings offered on equipment.

the light of the tests suggested above by the Bureau movement?

One advertiser who advertised this claim for his set explained to the National Vigilance Committee that he did not mean that any station that happened to be broadcasting at a given time could be picked up, but that he had in mind only stations the waves of which were sufficiently strong in the neighborhood of the set to be picked up. As against this, a vast number of people understand the expression "on the air" to refer to the fact that a station is broadcasting. These people, therefore, would purchase a radio set with the expectation that it could do what every technically-informed radio man knows is impossible, that is, bring in any station that happened to be broadcasting, day or night, regardless of distance. Dissatisfaction on the part of customers and their distrust of the radio industry, by reason of such misunderstandings, are problems that go to the very essence of good will building.

Clarity Needed in Advertising Radio Products

This all shows clearly the necessity for a clearer definition of terms used in advertising radio merchandise to the public, and emphasizes the necessity for the advertiser to state clearly and explicitly just what he means by the representations he makes. *Radio Retailing*, with the co-operation of the National Vigilance Committee of the Associated Advertising Clubs, proposes to point the way. In succeeding articles, specific instances of misleading advertising copy in the radio field will be analyzed and correct methods of representing merchandise, so as to avoid misunderstanding, will be suggested.

Hotel Supplies Free Radio Service for Guests

The Biltmore Hotel, New York City, one of the Bowman chain of hotels, has purchased a sufficient number of "Standadyne" console receivers to install one in each guest suite at the hotel, thereby proving that hotels are excellent markets for the sale not only of one, but several radio sets. Contrary to an item in a recent issue of *Radio Retailing*, the New York Biltmore does not rent the sets, but includes them without extra charge as part of the furnishings.

"Every Tree a Ready-Made Summer Radio Antenna," Says General Squier

By PAUL WOOTON

Washington Editor, "Radio Retailing"

TO THOSE who would reduce interference or who want radio music in any sylvan dell, Secretary of Commerce Hoover recommends a discovery by General George O. Squier, formerly chief of the Signal Corps. General Squier has proven by a long line of experiments that there is no better antenna than a tree. All that is necessary to make use of this natural antenna is to drive a nail three inches into its trunk and connect the nail with the set. Such an antenna should be used wherever possible, General Squier believes, since it is superior to any antenna that man can build. "A tree," says General Squier, "gives louder, clearer, cleaner signals than does any other antenna. It holds signals in a remarkable way and performs a wonderful function in equalizing static. The tree instead of being only a botanical thing with a long name, becomes now a highly organized electrical circuit, ready to sing to the farmer from his front yard; ready to bring him his market news and weather reports; ready to help in the education of his children, and ready to keep him abreast with the best thought of the day. It makes available to the humblest home the culture of the generation."

General Squier thinks his experiments should result in the sales of thousands of additional sets just at this time when the people are taking

advantage of the season to get close to nature. Every autoist, he thinks, ought to have a compact set that can be carried in his car. With a roll of lamp cord and a few eight-penny nails in his pocket the autoist can attach his instrument quickly under any inviting tree. That municipalities should install sets with adequate loud speakers at various points in public parks, is another of General Squier's suggestions.

Now that static is getting bad at this season and others are having trouble getting distance, General Squier is picking up European stations as easily as he did in the winter.

While General Squier has been able to demonstrate with modern apparatus the full advantages which now may be secured from the use of a tree as an antenna, he made the basic discovery in 1904. During army maneuvers at Camp Atascadero, in California, it was found that the character of the soil and its dryness rendered the field telegraph sets inoperative. He was able, however, to complete his ground circuit on connecting the wires with nails driven into trees or bushes.

Tree Antenna Cuts Down Summer Static

Subsequent experiments with the crude receiving equipment of that day demonstrated that the growing tree covered with foliage absorbs radio waves in an unusually efficient manner.

As a result of his work during the past few weeks, General Squier advises everyone who has a tree near his window to change his aerial for the summer and avoid static. Where extended or continued use is to be made of the tree, best results will be obtained, General Squier finds, by the use of a copper nail which should be three inches long so as to penetrate the tree's cambium layer. The wire leading to the receiving set should be insulated. Best results are obtained when the nail is inserted at a point two-thirds of the distance up the trunk. No injury to the tree results.

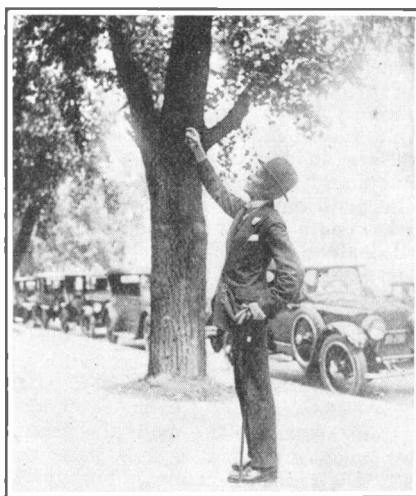

GENERAL GEORGE O. SQUIER

"To the Editor"

Says Rural Districts Are Still Unsold

Editor, *Radio Retailing*:

A letter came to me the other day from a moving picture man on location in Colorado. He was in a mountain valley where there were "many people but just a few old-fashioned sets," most of which had been ordered by mail because the people seldom went to the city and radio salesmen didn't come to them.

This leads me to express my thoughts to radio dealers on the subject of selling radio in rural districts. Pack a demonstrator in your car and start out on a tour. Every farmhouse, every out-of-the-way village presents real prospects.

Go to a summer resort, lake or river. Rent one of those rowboats with a gasoline pusher on the back and put off with your trusty demonstrator. Every cottage should have a radio set and would buy if you sold them hard enough on the necessity of it. There is no place more miserable than a summer cottage on a raw drizzly night. Radio is the only thing which will break the spell. Radio will bring them the news and the music from the crowded cities while they loll around in their seclusion and comfort.

Still other outlets are the gun clubs, fishing clubs, resort hotels, mountain taverns and even the hot dog stands along the road. Some of these have sets, but most of them would be out of date.

Hundreds of thousands of automobiles are on tour every summer. I refer to the ones on long trips. At night, dusty and weary, they set up their tents in the camp grounds. The ones who have radio are not only the centers of interest of the camp, but they have the greatest possible means of relaxation at a turn of the dials.

Radio has become a great national habit. Vacationists will want it if they are shown that it is available.

WALLACE B. BLOOD,
Chicago, Ill. Operadio Corporation.

Complains About Cincinnati Programs

Editor, *Radio Retailing*:

On reading the current copy of *Radio Retailing* I ran across an article on page 526 under the title "Many Broadcasting Features Planned This Summer."

If anything, I honestly believe that broadcasting is and has been the cause of the lack in interest at the present time for radio in general. It is all right to be optimistic—but let's not overlook a very urgent demand from owners and prospective owners, for far better programs than are generally heard over most of the stations.

I enclose a program list for one night, in which I outlined all items *not* dance music. Then I ask this question,

"What is the most popular form of music, both to young and old, in the summertime?"

I can't remember, through the whole period of broadcasting, of hearing over one hour of dance music from any one station. Which means that if anyone wishes to dance to radio, one must tune in one station after another to complete the program.

Why can't a station's weekly program be based such as this: Sun., Church Services. Mon., Talks. Tues., Orchestra. Wed., Dance Music. Thur., Concert, voice. Fri., Concert, instrumental. Sat., Dance Music; and then different stations might have the order advanced one or two days, so that not all stations give the same type of program on the same night. As it is now, if you wish to hear a band concert, you tune into about forty stations with "parlor-artists" programs before you ever hear anything like a band.

Where did all these wonderful (?) singers and other artists come from? Why are they wished on the radio listeners?

I will certainly be very much obliged if you can offer some suggestions, and frank viewpoints on this most vital question. Do many others in the country believe as I do, or is it just "local"?

KENNEDY KEECH,
Keech Eagle Radio Company,
Cincinnati, O.

Smother the "Gyp" by Going After Him

Editor, *Radio Retailing*:

We commend your efforts in attacking misrepresentation in advertising and want to tell you how we are co-operating with the local office of the Better Business Bureau movement of the Associated Advertising Clubs of the World.

Mr. Palmer of the Minneapolis office has been in constant touch with us for some time and seeks our advice and knowledge quite often. Whenever he finds any misrepresentation in local advertising, he immediately calls it to our attention and we give him our opinion. What happens after that, we don't know, except that there is generally a sudden cessation of the objectionable advertising.

In addition, we have furnished him with a complete list of the radio jobbers and dealers of the Twin Cities, the lines they represent and the names of their officials. He has sent to each of them several bulletins on this subject and has given personal advice to a number of them.

We would suggest that in view of the large number of local radio trade associations springing up about the country that each of these associations work with their local business bureaus to correct "gyp" advertising.

NORTHWEST RADIO TRADE ASSOCIATION,
Minneapolis, Minn. H. H. CORY.

Jobbers Can Control "Gyp" Dealers

Editor, *Radio Retailing*:

I have read with interest the article in your May issue, "A Body Blow to Gyp Advertising," and may I be permitted to say that you are unduly optimistic when you assume that the A. A. C. W. can clean up the situation.

Personally, I am of the opinion that there is just one effective means of ending the gyp. Every dealer in every community (except the metropolitan centers) knows the gyps; he also knows or can readily learn the jobbers who sell the gyp. If each honest and legitimate dealer will refuse to patronize a jobber who sells gyps and will tell the jobber who offends that he (the dealer) will not purchase of the offending jobber until he stops selling the gyp—the gyp will soon be without a source of supply and out of business.

Now do not start and yell Federal Trade Commission at me! I have heard that wheeze from sandless and tallow-backed manufacturers until I have a headache. The Federal Trade Commission cannot make me sell what is my property to any man I do not want to—and they know it and you know it.

Then before the situation is really clean there must be a feeling of mutual support and co-operation between manufacturers. Thus, last winter I called the attention of a manufacturer to what, to me, was a case of gypping his receiving sets. He investigated and told me the dealer was doing a legitimate business. This is how legitimate it was—The list price of the set was, say \$150, and the dealer was advertising it "complete" for \$200, and specified "complete" as being with five tubes, 90 volts of B battery, an A battery that listed at \$25, a speaker at \$30, a lightning arrester at \$1.50, one hundred feet of antenna, insulators, lead-in, etc. The set manufacturer informed me that the gyp was entirely satisfactory to him as he was getting \$150 for his set, but "to put the sales across was putting in the accessories at cost."

I suppose that if the accessory people, or the battery people investigated the situation (I do not know that they did, or did not) that the gyp informed them he was getting "full list" for their products to "put them across" and was slashing the receiving set!

Possibly in the metropolitan centers the gyps move a volume that is sufficiently large to make jobbers, or some jobbers, perfectly willing to lose "legitimate" business to retain it; but this is not the case out in the "sticks."

Just use a little of your space in suggesting that the ending of the gyp is just about as much in the hands of the honest retailer as it is in the hands of the honest jobber and manufacturer and you will be doing a real job.

F. G. MACOMBER,
Stern and Company, Inc.
Hartford, Conn.

"Radio Retailing's" Readers Express Opinions on Subjects of Interest

Radio Is "Style" Merchandise

Editor, *Radio Retailing*:

I would liken the radio business to that of the millinery business because I believe it is in exactly the same condition. The milliner to sell hats must have new styles and new designs, so in radio. The cabinet of today is gone tomorrow, the hookup of today is superseded by a new one next week. I am advised by good authority that the manufacturers of other products which run into large volume in jobbers' stocks are scrutinizing with utmost care the jobber who dabbles in radio because of the very nature of the business and its extreme susceptibility to style, depreciation and obsolescence.

It behooves the jobber as well as the retailer to go slow, watch his stocks and keep them down to a minimum, and back of them all is the one regrettable fact that it is a business of six or seven months out of the twelve.

These views are based on the actual knowledge which I have obtained from my two or three years in the radio business. The "gyp" method is the natural result of the mad rush of everybody to get out from under and the "gypping" starts with the manufacturer or jobber. I have in mind one large manufacturer who recently turned out a set listing a \$150. They had some 700 of these sets on hand. They suddenly discovered that they were a piece of junk so far as possibility of sale was concerned because a radical change had occurred which put their set in the background. The manufacturers dumped these sets on the market through the department stores and dealers at a price of \$35 or less. So why blame the type of cheap retailer

for some change which often emanates from much higher up and from sources which you would least suspect of such methods of merchandising.

It is the natural sequence of events which is governed primarily by the fact that self-preservation is naturally our first motive and the guy that is hooked is going to do his best to get out from under regardless of what may happen to the other fellow.

H. I. SACKETT ELECTRIC COMPANY,
Buffalo, N. Y. H. I. Sackett, Pres.

Cheating the Customer with Cheapness

Editor, *Radio Retailing*:

"I can buy the same set at the Premier Shop, complete with all accessories for \$74.89. So why should I pay you \$89?"

We have a good answer for this kind of a customer. Our store is the most successful in a Middle Western city of 28,000 population. It is the best because we sell "quality" goods and products of recognized merit. We do not confine "quality" to good receiving sets, for we know the value of furnishing high-grade accessories—tubes, batteries and loudspeakers—with our complete-set sales. True, the Premier Shop underprices us frequently, by substituting inferior accessories for those of recognized merit. But our short-sighted competitor does not hold his trade or win himself friends, when his customers find that his inferior loudspeaker must be replaced if good tonal quality is to be secured, and when inferior B batteries, after inadequate service, must be replaced.

There are tricks in every trade and many a dealer has sought new means to succeed in the scramble to make the first sale—usually at the cost of the customer's good will. By quoting the price of the "set complete with all accessories," at a lower figure than his competitor, such dealers have been able to appeal to the bargain hunter and so to secure his custom. Since the extras are often an important part of the total cost, the dealer catering to short-sighted shoppers has found that offering cheap and inferior accessories to accompany the complete radio set, results in low quotations. Admittedly, the cost of accessories often startles the new buyer. But we think this is no excuse for evading the duty of selling him good accessories with a good set, for that is the only way in which he can be retained as a permanent customer.

Let the bargain hunter and the conscientious dealer beware! The temptation to reduce the first purchase by \$5 or \$10 through the sale of bootleg tubes and batteries of questionable make is one to be resisted. The feelings of the customer when his "imitation" tubes and "just as good" B batteries are useless after a month's listening cannot be smoothed out by the most persuasive salesman in the Premier Shop.

Make all your new customers regular purchasers by insisting upon accessories of the same reputation and quality as you prescribe in the matter of receiving sets. You will attain a valuable advantage with respect to both customers and batteries—they will last longer. And the customers will come back to you for every radio need.

Chicago, Ill. PHILIP L. FAY.

"Three-in-One" Applied to Radio—A Combination Screen, Cellarette and Radio Set

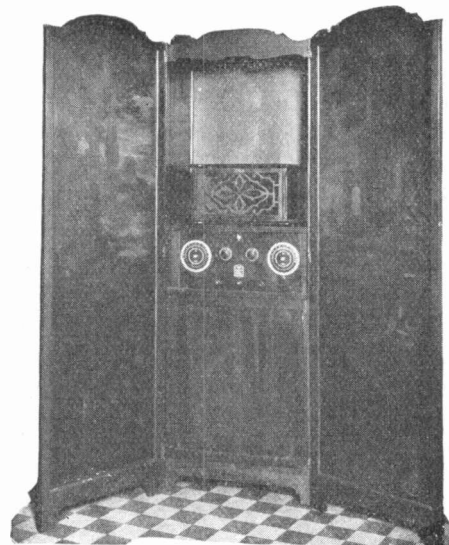
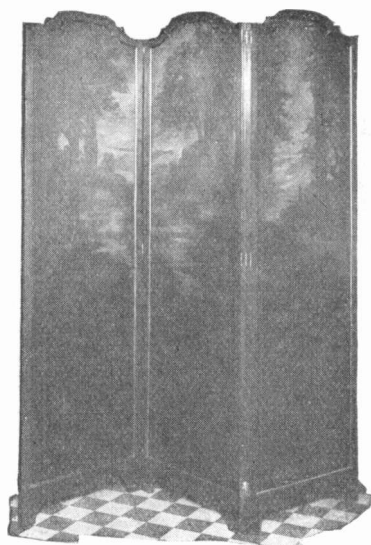

A screen, cellarette and radio receiver all in one is the latest merchandising idea put on the market. In its most innocent aspect, it has the appearance of an ordinary, artistically painted screen. Open the center panel, however, and a radio receiving outfit

is disclosed. Then go behind the screen and see what it hides! A cellarette for ginger ale, vichy, grape juice, loganberry juice, apple cider and other lawful thirst-quenchers. Or what have you? Of course, what is kept in the cellarette depends on

the owner. It can hold all kinds of bottles. What greater convenience can be found than listening over the radio to some song like, "Brown October Ale," or "Drink to Me Only with Thine Eyes," then turning the set around and having a real drink?

The Editors Have

Overcome the Prejudice Against Summer Radio

A FEW years ago, most automobile owners stored their cars for the winter. And nobody would think of eating ice-cream in cold weather. Today, the man who puts his machine away when it begins to get cold, misses the satisfaction enjoyed by his wiser brethren who have learned there are few winter days when a car cannot be used. And the public now accepts ice-cream as an all-year food.

How was this public attitude changed? By advertising. By "carrying on" when the seasonal slump was due, and taking it for granted that ice cream and automobiles, like neckties and baby carriages, are all-year-round propositions.

Radio can do the same. We can learn a significant lesson from the experience of these two trades. We have already overcome the odium of bad summer reception. Our duty now, is to inform the public that modern radio reception is powerful and clear,—day in and day out, day and night, spring and fall, summer and winter.

Stability Must Be Built

IN THE heyday of the phonograph industry, an established manufacturer with a product in strong popular demand, sold franchises to the jobbers and the dealers, that virtually made these distributors and retailers special representatives of the manufacturers. They received exclusive territories and ample protection and support, and they gave exclusive service. In the experimental stage of radio marketing this could not be done, but conditions are fast changing.

Today the radio dealer can procure sets that answer all purposes. Popular advertising is building prestige that will give the dealer a standing in the community that is proof against the irresponsible bootleg manufacturer and the pirate jobber. The trend in radio retailing can and must be toward adherence to the channels of regular distribution and the protection of the price by not dumping goods into some cut-price store with which the regular dealer cannot compete.

A Suggestion for Selling Used Sets

THE problem of "used sets" in radio is similar to that of the "second-hand car" in the automobile business—which suggests that it could be handled profitably along similar lines, possibly through a central depot for used radio sets operated co-operatively by local dealers. The customer who wished to turn in a set could then be told that no allowance was made for used outfits but that an opportunity was offered to sell the second-hand set through this channel. This would eliminate the undesirable competition of used material with the dealer's own stock, which he must suffer if he is to sell the set over his own counter. Furthermore it would make the sale of the second-hand equipment easier. The resale depot could be advertised without injuring other trade and would soon come to be looked upon as the place to go if a bargain of that type was

desired. Handling so many sets together would make it possible to make up deficiencies of one from another and to salvage much material which would otherwise be lost.

The Grass Always Seems Greener Over the Fence

"Towanda, Pa.— . . . Three cows were electrocuted today when they stuck their heads through a wire fence that had come in contact with a high-voltage line."—*News Item.*

A PARALLEL could be drawn between the plight of those cows and the present situation in radio. Liken the invisible high-voltage electricity to the equally invisible economic laws that govern trade—laws useful and constructive when properly understood and utilized, but frightfully destructive when diverted through ignorance or intent.

The grass may not *seem* as luscious in our own field but it really is—and we are safer there. The thought and time we spend in gazing at other fields would yield us greater profits if devoted to our own.

It doesn't pay to trespass.

Teach the Public That Radio Is Not a Gold Mine

A FIFTEEN-YEAR-OLD boy with eighty dollars in money and a boy knowledge of radio ran away from home not long ago, went to Albany, N. Y., hired a store, bought a cash register and furniture, got together a few radio sets and became a radio dealer. He did some business but after a few months sales fell off; he disposed of all his equipment to buy food, and finally walked into the police station half starved and asked for help. A plucky boy—yes—but what does this mean to the radio man?

People still think that the radio business is a gold mine. A few dollars, a little radio lore and the enthusiast thinks that he can climb aboard the wave and ride to fortune. But those times are gone, and happily so. The best thing that can be done for radio now is for the industry to convince the public that after all it is just a business, with all the risks and grief that go with any commercial enterprise. We want no more fifteen-year old, eighty-dollar dealers.

Radio Music in Every Room

SEND out to your own home four or five of your own loudspeakers. Have a bright boy, or a service man, run some bell-wire or telephone-wire through the walls, to connect the loudspeakers in the various upstairs rooms with your radio set. It's all very simple to do.

Then let your family try it out for one month. See what you and they think of the idea,—not only for your own house, but for your local customers in well-to-do homes that could spend \$50 to \$100 for extra loud speakers to get all the satisfaction this plan brings.

When you have actually tried the experiment of "radio music in every room" *Radio Retailing* would appreciate hearing what you think of it.

This to Say—

“Ask 'Em to Buy!”

IS THERE a practical suggestion for radio dealers in the “Ask 'Em to Buy” campaign conducted by the automotive trades?” That slogan was the result of a very interesting merchandising test. Several years ago the automotive accessories association sent a man out in an automobile with \$3,000 in his pocket, on a trip through the Eastern states where the towns are thick. This man was given definite instructions to buy anything in the accessory line that was offered him. He was to wire back if he needed more money than the \$3,000. He was to stop at every good garage for gas or oil, or to ask directions, or for any reason that would bring him to the attention of the garage owner. At only one stop was he approached on the subject of a purchase and this one garage owner asked him if he did not wish to buy a spark plug and he said yes, and bought it. He came back after a three weeks' trip, having spent just one dollar for the spark plug he was asked to buy.

Apparently we have something of the same condition in the ordinary radio store. Neither dealer nor clerk “asks them to buy.” If that one idea of asking the customer to buy can be put across to the trade, if he will only attempt some selling instead of waiting behind the counter to take orders, it will help the present situation more than anything else in the world.

Satisfaction Is the Answer

SOMEBODY said recently that the big names in radio in the future would be those that stood for *satisfaction* in the minds of *users*. In the past, and even today, the burden of maintaining this satisfaction is largely borne by the *dealer* and is reflected in his service costs.

Of course there are as many interpretations of service as there are dealers, but the constructive merchant knows his continued success depends upon the good will of his customers. Such merchants know and study their costs of doing business, and they tell us that in altogether too many sales the service costs, due to causes beyond their control, eat up their initial profits.

There is another source of unnecessary expense to the dealer and dissatisfaction to the user which should be eliminated by manufacturers without delay. We refer to the burning out of tubes, the exhaustion of batteries and similar troubles caused through faulty manipulation in the home. Improvement in apparatus and a more widespread understanding of operation will correct much of this, but what we need right now are devices on sets to *prevent* such occurrences.

The laboratory is not the real test, the home is. Radio is no longer the mysterious plaything of the titular head of the family. It is used—and abused—by all members of the family, including children of various ages. Parental “don'ts” only excite their desire to “monkey” with the radio set. To use an ugly phrase, radio apparatus for laymen must be “fool proof.”

Radio apparatus in the hands of a skilled operator is one thing,—in the hands of the average housewife

or child it is something quite different. When the average family makes a substantial investment in a radio set and something happens to that set so that it does not perform as it should, or as they think it should, they are not going to hunt around to place the blame on a member of the family. *They blame the set* and they complain to the dealer and he is faced with the necessity of making good at his own expense or antagonizing the entire family and possibly their relatives and friends.

This is not a situation for theory or logic, it is a condition that *exists* and will continue to exist as long as human nature is what it is. What the customer purchases is not a radio set but so much *reception* of a certain quality. The average family is not interested in, in fact is more frequently confused by, all this talk about transformers, condensers, grids, frequencies and the various “dynes,” “dons,” “cons” and “trons.” We must talk “reception,” sell reception and supply an outfit that will give satisfactory reception *despite* the conditions under which it is used.

The Customer Must Be Served

HERE is one consumer's experience that is causing him to wonder what is the matter with the radio industry. He was impressed by the performance of a certain radio accessory while visiting a friend's house and on his return to his home city tried to buy this accessory from his local dealers. They did not carry it so he wrote the manufacturer ordering the device shipped him C.O.D. He is an executive with a large company and the order was written on business stationery and was explicit as to what he wanted, viz.: the accessory in question, at list price, C.O.D.

After a time he received a letter from the manufacturer advising him that the order had been referred to a jobber in the purchaser's own city who would fill the order. The customer waited a week and then called the jobbing firm. The salesman on the phone had never heard of the order and explained that the firm did not carry the desired merchandise.

Radio Is Built on Consumer Acceptance

THE head of the firm was finally reached and admitted that they had had from the manufacturer a notice of the order, but that they did not carry the accessory nor did they intend to carry it. He further explained that this was a fairly common happening. Manufacturers seeking distribution would refer several orders for their product in the expectation that the jobber would stock. As in many cases the jobber did not take up the line, this indicated that consumers seeking to buy radio accessories or parts were having their orders juggled around and perhaps finally consigned to the dead file or the waste basket.

There can be no criticism of the manufacturer desiring to create jobber outlets, but the customer should be served and not be kept waiting. Radio is built on consumer acceptance, and this chief asset of the industry should not be recklessly played with.



What's New in Radio and

This editorial section is prepared purely as a news service, to keep readers of "Radio Retailing" informed of new products on the market.

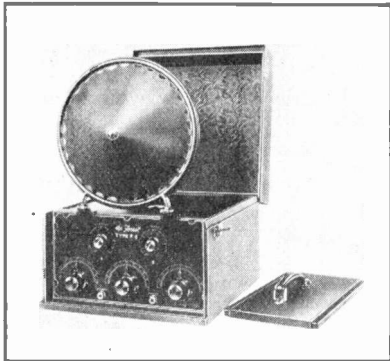

Five-Tube Portable Receiver

Radio Retailing, July, 1925

The new circuit of the DeForest Radio Company, Central Avenue and Franklin Street, Jersey City, N. J., consists of two stages of tuned radio frequency amplification, detector with tuned input and two stages of transformer coupled audio frequency amplification. It is a non-radiating and non-oscillating circuit, with the setting of the three tuning controls practically the same for a given station. The F-5 portable incorporating this circuit is entirely self contained and uses the new DeForest cone reproducer as shown in the illustration. The dimensions are 15 1/2 in. x 14 in. x 11 in. when closed for carrying and weighs 37 pounds complete with batteries. 150 feet of flexible antenna wire are wound on a built-in aluminum reel in addition to 15 feet of flexible ground wire conveniently assembled in a spring clip. Intended retail price is \$130. This same circuit is used in two other non-portable models which have intended retail prices of \$85 and \$90. Both are in walnut cabinets but the latter has B battery compartments.

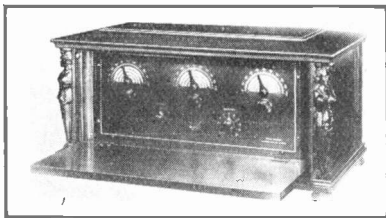

Four-Tube Receiver

Radio Retailing, July, 1925

David Grimes, Incorporated, 1571 Broadway, New York, has brought out the new model of inverse duplex receiver as shown in the illustration. Included in this model are two stages of tuned radio frequency amplification, tube detector and three stages of audio frequency amplification although the set actually uses only four tubes. Straight line condensers and a new form of inductance are used in the circuit. Intended retail price, less accessories, for the type illustrated, \$125. The Baby Grand model, a three tube reflex set has an intended retail price of \$49.50. Both models use UV-199 tubes.

Combination Book Case and Cabinet

Radio Retailing, July, 1925

Constructed along the same lines as the ordinary sectional book case, and made in either quartered oak or birch mahogany finishes, the F. E. Hale Manufacturing Company, Herkimer, N. Y., has added a combination book case and radio cabinet to its many types of radio furniture. If it is desired to place the batteries in the basement, two book sections filled with books may be placed under the radio section instead of the battery section. The total height of the four pieces making the assembly of the radio cabinet is 43 3/4 in. The intended retail price is \$32.

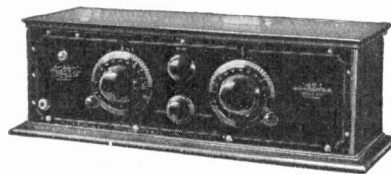
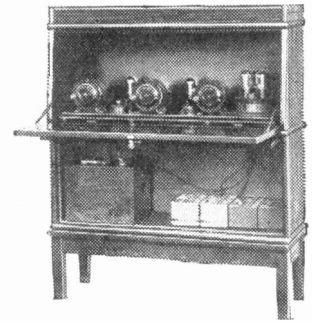

Five-Tube Receiver

Radio Retailing, July, 1925

Selectivity, true-tone reproduction and ease of operation are three outstanding features of the No. 830 receiver made by the Globe Electric Company, 14 Keefe Avenue, Milwaukee, Wis. It is a five tube receiver using two stages of tuned radio frequency amplification. The cabinet is of genuine mahogany with a panel opening of 7 in. x 21 in. Throughout the receiver all construction is of bakelite, with heavy metal brackets. The intended retail price is \$65.

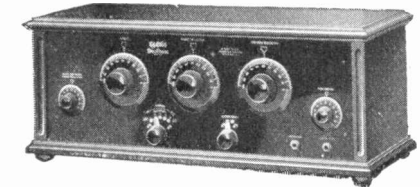

Six-Tube Receiver

Radio Retailing, July, 1925

The R. E. Thompson Manufacturing Company, 30 Church Street, New York City, has brought out a six-tube neutrodyne receiver known as the "Concert Grand," type S-70. It employs two stages of tuned-radio frequency amplification, a detector and three stages of audio-frequency amplification. The cabinet is of mahogany with a sloping panel, and has overall dimensions of 29 in. x 14 in. x 13 1/2 in. Special adapters for UV-199 tubes are furnished with the set. Intended retail price is \$180.

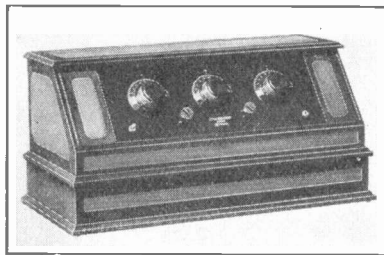

Three-Tube Receiver

Radio Retailing, July, 1925

The "Ray Isler" is a three-tube receiver made by the Ray Isler Radio Company, 1021 Park Avenue, Rochester, N. Y. The circuit uses a detector and two stages of audio frequency amplification. A feature pointed out by the maker is that the set will operate on either indoor or outdoor antenna. The cabinet, finished in walnut, has outside dimensions of 22 in. x 8 in. Intended retail price \$70.

Triple Socket

Radio Retailing, July, 1925 *

Made of molded "Ballsite," for either panel or base mounting, with phosphor bronze double contacts, flush bottom, and highly polished, nickel plated brass tube, is the socket produced by the Ballston Insulating and Composition Company, Inc., Ballston Spa, New York. The Ballston company also makes of the same material, single sockets, dials, reamed for 1/4-in. shaft and furnished with a case hardened steel set screws, in sizes from a 2-in. to a 4-in. diam., and several styles of knobs, as well as binding post tops.

Where to Buy It *News of Latest Products Gathered by the Editors*

It should be noted that all announcements appearing on these pages are published without advertising considerations of any kind whatsoever.

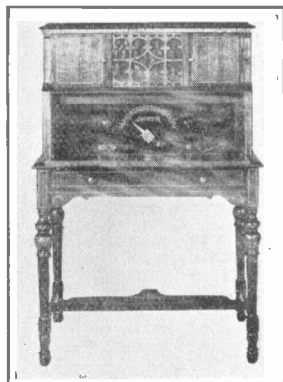

Three-tube Reflex Console Type Receiver

Radio Retailing, July, 1925

The Console model 419-3 built by the Electrical Research and Manufacturing Company, Waterloo, Iowa, is a three-tube reflex receiver using either dry cell or storage battery tubes. It is non-radiating and covers a wave band frequency of from 200 to 600 meters. There are compartments for log book, magazines, head sets, etc. The "Armstrong Symphony" reproducer is a built-in feature of the solid walnut cabinet. Intended retail price, without tubes or batteries, is \$250.



Radio Table

Radio Retailing, July, 1925

The Wasmuth-Goodrich Company, Peru, Ind., has recently placed on the market the radio table shown in the illustration. It is finished in duo-tone hand-rubbed varnish finish, with the top and front made of 5-ply select mahogany or American walnut. The size of the top is 14 in. x 30 in. and with both ends raised it is 47 in. long. The battery compartment is 10 in. x 24 in. x 13 1/2 in. Intended retail price is \$25.

Five-Tube Receiver

Radio Retailing, July, 1925

The "Hollywood Five" employing two stages of tuned radio frequency, detector, and two stages of audio frequency amplification, has been placed on the market by the Hollywood Radio Company, 154 Nassau Street, New York City. Three dials for tuning are provided, as well as a rheostat and potentiometer control. The wave band frequency covered is from 200 to 570 meters. The set is encased in a mahogany cabinet and wired with flexible braided wire. Intended retail price, \$45.

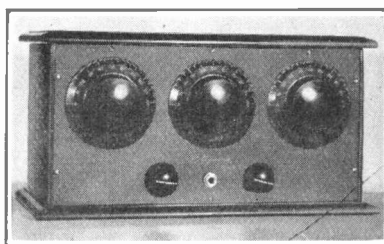

Five-Tube Receiver

Radio Retailing, July, 1925

The "Kenman-5", made by the Kenman Electric Company, 454 Merrick Road, Lynbrook, N. Y., is a five-tube receiver with low-loss construction throughout. The wave-band frequency covered is from 220 to 550 meters. Intended retail price is \$37.50.

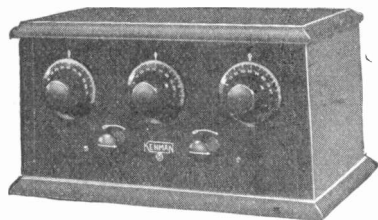

Four-Tube Portable

Radio Retailing, July, 1925

The "Ozarka" portable made by Ozarka, Inc., 855 Washington Boulevard, Chicago, Ill., is a four-tube tuned radio frequency set using UV-199 tubes. The loudspeaker is built in the top of the case, which is fabrikoid-covered. The set is furnished complete with aerial equipment, and has a weight of 25 lb. The intended retail price is \$75.

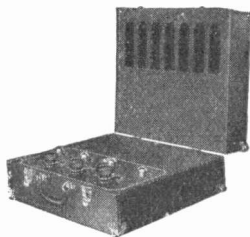

Spring Bumper for Radio Cabinet

Radio Retailing, July, 1925

A self leveling spring bumper with a very heavy rubber insert, to protect any furniture upon which the cabinet may be placed, is being made by the Lakeside Supply Company, 73 West Van Buren Street, Chicago, Ill. The "Protecto-Groove" is also made by this company and is a device used to keep the grooves in the cabinet in which the panel fits from breaking out. It is arranged so that either 1/2-in., 3/8-in. or 1/4-in. panels can be used, and is furnished in nickel, gold or any other color to match either the panel or the cabinet.

A, B, and C Batteries

Radio Retailing, July, 1925

Dry cell B and C batteries and storage A batteries are recent productions of the Music Master Corporation, 130 North Tenth Street, Philadelphia, Pa. The B batteries are made in 22 1/2 and 45-volt sizes, with intended retail prices of \$2 and \$3.75; while the C battery is a 4 1/2-volt battery with an intended retail price of 60c. All the batteries are unconditionally guaranteed. Two sizes of 6-volt storage batteries are also made of 90 and 110 ampere hour capacities. They are incased in mahogany boxes having the top of the battery sealed with a moulded hard rubber lid so that no metal parts are exposed.



Combined Lamp and Reproducer

Radio Retailing, July, 1925

The "Peerlite" is a product brought out recently by the Peerless Light Company, 539 Broadway, New York, which combines a high class reading lamp with a practical reproducer. The vase comes in a number of colors, including orange, maroon, black and jade, with a stippled gold base. It is fitted with two-light cluster on each side of the fiber horn. The shade is said to be unique because of its exquisite glow when the light strikes it from the outside, due to the imported bead overlay over the hand painted surface. The intended retail price complete is \$32.50.

What's New in Radio and Where to Buy It—

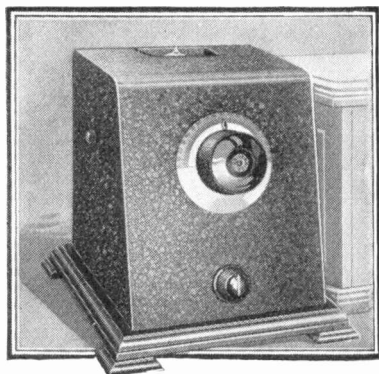

Tube Unit for Improving Reception

Radio Retailing, July, 1925

The "Penetrola" is a new radio device, recently introduced by the Walbert Manufacturing Company, 925 Wrightwood Avenue, Chicago, Ill., which improves the selectivity, volume and range of any receiving set to which it is connected without materially changing the logging of the latter. In addition, when connected to a receiver which ordinarily disturbs other receivers by radiating its own squeals and howls, the Penetrola prevents any such disturbance. This is due to a unique property which allows energy to flow only in one direction—from antenna to receiving set. By allowing the use of a shorter antenna, static interference is greatly reduced. No extra batteries or wires are necessary and no changes have to be made on the receiver. The unit is completely shielded and is equipped with the necessary connecting cables. It may be used as a volume control without affecting the quality of reception. Intended retail price, \$35.

Radio Tube

Radio Retailing, July, 1925

The DV-5 is a new type of tube developed by the DeForest Radio Company, Central Avenue and Franklin Street, Jersey City, N. J. Isolantite (synthetic quartz) used for the base of this tube, has a very high insulating value. This combined with improved internal tube construction, which includes a new chemical exhaust process, is said to give the tube freedom from disturbing noises and crackling, with radical increases in volume from weak signals. It is a 5-volt tube with a standard base and uses plate voltages from 135 to 270 volts. The intended retail price is \$3.

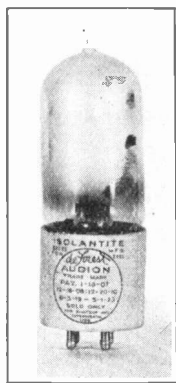

Radio Plug

Radio Retailing, July, 1925

"Polyplug" is a new addition to the line of radio parts made by the Polymet Manufacturing Corporation, 601 Broadway, New York. It is a spring type with a shell of bakelite. No tools are needed to tighten the phone tips and the polarity is plainly marked on the sleeve. The intended retail price is 50c.

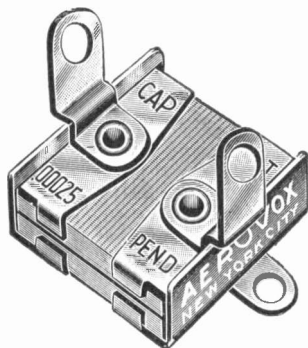
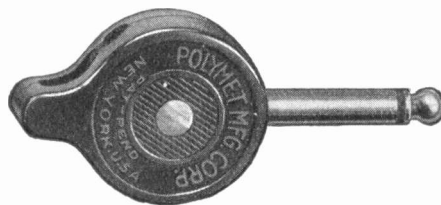

Fixed Condenser

Radio Retailing, July, 1925

The Aerovox Wireless Corporation, 489 Broome Street, New York City, is making a new type of fixed condenser as shown in the illustration. Atmospheric conditions have no effect on these condensers as they are thoroughly impregnated in a vacuum. A feature pointed out by the manufacturer is the standardization of the size and the distance between the mounting holes which makes substitution a simple matter. Capacities range from .0001 mfd. to 4 mfd. with corresponding intended retail prices of from 30c. to \$3.75.

Lamp Loudspeaker

Radio Retailing, July, 1925

The combination lamp and reproducer shown in the illustration is offered by the Simplex Radio Company, Sandusky, Ohio. A "Dictograph" unit is concealed in the base so that the sound waves travel up the inside of the column and vibrate against the inside of the shade. Any kind of a shade may be used as the fitting is standard. The overall height is 21 1/2 in., diameter of the shade 15 in., diameter of the base 8 in., and the total weight 11 1/2 pounds. Intended retail price complete is \$30.

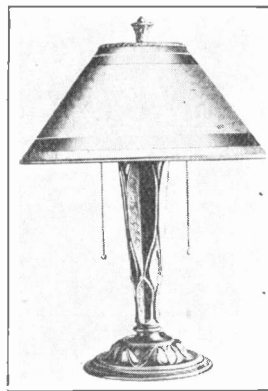

Radio Frequency Kit

Radio Retailing, July, 1925

A kit composed of three condensers, two radio frequency transformers, primary induction coil, and one neutrostat is the latest product of the Neutrowound Radio Manufacturing Company, 1721 Prairie Avenue, Chicago, Ill. The coils are wound with No. 24 green silk covered wire on bakelite forms. The intended retail price is \$25.

Superheterodyne Kit

Radio Retailing, July, 1925

A portable superheterodyne has been designed by Wm. Rosenbloom, 11 Deering Road, Mattapan, Mass., for which he manufactures the superheterodyne parts. The design is such that the complete set can be assembled on a small baseboard and then placed in a week-end case. The W. R. kit has an intended retail price of \$10 with blue prints. UV-199 tubes are to be used. Any standard parts can be used to complete the set.

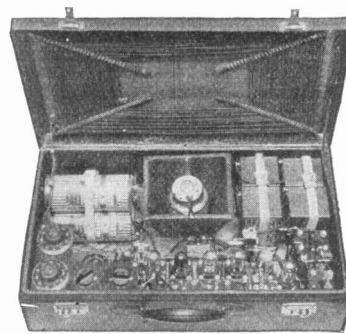

News of Latest Products Gathered by the Editors

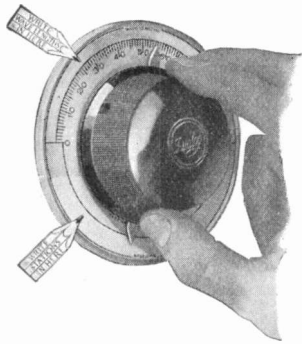

Vernier Dial

Radio Retailing, July, 1925

The "Dialog," a product of the Walnut Electric Manufacturing Company, 308 South Green Street, Chicago, Ill., is a multiple-action dial on which the big bakelite knob moves many times faster than the pointer. The metal logging disk is erasable and removable and on it may be marked both stations and wave lengths. There are no parts to cause back-lash or wear out. The intended retail price is \$1.25.

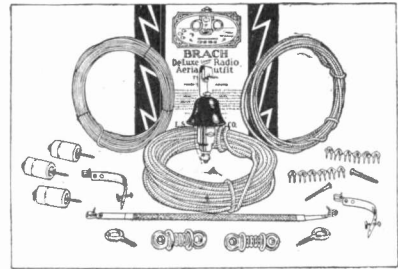

Aerial Outfit

Radio Retailing, July, 1925

The L. S. Brach Manufacturing Company, 127-129 Sussex Avenue, Newark, N. J., has placed four types of complete aerial outfits on the market. Every article necessary for a good installation is furnished, accompanied with an instruction sheet outlining the best method of erecting the aerial. All parts are approved by the National Board of Fire Underwriters. The intended retail price of the Storm King outfit is \$4, of the Storm Guard \$4.50, of the DeLuxe Junior \$5, and of the DeLuxe Senior \$5.50.

Multiple Variable Condenser

Radio Retailing, July, 1925

A compensated multiple variable condenser for single dial control has been placed on the market by the United Scientific Laboratories 80 Fourth Avenue, New York. It can be built into any tuned radio frequency circuit; is compact and space saving and reduces panel requirements. Each unit is of 0.00035 mfd. capacity and the multiple is of low-loss construction.

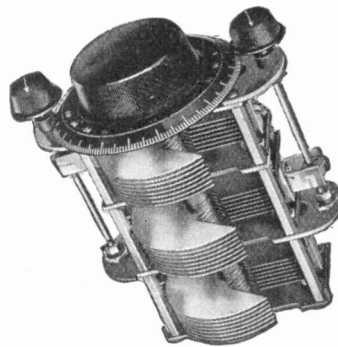

Variable Condenser

Radio Retailing, July, 1925

The "Nazeley" featherweight straight frequency condenser is manufactured by J. Nazeley Company, 571 Hudson Street, New York. The plates are so curved that each division on the dial is equivalent to 10 kilocycles in wave length. The construction is said to be very rugged and light in weight. It is also so designed that two or three condensers may be mounted on the same shaft. Capacities furnished are .00025, .000375, and .0005 mfd., with corresponding intended retail prices of \$3.60, \$3.80 and \$4.

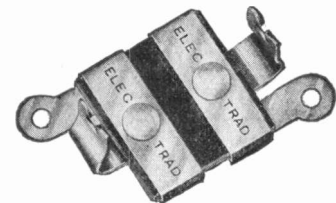
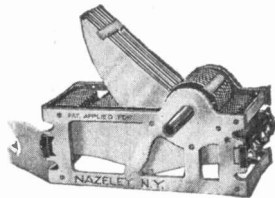

Fixed Condenser

Radio Retailing, July, 1925

Electrad, Incorporated, 428 Broadway, New York City, has augmented its line of radio products with a certified mica fixed condenser, here illustrated, which they have succeeded in calibrating to within 10 per cent of the marked capacity. To insure constancy in value and quiet operation, the condenser is clamped at each corner and at the rivets, making six points of pressure instead of the usual two. The soldering lug is stamped in one piece with the binding strap, assuring perfect electrical contact. These condensers are made in three types. The standard type is made with soldering lugs. Type "G" is made with brackets to receive grid leaks. Type "C-S" in addition carries punched connecting lugs which are especially convenient for attaching directly to socket terminals. Sizes range from .0001 mfd. to .02 mfd. with corresponding intended retail prices of from 30c. to \$1.70.

Extension Connector

Radio Retailing, July, 1925

The "Sherman" extension connector is used for extending or branching all double conductor wires, without the use of tape or solder, and is made by the H. B. Sherman Manufacturing Company, Battle Creek, Mich. Instant connection or detachment can be made with the aid of a screwdriver. In radio work it is recommended when it is desired to use multiple head phones or put an extension on the loud speaker cord. The intended retail price is 60c.

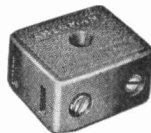

Cat Whisker

Radio Retailing, July, 1925

The "I X L Kat Whisker," made by the U. C. Battery and Electric Company, 2158 University Avenue, Berkeley, Cal., is composed of an alloy of gold, iridium and nickel. This will not corrode or oxidize as will those made from copper, phosphor bronze, etc. Each one is sealed up in a package and has an intended retail price of 25c.

Antenna Lead-in Insulator

Radio Retailing, July, 1925

The antenna "Lead-In-Sulator" made by the Philadelphia Rust-Proof Company, Montgomery Avenue at Howard Street, Philadelphia, Pa., is used to keep the lead-in wire away from the house. In this way good lightning protection as well as better reception is had. The device consists of a brown porcelain spool held in a pressed steel bracket, flanged at the base so it can be mounted by means of nails or screws. On page 571 of June *Radio Retailing* this was quoted at an incorrect price of 10c. The price should have read 25c.

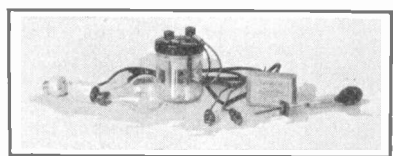

B Battery Charging Outfit

Radio Retailing, July, 1925

The complete B battery charging outfit illustrated is a recent product of the Willard Storage Battery Company, Cleveland, Ohio. A glass jar having a rubber cover and two metal rods, a wiring harness with a two-part plug and battery clips, a package of chemicals for making solution, a small specially designed hydrometer, and a 75-watt lamp constitute the outfit. In a pamphlet that is also furnished, wiring connections are shown so that the outfit may be attached permanently to the batteries by means of a switch. Intended retail price \$6.

What's New in Radio and Where to Buy It—

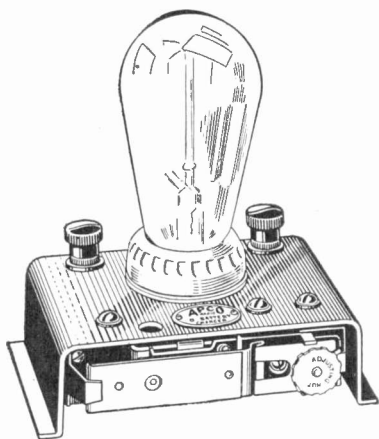

"B" Battery Charger

Radio Retailing, July, 1925

The Apco Manufacturing Company, Providence, R. I., announces a new "B" battery charger, that is a radical departure from anything heretofore manufactured. It is a combination electric light bulb and vibrator type, which charges either a 24-, 48- or 96-volt battery at from $\frac{1}{10}$ to $\frac{1}{4}$ of an amp., depending on the size of the lamp used, which is an ordinary electric light bulb of 25 to 150 watt capacity. The manufacturers claim that this is the only battery charger made that will charge 100 volts at one time in 10 hours, at a cost so insignificant that it is hardly measurable.

The device as shown in the illustration has an intended retail price of \$4.

Radio Highboy

Radio Retailing, July, 1925

A roomy, well-built cabinet is found in the "Superspeaker Highboy" produced by the Jewett Radio and Phonograph Company, 5680 Twelfth Street, Detroit, Mich. The Jewett Superspeaker is built in with plenty of room left for all batteries. Overall dimensions are 55½ in. x 36½ in. x 17½ in. with available room for the set of 30½ in. x 11¼ in. x 11 in. The receiving set compartment has three doors, each of which disappears when open. There is also a drawer 2½ in. x 17 in. x 14½ in. and a removable grill covering the loud speaker horn. The back is opened by two hinged doors. Can be obtained in either African Mahogany or American Walnut. The intended retail price is \$130; west of Rockies, \$140.

Audio Frequency Transformer

Radio Retailing, July, 1925

The type J-121, "Universal" audio frequency transformer is the product of the Connecticut Telephone and Electric Company, Meriden, Conn. It is a well constructed, thoroughly shielded, insulated and protected transformer. The winding ratio is 4½ to 1, with each winding insulated and impregnated. The intended retail price is \$5.

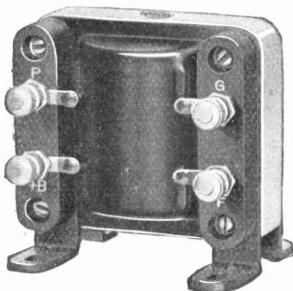

Device for Eliminating Storage Battery on Reflex Sets

Radio Retailing, July, 1925

The "Blax a.c. polarizer" made by Black Brothers, Incorporated, 502 Black Building, Los Angeles, Cal., is to be used with sets using a crystal detector and storage battery tubes, in eliminating the storage battery. The filament current is to be supplied by a door-bell transformer and by connecting this device across the filament leads, the a.c. hum is eliminated. The device consists of a flat resistance unit with a center tap which is connected to the ground. Intended retail price is \$1.



Reactance Amplifiers

Radio Retailing, July, 1925

The "King Cole" type F-3 reactance amplifiers, made by the Anylite Electric Company, Wall Street, Fort Wayne, Ind., are to be used where it is desired to obtain more than two stages of audio frequency amplification. The amplifiers consist of a reactance coil, high resistance leak and fixed condenser, all contained in a case which is small and easily mounted.

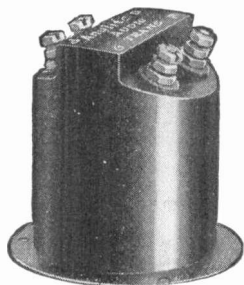

Anti-Corrode Paste

Radio Retailing, July, 1925

The Kant-Rust Products Corporation, Rahway, N. J., has brought out a new product called "Kant-Krode." It is a dark colored paste, packed in tubes for convenience, and is for use on any exposed metal where it is desired to combat corrosion. It is also said that metal treated with this paste loses none of its electrical properties. The intended retail price is 50c. per tube.



Fuse for Filament Protection

Radio Retailing, July, 1925

"Gem" radio fuses are designed to prevent the burning out of radio tubes due to the excessive current which would flow should the B battery be accidentally connected across the filament circuit. These are made by the Chicago Fuse Manufacturing Company, Laflin and Fifteenth Streets, Chicago, Ill. The base is of hard moulded insulating material and has two spring clips to hold the fuse firmly in place. If between 140 and 200 milliamperes flow, the fuse will burn out. The intended retail price of the base alone is 25c., while the fuses are three for \$1.

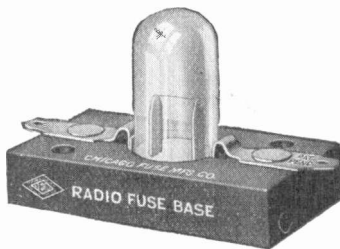

Aerial Wire

Radio Retailing, July, 1925

The "Gosilco" aerial wire consists of No. 14 copper wire, to which has been applied a heavy electro-plate of pure silver, which is then burnished, and a substantial plate of 24 karat gold put on, according to the American Luminous Products Company, Huntington Park, California. It can be silver soldered and used for hook-up wire. Intended retail price is 4c. per foot and length.

Low-Loss Tuner

Radio Retailing, July, 1925

For use in three-circuit work, the Transcontinental Sales Company, 241 Market Street, Newark, N. J., has introduced a new low-loss tuner. The coils are self-supporting with an adjustable primary. It has a range of from 200 to 600 meters when used with a .0005 mfd. condenser. Intended retail price, \$7.

News of Latest Products Gathered by the Editors

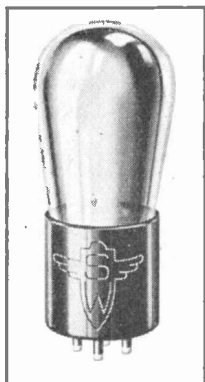

Tube

Radio Retailing, July, 1925

"Airtron" is the name of the tubes made by the H. & H. Radio Company, 514 Clinton Avenue, Newark, N. J. The bakelite bases are of very high electrical strength and do not absorb moisture. Type 200, 201-A, 12, 199 and 199-A are all made to sell at an intended retail price of \$3 each.

Tube

Radio Retailing, July, 1925

The Stewart-Warner Speedometer Corporation, 1826 Diversey Boulevard, Chicago, Ill., is now manufacturing 5-volt, 1/2-amp. tubes. These tubes are made by the high-vacuum flash process, mounted in a standard base, and put through rigid tests. A special filament wire is used which is said to give almost double the electron emission of thorium coated wire. The intended retail price is \$3.

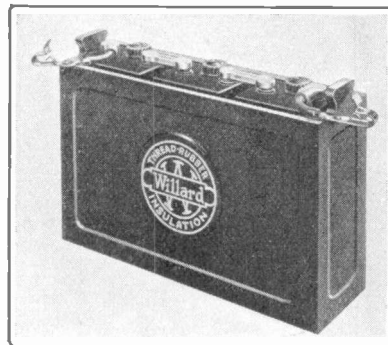
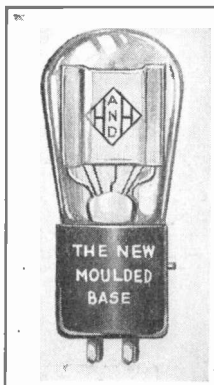

Cabinet Storage Batteries

Radio Retailing, July, 1925

The Willard Storage Battery Company, Cleveland, Ohio, has developed two new cabinet batteries, a 4-volt and a 6-volt battery. The MCRR-110 is the 4-volt battery, designed for Radiola cabinet sets and the MCRR-4 is the 6-volt battery size. They are contained in hard rubber cases and equipped with special Fahnestock terminals. The MCRR-110 has a special non-spill design and can be safely placed in the most expensively finished cabinet without danger from the acid. Intended retail price of the 4-volt battery is \$14.70, that of the 6-volt battery \$21.

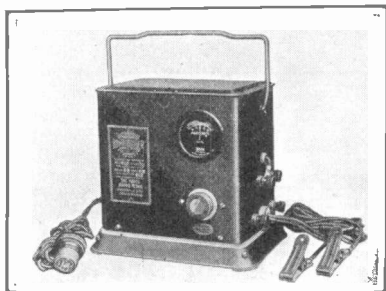

A and B Battery Charger

Radio Retailing, July, 1925

The "A-B Gold Seal Homcharger" made by the Kodol Radio Corporation, 120 West Third Street, Cincinnati, O., will charge either A or B batteries without disconnecting them from the set. It is equipped with an ammeter, five-foot attachment cord and plug, and a heavy rubber-covered, acid-proof charging cable with clips. The rate of charging is at five amps. Intended retail price is \$18.50.

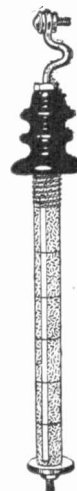

Lead-in Bushing

Radio Retailing, July, 1925

The "Fleron" porcelain lead-in bushing furnishes a satisfactory method of bringing the aerial lead-in wire into the house. It is made by M. M. Fleron and Son, Incorporated, 113 North Broad Street, Trenton, N. J. The bushing is made up of 1-in. tongue and grooved porcelain sections. These can be easily removed to shorten the bushing to fit the required space and the threaded brass rod can be shortened accordingly. The intended retail price is \$1.10.

Battery Clip

Radio Retailing, July, 1925

Made acid resisting and electroplated for better conductivity are important items pointed out by the Valley Electric Company, 3157 South Kingshighway, St. Louis, Mo., makers of the new "Valley" battery clip. It is attached to leads by an oval head screw and lugs are then bent over to hold the insulation of the lead wire from fraying. The overall length of the clip is 2 3/4 in. and it has jaws that will take up to a 3/4-in. battery post. It has a rated carrying capacity of 25 amps.

B Battery Eliminator Tube

Radio Retailing, July, 1925

"Rex" is the new tube that has been designed especially for B battery eliminators by the Connewey Electric Laboratories, 406 Jefferson Street, Hoboken, N. J. The bulb is round in shape and has a standard bakelite base with four prongs, although only three of them are used in the circuit. The tube has a rating of 5 watts and the filament draws 1 amp., which gives it a much longer useful life. Intended retail price is \$3.



Super-Heterodyne Kit

Radio Retailing, July, 1925

Obtainable for either six or nine tubes are the "Como" super-heterodyne kits put up by the Como Apparatus Corporation, Kelly Street, Manchester, N. H. The six tube outfit is arranged for UV 199 tubes, and is 16 1/2 in. x 8 in. x 4 in. No audio frequency amplification is provided for as it is intended for head-phone use only. The nine tube outfit is designed either for UV-199 tubes or UV-201-A tubes. If the former are used the dimensions are 24 in. x 8 in. x 4 in., and for the latter they are 26 1/2 in. x 9 1/2 in. x 4 3/4 in. Push-pull is used in the second stage of audio frequency amplification. Pictorial diagrams are furnished, instead of the usual blueprints, supplemented by five photographs of a completed set. The panel has all of the holes drilled ready for mounting. Intended retail prices are in order, \$87.50, \$125 and \$130.

What's New in Radio and Where to Buy It—

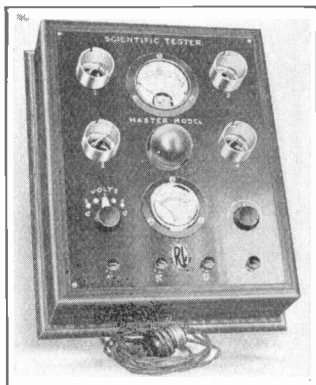

Tube Tester

Radio Retailing, July, 1925

Characteristics of tubes in order to determine where they will work best may be had by the use of the "Master" model tube tester made by the Quincy Radio Laboratories, Quincy, Ill. Tubes may also be tested for short circuits and recuperated in this tester. A smaller "Standard" model is made which is the same as the larger model except that it does not test for short circuits. The intended retail price of the Master model is \$45 and that of the Standard \$30.

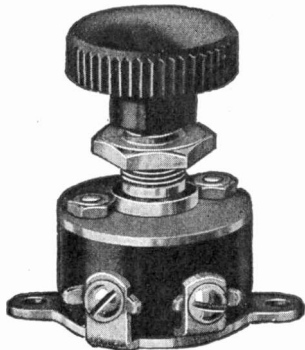

Variable Resistance Unit

Radio Retailing, July, 1925

The "Telo-Stat." made by the Connecticut Telephone and Electric Company, Meriden, Conn., is a variable resistance that may be used to stabilize all radio circuits and adjust all high-frequency currents. It is made in three sizes covering a range of from 30,000 ohms to 10 megohms. The intended retail price is \$1.25.

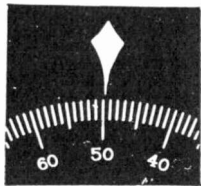

Dial Pointer

Radio Retailing, July, 1925

"Eureka" is the name of the polished nickel dial pointer being made by C. W. Butts, Incorporated, 42 Hedden Place, East Orange, N. J. As mounting is accomplished by means of a threaded screw that projects from the rear, all that one has to do is drill a small hole through the panel, and then tighten up the nut on the reverse side. The intended retail price is 10c. each.

Resistor Unit

Radio Retailing, July, 1925

Known as "Radio Vitrohm" is the resistance made by the Ward Leonard Electric Company, Mount Vernon, N. Y., to be used with recent models of a.c. battery chargers, of the Tungar type, in charging B batteries. Taps are provided so that lamps of 25, 40, 60 and 75-watt sizes may be replaced by this unit. The resistance wire is wound over a porcelain form which is vitreous enameled. Intended retail price \$12.50.

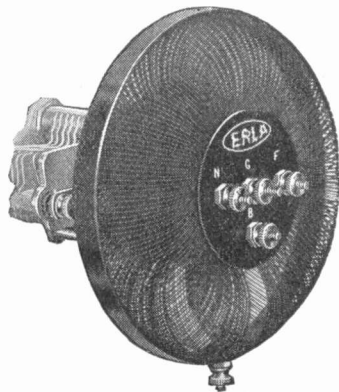
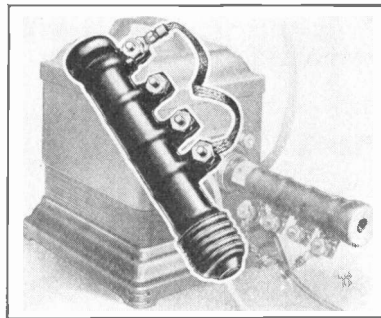

Ring Coil

Radio Retailing, July, 1925

The "Erla" balloon circloid coil has been introduced by the Electrical Research Laboratories, Chicago, Ill., as a coil which has no external field. Further, the turns are so arranged that when they are cut by another field, the induction is neutralized by the opposing turns. Thus, it is pointed out, both internal and external interference is eliminated. Each coil has a primary and secondary winding making it adaptable for tuned radio frequency circuits.

Socket Wrench Set

Radio Retailing, July, 1925

"Radio-Lectric" is the name of the socket wrench set made by the Bridgeport Hardware Manufacturing Corporation, Iranistan Avenue, Bridgeport, Conn. The sockets are $\frac{1}{8}$ in., $\frac{3}{16}$ in., and $\frac{1}{4}$ in., which are the three most commonly used sizes for hexagon nuts. Other sizes are furnished separately. The sockets snap on to the handle shaft which has a hollow shank to take projecting screws. The intended retail price is 50c. a set.

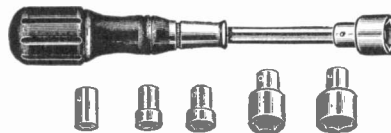

Glass Insulator

Radio Retailing, July, 1925

A glass insulator is now being made by the Alpha Radio Supply Company, 611 Broadway, New York City. It is guaranteed to withstand all natural temperature changes without cracking or breaking and has a high tensile strength. The intended retail price is 25c.

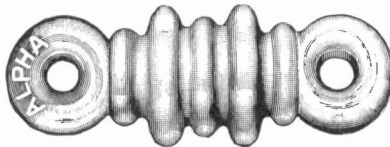

Filament Rheostat

Radio Retailing, July, 1925

A rheostat, of small size, and with a new type of contact arm is offered by the Electrical Research Laboratories of Chicago, Ill. As is pointed out by the designers, the arm, instead of running directly from the outside of the rheostat to the shaft, divides in the center, and the two halves fasten to the shaft at the sides. This feature gives flexibility and firm pressure. It is also a one-hole-mounting rheostat, being fastened to the panel by means of a single nut, which is screwed down over the threaded shaft bearing.

Matched Condenser Kit

Radio Retailing, July, 1925

Condensers that are guaranteed to have identical capacity curves are offered by the Duplex Condenser and Radio Corp., 36 Flatbush Avenue Extension, Brooklyn, New York, in its FR15-K kit. It is a sealed box containing three, matched, 15 plate condensers. These condensers, when used in tuned radio frequency sets, are said by the makers to give uniform dial settings. The intended retail price per set is \$14.25.

News of Latest Products Gathered by the Editors

Pilot Light Switch

Radio Retailing, July, 1925

The new No. 210 pilot light switch, made by the Yaxley Manufacturing Company, 217 North Desplaines Street, Chicago, Ill., is a decided novelty as well as a great utility for the radio receiving set. The device consists of a filament switch, socket and jewel. The lamp, which is mounted directly behind the jewel, indicates whether the set is on or off. The jewel and switch mount in panel holes of the same size. A miniature lamp, 0.1 amp. 6 volt, is furnished with the pilot light switch. However, any miniature 6-volt screw base lamps will operate satisfactorily with it. The intended retail price of the complete device is \$1.

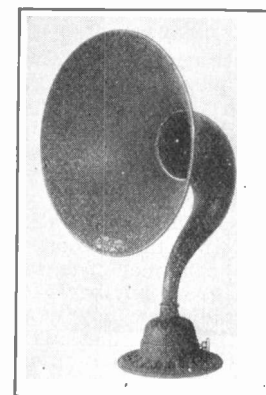
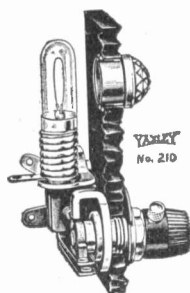

Reproducer

Radio Retailing, July, 1925

The Kleertone Radio Corporation, 298 Church Street, New York, is manufacturing a new reproducer unit with the diaphragm adjusted by means of gears. This arrangement gives a smooth adjustment action and also keeps all points on the magnet surfaces equidistant from the diaphragm. The intended retail price of the unit is \$5. This unit is also used in several models of horns made by the above company. The type illustrated, with a bell metal horn has an intended retail price of \$15, while another with a mahogany bell has an intended retail price of \$22.50

Combination Radio Table and Reproducer

Radio Retailing, July, 1925

The Stewart-Warner Speedometer Corporation, 37 West Sixty-fifth Street, New York City, is introducing a new piece of radio furniture in the No. 410 table. It is made of mahogany with the reproducer built-in one side, sliding compartments for batteries in the other and a drawer in the center. There is also a space in the back for B batteries and battery charger. The overall dimensions are approximately 31 in. x 15 in. and the intended retail price is \$65.



A.C. Tube Transformer

Radio Retailing, July, 1925

The Dougan Electric Manufacturing Company, 2987 Franklin Street, Detroit, Mich., is making a new type-B, a.c. tube transformer suitable for operating the McCullough tubes. It is a 75 watt transformer operating on 100-125 volts, 25 or 60 cycles. The voltage is variable in 1/2 volt steps up to 5 volts. Intended retail price is \$6.



Variable Condenser

Radio Retailing, July, 1925

Model 7-19 is the latest type of variable condenser to be made by the U. S. Tool Company, Ampere, N. J. It has been designed to fill the need for a compact and efficient condenser at a reasonable price. By using a one-piece stator, a single end plate and a long sleeve cone bearing, a sturdy condenser has been built of low minimum capacity.

Low Voltage Transformers for Use with A. C. Radio Tubes

Name of Manufacturer	Trade Name	List Price	Input Voltage	Freq. in Cycles	Output Voltage	Rating in Watts	Dimensions in inches	Weight in lbs.
Betts and Betts Corp., New York	Vim	\$3.50	110-120	60-140	3-30	50	4 1/2 x 2 1/2 x 3 1/2	2
Dougan Electric Mfg. Co., 2987 Franklin St., Detroit, Mich.	Type B-a.c. tube special	6.00	100-125	25 or 60	2 1/2-5	75	2 1/2 x 2 1/2 x 4	3 1/2
Electric Heat Control Co., Cleveland, Ohio	King	6.00	110 or 220	25 or 60	4-5-6	75-100	3 1/2 x 4 x 4 1/2	6
Holms Electric Mfg. Co., Chicago, Ill.	Holms	5.00	115 ± 5%	60	6-12	75	3 1/2 x 5 x 4	6
Ives Mfg. Corp., Bridgeport, Conn.	Ives No. 204	4.00	110	25-40-60	3-25	100	3 1/2 x 4 x 3	4
Jefferson Electric Mfg. Co., 511 So. Green St., Chicago, Ill. (for 220 volt, 60 or 25 cycle transformers, add 15%)	Midget-1621	4.50	100-120	50-133	1 1/2 to 24 volts in 1 1/2 volt steps	75		
	Midget-1221	5.50	25-40	25-40		75		
	Midget-2621	5.00	210-230	50-133		75		
	Midget-2221	6.50	210-230	25-40		75		
	No. 2-1622	6.00	100-120	50-133	5 1/2 to 23 volts in 1/2 volt steps	100		
	No. 2-1222	7.50	100-120	25-40		100		
	No. 2-2622	7.00	210-230	50-133		100		
	No. 2-2222	8.50	210-230	25-40		100		
	No. 3-1623	8.00	100-120	50-133	1 1/2 to 30 volts in 1 1/2 volt steps	150		
	No. 3-1223	10.00	100-120	25-40		150		
	No. 3-2623	9.00	210-230	50-133		150		
	No. 3-2223	11.50	210-230	25-40		150		
No. 6-1626	15.00	100-120	50-133	1 1/2 to 30 volts in 1 1/2 volt steps	250			
No. 6-1226	18.75	100-120	25-40		250			
No. 6-2626	17.25	210-230	50-133		250			
No. 6-2226	21.50	210-230	25-40		250			
Mohawk Electric Mfg. Co., 15 Kirk Place, Newark, N. J.	Mohawk	5.00	110-120	40-50-60	4-6 in 1/2 volt steps	75	5 x 5 x 4 1/2	4
Thordarson Electric Mfg. Co., 500 W. Huron St., Chicago, Ill.	Three Way	1.88 1.50	110 110	25 60	6-8-14	25	3 1/2 x 2 1/2 x 2	1 1/2
Viking Electric Co., New York	Veco	6.50	110	60	4	20	2 1/2 x 3 1/2 x 3 1/2	2 1/2
Waldron Electric Co., Cleveland, Ohio	Waldron	4.00	110	60	6-9-12	75	3 1/2 x 3 1/2 x 3 1/2	3

What the Trade Is Talking About

Retailing

With the Victor Talking Machine Company getting ready to market a combination phono-radio set, in conjunction with the Radio Corporation of America, the question of what to do with the old style phonographs is one of the most serious now confronting the music dealer.

The phono-radio combination has already shattered the market for the single phonograph machines, and, considering the great number of phonographs and radio sets now in use, the market for the combinations seems, necessarily, to be limited unless music dealers are willing to accept the old, single phonographs as part payment on the phono-radios.

And if they do that, how will they then dispose of the trade-ins? Will their profits be tied up in the practically marketless phonographs? How best to sell the phono-radio combinations without tying up a lot of money in second hand radio sets and phonographs is the "nigger in the woodpile." Maximilian Weil, president of The Audak Company, suggests that attempts be made to "radio-ize" the phonographs already sold, by inserting, in the upright models, a radio receiver in the record case. Several radio panels are made to fit the console phonographs but little effort has been exerted to make one for the upright models.

Inserting these radio panels in the various types of phonographs already sold is an excellent idea and one that can profitably be taken up by radio dealers. However, it does not sell the combination sets, which is the question before the trade, particularly the music trade, right now.

If you have any thoughts on "How to Sell the Phono-Radio Combinations," that might be of aid to your fellow dealers, send them to *Radio Retailing* for publication.

To charge for service or not to charge for service—that's the question that puzzles a great majority of radio dealers. And, like every question, there are two sides to it. The man who charges for the service he renders does so with the firm belief that he is making his service department pay for itself. The man who gives free service is equally as sure that his free service policy indirectly pays for itself because of the added business it brings him. The answer—which policy to pursue—is up to the individual dealer. Dealers should know their radio service costs; know whether "free service" is bringing in enough additional trade to warrant it, and then decide whether or not to charge for it.

During the course of a recent conversation between a radio dealer and the writer, the subject of service came up. The dealer made a charge for service—\$1 an hour—and put forth the claim that he was making 25c. on

every service dollar. That his service costs were 75c. an hour. So we took the component parts of the 75c. that made up his service costs and put them down on black and white—so many cents for salaries, so many cents for gasoline, so many cents for garage rent, etc. When we got through, we found that this dealer, instead of making a quarter on every service dollar, was losing a quarter—that is, we found that his service was costing him \$1.25 an hour, instead of the 75c. he had believed.

Here is a condition that is probably true of many dealers. Find out how much your service is actually costing you, how many sales you can attribute directly to it, then make up your mind whether or not to continue giving free service and act accordingly.

"Door-to-Door Selling vs. Municipal Authorities" was the gist of an interesting case recently before the Supreme Court. The City of Portland, Ore., passed an ordinance making it compulsory for house-to-house solicitors to take out a license and file a bond, in cases where an advance fee was required before delivery of the merchandise. Action was brought against the city officials by a manufacturer who had been selling merchandise house-to-house with the result that the Supreme Court has just decided the ordinance "materially burdens Interstate commerce and conflicts with the Commerce Clause," as most merchandise is transported from the State where it is manufactured, to other States for retailing. Thus is



"Honest, he was so-o-o-o big," boasts George Scoville, vice-president and sales manager of Stromberg-Carlson; only, as is not usually the case in fish stories, George has the fish to prove it. He has a habit of going across the border into Canada. That sounds alarming, but Mr. Scoville declares he goes to Canada for the sole purpose of fishing and the picture seems to bear out the theory that there are fish in Canada. There ought to be. Canada's such a wet country.

house-to-house selling upheld even by the Supreme Court!

The ruling of the National Electrical Code Committee that all radio storage batteries must be fused, directly affects all radio dealers. It provides one more thing for the radio dealer to sell and profit thereby.

Storage battery fuses must now be part of every radio installation, just as lightning arresters must be included in the aerial circuit. There are a few extra dollars to be made in installing them on sets already sold.

"Radioterias" should prove a big help to every regular retail outlet in their community. Chicago has been recently afflicted with a self-service radio store—the first in our infant industry—and neighboring radio shops felt that at last the final blow was delivered to their parts business.

But that is not true. "Radioterias" will eventually help you sell more parts. Radio is not a product that can be merchandised like groceries and chewing gum. Nine parts customers out of ten will go into your store, wanting to buy a certain part, but with little or no definite make in mind. He leaves it up to you to sell him the best you have. If he likes it he buys it. If not, he doesn't. But his own judgment in parts often borders on the atrocious.

When the customer goes into a self-service radio shop he has no salesman to "chew the fat" with—admittedly a great factor in the sale of parts—and he must rely on his own poor judgment. So he'll probably pick out something that either won't meet his requirements or won't work at all. But he has no comeback, his money is gone, his part won't work and he's then ready to go to the nearest legitimate radio store and let the radio doctor tell him what's what.

That's why we say the "radioteria" idea will do you more good than harm. It'll show the radio fans what a darn good store yours is, after all.

Manufacturing

"Radio Ensembles" is the latest innovation on the market. Music Master started it. Stewart-Warner, too, has now inaugurated it. The idea, borrowed from the automobile industry, is to sell a complete radio receiving outfit, all the accessories of which bear the same trademark. The set, reproducer, tubes, batteries and aerial equipment are manufactured and marketed under the same trademark and sold as a unit. Just as one buys an automobile, and gets the tires, bumpers, batteries, lights, etc., included in the purchase price, so these "Radio Ensembles" enable the consumer to buy his receiving equipment as a unit of a single manufacturer.

The industry has awaited this merchandising practice for some time. Its reception by the public will be watched with interest.

Sidelines to help the radio dealer over the summer is a much mooted question. Some say it is wise to sell a summer sideline, while others maintain that, done right, radio alone is sufficient to keep one busy. Therefore it is more or less of a sensational announcement when one manufacturer at least admits the necessity of a sideline during the summer. The Kodak Radio Corporation, Cincinnati, has just purchased the Mattman and Sinclair Air-O-Meter Company, manufacturers of patent air gages for automobile tires. "This was done," the announcement reads, "to provide year-round work for our staff of radio engineers and employees. It was thought best to manufacture this summer line during the hot weather, rather than lay off valuable men."

When a manufacturer recognizes that radio can be supplemented by a sideline that has its peak during the summer, and governs his business accordingly, it rather shoots holes in the claim that radio is an all-year round proposition. Still, a good many radio dealers, with no sideline to carry them over, manage to make money during the warm months. Summer success in selling radio seems to be up to the individual, rather than to climatic conditions.

The many new factories, being built or purchased by radio manufacturers is a sure indication that the future of radio is sound. New factories and the equipment necessary to furnish them cost money, and no concern is going to sink a fortune in expansion without a pretty safe guarantee that its investment will yield an excellent return.

Therefore, the other two branches of the trade, wholesaling and retailing, may well read between the lines and govern themselves accordingly. Radio is looking up, and past economic experience points to a banner year for radio in the season of 1925-6. It has been the experience of every trade, to go through a series of peaks and valleys in selling.

Radio has had its ups and downs. It is now passing through a valley. The upward trend is bound to come in the fall. It's a natural law of industry—any industry. The money is there to be spent. It is not being spent now. Therefore, it must be spent in the near future. Prepare for it.

Broadcasting

The next development, to which radio may look forward, is the broadcasting and reception of pictures, even of actual scenes. The radio trade need fear no radical or upsetting change in the broadcasting of sound. The next craze which will sweep the country, when it is developed, and that will be during the course of the next five or ten years, perhaps sooner, will be the broadcasting of motion pictures. Captain Richard Ranger, first to develop apparatus to send still photos across the Atlantic, admits motion picture broadcasting is an electrical possibility. The drawback is

that man has not yet developed instruments speedy enough to send and receive pictures with the rapidity required to transmit motion pictures.

But that will come in time. Science will develop these instruments of vision, just as it has developed instruments of hearing. The Department of Commerce, recognizing the importance of picture transmission, has just given official permission for amateurs to connect picture transmitting apparatus to their regular transmitting sets under their existing licenses and on any of the wavelengths authorized for amateur use. Thus, amateurs may play as important a part in the development of picture transmission as they have in voice transmission.

F. E. Conrad, a radio dealer of Reading, Pa., has an unusual thought about super-power broadcasting. Conrad believes that super-power cannot be given a fair trial until it's put to the test. His plan would consist of giving six or eight stations in widely separated principal cities, temporary licenses to broadcast on 5,000 watts and see what the public reaction would be.

Why not? It could cause no serious harm and might accomplish a great good. Try out super-power broadcasting in this way, Conrad asks, then ascertain, by actual experimentation, whether or not it is practical. Radio receivers will not radically improve for several years, at least. Better reception, resulting in the sale of more sets, must come from the broadcasting stations. Super-power will also do its share in bringing up the downward curve in summer selling.

No recent occurrence better illustrates the fact that the radio and music industries are closely allied and can be of great mutual benefit, than the discovery that the Victor Talking

Machine Company is now making records electrically. Instead of recording into a large horn, artists now play to a microphone, connected with wires to the recording apparatus, the sound vibrations being translated into electric energy, sent over the wires and translated back again into sound waves for the purpose of recording.

The improvement in records made in this way—suggested by the microphone system used in radio broadcasting—is noticeable to an extremely marked degree. Very little tone is lost and volume and clarity are much better in these new records.

They have not as yet been advertised by the Victor Company, due, in all probability, to a commendable desire not to spoil the market for the old style records until they are pretty well exhausted. However, the records made by the electrical process are distinguishable by a small "VE" in the center margin.

Jobbing

A Newark, N. J., jobber—the National Light and Electric Company—has put into practice a "dealer help" idea that is worthy of notice. This organization holds periodic service meetings (at which beer and hot dogs are given out, so the story goes, thus assuring a large attendance), and at these meetings the topic discussed is how best to service some one line of radio receivers. Engineers of various companies address the meetings, explaining the intricacies of their receivers, their essential points of difference from other receivers, and what to do when the set won't talk. That this is a real, practical aid to dealers and their service men is shown when it is claimed the average attendance is about 200. Truly, a great step forward in dealer-jobber-manufacturer co-operation.

Hunting for DX Made Conrad a Good Shot

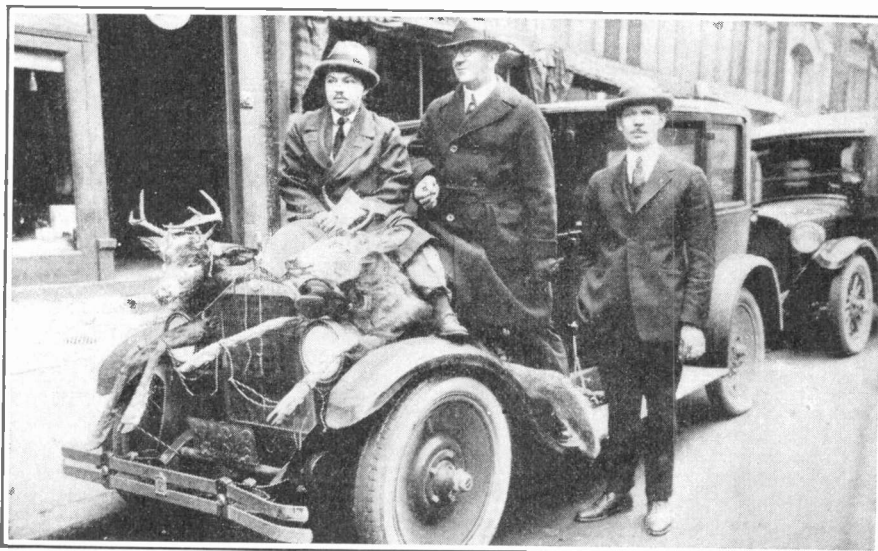

F. E. Conrad is a radio dealer of Reading, Pa., who did so much hunting for distance on his radio set that it made him an expert with the rifle. On a recent hunting trip into Pike County, Pa., Conrad and two friends (Yes, he's sold them each a set) shot the two deer seen on the running board of the car. Conrad is standing at the right and his radio shop may be seen in the background.

Radio Expositions Ahead

August 22-29: Pacific Radio Exposition, Civic Auditorium, San Francisco, Cal.

August 23-September 6: Canadian National Radio Exhibition, Exhibition Coliseum, Toronto, Canada.

September 3-9: Vancouver Radio Show, Hotel Vancouver, Vancouver, Canada.

September 5-12: Third Annual National Radio Exposition, Ambassador Auditorium, Los Angeles, Cal.

September 9-20: International Radio and Wireless Exhibition, Geneva, Switzerland.

September 12-19: Fourth Annual National Radio Exposition, Grand Central Palace, New York City.

September 14-19: Second Annual Radio World's Fair, 258th Field Artillery Armory, Bronx, New York City.

September 14-19: Pittsburgh Radio Show, Motor Square Garden, Pittsburgh, Pa.

September 14-19: Winnipeg Radio Show, Royal Alexandria Hotel, Winnipeg, Canada.

September 23-28: Calgary Radio Show, Memorial Hall, Calgary, Canada.

September 23-27: International Radio Exposition, Steel Pier, Atlantic City, N. J.

October 3-10: Philadelphia Radio Exposition, The Arena, Philadelphia, Pa.

October 5-10: Northwest Radio Exposition, St. Paul Auditorium, St. Paul, Minn.

October 5-11: Washington Radio Show, Convention Hall, Wash., D. C.

October 10-16: National Radio Show City Auditorium, Denver, Col.

October 12-17: St. Louis Radio Exposition, Coliseum, St. Louis, Mo.

October 12-17: Second Annual Montreal Radio Show, Windsor Hotel, Montreal, Canada.

October 17-23: Brooklyn Radio Show, Twenty-Third Regiment Armory, Brooklyn, N. Y.

October 19-25: Second Annual Cincinnati Radio Exposition, Music Hall, Cincinnati, O.

October 24-31: National Radio Exposition, American Exposition Palace, Chicago, Ill.

October 27-November 7: Second Wireless Exhibition, City Exhibition Hall, Manchester, England.

November 2-7: Second Annual Toronto Radio Show, King Edward Hotel, Toronto, Canada.

November 3-8: Detroit Radio Show, Arena Gardens, Detroit, Mich.

November 9-15: Milwaukee Radio Exposition, Civic Auditorium, Milwaukee, Wis.

November 17-22: Second Radio World's Fair, Coliseum, Chicago, Ill.

December 1-6: Boston Radio Show, Mechanics' Hall, Boston, Mass.

show opens October 12th and continues until the 17th. The Toronto Radio Show will open November 2 closing on the 7th. As greatly increased space is required it will be held this year in the Crystal Ball Room and Blue Room, at the King Edward Hotel.

500,000 Neutrodyne in Use at Present

Figures just made public by the Independent Radio Manufacturers, Inc., licensed by the Hazeltine Corporation to make radio receivers embodying the neutrodyne circuit, indicate that 504,504 neutrodyne sets have been sold since April, 1923, when the licenses were issued.

New Radio Club for Denver

Manufacturers' representatives and agents located in Denver, Col., have formed a local club with the idea of creating better co-operation between the manufacturer and jobber, and the jobber and retailer.

The club at present is composed of approximately ten members, who are now working on the idea of promoting a Denver radio show in the fall.

Trade Body Plans to Stop Interference

The Northwest Radio Trade Association, Minneapolis, Minn., has raised the sum of \$10,000, the majority of which is to be used in studying and eliminating "man-made interference" with radio reception in the vicinity of the Twin Cities. Prof. C. M. Jansky, Jr., of the University of Minnesota, is at the head of the interference research work and will shortly recommend a course of procedure to be followed in finding and stopping the noises.

Fourteen New Broadcasters

Fourteen broadcasting stations comprise the latest list of stations licensed by the Department of Commerce.

Three are high-powered stations: KTCL, American Radio Telephone Company, Seattle, Wash., 1,000 watts, 305.9 meters; WHT, Radiophone Broadcasting Corporation, Deerfield, Ill., 1,500 watts, 238 meters, and KPRC, Post Dispatch, Houston, Tex., 500 watts, 296.9 meters.

Smaller stations, whose licenses are of interest to the trade, are: KFVS, Cape Girardeau Battery Station, Cape Girardeau, Mo., 50 watts, 224 meters; WBRC, Bell Radio Corporation, Birmingham, Ala., 10 watts, 248 meters; WIBL, McDonald Radio Company, Chicago, Ill., 250 watts, 215.7 meters.

Other licenses under 100 watts include: Episcopal Church, Junction City, Kan.; Eugene Rossi, Moonlight Ranch, Denver, Col.; F. W. Morse, Jr., Chico, Cal.; Wilson Duncan Studios, Kansas City, Mo.; F. B. Zittel, Jr., Flushing, N. Y.; C. L. Carroll, Chicago, Ill.; University of the City of Toledo, Toledo, O.; H. M. Couch, Joliet, Ill.

High-Power Broadcasting Improves Reception

Radio reception this summer should be the most perfect in the history of radio, which, consequently, must of necessity react to the benefit of the man who sells radio.

There are 146 reasons why radio reception is going to be extraordinarily good this year and those 146 reasons are the 146 broadcasting stations that are transmitting on 500 watts or more.

From an analysis of the Government's latest list of licensed stations it has been found that many have increased their power since last summer, and that many more plan to do so this year.

One station—WLW, Cincinnati—is sending out on 5,000 watts, and by the time this paper reaches your hands, one or two more may be doing so. There is one 2,500-watt station—KGO, Oakland, Cal.—and one 2,000 watt station—WEAF, New York City. Nine 1,500-watt transmitters are broadcasting—KFI, Los Angeles; KFKX, Hastings, Neb.; KOA, Denver, Col.; KYW, Chicago; WBZ, Springfield, Mass.; WGY, Schenectady, N. Y.; WOC, Davenport, Iowa; WTAM, Cleveland, and WTAS, Elgin, Ill.

Eleven 1,000-watt stations are in the field: KDKA, Pittsburgh; WBAP, Fort Worth, Tex.; WEAR, Cleveland; WEBH, Chicago; WGBS, New York City; WGN, Chicago; WJZ and WJY,

New York City; WNYC, New York City; WOAW, Omaha, Neb.; and WKRC, Cincinnati, O.

Four 750-watt stations have been licensed—KTW, Seattle, Wash; WGR, Buffalo, N. Y.; WMH, Cincinnati, O.; WSB, Atlanta, Ga. Besides these, 119 500-watt stations are broadcasting in all sections of the country, and a new one, WSMB, New Orleans, has opened up new radio sales markets in the lower Mississippi territory, as WMBF did in Florida.

Five Canadian Radio Shows in Fall

Five Canadian radio shows under the management of the Canadian Exhibition Company, are billed for the autumn. The first of the 1925 Canadian radio shows will be held at Vancouver, opening September 3 and continuing until September 9. It will occupy much of the main floor of the Hotel Vancouver. The Winnipeg Radio Show will open September 14th at the Royal Alexandra Hotel where it will occupy practically all the mezzanine floor until September 19th.

The Calgary Radio Show will be held in Memorial Hall. It will open September 28, lasting until October 3. Three times the amount of space occupied last year for the show in the Windsor Hotel, Montreal, is required for this year's exhibition. The coming

Victor Company Passes Dividend

The effect that radio has had upon the operations of the Victor Talking Machine Company was brought to light last month when the board of directors met and failed to take action on the quarterly dividend of 2 per cent.

At one time the Victor company was looked upon as one of the most prosperous organizations in the country, in some years paying as high as \$80 in dividends to stockholders. Based on the increased capitalization, the interest rate of 8 per cent which was paid in 1923 and 1924 was equivalent to 56 per cent on the old capitalization, prior to stock dividend disbursements.

The report circulated in the past few months relating to the probable action to be taken by the directors on the dividend have been responsible for the sharp downward movement in the price of the common stock on the New York Curb. From a former high of 116½ recorded earlier in the year, the shares dropped to 65 just prior to the publication of the company's report.

Most of the radio shares on the Curb and Consolidated Exchange show fractional gains over last month. Immediately following the Music Master Convention in Philadelphia last month, this company's stock started on a rapid upward climb from a low of 8¾ to 18½. Ware stock has shown considerable strength, due to this company's recent agreement with Music Master Corporation whereby the latter will market the entire Ware line for the coming season.

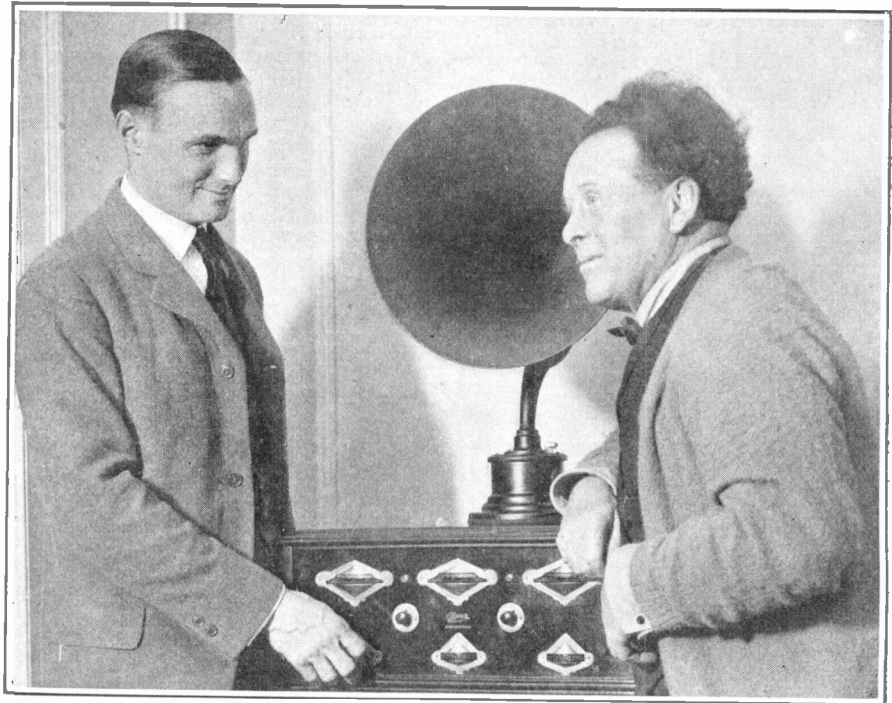

A. H. Grebe, (left) President of the A. H. Grebe Radio Co., Inc., Richmond Hill, N. Y., has but two major interests in life—radio and music. His company operates broadcasting station WAHG, and also manufactures the Grebe Synchronphase Receiver.

Radio is Mr. Grebe's greatest hobby and he is a great lover of music. He is shown here listening to a concert with William Mengelberg, conductor of the New York Philharmonic Orchestra. Their mutual interest in music has made them close friends.

The Canadian National Railways will shortly open a new broadcasting station, CNRY, at Lulu Island, British Columbia. A 500-watt transmitter is being installed by the Northern Electric Company, Vancouver, B. C.

Harold C. Bodman, who, since March 1, has been established in business under his own name, representing a number of radio manufacturers in the New York territory, has recently added to his lines the products of the following manufacturers: Haig & Haig Manufacturing Company, Rochester, N. Y.; Ganio-Kramer Company, New York City, and the Como Apparatus Company, Manchester, N. H. In view of the enlargement of his business, Mr. Bodman has resigned his former connection with *Radio Merchandising*, where he served temporarily as vice-president and editorial director.

Percy W. Harris, editor of the *Wireless Press* of London, England, was the guest of honor at a luncheon given to him by a number of radio editors at the Harvard Club, New York, May 27. Mr. Harris, who has just returned to England, spent six weeks in the United States getting first-hand information on radio conditions in this country.

Powel Crosley, Jr., president of the Crosley Radio Company, Cincinnati, Ohio, has been granted patent rights for his book-type variable condenser. This form of condenser is composed of two plates, one of which is moved outward from the stationary plate when the shaft is rotated. The conventional shaft and dial control is used and heavy clear mica is used to insulate the plates.

George E. Brightson, president of the Brightson Laboratories, New York City, manufacturers of True Blue radio tubes, was the principal speaker at the June meeting of the Talking Machine and Radio Men, Inc., held June 10 at the Cafe Boulevard, New York City.

Radio Stock Quotations

Stock	1924		1925		Current Market June 22
	High	Low	High	Low	
American Bosch Mag.	38 ⁷ / ₈	22 ¹ / ₂	54 ¹ / ₂	26 ¹ / ₈	35 ³ / ₈
American Tel. & Tel.	134 ³ / ₄	121 ¹ / ₈	144 ¹ / ₄	130 ³ / ₈	142
Apco Manufacturing Co., A			26 ³ / ₈	22	24 ³ / ₄
Brunswick-Balke Col. Co.	50 ¹ / ₂	48 ¹ / ₈	49 ³ / ₄	24 ¹ / ₄	25 ¹ / ₂
De Forest Radio	28 ³ / ₄	21	34	18 ¹ / ₄	26
Dubilier Condenser	33 ³ / ₄	32 ¹ / ₂	35 ¹ / ₄	12 ⁷ / ₈	15
Duplex Condenser	12 ³ / ₄	11	17	2 ¹ / ₂	7
Freed-Eisemann	33 ¹ / ₄	27	33 ³ / ₄	7	9 ¹ / ₄
Freshman Co., Chas.	23 ³ / ₄	21 ¹ / ₂	28	9 ¹ / ₂	14 ¹ / ₄
Garod Radio			17 ³ / ₄	2	4 ¹ / ₈
General Electric, Comm.	322	193 ¹ / ₂	320	227 ¹ / ₄	284
Grimes Co.			24 ³ / ₄	9	22
Hazeltine Corp.	48 ¹ / ₄	13	51 ³ / ₄	15	15
Inter Ocean Radio	16 ³ / ₄	6 ³ / ₄	14	3 ¹ / ₂	2
Jones, Jos. W. Co.	95	15	9	1	3 ¹ / ₂
Liberty Radio	8	5 ³ / ₈	9	7 ¹ / ₂	7 ¹ / ₈
Manhattan Electric Supply	49 ³ / ₄	33 ¹ / ₄	59	42 ¹ / ₄	51 ¹ / ₄
Music Master			21 ¹ / ₂	8 ³ / ₄	15 ¹ / ₈
Pathe Co., A.	49 ¹ / ₂	38 ³ / ₄	70 ³ / ₈	42 ¹ / ₄	70
Radio Corp. Comm.	66	19	77	48 ³ / ₈	51 ¹ / ₂
Rova Radio	18	9 ¹ / ₈	14 ¹ / ₂	3 ³ / ₈	4 ³ / ₄
Sleeper Radio	17	15	19 ³ / ₈	4 ² / ₂	6
Stewart-Warner	100 ⁷ / ₈	48 ¹ / ₂	77	55	66 ¹ / ₄
Thermodyne Co.	19 ¹ / ₂	12	22 ¹ / ₄	6 ¹ / ₂	12
Thompson Radio	21	7	25	6	8 ³ / ₄
Tower Manufacturing Co.	28 ⁷ / ₈	18 ¹ / ₂	24 ¹ / ₂	5	7 ¹ / ₂
Victor Talking Machine Co.			116 ³ / ₈	65	68
Ware Radio	39 ¹ / ₂	13 ³ / ₄	40 ¹ / ₂	8	14 ¹ / ₂
Weston, A.			24	19 ⁵ / ₈	23 ³ / ₈

Bringing the Tubes Back to Life

(Continued from page 41)

five tubes may be re-activated at once, and any one tube may be removed from rejuvenator without having effect on treatment of the other four.

When using the large rejuvenator for type 199 tubes it will be necessary to use 14 tubes in series instead of ten as shown. If desired two rows of standard sockets may be replaced with two rows of UV-199 sockets, using 14 sockets to the row. In the case of the small rejuvenator, simply use adapters in the standard sockets and use a voltage of from 3.5 to 5. It is advisable to fuse the circuit well when using the power mains.

The cost of construction of the rejuvenators described here is approximately \$25, the greatest cost being in the meters, which list from \$7.50 to \$9.50 each. Sockets at prices from 25c. to \$1.50, rheostats from \$1.40 to \$1.90, a suitable transformer for the small rejuvenator with an output voltage of 6, 12, and 18 is made by the Standard Transformer Company, Warren, Ohio, and sells for \$3.25, and also an extra heavy duty transformer made by the same concern for \$4, makes it possible to build the rejuvenators at varying prices. If suitable rheostats cannot be obtained for the large rejuvenator, which requires a rheostat with a current carrying capacity of 2 amperes, a 60-watt lamp may be used and the current varied by using larger or smaller lamps.

The Radio Corporation of America, New York City, has put into effect the following promotions and assignments: H. T. Melhuish becomes assistant sales manager in charge of sales administration, New York office; Meade Brunet is now assistant sales manager in charge of merchandising, New York office; Quinton Adams, assistant sales manager in charge of field supervision, New York office; E. A. Nicholas, district sales manager, New York district office; M. S. Tinsley, assistant district sales manager, New York district office; P. G. Parker, district sales manager, Chicago district office; A. R. Beyer, assistant district sales manager, Chicago district office. J. M. Sawyer remains in the capacity of assistant sales manager in charge of production and service.

The Herzog Radio Corporation, 718-28 Atlantic Avenue, Brooklyn, N. Y., manufacturers of the semi-automatic receiver and unilateral loop, has licensed a set to the Niagara Furniture Company, Middleport, N. Y. The receiver is known as "Niagara" and is entirely self contained with a console type cabinet.

The Precise Manufacturing Corporation, Rochester, N. Y., held its annual sales conference at Rochester, June 15 to 18. J. L. McLaughlin, research engineer of the company, exhibited a perfected variable plate condenser of novel design, as well as the new "Precise" audio transformer. McLaughlin also demonstrated his new one-control receiver. These items will be exhibited for the first time to the public at the radio exposition at Grand Central Palace, New York, in September.

William H. Priess, president of the Priess Radio Corporation, New York City, will bring out a new receiver early in August. The receiver will embody radically new features on which patents have been applied for.



As president of the Jewett Radio and Phonograph Company, E. H. Jewett doesn't find much time for leisure, but the time he does snatch away from the routine, he spends on his farm. He is a firm believer in taking young men into his business and encouraging them. (He is also fond of dogs.) He likes golf and is quite a sharp at trapshooting.

James F. Kerr, widely known radio exposition manager, died in New York City, June 14, after a short illness. He was born forty-seven years ago in Hamilton, Ontario, and is survived by his widow. He was director and general manager of the Radio World Fairs, the next one of which is to be held in New York City September 14 to 19.

The Music Master Corporation of Philadelphia, Pa., has appointed Fred T. Williams sales manager of the organization. Mr. Williams has been manager of the Chicago office of the company, and his promotion comes as the result of his long service with Music Master.

The Southern Automobile Supply Company of Washington, D. C., has been appointed distributor for Atwater Kent products in the Capitol and vicinity.

The Sonora Phonograph Company, Inc., of New York City, recently elected Warren J. Keyes, treasurer of the company, and Frank V. Goodman, sales manager, to the Board of Directors.

The Magnavox Company of Oakland, Cal., has adopted a new distribution system whereby the United States has been divided into twenty distributing zones, to be covered by one distributor in each territory. Magnavox products will, in future, be retailed only through authorized Magnavox dealers.

The Radio Manufacturers' Association will hold its first annual convention at Atlantic City, New Jersey, on July 10 and 11.

The Zenith Radio Corporation of Chicago, Illinois, recently elected S. I. Marks treasurer of the corporation. Mr. Marks has been connected with the Zenith organization since its early formation, acting in the capacity of chief of manufacturing operation and assistant treasurer. His office will be in the Straus Building, at Chicago.

A Jobber's Advice to His Radio Dealers

Max L. Haas, president of the Haas Electric Sales Company, Cleveland, has set down the following five principles of merchandising success for his company's radio dealers. Mr. Haas writes:

(1) **Stock standard brands** of radio sets and parts; merchandise of established, responsible manufacturers who are backing up the dealers with national magazines and local newspaper advertising. There is a ready market for such merchandise.

(2) **Feature the integrity** of the manufacturer, and your own reputation and service rather than depending upon price concessions to create sales.

(3) **Do not overstock.** No dealer need carry more than two weeks' supply of any radio item if he is buying from *well established, well-stocked* radio distributors. With small stocks and rapid turnovers the dealer avoids the ill effects of declining prices and obsolete radio items.

(4) **Watch your credit accounts;** get at least one-third down on time-payment sales. Be sure that your credit customer is not only honest, but also that he will be able to meet payments as they fall due.

(5) **Discount your bills** when due for discount payment. This is very important—a sure and prompt-pay dealer always gets preferred service from the distributor just as the distributor does from the manufacturer under similar conditions.

"These are the underlying principles on which all successful radio dealers have built up *profitable* businesses," counsels Mr. Haas. "Observe these policies diligently, and we hope that twelve months from now you will tell us that your *profits* made us good prophets."

The Stewart-Warner Speedometer Corporation of Chicago, announces the following appointments: C. E. Hall, formerly with Brunswick, Balke-Collender Company, is now assuming charge of the radio sales at the Minneapolis service station. Arthur Keeble is taking over the radio sales at St. Louis, and R. H. Woodford is now general manager of radio sales.

F. A. D. Andrea, 1581 Jerome Avenue, New York, has added to its sales department, C. Monroe Smith, former sales manager of the Domestic Electric Company, New York.

J. J. Rafferty has resigned as eastern general manager of the Manhattan Electrical Supply Company, New York City, where he had direction of domestic and export sales. Mr. Rafferty was formerly in sales and sales executive work for the Western Electric Company, at Newark and at New York City.

J. C. Grindell now heads the Interstate Electric Company, 4339 Duncan Avenue, St. Louis, Mo., manufacturers of the "Handy" battery charger. Charles Jehle, former president, has sold his interests to J. C. Grindell and Homer A. Dodson. The new officers are: J. C. Grindell, president and treasurer; E. Ballman, vice-president, and Homer A. Dodson, secretary.

The Charles Freshman Company, Inc., New York City, has just leased an additional factory at One Hundred and Thirty-Third Street and Brown Place, New York City, giving it 100,000 more square feet of space for the manufacture of Freshman radio products.

The International Exposition of Wireless Telegraphy, to be held at Geneva, Switzerland, announces a change in dates. Originally scheduled for September 23 to October 4, the exposition will, instead, be held September 9 to 20, so as to come within the period of the Assembly of the League of Nations. The address of the management has also been changed and is now 12 Boulevard du Theatre, Geneva.

Durham & Company, Inc., 1936 Market Street, Philadelphia, Pa., announces that the International Resistance Company, Inc., 728 Sansom Street, Philadelphia, Pa., has taken over the entire distribution and manufacture of the Durham metallized fixed resistance.

J. W. Tabb, formerly with the Western Electric Company, is now sales manager of the Precise Manufacturing Corporation, 254 Mill Street, Rochester, N. Y.

The Cochran Electric Company, 34 Madison Avenue, Atlanta, Ga., has recently been formed. It will do a jobbing business of radio goods exclusively.

The American Radio Stores, Inc., of Philadelphia, Pa., recently opened a new store at 4 East Eighth Street, Wilmington, Del. This firm will also open a store in the near future on the West Coast of Florida.

John A. Proctor, for the past three years chief engineer of the Wireless Specialty Apparatus Company, Boston, Mass., has been appointed general manager of the organization.

Clarence E. Ogden, president of the Kodol Radio Corporation, Cincinnati, Ohio, has been elected a director of the Carfax Company, Ltd., Manchester, England, one of the largest English radio manufacturers.

Fada Radio, Ltd., is the name of a Canadian corporation recently formed to manufacture a complete line of radio receivers for the Canadian market, in conjunction with the F. A. D. Andrea Company, Inc., of New York City. The new company is licensed under the Canadian Hazeltine patents and its address is 821 Queen Street, East Toronto, Canada. The officers are: F. A. D. Andrea, president; C. Andrea, vice-president; R. M. Klein, secretary; C. R. Fraser, manager, and T. M. Rozelle, superintendent.

The Splitdorf-Bethlehem Electrical Company has moved its executive offices to Newark, N. J., and will operate from the offices of the Splitdorf Electrical Company. The plant of the Bethlehem Spark Plug Company, at Bethlehem, Pa., will continue in production. The Splitdorf-Bethlehem Company is a consolidation of the Splitdorf Electrical Company and the Bethlehem Spark Plug Company, and has added a line of radio receivers to its products.

The American Sales Agency has moved its office from 38 Park Row, to 21 Warren Street, New York City.

The Polymet Manufacturing Corporation, manufacturer of radio accessories, is now in its new headquarters at 599 Broadway, New York City.



Walter L. Eckhardt, president of the Music Master Corporation, Philadelphia, is another one of those golfers who can always be found out at the links when not in his office devising ways and means of selling more Music Masters. "Keep your eye on the ball," is Walters' advice, and he says it applies to radio as well. "Keep your eye on the radio ball and you'll never get knocked out," is his motto.

The Oakland Radio Trade Association is the name of a new organization of radio men in Oakland, Cal. The officers are: E. M. Sargent, president; Thomas Traynor, secretary, and Bernard S. Goldsmith, treasurer. The office of the secretary is at the Oakland Phonograph Company, 473 Twelfth Street, Oakland, Cal.

The Colin B. Kennedy Corporation has moved its executive offices to No. 2017-23 Locust Street, St. Louis, Mo.

D. H. Boley and Company of 1440 Broadway, New York City has been appointed exclusive sales agent, for the Kellogg Switchboard and Supply Company of Chicago, Ill., in the Metropolitan district.

The Supertron Manufacturing Company, 32 Union Square, New York City, is stamping each tube with a serial number accompanied by a guarantee certificate bearing the same number. This gives the consumer the privilege of adjustment, exchange, and service within thirty days after purchase. The tubes are now retailing at \$2.

The Jewett Radio and Phonograph Company, Pontiac, Mich., entertained the members of the Radio Trade Association of Michigan at the Jewett factory May 28. Luncheon was served at the headquarters of the Board of Commerce of Pontiac, where speeches were made by E. H. Jewett, S. W. Edwards and Howard E. Campbell. After the noon meeting, the association members inspected the Jewett factory.

Elmer E. Bucher has been promoted by the Radio Corporation of America, New York City, from the position of manager, sales department, to general sales manager, with headquarters in New York, it is announced by General James G. Harbord, president of the corporation. It is also announced that Paul A. Dana has been promoted from the export division, New York, to the position of Radio Corporation representative in Brazil.

The Philadelphia Radio Exposition, under the auspices of Philadelphia Radio Jobbers and the Philadelphia Public Ledger, will be held at The Arena, Forty-sixth and Market Streets, Philadelphia, Pa., October 3 to 10.

Funk & Shore, 50 Church Street, New York, have recently been appointed factory representatives for the Premier Radio Corporation, Defiance, O., in New York, New Jersey and Connecticut. A. G. Autenrieth, formerly in the sales department of C. D. Tuska Company, Hartford, Conn., is now in charge of their radio department.

The Radio Products Sales Corp., Wilmington, Del., has been granted a Delaware charter for the purpose of acting as manufacturers sales agents. The amount of the charter was for \$100,000.

William R. McElroy, formerly with the Pittsburgh branch of the Music Master Corporation, has organized the William R. McElroy Company, with offices in the Federal Reserve Building at Pittsburgh, where the company will officiate as radio manufacturers' sales agents.

How Manufacturers Promote Dealer Sales

New "Dealer Helps" Offered to the Radio Retailer by the Manufacturer to Increase the Merchant's Radio Profits

Thirteen Suggestions for Summer Business

The Eagle Radio Company, Newark, N. J., in its monthly publication which is called *Eagle-Life* offers the following suggestions to be used by dealers in arousing interest in radio receivers for the summer months:

"Churches usually have fetes and festivals during the summertime. Get permission to install a set and supply part of the entertainment.

"Good clubs are always anxious to have the best music. Demonstrate the joy of dancing to metropolitan orchestras.

"Buses are splendid places to install receivers for demonstration. An Eagle installed on a bus will help the riders over the bumps.

"Have a place to entertain the children. Invite them at a certain hour regularly. In the summer parents will be glad of the diversion.

"In connection with the above, invite a local announcer to visit your store and talk to the youngsters.

"High school boys are fine radio fans and usually know a good deal about the instruments. Get several reliable young fellows to do some house to house canvassing and demonstrating.

"Don't overlook any chance for Summer sales. Have a set installed in the

hospital. Get the newspapers to write it up.

"Demonstrate the set in hotel dining rooms, also restaurants. A proprietor soon sees the immense value of the radio to his business.

"Install a receiver on a boat—big or little—Radio on a boat gives a real thrill.

"Get pictures of prominent persons at Eagle receivers.

"Install a radio in your park and bring the big bands to your city.

"Can you install an Eagle on a train? The commuter's train is a good one.

"Depots and rest rooms are fine places. Radio makes the time fly."

These are all ideas that may be utilized to advantage by energetic dealers.

Proper Selection of Colors Contrast Sample on Display Card



A very attractive 9 in. x 12 in. display card, with a sample fixed mica condenser attached, is being furnished to dealers by the Sangamo Electric Company, Springfield, Ill. The printing and the border is in dark blue with a sub-border of yellow. The letters are set against a brown background and the sample condenser which is itself a dark brown bakelite, is set against a yellow background bordered by blue. This gives a striking yet pleasing effect to the eye. An easel back comes on the card.

"To the Ladies"



A four-page leaflet with a very striking cover done in several bright colors, is furnished by the Stewart-Warner Speedometer Corporation, 37 West Sixty-Fifth Street, New York. The receiver as shown on the cover is displayed in a very advantageous position. The rest of the leaflet is devoted to a description of the Stewart-Warner ensemble accompanied by home scenes featuring it. On the back is space for the dealer's name and address.

"Take the World with You This Summer!" is the title of a little blue-and-tan folder of the Operadio Corporation, 8 South Dearborn Street, Chicago. All the joys of radio out-of-doors is pictured in the inside pages.

E. J. Cunningham, Inc., 182 Second Street, San Francisco, Cal., has issued a colorful little circular on radio tubes. "Radio has banished isolation from vacation land" is a message it brings.

Attractive Condenser Display



To help the dealer in selling fixed mica condensers as well as to provide a neat and compact means of stocking them, Electrad Incorporated, 428 Broadway, New York, is furnishing this display box. The display box contains six smaller boxes, each containing six mica condensers. The capacity value is stamped on each small box. These displays may be used either in the window or be placed on the show cases in the store.

Trilling and Montague, 49 North Seventh Street, Philadelphia, Pa., recently issued the first copy of a pamphlet called "Radio Talks." It is a commendable effort to aid in promoting distribution of radio merchandise. Data concerning popular circuits will be published from time to time as well as editorial matter calling attention to the various lines that this company is distributing.

David Grimes Incorporated, 1571 Broadway, New York, has issued a series of water colored window pasters which are being distributed through the Brown Advertising Agency, 110 West Fortieth Street, New York. The predominating colors are orange and blue on a white background which presents a very striking contrast.

The Zenith Radio Corporation, Chicago, Ill., is issuing a monthly dealer publication called the *Zenith Radiogram*. Zenith policies, personalities, window displays and letters from Zenith dealers will be featured in this house organ.

Now Hear Radio Music Better Than Ever Before

By the end of this year, we expect to see the beautiful new Crosley Musicone replace at least half a million of the best of present-day radio reproducing devices.

For the Crosley Musicone, designed and built on entirely new principles, covered by *basic patents* issued and pending, reproduces music and the speaking voice true to life—

Without distortion, extraneous overtones, resonance vibrations or other horn noises;
Over the *entire* musical scale, from lowest to highest notes, on *any* instrument;
Without overloading; and without chattering, because its diaphragm is a floating cone;
Without adjustments or additional batteries;
Without directional properties or a horn;
And at a price that is revolutionary.

Sound from it fills the entire room, the notes clear and round and mellow. No need to cluster round. Every note comes in at its true musical value—in solo, duet, chorus, orchestra and drums.

Undoubtedly, it will also be the means of introducing radio into homes which heretofore rejected it because of the impossibility of getting the life-like reproduction which the Crosley Musicone now makes possible for the first time.

Ten thousand radio dealers are now displaying and demonstrating the beautiful Crosley Musicone.

Order Crosley Musicones from your jobber today. Here is one of the fastest profit-making radio devices on the market.

The Crosley Radio Corporation, Cincinnati
Powel Crosley, Jr., President
7130 Sassafra St.

Guarantee

Dealers are authorized to sell the Crosley Musicone on five days' trial in your home. Satisfaction guaranteed or money refunded upon return.

Crosley manufactures receiving sets which are licensed under Armstrong U. S. Patent No. 1,113,149, and priced from \$14.50 to \$65, without accessories.

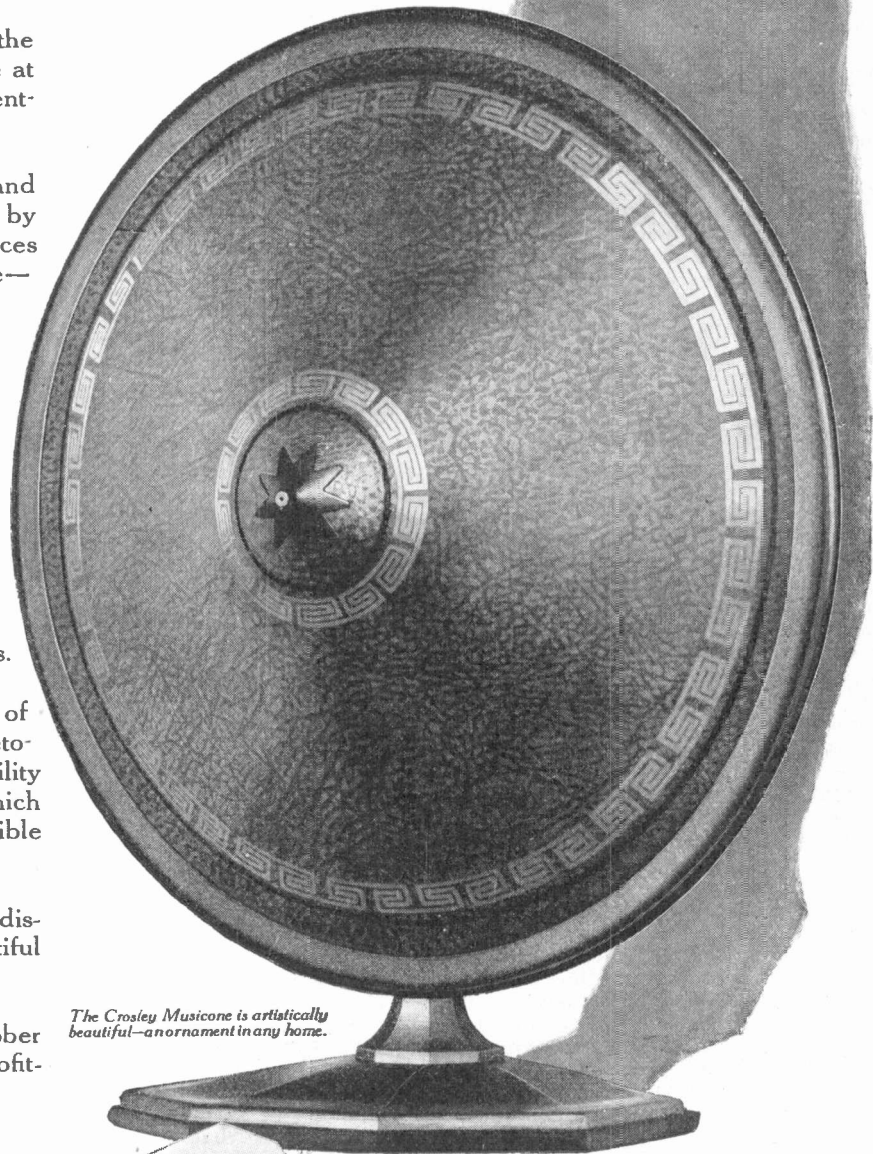

The Crosley Musicone is artistically beautiful—an ornament in any home.

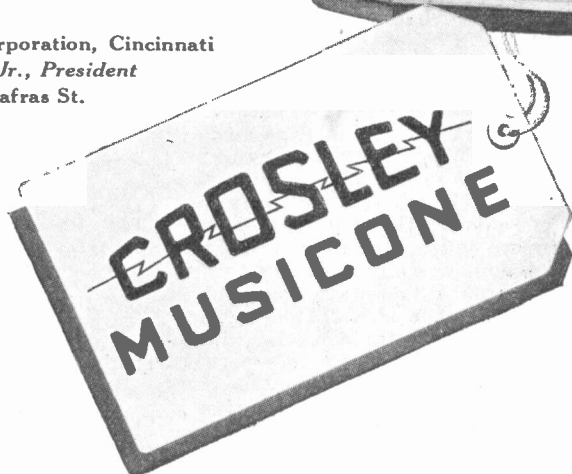

17⁵⁰

Add 10% West of Rocky Mountains.

Crosley owns and operates station WLW, Cincinnati, the first remotely controlled super-power broadcasting station.

Music Merchants Hold Convention

(Continued from Page 31)

to the dealers, "We, the manufacturers, have encouraged you to sell on longer terms; we ourselves have done what we could to prevail upon you dealers to give longer terms, but don't ask for larger discounts."

We must have larger discounts. No retail merchant in the music business can make a profit that is satisfactory with a 35 per cent discount unless he limits his terms and his turnover of terms to probably six months or four months. Let us ask the manufacturer to wake up and consider the problems of the dealer. Let's go after discounts that give us a chance to succeed.

Mr. Parker (Radio Corporation of America): I hear on one side a cry of "Cut out the gyp," and on the other side, "Give us a longer discount." I wonder if you gentlemen realize that if a longer discount were given and the gyp were still in the picture, he would have more to give away. I think that is exactly what would happen. It seems to me in the distribution of radio we have made progress and if you gentlemen will agree that we have made progress, I think that is the principal thing to consider at this time. Whether the music dealer can afford to handle radio on the margin that is at present afforded him is a question that he himself must decide. If he can't handle it on that margin, he makes his case clear to the manufacturer and receives an increased margin (or will in due course) because the manufacturer must look upon the dealer as his first line in sales, and the first line must be profitable; in other words, the manufacturer must see to it that it is profitable for the dealer to handle his line. If it is not profitable no manufacturer can long remain in business.

This problem of discount and proper distribution is one that we are not unmindful of, nor are we unmindful of the dealer's problem. The dealer's problem is one that we are giving careful study and consideration to, but we believe that there is an opportune time to make the right move. The right move made at the wrong time will not be any use to us, and, as a matter of fact, will not help you gentlemen with your problems.

Mr. Manning (Augusta, Ga.): It probably will be of interest to you to know that I held my hand up as making money out of radio—I mean the combination radio and phonograph. I never have handled the radio by itself. We, of course, were very dubious about taking on the radio line until we found something that we thought would give satisfaction to our customers. Last October we were persuaded to take two instruments, one a \$600 instrument and the other a \$285 instrument, on trial. If you will encourage your customers to buy good instruments, something that you know will give satisfaction and that you know you can recommend, you won't have as much trouble.

Other dealers in town immediately saw that Manning was getting all the business, they thought, and they wrote in to the company for this instrument.

The company sent representatives down and looked over the situation, and they found that we were doing a great deal of advertising and were giving them satisfaction, and they protected us in every way. Therefore, if the men will buy instruments from manufacturers who will protect them in this way, as these people have protected us, I think this gyp matter will be overcome.

G. G. Dailey (Milwaukee): The question of the gyp and the courtesy discounts I think is one of the big problems in our proposition today. We in Milwaukee have the same thing to contend with. Buy high-class merchandise and you are going to get protection. We handle four or five different makes. One of them was jobbed by different distributors in Milwaukee. It was about \$235 complete. They liked it very well generally. One person bought one and was satisfied with it; it was bought for a birthday surprise gift. After the birthday was over I was called up and they wanted the set removed. I was checking up on this individual salesman, and I went out there to see myself what was wrong, whether it was the installation, whether it was something else. One day it was all right and the next it wasn't. I found out this man who purchased the set was a car washer for a garage in Milwaukee, and one of the distributors who, by the way, is a retailer, also got in touch with him and said, "If you can order the same set through the Nash agency we will give you 40 per cent off on it." Naturally I lost the sale.

Manufacturers Will Protect Dealers Who Co-operate

It started to get my goat. I lost three or four deals, and other fellows in Milwaukee lost the same amount. I started bombarding the manufacturer, disregarding the distributor entirely, and said that I was closing the line out and wanted to know if he wanted to take them off of our hands or let us sell them at a cut price. The result was that this distributor has been cut off and one exclusive distributor in Milwaukee is handling this set. Get high class merchandise. If you can't get protection from your jobber and distributor, take it up direct. If you are a real dealer and are pushing their stuff, they want distribution and they will favor you. Bombard your manufacturer if you are not getting the right protection, and if you have got the right merchandise and are handling it properly, you will be O. K.

On the subject of manufacturer and dealer co-operation, my opinion is that manufacturers' advertising—national that is—doesn't help the dealer as much as it should. What the manufacturer should advertise in his national advertising is the fact that you are going to get out of radio the thing desired. You don't have to tell a woman how many condensers or how many dials or transformers or tubes there are, but you want to sell her the idea that she can get housekeeping problems for instance; you can sell the man the sporting element of it or the educational feature of a radio. You can sell the young people the dance music feature or the entertainment rather than sell

them the number of tubes, and so on, as I mentioned before.

Mr. Lewis: Gentlemen, I understand that the meeting must close in two minutes and I have two minutes to sum up, which is the privilege of the chairman, I suppose.

Now as to discounts, it seems to me that your bid as dealers for discounts is going to depend entirely on the functions that you are willing to perform in distributing the goods to the public. A retailer that is selling on time and creating a market is entitled to a fair discount to cover those operations. If you are merely slot-machining radio, you are not entitled to the discount and a manufacturer would be foolish to give it to you.

Now, gentlemen, it looks to me, when you consider that there are 1,500, maybe 2,000 people in the manufacturing end of this business and only a relatively small number that really are established, that you have got to take the better and larger manufacturers' time to clean the dead wood out of the picture. I think you will find that every large manufacturing organization is conscious of the fact that any retail organization that performs a service is entitled to meet expenses and a fair profit, and from my point of view the fact that ten per cent of the people here have made some money in this business is in itself a very encouraging sign, considering the thing is only three years old.

At the afternoon session, it was decided to hold the 1926 convention in New York City. New officers were elected, including: Henry E. Weisert, president; Edward H. Uhl, first vice-president; Charles Yahrling, second vice-president; Parham Werlein, secretary; Carl A. Droop, treasurer. The executive board will consist of William C. Hamilton, Alex. McDonald, Howard Beasley and John W. Booth. At this session, addresses were made by C. M. Tremaine and C. L. Dennis.

Also, on Wednesday, the Musical Merchandise Association had its meeting and in the evening the banquet of the Music Merchants' Association was held. Other organizations which held meetings during the week included the National Piano Manufacturers' Association, the National Association of Musical Instrument and Accessories Manufacturers, the National Band Instrument Manufacturers and the Phonograph Manufacturers' Association.

The final meeting of the Music Industries Chamber of Commerce closed the convention on Thursday. The following officers were elected: E. R. Jacobson, president; E. H. Droop, first vice-president; C. D. Greenleaf, second vice-president; Hermann Irion, secretary, and Alfred L. Smith, treasurer.



The new rugged, good-looking Exide 6-volt "A" battery with one-piece case.

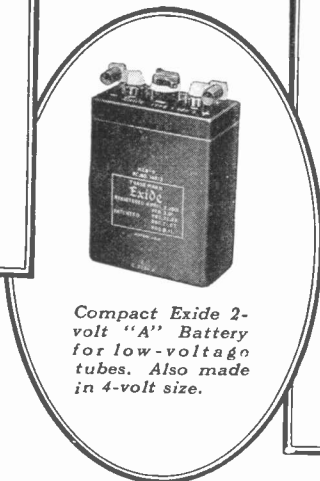

Compact Exide 2-volt "A" Battery for low-voltage tubes. Also made in 4-volt size.

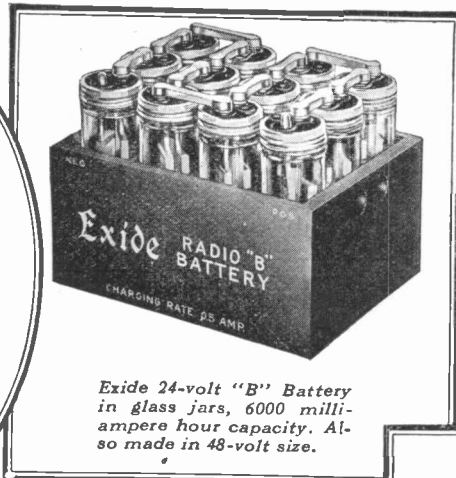

Exide 24-volt "B" Battery in glass jars, 6000 milli-ampere hour capacity. Also made in 48-volt size.

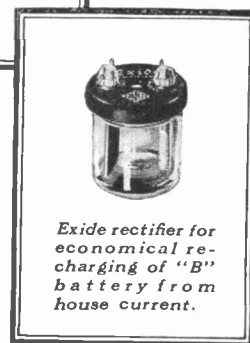

Exide rectifier for economical re-charging of "B" battery from house current.

It is no accident— this preference for Exide

These batteries are built especially for radio—behind them is 37 years' experience in storage battery manufacture

THE battery can make or mar radio reception. That is why the far-sighted radio merchant selects his battery stock with care, why the wise fan insists on having batteries he knows and trusts.

That is why dealers and users everywhere are turning to Exide Batteries, made by the world's largest manufacturers of storage batteries.

Long before the days of radio, Exide Batteries were used for every kind of storage battery job. An Exide battery today is the result of 37 years of painstaking development.

For years, vigorous national advertising has been telling millions about Exide Batteries. This year, Exide advertisements in great national magazines and radio publications are showing people why the Exide is the best buy on the battery market.

It pays the radio dealer in cash and reputation to stock and display this complete line of capable, good-looking, fast-selling Exide Batteries.

THE ELECTRIC STORAGE BATTERY COMPANY
PHILADELPHIA

In Canada, Exide Batteries of Canada, Limited
153 Dufferin Street, Toronto

Exide

RADIO BATTERIES

FOR BETTER RADIO RECEPTION USE STORAGE BATTERIES

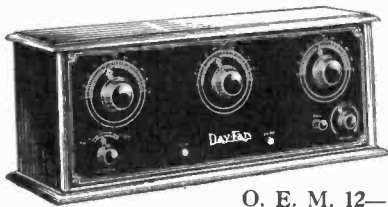

O. E. M. 12—4-Tube, \$75.00

This is the famous O. E. M. 7 Duoplex stripped of all cost not absolutely essential. Mahogany finished cabinet; four tube; triple dial control. A truly remarkable value.

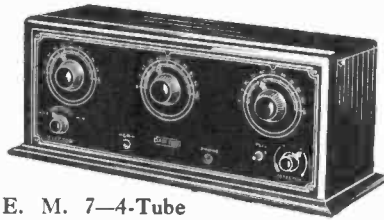

O. E. M. 7—4-Tube Super-Selective, \$98.00

Duoplex circuit, two stages of radio, detector, and two stages of audio amplification, with one tube doing double duty; prelogged at the factory.

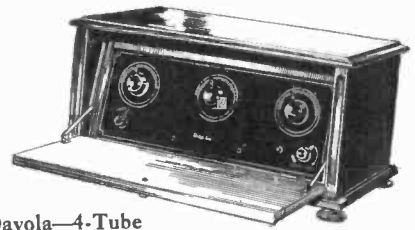

Dayola—4-Tube Super-Selective, \$110.00

This is the same as O. E. M. 7, but housed in a beautiful two-toned waxed and polished mahogany cabinet with inclined panel and room for "B" batteries. Duoplex circuit prelogged.



Day-Fan 5—5-Tube, \$115.00

This is the newest Day-Fan achievement. Five tubes, a new principle of tone reproduction, extreme selectivity, and a real and practical single dial control.

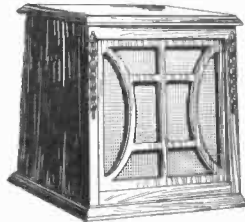

Day-Fan Speaker, \$30.00

Mahogany finish cabinet and grill—adjustable diaphragm on unit—and a tone quality that does justice to the Day-Fan Receiver.

1925 DAY-FAN RADIO 1926



Daycraft—5-Tube, \$145.00

This set combines the Day-Fan 5 and the new Day-Fan Loud Speaker, built into the beautifully figured mahogany cabinet, providing room for "B" batteries. It has all the qualities of the new 5-Tube Day-Fan circuit, with the exceptional tone quality of the Day-

Fan Loud Speaker. **DAY-CRAFT—WITH LEGS—5 TUBE, \$165.00.** This is the Daycraft set with the addition of demountable legs. These legs are also furnished separately to fit any Daycraft set at a list price of \$20.00.

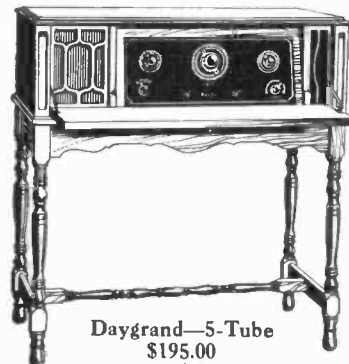

Daygrand—5-Tube \$195.00

This is a simpler Console model than the Daytonia, with room for "B" batteries, but without any equipment and with the new Day-Fan Speaker. It contains the same panel and set as the Day-Fan 5.

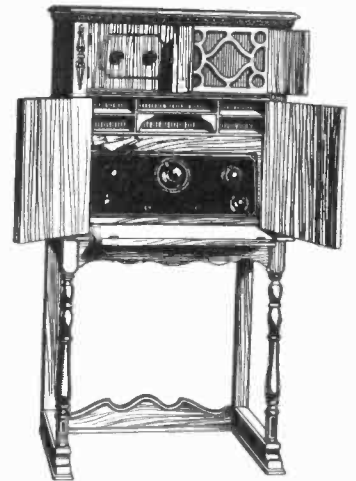

Dayroyal—5-Tube \$300.00

This is the Day-Fan 5 panel and set, housed in an exceptionally beautiful mahogany vertical type desk cabinet. Built-in Loud Speaker. Room is provided for all equipment and cabinet is completely wired for batteries and charger.



Dayphone—5-Tube, \$105.00

This is a phonograph model with the same circuit as the Day-Fan 5. It is designed to fit into any cabinet, such as the combination phonograph and radio cabinets furnished by some talking machine manufacturers. Panel size, 12x15 1/2 inches.



Daytonia—5-Tube, \$300.00

With All Equipment Except Tubes.

This is a Console model with built-in Loud Speaker, batteries and a special silent recharging apparatus. It contains the same panel and circuit as the Day-Fan 5.



**THE DAYTON FAN AND MOTOR COMPANY
DAYTON, OHIO**

For More Than 36 Years Manufacturers of High Grade Electrical Apparatus

FADA

Radio

Why gamble?

The Fada franchise is your certain opportunity

THE most important thing you can decide today is the basis on which you are going to operate in the radio business.

The progressive dealer knows that the day is past when he can carry a shifting assortment of sets and expect to make money.

Furthermore, last Spring taught him that, without notice, he may be up against a cut-rate competition that can literally knock the bottom out of his business.

Identify Yourself with the Leader

The Fada Franchise is the livest and most solid proposition that is being offered today to any dealer.

You are joining forces with a sound, established concern—an acknowledged leader in the industry. Concentrating your sales effort on the finest radio product on the market.

You are obtaining a guarantee of *liberal price protection*. Fada has never resorted to dumping or bargain sales and never will.

You are taking the first step towards establishing yourself as the logical leader and authority on radio in your community, because that is precisely the standing that a Fada Franchise will shortly give you.

The Fada Franchise Plan limits the number of selected dealers—dealers who are sound merchandisers, with their feet firmly on the ground.

A representative of our distributors will call on you to explain the Fada Franchise Plan in further detail. Talk the matter over thoroughly with him. It's the biggest chance that ever came your way.

F. A. D. ANDREA, INC.

1581 JEROME AVENUE, NEW YORK

Manufacturers of TUNED RADIO FREQUENCY receivers using the highly efficient NEUTRODYNE principle. Licensed under Hazeltine Patents Nos. 1,450,080 and 1,489,228 and other patents pending

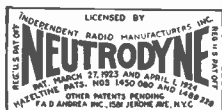
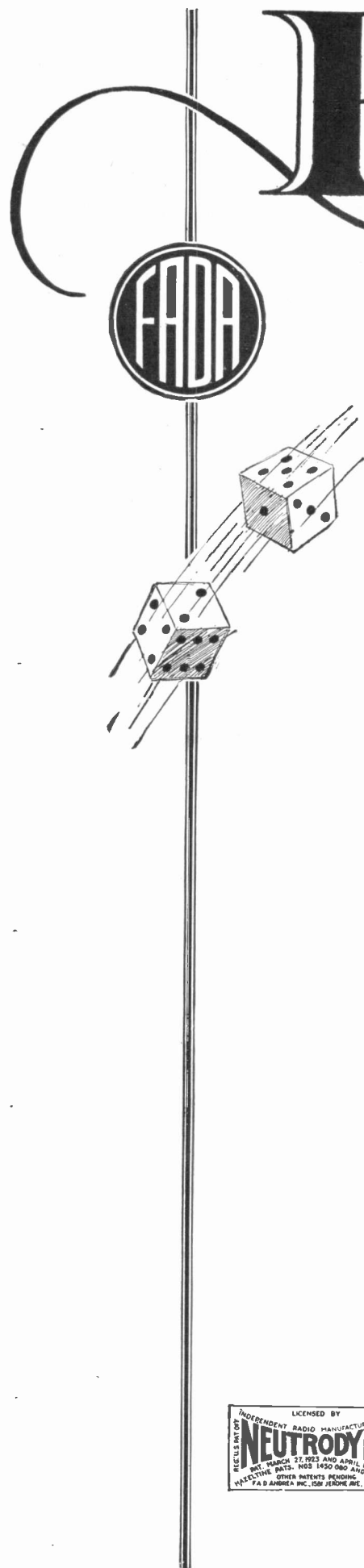

Stewart-Warner

Guarantees Dealers Profit—

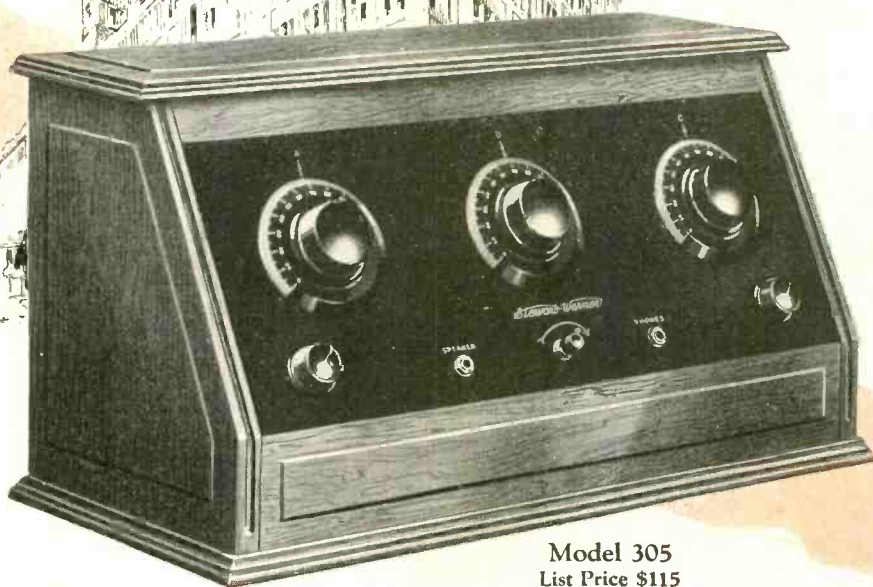

Model 305
List Price \$115

The First Complete Matched-Unit Radio

STEWART-WARNER RADIO is the "Matched-Unit" Radio. By this we mean that Stewart-Warner Radio Products—Instruments, Reproducers, Tubes and Accessories—are units that are all built by Stewart-Warner to function together in perfect unison. A combination of these units forms Stewart-Warner Matched-Unit Radio.

From the ground up this Radio is designed to achieve the utmost in radio reception. Because of the unified action of Stewart-Warner Radio, clear, full tones come in from stations near and far.

Here are the Matched Units of Stewart-Warner Radio—a complete line for dealers:

1. Stewart-Warner Radio Instruments, a model and a price to fit every purse and fill every need.
2. Stewart-Warner Reproducer, a perfect companion piece for Stewart-Warner Radio Instruments.
3. Stewart-Warner Radio Tubes—the tubes that have startled the radio world by their superior performance.
4. Aerial and Ground Equipment, and complete auxiliary apparatus of the highest quality.



Model 400
List Price \$25

Model 300
List Price \$65



Model 410
List Price \$65

Console Table, including Built-in Speaker and Battery Compartment, without Radio.

Stewart Matched-

"RADIO INSTRUMENTS—TUBES—

96 Direct Factory Branches

Radio Franchise Protection and Permanence

THE Stewart-Warner name is a by-word for quality. For more than twenty years Stewart-Warner has been manufacturing magnetic, electrical and mechanical automobile accessory equipment that has been the standard of the field. To-day, more than ten million cars carry Stewart-Warner Products as standard equipment. No doubt your car is equipped with a Stewart-Warner Speedometer, a Stewart-Warner Vacuum Tank or other accessory.

Stewart-Warner Radio is another Stewart-Warner achievement. The quality of Stewart-Warner Radio is unquestioned, because the entire world knows that any merchandise bearing the Stewart-Warner name is superior in every respect.

STEWART-WARNER is distributing its radio products to dealers solely through its own, long established, world wide organization of ninety-six exclusive Stewart-Warner Wholesale Distributors. We have been 15 years in building up this organization. It is the only organization of its kind in the radio field.

These Stewart-Warner Distributors positively will not wholesale Stewart-Warner Radio products to any one except dealers holding Stewart-Warner Radio Franchises. Stewart-Warner stands alone in its ability to give dealers this 100% protection.

We pledge you this opportunity to conduct a successful business—and our word is backed by years of sound business dealings with thousands of leading dealers all over the world.

Furthermore, every Stewart-Warner Wholesale Distributor maintains a corps of factory-trained experts—both sales and technical—whose explicit duties are to make a 100% success of

every Stewart-Warner Radio Dealer. Our Radio Dealer Franchise carries with it this expert aid—this service that insures a profitable business for every retailer of Stewart-Warner Radio.

The Stewart-Warner Franchise places dealers so that they are not in competition with each other. It gives the full measure of Profit to each and every dealer. It associates the dealer with a radio manufacturer of large resources. This means Permanence for the dealer because the large manufacturer is the manufacturer who endures.

Fill out the application blank below and mail it to us. Our representative will call with some additional information very interesting to you.

STEWART-WARNER SPEEDOMETER CORPORATION
CHICAGO - U. S. A.

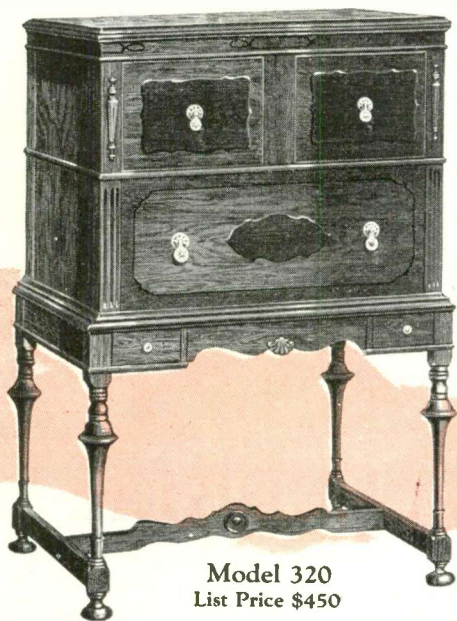

Model 320
List Price \$450

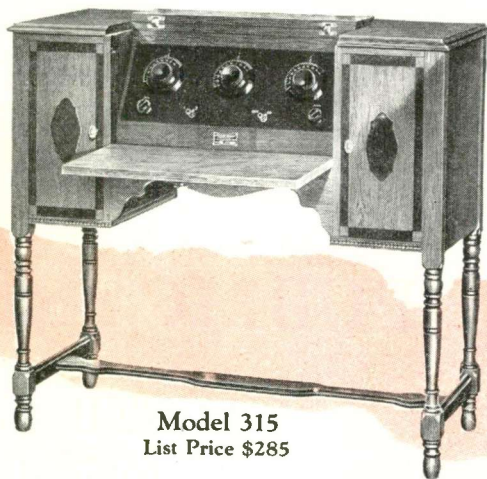

Model 315
List Price \$285



S-W
Radio Tube
List Price \$3

**Warner
Unit Radio**

REPRODUCERS—ACCESSORIES”

Throughout the World

Radio Division
Stewart-Warner Speedometer Corporation
1820 Diversey Pkwy., Chicago, Ill.

Gentlemen:—I want to be considered in connection with a Stewart-Warner Radio Dealership and to discuss the details with your representative.

Date _____ Name _____
Address _____
City _____ State _____

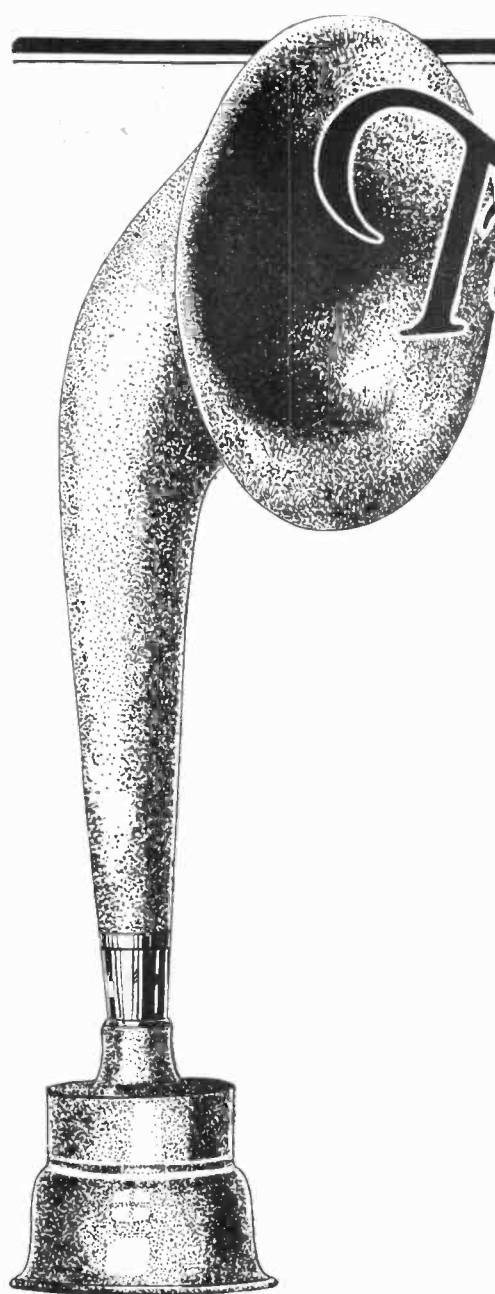

Tune In!

On America's Most Responsive Market

MAKE your Radio advertising appropriation 100% effective this season. Cultivate intensively the Philadelphia trading area, the country's most fruitful field for Radio products of merit, populated by prosperous individual home owners, proved by test after test unusually responsive to every new phase and development in Radio.



Then choose as your first medium the Radio columns of the Public Ledger—Morning, Evening and Sunday (including the Saturday Evening Public Ledger Weekly Radio Magazine—the only separate Radio Tabloid published in Philadelphia) which reach this Radio-keen and Radio-educated public—quickly—effectively—and most economically.

Circulation 350,000 Daily and 425,000 Sunday. Rate, Morning and Evening, 60c per line; Sunday and Evening, 75c.



PUBLIC LEDGER

and

NORTH AMERICAN

Independence Square

Philadelphia

New York
Detroit

Chicago
San Francisco

St. Louis
London, Eng.

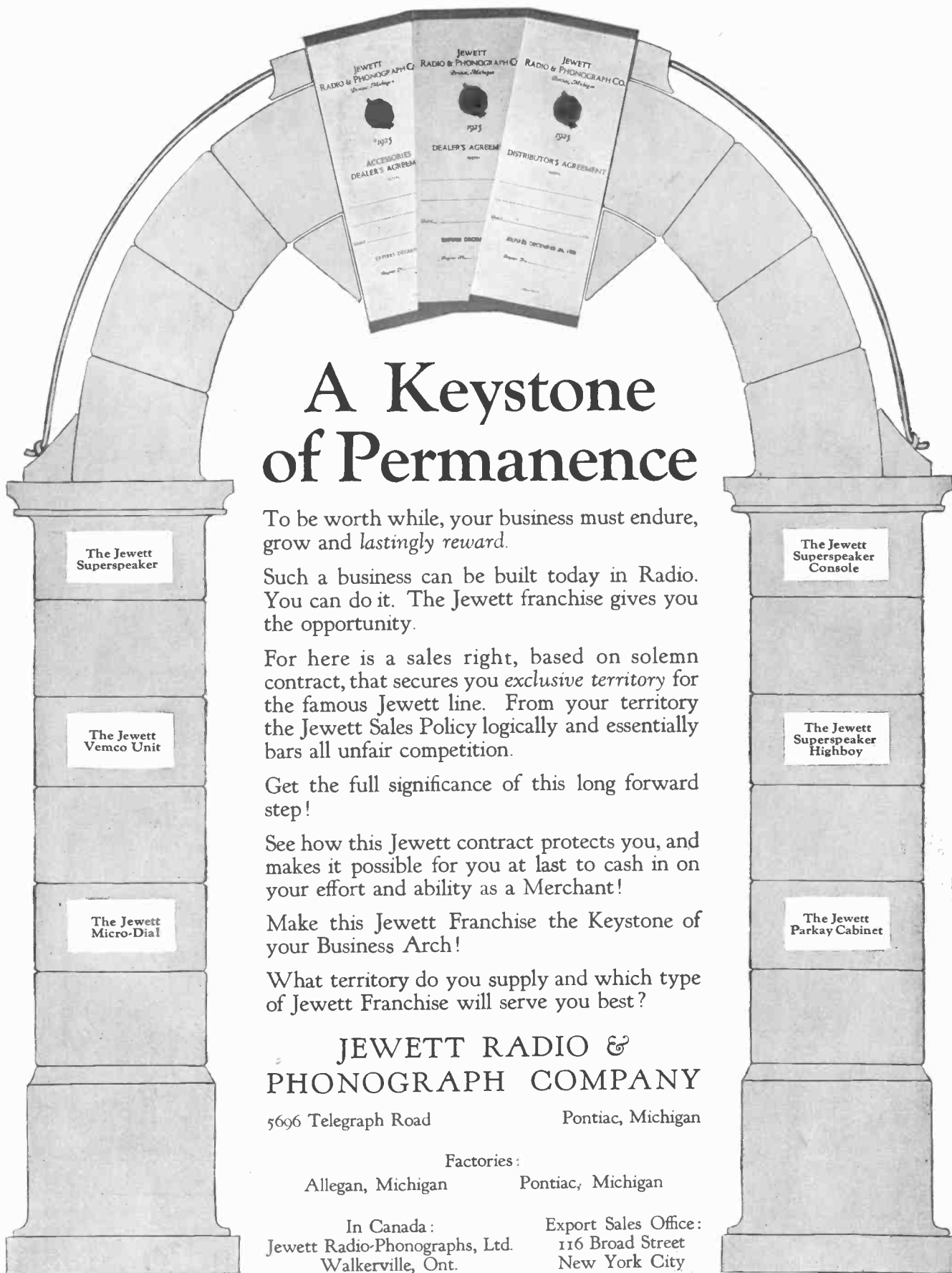

A Keystone of Permanence

To be worth while, your business must endure, grow and *lastingly reward*.

Such a business can be built today in Radio. You can do it. The Jewett franchise gives you the opportunity.

For here is a sales right, based on solemn contract, that secures you *exclusive territory* for the famous Jewett line. From your territory the Jewett Sales Policy logically and essentially bars all unfair competition.

Get the full significance of this long forward step!

See how this Jewett contract protects you, and makes it possible for you at last to cash in on your effort and ability as a Merchant!

Make this Jewett Franchise the Keystone of your Business Arch!

What territory do you supply and which type of Jewett Franchise will serve you best?

JEWETT RADIO & PHONOGRAPH COMPANY

5606 Telegraph Road Pontiac, Michigan

Factories:

Allegan, Michigan Pontiac, Michigan

In Canada:
Jewett Radio-Phonographs, Ltd.
Walkerville, Ont.

Export Sales Office:
116 Broad Street
New York City

Jewett Quality Products



FROM TIMBER

One Complete Organization

A business organization with solid business aims, yet with the thread of Romance running through every step.

Up in the great North Woods our own loggers select the finest trees to bring down. The cry of "Timber!" as a tree falls, the turbulent streams or puffing lumber "donkeys" taking logs to our own sawmills—the stripping of those logs and the selecting of the ones which can best be worked into veneer, the unfolding of the beautiful grain effects as our ply mills machine the logs—all this is action, romance, life.

Then science enters. The correct kiln drying of the plywood is vital. The value of all that has gone before and the permanence of the fine work of the cabinet-makers depend upon it.

And that brings us to the last step. Skilled workmen, artisans of a kind seldom found these days, build from the carefully prepared wood cabinets which have a grace of design, an exquisite matching of grains, and a handsomeness of finish that has made the reputation of Radio Master.

There is the interest of ownership throughout the organization. Every department head is a stockholder and before all there is a vision of the part he plays in building a product that will

Radio Master

A Ward
BAY CITY,

TO DISPLAY ROOM

uphold the good name of Radio Master and the associated Ward industries.

But what do these resources, this association with the great Ward industries, this division and craftsmanship of our men—mean to the radio set manufacturer? What do they mean to the radio jobber, and the radio retailer?

Here's what they mean: Being dependent upon no outside source of timber, owning and operating every factor in production, a product for which we accept full responsibility is turned out. No demand of the radio industry can strain our resources. Delivery dates, so nerve-racking during the rush season, are met regularly without the worry and high-pressure necessary with less complete organizations.

The uniformity of our raw material and processing assures a uniform high quality of product. Years of cabinet making for the phonograph industry has taught us the importance of this.

Not having to speculate upon prices of materials, Radio Master prices are based solely upon the cost of producing fine cabinets.

To all radio manufacturers, jobbers and dealers we offer the services of this resourceful, well financed organization.

Corporation of America
Industry
MICHIGAN

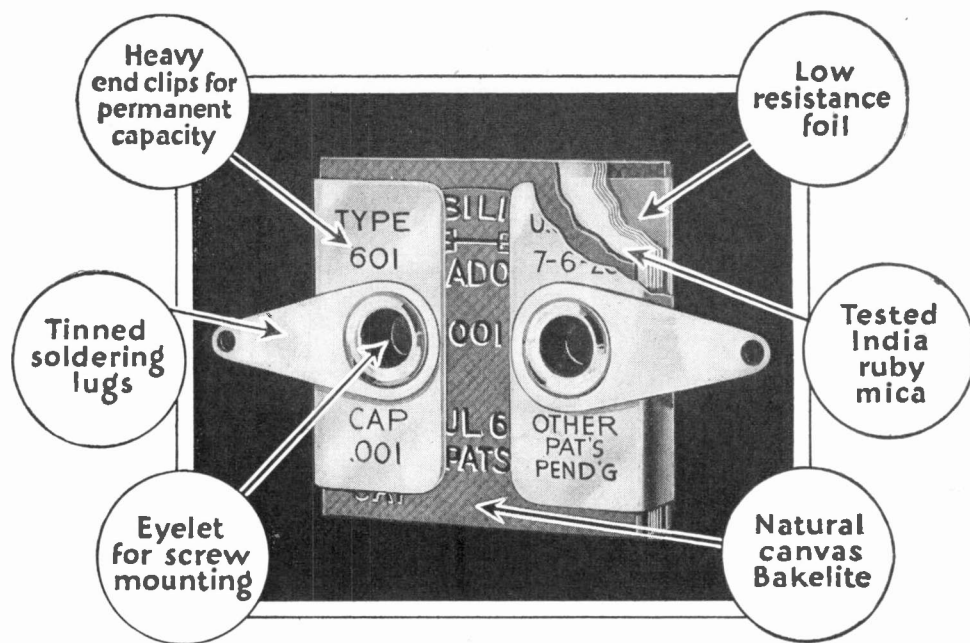

This cut shows the construction of a Micadon—shows a few of its points of superiority. It is a condenser of accurate and permanent capacity.

Stock Micadons

Stock Micadons. They mean sales because they are the *standard fixed condensers of radio*. They are used in 9 out of 10 sets made by manufacturers and *amateurs*.

Stock Micadons—for twelve-months-a-year sales.

Dubilier

CONDENSER AND RADIO CORPORATION



Sell the **ELKAY** Super-Selector

The Biggest Value of Them All

We Give You Exclusive Territory

We are now assigning exclusive territory to reputable representatives for distribution of our improved ELKAY five-tube Super-Selector during the coming season.

This set is a genuine triumph! It compares favorably in appearance, selectivity, volume, distance and tone quality with any set on the market at any price. It lists for only \$80.00. Yet you need have no hesitation in testing it out beside sets selling at twice the price.

This new set consists of one stage of RF, detector, one stage of transformer coupled amplification and two resistance coupled amplifiers. There are only two dials, the station logging is exact and there is perfect control over oscillation. In addition, a radio frequency choke permits the same smooth operation on the low wave lengths as on the high. There is also a control over the degree of selectivity. *This is a distinct departure—an L+K invention*—and is of extreme importance to dealers selling in territories close to B. C. centers.

We guarantee to maintain prices and discounts during the winter of 1925-26. We discourage overstocking. We sell on quality, not price. Our policy is "Constant improvement of product, but no new models."

We stand back of our product and guarantee satisfaction. As in the past, we shall advertise extensively.

We refuse to deal with the gyp or cut price houses. We believe in the square deal!

If interested, fill out the coupon or write on your letterhead.

The Langbein-Kaufman Radio Co.
511 Chapel St., Dept. M., New Haven, Conn.

- Resistance Coupling
- Control of Selectivity
- Low Retail Price
- Masterly Cabinet Work
- Price Maintenance Guarantee
- A Square Deal For All

MAIL THIS COUPON—or write

The Langbein-Kaufman Radio Co., Dept. M.,
511 Chapel St., New Haven, Conn.

Gentlemen:

Without obligating ourselves, we wish to negotiate for the following exclusive territory in which to sell the ELKAY SUPER-SELECTOR:

.....

 Firm name

Street Address

City

State

An L+K Product



At Last! An Answer to the Question "WHERE SHALL WE PUT IT?"

The table model set and its accessories have always been a flock of "Orphan Annie's" around the house, unsightly and with no definite place of their own.

Now comes the most complete radio table ever offered, with spaces for everything and a fine loud speaker horn built in behind the silk covered grill. The doors are hinged. The tray at the left slides out to facilitate servicing the "A" battery. It is lined with acid proof paint. There is plenty of room for battery and charger in the "B" battery compartment at the right. The drawer below it is for tools, earphones, programs, etc. Nothing has been overlooked.



No. 440 Table—Closed

A combination of simple design and finest workmanship make the No. 440 Utility Radio Table look at home in practically all surroundings.

This is a real sales opportunity for dealers. The price is reasonable. The discount is worth while. To insure getting your supply when you want it, we advise getting your order in right away.

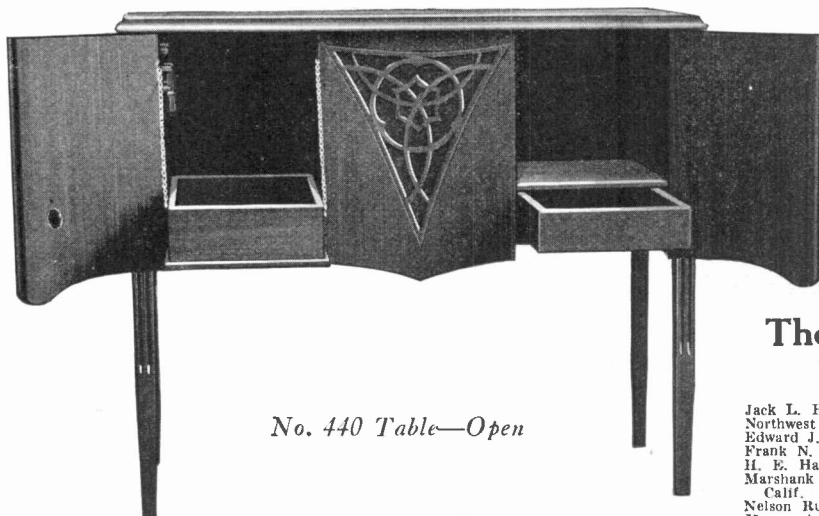

No. 440 Table—Open

The 300 line of stock cabinets promise to sell in volume this year. They are fine, moderate priced cabinets with hinged top, nickel plated stay, green felt lid pad, and rubber bumpers on the bottom.

The John O. Jesse Mfg. Co. Bryan, Ohio

Jack L. Hirsch Company, 1641 Stout St., Denver, Colo.
Northwest Sales Co., 364 Watwick Ave., So. St. Paul, Minn.
Edward J. Beckley, 154 Nassau St., New York, N. Y.
Frank N. Jones, 845 So. Wabash Ave., Chicago, Ill.
H. E. Haggerty, 236 Spencer Ave., Ferndale, Mich.
Marshall Sales Co., 926 Insurance Exchange Bldg., Los Angeles, Calif.
Nelson Rude Co., 16 California Ave., San Francisco, Calif.
Horace A. Fuld, P. O. Box 123, Trenton, N. J.

Manufacturers: WE SELL ONLY WHAT WE CAN DELIVER. If you want to get one worry off your mind, we will help you. It is our policy to take orders for what we can deliver, on a schedule we can live up to, AND NO MORE.

We are equipped to design or build any style cabinets you may need and when your schedule of deliveries has been agreed to you may be sure that your cabinets will be ready on time. Write to us now.

NEW! A radically new cushion socket with big sales opportunities

A unique advance in tube contact and socket wiring! Your store should profit by it.

STOCK this cushion socket now, because it is *new*. There is nothing else like it. It will help the reputation of your store for progressiveness. Na-Ald cushion mounting is simple, positive and unique.

Direct Contact

The part of the cushion to be fastened to the panel is the same metal that contacts direct with the tube terminals. If *above* panel wiring is used wires are soldered at these four panel connections.

No Binding Posts

Note that there are no binding posts. See the four little prongs, which are an integral part of the cushion and tube contact metal. If wiring is above the panel, attachment is made as just described and these prongs are left flat and are not used.

Wiring Hidden

Most set users today, however, wish to hide the wiring. Binding posts and consequent sacrifice of positive, direct connection with tube terminal contacts have been necessary up till now.

Even Sub-Panel Connections Are Direct

With Na-Ald cushion sockets, sub-panel connections are direct. Merely bend the four prongs to perpendicular. Mark points on the panel and drill four more holes. Let the prongs project down through the panel.

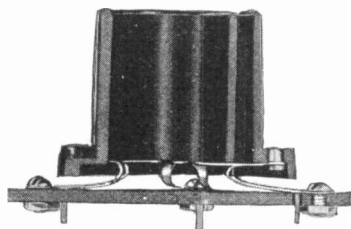

Cross-Section View of the New Na-Ald Cushion Socket

Wires are then soldered to proper prongs. Note that this connection is directly with the same piece of metal that contacts with the tube terminals. Contact is positive. Wiring is hidden. Losses are reduced. Signals increase in strength and clearness.

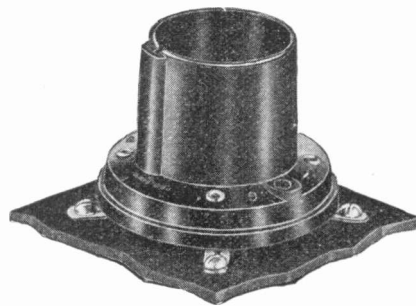

Na-Ald Cushion Socket

"It's the Contact that Counts"

This has always been the Na-Ald slogan. This new cushion socket is another expression of it. Cushion mounted sockets are desirable in order to eliminate vibration. But *direct* sub-panel wire connections are even more desirable. *Only Na-Ald cushion sockets* give your customers *both* advantages. The cushion feature is available with Na-Ald deLux socket (side scraping, dual contact), No. 400-S, 75c.; the small space socket, No. 401-S, 50c.; and also with No. 499 socket, No. 499-S, 50c.

No Spacers Needed

It is unnecessary to use washers or other makeshifts to fill space under terminals, when mounting the Na-Ald cushion sockets on a panel. The attachment is substantial and positive.

Vibration Adjusted

The period of vibration of Na-Ald cushion mounting is, so adjusted that instead of occasionally accenting microphonic noises, it always minimizes them. The degree of resiliency is worked out so that not only are accidental and extraneous vibrations absorbed, but also the troublesome vibration sometimes produced by loud speakers.

You Can Profitably Concentrate on the Na-Ald Line

This is just one of the new developments in

the Na-Ald line which you should put in stock now and sell at once, profitably. You can concentrate on Na-Ald because radio users know it as the standard in sockets and dials. Advertising, wide distribution, attractive packages, unique display, and quality insure this.

Concentrate on Na-Ald sockets and dials. Send the coupon for further information about the new Cushion Socket and data on the other new developments.

Feature Na-Ald Adapter No. 429 Now!

Portable sets are in vogue—folks are out of doors and in the open. The radio sets must accompany them—the storage battery cannot be carried along. Dry cells step in place and tube adapters are a necessity.

Right now display Na-Ald Adapters in your windows and prominently on your counters. Call your customers' attention to the practicability of portable sets—how they can install Adapters and enjoy radio in the camp, bungalow and on picnics.

Na-Ald Adapters No. 429 are especially made for use with U.V. 199 and C. 299 tubes, which are used with dry batteries. Display Na-Ald Adapters and you will enjoy an increased sale of Adapters, tubes and dry cell batteries. Put a display in today—don't delay.

ALDEN MANUFACTURING COMPANY
Dept. A7, Springfield, Mass.



Alden Manufacturing Company,
Dept. A7, Springfield, Mass.

Send further details about the new Na-Ald cushion sockets and Na-Ald adapters, also data on your other new developments.

Name

Firm

Street

City State

My jobber is

Multiply Your

This message is for manufacturers of every product used or sold in the radio industry:

YOU have been receiving copies of *The Radio Trade Directory* each issue since it was first published last November. You and your office staff have probably had many occasions to refer to it for buying information. And wherever you've gone you've seen copies of *The Radio Trade Directory* in use by other manufacturers. Doubtless you've noticed that jobbers and dealers who need buying information far more frequently than you do also use the *Directory* constantly.

SO multiply your desk by 20,000 and get an idea how often the 20,000 copies of the new August edition of *The Radio Trade Directory* will be used for fall buying. Thousands of busy radio jobbers and dealers will be stocking up parts, sets and accessories for the fall. Manufacturers, too, will need raw ma-



terials and supplies—tools and a score of other necessities. A hundred items will be needed in a rush—buying data must be had at once and that means *The Radio Trade Directory*.

DURING the fall buying season the radio dealer, jobber or manufacturer will make greater use of the *Directory* than ever before. He will when about to order turn to the *Directory* for buying data—will he find the information he needs on your product? Will he find specifications, finishes, prices, sizes, local distributors? All this data he will need before he can intelligently order.

RESERVE SPACE NOW in the August *Directory*—be sure that your product is properly catalogued in the medium to which 20,000 radio buyers will turn for buying data.

THE RADIO TRADE DIRECTORY

a product of the world's largest business publishing house

THE MCGRAW-HILL COMPANY, INC.

473 Tenth Avenue, New York City

Desk by 20,000

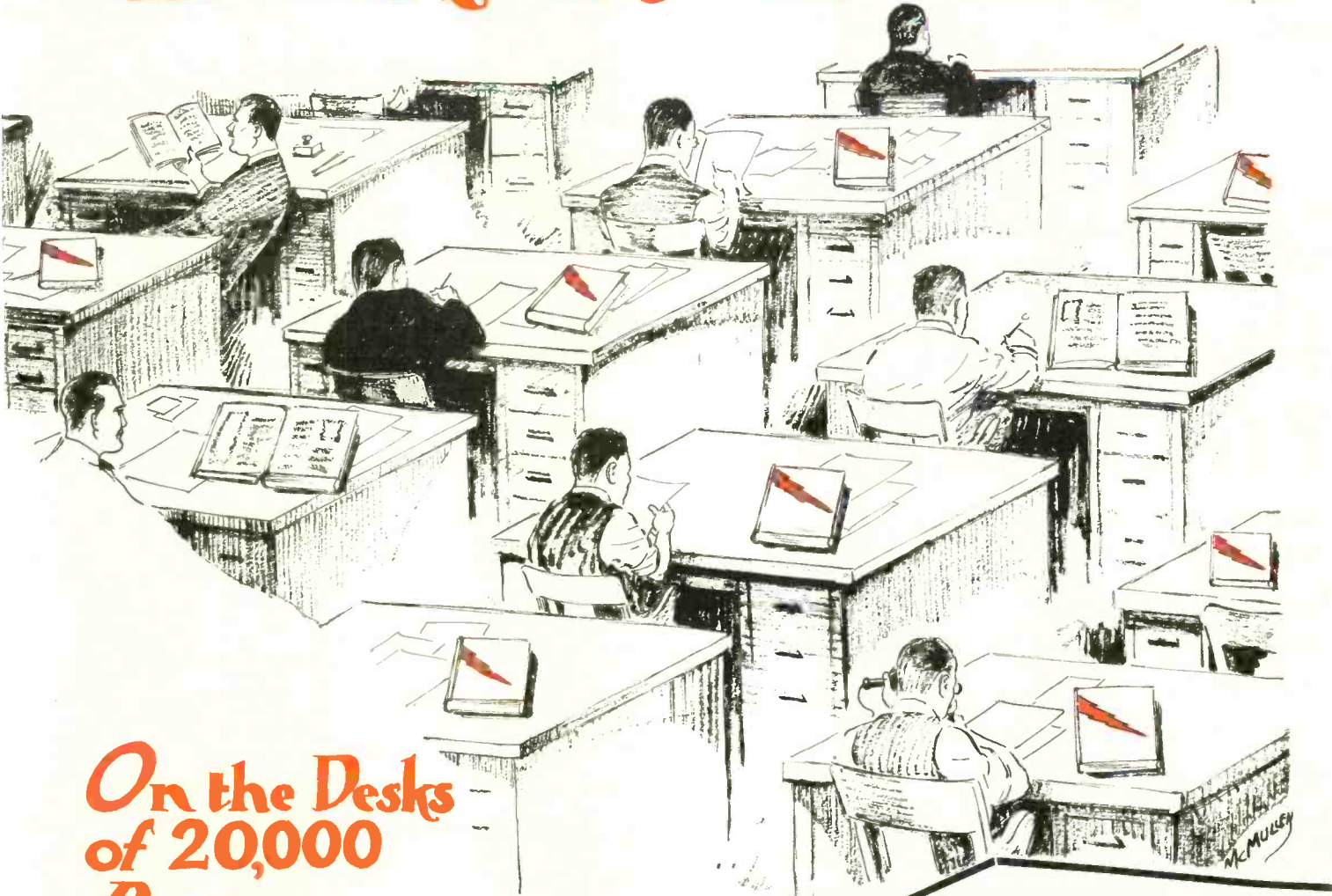

On the Desks
of 20,000
Buyers

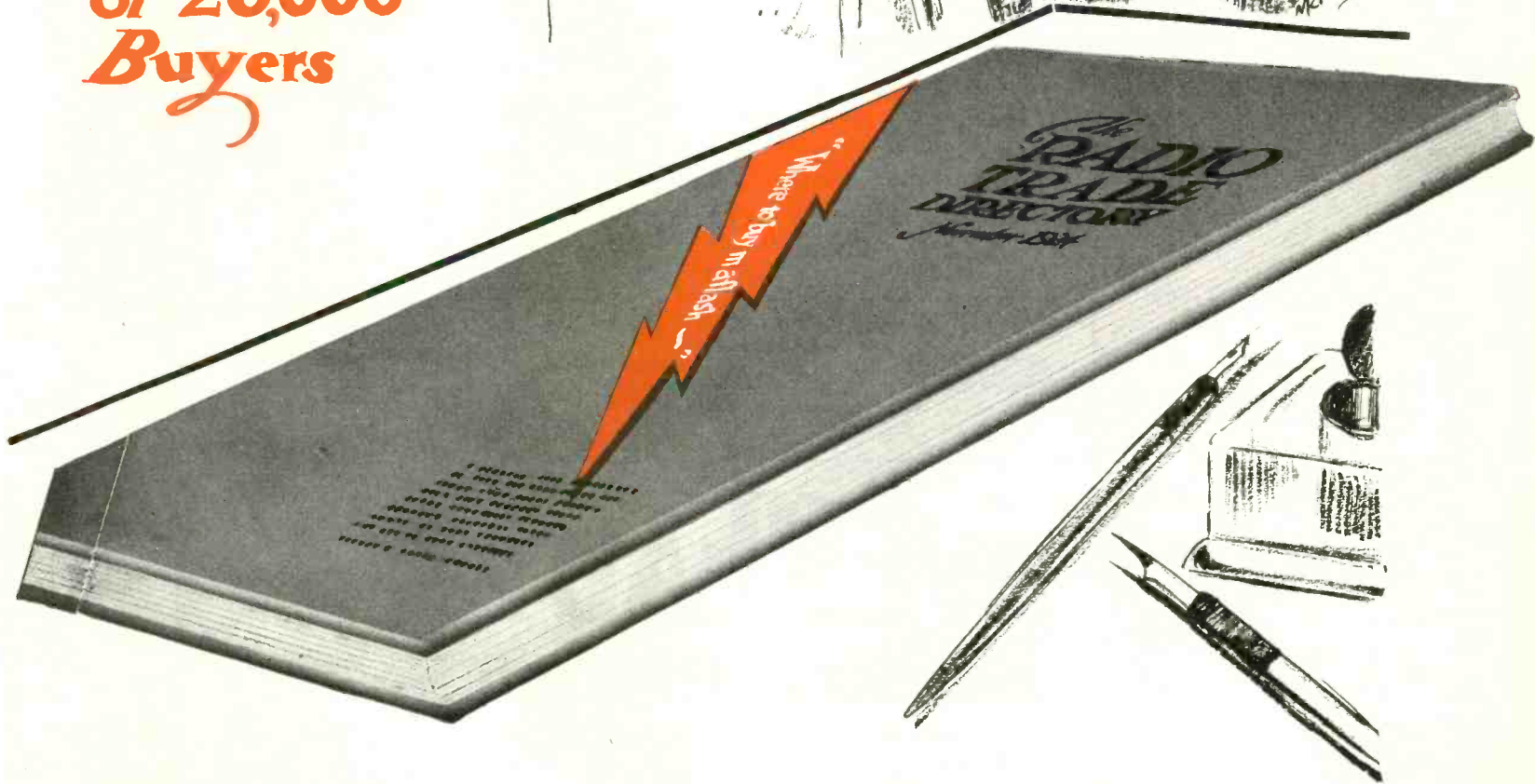

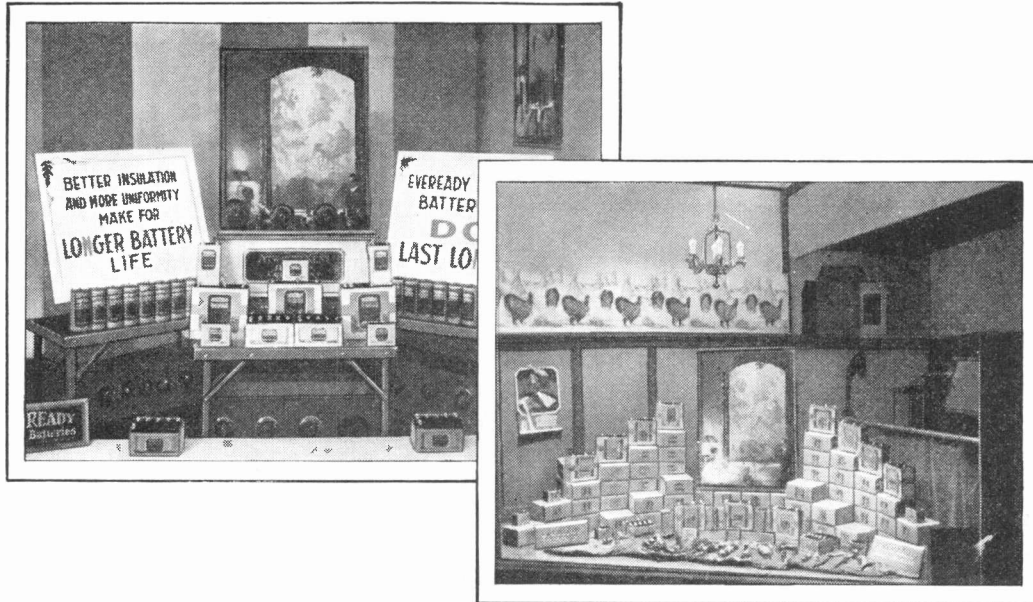

Double-barreled *evidence*

HARRY COATS, of the Coats Garage, Aurora, Ill., is one of the biggest radio dealers in the Middle West, as well as a mighty successful garage man. "I am convinced that Eveready Radio Batteries do last longer," says Mr. Coats, "not only by actual test, but because hundreds of my customers who have tried other batteries insist on Eveready, and public opinion speaks for itself."

THE Eveready Battery line is one of the two most attractive lines of merchandise a store can carry—Eveready Flashlights is the other line," says Mr. Jones, of the Rock River Electric Co., Sterling, Ill. "Dealers everywhere are cashing in on the name Eveready. The Eveready season is twelve months long—trim up an Eveready window and watch people stop, look and enter."

By making attractive window displays you can easily increase your sales of Eveready products. Sales-producing display material will be sent free on your request, from any one of our offices listed below. Order from your jobber.

Manufactured and guaranteed by

NATIONAL CARBON COMPANY, Inc., New York — San Francisco
 Atlanta Chicago Dallas Kansas City
 Canadian National Carbon Co., Limited, Toronto, Ontario

EVEREADY HOUR EVERY TUESDAY at 8 P. M.

(Eastern Standard Time)

For real radio enjoyment, tell your customers to tune in the "Eveready Group." Broadcast through stations

WEAF New York	WFI Philadelphia	WEAR Cleveland	WCCO Minneapolis
WJAR Providence	WGR Buffalo	WSAI Cincinnati	St. Paul
WEEI Boston	WCAE Pittsburgh	WWJ Detroit	WOC Davenport

EVEREADY

Radio Batteries

—they last longer

Another ELECTRAD Success!

The Fixed Mica Condenser Which the Radio World Has Long Been Seeking



Standard type packed in sealed, individual envelopes.

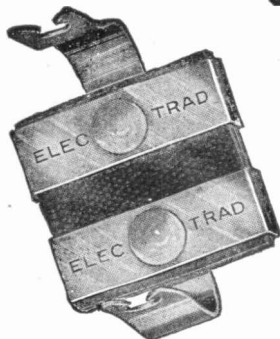
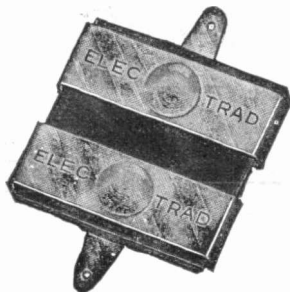

Type G—with bracket for grid leaks. Connections quickly soldered to base of bracket.

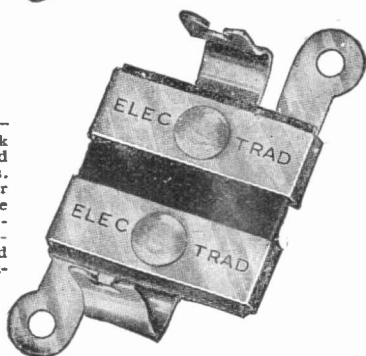

Type G-S—with grid leak brackets and special arms. Very handy for Resistance Coupled Amplification sub-panel work and socket mounting.

THE new "Electrad" Certified Fixed Mica Condenser introduces long needed improvements in condenser design, construction and materials. To the retailer this means quick turnover and splendid profits. To the radio fan, better reception.

A novel and rigid binding method gives *Six Pressure Points* in place of the customary two. Constant value, quiet operation and perfect electrical contact are assured always. Accuracy is guaranteed to be within 10% of the specified calibration.

The soldering lugs and binding straps are stamped in one piece and riveted in place. Nothing to work loose or change capacity. Heat, cold, dampness or other atmospheric conditions cannot damage the thin sheet copper and impair the condenser's operation.

The "Electrad" Certified Condenser is most convenient to install. Made with soldering lugs, grid leak brackets or specially designed arms for direct connection with socket terminal. In all standard capacities. List 30c. to 75c.

Licensed under Pat. No. 1,181,623, May 2, 1916 and applications pending.

A national advertising campaign in the fan's own publications are carrying these important features direct to set builders and owners. "Electrad" Certified Condensers will be asked for by fans everywhere. Prepare now to profit from this demand.

DEALERS AND JOBBERS Wire or Write

for samples and our proposition which also includes valuable selling opportunities on our other popular radio essentials,—Resistance Coupled Amplifier Kits, Audiohms, Variohms, Lamp Socket Antenna, Lightning Arresters, Lead-Ins, Grid Leaks and many others.

ELECTRAD Inc.

428 BROADWAY, NEW YORK CITY

**FRESHMAN
MASTERPIECE
Authorized Dealer**

*There is still
some territory open
but it is going fast!*

**If you want a real
protected franchise on
the greatest line of 5 tube
receivers ever offered under
a plan which eliminates**

**〔Cut throat competition〕
〔Losses on Installment Sales〕**

*Write - telephone or visit either
of our offices at once*

Chas. Freshman Co. Inc.
Radio Receivers and Parts
FRESHMAN BUILDING
240-248 WEST 40TH ST.-NEW YORK, N.Y.
CHICAGO OFFICE — 327 S. LA SALLE ST.

**For
HOME
Use**

For alternating current only

JEFFERSON TUBE REJUVENATOR
Keeps radio tubes like NEW!
FOR HOME USE

\$7.50

Monthly use insures 100% radio reception

Doubles and trebles tube life

JEFFERSON TUBE REJUVENATOR
Keeps radio tubes like NEW!

\$7.50
Attach to electric light socket

JEFFERSON TUBE REJUVENATOR
Keeps radio tubes like NEW!
Quickly pays for itself thru saving tubes and batteries

Takes large or small tubes
(201-A, 301-A, UV-199, C-299)

\$7.50
\$10 in Canada

IT'S no wonder that radio owners have been quick to buy the Jefferson Tube Rejuvenator! Here's just the device they long have hoped for—a home rejuvenator for radio tubes. Used once a month, it keeps tubes at full efficiency, insures uniformly good radio reception and increases the life of tubes. Completely restores paralyzed or exhausted tubes. Operates on a. c. electric light current—rejuvenates tubes in just 10 minutes. Takes large or small tubes—201-A, 301-A, UV-199, C-299. Retail price,

Jefferson Tube Rejuvenators are shipped to dealers in the above attractive display carton.

IS this sales-making display carton on your counter? If not, you ought to put it there without further delay. Dealers everywhere are enjoying fast sales on this immensely popular device. Every radio fan wants this low-cost, nationally-advertised rejuvenator so he can rejuvenate his tubes at home the same as he recharges his storage battery. Tie up your store with our national advertising in The Saturday Evening Post and fourteen other important magazines. Ask your jobber to send you a supply of Jefferson Tube Rejuvenators. Enter your order today.

Jefferson Electric Mfg. Co., 501 So. Green Street, Chicago

Makers of Jefferson Radio, Bell Ringing and Toy Transformers; Jefferson Spark Coils for Automobile, Stationary and Marine Engines; Jefferson Oil Burner Ignition Coils and Transformers.

It's the Setting That Sells Radio

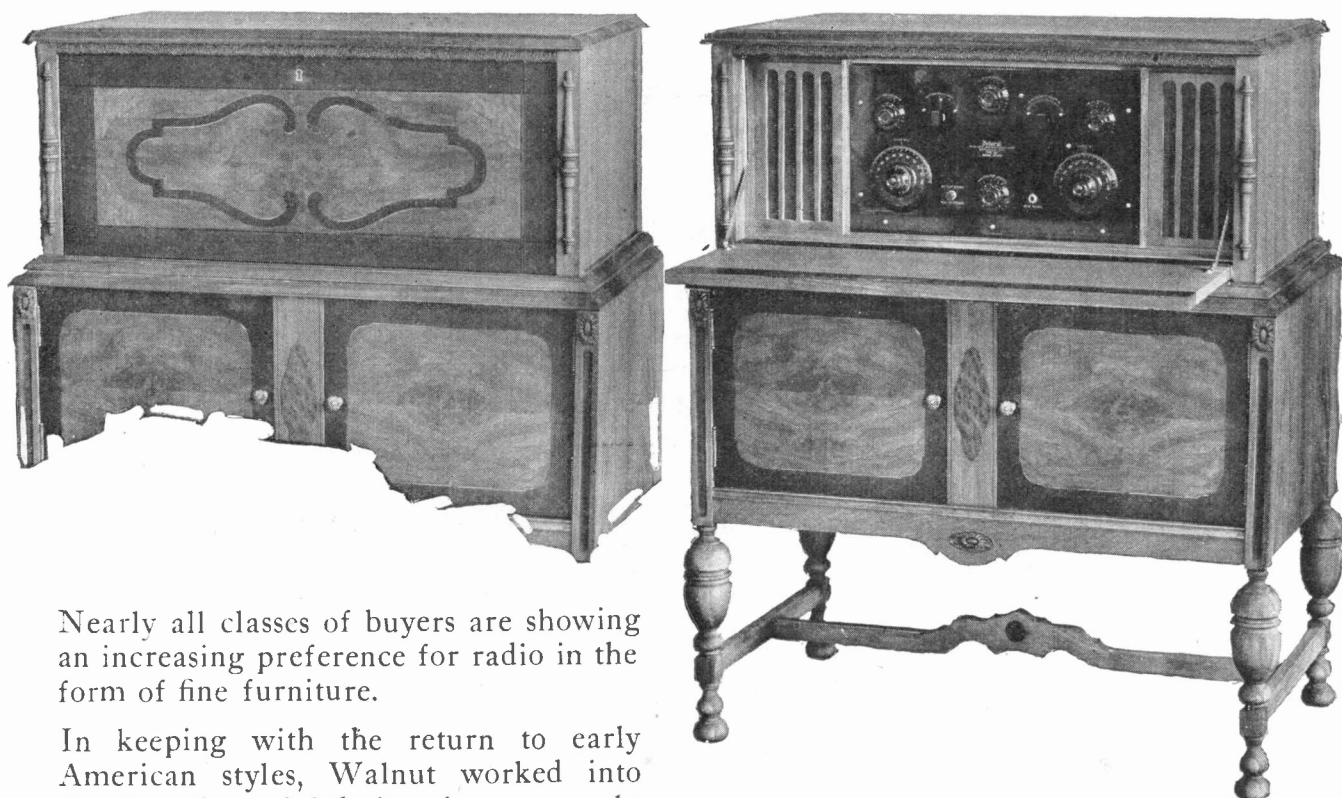

Nearly all classes of buyers are showing an increasing preference for radio in the form of fine furniture.

In keeping with the return to early American styles, Walnut worked into simple, substantial designs is most sought for.

The Harp-O-Radio Model 145 is made to appeal to all those people whose good taste has brought Walnut and the console model into such popularity.

The cabinet has compartments to house all batteries and charger, and a drop front that covers the radio panel and loud speaker.

The cabinet may be had with a Federal

Super-Selective Five Tube Receiver and speaker, or it may be had bare—without radio equipment—modified to take Atwater-Kent, Fada, or practically any set you sell.

It is not an extravagant claim, but a simple statement of fact, when we say that Model 145 Harp-O-Radio is one of the most beautiful pieces of radio furniture ever produced for sale through the trade at a price most folks can afford.

Don't forget: It's the setting that sells radio

FULL SPECIFICATIONS AND PRICES UPON REQUEST

The Harponola Company

CABINETS

PHONOGRAPHS

RADIOS

Celina, Ohio

Distributors

Edward J. Beckley, 15 Nassau Street, New York City
Frank N. Jones, 845 So. Wabash Ave., Chicago

Northwest Sales Co., 364 Warwick Ave., So., St. Paul
Jack L. Hursch Co., 1641 Storet St., Denver

The Logical Loudspeaker Outfit for Any Radio Set

Every radio owner has been looking for and wants this combination of radio table and loudspeaker—

The Console Master Speaker

It is a substantial and refined console table of beautiful design, finished in two-tone mahogany, with bevelled top and turned and fluted legs.



The Console Master Speaker

With built-in loudspeaker. Its proportions are correct in design. Size, 30 inches high; 36 inches long, and 16 inches wide.

Retail Price \$49.50
Complete with Loudspeaker
(Adjustable Unit)

Biggest Trade Discounts

DEALERS—Order from your nearest jobber or direct from us.

JOBBER—Write us for territory and our proposition.

The Console Master Speaker is the only table speaker with a front that may be opened to give convenient and quick access to batteries and speaker. This feature permits the use of a volume and quality control of the speaker—our own exclusive origination.

The Greatest Loud Speaker Value Today

Considered only as a piece of furniture or only as a loudspeaker the Console Master Speaker is worth the money. But as a combined cabinet and speaker it is the greatest loudspeaker value today.

The loudspeaker is concealed behind the silk covered grill and has a beautiful, natural tone of great volume.

All the experience of twenty years of phonograph manufacture is built into the horn, which is made of solid non-vibrant wood with brass tone arm.

A special and powerful loudspeaker unit is used, and we believe that there is nothing better made.



The Console Master Speaker

Showing the front let down, allowing convenient and quick access to batteries and speaker.

Will Hold: 1 "A" Battery.

1 Charger.

2 Dry or Wet "B" Batteries,

besides the built-in Loudspeaker

CONSOLE MASTER SPEAKER CO.

15 East 40th Street, New York



An EXTRA QUALITY Hard Rubber Radio Panel

Has all the superior electrical qualities you would look for in such a high grade rubber panel—low dielectric constant, phase angle difference; easy to drill and engrave—

but also

Beautifies the Set and gives it a Distinctive Appearance

Shows no fingerprints, smudges or scratches

One side has the Florentine finish, while the reverse can be had in either plain Black or Mahogany; this insures

Increased Sales and Quicker Stock Turn

Hood Panels also made in plain Black and Mahogany; packed in individual attractive Hood envelopes. *Write for samples, or name of distributor*

Hard Rubber Dept. **HOOD RUBBER CO.** Watertown, Mass.

1925

RADIO WORLD'S FAIR

258th Field Artillery Armory

NEW YORK CITY

SEPTEMBER MONDAY TO SATURDAY **14th to 19th**

Entire Exposition on Ground Floor

U. J. Herrmann, *Managing Director*

Business Offices—1500 Times Building, New York City 127 N. Dearborn St., Chicago, Ill.

Official
Show
R. M. A.

A Great Manufacturers' Exposition which will be attended by the Principal Radio Jobbers and Dealers of the Universe.

Official
Show
R. M. A.

25% More Windings and a Bigger Core

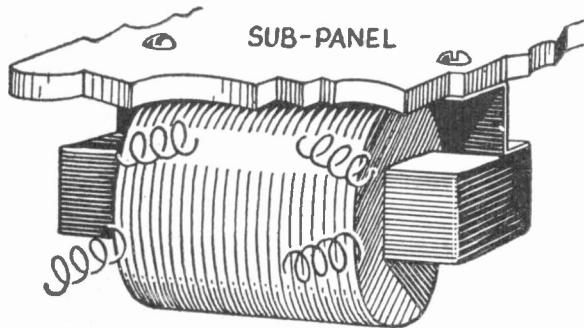

The best transformer
ever offered to set
manufacturers

The Modern transformer which we have designed for set manufacturers is, except for a few refinements, the same as the one which has sold so heavily to the public. It is "undressed," or stripped of the case and outside finish put on for retail selling.

It is a compact unit, designed for either of the two types of mounting illustrated to conserve space, yet it is the huskiest transformer offered to set manufacturers, containing about 25% more windings and a considerably bigger core.

As the trade and amateur set builders know, Modern transformers

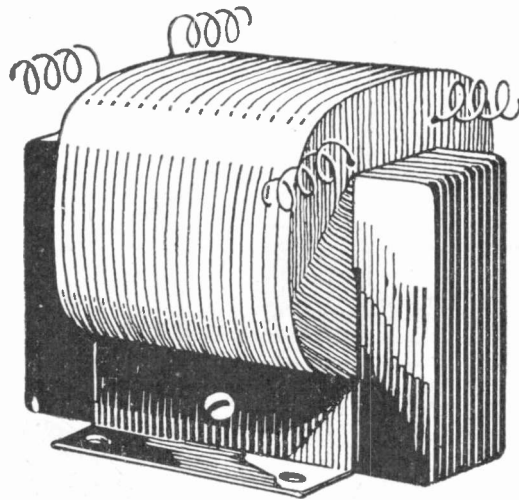

have a far greater range than cheaper units, passing lower and higher notes.

Yet we are able to sell set manufacturers at a price that compares favorably with "cheap" transformers. Prices on any quantities will be sent upon request.

As the public becomes more and more
radio wise it is becoming not only desirable
but necessary to use the best transformers.

Used by the Jewett Radio & Phonograph Corp. and Many Others

THE MODERN ELECTRIC MFG. CO.

1231 Summit St., Toledo, Ohio

One Model Double Volume



Now every feature of the talking machine's wonderful reproduction — including sound volume — brought to radio reception by the new, "double volume"

Dulce-Tone RADIO TALKING MACHINE SPEAKER

Reception with the new Dulce-Tone tests 59% louder on "local" broadcasting and over 100% louder on distant stations.
One model only. A simple adjusting nut brings out the best qualities of each individual talking machine.
Retail price remains at \$10. (In Canada, \$14.)
Write for a sample new Dulce-Tone and put it through conclusive tests.

THE TEAGLE COMPANY
1125 Oregon Ave., Cleveland, Ohio

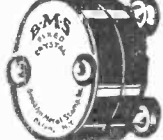
B.M.S. DETECTOR is a fixed crystal detector of the highest sensitivity. Cannot be beat for reflex sets. Moulded of solid bakelite; unbreakable and very compact. \$1.00 List.

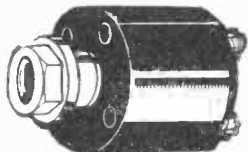

B.M.S. TRI-JACK. A super-compact jack that can be used as a single open, single closed or double closed circuit jack. Moulded or solid bakelite binding posts are accessible and clearly marked. Size 1 in x 1 in. (Patented). 90c. List.

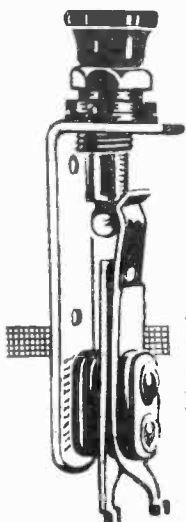

B.M.S. SWITCH JACK. embodies the exclusive principles of the Fantail Jack. Pulling out the stud makes a positive contact that can never become noisy. 50c. List.

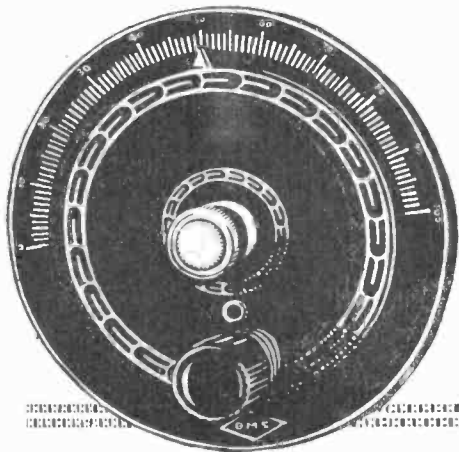

B.M.S. VERNI-JUSTER. with new features, is beautiful in appearance with its gold finish. The action is positive, with a 15:1 gearing. The insulated friction clutch eliminates hand capacity. *No tools whatever are required to attach it.* This will be the biggest selling vernier dial this season. Diameter 4-in. overall. \$1.50 List.

(Also made as the **VERNI-JUSTER Jr.**, 3 in. diameter \$1.00).

BROOKLYN METAL STAMPING CORP.
718 Atlantic Ave., Brooklyn, N. Y.

B.M.S. PLUG is absolutely shock-proof. Moulded of bakelite in a beautiful keystone design. Tips are held and released automatically; the tips being totally concealed when inserted. Positive and negative are marked. 50c. List.

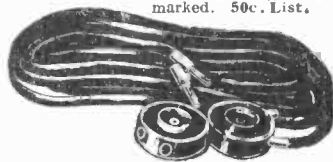

B.M.S. CORD with connector is an exceptionally handy device for lengthening loudspeaker cords. Furnished complete with 20 feet of high grade phone cord. \$1.25 List.

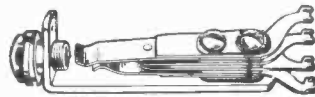

B.M.S. FANTAIL JACKS (Patented) have the fantail cupped lugs that make for easy soldering and accessible connections. Bakelite insulation, sterling silver contacts. Made in all types. Write for prices and discounts.

REPRESENTATIVES: F. L. Tomlinson Co., 443 So. San Pedro St., Los Angeles, Calif. B. J. Fitzner Co., 159 E. Elizabeth St., Detroit, Mich. Technical Sales Co., 31 Bedford St., Boston, Mass. Electric Sales Eng., 1406 First National Bank Bldg., Cincinnati, Ohio. EXPORT DEPT.: Melchior, Armstrong, Dessau Co., 116 Broad St., N. Y. City.

NEW

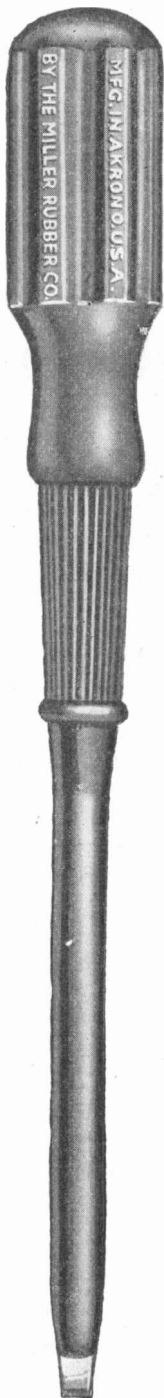

Here is something radio fans have been waiting for ever since radio became popular. "Ra-Drivers" will sell faster than tickets to a world series game.

Ra-Driver (Insulated)

This is the first screw driver to be put on the market which is absolutely insulated to within $\frac{1}{4}$ in. of the tip. It is built of finest tempered steel imbedded in quality hard rubber—and will withstand 1,000 volts or more without breaking through. The handle cannot turn or work loose.

"Ra-Drivers" will supply a real demand among the radio public. They are equally effective for electrical work or general purposes. Their remarkably low price will permit you to compete with ordinary screw drivers—and reap large profits.

Ask your jobber or write us direct for prices and complete information.

The Miller Rubber Co.
of N. Y.
Akron, Ohio

Another Miller Product

Sangamo Mica Condensers

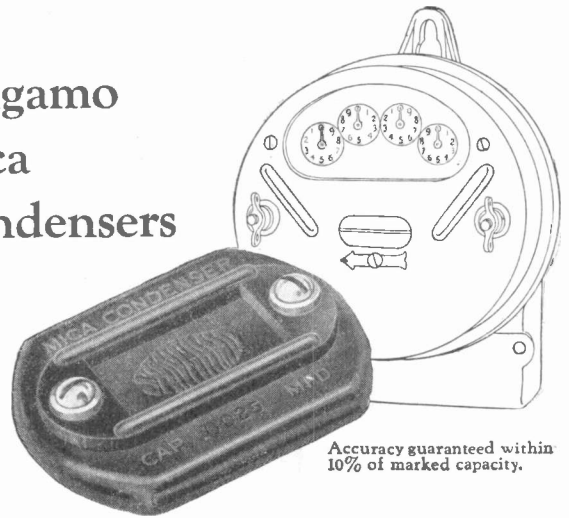

Accuracy guaranteed within 10% of marked capacity.

*Made by builders of
precision electric devices*

SANGAMO Mica Condensers are made with the same painstaking care that has given Sangamo Electric Meters a world-wide reputation for sustained accuracy.

In thousands of cities and towns, electric light and power companies put complete faith in the dependability of Sangamo Meters.

The whole success of a well-constructed radio receiver may depend upon accurate condensers that will stay accurate. You can assure your customers that Sangamo Condensers will do so.

Every nationally known radio laboratory has endorsed Sangamo Mica Condensers. They are guaranteed to be accurate within 10 per cent. of marked capacity—and the capacity never changes.

Being solidly molded in bakelite, they are

Waterproof

Heatproof

Fumeproof



THIS display card is now ready. It holds an actual condenser.

Ask your jobber.

Sangamo Electric Company
Springfield, Illinois

RADIO DIVISION, 50 Church Street, New York

1320-5

OFFICES IN PRINCIPAL CITIES For Canada—Sangamo Electric Co. of Canada, Ltd., Toronto For Europe—British Sangamo Co., Ponders End, Middlesex, Eng. For Far East—Ashida Engineering Co., Osaka, Japan



Sell 'em Radio

on the Meyer-Kiser Plan

Radio Financing Headquarters



The Meyer-Kiser Corporation, Indianapolis, for many years has served hundreds of automobile dealers by providing them with a finance plan for selling cars on a time payment basis.

Every transaction has been "open and above board," and dealers by the hundred have appreciated the service and have stayed with us year after year.

Ours is an organization with a special mission—we now have a service that radio dealers need. By availing himself of our service, the dealer makes more sales and more money. Our plan increases volume and turnover, and makes sales possible that otherwise could not be made.

Write today for details of the Meyer-Kiser Plan for financing time sales

Every dealer who expects to increase his sales must sometime begin the use of a time payment plan. Meyer-Kiser render a real service to radio dealers, as has been proved throughout the country, and we suggest that interested dealers communicate with us now—in anticipation of the 1925-6 selling season.

MEYER-KISER CORPORATION
 Meyer-Kiser Bank Building
 INDIANAPOLIS, INDIANA



A REAL SELLER— To Strengthen Summer Sales

Here's the Condenser to push for Summer use. Its special low loss features increase the Summer efficiency of any receiver and makes a satisfied customer you can depend upon this Fall.

Designed by R. E. Lacault, E.E., originator of the famous Ultradyne Receivers, and especially built along advanced scientific principles to overcome losses common with other condensers. Nationally advertised in leading radio magazines.

Manufacturers

Mr. Lacault will gladly consult with set manufacturers regarding the use of this Ultra Low-loss Condenser in their receivers.

ULTRA-LOWLOSS CONDENSER

Phenix Radio Corp., 114-116 E. 25th St., New York

No More Dissatisfaction

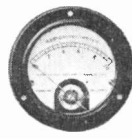

Model 301
 Filament
 Voltmeter



Radio
 Plug



Model 489
 Table
 Voltmeter

SELL your customers on real radio operation. Show them the advantages of tuning in at proper voltage. Make friends by telling them how to increase the life of their tubes. (You'll sell more tubes that way.) Show them how to catch everything on the air and show them a positive contact, instant change Radio Plug, the Weston.

Weston Model 301 Filament Voltmeter for panel mounting or Weston Model 489 Radio Table Voltmeter saves batteries and tubes, improves reception and makes Radio a real pleasure.

*The free booklet
 entitled*

*"Weston Radio Instruments"
 will make friends for you, sell
 accessories for you and give you
 specific information on Weston in-
 struments.*

Write for it today

WESTON ELECTRICAL INSTRUMENT CORP.
 25 Weston Avenue, Newark, N. J.



STANDARD THE WORLD OVER
WESTON

Pioneers since 1888





In all our years
as publishers
we have never made
a better offer
than this!

This unusual offer enables you to secure a tried and tested radio sales service through subscribing to *Radio Retailing* for only \$1 a year. It is the biggest value for \$1 ever offered in the radio field!

It's a special offer for a limited time. Fill in the coupon below, attach a dollar bill to it and return it without delay.

By enrolling as a charter subscriber now you have the service for a whole year for \$1 and you save \$1! We have never made a better offer than that!

A regular \$2 a year paper for \$1

Return the coupon below now!

Postage to countries outside U. S. and Canada \$1 extra.

RADIO RETAILING,
Tenth Ave. at 36th St., New York, N. Y.

Attached is \$1. Enroll me as a charter subscriber to *Radio Retailing*.

Name

Street

City

7-25

A PORTABLE SUPERHET FOR SUMMER ENTERTAINMENT



It is entirely self-contained, including loop, loud speaker and batteries.

It can be assembled on a small baseboard and fastened right into an ordinary week-end bag procurable anywhere.

Very light in weight—not over 30 pounds.

Uses standard batteries, with U. V. 199 tubes.

Every W. R. kit sold opens the way for the sale of thirty-five dollars worth of parts in addition to the price of the kit.

Included in the kit are complete plans for assembling the portable, and for the regular 8-tube set too. After vacation is over the same parts can be used for the regular set.

This portable Superhet hit offers you a real summer sales proposition!

No other set is so satisfactory for vacation use, with its ample power on a loop and its ability to bring in distant stations.

No other is so well suited to all localities, nor so independent of local conditions.

\$10⁰⁰ RETAIL

ASK YOUR JOBBER

Buy your sample set from us. Place your quantity order with your jobber.

William Rosenbloom Co.
11 Deering Rd.
Mattapan, Mass.

WILLIAM ROSENBLOOM CO., Boston, Mass.
11 Deering Rd., Mattapan, Mass.
Send me complete information about your Superhet kit set and the dealers' sample introductory offer.
Name _____
Address _____
Jobber's Name _____
Address _____

Molded Bakelite for *Radio*

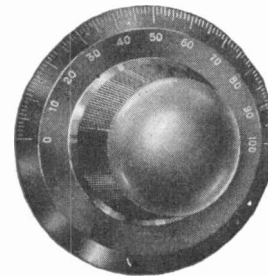
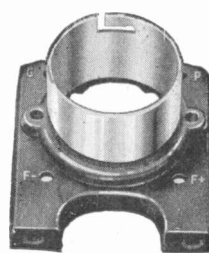

Bakelite and Condensite knobs, dials, socket bases, rheostat bases, condenser end plates, and other parts, produced by our large and experienced Molding Organization.

American Insulator Corp.
52 Vanderbilt Avenue, New York City

RADIO CABINETS

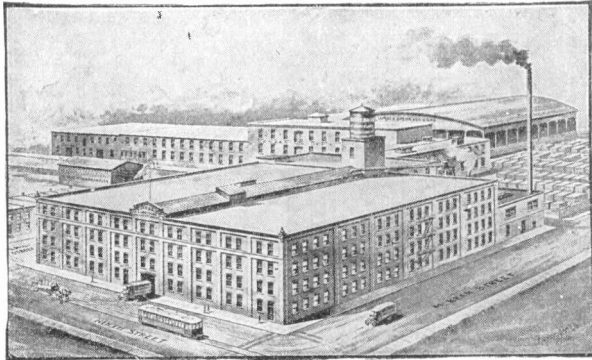

*Fifty Years
of Building Furniture*

*Let Us Build
Your*

**Radio
Cabinets**

Aside from our regular line of cabinets, we are building them by the thousands for large users of cabinets. With substantial orders, we build special, exclusive designs.

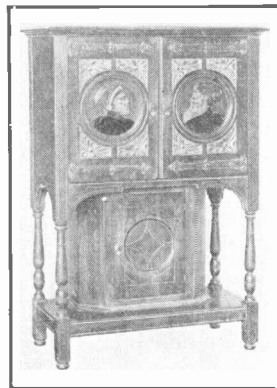

BURT BROS., INC.

2000 S. 9th Street, Philadelphia, Pa.

**—An Ideal Set for 6,800,000 Farmers
—A Fertile Market for You**

Recent statistics show that there are over 6,800,000 farms in the country without radio sets and most of them excellent radio prospects. Statistics also show that the average price of sets bought by farmers is from \$100 to \$150. It is a huge market for you with the Murdock five tube Neurodyne with a built-in loud speaker. This is it—the ideal set for the farmer. It isn't a kit—it is a standard Murdock product carefully built in a fine mahogany cabinet, with compartment for "B" batteries.

**A
Neurodyne
for \$100**

Also Model No. 101 with out Loud Speaker.
Sells at \$92.50
And Model No. 110 with Loud Speaker having an adjustable Loud Speaker Unit.
Sells at \$110

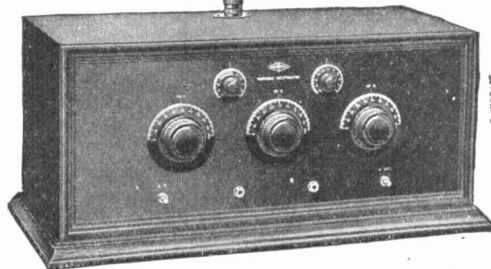
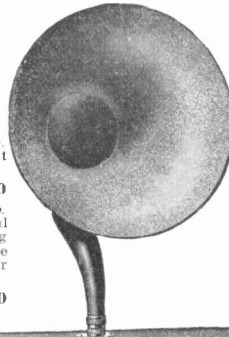

Dealers will be interested in our proposition—let us send you complete data.



MURDOCK

Wm. J. MURDOCK Co., Chelsea, Mass.

**Profits headed
your
way**

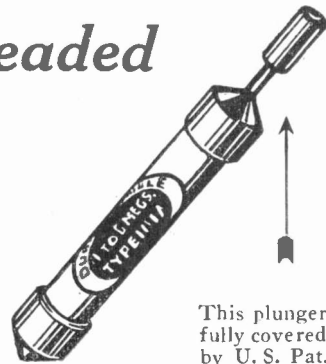

This plunger fully covered by U. S. Pat.

**DURHAM
Variable High
Resistance**

Every time a fan adjusts his detector or audio circuit with the patented DURHAM plunger—he is heading profits your way. For when a man likes something, he tells his friends—and those friends will come to you. So, stock DURHAMS.

Write for New Fall Sales Plan

DURHAM & CO., Inc.
1930 Market St., Philadelphia,

Canadian Distributors: De Forest Radio Corp., Ltd., Toronto

RADIO (H&H) PARTS

*"The Line Complete"
from Insulator to Ground Clamp*

DEALERS see stable profits in this complete, standardized line. It's the one way out of a duplicated, disjointed stock. With a smaller investment it means better service to set owners—in parts that work perfectly together.

- Loud Speaker Units**
- Transformers—Audio and Radio**
- Rheostats and H. R. Leaks**
- Condensers—Variable and Fixed**
- Potentiometers and Switches**
- Sockets—Bakelite and Porcelain**
- Headsets, Plugs, Jacks, etc.**

*They are
all stan-
dardized,
interchange-
able,
radio-elec-
trically
balanced.*

Every one of substantial Quality; every basis for growth and stability in your parts-business. Catalogue 4W will inform you fully.



**THE
HART AND HEGEMAN
HARTFORD CONN. U.S.A.**



Money in your pocket—the Master Fore Battery Charger

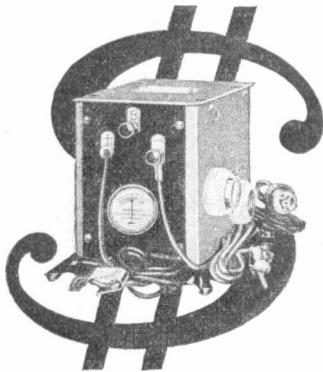

Rapid turnover with a handy margin of profit for you. For your customers, a dependable and economical battery charger for practically every requirement. The Master Fore Battery Charger charges any 6-volt Radio or Automobile Battery, also Radio "B" Batteries up to 48-volts in series and up to 120-volts in multiple. Easily operated by anyone—a big sales builder for you.

Fill in, clip and mail the coupon now—
TODAY

Manufactured by
Fore Electrical Mfg. Co.
5255 N. Market Street,
St. Louis, Mo.

Sales Department
The Zinke Company
1323 S. Michigan Ave.,
Chicago, Ill.

RADIOGRAM

Fore Electrical Mfg. Co., St. Louis, Mo., Manufacturers The Zinke Company, Chicago, Ill., Sales Department.

Send me free of charge complete information on how to make more money with the Master Fore.

Name

Address

City

State

Sell this special antenna with every set!

Greatest possible capacity and conducting surface, with less resistance, it actually increases range and volume.

It makes an excellent indoor antenna too! Made in copper, tinned copper, enameled copper. Put up in coils of 100 and 150 feet.

Ask your jobber for literature and sales-pulling prices!

ROSS WIRE COMPANY
69 Bath Street, Providence, R. I.

Note the many strands

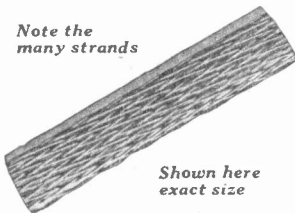

Shown here exact size

RADIO ANTENNA

The "Windham" Variable Condenser

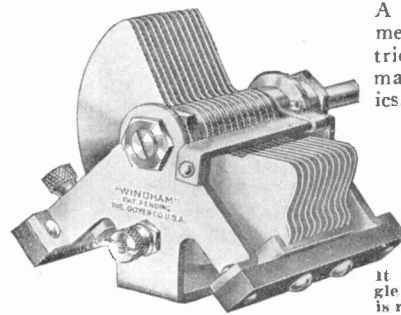

A durable, rigid instrument with correct electrical characteristics and made by skilled mechanics. It is provided with adjustable bronze cone bearings, the brake is independent of the bearings and adjustable. The plates are straight line.

It occupies small space, single hole mounting. The price is right.

Desirable territory open.

The Goyer Company, Willimantic, Conn.

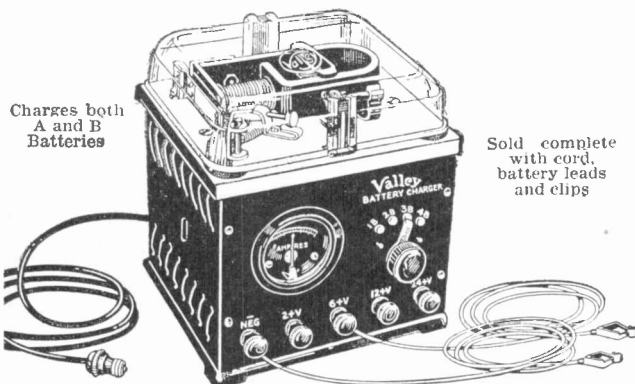

Charges both A and B Batteries

Sold complete with cord, battery leads and clips

Sell a Winner

It's just a small margin — that difference between profit and no profit. In radio chargers, sell a winner and be sure of that margin.

The Valley is the radio battery charger with ten points of superiority — ten selling points which move it for you. That's why it's a winner.

If you are not handling Valley Chargers you are missing sales, that's all. But that's enough for the progressive radio retailer. Order from your jobber or write us for information.

VALLEY ELECTRIC COMPANY
3157 S. Kingshighway—Saint Louis, Mo.

Valley Battery Chargers

AUDIOLA

announces

New improved models of recognized quality at new low prices.

"Big Six"

A six-tube tuned radio frequency set with power amplification. Designed especially to bring in distant stations with maximum volume. Efficient in operation, beautiful in appearance and reasonable in price.

"Sealed Five"

A medium-priced tuned radio frequency five-tube set. A quality instrument—the kind that will give satisfaction and stand up under the use and abuse given the average radio set.

"Audiola Protects Jobbers"

AUDIOLA RADIO COMPANY
430 South Green Street
CHICAGO

Salesmen! Exclusive territories now being allotted. Write for details today.

DUPLEX

DUPLEX STANDARD CONDENSERS

Made to Bureau of Standards specifications. Latest low-loss design. All standard capacities. Plain and vernier models.

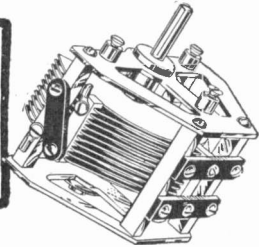

Duplex Matched Condensers

ALWAYS
READ
ALIKE



ALWAYS
MAKE
A SALE

Specially tested, matched and packed in sealed cartons of three. For uniform dial settings and simplified logging in all tuned radio frequency circuits.

Sold on a price-protecting guarantee. Write for details.

DUPLEX CONDENSER & RADIO CORP.
34 Flatbush Ave. Extension Brooklyn, N. Y.

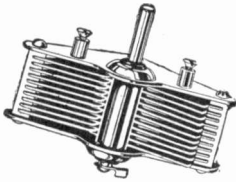

"Best at the Price"

DUPLEX JUNIOR CONDENSERS

A good, low-priced condenser. Die-cast rotor. Bakelite insulation. Many other features.

Sold!

The dealers, the public and over 150 manufacturers are "sold" on



BINDING POSTS

for the very good reason that the manufacturers specialized on this one product until perfection was reached. Furthermore, EBY Posts are intelligently merchandised, properly packed, nationally advertised and priced to retail at a worth-while profit.



The Tops Don't Come Off
25 Different Markings

The H. H. EBY MFG. CO.
Philadelphia, Pa.

15c
Plain or Engraved



The Best Battery for Your Customers is the Best for You

Ray-O-Vac Batteries give a quality and length of service that please your customers. Ray-O-Vacs are built for radio, and there's one particularly suited to every radio use. There's profit for both you and your customer in Ray-O-Vacs. Let us send you some interesting facts about selling batteries.

FRENCH BATTERY COMPANY, Madison, Wisconsin
ATLANTA DALLAS KANSAS CITY CHICAGO NEW YORK MINNEAPOLIS

FRENCH RAY-O-VAC
Radio's Best Batteries

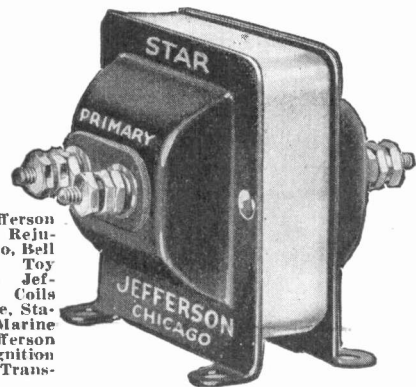

Makers of Jefferson Radio Tube Rejuvenators; Radio, Bell Ringing and Toy Transformers; Jefferson Spark Coils for Automobile, Stationary and Marine Engines; Jefferson Oil Burner Ignition Coils and Transformers.

"Quality" IS "Profit" in Radio

Your radio fan today wants the best parts he can buy. He usually knows enough to ask for them—to reject the mere "low price appeal." A few cents more means little to him—but it means that much more profit for you. And the satisfaction from quality brings repeat orders. Jefferson Transformers are quality products that are built to sell to everybody. They represent the best in transformers to critical purchasers. Built by the world's largest manufacturers of small transformers. And the reason for our size is our product.

Your jobber will tell you the rest.

JEFFERSON ELECTRIC MFG. CO.
501 So. Green St., Chicago, Illinois.

JEFFERSON TRANSFORMERS

The Preferred Aerial

More and more the users of today's popular types of radio sets are turning from unsightly, inconvenient outside aerials to the more selective, easily controlled efficient loop aerial.

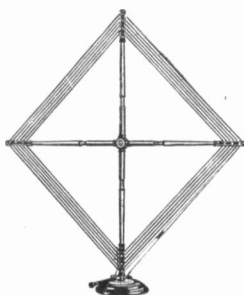

Radio enthusiasts, who demand the utmost in performance, are adopting the

BODINE
BASKET WEAVE
FOLDING LOOP

Interference is eliminated, static reduced and reception astonishingly improved through the exclusive basket weave method of winding the silk-insulated stranded wire. Its satin-silver calibrated dial makes directional logging of stations easy.

Take the Bodine anywhere. Easy to set up, and folds to fit into a box 3 1/2 x 6 x 1 1/2 inches in size. All loops are two feet square, have green silk covered wire, are handsomely finished in brown mahogany, with insulated handle for turning loop.

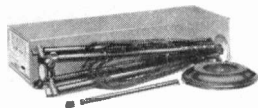

There is a Bodine Loop specially designed to give perfect service with every set suitable for loop reception. Gives extra fine results with the Remmler Superheterodyne and Grebe Synchronphase. Price \$8.50-\$10.

BODINE ELECTRIC CO.
2256 W. Ohio Street, Chicago, Ill.

The Real Proof of Value

is in the repeat order business
now coming in for

Knickerbocker Radio Cases

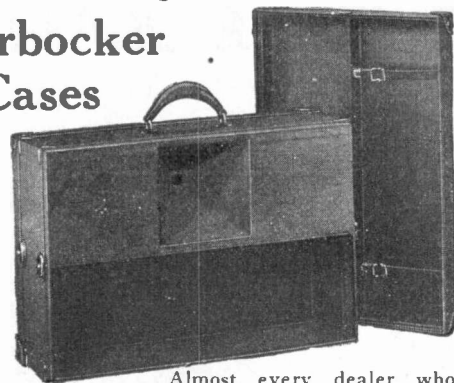

Retails
for
only
\$12.50
NOW

High Grade Black Artificial Leather Covered. Removable Back and Front. Wood Horn for Loud Speaker. Space for Panel 21 in. x 7 in. Deep cover for Dials and Straps to Hold Collapsible Aerial. Battery space both sides of Horn.

Almost every dealer who ordered a sample Knickerbocker Radio Case from our May and June advertisements in *Radio Retailing* have already sent in repeat orders. This indicates the tremendous demand for this Case and the wonderful sales opportunity ready for you.

Cash in on camping and tourist business. Sell them a Knickerbocker for building their own portable.

Liberal Discount to Dealers
KNICKERBOCKER CASE COMPANY
Specialists and Original Designers of Radio Cases—
all kinds, any quantity.

228-238 N. Clinton St., Chicago

THE TUBE SUPERTRON WITH A SENSIBLE GUARANTEE

PROTECTION



PUBLIC DEMAND
PRICE
\$2.00

An "unlimited," "unconditional," etc., guarantee with all kinds of promises is not sound—that's nonsense.

Specific limitations with means of identification is the only kind of guarantee that can be sound—that's sensible.

Each Supertron tube is serial numbered and wrapped in a guarantee certificate bearing a corresponding number for your protection.

Buy Supertron Fearless!
The dealers guarantee them fearlessly!

SUPERTRON
A SERIAL NUMBER GUARANTEE

SUPERTRON MFG. CO. 32 UNION SQUARE N.Y.
Export Div. 220 Broadway

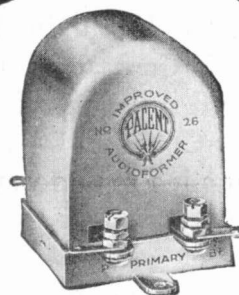

Just the thing for
the New A C Circuit

The Improved

Pacent Audioformer

BUILDS goodwill and gives you a quick turnover. Keeps customers sold on your service. Gives perfect amplification. No single high peaks. Approved and recommended by McCullough.

See your jobber or write us direct.



Trade Mark

PACENT ELECTRIC COMPANY, Inc.
91 Seventh Avenue, New York City

DON'T IMPROVISE - PACENTIZE

Can *Business* do what



TEMPTED by visions of vast domains, Napoleon led his invincible army beyond the borders of Central Europe to conquer Russia's scattered millions. Conquest was easy; yet the "Little Corporal"—with Russia at his feet—was compelled to undertake that disastrous retreat from Moscow. *He could not support his army in the territory he had penetrated.*

Are the Napoleons of Industry facing a similar situation today? Striking parallels to Napoleon's profitless undertaking are found in many present-day methods of industrial marketing. Thousands of scattered prospects, without potential buying power, are tempting manufacturers to extend their operations beyond the border line of profitable selling.

Ninety-five per cent of industry's purchases are made by 115,000 buyers. These include everything worth-while from the great industrial plants to the little shops with a big future. The five per cent market is scattered, of uncertain stability and low potential. Any manu-

facturer who attempts to sell it is but inviting another "Retreat from Moscow."

Four principles of Industrial Marketing

The buyers who comprise the ninety-five per cent market are the men most interested in methods, machines and materials which will increase the efficiency of their plants. They form the real market for manufacturers who sell to industry. As a preliminary to selling them, these four basic facts should be determined: (1) What are the worth-while markets (2) What are the buying habits of those markets (3) What are the most direct channels of approach to them (4) What are the most effective appeals.

These are all definitely known, easily determinable. Any manufacturer who desires to sell efficiently and economically must know these things. The information is readily available through the McGraw-Hill Company.

Napoleon could not?

What three industrial leaders say—

OTTO H. FALK, *President*

Allis-Chalmers Manufacturing Company

"To achieve success in industrial selling it is necessary that sales efforts be built on a secure foundation of market analysis to define worthwhile markets. Sales specialization is equally important to obtain a full share of business from each market."

GERARD SWOPE, *President*

General Electric Company

"There are natural markets for every manufacturer, and entry into such a market carries with it a responsibility for stewardship.

"For any manufacturer not to intensively cultivate and serve a natural market he has selected causes economic waste, just as it does when he lightly enters other markets where he is not prepared to assume responsibility."

E. M. HERR, *President*

Westinghouse Electric & Mfg. Co.

"The reward of an attractive and profitable volume of business may be expected by the manufacturer who first selects worth-while markets and then builds a specialized sales and service organization to serve each. Such procedure escapes the high sales resistance that inevitably results from scattered selling."

(These statements are excerpts from letters to Mr. James H. McGraw.)

And now, with a distinct trend towards the elimination of waste in distribution, the McGraw-Hill Company points the way to more scientific selling — with a wealth of data, a unique knowledge of the buying habits of industry, and a sincere desire to serve.

A unique service to manufacturers

The McGraw-Hill fingers are on the pulse of industry, contacting through fifteen publications. Some of these publications are spokesmen for whole industries, others for specific functions common to many industries. The intimate knowledge of industry thus acquired enables the McGraw-Hill Company to be of real service to manufacturers in lowering their costs of distribution.

It will be a pleasure to assist manufacturers and their advertising agents in such an undertaking. As a preliminary, it would be well to read "Industrial Marketing," which graphically covers the results of a recent survey of the buying habits of industry. This will be sent upon request to any manufacturer whose market embraces any of the industries covered by the McGraw-Hill Publications.

Trained to see the trends in industry and to interpret their significance, the McGraw-Hill Publications pointed the way in the great production development of the past half-century.

McGRAW-HILL COMPANY, Inc., NEW YORK, CHICAGO, PHILADELPHIA, CLEVELAND, ST. LOUIS, SAN FRANCISCO, LONDON, PUBLISHERS OF

McGRAW-HILL PUBLICATIONS

REACHING A SUBSTANTIAL MAJORITY OF THE POTENTIAL BUYERS IN THE INDUSTRIES THEY SERVE

Mining ENGINEERING & MINING JOURNAL PRESS COAL AGE Radio RADIO RETAILING RADIO TRADE DIRECTORY	Electrical ELECTRICAL WORLD JOURNAL OF ELECTRICITY ELECTRICAL MERCHANDISING	Industrial POWER . AMERICAN MACHINIST CHEMICAL & METALLURGICAL ENGINEERING INDUSTRIAL ENGINEER	Overseas AMERICAN MACHINIST (EUROPEAN EDITION) INGENIERIA INTERNACIONAL	Construction & Civil Engineering ENGINEERING NEWS-RECORD Transportation ELECTRIC RAILWAY JOURNAL BUS TRANSPORTATION
---	--	--	--	---

This advertisement is the third of the series which is appearing in the following newspapers — *New York Times, Philadelphia Public Ledger, Pittsburgh Gazette-Times, Cleveland Plain Dealer, Detroit Free Press, Chicago Tribune and New York Herald-Tribune*; in the following advertising papers — *Printers' Ink, Advertising and Selling Fortnightly, Class*, and in the McGraw-Hill Publications. The purpose of these advertisements is to arouse a national appreciation of the need for improving industrial sales efficiency, and to awaken a keener interest in the correct principles of industrial selling.

Telephone Cords

High-grade Cords for all makes of Headsets and Loud Speakers

We solicit your 1925 Business.

Write for Prices.

Gavitt Manufacturing Co., Inc., West Brookfield, Mass.

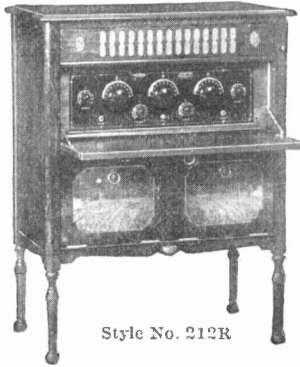

Style No. 212R

Quality Radio Cabinets

Our line of radio cabinets is complete. Our designs are original and the workmanship and finish of the best.

Write for Catalogue and Prices

THE ART NOVELTY CO., GOSHEN, IND.

The "Windham" Wire Former

A Handy Tool for Electricians, Radio Fans and Mechanics

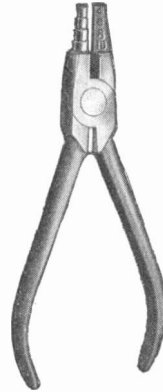

This rugged little tool not only makes accurate loops or eyes for No. 4, 6, 8 and 10 screws but will make either sharp or easy radius right angle bends and the sharp cutter will cut the toughest wire as well.

It is drop forged of the very best steel and carefully tempered in oil.

Retails for \$1.25. Dealers and Jobbers send for full information. Desirable territory still open.

THE GOYER COMPANY
Willimantic, Conn.

Engrave Panels for Radio Builders!

Keep Busy This Summer When Retail Sales Are Quiet

EVERY radio amateur who builds his own set wants engraved on the panel his name, trademark, dial markings, etc.

You can do it for him if you own a Rapid Engraving Machine, and make several dollars an hour doing it.

Complete equipment, \$135. Usual prices are several hundred dollars.

Be first to own one and coin money.

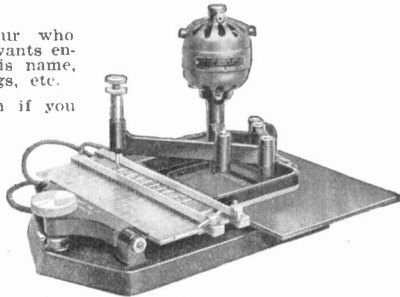

Branch Tool Co., Dept. H, Forestdale, R.I.

Now Here { PRACTICAL GLASS PANELS AND CABINETS

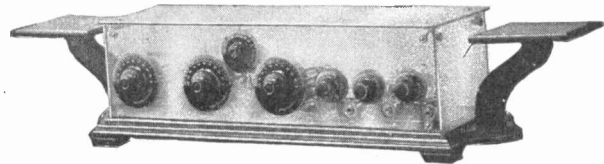

DRILLED FOR ANY HOOK UP

7x21-in. clear Panel only drilled for B.T. 3-tube hook-up, \$7.50 list. 7x26-in. clear Panel only drilled for B.T. 5-tube hook-up, \$10.00 list. Drillings equipped with Hornig Safety Bushings (pat. app.).

Ask Your Jobber for Our New Bulletin or Address

AUGUST W. HORNIG
3925 Dickens Ave., Chicago, Ill.
Tel. Spaulding 3156

ALPHABETICAL INDEX TO ADVERTISEMENTS

A	Page	Page	Page	Page	
A-C Electrical Mfg. Co., The...	6	Duplex Condenser & Radio Corp.	102	Jefferson Elec. Mfg. Co.	91-102
Air-Way Electric Appl. Corp.	7	Durham & Co., Inc.	100	Jewett Radio & Phonograph Co.	79
Alden Manufacturing Co.	85			John O. Jesse Mfg. Co.	84
Allen-Bradley Co.	1	E		K	
American Insulator Corp.	99	Eby, H. H. Mfg. Co.	102	Kennedy Corp., Colin B.	4
Andrea, F. A. D.	75	Electrad, Inc.	89	Knickerbocker Case Co.	103
Apeo Mfg. Co., Inside Back Cover		Electric Storage Battery Co.	73	L	
Art Novelty Co.	106	F		Langbein & Kaufman	83
Atwater Kent Mfg. Co.	16	Federal Telegraph Co.	8-9	M	
Audiola Radio Co.	101	Fore Electric Mfg. Co.	101	McGraw-Hill Publications	104-105
B		Freed-Eisemann Radio Corp.	10-11	Meyer-Kiser Corp.	98
Benjamin Electric Mfg. Co.	108	French Battery Co.	102	Miller Rubber Co. of N. Y.	97
Bodine Elec. Co.	103	Freshman Co., Chas., Inc.	90	Modern Electric Mfg. Co.	95
Branch Tool Co.	106	G		Murdoch Co., Wm. J.	100
Brandes, C., Inc., Inside Front Cover		Gavitt Mfg. Co.	106	Music Master Corp.	2-3
Brooklyn Metal Stamping	96	Goyer Co., The	101-106	N	
Burt Bros., Inc.	100	H		National Carbon Co.	88
C		Harponola Company	92	National Vulcanized Fibre Co.	13
Console Master Speaker Co.	93	Hart & Hegeman Mfg. Co.	100	New York Evening Journal	5
Cooper Corp., Back Cover		Hood Rubber Co.	94	O	
Crescent Braid Co.	107	Hornig, A. W.	106	Overstock Exchange	107
Crosley Radio Corp.	71	I		P	
D		Indiana Mfg. & Elec. Co.	107	Paent Elec. Co.	103
Dayton Fan & Motor Co.	74	J		Phenix Radio Corp.	98
Dubilier Condenser & Radio Co.	82	K		Pooley Co.	14-15
E		L		Premier Radio Corp.	12
F		M		Public Ledger Co.	78
G		N		R	
H		O		Radio Corp. of America	44-45
I		P		Radio Master Co.	80-81
J		Q		Radio Trade Directory	86-87
K		R		Radio World's Fair	94
L		S		Rosenbloom Co., William	99
M		T		Ross Wire Co.	101
N		U		S	
O		V		Sangamo Elec. Co.	97
P		W		Searchlight Section	107
Q		X		Stewart-Warner Speedometer Corp.	76-77
R		Y		Supertron Mfg. Co.	103
S		Z		T	
T				Teagle Company	96
U				V	
V				Valley Electric Co.	101
W				W	
X				Western Electrical Inst. Co.	98
Y					
Z					

SEARCHLIGHT SECTION

SURPLUS STOCKS—BUSINESS OPPORTUNITIES

UNDISPLAYED—RATE PER WORD:
 Positions Wanted, 6 cents a word, minimum \$1.25 an insertion, payable in advance.
 Positions Vacant and all other classifications, 10 cents a word, minimum charge \$2.00.
 Proposals, 40 cents a line an insertion.

INFORMATION:
 Box Numbers in care of any of our offices count 10 words additional in undisplayed ads.
 Discount of 10% if one payment is made in advance for four consecutive insertions of undisplayed ads (not including proposals).

DISPLAYED—RATE PER INCH:
 1 to 3 inches.....\$6.65 an inch
 4 to 7 inches..... 6.40 an inch
 8 to 14 inches..... 6.20 an inch
 Rates for larger spaces, or yearly rates, on request.
 An advertising inch is measured vertically on one column, 3 columns—30 inches—to a page.

Radio Retailing

REPRESENTATIVE AVAILABLE

An Established Radio Distributor covering the Province of Ontario, will be interested in the distributing of a 4 or 5-tube set, with loud speaker volume, to retail in Canada, complete, for \$100 or less. RA-5, Radio Retailing, Tenth Ave. at 36th St., New York.

\$ CASH PAID \$

We buy for cash, all electrical and radio goods, surplus stock, radio sets, parts, loud speakers, electric fans and motors, etc. We buy any quantity—No stock too large for us. Manufacturers and jobbers send us your close out lists.

STUART RADIO SURPLUS CORPORATION BOSTON MASS

Cash for Radio Merchandise

Jobbers and Manufacturers open to buy all Radio parts, large quantities. Can use obsolete goods. Send us your lists of Surplus.

Radio Market, Inc.
 183 Greenwich St., New York

Your Overstock is a Dead Investment—Move it at a Profit!!

Use the Radio Dealers' Overstock Exchange in Radio Retailing

What have you to turn into cash NOW? Get it into the "EXCHANGE" of the next issue of RADIO RETAILING.
 The cost will be small.

Subscribe now to Radio Retailing

Special Introductory Offer

\$1.00

Regular Price \$2.00

Postage to Countries Outside U.S. and Canada \$1.00 Extra

Radio Retailing

Tenth Avenue and 36th St., New York, N. Y.

Here is \$1.00. Please enter my subscription to begin with the next issue.

Name

Address

City State

7-25

Crescent Braid Co., Inc.
 Providence, Rhode Island

Makers of "Blue Ribbon" Extension Cords, Telephone Cords and Battery Cables for Radios.

Specializing in braided materials made for large manufacturers' specifications.

INDIANA HYPERDYNE RADIO

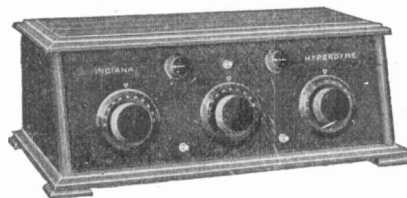

Model 500 Five Tube Receiver, Retail \$62.50

Solid Mahogany Cabinet—Our Own Sterling Parts

Write for Circulars and Discounts

INDIANA MFG. & ELECTRIC CO., Marion, Ind., Dept. 7

Super Radio Parts for Better Radio Sets

Benjamin Tuned Radio Frequency Transformers

Low Resistance—Low Distributed Capacity

Wires are space wound, adjacent coils are parallel, air insulated and so separated that while capacity is reduced to a minimum, inductance is maintained at a high point of efficiency.

Greater Tuning Range—Greater Selectivity

These coils are very uniform, both in inductance and distributed capacity, so that if desired they may be geared for single control of the three tuned stages. A minimum amount of material is used in the field of the coil, and an anti-capacity cement is used only where the wires cross. Coils are coupled so as to reduce capacity coupling to a minimum. Green double silk covering provides high insulation and gives a fine appearance to the coil.

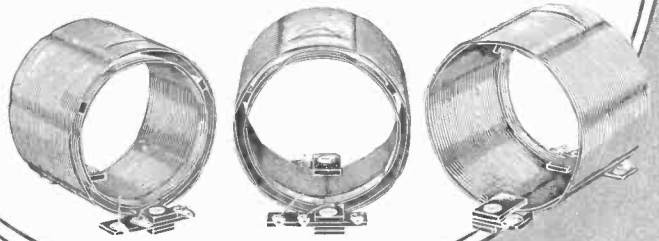

Benjamin Low Loss-Long Range Condensers

Straight line type. Definite and positive control of minute changes in condenser capacity, adapting it to both the higher and lower frequencies. Aids sharp tuning and increases selectivity.

No rear end plate. Minimum insulation. Leakage must go through long paths outside of strongest field. Unpolished silver plate finish. Small size of condenser makes it adaptable to any set, regardless of crowding of apparatus on sub-panel. Friction disc on rotor shaft adjusts tuning tension without throwing rotor plates out of alignment. Drilling template furnished with each condenser. Made in three sizes:

13 plate for .00025 Mfd.
17 plate for .00035 " "
25 plate for .0005 " "

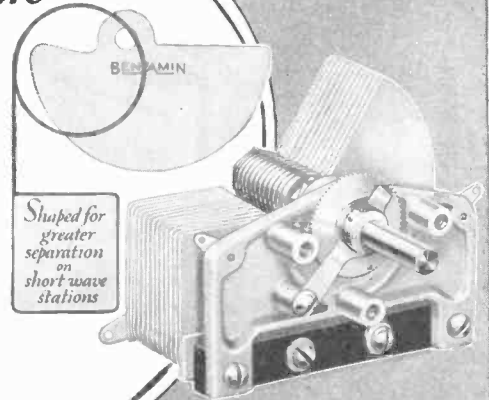

Benjamin Cle-Ra-Tone Sockets

Benjamin Cle-Ra-Tone Sockets prevent the transmission of outside vibrations into microphonic disturbances. Four delicately adjusted springs support the socket—"float" it above the base—and absorb all jars and shocks. An absolute necessity in portable sets. Used by leading manufacturers and recommended by radio engineers in their most popular hookups. There are no rubber parts to deteriorate. Bakelite is used wherever possible to insure sturdiness, long life and high insulation. Handy lugs make soldering easy. Stiff bus wiring does not affect the flexibility of the Cle-Ra-Tone springs.

Made also in gang sockets, mounted on Bakelite shelf, with binding posts and markers, leaving plenty of space for the mounting of accessory equipment.



SPRING SUSPENDED
SHOCK ABSORBING

Any one of these important elements will improve, in its particular functioning, the quality of reception. In combination they mean all that is humanly available today in eliminating disturbance and distortion, in reducing radio losses, in increasing tuning range, in providing greater selectivity, and in improving the appearance of a set. Just take their individual advantages and add them up—the answer is "Better Radio."

For further information address the nearest office

Benjamin Electric Mfg. Co.

120-128 S. Sangamon St., Chicago
247 W. 17th St. New York
448 Bryant St. San Francisco

Manufactured in Canada by the Benjamin Electric Mfg. Co. of Canada, Ltd., Toronto, Ontario

A Year's Stiff Test Has Proven The APCO Rectodyne Successful—

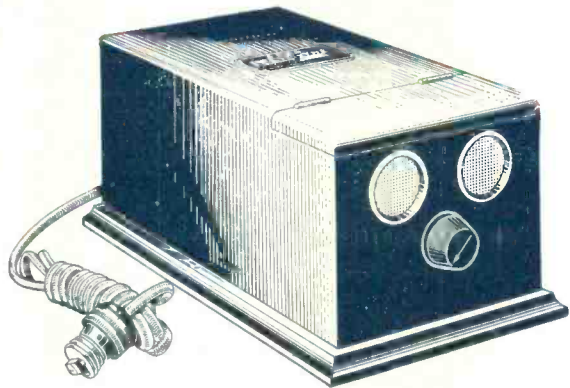

RECTODYNE
LIST PRICE \$44.00

The stiff test of actual use, this past year, has shown pretty conclusively that there's only one really successful "B" Battery Eliminator — The APCO Rectodyne.

Connected to a lamp socket and used with any good receiving set the APCO Rectodyne enables "B" Batteries to be forgotten forever.

Simply turning a knob controls from 0 to 120 volts with ample current output for the largest set. The cost of operation is negligible and any good standard 201-A or 301-A tube may be used. Also made for direct current. A complete unit in a handsome case, the Rectodyne is an ornament in any room.

For those who prefer to build their own "B" Battery Eliminator

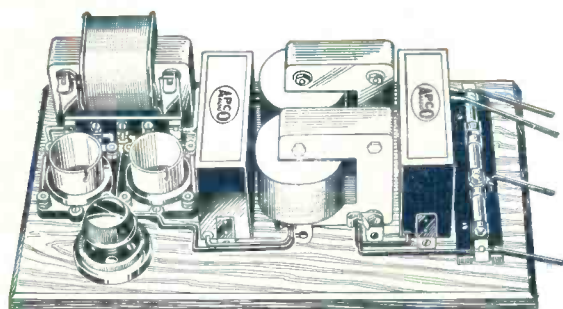

No. 65—Large

"B" KIT
LIST PRICE \$30.00

We offer the

APCO "B" Kit

It is made up of the parts used in the APCO Rectodyne mounted and ready to wire, which requires about an hour. Ten feet of lamp cord with plug, four feet of wire, and two 201-A or 301-A tubes are also needed.

Both the APCO Rectodyne and the "B" Kit are high-grade units of radio merchandise and the sale of either means a substantial profit. A concentrated sales effort on these backed by our national advertising will produce results as gratifying to you and your customers as to ourselves.

Apco Manufacturing Co.

Providence

RADIO DIVISION

Rhode Island

Convenient Branches for Quick Service

Apco Mfg. Co., Electrical and Export Office,
154 Nassau St., New York

Apco Mfg. Co.,
1438 S. Michigan Ave., Chicago

Apco Mfg. Co., 2005 E. 15th St., Kansas City, Mo.

Canadian Factory: Apco Canadian Co., Ltd., 3150 Jeanne Mance St., Montreal

Southwestern Office: M. L. Martin, 2006 1/2 Commerce St., Dallas, Texas

Who Will Be the First in YOUR Town to Sell this Successor to Radio Batteries?

After a full year of testing and proving, under all sorts of actual service conditions, the definite successor to radio batteries is ready for its huge market.

The Cooper A-n-B, filtering the current of the ordinary lighting circuit, provides the last link to radio—power without batteries and without noise, for all types of radio receivers.

The first announcement appears July 18th in the *Saturday Evening Post*. But this is merely the first gun of an immense national magazine campaign.

The dealer who "knew it would come," knows it by this announcement. Who will be first in your town to reap the certain profits?

Address

The Cooper Corporation
Cincinnati, Ohio

Now!

THE SATURDAY EVENING POST



Your RADIO POWER IS IN YOUR LIGHT SOCKET at last!

EVERY good product has its day. But it remains the best thing of its kind only until a better product comes to take its place. Once batteries performed a splendid service for radio. They gave to radio lovers the current that made entertainment possible. But no man goes to a well for water when a faucet brings it into his home. It is so with radio. The same socket that brings illuminating current that feeds the vacuum cleaner—that delivers electrical fuel to the washing machine—this same socket is now your source of radio power.

A new device, built by better engineers, has made this possible. It is the Cooper A-n-B. The A-n-B makes radio batteries as unnecessary as carpet sweepers, flat irons and washboards. At an average cost of a cent an hour it supplies the current your particular set requires. Unlike batteries which decrease in power with use, the Cooper A-n-B delivers the full measure of current at all times.

A and B circuits in your receiver always have the full voltage they require—the voltage at which performance is best. But the A-n-B goes farther than being merely the efficient successor to A and B batteries. The A-n-Bs better than radio batteries at their newest use is achieved without the loss of bell-toned clarity.

And it is as easy to install as connecting batteries to your receiver. It operates on all radio circuits and on all kinds of tubes. It is guaranteed by a company founded in 1904—a company whose word was never broken—whose character is unimpeachable—and whose ethical and financial standing are established beyond question. The A-n-B supplants radio batteries. Your radio power is in your light socket—at last.

THE COOPER CORPORATION, Cincinnati, Ohio
COOPER
A-n-B
Radio Battery Eliminator

The Cooper A-n-B is as new as this announcement. It will not be strange, therefore, if your dealer doesn't yet handle it. But we shall be glad to send you literature that fully describes it. In writing please tell us the name of your dealer so we may have a Cooper A-n-B where it can be demonstrated to you.

To Dealers and Jobbers who want for detailed Cooper A-n-B representation, there will be no need to write us an unsolicited proposal or to send us any business cards.

This is the Cooper A-n-B which operates on any type of radio set and eliminates batteries.