

CAPTURING SUN'S ENERGY WITH SOLAR BATTERIES

12 MAC

RADIO & TV NEWS

Leading Technical Magazine in the **ELECTRONICS WORLD**

DECEMBER 1958

35 CENTS

- TELEPHONE OF THE FUTURE
- MEASURE THAT FLUTTER
- SSB EXCITER ATTENUATOR PADS
- TAPE RECORDER LEVEL INDICATORS

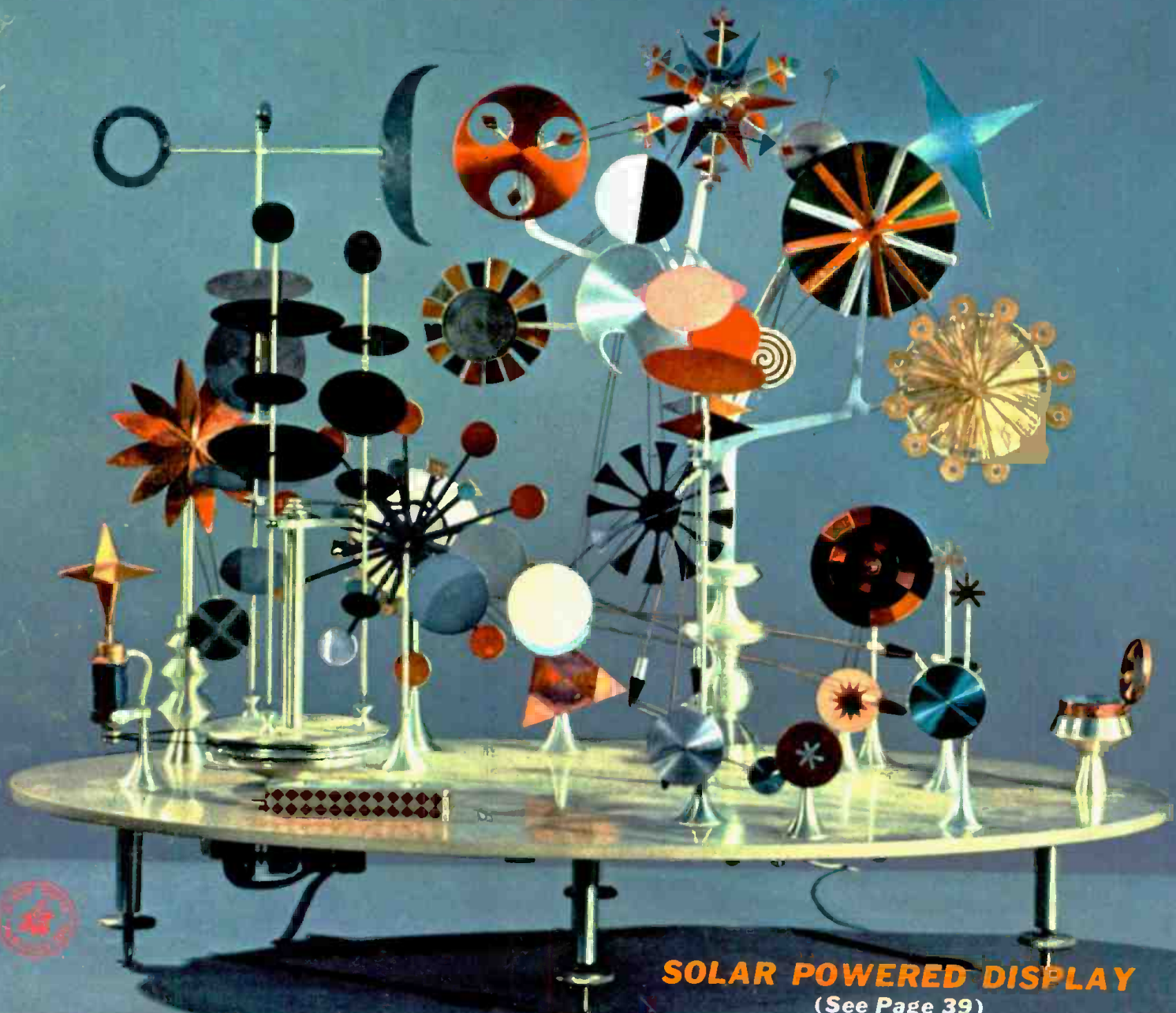
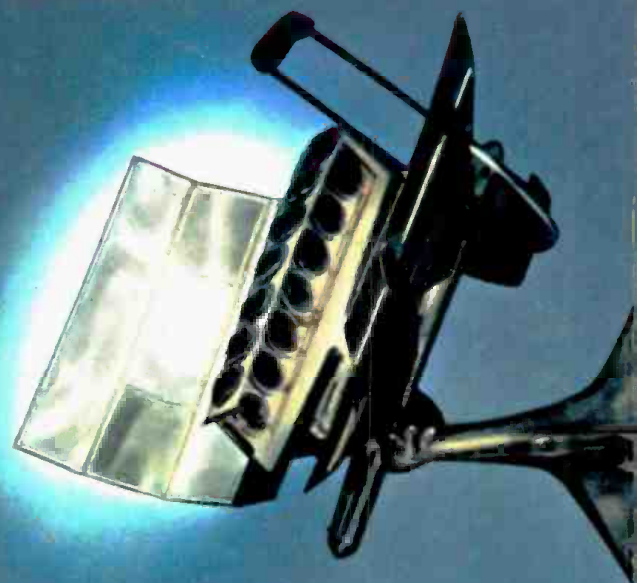

SOLAR POWERED DISPLAY

(See Page 39)

Mr. TV-Radio Service Dealer: MEET THE CHALLENGE

with this **REVOLUTIONARY,**

RAYTHEON

TUBE

MART





of the Corner Store Tube Tester

NEW, PROFIT-MAKING

The new RAYTHEON TUBE MART puts the profits where they belong — in the pockets of Service Dealers like yourself....

As a RAYTHEON TUBE MART AGENT *you* gain:



TOP PROFITS FROM TUBE SALES



CREDIT FOR HELPING SET OWNERS



EXTRA SERVICE BUSINESS



NEIGHBORHOOD ADVERTISING

Here's all you do. Place these handsome Raytheon Tube Marts in your neighborhood stores. Keep them stocked and earn a continuous flow of profits. You'll increase your servicing business, too, because each Tube Mart holds your imprinted leaflets — that direct customers to you for TV-Radio service.

It's easy to place Raytheon Tube Marts in profitable locations because you offer the shop owners a new source of extra profit.

For the complete story on how to become the money-making Raytheon Tube Mart Agent in your neighborhood, call your Raytheon Tube Distributor today.



DISTRIBUTOR PRODUCTS DIVISION
RAYTHEON MANUFACTURING COMPANY

Newton 58, Mass., 55 Chapel Street • Chicago, Ill., 9501 Grand Ave. (Franklin Park)
Atlanta 6, Ga., 1202 Zonolite Rd. N.E. • Los Angeles 16, Calif., 5057 W. Washington Blvd.



RADIO & TV NEWS is published monthly by Ziff-Davis Publishing Company, William B. Ziff, Chairman of the Board (1946-1953), at 434 S. Wabash Ave., Chicago 5, Ill. Entered as second-class matter July 21, 1948, at the Post Office, Chicago, Ill., under the act of March 3, 1879. Authorized by Post Office Department, Ottawa, Canada, as second-class matter. SUBSCRIPTION RATES: one year U. S. and possessions, and Canada, \$4.00; Pan American Union Countries \$4.50; all other foreign countries \$5.00.

RADIO & TV NEWS

Reg. U. S. Pat. Off.

First in radio-television-audio-electronics

Average Net Paid Circulation 236,101

Radio & Television News • Radio News • Television News Trademarks Reg. U. S. Pat. Off.

CONTENTS

DECEMBER, 1958

VOL. 60 ■ NO. 6

Publisher
OLIVER READ, D. Sc., WIETI

Editor
WM. A. STOCKLIN, B. S.

Technical Editor
MILTON S. SNITZER, W2QYI

Service Editor
SIDNEY C. SILVER

Associate Editor
P. B. HOEFER

Assistant Editor
J. JUSTER

Television Consultant
WALTER H. BUCHSBAUM

Art Editor
MILTON BERWIN

Art and Drafting Dept.
J. A. GOLANEK
JAMES A. ROTH
MILTON WHELPLEY

Advertising Director
JOHN A. RONAN, JR.

Midwest Adv. Manager
W. ROBERT WOLFE

Western Adv. Manager
JOHN E. PAYNE



ZIFF-DAVIS PUBLISHING COMPANY
 William Ziff, President; W. Bradford Briggs, Executive Vice-President; Michael Michaelson, Vice-President and Circulation Director; Hershel B. Sorbin, Secretary; Howard Staughton, Jr., Treasurer; Albert Gruen, Art Director.

Editorial and Executive Offices
 One Park Avenue
 New York 16, N. Y. OR. 9-7200



MEMBER
 INSTITUTE OF



BRANCH OFFICES: Midwestern Office, 434 S. Wabash Ave., Chicago 5, Ill.; Western Office, Room 412, 215 W. 7th St., Los Angeles 14, Calif.; John E. Payne, manager.

FOREIGN ADVERTISING REPRESENTATIVES: D. A. Goodall Ltd., London; Albert Milhado & Co., Antwerp and Dusseldorf.

ELECTRONICS—GENERAL

Four Hundred and Sixty-six Years (Editorial)	W. Stocklin	8
Spot News	Washington Correspondent	33
The Silicon Solar Battery	Harold S. Renné	37
Solar Powered Display (Cover Story)		39
Telephone of the Future	Harold McKay	44
Semiconductor Variable Capacitors	H. R. Smith	46
Transistors are Different	Ed Bukstein	62
Calendar of Events		126
Electronic Typesetter to be Marketed		128
Radio & TV News Index (Vols. 59-60)		150

HIGH FIDELITY AND AUDIO

Electronic Level Indicators for Tape Recorders	Herman Burstein	42
Automatic Phono with Transistor Amplifier	Kenneth W. Betsh	55
Measure that Flutter	H. R. Walter	60
Hi-Fi—Audio Product Review		88
"Tiny Tim" Portable P.A. Amplifier	Harold Reed	99
Certified Record Revue	Bert Whyte	116
Sound on Tape	Bert Whyte	133

TELEVISION-RADIO

Lazy Tube Cathodes	Charles T. McCormack & Clement D. Mackey	48
Multi-Set TV Installations: Problems & Principles (Part 2)	Jack Beever	49
The New Look in TV Service	William Leonard	54
To Troubleshoot—Remove Tubes	Cyrus Glickstein	58
Hot Chassis? Play it Safe	Kenneth Bramham	63
Tube Makers Fight Counterfeiting		127
Service Notes		144
Service Industry News		146

TEST EQUIPMENT

Build a Versatile LC Meter	Gene Brizendine	41
Mac's Service Shop	John T. Frye	66
Special Applications of the Square-Wave Generator	Louis E. Garner, Jr.	67
New Tube Tester Data		98

AMATEUR AND COMMUNICATIONS

SSB Exciter Attenuator Pads	Samuel J. Hyman, W9VRX	52
Advanced Ham Receiver in Kit Form		64
Receiving & Recording Satellite Signals	Frank K. Dearborn	138
6- and 10-Meter Transistorized Amateur Receiver	E. J. Holtke, W5YRJ	149

DEPARTMENTS

Letters from Our Readers	12	What's New in Radio	108
Within the Industry	28	Manufacturers' Literature	135
Technical Books	141		

Copyright © 1958 by Ziff-Davis Publishing Company. All rights reserved.

SUBSCRIPTION SERVICE: Forms 3579 and all subscription correspondence should be addressed to Circulation Department, 434 South Wabash Avenue, Chicago 5, Illinois. Please allow at least four weeks for change of address. Include your old address as well as new—enclosing if possible an address label from a recent issue.

CONTRIBUTIONS: Contributors are advised to retain a copy of their manuscripts and illustrations. Contributions should be mailed to the New York Editorial Office and must be accompanied by return postage. Contributions will be handled with reasonable care, but this magazine assumes no responsibility for their safety. Any copy accepted is subject to whatever adaptations and revisions are necessary to meet the requirements of this publication. Payment covers all author's, contributor's, and contestant's rights, title and interest in and to the material accepted and will be made at our current rates upon acceptance. All photos and drawings will be considered as part of the material purchased.



Jack Dempsey

The former world's heavyweight boxing champion says: "I know the value of good training, and believe me, for 27 years, DeVry has been one of America's outstanding electronics training centers! The Employment Service is 'tops' tool!"

THESE DEVRY TECH GRADUATES VERIFY WHAT DEMPSEY SAYS



NICK BARTON, Illinois, a DeVry graduate, now has his own business and tells us he is "literally snowed with work."

GEORGE D. CROUCH, California, was a retail store clerk. He took the DeVry program, and today is in business for himself.



EDWARD HAHN, Illinois. Now an electronics technician with Televiso, Inc. DeVry Tech training helped him prepare for his present position.

"If You Want to Make More Money Full or Part Time in TELEVISION RADIO • ELECTRONICS DeVry Tech Has An Answer," SAYS JACK DEMPSEY

NO TECHNICAL EXPERIENCE NEEDED— YOU CAN LEARN IN YOUR OWN HOME!

Great opportunities are found in Electronics—one of today's top fields. Good jobs in modern plants, TV — Radio studios, offices and laboratories await trained men who can build, install, operate and service Electronic equipment. And equally exciting are the possibilities for starting your own servicing shop. The coupon below will bring you full details — Free!

HERE'S HOW TO GET STARTED!

You can get Television-Radio-Electronics training right in your own home. You don't need previous technical experience, advanced education, or exceptional "aptitude." And the training DeVry Tech provides is "tops." What's more, DeVry helps you get started toward a job, or a servicing shop of your own!

TOO GOOD TO BE TRUE?

Not at all! Our files show that many men—high school graduates, truck drivers, store clerks, unskilled workers—now have the better jobs they wanted because of their DeVry diplomas. Age is no barrier — DeVry trains men 17 — 55.

TWO GREAT TRAINING CENTERS — CHICAGO and TORONTO

If you can come to either of DeVry's training centers—Chicago or Toronto — you can prepare under the close guidance of friendly, experienced instructors. You can use valuable equipment similar to that found in the field. Write today for complete information.

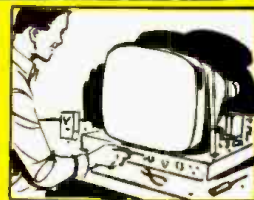

EARN AS YOU LEARN—by servicing radio and TV sets at home before you complete the training.



LIVE-WIRE EMPLOYMENT SERVICE — puts you in touch with job opportunities—even helps you establish a service shop of your own.

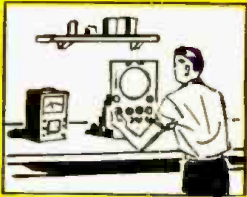

BUILD TEST EQUIPMENT— You assemble your own high quality test equipment to help you earn money servicing Radio and TV sets in your spare time.

A SAMPLE LESSON IS YOURS

See for yourself how DeVry trains you for real opportunities in Electronics. We'll also give you a free copy of an interesting booklet, "Electronics and YOU."

FREE!



ARE YOU OF DRAFT AGE?

We have valuable information for every man of draft age; so if you are subject to military service, be sure to check the coupon.

MAIL TODAY FOR FREE FACTS

DeVry Technical Institute
4141 Belmont Ave., Chicago 41, Ill., Dept. RN-12-0

Please give me a FREE Sample Lesson and your booklet, "Electronics and YOU."

Name Age

Please Print

Street Apt.

City Zone State

Check here if subject to Military Training.

DeVry Tech's Canadian Training Center is located at #1080 626 Roselawn Avenue, Toronto 12, Ontario

"One of America's Foremost Electronics Training Centers"



Accredited Member of National Home Study Council

DEVRY TECHNICAL INSTITUTE

CHICAGO 41, ILLINOIS

FORMERLY

DEFOREST'S TRAINING, INC.



5 new G-E "Stereo Classic" components

1 New "Golden Classic" stereo-magnetic cartridge

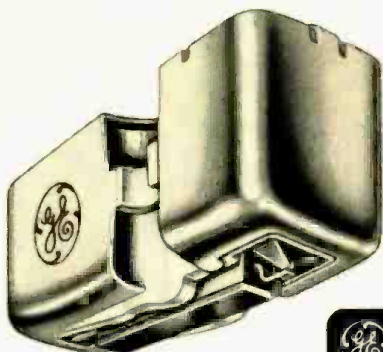

- Plays both stereo and monaural records
- Full frequency response, 20 through 20,000 cycles
- "Floating armature" design increases compliance and reduces record wear. Effective mass of stylus approximately 2 milligrams
- High compliance in all directions—lateral compliance 4×10^{-6} cm/dyne; vertical compliance 2.5×10^{-6} cm/dyne
- Recommended tracking force with professional-type tone arm 2 to 4 grams
- Consistently high separation between channel signals. (Specifications for Model GC-5.)

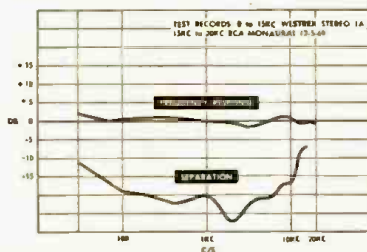

Model GC-7 (shown left) with .7 mil diamond stylus...\$23.95*
 Model GC-5 (for professional-type tone arms) with .5 mil diamond stylus...\$26.95*
 Model CL-7 with .7 mil synthetic sapphire stylus...\$16.95*

- A professional-type arm designed for use with G-E stereo cartridges as an integrated pickup system
- Features unusual two-step adjustment for precise setting of tracking force from 0 to 6 grams
- Lightweight brushed aluminum construction minimizes inertia; statically balanced for minimum friction, reduced stylus and record wear. \$29.95*

2

New "Stereo Classic" tone arm



New 40-watt "Stereo Classic" amplifier

- Full, balanced 20-watt power output from each channel at same time
- Flat response within 0.5 db from 20 to 20,000 cycles
- Outstanding sensitivity, extremely low hum and noise level
- Integrated single-knob controls for easy simultaneous adjustments of both stereo channels. Contour control provides smooth, gradual bass boost without apparent change in sound intensity. \$169.95*

New FM-AM tuner

- Receives weak signals with unusually low distortion, hum and noise level
- No audible drift
- Visual meter provides center channel tuning of FM and maximum AM signal
- RF amplifier stage in both FM and AM increases sensitivity
- FM multiplex jack for stereo adaptor. \$129.95*

3



4

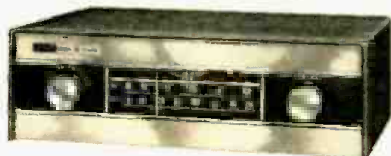

5

New "Stereo Classic" speaker systems

- New Extended Bass system produces 4 times the undistorted power at low frequencies (+6db) as standard 12" speakers in the same enclosure
- Amplifiers of only moderate power needed because efficiency is 2 to 4 times higher than comparable systems
- New direct radiator tweeter provides unusually smooth response and exceptional sound dispersion at higher frequencies without unnatural tone coloration.

Model LK-12: Separate woofer-tweeter kit with crossover network \$89.95*
 Model LC-12: Same basic woofer with tweeter coaxially mounted in front and crossover network . . . \$89.95*
 Model LH-12: Separate woofer, tweeter and crossover factory installed in 2 cu. ft. wood enclosure . . \$129.95*

Hear G-E "Stereo Classic" components at your dealer. For more information and nearest dealer's name, write General Electric Company, Dept. RT128, W. Genesee St., Auburn, N. Y.

*Mfr's. suggested resale prices.

GENERAL  ELECTRIC

NEW

HICKOK

Low-Price PORTABLE CARDMATIC TUBE TESTER



121

Fully Automatic

Tests any tube in 8 to 12 seconds . . . including handling of tube test data card.

Here is the new, low cost version of the famous Hickok Cardmatic so popular with leading lab engineers. Especially designed for high speed service work, this new 121 is high quality in a lightweight portable . . . and the price is low, too.

The Hickok Cardmatic switch sets up all tests automatically and eliminates fussing around with adjustments. You can accurately check a tube for dynamic mutual conductance, controlled emission, cutoff point "Knee" point, shorts, leakage, gas and voltage drop . . . and rectifier tubes at their rated loads. Any way you look at it, this new automatic tube testing machine will be helpful to you in your work. It will pay for itself in a very short time . . . and give you many years of accurate dependable service.

\$249⁵⁰
NET
(includes 300 cards)

Now is the time to . . .
TRADE UP TO A HICKOK

Ask for a demonstration of the new 121
or write for descriptive literature.

THE HICKOK ELECTRICAL INSTRUMENT CO.

...for the Record

By **W. STOCKLIN**
Editor



FOUR HUNDRED AND SIXTY-SIX YEARS

FOUR hundred and sixty-six years from the time Columbus discovered the Western Hemisphere, and almost to the hour, the United States Air Force launched one of its intended rocket flights to the moon. True, it wasn't as successful as had originally been hoped but the results that were attained were certainly a tremendous achievement. They were fantastic if one were to consider the relatively few years that scientists have been working on rocket propulsion.

The October 11 attempt to reach the moon resulted in a rocket traveling 79,000 miles into outer space. Since the moon is 221,463 miles away at its closest point to the earth, the distance reached was slightly better than one-third of the way. This may not look impressive but actually the rocket attained 98% of its objective in that only 2% additional velocity would have been required to cover the full distance.

The development pace is rapid. Shortly after the moon rocket attempt the Advanced Research Projects Agency, Department of Defense, announced and previewed for the first time a new experimental manned rocket ship, the X-15. It was developed by *North American Aviation* and flight tests up to 4000-4500 miles-per-hour are scheduled for January. According to information released to date, this new rocket ship will attain a height of 100 miles into the atmosphere. This will be man's first flight into outer space. Roy Johnson, director of the ARPA, made an announcement at the recent *CBS Laboratories* dedication in Stamford, Connecticut, that man will reach outer space within two to two and one-half years. In order to achieve this goal scientists must solve the re-entry problem. If this can be done within the time period mentioned by Mr. Johnson, the next foreseeable problem confronting the scientists is the dangerous radiation region between the earth and the moon. Work is progressing rapidly in accumulating all possible information on this radiation barrier and with the faith we have in the ability of the scientists working on this problem, it should not take too many years to solve. As far as we know now, a trip to the moon by man is many years closer than one could have expected a year ago.

It is unfortunate in some ways that many people in our country do not realize the near-future importance of these scientific developments that are occurring daily. Then, again, this is not unusual. Time must pass and people have to look back to be conscious of the great strides being made. To make all this possible, credit must be given to those individuals who have worked on the development of heat-resistant metals and the development of propulsion fuels (liquids and solids), but the greatest achievements and honors, at least in our opinion, go to those men who have been working on the electronic equipment which make outer space flight possible.

Electronics plays an extremely vital role in the control of missiles from the launching pad, its tracking into outer space, and only through electronics are we able to obtain scientific information from the rocket as it progresses from its launching into space. Our industry should be extremely proud of the role it is playing in these developments.

Although this phase of the electronic industry is small in comparison to the whole, the contributions being made are on a scientific level and can result only in man's furthering his knowledge of the universe. However, this is a two-way street. In return for the vital role played by this small but very important segment of the electronics industry, benefits accrue not only to the man-on-the-street but also to the electronics industry as a whole. For example, it will be possible to set up world-wide communication networks and relay stations. These might be used to transmit programs over a much greater area than is now possible. We will also be able to relay information quickly and over greater distances by use of satellites that are in permanent orbit above the earth. Such satellites would operate either as passive reflectors or as active transmitting stations themselves. Furthermore, much of the guesswork will be taken out of the science of meteorology. Accurate weather predictions that will be made far in advance will certainly become possible and this is just the beginning. For all of this and for much yet to come, we must be thankful for the brilliant combination of rocketry and electronics.

-30-

NOW!
at a price
you can afford!

MAKE MORE MONEY in TELEVISION RADIO-ELECTRONICS

**BETTER...MORE COMPLETE...LOWER COST...
WITH NATIONAL SCHOOLS SHOP-METHOD
HOME TRAINING!**

BETTER... Training that is proved and tested in Resident School shops and laboratories, by a School that is the **OLDEST** and **LARGEST** of its kind in the world.

MORE COMPLETE... You learn **ALL PHASES** of *Television-Radio-Electronics*.

LOWER COST... Other schools make several courses out of the material in our **ONE MASTER COURSE**... and you pay more for less training than you get in our course at **ONE LOW TUITION!**



These **FREE** books will show you how!

You get all information by mail... You make your own decision... at home! **NO SALESMAN WILL CALL**

TOP PAY... UNLIMITED OPPORTUNITIES LIFETIME SECURITY CAN BE YOURS!

You are needed in the Television, Radio, and Electronics industry! Trained technicians are in growing demand at excellent pay—in **ALL PHASES**, including Servicing, Manufacturing, Broadcasting and Communications, Automation, Radar, Government Missile Projects.

NATIONAL SCHOOLS SHOP-METHOD HOME TRAINING, with newly added lessons and equipment, trains you in your spare time at home, for these unlimited opportunities, including many technical jobs leading to supervisory positions.

YOU LEARN BY BUILDING EQUIPMENT WITH KITS AND PARTS WE SEND YOU. Your National Schools course includes thorough *Practical* training—**YOU LEARN BY DOING!** We send you complete standard equipment of professional quality for building various experimental and test units. You advance step by step, perform more than 100 experiments, and you build a complete TV set from the ground up, that is yours to keep! A big, new TV picture tube is included at no extra charge.

EARN AS YOU LEARN. We'll show you how to earn extra money right from the start. Many of our students pay for their course—and more—while studying. So can you!

RESIDENT TRAINING AT LOS ANGELES

If you wish to take your training in our Resident School at Los Angeles, the world's TV capital, start **NOW** in our big, modern Shops, Labs and Radio-TV Studios. Here you work with latest Electronic equipment - - professionally installed - - finest, most complete facilities offered by any school. Expert, friendly instructors. Personal attention. Graduate Employment Service. Help in finding home near school - - and part time job while you learn. Check box in coupon for full information.

LESSONS AND INSTRUCTION MATERIAL ARE UP-TO-DATE, PRACTICAL, INTERESTING. Every National Schools Shop-Method lesson is made easy to understand by numerous illustrations and diagrams. All instruction material has been developed and tested in our own Resident School Shops, Laboratories and Studios.

SEND FOR INFORMATION TODAY... it can mean the difference between **SUCCESS** and failure for you! Send for your **FREE BOOK** "Your Future in Television-Radio-Electronics" and **FREE Sample Lesson.** Do it **TODAY**, while you are thinking about your future. It doesn't cost you anything to investigate!

GET THE BENEFITS OF OUR OVER 50 YEARS EXPERIENCE

Approved for
GI Training



NATIONAL SCHOOLS

Los Angeles 37, Calif.

YOU GET...

- 19 Big Kits—**YOURS TO KEEP!**
- Friendly Instruction and Guidance
- Job Placement Service
- Unlimited Consultation
- Diploma—Recognized by Industry
- **EVERYTHING YOU NEED FOR SUCCESS!**

SHOP-METHOD HOME TRAINING COVERS ALL PHASES OF INDUSTRY

1. Television, including Color TV
2. Radio AM & FM
3. Electronics for Guided Missiles
4. Sound Recording and Hi-Fidelity
5. FCC License
6. Automation and Computers
7. Radar & Micro-Waves
8. Broadcasting and Communications

NATIONAL TECHNICAL SCHOOLS
WORLD-WIDE TRAINING SINCE 1905

**MAIL NOW TO
NATIONAL SCHOOLS, Dept RH-128**

4000 S. FIGUEROA ST. LOS ANGELES 37, CALIF.
Rush free TV-Radio "Opportunity" Book and sample lesson. No salesman will call.

NAME _____ AGE _____

ADDRESS _____

CITY _____ ZONE _____ STATE _____

Check if interested **ONLY** in Resident School training at Los Angeles
VETERANS: Give date of Discharge _____

free! ALLIED'S 1959

value-packed 452-page
ELECTRONIC SUPPLY CATALOG



the only COMPLETE guide
to everything in electronics

WORLD'S LARGEST STOCKS

- Latest Stereo Hi-Fi Systems— Everything in Hi-Fi Components
- Money-Saving, Build-Your-Own KNIGHT-KITS—Latest Models
- Values in Recorders and Supplies
- Latest Public Address Systems, Paging and Intercom Equipment
- Amateur Receivers, Transmitters and Station Gear
- Test & Laboratory Instruments
- Specialized Electronic Equipment for Industrial Application
- TV Tubes, Antennas, Accessories
- Huge Listings of Parts, Tubes, Transistors, Tools, Books

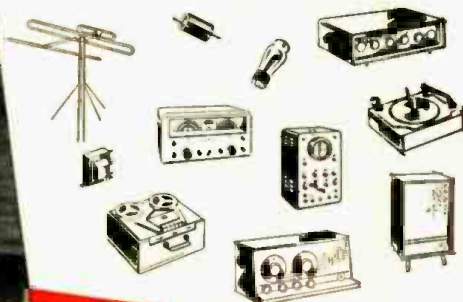

featuring:

MONEY-SAVING knight-kits: Finest electronic equipment in money-saving kit form. Complete selection of latest Hi-Fi amplifier, tuner and speaker kits (new Stereo units); Hobbyist kits; Test Instruments and Amateur kits. KNIGHT-KITS are an exclusive ALLIED product.

HI-FI! STEREO! See the world's largest selection of quality Hi-Fi music systems and famous name components. First with the latest in STEREO! Save on ALLIED-recommended complete systems. Own the best in Hi-Fi for less!

EASY PAY TERMS: Only 10% down; available on orders of \$20 or more. Fast handling—no red tape.

ALLIED RADIO



our 38th year
World's Largest Electronic Supply House

Send for ALLIED's 1959 Catalog—it's the leading supply guide—452 pages packed with the world's largest selection of quality electronic equipment at lowest, money-saving prices. Get every buying advantage at ALLIED: fastest shipment, expert personal help, lowest prices, guaranteed satisfaction...

send for the leading
electronic supply guide

FREE!

ALLIED RADIO CORP., Dept. 1-M8
100 N. Western Ave., Chicago 80, Ill.

Send FREE 452-Page 1959 ALLIED Catalog

Name _____

Address _____

City _____ Zone _____ State _____

There's something for everyone

in the great new
"SCOTCH" BRAND line!



NEW Package Designs!

Fresh, bright, colorful new designs for instant identification of all eight different "SCOTCH" BRAND Magnetic Tapes! Look for your favorite recording tape in its new package!



NEW! Plastic Storage Box! Tight-sealed, and moisture protected storage container of unbreakable plastic. Maintains ideal storage conditions for your valuable tape recordings. One of the most practical accessory items for your tape library!



NEW! "SCOTCH" BRAND Splicing Tape in handy blister-pac. Tape has a special white thermosetting adhesive that is guaranteed not to ooze. Makes splices that actually strengthen with age. It's available at your tape dealer's now.



Look for them all at your dealer's
"SCOTCH" BRAND TAPE CENTER!

You can't miss the inviting new "Plaid Pole" with its bright plaid design, convenient banks of "SCOTCH" BRAND Magnetic Tapes and other useful tape accessories. Everything you need for high-quality tape recording is yours in the "Tape Center."

REG. U. S. PAT. OFF.
SCOTCH Magnetic Tapes
BRAND

"SCOTCH" and the plaid design are registered trademarks of 3M Co., St. Paul 6, Minn. Export: 99 Park Ave., New York 16, Canada: London, Ontario.

MINNESOTA MINING AND MANUFACTURING COMPANY

... WHERE RESEARCH IS THE KEY TO TOMORROW



TAKE A LOOK AT YOUR FUTURE IN RADIO-TV-ELECTRONICS—FREE!

I.C.S. Career Kit tells you where the big-pay jobs are...who are the industry's most wanted men...how you can "cash in" in a big way on your own future.

Here's your chance to find out where you're going—fast! And it won't cost you a thing except the time it takes to clip and mail the coupon at the bottom of this page.

Radio-TV-Electronics is the fastest growing industry of all time. Opportunity for men in this field is almost unlimited. The rewards are great.

But to "cash in" you must be properly trained. You must know more than simply wires and tubes. You must be able to understand and apply the principles of Radio-TV-Electronics.

That's where I. C. S. comes in...the world's oldest and largest technical training school. Here are the people who know—who can tell you—what you need to go places in Radio-TV-Electronics.

You get the full story with your free I. C. S. Career Kit.

So take a minute now to get a look at your future in Radio-TV-Electronics. Send for your free I. C. S. Career Kit. You have nothing to lose. You can gain an exciting, well-paid career in a vital industry.

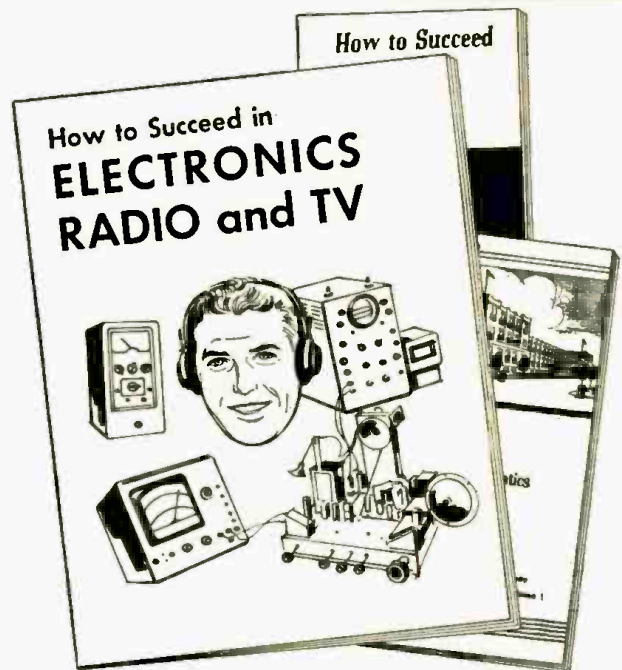

Send the coupon below for your free I. C. S. Career Kit!

- 1 "How to Succeed," 36-page guide to advancement
- 2 Electronics, Radio and TV handbook or the field of your choice
- 3 Sample lesson (Math) to demonstrate I. C. S. Method

For Real Job Security—Get an I.C.S. Diploma!

I. C. S., Scranton 15, Penna.

Accredited Member,
National Home Study Council

INTERNATIONAL CORRESPONDENCE SCHOOLS



BOX 91226L, SCRANTON 15, PENNA.

(Partial list of 259 courses)

Without cost or obligation, send me "How to Succeed" and the opportunity booklet about the field BEFORE which I have marked X (plus sample lesson):

RADIO TELEVISION ELECTRONICS

- General Electronics Tech.
- Industrial Electronics
- Practical Radio-TV Eng'r'g
- Practical Telephony
- Radio-TV Servicing

BUSINESS

- Cost Accounting
- Managing a Small Business
- Purchasing Agent

DRAFTING

- Electrical Drafting

HIGH SCHOOL

- High School Diploma
- Good English
- High School Mathematics

ELECTRICAL

- Electrical Engineering
- Elec. Engr. Technician
- Elec. Light and Power
- Practical Electrician
- Professional Engineer (Elec.)

LEADERSHIP

- Industrial Foremanship
- Industrial Supervision
- Personnel-Labor Relations
- Supervision

Name _____ Age _____ Home Address _____

City _____ Zone _____ State _____ Working Hours _____ A.M. to _____ P.M. _____

Occupation _____

Canadian residents send coupon to International Correspondence Schools, Canadian, Ltd., Montreal, Canada. . . . Special tuition rates to members of the U. S. Armed Forces.

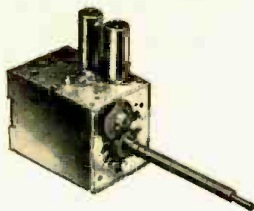

**Now YOU can get
TUNERS
repaired, or replaced,
in a hurry!
Send them to TARZIAN!**

● Sarkes Tarzian, Inc., announces a new tuner repair service and factory replacement program for Tarzian-manufactured tuners. Distributors, dealers and servicemen will welcome this direct factory service program which is designed to take delay and confusion out of the tuner repair business.

We're set up to offer a 48 hour service from the date of receipt to shipment to you.

Cost is reasonable, too. Only \$7.50 per unit (\$15 for UV combinations) and that includes ALL replacement parts! Both repaired—or exchange units if available from stock—carry a 90 day warranty against defective workmanship and part failure.

Replacements will be offered at these current prices* on units not repairable:

- VHF 12 position tuner... \$17.50
- VHF 13 or 16 position tuner..... 19.50
- VHF/UHF combination. 25.00
- UHF only..... 15.50

*Subject to change

When inquiring about tuner service, always refer to tuner by part number. When inquiring about direct replacements for tuners other than Sarkes Tarzian-manufactured, please indicate tube complement, shaft length, filament voltage, series or shunt heater. Use this address for quickest service:

SARKES TARZIAN, Inc.
 Aff: Service Mgr., Tuner Division
 East Hillside Drive
 Bloomington, Indiana



TARZIAN Electronic Product and Services include TELEVISION TUNERS . . . SELENIUM AND SILICON RECTIFIERS . . . BROADCAST EQUIPMENT . . . AIR TRIMMERS . . . TV STATIONS WTTV and WPTA, and RADIO STATION WTTs.

TESTING SPEAKERS

To the Editors:

Very rarely does one get the satisfaction given by reading an article so full of meaty information and so well written as the one "Testing the Properties of Loudspeakers" by Mr. J. L. Smith in your August, 1958 issue.

It is all too common in the electrical field, and more particularly in the hi-fi field, to find articles that are bogged down by involved technical details to the point of confusion, or else to find that the author—in an attempt to reach the popular reader—has written down to the cellar level of vague and trite generalities. In contrast, one finishes Mr. Smith's article with a feeling that here is a distillation of worthwhile years of experience, presented in a simple and understandable fashion and with a healthy respect for the intelligence of the reader.

SOL D. PRENSKY
 EE Department
 Fairleigh Dickinson University
 Rutherford, New Jersey

To the Editors:

I have read with great interest the article on testing loudspeakers in your August issue. I feel more articles on these same lines could be a great help not only for the purpose of evaluation, at least with some degree of precision, but also to increase knowledge about these transducers.

JORGE MORALES, E. I.
 Radio Progreso Broadcast Station
 Holguin, Cuba

We have another article along a somewhat similar vein in the works at present on testing loudspeakers. Watch for it.—Editors.

PHOTORHYTHMICON

To the Editors:

With reference to your August issue, I would appreciate receiving additional information on the "Photorhythmicon—Dancing Lights" by Mr. Leon A. Wortman.

Can this instrument be purchased, and if so, at what price? Is it available fully wired or in kit form? If the unit is not available for purchase, I wonder whether or not a pictorial diagram of the system is available.

NORMAN K. ROBINSON
 Garden City, Michigan

Both we and Author Wortman were really swamped with inquiries about the "Dancing Lights." The unit was homemade by the author from his own circuit and, as such, it cannot be purchased either wired or in kit form. We

are also sorry that there are no pictorial diagrams available, since the author built the unit directly from his own schematic. Inquiries have been so heavy on this unit that perhaps we can induce Mr. Wortman to see if some equipment or kit manufacturer is interested in putting out the unit.—Editors.

SINE-TO-SQUARE WAVE ADAPTER

To the Editors:

On completing my breadboarding of Rufus Turner's "Improved Sine-to-Square Wave Adapter" in your June, 1958 issue, I seemed to have a circuit that was a pulse generator rather than a square-wave generator. In other words, the waveform was not balanced and the positive half cycles did not have the same duration as the negative half cycles. It seemed that this difficulty might be overcome by suitable bias on transistor V_1 .

I experimented and found that adding a 2700-ohm resistor from the base of this transistor to the positive side of the battery produced an excellent balanced square wave. Also, I found that when feeding a low-impedance circuit, such as another transistor, it was necessary to increase the output capacitor to 1 μ fd. in order to get good low-frequency response. I also got excellent results using 2N170 transistors in place of the more expensive 2N168A's.

I am certainly very pleased with the results I am now getting from the circuit.

C. W. EVANS
 St. Louis, Missouri

Because of the variation among transistors, biasing the input transistor, as suggested by Reader Evans, would give a better square wave with a greater number of transistors that might be selected. Also, when the bias resistor is included, the resulting network serves to stabilize the input stage.—Editors.

DRILL CHUCK KEY

To the Editors:

Your August issue had a brief item on page 108 about chuck-key placement for electric drills. The main thing that I have against the suggestion is the placement of the key. If at any time someone should happen to hit the drill trigger with the key located as shown, it might fly up and hit the person in the face and cause injury.

I would prefer to see the band holding the key tied to the plug of the drill. Then the plug would have to be pulled in order to use the key, hence, there



RCA INSTITUTES



OFFERS YOU THE FINEST OF HOME STUDY TRAINING

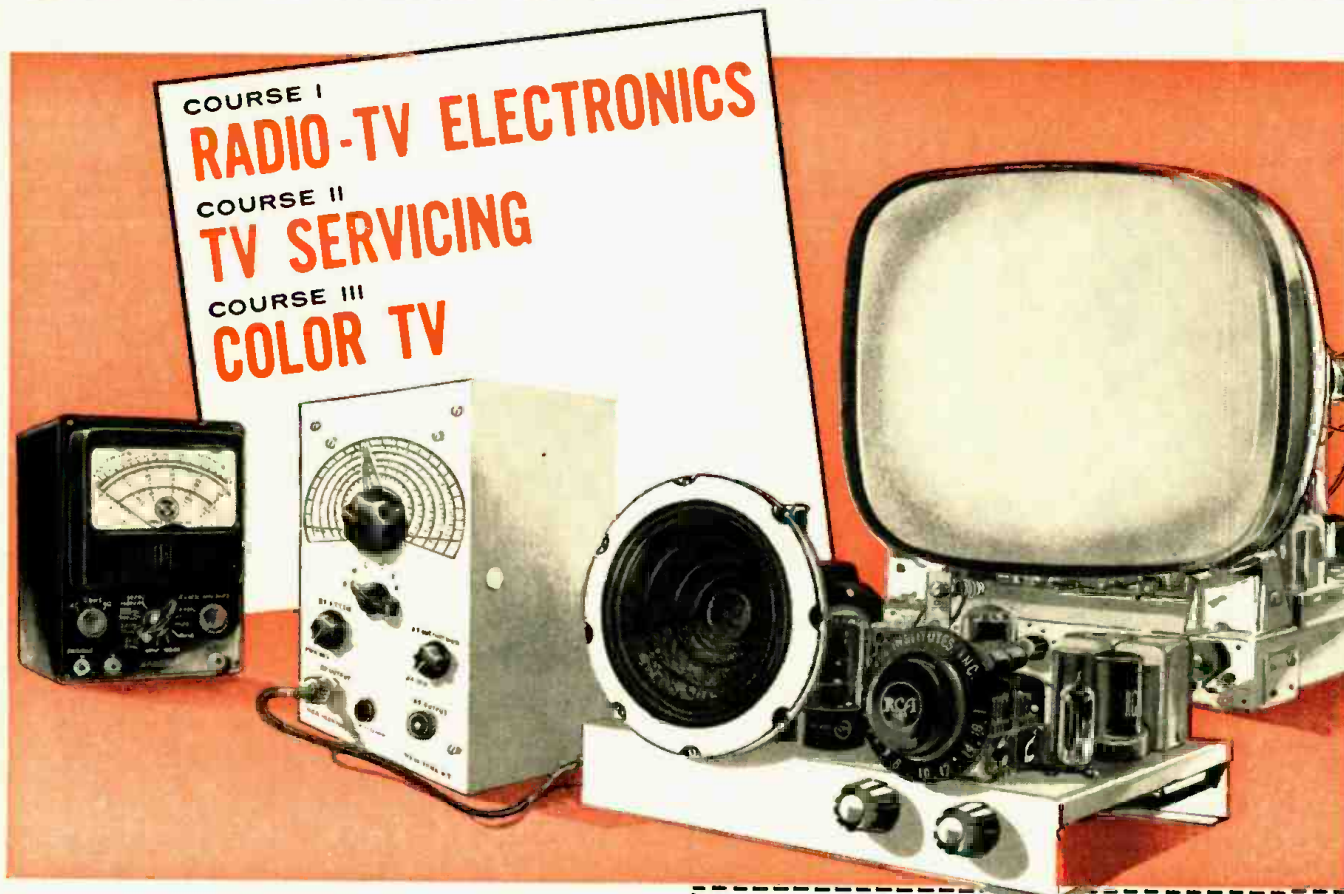

COURSE I
RADIO-TV ELECTRONICS
COURSE II
TV SERVICING
COURSE III
COLOR TV

The equipment illustrated and text material you get with each course is yours to keep. Practical work with very first lesson. Courses for the beginner and the advanced student. Pay-as-you-learn. You need pay for only one study group at a time.

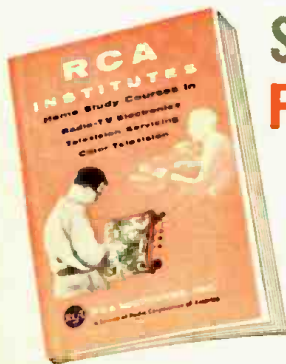

SEND FOR THIS FREE BOOK NOW

Resident School courses in New York City offer comprehensive training in Television and Electronics. Day and evening classes start four times each year. Detailed information on request.

RCA Institutes, Inc. Home Study Dept. RN-128
 A Service of Radio Corporation of America
 350 West Fourth Street, New York 14, N. Y.

Without obligation, send me FREE 52 page CATALOG on Home Study Courses in Radio, Television and Color TV. No Salesman will call.

Name.....
 Please print

Address.....

City.....Zone....State.....

Korean Vets! Enter discharge date.....

CANADIANS—Take advantage of these same RCA courses at no additional cost. No postage, no customs, no delay. Send coupon to:

RCA VICTOR COMPANY, LTD.
 5001 Cote de Liesse Rd., Montreal 9, Que.

To save time, paste coupon on postcard

a major
breakthrough
in
TV-FM
reception!



New **JERROLD** Amplified TV-FM HOME SYSTEM

IMPROVES TV-FM RECEPTION . . . IN EVERY ROOM!

Permits simultaneous operation of TV and FM sets in every room . . . provides better reception from existing antenna than if each set has its own antenna! Any number of additional receivers can easily be plugged in!

- Increases enjoyment of all TV Channels, FM Stations!
- Improves Color TV, Stereo and AM Radio Reception!
- Quick, easy Screwdriver Installation in New or Existing Homes!
- Use With Any Antenna—Indoor or Outdoor!

As Necessary to Modern Living As Electrical Outlets!

HOME SYSTEM KIT

Model HSK-300 \$6775 List
Contains everything (except antenna)
for installing 5-outlet system . . . in-
cluding Twin-Lead.

JERROLD's wire-grip-
ping plugs and outlets
require no wire strip-
ping...no soldering!



Write for Free 16-Page Booklet on
JERROLD TV-FM Home System



JERROLD

ELECTRONICS CORP.

Dept. PD 118, The Jerrold Building, Philadelphia 32, Pa.
Jerrold Electronics (Canada) Ltd.
Export Representatives, CBS International, New York 22, N.Y.

LOOK TO JERROLD FOR AIDS TO BETTER TELEVIEWING

would be no danger. Good lacing cord will also last a lot longer than a rubber band.

T/SGT. GLENN E. CRAVEN
Radar Maintenance Tech., U.S.A.F.
Midwest City, Oklahoma

We're glad to pass along Sgt. Craven's suggestion.—Editors.

BENCH PUZZLER & SERVICE NOTES

To the Editors:

Your RADIO & TV NEWS has always pleased me in some manner since my first subscription. Your general interest articles are good and the technical articles have been a valuable staff on numerous occasions.

In the July, 1958 issue, the "Test Bench Puzzler" is the type of article I would like to see printed more often. I have a lot to learn with regard to servicing of television, and this type of article does help.

Along with the good, I must send the bad. I have in the past cut out and saved the "Service Notes" articles for troubleshooting reference. However, the July issue is going to be hard to record under a set manufacturer since the article is back-to-back. I realize much conflict is encountered in magazine make-up, but I wonder if this can be avoided.

Again, I say thanks for a fine magazine.

DONALD C. ALVERSON
Cincinnati, Ohio

Concerning the matter of running the "Service Notes" back-to-back, we try to avoid this whenever possible. However, occasionally make-up problems prevent us from handling the items in the manner suggested by Reader Alverson.—Editors.

REALISTIC PROFIT MARGINS

To the Editors:

While reading my September issue of your magazine, I came across the article by William Leonard in which he refers to drugstore tube sales and the do-it-yourself trend. He said in the article that it was the TV man's fault for the rise in this type of business.

I would like to know if your author were put in the same spot as the little guy whose only income is the sale of tubes and TV repair, would he have the same feeling about giving profits away as he expressed in the article?

ED RAHM, JR.
Mulberry TV Service
Toledo, Ohio

William Leonard knew, as we did, that many people in service disagree with the basic premise he advanced. However, we have seen any number of articles and editorials in the monthly organs of various service organizations where exactly the same position was advanced. The most recent one we recall appeared in the "Guild News" published by the Radio & TV Guild of Long Island. These people advanced the belief that the serviceman must be firm in establishing the fact that he is en-

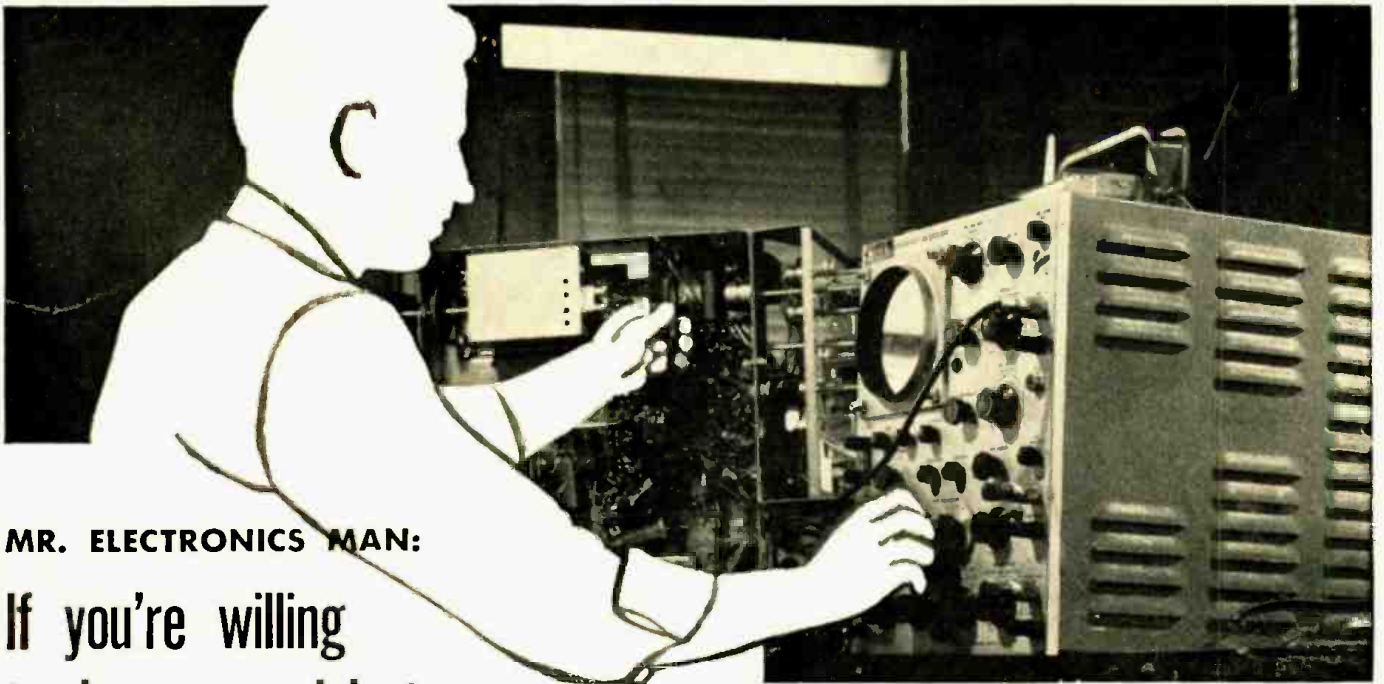

MR. ELECTRONICS MAN:

**If you're willing
to lose your job tomorrow
to a technically-trained man,
turn the page, mister**

Many of the men currently on the street are there for a reason. "As many as 8 out of 10 are dead-wood," estimates the chief engineer of a medium-sized Philadelphia firm; the problem is to find the live ones. —from *ELECTRONICS MAGAZINE*

If you're interested in an honest-to-goodness career in the vigorous young electronics industry, here's how you can step ahead of job-competition, move up to a better job, earn more money, AND BE SURE OF HOLDING YOUR TECHNICAL JOB, EVEN WHEN THE "DEADWOOD" IS BEING CLEANED OUT.

The "how" is advanced, professional home study training in Electronic Engineering Technology including SERVOMECHANISMS; COMPUTERS; RADAR; AUTOMATION; AERONAUTICAL ELECTRONICS; BROADCASTING; COMMUNICATIONS AND MANUFACTURING, and the ELECTRONIC PRINCIPLES ASSOCIATED WITH GUIDED MISSILES, TELEMETERING, ASTRONAUTICS and INSTRUMENTATION. You don't have to be a college graduate. You *do* have to be willing to study—at home. You can do it while holding down a full-time job. Thousands have. Since 1927 CREI has provided alert young men with the technical knowledge that leads to more responsibility, more job security, more money. And CREI has constantly kept pace with the rapid expansion and progress in electronic achievement.

Remember this: CREI starts with fundamentals and takes you along at your own speed. You are not held back by a class, not pushed to keep up with others. You set your own pace. CREI instructors guide you through the lesson material and *grade* your written work personally. You master the fundamentals, then get into more advanced phases of electronics engineering principles and practice. Finally you may elect training in highly specialized principles of electronic engineering technology as applied to guided missiles, servomechanisms, radar, computers, telemetering, automation, instrumentation and other applications.

Look at this partial listing of organizations that recommend CREI training for their own personnel: United Air Lines, Canadian Broadcasting Corp., Trans-Canada Airlines, Douglas Aircraft Co., The Martin Co., Columbia Broadcasting System, All-American Cables and Radio, Inc., Gates Radio Co., Canadair Ltd., Federal Electric Corp., and U.S. Information Agency (Voice of America).

What's the next step? *Certainly get more information than we can cram into one page. Fill out and mail the coupon below today, or write Capitol Radio Engineering Institute, Dept. 1112-Y, 3224 16th St., N.W., Washington 10, D. C.*

CREI ALSO OFFERS RESIDENCE TRAINING at the same high technical level in Washington, D. C. Classes start at regular intervals. Qualified residence school graduates earn degree, "Associate in Applied Science." You can qualify for CREI home study training if you have had electronic education, or experience in electronics—and realize the need of a high level technical knowledge to make good in the better electronic jobs. (Electronics experience is not required for admission to CREI Residence School.)

BRAND NEW COURSE ADDED—AUTOMATION AND INDUSTRIAL ELECTRONICS ENGINEERING TECHNOLOGY

Complete course, covers all phases of automation. Special emphasis on theory, functioning, and applications of servomechanisms and computers. Also noteworthy: Lessons on machine control, instrumentation, data-processing, and telemetry. A "must" for engineers and technicians seeking to enter this fascinating branch of electronic technology.

MAIL THIS COUPON FOR FREE BOOKLET!

CAPITOL RADIO ENGINEERING INSTITUTE

ECPD Accredited Technical Institute Curricula • Founded 1927
Dept. 1112-Y, 3224 Sixteenth St., N.W., Washington 10, D. C.

Please send me your course outline and FREE illustrated Booklet "Your Future in the New World of Electronics" describing opportunities and CREI home study courses in Practical Electronic Engineering Technology.

- CHECK FIELD OF GREATEST INTEREST
- Radar, Servo and Computer Engineering Technology
 - Electronic Engineering Technology
 - Broadcast (AM, FM, TV) Engineering Technology
 - Television Engineering Technology
 - Aeronautical Electronic Engineering Technology
 - Automation and Industrial Electronics Engineering Technology

13

Name Age

Street

City Zone State

Check: Home Study Residence School Korean Veteran

To help us answer your request intelligently, please give the following information:

Employed By.....

Type of Present Work.....

Education:
Yrs. High School.....

Other.....

Electronics Experience.....



these 4 knobs provide
unlimited control of
frequency response



NEW BLONDER-TONGUE MODEL A-1 HIGH FIDELITY AMPLIFIER

A unique B-T Development! The Model A-1 Audio Amplifier divides the audible spectrum into its *four* significant segments (BASS, LO-MIDDLE, HI-MIDDLE and TREBLE.) *Four* separate tone controls permit you to boost or attenuate any frequency range or combination of ranges. The result—a degree of tonal selectivity unobtainable *anywhere* in the amplifier field. Solo instrumentalists or vocalists may be drawn out of the orchestral background to take their places in front of the orchestra. Correction for poor room acoustics, or for deficiencies in associated equipment, is

instant and exact. Power output is 12 watts (music wave forms).

The Model A-1 gives you high fidelity performance you'd expect to find only in amplifiers costing considerably more! Frequency response is uniform within ½ db from 30 to 15,000 cycles; harmonic distortion, below 1% at 10 watts output. Inputs are provided for magnetic and crystal phono cartridges, with *automatic* RIAA equalization on both. Tape and tuner inputs add to its versatility. Complete function selection on front panel. Housed in a handsome, two-tone cabinet, the A-1 lists at **77.50**.

MATCH THE A-1 WITH THESE BLONDER-TONGUE COMPONENTS FOR A COMPLETE, VERSATILE HI-FI SYSTEM COSTING LESS THAN \$160



Model T-88 FM-AM Tuner—Amazing sensitivity on FM and AM. Frequency response, 20–20,000 cycles. Built-in FM antenna, with provision for external antenna. Built-in ferrite AM antenna. Simple, plug-in connection with A-1 amplifier for existing phonograph or TV receiver. Accurate and stable slide-rule tuning. **64.50**

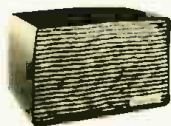

Model SS-2 Twin Speaker System—Housed in an acoustically correct enclosure, the SS-2 Twin Speaker System includes two carefully matched 4" speakers with overlapping frequency ranges. Ideal for use as a multiple speaker system in a monaural installation or, as a second system for conversion to stereo. 16-ohm impedance. **15.95**



Model R-98 FM-AM Radio—For those who prefer the convenience of a complete FM-AM radio, with *no sacrifice in quality*, the R-98 provides superb reception, free from interference of every kind—even in critical areas. Amazing sensitivity on FM and AM. Accurate and stable slide-rule tuning. **64.50**

For complete details, write to Dept. RTN-12



BLONDER-TONGUE LABORATORIES

9 Alling Street, Newark 2, New Jersey

titled to a respectable fee for his services on which he must place primary value. Once he does this, they also feel, he can afford to sell tubes at something below customary markup, which many people consider unrealistic. The argument is made that, by attempting to take such a high markup on components rather than on labor, the service dealer leaves himself vulnerable to others who are willing to work on more realistic markups.

We do not necessarily endorse this view which William Leonard shares with many people in service. However, it is an interesting viewpoint worth calling to the attention of our readers. We would be pleased to publish similar arguments advanced by those who oppose the attitude indicated in the article.—Editors.

ARMY MARS NET

To the Editors:

Your schedule of the Army MARS net's technical broadcast that appeared in your September issue led me to tune in on the September 24th broadcast on 4030 kc.

The talk on test equipment for the blind ham and technician by Robert Gunderson certainly showed a very worthy use of MARS network. Not only was the talk highly informative, but it was a great inspiration to handicapped and non-handicapped listeners alike.

Reception conditions were good and all stations in the SSB network came in loud and clear.

E. GILBERT

New York, New York

We caught the broadcast too, and we can certainly attest to the fact that it was very worthwhile listening to.—Editors.

STANDBY TRANSMITTER MIKE

To the Editors:

Your article in the June issue entitled "Compact 35-Watt Standby Transmitter" states that a T17B carbon transmitter can be converted to use an F1 microphone unit.

On the strength of this information, I purchased an F1 unit, assuming that it would fit into the space where my T17B carbon button is presently placed. However, I find that the F1 unit is too large to fit the space, and there is no way to make the connections to the push-to-talk switch.

HARRIS M. PERRY, W4OBM
Virginia Beach, Virginia

According to Author Bumbaugh, he has had so many T17B's fitted with F1 units that it just never occurred to him to describe the method. He had a machine shop turn up a dural ring with inside threads to fit the T17B case, the outer half having a diameter to fit the F1 unit. A little lip on the outside edge served to retain the F1 unit. He considered the cost for this operation (\$1.00) justified in view of the superiority of the F1 unit. Perhaps another way may suggest itself to our readers.—Editors.

WE'RE MAKING IT EASIER THAN EVER TO BECOME A WELL PAID RADIO-TELEVISION SERVICE TECHNICIAN

NOW - Just \$6 Starts You Training in
RADIO-TELEVISION
the SPRAYBERRY "Learn-by-Doing" Way . . .

25 BIG, COMPLETE KITS of PARTS & EQUIPMENT

To help you learn fast the practical side of Radio-Television, we send you expertly engineered training kits to test and assemble for interesting, valuable shop-bench practice!

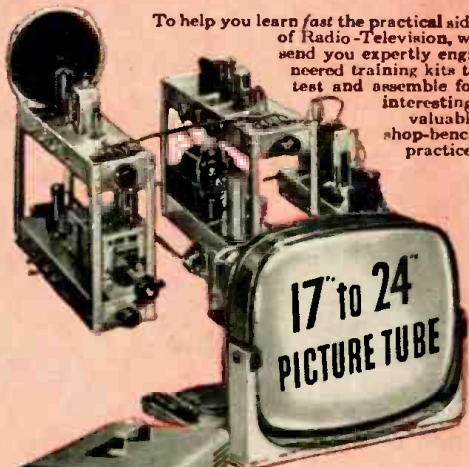

• The new Sprayberry Training Television Receiver, built and tested in 5 sections.

• Now offered . . . this fine modern oscilloscope.

• You build this powerful two-hand superheterodyne radio receiver.



Big New CATALOG AND Sample Lesson FREE!



You build the new Sprayberry tester—a complete 18-range Volt-Ohm-Milliammeter test meter.

★ ★ ★ ★ This great industry is begging for trained men . . . to step into good paying jobs or a profitable business of their own! Our new plan opens the doors of Radio-Television wide to every ambitious man who is ready to act at once!

Men by the thousands . . . trained Radio-Television Service Technicians . . . are needed at once! Perhaps you've thought about entering this interesting, top paying field, but lack of ready money held you back. Now—just \$6 enrolls you for America's finest, most up to date home study training in Radio-Television! Unbelievable? No, the explanation is simple! We believe Radio-Television *must* have the additional men it needs as quickly as possible. We are willing to do our part by making Sprayberry Training available for less money down and on easier terms than ever before. This is your big opportunity to get the training you need . . . to step into a fine job or your own Radio-Television Service Business.

Complete Facts Free—Act Now; Offer Limited

Only a limited number of students may be accepted on this liberal and unusual basis. We urge you to act at once . . . mail the coupon below and get complete details plus our big new catalog and an actual sample lesson—all free. No obligation . . . no salesman will bother you.

HOME STUDY TRAINING IN SPARE TIME

Under world-famous 27-year old Sprayberry Plan, you learn entirely at home in spare time. You keep on with your present job and income. You train as fast or as slowly as you wish. You get valuable kits of parts and equipment for priceless shop-bench practice. And everything you receive, lessons and equipment alike, is all yours to keep.

LET US PROVE HOW EASILY YOU CAN LEARN!

Radio-Television needs YOU! And Sprayberry is ready to train you on better, easier terms, that any ambitious man can afford. Just \$6 starts you! Mail coupon today . . . let the facts speak for themselves. You have everything to gain. Let us prove the kind of opportunity that's in store for you!

SPRAYBERRY Academy of Radio-Television
 1512 Jarvis Avenue, Dept. 25-P, Chicago 26, Illinois

Mail This Coupon Now—No Salesman Will Call

Sprayberry Academy of Radio-Television
 Dept. 25-P, 1512 W. Jarvis Ave., Chicago 26, Ill.

Please rush all information on your ALL-NEW Radio-Television Training Plan. I understand this does not obligate me and that no salesman will call upon me. Include New Catalog and Sample Lesson FREE.

NAME _____ Age _____

ADDRESS _____

CITY _____ ZONE _____ STATE _____



New Product Developments

MAKE CBS-HYTRON PRODUCTS BETTER FOR YOU

core-driver use in computers. Watch for many more CBS-Hytron transistor developments.

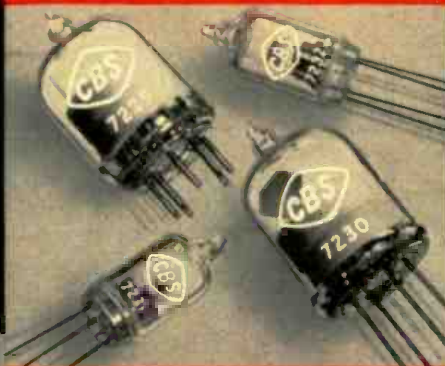

tangular and CBS-Colortron picture tubes, these new 110-degree Silver Vision aluminized tubes offer the advantages of a picture that remains brighter and clearer throughout their longer life. A precision electron gun and uniformly controlled processes for aluminizing and screen settling assure dependability . . . the dependability of the best-known name in television.



Constant Displacement Stereo Cartridge

New Columbia CD is most linear stereo cartridge. Its constant displacement lever system assures that, regardless of frequency, the output voltage is essentially constant for a given displacement of stylus. This unrivalled cartridge, best for conversion or replacement, was designed by Columbia Records. It is first of a series of audio components from CBS-Hytron.

Krytron . . . New Electronic Switch

These CBS-Hytron originals introduce a new and growing family of krytrons, reliable cold-cathode trigger tubes. They replace relays and thyratrons in simplified circuits; control up to 500 amperes with inputs of less than 20 micro-amperes. Krytrons present another addition to CBS-Hytron's industrial tubes . . . most inclusive selection in the industry.



Heavy-duty TV Receiving Tubes

First to introduce receiving tubes especially for television . . . first to originate heavy-duty tubes for TV work-horse sockets (horizontal amplifier, high-voltage rectifier, etc.) . . . CBS-Hytron's leadership continues in the application of advanced engineering and technology developed for reliable military and industrial tubes to all its TV receiving tubes.

Most Comprehensive Diode Line

Of particular interest for their freedom from shorts and opens are these new indium-bonded computer diodes. The CBS-Hytron diode line has become the most comprehensive, including general-purpose, or computer . . . germanium or silicon . . . glass or plastic, in a wide range of types.



New Transistor Lines

CBS-Hytron now offers the most complete line of PNP power transistors: EIA, military and special . . . 6 packages . . . 20-, 30-, 40-watt groups . . . a total of over 100 types. NPN high-speed switching transistor line is also the most complete for logic-circuit and



More Dependable TV Picture Tubes From the originator of the rec-



Watch for More reliable products through Advanced-Engineering

CBS-HYTRON, Danvers, Massachusetts
A Division of
Columbia Broadcasting System, Inc.

Learn TELEVISION-RADIO

**Servicing or Communications
by Practicing at Home in Spare Time**



NRI gives you kits to build these and other equipment

Electronic Technicians Have High Pay, Prestige Jobs

People look up to and depend on the Technician, more than ever before. His opportunities are great, and are increasing. Become a Radio-Television-Electronic Technician. At home, and in your spare time, you can learn to do this interesting, satisfying work—qualify for important pay. A stream of new Electronics products is increasing the job and promotion opportunities for Television-Radio-Electronic Technicians. Right now, a solid, proven field of opportunity for good pay is servicing the millions of Television and Radio sets now in use. The hundreds of Television and Radio stations on the air offer interesting jobs for Operators and Technicians. The military services reward qualified Technicians with higher rank and pay. Police, Aviation, Mobile Two-Way Radio are expanding. To ambitious men everywhere: here is rich promise of fascinating jobs, satisfaction and prestige, increasing personal prosperity.

Make Extra Money Soon, \$10 to \$15 a Week in Your Spare Time

NRI students find it practical and profitable to start fixing sets for friends and neighbors a few months after enrolling. Picking up \$10, \$15 and more a week gives substantial extra spending money. Use the Tester built with parts NRI furnishes, to locate and correct Radio-TV receiver troubles. Many who start in spare time, soon build full time Television-Radio sales and service businesses; others enjoy profitable spare time businesses and the security of a source of income to fall back on in case of layoffs, hard times or other changes in regular job. Postage free card will bring you complete facts about the NRI tested way to better pay.

NRI Has Trained Thousands for Successful Careers in TV-Radio



Studio Engr., Station KATV
"I am now Studio Engineer at Television Station KATV. Before enrolling for the NRI Course, I was held back by limitation of a sixth grade education." **BILLY SANCHEZ**, Pine Bluff, Ark.



Has All the Work He Can Do
"Since finishing NRI Course I have repaired more than 2,000 TV and Radio sets a year. NRI training certainly proved to be a good foundation." **H. R. GORDON**, Milledgeville, Ga.



Has Good Part Time Business
"Quite early in my training I started servicing sets. Now have completely equipped shop. My NRI training is the backbone of my progress." **E. A. BREDA**, Tacoma, Wash.

Cut Out and Mail Postage-Free Card NOW

Sample Lesson and Catalog Both FREE

SEE OTHER SIDE

OLDEST & LARGEST HOME STUDY RADIO-TV SCHOOL National Radio Institute

Dept. C D , Washington 16, D.C.

Please send me sample lesson of your Radio-Television Training and Catalog FREE. (No salesman will call.)

Name..... Age.....

Address.....

City..... Zone..... State.....

ACCREDITED MEMBER NATIONAL HOME STUDY COUNCIL



ACT NOW FIND OUT WHAT NRI OFFERS YOU

NRI SUPPLIES LEARN-BY-DOING KITS WITHOUT EXTRA CHARGE
Technical Know-How Pays Off in Interesting, Important Work



YOU BUILD AC-DC Superhet Receiver

NRI Servicing Course includes all needed parts. By introducing defects you get actual servicing experience practicing with this modern receiver. Learn-by-doing.



YOU BUILD This 17 Inch Television Receiver

As part of your NRI course you can get all components, tubes, including 17" picture tube, to build this latest style Television receiver; get actual practice on TV circuits.

YOU BUILD Broadcasting Transmitter

As part of NRI Communications Course you build this low power Transmitter, learn commercial broadcasting operators' methods, procedures. Train for your FCC Commercial Operator's License.



YOU BUILD Vacuum Tube Voltmeter

Use it to earn extra cash fixing neighbors' sets; bring to life theory you learn from NRI's easy-to-understand texts.



For Higher Pay, Better Jobs
Be a TV-Radio-Electronic Technician



Servicing Needs More Trained Men

Portable TV, Hi-Fi, Transistor Radios, Color TV are making new demands for trained Technicians. Good opportunities for spare time earnings or a business of your own.

Broadcasting Offers Satisfying Careers

4000 TV and Radio stations offer interesting positions. Govt. Radio, Aviation, Police, Two-Way Communications are growing fields. Trained Radio-TV Operators have a bright future.



J. E. Smith, Founder

Train at Home the NRI Way Famous for Over 40 Years

NRI is America's oldest and largest home study Television-Radio school. The more than 40 years' experience training men for success, the outstanding record and reputation of this school—benefits you in many ways. NRI methods are tested, proven. Successful graduates are everywhere, from coast to coast, in small towns and big cities. You train in your own home, keep your present job while learning. Many successful NRI men did not finish high school. Let us send you an actual lesson, judge for yourself how easy it is to learn.

No Experience Necessary—NRI Sends Many Kits for Practical Experience

You don't have to know anything about electricity or Radio to understand and succeed with NRI Course. Clearly written, well-illustrated NRI lessons teach TV-Radio-Electronic principles. You get NRI kits for actual experience. All equipment is yours to keep. You learn-by-doing. Mailing the postage-free card may be one of the most important acts of your life. Do it now. Reasonable tuition. Low monthly payments available. Address: NATIONAL RADIO INSTITUTE, Washington 16, D. C.

NRI Graduates Do Important Work



Now Quality Control Chief

"Had no other training in Radio before enrolling, obtained job working on TV amplifiers before finishing course. Now Quality Control Chief." T. R. FAVAROLO, Norwich, N. Y.

NRI Course Easy to Understand

"I opened my own shop before receiving my diploma. I have had to hire extra help. I am independent in my own business." D. P. CRESSEY, Stockton, Cal.

Works on Color-TV

"NRI changed my whole life. If I had not taken the course, probably would still be a fireman, struggling along. Now Control Supervisor at WRCA-TV." J. F. MELINE, New York, N. Y.

FIRST CLASS

Permit No. 20-R

(Sec. 34.9, P. L. & R.)

Washington, D.C.

BUSINESS REPLY CARD

No Postage Stamp Necessary if Mailed in the United States

POSTAGE WILL BE PAID BY

NATIONAL RADIO INSTITUTE
3939 Wisconsin Avenue
Washington 16, D.C.

SAMPLE LESSON
64-page CATALOG
both FREE

SEE
OTHER
SIDE

ownership of a complete and currently maintained
PHOTOFACT SERVICE DATA LIBRARY
SPELLS SUCCESS FOR SERVICE TECHNICIANS

here's actual proof from the men who know!



"PHOTOFACT more than doubles the amount of work a shop can turn out. The time saved by their use is inestimable...cuts labor costs, too..."

—Warren G. Kunkle, Denver, Colorado

(Operator of Warren G. Kunkle & Co.—
in business for over 27 years)

HERE'S MORE PROOF...FROM COAST-TO-COAST

VIRGINIA

"I have been using PHOTOFACT since it started, I believe that was in 1946. I don't see how I could do without it..."

—Glen Edwards
Norton, Va.

PENNSYLVANIA

"PHOTOFACT cuts servicing time in half..."

—Norman E. Rick
Reading, Pa.

NEW YORK

"It's the only complete circuit data service available to the industry..."

—Herbert Cook
Rochester, N. Y.

KANSAS

"I find I can save 50% of my time by using PHOTOFACT for everything—alignment, replacement parts, schematics, etc. In fact, if anything happened to my PHOTOFACT and I couldn't replace them, I think I'd just close my shop."

—Charles F. Burket
Elkhart, Kansas

CALIFORNIA

"We use PHOTOFACT daily. I don't believe we could conduct a first-class service shop without them. They are a time saver. With them, you can get to the base of your troubles in a hurry."

—P. W. Earls
Fallbrook, Calif.

OHIO

"I consider PHOTOFACT indispensable in daily use on practically every set which comes to the shop..."

—Dwight L. Benson
Edison, Ohio

TEXAS

"Sams PHOTOFACT is the easiest and fastest method I have found..."

—Leroy Holloman
Odessa, Texas

IOWA

"I would find it impossible to give consistently reliable service without a complete PHOTOFACT file of service information."

—Ralph L. Reints
Ottumwa, Iowa

(These are just a few of the hundreds of "Success with PHOTOFACT" letters in our files)

NEW! EASY-BUY PLAN

—the money-saving way to build your complete profit-making PHOTOFACT Library!

NO INTEREST—NO CARRYING CHARGE—AS LITTLE AS \$10 DOWN



free!

VALUABLE STEEL FILE CABINETS FOR REGULAR PHOTOFACT SUBSCRIBERS AND PHOTOFACT LIBRARY PURCHASERS

GET THE FULL DETAILS

SEE YOUR SAMS DISTRIBUTOR TODAY, or write to Howard W. Sams for details



HOWARD W. SAMS & CO., INC.

2203 E. 46th St., Indianapolis 6, Ind.

- Send details on PHOTOFACT Easy-Buy Plan and FREE File Cabinet offer.
- I'm a Service Technician: full-time; part time

My Distributor is: _____

Shop name _____

Attn. _____

Address _____

City _____ Zone _____ State _____



INSTALL THE PICTURE TUBE MILLIONS KNOW BY NAME!

You make more money by handling products the public knows...and wants. "Black-Daylite" is a brand name familiar to TV set owners everywhere. Black-Daylite stands for quality, for real-life picture performance.

These tubes are better-built and better-tested, to give your customers the finest in television reception. Because their long history of quality is tops, Black-Daylite Alumimized Picture Tubes are preferred in every home. When you install them, you supply a *pre-sold* product—with a name backed by years of G-E marketing effort and millions of dollars of consumer advertising.

Three modern, fully-equipped General Electric plants, located for fast deliveries, build Black-Daylite picture tubes to the industry's highest standards. Your nearby G-E tube distributor stocks these well-known, fast-selling tubes in an across-the-board range of types. Phone him today! *Distributor Sales, Electronic Components Division, General Electric Company, Owensboro, Kentucky.*

Progress Is Our Most Important Product

GENERAL  ELECTRIC

11-13-201



BLACK-DAYLITE
ALUMINIZED PICTURE TUBE



Micro-inspecting G-E picture tube guns for precision workmanship.

100% testing: one reason why G-E Black-Daylite picture tubes are superior.

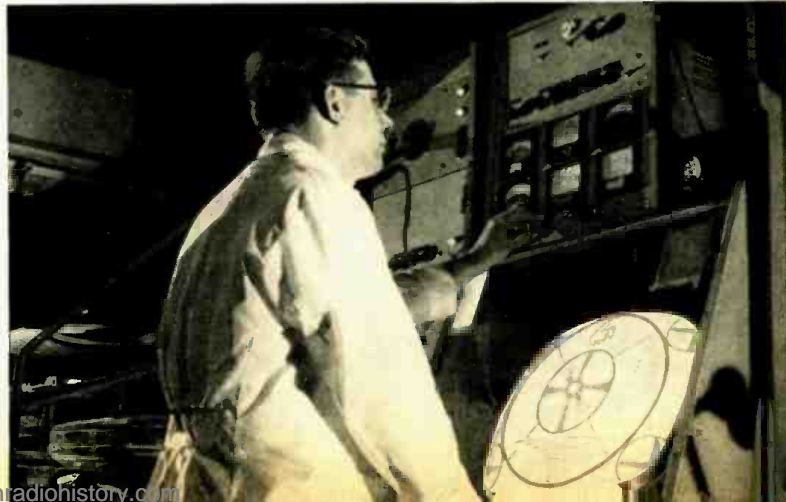

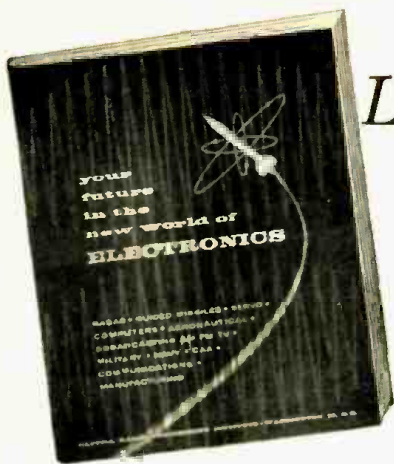

The data that Launched Thousands of Careers is yours FREE } tells how you can be successful in **RADIO-TV ELECTRONICS**

Servomechanisms . . . Computers . . . Radar . . . Automation . . .
Aeronautical Electronics . . . Broadcasting . . . Communications
and Manufacturing, and the Electronic Principles Associated with
Guided Missiles, Telemetry, Astronautics, and Instrumentation.

Send for your Free Copy today!

This is a brand new edition of the book which has launched thousands of men on good-paying careers in radio-TV-electronics.

It brings you completely up to date—answers important questions on newest career developments in electronics, including Radar, Guided Missiles, Servomechanisms, Computers, as well as Aeronautical Electronics, Broadcasting (AM, FM, TV), Military, Navy and CAA Electronics, Communications and Electronics Manufacturing.

This book, "Your Future in the New World of Electronics," also shows you how CREI Home Study leads the way to greater earnings in the booming electronics world.

However, CREI does not promise you a "snap." With accredited technical school curricula such as CREI offers, you must study to convert your ambition into technical knowledge which you can sell in the fabulous field of Electronics. Since its founding in 1927, CREI has provided thousands of professional electronics men with technical education. During World War II, CREI trained thousands for the Armed Services. Leading firms recommend CREI training for their own personnel. Among them: United Air Lines, Canadian Broadcasting Corporation, Trans-Canada Airlines, Douglas Aircraft Co., The Martin Co., Columbia Broadcasting System, All-American Cables and Radio, Inc., Gates Radio Co., Canadair, Ltd., Federal Electric Corp., and U.S. Information Agency (Voice of America).

CREI courses are prepared by recognized experts, in a practical, easily understood manner, and constantly revised to meet the new electronic challenges of our time. You get the benefit of time-tested study assignments under the personal supervision of a CREI staff instructor. Your studies are accomplished on your own time, during hours selected by you, and controlled by your own willpower. This complete training is the reason that graduates find their CREI diplomas keys-to-success in even the most advanced of electronic applications. CREI alumni hold top positions in America's leading firms. At your

service is the CREI Placement Bureau, which maintains constant contact with electronic industry, and cooperates with employers and graduates in making satisfactory placements. This free service is available to students, as well as graduates. Fill out the coupon below completely and mail it now. We'll promptly send you your free copy of "Your Future in the New World of Electronics." The rest—your future—is up to you!

**ELECTRONIC
TECHNICIANS**

Following Peninsula Co. has openings for 1st class electronic technicians to work directly with engineering in development of new products. Only those with CREI or equal training and 3 years minimum commercial experience will be considered. Top salaries to qualified applicants. Call Mr. McQueeney, A. 4-4733 for appointment. LTO SCIENTIFIC Co., Inc. 855 COMMERCIAL ST. PALO ALTO

**ENGINEERING
AIDES
AND
TECHNICIANS**

Immediate Positions Available

C.R.E.I. or other formal electronic training desirable.

Experienced in reading schematics, breadboard construction of electronic circuits and chassis preparation.

**EMERSON
RESEARCH
LABORATORIES**

CREI ALSO OFFERS residence training in Washington, D. C. . . . at the same high technical level. Day and evening classes start at regular intervals. Qualified residence school graduates earn degree as "Associate in Applied Science." If you have had a high school education, and experience in electronics—you can qualify for CREI home study training. (Electronics experience is not required for admission to CREI Residence School.) Check coupon if you prefer residence or home study information . . . or write Capitol Radio Engineering Institute, Dept. 1112-E, 3224-16th St., N.W., Wash. 10, D. C.

INDUSTRY CALLS FOR CREI TRAINING BY NAME . . . SO SHOULD YOU!

Here you see actual help wanted ads—one from a San Francisco newspaper, another seen in Washington. They are just two of many which specify, "CREI or equal" education. This shows that industry approves CREI training, even insists on it. Experience has taught many, many companies that CREI students are taught what industry needs and wants them to know. Let this be your cue when you choose your educational program.

BRAND-NEW COURSE ADDED . . . AUTOMATION AND INDUSTRIAL ELECTRONICS ENGINEERING TECHNOLOGY. Complete course, covers all phases of automation. Special emphasis on theory, functioning, and applications of servomechanisms and computers. Also noteworthy: Lessons on machine control, instrumentation, data-processing, and telemetry.

MAIL TODAY FOR YOUR FREE BOOKLET

CAPITOL RADIO ENGINEERING INSTITUTE
ECPD Accredited Technical Institute Curricula—Founded 1927
Dept. 1112-E 3224 Sixteenth St., N.W., Washington 10, D. C.

Please send me your course outline and FREE illustrated Booklet, "Your Future in the New World of Electronics" . . . describing opportunities and CREI Home Study courses in Practical Electronic Engineering Technology.

CHECK FIELD OF GREATEST INTEREST

<input type="checkbox"/> Radar, Servo and Computer Engineering Technology	B1
<input type="checkbox"/> Electronic Engineering Technology	
<input type="checkbox"/> Broadcast (AM, FM, TV) Engineering Technology	
<input type="checkbox"/> Television Engineering Technology	
<input type="checkbox"/> Aeronautical Electronic Engineering Technology	
<input type="checkbox"/> Automation and Industrial Electronics Engineering Technology	

Name..... Age.....

Street

City..... Zone..... State.....

Check: Home Study Residence School Korean Veteran

To help us answer your request intelligently, please give the following information:

Employed By.....

Type of Present Work.....

Education:
Yrs. High School.....

Other.....

Electronics Experience.....

CHANNEL MASTER

Sells Antenna



**Dave
Garroway**

TEAMS UP WITH THE

T-W

ON NETWORK TV

*One of America's
most persuasive
TV personalities
is now telling his
tremendous audience—
from coast to coast—
all about the world's most
powerful television antenna*

on the **"TODAY"** show
over the entire **NBC-TV** Network

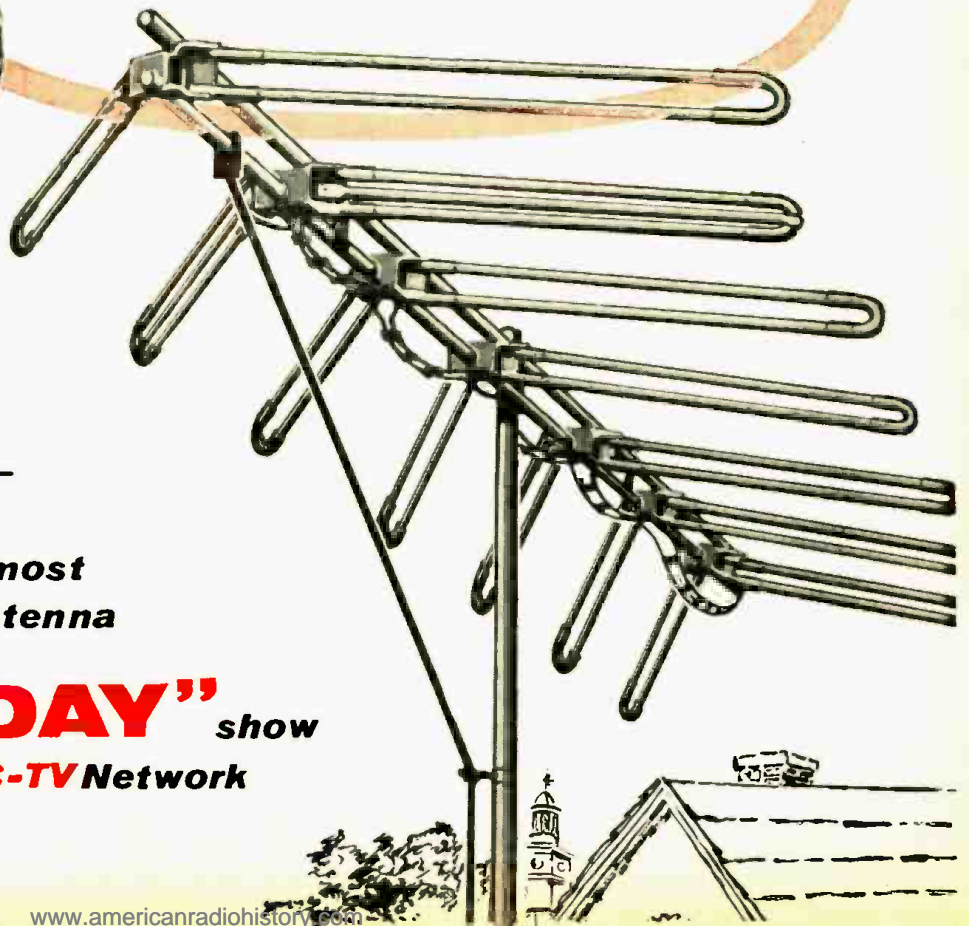

AD BLITZ

Replacements

New
CHANNEL MASTER Campaign
in America's Largest
Circulation Magazines...

Puts new **LIFE** into your antenna business

POSTS your customers on the need
for antenna replacements

Gives set owners a **LOOK** at better
reception with the T-W antenna

GUIDES prospects to your door
for an antenna check-up

Helps you **FARM** fertile new
fields of antenna profits

and now

CHANNEL MASTER TRANSISTOR RADIOS

America's #1
RADIO Value

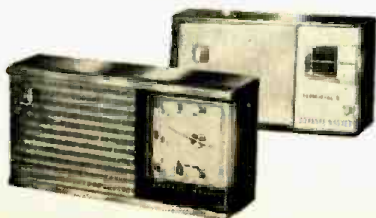

Copyright 1958 Channel Master Corp

STEP-UP TO STEREO... ON A BUDGET

with Stereo's Standard



STEREO'S STANDARD

IF THIS IS YOUR PRESENT OR PROPOSED SPEAKER SYSTEM

costing between **\$60-\$90**

costing between **\$90-\$120**

costing between **\$120-\$140**

costing between **\$140-\$200**

Includes an 8" coaxial speaker such as:
E-V CORONET (with SP8B), Net \$65
E-V BARONET (with SP8B), Net \$74.50
 SP8B: Wide range, economical, super-efficient coaxial speaker. Small high-frequency propagator insures fine dispersion.

Includes a two-way separate system such as:
E-V CORONET IA, Net \$102
E-V BARONET III, Net \$111.50
E-V REGAL IA, Net \$103
 or include a 15" coaxial speaker such as:
E-V MARQUIS (with SP12B), Net \$88
E-V ARISTOCRAT (with SP12B), Net \$107
 SP12B: Added efficiency with lower-to-mid range search. Extends fundamental low range. Excellent dispersion for widest stereo effect.

Includes three-way speaker such as:
E-V MARQUIS (with 12TRX8), Net \$129
E-V ARISTOCRAT (with 12TRX8), Net \$138

12TRX8: Has all the features of the SP12B—plus a separate high-frequency driver with electrical crossover for still lower distortion. Gives widest spread of vital stereo range to achieve large stereo listening area.

such as the new **E-V REGAL III**
REGAL Super-compact, specially designed system with tailored components to give enhanced range and purity of tone with least loss of efficiency. Does not require high powered amplifier. Net \$147.50

Includes a 15" three-way speaker such as:
E-V EMPIRE (with 15TRX8), Net \$178
EMPIRE 15TRX8: Similar to added bass efficiency from large cone, and delivering best response.

* E-V systems which can be expanded with E-V Building Blocks whenever your budget permits.

NOTE: All E-V enclosures also available in limed oak or walnut finishes.

STEP ONE

You need the totally compatible **E-V STEREO CARTRIDGE**

- * the first stereo cartridge
 - * the only field tested stereo cartridge
- Thousands already in use prove it
- * Plays ALL RECORDS BETTER
 - * Uneexcelled for stereo; superior even to your present cartridge for monaural
 - * Highest vertical and horizontal coil alignment
 - * For superior tracking, longest record wear
 - * Best channel separation over 20 db between channels
 - * Flattest response
 - * Flat beyond audibility to RIAA curve
 - * Hum and rumble far below any magnetic cartridge
 - * Two ceramic elements deliver precise RIAA curve with no hum!
 - * Exclusive E-V Built-in Vertical Rumble Suppressor allows record changer use for stereo
 - * 7-mil replaceable (disposed or tapping) stylus is the ideal size... gives you better reproduction, longer record wear

Then choose a second amplifier and pre-amplifier, if this is your initial high fidelity system, start with any stereophonic dual amplifier-preamplifier. Play monaurally until you add a second speaker for stereo.

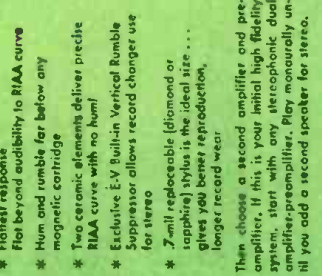

The **E-V Totally Compatible Stereo Cartridge** is the industry's standard. Choose the model to fit your needs:

- MODEL 21D—Stereo with 7-mil Diamond Stylus, Net \$19.50
- MODEL 26DST—Dual Stylus Turnover from 7-mil Diamond Stereo to 3-mil Sapphire Monaural, Net \$22.50
- or the **E-V Velocity Stereo Cartridge**
- MODEL 21MD—Stereo with 7-mil Diamond Stylus, Net \$19.50
- MODEL 26MDST—Dual Stylus Turnover from 7-mil Diamond Stereo to 3-mil Sapphire Monaural, Net \$22.50

STEP TWO



Add-on E-V BARONET... smallest folded-horn corner enclosure for best musical balance and response range; phenomenal bass range extended two full octaves. Matches the Coronet and other comparable speaker systems. With SP8B, Net \$74.50, or BARONET III with SP8B and T35B VHF driver, Net \$111.50



Add-on E-V ARISTOCRAT... popular folded-horn corner enclosure... compact, economical... delivers most extended bass range for its size. With SP12B, Net \$107.00; with 3-way 12TRX8, Net \$138



Add-on E-V REGAL III... super-compact, specially designed system with tailored components to give enhanced range and purity of tone with least loss of efficiency. Does not require high powered amplifier. Net \$147.50

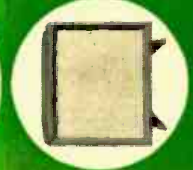

Add-on E-V EMPIRE... direct radiating, Super-Excited low-bay enclosure tailored for ultra-extended bass and in concert with extended bass response. With Electro-Voice 15TRX8 3-way speaker, Net \$178

Add-on the new E-V CORONET... five, balanced high fidelity reproduction in extremely small economical space-saving form; only 10 inches of wall space required. Complements Aristocrat, Marquis, Baronet or comparable speaker system. With SP8B 8-inch speaker, response down to 70 cps., Net \$45.00 or add-on CORONET IA with SP8B and T35B VHF driver, \$102.00, or add-on REGAL IA, Net \$103



Add-on STEREO IA
 The all-new Electro-Voice speaker system that solves your space problem—saves you money. Where space doesn't permit you to add a second full-range speaker, a Stereo IA is the answer. It's compact, because the Stereo reproduces only those frequencies needed for stereo. Bass below 300 cps does not contribute to the stereo effect, so bass from both is handled by your present full-range speaker through the accessory XX3 Stereo Control Filter. (Finest E-V mid-bass, treble and high frequency components give smooth response from 300 to 19,000 cps.)

Add-on STEREO IA
 The all-new Electro-Voice speaker system that solves your space problem—saves you money. Where space doesn't permit you to add a second full-range speaker, a Stereo IA is the answer. It's compact, because the Stereo reproduces only those frequencies needed for stereo. Bass below 300 cps does not contribute to the stereo effect, so bass from both is handled by your present full-range speaker through the accessory XX3 Stereo Control Filter. (Finest E-V mid-bass, treble and high frequency components give smooth response from 300 to 19,000 cps.)

Add-on STEREO IA
 The all-new Electro-Voice speaker system that solves your space problem—saves you money. Where space doesn't permit you to add a second full-range speaker, a Stereo IA is the answer. It's compact, because the Stereo reproduces only those frequencies needed for stereo. Bass below 300 cps does not contribute to the stereo effect, so bass from both is handled by your present full-range speaker through the accessory XX3 Stereo Control Filter. (Finest E-V mid-bass, treble and high frequency components give smooth response from 300 to 19,000 cps.)

Add-on STEREO IA
 The all-new Electro-Voice speaker system that solves your space problem—saves you money. Where space doesn't permit you to add a second full-range speaker, a Stereo IA is the answer. It's compact, because the Stereo reproduces only those frequencies needed for stereo. Bass below 300 cps does not contribute to the stereo effect, so bass from both is handled by your present full-range speaker through the accessory XX3 Stereo Control Filter. (Finest E-V mid-bass, treble and high frequency components give smooth response from 300 to 19,000 cps.)

Electro-Voice
 ELECTRO-VOICE, INC., BUCHANAN, MICHIGAN
 Foremost in Electro-Acoustics—Microphones, Phono Cartridges, High-Fidelity Loudspeakers and Enclosures, Public Address Systems, Music Instruments, DMI (The International Electronic Instruments and Military Music)

step UP your speaker system with **ELECTRO-VOICE BUILDING-BLOCK KITS**

first, choose an acoustically-perfect Electro-Voice factory-assembled enclosure or a do-it-yourself enclosure kit

		
E-V Coronet net \$35.50	E-V Aristocrat net \$72 E-V Aristocrat KD6 Kit net \$39 or its along-the-wall counterpart the new E-V Marquits net \$63	E-V Regency net \$120 E-V Regency KD4 Kit net \$73
		
E-V Baronet net \$45 E-V Baronet KD7 Kit net \$26	E-V Empire net \$99 E-V Empire KD5 Kit net \$51	

second, choose an Electro-Voice full-range coaxial two-way speaker

				
SP88 net \$29.50	SP12B net \$35	SP12 net \$66	SP15B net \$43	SP15 net \$89

STEP ONE add-on an Electro-Voice high-frequency Building-Block Kit for a separate two-way system

		
BB1 BUILDING-BLOCK KIT includes T358 Super-Sonax VHF Driver, X36 Crossover, AT37 Level Control, Wiring Harness net \$37	BB2 BUILDING-BLOCK KIT includes T35 Super-Sonax VHF Driver, X36 Crossover, AT37 Level Control, Wiring Harness net \$50	BB3 BUILDING-BLOCK KIT includes T10A Driver, 8HD Horn, X8 Crossover, AT37 Level Control, Wiring Harness net \$86

or start with an Electro-Voice integrated three-way speaker (equivalent to coaxial plus high-frequency driver)

			
12TRXB net \$66	12TRX net \$125	15TRXB net \$79	15TRX net \$149

STEP TWO add-on an Electro-Voice mid-range Building-Block Kit for a separate three-way system, the ultimate in high fidelity reproduction

		
BB3 BUILDING-BLOCK KIT includes T10A Driver, 8HD Horn, X825 Crossover, AT37 Level Control, Wiring Harness net \$86	BB4 BUILDING-BLOCK KIT includes T25A Driver, 8HD Horn, X8 Crossover, AT37 Level Control, Wiring Harness net \$114	BB4 BUILDING-BLOCK KIT includes T25A Driver, 8HD Horn, X8 Crossover, AT37 Level Control, Wiring Harness net \$114



Picture your speaker system with E-V Building-Block Kits. You can start with a single, full-range Electro-Voice Loudspeaker and expand it step-by-step to a multi-way system as your budget permits.

Electro-Voice enclosures are ready for future addition of high-frequency and mid-range speakers. Your E-V enclosure can never be obsolete because there's always room to expand your system.

*E-V Building Block Kits may also be used with some non-E-V quality systems. Ask your high fidelity specialist or write Electro-Voice for details.

Two ways to a Separate Three-Way System

1. Start with an Electro-Voice full-range coaxial speaker. Then, when your budget permits, add-on the correct E-V high-frequency Building-Block Kit to give you a separate two-way system; later add-on the E-V mid-range Building Block Kit for a superlative separate three-way system.
 2. Or, begin your system with an E-V integrated 3-way speaker; merely add-on the E-V mid-range Building-Block Kit to achieve a separate three-way system.
- Of course, you can purchase a complete three-way system composed of low-frequency driver, high-frequency driver BB Kit, and mid-range driver BB Kit.

Electro-Voice

® FOREMOST IN ELECTRO-ACOUSTICS—Microphones, Phono-Cartridges, High Fidelity Loudspeakers and Enclosures, Public Address Speakers, Marine Instruments, EVI Professional Electronic Instruments and Military Material.
ELECTRO-VOICE, INC., Buchanan, Michigan

Electro-Voice has the industry's most complete and versatile line of speakers, enclosures, and kits.
Ask your high fidelity dealer or write E-V for complete information on how to step-up your system.

you learn **MORE**
from a **SAMS BOOK**

over 1,000,000 bought to date

NEW BOOKS JUST OUT!



"101 Ways to Use Your Sweep Generator"

Robert G. Middleton's fine new book shows you the multiple applications possible with a sweep generator

A complete and practical guide to the fullest use of your sweep generator. Each application is covered concisely, with full data on connections required, additional equipment needed, proper test procedure and evaluation of results. Specific sections cover use of the sweep generator for checking and calibrating test equipment, antenna measurements, RF and IF alignment and measurements, special uses in color receiver tests, etc. Over 250 illustrations, waveforms and diagrams. Invaluable for technicians, engineers and students. 148 pages; 5 1/2 x 8 1/2". Only \$2.00



"Servicing Transistor Radios" ... Vol. 2

Complete analysis of 60 popular transistor radio models—helps you become an expert on transistorized radios

You'll save time, you'll earn more on Transistor Radio repairs with this complete data on 60 late models. Based on actual lab analysis of each set. You get the famous Sams Standard Notation schematics; full photo views of each chassis; complete alignment data; full parts replacement information—everything you need to be successful in fast-growing transistorized radio servicing. Includes valuable section on transistor circuits in general, along with useful troubleshooting chart. Here's a "must" for your bench. 160 pages, 8 1/2 x 11". Order now! Only \$2.95



"Television Tube Location Guide" ... Vol. 8

Latest volume in this invaluable series, covering tube location data in TV sets produced in 1957-1958

Only publication of its kind—shows position and function of tubes in each model; just find the trouble and replace defective tubes without removing chassis! Has all these "extras": shows major component placement; signal path; pin orientation on socket; series string filaments; fuse location; includes tube failure check charts; cumulative index from Vol. 4 (1952) on. 196 pages; 5 1/2 x 8 1/2"; comb binding. Only \$2.00

HOWARD W. SAMS & CO., INC.

Order from your Sams Distributor today, or mail to Howard W. Sams & Co., Inc., Dept. 1-M8 2201 E. 46th St., Indianapolis 6, Ind.

- Send me the following books:
- "101 Ways to Use Your Sweep Generator" (TEM-1).
 - "Servicing Transistor Radios," Vol. 2 (TSM-2).
 - "Television Tube Location Guide," Vol. 8 (TGL-8).
- \$..... enclosed. Send Free Book List

Name.....
Address.....
City..... Zone..... State.....
(outside U.S.A. priced slightly higher)

Within the Industry

LINDSEY R. PERRY has been appointed product manager, special purpose tubes and high-fidelity components for CBS-Hytron, electronic manufacturing division of Columbia Broadcasting System, Inc. He was formerly manager, production planning and control, for the entire organization.



Mr. Perry joined the company in 1949. During the development of color TV picture tubes he was assigned to the cathode-ray tube research and development laboratory. He later became production superintendent for the firm's "Colortron" manufacturing operations, and in 1956 was made manager of the TV picture tube plant in Newburyport, Mass.

Mr. Perry is a graduate of MIT.

WEST COAST ELECTRONIC MANUFACTURERS ASSOCIATION (WCEMA) has formed a new council.

The "North-West" Council was formally recognized and consists of firms in the greater Portland and Seattle areas. Serving as officers are: Lawrence R. Rockwood, vice-president of Electro-Measurements, Inc., chairman; Ray Dilling, vice-president of Tally Register Corp., Seattle, vice-chairman; and Bill Webber, vice-president administration, Tektronix, Inc., Portland, vice-chairman. Mr. Rockwood automatically becomes a WCEMA vice-president and director.

Nucleus of this new Council is: Electro-Measurements, Inc.; John Fluke Mfg. Co.; Osborne Electronic Corp.; Tally Register Corp.; Tektronix, Inc.; Iron Fireman-Electronic Div.; and Morrow Radio Mfg. Co. Some fourteen other electronic firms are expected to actively participate.

DONALD H. KUNSMAN has been appointed president of the RCA Service Company, a division of the Radio Corporation of America.



Mr. Kunsman joined the firm in 1949 as an assistant to the president and has held various management positions including treasurer and controller; vice-president, consumer products service department; and vice-president and operations manager. In the last position, which he assumed in July, 1957, he has been responsible for all service and sales functions.

Mr. Kunsman succeeds Edward C. Cahill who headed the firm since its inception in 1943.

ROBERT E. SVOBODA, distributor sales manager of Amphenol Electronics Corp., has been elected first vice-president of the Association of Electronic Parts & Equipment Manufacturers, Inc.

Irving Rossman, president of Pen-tron Corp., has been elected second vice-president of the association.

HENRY B. NELSON, JR., has been appointed manager of trade relations and electronic components distributor development for the General Electric Co.



Since 1952 Mr. Nelson has been district sales manager for tubes and other electronic components sold to distributors in Ohio, West Virginia, and Kentucky.

In his new position he will be responsible for maintaining liaison with more than 300 trade associations and developing new sales training programs and techniques in distributor and dealer operations.

ELECTRONIC INDUSTRIES ASSOCIATION has accepted thirteen additional firms for membership.

The companies are: Aeromutronic Systems, Inc., Glendale, Calif.; Amco Engineering Co., Chicago, Ill.; Columbus Electronics Corp., Semiconductor Div., Yonkers, N. Y.; Continental Illinois National Bank & Trust Co., Chicago, Ill. (associate member); The Martin Co., Baltimore, Md.; Master Mobile Mounts, Inc., Los Angeles, Calif.; Resistron Laboratories, Inc., Santa Monica, Calif.; The Siegler Corp., Los Angeles, Calif.; SNC Manufacturing Co., Inc., Oshkosh, Wis.; Syncro Corp., Electronics Div., Hicksville, Ohio; U. S. Semiconductor Products, Inc., Phoenix, Ariz.; United Transformer Corp., New York, N. Y.; and Wyco Metal Products, North Hollywood, Calif.

THE GABRIEL COMPANY proposes to acquire the TALCO ENGINEERING CORPORATION of Mesa, Arizona. The parent company will take over all of the assets of its subsidiary... COMPUTER EQUIPMENT CORP. is the new name of the company formerly known as DIGITRON, INC. The name change was effected in order to clarify the nature of the business in which the firm is engaged...



There's
no question
about it!

IF IT'S AN RCA TUBE...IT HAS TO BE "HEALTHY"!

RCA specializes in the production of "healthy" tubes. Take the RCA-6AX4-GT, for example. It features important built-in safety factors that minimize internal breakdowns and "arc-over", reducing early-hour failures—while providing reliable performance in TV damper circuits. Here are some of the ways RCA builds this "good health" into the 6AX4-GT:

Heater wire has been specially developed to improve welds, thereby reducing early-hour failures due to an open circuit at the weld point. Heater-spacer assemblies are pre-fired to eliminate leakage-producing contamination during tube production. And micas are specially sprayed to control plate-to-cathode leakage.

These are some of the reasons why many designers and manufacturers of TV sets specify RCA's 6AX4-GT—the very same reasons why you should always ask your RCA Tube Distributor to "Ship RCA Only"!

**RCA Technical
Booklet Available**

RCA Receiving Tubes and Picture Tubes for AM, FM, and Television Broadcast (1275-H) ... includes socket information and useful data for more than 700 tube types. Ask your RCA Tube Distributor for your copy today!



RADIO CORPORATION OF AMERICA

Electron Tube Division

Harrison, N. J.



IMPORTANT NEW BOOKS

FUNDAMENTALS OF TRANSISTORS (2nd edition) by *Leonard M. Krugman, P.E.* This, the second edition, (revised and expanded) modernizes the highly successful and popular first edition, so as to embrace the latest developments in the transistor art. #160, \$3.50.

A-C CIRCUIT ANALYSIS (Electronic Technology Series) edited by *Alexander Schure, Ph.D.* Fundamental concepts of alternating current made completely understandable. Comprehensive mathematical treatment. #166-19, \$1.80.

CONDUCTANCE DESIGN OF ACTIVE CIRCUITS by *Keats A. Pullen, Jr., Eng.D.* The non-linearity of electron tubes and transistors has for many years greatly complicated the design of active circuits associated with these devices. This book presents a proven method of overcoming these complications. It presents the conductance technique as applied to the design of a wide variety of vacuum tube and transistor amplifier, mixer and oscillator circuitry, in the broadest sense. #207, Cloth Bound, \$9.95.

BASIC PULSES by *Irving Gottlieb, P.E.* Pulses are vital in every area of electronics-computer, radar, industrial, television. This "picture-book" course covers the nature, measurement and application of pulses—what they are and how they are used. #216, \$3.50.

VACUUM TUBE CHARACTERISTICS (Electronic Technology Series) edited by *Alexander Schure, Ph.D.* Provides an extremely comprehensive discussion on vacuum tubes, their constants and characteristics making the fundamentals of vacuum tubes fully understandable. #166-22, \$1.80.

HOW TO TROUBLESHOOT A TV RECEIVER (2nd edition) by *J. Richard Johnson.* The second edition of this highly popular book has been expanded and brought up-to-date. Shows how to pinpoint troubles in all types of TV receivers and how to repair them quickly. #152, \$2.50.

METALLIC RECTIFIERS & CRYSTAL DIODES by *Theodore Conti.* Covers background, construction, characteristics and applications of crystal diodes and metallic rectifiers. #213, \$2.95.

FAMOUS 'PICTURE-BOOK' COURSES

Easy, Low Cost Way to the Most Modern Electronic Know-How

BASICS OF DIGITAL COMPUTERS by *John S. Murphy.* #196, 3 vols., soft covers, \$6.95; #196H, Cloth Bound, \$7.95.

BASIC TELEVISION by *Alexander Schure, Ph.D.* #198, 5 vols., soft covers, \$10.00; #198H, Cloth Bound, \$11.50.

BASIC ELECTRICITY by *Van Valkenburgh, Nooger & Neville, Inc.* #169, 5 vols., soft covers, \$10.00; #169H, Cloth Bound, \$11.50.

BASIC ELECTRONICS by *Van Valkenburgh, Nooger & Neville, Inc.* #170, 5 vols., soft covers, \$10.00; #170H, Cloth Bound, \$11.50.

BASIC SYNCHROS & SERVOMECHANISMS by *Van Valkenburgh, Nooger & Neville, Inc.* #180, 2 vols., soft covers, \$5.50; #180H, Cloth, \$6.95.

BASIC ELECTRICAL POWER DISTRIBUTION by *Anthony J. Pansini, P.E.* #187, 2 vols., soft cover, \$4.80 per set.

WHICH OF THESE RIDER TITLES WILL HELP YOU KNOW MORE... EARN MORE IN 1959?

FOR MORE HOBBY FUN, CAREER ADVANCEMENT

TELEVISION—HOW IT WORKS (2nd edition) by *J. Richard Johnson.* #101, Marco, \$4.60; #101H, Cloth Bound, \$5.50.

BASIC VACUUM TUBES AND THEIR USES by *Rider & Jacobowitz.* #171, soft cover, \$3.00; #171H, Cloth Bound, \$4.50.

REPAIRING TELEVISION RECEIVERS by *Cyrus Glickstein.* #191, \$4.40.

BASICS OF PHOTOTUBES & PHOTOCELLS by *David Mark.* #184, \$2.90.

INTRODUCTION TO PRINTED CIRCUITS by *Robt. L. Swiggert.* #185, \$2.70.

INDUSTRIAL CONTROL CIRCUITS by *Sidney Platt.* #202, \$3.90.

RADIO OPERATOR'S LICENSE Q & A MANUAL (6th edition) by *Milton Kaufman.* #130, Cloth Bound, \$6.60.

OBTAINING & INTERPRETING TEST SCOPE TRACES by *John F. Rider.* #146, \$2.10.

GETTING STARTED IN AMATEUR RADIO by *Julius Berens, W2PIK.* #199, \$2.40.

HOW TO READ SCHEMATIC DIAGRAMS by *David Mark.* #208, \$3.50.

MARINE RADIOTELEPHONE PERMIT Q & A MANUAL—Third Class Operator by *Milton Kaufman.* #206, \$1.35.

ELECTRONICS TECHNOLOGY SERIES
#166-RC & RL Time Constant, \$.90, #166-2-FM Limiters & Detectors, \$.90, #166-3-Frequency Modulation, \$.90, #166-4-Crystal Oscillators, \$1.25, #166-5-A-M Detectors, \$1.25, #166-6-Limiters & Clippers, \$1.25, #166-7-Multivibrators, \$.90, #166-8-R-F Transmission Lines, \$1.25, #166-9-Amplitude Modulation, \$1.25, #166-10-Blocking Oscillators, \$1.25, #166-11-Wave Propagation, \$1.25, #166-12-Super-heterodyne Converters & I-F Amplifiers, \$.90, #166-13-L-C Oscillators, \$1.25, #166-14-Antennas, \$1.50, #166-15-Inverse Feedback, \$.90, #166-16-Resonant Circuits, \$1.25, #166-17-Electrostatics, \$1.35, #166-18-D-C Circuit Analysis, \$1.35, #166-21-Vacuum Tube Rectifiers, \$1.50, #166-23- Impedance Matching, \$2.90, #166-24-Gas Tubes, \$1.50.

GET THE MOST OUT OF YOUR HI-FI EQUIPMENT

STEREOPHONIC SOUND by *Norman H. Crowhurst.* #209, \$2.25.

HIGH FIDELITY SIMPLIFIED (3rd edition) by *Harold D. Weiler.* #142, \$2.50.

HI-FI LOUSPEAKERS & ENCLOSURES by *Abraham B. Cohen.* #176, Marco, \$4.60; #176H, Cloth Bound, \$5.50.

FOR BETTER AND MORE

PORTABLE & CLOCK RADIOS by *Ben Crisses & David Gnessin.* #224, \$2.75.

HOME AIR CONDITIONING—Installation & Repair by *J. Derman, F. Makstein, H. Seaman.* #211, \$3.50.

ADVANCED TV SERVICING TECHNIQUES by *Zhar & Schildkraut.* #161, \$3.60. **LABORATORY WORKBOOK.** #161-2, \$.95.

HOW TO INSTALL & SERVICE INTERCOMMUNICATION SYSTEMS by *Jack Darr.* #189, \$3.00.

REPAIRING HI-FI SYSTEMS

REPAIRING HI-FI SYSTEMS by *David Fidelman.* #205, \$3.90.

GUIDE TO AUDIO REPRODUCTION by *David Fidelman.* #148, \$3.50.

HOW TO SELECT & USE YOUR TAPE RECORDER by *David Mark.* #179, \$2.95.

PROFITABLE SERVICING

HOW TO SERVICE TAPE RECORDERS by *C. A. Tathill.* #167, \$2.90.

TV PICTURE TUBE-CHASSIS GUIDE by *Rider Lab Staff.* #204, \$1.35.

TV TUBE LOCATION & TROUBLE GUIDE (RCA) by *Rider Lab Staff.* #194, \$1.25.

SERVICING TV AFC SYSTEMS by *John Russell Jr.* #192, \$2.70.

SERVICING TV VERTICAL & HORIZONTAL OUTPUT SYSTEMS by *Harry Thomas.* #150, \$2.40.

VALUABLE AIDS FOR ENGINEERS, ADVANCED TECHNICIANS

TRANSISTOR ENGINEERING REFERENCE HANDBOOK by *H. E. Marrows.* #193, Cloth Bound, \$9.95.

CONDUCTANCE CURVE DESIGN MANUAL by *Keats A. Pullen Jr., Eng.D.* #210, Still Cover Spiral Bound, \$4.25.

PHYSICS & MATHEMATICS IN ELECTRICAL COMMUNICATION by *James Owen Perrine, Ph.D.* #219, Cloth Bound, \$7.50.

Look for these books at your jobber or bookstore. If not available order direct. RTN-12

JOHN F. RIDER PUBLISHER, INC. 116 W. 14th St., N. Y. 11, N. Y.

Canada: **CHARLES W. POINTON, LTD.**, 6 Alcina Avenue, Toronto, Ontario

Note: All books soft cover except where noted.

BECKMAN INSTRUMENTS, INC. announces formation of the **SHOCKLEY TRANSISTOR CORPORATION** as a subsidiary company to expand development and manufacture of specialized semiconductor components for electronic instruments, communications equipment, and control systems.

"THE REPRESENTATIVES" of Electronic Products Manufacturers, Inc. will have an expanded role in the 1959 Electronic Parts Distributors Show to be held next May in Chicago.

The president of the organization will be asked to appoint from the membership a special advisory committee for the Show. This committee will work with the Show Corporation's board of directors, show management, and Show Corporation committees on all 1959 Parts Show activities.

Eligibility for "Rep" badges will be extended to all individuals whose companies are members of this group.

Also, special badges will be issued to registrants whose companies belong to "The Representatives." These badges will carry a special insignia.

CHARLES L. McCABE has been named manufacturers' sales manager of *Shure Brothers, Inc.*, Evanston, Illinois.



Mr. McCabe joined the organization five years ago. His most recent position was staff assistant to the vice-president in charge of sales.

In his new capacity Mr. McCabe will be in charge of sales to original equipment manufacturers in the electronics field.

JOHN M. LESLIE, JR. has been named general manager of *ORRadio Industries, Inc.* . . . **WALTER F. GREENWOOD** has been appointed manager of marketing for *General Electric's* receiving tube department . . . Two new managers have been named to *Raytheon Manufacturing Company's* receiving tube division. They are: **JOSEPH J. GRABIEC**, marketing manager; and **GEORGE LOOMIS**, manufacturing manager . . . The *RCA* semiconductor and materials division has appointed **ERWIN B. MAY** as manager of promotion . . . **DAVID PETRIG** is now chief engineer of the manufacturing division of *ORRadio Industries, Inc.* . . . The appointments of **DONALD F. WENTZLER** as director of planning and organization and **EDWARD J. FELESINA** as director of public relations and advertising at *ITT Laboratories* has been made known. The firm is a division of the *International Telephone and Telegraph Corp.* . . . *Michigan Magnetics, Inc.* announces the appointments of **GORDON E. PARKER** as production manager for the Vermontville, Michigan plant and **JACK L. METZ** as chief research engineer . . . **WILLIAM BROWN** is now manager of sales for *Magnetic Research Corp.* . . . *Admiral Corp.* has appointed **WILLIS L. WOOD** as national (Continued on page 114)

SYLVANIA TV

has always stood
behind the
independent,
service man!

Recently, a spokesman for the Federation of Radio-Television Service Associations of Pennsylvania cited SYLVANIA TV as one of two TV manufacturers whose policies "have been favorable to the independent service industry."

In 1956—Robert L. Shaw, General Marketing Manager, SYLVANIA TV Division said:

"We have never expressed an intention of going into factory service at the local level and it is not our intention to do so. We feel that the local factory service is justified only when distributors, dealers and independent servicemen fail to meet the demands of the public. We see *no evidence* of such failure and have no intention of entering the factory service field."

Released for publication Dec. 5, 1956.

SYLVANIA has never felt the need to change this long established policy. SYLVANIA will continue to rely on independent distributors, dealers and accredited independent servicemen for post-factory service.



**Recommend SYLVANIA TV—
the line that supports the independent serviceman**

THIS IS IT!



a **NEW** stereo speaker system that combines...

- Unprecedented compactness - only 30" wide, 25" high, 12½" deep
- A third dimension to stereo sound ... DEPTH
- Placement anywhere in a room
- Use for both monophonic and stereophonic reproduction
- Uncompromised quality at an attractive price

"Now, I must tell you, I have heard a speaker system that approaches the authenticity of concert hall performance."

MISCHA ELMAN

Now celebrating the 50th anniversary of his American debut, acclaimed throughout the world for his supreme virtuosity... internationally celebrated violinist Mischa Elman is an artist whose preference for concert hall performance over recorded music is a matter of public record. His enthusiasm after hearing the TMS-2 in his home is shared by many other leading artists, musical authorities and audio experts who also subjected the TMS-2 to critical listening tests under at-home conditions.



PATENT APPLIED FOR



The TMS-2 with deflector doors opened for full stereo reproduction.

Here the TMS-2 is shown with deflector doors closed for monophonic use.

University's NEW 'trimensional' stereo speaker TMS-2

Here is the most significant loudspeaker achievement since the advent of popular stereo... a University development which, at last, actually eliminates all the problems of placement, space limitations, decor and cost... but most important of all, produces a new kind of stereo sound... the authenticity of concert hall depth.

COMPACT By utilizing the exclusive dual voice coil feature of the C-12HC woofer, only one bass enclosure and woofer are required to handle the entire low frequency range of both stereo channels. Extended, undistorted bass is superbly reproduced by making use of the RRL enclosure design so successfully employed in University's Ultra Linear Response systems. See fig. 1.

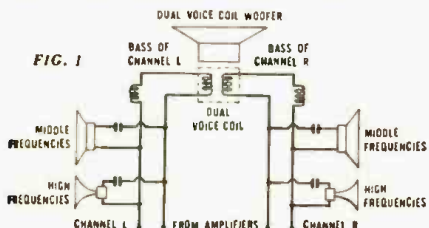

REALISTIC STEREO The breadth, depth and clarity of stereophonic sound is accomplished by utilizing the walls of a room, just as the symphony orchestra uses the acoustical properties of the concert hall. The woofer sound emanates at

the rear of the enclosure; one mid-range and one high frequency speaker for each channel project sound from each side of the cabinet. By thus deflecting all frequencies, in proper relationship, to the rear and side walls of the room, multiple stereo sound sources are created that not only provide the otherwise missing dimension of depth, but also preserve the stereo effect virtually throughout the room. See fig. 2.

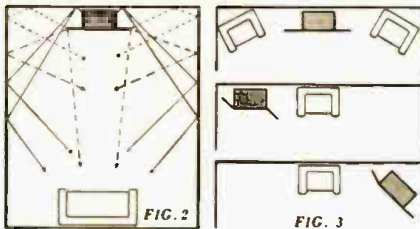

USE ANYWHERE The unique design of the TMS-2 provides you with two distinct advantages: place it in a corner or anywhere along a wall, by merely positioning the deflectors as shown in fig. 3, and since there are no particularly critical listening positions, you, your family, your friends—any number of listeners—can enjoy the TMS-2 from most anywhere in the room.

MONOPHONIC OR STEREOPHONIC With deflectors closed, the TMS-2 is an outstanding, wide-range monophonic speaker system. "Presence" and "brilliance" controls are provided for both sets of mid and high frequency speakers. In addition to being used for balancing the system to

room acoustics and personal taste, these controls and the deflectors may be adjusted to produce a pseudo-stereo effect with monophonic program material as well. Whether you start your high fidelity system with monophonic equipment, or go right into stereo, the TMS-2 is the best investment you can make... it is equally "at home" with any kind of program material, and no further additions to the speaker system are ever required.

DESIGNED RIGHT-PRICED RIGHT Flawlessly designed along simple, classical lines, beautifully proportioned to compliment the most exacting taste, the TMS-2 will enhance any decor. In fact, it looks more like a piece of fine furniture than a typical speaker cabinet. Breathtaking in its performance... beyond the scope of conventional monophonic or stereophonic reproduction, the engineering concept of the TMS-2 eliminates redundant components; makes use of the latest, most advanced acoustic principles. RESULT: the ultimate in uncompromised value. In Mahogany—\$258, Blonde or Walnut—\$263, User Net.

See and hear the TMS-2 at your dealer... NOW! You too, will agree with musical and audio experts that it marks one of the most extraordinary advances in high fidelity and stereo history!



UNIVERSITY LOUSPEAKERS, INC., WHITE PLAINS, N.Y.

RADIO & TV NEWS

STEREO STEREO AND MONAURAL

the
experts
say...
in HI-FI
the best buys are

EICO®

World-famous
EICO advantages
guarantee your complete satisfaction:

- Advanced engineering • Finest quality components
- "Beginner-Tested," easy step-by-step instructions
- LIFETIME service & calibration guarantee
- IN STOCK — Compare, then take home any EICO equipment—right "off the shelf"—from 1900 neighborhood EICO dealers.



Stereo Preamplifier HF85



FM Tuner HFT90



Stereo
Amplifier-Preamp
HF81



Monaural Integrated Amplifiers:
50, 30, 20, and 12-watt
(use 2 for Stereo)



Bookshelf
Speaker System
HFS1



Speaker System HFS2
36" H x 15 1/4" W x 11 1/2" D

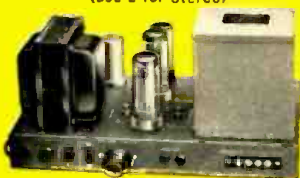

Monaural Power Amplifiers:
60, 50, 35, 30, 22 and 14-Watt
(use 2 for Stereo)



Monaural Preamplifiers:
HF65, HF61
(stack 2 for Stereo)



Over 1 MILLION EICO instruments in use throughout the world.

NEW STEREOPHONIC EQUIPMENT

HF85: Stereo Dual Preamplifier is a complete stereo control system in "low silhouette" design adaptable to any type of installation. Selects, preamplifies, controls any stereo source—tape, discs, broadcasts. Superb-variable crossover, feedback tone controls driven by feedback amplifier pairs in each channel. Distortion borders on unmeasurable even at high output levels. Separate lo-level input in each channel for mag. phono, tape head, mike. Separate hi-level inputs for AM & FM tuners & FM Multiplex. One each auxiliary A & B input in each channel. Independent level, bass & treble controls in each channel may be operated together with built-in clutch. Switched-in loudness compensator. Function Selector permits hearing each stereo channel individually, and reversing them; also use of unit for stereo or monophonic play. Full-wave rectifier tube power supply. 5-12AX7/ECC83, 1-6X4. Works with any 2 high-quality power amplifiers such as EICO, HF14, HF22, HF30, HF35, HF50, HF60. Kit \$39.95. Wired \$64.95. Includes cover.

HF81: Stereo Dual Amplifier-Preamplifier selects, amplifies & controls any stereo source—tape, discs, broadcasts—and feeds it thru self-contained dual 14W amplifiers to a pair of speakers. Monophonically: 28 watts for your speakers; complete stereo preamp. Ganged level controls, separate focus (balance) control, independent full-range bass & treble controls for each channel. Identical Williamson-type, push-pull EL84 power amplifiers, excellent output transformers. "Service Selector" switch permits one preamp-control section to drive the internal power amplifiers while other preamp-control section is left free to drive your existing external amplifier. Kit \$69.95. Wired \$109.95. Incl. cover.

MONAURAL PREAMPLIFIERS (stack 2 for Stereo)
NEW HF65: superb new design, inputs for tape head, microphone, mag-phono cartridge & hi-level sources. IM distortion 0.04% @ 2V out. Attractive "low silhouette" design. HF65A Kit \$79.95, Wired \$44.95. HF65 (with power supply) Kit \$33.95. Wired \$49.95.

HF61: "Rivals the most expensive preamps" — Marshall, AUDIOCRAFT. HF61A Kit \$24.95, Wired \$37.95, HF61 (with power supply) Kit \$29.95. Wired \$44.95.

MONAURAL POWER AMPLIFIERS (use 2 for STEREO)

HF60: 60-Watt Ultra Linear Power Amplifier with Acro T0-330 Output Xfmr. "One of the best-performing amplifiers extant; an excellent buy." AUDIOCRAFT Kit Report. Kit \$72.95. Wired \$99.95. Cover E-2 \$4.50.

HF50: 50-Watt Ultra Linear Power Amplifier with extremely high quality Chicago Standard Output Transformer. Identical in every other respect to HF60, same specs at 50W. Kit \$57.95. Wired \$87.95. Cover E-2 \$4.50.

NEW HF35: 35-Watt Ultra-Linear Power Amplifier. Kit \$47.95. Wired \$72.95. Cover E-2 \$4.50.

HF30: 30-Watt Power Amplifier. Kit \$39.95. Wired \$62.95. Cover E-3 \$3.95.

NEW HF22: 22-Watt Power Amplifier. Kit \$38.95. Wired \$61.95. Cover E-2 \$4.50.

NEW HF14: 14-Watt Power Amplifier. Kit \$23.50. Wired \$41.50. Cover E-6 \$4.50.

MONAURAL INTEGRATED AMPLIFIERS (use 2 for STEREO)

HF52: 50-Watt Integrated Amplifier with complete "front end" facilities & Chicago Standard Output Transformer. "Excellent value!"—Hirsch-Houck Labs. Kit \$69.95. Wired \$109.95. Cover E-1 \$4.50.

HF32: 30-Watt Integrated Amplifier. Kit \$57.95. Wired \$89.95. Both include cover.

HF20: 20-Watt Integrated Amplifier. "Well-engineered" — Stockin, RADIO TV NEWS. Kit \$49.95. Wired \$79.95. Cover E-1 \$4.50.

HF12: 12-Watt Integrated Amplifier. "Packs a wallop!"—POP ELECTRONICS. Kit \$34.95, wired \$57.95.

SPEAKER SYSTEMS (use 2 for STEREO)

HFS2: Natural bass 30-200 cps via slot-loaded 12-ft. split conical bass horn. Middles & lower highs: front radiation from 8 1/2" edge-damped cone. Distortionless spike-shaped super-tweeter radiates omni-directionally. Flat 45-20,000 cps, useful 30-40,000 cps. 16 ohms. HWD 36", 15 1/4", 11 1/2". "Eminently musical; would suggest unusual suitability for stereo."—Holt, HIGH FIDELITY. Completely factory-built: Walnut or Mahogany. \$139.95; Blonde, \$144.95.

HFS1: Bookshelf Speaker System, complete with factory-built cabinet. Jensen 8" woofer, matching Jensen compression-driver exponential horn tweeter. Smooth clean bass; crisp extended highs. 70-12,000 cps range. Capacity 25 w. 8 ohms. HWD: 11" x 23" x 9". Wiring time 15 min. Price \$39.95.

FM TUNER

HFT90: surpasses wired tuners up to 3X its cost. Pre-wired, pre-aligned, temperature-compensated "front end" — drift-free. Precision "eye-tronic" tuning. Sensitivity 1.5 uv for 20 db quieting — 6X that of other kit tuners. Response 20-20,000 cps ± 1 db. X-follower & multiplex outputs. "One of the best buys you can get in high fidelity kits." — AUDIOCRAFT KIT REPORT. Kit \$39.95*. Wired \$65.95*. Cover \$3.95.

BEFORE YOU BUY, COMPARE:

You may examine the complete EICO line at any of 1900 neighborhood EICO distributors coast to coast. Compare critically with equipment several times the EICO cost—then you judge. You'll see why the experts recommend EICO, kit or wired, as your best buy.

EICO, 33-00 NORTHERN BLVD., L. I. C. 1, N. Y.
Fill out coupon on other side for FREE CATALOG

Copyright 1958 by Electronic Instr. Co., Inc. 33-00 N. Blvd., L. I. C. 1, N. Y.

Add 5% in the West.

* LES COVER, P. E. T., INC.

the specs prove it . . .
your **BEST BUY** is

TEICO®

for COLOR & Monochrome TV servicing

FREE CATALOG

shows you **HOW TO SAVE 50%**
on 50 models of top quality
professional test equipment.
MAIL COUPON NOW!

NEW!
TV-FM SWEEP
GENERATOR &
MARKER #368

KIT \$69⁹⁵ WIRED \$119⁹⁵

Entirely electronic sweep circuit (no mechanical devices) with accurately-biased inductor for excellent linearity. Extremely flat RF output: new AGC circuit automatically adjusts osc. for max. output on each band with min. amp. variations. Exceptional tuning accuracy: edge-lit hairlines eliminate parallax. Sweep Use. Range 3-216 mc in 5 fund. bands. Variable Marker Range 2-75 mc in 3 fund. bands; 60-225 mc on harmonic band. 4.5 mc Xtal Marker Osc., xtal supplied. Ext. Marker provision. Sweep Width 0.3 mc lowest max. deviation to 0-30 mc highest max. dev. 2-way blanking. Narrow range phasing. Attenuators: Marker Size, RF Fine, RF Coarse (4-step decade). Cables: output, scope horiz., scope vertical. Deep-etched satin aluminum panel; rugged grey wrinkle steel cabinet.

**NEW! RF
SIGNAL GENERATOR
#324**

KIT \$26⁹⁵ WIRED \$39⁹⁵



150 kc to 435 mc with ONE generator! Better value than generators selling at 2 or 3 times its cost! Ideal for IF-RF alignment, signal tracing & trouble-shooting of TV, FM, AM sets; marker gen.; 400 cps audio testing; lab. work. 6 fund. ranges: 150-400 kc, 400-1200 kc, 1.2-3.5 mc, 3.5-11 mc, 11-37 mc, 37-145 mc; 1 harmonic band 111-435 mc. Freq. accurate to $\pm 1.5\%$; 6:1 vernier tuning & excellent spread at most important alignment freqs. Etched tuning dial, plexiglass windows, edge-lit hairlines. Colpitts RF osc. directly plate modulated by K-follower for improved mod. Variable depth of int. mod. 0-50% by 400 cps Colpitts osc. Variable gain ext. amplifier: only 3.0 v needed for 30% mod. Turret-mounted coils slug-tuned for max. accuracy. Fine & Coarse (3-step) RF attenuators. RF output 100,000 uv; AF sine wave output to 10 v, 50-ohm output Z; 5-way jack-top binding posts for AF in/out; coaxial connector & shielded cable for RF out. 12AU7, 12AV7, selenium rectifier; xfmr-operated. Deep-etched satin aluminum panel; rugged grey wrinkle steel cabinet.

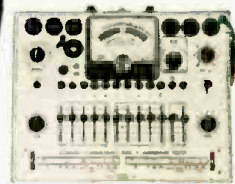

**NEW! DYNAMIC
CONDUCTANCE
TUBE & TRANSISTOR
TESTER #666**
KIT \$69⁹⁵ WIRED \$109⁹⁵

COMPLETE with steel cover and handle.

SPEED, ease, unexcelled accuracy & thoroughness. Tests all receiving tubes (and picture tubes with adapter). Composite indication of Gm, Gp & peak emission. Simultaneous set of any 1 of 4 combinations of 3 plate voltages, 3 screen voltages, 3 ranges of continuously variable grid voltage (with 5% accurate pot). New series-string voltages: for 600, 450, 300 ma types. Sensitive 200 ua meter. 5 ranges meter sensitivity (1% shunts & 5% pot). 10 SIX-position lever switches: freepoint connection of each tube pin. 10 pushbuttons: rapid insert of any tube element in leakage test circuit & speedy sel. of individual sections of multi-section tubes in merit tests. Direct-reading of inter-element leakage in ohms. New gear-driven rollechart. Checks n-p-n & p-n-p transistors: separate meter readings of collector leakage current & beta using internal dc power supply. Deep-etched satin aluminum panel; rugged grey wrinkle steel cabinet. CRA Adapter \$4.50

COLOR

and Monochrome
DC to 5 MC LAB & TV
5" OSCILLOSCOPE

#460
KIT \$79⁹⁵ WIRED \$129⁵⁰

• Features DC Amplifiers!

Flat from DC-4.5 mc, usable to 10 mc. **VERT. AMP'L.:** sens. 25 rms mv/in; input Z 3 megs; direct-coupled & push-pull thruout; K-follower coupling bet. stages; 4-step freq-compensated attenuator up to 1000:1. **SWEEP:** perfectly linear 10 cps-100 kc (ext. cap. for range to 1 cps); preset TV V & H positions; auto. sync. ampl. & lim. **PLUS:** direct or cap. coupling; bal. or unbal. inputs; edge-lit engraved lucite screen; dimmer; filter; bezel fits sid photo equip. High intensity trace CRT. 0.06 usec rise time. Push-pull hor. ampl., flat to 400 kc, sens. 0.6 rms mv/in. Built-in volt. calib. Z-axis mod. Sawtooth & 60 cps outputs. Astig. control. Retrace blanking. Phasing control. 5" PUSH-PULL Oscilloscope -425: KIT \$44.95, Wired \$79.95. 7" PUSH-PULL Oscilloscope -470: KIT \$79.95, Wired \$129.50.

**NEW! PEAK-to-PEAK
VTVM #232 & UNI-
PROBE (pat. pend.)**

KIT \$29⁹⁵ WIRED \$49⁹⁵



Half-turn of probe tip selects DC or AC-Ohms.

Uni-Probe - exclusive with EICO - only 1 probe performs all functions!

Latest circuitry, high sensitivity & precision, wide ranges & versatility. Calibration without removing from cabinet. New balanced bridge circuit. High Z input for negligible loading. 4 1/2" meter, can't burn-out circuit. 7 non-skip ranges on every function. 4 functions: +DC Volts, -DC Volts, AC Volts, Ohms. Uniform 3 to 1 scale ratio for extreme wide-range accuracy. Zero center. One zero-adj. for all functions & ranges. 1% precision ceramic multiplier resistors. Measure directly peak-to-peak voltage of complex & sine waves: 0.4, 14, 42, 140, 420, 1400, 4200. DC/RMS sine volts: 0-1.5, 5, 15, 50, 150, 500, 1500 (up to 30,000 v with HVP probe & 250 mc with PRF probe). Ohms: 0.2 ohms to 1000 megs. 12AU7, 6AL5, selenium rectifier; xfmr-operated. Deep-etched satin aluminum panel, rugged grey wrinkle steel cabinet.



New!
Series/Parallel
R-C COMBINATION
BOX #1140
KIT \$13.95
WIRED \$19.95



**TUBE TESTER
#625**
KIT \$34.95
Wired \$49.95
• tests 600
mil series
string type
tubes
• illuminated
roll-chart

Pix Tube Test Adapter \$4.50



**6V & 12V BATTERY
ELIMINATOR
& CHARGER #1050**
KIT \$29.95
WIRED \$38.95
Extra-filtered for
transistor equip.
-1060 KIT \$38.95
WIRED \$47.95



New!
Miniaturized
MULTI-SIGNAL
TRACER #145A
KIT \$19.95
WIRED \$28.95



**20,000 Ohms/Volt
V-O-M #565**
KIT \$24.95
Wired \$29.95

**1000 Ohms/Volt
V-O-M #536**
KIT \$12.90
Wired \$14.90



Reads 0.5 ohms
-500 megs, 10
mmfd-5000 mfd,
power factor.

KIT
\$19.95
Wired
\$29.95

**R-C BRIDGE & R-C-L COMPARATOR
#950B**



VTVM PROBES	KIT	Wired
Peak-to-Peak	\$4.95	\$6.95
RF	\$3.75	\$4.95
High Voltage Probe-1		\$6.95
High Voltage Probe-2		\$4.95

SCOPE PROBES	KIT	Wired
Demodulator	\$3.75	\$5.75
Direct	\$2.75	\$3.95
Low Capacity	\$3.75	\$5.75

SEE OUR ALMO'S "HAM" ADVERTISEMENT ON PAGE 142

TURN PAGE
FOR MORE
EICO VALUES

TEICO®

Send for
FREE CATALOG
now

Prices 5% higher on West Coast.

L.I.C. 1, N.Y.

EICO, 33-00 Northern Blvd., R-12
L.I.C. 1, N.Y.
Show me **HOW TO SAVE 50%** on Test Instruments Hi-Fi Ham Gear. Send me **FREE** Catalog, name of neighborhood dealer.
Name.....
Address.....
City..... Zone..... State.....

The Silicon Solar Battery

By
HAROLD S. RENNÉ

NOW that "Vanguard I" is traveling merrily around in its orbit, with its solar-battery-powered radio transmitter, interest in solar batteries has risen to a new high. There is a chance that this transmitter and the solar batteries will continue to operate as long as the satellite remains aloft—which has been variously estimated at up to 200 years or possibly longer.

The silicon solar battery was announced by *Bell Telephone Laboratories* in April, 1954 and since then has become widely known as the *Bell Solar Battery*. It was employed to power a rural carrier-telephone system in Americus, Georgia for a period of time and carried out this task with flying colors. However, because of its cost, it was not considered competitive with other more conventional sources of power. Now, however, cells are being manufactured by *Hoffman Electronics Corp.*'s Semiconductor Division and by *International Rectifier Corp.* at prices which make them highly attractive for experimental purposes and perhaps even for some commercial applications.

Available Power

How much power can be obtained from a solar battery? The answer to this question depends primarily on two factors—the intensity of the radiation striking the cell and the efficiency of the cell. It has been established that the energy falling on one square meter of the earth's surface in Phoenix, Arizona at high noon is approximately 1000 watts—truly an appreciable amount of power, if all of it could be harnessed.

Looking at it in another way, the energy reaching the outer atmosphere of the earth amounts to about 3.5 billion watts per square mile. The cross-sectional area of the earth is about 50 million square miles, so the total radiation reaching the earth is the fantastic figure of 1.8×10^{17} watts! This figure can be appreciated a little better if we realize that in 40 hours the sun provides us with as much energy as is available in our total oil and gas reserves. Even allowing for atmospheric absorption, energy equivalent to total annual world requirements falls on only 12,000 square miles of land area in Arizona!

The first silicon solar cells built at



This solar battery is used to supply power to terminal equipment on rural phone lines.

*Will our future electricity all come from the sun?
Here's a way of tapping a small bit of sun power.*

Bell Laboratories had an efficiency of about 6% or less. However, this figure has now been nearly doubled and com-

Editor's Note: The silicon solar battery described in this article is not to be confused with the selenium photovoltaic cell which has been in use for a number of years. The selenium cell, although much less expensive than the silicon type, has an efficiency of roughly one-tenth of the silicon cell. Manufacturers of the selenium cell include the General Electric Co. and the International Rectifier Corp.

Silicon solar cells, mounted in the temple bar of the new Zenith eyeglass hearing aid, are shown here producing an output voltage as a flashlight illuminates them. The cells are used to recharge the tiny nickel-cadmium storage battery that powers the 4-transistor hearing-aid circuit.



mercially available cells have efficiencies as high as 11% or more. Still higher efficiencies will undoubtedly be obtained as research continues. Thus, with one square meter of surface exposed, a solar battery could produce up to 110 watts of power.

How Does It Work?

How does the silicon solar cell work? To understand its operation, we will review briefly some information about solid-state physics and about *p-n* junctions, as the cell consists primarily of a silicon *p-n* junction.

First let's discuss what is meant by *p*-type and *n*-type silicon. The two types are the same as those employed in silicon transistors—*p*-type means an excess of holes whereas *n*-type refers to an excess of electrons. The two types are obtained by "doping" the silicon, that is, by adding very small, controlled amounts of certain impurities.

A *p-n* junction is just what its name signifies—a junction between *p*-type and *n*-type silicon. Later we will describe how this junction can be formed. Fig. 1 indicates the electrical conditions at a *p-n* junction. An electrical barrier is built up so that the free electrons from the *n* region and the



The power needed to transmit a telephone conversation can now be obtained directly from the sun. In this indoor demonstration, Gerald L. Pearson, one of the co-inventors of the Bell Solar Battery, holds the device under artificial light. Battery shown can achieve efficiency comparable to gasoline engine.

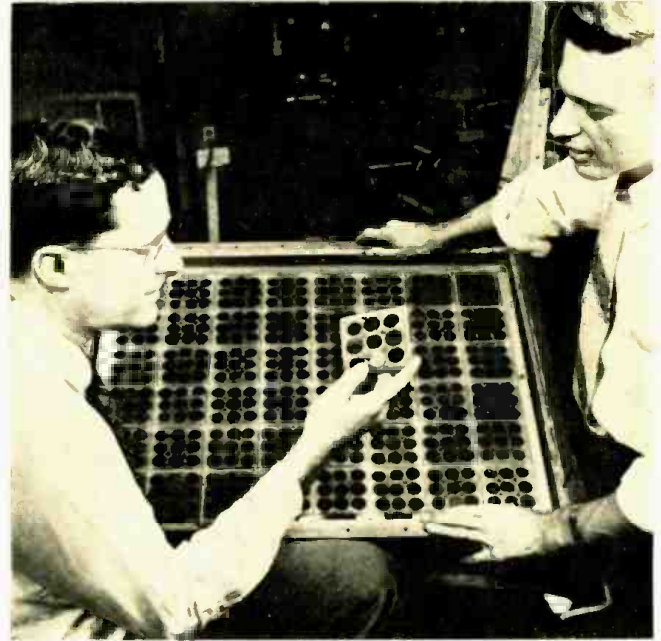

The solar battery is shown here being assembled. The device uses discs of water-thin silicon about the size of quarters. Small modules like that in the center are electrically linked together to form the larger 432-cell solar battery. The discs can deliver power at the rate of 100 watts per square yard.

free holes from the *p* region cannot intermix. This electrical barrier, or field, forms the heart of the *p-n* junction. When light strikes this region, some of its energy is utilized to eject an electron from a silicon atom, thus forming a hole-electron pair. The built-in field serves to separate these charges before they can recombine. When such a situation occurs, a potential will develop across the junction

and current will flow in an external circuit.

A solar cell consists of a very thin slice of silicon (about 1/25 of an inch thick) cut from a single crystal of *n*-type material, silicon which has been doped with a tiny amount of an impurity such as arsenic. The amount of arsenic required is very minute—perhaps one part in a million. To form the *p*-type material, a small amount

of boron or similar impurity is diffused into the surface of this wafer to a depth of about one ten-thousandth of an inch. To carry out this diffusion process, the silicon wafers are heated to about 1200° C in an atmosphere containing boron or a boron compound. The depth to which the boron will diffuse is accurately controllable and is determined by the temperature and the length of time the wafers are exposed.

Following the diffusion process, leads are attached—one to the *n*-layer and one to the *p*-layer. A new process called "thermoccompression bonding," recently developed at Bell Labs, is ideal for making such attachments. Other techniques such as soldering and plating can also be employed, but to obtain a good, reliable, low-resistance bond requires a considerable amount of skill and experience. Fig. 2 shows the general construction of a typical cell.

Fig. 1. How the solar battery works. (A) Light is absorbed in a silicon crystal by liberating free-to-move negative charges, or electrons—and free-to-move positive charges, called holes. (B) An electric field exerts a force on charge particles causing them to move if they are free. The force moves holes in one direction and electrons in the opposite direction. (C) In a thin barrier at the junction between an electron-rich "*n*"-region and a hole-rich "*p*"-region in a silicon crystal, a strong built-in electric field exists which keeps the electrons in the "*n*" side and holes in the "*p*" side. (D) When light is absorbed liberating electrons and holes in the barrier region at "*p-n*" junction, the built-in field forces the holes into the "*p*" side, making it positive, and the electrons into the "*n*" side, making it negative. This displacement of the newly freed charges causes a voltage to appear between the ends of the crystal, a voltage that is a source of electric power. Hence, light is converted into electricity. (Courtesy: Bell Telephone Lab.)

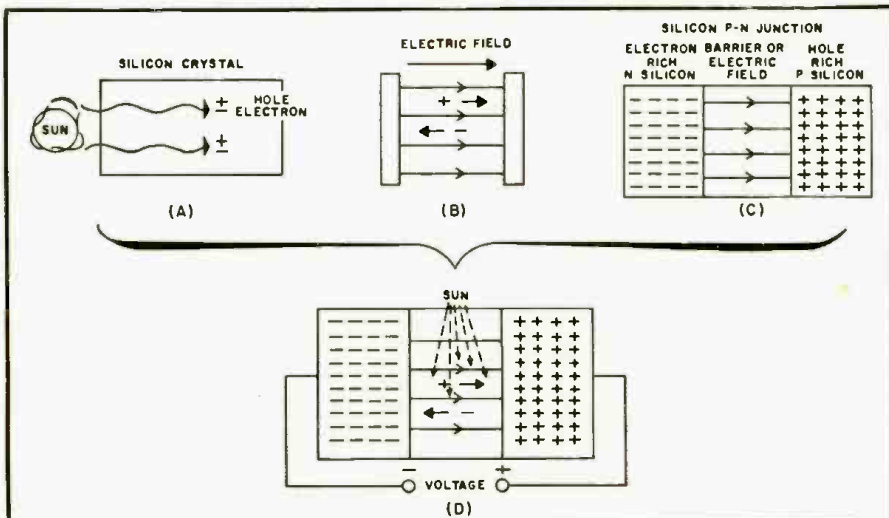

Operation

A solar cell in full sunlight will generate an open-circuit voltage of about 0.6 volt. For a cell having an active area of one square inch, a short-circuit current of well over one hundred milliamperes may be produced. Typical characteristics are shown in Fig. 3. By connecting a number of cells in various series-parallel combinations, practically any desired voltage or current can be obtained for any required specific application.

For the Americus, Ga. trial carried out by Bell Laboratories a total of 432 cells was employed, made up of 48 9-cell modules. This combination provided an output of about one-half ampere at 22 volts in full sunlight, which was used to charge a nickel-cadmium

storage battery. The battery, in turn, powered the transistorized carrier-telephone equipment.

In an application of this kind, it is necessary to provide some means to prevent the storage battery from discharging through the solar battery during periods of darkness. This is accomplished by connecting a diode in series, so arranged that it has very low resistance when the battery is charging and a very high resistance when it is attempting to discharge through the solar battery. A typical circuit is shown in Fig. 4. If no storage battery is used, the solar battery would be connected directly to the load just like a regular battery. In this case, of course, no current would flow through the load when the cells were not illuminated.

Applications

Most applications of the solar battery to date have been of an experimental nature. For example, *Admiral* built a solar-battery-operated radio which would play in full sunlight without any other source of power. Expense was the principal deterrent to widespread consumer acceptance of this unit. Recently *Hoffman* developed and is marketing a portable which uses a silicon pack of its own manufacture. Also, the Signal Corps has experimented with a portable transmitter powered by a solar battery mounted on the soldier's helmet. All this equipment is, of course, transistorized for low power drain.

A small, transistorized audio oscillator has been made at *Bell Labs* which produces audible oscillations even when illuminated by a relatively dim light. This brings up an interesting point—the solar battery will operate under artificial light, the actual output again depending on the intensity of illumination.

Animated displays are another possible application of solar batteries. *Hoffman Electronics* has built a model of a 4-motor airplane in which the propellers are driven by electric motors which obtain their power from solar batteries. Various other types of window displays are possible and it is likely that such applications will become fairly widespread.

The silicon solar cell is, of course, a photovoltaic cell and as such can be used in exposure meters and the like. Because of its high efficiency, such meters can be made with higher sensitivity and with more rugged meter movements than is possible with previously available cells. Also, it can be adapted to many industrial counting and sorting operations where sensitivity to variations in light intensity is necessary. In counting operations, it can readily follow light interruptions as fast as 50,000 per second.

An interesting possible application was mentioned in a recent *Hoffman* advertisement. Solar batteries could be used to operate runway flashing lights on emergency landing fields. The primary source of power would be

COVER STORY SOLAR POWERED DISPLAY



OUR MOST inexhaustible and stupendous potential source of energy—the sun—was harnessed to a unique design when Charles Eames created the "Solar Toy," shown on our cover, for the "Forecast Collection" of Aluminum Company of America. Intrigued by the possibilities of a future where man would use an energy source 93-million miles distant, Eames fashioned a design so that people may "see a living demonstration of the fantastic potential of the work that solar energy can perform for mankind."

The Solar Toy, performing no function in itself, amply demonstrates the potential of the sun as it converts solar into electrical energy to turn wheels, spin crankshafts, and create optical illusions.

Heart of the unit is a bank of silicon solar cells made by International Rectifier Corp. Mounted in a reflector unit, oriented toward the sun by a unique tracking device, the cells are practical photovoltaic devices, capable of directly converting radiant or solar energy into electrical power of useful proportions.

Cells used are of the "p-n" type. The junction is formed on the wafer surface that is exposed to illumination and is composed of "n"-type and "p"-type semiconductor materials.

The "p"-type and "n"-type silicon are separated by a microscopic barrier layer, in which a built-in, permanent electric field exists. Current flow from this field occurs when light is absorbed by a silicon crystal,

causing movement and displacement of electrons and holes. Subsequently, a voltage difference is created at the "p-n" junction between the silicon layers of the cell and an electric current is produced.

A group of solar cells, arranged in a series-parallel configuration designed to give optimum power transfer to the load, becomes a solar battery. Power generated in excess of operating needs may be fed to storage batteries for use during periods of darkness or overcast skies.

On Eames' Solar Toy, the converted energy drives a group of seven, German-made "Aristo" motors. The tiny, 1½- to 3-volt motors are each connected directly to a drive or crankshaft of the Toy.

The purpose of Alcoa's "Forecast" program, in which Eames' design was the eleventh creation, is to commission great designers to predict problems for tomorrow and solve them now, imaginatively, through great design in aluminum. The program is broadly concerned with design for the home and family. Alcoa has gone wherever the imagination sufficient to do the task exists; to a Paris couturier, a graphic artist, sculptor, painter, and architect.

It is reasonable to assume that the sun, both as an energy source and as an intimate part of man's environment, will be a concern in several future "Forecast" designs. Charles Eames has pointed the way with his ultimately functional, functionless Solar Toy.

(Photo by Aluminum Co. of America.)

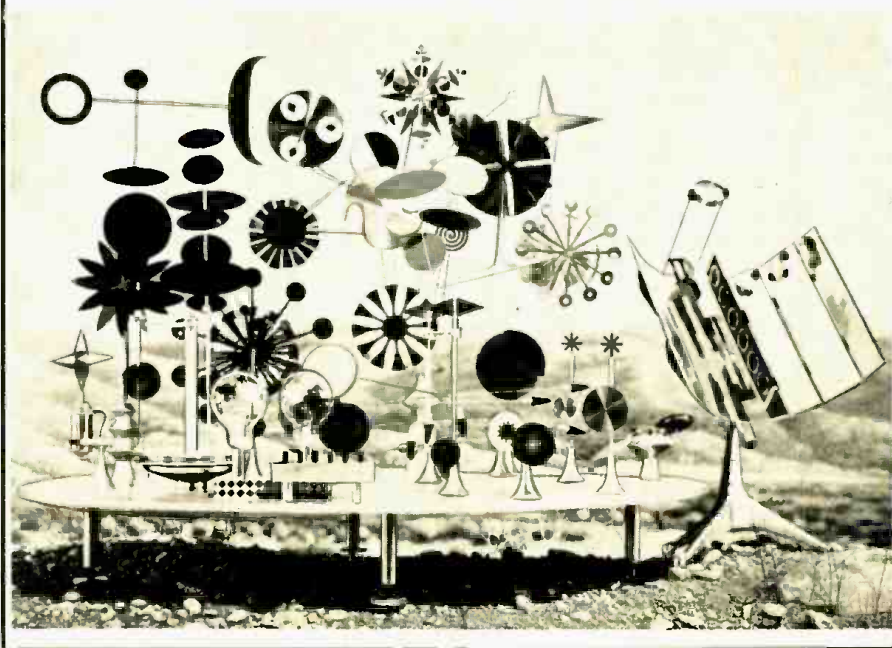

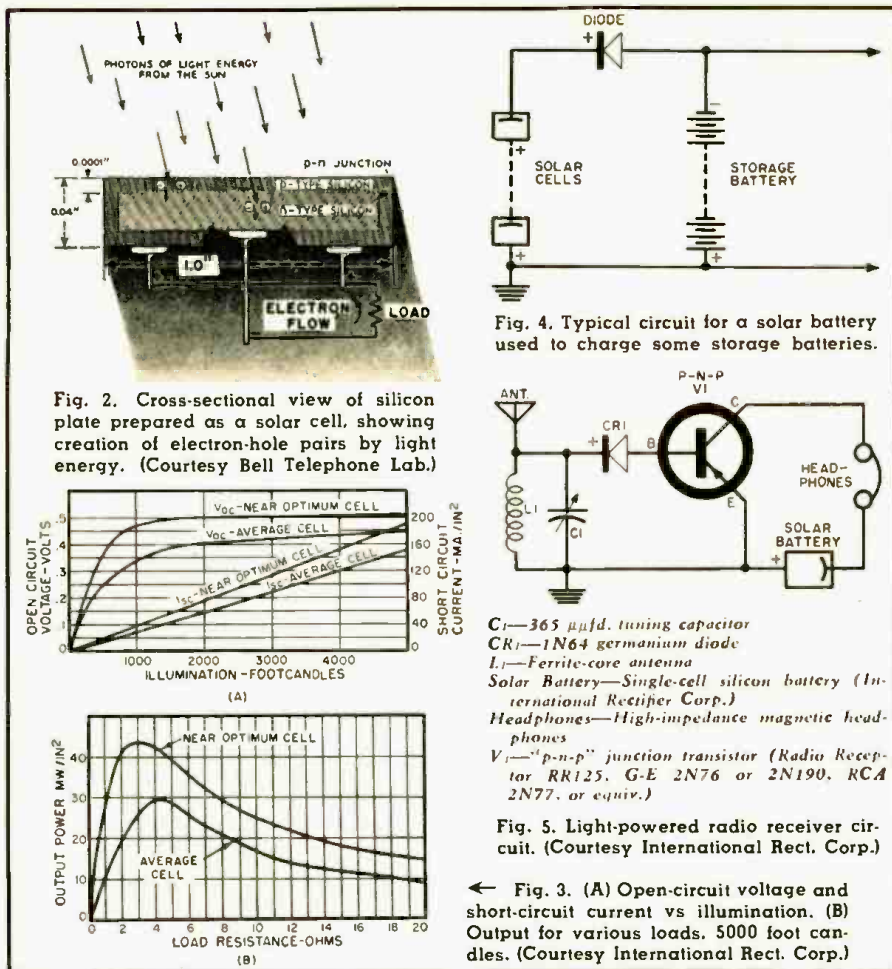

a storage battery, but this battery would be kept charged by solar batteries. It is interesting to note that silicon solar cells operate effectively under widely varying environmental conditions—from -65°C . to $+175^{\circ}\text{C}$.

A very novel and interesting application appears in the new "Solaris" hearing aid recently announced by *Zenith Radio Corporation*. Four tiny silicon solar cells are mounted on top of hearing-aid eyeglass frames in

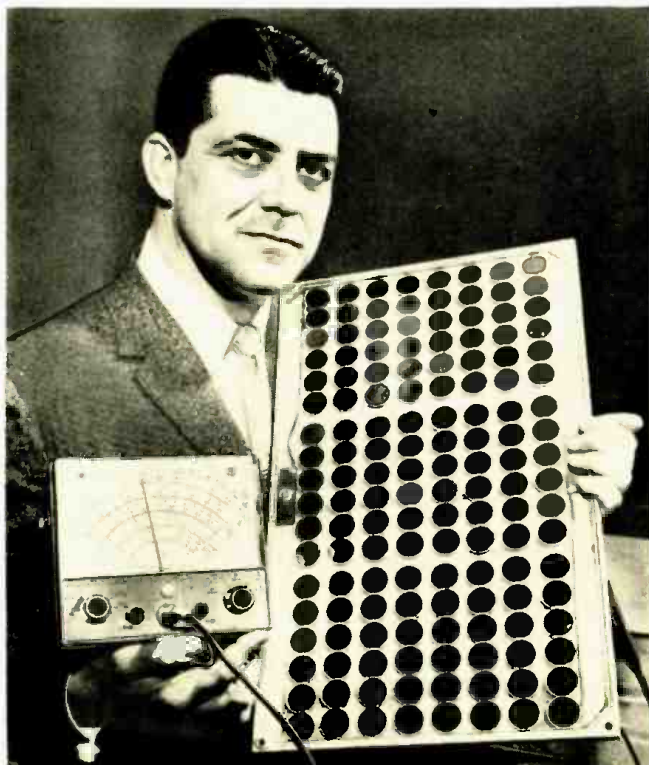

Shown connected to a voltmeter is a practical solar energy unit developed by Hoffman. The 144 silicon solar cells will supply five watts of power to a 6-volt battery system in bright sunlight.

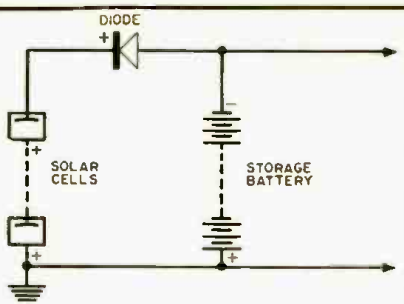

Fig. 4. Typical circuit for a solar battery used to charge some storage batteries.

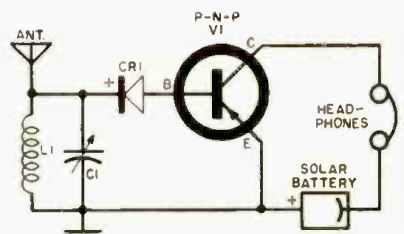

Fig. 5. Light-powered radio receiver circuit. (Courtesy International Rect. Corp.)

CI—365 μfd . tuning capacitor
 CR1—1N64 germanium diode
 LI—Ferrite-core antenna
 Solar Battery—Single-cell silicon battery (International Rectifier Corp.)
 Headphones—High-impedance magnetic headphones
 VI—"p-n-p" junction transistor (Radio Receiver RR125, G-E 2N76 or 2N190, RCA 2N77, or equiv.)

Fig. 5. Light-powered radio receiver circuit. (Courtesy International Rect. Corp.)

which the transistorized amplifier is installed. Sufficient power can be obtained to operate the hearing aid on a bright or slightly overcast day. An auxiliary battery provides the necessary power when the output of the solar battery is too low for proper operation.

A good project for the experimenter is the light-powered radio receiver shown in Fig. 5. With a single silicon solar cell as the only power source, this receiver will bring in local stations at headphone volume even in fairly dim artificial light. With bright light, powerful local stations, and a length of wire added to the ferrite-core type antenna, the receiver will drive a small loudspeaker. In this case a universal output transformer is employed, with the highest impedance primary connected in place of the headphones.

Silicon solar cells are expected to have an extremely long life under normal operating conditions. They are solid-state devices and are essentially rugged. If properly cared for, they certainly should last as long as silicon transistors.

Efficiency

What about possible increases in efficiency? A great deal of research is being devoted to this problem and it appears that further moderate increases may be obtained. Because of the nature of light and the characteristics of silicon, the maximum theoretical efficiency is about 23%.

Losses in the cell include reflection from the surface, recombination of the hole and electron pairs before they can be separated by the field, and ohmic losses in the cell itself. All of these sources of loss are subject to further minimization, resulting in higher efficiencies.

Cost

Can the cost of solar cells be decreased? This, again, depends on many factors but it is obvious that with improved technology and higher production, costs should continue to go down. There has been a very sizable decrease since the cells were first introduced on the market a few years back.

Although silicon is one of the most plentiful elements on the face of the earth, it is also one of the most chemically active. Thus, purification poses a real problem and silicon of the proper purity is very expensive. The actual amount of silicon in each cell is rather small, of course, but the many handling and processing operations which are required add to the total cost.

The situation may be likened somewhat to that which exists with transistors. The cost of transistors has decreased steadily as demand has risen and new production techniques developed. The same can be expected of silicon solar cells. In the meantime, they can be classed as extremely interesting experimental devices of considerable practical potential.

Fig. 1. Dial of the unit is calibrated in units of capacitance and inductance.

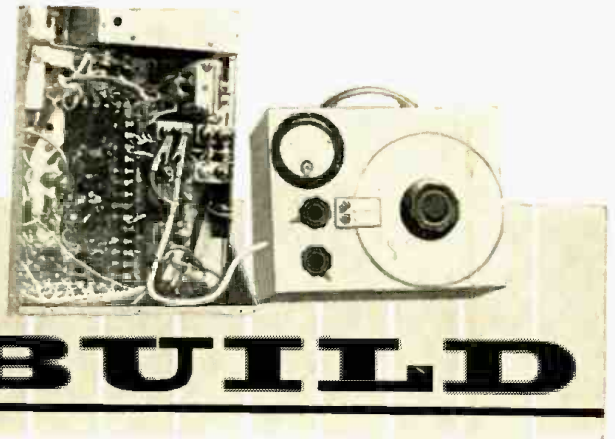

BUILD

A Versatile LC Meter

By
GENE BRIZENDINE

Wide-range, in-circuit capacitor testing without complications is just one of the jobs it will do.

SMALL capacitors are probably the most elusive of all components when it comes to pinning down their exact capacity. This is largely due to the several marking systems in use and their myriad shapes and sizes. Also, when they are removed for testing and resoldered back into the chassis, the same lead capacitance is seldom in effect. To alleviate this situation, this direct-reading, "in-the-circuit" instrument (Fig. 1) was devised. In use, the leads are clipped across the capacitor, the dial rotated for minimum meter reading, and—presto—the component value is shown directly on the dial. Values from 1 $\mu\text{fd.}$ to .01 $\mu\text{fd.}$ are easily read. In addition, the instrument can check the value of inductors in the range from 1 microhenry to 200 microhenrys.

Circuit

Basically, the circuit is a crystal-controlled grid-dip meter. The use of a crystal stabilizes operation. Fortunately, it also actually reduces the number of components required. The crystal frequency is not critical, provided it is in the resonance range of the measuring tanks, as described later. The one actually used was a 4.5-mc. unit.

The 3S4 tube (V_1 in Fig. 2) was chosen due to the modest voltage requirements. Also, less heat results from the smaller filament-dropping resistor. Excessive heat could cause drift in readings if a larger tube were used. Use of a.c. and the simple filament resistor eliminates need for the

usual power supply and transformer.

The variable measuring tank is coupled to the Pierce crystal oscillator so that a sharp minimum is indicated by the meter when the measuring-tank dial is adjusted to resonate at the crystal frequency. When the instrument is clipped across an unknown capacitor, the dial is rotated to reduce the total tank capacity by the

amount of the unknown capacitor. Since the dial is calibrated in capacity, the value of the unknown capacitor can be read directly.

The capacity contributed by the 3-foot test lead is a permanent part of the tank capacity and is automatically compensated for in the calibrating procedure.

(Continued on page 124)

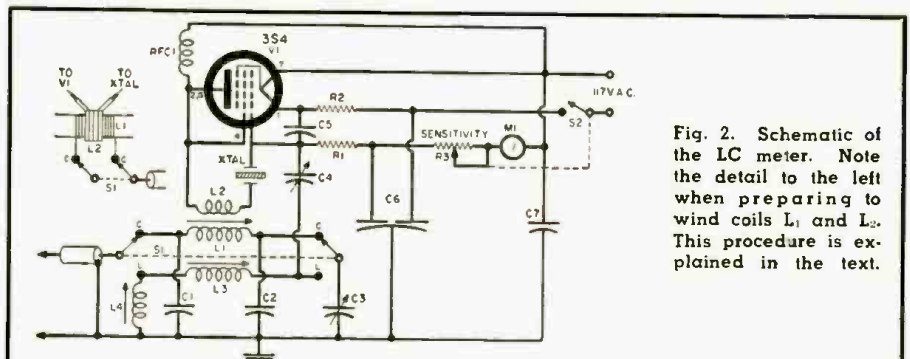

Fig. 2. Schematic of the LC meter. Note the detail to the left when preparing to wind coils L_1 and L_2 . This procedure is explained in the text.

- R_1 —10,000 ohm, $\frac{1}{2}$ w. res.
- R_2 —750 ohm, 10 w. wirewound res.
- R_3 —500,000 ohm pot ("Sensitivity")
- C_1 —60 $\mu\text{fd.}$ silver mica capacitor
- C_2 —70 $\mu\text{fd.}$ silver mica capacitor
- C_3 —140 $\mu\text{fd.}$ midjet tuning capacitor (Hammarlund MC-140-S, "Meter Tuning")
- C_4 —2.5-6 $\mu\text{fd.}$ ceramic trimmer (Centralab 820, "L" range coupling)
- C_5 —50 $\mu\text{fd.}$ mica capacitor
- C_6 —.004/.004 $\mu\text{fd.}$ dual ceramic button capacitor
- C_7 —.0015 $\mu\text{fd.}$ mica capacitor
- M_1 —.01 ma. meter (Weston Model 507 or equiv.)
- RFC—2.5 mhy. r.f. choke (National R-100 or equiv.)

- Xtal.—4.5 mc. crystal, sealed, wired-in leads (Hunt Corp., type not critical)
 - S_1 —D.p.d.t. switch
 - S_2 —S.p.s.t. switch (on R_3)
 - L_1^* —35 t. #30 en., closewound on $\frac{3}{8}$ " slug-tuned form (Bud 69052)
 - L_2^* —5 t. small-gauge, shielded wire with overall insulation, closewound over L_1 . Shield connected to pin 7 of V_1 .
 - L_3 —37 t. #30 en., closewound on $\frac{3}{8}$ " slug-tuned coil form (Bud 69052)
 - L_4 —61 t. #30 en., closewound on $\frac{3}{8}$ " slug-tuned coil form (Bud 69052)
 - V_1 —3S4 tube
- *Connections to L_1 must be made exactly as shown in sketch at upper left of diagram, including L_1 shield, which forms a Faraday shield between L_2 and L_1 .

Electronic Level Indicators For Tape Recorders

By HERMAN BURSTEIN

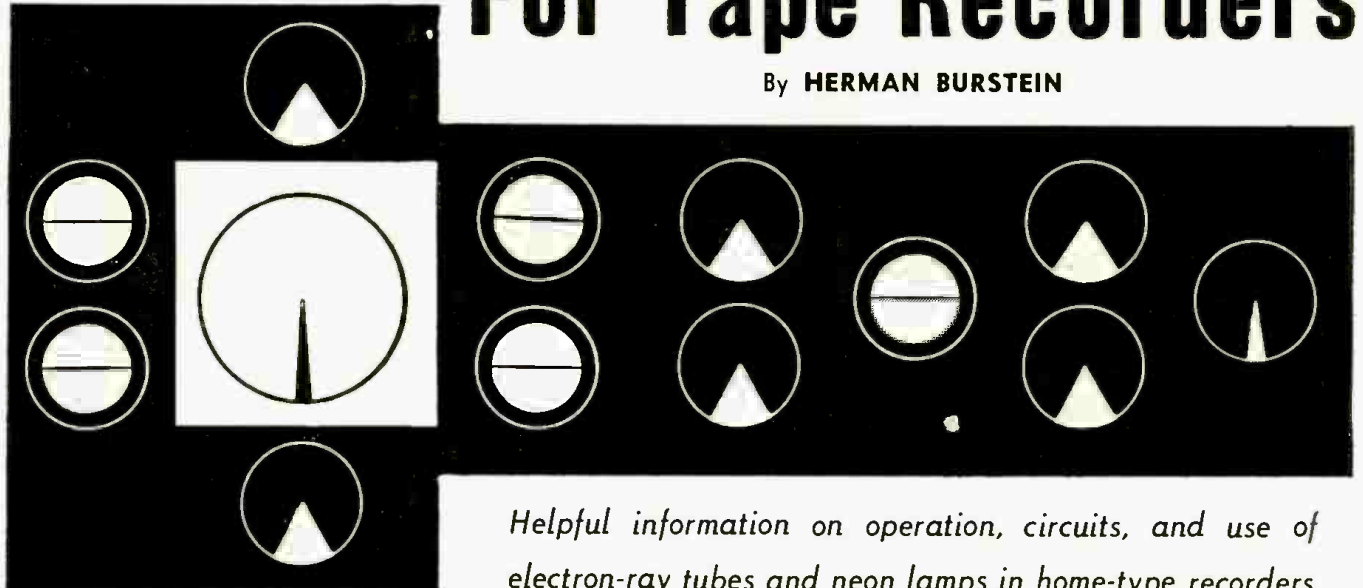

Helpful information on operation, circuits, and use of electron-ray tubes and neon lamps in home-type recorders.

A TAPE recorder should include an indicator of some sort to inform the user whether he is recording at a proper level or not, since excessive distortion will result from too high a level and an inferior signal-to-noise ratio from too low a level. Although a number of tape machines, particularly professional and semi-professional ones, employ vu and similar meters, electronic indicators are generally used in home-type recorders. This includes a number of tape machines suitable for high-fidelity applications.

Electronic indicators are of two kinds, the electron-ray ("magic eye") tube and the neon glow lamp. An understanding of how they operate, of their circuitry, of their advantages and disadvantages relative to meter indicators, and of the various problems associated with their use should be of value to the technician called upon to

repair, adjust, or modify a home tape recorder. It should also be helpful to the audiophile desiring best results from his tape recorder, especially if he is inclined to tinker with the insides of his audio equipment from time to time. Unless the technician or audiophile understands electronic indicator circuitry, it is quite possible that in making a repair, adjustment, or change he may defeat the true purpose of the indicator.

The Electron-Ray Tube

Action of the electron-ray tube—the 6E5 is probably the most popular type—is illustrated in Fig. 1. The audio signal fed to the grid of the tube causes the shadow of the eye to be just barely open when maximum permissible recording level is reached. Excessive recording level causes the eye to close or overlap, while insufficient level causes it to remain substantially or completely open.

When recording, the user tries to set gain to nearly close the eye on audio peaks. If the eye does close occasionally on a transient, there is probably no harm done but if the eye is closed much of the time, tape distortion will be manifest in playback.

The Neon Lamp

The less expensive recorders tend to employ a neon glow lamp, usually an NE-51, as an indicator. At maximum permissible recording level, the audio signal fed to the lamp causes it to fire.

Although a single neon lamp can indicate when recording level is too high, it cannot also indicate whether the level is too low. Therefore frequent practice is to use a second lamp which ignites at a lower recording level. When the latter is ignited, the re-

cordist knows that he is putting enough signal on the tape to produce an adequate signal-to-noise ratio. Thus he tries to set the gain control of the recorder so as to keep the second lamp ignited as long as possible without causing the distortion indicating lamp to fire more than once in a while.

Indicators vs Meters

The electronic indicators in common use are generally not as uniform, reliable, or stable as a good meter, particularly the vu meter, which has been especially designed for audio use. Production tolerances for electron-ray tubes or for neon lamps allow individual units to produce significantly different indications. While one NE-51 may require as much as 65 volts a.c. to fire, another may need only 45 volts. This is a difference of about 3 db and when recording at a high level, a further increase of 3 db can raise distortion substantially. When an electron-ray tube or a neon lamp must be replaced, the new one may have significantly different characteristics than the original one.

The skilled recordist knows that maximum permissible recording level varies according to the audio source, since a given amount of distortion is less offensive for certain sounds than others. A meter enables him to adjust recording level fairly precisely. The electron-ray tube permits considerably less accuracy, while the neon lamp is essentially a "go-no-go" device and does not provide intermediate indications.

Electronic indicators require substantially greater driving voltage than do meters. An electron-ray tube such as the 6E5 requires between -6 and -8 volts to completely close the eye, while

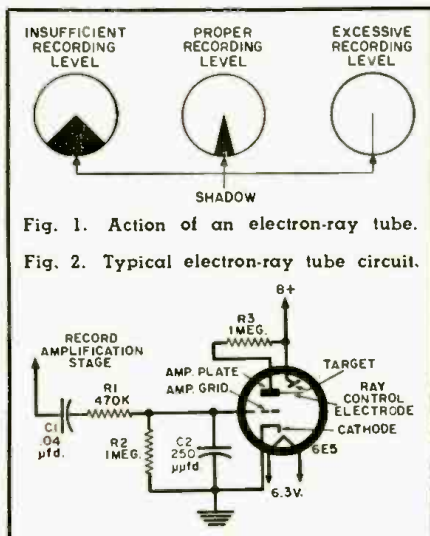

Fig. 1. Action of an electron-ray tube.

Fig. 2. Typical electron-ray tube circuit.

the neon lamp requires at least 65 volts d.c. and, more typically, about 80 volts d.c. to fire.

Bias current fed to the record head has a fairly critical value if one is to obtain an optimum combination of low distortion, good treble response, and high signal-to-noise ratio. Therefore in tape machines employing a vu meter as a record-level indicator it is frequent practice to also use the meter for measuring bias current by means of a switching arrangement. Unfortunately, the electron-ray tube and neon glow lamp do not have sufficiently accurate characteristics to permit their use in this respect.

Advantages of Indicators

Much lower cost is the primary advantage of the electronic indicator. In terms of function, the electronic indicator has an important advantage in that it reads true peak level, without the lag that occurs in the meter because of the mechanical nature of the latter. The electronic indicator responds immediately to the rapid transients found in music and speech, whereas the relatively slow-moving meter only partially indicates true level. To minimize distortion and maximize signal-to-noise ratio, it is highly desirable to know the actual peak recording level. In the case of the meter, an allowance has to be made for the difference between the meter reading and the actual level on transients. Depending upon the program metered, peaks may be from 5 to 20 db above the meter reading, so that considerable experience is required to accurately judge the true peak level.

Electron-Ray Circuits

A typical magic-eye circuit, employing a 6E5, is shown in Fig. 2. The ray control electrode partially deflects the electron stream flowing from cathode to target, thereby forming a shadow in the circular fluorescent pattern caused by this stream. When the amplifier grid goes negative and the amplifier plate therefore goes positive, the control electrode, connected to the plate, also goes positive, and its ability to deflect (repel) the cathode-target electron stream is decreased, thus the shadow decreases, that is, the eye closes.

The 6E5 grid is driven by an audio voltage from a stage of the recording amplifier. To provide the correct amount of signal to the grid, so that virtually full closure of the eye corresponds to maximum permissible distortion, a voltage divider is employed. This consists of R_1 and R_2 in Fig. 2.

A circuit such as Fig. 2 allows the electron-ray tube to flicker rapidly as it follows the changes in audio signal and is, therefore, difficult to gauge the maximum eye indication. To correct this condition a "floating action" circuit, like that shown in Fig. 3, is often used, maintaining the eye for a short while at the maximum position reached.

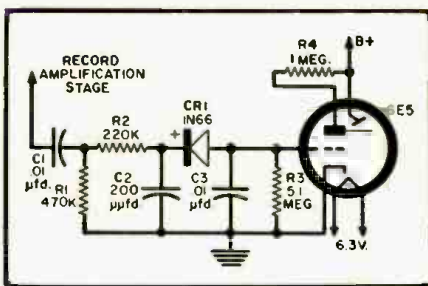

Fig. 3. Typical electron-ray tube circuit uses "floating action." See text.

The values of R_2 and C_3 are chosen so that C_3 is substantially charged by the negative portion of the audio signal in about .001 second through the 1N66 diode. The very high back resistance of the diode requires that C_3 discharge essentially through R_3 . The high value of R_3 results in a discharge time of about .05 second for C_3 , so that the magic eye reading is maintained long enough to be readily noted.

If it becomes necessary to replace CR, in a circuit similar to Fig. 3, the same type of diode must be used. If a popular diode such as the 1N34 were used as a replacement, its much lower back resistance would impair the performance of the circuit. Instead of a crystal diode, some tape recorders employ the spare half of a dual triode—in order to achieve the required high back resistance.

Neon Lamp Circuit

Fig. 4 shows the neon lamp in a typical record-level indicator circuit. In some tape machines enough audio voltage is available to fire the lamp. About 65 volts a.c. or 90 volts d.c. is the maximum required to fire the lamp, although appreciably less is often sufficient. Audio voltages of this magnitude are sometimes present as the result of using a high inductance head in the recorder. This, in turn, requires a large constant-current resistor in series with the head (to prevent the head's inductance from discriminating against treble frequencies). Because of the high circuit impedance, a large voltage—65 volts a.c. or more—may be necessary to drive sufficient current through the head to obtain the desired recording level on the tape. By employing a power tube such as a 6AQ5, 6V6, EL84, etc., voltages of the required magnitude can be obtained. The power tube that is used ordinarily serves a double purpose, because in playback it is switched into service as an output tube that is employed to drive the self-

Fig. 4. Typical neon glow lamp circuit.

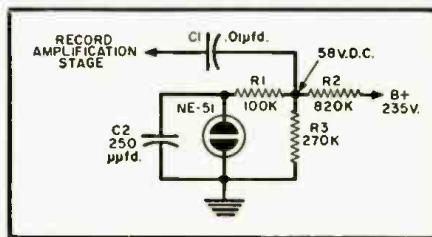

contained speaker in the tape recorder.

In many tape machines, however, audio voltages of sufficient level to drive the neon lamp are not available. Therefore the neon lamp is "biased" by a d.c. voltage obtained from the power supply. In this case the audio signal has to supply only the difference between the biasing voltage and the voltage needed to fire the lamp. In Fig. 4, a voltage divider network comprising R_2 and R_3 produces a 58-volt d.c. bias voltage. The audio voltage is in series with the 58 volts d.c. Positive halves of the audio signal raise the total voltage to the magnitude necessary to ignite the lamp.

Fig. 5 is a circuit where a "normal" lamp is added to indicate whether recording is at sufficiently high level. The "normal" lamp fires at a lower audio signal, about 6 db less, than that required to fire the "distort" lamp. The latter requires a higher voltage because of the voltage divider action of R_2 and R_3 . Instead of a d.c. biasing voltage, the supersonic bias current is employed here to help fire the lamps; C_2 and C_3 adjust the bias current to the proper level.

The neon lamp has a built-in "floating action" inasmuch as the extinction voltage is appreciably less than the firing voltage. For example, if 90 volts d.c. is necessary to fire the NE-51, the lamp will stay on until the voltage drops to about 50 volts d.c.

Loading Distortion

Irrespective of the type of record-level indicator used, meter or electronic, precautions must be taken so that the indicator will not seriously load down the audio signal and thereby cause significant distortion. This requires that the impedance of the indicator circuit be considerably greater—at least 10 times—than that of the audio circuit impedance. If one is tempted to make changes in a record-level indicator circuit, one must be careful not to substantially reduce the load impedance presented by the indicator.

In a typical electron-ray circuit such as the one shown in Fig. 2, application of the positive portion of the audio signal to the grid causes electron flow from cathode to grid; since the cathode is at ground, no negative bias exists on the grid. In effect, on positive signal swings the load (the magic-eye tube) presents a small resistance to the signal in view of the current flowing from cathode to grid. On negative signal

(Continued on page 131)

Fig. 5. Circuit using two neon glow lamps.

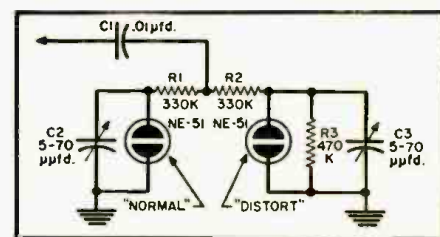

Telephone of the Future

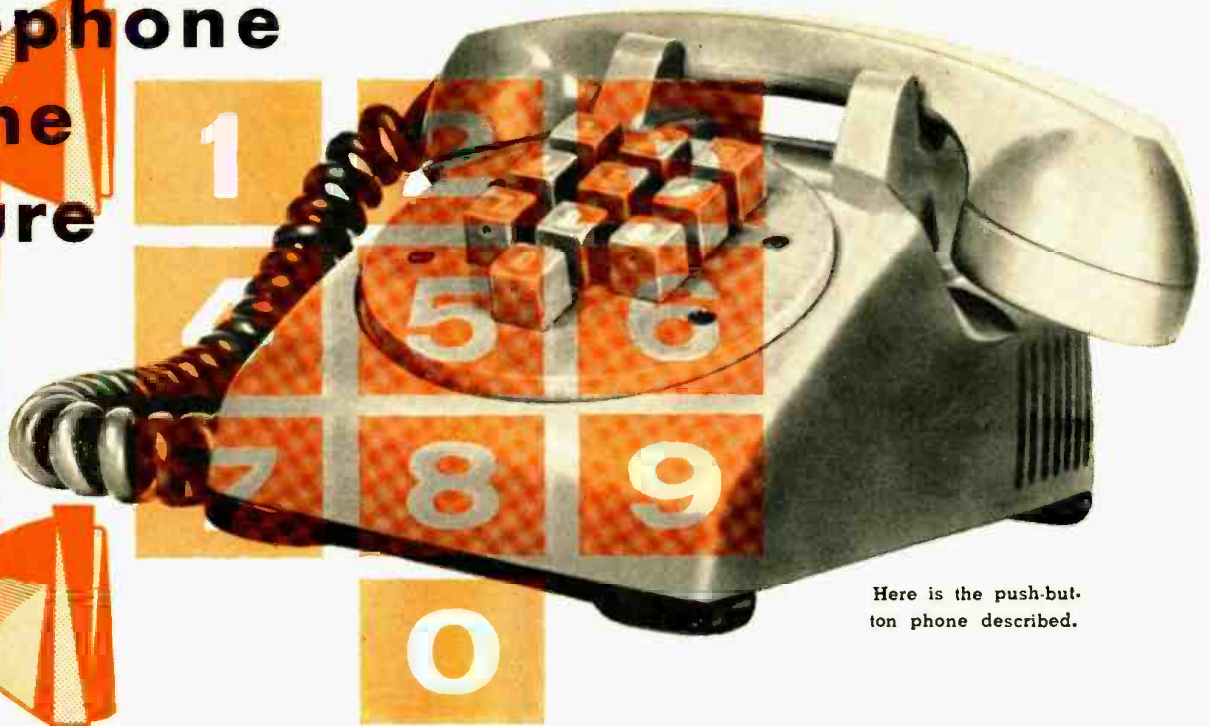

Here is the push-button phone described.

By HAROLD McKAY

Push-buttons take the place of the dial and transistor "sound radiator" takes the place of a bell in this unit.

THE dial system which has served the nation's telephone needs for the past 50 or more years is built around circuits which use electromagnetic relays and multiple-position switches. These operate either by electromagnetic ratchets or electric motors. While the telephone companies pioneered the use of the vacuum tube in amplifiers, electronics has been slow to come to the switching branch of the business.

One of the difficulties in adapting any new idea to the telephone system is that it must be made to work with the older equipment already installed. The rapid advances in the computer field have resulted in electronic switching techniques which would readily work in a telephone system, if such a

system could be made all electronic.

For example, a subsidiary of the *International Telephone and Telegraph Corporation* developed a shipboard electronic telephone system for the French Navy. Another all-electronic telephone system was developed for the United States Navy by *Stromberg-Carlson Company*. At a recent telephone convention electronic switching systems were exhibited by *Automatic Electric Company* and *Stromberg-Carlson*. Both of these systems used regular telephone instruments equipped with dials, but the dial pulses instead of actuating ratchet switches were counted by semiconductor devices and vacuum tubes.

A good part of the long-distance calling in the United States today is

not done by dial pulses but by tones of different frequencies. One reason for this is that dial pulses of ordinary telephones consist of interrupted direct current, which is fine for relays and switches, but will not go through amplifiers and carrier systems.

In a central office when an operator calls a long-distance number, she uses a small keyset like that on an adding machine, which sends tones in the audio range over the long-distance circuit. If the customer dials the number, the direct current pulses from his dial are converted by relays into spurts of tone of different frequencies.

Engineers dream of applying the multi-frequency principle to ordinary telephones, but the system used by the operator is out of the question because it involves separate vacuum-tube oscillators for each of the several frequencies. Another consideration is that if a set of push-buttons is to take the place of a dial on a telephone a means must be found whereby these buttons will operate the relays in an old-fashioned direct-current office.

An experimental instrument has been developed by the *Bell Telephone Laboratories* which might well be a prototype for the telephone of the future. It consists of an ordinary handset with a set of ten push-buttons in place of a dial. Beneath the push-buttons is a cross-wire network which is connected to a tapped inductance on one side and a set of three capacitors on the other. The wiring is so arranged that pushing any button causes a connection to be established between one of the taps on the coil

Fig. 1. Push-button wiring employed in the base of the telephone described.

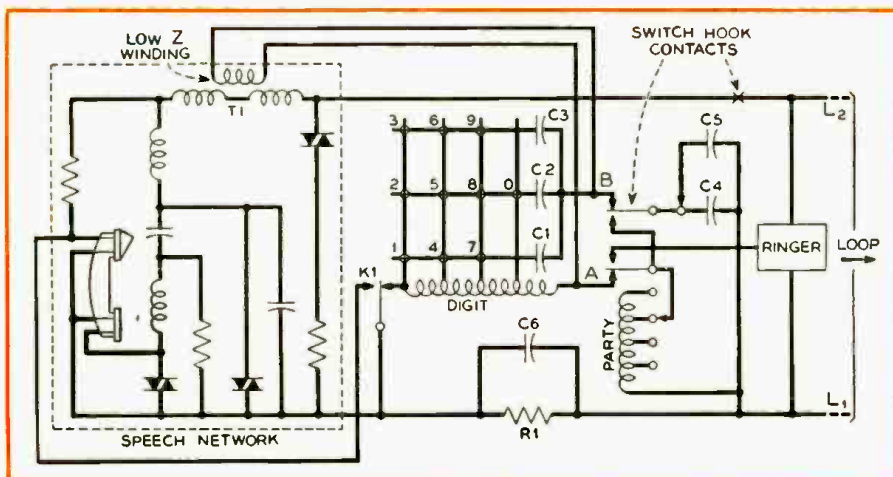

and one of the capacitors. This numbered network is shown in the center of Fig. 1.

In operation, when the receiver is removed from the switch hook, direct current will flow in on L_1 through the coil marked "Party," through contact A, through the coil marked "Digit," through the contact K_1 , the telephone transmitter, transformer T_1 , and out to the line at L_2 . This will cause the two coils to be electromagnetically charged. When any one of the numbered buttons is pressed, one of the three capacitors will be connected across a portion of the coil. This will establish a series-resonant circuit for a definite frequency which lies somewhere in the range of 1111 to 2868 cycles. As the push-button is pushed all the way down, switch K_1 operates. This switch has a "Micro-switch" type of action so that it snaps over after the cross-point connections have been made.

The operation of K_1 opens the circuit by which the direct current was flowing through the two coils. This causes the digit coil to react with one of the capacitors to produce a short wavetrain of a definite frequency. This spurt of tone is induced from the low-Z winding of T_1 onto the telephone line where it is transmitted to the office.

A difficulty which might occur with this type of system is known as "talk-off." This is the condition which would arise if voices or other sounds which might be picked up by the telephone transmitter contain frequency components the same as one of the digits. If these were received by the central office, it could result in wrong numbers. In order to prevent this, the central office circuit has an enabling device which will recognize frequencies only during the instant that the telephone button is pushed. Switch K_1 does this. At the moment it cuts out the coil it cuts in resistor R_1 . This instantly lowers the direct current flow in the line which causes a gate circuit in the office to open to receive the tone. At the same time switch K_1 also short circuits the telephone transmitter so that voices or other sounds will not interfere with the tone as it is being transmitted.

On party telephone lines it is necessary, for billing purposes, to know which of the parties originates a call. This would be accomplished in the proposed telephone by means of the coil marked "Party" and capacitors C₁ and C₂. By changing the connections on the coils and capacitors any one of eight different resonant-frequency circuits can be set up. These frequencies would lie in the range of 478 to 1000 cycles-per-second, so as not to interfere with the digit frequencies.

When switch K_1 operates as a button is pushed down, the "Party" coil and capacitors also send a spurt of tone which will identify the party making the call. This identification will be made each time a button is pressed. The unlabeled components

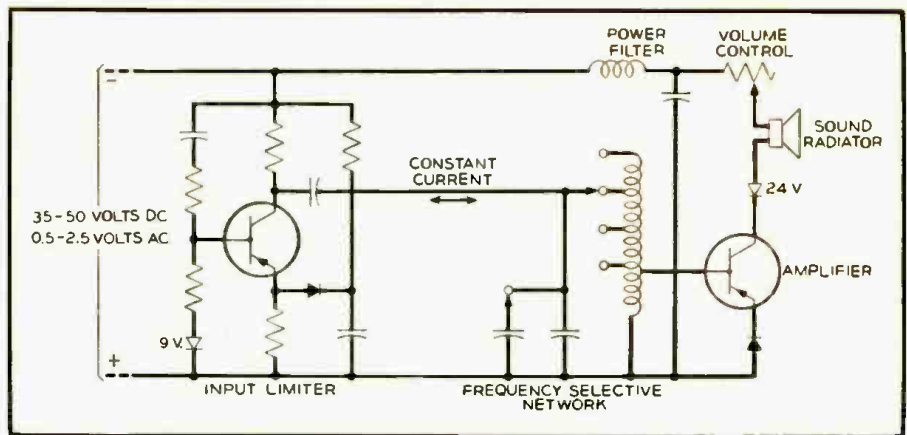

Fig. 2. Instead of a mechanically operated bell, this circuit is employed.

in the speech network perform various functions, such as keeping direct current from demagnetizing the receiver, preventing excessive feedback or "side tone" from the transmitter feeding into the receiver, and current limiting by means of varistors.

If a telephone of this sort were to be connected to an electronic central office, its various frequencies might be received by different tuned circuits or frequency-responsive relays much in the fashion of the devices used in mobile radio. However, present-day mechanical dial switching offices have devices which count dial pulses and "register" the number dialed upon a set of relays. Rather than use ten-digit relays on each position of the register, equipment is conserved by using only five. In some systems these might be numbered 0, 1, 2, 4, and 7. The missing numbers are made up by a combination of two of the foregoing digits. For instance, if the customer dials a 3, relays 1 and 2 are actuated; if he dials 6, relays 2 and 4 operate.

In order to co-ordinate this type of system with a multi-frequency push-button telephone, a special circuit could be used. Here the line connects to the push-button telephone. An enabling circuit, a transistor-fed relay, responds to the drop in current when switch K_1 in the telephone operates. Its operation supplies plate voltage to thyatron tubes and register relays for each digit.

A cut-a-part filter separates the digit frequency and the party frequency, although each is handled in a similar manner after being separated. The transistor amplifier connects with a set of selective circuits, each of which is tuned to a different one of the frequencies which can be received. These are shunt-resonant circuits so each will pass a single frequency.

When a given frequency is passed by one of these circuits it goes through crystal diodes to two thyatron tubes and relays. This is in accordance with the "2 out of 5" requirement of the register circuit in the dial office. Thus any one frequency goes through two crystal diodes into two tubes, which, in turn, operate two of the register relays. This will

satisfy the requirements of the electro-mechanical equipment in the dial central office, which will take over and handle the call from that point. The use of the crystal diodes in the translator prevents the current from the wire of one frequency backing up onto one of the others.

A telephone to be completely electronic could not use a telephone bell as we know it today. One reason for this is that present telephone bells are inefficient by electronic standards. It takes about 1 watt of power to energize the armature and the clapper which strikes the bell. On the other hand, good speech can be reproduced over a telephone with as little as 1 milliwatt of power. Thus it would be one thing to build an electronic system which would handle 1/1000 of a watt in order to provide voice transmission and switching, but quite a different order of magnitude to provide a system which would also supply 1000 times this amount of power to ring the bell.

Again, any approach to altering this situation should recognize that the new system must be compatible with the old.

An answer seems to be a "sound radiator," a small loudspeaker which can be concealed inside the base of the telephone and which will emit a pleasing tone when the customer is called. A device for use with present-day telephones consists of a transistor oscillator in which the winding of the speaker forms part of the tuned circuit. On present-day telephone lines, which use 105 volt, 20-cycle a.c. to ring the bell, a diode rectifier would convert this to d.c. to operate the oscillator and cause the speaker to sound. An all-electronic system could use a circuit such as that shown in Fig. 2. Here the 35 to 50 volts direct current shown represents the d.c. that is always on a telephone line. The .5 to 2.5 volts a.c. represents the voice-frequency signal voltage. These are shown as variables, because actual telephone lines may be of different lengths or characteristics.

The input stage of Fig. 2 consists of a transistor-limiter circuit, the a.c. output of which is a symmetrically

(Continued on page 107)

Semiconductor Variable Capacitors

By H. R. SMITH

A new circuit element in which changes in voltage applied are used to produce changes in capacitance.

Engineers are examining a gold-bonded diode modulator similar to that employed in a new microwave radio relay system.

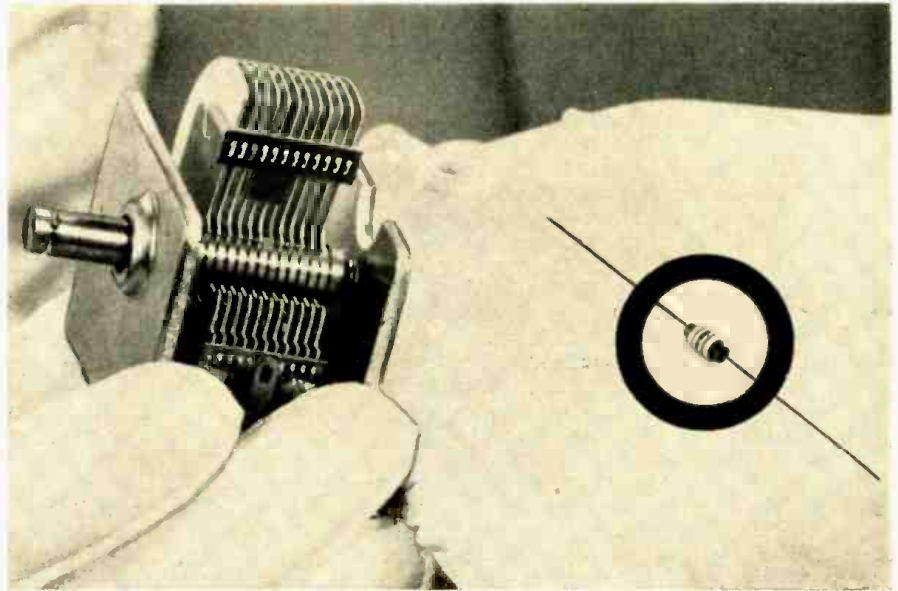
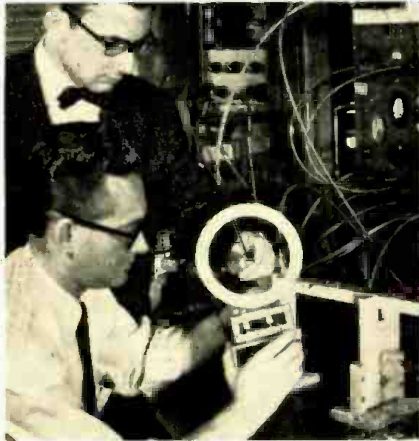

"Varicap" is compared with ordinary tuning capacitor.

characteristic of the *p*-type material.

Now that we have *n*-type and *p*-type material, we form our *p-n* junction by placing these two materials next to each other. This can be done in several different ways. A technique developed at *Bell Telephone Laboratories*, called diffusion, is an excellent way of doing it. We start with *n*-type material and diffuse into it a small amount of *p*-type impurity thus forming the desired *p-n* junction.

Here we have the basic elements of a capacitor—two conductors (the *p*-type and *n*-type material) separated by an insulator. The neutral layer between the *p*-type and *n*-type material serves as the insulator. Thus we have a diode capacitor.

Now let's see what happens if we apply a voltage to this diode. We can see immediately that the effects of this voltage will depend on its polarity, so let's first connect the positive terminal to the *p*-type material and the negative terminal to the *n*-type. The electrons in the *n*-region will be repelled over into the *p*-region and the positive holes will tend to move from the *p*-region to the *n*-region. Thus we have all the conditions for a flow of current and this is exactly what takes place. We say that the diode is "forward-biased" and will pass current.

If we reverse the voltage on the diode, the positive voltage tends to attract the electrons in the *n*-region, keeping them from moving over into the *p*-region. Also, the negative voltage attracts the positive holes, preventing them from moving across into the *n*-region. Therefore we will have no flow of current. Furthermore, the applied voltage will produce a region between the two layers where no charge exists and the higher the voltage the

thicker this no-charge region. We call this the "reverse-bias" condition for the diode. This is shown schematically in Figs. 2B and 2C.

We know that the actual capacitance of a capacitor depends inversely on the thickness of the dielectric between the two conducting plates, all other things being equal; that is, the thicker the dielectric, the less the capacity. Thus, we have here in our reverse-biased diode all of the conditions for a variable capacitor. At zero bias, we have minimum thickness of the center layer and thus maximum capacity. As the reverse bias is increased, the thickness of this center layer increases and the capacity decreases up to the point where the reverse voltage is sufficient to cause breakdown.

This explanation is perhaps somewhat oversimplified and ignores many factors which should be taken into consideration; however, it does give a reasonably accurate picture of the conditions in a reverse-biased diode capacitor.

Semiconductor capacitors are available from at least two companies. *Pacific Semiconductors, Inc.* uses the tradename "Varicap" for its alloy junction silicon units while *International Rectifier Corp.* has selected the tradename "Semicap." If you are interested in experimenting with this new component, representative units are available on the open market.

With a new component of this nature, a problem arises as to the best means of indicating it on a schematic diagram. *Pacific Semiconductors* has selected the representation shown in Fig. 3. It is a composite representation and includes the two plates for a capacitor, an arrow to indicate variability, and the conventional diode symbol

D ID YOU ever think of a germanium or silicon diode as a variable capacitor? Probably not—but it can be and a good one at that! In a properly constructed diode, the capacitance can be varied over fairly wide limits by merely varying the voltage across it.

To understand how this can be, let's briefly examine the basic structure of a typical junction diode. This structure is indicated in Fig. 1, where you can see that it consists essentially of a junction between *p*-type and *n*-type silicon or germanium.

We should perhaps pause here a moment to discuss what is meant by *p*-type and *n*-type material. Absolutely pure semiconductor material is completely neutral, that is, it has neither an excess nor a deficiency of electrons in its crystalline structure. However, if we add a very minute amount of an impurity, such as arsenic, we can introduce an excess of electrons, leading to *n*-type material. By introducing a different impurity, such as gallium, we can rob the material of some electrons, leaving positively charged "holes," a

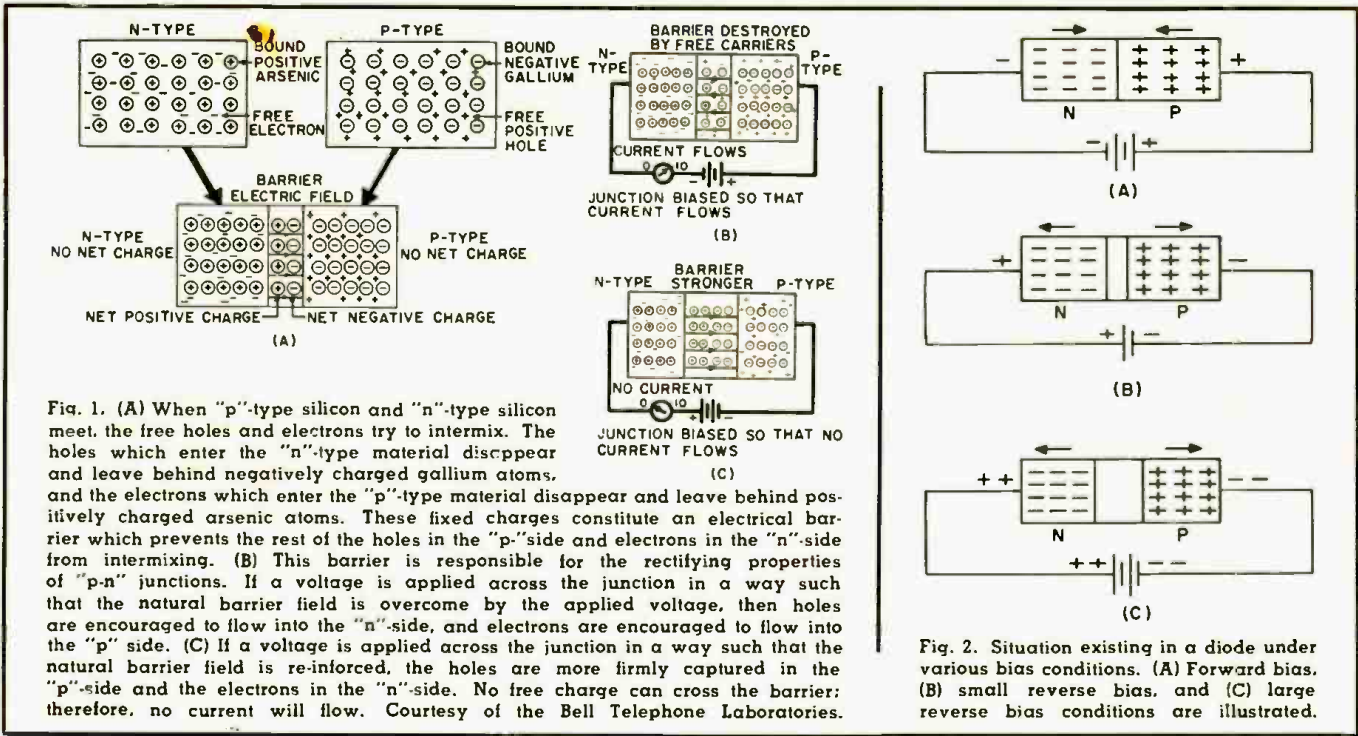

in the background. We will stick to this representation in the diagrams presented here.

What sort of capacitance and "Q" (figure of merit) values are available with this new component? Fig. 4 shows the variation of capacity vs voltage for a typical "Semicap." As can be seen, the capacity ranges from about 38 $\mu\text{fd.}$ down to 3 $\mu\text{fd.}$, a very useful variation for many applications. The "Q," as indicated in Fig. 5, is well over 1000 at one megacycle, which is as good as that of many fixed capacitors. The "Q" decreases with frequency, as can be expected, but the units may be used up to 500 mc. in applications where high "Q" is not required. The "Q" can be effectively increased by placing a high-quality fixed capacitor in series with the diode.

"Varicaps" are available with capacitance values of 20 to 56 $\mu\text{fd.}$ at

-4 volts bias. Total variation available is better than 4-to-1 within the voltage ratings. Maximum permissible voltage on most units is around -20 volts.

Continued efforts are being made to increase the "Q" by decreasing the effective series resistance. For example, scientists at *Bell Telephone Laboratories* are working on an experimental diffused-base silicon diode which is useful at frequencies well up into the thousands of megacycles. This unit has an active diameter of about .002 inch and incorporates a special construction to minimize inductance and capacitance of the attached contacts. Series resistance is extremely low, with the result that "Q" is high.

Now that we have this variable capacitor, what is it good for? *Pacific Semiconductors* lists sixteen potential applications and implies that others will undoubtedly come to mind as en-

gineers and scientists continue their exploratory work.

Probably the most logical application is that of voltage tuning, as shown in Fig. 6. Here the capacitor is a part of the tuned circuit and is isolated from it for d.c. purposes by a large blocking capacitor. Z is a choke to prevent r.f. from feeding back into the bias source. Tuning is accomplished by varying the potentiometer setting, thus varying the voltage across the diode capacitor. If this voltage were derived from a suitable control circuit, such an arrangement could be used for automatic frequency control in AM or FM receivers.

If the d.c. control voltage is replaced by an a.c. source, we have a ready means of obtaining frequency modulation. A circuit proposed by *Pacific Semiconductors* for this purpose is shown in Fig. 7. Such an arrangement *(Continued on page 122)*

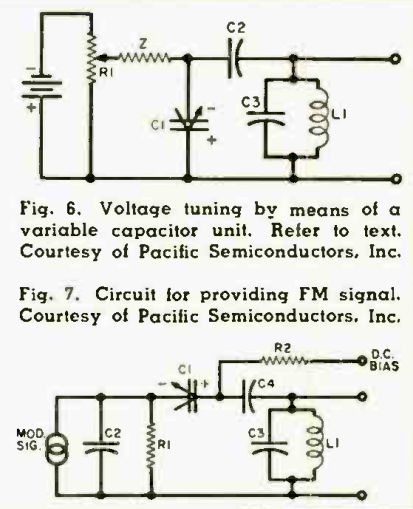
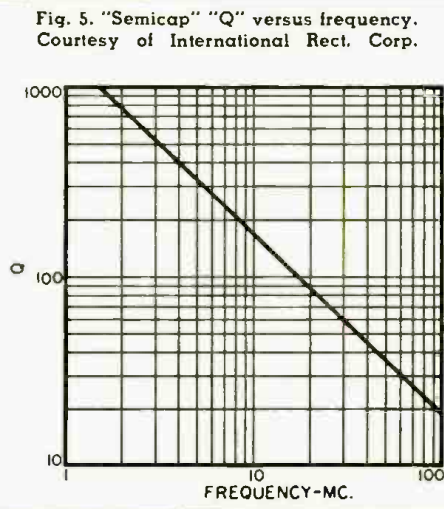
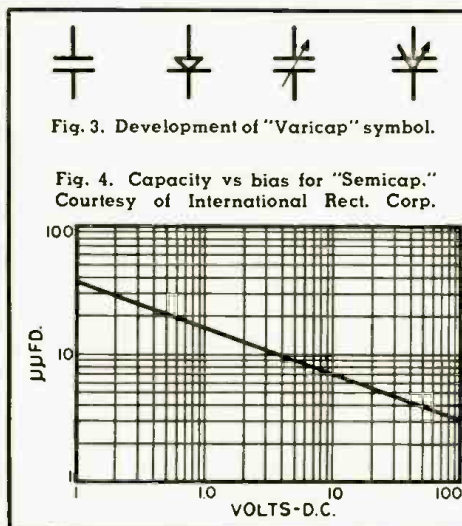

AS NEWER and more complex circuits come into regular use, they bring with them new types of malfunctions to plague the electronic service technician. The causes of many of these are elusive. One such baffling condition, actually originating in the tube, may show up in either of two ways. Sometimes there is a loss in gain for the circuit involved which cannot be explained in terms of conventional defectiveness. At other times, it shows up as a strange overshoot at the leading edge of the pulse or other output signal from a stage, whose origin is similarly mystifying. In either case, the malfunction may persist even after replacement of tubes or other parts that are suspected of being defective.

A film of material, called the cathode interface layer, often develops in many vacuum-tube cathode structures. As Fig. 2 shows, this layer forms between the active emitting surface of the cathode and the base metal on which it is deposited. Development of the interface compound is the result of chemical interaction between the emitting material itself and the base metal or some constituent of the base metal.

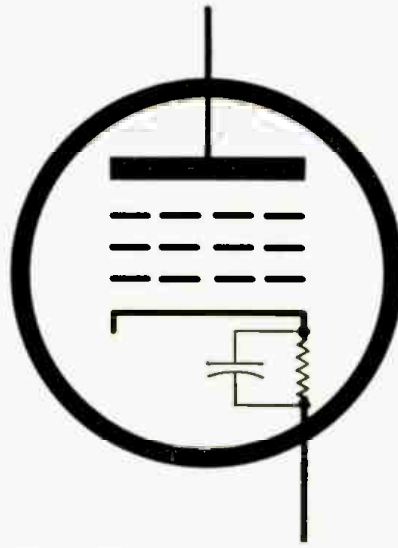

Fig. 1. The interface layer has some resistance. Also, it acts as a dielectric between the emitting coating and the base metal. Thus it helps to form a capacitor that is in parallel with its own resistance—an RC network.

trying to correct faults believed to exist in associated circuitry.

Cathode interface resistance which develops in amplifier tubes may become much more serious in some applications than in others. For example, take the case of a binary divider. The flow of cathode current normally inhibits or deters the formation of interface resistance; but in a binary, one tube is normally cut off. Under cut-off conditions, the deterring effect of cathode current is not present and the interface resistance layer may develop to much larger proportions. When a tube is operated at cut-off with a heated cathode for many hundreds of hours, the interface resistance may become so great that, when the tube is finally turned on, cathode current may be reduced to half its normal value. Hence when a binary has remained in one state for a long interval of time, it may well be impossible to induce a permanent transition. This particular condition or "disease" of the tube has been dubbed "sleeping sickness."

Interface resistance is present, to some extent, in all tubes with oxide-coated cathodes but is especially pro-

Lazy Tube Cathodes

By **CHARLES T. McCORMACK**
and
CLEMENT D. MACKY

Many puzzling types of circuit malfunction are caused by a subtle change inside the tube itself.

Once formed, the interface layer may exhibit several interesting properties.

For one thing, the compound may act as a semiconductor. The resistance of the layer may range from a few ohms to several hundred ohms. Unexpected circuit elements of this nature can obviously have appreciable influence on the tube's operation. Nor is this all. Once the interface layer is present, it can act as a dielectric, although a rather leaky one, between the emitting coating and the base metal. The two last-mentioned elements then become the electrodes of a capacitor.

The over-all effect of the interface layer, then, is to introduce into the cathode circuit a parallel resistance-capacitance combination (Fig. 1). The time-constant of this RC network has been determined experimentally to lie in the approximate range between .2 and 2 microseconds. In individual cases it can be much longer.

In video amplifiers, the effect of cathode interface resistance may well be serious. For a signal whose duration is very long as compared to the interface time-constant, the principal effect is a loss in gain, since the effective transconductance of the tube will be reduced. An abrupt discontinuity applied to the tube grid will appear at the output similarly reduced in amplitude, but accompanied by an overshoot at the leading edge of the pulse.

The symptom in the "diseased" cathode, often characteristic of video amplifier tubes, carries the popular designation "slump." The term is applied to a tube which behaves as though there were present in the cathode circuit a parallel resistance-capacitance combination with a time-constant up to several seconds. The response of such a tube to an input negative step or pulse of long duration is an output positive step which gradually slumps to a lower voltage level. The origin of the slump is not well understood. The effect is often a source of difficulty in the design of d.c. amplifiers for cathode-ray oscilloscopes. When the "disease" shows up in equipment that has been operating for some time, the real source is often not suspected. As a result, many needless hours are spent

nounced in tubes whose cathode base material contains large amounts of silicon. It increases with the length of time the cathode is heated. It increases more in tubes operated at cut-off than in tubes drawing continuous plate current. It may appear in new tubes that have had prolonged shelf life. The end of the useful life of a tube may be the result of interface resistance rather than loss in cathode emission.

In recent years a series of special dual-triode vacuum tubes has been developed. The cathodes of these have been carefully treated to remove all impurities, such as silicon, which give rise to interface resistance. At first these tubes were designed specifically for military computer service, but they are available on the open market and are particularly useful in many video, pulse, and digital circuits. Notable among these are the types 5963, 5965, and 5844. The 5963 is similar to the 12AU7. The 5965 and 5844 incorporate other improvements, such as better balance to cut-off in the two sections and a high zero-bias plate current to permit the use of small plate-load resistors. The change to use of special tube types is often the best-advised remedy in cases where the symptom recurs. In any event, careful tube selection should be considered before the tube is operated in circuits that are subject to the malfunctions noted here.

Fig. 2. As a result of chemical interaction between the cathode emitting material and the cathode base metal on which it is deposited, an intervening film, the interface layer, may develop.

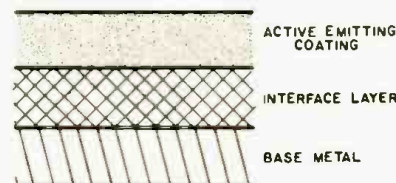



An outdoor tap in a buried-cable system, often used in motel jobs.

Multi-Set TV Installations—

Problems & Principles

By JACK BEEVER
Jerrold Electronics Corp.

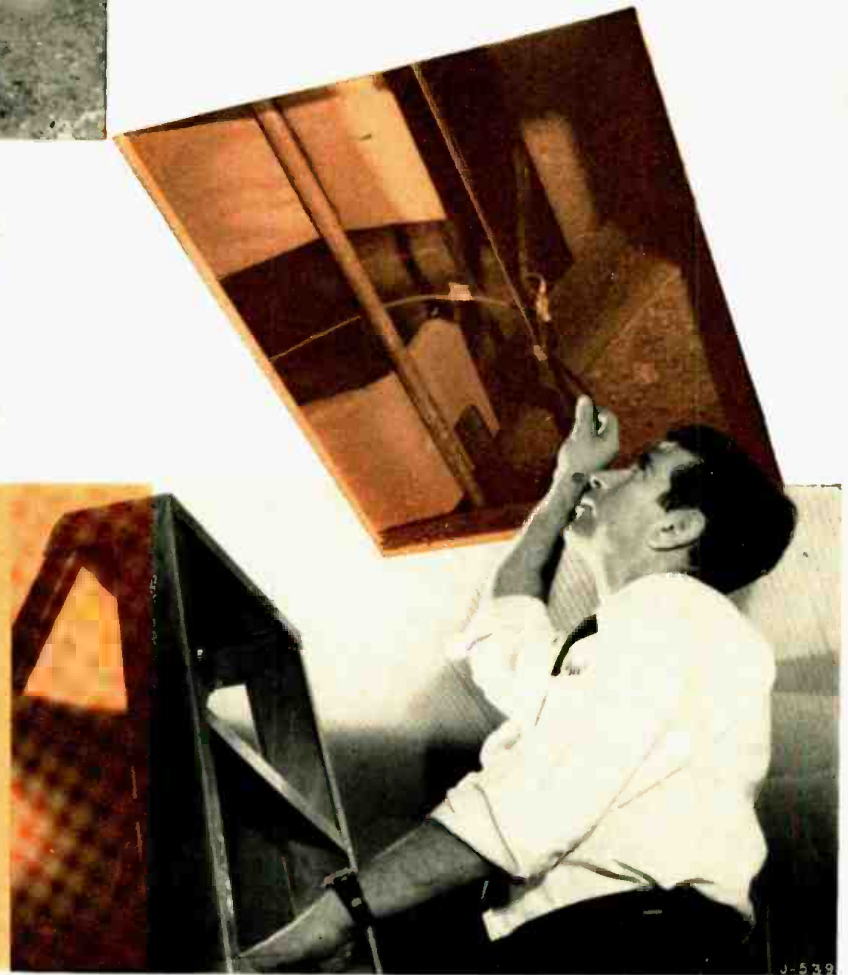

Installing an indoor, non-matching tap-off in the dead space above a ceiling.

Part 2. System layout methods, including an actual case. Common troubles and system troubleshooting.

UP TO THIS POINT we have already given thought to the major components in a signal distribution system. This includes the various cables used, preamplifiers and distribution amplifiers, line splitters, and tap-off units.

We have also discussed signal level in the system in a general way, including losses and the general methods for providing needed gain.

This has been on a more or less abstract level. Photos on this page and the one following will give the reader an idea of what some elements in the chain look like. Actually working out an installation problem, albeit on paper, should further enhance a practical understanding.

System Layout Methods

By this time, the layout of a system should have resolved itself to a fairly simple problem; but two general methods of attack are used. The first and

simplest is called the *break-even* system; the other uses a fixed reference level which is usually the level required at a set in a normal installation, generally 1000 μ v. per channel. This level of 1000 μ v. has become a standard reference level and is used as the "zero db" figure in systems. Manufacturers use varying terminology; *Jerrold's* being dbj, the j indicating that 0 db = 1000

EDITOR'S NOTE: A fistful of theory is necessary with something new. We had that in Part 1. Here theory is applied to an actual multi-set installation.

μ v. Others use the somewhat clumsier but more descriptive db/mv. (decibels over a millivolt).

The break-even system is based upon calling the antenna signals zero db. In the case of varied levels of signals, the system should be computed on the basis of the lowest level. Unless there is a great discrepancy in levels (30 to 40

db) the larger signals will take care of themselves, since TV sets can handle signal variations up to 40 db (100x). The best method of presentation is to lay out a hypothetical job which can be, for purposes of illustration, a 20-unit motel. Fig. 13 is a sketch of the floor plan.

In this establishment, the office is in the center, with 10 units on each side. The antenna, on a 40-foot mast, is behind the office. It is obvious that we have a layout resembling an inverted T, in terms of the cable run. It will require that we split the cable once, in the office. In order to determine what gain will be required to operate this system and what value of isolation will be required at tap-off units, we must know the over-all loss in the system. To determine the loss, we can lay out a schematic of all loss-producing components in the system, ignoring the gain until we know how much gain is required to overcome the loss.

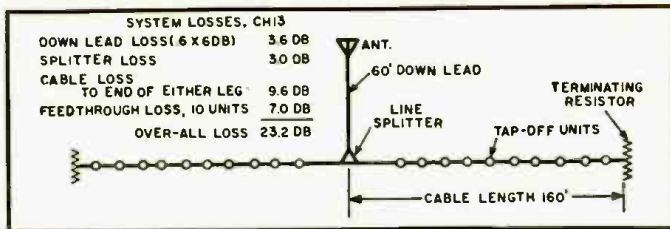

Fig. 11. Diagram of losses for the layout of Fig. 13.

Loss-producing components are cable, splitters, and tap-off units. The schematic of Fig. 11 shows these units inserted into the T wiring. The down-lead wiring should run to about 60 feet and we can take as a first approximation the RG-59/U size cable. This represents a loss of 0.6 (6/10 of a hundred feet) times 6 db (loss of a hundred feet at channel 13), equaling 3.6 db. The line splitter has a 3 db loss per leg. Since both legs of this system are the same, if we calculate one leg, the other need not be figured. It will behave in the same manner. (If we had an asymmetrical system, we would calculate the longer leg, then the shorter one.)

One wing of the motel in Fig. 13 is 130 feet long. However, we are not interested in the building's length, but the cable's length. Inspection of the premises indicates that the wiring from tap-off unit to tap-off unit of adjacent rooms will require 16 feet of cable, making the run along one wing 160 feet, or 1.6 hundreds of feet. The total cable loss will be $1.6 \times 6 \text{ db} = 9.6 \text{ db}$. We still have the feedthrough losses of the tap-off units to contend with; and we cannot at present determine the amount of isolation required which will, in turn, determine the feedthrough loss. We can, however, assume an average. It has been found that a tentative figure of 0.7 db average per tap-off will be reasonable. Ten units, then, will add 7 db to our total, although we are cheating a bit, since the last one doesn't feed through to anything, and doesn't need to be counted.

The addition on Fig. 11 shows a total system loss of 23.2 db to the end of either leg. Isolation between set and system on these "close-coupled" systems should not be less than 10 db per set, allowing the sets to be isolated from each other by a total of 20 db (10 db from any set to system and 10 db

from system to adjacent set). This brings our total loss between antenna and the farthest set on the system to 23.2 db plus 10 db or 33.2 db. We need at least this much gain in our system if we are going to arrive at the last set of the system with zero db, which is the antenna signal.

The above calculation, though, allows us no leeway. It assumes that, if we have this gain, we will retain this gain. Unfortunately, amplifiers use tubes and tubes age. A system should operate with at least 6 db excess gain, bringing our gain figures up to 39.2—practically 40 db. If we know that these sets are to operate in an area of high ambient noise, perhaps caused by neon tubes or fluorescent lights, then we may decide to add another 6 db to provide a good signal-to-noise ratio at the set, making our required gain 46 db.

The break-even system tacitly assumes that the antennas do not develop more signal than is needed. However, if this is not true, we can eliminate some of the required gain by considering surplus antenna signal as "gain." In doing this, we have changed from the break-even system to the "dbj" system. This can best be demonstrated by an example.

Assume that at the particular location we are describing the antennas develop 4000 μv . at channel 2, 3000 at channel 5, and 3000 at channel 13. Since these are all similar in signal strength and our losses are greatest at channel 13, the highest frequency channel, the channel-13 signal can be the critical one. We have already indicated that a 1000- μv . signal is our basic unit. Our air signal is about three times as much. The db chart indicates that a ratio of three times is very nearly 10 db. Then we can use this as a gain figure, assigned to the antenna, which now delivers a signal of +10 dbj instead of

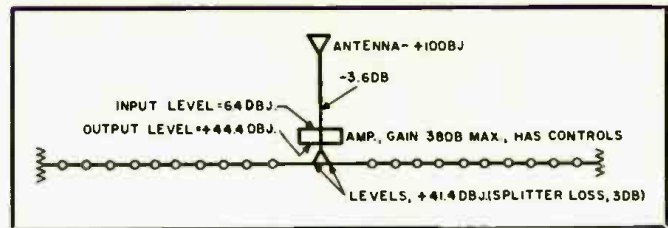

Fig. 12. Signal levels throughout final installation.

zero db. The gain we required, 46 db, can be reduced by this amount, leaving 36 db necessary.

We can add the new information to our schematic (Fig. 11) as soon as we decide on what amplifiers are needed. This information can be found from a perusal of manufacturers' catalogues. We decide on a mast-mounted preamplifier, since the place to be serviced is polluted with neon lights. This preamp location will let us bring a high-level signal down into the noisy area and will keep it protected in coax. The one we choose has a 25 db gain.

The same maker lists a small distribution amplifier with the same gain, 25 db, giving us a total of 50 db gain. (We had decided we only needed 36 db, so that we have 14 db reserve gain.) We put these two units in the layout—the preamplifier at the antenna and the distribution amplifier in the office. Now we must check, since we have cascaded a pair of amplifiers, to see that we are not overloading the distribution amplifier.

This we can figure easily since we have already set our antenna at +10 dbj, which gives the preamplifier output as $10 + 25 \text{ dbj} = 35 \text{ dbj}$. The 60 feet of downlead has 3.6 db loss leaving a level of 31.4 dbj at the input to the amplifier. 31.4 dbj represents a ratio of about 37 times—meaning that we are hitting the distribution amplifier with 37,000 μv . The manufacturer says the maximum input signal is 5500 μv . We cannot use this setup unless we pad the downlead (use attenuators) to destroy most of the gain of the preamplifier! This is very wasteful. We must look further.

The manufacturer lists a distribution amplifier with 38 db gain, 2 db more than we need. This amplifier should have an input signal in the neighborhood of 1000 μv . but will accept

Blonder-Tongue MLA amplifier, with associated a.g.c. unit.

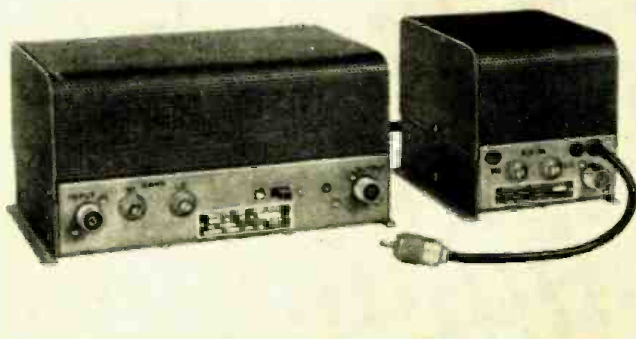

Jerrod 2300 amplifier provides adjustable gain and tilt.



up to 26,000. Let's see how it fits in.

We have a signal at the antenna which is 10 db over 1000 μv . The downlead will lose 3.6 db if we remain in coaxial cable, which we can do by using a matching transformer at the antenna. At the amplifier input, we will have a level of 6.4 db so that we meet input requirements, having at least 2000 μv . per channel at the input (6 dbj = 2000 μv .). The amplifier output will be 6.4 + 38, or 44.4 dbj. See Fig. 12.

Let us check the output limits. The manufacturer says his amplifier will deliver .3 volt per channel, with 9 channels in, so that it will certainly deliver more than this with only 3 channels. We need to convert our 44.4 dbj to microvolts to check this. The conversion table says that 44 db is about 150 times—or 150,000 μv ., since 0 db is 1000 μv . This is .15 volt so that we are well below rated output. This appears to be the proper amplifier for the job.

Now we need to select the proper values of isolation for each tap along the feeder lines. The general rationale of this procedure is that the isolation be such that the set see a signal not less than 0 dbj in normal cases, nor less than 6 dbj where noisy conditions are expected, as in the hypothetical case we have described. We have also allowed 6 db "reserve" for tube aging. Therefore, if we use the maximum gain the amplifier has for our figuring, we should use an isolation value which will leave at least 12 dbj at the set when subtracted from the line level obtained at this particular tap-off unit. (This sounds as though it may be high, but 12 db is only four times, meaning 4000 μv . Remember that the db is not a linear unit. For example, 20 db is ten times and 40 db is 100 times a given value of input signal voltage.)

We can do this best by setting up a column of numbers (Table 3) starting with the input level of the feeder line. We can find this level by subtracting the splitter loss from the amplifier output level (Fig. 12), which gives us 41.4 dbj. From this point, we can determine the remanent (remaining) line level at each point by subtracting losses as they occur. We determined that the line length between tap-off units was 16 feet long. This represents a loss of 0.96 db (.16 \times 6 db) which we had better call 1 db. Then, at the first tap we have lost 1 db in the line. We have a remanent level in the line of 40.4 dbj, as is shown in Table 3, after the first tap-off.

Since we are allowing 12 db total reserve, the maximum isolation loss we can stand is 40.4 - 12 = 28.4 db. At this point in the line, channel-2 signals will be only about 2 db higher than the channel-13 signals due to line *delta*, so that we must choose an attenuation value for the tap-off unit which will not be more than 30 db at channel 2. From Table 2, we find that a 2.2- μfd . capacitor does this trick. The feedthrough loss at channel 13 with this value would be .15 db.

These figures give us the loss to the next unit, which will be 1.0 db line loss plus .15 db feedthrough loss, leaving a

remnant line level of 39.25 db. We can proceed this way to the end of the line, checking the levels at channel 2 for only the first few taps. On following ones, extra line loss at channel 13 makes it unnecessary to check 2 again, since it will be higher than channel-13 signals. It will take us a total of ten operations to determine the value of the isolation in the tap-off units for the whole system. This system can correct for errors to a great extent, since the larger distribution amplifiers almost always have some form of gain control, usually a control for each of the two v.h.f. bands.

System Troubles

Although the development of a multi-set system requires far more work and understanding than the maintenance

set to set. They may only occur on one branch of a system. Check terminating resistors and cable connections.

Snowy pictures: Weak signals can be caused by open center conductor of coax; defective amplifier or tube. Mis-oriented antenna or parted antenna leads may be responsible. Check signal strength at inputs and outputs of amplifiers to pin down troubles.

Windshield-wiper effects, or overlaid pictures: This is cross-modulation caused by an overdriven amplifier. The point to watch is that the offending signal will be one that looks good itself. Remedy is to reduce the strength of the offending signal.

Sync instability: This is caused by overdrive. In single-channel amplifiers, overdrive will not show up as windshield-wiper patterns, but instead as

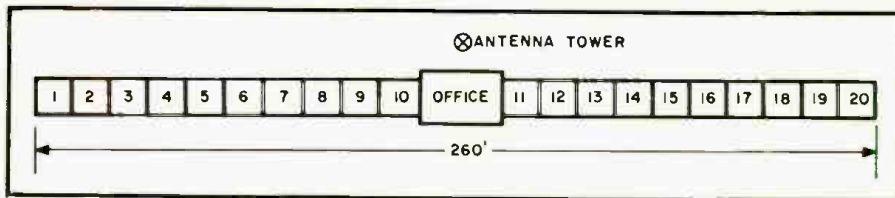

Fig. 13. Sample case: physical layout of a 20-unit motel with central office.

CAP. (μfd .)	CH.2		CH.6		CH.7		CH.13	
	I	FT	I	FT	I	FT	I	FT
.47	42	*	34	*	33	*	29	*
1.0	34	*	28	*	26	*	22	.05
2.2	27	*	21	.1	17	.11	15	.15
3.3	22	.06	18	.12	14	.25	11	.5
5.0	19	.12	16	.2	11	.54	9	.9
6.8	16	.17	13	.3	9	.91	6	1.5
10.0	13	.3	9	.6	Not used in this band			

* = Insignificant loss; I = Isolation loss in db; FT = Feedthrough loss in db.

Table 2. Capacitor values commonly used in tap-off units, with their losses.

Table 3. How isolation values for the tap-off units are taken into account.

Starting level of feeder	41.4 dbj	
Line loss to first tap	1.0 db	
Line level at first tap	40.4 dbj	(less 12 db reserve = 28.4 db, required max. isolation*)
Line loss and feedthrough loss to next tap	1.15 db	
Line level at next tap	39.25 dbj	(less 12 db reserve = 27.25 db, required max. isolation*)

* N.B. Less isolation is permissible, more is not.

and troubleshooting of one that has been built up, things can and do sometimes go wrong. Fortunately, systems of this nature are almost self-diagnosing. The symptoms are generally distinctive and indicative. To assist technicians who have not had much experience in this field, a list of symptoms follows, together with causes and checkpoints.

No pictures: Usually a dead amplifier; sometimes a parted antenna lead; but very rarely a broken cable. Shorted or open coaxial cables usually result in weak, ghostly pictures.

Ghosts that are not seen at the antenna lead: These are reflection ghosts due to open or mismatched lines. Characteristically they are ghosts whose placement and strength varies from

sync-tip compression, causing the sets to be critical of sync adjustment.

Hum bars in raster of all sets past a given amplifier: Hum in power supply of amplifier. May be defective filters or cathode-heater short in tube.

Sound bars in all sets: Excessive level of sound carrier. Can be caused by misaligned amplifier or defective antenna.

Impact-sensitive flashing or flickering of pictures: Usually defective tube or loose connection. Usual locating techniques apply (shaking cables, tapping tubes).

Other troubles: Any installation is unique and "Finagle's first law" applies. This states that, in any experiment, if anything can go wrong, it will. You have our blessing!

SSB EXCITER



ATTENUATOR PADS

Fig. 1. A 9-db pad as constructed by author.

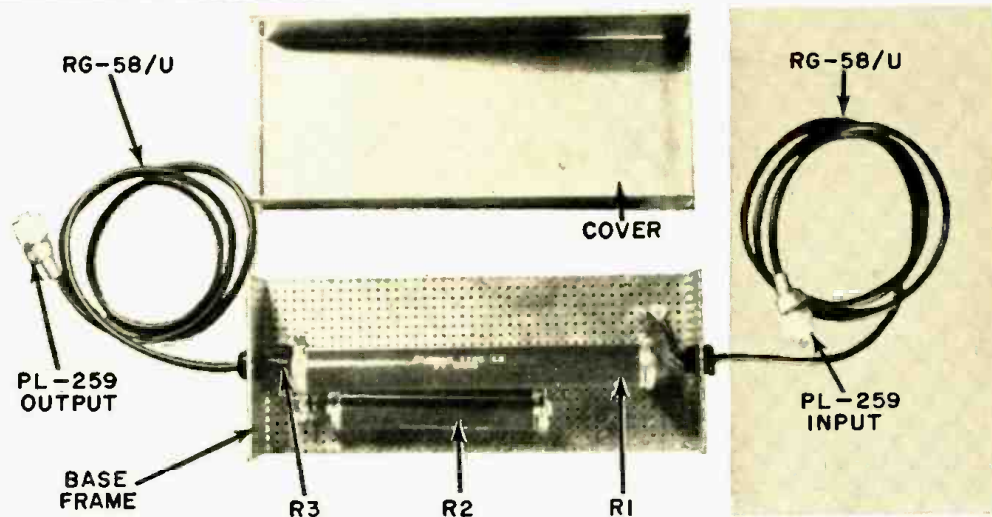

By **SAMUEL J. HYMAN, W9VRX**
Engineering Department
The Hallicrafters Co.

A pad between exciter and amplifier improves carrier suppression and signal-to-noise, reduces distortion.

SINGLE-SIDEBAND transmission is no longer considered a new fad in ham radio. Its advantages relative to solid "QSO's," reduced "QRM," and the realization of equivalent high AM power with smaller tubes and power supplies are no longer questioned.

Most single-sideband exciters, whether purchased or home-built, have an output power range from ten to one-hundred watts. When a linear amplifier is added after the exciter and using the FCC method of measuring sideband input plate current, it is possible to obtain over 800 watts of sideband power output directly into the antenna.

When a linear amplifier is driven by a single-sideband exciter, it is possible to overlook an important consideration. How should the exciter output be reduced to the proper drive level for the linear amplifier?

The simplest and most readily available method is to reduce the microphone gain by adjusting the microphone gain control.

Too often we may advise someone that he has a considerable amount of carrier present. You volunteer to run tests for him. First, his exciter, barefoot, sounds good. But when he switches to his linear amplifier, up pops his carrier again.

This disturbs him no end. He may not understand the cause. The only difference between running his exciter barefoot *versus* exciter plus linear-power amplifier was the reduction of his microphone gain in the latter case.

Simple, yes, but that was his big mistake. Let's get a little technical and perhaps you will get the idea.

It is easier to understand an analysis if extreme cases are considered. So, let's consider a sideband exciter capable of delivering 100 watts of sideband power output. We will also consider a linear-power amplifier that will require only 10 watts of driving power to develop full power output. The power output of the linear amplifier, for our discussion, will be 800 watts.

Let's look into our exciter first. The specifications tell us that at the 100-watt single-sideband output level, the carrier is suppressed 50 db. This figure was obtained using the "two-tone" test method. This is an excellent method for laboratory test purposes. It permits tests and comparisons to be made with good accuracy and capabilities of repeatability.

When the exciter is in actual use, the human voice is involved. Unfortunately, the human voice is not a constant-amplitude source. The exciter under discussion does not have any special circuits for speech clipping or amplitude compression thus, we must set our microphone gain control so that our voice peaks do not clip and distort. This moves our effective output power for speech purposes to about a 60-watt level and our carrier is now suppressed below this level by 47.8 db.

We now reduce the power output from the exciter by reducing the microphone gain so that the peak-envelope-power is only 10 watts. The carrier (-50 db at 100-watt level = 0.001 watt) level has not changed. It is still 0.001 watt or now $[db = 10 \log (P_1/P_2) = 10/.001]$ it is suppressed only 40 db.

We now realize a loss of 10 db of carrier suppression by using our micro-

phone gain control to reduce the exciter drive to the linear amplifier and, with speech present, the carrier is down only 37.8 db.

There is another point to consider. The carrier suppression is partially or wholly dependent upon the balanced modulators. The balanced modulators are dependent upon their inherent circuit stability. Unfortunately, there is a warm-up period required. When the exciter is first turned on, it is not uncommon to have only 30 db carrier suppression.

The warm-up period for the carrier balance to settle down may range from 15 minutes to 2 hours. During this period, the suppression may start at 30 db and may never get down to 50 db. Without additional adjustments within the exciter, it is possible for the final warm-up suppression to be only 40 db.

This is not objectionable if we use the exciter barefoot. But if the exciter is used to drive a linear amplifier, as previously discussed, there would be an additional 10 db lost and the carrier suppression would be only 30 db.

But most of us would not wait one to two hours for the rig to warm up before going on the air. Therefore, it is possible to have only 30 db carrier suppression in the exciter during the first "QSO" and better suppression as the rig is used continuously, *i.e.* without being turned off.

Again, using the microphone gain control to adjust the drive to the power amplifier, only 20 db carrier suppression can be realized. This is not good. Is it? With speech, it's down only 17.8 db.

Now, let's look into the exciter a lit-

the farther. We find mixers, i.f.'s, oscillators, class A amplifiers, both r.f. and audio, and an audio gain control. Sounds like we are describing a superheterodyne receiver. Well, they are similar.

Just as there is a signal-to-noise ratio in the superheterodyne receiver, there is also a similar signal-to-noise ratio in the single-sideband exciter. These noises are inherent. They are developed within the vacuum tubes and associated circuitry. Hum is also considered as a noise component.

The signal-to-noise ratio is unaffected by the volume control in the receiver but the signal-to-noise ratio is affected by the microphone gain control in the exciter.

The noise in the receiver is over-ridden or swamped out when a strong signal is received. The exciter is similar in this respect. However, we can control the desired signal ourselves. The microphone gain control is adjusted for maximum signal output at a point where the distortion products are not undesirable.

Now, the undesirable noise in the exciter can become audible in our transmitted signal if the microphone gain control is used as the means of reducing the excitation to the linear amplifier.

We can take full advantage of the carrier suppression within the exciter with no loss and keep the signal-to-noise ratio at a maximum by using a fixed pad between the exciter and the power amplifier. The pad forces the exciter to operate at near maximum output and attenuates the output to the proper drive level for the power amplifier requirements.

We cannot overlook another advantage when a pad is used. It permits the exciter to work into a "stiff" load which means that the distortion products developed in the final stage remain at their lowest level. This is particularly true if the final power amplifier is operating class B.

Now, let us go through a typical pad design. The most common and most popular pad used today is the "T" type. See Fig. 2.

In this diagram Z_s = impedance of the source and Z_L = impedance of the load—both of which should be considered as pure resistance. R_1 and R_3 are the "T"-pad series arms while R_2 is the "T"-pad shunt arm.

With this information we can set up the following formulas for determining values:

$$R_2 = \frac{2\sqrt{N Z_s Z_L}}{N - 1}$$

$$R_1 = Z_s \left(\frac{N + 1}{N - 1} \right) - R_2$$

$$R_3 = Z_L \left(\frac{N + 1}{N - 1} \right) - R_2$$

$$N = \frac{\text{power delivered to pad}}{\text{power delivered to load}}$$

Thus, where $Z_s = Z_L$, then $R_1 = R_3$.

Here is how we would compute the "T"-pad to be used with the exciter—linear-power amplifier discussed in this

DESIRED ATTENUATION (db)	SERIES-ARMS RESISTANCES (ohms)	SHUNT-ARM RESISTANCE (ohms)
2	5.8	215
3	8.6	140
4	11	105
5	14	82
6	17	67
7	19	56
8	22	47
9	24	40
10	26	35

Table 1. Resistances for various attenuation between 50-ohm source and load.

article. Assume that the exciter power output is equal to 100 watts; power amplifier drive required is 10 watts; power delivered to the pad is 100 watts; and Z_s and Z_L are 50 ohms. First we will compute "N."

$$N = \frac{100}{10} = 10$$

Next, we compute the value for R_2 :

$$R_2 = \frac{2\sqrt{10 \times 50 \times 50}}{10 - 1} = \frac{2\sqrt{25000}}{9} = 35 \text{ ohms}$$

R_1 and R_3 are computed as follows:

$$R_1 \text{ and } R_3 = 50 \left(\frac{10 + 1}{10 - 1} \right) - 35$$

$$= 61 - 35 = 26 \text{ ohms}$$

The circuit derived from these computations is shown in Fig. 3.

To compute the power dissipated in each resistor in the pad, the circuit can be redrawn as shown in Fig. 4. The formulas then become:

$$P_{R_1} = I_1^2 R_1 = (1.42)^2 \times 26 = 52 \text{ watts}$$

$$P_{R_2} = I_2^2 R_2 = (.972)^2 \times 35 = 33 \text{ watts}$$

$$P_{R_3} = I_3^2 R_3 = (.448)^2 \times 26 = 5.2 \text{ watts}$$

This totals 90.2 watts. The power figure would be exactly 90 watts if the decimals were carried out farther.

We have now completed our design. For safety reasons, we increase the power ratings of the resistors, as indicated in Fig. 5.

The chart of Table 1 gives values for the series-arm and shunt-arm resistances at various desired attenuations. These are not exact values but since the errors involved are small it makes very little difference in the final result.

The resistors used in the pad construction must be non-inductive. Non-inductive resistors should not be un-

known in our hobby. Actually the most common type is the "carbon" resistor. There are, however, special wire-wound resistors which are made specifically as "non-inductive" types. Among the firms making this type of resistors are: *International Resistance Corp.*, *Ohmite*, and *Sprague*.

Again, we would like to stress that only non-inductive resistors should be used in these pads. As we know, inductances are coils, chokes, and transformers. They have a reactance or a.c. ohmic value which is dependent upon the frequency at which the inductance is being used. Further, these inductances have self-resonant frequencies. When the distributed capacity within the coil has a reactive value equal to the inductive-reactance value, resonance occurs.

It is often necessary to connect several resistors in parallel to obtain adequate dissipating capabilities. The power dissipation of the parallel group is equal to the sum of the power dissipated by each resistor in the group. The easiest way to ascertain the proper ohmic value for each resistor in the parallel group is to use resistors of the same resistance value. Then, the final ohmic resistance value for the parallel group is equal to the resistance value of one resistor divided by the number of resistors used in the group.

In this particular application, the resistors may have a $\pm 10\%$ tolerance.

Taking the time to compute and construct the correct "T"-pad for your rig will pay off in operating convenience and a clean signal.

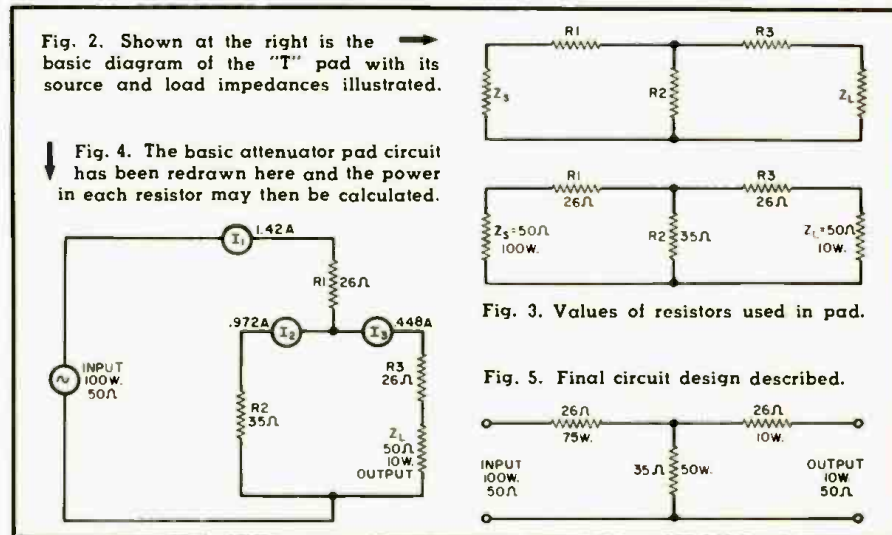

the **NEW LOOK** **IN TV SERVICE**

By **WILLIAM LEONARD**

The younger generation of TV service dealers reflects change in the nature of the industry.

THE MOST interesting and potentially important factor in the independent electronic service industry of today is the dynamics of youth evident in the direction of TV service businesses. Seasoned observers, who have watched developments in electronic service over a period of years, have been deeply impressed by the number of young men who now operate their own TV service businesses. It is apparent from their participation in association activities that these young men are determined to have a hand in shaping the future of their industry.

To appreciate the significance of "youth in the saddle" in electronic service management, it is necessary to

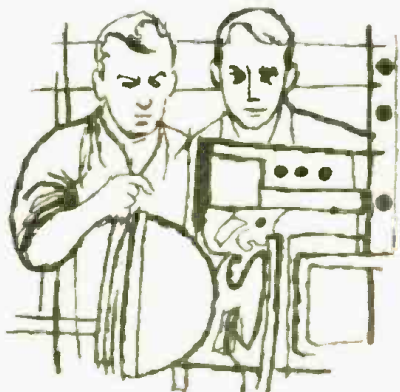

review the history of the activity since the introduction of television.

During the early days of TV, contract service spawned a large number of service contractors. The majority of set dealers were so busy selling TV receivers that they did not want to be saddled with the responsibility for installing and servicing them. The prepaid installation and service contracts were assigned to selected, independent service companies that provided the necessary facilities and manpower to carry them out.

The majority of these service-contractor businesses were completely financed by the monies received for prepaid service. The tremendous volume of business available to them encouraged over-expansion. Service organizations that employed fifty or more men were not uncommon.

The prepaid installation and service-contract plan hit the skids in the early fifties. By that time, the competition

for TV set sales had become so intense that many non-servicing dealers sold receivers at close to their own costs and chiseled their profit out of the contractors who handled service for them. This situation, coupled with poor financial management, pushed many service contractors into bankruptcy. The failure of these service contractors left thousands of set owners out on a limb for the service they had paid for when they bought their sets.

During this same period service gyps, fly-by-nights, and incompetents were fleeing the public without restriction. The Better Business Bureaus across the country were swamped with complaints about raw deals on TV service. The failure of many TV service contractors fanned the flames of public resentment against all independent TV service shops.

Concurrently with these developments, thousands of men who had converted their radio service businesses to handle TV service were quietly building a strong foundation of honest, ethical TV service businesses. Since they were basically technicians, they confined their efforts to servicing sets that were out of the area of contract service. They had a tough problem of customer relations because set owners were inclined to show little respect for any TV service dealer or technician.

While television was floundering about, electronic developments in an expanding national defense program reached out with attractive offers to practically every competent technician in the industry. There was some feeling that other electronic activities would drain the service industry of most of its competent technicians and completely

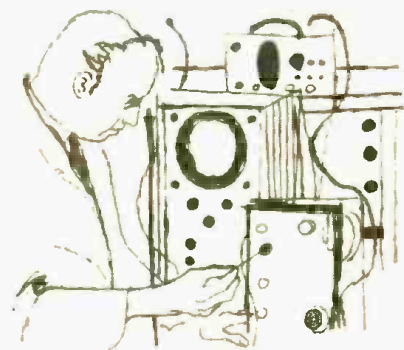

absorb the graduating classes of trade schools, leaving the independent service industry with only a skeleton organization to handle the growing business of consumer service.

Two forces were at work, however, that would have a strong bearing on the future of independent service. Ambitious technicians who acquired practical experience as employees of dealers or service contractors started their own service businesses. Most of these men enjoyed the business, had a flair for promoting service, and a knack for handling customers. They stepped into their businesses at a time when economic conditions favored the small, low-overhead businesses.

The other force was made up of the trained and skilled technicians who left the regimented life of military service and sought some business opportunity that would give them freedom of thought and action. In various ways, many of these energetic and ambitious young men got into the business.

The outstanding characteristic of this younger generation of service dealers is the objective approach they use in solving their management problems. They view TV service as a business and are quick to take advantage of plans and ideas that appear to be sound for their businesses. In contrast, their counterparts in radio service in years gone by depended more on their technical capabilities than on their business management "know-how" to stay in business.

On the whole, the service industry nationally has been passing through a period of economic re-adjustment and mental transition. In the wake of the former, there has been a sharp reduction.
(Continued on page 132)

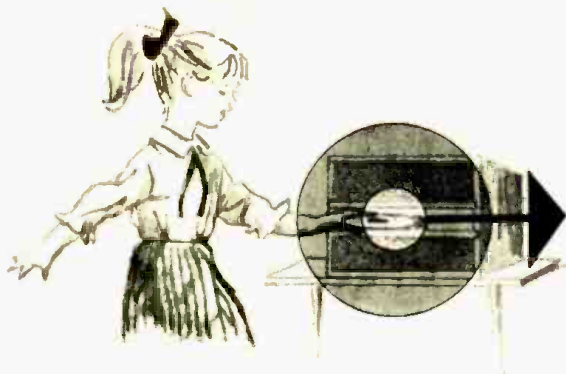
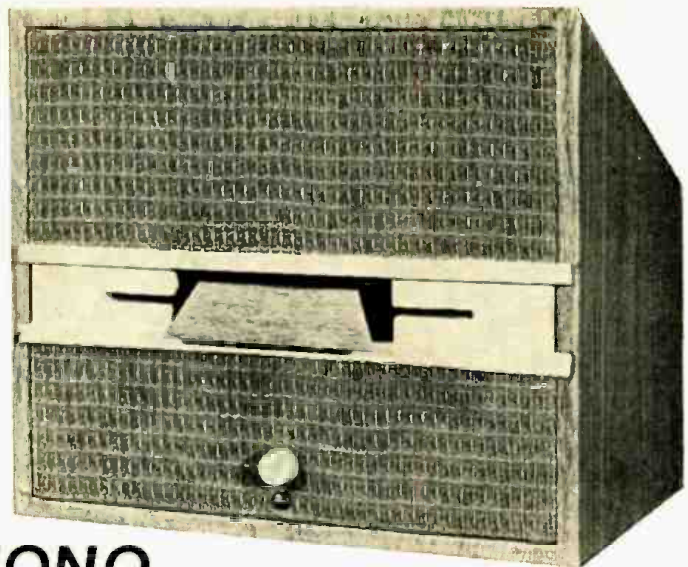

Fig. 1. Front view of the completed unit.



AUTOMATIC PHONO WITH TRANSISTOR AMPLIFIER

Compact child's phono uses a.c.-operated 1½-watt transistor audio amplifier and 45 rpm record player.

By **KENNETH W. BETSH**

AN a.c.-operated 1½-watt transistor audio amplifier and an RCA "Slide-O-Matic" 45 rpm mechanism are combined to make a small, compact phonograph designed especially for children. Not requiring a warm-up time, music starts the moment a record is inserted in the slot and the "play" bar is raised. A front view of the phonograph, housed in a cabinet built by the author, is shown in Fig. 1.

There are several reasons for using a transistorized amplifier in this type of phonograph. Besides requiring no warm-up time, there is no shock hazard since power is derived from a 12-volt filament transformer. A compact, totally enclosed cabinet can be used since practically no heat is radiated by the amplifier. Because inexpensive transistors are used, the parts cost compares favorably with that of an a.c.-operated vacuum-tube amplifier; the use of an a.c.-d.c. amplifier by children being ruled out. Last, but not least, there is the experience with transistor circuits to be gained by constructing this unit.

The RCA mechanism, priced quite reasonably, has been on the market for some time. Finding one at a dealer or buying one second-hand should not be too difficult. Many stores are now offering these units at drastically reduced prices.

The schematic of the amplifier is given in Fig. 3. Since the circuit may seem unusual to one whose experience has been limited to tube-operated equipment, a detailed explanation of its operation will be given.

The amplifier contains four transistors: three are 2N229's, and one,

the output stage, is a 2N307. When this amplifier was designed, these were the cheapest available, the total cost being \$3.75 for all four. The 2N307 is one of the types designed for 12-volt automobile radios, therefore a 12-volt d.c. power supply is used. Oddly enough, unlike vacuum-tube circuits, the 12-volt supply is made negative with respect to the chassis ground of the unit.

The crystal pickup used in this player delivered about 0.3 volt from a frequency test record. This was measured across the 180,000-ohm load resistor wired across the pickup leads. The response, again using a test record, was found to be very close to the RIAA curve from 200 cps to almost 10 kc. The roll-off below 200 cps is due to the load resistor. This was found desirable to control the rumble reproduced by the pickup and to limit the resonance of the 4" x 6" oval speaker when mounted in the cabinet.

Like all crystal pickups, the frequency at which roll-off occurs goes up as the value of the load resistor is reduced. With the very high input resistance of a vacuum-tube amplifier, this load resistor is placed in parallel with the tube input. A transistor, however, has a very low input resistance. As a result, the load resistor, R_1 in Fig. 3, is in series with the transistor input. While this reduces the signal voltage to the first transistor, the signal current, which is just as important, is not reduced. C_1 is used to provide d.c. isolation.

The 2N229 transistors are of the *n-p-n* type, which means the collector (analogous to the plate of a tube) is positive with respect to the emitter

which is analogous to the cathode. The arrows of the transistor symbol show the positive-to-negative current flow. Since a negative voltage supply is used, the collector load resistors (R_2 of the first stage and R_3 of the second) are tied to ground while the emitters are tied directly to the power supply. This arrangement simplifies wiring and eliminates the possibility of destroying a transistor by accidentally shorting any transistor lead to the chassis.

To get collector current to flow, bias resistors R_4 and R_5 are used. This bias current is taken through the collector load resistors to obtain two feedbacks—d.c. to aid in stabilizing the collector current and a.c. to reduce noise and distortion.

The first and second stages are used as common-emitter amplifiers in which the base is the input and the collector is the output. C_2 couples the first stage to the volume control R_6 . This control can be of almost any value over 10,000 ohms, and should preferably be of the audio taper type. Notice that the sliding and high-end terminals are connected just the reverse of those used in vacuum-tube amplifiers. The combination of R_7 and C_3 gives a fixed amount of bass boost in the 500 cps area to offset the lack of low-frequency response and to give a balanced sound at normal listening levels that may be used.

The signal is coupled by C_4 to the third stage which is another 2N229. This transistor is connected as a common-collector amplifier to act as a direct-coupled driver to the output stage. Bias current for the driver flows through R_8 . The value of R_9 is such

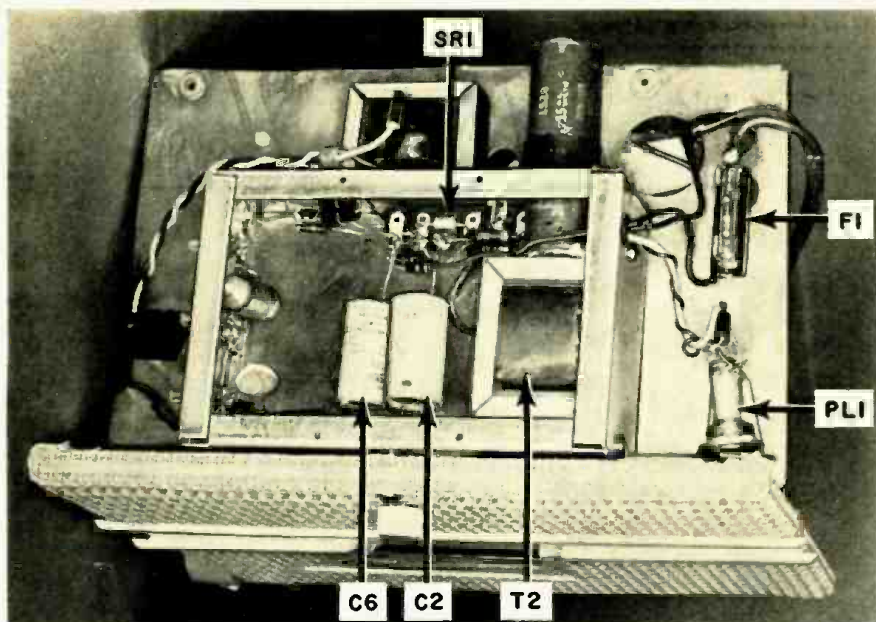

Fig. 2. Bottom view of phono shows placement of the rectifier and other components.

that, with no signal, half the current goes through the driver and the other half through the base of the output stage. As an incoming signal increases the base current of the driver, its collector current (and also the emitter current) is increased. This increases the voltage drop across R_{10} . As a result, the base current of the output stage is proportionately reduced.

Since the current through R_{10} determines the collector current of the $p-n-p$ output stage, its value has to be definitely set. With the average 2N307, a value of 1000 ohms results in a collector current of 600 milliamperes if the driver is cut off. With the driver collector drawing proper current, the 600 ma. falls to 300 ma. R_{12} is required to allow sufficient operating voltage for the driver since the base-to-emitter voltage drop of the output stage is a fraction of a volt.

The output transformer, T_1 , is connected between the collector of the output stage and the negative power supply. It should have a primary impedance of 24 to 32 ohms.

The power supply consists of a 12.6-volt filament transformer, a 500 ma. rectifier, three resistors (R_6 , R_{11} , and R_{13}) and three capacitors (C_2 , C_6 , and C_7). The purpose of R_{11} is to limit the peak current drawn through the rectifier to charge C_7 . This unit has sufficient capacity to smooth the d.c. for the output-stage collector. It is not filtered enough, however, for the output-stage base current. The advantage of the negative power supply is that the base current alone can be given additional filtering much cheaper than if all the current drawn by the output stage had to be well filtered.

The filament transformer used by the author had a center tap, so a 6.3-volt pilot lamp was wired in. It was so bright that a 10-ohm series resistor, R_{14} , was added. This should prolong the life of the bulb. A $\frac{1}{4}$ amp. fuse

was placed in the transformer primary as a safety precaution. In case of a circuit defect it won't save the transistor from burn-out (since they can burn out faster than a fuse) but it could save a rectifier or transformer. No power switch is shown since the motor switch on the record player is used to turn the amplifier on and off.

Construction

This amplifier was constructed on a 4" x 6" x 2" aluminum chassis. It was constructed in a "pancake" arrangement with all the parts around the edges of the chassis and none on the top. This kept the height of the finished unit to two inches. Two views of the chassis after being bolted to the record player are shown in Figs. 2 and 4.

The power transformer is placed inside the chassis. The transformer should have a 12.6-volt secondary. While the current drain is about one-half an ampere, the only readily available types have much higher ratings.

The output transformer is on the outside mounted between the large filter capacitor, C_5 , and the output transistor. This transistor, like all others of its type, has its collector internally connected to the case. This is so that the heat generated at the collector can be conducted away. In addition, the transistor must have its flat surface mounted against a heat sink which can be the chassis. However, since the circuit will not permit grounding of the collector and operation without a heat sink is risky, a problem exists. The answer is a transistor mounting kit made by *Bendix* which is available from *Lafayette Radio*. It contains an anodized aluminum plate (the anodizing making the surface an insulator), two insulated mounting bushings, and a socket for the base and emitter leads.

The other transistors are mounted

along the side of the chassis. While not necessary, the use of sockets for these transistors may prove convenient for testing.

While not used in the amplifier shown, a clip-in silicon rectifier, of the type made by *Sarkes Tarzian*, is recommended. A rectifier with a 500 ma. rating is necessary. Most such units have an inverse voltage rating of 250 to 400 volts, but in this application a 30 volt peak is certainly quite adequate.

Autotransformers may be available for the output transformer. These simply have a tap on the collector winding instead of a secondary. One was tested and found to be satisfactory. The only disadvantage is that the speaker leads are at a 12-volt d.c. potential above ground. Irrespective of type, the transformer must have a minimum primary current rating of 300 ma.

Completing the Phonograph

The RCA "Slide-O-Matic" comes in a shallow plastic case with an audio lead for plugging into a separate amplifier. The author discarded both the plastic enclosure and the plastic front piece. A new wooden front was made and the player was attached by using right-angle brackets between it and the copper-plated base plate of the mechanism.

The wooden panel extends below the base plate the same amount as the height of the chassis, i.e., two inches. A self-tapping screw through the front panel just below the volume control and two screws between the chassis and the base plate hold them together. The speaker, a 4" x 6" PM type, is screwed to the front panel above the slot. This slot is cut in much the same way as the cut-out of the original plastic piece.

This assembly is installed in the new cabinet from the front. It is held in place by a large self-tapping screw which runs through the back of the cabinet and into a bracket on the mechanism. Care must be taken to avoid excessive screw length since this would block the shut-off operation.

The cabinet shown in the photographs was made of plywood. Half-inch wood was used for the ends and quarter-inch for the rest. All except the front is covered with "Contact" in a simulated blonde mahogany finish. Other designs and simulated wood finishes are available and can be selected to match a child's bedroom or play area color scheme.

Many cabinet variations are possible. For greater simplicity, the mechanism in its original enclosure could be bolted to a matching box containing the amplifier and speaker. This, however, would not be as durable under a child's handling.

Testing

Builders having access to a voltmeter can make a few measurements that will insure proper operation. Before turning the amplifier on, it is wise to check with an ohmmeter to see that

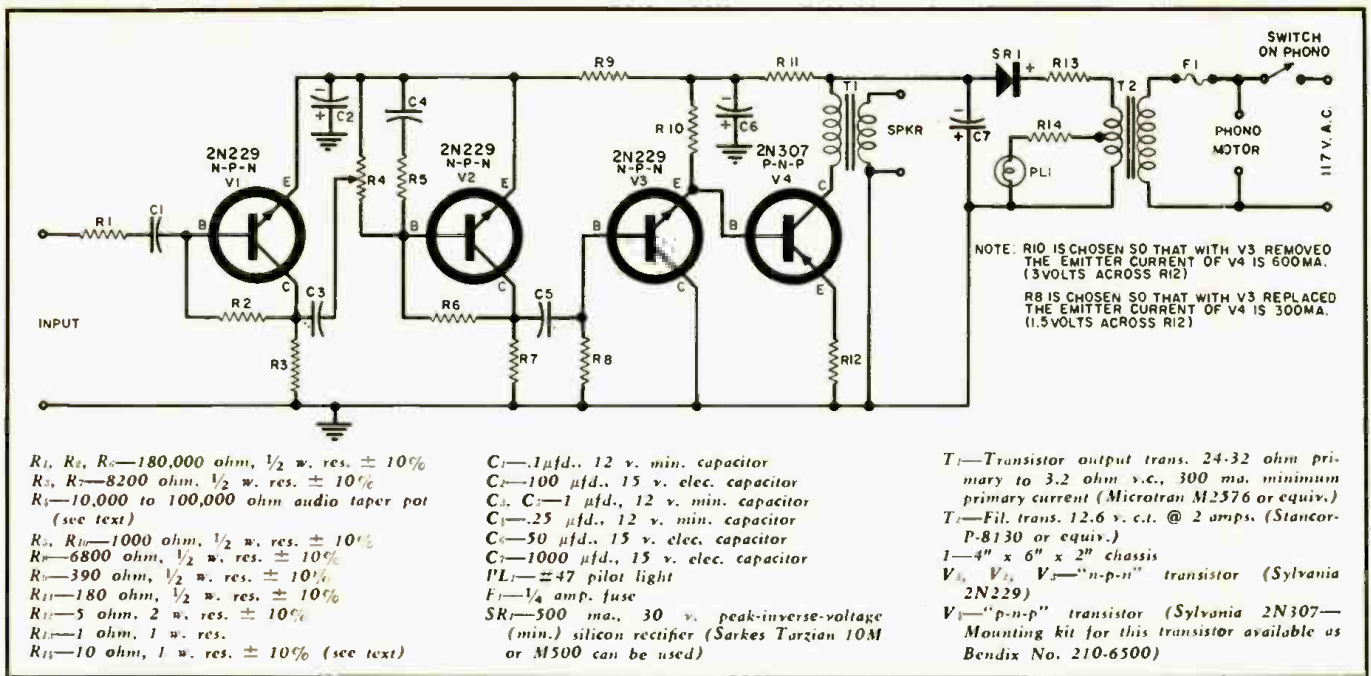

Fig. 3. Complete schematic diagram and parts listing for the transistorized phonograph amplifier discussed.

the output transistor is properly insulated.

After turning on the unit, measure the voltage across R₁₂. Since it should be 5 ohms, by Ohm's Law E should be 1.5 volts if 300 ma. is flowing. If this reading is over 4 volts, turn the amplifier off immediately and check for errors. With power off, disable the driver by either unplugging that transistor or by shorting its base to emitter. Turn the unit on briefly and measure the same voltage. It should be double, or 3 volts. If not, change R₁₀ to give a reading of 3 volts. Increasing the value of the resistor will decrease the voltage. Once this is set, restore the driver, and if the voltage doesn't drop to one-half, change the value of R₈ until it does. In this case increasing the resistance will increase the voltage.

As is the case in almost all transistor circuits, the voltage between the base and emitter is a fraction of a volt. The collector voltage of the first two stages should be between 5 and 9 volts to ground. A suspected defective output transistor can be checked with an ohmmeter. Checking base-to-emitter or base-to-collector should show a low resistance with one connection of the meter leads and a high resistance when reversed. The emitter-to-collector resistance should be high in either case.

Parts Substitution

All the resistance values in this circuit are fairly critical and changes, except where measurements show otherwise, should not be made. Capacitor values are not, however, critical. Decreasing their values will only affect frequency response or the hum level.

As far as substituting other transistors is concerned, changes from n-p-n to p-n-p cannot be made without interchanging the positive and nega-

tive voltage connections and the polarity of the electrolytics. Even if other n-p-n transistors are substituted for the 2N229's, it probably will be necessary to change the bias resistors, R₂, R₆, and R₈. However, as long as the voltages read as indicated previously, the substitutions are all right.

All power transistors now manufactured are of the p-n-p variety and other types could be substituted. Most of the others are more costly, although they have higher current gains. This means that the value of R₁₀ would have to be increased to keep the collector current at 300 ma.

This amplifier has plenty of gain even with the relatively low-output crystal pickup. With some of the high output crystal cartridges that put out several volts, the first stage probably

could be eliminated by tying C₁ directly into the volume control.

Conclusion

Everyone has commented favorably on the instant-playing feature and the quality of sound put out by this unit. Needless to say, it won instant approval with the children. The automatic shut-off is appreciated by the parents who have often had to turn off a non-automatic record player after the children have started it and then walked off and ignored it.

The author wishes to thank his associates at Bendix Radio Division for their advice and for the photography. This project was, however, original with the author and does not represent any product or idea of his company.

Fig. 4. This bottom view shows the location of the four transistors employed.

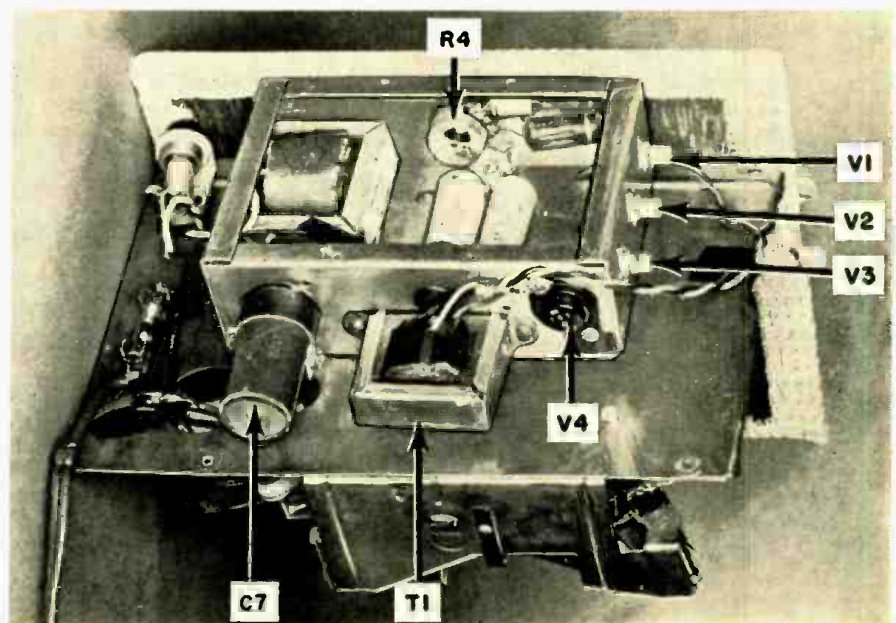

TO TROUBLESHOOT- REMOVE TUBES

By **CYRUS GLICKSTEIN**

Author, "Repairing Television Receivers"

Checking a stage with its tube out of the socket may yield results when conventional methods fail.

MANY KINDS of TV troubles can be located faster by first removing a tube in the stage thought to be faulty, then checking the stage. That's right—checking the circuit while the tube is out. Obviously, this procedure is somewhat different from the standard TV practice of removing tubes suspected of being defective and substituting good tubes.

This is not meant to imply that tube substitution is no longer necessary. Replacing tubes which may be bad is still one of the first and most important steps. However, once it has been found that the trouble in the set is not caused by a defective tube, other troubleshooting steps are obviously required. Tube removal is simply one of these other methods and can be very helpful, especially for some tricky faults such as intermittents and tough troubles in the sweep and horizontal a.f.c. circuits.

Surprising as it may seem, this method can be used to locate various troubles in series filament sets. Several examples will show how useful this procedure can be.

Case No. 1. An intermittent Christmas-tree effect was noted on the screen (Fig. 1), with the picture and raster breaking up horizontally. The set was an RCA chassis KCS-102B—a transformer-type receiver. Control adjustments and tube substitutions in the horizontal sweep circuit had no effect in eliminating the trouble. The chassis was pulled and d.c. voltage readings were taken around the horizontal oscil-

lator and output stages. These were found to be within the normal tolerance of the voltage readings noted on the schematic. Oscilloscope patterns around the horizontal sweep circuit appeared to be normal.

Since the fault was evidently a horizontal frequency defect, the oscillator tube was removed. Power was re-applied to the set and voltage readings were again taken around the stage (Fig. 3). The following readings were obtained: Pin 1, 240 volts; Pin 2, 1 volt; Pin 3, 3.5 volts; Pin 6, 240 volts; Pin 7, 5 volts; and Pin 8, 0 volts.

With the tube removed and no current flowing through the cathode-plate circuits, zero voltage would normally be expected on pins 2 and 7 (grids) and pin 3 (cathode of the control tube). Positive voltages on these pins indicate a leaky capacitor. Since all of these pins are interconnected through a resistive network, it was quite likely that all of the positive voltages were due to a single faulty part. Inasmuch as the highest unexpected positive voltage was measured on pin 7, it was probable that this pin was closest to the defect and the lower voltages on pins 2 and 3 were due to the voltage-divider effect of the resistive network.

The only possible source of the higher positive voltage applied to pin 7 was a leaky capacitor, C_{103} , connected between the horizontal-frequency coil, L_{103} , and the control grid (pin 7). The capacitor lead to the control grid was clipped and the voltages rechecked with the tube

still out. The two grids and the cathode now measured 0 volts. Replacing the capacitor with a new one resulted in normal operation.

A point to keep in mind is that a small amount of leakage may occur in some "intermittent" capacitors even during periods when the set seems to be operating normally. Especially in oscillator stages, the leakage may not be sufficient to affect voltage readings beyond the usual tolerance. In a horizontal-oscillator stage, for example, practically every pin has a substantial positive or negative voltage with the tube in the circuit, thus a small amount of leakage may not affect the readings enough to point to the defect. Yet, with the tube out of the circuit, the small amount of leakage can be detected immediately if one or more pins which should then have no voltage reading should show positive voltage.

Exactly the same procedure can be followed if a similar trouble occurs in a series-filament set. The tube is removed and voltages measured around the stage. True, removing one tube in a series-filament set opens the filament string and no tubes light. However, these sets usually have selenium-rectifier low-voltage power supplies, and "B+" voltage is generated as usual even with no heaters lit. A leaky coupling capacitor shows up in this type of set in exactly the same way as in the transformer type.

One precaution is worth noting. In some horizontal oscillator circuits, there is a small amount of positive voltage fed back from the plate circuit to the control grid of the horizontal oscillator to reduce the amount of negative voltage on the grid (R_1 , Fig. 2). With the tube removed, feedback resistor R_1 normally would place a positive voltage on the grid pin which would mask any capacitor leakage. This can be eliminated during a tube removal check by unsoldering one end of R_1 before making the voltage check around the tube socket with the tube out.

A set may have an intermittent trouble which doesn't show up when measurements are made with the tube removed. The standard procedures for breaking down the intermittent should then be followed—warm air from a hair dryer applied to the stage, placing a heated soldering gun under a suspected part for a short time, and so on



Fig. 1. In this puzzling intermittent, the raster would occasionally break into a "Christmas-tree" pattern, as shown. The cause was run down by taking voltage readings in the horizontal oscillator stage with the tube out of its socket.

—with the tube still out. If an oscillator-circuit capacitor, for example, becomes leaky, it will often show up sooner with the tube removed as voltage measurements are made around the circuit.

Case No. 2. When a fuse blows in the "B+" or horizontal-output circuits, the usual procedure is to replace the fuse without any further troubleshooting, since the cause may simply have been a current surge. In many cases, no further servicing is necessary after the fuse is replaced and it is found the set operates normally. However, it is advisable to rule out the possibility that an intermittent breakdown caused the original fuse to open. The set should be run for a short time with a higher-than-usual voltage after the fuse is replaced. This is done most readily in power-transformer sets by removing the sound-output tube before turning on the power. This reduces the load on "B+," causes an increase in the low-

voltage "B+," and consequently in the boosted "B+" and high voltage as well. An intermittent is more likely to show up with an increase in the applied voltage. Removing the sound-output tube therefore serves to check for a possible intermittent in either the "B+" line or the horizontal-output circuit.

A similar check can be made to determine if an intermittent caused the "B+" fuse to blow in a series-filament set. Simply replace the fuse and remove one tube. This opens the filament string and removes the complete load from the low-voltage power supply, raising the "B+" voltage output. If the intermittent part is in the low-voltage power supply proper, the higher "B+" voltage will, in many cases, cause it to break down.

Case No. 3. If a blown fuse is replaced and then the replacement fuse blows, this can become a rather involved trouble to find. The blown replacement fuse definitely points to

trouble in the set. Resistance checks very often do not help in finding the trouble, since the faulty part may not break down until voltage is applied. Yet as soon as voltage is applied, the replacement fuse blows. The problem is usually resolved by applying methods that will blow as few replacement fuses as possible and still track down the trouble in the shortest possible time.

One conventional method is to disconnect the complete load from the fused circuit. The fuse is then replaced and each branch of the load progressively reconnected until the fuse again blows. The last circuit reconnected is generally the defective one. Unfortunately, this technique is slow and painstaking.

In transformer-type sets with horizontal-output fuse trouble, it may be possible to localize the defect quickly by first removing the horizontal-output

(Continued on page 113)

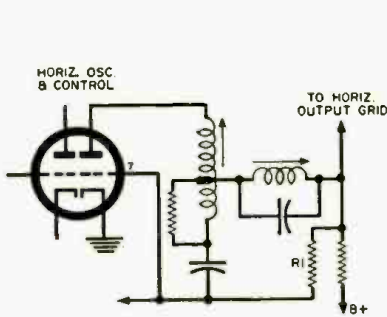

← Fig. 2. Feedback resistor R₁, normally reduces negative voltage on pin 7, but applies positive voltage when the tube is removed.

→ Fig. 3. Horizontal oscillator and control stage for the RCA KCS-102B.

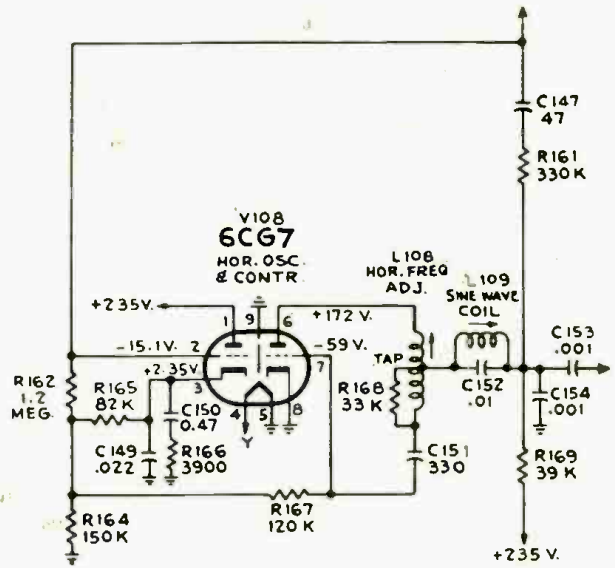
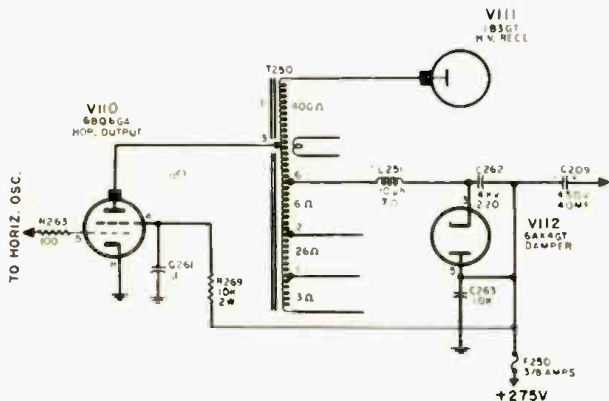
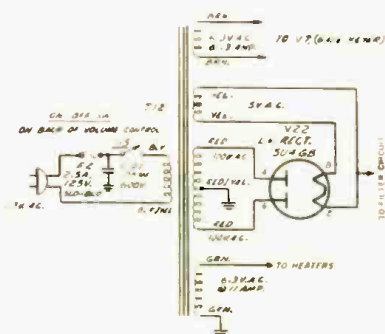
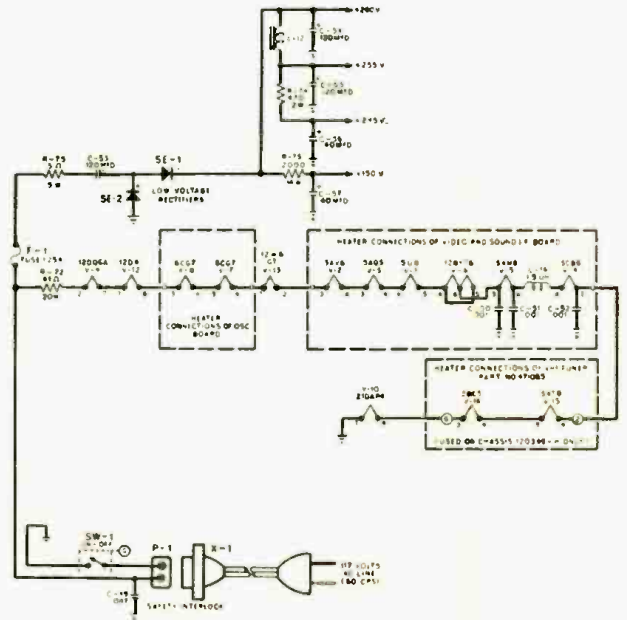

Fig. 4. Fused horizontal-output circuit, used in G-E "U" line.



← Fig. 5. Fuse (F₂) in primary circuit of a transformer-powered receiver (Andrea VQ21 series).

→ Fig. 6. Fuse (F₁) as used in the "B+" supply of a series-filament receiver (Emerson 120380H).



Measure That Flutter

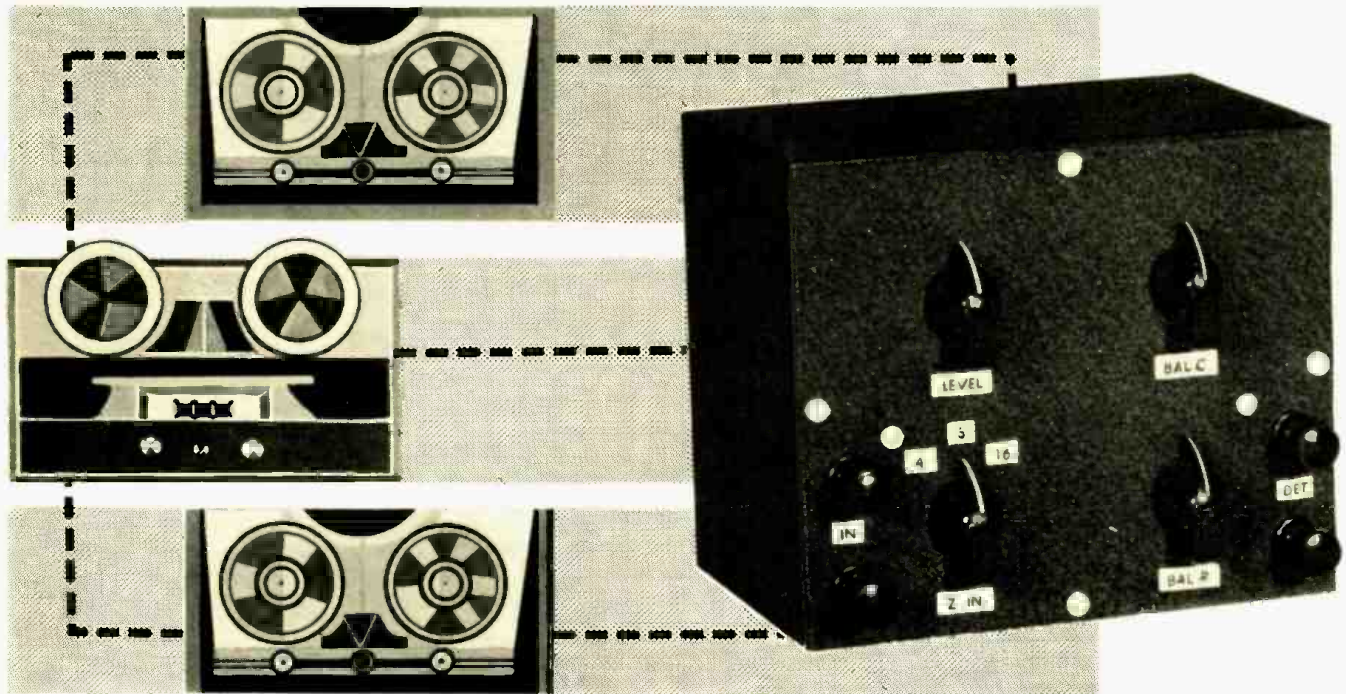

Flutter tester is built in a 4 x 5 x 6 inch metal box.

By H. R. WALTER

Construction details on tape recorder flutter tester that can be made from commercially available parts.

ELECTRONIC service technicians, serious-minded audiophiles, and hi-fi hobbyists are always faced with the problem of tape recorder flutter and are concerned with the best possible mechanical adjustments to keep flutter to a minimum. Flutter is caused by variations in tape speed as the tape passes over the recorder heads and although it may be understood that minimum flutter results when optimum mechanical adjustments are made in the tape transport mechanism, together with replacement of worn parts such as drive wheels, belts, capstans, pressure rollers, etc., the question often arises, how can one know when optimum conditions have been attained?

Tape speed variations, or flutter, are particularly noticeable when a sine-wave signal or sustained notes from a musical instrument, such as the violin, are reproduced from the magnetic tape. Listening tests may result in reduction of flutter as various mechanical adjustments are made, but this method does not provide assurance that speed variations have actually been minimized.

The author has worked with laboratory-type flutter indicators which indicate the per-cent flutter of a mechanical system when used to reproduce a sine-wave signal. Since these instruments provide a high degree of accuracy, they are quite costly and

are, therefore, usually found only in laboratories engaged in audio work.

The author has often wondered if a practical instrument, using readily available parts at reasonable cost, could be constructed to enable the audio worker to check the results of mechanical adjustments and provide visual indication of his efforts.

Principles of Operation

A flutter indicator will measure variations in a sine-wave signal frequency, reproduced from a tape transport mechanism, due to speed variations of the magnetic tape.

The input circuit consists of an impedance matching transformer which may work into a bandpass filter network. The primary winding of the transformer may be tapped for common impedances, such as 4-, 6-, 8-, 16- and 600 ohms. The bandpass filter is designed for the flutter indicator fundamental frequency and attenuates

hum and noise components in the recorder and amplifier system outside of the passband.

A special form of general purpose, or Wheatstone, bridge is connected to the output of the bandpass filter. This is known as a resonance bridge and is composed of three resistive arms and one series-resonant arm. By manipulating a capacitance-balance and a resistance-balance control the bridge can be balanced at the fundamental frequency and usually about 2% either side of this frequency, that is, minimum indication will be obtained on the null detector since at resonance the inductive and capacitive reactances are equal and, therefore, cancel out, leaving only a resistive component in this series-resonant arm.

With variations in tape speed, the fundamental frequency recorded on the tape will also vary and these deviations from the fundamental will result in a reactive component in the series-resonant arm. Under this condition the bridge, of course, will be unbalanced and the null detector will indicate some value above the minimum reading. Since the bridge becomes unbalanced when the tape test-signal frequency varies with tape speed, the null indicator will furnish information concerning the tape speed variation, or flutter. The null indicator, or meter, may be calibrated in per-cent flutter which is pro-

Fig. 1. Diagram of 3-element "T"-section bandpass filter with mathematical terms.

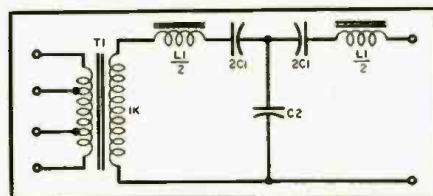

portional to the frequency deviations.

The flutter tester to be described was built to make comparative flutter tests and so was not calibrated. However, some calibration procedures are suggested later in the article.

Circuit Analysis

The input and bandpass filter circuit is shown in Fig. 1. The input transformer, T_1 , is a line-to-speaker-voice-coil type and may have a tapped low-impedance winding or a single impedance for the input. This transformer works into the three-element "T" section bandpass filter which was designed for a frequency of 3500 cycles. Mathematical equations used in the filter design are given later for the benefit of the reader interested in constructing a filter with different operating characteristics.

The design frequency of 3500 cycles and impedance of 1000 ohms were used because it made possible the use of a transformer, inductors, and capacitors that happened to be available. Any design frequency may be chosen, but it would seem desirable to work between about 1000 and 4000 cycles. Low frequencies result in large inductors and capacitors. Higher frequencies bring on loss and intercoupling problems and more critical parts placement.

The bridge circuit, as mentioned previously, is a modified form of the Wheatstone bridge, known as a resonance bridge. In this bridge configuration, three of the arms contain only resistive components and one arm includes both inductive and capacitive reactances. See Fig. 2. The bridge is balanced by manipulating potentiometer R_4 and variable capacitor C . The reactance arm is adjusted by the capacitor, causing cancellation of the reactive components, resulting in only a resistance impedance at the audio signal frequency. If the input frequency to the bridge increases or decreases from the fundamental frequency, this will exhibit a reactive component and an a.c. vacuum-tube voltmeter or other null detector placed across the null indicator terminals will give a reading above the balanced condition, depending on the amount of frequency deviation. The null detector may be a v.t.v.m., oscilloscope, or headphones, but for this purpose an a.c. voltmeter is most suitable.

As in the case of the bandpass filter, mathematical treatment for the bridge circuit is given later for the reader wishing to design his own circuit. The complete schematic diagram of the flutter tester with parts values is shown in Fig. 3.

Any physical arrangement of parts will be satisfactory but there are several necessary precautions. The inductors should be of the shielded type. They should not be mounted too close to each other in order to avoid coupling effects. High "Q" inductors are desirable and for best results this is especially important in selecting the bridge circuit inductor.

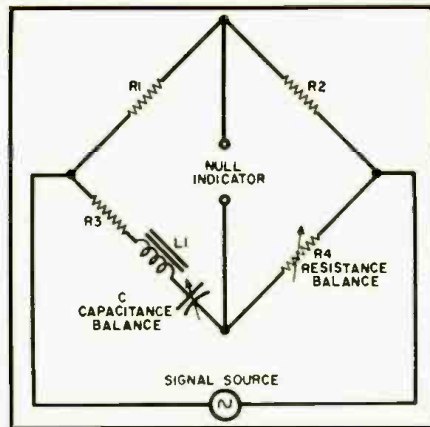

Fig. 2. Modified Wheatstone bridge circuit.

The desired bandpass for the filter network, as designed from the mathematical formulas, was obtained when the response was measured with resistive terminations. The band shifted slightly when the filter was connected in the complete circuit of Fig. 3. These filters should operate with resistive terminations with no, or very little, reactive components. Transformer reactance could possibly be cancelled out, but by experimentally altering the series capacitors in the network slightly, correction can be obtained.

This flutter tester was built for a service technician for making comparative flutter checks, to provide information concerning mechanical adjustments, and to indicate when the best possible adjustment has been affected. For this purpose the following procedure is recommended.

Feed a 3500-cycle signal from an audio oscillator to the input of the tester. Extreme accuracy of the oscillator frequency is not required since the bridge circuit covers the range from 3400 to 3600 cycles. Connect an a.c. vacuum-tube voltmeter across the null detector terminals. The oscillator output control and input control of the flutter tester should be set for a suitable reading on the meter. Adjust the balance controls on the tester to obtain a minimum reading on the meter. The sensitivity of the voltmeter should be increased by means of its range switch.

as required, to obtain the minimum indication. Make a note of this reading. Measure and note the audio voltage input to the tester. The same voltmeter may, of course, be used for this purpose. Now, feed the oscillator to the tape recorder and record this same signal frequency on a tape in the normal manner. This tape is then played back through the recorder and the output fed to the input of the flutter tester. The input impedance of the tester should be selected to be close to the output impedance of the recorder. Adjust the signal level by means of the volume control on the recorder to obtain the same voltage level to the tester that was noted when the oscillator was fed to its input. Observe the reading of the voltmeter connected across the null detector terminals. After making mechanical adjustments or replacing worn parts on the tape transport mechanism, this same test tape is again played back to the flutter tester. The main purpose of the test is to obtain the lowest possible reading on the vacuum-tube voltmeter, or null detector, which corresponds to minimum flutter.

In making this comparative test, it should be noted that the balance controls are adjusted only when originally feeding the oscillator directly to the flutter tester and are not to be changed when playing back the signal recorded on the tape to the tester. The foregoing procedure may at first sound involved, but actually it isn't once the operator runs through the test once or twice.

If the recorder level is not high enough, or the output impedance does not provide a suitable match, the recorder may be played through the regular audio system or through a utility amplifier. The unit shown, however, operated satisfactorily with as little as 0.2 volt to the input.

Other Procedures

Since the flutter tester was constructed for comparative flutter tests, it was not equipped with a self-contained null detection meter nor was it calibrated to indicate the magnitude

(Continued on page 106)

Fig. 3. Flutter tester circuit. Other input Z's, including 600 ohms, may be used.

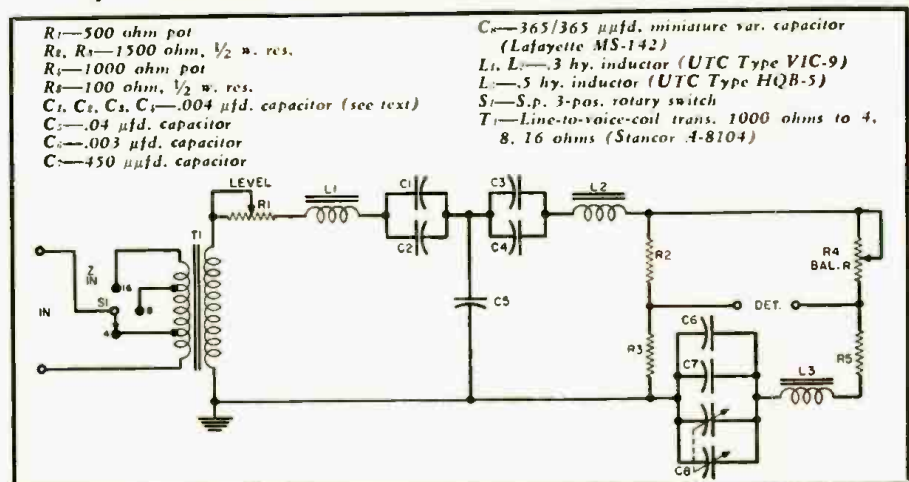

Transistors are Different

By ED BUKSTEIN

Northwestern Television & Electronics Institute

Explaining transistor operation with vacuum-tube analogies may result in several misconceptions.

BECAUSE learning is a process of viewing the unfamiliar in terms of the familiar, it is natural to attempt to study transistors by comparing them to vacuum tubes and noting the similarities. Although some such similarities exist, the transistor differs from the vacuum tube in more respects than it resembles it. For this reason, it is more fruitful to consider the differences rather than the similarities:

1. *The relationship between bias and output current in a transistor is opposite that of a vacuum tube.* In the vacuum tube, bias is a voltage applied between grid and cathode. Increasing the value of bias will result in a decrease of plate current. This is shown in Fig. 1A, where closing the switch would cause the meter pointer to swing down in the direction of the broken arrow. In a transistor, bias is a current which flows through the emitter-base circuit. Increasing the value of bias will result in an increase of collector current, as in Fig. 1B.

2. *Cut-off in a transistor is a condition of minimum, but not zero, collector current.* When a vacuum tube is cut off (by increasing the bias sufficiently), the plate current is zero. (Fig. 4A.) When a transistor is cut off (by removing the bias), a small amount of current still flows in the collector circuit. (Fig. 4B.) The collector current which continues to flow when the emitter current is zero is known as the cut-off current, or I_{co} .

3. *The transistor is a temperature-sensitive device.* Within a wide range of temperatures, the performance of a vacuum tube remains relatively unaffected. A radio receiver employing vacuum tubes may work as well outdoors during an Alaskan winter as it does on a hot beach in July. The operation of a transistor, however, shows a much greater dependence on temperature. A temperature change of only a few degrees may be sufficient to prevent normal operation of a transistor

circuit unless stabilizing techniques are employed. Stabilization circuits are necessary to prevent thermal runaway, since an increase of temperature will result in an increase of current, and an increase of current will result in a further increase of temperature, *ad infinitum*. See Fig. 5.

4. *Incorrect polarity of collector volt-*

age will damage the transistor. If the "B" supply of a vacuum tube is accidentally reversed, the circuit will be inoperative but the tube will not ordinarily be damaged. (Fig. 2A.) By contrast, the transistor will be ruined if voltage of improper polarity is applied to the collector. (Fig. 2B.) Under these conditions, the collector junction will be biased in the forward direction, excessive current will flow, and the junction will overheat. For proper operation of an *n-p-n* transistor, the collector should be operated at a positive potential. The *p-n-p* transistor requires a negative collector voltage.

5. *The input impedance of a transistor is relatively low.* The input impedance of a vacuum tube is high, particularly in circuits which do not draw grid current. For this reason, vacuum-tube circuits may be cascaded without introducing excessive loading of the preceding stage. This is shown in Fig. 3A, where the connection of the second vacuum tube drains off very little current from the first stage. Cascading of transistor stages, however, presents a greater problem because the low input impedance of each stage tends to load the output circuit of the preceding stage, as in Fig. 3B. Adding the second transistor stage causes some current to flow from the first stage. Such loading has an adverse influence on gain and frequency response. The exact numerical value of input impedance depends upon the type of transistor, parts values, and the type of circuit connection. Grounded-collector stages have higher values of input impedance than grounded-emitter or grounded-base stages, but the voltage gain of the grounded-collector circuit is less than one. Another consequence of the low input impedance of the transistor is that large values of coupling capacitance must be used to maintain adequate low-frequency response. Coupling capacitors from 2 to 50 μfd . are not rare in transistor audio stages. —30—

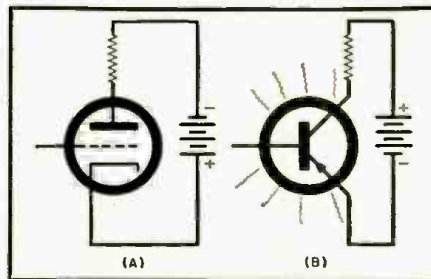

Fig. 2. If applied voltage polarity is wrong, a tube (A) will not function but a transistor (B) will be ruined.

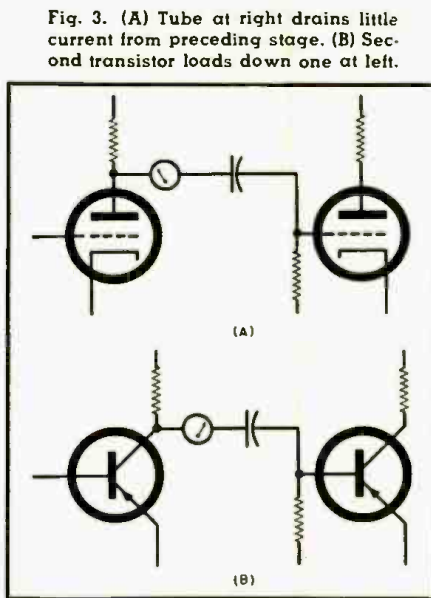

Fig. 3. (A) Tube at right drains little current from preceding stage. (B) Second transistor loads down one at left.

Fig. 1. Closing switch to increase bias reduces plate current (broken arrow in A) but increases collector current (B).

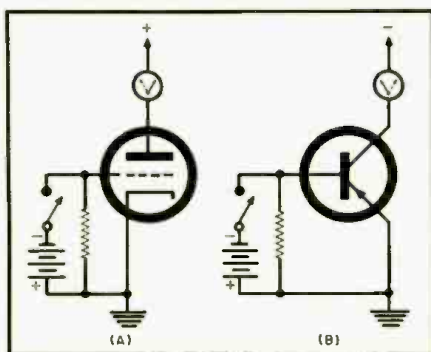

Fig. 4. Plate current is zero (A) in a cut-off tube. Some cut-off current flows (B) through a transistor's collector.

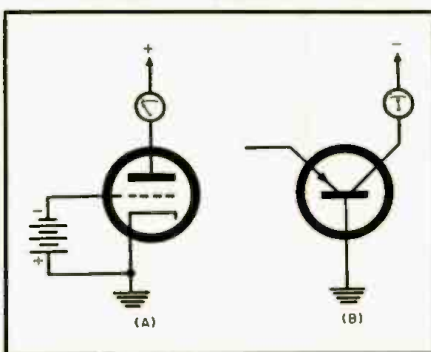
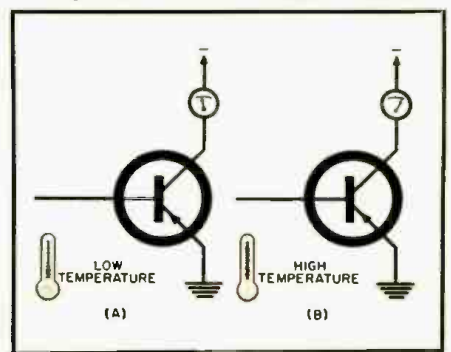

Fig. 5. The collector current of a transistor increases (see ammeters) as its temperature increases during warmup.



Any transformerless set you service gets a quick safety check with this easy-to-build test unit.

HOT CHASSIS?

By KENNETH BRAMHAM

PLAY IT SAFE



EDITOR'S NOTE: Working on a chassis that is not isolated from the supply line is an old story for experienced technicians. However the lay owner of such a set, less well informed, may unwittingly place himself in danger. Service people concerned with this problem will welcome the improvement in the safety factor made possible by the author's technique. Publicizing such a safety check is a good selling point with customers.

A RADIO OR TV chassis that is connected directly to the power line is nothing new to service technicians. Before the advent of transformerless TV receivers, there were the common a.c.-d.c. radios. Servicing such equipment has always called for some caution to protect personnel and test equipment. An occasional shock or blown fuse is nothing new. However, what is an inconvenience to the technician may become a hazard for the set owner.

Aggravating this problem is the use of metal cabinets in so many of today's transformerless receivers. If the chassis becomes shorted to such a cabinet, the shock hazard is obvious. However, the full extent of this hazard is often overlooked. A live cabinet is often the potential source of a 220-volt shock. That's right—not 110 volts, but 220.

The electrical system of an increasing number of homes on this continent consists of a three-wire system, as shown in Fig. 1. This is not confined to homes in which 220-volt wiring is specifically available for electric ranges, dryers, air conditioners, and the like. Even where all available outlets provide 110 volts, they may be arranged in two lines in the configuration shown. Only 110 volts may be present between the hot side of outlet A and ground, or outlet B and ground, but the full 220 volts can be measured between the hot side of outlets A and B.

Take the case of a TV receiver plugged into outlet A with a chassis-to-cabinet short. Near the set may be a defective lamp plugged into outlet B. An unsuspecting citizen reaches for the light while manipulating his TV set . . . if 110 volts can be lethal, 220 is considerably more dangerous. This,

of course, is just one of many possibilities. Why take a chance on losing a customer the hard way?

Complicating the problem is the fact that most metal-cabinet, live-chassis TV receivers have a resistor between chassis and cabinet to prevent the development of a potential between these two elements. Usually on the order of a quarter megohm, this resistor is shown as 270,000 ohms in the specific circuit of Fig. 2A. Even under near-perfect conditions with this resistor in the circuit, a slight shock may sometimes be felt. This source of complaint can easily be remedied by reversing the polarity of the line plug in its socket. Unfortunately, the set owner is seldom in a position to judge whether a slight shock received is a normal one that can be handled in this way or whether there is an actual defect that requires attention.

A vexing problem based on this set-owner experience often occurs shortly after a transformerless receiver has been serviced and returned to its owner. If the owner has managed to get the plug into the outlet the wrong way, a call to the service company will doubtless result. If the service dealer cannot be reasonably sure that the only cause is a reversed plug, an additional service call, usually charged to "customer relations," is often necessary just to reverse the plug.

This extra call can be eliminated and the customer can be told over the phone to reverse the plug if a reliable system of testing for chassis-to-cabinet shorts is adopted at the time of service. Aside from the specific case just described, such a system of testing is valuable in general. It protects the customer against serious shock and the service dealer against possible liability. A rapid and dependable method of checking can be provided with a simple device that the service establishment can put together for its own use.

The ohmmeter would appear to be adequate for such service, but its low internal voltage is not satisfactory. During the original factory check of transformerless sets in metal cabinets, manufacturers use something in the

range between 700 and 1100 volts. In this way, marginally defective capacitors or other components that would be missed in a low-voltage test are shown up.

The checker whose schematic is shown in Fig. 3 can be built up for less than \$10—still less if "junk-box" parts are used—and housed in the plastic cabinet of a discarded portable radio or a small utility cabinet. Power transformer T_1 may be a TV type unit providing 700 volts or more across its secondary. An old one that has been discarded because one of its filament

(Continued on page 145)

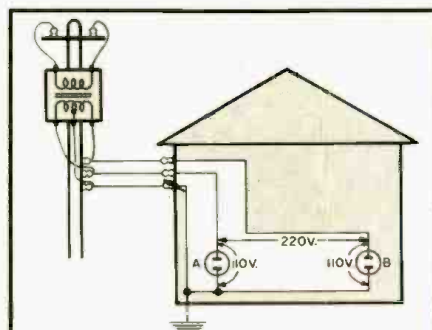
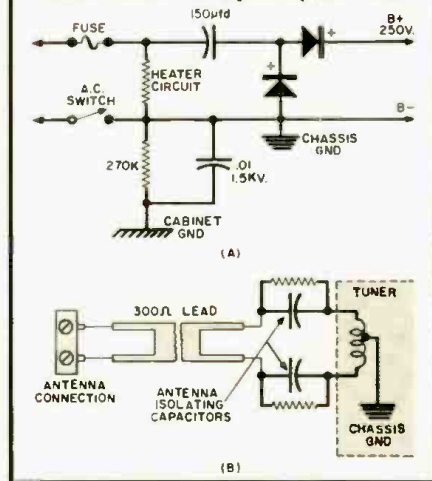

Fig. 1. A 220-volt shock is possible from normally wired 110-volt outlets.

Fig. 2. Breakdown of .01- μ fd. unit in (A) or isolating capacitors in (B) may render cabinet or exposed parts "hot."



Advanced Ham Receiver in Kit Form

EVER since the emergence of the kit, we have felt that it would be just about impossible to design, for the home constructor, a truly "professional" ham communications receiver in kit form. We believed that the problems would be too many and the complexity would be too great. But the *Heath Co.* has gone right ahead and done it with its new "Mohawk" receiver. Admittedly, this kit is by far the most expensive and most elaborate receiver in the firm's line. It costs about \$275 and comes in three large cartons weighing a total of 90 pounds. When the heaviest carton, which has all the components in it, is unpacked, even the experienced constructor is apt to be taken aback. There are almost enough parts in it to go into competition with your local parts dealer. We must say, though, that after 38 hours of mounting and wiring and another 7 hours of checking parts, double-checking the wiring, and (after a brief listening tryout) complete alignment, it was well worth all the time and effort. It was certainly a thrill, after stringing 2 dial cords, plugging in 3 crystals, and inserting 15 tubes and 5 pilot lights, to turn the receiver on and to hear, immediately, a good many ham stations. And this was before a single alignment screw was touched!

"Professional Receiver"

What do we mean when we say that

an amateur receiver is "professional?" First, it compares favorably with already assembled units costing about \$400. Second, it has the special features required for advanced ham use. It must be emphasized that this is not a general-coverage receiver, but that it tunes only the strictly ham frequencies from the 160-meter band up to the 10-meter band, spreading each ham band out along the 10-inch dial.

Basically, the set is a 15-tube, double-conversion superhet with selectable sideband. The first intermediate frequency is 1682 kc. while the second intermediate frequency is 50 kc. Variable selectivity, from 5 kc. down to 500 cps, is provided along with a 50 db rejection notch from a bridged-T notch filter for heterodyne rejection. The signal-to-noise ratio is given by the manufacturer as 10 db at less than 1 μ v. input. Output power is 2 watts into an 8-ohm speaker or a 500-ohm line or phones. Neither the speaker nor the phones is supplied with the kit. For stability the high-frequency oscillator is voltage regulated and cathode-follower isolated. Crystal oscillators are used for the lower frequency i.f. Still another crystal oscillator is used as a 100 kc. calibrator in order to obtain exact dial readings. Low-noise tubes are used where required.

The front end, comprising the r.f. amplifier, first mixer, and first oscillator, is completely prewired and

aligned. This eliminates what would have been a fairly difficult construction and adjustment procedure.

Construction

Since the receiver was designed for the advanced ham who has had quite a bit of experience building more complex gear, one might think that assembling this kit is a difficult job. Elaborate and time-consuming it is, but difficult it is not. This is due to the straightforward design and the complete 70-page instruction manual which comes with the kit. True, there were some discrepancies in the first printing of the manual, the one we used. These have been reported to the manufacturer and we feel sure that corrections will be made before any more manuals go out.

To simplify construction, the small 3-tube 1682 kc. i.f. subchassis is wired first. (See bottom view.) Then, the 5-wafer selectivity switch is wired. Next, the large 50 kc. i.f. and audio subchassis is put together and mounted in place on the main frame. Then, the dial mechanism is assembled and installed. This is followed by mounting of the small i.f. subchassis and the prewired front end. Front panel controls are mounted and wired in, and you're in business.

All the wiring is strictly point-to-point and no printed circuits are used. There is one pre-assembled laced wir-

RADIO & TV NEWS
LAB  TESTED

**Double-conversion 15-tube amateur-only receiver
with selectable sideband has excellent performance.**



Front-panel and top-chassis views of the assembled receiver are shown here.

ing harness employed. This tremendously simplifies interconnections between the 50-kc. chassis and components on the front and rear panels. Even the entire dial assembly, along with its several gears, pulleys, and two dial cords must be built from scratch. (One of these cords moves the dial pointer while the other rotates the entire dial drum when the frequency band is changed.) Although there are a good many individual parts that go into this assembly, the final operation is quite smooth except for a slight amount of backlash in the main tuning. This was caused by some movement on its shaft of the nylon gear used in the gear train drive.

A most useful special tool, supplied with the kit, was a little red plastic nut starter used to hold small nuts and get them started on their matching screws. Particularly helpful in locations not too easily reached with the fingers, this little tool saved plenty of time in the mounting of parts and in the mechanical assembly.

During the final stages of the assembly a short prefabricated coax cable with phono-plug fittings on it is used to interconnect the front end output to the 1682 kc. i.f. chassis input. In the kit assembled, this lead was just a bit too short. If the cable is "stretched" to make it fit, the strain on one of the end fittings could result in a "B+" short to ground at the phono jack. This would not only remove signal but would also overheat the decoupling resistors in the 1682 kc. i.f. chassis before the fuse has a chance to go. To prevent this, we filed a slot in the mounting bracket around which the cable had to be stretched. This lead certainly should be supplied a little longer so that the filing would not be necessary.

Circuit

The block diagram (Fig. 1) shows the circuit. The antenna is coupled to

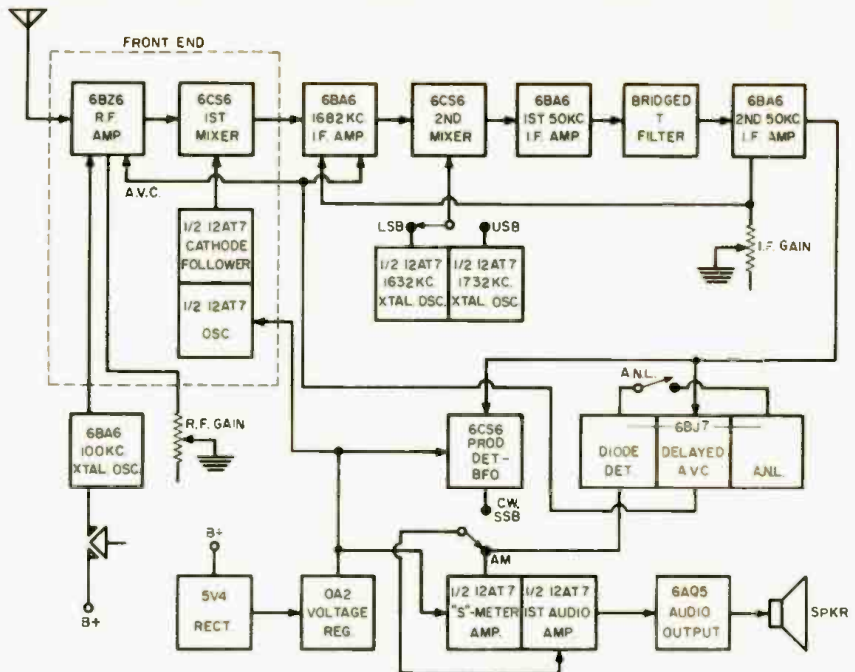

Fig. 1. Complete block diagram of the ham communications receiver is shown here.

a 6BZ6 r.f. amplifier. This stage has a separate manual gain control to prevent overloading. Delayed a.v.c. is also used here. High-"Q" coils on ceramic forms keep losses down and improve stability. A front panel antenna trimmer peaks up the input circuit for various antennas. The amplified r.f. is then applied to a 6CS6 first mixer, a dual-control pentagrid type which was chosen for its high gain and low noise. Also feeding the mixer through a cathode-follower is the output of the first conversion oscillator. A 12AT7 twin triode is used here for both these functions. A front panel oscillator trimmer fine-tunes this circuit for exact dial reading as marked by the 100 kc. crystal oscillator. High-"Q" circuits are also used for the mixer and oscillator. The mixer output is connected through

a short length of coax to the 1682 kc. i.f. subchassis.

The 1682 kc. amplifier is a transformer-coupled 6BA6 which is a.v.c.-controlled. Front panel control of bias is used for manual i.f. gain control. The use of this high i.f. virtually eliminates any image response. The signal is then transformer-coupled to a 6CS6 second mixer. Also applied to this stage is the output of either one of two crystal oscillators (12AT7 tube). One of these operates 50 kc. below 1682 kc. while the other operates 50 kc. above 1682 kc. This allows either sideband of an incoming signal to be placed within the bandpass of the receiver. The feature is used mainly in the reception of SSB signals. The mixer output is 50 kc., which is the second i.f. By using this low frequency a high degree of selectivity is obtained. The second i.f. is then fed to the large 50 kc. i.f. subchassis, which also has the audio and power circuits on it.

Next in line is a two-stage 50 kc. i.f. amplifier using 6BA6 tubes. Since selectivity is more important than gain here, the first 6BA6 is triode-connected. Both input and output of this amplifier are made up of two high-"Q" 50 kc. i.f. coils that are capacity coupled and resistance loaded. A front-panel selectivity switch varies the coupling and the loading to change the over-all selectivity of this amplifier. The cathode of the second 6BA6 is connected to the manual i.f. gain control. Between the two i.f. amplifiers is a bridged-T notch filter to reject unwanted signals. Sharply tuned LC components are used to produce a 50 db rejection notch. The position of this notch is adjustable from the operating panel. The notch circuit may be shorted out when it is not needed to reject an interfering signal.

The 50 kc. output is then applied to a

(Continued on page 130)

Under-chassis view of the receiver with major assemblies labeled. Refer to text.

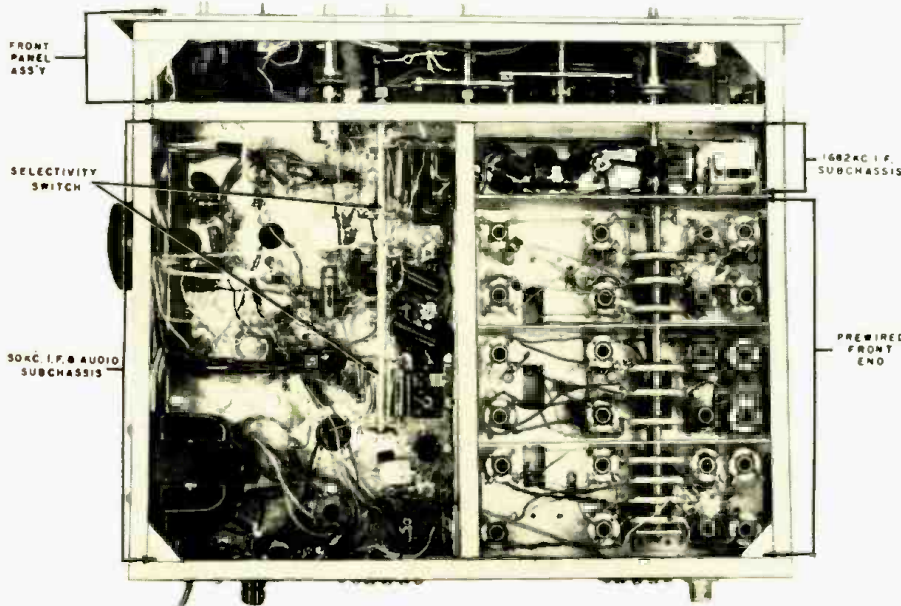



By JOHN T. FRYE
THESE ARE PROBES?

"B R-R-R-R! Baby, it's cold outside!" Barney exclaimed as he came stomping into the front room of the service shop and laid a chilly hand against the back of Miss Perkins' neck. The office girl let out a shriek and grabbed up a paperweight with which to defend herself against the grinning youth whose blue eyes twinkled down at her as he brushed away the huge snowflakes clinging to his coppery red hair. Suddenly his face took on a look of mock fright, and holding his arm crooked defensively in front of his face, he went through the service department door at a stumbling run.

"Whew! That Matilda's temper gets worse every day," he announced to his employer, Mac, who was sitting at the bench examining a group of odd-looking, black, cylindrical objects spread out in front of him. "Hey, what you got there; something new?"

"Yep. These are new probes put out by the Doss Electronic Research people and Jim, the salesman, left them here. He wants me to play around with them a little and tell him what I think of them."

"I imagined the probe field had been pretty well developed."

"Well, several of these gadgets stretch the word 'probe' pretty far. Actually they are specialized service instruments in compact, portable form."

"That ought to make them pretty useful on house calls."

"I was thinking along the same line. As you know, several times each day the technician has to make an important decision: can a set be properly repaired in the home or should it be taken to the shop? To make the decision intelligently, he must know the nature and extent of the repairs needed. What's more, if the set has to go to the shop, the customer is very likely going to want an estimate of the cost in advance. That means the technician must be able to localize the trouble right on the spot and make a good guess as to what will be needed to correct it. All this means that any instruments that he can easily take with

him that will aid in cornering the trouble are worth his consideration."

"You prefer to repair the set in the home if at all possible, don't you?"

"It's not a matter of preference; it's nearly a matter of necessity. We both know that it is a lot more convenient for the technician to work at the service bench where all the tools and instruments he needs are right at his fingertips, where the light is good, and where he can work in familiar, comfortable, distraction-free surroundings. Since the set can be checked thoroughly and test-run for an adequate length of time, the chance of a callback is lessened. On the other hand, the customer understandably prefers home repairs because the set will be out of use a minimum amount of time; the charge will be for only one trip to the house; and he can see—or so he fondly, but mistakenly, believes—if he is getting his money's worth.

"The whole situation reminds me of when I was a boy in a backwoods section of Arkansas and my dad operated a rural taxicab business. One of his best customers was the doctor; and Doc, too, had to perform his work in the home, if at all possible, because there was no hospital close; there was no hospital insurance; and many of the patients had a mortal fear of going to the hospital. As a result, Doc really went prepared. I'll never forget that huge black bag he lugged around. It bore little resemblance to the sleek little bags doctors carry today. With the contents of his bulging satchel Doc could deliver a baby, treat a snakebite, remove an appendix, or rout a deep-seated case of malaria. That bag was a miniature pharmacy, operating room, and laboratory, all rolled into one."

"And you think the service technician today needs similar furnishings for his tool chest?"

"Right. Unless he has the proper instruments with him, he can waste a lot of time trying to locate trouble and then have to give up and take the set to the shop for diagnosis. This means the time spent at the house is wasted.

Any attempt to estimate the cost of repairing the set can be nothing more than a wild guess."

"Do you think these probes will help?"

"We won't know until we try them, but some look promising. Take this one, called 'Electrolytic Substitute,' for example. It's a streamlined version of an old dodge we've used for years. You know how a good filter unit bridged across an open one will often produce a surge of current that temporarily heals the defective electrolytic so you're not sure if it was bad or not. We got around this by 'easing' the new capacitor into the circuit with a series variable resistance that was gradually reduced to zero value.

"Doss does it a little differently. They use a fixed resistor that can be switched in series with either of two values of capacity inside the probe. One value is for use in bridging capacitors in the 10-40 μ f.d. range; the other for bridging larger capacitors. The probe capacitor charges slowly through this resistance until a neon lamp in the probe lights up to indicate it is fully charged. Then a switch is thrown to cut out the series resistor. This switch permits the probe capacity to be cut in and out of the circuit at will, maintaining the capacitor fully charged all the while, without causing any circuit-disturbing surge of current."

"That ought to be real George for checking the electrolytics in a hurry. How about this thing that's called a 'Sweep Analyzer'?"

"You'd never guess from the name, but that probe is for checking any sort of transformer or yoke winding for shorted turns or shorts to the core or between windings."

"How does it work?"

"You use it with a scope. The three leads coming out of the shielded cable go to the vertical and horizontal input terminals, like so. Now we plug the a.c. cord into a socket and flip this little switch on the side of the probe. This connects a charged capacitor across these two leads not yet connected and across the scope leads. A phase-shifting network in the leads going to the scope produces that inverted "L" pattern as long as there is no inductance connected to the test leads, but when an inductance is between these two leads, the sharp pulse of current and the bridging capacitor sets up a damped oscillation that is seen on the scope as a spiral. Usually the spiral will have several complete revolutions, but the presence of a single shorted turn in the winding between the leads or in any other winding of the transformer will load the circuit so heavily that a complete revolution will never be made."

"I suppose you would have to disconnect any heavy loads, such as tube filaments, speaker voice coils, and so on, when making the test?"

"That's right, and in checking yoke windings, you have to disconnect any damping resistors. In this case you

(Continued on page 126)

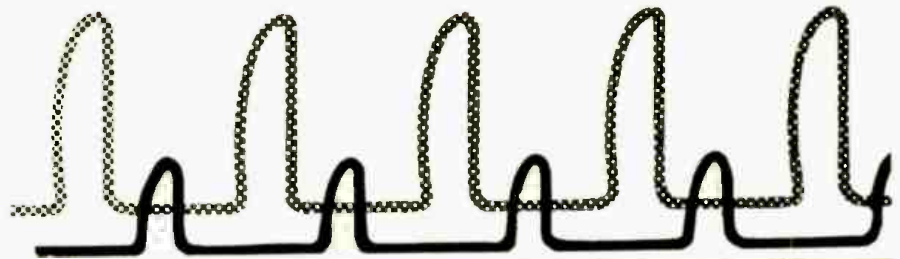

SPECIAL APPLICATIONS OF THE SQUARE-WAVE GENERATOR

Form your own saw-tooth waveforms, peaked pulses, triangular waves, and high-frequency sine waves. Also use for blanking, marking, and counting.

THE USE OF a square-wave generator for testing amplifier circuits has been described frequently. The applications of this device are not limited to amplifier testing, however. Like many other pieces of electronic equipment, its applications are almost unlimited, the governing factor being the ingenuity and skill of the user. With but few accessories, the square-wave generator may be used as a bi-directional pulse generator, uni-directional pulse generator, triangular wave generator, sine-wave generator, or linear saw-tooth signal generator. It may be used for checking the frequency of a tuned circuit and for determining the frequency of an unknown signal. It is also valuable as a blanking-signal source and marker generator.

In every case, the accessory circuits required can be assembled from stock-value parts by any competent technician. Except in the case of those few circuits requiring tubes, assembly time should be a matter of minutes.

No effort will be made here to expand upon the uses of the various signals that may be obtained from the square-wave generator, nor to give more than two or three examples of its use for frequency measuring, blanking, and as a marker. Instead, the development of the special output pulses themselves will be discussed.

Bi-directional Pulses

Probably the easiest special signal to obtain from a square-wave generator (other than a square wave!) is a

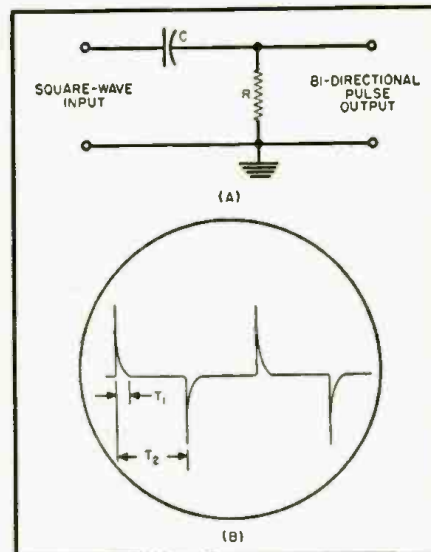

Fig. 1. Simple network (A) for forming peaked bi-directional pulses (B).

f (pps)	C	R
50	.05 μ d.	1000
1000	.005 μ d.	1000
10,000	.0005 μ d.	1000
100,000	50 μ d.	1000

Table 1. Values for producing sharply peaked pulses with circuit of Fig. 1.

Table 2. Values for greater pulse width than provided by constants of Table 1.

f (pps)	C	R
50	.1 μ d.	1000
1000	.01 μ d.	1000
10,000	.001 μ d.	1000
100,000	100 μ d.	1000

bi-directional pulse. All that is necessary is a resistor and capacitor connected in series to form a simple differentiation circuit (Fig. 1A). The square-wave generator is connected across the RC combination and the bi-directional pulse obtained across the resistor.

The amplitude of the pulse will approach the amplitude of the applied square-wave signal provided capacitive loading across the resistor is kept to a minimum and provided the applied square wave has a short rise time. Pulse width will depend on the RC time constant, as will the decay time of the pulse signal.

In Tables 1 and 2 are given RC values for a differentiation circuit permitting narrow pulses at the repetition rates (f) shown. The value of R has purposely been kept constant at 1000 ohms to minimize any loading by the circuit in which the pulses are to be used. The values given for C are indicated rather than actual (variation depending on parts tolerances) and were determined empirically.

Referring to Fig. 1B, the ratio of pulse duration time (T_1) to time between pulses (T_2) has been used as an indication of pulse width. Table 1 gives the values used for $T_1 = .05T_2$, while Table 2 gives the values used for $T_1 = .1T_2$.

For good pulse formation, the time constant of the RC circuit (time constant = RC, with R in megohms, C in microfarads, T in seconds) should be less than .01 of the time for one cycle

f (pps)	C	R
50	.1 μ fd.	200,000
1000	.01 μ fd.	100,000
10,000	.001 μ fd.	100,000
100,000	.001 μ fd.	10,000

Table 3. R and C values for forming triangular waves at various frequencies.

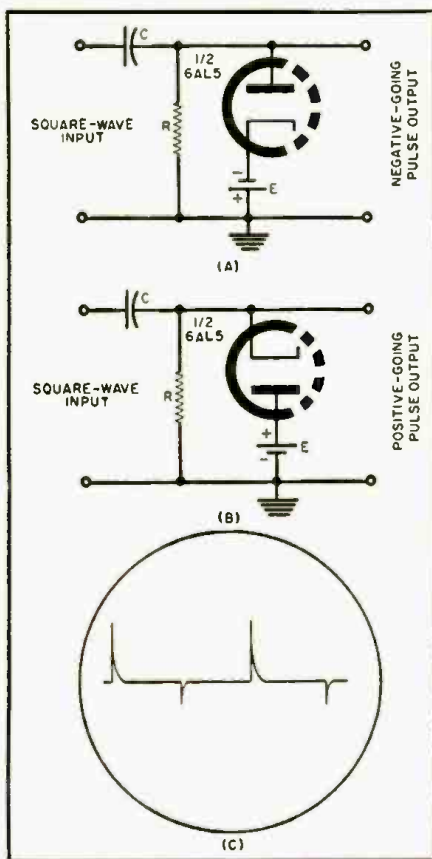
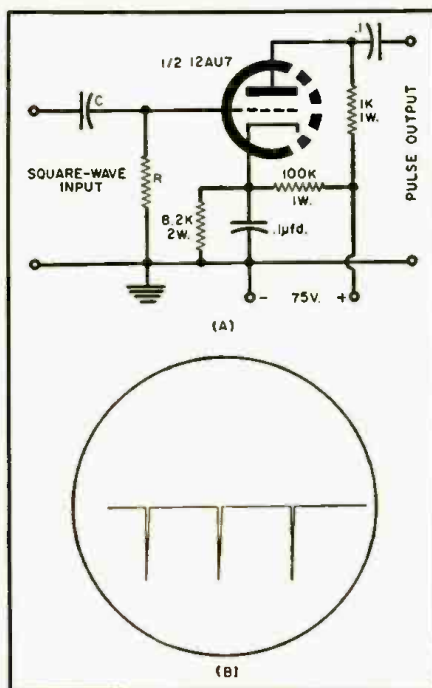

Fig. 2. Diodes yield basically uni-directional pulses, positive or negative.

Fig. 3. True uni-directional output pulses are yielded by a triode clipper.



at the repetition rate of the square wave used. Better pulses are obtained as the time constant is reduced still further. This "rule of thumb" may be used for pulse repetition rates other than those given in Tables 1 and 2.

If preferred, a median value may be chosen for C and R replaced by a rheostat whose value depends on C . If C is 500 μ fd., use a 25,000-ohm pot. This permits the differentiation circuit to be wired as a permanent accessory. R is then adjusted for the pulse width desired at the repetition rate used in different applications.

Uni-directional Pulses

Often a bi-directional pulse will not be suitable in the desired application and a pulse that is partially or wholly uni-directional is required. In such cases, it is a fairly simple matter to add a clipper circuit to the differentiation circuit just described.

The simplest clipper is a shunt diode (Fig. 2). The diode acts to "short" the applied signal when conducting and thus permits pulses that are predominantly uni-directional to be obtained. Whether positive- or negative-going pulses are obtained depends on how the diode is connected, that is, whether conduction occurs on the positive or negative "half" of the applied signal. Compare Fig. 2A with Fig. 2B.

Best results from the shunt diode clipper are obtained when a "starting" bias is applied to aid conduction, hence the battery or voltage source E shown in Fig. 2. This may be provided by a penlite or flashlight cell or by a small bias battery. Any value from 1.5 to 4.5 volts is satisfactory. Filament voltage for the diode may be obtained from an experimental power supply, from the equipment under test, or from a 6.3-volt, 1-ampere filament transformer.

The RC circuit shown in Fig. 2 is the differentiation circuit just described and the values may again be as given in Tables 1 and 2.

Although the pulses obtained at the output of the clipper circuit are predominantly uni-directional, they are not wholly so. See Fig. 2C. This is due to the fact that the diode is not a perfect "short" when conducting, but has a certain amount of internal resistance which permits a small pulse of the opposite polarity to appear. With E equal to 3 volts and the RC values given in Table 1 for a repetition rate of 1000 cps, it was found that the desired pulse amplitude had a relative height of 10 compared to 4 for the undesired pulse of opposite polarity. However, for many applications this differential in pulse amplitudes is satisfactory.

For those special applications requiring a true uni-directional pulse, a biased triode clipper may be used in place of the shunt diode. A satisfactory circuit is shown in Fig. 3A. This circuit, as well as the other circuits requiring a tube, may be built on a small chassis and used as a permanent accessory. Power may be obtained

from the power supply under test, or the experimental power supply in the differentiation generator's equipment before. The values of the components are given directly in the experimental program.

In operation, the triode is heavily biased by the large cathode resistor. Since complete plate-current cut-off is not obtained by cathode bias alone, additional current is drawn through the cathode resistor by means of the 100,000-ohm bleeder connected to "B+." This increases the bias of the triode past the cut-off value. A comparatively small plate-load resistor is used to minimize the effects of distributed wiring capacity and tube internal capacity. This permits the waveshape of the output pulse to be maintained even with narrow pulses and high repetition rates.

With the tube normally biased to cut-off, no plate current flows except when the grid is driven in a positive direction past the cut-off bias. This occurs only on the positive-going pulses of the signal appearing across R . Hence the output pulses are completely uni-directional. The phase inversion of the single stage results in negative-going output pulses, as shown in Fig. 3B.

If pulses of higher amplitude are desired, the clipper may be followed with one or more stages of resistance-coupled amplifiers. Conventional circuits may be used, but plate-load resistors should be kept low in value and distributed wiring capacity held to a minimum if good pulse waveshape is to be maintained. Use an even number of stages if negative-going pulses are desired for final output and an odd number of stages if positive-going pulses are wanted.

If the clipper is followed by a conventional phase-splitter stage, both positive-going and negative-going pulses may be obtained simultaneously or separately from cathode or plate. Selection of either may then be made by means of a s.p.d.t. switch.

Triangular Waves

A triangular wave is distinguished from a saw-tooth wave (which also has a waveform resembling a triangle) in that the positive and negative slopes are usually more equal. Generally, the expression "triangular wave" refers to a signal more properly called an "equilateral triangular wave" in which the slopes of the waveform are similar to the sides of an equilateral triangle, as in Fig. 4B.

Triangular waves are used in a number of special electronic applications and are often desirable in experimental work. They may be obtained from a square-wave generator by reversing the positions of R and C in the simple differentiation circuit previously described, thus forming an integration circuit, as shown in Fig. 4A.

In Table 3 are given values of R and

C for good triangular wave formation for different square-wave repetition rates. The values given may be considered the minimum necessary to form a triangular wave with reasonably straight sides and good amplitude. Increasing either R or C (or both) in any particular case will improve the waveform slightly, but at the expense of amplitude. However, with the values given, considerable expansion of the waveform horizontally and vertically (on the screen of a CRO) is necessary to distinguish any variation from a "straight-line" slope.

Unfortunately, the distributed wiring capacity and the impedance of the circuit connected across C may affect the waveshape if changes in the square-wave repetition rate are made without changing both R and C . Note that neither R nor C may be kept constant over the entire range of frequencies considered (Table 3). If R is increased to an extremely large value (C kept constant) for the lower frequencies, the sides of the triangular wave will become curved (Fig. 4C). Reducing R and increasing C will restore the waveshape even though the time constant of the RC circuit may stay the same.

Sine-wave Formation

Sine waves of very good shape can be obtained from a square-wave generator by connecting an LC tuned circuit across the output and obtaining the sine-wave signal from across either L or C , as shown in Fig. 5B. The sine wave obtained (Fig. 5A) will be almost "perfect" if the " Q " of the tuned circuit is reasonably high. Even with a comparatively low " Q ," it is difficult to distinguish the signals obtained from a true sine wave upon casual observation.

It is mandatory, however, that the resonant frequency of the tuned circuit be reasonably close to the square-wave frequency (or repetition rate). The author used a choke rated at 1 henry and a paper tubular capacitor rated at .05 μ fd. to form sine waves of approximately 1000 cps.

The frequency of the sine wave depends on the frequency of the tuned circuit, while the "quality" of the waveshape depends on the " Q " of the circuit and also on how closely the square-wave frequency approaches the tuned-circuit frequency. Because of this, the circuit connected across C (Fig. 5B) should not load the output appreciably. If desired, a single-stage, resistance-coupled amplifier may be used as a buffer between the output and load.

Frequency Measurement

If the LC combination shown in Fig. 5B represents a tuned circuit whose frequency is unknown, the square-wave generator may be used to determine the frequency of this circuit. To do this, connect a cathode-ray oscilloscope across C . Start with a low-frequency square wave and increase the frequency in steps until a waveform approaching that shown in Fig. 5C is obtained. The number of cycles of

damped oscillation appearing on the square wave is not too important, as long as the individual cycles can be distinguished and counted. The relative amplitude of the damped oscillations and the "square-wave" portion of the signal will depend on the " Q " of the tuned circuit. A waveform like that shown in Fig. 5C is obtained with low-" Q " circuits.

If the circuit being checked has high " Q ," the "square" portion of the wave may be lost entirely, making interpretation difficult. In such a case, a small resistor (100 to 1000 ohms) may be connected in series with C to lower the " Q " of the circuit without changing its resonant frequency.

To determine the frequency of the tuned circuit, count the number of "cycles" contained in the upper (or lower) portion of the square wave. In Fig. 5C, approximately five cycles would be present, even though the signal is damped out by the fourth cycle. Multiply this value by two to obtain the number of cycles that would occur during a complete cycle

of the square wave. Then multiply this product by the frequency of the square wave itself to obtain the frequency of the tuned circuit.

In the example given, five cycles in the upper portion of the square wave represents ten cycles total. Hence, the frequency of the tuned circuit is ten times the frequency of the square wave used. Assuming the square wave to have a frequency of 100 pulses-per-second, the tuned circuit's frequency is 1000 cps.

Although this technique sounds time-consuming, in practice it is quite rapid, once learned. In many cases, the frequency of a tuned circuit (particularly one having low " Q ") may be determined much more rapidly with this technique than by using a variable-frequency oscillator, a v.t.v.m. (or scope) and then adjusting for peak output.

Linear Saw-tooth

Extremely linear saw-tooth signals are often required for the horizontal sweep of an oscilloscope. While the

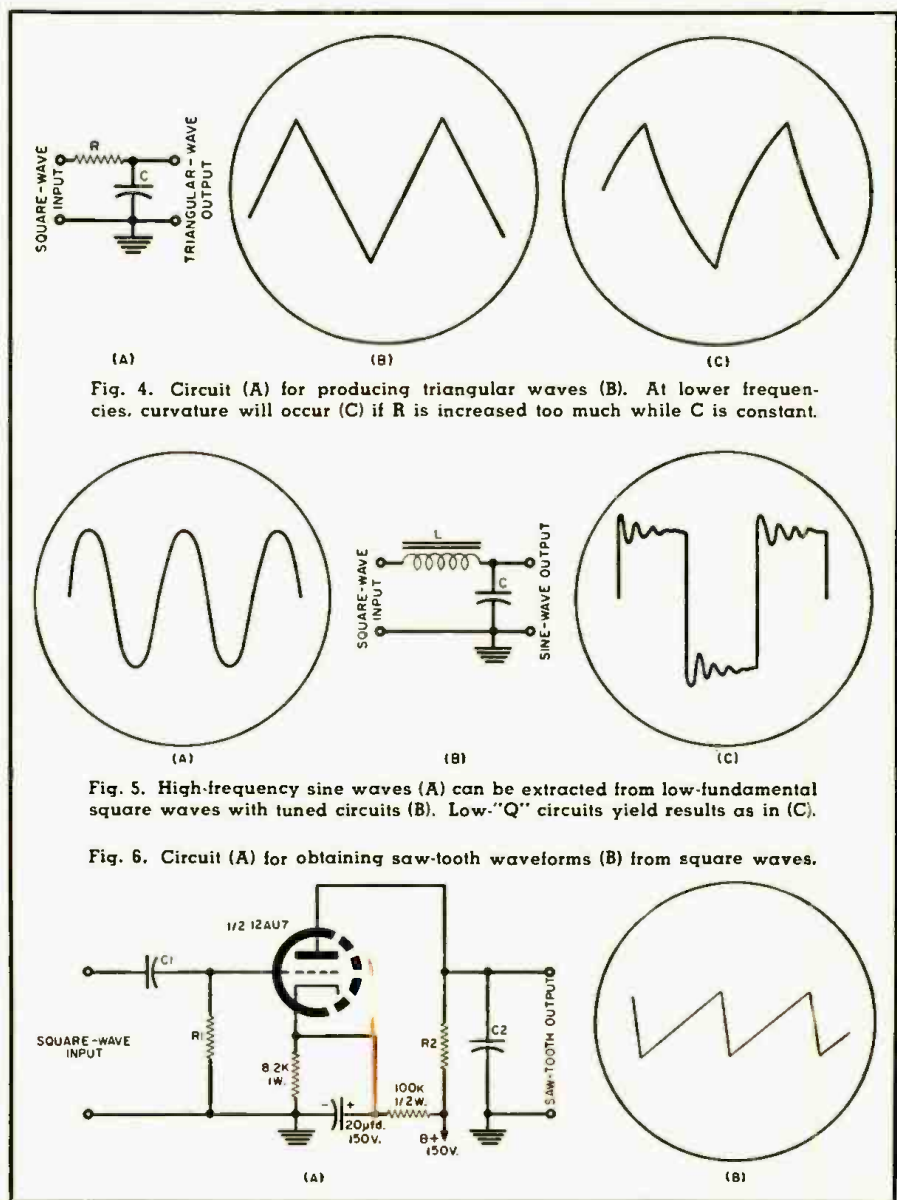

Fig. 4. Circuit (A) for producing triangular waves (B). At lower frequencies, curvature will occur (C) if R is increased too much while C is constant.

Fig. 5. High-frequency sine waves (A) can be extracted from low-fundamental square waves with tuned circuits (B). Low-" Q " circuits yield results as in (C).

Fig. 6. Circuit (A) for obtaining saw-tooth waveforms (B) from square waves.

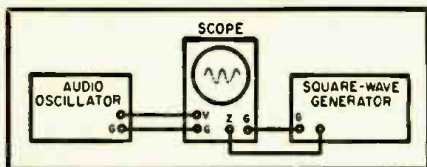

Fig. 7. Where a blanking pulse is desired, a square wave is the best type to use. As shown, the blanking square wave is fed to the Z-axis, with the audio or other signal to the Y-axis.

majority of better scopes have reasonably linear sweeps, few but the most expensive have almost perfect linearity. In addition to this, it is sometimes desirable to have a linear sweep at a frequency higher or lower than that which can be obtained from the built-in sweep of the instrument.

In either case, having a linear saw-tooth signal available which can be fed to the horizontal amplifier of the scope increases the usefulness of the instrument.

It is possible to obtain a saw-tooth signal having almost perfect linearity from the square-wave generator simply by adding a discharge capacitor to the triode clipper used for pulse formation and previously described. The complete circuit is shown in Fig. 6A. The saw-tooth signal obtained (Fig. 6B) across C_2 is of sufficient amplitude for most work. For some scopes, it may prove desirable to add a stage of amplification, however. This may be the other half of the 12AU7.

The operation of the saw-tooth forming circuit may best be explained by considering that the triode acts as a switch. Refer to Fig. 6A. Normally the tube is biased to cut-off by the voltage across the cathode resistor plus the positive voltage through the 100,000-ohm resistor. This allows C_2 to be charged slowly through R_2 . On positive pulses, the tube can conduct heavily, acting as a short to discharge

C_2 . The charging action is repeated between positive pulses.

C_1R_1 is the simple differentiation circuit previously described. Since the discharge takes place only while the grid of the triode is driven positive, the pulse-width across R_1 determines the discharge (flyback or retrace) time. Hence, varying the time constant of C_1R_1 will vary the retrace time. Good results are obtained with the values given in Table 1.

The linearity obtained depends primarily upon the portion of the R_2C_2 charging curve used. For best results, keep the time constant of R_2C_2 at least several times larger than the time for one cycle of the square wave used. For 1000 cps, values of 20,000 ohms for R_2 and .1 μ fd. for C_2 give satisfactory results.

The frequency of the saw-tooth is equal to the frequency (repetition rate) of the applied square wave. If the saw-tooth is used as the horizontal sweep of the scope for observing another signal, sync the square-wave generator with the signal to be observed.

Blanking and Marking

Rectangular or square waves are the most desirable for blanking the trace of a CRO because of the rapid change from positive to negative value. Where sine waves or similar signals are used for blanking, the change from light to dark is not clearly defined. A long discussion of blanking and marking techniques would be inappropriate here, but the basic methods may be easily demonstrated by the technician, using a CRO, a square-wave generator, and an audio oscillator. Connections are as shown in Fig. 7.

Note that the square-wave generator is connected to the Z-axis terminal of the CRO. On some scopes this may be marked "Grid," "Cathode," or "In-

tensity." The built-in linear sweep of the CRO is used. Adjust the "Intensity" control of the CRO for proper blanking with the square-wave signal used. If too much intensity is used, or if insufficient blanking signal is applied, complete blanking may not be obtained.

When the audio oscillator and the square-wave generator are adjusted to the same frequency, half of each cycle of the observed sine wave will be blanked out. This may be either the upper or lower half of the signal (Fig. 8A), or even another portion of the wave (Fig. 8B), depending on the phase relationships between the square wave and sine wave. (In Figs. 8A, 8B, and 8C, the blanked-out portion of the observed signal is shown in broken lines, although this would normally not be visible on the CRO screen.)

If the frequency of the sine wave is higher than that of the square wave, whole cycles will be blanked out, as in Fig. 8C. Here, the frequency of the sine wave is four times that of the square wave.

On the other hand, if the frequency of the square wave is higher than that of the sine wave, the sine wave will be broken into a series of dashes and will appear as a dashed line (Fig. 8D). The number of "dashes" obtained depends on the ratio of square-wave frequency to sine-wave frequency. In Fig. 8D, the square wave is approximately 12 times higher in frequency than the sine wave.

Measuring the frequency of an unknown signal, irrespective of wave-shape, is made comparatively easy using the techniques described, provided the frequency of the square-wave signal is known. This method offers many advantages over the conventional means of using Lissajous patterns formed with sine waves, for two reasons. First, where the unknown signal is not a sine wave, interpretation of the resultant Lissajous pattern becomes extremely difficult, if not impossible. Second, with wide frequency ratios (between known and unknown signals), the Lissajous pattern becomes too complex for rapid and accurate interpretation.

To demonstrate the technique, let us consider signals both higher and lower in frequency than the square wave used for blanking.

In Fig. 8C, two cycles of the unknown signal occur during an "unblanked" interval. This interval is equal to one half-cycle of the square wave, hence, the frequency of the unknown signal is four times that of the square wave. Up to ten cycles of the square wave may be counted easily on the screen of a 5" CRO (up to 20 cycles with horizontal expansion). Thus, it is possible to measure frequencies up to 20 or 40 times the highest frequency of the square-wave generator!

Where the unknown signal is lower in frequency than the square wave used for blanking, the unknown signal

(Continued on page 129)

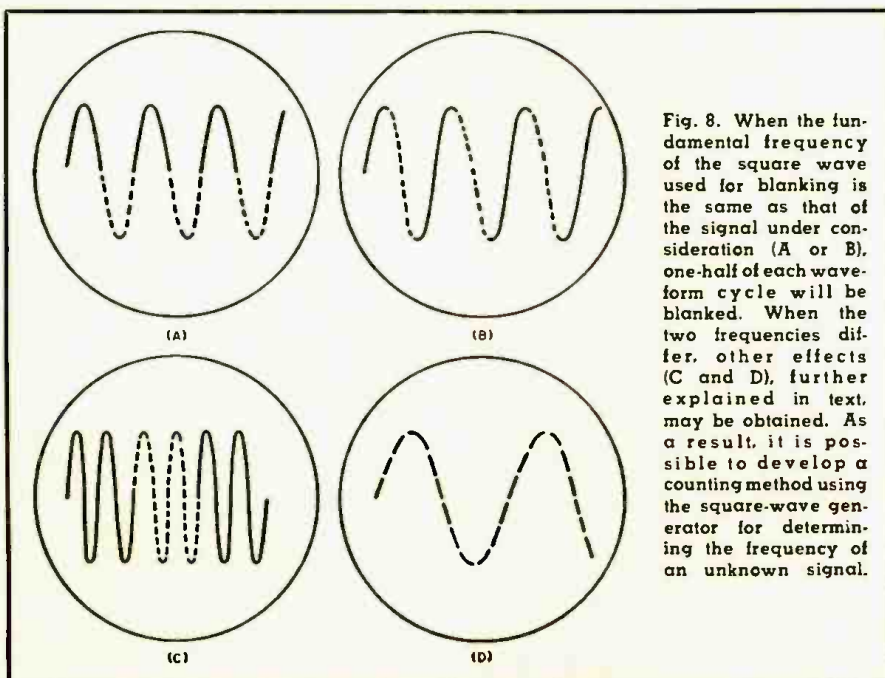

Fig. 8. When the fundamental frequency of the square wave used for blanking is the same as that of the signal under consideration (A or B), one-half of each waveform cycle will be blanked. When the two frequencies differ, other effects (C and D), further explained in text, may be obtained. As a result, it is possible to develop a counting method using the square-wave generator for determining the frequency of an unknown signal.

Simply by checking

all the tubes in the TV set with

B&K DYN-A-QUIK

YOU CAN INCREASE YOUR INCOME



\$50*
PER WEEK

*ACTUAL EXPERIENCE SHOWS
TV SERVICEMEN AVERAGE

2 extra tube sales per call
5 calls per day in
5 days equal \$50.00

**NEW
MODEL
650**

Fastest, Most Complete, Portable DYNAMIC MUTUAL CONDUCTANCE TUBE & TRANSISTOR TESTER

Checks over 99% of the tubes most widely used in television receivers, plus popular home and portable radio tubes. Tests over 500 tube types. Lists over 125 tube types, with settings, on socket panels for maximum operating speed. Complete listing in fast telephone-index type selector. Includes 16 spare sockets and sufficient filament voltages for future new tube types. Tests each section of multiple tubes separately for Gm—Shorts—Grid Emission—Gas Content—and Life. Provides instantaneous Heater Continuity check. Shows tube condition on "Good-Bad" scale and in micromhos. Special bridge assures automatic line compensation. No multiple switching—No roll chart. Includes pin straighteners. Transistor Tester checks junction, point contact and barrier transistors, germanium and silicon diodes, selenium and silicon rectifiers. Net, **\$169⁹⁵**

- Each Dyna-Quik Tube Tester completely tests each tube in seconds
- Eliminates substitution testing
- Shows customer true condition and life expectancy of tubes
- Sells more tubes right on-the-spot
- Cuts servicing time, wins customer confidence
- Saves costly call-backs, brings more profit

MODEL 500B Money-Making Portable DYNAMIC MUTUAL CONDUCTANCE TUBE TESTER

Thousands of the famous B&K Dyna-Quik are in profitable use today by service technicians everywhere. Servicemen say: "Best tube tester I've ever owned for speed and dependability!" "Makes money. Really indispensable!" "Have two...one for the shop and one for house calls!"

Now, with more tube sockets, the new Model 500B makes it easy to test more tubes faster and make more money. Accurately quick-checks most of the TV and radio tubes usually encountered in everyday service work. Tests tubes for shorts, grid emission, gas content, and leakage. Measures true dynamic mutual conductance with laboratory accuracy in the home or shop. Makes complete tube test in seconds, tests average TV set in a few minutes. Quickly detects weak or inoperative tubes. Shows tube condition on "Good-Bad" scale and in micromhos. Life Test shows customer the tube life expectancy. Makes it easy to sell more tubes right-on-the-spot.

One switch tests everything. No multiple switching. No roll chart. Automatic line voltage compensation. 7-pin and 9-pin straighteners. New tube reference charts are made available by the factory at regular intervals. Net, **\$129⁹⁵**



**FAST AND ACCURATE
Quickly Pays
for Itself**

See your B & K Distributor,
or write for Bulletin AP12-N



B&K MANUFACTURING CO.
3726 N. Southport Ave., Chicago 13, Illinois
Canada: Atlas Radio Corp., 50 Wingold, Toronto 10, Ont.
Export: Empire Exporters, 458 Broadway, New York 13, U.S.A.

"HEATHKITS®

gave me my start and I'm still sold!"

"... they are my lowest cost way to real quality and dependability in electronic equipment of any kind ...

... The clean, modern styling of HEATHKITS make me proud to own them. They make a handsome and useful addition to my workshop.

... Rigid quality standards of components used in HEATHKITS assure me of performance equal to or surpassing instruments costing many times more.

... after assembling a HEATHKIT myself, I know what "makes it tick"... I know that the thoughtful circuitry design and name-brand components used throughout guarantee me years of trouble-free service.

... HEATHKITS cost me half as much as ordinary equipment ... and I get so much more. In assembling my own instruments I am sure of the quality that goes into them. Plus the complete assembly and operating instructions as well as detailed schematics that are at my fingertips for future reference."



NEW: Stereophonic Sound for your home with the new HEATHKIT STEREO CENTER. This, and other exciting new high fidelity developments are now available from the world's largest maker of "do-it-yourself" electronic kits.

NEW: For the Ham Radio fans—an all new Ham Transmitter and companion Receiver—featuring all the latest developments in Ham communication—including single-sideband operation.

NEW: A completely up-to-date Oscilloscope answering the long felt needs of electronic engineers and servicemen everywhere.

NEW: A host of newly developed marine instruments for the safety and convenience of the boat owner.



HEATH COMPANY Benton Harbor 15, Michigan

 Subsidiary of Daystrom, Inc.

The HEATH TIME PAYMENT PLAN allows you to outfit your whole workshop at one time with needed test instruments while you pay in easy monthly installments.



PROFESSIONAL OSCILLOSCOPE KIT

An exciting development in the Heathkit test instrument line is the introduction of the Heathkit model OP-1 Professional Oscilloscope. Emphasizing complete flexibility in any application, the OP-1 features DC coupled amplifiers and also DC coupled CRT tube un-blanking. The triggered sweep circuit will operate on either internal or external signals and may be either AC or DC coupled. The polarity of the triggering signal may also be selected, and any point on the wave form may be selected for the start of the sweep by using the "triggering level" control. An automatic position is also provided, in which the sweep recurs at a 50 cycle rate, but can be driven over a wide range of frequencies with no additional adjustments. The sweep frequencies are provided by switch-selected base rates of 2 and .2 milliseconds/CM, and 20, 2, and 1 microseconds/CM, in conjunction with a continuously variable 10 to 1 multiplier. Sweep frequencies are calibrated to within 10% at all control settings, and the sweep frequency may be reduced by adding capacity to the "ext. cap" binding post on the front panel. A 5ADP2 flat face CR tube is used for accurate readings on an edge lighted grid screen. A high quality conetic-fernetic CR tube shield prevents stray AC fields from distorting trace. A 12-position vertical attenuator is calibrated in volts-per-CM and the horizontal sweep is calibrated in time-per-CM. Prewired terminal boards are used for rapid, easy assembly of all critical circuits. Simply install and connect the color coded leads. Power supply is transformer operated utilizing silicon diode rectifiers and is fused for protection. Under development for over a year the OP-1 promises outstanding results in any application requiring the use of an oscilloscope.



HEATHKIT
OP-1
\$179⁹⁵

*Here's the scope you've
been waiting for!*



**Laboratory
Performance At Less
Than Utility Scope
Price**

HEATHKIT
O-12 **\$65⁹⁵**



**A Scope You Will Be
Proud To Own**

HEATHKIT
OM-3 **\$39⁹⁵**

"EXTRA DUTY" 5" OSCILLOSCOPE KIT

Top quality features at half the cost of ordinary equipment sum up the advantages of this popular kit. Critical observations in your laboratory or shop are handled easily, with clear, sharp pattern displays in every application. Vertical frequency response extends from 3 CPS to 5 mc ± 1.5 db -5 db without extra switching. Response is down only 2.2 db at 3.58 mc. The Heath patented sweep circuit functions effectively from 10 CPS to better than 500 kc in five steps, giving you 5 times the usual sweep obtained in other scopes. An automatic sync circuit with self-limiting cathode follower provides excellent linearity and lock-in characteristics. Extremely short retrace time and efficient blanking action. Both vertical and horizontal output amplifiers are push-pull and the scope incorporates a 1 V peak-to-peak calibrating source, step attenuated and frequency compensated vertical input, plastic molded capacitors and top quality parts throughout. The 11-tube circuit features a 5U1 cathode ray tube, and provision is made for Z-axis input for intensity modulation of the beam. Frequency response of the horizontal amplifier is within ± 1 db from 1 CPS to 200 kc. Horizontal sensitivity is 0.3 volts RMS per inch. Construction is simplified through the use of two metal circuit boards and pre-cut, cable wiring harness. Shpg. Wt. 22 lbs.

GENERAL PURPOSE 5" OSCILLOSCOPE KIT

For servicing and routine laboratory work this fine kit is a favorite with technicians throughout the country. It incorporates many extras not expected at this low price. Features wide vertical amplifier frequency response, extended sweep generator operation, and improved stability. Frequency response of the vertical amplifier is within ± 3 db from 4 CPS to 1.2 mc. Vertical sensitivity is .09 volts RMS per inch at 1 kc. Sweep generator functions reliably from 20 CPS to over 150 kc. A modern etched circuit board is featured for high stability and reduces assembly time considerably. Standard components are mounted on this board with each position clearly marked preventing wiring errors. Both vertical and horizontal amplifiers are push-pull types. Uses a 5BP1 CRT. Provision for external or internal sweep or sync, built in 1 V peak-to-peak reference voltage and calibrated grid screen. An adjustable "spot shape" control is provided to insure a sharp trace. Input to the vertical amplifiers is through a step attenuated, frequency compensated circuit. The OM-3 is an extremely versatile instrument and has a multitude of practical uses in electronic testing fields. Particularly useful in alignment of television receivers, for testing audio amplifiers and circuits, and checking the quality of modulated RF signals in Ham Radio transmitters. Shpg. Wt. 22 lbs.



Equip Your Service Bench...



HEATHKIT
CD-1 **\$59⁹⁵**

Cash In Now On Color TV

- ★ 10 VERTICAL COLOR BARS
- ★ CRYSTAL CONTROLLED ACCURACY
- ★ CHOICE OF 6 DIFFERENT PATTERNS

COLOR BAR AND DOT GENERATOR KIT

Colored television is now a reality and as the number of these sets increase the need for a reliable service instrument is apparent. Nothing on the market... in this type of generator has as many features as the CD-1 at such a tremendous price saving. This unit combines two basic color service instruments, a color bar generator, and white dot generator in one versatile portable unit which has crystal controlled accuracy and stability for steady locked-in patterns (requires no external sync leads). Color receivers converged with the CD-1 will still be converged properly on a television program from the station. The 13-tube circuit has been carefully laid out for ease of assembly and provides choice of six different patterns. Produces white-dots, cross hatch, horizontal and vertical bars, ten vertical color bars, and a new shading bar pattern for screen and background adjustments. Variable RF output on any channel from 2 to 6. Positive or negative video output, variable from 0 to 10 volts peak-to-peak. Crystal controlled power supply carrier with off-on switch. Voltage regulated power supply uses long-life silicon rectifiers. Kit includes three crystals and test lead, plus an information packed instruction manual covering convergence, and screen and background adjustments of a color TV set. Compare with other generators on the market and you will see that this instrument is loaded with extras and top quality all the way through. Shpg. Wt. 13 lbs.



HEATHKIT
TS-4A **\$49⁵⁰**

*For fast,
easy alignment
of TV sets*



HEATHKIT
AG-10 **\$49⁹⁵**

*Sine and
square waves for
countless uses*



HEATHKIT
MM-1 **\$29⁹⁵**

*High accuracy
in a
portable meter*



HEATHKIT
M-1 **\$17⁹⁵**

*An all-round
meter of
many uses*

TV ALIGNMENT GENERATOR KIT

This generator has many special design features for flexible, easy operation and reliability. The all-electronic sweep circuit insures stability and covers 3.6 mc to 220 mc in four bands. Sweep deviation is controllable from 0 to 42 mc. Crystal and variable marker oscillators are built in. Crystal (included with kit) provides output at 4.5 mc and multiples thereof. Variable marker provides output from 19 to 60 mc on fundamentals and from 57 to 180 mc on harmonics. Effective two-way blanking and phasing control also provided. A truly outstanding number of features at a tremendous price saving. Shpg. Wt. 16 lbs.

SINE-SQUARE GENERATOR KIT

High quality sine and square waves are produced by this generator over a wide range. Frequency response is ± 1.5 db from 20 CPS to 1 mc on both sine and square waves, with less than .25% sine wave distortion, 20 to 20,000 CPS. Output impedance is 600 ohms on sine wave and 50 ohms on square wave (except on 10 volt range). Square wave rise time less than .15 microseconds. Five-position bandswitch—continuously variable tuning—shielded oscillator circuit—separate step and variable output attenuators in ranges of 10, 1 and .1 volts with extra range of .01 volt on sine wave. Shpg. Wt. 12 lbs.

20,000 OHMS/VOLT VOM KIT

This meter is ideal for use in field applications where accuracy is important. Employs a 50 μ a $4\frac{1}{2}$ " meter, and features 1% precision multiplier resistors for high accuracy. Requires no external power for operation (batteries supplied). Sensitivity is 20,000 ohms-per-volt DC and 5,000 ohms-per-volt AC. Measuring ranges are 0-1.5, 5, 50, 150, 500, 1500 and 5,000 volts AC and DC. Measures direct current in ranges of 0-150 μ a, 15 ma, 150 ma, 500 ma and 15 a. Resistance multipliers are x 1, x 100 and x 10,000. Covers -10 db to +65 db. Batteries and test leads are also included with this kit. Shpg. Wt. 6 lbs.

HANDITESTER KIT

Small enough to carry with you wherever you go, this fine handitester is ideal for use in portable applications when making tests away from the work bench or as an "extra" meter in the service shop, when the main instruments are occupied. The combination function-range switch simplifies operation. Measures AC or DC voltage from 0-10, 30, 300, 1000 and 5000 volts. Direct current ranges are 0-10 ma and 0-100 ma. Ohmmeter ranges are 0-3000 and 0-300,000. Top quality precision components employed throughout. Very popular with home experimenters and electricians. Shpg. Wt. 3 lbs.

with Low-Cost Dependable Heathkits



ETCHED CIRCUIT VTVM KIT

The fact that this instrument is outselling all other VTVM's says a great deal about its accuracy, reliability, and overall quality. The precision and quality of the components used in this VTVM cannot be duplicated at this price through any other source. Its attractive appearance as well as its performance will make you proud to own it. A large 4½" panel meter is used for indication, with clear, sharp calibrations for all ranges. Front panel controls consist of a rotary function switch and a rotary range selector switch, zero-adjust and ohms-adjust controls. Precision 1% resistors are used in the voltage divider circuit. An etched circuit board is employed for most of the circuitry, cutting assembly time and eliminating the possibility of wiring errors. It also assures duplication of laboratory instrument performance. This multi-function VTVM will measure AC voltage (RMS), AC voltage (peak-to-peak), DC voltage and resistance. There are 7 AC (RMS) and DC voltage ranges of 1.5, 5, 15, 50, 150, 500 and 1500. In addition there are 7 peak-to-peak AC ranges of 0-4, 14, 40, 140, 400, 1400 and 4,000. Seven ohmmeter ranges providing multiplying factors of x 1, x 10, x 100, x 1000, x 10 k, x 100 k and x 1 megohm. Center scale resistance readings are 10, 100, 1000, 10 k, 100 k ohms, 1 megohm and 10 megohms. A zero-center scale db range is also provided. Battery and test leads included with kit. Shpg. Wt. 7 lbs.



HEATHKIT
V-7A
\$25⁹⁵

**World's largest selling
VTVM kit**

- ★ LARGE EASY-TO-READ 4½" 200 UA METER
- ★ 1% PRECISION RESISTORS EMPLOYED FOR HIGH ACCURACY



HEATHKIT
C-3 **\$19⁵⁰**

**Checks all types of
condensers accurately**



HEATHKIT
T-4
\$19⁹⁵

**Locate faults quickly
by tracing signals**



HEATHKIT
SG-8 **\$19⁵⁰**

**Easy-to-build—prewound
and calibrated coils**

CONDENSER CHECKER KIT

Check unknown condenser and resistor values quickly and accurately. Capacity measurements are made in four ranges of .00001 mfd-.005 mfd; .001 mfd-.5 mfd; .1 mfd-50 mfd; 20 mfd-1,000 mfd. Checks paper, mica, ceramic, and electrolytic condensers. Leakage test provides switch selection of five polarizing voltages, 25 volts to 450 volts DC to indicate condenser operating quality under actual load conditions. Electron beam "eye" tube indicates balance and leakage. A spring return test switch automatically discharges condenser under test and eliminates shock hazard to the operator. Measures resistance from 100 ohms to 5 megohms in two ranges. Shpg. Wt. 7 lbs.

VISUAL-AURAL SIGNAL TRACER KIT

Here is a brand new signal tracer completely redesigned with compact dimensions and new circuit layout. Features built-in speaker and electron beam "eye" tube for signal indication and a unique noise locator circuit. Ideal for use in AM, FM and TV circuit investigation. RF and audio inputs are provided in one convenient probe with switch on probe to select either input. Useful for checking microphones, phono cartridges, record changers, tuners, etc. Makes a handy substitution speaker for servicing TV sets at the shop. Transformer operated for safety and high efficiency. Complete with test leads and informative construction manual. Shpg. Wt. 6 lbs.

RF SIGNAL GENERATOR KIT

Save valuable time in aligning RF tuned circuits of all kinds with this easy-to-use kit. Also a quick way to trace signals in faulty RF, IF and audio circuits. Designed for general service applications—the SG-8 covers 160 kc to 110 mc on fundamentals in five bands, and from 110 mc to 220 mc on calibrated harmonics. The entire oscillator circuit is built on a special sub-chassis, using prewound and calibrated coils. No further calibration is required so it is ready to use as soon as construction is completed. RF output is in excess of 100,000 microvolts, controlled by both step and continuously variable controls. Complete with output cable and instructions. Shpg. Wt. 8 lbs.

HEATH COMPANY • a subsidiary of Daystrom, Inc. • Benton Harbor 15, Mich.

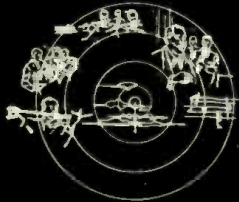

Enjoy Rich 3 Dimension Sound...

Beautifully Styled with Plenty of Room for the Most Complete Stereo System

AVAILABLE IN THE FOLLOWING MODELS:

Model SE-1B—Stereo Equipment Cabinet (birch)	} \$149⁹⁵ ea.
Model SE-1M—Stereo Equipment Cabinet (mahogany)	
Model SC-1BR—Stereo Wing Speaker Enclosure (birch—right end)	} \$39⁹⁵ ea.
Model SC-1BL—Stereo Wing Speaker Enclosure (birch—left end)	
Model SC-1MR—Stereo Wing Speaker Enclosure (mahogany—right end)	
Model SC-1ML—Stereo Wing Speaker Enclosure (mahogany—left end)	



STEREO EQUIPMENT CABINET KIT

Imagine!... Stereophonic sound in your own home. This superbly designed cabinet holds all of your hi-fi stereo equipment and lends striking elegance to your living room. The attractive gold and black panels, trim and hardware brilliantly highlight the overall effect. Rich toned grille cloth, flecked in gold and black, complement the cabinet. The unit has ample room provided for an AM-FM tuner, tape deck, stereo pre-amplifier, amplifiers, record changer, record storage and speakers. Beautifully grained 3/4" solid core Philippine mahogany or select birch plywood is used for construction. The top features a shaped edge and sliding top panel for easy access to the stereo tape deck and stereo preamplifier. Sliding doors are employed for convenient front access to the

changer and record storage compartment. All parts of the cabinet are precut and predrilled for simple assembly. The speaker wings and center cabinet may be purchased separately if desired. Note: the kit is delivered equipped with panels pre-cut to accommodate Heathkit components and also blank panels to cut out for your own equipment. Measurements of the individual component areas follow: tape deck and preamplifier area 20 3/4" L. x 17 3/4" W. x 10" D., record changer area 21" W. x 16" D. x 9 5/8" H., record storage area 22 5/8" W. x 14 1/2" H. x 12 1/2" D., speaker wing area (inside) 14" W. x 29 1/2" H. x 15 3/4" D., AM-FM Tuner area 20 1/2" W. x 5 1/4" H. x 14" D., amplifier (2 areas) 15 1/4" W. x 10 3/4" H. x 13 1/4" D.

Model HH-1B Birch
Model HH-1M Mahogany
Now only **\$299⁹⁵** each



The Same Superior Performance At a New Low Price



HEATHKIT SS-2 **\$39⁹⁵**

OPTIONAL LEGS EXTRA

Economical Hi-Fi For Your Home

"LEGATO" HI-FI SPEAKER SYSTEM KIT

The increasing sales of the Legato has made more economical quantity production possible so we are passing the savings on to you by offering you this magnificent speaker system at a reduced price. Truly a "queen" among hi-fi speaker systems, the Legato was specially designed to meet and surpass the most stringent requirements of high fidelity sound reproduction. Two 15" Altec Lansing low frequency drivers cover frequencies of 25 to 500 CPS while a specially designed exponential horn with high frequency driver covers 500 to 20,000 CPS. A unique crossover network is built in making electronic crossovers unnecessary. Internal reflections are absorbed by splayed back panel and a 3" fiber glass lining. The Legato emphasizes simplicity of line and form to blend with modern or traditional furnishings. Cabinet construction is 3/4" veneer surface plywood in either African mahogany or white birch and measures 41" L. x 22 1/4" D. x 34" H. All parts are precut and predrilled for easy assembly. Shpg. Wt. 195 lbs.

"BASIC RANGE" HI-FI SPEAKER SYSTEM KIT

True high fidelity performance at modest cost make this basic speaker system a spectacular buy for any hi-fi enthusiast. The amazing performance of this popular kit is made possible by the use of high quality speakers in an enclosure specially designed to receive them. The cabinet is a ducted port bass reflex type enclosure 11 1/2" H. x 23" W. x 11 3/4" D. It features an 8" mid range woofer to cover 50 to 1600 CPS and a compression-type tweeter with flared horn covering 1600 to 12,000 CPS. Both speakers are by Jensen. The adjustable flared tweeter horn allows speaker to be used in either upright or horizontal position. The cabinet is constructed of 1/2" veneer surfaced plywood suitable for light or dark finish of your choice. All wood parts are precut and predrilled for easy assembly. Shpg. Wt. 25 lbs.

Attractive brass tip accessory legs convert SS-2 into attractive console. Legs screw into brackets provided. All hardware included. Shpg. Wt. 3 lbs. No. 91-26 \$4.95

with a Heathkit Stereo System

HEATHKIT

HIGH FIDELITY TAPE RECORDER KIT

Popular request for high quality, low cost tape recording and playback facilities have prompted the addition of this fine unit to our line. The TR-1A provides monaural record/playback with fast forward and rewind functions. Incorporates separate erase and combination record/playback heads. Two speeds, $7\frac{1}{2}$ and $3\frac{3}{4}$ IPS, are selected by changing belt drive. Flutter and wow are held to less than 0.35%. Frequency response at $7\frac{1}{2}$ IPS ± 2.0 db 50-10,000 CPS, at $3\frac{3}{4}$ IPS ± 2.0 db 50-65,000 CPS. The extremely simple mechanical assembly is ideally suited to kit construction. One control lever selects all functions on deck, greatly simplifying operation. Mount in vertical or horizontal position. The model TE-1 record/playback tape pre-amplifier, supplied with the mechanical assembly, provides NARTB playback equalization. A record interlock prevents accidental tape erasure. Recording level is indicated by a 6E5 "magic eye" tube. A two-position input selector switch provides for mike or line input. Separate record and playback gain controls. Filament balance control allows adjustment for minimum hum level. Cathode follower output from playback channel is approximately 600 ohms impedance. Two circuit boards are used for easy assembly. Templates and instructions are provided to cut out panels for mounting. Overall dimensions of tape deck and preamp are $15\frac{1}{2}$ " W. x $13\frac{1}{2}$ " H. x 8" D. Signal-to-noise ratio is better than 45 db below normal recording level with less than 1% total harmonic distortion. (Tape mechanism not sold separately.) Shpg. Wt. 22 lbs.



HEATHKIT
TR-1A \$99⁹⁵

(Includes tape deck, tape recorder electronics, mike and roll of tape.)

Make Your Own
Home Recordings

TAPE RECORDER ELECTRONICS KIT

The model TE-1 Electronics Kit can be purchased separately to replace the electronics in your present tape recorder, or used in addition to it for stereo playback of pre-recorded tapes where a second playback channel is required. Circuit may be modified for use with different head types. Shpg. Wt. 9 lbs.

HEATHKIT
TE-1
\$39⁹⁵



HEATHKIT
SS-1B
\$99⁹⁵

Fill out the Hi-Fi Range
of Your SS-2 Speaker



HEATHKIT
SW-1 \$24⁹⁵

Save Time Rewinding Tape



HEATHKIT
TK-1 \$9⁹⁵

All The Tools You Need For
Building Heathkits

"RANGE EXTENDING" HI-FI SPEAKER SYSTEM KIT

This is not a complete speaker system in itself, but is designed to extend the range of the SS-2. The SS-1B uses a 15" woofer and a small super tweeter to supply the very high and very low frequencies to fill out the response of the basic SS-2. The SS-2 and SS-1B when used together, form an integrated four-speaker system. The SS-2 and SS-1B combination provide an overall response of ± 5 db from 35 to 16,000 CPS. The kit includes circuit for crossover at 600, 1600 and 4,000 CPS. Impedance is 16 ohms and power rating is 35 watts. A control is also provided to limit output of super tweeter. The handsome cabinet measures 29" H. x 23" W. x $17\frac{1}{2}$ " D. Constructed of beautiful $\frac{3}{4}$ " veneer surface plywood. Complete step-by-step instructions make this kit easy to build. No wood-working experience required. Shpg. Wt. 80 lbs.

"SPEEDWINDER" KIT

This handy device leaves your tape recorder free for operation while it rewinds tape at the rate of 1200' in 40 seconds. Prevents unnecessary wear to the tape and recorder by eliminating wear against guides and heads. It will handle up to $10\frac{1}{2}$ " tape reels as well as 800' reels of 8 and 16 millimeter film. A very useful aid to operators of movie projection equipment. The Heathkit Speedwinder features an automatic shutoff which prevents whipping of tape when it has rewound. A manual shutoff is also provided. An automatic braking device is built in for protection against power failure. Driven by a heavy duty four pole motor. Handsome cabinet is constructed of furniture grade plywood. Step-by-step instructions are provided to make this kit easy to assemble even by one with no experience. Shpg. Wt. 12 lbs.

COMPLETE TOOL SET

A clear illustration of just how easy Heathkit building is. The pliers, diagonal sidecutters, two screw drivers and soldering iron are all the basic tools you need for building practically any Heathkit. Pliers and sidecutters are equipped with insulated rubber handles. The American Beauty soldering iron has a replaceable tip to facilitate cleaning. All the tools are of top quality case hardened steel for rugged duty and long life. With these simple, inexpensive tools in your hand you need not be afraid to tackle the most elaborate kit. The manual included with this handy kit provides you with many useful tips on the use and care of your tools. It shows the all important step of making proper solder connections. A truly worthwhile investment for the beginner in electronic kit building. Shpg. Wt. 3 lbs.

HEATH COMPANY • a subsidiary of Daystrom, Inc. • Benton Harbor 15, Mich.



Plan Your Hi-Fi System...



HEATHKIT
SP-2 **\$56⁹⁵**

Model SP-1 (monaural)
\$37.95

Model C-SP-1 (converts SP-1 to SP-2)
\$21.95

**Control both stereo
channels simply
and conveniently**

MONAURAL-STEREO PREAMPLIFIER KIT

This expertly designed preamplifier provides all the controls required for either standard monaural (single channel) or stereo (dual channel) sound reproduction. Features building block design... you can start with a basic preamplifier and add a second channel for stereo later on, without rewiring. Second channel plugs in for fast conversion. The complete model SP-2 (stereo) features twelve separate inputs, six on each channel with input level controls. Six dual-concentric controls consist of: two 8-position selector switches, two bass, two treble, two volume level and two loudness controls, a scratch filter switch and a 4-position function switch (separate on-off switch). The function switch provides settings for stereo, two-channel mix, channel A or B for monaural use. Inputs consist of tape, mike, mag phono and three high-level inputs. Tape input has NARTB equalization and input selector provides for RIAA, LP, 78 record compensation. EF86 tubes are used in the input stages along with hum balance controls to assure low hum and noise. Two cathode follower outputs with level controls provided in addition to two separate tape outputs for stereo recording. A remote balance control with twenty feet of cable allows balancing the stereo system from listening position. Construction is greatly simplified through the use of two printed circuit boards (one in each channel) and encapsulated printed circuits. The beautiful vinyl clad steel cover has leather texture in black with inlaid gold design. Built-in power supply.



HEATHKIT
WA-P2
\$19⁷⁵

**Finger-tip controls for
your operating convenience**



HEATHKIT
UA-1
\$21⁷⁵

**A low cost
versatile performer**

"MASTER CONTROL" PREAMPLIFIER KIT

Designed as a control center for basic amplifiers the WA-P2 provides you with true high fidelity performance for the finest audio systems. Five switch-selected inputs accommodate a record changer, tape recorder, AM-FM tuner, TV receiver, microphone, etc., each with level control. Provision is also made for a tape recorder output. Ideal for "remote" installations, the WA-P2 features a low impedance cathode-follower output circuit allowing greater length of output lead. Full frequency response is obtained within $\pm 1\frac{1}{2}$ db from 15 to 35,000 CPS and will do full justice to the finest available program sources. Equalization is provided for records through separate turnover and rolloff switches for LP, RIAA, AES, and early 78's. A special hum balance control allows setting for minimum hum level. Power for operation is required from basic amplifier or external source. Shpg. Wt. 7 lbs.

"UNIVERSAL" 12-WATT AMPLIFIER KIT

A true high fidelity performer in every sense of the word, the UA-1 makes an ideal basic amplifier for any hi-fi system and is a perfect addition to gear your present hi-fi system for stereo sound. Uses 6BQ5/EL84 push-pull output tubes for less than 2% harmonic distortion throughout the entire audio range (20 to 20,000 CPS) at full 12 watt output. The on-off switch is located right on the chassis and an octal socket is provided for connecting a preamplifier for remote control operation. The specially designed output transformer provides excellent stability and frequency response. Taps for 4, 8 and 16 ohm speakers, with switched damping for "unity" or "maximum" on the 16-ohm tap. An input level control is provided for use in wired music systems where a preamplifier is not required. This versatile unit is the latest addition to the fine line of Heathkit basic amplifiers. Shpg. Wt. 13 lbs.

With Flexible Heathkit Components



DELUXE AM-FM TUNER KIT

Outstanding features in both styling and circuitry are combined in this 16-tube deluxe AM-FM combination tuner to bring you the very finest in program sources for your listening enjoyment. Features include three circuit boards for easy construction and high stability—prewired, prealigned FM front end—built-in AM rod antenna—tuning meter—AFC (automatic frequency control) with on-off switch and flywheel tuning. AM and FM circuits are separate and individually tuned making it ideal for stereo applications. Cathode follower outputs with individual controls are provided for both AM and FM. Other features include variable AM bandwidth, 10 kc whistle filter, tuned-cascade FM front end, FM AGC and amplified AVC for AM. The unique IF limiter design automatically provides the number of limiting and IF stages required for smooth non-flutter reception. The silicon diode power supply is extremely conservatively rated and is fuse protected assuring long service life. A tuning meter shows when the station is tuned-in for clearest reception on AM or FM. Use of three circuit boards greatly simplifies construction of circuit, you do only a minimum of wiring. All IF transformers and coils are prealigned so it will be ready to operate as soon as construction is completed. Appearance of this top-quality unit is further enhanced by the vinyl-clad steel cover in black with inlaid gold design. A multiplex jack is provided for addition of converter unit to receive multiplex stereo broadcasts on FM. A top dollar value.



HEATHKIT
PT-1 **\$89⁹⁵**

**A deluxe AM-FM
tuner combination
loaded with extras!**



HEATHKIT
BC-1A
\$26⁹⁵

Wide range broadcast reception

HIGH FIDELITY AM TUNER KIT

This AM tuner was designed especially for high fidelity applications. It incorporates a special detector using crystal diodes, and the IF circuit features broad bandwidth to assure low signal distortion. Audio response is ± 1 db from 20 CPS to 9 kc, with 5 db of pre-emphasis at 10 kc to compensate for station rolloff. Sensitivity and selectivity are excellent and the tuner covers the entire broadcast band from 550 to 1600 kc. Quiet performance is assured by a 6 db signal-to-noise ratio at 2.5 uv. Prealigned RF and IF coils eliminate the need for special alignment equipment. Incorporates AVC, two outputs, two antenna inputs, and built-in power supply. Edge-lighted glass slide rule dial for easy tuning. Your "best buy" in an AM tuner. Shpg. Wt. 9 lbs.

HEATH COMPANY • a subsidiary of Daystrom, Inc. • Benton Harbor 15, Mich.



HEATHKIT
FM-3A
\$26⁹⁵

Enjoy static-free FM entertainment

HIGH FIDELITY FM TUNER KIT

FM programming, your least expensive source of high fidelity will provide you with years of real enjoyment. This beautifully styled FM tuner features broad-banded circuits for full fidelity and better than 10 uv sensitivity for 20 db of quieting to pull in stations with clarity and full volume. Covers the complete FM band from 88 to 108 mc. Stabilized, temperature-compensated oscillator assures negligible drift after initial warmup. A ratio detector provides high-efficiency demodulation without sacrificing hi-fi performance. IF and ratio transformers are prealigned, as is the front end tuning unit, making special alignment equipment unnecessary. Edge-lighted glass slide rule dial for easy tuning. You need not wait to have FM in your home at this low price. Shpg. Wt. 8 lbs.

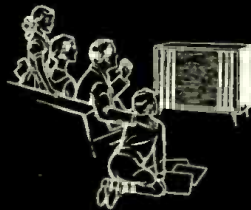

You can be sure you're buying High Fidelity



HEATHKIT
W-7M **\$54⁹⁵**

**55 watts of hi-fi power at
only \$1 per watt**

- ★ BEAUTIFULLY STYLED IN BLACK AND GOLD
- ★ UNITY OR MAXIMUM DAMPING

**"EXTRA PERFORMANCE"
55 WATT HI-FI AMPLIFIER KIT**

Another Heathkit first! An honestly rated high power amplifier with many top quality features at less than a dollar per watt. Full audio output is conservatively rated at 55 watts from 20 CPS to 20 kc with less than 2% total harmonic distortion throughout the entire range. Unique paired output connections permit instant switch selection of "unity" or "maximum" damping factors for all 4, 8 or 16 ohm speakers. Each output has an optimized current feedback circuit for unity damping so that there will be no compromise in performance when any of the impedances is used. This current feedback circuitry is entirely shorted out when not in use to obtain the highest possible damping factor. Features include level control and "on-off" switch right on the chassis plus provision for remote control from preamp, etc. Famous "bas-hal" circuit conveniently balances EL-34 output tubes. These heavy duty push-pull tubes operate into a high quality tapped-screen transformer designed especially for this unit. A 70-volt output on the transformer provides for P.A. or large music systems. The silicon diode power supply features a protection device that controls current until tubes have warmed up, greatly increasing service life of all components. The stylish black and gold case measures 6" H. x 8½" D. x 15" W. Convenient pilot light on the chassis. Thoughtful circuit layout makes this kit easy to build. Dollar for watt you can't beat this buy. Shipped express only. Shpg. Wt. 28 lbs.



HEATHKIT
W-6M **\$109⁹⁵**

**Plenty of Reserve Power
Without Distortion**



HEATHKIT
W-5M **\$59⁷⁵**

**Top-Flight Performance
for the Critical Listener**

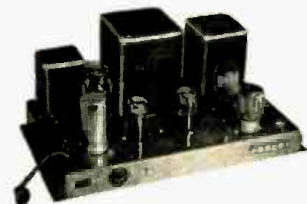

HEATHKIT
W-4-AM **\$39⁷⁵**

**Faithful Sound Reproduction
with Minimum Investment**

"HEAVY DUTY" 70-WATT HI-FI AMPLIFIER KIT

Here is an amplifier that will provide the extra "push" needed to drive any of the fine speaker systems available today, for truly fine performance at any power level. Silicon-diode rectifiers are used to assure long life and a heavy duty transformer gives you extremely good power supply regulation. Variable damping control provides optimum performance with any speaker system. Quick change plug selects 4, 8 and 16 ohms or 70 volt output and the correct feedback resistance. Frequency response at 1 watt is from 5 CPS to 80 kc with controlled HF rolloff above 100 kc. At 70 watts output harmonic distortion is below 2%, 20 to 20,000 CPS and IM distortion is below 1%, 60 and 6,000 CPS. Hum and noise 88 db below full output. Metered balance circuit. Designed especially for easy assembly and years of dependable service. Shipped express only. Shpg. Wt. 52 lbs.

25-WATT HI-FI AMPLIFIER KIT

Considered top value in its power class by leading independent research organizations, the W-5M incorporates all the design features required by the super critical listener. Features include a specially designed Peerless output transformer and KT66 tubes. The circuit is rated at 25 watts and will follow instantaneous power peaks of a full orchestra up to 42 watts. A "tweeter saver" suppresses high frequency oscillation and a new type balancing circuit facilitates adjustment of the "dynamic" balance between output tubes. Frequency response is ±1 db from 5 CPS to 160,000 CPS at 1 watt and within 2 db from 20 to 20,000 CPS at full 25 watts output. Harmonic distortion is less than 1% at 25 watts and IM distortion is 1% at 20 watts (60 and 3,000 CPS, 4:1). Hum and noise are 99 db below 25 watts for truly quiet performance. Rich black and gold colored styling. Shipped express only. Shpg. Wt. 31 lbs.

20-WATT HI-FI AMPLIFIER KIT

This fine amplifier will amaze you with its outstanding performance. It features a true Williamson circuit with extended frequency response, low distortion, and low hum levels. Enjoy true hi-fi with only a minimum investment compared to other units on the market. 5881 tubes and a special Chicago-Standard output transformer are employed to give you full fidelity at minimum cost. Frequency response extends from 10 CPS to 100 kc within ±1 db at 1 watt assuring you of full coverage of the audio range. Clean, clear sound amplification takes place in circuits that hold harmonic distortion at 1.5% and IM distortion below 2.7% at full 20 watt output. Hum and noise are 95 db below full output. Taps on the output transformer are at 4, 8 or 16 ohms to match the speaker system of your choice. An outstanding performer, this investment will bring you years of listening enjoyment. Shipped express only. Shpg. Wt. 28 lbs.

All basic amplifiers recommended for use with model WA-P2, SP-1 or SP-2 preamplifiers

...When You Buy Heathkits

HEATHKIT

"BOOKSHELF" 12-WATT AMPLIFIER KIT

The model EA-2 combines eye-pleasing style and color with many extra features for high quality sound reproduction. This fine amplifier provides full range frequency response from 20 to 20,000 CPS within ± 1 db. Harmonic distortion is less than 1% at full 12 watt output over the entire range (20-20,000 CPS). IM distortion is less than 1.5% at 12 watts with low hum and noise. Miniature tubes are used throughout the advanced circuitry, including EL84 output tubes in a push-pull tapped-screen output circuit using a special designed output transformer. Transformer has taps at 4, 8 and 16 ohms. The model EA-2 has its own built-in preamplifier with provision for three separate inputs, mag phono, crystal phono and tuner. The mag phono input features RIAA equalization. Separate bass and treble controls are provided with boost and cut action. A special hum-balance control assures quiet operation. The luxury styled cabinet has a smooth simulated leather texture in black with inlaid gold design and is constructed of vinyl plastic bonded to steel. It resists scuffing, wear, abrasion, and chemicals. The front panel features brushed-gold trim and buff knobs with gold inserts for a very pleasing appearance. An amber neon pilot lamp indicates when the amplifier is on. Cabinet measures $12\frac{1}{2}$ " W. x $3\frac{3}{16}$ " D. x $4\frac{3}{8}$ " H. making it suitable for use on a bookshelf, end table, etc. High quality is emphasized throughout for performance matching amplifiers costing many times more. Shpg. Wt. 15 lbs.



HEATHKIT
EA-2 \$28⁹⁵

**Combines beauty, style
and quality**

- ★ LESS THAN 1% DISTORTION AT FULL OUTPUT OVER ENTIRE AUDIO RANGE.
- ★ BUILT-IN PREAMPLIFIER



HEATHKIT
A9-C \$35⁵⁰

**A Bargain Package of
Power and Performance**



HEATHKIT
AV-3 \$29⁹⁵

**Invaluable for
Hi-Fi Testing**



HEATHKIT
AW-1 \$29⁵⁰

**Measure Exact
Power Output**

GENERAL-PURPOSE 20-WATT AMPLIFIER KIT

The A9-C combines a preamplifier, main amplifier and power supply all on one chassis providing a compact unit to fill the need for a good high fidelity amplifier with a moderate cash investment. Designed primarily for home installations, it is also capable of fulfilling P.A. requirements. The preamplifier section features four separate switch selected inputs. Separate bass and treble tone controls offer 15 db boost and cut. A true high fidelity performer, the A9-C covers 20 to 20,000 CPS within ± 1 db. Front panel is detachable, and can be installed on the outside of a cabinet where the chassis comes through, for custom installations. A fine unit with which to start your hi-fi system. Shpg. Wt. 23 lbs.

AUDIO VTVM KIT

Critical AC voltage measurements are made easy with this high quality vacuum tube voltmeter which emphasizes stability, broad frequency response and sensitivity. Features large $4\frac{1}{2}$ " 200 microampere meter, with increased damping in the meter circuit for stability in low frequency tests. Extremely high voltage range handles measurements from a low value of 1 millivolt to a maximum of 300 volts. AC (RMS) voltage ranges are: 0-.01, .03, .1, .3, 1, 3, 10, 30, 100 and 300 volts. Db ranges cover -52 to $+52$ db. Employs 1% precision multiplier resistors for maximum accuracy. High input impedance (1 megohm at 1,000 CPS). Frequency response is essentially flat from 10 CPS to 200 kc. Shpg. Wt. 6 lbs.

AUDIO WATTMETER KIT

Here is a fine meter to accurately measure output wattage. Five power ranges cover 0-5 mw, 50 mw, 500 mw, 5 w and 50 w full scale. Five switch selected db ranges cover -10 db to $+30$ db. All indications are read directly on the large $4\frac{1}{2}$ " 200 ua meter. Frequency response is ± 1 db from 10 CPS to 250 kc. External or internal load resistors are selected with convenient front panel switch. Non-inductive load resistors are built in for 4, 8, 16 or 600 ohms impedance. Precision multiplier resistors are used for high accuracy and incorporates a crystal diode bridge for wide-range frequency response. Modern styling and convenient front panel design. Cabinet is ventilated to allow efficient cooling of load resistors. Shpg. Wt. 7 lbs.

HEATH COMPANY • a subsidiary of Daystrom, Inc. • Benton Harbor 15, Mich.

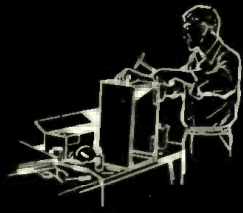

Easy to Buy - Easy to Build - Easy to Use...



CONTEMPORARY
Model CE-1B Birch
Model CE-1M Mahogany

HEATHKIT
CE-1
\$4395
each



TRADITIONAL
Model CE-1T Mahogany

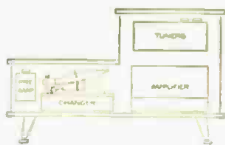

Combine all your Hi-Fi equipment
in this attractive cabinet

CHAIRSIDE ENCLOSURE KIT

This Chairside Enclosure lets you combine all of your hi-fi equipment into one compact control center and, at the same time add a beautiful piece of furniture to your home. The CE-1 is designed to house the AM and FM tuners (BC-1A and FM-3A) and the WA-P2 preamplifier along with the majority of record changers which will fit into the space provided. Adequate room is available in the rear of the unit to house any of the Heathkit amplifiers designed to operate with the WA-P2. The enclosure is flexible enough to give you a large choice in component installation. If only one tuner and the preamplifier are used, the two units can be installed in the tilt-out drawer, or if more convenient, either unit can be placed in the space provided in front of the changer compartment. The tilt-out shelf can be installed on either right or left side and the lift-top lid is similarly designed to lift from either side depending on your choice during construction. Good ventilation is achieved through appropriately placed slots in the bottom and back of the enclosure. Overall dimensions are 18" W. x 24" H. x 35½" D. The changer compartment measures 17¾" L. x 16" W. x 9⅝" D. All parts are precut and predrilled for easy assembly and attractive hardware is supplied to match each style. The contemporary cabinet is available in either mahogany or birch and the traditional cabinet is available in mahogany only. Furniture grade plywood can be finished to your taste. Shpg. Wt. 46 lbs.



HEATHKIT
AG-9A **\$34.50**

Your own source of
Hi-Fi audio signals

AUDIO SIGNAL GENERATOR KIT

The model AG-9A is "made to order" for high fidelity applications, and provides quick and accurate selection of low-distortion signals from 10 CPS to 100 kc. Three rotary switches select two significant figures and a multiplier to determine audio frequency. Incorporates step-type and a continuously variable output attenuator. Output indicated on large 4½" panel meter, calibrated in volts and db. Attenuator system operates in 10 db steps, corresponding to meter calibration, in ranges of 0-.003, .01, .03, .1, .3, 1, 3 and 10 volts RMS. "Load" switch permits use of built-in 600-ohm load, or external load of different impedance. Output and frequency indicators accurate to within ± 5%. Distortion less than .1 of 1% between 20 and 20,000 CPS. Shpg. Wt. 8 lbs.



HEATHKIT
AA-1 **\$49.95**

3 Audio test instruments
in one compact unit

AUDIO ANALYZER KIT

Complete high fidelity testing facilities are yours in the AA-1. It combines the functions of three separate instruments; an AC VTVM, audio wattmeter and a complete IM analyzer with filters and high and low frequency oscillators built in. VTVM ranges are: 0-.01, .03, .1, .3, 1, 3, 10, 30, 100 and 300 volts (RMS). Db scale reads from -65 to +52 dbm. Wattmeter ranges are: .15 mw, 1.5 mw, 15 mw, 150 mw, 1.5 w, 15 w and 150 w. IM scales are 1%, 3%, 10%, 30% and 100% full scale. Provides internal load resistors of 4, 8, 16 or 600 ohms. Combining and consolidating functions reduces the number of test leads and controls required for the same test. Complete instructions are provided for easy assembly, also valuable information on use of instrument. Shpg. Wt. 13 lbs.



HEATHKIT
HD-1 **\$49.50**

Check amplifier
distortion quickly

HARMONIC DISTORTION METER KIT

Valuable in both designing and servicing of audio circuits, the HD-1 used with an audio signal generator, will accurately measure harmonic distortion at any or all frequencies between 20 and 20,000 CPS. Distortion is read on panel meter in ranges of 0-1, 3, 10, 30 and 100% full scale. Full scale voltage ranges of 0-1, 3, 10 and 30 volts are provided for the initial reference settings. Signal-to-noise ratio is measured on a separate meter scale calibrated in db. Features high input impedance (300,000 ohms) and 1% precision resistors in the VTVM voltage divider circuit for excellent sensitivity and accuracy. High quality components insure years of dependable service. Complete instructions provided for easy assembly and operation. Shpg. Wt. 13 lbs.

Heathkits are Your Best Dollar Value



TRANSISTOR PORTABLE RADIO KIT

The overwhelming sales of this outstanding transistor portable have made a substantial price reduction possible... in addition, an all new plastic molded case adds the finishing touch to the exceptional circuitry. Six name-brand (Texas Instrument) transistors are used for extra good sensitivity and selectivity. The 4" x 6" PM speaker with heavy magnet provides excellent tone quality. Use of this large speaker and roomy chassis make it unnecessary to crowd components adding greatly to the ease of construction. Transformers are prealigned so it is ready for service as soon as construction is completed. A touchup in alignment is easily accomplished on a station by following simple instructions in manual. Alignment tool furnished. Has built-in rod-type antenna for reception in all locations. Six standard size "D" flashlight cells are used for extremely long battery life (between 500 and 1000 hours) and they can be purchased almost anywhere. Cabinet is two-tone blue molded plastic with pull-out carrying handle. Dimensions are 9½" L. x 7¼" H. x 4" D. Shpg. Wt. 6 lbs.

Model XR-1-L: Identical to XR-1-P except in genuine leather case. Rich, warm sun-tan tone. Leather carrying strap included. Shpg. Wt. 7 lbs.

Leather Case: can be purchased separately if desired. Fits all XR-1P's and XR-1's. No. 93-1. Shpg. Wt. 3 lbs. \$6.95.



MODEL XR-1-L
\$34⁹⁵

HEATHKIT
XR-1-P **\$29⁹⁵**

Newly designed plastic case... new low price!

- ★ 4" X 6" SPEAKER FOR "BIG SET" TONE
- ★ LONG BATTERY LIFE (500 to 1000 Hours)



HEATHKIT
CT-1
\$7⁹⁵

Test condensers right in the circuit



HEATHKIT
DF-1 **\$54⁹⁵**

Pin-point your exact location



HEATHKIT
FD-1 **\$35⁹⁵ each**
(6 volt model FD-1-6)
(12 volt model FD-1-12)

Detects gas fumes



HEATHKIT
MC-1
\$42⁹⁵

Save your boat batteries

IN-CIRCUIT CAPACI-TESTER KIT

Check most capacitors for "open" or "short" right in the circuit with this handy kit. Detects open capacitors from about 50 mmf up, not shunted by an excessively low resistance value. Checks shorted capacitors up to 20 mfd (not shunted by less than 10 ohms). (Does not detect leakage nor check electrolytic condensers.) Employs a 60-cycle frequency for the short test and a 19 megacycle frequency for the open test. Uses electron beam "eye" tube for quick indication. Test leads included. Shpg. Wt. 5 lbs.

TRANSISTOR RADIO DIRECTION FINDER KIT

This transistor radio compass will double as a portable radio. Covers the standard broadcast band from 540 to 1600 kc. Ideal for use aboard boats and also on land by hunters, hikers, etc. A directional high-Q ferrite antenna rotates from the front panel to obtain a fix on a station. A 1 ma meter serves as null and tuning indicator. Prealigned IF transformers—six transistor circuit. Powered by tiny 9-volt battery with spare included. Dimensions 7½" W. x 5 ¾" H. x 5 ¼" D. Shpg. Wt. 5 lbs.

FUEL VAPOR DETECTOR KIT

Protect your boat and passengers against fire and explosion with one of these fuel vapor detector kits. Indicates the presence of fumes on a three-color "safe-dangerous" meter scale and immediately shows if it is safe to start the engine. A pilot lamp shows when the detector is operating. Easy to build and install, even by one not having previous experience. Operates from your boat battery. The kit is complete with heavy-duty neoprene insulated cable and includes spare detector unit. Shpg. Wt. 4 lbs.

MARINE CONVERTER KIT

Charge 6 or 12 volt batteries with this marine converter and battery charger. A panel mounted 25 ampere meter continuously monitors the charging current. Moisture and fungus proofed for rugged marine use. Convection cooling prevents unsafe temperature rise. The MC-1 has no moving parts, tubes nor blowers to wear out or break. Mounting brackets are supplied for easy installation on any boat. Ideal for keeping batteries fully charged or to supply extra current for appliances. Shpg. Wt. 16 lbs.

HEATH COMPANY • a subsidiary of Daystrom, Inc. • Benton Harbor 15, Mich.



New Styling - New Features...



HEATHKIT
TX-1 **\$229⁵⁰**

**Complete Versatility for Top-
Notch Amateur Communications**

- ★ NEWLY DESIGNED VFO—ROTATING SLIDE RULE DIAL
- ★ MODERN STYLING—PROVISION FOR SSB ADAPTER

"APACHE" HAM TRANSMITTER KIT

Fresh out of the Heath Company laboratories, the brand-new "Apache" model TX-1 ham transmitter features modern styling and the latest in circuitry for extra fine performance. The "Apache" is a high quality transmitter operating with a 150 watt phone input and 180 watt CW input. In addition to CW and phone operation, built-in switch selected circuitry provides for single-sideband transmission through the use of a plug-in external adapter. These SSB adapters will be available in the near future. A compact, stable and completely redesigned VFO provides low drift frequency control necessary for SSB transmission. A slide rule type illuminated rotating VFO dial with vernier tuning provides ample bandspread and precise frequency settings. The bandswitch allows quick selection of the amateur bands on 80, 40, 20, 15 and 10 meters. (11M with crystal control). This unit also has adjustable low level speech clipping and a low distortion modulator stage employing two of the new 6CA7/EL-34 tubes in push-pull class AB operation. Time sequence keying is provided for "chirpless" break-in CW operation. The final amplifier is completely shielded for greater TVI protection and transmitter stability. Die-cast aluminum knobs and front panel escutcheons add to the attractive styling of the transmitter. Pi network output coupling matches antenna impedances between 50 and 72 ohms. Shpg. Wt. 107 lbs.

\$50.00 deposit required on C.O.D. orders. Shipped motor freight unless otherwise specified.



HEATHKIT
DX-20 **\$35⁹⁵**

**An Ideal
Code Transmitter**



HEATHKIT
DX-100 **\$189⁵⁰**

**You'll be Proud to Own
This Outstanding Performer**



HEATHKIT
DX-40 **\$64⁹⁵**

**Phone & CW Facilities
at Low Cost**

DX-20 CW TRANSMITTER KIT

Designed especially for CW work, the DX-20 features high efficiency at low cost. An ideal rig for the novice or advanced-class CW operator. Plate power input is 50 watts, and covers 80, 40, 20, 15, 11 and 10 meters with single knob bandswitching. Features a single 6DQ6A tube in the final amplifier stage and a 6CL6 as a crystal oscillator. Pi network output circuit matches various antenna impedances between 50 and 1000 ohms and reduces harmonic output. Top-quality parts are featured throughout, including "potted" transformers, etc., for long service life. Complete shielding to minimize TVI. Removable metal pull-out plug on left end of cabinet provides access for crystal changing. Very easy to build with complete instructions supplied. Shpg. Wt. 19 lbs.

DX-100 PHONE AND CW TRANSMITTER KIT

Well known for its high quality and fine performance the DX-100 features a built-in VFO, modulator, and power supply, complete shielding to minimize TVI, and a pi network coupling to match impedances from 50 to 600 ohms. RF output is in excess of 100 watts on phone and 120 watts on CW, for clean strong signals on all ham bands from 10 to 160 meters. Single knob bandswitching and illuminated VFO dial and meter face add real operating convenience. RF output stage uses a pair of 6146 tubes in parallel, modulated by a pair of 1625's. High quality components are used throughout, such as potted transformers, silver-plated or solid coin silver switch terminals, aluminum-heat dissipating caps on the final tubes, copper plated chassis, etc. Shpg. Wt. 107 lbs.

\$50.00 deposit required on C.O.D. orders. Shipped motor freight unless otherwise specified.

DX-40 PHONE AND CW TRANSMITTER KIT

An outstanding buy in its power class the DX-40 provides both phone and CW operation on 80, 40, 20, 15, 11 and 10 meters. A single 6146 tube is used in the final amplifier stage to provide full 75 watt plate power input on CW, or controlled carrier modulation peaks up to 60 watts for phone operation. Modulator and power supplies are built in and single-knob bandswitching is combined with the pi network output circuit for complete operating convenience. Complete shielding to minimize TVI. Provision is made for three crystals. A four-position switch selects any of the three crystals or a jack for external VFO. Crystal sockets are reached through access door in rear of cabinet. High quality D'Arsonval movement panel meter. Shpg. Wt. 25 lbs.

For Real Ham Enjoyment



"MOHAWK" HAM RECEIVER KIT

Here is a ham receiver that any radio operator would be proud to own. The "Mohawk" has all the functions required for high quality communications with clear, rock-steady reception on all bands. This 15-tube receiver features double conversion with IF's at 1682 kc and 50 kc and covers all of the amateur frequencies from 160 through 10 meters on seven bands with an extra band calibrated to cover 6 and 2 meters using a converter. Receiver accommodations are provided for these converters which will be available in Heathkits soon. The "Mohawk" is specially designed for single-sideband reception with crystal controlled oscillators for upper and lower sideband selection. A completely preassembled, wired and aligned front end coil assembly assures ease of construction and top performance of the finished unit. Other features include five selectivity positions from 5 kc to 500 CPS, bridged T-notch filter for maximum heterodyne rejection, and a built-in 100 kc crystal calibrator. The set provides a 10 db signal-to-noise ratio at less than 1 microvolt input. Front panel features S meter, separate RF, IF and AF gain controls, T-notch tuning, T-notch depth, ANL, AVC, BFO, bandswitch, tuning, antenna trimmer, calibrate set, calibrate on, CW-SSB-AM, receive-standby, upper-lower sideband, selectivity, phone jack and a wide band rotating slide rule type vernier tuning dial with easy to read calibrations. Shpg. Wt. 67 lbs. \$50.00 required on C.O.D. orders. Shipped motor freight unless otherwise specified.



HEATHKIT
RX-1 **\$274⁹⁵**

Now in Kit Form a Top Quality Ham Band Receiver

- ★ PREWIRED AND ALIGNED FRONT END COIL ASSEMBLY.
- ★ CRYSTAL CONTROLLED OSCILLATORS FOR DRIFT-FREE RECEPTION.



HEATHKIT
B-1 **\$8⁹⁵**

**Get Proper Match
Between Transmitter
and Antenna**

BALUN COIL KIT

Unbalanced coax lines used on the most modern transmitters can be matched to balance lines of either 75 or 300 ohms impedance by using the model B-1 Balun Coil Kit. Can be used with transmitters and receivers without adjustment over the frequency range of 80 through 10 meters, and will handle power inputs up to 200 watts. Cabinet size is 10" square by 5" D. and may be located any distance from the transmitter or antenna. A protective cover is supplied to prevent damage in outdoor installations. Shpg. Wt. 4 lbs.

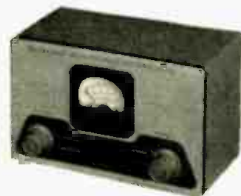

HEATHKIT
AM-2 **\$15⁹⁵**

**Measure Standing
Wave Ratio**

REFLECTED POWER METER KIT

The match of your antenna transmission system can be checked by measuring the forward and reflected power or standing wave ratio from 1:1 to 6:1 with this fine unit. Designed to handle a peak power of well over 1 kilowatt of energy the AM-2 may be left in the antenna system feed line at all times. Band coverage is 160 meters through 2 meters. Input and output impedances for 50 or 75 ohm lines. No external power required for operation. Cabinet size is 7 3/4" x 4 3/4" x 4 3/4". Shpg. Wt. 3 lbs.



HEATHKIT
VX-1 **\$23⁹⁵**

**Eliminates Hand
Switching**

ELECTRONIC VOICE CONTROL KIT

This unique device allows you to switch from receiver to transmitter merely by talking into your microphone. . . you get the advantage of "telephone-type conversation" as in single sideband but with regular AM transmission. The unit is adjustable to all conditions by sensitivity controls provided. A variable time delay control changes the "hold" time. Provision is made for receiver and speaker connections and also for a 117 volt antennarelay. Built-in power supply. Complete instructions provided. Shpg. Wt. 5 lbs.

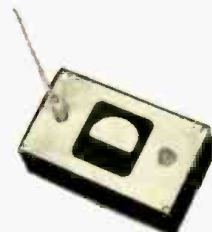

HEATHKIT
PM-1 **\$14⁹⁵**

**Quick Check of
Transmitter Operation**

RF POWER METER KIT

This self contained unit requires no power for operation. You simply place it close to the transmitter antenna to sample the RF field which is then indicated on the panel meter. Operates with any transmitter having an output frequency between 100 kc and 250 mc, regardless of power. Sensitivity is 0.3 volts RMS full scale, and a special control on the panel allows for further adjustment of the sensitivity. Measures 3 1/4" W. x 6 1/4" L. x 2" D. An easy way to put your mind at ease concerning transmitter operation. Shpg. Wt. 2 lbs.

HEATH COMPANY • a subsidiary of Daystrom, Inc. • **Benton Harbor 15, Mich.**

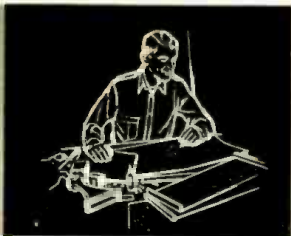

Choose from a wide variety of Heathkits

DUAL-CHASSIS 20 WATT HI-FI AMPLIFIER KIT

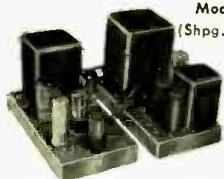

Model WJ-AM
(Shpg. Wt. 29 lbs.)

\$49⁷⁵

12" UTILITY SPEAKER



Model 401-6
(Shpg. Wt. 7 lbs.)

\$7⁵⁰

ALL-BAND RADIO KIT

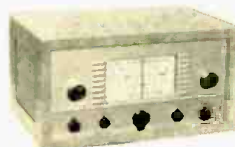

Model AR-3
(Shpg. Wt. 12 lbs.)

\$29⁹⁵
(less cabinet)

CRYSTAL RADIO KIT



Model CR-1
(Shpg. Wt. 3 lbs.)

\$7⁹⁵

BROADCAST BAND RADIO KIT



Model BR-2
(Shpg. Wt. 10 lbs.)

\$18⁹⁵
(less cabinet)

ELECTRONIC CROSSOVER KIT



Model XO-1
(Shpg. Wt. 6 lbs.)

\$18⁹⁵

"Q" MULTIPLIER KIT



Model QF-1
(Shpg. Wt. 3 lbs.)

\$9⁹⁵

"AUTOMATIC" CONELRAD ALARM KIT



Model CA-1
(Shpg. Wt. 4 lbs.)

\$13⁹⁵

GRID DIP METER KIT



Model GD-1B
(Shpg. Wt. 4 lbs.)

\$21⁹⁵

VIBRATOR POWER SUPPLY KIT



6 volt Model VP-1-6
12 volt Model VP-1-12
(Shpg. Wt. 4 lbs.)

\$7⁹⁵
ea.

VARIABLE FREQUENCY OSCILLATOR KIT



Model VF-1
(Shpg. Wt. 7 lbs.)

\$19⁵⁰

PROFESSIONAL RADIATION COUNTER KIT



Model RC-1
(Shpg. Wt. 8 lbs.)

\$79⁹⁵

ISOLATION TRANSFORMER KIT



Model IT-1
(Shpg. Wt. 9 lbs.)

\$16⁵⁰

ELECTRONIC SWITCH KIT



Model S-3
(Shpg. Wt. 8 lbs.)

\$21⁹⁵

REGULATED POWER SUPPLY KIT



Model PS-3
(Shpg. Wt. 17 lbs.)

\$35⁵⁰

VOLTAGE CALIBRATOR KIT



Model VC-3
(Shpg. Wt. 4 lbs.)

\$12⁵⁰

DIRECT-READING CAPACITY METER KIT



Model CM-1
(Shpg. Wt. 7 lbs.)

\$29⁵⁰

TUBE CHECKER KIT



Model TC-2
(Shpg. Wt. 12 lbs.)

\$34⁹⁵

EASY TIME PAYMENTS

AVAILABLE FOR YOUR
CONVENIENCE...

Any order totaling \$90 or more can
be paid for in small monthly pay-
ments (send for complete details).

RESISTANCE SUBSTITUTION BOX KIT



Model RS-1
(Shpg. Wt. 2 lbs.)

\$5⁵⁰

CONDENSER SUBSTITUTION BOX KIT



Model CS-1
(Shpg. Wt. 2 lbs.)

\$5⁵⁰

CATHODE RAY TUBE CHECKER KIT



Model CC-1
(Shpg. Wt. 10 lbs.)

\$24⁹⁵

LABORATORY RF GENERATOR KIT



Model LG-1
(Shpg. Wt. 16 lbs.)

\$48⁹⁵

"Q" METER KIT



Model QM-1
(Shpg. Wt. 14 lbs.)

\$44⁵⁰

DECADE CONDENSER KIT

Model DC-1
(Shpg. Wt. 3 lbs.)

\$16⁵⁰



DECADE RESISTANCE KIT

Model DR-1
(Shpg. Wt. 4 lbs.)

\$19⁵⁰

...to Fill Your Exact Needs



PORTABLE TUBE CHECKER KIT
 Model TC-2P
 (Shpg. Wt. 1.5 lbs.)

\$38⁹⁵

TV PICTURE TUBE TEST ADAPTER FOR TC-2 AND TC-2P

Model 355
 (Shpg. Wt. 1 lb.)

\$4⁵⁰

BINDING POST KIT

Model 362
 (Shpg. Wt. 1 lb.)

\$4⁰⁰

BATTERY TESTER KIT

Model BT-1
 (Shpg. Wt. 2 lbs.)

\$8⁵⁰

ELECTRONIC IGNITION ANALYZER KIT

MODEL IA-1
 (Shpg. Wt. 20 lbs.)

\$59⁹⁵

SCOPE PROBES
 Scope Demodulator Probe Kit

Model 337-C
 (Shpg. Wt. 1 lb.)

\$3⁵⁰

Low Capacity Probe Kit
 Model 342
 (Shpg. Wt. 1 lb.)

\$3⁵⁰

VTVM PROBES

30,000 Volt DC HV Probe Kit No. 336
 Shpg. Wt. 2 lbs. **\$4.50**

Etched Circuit RF Probe Kit No. 309-C
 Shpg. Wt. 1 lb. **\$3.50**

Peak-to-peak Voltage Probe Kit No. 338-C
 Shpg. Wt. 2 lbs. **\$5.50**

ENLARGER TIMER KIT

Model ET-1
 (Shpg. Wt. 3 lbs.)

\$11⁵⁰

IMPEDANCE BRIDGE KIT

Model IB-2A
 (Shpg. Wt. 12 lbs.)

\$59⁵⁰

"LOW RIPPLE" BATTERY ELIMINATOR KIT

Model BE-5
 (Shpg. Wt. 21 lbs.)

\$39⁹⁵

ELECTRONIC ANALOG COMPUTER KIT
 Full Computer Group C

\$94⁵⁰⁰

Write for free folder.

Free Catalog

Send for this informative booklet describing these and many other do-it-yourself kits.

ORDER DIRECT BY MAIL . . . from the WORLD'S LARGEST MANUFACTURER OF ELECTRONIC INSTRUMENTS IN KIT FORM

Save 1/2 or more over equivalent ready-made products by buying direct and assembling them yourself. You gain priceless knowledge through complete and informative construction manuals.



HEATH COMPANY A Subsidiary of Daystrom, Inc. **BENTON HARBOR 15, MICH.**

ORDER BLANK

NOTE: All prices and specifications subject to change without notice.

Enclosed find () check () money order for _____ Please ship C.O.D. () postage enclosed for _____ pounds.

On Express orders do not include transportation charges—they will be collected by the express agency at time of delivery.

On Parcel Post Orders include postage for weight shown. All prices are NET F.O.B. Benton Harbor, Michigan, and apply to Continental U.S. and Possessions only.

Name _____
 Address _____
 City & Zone _____ State _____
 (PLEASE PRINT)

SHIP VIA
 Parcel Post
 Express
 Freight
 Best Way

QUANTITY	ITEM	MODEL NO.	PRICE
		POSTAGE	
		TOTAL	

SEND FREE Heathkit Catalog

Precision

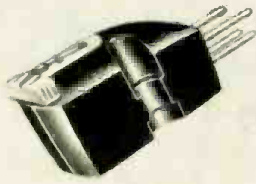

...precisely
for music!

A pickup precisely designed for music!
A stereo pickup with all the compliance, frequency response and distortion-free performance required for the highest quality music reproduction.

This...is the
STANTON Stereo-FLUXVALVE...
where quality starts and the music begins!

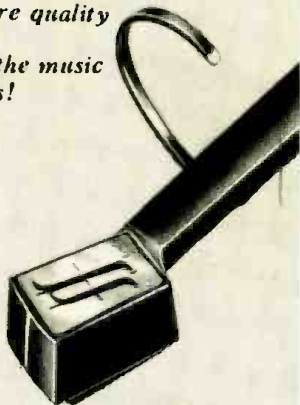

The STANTON Model 196 UNIPOISE Arm with integrated Stereo-FLUXVALVE Pickup—\$59.85 with replaceable 0.7 mil diamond T-GUARD Stylus.

The STANTON Model 371 Stereo-FLUXVALVE Cartridge—\$29.85 with replaceable 0.7 mil diamond T-GUARD Stylus.

Hermetically sealed for a lifetime of trouble-free use, the STANTON Stereo-FLUXVALVE performs in a way no other pickup can equal. Use it in automatic or manual record playing systems.

PHOTOGRAPHED BY MORT WELDON



For those who can hear the difference

FINE QUALITY HIGH FIDELITY PRODUCTS BY

PICKERING & COMPANY, INC.,

Plainview, N. Y.

FLUXVALVE, T-GUARD, UNIPOISE are registered trademarks

Address Dept. F-128 for a free copy of
IT TAKES TWO TO STEREO by Walter O. Stanton.



STEREO "MUSIC WALL"
David Bogen Company, P. O. Box 500, Paramus, N. J. has developed a stereo "Music Wall" which is designed to overcome distaff objections to hi-fi gear in the living room.
By housing the company's dual



stereo 12-watt amplifier-preamp, four speed stereo changer, and AM-FM tuner in two furniture-finished wood cabinets which can be mounted on the living room wall, the family can have its stereo music and the necessary floor space for other activities. Record storage space is provided in the cabinet housing the tuner.

The cabinets are currently available in walnut finish with other finishes to be offered at a later date. The stereo units are provided without speakers so that users may select speaker systems to meet room requirements.

Further information on the "Music Wall" is available from the manufacturer on request.

LOW-COST FM TUNER

Granco Products, Inc., 36-07 20th Avenue, Long Island City 5, N. Y. has announced the availability of a new

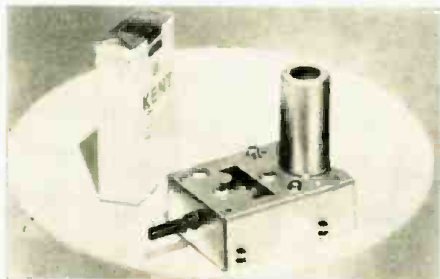

tuning device which substantially reduces the cost of manufacturing FM receivers.

No larger than a pack of king-size cigarettes, the sensitivity of the unit is 5 μ v. for 20 db of quieting. According to the company, audio characteristics

are in keeping with the demands of high-fidelity FM broadcasting and well beyond even the widest of wide-range AM transmissions. Drift is said to be negligible.

The tuner will be incorporated in the firm's 1959 line of FM and AM-FM radio receivers and will be offered to other manufacturers at a later date.

POWER MEGAPHONE

A new power megaphone for hand-held, portable sound projection is being offered by Argonne Electronics Mfg. Corp., 165-11 South Road, Jamaica 33, N. Y.

The unit features a rubber-rimmed spun aluminum reflex horn measuring 12½ inches long and with a mouth diameter of 8¼"; high audio power and directivity giving a range of 1000 feet; a pistol grip and grip switch for ease of handling, aiming, and starting; operation from four low-cost "D" batteries; and non-linear current limiter for maximum battery life.

Catalogued as the AR230, the new megaphone weighs only 4½ pounds.

CHANGERS FOR STEREO

Rockbar Corporation, Mamaroneck, N. Y., U. S. sales representative for Collaro, Ltd., has announced the current availability of a new line of record



changers which has been specifically engineered for stereo applications.

The three new changers are: "The Continental" (Model TSC-810), "The Coronation" (Model TSC-740), and "The Conquest" (Model TSC-640). The first unit features a two-piece arm with the all-new 5-terminal plug-in head. The counterbalanced transcription-type tonearm will accept any standard stereo or monaural cartridge. The changer has four speeds, a manual switch to permit playing a single record or portion of a record, wow and flutter of 0.25% r.m.s. at 33½ rpm, automatic shut-off after last record, and automatic intermix (7", 10", or 12" records). The motor is of the heavy-duty, 4-pole induction type.

The second unit features the same type of tonearm and, in addition, includes an extra-heavy-duty 4-pole motor; heavy rim-weighted, balanced

turntable for flywheel action; 4 speeds plus manual switch for turntable action; and stereo muting switch. The "Conquest" is a popularly priced model with one-piece stereo tonearm. The turntable is driven by a heavy-duty, 4-pole induction motor, has 4 speeds with manual switch for turntable operation, and wow and flutter of 0.25% r.m.s. at 33 $\frac{1}{3}$ rpm. The change cycle is 8 seconds, independent of record speed.

JANSZEN SPEAKER SYSTEM

Neshaminy Electronic Corporation, Easton Road, Neshaminy, Pa. is now offering its Z-300 system, a new unit in the "Janszen" line of audio components.

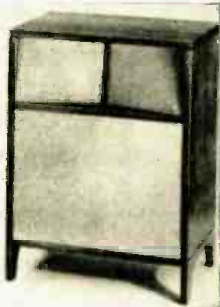

The new two-way system can be used in pairs for stereo reproduction or singly for monaural listening. The enclosure houses the company's electrostatic tweeter and a newly designed direct-radiator-cone woofer with the tweeter and woofer carefully matched. The tweeter utilizes two push-pull electrostatic radiators set in an arrangement to obtain maximum dispersion and broad sound source. The Model 350 woofer is an all-new design, 11" in diameter, properly baffled in a 2.2-cubic foot Fiberglass-filled enclosure. Its long voice-coil structure and flexible suspension make it possible to handle high power with low harmonic distortion. Transient distortion is avoided by use of a very light cone carefully controlled over its operating range and rolled off mechanically above 2000 cps rather than resorting to a crossover network.

The cabinet housing the system measures 28" high x 20" wide x 13" deep. It is available in rubbed mahogany, maple (birch), and walnut finishes with natural bouclé grille cloth.

STEREO BALANCE METER

Lafayette Radio, 165-08 Liberty Ave., Jamaica 33, N. Y. is now offering a new dual audio-output-level indi-

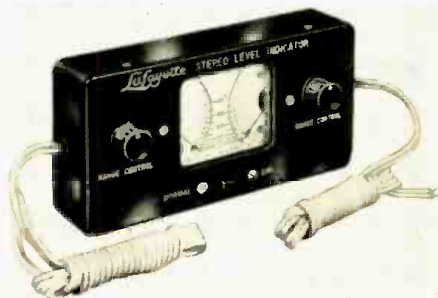

cator, incorporating two independent well damped meter movements with scales calibrated in vu and per-cent.

The Model TM-40 has a separate continuously variable attenuator for up to 20 db of attenuation in each channel and a switch to permit calibrating one meter against the other.



BY *Grommes*

You turn a dial . . . and something wonderful happens!
 You're there . . . reliving the original performance,
 hearing the songs you love with a new
 brilliant clarity . . . hearing the depth of life
 in each musical passage. Grommes
 Stereo is stereophonic reproduction at
 it's finest . . . superb fidelity
 with a new realistic depth . . .
 bringing you truly, music
 that lives.



*Handsomely styled
 in gleaming gold and white
 set in a leatherette case*

*You be the judge . . . Your Grommes High Fidelity Dealer
 will be happy to demonstrate this exciting new line of
 Grommes Stereo Amplifiers.*



Grommes — Division of Precision Electronics Inc.
 Dept. R-12, 9101 King Street, Franklin Park, Illinois

Send me full details
 on the new Grommes
 Stereo Line

Name _____
 Street _____
 City _____ Zone _____ State _____

? GOING STEREO



YOU'RE LUCKY IF YOU ALREADY HAVE A BOZAK!

Quality stereo demands matched speakers. To match your present Bozak, simply select a similar Bozak system at random or assemble a duplicate*. Presto! — your stereo team-mates are musical soul-mates, identical in their full-frequency response, natural balance, tonal consonance, room-wide coverage and broad-front sound. No need of special matching or balancing, no "hole-in-the-middle" or "ping-pong" effect with good program material — and no later regrets that you didn't start with the best! See a Bozak Franchised Dealer, write for literature.

* — E-300 Contemporary Kits with three-way B-302A systems are ideal for high-standard stereo on a low budget.

THE R. T. BOZAK SALES CO., DARIEN, CONN.



RUINED...

Why let an ordinary diamond needle chew up your records? They can become as chisel-sharp as a dog's fangs. Avoid this risk with the "needle that remembers". The fabulous Duotone Diamond Needle that tells you when to check or change your needle. The perfectly-made needle that Independent Laboratory tests show to excel in contour, polish, radius tolerances, mounting and construction. Costs no more than an ordinary diamond needle. Yet gives you a needle 5 ways better — with this extra priceless memory to protect your records. Send for booklet. DUOTONE COMPANY, INC., Keyport, N. J.

DUOTONE...

is different

RCA Sound Tape



... on "Load-Easy" reels for fast tape threading!

Now available wherever superior-quality magnetic tape is sold. On 5" and 7" Load-Easy Reels for fast, simplified threading. Excellent for low-noise, extended-range recording and playback!



RADIO CORPORATION OF AMERICA

Electron Tube Division Harrison, N. J.

Input impedance is 10,000 ohms per channel and sensitivity is 1.4 volts for zero vu. Blocking capacitors are internally installed to prevent meter damage by d.c.

The damped meter movements respond to average values of music or speech voltage waveforms and are ideal for maintaining control of recording level on tape recorders or output level on stereo tuners, preamps, paging or music distribution amplifiers, or for comparing levels in any two audio channels.

The instrument is housed in a compact rectangular case and comes complete with leads.

12-WATT AMPLIFIER KIT

Heath Company of Benton Harbor, Mich. is now offering a new basic amplifier in kit form which is designed to be used as the second amplifier in a stereo system or as the only amplifier in a low-power audio setup.

The Model UA-1 uses 6BQ5/EL84 push-pull output tubes and has less than 2% harmonic distortion through-



out the entire range (20 to 20,000 cps) at full 12-watt output. The "on-off" switches are located on the chassis and an octal plug is also provided to connect a preamplifier for remote control operation.

A specially designed output transformer provides good stability and low-frequency response while voltage feedback around the entire circuit reduces distortion. Taps for 4-, 8-, and 16-ohm speakers are provided. The 16-ohm tap features switch damping for unity or maximum.

An input level control makes this unit adaptable for use with wired music systems where a preamp is not required.

SCOTT STEREO AMPLIFIER

H. H. Scott, Inc., 111 Powdermill Road, Maynard, Mass. has announced the development of a new stereo amplifier which consists of dual 20-watt power amplifiers and dual preamps on a single chassis.

The Model 299 can be used with any stereo or monaural source or as an electronic crossover. Its front-panel controls include a pickup selector switch for selection between two separate stereo phono pickups, scratch filter, rumble filter, loudness-volume control, input selector, function selector, separate treble and bass controls for channel A and channel B, stereo balance control, loudness control, and phase reversal switch. A unique indicator panel gives quick visual indication of operating mode.

When used with a stereo source, the Model 299 delivers 20 watts of power for each channel. On monaural pro-

RADIO & TV NEWS

gram sources the unit automatically uses the power for both sections, making it a 40-watt amplifier. There are special facilities for quick and accurate balancing of both channels.

There are two low-level stereo inputs and three high-level stereo inputs. The

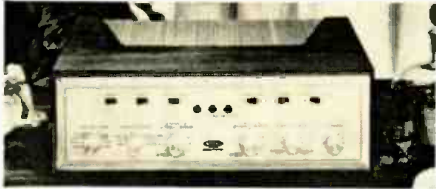

preamp heaters are d.c. operated to eliminate hum. The self-balancing phase inverter stage automatically compensates for variation in output tubes due to aging. The d.c. bias and a.c. balance controls are included for laboratory adjustment of the amplifier.

For complete technical specs on the Model 299, write to Department P of the company.

TURNTABLES FOR STEREO

Rek-O-Kut, Inc., 38-19 108th St., Corona 68, N. Y. is now offering three new turntables which have been especially designed with the needs of the stereo disc user in mind.

The Model K-33 is a single-speed unit in kit form. It may be assembled in approximately 30 minutes without use of special tools. A 4-pole induction motor drives the turntable at 33 $\frac{1}{3}$ rpm. The special endless woven fabric belt is held to a tolerance of $\pm .001$ inch. There is a built-in strobe disc for checking speed. Noise level is -47 db.

The Model B-12GH is driven by a three-speed hysteresis synchronous motor and provides operation at 33 $\frac{1}{3}$, 45, and 78 rpm. The 45 rpm hub is built-in and retractable. The turntable is of lathe-turned solid cast aluminum.

Model N-33H features a single-speed hysteresis synchronous motor with special braking for reduction of coasting. This turntable operates at 33 $\frac{1}{3}$ rpm



and is belt-driven. Like the Model B-12GH, this unit includes a built-in strobe disc and has a noise level of -53 db.

All three of these "Rondine" turntables can be used with the company's S-120 monaural tonearm or its new stereo tonearms. A catalogue covering all of these turntables is available on request.

SMALL SPEAKERS FOR STEREO

Sonotone Corporation, Elmsford, N. Y. has developed a shelf-size speaker system which is designed to overcome



Quam Hi-Fi Speakers are the List Price line. They are never promoted to the public at "audiophile net," or some similar phrase which deprives you of the opportunity to make your legitimate profit. When you sell and install Quam High Fidelity speakers, you come out way ahead on the deal.

So does your customer. The speaker he buys from you at *list* compares favorably with any other hi-fi speaker at the same dollar cost *net*. **That's because**

1. The design of Quam speakers emphasizes *performance* rather than non-functional decorative features.
2. Quam Hi-Fi Speakers represent the accumulated skill and experience of thirty years of fine speaker manufacturing.
3. Quam's position as the world's largest exclusive speaker manufacturer permits many production economies to be passed along to you and to your customer.

See your Quam distributor for complete information about the full line of Quam Hi-Fi Speakers—extended range, tweeters, woofers, coaxials. *Quality* is built into every one of them—and so is your profit!

QUAM-NICHOLS COMPANY

238 East Marquette Road • Chicago 37, Illinois

CANADA:

A.T.R. Armstrong, Ltd., 700 Western Road, Toronto 9, Ontario

D. Eldon McLennan, Ltd., 1624 W. Third Avenue, Vancouver 9, B.C.

SEND RADIO & TV NEWS EVERY MONTH



name _____

address _____

city _____ zone _____ state _____

Check one: 3 years for \$10
 2 years for \$ 7
 1 year for \$ 4

In the U. S., its possessions, and Canada.
 Foreign rates: Pan American Union countries, add .50 per year; all other foreign countries, add \$1.00 per year.

Mail to: RADIO & TV NEWS
 Dept. R-12-8
 434 S. Wabash Ave., Chicago 5, Ill.

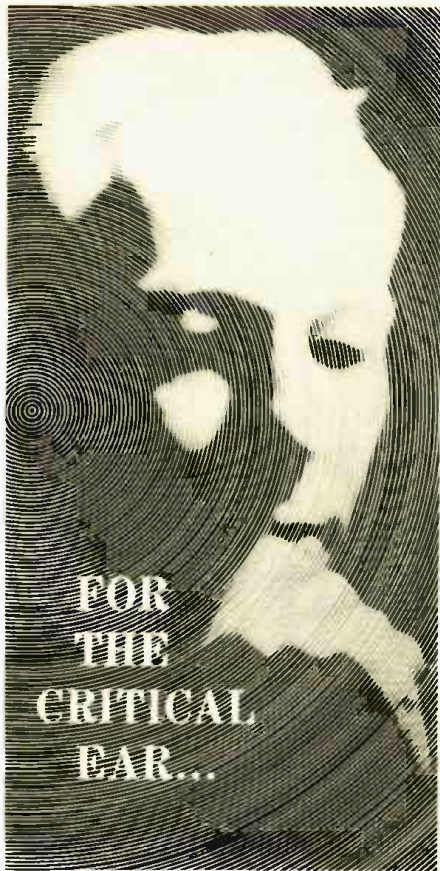

FOR
THE
CRITICAL
CAR...

the incomparable

SHURE
PROFESSIONAL

Stereo Dynamic
CARTRIDGE

The Shure Stereo Dynamic Moving-Magnet Cartridge is designed and made specifically for the listener who appreciates accuracy and honesty of sound. It separates disc stereo sound channels with incisive clarity. It is singularly smooth throughout the normally audible spectrum...and is without equal in the re-creation of clean lows, brilliant highs, and true-to-performance mid-range.



MODEL M3D

Fits 3 and 4-lead transcription type and record changer stereo arms. Completely compatible, plays monaural or stereo. 10-second stylus replacement.

Individually tested to meet or exceed these specifications: Frequency response, 20 to 15,000 cps. Output level, 5 mv at 1,000 cps. Compliance, 4.0 x 10⁻⁶ cm per dyne. Channel separation, more than 20db throughout the critical stereo frequency range. Recommended tracking, 3 to 6 grams.

Note to Service Technicians: Shure Stereo-Dynamic cartridges are checked electrically, mechanically and acoustically to insure trouble-free performance that puts an end to profitless service call-backs.

Literature available: Department 13-L

SHURE BROTHERS, INC.
222 Hartrey Avenue, Evanston, Illinois

the problem of limited space confronting many audiophiles who are contemplating stereo set-ups.

A new 55 to 15,000 cps 8-inch speaker serves as the "heart" of the new system. Its wide range provides excellent stereo reproduction when teamed up with a quality primary system. The speaker unit is less than 11" deep and will fit comfortably on any standard bookshelf.

The WR-8 speaker uses a curvilinear cone and a special stiffening processing method which combine to prevent cone decoupling. Driving this cone is a

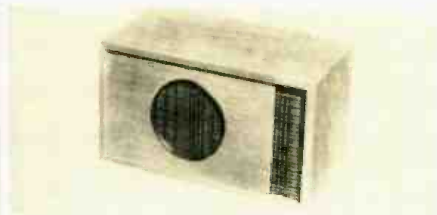

magnetic assembly which is larger than those normally found in speakers of this size.

Two models of the enclosure are currently available: the "Caprice" for a single WR-8 is only 20" wide, 11" high, and 10" deep. The "Mazurka" which is designed to accommodate two of the speakers measures 24" x 17½" x 10¾". Standard acoustical construction with ¾" veneered plywood, screwed, glued, and re-inforced for maximum rigidity, plus Fibreglas lining for critical damping, insure distortion-free performance. The enclosures are available in mahogany, walnut, fruitwood, cherry, ebony, and blonde finishes.

AUDIO CATALOGUES

ORIGINS OF 45-45 DISC

The special "stereo issue" of the "Journal of the Audio Engineering Society," P. O. Box 12, Old Chelsea Station, New York 11, N. Y. contains an interesting and informative article describing the original conception of the 45-45 stereo disc in addition to other pertinent material on stereophonic reproduction.

Contributors to this issue include Dr. H. F. Olson of RCA, M. G. Crosby, P. W. Klipsch, among others. This issue of the "Journal," which is mailed free to AES members, can be purchased by

non-members for \$2.00 a copy. Send orders and payment direct to the Society at the address given.

OXFORD SPEAKERS

Oxford Components, Inc., 556 W. Monroe St., Chicago 6, Ill. has issued a two-color catalogue featuring its line of "Tempo" high-fidelity speakers.

Complete information and photographs are included on the firm's full-range speakers, its coaxial models, tweeters, woofers, and three-speaker system with crossover.

Copies of this catalogue will be supplied without charge on written request.

PICKERING STEREO BOOKLET

Pickering and Company, Inc., Sunnyside Blvd., Plainview, N. Y. is now offering free copies of a new booklet entitled "It Takes Two to Stereo."

Written by Walter O. Stanton, the new booklet describes the stereo disc and explains its operating principle. Twelve pages of information tell the hi-fi enthusiast what to expect and what to do to convert from a monaural to stereo system.

Diagrams and drawings illustrate the differences between conventional and stereo records—how they are recorded and reproduced.

The booklet is being offered free. It is available from the firm's dealers or from Dept. SB of the company direct.

FISHER BROCHURES

Fisher Radio Corporation, 21-21 44th Drive, Long Island City 1, N. Y. has announced the availability of two brochures covering its new line of stereophonic and monaural consoles and components.

The radio-phonograph catalogue contains complete information and illustrations on nine new units: two stereo radio-phonographs complete in one cabinet, five units equipped with stereophonic controls and cartridges, a companion amplifier-speaker system, and a companion speaker system.

The component line folder offers a description of fourteen models. Included are the new stereophonic FM-AM tuner and the stereophonic master audio-control/duplex amplifier.

Either or both of these brochures will be supplied upon written request to the manufacturer.

-30-

CBS Laboratories Research Center in Stamford, Conn. is now in operation following elaborate dedication ceremonies held in October. The glass-walled aluminum and steel structure, containing laboratory facilities for research and development in many areas of scientific activity, occupies a 23-acre site on High Ridge Road in Stamford. In addition to the working facilities at the new Research Center, the building contains a recreational area for employees and an open-air inner court. Clear glass floor-to-ceiling walls give a full view of the court.



48¢

ea.

for any tube

\$45.00 Per Hundred

STANDARD LINE

ELECTRIC COMPANY

FREE TUBE BRIGHTENER ON ORDERS OF \$10.00 OR MORE

FREE POSTAGE IN U.S.A. & TERRITORIES

ANNOUNCING OUR NEW PRICE SCHEDULE

Effective July 25, 1958 all tubes (Radio & Television receiving) will be sold and shipped at the fantastic price of only 48c ea. or \$45.00 per hundred. Any "on hand" orders at that time will receive credit for future purchases.

THE TUBES ADVERTISED HEREIN ARE NOT NECESSARILY NEW TUBES BUT MAY BE ELECTRICALLY PERFECT FACTORY SECONDS OR USED TUBES AND ARE SO MARKED

All TV & Radio Tubes are tested by our supplier under actual conditions in Radio & TV chassis or in Hickock Tube Testers Model 533A.

And, of course, the famous Standard Line guarantee remains in effect: All tubes guaranteed to be replaced free if they fail to function efficiently within one year's time. (defective tubes must be returned intact, postage paid. Refunds will be cheerfully made within five (5) days if not completely satisfied.)

0B2	3A1S	5V6GT	6BE6	6S4	7F7	12Q7	3217GT
0Z4	3AU6	5W4GT	6BF5	6S8GT	7F8	12SA7	35/51
1A5GT	3AV6	5X4G	6BG4G	6SA7	7G7	12S7G	35A5
1A7GT	3BA6	5X8	6BH6	6S87Y	7H7	12S7J	35B5
1B3GT	3BC5	5Y3GT	6BH8	6S7	7J7	12S7K	35C5
1C5GT	3BE6	5Y4G	6BJ6	6SF5	7K7	12SN7GT	3516GT
1C6	3BN6	5Z3	6BK5	6SF76S7	7L7	12SQ7	35W4
1C7	3BU8	5Z4	6BK7	6SH7	7N7	12SR7	35Y4
1H4G	3BY6	6A8	6BL7GT	6S17	7Q7	12V6GT	35Z4GT
1H5GT	3BZ6	6AB4	6BN6	6SK7	7R7	12W6GT	35Z5GT
1L6	3C2	6AC7	6BQ6GT	6S17GT	7S7	12X4	≠ 37
1LA4	3C86	6AF4	6BQ7	6SN7GT	7V7	12Z3	≠ 39/44
1LA6	3CF6	6AG5	6BR8	6SQ7	7W7	14A7	≠ 41
1LB4	3CS6	6AG7	6BS8	6SR7	7X6	14AF7	≠ 42
1LC5	3DT6	6AH4GT	6BY5G	6T4	7X7	14B6	≠ 43
1LC6	3Q4	6AH6	6BZ6	6T8	7Y4	14F7	≠ 45
1LH4	3Q5GT	6AK5	6BZ7	6U4GT	7Z4	14F8	≠ 47
1LN5	3S4	6AK6	6C4	6U5	8AW8	14H7	50A5
1N5GT	3V4	6ALS	6C5	6U8	12A8	14N7	50B5
1P5GT	4BC8	6AL7GT	6C85	6V3	12A85	14Q7	50C5
1Q5GT	4BQ7A	6AMB	6CB6	6V6GT	12AB5	14S7	50C6G
1R5	4B58	6AN8	6CD6G	6W4GT	12AT6	17AX4GT	5016GT
1S5	4BU8	6AQ5	6CF6	6W6GT	12A7	17DQ6	50Y6
1T4	4BZ7	6AQ6	6CG7	6X4	12AU6	19AU4	50Y7
1T5GT	4CB6	6AQ7GT	6CG8	6XSGT	12AU7	19B6G6	≠ 57
1U4	5AM8	6AR5	6CH8	6X8	12AV6	19C8	≠ 58
1U5	5AN8	6AS5	6CL6	6Y6G	12AV7	19J6	≠ 80
1V	5AQ5	6AS8	6CM6	7A4	12AX4GT	19T8	≠ 81
1V2	5AS8	6AT6	6CM7	7A5	12AX7	19X8	117L7GT
1X2	5AT8	6AU4GT	6CM7	7A6	12AZ7	25AC5	117N7GT
2A3	5AV8	6AUSGT	6CU6	7A7	12B4	25AV5GT	117P7GT
2A5	5AW4	6AU6	6DG6	7A8	12BA6	25AX4GT	117Z3
2A7	5AZ4	6AUB	6DQ6	7B4	12BE6	25BK5	117Z4GT
2AF4A	5BK7	6AV5GT	6DT6	7B5	12BF6	25Q06	117Z6GT
2B7	5BR8	6AV4	6E5	7B6	12BH7	25CD6G	807
2BN4	5BQ7	6AW8	6H6	7B7	12BK5	25CU6	9002
2D21	5BZ7	6AX4GT	6J4	7B8	12BQ6	25L6GT	9003
2E5	5CG8	6AX5GT	6J5	7C4	12BR7	25W4GT	9006
2X2A	5J6	6AZ8	6J6	7C5	12CA5	25Z5	
3A2	5T8	6BA6	6K6GT	7C6	12CU6	25Z6	
3A3	5UB	6BC5	6K7	7C7	12DQ6	≠ 27	
3A4	5U4G	6BC8	6L6	7E6	12J5	≠ 30	
3A5	5V4G	6BD6	6L7	7E7	12L6GT	≠ 31	

ALL RECEIVING TUBES SENT POSTAGE PAID.

Please send 25c handling for orders under \$5.00. Send 25% deposit on C.O.D. orders and please send approximate postage on Canadian and foreign orders.

Above is only a partial list — order any type at the same price or send for free tube list and order blank. We have over 5,000 tube types on hand or at easy access, including special purpose, industrial and transmitting tubes which are slightly higher.

ALL TUBES GUARANTEED ONE FULL YEAR...

NOTE: When ordering receiving tubes be sure to enclose 48c for each tube or \$45.00 per hundred.

Thousands of TRADE-IN TVs

Please Specify Console or Table Model When Ordering
Reconditioned By Factory Trained Technicians! Guaranteed To Be In Working Condition When You Receive Them!

10" -----	\$25.00	19" -----	\$56.00
12" -----	\$30.00	20" -----	\$63.00
14" -----	\$35.00	21" -----	\$70.00
16" -----	\$42.00	24" (when -----	\$95.00
17" -----	\$49.00	27" available) -----	\$129.00

Get yourself a second set or buy some for re-sale!
All TV's sent motor freight or Railway Express F.O.B. our warehouse. Sorry, no A.P.O. shipments.
FREE INDOOR ANTENNA with each TV Purchase

below is our new price schedule of pix tubes. These famous make tubes contain all new parts with the exception of the glass bulb which does not wear out.

Any 10" Tube ---	\$ 9.95	Any 16" Tube ---	15.95
Any 12" Tube ---	10.95	Any 17" Tube ---	18.29
Any 14" Tube ---	13.95	Any 19" Tube ---	20.29
		Any 21" Tube ---	24.29

Prices On Larger Tubes On Request

Remember
Only 48¢ ea.
\$45 Per Hundred

ANY TYPE
ANY QUANTITY

Remember — NO Dud Required.
All tubes guaranteed one year.
Picture Tubes shipped F.O.B. Harrison, N. J.

STANDARD LINE

ELECTRIC COMPANY

432 HARRISON AVENUE, HARRISON, N. J. - Phone: HUmboldt 4-4997

UNBEATABLE!

SPAULDING

"STRATO-TOWER"

FEATURING THE

ALL NEW SCREW ANCHOR BASE

1. No Concrete Necessary
2. Completely Self-Supporting
3. Unconditionally Guaranteed
(Base more satisfactory than concrete or your money back)
4. Absolutely No Hole To Dig
5. Fast Installation . . . Base in 15 Min., Tower in 90 Min. (2 men)
6. One Base Fits All Tower Sizes To 48 Ft.
7. Tower Completely Galvanized
8. All Riveted Construction
9. Beaded Channel Leg (Will not rust inside like tubular type towers)

No. X40B (ILLUSTRATED)
40 FT. HIGH
LIST \$99.95

OTHER MODELS FROM 8 FT. TO 64 FT.

U. S. Patent No. 2806560

How
Tower
Mounts
On
Screw
Anchor
Base



WRITE

today for complete literature and details on where to get Spaulding Strato-Towers for TV—Ham—Civil Defense—Industrial Communications.

SPAULDING PRODUCTS COMPANY

550 West Barner Street • Frankfort, Indiana

IN CANADA: Delhi Metal Products Co., Delhi, Ontario

New Tube Tester Data

If you own a Heathkit checker with an old chart, these listings of more recent tubes will help you.

HEATHKIT MODELS TC-1, TC-2 AND TC-2P

TUBE	TYPE	FIL.	PLATE	TOP	BOTTOM
1Z2	1	1.4 (Good tube reads 30)	90	K	BEG
2AF4	2	2	21	ABFG	DE
2B3	2	2	80	K	B
		(Good tube reads 10)			
2BN4	1	2	19	BEG	ADF
2CY5	3	2	22	AEF	BCG
2E26	3	6.3	21	CEK	ABDF
2E30	3	2.5	26	ABEF	CD
2T4	2	2	22	ABFG	DE
2V2	4	1.4	97	K	BDFGH
2X2(879)	4	2.5	52	K	D
2X2A	4	2.5	44	K	D
		(Good tube reads 40)			
3A2	4	2.5	54	K	ADFJ
3A3	4	2.5	75	K	G
3A4	2	1.4	26	BCDF	AG
3AF4	2	3.3	21	ABFG	DE
3B2	1	3.3	50	K	ACDEG
3BA6	2	2.5	23	ABEF	DG
3BC5	2	2.5	21	AEF	BCG
3BE6	2	2.5	21	A	BD
3BN4	1	2.5	19	EFG	BD
3BN6	1	2.5	35	BEG	ADF
		(Good tube reads 20)		BEFG	AC
3BU8	1	3.3	22	BCFG	AE
	1	3.3	22	BGHJ	AE
3BY6	2	3.3	25	AF	BD
	1	3.3	30	EG	BD
3BZ6	1	2.5	20	AEFG	BC
3CB6	2	2.5	21	AEFG	BC
3CE5	2	3.3	20	AEF	BDG
		(No open element test on lever E)			
3CF6	1	2.5	19	AEFG	BD
		(No open element test on levers E, G)			
3CS6	1	2.5	21	AF	BC
	1	2.5	25	EG	BC
3CY5	3	3.3	22	AEF	BCG
3DK6	3	3.3	22	AEF	BCG
3DT6	1	3.3	20	AEFG	BD
4BC5	1	5	18	AEF	BCG
4BC8	2	5	22	AB	CD
	2	5	22	FG	DH
	2	5	20	A	BD
4BE6	2	5	20	EFG	BD
4BN6	1	5	36	BEFG	AC
		(Good tube reads 23)			
4BS8	2	5	22	AB	CD
	2	5	22	FG	DH
4BU8	1	5	22	BCFG	AE
4CY5	3	5	22	BGHJ	AE
	1	5	18	AEF	BCG
	1	5	18	BCFJ	AD
5AM8		(No open element test on levers F, J)			
	1	5	18	H	DG
	2	5	22	FGH	EJ
5AN8		(No open element test on lever F)			
	2	5	23	AB	CE
5AQ5	3	5	27	AEFG	BD
5AS4	1	5	23	D	H
	1	5	23	F	H
5AS8	3	5	22	ABJ	CD
	2	5	24	F	DH
	2	5	21	AB	CE
5AT8	2	5	20	FGHJ	CE
		(No open element test on levers F, H)			
5AU4	3	5	30	F	H
	3	5	30	D	H
	2	5	22	FHJ	EG
5AV8		(No open element test on lever F)			
	2	5	23	BC	AE
5AW4	4	5	18	D	H
	4	5	18	F	H
	3	5	40	D	B
5AX4GT	3	5	40	F	H
	3	5	40	F	H
	2	5	21	BC	AE
5B8	2	5	21	FHJ	ABCEG
		(No open element test on lever J)			
	2	5	20	AB	CE
5BE8	2	5	20	FGJ	CEH



Using "Tiny Tim" with a 25-watt horn type loudspeaker for outdoor activities. The amplifier is held on the lap and is plugged into the cigarette lighter socket.

"TINY TIM" PORTABLE P.A. AMPLIFIER

By HAROLD REED

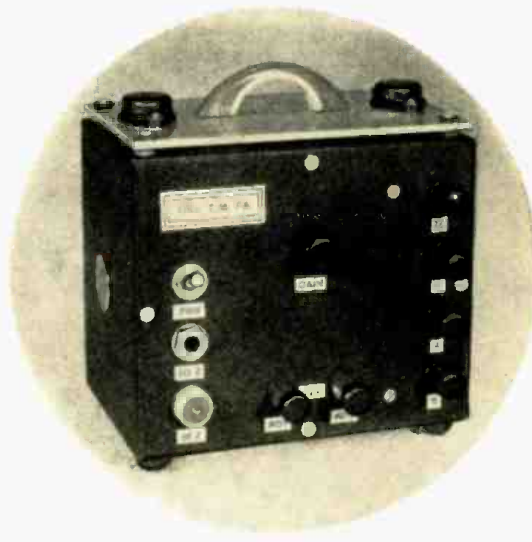

Front view of the p.a. amplifier in its cabinet. After installing the power transistors on the heat sink plate, it is wise to check between the transistor cases and the plate with an ohmmeter to make certain that there is no short.

Compact transistorized sound system can be powered directly from your car's cigarette lighter socket.

FOR many years sound re-inforcing systems have been used in numerous ways, both inside and out of doors. There are the large permanent installations, portable type equipment, and mobile setups. Power ratings also vary over a considerable range, from a few watts to many watts of power output.

Those engaged in commercial public-address work often need high-power systems, but the electronic experimenter and audio hobbyist are more likely to require a sound system ranging from a few to about 10 watts' output. Even within this range of power, systems employing tubes are relatively large and heavy. For one thing, the power supply for such a system contributes considerably to the weight and size and, if it is to be operated where 117-volt a.c. is unavailable, a vibrator or rotary converter type of power supply must be carried

along with the rest of the equipment.

A transistorized sound system overcomes these disadvantages both as to weight and size and may be operated directly from an automobile battery without the need for a power converter.

The "Tiny Tim" circuit is shown in Fig. 1. It incorporates two inputs, one for high-impedance crystal or ceramic microphones and the other for low-impedance dynamic types. The high-impedance input works into transformer T_1 , which is connected to the first transistor V_1 , a *p-n-p* junction type, through capacitor C_1 . T_1 has a primary impedance of 200,000 ohms and secondary impedance of 1000 ohms, which is suitable for working between a high-impedance transducer and the base input of a transistor. The low-impedance input circuit bypasses the input transformer and is fed directly to the base of V_1 through

coupling capacitor C_1 . The 3-circuit input jack automatically opens the transformer secondary connection when the low-impedance microphone plug is inserted. The output of the first transistor stage works into the gain-control potentiometer R_2 . After the gain control are two more *p-n-p* amplifying stages, V_2 and V_3 , followed by a CBS-2N255 transistor, the output of which is connected to transformer T_2 . This transformer has a primary impedance of 100 ohms and the secondary impedance is 200 ohms with a center-tap. Transformer T_2 is the driver transformer for the push-pull, class B output stage consisting of CBS-2N256 transistors V_4 and V_5 . The output transformer T_3 is a 10-watt "universal" type designed especially for transistor amplifiers. The primary impedance should be from 24 to 32 ohms. The secondary is tapped at 4, 8, and 16 ohms for speaker matching.

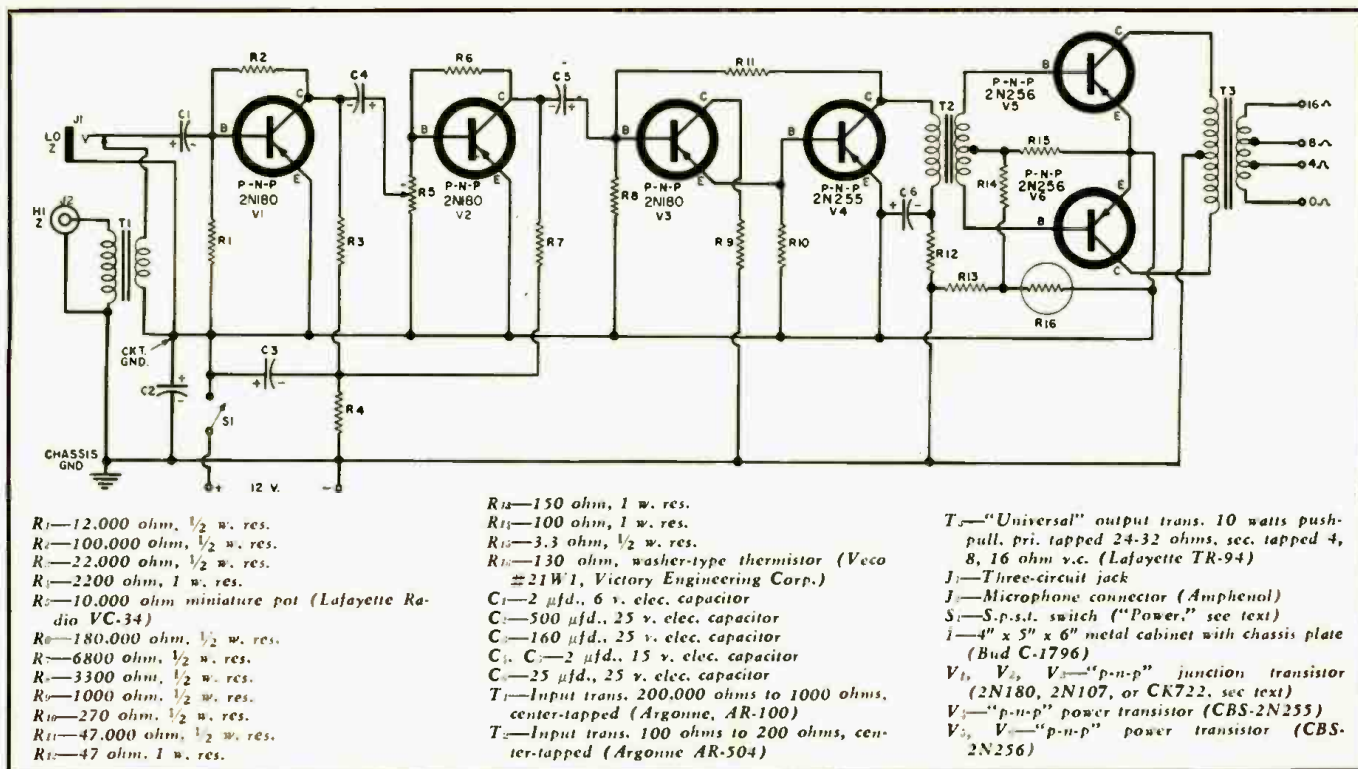

Complete schematic and parts listing for the portable p.a. amplifier. Note the use of stabilizing thermistor R_{10} .

The first three stages, V_1, V_2, V_3 , may be CBS transistors, type 2N180 with a rated *beta* of 60. With these transistors a power output of 10 watts can be obtained. Less expensive, lower gain types such as the 2N107 and CK722 may be employed if the builder is willing to settle for lower output.

Designing the output stage for class B service provides most efficient operation. It results in maximum power output from a pair of transistors. The power demand is lower since the output current is very small when there is no audio signal applied to the amplifier input. This is very important when working with battery-operated devices. At full 10 watts output, current drain will be over 1.5 amperes.

The circuit, except for some modifications, is similar to one suggested by CBS for its 2N256 transistors in class B service.

A thermistor, R_{10} , is used in the output stage. It provides protection when the transistors are subjected to high operating temperatures. The temperature change affecting the thermistor may arise externally or may be the result of current flow through it. In either case, its resistance varies. This automatically adjusts the transistor bias current as operating conditions vary.

Construction Data

As can be seen in the photographs, the amplifier is assembled in a 4" x 5" x 6" metal cabinet. A 3 $\frac{3}{8}$ " x 4 $\frac{1}{2}$ " steel chassis plate, which is included with the cabinet, is welded to the rear of the front panel. This plate was used, not only for mounting the parts but for the shielding it provides between the input and output sections

of the compact transistorized amplifier.

One great advantage with transistor circuitry is the absence of 60-cycle hum induction in low-level input circuits since no a.c. filament supply is required. In this unit, care must be exercised in placing the transformers because they are housed in such a small area. To prevent unwanted coupling effects, the transformers are oriented with respect to each other to keep inter-coupling to a minimum. This arrangement can be seen in the rear-view photo. This precaution, together with the shielding afforded by the chassis plate, resulted in a stable amplifier.

The first three transistors and most of the other small component parts are wired to a perforated, 2" x 2 $\frac{3}{4}$ " Bakelite board equipped with solder terminals. The board and terminals shown in the photo are of a type used in commercial devices but the constructor can assemble a similar terminal plate with the boards and flea clips sold by Lafayette Radio. Because of their long life, the small transistors were wired directly to the terminals instead of using sockets.

A miniature 7-pin tube socket is attached to the chassis plate of the cabinet and the 2N255 driver transistor for the output stage is plugged into pins 1 and 5 of this socket. A 1 $\frac{1}{4}$ " x 2 $\frac{1}{4}$ " x $\frac{1}{8}$ " piece of Bakelite is placed on the opposite side of the chassis from the socket and countersunk, flat-head machine screws hold the socket and piece of Bakelite to the chassis. Two holes, tapped for 4-36 machine screws, are provided in the Bakelite strip and these screws pass through the transistor flange and hold the assembly in place. Two holes are drilled

in the Bakelite piece directly over pins 1 and 5 for passage of the emitter and base pins into the socket. This arrangement secures the transistor firmly in place but keeps its case from making contact with the metal chassis. The case, base, and emitter pins must not touch the chassis.

The “Veco” thermistor, which is a washer-type made by Victory Engineering Corporation, is mounted on a small bracket which is attached to the chassis plate. Shoulder and flat fiber washers are used to insulate the thermistor from the metal bracket and solder lugs are placed next to the contact surfaces of the thermistor for electrical connection. Care should be used in mounting the thermistor. These washer-types are easily broken.

The power and output binding posts and microphone jack are insulated from the front panel by fiber shoulder washers. It should be noted that the circuit ground is not connected directly to the metal cabinet. All connections to this ground point are taken to one terminal of a three-terminal stand-off strip mounted on the chassis. This point is then bypassed to chassis ground and the negative side of the d.c. supply by the 500 μ fd. capacitor, C_2 . The chassis ground point is taken to the center terminal of this strip.

Power transistors run hot at 10 watts' output. The two power output transistors are, therefore, mounted outside of the cabinet to obtain maximum ventilation. This was arranged by attaching two 7-pin miniature tube sockets to the top of the cabinet. These are the bottom-mounting type of socket without shield flange. A 3 $\frac{3}{4}$ " x 5 $\frac{7}{8}$ " x $\frac{1}{8}$ " aluminum plate, or

heat sink, is placed over these sockets and is insulated and spaced from the cabinet by means of fiber shoulder and flat washers. Holes are drilled through the plate directly over pins 1 and 5 of the sockets to allow passage of the transistor base and emitter pins which plug into pins 1 and 5 of the sockets. The transistor pins must not touch the plate. Two holes, tapped for 4-36 machine screws, are provided in the plate to secure the transistor cases. A small piece of spaghetti tubing is placed over the screws where they go through the cases and flat fiber washers are used under the heads. Very thin mica is placed under the transistor cases to completely insulate them from the heat sink plate.

A solder lug is placed under one of the mounting screws to provide connection to the transistor collectors which are internally connected to the transistor case. The leads for the collectors are taken through small holes in the plate, through the center holes in the tube sockets, and soldered to terminal 3 of the sockets. Wires of suitable length are soldered to base, emitter, and collector terminals of the sockets and these are connected to appropriate tie points on the chassis plate just before the unit is placed in the cabinet. Since maintenance of the device is nil, this is no inconvenience and, even so, the panel and chassis can still be pulled far enough out of the cabinet to make tests, if necessary.

A carrying handle is attached to the aluminum plate. This heat sink need not be aluminum. It may be other metal, but it is desirable to use a plate at least 1/8-inch thick for good heat dissipation. Two ventilating louvers are used, one in each end of the cabinet, to provide air circulation although this is probably unnecessary. The 2N255 transistor is "just coasting." Rubber feet are mounted to the bottom of the cabinet. A 6-foot power supply cord with tinned leads on one end for connection to the amplifier binding posts and a connector on the

other end for plugging into the cigarette lighter socket is used for obtaining the 12-volt d.c. potential required for the unit.

Although the unterminated, tinned leads of the power cord should present no problem if the amplifier is used only by the constructor, it was realized after the device was completed, that if other persons use the equipment it would be desirable to provide suitable connectors on the amplifier and power cord, since individuals not familiar with the problem may plug the cord into the cigarette lighter socket first and then short out the open tinned leads on the other end.

Except for the two output transistors, all parts are mounted either on the front panel or chassis. A power switch is included on the panel. The front panel was laid out, not with good looks in mind, but for convenience in operating the device. With all connections at the front, the unit may be set upright on a table or laid down on an auto seat, the car floor, or on the ground.

Operating Procedure

Setting up the "Tiny Tim" p.a. system is very simple. Select the proper output terminals to match the loudspeaker impedance, that is, 4, 8, or 16 ohms. More than one speaker may be used. For instance, two 8-ohm speakers could be connected in parallel across the 4-ohm output. Likewise, two 4-ohm speakers may be connected in series across the 8-ohm output terminals. The power cord is connected to the terminals marked "12 volts" and the cigarette lighter plug is inserted in the lighter socket in place of the cigarette lighter. It is extremely important that the plus and minus polarities from the battery correspondingly connect to the plus and minus binding posts on the amplifier panel. If in doubt, check polarity at the ends of the cord with a d.c. voltmeter with the lighter plug inserted before connecting the tinned leads to the am-

plifier terminals. When the leads are identified, it is wise to dab some red paint on the one that is to connect to the plus terminal. The transistors can be permanently damaged if battery polarity is incorrect.

Turn the gain control all the way down and plug in the microphone. High-impedance microphones are to be connected to the bottom *Amphenol* connector and low-impedance microphones should be plugged into the phone jack immediately above. Throw the power switch on. Bring the gain control up slowly and speak into the microphone. Adjust the gain control for the desired volume level.

As is the case with all sound reinforcing systems, if the microphone is used close to the loudspeaker, acoustic feedback will occur, causing a "howling" condition when the gain control is advanced beyond a certain point. The farther away the microphone is from the speaker, the higher the gain control can be set without causing feedback. Also, the loudspeaker should be turned away from the microphone.

Current drain is low with no audio signal at the amplifier input and, since no warm-up time is required, the power switch may be kept off except when the unit is actually in use. An added feature would be to connect a "push-to-talk" switch across the main power switch, then with the main switch off, the amplifier could be operated intermittently with the push switch.

Although "Tiny Tim" was built for portable/mobile use with battery supply, it can serve in a fixed installation and powered with any type supply capable of meeting the necessary voltage and current requirements.

Other transistor types may, of course, be employed. Care should be taken not to exceed their power ratings and, if *n-p-n* types are used, the battery potential polarities must be reversed. In addition, all electrolytic capacitor connections would have to be transposed in such a case. —30—

Rear view of the amplifier. Terminal strips are soldered to the top of the output transformer for lead connections. This is not necessary but is handy for experimental work. The thermistor can be seen below the 500- μ fd. capacitor.

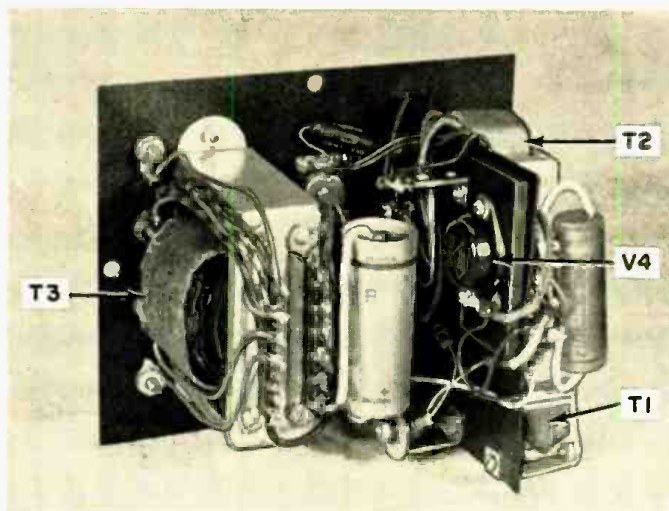

Here is another view of the unit. This one shows the layout of the input section. The three small transistors are soldered directly to the terminals on the Bakelite board. The socket for the 2N255 power transistor can also be seen.

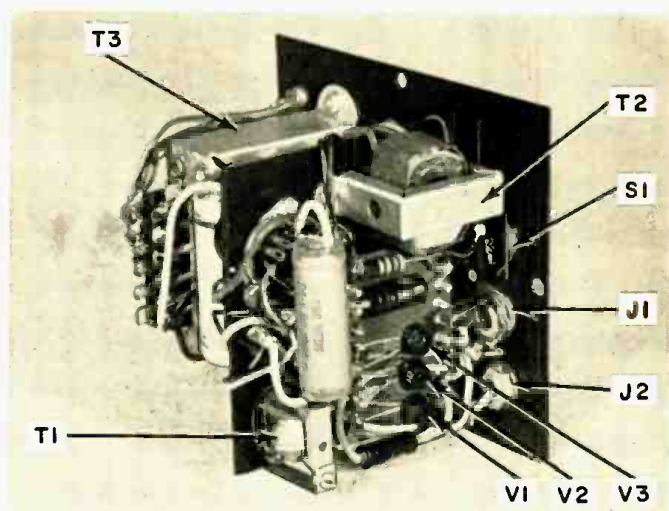

SUPERIOR'S NEW MODEL TW-11

STANDARD
PROFESSIONAL

TUBE TESTER



- ★ Tests all tubes, including 4, 5, 6, 7, Octal, Lock-in, Hearing Aid, Thyatron, Miniatures, Sub-miniatures, Novals, Sub-minars, Proximity fuse types, etc.
- ★ Uses the new self-cleaning Lever Action Switches for individual element testing. Because all elements are numbered according to pin-number in the RMA base numbering system, the user can instantly identify which element is under test. Tubes having tapped filaments and tubes with filaments terminating in more than one pin are truly tested with the Model TW-11 as any of the pins may be placed in the neutral position when necessary.
- ★ The Model TW-11 does not use any combination type sockets. Instead individual sockets are used for each type of tube. Thus it is impossible to damage a tube by inserting it in the wrong socket.
- ★ Free-moving built-in roll chart provides complete data for all tubes. All tube listings printed in large easy-to-read type.
- ★ NOISE TEST: Phono-jack on front panel for plugging in either phones or external amplifier will detect microphonic tubes or noise due to faulty elements and loose internal connections.

EXTRAORDINARY FEATURE

SEPARATE SCALE FOR LOW-CURRENT TUBES. Previously, on emission-type tube testers, it has been standard practice to use one scale for all tubes. As a result, the calibration for low-current types has been restricted to a small portion of the scale. The extra scale used here greatly simplifies testing of low-current types.

The Model TW-11 operates on 105-130 Volt 60 Cycles A.C. Comes housed in a beautiful hand-rubbed oak cabinet complete with portable cover.

\$47⁵⁰
NET

Model TW-11 — TUBE TESTER . . . Total Price \$47.50 — Terms: \$11.50 after 10 day trial, then \$6.00 per month for 6 months.

SUPERIOR'S NEW MODEL 82



Multi-Socket Type TUBE TESTER

TEST ANY TUBE IN 10 SECONDS FLAT!

- 1 Turn the filament selector switch to position specified.
- 2 Insert tube into a numbered socket as designated on our chart (over 600 types included).
- 3 Press down the quality button —

THAT'S ALL! Read emission quality direct on bad-good meter scale.

Model 82 — TUBE TESTER . . . Total Price \$36.50 — Terms: \$6.50 after 10 day trial, then \$6.00 monthly for 5 months.

Primarily, the difference between the conventional tube tester and the multi-socket type is that in the latter, the use of an added number of specific sockets (for example, in Model 82 the noval is duplicated eight times) permits elimination of element switches thus reducing testing time and possibility of incorrect switch readings.

To test any tube, you simply insert it into a numbered socket as designated, turn the filament switch and press down the quality switch—THAT'S ALL! Read quality on meter. Inter-element leakage, if any indicates automatically.

Production of this Model was delayed a full year pending careful study by Superior's engineering staff of this new method of testing tubes. Don't let the low price mislead you! We claim Model 82 will outperform similar looking units which sell for much more — and as proof, we offer to ship it on our examine before you buy policy.

- Tests over 600 tube types.
- Tests OZ4 and other gas-filled tubes.
- Employs new 4" meter with sealed air-damping chamber resulting in accurate vibrationless readings.
- Use of 22 sockets permits testing all popular tube types and prevents possible obsolescence.
- Dual Scale meter permits testing of low current tubes.
- 7 and 9 pin straighteners mounted on panel.
- All sections of multi-element tubes tested simultaneously.
- Ultra-sensitive leakage test circuit will indicate leakage up to 5 megohms.

Model 82 comes complete, housed in portable, hand-rubbed oak cabinet with removable cover. Only

\$36⁵⁰
NET

SHIPPED ON APPROVAL
NO MONEY WITH ORDER — NO C.O.D.

Try for 10 days before you buy! If completely satisfied, send down payment after trial and pay balance at indicated monthly rate — NO INTEREST OR FINANCE CHARGES ADDED. If not completely satisfied, return to us, no explanation necessary.

See page 105 for complete details

MOSS ELECTRONIC, INC.

3849 TENTH AVE., NEW YORK 34, N. Y.

SUPERIOR'S NEW MODEL 83

C.R.T. TESTER

Tests and Rejuvenates ALL PICTURE TUBES



Model 83 — C.R.T. TUBE TESTER . . . Total Price \$38.50 — Terms: \$8.50 after 10 day trial, then \$6.00 monthly for 5 months.

ALL BLACK AND WHITE TUBES

From 50 degree to 110 degree types—from 8" to 30" types.

ALL COLOR TUBES

Test **ALL** picture tubes—
in the carton—
out of the carton—in the set!

Specifications:

- ✓ Model 83 is not simply a rehashed black and white C.R.T. Tester with a color adapter added. Model 83 employs a new improved circuit designed specifically to test the older type black and white tubes, the newer type black and white tubes and all color picture tubes.
- ✓ Model 83 provides separate filament operating voltages for the older 6.3 types and the newer 8.4 types.
- ✓ Model 83 employs a 4" air-damped meter with quality and calibrated scales.
- ✓ Model 83 properly tests the red, green and blue sections of color tubes individually—for each section of a color tube contains its own filament, plate, grid and cathode.
- ✓ Model 83 will detect tubes which are apparently good but require rejuvenation. Such tubes will provide a picture seemingly good but lacking in proper definition, contrast and focus. To test for such malfunction, you simply press the rej. switch of Model 83. If the tube is weakening, the meter reading will indicate the condition.
- ✓ Rejuvenation of picture tubes is not simply a matter of applying a high voltage to the filament. Such voltages improperly applied can strip the cathode of the oxide coating essential for proper emission. The Model 83 applies a selective low voltage uniformly to assure increased life with no danger of cathode damage.

Model 83 comes housed in handsome portable Saddle Stitched Texan case—complete with sockets for all black and white tubes and all color tubes. Only **\$38⁵⁰**

The Problem:

Required, a tester—housed in a single carrying case capable of testing and rejuvenating all picture tubes including black and white and color; 50 degree, 90 degree or 110 degree. A tester capable of testing these ever increasing types speedily and efficiently. A tester capable of proving to the satisfaction of the set owner that the picture tube is definitely good, bad or weak. To do so the serviceman must be able to instantly switch from the comparative simple testing of a black and white tube to the complex requirements for testing each individual section in a tri-gun color tube.

The Solution:

The Model 83 more than meets the requirements specified above. It will not only test every type of picture tube ever made but will test them for leakage, emission and gas content. Furthermore even if the tube tests "good" Model 83 will help you to predict the length of time the tube will remain "good." The Model 83 will also enable you to extend the useful life of a "weak" tube by properly controlled application of rejuvenating voltage.

SHIPPED ON APPROVAL
NO MONEY WITH ORDER — NO C.O.D.

Try for 10 days before you buy! If completely satisfied, send down payment after trial and pay balance at indicated monthly rate — NO INTEREST OR FINANCE CHARGES ADDED. If not completely satisfied, return to us, no explanation necessary.

See page 105 for complete details

MOSS ELECTRONIC, INC.

3849 TENTH AVE., NEW YORK 34, N. Y.

SUPERIOR'S NEW MODEL 77

VACUUM TUBE VOLTMETER

WITH NEW 6" FULL-VIEW METER



Model 77 — VACUUM TUBE VOLT-METER... Total Price \$42.50 — Terms: \$12.50 after 10 day trial, then \$6.00 monthly for 5 months.

- Compare it to any peak-to-peak V. T. V. M. made by any other manufacturer at any price!
- ✓ Model 77 completely wired and calibrated with accessories (including probe, test leads and portable carrying case) sells for only \$42.50.
 - ✓ Model 77 employs a sensitive six inch meter. Extra large meter scale enables us to print all calibrations in large easy-to-read type.
 - ✓ Model 77 uses new improved SICO printed circuitry.
 - ✓ Model 77 employs a 12AU7 as D.C. amplifier and two 9006's as peak-to-peak voltage rectifiers to assure maximum stability.
 - ✓ Model 77 uses a selenium-rectified power supply resulting in less heat and thus reducing possibility of damage or value changes of delicate components.
 - ✓ Model 77 meter is virtually burn-out proof. The sensitive 400 microohms meter is isolated from the measuring circuit by a balanced push-pull amplifier.
 - ✓ Model 77 uses selected 1% zero temperature coefficient resistors as multipliers. This assures unchanging accurate readings on all ranges.

AS A DC VOLT-METER: The Model 77 is indispensable in Hi-Fi Amplifier servicing and a must for Black and White and color TV Receiver servicing where circuit loading cannot be tolerated.

AS AN AC VOLT-METER: Measures RMS values if sine wave, and peak-to-peak value if complex wave. Pedestal voltages that determine the "black" level in TV receivers are easily read.

AS AN ELECTRONIC OHMMETER: Because of its wide range of measurement leaky capacitors show up glaringly. Because of its sensitivity and low loading, intermittents are easily found, isolated and repaired.

Model 77 comes complete with operating instructions, probe and test leads. Use it on the bench—use it on calls. A streamlined carrying case, included at no extra charge, accommodates the tester, instruction book, probe and test leads. Operates on 110-120 volt 60 cycle. Only

SPECIFICATIONS

• DC VOLTS — 0 to 3/15/75/150/300/750/1,500 volts at 11 megohms input resistance. • AC VOLTS (RMS) — 0 to 3/15/75/150/300/750/1,500 volts. • AC VOLTS (Peak to Peak) — 0 to 8/40/200/400/800/2,000 volts. • ELECTRONIC OHMMETER — 0 to 1,000 ohms/10,000 ohms/100,000 ohms/1 megohm/10 megohms/100 megohms/1,000 megohms. • DECIBELS — -10 db to + 18 db, + 10 db to + 38 db, + 30 db to + 58 db. All based on 0 db = .006 watts (6 mw) into a 500 ohm line (1.73v). • ZERO CENTER METER — For discriminator alignment with full scale range of 0 to 1.5/7.5/37.5/75/150/375/750 volts at 11 megohms input resistance.

\$42⁵⁰ NET

SUPERIOR'S NEW MODEL 79

The Most Versatile All-Purpose Multi-Range Tester Ever Designed!

SUPER-METER

WITH NEW 6" FULL-VIEW METER



Model 79 — SUPER-METER... Total Price \$38.50 — Terms: \$8.50 after 10 day trial, then \$6.00 per month for 5 months.

A Combination VOLT-OHM MILLIAMMETER. Plus CAPACITY, REACTANCE, INDUCTANCE AND DECIBEL MEASUREMENTS. Also Tests SELENIUM AND SILICON RECTIFIERS, SILICON AND GERMANIUM DIODES

The Model 79 represents 20 years of continuous experience in the design and production of SUPER-METERS, an exclusive SICO development.

In 1938 Superior Instruments Co. designed its first SUPER-METER, Model 1150. In 1940 it followed with Model 1250 and in succeeding years with others including Models 670 and 670-A. All were basically V.O.M.'s with extra services provided to meet changing requirements.

Now, Model 79, the latest SUPER-METER includes not only every circuit improvement perfected in 20 years of specialization, but in addition includes those services which are "musts" for properly servicing the ever increasing number of new components used in all phases of today's electronic production. For example with the Model 79 SUPER-METER you can measure the quality of selenium and silicon rectifiers and all types of diodes—components which have come into common use only within the past five years, and because this latest SUPER-METER necessarily required extra meter scale, SICO used its new full-view 6-inch meter.

Model 79 comes complete with operating instructions and test leads. Use it on the bench—use it on calls. A streamlined carrying case included at no extra charge accommodates the tester, instruction book and test leads.—Only

Specifications

D.C. VOLTS: 0 to 7.5/15/75/150/750/1,500.
A.C. VOLTS: 0 to 15/30/150/300/1,500/3,000.
D.C. CURRENT: 0 to 1.5/15/150 Ma. 0 to 1.5/15 Amperes.
RESISTANCE: 0 to 1,000/100,000 Ohms. 0 to 10 Megohms.
CAPACITY: 001 to 1 Mfd. 1 to 50 Mfd.
REACTANCE: 50 to 2,500 Ohms, 2,500 Ohms to 2.5 Megohms.
INDUCTANCE: .15 to 7 Henries, 7 to 7,000 Henries.
DECIBELS: -6 to +18, +14 to +38, +34 to +58.

The following components are all tested for QUALITY at appropriate test potentials. Two separate BAD-GOOD scales on the meter are used for direct readings.

All Electrolytic Condensers from 1 MFD to 1000 MFD.
All Selenium Rectifiers. All Germanium Diodes.
All Silicon Rectifiers. All Silicon Diodes.

\$38⁵⁰ NET

SHIPPED ON APPROVAL
NO MONEY WITH ORDER—NO C.O.D.

Try for 10 days before you buy! If completely satisfied, send down payment after trial and pay balance at indicated monthly rate — NO INTEREST OR FINANCE CHARGES ADDED. If not completely satisfied, return to us, no explanation necessary.

See following page for complete details

MOSS ELECTRONIC, INC.

3849 TENTH AVE., NEW YORK 34, N. Y.

SUPERIOR'S NEW MODEL TV-50A GENOMETER



Model TV-50A GENOMETER . . . Total Price \$47.50 — Terms: \$11.50 after 10 day trial, then \$6.00 monthly for 6 months.

7 Signal Generators in One!

- ✓ R.F. Signal Generator for A.M.
- ✓ R.F. Signal Generator for F.M.
- ✓ Audio Frequency Generator
- ✓ Bar Generator
- ✓ Cross Hatch Generator
- ✓ Color Dot Pattern Generator
- ✓ Marker Generator

A versatile all-inclusive GENERATOR which provides ALL the outputs for servicing: A.M. Radio • F.M. Radio • Amplifiers • Black and White TV • Color TV

Specifications

R. F. SIGNAL GENERATOR: The Model TV-50A Genometer provides complete coverage for A.M. and F.M. alignment. Generates Radio Frequencies from 100 Kilocycles to 60 Megacycles on fundamentals and from 60 Megacycles to 180 Megacycles on powerful harmonics.

VARIABLE AUDIO FREQUENCY GENERATOR: In addition to a fixed 400 cycle sine-wave audio, the Model TV-50A Genometer provides a variable 300 cycle to 20,000 cycle peaked wave audio signal.

The Model TV-50A comes complete with shielded leads and operating instructions. Only

BAR GENERATOR: The Model TV-50A projects an actual Bar Pattern on any TV Receiver Screen. Pattern will consist of 4 to 16 horizontal bars or 7 to 20 vertical bars.

CROSS HATCH GENERATOR: The Model TV-50A Genometer will project a cross-hatch pattern on any TV picture tube. The pattern will consist of non-shifting, horizontal and vertical lines interlaced to provide a stable cross-hatch effect.

DOT PATTERN GENERATOR (FOR COLOR TV) Although you will be able to use most of your regular standard equipment for servicing Color TV, the one addition which is a "must" is a Dot Pattern Generator. The Dot Pattern projected on any color TV Receiver tube by the Model TV-50A will enable you to adjust for proper color convergence.

MARKER GENERATOR: The Model TV-50A includes all the most frequently needed marker points. The following markers are provided: 189 Kc., 262.5 Kc., 456 Kc., 600 Kc., 1000 Kc., 1400 Kc., 1600 Kc., 2000 Kc., 2500 Kc., 3579 Kc., 4.5 Mc., 5 Mc., 10.7 Mc., (3579 Kc. is the color burst frequency).

\$47.50 NET

For the first time ever: ONE TESTER PROVIDES ALL THE SERVICES LISTED BELOW!

SUPERIOR'S NEW MODEL 76

ALL PURPOSE BRIDGE



Model 76 . . . Total Price \$26.95 — Terms: \$6.95 after 10 day trial, then \$5.00 monthly for 4 months.

IT'S A CONDENSER BRIDGE
with a range of .00001 Microfarad to 1000 Microfarads (Measures power factor and leakage too.)

IT'S A RESISTANCE BRIDGE
with a range of 100 ohms to 5 megohms

IT'S A SIGNAL TRACER
which will enable you to trace the signal from antenna to speaker of all receivers and to finally pinpoint the exact cause of trouble whether it be a part or circuit defect.

IT'S A TV ANTENNA TESTER
The TV Antenna Tester section is used first to determine if a "break" exists in the TV antenna and if a break does exist the specific point (in feet from set) where it is.

CAPACITY BRIDGE SECTION
4 Ranges: .00001 Microfarad to 1000 Microfarads. Will also locate shorts and leakages up to 20 megohms. Measures the power factor of all condensers from .1 to 1000 Microfarads. (Power factor is the ability of a condenser to retain a charge and thereby filter efficiently.)

RESISTANCE BRIDGE SECTION
2 Ranges: 100 ohms to 5 megohms. Resistance can be measured without disconnecting capacitor connected across it. (Except, of course, when the R C combination is part of an R C bank.)

SIGNAL TRACER SECTION
With the use of the R.F. and A.F. Probes included with the Model 76, you can make stage gain measurements, locate signal loss in R.F. and Audio stages, localize faulty stages, locate distortion and hum, etc. Provision has been made for use of phones and meter if desired.

TV ANTENNA TESTER SECTION
Loss of sync., snow and instability are only a few of the faults which may be due to a break in the antenna, so why not check the TV antenna first? 2 Ranges: 2' to 200' for 72 ohm coax and 2' to 250' for 300 ohm ribbon.

Model 76 comes complete with all accessories including R.F. and A.F. Probes; Test Leads and operating instructions. Nothing else to buy. Only

\$26.95 NET

SHIPPED ON APPROVAL NO MONEY WITH ORDER — NO C. O. D.

MOSS ELECTRONIC, INC.
Dept. D-541 3849 Tenth Ave., New York 34, N. Y.

Please send me the units checked on approval. If completely satisfied I will pay on the terms specified with no interest or finance charges added. Otherwise, I will return after a 10 day trial positively cancelling all further obligation.

Name

Address

City Zone State

All prices net. F.O.B. N. Y. C.

- Model TW-11 Total Price \$47.50
\$11.50 within 10 days. Balance \$6.00 monthly for 6 months.
- Model 82 Total Price \$36.50
\$6.50 within 10 days. Balance \$6.00 monthly for 5 months.
- Model 83 Total Price \$38.50
\$8.50 within 10 days. Balance \$6.00 monthly for 5 months.
- Model 77 Total Price \$42.50
\$12.50 within 10 days. Balance \$6.00 monthly for 5 months.
- Model 79 Total Price \$38.50
\$8.50 within 10 days. Balance \$6.00 monthly for 5 months.
- Model TV-50A Total Price \$47.50
\$11.50 within 10 days. Balance \$6.00 monthly for 6 months.
- Model 76 Total Price \$26.95
\$6.95 within 10 days. Balance \$5.00 monthly for 4 months.

**FAST!
ACCURATE!**

SECO Test Equipment

**Saves time . . . makes
more money for you!**

WRITE TODAY FOR COMPLETE
SPECIFICATIONS AND FEATURES!

- Outstanding Reliability and Performance!
- Unique, Time-Saving Features!
- Low First Cost Makes You Money From the Start!

107 TUBE TESTER—Outstanding performance and accuracy—provides 3 important tests: amplifier types tested for gain by Dynamic Mutual Conductance method—power types tested for cathode current by Cathode Emission method—all types tested for shorts and grid error by Grid Circuit Test developed and patented by Seco. Dynamic Mutual Conductance Test pre-wired to eliminate elaborate set-up. Cathode Emission Test done by free point pin-selector method—will not be obsolete. Completely self-contained in portable carrying case. Furnished with handy flip chart for fast tube set-up data.
MODEL 107 \$139.50 NET



GCT-8 GRID CIRCUIT TUBE TESTER—Perfect companion to any tester—checks critical "control grid" condition of vacuum tubes fast, accurately. Electron eye tube indicates faults at a glance. As many as eleven simultaneous checks—automatically.

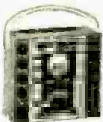

MODEL GCT-8—Kit \$19.95 NET
MODEL GCT-8—Wired & tested \$29.95 NET

208VTVM—"Fool-proof"—many new features! Easy-to-read 4½" 200 microamp meter mounted on sloping panel—7 DC, 7 AC, 7 ordinary Ohm ranges, plus RETMA (EIA) Ohm scale to check standard color-coded resistance values and tolerance limits. Specially designed "shift-lever" type function switch identifies and automatically connects proper probe. With stand, 40" leads, and common lead with clip.



MODEL 208 \$74.50 NET
Leather, felt-lined carrying case. **\$9.95 NET**

PS-2 BATTERY ELIMINATOR—Compact unit takes place of battery normally used to operate and service low-powered transistorized equipment. Supplies clean, filtered DC—can't be damaged by a short. Quickly spots faulty batteries by substitution. Output continuously variable from 0 to 15 V.—ideal for experimenters. Complete with jacks, leads, and clips.



MODEL PS-2 \$13.95 NET

FB-4 FLYBACK CIRCUIT AND INDUCTANCE ANALYZER—Quick "yes" or "no" answer on condition of flyback transformer and yoke—100% accuracy!

MODEL FB-4 \$38.95 NET

NEW! HC-6 CURRENT CHECKER

Provides positive, on-the-spot method of checking TV horizontal output circuits—fast, accurate way to adjust horizontal drive and linearity. Easy to use—can be placed in circuit in seconds—compact size. Complete, ready to use.
MODEL HC-6 \$12.95 NET

Get the complete story on Seco's exciting line of test equipment. See your distributor—or write for complete information today!

SECO MANUFACTURING CO.

**5015 Penn Avenue So.
Minneapolis, Minn.**

Measure That Flutter

(Continued from page 61)

of the existing flutter, which is usually expressed as a percentage. One method that will give an idea of the per-cent flutter is as follows.

Record a 3500-cycle signal from the oscillator and play back this tape to the flutter tester. Adjust for minimum reading on the null meter. Remove the recorder output from the tester and connect the oscillator in its input. Adjust the oscillator output control to obtain the same signal voltage to the tester as existed when the tape was played. Vary the frequency of the oscillator to again obtain lowest reading of the null meter. Do not change the balance controls. Note the oscillator frequency which gives this null indication. Now we can learn something about the flutter. If the deviation frequency is found to be higher than the fundamental frequency, then, **Per-cent Flutter** = $[(f_2 - f_m)/f_m] 100$, where f_m is the mid, or fundamental, frequency and f_2 the deviation frequency. When the deviation frequency is found to be lower than the mid-frequency, then: **Per-cent Flutter** = $[(f_m - f_1)/f_m] 100$, where f_1 again represents the deviation frequency.

Consider the following examples. f_m = 3500 cycles, f_2 = 3570 cycles. Then, $[(3570 - 3500)/3500] 100 = 2\%$ flutter. Also, if f_1 = 3430 cycles then, $[(3500 - 3430)/3500] 100 = 2\%$ flutter. Thus we may term these two results as $\pm 2\%$ flutter which is actually the percentage change from the mid-frequency.

Two per-cent would represent a considerable amount of flutter since present-day recorders have flutter percentages somewhat below 1%. It is interesting to note that the author, when checking flutter as just explained, found one of the earlier model machines had 2% flutter, whereas a late model unit costing \$50.00 less than the older unit, had only 0.3% flutter. This indicates the great advances that have been made in tape transport mechanisms. Of course, the old model may have done better with new parts but since they were not badly worn it probably would not have done better than about 1½%.

The flutter tester could be equipped with a self-contained a.c. meter and calibrated in the manner just outlined where the 2% flutter point was found. Meter scale markings would be from 0 to 2%. Accuracy will depend on how the constructor interprets the frequency of his oscillator for each setting.

A d.p.d.t. switch may be used to connect the meter to the bridge null connections or to the input of the bridge to calibrate the meter before making a flutter check. The meter would include a "CAL" marking on its scale and the input level would be adjusted so the meter would deflect to this mark when switched to the bridge input.

A preferred method for calibrating the tester, if the builder is in a position to do so, is to calibrate the device

against a laboratory-type flutter indicator.

This section is included for the benefit of the reader interested in designing his own filter and bridge circuits.

The following terms and equations apply to the bandpass network. The term f_1 represents the low cut-off frequency while f_2 is used to indicate the high cut-off frequency. The geometric mean, or mid-frequency, of f_1 and f_2 is f_m . Therefore $f_m = \sqrt{f_1 f_2}$. Bandwidth of the circuit is $(f_2 - f_1)/f_m$. The characteristic impedance is symbolized by R .

The inductance of L_1 , in Fig. 1, is then found from the equation $L_1 = R/\pi(f_2 - f_1)$ where f_1 and f_2 are in cycles per second, R is in ohms, and L is in henrys.

The capacitance of C_1 , in Fig. 1, is given by $C_1 = (f_2 - f_1)/(4\pi f_1^2 R)$ and the value of C_2 is found by solving the equation $C_2 = 1/\pi(f_1 + f_2)R$ where C is in farads.

In the bandpass filter network of the complete circuit of Fig. 3, the values chosen were $f_m = 3500$ cycles, $f_1 = 3248$ cycles, $f_2 = 3773$ cycles, bandwidth 0.15, and $R = 1000$ ohms.

Mathematical data for the resonance bridge circuit of Fig. 2 is as follows: When the four arms of the bridge are purely resistive, then the bridge can be balanced, when $R_1/R_2 = R_3/R_4$. Also $R_3 = (R_1/R_2)R_4$, where R_3 is the total resistance in this arm, including the series resistance of L . Now the inductive reactance is $X_L = 2\pi fL$ and the capacitive reactance is $X_C = 1/(2\pi fC)$. In Fig. 3, L_1 and the parallel combination of $C_1 - C_2 - C_3$ form the series-resonant circuit and the values of the component parts were chosen so that resonance occurs at the mid-frequency, f_m , previously selected for the bandpass filter with ½ of C_3 . At this frequency, $X_L = X_C$, leaving only a resistive component, and the bridge balances. This resonant condition is obtained with the rotor plates of variable capacitor C_4 about half meshed. The capacitor will actually tune the resonant circuit from 3400 to 3600 cycles—which is 2.86% above and below f_m . -30-

CONSTANT GENERATOR OUTPUT FOR IMPROVED SCOPE SYNC

By CHARLES ERWIN COHN

AUDIO oscillators, square-wave generators, etc. bring their outputs out through attenuators. It is a good idea to add an auxiliary output jack on such instruments, connected to a point on the instrument ahead of the attenuators so that it would have constant output signal irrespective of attenuator setting.

The utility of this extra jack becomes apparent when the generator is used in conjunction with an oscilloscope. The extra jack can be connected to the external sync jack on the scope and used to provide a sync signal. Thus, when the attenuator is varied during testing at one frequency, the oscilloscope synchronization will be undisturbed.

In most popular audio generator kits, the place to connect this jack is at the high side of the output level pot. -30-

Phone of the Future
(Continued from page 45)

clipped sine wave with a peak-to-peak value of about 100 microamperes. This is of a constant-current nature and is coupled to the frequency-selective network. This network is the same one shown in Fig. 1, as the "Party" coil and capacitors. It can be connected to respond to any one of eight different frequencies, so that the sound radiator will respond only to its own call on an eight-party line depending on the frequency which is sent out from the central office.

As in the case of the digit frequencies, the problem of "talk-off" could be present in this type of a circuit. For example, when people started to talk some of the voice frequencies might come out of the loudspeaker not only in the customer's own telephone but on all the others on the line as well.

To prevent this, a silicon diode is placed in series with the sound radiator and the amplifier which drives it. This diode is of the type which has an avalanche breakdown voltage of 24 volts; that is, it will not conduct unless there is a potential of 24 volts across it. When no one is talking on the line, this voltage will be available from the 35 to 50 volts direct current which is normally on the line, so under these conditions it will be possible to sound the speaker. However, once a telephone is taken off the hook, the current flow through the transmitter will drop this voltage to a point well below 24 volts, which effectively opens the path to the sound radiator.

The push-button telephone is not in service as yet, in fact it is only an experimental device. However, the tone radiator is already a reality and is now undergoing field trials.

It is interesting to note that the size of a loudspeaker which can be concealed in the base of a telephone automatically puts it in the tweeter class and the frequencies which would radiate most efficiently from it might sound shrill to the user. However, frequencies may be used which are harmonics of a lower frequency, which is below the ability of the speaker to reproduce. A quirk of the human ear is that when it hears these higher harmonics it automatically supplies the missing fundamental. Therefore, the customer may hear a pleasing tone which does not exist!

-50-

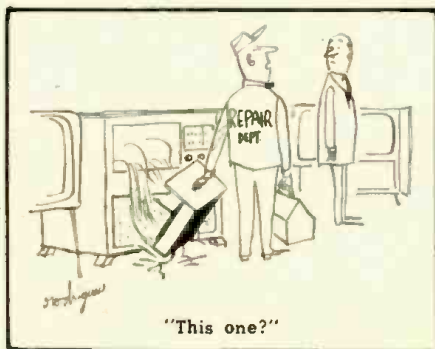

**COMMUNICATED
DATA**

Modern military weapons systems require instantaneous computation of data... Burroughs, consistent with its recognized leadership in equipment, skills and manpower, is providing the answers for complex military weapons systems through automatic suprahuman computation.

The qualified electronics technician who seeks in his work a sense of gratification for a challenge imaginatively met... will find that challenge and its reward in a career in digital computation with Burroughs Military Field Service Division.

Add up these facts

1. Formal 22 week training program in Data Processing Systems, PLUS
2. Starting salaries commensurate with ability and experience, PLUS
3. Full salary during entire training program, PLUS
4. Advancement opportunities based on individual performance, AND
5. Fine fringe benefits including educational assistance (in addition to above training), PLUS
6. Nationwide field assignments after completion of training program.

If you are a graduate of an accredited Technical School and/or have military training in radar or communications equipment, plus at least 2 years' experience in electronics, you are invited to address your inquiries to Personnel Department, MILITARY FIELD SERVICE DIVISION, 511 North Broad Street, Philadelphia 23, Pa.

Burroughs Corporation
"NEW DIMENSIONS / in electronics and data processing systems"

What's

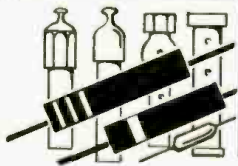

New in Radio

DELUXE HAM RECEIVER

The National Company, Inc. of Malden, Mass. has recently introduced a deluxe amateur-band receiver, the Model NC-303.

The new unit covers all amateur bands from 1 1/4 to 160 meters with WWV coverage available by means of



an accessory converter. A five-position i.f. selector provides sharp, SSB-1, SSB-2, medium, and broad selectivity. Bandwidths of .5, 2, 4, and 8 kc. provide optimum selectivity for SSB, c.w., phone, phone net, and v.h.f. plus sideband selection. A tone switch provides attenuation of highs, lows, or both for maximum readability. There is a separate automatic noise limiter for AM and a double-ended manual limiter for c.w. and SSB. A fine-tuning vernier dial drive provides precision c.w. and SSB tuning. The high-speed 40:1 tuning dial includes a logging scale.

A data sheet covering this new addition to the firm's line of equipment for the radio amateur is available without charge from the company.

RECTIFIER ADAPTER KIT

International Rectifier Corp., 1521 E. Grand Ave., El Segundo, Calif. is in production on an all-purpose replacement kit which is designed to eliminate the necessity for service techni-



cians to carry two or three styles of 500-ma., 130-volt silicon diodes.

The SD-500 kit offers the technician a fast, simplified means of replacing all existing radio-TV silicon rectifier types. It contains a hermetically sealed, pig-tail-style diode which may be wired in to replace axial-lead-type units or plugged into existing fuse-clip-type sockets in a rapid 10-second conversion.

Designed specifically for replacement

applications, the new silicon junction rectifier can operate at 100 degrees C ambient with resistive, inductive, or capacitive load and can supply full-rated power under normal convection cooling with no external heat sink required. The SD-500 may also replace existing selenium rectifier types or if a direct mechanical replacement is required, the firm's "Unistac" TV-500 may be used with no conversion required.

The company's authorized distributors have this new unit in stock.

TRANSISTOR-RADIO TESTER

The Hickok Electrical Instrument Company, 10524 Dupont Ave., Cleveland 8, Ohio has developed a new "Traceometer" which has been de-



signed specifically for troubleshooting and servicing transistorized portables and auto radios.

The Model 810 is actually three instruments in one: a tuned receiver, AM signal generator, and transistor tester. The tuned receiver provides 200-575 kc. for troubleshooting i.f. stages, 550-1600 kc. for troubleshooting the r.f. stages, an audio amplifier for signal-tracing the audio stages, and a low-impedance 400-cycle audio output for signal injection.

The signal generator portion of the instrument covers 200-575 kc. for i.f. alignment and 500-1600 kc. for r.f. alignment. A cathode-follower input probe is included.

The transistor tester circuit checks leakage and gain. A built-in loud-speaker is used as the indicator for signal tracing.

Model 810 is housed in a portable steel case which measures 11 1/4" wide, 9" high, and 7" deep. It will operate from 105-125 volt, 50-70 cycle a.c. sources. Additional information on this new unit will be supplied on request.

ZENER REGULATORS

The Semiconductor Division of Hoffman Electronics Corporation, 3761 S. Hill St., Los Angeles 7, Calif., has announced the development of a diversi-

fied line of silicon diffused junction zener power voltage regulators which embraces 114 type and size combinations.

The line consists of 38 types in each of three power categories (1/4 watt, 1 watt, and 10 watts). The line was developed for circuit applications requiring higher power than can be obtained with conventional zener diodes and where temperature stability does not call for a closely compensated reference device.

The zener voltage in each power rating ranges from 5.6 volts through 200 volts in 10% voltage steps. The units

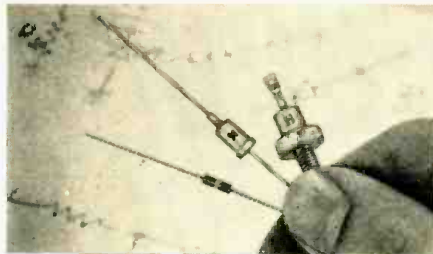

are offered in ±10% zener voltage tolerance and ±5%, up to 56 volts. Dynamic impedance ranges from 1400 ohms for the 200-volt, 1/2-watt zener regulator type down to 1 ohm for the 5.6-volt, 10-watt unit. Test current varies from 1 ma. up to 1000 ma.

Technical Bulletin No. 30-58, available from the manufacturer, supplies detailed data on the line.

D.C.-TO-D.C. TRANSFORMERS

Microtran Company, Inc., 145 E. Mineola Ave., Valley Stream, N. Y. is now offering a series of d.c.-to-d.c. converter transformers.

These new units permit conversion of low-voltage direct current to high voltage for operating mobile and military electronic equipment. These miniaturized, high-efficiency transformers when used in transistor switching circuits provide improved reliability, efficiency, and ruggedness.

All transformers are hermetically sealed and constructed in accordance with MIL-T-27A, Grade 4, Class R, 10,000-hour minimum life specs. Input voltage range is 13.6 to 28 volts d.c. with output ranging from 125 to 500 volts d.c. Full-wave and CT loads may be drawn simultaneously. Output voltage to input of the rectifier is a 1600-cycle nominal square wave permitting ease of filtering.

The transformers are now available as stock items from the firm's distributors.

NEW "HANDIE-TALKIES"

The Communications and Industrial Electronics Division of Motorola Inc., 4501 W. Augusta Blvd., Chicago 51, Ill.



HOW TO PASS Your FCC Commercial LICENSE EXAMS*

We guarantee
to train you until you receive
Your FCC license
—or your money back

The Master Course in Electronics will provide you with the mental tools of the electronics technician and prepare you for a First Class FCC License (Commercial) with a radar endorsement. When you successfully complete the Master Course, if you fail to pass the FCC examination, you will receive a full refund of all tuition payments.

"License and Good Job . . . Thanks"

"After finishing your Master Course, I passed the FCC exam for the 1st class license. I had my ticket for only one week and I got a job at WOC-TV, AM-FM. Incidentally, WOC is the oldest radio station west of the Mississippi. I sincerely feel that if it weren't for taking your Master Course, I would not have received my 1st class ticket. So I want to take this occasion to again thank you for such a fine, complete and composite study for electronics work."

Francis J. McManus
Davenport, Iowa

Cleveland Institute training results in job offers like these:

Service Technician:
Man needed in Cleveland, Ohio to service and maintain electronic medical instruments and equipment. Must have a solid knowledge of electronic fundamentals. A car is required. Company benefits include retirement plan.

Radio Operators & Technicians:
American Airlines — Chicago, Detroit, St. Louis, Cincinnati and Cleveland—has openings for radio operators and radio mechanics. Operators must have a 2nd class FCC license and ability to type 40 wpm. Many company benefits.

CLEVELAND INSTITUTE OF RADIO ELECTRONICS

Desk RN-24 4900 Euclid Ave. Cleveland 3, Ohio

**Mail Coupon Now
and get all three FREE**

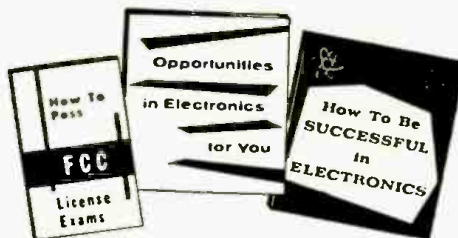

We can train you to pass your License Exams if you've had any practical experience — amateur, military, radio servicing, or other. Our proven plan can help put you on the road to success.

* Your FCC ticket will be recognized by employers as proof of your technical ability.

good training doesn't cost . . . it pays!

Accredited by the National Home Study Council

Cleveland Institute of Radio Electronics

Desk RN-24, 4900 Euclid Ave., Cleveland 3, Ohio

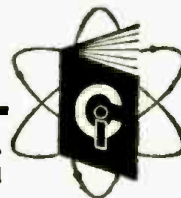

Please send Free Booklets prepared to help me get ahead in Electronics. I have had training or experience in Electronics as indicated below.

- | | |
|---|---|
| <input type="checkbox"/> Military | <input type="checkbox"/> Broadcasting |
| <input type="checkbox"/> Radio-TV Servicing | <input type="checkbox"/> Home Experimenting |
| <input type="checkbox"/> Manufacturing | <input type="checkbox"/> Telephone Company |
| <input type="checkbox"/> Amateur Radio | <input type="checkbox"/> Other _____ |

In what kind of work are you now engaged?

In what branch of Electronics are you interested?

Name _____ Age _____

Address _____

City _____ Zone _____ State _____

RN-24



TRADE UP TO COLLINS AT HARVEY

COLLINS 75S-1 RECEIVER •495.00



The 75S-1 provides SSB, CW and AM reception on all amateur bands between 3.5 and 29.7 mc. It is capable of coverage of the entire HF spectrum between 3.5 and 20 mc by selection of the appropriate high frequency beating crystals.

COLLINS 32S-1 TRANSMITTER •590.00



The 32S-1 is an SSB or CW transmitter with a nominal output of 100 watts for operation on all amateur bands between 3.5 and 29.7 mc. Input power is 175 watts PEP on SSB or 160 watts on CW.

516F-2 AC POWER SUPPLY for the 32S-1 \$105.00

**MAIL ORDERS SHIPPED
SAME DAY AS RECEIVED**
Include with your payment a generous allowance for shipping charges — the excess will be promptly refunded.

HARVEY Estab. 1927
RADIO CO., INC.
103 West 43rd Street JU 2-1500
New York 36, N.Y.

110

has announced the field-testing of a new "Handle-Talkie" pocket receiver and its companion pocket transmitter for service in the 25-54 mc. and 144-174 mc. bands.

The fully transistorized receiver utilizes 17 transistors and 5 diodes. The antenna is built-in but may be supple-



mented by a plug-in external antenna for maximum range. The use of semi-conductors also contributes to the low power drain characteristics and high reliability standards of the receiver. Modular printed circuits make up the entire inner chassis which is shock mounted on a rubber cushion in the shatterproof plastic case. The unit is powered by mercury cells or rechargeable nickel-cadmium cells. The receiver weighs 10½ to 12 ounces, depending on the battery used. It measures less than 6" long, 2½" wide, and 1½" deep.

The 46-ounce transmitter measures approximately 8" x 4" x 1½" and provides a full 1¼ watt r.f. output on the 25-54 mc. band and 1 watt in the 144-174 mc. band.

MIDGET PLIERS

Mathias Klein & Sons, 7200 McCormick Road, Chicago 45, Ill. is introducing a new line of midget pliers which has been especially designed for the wiring and servicing of delicate electronic equipment.

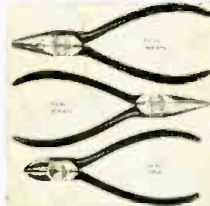

These pliers measure from 4" to 4½" long and in all respects are the equals of the firm's standard line of tools. Four models are available: 257-4 oblique cutting plier, 321-4½ long-nose plier, 322-4½ long-nose plier with knurl, and 224-4½ end-cutting plier. All of the models are available with coil spring to keep jaws open and may be had with plastic-dipped handles if desired.

Bulletin 758 describing the new line in detail is available without charge upon written request to the manufacturer.

"UNIVERSAL BASE" ELECTROLYTIC

Sprague Products Co., 51 Marshall St., North Adams, Mass. has developed a new "universal base" electrolytic in its "Print-Lok" line of capacitors.

The base of the new type component is designed to fit all sets using printed wiring boards. A pair of pliers is all that is needed to adapt these capacitors to any one of three different types

of printed circuit bases. They can also be used to replace standard twist-base electrolytics.

The capacitors are hermetically sealed in aluminum cases to give extra long life and dependable performance. Complete ratings for these new units are given in the company's recently published "TV Electrolytic Capacitor Replacement Guide," K-103. Free copies are available from the company's distributors or by sending 10 cents in coin to the company direct.

2- AND 4-SET COUPLERS

Blonder-Tongue Laboratories, 9 Alling St., Newark, N. J. has announced the availability of a new series of 300-ohm TV and FM installation accessories.

Marketed as "Exact-Match" TV couplers, the units feature newly developed, patented circuitry which provides maximum signal transfer, maxi-



mum isolation between receivers or antennas, and excellent impedance match to insure sharp, ghost-free reception.

The A-102 two-set coupler feeds two v.h.f. or FM receivers from one antenna or mixes two antennas into one line. These two-set couplers feature 12-20 db isolation and 3.5 db loss. The four-set unit (A-104) feeds four v.h.f. or FM receivers from one antenna or mixes four antennas into one line. This unit provides 12-20 db isolation at only 7.5 db loss.

Requiring no power and sealed in weatherproof, non-breakable cases, these couplers can be mounted on an outdoor antenna mast by means of the A-100 hardware kit. The units may also be installed indoors with the terminals concealed.

"CURRENT CHECKER"

Seco Manufacturing Company, 5015 Penn Avenue, South, Minneapolis, Minn. is in production on its Model HC-6 "Current Checker" which is designed to provide TV technicians with

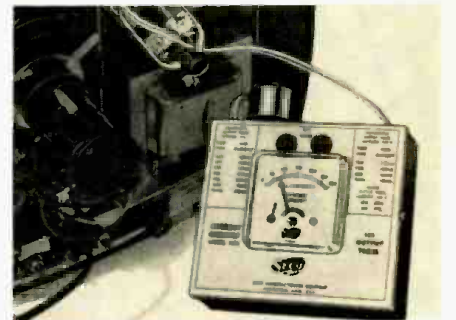

a fast, positive, on-the-spot method of checking horizontal output circuits.

The instrument can be placed in the circuit in seconds without disconnecting the cathode and immediately indi-

RADIO & TV NEWS

cates whether the cathode current of the horizontal deflection output tubes is within manufacturers' recommended limits. The proper use of the HC-6 is said to minimize the chance of premature failure of horizontal output transformers and, in some cases, the failure of the power transformer and rectifiers.

The device measures 5¼" wide, 5¾" long, and 1½" high. It comes completely assembled and with operating instructions. Write the manufacturer for further information and price.

TRANSISTOR RADIO LINE

The Electronics Division of *Channel Master Corp.*, Ellenville, N. Y., has entered the receiver field with a new line of transistor radios.

Two 6-transistor models are being offered initially, along with a full line of accessories. The Model 6506 utilizes six matched transistors, plus 1 diode and 1 thermistor. It measures 5¾" long, 3" high, and 1¾" deep and is powered by four 1½-volt penlite cells. Other features include a superhet circuit, push-pull output, built-in ferrite antenna plus a plug-in extension antenna, safety tuning dial, non-breakable plastic case, earphone jack, extension speaker outlet, sealed variable capacitor, and 2½" speaker. The accessories include a cowhide carrying case with leather shoulder strap, magnetic earphone for private listening,



and earphone case. This model is available in black and gold or maroon and bronze.

The Model 6501 measures 4⅝" x 2¼" x 1¼" and uses six matched transistors plus 1 diode. A 9-volt battery powers the circuit.

Write the manufacturer direct for full details on the line and prices.

"TRANSFORMERETTES"

Amplifier Corp. of America, 398 Broadway, New York 13, N. Y., has recently introduced a new line of Mumetal-shielded miniature transformers which has been especially designed for transistor applications.

This series of ruggedized transformers is epoxy impregnated for optimum freedom from moisture penetration and housed in drawn, annealed Mumetal shields. All units use nickel-alloy core material and are wound on either Bakelite molded coil forms or nylon bobbins. Bifilar windings and one-piece gapless core construction are used in some units.

Thirteen basic types of input, driver, output, and interstage transformers are available for use in 90 different impedance-matching circuits. Four frequency response ranges are available.

The new "Transformerettes" are primarily designed for miniaturized and transistorized equipment and for industrial, commercial, and experimental applications. Complete technical specifications and factory prices are available from the Transformer Division.

"HYBRID" SET TUBES

The Electron Tube Division of *Radio Corporation of America*, Harrison, N. J., is now offering a 9-pin miniature type tube containing two diodes and a high-perveance power tetrode in a single envelope.

The 12DS7 was specially designed for use in "hybrid" auto radio receivers in which the tube and transistor electrode voltages are obtained directly from a 12-volt storage battery. In such receivers, the diode units are used for AM signal detection and a.v.c. The tetrode unit, which is of the space-charge-grid type, is intended for use as a driver to supply high input power at low distortion to the transistorized a.f. power-output stage.

Space-charge-grid operation of the tetrode unit is accomplished by operating grid No. 1 at a positive potential and using grid No. 2 as the control electrode. This method of operation, in addition to the high perveance of the tetrode unit, enables the 12DS7 to supply high plate current with only 126 volts on the plate.

NEW BEAM POWER PENTODES

The Electronic Tube Division of *Westinghouse Electric Corporation*, P. O. Box 284,

Elmira, N. Y. has announced the development of two beam power pentodes which have been especially designed to provide reliable vertical deflection to drive wide deflection angle cathode-ray tubes. These 9-pin miniatures will conservatively drive a 110-degree vertical deflection system.



The heater of the 12DT5 is designed to operate in circuits employing 600 ma. series-connected heater strings. Warmup characteristics are controlled to minimize heater surge. The 6DT5 displays the same characteristics as its 12 volt counterpart. Both types feature controlled high zero-bias plate current and low zero-bias screen current at a specified low plate voltage. This low knee characteristic, coupled with a tightly controlled cut-off characteristic, assures the circuit designer of ample linear vertical deflection.

Full specifications on these two new types will be supplied by the manufacturer upon request.

ERIE "PAC" UNITS

Erie Resistor Corporation, Erie 6, Pa. has announced the development of "PAC" (Pre-Assembled Components)



Partners Ray Kirlhart and Joe Kopin of Picture Tube Center, 154L North Western Avenue, Hollywood 27, California.

"We Operate 38 Sets from One Antenna without Amplification"

"Good reception is the most important factor in selling a TV set, and no matter how good a set is, a poor antenna system can make it look bad. We started with individual antennas . . . later we put in two distribution amplifiers and operated sixteen sets from one antenna. Today, with Wizards, we are operating *Thirty-Eight* sets from one antenna with *No Amplification* and have the finest reception we've ever seen.



for: UHF and VHF

The new Electro-Magnetic set coupler for 300 ohm flat line that is not limited to 2, 3 or 4 sets

High Signal Response
Low Insertion Loss
Impedance Automatically Matched
Installation Fast & Simple
List Price \$1.95

For additional information write:

CHARLES ENGINEERING, INC.
6053 Melrose, Los Angeles, California

**COYNE offers
LOW COST**

TELEVISION

Training in
Spare Time **AT HOME**

The future is YOURS in TELEVISION—RADIO COLOR TV!

A fabulous field—good pay—fascinating work—a prosperous future! Good jobs, or independence in your own business!



Coyne brings you MODERN—QUALITY Television Home Training; training designed to meet Coyne standards. Includes RADIO, UHF and COLOR TV. No previous experience needed. Practical Job Guides to show you how to do actual servicing jobs—make money early in course. You pay only for your training, no costly "put together kits."

Send coupon or write to address below for **FREE Book**

and full details including easy Payment Plan. No obligation, no salesman will call.



B. W. Cooke, Jr., President

Coyne — the institution behind this training... the largest, oldest, best equipped residential school of its kind now in its new home pictured here... Founded 1899.

COYNE ELECTRICAL SCHOOL

1501 W. Congress Pkwy., Chicago, Dept. 98-H6
Chartered as an Educational Institution
Not For Profit

COYNE Television, Home Training Division
Dept. 98-H6—New Coyne Building
1501 W. Congress Pkwy., Chicago 7, Ill.
Send Free Book and details on how I can get Coyne Quality Television Home Training at low cost and easy terms.

Name _____

Address _____

City _____ State _____

(It is understood no salesman will call)

with wire leads for universal wiring.

Formerly available only to manufacturers using printed wiring boards, the new units enable companies using point-to-point wiring methods to em-

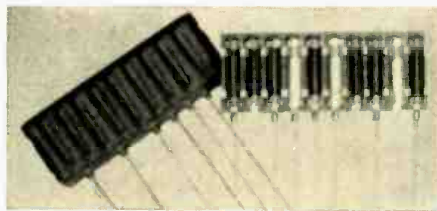

ploy "PAC" without circuit redesign.

The capacitor-resistor networks provide capacitance values of 10 μ fd. to .01 μ fd. in the ceramic dielectric and from .01 μ fd. to .1 μ fd. in the Mylar dielectric with tolerance ranges of +100%, -0%, \pm 20%, \pm 10% and \pm 5%. Resistance range of 10 ohms to 50 megohms at tolerances of \pm 5%, \pm 10%, and \pm 20% are available.

Detailed information on this new circuit component will be supplied by the manufacturer on request.

SHORT-WAVE RADIO KIT

Lafayette Radio, 165-08 Liberty Ave., Jamaica 33, N. Y. has added a four-



band, three-tube regenerative receiver to its line of electronic kits.

Suitable for the Novice Amateur as well as SWL's who enjoy "monitoring" the ham frequencies, this receiver covers the standard broadcast band and the 1.7-5 mc., 5-14 mc., and 14-30 mc. short-wave bands. When assembled in its wooden case, the circuit is powerful enough to drive the 4" PM speaker,

which is mounted behind a grille on the front panel, to high-level output. Phones may be used by plugging into the rear-mounted jack which automatically cuts out the speaker.

The "Explor-air" will operate on 110-115 volts a.c. or d.c. and measures 10" x 7" x 5". It comes complete with all parts, detailed step-by-step instruction booklet, and giant pictorial diagram. The kit is catalogued as the KT-135.

REPLACEMENT FLYBACK

Chicago-Standard Transformer Corp., 3501 W. Addison St., Chicago, Ill. has announced the availability of an exact replacement flyback for General Electric and Hotpoint Part No. RTO-196.

The new unit, designated as HO-288, requires no chassis or circuit alterations since it is an exact duplicate, electrically and physically, of the original part.

This Stancor flyback is described in detail in Bulletin 548 which is available from the company's distributors or from the manufacturer direct. —30—

NEW RAYTHEON DIVISION

IN A program said to be unique in the electronics industry, Raytheon Manufacturing Company has established a Distributor Products Division which will assume full responsibility and all the needed manufacturing and merchandising resources to team up with the independent parts distributor to their mutual advantage. The new division will stock, in the same warehouses, the firm's complete line of receiving tubes, picture tubes, semiconductor, magnetrons and power tubes, industrial tubes, as well as knobs and other components formerly handled by separate divisions. The consolidation of sources of supply is designed to save distributors both time and money.

Headed by John T. Thompson as manager, the division's key personnel includes F. E. Anderson, general sales manager; John A. Hickey, industrial products manager; Frederick H. Keswick, dealer products manager; William Grey, merchandising manager; E. I. Montague, director of personnel development and trade relations; John Manchester, controller; and Harold Hennig, market research manager. —30—

Sylvania Electric Products Inc. has placed a new 48,000-square-foot engineering, research, and development laboratory in operation at Towanda, Pa. Equipped for advanced experimentation in the fields of high temperature metals, semiconductor materials, and phosphors for lighting and television, the new facility is part of the company's Chemical and Metallurgical Division. The modern building houses engineering offices, laboratory, and pilot plant facilities for more than 100 scientists, engineers, and technicians. The lab was formally opened in October.



To Troubleshoot Pull Tubes
(Continued from page 59)

tube, then replacing the fuse, and finally applying power. If the fuse blows now, we can narrow things down considerably. In the circuit for Fig. 4, for example, capacitor C_{200} would probably be shorted. If the fuse doesn't blow, this indicates several other possibilities—a defective horizontal-output tube, defective damper, defective horizontal-oscillator stage resulting in no drive to the output tube, or other trouble causing excessive current through the damper or output tube. These possibilities would then have to be investigated more closely.

In transformer-type sets with fuses in the transformer primary circuit (Fig. 5), similar fuse troubles can be localized by removing the rectifier tube, then inserting another replacement fuse and checking operation. If the fuse blows now, the trouble is in the transformer or primary circuit. If the fuse doesn't blow, the trouble is probably a defective rectifier tube, a short in the "B+" supply, or other more conventional one.

This technique of narrowing down the possible circuit defects by tube removal can also be used in series-filament sets with fuse trouble. For example, assume the "B+" fuse is blown (F_1 in Fig. 6). The fault may be due either to a defect in the "B+" line proper or to a defective stage drawing excessive current which overloads the "B+" line. A simple way to rule out one of these two broad possibilities is to remove a tube in the series-filament line in order to open the filament string, replace the "B+" fuse, and turn the power on. If the defect is in the "B+" line, the fuse will probably blow again. On the other hand, if the fault is a defective tube or a trouble which causes excessive current through one of the other stages, the fuse will not blow since no tube is operating. Further checks are then made on the basis of this test.

Case No. 4. Tube removal can also help localize certain signal-circuit faults. For example, a 60-cycle buzz in the sound may be sync buzz, over-amplified power-supply hum, or pickup from the vertical-sweep circuit. Removing the vertical-oscillator tube in a transformer-type set would quickly determine whether the pickup comes from the vertical circuit or elsewhere in the set.

In series-filament sets, where removal of a tube disables all of the signal circuits, the same effect can be achieved instead by shorting the grid of the vertical oscillator (or other tube being checked) to disable operation of the stage.

Obviously, tube removal is not a revolutionary cure for all defects. Nevertheless it can be a valuable addition to the technician's store of troubleshooting weapons. Of these he can never have too many.

First Time At Vibrator Prices . . .

Really Dependable Mobile Power You Plug Right In To The Vibrator Socket!



transistorized **UNIVISTORS**

- ELIMINATE VIBRATOR MAINTENANCE PROBLEMS
- MORE THAN 20 TIMES LONGER LIFE
- ELIMINATE "VIBRATOR HASH"

You can now install Mobile Power with new highs in efficiency; power without the repeated breakdowns so common wherever Vibrators are used. One compact, Univistor is all you need to convert a troublesome mechanical power supply into a truly modern, all-electronic supply. Plug it right into the vibrator socket—there are no wiring or circuit changes required—and you'll get tremendously increased efficiency and reliability.

The Univistor has no moving parts to wear out. Unlike a vibrator, it does not damage the buffer capacitor, another source of mechanical power supply problems. It also eliminates electrical and mechanical noise to provide cleaner output throughout its entire life. With an operating life more than 20 times greater, the cost of the Univistor's superior service is actually much less than a vibrator's. The serviceman avoids unprofitable call-backs. The customer gets longer, trouble-free service which more than pays for itself.

Univistors are available with bases corresponding to commercially available vibrators. Since its two germanium power transistors comprising the amplifying elements of the system are independent of the power transformer action, the Univistor may also be interchanged as a separate component in power inverters and converters. In addition it can not be damaged by input polarity reversal and it is unconditionally guaranteed.

IMMEDIATE DELIVERY FROM STOCK. The next time YOU replace a vibrator—and you must—supply the exceptional dependability of the transistorized Univistor!



See your Universal Distributor or write:

UAC Electronics A DIVISION OF **UNIVERSAL**
TRANSISTOR PRODUCTS CORP.

Dept. RT1 • 17 Brooklyn Ave., Westbury, L.I., N.Y. • EDgewood 3-3304 • TWX #255, Westbury, N.Y.

NO OTHER TUBE TESTER MADE- AT ANY PRICE—can MATCH the VALUE of the CENTURY FAST-CHECK

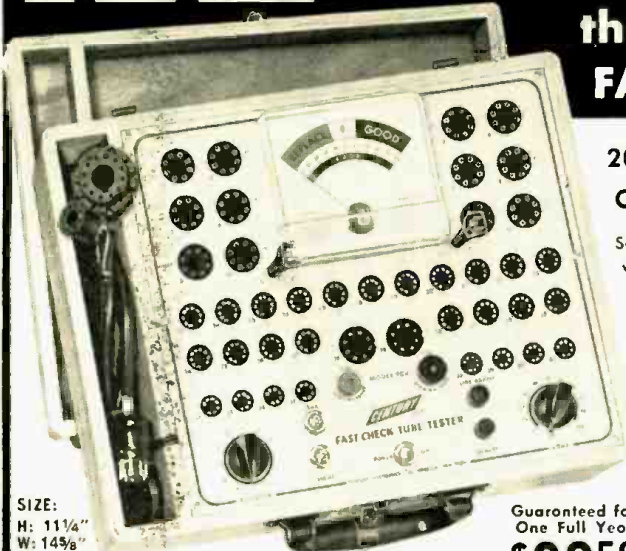

SIZE:
H: 11 1/4"
W: 14 3/8"
D: 4 3/8"

Model FC-2—housed in sturdy wood carrying case complete with CRT adapter . . . only

Guaranteed for
One Full Year
\$6950
Net

20,000 SERVICEMEN CAN'T BE WRONG!

See for yourself—AT NO RISK—why over 20,000 servicemen selected the FAST-CHECK above all other tube testers—regardless of price. With the FAST-CHECK you will make every coil pay extra dividends by merely showing your customer the actual condition and life expectancy of the tube. The extra tubes you will sell each day will pay for the FAST-CHECK in a very short time.

Special compartment accommodates line cord and Picture Tube Test Adapter

PICTURE TUBE TEST ADAPTER INCLUDED WITH FAST-CHECK

Enables you to check all picture tubes (including the new short-neck 110 degree type) for cathode emission, shorts and life expectancy . . . also to rejuvenate weak picture tubes. This feature eliminates the need of carrying extra instruments and makes the FC-2 truly an all-around tube tester.

FAST-CHECK'S low price is made possible because you are buying direct from the manufacturer.

Just 2 settings on the FAST-CHECK TUBE TESTER tests over 650 tube types completely, accurately — AND IN SECONDS!

- **POSITIVELY CANNOT BECOME OBSOLETE**
Circuitry is engineered to accommodate all future tube types as they come out. New tube listings are furnished periodically at no cost.
- **NO TIME CONSUMING MULTIPLE SWITCHING**
Only two settings are required instead of banks of switches on conventional testers.
- **NO ANNOYING ROLL CHART CHECKING**
Tube chart listing over 650 tube types is conveniently located inside FAST-CHECK cover. New tube listings are easily added without costly roll chart replacement.

COMPARE FAST-CHECK WITH OTHER TESTERS RANGING FROM \$40 TO \$200

RANGE OF OPERATION

- ✓ Checks quality of over 650 tube types, which cover more than 99% of all tubes in use today, including the newest series-string TV tubes, auto 12 plate-volt tubes, OZ4s, magic eye tubes, gas regulators, special purpose hi-fi tubes and even foreign tubes.
- ✓ Checks for inter-element shorts and leakage.
- ✓ Checks for gas content.
- ✓ Checks for life-expectancy.

IMPORTANT FEATURES

- Checks each section of multi-section tubes and if only one section is defective the tube will read "Bad" on the meter scale ● Less than 10 seconds required to test any tube ● 41 long lasting phosphor-bronze tube sockets accommodate all present and future tube types . . . cannot become obsolete ● 7-pin and 9-pin straighteners mounted on panel ● Large D'Arsonval type meter is extremely sensitive yet rugged — fully protected against accidental burn-out ● Special scale on meter for low current tubes ● New tube listings furnished periodically at no cost ● Compensation for line voltage variation.

Other testers may have some of the above features . . . but only the FAST-CHECK has them all!

SHIPPED ON APPROVAL FOR 10 DAY FREE TRIAL

Try the FC-2 before you buy it! No obligation to buy.

PAY IN SMALL MONTHLY PAYMENTS

Easy to buy if you're satisfied. Pay at net cash price . . . no financing charges.

**NO MONEY REQUIRED
WITH ORDER . . .**

CENTURY ELECTRONICS CO., INC.

Dept. 212, 111 Roosevelt Ave., Mineola, N. Y.

Rush the FAST-CHECK for a 10 day trial period. If not completely satisfied I will return the instrument within 10 days without further obligation. If fully satisfied I agree to pay the down payment within 10 days and the monthly installments as shown. No financing charges are to be added.

Model FC-2 . . . \$69.50 — Pay \$14.50 within 10 days. Balance \$11.00 monthly for 5 months.

Name.....

Address.....

City..... State.....

F.O.B., Mineola, N.Y.

Within the Industry
(Continued from page 30)

service manager . . . JOHN T. HICKEY is now assistant to the president of Motorola Inc. . . . JAY C. CARVER has been named to the post of audio sales and merchandising manager for Record & Sound Retailing and The Harrison Catalogs . . . EDWARD J. CARNEY is now manager, advertising and sales promotion, semiconductors and components, RCA electron tube division.

ELECTRONIC INDUSTRIES ASSOCIATION'S board of directors has reaffirmed its position in favor of establishment by the Government of a commission to make a long-range study of the radio spectrum and its usage.

In addition, three new directors were elected: John G. Brooks, president, The Siegler Corp.; Jennings B. Dow, vice-president, Hazeltine Electronics Div., Hazeltine Corp.; and B. K. Wickstrum, senior vice-president, marketing, Sylvania Electric Products Inc.

REEVES SOUNDCRAFT CORP. has moved to its new home on Great Pasture Road in Danbury, Conn. The plant covers 50,000 square feet and is fully air-conditioned and dust-free . . . **PACIFIC SEMICONDUCTORS, INC.** has added a fifth building to its facilities in Culver City, Calif.

ARMY MARS TECHNICAL BROADCASTS

HERE is the December schedule for the First Army MARS SSB Technical Net whose purpose is the dissemination of technical knowledge by radio.

Transmissions are on Wednesday evenings, 9 p.m. (N.Y. time) on 4030 kc. upper sideband.

Dec. 3—"International Radio Communication Systems" by E. D. Beeken, asst. vice-pres. and chief operations engineer, RCA Communications Company.

Dec. 10—"FM Multiplex Stereo System" by Murray G. Crosby, president, Crosby Laboratories.

Dec. 17—"VHF Radio Propagation" by Edward P. Tilton, VHF editor, ARRL.

C. M. Edwards, director of advertising and sales promotion for the Heath Co., Benton Harbor, Mich. is shown below (left) accepting an award from the Direct Mail Advertising Association, Inc. The presentation was made by Colin Campbell, executive vice-president of Campbell-Ewald Company. The certificate was presented to the Heath Co. in recognition of its mail advertising during the year ending August 1, 1958.



THIS SELF-SERVICE TUBE TESTER IS YOUR STEPPING-STONE TO A BRIGHT NEW PROSPEROUS FUTURE

EARN BIG MONEY AND ACHIEVE FINANCIAL STABILITY

If you've ever longed for a business of your own . . . to be your own boss and to work your own hours, then here's your opportunity to get in on one of today's biggest money-making opportunities — *the self-service tube testing business*. It's the easiest business to get into . . . requires no experience, little time and small investment.

A basic principle for making money is to have something work for you, rather than you yourself doing the work. As an operator of a **FAST-CHECK SELF-SERVICE TUBE TESTER ROUTE** you can be the proud owner of a solid fast-growing business . . . earning money while you take life easy. Business can be started without giving up your present source of income and can be operated from home. All you do is make calls once a week to restock testers and collect profits.

WHAT IS THE SELF-SERVICE TUBE TESTING BUSINESS?

The self-service tube testing business is a take-off on the highly profitable vending machine business . . . Drug stores, luncheonettes, supermarkets, etc. welcome having a tube tester placed in their store. You place testers and tube stock in stores on consignment — the store location contributes floor space for the self-service tube tester — store patrons are offered the use of the tube tester free — they in turn buy their replacement tubes from the tube stock in the tester. The store pays you for all the tubes sold less his commission. Each tester placed can net up to \$1000 a year for you.

NO SELLING REQUIRED

Century's self-service tube testers check and sell TV and radio tubes automatically 12 hours a day — 7 days a week. Consumers do their own testing and defective tubes are replaced on the spot for highly profitable sales. *Your testers are your high powered salesmen.*

MANUFACTURER-TO-YOU PRICES

Since we are the manufacturers and sell direct to you, we have been able to price the FAST-CHECKS so low that they represent the greatest value in testers available. Our unusually low prices enable you to place more units with less investment.

FAST-CHECK SPECIFICATIONS

- 46 long lasting phosphor-bronze sockets accommodate all present and future tube types — cannot become obsolete.
- Attractive red and hammer-tone gray durable metal cabinet. Takes only 19" x 19" of floor space.
- Tube compartment with own lock holds 400 or more tubes.
- Removable tube storage trays with specially designed dividers separate tube cartons — make it easy to restock tubes that are sold.
- Large seven inch easy to read meter is extremely sensitive yet rugged — is fully protected against accidental burn-out.
- Completely self-service — easy to operate.
- Built-in 7-pin and 9-pin straighteners on panel for customers convenience.
- Quick reference tube chart lists over 650 tube types — conveniently mounted.
- A colorful illuminated point-of-sale display tops the cabinet — designed to attract everyone that comes into the store.
- Each unit is covered by a 3 month guarantee.

FREE BOOK TELLS ALL ABOUT THIS BOOMING BUSINESS

If you are interested in starting a lifetime business, then **ACT NOW** and send for **FREE** book to convince yourself that this is today's greatest business opportunity.



Model SS-1F (floor model) **FAST-CHECK SELF-SERVICE TUBE TESTER** **\$134.50** Net

Model SS-1C (counter model) **An ideal unit for shops with limited floor space. \$98.50** Net

ATTENTION SERVICE SHOP OWNERS

Put the **FAST-CHECK SELF-SERVICE TUBE TESTER** in your shop with only a \$34.50 down payment. You'll gain a valuable profit producing assistant working for you every open hour.

Do-it-yourself customers will welcome the opportunity to bring their tubes to your store where they can test tubes to their heart's content. If the tubes register "Bad" or "Weak" you are assured of profitable tube sales. And best of all you don't have to stop working when a customer brings in a bag of tubes to check. The **FAST-CHECK** does it all for you. If on the other hand a customer's tubes register "Good" you are on the spot for consultation or a service call.

Colorful window streamers and advertising material provided **FREE** by us will attract many new customers to your shop. Servicemen are not only increasing tubes sales, but are actually enlarging their service business as well, with a **FAST-CHECK** in their shop. Act now! Place a unit in your shop and double your tubes sales . . . save valuable working time.

TIME PAYMENT PLAN

Pay in small monthly payments at net cash prices.

NO INTEREST OR FINANCING CHARGES

CENTURY ELECTRONICS CO., Inc. 111 ROOSEVELT AVENUE Dept. T-12, Mineola, N. Y.

Please send the units I have indicated below on your **TIME PAYMENT TERMS**. Include a complete plan of operation — plus all advertising material needed to get started in the self-service tube testing business. I understand no interest or financing charges will be added, and they are shipped on a 10 day money-back guarantee.

Quantity	Description	Unit Price	Extend Total
	Model SS-1F (floor model) FAST-CHECK TUBE TESTER Enclose \$34.50 down payment with order for each tester. Balance payable in 5 monthly payments of \$20.00 for each tester starting 30 days after shipment.	\$134.50	
	Model SS-1C (counter model) FAST-CHECK TUBE TESTER Enclose \$23.50 down payment with order for each tester. Balance payable in 5 monthly payments of \$15.00 for each tester starting 30 days after shipment.	\$ 98.50	

All prices net F.O.B. Mineola, N. Y.

I am interested. Please send me **FREE** book and particulars about setting-up a tube tester route. No salesman will call.

Name..... Please Print

Address.....

City..... State.....

Total Amount
Advance Payment
Balance

CHECK HERE TO SAVE SHIPPING CHARGES

Enclose total amount with order and Century will pay all shipping costs. 10 day money-back guarantee.

1955

The recording tape industry introduces the new "double play" tapes, made on 1/2-mil Mylar* polyester film base, making available twice the normal length of tape on any given reel size and effectively doubling the normal playing time. **Problem:** The new tape is "twice as long," to be sure, but quite fragile, requiring special care in handling.

1957

The recording tape industry introduces the new "ten-silized" or "fortified" double play tapes, now made on a special type of reinforced 1/2-mil Mylar* base that is twice as resistant to stretching and breaking as the 1955 kind. **Problem:** The new tape is indeed "twice as long and twice as strong" now (just as strong as normal tape, in fact), but the price is astronomical.

1958

Beginning November 1, 1958, all **Irish** "Double Play" recording tape on the market will be of the reinforced, 1957 kind — but at the moderate price of the older, 1955 kind. **End of Problem:** This latest **Irish** "Double Play" tape has the length (2400 feet on a standard 7-inch reel), it has the strength (6 lbs. tensile force) — and you can afford it!

*DuPont's registered trademark



Irish
BRAND
recording tapes

are made by the exclusive FERRO-SHEEN® process and are available wherever quality tape is sold. Manufactured by ORRAOIO INDUSTRIES, Inc., Opelika, Alabama, U.S.A.

Export: Morhan Exporting Corp., New York, N.Y.
Canada: Atlas Radio Corp., Ltd., Toronto, Ontario



By BERT WHYTE

AS EXPECTED, the New York High Fidelity Show of the Institute of High Fidelity Manufacturers was widely heralded as the "dawn of the Age of Stereo." Anyone who attended the show can tell you that this appellation was thoroughly justified. Man, you just couldn't escape stereo in all of its forms.

From every room emanated two-channel sound backed up by aggressive two-listed selling. Yessir, the "putsch" was on for stereo and, friends, you should have seen the enthusiasm! This is the truly amazing thing about this whole phenomenon . . . the acceptance has been so immediate and so complete that one might think that the public has been waiting for stereo for years. Of course, in any show where the emphasis is on component hi-fi, one expects strong support from the "hi-fi cadre." What is more astonishing is that there were great numbers of people attending the New York show, who quite obviously were not audiophiles, but who displayed a lively interest in stereo. Like it or not, one must admit that this was in no small measure the result of the heavy advertising the "package manufacturers" are giving to stereo. Without going into the logistics of the situation, it is obvious that whatever side of the fence . . . component or package . . . stereo has arrived, is here to stay, and is bound to have a profound effect on our musical lives!

As to the wares displayed at the show, they were almost without exception designed for stereo usage. There was a rash of new stereo preamps, self-contained stereo amplifiers, many small new speakers in matched pairs, as well as stereo pickup cartridges of both magnetic and ceramic varieties.

The cartridge exhibits were very well attended and rightly so . . . for this is the major area of newness . . . and controversy . . . as far as stereo disc is concerned. After all, most hi-fi enthusiasts can convert to stereo fairly easily by adding to their present monaural rigs a duplicate or equivalent of the equipment they now own. This is familiar ground and the audiophile knows what to expect. But a stereo pickup is really an unknown quantity to most. There are more than a few on the market and clearing one's way through the literature that surrounds them is not easy.

If pickups were a sore point in monaural usage, their stereo counterpart is even worse. Among the things that have harassed the stereo disc enthusiast, is difficulty in eliminating hum, poor tracking ability, excessive stylus pressure, and poor interchannel separation. With so many stereo discs variable as to the manner in which they were cut, this trouble of channel separation is often compounded. Of course, the picture isn't entirely dark . . . there are some pickups that perform quite admirably, but deciding which

to buy will call for controlled concentrated listening and comparison.

The major stereo emphasis at the show was the disc, with tape still present but, at the moment, in the background. There was, however, one other stereo item which made its debut at the show and this was the long anticipated adapters for FM multiplex stereo. This was particularly gratifying to me, as long-time readers of this column will remember that quite a few years ago I campaigned for this type of stereo transmission rather than the AM-FM variety and, in fact, I am happy to say that I had an active part in the promotion of the multiplex stereo idea.

Here is the situation as it stands now . . . virtually all of the component tuner manufacturers such as Fisher, McIntosh, Pilot, Madison-Fielding, Harmon-Kardon, Sherwood, have become licensees for the Crosby "Compatible FM Multiplex" system. All of them intend to produce multiplex adapters under this license and several of these companies had production models displayed and actually demonstrated stereo multiplex at the show. This was accomplished by tuning to New York station WBAI, which is the first in the country to have installed the Crosby transmission equipment.

Although operating on an FCC experimental permit at present, it is hoped that this will soon become a permanent situation. As with almost any new thing there have been a few teething troubles, but for the most part the response of the fortunate few equipped with multiplex adapters is quite enthusiastic. I have one of the adapters at home and can report to you that the other evening WBAI did a multiplex stereo transmission of the Victor tape of "South Pacific." My home is 40 miles from the transmitter and yet in terms of all the stereo effects, plus frequency wideness and dynamic range, the tape sounded almost the same as when I reproduce it on my Ampex. When I switched to hearing the tape from the monaural tuner alone, the Crosby system lived up to its claims and there was a perfectly balanced monaural signal of the left and right components of the stereo tape.

When will multiplex stereo become a general country-wide service? This depends on several factors. Negotiations are in progress with FM stations in almost all sections of the country and in New York, for example, the giant of the National Broadcasting Co., WNBC, reportedly will begin stereo multiplex transmission before the end of this year. The fly in the ointment, however, is that at present the FCC will issue only experimental permits, pending a decision which will es-

The opinions expressed in this column are those of the reviewer and do not necessarily reflect the views or opinions of the editors or the publishers of this magazine.

establish multiplex standards. As you may know, one of the other uses for multiplex is the transmission of two *separate* signals, or programs, from a single FM station. This has found use in the broadcasting of background music to stores, restaurants, etc.

The proponents of another method of multiplexing have proposed that a *third* channel emanate from the same FM station. In this way, two of the channels could be used for stereo, while the third channel would provide the background music. This would afford additional revenue, which it is argued would help pay for the stereo. There is certainly merit in this idea, but unfortunately there is a serious flaw in actuality. Because of the limitations of available bandwidth, when *three* channels are multiplexed on a single FM transmitter each channel is restricted to roughly 5000 or 6000 cycles and, in addition, the signal-to-noise is much poorer. Even worse, this system is incompatible with monaural FM tuners. When tuning to this type of signal, only *one* channel . . . either the left or right as the case may be . . . can be received and the listener is obviously off-axis. In other words, when listening to a multiplex stereo FM transmission that does not employ the wide-range Crosby system, you must contend with low fidelity and the poor monaural listener must contend with a "lop-sided" program. With some stereo material which has wide separation and in the case of concertos and vocalists who may be on the opposite channel to that being received, the result can be devastating.

It is generally felt that the FCC will not give approval to any multiplex stereo system in which the monaural FM listener (who after all will still be in the majority for a long time) receives a degraded signal. It is this impression and the knowledge that the Crosby system is capable of coping with all these objections that has given multiplexing its present impetus. Thus stereo has come into full flower, we have stereo tape, disc, and FM and I think it is fairly safe to say that after all the smoke has cleared away, that no single form of stereo will dominate the hi-fi scene, but each will have its supporters and a happy state of co-existence will develop.

In the meanwhile, there's much to be done with the stereo disc and while this column will most certainly report on the best of them, the coverage of monaural discs will also continue. I may get shot for saying this, but forgetting for a moment the virtues of the stereo effect, and apart from this . . . the technical quality of the finest monaural discs in terms of wide frequency and dynamic range, low distortion and quiet surpasses that of all but a few of the stereo discs thus far issued!

BERLIOZ REQUIEM

Hartford Symphony Orchestra and Chorus conducted by Fritz Mahler. Vanguard Stereo VSD-2006. Price \$11.90.
Orchestra and Chorus conducted by Hermann Scherchen. Westminster Stereo WST-201. Price \$11.90.

The advent of a recording of the Berlioz "Requiem" in its monaural format was an occasion for some excitement. The advent of two such recordings at the same time could be considered quite extraordinary. And, at this stage of the stereo disc, the advent of *two* stereo disc recordings of the Berlioz "Requiem" is nothing short of staggering! This vast work has, of course, been waiting, as it were, for stereo to come along so that its tremendous musical canvas could be accommodated. Imagine, if you will, a huge augmented orchestra, several hundred choris-

YOU CAN'T HEAR A 'SPEC' SHEET!

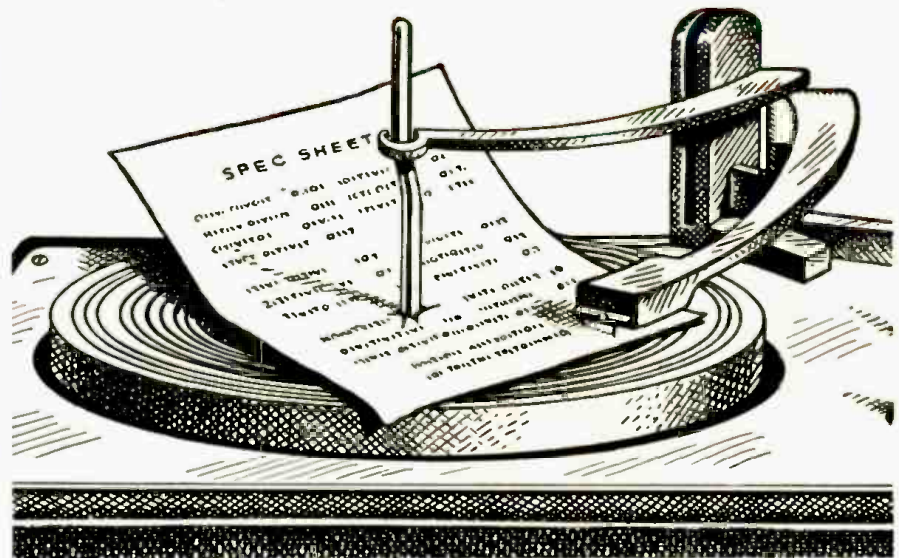

Sonotone's stereo cartridge has more than just good specs... it gives brilliant performance! More phono makers specify Sonotone for the top of their line—here's why:

Only Sonotone gives true sound *without* distortion... high frequency response *without* record cutting! Sonotone stereo gives a performance so superior you can truly *hear* the difference. The secret? Sonotone's four exclusive *operating* features:

1. Extremely high compliance.
2. Amazingly clean wide range frequency response.
3. Wide channel separation, due to Sonotone's pantagraph yoke.
4. Rumble filter to screen out vertical turntable noise.

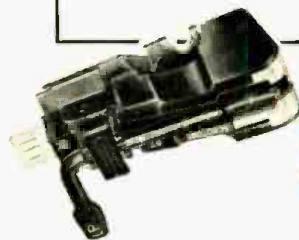

SPECIFY...STOCK...SELL...

Sonotone

Electronic Applications Division, Dept. CN-128

ELMSFORD, NEW YORK

PROG.
®

NOW 2 ASSEMBLE-IT-YOURSELF

**SAVE HALF
NO SPECIAL SKILLS
PAY KIT-BY-KIT**

Schober ELECTRONIC ORGANS

Now you can afford an electronic organ. Whether you choose the full Concert model or the smaller Consolette, you have an organ equal to any made by the foremost manufacturers. In addition, you save over 1/2 the cost because you assemble it yourself... and you enjoy the thrill of achievement. Too, you purchase each kit only when you are ready for it.



**2 different MODELS
2 different SIZES
2 different PRICES**



CONCERT MODEL

- ☆ TWO FULL SIZE PIPE-ORGAN MANUALS, 122 KEYS
- ☆ OCCUPIES 3'5" x 4'7" FLOOR SPACE
- ☆ 26 STOPS AND COUPLERS
- ☆ 32 BASS PEDALS
- ☆ ASSEMBLED CONSOLE
- ☆ CONFORMS TO AMERICAN GUILD OF ORGANISTS SPECIFICATIONS FOR PIPE ORGANS
- ☆ COMPLETE STEP-BY-STEP INSTRUCTIONS

CONSOLETTE MODEL

- ☆ OCCUPIES ONLY 2' x 3'2" FLOOR SPACE
- ☆ TWO FULL SIZE PIPE-ORGAN MANUALS, 122 KEYS
- ☆ 22 STOPS — ABOVE-KEYBOARD TABS
- ☆ 13 HEEL-AND-TOE BASS PEDALS
- ☆ 7 FULL OCTAVES OF TONE (DOWN TO 32 CPS)
- ☆ BUILT-IN SPEAKERS OPTIONAL
- ☆ ASSEMBLED CONSOLE
- ☆ COMPLETE STEP-BY-STEP INSTRUCTIONS

**10" LP RECORD DEMONSTRATING BOTH MODELS
AVAILABLE FOR \$2, REFUNDABLE UPON PURCHASE**

FREE NEW 1959 EDITION OF 16 PAGE ILLUSTRATED BOOKLET ON REQUEST

Write Now — See What Fine Instruments You Get At Such Great Savings

The **SCHOBBER ORGAN Corporation** • 2248-A BROADWAY • NEW YORK 24, N. Y.

SCHOBBER KITS ALL OVER THE WORLD

☆ Designed by Richard H. Dorf.

**Grommes
Little Genie
HIGH FIDELITY KITS**
• LAYER BUILT • COLOR GUIDE

Before you build another kit, see this new method of kit assembly. Each kit complete with all parts and instructions.

"So simple . . . it's like magic"



20PG8-K

- 20PG8-K 20 Watt Amplifier with built-in pre-amplifier and all controls. Net 59.50
- LJ-6K 10 Watt Amplifier (Little Jewel). Has built-in preamplifier and record compensator on phono channel. Net 24.95
- 207A-K Hi-Fi Preamplifier (Self-Powered). Feedback circuit with 10 controls. Net 44.50
- 250-K 60 Watt Basic Hi-Fi Amplifier. For use with a preamplifier (such as 207A-K). Net 79.50

Grommes—Div. of Precision Electronics, Inc.
Dept. R-12, 9101 King St., Franklin Park, Ill.

Name of Dealer _____

Send complete Kit details.

Name _____

Address _____

City _____ Zone _____ State _____

**PURCHASING
A HI-FI
SYSTEM?**

Send Us
Your
List Of
Components
For A
Package
Quotation

**PARTIAL LIST
OF BRANDS
IN STOCK**

- Altec Lansing
- Electrovoice
- Jensen
- Hartley
- University
- Acoustic Research
- Janszen
- Wharfedale
- Karlson
- Viking
- Concertone
- Bell • G.E.
- Weathers
- Harman—Kardon
- Eico • Pilot
- Sherwood
- AcraSound
- Fisher
- Bogen • Leak
- Dynakit
- H. H. Scott
- Pentron
- Ampro • VM
- Revere
- Challenger
- Wollensak
- Garrard
- Miracord
- Glaser—Steers
- Rek-O-Kut
- Components
- Narelco
- Fairchild
- Pickering • Gray
- Audio Tape

**AIREX
RADIO**

CORPORATION
64-R Cortlandt St., N. Y. 7, CO 7-2137

Full Line of
Cabinets

ters, four brass bands, and sixteen (count 'em) tympani, and you'll get some idea of the scope of this work.

There have been two recordings of this in the LP era: the first was recorded in St. Eustace Church in Paris and, while an exciting performance, suffered from excessive reverberation; of more recent vintage, a recording made by the Rochester Choral Society which, while more modern in sound, still left much to be desired and was not particularly distinguished in performance.

It would be nice to report that either or both of these present stereo disc recordings of the "Requiem" was a great success and the sonic thrill supreme. Unhappily, both fall far short of expectations. In the *Vanguard* recording, Fritz Mahler gives us a reading which is workmanlike and competent but not overly inspired and there is a large chorus whose enthusiasm is pleasing but whose talents are somewhat wanting. But the main fault here is the fault of so many of these early stereo disc recordings. I should, in all fairness to *Vanguard*, point out that the dynamic range of the Berlioz "Requiem" is one of the widest in the literature, making the task of cutting a satisfactory stereo disc truly formidable. The trouble here, of course, is level. The very opening of the work is many, many decibels below what the same opening would be on a monaural disc and when it comes to the huge crashing climaxes of this work, especially the all-out fervor of the "Tuba Marum," one has to crank up the gain on the amplifier to such an extent that unless the amplifier is of very high quality and extraordinarily quiet, the music will be ruined by excessive hum and rumble. If your amplifier can do this, admittedly the effect of the climax is stupendous. From a strictly stereo standpoint, this *Vanguard* recording is pretty good, meaning that directionality is easily apparent, the hole-in-the-middle has been well filled, and there is a strong feeling of depth.

In the *Westminster-Scherchen* recording, they went all out for authenticity in the performance. This was actually recorded in the Invalides in Paris where Berlioz conducted the first performance. This was a praiseworthy and notable endeavor and one which, I am sure, called for considerable courage, since one listen to the reverberation characteristics of the Invalides would be enough to drive the average recording engineer stark mad. No doubt the engineers tried mightily but to no particular avail. The reverberation time is so great that for the most part the sound is amorphous and is a particularly devastating thing with stereo. Except in the very loudest sections, directionality was something one had to look for or listen for and what should have been the shattering roar of sixteen tympani was more reminiscent of sixty-cycle hum. In other words, articulation was almost totally absent. There is no denying that there were, however, some fascinating sounds in depth and, in the right places at the right time, some fabulous anti-phonal effects.

Performance-wise, Herr Scherchen has chosen to impose some of his ideas in certain places in the score and, at other places, to act quite well-behaved and stick to the letter and note. He had the advantage of a very capable, well-trained choir and an orchestra used to Berlioz. The result of all this is a somewhat jerky and uneven performance which has its compensations in some vast and glorious outpourings of sound. The *Westminster* recording suffered, but not quite as greatly, from reduced level. In both recordings, the bass is diminished from its monaural counterpart and once again this seems to be a concomitant of less-than-satisfactory stereo disc recording.

In summation, neither performance can be

RADIO & TV NEWS

cates whether the cathode current of the horizontal deflection output tubes is within manufacturers' recommended limits. The proper use of the HC-6 is said to minimize the chance of premature failure of horizontal output transformers and, in some cases, the failure of the power transformer and rectifiers.

The device measures 5¼" wide, 5¾" long, and 1½" high. It comes completely assembled and with operating instructions. Write the manufacturer for further information and price.

TRANSISTOR RADIO LINE

The Electronics Division of *Channel Master Corp.*, Ellenville, N. Y., has entered the receiver field with a new line of transistor radios.

Two 6-transistor models are being offered initially, along with a full line of accessories. The Model 6506 utilizes six matched transistors, plus 1 diode and 1 thermistor. It measures 5¾" long, 3" high, and 1¾" deep and is powered by four 1½-volt penlite cells. Other features include a superhet circuit, push-pull output, built-in ferrite antenna plus a plug-in extension antenna, safety tuning dial, non-breakable plastic case, earphone jack, extension speaker outlet, sealed variable capacitor, and 2½" speaker. The accessories include a cowhide carrying case with leather shoulder strap, magnetic earphone for private listening,



and earphone case. This model is available in black and gold or maroon and bronze.

The Model 6501 measures 4⅝" x 2¼" x 1¼" and uses six matched transistors plus 1 diode. A 9-volt battery powers the circuit.

Write the manufacturer direct for full details on the line and prices.

"TRANSFORMERETTES"

Amplifier Corp. of America, 398 Broadway, New York 13, N. Y., has recently introduced a new line of Mumetal-shielded miniature transformers which has been especially designed for transistor applications.

This series of ruggedized transformers is epoxy impregnated for optimum freedom from moisture penetration and housed in drawn, annealed Mumetal shields. All units use nickel-alloy core material and are wound on either Bakelite molded coil forms or nylon bobbins. Bifilar windings and one-piece gapless core construction are used in some units.

Thirteen basic types of input, driver, output, and interstage transformers are available for use in 90 different impedance-matching circuits. Four frequency response ranges are available.

The new "Transformerettes" are primarily designed for miniaturized and transistorized equipment and for industrial, commercial, and experimental applications. Complete technical specifications and factory prices are available from the Transformer Division.

"HYBRID" SET TUBES

The Electron Tube Division of *Radio Corporation of America*, Harrison, N. J., is now offering a 9-pin miniature tube containing two diodes and a high-perveance power tetrode in a single envelope.

The 12DS7 was specially designed for use in "hybrid" auto radio receivers in which the tube and transistor electrode voltages are obtained directly from a 12-volt storage battery. In such receivers, the diode units are used for AM signal detection and a.v.c. The tetrode unit, which is of the space-charge-grid type, is intended for use as a driver to supply high input power at low distortion to the transistorized a.f. power-output stage.

Space-charge-grid operation of the tetrode unit is accomplished by operating grid No. 1 at a positive potential and using grid No. 2 as the control electrode. This method of operation, in addition to the high perveance of the tetrode unit, enables the 12DS7 to supply high plate current with only 12.6 volts on the plate.

NEW BEAM POWER PENTODES

The Electronic Tube Division of *Westinghouse Electric Corporation*, P. O. Box 284,

Elmira, N. Y. has announced the development of two beam power pentodes which have been especially designed to provide reliable vertical deflection to drive wide deflection angle cathode-ray tubes. These 9-pin miniatures will conservatively drive a 110-degree vertical deflection system.



The heater of the 12DT5 is designed to operate in circuits employing 600 ma. series-connected heater strings. Warmup characteristics are controlled to minimize heater surge. The 6DT5 displays the same characteristics as its 12 volt counterpart. Both types feature controlled high zero-bias plate current and low zero-bias screen current at a specified low plate voltage. This low knee characteristic, coupled with a tightly controlled cut-off characteristic, assures the circuit designer of ample linear vertical deflection.

Full specifications on these two new types will be supplied by the manufacturer upon request.

ERIE "PAC" UNITS

Erie Resistor Corporation, Erie 6, Pa. has announced the development of "PAC" (Pre-Assembled Components)



Partners Ray Kirshart and Joe Kopin of Picture Tube Center, 154L North Western Avenue, Hollywood 27, California.

"We Operate 38 Sets from One Antenna without Amplification"

"Good reception is the most important factor in selling a TV set, and no matter how good a set is, a poor antenna system can make it look bad. We started with individual antennas . . . later we put in two distribution amplifiers and operated sixteen sets from one antenna. Today, with Wizards, we are operating *Thirty-Eight* sets from one antenna with *No Amplification* and have the finest reception we've ever seen.



for: UHF and VHF

The new Electro-Magnetic set coupler for 300 ohm flat line that is not limited to 2, 3 or 4 sets

High Signal Response
Low Insertion Loss
Impedance Automatically Matched
Installation Fast & Simple
List Price \$1.95

For additional information write:

CHARLES ENGINEERING, INC.
6053 Melrose, Los Angeles, California

**COYNE offers
LOW COST**

TELEVISION

Training in
Spare Time **AT HOME**

The future is YOURS in TELEVISION—RADIO COLOR TV!

A fabulous field—good pay—fascinating work—a prosperous future! Good jobs, or independence in your own business!



Coyne brings you MODERN—QUALITY Television Home Training; training designed to meet Coyne standards. Includes RADIO, UHF and COLOR TV. No previous experience needed. Practical Job Guides to show you how to do actual servicing jobs—make money early in course. You pay only for your training, no costly “put together kits.”

Send coupon or write to address below for **FREE Book**

and full details including easy Payment Plan. No obligation, no salesman will call.



B. W. Cooke, Jr., President

Coyne—the Institution behind this training... the largest, oldest, best equipped residential school of its kind now in its new home pictured here... Founded 1899.

COYNE ELECTRICAL SCHOOL

1501 W. Congress Pkwy., Chicago, Dept. 98-H6
Chartered as an Educational Institution
Not For Profit

COYNE Television, Home Training Division
Dept. 98-H6—New Coyne Building
1501 W. Congress Pkwy., Chicago 7, Ill.
Send Free Book and details on how I can get Coyne Quality Television Home Training at low cost and easy terms.

Name _____

Address _____

City _____ State _____

(It is understood no salesman will call)

with wire leads for universal wiring.

Formerly available only to manufacturers using printed wiring boards, the new units enable companies using point-to-point wiring methods to em-

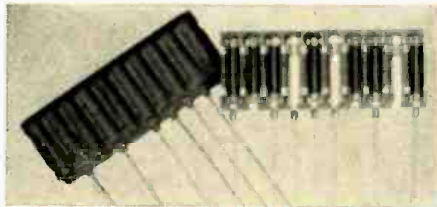

ploy “PAC” without circuit redesign.

The capacitor-resistor networks provide capacitance values of 10 $\mu\text{fd.}$ to .01 $\mu\text{fd.}$ in the ceramic dielectric and from .01 $\mu\text{fd.}$ to .1 $\mu\text{fd.}$ in the Mylar dielectric with tolerance ranges of +100%, -0%, $\pm 20\%$, $\pm 10\%$ and $\pm 5\%$. Resistance range of 10 ohms to 50 megohms at tolerances of $\pm 5\%$, $\pm 10\%$, and $\pm 20\%$ are available.

Detailed information on this new circuit component will be supplied by the manufacturer on request.

SHORT-WAVE RADIO KIT

Lafayette Radio, 165-08 Liberty Ave., Jamaica 33, N. Y. has added a four-



band, three-tube regenerative receiver to its line of electronic kits.

Suitable for the Novice Amateur as well as SWL's who enjoy “monitoring” the ham frequencies, this receiver covers the standard broadcast band and the 1.7-5 mc., 5-14 mc., and 14-30 mc. short-wave bands. When assembled in its wooden case, the circuit is powerful enough to drive the 4” PM speaker,

which is mounted behind a grille on the front panel, to high-level output. Phones may be used by plugging into the rear-mounted jack which automatically cuts out the speaker.

The “Explor-air” will operate on 110-115 volts a.c. or d.c. and measures 10” x 7” x 5”. It comes complete with all parts, detailed step-by-step instruction booklet, and giant pictorial diagram. The kit is catalogued as the KT-135.

REPLACEMENT FLYBACK

Chicago-Standard Transformer Corp., 3501 W. Addison St., Chicago, Ill. has announced the availability of an exact replacement flyback for General Electric and Hotpoint Part No. RTO-196.

The new unit, designated as HO-288, requires no chassis or circuit alterations since it is an exact duplicate, electrically and physically, of the original part.

This Stancor flyback is described in detail in Bulletin 548 which is available from the company's distributors or from the manufacturer direct. —30—

NEW RAYTHEON DIVISION

IN A program said to be unique in the electronics industry, Raytheon Manufacturing Company has established a Distributor Products Division which will assume full responsibility and all the needed manufacturing and merchandising resources to team up with the independent parts distributor to their mutual advantage. The new division will stock, in the same warehouses, the firm's complete line of receiving tubes, picture tubes, semiconductors, magnetrons and power tubes, industrial tubes, as well as knobs and other components formerly handled by separate divisions. The consolidation of sources of supply is designed to save distributors both time and money.

Headed by John T. Thompson as manager, the division's key personnel includes F. E. Anderson, general sales manager; John A. Hickey, industrial products manager; Frederick H. Keswick, dealer products manager; William Grey, merchandising manager; E. I. Montague, director of personnel development and trade relations; John Manchester, controller; and Harold Hennig, market research manager. —50—

Sylvania Electric Products Inc. has placed a new 48,000-square-foot engineering, research, and development laboratory in operation at Towanda, Pa. Equipped for advanced experimentation in the fields of high temperature metals, semiconductor materials, and phosphors for lighting and television, the new facility is part of the company's Chemical and Metallurgical Division. The modern building houses engineering offices, laboratory, and pilot plant facilities for more than 100 scientists, engineers, and technicians. The lab was formally opened in October.

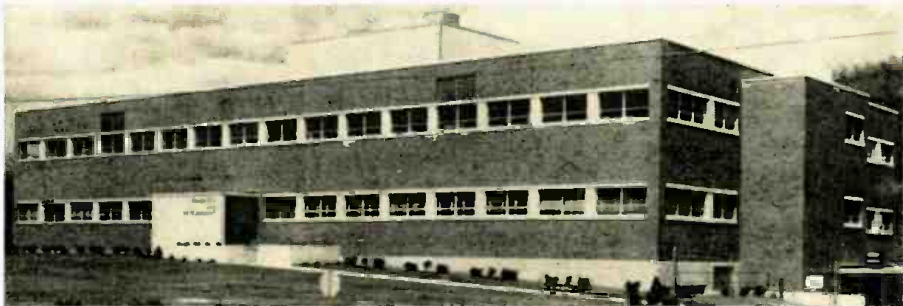

said to be the final word on the subject and, in matters of sound, the perfect stereo realization of this work is yet to come. Let's put it this way. If you are an absolutely wild-eyed admirer of the Berlioz "Requiem," either of these two recordings may give you some of that thrill you are looking for but if your interest in the "Requiem" lies in the musical as well as sonic aspects of the work, then one can only ask for patience. Too bad, but a tip of the hat to both *Vanguard* and *Westminster*, both considered "small" companies, but whose ideas are big and most of the time, anyway, very fruitful.

**BEETHOVEN
PIANO CONCERTO NO. 5
(THE EMPEROR)**

Clifford Curzon, pianist, with Vienna Philharmonic Orchestra conducted by Hans Knappertsbusch. London Stereo CS-6019. Price \$4.98.

This is one of the first Piano Concertos to be heard on a stereo disc and would that all the rest are as good as this! In its monaural format, this was a tremendous experience. Now hearing it in stereo, it is even more apparent what a superb performance this is. This has always been a Curzon specialty and he affords us a performance in the grand old manner—full, robust, a thundering peroration that is tremendously exciting. Hans Knappertsbusch, who is not normally noted for his displays of ebullience, seems to have been caught up in the mood and spirit with which Curzon endows the work and he is in excellent rapport at nearly all times and elicits from the Vienna Philharmonic some of the most exemplary string playing I have heard in a long time.

This has the stereo virtues in prolific abundance. Instrumental separation and directionality are very apparent. There is an almost magical balance between piano and orchestra. The whole piece has a sonic strength and forward projection that is almost overwhelming. The recording was made moderately close up but not so much so that the reverberation can't lend itself to the situation and furnish us with a compellingly realistic sense of depth. Add the virtues of wide dynamics fully realized, good high level sound throughout, and nice quiet surfaces and this gives us a final nugget of desirability. Don't miss it!

**RAVEL
BOLERO
MOTHER GOOSE SUITE
CHABRIER
BOUREE FANTASQUE**

Detroit Symphony Orchestra conducted by Paul Paray. Mercury Stereo SR90005. Price \$4.98.

With the great variance in the quality of stereo discs I was most anxious to hear some samples of *Mercury's* efforts in this new field. Most particularly, I wanted to find out if *Mercury* had been able to impress on a stereo disc, the same high level of technical excellence that has characterized their brilliant "Olympian" series monaural recordings. On listening and comparison, it was most pleasant to find that while the stereo disc could not match its monaural counterpart in some respects, on the whole it was of very high quality and deserves to share with *London Records* and a few others, the distinction of producing the best of today's stereo.

I was quite impressed with the fact that the *Mercury* engineers had been able to retain almost as great a dynamic range and over-all volume level as their monaural product. Nor was this accomplished by drastically reducing bass response. The low strings and the bass drum and tympani were very clean and solid and at no time did I experience difficulty in tracking the disc. It must be noted, however, that high-frequency

DYNAKIT *for the audio perfectionist*

- Products which excel in design, in component quality, and in sound
- Superior for monophonic use and fully compatible with stereophonic requirements

DYNAKIT MARK III



- ★ Ease of assembly due to uniquely simple circuitry and printed circuit construction with factory-mounted parts.
- ★ Highest stability suitable for all loudspeaker systems including electrostatic.
- ★ Dyna Biaset (patent pending) for simplified adjustment and complete freedom from effects of unbalanced components.
- ★ Dynaco Super-Fidelity output transformer. This is the finest available transformer of its type for the most critical audio uses.

60 watts \$79.95* net

Mark III also available with added 70 volt output.
Mark III-70 \$84.95* net

MARK II 50 watts
\$69.75* net

DYNAKIT PREAMPLIFIER

- ★ Finest Quality Available of Circuitry and Components
- ★ Lowest Distortion and Noise
- ★ Easiest Assembly Using Pre-Assembled Printed Circuit
- ★ Handsome Styling—Selected for Display at Brussels World's Fair
- ★ Only \$34.95* net



Power supply available for 2 pre-amplifiers PS-1 Kit \$8.95* net

DYNAKIT STEREO CONTROL



Stereo control with 2 preamplifiers

- ★ Adds Complete Stereo Control to Two Preamps Without Noise or Distortion
- ★ Unique Blend Control Fills In "Hole in Middle"
- ★ Level, Balance, Loudness, Channel Reverse, and Dual Tape Monitor Controls
- ★ Only \$12.95* net

DYNACO-B&O PHONO PICKUP

- ★ New completely symmetrical push pull magnetic pickup for either monophonic or stereo records.
- ★ High compliance in all directions permits tracking at 2 grams.
- ★ Smooth, peak-free response beyond 15kc with low cross talk.
- ★ With .7 mil replaceable diamond stylus for only \$29.95.

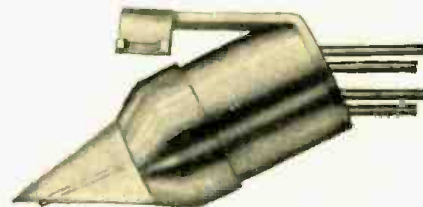

Available for leading Hi-Fi dealers everywhere. Descriptive brochure available on request.

* Slightly higher in West
Export Division:
25 Warren St., New York 7, N. Y.

DYNACO INC., Dept. RN, 617 N. 41st St., Philadelphia 4, Pa.

When Converting Your Phono to Stereo...Use

The ERIE AUDIO-AMPLIFIER KIT featuring "PAC" and an ERIE Printed Wiring Board

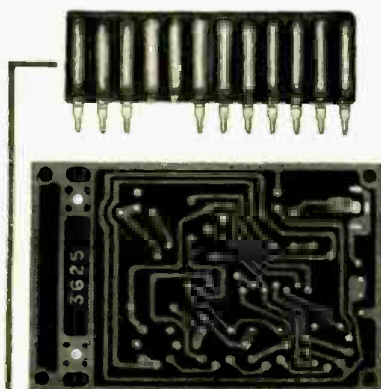

With these Plug-in Components:

- ERIE "PAC" (Pre-Assembled Components)
- ERIE PRINTED BOARD
- OUTPUT TRANSFORMER
- FILTER CAPACITOR
- VOLUME CONTROL and SWITCH
- TUBE SOCKETS
- CAPACITORS
- TONE CONTROL
- TUBES

SPECIFICATIONS FOR ERIE STANDARD AUDIO-AMPLIFIER

- Frequency Response: 30 cycles to 12,000 cycles +0, -3.5 db.
- Sensitivity: 0.56 volt RMS (input at 1 KC) for 2 watt output.
- Power Output: 2 watts • Input Impedance: 2 megohms.
- Output Impedance: 4 ohms • AC Power Consumption: 17 watts.
- Overall Dimensions: 6 3/4" L x 4 1/2" W x 3 3/8" H • Shipping Weight: 2 lbs.

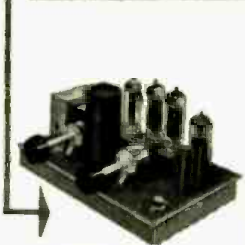

MODEL
PAC-AMP-1

See and hear it at
your local distributor
or Write for
nearest source.



response is down somewhat in comparison to the monaural recording. This is, I understand, not uncommon with almost all stereo discs, being an inadequacy of the stereo cutter.

The stereo effects *per se* were well maintained . . . there was excellent directivity and instrumental positioning, good center fill which afforded a nice over-all "wall" of sound, and the acoustic treatment was such as to give a very full sense of airy spaciousness and depth. All the various choirs of the orchestra were as bright and forward as is usual with Mercury. On the debit side could be listed such things as an occasional high level overload, probably due to the failure of the cutter to maintain sufficient inter-channel separation at such high peak inputs, and some of the "swish-swash" types of odd modulations which seem to affect stereo discs at times. Of course, much of this is due to spindle hole eccentricities and warpage and can be avoided, at least partially, by scrupulous inspection of the records you purchase.

As to the music, as has been noted in the earlier monaural review, Paray is masterful in his readings of Ravel and as heard with all of the added virtues of stereo, his art is all the more appreciated. The "Bolero" is an excellent recording to use for checking whether or not your speakers are properly balanced and in phase. If all is correct, that wonderfully insistent drum that grows ever and ever louder will be positioned exactly between the two speakers.

All in all, a very auspicious beginning for Mercury stereo disc and now we can look forward to many of the fine recordings they have tucked away in their stereo backlog.

TCHAIKOVSKY PIANO CONCERTO #1

Van Cliburn, pianist, with a symphony orchestra conducted by Kiril Kondrashin. Victor LSC 2252. Price \$4.98.

After all the whoop-la about Van Cliburn, frankly I was a bit cynical and expected that when I finally got a chance to hear him, I would find that he had many graces and virtues all of which had been blown up quite out of proportion in comparison with the talents of some of our great established artists. Imagine my surprise when he turned out to be "as advertised"! He has truly astonishing ability for one so young and displays a tremendous *bravura* style in the "grand tradition". Yet for all his thundering and drama, he is a true poet and his eloquent, beautifully proportioned reading is as ingratiating a performance as I have heard in years.

This is the stereo version and, as such, helps a great deal in maintaining a sense of realism. It is not, however, a completely satisfactory stereo recording. The level was several db below monaural standards, there was a definite diminution of bass response, an annoying lack of body in the strings. If your system is quiet enough to bring up the level and the bass response, things sort out a bit and as directivity and depth were fairly good the over-all effect reasonably stimulating.

MAHLER SYMPHONY #2 (RESURRECTION)

New York Philharmonic conducted by Bruno Walter with Emelia Cundari, soprano; Maureen Forrester, contralto; Westminster Choir. Columbia M2S601. Price \$7.96. Two discs.

If you don't know this work, the first thing I can do here is to urge you to listen to one of the most beautiful and great of symphonic masterpieces. This is a huge work and the problems in recording it are formidable. Needless to say stereo is a big help in this, but as with so many stereo discs, it

ENGINEERING DEGREES



E.E. Option Electronics or Power
Earned through Home Study
Residence classes also available
Colleges of Engineering, Physics,
and Business Administration
5719R Santa Monica Blvd.
Hollywood 38, California

TAPE RECORDERS



HI-FI COMPONENTS Tapes • Accessories

MERITAPE
Low cost, high quality
recording tape, in boxes
or cans.
UNUSUAL
VALUES
Send for
Free Catalog
DRESSNER, 69-02 RA, 174 St., Flushing 65, N.Y.

3-WAY ACOUSTIC BAND EXTENDER

an ABE COHEN product



"ADD-ON" QUALITY

INSTANTLY converts 12" woofer or general purpose speaker to 4-channel integrated system . . . and ELIMINATES all baffle carpentry. Complete with high pass NETWORK element, sealing gasket and FULL ILLUSTRATED INSTRUCTIONS.

SPECS:

3 BANDS	1-3.5 KC	3.5-5.5 KC	5.5-18 KC
	Rear loaded	Front loaded	Direct Hemispherical
	Dual flared horn	Dual slit horns	Radiator
3.2 Alnico V slug—custom molded phenolic diaphragm.			
8 ohm—25 watts with network element.			

MOUNTS DIRECTLY
ON SPEAKER FRAME

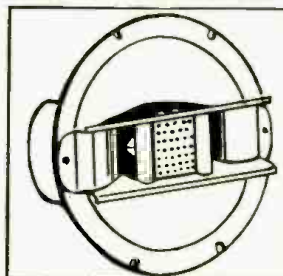

Audiophile net \$10.95

ADVANCED ACOUSTICS CO. 1875 CARTER AVE., BRONX 57, N. Y.

presents problems of its own. There are some passages of transcendent beauty which could only have been realized with stereo... there are other moments which are somewhat less than satisfactory. Stereo effects are fair here, but on a minimal basis. Directivity was all right, but the over-all balance and especially the handling of the acoustic perspective was far from perfect. Level was down a bit, bass reduced somewhat, dynamic range (so important in the stirring finale) was restricted. And the sin of having the solo voices override the chorus in the finale is almost unparadiseable.

Despite all this, this is a stereo recording I wouldn't want to part with unless there was a very, very good replacement. This affection is based on the appeal of the work, the fine playing of the Philharmonic and, above all, the inspired reading of Bruno Walter. For him this was truly a labor of love, a fact which is audibly evident in every bar and measure of the score.

RIMSKY-KORSAKOV

**THE TALE OF THE TSAR SULTAN
MAY NIGHT
RUSSIAN EASTER OVERTURE**
L'Orchestre de la Suisse Romande conducted by Ernest Ansermet. London CS6012. Stereo. Price \$4.98.

This is still another fine stereo disc from London, which has now settled down to turning out stereo discs which for the most part one can buy with confidence that the stereo aspects will be of high technical excellence. A very tasty potpourri of Rimsky who surely must have composed many of his works with stereo in mind. Or so it almost seems, so perfectly does his orchestration lend itself to this medium. Directionality, depth perspective, fine bright projection, superb aural positioning of individual instruments, all add up to splendid sounding disc.

If these numbers are among your favorites monaurally, you'll really get a lift from these stereophonic versions!

HITS I MISSED

Ted Heath and his orchestra. London PS116. Price \$4.98.

For stereo in the popular vein this is hard to beat. Ted Heath plays a group of numbers such as "Ebb Tide," "High Noon," "Three Coins in the Fountain," "Love is a Many Splendored Thing," and others with very clever arrangements which take full advantage of stereo's capabilities. This is very full, big band stuff, with typical Heath drive and spirit.

This is a stereo disc with level to burn and it sounds great even on the very small packaged stereo rigs.

"JOIN A RADIO CLUB"

THE Chicago Area Amateur Radio Club Council is sponsoring a "Join a Radio Club" campaign to assist those interested in amateur radio find the organization meeting their particular hobby objectives.

To assist in making this choice, the Council has published a free directory of ham clubs which is being distributed by amateur radio supply stores in the Chicagoland area or may be obtained by sending a self-addressed, stamped envelope to Ray Birren, W9MSG, 702 Spring Road, Elmhurst, Ill., or George Boyd, W9SPT, 3540 N. Seeley Ave., Chicago.

The directory lists meeting places, dates, officers, and activities. Clubs range in specialization from u.h.f. to mobile to social. In addition, there are two ham clubs for the distaff ops. The litchstring is out and the Council welcomes inquiries from Chicago area hams.

**HERE'S WHY THESE REVOLUTIONARY
All-transistor
stereo units
ARE THE SENSATION OF THE HI-FI INDUSTRY!**

- No tubes to heat up, break or wear out! Transistors have almost unlimited life span!
- Amazingly compact! Transistors save space. Outside cabinet size only 10 3/8" long by 5" deep by 3 1/2" high!
- Fully transistorized circuits are more efficient, almost unbreakable, with less heat, hum.
- Unique circuitry and engineering reduce production costs. You get high quality at real down-to-earth prices!



**ALL-TRANSISTOR
STEREO MASTER CONTROL UNIT**

Make this Stereo Preamp the center of your stereo ensemble. Here's maximum performance at minimum price. Completely guaranteed. In stunning walnut cabinet with gold anodized aluminum panel. **\$69.95**

Includes these features for versatile use with stereo records or tape, magnetic or ceramic cartridge, FM-AM tuner, or from any monaural source: separate bass and treble controls; volume, loudness, and bal-

ance controls; stereo reverse switch; scratch filters; 8 inputs (4 pairs); stereo or monaural selector (plays monaural through one or both channels); 3 AC power receptacles. Powers Extron all-transistor amplifiers, or conventional tube-type units.



**ALL-TRANSISTOR
POWER AMPLIFIER**

This exciting, all-transistor amplifier powers even the largest speaker systems. Special circuit eliminates output transformer (saves space, cost). Self-powered by 6-volt lantern battery for portable or regular use. (Battery interchangeable with 110-volt AC power unit, optional at \$14.95.) Compact enough to fit anywhere, even in speaker cabinet! Use two with above Master Control Unit for deluxe stereo. Or connect one directly to second phono stereo channel for low-cost conversion from monaural system! Guaranteed.

Basic amplifier in metal case

\$24.95

In metal case with level and tone controls

\$27.95

In deluxe walnut cabinet, stunning panel, level and tone controls **\$34.95**

Patent pending

Paste on Postcard - Mail Today!



ALL-TRANSISTOR COMPONENTS

Extron Corporation
600 South Marshfield Avenue
Chicago 12, Illinois

Please send more information, including complete specifications, on your all-transistor Hi-Fi equipment.

Name _____
Address _____
City _____ State _____

**NEW! TRANSISTOR
TRANSFORMERETTES***

**MU-METAL SHIELDED
Miniature Transformers**



1/3 ACTUAL SIZE

Thirteen types of Input, interstage, driver, and output transformers for use in 90 different impedance matching circuits. Available in rectangular, cylindrical, octal and novel plug-in cases. Epoxy impregnated for moisture protection. Hermetically sealed units meet MIL-T-27A. Manufactured with most modern core materials in accordance with newest engineering techniques. Rectangular size: 13/16" long, 17/32" wide, 17/32" high. Weight: less than 1/2 ounce. Used in all miniaturized, transistorized equipment for industrial, commercial, and experimental applications.

Write to Dept. RT for complete list and direct factory prices.

AMPLIFIER CORP. of AMERICA 398 Broadway, New York 13, N. Y.

ENGINEERING



**B.S. DEGREE
IN 27 MONTHS**

Prepare for unlimited opportunities of the Electronic Age! Earn your B.S. DEGREE IN 27 MONTHS in Aeronautical, Chemical, Civil, Electrical or Mechanical Engineering; in 36 MONTHS in Mathematics, Chemistry, Physics, Intensive, specialized courses. Comprehensive training in electronics, television, advanced radio theory and design, math, nuclear physics and electronic engineering. Engineering Science preparatory courses. Low rate. Graduates in demand. Spacious campus; 20 blocks, dorms, gym, playing field. Earn part of your expenses in Fort Wayne while studying. G.I. approved. Enter Dec., March, June, Sept. Catalog.

INDIANA TECHNICAL COLLEGE

1928 E. Washington Blvd., Fort Wayne 2, Indiana
Please send me free information on B.S. ENGINEERING DEGREE IN 27 MONTHS as checked.

- Electronics
- Chemical
- Aeronautical
- Civil
- Mechanical
- Electrical
- B.S. DEGREE IN 36 MO. IN Math. Chem. Physics

Name _____
Address _____

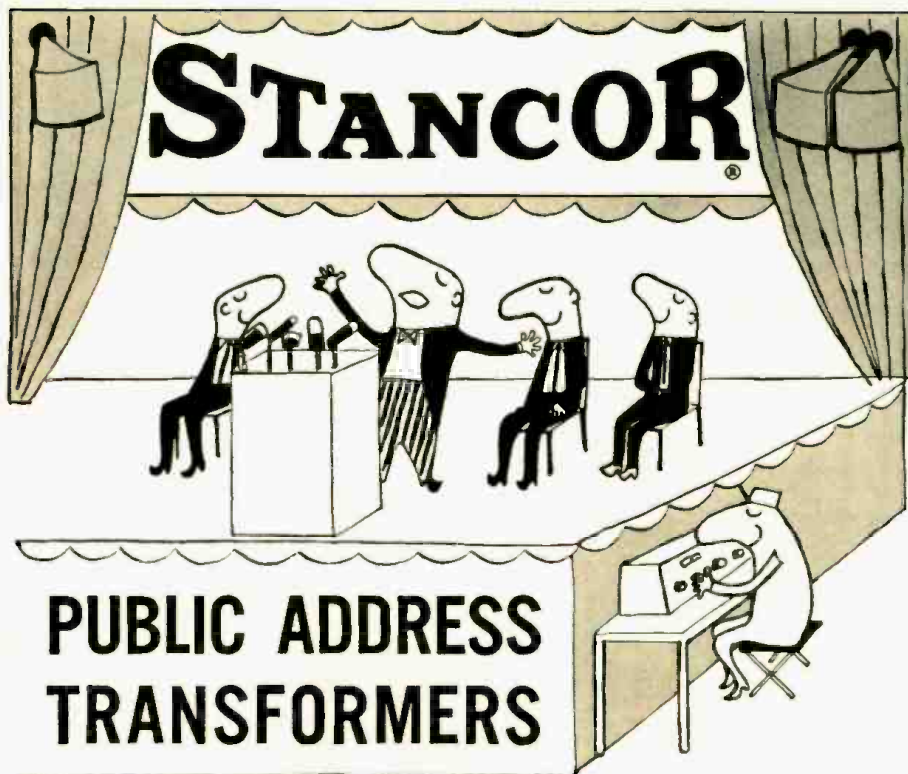

PUBLIC ADDRESS TRANSFORMERS

The MOST COMPLETE LINE in the industry

For all your public address needs, STANCOR offers your widest choice of transformer types and ratings:

- * 25 Volt Line to Voice Coil
- * 70.7 Volt Line to Voice Coil
- * 140 Volt Line to Voice Coil
- * Intercom and Transceiver
- * Microphone to Grid or Line
- * High Fidelity Output



FREE: STANCOR'S General transformer catalog listing 700 transformers including over 200 units for public address use. See your STANCOR distributor or write Chicago Standard for your copy.



CHICAGO STANDARD TRANSFORMER CORPORATION

3505 ADDISON STREET • CHICAGO 18, ILLINOIS

DEPENDABLE TV-RADIO TUBES



1-YEAR GUARANTEE

Tubes for TV-Radio Servicemen, Dealers, Experimenters.

Nationally sold ZALYTRON Tubes are BRAND NEW Quality Tubes, priced low to help you meet competition in your area — and guaranteed to perform as well and as long as tubes much higher priced. Why pay more? Try them once, you'll buy them always. Every tube we ship is covered by our Full Refund Guarantee. . . . YOU be the judge! Send today for new Price List "RN"

BE YOUR OWN BOSS RUN A SELF-SERVICE TUBE BUSINESS

Get This Modern Sturdy Tube Tester

FREE

with "Package Deal" order for nationally sold ZALYTRON Quality Brand Receiving Tubes. We'll show you how to start a successful Tube Tester Route, and get YOUR share of today's Big Profits in Self-Service Tube Sales! This is no "Get-Rich-Quick" scheme but a solid, proven business that will reward you well — if you WORK at it. But, INVESTIGATE before you INVEST! Get full details on the best "Deal" now being offered, send today for our Booklet "RN"

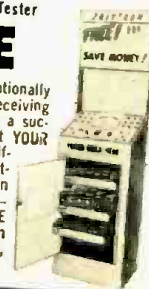

ZALYTRON TUBE CORP.
220 West 42nd St.,
New York 36, N. Y.

Semiconductor Capacitors

(Continued from page 47)

could be used in ham transmitters, signal generators, and the like. In this circuit R_1 is a load for the audio signal and C_2 is an r.f. bypass capacitor. R_2 is the r.f. isolation resistor (or r.f. choke), C_3 the d.c. blocking capacitor, L_1-C_4 the oscillator tank circuit, and C_1 the "Varicap," which is effectively across the tank circuit. The center frequency of the oscillator may be controlled by varying the d.c. bias through R_2 . Signal voltage across R_1 varies the bias on the "Varicap," changing its capacitance and the resonant frequency of the tank circuit, resulting in frequency modulation of the oscillator.

A very unusual application of the variable capacitor diode has been under study for some time. This is its use as the variable reactance component in a whole new class of amplifiers known as variable reactance or "varactor" amplifiers. These units require a variable reactance, or "varactor," as the active element. The semiconductor diode capacitor can serve as the "varactor" since its capacity and thus its reactance varies with the applied voltage.

Extensive work on "varactor" amplifiers has been carried out at *Bell Telephone Laboratories*, where it has been found that useful low-noise amplification is possible with the semiconductor diode serving as the "varactor" element. In fact, using several of the diodes in a sort of traveling-wave-tube configuration, a bandwidth of 100 megacycles at a frequency of 400 megacycles has been achieved. This amplifier introduces less noise into the signal being amplified than conventional vacuum-tube amplifiers or mixers, thus making it potentially useful in u.h.f. television receivers.

In another experimental diode amplifier undergoing tests at *Bell Telephone Laboratories*, useful low-noise amplification was obtained at 6000 megacycles, with a bandwidth of about 8 megacycles. Such performance indicates that this type of amplifier can be of value in improving the sensitivity of microwave receivers associated with such systems as radar, radio astronomy, and microwave relays.

Another interesting application of the semiconductor diode capacitor is its use as an up-converter with gain. In a new type of microwave system under development at *Bell Telephone Laboratories*, such diodes are used to provide gain in up-converters where the frequency is changed from approximately 70 megacycles to about 6000 megacycles. This is the first instance of up-conversion using a semiconductor diode in which there was no measurable loss.

From the foregoing we can see that solid-state research has led to a new device which shows promise of becoming an extremely useful component in the electronic industry.

36 FABULOUS STEREO WATTS

ONLY \$69⁵⁰

**\$7 DOWN
\$7 MONTHLY**



MONEY-BACK GUARANTEED TO EQUAL UNITS COSTING UP TO \$130!

A RADIO SHACK EXCLUSIVE! It took all of Radio Shack's 36 years of engineering and production know-how to produce a low-cost stereo/monaural amplifier without compromising the highest possible standards of audio quality! Compare the laboratory-verified, guaranteed specifications and see why the REALISTIC STEREO 36 is America's biggest monaural and stereo amplifier value!

STEREO/MONAURAL!
MASTER GAIN!
REVERSE STEREO!
UNDER 1 db DISTORTION!
MODE INDICATOR LIGHTS!

BALANCE CONTROL!
SPEAKER PHASING!
20-20,000 cps \pm .5 db!
LOUDNESS ON/OFF!
BASS & TREBLE CONTROLS!

Realistic "Stereo-36"

STEREO/MONAURAL AMP/PRE-AMP! COMPLETELY WIRED FOR LESS THAN KIT PRICE!

Power Output: 18 watts per channel (36 watts peak!). Freq. Response: 20-20,000 cps \pm 0.5 db. Hum and Noise: 80 db down on high level inputs; 55 db down on Mag. Phono, 50 db down on Tape Head. Distortion: less than 1 db at full rated output! Sensitivity: (for full output) Phono—2.5 mv., Tape Head—2.5 mv., Tuner and Aux. 0.25 v. Operational controls include: Separate wide-range (\pm 12 db) bass and treble controls; Twin-section, single-action master volume control with loudness off-on switch; Channel balance control; Variable equalization control; Channel mode selector with indicator lights and rumble reduction setting for use on monaural records; 4-position input selector (Mag. Phono, Ceramic Phono, Tape Head, Tuner and auxiliary.); Speaker phasing switch. Has 4, 8 and 16 Ω outputs for each channel plus 2 low imp. outputs for direct input to tape recorder. Tubes include 5—12AX7 (ECC83), 4—6BQ5 (7189) and 1—GZ-34 rectifier. Amplifier is fully fused and has 2 convenience AC receptacles. 140 watts, 115-volts AC. Faceplate is flat white with etched gold and maroon design. Brushed-gold finished metal cabinet. 5/4" h. x 14 1/2" w. x 11 1/2" d. Ship. wt. 13 lbs.

SAVE EVEN MORE ON THESE SUPERB STEREO SYSTEMS!



	Reg. Value
Realistic Stereo-36 HI-Fi Amplifier	\$129.95
British Monarch Hi-Fi Changer	54.50
G-E Diamond Stereo GC-7 Cartridge	23.47
2-Realistic Solo Speakers in Cabinets	39.90
Total Reg. Value	\$247.82

SAVE \$118.32 \$129.50

Order No. RX-SS7MY, Ship. Wt. 70 lbs.
\$13 DOWN, \$10 MONTHLY
Base for Changer, R-5900B
Wt. 4 lbs. — Net \$3.49

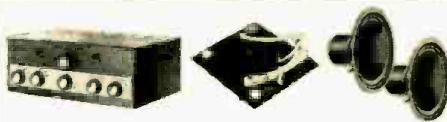

	Reg. Value
Realistic Stereo-36 Hi-Fi Amplifier	\$129.95
Garrard RC-121/II Stereo Changer	41.65
G-E Diamond Stereo GC-7 Cartridge	23.47
2-E-V SPI2B Hi-Fi 12" Coax Speakers	68.60
Total Reg. Value	\$263.67

SAVE \$103.72 \$159.95

Order No. RX-SS8GY, Ship. Wt. 65 lbs.
\$16 DOWN, \$12 MONTHLY
Base for Garrard, 15C785
Wt. 4 lbs. — Net \$4.51



	Reg. Value
Realistic Stereo-36 Hi-Fi Amplifier	\$129.95
Harman-Kardon T-224 Stereo FM-AM Tuner	114.95
Garrard RC-121/II Stereo Changer	41.65
Pickering Stereo Diamond Cart. 371	29.85
2-University UXC-122 Hi-Fi 12" Diffaxials	64.68
Total Reg. Value	\$381.08

SAVE \$121.13 \$259.95

Order No. RX-SS9H, Ship. Wt. 83 lbs.
\$26 DOWN, \$16 MONTHLY
Base for Garrard, 15C785
Wt. 4 lbs. — Net \$4.51

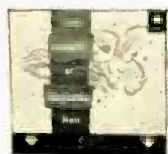

FREE CHRISTMAS ALBUM!

With purchase of Realistic Stereo 36 amp. or any of above systems! Fabulous London frrr! "Carol Singing at Kingsway Hall" — beloved favorites in glorious hi-fi!

RADIO SHACK

C O R P O R A T I O N

FREE!
Fabulous new 1959 232-page catalog.



730 Commonwealth Ave., Boston 17, Mass.
167 Washington St., Boston 8, Mass.
230-240 Crown St., New Haven 10, Conn.

Dept. 12F

Radio Shack Corp.

730 Commonwealth Ave., Boston 17, Mass.

Please send me Realistic Stereo 36 amplifier

RX-SS7MY system RX-SS8GY system

RX-SS9H system Include changer base for system checked. Check or money order is enclosed.

Send free 232-page 1959 catalog.

NAME.....

ADDRESS.....

CITY..... ZONE..... STATE.....

UHF-VHF

AN/APR-4 38-4000 MC RECEIVER—

This is a precision receiver covering 38-1000 mc. The set utilizes 5 tuning units with direct reading dials in megacycles. The receiver has a wide and narrow band-width 30 mc I.F. strip which may be selected at will. An output meter is provided to measure signal strength. Outputs are provided for a pulse analyzer and pan adapter. 110V AC. 60-2600 cycle. With 3 tuning complete unit, excellent. **\$159.50**

BC603 FM RECEIVER

20-27 mc. Equipped with 10 push buttons for selecting channels. Cont. variable tuning over the entire range. Unit complete with tubes, built-in loudspeaker, squelch circuit, head phone jacks, schematic diagram on bottom of case. Approx. weight 34 lbs. For conversion to 6 meters AM or FM write for further information. Unused **\$12.95**

Original 12 Volt Dynamotor for above DM 34. Unused..... **4.95**

BC 604—Companion Transmitter for above 20 to 27 MC FM. Unused.. **7.95**

Original 12 Volt input Dynamotor for above—625 VDC C 225MA output. Unused **10.95**

FT 237—Mounting rack for above Rec. & Transmitter. Unused..... **4.95**

BC-659 FM RECEIVER-TRANSMITTER

Xtal controlled, two channels, freq. range 27-38.9, 9 mc. 13 tubes, built-in speaker, dual meter for testing filament and plate circuits.

EXC. **\$6.95**

PE-117—6 or 12 Volt vibrator type Power Supply for BC 659. **\$5.95**

I-177 TUBE CHECKER

A portable dynamic or mutual transductance type. 3" circular meter indicates condition of tube for normal operation. Presence of gas, short circuits between elements and noise, also measures the dynamic mutual conductance. 110 V. AC—60 Cycle. **\$16.95**

USED.....

ARB/RCA SIX TUBE RECEIVER

All purpose super het receiver covering 195 KC to 9000 KC including weather, lighthouse, aircraft, radio range, broadcast, marine and amateur 160 meter, 80 meter, 75 meter and 40 meter, with tubes, 24 volt dyna. and schematic. EXC. **\$17.95**

Accessories for remote tuning per set **5.00**
Write for information on conversion.

\$45.00 HI-FI HEADSET

Uses annular grooved plastic fibre, comes with voice coils as in speakers and brand new rubber ear pads to obtain spacing for correct acoustical load. GIVES FINEST MUSIC REPRODUCTIONS! Imp.: 300 Ohms per unit or 600 Ohms when wire series. BRAND NEW. **\$7.95**

HS-23—2000 Ohm Headphones. **4.95**

CD-307. Extension Cord for above. **.97**

ARC-1—100-156 MC Transceiver **\$59.50**

EXC.

BC 669. Six Channel Crystal Controlled, 50 Watt Radio Telephone, 1600 to 4500 KC. Ideal for boats or land station, less power supply. Used **\$59.50**

LM-20 FREQ. METER with original Calibration Book and Crystal. **\$79.50**

BRAND NEW.

LM-13 FREQ. METER with original Crystal and Calibration Book. **\$49.50**

Used—EXC.

T-19—3.4 MC XMTR. EXC. **5.95**

BC 458—5.37 MC—EXC. **5.95**

T-23—100-156 MC XMTR. NEW. **13.95**

R-28—100-156 MC RECEIVER. EXC. **15.95**

TA-12—XMTR, 100 Watt. EXC. **\$19.95**

MP-28—MODULATOR and 28 V. DC Power Supply for above. EXC. **14.95**

WRITE FOR LATEST FLYER

R W ELECTRONICS

2430 S. Michigan Ave., Dept. N
Phone CALumet 5-1281 Chicago 16, Ill.

Versatile LC Meter

(Continued from page 41)

Inductance measurements are made in the same direct manner, the remaining 180 degrees of the dial face being utilized for coil values. This arrangement results in a positive, easily read dial.

The circuit is stable and readily adjusted. Parts placement is not critical, the only precaution being that coil L_2 must be constructed and wired exactly as pictured. (See Figs. 2, 3, and 4.) Connections of correct polarity are a "must."

Construction

For ease of assembly, the small parts are pre-mounted on an insulating strip (Fig. 3) in lieu of a chassis. After wiring, the strip is bolted to the cabinet, using small brackets. The meter tuning capacitor C_3 , and the "Sensitivity" potentiometer, R_3 , are best mounted before attaching the strip.

Calibration

With the switch set to "C" (capacitance) and clip leads *not* touching, position the main dial so that the plates of C_3 are fully meshed. Now, turn the L_2 coil slug until a pronounced meter dip occurs. This dial point may be marked as "zero," for the capacitance scale. If a minimum meter reading does not occur as the slug is adjusted through its complete range, adjustment of the number of turns on L_2 may be necessary to obtain resonance. Silver micas of 5 per-cent tolerance are preferred for use as calibration standards to set up the rest of the scale; however other types, of known values, may be used.

Inductance scale calibration is equally simple. Switch to "L" (inductance) being sure that the leads *are* clipped together this time. Rotate the dial again to the same, fully meshed point. Adjust the L_2 slug for a minimum meter reading. This point becomes the inductance scale "zero." Standards for calibrating the inductance portion of the dial may be video

peaking coils, r.f. chokes, and other known values of inductance. A value of 200 microhenrys should be used for calibrating the high-value end of the dial, adjusting the L_2 slug for a meter dip. As in the case of the capacitance range, known-value coils are clipped to the instrument, the dial is rotated for a meter minimum and the dial marked accordingly. This process is continued with different coils, for as many calibration points as desired.

Operation

The simplicity of use has already been outlined. For in-the-circuit use, capacitors may be accurately measured even though paralleled by resistances as low as 10,000 ohms. Additional uses are many, including measurement of transmission-line capacitance, wiring, and component stray capacitance, etc. Sealed coils, i.f. transformers, and other inaccessible windings are conveniently measured. The meter "Sensitivity" control R_3 is provided to limit the grid current and permit on-scale meter readings under all conditions. Since the tube is well loaded, only sufficient grid current should be used to enable reliable readings.

Clearing a single TV chassis "dog" more than justifies the small investment in this versatile instrument. This utility is being obtained with all these other advantages: Measurements down to 1 $\mu\text{fd.}$, in the circuit, with a single, permanent test lead for all work; crystal-controlled accuracy in a stable, drift-free unit; cold test leads that eliminate shock despite the absence of an isolation transformer; and instant heating without warm-up.

Also, the instrument provides indication of shorted and open conditions; permits fast, one-hand operation with a single, direct-reading scale that needs no range-switching; and is made up of standard, rugged commercial parts, with the exception of the coils, which are easily hand wound. It is compact and light enough (less than 3½ lbs.) to create no space problem and to be carried about easily. Its current drain is so low that it may be left on continuously.

-30-

Fig. 3. Rear view of chassis showing the location of important components.

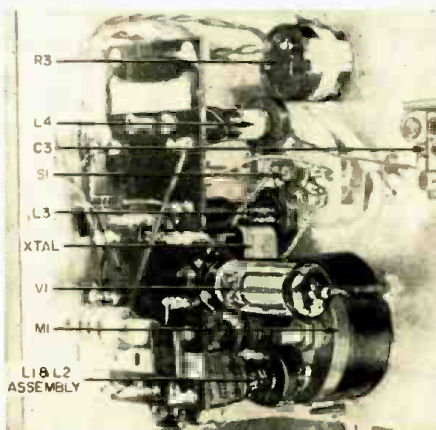
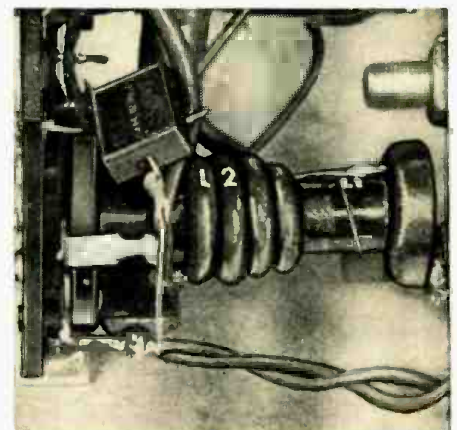

Fig. 4. Close-up of the L_2 assembly. See text for construction particulars.



LORAN R-65/APN-9 RECEIVER & INDICATOR



Used in ships and aircraft. Determines position by radio signals from known transmitters. Accurate to within 1% of distance. Complete with tubes and crystal. Exc. used. Value \$12.00. Our Price **\$89.50**

TS-100/AP OSCILLOSCOPE

(worth \$750) OUR LOW PRICE **\$333**

Can be used with linear sweep or general purpose test scope. Cables included. Also used with circular sweep as precision range callibrator. Self-contained in metal case 8" x 12 1/2" x 16" deep. For 110 V 50 to 1200 cycles AC. Excellent used, like new, with all tubes including crystals and C. R. Tube.

SCR-522 2-METER RIG!

Terrific buy! VHF Transmitter-receiver, 100-150 Mc. 4 channels. Xtal-controlled. Amplitude modulated voice. They're going fast! Excellent condition. SCR-522 Transmitter-Receiver, complete with all 18 tubes, top rack and metal case. **\$33.33**

Receiver only, with all tubes... \$19.50
Transmitter Only, with all tubes... \$22.25
Accessories for above available.

BC-620 FM TRANSCEIVER, 20-28 Mc. BRAND NEW **\$9.95**
PE-120 6-12V POWER SUPPLY, with Tubes and Vib. NEW **\$11.95**
Shock Mt. Rack, NEW **\$2.95**
ARB Receiver 4 band 195-9050 Kc. **\$17.95**
with all Tubes, Like New.
Brand New, with Tubes and Dynamotor... **\$34.50**

LORAN APN-4 FINE QUALITY NAVIGATIONAL EQUIPMENT



Determine exact geographic position of your boat or plane. Indicator and receiver complete with all tubes and crystal. INDICATOR ID-6B/APN-4, and RECEIVER R-9B/APN-3. BRAND NEW **\$48.49**

Complete Kit of Accessories for Above: PE-208 Inverter, Set of Plugs, Visor for Indicator, Operation Manual. ALL BRAND NEW **\$49.50**

SPECIAL APN-9A LORAN Receiver Indicator

less tubes, NEW (demilitarized) **\$24.50**

I-152-AM ALTIMETER INDICATOR

Brand New, With Tubes. Only **\$17.95**

LORAN APN/4 OSCILLOSCOPE



Easily converted for use on radio-TV service bench. Completely Assembled

BRAND NEW! Supplied with 5" Scope, type SCPI only **\$19.95**
Excellent. Used... **\$14.95**

DYNAMIC HANDMIKE, with "Press-to-talk" Switch on handle, cord and plug—BRAND NEW, only **\$2.95**

DYNAMIC HANDMIKE, aircraft, made by Telephonics Corp. Press-to-talk switch on mike. BRAND NEW **\$4.95**

Hi-Fi DYNAMIC HEADSET with Cushions

Freq. Range: 40-14000 CPS. No Distortion. BRAND NEW **\$7.95**

MICROPHONES

Model	Description	Excellent Used	BRAND NEW
T-17	Carbon Hand Mike	\$4.95	\$7.45
T-30	Carbon Throat Mike	.39	.79
T-45	Army and Navy Lip Mike	1.33	1.33
T-24	Carbon Mike	5.95	5.95
TS-9	Handset	3.88	3.88
RS-38	Navy Type	2.79	4.95

HEADPHONES

Model	Description	Excellent Used	BRAND NEW
HS-23	High Impedance	\$2.25	\$4.75
HS-33	Low Impedance	2.79	4.75
HS-30	Low Imp. (featherwt.)	1.25	1.99
H-16/U	High Imp. (2 units)	3.75	7.95

TELEPHONICS—600 ohm Low Impedance HEADSETS. BRAND NEW, PER PAIR... **\$3.45**

CD-307A Cords, with PL55 plug and JK26 Jack .99
Earphone Cushions for above—pair... **.50**

Type	Each	Type	Each	Type	Each
2C42	\$4.95	VR150	.49	826	4.44
SD21	4.50	807	1.19	832A	7.50
RK65	7.25	813	6.95	5CP1	2.45
VR105	.49	815	2.99	5FP7	1.44

WILLARD 6-VOLT MIDGET STORAGE BATTERY



3 Amp. Hour. BRAND NEW. 3 5/8" x 1-13/16" x 2 3/4". Uses Standard Electrolyte. Only **\$2.69**

2 VOLT BATTERY "PACKAGE"



1-2V, 20 Amp. Hr. Willard Storage Battery **\$2.79**
1-2V, 7 Bronk Synchronous Plug-in Vibrator **1.49**
1-Quart Bottle Electrolyte (for 2 cells) **1.49**
ALL BRAND NEW!
Combination Price **\$5.45**

110V AC to 110V DC RECTIFIER & CHARGER



Manufactured by Hallicrafters

INPUT: 95 to 125V 50-60 cycle AC, or 100 to 250V 50-60 cycle AC. OUTPUT: 115V DC up to 400 Ma.; 115V AC up to 4.95 Amps. This unit is ideal for Garages, Gas Stations, Auto Supply Stores, to maintain a series of batteries on display. Also fine for Research Labs, Engineers, Manufacturers, operate DC Teletype Equipment, etc. A TERRIFIC BUY AT OUR SMASHING LOW **\$11.95**
PRICES: Like New...
Brand New... **\$14.95**

BC-652A RECEIVER

Hot Special! 2 to 6 Mc Receiver, 2-band, complete with all tubes and 12V dynamotor. Fine for 80-meter Ham band, Marine etc. Provider for CW, MVC, AVC. Speaker Jack and two headphone jacks. Like New, only **\$29.50**

BC-659 TRANSMITTER & RECEIVER

27 to 38.9 Mc F.M. Two preselected channels crystal controlled. 5 to 10 watts. Complete with speaker, tubes. Brand New **\$11.95**
Exc. Used... **\$7.95**
Vibrator Supply for 6-12-24 Volts, NEW... **\$9.95**

BC-645 XMTR RECEIVER



15 Tubes 435 To 500 MC

Can be modified for 2-way communication, voice or code, on ham band 420-450 mc. citizens radio 460-470 mc. fixed and mobile 450-460 mc. television experimental 470-600 mc. 15 tubes (tubes alone worth more than sale price!); 4-7F, 4-7H7, 2-7E6, 2-6F6, 2-9E5 and 1-WE316A. Now covers 460 to 490 mc. Brand new BC-645 with tubes, less power supply in factory carton. **\$29.50**

Shipping weight 25 lbs.

PE-101C DYNAMOTOR for BC-645, has 12-24V input (easy to convert for 6V Battery operation) **\$7.95**
UHF ANTENNA ASSEMBLY, for BC-645... **\$2.45**
Complete set of 10 Plugs **\$5.50**
for BC-645 **\$5.50**
CONTROL BOX for above... **\$2.25**
SHOCK MOUNT for above... **1.25**
CONVERSION BOOKLET, Instructions **\$2.50**
for most useful surplus rigs.

NEW VALUES—JUST ARRIVED!

BC-348 SUPERHET RECEIVER. Locally controlled 8-tube 6-band receiver for aircraft, communications type, for voice, tone and CW. 200 to 500 Kc and 1.5 to 18 Mc. For operation on 24 V DC with self-contained dynamotor. Complete with tubes. **\$88.88**

Exc. used **\$59.50**

AN/ARN-7 AIRCRAFT NAVIGATIONAL INSTRUMENT. Superhet radio receiver. Range 100 Kc to 1750 Kc in 4 bands. **\$59.50**
Exc. used **\$169.50**

AR/ARN-6 RADIO COMPASS EQUIPMENT. Frequency 100 to 1750 Kc in 4 bands. 24 V DC operation. **\$119.50**
Exc. used **\$169.50**

BC-733 VHF 10-TUBE AIRCRAFT RECEIVER. 6-channel xtal control. Freq. 108.3 to 110.3 Mc. Dual filter range. Easily converted for tracking Sputniks! **\$9.95**
Exc. used **\$12.95**
BRAND NEW **\$12.95**
Dynamotor for above 12/24 V.—New **\$5.95**

AN/APR-4 RECEIVER only. 38 to 4000 Mc in 6 tuning unit ranges. High precision laboratory instrument used to monitor or indicate frequency of any signals within its range. Includes wide and narrow band IF strip selected from panel. Outputs provided for attachments to pulse analyzer, panadapter, etc. **\$69.50**
Input 115 V 60 cy. BRAND NEW **\$69.50**
Tuning Units for above—each **\$39.50**

AN/ARC-1 Airborne radiophone ground to plane Rev-Xmitter. 10-channel xtal controlled, easily converted to 20 or 50 channel, VHF 100 to 156 Mc AM. Complete with tubes, mtg rack, dynamotor. OUR LOW PRICE **\$89.50**
Exc. **\$16.95**

AN/ARN-5A AIRCRAFT RECEIVER. 11 tube superhet. 3-crystal control UHF for static-free reception. **\$16.95**
Exc. used with tubes... **\$19.95**
BRAND NEW

BC-312 RADIO RECEIVER FOR VEHICLES

6 Bands 1500 KC to 18 Mc. continuous tuning. Phone and CW, internal 12v. dynamotor. Swell ham mobile receiver very clean, dia-gram included. Exc. Used. **\$54.50**

Please include 25¢ deposit with order—Balance C.O.D. 50¢ Handling Charge on all orders under \$5.00. All shipments F.O.B. Our Warehouse, N.Y.C.

G & G Radio Supply Co.

Telephone: CO 7-4605
51 Vesey St., New York 7, N. Y.

MOBILE-MARINE DYNAMOTOR



Input 12v DC. Output: 625 V DC @ 225 Ma. for press-to-talk intermittent operation. Shpg. wt. 14 lbs. **\$7.88**
OUR LOW PRICE

OTHER DYNAMOTOR VALUES: Excellent BRAND

Type	Input	Output	Used	NEW
DA-19-A	28V 11A	400V .400A	\$4.99	\$6.95
DM-28	28V	224V .07A	2.95	4.95
DM-32A	28V 1.1A	250V .05A	2.95	5.95
DM-33A	28V 5A	575V .16A		
	28V 7A	540V .25A	1.95	3.95
DM-34D	12V 2A	220V .080A	4.25	5.50
DM-37	25.5V 9.2A	625V .225A	5.95	8.95
DM-40	14V 3.4A	172V .138A	1.75	3.45
DM-53A	28V 1.4A	220V .080A	3.95	5.95
PE-73C	28V 20A	1000V .350A	8.50	11.50
PE-86	28V 1.25A	250V .050A	2.95	5.24
PE-186	28V 11A	400V .400A		6.95
2880	14V 2.4A	250V .060A		5.95

SCR-274 COMMAND EQUIPMENT

ALL COMPLETE WITH TUBES

Type	Description	Used	Like NEW
BC-453	Receiver 190-550 KC.	\$14.95	\$16.95
BC-454	Receiver 3-6 Mc.	9.95	12.95
BC-455	Receiver 6-8 Mc.	10.95	13.50
BC-450	3-Receiver Control Box.	1.49	1.95

110 Volt AC Power Supply Kit, for all 274-N and ARC-5 Receivers. Complete with metal case, instructions. Factory wired, tested, ready to operate. **\$7.95** \$11.50

SPLINED TUNING KNOB for 274-N and ARC-5 RECEIVERS. Fits BC-453, BC-454 and others. Only **49c**

BC-457 TRANSMITTER—4-5.3 Mc. complete with all tubes and crystal. BRAND NEW **\$7.88**
BC-458 TRANSMITTER—5.3 to 7 Mc. Complete with all tubes and crystal. **\$7.88**
BRAND NEW
BC-459 TRANSMITTER—7-9.1 Mc. complete with all tubes and crystal. **\$12.95**
BRAND NEW
ARC-5/T-19 TRANSMITTER—3 to 4 Mc. BRAND NEW complete with all tubes & crystal **\$8.88**
ARC-56 Modulator. USED 3.45. NEW 4.95
BC-451 Transmitter Control Box. 1.25. NEW 1.49

UNIVERSAL POWER SUPPLY KIT For All Command Transmitters and others with similar power requirements. Input: 117V 60 cycles AC. Outputs: 450 V DC @ 150 Ma., 250 V DC @ 50 Ma., 24 V DC @ 2 Amps. Specially designed for Command Xmitter power requirements, but can be used on other similar equipment. Carefully designed, uses quality components. A really substantial, good-looking unit, very low priced! **\$29.50**

ARC-5/R28 RECEIVER



2-meter Superhet. 100 to 150 Mc in 4 crystal channels. Complete with 14 45 BRAND NEW **\$24.45**
110V AC Power Supply Kit for above. **\$9.75**

ARC-5/T-23 TRANSMITTER

100-150 Mc Includes 2-832A, 2-1025 Tubes. **\$21.50**
BRAND NEW
SPECIAL Limited quantity ARC-5/T23 xmitters. BRAND NEW, less tubes. **\$7.95**
OFFER! Excellent Used, less tubes. **\$5.95**

ARC-5 MARINE RECEIVER-TRANSMITTER

Navy Type Comm. Receiver 1.5 to 3 Mc. BRAND NEW with 6 tubes... **\$16.95**
Navy Type Comm. Transmitter 2.1-3 Mc. BRAND NEW with 4 tubes and Xtal... **\$12.45**
MODULATOR for above, new with tubes... **\$4.95**

BC-603 FM RECEIVER. 10-channel push button tuning or continuous tuning. 20-28 Mc. Complete with speaker, tubes, squelch. **\$10.95**
Exc. Used **\$14.95**
BRAND NEW **\$14.95**
12 or 24V Dynamotor for Above **Brand New \$5.50**
Exc. Used **\$4.25**

BC-683 same as above except 27 to 38.9 Mc. **\$19.50**
BRAND NEW **\$24.95**

AC POWER SUPPLY for BC603, 683. Interchangeable. replaces dynamotor. No revr change except add on-off switch to front panel. Provides 220VDC @ 80 Ma. 24VAC @ 2 Amps. Complete kit, with **\$10.50**
easy instructions

BC-906 FREQ. METER—SPECIAL!



Cavity type. 145 to 235 Mc. BRAND NEW, complete with antenna. Manual included. OUR LOW PRICE **\$9.99**

BC-221 FREQUENCY METER



SPECIAL BUY! This excellent frequency standard is equipped with original calibration charts, and has ranges from 125 Kc to 20,000 Kc with crystal check points in all ranges. At our smashing low price it's FIRST COME FIRST SERVED! Hurry, quantity is limited! Like New... Only **\$88.88**
BC-221 Modulated Type... **\$129.50**

CABINET for above BC-221 **\$3.99**
Original 1000 Kc Crystal for BC-221. BRAND NEW **\$8.45**

SCHEMATIC DIAGRAMS For any equipment on this page, each... **65c**

Your choice of school
is highly important
to your career in



**INDUSTRIAL
ELECTRONICS**



**RADIO-
TELEVISION**



**ELECTRONICS
COMMUNICATIONS**

Become an
**ELECTRICAL
ENGINEER**
or an
**ENGINEERING
TECHNICIAN**
at

MSOE in Milwaukee

Choose from courses in:

ELECTRICAL ENGINEERING

Bachelor of Science Degree
in 36 months—
Communications or
Electrical Power.

ENGINEERING TECHNOLOGY

Associate in Applied Science
degree in 18 months—
Electronics Communications
Electrical Power or Computers.

MSOE—located in Milwaukee, one of America's largest industrial centers—is a national leader in electronics instruction—with complete facilities, including the latest laboratory equipment, visual aid theater, amateur radio transmitter—offers 93 subjects in electrical engineering, electronics, radio, television, electrical power, and electricity.

Advisory committee of leading industrialists. Courses approved for veterans. Over 50,000 former students. Excellent placement record. Previous educational, military, and practical experience is evaluated for advanced credit.



QUARTERS BEGIN SEPTEMBER,
JANUARY, MARCH, JULY

Choose wisely—your
future may depend on it.
Mail coupon today!

MILWAUKEE

SCHOOL OF ENGINEERING
Dept. RT-1258, 1025 N. Milwaukee St.
Milwaukee, Wis.
Please send free illustrated career booklet
(please print)

I'm interested in.....
Name..... Age.....
Address.....
City..... State.....
Are you eligible for veterans educational
benefits?
Discharge date.....

MS-57

Mac's Service Shop

(Continued from page 66)

compare the pattern produced by one half of the yoke winding with that produced by the other half to see if any unbalance exists. Admittedly this takes time, but when you don't have a replacement yoke with you it could be a great help in pinpointing trouble and making an accurate estimate."

"How about this probe that looks like the baby brother of a grease gun?"

"That's called a 'Slave Oscillator.' Actually it contains separate vertical and horizontal multivibrator oscillators that can be substituted for those in the TV set. The 12BH7A tube filament is supplied through a line cord resistor. 'B' voltage is taken from the set. Horizontal and vertical hold controls and a vertical size control are provided. The slave oscillator can be operated free-running or it can be controlled by sync signals from the receiver. To use the probe, you simply open the lead connecting the receiver oscillator to the output stage and clip the proper lead from the probe to the input of the output stage."

"That would certainly show up anything wrong with the oscillator in a hurry," Barney observed.

"Yes, and by being able to pick off the 'B-plus' and the sync input at different places, you can tell a lot about other stages, too. But let's see how smart you are. What do you suppose this probe, called 'Video Master,' is supposed to do?"

"I give up. The fellow who named these probes is too subtle for me."

"It's a high-gain tuned stage operating into a demodulator. I'd call it a TV i.f. signal tracer myself. Two calibrated tuning ranges are available that tune through the 20 mc. and 40 mc. i.f. frequencies. The output of the probe feeds into a scope and permits you to view the composite signal right from where it comes out of the tuner clear to the input of the video detector. That allows you to spot a defective stage immediately. By moving the i.f. carrier frequency around with the fine tuning and then picking it off at the proper point with the probe, you can tell where any stage is peaked. In fact, the manufacturer insists you can use the probe to align the i.f. portion of a set completely, even to setting the traps, by following instructions."

"I'll not call him a liar," Barney offered generously. "I've used a tuned probe some in radio servicing and know how versatile it can be."

"Well, we've got to get to work," Mac said as he laid the little probe down on the bench, "but I'd like for you to take these along with you on your house calls next week—after you have played around with them here until you know what they will do—and see how much use you find for them. When you are in a customer's home, reach for one of the probes only if you feel it will give you the information

you want faster and better than the other instruments you have with you. Try to decide if one of the probes can take the place of two or three other instruments you normally take with you. At the end of the week let me know what you think. I'll buy any of the probes you say you would like to have."

"OK," Barney agreed; "and I'll keep in mind what you have told me about not getting 'instrument happy' and buying every new service tool that comes out. But I can tell you right now, that no matter how these particular probes turn out, I'm glad to see manufacturers doing some thinking about our problems and coming out with compact, lightweight, specialized service instruments that will help in diagnosing and correcting trouble in the home. That tool box gets pretty doggone heavy by the end of the day and having to scamper up and down several flights of stairs to get other stuff from the truck is no snap, either. A brain that can pack a complete transistor radio into a few cubic inches ought to be able to bring out finer, more compact service instruments; and these probes look to me like a step in the right direction!"

-30-

Sun	Mon	Tue	Wed	Thu	Fri	Sat
			1	2	3	4
						5
						12
						19
						26

**CALENDAR
of EVENTS**

DECEMBER 3-5

Eastern Joint Computer Conference. Sponsored by IRE, PGEC, AIEE, and ACM. Bellevue-Stratford Hotel, Philadelphia. Program information from Dr. F. M. Verzuh, MIT Computation Center, Cambridge 39, Mass.

Second National Symposium on Global Communications. Sponsored by IRE, PGCS, and AIEE. Colonial Inn Desert Ranch, St. Petersburg Beach, Fla. Merle R. Donaldson, Electronic Communications Inc., 1501-72nd St., N., St. Petersburg, Fla., program chairman.

DECEMBER 4-5

PGVC Annual Meeting. Sponsored by IRE-PGVC. Hotel Sherman, Chicago. K. V. Glentzer, Illinois Bell Telephone Co., 208 W. Washington St., Chicago, for program information.

DECEMBER 9-11

Mid-America Electronics Convention. Sponsored by Kansas City Section of IRE. Municipal Auditorium, Kansas City, Mo. Wilbert O'Neal, The Vendo Co., 7400 E. 12th, Kansas City, will supply information on program.

JANUARY 12-14, 1959

Fifth National Symposium on Reliability & Quality Control. Sponsored by IRE, PGRQC, AIEE, ASQC, and EIA. Bellevue-Stratford Hotel, Philadelphia. W. T. Sumerlin, Philco Corp., 4700 Wissahickon Ave., Philadelphia 44, Pa., in charge of program.

Tube Makers Fight Counterfeiting

EIA adopts code to hinder processing of old tubes.

ON THE RECOMMENDATION of its Tube and Semiconductor Division, the Board of Directors of the Electronic Industries Association has adopted a code of ethics to counteract tube counterfeiting and related practices throughout the industry. The opportunity for making various uses of old tubes, EIA points out, arises from the availability of hundreds of thousands of defective, out-of-warranty receiving tubes.

Counterfeiters arrange to obtain and "wash" these to remove identifying marks that would indicate original manufacturer and warranty date code. The tubes are then imprinted with new, spurious markings to take advantage of existing manufacturer warranties and are used to obtain new tubes from these sources. In some cases the discarded tubes are re-marked so that they can be sold again on the open market.

First of the five points covered by the code is a pledge of cooperation on the part of the manufacturer with law-enforcement authorities in the detection, investigation, and prosecution of those engaged in the improper use of discarded tubes. The second point covers education of interested segments of the electronic industry to the dangers involved. This includes assistance in exposing fraudulent tube operations and emphasizing the importance of the problem to distributors, set manufacturers, and service technicians.

In addition tube manufacturers should attempt to put into effect the recommendations of grand juries and other public bodies wherever possible. Inasmuch as there is no known method of successfully renewing worn-out tubes, the code further states, manufacturers must continue present efforts to dry up the supply of discarded ones by encouraging their destruction by receiver manufacturers and on all levels of distribution.

Final point in the code deals with tube warranties. The EIA feels that it is unfair for the industry to dictate a uniform policy to be followed by all tube manufacturers. However, these programs should be established and administered in such a way as to insure against the re-introduction of discarded tubes into the market. It is felt that this can be done without infringement of each producer's right to establish his own system.

In cooperation with the spirit of this code, RADIO & TV NEWS will continue its long established policy of carefully scrutinizing all tube advertising to ascertain that the offered merchandise is correctly and legally identified. —30—

POWER YOUR ELECTRONIC DEVICES WITH LOW COST SUN BATTERIES

International Rectifier Corporation

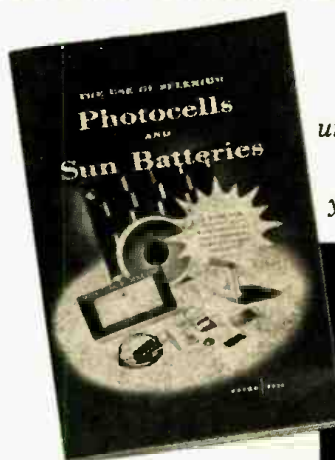

this easy-to-understand book shows you how!

84 pages cram-packed with illustrations, plans, wire diagrams. Book fully explains basic theory and applications. Dozens of exciting projects thoroughly yet simply described. It's a "must"... only \$1.50

FAMOUS B2M SUN BATTERY

only \$1.50



Most widely used sun battery. Build your own light-powered radios, motors, sun relays, oscillators or light meters.

Just Released-Satellite Type Silicon Solar Cells

Designed for even higher efficiency, these ruggedized silicon photo-voltaic cells are capable of converting up to 9% of the radiant energy falling on their surface. Gives you higher output in less space.

BUY SUN BATTERIES, BOOK AND COMPONENTS AT YOUR ELECTRONIC PARTS DISTRIBUTOR.

If not available in your area, send check or money order (no C. D. 's, please) to:
DISTRIBUTOR SALES DIVISION
INTERNATIONAL RECTIFIER CORPORATION
EL SEGUNDO, CALIFORNIA



International Rectifier Corporation

DISTRIBUTOR SALES DIVISION EL SEGUNDO, CALIFORNIA

**For my Money
XCELITE Tools are
the Finest!**

... Superbly made and designed for Radio, T.V. and Electronic Technicians. See your Distributor ... only one quality ... the finest—whether you choose individual items or the handy kits ...

Use the Tools the Professionals use!

XCELITE, INCORPORATED
ORCHARD PARK, NEW YORK
Canada: Charles W. Pointon, Ltd., Toronto

XCELITE
Quality Hand Tools
PREFERRED BY THE EXPERTS

ELECTRONIC TYPESETTER TO BE MARKETED

Prepares type more than three times as fast as normal means.

THE Wall Street Journal and RCA have announced an agreement under which RCA will produce and market an electronic typesetting machine, developed by Dow Jones & Co., Inc., and capable of preparing metal type more than three times as fast as conventional methods. The pact includes not only the "Electro-Typesetter" but also tape editing and collation apparatus, and a strip labeler for addressing newspapers, periodicals, and other printed matter. The strip labeler can print addresses on a mailing strip at the rate of 15,000 an hour—two to three times as fast as devices now in use. Earlier this year, RCA announced the development of a transistorized newspaper counter which is now in use at *The Detroit News*. All these devices are designed to help produce papers more efficiently as well as to cut some of the costs of production.

The "Electro-Typesetter," is controlled by a perforated tape produced on conventional perforator machines using a typewriter-like keyboard. When an operator taps a key, the machine cuts holes in a paper tape. This tape, in turn, is fed into a tape reading device which transmits electrical signals to the type casting machine. When a sufficient number of characters have been selected to complete a line of type, a signal perforated in the tape instructs the machine to cast the characters into a line of lead type. New versions of the machine may be operated automatically as well as manually. In this case, the keyboard is not used at all. Instead, either electrical or mechanical devices are substituted for the keyboard operator's fingers.

The counting system mentioned above can total simultaneously the output of forty different production, processing, and packaging operations, counting up to 120,000 units per minute. The system can be given a dialed order for the exact quantities desired. When that amount has been recorded, an alarm system goes into operation, and the presses or conveyers are stopped automatically. The operation permits a newspaper not only to count precisely the number of papers printed, but to limit production and prevent costly over-runs or premature press shutdowns.

The system's high-speed counting ability stems from its built-in electronic memory system, which stores counting signals and then releases them in the rapid sequence required for quick totaling.

BARGAIN HUNTERS!

BUY NEW MDSE. FROM OLD PAPPY DOW

POWER TRANSFORMERS:

5-K.W., 220 V., Pri. 3800 V.C.T. @ 2.7 amps. Wt. 308 lbs.	\$49.95
Pri. 115 V., 60 Cy., Sec. 1., 850 V.C.T., 142 ma. Sec. 2., 6.3 V., @ 10 amps. Sec. 3., 6.3 V., @ 8 amps. Sec. 4., 5 V.C.T. @ 3 amps. Secondary 5-6.5 V. Bias @ 142 ma.	4.95
Pri. 115 V., 60 Cy., Sec. 1-750 V., ct. 113 ma., Sec. 2-6.3 V., @ 5 amps. Sec. 3-5 V., @ 3 amps.	2.95
Choke 12.8 Hy. @ 200 mill. 142 ohms.	\$1.85 ea. 2 for 3.00
Choke 12 Hy. @ 150 mill. 195 ohms.	.95 ea. 2 for 1.70
Resonance Modulators, Full of Parts.	.75 ea. 2 for 1.35
Blower, 115 V., 400 Cy., 22 CFM, w/bracket.	2.75 ea. 2 for 5.00

OIL CONDENSERS:

4 x 2 mid x 600 V., wkg. used in Super Pro.	\$1.50 ea.
w/brackets.	\$ 1.75
8 mid x 1000 V., wkg.	\$1.50 ea. 2 for 2.75
9 mid x 1000 V., wkg.	1.50 ea. 2 for 2.75
15 mid x 1000 V., wkg.	1.95 ea. 2 for 3.50
1 mid x 3000 V., wkg.	.75 ea. 3 for 2.00
2 mid x 3000 V., wkg.	3.95 ea. 2 for 7.00
4 mid x 3000 V., wkg.	4.95 ea. 2 for 9.00
1 mid x 5000 V., wkg.	.95 ea. 2 for 1.50
.5 mid x 10,000 V., wkg.	7.95 ea. 2 for 14.00
.25 x 6000 V., wkg.	.75 ea. 3 for 2.00
Westinghouse Cond. 5 mid x 10,000 V.	60.00 ea. 2 for 100.00

MICA CONDENSERS:

01 @ 200 V. Patent Stamp size.	.05 ea. 25 for \$ 1.00
01 @ 1000 V. Wire Leads.	.10 ea. 15 for 1.00
08 @ 1000 V. Wire Leads.	.08 ea. 20 for 1.00

BATHYUB CONDENSERS:

2 mid 600 V., wkg. Side Lug.	\$.25
2 x 1 mid x 600 V., Side Lug.	10 for 1.00
5 mid x 400 V., Side Lug.	10 for 1.00
.25 mid x 600 V., Top Lug.	10 for 1.00
25 mid x 50 V., One Top Lug.	25 for 1.00

DYNAMOTORS:

Dynamotors, 12 V., input DMI 34.	15.00
Dynamotors, 12 V., input DMI 34.	5.00
Dynamotors, DMI 41A new 12 V. input. 172 @ 134 ma.	2.95
Perfor. Type Resistors, Your Choice.	4 for 1.00

200 WATT	150 WATT	100 WATT	50 WATT
200 ohms	200 ohms	600 ohms	25 ohms
36 ohms	1000 ohms	2000 ohms	2000 ohms
30 ohms	2000 ohms	3000 ohms	3000 ohms
80 ohms	3150 ohms	10,000 ohms	10,000 ohms
1500 ohms		12,500 ohms	
2000 ohms			

Clips ea. \$.10

3 megohm, 200 watt resistors w/clips.	ea. 1.00
10 K & 15 K—200 watt resistors w/clips.	ea. .50
10 K & 15 K—150 watt resistors w/clips.	2 for 1.00

J-14 High Speed Hand Telegraph Key with On-Off switch, adjustable spring tension and contact spacing 1/8 in. silver contacts, mounted on Bakelite base. Prepaid 1.60

R-1 Headphones, 8000 ohm imp. Prepaid 2.95

329825-145 Switch, Bistable Insulation 1/4 in. shaft, 1/4 in. long 1.01, 3 position. .25 ea. 10 for 2.00

M X 30/AP Probes, Type used on TS 34 AP Scopes. .95

3 E 7240-3 Lead set High Voltage Test Leads. .95

Relays, 6 V. DC. D1/D2, small. .95 ea. 2 for 1.75

Relays, 12 V. DC. 3 P.R.T. small. .75 ea. 2 for 1.25

Testite Switch, DPST, 5 amp. .95 ea. 2 for 1.90

1 mekolim Vol. Control w/AC switch. .95 ea. 2 for 1.50

25 watt Ohmic Pots, 2500 ohms. .85 ea. 2 for 1.50

Size tuned coils 3/8 Dia. x 1 1/4 in. w/ant. .75 ea. 2 for 1.50

C.R. Tube Sockets for 6CP1 & 3 BP1 etc. s. .75 ea. 2 for 1.50

Triple Pilot Hires, Red, Green, White. ea. .45

Intercom Tel Handsets. ea. 1.95

Transf. Midget Hipot. 20 K. C. Tap to 600 ohms—1 watt. 3.75

IF YOU PRIZE IT... KRYLON-IZE IT!

Completely seals electronic parts with no delay

KRYLON

**CRYSTAL-CLEAR
ACRYLIC SPRAY**

Radio, TV and hi-fi equipment need Krylon Crystal-Clear, the protective coating with high dielectric strength and weatherproof qualities that seal the surface indefinitely.

- Prevents corona in high voltage section
- Keeps lead-in connections tight
- Prevents rusting and pitting of antenna
- Goes on in seconds—DRIES IN MINUTES

At your favorite radio-TV repair shop.

Use Krylon Spray Paints (21 colors) for quick, easy, professional touch-up jobs

IF YOU PRIZE IT... KRYLON-IZE IT!

Square-Wave Applications

(Continued from page 70)

will be broken into a dashed line, with the number of dashes within one cycle equal to the number of square-wave cycles occurring during the same time. To determine the frequency of the unknown signal, simply divide the frequency of the square-wave generator by the number of dashes appearing during one cycle of the unknown signal. In Fig. 8D, the frequency of the square-wave generator would be divided by 12.

Assuming ten dashes to be the optimum number that may be readily distinguished and counted, it becomes possible to measure, easily, unknown signals with a frequency one-tenth the lowest frequency of the square-wave generator. Accuracy of the technique depends on the care taken in making the observation and the accuracy and stability of the square-wave generator used.

As a marker generator, the square-wave generator may be used to check short time intervals, for determining the rise or decay time of a transient pulse, and in similar applications. The connections are essentially as used for blanking purposes and the technique is similar. However, to determine the rise time, decay time, or pulse duration of a complex signal, it becomes necessary to convert the square-wave

frequency into terms of microseconds (or milliseconds) of time duration. This can be done by dividing the square-wave frequency (in pulses-per-second) into one million (for microseconds) or one thousand (for milliseconds).

Thus, a 500,000 pps square-wave signal has a time duration of two microseconds. When used for blanking the trace of a CRO, the trace is visible for one microsecond (half-cycle). From this, if the pulse being checked rises from 10% to 90% of its peak value during the unblanked interval, its rise time is 1 microsecond. If this happens during half the unblanked interval, the rise time is .5 microsecond. By using the graph screen of the CRO as a scale, it is possible to make quite accurate estimates in terms of small fractions of a microsecond.

Conclusion

As we have seen, the applications of the square-wave generator are almost unlimited. In this article we have attempted to cover only the simpler applications, requiring little additional equipment. By using additional equipment and more complex accessory circuits, it is possible to extend the applications beyond those covered here.

The square-wave generator is rapidly becoming an instrument as useful and as important as the v.t.v.m., CRO, and sine-wave generator to the experimenter, development laboratory engineer and service technician. —30—

terado Trav-Electric

MOBILE POWER CONVERTERS

Give You
110 A.C. HOUSE CURRENT ANYWHERE
You Drive or Cruise



For 6 and 12 Volt Car Batteries— Capacities: 15 to 200 Watts

\$12.95 UP

NO INSTALLATION
Just plug into cigar lighter on dash of car, truck, or boat—and away we go

OPERATE PORTABLE TV, SMALL DO-IT-YOURSELF TOOLS WHEREVER NEEDED
One of the great conveniences of our electronic age

101 USES

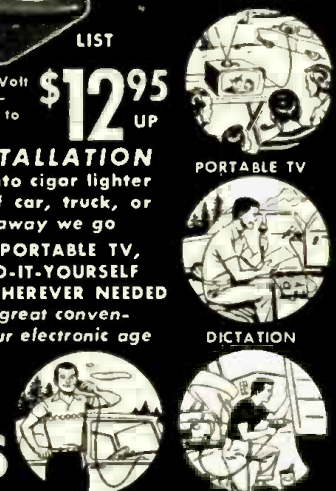

ALL ELECTRIC SHAVERS DO-IT-YOURSELF HOBBY TOOLS

See Your Electronic Parts Dealer or Jobber
terado COMPANY
DESIGNERS & MFRS. OF ELECTRONIC EQUIPMENT SINCE 1927
1058 RAYMOND AVE., ST. PAUL 14, MINNESOTA
IN CANADA: ATLAS RADIO CORPORATION LTD. - ONTARIO

BUILD 16 RADIO CIRCUITS AT HOME



New Deluxe 1959
PROGRESSIVE RADIO "EDU-KIT"®
ONLY **\$22.95**
A Complete Home Radio Course

NOW INCLUDES
★ TRANSMITTER ★ SIGNAL INJECTOR
★ SIGNAL TRACER ★ CODE OSCILLATOR
★ 12 RECEIVERS

WHAT THE "EDU-KIT" OFFERS YOU

The 1959 "Edu-Kit" offers you an outstanding PRACTICAL HOME RADIO COURSE at a rock bottom price. You will learn Radio theory, construction and servicing. You will learn how to build radios, using regular schematics; how to solder and wire in a professional manner; how to service and trouble-shoot radios. You will learn how to work with punched metal chassis as well as the new Printed Circuit chassis. You will learn the principles of RF and AF amplifiers and oscillators, detectors, rectifiers, test equipment. You will learn and practice role, using the Progressive Code Oscillator. You will build 16 Receiver, Transmitter, Code Oscillator, Signal Tracer and Signal Injector circuits, and learn how to operate them. You will receive an excellent background for TV. In brief, you will receive a fine education in Electronics and Radio, worth many times the small price you pay, only \$22.95 complete.

TROUBLE-SHOOTING LESSONS

You will learn to trouble-shoot and service radios, using the professional Signal Tracer, the unique Signal Injector, and the dynamic Radio and Electronics Tester. Our Consultation Service will help you with any technical problems.

J. Stasivis, of 25 Ponder Mill, Waterbury, Conn., writes: "I have repaired several sets for my friends and made money. The 'Edu-Kit' paid for itself. I was ready to spend \$240 for a course, but I found your ad and sent for your kit."

PROGRESSIVE TEACHING METHOD

The Progressive Radio "Edu-Kit" is the foremost educational radio kit in the world, and is universally accepted as the standard in the field of electronics training. The "Edu-Kit" uses the modern educational principle of "Learn by Doing." You begin by building a simple radio. Gradually, in a progressive manner, and at your own rate, you construct more advanced multi-tube radio circuits, learn more advanced theory and techniques, and do work like a professional radio technician.

THE KIT FOR EVERYONE

You do not need the slightest background in radio or science. The "Edu-Kit" is used by young and old, schools and clubs, by Armed Forces Personnel and Veterans Administration for training and rehabilitation. One of the most important aspects of the "Edu-Kit" is the Consultation Service which we provide. We welcome students to send us their problems, whether related to any of the material covered in the "Edu-Kit" course, or encountered in other experiences in the field of electronics.

THE "EDU-KIT" IS COMPLETE

You will receive all parts and instructions necessary to build 16 different radio and electronics circuits, each guaranteed to operate. Our kits contain tubes, tube sockets, variable, electrolytic and paper dielectric condensers, resistors, the strips, coils, hardware, tubing, punched metal chassis, Instruction Manuals, etc. In addition, you receive Printed Circuit materials, including Printed Circuit Chassis, special tube sockets, hardware and instructions. You also receive a useful set of tools, pliers-cutter, an alignment tool, professional electric soldering iron, and a self-powered, dynamic Radio and Electronics Tester. The "Edu-Kit" also includes Code Instructions and the Progressive Code Oscillator. You will also receive lessons for servicing with the Progressive Signal Tracer and the Progressive Signal Injector, a High Fidelity Guide, FCC Amateur License Training Book, and a Quiz Book. All parts, components, etc., of the "Edu-Kit" are 100% unconditionally guaranteed, brand new, carefully selected, tested and matched. Everything is yours to keep. The complete price of this practical home Radio and Electronics course is only \$22.95.

FREE EXTRAS

- SET OF TOOLS • RADIO & ELECTRONICS TESTER • ELECTRIC SOLDERING IRON • TESTER INSTRUCTION MANUAL • MEMBERSHIP IN RADIO-TV CLUB • CONSULTATION SERVICE • HI-FI GUIDE
- QUIZZES • TV BOOK • FCC AMATEUR LICENSE TRAINING • RADIO BOOK • PRINTED CIRCUITRY
- PLIERS-CUTTERS • ALIGNMENT TOOL • WRENCH SET • CERTIFICATE OF MERIT • VALUABLE DISCOUNT CARD

UNCONDITIONAL MONEY-BACK GUARANTEE

The Progressive Radio "Edu-Kit" has been sold to many thousands of individuals, schools and organizations, public and private, throughout the world. It is recognized internationally as the ideal radio course. By popular demand, the Progressive Radio "Edu-Kit" is now available in Spanish as well as English. It is understood and agreed that should the Progressive Radio "Edu-Kit" be returned to Progressive "Edu-Kits" Inc., for any reason whatever, the purchase price will be refunded to you without question, and without delay. The high recognition which Progressive "Edu-Kits" Inc. has earned through its many years of service to the public is due to its unconditional insistence upon the maintenance of the highest instructional standards and 100% adherence to its Unconditional Money-Back Guarantee. As a result, we do not have a single dissatisfied customer throughout the entire world.

Send "Edu-Kit" Postpaid. I enclose full payment of \$22.95.
 Send "Edu-Kit" C.O.D. I will pay \$22.95 plus postage.
 Send me FREE additional information describing "Edu-Kit." Also send FREE Radio, TV & Hi-Fi Books worth \$1.50. No obligation.

Name _____
Address _____

Progressive "EDU-KITS" Inc. 1186 Broadway, Dept. 84-E
Hewlett, New York

WALTER ASHE SAYS— WE NEED YOUR USED* EQUIPMENT RIGHT NOW!

Today's king size Walter Ashe "Surprise" Allowances prove you get the deal of a lifetime . . . if you trade now!

*Made since 1945

Tell us what you want . . . and what you have to trade! The coupon brings our top "Surprise" Allowance on the newest models of famous brand equipment!

Your used equipment is just like money in the bank . . . only now it's worth a lot more in trade with Walter Ashe. Choose any item you want from the brand new 1959 Ashe catalog . . . your choice of Amateur Equipment, Test Equipment or High Fidelity. But whether you have a trade or not . . . you can always count on worthwhile savings when you "order from Ashe." Make us your "One Stop Supermarket" for everything in Radio, Television and Electronics. Our stocks of replacement or original parts, receivers, transmitters, amplifiers and associate equipment were never more complete. Of course, our experienced staff is always ready to help you and speed along your orders.

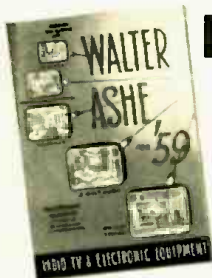

FREE! 1959 Catalog

New 144-page catalog ready now mail the coupon for your FREE copy! You'll find everything you need at lowest money saving prices. Here are the very latest in receivers, transmitters, tubes, books, test instruments, amplifiers and components . . . In stock for prompt shipment. Send today for your complete Radio-TV-Hi-Fi Buyers Guide Catalog!

ASK ABOUT TIME PAY PLAN

TRADE BIGGER—TRADE NOW

Walter Ashe
RADIO CO.

ONE STOP SUPERMARKET
1125 Pine Street—St. Louis 1, Mo.

AMATEUR GEAR



The newest from Collins, Hammarlund, National and all the other top names. Best terms, always!

TEST EQUIPMENT

We've been servicemen's equipment headquarters for over 37 years. See all the latest Radio-TV Test equipment first in our new catalog.



HI-FI COMPONENTS



Trade your present speakers, amplifiers or tuners for new monaural or stereo equipment. Ask for our big "Surprise" Allowance.

"SURPRISE TRADE-IN" COUPON

WALTER ASHE RADIO CO.
YOUR ONE-STOP SUPERMARKET
Dept. R-1258 • St. Louis 1, Mo. In Our 37th Year

- Rush New Catalog
 Send latest lists of guaranteed Used Equipment
 Rush "Surprise Trade-in" offer on my _____

For _____
(Show make and model of equipment desired)
Name _____
Address _____
City _____ Zone _____ State _____

WANTED!

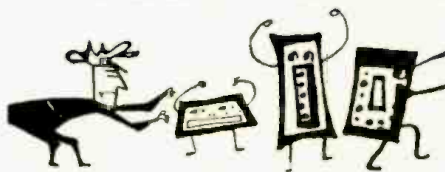

EQUIPMENT, COMPONENTS OR PARTS!

The more than 236,000 readers of RADIO & TV NEWS are always in the market for a good used equipment buy. So, if you have something to sell, let RADIO & TV NEWS readers know about it in our classified section. It costs very little: just 50¢ a word, in-

cluding name and address. Minimum message: 10 words. For further information, write:

Martin Lincoln
RADIO & TV NEWS
One Park Avenue
New York 16, New York

Amateur Receiver Kit

(Continued from page 65)

6BJ7 triple diode and to a 6CS6 pentagrid tube. The 6BJ7 is used for AM detection, delayed a.v.c., and automatic noise limiting. The 6CS6 is a combined product detector and b.f.o. tube used for SSB and c.w. signals. Diode detector output is applied to half of a 12AT7, whose cathode current is measured by a calibrated "S" meter. The other half of the 12AT7 takes audio from either the diode detector or the product detector, amplifies it, and then applies it to a 6AQ5 audio output tube. This tube's output is connected to a speaker or to a pair of phones.

Power supply for the receiver is a conventional full-wave rectifier using a 5V4 whose output feeds an LC filter. Regulated voltage, obtained from an OA2, is applied to the 100 kc. oscillator, the high-frequency oscillator, the product detector, the "S" meter amplifier, and the gain control circuits.

Alignment and Performance

Even though the receiver worked "the first time" without alignment, in order to get the top performance of which the set is capable, a careful alignment must be done. Fortunately this can be done very accurately without using any equipment outside the receiver itself. After all, the set has its own crystal oscillators that can be used as signal generators, and it has its own tuning meter that can be used as an output indicator.

The receiver is first temporarily shifted (by means of added preset mixer and oscillator trimmers) to 10 mc. so that WWV may be picked up. The 100 kc. crystal oscillator is then carefully trimmed so that its 100th harmonic zero-beats with WWV. Then the second harmonic of the 50 kc. b.f.o. is zeroed against the 100 kc. crystal oscillator. Next, the 50 kc. i.f. circuits are peaked, using the b.f.o. as signal generator. Now with these circuits accurately aligned, with the front end previously aligned by the manufacturer, and with crystal oscillators feeding the second mixer, it is only necessary to peak up the 1682 kc. i.f. circuits for a maximum reading on the "S"-meter.

We found it necessary to touch up front end adjustments for the 10-, 15-, and 20-meter bands in order to center the range of the oscillator calibration control. This may or may not be necessary in all cases.

After the complete alignment, we were able to just sit back and enjoy the fine performance of the set. It operated like a charm with all controls performing exactly as they should. The set has excellent sensitivity and selectivity and the rock-like stability needed for SSB reception.

To sum up then: the "Mohawk" is a lot of work to build, but you get a lot of receiver for your work. In short, it's well worth the effort.

-30-

Electronic Level Indicators (Continued from page 43)

swings, however, the effective resistance between cathode and grid becomes infinite since there is no current flow between these tube elements. This changing load resistance would cause severe distortion if it were not for the intervening resistance between the signal and the tube, R_1 and R_2 respectively in Figs. 2 and 3.

A similar thing happens when a neon lamp is employed as an indicator. The effective resistance of the lamp changes from about 100,000 ohms when it is fired to infinity when it is extinguished. Again a series resistor between signal and lamp is necessary to prevent the changing resistance from loading down the audio source. R_1 serves this purpose in Fig. 4, and R_1 and R_2 in the circuit of Fig. 5.

Preventing Bias Pickup

Ordinarily it is of fundamental importance that the bias current supplied to the record head does not reach the record-level indicator, thereby causing the latter to give a false reading. In Fig. 2, bias current is filtered out by C_2 in conjunction with R_1 and R_2 . In Fig. 3, filtering is essentially due to C_2 in conjunction with R_2 . In Fig. 4, filtering is accomplished by C_2 and R_1 . In Fig. 5, we have the exceptional case where bias current is deliberately al-

be further discussed below.

One of the means employed to minimize the amount of bias current reaching the record-level indicator is to pick off the audio signal prior to the stage that drives the record head. Thus the tube that supplies current to the head serves as a buffer between the bias current and the indicator.

Adjustment

If the record-level indicator is not fairly accurate in its indications, serious over-recording or serious under-recording may result. Generally, tape recorders employing an electronic indicator do not provide means for readily adjusting the indicator to correspond to maximum permissible recording level. However, Fig. 5 is an exception. The neon lamps in this circuit are fired by a combination of the audio signal and a certain amount of bias current. The variable capacitors regulate the amount of bias current reaching the lamps and thereby afford a means of adjusting the level at which they ignite.

If adjustments are desired in the circuits of Figs. 2, 3, and 4, one could change values in the voltage-divider networks. In Fig. 2, one could change R_1 . In Fig. 3, one could change R_2 , although this would also require corresponding changes in C_2 and R_2 to preserve the "floating action" time-constants of the circuit. In Fig. 4, R_2 or R_3 could be changed to place a different "bias" voltage on the lamp.

Always Buy Columbia

MEASUREMENTS CORP.
MODEL 80 SIG. GENERATOR
Freq.: 2-600 MC in 6 bands, accurate to $\pm 0.5\%$; Output voltage continuously variable from 0.1 to 100,000 microvolts. Amplitude mod. is continuously variable from 0 to 30%. Power input, 117 V., 50-60 cycles. 70 W. ORIGINAL COST WAS \$625.00; Dim.: $11\frac{1}{2} \times 19\frac{1}{2} \times 11\frac{1}{2}$ " Excellent cond. Wt. 7.5 lbs. ONLY... **\$295.00**

MEASUREMENTS CORP.
MODEL 84 SIG. GENERATOR
Freq.: 300-1100 MC in one band, direct reading dial. Freq. accurate to $\pm 0.5\%$. Output voltage continuously variable from 0.1 to 300,000 microvolts; Output impedance 50 ohms. Modulation 0.0 to 30%. Choice of 400, 1000 to 2500 cycles. Pulse freq.: 60 to 100 kc in 3 ranges: 60-1,000, 600-10,000, and 6,000-100,000 pulses per second. Power supply 117 V., 50-60 cycles. ORIGINAL COST WAS \$1,900.00; Dim.: $13 \times 26 \times 12\frac{1}{2}$ " Excellent condition. Wt. 15 lbs. ONLY... **\$250.00**
BOTH ABOVE UNITS! ONLY... **\$525.00**

T-85/APT-5 SIGNAL GENERATOR OR TRANSMITTER
Hi power. Freq.: 300-1500 MC with up to 10 W. output. Complete with 3C22 oscillator in resonant cavity, and all tubes. Excellent cond. Only... **\$49.95**

BC-342 COMMUNICATIONS RECEIVER
1.5-15 MC in 6 bands. Has 2 RF stages, xtal filter and 110 VAC power supply. Excellent cond. Only... **\$72.50**

BC-312 COMMUNICATIONS RECEIVER
Same as above but with 12 VDC dyn. instead of 110 V. power supply. Excellent cond. Only... **\$49.95**

BC-610 TRANSMITTER
500 W. GIANT! It takes an expert even to recognize this astounding value! 2-18 MC. WITH BC-614 speech amplifier, WITH antenna, WITH tuning unit, coils etc. Excellent condition. SPECIAL... **\$695.00**

APN-9 LORAN! IT'S THE LATEST!
Want the newest on the surplus market? This is it! Complete indicator and receiver. Small, compact case. Limited quantity—so **\$99.50**
hurry! Excellent condition. Only

WAR TRANSMITTER-RECEIVER
12 or 24 VDC or 115-230 V. AC Freq. 200-400 MC. Power output 10 W. crystal controlled. Makes everything before it obsolete! Complete, excellent condition. Only... **\$49.50**

SAN FERNANDO VICTORY TEST!
Visit our brand new retail branch outlet at 4900 Lankershim Blvd., No. Hollywood, Cal.

ELECTRONICS
2251 W. WASHINGTON BLVD.
LOS ANGELES 18, CALIFORNIA

Columbia

Just Out

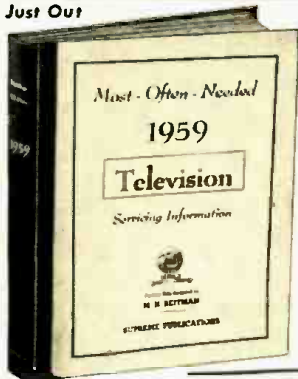

New SUPREME 1959 TV Manual

AMAZING BARGAIN

The new 1959 TV manual is the bargain of the year. Covers all important sets of every make in one giant volume. Your price for this mammoth manual is only \$3. This super-value defies all competition. Other annual volumes at only \$3 each. Factory service material simplifies repairs. Includes all data needed for quicker TV servicing. Practically tells you how to find each fault and make the repair. More pages, more diagrams, more service data per dollar of cost.

TELEVISION SERVICING COURSE

Let this new course help you in TV servicing. Amazing bargain, complete, only \$3, full price for all lessons. Giant in size, mammoth in scope, topics just like a \$200.00 correspondence course. Lessons on picture faults, circuits, adjustments, short-cuts, UHF, alignment facts, hints, antenna problems, trouble-shooting, test equipment, picture analysis. Special, only **\$3**

Companion RADIO COURSE, Introduction to TV

Here is your complete radio training in 21 easy-to-follow lessons. Covers fundamentals, fault finding, use of test equipment. Everything in radio, Introduction to TV. Self-test questions. New edition. Special, only... **\$2.50**

17 RADIO VOLUMES

RADIO DIAGRAMS

Supreme is your best source for all needed RADIO diagrams and service data. Covers everything from the most recent 1958 radios to pre-war old-timers: home radios, auto sets, combinations, changers, HI-FI, FM, and portables. Sensational values. Only \$2 for many volumes. Every manual has extra large schematics, all needed alignment facts, parts lists, voltage values, trimmers, dial stringing, and helpful hints. Volumes are large in size, $8\frac{1}{2} \times 11$ inches, about 190 pages. See coupon at right for a complete list of these radio manuals. →



COVERS ALL POPULAR SETS

Here is your service data for faster, easier TV repairs. Lowest priced. Best by comparison. Supreme TV manuals have all needed service material on every popular TV set. Helpful, practical, factory-prepared data that will really make TV servicing and adjustment easy for you. Benefit and save with these amazing values in service manuals. Only \$3 per large volume. The choice of 100,000 wise servicemen.

SIMPLIFIES TV REPAIRS

These giant TV manuals have complete circuits, needed alignment facts, printed boards, servicing hints, production changes, voltage charts, waveforms, and double-page schematics. Here are your authentic service instructions to help you do expert work quicker, and priced at only \$3 per large annual manual. Repair any TV model ever made by having in your shop all 14 volumes as listed in coupon. Your special price for all, only \$40. Or try the new 1959 TV manual to see what an amazing bargain you get for \$3. Send no-risk trial coupon today.

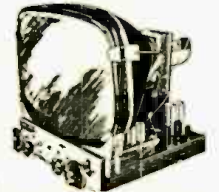

The repair of any television set is really simple with Supreme TV service manuals. Every set is covered in a practical manner that will simplify trouble-shooting and repair. This is the help you need to find toughest faults in a jiffy. Each \$3 TV volume covers a whole year of service material. New Television Servicing Course will aid you in learning TV. Be wise, buy Supreme Manuals only once each year instead of spending dollars every week.

NO-RISK TRIAL ORDER COUPON

SUPREME PUBLICATIONS, 1760 Balsam Rd., Highland Park, Ill.

- Radio Servicing Course, complete, 21 lessons, \$2.50
- 1958 Radio Diagrams, \$2.50
- 1957 Radio Manual, \$2.50
- 1956 Radio Diagrams, \$2.50
- 1955 Radio Manual, only \$2
- 1954
- 1953
- 1952
- 1951
- 1950
- 1949
- 1948
- 1947
- 1946
- 1941
- 1940
- 1939
- 1926-1938 Manual, \$2.50
- Radio & TV Master INDEX, 25c

THIS GROUP
\$2
EACH

Rush today TV manuals checked below and Radio manuals at left. Satisfaction guaranteed.

New 1959 Television Servicing Manual, only... \$3.
 1958 Television Manual, \$3. Early 1957 TV, \$3.
 Additional 1957 TV, \$3. 1956 TV Manual, \$3.
 Early 1955 TV, \$3. Additional 1955 TV, \$3.
 1954 TV, \$3. 1953 TV, \$3. 1952 TV, \$3.
 1951 TV, \$3. 1950 TV, \$3. 1949 TV, \$3.
 1948 TV, \$3. 1957-58 RCA Victor TV, \$1.50
 New Television Servicing Course, complete... \$3.

I am enclosing \$..... Send postpaid.
 Send C.O.D. I am enclosing \$..... deposit.

Name: _____
Address: _____

Supreme Publications
Sold by All Leading Parts Jobbers

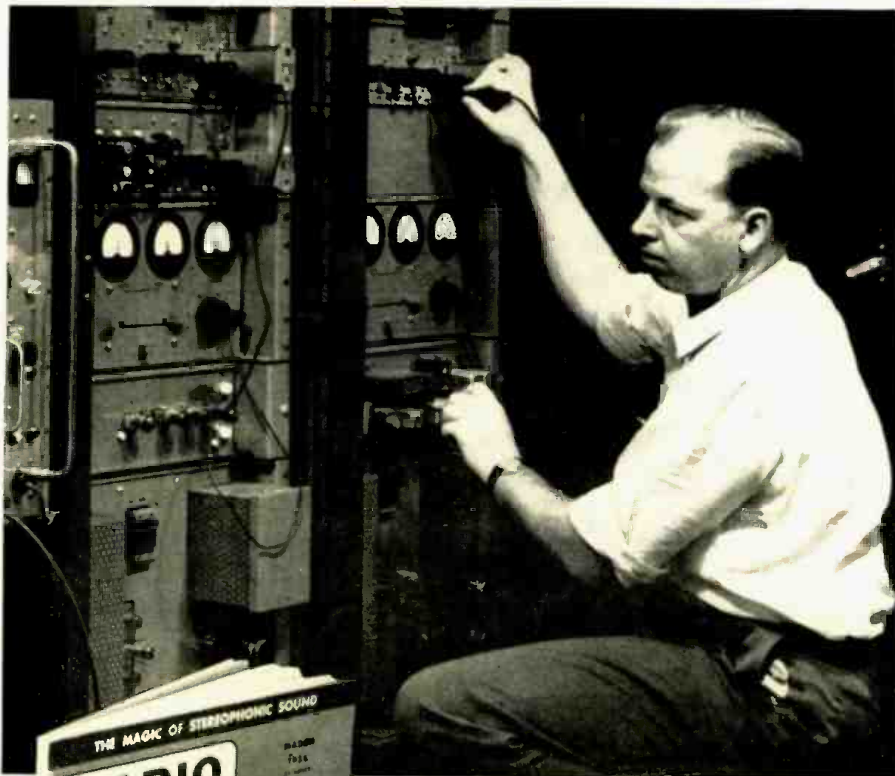

Photo courtesy National Co., Inc.

New Look in TV Service
(Continued from page 54)

tion in the size of service organizations. The average shop now employs about three people during peak seasons as compared to the five which was "average" about four years ago. The most successful service businesses seem to be those that employ three men, including the owner, and a competent "girl Friday" who handles the phone calls and most of the shop traffic. While this currently "ideal" business depends upon service for its primary income, it retails TV sets and some hi-fi components.

In the process of mental transition, service dealers in the mass are gradually moving toward the recognition of their responsibilities and obligations as an important part of the business segment of our economic system. For many years, the service industry had a "persecution complex." In the eyes of service dealers, everyone was against them. They were misunderstood by the public, double-crossed by their parts distributors, and un-wanted step-children of the set and component manufacturers.

The transition process, which started with the formation of business associations for service dealers, has been gradually bringing about recognition of the fact that many of the troubles that beset independent service are due to the acts of omission and commission on the part of service dealers themselves. As it becomes apparent to association members that they have both the responsibility and the tools for solving some of the industry's most pressing problems, they set the wheels in motion to do something about it. The service industry is fast losing its "persecution complex."

While practically all of the aggressive associations are under the leadership of seasoned veterans, they get a lot of their driving force from the younger generation of service dealers who are determined to build electronic service into one of the country's most stable and respected industries. —30—

TV SERVICE TECHNICIAN ALL-AMERICAN AWARDS

THREE MEN of national prominence have been chosen as judges in General Electric's second annual All-American Awards for public service by TV repairmen. They are Sen. John Sparkman, chairman of the U.S. Senate Small Business Committee; Bennett Cerf, TV panelist and head of Random House publishing firm; and Charles Shearer, president of the National Junior Chamber of Commerce.

In announcing the judges, Irvine D. Daniels, chairman of the 1958 All-American Award committee, said TV technicians are "trail-blazing pioneers whose work will lead to all-around electronic home servicing in the future."

The judges will select the ten technicians who perform the most outstanding public or community service. Trophies and prizes of \$500 will be presented to the winners. —30—

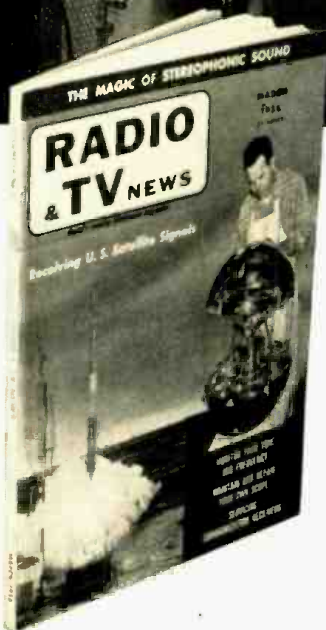

IF THIS MAN IS ON YOUR CHRISTMAS LIST —

A subscription to RADIO & TV NEWS will make a perfect gift for him, and every other man with a stake in electronics.

If he makes his living in electronics or is an advanced hobbyist who loves Hi-Fi, Radio, TV, Audio, R/C, ham radio and communications, he'll be delighted to get RADIO & TV NEWS as a gift. For RADIO & TV NEWS offers the best

technical coverage in the field. It provides men in electronics with tips and techniques on repairing, installing and maintaining radio and TV sets and circuits, latest Hi-Fi developments, newest ham techniques, fresh audio ideas, test equipment, and current industry news. There is no more thoughtful Christmas gift, or flattering one, than a subscription to RADIO & TV NEWS, the first and most authoritative magazine in the field. Each of your gift subscriptions will be announced by an attractive card, inscribed with your name. What's more, you can enter or extend your own subscription to RADIO & TV NEWS at these special Christmas gift subscription rates, too!

First 1-year gift subscription \$4
Each additional 1-year gift subscription \$3

Fill in and return the postage-paid envelope facing this page for your own and gift subscriptions. List additional gift orders on an extra sheet of paper.

WRAP UP YOUR CHRISTMAS GIVING NOW! DO IT EASILY, AND APPROPRIATELY, WITH RADIO & TV NEWS



RADIO & TV NEWS • 434 S. WABASH AVE. • CHICAGO 5, ILL.

SOUND ON TAPE

By BERT WHYTE

AT THE recent New York High Fidelity Show, one thing was conspicuous by its absence and that was the sign of any production models of the 4-channel, 3 1/4-ips tape machines. This was true of the proposed cartridge types and, for the most part, of the reel types as well. Of course, *Ampex* had its unit, which will play either the present 7 1/2-ips, two-channel or the new 4-channel stuff, on display. But let's face the fact that not everybody can afford an *Ampex*! Of 4-channel tapes themselves, there were a few examples about, mostly experimental stuff. Through a decent rig some of them sounded quite acceptable and some were just awful. In all cases, I heard nothing which can approach the quality of our present 7 1/2-ips tapes.

Where were the new machines and the 4-channel tapes? From what I can gather the reasons for the delay are manifold—production difficulties is one, temporary shelving because of pre-occupation with the stereo disc is another, and one hard to beat reason... so say some manufacturers... "we won't produce 4-channel tapes until there are sufficient machines to constitute a market"... "we won't produce 4-channel tape machines until tapes for them are produced in quantity." In other words it's the old "chicken and the egg" routine and it won't be resolved until somebody with enough courage... and a lot of loot... decides to take a chance.

In the meanwhile, despite the stereo disc, there are a few stirrings of interest in our present 7 1/2-ips market. Some tapes are still being produced and other companies have decided to resume production. I wish I were at liberty to tell you of a development which will really set the tape world in an uproar. It is quite sensational, but I've been sworn to secrecy. I can say this though... anyone who has thought of holding funeral services for 7 1/2-ips tape is not only premature, but ill-advised. After a long drought a few tapes have trickled in and of fine quality too!

RAVEL BOLERO BIZET

L'ARLESIEUNNE SUITE #2
Detroit Symphony Orchestra conducted by Paul Paray. Mercury MCS5-50. Price \$11.95.

Since the *Mercury* stereo disc of this "Bolero" arrived at the same time (it is reviewed in this month's record column) it affords a fine opportunity for comparison. The stereo disc was of unusually high quality, one of the best that has been issued, so the comparison is in no way unfair.

December, 1958

BARGAINS—OUTSTANDING SURPLUS ELECTRONICS

BC-611 WALKY-TALKY

COMPLETE WITH CASE



Now, for the first time, Telemarine offers the BC-611 Hand-held Walky-Talky in complete form. Nothing extra to buy, except batteries which are readily available from most radio distributors. The BC-611 is a crystal-controlled transmitter and receiver covering the frequency range of 3.5 to 6.0 mc. Any good radio technician could easily modify this unit for operation up to 30.0 mc., or for operation in the 2.0-3.0 mc. Marine Band where it can ideally serve as an emergency transceiver (on 2182 KC) on boats too small for regular radiotelephone installation. Excellent for many other emergency applications, because of its compactness (measures 7 1/2" x 4 1/2" x 1 1/2" W. x 5 3/4" D.) and light weight, only 5 1/2 lbs., complete with batteries. Supplied Complete with coils (plug-in type, installed), crystals (one for "transmit"; one for "receive") for 1 frequency in 3.5 to 6.0 mc. range (no selection of frequency permitted on "Use" sets), tubes, and "A" Battery Adaptor which permits use of conventional 2 Flash-High type in place of special "B" battery. "B" battery required is special 103 volt long rectangular unit, mid-

by Burgess Batteries, Inc.
BC-611 WALKY-TALKY, as described. Used-Very Good Condition (not tested, pre-set for 1 frequency in 3.5 to 6.0 mc. range). Includes 2 "A" batteries, 2 "B" batteries. Shpg. wt. 15 lbs. **EACH \$49.50**
BC-611 WALKY-TALKY COMPLETE NEW, as described above but NEW, TESTED. Any good radio technician could easily modify this unit for a desired frequency from 3.5 to 6.0 mc. **EACH \$74.50**
BC-611 WALKY-TALKY CHASSIS NEW: Excellent, new Spare Chassis for above, priced so low that in the event of trouble it would be cheaper to insert a new chassis. Also excellent for the Amateur or Technician who prefers to make his own style of Walky-Talky. Supplied less tubes (1-1T5, 1-1T3, 1-1T4, and 2-3A4 tubes required), and less plug-in Osc. and RF Ant. Coils, less crystals. Supplied with Schematic Wiring Diagram. Shpg. wt. 8 lbs. **EACH \$8.95**
W.C. CHASSIS, as described. **\$1.25**
PAIR OF COILS, for above, RF Ant. & Osc. **\$1.25**

50 WATT, 6 CHANNEL RADIOTELEPHONE

THE RADIOTELEPHONE BARGAIN all the Pleasure and Fishing Boats are talking about. This Transmitter-Receiver (HC-609, part of SCT-543) is beautifully and ruggedly built. Provides 6 fixed channels of crystal-controlled transmission and reception. In addition to manual tuning, when desired for Reception, provides 1800 to 4500 KC. HC-609 FCC currently accepted 2-3 mc. marine band. With recommended 100 watt DC or 24 Dyn. dynamotor power supply will deliver 50 watts output. Supplied with instruction book, connecting cable, power supply constructional data, all tubes all tested and guaranteed. See our Ad in *Radio and Telev. News* for illustration and complete data, or send for descriptive bulletin.
50 W. RADIOTELEPHONE (HC-609 A, B, or C) USED-EXCELLENT, as described above. Shpg. wt. **\$99.50**
18 1/2 lbs. **EACH**
SAME AS ABOVE NEW-UNUSED. EACH \$139.50
12 V. DC POWER SUPPLY for above, 2 Dyn. motors, one for transmitter (540 V. at 450 ma.) and one for receiver. Produces 50/60 watts output. All wires and terminals. See our Ad in *Radio and Telev. News* for illustration and complete data, or send for descriptive bulletin. **\$89.50**
COMPLETE 12 V. DC POWER SUPPLY KIT. Assemble and wire yourself. All material and diagram. **\$45.00**
RE-110 A, B, or C POWER SUPPLY KIT for 110 V. 60 cycles AC operation. LIKE NEW condition. **\$89.50**
HANDSET FOR ABOVE with appropriate PLUG connector. **\$14.50**

30-40 MC DELUXE FM RECEIVER FOR MOBILE POLICE & FIRE CALLS

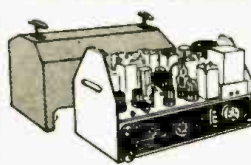

This FM receiver, the R-297 part of an A37 VRC-2 set, is a single channel-crystal controlled receiver covering Industrial, police, and fire dept. frequencies. It is of superb design and construction with all of the best features such as: double conversion superhet (455 KC and 4.3 mc.), with in-circuit oscillator crystal-controlled, noise squeelch, double limiter stages, auto-protection, etc. Exceptionally well built, loud-speaker output, etc. Uses a total of 13 tubes, 2 in the vibrator-power supply which is designed for 6 V. DC operation. All units are in practically perfect condition and exceptionally clean. Dimensions with removable cover, illustrated, 11 1/2" x 10" x 1 1/2". Separate loud-speaker, or phones (if desired) required. Supplied with tubes and schematic diagram, but less crystals, loud-speaker, etc. Shpg. wt. 6 1/2 lbs. **\$29.95**
PRICE, EACH Not tested. **\$19.95**
CRYSTAL for 2nd Conv. Osc. 4755KC. **\$1.50**
CONTROL UNIT, contains Squeelch & Vol. Controls, Pilot Lights, On-Off Switches, for both Rev'r. & Trans. **EACH \$5.95**

TRANSMITTER COMPANION FOR ABOVE

Transmitter T-193/VRC-2 complements the Receiver described above, to provide FM voice transmissions in the 30 to 40 MC band. Transmitter is crystal controlled, and provides a power output of 25 watts. Transmitter is same as Gaijin Okorola type FMTR-25 M, and is physically the same in appearance as the receiver shown above. Designed for operation from 6V. DC, has self-contained power supply which in some instances can be used in others. Vibrator Power Pack. All units are in Used-Excellent condition, in fact almost "like-new," but are untested at the Low price, even a quoting. Supplied with tubes, schematic diagram, but less crystal or control head. Shpg. wt. 70 lbs. **\$19.95**
PRICE, EACH Transmitter T-193/VRC-2. **\$19.95** as described.

BC-342 SIGNAL CORPS COMMUNICATIONS RECEIVER

Work horse of the Signal Corps, this popular Communications Receiver is a well known favorite of Amateurs, Communications experts and commercial operators. Receives CW, MCW and Phono over the frequency range of 1500 to 18000 KC in 8 Bands. Very ruggedly built, extremely stable and simple to operate. Includes in IFR. Crystal Filter and Phasing Control, loudspeaker output (separate speaker required), and smooth operating variable dial (with locking feature). Precision calibrated for each band. This receiver is designed for 110 V. AC operation (excellent for ham or commercial application). Units NEW-UNUSED, in perfect condition, but untested. Supplied Complete with tubes & Instruction Book. Shpg. wt. 70 lbs. **\$110.00**
EACH

BC-221 FREQUENCY METER

This Frequency Meter is a must in any laboratory, and is well known and highly regarded by most technicians and engineers. It is a high precision secondary standard for checking frequency of transmitters, signal generators, alignment of receivers, calibration curves, etc. Frequency range is 125 to 20,000 KC; employs heterodyne receiving circuit, precision calibrated signal generator circuit, and extremely stable crystal-controlled oscillator with 1,000 KC crystal whose harmonics are utilized for calibrating the variable frequency oscillator in the signal generator portion. Designed for battery operation, requiring 4-1 1/2 volt "A" batteries and 6-22 1/2 volt "B" batteries, which may be replaced by a simple-to-construct 110 V. AC pack. All units available are without modulation (but have provision for external modulation), complete with tubes and calibrating crystal, and a Training calibration book. All units tested for operation before shipment. Shipping weight 30 lbs.
BC-221 FREQUENCY METER, As described **\$84.50** above, less batteries. **EACH**

250 WATT BEACHMASTER AUDIO AMPLIFIER

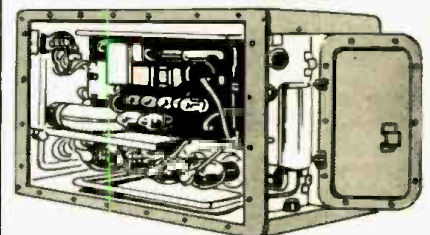

SUPER-POWER complete amplifier. Designed by Bell Tel. Labs. All self-contained in waterproof metal case, with blower system for ventilation, built-in loudspeakers, etc. Ideal for large auditoriums, airports, baseball parks, etc., or easy to convert to modulator for 500 Watt Transmitter. Operates from 6 V. 50/60 cycles AC. Uses total of 14 tubes, including 2-805 triodes in push-pull power stage and 1-6E5 magic-eye tube to indicate gain. Like-new condition equipment. Dim. 26 1/2" x 16 3/4" x 10". Shipping weight, complete with tubes, 100 lbs. Supplied with connecting plugs and schematic diagram. **\$169.50**
PRICE EACH SLASHED TO

FM TRANSCIEVER 29-39 MC

Signal Corps BC-659, part of popular SCT-609 610 Vehicular eqpt. Combination transmitter and receiver for FM communications. 2-channels both crystal-controlled. Transmitter uses recommended except for military or special applications, but receiver is ideal for monitoring 28.3 to 38.8 mc can be extended by removing a few coil turns, incorporating a variable capacitor and construction is such to permit easy under dash mounting to permit complete access to front panel controls. Separate power supply required to provide 80 to 150 volts "B" supply, and 1.5 volts "A" supply. The RE-117 or 120, available separately, supplies these voltages from either a 6, 12 or 24 volt transformer, but batteries or other supply can be easily adapted. Dim. of Transceiver 16" L x 13" W x 7 1/2" H. Supplied complete with all tubes and Schematic Diagram. **\$9.95**
PRICE PER SET
BRAND NEW, UNUSED, SLASHED TO \$9.95
PRICE-RE-117 or 120 (Specify which). Power Supply for above. Used-Good.

LORAN RECEIVING EQPT., APN-4, AT LOWEST PRICE EVER!!!

We made a "buy" on this popular model APN-4 Loran unit, used on Fishing and Pleasure boats and Aircraft for navigational purposes. All are used but in Very Clean condition, complete with tubes and crystal. Each set consists of an APN-4 Receiver and an ID-8/APN-4 in standard metal cabinet. The Receiver costs \$10.00 or more per set. It would be wise to buy an extra set for "Spare" while available at this real low price. Sorry, no accessories or inverter (80 amp tubes, 400 to 2400 cycles required) available at this time. Inverters for this eqpt. are available from many surplus houses. **PRICE PER SET**, each consisting of one Indicator and one Receiver as above. Over 50 modern type tubes in eqpt. Not Tested. **\$25.50**
Excellent-Used. Shpg. wt. 80 lbs.

LIMITED QUANTITY BARGAINS

CAR OR TRUCK WINDOW DEFROSTERS. Designed for use on gov't. trucks, jeeps, etc. Excellent for passenger cars, commercial vehicles, in stormy weather. Easily removed and stored away when not needed. Operates from electric 6V. DC. Fuse two defrosters-in series for 12V. DC systems. One can be installed on rear windows and each set is complete with switches, fuse holder, and necessary wire. Defroster has 4 resistance wires running inside glass 18" x 16" to produce heat for defrosting window. Defroster is held to window by 4 suction cups. NEW, UNUSED condition, each packed in metal case. Shpg. wt. 7 lbs. **EACH \$6.95**
MINI-TRIP STORAGE "A" & "B" BATTERIES. For Walkie-Talkies, Radio Portables, Radio-Controlled Receivers, Radio-Sandies, or equivalent meteorological devices. Supplied as a set of 2-"B" batteries of 36 volts each, and 1-"A" battery of 6 volts. Batteries are charged, less electrolyte, and packed in a hermetically sealed vacuum metal container which prevents possibility of deterioration or loss of efficiency until opened and ready for use. Both "A" battery (BB-51) and "B" battery (BB-52) are 3/8" deep x 1 1/2" high x 3 1/4" long, with 2 connecting terminals of 1/4" diameter. One charged, less electrolyte, and packed in a hermetically sealed vacuum metal container which prevents possibility of deterioration or loss of efficiency until opened and ready for use. Full instructions supplied with each set of batteries, or filling and charging. NEW-UNUSED. Shpg. wt. 4 lbs. **PER SET (4 Batteries), as described \$3.95**

All Above Material Subject to Prior Sale. 25% Minimum Deposit with All C.O.D.'s. Min. Order —\$5.00. All Prices F.O.B. Our Address.

—TELEMARINE—
COMMUNICATIONS CO., INC.
140 WEST 87TH WAY, NEW YORK 13, N. Y.
CORland 7-5444
Cable Address: Telemarine N. Y.

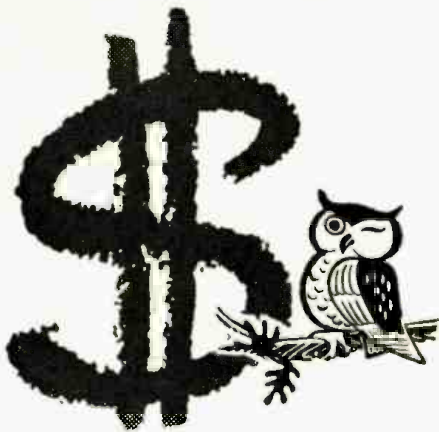

It's smart to get the BEST and keep the rest of your PROFITS! . . . with EMC TEST EQUIPMENT . . . the finest quality line of precision instruments at the lowest possible prices.



Model 102 Volometer
Features a 3½", 2% accurate—800 microamperes D'Arsonval-type plastic front meter with 3 AC current ranges; and the same zero adjustment for both resistance ranges. Specifications . . . AC Voltage—5 Ranges: 0 to 12, 120, 600, 1200-3000 volts. DC Voltage—5 Ranges: 0 to 6-60, 300-600-3000 volts. AC Current—3 Ranges: 0 to 30-150-600 ma. DC Current—4 Ranges: 0 to 6-30-130 ma. 0 to 1.2 amps. Two Resistance Ranges: 0 to 1000 ohms, 0 to 1 megohms. Model 102, Wt. 1 lb. 5 oz. Size: 3½" x 6¼" x 2". \$14.90. Kit, \$12.50.

Model 204 Tube-Battery-Ohm Capacity Tester

Emission tube tester. Completely flexible switching arrangement. Checks batteries under rated load on "reject-good" scale. Checks condenser leakage to 1 meg. Checks resistance up to 4 megs. Checks capacity from .01 to 1 mfd. Model 204P, illustrated, \$55.90. Model CRA, Cathode ray tube adaptor, \$4.50.

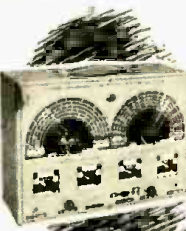

Model 700 RF-AF Crystal Marker TV Bar-Generator

Complete coverage from 18 cycles to 108 megacycles on fundamentals. Bar generator for TV adjustment with a variable number of bars available for horizontal or vertical alignment. Square wave generator to 20 kilocycles. Wien Bridge AF oscillator with sine wave output from 18 cycles to 300 kilocycles. Crystal marker and amplitude control. Individually tuned coils. Constant RF output impedance. Stepped RF attenuator. Variable percentage of modulation. Model 700 \$55.90

Model 205 Tube Tester

Uses standard emission test. Tests all tubes including Novol and subminiatures. Completely flexible switching arrangement. Checks for shorts, leakages and opens. Model 205P, Hand rubbed oak carrying case, \$47.50 (illustrated). Kit, \$36.20. Model CRA, Cathode ray tube adaptor, \$4.50.



Model 104 Volometer

Features a 4½", 50 microampere meter, with 3 AC current ranges and 3 resistance ranges to 20 megohms. Specifications . . . DC Voltage 5 ranges (20,000 ohms per volt): 0 to 6-60-300-600-3000 volts. AC Voltage 5 ranges (1,000 ohms per volt): 0 to 6-60-300-600-3000 volts. DC Current—3 Ranges: 0 to 6-60-600 ma. AC Current—3 Ranges: 0 to 30-300 ma. 0 to 3 amps. 3 Resistance Ranges: 0 to 20K, 0 to 200K, 0 to 20 megs. 5 DB Ranges: -4 to +67 DB. Model 104, with carrying strap, Wt. 2 lbs. 5 oz. Size: 5¼" x 6¾" x 2¼". \$26.95. Kit, \$19.95. Model HVT, 30,000 volt probe for Model 104, \$7.95.

Well, despite all the attractiveness of the disc, it simply is not in the same league with the tape. In terms of dynamic range and especially frequency response, lack of distortion, absence of spurious modulations and, need I say, infinitely superior interchannel separation with subsequent better positioning of instruments, directivity, depth perspective, and the big, full, bright over-all, sound, it is virtually no contest.

I would ask the wild-eyed devotees of the disc and those who would eliminate 7½-ips tape to listen and compare. If they were honest and unbiased, their only conclusion would be that the tape is still in a class by itself when it comes to stereo. And I still say that there are plenty of discriminating audiophiles who want this superior quality in spite of the price differential. The "L'Arlesienne Suite" is not on the disc so is an added bonus of listening pleasure on the tape. As noted in the record column, Paray deals with this music particularly effectively. I rest my case here, but urge you once again to make this comparison if at all possible . . . it's an eye-opener!

**GERSHWIN
RHAPSODY IN BLUE**

Eugene List, pianist, with Eastman Rochester Symphony Orchestra conducted by Howard Hanson. Mercury MWS5-47. Price \$6.95.

Of the several stereo tape versions that have appeared of this most popular of all Gershwin works, this is quite easily the best. List is not as perceptive as he might be, but his performance is strong, honest, and workmanlike. His little inadequacies are made up for by the sound on this tape which is extremely brilliant, well projected,

with excellent directivity and fairly good depth sense.

The piano stays just left of center where it is supposed to be and doesn't wander from left to right speaker. Extremely wide dynamics here and broad frequency response. The piano reproduces beautifully with sharp, clean sound—a result of fine transient response and over-all low distortion. Dr. Hanson lends good support to List and, as always, his orchestra responds willingly to his urgings. Here, again, the stereo disc of this is available and gives you still another area for comparison.

MAX ROACH PLUS FOUR
Max Roach and his orchestra. Mercury MVS3-12. Price \$7.95.

This was an outstanding disc in its monaural version and it's strictly sensational here in the stereo medium. As mentioned in the monaural review, this is characterized by Roach's terrific hard-driving style and the excellence of his sidemen. In a program consisting mostly of originals, Max churns up quite a storm with his drums and the stereo and the sound is great.

This is a multi-mix job done with good taste and just the right spread and fill—making for very natural sounding stereo. The over-all sound is very big and brilliant and is projected well forward. If a stereo disc of this is issued, as I am sure it will be, all other things being equal I don't think the comparison will be quite as drastic as in the case of classical material, mostly due to the greatly reduced scoring and scale of the music. Yet I think there will, even in this instance, be enough of a difference to make it more worthwhile to some people than the less costly disc. In any case this is a fine stereo tape for "cooler cats." -50-

Major Gilbert, engineer at Hoffman Electronics Corp., and operator of amateur radio station K6LMW, calls in two other ham stations 2000 miles away with equipment powered entirely by energy from the sun. The transmitter used operates on the 10-meter band and has an output of about 75 milliwatts. The power supply for the call was a bank of 72 of the half-dollar-size Hoffman silicon solar cells.

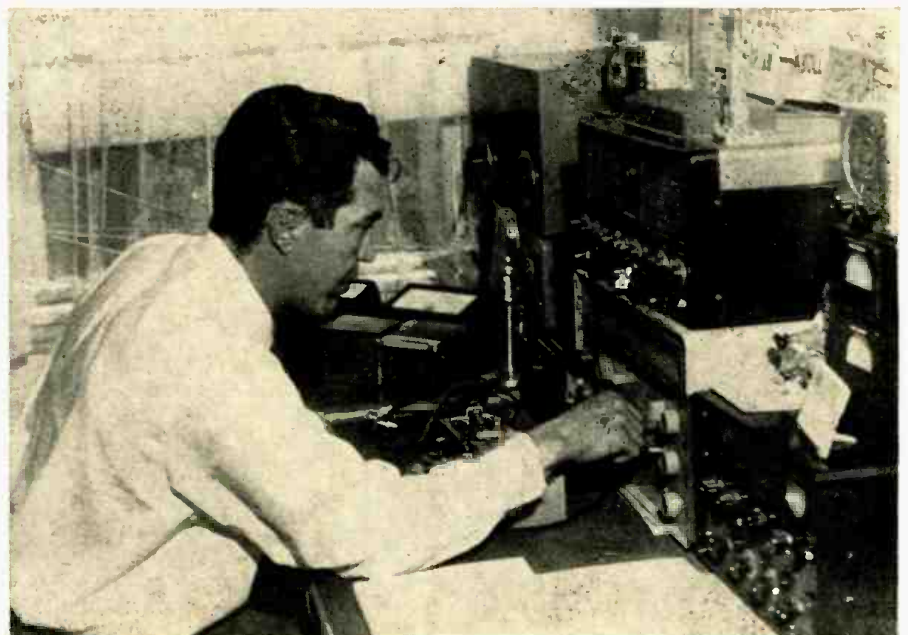

Yes, tell me more, send me FREE—a detailed catalog of the complete EMC line. RN-12-58

NAME _____
STREET _____
CITY _____ STATE _____

EMC Electronic Measurements Corp.
625 B'way, New York 12, N. Y.
Ex. Dept., 431 Greenwich St., New York 13, N. Y.

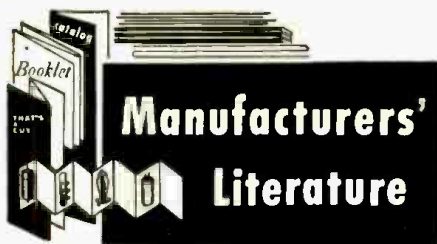

FRAME-GRID TUBES

A new brochure containing a detailed description of the advanced frame-grid tube entitled, "Amperex 'PQ' (premium quality) Reliable Frame-Grid Tubes," has been announced by *Amperex Electronic Corp.*, 230 Duffy Ave., Hicksville, Long Island, N. Y.

Contained in the brochure is a detailed description of what the frame-grid is, how it is made, specific military and industrial applications of frame-grid tubes, and a comprehensive working definition of tube life and reliability. Also included are general descriptions of the firm's three new frame-grid tubes for military systems requirements and industrial applications: the type 5847, type 6688, and type 6922. The first is a high-gain miniature pentode designed for broadband amplifier applications where a high figure of merit is required; the second is for similar applications but with improved base pin arrangement and higher transconductance; and the third is a twin-triode with separate cathodes.

Free copies of this booklet and detailed specifications on the three tubes may be obtained by writing to the company's advertising department at the above-mentioned address.

RADIO SHACK FLYER

Radio Shack Corp., 167 Washington St., Boston 3, Mass. has made available its new flyer, complete with mail-order blank.

This 24-page catalogue, No. 67, features the firm's "Expansion Sale Specials" which include such items as portable phonographs, electronic flashes, cameras, hi-fi components, and many other items.

Write direct to the company for a copy of this flyer.

"AMPROBE" SALES CATALOGUE

Pyramid Instrument Corporation, 630 Merrick Rd., Lynbrook, N. Y. has issued an all-inclusive sales catalogue, No. A-583, that delineates complete information on its "Amprobe" line.

Model numbers, specifications, applications, and price lists are included in the brochure.

The booklet may be obtained by writing to the firm in care of the "Amprobe" Division at the above address.

INDUSTRIAL TUBE CATALOGUES

Four new catalogues describing the *CBS-Hytron* expanded industrial tube line present technical data and application information on over 400 types

FREE

GIANT ALL NEW 1959 B-A CATALOG

WITH THE BIGGEST SAVINGS ANYWHERE

A COMPLETE BUYING GUIDE FOR EVERYTHING IN
RADIO TV
ELECTRONICS
BA 1959
ANNUAL CATALOG 591
SINCE 1927

180 KING-SIZED PAGES

EVERYTHING IN RADIO TV AND ELECTRONICS

100'S OF NEW ITEMS LISTED HERE FOR 1st TIME

21 PAGES OF BARGAINS NOT IN ANY OTHER CATALOG

Guarantee
We guarantee everything in our Catalog to be of the quality and value represented. We will replace or refund the purchase price in full if you are not completely satisfied. No questions asked.

RUSH COUPON TODAY!

BURSTEIN-APPLEBEE

NAME _____
ADDRESS _____
CITY _____ STATE _____

Send Free 1959 B-A Catalog No. 691.

Wholesale Only SELLING

Receivers, Transmitters, Radar, Special Purpose Tubes, Relays, Meters, Switches, Connectors, Rectifiers, Transformers, Motors & Generators, Wiring Cable, Instruments and All Electronic Components.

RADIO & ELECTRONIC SURPLUS

14000 BRUSH STREET
Detroit 3, Mich. TO 9-3403

ARROW SALES EXPANDS!

Need hi fi equipment, record changers, speakers, tubes, mikes, stereo gear, surplus electronics? Eye it—try it—buy it at any of our retail sales showrooms—and save!

Go to any **ARROW SALES** branch:

NORTH HOLLYWOOD, CAL.: 7035 Laurel Canyon.
CULVER CITY, CAL.: 5429 So. Sepulveda Blvd.
PASADENA, CAL.: 2650 E. Colorado Blvd.
CHICAGO, ILL.: 2534 So. Michigan Ave.
SANTA ANA: Opens early in '59! Watch for It!
ARROW SALES, INC. are authorized RCA distributors.

YOU OWN 80%

of this Brand New
HALLICRAFTERS
All-Band Commu-
nications Receiver
R-45/ARR-7
Your taxes helped
Signal Corps pay
\$750 for the best
possible quality.
In factory-packed
sealed cartons.

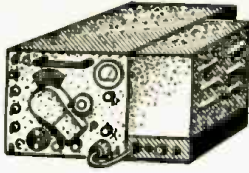

So pay only 20%!

READY TO PLUG INTO 115 v, 50/60 cy LINE, AND USE.

You get cords, plugs, and power supply for all re-
ceiver voltages including dc for automatic tuning.
550 kc to 43 mc continuous in 6 spread-out bands.
Factory aligned and ready to use.

• Sensitive 2—6SK7 RF's, 6SA7 mixer, 2—
6SK7 IF's. • Selective 3 Crystal-Filter and
3 IF-pass switch positions, plus Crystal Phasing
knob. • Noise-Limiter switch in 6H6 pip-
clipper network. • Drift-free VR150 regu-
lates the separate 6SA7 oscillator. • S-Meter
adjustable; 6 db/unit. • BFO separate 6F5
and Pitch control. • AVC or MVC. • AF and RF
Gain controls. • Standby switch. • AF 6SQ7
and 6V6 to hi-impedance phones. • Video
coax SO plugs shows AF on any scope. • Pan-
oramic SO plug feeds 455 kc to any stand-
ard Panadapter. • Dial large, easy-reading,
back-lighted, translucent. • Tuning hand-
crank vernier knob or lazy-man's automatic-re-
versing slow-motion motor. • You get Oper.
Manual, schematic, illustrated alignment info.

**Send only \$14.95 with order,
balance \$12.55/mo., 12 mos.**

Revr: 7 3/4" ht, 10 1/2" wd, 19 1/2" dp plus controls.
Pwr. Sply: 8 3/4" ht, 5" wd, 13 1/2" dp plus controls.
Shpg wt 80 lbs. FOB Stockton, Calif. Calif. buyers
add Sales Tax. Full cash price, only \$149.50

a TERRIFIC BARGAIN in a



**SOLA CONSTANT-
VOLTAGE
TRANSFORMER**
Ends fluctuating line
voltage!

Big Discount Off

the factory price, 60 cy. Output 115.0v at 85% PF.
If load is resistive, output is fixed at a value closer
to the more modern standard of 120v. Holds to 2%
at inputs 95-125 v, to 2% at 92-138 v. Used, clean,
checked out to ratings; no moving parts or tubes.
250/300 lbs. FOB Los Angeles. **\$125.00**

METERED DUMMY LOAD

1-83 Dynamotor Test Set may be
used as-is or changed to check
any power supply. Has 3 matched
3 1/2" meters 0-35v, 0-10A, 0-
750v, 0-500 ma, dc, plus ac 0-2v
at 10K ohms/v; two 250 W rheo-
stats, multitap ripple stop-up
xfrm, 7-position switch with 14
precision metering resistors, etc.
Panel 12 1/2" x 15". New. Shpg.
wt. 40 lbs. **\$24.50**
FOB Chicago, only



6 AND 12 VOLT DYNAMOTORS



Both are BRAND NEW, and in
original cartons. Both have 4
leads; neg. or pos. ground.
6 V: Eicor, with base; output
rating 600v, 175 ma.

12 V: West., no base, rated 385v .5A; tests 390v
.4A 69% efficient; 393v .35A; 397v .3A; 402v .25A;
407v .2A.
EITHER, fob Los Angeles, only. **\$9.95**

VARIABLE VOLTAGE TRANSFORMER

UTC 31029 or equal Mil Spec T-27 Grade 1 Class A
HS Transformer, 50/60 cy, 95, 117, 130, 190, 210,
234 260v. Sec.'s 305-0-305v. 15A; 6.3v 5A; 5v 3A;
7.5v 2A; 7.5v 2A. Vary sec. outputs with pri. taps.
Example: 95, 117, 130v taps give 123%, 100%,
and 90% to any sec or series'd sec. combo. 4 1/2"
dia., 5 1/2" high, 20 bottom lugs.
NEW. FOB Chicago, only. **\$2.95**

Add up your selections and buy all on Time Pay
Plan. See our Sept./Oct./Nov. ads. Send order.
We'll send details.

SCHEMATICS—CONVERSIONS FOR SURPLUS GEAR

Send stamped addressed envelope for NEW List E;
has many new items. Includes many Tech Manuals.
Add 25¢ for chart explaining AN Nomenclature.
DO IT TODAY!

R. E. GOODHEART CO.

P. O. Box 1220-A Beverly Hills, Calif.

of power tubes, gas tubes, and power
rectifiers, as well as military and spe-
cial-purpose tubes, and phototubes and
photocells.

Bulletin E-290T includes industrial
power triodes and tetrodes, pentodes
and beam tubes, with information on
construction, ratings, applications and
basing. Gas diodes, grid-controlled gas
tubes, and power rectifiers are de-
scribed in Bulletin E-290C.

Bulletin E-290S covers military and
special-purpose tubes and Bulletin
E-290P embraces vacuum and gas
phototubes and photoconductive cells.

These catalogues are obtainable
from the firm's distributors or from
its Advertising Service, Newburyport,
Mass. The bulletin numbers should be
specified for each catalogue requested.

COLUMBIA WIRE SUPPLEMENT

Columbia Wire & Supply Co., 2850
W. Irving Park Road, Chicago 18, Ill.
announces a new 4-page supplement
to its catalogue No. 107. Many new
items in the wire and cable field have
been added to this new brochure.

Copies of both the catalogue and
supplement can be obtained by writing
directly to the firm.

P-N-P TRANSISTOR LISTING

Workman TV Inc., 309 Queen Anne
Road, Teaneck, N. J. has issued a mas-
ter cross-reference sheet and price list
on p-n-p transistors.

The sheet carries information on
types, suggested list and dealer prices,
and an interchangeability guide. This
comprehensive listing may be obtained
direct from the company upon request.
Ask for Form CS41.

ELECTRONIC COMPONENT BULLETIN

Richard Electrocraft, Inc., 4432 N.
Kedzie Ave., Chicago, Ill. is offering a
new 12-page bulletin, No. 558, giving
complete information on its line of
electronic components.

Included are standard and miniature-
sized plugs, phono plugs and jacks,
push-button switches, stack assem-
blies, and standard and miniature con-
nectors, among other components.

All parts are illustrated and line
drawings show complete construction
details. Tables list sizes and types
available.

R/C SYSTEM CATALOGUE

Perma-Power Company's radio con-
trol systems for industrial, commer-
cial, and residential uses are carefully
described and illustrated in a new
color catalogue, B-138.

Complete information, including
technical data and prices, are given
so that most applications can be com-
pletely specified from the brochure.

For complete information and this
new catalogue, write directly to the
firm at 3100 N. Elston Ave., Chicago
18, Illinois.

POWER SUPPLY KIT FOLDERS

Two 4-page folders covering the uses
and specifications of two power supply
kits have been announced by *Electro*

Products Labs., 4500 N. Ravenswood
Ave., Chicago 40, Ill.

The folders cover Models KPS-2 and
K-612T, both filtered d.c. power supply
kits.

These illustrated brochures are
available from the company by writing
to the attention R. C. Crossley.

"PRINTED CIRCUIT SOLDERING"

Anchor Metal Company, Inc. has pub-
lished detailed instructions on "Printed
Circuit Soldering" that are of particu-
lar interest to design and production
supervisors.

The brochure includes a general dis-
cussion of printed circuitry, an ex-
planation of proper solder composition,
flux requirements, solder pot consid-
erations, and a step-by-step clarifica-
tion of the techniques of dip soldering.

Copies may be obtained by writing
to Herbert Drapkin at the company,
966 Meeker Ave., Brooklyn 22, N. Y.

LAFAYETTE 1959 CATALOGUE

Lafayette Radio has released its 1959
general catalogue of electronic parts
and equipment, including a complete
line of stereo high-fidelity components.

The new 260-page catalogue features
64 pages in 2-color rotogravure and 4-
color covers and is 8" x 10" in page size.
Highlights include a comprehensive
listing of the newest stereophonic
sound equipment and complete stereo
systems, including components for con-
version of conventional hi-fi systems to
stereophonic sound. A full presentation
of radio and TV parts, transistor kits
and miniaturized components, antennas
and installation accessories, amateur
gear, tools, technical books, and many
other items is featured.

This new catalogue, No. 590, is avail-
able free upon request. Write to the
company at 165-08 Liberty Avenue,
Jamaica 33, N. Y.

CAPACITOR MANUAL

Sprague Products Company an-
nounces the ninth edition of its popular
"TV Replacement Capacitor Manual."

The current edition gives complete,
up-to-date listings of all replacement
capacitors used in TV sets manufac-
tured from 1946 through 1957. Each
manufacturer is listed alphabetically
with original part numbers in numeri-
cal order and cross-referenced to the
firm's replacements. Brief descriptions
of the parts, complete with prices, are
also included.

Copies of the 56-page manual are
available at no charge from the com-
pany's distributors or by sending 10¢
for Manual K-103 to the firm at 51
Marshall St., North Adams, Mass.

RTTA GUIDEBOOK

*Radio-Television Training Associa-
tion* has a new catalogue called "How
To Make Money in Radio, Television,
Electronics, and Color TV".

An innovation in the presentation of
catalogue material is achieved with a
feature dubbed "A Trip Around RTTA"
—with Tommy Drake. Tommy Drake
is actually a student and he performs
the job of personally conducting the

reader on an "excursion" of the school.

The 16-page booklet is interestingly illustrated throughout. It contains a description of the school's courses as well as a listing of all lessons for each course. A double-page spread is devoted to a display of kits students build and keep as part of their training. Another highlight is a Career Opportunities Listing. It gives a breakdown of positions and duties, qualifications, training, and salary range of each job.

Free copies of the catalogue are available by writing to RTTA, % Dept. PR-3, 52 E. 19th St., N.Y.C.

NEW BOOK CATALOGUE

D. Van Nostrand Company, Inc. has a new catalogue which describes some 1000 recent and published works in engineering, chemistry, electronics, aeronautics, physics, nuclear science, mechanics, biology, mathematics, technical dictionaries, and many other specialties.

The 144-page booklet is available from the company, 120 Alexander St., Princeton, New Jersey.

NEW EIA STANDARDS

Electronic Industries Association has released five new recommended Standards. They are:

RS-165-A, Ceramic Dielectric Capacitors. Classes 1 & 2—1000-7500 Volt Rating, price 80¢.

RS-207, Television Tuner Performance Presentation and Measurement, price 25¢.

RS-210, Terminating and Signaling Equipment for Microwave Communications Systems, Part 1, price \$1.10.

RS-211, Dimensional Characteristics of Phonograph Records for Home Use—78 rpm, 45 rpm, 33 $\frac{1}{3}$ rpm, price 60¢.

RS-212, Numbering of Electrodes and Designation of Units in Electron Tubes, price 25¢.

These Standards are available from the Association's Engineering Dept., 11 W. 42nd Street, New York 36, N. Y.

"FLIP CHART KIT"

Seco Manufacturing Co., 5015 Penn Avenue South, Minneapolis 19, Minn. is offering an up-to-date "Flip Chart Kit" for its Model 107 tube tester.

The chart includes a complete set of cards and a new index panel. Data on all tubes, including late releases, is provided.

This information is available by writing direct to the company.

1959 ALLIED CATALOGUE

Allied Radio Corp. has released its 1959 general catalogue of electronic parts and equipment. This new 452-page book lists over 32,000 items.

Among the many items included are the firm's line of "Knight-Kits," radio amateur kits, industrial equipment, high-fidelity, technical books, a TV section which includes antennas, and a complete listing of the newest stereophonic sound equipment.

Highlighting the audio section are details on complete stereo systems,

leading types of individual stereo units, recording and playback decks, and add-on components for conversion of conventional systems to stereo. Also listed is a special selection of new stereo records as well as a wide choice of recorded stereo tapes.

The catalogue is available free from the firm, 100 N. Western Ave., Chicago 80, Ill.

TRANSISTORIZED ELECTRONIC CIRCUITS

Free brochures outlining transistorized electronic circuits of interest to the hobbyist, engineer, and student are being made available by the semiconductor division of *Motorola Inc.*

The brochures provide some unique as well as practical applications of transistorized circuits.

The booklets are available free upon request from distributors of the firm's semiconductor products or by writing to the company direct at 5005 East McDowell Road, Phoenix, Arizona.

CENTRALAB "COMPENTROL"

A revised edition of the *Centralab* booklet on the "Compentrol," compensated volume control for high-fidelity, is now available.

This 20-page booklet is profusely illustrated and contains simple installation instructions for the unit. It is available without charge by writing to the firm, a division of *Globe-Union, Inc.*, 900 E. Keefe Avenue, Milwaukee 1, Wisconsin.

-30-

GET ON THE AIR...

WITH

VOCALINE

LOWEST-COST 2-WAY RADIO

FOR AIR—LAND—SEA COMMUNICATIONS

Model JRC-400 **VOCALINE** \$74.75

Model JRC-425DIO TRANSCRIber \$104.75

Model CUB/MP Model JRC 400 \$179.50 (Base Station with Squelch)

See your local Radio-TV Dealer or write

VOCALINE COMPANY OF AMERICA, INC. OLD SAYBROOK, CONN.

STORAGE CELL

2 Volt, 20 Amp. Clear Plastic Case. Ball Charge Indicator. Shipped dry charged. **\$2.49**
BRAND NEW.....Ea.

OIL CAPACITOR SPECIAL

24 MFD 600V. WVOC (3x8) Size: W-3 1/4" x H-4 3/4" x D-1 3/4". Suitable for crossover network or complete 2 or 3 section filter for any power supply. **\$2.49**
Mfgs. quantity.....5 for \$10.00

MINIATURE MICROAMMETER

1 1/2" Square 0-100 Micro. Suitable for grid dipper field strength, 5 meter. **\$3.95**
A BARGAIN AT.....ea.

MICROAMMETER SPECIAL

2 1/2" 0-50 Microamps. (Scale 0-5.) **\$4.95**
Each.....ea.

POWER TRANSFORMER

Pri. 110V. 60 Cy. Sec. 300-0-300 V. 125 Ma. 12 Volt CT @ 3 Amps; 12 Volts @ 3 Amps; 5V @ 2 Amps/Replacement Transf. for 8C 342 Rec. **\$2.50**
Pri. 115V. Sec. 320-0-320V. @ 5V. Ma. 5V. @ 2 Amos 6.3V. @ 3 Amps. Pri. 115 or 230V. Secs. 450-0-450 @ 250 Ma. 5V. @ 3 Amps. 6.3V. @ 8 Amps **\$5.95**
Write for quantity prices

FILAMENT TRANSFORMERS

PrIm. 115V. cr 230V.-60 cy. Sec. 6.3V. @ 20 Amps. H-4 1/2" x W-4" x D-3 1/2". ea. **\$3.50**
Primary 110 or 220. 120. 160. cy. Sec. 5 V. @ 10 Amps. Ins. 10,000 V. Small size. 2 for \$7.50. Each **\$3.95**
Pri. 115 V. or 230 V. 60 cy. sec. 6.3 V. @ 5 amps. Primary 110 volts 60 cycle. Secondary 2 1/2 V. 10 Amps. 10,000 V. Insulation. Suitable for pair of 866 tubes. **\$3.95**

CHOKE—FULLY CASED

10 HENRY 80 Mill (unshielded)90c
6 HENRY 150 Mill\$1.50
5 HENRY @ 200 Ma1.95
10 HENRY 315 Mill3.95
12 HENRY 500 Mill4.95
3 HENRY 630 Mill3.95
4 HENRY 900 Mill12.95
6 HENRY 600 Mill1.95
7 HENRY 1.6 Amp.19.95

BRAND NEW OIL CONDENSERS

2 MFD 600 VDC .50	1 MFD 2000 VDC .85
3 MFD 600 VDC .60	2 MFD 2000 VDC 1.50
4 MFD 600 VDC .75	4 MFD 2000 VDC 3.50
5 MFD 600 VDC .80	1 MFD 2500 VDC 4.95
6 MFD 600 VDC .85	8 MFD 2000 VDC 5.95
8 MFD 600 VDC .95	2 MFD 2500 VDC 2.50
10 MFD 600 VDC 1.10	1 MFD 3000 VDC 1.85
12 MFD 600 VDC 1.50	2 MFD 3000 VDC 3.50
1 MFD 1000 VDC .60	4 MFD 3000 VDC 6.95
2 MFD 1000 VDC .85	4 MFD 4000 VDC 13.95
4 MFD 1000 VDC 1.15	4 MFD 5000 VDC 15.95
8 MFD 1000 VDC 1.95	1 MFD 7500 VDC 6.95
10 MFD 1000 VDC 2.50	5 MFD 7500 VDC 2.95
12 MFD 1000 VDC 3.00	1 MFD 12,500 " 24.95
15 MFD 1000 VDC 3.50	1 MFD 15,000 " 34.50
1 MFD 1200 VDC .45	1 MFD 25,000 " 69.50
1 MFD 1500 VDC .75	1 MFD 300 AC. 1.95
2 MFD 1500 VDC 1.10	10 MFD 330 AC. 1.95
4 MFD 1500 VDC 1.95	15 MFD 410 AC. 2.50

REDMOND BLOWER

110V. 60 cyc. .3 Amp. 1600 Rpm. 3 3/4" Blower wheel—Outlet 2" Diameter. **\$7.95**
Blower wheel—Outlet 2" Diameter. 2 for \$15.00

SIGMA 5F RELAY

16,000 ohm in dust 8,000 ohm coils. (Can be paralleled) SPDT adjustable silver contacts. Adjustable armature tension. Operates on 500 microamperes or less. **\$3.95**
Write for quantity prices.

RELAYS

Allied Relay 110 V. AC. DPSTea. **\$1.35**
Clair Telephone Type 11,300 ohm coil DPDT cont. 10 amp 125V. Sens. 4MA. ea. **\$3.95**
Hermetically Sealed Relay Coil 110V AC 60 cy SPDT Contact 5 Amps. **\$1.50**
Sigma Sens. Plug-in H. S. 16,000 ohms 1 mil. -1 pole SPDT, #2 pole SPST. ea. **\$1.95**
6 Volt DC DPDT H.S.ea. **99c**
12 Volt DC DPDT DC Relay.ea. **\$1.35**
12 Volt DPST Advance Relayea. **\$1.05**
E. Plug In Relay 5 prong 10,000 ohm coil 1 mil. SPDT.ea. **\$2.50**
E. Relay control contains 8000 ohm relay, sensitivity 2 mils. 10 for \$9.25. ea. **\$1.10**

PANEL METERS

G.E., WESTINGHOUSE, W.E. SIMPSON, etc.

2" METERS	
0-500 Micro DC.....3.50	0-10 Mill DC.....3.95
0-1 Mill (270° Weston).....3.95	0-50 Mill DC.....3.95
0-300 Mill DC.....2.95	0-100 Mill DC.....3.95
0-500 Mill DC.....2.95	0-150 Mill DC.....3.95
1-0-1 Amps DC.....2.95	0-500 Mill DC.....3.95
0-10 Amps DC.....2.95	0-12 Volts AC.....3.95
0-25 Amps DC.....2.95	0-50 Volts DC.....3.95
18-36 Volts DC.....1.99	0-500 Volts DC.....4.50
0-150 V. AC.....3.49	0-800 Volts DC.....4.50
0-4 Amps RF.....2.95	0-2.5 KV DC.....5.50
	0-3.5 KV DC.....7.50
	0-30 Amps RF with couple.....12.95
	Running Time Meter 0-9,999 hrs. 110 V. 60 cy. \$12.95
	(0-3 1/2" KV scale) 3.95 Used 7.95

MISCELLANEOUS SPECIALS

N.E. 51 NEON LAMP. Box of 10. ea. **\$1.00**
50 OHM 6 watt (Non-Inductive Resistor).....ea. **35c**
36 OHM 50 Watt Globar Non-Ind. Res. 60c ea. **60c**
3-12 MMF Eric Ceramic Trimmers.....2 for **\$1.00**
Replacement 6' phone cord for Standard Headsets.....**35c**
OHMITE TAP SWITCH Model 608 Double Pole 4-Throw, 100 Amps. AC.....ea. **58.95**
UTC OUNCER TRANS. Pri. 100 ohm. Sec. 125,000 ohm. Ideal for mike or phone patch—2 for **\$1.00**. **59c**
CUTLER-HAMMER TOGGLE SWITCH SPDT (ST42D)—5 for **\$1.10**. **25c**
Write for quantity prices on all special items

All merchandise sold on a 10 day money back guarantee basis

Min. Order \$3.00—25% with Order—F.O.B. New York
PEAK
ELECTRONICS COMPANY
66 W. Broadway, New York 7, N. Y., WO-2-5439

Receiving & Recording Satellite Signals

By
FRANK K. DEARBORN
Air Force Cambridge Research Center

Notes for hams and SWL's on the proper way to tape signals so as to be of greatest value.

THE response of amateurs and others to the request for measurements of the U. S. satellite signals has been gratifying and, as was expected, has provided valuable information. The author would like to review, very briefly, the two major fields of measurements that may be undertaken by independent investigators such as amateurs and SWL's.

The first field is that of Doppler measurement which requires the use of receiving equipment of a high degree of frequency stability. It must not be subject to either local or beat oscillator drift or a.g.c. frequency pulling effects. These measurements, then, require the use of a crystal-controlled heterodyne oscillator at the carrier frequency (or a subharmonic thereof) or a receiver whose internal construction provides a comparable stability. These measurements can and are being made by various amateurs and the data obtained will be of value in many cases.

The second major contribution is the direct recording of telemetry signals from the satellite transmitters. We have had occasion to request the loan of quite a few amateur tape recordings of satellite telemetry signals which were recorded at what was considered to be critical periods. It has been noted that in all cases they suffer from one particular defect—the use of a heterodyne oscillator either at the carrier or intermediate frequency. It is likely in most cases that the heterodyne oscilla-

tor was used for Doppler measurement purposes.

Simultaneous Doppler measurements and telemetry reception by the same receiver tend to be incompatible. Assuming an amplitude-modulated transmission, two reasons may be advanced to support this statement:

1. A beat oscillator produces its strongest output signal by heterodyning against the carrier frequency itself. The fact that this frequency varies because of receiver instability and/or Doppler shift makes it exceedingly difficult to remove with a filter. If the heterodyne falls within a desired telemetry channel and close to the telemetered frequency, the data becomes almost impossible to read. This is generally true at least part of the time.

2. The best oscillator also heterodynes against the sideband components produced by the telemetry frequencies. As these frequencies are rather closely spaced to the carrier frequency and each other, the result is the generation of at least two complete sets of spurious frequencies plus the original beat frequency, all of which are continuously changing from Doppler shift and/or receiver instability.

If, in addition to this, harmonic distortion is present within the receiver or tape recorder, then to add to the existing woes a second order collection of intermodulation products appear in the output. The result is similar to the "search for a needle in the haystack"

Author is shown at the right using data reduction gear to read satellite signals.

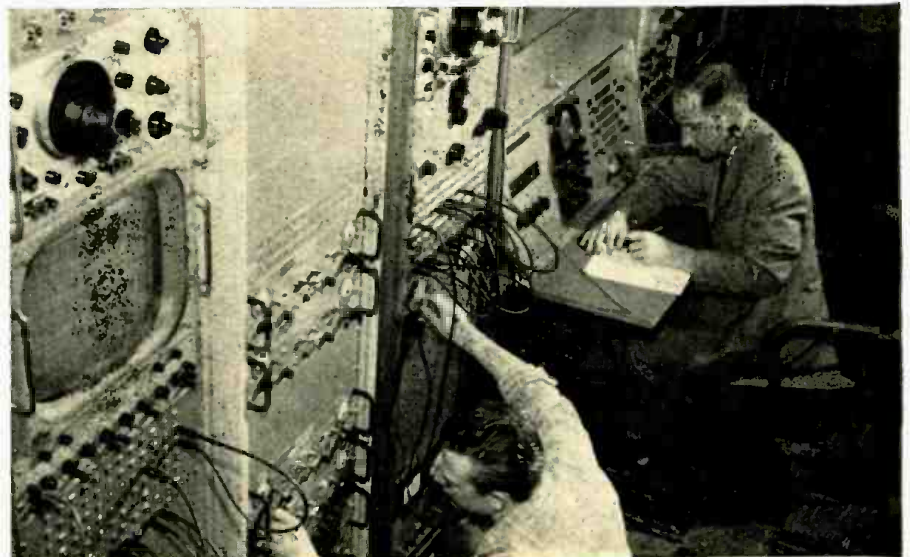

"ONE DOLLAR" buys

As much as \$15 worth—Everything Brand New and sold to you with a money back guarantee.

DEDUCT 10% ON ANY ORDER OF \$10 OR OVER

Plus a FREE SURPRISE PACKAGE

- \$15 — "JACKPOT" TELEVISION PARTS...\$1
- 40 — ASST. PRECISION RESISTORS best sizes \$1
- 35 — ASST. DISC CERAMICS best numbers...\$1
- 10 — TV CARTWHEEL CONDENSERS 10KV-500mmf \$1
- 1 — 5" PM SPEAKER alnico #5 magnet...\$1
- 20 — TUBULAR CONDENSERS .05-600v...\$1
- 20 — TUBULAR CONDENSERS .25-600v...\$1
- 20 — TUBULAR CONDENSERS .001-1000v...\$1
- 100 — ASSORTED FUSES popular sizes...\$1
- 100 — ASST. 1/2 WATT RESISTORS some 5% \$1
- 70 — ASSORTED 1 WATT RESISTORS...\$1
- 35 — ASSORTED 2 WATT RESISTORS...\$1
- 50 — ASST. TUBULAR CONDENSERS...\$1
- 10 — 6' ELECTRIC LINE CORDS with plugs...\$1
- 5 — TV CHEATER CORDS with both plugs...\$1
- 4 — 50' SPOOLS HOOK-UP WIRE 4 colors...\$1
- 50 — STRIPS ASST. SPAGHETTI best sizes...\$1
- 100 — ASST. RUBBER GROMMETS best sizes...\$1
- 100' — TWIN LEAD-IN WIRE 300? heavy duty...\$1
- 50' — FLAT 4-CONDUCT. WIRE many purposes...\$1
- 25' — INSULATED SHIELDED WIRE...\$1
- 1 — \$7 INDOOR TV ANTENNA hi-gain 3 section \$1
- 20 — ASST. TV KNOBS, ESCUTCHEONS, Etc. \$1
- 3 — ASST. TOGGLE SWITCHES asst. dpdt, etc. \$1
- 6 — ASST. SLIDE SWITCHES asst. dpdt, etc. \$1
- 4 — BAKELITE KNIFE SWITCHES dpdt...\$1
- 15 — ASST. ROTARY SWITCHES \$15 worth...\$1
- 100' — FINEST NYLON DIAL CORD best size...\$1
- 200 — SELF TAPPING SCREWS #8 x 1/2" \$1
- 35 — ASST. RADIO KNOBS screw and push-on...\$1
- 100 — KNOB SPRINGS standard size 3/8" x 1/2" \$1
- 100 — ASSORTED KNOB SET-SCREWS...\$1
- 25 — ASSORTED CLOCK RADIO KNOBS...\$1
- 400 — ASST. H/DWARE screws, nuts, rivets, etc. \$1
- 50 — ASST. SOCKETS octal, noval and miniature \$1
- 20 — ASSORTED TUBE SHIELDS best sizes...\$1
- 50 — ASST. MICA CONDENSERS some in 5% \$1
- 50 — ASST. CERAMIC CONDENSERS...\$1
- 10 — ASST. VOLUME CONTROLS less switch \$1
- 5 — ASST. VOLUME CONTROLS with switch...\$1
- 100 — VOLUME CONTROL HEX NUTS...\$1
- 20 — ASST. PILOT LIGHTS popular types...\$1
- 10 — PILOT LIGHT SKTS. bayonet type, wired...\$1
- 50 — ASST. TERMINAL STRIPS 1, 2, 3, 4 lug \$1
- 10 — ASST. RADIO ELECTRO. CONDENSERS \$1
- 5 — ASST. TV ELECTROLYTIC CONDENSERS \$1
- 25 — ASST. MICA TRIMMER CONDENSERS \$1
- 50 — TUBULAR CONDENSERS .001-600v...\$1
- 50 — TUBULAR CONDENSERS .01-400v...\$1
- 2 — ELECTROLYTIC COND. 40/40-450v...\$1
- 2 — ELECTROLYTIC COND. 40/10/10-450v...\$1
- 30 — FP CONDENSER MOUNTING WAFERS \$1
- 3 — ELECTROLYTIC COND. 80-450v...\$1
- 3 — ELECTROLYTIC COND. 80/30-150v...\$1
- 10 — HV TUBULAR CONDENSERS .001-6000v \$1
- 10 — HV TUBULAR CONDENSERS .005-3000v \$1
- 35 — MICA COND. 20-100 mmf & 15-270 mmf...\$1
- 35 — MICA COND. 20-470 mmf & 15-680 mmf...\$1
- 35 — MICA COND. 20-820 mmf & 15-1000 mmf...\$1
- 35 — CERAMIC COND. 20-5 mmf & 15-10 mmf...\$1
- 35 — CERAMIC COND. 20-25 mmf & 15-47 mmf...\$1
- 35 — CERAMIC COND. 20-56 mmf & 15-82 mmf...\$1
- 35 — CERAMIC COND. 20 100 mmf & 15-150 mmf...\$1
- 35 — CERAMIC COND. 20-270 mmf & 15-470 mmf...\$1
- 35 — CERAMIC COND. 20-1000 mmf & 15-1500 mmf...\$1
- 35 — CERAMIC COND. 20-2000 mmf & 15-5000 mmf...\$1
- 50 — 100K 1/2 WATT RESISTORS 5%...\$1
- 75 — 470K 1/2 WATT RESISTORS 10%...\$1
- 50 — 470K 1 WATT RESISTORS 10%...\$1
- 35 — 100K 2 WATT RESISTORS 10%...\$1
- 10 — ASST. WIREW'ND RES. 5, 10, 20 watt...\$1
- 3 — AUDIO OUTPUT TRANS. 50L6 type...\$1
- 3 — AUDIO OUTPUT TRANS. 6X6 or 6V6 type \$1
- 3 — I.F. COIL TRANSFORMERS 456 kc...\$1
- 3 — I.F. COIL TRANSFORMERS 10.7 mc FM...\$1
- 4 — OVAL LOOP ANTENNAS ass't hi-gain types \$1
- 3 — LOOPSTICK ANT. new ferrite adjustable...\$1
- 12 — RADIO OSCILLATOR COILS 456 kc...\$1
- 3 — 1/2 MEG VOLUME CONTROLS with switch \$1
- 5 — 50K VOLUME CONTROLS less switch...\$1
- 10 — SURE GRIP ALLIGATOR CLIPS...\$1
- 1 — GOLD GRILLE CLOTH 14"x14" or 12"x18" \$1
- 5 — SETS SPEAKER PLUGS wired...\$1
- 10 — SETS PHONO PLUGS and PIN JACKS...\$1
- 2 — \$2.50 SAPPHIRE NEEDLES 4000 playings...\$1
- 5 — DIODE CRYSTALS 2-IN21 2-IN22 1-IN24 \$1
- 2 — SELENIUM RECTIFIERS 1-65 ma & 1-150 ma \$1
- 15 — ASST. TV COILS sync, peaking, width, etc \$1
- 1 — TV VERT. OUTPUT TRANS. 10 to 1 ratio...\$1
- 5 — TV CRT. SOCKETS with 18" leads...\$1
- 5 — HI-VOLT. ANODE LEADS with 18" leads...\$1
- 1 — TV RATIO DETECTOR TRANS. 4.5 mc...\$1
- 1 — SET TV KNOBS standard type Incl. decals...\$1
- 1 — LB ROSIN CORE SOLDER 40/60...\$1
- 6 — SPIN TIGHT SOCKET SET 3/16" to 7/16" \$1
- 3 — TV ALIGNMENT TOOLS 5", 7", 12" \$1

HANDY WAY TO ORDER—Simply tear out advertisement and pencil mark items wanted (X in square is sufficient); enclose with money order or check. You will receive a new copy of this ad for re-orders.

ON SMALL ORDERS—Include stamps for postage; excess will be refunded. Larger orders shipped express collect.

BROOKS RADIO & TV CORP.

84 Vesey St., Dept. B, New York 7, N. Y.

an oscilloscope whose vertical input is the telemetered signal and whose horizontal input is an external audio oscillator. The technique, of course, is that of frequency measurement of the sub-carrier oscillator by zero-beating the reference oscillator. The approach is both simple and reliable and has been used in reading many data tapes. This method may be satisfactorily employed even without the use of band separation filters for the various telemetry channels.

Recording Time

The final data interpretation from both amateur and professional tape recordings is highly dependent upon an accurate knowledge of the time at which the recordings were made. The signal strength at each receiving station varies greatly between the different satellite passes as well as during a single pass. It is necessary, therefore, to analyze the data from several stations which may be receiving the signal at approximately the same time. If the recorded time is not known for each station, the data may be incomplete, confusing, or even worthless. In general, this requirement has been recognized by amateurs who have participated in this program.

Various methods of recording time have been used by amateurs. One amateur handled the problem by switching from telemetered data to WWV for both the five-minute voice and code announcements with a few seconds break for each one-minute mark. This method, while excellent, generally requires the use of a second receiver. An alternate method that should be quite good would be the accurate setting of a clock or watch to WWV before the satellite pass and voice recording the time for each minute- and five-minute period. A third possibility would be the recording of time in code by either an accurate 400-cycle oscillator or the 60-cycle a.c. line. In either case, the start of the minute would be indicated by a five- to ten-second dash following the code announcement. The use of either an accurate 400-cycle or 60-cycle frequency has the additional merit of providing a check on the exact speed of the recording and reproducing equipment. A worthwhile modification of the idea would be to continuously record the selected tone at a low level and amplitude key its level for code recording. If possible, the time error should be held to less than one second.

The foregoing suggestions are not meant to discourage the efforts of those who have undertaken measurements of the satellite transmissions but merely to point out possible improvements which might be made in the receiving and recording of data.

The author wishes to express his appreciation to Messrs. N. W. Mathews of the Naval Research Laboratory and L. N. Cormier of the National Academy of Sciences for their comments and suggestions on the preparation of this article.

save on hi-fi,
ham radio, other
electronics devices
by using
easy-to-assemble kits!

New ELECTRONICS KITS GUIDE and DIRECTORY ON SALE NOW!

There's lots of fun and satisfaction—as well as big savings—in building electronics devices from kits. And now, for the first time, you can get a publication that tells you all you need to know about putting together your own hi-fi set, electronics laboratory, short-wave receiver, electronics accessories for car and boat, photoelectric eyes, pocket radios—dozens of practical, enjoyable electronics devices.

Whether you're an old hand at kit construction or have never used a soldering iron, you'll find this 160-page guide to ELECTRONICS KITS a windfall of valuable information. Edited by the Ziff-Davis Electronics Division, this new Annual contains 30 construction articles and 640 illustrations!

KIT BUILDERS GUIDE — Why build kits? What tools you should have. Contents of a typical kit.

FOR YOUR HI-FI — Assembling your kit-built hi-fi. Construction kits for typical hi-fi tuner, integrated amplifier, Pre-amplifier, Power amplifier, Speaker enclosure, Turntable and pickup arm.

FOR YOUR SHOP — What type of test instruments should you buy? How to construct a vacuum tube voltmeter. A Multitester, R.F. Generator, Condenser Checker, Audio Generator, TV Sweep Generator, Tube Tester.

KITS FOR THE HAM — How to build an All-Band Receiver, Variable Frequency Oscillator, Grid Dip Meter, CW Transmitter, Market Generator, Modulator, CW and Phone Transmitter.

KITS FOR THE HOME — How to construct an Intercom System, Portable Radio, Burglar Alarm, Auto Ignition Analyzer, Games for Children.

PLUS: World's only complete directory of electronics kits, including specifications, prices and manufacturers' names.

This big, new builder's guide and directory to ELECTRONICS KITS is now on sale. Pick up your copy today at your favorite newsstand or radio parts store—only \$1.00.

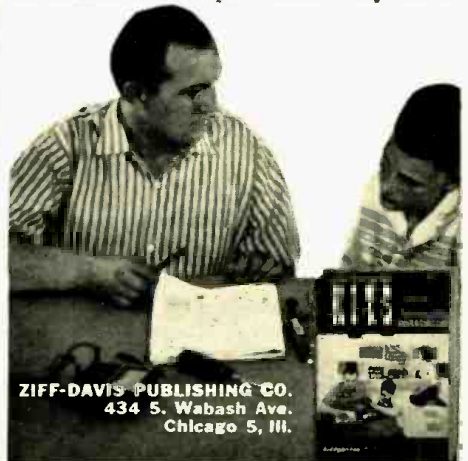

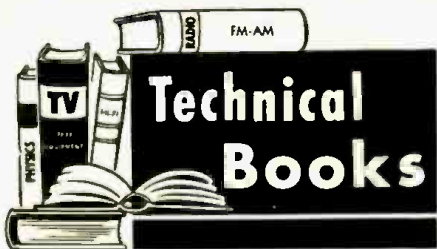

"SERVICING HI-FI AND ASSOCIATED AUDIO EQUIPMENT" compiled and published by *Howard W. Sams & Co., Inc.*, Indianapolis. 153 and 148 pages (Vols. 1 and 2 respectively). Price \$2.95 each. Soft cover.

This two-volume "library" of servicing information and schematic data should prove a decided boon to technicians involved in keeping hi-fi equipment operating at peak performance. Each item covered receives "Photofact" treatment with schematic, parts list, voltage and resistance measurements, in addition to complete service dope.

Volume 1 covers twenty-six models of 1956-1958 equipment including power amplifiers, preamps, AM-FM receivers and tuners, and p.a. amplifiers. A special section covers planning, installation, and maintenance of home music systems.

The second volume provides similar coverage on twenty-seven models of 1956-1958 equipment plus a special section on the planning and installation of stereo music systems for the home. A cumulative index covers both volumes.

Serious audiophiles with a good technical background will find these volumes as useful as will the man whose business it is to keep audio gear up to professional standards.

"CLOSED-CIRCUIT TELEVISION SYSTEMS" prepared by Government Service Department, RCA Service Company. Published by *Radio Corporation of America*, Camden, N. J. 348 pages. Price \$4.50.

This handbook has been prepared for the information and enlightenment of engineers, industrialists, and technicians who are concerned with the installation, servicing, and planning of closed-circuit television projects.

The text material is divided into three major sections dealing with monochrome systems, color systems, and pertinent data which applies to both types of transmission. Book 1, dealing with black-and-white installations, covers a general introduction to the subject, fundamentals and techniques of closed-circuit TV, factors to be considered in the selection of CCTV equipment, general systems planning, and system planning and specific applications.

Book 2, on color systems, follows much the same informational pattern as for the monochrome systems but, of course, applies to the tinted transmissions. The "Addenda" section includes the index for the main body of the text and two sections on educational TV and industrial TV. The former in-

ALL BAND RECEIVER



NAVY ARB/CRV 46151-190 to 9050 KC—Four Band, 6 Tube Superhet—Local & remote tuning and band change—Illuminated dial, sharp & broad tuning; AVC, CW provisions for operation of DU-1 Loop. Complete with Tubes: 1/12SA7, 1/12A6, 4/12SF7, & 24 Volt Dynamotor. Size: **\$18.95**
8 x 7 x 16" Used: \$24.95
ABOVE—Converted to 12 Volt with Dynamotor (No electric band change) \$24.95
Conversion for 115 V 60 cycle with Sensitive Dial, Phone Jack, CW, Volume Control, On & Off Switch (All on front panel) —KIT of Parts with Instructions \$10.00
Conversion—as Above—for 12 Volt DC—KIT of Parts, with Dynamotor 10.00
Remote Control Box 2.00
Remote Control Shaft 1.50
Remote Control Head 1.00
Tuning Knob for large split shaft 1.00
T-Shaft Adapter for remote and local tuning 1.50
PLUGS only—for Receiver or Control Box, Each: 1.00

RECEIVERS:

R-23/ARC-5 Receiver—190 to 550 KC. Used: \$14.95
R-26/ARC-5 Receiver—3 to 6 MC. Used: 7.95
R-27/ARC-5 Receiver—6 to 9 MC. Used: 8.95
R-28/ARC-5 Receiver—100 to 156 MC. Used: 14.95
RAX-1 Receiver—200 to 1500 KC. Used: 18.95
RAX-2 Receiver—1500 to 9000 KC. Used: 18.95
RAX-3 Receiver—7000 to 27000 KC. Used: 18.95
BC-652 Receiver—2 to 6 MC—Used: 24.95
BC-312/342 Receiver—1.5 to 18 MC—Used: 29.50
BC-733 Revr—108 to 110 MC—U: 39.95 No Tubes: 4.95
BC-683 FM Receiver—20 to 28 MC—Used: 14.95
BC-683 FM Receiver—27 to 38 MC—Used: 24.95
BC-3050 FM Revr—30 to 50 (10 MC Spread) N: 29.95
BC-1206 Receiver—200 to 400 KC—U: \$4.95—N: 9.95

MACY PHONE PATCH CONVERSION UNIT

Remote Control RM-52—Can be used with RM-53 or used as a separate telephone system. Uses 4 flashlight batteries. Also can be used as a direct remote control for radio equipment. Provides bias for Mic. & Sidetone to headset. High or low imp. Mic. & Phone Jack. Easily converted to Phone Patch—See October '58 CQ Magazine. Prices: Used \$1.95—New \$2.95

TRANSmitters:

BC-191 AM—100 Watt—1.5 to 12 MC. Used: \$24.95—New: \$34.95
BC-375 AM—100 Watt—1.5 to 12 MC—24 V—U: 24.95
BC-604 FM—30 Watt—20 to 28 MC—U: 4.95 N: 14.95
BC-684 FM 30 Watt—27 to 38 MC. Used: 14.95
BC-1158 AM—50 Watt—53.3 to 95 MC—U: \$29.95—N: 39.95
T-23/ARC-5—100 to 156 MC. Used: 14.95
BC-457 AM/Comm. 4 to 5.3 MC. Used: 4.95
Navy/BC-696 AM/Comm.—2 to 4 MC. Used: 4.95
Navy Type AM/Comm.—3 to 3 MC—U: \$7.95—N: 8.95

MISCELLANEOUS:

BC-221 Frequency Meter—Used: \$79.50
Magnets—Rams Horn—200 Gauss. Used: 12.95
Magnets—Horseshoe, 75 lb. lift: \$4.95—25 lb. lift: 2.95
I-208 SIGNAL GENERATOR—Used: 59.50
Blank Paper Code Tapes: 30 Rolls \$3.00—60 Rolls 5.00
CODE TAPES—15 Rolls to a Set—New: 18.95
AN/APS-4 Radar 3 CM—New: 69.50
C-114 Loading Coil or C-161 Phone Coil Each: 1.95
Navy Filters, Same as FL-8—No Cord \$1.50—W/Cord 1.95
Tuning Units F/BC-375/BC-191—Prices from \$9.95 to 5.95
BC-929 Radar Oscilloscope—8 Tubes—U: \$9.95—N: 14.95
BC-1268—Oscilloscope Radar, 25 Tubes—New: 14.95
BC-906 Freq. Meter—143 to 227 MC—U: \$7.95—N: 9.95
RD-7/APA-23 Recorder—Used: \$22.95—New: 29.95
TS-385—Oscillator—376 to 418 MC—U: \$9.95—N: 12.95
BC-1203 Audio Amplifier Modulator—New: 19.95
Navy RDP Panoramic Adapter—Used: 34.95

RECEIVER-TRANSMITTER



BC-1000 FM Receiver-Transmitter—40 to 48 MC; low power, portable, 18 Tubes. Variable tuning of Rec-Trans. Simultaneously on calibrated dial. Squelch circuit. Dry battery voltage required: 150 VDC 50 MA, 90 VDC 25 MA, & 4 1/2 VDC 1/2 A. Size: 5 1/2 x 11 1/2 x 7 1/2". Complete w/Tubes Used: **\$38.95**
AN-131 Antenna for above: \$1.95
RECEIVER-TRANSMITTER BC-1306—3800 to 6500 KC. Voice 15 Mile. CW 30 Mile. MO or Crystal Control. Crystal Calb. & Net Controls. Used: \$29.95
PE-237 Power Supply for BC-1306—6, 12, or 24 Volt. U: 14.95
Large Plug to fit BC-1306 or PE-237. Each: 1.50
SCR-522 Rec.-Trans.—100 to 156 MC. Used: 29.95
RT-18/ARC-1 Rec.-Trans.—100 to 156 MC. Used: 89.50
BC-1335—FM Rec.-Trans.—27 to 38 MC. Used: 24.95
BC-659 FM Rec.-Trans.—27 to 38 MC. Used: 14.95
BC-620 FM Rec.-Trans.—21 to 28 MC. New: 14.95

DYNAMOTORS:



DM-35 DYNAMOTORS—12 V input; 625 V 225 MA output—Size: 8 x 4 x 4"
\$7.95 \$9.95 \$12.95
USED RE-ISSUE NEW
NOTE: Extra Set of Brushes included with the New!

12 VDC	220 VDC	80 MA	DM-34	NEW USED
12 VDC	375 VDC	150 MA	BD-83	6.95 4.95
12 VDC	540 VDC	450 MA	DA-12	9.95 6.95
12 VDC	425 VDC	163 MA	WE-277	12.95 9.95
12 VDC	225 VDC	100 MA	D-402	8.95 5.95
12 VDC	250 VDC	60 MA	DM-32 12 V	4.95
12 VDC	275 VDC	150 MA	M-64	8.95
12 VDC	185 VDC	210 MA	DM-40	4.95 2.95
12 VDC	1000 VDC	350 MA	BD-77	9.95
12 VDC	300 VDC	260 MA	PE-98	19.95 12.95
6 or 12	500 VDC	160 MA	PE-103	19.95
6 VDC	640 VDC	260 MA	—Reconditioned by G. E.	\$12.95
6 VDC	420 VDC	60 MA	—Reconditioned by G. E.	9.95
6 VDC	275 VDC	60 MA	DM-9450	\$6.95 4.95

POWER SUPPLIES:

PE-120 G-12 Volt 1/BC-659/BC-620. Used: \$ 9.95
RA-20 110 V 60 cycle 1/BC-312/BC-342. Used: 9.95
AC 1/BC-603-683-3050—Kit: \$10.00—Wired: 14.95
AC 1/Command or ARC-5—Kit: \$12.00—Wired: 18.95
PE-125 Vibrator 12 VDC—500 VDC 160 MA—N: 9.95
PE-104 Vibrator Supply BC-654—Used: 9.95

PHONES • MIC'S • HEADSETS

EE-8 Field Telephone—Reconditioned: \$14.95
BD-71 Switchboard—6 Line—New: \$24.95—Used: 14.95
BD-72 Switchboard—12 Line. Used: 24.95
BD-89 Switchboard Console Type, 60 Lines—U: 100.00
TS-9 Handset—New: \$4.95—Used: 2.95
T-17 Microphones—New: \$6.95—Used: 3.95
TS-13 Handset—New: \$1.95—Used: 3.95
T-26 Microphone F-1 Button—New: \$1.95—Used: 1.25
HS-30 Headset—New: \$1.50—Used: .75
Lip Mic. —New: \$1.50—Used: 1.00
Throat Mic. —New: .75—Used: .50

CABLES & PLUGS:

Cables with PL-59-64 or 61 ea. end. Each Cable: \$2.75
TCS Cable P.S. to Trans. or Rec. to P.S. Ea. 2.75
Battery Cable & Plug for BC-603, 683, or 3050. 2.75
Plugs Only: SCR-522, BC-375, Command Sets. Ea. 1.00

MOUNTINGS AND RACKS:

FT-237 Mtg. for BC-603 & BC-603—Used: \$9.95
FT-346 Mtg. for BC-603-683-3050—New: 4.95
FT-253 Mtg. for BC-652 & BC-653—New: 9.95
FT-220 for Command or ARC-5—3 receiver—New: 2.00
FT-162 for BC-312 & BC-342—New: 2.95

The WORLD'S FINEST SURPLUS BARGAINS!

For Details on Items Previously Advertised—SEND for FREE CATALOG #M-58!

Address Dept. RN • \$5.00 Order Minimum, & 25% Deposit on C.O.D.'s • Prices are F.O.B. Lima, Ohio

FAIR RADIO SALES

132 SOUTH MAIN ST. LIMA, OHIO

LOOK
NO FURTHER... IF YOU'RE UNHAPPY WITH "HI" HI-FI PRICES. WRITE FOR OUR UNUSUAL AUDIO CATALOG.
KEY ELECTRONICS CO.
120-C Liberty St., N.Y. 6,
Phone EV 4-6071

BARGAIN HUNTING?
TV SERVICEMEN!
Write for SENSATIONAL CATALOG
HENSHAW RADIO SUPPLY
3619 TROOST KANSAS CITY, MO.

college grads get ahead faster!
... have higher incomes... advance more rapidly. Grasp your chance for a better life. Share rewards awaiting college men. Important firms visit campus regularly to employ Tri-State College graduates. Start any quarter. Approved for Vets.
Bachelor of Science degree in 27 months
Electrical Engineering with either an Electronics or Power major. Mechanical, Civil, Chemical, Aeronautical Engineering. In 36 months a B.S. in Business Administration (General Business, Accounting, Motor Transport Management). Superior students faster. More professional class hours. Small classes. Enrollment limited. Beautiful campus. Well-equipped labs. Prep courses. Enter Jan., March, June, Sept. Earnest capable students (whose time and budget require accelerated courses and modest costs) are invited to write Jean McCarthy, Dir. Adm., for Catalog and book "Your Career in Engineering and Commerce."
TRI-STATE COLLEGE
16128 College Ave. Angola, Indiana

Another Britener First!

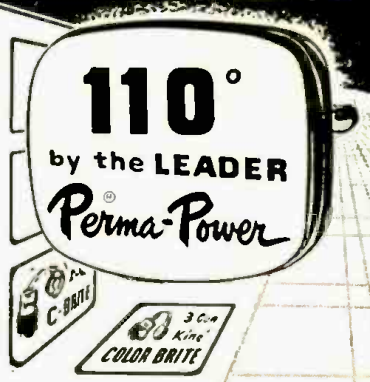
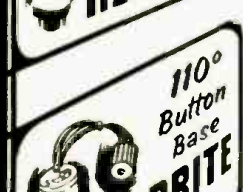

Designed by engineers for quality, low cost, small size. Attractively packaged for quick, easy selling... consistently profitable.

The Perma-Power TV Tube Britener design is original and unique. It is fully protected by U. S. Patent No. 2,757,316.

Perma-Power COMPANY
3100 N. ELSTON AVE. CHICAGO 18, ILL.
Manufacturers of Electronic Equipment Since 1929

from **ALMO RADIO**
IMMEDIATE DELIVERY
on new value-packed
EICO® HAM GEAR



90-WATT CW TRANSMITTER #720
KIT \$79.95 WIRED \$119.95



UNIVERSAL MODULATOR-DRIVER #730
KIT \$49.95
WIRED \$79.95 Cover E-5 \$4.50



GRID DIP METER #710
KIT \$29.95 WIRED \$41.95
including coils for full band coverage

ALMO RADIO CO. R12 913 Arch St., Phila, Pa.
 Send QUANTITY each of EICO Models
I enclose \$..... in check or M.O.
 Send complete EICO catalog on ham, hi-fi, test equipment.
Name.....
Address.....
City..... Zone..... State.....

See Specs in EICO Ad on Page 36

 * BC-645 XMTTR Receiver BRAND NEW 19.95 *
 * 435 to 500 mc BRAND NEW 1.49 *
 * Control Box for above BRAND NEW 1.49 *
 * PE-101C Dynamotor BRAND NEW 5.95 *

 Western Electric Monitor Range Indicator-D151821
 Complete w/GAP1 & Tubes 113 VAC 1000
 Indicator-ID-11/APS-4 3" scope 3PPT & 2/8J6
 Tubes BRAND NEW 2.75
 Radio Sonda Transmitter w/3A5 1.49
 Code Practice Oscillator VO-3-F NEW 19.95
 Dynamotor 14V in-output 172V/188MA fused with
 BC-652L Receiver 2.5mc w/tubes & dyn. Like New 14.95
 Dynamotor-Eicor 6/0V in-output 600V/150MA
 Supply RA-201 BRAND NEW 2 for 13.00
 Power Supply Unit PE-110-B 115V/80 cye. (used
 with HC-60B) LIKE NEW 49.95
 Raytheon Rectl Charger for telephone switchboard serv-
 ice (Al. No. W5853) BRAND NEW 99.50
 Test Set TS-543/up Echo Box 1150 T 1350 M
 w/accessories & manual 39.95
 BC-652 Receiver 2.5mc w/tubes & dyn. Like New 14.95
 Less tubes & dyn. Good Cond. 7.95
 BC-344 Receiver 150-1500 KC w/115 VAC Power
 Supply RA-201 BRAND NEW 29.95
 BC-1306 XMTTR Receiver Complete w/tubes 9800-
 6500 KC CW-Voice BRAND NEW 9.75
 BC-638A Freq. Meter 100-150 mc Comprises fixed
 freq. crystal-controlled osc. for calibrating Receiver
 BC639 24.95
 BC-604 Transmitter w/tubes 4.95
 APM-1 420-465 mc Complete w/tubes & dyn. 9.95
 TS-35 Signal Generator NEW 49.95
 R.F. Interference Filter contains 2 Sprague bypass
 .25 mfd. inductive cond. mounted on bracket
 NEW 1.95
 Vacuum Cond. Jennings JCR-2A 24 mmfd 10 KV
 NEW 2.95
 4 MFD 4000 V Sprague Oil Condenser CP70E1FM40K
 NEW 10.75
 Power Trans PRT 115V or 220V 60 cye. Sec. 1400
 VCT 300 MA (Conservative) 6.3V-1A/6.3V-1A/5V-4A.
 Mfd. by W. E. Co. Body dim 7 21/32 h x 6 23/32
 lg. 5 15/16 wd. 7.95; 2 for 15.00
 Heavy Duty Power Trans PRT 220 V 60 cye (can
 be tapped for 115V) Sec. 3600 VCT 300 MA Mfd.
 by W. E. Co. 8 1/2 h x 0 1/2 x 9 wd. 15.95; 2 for 30.00
 Power Trans 115V 60 cye. Sec. 800 V.C.T. 150 MA.
 6.3V-1A C.T. Very neat 4.95; 2 for 9.00
 Heavy Duty Choke. 15.7 Hly 450 MA (800MA Con-
 servative) Mfd. by Merit 6.95
 Audio Trans PRT. 8500 V Sec. Herm. Sealed
 S.S.B. Trans. 2 for 1.00
 Micropositioner/Barber Colman NEW 9.95
 Carbon Chestmike w/single ear phone 1.95

 * 0-500 Microamps (Basic Movement) 3 1/2 Air-
 * craft Meter. Marked fuel Air Ratio mfd. by *
 * Cambridge Instrument 2 for 3.00; 1.59 ea. *

 0-100 Microamps 3" rd. 5.85
 0-100 Microamps 1 1/2" Sq. miniature 3.85
 0-300 MA 2" rd. 2.4V/0-800 VDC 3" rd. 2 for 9.95
 LARGE QUANTITY OF LATEST COMPONENTS
 IN STOCK
 SEND LIST WILL QUOTE-LARGE OR SMALL

SPARKS RADIO SUPPLY
194 GENESEE ST., BUFFALO 3, N.Y.

cludes medical applications and general educational uses. The section on industrial applications covers CCTV in the railroad industry, the aircraft, metals, paper, and power fields, and in commercial and business houses.

The text is lavishly illustrated with line drawings, graphs, scope patterns, and photographs of actual equipment and installations. Those involved in this burgeoning field will find this handbook especially valuable as a reference source as well as a practical guidebook.

"MAGNETIC RECORDING TECHNIQUES" by W. Earl Stewart. Published by McGraw-Hill Book Company, New York, 268 pages. Price \$8.50.

This is an engineering text for those directly concerned with magnetic recording methods and devices as used in audio, television, communications, automation, computers, and related fields.

The text is divided into six chapters and a 9-part appendix. The first chapter deals with the basic magnetic recording processes with the balance of the book covering magnetic recording media, the reproducing process, magnetic recording mechanisms, ferromagnetism, and magnetic recording standards. The appendices cover self-demagnetizing formula, the influence of head and tape constants on the signal recorded on a magnetic tape, accidental-printing formulas, reproduction of signals recorded on magnetic tape, gap-loss formula, spacing and thickness loss formula, magnetic loop tracer, definitions of magnetic quantities, and conversion factors.

Although the emphasis is on the industrial applications of magnetic recording rather than the home-entertainment aspects, the basics are discussed as applying to the technique in general, irrespective of end use. Since the book is intended as an engineering reference text, the physics and mathematical background material has been held to a minimum.

"IMPEDANCE MATCHING," "ELECTROSTATICS," "D-C CIRCUIT ANALYSIS" edited by Alexander Schure. Published by John F. Rider Publisher, Inc., New York. 119, 64, and 72 pages respectively. Prices \$2.90, \$1.35, and \$1.35 respectively. Soft cover.

These are three of the latest titles in this publisher's "Electronic Technology Series." The first volume above deals comprehensively with the problem of impedance matching at audio and radio frequencies. Various types of "generators" and "loads" are discussed along with many types of impedance-matching devices and circuits. A separate chapter on impedance matching in transistor circuits is included.

The second volume covers electric charges and the nature of the electric field. Electric potential and its relation to capacitance is also discussed. Various electrostatic devices and applications are covered.

The third volume deals with basic electrical concepts including factors

that affect resistance. Simple d.c. circuits are analyzed and the reader is then led to more complex d.c. networks.

All three volumes include many numerical examples, along with review questions and indexes.

"BASIC ELECTRICITY FOR COMMUNICATIONS" by William H. Timbie, revised by Francis J. Ricker. Published by John Wiley & Sons, Inc., New York. 527 pages. Price \$6.25. Second Edition.

The fifteen years that have elapsed since the first edition of this text appeared have seen notable advances in the field of communications. Because of the many new devices and techniques being employed, this second and revised edition has been issued.

Although adhering to the basic plan and approach for which Prof. Timbie is so justly famous, this revised edition has been broadened to include more fields of application. The text now includes industrial electronics and instrumentation as well as communications. There is revised material on circuit analysis, Ohm's Law, Kirchhoff's Laws, and Thevenin's Theorem in order to take advantage of the newer approaches to these subjects.

New material includes discussions of metallic rectifiers, crystal diodes, transistors and other semiconductor devices, the application of thyratrons to controlled rectifiers, industrial applications of gaseous tubes, and the

time constant in capacitive and inductive circuits.

The inclusion of twelve appendices and a generous helping of test problems at the end of each chapter makes this book suitable for home study if the student has an adequate background in mathematics.

"ELECTRONIC MEASURING INSTRUMENTS" by E. H. W. Banner. Published by The Macmillan Company, New York. 491 pages. Price \$7.95. Second Edition.

This is a new and revised edition of a British text which originally appeared in 1954. Written for the instrument engineer, instrument user, advanced student, and nuclear research engineer, the text covers the principles of electronic instruments, their principal types, and component devices. Because many such measuring devices include vacuum tubes and CR tubes, there are two sections devoted to these components.

The instruments covered in the text include devices used in industrial, scientific, and medical applications. Service instruments, with the exception of the vacuum-tube voltmeter, are not included. The equipment discussed, diagrammed, and illustrated is of British manufacture but since most of the units have U. S. counterparts, the validity of the material is not impaired.

This edition carries, in addition to amplified and up-to-date data on the

material discussed in the earlier volume, new sections on special reliability and subminiature tubes, junction transistors, thermo-variable resistors (thermistors), waveform error, multi-wave voltmeters, flying-spot microscopes, portable radiation pyrometers, metal rectifier instruments, survey and combination meters, recorders, palladium leak detectors, electronic tachometers, etc.

"NUCLEAR ENERGY" and "MECHANICS" by Alexander Efron. Published by John F. Rider Publisher, Inc., New York. 63 and 112 pages respectively. Prices \$1.25 and \$1.50 respectively. Soft cover.

Above are two of the latest volumes in the publisher's "Basic Science Series" which provide the reader with a rigorously accurate but readable and interesting coverage of the various separate areas of physics. These books start at a level suitable to the general reader and then proceed to a junior college level.

The first volume introduces basic atomic theory, nuclear particles, sources and applications of nuclear energy, and includes the modern physicist's view of the atom. The second volume is an interesting treatment of basic mechanics. Such topics as vectors; moments and torques; kinematics, force and motion; work, energy, machines, and power are thoroughly treated.

-30-

LIQUIDATING MOBILE RADIO EQUIPMENT AT TREMENDOUS SAVINGS!

Manufactured by the famous LINK RADIO CORP.

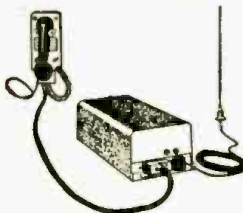

MODEL 2210
152-162 MC
FM MOBILE TRANS.
& REC.—6 VOLTS

Complete with antenna, cables, control head, mike & crystals ground to your specific frequency. Unit as outlined complete for immediate installation. Specially

priced. **\$139.50**

MODEL 2210—same as above, for operation on 12 Volts. **\$162.50**

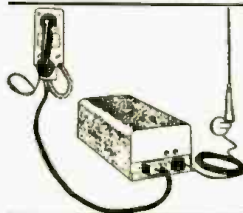

MODEL 2365
25-40 or 30-50 MC
FM MOBILE TRANS.
& REC.—6 VOLTS

Complete with antenna, cables, control head, mike & crystals ground to your specific frequency. Ready for immediate installation. Specially

priced. **\$119.50**

MODEL 2365—same as above, for operation on 12 Volts. **\$149.50**

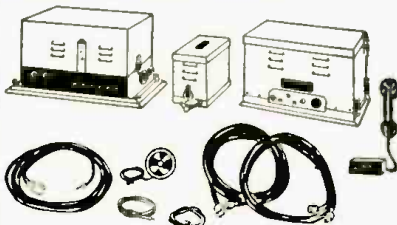

MODEL FMTR 30-50 MC
FM MOBILE TRANS. & REC.—6 VOLTS

Unit complete with Peak Modulation, control head, mike, antenna, cables & crystals ground to your specific frequency. Ready for immediate installation. A sensational buy at

\$109.95

MODEL FMTR—same as above, for operation on 12 Volts. **\$149.95**

HI-FI AMPLIFIER

12 watts. (Manufactured by AMPRO—note for quality performance.) Use for paging systems, burglar-alarm using photo-electric cell. Originally used as the motor, amplifier, projection lite & control system for a sound movie projector. For operation on 110-120V AC 60 cycle. Built-in heavy-duty blower. Tube lineup: 1 6X4, 3 6Y6, 1 6J7, 1 6J5. With all tubes & schematic less line cord. Sensational value at. **\$19.95**



BC-221 FREQUENCY METER

Real value! QUANTITY IS LIMITED—no first come, first served. They are just like new, with original calibration charts. Range 125-20,000 KC with crystal check points in all ranges. Complete with crystal and tubes. **\$119.50**
MODULATED TYPE... **\$139.50**
AC Power Supply... **159.50**
These Frequency Meters are factory tested, checked for frequency alignment and GUARANTEED.



These Frequency Meters are factory tested, checked for frequency alignment and GUARANTEED.

ATTENTION—Radio Amateurs, Members RTTY Communication Companies, Railroads, Utilities

For the first time—realistic value!



TELETYPE

Model 15 send/receive. Equipped with pulling magnet selectors. **\$249.50**
series motors. Excellent condition.

COMMAND EQUIPMENT

BC-457 Trans. 4 to 5.3 mc. good used **\$3.95**
BC-458 Trans. 5.3 mc to 7 mc. good used **\$3.95**
BC-696 Trans. 3-4 mc. good used, as is **\$2.95**
T-18/ARC-5, 2.1-3 mc. new **\$12.95**
BC-602 Control head for SCR-522, new **\$0.79**
Plugs for Above Command Sets, PL-152-A or PL-156-A **\$0.55**



HEADSETS

HS-23 high impedance, brand new **\$4.55**
HS-33 low impedance, brand new with cord and PL-54 plug **4.65**
Navy-type M/63-U 600 ohm impedance **6.95**
6 ft. Extension Cord with Jack & plug for above headsets **\$1.19**
High Impedance Matching Transformer from low to high **.79**



Mounted on black bakelite base, 4 3/4" x 3" easily attached to operating desk. Has jumper strip, binding posts and circuit closing switch, full adjustable. 1/16" solid silver keying contacts. Metal parts are cadmium-plated. New **\$1.29**
J-45 Key with metal knee band. Brand new... **\$2.95**

RETAIL DEPT. OPEN SATURDAYS

Immediate delivery. Include 25% deposit with order—balance C.O.D. 50¢ HANDLING CHARGE ON ALL ORDERS UNDER \$5.00. All shipments F.O.B. our warehouse, N.Y.C.

PLATT ELECTRONICS CORP.

20 MURRAY ST., NEW YORK 7, N. Y.
Telephone: COrtlandt 7-2575

FEDERAL PORTABLE MOBILE SIGNAL GENERATOR—110 V. AC POWER—TYPE 104A

Designed to facilitate alignment of FM mobile and land station receivers in the field. Provides a continuous source of frequency modulated carrier, the frequency of which is determined by the multiplier-type crystal that is used in the unit. It will, by the proper selection of crystals, provide a signal suitable for the alignment of FM mobile receivers in both the 25-50 MC band and the 148-174 MC band. In addition to these frequencies, the type 104A Mobile Signal Generator provides a 1000 cycle signal that may be used to check audio circuits. Unit has external power facilities. **\$49.50**





The data that launched thousands of careers is yours **FREE**

TELLS how you can be successful in **ELECTRONICS . . . including:**

Television . . . Broadcasting . . . Guided Missiles . . . Radar . . . Instrumentation . . . Computers . . . Automation . . . Astronautics . . . Servomechanisms . . . Aeronautical Electronics . . . Telemetry . . . Communications . . . Manufacturing

Send for your Free Copy today!

This is a brand new edition of the book which has launched thousands of men on good-paying careers in radio-TV-electronics.

It brings you completely up to date—answers important questions on newest career developments in Electronic Engineering Technology including Servomechanisms; Computers; Radar; Automation; Aeronautical Electronics; Broadcasting; Communications and Manufacturing, and the Electronic Principles Associated with Guided Missiles, Telemetry, Astronautics, and Instrumentation.

This book, "Your Future in the New World of Electronics," also shows you how CREI Home Study leads the way to greater earnings in the booming electronics world.

However, CREI does not promise you a "snap." With accredited technical school curricula such as CREI offers, you must study to convert your ambition into technical knowledge which you can sell in the fabulous field of Electronics.

Since its founding in 1927, CREI has provided thousands of professional electronics men with technical educations. During World War II, CREI trained thousands for the Armed Services. Leading firms recommend CREI training for their own personnel. Among them: United Air Lines, Canadian Broadcasting Corporation, Trans-Canada Airlines, Douglas Aircraft Co., The Martin Co., Columbia Broadcasting System, All-American Cables and Radio, Inc., Gates Radio Co., Canadair, Ltd., Federal Electric Corp., and U. S. Information Agency (Voice of America).

CREI courses are prepared by recognized experts, in a practical, easily understood manner, and constantly revised to meet the new electronic challenges of our time. You get the benefit of time-tested study assignments under the personal supervision of a CREI staff instructor. Your studies are accomplished on your own time, during hours selected by you, and controlled by your own will power. This complete training is the reason that graduates find their CREI diplomas keys to success in even the most advanced of electronic applications. CREI alumni hold top positions in America's leading firms.

At your service is the CREI Placement Bureau, which helps to find positions for advanced students, and graduates, although

CREI does not guarantee jobs. Now is the time of decision for you. Luck will not propel you forward unless it finds you trained. Contacts won't budge you an inch unless you have the skill to back them up. The answer is: Technical Training . . . and willingness to learn. Together they will bring you increased earnings in the new Age of Electronics. Fill out the post card below *completely* and mail it now to Capitol Radio Engineering Institute, 3224 16th St. N.W., Washington 10, D.C. We'll promptly send you your free copy of "Your Future in the New World of Electronics." The rest—your future—is up to you!

CREI ALSO OFFERS RESIDENCE TRAINING in Washington, D. C. at the same high technical level. Day and evening classes start at regular intervals. Qualified residence school graduates earn degree, "Associate in Applied Science." Check coupon if you prefer residence study.

VETERANS: If eligible for training under the new G.I. Bill of Rights, check the coupon for full information.

ELECTRONIC TECHNICIANS

Growing Peninsula Co. has openings for 1st class electronic technicians to work directly with engineering in development of new products. Only those with CREI or equal training and 3 years minimum commercial experience will be considered. Top salaries to qualified applicants. Call Mr. McQueeney, D.A. 4-1733 for appointment. ALCO SCIENTIFIC Co., Inc. 855 COMMERCIAL ST. PALO ALTO

ENGINEERING AIDES AND TECHNICIANS

Immediate Positions Available

CREI or other formal electronic training desirable

Experienced in reading schematics, breadboard construction of electronic circuit and chassis preparation.

EMERSON RESEARCH LABORATORIES

INDUSTRY CALLS FOR CREI TRAINING BY NAME . . . SO SHOULD YOU!

Here you see actual help wanted ads—one from a San Francisco newspaper, another seen in Washington. They are just two of many which specify "CREI or equal" education. This shows that industry approves CREI training, even insists on it. Experience has taught many, many companies that CREI students are taught what industry needs and wants them to know. Let this be your cue when you choose your educational program.

FREE BOOKLET! MAIL THIS POSTAGE-FREE POST CARD TODAY

CAPITOL RADIO ENGINEERING INSTITUTE
ECPD Accredited Technical Institute Curricula • Founded 1927

Dept. 119-E 3224 16th St., N.W., Washington 10, D. C.

(R.E. Nov. 58)

B₂E₂

Please send me your course outline and FREE illustrated Booklet "Your Future in the New World of Electronics" . . . describing opportunities and CREI home study courses in Practical Electronic Engineering Technology.

- CHECK FIELD OF GREATEST INTEREST
- Radar, Servo and Computer Engineering Technology
 - Electronic Engineering Technology
 - Broadcast (AM, FM, TV) Engineering Technology
 - Television Engineering Technology
 - Aeronautical Electronic Engineering Technology

Name _____ Age _____

Street _____

City _____ Zone _____ State _____

Check: Home Study Residence School Korean Veteran

If you have had electronic education, or experience in electronics—and realize the need of a high-level technical knowledge to make good in the better electronic jobs—you can qualify for CREI home study training. (Electronics experience is not required for admission to CREI Residence School.) Please fill in the following information.

Employed By _____

Type of Present Work _____

Education: _____

Yrs. High School _____

Yrs. College _____

Electronics Experience _____

COMPLETE TRAINING FOR BETTER RADIO-TV SERVICE JOBS

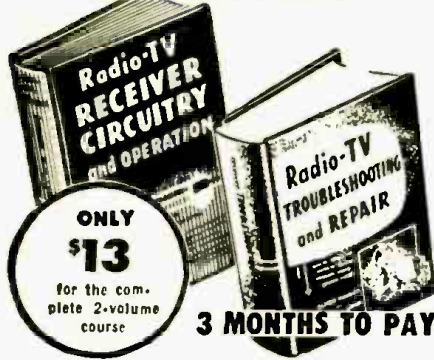

Let these two world-famous Ghirardi training books teach you to handle all types of AM, FM and TV service jobs by approved professional methods—and watch your efficiency and earnings soar!

Completely modern, profusely illustrated and written so you can easily understand every word, these books pave the way to fast, accurate service on any type of radio and TV set ever made. Each book contains the latest data on the latest methods and equipment—NOT a re-hash of old, out-of-date material. Each is co-authored by A. A. Ghirardi whose famous **RADIO PHYSICS COURSE** and **MODERN RADIO SERVICING** were, for 20 years, more widely used for military, school and home study training than any other books of their type!

THE NEW Ghirardi RADIO-TV SERVICE LIBRARY

Almost 1500 pages and over 800 clear illustrations show step-by-step how to handle every phase of modern troubleshooting and servicing.

1—Radio and Television Receiver TROUBLESHOOTING AND REPAIR

A complete guide to profitable professional methods. For the beginner, it is a comprehensive training course. For the experienced serviceman, it is a quick way to "brush up" on specific jobs, to develop improved techniques or to find fast answers to puzzling service problems. Includes invaluable "step-by-step" service charts. 820 pages, 417 illus., price \$7.50 separately. (Outside U.S.A. \$8.00.) See combination offer below!

2—Radio and Television Receiver CIRCUITRY AND OPERATION

This 669-page volume is the ideal guide for servicemen who realize it pays to know what really makes modern radio-TV receivers "tick" and why. Gives a complete understanding of basic circuits and circuit variations; how to recognize them at a glance; how to eliminate guesswork and useless testing in servicing them. 417 illus. Price separately \$6.75 (outside U.S.A. \$7.25).

New low price...you save \$1.25!

If broken into lesson form and sent to you as a "course," you'd regard these two great books as a bargain at \$50 or more! Together, they form a complete modern servicing library to help you work faster, more efficiently and more profitably. Completely indexed so you can look up needed facts in a jiffy.

Under this new offer, you save \$1.25 on the price of the two books—and have the privilege of paying in easy installments while you use them! No lessons to wait for. You learn fast—and you learn right!

STUDY 10 DAYS FREE!

Dept. RN-128, RINEHART & CO., Inc.
232 Madison Ave., New York 16, N. Y.

Send books below for 10-day FREE EXAMINATION. In 10 days, I will either remit price indicated (plus postage) or return books postpaid and owe you nothing.

Radio & TV Receiver TROUBLESHOOTING & REPAIR (Price \$7.50 separately)

Radio & TV Receiver CIRCUITRY & OPERATION (Price \$6.75 separately)

Check here for MONEY-SAVING COMBINATION OFFER... Save \$1.25. Send both of above big books at special price of only \$13.00 for the two (retail price \$14.25)... you save \$1.25. Payable at rate of \$4 (plus postage) after 10 days if you decide to keep books and \$3 a month thereafter until \$13 has been paid.

Name _____

Address _____

City, Zone, State _____

Outside U. S. A.—\$8 for TROUBLESHOOTING & REPAIR; \$7.25 for CIRCUITRY & OPERATION; \$14 for both. Cash with order only, but same 10 day return privilege.

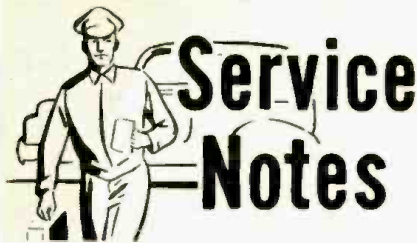

IMPROVE PACKARD-BELL AUDIO

On receivers using chassis 2710 and 2720—these include models 2721 to 2724—over-all audio quality can be improved by a simple change involving two components. Capacitor C_{13} , a .005- μ fd. unit connected between plate and cathode of the audio-output tube (V_5 , 6V6), should be replaced with a .01- μ fd.

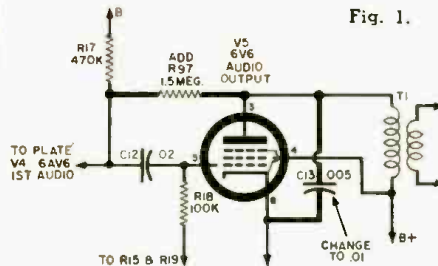

Fig. 1.

capacitor. At the same time, a 1.5-meg-ohm resistor, designated as R_{301} , should be added between the plate of this stage and the plate of the 1st audio amplifier (V_4 , 6AV6). These changes are shown in Fig. 1. The two components involved and their locations are indicated by the heavy lines on the schematic.

FIRESTONE: FREQUENCY DRIFT

Some TV receivers using neotrone tuners, like the 25A1148 front end, may show a tendency to shift frequency while in operation, requiring re-adjustment of fine tuning. Models that may be so affected are in the series from 13-G-210 to 13-G-226. The probable cause is a defective capacitor in the circuit of the local oscillator, C_{13} in Fig. 2. Due to faulty tinning of the ceramic disc, this 6.8- μ fd. unit may

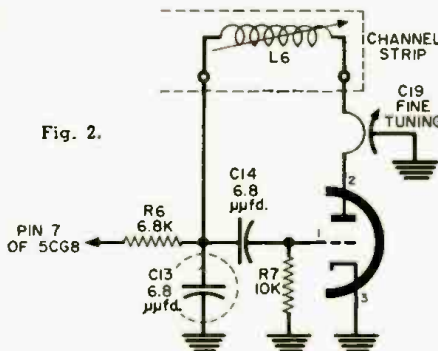

Fig. 2.

have an intermittent internal connection. Replacement of the component is the remedy.

In putting in a substitute part, several precautions must be observed. Since C_{13} is a special temperature-compensated unit, it cannot be replaced indiscriminately. It must have a tolerance of $\pm 5\%$ and an N2200 char-

acteristic. An exact replacement is *Standard Coil* part No. 13R-007. The soldering iron used should not be rated at more than 50 watts. Also a fork-shaped iron tip should be used to facilitate removal of the defective component. This will permit the simultaneous application of heat to both sides of the capacitor.

ADMIRAL: PIX CUT-OFF

When a very strong video signal is being received on models using chassis 21B1 or 21F1, the video amplifier may be driven to cut-off, thus blocking the picture signal from the picture tube. Also, when this amplifier is cut off, there is an increase in the "B+" applied to the CRT cathode. As a result, the picture tube is likewise cut off, and the viewing screen will be entirely dark.

Ordinarily, a.g.c. action works to prevent such a condition. However, since the a.g.c. section in these receivers depends on the video amplifier, once the latter is cut off a.g.c. is ineffective. However, the addition of two resistors, the change in value of a third, and a wiring change can correct this condition, as shown in Fig. 3.

Changes are as follows: 1. Remove resistor R_{301} (4000 ohms). 2. Connect the positive terminals of filter capaci-

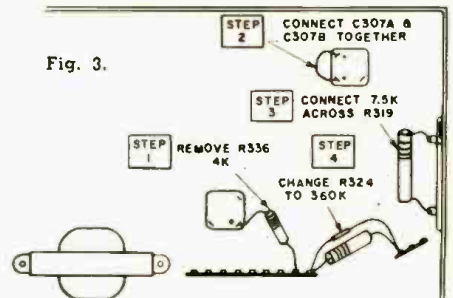

Fig. 3.

tors C_{307A} and C_{307B} together. 3. Shunt a 7500-ohm, 5-watt resistor across R_{319} . 4. Change resistor R_{324} from 180,000 ohms to 560,000 ohms, $\frac{1}{2}$ watt.

TRAV-LER: AUDIO ARCING

When the cabinet top is removed to service the underside of the chassis in models 1700, 1710, and 1710U, arcing may result at the socket of the audio-output tube, which is the pentode section of VT_4 , a 6AW8. Since service involves unloading the secondary of the output transformer, signals reaching the grid of the output tube cause excessive peaks in the plate circuit. This results in arcing between the plate (pin 9) and the screen grid (pin 8) which may permanently damage the tube socket. A warning sign will appear in the form of white flashes in the picture.

To prevent damage, the secondary leads of the output transformer should be joined together, or an external speaker load should be connected. If neither of these measures is convenient, the minimum preventive step should be turning the volume control to its lowest position to keep signal off the grid.

Hot Chassis? Play It Safe
(Continued from page 63)

windings has gone open will serve the purpose. Instead, a vertical-output transformer with a step-up ratio of about 10:1 will be suitable. If a new transformer is going to be purchased, the latter choice will be less bulky and less expensive. Do not use an auto-transformer, unless you open up the insulation, carefully separate the ends of the connected wires, and install an additional lead.

After construction, the unit is readily calibrated by connecting a 180,000-ohm resistor across its output, from the test socket to the test probe. Potentiometer R_5 is then adjusted to the point where PL_1 just begins to glow faintly. The 180,000-ohm resistor is then removed and the unit is ready to use with the bulb brightly aglow.

Testing a receiver for shock-producing shorts takes but a few seconds. Simply plug the receiver into the test socket, turn it on, and apply the probe to various sections of the cabinet, handles, exposed antenna connections, and so on—in short, any exposed portion of the receiver that might become live due to a defect. While this is being done, the set should be jarred lightly to expose intermittent shorts that might be caused by loose metal shavings, intermittent contact between live parts and the cabinet, and the like. In the event of a short or leakage, the neon bulb will cut out or dim. As long as the bulb continues to glow at full brilliance, chassis-to-cabinet resistance is normal.

If a short is indicated, the most likely trouble points will be the .01- μ fd. bypass capacitor of Fig. 2A, the antenna isolating capacitors of Fig. 2B, and over-length or improperly inserted chassis mounting bolts. Improper positioning of insulating washers, stand-offs, and other material designed to prevent contact between chassis and cabinet is also possible.

If you are lucky, the tester may never diagnose a fault—but why take a chance?

Fig. 3. Schematic diagram and parts list for the shock-hazard tester circuit.

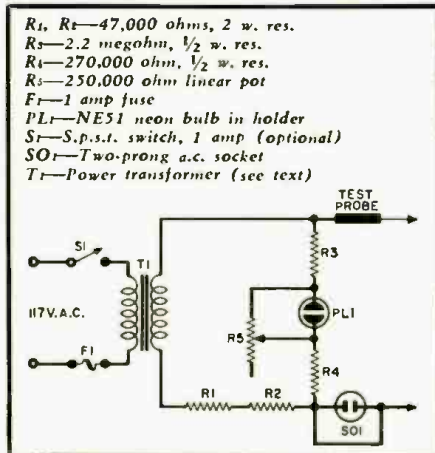

LEKTRON'S BIGGEST GIVEAWAY!
World-Famous! Our Annual Christmas
DOUBLE-BONUS OFFER!

UNTIL DEC. 30, THESE TWO BONUSES FREE WITH EVERY \$8 ORDER!

1 YOUR CHOICE OF ANY ITEM IN THIS AD . . . FREE! + **2 SPECIAL ASSORTMENT \$15 WORTH OF RADIO PARTS . . . FREE!**

BOTH BONUSES FREE WITH EVERY \$8 ORDER!

58 of 58's Best \$1 POLY-PAKS

- | | | | |
|---|--|--|--|
| <p>4 TRANSISTOR OSC. COILS</p> <ul style="list-style-type: none"> <input type="checkbox"/> for printed circuit & transistor portable & radios. Reg. \$5. \$1 5 Rolls "Micro" Wire <ul style="list-style-type: none"> <input type="checkbox"/> Sizes 24 thru 32; for mini circuits. Wt. 1 lb. \$1 <input type="checkbox"/> Ass'd. colors, insulation. Same worth \$1 ea. Wt. 2 lbs. Reg. \$1 15 VOLUME CONTROLS <ul style="list-style-type: none"> <input type="checkbox"/> incl. duals. To 1 meg; some w/switch. 2 \$1 lbs. Reg. \$12. 15-PC. TWIST DRILL KIT <ul style="list-style-type: none"> <input type="checkbox"/> 1/16 thru 1/4" by 64ths. w/calibrated case. Reg. \$9. \$1 MINI-METER <ul style="list-style-type: none"> <input type="checkbox"/> 1 3/4" diameter. 0-6 amps. AC. 1 lb. \$1 Reg. \$9. 20 PRINTED CIRCUITS <ul style="list-style-type: none"> <input type="checkbox"/> Built-in R/C circuits. incl. integrals. 1 \$1 lb. Reg. \$7. SUN" BATTERY <ul style="list-style-type: none"> <input type="checkbox"/> Similar to famed B2M. 1 onc. Reg. \$1 \$2.50. 30 MOLDED CONDENSERS <ul style="list-style-type: none"> <input type="checkbox"/> Black beuties. incl. finest made! Wt. 2 lbs. \$1 Reg. \$12. 15 ROTARY SWITCHES <ul style="list-style-type: none"> <input type="checkbox"/> Ass'd. gangs. 3 lbs. \$1 Reg. \$12. 40 DISC CONDENSERS <ul style="list-style-type: none"> <input type="checkbox"/> Water-tight. to .01 mf. Reg. \$5. \$1 <input type="checkbox"/> Clear plastic, hinged. w/8 nap 10 cks. Ass'd. sizes. Wt. 1 lb. \$1 40 SUB-MINI CONDENSERS <ul style="list-style-type: none"> <input type="checkbox"/> for transistor. printed circuit work. 1 lb. \$1 Reg. \$7. 4 OUTPUT TRANSFORMERS <ul style="list-style-type: none"> <input type="checkbox"/> 501.6, etc. Wt. 3 lbs. \$1 Reg. \$9. 8 TRANSISTOR SOCKETS <ul style="list-style-type: none"> <input type="checkbox"/> Mica-filled; for sub-mini tubes, etc. \$1 | <p>40 HI-Q CONDENSERS</p> <ul style="list-style-type: none"> <input type="checkbox"/> Finest porcelain. NPO's. tool 1 lb. Reg. \$1 \$8. 35 POWER RESISTORS <ul style="list-style-type: none"> <input type="checkbox"/> WW. 5 to 50W. to 10,000 ohms; incl. vitreous. 3 lbs. Reg. \$1 \$15. 40 PRECISION RESISTORS <ul style="list-style-type: none"> <input type="checkbox"/> 1%. 1/2 & 1W. Carboloy & WW. 100 ohms to 1 meg. Reg. \$1 \$17. 70 COILS, CHOKES <ul style="list-style-type: none"> <input type="checkbox"/> IF. 1F. ant. slug-tuned. too. 3 lbs. \$1 Reg. \$18. HEARING AID PHONE <ul style="list-style-type: none"> <input type="checkbox"/> Crystal. w/cord & plug. Reg. \$3. \$1 70 TERMINAL STRIPS <ul style="list-style-type: none"> <input type="checkbox"/> Solder-lug & binding; to 20 terminals. \$1 2 lbs. Reg. \$7. 60 ONE-WATERS <ul style="list-style-type: none"> <input type="checkbox"/> Ass'd. value carbon resistors. 5%. tool \$1 2 MINIATURE SOLENOIDS <ul style="list-style-type: none"> <input type="checkbox"/> 12 VDC. Needs small battery to actuate. \$1 plunger. Reg. \$6. 1 lb. \$1 80 HALF-WATERS <ul style="list-style-type: none"> <input type="checkbox"/> Ass'd. value carbon resistors. incl. 5%. \$1 Reg. \$12. 15 INSTRUMENT KNOBS <ul style="list-style-type: none"> <input type="checkbox"/> Raytheon. Bakelite. w/ brass insert & set-screws. Skirted incl. Wt. 2 lbs. Reg. \$1 \$12. 0000-9999 COUNTER <ul style="list-style-type: none"> <input type="checkbox"/> Veeder-root. w/double shafts. Reg. \$5. \$1 75 MICA CONDENSERS <ul style="list-style-type: none"> <input type="checkbox"/> .00025 to .01 to 1200 V. Silver. too. 25 \$1 values. Reg. \$28. 10 ELECTROLYTIC <ul style="list-style-type: none"> <input type="checkbox"/> Radio. TV. 10-500mf to 450 VDC. \$1 3 lbs. Reg. \$12. SYLVANIA TV MIRROR <ul style="list-style-type: none"> <input type="checkbox"/> 10 x 12" stainless steel. Many uses! \$1 2 lbs. Reg. \$4. \$25 SURPRISE PACK! <ul style="list-style-type: none"> <input type="checkbox"/> Large & varied asst. radio & TV parts. \$1 3 lbs. Reg. \$8. | <p>FILAMENT TRANSFORMER</p> <ul style="list-style-type: none"> <input type="checkbox"/> 115/100 cycles to 0.3 VCT @ 1.5A. 2 \$1 lbs. Reg. \$4. 40 TUBE SOCKETS <ul style="list-style-type: none"> <input type="checkbox"/> 4 to 9-pin; ceramic mica. shield-based. \$1 incl. 2 lbs. Reg. \$10. 70 HI-Q RESISTORS <ul style="list-style-type: none"> <input type="checkbox"/> Carbon JIC. ohmite. 177. incl. 1/2. 2W. 10 ohms to 10 megs. 2 \$1 lbs. Reg. \$13. 125 CERAMIC CONDENSERS <ul style="list-style-type: none"> <input type="checkbox"/> HI-Q discs. tubulars; to .01 mf. 2 lbs. \$1 Reg. \$12.50. 60-CONDENSER SPECIAL! <ul style="list-style-type: none"> <input type="checkbox"/> Molded. paper. ceramic. oil. mica. discs. \$1 variable. 2 lbs. 75-PC. RESISTOR SPECIAL! <ul style="list-style-type: none"> <input type="checkbox"/> WW. precision. carbon. variable. mini types. 3 lbs. Worth \$15 WORLD'S SMALLEST RADIO <ul style="list-style-type: none"> <input type="checkbox"/> 2 x 1 x 1" Kit includes loopstick. Jacks. diode, etc. w/instructions. Wt. 1 lb. Reg. \$3. \$1 6 SILICON DIODES <ul style="list-style-type: none"> <input type="checkbox"/> Sylvania IN22. \$1 IN23. Reg. \$36. 2 PNP TRANSISTORS <ul style="list-style-type: none"> <input type="checkbox"/> Pop. make. for hinged projects. \$5 \$1 value. 2 MIKE TRANSFORMERS <ul style="list-style-type: none"> <input type="checkbox"/> Carbon. imp. 100 to 100K ohms Leads. enclosed. 2 lbs. Reg. 10. \$1 5-IN-1 DRILL BIT <ul style="list-style-type: none"> <input type="checkbox"/> Reams. saws. shapes drills. cones. Fits hand or electric drill. \$1 70 TUBULAR CONDENSERS <ul style="list-style-type: none"> <input type="checkbox"/> Paper. molded. oil. porc. .0002 to .5mf to 1000V. 2 lbs. Reg. \$1 \$14. 8 GERMANIUM DIODES <ul style="list-style-type: none"> <input type="checkbox"/> w/long leads. Glass \$1 sealed. Reg. \$5. 300-FT. HOOKUP WIRE <ul style="list-style-type: none"> <input type="checkbox"/> Tinned. asst. colors. sizes. 2 lbs. Reg. \$1 \$5. | <p>POSTAGE STAMP MIKE</p> <ul style="list-style-type: none"> <input type="checkbox"/> Crystal. 100 to 8,000 cps. 1 lb. Reg. \$1 \$7. 3 VARI-LOOPSTICKS <ul style="list-style-type: none"> <input type="checkbox"/> Adj. 510-1500 kc. Transistor radios. \$1 etc. 1 lb. 60 PLUGS, RECEPTACLES <ul style="list-style-type: none"> <input type="checkbox"/> Audio. power. speaker. etc. 2 lbs. \$1 150 CARBON RESISTORS <ul style="list-style-type: none"> <input type="checkbox"/> 1/2 to 2W. 15 ohms to 1 meg. incl. insu- \$1 lated types. 1 lb. 8-PC. NUTDRIVER KIT <ul style="list-style-type: none"> <input type="checkbox"/> \$3 value. Plastic handle. 3/16, 7/32, 1/4, 3/16, 1/2, 3/8, 7/16" steel socket wrenches in plastic case. 1 lb. \$1 24 CAMEL HAIR BRUSHES <ul style="list-style-type: none"> <input type="checkbox"/> 100% pure bristle. Sizes 1-10. \$1 \$2.50. 2000 PCS. HARDWARE <ul style="list-style-type: none"> <input type="checkbox"/> Nuts, screws, washers, etc. 2 lbs. Reg. \$1 \$8. 0-60 MINUTE TIMER <ul style="list-style-type: none"> <input type="checkbox"/> W/dial & knob. Sounds clear alarm. 2 lbs. \$1 Reg. \$5. 3 AC-DC CHOKES <ul style="list-style-type: none"> <input type="checkbox"/> for power supplies. \$0 to 200 ma. Open \$1 frame. 3 lbs. Reg. \$9. TEN 3-SECOND TIMER <ul style="list-style-type: none"> <input type="checkbox"/> mechanicals. Precision geared. 2 lbs. Reg. \$1 \$50. TWO 115 VAC TWO 115 VAC MOTORS <ul style="list-style-type: none"> <input type="checkbox"/> 1700 rpm. Wt. 4 \$1 lbs. Reg. \$8. 40 PRINTED CIRCUIT PARTS <ul style="list-style-type: none"> <input type="checkbox"/> Diodes. chokes. resistors. cond. boards. \$1 1 lb. Reg. \$7. 3 TRANSISTOR IFS <ul style="list-style-type: none"> <input type="checkbox"/> 1/2" square. 450 \$1 kc. 60 SUB-MINI RESISTORS <ul style="list-style-type: none"> <input type="checkbox"/> 1/2. 10 values; 1/2W to 10 megs. \$1 Reg. \$6. |
|---|--|--|--|

FREE! WRITE FOR GIANT 16-PAGE BARGAIN FLYER!
THOUSANDS OF ITEMS AT DISCOUNT PRICES! RADIO—HOUSEWARES—GIFTS FOR MEN, WOMEN!

HOW TO ORDER Check items wanted. Return entire ad w/check or M.O. including sufficient postage; excess returned. C.O.D. orders 25% down; rated, net 30 days. Print name, address with POSTAL ZONE NO., amount money enclosed, in margin. (Canada postage, 48c 1st lb., 28c ea. add'l. lb.) EXPORT ORDERS INVITED.

LEKTRON 133 EVERETT AVE. CHELSEA 50, MASS.

1959 edition of
ELECTRONIC EXPERIMENTER'S HANDBOOK will be out in January

You won't want to miss the 1959 edition of the ELECTRONIC EXPERIMENTER'S HANDBOOK—now being readied for publication in January. It will bring you 50 projects like:

- a satellite tracking station
- hi-fi and stereo equipment
- projects for your home, your car, your boat
- receivers and converters
- electronic games to play
- projects for your workshop or ham shack



The 1959 edition of the ELECTRONIC EXPERIMENTER'S HANDBOOK goes on sale in January—watch for it!

ZIFF-DAVIS PUBLISHING COMPANY
434 South Wabash Avenue, Chicago 5, Ill.

RADIO ELECTRONIC SURPLUS



NEW BC683 FM RECEIVER
27-39 mc. Equipped with 10 push buttons for selecting channels. Cont. variable tuning over the entire range. Unit complete with tubes, built-in loud speaker, squelch circuit, head phone jacks, schematic diagram on bottom of case. Approx. weight 34 lbs. **\$19.95**
12- or 24-volt D.C. Dynamotor each **\$3.95**

BC603 FM RECEIVER

Some description as BC683 except that range is 20-27 mc. This unit complete with tubes.
Like New each **\$6.95**
Manual with schematic for BC603 & BC604 **\$1.00** each

BC684 TRANSMITTER

(Used with BC683 receiver.) Used, good. **\$4.95** each
CRYSTALS (set of 80) for BC604 transmitter. **\$5.00**

BC659 FM TRANSCEIVER

29-40 mc, 2 channels, crystal control. Unit complete with tubes, built-in speaker and dual meter for testing filament and plate circuit. Approx. dimensions 16" x 13" x 7 1/2".
Like New each **\$6.95**
Manual with schematic for BC659 each **\$1.00**

NEW PE120 POWER SUPPLY

6, 12 or 24 volt (specify voltage)
Used with BC659 and 620 **\$7.95** each

HIGH-QUALITY OPTICAL PARTS

5" Schmidt Ultra Hi-Speed
Objective Lens System

Eastman Kodak infra-red receiver, formerly known as U.S. Navy Metascope. Type B, 7" long with 5" SCHMIDT ultra-high speed Objective Lens (approx. f 0.5). Elaborate optical system, many coated lenses. Uses 2 penlight batteries. Govt. cost approx. \$300. Factory new. Shipping wt. 9 lbs.



Price **\$19.95**
Waterproof Carrying Case, extra. Shipping wt. 3 lbs. Price **\$3.00**
Dual purpose U.S.N. Floodlight throws strong beam of invisible infra-red rays. With infra-red lens, spare sealed beamlamp, batteries. Shipping wt. 23 lbs. Price **\$14.95**

TEST SCOPE—SYNCHROSCOPE— PULSE ANALYZER



ID-59/APA-11. Late production. Modular subassembly construction. Video amplifier is flat to 4 mc, 3BP1 presentation. Test-scope sawtooth 25-20,000 cy. Has all normal test-scope controls. As synchroscope and pulse analyzer, accepts positive or negative pulses. Video delay circuit permits leading edge of pulse to be seen. Calibrated-dial horizontal shift measures pulse durations from 0.5 to 100 microseconds. Sine-wave-oscillator calibrator measures recurrence rates from 200 to 6000 pps accurate within 0.4%. Built-in power supply requires 115v, 400 cy, 196 watts. External 60 cy power supply may be made to furnish plus 350 and -1300 vdc and 6.3 vac. In excellent condition, with all 19 tubes, schematic with parts values, parts-location pictures, operating instructions, theory explanation, and maintenance charts. Shipping weight 60 lbs. Used, good. Price each **\$16.95**

30-40 MC FM RECEIVER R-435/VRC-2X



Single channel, crystal controlled, covering police and fire department freq. Double conversion superhet (455 kc and 4.3 mc. I.F.'s); both oscillator and crystal control. Noise squelch, double limiter stages, loud speaker output. Contains vibrator supply, operates on 24 volts

D.C. Removable cover. Approx. dimensions: 9" X 12" X 15". Unused, good condition. Price **\$19.50**

NO C.O.D.'s. REMIT FULL AMOUNT WITH ORDER. ALL PRICES F.O.B. PASADENA.

C & H SALES CO.

2176 E. Colorado St. - Pasadena 8, Calif.

Service Industry

RADIO SERVICE
TV
SERVICE
News

THE STEADY march of independent service toward unification of effort was emphasized this year in the success of many of the association-promoted conventions that have gained recognition as established, annual events. One of the most significant trends in this process has been the growing interest in correlating association effort at the state level. With very active statewide associations now operating in a dozen states, the pattern of success that has been established by several of these organizations is capturing the interest of all association officers and members.

The first statewide association of record was formed in Pennsylvania about ten years ago. This organization was set up by a group of radio service associations and was initially incorporated as the Federation of Radio Service Associations of Pennsylvania.

At the time FRASAP was formed, the bulk of TV service in eastern metropolitan areas was in the hands of relatively large contractors. These companies were inclined to look with some disdain on the efforts of the smaller shops in TV service work. Ironically, most of the service contractors of that period have long since faded from the TV service scene.

Shortly after the formation of the Pennsylvania Federation, the Empire State Federation of Electronic Dealers Associations was organized in New York State. Almost from the outset, however, ESFEDA ran into difficulties. These resulted from the differences of opinion among the affiliates over national-association affiliation. While some of its locals were members of NATESA, a group of them joined with other eastern associations to form the National Electronic & Television Service Dealers Association (NETSDA). This split appeared to rob the Empire State Federation of needed unity.

In 1951, delegates from associations in the four largest cities in Texas met and formed the Texas Electronic Association. In their efforts to correlate the activities of local associations on a statewide basis, TEA officers decided to center its annual convention around a 3-day clinic and electronic service fair that would be rotated from year to year among the four largest cities. The first of these events was held in Fort Worth in 1953. It proved to be an outstanding success. In the succeeding years, the competition among the "host" cities to outdo the previous shows resulted in the steady growth of interest in TEA's annual clinics.

In recent years, statewide organizations in Connecticut and Indiana have

shown progress in developing cohesive programs. IESA, which held its second annual service fair and convention during the early Fall, is embarked on an educational program to acquaint dealers and technicians with the provisions of the statewide licensing law they hope to have passed at the next session of the Hoosier Legislature.

The California State Electronic Association has been moving steadily forward under the guidance of its new executive secretary and former president, H. Lawrence Schmitt. He is a former president of RTASCV and is currently active in TSDA of San Mateo County. The address of CSEA is: H. Lawrence Schmitt, Executive Secretary, 330 Ventura, Apt. 2, Palo Alto, Cal.

In the Buckeye State, TESA-Ohio appears to be bringing into existence a truly representative statewide organization. With local associations in Cincinnati, Columbus, Springfield, Toledo, and Cleveland carrying the ball, the organization has developed a rotating-meeting plan that will bring its work to the attention of all service dealers in the state.

Massachusetts, which justly merits recognition as the home state of the first effective radio technicians' association, recently witnessed the first statewide convention of its Electronic Technicians Guild. Of the nine local associations currently active in the Bay State, two of them still retain a name connection with the original guild. The RTTG of Fall River and the RTTG of New Bedford carry the TV-modernized name of the first Radio Technician's Guild, which was formed in Boston almost thirty years ago.

Officers were elected at the first statewide convention to head the ETG for the coming year. Nicholas Averinos of the *Colonial Radio & Appliance Co.*, 519 Columbian Street, South Weymouth, Mass., was chosen as president of the organization; Edmund Chebator of *Ed's TV & Radio Lab*, 26 Cedar Street, Cambridge, Mass., was elected vice-president; Leonard Smith was named secretary, and Albert N. Giddis were chosen as treasurer.

NATESA Q & A

As promised last month, we are running the series of questions addressed to NATESA by Frank Teskey, co-editor of the "Hoosier Test Probe," at the latest convention of the National Alliance of Television and Electronic Service Associations, along with the answers. Here are the questions:

1. What is NATESA's financial standing? Over the past five years,

how much money has come in, from whom, and how was it spent? Have there been any receipts from any other type of organizations such as labor unions, manufacturers, distributors, NEDA, EIA, etc.? Have there been any expenditures to any such groups? How much money does NATESA presently have? How much does it owe?

2. How is NATESA incorporated? Who are the incorporators, where was it incorporated, and under what conditions? Who owns the NATESA name and emblem? Who owns the "NATESA Scope?"

3. What is NATESA's liability to Frank Moch? What about salary voted in the past, but uncollected, for Frank Moch? Could this come due at some future date and embarrass the association? What about any fees possibly collectable at a later time for past services rendered?

4. What would happen to NATESA if Frank Moch was voted out of office?

5. What liabilities, due to corporate structure, would individuals (as associate members) or local affiliates incur by joining NATESA? Can either local affiliates or associate members be sued if NATESA could not pay some future judgment that might be levied against it? How about the individual members of local affiliates?

6. Would it not be better all around if membership in NATESA were by state associations, where these existed, rather than having the dual status that now exists?

7. Dues. What does NATESA do with the \$5.00 per individual member (minimum of \$50.00) it collects from each affiliate? Does each and every affiliate pay this amount? Are there, or have there been, any special deals? Is this large amount of dues necessary? If so, how is it planned to use them? Huge surplus funds are unwise.

The answers supplied by NATESA and adhering closely to the oral reply delivered by Frank Moch at the convention, are as follows:

"1. The financial condition of NATESA is very sound. As a non-profit corporation, we operate on a pay-as-you-go basis. This is possible to a great degree because of volunteer services of officers. The actual expenditures for any period are reported by the treasurer to the Executive Council and can be verified by any member checking with the treasurer at conventions. No money has ever been paid to or received from any manufacturer, union, or other group, except, of course, revenue derived from advertising in the 'NATESA Scope' and Yearbook which is sold *without* selling our principles."

"2. NATESA was incorporated in the District of Columbia as a national, non-profit corporation. Since NATESA principal offices are located in Chicago, NATESA is, in keeping with laws of Illinois, also incorporated under what is known as the Alien Corporations Act. The original incorporators were the eight charter members. New offi-

cers are reported, as required by law, each year to the Illinois Secretary of State. The NATESA name and emblem are copyrighted at Washington by NATESA. NATESA owns the 'NATESA Scope.' A sizable sum was paid into the treasury by 'Scope' for several years, voluntarily and despite the fact that Frank Moch's personal investment has not yet been repaid."

"3. Frank Moch, entirely voluntarily, at the 1958 convention, waived claims to all past due salaries which had accumulated to the sum of \$30,000."

"4. If Frank Moch is voted out under due process, nothing happens, providing, of course, that someone else will undertake the fulfillment of the job."

"5. The liabilities of individual members or affiliates are limited by virtue of operation under the non-profit corporation act. They are virtually non-existent."

"6. Membership by states is already part of the NATESA rules, but if it is meant that this should preclude direct membership of local affiliates, then the answer is definitely 'no.' First, only eight states have state groups and their importance varies greatly. There is even no unanimity of opinion on the actual value of state groups. Second, electronic service problems are *not* based on state lines and, in fact, adjoining groups in several states often have much more in common than groups in the same state. Third, the problems of groups in the same state often are diametrically opposed. Fourth, to permit a few highly populated states to dominate NATESA by proxy voting is highly undemocratic and unacceptable."

"7. Dues are uniformly collected. How much is \$5.00 per year? Could anyone be serious in asking, 'Is this large an amount of dues necessary?' What dues do you pay locally and what do you get for them? We believe you will agree quickly that the question is ridiculous if you add up only a few basic costs borne by NATESA voluntarily for regular and special materials and services:

	Per Year
Individual 'Scope' each month, actual cost	\$3.60
Certificate	.50
Decalcomania	.15
Pressure-sensitive sticker	.15
Each local member's minimum share of basic material given to each affiliate, such as Organizational Handbook, Affiliate Certificate, etc.	1.50
	Total \$5.90

This does not include general stationery, phone, telegrams, printing, postage, bulletins (of which there were about 120 in the year 1957-58), travel, or other normal costs. Instead of questions about 'large dues', the question should be, 'How can NATESA do so much for us at so little cost?'"

ESFETA-State Cooperation

A meeting between Robert Larsen, president of the Empire State Federa-

Get

Your First Class Commercial

F.C.C. LICENSE

in

12 Weeks!

F.C.C. LICENSE—THE KEY TO BETTER

JOBS—An F.C.C. commercial (not amateur) license is your ticket to higher pay and more interesting employment. This license is Federal Government evidence of your qualifications in electronics. Employers are eager to hire licensed technicians.

GRANTHAM TRAINING PREPARES

YOU—Grantham School of Electronics specializes in preparing students to pass F.C.C. examinations. Training is available either by correspondence or in resident classes—NO previous training required. A beginner may qualify for his first F.C.C. license in as little as 12 weeks.

The Grantham Communications Elec-

tronics Course offers you complete preparation for a **first class F.C.C. license**. Even though it is planned primarily as preparation for F.C.C. examinations, it is *not* a "cram course" but prepares you by **TEACHING** you electronics.

THREE COMPLETE SCHOOLS: To better serve our many students throughout the entire country, Grantham School of Electronics maintains three complete schools—one in Washington, D. C., one in Hollywood, Calif., and one in Seattle, Wash. All schools offer the same rapid courses in FCC license preparation, either home study or resident classes.

MAIL COUPON FOR FREE BOOKLET:

Our free booklet, *Careers in Electronics*, gives details of how you can prepare quickly for your FCC license. For your free copy of this booklet, clip the coupon below and mail it to the Grantham School nearest you.

WASHINGTON D. C.	Grantham School of Electronics 821-19th Street, N.W. Washington 6, D. C.
HOLLYWOOD CALIF.	Grantham School of Electronics 1505 N. Western Avenue Hollywood 27, California
SEATTLE WASH.	Grantham School of Electronics 408 Marion Street Seattle 4, Washington

(Mail in envelope or paste on postal card)

TO: GRANTHAM SCHOOL OF ELECTRONICS
Washington • Hollywood • Seattle

Gentlemen:
Please send me your free booklet telling how I can get my commercial F.C.C. license quickly. I understand there is no obligation and no salesman will call.

Name _____ Age _____

Address _____

City _____ State _____

I am interested in:

Home Study, Resident Classes 86-T

ELECTRONICS

CAREER OF THE FUTURE!



NEW EDITION OF YOUR CAREER IN ELECTRONICS NOW ON SALE

Whether you're already in electronics and are eager to get ahead or are looking for a field with a definite future—YOUR CAREER IN ELECTRONICS is a publication you're sure to profit from.

On sale now at newsstands, YOUR CAREER IN ELECTRONICS could well be one of the most important publications you've ever read. Its 128 pages are devoted to electronics—its growth, its present, its future—and how you fit into this big, exciting field. Compiled by the editors of the Ziff-Davis Electronics Division, this 1959 Edition covers:

THE FIELD OF THE FUTURE

Career opportunities and where you fit in, how to get started, what an electronics company expects of you.

PEOPLE AT WORK

Helpful personal experiences of men actually in electronics: a field engineer, a patent research specialist, tech writer, missile man, the owner of a radio-TV repair shop, and many more!

GETTING THE KNOW-HOW

Important section on deciding your future, including career planning chart and aptitude test. Reports on vocational and technical schools, colleges, getting your radio operator's license, learning technical writing, how on-the-job training works.

EARN MONEY IN YOUR SPARE TIME

How to set up a part-time service shop, make money with home intercoms, sell your ideas to magazines, earn money with your tape recorder.

YOUR CAREER IN ELECTRONICS is now on sale. Be sure to pick up your copy now at your favorite newsstand . . . only \$1.00 per copy.

Ziff-Davis Publishing Co., 434 S. Wabash Ave., Chicago 5, Ill.

tion of Electronic Technicians Associations, and New York State Attorney General Louis J. Lefkowitz has been most profitable. Arranged by ESFETA secretary, George Carlson, the conference was highlighted by the Attorney General's proposal that ESFETA create a statewide grievance committee. The five-man committee was formed with ESFETA vice-president, Irving J. Toner, filling the post of chairman.

Mr. Toner's address is 703 Main St., East Aurora, N. Y. All consumers with complaints on service are urged to direct themselves to this address. Affiliates of ESFETA are being asked to publicize this committee and its location. Non-affiliated groups are also urged to contact Mr. Toner for assistance in dealing with local complaints. Formed with the knowledge of the Attorney General, the committee is expected to have his cooperation and support.

ESFETA members have also met with Dr. Persia Campbell of Governor Harriman's Consumer Council to discuss her recent investigation of service in the Albany, Troy, and Schenectady areas. Dr. Campbell appeared anxious to work with the association. Strongest suggestion to come out of the meeting was a proposal for legislation requiring all service dealers in the state to itemize all repair bills. Also suggested was a law requiring the words "rebuilt picture tube" to be written on all bills where applicable.

New Rhode Island Group

The Electronic Dealers of Rhode Island, recently chartered as a non-profit corporation in Rhode Island, selected its officers for 1958-59 at a recent meeting. Those elected to handle the several offices include: president, Norman F. Gladu, 30 James Street, Providence; vice-president, Donald DiBiaso, 748 Cranston Street, Providence; secretary, Len Erickson, 15 Wilson Ave., East Providence; corresponding secretary, Ray Cohen, 97 Broad Street, Providence; treasurer, Ben Lauretti, 801 High Street, Lonsdale, R. I.

Jobber Lauds Association

The "Parts Peddler," a newsletter issued by *Radio Parts of Arizona*, a Phoenix jobber, recently spoke very highly of the action taken by the Better Electronic Service Technicians (BEST) Association of that city, to participate in a joint State-Federal Electronic Apprenticeship Training Program. The "Parts Peddler" reported:

"Under this new plan, the Government pays no part of the apprentice's salary. He must earn the small salary he will get at the beginning of his training. All applicants are screened so that only capable, earnest men can even start apprenticeship training. No shop gets a trainee unless the shop wants one. BEST has taken on a very difficult and arduous task. They are to be very highly congratulated." —30—

6- and 10-Meter Transistorized Amateur Receiver

By E. J. HOLTKE, W5YRJ

AN article describing a transistorized 10-meter receiver, which appeared in the September, 1957 issue of this magazine, stirred the imagination of this author. Could the same results be obtained with a lower-priced transistor? If so, would it work at higher frequencies than 10 meters?

The circuit and layout as described in the original article appeared to provide a good starting point. The major differences, as can be seen in Fig. 1, are partly the result of component availability (the ubiquitous junk-box). The transistor, V_1 , was selected for its cut-off frequency characteristic (50 mc.). This *Texas Instrument* unit is a grown-diffused-junction germanium transistor especially designed for 18 mc. r.f. amplifier operation.

It was decided that the first attempt would be for a 10-meter receiver, then if satisfactory results were obtained, to push on for 6 meters. The author learned, after several attempts, that a high-"Q" coil is a "must" for this type of operation. This coil, L_2 , was wound with #14 tinned copper wire and mounted in a horizontal position. The one-turn link, L_1 , was made from #26 insulated wire interwound at the collector end of the coil. Adjust the coupling between L_1 and L_2 for maximum signal.

A swamping resistor, R_2 , was added across the audio choke to suppress an audio howl that developed at 50 mc. This resistor may not be required if CH_1 is of lower inductance than specified in the parts list.

The audio transistor, V_2 , was biased by the addition of R_3 which increased the audio output appreciably. The exact value for this resistor will depend on the transistor used and should, therefore, be selected by trial for best results.

The LC combination shown provides a tuning range of 27 mc. to 55 mc. An 8-foot antenna permits reception on 10 and 6 meters while a 5-foot antenna will handle 6 meters adequately. A longer antenna will give better results, but presents a problem in portability. The headphones used with this receiver should be of the 500-1000 ohm type.

The author was pleasantly surprised by the reception obtained on 10 meters—KZ5, W6, to mention a few. The performance on 6 meters was much better than expected, especially in view of the 50 mc. cut-off frequency of the transistor. A test was conducted between K5AON and K5CHF. The fixed transmitter was a *Gonset* linear (60-watt) unit with a vertical antenna on a 48-foot tower. At six miles, reception was solid using a 5-foot whip on the receiver.

As a further check on the sensitivity, a *Hewlett-Packard* signal generator was used, connected to the antenna link. At 20 μ v., modulated 30 per-cent with a 1000 cps tone, the signal was readable on both 28 mc. and 50 mc.

Since the local services between 10 and 6 meters were also received clearly during subsequent tests, it is probable a bandspread system would be an aid to tuning.

Fig. 1. Complete schematic diagram and parts list of transistorized receiver.

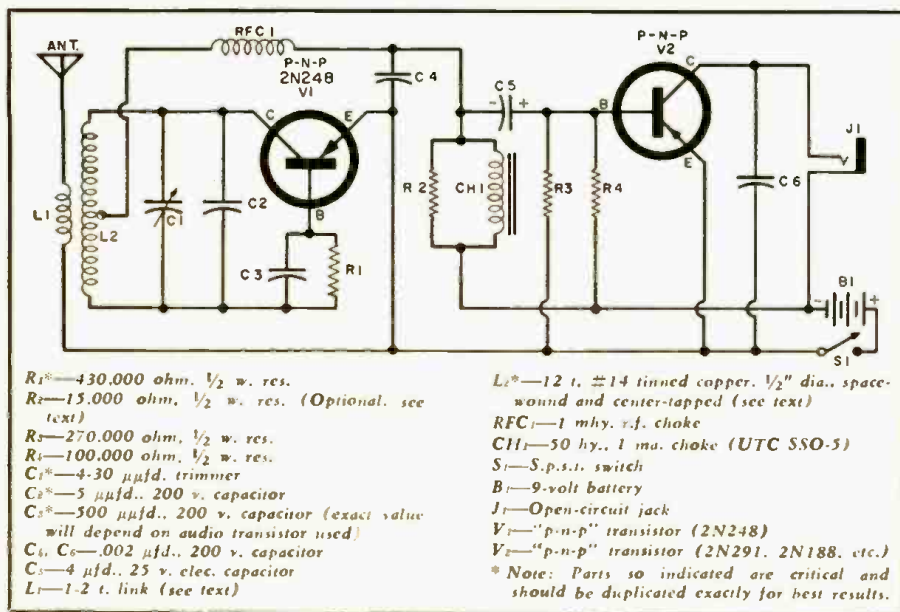

These men are getting practical training in...

Electronics

ELECTRICITY ELECTRONICS

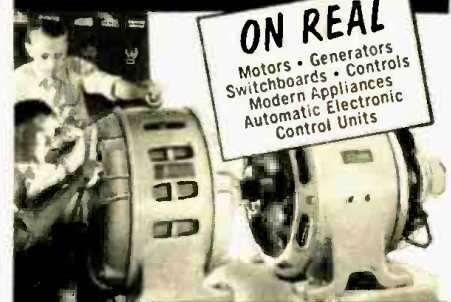

ON REAL

Motors • Generators
Switchboards • Controls
Modern Appliances
Automatic Electronic
Control Units

TELEVISION RADIO ELECTRONICS



ON REAL

TV Receivers
Black & White and Color
AM-FM and Auto Radios
Transistors • Printed
Circuits • Test Equipment

Train in NEW Shop-Labs of COYNE

in Chicago — Electronic Center of the World. Prepare for a better job and a successful future in the OPPORTUNITY FIELD. Train on real full size equipment at COYNE where thousands of successful men have trained for 60 years—largest, oldest, best equipped school of its kind. Professional and experienced instructors show you how, then do practical jobs yourself on more than a quarter of a million dollars worth of equipment. No previous experience or advanced education needed. Employment Service to Graduates.

Start Now — Pay Later — Liberal Finance and Payment Plans. Pay most of tuition after graduation. Part-time employment help for students. Choose from nine yearly Starting Dates.

Mail Coupon For Free Book—"Guide to Careers." Whether you prefer ELECTRICITY-ELECTRONICS, TELEVISION-RADIO ELECTRONICS or COMBINED ELECTRONICS TRAINING, this book describes all training offered and gives all the facts to Vets and Non-Vets.

Information comes by mail. No obligation and NO SALESMAN WILL CALL.

B. W. Cooke, Jr., Pres. Founded 1899
COYNE ELECTRICAL SCHOOL
Chartered Not For Profit
1501 W. Congress Pkwy., Chicago 7, Ill., Dept. 98-6A

MAIL COUPON FOR BOOK

Coyne Electrical School, Dept. 98-6A
1501 W. Congress Pkwy.
Chicago 7, Ill.
Send FREE book, "Guide to Careers" and details of all training you offer.

Name

Address

City State

(I understand no Salesman will call!)

Advance

BUY of the MONTH!

★★★★ GR-VARIACS ★★★★★
 110 V AC in 0-270 V AC 2 Amps. NEW. Fully Cased. W/ Knob, Dial. 6 Ft. Line Cord, Receptacle; And On/Off Switch. Original Ctns. \$16.95

POWER SUPPLY KIT BARGAIN!

Primary 115V, 60 Cy. Sec., 400-0-400 V. @ 200 Ma., 6.3 V @ 5 Amp., 5 V @ 4 Amp std. mounting plus 8 Hy 200 Ma chokes and two 8 Wd. oil condensers. Kit \$7.50
 DC Power Supply Kit 24 VDC—2 amp output. \$3.95

BUYS . . . RELAYS . . . BUYS

110 VAC	12 VDC DPDT Plus SPST
3 PDT ceramic, Leach #1177 .5 3.25	10 amp contact. \$1.39
5 pST hvy dty	SIGMA 4F.
Dunco . . . 4.79	24VAC or 6VDC 1.49
12 PDT Dunco . . . 16.95	W/ Isfr for 110 VAC
6 VDC. P&B. . . 1.79	SIGMA 4F.
DPST . . . 1.79	500-ohm plate pull-in 2 Ma 2.25

LARGE STOCK AC, DC RELAYS

★★★★★★★★ Solenoids ★★★★★★★

A-B #200 \$2.95 115V 60 Cyc cont. duty. (2 for \$5.50) 18 Lb. pull. each \$5.50
 24V & 230V SORENG IN STOCK!

STEPPING RELAYS

Resettable type. 3 deck, 10 pos, 24 VDC. . . ea. \$8.95
 3 deck, 25 pos, no reset ea. \$6.95
 2 deck, 44 pos, no reset ea. \$6.95
 5 deck, 23 pos, no reset ea. \$7.50

STEP UP-DOWN TRANSFORMER

500 Watt 110/220 V. 60 cycle. ea. \$4.95
 30 Watt 110/220 V. ea. \$1.45

CHOKES FULLY CASED

8 hy. 100 Ma. \$1.49
 8 hy. 200 Ma. 1.89
 10 hy. 150 Ma. 2.19
 22 hy. 100 Ma. 2.59

WHIP ANTENNAS

#AN-131 collapses to 17", opens to 10 feet. Ideal for mobile and portable operations. each \$1.89
 3 for \$5.25

★★★★★ Transformers ★★★★★

6.3 V FILAMENT 12V. 2 Amp. \$1.49
 20 Amp. \$3.95 24 V 2 Amp. 1.59
 15 Amp. 2.59 2 1/2 V Sec. 10 Amps.
 10 Amp. 2.19 Excellent for pr.
 7 1/2 Amp. 1.99 of 866's \$3.95
 3 Amp. 1.89

ISOLATION TRANSFORMER

115 in. 115 out. Conservatively rated 250 watts. W/cord. and receptacle. \$6.50

SCOOP! RG-8U CO-AX CABLE

52-ohm impedance, 100-ft. length. (1000 ft. \$60)

OIL CONDENSER BARGAINS

18 Mfd 1500 VDC \$2.95	
1 Mfd 600 VDC \$.25	8 Mfd 1500 VDC \$2.95
2 Mfd 600 VDC .45	10 Mfd 1500 VDC 3.75
4 Mfd 600 VDC .75	2 Mfd 2000 VDC 1.50
10 Mfd 600 VDC 1.10	3 Mfd 2000 VDC 2.75
20 Mfd 650 VDC 2.75	1 Mfd 3000 VDC 1.85
1 Mfd 1000 VDC .60	2 Mfd 3000 VDC 3.95
2 Mfd 1000 VDC .75	2 Mfd 5000 VDC 8.75
4 Mfd 1000 VDC 1.25	1 Mfd 6000 VDC 5.95
8 Mfd 1000 VDC 1.75	2 Mfd 7500 VDC 8.95
10 Mfd 1000 VDC 1.75	2 Mfd 10000 VDC 32.50
15 Mfd 1000 VDC 2.45	1 Mfd 12500 VDC 28.50
4 Mfd 1500 VDC 1.25	2 Mfd 12500 VDC 35.00
6 Mfd 1500 VDC 2.45	

(Limited Supply) ESTERLINE-ANGUS RECORDER model AW, portable.

0-1 Ma. \$159.50

SPECIAL! PANEL METERS

1" METERS		3" METERS	
0-200 Micro. . . \$5.45	0-100 Microamps. . . \$5.95	0-100 Microamps. . . \$5.95	0-200 Microamps. . . 5.95
0-1 Ma. . . 4.95	0-500 Microamps. . . 5.95	0-500 Microamps. . . 5.95	0-1000 Microamps. . . 3.95
2" METERS		0-150 VAC. . . 4.95	
0-1 Ma (0-150 scale) . . . \$3.95	0-1 Ma. . . 3.95	0-1 Ma. . . 3.95	0-1 Ma. . . 3.95
0-4 Amps RF. . . 3.95	0-25 Ma. . . 3.95	0-100 Ma. . . 3.95	0-250 Ma. . . 3.95
0-200 Micro, rubber mnt. . . 2.95	0-100 Ma. . . 3.95	0-100 Ma. . . 3.95	200-0-200 VDC. . . 3.95
0-30 Ma. . . 3.95	0-100 Ma. . . 3.95	0-100 Ma. . . 3.95	0-5 Amp. AC. . . 3.95
0-300 VAC. . . 3.95	0-300 DC. . . 3.95	0-300 DC. . . 3.95	0-300 DC. . . 3.95
-10.0 to +6 DB (Weston) . . . 4.95	w/shunt . . . 6.50	0-2 KV DC. w/shunt. . . \$5.95	0-15 KV DC. w/shunt. . . 6.95
0-15 KV DC. w/shunt. . . 6.95	0-3 1/2 KV. 3". w/shunt. . . 6.95	0-15 KV DC. w/shunt. . . 6.95	0-3 1/2 KV. 3". w/shunt. . . 6.95
Dual Scale w/ high and low switch	0-150 VDC. 0-7 1/2 VDC. . . 6.95	-15 to +3 DB. 4" sq. . . 6.95	

115 V. 60 Cyc. SELSYNS High torque. Useful as antenna indicators, etc. \$5.95 each (\$30.50 pr.)
 Du Mont Power Transformer 950 V. CT 200 ma; 2 6.3 V 5 Amps; 4 V. Amps; 4 Amps. ea \$7.50
 SELENIUM RECTIFIERS 30-35 VAC input. 24-28 VDC output. 5 Amps. \$4.50
 2 Amps. \$2.19
 1 1/2 Amp. \$1.19
 150 Ma. \$1.29
 110 V. 1 1/2 Amp. \$5.19

Special on . . . POWER SUPPLIES!

All wired—Ready to use.
 PRI—115 V AC
 SEC.—540-0-540 V @ 280 MA
 5.4 & 5 V @ 6 Amps CT
 12 V @ 5 Amps
 40 V @ 50 MA
 6.3 V CT @ 7 Amps
 12 Hy Choke @ 300 Ma
 4 10 Mfd. 600 V Cap.
 3 5U4's \$21.95
 PRI—115 V AC
 SEC.—940-0-940 V @ 230 MA
 24 1/2 V CT @ 10 Amps
 1-6.3 CT @ 4 Amps
 1-3 CT @ 4 Amps
 10 Hy choke @ 250 Ma.
 8 Mfd. 1500 V Cap.
 2 #836's \$23.95

Min. Order \$3.00—25% with order F.O.B. New York 10 DAY GUAR. PRICE OF MDSE. ONLY

Advance Electronics
 6 West Broadway - New York 7, N. Y. - Rector 2-0270

1958 INDEX VOLUMES 59-60

As a service to our readers we are again presenting a complete listing of all feature articles which appeared in RADIO & TV NEWS during 1958. We suggest you keep this for reference.

AMATEUR

ANTENNAS
 Adding 21 mc. to the Off-Center-Fed Antenna (Minarik, W9GJY) 48 June
 Listening to the Satelllites (Kunze, W0WVM) 44 Nov.
 Putting the Helix to Work (Blair, K6QXW) 66 Nov.
 This Month's Cover. 45 Nov.

HAM GEAR
 Advanced Ham Receiver in Kit Form 64 Dec.
 Automatic Tracking Mobile System (Keen, W2GTK) 53 Oct.
 Compact 35-Watt Standby Transmitter (Bumbaugh, W6HD) 59 June
 "Control Master"—A Crystal Dialing Unit (Brizendine, W4ATE) 49 Mar.
 Frequency Meter Doubles as SSB and C.W. Detector (Longerich, DL4RX/W2GQY) 100 Sept.
 Linear Amplifier for SSB Exciters (Marriner, W6BLZ) 69 Nov.
 "Mighty Milliwatt" (Stoner, W6TNS) 51 Sept.
 "Muscle Mouse"—A Compact 50-Watt Transmitter (Stanley) 54 Feb.
 Shunt-Fed Modulation for Your AM Transmitter (Genaille, W3FEP) 46 Aug.
 Simple Transistor Keyer Unit (McCarthy, K6EAW) 39 Apr.
 6- and 10-Meter Transistorized Amateur Receiver (Holke, W5YRI) 149 Dec.
 SSB Exciter Attenuator Pads (Hyman, W9VRX) 52 Dec.
 30-Watt Transistor Mobile Modulator (Jordan, W9PUK & Prewitt, W9UKT) 42 Jan.
 Transistorized Automatic Key (McCarthy, K6EAW) 36 July
 Transistorized Code Oscillator (McDonald) 47 May
 Two-Band V.H.F. Converter (Taylor, W8NAF) 60 July
 Zero Clipper (French, W1JKZ) 40 May

MISCELLANEOUS
 Army MARS Net Resumes Technical Broadcasts. 91 Sept.
 Far East Ham Convention on Guam 110 Feb.
 Modern Ham Shack 100 Feb.
 1957 Ham of the Year. 96 Apr.
 Receiving & Recording Satellite Signals (Dearborn) 138 Dec.
 Using Your Bug Right! (Dorsey, ex-W4KXX) 111 Sept.

AM-FM RECEIVERS
 FM Tuner Kit Features Novel "Front End" 56 June
 Improving Your FM Tuner (Bernard) 54 Sept.
 New G-E FM Detector (Burns) 80 June
 Simple Hi-Fi AM Tuner (Morris) 33 Aug.
 Transistorized FM Receiver (Najork) 115 May

WELD-SOLDER ANYTHING FAST!

THE WORLD'S MOST POWERFUL MINIATURE SOLDERING IRON MENDS AND REPAIRS 1001 ITEMS IN A JIFFY



AMAZING "MIGHTY-MITE SOLDER-ETTE" SAVES HUNDREDS OF DOLLARS IN REPAIRS . . . FIXES EVERYTHING FROM TV SETS TO TOYS! You can save up to \$25.00 the very first time you use your Solder-Ette. Stop paying expensive repair bills. Precision engineered, Solder-Ette permits you to make thousands of household and shop repairs in a jiffy! Repair appliances, TV & Radio Sets, lamps, electrical wiring, motors, toys, jewelry, etc. Easy-grip handle is heat-proof. Modern design permits use in even most crowded spots. Copper alloy tip screws into super-heat element, permitting easy replacement. Complete with quality line cord. 25 watts 110-120V AC/DC. FULLY GUARANTEED. If not delighted return within 10 days for full refund. Send \$2.98 Postpaid plus 25¢ for PP & handling. Sorry, no C.O.D.

Tube Wholesalers Co., Dept. S-RT
 Box 61, Baldwin, L.I., N.Y.

CENTER ELECTRONICS
 ALWAYS ON THE SPOT WITH SPECIALS

STEPHENS 206 AXA
 15" 2-Voice Coil Coaxial Speaker
 Freq. response 20-20,000 cps—BRAND NEW
 Audiophile Net PRICE \$99.50
 \$162.50

Mail Orders 25% deposit, Balance COD
GET OUR SPECIAL PRICES ON YOUR HI-FI REQUIREMENTS

CENTER ELECTRONICS CO., INC.
 Dept. N-1, 72 Cortlandt St., New York 7

ELECTRONICS

PREPARE FOR A GOOD JOB!
 BROADCAST ENGINEER
 RADIO SERVICING AUTOMATION

TELEVISION SERVICING
 BLACK & WHITE—COLOR

APPROVED FOR VETERANS AND SURVIVORS OF VETERANS
 BUILDING AIR CONDITIONED SEND FOR FREE LITERATURE
BALTIMORE TECHNICAL INSTITUTE
 1425 EUTAW PLACE, BALTIMORE 17, MD.

Transistor Superregen FM Tuner (Fisk)	60 Nov.
Russian Receiver Powered by Kerosene Lamp	37 Aug.
SERVICING	
Alignment of Midget Radios (Johnson)	39 Jan.
Basic Facts on Mobile Radio (Lytel)	43 Apr.
Breakdowns in AM I.F. Transformers (Doyle)	92 May
Servicing Communication Receivers (Van Sutphin)	46 Mar.
System Maintenance in Two-Way Mobile (De Bra)	34 June
Troubleshooting AM-FM Combinations (Johnson)	52 July
Two-Way Mobile Service Business (De Bra)	62 Feb.
COMPONENTS	
Recharging and Storing Dry Batteries	116 Feb.

BOOK REVIEWS

Audio Design Handbook (Hartley)	154 Sept.
Audio Amplifiers and Associated Equipment (Sams Staff)	168 Mar.
Automatic Record Changer Service Manual (Sams Staff)	150 May
Auto Radio Removal (Sams Staff)	122 June
Basic Electricity (Marcus)	122 Aug.
Basic Electricity (Turner)	165 Jan.
Basic Electricity for Communications (Timble & Ricker)	143 Dec.
Basic Television (Schure)	150 May
Basics of Digital Computers (Murphy)	132 Nov.
Care and Repair of Hi-Fi (Feldman)	126 July
Closed-Circuit Television Systems (RCA Service Co. Staff)	141 Dec.
Closed Circuit TV System Planning (Mayers & Chipp)	164 Jan.
Color TV Principles and Practices (Electronic Components Div., General Electric Co.)	126 July
Commercial Radio Operator's License Guide—Elements 1 & 2 (Schwartz)	164 Jan.
Commercial Radio Operator's License Guide—Element 3 (Schwartz)	126 July
D-C Circuit Analysis (Schure, ed.)	142 Dec.
Electronic Hobbyists' Handbook (Turner)	122 Aug.
Electronic Measuring Instruments (Banner)	143 Dec.
Electronic Puzzles and Games (Mandl)	101 Oct.
Electrostatics (Schure, ed.)	142 Dec.
Electron-Tube Circuits (Seely)	133 Nov.
Elements of Magnetic Tape Recording (Haynes)	165 Jan.
Elements of Tape Recorder Circuits (Burstein & Pollak)	166 Mar.
Feedback Theory and Its Applications (Hammond)	123 June
F.M. Radio Servicing Handbook (King)	100 Oct.
Foundations of Wireless (Scroggie)	126 July
Fundamental Principles of Transistors (Evans)	123 June
High Fidelity Simplified (Weiler)	173 Feb.
High Quality Sound Reproduction (Moir)	101 Oct.
How to Read Schematic Diagrams (Mark)	166 Mar.
Impedance Matching (Schure, ed.)	142 Dec.
Industrial Control Circuits (Platt)	122 Aug.
Industrial Electronics Handbook (Kretzmann)	166 Mar.
Low-Cost High-Quality Amplifier (Baxandall)	122 June
Magnetic Recording Techniques (Stewart)	142 Dec.
Mechanics (Elron)	143 Dec.



LEO I. MEYERSON, W0GFQ

LEO SAYS: "HAMMARLUND HAS IT"

AND SO DOES WORLD RADIO LABORATORIES

"The World's Largest Distributor of Amateur Radio Products"

The Remarkable

HQ-170

TRIPLE CONVERSION SSB AMATEUR RECEIVER

All the best features of the finest SSB converters, plus the best features of the finest amateur receivers wrapped up in a single, outstanding receiver. Covers the 6, 10, 15, 20, 40, 80 and 160 meter amateur bands. Separate vernier tuning. Dual and triple conversion 17-tube superheterodyne. Adjustable 60 db notch filter. IF passband tuning. Adjustable AVC.

\$35⁹⁰
Down

\$20⁵⁰
per mo.

or \$359.00 Amateur Net.

Telechron clock-timer, \$10 extra.

Send for brochure on the Complete Hammarlund Line!



And Send for Your Brand New

FREE 1959 CATALOG

Just off the press, this colorful new catalog contains hundreds of bargains for the amateur, hi-fi enthusiast, experimenter and dealer-serviceman. Send for yours right now.



WORLD'S MOST PERSONALIZED ELECTRONIC SUPPLY HOUSE

World Radio LABORATORIES
PH. 2-0277

3415 W. BROADWAY COUNCIL BLUFFS IOWA

Please send me Free Catalog and complete info on the Hammarlund line. RTV-12

NAME: _____

ADDRESS: _____

CITY & STATE: _____

"NOISE" BIG 3
Beware Of Cheap Substitutes!

NO-NOISE NEW RUBBER COAT SPRAY
6 Oz. Spray Can

- Insulates where applied
- Protects indelibly
- Prevents arcing, shorting, corrosion
- Waterproofs thoroughly
- Non-inflammatory
- Contains no plastic

\$3²⁵
Net To Servicemen

NO-NOISE VOLUME CONTROL and CONTACT RESTORER

- Cleans
- Protects
- Lubricates
- NOT A CARBON TET SOLUTION

2 Oz. Bottle **\$1⁰⁰** 6 Oz. Spray Can **\$2²⁵**
Net To Servicemen

NO-NOISE TUNER-TONIC
With PERMA-FILM

- Economical—a little does a lot.
- Cleans, lubricates, restores all tuners, including water type.
- Non-toxic, non-inflammatory
- Use for TV, radio and FM

6 Oz. Aerosol Can **\$3²⁵**
Net to Servicemen

ELECTRONIC CHEMICAL CORP.
812 Communipaw Avenue Jersey City 4, N. J.

KEEP CANDEE HANDY!

MODEL 80 MEASUREMENTS CORPORATION SIGNAL GENERATOR
Operates on 115 VAC 60 cycles. Free coverage, 2-400 MC. Amplitude modulated 0-30% @ 400 or 1,000 cycles. RF output 1-100,000 microvolts. Output impedance 50 ohms. Provision for external modulation and external pulse. Excellent cond. A terrific buy at this fabulous low price. Only **\$300.00**

MODEL 84 MEASUREMENTS CORPORATION SIGNAL GEN.
Same as above, except frequency coverage is 300-1,000 MC. Excellent condition. **\$250.00**
Offered first time at only **\$525.00!**
SAVE BY BUYING BOTH MODELS for only \$525.00!

APT-5 TRANSMITTER
Has lighthouse tube 3C22 oscillator in tunable cavity modulated by two type 8201 tubes powered by 931 noise generating photocell. Output approx. 30 W. CW @ 115 V, 400 cycles. **\$49.95**
Excellent cond.

ART-13 COLLINS TRANSMITTER
Removed from aircraft so you know it's good—and sold at lowest price ever! 10-channel auto-tune or manual. 2-18.1 MC for ham rig with 813 final. Output 60-100 W. CW or modulated. Crystal calibrated for VFO. Includes dynamotor. Excellent. Only **\$129.95**

AN/APN-9 LORAN SYSTEM
Used in ships and aircraft. Determines position by radio signal from known transmitters. Accuracy to within 1% of distance. Complete with tubes and crystal. Like new **\$88.88**

APN/48 LORAN EQUIPMENT
Marine or air. Long range navigational gear to determine position of ship or plane up to 1200 miles from base. Complete with scope, receiver, tubes, crystals, rack and plugs. **\$39.95**
ONLY

BC-683 FM RECEIVER
27-38.8 MC. 10 push-buttons for channel selection. Continuous tuning. Stereo circuit. Complete with tubes, speaker, (less dynamotor). Excel. **\$14.95** NEW **\$19.95**

BC-603 FM RECEIVER
Same as above except freq. is 20-27.9 MC. Excellent condition. **\$6.95**

12 V. DM-34D DYNAMOTOR: for above. Excel. **\$3.95**

110 VAC POWER SUPPLY: for above. Just plug in. No conversion needed. Brand New. **\$11.95** In Kit Form. **\$7.95**

All items FOB, Burbank, Calif., subject to prior sale. In Calif. add 4%. Min. order \$3.95.

J. J. CANDEE CO. Dept. R
509 No. Victory Blvd., Burbank, Calif.
Phone: Victoria 9-3053

take it from a
hi-fi dealer—



KNOW YOUR HI-FI EQUIPMENT BEFORE YOU BUY!

Any dealer will confirm it. The hi-fi fan who makes the smartest buy usually knows his equipment, prices and specifications before he even steps into a store.

Where can you get such helpful information? It's available in the HI-FI DIRECTORY & BUYERS' GUIDE—the world's most complete reference for the high fidelity fan. Virtually every piece of hi-fi equipment manufactured is listed in the 1959 HI-FI DIRECTORY & BUYERS' GUIDE—complete with prices, specifications and illustrations.

This year's edition is bigger than ever—180 pages of useful information, arranged conveniently into sections on tuners, amplifiers and preamps, record players, changers, turntables, tone arms, cartridges, tape recorders, loudspeakers and systems, enclosures and equipment cabinets.

In addition to listings, the HI-FI DIRECTORY & BUYERS' GUIDE contains helpful articles and features on what to look for, how to buy, advantages and disadvantages of different models, how to judge quality and recognize a bargain. Whether you're a hi-fi beginner or a veteran audiophile, this publication is worth its weight in diamond styli to you. Yet it costs

only \$1.00. The Hi-Fi Directory & Buyers' Guide is now on sale—be sure to pick up a copy at your favorite newsstand, hi-fi salon or electronics parts dealer.



Ziff-Davis Publishing Co.,
434 S. Wabash Ave., Chicago 5, Ill.

Most-Often-Needed 1958 Radio Diagrams and Servicing Information (Beitman, ed.).....	122	Aug.
Most-Often-Needed 1958 Television Servicing Information (Beitman, ed.).....	168	Mar.
Nuclear Energy (Efron).....	143	Dec.
Official Registry of Radio Systems In the Transportation Services (Communication Engineering Book Co.).....	154	Sept.
Pin-Point Color TV Troubles in 15 Minutes (Manly & Coyne Staff)...	132	Nov.
Portable Transistor Receiver (Amos).....	122	June
Profitable Television Troubleshooting (Anthony).....	164	Jan.
Radio Amateur's Handbook (ARRL Staff).....	126	July
RCA Victor 1957-58 Television Servicing Information (Beitman, ed.).....	164	Jan.
Receiving Aerial Systems (Davidson).....	172	Feb.
Repairing Hi-Fi Systems (Fidelman).....	172	Feb.
Repairing Portable and Clock Radios (Crisses & Gnessin).....	100	Oct.
Selection and Application of Metallic Rectifiers (Jackson).....	150	May
Servicing Hi-Fi and Associated Audio Equipment (Sams Staff)...	141	Dec.
Servicing TV Sync Systems (Dines).....	172	Feb.
Single Sideband for the Radio Amateur (ARRL Staff).....	134	Nov.
Sound (Efron).....	166	Mar.
Stereophonic Sound (Crowhurst) ..	164	Jan.
Surplus Communication Equipment and Its Use in Civil Defense Organizations (FCDA).....	138	Apr.
Tape Recorder Manual, Vol. 1 (Sams Staff).....	150	May
Tape Recorder Manual, Vol. 2 (Sams Staff).....	133	Nov.
Techniques of Magnetic Recording (Tall).....	166	Mar.
Television in Science and Industry (Zworykin, Ramberg, & Flory)...	122	June
Television Interference, Its Causes and Cures (Rand).....	150	May
Television Tube Location Guide (Sams Staff).....	138	Apr.
Transistor Manual (Semiconductor Products Dept., General Electric Co.).....	133	Nov.
Transistor Physics and Circuits (Riddle & Ristenbatt).....	140	Apr.
TV and Radio Tube Troubles (Heller).....	151	May
TV Distribution Systems and Antenna Techniques (Beever)...	154	Sept.
Ultra High Frequency Performance of Receiving Tubes (Benham & Harris).....	138	Apr.
Vacuum Tube Rectifiers (Schure)...	122	June
What Makes Guided Missiles Tick! (Kemp).....	122	June

BUSINESS MANAGEMENT

Are You in a Rut? (Leonard)...	62	Apr.
"Collective Security" for Service (Leonard).....	60	Oct.
Don't Blame "Competition" (Leonard).....	54	Aug.
Mac's Service Shop (Frye).....	74	Jan.
Mac's Service Shop (Frye).....	68	Feb.
Mac's Service Shop (Frye).....	72	Mar.
Mac's Service Shop (Frye).....	68	Apr.
Mac's Service Shop (Frye).....	64	May
Mac's Service Shop (Frye).....	62	June
Mac's Service Shop (Frye).....	58	Aug.
Mac's Service Shop (Frye).....	68	Sept.
Mac's Service Shop (Frye).....	64	Oct.
Mac's Service Shop (Frye).....	68	Nov.
Mac's Service Shop (Frye).....	66	Dec.
"Musts" for Business Growth (Leonard).....	62	Nov.

LIBERTY MAIL ORDER T. V. PICTURE TUBES

AMERICA'S BEST... AMERICA'S LOWEST PRICE
GUARANTEED FOR ONE (1) FULL YEAR

LICENSED BY... RCA... OUMONT...

10BP4	\$7.50	17CP4	\$16.50	21AMP4	\$18.95
12LP4A	8.75	17GP4	15.50	21AU	
14B/CP4	9.50	17H/LP4	13.50	AVP4	19.95
16AP4	14.95	17QP4	11.50	21EP4	14.50
16DP4	13.50	17TP4	16.50	21F/KP4	15.75
16GP4	15.95	19AP4	17.75	21MP4	19.95
16K/LP4	10.50	20CP4	13.50	21YP4	15.50
16R/WP4	10.50	20HP4	15.00	21WP4	14.75
16T ZP4	10.50	20MP4	14.00	21ZP4	15.00
17AVP4	13.50	21AP4	19.95	24CP4	26.00
17BP4	10.95	21AL/ATP4	19.95	24DP4	28.00

For Aluminized Tubes Add 54.00. Prices are subject to change without notice. Write for price on non-listed tubes. All prices F.O.B. Wallingford, Conn. Prices include duty. Send \$5.00 deposit when old tube duty is not returned. Deposit refundable at time of return of duty. Duty must be returned prepaid. We ship anywhere, domestic, foreign, export.

TERMS: 25% WITH ORDER—BALANCE C.O.D. 10% reduction for orders of 6 or more tubes.

LIBERTY TUBE CO.

Dept. CRT HALL AVE., COR. CHERRY ST.
WALLINGFORD, CONN. COLONY 9-8038

STATEMENT REQUIRED BY THE ACT OF AUGUST 24, 1912, AS AMENDED BY THE ACTS OF MARCH 3, 1933, AND JULY 2, 1946 (Title 39, United States Code, Section 233) SHOWING THE OWNERSHIP, MANAGEMENT, AND CIRCULATION OF RADIO & TV NEWS published Monthly at Chicago, Illinois for October 1, 1958

1. The names and addresses of the publisher, editor, managing editor, and business managers are: Publisher, Ziff-Davis Publishing Company, 434 S. Wabash Ave., Chicago 5, Ill.; Editor, William Stocklin, One Park Avenue, New York 16, N. Y.; Business manager, Howard Stoughton, Jr., One Park Avenue, New York 16, N. Y.

2. The owner is: Ziff-Davis Publishing Company, 434 S. Wabash Ave., Chicago 5, Ill.; Estate of William B. Ziff, One Park Avenue, New York 16, N. Y.; A. M. Ziff, One Park Avenue, New York 16, N. Y.

3. The known bondholders, mortgagees, and other security holders owning or holding 1 percent or more of total amount of bonds, mortgages, or other securities are: None.

4. Paragraphs 2 and 3 include, in cases where the stockholder or security holder appears upon the books of the company as trustee or in any other fiduciary relation, the name of the person or corporation for whom such trustee is acting; also the statements in the two paragraphs show the affiant's full knowledge and belief as to the circumstances and conditions under which stockholders and security holders who do not appear upon the books of the company as trustees, hold stock and securities in a capacity other than that of a bona fide owner.

5. The average number of copies of each issue of this publication sold or distributed, through the mails or otherwise, to paid subscribers during the 12 months preceding the date shown above was: (This information is required from daily, weekly, semiweekly, and triweekly newspapers only.)

H. STOUGHTON, JR., business manager.

Sworn to and subscribed before me this 18th day of September, 1958.

(SEAL) WILLIAM PROEHMER, Notary Public.
(My Commission expires March 30, 1960)

CRYSTAL CONTROLLED CONVERTERS

POLICE • FIRE • COMMERCIAL



For use with
12 V. Transistor type
car radios—
30-50 MC.

\$24.50

Can be self installed in seconds. Other models for 152-162 MC available. Also complete line of conventional powered converters, tuners and receivers.

A practical converter for emergency use with powered home or auto sets. Tuneable over 8 MC. 26-50 MC or 108-174 MC.

\$13.95

Also available crystal controlled up to 54 MC \$18.95.



WRITE FOR LITERATURE

KUHN ELECTRONICS
20 GLENWOOD CINCINNATI 17, OHIO

New Look in TV Service (Leonard)	54 Dec.
Operating Costs—Fact and Fantasy (Leonard)	54 July
Realistic Profit Margins (Leonard)	64 Sept.
Service and Public Relations (Leonard)	61 Jan.
Service Business Budgets (Leonard)	56 May
Service Dealers and Set Sales (Leonard)	58 Feb.
Service Salesmanship (Leonard)	56 Mar.
Tube Makers Fight Counterfeiting	127 Dec.
Your Business Telephone (Leonard)	58 June

GENERAL

COMPUTERS

Basic Binary Counting Circuits (Bukstein)	48 May
Basic Decade Counters (Bukstein)	34 Aug.
Basic Electronic Counting (Bukstein)	122 Mar.
Basics of Preset Counters (Bukstein)	46 Nov.

CONSTRUCTION PROJECTS

"D.C. Variometer"—an Ultra-Versatile Wide-Range Power Supply (Tooker)	63 Apr.
Designing a Telephone Amplifier (Todd)	55 July
"Electro-Melodeon" (Smith, W8VVD)	61 Sept.
Electronic Photoflash (Graham)	47 Feb.
Gremlin Sentry—an Automatic Control Switch (Landis)	49 June
"Photorythmic"—Dancing Lights (Wortman)	50 Aug.
Picture-Frame Transistor Set	126 Oct.
Slave Flash Trigger (Winklepleck)	33 June
Slide-Projector Fade Control (Lingel)	115 Nov.
Stabilized Stroboscope (Dollens)	49 Jan.
Subminiature Transistor Power Supply (Tooker)	73 Jan.
Transistor Electronic Buzzer (Turner)	66 Sept.
Transistorized Electronic "Accordion" (Garner, Jr.)	53 May

IGY

Five Months of IGY Disclose Space Secrets	159 Mar.
FM Receiver Conversion for U. S. Satellite Signals (House)	160 Mar.
Giant Telemetry Antenna	32 Aug.
Ham Participation in IGY (Editorial)	8 Jan.
New Transmitter for U. S. Satellite Radio Astronomy and the Jodrell Bank Radio Telescope (Lovell)	35 Feb.
Receiving "Explorers'" Radio Signals (Ripani, W9JAO)	98 May
Receiving U. S. Satellite Signals (Matthews)	35 Mar.
Report on the Soviet Earth Satellite	124 Feb.

MISSILES & MILITARY

Four Hundred and Sixty-six Years (Editorial)	8 Dec.
Miss-Distance Indicator Improves Navy Target Scores	122 Apr.
Missile Master Air Defense System Radio Communication Terminal Carried by Air	144 Feb.
Rocket-Rider Radio	130 Sept.
Scatter Communication (Johnson, M. P.)	29 Aug.
Ultra-Modern Signal Corps Communications Center (Schauers)	40 Apr.
World's Most Accurate Radar	41 Sept.

PUZZLES

Circuitry Crossword (Comstock)	109 Aug.
Electronic Crossword (Gill)	144 Sept.
Hi-Fi Anagram (Comstock)	105 July
Radio Crossword (Gill)	135 Oct.
Radio-TV Parts Puzzle (Comstock)	167 Feb.

December, 1958



LAMPKIN METERS + FCC LICENSE = HIGHER INCOME!

Over a million mobile-radio installations need regular, high-grade maintenance and measurements per FCC regulations!



**LAMPKIN
105-B MICROMETER
FREQUENCY METER**

Range 0.1 to 175 mc. (to 3,000 mc. by checking multipliers). Gives error from assigned frequencies. VHF CW signal generator. Weight 13 lbs., width 13". \$220.00

**LAMPKIN 205-A FM
MODULATION METER**

Reads peak FM voice deviation ± 12.5 kc. and ± 25 kc., tunes 25-500 mc. in one band. Relative field-strength meter. Speaker. Jack for oscilloscope. Weight 13 lbs., width 12". \$240.00.

LAMPKIN LABORATORIES, INC.
BRADENTON, FLORIDA

This means money... steady income... right in your own area.

LAMPKIN METERS are the preferred test equipment!

Send for free booklet... "HOW TO MAKE MONEY IN MOBILE-RADIO MAINTENANCE". No charge... just use coupon below.



LAMPKIN LABORATORIES, INC.
MFM Division, Bradenton, Florida

At no obligation to me, please send

Free booklet Data on Lampkin meters.

Name _____
Address _____
City _____ State _____

STAMP OF APPROVAL!

QUIETROLE

Only Known Merit marks a product as the "BEST"

for quieting Noisy Controls and Switches
QUIETROLE produces results superior to any other product. That's why it's known as the "Best" and that's why more users prefer it to any other. It's the dependable Original product of its kind... a first in the Industry.



QUIETROLE Spray-Pack

or the **QUIETROLE** Bottle with the Eye Dropper Cap

QUIETROLE offers you both types of containers. Either way assures you of the same un-failing results that QUIETROLE is known for.

The Lubricant Cleaner of the Electronic World. Tailored for the industry by over 15 years of authentic research, plus 4 years of rigid and exacting tests before marketing.

In 2 oz. bottle with dropper and 6 oz. QUIETROLE SPRAY-PACK

Ask for QUIETROLE and be sure you get it!

manufactured by
QUIETROLE COMPANY
Spartanburg,
South Carolina

SURPLUS BUYS



RCA OSCILLOSCOPE MODEL 155

This scope is a highly efficient conventional 3" oscillograph. Operates from 115VAC-60 cycles. The perfect instrument for service, labs, schools, industry, experimentation. All features of high priced lab scopes available to you at less than the price of a kit. **FOB N. Y. \$29.95**

14" Wt. 23 lbs.

ARC-5 XMTR—3-4MC—Exc. \$5.95
ARC-5 XMTR—5.3-7MC—Exc. \$6.95
OIL CONDENSER—8-8 Mfd.—600VDC—with brackets compact (Tobe or Nat'l) New... \$2.50
MINIATURE METER—1" Sq. Weston, Etc.—0-100 Microamps. Br. New. Orig. Scale. Now only \$3.95

OIL CONDENSERS

1 Mfd-600V	\$.25	4 Mfd-600V	\$.50
2 Mfd-600V	\$.25	2 Mfd-1000VDC	\$.75
.05--0.5 600V	\$.25	1 Mfd-1000VDC	1.50
10 Mfd-600V	1.00	3 Mfd-1000VDC	.79

METERS

500 Microamps	\$3.29	300 VDC	\$3.75
500 Milliamps	2.95	1 Amp RP	4.95
1 Ampere DC	2.95	50 Amp AC	4.95
10 Amps DC	2.95	(6AFS)	4.95
140 MMFD VARIABLE APC TYPE (Hammar.)			
39 Plate—3/4" Shaft		3 for \$2.00	
SENSITIVE MICROAMMETER Ruggedized—0-100			
—New 3"			\$5.95

XFORMERS ALL 115V—60CY. PRI.

T1—2.5V—10A—10KV—Insul.	\$3.95
T2—6.3V—20A—Pri 115/250—Cased	\$3.95
T3—5.0V—10A—10KV—Insul.	\$3.95
T4—450-0-450—275Ma—5V—3A;	
6.3V—8A—Cased	\$5.95
T5—(ARC5 and Surplus Gear) 300-0-300;	
100 Mils; 12.6VCT—3A; 12.6V—3A;	
6.0V—2A—Compact	\$2.49

CHOKES

L1—8Hly—200Ma. (Very Small) Cased	\$1.95
L2—12Hly—500Ma. Cased	\$6.95
L3—4Hly—900Ma.	\$12.95

50 FT. AIR FORCE TOWER—Selling in 10 ft. sections. Pfaff & Kendall #337 solid steel lattice triangular construction. (White or Orange) 29 Lbs. Sides 7"x7"x7". Suitable beams, TV, etc. **FOB N. Y. \$8.95** 10 ft. Sect.

REX RADIO SUPPLY CO.

88 Cortlandt St.
New York 7, N. Y.

In the Heart of New York's Radio Row

**Train for a secure career
—not just another job!
Success ahead for trained men
only in**



Electronics

including Guided Missiles . . . Radar . . . Instrumentation . . .
Computers . . . Automation . . . Astronautics . . . Servomechanisms
. . . Aeronautical Electronics . . . Telemetry . . . Television
. . . Manufacturing . . . Communications . . . Broadcasting

Stop Dreaming! Start Planning! START YOUR CREI CAREER TRAINING AT HOME TO INSURE MORE INCOME!

What would a \$10 or \$20 a week raise mean to you? Only one \$10-a-week raise will repay your investment in CREI training, and leave you a substantial profit the very first year! Your increases in pay thereafter are all pure profit, and you'll be prepared for many more promotions and pay raises in the future years of your life!

WHAT YOU DO NOW—today, tomorrow, next week—will decide your success in the electronics field. Every day counts because the *well-trained* technicians are the ones who get the "plums" when promotions are handed out. How can you be sure to step ahead of competition, to earn more money, to get the position that carries more responsibility—and the pay that goes with it? The answer is contained in a CREI booklet called "Your Future in the New World of Electronics."

ERA OF ELECTRONICS

This is the era of guided missiles, automation, astronautics, instrumentation. This is the era of defense orders and a manufacturing industry which last year alone sold billions of dollars worth of electronic equipment, which will top ten billion dollars (without military) this year. This is the era of electronic development, research, design, production, testing, inspection, manufacture, broadcasting, telecasting and servicing. This is the era of electronic careers—well-paid, interesting, and secure.

PRACTICAL COURSES

Your work is under the supervision of a regular staff instructor who knows and teaches what industry needs. Training is accomplished on your own time, during hours chosen by you.

KEY TO SUCCESS—As a graduate you'll find your CREI diploma the key to success in the entire field of electronics. At your service is the CREI Placement Bureau which helps to find positions for advanced students and graduates. No short cuts are promised; no jobs are guaranteed—but requests for CREI-trained personnel come in regularly.

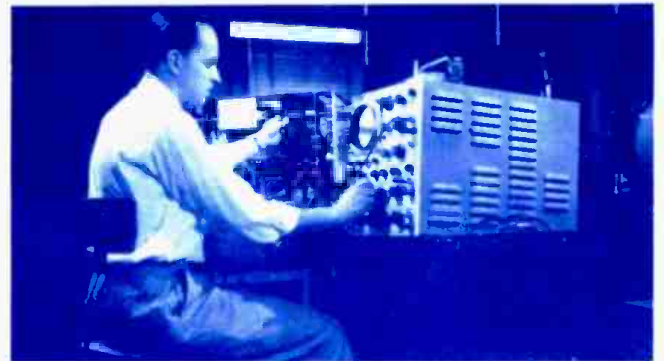

COLLEGE DEGREE NOT ESSENTIAL—This is *professional* training, not for beginners, but you don't have to be a college graduate to benefit from CREI's famed courses. You *do* have to be willing to study at home. You can do it while holding down a full-time job. Thousands have. If you have had *some* electronics experience, CREI has a course for you.

CREI's professional guidance is recognized all over the world. Since 1927 CREI has trained practical electronic engineers and engineering technicians; you find them in radio and television stations; you find them in electronics planning and manufacture; you find them everywhere and, generally, near the top. Leading firms recommend CREI training for their own personnel (among them are United Air Lines, Canadian Broadcasting Corp., Douglas Aircraft Co., The Martin Co., and All-American Cables & Radio, Inc.).

THIS CAN BE YOUR BIG YEAR!

Write today for this **FREE BOOKLET**. Tuition is reasonable, terms are easy, information is free. Fill out the postage-paid reply card completely, and mail today to Capitol Radio Engineering Institute, 3224 16th St., N.W., Washington 10, D.C.



Available to Veterans Under GI Bill!

1st Class

Permit No. 288-R

Washington, D. C.

BUSINESS REPLY CARD

No Postage Stamp Necessary If Mailed in the United States

Postage Will Be Paid By

CAPITOL RADIO ENGINEERING INSTITUTE

3224 16th Street, N.W.

Washington 10, D. C.

ORDER by MAIL and SAVE! TV PICTURE TUBES

10BP4	\$ 7.95	17BP4	\$10.95	21AMP4	\$19.95
12LP4	8.95	17CP4	17.00	21ATP4	20.95
14B/CP4	9.95	17GP4	17.60	21AUP4	20.95
16DP4	14.95	17HP4	13.60	21EP4	14.95
16EP4	15.90	17LP4	13.60	21FP4	15.95
16GP4	15.90	17QP4	11.95	21WP4	17.30
16KP4	10.95	17TP4	19.30	21YP4	15.95
16LP4	10.95	19AP4	19.30	21ZP4	14.95
16RP4	10.95	20CP4	13.90	24CP4	23.95
16WP4	15.20	20HP4	17.95	24DP4	26.95
16TP4	10.95	21AP4	22.10	27EP4	39.95
17AVP4	15.20	21ALP4	20.95	27RP4	39.95

27"-6 month Guarantee—all others 1 year. Aluminized Tubes \$5.00 more than above prices. These prices are determined to include the return of an acceptable similar tube under vacuum.

ALL PRICES FOR CHICAGO, ILLINOIS. Deposit required, when old tube is not returned, refundable at time of return. 25% deposit required on COD shipments. Old tubes must be returned prepaid. We ship anywhere.

WRITE FOR COMPLETE LIST.

— PICTURE TUBE OUTLET —
3032 MILWAUKEE AVE.
CHICAGO 18, ILLINOIS
Dickens 2-2048

2 WAY PORTABLE RADIO SET

Sends—Receives up to 10 miles as shown

of hundreds of miles with outside antenna 80 and 40 meter amateur radio bands (includes also A1erairt and overrange broadcast (2 to 8 mc.) POWERED WITH SELF-CONTAINED PORTABLE RADIO BATTERIES. NO AC PLUG-IN REQUIRED! Take it with you everywhere you go—Keep in contact with home, friends, has 5 watt crystal controlled transmitter—Sensitive Regenerative Receiver. Send receive switch. Wt. only 3 lbs. Size, only 6" x 4" x 4" TESTED—PROVED—SIMPLIFIED—PRACTICAL! Full information given on quick easy to get license.



SEND ONLY \$3.00 (bill, ck. mo) plus \$12.95 COD postage on arrival or send \$15.95 for postpaid delivery. Complete kit includes all parts, tube, coil, nickel cabinet, easy instructions. (Set of batteries—\$3.49; crystal \$1.49) COMPLETELY WIRED AND TESTED POSTPAID \$19.95. A regular \$49.95 value—Order now before price goes up. GUARANTEED AVAILABLE ONLY FROM:

WESTERN RADIO Dept. BNT-12 KEARNEY, NEBR.

STOP MAGNETIC RADIATION

Find the source causing hum and other magnetic interference in tubes, tape recording and playback heads, input transformers, high gain amplifiers and other magnetically sensitive components. Stop these troubles with non-shock sensitive non-retentive Co-Netic shielding foil. Used in numerous commercial and critical military applications. Cuts easily with ordinary scissors, bends into and retains any desired shape. Magnetic Shielding Experimental Kit contains 3 shielding foil strips in these handy sizes: 2"x9½", 2½"x8", 3"x7". Only \$3.60 postpaid. Includes application information.

Magnetic Shield Division
Perfection Mica Co.

1322 No. Elston Ave. • Chicago 22, Ill.

Enclosed is \$3.60 (check or money order—no cash, please) for Magnetic Shielding Experimental Kit. Please send postpaid.

Name _____

Street & No. _____

City _____ Zone _____ State _____

Radio-TV Units Puzzle (Comstock)	120	Apr.
Transistor Terminology (Comstock)	129	Nov.
TV Circuits Puzzle (Comstock)	125	May

TUBES & TRANSISTORS

Lazy Tube Cathodes (McCormack & Mackey)	48	Dec.
Transistor Heat Sinks (Penfield, Jr.)	70	Mar.
Transistors Are Different (Bukstein)	62	Dec.
Twelve Volts-Heater and Plate (Burgess)	68	Mar.
Why Tubes Fail Prematurely (Heller)	70	Sept.

MISCELLANEOUS

All-Electronically Controlled Machine Tool Line	110	June
Behind the Scenes in Publishing (Editorial)	8	Nov.
Citizens Radio Faces the Future (McKay)	37	Nov.
Communications in Fire Control (Zitko)	33	July
Electro-Chemical Elapsed Time Indicator	136	Jan.
Electroluminescence—Light of the Future (Martin)	35	Jan.
Electronics at Disneyland	39	June
Electronics In Our Economy (Editorial)	8	Mar.
Electronic Typesetter to Be Marketed	128	Dec.
Facsimile Signals Bounced From Meteor Trails	116	Mar.
Farm Housewife Helps Over-Horizon Radio Study	98	Apr.
How Small Can They Get? (Editorial)	10	July
Industry Responsibility (Editorial)	8	May
"Istor" Story (Graf)	144	Nov.
Magnetic Check for Tools (Jason)	112	Sept.
Micro-Modules—the Ultimate in Miniaturization (Gootée)	48	Sept.
New Converter Changes Heat to Electricity	157	Feb.
New Device Reads Written Numerals	127	Feb.
Radiation Detectors—A Technician's View (Part 1) (Lytel)	44	July
Radiation Detectors—A Technician's View (Part 2) (Lytel)	52	Aug.
Radio Aids Rescue Operations	47	Sept.
Semiconductor Variable Capacitors (Smith, H. R.)	46	Dec.
Silicon Solar Battery (Renné)	37	Dec.
Solar Powered Display	39	Dec.
Subliminal Ads Tried on TV	143	Feb.
Telephone of the Future (McKay)	44	Dec.
This Month's Cover	39	June
This Month's Cover	33	July
This Month's Cover	47	Sept.

HIGH-FIDELITY AUDIO

AMPLIFIERS

Basic Feedback Amplifiers (Westphal)	44	Aug.
Compact Hi-Fi Amplifier (Wortman)	110	Jan.
Dyna Preamp	69	Sept.
Hi-Fi 50-Watt	51	July
KT-300 Preamp	160	Apr.
Low-Cost Hi-Fi Amplifier (Kaplan)	57	May
"Mark III"	138	Mar.
70 Watts for Hi-Fi	53	Jan.
70 Watts with KT88's	94	June
"Tiny Tim" Portable P.A. Amplifier (Reed)	99	Dec.
25-Watt Power Amp	65	Sept.
Upgrading the Hi-Fi Amplifier (Burstein)	50	Mar.

CIRCUITS

Audio "Mix-It" Box (Wortman)	42	Sept.
Audio Operated Switch (Reed)	60	Apr.
Feedback (Klipsch)	140	Mar.
Is a Loudness Control Necessary? (Hines)	34	July
RC Filter Tone Controls (Schwan)	61	Mar.

shoot for
home movies
that look
professional!

Learn how in the world's first HOME MOVIE MAKING ANNUAL (prepared by the Editors of Popular Photography).

- includes:
- 25 SECRETS FOR SUCCESSFUL MOVIE MAKING
- STEP-BY-STEP PROCEDURE FOR MAKING A MOVIE
- 100 IDEAS FOR HOME MOVIES
- HOW TO MAKE AN OLD TIME COMEDY (complete with custard pie!)
- HOW TO EDIT, ADD SOUND, WRITE A SCRIPT
- COMPLETE DIRECTORY OF MOTION PICTURE EQUIPMENT



HOME
MOVIE
MAKING

NOW
ON SALE
only \$1.00

Simple 3-Channel Mixer (Voss)...	51 Feb.
Simple Transistor Mixer (Johnson, G.)	47 July
3-D Hi-Fi Amplifier (Martin).....	59 July

MISCELLANEOUS

FM Station Sends Three Programs At One Time.....	141 Apr.
"High-Power" Portable Paging System (Garner, Jr.).....	45 June
Hi-Fi in the Home.....	59 Jan.
Indoor Public Address Systems (Crowhurst)	54 Nov.
Magnetic Recording-1914 Style (Tremaine)	90 July
Outdoor Public Address Systems (Crowhurst)	29 June
Test Report—Hi-Fi Components...156 Sept.	
Which Way to High Fidelity?—Buy Now or Later? (Crowhurst).	44 Feb.

PHONO

Automatic Motor Control for Hi-Fi Turntables (Andrews)	86 July
Automatic Phono With Transistor Amplifier (Betsh)	55 Dec.
Loading the Phono Cartridge (Burstein)	40 Nov.
Novel Features Highlight New Record Changer	120 Jan.
"Ultra-Linear II"	120 Oct.

SERVICING

Additional Notes on "Testing FM Tuners at Home".....	130 Jan.
Approach to Hi-Fi Service (Fidelman)	57 Oct.
Field Hi-Fi Service (Fidelman)....	69 Apr.
Removing Hi-Fi System Resonances (Southworth)	44 Sept.
Testing FM Tuners (Buchsbaum)...	50 May

SPEAKERS-HOUSINGS

All About Audio and Hi-Fi—Speaker Power and Efficiency (Part 8) (Briggs).....	56 Feb.
All About Audio and Hi-Fi—Speaker Mounting (Part 9) (Briggs)	64 Mar.
Electrostatic Loudspeakers—Questions and Answers (Philbrook)	36 June
Speakers for Stereo (Burstein)....	29 July
Testing the Properties of Loudspeakers (Smith, J. L.).....	39 Aug.
"Ultra-Linear" Hi-Fi Speaker Systems (Sioles).....	58 Jan.
Weakest Link—First or Last? (Burstein)	46 Apr.

STEREO

All-Linear Stereo Disc Demonstrated	125 Apr.
Behind the Stereo Scene.....	42 Oct.
Converting to Stereo Disc.....	44 Oct.
Cover Story	43 Oct.
Magic of Stereophonic Sound (Garner, Jr.)	42 Mar.
New Compatible Stereo Disc (Snitzer)	53 June
Pickup Cartridges for Stereo (Crowhurst)	35 Oct.
RCA's 4-Track Stereo Cartridge... 80 Aug.	
Simple Stereo Amplifier (Timmerman)	49 Oct.
Stereo Boom Ahead (Editorial)....	8 Aug.
Stereo Broadcasting—Now and in the Future (Snitzer).....	65 Oct.
Stereo Control Center (Flores)....	56 Jan.
Stereo Control Center.....	38 July
Stereo Control Unit.....	43 Aug.
Stereo Disc (Editorial).....	8 Apr.
Stereo Disc Recording Methods (Minter)	66 Oct.
Stereo Glossary (Burstein).....	68 Oct.
Stereomaster 130	48 Oct.
Stereophonic Cartridge Directory..	37 Oct.
Stereo Tape Directory	46 Oct.
Stereo Tape or Disc? (Editorial)...	8 Oct.

Stereo—Tape or Disc? (LeBel)....	40 Oct.
Varied Program Available on Stereo Discs	112 Oct.

TAPE RECORDING

Adding a Stereo Tape Head and Preamp (Gicca)	51 Apr.
Adding a VU Meter to the "Outboard" Amplifier (Snader).....	106 Nov.
Electronic Level Indicators for Tape Recorders (Burstein)	42 Dec.
Mac's Service Shop (Tape Recorder Tips) (Frye)	62 July
Measure That Flutter (Walter)....	60 Dec.
Measuring Tape Recorder Wow and Flutter (Graham).....	40 Jan.
Microphones for Tape Recorders (Crowhurst)	43 May
"Outboard" Equalizer-Bias Amplifier for Tape Recording (Snader)	69 Jan.
Playback Standardization for Tape Amplifiers (Burstein)	69 Feb.
Reducing Tape Recorder Noise and Hum (Burstein & Pollak)...	57 Sept.
Transistor-Tube Tape Preamp (Jones)	48 Aug.
What Do You Know About Recording Tape? (Hard).....	111 Feb.

TELEVISION

ANTENNAS

Choosing the Right Antenna.....	37 Sept.
Make More \$\$ On TV Antenna Replacements	56 Aug.
Multi-Set TV Installations: Problems & Principles (Part 1) (Beever)	51 Nov.
Multi-Set TV Installations: Problems & Principles (Part 2) (Beever)	49 Dec.
No Time for Makeshifts (Editorial).	8 Sept.
Parabolic Antenna for U.H.F. TV (Harris & Mattern).....	50 July
Rhombic Antennas for TV (Cooper, Jr.)	64 Feb.

COLOR

Color Case History: 3.58-mc. Oscillator Failure (Smith, W. J.)....	55 Aug.
Color TV Programs on Tape.....	155 Jan.
How to Test and Adjust Chroma Circuits (Middleton)	66 Jan.
Practical Color TV for the Technician (Part 6) (Kleidon).....	62 Jan.
3-D Color TV for the Future? (Snitzer)	39 May
3 Dimensional TV System (Mengle)	45 Oct.
Video Color Converter "Pre-viewed" by Long Distance Phone	148 Feb.

MISCELLANEOUS

Airborne Closed-Circuit Television.	95 May
All-Transistor TV Set.....	136 Apr.
Closed-Circuit TV (Shea).....	35 May
Complete TV Remote Control (Peters)	55 Apr.
Does Licensing Work? (Editorial)...	8 June
Eye for an Eye.....	37 May
How the Videotape Recorder Works (Roizen).....	48 Nov.
New CRT Changes Philco TV Design	50 Sept.
New Silicon and Germanium TV Rectifiers (Buchsbaum)	39 Feb.
New TV Front End Designs (Buchsbaum)	65 May
New Westinghouse TV Circuits... 54 Jan.	
1958 Tube Inventory for Service Shops (Barlowe)	152 Apr.
Role of the Service Association (Editorial)	8 Feb.
Service Association of the Month. (MARTS) 100, June; (ARTSNY) 80, July; (NATESA) 82, Aug.; (ESA, Detroit) 92, Sept.; (TESA-RTTA, Fort Smith, Ark.) 140, Oct.; (Alameda County Assn.) 116, Nov.	

(Continued on page 158)

XMAS SURPLUS !!

BC 604 TRANSMITTER
20-28 MC FM Tank Transmitter Crystal Controlled. Push button Tuning. Convert for 10 meters or use for parts. Complete with all tubes. ALL NEW. Ea. **\$4.95**

POLAR RELAY
Plug-In Type ± 255 A. Ideal for Teletype use. Ultra Sensitive coil with adjustable contacts. With removable cover, used. Exc. Cond. Ea. **\$2.50**

AIRCRAFT BATTERY
12 Volt, 34 Amp. Hour. TYPE AN-3152 Completely Enclosed with removable top. Use for All Light Aircraft. All Used—DRY CHARGED. New Surplus. Special Ea. **\$12.50**

6 VOLT WET CELL
6 Volt 2 Amp. Hours Wet Cell Battery. Dimensions 3 1/2" x 1 1/2" x 1 1/2". Type NT-6 Ideal for all Model Hobby Work—Boats, Cars, Trains, Etc. ALL NEW. Dry Charged. Ea. **\$1.95**

TELESCOPIC ANTENNA
Type AN-29C 12 Ft. Telescoping Section Antenna. 12 Brass Sections which fold down to 18" ideal for mobile or portable use. ALL NEW. Ea. **\$2.50**

WHIP ANTENNA
10 Sections, each 1 foot long which plug into each other to make a 10 foot whip. Ideal for mobile or portable use. ALL NEW. Ea. **\$1.95**

TYPE TS-10 SOUND POWER PHONES
Use these phones without any external or internal voltage supply. Two or more can be used with only 2 wires interconnecting them. Use for TV installation, house to house or house to garage. Exc. Cond. Lowest price in years. Per Pair **\$15.95**

PROP PITCH MOTORS
For your Beam Antenna: 20 Volt to 32 Volt. A.C. or D.C. 1/2 H.P. Motor. 1 1/4 H.P. Gear Reduction. 7000 to 1. Used. Good Cond. Each **\$16.95**

See our previous ad for Special Surplus Items. All prices F.O.B. S. F., Calif. Calif. orders add 3% Sales Tax. 9% Dep. on all C.O.D.'s. Packages under \$3.00 send full amount. Items subject to prior sale.

STANDARD SURPLUS

1230 Market St., San Francisco 3, Calif.
Telephone HEMlock 1-3106

NEW! IMPROVED!

SENCORE

TRC4

TRANSISTOR CHECKER

Another Sencore Time-Saver



Only tester that checks car radio power transistors

NOW CHECKS:

- ★ Transistors for opens, shorts, leakage and current gain. Includes new gain test on power transistors.
- ★ Crystal Diodes checks forward to reverse current ratio on all diodes.
- ★ Selenium Rectifiers checks forward and reverse currents.

Controls are accurately set for each transistor by referring to replaceable set-up chart on rear. Test leads or socket provides for fast hook-up.

See your parts distributor.

Mfg by **SERVICE INSTRUMENTS CORP.**
171 OFFICIAL RD., ADDISON, ILL.

ONLY \$17.95
Dealer Net

SIMPLE TO OPERATE
Cannot become obsolete. Approved by leading manufacturers.

Cut out this ad now for further information

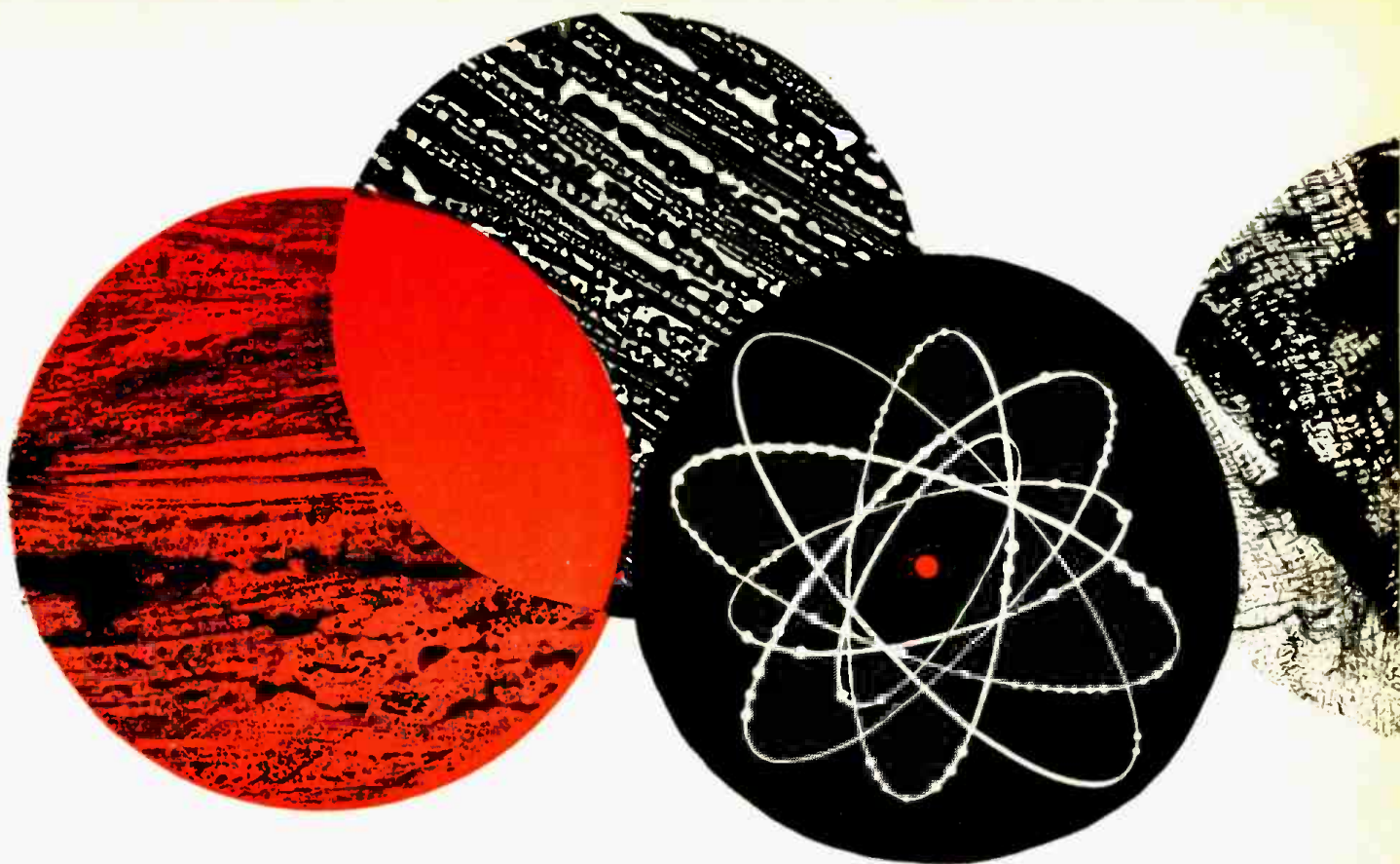

ELECTRONICS WORLD...

What's in store for the Electronics World in 1959? What new frontiers will be opened...equipment perfected...techniques improved?

The staff of RADIO & TV NEWS has put together this brief rundown of possible developments and trends in the industry during 1959. In such a dynamic field, we too have to work ahead...estimating far in advance the events and achievements which will deserve editorial coverage in the year ahead.

Here's the way we see it. And in the months ahead, you'll see it, too—more complete and more authoritative than anywhere else—in the pages of RADIO & TV NEWS, the world's most widely read technical electronics magazine.

HI-FI STEREO

Equipment manufacturers expect 1959 to be an even bigger year for hi-fi components and parts. More and more Americans will become interested in the world of high fidelity sound. And 1959 will see the growth and refinement of stereo—possibly lower prices, certainly new equipment and techniques. RADIO & TV NEWS will serve a twofold purpose: by reporting on ways to get the utmost enjoyment from existing equipment and records, and by giving expert advice on the best purchases in new tapes and discs.

SERVICING

The service technician will find more material than ever before in RADIO & TV NEWS—all designed to help him make more money in his day-to-day operations. Two new facets of servicing look big for '59:

- 1) **COLOR TV**—There'll be more sales of color TV sets next year, because of the growing number of top TV programs being presented in color. This means an increased demand for service technicians who have the know-how to install and repair these complex sets. The pages of R&TVN will give you charts, diagrams and expert tips on getting into this lucrative field.
- 2) **INDUSTRIAL SERVICING** will become even more important as automation becomes widespread in industrial plants. This is a golden opportunity for the service technician—with more jobs available than ever before (both on a full-time and free-lance basis).

SATELLITE PROGRAM

Whether electronics is your profession or your hobby, you'll want to be well-informed on developments in satellites, rockets, and missiles. RADIO & TV NEWS will keep you up-to-date on the techniques of tracking missiles, transmitting signals, receiving and interpreting information—and what the results mean.

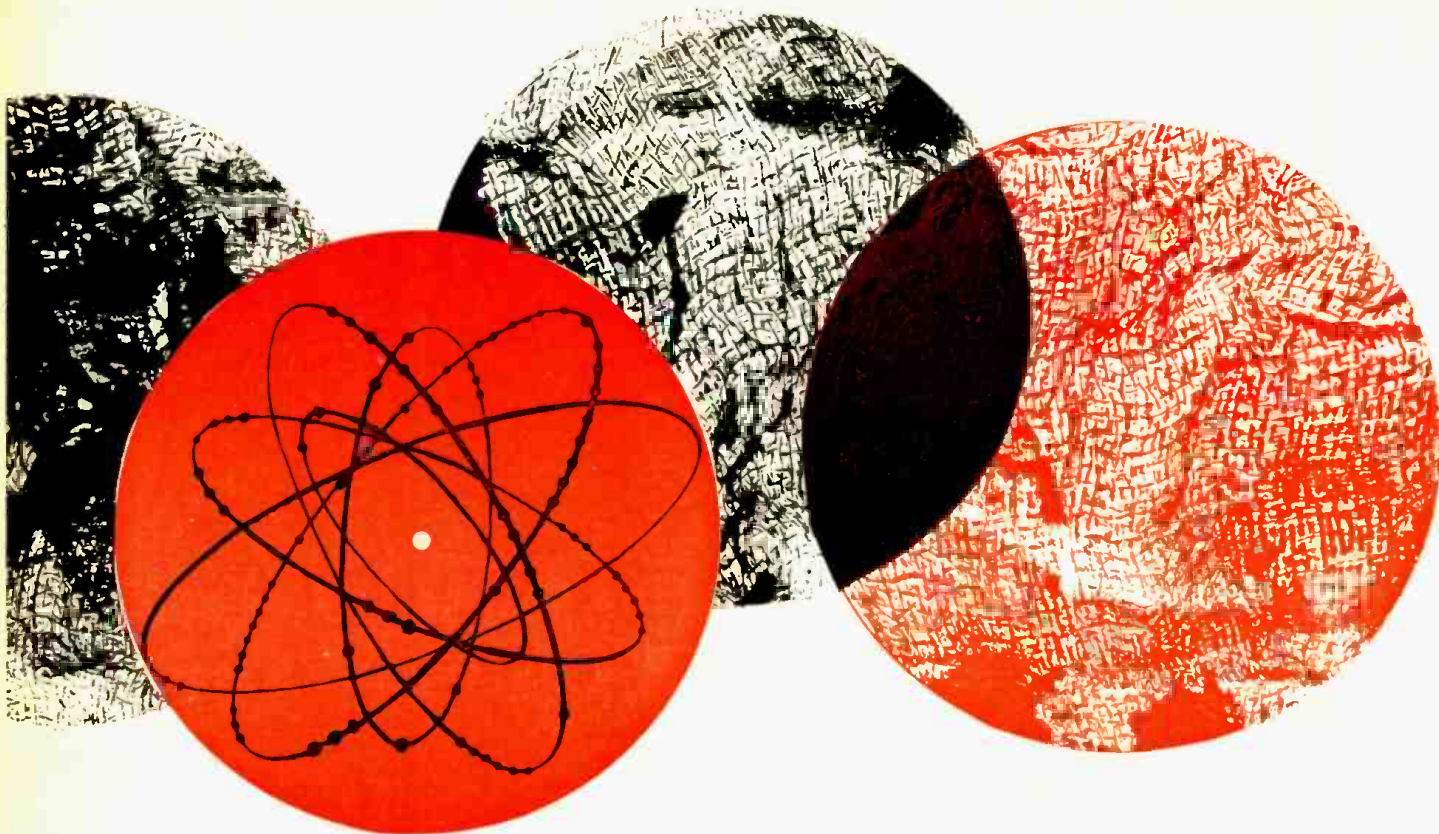

..1959

A Message from the Publisher about the Coming Year...

IGY PROGRAM

Much of the information and results of the International Geophysical Year will be released to the public for the first time in 1959. This will lead to a number of major break-throughs in such fields as meteorology, aurora and air glow, cosmic rays, oceanography, seismology, gravity, solar activity, glaciology, geomagnetism, and ionospheric physics.

There is no doubt that these findings will lead to better navigation, improved radio communications, and better weather forecasting. And what is learned from this great scientific experiment is sure to make itself felt in other fields in which electronics plays a major role. RADIO & TV NEWS will report *in depth* on the major findings on the IGY—and how these findings affect the various facets of electronics.

INFRA-RED

Here's a division of electronics that will assume tremendous importance in the years ahead—in solving re-entry problems for satellites, in medical analysis (particularly in the detection of cancer), and as a replacement for radar in defense. The editors of RADIO & TV NEWS believe that the uses of Infra-Red will mark a significant era in electronics and have planned several articles on the subject.

As never before, 1959 will prove that this is indeed an Electronics World! And whatever your field of interest, you'll find it covered thoroughly in the coming year in RADIO & TV NEWS. That's why you would be wise indeed to make sure you get every issue of RADIO & TV NEWS during 1959.



Oliver Read

Oliver Read
Publisher

REGULAR SUBSCRIPTION RATES:
one year \$4 two years \$7 three years \$10

ZIFF-DAVIS PUBLISHING COMPANY
One Park Avenue, New York 16, New York

New! HAM GEAR

BRAND NEW STOCKS

Following items all are in Factory-Sealed Cartons. Latest Serial Nos. We are Authorized Factory Distributors for all the following lines:—Other items in Stock—Write

- Hammarlund Receivers—HQ-100 Receivers Net \$189.00
- HQ-110 Receivers...Net \$249—HQ-160 receivers...Net \$379.
- HQ-170 Receivers...Net \$359—S-100 Hammarlund Matching Speaker...Net \$14.95.
- National Co. Receivers—NC-60...\$ 59.95
- Gelo—Ham Receiver—G-209...\$299.50
- Gelo—Ham XMTR—G-212, TR...\$249.50
- Gelo—Portable Tape and Stenotype Recorder, Model G-255SP only 7 1/2 lbs.—Only 5 3/4" x 5 1/2" x 9 3/4" (Write for Brochure)—\$179.95
- Vocaline—Citizen's Band Transceivers Model JRC-400 \$69.75 each, \$139.50 per pair Model JRC-425 \$99.75 each, \$199.50 per pair
- E. F. Johnson Co.—Ranger—Factory Wired...\$329.50
- Johnson—Viking Courier—Wired...\$289.50
- Johnson—Navigator—Kit...\$149.50
- Johnson—Navigator—Wired...\$199.50
- Johnson—Viking Valiant—Wired...\$439.50
- Johnson—Viking Kilowatt \$1,595.00, Desk...\$132.00
- Borker & Williamson—L-1001A Amplifier...\$240.00

We are factory distributors for Vocaline, Gonsel, E. F. Johnson, Eimac B&W Hexacon, Adjust-A-Volt, CBS, Hammarlund, National and Gelo. Trade-ins accepted.

LATE TRANSFORMER SPECIALS

ALL UNUSED, ALL COMPLETELY SHIELDED

- FT-2368 Plate Transformer.
Primary: 117 for 230 Volts AC, 50/60 cycles.
Secondary: 1,000 Volts CT @ 350 Ma continuous, 3,000 Volts test.
Size: 5 19/32" H x 5" x 4 3/8". Price: \$3.50 each.
FT-2369 Choke, 8 Hys. @ 350 Ma., 2500 Volts test. Price \$2.50 each.
Size: 5 3/8" H x 1 1/2" x 4 3/8".
- FT-2370 Transformer, Filament.
Primary: 117 for 230 Volt AC, 50/60 cycles.
Secondaries: (1) 6.7 volts @ 20 amps.
(2) 6.3 volts @ 1 amp.
(3) 5.0 volts @ 4 amps.
- Size: 4 1/2" H x 4 1/2" x 4 1/2". Price \$2.50 each.
FT-2366 Transformer, Filament (Bridge type).
Primary: 117 for 230 Volts AC, 50/60 cycles.
Secondaries: (1) 6.3 volts @ 9 amps.
(2) 5.0 volts @ 3 amps., 3,000 volt test.
(3) 5.0 volts @ 3 amps., 3,000 volt test.
(4) 5.0 volts @ 3 amps., 3,000 volt test.
- Size: 4 1/2" H x 3 1/2" x 3 1/2". Price \$2.50 each.
- FT-2365 Transformer, Filament. (Ideal for 813, etc.).
Primary: 117 volts, AC 60 cycles.
Secondary: 10 volts @ 6 amps. Price \$1.50 each.
Size: 1 1/2" x 3 1/2" square.
- FT-2360 Transformer, Variable. Powerstat—New Surplus—Original Sealed Cartons.
Primary: 115 volts, 60 cycles AC.
Secondary: 0 to 115 Volts AC @ 7.5 amps., 3/8" shaft.
Special Only...Price \$13.50
- Large Knob and Plate DUMONT Plate Transformer.
Primary: 115 volts, 60 cycles AC.
Secondary: 500-0-500 VAC (1,000 volts AC CT) @ 350 ma.
Size: 5 3/4" H x 5" x 4 3/8". Price \$3.50 each.

• New Lot of over 1,000 Meters—All Popular Types—Write Your Needs!

WRITE FOR LATEST TUBE CATALOG FREE! Receiving, transmitting, special purpose tubes, diodes, transistors, etc. We have a large diversified stock at sensible prices. Export inquiries welcomed.

2-COLOR TUBE CARTONS

Keeps Your tube stock neat. New safety partition prevents tube breakage. Distinctively lithographed in glossy red and black. The most distinctive tube carton available today. Minimum quantity: 100 of any one size. Write for case lot prices. Packed 1000 to case. F.O.B. N.Y.C. No C.O.D.'s on cartons—Send full remittance including postage—Excess refunded.

Size For Tube Per 100
Miniature...6AU6, etc...\$1.00
GT...6SN7, etc...1.25
Large GT...183, etc...1.50
Large G...5U4G, etc...2.00



WHITE GLOSSY CARTONS Completely blank. No printing or color. Otherwise same as above. Same high quality, same low prices. Specify "WHITE" when ordering. When color is not stated, 2 color cartons will be shipped.

HOW TO ORDER: Send full remittance and save C.O.D. collection fee—Include sufficient money for postage—We refund unused amount—If you desire shipment C.O.D., include 25% deposit—Send cash by registered mail. No C.O.D.'s on tube cartons. All Prices F.O.B. N.Y.C. Specify How to Ship.

Open Monday to Saturday—Come in and Browse—We are near Prince St./BMT Station—Spring St./IRT Sta. 1 Flight up—10,000 Sq. feet of values.

TWX: NY 1-3731

BARRY ELECTRONICS CORP.

512 Broadway, Dept. RN-12, N.Y. 12, N.Y.
Phone: WAiker 5-7000

- Service Holds a Convention (Silver)..... 57 Nov.
- Service Technicians' All-American Award Winners..... 52 Feb.
- Telecopter—A Flying TV Station... 39 Oct.
- Video Tape—Tape That Takes Pictures (Anderson)..... 42 July
- X-Rays from TV Sets: Are They Harmful? (Maduell, Jr.)..... 58 Nov.

SERVICE NOTES

- "Automatic Rheostat" Protects TV Sets (Gotwald, Jr.)..... 42 Feb.
- Convergence Time Savers (Hadrick) 56 Sept.
- Day in the Shop (Eldridge)..... 60 May
- Facts About Vertical-Sweep Circuits (Philbrook)..... 52 Mar.
- Field Test for Gassy Picture Tubes (Jason)..... 52 Oct.
- Hidden Bypass Action (McRoberts) 39 Mar.
- Hot Chassis? Play It Safe (Bramham)..... 63 Dec.
- How the G-Y Signal is Used (Middleton)..... 62 May
- I. F. Alignment? It's Easy! (Eldridge)..... 40 June
- Intermittents Can Be Licked (Sappe)..... 40 Mar.
- Key Test Points in TV Sets (Eldridge)..... 61 Oct.
- New TV Circuits for '58 (Buchsbaum)..... 35 Apr.
- New TV Test Signals Aid Servicing (Risse)..... 48 Apr.
- Series-String Tubes and Circuits (Hughes)..... 64 Jan.
- Service Notes 114 Jan.; 120 Feb.; 152 Mar.; 148 Apr.; 120 May; 116 June; 121 July; 96 Aug.; 116 Sept.; 130 Oct.; 160 Nov.; 144 Dec.
- Servicing Relays in TV Circuits (Buchsbaum)..... 46 Jan.
- "Sound" Advice for TV (Eldridge). 38 Aug.
- Taming Tough Dogs (Rosen)..... 44 Jan.
- Test Bench Puzzler: No. 1 (Margolis)..... 115 July
- Test Bench Puzzler: No. 2 (Eldridge)..... 118 Aug.
- Test Bench Puzzler: No. 3 (Margolis)..... 108 Nov.
- To Troubleshoot—Remove Tubes (Glickstein)..... 58 Dec.
- Troubles in Retrace Blanking Circuits (McRoberts)..... 66 Feb.
- TV Circuit Improvements (Buchsbaum)..... 39 July

TEST EQUIPMENT

- AMATEUR "Mobile-Dip"—a Portable Grid-Dip Meter (Burgess)..... 58 Apr.
- Monitor Your Tone and Frequency (Wortman, W2LJU)..... 66 Mar.
- Multi-Dipper (Popenoe, Jr., W61WM)..... 59 Aug.
- Multipurpose Ham Accessory (Myerholtz, Jr.)..... 98 Feb.
- AM-FM Boost Your Scope's Sensitivity (Lederer)..... 54 June
- Build a Versatile LC Meter (Brizendine)..... 41 Dec.
- Cable Tracer-Checker (Frantz, Sr.) 42 May
- Extend Your Signal Generator's Range (Pugh, Jr.)..... 42 June
- Improved Multi-Purpose Probe (Kaye)..... 63 Nov.
- Improved Sine-to-Square-Wave Adapter (Turner)..... 107 June
- Maintain and Repair Your Own Scope (Buchsbaum)..... 57 Mar.
- Multi-purpose Scope Probe (Russell)..... 52 Jan.
- Scope Calibrator and Pulse Generator (Chioma)..... 70 Nov.

- Transistor Galvanometer Amplifier (Bernard)..... 43 Feb.
- Transistorized A.F.-R.F. Signal Tracer (Turner)..... 64 Nov.
- Universal Test Leads (Diers)..... 52 June

MISCELLANEOUS

- Checker for Intermittent Tube Shorts (Cotter)..... 116 Apr.
- Electronic Ignition Analyzer (Peters)..... 48 July
- Know Your V.O.M. (Buchsbaum)... 60 Sept.
- New Tube Tester Data 118 Jan.; 158 Feb.; 118 Apr.; 92 June; 84 July; 117 Aug.; 118 Oct.; 130 Nov.; 98 Dec.
- Special Applications of the Square-Wave Generator (Garner)..... 67 Dec.
- This Month's Cover..... 45 Apr.
- Tube Checkers Promote Service... 45 Apr.

TELEVISION

- Flyback Tester (Eldridge)..... 48 Mar.
- Get Color Bars from Your Linearity Generator (Lowry)..... 142 Apr.
- TV Analyzing—Simplified (Kiver)... 46 Sept.
- Use Your TV Set As An Oscilloscope (Southworth)..... 66 Apr.
- Video-Frequency Response Testing (Middleton)..... 59 Feb.
- Wide-Range Field-Strength Meter Adapter (Brizendine)..... 43 Nov.

-30-

OLD PM SPEAKER MAGNETS AID PM SPEAKER WORK

By A. VON ZOOK

BEFORE discarding defective small PM speakers, it is a good idea to remove the voice-coil magnets and save them. Small magnets have many uses about the service bench. One worthwhile application comes up when it becomes necessary to drill out the rivets of a defective audio-output transformer that is mounted on the frame of its associated PM speaker. When such drilling is done, iron filings are generally attracted to the magnet in the speaker itself. An otherwise good speaker may be ruined in this way. If some small magnets salvaged from old speakers — about four will do — are grouped about the rivet to be drilled out, iron filings will be attracted to these magnets rather than to the one in the speaker itself.



"Chief wants to see you, Reilly."

PHOTO CREDITS

Page	Credit
37 (top), 38, 44, 46 (left)	Bell Telephone Labs.
37 (bottom)	Zenith Radio Corporation
39	Aluminum Co. of America
40, 134	Hoffman Electronics Corp.
46 (right)	Pacific Semiconductors, Inc.
49, 50 (right)	Jerrold Electronics Corp.
50 (left)	Blonder Tongue Labs.
52	The Hallicrafters Co.
64, 65, 114	Heath Company
92	CBS Laboratories
112	Sylvania Electric Products Inc.
138	Official USAF Photo

Big Savings on Christmas Gifts From OLSON!



8 Olson Wholesale Catalogs



• RADIO • TV
• TOOLS • HI-FI
• APPLIANCES, ETC.

SAVE UP TO 1/2

Nationally Known Brands...
• GE • RCA • MAGNAVOX
• NORELCO • UNIVERSITY
• JENSEN and many more!

Our \$1,000,000.00 inventory includes 2,500 Super Values in Hi-Fi's, Tools, Appliances, Speakers, Amplifiers, Antennas, Tubes, Etc.—made by manufacturers such as GE, RCA, Magnavox, Bogen, Garrard, University, Norelco, Jensen, Stewart-Warner, and many others.

HERE'S OUR OFFER

Send \$1.00 with the coupon at right and we will mail you the 8 Wholesale Catalog issues, one every 6 weeks. We will deduct the \$1.00 from your first order and still send you the remainder of the catalogs FREE! If you are not 100% satisfied, return the first catalog and we will send you your \$1.00 back. Every item sold is 100% guaranteed.

FREE OF CHARGE!

Order merchandise from this page and we will send you all 8 catalogs (one every 6 weeks) FREE OF CHARGE!

Norelco
SPEEDSHAVER
Model SC-7900
Reg. \$24.95
\$14.97
3 for \$42.50
Stock No. EA-13



Quiet, high speed motor drives 6 self sharpening rotary blades. Five built-in capacitors lessen radio and TV interference. With cord and matening grey and white case. For 90-130 volts AC or DC. Shpg. wt. 3 lbs.

TRANSISTORS

New! JETEC Case
Individually packed with base diagram and lead identification. Hermetically sealed.

69¢	3 for \$2.00
	10 for \$4.95
	50 for \$19.95
	100 for \$37.50

NPN—Stock No. X-753
Similar to General Transistor GT-229. General Electric 2N170. or Sylvania 2N229.

PNP—Stock No. X-752
Similar to General Transistor GT-222. General Electric 2N107 and Raytheon CK-722.

Norelco
HI-FI CARTRIDGE
Reg. \$29.95
\$7.93
3 for \$23.00
Stock No. PC-47



1 mil Diamond stylus, 10 to 20,000 cps—2 DB. Tracks at 2 grams or less depending on arm. Load: 68,000 ohms. Mtr. ctrs. 1 1/2".

Say Merry Christmas with this...

PORTABLE PHONOGRAPH

* Deluxe 3-Speed
* Plays 7, 10 or 12"
Discs at 33, 45 & 78 RPM.

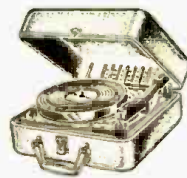

\$15.88

Stock No. RP-153

Modern slim line styled high-impact polystyrene cabinet with easy grip handle for convenient carrying. Nickel plated hardware. Plays 7" 10", or 12" record at 33, 45, or 78 RPM. Special recessed turntable for 45 RPM records. Lightweight pick up arm with quality needle. Powerful one tube amplifier and selenium rectifier provide clear, crisp power. For 110-117 volts, 60 cps AC only. 4 3/4" x 12 3/4" x 10 1/4". Shpg. wt. 5 lbs.

FLASH CAMERA KIT



\$6.63 Reg. \$9.95

Stock No. EA-24

Compact camera with built-in flash unit, uses 127 film for 12 2" x 2" pictures, or color slides. Includes 2 batteries, 4 G.E. 2 flash bulbs, 1 roll Eastman-Kodak film and instruction book. Camera 4 3/4" x 2 3/4" x 2" Shpg. wt. 5 lbs.

GENERAL ELECTRIC FLASH BULBS

Reg. \$1.32	No. M-2	Reg. \$1.68	No. 5
Package of 12	99¢	Package of 12	\$1.19
Lots of 144	\$10.99	Lots of 144	\$12.99

Stock No. PL-47

Magnavox 4-Piece High Fidelity SPEAKER SYSTEM

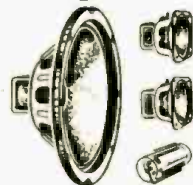

\$14.88

COMPLETE Stock No. AS-371

If you have been waiting for a first quality, Hi-Fi Speaker System, at a low, low price—wait no longer. This is the Genuine Magnavox quality construction throughout. The 15" Woofer delivers powerful bass and amazing mid-range response. 8 ohms. Rated at 20 watts with a response of 40—8,000 cps. Heavy cadmium plated frame, dust cover and 1 1/2" dia. voice coil. Combine the 15" Woofer with the two 4" Tweeters, that reach a peak of 17,000 cps, add the special non-polarized capacitor and your assurance of full range brilliance is guaranteed. Shpg. wt. 12 lbs.

Reg. \$25.25

STATION WAGON SPEAKER KIT

Stock No. S-343
\$6.96

Complete with speaker, chrome grille, selector switch, adapters and wire. Fits Ford, Plymouth, Chevrolet, Buick, Dodge, DeSoto, Chrysler, Mercury, Pontiac and Oldsmobile cars from 1956 through to 1958. Shpg. wt. 5 lbs.

ELECTRIC CORN POPPER

Reg. \$4.95
\$3.30
3 for \$9.00
Stock No. EA-7



Less cord
Two piece, two quart Polished aluminum popper with black bakelite handle and feet. Transparent heat resistant cover. Will operate on any standard appliance cord. 115 volts AC or DC. 400 watts, U.S. approved. 8 3/4" h. x 7 1/4" dia. Shpg. wt. 3 lbs.

RECEIVER KIT

TWO BAND
Reg. \$20
\$11.98
Stock No. KB-67



Receives regular broadcast band (550 to 1700 KC) & short wave (6 to 18 MC). Two tubes plus rectifier. With formed chassis, speaker and instructions. Less tubes. Shpg. wt. 7 lbs. Tubes for above. Stock No. AS-403... \$4.16

SEPARATE UNITS ALSO AVAILABLE

Magnavox 15" Hi-Fi Woofer
40-8,000 cps. 8 ohms—20 watts
Reg. \$13.50 3 for **\$8.95**
Stock No. S-331 \$25.00 Ea.

Magnavox 4" Tweeter
To 17,000 cps. 8 ohms
Reg. \$5.25 3 for **\$2.99**
Stock No. S-332 Ea.

Magnavox Crossover Capacitor
Reg. \$1.25 3 for **88¢**
Stock No. C-871 \$2.50 Ea.

OLSON

Stores In:

- AKRON
73 E. Mill St.
- CHICAGO
4101 N. Milwaukee
- CHICAGO
123 N. Western
- CLEVELAND
2020 Euclid Ave.
- PITTSBURGH
5918 Penn Ave.
- MILWAUKEE
423 W. Michigan
- BUFFALO
711 Main St.

IT'S EASY TO ORDER FROM OLSON'S

How to order: Order directly from this ad. For convenience use this order blank. Fill in columns below with quantity desired, stock number, description, and price. You may send remittance with order (include enough for postage or parcel post shipment), or if you prefer send a \$2.00 deposit with your order and Olson will ship C.O.D. for the balance. Mail your order to: T-128 Forge St., Akron 8, Ohio.

MONEY BACK GUARANTEE: Everything you order from Olson is guaranteed as advertised. If you are not more than satisfied, you may return merchandise for cash refund.

Minimum Order \$5.00

Quan.	Stock Number	DESCRIPTION	Price Each	TOTAL

Here is my order for merchandise from this page. This entitles me to the 8 FREE Wholesale catalog issues.
 Enclosed find \$1.00 for the 8 Wholesale catalog issues to be sent to me one every 6 weeks.

NAME	T-128	Total
ADDRESS		Add Postage
CITY	ZONE STATE	TOTAL AMOUNT

Olson Radio Warehouse

T-128 FORGE ST.
AKRON 8, OHIO

CLASSIFIED

RATE: 50¢ per word. Minimum 10 words. February Issue closes December 10th. Send order and remittance to: RADIO & TV NEWS, 1 Park Ave., N. Y. C. 16, N. Y.

RADIO ENGINEERING

ELECTRONICS! Associate degree—29 months. Technicians, field engineers, specialists in communications, missiles, computers, radar, automation. Start February, September. Valparaiso Technical Institute, Dent. N., Valparaiso, Indiana.

FOR SALE

RADIO & TV Tubes at manufacturers prices. Guaranteed—Send for free price list. Edison Electronic Tube Co., Menlo Park, N. J.

GOVERNMENT Sells—Surplus Electronics; Walkie-Talkies; Transceivers; Test Equipment; Oscilloscopes; Radar; Voltmeters; Misc.—Fraction of Army costs—Buy direct now from U. S. Government—"Depot List & Procedure" \$1.00—Brody, Box 8-RT, Sunnyside 4, New York.

TUBES—TV, Radio, Transmitting And Industrial Types At Sensibly Low Prices. New, Guaranteed, 1st Quality. Top Name Brands Only. Write For Free Catalog or Call Walker 5-7000, Barry Electronics Corp., 512 Broadway, New York 12N, N. Y.

TELEVISION Sets \$11.95. Plus shipping. Jones TV, Saratoga, Pa.

TELEVISION & Radio Tubes, Parts and Supplies Guaranteed. Hi-Quality Tube Co., Inc., 284 Lafayette St., Rahway, New Jersey.

DIAGRAMS for repairing radios \$1.00. Television \$2.00. Give make, model. Diagram Service, Box 672-RN, Hartford 1, Conn.

BUILD Your Own 8 Channel Radio Control Receiver. 8 Channel reed unit with transmitter and three receiver circuits \$9.95. Money back guarantee. Write for information. Hixon Electronics Co., 13444 W. McNichols Rd., Detroit 35, Michigan.

PHOTOFACT Folder sets 75¢ each, complete, good condition. Other manuals, publications, TV test instruments, \$1.00, applicable to first order, brings catalogued listing. Television, P. O. Box 1525, Chattanooga, Tenn.

TELEPHONE Answering device disconnects your receiver when other party hangs up. Special 2-coil polarized relay, with detailed plans, \$5.00. Engineering, Fairhills Box 26E, Dayton 19, Ohio.

WHOLESALE Prices on transistor supplies. Hi-Fi amplifiers, changers, speakers, kits, tubes, etc. Selaak Electronics, 3867-B Minnehaha Ave., Minneapolis 6, Minnesota. PA 9-8382.

WHY Guess? Build Impedance Bridge for measuring inductance, capacitance, resistance. Description, circuitry, photos, \$3.00 postpaid. Lester, 3820 Purdue, Houston, Texas.

SAVE Money. Get our quotations before you buy. Write to Dept. T., Professional HiFi, Box 62, Canal St. Station, N.Y.C. 13.

FREE Fluorescent Lighting Catalog. Inexpensive kits, parts, fixtures. Shoplite, 650N Franklin, Nutley 10, New Jersey.

UNIQUE Hi-Fi Cabinet, any Components fit. Expandable. Suitable for any size system. Large scale plans \$2.00. Act now. Offer closes March 30. Designer, Box 811, Atlanta 1, Georgia.

POWER Supply PE 120, 6-12 Volt for RC-659/BC-620. New \$10.00, used \$7.50. Phone Plugs—PL 54—10/\$1.00. Volume Controls—Send for List 10/\$1.00. J. W. Simmons, 3841 James Ave., Fort Worth, Texas.

DIAGRAMS For Surplus Electronics. Stamp for List. Alvaradio, P.O. Box 151, North Hollywood, Calif.

WALKIE-TALKIE. PC-611 Batteries, \$2.50 pair postpaid. SCR-522's, complete set, \$25.00 ART-13. Transmitters \$95.00. Bill Step, Box 158, Ellenton, Florida.

DISCOUNTS to 50% recorders, tapes, hi-fi components, consoles, photograph equipment. Request specific prices only. Long Island Audio & Camera Exchange, 3 Bay 26th Street, Brooklyn 14-N, N. Y.

JAN Receiving Tubes, guaranteed new. 6SH7 10 for \$2.90, 100 for \$19.95. 6H6 10 for \$3.90, 100 for \$24.95. Minimum order 10 tubes. Postage prepaid in U.S. when cash sent with order. 25% dep. on C.O.D.'s. Irving Joseph, Inc., 5959 W. Fullerton, Chicago, Ill.

NOTICE

In replying to box numbers be sure to address letters to

RADIO & TV NEWS
1 Park Ave., New York 16, N. Y.

Note: This does not apply to box numbers where city and state are shown

WANTED

CYLINDER and old disc phonographs. Edison, Conqueror, Idella, and Oratorio models. Berliner Gramophones and Zono-ophones, Columbia cylinder Graphophones, and coin-operated cylinder phonos. Want old catalogues and literature on early phonos prior to 1919. Will pay cash or trade late hi-fi components. Classified Box 50 % Radio & TV News, 1 Park Ave., N. Y. C. 16, N. Y.

CASH Paid! Sell your surplus electronic tubes. Want unused, clean transmitting, special purpose, receiving, TV types, magnetrons, Klystrons, broadcast, etc. Also want military & commercial lab test and communications gear. We swap too, for tubes or choice equipment. Send specific details in first letter. For a fair deal write, wire or telephone: Barry, 512 Broadway, New York 12, N. Y. Walker 5-7000.

LABORATORY Quality Equipment and Military Surplus Electronics bought, sold. Engineering Associates, 432 Patterson Road, Dayton 9, Ohio.

ATTN: Hams Heavy. Wanted, new or used AN-104-B antennas, RL-41, Reel assy or 12V motors for RL-41, APN-6 sets and parts. MC215 shafting cable 18' or longer for RC-461 control boxes. MO-31 Motors, 12 and 21V for the RL-41 and RL-42 reel assy. Vets. Dist. Co., 3613 N. Western Pky., Louisville 12, Ky. SP-88901.

WANTED: Model A160 Field Strength Meter Mfg. by Approved Electronic Instrument Co. Van Horn Cable Company, Van Horn, Texas.

PLATINUM electronic scrap bought. Noble Metals, Box 1113, Santa Monica, California.

HIGH FIDELITY

DISGUSTED with "Hi" Hi-Fi Prices? Unusual Discounts On Your High Fidelity Requirements. Write, Key Electronics, 120 Liberty St., New York 6, N. Y. EVERgreen 4-6071.

WORLD Renowned Hartley Speakers now available to Dealers, Servicemen, Custom Installers. Lowest franchise requirements in high fidelity. Write Hartley Products Company, 521 East 162 Street, New York 51, N. Y.

PRICES? Try Ours! Everything in Hi-Fi. Factory-sealed components. Send for free catalog. Audion, 25T Oxford Road, Massapequa, L. I., N. Y.

TAPE & TAPE RECORDERS

RECORDERS, HiFi, Tapes, Free Wholesale Catalog. Carston 215-R East 88 St., N. Y. C. 28.

TAPE Recorders, hi-fi components, tapes. Unusual Values. Free catalog. Dressner, 69-02 R, 174 St., Flushing 65, N. Y.

DISCOUNTS to 50%, recorders, tapes, hi-fi components, consoles, photograph equipment. Request specific prices only. Long Island Audio & Camera Exchange, 3 Bay 26th Street, Brooklyn 14-N, N.Y.

AM-EX, Concertone, Crown, Ferrograph, Presto, Tandberg, Pentron, Bell, Sherwood, Rek-O-Kut, Dynakit, Others. Trades, Boynton Studio, 10RT Pennsylvania, Yonkers, N. Y.

RECORDERS, Tape Decks, Stereo, Tapes, Accessories, Excellent Values. Catalogue. Efseo, 270S Concord, West Hempstead, N. Y.

Hi-Fi. Stereo Components. Recorders. Tape, Records. Wholesale catalog free. Audio Fair, 1799R First Avenue, New York 28, N. Y.

REPAIRS & SERVICING

ALL Makes High Fidelity Speakers Repaired. Amprite, 70 Vesey St., N. Y. 7, N. Y. BA 7-2580.

Hi-Fi Doctor—Will solve your hi-fi problems on-the-spot. Acoustic, Audio, Radio Engineer. Stereo Designing. Professional visits, day, evening. New York area. William Bohn, Plaza 7-8569, Week-days.

TECHNICAL INSTITUTES

ELECTRONIC And Aeronautical Engineering Technology. Two Year Courses. Bachelor of Science Degree in three years. Northrop Institute in Southern California prepares you for highly paid positions in Aviation and Electronic industries. Employment assistance during school and after graduation. Approved for Veterans. Write for free catalog. Northrop Aeronautical Institute, 1183 Arbor Vitae, Inglewood 1, California.

BUSINESS OPPORTUNITIES

FAMOUS Brand Speaker and Audio manufacturer with national reputation requires alert, progressive sales representatives for several choice territories. Write stating territory now covered and lines carried. P. O. Box 352, Ridgefield, N. J.

TV Picture tube rebuilding plant and training program still available for many territories. Investment \$8,000-\$11,000. Annual volume \$25,000 to \$100,000. Windsor Co., 999 N. Main St., Glen Ellyn, Illinois.

INSTRUCTION

RADIO Handbooks—30¢. Many titles. Laboratories, 1131-H Valota, Redwood City, California.

ENGINEERING Degrees earned through Home Study. Electronics, Electrical, Mechanical, Civil, Physics. When writing specify course desired. Residence classes also available. Pacific International University, 5719-C. Santa Monica Boulevard, Hollywood 38, California.

CORRESPONDENCE COURSES

USED Correspondence Courses and Books sold and rented. Money back guarantee. Catalog free. (Courses bought.) Lee Mountain, Pisgah, Ala.

MISCELLANEOUS

SAVE Money! Don't Buy until you get Our price list! All types Radio & TV tubes at Mfrs. prices! 100% Guaranteed! 24-Hour Service! Write United Radio Co., Newark, N. J.

DECALS—Trademarks, Service, Sales, etc. Write Allied Decals, Inc., 8378 Hough, Cleveland, Ohio.

ENGRAVED Call Letters. Weatherproof. No Paint. \$1.00 ppd. Engraving. Box 1014R, Wyandotte, Michigan.

AVAILABLE—Manufacturers Representative. Selling to electronic supply companies. Los Angeles Area. Box 568. % Radio & TV News, One Park Ave., New York 16, N. Y.

PHONOGRAPH Records cheap, postpaid. Catalogue. Paramount, Box 242-N, Williamsport, Penna.

NEW Organ Builders Manual—Guide to assembling your own electronic organ. 123 pages, profusely illustrated. \$2.00 postpaid. Electronic Organ Arts I Box 41081, Los Angeles, Calif.

SAVE Money. Get our quotations before you buy. Write to Dept. T., Professional HiFi, Box 62, Canal St. Station, N. Y. C. 13.

While every precaution is taken to insure accuracy, we cannot guarantee against the possibility of an occasional change or omission in the preparation of this index.

ADVERTISER PAGE NO. Advance Electronics 150, Advanced Acoustics Co. 120, Airex Radio Corporation 118, Allied Radio Corp. 9, 94, 95, 96, 97, Almo Radlo Co. 142, Amplifier Corp. of America 121, Arrow Sales, Inc. 135, Ashe Radio Co., Walter 130, B & K Manufacturing Co. 71, Baltimore Technical Institute 150, Barry Electronics Corp. 158, Blonder-Tongue Laboratories 16, Bozak Sales Co., The, R. T. 90, Brooks Radio & TV Corp. 140, Burroughs Corporation 107, Burstein-Applebee Co. 135, C & H Sales Co. 146, CBS-Hytron 18, Candee Co., J. J. 151, Candier System Co. 139, Capitol Radio Engineering Institute 15, 23, Carston Studios 139, Center Electronics Co., Inc. 150, Century Electronics Co., Inc. 114, 115, Channel Master Corp. 24, 25, Charles Engineering, Inc. 111, Chicago Standard Transformer Corporation 122, Christmas Gift Subscription 132, Cleveland Institute of Radio Electronics 109, Columbia Electronics 131, Coyne Electrical School 112, 149, DeVry Technical Institute 5, Dressner 120, Duotone 90, Dynaco Inc. 119, EICO 35, 36, Electro-Voice, Inc. 26, 27, Electronic Chemical Corp. 151, Electronic Experimenters Handbook 145, Electronic Measurements Corp. 134, Electronics Kits 140, Erle Resistor Corporation 120, Extron Corporation 121, Fair Radio Sales 141, G & G Radio Supply Co. 125, General Electric Company 6, 22, Goodheart Co., R. E. 136, Grantham School of Electronics 147, Grommes—Div. of Precision Electronics Inc. 89, 118, Harvey Radio Co., Inc. 110, Heath Company 72, 73, 74, 75, 76, 77, 78, 79, 80, 81, 82, 83, 84, 85, 86, 87, Henshaw Radio Supply 141, Hi-Fi Directory & Buyers' Guide 152, Hickok Electrical Instrument Co., The 8, Home Movie Making Annual 154, Indiana Technical College 121, International Correspondence Schools 11, International Rectifier Corporation 127, Jerrold Electronics Corp. 14, Key Electronics Co. 141, Krylon 128, Kuhn Electronics 152, L. R. Electronics 128, Lafayette Radio 162, 163, 164, Lamphin Laboratories, Inc. 153, Lektron 145, Liberty Tube Co. 152

ADVERTISER PAGE NO. Mallory & Co., Inc., R. R... FOURTH COVER, Milwaukee School of Engineering 126, Minnesota Mining and Manufacturing Company 10, Moss Electronic, Inc. 102, 103, 104, 105, National Radio Institute 19, 20, National Schools 7, Olson Radio Warehouse 159, ORRadio Industries, Inc. 116, Pacific International University 120, Peak Electronics Company 138, Perfection Mica Co. 154, Perma-Power Company 142, Pickering & Company, Inc. 88, Picture Tube Outlet 154, Platt Electronics Corp. 143, Progressive "Edu-Kits" Inc. 129, Quam-Nichols Company 91, Quietrol Company 153, RCA Institutes, Inc. 13, R W Electronics 124, Radio & Electronic Surplus 135, Radio & TV News 156, 157, Radio & TV News Classified 130, Radio & TV News Subscriptions 91, Radio Corporation of America 29, 90, Radio Shack Corporation 123, Raytheon Manufacturing Company SECOND COVER, 3, Rex Radio Supply Co. 153, Rider Publisher, Inc., John F. 30, Rinehart & Co., Inc. 144, Sams & Co., Inc., Howard W. 21, 28, Sarkes Tarzian, Inc. 12, Schober Organ Corporation, The 118, Seco Manufacturing Co. 106, Service Instruments Corp. 155, Shure Brothers, Inc. 92, Sonotone Corp. 117, Sparks Radio Supply 142, Spaulding Products Company 98, Sprayberry Academy of Radio-Television 17, Standard Line Electric Company 93, Standard Surplus 155, Supreme Publications 131, Sylvania Electric Products Inc. THIRD COVER, 31, "TAB" 161, Telemarine Communications Co., Inc. 133, Terado Company 129, Tri-State College 141, Tube Wholesalers Co. 150, Universal Transistor Products Corp. 113, University Loudspeakers, Inc. 34, Valparaiso Technical Institute 139, Vapo Electric Company 139, Vocaline Company of America, Inc. 137, Weller Electric Corporation 32, Western Radio 154, World Radio Laboratories 151, Xcelite, Incorporated 128, Your Career in Electronics 148, Zalytron Tube Corp. 122

"TAB" Tubes Tested, Inspected, Boxed

Table listing various vacuum tubes with specifications, prices, and quantities. Includes categories like 'Wanted surplus electronics from Schools & U.I.' and 'Wanted 200TL tubes'.

TUBES WANTED WE BUY! SELL & TRADE!

NEW SILICON 500MA 100°C/280VAC/400P-V. Rectifier Hmt Sealed, \$1.50. \$5 for \$6.50. 40 for \$46. 100 for \$100.

"ERIN" FINEST HI-FI RECORDING TAPE SO GOOD WE CANNOT USE THE MFGRS TRUE NAME! 1200 Ft.—7" Reel \$1.45 ea. of 3 Money Back Gtd. Add 15c each Postpaid 48 States

XMAS SPECIAL!! DIAMOND PHONO-NEEDLES Registered in States REGISTERED ONE YR GUARANTEED BY THE MFR! ALL MAKES 100% GANE DIAMOND \$4.80 TWO DIAMONDS \$9.45. DIAMOND SAPPHIRE \$7.70 PLEASE SEND CARTRIDGE NAME & NUMBER

Hams Transistorized DC to DC "TABSTAT" static supply 12 VDC to HI-VDC POWER SUPPLY!!! Kit or Assembled. Filtered, small in size. Quiet! Light Wgt. Input 12 to 24VDC. Idle Current 400mA. Output 450mA@250VDC at up to 150mA/45 watts. Int. Built. TR90CB \$35. In Kit form preassembled. U-Hold T100CK \$30

"TAB"—BARGAINS! That's A Buy!! Rectifier Tubular 450VAC/272VDC/58ma Cond/Inpt Int'l Mfr \$1.40. 2for\$7. 8for\$24. Choke 4M 450MA USN&W.E \$3. 2for\$5. Auto Vibrator Sort2V/4in \$4. 2for\$8. Slim Jim Dynamic Mics & Trans \$13. 2for\$26. Co-Ax Cnctrs PL259orSO239 40c @ 10. 53 G.E. Pyralox Cond'r 15Wfd 1000VDC/330VAC \$2 @ 6for\$9. RC457 4 to 5.3Mcs as is good for parts \$1.98 AN-AR2 Rev. as is good for parts \$1.89 RDZ USN Revr 200to400mcs less dust \$9. RF-Filter Line 10Amp@130VAC \$2 @ 4for\$6 RF-Filter Line Dual 50Amp@250VAC \$8 @ 4 \$25 RF-Filter Line 200Amp@130VAC \$45. 2for\$25 Willard 6V 6Amp Plastic Battery \$2.95 Willard 2V 20Amp Plastic Battery \$2.50 Transistors 2N285 \$1.30. 2N55 \$3. RT50 \$3. CK722 95c @ 2N38 98c @ 1N34 45c 5 \$2

NEW "TEKSEL" SELENIUM BRIDGE FULL WAVE RECTIFIERS. ONE YEAR GTD! AMP 18VAC 35VAC 72VAC 144VAC CONT. 14VDC 28VDC 56VDC 112VDC 2AMP \$ 1.30 2.00 4.50 9.45 3AMP 2.15 3.00 6.25 12.30 4AMP 2.90 4.00 8.60 16.75 6AMP 4.15 4.00 8.60 16.75 10AMP 6.10 12.15 26.30 48.90 15AMP 8.90 19.00 40.00 66.60 24AMP 15.00 29.45 47.50 104.65 BATTERY CHARGER KIT 3 or 4 Amps. Charge 2-4 D & 12 Volt Batteries. Kit BCK-1 \$11. Built \$12.75

NEW TPSK2 DC POWER FOR TRANSISTORS!! Transistor! Filtered Power Supply Kit used to power transistor circuits, amplifiers, etc. Delivers 12VDC at 2AMS filtered less than 0.5% ripple or 28VDC at 1A TPSK2 Kit \$18. TPS2W assembled & wired \$24. 115VAC Inpt. Transformer & Full Wave Bridge Rectifier for 28VDC@2AMS. or RECTRAN KIT RTIK... \$4.50 RT1W Assembled & Wired... \$8.50 RT5K Kit 12 or 18VDC at 2AMS \$9.00 RT2W Assembled & Wired... \$14.75

KITS! "TAB" THE BEST KITS! All Kits Contain Most Popular Values & Sizes Kit 5 Mycalex Glass Strips Kit 35 Precision Resistors Kit 10 Switches Kit 75 Resistors 1/2, 1 2W Kit 150 Carbon Resistors Kit 25 Panel Lamps Kit 12 Electrolytic Cond's Kit 15 Volume Controls Kit 56 Tube Sockets Kit 65 Tubular Condensers Kit 50 Logic & Eyelets Kit 10 Bathub Oil Cond's Kit 5 lbs. Surprise Package Kit 10 Kmltr Mica Cond'r. Kit Glyptal & Cement Kit 3 Phone Patch Xfms Kit 4 W/Reflector Lbrs Kit 6 Insult Tuning Tools Kit 6 AN plugs & cnctrs Kit 3 Searchlights Kit 12 Alligator Clips asstd Kit 2 Bakelite Panels 6x12 Kit 8 Circular Slide Rule Kit 5 Sub-Min Tubes Kit 44 Sanded Insulators Kit 35 Power Resistors Kit 75 Mica Condensers Kit 5 Crystal Diodes Kit 100 Fuses, Asstd Types Kit 100 Ceramic Cond's Kit 50 Con. Forams Kit 5 FT243 Xtal Holders Kit 6 Inductors & Coils Kit 5 Microswitches Kit 10 Wheat Lamps Kit 5 Transistor Xfms Kit 8 Xtal Osc-Blanks Kit 4 Asstd Rectifiers Kit 100 Self Tap Screws Kit 25 3/4" Hookup Wire Kit 2 Connector Kit 2 Computer Toroids

BUY 10 KITS GET ONE FREE! EACH KIT 99c TERMS: Money Back Guarantee! Our 14th year. \$2 min. order F.O.B. N.Y.C. Add shgp charges or for C.O.D. 25% Dep. Prices shown subject to change. 111-RR LIBERTY ST. N. Y. 6, N. Y. Send 25c PHONE: RECTOR 2-6245 for Catalog

KT-500
IN KIT
FORM
74.50

New! Years Ahead!

LAFAYETTE STEREO TUNER KIT

**ONLY
\$7.45
DOWN
7.00 MONTHLY**



Use it as a Binaural-Stereophonic
FM-AM tuner

Use it as a Dual-Monaural
FM-AM tuner

Use it as a straight Monaural
FM or AM tuner

THE MOST FLEXIBLE TUNER EVER DESIGNED

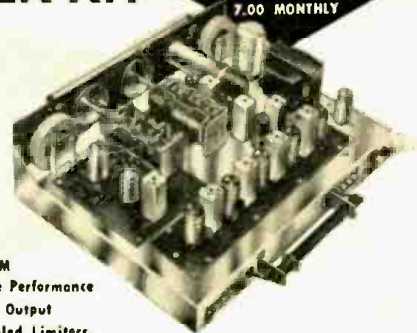

- Multiflex Output for New Stereo FM
- 10KC Whistle Filter • Pre-aligned IF's • Tuned Cascade FM
- 11 Tubes (including 4 dual-purpose) + Tuning Eye + Selenium rectifier Provide 17 Tube Performance
- Separately Tuned FM and AM Sections • 12 Tuned Circuits • Dual Cathode Follower Output
- Armstrong Circuit with FM/AFC and AFC Defeat • Dual Double-Tuned Transformer Coupled Limiters.

More than a year of research, planning and engineering went into the making of the Lafayette Stereo Tuner. Its unique flexibility permits the reception of binaural broadcasting (simultaneous transmission on both FM and AM), the independent operation of both the FM and AM sections of the same time, and the ordinary reception of either FM or AM. The AM and FM sections are separately tuned, each with a separate 3-gang tuning condenser, separate flywheel tuning and separate volume control for proper balancing when used for binaural programs. Simplified accurate knife-edge tuning is provided by magic eye which operates independently on FM and AM. Automatic frequency control "locks in" FM signal permanently. Aside from its unique flexibility, this is, above all else, a quality high-fidelity tuner incorporating features found exclusively in the highest priced tuners.

FM specifications include grounded-grid triode low noise front end with triode mixer, double-tuned dual limiters with Foster-Seely discriminator, less than 1% harmonic distortion, frequency response 20-20,000 cps \pm 1/2 db, full 200 kc bandwidth and sensitivity of 2 microvolts for 30 db quieting with full limiting at one microvolt. AM specifications include 3 stages of AVC, 10 kc whistle filter,

built-in ferrite loop antenna, less than 1% harmonic distortion, sensitivity of 5 microvolts, 8-kc bandwidth and frequency response 20-5000 cps \pm 3 db.

The 5 controls of the KT-500 are FM Volume, AM Volume, FM Tuning, AM Tuning and 5-position Function Selector Switch. Tastefully styled with gold-brass escutcheon having dark maroon background plus matching maroon knobs with gold inserts. The Lafayette Stereo Tuner was designed with the builder in mind. Two separate printed circuit boards make construction and wiring simple, even for such a complex unit. Complete kit includes all parts and metal cover, a step-by-step instruction manual, schematic and pictorial diagrams. Size is 13 3/4" W x 10 3/4" D x 4 1/2" H. Shpg. wt., 22 lbs.

The new Lafayette Model KT-500 Stereo FM-AM Tuner is a companion piece to the Models KT-300 Audio Control Center Kit and KT-400 70-watt Basic Amplifier Kit and the "Triumvirate" of these 3 units form the heart of a top quality stereo hi-fi system.

KT-500 Net **74.50**
LT-50 Same as above, completely factory wired and tested..... Net **124.50**

NEW! LAFAYETTE PROFESSIONAL STEREO MASTER AUDIO CONTROL CENTER



KT-600
79.50
IN KIT
FORM

**ONLY 7.95 DOWN —
8.00 MONTHLY**

The Lafayette KT-600 Solves Every Stereo/Monaural Control Problem!

- UNIQUE STEREO & MONAURAL CONTROL CENTER FACILITIES!
- OUTSTANDING PERFORMANCE SUPERIORITY!
- AMAZING NEW BRIDGE CIRCUITRY & CONTROL FOR 3d CHANNEL OUTPUT FOR 3-SPEAKER STEREO SYSTEMS!
- VARIABLE CROSS-CHANNEL SIGNAL FEED ELIMINATES "PING-PONG" EFFECTS!
- PRECISE "NULL" BALANCING & CALIBRATING SYSTEM — BETTER THAN METERS!
- 24 EQUALIZATION POSITIONS PER CHANNEL!
- CLUTCH-TYPE DUAL VOLUME-BALANCE CONTROLS!

- RESPONSE 10-25,000 CPS \pm 0.5 DB
- TAPE HEAD PLAYBACK EQUALIZATION FOR NEW 4-TRACK STEREO
- 1.78 MILLIVOLTS SENSITIVITY FOR 1 VOLT OUT
- LESS THAN .03% 1M DISTORTION
- 6 CONCENTRIC FRONT PANEL CONTROLS
- 4 CONCENTRIC REAR PANEL INPUT LEVEL CONTROLS
- 180° ELECTRONIC PHASE REVERSAL

A REVOLUTIONARY DEVELOPMENT IN STEREO HIGH FIDELITY. Provides such unusual features as a Bridge Control, for variable cross-channel feed for elimination of "ping-pong" (exaggerated channel separation) effects and for control of a 3d-channel output for 3-speaker stereo systems; the 3d-channel output also serves for converting stereo program material to high quality monaural for recording or to play a stereo program monaurally through a separate amplifier and speaker system. The KT-600 also has full input mixing of monaural program sources (such as tape recorder and phonograph, etc.), a special "null" stereo balancing and calibrating system (better than meters), 24 equalization positions per channel, 12 db per octave rumble and scratch filters, and a loudness on-off switch. Has clutch-type dual concentric volume controls which operate independently for balancing or simultaneously as the Master Level Control. Other features include channel reverse, 180° phase reversal, input level controls at all inputs. Sensitivity is 1.78 millivolts for 1 volt out. Dual low impedance outputs ("plate followers," 1300 ohms) are provided. Frequency response is 10-25,000 cps \pm 0.5 db; less than .03% 1M distortion. Uses 7 new 7025 low-noise dual triodes. Size 14" x 4 1/2" x 10 1/4". Shpg. wt., 16 lbs. Complete with printed circuit board, modern-styling metal chassis and case, profusely illustrated instructions, all necessary parts.

LAFAYETTE KT-600 Stereo Preamplifier Kit Net **79.50**

NEW! LAFAYETTE STEREO/MONAURAL BASIC POWER AMPLIFIER KIT



KT-310

**ONLY 4.75 DOWN
5.00 MONTHLY**

47.50

- 36-WATT STEREO AMPLIFIER -18-WATTS EACH CHANNEL
- FOR OPTIONAL USE AS 36-WATT MONAURAL AMPLIFIER
- EMPLOYS 4 NEW PREMIUM-TYPE 7189 OUTPUT TUBES
- 2 PRINTED CIRCUIT BOARDS FOR NEAT, SIMPLIFIED WIRING
- RESPONSE BETTER THAN 35-30,000 CPS \pm 1/2 DB AT 18 WATTS
- LESS THAN 1% HARMONIC OR INTERMODULATION DISTORTION

A superbly-performing basic stereo amplifier, in easy-to-build kit form to save you lots of money and let you get into stereo now at minimum expense! Dual inputs are provided, each with individual volume control, and the unit may be used with a stereo preamplifier, for 2-18 watt stereo channels or, at the flick of a switch, as a fine 36-watt monaural amplifier — or, if desired, it may be used as 2 separate monaural 18-watt amplifiers! **CONTROLS** include 2 input volume controls, channel Reverse switch (AB-BA), Monaural-Stereo switch. **DUAL OUTPUT IMPEDANCES** are: 4, 8, 16 and 32 ohms (permitting parallel (monaural) operation of 2 speaker systems of up to 16 ohms. **INPUT SENSITIVITY** is 0.45 volts per channel for full output. **TUBES** are 2-6AN8, 4-7189; GZ-34 rectifier. **SIZE** 9-3/16" d (10-9/16" with controls) x 5 1/4" h x 13 1/4" w. Supplied complete with perforated metal cage, all necessary parts and detailed instructions. Shpg. wt., 22 lbs.

KT-310 Stereo Power Amplifier Kit Net **47.50**

LAFAYETTE RADIO DEPT RL
165-08 Liberty Ave. JAMAICA 33; N. Y. Write for FREE Bargain Packed Catalog!
PLEASE INCLUDE POSTAGE WITH ORDER

100 SIXTH AVE., NEW YORK, N. Y.
BOSTON, MASS., 110 Federal St.
PLAINFIELD, N. J., 139 West 2nd St.
NEWARK, N. J., 24 Central Ave.
BRONX, N. Y., 542 E. Fordham Rd.

NEW! LAFAYETTE "STEREO" HI-FI PHONO MUSIC SYSTEM

AN IDEAL QUALITY SYSTEM FOR LISTENING
TO THE NEW HIGH-REALISM STEREO SOUND!
For Stereo & Monaural Reproduction



LA-90



RC121/11



SK-58



CAB-16

COMPONENTS	
Lafayette LA-90 28-Watt Stereo Amplifier	72.50
Garrard RC121/11 Changer	41.65
Lafayette PK-111 Wood Base	3.95
GE GC-7 Stereo Magnetic Cartridge	23.47
2-Lafayette SK-58 Coaxial 12" Speakers	59.00
Total Reg. Price	200.57

YOU PAY ONLY 167.50—SAVE 33.07!

A complete superb stereo hi-fi phono music system brought to you by Lafayette to bring out the thrilling capabilities of the new stereo recordings. Heart of the system is the new Lafayette LA-90 with 28 watts per channel and with all the inputs necessary for a complete stereo control center. Other fine components are the famous new Garrard RC121/11 4-speed automatic record changer ready to accept stereo cartridges, the Lafayette PK-111 wood base for changer, of fine selected woods; the new GE GC-7 stereo/monaural variable reluctance cartridge with 0.7 mil genuine GE diamond stylus; and 2 of the unbeatable, far performance-value, Lafayette SK-58 12" coaxial speakers with built-in crossover network and brilliance level control. Supplied complete with cables, connectors, and easy-to-install instructions. Shpg. wt., 66 lbs.

- HF-374 Stereo Phono System, with mahogany or blonde wood changer base (please specify) Net **167.50**
- HF-375 Same as HF-374 but with 2-Lafayette CAB-16 mahogany or walnut or CAB-17 blonde Resonator-type speaker enclosures (specify which) Net **222.50**

LAFAYETTE STEREO FM/AM-PHONO MUSIC SYSTEM

- Same as HF-374 above but with new Lafayette stereo Model LT-99 FM/AM Tuner. Net **237.00**
- HF-376 Stereo FM/AM-Phono System Net **237.00**
- HF-377 Same as HF-376 but with 2-Lafayette CAB-16 mahogany or walnut or CAB-17 blonde speaker enclosures Net **292.00**

**ONLY 16.75 DOWN
12.00 MONTHLY**

LAFAYETTE MASTER AUDIO CONTROL CENTER with BINAURAL CHANNEL AND DUAL VOLUME CONTROL.

- Self-Powered • OC On All Filaments • 24 Positions of Equalization
- Tape Head Input, High Impedance • Dual Cathode Follower Output Stages

This is not only the finest hi-fi preamp characterized by unmatched features, but it has been functionally designed to keep pace with the conversion of your present hi-fi system to binaural (Stereo) sound. Incorporates an extra channel and dual volume control for binaural reproduction. Features include DC on all tube filaments, negative feedback in every stage, dual cathode follower output stages and latest printed circuit construction. Less than 0.09% TH distortion and less than 0.07 harmonic distortion at 1V. Hum and noise level better than 80 db below 3V. Uniformity flat frequency response over entire audible spectrum. 7 inputs for every type of phono, tuner or tape. Tasteful styling, brilliantly executed. Size 12 1/2" x 9 1/2" x 3 1/2". Shpg. wt., 10 1/2 lbs.

- KT-300—Lafayette Master Audio Control Kit Complete with cage and detailed assembly instructions. Net **39.50**
- LT-30—Same as above completely wired and tested with cage and instruction manual. Net **59.50**

DELUXE 70 WATT BASIC AMPLIFIER

- Conservatively Rated At 70 Watts • Inverse Feedback • Variable Damping
- Metered Balance And Bias Adjust Controls • Available In Kit and Wired Form

Here's ultra-stability in a 70 watt basic power amplifier employing highest quality components conservatively rated to insure performance and long life. Features matched pair KT 88's and wire range linear Chicago output transformer, variable damping control, meter for bias and balance and gold finish chassis. Frequency response 10-100,000 cps \pm 1db. Hum and noise 90 db below full output. IM distortion less than 1 1/2% at 70 watts, less than 0.3% below 30 watts. Harmonic distortion less than 2% at 70 watts from 20 to 20,000 cps \pm 1 db. Output impedance 4, 8 and 16 ohms. Handsome decorative cage perforated for proper ventilation. Size 14 1/2" x 10" x 7 1/2" including cage and knobs. Shpg. wt., 40 lbs.

- KT-400—Lafayette 70 watt Deluxe Basic Amplifier Kit complete with cage and detailed assembly instructions. Net **69.50**
- LA-70—Same as above completely wired and tested with cage and instruction manual. Net **94.50**



**KT-300
IN KIT
FORM
39.50**



**KT-400
IN KIT
FORM
69.50**

**ONLY 6.95
DOWN
7.00 MONTHLY**

COMPLETE STEREO PHONO SYSTEM KIT

- ASSEMBLE THE STEREO AMPLIFIER AND SAVE REAL MONEY
- PLAYS STEREO AND MONAURAL RECORDS

REGULAR	ONLY
76.53	59.95

Enjoy fine stereo performance with this "easy-to-assemble" exclusive Lafayette package. The complete system consists of Lafayette KT-126 basic stereo phono amplifier kit, the renowned Collaro TSC-640 4-speed automatic record changer, the new Ronette "OV" Turnover Stereo cartridge with dual sapphire styli for stereo and monaural records, and two Lafayette SK-109 Miniature Hi-Fi Speakers and Enclosures. The amplifier kit has many fine features including 2 watts per channel with separate volume control, "stereo-reversal-monaural operation" switch, and isolation transformer to eliminate shock hazard. The 4" x 6" 5 watt speakers are housed in beautiful mahogany wood cabinets, work from either 4 or 8 ohm outputs and are supplied with 25 ft. of cable for hookup. You save 16.58 over regular catalog prices!

- PK-299 Stereo Phono Kit System Net **59.95**
- KT-126 Stereo Amplifier Kit Only. Complete with all tubes, parts and instructions. Shpg. wt., 7 lbs. Net **18.95**

COMBINATION MONEY SAVER

- The KT-126 Stereo Amplifier Kit and Ronette "OV" Stereo Turnover Cartridge with dual sapphire styli. Net **24.90**



Lafayette KT-126

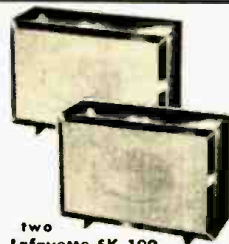

two Lafayette SK-109



Collaro TSC-640



Ronette "OV" Turnover Stereo cartridge

Lafayette Radio

165-08 LIBERTY AVE.
JAMAICA 33, N. Y.

Dept. RL

NEW YORK, N. Y. 100 6th Ave. WOrth 6-5300
BOSTON, MASS. 110 Federal St. HUbbard 2-7850
BRONX, N. Y. 542 E. Fordham Rd. FOrdham 7-8813
NEWARK, N. J. 24 Central Ave. Market 2-1661
PLAINFIELD, N. J. 139 W. 2nd St. Plainfield 6-4718

PLEASE INCLUDE POSTAGE WITH ORDER



The data that launched thousands of careers is yours **FREE**

TELLS how you can be successful in **ELECTRONICS . . .** including:

Television . . . Broadcasting . . . Guided Missiles . . . Radar . . . Instrumentation . . . Computers . . . Automation . . . Astronautics . . . Servomechanisms . . . Aeronautical Electronics . . . Telemetry . . . Communications . . . Manufacturing

Send for your Free Copy today!

This is a brand new edition of the book which has launched thousands of men on good-paying careers in radio-TV-electronics.

It brings you completely up to date—answers important questions on newest career developments in Electronic Engineering Technology including Servomechanisms; Computers; Radar; Automation; Aeronautical Electronics; Broadcasting; Communications and Manufacturing, and the Electronic Principles Associated with Guided Missiles, Telemetry, Astronautics, and Instrumentation.

This book, "Your Future in the New World of Electronics," also shows you how CREI Home Study leads the way to greater earnings in the booming electronics world.

However, CREI does not promise you a "snap." With accredited technical school curricula such as CREI offers, you must study to convert your ambition into technical knowledge which you can sell in the fabulous field of Electronics.

Since its founding in 1927, CREI has provided thousands of professional electronics men with technical educations. During World War II, CREI trained thousands for the Armed Services. Leading firms recommend CREI training for their own personnel. Among them: United Air Lines, Canadian Broadcasting Corporation, Trans-Canada Airlines, Douglas Aircraft Co., The Martin Co., Columbia Broadcasting System, All-American Cables and Radio, Inc., Gates Radio Co., Canadair, Ltd., Federal Electric Corp., and U. S. Information Agency (Voice of America).

CREI courses are prepared by recognized experts, in a practical, easily understood manner, and constantly revised to meet the new electronic challenges of our time. You get the benefit of time-tested study assignments under the personal supervision of a CREI staff instructor. Your studies are accomplished on your own time, during hours selected by you, and controlled by your own will power. This complete training is the reason that graduates find their CREI diplomas keys to success in even the most advanced of electronic applications. CREI alumni hold top positions in America's leading firms.

At your service is the CREI Placement Bureau, which helps to find positions for advanced students, and graduates, although

CREI does not guarantee jobs. Now is the time of decision for you. Luck will not propel you forward unless it finds you trained. Contacts won't budge you an inch unless you have the skill to back them up. The answer is: Technical Training . . . and willingness to learn. Together they will bring you increased earnings in the new Age of Electronics. Fill out the post card below *completely* and mail it now to Capitol Radio Engineering Institute, 3224 16th St. N.W., Washington 10, D.C. We'll promptly send you your free copy of "Your Future in the New World of Electronics." The rest—your future—is up to you!

CREI ALSO OFFERS RESIDENCE TRAINING in Washington, D. C. at the same high technical level. Day and evening classes start at regular intervals. Qualified residence school graduates earn degree, "Associate in Applied Science." Check coupon if you prefer residence study.

VETERANS: If eligible for training under the new G.I. Bill of Rights, check the coupon for full information.

ELECTRONIC TECHNICIANS

Growing Peninsula Co. has openings for 1st class electronic technicians to work directly with engineering in development of new products. Only those with CREI or equal training and 3 years minimum commercial experience will be considered. Top salaries to qualified applicants. Call Mr. McQueeney, DA. 4-1733 for appointment. ALTO SCIENTIFIC Co., Inc. 855 COMMERCIAL ST. PALO ALTO

ENGINEERING AIDES AND TECHNICIANS

Immediate Positions Available

CREI or other formal electronic training desirable.

Experienced in reading schematics, breadboard construction of electronic circuits and chassis preparation.

EMERSON RESEARCH LABORATORIES

INDUSTRY CALLS FOR CREI TRAINING BY NAME . . . SO SHOULD YOU!

Here you see actual help wanted ads—one from a San Francisco newspaper, another seen in Washington. They are just two of many which specify "CREI or equal" education. This shows that industry approves CREI training, even insists on it. Experience has taught many, many companies that CREI students are taught what industry needs and wants them to know. Let this be your cue when you choose your educational program.

FREE BOOKLET! MAIL THIS POSTAGE-FREE POST CARD TODAY

CAPITOL RADIO ENGINEERING INSTITUTE
ECPD Accredited Technical Institute Curricula • Founded 1927

Dept. 119-E 3224 16th St., N.W., Washington 10, D. C.

(R.E. Nov. 58)

B₂E₂

Please send me your course outline and FREE illustrated Booklet "Your Future in the New World of Electronics" . . . describing opportunities and CREI home study courses in Practical Electronic Engineering Technology.

- CHECK FIELD OF GREATEST INTEREST
- Radar, Servo and Computer Engineering Technology
 - Electronic Engineering Technology
 - Broadcast (AM, FM, TV) Engineering Technology
 - Television Engineering Technology
 - Aeronautical Electronic Engineering Technology

Name..... Age.....

Street.....

City..... Zone..... State.....

Check: Home Study Residence School Korean Veteran

If you have had electronic education, or experience in electronics—and realize the need of a high-level technical knowledge to make good in the better electronic jobs—you can qualify for CREI home study training. (Electronics experience is not required for admission to CREI Residence School.) Please fill in the following information.

Employed By.....

Type of Present Work.....

Education:

Yrs. High School.....

Yrs. College.....

Electronics Experience.....



LAFAYETTE'S 1959 CATALOG

"Everything in Electronics"

260 GIANT-SIZED PAGES

Our 38th Year

The Complete Catalog Featuring
"The Best Buys In The Business"

FOR THE NEWEST AND FINEST IN
STEREOPHONIC HI-FI EQUIPMENT AND SYSTEMS

- TAPE RECORDERS ● PUBLIC ADDRESS SYSTEMS
- AMATEUR EQUIPMENT ● INDUSTRIAL SUPPLIES
- MINIATURE COMPONENTS ● RADIO & TV TUBES AND PARTS
- EXCLUSIVE LAFAYETTE TRANSISTOR & HI-FI KITS

Send for Lafayette's 1959 Catalog — the most complete, up-to-the-minute electronic supply catalog crammed full of everything in electronics at our customary down-to-earth money-saving prices.

CONTAINS HUNDREDS OF EXCLUSIVE LAFAYETTE ITEMS NOT AVAILABLE IN ANY OTHER CATALOG OR FROM ANY OTHER SOURCE — SEND FOR YOUR COPY NOW!

A "must" for the economy-minded hi-fi enthusiast, experimenter, hobbyist, engineer, technician, student, serviceman and dealer.

Leaders in Hi-Fi

The most complete selection and largest stocks of hi-fi components and systems—available for immediate delivery at the lowest possible prices. Save even more on Lafayette endorsed "best-buy" complete systems.

EASY PAY TERMS Available on orders over \$45—
Only 10% down—Up to 18 months to pay

NEW!



Lafayette
**TRANSCRIPTION PLAYER
WITH 3 LB. 12"
ALUMINUM TURNTABLE**

Professional 4-speed player

ideally suited for stereo. Has magnetic eddy-current brake permitting $\pm 10\%$ speed variation. Amazingly low priced! Shpg. wt., 14 lbs.

PK-240 Net 37.50

**NATIONALLY ADVERTISED
4-SPEED AUTOMATIC
RECORD CHANGER**



Plays Stereo
and Monaural Records

Famous brand latest model with new GE GC-7 Magnetic Compatible Stereo Cartridge with diamond stylus. Guaranteed to please or money refunded! Regular 69.50 Value! Shpg. wt., 21 lbs.

PK-251—(less Wood base)
Net 39.50

NEW!



STEREO BALANCE VU METER

Dual audio output level indicator with two meters, for comparing audio levels. Ideal for balancing hi-fi stereo systems.

TM-40 Net 8.95

**NEW MINIATURE
HIGH SENSITIVITY MULTITESTER**
20,000 OHMS PER VOLT DC —
10,000 OHMS PER VOLT AC



20,000 ohms per volt DC and 10,000 ohms per volt AC instrument. Has 23 most used ranges selected by single switch. With batteries and leads. Shpg. wt., 3 lbs.

RW-60 Net 13.50

NEW!



**LAFAYETTE-GOODMANS
12" 3-WAY SPEAKER**

- 30 WATTS
- FREQUENCY RESPONSE
30-20,000 CPS
- PLUG-IN 12 DB/OCTAVE
CROSSOVER NETWORK
WITH LEVEL CONTROL

Custom-built by Goodmans of England with $1\frac{3}{4}$ lb. Alcomax 3 Magnet. Features axially mounted, free-edged wide range woofer, stiff-coned mid-range radiator and compression-driver tweeter.

SK-110 Net 47.50
Two for Stereo ... Net 89.00

FREE

**LAFAYETTE RADIO, Dept. RL
P. O. Box 511, Jamaica 31, N. Y.**

SEND FOR THE WORLD'S LEADING ELECTRONICS,
RADIO, T.V., INDUSTRIAL, AND HI-FI GUIDE

Send FREE LAFAYETTE Catalog 590

Name

Address

City..... Zone.... State.....

JAMAICA, N. Y.
165-08 Liberty Ave.
AXtel 1-7000

NEW YORK, N. Y.
100 6th Ave.
WOrth 6-5300

BOSTON, MASS.
110 Federal St.
HUBbard 2-7850

BRONX, N. Y.
542 E. Fordham Rd.
FOrdham 7-8813

NEWARK, N. J.
24 Central Ave.
MArkett 2-1661

PLAINFIELD, N. J.
139 W. 2nd St.
PLAINfield 6-4718

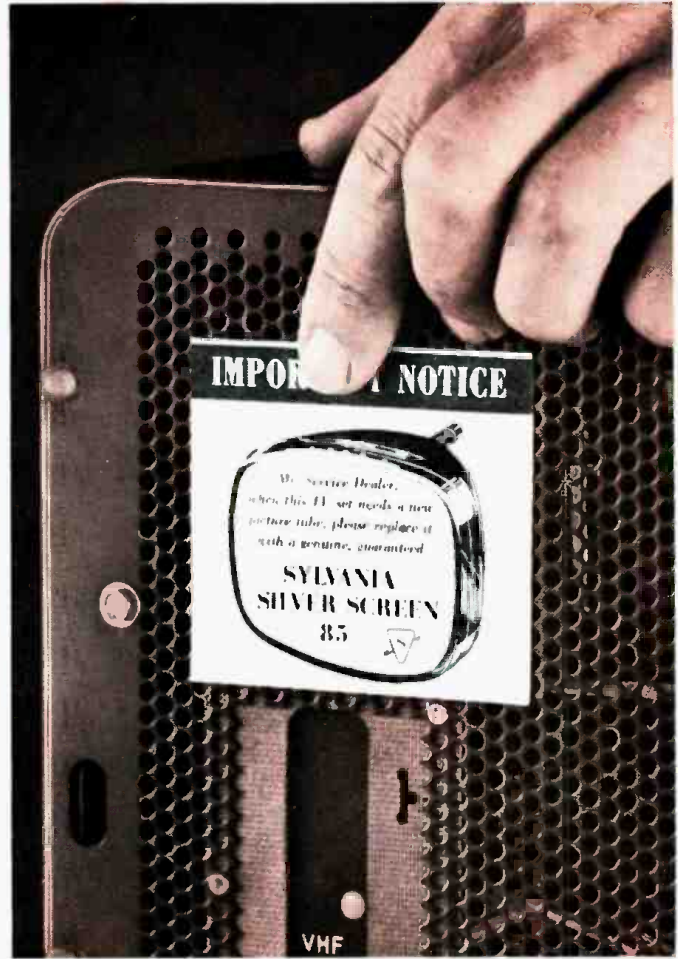
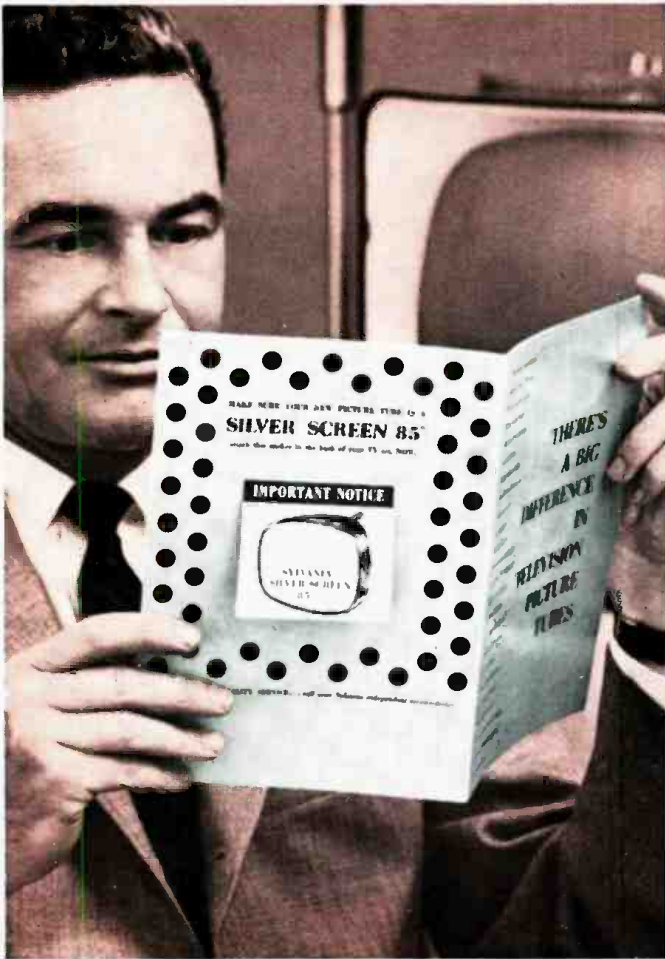

This label is your signal that a value-minded customer has been sold up to Silver Screen 85.

New consumer booklet from Sylvania helps you

SELL UP TO SILVER SCREEN 85

Free booklet tells the story of Silver Screen 85's superior performance—
detachable sticker lets the consumer tell you he's *presold* on Silver Screen 85

Leave a copy on every service call or make a complete mailing to your customers and prospects. Either way, Sylvania's new booklet, "There's A Big Difference In Television Picture Tubes," can help you sell up to more profits through more Silver Screen 85 sales.

In layman's language, this booklet details the difference between Silver Screen 85 and cut-rate off-brand tubes. It's chock-full of facts as they were revealed in Sylvania's recent test of a

nationwide sample. What's more, there's a handy sticker on the back of each booklet for the customer to attach to the back of his TV set. This is your signal that he's *presold up* to Silver Screen 85.

Get on the bandwagon. Let Sylvania help you sell up. Give each of your customers and prospects a copy of this new booklet. It's available free, complete with mailing envelope, from your Sylvania Distributor. Or write for a sample copy.



Bill Shipley's your No. 1 Salesman in the industry's biggest consumer advertising campaign.

 **SYLVANIA**

SYLVANIA ELECTRIC PRODUCTS INC.
1740 Broadway, New York 19, N. Y.
In Canada: Sylvania Electric (Canada) Ltd.
University Tower Bldg., Montreal

NEW Silicon Rectifier

Built for Reliability—Priced for Economy

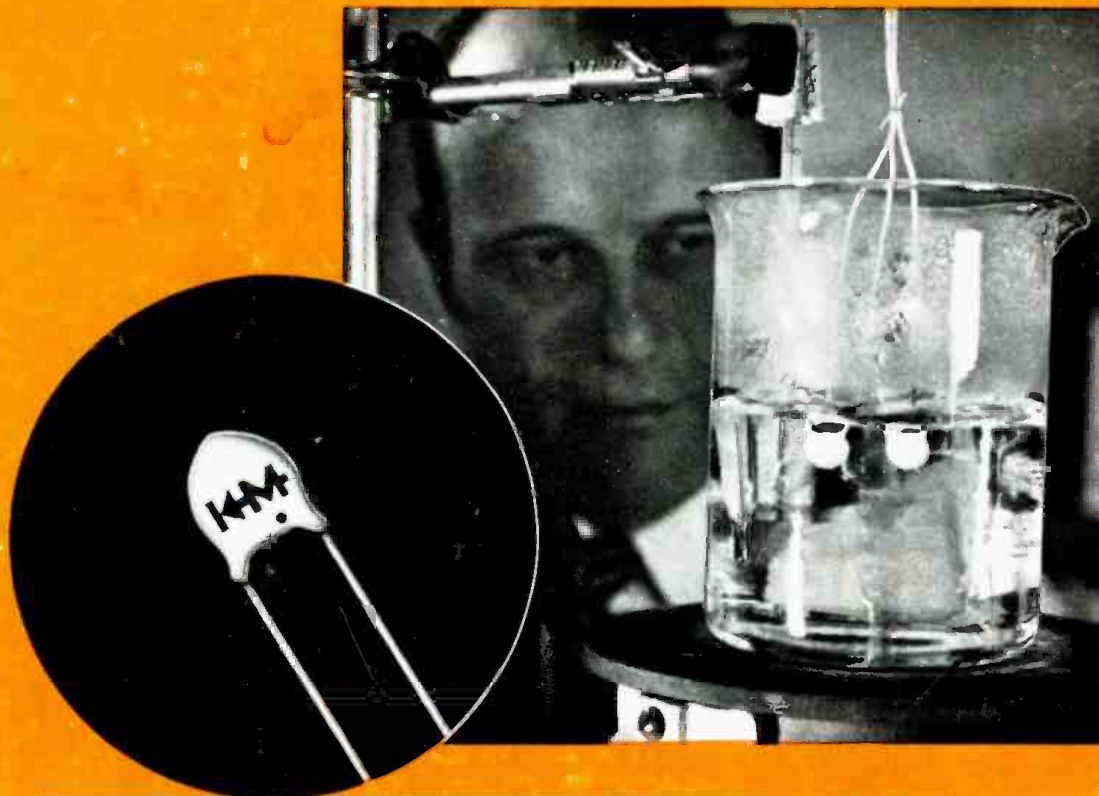

After 500 hours in boiling water, the new Mallory silicon rectifier is still going strong! That's just one of the ways we've proved that this new rectifier, product of Mallory semi-conductor research, gives you superior reliability and humidity resistance—at a price that is practical and profitable for TV and radio service jobs.

New Moisture-Proof Design, using unique Mallo-Seal* encapsulation, enables the rectifier to pass *four times* the tropical torture of military humidity tests . . . without a single failure.

New Performance. Compare these figures: reverse leakage less than 250 microamperes; forward drop less than 0.5 volt; no drop in characteristics after 2000-hour life test at 85° C ambient.

New Reliability. No premature failures, no call-backs—because 100% inspection assures quality in every rectifier.

New Economy. Highest quality and reliability at a new low price for commercial silicon rectifiers.

Several models are available: the encapsulated type for conversions, a plug-in model for sets already using silicon conversions—and a line of "top hat" and stud mounted models for military and industrial use. See your Mallory distributor soon for complete details.

*Trade Mark, P. R. Mallory & Co. Inc.

- Capacitors
- Controls
- Vibrators
- Switches
- Resistors
- Filters
- Power Supplies
- Rectifiers
- Mercury and Zinc-Carbon Batteries

P. R. MALLORY & CO. Inc.
MALLORY

P. R. MALLORY & CO. Inc., INDIANAPOLIS 6, INDIANA

