

**MULTI-SET TV FROM SINGLE ANTENNA SYSTEM**

11 MAC

# **RADIO & TV NEWS**

*Leading Technical Magazine in the Electronics World*

**NOVEMBER  
1958  
35 CENTS**

**CITIZENS RADIO AND ITS FUTURE  
ARE X-RAYS FROM TV SETS HARMFUL?  
DESIGNING INDOOR P. A. SYSTEMS  
LOADING THE PHONO CARTRIDGE**

**"HAM" OPERATOR  
TRACKS SATELLITES**  
(See Pages 44, 45 & 66)





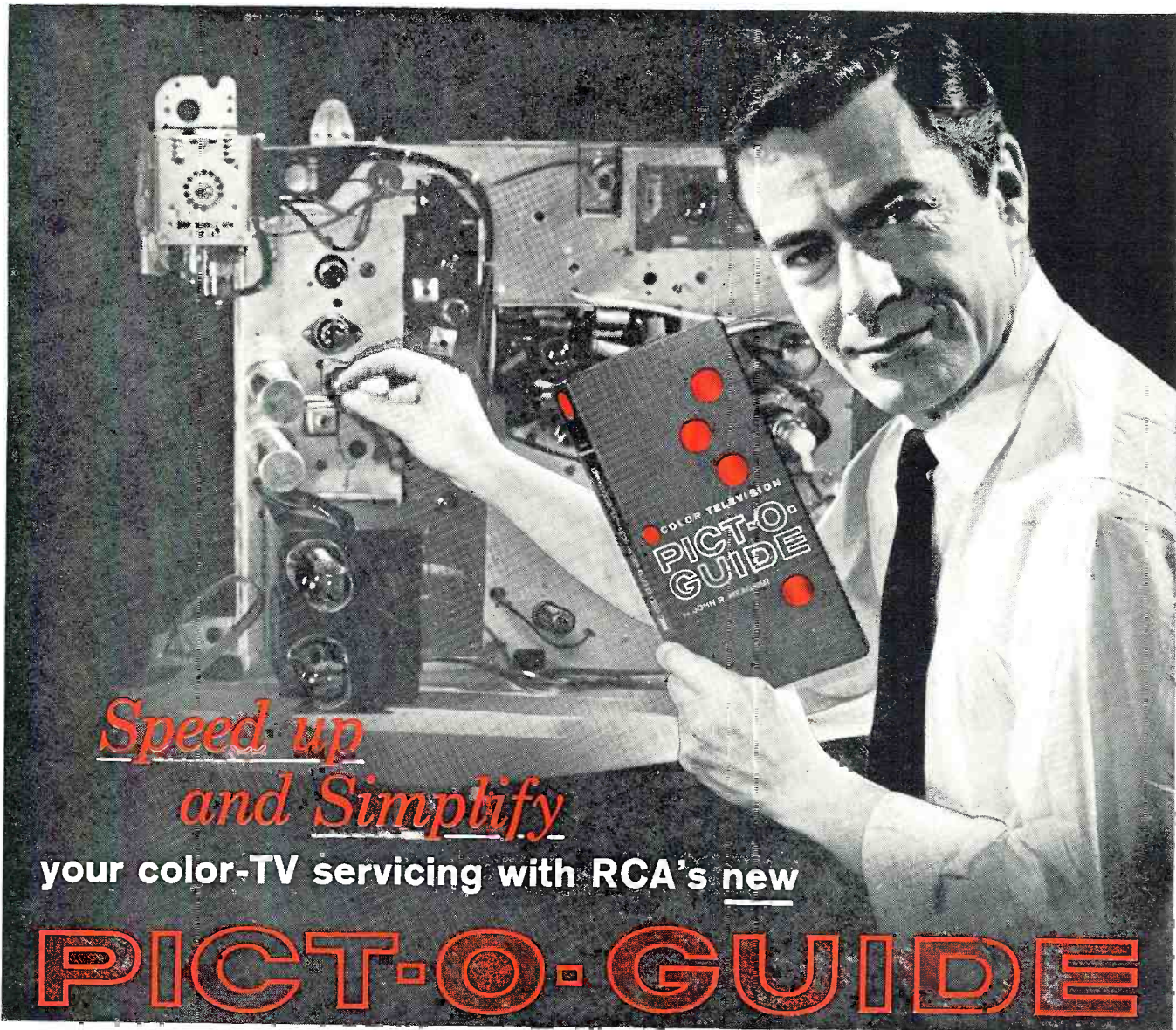

*Speed up  
and Simplify*

your color-TV servicing with RCA's new

# PICT-O-GUIDE

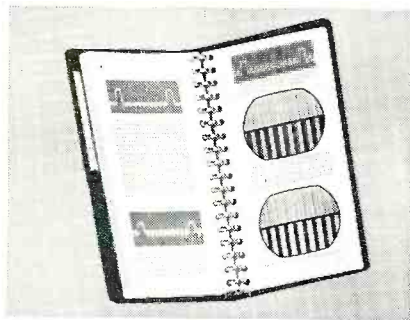

AVAILABLE THROUGH YOUR RCA TUBE DISTRIBUTOR

Or, fill out the coupon below and forward with \$4.50 in check or money order payable to Radio Corporation of America for each Color TV PICT-O-GUIDE ordered.

RCA Commercial Engineering  
415 South 5th St., Harrison, N. J.  
Gentlemen:  
Enclosed please find check  or money order   
for ..... Color-TV PICT-O-GUIDES. Send to:  
Name .....  
Address .....  
City ..... Zone ..... State .....

It's chock-full-of practical information and illustrations—just what you need for profitable color-TV servicing.

If you are planning to build your share in the business of color-TV servicing, you are sure to find RCA's Color-TV Pict-O-Guide the most useful "bench" friend you have ever had. Whether you are "learning" or are already "doing", the clearly written descriptions, step-by-step instructions, diagrams, and full-color photographs of trouble symptoms make this valuable book a "must"! It was prepared and written by John R. Meagher, RCA's well known authority on TV servicing techniques. Get your copy today!

New Color-TV Pict-O-Guide contains sections on:

Color Mixing • RCA Compatible Color TV System • Purity • Troubleshooting Convergence • Gray-Scale Tracking • Color Operating Controls • Antenna Considerations • RF-IF-Bandpass Alignment • Color-Bar Patterns • Color Test Equipment • Signal Tracing • Interference • "Green Stripe" Test Signals



**RADIO CORPORATION OF AMERICA**

Electron Tube Division

Harrison, N. J.



**you can convert  
to stereo  
without a  
second woofer  
or expensive  
network  
IF YOUR WOOFER**



**HAS FOUR TERMINALS**

*These four terminals lead to an exclusive University feature... THE DUAL VOICE COIL... two electrically separate voice coils on a single woofer that provide perfect bass from both stereo channels, without the need for expensive or complicated stereo adapter networks or "control" filters.*

This means the tonal magnificence of University stereo adapted speaker systems can be perfectly matched for stereo with the sole addition of an inexpensive, compact stereo "add-on" speaker, or other suitable limited range speaker. This is possible because stereo effect is created largely by frequencies above the nominal bass range.

**How University dual voice coil woofers work:**

Voice Coil A of the woofer receives the full bass from one stereo channel. Voice Coil B receives the full bass from the other channel. Then...exactly as done in two-woofer stereo systems...both bass signals are blended acoustically. Result: authentic, balanced, full-bodied bass that will give you the enduring satisfaction of superb stereophonic sound.

**Thus, you save the expense and space of an additional woofer and its enclosure.**

Whether you are investing in a complete stereo system...or starting with a monaural system for later conversion...a University speaker system\* featuring a dual voice coil woofer proves once again... with University it pays to own the very finest!

*\*University woofers having dual voice coils are models: C-15W, C-12SW, C-15HC and C-12HC. These are employed in speaker systems: Debonaire-12 S-3, S-3S; Senior S-5, S-5S; Master S-6, S-6S; Dean S-7, S-7S; Classic S-8, S-8S, S-9, S-9S; Ultra Linear S-10, S-10S, S-11, S-11S; Troubadour S-12, S-12S. (System models in light type are fully stereo adapted. System models in bold type can be easily and inexpensively prepared for stereo with kit SK-1. User net: \$5.95)*



LISTEN... **University** SOUNDS BETTER!

**How to achieve your University stereo system**

Select the stereo adapter speaker(s) that best suits your budget, decor and space requirements. Each of University's all-new stereo adapter speakers has been specially designed to provide a perfect stereo match by direct connection to your dual voice coil system. (For systems not having a dual voice coil woofer, a stereo adapter network is available.) Stereoflex I is well suited for bookshelf installations. Stereoflex II, with its narrow silhouette, makes a fine end table. Model SLC can be affixed to a wall or "lite-pole," its decorative fibreglass housing blending smartly with modern furnishings.

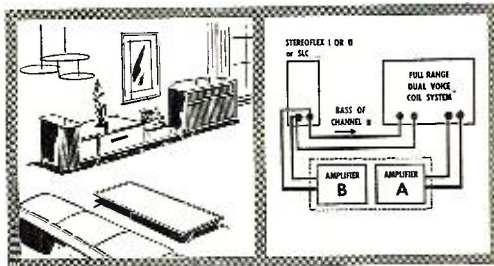

These illustrations are typical of how any of the University stereo adapter speakers may be used in 2-speaker and 3-speaker stereo system combinations. Above, is a Stereoflex II connected to a full-range speaker system. Below, are two Stereoflex I's used with just a dual voice coil woofer in a suitable enclosure.

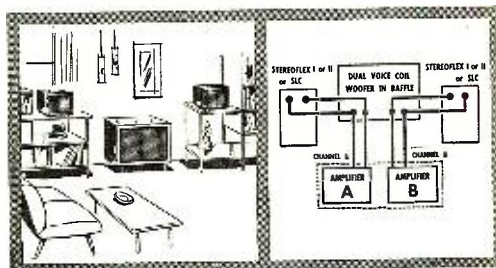

See your dealer for any desired additional information, or write to Desk S-8, Technical Service Department, University Loudspeakers, Inc., White Plains, N. Y.



**STEREOFLEX I:** Double horn-loaded, with 6" mid-range driver and 2000 cps crossover wide-angle tweeter. Response: 150-15,000 cps. Hardwood furniture finishes. 11½" h. x 12½" w. x 10½" d. User net: Mahogany—\$54.50, Blond or Walnut—\$56.50.

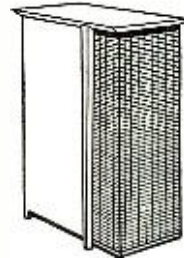

**STEREOFLEX II:** Double horn-loaded, using an extended air column mid-range with heavy duty compression driver and 3000 cps crossover wide-angle tweeter. Built-in BRILLIANCE control. Response: 150 cps to beyond audibility. Hardwood furniture finishes. 25½" h. x 10" w. x 19½" d. User net: Mahogany—\$110.00, Blond or Walnut—\$113.00.



**MODEL SLD:** Same as Stereoflex I, but with decorator charcoal gray fibreglass housing and gold anodized front grille and adjustable tilting stand. 11½" h. x 12¾" w. x 10½" d. User net: \$43.50.

**STEREO ADAPTER NETWORK A-1:** Available for use with any brand of speaker system not having a dual voice coil woofer. Not needed with University speaker systems: Debonaire-12, Senior, Master, Troubadour, Dean, Classic, Ultra Linear-12 or -15. User net: \$30.00.

RADIO & TV NEWS is published monthly by Ziff-Davis Publishing Company, William B. Ziff, Chairman of the Board (1946-1953), at 434 S. Wabash Ave., Chicago 5, Ill. Entered as second-class matter July 21, 1948, at the Post Office, Chicago, Ill., under the act of March 3, 1879. Authorized by Post Office Department, Ottawa, Canada. Second-class matter. SUBSCRIPTION RATES: one year U. S. and possessions, and Canada \$4.00; Pan American Union Countries \$4.50; all other foreign countries \$5.00.

# RADIO & TV NEWS

Reg. U. S. Pat. Off.

First in radio-television-audio-electronics

Average Net Paid Circulation 236,101

Radio & Television News • Radio News • Television News Trademarks Reg. U. S. Pat. Off.

# CONTENTS

NOVEMBER, 1958

VOL. 60 ■ NO. 5

**Publisher**

**OLIVER READ, D. Sc., W1ET1**

**Editor**

**WM. A. STOCKLIN, B. S.**

**Technical Editor**

**MILTON S. SNITZER**

**Service Editor**

**SIDNEY C. SILVER**

**Associate Editor**

**P. B. HOEFER**

**Assistant Editor**

**J. JUSTER**

**Television Consultant**

**WALTER H. BUCHSBAUM**

**Art Editor**

**MILTON BERWIN**

**Art and Drafting Dept.**

**J. A. GOLANEK  
JAMES A. ROTH  
MILTON WHELPLEY**

**Advertising Director**

**JOHN A. RONAN, JR.**

**Midwest Adv. Manager**

**W. ROBERT WOLFE**

**Western Adv. Manager**

**JOHN E. PAYNE**



**ZIFF-DAVIS PUBLISHING COMPANY**  
William Ziff, President; W. Bradford Briggs, Executive Vice-President; Michael Michaelson, Vice-President and Circulation Director; Hershel B. Sarbin, Secretary; Howard Stoughton, Jr., Treasurer; Albert Gruen, Art Director.

Editorial and Executive Offices  
One Park Avenue  
New York 16, N. Y. OR. 9-7200



Member  
Audit Bureau of  
Circulations

MEMBER  
INSTITUTE OF



**BRANCH OFFICES:** Midwestern Office, 434 S. Wabash Ave., Chicago 5, Ill.; Western Office, Room 412, 215 W. 7th St., Los Angeles 14, Calif., John E. Payne, manager.

**FOREIGN ADVERTISING REPRESENTATIVES:** D. A. Goodall Ltd., London; Albert Milhado & Co., Antwerp and Dusseldorf.

## ELECTRONICS—GENERAL

Behind the Scenes in Publishing (Editorial).....	W. Stocklin	8
Spot News.....	Washington Correspondent	33
Basics of Preset Counters.....	Ed Bukstein	46
Calendar of Events.....		98
Slide-Projector Fade Control.....	Fred J. Lingel	115
Transistor Terminology.....	John A. Comstock	129
The "Istor" Story.....	Rudolf F. Graf	144

## HIGH FIDELITY AND AUDIO

Loading the Phono Cartridge.....	Herman Burstein	40
Indoor Public Address Systems.....	Norman H. Crowhurst	54
Transistor Superregen FM Tuner.....	Irving E. Fisk	60
Hi-Fi—Audio Product Review.....		90
Adding a VU Meter to the "Outboard" Amplifier.....	Earl E. Snader	106
Sound on Tape.....	Bert Whyte	122
Certified Record Revue.....	Bert Whyte	138

## TELEVISION-RADIO

How the Videotape Recorder Works.....	Joseph Roizen	48
Multi-Set TV Installations: Problems & Principles (Part 1).....	Jack Beever	51
Service Holds a Convention.....	Sidney C. Silver	57
X-Rays from TV Sets: Are They Harmful?.....	Charles R. Maduell, Jr.	58
"Musts" for Business Growth.....	William Leonard	62
Mac's Service Shop.....	John T. Frye	68
Test Bench Puzzler: No. 3.....	Art Margolis	108
Service Association of the Month (Alameda County Television & Radio Assn.).....		116
Antenna News.....		135
Service Industry News.....		154
Service Notes.....		160

## TEST EQUIPMENT

Wide-Range Field-Strength Meter Adapter.....	Gene Brizendine	43
An Improved Multi-Purpose Probe.....	Nathan Kaye	63
A Transistorized A.F.-R.F. Signal Tracer.....	Rufus P. Turner	64
Scope Calibrator and Pulse Generator.....	Leonard Chioma	70
New Tube Tester Data.....		130

## AMATEUR AND COMMUNICATIONS

Citizens Radio Faces the Future.....	Harold B. McKay	37
Listening to the Satellites.....	E. C. Kunze, W0WYM	44
This Month's Cover.....		45
Putting the Helix to Work.....	William L. Blair, K6QXW	66
Linear Amplifier for SSB Exciters.....	E. H. Marriner, W6BLZ	69

## DEPARTMENTS

Letters from Our Readers.....	14	Technical Books.....	132
Within the Industry.....	22	What's New in Radio.....	149

Copyright © 1958 by Ziff-Davis Publishing Company. All rights reserved.

**SUBSCRIPTION SERVICE:** Forms 3579 and all subscription correspondence should be addressed to Circulation Department, 434 South Wabash Avenue, Chicago 5, Illinois. Please allow at least four weeks for change of address. Include your old address as well as new—enclosing if possible an address label from a recent issue.

**CONTRIBUTIONS:** Contributors are advised to retain a copy of their manuscripts and illustrations. Contributions should be mailed to the New York Editorial Office and must be accompanied by return postage. Contributions will be handled with reasonable care, but this magazine assumes no responsibility for their safety. Any copy accepted is subject to whatever adaptations and revisions are necessary to meet the requirements of this publication. Payment covers all author's, contributor's, and contestant's rights, title, and interest in and to the material accepted and will be made at our current rates upon acceptance. All photos and drawings will be considered as part of the material purchased.

RADIO & TV NEWS





**Now! Work Over  
300 PRACTICAL  
PROJECTS with these  
PARTS AT HOME!**



to help You learn

**ELECTRONICS**  
**RADIO - TELEVISION - RADAR**

NOW . . . at home in your spare time you can get the very kind of training and subsequent Employment Service you need to get started toward real earnings in one of today's brightest opportunity fields—TELEVISION-RADIO-ELECTRONICS. Now that Electronics is entering so many new fields, here is a chance of a lifetime to prepare to cash in on its remarkable growth.

DeVry Tech's amazingly practical home method enables you to set up your own HOME LABORATORY. You spend minimum time to get maximum knowledge from over 302 practical projects, using the same type of basic equipment used in our modern Chicago and Toronto Training Centers!

**DeVry Tech Provides EVERYTHING YOU NEED . . .**

—to help you master TV-ELECTRONICS. In addition to the home laboratory and easy-to-read lessons, you even use HOME MOVIES—an exclusive DeVry Tech advantage. You watch hidden actions . . . see electrons on the march. Movies help you to learn faster . . . easier . . . better.

**LABORATORY TRAINING**

Full time day and evening training programs in our modern Chicago and Toronto Laboratories are also available. MAIL COUPON TODAY for facts.

**EARN WHILE YOU LEARN**

DeVry Tech's practical training helps you toward spare time income servicing Radio and Television sets.

**BUILD and KEEP Valuable  
TEST EQUIPMENT**

As part of your training, you build and keep a fine Jewel-Bearing Vacuum Tube VOLTMETER and a 5-inch COLOR OSCILLOSCOPE—both high quality, needed test instruments.

**EFFECTIVE  
EMPLOYMENT SERVICE**

Get the same Employment Service that has helped so many DeVry Tech graduates get started in this fast-growing field.

"One of North America's Foremost Electronics Training Centers"

Accredited Member  
of National Home  
Study Council



**DeVRY TECH INSTITUTE**  
Formerly DeForest's Training, Inc.  
CHICAGO 41, ILLINOIS

**✓ CHECK  
These Exciting  
Job  
Opportunities:**

- TV-Radio Broadcast Technician
- Color Television Specialist
- Radar Operator
- Laboratory Technician
- Airline Radio Man
- Computer Specialist
- Quality Control Manager
- Your Own Sales & Service Shop
- . . . PLUS MANY OTHERS

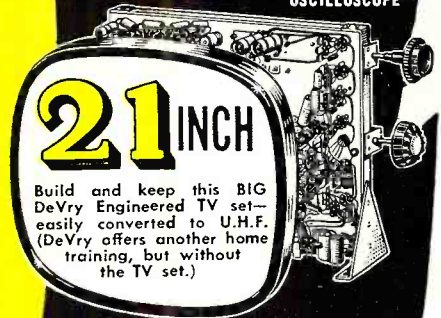

**21 INCH**  
Build and keep this BIG DeVry Engineered TV set—easily converted to U.H.F. (DeVry offers another home training, but without the TV set.)

VACUUM  
TUBE  
VOLTMETER

5 INCH  
COLOR  
"SCOPE"

5 INCH  
COLOR  
OSCILLOSCOPE

**MAIL COUPON TODAY!**

**DeVRY TECHNICAL INSTITUTE**  
4141 Belmont Ave., Chicago 41, Ill., Dept. RN-11-0

Please give me your FREE booklet, "Electronics and YOU," and tell me how I may prepare to enter one or more branches of Electronics.

Name \_\_\_\_\_ Age \_\_\_\_\_  
PLEASE PRINT  
Street \_\_\_\_\_ Apt. \_\_\_\_\_  
City \_\_\_\_\_ Zone \_\_\_\_\_ State \_\_\_\_\_  
2045 Canadian residents address DeVry Tech of Canada, Ltd.  
626 Roselawn Ave., Toronto 12, Ontario



## New amplifier battles "noise"



Four-stage junction diode amplifier was developed at Bell Telephone Laboratories by Rudolf Engelbrecht for military applications. Operates on the "varactor" principle, utilizing the variable capacitance of diodes. With 400-mc. signal, the gain is 10 db. over the 100-mc. band.

The tremendous possibilities of semiconductor science are again illustrated by a recent development from Bell Telephone Laboratories. The development began with research which Bell Laboratories scientists were conducting for the U. S. Army Signal Corps. The objective was to reduce the "noise" in UHF and microwave receivers and thus increase their ability to pick up weak signals.

The scientists attacked the problem by conducting a thorough study of the capabilities of semiconductor junction diodes. These studies led to the conclusion that junction diodes could be made to amplify efficiently at UHF and microwave frequencies. This was something that had never been done before. The theory indicated that such an amplifier would be exceptionally free of noise.

At Bell Laboratories, development engineers proved the point by developing a new kind of amplifier in which the active elements are junction diodes. As predicted, it is extremely low in noise and efficiently amplifies over a wide band of frequencies.

The new amplifier is now being developed for U. S. Army Ordnance radar equipment. But it has numerous other possibilities. In radio astronomy, for example, it could be used to detect weaker signals from outer space. In telephony, it offers a way to increase the distance between relay stations in line-of-sight or over-the-horizon communications.



**BELL TELEPHONE LABORATORIES**  
WORLD CENTER OF COMMUNICATIONS RESEARCH AND DEVELOPMENT



**NOW!**  
at a price  
you can afford!

# MAKE MORE MONEY in TELEVISION RADIO-ELECTRONICS

**BETTER...MORE COMPLETE...LOWER COST...  
WITH NATIONAL SCHOOLS SHOP-METHOD  
HOME TRAINING!**

**BETTER...** Training that is proved and tested in Resident School shops and laboratories, by a School that is the **OLDEST** and **LARGEST** of its kind in the world.

**MORE COMPLETE...** You learn **ALL PHASES** of *Television-Radio-Electronics*.

**LOWER COST...** Other schools make several courses out of the material in our **ONE MASTER COURSE** . . . and you pay more for less training than you get in *our course* at **ONE LOW TUITION!**

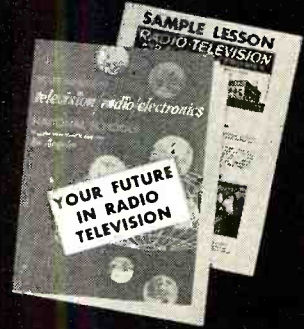

These **FREE** books will show you how!

You get all information by mail . . . You make your own decision . . . at home! **NO SALESMAN WILL CALL**

## TOP PAY... UNLIMITED OPPORTUNITIES LIFETIME SECURITY CAN BE YOURS!

You are needed in the Television, Radio, and Electronics industry! Trained technicians are in growing demand at excellent pay—in **ALL PHASES**, including Servicing, Manufacturing, Broadcasting and Communications, Automation, Radar, Government Missile Projects.

**NATIONAL SCHOOLS SHOP-METHOD HOME TRAINING**, with newly added lessons and equipment, trains you in your spare time at home, for these unlimited opportunities, including many technical jobs leading to supervisory positions.

**YOU LEARN BY BUILDING EQUIPMENT WITH KITS AND PARTS WE SEND YOU.** Your National Schools course includes thorough *Practical* training—**YOU LEARN BY DOING!** We send you complete standard equipment of professional quality for building various experimental and test units. You advance step by step, perform more than 100 experiments, and you build a complete TV set from the ground up, that is yours to keep! A big, new TV picture tube is included at no extra charge.

**EARN AS YOU LEARN.** We'll show you how to earn extra money right from the start. Many of our students pay for their course—and more—while studying. So can you!

**LESSONS AND INSTRUCTION MATERIAL ARE UP-TO-DATE, PRACTICAL, INTERESTING.** Every National Schools Shop-Method lesson is made easy to understand by numerous illustrations and diagrams. All instruction material has been developed and tested in our own Resident School Shops, Laboratories and Studios.

**SEND FOR INFORMATION TODAY . . .** it can mean the difference between **SUCCESS** and failure for you! Send for your **FREE BOOK** "Your Future in Television-Radio-Electronics" and **FREE Sample Lesson.** Do it **TODAY**, while you are thinking about your future. It doesn't cost you anything to investigate!

### GET THE BENEFITS OF OUR OVER 50 YEARS EXPERIENCE

Approved for  
GI Training



**NATIONAL SCHOOLS**  
Los Angeles 37, Calif.

### YOU GET...

- 19 Big Kits—**YOURS TO KEEP!**
- Friendly Instruction and Guidance
- Job Placement Service
- Unlimited Consultation
- Diploma—Recognized by Industry
- **EVERYTHING YOU NEED FOR SUCCESS!**

#### SHOP-METHOD HOME TRAINING COVERS ALL PHASES OF INDUSTRY

1. Television, including Color TV
2. Radio AM & FM
3. Electronics for Guided Missiles
4. Sound Recording and Hi-Fidelity
5. FCC License
6. Automation and Computers
7. Radar & Micro-Waves
8. Broadcasting and Communications

## NATIONAL TECHNICAL SCHOOLS

WORLD-WIDE TRAINING SINCE 1905

MAIL NOW TO

**NATIONAL SCHOOLS, Dept RH-118**

4000 S. FIGUEROA ST. LOS ANGELES 37, CALIF.

Rush free TV-Radio "Opportunity" Book and sample lesson. No salesman will call.

NAME \_\_\_\_\_ AGE \_\_\_\_\_

ADDRESS \_\_\_\_\_

CITY \_\_\_\_\_ ZONE \_\_\_\_\_ STATE \_\_\_\_\_

Check if interested **ONLY** in Resident School training at Los Angeles.

VETERANS: Give date of Discharge \_\_\_\_\_

### RESIDENT TRAINING AT LOS ANGELES

If you wish to take your training in our Resident School at Los Angeles, the world's TV capital, start **NOW** in our big, modern Shops, Labs and Radio-TV Studios. Here you work with latest Electronic equipment - - professionally installed - - finest, most complete facilities offered by any school. Expert, friendly instructors. Personal attention. Graduate Employment Service. Help in finding home near school - - and part time job while you learn. Check box in coupon for full information.



ONLY  
**SOUNDCRAFT**  
 dares prove its  
 superior quality!

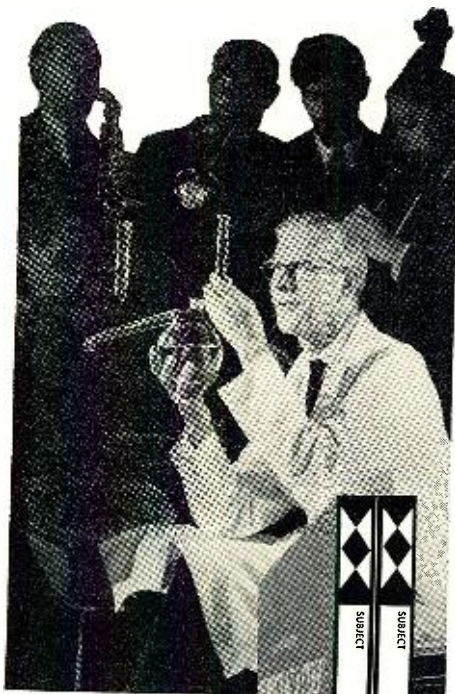

HEAR IT FOR YOUR-  
 SELF... In "SWEET  
 MOODS OF JAZZ IN  
 STEREO"

featuring Coleman Hawkins, "Red" Allen, Marty Napoleon and other jazz greats in interpretations of "Summertime," "Tea for Two," "Stormy Weather" and other favorites.

YOURS FOR JUST \$1.00 EXTRA... when you buy  
 two 7" reels of tape in

### SOUNDCRAFT'S New PREMIUM PACK

containing two reels of Soundcraft tape with "Sweet Moods of Jazz in Stereo" recorded on one of the reels.

This is Soundcraft's way of demonstrating the markedly superior quality of Soundcraft Tape...the only tape Micropolished to preserve your "highs"...and Uni-level coated with plasticizer-free oxide formulation for greater uniformity and stability! Insist on Soundcraft Tape in the new PREMIUM PACK!

ask about these other  
**SOUNDCRAFT PROMOTIONAL RECORDINGS**

"Sounds of Christmas"—traditional Christmas melodies (monaural only)  
 "Dixieland Jamfest in Stereo"—a jazz classic

**REEVES SOUNDCRAFT CORP.**

Great Pasture Road, Danbury, Connecticut  
 West Coast: 342 N. LaBrea, Los Angeles 36, Calif.  
 Canada: 700 Weston Road, Toronto 9, Ont.

RS3

## ...for the Record

By **W. STOCKLIN**  
 Editor



### BEHIND THE SCENES IN PUBLISHING

WE HAVE often wondered how many of our readers would be able to identify the abbreviations MPA and ABC or could explain the significance of the organizations thus identified. These initials designate two important organizations within the publishing field—the Magazine Publishers Association, Inc. and the Audit Bureau of Circulations. We regret that, for the most part, information on the activities of these two groups has, to a large extent, been confined to the publishing field and, in particular, to the trade journal segment of the industry.

The activities of these two groups are of vital importance to you, our readers, in that because of these organizations we are able to bring you a much better magazine—one with articles to your liking, presented attractively—all at the lowest possible cost. You, as a reader of *RADIO & TV NEWS*, can, to some extent, consider yourself a member of these organizations. Whenever you buy a magazine, whether it be "*Life*," "*Reader's Digest*," or this publication—you participate in the multi-faceted activities of these groups.

#### MPA

The Magazine Publishers Association, Inc., is an organization of publishers, editors, and their circulation and advertising personnel. In this association editors and publishers can get together to discuss their mutual problems and your interests as readers. We learn such things as the effect of newspapers and TV, for example, on your magazine buying habits. We learn of changes in reader interest, not only with regard to subject but in matters of general magazine make-up. We obtain information on your reactions to two-color and even four-color art work presentations. These are only a few of the things that are studied. One of the most important functions of this organization to you as a reader is the continuous crusade being waged to uphold our constitutional guarantees as set forth in the Bill of Rights, *i.e.*, Freedom of Speech and Freedom of the Press. The organization is constantly on guard against undue censorship and the unnecessary withholding of information from the public.

Of vital importance to the association was the recent postal rate increase. This increase was actually a tremendous blow to publishers and, indirectly, to you as a reader. The MPA was active in trying to block an unreasonable increase and to some ex-

tent won its battle in that it helped to prevent an even larger increase than was finally enacted by Congress. This postal increase, although not as large as was originally projected, was like the proverbial "straw that broke the camel's back" in that it piles an additional burden on publishers over and above the ever rising cost of printing—especially in the case of magazines such as ours with large national and international distribution. The inevitable result will be an increase in the price of not only our publication, but probably all magazines in general.

#### ABC

The Audit Bureau of Circulations is a voluntary, non-profit association whose membership is made up of advertisers, advertising agencies, and publishers. Its function is to insure the dissemination of dependable and accurate circulation statements to media buyers.

One fact that many magazine readers tend to overlook is that without the revenue derived from loyal and consistent advertisers the price of their favorite publications would be prohibitively high. In almost every case the price paid represents only a token sum toward the actual cost of putting out the magazine. Virtually all publishers must depend on advertising revenue to support their efforts. Thus, once a year our books are opened to ABC auditors. They check our entire paid circulation and submit a report on these facts about our publication. When a company advertises in *RADIO & TV NEWS* it is actually paying for the opportunity of talking to people like you who buy and read our publication.

The ABC report is also our yardstick whereby we can measure how well we are serving you, our reader, because the Bureau develops important facts about our circulation. It keeps us on our toes because in order to insure your patronage year after year we must render an editorial service worthy of your loyal support. It also stimulates us to still greater effort to provide the kind of material you find most valuable—presented in the most attractive manner possible.

Your purchase of a copy of *RADIO & TV NEWS* is, therefore, a "vote of confidence" which, needless to say, is appreciated. The ABC report tells us that you like our publication and it also tells the advertiser that he has your interest and confidence. We are extremely

(Continued on page 125)



# free!

# ALLIED'S 1959

## value-packed 452-page ELECTRONIC SUPPLY CATALOG

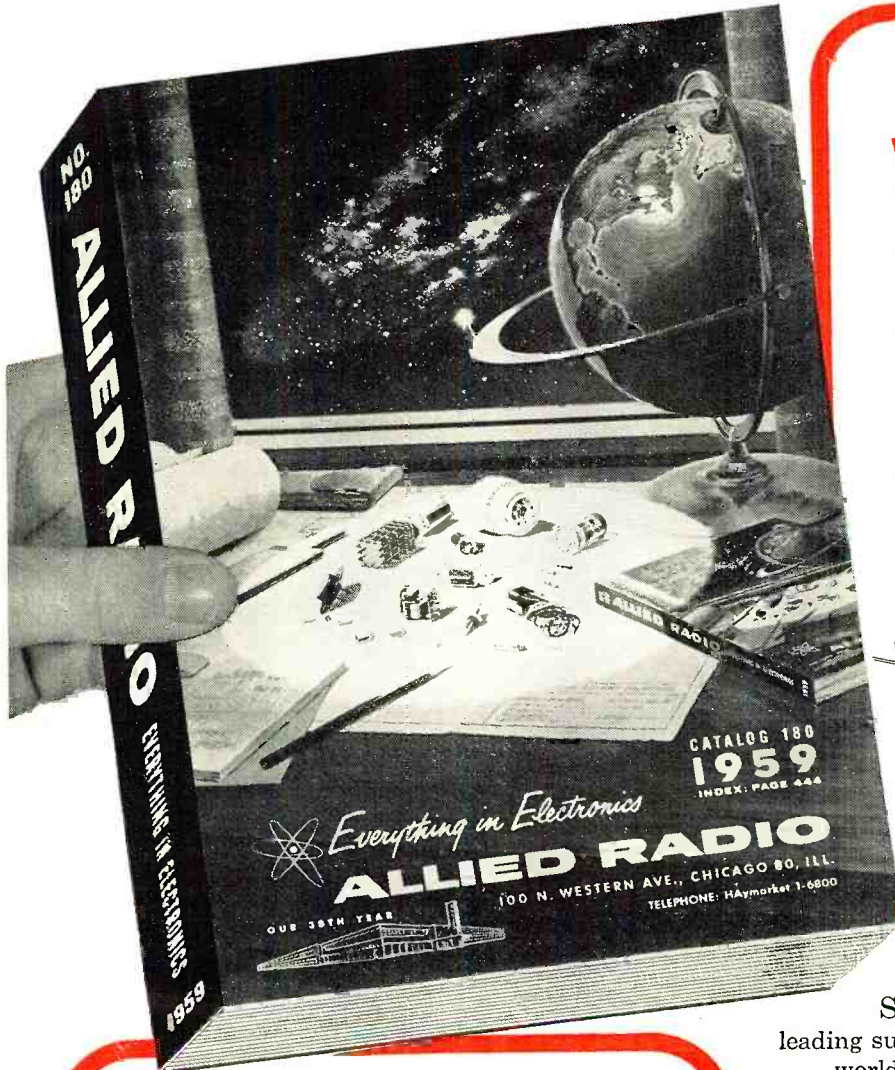

the only COMPLETE guide  
to everything in electronics

### WORLD'S LARGEST STOCKS

- Latest Stereo Hi-Fi Systems— Everything in Hi-Fi Components
- Money-Saving, Build-Your-Own KNIGHT-KITS—Latest Models
- Values in Recorders and Supplies
- Latest Public Address Systems, Paging and Intercom Equipment
- Amateur Receivers, Transmitters and Station Gear
- Test & Laboratory Instruments
- Specialized Electronic Equipment for Industrial Application
- TV Tubes, Antennas, Accessories
- Huge Listings of Parts, Tubes, Transistors, Tools, Books

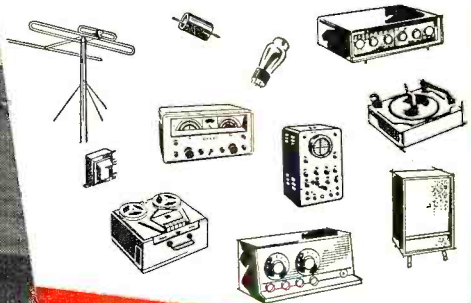

### featuring:

**MONEY-SAVING knight-kits:** Finest electronic equipment in money-saving kit form. Complete selection of latest Hi-Fi amplifier, tuner and speaker kits (new Stereo units); Hobbyist kits; Test Instruments and Amateur kits. KNIGHT-KITS are an exclusive ALLIED product.

**HI-FI! STEREO!** See the world's largest selection of quality Hi-Fi music systems and famous name components. First with the latest in STEREO! Save on ALLIED-recommended complete systems. Own the best in Hi-Fi for less!

**EASY PAY TERMS:** Only 10% down; available on orders of \$20 or more. Fast handling—no red tape.

## ALLIED RADIO



our 38th year

World's Largest Electronic Supply House

Send for ALLIED'S 1959 Catalog—it's the leading supply guide—452 pages packed with the world's largest selection of quality electronic equipment at lowest, money-saving prices. Get every buying advantage at ALLIED: fastest shipment, expert personal help, lowest prices, guaranteed satisfaction...

send for the leading  
electronic supply guide

**FREE!**

ALLIED RADIO CORP., Dept. 1-LB  
100 N. Western Ave., Chicago 80, Ill.

Send FREE 452-Page 1959 ALLIED Catalog

Name \_\_\_\_\_

Address \_\_\_\_\_

City \_\_\_\_\_ Zone \_\_\_\_\_ State \_\_\_\_\_



# Use Delco Radio Service Parts!

DS501—Highest power transistor used in auto radios.

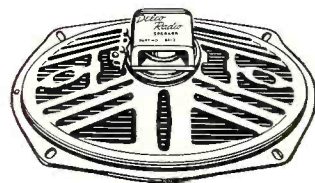
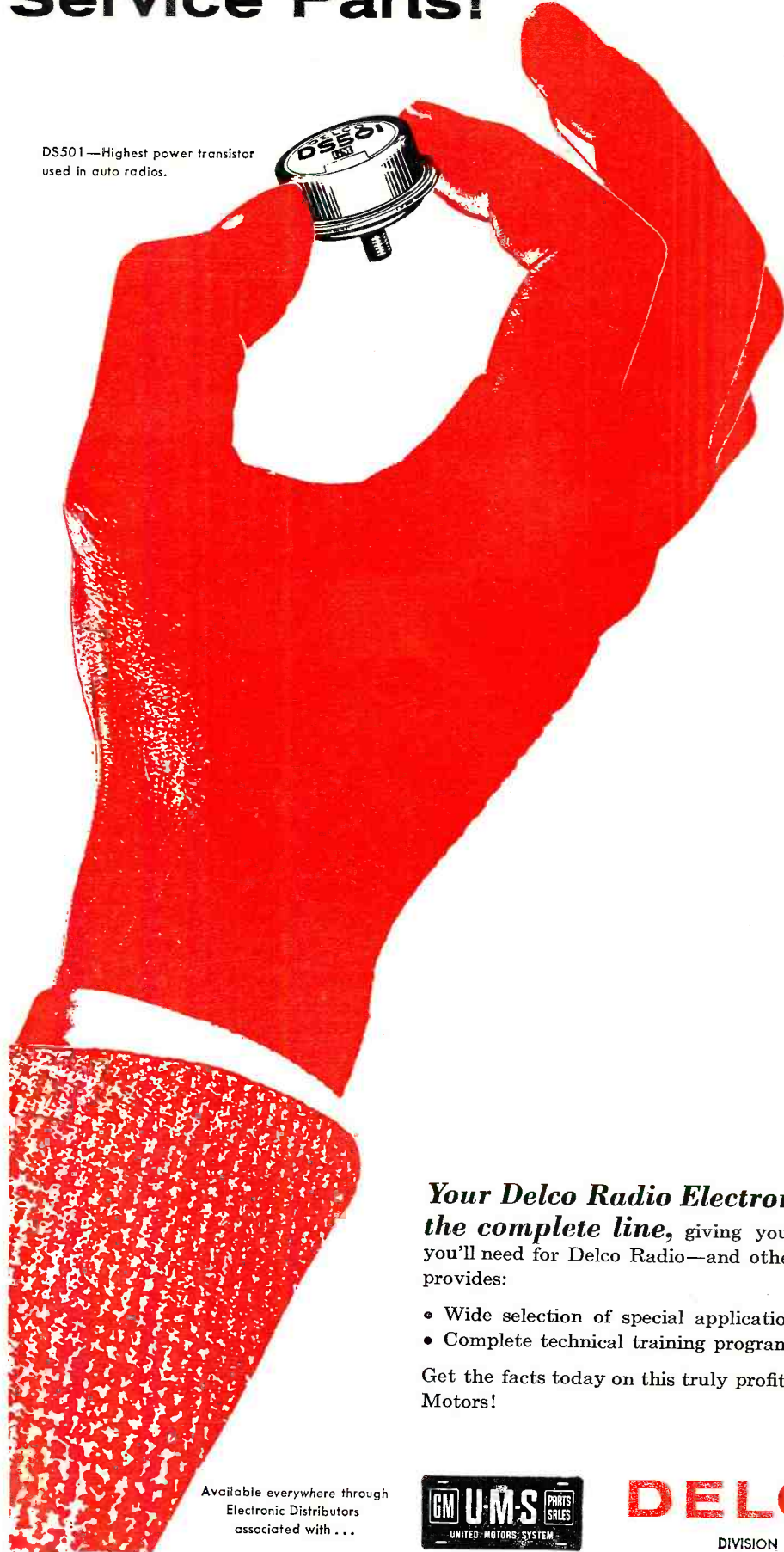

SPEAKERS



IRON CORES



RESISTORS



CAPACITORS

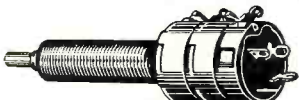

CONTROLS



TUBES



COILS



VIBRATORS

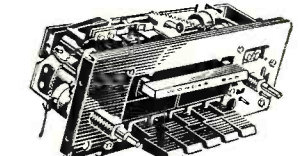

TUNER PARTS

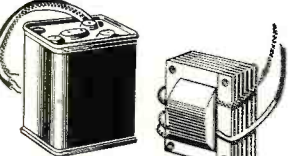

TRANSFORMERS

*Your Delco Radio Electronic Parts Distributor carries the complete line, giving you fast, dependable service on the items you'll need for Delco Radio—and other radio—service work. Delco Radio also provides:*

- Wide selection of special application parts
- Complete technical training program
- Effective warranty program
- Dealer identification signs

Get the facts today on this truly profitable dealer setup, and grow with General Motors!

Available everywhere through Electronic Distributors associated with . . .



## DELCO RADIO

DIVISION OF GENERAL MOTORS, KOKOMO, INDIANA

RADIO & TV NEWS



# TAKE A LOOK AT YOUR FUTURE IN RADIO-TV-ELECTRONICS—FREE!

I.C.S. Career Kit tells you where the big-pay jobs are...who are the industry's most wanted men...how you can "cash in" in a big way on your own future.

Here's your chance to find out where you're going—fast! And it won't cost you a thing except the time it takes to clip and mail the coupon at the bottom of this page.

Radio-TV-Electronics is the fastest growing industry of all time. Opportunity for men in this field is almost unlimited. The rewards are great.

But to "cash in" you must be properly trained. You must know more than simply wires and tubes. You must be able to understand and apply the principles of Radio-TV-Electronics.

That's where I. C. S. comes in . . . the world's oldest and largest technical training school. Here are the people who know—who can tell you—what you need to go places in Radio-TV-Electronics.

You get the full story with your free I. C. S. Career Kit.

So take a minute now to get a look at your future in Radio-TV-Electronics. Send for your free I. C. S. Career Kit. You have nothing to lose. You can gain an exciting, well-paid career in a vital industry.

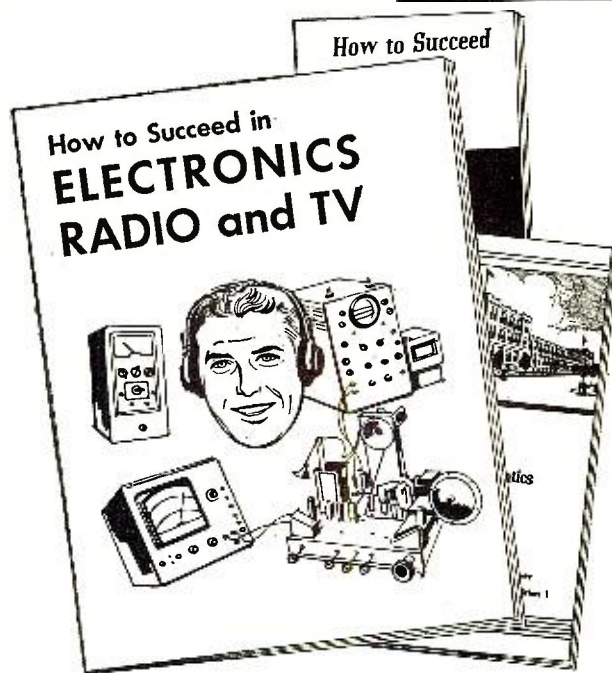

Send the coupon below for your free I. C. S. Career Kit!

- 1 "How to Succeed," 36-page guide to advancement
- 2 Electronics, Radio and TV handbook or the field of your choice
- 3 Sample lesson (Math) to demonstrate I. C. S. Method

For Real Job Security—Get an I. C. S. Diploma!

I. C. S., Scranton 15, Penna.

Accredited Member,  
National Home Study Council

## INTERNATIONAL CORRESPONDENCE SCHOOLS



BOX 91226K, SCRANTON 15, PENNA.

(Partial list of 259 courses)

Without cost or obligation, send me "How to Succeed" and the opportunity booklet about the field BEFORE which I have marked X (plus sample lesson):

### RADIO TELEVISION ELECTRONICS

- General Electronics Tech.
- Industrial Electronics
- Practical Radio-TV Eng'r'g
- Practical Telephony
- Radio-TV Servicing

### BUSINESS

- Cost Accounting
- Managing a Small Business
- Purchasing Agent

### DRAFTING

- Electrical Drafting

### HIGH SCHOOL

- High School Diploma
- Good English
- High School Mathematics

### ELECTRICAL

- Electrical Engineering
- Elec. Engr. Technician
- Elec. Light and Power
- Practical Electrician
- Professional Engineer (Elec.)

### LEADERSHIP

- Industrial Foremanship
- Industrial Supervision
- Personnel-Labor Relations
- Supervision

Name \_\_\_\_\_ Age \_\_\_\_\_ Home Address \_\_\_\_\_  
 City \_\_\_\_\_ Zone \_\_\_\_\_ State \_\_\_\_\_ Working Hours \_\_\_\_\_ A.M. to \_\_\_\_\_ P.M. \_\_\_\_\_  
 Occupation \_\_\_\_\_

Canadian residents send coupon to International Correspondence Schools, Canadian, Ltd., Montreal, Canada. . . . Special tuition rates to members of the U. S. Armed Forces.



# CHANNEL MASTER

## Sells Antenna



### Dave Garroway

TEAMS UP WITH THE

## T-W

ON NETWORK TV

*One of America's  
most persuasive  
TV personalities  
is now telling his  
tremendous audience—  
from coast to coast—  
all about the world's most  
powerful television antenna*

on the **"TODAY"** show  
over the entire **NBC-TV** Network

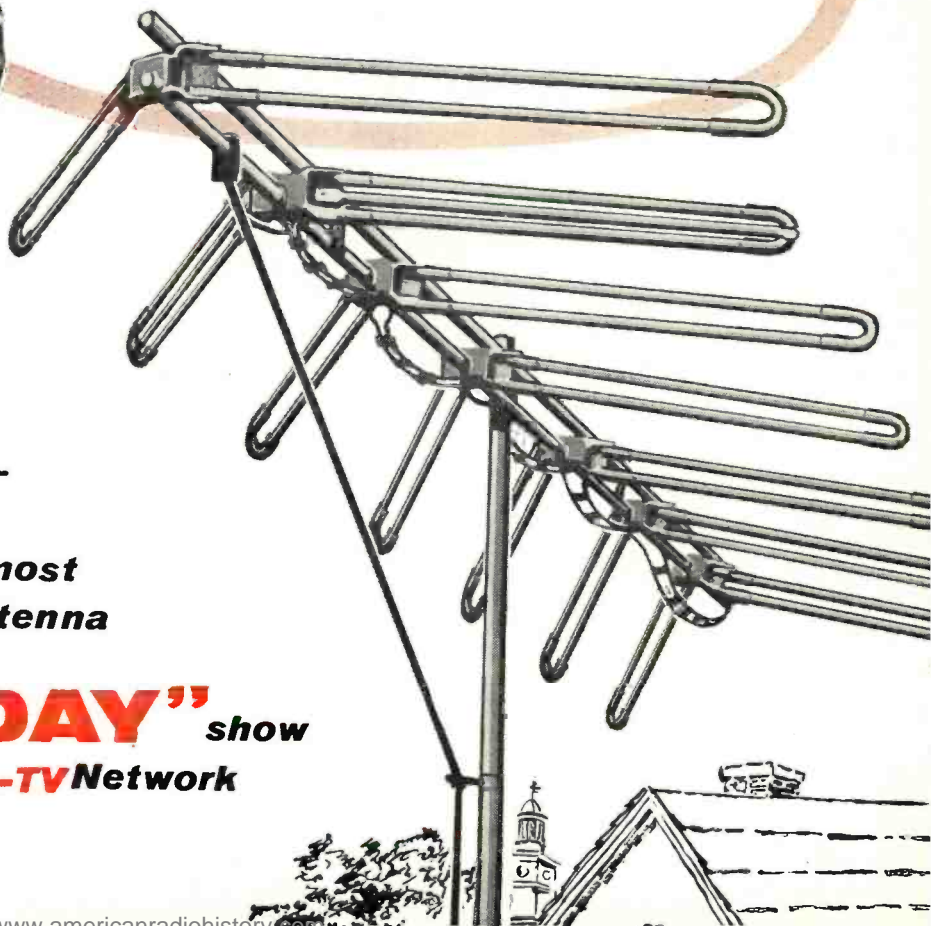



# AD BLITZ

## Replacements

New  
**CHANNEL MASTER** Campaign  
in America's Largest  
Circulation Magazines...

Puts new **LIFE** into your antenna business

**POSTS** your customers on the need  
for antenna replacements

Gives set owners a **LOOK** at better  
reception with the T-W antenna

**GUIDES** prospects to your door  
for an antenna check-up

Helps you **FARM** fertile new  
fields of antenna profits

and now

## **CHANNEL MASTER** TRANSISTOR RADIOS

America's #1  
RADIO Value

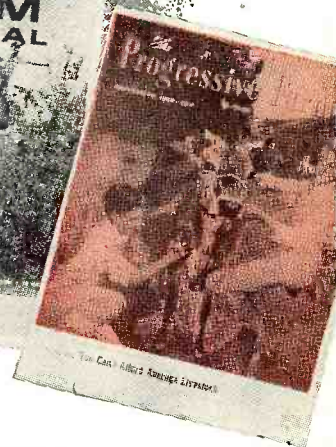
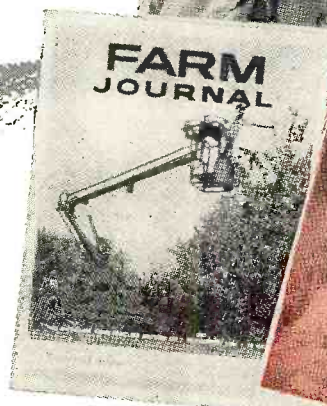
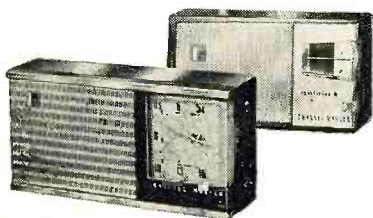

Copyright 1958 Channel Master Corp



# NEW FM & AM STEREO TUNER with built-in STEREO PREAMPLIFIER by

## Pilot



MODEL FA-690

**\$269<sup>50</sup>**

complete with cabinet (as illustrated)

### Tuner features include:

- 1 microvolt FM sensitivity with cascade front end
- independent FM and AM operation for FM-AM stereo
- independent FM and AM tuning meters
- broad/narrow AM bandwidth selector
- FM interstation muting with defeat switch
- multiplex jacks for FM-FM stereo

### Preamp features include:

- stereo volume, tone and balance controls
- inputs with equalization for stereo records, tape heads, recorder and dual microphones
- output for stereo and monaural tape recordings

also **PILOT MODEL FA-680**  
**FM AND AM STEREO TUNER**  
**\$199.50 COMPLETE**

identical to model FA-690,  
less preamp section.

prices slightly higher in West

### PILOT RADIO CORP.

37-10 36th Street  
Long Island City 1, New York

Please send complete details of  
FA-690, FA-680 and other PILOT  
Tuners.

Name \_\_\_\_\_

Address \_\_\_\_\_

City \_\_\_\_\_ Zone \_\_\_\_\_ State \_\_\_\_\_

Electronics manufacturer for over 39 years.



from our Readers

### ARTSNY

To the Editors:

On behalf of myself and the ARTSNY, I wish to thank you for the article on our organization that appeared in the July issue. RADIO & TV NEWS is to be commended as being the first publication to devote two full pages to service industry news. The educational and instructive articles presented in your publication each month, in addition to providing ample space for service industry material, makes it easy to see why you remain a leader in the field.

There is a slight error made in our mailing address in the article. The address was given as Brooklyn 32, New York rather than Brooklyn 37, New York, which is correct. We would appreciate your bringing this to the attention of your readers.

MARTY BOXER

President, ARTSNY

Brooklyn 37, New York

*Thanks to President Boxer for his comments on this publication.—Editors.*

\* \* \*

### THE GREMLIN SENTRY

To the Editors:

Regarding the article on the automatic control switch described on page 49 of your June issue, I have found a few improvements that might be of interest to anyone using the circuit as a capacity relay. I am using the circuit as a burglar alarm at my home after three attempts at entry by unknown parties when we were asleep.

I have connected point A in Fig. 2 along with four screens and I have made the following circuit changes: Change the 1000-ohm resistor between D and E to 13,000 ohms, change R<sub>11</sub> to 2500 ohms, and put a small capacitor of about .005 to .01 μfd. between point A and the screens. This keeps the alarm from going off in damp or rainy weather, and provides an excellently operating circuit.

E. T. MANLEY  
Lucille Ave. TV  
Atlanta, Georgia

*We know that Reader Manley's experiences with the circuit will be of interest to many of our readers who are thinking about trying it out.—Editors.*

\* \* \*

### THERMOCOUPLE-OPERATED SETS

To the Editors:

Our Principals in Eindhoven, Holland have developed a kerosene-lamp-operated radio several years ago and we take pleasure in enclosing a description

of this product. No doubt, Philips in Eindhoven would be pleased to give you any further information you might require.

May we take this opportunity of saying how much we in New Zealand enjoy reading your magazine.

B. D. GARDEN

Philips Electrical Industries of  
New Zealand Limited  
Wellington, New Zealand

To the Editors:

We learned from the "Readers" column of the May, 1958 issue of your magazine that you are interested in learning more about the use of a thermocouple heated by a kerosene lamp to power a radio receiver or other electrical appliances.

We are one of the leading West German manufacturers, not only of television sets and export and home market radio receivers, but also of kerosene lamps, and a special department of our technical development branch here has been working for a long time on the design of such equipment, with the result that we have now gathered considerable experience in this field.

GRAETZ KOMMANDITGESELLSCHAFT  
Altena (Westf.), Germany

*We are still getting letters on the Russian set first mentioned in our May "Letters" column and described more fully in our August issue.—Editors.*

\* \* \*

### MOBILE RADIO SERVICE

To the Editors:

On page 44 of the April issue concerning maintenance of mobile radio, Allan Lytel says, "Repairing mobile radio is more exacting than ordinary radio or television for several reasons. The technician making the required frequency checks on transmitters, by law, is responsible to the FCC for the accuracy of his work." I am a non-electronics man and an altogether too frequent user of TV and radio repair services. Am I to infer from this statement that Mr. Lytel believes that the craftsman's responsibility to me, his customer, for accuracy in his work is lessened because not regulated by law?

G. C. TENOLD, LCDR, USN  
Springfield, Virginia

*We are sorry that Commander Tenold misunderstood the intent of Mr. Lytel's statements. All transmitters are subject to rigid FCC regulations in order to prevent harmful interference. Therefore, the technician has a legal responsibility in addition to his*



ownership of a complete and currently maintained  
**PHOTOFACT SERVICE DATA LIBRARY**  
**SPELLS SUCCESS FOR SERVICE TECHNICIANS**  
*here's actual proof from the men who know!*

"Sams PHOTOFACT is a must in my shop and I place it in highest regard. It is my most reliable service instrument if I may call it that, in the entire shop... makes for much faster servicing..."

—Gordon La Vier  
 La Vier Television  
 Midland, Mich.

"PHOTOFACT cuts our bench work to a minimum. Gives us a chance to realize a profit instead of a loss."

—Lee P. Shumavon  
 Shumavon Service  
 Dorchester, Mass.

"I spend less time in diagnosis and repair of all bench jobs... would hate to think of Service without a good service library such as Sams PHOTOFACT."

—Gerry Brown  
 Brown Electronic Service  
 Ottumwa, Iowa



These are just a few of the hundreds of "Success with PHOTOFACT" letters in our files. From coast-to-coast, Service Technicians everywhere are enjoying the profit-making advantages of a complete PHOTOFACT Library. If you're not yet among them, see your Sams Distributor today, or write to Howard W. Sams for full details.

**NEW! EASY-BUY PLAN**

—the money-saving way to build your complete profit-making PHOTOFACT Library!

NO INTEREST—NO CARRYING CHARGE—AS LITTLE AS \$10 DOWN

**FREE!** VALUABLE STEEL FILE CABINETS FOR REGULAR PHOTOFACT SUBSCRIBERS AND PHOTOFACT LIBRARY PURCHASERS

**GET THE FULL DETAILS**



**HOWARD W. SAMS & CO., INC.**

2203 E. 46th St., Indianapolis 6, Ind.

- Send details on PHOTOFACT Easy-Buy Plan and FREE File Cabinet offer.  
 I'm a Service Technician:  full-time;  part time

My Distributor is: \_\_\_\_\_

Shop name \_\_\_\_\_

Attn. \_\_\_\_\_

Address \_\_\_\_\_

City \_\_\_\_\_ Zone \_\_\_\_\_ State \_\_\_\_\_





Mr. Dealer  
**PHILCO**

offers you a Complete and Universal line of  
**FULL FIDELITY NEEDLES**

- DIAMOND
- SAPPHIRE
- OSMIUM

Now, one complete line of precision-engineered and custom-designed needles to fit every make and model phonograph and High Fidelity receiver. Every Philco needle measures up to the highest quality and life test standards. All Philco needles are individually packaged for absolute protection.

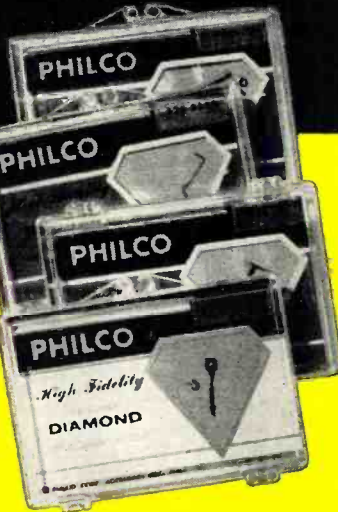

**FREE! NEEDLE COUNTER DISPLAY!**

Ask your Philco Distributor how you can get this sparkling, jewel case needle dispenser free. It's a sales-maker for you right on your counter at the point of sale.



**COMPLETE PHILCO NEEDLE CATALOG**

The most accurate, up-to-date, easy-to-read needle catalog in the industry. Cross references are complete... Illustrations are big... Makes selling easy.

**PHILCO FIDELITAPE**

will bring new customers into your store. Unequalled in uniformity of output. Guaranteed splice free. Extra strength and extra length.

**See Your Philco Distributor Today!**



**World-Wide Distribution**

Service Parts • Power-Packed Batteries • Universal Components • Long-Life Tubes • Heavy-Duty Rotors • Star-Bright 20/20 Picture Tubes • Long-Distance Antennas • Appliance Parts • Laundry Parts • Universal Parts and Accessories



normal responsibility to his customer. This is not to say that the technician who works strictly on receivers for consumers has any less responsibility to his customers in handling these sets, but this responsibility is not regulated by federal law.—Editors.

**INVERTED VERTICAL-SYNC PULSE**

To the Editors:

The article "Facts About Vertical-Sweep Circuits" in your March issue was very interesting. However, when I examined the vertical-sync pulse shown in Fig. 6, and then proceeded to compare it with my TV set. I was amazed to see a somewhat different picture. My vertical-sync pulse appeared at the top of the blanking bar and there was a gap to the left of it.

I am stationed with the Air Force in Tripoli and we are served by one TV station operated by AFRS. Here most set owners must turn their contrast controls completely down or the picture tears and is too dark. Could the position of the sync pulse in the blanking bar of our set be the cause?

M/SGT. JOSEPH GAGNE  
APO 231, New York

*We are afraid that Sgt. Gagne will have to look for some other solution to his problem of poor TV reception in Tripoli. His vertical-sync pulse is quite normal. The trouble is that our illustration is upside-down.—Editors.*

**WORLD'S HIGHEST TRANSMITTER?**

To the Editors:

Your August issue showed a photo of an 8210-ft. Swiss TV transmitter said to be the highest in Europe, and "perhaps the world." I would like to point out that there are three TV transmitters near Albuquerque about 10,800 ft. above sea level on Sandia Crest. They are KOB-TV, KGGM-TV, and KOAT-TV.

PAUL F. BAHR  
Albuquerque, New Mexico

**GENERATOR RANGE EXTENDER**

To the Editors:

Please refer to page 43 of the June, 1958 issue of RADIO & TV NEWS ("Extend Your Signal Generator's Range"). Through a typographical error, your formula for determining the cut-off frequency ( $F_c$ ) is shown the same where either a low-pass filter or high-pass filter is used.

DUANE R. ANDRUSS  
Norman, Oklahoma

Obviously the formula for determining the cut-off frequency of the high-pass filter should not be identical to the one used for the low-pass filter. The printer fumbled twice on this one. We had called for a correction from him to eliminate an ambiguity in the second formula used for high-pass filters. In making this change, he dropped a diagonal line that would have indicated division. Accordingly, the formula for the cut-off frequency of a high-pass filter should be  $F_c = F_\infty / \sqrt{1 - M^2}$ .—Editors.



**'RE MAKING IT EASIER THAN EVER TO BECOME A WELL PAID RADIO-TELEVISION SERVICE TECHNICIAN**

**NOW - Just \$6 Starts You Training in**  
**RADIO-TELEVISION**  
**the SPRAYBERRY "Learn-by-Doing" Way . . .**

**25 BIG, COMPLETE KITS of PARTS & EQUIPMENT**

To help you learn *fast* the practical side of Radio-Television, we send you expertly engineered training kits to test and assemble for interesting, valuable shop-bench practice!

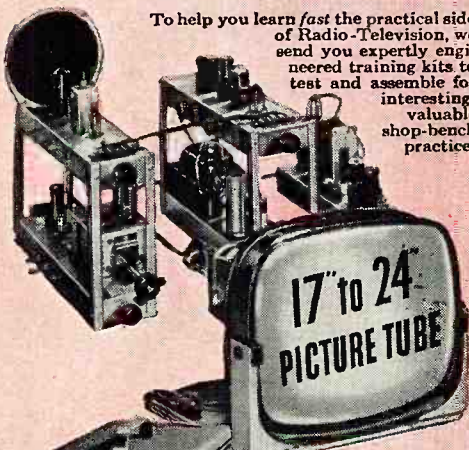

- The new Sprayberry Training Television Receiver, built and tested in 5 sections.

- Now offered . . . this fine modern oscilloscope.

- You build this powerful two-band superheterodyne radio receiver.

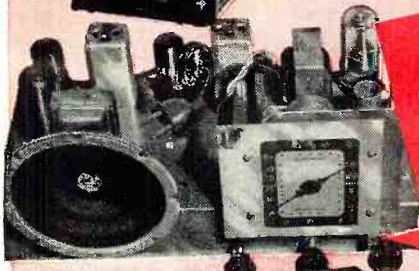

**Big New CATALOG AND Sample Lesson FREE!**



You build the new Sprayberry tester—a complete 18-range Volt-Ohm-Milliammeter test meter.



★ ★ ★ ★ This great industry is begging for trained men . . . to step into good paying jobs or a profitable business of their own! Our new plan opens the doors of Radio-Television wide to every ambitious man who is ready to act at once!

Men by the thousands . . . trained Radio-Television Service Technicians . . . are needed at once! Perhaps you've thought about entering this interesting, top paying field, but lack of ready money held you back. Now—just \$6 enrolls you for America's finest, most up to date home study training in Radio-Television! Unbelievable? No, the explanation is simple! We believe Radio-Television *must* have the additional men it needs as quickly as possible. We are willing to do our part by making Sprayberry Training available for less money down and on easier terms than ever before. This is your big opportunity to get the training you need . . . to step into a fine job or your own Radio-Television Service Business.

**Complete Facts Free—Act Now; Offer Limited**

Only a limited number of students may be accepted on this liberal and unusual basis. We urge you to act at once . . . mail the coupon below and get complete details plus our big new catalog and an actual sample lesson—all free. No obligation . . . no salesman will bother you.

**HOME STUDY TRAINING IN SPARE TIME**

Under world-famous 27-year old Sprayberry Plan, you learn entirely at home in spare time. You keep on with your present job and income. You train as fast or as slowly as you wish. You get valuable kits of parts and equipment for priceless shop-bench practice. And everything you receive, lessons and equipment alike, is all yours to keep.

**LET US PROVE HOW EASILY YOU CAN LEARN!**

Radio-Television needs YOU! And Sprayberry is ready to train you on better, easier terms, than any ambitious man can afford. Just \$6 starts you! Mail coupon today . . . let the facts speak for themselves. You have everything to gain. Let us prove the kind of opportunity that's in store for you!

**SPRAYBERRY Academy of Radio-Television**  
 1512 Jarvis Avenue, Dept. 25-N, Chicago 26, Illinois

**Mail This Coupon Now—No Salesman Will Call**

**Sprayberry Academy of Radio-Television**  
 Dept. 25-N, 1512 W. Jarvis Ave., Chicago 26, Ill.  
 Please rush all information on your ALL-NEW Radio-Television Training Plan. I understand this does not obligate me and that no salesman will call upon me. Include New Catalog and Sample Lesson FREE.

NAME..... Age.....

ADDRESS.....

CITY..... ZONE..... STATE.....



here's your convenient,  
 economical way to buy dependable  
 crystal diodes...  
 at your CBS-Hytron  
 distributor's now

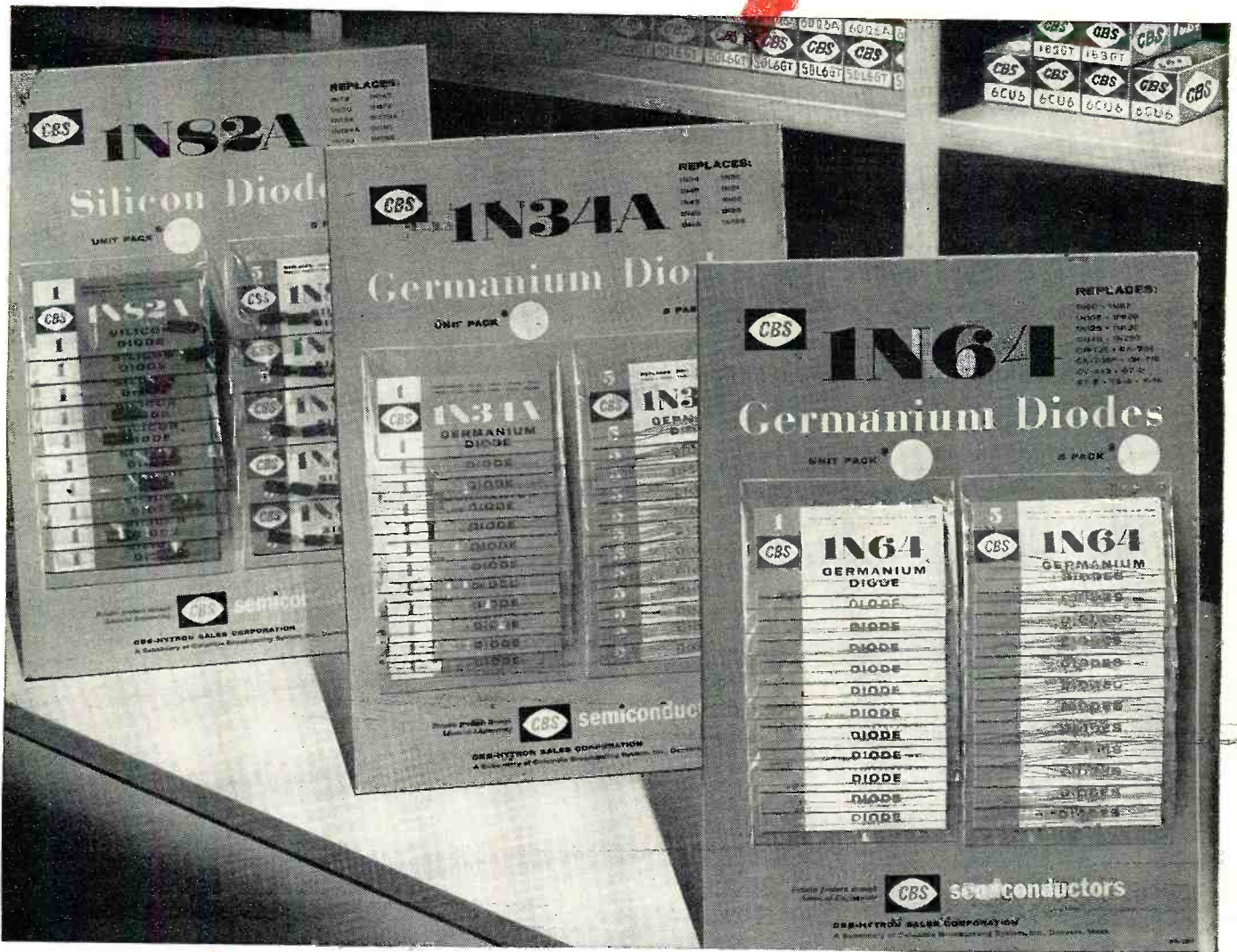

*\* More reliable products through Advanced-Engineering*

**CBS-HYTRON**, Danvers, Massachusetts • A Division of Columbia Broadcasting System, Inc.



# Learn TELEVISION ON RADIO

**Servicing or Communications  
by Practicing at Home in Spare Time**

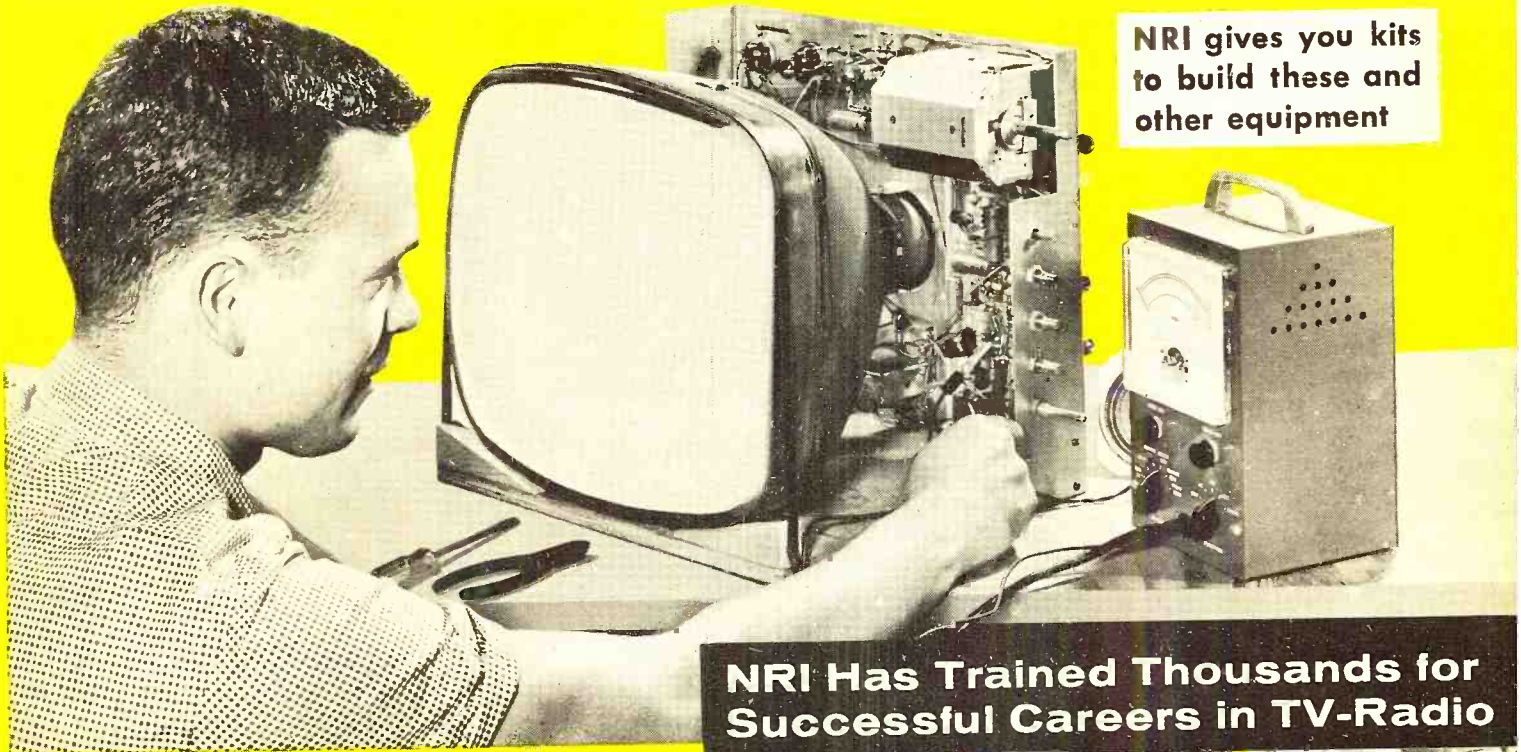

**NRI gives you kits  
to build these and  
other equipment**

## Electronic Technicians Have High Pay, Prestige Jobs

People look up to and depend on the Technician, more than ever before. His opportunities are great, and are increasing. Become a Radio-Television-Electronic Technician. At home, and in your spare time, you can learn to do this interesting, satisfying work—qualify for important pay. A stream of new Electronics products is increasing the job and promotion opportunities for Television-Radio-Electronic Technicians. Right now, a solid, proven field of opportunity for good pay is servicing the millions of Television and Radio sets now in use. The hundreds of Television and Radio stations on the air offer interesting jobs for Operators and Technicians. The military services reward qualified Technicians with higher rank and pay. Police, Aviation, Mobile Two-Way Radio are expanding. To ambitious men everywhere: here is rich promise of fascinating jobs, satisfaction and prestige, increasing personal prosperity.

**Make Extra Money Soon, \$10 to \$15 a Week in Your Spare Time**

NRI students find it practical and profitable to start fixing sets for friends and neighbors a few months after enrolling. Picking up \$10, \$15 and more a week gives substantial extra spending money. Use the Tester built with parts NRI furnishes, to locate and correct Radio-TV receiver troubles. Many who start in spare time, soon build full time Television-Radio sales and service businesses; others enjoy profitable spare time businesses and the security of a source of income to fall back on in case of layoffs, hard times or other changes in regular job. Postage free card will bring you complete facts about the NRI tested way to better pay.

**NRI Has Trained Thousands for  
Successful Careers in TV-Radio**



**Studio Engr., Station KATV**  
"I am now Studio Engineer at Television Station KATV. Before enrolling for the NRI Course, I was held back by limitation of a sixth grade education." **BILLY SANCHEZ**, Pine Bluff, Ark.



**Has All the Work He Can Do**  
"Since finishing NRI Course I have repaired more than 2,000 TV and Radio sets a year. NRI training certainly proved to be a good foundation." **H. R. GORDON**, Milledgeville, Ga.



**Has Good Part Time Business**  
"Quite early in my training I started servicing sets. Now have completely equipped shop. My NRI training is the backbone of my progress." **E. A. BREDA**, Tacoma, Wash.

**Cut Out and Mail Postage-Free Card NOW**

**Sample Lesson and  
Catalog Both FREE**

SEE  
OTHER  
SIDE

**OLDEST & LARGEST HOME STUDY RADIO-TV SCHOOL**  
**National Radio Institute**  
Dept. C D , Washington 16, D.C.

Please send me sample lesson of your Radio-Television Training and Catalog FREE. (No salesman will call.)

Name.....Age.....

Address.....

City.....Zone.....State.....

ACCREDITED MEMBER NATIONAL HOME STUDY COUNCIL



**ACT NOW FIND OUT WHAT  
NRI OFFERS YOU**



**NRI SUPPLIES LEARN-BY-DOING KITS WITHOUT EXTRA CHARGE**  
**Technical Know-How Pays Off in Interesting, Important Work**



**YOU BUILD AC-DC Superhet Receiver**

NRI Servicing Course includes all needed parts. By introducing defects you get actual servicing experience practicing with this modern receiver. Learn-by-doing.

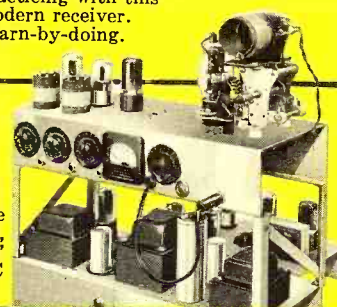

**YOU BUILD This 17 Inch Television Receiver**

As part of your NRI course you can get all components, tubes, including 17" picture tube, to build this latest style Television receiver; get actual practice on TV circuits.

**YOU BUILD Broadcasting Transmitter**

As part of NRI Communications Course you build this low power Transmitter; learn commercial broadcasting operators' methods, procedures. Train for your FCC Commercial Operator's License.

**YOU BUILD Vacuum Tube Voltmeter**

Use it to earn extra cash fixing neighbors' sets; bring to life theory you learn from NRI's easy-to-understand texts.



**For Higher Pay, Better Jobs**  
**Be a TV-Radio-Electronic Technician**



**Servicing Needs More Trained Men**

Portable TV, Hi-Fi, Transistor Radios, Color TV are making new demands for trained Technicians. Good opportunities for spare time earnings or a business of your own.



J. E. Smith, Founder

**Train at Home the NRI Way Famous for Over 40 Years**

NRI is America's oldest and largest home study Television-Radio school. The more than 40 years' experience training men for success, the outstanding record and reputation of this school—benefits you in many ways. NRI methods are tested, proven. Successful graduates are everywhere, from coast to coast, in small towns and big cities. You train in your own home, keep your present job while learning. Many successful NRI men did not finish high school. Let us send you an actual lesson, judge for yourself how easy it is to learn.

**Broadcasting Offers Satisfying Careers**

4000 TV and Radio stations offer interesting positions. Govt. Radio, Aviation, Police, Two-Way Communications are growing fields. Trained Radio-TV Operators have a bright future.



**No Experience Necessary—NRI Sends Many Kits for Practical Experience**

You don't have to know anything about electricity or Radio to understand and succeed with NRI Course. Clearly written, well-illustrated NRI lessons teach TV-Radio-Electronic principles. You get NRI kits for actual experience. All equipment is yours to keep. You learn-by-doing. Mailing the postage-free card may be one of the most important acts of your life. Do it now. Reasonable tuition. Low monthly payments available. Address: NATIONAL RADIO INSTITUTE, Washington 16, D. C.

**NRI Graduates Do Important Work**



**Now Quality Control Chief**  
 "Had no other training in Radio before enrolling, obtained job working on TV amplifiers before finishing course. Now Quality Control Chief." T. R. FAYALORA, Norwich, N. Y.

**NRI Course Easy to Understand**  
 "I opened my own shop before receiving my diploma. I have had to hire extra help. I am independent in my own business." D. P. CRESSEY, Stockton, Cal.

**Works on Color-TV**  
 "NRI changed my whole life. If I had not taken the course, probably would still be a fireman, struggling along. Now Control Supervisor at WRCA-TV." J. F. MELINE, New York, N. Y.

FIRST CLASS  
 Permit No. 20-R  
 (Sec. 34.9, P. L. & R.)  
 Washington, D.C.

**BUSINESS REPLY CARD**

No Postage Stamp Necessary if Mailed in the United States

POSTAGE WILL BE PAID BY

**NATIONAL RADIO INSTITUTE**  
 3939 Wisconsin Avenue  
 Washington 16, D.C.

**SAMPLE LESSON**  
**64-page CATALOG**  
**both FREE**

**SEE**  
**OTHER**  
**SIDE**



*Would you go back to  
the old 12 cylinder Auto?*

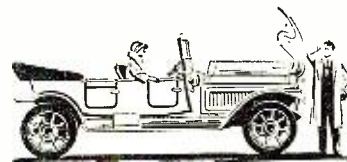

**1915 AUTOMOBILE**

In 1915, the 12-cylinder engine in this automotive wonder was hailed as a great advance because it produced 95 horsepower and only weighed 800 lbs.!



**1959 SPORTS COUPE**

The engine in one of today's new 1959 sports cars delivers 300 horsepower and weighs only 660 lbs.! More than four times as efficient!

Thanks to the miracle of automation, automotive engineers have been able to pack a modern passenger car chassis with power never before thought possible for the size

and weight. Sylvania has been a pioneer in applying automation to the manufacture of TV chassis, bringing more compact, better performing components.

# SYLVANIA S-110 CHASSIS

**the chassis modern manufacturing methods built**

- **Better performance under the extremes of line voltage variation.** The advanced high-voltage design of the SYLVANIA S-110 Chassis adjusts automatically for maximum performance at both high- and low-voltage extremes.
- **Better performance under heat, humidity and freezing conditions.** The rigid specifications of reliability of components in the SYLVANIA S-110 Chassis assures better performance and longer trouble-free life under extremes of humidity and temperature conditions.  
Alkyd Resin used in the high-voltage socket of the S-110 Chassis withstands moisture, dirt and even frost accumulations without any permanent damage, even if these conditions are severe enough to cause arcing. Top performance is assured regardless of warehouse locations.
- **Cuts repair time by 60%.** The orderly arrangement of components in the SYLVANIA S-110 Chassis means that most defects can be located in seconds. Circuit can be traced easily from either side by shadow graph method over your bench light.
- **Designed for maximum strength and minimum weight.** The SYLVANIA S-110 Chassis has all-around girder frame construction which gives it the most favorable strength to weight ratio in the industry. This means easier handling and faster servicing because of its light weight. Yet the S-110 is sturdy and rigid when mounted in the cabinet.

**Advanced printed circuitry and components** of the type used in the performance-proved SYLVANIA S-110 Chassis are required and specified in the design and production of guided missiles and space equipment where absolute reliability and ruggedness are demanded.

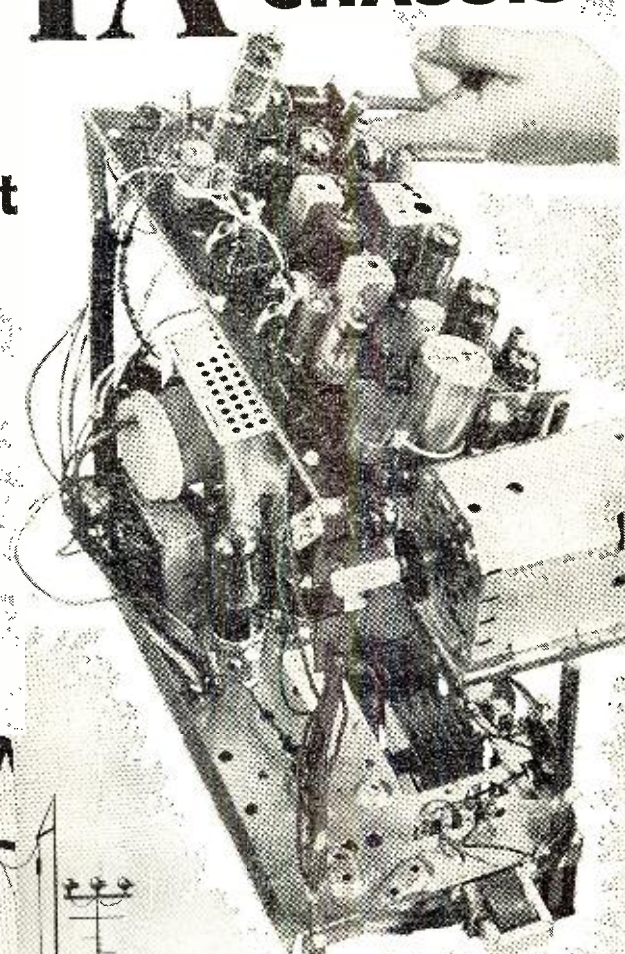

\*Only 10½ lbs. without yoke



**SYLVANIA**  **Pioneers in modern manufacturing methods**



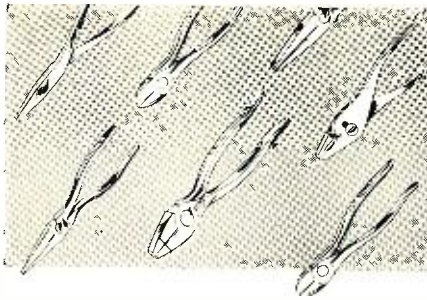

skilled hands reach for...

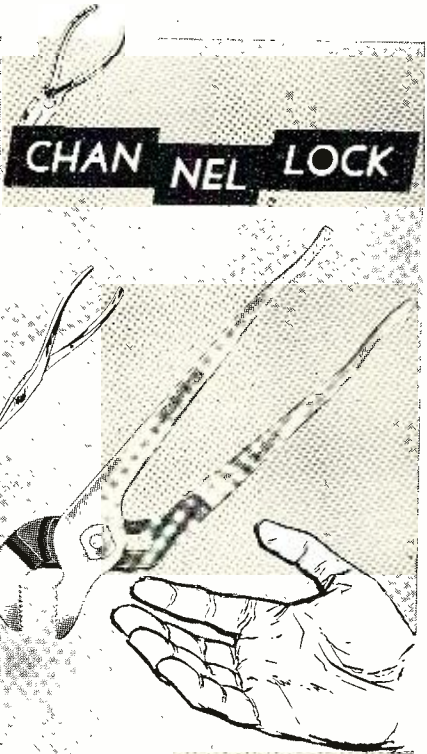

• Skilled mechanics... thousands of them every year... reach for and buy Channellock pliers. Why? Ask them. They'll tell you they like the positive gripping power... the rugged strength... the precision balance... the all round handy "feel" of these quality pliers. And you will too!

CHAMPION DEPARTMENT TOOL COMPANY  
MEADVILLE, PENNSYLVANIA

ASK YOUR TOOL SUPPLIER  
FOR *Genuine*  
CHANNELLOCK PLIERS

# Within the Industry

**ROBERT ERICKSON** has been named executive vice-president of *Beckman Instruments, Inc.*, Fullerton, Calif. He was formerly president and director of the *Heath Company* of Benton Harbor, Mich., a subsidiary of *Daystrom, Inc.*



A long-time executive within the parent organization, Mr. Erickson held the posts of vice-president of *Daystrom, Inc.*, operating vice-president of the firm's instruments division, and was a member of the board of subsidiary companies. Previously he was general plant manager of the home instruments division of *Radio Corporation of America*.

A graduate of Northeastern University with a bachelor of science degree in mechanical engineering, Mr. Erickson also received a master's degree in business administration from the Graduate School of Business, Boston University and undertook additional graduate study at M.I.T., University of Chicago, and Northwestern University.

**WILLIAM S. PARSONS** has been elected president of the Electronic Industry Show Corporation. He is president of *Centralab*, a division of *Globe-Union, Inc.*

Three other well-known industry leaders were also named Show Corporation officers for one-year terms. They are: William H. Thomas, president of *James B. Lansing Sound, Inc.*, elected vice-president; Morris Green, president of *Almo Radio Company*, elected secretary; and Karl W. Jensen, president of *Jensen Industries*, named treasurer.

**J. T. CATALDO** has been named vice-president in charge of sales for *International Rectifier Corporation*.

Mr. Cataldo joined the firm in 1952 as sales manager and assistant general manager. Previously he was project advisor responsible for research and development activities on metallic rectifiers and other products at the Signal Corps Engineering Laboratories, Fort Monmouth, New Jersey.

He holds engineering degrees from Clarkson College of Technology and Brooklyn Polytechnic Institute and has done graduate work at B.P.I. and Rutgers University. Mr. Cataldo is a member of the IRE, has authored more than sixty papers on theory and ap-



plications of metallic rectifiers, and now holds several patents pertinent to this field.

**ELECTRONIC INDUSTRY SHOW CORPORATION** has announced committee appointments for its 1959 show to be held in Chicago.

Committee chairmen are as follows: Mrs. Helen Quam, *Quam-Nichols Co.*, entertainment; Morris Green, *Almo Radio Co.*, housing; Lew W. Howard, *Triad Transformer Corp.*, publicity; Sidney Harman, *Harman-Kardon, Inc.*, educational and program; Ruben Green, *Green Tele-Radio Distributors Inc.*, credentials; William H. Thomas, *James B. Lansing Sound, Inc.*, space and arrangements; and Karl W. Jensen, *Jensen Industries*, finance.

**ROBERT SACKMAN**, vice-president and general manager of *Ampeex Corporation*, has been named to the board of directors of *ORRadio Industries, Inc.*

Mr. Sackman has been with the magnetic recording equipment manufacturing firm since 1953 and was successively manager of the company's Washington, D. C. district office and vice-president and manager of the instrumentation division prior to his present position.

He has had over twenty years of engineering and management experience in the electronics industry including director of a large research and development group in the Department of Defense, specializing in data processing systems, magnetic recording devices, and communication equipment.

Mr. Sackman is a member of the IRE, Armed Forces Communications and Electronics Association, Instrument Society of America, and the American Management Association.



**CBS LABORATORIES**, a division of the *Columbia Broadcasting System, Inc.*, has made arrangements to purchase a tract of over twelve acres adjoining the eleven acre site of its new research center in Stamford, Conn. . . . **EITEL-McCULLOUGH, INC.** has established a new location for the firm's executive and business offices at 301 Industrial Road, San Carlos, Calif. . . . **GYRO ELECTRONICS CO.** has moved to larger quarters at 36 Walker Street, New York City . . . The Chicago offices of **INTERNATIONAL WIRE & CABLE COMPANY** are now situated at 1665 North Milwaukee Avenue . . . Expansion of the ferrite development and manufacturing pro-

RADIO & TV NEWS





RCA INSTITUTES offers you the finest of home study training. The equipment illustrated and text material you get with each course is yours to keep. Practical work with very first lesson. Courses for the beginner and the advanced student. Pay-as-you-learn. You need pay for only one study group at a time.

**Send for this  
FREE Book Now** 

**RESIDENT SCHOOL** courses in New York City offer comprehensive training in Television and Electronics. Day and evening classes start four times each year.

Detailed information on request

**RCA INSTITUTES, Inc.** Home Study Dept. RN-118

A Service of Radio Corporation of America  
350 West Fourth Street, New York 14, N. Y.

Without obligation, send me FREE 52 page CATALOG on Home Study Courses in Radio, Television and Color TV. No salesman will call.

Name.....  
please print

Address.....

City..... Zone..... State.....

Korean Vets! Enter discharge date.....

**CANADIANS** — Take advantage of these same RCA courses at no additional cost. No postage, no customs, no delay. Send coupon to:  
RCA Victor Company, Ltd., 5001 Cote de Liesse Rd., Montreal 9, Quebec  
To save time, paste coupon on postcard.



## This Man is Using an Electronic Crystal Ball

The H. H. Scott advance development team must foresee the future. They must design new products so that they stay current for many years. Hermon Hosmer Scott insists on this as a protection to your investment.

The new 130 Stereo preamp is an example of the way Scott engineers work ahead. Engineering of this brand new product was started when stereo was nothing more than a hobbyist's delight. This allowed time for thorough testing of its many advanced features.

Every H. H. Scott component is designed to defy obsolescence. Careful planning, fine engineering, exceptional quality mean your investment in the new H. H. Scott stereo-preamp . . . or any H. H. Scott product . . . is an investment in a component that will still be up-to-date many years from now.

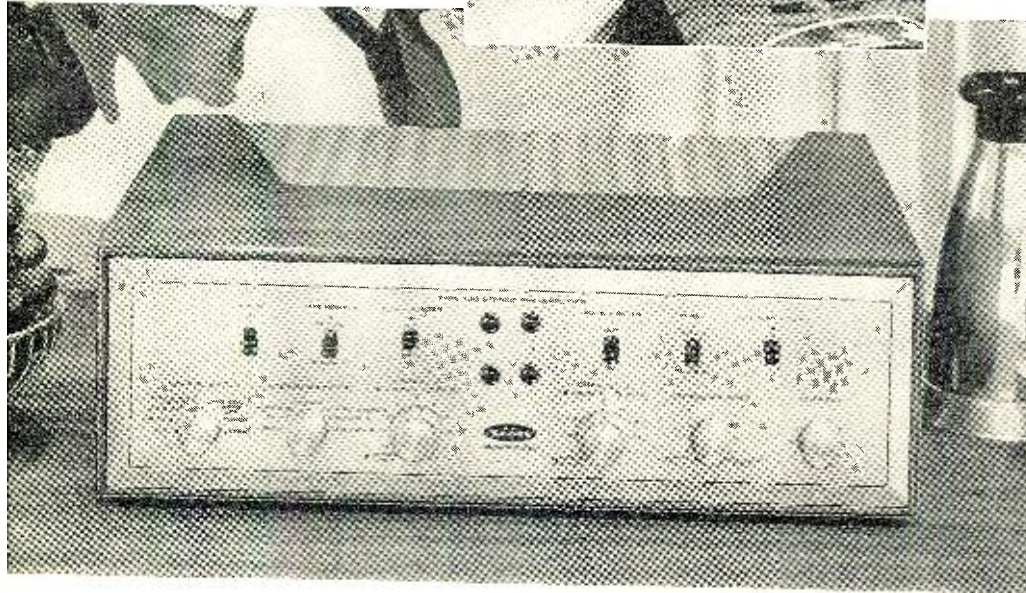

17 reasons why you should buy the

# New H. H. Scott Stereo-Preamp

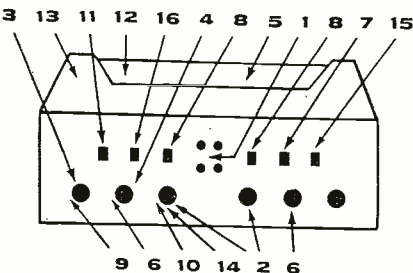

10 Use as an electronic crossover at any time. 11 Two stereo low-level inputs. You can connect both a stereo phono pickup and stereo tape head. 12 Stereo tape recorder inputs and outputs. 13 Provision for operating stereo tape heads without external preamps. 14 Quick-set dot controls allow any member of your family to use equipment. 15 Loudness-volume switch. 16 Stereo tape monitor switch. 17 The exceptional quality of all H. H. Scott components . . . PLUS all the features and specifications long associated with H. H. Scott monaural preamplifiers.

Sensitivity  $1\frac{1}{2}$  millivolts on tape head input, 3 millivolts on phono for full output. Hum level 80 db below full output on high level outputs. Size in accessory case  $15\frac{1}{2}$ w x 5h x  $12\frac{1}{2}$ d. Model 130. Price \$169.95 (\$172.95, West of Rockies).



Write for complete technical specifications and new catalog R-11.



H. H. SCOTT, INC., 111 POWDERMILL RD., MAYNARD, MASS.  
EXPORT: TELESCO INTERNATIONAL CORP., 36 W. 40TH ST., N. Y. C.

gram of the **AIRTRON, INC.** division of *Litton Industries* has begun by the move into a new 100,000-square-foot plant in Morris Plains, N. J. . . . **VO-KAR** has moved to larger quarters at 201 East Catherine Street, Ann Arbor, Michigan.

\* \* \*

**NORMAN L. HARVEY** has been appointed vice-president, engineering, of *CBS-Hytron*, the electronic manufacturing division of *Columbia Broadcasting System, Inc.*



He was formerly manager of special tube operations for *Sylvania Electric Products Inc.* in Williamsport, Pennsylvania. Mr. Harvey joined the firm in 1941 as a research engineer and successive promotions led to his appointment as head of the applied research branch in 1948. In 1950 he was named chief engineer of the radio and TV division and was given his most recent assignment in 1956.

Mr. Harvey is a graduate of Iowa State College and is a fellow of the IRE.

\* \* \*

**ACOUSTICA ASSOCIATES, INC.** has acquired **THE GENERAL ULTRASONICS COMPANY.** The latter will operate as a wholly owned subsidiary of the parent company . . . **KENYON ELECTRONIC SUPPLY CO.** is the new name of *Kenyon Radio Supply Co.* There has been no change in ownership, officers, or management . . . **RCA** has acquired the production plant of the *Applied Science Corporation* of Princeton, N. J. The firm will use the plant as a long-term engineering and production facility for its Astro-Electronic products division . . . A new company, **CERAMICS FOR INDUSTRY CORP. (CFI)**, has been formed. Located at Mineola, New York, the firm manufactures a variety of precision ceramic parts and composites.

\* \* \*

**DANIEL J. WEBSTER** has been named general sales manager of *Tung-Sol Electric Inc.*



Mr. Webster was formerly assistant division manager, commercial equipment division, *Raytheon Manufacturing Company.* He also held executive posts with *Westinghouse* and *Murray Manufacturing Corp.*

In his new position Mr. Webster will direct the firm's field sales activities, including electronic and automotive original equipment, distributor, export, and government sales.

\* \* \*

**ELECTRONIC INDUSTRIES ASSOCIATION** has elected members of the Organization Committee for the fiscal year 1958-59.

Paul V. Galvin, board chairman of *Motorola Inc.* was named chairman. Other members are: Max F. Balcom.

(Continued on page 96)





# FREE

tells how

EFFECTIVE  
JOB FINDING  
SERVICE HELPS CARE  
TRAINEES GET  
BETTER JOBS

HERE'S PROOF  
FCC LICENSES  
ARE OFTEN SECURED  
IN A FEW HOURS  
WITH OUR  
COACHING

EMPLOYERS  
MAKE JOB OFFERS  
LIKE THESE TO OUR  
GRADUATES EVERY  
MONTH



**Act Now!**

## Get your FCC Commercial License —or your money back

The Master Course in Electronics will provide you with the mental tools of the electronics technician and prepare you for a First Class FCC License (Commercial) with a radar endorsement. When you successfully complete the Master Course, if you fail to pass the FCC examination, you will receive a full refund of all tuition payments.

### "License and \$25 raise due to Cleveland Institute training"

"I sat for and passed the FCC exam for my second class license. This meant a promotion to Senior Radio Technician with the Wyoming Highway Department, a \$25 a month raise and a District of my own for all maintenance on the State's two-way communication system. I wish to sincerely thank you and the school for the wonderful radio knowledge you have passed on to me. I highly recommend the school to all acquaintances who might possibly be interested in radio. I am truly convinced I could never have passed the FCC exam without your wonderful help and consideration for anyone wishing to help themselves."

**CHARLES C. ROBERSON**  
Cheyenne, Wyoming

Name and Address	License	Time
John H. Johnson, Boise City, Okla.	1st	20 weeks
Prentice Harrison, Lewes, Delaware	1st	27 weeks
Herbert W. Clay, Phoenix, Arizona	2nd	22 weeks
Thomas J. Bingham, Finley, North Dakota	2nd	9 weeks
William F. Masterson, Key West, Fla.	2nd	24 weeks

### Employers Make Job Offers Like These To Our Graduates Every Month

**Broadcast Station in Illinois:** "We are in need of an engineer with a first class phone license, preferably a student of Cleveland Institute of Radio Electronics; 40 hour week plus 8 hours overtime."

**West Coast Manufacturer:** "We are currently in need of men with electronics training or experience in radar maintenance. We would appreciate your referral of interested persons to us."

Your FCC Ticket is recognized by employers as proof of your technical ability

**Cleveland Institute of Radio Electronics**  
Desk RN-23, 4900 Euclid Bldg., Cleveland 3, Ohio



Please send Free Booklets prepared to help me get ahead in Electronics.

I have had training or experience in Electronics as indicated below:

- Military                       Amateur Radio                       Telephone Company  
 Radio-TV Servicing               Broadcasting                       Other .....  
 Manufacturing                       Home Experimenting

In what kind of work are you now engaged? .....

In what branch of Electronics are you interested? .....

Name..... Age..... Address.....

City..... Zone..... State.....

RN-23



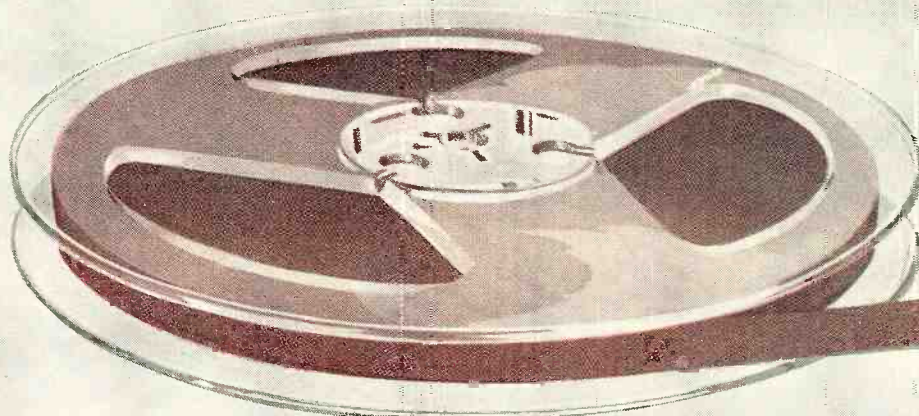

All-purpose "SCOTCH" BRAND Magnetic Tape No. 111. Flawless sound reproduction at low cost. Has acetate backing and exclusive built-in dry lubrication. Recommended for all general recording needs. The international standard of recording industry.



Long-playing "SCOTCH" BRAND Extra Play Magnetic Tape No. 190. 50% more tape on a standard-size reel. Gives you as much recording time as 1½ reels of standard tape—plus brilliant sound, from new high-potency oxide. You enjoy freedom from reel change.

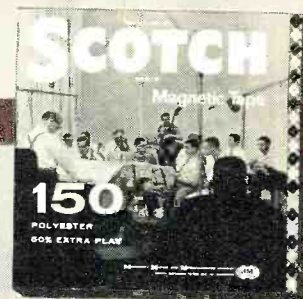

Weather-balanced "SCOTCH" BRAND Extra Play Magnetic Tape No. 150. Made for use in extremes of temperature and humidity. Ideal for all-weather outdoor recording. 50% extra playing time. Super-potent oxide produces uniform response, crisper tones.

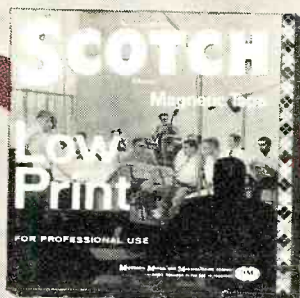

Low Print "SCOTCH" BRAND Magnetic Tape 131. Reduces print-through to a point below noise level on most professional machines... in fact, 8 db lower print level than conventional tapes. Has excellent recording characteristics.

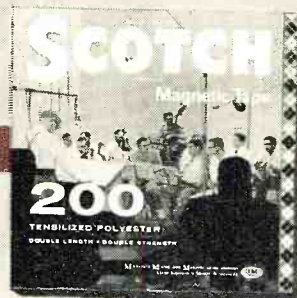

Tensilized 200 "SCOTCH" BRAND Magnetic Tape. The original no-break, no-stretch tape that plays twice as long... double strength, and double length: You get as much recording time as with two reels of conventional tape.



New Quick-Load Cartridge! Fits new quick-load cartridge machines. Records both monaural and stereo sound. Eliminates threading, rewinding, spare reels. Convenient, pocket size is ideal for easy storage in home tape libraries.

## Send coupon for full details

If your dealer does not stock these new items, send for complete information.

3M Company, Dept. A-6789  
St. Paul 6, Minn.

Rush me detailed information on:

- "SCOTCH" BRAND Quick-Load Tape Cartridge
- "SCOTCH" BRAND Magnetic Tapes
- "SCOTCH" BRAND Plastic Storage Box
- "SCOTCH" BRAND Splicing Tape

Name \_\_\_\_\_

Address \_\_\_\_\_

City \_\_\_\_\_ Zone \_\_\_\_\_ State \_\_\_\_\_

My Dealer's Name \_\_\_\_\_

**MINNESOTA  
MINING AND  
MANUFACTURING COMPANY**



... WHERE RESEARCH IS THE KEY TO TOMORROW



# There's something for everyone in the great new "SCOTCH" BRAND line!

## NEW Package Designs!

Fresh, bright, colorful new designs for instant identification of "SCOTCH" BRAND Magnetic Tapes! Lock for your favorite in its brand new package!

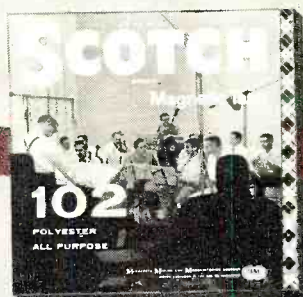
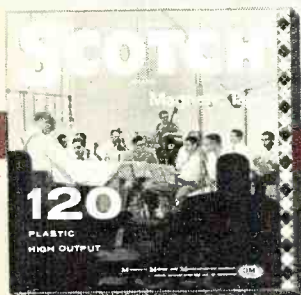

High-fidelity "SCOTCH" BRAND High Output Magnetic Tape No. 120. With this tape you enjoy music with greater dynamic range, freedom from distortion on signal peaks and 133% more output for brilliant sound reproduction. A must for all high-fidelity fans.

Super-strong "SCOTCH" BRAND Magnetic Tapes Nos. 102 (formerly 111 AM) and 122 (formerly 120 AM). Coated on weather-balanced 1½ mil polyester backing, these are the toughest tapes made. Their superb recording characteristics are similar to Nos. 111 and 120. Ideal for long term storage of your valuable, irreplaceable recordings.



New Plastic Storage Box! Tight-sealed, moisture protected storage container of unbreakable plastic. Maintains ideal storage conditions for your valuable tape recordings. One of the most practical accessory items you can buy!



"SCOTCH" BRAND Splicing Tape has a special white thermosetting adhesive that is guaranteed not to ooze. Makes splices that actually strengthen with age. Available in handy blister-pac display card at your tape dealer's now.



Look for them all at your dealer's  
"SCOTCH" BRAND TAPE CENTER!

You can't miss the inviting new "Plaid Pole" with its bright plaid design, convenient banks of "SCOTCH" BRAND Magnetic Tapes and, new Quick-Load Cartridges. Everything you need for high-quality tape recording is yours in the "Tape Center."

REG. U. S. PAT. OFF.

# SCOTCH BRAND Magnetic Tapes

"SCOTCH" and the plaid design are registered trademarks of 3M Co., St. Paul 6, Minn. Export: 99 Park Ave., New York 16, Canada: London, Ontario.



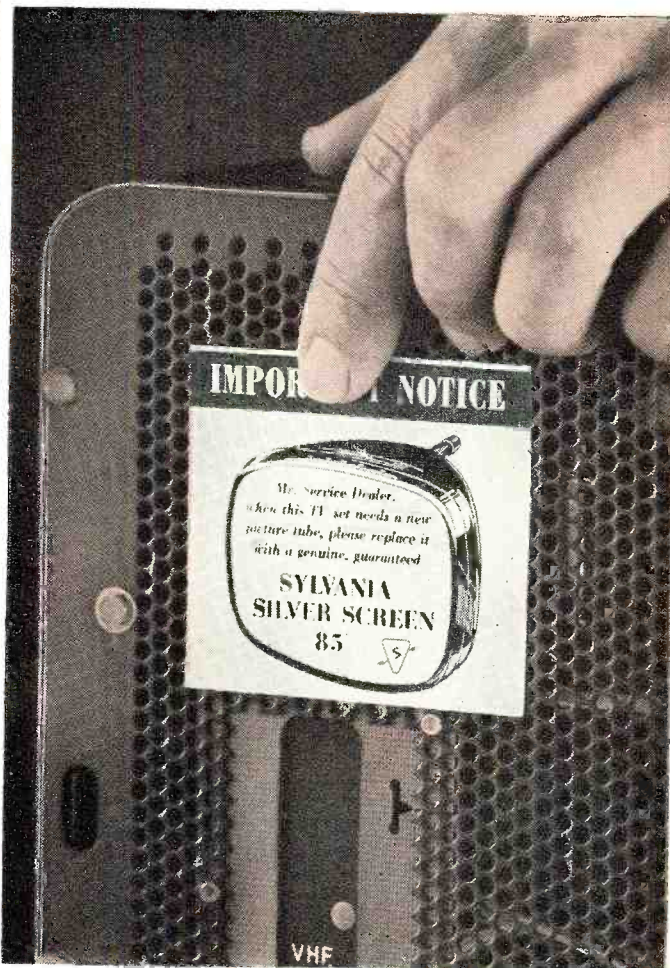
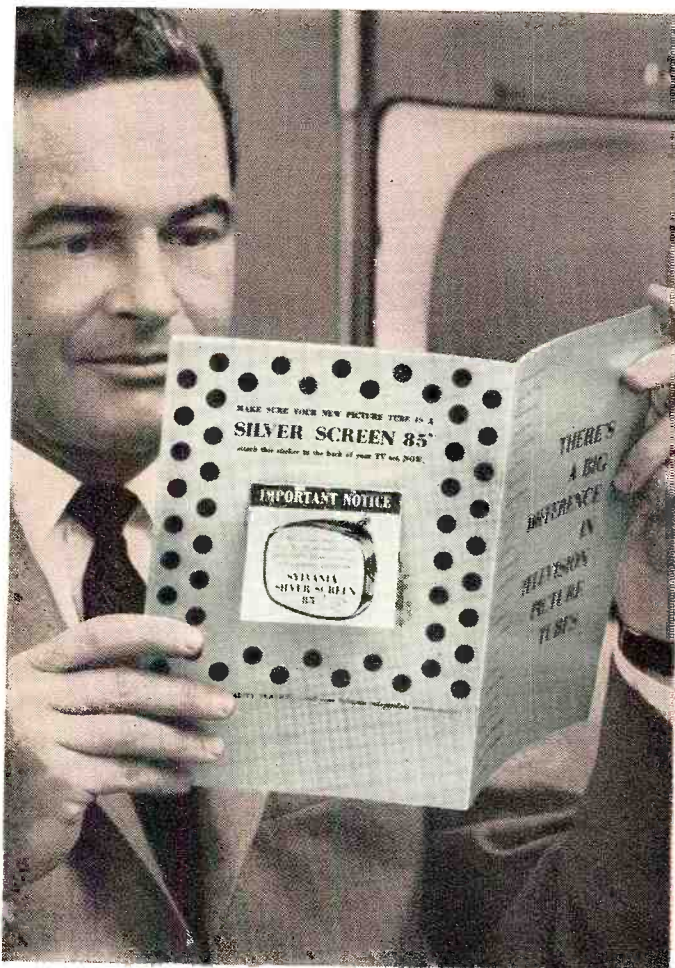

This label is your signal that a value-minded customer has been sold up to Silver Screen 85.

New consumer booklet from Sylvania helps you

## SELL UP TO SILVER SCREEN 85

Free booklet tells the story of Silver Screen 85's superior performance—  
detachable sticker lets the consumer tell you he's *presold* on Silver Screen 85

Leave a copy on every service call or make a complete mailing to your customers and prospects. Either way, Sylvania's new booklet, "There's A Big Difference In Television Picture Tubes," can help you sell up to more profits through more Silver Screen 85 sales.

In layman's language, this booklet details the difference between Silver Screen 85 and cut-rate off-brand tubes. It's chock-full of facts as they were revealed in Sylvania's recent test of a

nationwide sample. What's more, there's a handy sticker on the back of each booklet for the customer to attach to the back of his TV set. This is your signal that he's *presold up* to Silver Screen 85.

Get on the bandwagon. Let Sylvania help you sell up. Give each of your customers and prospects a copy of this new booklet. It's available free, complete with mailing envelope, from your Sylvania Distributor. Or write for a sample copy.



Bill Shipley's your No. 1 Salesman in the industry's biggest consumer advertising campaign.



# SYLVANIA

SYLVANIA ELECTRIC PRODUCTS INC.  
1740 Broadway, New York 19, N. Y.  
In Canada: Sylvania Electric (Canada) Ltd.  
University Tower Bldg., Montreal

LIGHTING • TELEVISION • RADIO • ELECTRONICS • PHOTOGRAPHY • ATOMIC ENERGY • CHEMISTRY-METALLURGY



# RADIO SHACK SMASHES PRE-RECORDED STEREO TAPE MARKET WIDE OPEN



ENTIRE FAMOUS  LIBRARY  
PRICED BELOW DEALER COST!

Radio stations! Dealers! Schools! Audiophiles! For quick cash, Radio Shack bought this famous company's fabulous in-line Stereo tapes in carload quantities fantastically off price! Now, enjoy the ultimate in stereo (acclaimed by "High Fidelity," "Hi-Fi Music Review," "Audio," etc.) for little more than the cost of top quality raw tape! Standard stacked stereo 7 1/2 ips tapes. Can also be played monaurally or on full-track heads. Even if you're just now planning to convert, rush your mail order while they last! Ship. wt. app. 1 3/4 lb. per reel.

**A NEVER-BEFORE, NEVER-AGAIN OPPORTUNITY! CLASSICAL! SEMI-CLASSICAL! POPULAR!**

REG. \$7.95 & \$8.95 **\$4.99**

**MVS2-16 DREAMLAND** U. S. A. Hal Mooney & Orch. California Here I Come, Beautiful Ohio, Back Bay, When It's Sleepy Time Down South, Manhattan, Dreamland U. S. A. Reg. \$7.95.

**MVS2-14 FLORIAN ZABACH.** Till the End of Time, The Very Thought of You, I Married an Angel, Ain't Misbehavin', Tenderly, Lovely to Look At, Anniversary Waltz. Reg. \$7.95.

**MVS2-18 PATTI PAGE.** Falling in Love With Love, The Boy Next Door, What'll I Do, Memories, Till We Meet Again, Remember. Reg. \$7.95.

**MVS2-19 THE FEATHERY FEELING.** David Carroll Orch. Fascination, Swingin' Sweethearts, A Beautiful Lady in Blue, Dinner at Eight, Ski Song, I Love You Truly, Treadmill. Reg. \$7.95.

**M52-21 JIMMY PALMER ORCH.** Three sparkling stereo hi-fi medleys of all-time favorite show and pop tunes arranged especially for dancing. Reg. \$8.95.

**MVS2-22 BILLY ECKSTINE.** Boulevard of Broken Dreams, You Don't Know What Love Is, Babalu, Stella by Starlight, Where Have You Been, Zing! Went the Strings of My Heart. Reg. \$7.95.

**MVS2-24 GRIFF WILLIAMS SOCIETY ORCH.** Let's Fly Away, Dance Medley, The Petite Waltz, I Know That You Know, When Day Is Done, The Girl Friend. Reg. \$7.95.

**MVS2-27 RALPH MARTERIE ORCH.** Happy Ballerina, I'll See You in My Dreams, Mambocerto, Concerto, Eternally, Rhumba Concerto, Lonely Winter, Dancing Trumpet. Reg. \$7.95.

**MVS5-41 JOHANN STRAUSS.** Voices of Spring, Champagne Polka, Roses from the South, Minneapolis Sym. Orch., Antal Dorati cond. Reg. \$7.95.

**M55-48 SUPPE OVERTURES.** Light Cavalry, Jolly Robbers, The Beautiful Galatea, The Halle Orch., John Barbirolli cond. Reg. \$8.95.

**MVS5-25 VARIATIONS ON A THEME BY HAYDN (BRAHMS).** London Sym. Orch., Dorati cond. Reg. \$7.95.

**M52-13 STEREO DANCE PARTY** Ralph Marterie Orch. All-time song

hits specially arranged for dancing and brilliantly alive in stereo. Reg. \$8.95.

**M52-17 SARAH VAUGHAN SINGS GEORGE GERSHWIN.** Gershwin's most beloved song hits recorded in sparkling stereo by a great interpreter. Reg. \$8.95.

REG. \$12.95 **\$6.99**

**MDS2-1 SARAH VAUGHAN.** Great Songs From Hit Shows. A Tree in the Park, Little Girl Blue, Comes Love, But Not For Me, Lucky in Love, Autumn in New York, I Never Entered My Mind, If This Isn't Love, September Song, My Ship. Reg. \$12.95.

**MDS2-2 HAVANA IN HI-FI** Richard Hayman & Orch. Rhapsodero, My Hopeful Heart, Cordoba, Tropical Merengue, Maria-La-O, Caminito, La Comparsa, I Won't Stand in Your Way, Love and the World Loves With You. Reg. \$12.95.

**MDS2-4 MUSIC FROM THE BIG TOP.** Carl Stevens & Circus Band. William Tell Gallop, Mosquito Parade, The Thunderer, Asleep in the Deep, El Capitan, Dance of the Snake Charmer, Colonel Bogey, Muskrat Ramble, Fairest of the Fair, Bombasto, Invincible Eagle, Anchors Aweigh, Marines' Hymn, U.S. Air Force March, Semper Paratus, West Point March. Reg. \$12.95.

**MDS2-7 AMERICA'S MOST DANCEABLE MUSIC.** Griff Williams Orch. The Lady Is a Tramp, I Could Write

a Book, Tales From the Vienna Woods, Medley, When Spring Is in the Air, La Golondrina, Why?, What Is There to Say, Thou Swell, Artist's Life, Medley. Reg. \$12.95.

**MDS2-9 BILLY ECKSTINE, SARAH VAUGHAN.** Alexander's Ragtime Band, Isn't This a Lovely Day, I've Got My Love to Keep Me Warm, All of My Life, Cheek to Cheek, You're Just in Love, Remember, Always, Easter Parade. Reg. \$12.95.

**MDS2-35 SONGS FROM GREAT FILMS.** Herman Clebanoff Strings. Song From Moulin Rouge, Gigi, Wild Is the Wind, Sayonara, Song of Rain-tree County, Farewell to Arms Theme, Very Precious Love, Terry's Theme, Three Coins in the Fountain, Tammy, Moonglow & Theme From Picnic, Friendly Persuasion. Reg. \$12.95.

**MDS5-1 HARRY JANOS SUITE (KODALY).** Antal Dorati & Minneapolis Sym. Orch., in astounding hi-fi. Reg. \$12.95.

**MDS2-11 BRASS IN HI-FI.** Pete Rugolo Orch. My Mother's Eyes, All the Things You Are, God Child, Brass at Work, Temptation, A Rose For David, Everything Happens to Me, Salute, Song For Tuba. Reg. \$12.95.

REG. \$9.95 & \$11.95 **\$5.99**

**MB55-7 POLEVETZIAN DANCES (BOR-**

**ODIN) & CAPPRICCIO ITALIEN (TCHAIKOVSKY).** London & Minneapolis Sym. Orch., Antal Dorati cond. Reg. \$10.95.

**MC55-27 GRIEG'S PIANO CONCERTO.** Richard Farrell & Halle Orch., George Weldon cond. Reg. \$11.95.

**MC55-50 BOLERO (RAVEL), L'ARLES- SIENNE SUITE NO. 2 (BIZET)** Detroit Sym., Paul Paray cond. Reg. \$11.95.

**MC55-15 GAITE PARISIENNE (OFFENBACH).** Minneapolis Sym., Dorati cond. Reg. \$11.95.

**MB55-19 IBERIA (ALBENIZ).** Minneapolis Sym. Orch., Dorati cond. Reg. \$10.95.

REG. \$6.95 **\$3.99**

**MW55-29 MARCH TIME.** Fred Fennel Eastman Sym. Wind Ensemble. Bugles & Drums, Illinois March, Children's March, The Interlochen Bowl, Onward-Upward, Boy Scouts of America. Reg. \$6.95.

REG. \$14.95 **\$7.99**

**MF55-10 VIOLIN CONCERTO (BARTOK).** Yehudi Menuhin & Minneapolis Sym. Orch., Antal Dorati cond. Reg. \$14.95.

REG. \$17.95 **\$8.99**

**MJS5-17 SYMPHONY NO. 2 IN E MINOR (RACHMANINOFF).** Detroit Sym. Orch., Paray cond. Reg. \$17.95.



**FREE!**

Fabulous new  
1959 232-page  
catalog.

Latest in stereo hi-fi, ham radio, electronics, parts, records, etc.



**RADIO SHACK**  
730 Commonwealth Ave.  
Boston 17, Mass.

Mail orders to Dept. 11F

Check or money order enclosed. Please send following stereo tapes (please print order numbers clearly):

Send free 232-page 1959 catalog.

NAME \_\_\_\_\_

ADDRESS \_\_\_\_\_

CITY \_\_\_\_\_ ZONE \_\_\_\_\_ STATE \_\_\_\_\_

**RADIO SHACK CORP.**

**Stores:**

730 Commonwealth Ave., Boston 17 and  
167 Washington St., Boston 8, Mass. and  
230-240 Crown St., New Haven 10, Conn.



# 5 new G-E "Stereo Classic" components

## 1 New "Golden Classic" stereo-magnetic cartridge

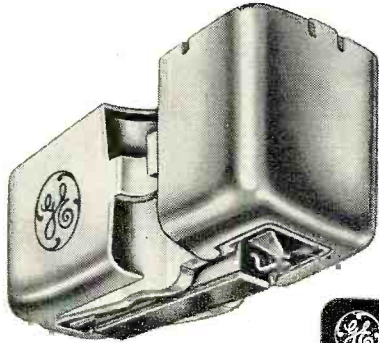

- Plays both stereo and monaural records • Full frequency response, 20 through 20,000 cycles • "Floating armature" design increases compliance and reduces record wear. Effective mass of stylus approximately 2 milligrams • High compliance in all directions—lateral compliance  $4 \times 10^{-6}$  cm/dyne; vertical compliance  $2.5 \times 10^{-6}$  cm/dyne • Recommended tracking force with professional-type tone arm 2 to 4 grams • Consistently high separation between channel signals. (Specifications for Model GC-5.)

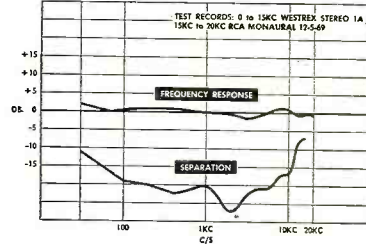

Model GC-7 (shown left) with .7 mil diamond stylus.....\$23.95\*  
 Model GC-5 (for professional-type tone arms) with .5 mil diamond stylus.....\$26.95\*  
 Model CL-7 with .7 mil synthetic sapphire stylus.....\$16.95\*

- A professional-type arm designed for use with G-E stereo cartridges as an integrated pickup system
- Features unusual two-step adjustment for precise setting of tracking force from 0 to 6 grams
- Lightweight brushed aluminum construction minimizes inertia; statically balanced for minimum friction, reduced stylus and record wear. \$29.95\*

## 2 New "Stereo Classic" tone arm



## 3 New 40-watt "Stereo Classic" amplifier

- Full, balanced 20-watt power output from each channel at same time
- Flat response within 0.5 db from 20 to 20,000 cycles
- Outstanding sensitivity, extremely low hum and noise level
- Integrated single-knob controls for easy simultaneous adjustments of both stereo channels. Contour control provides smooth, gradual bass boost without apparent change in sound intensity. \$169.95\*

## 4 New FM-AM tuner

- Receives weak signals with unusually low distortion, hum and noise level
- No audible drift
- Visual meter provides center channel tuning of FM and maximum AM signal
- RF amplifier stage in both FM and AM increases sensitivity
- FM multiplex jack for stereo adaptor. \$129.95\*

## 5 New "Stereo Classic" speaker systems

- New Extended Bass system produces 4 times the undistorted power at low frequencies (+6db) as standard 12" speakers in the same enclosure
- Amplifiers of only moderate power needed because efficiency is 2 to 4 times higher than comparable systems
- New direct radiator tweeter provides unusually smooth response and exceptional sound dispersion at higher frequencies without unnatural tone coloration.

Model LK-12: Separate woofer-tweeter kit with crossover network ..... \$89.95\*

Model LC-12: Same basic woofer with tweeter coaxially mounted in front and crossover network . . . \$89.95\*

Model LH-12: Separate woofer, tweeter and crossover factory installed in 2 cu. ft. wood enclosure . . \$129.95\*



Hear G-E "Stereo Classic" components at your dealer. For more information and nearest dealer's name, write General Electric Company, Dept. RT118, W. Genesee St., Auburn, N. Y.  
 \*Mfr's. suggested resale prices.

GENERAL  ELECTRIC





**Latest Information  
on the Electronic Industry**

*Spot News*

By RADIO & TV NEWS'  
WASHINGTON EDITOR

**SATELLITES TO AID FUTURE WEATHER MEN**—Electronic forecasting using satellites will soon be employed to obtain and transmit data concerning cloud cover, storm patterns, radiation values, meteorological dust concentrations, ozone layers, and other space information of value in weather research, according to the Office of Meteorological Research in the Weather Bureau in Washington. Satellites are expected to include television devices to view the earth from hundreds of miles up as they orbit the earth many times a day. Forecasters who now make predictions of the weather up to five days ahead have long wanted, for example, a continuous and enlarged "moon's-eye" view of the ever-changing storm patterns around the entire globe, and especially over those marine and polar areas where few observations are available.

**RADAR NOW KEY STORM FORECAST TOOL**—Meteorologists are today enthusiastic about the bright prospects raised by new radar equipment in bringing new knowledge of precipitation processes and local variation in heavy rainstorms. Later this year the Weather Bureau will begin the installation of newly designed weather search radar equipment that will give severe-storm forecasters more of the detailed three-dimensional data they need to follow rapidly changing developments in advancing rain areas, squall lines, thunderstorms, hailstorms, and tornados. A network of 31 search radar stations will be established to warn of severe storms and alert the public to possible flash floods.

**CAA AND AIR DEFENSE TO USE JOINTLY MILITARY RADAR FOR AIR TRAFFIC**—An extensive program for the joint use of civil and military radar in air-traffic control has been completed by the Civil Aeronautics Administration and the U.S. Air Force Air Defense Command and is expected to be put into effect some time this Fall. Thirty-one new high-power, long-range radars will be used for control operation. This joint use program represents a savings of many millions of dollars in equipment, installation, and recurring maintenance costs. Serious radar interference problems have been avoided and improved coordination developed in the missions of these agencies through their joint actions in the program.

**NEARLY \$1-MILLION OK'ED FOR NEW TV TRANSLATORS**—The translator—a blueprint plan only a short while ago—has blossomed into a million-dollar operation; that much has been and will be budgeted for 169 translators that have been and will be installed in 100 areas covering 140 communities. As of late summer, there were 125 translators in operation. Average costs for a 1-channel translator is about \$6000; 2-channel units are priced at about \$13,000; 3-channel systems cost about \$20,000.

**TV BROADCAST INCOME REACHES NEW PEAK**—Total television broadcast revenues during 1957 were \$943.2 million or 5.2 per-cent above the 1956 figures. Industry profits (before Federal Income Tax) amounted to \$160 million. The foregoing income covered u.h.f. and v.h.f. income, however, the "U" stations suffered a loss, their revenue (for 88 stations) dropped from \$32.5 million to \$26.7 million for a loss of \$3.5 million, as compared to a 1956 loss of \$1.9 million when 95 stations were on the air.

**RADAR TO SHINE IN \$175-MILLION AIR-TRAFFIC CONTROL PROGRAM**—The fiscal 1959 air-navigation facility program, based on an appropriation of \$175 million—the largest of its kind in the history of the CAA—places great emphasis on the use of radar for all types of traffic control. Plans call for a total of 19 airport surveillance radars (ASR) to be installed at CAA control towers and 10 of the towers to be equipped with airport surface detection equipment (ASDE).

**NAVY AWARDS MILLION-DOLLAR RADIO CONTRACTS TO INDUSTRY**—The Navy has announced award of contracts totalling \$22 million to Westinghouse for the production of ship-board radio transmitters and radars. One contract, worth more than \$8 million, calls for the manufacture of an advanced air-search radar for cruisers, aircraft carriers, and other surface ships. Another contract, for more than \$12 million, covers transmitters for surface and submarine service.

—30—





THE LIFE  
OF A  
FIELD ENGINEER

George Tally is one of the Hughes Field Engineers assigned to an Air Force base in California. He is highly respected, for, to the personnel of this base, he represents all the technical knowledge of the Hughes Aircraft Company.

Hughes Field Engineers are responsible for all phases of support for the maximum field performance of Hughes electronic armament controls systems and guided missiles.

The background and experience they gain by such activities provide an over-all systems knowledge which is unsurpassed. Their training assures them an unlimited future in the field of electronics.

IF YOU ARE AN ENGINEER OR PHYSICIST interested in this stimulating and rewarding type of work, send a brief outline of your experience to the address below.

*The West's leader in advanced electronics*

**HUGHES**

RESEARCH & DEVELOPMENT LABORATORIES *Scientific and Engineering Staff, Hughes Aircraft Co., Culver City 16, California*



# STEREO STEREO AND MONAURAL

the  
experts  
say...  
in HI-FI  
the best buys are

## EICO®

World-famous  
EICO advantages  
guarantee your complete satisfaction:

- Advanced engineering • Finest quality components
- "Beginner-Tested," easy step-by-step instructions
- LIFETIME service & calibration guarantee
- IN STOCK — Compare, then take home any EICO equipment—right "off the shelf"—from 1900 neighborhood EICO dealers.



Stereo Preamplifier HF85



FM Tuner HFT90



Stereo  
Amplifier-Preamp  
HF81



Bookshelf  
Speaker System  
HFS1



Monaural Integrated Amplifiers:  
50, 30, 20, and 12-Watt  
(use 2 for Stereo)



Speaker System HFS2  
36" H x 15 1/4" W x 11 1/2" D



Monaural Power Amplifiers:  
60, 50, 35, 30, 22 and 14-Watt  
(use 2 for Stereo)



Monaural Preamplifiers:  
HF65, HF61  
(stack 2 for Stereo)



Over 1 MILLION EICO instruments in use throughout the world.

### NEW STEREOPHONIC EQUIPMENT

**HF85: Stereo Dual Preamplifier** is a complete stereo control system in "low silhouette" design adaptable to any type of installation. Selects, preamplifies, controls any stereo source—tape, discs, broadcasts. Superb-variable crossover, feedback tone controls driven by feedback amplifier pairs in each channel. Distortion borders on unmeasurable even at high output levels. Separate lo-level input in each channel for mag. phono, tape head, mike. Separate hi-level inputs for AM & FM tuners & FM Multiplex. One each auxiliary A & B input in each channel. Independent level, bass & treble controls in each channel may be operated together with built-in clutch. Switched-in loudness compensator. Function Selector permits hearing each stereo channel individually, and reversing them; also use of unit for stereo or monophonic play. Full-wave rectifier tube power supply. 5-12AX7/ECC83, 1-6X4. Works with any 2 high-quality power amplifiers such as EICO, HF14, HF22, HF30, HF35, HF50, HF60. Kit \$39.95. Wired \$64.95. Includes cover.

**HF81: Stereo Dual Amplifier-Preamplifier** selects, amplifies & controls any stereo source—tape, discs, broadcasts—and feeds it thru self-contained dual 14W amplifiers to a pair of speakers. Monophonically: 28 watts for your speakers; complete stereo preamp. Ganged level controls, separate focus (balance) control, independent full-range bass & treble controls for each channel. Identical Williamson-type, push-pull EL84 power amplifiers, excellent output transformers. "Service Selector" switch permits one preamp-control section to drive the internal power amplifiers while other preamp-control section is left free to drive your existing external amplifier. Kit \$69.95. Wired \$109.95. Incl. cover.

**MONAURAL PREAMPLIFIERS** (stack 2 for Stereo)  
**NEW HF65:** superb new design. Inputs for tape head, microphone, mag-phono cartridge & hi-level sources. IM distortion 0.04% @ 2V out. Attractive "low silhouette" design. HF65A Kit \$29.95. Wired \$44.95. HF65 (with power supply) Kit \$33.95. Wired \$49.95.

**HF61:** "Rivals the most expensive preamps" — Marshall, AUDIOCRAFT. HF61A Kit \$24.95. Wired \$37.95. HF61 (with power supply) Kit \$29.95. Wired \$44.95.

### MONAURAL POWER AMPLIFIERS (use 2 for STEREO)

**HF60: 60-Watt Ultra Linear Power Amplifier** with Acro TO-330 Output Xfmr.; "One of the best-performing amplifiers extant; an excellent buy." AUDIOCRAFT Kit Report. Kit \$72.95. Wired \$99.95. Cover E-2 \$4.50.

**HF50: 50-Watt Ultra Linear Power Amplifier** with extremely high quality Chicago Standard Output Transformer. Identical in every other respect to HF60, same specs at 50W. Kit \$57.95. Wired \$87.95. Cover E-2 \$4.50.

**NEW HF35: 35-Watt Ultra-Linear Power Amplifier.** Kit \$47.95. Wired \$72.95. Cover E-2 \$4.50.

**HF30: 30-Watt Power Amplifier.** Kit \$39.95. Wired \$62.95. Cover E-3 \$3.95.

**NEW HF22: 22-Watt Power Amplifier.** Kit \$38.95. Wired \$61.95. Cover E-2 \$4.50.

**NEW HF14: 14-Watt Power Amplifier.** Kit \$23.50. Wired \$41.50. Cover E-6 \$4.50.

### MONAURAL INTEGRATED AMPLIFIERS (use 2 for STEREO)

**HF52: 50-Watt Integrated Amplifier** with complete "front end" facilities & Chicago Standard Output Transformer. "Excellent value"—Hirsch-Houck Labs. Kit \$69.95. Wired \$109.95. Cover E-1 \$4.50.

**HF32: 30-Watt Integrated Amplifier.** Kit \$57.95. Wired \$89.95. Both include cover.

**HF20: 20-Watt Integrated Amplifier.** "Well-engineered" — Stocklin, RADIO TV NEWS. Kit \$49.95. Wired \$79.95. Cover E-1 \$4.50.

**HF12: 12-Watt Integrated Amplifier.** "Packs a wallop"—POP ELECTRONICS. Kit \$34.95. Wired \$57.95.

### SPEAKER SYSTEMS (use 2 for STEREO)

**HFS2: Natural bass** 30-200 cps via slot-loaded 12-ft. split conical bass horn. Middles & lower highs: front radiation from 8 1/2" edge-damped cone. Distortionless spike-shaped super-tweeter radiates omni-directionally. Flat 45-20,000 cps, useful 30-40,000 cps. 16 ohms. HWD 36", 15 1/4", 11 1/2". "Eminently musical; would suggest unusual suitability for stereo."—Holt, HIGH FIDELITY. Completely factory-built: Walnut or Mahogany. \$139.95; Blonde, \$144.95.

**HFS1: Bookshelf Speaker System**, complete with factory-built cabinet. Jensen 8" woofer, matching Jensen compression-driver exponential horn tweeter. Smooth clean bass; crisp extended highs. 70-12,000 cps range. Capacity 25 w. 8 ohms. HWD: 11" x 23" x 9". Wiring time 15 min. Price \$39.95.

### FM TUNER

**HFT90:** surpasses wired tuners up to 3X its cost. Pre-wired, pre-aligned, temperature-compensated "front end" — drift-free. Precision "eye-tronic" tuning. Sensitivity 1.5 uv for 20 db quieting — 6X that of other kit tuners. Response 20-20,000 cps ± 1 db. K-follower & multiplex outputs. "One of the best buys you can get in high fidelity kits." — AUDIOCRAFT KIT REPORT. Kit \$39.95\*. Wired \$65.95\*. Cover \$3.95.

### BEFORE YOU BUY, COMPARE:

You may examine the complete EICO line at any of 1900 neighborhood EICO distributors coast to coast. Compare critically with equipment several times the EICO cost—then you judge. You'll see why the experts recommend EICO, kit or wired, as your best buy.

EICO, 33-00 NORTHERN BLVD., L. I. C. 1, N. Y.  
Fill out coupon on other side for FREE CATALOG

\* Less cover, f. t. incl.

Copyright 1958 by Electronic Instr. Co. Inc. 300 N. Blvd.

Copyright 1958 by Electronic Instr. Co. Inc. 300 N. Blvd.



the specs prove it ..  
your BEST BUY is

**EICO**®

for COLOR & Monochrome TV servicing

**FREE CATALOG**

shows you HOW TO SAVE 50%  
on 50 models of top quality  
professional test equipment.  
**MAIL COUPON NOW!**

**NEW!**  
**TV-FM SWEEP  
GENERATOR &  
MARKER #368**

**KIT \$69<sup>95</sup> WIRED \$119<sup>95</sup>**



Entirely electronic sweep circuit (no mechanical devices) with accurately-biased inductor for excellent linearity. Extremely flat RF output: new AGC circuit automatically adjusts osc. for max. output on each band with min. ampl. variations. Exceptional tuning accuracy: edge-lit hairlines eliminate parallax. Swept Osc. Range 3-216 mc in 5 fund. bands. Variable Marker Range 2-75 mc in 3 fund. bands; 60-225 mc on harmonic band. 4.5 mc Xtal Marker Osc., xtal supplied. Ext. Marker provision. Sweep Width 0-3 mc lowest max. deviation to 0-30 mc highest max. dev. 2-way blanking. Narrow range phasing. Attenuators: Marker Size, RF Fine, RF Coarse (4-step decade). Cables: output, 'scope horiz., 'scope vertical. Deep-etched satin aluminum panel; rugged grey wrinkle steel cabinet.

**NEW! RF  
SIGNAL GENERATOR  
#324**

**KIT \$26<sup>95</sup> WIRED \$39<sup>95</sup>**



150 kc to 435 mc with ONE generator! Better value than generators selling at 2 or 3 times its cost! Ideal for IF-RF alignment, signal tracing & trouble-shooting of TV, FM, AM sets; marker gen.; 400 cps audio testing; lab. work. 6 fund. ranges: 150-400 kc, 400-1200 kc, 1.2-3.5 mc, 3.5-11 mc, 11-37 mc, 37-145 mc; 1 harmonic band 111-435 mc. Freq. accurate to  $\pm 1.5\%$ ; 6:1 vernier tuning & excellent spread at most important alignment freqs. Etched tuning dial, plexi-glass windows, edge-lit hairlines. Colpitts RF osc. directly plate-modulated by K-follower for improved mod. Variable depth of int. mod. 0-50% by 400 cps Colpitts osc. Variable gain ext. amplifier: only 3.0 v needed for 30% mod. Turret-mounted coils slug-tuned for max. accuracy. Fine & Coarse (3-step) RF attenuators. RF output 100,000 uv; AF sine wave output to 10 v. 50-ohm output Z. 5-way jack-top binding posts for AF in/out; coaxial connector & shielded cable for RF out. 12AU7, 12AV7, selenium rectifier; xmfr-operated. Deep-etched satin aluminum panel; rugged grey wrinkle steel cabinet.

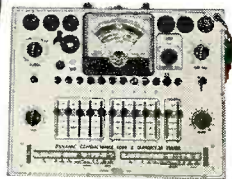

**NEW! DYNAMIC  
CONDUCTANCE  
TUBE & TRANSISTOR  
TESTER #666**  
**KIT \$69<sup>95</sup> WIRED \$109<sup>95</sup>**

**COMPLETE with steel cover and handle.**

**SPEED**, ease, unexcelled accuracy & thoroughness. Tests all receiving tubes (and picture tubes with adapter). Composite indication of Gm, Gp & peak emission. Simultaneous sel of any 1 of 4 combinations of 3 plate voltages, 3 screen voltages, 3 ranges of continuously variable grid voltage (with 5% accurate pot). New series-string voltages: for 600, 450, 300 ma types. Sensitive 200 ua meter. 5 ranges meter sensitivity (1% shunts & 5% pot). 10 SIX-position lever switches: freepoint connection of each tube pin. 10 pushbuttons: rapid insert of any tube element in leakage test circuit & speedy sel. of individual sections of multi-section tubes in merit tests. Direct-reading of inter-element leakage in ohms. New gear-driven rollehart. Checks n-p-n & p-n-p transistors: separate meter readings of collector leakage current & Beta using internal dc power supply. Deep-etched satin aluminum panel; rugged grey wrinkle steel cabinet. CRA Adapter \$4.50

**COLOR  
and Monochrome  
DC to 5 MC LAB & TV  
5" OSCILLOSCOPE  
#460**

**KIT \$79<sup>95</sup> WIRED \$129<sup>50</sup>**



• Features DC Amplifiers!

Flat from DC-4.5 mc, usable to 10 mc. **VERT. AMPL.:** sens. 25 rms mv/in; input Z 3 megohms; direct-coupled & push-pull thruout; K-follower coupling bet. stages; 4-step freq-compensated attenuator up to 1000:1. **SWEEP:** perfectly linear 10 cps-100 kc (ext. cap. for range to 1 cps); pre-set TV V & H positions; auto. sync. ampl. & lim. **PLUS:** direct or cap. coupling; bal. or unbal. inputs; edge-lit engraved lucite screen; dimmer; filter; bezel fits std photo equip. Push-pull hor. ampl., flat to 400 kc, sens. 0.6 rms mv/in. Built-in volt. calib. Z-axis mod. Sawtooth & 60 cps outputs. Astig. control. Retrace blanking. Phasing control. **5" PUSH-PULL Oscilloscope = 429: Kit \$44.95, Wired \$79.95.** **7" PUSH-PULL Oscilloscope = 470: Kit \$79.95, Wired \$129.50.**

**NEW! PEAK-to-PEAK  
VTVM #232 & UNI-  
PROBE (pat. pend.)**

**KIT \$29<sup>95</sup> WIRED \$49<sup>95</sup>**



Half-turn of probe tip selects DC or AC-Ohms.

Uni-Probe - exclusive with EICO - only 1 probe performs all functions!

Latest circuitry, high sensitivity & precision, wide ranges & versatility. Calibration without removing from cabinet. New balanced bridge circuit. High Z input for negligible loading. 4 1/2" meter, can't burn-out circuit. 7 non-skip ranges on every function. 4 functions: +DC Volts, -DC Volts, AC Volts, Ohms. Uniform 3 to 1 scale ratio for extreme wide-range accuracy. Zero center. One zero-adj. for all functions & ranges. 1% precision ceramic multiplier resistors. Measure directly peak-to-peak voltage of complex & sine waves: 0-4, 14, 42, 140, 420, 150, 500, 1500 (up to 30,000 v with HVP probe & 250 mc with PRF probe). Ohms: 0.2 ohms to 1000 megohms. 12AU7, 6AL5, selenium rectifier; xmfr-operated. Deep-etched satin aluminum panel, rugged grey wrinkle steel cabinet.



**New!**  
Series/Parallel  
R-C COMBINATION  
BOX #1140  
**KIT \$13.95  
WIRED \$19.95**



**TUBE TESTER  
#625**  
**KIT \$34.95  
Wired \$49.95**  
• tests 600 mil series string type tubes  
• illuminated roll-chart

Pix Tube Test Adapter .....\$4.50

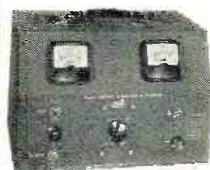

**6V & 12V BATTERY  
ELIMINATOR  
& CHARGER #1050**  
**KIT \$29.95  
WIRED \$38.95**  
Extra-filtered for transistor equip.  
#1060 KIT \$38.95  
WIRED \$47.95



**New!**  
Miniaturized  
MULTI-SIGNAL  
TRACER #145A  
**KIT \$19.95  
WIRED \$28.95**



**20,000 Ohms/Volt  
V-O-M #565**  
**KIT \$24.95  
Wired \$29.95**



**1000 Ohms/Volt  
V-O-M #536**  
**KIT \$12.90  
Wired \$14.90**



Reads 0.5 ohms - 500 megohms, 10 mmfd - 5000 mfd, power factor.

**KIT \$19.95  
Wired \$29.95**

**R-C BRIDGE & R-C-L COMPARATOR  
#950B**



VTVM PROBES	KIT	Wired
Peak-to-Peak	\$4.95	\$6.95
RF	\$3.75	\$4.95
High Voltage Probe-1		\$6.95
High Voltage Probe-2		\$4.95
SCOPE PROBES		
Demodulator	\$3.75	\$5.75
Direct	\$2.75	\$3.95
Low Capacity	\$3.75	\$5.75

SEE OUR "HAM" ADVERTISEMENT ON PAGE 129

TURN PAGE  
FOR MORE  
EICO VALUES

**EICO**®

Send for  
**FREE CATALOG**  
now

EICO, 33-00 Northern Blvd., L.I.C. 3, N. Y. R-11  
Show me HOW TO SAVE 50% on  Test Instruments  Hi-Fi  Ham Gear. Send me FREE Catalog, name of neighborhood dealer.  
Name.....  
Address.....  
City..... Zone..... State.....

Prices 5% higher on West Coast.

L.I.C. 3, N.Y.



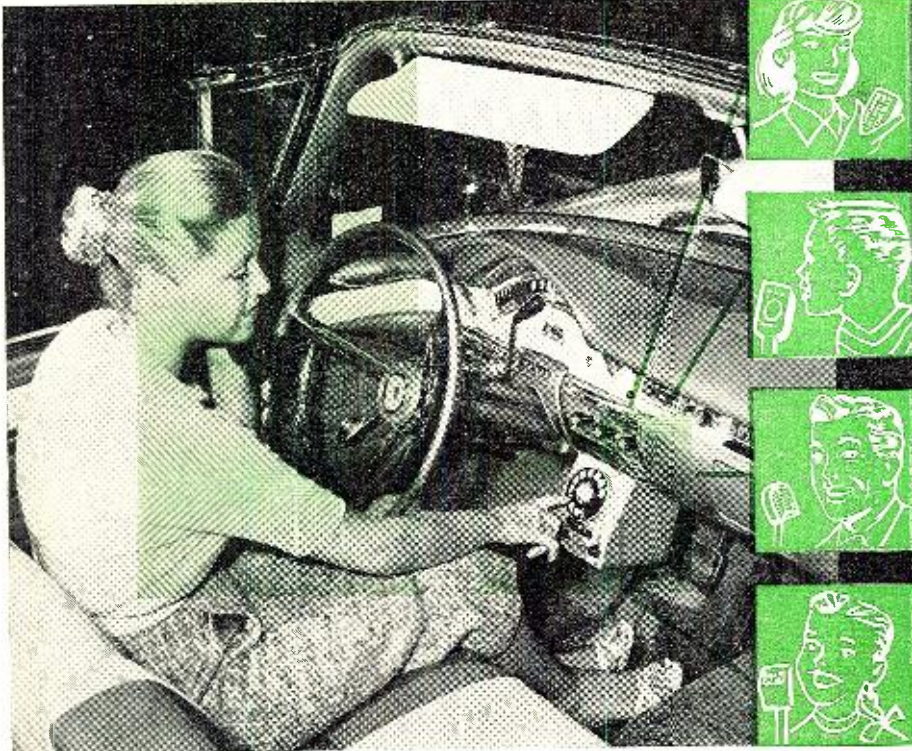

# Citizens Radio Faces the Future

By  
HAROLD B. MCKAY

Interference on Citizens Band frequencies may be minimized by the use of code selective devices like the Secode control unit that is shown in operation here.

*What's happening to radiotelephony in the 460-470 mc. band? Here's an informative and interesting summary.*

**C**ITIZENS Radio was born in the immediate post-war era in a climate which was supposed to be favorable to the common man. The reasons for creating the Citizens Service were partly altruistic. Some of the commissioners on the FCC at the time felt that the plain ordinary citizen should be allowed to have a radio transmitter if he wanted it—not because he owned a business or was part of a corporation, not because he was a policeman, fireman, or doctor—but simply because he wanted a radio to use. The “Buck Rogers,” push-button age thinking helped foster these views.

The motives probably included some selfish aspects. The FCC had been constantly bombarded by demands for radio licenses by businesses which did not qualify under rules existing at the time. This motive still exists; there are many needs for radio, in delivery vehicles, on farms, and in small business. The Citizens Band has been a convenient catch-all for these groups.

At the time the band was first opened for experimental use, little was known of communication techniques in the 400 to 500 megacycle band. Amateurs operating on 420 megacycles had to use tubes and components designed for other services and which produced poor results at this frequency.

A few experimenters pioneered the Citizens Band and found out that transmission was a fickle thing. The tiny amounts of power which were generated capriciously faded out even when the two stations were in sight

of each other, yet at other times boomed in loudly behind hills and in between buildings as multiple reflections tossed the signal around.

Even with the commercially built equipment which followed later, this difficulty hampered acceptance of the service. *Stewart-Warner* made the “Portaphone,” a self-contained radio transmitter and receiver in a telephone handset. The transmitter consisted of an oscillator tube and a modulator, with a printed circuit tuner which held to the required frequency tolerance. The same two tubes functioned as a superregenerative receiver when listening.

*Stewart-Warner* ultimately abandoned production on this item because of the erratic behavior, not of the equipment, but of the band itself. For instance, communication was possible between different floors of a steel and concrete building, yet failed over short distances of open street where the users were within hailing distance. While this performance would be acceptable to amateurs or other experimenters, the citizen for whom the service was created expected more; he wanted the sets to work like his telephone. He expected to be able to pick up the handset and talk—at any time or place.

A further difficulty from the user's viewpoint was that the superregenerative receiver in these units required tuning or “hunting” for the transmitted signal, and might require re-adjustment during use. This, of course, is characteristic of this type

of circuit and is a necessary evil in an instrument small enough to be hand-held.

This, then, was the common man's radio, the Class B Citizens Service. It had a broad band centered on 465 mc. and relatively simple circuitry would suffice. The Class A Citizens Service which included the upper and lower frequencies in the 460-470 mc. band, required a much closer frequency tolerance. As equipment was developed, this became the area of crystal-controlled mobile units, costing hundreds of dollars. The limitations of the Class B service with its low power (150 mw. in the “Portaphone”) were overcome by using elevated antennas and pouring on more power, the classic remedy for all radio service. The prospective user of Class B couldn't afford all this, so little has been done to expand this type of service.

Still manufactured and still popular with radio-minded people is the *Vocaline*, a compact 3-tube transceiver which can be operated anywhere that 117 volts a.c. or 6 volts d.c. power is available.

## Band Shortage & Rule Changes

As in the case of the various amateur bands, once a few brave souls had pioneered the Citizens Service and found that it could be made to work for farm vehicles and delivery trucks, those who bet only on sure things began to covet the band. Citizens Radio rules had a provision that applications would not be accepted from those who could qualify for other services.





General Electric's desk-top Citizens Radio station is housed in a mobile-type case that will front-mount under auto dashboards or under truck seats.



The Kaar TR 500 is a medium-powered transmitter and receiver. Final amp is pair of Ampere 6939's, 12 w. input.



Motorola's mobile unit has an r.f. power output of over 18 w. and uses two 2C39A's in tuned cavity circuits as tripler-driver and final amplifier.

But soon the industrial, taxicab, telephone, and other services began to overflow their assigned bands and the little-used Citizens Band looked tempting. First attempts to get a re-assignment came from the telephone companies whose expanding businesses needed more frequencies for services to inaccessible spots, two-way mobile, and microwave.

Next, groups like the National Association of Manufacturers' Radio Committee and the American Trucking Association expressed interest in the band.

One of the big demands for re-allocation of the Citizens Band has been from businesses, which qualify under the industrial services, for equipment to communicate with vehicles within their plant or yard areas. These companies would like to communicate with their trucks wherever they are, in or out of the plant. This would be permissible in the Citizens Service, but not in some of the others.

As of June 1958, there were over 140,000 transmitters authorized in the Citizens Service, according to an FCC count. Commission records do not have a breakdown to show the type of user of this service; however, it is safe to say that the applications of the service are practically unlimited. The "Official Registry of Radio Systems in the Transportation Services" shows that almost any type of business enterprise that you can think of uses Citizens Radio.

The pressure from the people who used the old Class A Citizens Band finally had its effect and the FCC changed its rules on August 1, 1958. The new rules save a spot in the middle of the band and the equivalent of the old Citizens station will still be in business for the present. That the citizen got this much was largely due to the strong case presented to the Commission by *Vocaline*.

The remainder of the band, the old Class A allocations, have been excised from the Citizens service and given to others. A total of 6.550 mc. in the 460-470 mc. band has been transferred to industrial services. A total of 2.450 mc. has been retained for use by the Citizens Service. Of this, the FCC warns, 1.900 mc. may be re-allocated later. (See Table 1.)

This is more than a mere change of name of Class A Citizens to industrial, business, or manufacturers' radio. Under Citizens Band rules power was limited and eligibility requirements were simple. The new rules permit more power but tighten eligibility requirements.

The changes in operating authority mean more protection for the industrial class user. The increased power means less protection for the remaining Citizens Band.

### Propagation

As mentioned earlier, one of the biggest drawbacks to Citizens Radio has been the erratic propagation characteristics of the band. Of course, no radio at any frequency gives 100% results.

Extensive tests were conducted by the University of Idaho in 1955 to determine the effective range of Citizens Radio. Both *Stewart-Warner's* "Portafone" and *Motorola's* mobile equipment were used in the tests. The following results, obtained with the "Portafone," are indicative of the service which can be expected with low-power, hand-held equipment: level land, desert, meadowland, cropland, 1100 to 1400 yds.; open forest (no underbrush), 1000 to 1200 yds.; dense forest (low branches, close trees), 250 to 300 yds.; rolling land (pasture), 1000 yds.; and between hilltops, up to 8 miles.

In mountainous country, communication may extend to 35 miles, between line-of-sight points, but will be nonexistent in cuts and ravines. Over lakes with the antenna three to five feet above the water, the range is less than 1000 yards, according to the University's survey.

In cities, the range was found to be from 300 to 800 yards depending upon building height and street width. Experiments in moving vehicles often produced a "flutter" effect on the received voice. This is due to the multipath reflections and the fact that different waves arrive in different phase relationships. This causes the received signal to fade and restore rapidly, possibly due to the short (25-inch) wavelength.

In mine shafts and tunnels, the range was found to be less than 250 yards. In most cases it was found that moving the transceiver slightly would mean the difference between a signal and no signal.

### Equipment

Another handicap to the development of Citizens Radio has been the tricky equipment necessary for use in the 460-470 mc. band. This is a sort of twilight zone in radio, where the lower frequency techniques of coil-capacitor assemblies give way to the butterfly tuners, cavity resonators, and tuned lines.

The Class B service has had an FCC-imposed frequency tolerance of .5% at 465 megacycles, that is, the deviation plus the transmitted band-

Table 1. Shown below is a listing of the new assignments in the old Citizens Band.

THE FORMER 460-470 mc. Citizens Radio Band has been sliced up by the FCC. Very little of this spectrum space has been retained for this service. Here is a listing of the new frequency assignments, effective August 1, 1958:

FREQUENCY IN MC.	BANDWIDTH IN MC.	SERVICE
461.000-462.525	1.525	Industrial
462.525-463.225	.700	Undecided*
463.225-464.725	1.500	Industrial
464.725-465.275	.550	Citizens
465.275-466.475	1.200	Undecided*
466.475-470.000	3.525	Industrial

\*Subject to final allocation later. For the present, Class B Citizens stations may be operated in the range 462.525-467.475, with power limited to 5 watts input to the final r.f. stage.

AMONG THE SERVICES which will be assigned in the Industrial bands above are: Business Radio Service, which supersedes the low-power industrial service, and a new Manufacturers Radio Service.



width had to be within plus or minus one-half of 1%. This allowed 4.65 megacycles at the center frequency. Equipment which earned type approval from the Commission had to meet this figure under a temperature range of from 0° to 125°, and had to be able to take the usual knocks and shocks that a portable instrument would experience.

Considerable ingenuity was displayed by manufacturers who qualified their products. The "Portafone" uses a 6AK4 tube as an oscillator and a tuning loop and butterfly arrangement for the 465 mc. tuning unit. A 3A4 modulator tube also serves as an audio amplifier when the set is receiving. The transmitter oscillator tube doubles as a superregenerative detector during reception.

The *Vocaline* uses a u.h.f. television tube, the 6AF4A, as an oscillator in a balanced-transmission-line circuit. A 6AV6 and a 6AS5 comprise a two-stage modulator. Like the "Portafone," the tubes function as superregenerative detector and amplifier when receiving.

Greater ingenuity will certainly be required to meet the .550 mc. bandwidth when and if it finally does go into full effect.

#### Car-Mobile Service

Probably the users who obtained the greatest range and best performance with Citizens Radio have been Class A users—those who have crystal-controlled equipment operating at the top and bottom of the 460-470 mc. band. Reliable equipment can be had for this service.

Combined transmitter-receiver installations are available at prices from \$500 to \$700. They are manufactured as mobile units or as fixed station units; some are combinations, that is, they may be changed from fixed to mobile use by simply changing power cords. Mobile stations may use simple ground-plane or coaxial antennas. However, a fixed station which is to communicate with many mobile units may require precisely engineered antennas fed by air-dielectric coaxial lines.

The circuitry used in modern 460 to 470 mc. radios has come a long way from the tricky systems used in World War II radar and transponder equipment. Present day equipment uses sound engineering techniques and the equipment is as reliable as that in any other service. However, because this frequency is in a border region technically, different manufacturers have used different techniques to tune the frequency.

*Motorola*, for instance, in its 9-tube FM transmitter starts with a 12AT7 oscillator followed by three frequency doublers. A 2C39A lighthouse tube tuned by a cavity then serves as a tripler, which drives another 2C39A in another cavity as a power amplifier. The receiver used with this equipment also uses tuned cavities to reach the 450-470 mc. range.

**Communications Co., Inc.**  
300 Greco Avenue  
Coral Gables, Florida

**General Electric Company**  
Electronics Park  
Syracuse, New York

**Kaar Engineering Company**  
2995 Middlefield Road  
Palo Alto, California

**Vocaline Company of America, Inc.**  
Old Saybrook, Connecticut

**Motorola Inc.**  
4501 W. Augusta Boulevard  
Chicago, Illinois

**Radio Corporation of America**  
Building 2-4  
Camden, New Jersey

**Royalcall**  
Royal Communications Systems  
11462 Euclid Ave.  
Cleveland 6, Ohio

Table 2. Some makers of the type of radiotelephone gear described in article.

While the Citizens Band only actually included 460-470 megacycles, other mobile services are authorized in the ten megacycles which just precede this band. Therefore, most equipment of the crystal-control type is made to handle the 450-470 megacycle band. *G-E*, *RCA*, and others also make equipment for this service. Output powers usually run from 15 to 20 watts, and the use of FM is common.

#### Repeaters and Code Devices

Transmission range of Citizens Radio has been extended by means of repeater stations, which will receive the signal from one transmitter and re-transmit it to a distant receiver. Such a repeater might be located on a hilltop, tall building, or similar advantageous position. Specific frequencies were not assigned to users in the Citizens Band and people who operated in the 460-470 megacycle region had to get along with their neighbors and select or share frequencies as required.

This introduced the possibility that a repeater installed and maintained by one company might be used by any other person who could determine the right frequency to trigger it. This might call for the use of some sort of selective mechanism, which would require knowledge of a predetermined code in order to turn on the repeater unit.

Devices of this sort are now used with radio-dispatch systems where it is desired to alert only one of several mobile units. They can also be used on remotely controlled devices such as garage-door openers which also operate on this Citizens Band service. Typical of equipment of this sort is a decoder unit manufactured by *Secode Corporation* of San Francisco, California. This is an electro-mechanical device known as the "Secode Decoder." It consists of an electromagnet and a code wheel. It can be arranged to respond to any one of several thousand code combinations which can be generated with an ordinary telephone dial. These devices are now widely used by wireline companies to selectively turn machinery on and off at distant points, and are also used by telephone companies to provide dial mobile radio service in automobiles.

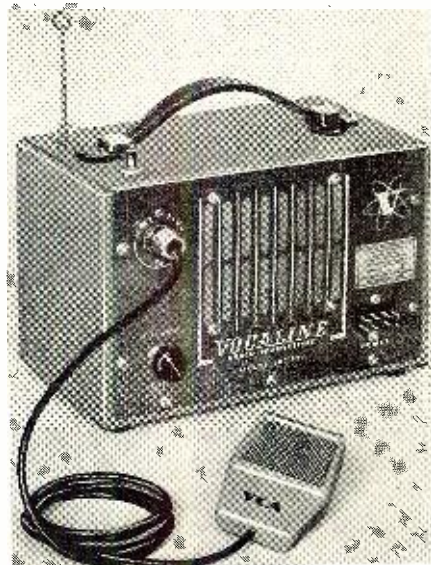

The Vocaline series JRC is a complete Citizens Band radio transceiver for Class B use. The unit is designed to operate on either 117 v.a.c. or 6 v.d.c.



The RCA Carfone 450 is a complete mobile transmitting-receiving unit. The separate dash-mounted control and universal mounting speaker are shown.

Cars so equipped may dial other cars or central office numbers. Code devices such as this could help reduce interference in the shared radio service and could also prevent the unauthorized use of repeater stations.

In conclusion then, it would appear that Citizens Radio is looking at its future with some uncertainty. We will just have to keep our eyes on it and on more pending FCC rule changes to see where it goes from here.



# LOADING THE PHONO CARTRIDGE

**C**ORRECT loading of the phono cartridge pays dividends in terms of the smoothest and widest frequency response that the cartridge permits and, often, reduced distortion as well. This is true for both magnetic and piezoelectric (crystal and ceramic) pickups—the two most commonly employed types. Load requirements differ widely between magnetic and piezoelectric units. In addition, there are considerable differences among magnetics and among piezoelectrics; merely connecting the cable from the cartridge to a jack designated for a magnetic or piezoelectric pickup doesn't automatically guarantee that all will be well.

The load across a cartridge is both resistive and capacitive. The resistive load consists of a resistor (sometimes a potentiometer or fixed voltage divider) across the input jack or the grid resistor of the input stage, or a combination of the two. The capacitive load includes cable capacitance and input capacitance of the first stage. The latter consists mainly of grid-plate capacitance, which can be quite large in the case of triodes, due to the Miller effect; there is also grid-cathode and stray wiring capacitance. Altogether, it is not unusual for input capacitance to be 50  $\mu\text{mfd.}$  or more in the case of triodes.

In determining load requirements, the inductance, winding capacitance, and d.c. resistance of magnetic cartridges and the capacitance of piezoelectric cartridges have to be taken into account. The following discussion will review the basic principles of loading magnetic and piezoelectric cartridges, taking all the above-mentioned factors

into consideration and listing the impedances of a number of popular cartridges and the loads recommended by their manufacturers.

## Magnetic Cartridges

Fig. 1 shows the principal circuit impedances when a magnetic pickup is used. The winding contains inductance and d.c. resistance in series, shunted by the cartridge's winding capacitance, the load resistance, and the load (cable and input) capacitance in parallel.

Omitting the resistances, the inductance and total shunt capacitance form a series-resonant circuit, as shown in Fig. 2. Output, across  $C$ , is maximum at approximately the resonant frequency,  $f = 1 / (2 \pi \sqrt{LC})$ . Therefore response is not smooth but exhibits a peak at  $f$ , as shown in Fig. 3. If  $L$  and  $C$  are relatively small, electrical resonance occurs far outside the audio range and is not a problem.

However, high-impedance cartridges, such as the variable-reluctance type, have relatively large inductance, which together with typical circuit capacitance brings  $f$  dangerously close to or within the audio range. To illustrate, assume  $L$  is .6 henry, which is fairly representative, and that  $C$  is 400  $\mu\text{mfd.}$ , in large part due to a long length of high-capacitance cable. Therefore  $f$  is slightly above 10,000 cycles, producing an audible peak.

One purpose of load resistor  $R_L$  is to damp the peak. The smaller  $R_L$ , the smaller is the resonant peak. But most things have a price and in the present case what happens is that  $L$  and the circuit resistances form a low-pass filter, as shown in Fig. 4. The circuit

resistance ( $R_L + R_w$ ) must be large enough to prevent a significant dip in response below 15,000 cycles or so. For example, if  $L$  is .6 henry and we select 20,000 cycles as the point where we are willing to let response drop 3 db due to low-pass filter action, then  $R_L + R_w = 2 \pi fL = 75,000$  ohms. Assume that  $R_w$  is 1000 ohms. Thus,  $R_L$  should be 74,000 ohms. The nearest standard value, 75,000 ohms, is adequate.  $R_L$  is not critical and any value within  $\pm 10\%$  of the calculated one is generally suitable.

Across the magnetic phono input jack of many control amplifiers there is a load resistor of 47,000 ohms or thereabouts. However, as shown by the example just cited, this can be far too low for some cartridges and, for others, it may be too high. It is important to make whatever changes are required to provide a correct load for the cartridge employed.

Table 1 shows, to the extent that the author has been able to obtain the data, the inductance, d.c. resistance, winding capacitance, recommended load resistance, and permissible load capacitance as given by the manufacturers of a number of popular magnetic pickups. Permissible shunt capacitance (winding, cable, and input capacitance) can be calculated by the formula  $C = 1 / (4 \pi^2 f^2 L)$ .  $L$  is the cartridge inductance, while a value of 12,000 to 15,000 cycles may be used for  $f$ . For ease of calculation, using 15,000 cycles as  $f$ , the formula may be put into the form:  $C = 113/L$  with  $C$  in  $\mu\text{mfd.}$  For example, if  $L$  is .6 henry,  $C$  is about 190  $\mu\text{mfd.}$

The reader may wonder why, as long as the resonant peak is damped by  $R_L$ , it is necessary to keep the resonant

By **HERMAN BURSTEIN**

*Get the best performance from your hi-fi pickup by using the proper cartridge loading circuits.*

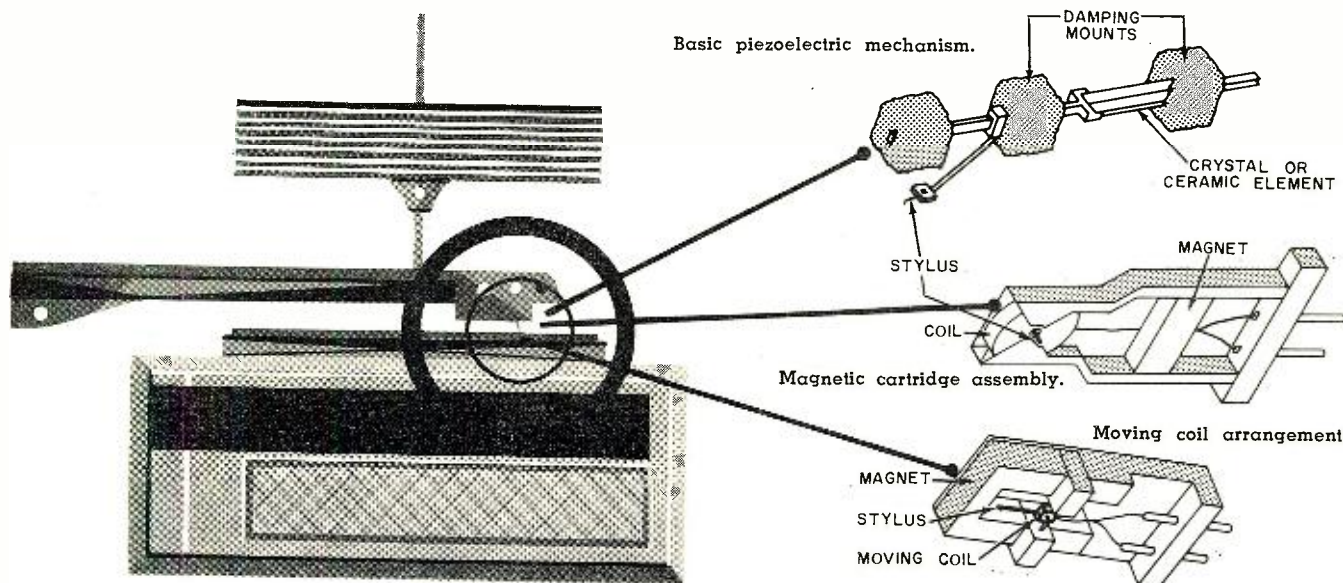



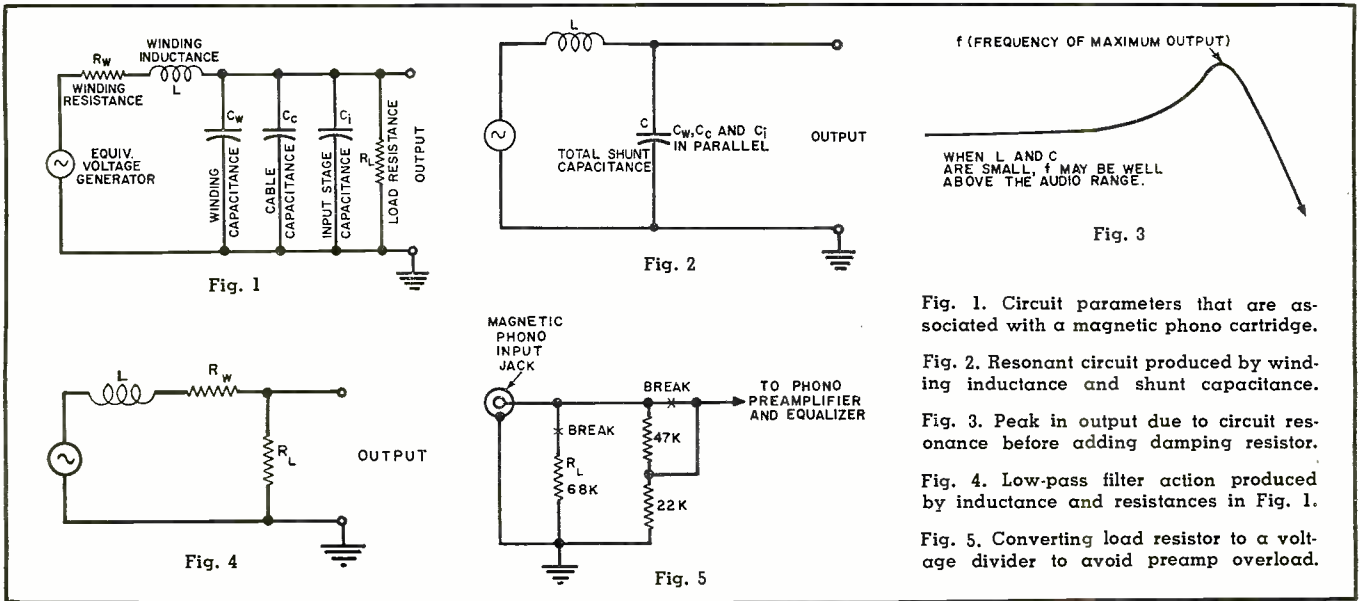

peak well up in the audio range or just above it. The answer is that response drops very sharply above resonance, as shown in Fig. 3.

Phono pre-equalization cuts the lows and boosts the highs, requiring the opposite equalization in playback, namely bass boost and treble droop. In a few preamplifiers it has been the practice to supply only bass boost, with treble cut obtained through a suitably small load resistor (for example, the G-E Model A1-203); as explained in connection with Fig. 4, winding inductance and circuit resistance—mainly the load resistor  $R_L$ —produce treble attenuation.

RIAA equalization, almost universally used today, requires that playback response be 3 db down at 2122 cycles and continue to drop at a rate approaching 6 db per octave. The required circuit resistance is given by  $R_L + R_w = 2\pi fL = 6.3 \times 2122 \times L$ . To illustrate, if  $L$  is .6 henry, then the required circuit resistance is about 8000 ohms. Assume the d.c. resistance of the coil is 1000 ohms. Then  $R_L$  should be 7000 ohms. In this case the nearest standard value, 6800 ohms, would be used.

This method of achieving treble cut, prior to the preamplifier, has both advantages and disadvantages. Use of a very small load resistor almost completely damps out resonance. The reduced signal presented to the first stage tends to decrease distortion. A considerable amount of load capacitance can be tolerated without ill effect. On the other hand, signal-to-noise ratio of the playback system is smaller if treble cut takes place before rather than after the input stage; treble cut after the input stage simultaneously reduces noise of this stage.

The problem of electrical resonance ordinarily does not concern the moving-coil type of cartridge, which typically has but a few millihenrys inductance, so that practical values of circuit capacitance place resonance far above the audio range. The load resistor can range in value from a few hundred

ohms up to high-impedance loads. The low inductance of the cartridge makes it impractical to obtain treble cut through a suitable load resistor, which would have to be extremely small. Moreover, the relatively low output characteristic of a moving-coil pickup (in exchange for high-quality performance) makes it all the more desirable to obtain reduction of input stage noise concomitant with treble attenuation following this stage.

Some magnetic pickups have quite a large signal output—as much as 100 millivolts on peaks. This might overload the first stage, hence it may be desirable to attenuate the signal from the cartridge. This can easily be done by converting the load resistor to a volt-

age divider, as illustrated in Fig. 5. Some control amplifiers have an extra input jack intended for high-level magnetic pickups, with a voltage divider across the jack. However, it may be necessary to change these values in order to make their total resistance equal to the load requirement of the cartridge.

#### Piezoelectric Pickups

Whereas the output of a magnetic cartridge is proportional to groove velocity, the output of a piezoelectric cartridge is proportional to groove amplitude. As a result of RIAA pre-equalization, groove amplitude varies with frequency in the manner shown by Fig. 6; there is a good deal of bass boost and a moderate amount of treble cut on

CARTRIDGE	INDUCTANCE	D.C. RES.	WINDING CAP.	RECOMMENDED LOAD RES.	MAXIMUM LOAD CAP. (Note A)
Audiogersh MST-1 (Note B)	320 mhy.	1400 ohms	Note C	47,000 ohms	200 $\mu$ fd.
Audiogersh MST-2	Note C	Note C	Note C	100,000 ohms	200 $\mu$ fd.
Electro-Sonic C-60	1 mhy.	40 ohms	Unmeasurable	100 to 100,000 ohms	Very large (Note D)
Electro-Sonic P-60	1 mhy.	40 ohms	Unmeasurable	100 to 100,000 ohms	Very large (Note D)
G-E VR-II (Note E)	520 mhy.	600 ohms	about 50 $\mu$ fd.	100,000 ohms	300 $\mu$ fd.
G-E VR-II (Note F)	250 mhy.	400 ohms	Note C	100,000 ohms	300 $\mu$ fd.
Grado F28D	Very low	600 ohms	Note C	5000 ohms & up	Note J
Norelco AG3121	600 mhy.	1200 ohms	70 $\mu$ fd. (Note G)	68,000 ohms	250 $\mu$ fd.
Shure "Studio Dynetic"	130 mhy.	180 ohms	40 $\mu$ fd. (Note H)	10,000 ohms	1500 $\mu$ fd.
Shure "Professional Dynetic"	350 mhy.	440 ohms	30 $\mu$ fd. (Note I)	27,000 ohms	Note C
Tannoy "Mark II"	320 mhy.	1100 ohms	230 $\mu$ fd.	100,000 ohms	150 $\mu$ fd.

NOTES: A=cable capacitance and input stage capacitance; B=model with diamond stylus; C=information not supplied by manufacturer; D=the manufacturer states, "The cartridge will be unaffected by any cable or tube capacitances encountered"; E=high-impedance model; F=low-impedance model; G=calculated on basis of resonant frequency at 25,000 cycles, per manufacturer; H=calculated on basis of resonant frequency at 70,000 cycles, per manufacturer; I=calculated on basis of resonant frequency at 50,000 cycles, per manufacturer; J=cables in excess of 10 feet may be used.  
For information on cartridges not covered, contact the manufacturers direct.

Table 1. Characteristics and loading for some representative magnetic cartridges.

Fig. 6. Variation of the groove amplitude with frequency due to RIAA recording equalization, assuming there is a constant signal input at all the frequencies depicted.

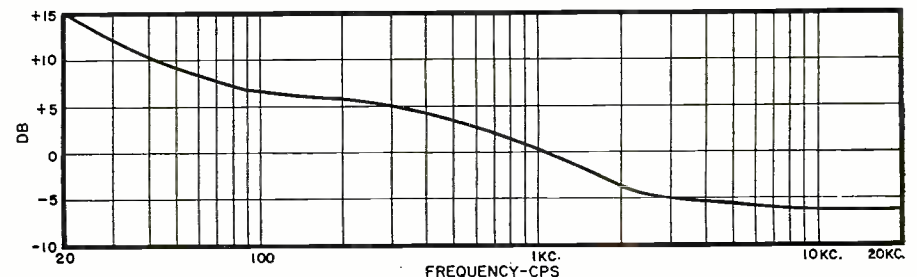



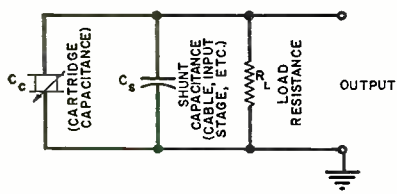

Fig. 7. Circuit parameters that are associated with a piezoelectric cartridge.

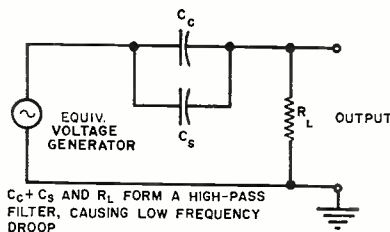
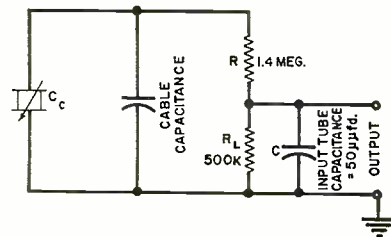
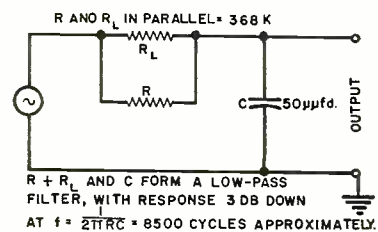

Fig. 8. Equivalent circuit of Fig. 7 with respect to low-frequency response.



(A)



(B)

Fig. 10. (A) Effect of using a voltage divider as load resistor for piezoelectric cartridge is shown here. (B) Equivalent circuit of Fig. 10A at high frequencies.

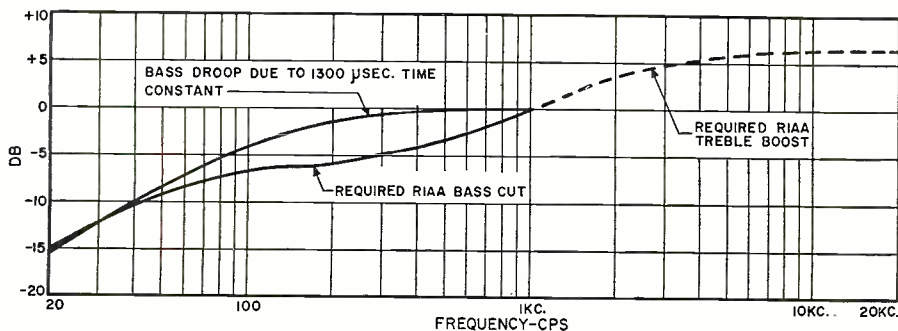

Fig. 9. Comparison of RIAA bass cut required when using amplitude-responsive pickup with bass droop produced by circuit impedances having time constant of 1300  $\mu$ sec.

the record. Thus, when a piezoelectric cartridge is used for playback, bass cut and treble boost are required, which is just the opposite of the requirements for a magnetic cartridge.

Fig. 7 shows the basic circuit elements when a piezoelectric cartridge is used. Fig. 8 is the equivalent circuit and it can readily be seen that the circuit capacitances, effectively in parallel as far as frequency response is concerned, form a high-pass filter in conjunction with the load resistor. In other words, these elements produce bass cut. To achieve bass cut that corresponds fairly accurately to RIAA requirements for an amplitude-responsive cartridge, the time-constant of the total circuit capacitance and the load resistor should be between approximately 1000 and 1300 microseconds. This means a bass droop characteristic with a turnover frequency (3 db decline) between 160 and 120 cycles and declining thereafter with decreasing frequency at a rate approaching 6 db per octave. Fig. 9 compares the required RIAA bass droop with that achieved by circuit elements having a time-constant of 1300 microseconds (120-cycle turnover frequency).

The principal circuit capacitance is

Fig. 11. Shown below is the equivalent circuit of Fig. 5 with respect to the voltage divider action produced by means of the shunt capacitance of the circuit.

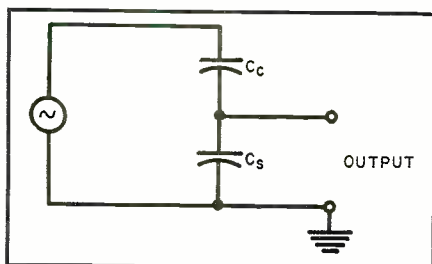

usually that of the cartridge, varying from about 400  $\mu$ fd. to as much as 2000  $\mu$ fd. The other circuit capacitances, chiefly that of the cable and the input tube, have a total value which typically ranges from 150 to 250  $\mu$ fd., although a long run of high capacitance cable can raise this figure appreciably.

To illustrate the method of calculating the required load resistance to produce the correct amount of bass droop, assume that the pickup has 500  $\mu$ fd. capacitance and that cable and input tube capacitance totals 200  $\mu$ fd. To obtain a time-constant of, say, 1300 microseconds with circuit capacitance of 700  $\mu$ fd., the load resistor has to be about 1.9 megohm. The nearest standard values of 1.8 or 2 megohms will work satisfactorily.

The signal output of a piezoelectric cartridge may, in some cases, reach as much as 1 or 2 volts on peaks, indicating that these pickups are meant to be connected to high-level inputs. But the typical input impedance at the high-level jack of a control amplifier is 50,000 ohms. This is too low for most piezoelectric cartridges, that is, the time-constant of the circuit capacitances and load resistor will cause too much bass cut.

The remedy is simple: either (1) increase the input impedance to the required value, perhaps by changing the grid resistor of the input tube, if its characteristics permit, or (2) place a capacitor of suitable value across the cartridge to increase the circuit capacitance.

The second method is simpler since the capacitor can be mounted directly across the cartridge terminals, making it unnecessary to go into the control amplifier. To illustrate, if the load resistance is 500,000 ohms, then 2600  $\mu$ fd. of circuit capacitance is required for a time-constant of 1300 microsec-

onds. Assuming the capacitance of the cartridge, cable, and input stage total 700  $\mu$ fd., then another 1900  $\mu$ fd. of capacitance is required. A capacitor of .002  $\mu$ fd. across the cartridge would be close enough in value to achieve the objective of correct bass attenuation.

If the volume control of the control amplifier follows rather than precedes the input stage for high-level sources, this stage may be overloaded by the signal from a high-output cartridge. It might seem that the simplest way to attenuate the signal would be through use of a voltage divider as the load resistance (see Fig. 5). Generally, however, this is a poor idea because it may well entail substantial high-frequency loss. Fig. 10 shows why. Fig. 10A represents a voltage divider having a total resistance of about 2 megohms and with the values chosen to produce about 12 db attenuation. The input capacitance of the first stage is assumed to be 50  $\mu$ fd., a plausible value. Fig. 10B is the equivalent circuit for high-frequency response. The load resistors are effectively in parallel and this parallel value forms a low-pass filter in conjunction with the input capacitance. For the values shown, namely, effective parallel resistance of 368,000 ohms and 50  $\mu$ fd. capacitance, high-frequency response is 3 db down at about 8500 cycles, declining thereafter at a rate approaching 6 db per octave.

Thus it is better to attenuate the signal by means of a shunt capacitor of suitable value connected across the cartridge. Fig. 11 shows how the cartridge capacitance and the other circuit capacitances effectively form a voltage divider. The bottom leg of the voltage divider consists of the parallel value of all the circuit capacitances other than the cartridge. If the capacitance of the bottom leg is increased, its reactance

(Continued on page 127)



# WIDE-RANGE FIELD-STRENGTH METER ADAPTER

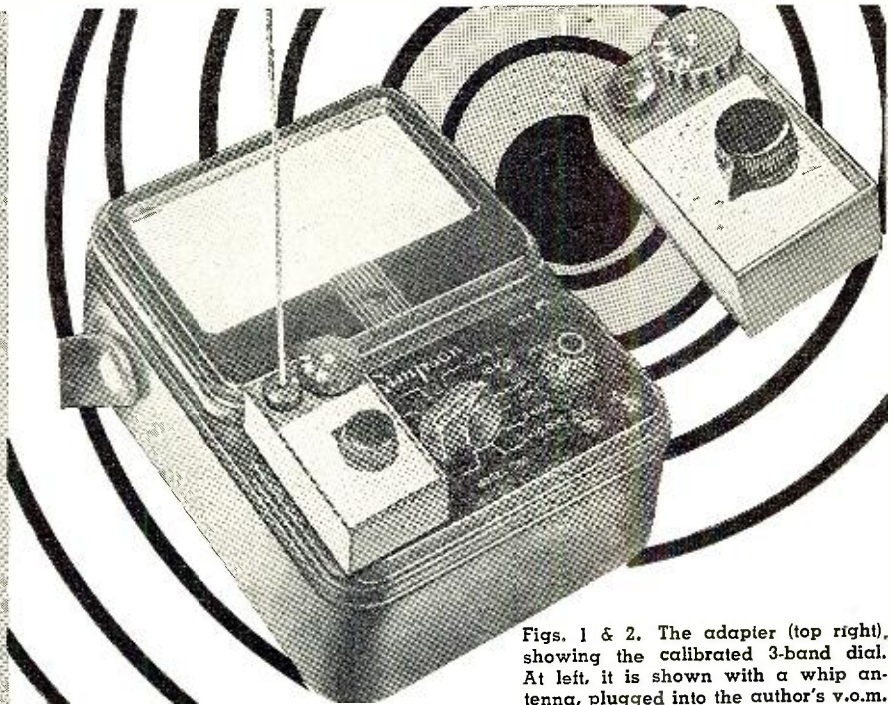

Figs. 1 & 2. The adapter (top right), showing the calibrated 3-band dial. At left, it is shown with a whip antenna, plugged into the author's v.o.m.

By GENE BRIZENDINE

*A simple, plug-in unit gives you signal-strength readings from 1.6 to 170 mc. on your test meter.*

**T**HIS TINY adapter will quickly turn your volt-ohm-milliammeter into a very wide-range field-strength meter, useful for many purposes. The unit (Figs. 1 and 2) covers the surprising spectrum of 1.6 to 170 megacycles, in only three ranges. Such wide coverage is made possible by the high maximum-to-minimum ratio of the midget tuning capacitor,  $C_1$ .

With this adapter, non-oscillation of a TV set's local oscillator may be quickly found. Two-way mobile transmitter output may be peaked. Oscillating i.f. stages may be localized.

Using the sensitive microammeter movement of the average service-type volt-ohm-milliammeter, the circuit (Fig. 3) comprises a pickup antenna, a three-range tuning tank, a germanium diode, and output plugs.

The compact adapter can be assembled in a plastic parts box measuring 1" high, 1 3/8" wide, and 2 1/16" long, as shown in Fig. 4. Being this small, the device does not overhang the v.o.m. and seems to be a part of the meter.

The bottom half of the plastic box contains two pin-tip plugs, which mate with the meter's measuring jacks. Also, a large hole accommodates the v.o.m.'s function knob, allowing the adapter to fit flat onto the meter. A Simpson 260 meter is shown, but other makes are equally adaptable.

The top half of the box is drilled to mount the tiny tuning capacitor, the range selector, and the antenna pin jack. A coat of black enamel, applied inside the case, results in a glossy finish.

Three ranges, "High," "Medium," and "Low," are indicated by decal letters on the range knob. A spot of white

enamel on the adjacent antenna jack serves as the index for the range knob.

The medium-range, 5-to-30 megacycle coil ( $L_2$ ) is simply a TV filament choke, "pruned" to cover this range by removing four turns of wire. The low-range ( $L_3$ ) coil (1.6 to 5 mc.) is made of one pi section removed from a small 2 1/2-millihenry r.f. choke. This section is cemented at one end of the medium-range coil, to conserve space. The high-range ( $L_1$ ) coil (30 to 170 mc.) is formed of 2 turns of #16 enameled wire, 3/32" in diameter. This may be wound on any smooth, round form, after which the form is removed. Care in soldering to the germanium diode and other delicate components is necessary to avoid damage from heat.

Calibration of the finished unit is best accomplished with a signal generator loosely coupled to the adapter. The generator dial readings are transferred to the adapter dial, after locating the maximum meter reading by means of the adapter tuning knob. This process is repeated for each mark desired.

During adjustment of transmitters and associated antennas, a short whip antenna may be plugged into the adapter's jack for greater sensitivity. For close-in chassis explorations, the antenna is removed. In this application, the adapter is held close to the various stages to detect any desired or undesired oscillations.

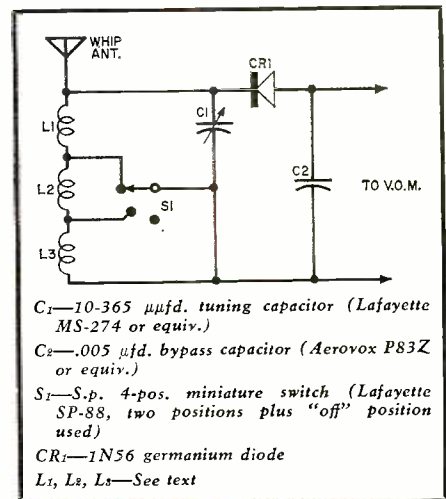
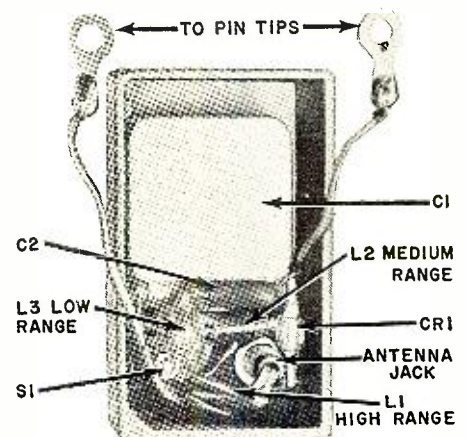

Fig. 3. Schematic and parts list for the simple, wide-range fs adapter.

Fig. 4. Inside view of the compact adapter, with parts locations shown.



**EDITOR'S NOTE:** *Something familiar about this device? If there is, you have a good memory: the author described "A V.H.F. Field-Strength Meter Adapter" back in January 1957, on page 71. The present variation covers a wider range, made possible by the tuning capacitor used, which overlaps the frequency coverage of its precursor. You may find it interesting to compare the two.*



# Listening to the SATELLITES

By E. C. KUNZE, WØWVM

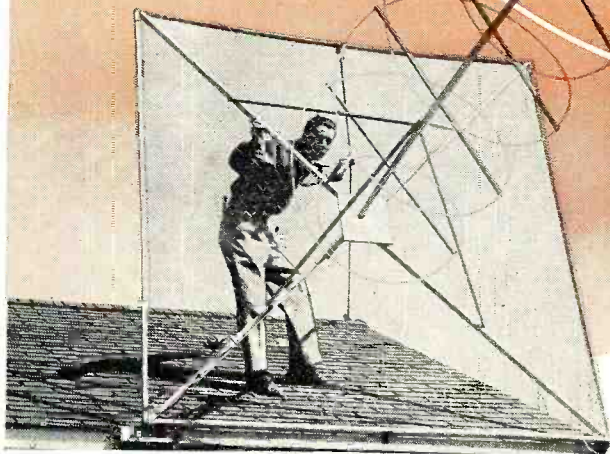

Author sets up his helical antenna.

*How any ham or SWL can get good results with little expense. Here is one ham's experience.*

**M**ONITORING of signals from the extremely low power transmitters aboard the U. S. satellites in orbit has generally been regarded as a project better left to the Minitrack stations, the major radio observatories, and other elaborate and expensive receiving stations. It is, however, entirely possible for any ham or SWL to build and equip his own shack with simple gear for satellite reception and to get good results with little expense.

It is definitely not necessary for the receiving station to be located under, or even near, the orbits. The signals can be picked up from surprisingly great distances at usable intensities. DX of four- to five-thousand miles is a regular occurrence and the signal strength, even at that distance, is usually several "S" units above the noise level. Any time or money invested in building a layout for monitoring the 108 megacycle channels will pay off as a fascinating activity for any radio man. Probing space for signals from earth satellites provides the rudiments of what can and will be done on this new frontier in the next few years.

Without question the most important piece of equipment is a good antenna. A "good" antenna for this purpose is one that has at least 10 db forward gain, is adjustable in both azimuth and elevation, and has a low-loss, matched transmission line. A well built, carefully adjusted 108 mc. crystal-controlled converter is an advan-

tage, but satisfactory results can be obtained with simpler types, if care is taken to stabilize the oscillator and to reduce the r.f. stage and mixer noise to a minimum. A communications receiver with good selectivity will be needed as an i.f. channel. Other required equipment includes a world globe, a caliper, and plenty of pencils, paper, and patience.

Since the launching of Explorer I, the monitoring project here at WØWVM has, like Topsy, "just grewed." The first signal from the high-power transmitter of 1958 Alpha was heard toward the end of its eleventh orbit and was recorded on tape along with time checks from WWV in order that any data received would be pinpointed as to time. Nine passes of the 60 milliwatt AM transmitter were recorded before it failed. The signal strength was much higher from that transmitter than from the other lower power satellite transmitters that have since been heard and recorded at this location.

After the high-power signal was off the air, attention was turned to the low-power signal. Subsequently, over 50 passes of the 10 milliwatt phase-modulated transmitter of 1958 Alpha have been taped and logged as part of a study of propagational effects as observed from this northern location (St. Paul, Minn.).

Vanguard (1958 Beta) has been recorded numerous times beginning with

transits numbers 8, 9, 10, and 11. Both the 108 mc. battery transmitter and the 108.03 mc. sun-powered transmitter were readable, although the fast fading effect made it impossible to demodulate telemetry. It is, incidentally, a weird experience to hear the solar-powered transmitter chugging along up there in the sun at midnight.

Explorer III (1958 Gamma) has been heard and recorded a number of times but, as Alpha is of prime interest, these Gamma passes have been logged simply to prevent confusion as to which is which, because both Alpha and Gamma sound the same.

Depending on the altitude of the satellite at the time of transit over or near the United States, the duration of a "radio sighting" varies from several minutes to as long as forty minutes. This allows sufficient time to lay out the orbits on the globe and keep a running check as to just where the satellite is at any given moment. Alpha has been followed by radio from points several thousand miles out over the Pacific Ocean and at other times as far to the east as the coast of Africa. As a matter of fact, the first three satellites that were launched were followed for these great distances when in or near apogee at the time of transit. The term apogee (opposite of perigee) is defined for this purpose, as the point in the orbit at the greatest height.

Precise information about the orbits can be readily obtained by tuning to the nightly voice broadcasts of satellite prediction data on the command station VPØ on 4275 kc. at 1900, 2000, and 2100 EST. Regional repeats of this data are given at 2030 local standard time by other CAP stations on channels slightly higher in frequency. The time and longitude of the satellite's northern vertex is given on these transmissions. The "vertex" is defined as "the northernmost point of sub-satellite trace." This, and other information on the orbits as given in these broadcasts, is of value in determining when and where to listen for a pass.

Lacking current vertexing informa-



tion, it is still possible to pick up signals and plot a trace for that particular pass. Several characteristics of the received signal are informative as to position. The Doppler shift effect and the fading pattern alone will indicate whether the satellite is approaching, is at the point of nearest approach, or has passed and is receding in the distance. Rotation of the beam antenna onto the satellite is also an aid in getting a fix. A simple signal-strength check is of help in many cases, but it must be remembered that, in general, the signal strength is greater when the signal source is over water than when over land. (This is probably less often the case in the southern half of the United States since the satellites do, at times, pass directly overhead in which instance the signals would be very strong.) The arid regions of southwestern USA and northern Mexico cause a noticeable drop in signal strength when the satellite is over those areas. Given one reasonably good fix on a satellite, it is not difficult to plot the next orbit or the orbits for the next day or even the next week (except for Gamma, which has been officially labeled as having an erratic orbit).

A tape recorder has been of help in keeping a running log of propagational effects as well as a record of the satellite sounds and time checks. A microphone was hooked into the circuit, and a running commentary could then be injected to give signal-strength readings, computed position, or any other normal or abnormal effects that were being noticed at the time. Among these effects are such things as abnormal propagation *via* auroral bounce from extreme distance, effective blocking out of the signal by aurora, surges in signal strength, and sudden shifts in the frequency of the signal. (Some of the surges and shifts were very likely caused by reflections of the signal from meteor trails or from ion clouds set up by another satellite.) The most consistent and recurring effect was the definite drop in signal strength when the satellite passed over land masses. Occasionally more than one satellite has been heard at the same time—sometimes so close together in both frequency and position as to make separation and identification difficult.

Few, if any, of these observations would have been possible without the aid of efficient antenna systems. Two beam antennas are now in use, one being the eight-element stacked yagi array initially set up for the project. This one can be rotated horizontally, but cannot be tilted upward so as to "look" directly at the satellites when they are at high altitude over the United States. The other is a helical antenna with a rather large ground screen backing it up. This one can be raised or lowered to any angle on the meridian. These two antennas make it possible to receive the signals with good strength during passes vertexing in the western hemisphere.

## THIS MONTH'S COVER

**A**UTHOR Kunze is setting up his high-gain helical antenna on the roof of his home. The antenna is being oriented upward for optimum reception of satellite signals. The helix is made up of a 75-foot length of quarter-inch aluminum wire, wound to form a 6-turn coil, 40 inches in diameter with a turn separation of 26 inches. The reflecting screen behind the helix is 8 feet square and is made of ordinary chicken wire. Open-wire transmission line, connected to the antenna through a matching stub, is led down into a 108-megacycle converter in the shack. Antenna gain is in excess of 10 db.  
(Photograph by Warren Johnson, WØNGF.)



The main line run to each antenna is made with 250-ohm (u.h.f. type) open-wire transmission line. The horizontal yagi, being a balanced device, is matched to the line by a linear (quarter wavelength) transformer to step up the rather low antenna impedance to the impedance of the line. At the other end of the line, a balun is used to provide an unbalanced, low-impedance feed to the receiving equipment. A balun is also used at the connection to the helical antenna in order to convert from the unbalanced antenna output to the balanced feedline. A d.p.d.t. toggle switch is used at the operating position to select antennas.

The helix consists of about 75 feet of ¼-inch aluminum wire, that is wound to form a 6-turn coil, 40 inches in diameter with a turn separation of 26 inches. The ground screen is made of chicken wire and measures 8 feet square. The matching device is a half wavelength open stub, made by simply bringing the bottom end of the helical winding out from the spiral and into a straight line three inches from the screen, and parallel to it for 56 inches. The transmission line is connected 18 inches from the open end of this stub.

The gain and performance of the two antennas is about the same, with the notable exception that the circularly polarized helix is less sensitive to man-made noise by a margin of three or four db. This feature of the helix is a definite advantage when working with low-intensity signals in an average residential area. Solar noise is at a high level in the late afternoon and early evening but neither that nor persistent ignition noise has been too troublesome at this location and at the frequencies involved. During the very early morning hours the noise level is lowest and it is then possible to demodulate telemetry from the low-power Explorer signals. Even though narrow-band phase modulation is used in these transmitters, the AM detector in the receiver does a fair job of detection. It is suspected that the transmitters are being modulated slightly in amplitude as well as in phase, because the tones come through without having to detune onto the slope of the i.f. curve.

The 108 mc. converter used here consists of a 417A first r.f. amplifier, feeding a grounded-grid 6AJ4 second r.f.  
(Continued on page 104)

The author is running his 108-megacycle converter through his receiver in this photo.





# Basics of Preset Counters

By **ED BUKSTEIN**  
Northwestern Television  
and Electronics Institute

*Widely used in counting and packaging operations, these circuits are finding increased acceptance in industry.*

**T**HE PRESET COUNTER is one which produces an output pulse after it receives a number of input pulses determined by the settings of the front-panel controls. Since these settings can be changed, the preset counter can serve as a variable-ratio frequency divider. Units of this type are widely used in counting, batching, and packaging equipment.

In pill-packaging operations, for example, the preset counter is often adjusted to produce one output pulse after it receives one hundred input pulses. These input pulses are produced as the pills fall through a light beam, blocking illumination to a phototube. As the hundredth pill passes through the light beam, the preset counter produces an output pulse. This pulse is used to actuate a gate mechanism which directs the pills into the next bottle on a conveyor belt. Similar arrangements are used for packaging screws, washers, machined parts, etc.

Purely mechanical counters can, of course, be used to control packaging operations, but only at a considerable sacrifice of speed. Since the production rate is a primary consideration in any manufacturing operation, the electronic preset counter is used extensively. For example, the pill-packaging operation just described is accomplished at a rate of 15,000 pills per minute. Many of the commercially available preset

counters operate at rates in excess of 50,000 counts per second so that the counting operation is no longer the weak link in the chain of production. Another significant advantage of the electronic counter over a purely mechanical system is that the ratio can be changed simply by setting front-panel controls. A similar change in a mechanical system requires gear and cam adjustments.

Most preset counters consist basically of a cascade of flip-flop (binary) stages. The maximum ratio of such an instrument would therefore be  $2^n$ , where  $n$  is the number of stages. In the preset counter, *binary preset* switches can be adjusted to cause an output pulse after any number of input pulses up to the maximum ratio. A four-stage flip-flop, for example, will have a maximum ratio of  $2^4$  or 16. The binary preset switches, however, can be adjusted to make the circuit produce an output pulse after any number of input pulses fewer than 16.

Table 1 shows the normal switching sequence of a four-stage flip-flop circuit. The figures 0 and 1 in this table are used to indicate the conditions of the flip-flop stages. A stage is considered to be in the 0 condition when its left-hand tube is cut off and the right-hand tube is conducting. The opposite condition is represented by a 1. (See "Basic Binary Counting Circuits"

in the May, 1958 issue of RADIO & TV NEWS.) It is apparent from Table 1 that the maximum ratio is 16 and that this ratio will be achieved if all four stages start in the 0 condition (0000). The output pulse is produced when the fourth stage switches back to the 0 condition at the time the 16th input pulse is applied.

If the four flip-flops are started in some condition other than 0000, fewer than 16 pulses will be required to produce an output pulse. Assume, for example, that the circuit is adjusted to the 0110 condition at the start. As shown in Table 1, this condition would normally be attained after 6 input pulses. If the circuit is started in this condition, only 10 actual input pulses will be required to complete the switching sequence and to produce an output pulse. This technique is known as *complement setting*, because 6 is the complement of 10 with respect to the maximum ratio of 16. Likewise, if we wish to obtain an output pulse after 7 input pulses, we would start the circuit in the condition representing 9 which, as Table 1 shows, would be 1001.

Any desired starting conditions can be set up by means of the binary preset switches which are wired as shown in Fig. 1. The switches are shown in position No. 12. The circuit will therefore produce one output pulse for every 12 input pulses. This would be the case,

Fig. 1. The circuit of a basic preset counter is shown here. When the relay is energized, a positive potential is applied to one of the two grids for each stage. Which grids will receive this positive voltage is determined by the positions to which the switches are preset. The circuit can be adjusted to produce an output pulse after any number of input pulses up to sixteen.

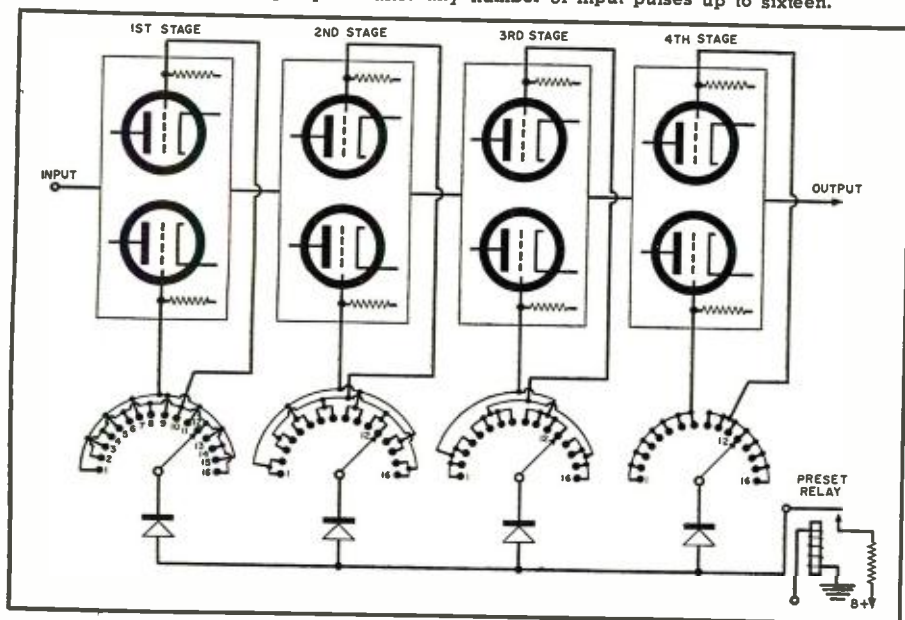
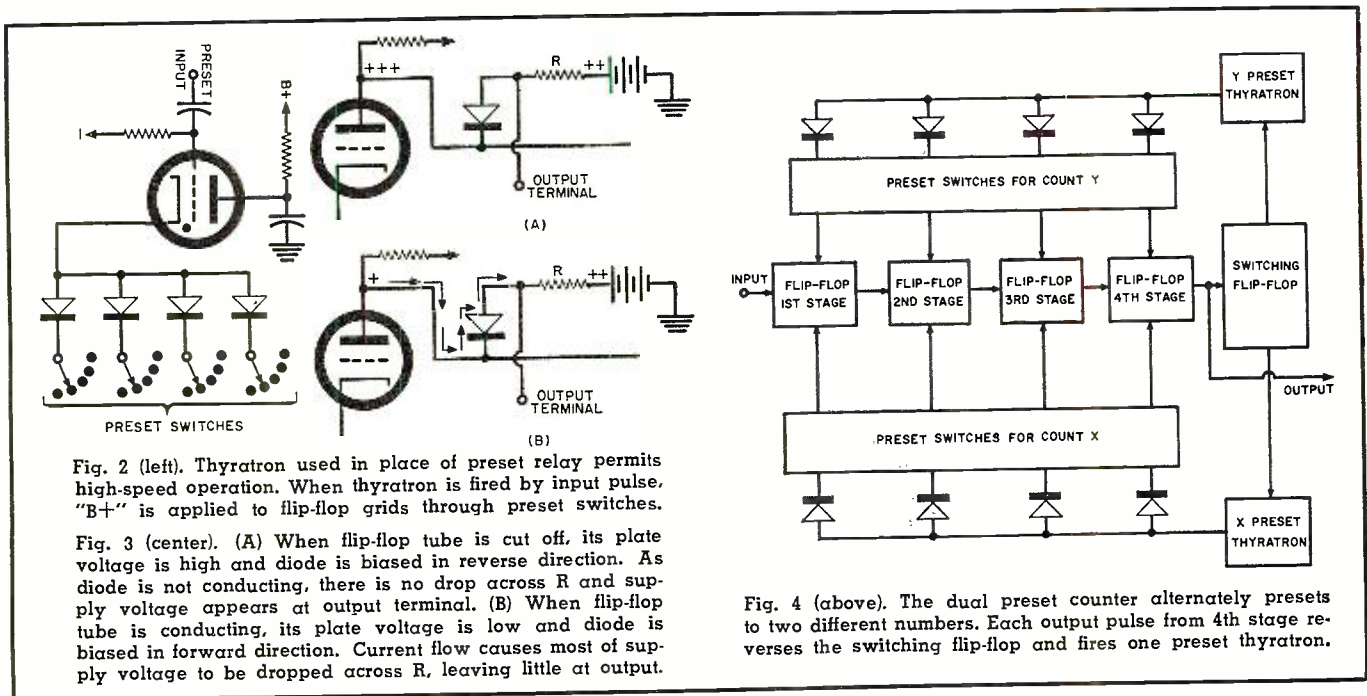

Table 1. Normal switching sequence of a four-stage flip-flop circuit. The figures "0" and "1," as used here, indicate the conditions of the flip-flop stages. Refer to text for details on how notation applies.

INPUT PULSE	4TH STAGE	3RD STAGE	2ND STAGE	1ST STAGE
0	0	0	0	0
1	0	0	0	1
2	0	0	1	0
3	0	0	1	1
4	0	1	0	0
5	0	1	0	1
6	0	1	1	0
7	0	1	1	1
8	1	0	0	0
9	1	0	0	1
10	1	0	1	0
11	1	0	1	1
12	1	1	0	0
13	1	1	0	1
14	1	1	1	0
15	1	1	1	1
16	0	0	0	0





for example, if we wished to use this circuit to control a packaging operation requiring one dozen items in each package. With the preset switches in the "12" position, the flip-flop stages are preset to represent a count of 4 (the complement of 12 with respect to 16).

The presetting operation is accomplished by energizing the preset relay. The contacts of this relay now apply a positive potential, through the preset switches, to the grids of the following tubes: right-hand (upper) grids of the first, second, and fourth stages and left-hand (lower) grid of the third stage. These tubes will therefore conduct and the four stages will be preset to 0100. As Table 1 shows, this represents a preset count of 4. Since the circuit starts in the 0100 condition, only 12 input pulses will be required to complete the switching sequence all the way to 0000.

After 12 input pulses have been applied to the circuit shown in Fig. 1, the circuit is in the 0000 condition. To repeat the operation for another count of 12, the circuit must be preset again to 0100. This can be accomplished automatically by feeding the output pulse from the fourth and final stage to the preset relay. In this way, the circuit will automatically preset to 0100 after every 12th input pulse.

When counting rates are too high to permit the use of the preset relay, it can be replaced by a tube, as shown in Fig. 2. After every 12th input pulse, the thyatron is fired by a positive pulse from the left-hand plate of the fourth stage. The "B+" voltage is now connected, through the conducting thyatron, to the proper grids to establish the 0100 condition. The capacitor connected to the plate of the thyatron provides for automatic shut-off of the tube. After the thyatron is fired and has done its job of applying positive potential to the preset switches, this

capacitor discharges through the tube until the plate voltage is brought down to the de-ionization value.

The diodes shown in Fig. 1 are used for isolation. They prevent interaction between grid circuits, which would otherwise be connected together through the preset switches. Four stages are shown in Fig. 1, but the same technique can be extended to include any number of stages. The pre-

set switches are of the multi-position rotary type, with one deck for each flip-flop stage.

The dual preset counter is one which will preset alternately to two different numbers. A block diagram of this type of instrument is shown in Fig. 4. Assume that the four stages are initially preset for a count of X. After X input pulses have been applied, the fourth

*(Continued on page 142)*

Fig. 5. The diode matrix consists of an array of vertical and horizontal wires, some of which are connected by diodes. As input pulses are applied to flip-flop, output pulse will transfer from one output terminal to the next. Each output terminal is numbered to indicate the required number of input circuit pulses.

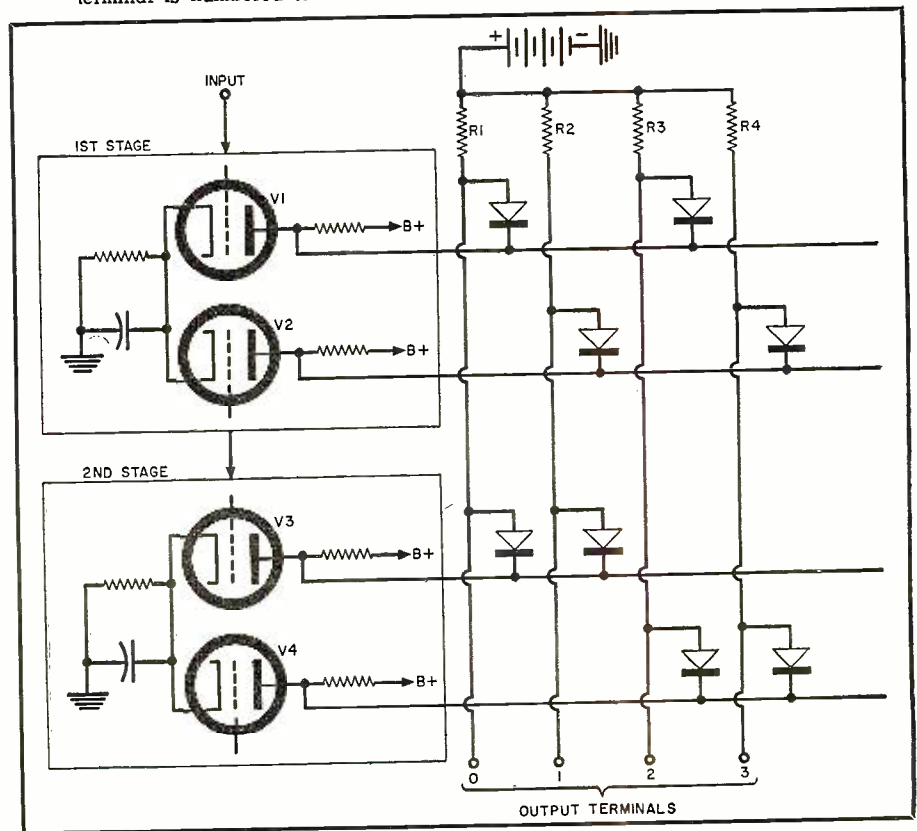



**S**INCE the advent of magnetic tape recording in the audio field and as its inherent advantages of good quality, immediate playback, and tape reusability were recognized, the possibility of utilizing the same process for recording television images has stimulated engineering minds.

As video and audio information are both made up of varying electrical voltages, differing only in the frequency ranges involved, it would seem that a simple extension of audio recording techniques would serve to put pictures on tape. This, unfortunately, is not the case and we must examine the fundamentals of magnetic recording to understand the problems involved.

It is a paradox of magnetic recording that you cannot put both a very high and a very low frequency on the same tape and expect to get good output and adequate signal-to-noise ratio from both. The range of audio signals (30 to 15,000 cycles) represents about the maximum latitude possible. But video frequencies extend from nearly d.c. to above 5 megacycles!

The diagram of Fig. 1 shows that the maximum frequency you can record and play back is controlled by head gap size and tape velocity. When the tape velocity is such that a full wavelength (1 cycle) of the recorded signal is approaching or is equal to the gap dimension, no output is possible. If the head instantaneously sees equal amounts of positive and negative flux density on the tape, then they cancel. A range of frequencies before this upper limit and spanning approximately 10 octaves represents the usable spectrum and even though the output from the head drops in amplitude proportional to the reduction in frequency, an equal and opposite response curve of the amplifier following the head will correct for this condition and give usable output over this range.

Since the head output is dependent on the *rate of change* of flux density, we soon reach a low limit where the rate becomes so slow that no useful output can be obtained and the signal-to-noise level becomes prohibitive. The Ampex VR-1000 "Videotape Recorder"

solves the various problems in recording television signals by these three methods:

1. The video signal is altered, in form, from an AM signal extending from 0 to 5 megacycles to an FM signal containing the same inherent information but transposed into a spectrum of 1.5 to 6.5 megacycles. This meets the basic requirement of having upper and lower frequency limits within the conditions as specified.

2. To get adequate playing time from a compact reel of tape, the system utilizes a 2-inch wide tape (compared to ¼-inch used in audio recording) and a rotating head assembly with heads spaced 90° apart which provides the high head-to-tape velocity (1500 ips) necessary for recording the very high frequencies involved.

3. Precision-made head assemblies and a very accurate servo system make it possible to play tapes made on one machine on any other machine adjusted to established standards. This allows for interchangeability of tapes between users in the United States and

# How the Videotape Recorder Works

*Many TV programs are now on tape. Here's the recorder responsible for this revolution in TV broadcasting.*

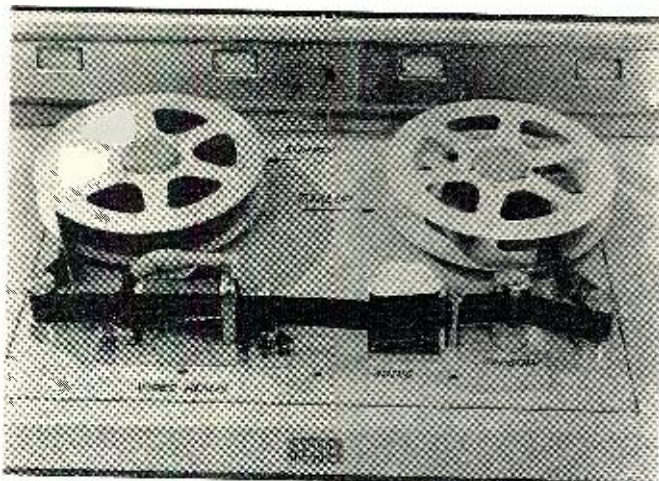

Close-up view of transport with cover plate removed.

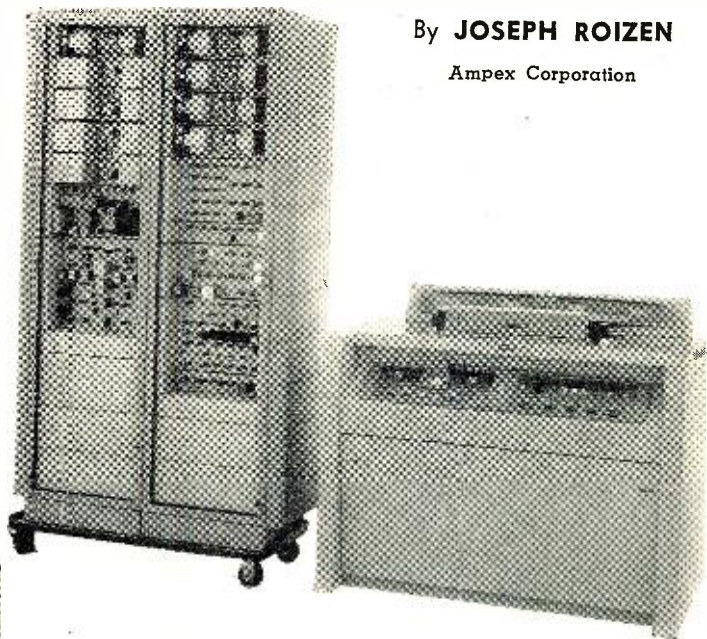

By **JOSEPH ROIZEN**

Ampex Corporation

The complete machine comprises two racks and console.

This is what the video head assembly looks like.

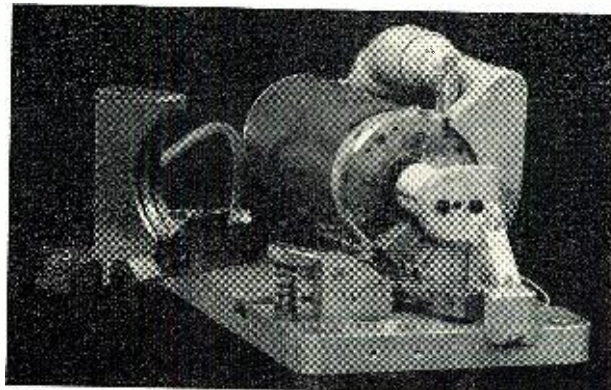



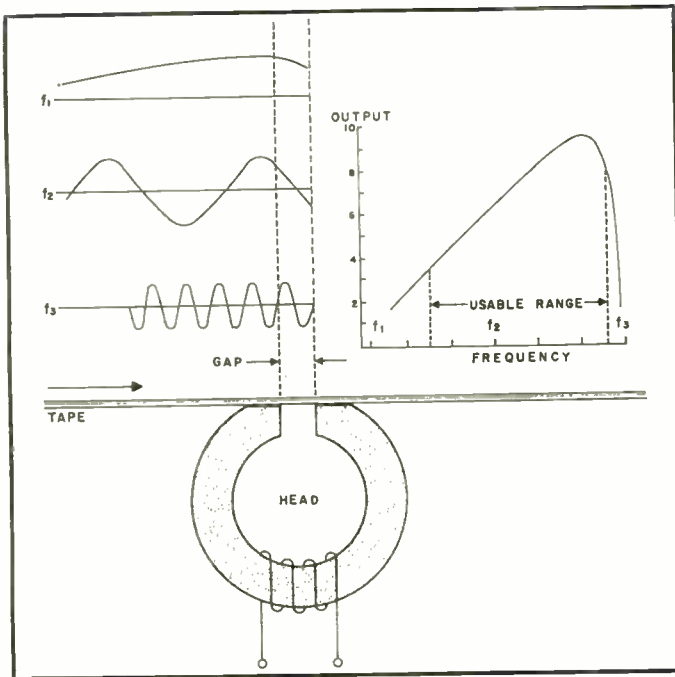

Fig. 1. Maximum frequency is controlled by gap and tape speed.

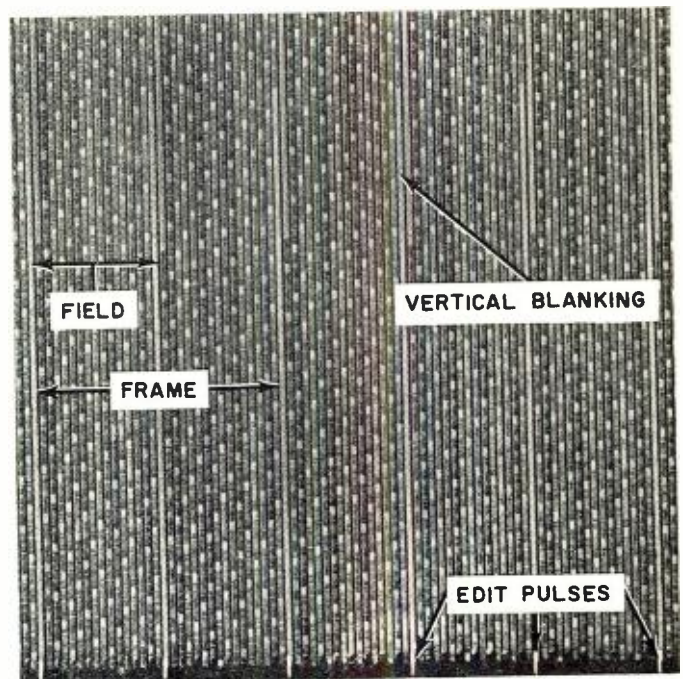

Fig. 2. A "visualized" tape with a monoscope pattern recorded.

Canada and, in some cases, even with foreign countries. It also permits commercials made on different machines to be spliced in with program material recorded at a different locale.

The "Videotape" unit is capable of recording for indefinite storage or immediate playback (without processing) a complete television program of up to 90 minutes in length, including both picture and sound. A standard one-hour reel is 12 inches in diameter and holds approximately 4800 feet of tape. The tape consists of a specially manufactured Mylar base, 1 mil thick, coated with oxide on one side. It can be re-recorded over 100 times. Tape speed is the standard 15 inches-per-second employed in professional audio recording equipment.

The recorded signals include the picture information (video) laid down at right angles to the tape by the rotating head assembly. The sound portion is recorded along the upper edge of the tape with the timing reference signal (control track), the cue track, and edit pulses recorded at the lower edge. Although these signals are invisible to the naked eye, it is possible to bring them up for editing and splicing purposes. Fig. 2 shows a "visualized" tape which has a monoscope pattern recorded on it. The transverse lines carrying the video signal are 10 mils wide with a 5 mil spacing between them. Each scan of one head in the drum assembly covers 16 to 17 active television lines. Enough overlap of video information is available so that there is ample time for switching from head to head while maintaining proper continuity.

Fig. 3 is a simplified diagram showing the "Videotape Recorder" in the "record" mode. Vertical sync signals derived from incoming video information are used as a reference for main-

taining the rotational speed of the drum motor at exactly 240 revolutions-per-second (14,400 rpm). The servo loop picks the signal from the head assembly off a photocell and feeds it back to the servo control unit for comparison with vertical sync. The resultant is used to control the speed of the drum motor. The photocell signal is also recorded on the bottom edge of the tape by the control-track record head as a timing reference to be used in playback and the edit pulses are superimposed on it. Two binary counters reduce the 240-cycle signal to 60 cycles—the frequency used to drive the capstan motor pulling the tape.

The same video signal that controls the drum servo is fed to a modulator which transforms it to FM and is then applied through four identical channels to the individual heads on the drum.

A slip ring and brush assembly serve to transfer the signal to the head drum. Since only one head at a time is in contact with the tape, each head lays down its track in sequence. To maintain a perfect pressure gradient across the tape in contact with the revolving heads, the tape is held in a concave guide by an applied vacuum. This guide can be minutely adjusted to make playback time exactly equal to record time even when the head wear has somewhat reduced the diameter of the head drum assembly. The average life of a head drum assembly is in excess of 100 hours and they are refurbished on a rotational exchange basis.

Fig. 4 shows the test pattern which results when the guide is slightly mis-adjusted. This demonstrates the group of picture lines each head covers and the result of a timing error which was

Fig. 3. Simplified diagram showing "Videotape Recorder" in the "record" mode.

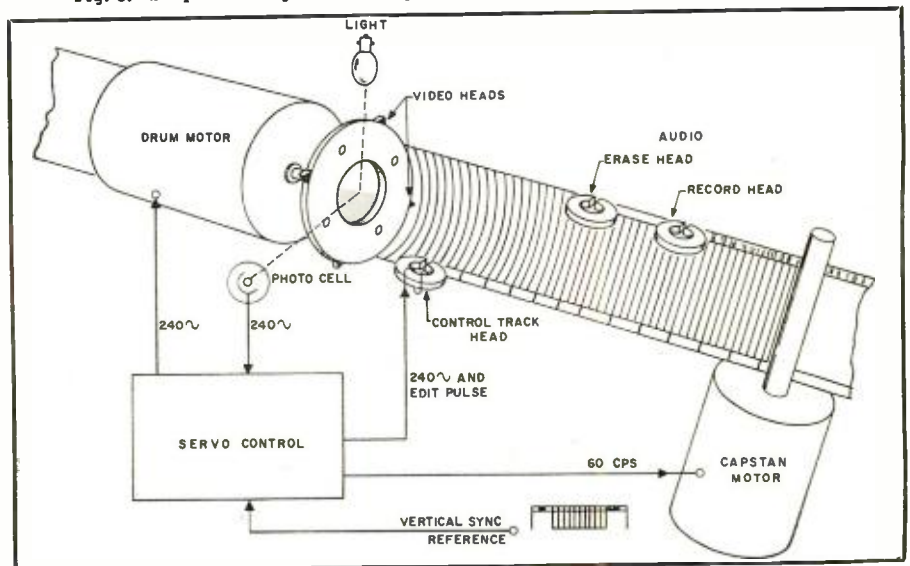



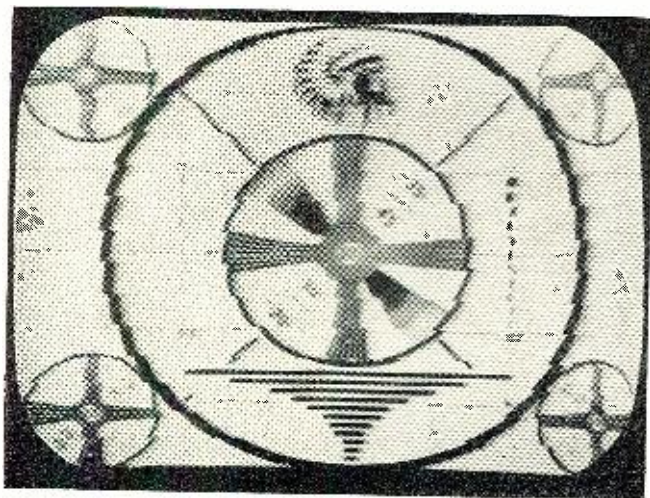

Fig. 4. Test pattern resulting from slight guide misadjustment. This shows the group of picture lines each head covers and the result of a timing error which was purposely induced in this case. This condition is called "picture skewing" and it is corrected for by automatic compensation.

purposely induced in this case. We refer to this condition as "picture skewing" and an automatic compensating device corrects for it.

The edit pulses along the bottom edge of the tape are referenced to vertical sync and serve to locate the exact point at which a splice can be made so that it will occur during vertical blanking and be invisible to the viewer. An accessory precision splicer performs this function very simply and with the required amount of accuracy.

We will now follow the path of a standard television picture signal which would normally be obtained from a live camera chain, film chain, or microwave source as it goes through the processing required to have it recorded on video tape and then played back for previewing or air transmission. Fig. 5 is a simplified block diagram of the video signal path. In the "record" mode a video AM signal of approximately 1.4 volts peak-to-peak is applied to the input of a multivibrator type modulator whose normal rest frequency (4.75 mc.) is made to deviate approximately 2 mc. by variations in the video voltage. The output of this modulator is now an FM signal whose frequency

is proportional to the original video amplitude. This FM signal is further amplified and applied, through four identical drivers, to the video record heads on the drum assembly. The signal is then laid down on the tape as previously explained. In the "playback" mode the servo control system insures that each head will follow closely the tracks that have been recorded and the sequenced, overlapping outputs of these heads are fed to individual preamplifiers and into the switching system.

The "switcher" is a fairly complex electronic device capable of precisely sequencing the FM signal from the tape in such a way that no overlap or absence of signal occurs and that switching transients are timed by horizontal sync and do not appear in the picture. The now continuous FM signal is then channeled through a demodulator chassis which applies considerable amplitude limiting (to make up for variations in head outputs). The signal now has a constant amplitude and is applied to a delay-line slope detector and a full-wave rectifier where it is converted back to an AM video signal. Although the output of the de-

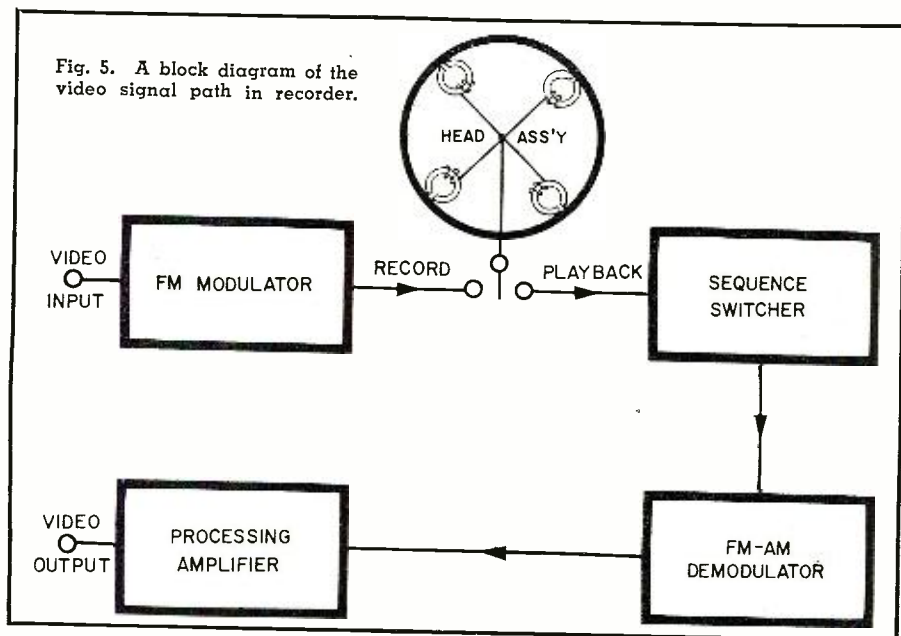

Fig. 5. A block diagram of the video signal path in recorder.

modulator can be used to provide high-quality television reproduction, the degradation of the sync signals is such that the composite video would not meet FCC requirements for commercial re-broadcast. To overcome this deficiency a processing amplifier, somewhat similar in action to stabilizing amplifiers used by television stations, is utilized. The processing amplifier regenerates new blanking signals and amplifies, clips, and gates synchronizing pulses. The newly blanked video is combined with the noise immune, as well as cleaned up sync signals and the resultant composite video output is now acceptable for standard transmission.

Because of the inherent linearity of the system there is no expansion or compression of the gray scale and the reproduced images are almost indistinguishable from the original on the home receiver. The over-all bandwidth allows an off-the-tape picture of better than 400 lines resolution with a standard monoscope pattern to be played back. The major limiting factor in video tape recording today is the maximum signal-to-noise ratio that can be achieved. At the present state of the art, between 33 and 36 db of signal-to-noise appears to be the maximum. This permits commercially acceptable third-generation copies (a copy of a copy of a copy).

At the present time, to make high-quality copies it is necessary to utilize the original tape feeding a group of "Videotape Recorders" in parallel, each of which is recording the duplicate on a one-to-one time basis. Network tape centers equipped with batteries of these recorders are located in New York, Chicago, and Los Angeles as well as at independent stations all over the world. Foreign stations in Canada, Mexico, Japan, Great Britain, Germany, Australia, and France are using these recorders for day-to-day programming.

The recording of color television signals on video tape, although presenting a much more difficult technical problem, has been successfully demonstrated and its adoption is just a matter of time. A group of *Ampeex* VR-1000's has already been converted by *NBC* engineers to record and play back its major color shows (Steve Allen, etc.) and the company is now delivering color conversion kits to its "Videotape Recorder" customers.

A tremendous variety of non-broadcast uses have been opened up by video tape recording. At the AMA convention in San Francisco, in co-operation with *Smith, Kline and French* whose color facilities were being used to telecast surgical operations, color recordings and repeated playbacks served to demonstrate the potentialities of the medium as a medical training tool. The applications of video tape recording to educational and closed-circuit work are being expanded while modified versions of the technique are finding gradual acceptance in the instrumentation field.



# Mult-Set TV Installations

## PROBLEMS & PRINCIPLES

By JACK BEEVER  
Jerrold Electronics Corp.

*Part 1. These profit-makers can be handled by small independents. Here is the necessary background.*



**M**ULTIPLE-TV systems, in which one antenna feeds up to 1000 sets, are becoming a definite part of the American scene. There are, at present, at least 100,000 such v.h.f. systems in use. Of special significance to the average service technician is the fact that a very large number of these are not complex, expensive systems that are beyond the scope of the small service shop.

Many modest systems are now in use in motels, trailer courts, hospitals, smaller multiple dwellings, and even in private homes, where it is considered convenient to have several antenna outlets strategically located throughout the house so that a portable TV set can be provided with good signal no matter where it may be used. Such a system is also a valuable asset in a set dealer's showroom, enabling the demonstration of any receiver on the floor to its best advantage.

Despite the encouraging prospect, the lack of real information on the layout, maintenance, and "bugging out" of these systems leaves many technicians out in the cold. In actuality, such a system, once the principles involved are understood, is much simpler to handle than a monochrome TV receiver.

A multi-set TV installation consists primarily of three constituents—an antenna, an amplifier, and the tap-off units. These are all interconnected through a transmission line. The purpose of the installation is to deliver signal from the antenna system to each TV set with the least possible degradation, irrespective of what is happening at the other sets. Any such system can be analyzed into a series of gains (amplification), which are lumped, and losses, which are distributed. Essentially, it is a tree-like structure with trunk and branches having sets attached to the branches, like leaves on

a twig. Fig. 1 is a block diagram of such a structure.

If the total of all losses seen by any one set on the branch line is less than the gain of the amplifier, the signal delivered to the receiver input will be stronger than that developed at the input of the entire system. In cases where the antenna develops more than enough signal to drive one set adequately, the surplus signal can be considered as part of the system gain. It may thus be used to reduce the gain requirements of the entire installation.

### Transmission Lines

It is important that, over the area being served, signal be carried through suitable transmission lines. Parallel-pair lines, such as 300-ohm twin-lead, have the unfortunate characteristic of radiating comparatively large amounts of the signals they carry. This can result in similar and ghosting caused by bad impedance matching and reception of re-radiated signals by the receiving antennas. Coaxial cables do not radiate significantly and are less affected by surrounding materials. These attributes make such cables the logical choice. Since the greatest losses in a system are introduced by these lines, we must be familiar with them.

One of the most important peculiarities to keep in mind is the fact that transmission lines produce greater losses as we go up in frequency. This frequency discrimination, shown by the figures in Table 1, greatly affect the design of multi-set systems. Loss is stated in decibels per 100 feet of cable, with three types being listed. The most commonly used is RG-59/U, which is about  $\frac{1}{4}$ " in diameter. Next in order of use is RG-11/U,  $\frac{1}{2}$ " in diameter. An in-between size, RG-6/U, is also used. Each of these has a characteristic impedance of 75 ohms nominal, which is



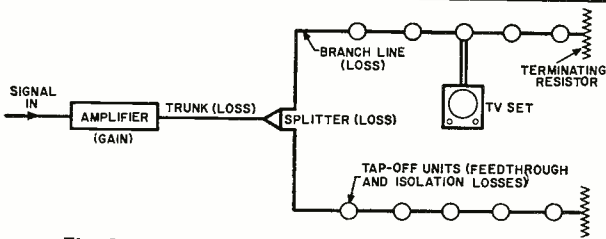

Fig. 1. This simplified layout diagram of a multi-set installation shows all the principal elements.

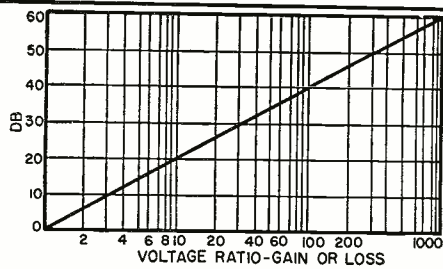

Fig. 2. A graph like the one shown can be used to convert voltage gain and loss ratios into decibels for more convenient system calculations.

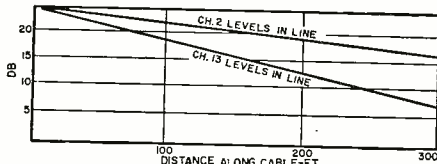

Fig. 3. Cable losses increase with greater lengths and higher channels.

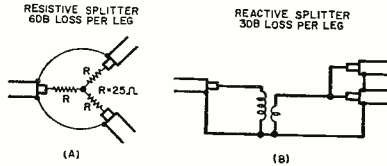

Fig. 4. Line splitters may be resistive (A) or of the reactive type (B).

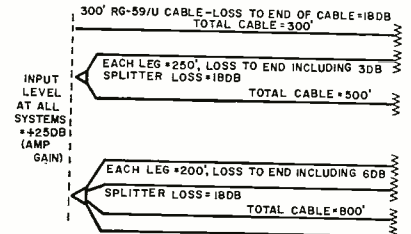

Fig. 5. How splitters can increase cable coverage with a given loss.

practically standard for v.h.f. TV use.

### Measurement Units

Use of the decibel in the table brings up another point: it is advantageous to state all gains and losses in the same, compatible terms. Despite the fact that its complex derivation causes many technicians to distrust it, the decibel is the unit that, in practical application, simplifies all calculations.

For convenience, graphs similar to the one shown in Fig. 2 are often used to convert from db to voltage ratios. Values are directly read when dealing with gain. Where loss is involved, the reciprocal of the gain figure is used. For example, 6 db gain is achieved with twice the initial voltage; but -6 db is one half the voltage. Also, a loss of 40 db means a reduction to 1/100th the voltage. For those adept with the slide-rule and owning one with log-log scales, a direct means of conversion is available. The method, involving the *C*, *D*, and *LL* scales, is described in the "Radiotron Designers' Handbook."

The use of the decibel is amply justified by the great simplification it provides in system calculation. The decibel is based, mathematically, on the common logarithm, which boils down essentially to the exponent required to raise the base 10 to any desired number. Once this operation, a laborious one, has been performed, the functions of multiplication and division are replaced by addition and subtraction. It is important to bear in mind that, when decibels are added, the actual operation is one of multiplication and when decibels are subtracted, the operation is division.

For example, 20 db corresponds to a ratio of 10:1, therefore a gain of 20 db is 10 times, and a loss of 20 db will be a division by 10. Reference to Fig. 2 indicates that 40 db is a ratio of 100:1 and therefore, when gain, is 100 times. If we add 20 db and 20 db we get 40 db. To derive the corresponding answer in arithmetical ratios, we would have to multiply the corresponding ratio of 20 db, thus,  $10 \times 10 = 100$ . Understanding this relationship allows us to approach

a quick estimate of the ratio corresponding to a db number by remembering that a ratio of 2:1 equals approximately 6 db. Knowing this, we can add up sixes until we approximate the number. Each time we add 6 db, we double the ratio.

For example, take 36 db. 6 db + 6 db = 12 db, ( $2 \times 2 = 4$ ). 12 db + 6 db = 18 db ( $2 \times 4 = 8$ ), 18 db + 6 db = 24 db ( $2 \times 8 = 16$ ), 24 db + 6 db = 30 db ( $2 \times 16 = 32$ ) and 30 db + 6 db = 36 db ( $2 \times 32 = 64$ ). Thus, 36 db is roughly 64 times. The rule is simple. If you add 6 db, you double the ratio.

This article will always use decibels for *voltage* ratios, which brings up a precaution to be observed. One can only compare the voltage of two points when both points have the same impedance. Amplifiers and coaxial cables commonly used in v.h.f. distribution systems are designed to a characteristic impedance of 75 ohms and the "microvolts" mentioned will be considered to have been read at this impedance, unless otherwise stated. There is a simple, helpful relationship between the voltages at 75 ohms and 300 ohms. The same power is represented at 300 ohms when the voltage is doubled. For example, an efficient matching transformer from 75 to 300 ohms would provide, at its 300-ohm output, double the input voltage and half the input current.

To return to coaxial cable, the important thing which affects its use in systems is the differential loss. Reference to Table 1 shows that RG-59/U has 2.8 db loss per hundred feet at the video carrier of channel 2, while the loss is 5.9 db at channel 13. These figures are rounded out in practice to 3.0 db and 6.0 db. The effect on a system can be readily seen if we assume an amplifier of the broadband type, with a gain of 25 db, feeding into 300 feet of RG-59/U. If the signals of interest are channels 2 and 13, then channel 2 will be dropped 9 db ( $3 \times 3$  db) at the end of the line and channel 13 will be dropped 18 db ( $3 \times 6$  db). See Fig. 3. Assuming an arbitrary signal level of 25 db to start with, there is a drop to 16 db on channel 2 and 7 db on channel 13.

This is a difference of 9 db, or almost three times the voltage. It would seem obvious that the important losses in the system will be the losses of the highest channel. This is the usual rule and, in practice, since one cannot predict what channels will eventually be available in an area, channel 13 losses are used for laying out systems, whether channel 13 is in operation or not.

### Line Splitters

It is rare that a system can be laid out with a single line running from an amplifier to the end of the system; as a rule, the line must be "split" or branched. When this is done, the splitting device must maintain impedance match in all directions to avoid reflections and standing waves. Mismatches result in unpredictable levels and ghosts.

Two types of splitters are in common use: the resistive and reactive types. The resistive type, consisting of a Y network, is more stable and tends to improve over-all system impedance match, but has the disadvantage of higher loss, usually 6 db for a two-way split. One such unit is shown in Fig. 4A. The reactive type is essentially an impedance-matching transformer used to match the input 75-ohm impedance to the paralleled impedances of two output lines. These devices show a forward loss of 3 db, equal to half the power in each leg. They are, however, dependent for their efficiency upon seeing a good match at all terminals. A basic schematic is shown in Fig. 4B. In reality, in order to get good bandwidth and flat response, these devices are generally more complex and usually have a specified frequency range. The use of these devices produces some peculiar anomalies in system layouts. For instance, the amount of cable coverage by a given amplifier is *increased* when a splitter is used. Fig. 5 helps to illustrate this action and also indicates how a four-way splitter may be used to advantage.

At the top of the illustration, we see signal being fed from an amplifier with 25 db gain to a 300-foot length of RG-



59/U cable. With the high-channel loss of 6 db per 100 feet, 18 db of loss will be incurred to the end of the cable, leaving a signal at the end which is 7 db over the amplifier's input (25-18=7 db). If we take this figure, 7 db, as an arbitrary limiting figure, below which we will not go, we can compare the total footage of cable covered when splitters are used.

The second illustration from the top shows the same amplifier feeding into a two-way splitter, which has a loss of 3 db in each leg. Each cable, therefore, sees a usable gain of 25-3 or 22 db. Since we require that 7 db be left at the end of the cable, then we may lose 22-7, or 15 db, in the cable. Two and one-half times 6 db is 15 db, therefore, each cable can be 250 feet long (6 db loss per 100 feet). The amplifier is now supplying a total of 500 feet of cable, an increase of 40% over the coverage of the single cable. We cannot get farther away from the amplifier, but if the amplifier is centrally located, then we can cover a linear distance of 500 feet, as opposed to 300 feet without the split.

The four-way splitter at the bottom of Fig. 5 has a 6 db loss per leg. This is an increase of 3 db over the two-way splitter, which will reduce the loss we can allow in the branch legs by 3 db. Fifty feet of cable is 3 db of loss and each leg must be 50 feet shorter, making them each 200 feet long. We now have four legs of 200 feet or 800 feet of cable, two and two-thirds as much as the unsplit cable.

Some manufacturers produce asymmetrical splitters, which show different losses to each output. These are sometimes called "matched tapping pads."

### Tap-Off Units

The previous discussion points out that the distribution cables from the output of an amplifier contain signals which vary in strength along the cable, being weakest at the cable's ends. If this distribution system is to feed a number of television receivers, it would be better if the sets received signals of approximately equal strength. This imposes restrictions on the design of the tap-off devices. Possibly the best way to describe the functions of tap-off units is in terms of the old, familiar water analogy.

If we consider the distribution cable to be a pipe of fixed bore, carrying a steady flow of water, we can describe the tap-off unit as a faucet tapped into the pipe. If this faucet has the same bore as the pipe and is opened to its fullest extent, one-half the water flow will emerge from the faucet and one-half the flow will continue along the pipe. This would result in the pipe's volume of flow, at a point past the faucet, being one-half the input volume. A similar faucet farther down the pipe would again extract half and this process would rapidly result in very little water emerging from the more remote faucets.

However, if we reduce the flow from the first faucet, the other faucets will have increased flow. By properly ad-

justing the faucets, we can equalize the flow all along the line. This will result in a condition where the first faucet is almost closed and each succeeding faucet is opened wider than the one preceding it.

We can now relate the analogy to electrical behavior. The closing of the faucet valve is directly analogous to a resistance—so that the tap-off unit must impose a resistance between the line and the load (TV receiver). Such a resistance will cause the voltage developed across the load to be less than the voltage on the line. We can express this difference in db, since the ratio will be the same irrespective of the absolute levels on the line. This difference which, from the viewpoint of the receiver, is a loss, is called "isolation loss," since it also serves to isolate the set from the system by the amount of the loss.

To return to the water analogy—the faucet allows some water to escape, reducing the volume in the line. This loss in the line, caused by the insertion of the tap-off unit, is called "feedthrough loss" or "insertion loss." The term "feedthrough" is preferred, to avoid confusion with insertion losses in other applications.

The isolation loss is important for a number of reasons other than that of adjusting the amount of signal taken from the line. It reduces the feedback of extraneous signals caused by TV receiver local oscillators or arcing tuner contacts into the signal line and presents an isolation between any two sets which is the sum of two tap-off isolation losses. The isolation also prevents the widely varying input impedances of individual receivers from disturbing system impedances to a significant degree.

We can see that three aspects are important to us in system layout: 1. Feedthrough loss, which appears as a general system loss. 2. Isolation loss, which is seen by the individual set to the system only. 3. Matching of impedances, necessary to maintain system balance.

The function of impedance matching is not always found in the same unit as the tap-off device. In some cases, the tap-off unit will feed its reduced signal to a length of coaxial cable which terminates in a matching transformer. This technique is common where very high ambient signal levels are found and it is necessary to prevent the set from picking up direct signals on its lead wire.

Two methods of tapping a feeder line are generally used; the resistive and the capacitive. These are shown in Fig. 6. In neither case does the output represent a 75-ohm source; but, if the load at the end of the tap-line is a 75-

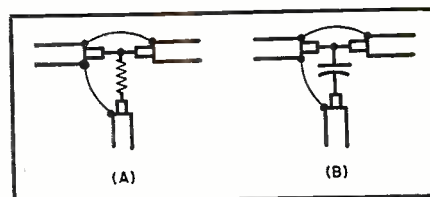

Fig. 6. Resistive (A) and capacitive (B) methods for tapping a feeder line.

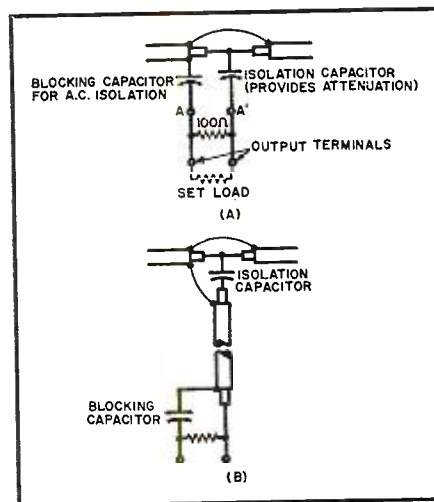

Fig. 7. Typical tap-off configurations: combined type (A) and separated type (B).

ohm load, no reflections will occur and the system will not be significantly disturbed. It has been found that capacitive taps have a less disturbing effect on the system and these are the usual choice. A matching transformer, for example, will reflect any impedance variation seen at its secondary to its primary, which is what the system sees. Although matching transformers are more efficient under proper conditions, their use is not always advisable.

A resistor is not generally frequency sensitive. Within limits, 75 ohms of resistance will be 75 ohms as frequency increases until the lead length or the resistor element becomes an appreciable inductance (which should be a warning against using wire-wound resistors). With this in mind, we can see that the load should be as resistive as possible and should be 75 ohms, the characteristic impedance of the cable. A simple circuit is almost universally used as a matching network in these instances. This circuit is shown in Fig. 7. Examination of the circuit shows that the tap-off circuit's 75-ohm output, across points A and A' in Fig. 7A, sees as a load the 100-ohm resistor paralleled with the nominal 300 ohms of the set. The impedance will therefore always be something less than 100 ohms, approaching the required system impedance. The major component will

(Continued on page 145)

Table 1. Attenuation factors for three chief cable types on v.h.f. channels.

CABLE*	TELEVISION CHANNELS												
	2	3	4	5	6	FM	7	8	9	10	11	12	13
RG-59/U	2.8	3	3.2	3.4	3.6		5.3	5.4	5.5	5.6	5.7	5.8	5.9
RG-6/U	2.1	2.2	2.3	2.4	2.6		4.0	4.05	4.10	4.15	4.20	4.25	4.3
RG/11U	1.6	1.7	1.8	1.9	2.0		2.7	2.75	2.80	2.85	2.90	2.95	3.0

\* Cable attenuation in db per 100 feet



# INDOOR PUBLIC

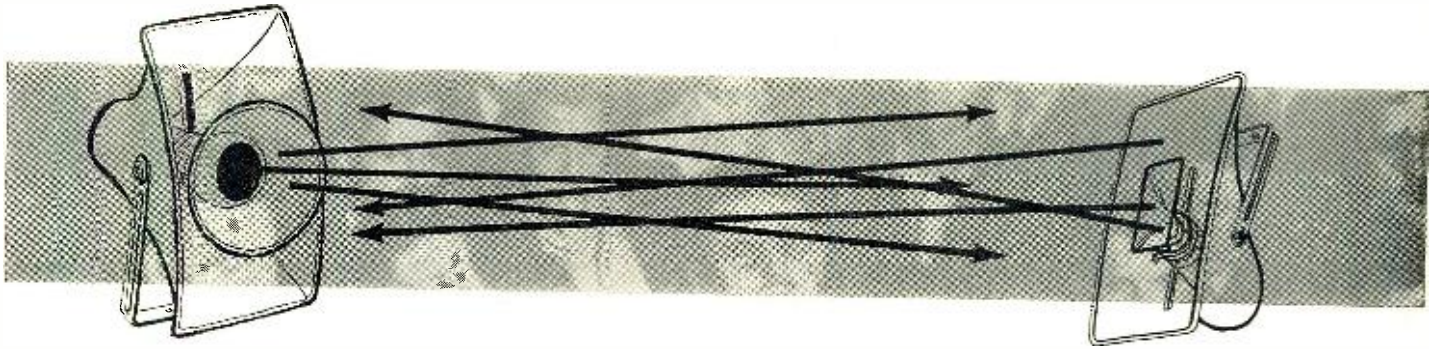

**A**S THE days grow shorter and temperatures drop, the various social events that call for the services of a p.a. man move indoors—so he has to adapt his facilities to indoor work in order to meet this need. Knowing your business is just as important in making indoor installations as it is for handling outdoor jobs. The same questions have to be answered: "How many and what kind of microphone? How many, what kind, and where to put the loudspeakers. How many watts and what features does the p.a. amplifier need? Are any other facilities required?" The answers to such questions can be quite different from those pertaining to outdoor jobs.

In the outdoor department, microphones have to be chosen for ruggedness and for the ability to pick up despite a wind. Although these are not problems encountered in microphones for indoor installations, we have dissimilar but equally important problems. Indoors the big concern of sound re-inforcement is getting sufficient amplification without acoustic feedback or "howlback." To get best results in this direction, care must be exercised

all along the line—microphones, amplifiers, accessory units, and loudspeakers.

## Microphones

As a general rule, the best microphone for such indoor p.a. applications has a directional response—cardioid or "variable D"—and the smoothest possible frequency response. But this rule, too, has exceptions. In some indoor installations the acoustic reverberation characteristic of the building may be very "peaky" due to the building structure—use of paneling, glass, or tiled surfaces, etc. Sometimes a microphone that would be bad anywhere else turns out to be good in this particular building because the peaks in the microphone response just happen to avoid those produced by the building acoustics.

One such case occurred recently. Testing microphones side by side, a high-quality cardioid definitely gave the most natural reproduction of individual voices, but a microphone that sounded quite harsh, because of its peaky response, could have the volume turned up so both intelligibility and

apparent loudness were better, although the quality was not as natural. The decision went to the lower quality mike for this particular job. In a different building quite different results might have been observed and another "bad" microphone might have proved to be the best.

If you have, or are prepared to buy, a variety of microphones and are likely to have the opportunity to try them out on each indoor job you get, you may find that such inferior quality microphones will accidentally suit the job at hand. The approach is a little more tedious, but sometimes worthwhile. However, often this approach is impractical since there is no opportunity for testing a number of microphones ahead of time.

A better and surer approach is to use the best microphone of the type suited for the job and a flexible amplifier that will make the best of the acoustic problem. By suiting the microphone to the job, we mean choosing a directional pickup pattern to suit the type of program material to be presented.

For a single voice pickup, the cardioid is usually best—although a ribbon (gradient or velocity type) often does as well. For a small group that can conveniently get "in front of" a cardioid, this type is also very satisfactory.

For larger pickup areas, such as an orchestra or dramatic presentation, more than one microphone is needed. American practice favors pressure units, usually dynamic, for this purpose. European practice leans toward the use of ribbons carefully placed—and the results often validate the claim of its superiority made by the proponents of this method. This latter technique is somewhat more fussy to use since you not only have to get the microphones in the right places but they must be oriented correctly. Dynamic types, correctly phased, can be used close together but it is always best to keep ribbons spaced well apart, consistent with proper coverage of the required pickup area.

Here is an integrated indoor sound distribution system, recently announced by DuKane, that also includes closed-circuit TV, emergency alarms, along with timing circuits.





Planning and setting up a system requires special know-how. Here's help for the would-be p.a. man.

# ADDRESS SYSTEMS

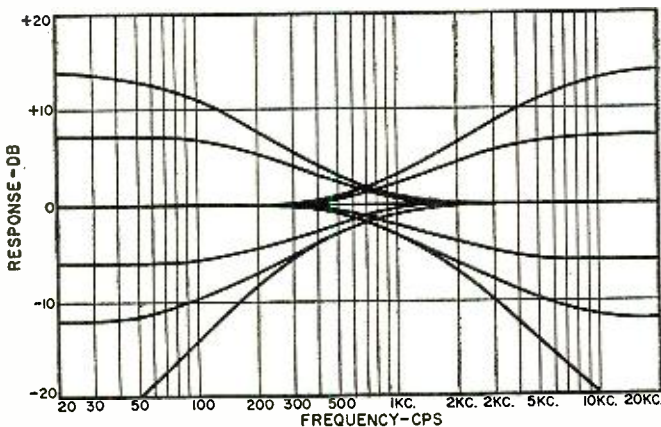
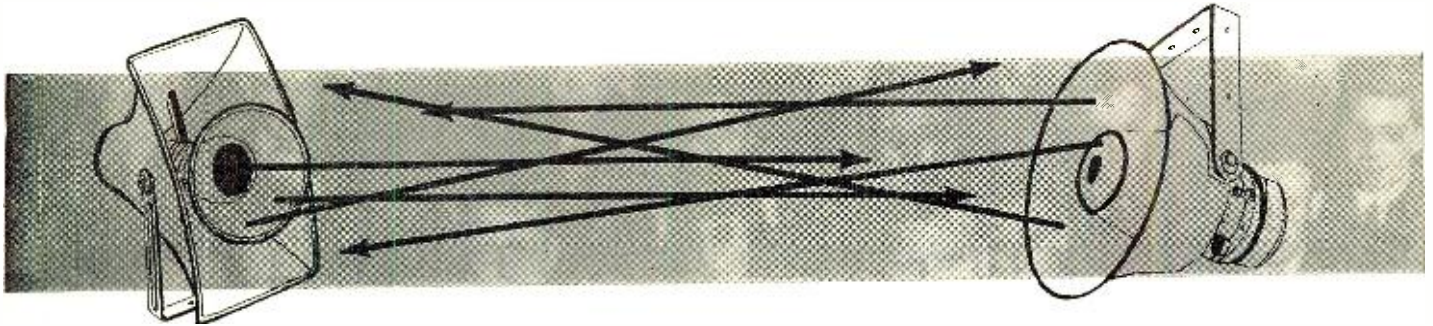

Fig. 1. Here are typical frequency response changes that are produced by the tone controls in a high-fidelity amplifier.

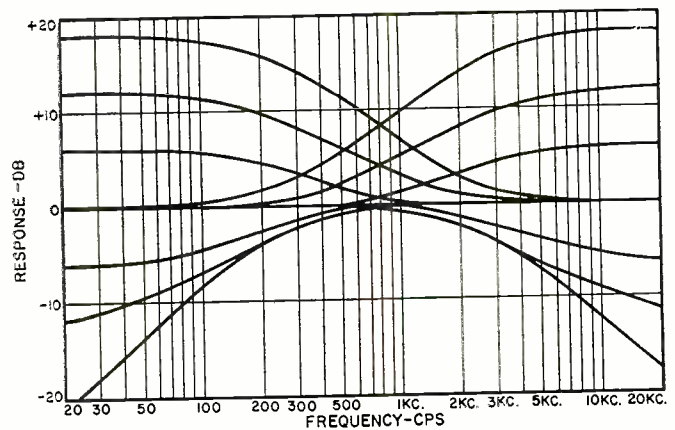

Fig. 2. Shown here are the response changes that would provide more suitable control in a public-address amplifier.

Where two or more microphones are needed, due to spacing considerations, better operation can be obtained by arranging to have only one, or a minimum number, "live" at one time. For example, a platform mike for the chairman, with another at the front of the auditorium, may be used for interviews. A quick-fade device, so only one mike is "on" at a time but fixed so that changeover can be made as quickly as the dialogue alternates, will enable a better "howl-free" level to be achieved. The operator cannot read the "funnies" during this kind of program, but the improved results are well worth his extra attention.

Of course there are simple "mechanical" things about choosing the correct microphone, such as making sure its impedance is right and the plugs fit the amplifier input sockets—or at least that you have the necessary adapters.

Choice of impedance is not merely a matter of matching microphone to amplifier. If the microphone is always near the amplifier, so a short connecting cable (not more than 10 to 15 feet) can be used, then impedance is unimportant, provided you match. If, on the other hand, you anticipate using longer input runs, it is worth investing in microphones that use a line imped-

ance (150, 250, 500, or 600 ohms) and an amplifier with line input transformers to match, either internally or externally. If external transformers are used, watch your connections to maintain complete shielding and grounds.

Another mechanical detail is that of shock mounting. The indoor mike faces no problem of wind, but it often meets one involving the transmission of vibration from the floor on which it stands. In a bad case, where a vibration mount proves inadequate, the solution may be to suspend the microphones by cables from suitable high points. One disadvantage of this method is that the right position must be carefully determined in advance since it may prove difficult or impossible to make changes during a program.

## Amplifiers

The use of an amplifier designed for the purpose can go a long way toward improving the performance of an indoor p.a. system. Convenient controls for individual microphones to facilitate the quick-fade method of operation, a comprehensive tone control arrangement, and possibly an anti-feedback device, can all contribute to more effective amplification on difficult jobs.

The luxury way to do the job is to

use a separate microphone preamp for every mike, each with its own tone-control circuit so that performance can be individually optimized. The outputs of these preamps are then fed into separate high-level inputs on the main amplifier and the controls on these inputs used for quick-fade operation. For a truly "deluxe" system, the controls could be remotely operated by using electronic gain and tone controls—but such units are not commercially available.

Tone controls for p.a. work should provide a different form of response variation than that usually incorporated in high-fidelity amplifiers. In a hi-fi amplifier the main purpose of such controls is to adjust for deviations in the quality of the program source. For p.a. purposes the controls have to adapt the performance of the system to the acoustics of the hall or auditorium. The usual response variation of a hi-fi system is shown in Fig. 1 while Fig. 2 shows the desirable characteristics for a p.a. system. The object is to adjust the relative level of different parts of the audio spectrum.

The usefulness of an anti-feedback device, consisting of an adjustable rejection circuit, depends on the location. If acoustic feedback occurs at one very





Although not specifically designed for p.a. this Stromberg-Carlson speaker is only about 3" deep, making it suitable for installation in shallow walls or partitions.



Many p.a. speakers, such as these by Electro-Voice, may be used indoors or outdoors.

In temporary installations the speakers may be installed on heavy-duty supports, such as this Atlas telescoping stand.

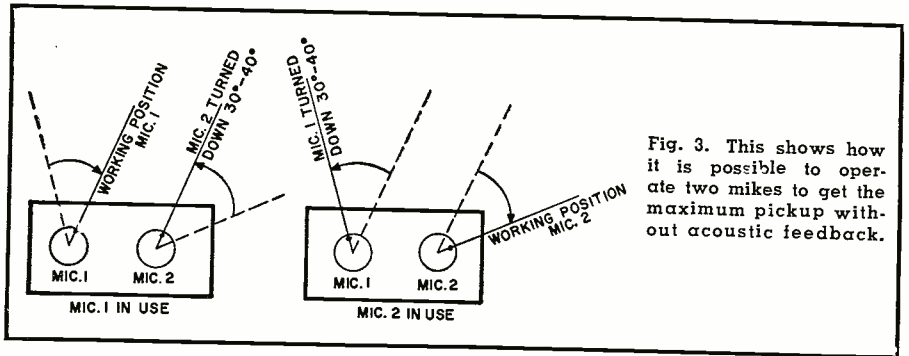
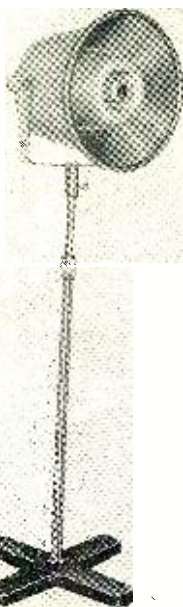

Fig. 3. This shows how it is possible to operate two mikes to get the maximum pickup without acoustic feedback.

definite frequency, use of a filter adjusted to this frequency will enable the gain to be turned up much farther before acoustic "howback" is encountered. In many buildings, however, acoustic feedback can start at a number of frequencies, almost at once. Eliminating the one that happens first will then give very little margin.

As well as being flexible in its controls a p.a. amplifier for general use must be adaptable in its input and output arrangements—particularly the inputs. Although the simplest system—consisting of a microphone, amplifier, and one or two loudspeakers, all designed to go together—can handle many of the smaller jobs quite well, for larger jobs a more flexible amplifier will be required.

Provision should be made for several separate inputs, both at line impedance and at low or high impedance, as well as for high-level inputs to suit the output from tuners, phono preamps, or microphone preamps. Each input should have an independent gain control. Some amplifiers incorporate a variety of input sockets which may be selected by switch, using the same gain control for all. Although the best way of operating is to keep only the active circuit of the moment "live," it is not too practical to switch live input circuits. For one thing, it may produce quite objectionable plops and, for another, the level invariably needs to be adjusted. The gain control must have its setting changed simultaneously with each change of switch position which can be a difficult and confusing operation. The better way is to get an amplifier with the necessary number of multiple inputs and individual controls for each.

If the operation of the controls, using this method, calls for considerable rotation from "off" to the desired setting, a simple trick during an interview is to turn the "off" mike down only a few degrees. It will still be "live," but it will not contribute to possible feedback while not in use. Then you can follow changes from one mike to the other merely by turning the two knobs about the same angle of rotation in opposite directions—a very easy operation to do quickly and repeatedly without confusion (see Fig. 3).

Of course the amplifier must have sufficient power for the job. This is less often a problem in indoor installations than in outdoor jobs where sound "gets lost" so easily. Usually the problem with indoor p.a. systems is one of con-

trolling the sound rather than getting enough of it. In larger indoor jobs or where there are tie-ins with other buildings, more than one amplifier is needed, but that is getting into the bigger installations.

### Loudspeakers

As for loudspeakers, at one time the author would have deplored the use of horns, of any type whatsoever, in indoor applications. However, some of the newer varieties exhibit considerably reduced "horny" characteristics. The trouble with the older type horns for indoor use was not only that the sound was unpleasant when enclosed but that acoustic feedback problems were exaggerated. They had some peaks in their response, which would cause a howl that could override intelligible sound.

Loudspeakers with the smoothest possible frequency response pay big dividends in indoor p.a. work. For the legion-hall-type installation, a good cabinet type system, similar to the hi-fi variety, but preferably more ruggedly built, will give results that justify its increased cost. In fact, two loudspeakers of this type, one on each side at the front of the hall, will often do a better job than many more smaller units distributed around the place. So, in this case, the more expensive units do the least costly job in the long run.

In some buildings, however, it is not practical to use such a simple loudspeaker installation. Odd corners would not be served with sound, so extra units are necessary and often these must be compact due to space limitations. This is where some of the newer wide-range composite horns prove useful. They are compact and give smooth, extended-range reproduction.

For outdoor installations the loudspeakers have to cover audience area, but indoors it is often more a question of volume, with due attention being paid to relative reverberant effects. A problem that poses typical variations is a movie theater, disused for its original purpose, in which p.a. or sound reinforcement is required. A single group of loudspeakers cannot be clumped together at the former site of the screen because this would feed them right into the mikes. They have to be installed at the sides despite the fact that they will not cover the entire audience area as well. See Fig. 4.

(Continued on page 112)



# Service Holds a Convention

By **SIDNEY C. SILVER**  
Service Editor  
RADIO & TV NEWS



*National Alliance of Television & Electronic Service Associations meets in Chicago. An editor's impressions in an open letter.*

Mr. Frank J. Moch, Executive Director  
NATESA  
5908 South Troy Street  
Chicago 29, Illinois  
Dear Frank:

As I had mentioned to you out in Chicago, the opportunity to sit in on the annual NATESA convention was a most rewarding one. There were some points along the way when unpleasant doubts almost spoiled the fun. Happily, these were resolved, by and large. The final impression was one of a vigorous group boasting an active and alert membership, meeting controversy and touchy issues head on, letting all be heard who wished to be heard. Your own actions at the final session were particularly commendable. A check with observers, not affiliated with NATESA, who were present in Chicago indicates that others share this opinion.

Attempts to deal with such problems as captive service, "inboard" warranties, licensing, marketing, tube-sale abuses, set safety, and others were impressive. So was the long-range planning evident in the handling of such matters as expansion of the manpower pool and development of an educational degree for technicians. We look forward to saying more about these matters as your committee reports become available in the future.

We also enjoyed observing a vigorous, old-fashioned election, concerning which we report further in "Service Industry News" this month. The attempt to answer questions involving the internal organization of NATESA, posed by non-affiliated persons, was also reassuring.

As for those unpleasant doubts: although resolved, they are worth raking over because they contain constructive lessons for all of us concerned with the future of the service industry. Largely, these doubts involve the early attitudes shown toward press coverage of the convention and toward questions concerning the internal organization of NATESA posed by unaffiliated persons.

Let's go back to a few weeks before the convention. Frank Teskey, editor of "The Hoosier Test Probe" (Indianapolis Television Technicians Association), had sent you an exhaustive set of questions covering organization, control, and finances of NATESA. He would like answers, he felt, before he could recommend NATESA affiliation to his own group or other related ones in the state-wide Indiana Electronic Service Association.

Although Teskey himself did no trumpeting, RADIO & TV News was able to obtain copies of the queries from a secondary source. To avoid a one-sided picture, we asked you for your answers, for publication. However, you felt that many of the questions had the loaded flavor of "When did you stop beating your wife?" Others, you believed, involved matters privy only to NATESA and its members. No matter how innocent these matters, you felt, disclosure to outsiders might be turned to work against the best interests of the national group. To these, the only answer you considered practical was, "None of your business until you join." Since honoring the questions as a whole would only provide grist to the mills of NATESA opponents, you

felt the wisest course would be for NATFESA to stand on its prerogative as a corporate body and ignore the questions altogether. You also suggested that publication of the questions would not be in the best interests of service. Even acknowledging a certain amount of logic in this stand, we were not wholly satisfied.

Arriving in Chicago, we soon heard another unhappy note struck. However politely it was done, we were informed that we would not be permitted to attend regular business meetings from the outset. Nothing personal, you hastened to assure us. Until a couple of years ago, the conventions had been wide-open affairs. Then along came an observer for another publication, you told us, who sat down among you, listened quietly, and went home to cover the meetings in a way you felt to be so unfair that the organization was damaged by his story.

Also excluded was Frank Teskey. Regarded as a member of the anti-NATESA forces, he might use the floor to snipe and to disrupt, to interfere with the normal completion of the convention's pressing business, you feared.

At this point, a first impression was beginning to form: As some opponents had been shouting, NATESA looked as though it could indeed be run by a band of arbitrary thugs, working out of public view as much as possible, secretly, in the dead of night.

Now we sought out Frank Teskey. From him we learned several things and formed more conclusions. We were convinced of his personal integrity. We also discovered his own position. To begin with, he was sold on the idea that national unity is absolutely essential. Also, although he knew that NATESA is not now the single undisputed instrument toward that goal, he believed it was as close as any organization had come or is likely to come. For this reason, he felt that the immediate objective should be reconciliation of all service people within NATESA.

So convinced was he on this point that he was actually going about trying to sell the same attitude to representatives of other groups still withholding affiliation. In effect, *he was drumming up potential NATESA members!*

Part of his campaign involved accumulating all the reservations he could from as many hold-out groups as he was able to contact. It was from this effort that his exhaustive composite of questions grew. His hope was to resolve all doubts once and for all. After his exclusion, he appeared to feel no anger. Instead he felt that he may have himself been largely responsible by an inadvertently un-diplomatic presentation, for having antagonized NATESA. He was ready to return home, his mission a failure, to concentrate on local activities.

Let's assess what had *almost* happened up to this point. The chief vehicle through which non-NATESA people must learn of your organization, the industry press, had been left with a disappointing impression. A sympathetic outsider was ready to turn away, for the time being, from the national group that must look to people like him for its long-term growth and strength. All this in the presence of representatives of other unaffiliated groups, including

*(Continued on page 131)*



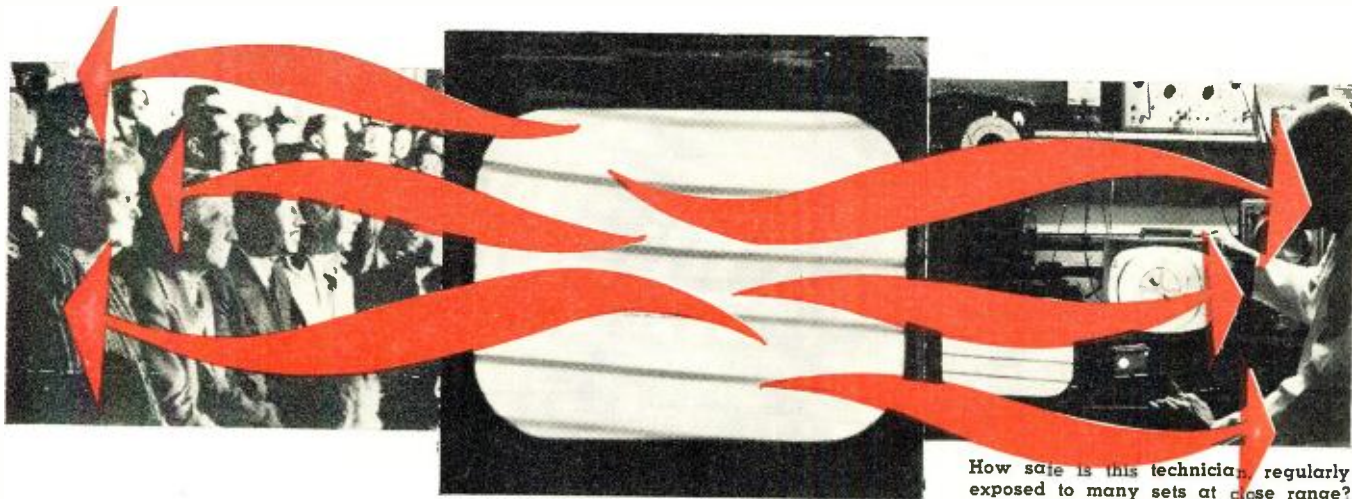

How safe is this technician, regularly exposed to many sets at close range?

# X from TV Sets: Are They Harmful?

By CHARLES R. MADUELL, Jr.

*Do viewers and technicians have a real cause for worry? What bearing does prolonged exposure have?*

**EDITOR'S NOTE:** Data on possible harmful effects of x-radiation from TV receivers has been as scarce as questions on this subject have been plentiful. The author is well equipped to shed needed light: he has been trained as a physicist; he services TV and other electronic gear—including medical electronic equipment; he has access to the required measuring equipment; and he knows how to use it.

**T**HERE have been many statements and questions of late concerning the x-rays that may emanate from television picture tubes. To evaluate the situation, there must be some understanding of what is involved.

First, it might be advantageous to describe how x-rays are produced, what they are, and how they act. They are actually electromagnetic rays, similar to radio waves, but of extremely short wavelength. As such, they travel at the speed of light. Their effects, production, and transmission through media such as glass, metals, the human body, etc., bear some relation to the action of radio waves or light radiation.

X-rays are produced within the atom. When high-velocity electrons, such as those produced from a hot cathode and accelerated by a high voltage, are made to hit a target, x-rays result. Of course, in any x-ray tube, most of the high energy of the electrons is dissipated in the form of heat and less than one per-cent actually penetrates the atoms of the target material to change the energy into x-rays. See Fig. 1A. A very complicated part of the electron theory is used by physicists to describe how high-energy electrons lose their energy to an atom, making the atom give off x-rays. It is not important to go into detail here, except to state that there

is a definite relationship between the voltage across the x-ray tube (giving the electrons their high velocity and therefore their high energy) and the wavelength of the x-rays produced. In medicine, x-rays produced by electrons accelerated at from 15,000 volts upward have medical value and pathological effects.

The so-called "soft" x-rays are produced by electrons which are accelerated by voltages of from 15,000 to 30,000 volts. X-ray equipment for "picture taking" is usually shielded in such a manner that these soft rays rarely leave the instrument. The x-rays used for picture taking are accelerated by voltages which vary from 30,000 to 125,000, the latter figure being the present upper limit of x-rays for medical picture taking. Higher voltages are, however, used in x-ray therapy (treatment), as high, in fact, as one-million volts. In industrial x-ray instruments, voltages on the order of hundreds of thousands of volts are employed, but such equipment has been replaced to a great extent by spontaneous atomic radiations from isotopes, which is another subject!

In general, however, x-rays can be produced by high-energy electrons hitting any material, be it a metal target or the screen of a television set. It is a fact, therefore, that perhaps one per-cent of the electron energy that produces the picture on the television screen makes the screen material give off x-rays of the so-called "soft" variety of from 15,000 to 30,000 volts. Compare Figs. 1A and 1B. This has given rise to needless worry which can best be dispelled by examining the problem.

The penetrating power is directly re-

lated to the wavelength (and therefore the voltage) of the x-rays. An x-ray technician selects a higher kilovoltage to penetrate a stout person than for a thin person, and to penetrate a chest than would be used on a hand. The quantity or density of x-rays, however, is dependent on several factors which we will now examine.

First, x-rays behave much like radio waves emanating from an antenna. If a greater r.f. current is fed into the antenna, more radio waves will be given off. Similarly, if a higher current flows through an x-ray tube, more x-rays are given off. The quantity or density of the x-rays produced at the screen of a television picture tube is directly related to the current through the tube itself; and penetrating power or hardness to kilovoltage.

In an x-ray tube, the electron beam is focused on a very small target area at a current of several hundred milliamperes. Such x-rays are of high density and heavily concentrated at a single spot. In a television picture tube, on the other hand, the current is from a few hundredths to thousandths of that used in an x-ray tube (100  $\mu$ a. compared with 50-500 ma.). Although the beam is focused on a similar small spot, the spot is scanned, hence, the small amount of x-rays produced are distributed over the entire screen area. See Fig. 2.

The second factor affecting quantity is time. If two drops of water per second are allowed to drip into a glass and two hundred drops per second from a second faucet into another glass, if the first faucet dripped for 100 seconds and the second faucet for one second, at the end of the experiment both



glasses would contain the same amount of water.

In the case of a television picture tube, although the current is rather low, the instrument is on for many hours at a time. On the other hand, an x-ray machine, with its high current, is usually on for only a small fraction of a second. Simple arithmetic will show that a television picture tube operating at 30,000 volts with a current of 100  $\mu$ a., will produce the same quantity of x-rays in an hour as an x-ray generator using 100 ma. and operating at 30,000 volts will produce in slightly more than 3½ seconds.

The quantity of x-rays is dependent on several additional factors, two of which are very important to us. The first factor is distance. X-rays, just like light or radio waves, travel in straight lines. They can, however, be deflected by intervening objects but not to the extent that light or radio waves can be deflected. They do, however, suffer a loss which is governed by the so-called "inverse square law."

An x-ray beam has one fourth its strength at double the distance, just like radio waves. Therefore, to produce the same effect four feet from the tube as was originally produced at two feet, the quantity (amount) would have to be increased by four (by increasing the current through the tube four times or by quadrupling the time). The viewing distance for a television picture is two to three times that involved in taking x-ray pictures but is many times the distance in x-ray therapy, where the tube is often almost in contact with the part being radiated.

What is of most importance, however, is the relative absorption of x-rays through materials. It is known that in so-called "Grenz ray" therapy, 15,000 to 30,000-volt soft x-rays are used. In order to get these x-rays out of the tube, it is usually necessary to have

special tubes constructed with extra thin glass or beryllium windows.

Grenz rays are used in surface therapy, in treatment of skin diseases, and occasionally in cases of internal injuries involving areas near body orifices through which the tube can be inserted. These rays are heavily absorbed by surface layers of body tissue and do not penetrate much beyond the skin.

In an x-ray machine of the standard radiographic type, practically all the radiation of less than 30,000 volts is filtered out through the glass of the tube and the oil in the tube housing. Whatever remains is usually filtered out by 2 mm. of aluminum in the form of a small aluminum plate less than 1/10 inch thick placed directly in the path of the x-rays.

X-rays are absorbed in what mathematicians call an "exponential" fashion. If a filter 1 mm. thick absorbs 90 percent (transmitting 10 per-cent) then a 2 mm. filter of the same material will not absorb all the rest but will absorb 90 per-cent plus 9 per-cent, or 99 percent. This brings us back to our original point concerning TV set radiation.

The glass on a television picture tube is fairly thick, in fact it is ten to fifteen times thicker than the glass in the window portal of an x-ray tube. Since soft x-rays are more easily absorbed than hard and since the x-rays produced in a television picture tube are all of the soft variety, only extremely small amounts of x-rays would reach the outside of the glass. See Fig. 3. Even these would probably be completely lost in the safety glass and the wood or metal cabinet of the instrument.

Experimental analysis indicates this to be true. An "R" meter chamber (used for measuring x-rays for therapy dosages) was taped to the front of a television picture tube and left there for several hours. The x-ray-producing

(and light-producing) electron beam was less than an inch away but no measurable radiation was indicated on the "R" meter.

A somewhat different situation was found, however, when the same experiment was tried in the high-voltage cage near the rectifier tube. These tubes are constructed with thin glass envelopes and therefore some x-rays should be measurable. We discovered that a reading taken one inch away from the 1B3 tube operating at 16,500 volts indicated .01 roentgen unit of x-rays per hour.

In a TV service shop where from 5 to 10 sets are on all day, a radiation detector chamber placed less than 10 feet from the sets indicated approximately .05 roentgen (50 milliroentgens) of radiation in one month. This is not much more than the normal background count, due to all sources of radiation, in many parts of our country. Thus it can be stated that no appreciable x-rays were found in the TV service shop checked by the author.

The radiation standard adopted for the guidance of x-ray personnel specifies that exposure to no more than 100 milliroentgens per week comes within allowable limits. A hand placed within the high-voltage cage near the 1B3 would receive this dosage in ten hours. Since no one would willingly place his hand in the high-voltage cage for even one second with the power on, the radiation "hazard" is virtually non-existent. No sane person would take such a chance with the voltages involved, let alone the radiation.

If you are still worried about radiation from your TV set, here is a simple and inexpensive test that should convince you. Purchase a small dental x-ray film from your dentist—he might even give it to you. Place a paper clip on the edge of the film. Place this film in the high-voltage cage of your TV  
(Continued on page 107)

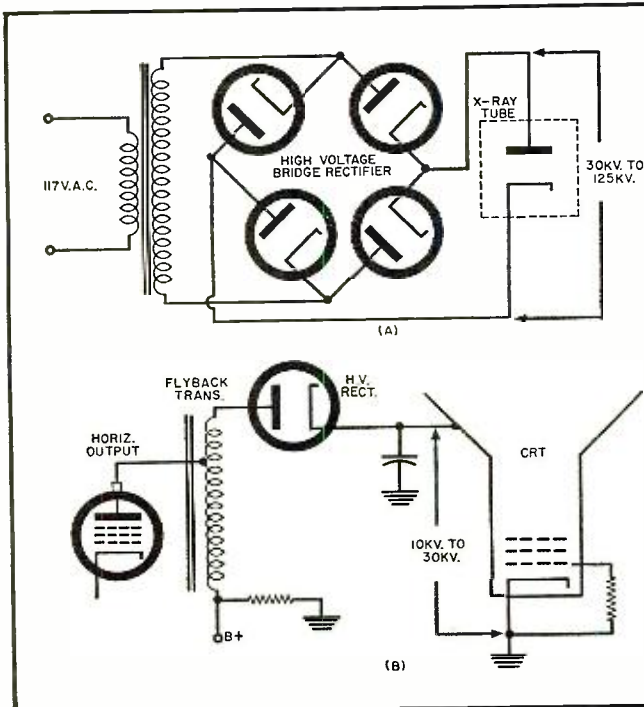
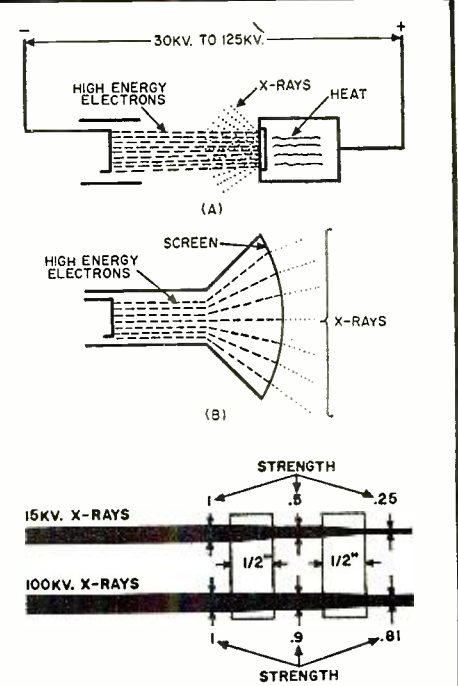

Fig. 1. The circuit for generating x-rays (A) is a big uncle to the more familiar television high-voltage circuit of (B).

Fig. 2. In an x-ray tube (A), a heavy stream of electrons is concentrated on a small area. In a picture tube (B), a lighter stream is diffused, by deflection, over the entire screen of the cathode-ray tube.

Fig. 3. When x-rays pass through such media as glass, there is much more absorption of soft x-rays (top diagram) than of the hard radiation shown below.









checked for excessive voltage and/or current drain.

A four-terminal Cinch-Jones barrier strip may be seen at the rear of the tuner. Two terminals are for the antenna input and two for the external negative six-volt power source. The positive three volts is obtained from two of the large penlite cells connected in series. These are mounted inside the box and are visible in the upper right-hand corner. Current drain from the six-volt supply is 400  $\mu$ a. and from the three-volt supply is only 300  $\mu$ a. Under normal use, the batteries should last about a year. If a nine-volt battery is available, and can be tapped at six volts, the power supply can be made more compact. Just ground the six-volt tap and you have a negative six-volt and a positive three-volt source in one package.

An a.c. power supply is shown in Fig. 1. This provides plenty of current to power a good transistor amplifier, such as the one described by Paul Penfield, Jr. in the August, 1956 issue of RADIO & TV NEWS, plus this FM tuner, and perhaps a regenerative AM transistor tuner as well. Just such a set-up as this is being used daily by the author and has been for several months.

Three six-inch PM speakers with their 8-ohm voice coils connected in series work very nicely. The Zener diode ( $CR_6$ ) shown in Fig. 1 costs between \$3.00 and \$5.00. A pot set at +3 volts will work, but not as well. Decoupling must be used between the first two stages of the Penfield amplifier, to prevent motorboating, when the power supply of Fig. 1 is used. If a six-volt battery is used, this will not be necessary because of the lower impedance.

Since the author is a staunch defender of the term "high-fidelity" he makes no claims that this tuner is a "hi-fi unit"—but it does sound remarkably good when played through the transistor amplifier or either of his vacuum-tube stereo channels. We are fortunate, here in the Los Angeles area, in having excellent FM-FM stereocasts

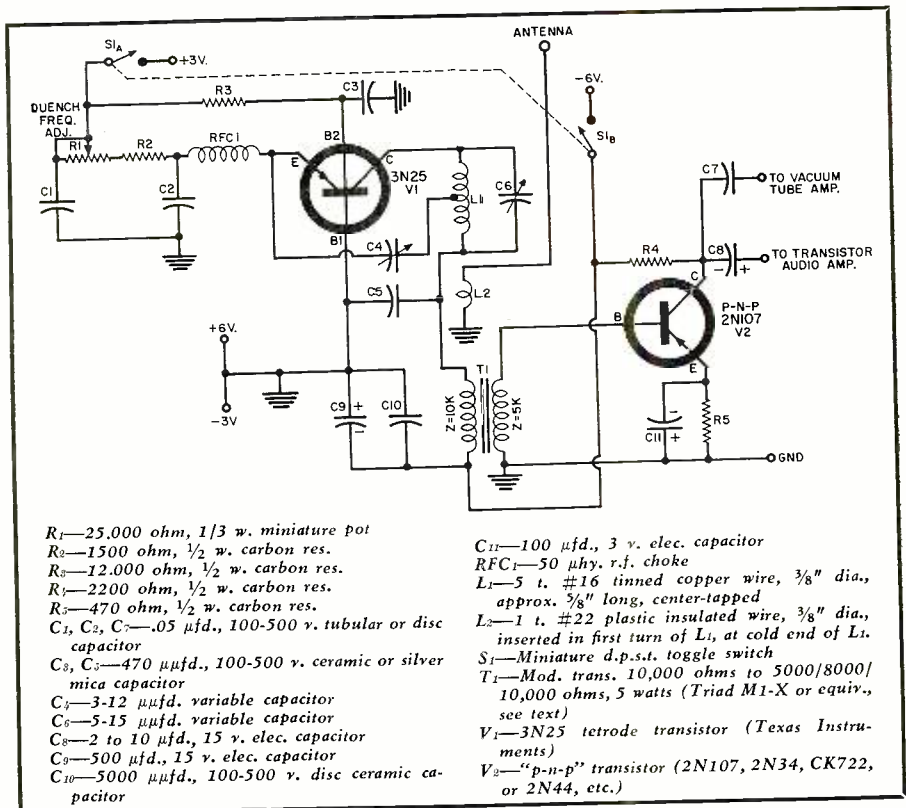

Fig. 2. Complete schematic diagram and parts list for the superregen receiver.

available daily for sixty minutes and for a three-hour period every Sunday. This FM tuner gives a good account of itself on these broadcasts. There is no problem of re-radiation from the superregenerative tuner as the stations are far enough apart, frequency-wise, to eliminate this possibility.

Perhaps you won't want to use this unit with your home amplifier. With a little imagination, many other uses will occur to you. It could be added to your car radio by feeding the output of the tuner into the audio system of your car radio. A small jack and a d.p.d.t. switch would take care of that. If you have a positively grounded six-volt ignition system—your negative six volts is

ready—although this, too, had better come through the hash filter of your car radio. A negative twelve-volt system would require a voltage-dropping resistor.

Just as it is, the tuner puts out fair headphone volume. One more audio stage should make it usable as an FM pocket receiver with plenty of gain and low battery drain. For  $T_1$  (Fig. 2), one of the many subminiature interstage transformers would work well here as low-frequency response is not a criterion of earphone operation.

Tuning is not as broad as with the ordinary vacuum-tube superregenerative receiver. There are two spots  
(Continued on page 126)

Rear panel mounts 4-terminal barrier strip and output jacks.

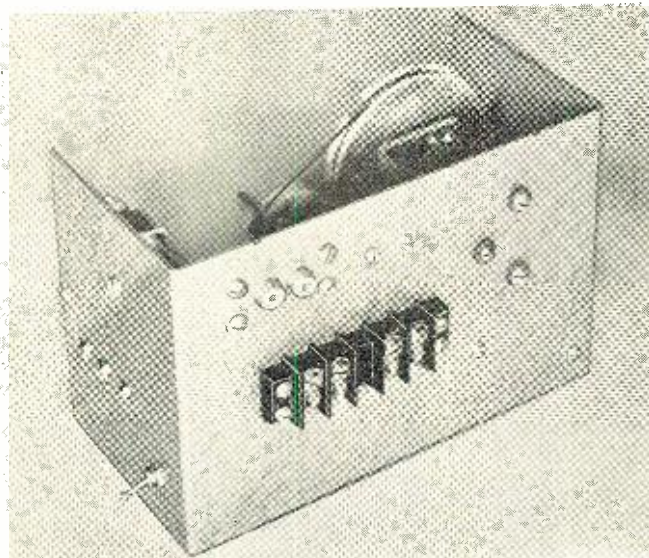

Inside view of the compact receiver shows all the components.

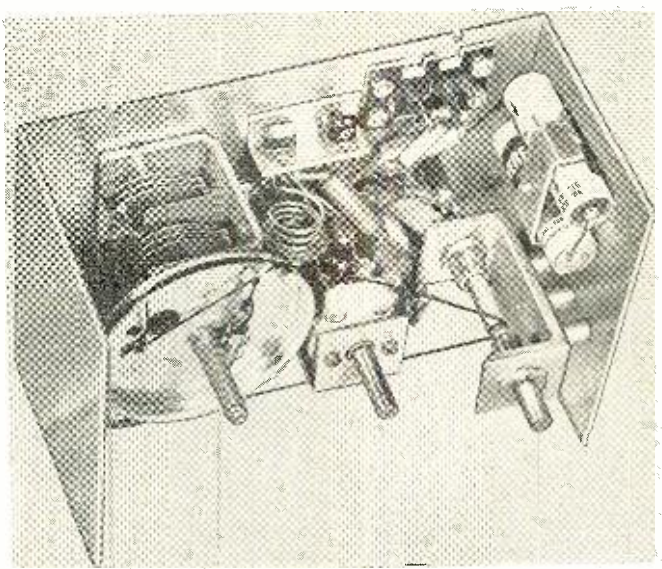



# MUSTS

## FOR BUSINESS GROWTH

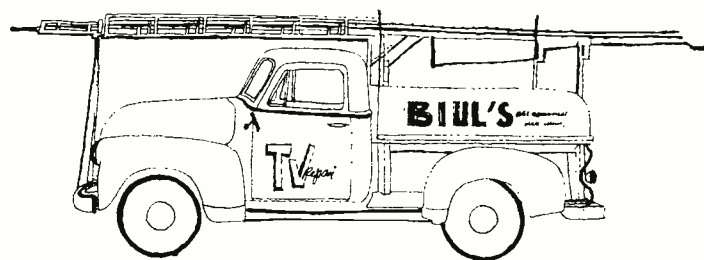

By **WILLIAM LEONARD**

*Before you can take advantage of new electronic service opportunities, present net profits must be adequate.*

**A**S A SERVICE dealer or technician, you are engaged in the fastest growing industry our economy ever has experienced. You are in an industry that offers you tremendous possibilities for growth. For consumers, for manufacturers and processors, for retailers and for public services, the electronic development laboratories continue to pour out a stream of electronic devices that stagger the imagination with their business potentials.

Irrespective of the fond dreams of manufacturers that virtually service-free electronic devices are in the foreseeable future, the installation and servicing of the new devices, as well as service on current products, will continue to increase the demand for competent service personnel and facilities in the years ahead.

Where do you fit in this opportunity picture? Are you making enough actual profit out of your business to finance the necessary expansion to take advantage of new possibilities? Do your operating statements reveal a well-managed, profitable establishment that would justify a business loan for expansion purposes?

To a certain degree, most service dealers are faced with the same kind of financing problems that their parts distributors are trying to solve for themselves. Here is a synopsis of the average parts distributor's financing problems as outlined by Gordon K. Douglass, manager of financial and operations analysis for *Sylvania Electric Products Inc.* Under the title "Treadmill to Oblivion," in a recent issue of the "NEDA Journal," Mr. Douglass said:

"The market for replacement electronic parts is growing at a faster rate than is healthy for the average electronic parts distributor. All of you are

running like the devil just to stay in place. You're trying the best ways you know how to generate enough profit in your business to pay yourself a fair wage and still have enough left over to 'finance' the growth you must have to retain your share of the market.

"Unfortunately, the majority of you are not making quite enough profit to do both of these things. You are on a treadmill, and whether or not you are on a 'treadmill to oblivion' will depend upon the speed with which you learn how to manage your affairs better, and the wisdom with which the industry or the financial community makes available to you the funds for your growth which you cannot generate yourselves."

Since TV servicing has been responsible for the development of the current independent electronic service industry, with its nucleus of thousands of excellent small businesses, it can also serve as the base for expansion into new fields of activity for those dealers whose operations are profitable enough to finance expansion. An important factor in this potential development is, of course, whether the operating profits of TV service businesses are keeping pace with the rising costs of operating.

In a recent speech to the American Society of Refrigerating Engineers, Robert S. Geran, general service manager for the *Kelvinator Division* of the *American Motors Corporation*, told his audience that "it costs \$6.02 an hour currently in a typical large U. S. city just to keep a service man on the street." He said this includes basic wages and fringes, truck operating costs, and some overhead, with no allowance for special expenses or profits. "Ten years ago these costs were \$3.77 an hour," he said.

While many small service dealers claim their costs of operating are considerably less than six dollars per-hour-per-man, they readily admit they have not increased their service charges during the past five years in proportion to the increases in living costs and in the costs of doing business during the same period. One result of this steady narrowing of the usable income from these businesses is that test equipment, tools, service cars, and trucks are not being replaced at economically wise intervals. This would indicate that adequate depreciation charges are not being taken into account in determining the costs of doing business.

Another vitally important business operating factor that is being neglected is that of repainting, redecorating, and re-arranging service stores and shops at regular intervals. In modern merchandising, the maintenance of a good appearance—a front—is considered vitally important in retaining customer interest. This interest-inspiring promotional force is not being used by the average service dealer, largely because his usable income is not sufficient to pay for it. This, too, would indicate the failure to take business-property maintenance into account when figuring operating costs.

Many excellent opportunities to increase service income from home owners have been made available to dealers during the past few years. One in particular is the growing consumer interest in FM. This resurgence of interest in FM programs, largely through the promotional efforts of the many new, small FM stations that have been licensed, has been an interesting development. Some TV service dealers who were in a position to finance the expansion of their businesses into this

*(Continued on page 99)*



# An Improved Multi-Purpose Probe

*A single body eliminates the bother of switching scope probes; may also be adapted for meter use.*

**L**IKE OTHERS of the servicing fraternity, the author had suffered long from that unhappy bench disease, T.T.T. (Terrible Tangle of Test-leads) when "The Multi-purpose Scope Probe" appeared in the January, 1958 issue of RADIO & TV NEWS. A fine idea, but not all of us have the time, talent, and turret lathe to construct that fancy a probe. What to do?

The solution, happily enough, was achieved at little cost and the advantages of the original model were preserved. In addition, some helpful modifications were made and the construction time was reduced to about an hour.

The new, simplified construction incorporates several electrical design improvements over the original. For example, the low-capacity probe function on the original model will pick up hum because of the high order of impedances involved. Shielding on the new model eliminated that problem and the larger internal diameter of the tube used enabled the installation of a trimmer capacitor for exact compensation to the input characteristics of the particular scope on the service bench. As a logical further step, a small hole was drilled in the probe shell to facilitate trimmer adjustment without probe disassembly.

The use of an octal socket afforded several additional input positions. These can be put to good use in such esoteric functions as voltage-doubling demodulation, voltage division, etc., at the option of the user.

The probe assembly is shown clearly in Figs. 1, 2, and 3. The octal socket is held on the end of the perforated Bakelite strip by interweaving the leads of the components going to each of the socket pins through the perforations. The Bakelite component-mounting strip is cut or broken from a larger section of perforated board (*Lafayette MS305*) to a size that will slide snugly  
*(Continued on page 119)*

By  
**NATHAN KAYE**

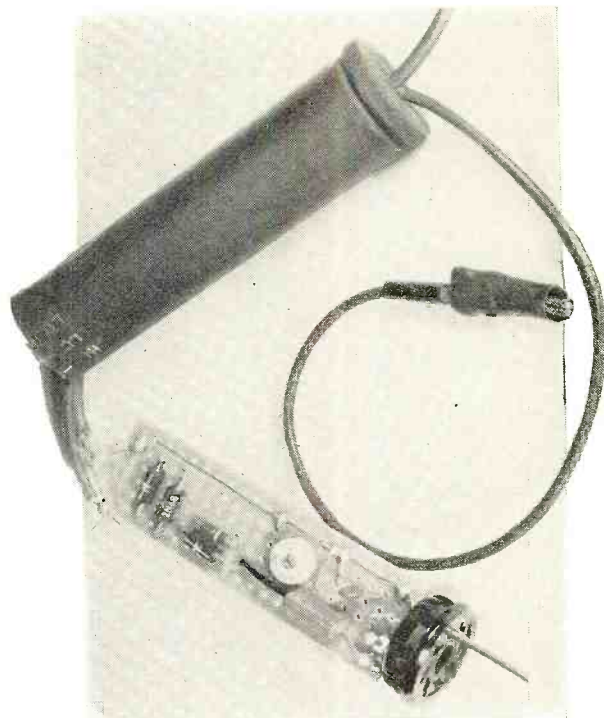

Fig. 1. When the component board is slid into the tubular housing with only the socket showing, this version of the multi-purpose probe will be complete.

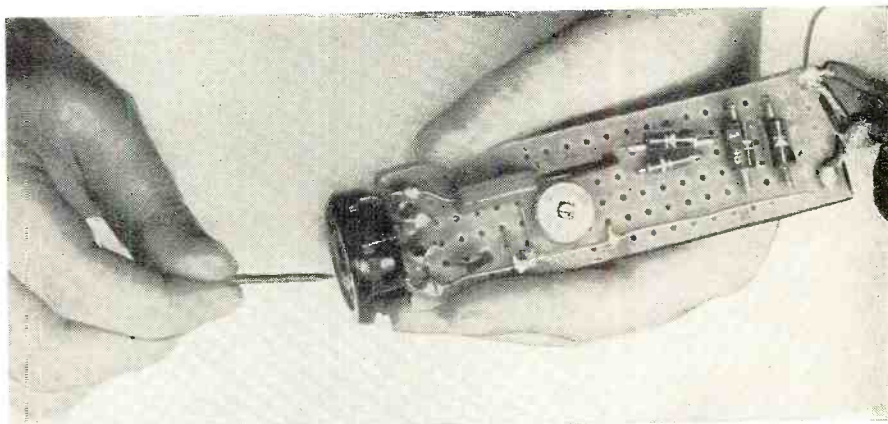
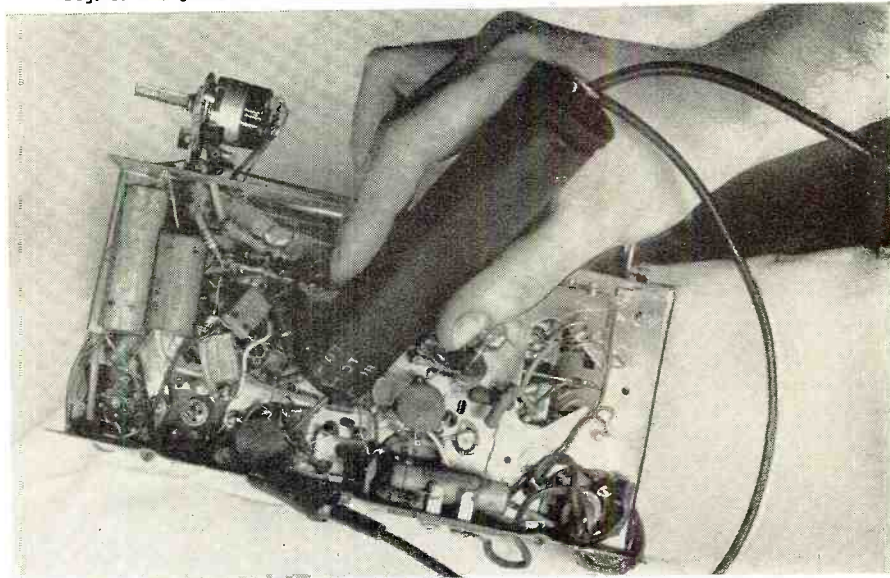

Fig. 2. Inserting the tip in the various socket holes selects probe function.

Fig. 3. The probe in use. Note the identifying function markings on the body.





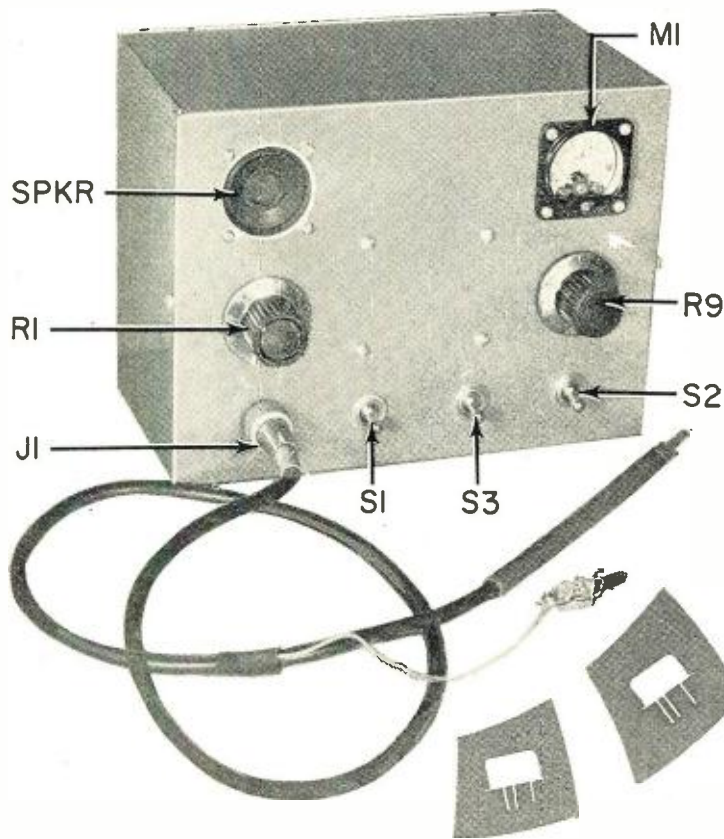

Fig. 1. Front-panel view of the completed instrument.

By  
RUFUS P. TURNER

# A Transistorized A.F.-R.F. Signal Tracer

*A packaged transistor circuit and line-cord-free portability make this unit easy to build and use.*

**B**ATTERY operation of a signal tracer is very desirable, since the isolation it provides eliminates the interaction and the hum troubles often encountered with power-line-operated instruments. Also, portable operation is provided and warm-ups are eliminated. However, most of the transistorized signal tracers described in previous construction articles have not been comparable to tube-type tracers by any stretch of the imagination.

To begin with, most of them have had an input impedance of 1000 ohms, which makes serious signal tracing impossible in any but the lowest-impedance circuits. An occasional instrument has been equipped with a step-down input transformer in an attempt to provide higher input impedance, but a transformer at the input of a high-gain amplifier is extremely susceptible to hum pickup. Additionally, most of these earlier instruments provide only headphone operation, and the use of headphones in signal tracing often is a nuisance and sometimes is dangerous. A few instruments which did use loudspeakers had insufficient audio power for good volume. Very few gave any form of visual indication.

The a.f.-r.f. signal tracer described here (Fig. 1) overcomes the shortcomings of earlier models. It has the flexibility of the tube-type signal tracers and is more sensitive than some of these instruments. Following are its important features: (1) input impedance, 1 megohm; (2) visual

(meter) indication; (3) aural (loudspeaker) indication with adequate speaker volume; (4) by means of switches, operator may select visual indication, aural indication, or both; (5) no input or interstage transformers; (6) economical operation from flashlight-type batteries (total d.c. drain is 15 ma.). The completed instrument is only slightly larger than a standard multimeter. It weighs about 3 pounds and runs cool.

## Circuit Description

Fig. 2 shows the complete circuit of the signal tracer. This arrangement consists of a 4-stage, high-gain audio amplifier followed by a class A power-output amplifier. The power amplifier, employing a single CK751 transistor, delivers approximately 20 milliwatts to the loudspeaker. This gives adequate volume. The 4-stage, low-noise amplifier is a commercial subminiature unit (*Centralab* TA-11) which is only 1.175" long, 0.665" wide, and 0.250" thick. As shown in Figs. 2 and 3, this tiny amplifier has only seven pigtails for connection into the tracer circuit. (All capacitors, resistors, and transistors are self-contained in the hermetically sealed TA-11 unit.) By employing a ready-built commercial amplifier in this critical position, much of the mechanical construction and wiring are eliminated. (The TA-11 amplifier contains 39 internal connections.) Moreover, this amplifier is of smaller size than the average experi-

menter could achieve with commercial transistors, capacitors, and resistors.

The only external stage required is the power amplifier for driving the loudspeaker. This stage contains a CK751 medium-power transistor. Bias stabilization in the output stage is provided by the base voltage divider ( $R_6$ - $R_7$ ) and the emitter resistor ( $R_8$ ). The subminiature 30- $\mu$ fd. electrolytic capacitor ( $C_1$ ) adequately bypasses the emitter resistor to prevent degenerative loss.

The meter indicator circuit contains a 0-50 d.c. microammeter ( $M_1$ ) meter-sensitivity control potentiometer ( $R_9$ ), two CK705 germanium diodes ( $CR_1$  and  $CR_2$ ), meter switch ( $S_2$ ), and coupling capacitor ( $C_2$ ).

Visual indications of signal strength are obtained when switch  $S_2$  is closed. The output amplifier and loudspeaker are switched into operation for aural indications of signal strength when switch  $S_3$  is closed. Both meter and speaker are placed in operation by closing both  $S_2$  and  $S_3$ . The gain-control potentiometer,  $R_1$ , is placed at the input of the instrument to prevent overloading of the TA-11 amplifier by high-amplitude signals. The meter-sensitivity control potentiometer,  $R_9$ , serves to set the meter to full scale (or to any other scale point) for any selected input-signal voltage.

The instrument is powered by a 6-volt battery consisting of four 1½-volt Size-C flashlight cells connected in series. A tap is taken at the negative terminal of the first cell in the series to provide -1½ volts for the TA-11 amplifier. The CK751 receives the full 6 volts.

The input a.f. signal is applied to a concentric jack,  $J_1$ , which accommo-



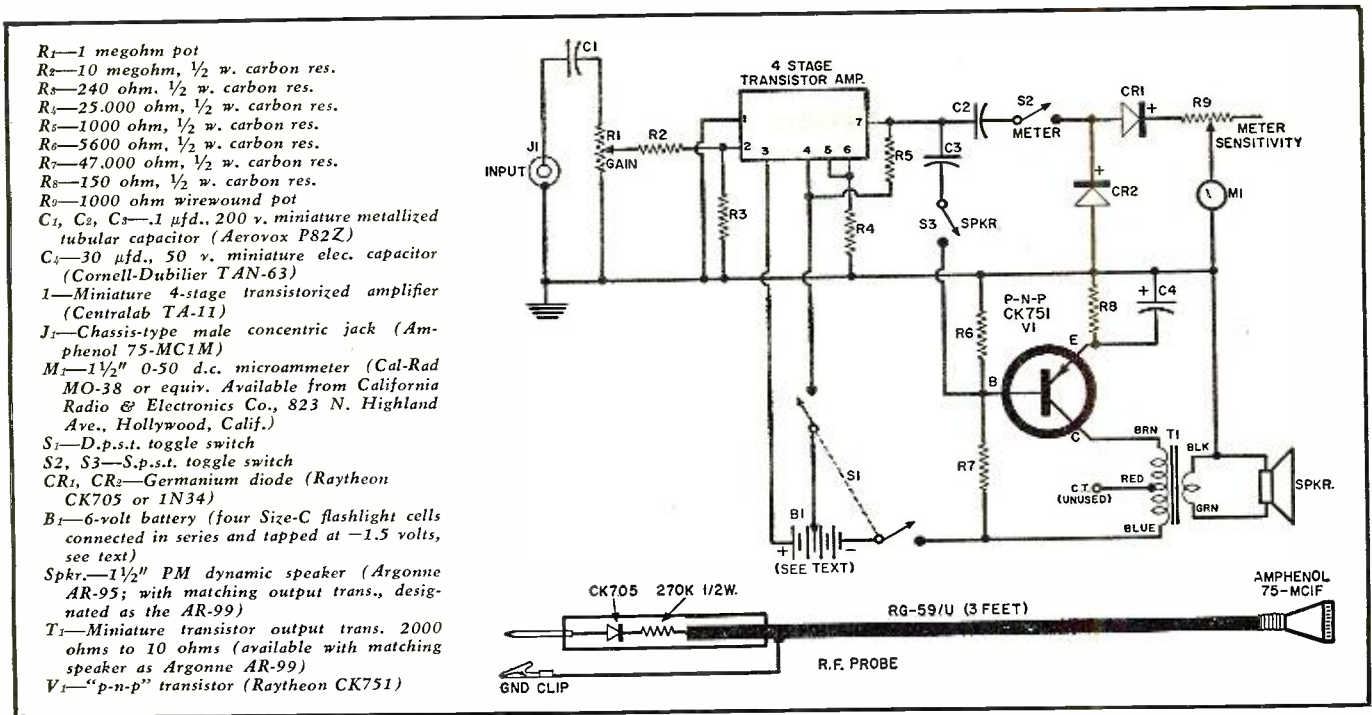

Fig. 2. The signal tracer circuit built around the packaged transistor amplifier. The auxiliary r.f. probe is also shown.

dates the shielded a.f. and r.f. probes. The a.f. probe is a conventional shielded test probe. No capacitor or diode is required in this probe. The r.f. probe, shown in Fig. 2, contains a CK705 germanium diode which demodulates the amplitude-modulated test signal. Connected in series with this diode is a 270,000-ohm resistor for isolating the cable capacitance and tracer-circuit input capacitance.

### Construction and Wiring

Many different layouts are possible. As shown in the photographs, the instrument is built in an aluminum chassis box 8" long, 6" high, and 4"

deep (LMB No. 146). Figs. 1, 3, and 4 show construction details.

Most of the components are mounted on a perforated phenolic board  $5\frac{1}{4}$ " long, 3" wide, and  $\frac{1}{16}$ " thick. (See Figs. 3 and 4.) The pigtails of the components are passed through perforations in this board and interconnected underneath to complete the circuit. In this way, a simple assembly is obtained which has much of the compactness of a printed circuit. Twelve solder lugs, secured along three edges of the board, provide connection points for external wiring. The subminiature output transformer ( $T_1$ ) is held to the board by means of

Duco cement. Before applying the cement to both transformer core and board, scrape the glaze away from the board in the area to be occupied by the transformer. Coupling capacitor  $C_3$  has been mounted under the board in the author's instrument, hence does not appear in the illustrations. However, this capacitor may easily be mounted on top of the board with the other amplifier components. The CK751 transistor has a mounting lug which holds it to the board with a 6-32 screw and nut.

The circuit board is held to the floor of the instrument case by four 1"-long  
(Continued on page 162)

Fig. 3. The circuit board, with most components mounted.

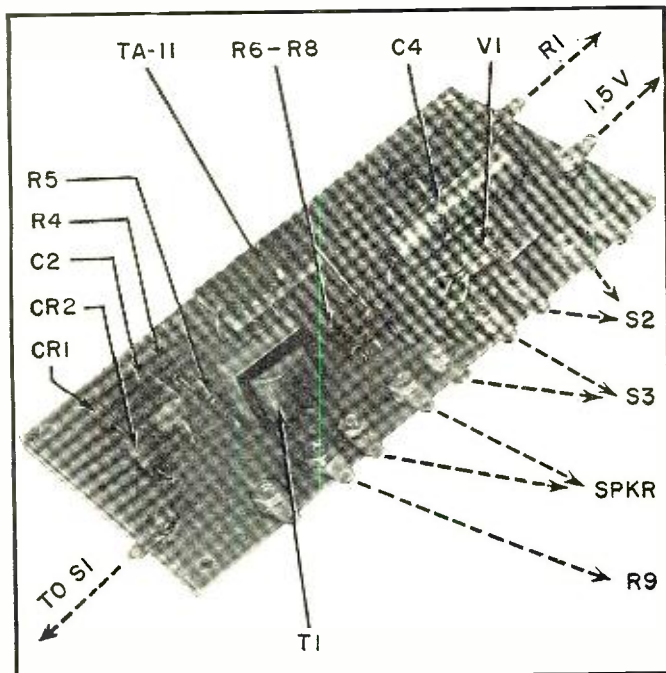
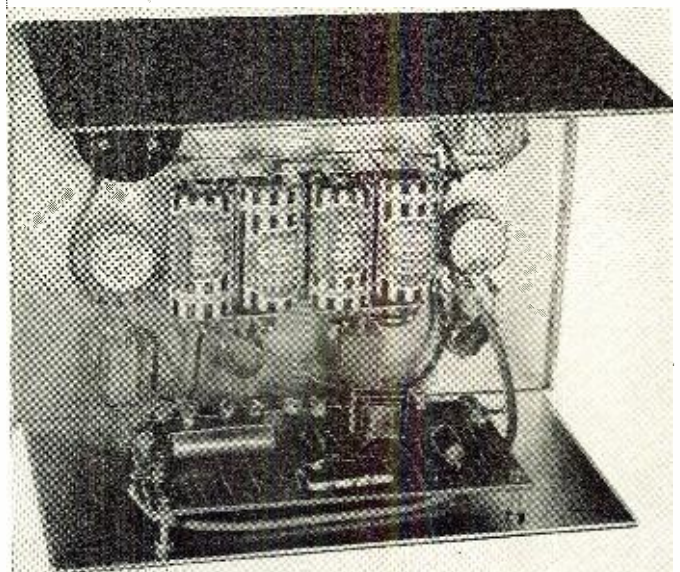

Fig. 4. Inside view of the housing for the signal tracer.





# Putting the HELIX to Work

*The simplicity and effectiveness of this proven antenna make it ideal for u.h.f. TV and the higher ham bands.*

**T**HE helix is one type of antenna which has not become too popular with amateurs thus far. This is so because, for frequencies of 144 mc. and below, its dimensions become large and the antenna is usually unwieldy to handle. (*Editor's Note: For information on a 108-mc. helix, see the article "Listening to the Satellites" on page 44 of this issue.*) However, as more and more amateurs explore the higher frequencies, the helix may well become "old reliable" in a relatively short period of time.

In planning for operations in the higher amateur bands, enthusiasm mounts quickly when one begins to list the advantages of the helical antenna. For example: (1) it has almost uniform characteristics over a broad band (maximum to minimum frequency ratio approaching 1.8 to 1); (2) gains of 15 db over this band are readily obtainable; (3) the radiation pattern is a single major lobe with typical half-power beamwidth of 30 degrees; (4) the dimensions of the helix are not at all critical; (5) it intercepts either horizontally or vertically polarized waves equally well; and (6) the an-

tenna is backed by a ground plane and is ideally fed with coaxial cable.

An excellent theoretical discussion on helical antennas is included in the book "Antennas" by John D. Kraus. However, only the general design equations are necessary for the construction of practical antennas.

Fig. 1A indicates the important dimensions of a helix and its ground plane.  $D$  is the diameter of the helix,  $L$  the length of one turn,  $S$  the distance between turns,  $n$  the number of turns, and  $d$  the diameter of the ground plane. If one imagines that one turn has been unwrapped and laid out flat, the triangle of Fig. 1B results. The pitch angle  $\alpha$  (alpha) is the angle whose tangent is  $S$  divided by the circumference of the helix,  $\pi D$ .

Figs. 1C and 1D show side and end views, respectively, of the helix. The plus and minus signs indicate an instantaneous distribution of charge for the axial mode of operation. This is the mode most commonly used and is one which results in a highly directional radiation pattern. In order that the charge be so distributed, the circumference must be on the order of one wave-

length at the desired operating frequency. As examples of the latitude permissible in the dimensions, this axial mode of operation is readily obtained with circumferences between  $\frac{3}{4}$  and  $\frac{1}{2}$  of a wavelength, pitch angles from 12 to 15 degrees, and any number of turns greater than 3.

Fig. 2 shows how the antenna gain and beamwidth vary as a function of the number of turns in the helix. These curves are computed for an ideal helix with a circumference equal to one free-space wavelength and a pitch angle equal to 12.5 degrees. From these two values, Fig. 1B shows that the spacing between turns is equal to .22 free-space wavelength. It is interesting to note that doubling the number of turns in the helix results in 3 db greater gain and a reduction in beamwidth by a factor of .707. Generally even for high-frequency antennas, it is not too practical to build helices with more than about 15 turns since the gain does not increase very rapidly above this number and support of the structure becomes more of a problem.

In the event that the dimensions of a particular helix are not those used in calculating the curves, the following approximate equations may be used to determine gain and beamwidth:

$$\text{Gain} = 15 C_{\lambda}^2 n S_{\lambda} k$$

$$\text{Beamwidth (half power)} = \frac{52}{C_{\lambda} \sqrt{n S_{\lambda}}} \text{ degrees.}$$

Table 1. Dimensions of helical antennas for various amateur and television bands.

BAND	HELIX DIA.	TURNS SPACING	MIN. GROUND PLANE DIA.
50-54 mc.	72"	50"	114"
144-148 mc.	26"	18"	41"
220-225 mc.	17"	11½"	27"
420-450 mc.	8½"	6"	14"
1215-1300 mc.	3"	2"	5"
2300-2450 mc.	1½"	1½"	3"
3300-3500 mc.	1½"	¾"	2"
5650-5925 mc.	¾"	7/16"	1½"
10,000-10,500 mc.	¾"	¼"	1"
470-890 mc. (u.h.f. TV)	5¼"	3⅞"	3"

(Circumference =  $\lambda$ ; pitch angle = 12.5°)



In these equations,  $C_\lambda$  and  $S_\lambda$  are the circumference and turns spacing, respectively, in wavelengths. They apply only for the axial mode of operation where  $C_\lambda$  is between  $\frac{3}{4}$  and  $\frac{4}{3}$ ,  $\alpha$  is between 12 and 15 degrees, and  $n$  is greater than 3. Gain in db may be determined by taking ten times the logarithm of the number obtained from the first equation. In this equation  $k$  is the radiation efficiency factor. For the ideal loss-less antenna assumed in the curves,  $k = 1$ , but where losses are present,  $k$  is always somewhat less than 1. In approximating the gain of a particular antenna, the value obtained from the curve should be reduced by 2 to 3 db in order to account for this factor.

Table 1 gives the dimensions of helical antennas suitable for several of the higher frequency amateur bands, as well as for the u.h.f. television band. In television, this type of antenna is especially effective because of its high gain over such a broad bandwidth. Some amateurs have built helical antennas for the lower ham bands, but the size of the structures becomes larger as the frequency goes down and rotation becomes a problem. However, for propagation in one fixed direction this type of antenna holds out real possibilities. In this case the ground plane would be fabricated of large mesh screening in order to reduce wind resistance.

The three antennas shown in the photographs were constructed for operation in the microwave bands. From the largest to the smallest, the center frequencies are: 1250 mc., 3000 mc., and 10,000 mc. respectively. The two smaller ones were wound on wooden dowels while the largest one had a hollow 3" cardboard tube for the helix support. In the latter case, wooden plugs cut from  $\frac{1}{2}$ " plywood were inserted in the ends of the tube for rigidity.

In each instance the ground plane

was made by fastening sheet aluminum to  $\frac{1}{2}$ " plywood with wood screws. The diameter of the ground plane is not critical as long as it is equal to or greater than one-half wavelength at the operating frequency. A type UG-58/U coax connector was mounted behind the ground plane by means of machine screws which passed through the plywood and aluminum sheet. Lock washers should be used under both the heads of the screws and the nuts in order to insure good electrical contact between the coax shield and the ground plane.

The largest helix was wound with No. 14 solid copper wire while No. 16 bus wire was used for the two smaller units. A uniform spacing of the turns is easily obtained by cutting a strip of cardboard as wide as the desired spacing and then winding it with the wire between turns. If the strip of cardboard is not long enough for the whole helix, it may be advanced as the winding progresses.

The end of the winding is anchored in place by fashioning a small bend in the end of the wire and inserting it in a small hole appropriately placed at the end of the tube or dowel. For protection from the weather several coats of Krylon spray-on plastic and a final coat of paint were applied.

An empirical equation for the antenna impedance, in ohms, is:

$$R = 140 \times \frac{\text{circumference in wavelengths}}{\text{wavelengths}}$$

For the preceding examples of helices with circumferences equal to one wavelength, a 93-ohm coaxial transmission line could be used for a good match. However, for the antennas pictured, a 75-ohm line was used with excellent results.

Because of the configuration of the helical antenna, the radiation is, in general, elliptically polarized or, for certain dimensions, circularly polarized. The direction of rotation of the polarization

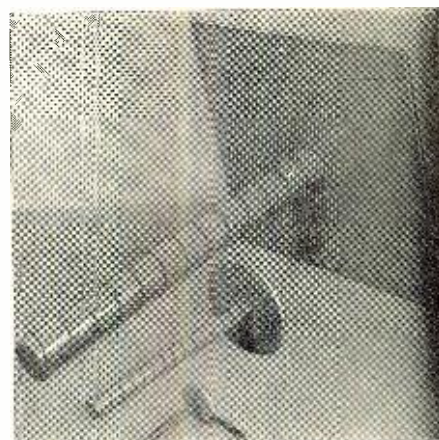

The three helical microwave antennas shown in the lead photo are displayed here before being mounted on the mast.

is either right- or left-handed, depending upon the direction of the helix winding. This characteristic is fortunate when the helix is used as a receiving antenna since it will intercept either horizontally or vertically polarized signals.

For communication between two locations both using helical antennas, it is necessary that both antennas be wound in the same direction. An electromagnetic wave possessing one direction of polarization rotation will have a minimum interaction with an antenna designed for the opposite direction of polarization rotation. It is recommended that a right-hand sense convention be used for uniformity.

In general, it may be said that the helical antenna is one of the simplest and most effective beam-type antennas it is possible to make. So, when the day finally arrives when you get around to firing up those klystrons that came in your big surplus "buy"—think of the "old reliable" helix and put it to work!

-30-

Fig. 1. (A) Dimensions and radiation pattern. (B) Pitch angle. (C) Charge distribution, side and (D) end views.

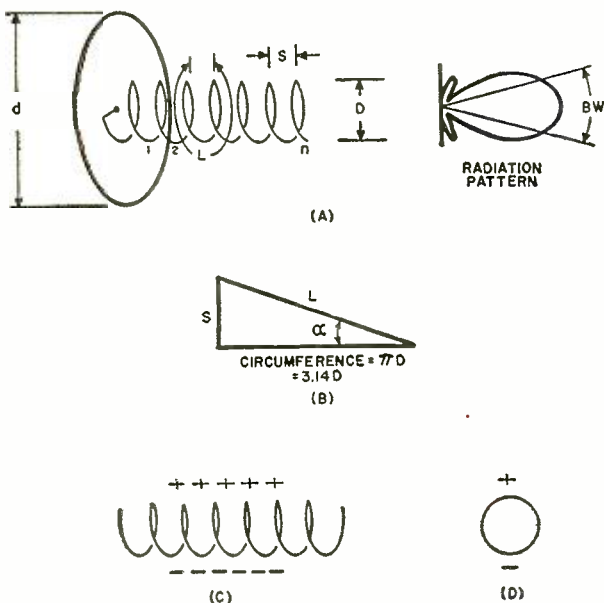
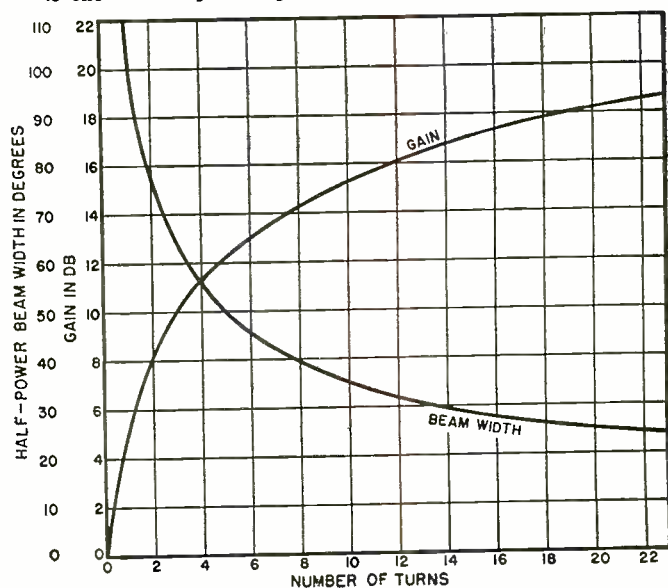
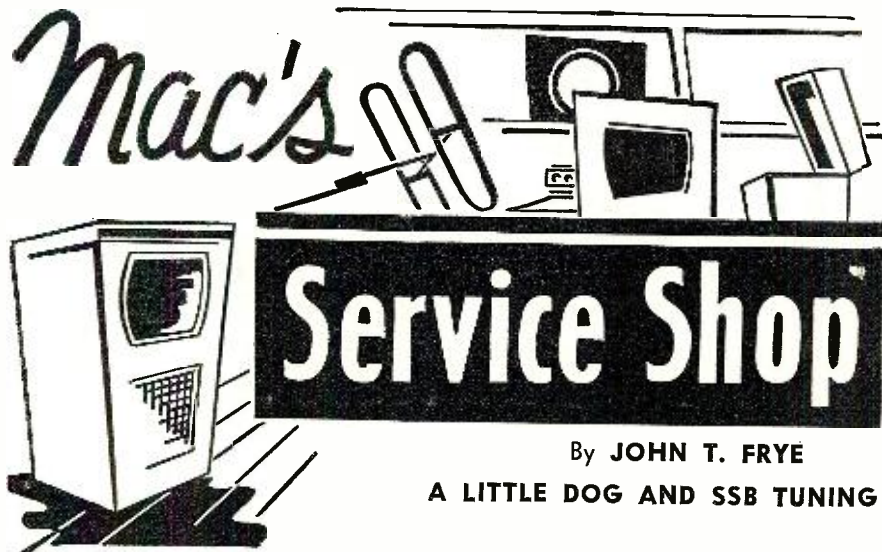

Fig. 2. Antenna gain and beamwidth shown as a function of the number of turns, for a helix having a circumference equal to one wavelength along with a pitch angle of 12.5 degrees.







By JOHN T. FRYE  
A LITTLE DOG AND SSB TUNING

**B**ARNEY was muttering to himself and Mac, his employer, knew from experience that this meant the youth was having trouble with his work. Finally the older man laid down his solder gun and strolled over to where the youth was poking aimlessly around the wiring of a little a.c.-d.c. receiver with the noise probe of the signal tracer.

"Want to tell Daddy?" Mac asked soothingly.

"I want to tell somebody!" Barney exploded. "This cotton-picking set about has me ready to blow my stack. For a while it plays fine; then it starts getting noisy; next it goes dead on all but local stations; finally it will play OK again for a half hour or so. And it's *not* tubes, for I've changed 'em all," he concluded.

Mac cocked a practiced ear at the set that was now in the noisy part of its cycle.

"Bad i.f. transformer?" he hazarded.

"Nope," Barney denied with conviction. "I tacked in new ones to make sure."

"I see it has an r.f. stage. How about the coupling capacitor between it and the mixer?"

"Ain't no such animal. This little gem uses a regular tuned transformer for coupling."

"Maybe one of the transformer windings is bad?"

Barney shook his head. "I was just checking both windings with the noise probe of the signal tracer. When you pass a current through a winding from this probe, if there is the least sign of a break in the winding you get a heck of a racket from the tracer speaker."

"Oscillator coil?" Mac suggested as he picked up the diagram.

"I checked out the two main windings on that, too," Barney said triumphantly.

"Hm-m-m-m," Mac said as he studied the diagram. "This oscillator coil is a little unusual: it actually has three windings. One is the tuned, frequency-determining winding that has its bottom connected to the a.v.c. bus. Then

there is this feedback winding between the cathode of the 12BE6 mixer and ground. Finally there is this little gimmick winding that has one end going through a 1000-ohm resistor to the oscillator grid. The other end is free. Apparently they just use it for capacity coupling to the tuned circuit. Have you checked for leakage *between* windings?"

Barney shook his head in a crestfallen manner and picked up the noise probe. When its leads were connected between the gimmick winding and the tuned circuit winding, a scratching crackling sound came from the signal tracer speaker.

"Guess that's the trouble," Mac said as he continued to study the diagram. "When that gimmick winding intermittently short-circuits to the tuned winding, it places the oscillator grid voltage on the a.v.c. bus and biases the tubes so high only the local stations can get through."

"I'll buy that, but what do we do about it? This set's an orphan, and we can't get an exact replacement; but on that crowded, shallow chassis, an exact replacement is about the only thing that will fit. I hate to try re-vamping the oscillator circuit."

"Maybe you won't have to. Try connecting a small mica capacitor, say about a .001  $\mu$ fd., between that gimmick coil terminal and the 1000-ohm resistor. That should furnish a path for the r.f. but block off the oscillator d.c. voltage. Then the gimmick coil can short or not, just as it pleases."

Barney carried out this suggestion and the receiver acted perfectly normal. Oscillator tracking was not disturbed and there was no sign of noise.

"Why didn't I think of that?" Barney growled. "This must be one of my stupid days."

"You would have thought of it," Mac said soothingly. "You were on the trail. I just used my experience to beat you to it. I've had quite a bit of trouble with that same general condition with two-winding oscillator coils in which a mica coupling capacitor between the

tuned winding and the oscillator grid becomes leaky and produces the same symptoms. But let's talk about something else. How are you making out with that new selectable-sideband ham receiver of yours?"

"Fine, fine," Barney said; "and you know something? I'm finding out that quite a few hams who own this general type of receiver do not know how to tune them correctly."

"Yeah," Mac said skeptically.

"I know it sounds wacky, but it's true. It's on tuning AM stations they fall down. On SSB, either you tune the thing right or you get nothing but gobbledygook; but you can get some reception of AM stations even though you mistune the set."

"Spell it out for me," Mac suggested.

"Well, the main point is that you're supposed to receive just one sideband of an AM station at a time with these receivers. That's all you need since the two sidebands ordinarily carry the same information. Now in order to receive just one sideband, the carrier has to be placed pretty exactly on the selectivity curve of the 50 kc. i.f. passband. You don't place the carrier in the center of that passband the way you do with an ordinary receiver; you put it on the low-frequency skirt."

"Why?"

"Well, suppose this is the 50 kc. selectivity curve," Barney said as he sketched a flat-topped hairpin on a piece of paper. "Now suppose we have the passband adjusted for 3 kc. bandwidth. If we put the carrier in the center, that leaves only 1.5 kc. on either side, which means our high-frequency response will be restricted to 1500 cycles. But if the carrier is put over here about half-way down on the low-frequency skirt of the curve, the sideband can use the full 3 kc. bandwidth, giving us frequency response up to 3000 cycles. There will be some attenuation of the frequencies immediately adjacent to the carrier, but these are very low frequencies that would never be passed by the receiver's audio system anyway."

"Isn't it pretty hard to know when you have the carrier in just the right place?"

"Not really. There's a simple way of doing it. First, you set the b.f.o. to exactly 50 kc. This is done by tuning in a steady carrier and adjusting the b.f.o. and receiver tuning as you keep flipping back and forth between upper and lower sidebands. When the b.f.o. is set right on the nose, the receiver will stay at zero-beat with the incoming signal as either sideband is selected. From this point on, you do not touch the b.f.o. tuning.

"Now you are ready to tune in an AM station the way it should be tuned. To do this, you simply turn on the b.f.o. and zero-beat the carrier of the phone signal. Then you turn the b.f.o. off. The station will be heard clearly and the full bandwidth can be utilized by the desired sideband to provide maximum high-frequency response. If

(Continued on page 158)







Over-all view of scope calibrator and pulse generator.

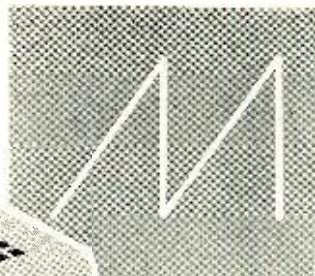
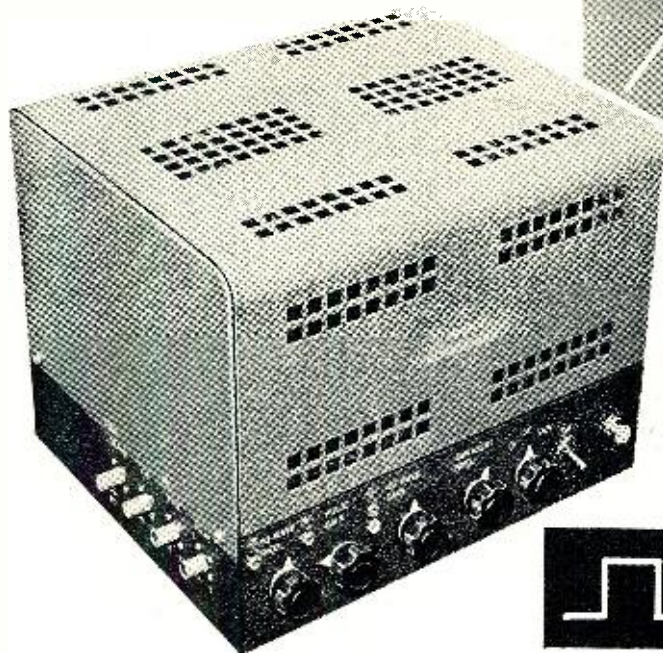

and



# Scope Calibrator

# and Pulse Generator

By **LEONARD CHIOMA**  
The Glenn L. Martin Co.

*Construction of a versatile accessory which provides square waves and pulses for many testing purposes.*

**T**HE complexity of today's electronic devices often taxes the ingenuity of the engineer who must develop appropriate equipment for testing, servicing, and altering such gear. Even television circuitry requires pulse measurements, a procedure heretofore required only in radar applications. The scope used for television must be capable of measuring synchronizing pulses and video signals.

The relative gain of video amplifiers, in terms of voltage, can be determined by simply measuring a given amount of vertical deflection produced by a signal input to the grid of an amplifier and then comparing this with the vertical deflection produced at the output, e.g., if the input deflects the oscilloscope five divisions and the output produces a deflection of fifty divisions, then we know that the gain is ten. As we do not know what each single division on the screen represents in terms of voltage, it is necessary to calibrate the scope. The calibrator to be described meets this need.

Some commercial scopes have an internal a.c. voltage, ranging from 1.5 to 6.3 volts, provided for calibrating purposes. A simple conversion reveals the peak-to-peak voltage reading. The a.c. voltage that is measured or known is simply multiplied by 2.83 to give the peak-to-peak reading. Fig. 2A illustrates this principle. The simplest calibrator that can be built externally consists of a filament transformer with an output of 6.3 volts shunted by a 5000-ohm potentiometer. The reading

is taken on a rectifier-type a.c. meter. See Fig. 2B.

This method will provide a maximum of 17.83 volts peak-to-peak. This output is used as follows: The gain (vertical) control of the oscilloscope is set so that the pattern occupies a definite number of squares on the cross-hatch screen at a given voltage input from the calibrator. The calibrator is then disconnected and the height of the unknown signal is measured. For example, if the voltage from the calibrator was set at ten volts and the amplitude of the scope set to ten divisions, then each division represents one volt peak-to-peak. The amplitude of the unknown signal is measured directly by counting divisions.

Although calibrators of this type are convenient, it was felt that a unit which would produce signals of the type encountered in actual servicing would be more convenient, thus eliminating meter readings and conversion factors. The various waveshapes are provided so that the unknown signal can be compared with a similar signal. This is advantageous in that all frequencies or waveshapes are not amplified equally in the lower priced oscilloscopes and thus a true comparison of readings would be inaccurate.

The instrument to be described overcomes all of these basic objections. It provides square waves, one fixed at 60 cps with a calibrated step output of 1, 10, and 100 volts peak-to-peak, and the other variable from approximately 180 to 1500 cps at an output voltage of

from 0 to 120 volts peak-to-peak; a pulse with positive polarity, derived from the square-wave generator, variable from 0 to 50 volts peak-to-peak; a variable saw-tooth frequency, 12 volts peak-to-peak; and a fixed sine-wave voltage of 6.3 volts, or 17.83 volts peak-to-peak.

The complete schematic of the instrument is given in Fig. 1.  $V_1$  is the variable square-wave generator. A 6SN7GT tube is used in the familiar free-running multivibrator circuit. This basic multivibrator is a simple two-stage RC-coupled amplifier with the output of the second stage coupled through a capacitor to the grid of the first tube. Since multivibrator theory has been thoroughly covered in the literature, it will not be discussed here. The output from the multivibrator is coupled to a 6C4 ( $V_2$ ) tube used as an overdriven amplifier in which grid- and plate-circuit clipping occurs. The grid-cathode path of the tube and the grid series resistor form a diode clipper circuit which removes the positive peaks and leaves the negative peaks unaltered. The elimination of the positive half of the grid-voltage wave input from the multivibrator, because of grid current, is called grid-circuit clipping. The flattening of the top of the waveform is the result of the grid voltage falling below the cut-off value and is known as plate-current cut-off clipping. The combination of grid-circuit clipping and plate-current cut-off clipping results in a conversion of the multivibrator output into a good square-wave output. The square-wave output of the 6C4 is coupled to a 6SN7GT used as a dual cathode-follower. The two outputs are taken



from across the 5000-ohm linear-taper pots,  $R_{13}$  and  $R_{14}$ , which should have calibrated dials for direct readings.

The square-wave input of one section of the cathode-follower ( $V_3$ ) is differentiated by  $R_{12}$  and  $C_4$ . As only a positive-going pulse is required, a pair of 1N34 crystal diodes is used to clip the negative-going peaks of the differentiated wave.  $CR_1$  is a series diode used to limit negative signals, as shown in Fig. 3.

The 1N34 crystals are used in a series- and parallel-limiting diode circuit. The characteristics of a diode are such that it conducts only when the anode is positive with respect to the cathode or when the cathode is negative with respect to the anode. The series diode is used to limit the negative swing of the input voltage. The diode is closed (conducting) during the positive swing of the input voltage and open (cut-off) during the negative swing.

The second crystal diode,  $CR_2$ , is the parallel diode limiter connected so as to limit the negative swing. The anode of the diode is held at ground potential so that the diode does not conduct during the positive half cycle, thus the output voltage equals the input voltage. During the negative half cycle of the input voltage, the cathode is negative with respect to the anode and the diode conducts. The output voltage is limited to the very low voltage drop across the crystal. The cathode-follower output is variable from 0 to 50 volts. The 60-cycle square-wave voltage is developed in another 6C4 ( $V_7$ ), utilizing a combination of grid limiting and cut-off limiting. (For an explanation of this technique, refer to "Principles of Radar" published by McGraw-Hill Book Company, New York.)

In the circuit of Fig. 5 the tube is operated in a highly overloaded condition. Although the in-circuit operating voltage is high, there have been no tube failures with this equipment even after many hours of operation. Generally, a test unit of this type is operated for relatively short periods of time and under such conditions will provide trouble-free performance.

The amplitude of the input voltage is sufficiently high to hold the grid beyond cut-off for the greater part of the negative swing. This type of circuit requires large voltage inputs which, in this unit, are derived from the secondary winding of the power transformer.

As the grid tends to go positive relative to the cathode, grid current is drawn. The grid current causes a voltage drop across the series grid resistor from  $b$  to  $a$ . The magnitude of the grid current drawn is sufficient to prevent the grid from ever going more than slightly positive. During the negative half cycle, no grid current flows through the grid resistor from  $b$  to  $a$  and therefore the voltage wave at  $b$  has the same shape as that at  $a$  during this half cycle. As the grid becomes more negative, the plate current drops and plate voltage rises until

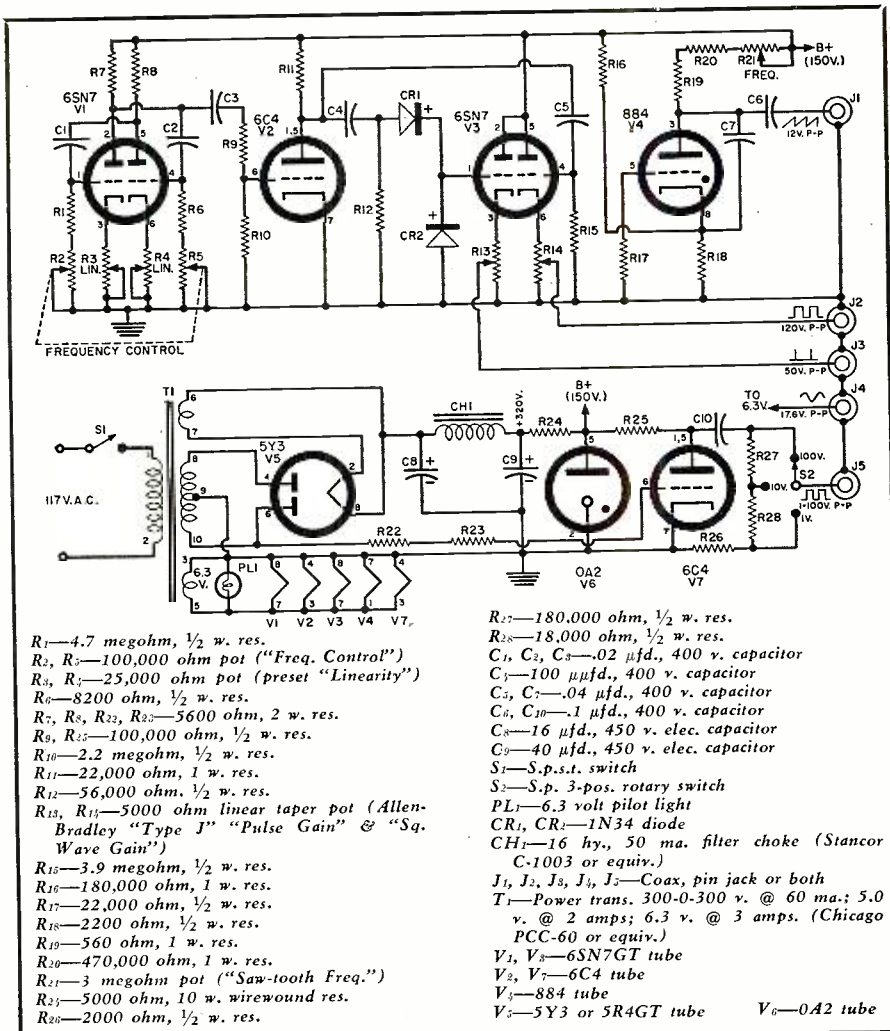

Fig. 1. Complete circuit diagram and parts listing of the accessory test unit.

This top view of the scope calibrator, with its cover removed, clearly shows the placement of the tubes that are used along with filters and power transformer.





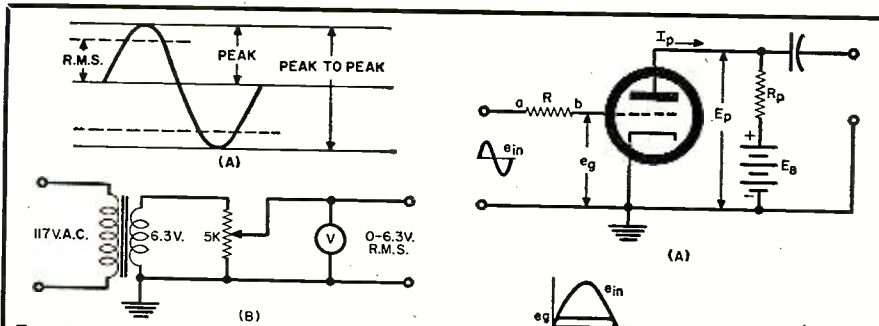

Fig. 2. (A) Sine-wave relations discussed. (B) A simple scope calibrator may be built.

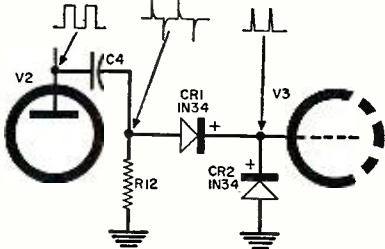
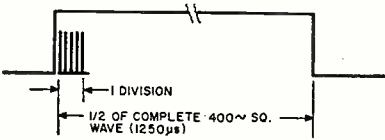

Fig. 3. Partial schematic showing pulse formation and then clipping by the diodes.

Fig. 4. Method employed to determine the frequency of an unknown series of pulses.



the grid voltage reaches cut-off. Plate voltage remains at the supply voltage  $E_B$  during the time the grid is below cut-off. This results in a square wave at the plate.

The saw-tooth generator is an 884 thyratron, connected in a circuit similar to the scope's horizontal time-base generator. The operation is as follows:  $R_{16}$  and  $R_{18}$  (Fig. 1) form a

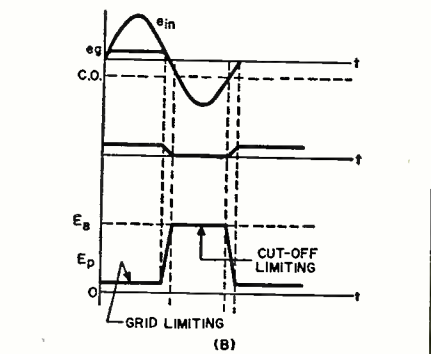
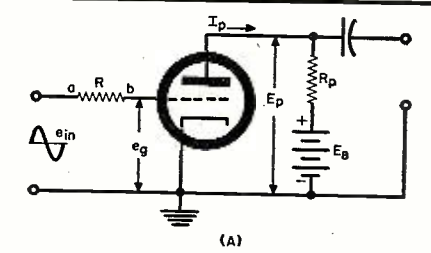

Fig. 5. (A) A combination of grid and cut-off limiting produces 60 cps square waves.

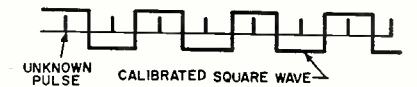

Fig. 6. Electronic-switch-produced pattern.

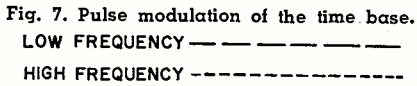

Fig. 7. Pulse modulation of the time base.

This collapse of plate voltage restores bias control on the thyratron and the cycle repeats, producing a continuous saw-tooth voltage output.

The unit was calibrated using an RCA "VoltOhmyst WV-75A." The measurement was made with the gain controls set at maximum and then noting the peak-to-peak readings on the proper scale. Another method is to use the circuit shown in Fig. 2B and follow the technique described.

The two cathode-follower pots used in the construction are of the linear type (Allen-Bradley "Type J"). A dial scale of the type used as an amplifier gain control indicator can be employed to give direct readings. Suitable units with dial markings of 0-100 are available. As the potentiometers are reasonably linear, the voltage outputs can be read directly, for example, on a pulse output of 50 volts with the dial scale set to 100, one-half will be 25 volts, etc. For maximum accuracy care should be taken in initially setting the dial pointers.

### Applications

In applying the calibrator, the variable outputs are substituted for the signal under test and varied for equal peak-to-peak deflection. The calibrator voltage is then read directly on the calibrated dials. The use of an electronic switch, in which the calibrating and unknown voltages are shown on the scope screen simultaneously, is a good method of comparison since it is unnecessary to switch the two signals. An example of this technique is shown in Fig. 6. Here the unknown is the pulse and the variable square-wave output is used. As shown, the pulse is of lesser amplitude and the square wave must be reduced to match.

If the variable square-wave generator is set at 400 cycles it represents a total cycle time of 2500 microseconds. By using the positive alternation as a fixed time-base and spreading it across the scope screen so that it covers exactly 25 spaces, each space will represent 50 microseconds. With this technique, the unknown pulse frequency can be determined, as indicated in Fig. 4. For example, if five pulses appear per square then we know the pulse spacing is 10 microseconds with a repetition frequency of 100 kc.

Further uses of the calibrator include measurement of the phase, distortion, and frequency response of audio amplifiers, using both the sine- and square-wave outputs; video amplifier measurement and response; square-wave modulation of high-frequency signal generators used in waveguide tests, etc. The various outputs can also be used to pulse modulate the horizontal time-base of an oscilloscope when connected to the brightness or Z-axis. See Fig. 7.

Considering the versatility of this calibrator and pulse generator, it is well worth the time and effort involved in building and calibrating such an instrument.

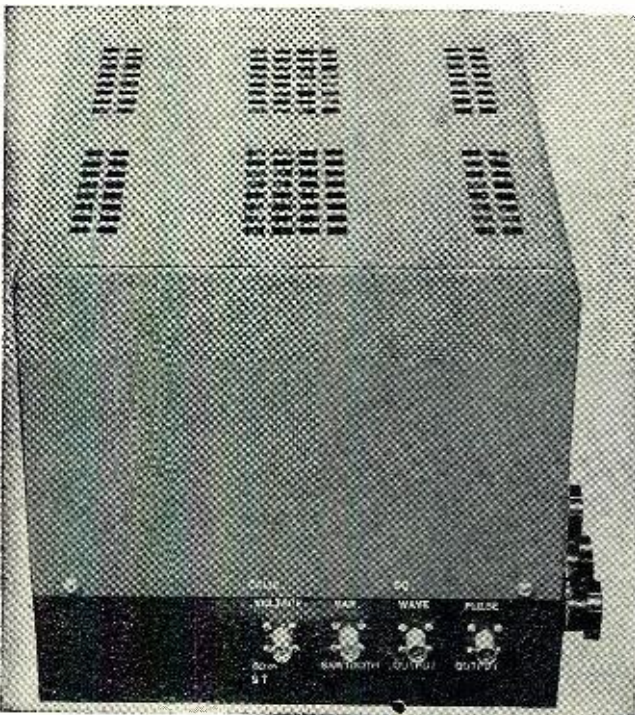

Side view of the scope calibrator and pulse generator shows four coax fittings that provide the outputs of the unit. Pulses, saw-tooth waves, sine waves, and square waves are all available from the device.



Simply by checking  
all the tubes in the TV set with

**B&K** **DYNA-QUIK**

**YOU CAN INCREASE YOUR INCOME**

**FAST AND ACCURATE**

- Tests complete set in minutes
- Wins customer's confidence
- Saves costly call-backs
- Sells more tubes on-the-spot
- Avoids substitution testing
- Makes more money every day

**\$50\***  
**PER WEEK**

\*ACTUAL EXPERIENCE SHOWS  
TV SERVICEMEN AVERAGE

**2 extra tube sales  
PER CALL**

**5 calls per day in  
5 days equal \$50**

**MEASURE TRUE DYNAMIC MUTUAL CONDUCTANCE**

Thousands of technicians are doing a better servicing job and are making more money today with the famous B&K DYNA-QUIK. Completely tests each tube in seconds, with laboratory accuracy, in home or shop. *Measures true dynamic mutual conductance.* Shows tube condition on "Good-Bad" scale and in micromhos. No multiple switching or roll chart. Quickly detects weak, short-life, or inoperative tubes. Shows customer the true condition and life-expectancy of tubes in the set; sells more tube replacements per call. Assures customer satisfaction and protects the service guarantee.



MODEL 675

**Model 675 AUTOMATIC**  
*Simplified, Portable, DYNA-QUIK*  
**TUBE AND TRANSISTOR TESTER**

With only 60 indexed phenolic Dyna-Cards, you can test over 500 tube types. Dyna-Card automatically sets socket connections for quick, accurate tube test. Checks over 99% of the tubes most widely used in television receivers, plus popular home and portable radio tubes. Easily kept up-to-date by adding new Dyna-Cards. Tests each section of multiple tubes separately for Gm, Shorts, Grid Emission, and Life. Tests each tube for Gas Content and Grid Emission simultaneously with Short Check. Provides instantaneous Heater Continuity test. Transistor Section checks junction, point contact, and barrier transistors, germanium and silicon diodes, selenium and silicon rectifiers.

Net, **\$169<sup>95</sup>**

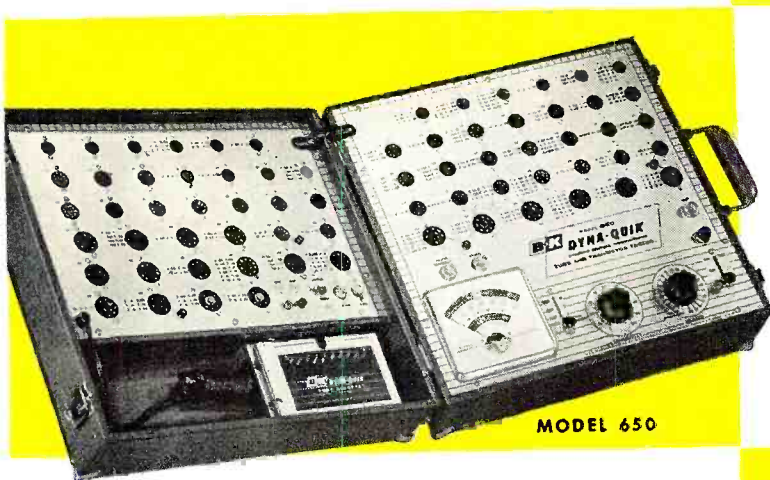

MODEL 650

**Model 650 DYNA-QUIK**  
*Fastest, Most Complete, Portable*  
**TUBE AND TRANSISTOR TESTER**

Checks over 99% of the tubes most widely used in television receivers, plus popular home and portable radio tubes. Tests over 500 tube types. Lists over 125 most commonly used tube types, with settings, on socket panels for maximum operating speed. Complete listing in fast telephone-index type selector. Tests each section of multiple tubes separately for Gm, Shorts, Grid Emission, and Life. Tests each tube for Gas Content. Provides instantaneous Heater Continuity check. Includes 16 spare sockets and sufficient filament voltages for future new tube types. Transistor Section checks junction, point contact and barrier transistors, germanium and silicon diodes, selenium and silicon rectifiers.

Net, **\$169<sup>95</sup>**

*Manufacturers of Tube Testers, Cathode Rejuvenator Tester, Television Analyst, Dyna-Scan, Transistor Tester, and other specialized instruments.*



See your B&K Distributor or  
Send now for Bulletin AP12-N

**B & K MANUFACTURING CO.**  
3726 N. Southport Ave. • Chicago 13, Illinois

Canada: Atlas Radio Corp., 50 Wingold, Toronto 10, Ont.  
Export: Empire Exporters, 458 Broadway, New York 13, U.S.A.



# "HEATHKITS"®

*gave me my start and I'm still sold!"*

"... they are my lowest cost way to real quality and dependability in electronic equipment of any kind . . .

. . . The clean, modern styling of HEATHKITS make me proud to own them. They make a handsome and useful addition to my workshop.

... Rigid quality standards of components used in HEATHKITS assure me of performance equal to or surpassing instruments costing many times more.

. . . after assembling a HEATHKIT myself, I know what "makes it tick". . . I know that the thoughtful circuitry design and name-brand components used throughout guarantee me years of trouble-free service.

. . . HEATHKITS cost me half as much as ordinary equipment . . . and I get so much more. In assembling my own instruments I am sure of the quality that goes into them. Plus the complete assembly and operating instructions as well as detailed schematics that are at my fingertips for future reference."

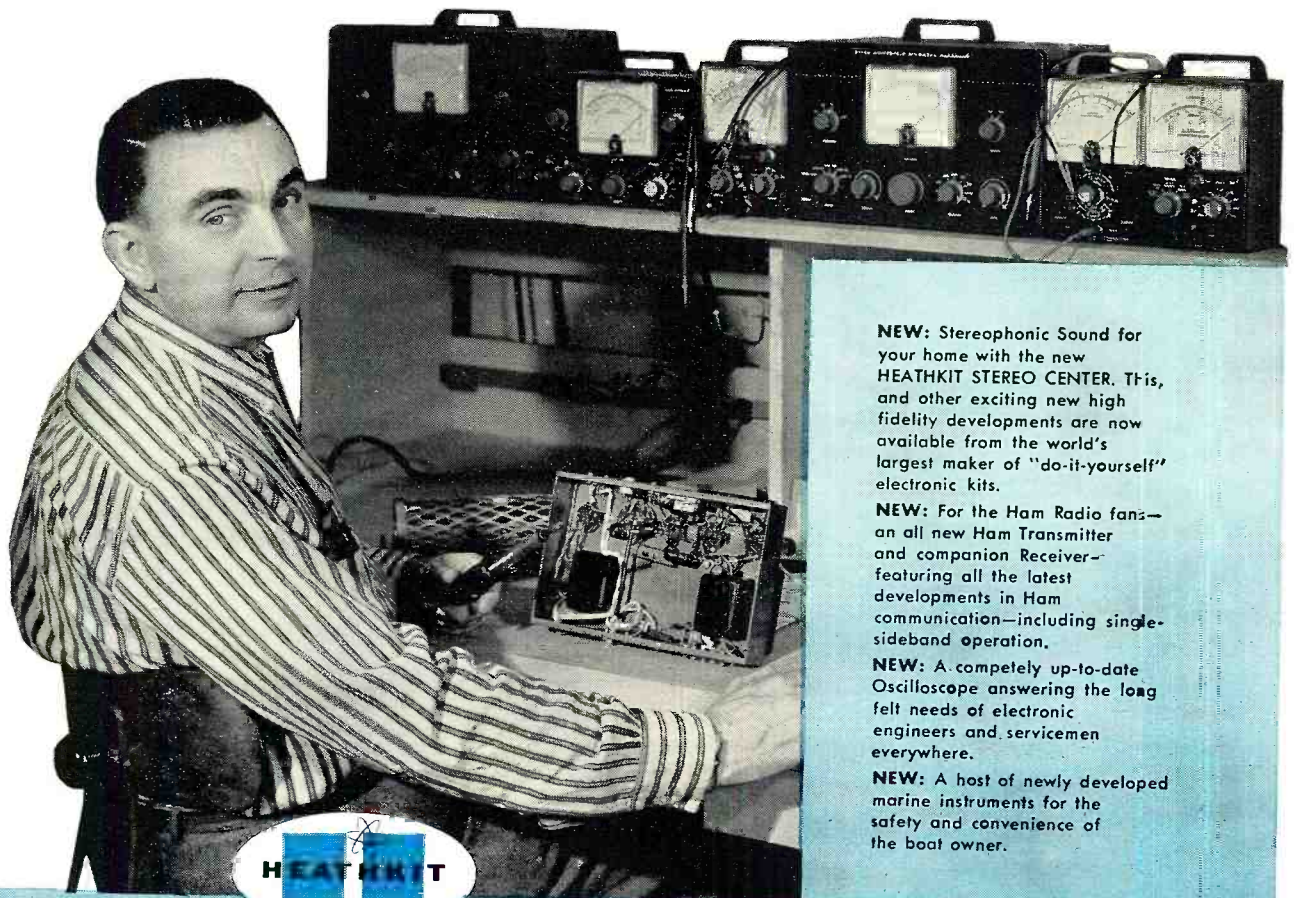

**HEATH COMPANY** Benton Harbor 15, Michigan

 a subsidiary of Daystrom, Inc.

**NEW:** Stereophonic Sound for your home with the new HEATHKIT STEREO CENTER. This, and other exciting new high fidelity developments are now available from the world's largest maker of "do-it-yourself" electronic kits.

**NEW:** For the Ham Radio fans—an all new Ham Transmitter and companion Receiver—featuring all the latest developments in Ham communication—including single-sideband operation.

**NEW:** A completely up-to-date Oscilloscope answering the long felt needs of electronic engineers and servicemen everywhere.

**NEW:** A host of newly developed marine instruments for the safety and convenience of the boat owner.

**The HEATH TIME PAYMENT PLAN** allows you to outfit your whole workshop at one time with needed test instruments while you pay in easy monthly installments.





### PROFESSIONAL OSCILLOSCOPE KIT

An exciting development in the Heathkit test instrument line is the introduction of the Heathkit model OP-1 Professional Oscilloscope. Emphasizing complete flexibility in any application, the OP-1 features DC coupled amplifiers and also DC coupled CRT tube un-blanking. The triggered sweep circuit will operate on either internal or external signals and may be either AC or DC coupled. The polarity of the triggering signal may also be selected, and any point on the wave form may be selected for the start of the sweep by using the "triggering level" control. An automatic position is also provided, in which the sweep recurs at a 50 cycle rate, but can be driven over a wide range of frequencies with no additional adjustments. The sweep frequencies are provided by switch-selected base rates of .2 and .2 milliseconds/CM, and 20, 2, and 1 microseconds/CM, in conjunction with a continuously variable 10 to 1 multiplier. Sweep frequencies are calibrated to within 10% at all control settings, and the sweep frequency may be reduced by adding capacity to the "ext. cap" binding post on the front panel. A 5ADP2 flat face CR tube is used for accurate readings on an edge lighted grid screen. A high quality conetic-fernetic CR tube shield prevents stray AC fields from distorting trace. A 12-position vertical attenuator is calibrated in volts-per-CM and the horizontal sweep is calibrated in time-per-CM. Prewired terminal boards are used for rapid, easy assembly of all critical circuits. Simply install and connect the color coded leads. Power supply is transformer operated utilizing silicon diode rectifiers and is fused for protection. Under development for over a year the OP-1 promises outstanding results in any application requiring the use of an oscilloscope.



HEATHKIT  
OP-1  
**\$179<sup>95</sup>**

**Here's the scope you've  
been waiting for!**

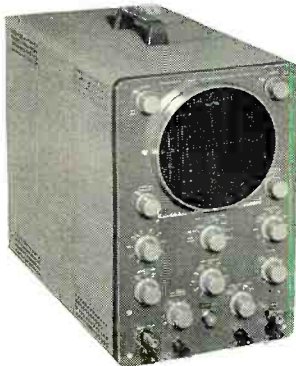

**Laboratory  
Performance At Less  
Than Utility Scope  
Price**

HEATHKIT  
O-12  
**\$65<sup>95</sup>**



**A Scope You Will Be  
Proud To Own**

HEATHKIT  
OM-3  
**\$39<sup>95</sup>**

### "EXTRA DUTY" 5" OSCILLOSCOPE KIT

Top quality features at half the cost of ordinary equipment sum up the advantages of this popular kit. Critical observations in your laboratory or shop are handled easily, with clear, sharp pattern displays in every application. Vertical frequency response extends from 3 CPS to 5 mc  $\pm 1.5$  db  $-5$  db without extra switching. Response is down only 2.2 db at 3.58 mc. The Heath patented sweep circuit functions effectively from 10 CPS to better than 500 kc in five steps, giving you 5 times the usual sweep obtained in other scopes. An automatic sync circuit with self-limiting cathode follower provides excellent linearity and lock-in characteristics. Extremely short retrace time and efficient blanking action. Both vertical and horizontal output amplifiers are push-pull and the scope incorporates a 1 V peak-to-peak calibrating source, step attenuated and frequency compensated vertical input, plastic molded capacitors and top quality parts throughout. The 11-tube circuit features a 5UP1 cathode ray tube, and provision is made for Z-axis input for intensity modulation of the beam. Frequency response of the horizontal amplifier is within  $\pm 1$  db from 1 CPS to 200 kc. Horizontal sensitivity is 0.3 volts RMS per inch. Construction is simplified through the use of two metal circuit boards and precut, cable wiring harness. Shpg. Wt. 22 lbs.

### GENERAL PURPOSE 5" OSCILLOSCOPE KIT

For servicing and routine laboratory work this fine kit is a favorite with technicians throughout the country. It incorporates many extras not expected at this low price. Features wide vertical amplifier frequency response, extended sweep generator operation, and improved stability. Frequency response of the vertical amplifier is within  $\pm 3$  db from 4 CPS to 1.2 mc. Vertical sensitivity is .09 volts RMS per inch at 1 kc. Sweep generator functions reliably from 20 CPS to over 150 kc. A modern etched circuit board is featured for high stability and reduces assembly time considerably. Standard components are mounted on this board with each position clearly marked preventing wiring errors. Both vertical and horizontal amplifiers are push-pull types. Uses a 5BP1 CRT. Provision for external or internal sweep or sync, built in 1 V peak-to-peak reference voltage and calibrated grid screen. An adjustable "spot shape" control is provided to insure a sharp trace. Input to the vertical amplifiers is through a step attenuated, frequency compensated circuit. The OM-3 is an extremely versatile instrument and has a multitude of practical uses in electronic testing fields. Particularly useful in alignment of television receivers, for testing audio amplifiers and circuits, and checking the quality of modulated RF signals in Ham Radio transmitters. Shpg. Wt. 22 lbs.





Equip Your Service Bench...

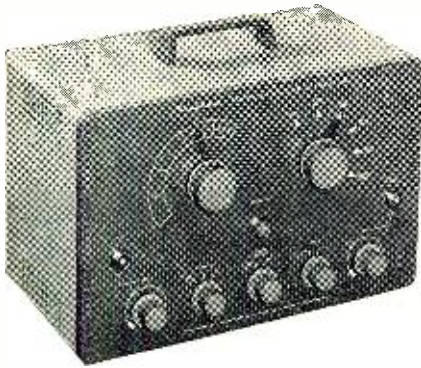

HEATHKIT  
CD-1 \$59<sup>95</sup>

### Cash In Now On Color TV

- ★ 10 VERTICAL COLOR BARS
- ★ CRYSTAL CONTROLLED ACCURACY
- ★ CHOICE OF 6 DIFFERENT PATTERNS

### COLOR BAR AND DOT GENERATOR KIT

Colored television is now a reality and as the number of these sets increase the need for a reliable service instrument is apparent. Nothing on the market... in this type of generator has as many features as the CD-1 at such a tremendous price saving. This unit combines two basic color service instruments, a color bar generator, and white dot generator in one versatile portable unit which has crystal controlled accuracy and stability for steady locked-in patterns (requires no external sync leads). Color receivers converged with the CD-1 will still be converged properly on a television program from the station. The 13-tube circuit has been carefully laid out for ease of assembly and provides choice of six different patterns. Produces white-dots, cross hatch, horizontal and vertical bars, ten vertical color bars, and a new shading bar pattern for screen and background adjustments. Variable RF output on any channel from 2 to 6. Positive or negative video output, variable from 0 to 10 volts peak-to-peak. Crystal controlled sound carrier with off-on switch. Voltage regulated power supply uses long-life silicon rectifiers. Kit includes three crystals and test lead, plus an information packed instruction manual covering convergence, and screen and background adjustments of a color TV set. Compare with other generators on the market and you will see that this instrument is loaded with extras and top quality all the way through. Shpg. Wt. 13 lbs.



HEATHKIT  
TS-4A \$49<sup>50</sup>

For fast,  
easy alignment  
of TV sets



HEATHKIT  
AG-10 \$49<sup>95</sup>

Sine and  
square waves for  
countless uses



HEATHKIT  
MM-1  
\$29<sup>95</sup>

High accuracy  
in a  
portable meter



HEATHKIT  
M-1  
\$17<sup>95</sup>

An all-round  
meter of  
many uses

#### TV ALIGNMENT GENERATOR KIT

This generator has many special design features for flexible, easy operation and reliability. The all-electronic sweep circuit insures stability and covers 3.6 mc to 220 mc in four bands. Sweep deviation is controllable from 0 to 42 mc. Crystal and variable marker oscillators are built in. Crystal (included with kit) provides output at 4.5 mc and multiples thereof. Variable marker provides output from 19 to 60 mc on fundamentals and from 57 to 180 mc on harmonics. Effective two-way blanking and phasing control also provided. A truly outstanding number of features at a tremendous price saving. Shpg. Wt. 16 lbs.

#### SINE-SQUARE GENERATOR KIT

High quality sine and square waves are produced by this generator over a wide range. Frequency response is  $\pm 1.5$  db from 20 CPS to 1 mc on both sine and square waves, with less than .25% sine wave distortion, 20 to 20,000 CPS. Output impedance is 600 ohms on sine wave and 50 ohms on square wave (except on 10 volt range). Square wave rise time less than .15 microseconds. Five-position bandswitch—continuously variable tuning—shielded oscillator circuit—separate step and variable output attenuators in ranges of 10, 1 and .1 volts with extra range of .01 volt on sine wave. Shpg. Wt. 12 lbs.

#### 20,000 OHMS/VOLT VOM KIT

This meter is ideal for use in field applications where accuracy is important. Employs a 50  $\mu$ a  $4\frac{1}{2}$ " meter, and features 1% precision multiplier resistors for high accuracy. Requires no external power for operation (batteries supplied). Sensitivity is 20,000 ohms-per-volt DC and 5,000 ohms-per-volt AC. Measuring ranges are 0-1.5, 5, 50, 150, 500, 1500 and 5,000 volts AC and DC. Measures direct current in ranges of 0-150  $\mu$ a, 15 ma, 150 ma, 500 ma and 1.5 a. Resistance multipliers are x 1, x 100 and x 10,000. Covers -10 db to +65 db. Batteries and test leads are also included with this kit. Shpg. Wt. 6 lbs.

#### HANDITESTER KIT

Small enough to carry with you wherever you go, this fine handitester is ideal for use in portable applications when making tests away from the work bench or as an "extra" meter in the service shop, when the main instruments are occupied. The combination function-range switch simplifies operation. Measures AC or DC voltage from 0-10, 30, 300, 1000 and 5000 volts. Direct current ranges are 0-10 ma and 0-100 ma. Ohmmeter ranges are 0-3000 and 0-300,000. Top quality precision components employed throughout. Very popular with home experimenters and electricians. Shpg. Wt. 3 lbs.



with Low-Cost Dependable Heathkits

HEATHKIT

### ETCHED CIRCUIT VTVM KIT

The fact that this instrument is outselling all other VTVM's says a great deal about its accuracy, reliability, and overall quality. The precision and quality of the components used in this VTVM cannot be duplicated at this price through any other source. Its attractive appearance as well as its performance will make you proud to own it. A large 4½" panel meter is used for indication, with clear, sharp calibrations for all ranges. Front panel controls consist of a rotary function switch and a rotary range selector switch, zero-adjust and ohms-adjust controls. Precision 1% resistors are used in the voltage divider circuit. An etched circuit board is employed for most of the circuitry, cutting assembly time and eliminating the possibility of wiring errors. It also assures duplication of laboratory instrument performance. This multi-function VTVM will measure AC voltage (RMS), AC voltage (peak-to-peak), DC voltage and resistance. There are 7 AC (RMS) and DC voltage ranges of 1.5, 5, 15, 50, 150, 500 and 1500. In addition there are 7 peak-to-peak AC ranges of 0-4, 14, 40, 140, 400, 1400 and 4,000. Seven ohmmeter ranges providing multiplying factors of x 1, x 10, x 100, x 1000, x 10 k, x 100 k and x 1 megohm. Center scale resistance readings are 10, 100, 1000, 10 k, 100 k ohms, 1 megohm and 10 megohms. A zero-center scale db range is also provided. Battery and test leads included with kit. Shpg. Wt. 7 lbs.

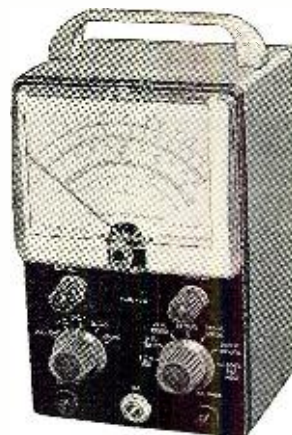

HEATHKIT  
V-7A  
\$25<sup>95</sup>

### World's largest selling VTVM kit

- ★ LARGE EASY-TO-READ 4½" 200 UA METER
- ★ 1% PRECISION RESISTORS EMPLOYED FOR HIGH ACCURACY



HEATHKIT  
C-3  
\$19<sup>50</sup>

Checks all types of  
condensers accurately



HEATHKIT  
T-4  
\$19<sup>95</sup>

Locate faults quickly  
by tracing signals



HEATHKIT  
SG-8  
\$19<sup>50</sup>

Easy-to-build—prewound  
and calibrated coils

#### CONDENSER CHECKER KIT

Check unknown condenser and resistor values quickly and accurately. Capacity measurements are made in four ranges of .00001 mfd-.005 mfd, .001 mfd-.5 mfd, .1 mfd-50 mfd, 20 mfd-1,000 mfd. Checks paper, mica, ceramic, and electrolytic condensers. Leakage test provides switch selection of five polarizing voltages, 25 volts to 450 volts DC to indicate condenser operating quality under actual load conditions. Electron beam "eye" tube indicates balance and leakage. A spring return test switch automatically discharges condenser under test and eliminates shock hazard to the operator. Measures resistance from 100 ohms to 5 megohms in two ranges. Shpg. Wt. 7 lbs.

#### VISUAL-AURAL SIGNAL TRACER KIT

Here is a brand new signal tracer completely redesigned with compact dimensions and new circuit layout. Features built-in speaker and electron beam "eye" tube for signal indication and a unique noise locator circuit. Ideal for use in AM, FM and TV circuit investigation. RF and audio inputs are provided in one convenient probe with switch on probe to select either input. Useful for checking microphones, phono cartridges, record changers, tuners, etc. Makes a handy substitution speaker for servicing TV sets at the shop. Transformer operated for safety and high efficiency. Complete with test leads and informative construction manual. Shpg. Wt. 6 lbs.

#### RF SIGNAL GENERATOR KIT

Save valuable time in aligning RF tuned circuits of all kinds with this easy-to-use kit. Also a quick way to trace signals in faulty RF, IF and audio circuits. Designed for general service applications—the SG-8 covers 160 kc to 110 mc on fundamentals in five bands, and from 110 mc to 220 mc on calibrated harmonics. The entire oscillator circuit is built on a special sub-chassis, using prewound and calibrated coils. No further calibration is required, so it is ready to use as soon as construction is completed. RF output is in excess of 100,000 microvolts, controlled by both step and continuously variable controls. Complete with output cable and instructions. Shpg. Wt. 8 lbs.

HEATH COMPANY • a subsidiary of Daystrom, Inc. • Benton Harbor 15, Mich.





Enjoy Rich 3 Dimension Sound...

**Beautifully Styled with Plenty of Room for the Most Complete Stereo System**

AVAILABLE IN THE FOLLOWING MODELS:  
 Model SE-1B—Stereo Equipment Cabinet (birch)  
 Model SE-1M—Stereo Equipment Cabinet (mahogany)

**\$149<sup>95</sup>** ea.

Model SC-1BR—Stereo Wing Speaker Enclosure (birch—right end)  
 Model SC-1BL—Stereo Wing Speaker Enclosure (birch—left end)  
 Model SC-1MR—Stereo Wing Speaker Enclosure (mahogany—right end)  
 Model SC-1ML—Stereo Wing Speaker Enclosure (mahogany—left end)

**\$39<sup>95</sup>** ea.

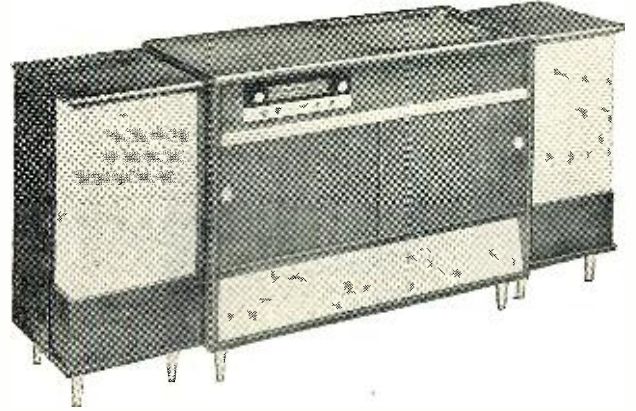

**STEREO EQUIPMENT CABINET KIT**

Imagine!... Stereophonic sound in your own home. This superbly designed cabinet holds all of your hi-fi stereo equipment and lends striking elegance to your living room. The attractive gold and black panels, trim and hardware brilliantly highlight the overall effect. Rich toned grille cloth, flecked in gold and black, complement the cabinet. The unit has ample room provided for an AM-FM tuner, tape deck, stereo pre-amplifier, amplifiers, record changer, record storage and speakers. Beautifully grained 3/4" solid core Philippine mahogany or select birch plywood is used for construction. The top features a shaped edge and sliding top panel for easy access to the stereo tape deck and stereo preamplifier. Sliding doors are employed for convenient front access to the

changer and record storage compartment. All parts of the cabinet are pre-cut and pre-drilled for simple assembly. The speaker wings and center cabinet may be purchased separately if desired. Note: the kit is delivered equipped with panels pre-cut to accommodate Heathkit components and also blank panels to cut out for your own equipment. Measurements of the individual component areas follow: tape deck and pre-amplifier area 20 3/4" L. x 17 3/4" W. x 10" D., record changer area 21" W. x 16" D. x 9 5/8" H., record storage area 22 5/8" W. x 14 1/2" H. x 12 1/2" D., speaker wing area (inside) 14" W. x 29 1/2" H. x 15 3/4" D., AM-FM Tuner area 20 1/2" W. x 5 1/4" H. x 14" D., amplifier (2 areas) 15 1/4" W. x 10 3/4" H. x 13 1/4" D.

Model HH-1B Birch  
 Model HH-1M Mahogany  
 Now only **\$299<sup>95</sup>** each



**The Same Superior Performance At a New Low Price**



HEATHKIT SS-2 **\$39<sup>95</sup>**

OPTIONAL LEGS EXTRA

**Economical Hi-Fi For Your Home**

**"LEGATO" HI-FI SPEAKER SYSTEM KIT**

The increasing sales of the Legato has made more economical quantity production possible so we are passing the savings on to you by offering you this magnificent speaker system at a reduced price. Truly a "queen" among hi-fi speaker systems, the Legato was specially designed to meet and surpass the most stringent requirements of high fidelity sound reproduction. Two 15" Altec Lansing low frequency drivers cover frequencies of 25 to 500 CPS while a specially designed exponential horn with high frequency driver covers 500 to 20,000 CPS. A unique crossover network is built in making electronic crossovers unnecessary. Internal reflections are absorbed by sprayed back panel and a 3" fiber glass lining. The Legato emphasizes simplicity of line and form to blend with modern or traditional furnishings. Cabinet construction is 3/4" veneer surface plywood in either African mahogany or white birch and measures 41" L. x 22 1/4" D. x 34" H. All parts are pre-cut and pre-drilled for easy assembly. Shpg. Wt. 195 lbs.

**"BASIC RANGE" HI-FI SPEAKER SYSTEM KIT**

True high fidelity performance at modest cost make this basic speaker system a spectacular buy for any hi-fi enthusiast. The amazing performance of this popular kit is made possible by the use of high quality speakers in an enclosure specially designed to receive them. The cabinet is a ducted port bass reflex type enclosure 11 1/2" H. x 23" W. x 11 3/4" D. It features an 8" mid range woofer to cover 50 to 1600 CPS and a compression-type tweeter with flared horn covering 1600 to 12,000 CPS. Both speakers are by Jensen. The adjustable flared tweeter horn allows speaker to be used in either upright or horizontal position. The cabinet is constructed of 1/2" veneer surfaced plywood suitable for light or dark finish of your choice. All wood parts are pre-cut and pre-drilled for easy assembly. Shpg. Wt. 25 lbs.

Attractive brass tip accessory legs convert SS-2 into attractive console. Legs screw into brackets provided. All hardware included. Shpg. Wt. 3 lbs. No. 91-26 \$4.95



with a Heathkit Stereo System

HEATHKIT

### HIGH FIDELITY TAPE RECORDER KIT

Popular request for high quality, low cost tape recording and playback facilities have prompted the addition of this fine unit to our line. The TR-1A provides monaural record/playback with fast forward and rewind functions. Incorporates separate erase and combination record/playback heads. Two speeds,  $7\frac{1}{2}$  and  $3\frac{3}{4}$  IPS, are selected by changing belt drive. Flutter and wow are held to less than 0.35%. Frequency response at  $7\frac{1}{2}$  IPS  $\pm 2.0$  db 50-10,000 CPS, at  $3\frac{3}{4}$  IPS  $\pm 2.0$  db 50-65,000 CPS. The extremely simple mechanical assembly is ideally suited to kit construction. One control lever selects all functions on deck, greatly simplifying operation. Mount in vertical or horizontal position. The model TE-1 record/playback tape pre-amplifier, supplied with the mechanical assembly, provides NARTB playback equalization. A record interlock prevents accidental tape erasure. Recording level is indicated by a 6E5 "magic eye" tube. A two-position input selector switch provides for mike or line input. Separate record and playback gain controls. Filament balance control allows adjustment for minimum hum level. Cathode follower output from playback channel is approximately 600 ohms impedance. Two circuit boards are used for easy assembly. Templates and instructions are provided to cut out panels for mounting. Overall dimensions of tape deck and preamp are  $15\frac{1}{2}$ " W. x  $13\frac{1}{2}$ " H. x 8" D. Signal-to-noise ratio is better than 45 db below normal recording level with less than 1% total harmonic distortion. (Tape mechanism not sold separately.) Shpg. Wt. 22 lbs.

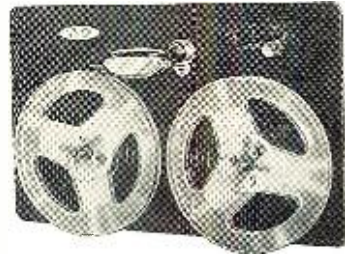

HEATHKIT  
TR-1A

\$99<sup>95</sup>

(Includes tape deck, tape recorder electronics, mike and roll of tape.)

Make Your Own  
Home Recordings

### TAPE RECORDER ELECTRONICS KIT

The model TE-1 Electronics Kit can be purchased separately to replace the electronics in your present tape recorder, or used in addition to it for stereo playback of pre-recorded tapes where a second playback channel is required. Circuit may be modified for use with different head types. Shpg. Wt. 9 lbs.

HEATHKIT  
TE-1  
\$39<sup>95</sup>

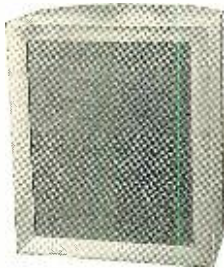

HEATHKIT  
SS-1B

\$99<sup>95</sup>

Fill out the Hi-Fi Range  
of Your SS-2 Speaker

### "RANGE EXTENDING" HI-FI SPEAKER SYSTEM KIT

This is not a complete speaker system in itself, but is designed to extend the range of the SS-2. The SS-1B uses a 15" woofer and a small super tweeter to supply the very high and very low frequencies to fill out the response of the basic SS-2. The SS-2 and SS-1B when used together, form an integrated four speaker system. The SS-2 and SS-1B combination provide an overall response of  $\pm 5$  db from 35 to 16,000 CPS. The kit includes circuit for crossover at 600, 1600 and 4,000 CPS. Impedance is 16 ohms and power rating is 35 watts. A control is also provided to limit output of super tweeter. The handsome cabinet measures 29" H. x 23" W. x  $17\frac{1}{2}$ " D. Constructed of beautiful  $\frac{3}{4}$ " veneer surface plywood. Complete step-by-step instructions make this kit easy to build. No wood-working experience required. Shpg. Wt. 80 lbs.

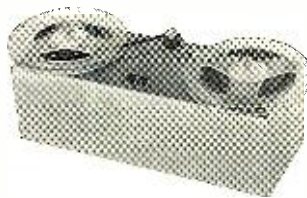

HEATHKIT  
SW-1

\$24<sup>95</sup>

Save Time Rewinding Tape

### "SPEEDWINDER" KIT

This handy device leaves your tape recorder free for operation while it rewinds tape at the rate of 1200' in 40 seconds. Prevents unnecessary wear to the tape and recorder by eliminating wear against guides and heads. It will handle up to  $10\frac{1}{2}$ " tape reels as well as 800' reels of 8 and 16 millimeter film. A very useful aid to operators of movie projection equipment. The Heathkit Speedwinder features an automatic shutoff which prevents whipping of tape when it has rewound. A manual shutoff is also provided. An automatic braking device is built in for protection against power failure. Driven by a heavy duty four pole motor. Handsome cabinet is constructed of furniture grade plywood. Step-by-step instructions are provided to make this kit easy to assemble even by one with no experience. Shpg. Wt. 12 lbs.



HEATHKIT  
TK-1

\$9<sup>95</sup>

All The Tools You Need For  
Building Heathkits

### COMPLETE TOOL SET

A clear illustration of just how easy Heathkit building is. The pliers, diagonal sidecutters, two screw drivers and soldering iron are all the basic tools you need for building practically any Heathkit. Pliers and sidecutters are equipped with insulated rubber handles. The American Beauty soldering iron has a replaceable tip to facilitate cleaning. All the tools are of top quality case hardened steel for rugged duty and long life. With these simple, inexpensive tools in your hand you need not be afraid to tackle the most elaborate kit. The manual included with this handy kit provides you with many useful tips on the use and care of your tools. It shows the all important step of making proper solder connections. A truly worthwhile investment for the beginner in electronic kit building. Shpg. Wt. 3 lbs.

HEATH COMPANY • a subsidiary of Daystrom, Inc. • Benton Harbor 15, Mich.



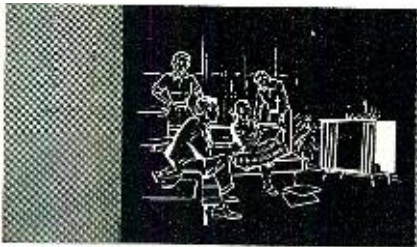

# Plan Your Hi-Fi System...



HEATHKIT  
SP-2 **\$56<sup>95</sup>**

Model SP-1 (monaural)  
\$37.95

Model C-SP-1 (converts SP-1 to SP-2)  
\$21.95

**Control both stereo  
channels simply  
and conveniently**

## MONAURAL-STEREO PREAMPLIFIER KIT

This expertly designed preamplifier provides all the controls required for either standard monaural (single channel) or stereo (dual channel) sound reproduction. Features building block design... you can start with a basic preamplifier and add a second channel for stereo later on, without rewiring. Second channel plugs in for fast conversion. The complete model SP-2 (stereo) features twelve separate inputs, six on each channel with input level controls. Six dual-concentric controls consist of: two 8-position selector switches, two bass, two treble, two volume level and two loudness controls, a scratch filter switch and a 4-position function switch (separate on-off switch). The function switch provides settings for stereo, two-channel mix, channel A or B for monaural use. Inputs consist of tape, mike, mag phono and three high-level inputs. Tape input has NARTB equalization and input selector provides for RIAA, LP, 78 record compensation. EF86 tubes are used in the input stages along with hum balance controls to assure low hum and noise. Two cathode follower outputs with level controls provided in addition to two separate tape outputs for stereo recording. A remote balance control with twenty feet of cable allows balancing the stereo system from listening position. Construction is greatly simplified through the use of two printed circuit boards (one in each channel) and encapsulated printed circuits. The beautiful vinyl clad steel cover has leather texture in black with inlaid gold design. Built-in power supply.

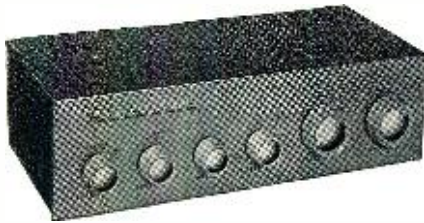

HEATHKIT  
WA-P2  
**\$19<sup>75</sup>**

**Finger-tip controls for  
your operating convenience**

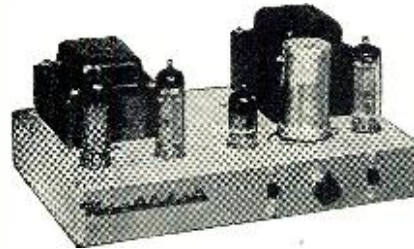

HEATHKIT  
UA-1  
**\$21<sup>95</sup>**

**A low cost  
versatile performer**

## "MASTER CONTROL" PREAMPLIFIER KIT

Designed as a control center for basic amplifiers the WA-P2 provides you with true high fidelity performance for the finest audio systems. Five switch-selected inputs accommodate a record changer, tape recorder, AM-FM tuner, TV receiver, microphone, etc., each with level control. Provision is also made for a tape recorder output. Ideal for "remote" installations, the WA-P2 features a low impedance cathode-follower output circuit allowing greater length of output lead. Full frequency response is obtained within  $\pm 1\frac{1}{2}$  db from 15 to 35,000 CPS and will do full justice to the finest available program sources. Equalization is provided for records through separate turnover and rolloff switches for LP, RIAA, AES, and early 78's. A special hum balance control allows setting for minimum hum level. Power for operation is required from basic amplifier or external source. Shpg. Wt. 7 lbs.

## "UNIVERSAL" 12-WATT AMPLIFIER KIT

A true high fidelity performer in every sense of the word, the UA-1 makes an ideal basic amplifier for any hi-fi system and is a perfect addition to gear your present hi-fi system for stereo sound. Uses 6BQ5/EL84 push-pull output tubes for less than 2% harmonic distortion throughout the entire audio range (20 to 20,000 CPS) at full 12 watt output. The on-off switch is located right on the chassis and an octal socket is provided for connecting a preamplifier for remote control operation. The specially designed output transformer provides excellent stability and frequency response. Taps for 4, 8 and 16 ohm speakers, with switched damping for "unity" or "maximum" on the 16-ohm tap. An input level control is provided for use in wired music systems where a preamplifier is not required. This versatile unit is the latest addition to the fine line of Heathkit basic amplifiers. Shpg. Wt. 13 lbs.



With Flexible Heathkit Components



### DELUXE AM-FM TUNER KIT

Outstanding features in both styling and circuitry are combined in this 16-tube deluxe AM-FM combination tuner to bring you the very finest in program sources, for your listening enjoyment. Features include three circuit boards for easy construction and high stability—prewired, prealigned FM front end—built-in AM rod antenna—tuning meter—AFC (automatic frequency control) with on-off switch and flywheel tuning. AM and FM circuits are separate and individually tuned making it ideal for stereo applications. Cathode follower outputs with individual controls are provided for both AM and FM. Other features include variable AM bandwidth, 10 kc whistle filter, tuned-cascode FM front end, FM AGC and amplified AVC for AM. The unique IF limiter design automatically provides the number of limiting and IF stages required for smooth non-flutter reception. The silicon diode power supply is extremely conservatively rated and is fuse protected assuring long service life. A tuning meter shows when the station is tuned-in for clearest reception on AM or FM. Use of three circuit boards greatly simplifies construction of circuit, you do only a minimum of wiring. All IF transformers and coils are prealigned so it will be ready to operate as soon as construction is completed. Appearance of this top-quality unit is further enhanced by the vinyl-clad steel cover in black with inlaid gold design. A multiplex jack is provided for addition of converter unit to receive multiplex stereo broadcasts on FM. A top dollar value.



HEATHKIT  
PT-1 \$89<sup>95</sup>

**A deluxe AM-FM  
tuner combination  
loaded with extras!**



HEATHKIT  
BC-1A \$26<sup>95</sup>

**Wide range broadcast reception**



HEATHKIT  
FM-3A \$26<sup>95</sup>

**Enjoy static-free FM entertainment**

### HIGH FIDELITY AM TUNER KIT

This AM tuner was designed especially for high fidelity applications. It incorporates a special detector using crystal diodes, and the IF circuit features broad bandwidth to assure low signal distortion. Audio response is  $\pm 1$  db from 20 CPS to 9 kc, with 5 db of pre-emphasis at 10 kc to compensate for station rolloff. Sensitivity and selectivity are excellent and the tuner covers the entire broadcast band from 550 to 1600 kc. Quiet performance is assured by a 6 db signal-to-noise ratio at 2.5 uv. Prealigned RF and IF coils eliminate the need for special alignment equipment. Incorporates AVC, two outputs, two antenna inputs, and built-in power supply. Edge-lighted glass slide rule dial for easy tuning. Your "best buy" in an AM tuner. Shpg. Wt. 9 lbs.

### HIGH FIDELITY FM TUNER KIT

FM programming, your least expensive source of high fidelity will provide you with years of real enjoyment. This beautifully styled FM tuner features broad-banded circuits for full fidelity and better than 10 uv sensitivity for 20 db of quieting to pull in stations with clarity and full volume. Covers the complete FM band from 88 to 108 mc. Stabilized, temperature-compensated oscillator assures negligible drift after initial warmup. A ratio detector provides high-efficiency demodulation without sacrificing hi-fi performance. IF and ratio transformers are prealigned, as is the front end tuning unit, making special alignment equipment unnecessary. Edge-lighted glass slide rule dial for easy tuning. You need not wait to have FM in your home at this low price. Shpg. Wt. 8 lbs.

**HEATH COMPANY • a subsidiary of Daystrom, Inc. • Benton Harbor 15, Mich.**



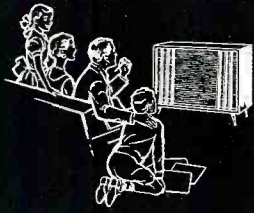

You can be sure you're buying High Fidelity

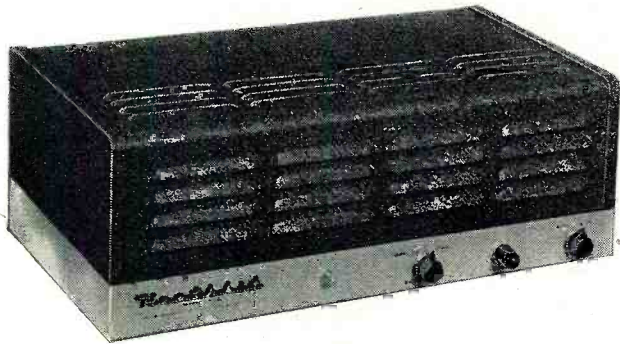

HEATHKIT  
W-7M **\$54<sup>95</sup>**

**55 watts of hi-fi power at  
only \$1 per watt**

- ★ BEAUTIFULLY STYLED IN BLACK AND GOLD
- ★ UNITY OR MAXIMUM DAMPING

**"EXTRA PERFORMANCE"  
55 WATT HI-FI AMPLIFIER KIT**

Another Heathkit first! An honestly rated high power amplifier with many top quality features at less than a dollar per watt. Full audio output is conservatively rated at 55 watts from 20 CPS to 20 kc with less than 2% total harmonic distortion throughout the entire range. Unique paired output connections permit instant switch selection of "unity" or "maximum" damping factors for all 4, 8 or 16 ohm speakers. Each output has an optimized current feedback circuit for unity damping so that there will be no compromise in performance when any of the impedances is used. This current feedback circuitry is entirely shorted out when not in use to obtain the highest possible damping factor. Features include level control and "on-off" switch right on the chassis plus provision for remote control from preamp, etc. Famous "bas-bal" circuit conveniently balances EL-34 output tubes. These heavy duty push-pull tubes operate into a high quality tapped-screen transformer designed especially for this unit. A 70-volt output on the transformer provides for P.A. or large music systems. The silicon diode power supply features a protection device that controls current until tubes have warmed up, greatly increasing service life of all components. The stylish black and gold case measures 6" H. x 8½" D. x 15" W. Convenient pilot light on the chassis. Thoughtful circuit layout makes this kit easy to build. Dollar for watt you can't beat this buy. Shipped express only. Shpg. Wt. 28 lbs.

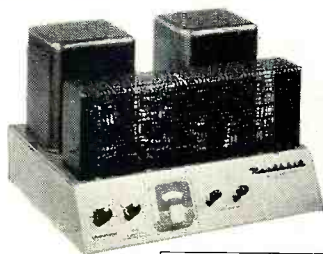

HEATHKIT  
W-6M **\$109<sup>95</sup>**

**Plenty of Reserve Power  
Without Distortion**



HEATHKIT  
W-5M **\$59<sup>75</sup>**

**Top-Flight Performance  
for the Critical Listener**

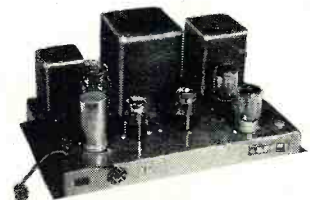

HEATHKIT  
W4-AM **\$39<sup>75</sup>**

**Faithful Sound Reproduction  
with Minimum Investment**

**"HEAVY DUTY" 70-WATT HI-FI AMPLIFIER KIT**

Here is an amplifier that will provide the extra "push" needed to drive any of the fine speaker systems available today, for truly fine performance at any power level. Silicon-diode rectifiers are used to assure long life and a heavy duty transformer gives you extremely good power supply regulation. Variable damping control provides optimum performance with any speaker system. Quick change plug selects 4, 8 and 16 ohms or 70 volt output and the correct feedback resistance. Frequency response at 1 watt is from 5 CPS to 80 kc with controlled HF rolloff above 100 kc. At 70 watts output harmonic distortion is below 2%, 20 to 20,000 CPS; and IM distortion is below 1%, 60 and 6,000 CPS. Hum and noise 88 db below full output. Metered balance circuit. Designed especially for easy assembly and years of dependable service. Shipped express only. Shpg. Wt. 52 lbs.

**25-WATT HI-FI AMPLIFIER KIT**

Considered top value in its power class by leading independent research organizations, the W-5M incorporates all the design features required by the super critical listener. Features include a specially designed Peerless output transformer and KT66 tubes. The circuit is rated at 25 watts and will follow instantaneous power peaks of a full orchestra up to 42 watts. A "tweeter saver" suppresses high frequency oscillation and a new type balancing circuit facilitates adjustment of the "dynamic" balance between output tubes. Frequency response is ±1 db from 5 CPS to 160,000 CPS at 1 watt and within 2 db from 20 to 20,000 CPS at full 25 watts output. Harmonic distortion is less than 1% at 25 watts and IM distortion is 1% at 20 watts (60 and 3,000 CPS, 4:1). Hum and noise are 99 db below 25 watts for truly quiet performance. Rich black and gold colored styling. Shipped express only. Shpg. Wt. 31 lbs.

**20-WATT HI-FI AMPLIFIER KIT**

This fine amplifier will amaze you with its outstanding performance. It features a true Williamson circuit with extended frequency response, low distortion, and low hum levels. Enjoy true hi-fi with only a minimum investment compared to other units on the market. 5881 tubes and a special Chicago-Standard output transformer are employed to give you full fidelity at minimum cost. Frequency response extends from 10CPS to 100 kc within ±1 db at 1 watt assuring you of full coverage of the audio range. Clean, clear sound amplification takes place in circuits that hold harmonic distortion at 1.5% and IM distortion below 2.7% at full 20 watt output. Hum and noise are 95 db below full output. Taps on the output transformer are at 4, 8 or 16 ohms to match the speaker system of your choice. An outstanding performer, this investment will bring you years of listening enjoyment. Shipped express only. Shpg. Wt. 28 lbs.

*All basic amplifiers recommended for use with model WA-P2, SP-1 or SP-2 preamplifiers*



...When You Buy Heathkits

HEATHKIT

### "BOOKSHELF" 12-WATT AMPLIFIER KIT

The model EA-2 combines eye-pleasing style and color with many extra features for high quality sound reproduction. This fine amplifier provides full range frequency response from 20 to 20,000 CPS within  $\pm 1$  db. Harmonic distortion is less than 1% at full 12 watt output over the entire range (20-20,000 CPS). IM distortion is less than 1.5% at 12 watts with low hum and noise. Miniature tubes are used throughout the advanced circuitry, including EL84 output tubes in a push-pull tapped-screen output circuit using a special designed output transformer. Transformer has taps at 4, 8 and 16 ohms. The model EA-2 has its own built-in preamplifier with provision for three separate inputs, mag phono, crystal phono and tuner. The mag phono input features RIAA equalization. Separate bass and treble controls are provided with boost and cut action. A special hum-balance control assures quiet operation. The luxury styled cabinet has a smooth simulated leather texture in black with inlaid gold design and is constructed of vinyl plastic bonded to steel. It resists scuffing, wear, abrasion, and chemicals. The front panel features brushed-gold trim and buff knobs with gold inserts for a very pleasing appearance. An amber neon pilot lamp indicates when the amplifier is on. Cabinet measures 12½" W. x 3¾" D. x 4¾" H. making it suitable for use on a bookshelf, end table, etc. High quality is emphasized throughout for performance matching amplifiers costing many times more. Shpg. Wt. 15 lbs.



HEATHKIT  
EA-2 \$28<sup>95</sup>

Combines beauty, style  
and quality

- ★ LESS THAN 1% DISTORTION AT FULL OUTPUT OVER ENTIRE AUDIO RANGE.
- ★ BUILT-IN PREAMPLIFIER



HEATHKIT  
A9-C \$35<sup>50</sup>

Bargain Package of  
Power and Performance

#### GENERAL-PURPOSE 20-WATT AMPLIFIER KIT

The A9-C combines a preamplifier, main amplifier and power supply all on one chassis providing a compact unit to fill the need for a good high fidelity amplifier with a moderate cash investment. Designed primarily for home installations, it is also capable of fulfilling P.A. requirements. The preamplifier section features four separate switch selected inputs. Separate bass and treble tone controls offer 15 db boost and cut. A true high fidelity performer, the A9-C covers 20 to 20,000 CPS within  $\pm 1$  db. Front panel is detachable, and can be installed on the outside of a cabinet where the chassis comes through, for custom installations. A fine unit with which to start your hi-fi system. Shpg. Wt. 23 lbs.



HEATHKIT  
AV-3 \$29<sup>95</sup>

Invaluable for  
Hi-Fi Testing

#### AUDIO VTVM KIT

Critical AC voltage measurements are made easy with this high quality vacuum tube voltmeter which emphasizes stability, broad frequency response and sensitivity. Features large 4½" 200 microampere meter, with increased damping in the meter circuit for stability in low frequency tests. Extremely high voltage range handles measurements from a low value of 1 millivolt to a maximum of 300 volts. AC (RMS) voltage ranges are: 0-.01, .03, .1, .3, 1, 3, 10, 30, 100 and 300 volts. Db ranges cover -52 to +52 db. Employs 1% precision multiplier resistors for maximum accuracy. High input impedance (1 megohm at 1,000 CPS). Frequency response is essentially flat from 10 CPS to 200 kc. Shpg. Wt. 6 lbs.



HEATHKIT  
AW-1 \$29<sup>50</sup>

Measure Exact  
Power Output

#### AUDIO WATTMETER KIT

Here is a fine meter to accurately measure output wattage. Five power ranges cover 0-5 mw, 50 mw, 500 mw, 5 w and 50 w full scale. Five switch selected db ranges cover -10 db to +30 db. All indications are read directly on the large 4½" 200 ua meter. Frequency response is  $\pm 1$  db from 10 CPS to 250 kc. External or internal load resistors are selected with convenient front panel switch. Non-inductive load resistors are built in for 4, 8, 16 or 600 ohms impedance. Precision multiplier resistors are used for high accuracy and incorporates a crystal diode bridge for wide-range frequency response. Modern styling and convenient front panel design. Cabinet is ventilated to allow efficient cooling of load resistors. Shpg. Wt. 7 lbs.

HEATH COMPANY • a subsidiary of Daystrom, Inc. • Benton Harbor 15, Mich.



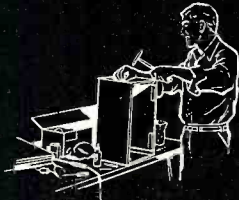

Easy to Buy - Easy to Build - Easy to Use...



CONTEMPORARY  
Model CE-1B Birch  
Model CE-1M Mahogany

HEATHKIT  
CE-1  
\$4395  
each



TRADITIONAL  
Model CE-1T Mahogany

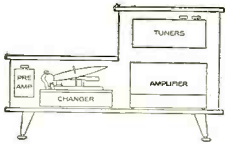

Combine all your Hi-Fi equipment  
in this attractive cabinet

### CHAIRSIDE ENCLOSURE KIT

This Chairside Enclosure lets you combine all of your hi-fi equipment into one compact control center and, at the same time add a beautiful piece of furniture to your home. The CE-1 is designed to house the AM and FM tuners (BC-1A and FM-3A) and the WA-P2 preamplifier along with the majority of record changers which will fit into the space provided. Adequate room is available in the rear of the unit to house any of the Heathkit amplifiers designed to operate with the WA-P2. The enclosure is flexible enough to give you a large choice in component installation. If only one tuner and the preamplifier are used, the two units can be installed in the tilt-out drawer, or if more convenient, either unit can be placed in the space provided in front of the changer compartment. The tilt-out shelf can be installed on either right or left side and the lift-top lid is similarly designed to lift from either side depending on your choice during construction. Good ventilation is achieved through appropriately placed slots in the bottom and back of the enclosure. Overall dimensions are 18" W. x 24" H. x 35 1/2" D. The changer compartment measures 17 3/4" L. x 16" W. x 9 5/8" D. All parts are precut and predrilled for easy assembly and attractive hardware is supplied to match each style. The contemporary cabinet is available in either mahogany or birch and the traditional cabinet is available in mahogany only. Furniture grade plywood can be finished to your taste. Shpg. Wt. 46 lbs.



HEATHKIT  
AG-9A \$34.50

Your own source of  
Hi-Fi audio signals



HEATHKIT  
AA-1 \$49.95

3 Audio test instruments  
in one compact unit



HEATHKIT  
HD-1 \$49.95

Check amplifier  
distortion quickly

#### AUDIO SIGNAL GENERATOR KIT

The model AG-9A is "made to order" for high fidelity applications, and provides quick and accurate selection of low-distortion signals from 10 CPS to 100 kc. Three rotary switches select two significant figures and a multiplier to determine audio frequency. Incorporates step-type and a continuously variable output attenuator. Output indicated on large 4 1/2" panel meter, calibrated in volts and db. Attenuator system operates in 10 db steps, corresponding to meter calibration, in ranges of 0-.003, .01, .03, .1, .3, 1, 3 and 10 volts RMS. "Load" switch permits use of built-in 600-ohm load, or external load of different impedance. Output and frequency indicators accurate to within ±5%. Distortion less than .1 of 1% between 20 and 20,000 CPS. Shpg. Wt. 8 lbs.

#### AUDIO ANALYZER KIT

Complete high fidelity testing facilities are yours in the AA-1. It combines the functions of three separate instruments; an AC VTVM, audio wattmeter and a complete IM analyzer with filters and high and low frequency oscillators built in. VTVM ranges are: 0-.01, .03, .1, .3, 1, 3, 10, 30, 100 and 300 volts (RMS). Db scale reads from -65 to +52 dbm. Wattmeter ranges are: .15 mw, 1.5 mw, 15 mw, 150 mw, 1.5 w, 15 w and 150 w. IM scales are 1%, 3%, 10%, 30% and 100% full scale. Provides internal load resistors of 4, 8, 16 or 600 ohms. Combining and consolidating functions reduces the number of test leads and controls required for the same test. Complete instructions are provided for easy assembly, also valuable information on use of instrument. Shpg. Wt. 13 lbs.

#### HARMONIC DISTORTION KIT

Valuable in both designing and testing circuits, the HD-1 used as a distortion generator, will accurately measure distortion at any or all frequencies from 20,000 CPS. Distortion is measured in percentages of 0-1, 3, 10, 30 and 100. Scale voltage ranges of 0-1, 3, 10, 30 and 100 volts provided for the initial reference. Signal-to-noise ratio is measured on a scale calibrated in db. Features high impedance (300,000 ohms) and 1% precision resistors in the VTVM voltage divider circuit for excellent sensitivity and accuracy. High quality components insure years of dependable service. Complete instructions provided for easy assembly and operation. Shpg. Wt. 13 lbs.



Heathkits are Your Best Dollar Value



### TRANSISTOR PORTABLE RADIO KIT

The overwhelming sales of this outstanding transistor portable have made a substantial price reduction possible... in addition, an all new plastic molded case adds the finishing touch to the exceptional circuitry. Six name-brand (Texas Instrument) transistors are used for extra good sensitivity and selectivity. The 4" x 6" PM speaker with heavy magnet provides excellent tone quality. Use of this large speaker and roomy chassis make it unnecessary to crowd components adding greatly to the ease of construction. Transformers are prealigned so it is ready for service as soon as construction is completed. A touchup in alignment is easily accomplished on a station by following simple instructions in manual. Alignment tool furnished. Has built-in rod-type antenna for reception in all locations. Six standard size "D" flashlight cells are used for extremely long battery life (between 500 and 1000 hours) and they can be purchased almost anywhere. Cabinet is two-tone blue molded plastic with pull-out carrying handle. Dimensions are 9½" L. x 7¼" H. x 4" D. Shpg. Wt. 6 lbs.



MODEL XR-1-L  
**\$34<sup>95</sup>**

HEATHKIT  
XR-1-P **\$29<sup>95</sup>**

Model XR-1-L: Identical to XR-1-P except in genuine leather case. Rich, warm sun-tan tone. Leather carrying strap included. Shpg. Wt. 7 lbs.

Leather Case: can be purchased separately if desired. Fits all XR-1P's and XR-1's. No. 93-1. Shpg. Wt. 3 lbs. \$6.95.

**Newly designed plastic case . . . new low price!**

- ★ 4" X 6" SPEAKER FOR "BIG SET" TONE
- ★ LONG BATTERY LIFE (500 to 1000 Hours)



HEATHKIT  
CT-1  
**\$7<sup>95</sup>**

**Test condensers right in the circuit**



HEATHKIT  
DF-1 **\$54<sup>95</sup>**

**Pin-point your exact location**



HEATHKIT  
FD-1 **\$35<sup>95</sup> each**  
(6 volt model FD-1-6)  
(12 volt model FD-1-12)

**Detects gas fumes**



HEATHKIT  
MC-1  
**\$42<sup>95</sup>**

**Save your boat batteries**

#### IN-CIRCUIT CAPACI-TESTER KIT

Check most capacitors for "open" or "short" right in the circuit with this handy kit. Detects open capacitors from about 50 mmf up, not shunted by an excessively low resistance value. Checks shorted capacitors up to 20 mfd (not shunted by less than 10 ohms). (Does not detect leakage nor check electrolytic condensers.) Employs a 60-cycle frequency for the short test and a 19 megacycle frequency for the open test. Uses electron beam "eye" tube for quick indication. Test leads included. Shpg. Wt. 5 lbs.

#### TRANSISTOR RADIO DIRECTION FINDER KIT

This transistor radio compass will double as a portable radio. Covers the standard broadcast band from 540 to 1600 kc. Ideal for use aboard boats and also on land by hunters, hikers, etc. A directional high-Q ferrite antenna rotates from the front panel to obtain a fix on a station. A 1 ma meter serves as null and tuning indicator. Prealigned IF transformers - six transistor circuit. Powered by tiny 9-volt battery with spare included. Dimensions 7½" W. x 5¾" H. x 5¼" D. Shpg. Wt. 5½ lbs.

#### FUEL VAPOR DETECTOR KIT

Protect your boat and passengers against fire and explosion with one of these fuel vapor detector kits. Indicates the presence of fumes on a three-color "safe-dangerous" meter scale and immediately shows if it is safe to start the engine. A pilot lamp shows when the detector is operating. Easy to build and install, even by one not having previous experience. Operates from your boat battery. The kit is complete with heavy-duty, neoprene insulated cable and includes spare detector unit. Shpg. Wt. 4 lbs.

#### MARINE CONVERTER KIT

Charge 6 or 12 volt batteries with this marine converter and battery charger. A panel mounted 25 ampere meter continuously monitors the charging current. Moisture and fungus proofed for rugged marine use. Convection cooling prevents unsafe temperature rise. The MC-1 has no moving parts, tubes nor blowers to wear out or break. Mounting brackets are supplied for easy installation on any boat. Ideal for keeping batteries fully charged or to supply extra current for appliances. Shpg. Wt. 16 lbs.

**HEATH COMPANY • a subsidiary of Daystrom, Inc. • Benton Harbor 15, Mich.**





New Styling - New Features...



HEATHKIT  
TX-1 \$229<sup>50</sup>

**Complete Versatility for Top-Notch Amateur Communications**

- ★ NEWLY DESIGNED VFO—ROTATING SLIDE RULE DIAL
- ★ MODERN STYLING—PROVISION FOR SSB ADAPTER

**"APACHE" HAM TRANSMITTER KIT**

Fresh out of the Heath Company laboratories, the brand-new "Apache" model TX-1 ham transmitter features modern styling and the latest in circuitry for extra fine performance. The "Apache" is a high quality transmitter operating with a 150 watt phone input and 180 watt CW input. In addition to CW and phone operation, built-in switch selected circuitry provides for single-sideband transmission through the use of a plug-in external adapter. These SSB adapters will be available in the near future. A compact, stable and completely redesigned VFO provides low drift frequency control necessary for SSB transmission. A slide rule type illuminated rotating VFO dial with vernier tuning provides ample bandspread and precise frequency settings. The bandswitch allows quick selection of the amateur bands on 80, 40, 20, 15 and 10 meters. (11M with crystal control). This unit also has adjustable low level speech clipping and a low distortion modulator stage employing two of the new 6CA7/EL-34 tubes in push-pull class AB operation. Time sequence keying is provided for "chirpless" break-in CW operation. The final amplifier is completely shielded for greater TVI protection and transmitter stability. Die-cast aluminum knobs and front panel escutcheons add to the attractive styling of the transmitter. Pi network output coupling matches antenna impedances between 50 and 72 ohms. Shpg. Wt. 107 lbs.

\$50.00 deposit required on C.O.D. orders. Shipped motor freight unless otherwise specified



HEATHKIT  
DX-20 \$35<sup>95</sup>

**An Ideal Code Transmitter**



HEATHKIT  
DX-100 \$189<sup>50</sup>

**You'll be Proud to Own This Outstanding Performer**



HEATHKIT  
DX-40 \$64<sup>95</sup>

**Phone & CW Facilities at Low Cost**

**DX-20 CW TRANSMITTER KIT**

Designed especially for CW work, the DX-20 features high efficiency at low cost. An ideal rig for the novice or advanced-class CW operator. Plate power input is 50 watts, and covers 80, 40, 20, 15, 11 and 10 meters with single knob bandswitching. Features a single 6DQ6A tube in the final amplifier stage and a 6CL6 as a crystal oscillator. Pi network output circuit matches various antenna impedances between 50 and 1000 ohms and reduces harmonic output. Top-quality parts are featured throughout, including "potted" transformers, etc., for long service life. Complete shielding to minimize TVI. Removable metal pull-out plug on left end of cabinet provides access for crystal changing. Very easy to build with complete instructions supplied. Shpg. Wt. 19 lbs.

**DX-100 PHONE AND CW TRANSMITTER KIT**

Well known for its high quality and fine performance the DX-100 features a built-in VFO, modulator, and power supply, complete shielding to minimize TVI, and a pi network coupling to match impedances from 50 to 600 ohms. RF output is in excess of 100 watts on phone and 120 watts on CW, for clean strong signals on all ham bands from 10 to 160 meters. Single knob bandswitching and illuminated VFO dial and meter face add real operating convenience. RF output stage uses a pair of 6146 tubes in parallel, modulated by a pair of 1625's. High quality components are used throughout, such as potted transformers, silver-plated or solid coin silver switch terminals, aluminum-heat dissipating caps on the final tubes, copper plated chassis, etc. Shpg. Wt. 107 lbs.

\$50.00 deposit required on C.O.D. orders. Shipped motor freight unless otherwise specified.

**DX-40 PHONE AND CW TRANSMITTER KIT**

An outstanding buy in its power class the DX-40 provides both phone and CW operation on 80, 40, 20, 15, 11 and 10 meters. A single 6146 tube is used in the final amplifier stage to provide full 75 watt plate power input on CW, or controlled carrier modulation peaks up to 60 watts for phone operation. Modulator and power supplies are built in and single-knob bandswitching is combined with the pi network output circuit for complete operating convenience. Complete shielding to minimize TVI. Provision is made for three crystals. A four-position switch selects any of the three crystals or a jack for external VFO. Crystal sockets are reached through access door in rear of cabinet. High quality D'Arsonval movement panel meter. Shpg. Wt. 25 lbs.



For Real Ham Enjoyment



### "MOHAWK" HAM RECEIVER KIT

Here is a ham receiver that any radio operator would be proud to own. The "Mohawk" has all the functions required for high quality communications with clear, rock-steady reception on all bands. This 15-tube receiver features double conversion with IF's at 1682 kc and 50 kc and covers all of the amateur frequencies from 160 through 10 meters on seven bands with an extra band calibrated to cover 6 and 2 meters using a converter. Receiver accommodations are provided for these converters which will be available in Heathkits soon. The "Mohawk" is specially designed for single-sideband reception with crystal controlled oscillators for upper and lower sideband selection. A completely preassembled, wired and aligned front end coil assembly assures ease of construction and top performance of the finished unit. Other features include five selectivity positions from 5 kc to 500 CPS, bridged T-notch filter for maximum heterodyne rejection, and a built-in 100 kc crystal calibrator. The set provides a 10 db signal-to-noise ratio at less than 1 microvolt input. Front panel features S meter, separate RF, IF and AF gain controls, T-notch tuning, T-notch depth, ANL, AVC, BFO, bandswitch, tuning, antenna trimmer, calibrate set, calibrate on, CW-SSB-AM, receive-standby, upper-lower sideband, selectivity, phone jack and a wide band rotating slide rule type vernier tuning dial with easy to read calibrations. Shpg. Wt. 67 lbs. \$50.00 required on C.O.D. orders. Shipped motor freight unless otherwise specified.



HEATHKIT RX-1 **\$274<sup>95</sup>**

### Now in Kit Form a Top Quality Ham Band Receiver

- ★ PREWIRED AND ALIGNED FRONT END COIL ASSEMBLY.
- ★ CRYSTAL CONTROLLED OSCILLATORS FOR DRIFT-FREE RECEPTION.



HEATHKIT B-1 **\$8<sup>95</sup>**

**Get Proper Match Between Transmitter and Antenna**

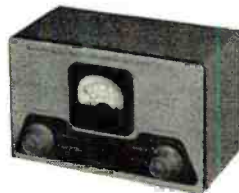

HEATHKIT AM-2 **\$15<sup>95</sup>**

**Measure Standing Wave Ratio**



HEATHKIT VX-1 **\$23<sup>95</sup>**

**Eliminates Hand Switching**

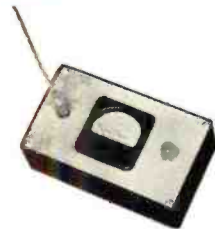

HEATHKIT PM-1 **\$14<sup>95</sup>**

**Quick Check of Transmitter Operation**

#### BALUN COIL KIT

Unbalanced coax lines used on the most modern transmitters can be matched to balance lines of either 75 or 300 ohms impedance by using the model B-1 Balun Coil Kit. Can be used with transmitters and receivers without adjustment over the frequency range of 80 through 10 meters, and will handle power inputs up to 200 watts. Cabinet size is 10" square by 5" D. and may be located any distance from the transmitter or antenna. A protective cover is supplied to prevent damage in outdoor installations. Shpg. Wt. 4 lbs.

#### REFLECTED POWER METER KIT

The match of your antenna transmission system can be checked by measuring the forward and reflected power or standing wave ratio from 1:1 to 6:1 with this fine unit. Designed to handle a peak power of well over 1 kilowatt of energy the AM-2 may be left in the antenna system feed line at all times. Band coverage is 160 meters through 2 meters. Input and output impedances for 50 or 75 ohm lines. No external power required for operation. Cabinet size is 7 3/4" x 4 1/2" x 4 3/8". Shpg. Wt. 3 lbs.

#### ELECTRONIC VOICE CONTROL KIT

This unique device allows you to switch from receiver to transmitter merely by talking into your microphone . . . you get the advantage of "telephone-type conversation" as in single sideband but with regular AM transmission. The unit is adjustable to all conditions by sensitivity controls provided. A variable time delay control changes the "hold" time. Provision is made for receiver and speaker connections and also for a 117 volt antenna relay. Built-in power supply. Complete instructions provided. Shpg. Wt. 5 lbs.

#### RF POWER METER KIT

This self contained unit requires no power for operation. You simply place it close to the transmitter antenna to sample the RF field which is then indicated on the panel meter. Operates with any transmitter having an output frequency between 100 kc and 250 mc, regardless of power. Sensitivity is 0.3 volts RMS full scale, and a special control on the panel allows for further adjustment of the sensitivity. Measures 3 3/4" W. x 6 1/4" L. x 2" D. An easy way to put your mind at ease concerning transmitter operation. Shpg. Wt. 2 lbs.

**HEATH COMPANY** • a subsidiary of Daystrom, Inc. • **Benton Harbor 15, Mich.**



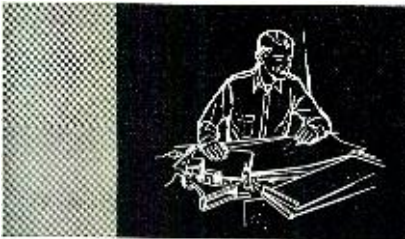

# Choose from a wide variety of Heathkits

## DUAL-CHASSIS 20 WATT HI-FI AMPLIFIER KIT



Model W3-AM  
(Shpg. Wt. 29 lbs.)

**\$49<sup>75</sup>**

## 12" UTILITY SPEAKER



Model 401-6  
(Shpg. Wt. 7 lbs.)

**\$7<sup>50</sup>**

## ALL-BAND RADIO KIT

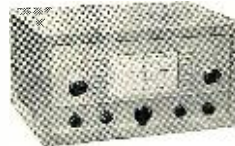

Model AR-3  
(Shpg. Wt. 12 lbs.)

**\$29<sup>95</sup>**  
(less cabinet)

## CRYSTAL RADIO KIT



Model CR-1  
(Shpg. Wt. 3 lbs.)

**\$7<sup>95</sup>**

## BROADCAST BAND RADIO KIT



Model BR-2  
(Shpg. Wt. 10 lbs.)

**\$18<sup>95</sup>**  
(less cabinet)

## ELECTRONIC CROSSOVER KIT



Model XO-1  
(Shpg. Wt. 6 lbs.)

**\$18<sup>95</sup>**

## "Q" MULTIPLIER KIT



Model QF-1  
(Shpg. Wt. 3 lbs.)

**\$9<sup>95</sup>**

## "AUTOMATIC" CONELRAD ALARM KIT

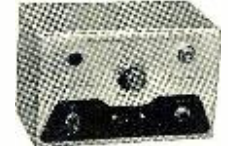

Model CA-1  
(Shpg. Wt. 4 lbs.)

**\$13<sup>95</sup>**

## GRID DIP METER KIT



Model GD-1B  
(Shpg. Wt. 4 lbs.)

**\$21<sup>95</sup>**

## VIBRATOR POWER SUPPLY KIT



6 volt Model VP-1-6  
12 volt Model VP-1-2  
(Shpg. Wt. 4 lbs.)

**\$7<sup>95</sup>**  
ea.

## VARIABLE FREQUENCY OSCILLATOR KIT



Model VF-1  
(Shpg. Wt. 7 lbs.)

**\$19<sup>50</sup>**

## PROFESSIONAL RADIATION COUNTER KIT



Model RC-1  
(Shpg. Wt. 8 lbs.)

**\$79<sup>95</sup>**

## ISOLATION TRANSFORMER KIT



Model IT-1  
(Shpg. Wt. 9 lbs.)

**\$16<sup>50</sup>**

## ELECTRONIC SWITCH KIT



Model S-3  
(Shpg. Wt. 8 lbs.)

**\$21<sup>95</sup>**

## REGULATED POWER SUPPLY KIT

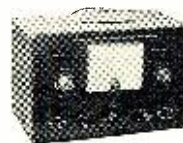

Model PS-3  
(Shpg. Wt. 17 lbs.)

**\$35<sup>50</sup>**

## VOLTAGE CALIBRATOR KIT



Model VC-3  
(Shpg. Wt. 4 lbs.)

**\$12<sup>50</sup>**

## DIRECT-READING CAPACITY METER KIT

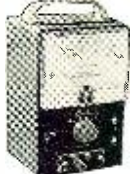

Model CM-1  
(Shpg. Wt. 7 lbs.)

**\$29<sup>50</sup>**

## TUBE CHECKER KIT



Model TC-2  
(Shpg. Wt. 12 lbs.)

**\$34<sup>95</sup>**

## EASY TIME PAYMENTS

AVAILABLE FOR YOUR  
CONVENIENCE...

Any order totaling \$90 or more can  
be paid for in small monthly pay-  
ments (send for complete details).

## RESISTANCE SUBSTITUTION BOX KIT



Model RS-1  
(Shpg. Wt. 2 lbs.)

**\$5<sup>50</sup>**

## CONDENSER SUBSTITUTION BOX KIT



Model CS-1  
(Shpg. Wt. 2 lbs.)

**\$5<sup>50</sup>**

## CATHODE RAY TUBE CHECKER KIT



Model CC-1  
(Shpg. Wt. 10 lbs.)

**\$24<sup>95</sup>**

## LABORATORY RF GENERATOR KIT



Model LG-1  
(Shpg. Wt. 16 lbs.)

**\$48<sup>95</sup>**

## "Q" METER KIT



Model QM-1  
(Shpg. Wt. 14 lbs.)

**\$44<sup>50</sup>**

## DECADE CONDENSER KIT

Model DC-1  
(Shpg. Wt. 3 lbs.)

**\$16<sup>50</sup>**



## DECADE RESISTANCE KIT



Model DR-1  
(Shpg. Wt. 4 lbs.)

**\$19<sup>50</sup>**







By Design...

# COLUMBIA CD Most Linear STEREO CARTRIDGE

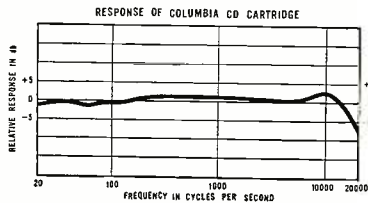

In the Columbia Constant Displacement cartridge, motion of the stylus is transmitted directly to the two wafers that generate the output voltages. This is accomplished by a simple lever, frictionless and featherweight. The precise mechanical design assures that, regardless of frequency, the output voltage is essentially constant for a given displacement of the stylus.

Discover for yourself that the Columbia Constant Displacement cartridge is designed to reproduce *all* the exciting breadth, depth and realism of stereo records. Remember, this cartridge was designed by Columbia Records drawing on its over 60 years of recording experience. Get the best. Insist on the Columbia Constant Displacement cartridge.



Columbia  
Model SC-1...  
Cost \$24.25

## SPECIFICATIONS

Diamond stylus..... 0.0008 inch radius  
Recommended needle force..... 5 to 7 grams  
High compliance... superior tracking, reproduction  
Open-circuit voltage..... 0.5 volts  
Extended stereo range,  $\pm 2.5$  db... 20 to 61,000 cps  
Channel separation..... in excess of 20 db  
Complete compatibility..... stereo and monaural  
4 speeds..... 33 $\frac{1}{3}$ , 45, 78 and 16 $\frac{2}{3}$

**CBS-HYTRON**, Danvers, Massachusetts  
A Division of Columbia Broadcasting System, Inc.

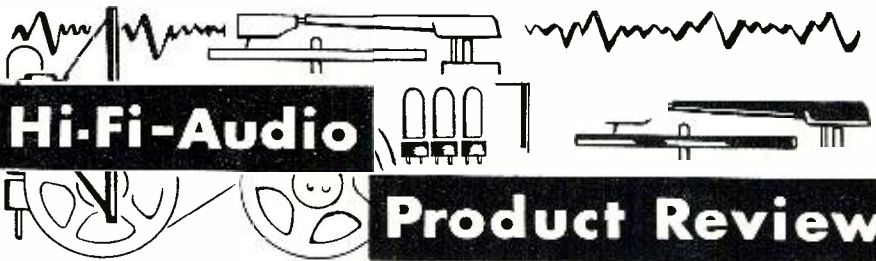

**CROSSOVER NETWORK**  
*Olson Radio Warehouse, Inc.*, 260 S. Forge St., Akron 8, Ohio is now offering a new variable-control crossover network for use with matched or unmatched three-way speaker system.

This new unit in the "Shield" line can be used with any set of three 8-ohm speakers or speakers of mixed impedances may be connected to the

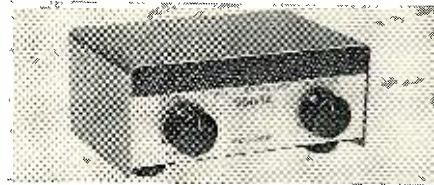

unit. A universal terminal strip allows the internal network to be connected into the circuit to compensate for unequal impedances.

Housed in a metal cabinet with gold panel and contrasting black trim and knobs, the crossover has separate variable controls to allow mid-range speakers and tweeters to be adjusted to suit individual tastes. The device is said to stop tweeter blast and coloration due to uncontrolled speaker output. Crossover frequencies are 500 and 3300 cps. The over-all size is 6" x 4 $\frac{1}{2}$ " x 3".

Write the distributor direct for any additional details required on the No. VC-208 crossover.

## TRANSISTORIZED TAPE RECORDER

*Kingdom Products Ltd.*, 514 Broadway, New York 12, N. Y. has just introduced a transistorized tape recorder that weighs only four pounds.

The new "Fi-Cord" has a frequency range of 50 to 12,000 cps  $\pm 3$  db. The instrument has two speeds, 1 $\frac{1}{2}$  and 7 $\frac{1}{2}$  ips. It is completely battery operated

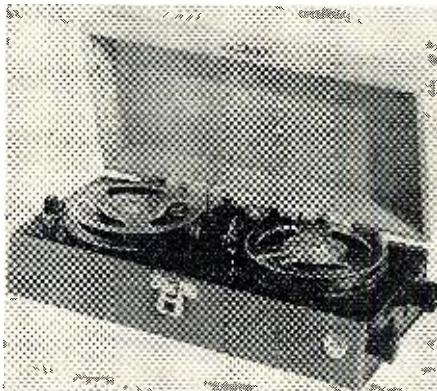

and comes with a specially developed charger which permits the four miniature batteries to be recharged simultaneously. A recharge takes a few hours.

The program material can be moni-

tored by means of a small earpiece, or stethophone. The unit also includes a built-in loudspeaker.

The instrument is housed in a padded leatherette case which measures 9 $\frac{1}{2}$ " x 5" x 2 $\frac{1}{2}$ " and comes complete with dynamic microphone which has an "on-off" switch that also controls the motor. If desired, a studio microphone can be used when critical performance is required.

Write the manufacturer for full specifications and price.

## GARRARD CONVERSION KIT

All recent model *Garrard* record players may now be converted to stereo by means of the new conversion kit being offered by *Garrard Sales Corporation*, Port Washington, N. Y.

Although all current record players from the company are fully wired for stereo, this new kit will enable the owners of Models RC-88, RC-98, RC-121, RC-122/II, and T mk II to con-

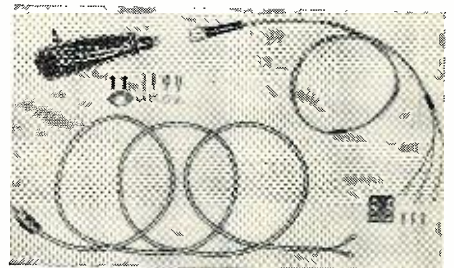

vert their units. The kit consists of a female connector wired with two leads for the tone arm, a complete audio cable with plug for the second amplifier, a new stereo shell in which to mount the cartridge, hardware, and complete step-by-step instructions. No soldering operations are required.

The Model SCK-1 will convert all of the above-mentioned models except the RC-121/II. The conversion kit for this unit has been designated as the Model SCK-2.

## STEREO PREAMP KIT

*Lafayette Radio*, 165-08 Liberty Ave., Jamaica 33, N. Y. is now marketing a new stereo preamplifier, the KT-600, which features unique stereo and monaural control-center facilities.

The instrument includes a dual (input and output) bridge control for obtaining accurate balance of the two stereo channels by means of an audible, sharp null. A "third channel" output is provided to drive a third-channel amplifier and speaker for eliminating "hole-in-the-middle" and "ping-pong" effects. A control is available which acts as a volume control for this third channel or optionally



supplies variable amounts of cross-feed between the two channels to eliminate "ping-pong" effects when using only two speakers.

Other features include tape head equalization for the new 3.75 and 7.5 ips half-track stereo tapes; a new clutch-type master gain control; separate turnover and roll-off controls providing 24 positions of equalization on each channel; inputs for both magnetic and ceramic, crystal, or capacitive cartridges; separate input level controls for each channel, etc.

The company will supply complete technical specifications and price information upon request.

#### "DYNAKIT" STEREO CONTROL

Complete stereo control facilities can be added to a pair of "Dynakit" preamplifiers with the new DSC-1 stereo control unit being offered by Dynaco Inc., 617 N. 41st, Philadelphia 4, Pa.

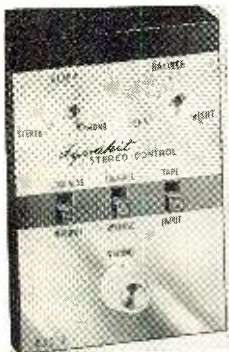

The kit, which can be assembled in less than one hour, incorporates all the features required for optimum usage of a combined stereo-monaural hi-fi system and introduces no noise or distortion.

In addition to the conventional dual volume control, the DSC-1 includes a balance control to equalize inter-channel levels, loudness compensation with a disabling switch, a channel reversing switch, and a dual tape monitor switch. A unique auxiliary control is the "blend" control which permits mixing the stereo channels in controllable proportion. This allows the user to fill in "the hole-in-the-middle." It also allows the reproduction of stereo program sources through monaural systems so that stereo discs can be played monaurally without the need to change the cartridge hookup.

The DSC-1 matches the firm's preamp in decor. It measures 3 3/4" x 6" x 5 1/2". Descriptive literature on this new kit is available from the manufacturer on request.

#### STEREO PREAMP-EQUALIZER

Fisher Radio Corporation, 21-21 44th Drive, Long Island City 1, N. Y. has just introduced a single-chassis, self-contained and self-powered stereophonic preamp-equalizer as its Model PR-66.

Designed for remote operation, the unit has no controls. It provides the necessary preamplification for low-level stereophonic cartridges and the correct equalization for the new stereo discs. With a simple modification, the PR-66 may be used as a preamp-equalizer for direct connection from stereo tape playback heads or as a two-channel preamp for two microphones.

Monaurally, the PR-66 serves as a two-channel preamp for two low-level

## First the fabulous TD-124



TD-124 \$99.75 net

# NOW

## two new "TD" Stereo-Monaural turntables



TD-134 \$60.00 net

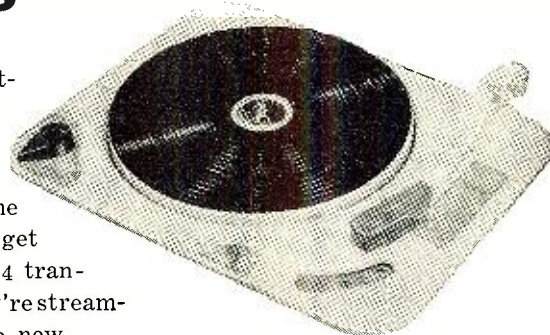

TD-184 \$75.00 net

Here's good news for budget-minded hi-fi aficionados. These two new Thorens turntables (with integral tone arm) give you the same basic drive mechanism you get in the ultra-precise TD-124 transcription turntable, but they're streamlined for economy. See the new TD-184 and TD-134 at your authorized Thorens hi-fi dealer's today.

**TD-134 Manual Player.** 4 speeds. It has the same precision-machined, adjustable-speed drive as the Thorens TD-124 transcription turntable for minimum wow, flutter and rumble. Turntable floats on nylon bearings. Integral tone arm equals tracking performance of separate arms costing as much as half the price of this entire unit. Plug in adapter for standard stereo or monaural cartridges. 15" x 12", extends 2 1/2" below panel, 3" above.

**TD-184.** Same as TD-134 with semi-automatic operation: One dialing motion selects 7", 10" or 12" record size, starts motor. Arm literally floats down into first record groove on air; adjustable piston controls lowering speed. Absolutely no connection between arm and table during playing. Featherweight position trip shuts off player at end of record, idler disengages and arm lifts. Manual reject control permits shut-off, interruption or manual operation.



Thorens celebrates 75 years of progress in music reproduction

# THORENS

**SWISS MADE PRODUCTS**  
HI-FI COMPONENTS • LIGHTERS  
SPRING-POWERED SHAVERS  
MUSIC BOXES  
NEW HYDE PARK, NEW YORK



# SUPERB FOR STEREO

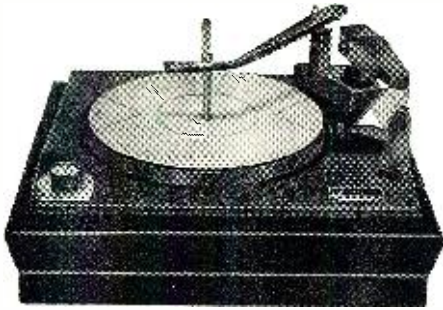

... and better than ever  
for monaural records

new

# GLASER- STEERS GS-77

the modern record changer

When it comes to the selection of a record changer to meet the exacting requirements of both modern stereo and modern high fidelity monaural records — there is only one choice, the GS-77.

From the day this modern record changer was born, strict adherence to rigid precision standards and advanced engineering made it the ideal high fidelity record changer. Now, new features have been added to make it the ideal stereo changer. An easily accessible stereo-monaural switch directs the stereo signal to the proper speaker. On monaural records, it provides a signal to both speakers adding extra depth. A double channel muting switch assures complete silence at all times except when the stereo record is being played. New GS-77 quick-change cartridge holder makes it easy to change from stereo to monaural cartridge with the turn of a knob.

Other GS-77 features assure the finest reproduction, stereo or monaural. The tone arm exhibits no resonance in the audible spectrum, and virtually eliminates tracking error. The arm counterbalance is so designed that stylus pressure between the first and tenth record in the stack does not vary beyond 0.9 gram. These characteristics virtually eliminate vertical rumble — to which stereo is sensitive. Turntable pause eliminates the grinding action which takes place where records are dropped on a moving turntable or disc — protecting the delicate stereo record grooves.

The GS-77 is the perfect record changer for stereo as it is for monaural high fidelity. \$59.50 less cartridge and base. At hi-fi dealers, or write: Glaser-Steers Corp., 155 Oraton St., Newark 4, N. J.  
In Canada: Glaser-Steers of Canada, Ltd., Trenton, Ontario. Export: M. Simons & Sons Co., Inc., N. Y. C. Dept. RTN-11.

monaural phono cartridges, one monaural phono cartridge and a monaural tape playback head, or one or two microphones. There is a total of two

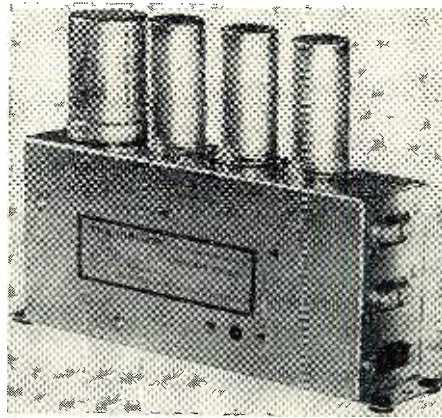

inputs and two outputs and an a.c. hum-balance potentiometer.

Over-all dimensions are 8" wide, 1 7/8" deep, and 5 1/2" high. Write the manufacturer for additional details.

### OXFORD THREE-WAY SYSTEM

Oxford Components, Inc., 556 W. Monroe St., Chicago 6, Ill. is now offering a new three-way speaker system which comes complete with bass reflex enclosures.

The new cabinets feature double-duty design in that they can be used either horizontally or vertically. To match the decor of any room, both



tapered legs and bar runners are provided at no extra cost. The cabinets, which are available in red mahogany, cherry, or blonde oak, are finished on all four sides.

The cabinets house the company's 3-speaker system with crossover network. The system includes a 12" woofer, 8" mid-range, and 3 1/2" tweeter.

For further information, write the company direct.

### "SPEAKER SAVER"

ProSound Corporation, 175 Fifth Ave., New York 10, N. Y. is currently introducing its compact "Gramercy Speaker-Saver" which is designed to prevent speaker voice-coil failure caused by amplifier overloads, faulty wiring, switching transients, and amplifier failure.

The unit is wired to accommodate speakers whose voice-coil impedance is low-efficiency 4 ohms, 4 ohms, 8 ohms, and 16 ohms. Instrument fuses and hardware are mounted on a phenolic board to insure electronic isolation. The black polystyrene box with clear



# STEREO THAT MEETS THE REAL TEST SOUND REALISM at REALISTIC PRICES!



### SPA-55 STEREO AMP

Priced for everyone's budget, here at last is a STEREO amp which is almost a must for every STEREO fan! Housing two identical 27 1/2 watt distortion-free amplifiers the SPA-55 is unsurpassed in quality and performance. The SPA-55 may be used as a STEREO amp, a bi-amp, and as a 55 watt Monaural unit.

Wired and tested \$79.95 Easy-to-build-kit \$64.95  
SPA-35 35 watt \$62.95 Easy-to-build-kit \$49.95



### SP-6 STEREO CONTROL CENTER

The SP-6 is a completely self powered sensitive dual pre-amp with dual inputs and outputs. Engineered to fit your requirements today, as well as tomorrow, the SP-6 provides unparalleled flexibility. Output of both amps is individually adjusted by one control, reverse position, hi lo filters, etc.

Prices less cover— Wired and tested \$62.95  
for panel mounting SAVE! Easy-to-build-kit \$39.95

### ST-11 AM-FM STEREO TUNER

Here, for the first time, is an AM-FM STEREO Tuner within the reach of every audiophile. Unmatched by units costing twice the price, the ST-11 is two distinct receivers in one, featuring 4 μV. for 20 db quieting. Variable AFC. Single front panel switch controls AM, FM or STEREO selection.

Wired and tested \$74.50  
SAVE! Easy-to-build-kit \$49.95



### SA-25 STEREO PRE-AMP PLUS ONE 25 WATT AMP

Here is the finest dual channel pre-amp and amp on one precisely engineered and designed chassis. When the SA-25 is attached to your present power amplifier it reproduces two separate channels of sound for STEREO from tape, records, and AM-FM. One easy, inexpensive step brings you the realistic, breathtaking magic of STEREO—with Arkay's SA-25.

Wired and tested \$89.95  
SAVE! Easy-to-build-kit \$59.95

### HFT-7 AM-FM TUNER

World renowned as a standard of excellence, the HFT-7 is a compact self-powered AM-FM tuner of superb engineering and performance. Temperature compensated FM RF circuits and Automatic Frequency Control assures excellent stability and no drift. Foster-Seeley discriminator, Grounded Grid RF amp, flat type construction, AFC with provisions for AFC erase.

Wired and Tested \$49.95  
SAVE! Easy-to-build-kit \$32.00

All prices 5% higher west of Mississippi.

# FREE!

Now at your local dealer!

### FL-30 AMP AND PRE-AMP

Reasonably priced... superlative in quality, the FL-30 now brings to you an amp/pre-amp with fully transistorized front end designed to provide hum & distortion-free reproductions. Freq. response ±db. 10-40,000 cps @ 30 watt peak. Inputs for magnetic pickup, tuner, tape and 2 aux..

Wired and tested \$74.50  
SAVE! Easy-to-build-kit \$49.95

16 page illustrated catalogue giving complete details and specifications of Radio, Hi-Fi & Stereo equipment. Write today for your free copy.



RADIO & TV NEWS



crystal door houses the fuse assembly and is drilled so that it may be mounted directly on the rear of the speaker enclosure or near the amplifier.

Marked terminal strips indicate the correct connections for the amplifier

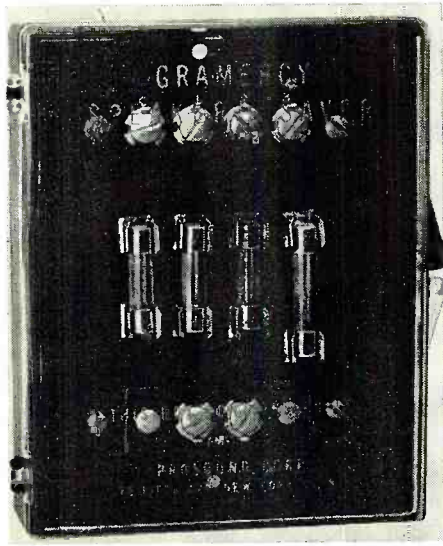

and speaker. Over-all dimensions are 3 3/4" x 4 3/4" x 1 1/8". Write the company for a data sheet on this unit.

### AUDIO CATALOGUES

#### HI-FI SPEC SHEETS

The Specialty Electronic Components Department of *General Electric Company*, West Genesee St., Auburn, N. Y. has announced the availability of spec sheets on four of its hi-fi components.

The publications are: EP-581 two-page data sheet on the "Stereo Classic" Model TM-2G compatible stereophonic and monaural tone arm; EP-588 four-page brochure covering the "Stereo Classic" Model LH-6 and Model LK-6 series extended-bass bookshelf speaker systems; and the EP-593 two-page sheet on the "Stereo Classic" Model EQ-1 series equipment cabinet.

Write the department direct for any or all of these publications. Please specify the spec sheet numbers as indicated.

#### BELL'S HI-FI HANDBOOK

*Bell Sound Systems, Inc.*, 555 Marion Road, Columbus, Ohio has issued a 24-page booklet which covers the firm's complete line of high-fidelity components.

Containing photographs and complete specs, the catalogue is being offered without charge. Included in the line described and pictured in Catalogue 101 are amplifiers, tape transports, and tuners in addition to the company's stereo line.

Two special sections of the handbook are devoted to questions about high-fidelity and stereo to help readers plan their own home installations.

Those requesting copies of the handbook will also receive a complete listing of dealers where the components described in the catalogue may be seen and tested.

-50-

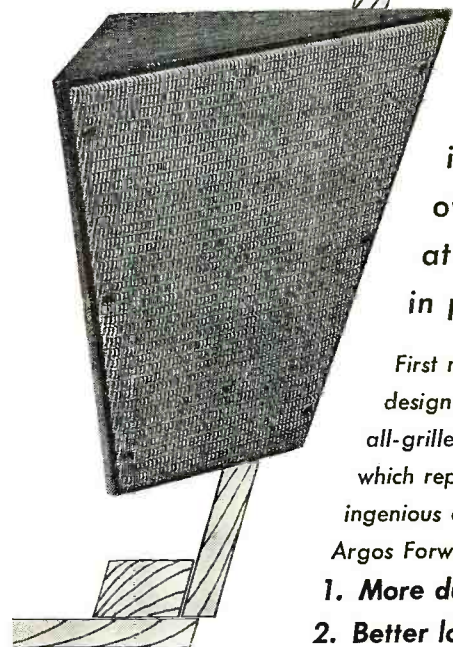

# NEW FORWARD FRONT Baffles



19% to 32% more air volume in the same overall size— at no increase in price

First new development in baffle design since Argos introduced the all-grille-cloth "look" four years ago, which replaced the old round hole. By an ingenious construction feature, the Argos Forward Front design is actually

1. More durable,
2. Better looking, and
3. Better sounding (more air volume).

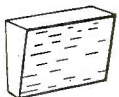
		Spkr. Size	Cubic Inches	Net Price
	SLANTING CORNER Baffles 24% to 26% more air volume in same size	8"	680	\$ 7.90
		12"	1240	10.95
	CORNER Baffles 19% to 23% more air volume in same size	8"	525	7.41
		12"	1520	10.95
	NEW DELUXE Baffles 29% to 32% more air volume in same size. Selected white birch, platinum or modern walnut finish	8"	490	6.00
		12"	1180	8.40
	PRESTIGE Baffles New rectangular shape gives almost twice the usual air volume for slight extra cost	8"	690	5.25
		12"	1580	7.80



Other Argos baffles from 4" size up. Ask your Parts Distributor or write Dept. R for FREE Catalog

*Craftsmanship in Cabinets*



see what's new in electronic kits...



SEE THEM IN ALLIED'S 1959 CATALOG... THE WORLD'S

**FREE** send for it!

typical **knight-kit** values . . . see these and dozens or



**knight-kit Stereo Adapter Control Kit**..... Model Y-778 **\$9<sup>95</sup>**

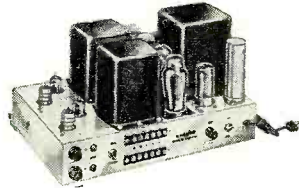

**knight-kit 60-Watt Stereo Hi-Fi Amplifier Kit**.... Model Y-777 **\$84<sup>50</sup>**



**knight-kit "Space Spanner" 2-Band Receiver Kit**..... Model Y-259 **\$18<sup>95</sup>**

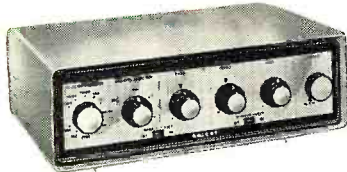

**knight-kit Stereo Deluxe Preamp Kit**..... Model Y-776 **\$62<sup>50</sup>**

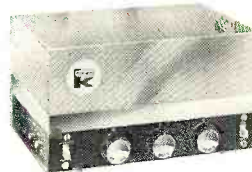

**knight-kit 12-Watt Hi-Fi Amplifier Kit**..... Model Y-784 **\$19<sup>95</sup>**  
(less case)

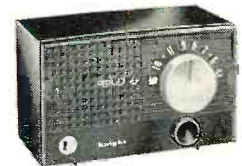

**knight-kit "Ranger III" AC-DC Radio Kit**..... Model Y-736 **\$16<sup>95</sup>**

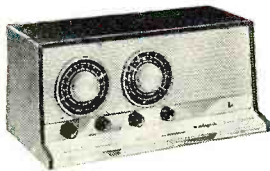

**knight-kit "Span-Master" 4-Band Receiver Kit**..... Model Y-258 **\$24<sup>95</sup>**



**knight-kit "Ranger" Clock-Radio Kit**..... Model Y-737 **\$24<sup>95</sup>**



**knight-kit "Ranger" Radio-Intercom Kit**..... Model Y-739 **\$27<sup>50</sup>**

**EASY TERMS AVAILABLE ON knight-kit ORDERS AS LOW AS \$20**



there's a money-saving **knight-kit**

SEE PAGE AFTER PAGE OF FASCINATING KITS, INCLUDING:

**HI-FI KITS**

- 18-Watt Amplifier
- 30-Watt Amplifier
- FM-AM Tuner
- FM Tuner
- Hi-Fi Preamplifier
- 25-Watt Basic Amplifier
- 2-Way Speaker Systems
- 3-Way Speaker Systems

**HOBBY KITS**

- Printed Circuit Radio
- "Ocean-Hopper" Radio
- 5-Transistor Portable
- 2-Transistor Pocket Set
- Transistor Lab Kit
- 1-Transistor Radio
- 2-Way Intercom
- Photoelectric System
- Crystal Receiver
- Wireless Broadcaster
- Electronic Photoflash

**INSTRUMENT KITS**

- 5" Oscilloscopes
- Vacuum Tube Voltmeter
- Tube Testers
- Volt-Ohm-Milliammeters
- RF Signal Generator
- Signal Tracer
- Audio Generator
- Sweep Generator
- Capacitor Checker
- R/C Tester

(Go to next page)

**ALLIED RADIO**



# see the outstanding 1959 **kn ght-kits**

AN ALLIED RADIO PRODUCT

## LEADING ELECTRONIC SUPPLY GUIDE

### other EASY-TO-BUILD kits



knight-kit Amateur Communications Receiver... Model Y-726 \$104<sup>50</sup>



knight-kit "400" Tube Checker Kit... Model Y-707 \$19<sup>95</sup>

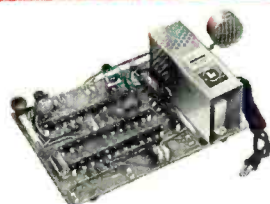

knight-kit 12-in-1 Electronic Lab Kit... Model Y-272 \$14<sup>95</sup>

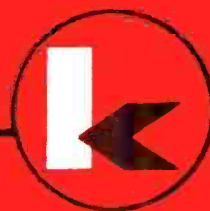

**DO-IT-YOURSELF**  
WITH QUALITY  
**knight-kits**  
**SAVE UP TO 50%**

**LOWEST IN COST:** ALLIED'S giant buying power passes biggest savings on to you—you do the easy assembly yourself and your finished equipment equals the performance, appearance and quality of factory-built units selling for several times the low KNIGHT-KIT price. You save most with KNIGHT-KITS.

**EASIEST TO BUILD:** KNIGHT-KIT "Step-and-Check" instruction manuals with wall-sized picture diagrams are marvels of clarity—it's like having a good instructor at your side, guiding you every step of the way. You don't have to be an "expert" to enjoy building a KNIGHT-KIT; all parts are clearly marked and identified; wires are pre-cut to size, stripped and colored for easy proper use; printed circuitry and printed-circuit switches eliminate complex wiring. You'll have only the highest praise for KNIGHT-KIT ease of assembly. You'll be proud of your work.

**LATEST DESIGN:** We design the latest circuitry into our KNIGHT-KITS to achieve top-quality performance. We field-test each kit to assure perfection. We apply quality control standards to every step of our kit manufacturing process. Tried and proved professional design, precise manufacturing skill and premium quality parts help to insure your building success.

**THE KITS WITH THE MONEY BACK GUARANTEE**  
**EASY TERMS ON ORDERS OF \$20 OR MORE**

### for every need

- Transistor Checker
- Flyback Checker
- R/C Substitution Boxes
- Voltage Calibrator
- Battery Eliminator

#### AMATEUR KITS

- 50-Watt Transmitter
- Self-Powered VFO
- 100 kc Crystal Calibrator
- RF "Z" Bridge
- Code Practice Oscillator

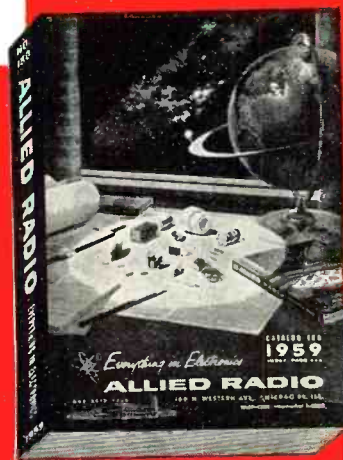

the world's largest  
electronic supply house

**FREE**

send for the 452-page  
**1959 ALLIED CATALOG**

Send for the value-packed 1959 ALLIED Catalog featuring the complete KNIGHT-KIT line. See this leading Buying Guide for everything in Electronics. Write for your FREE copy today.

ALLIED RADIO CORP., Dept. 131-L8  
100 N. Western Ave., Chicago 80, Ill.

Send FREE ALLIED 452-Page 1959 Catalog

Name \_\_\_\_\_

Address \_\_\_\_\_

City \_\_\_\_\_ Zone \_\_\_\_\_ State \_\_\_\_\_

Our 38th Year





# NEW

midget pliers  
added to  
**KLEIN** line

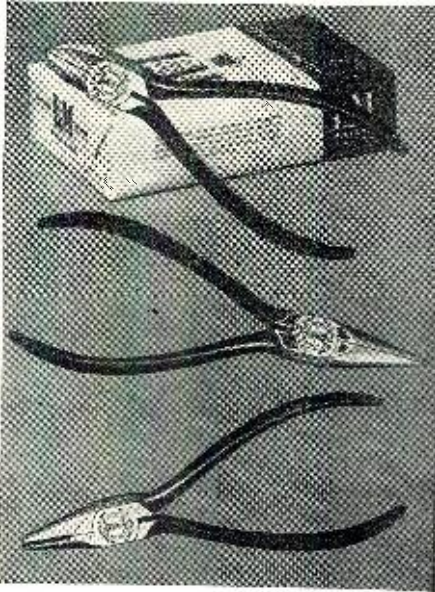

Hardly larger than a package of your favorite cigarettes, these new Klein Midget Pliers will simplify many of those small jobs where space is confined.

Midgets in size but giants in performance, they solve major problems when wiring up electronic assemblies; making model trains, airplanes, automobiles, or in any extremely small or confined work.

These new midgets are additions to the famous Klein line of high-quality pliers that are backed by over a century of manufacturing experience. See your dealer.

- No. 257-4 Oblique Cutting Plier Size 4 in.**
- 321-4 1/2 Long Nose Plier 4 1/2 in.
  - 322-4 1/2 (Without Knurl) 4 1/2 in.
  - 224-4 1/2 End Cutting Plier 4 1/2 in.

### Free Bulletin on Klein Pliers



Bulletin 758 lists the many various pliers in the Klein line. A copy is yours for the asking. Write for it today.



**Mathias KLEIN & Sons**  
Established 1857  
7200 McCormick Road • CHICAGO 45, ILLINOIS

## Within the Industry (Continued from page 24)

*Sylvania Electric Products Inc.; H. Leslie Hoffman, Hoffman Electronics Corp.; Robert C. Sprague, Sprague Electric Co.; Leslie F. Muter, The Muter Co.; Robert S. Bell, Packard-Bell Electronics Corp.; S. R. Curtis, Stromberg-Carlson, a division of General Dynamics Corp.; C. Russell Cox, Andrew Corp.; Russell E. Cramer, Jr., Radio Condenser Co.; A. L. Chapman, CBS-Hytron; George T. Scharffenberger, Kellogg Switchboard and Supply Co.; and D. R. Hull, ex-officio, Raytheon Manufacturing Co.*

\* \* \*

**JOE RAMER** has assumed new duties as chief engineer, engineering department, *Heath Company*, a subsidiary of *Daystrom, Inc.*

Formerly engineering advisor, Mr. Ramer's line of administrative authority will extend directly to all senior engineers, project engineers, technicians, and engineering department supporting activity. He will report to the director of engineering.



Prior to joining the organization he was engaged in electronic development for the National Bureau of Standards and later headed the Fuze Department, U. S. Naval Ordnance Laboratory where he supervised highly classified electronic work for the government.

During World War II he served as a senior engineer in the Navy Radar Development Program. Mr. Ramer has been in the electronics field for over twenty years, fifteen of them with the U. S. Government.

\* \* \*

**STEPHEN J. WELSH** has been appointed to the new position of manager of marketing for high-fidelity components in *General Electric Company's* specialty electronic components division . . . *CBS-Hytron* has named **FRANK A. SULLIVAN** semiconductor general sales manager . . . Consolidation of all sales and marketing activities for the *Westinghouse* television-radio division under **C. J. URBAN**, marketing manager, has been made known . . . **DR. WILLIAM J. PIETENPOL** is now vice-president and general manager of the semiconductor division of *Sylvania Electric Products Inc.* . . . **JOHN A. RHOADS** has joined *Packard-Bell Electronics Corp.* as director of engineering in the technical products division . . . **RCA** has announced three appointments in the engineering department of the semiconductor and materials division. **B. V. DALE** has been named manager, modules engineering; **DR. F. E. VINAL** is now manager, materials engineering; and **D. H. WAMSLEY** becomes manager, semiconductor engineering . . . **FRANK D. LINTERN** has joined *Jensen Mfg. Co.* as assistant sales manager of the dis-

## RADIO ELECTRONIC SURPLUS



**NEW BC683 FM RECEIVER**  
27-39 mc. Equipped with 10 push buttons for selecting channels. Cont. variable tuning over the entire range. Unit complete with tubes, built-in loud speaker, squelch circuit, head phone jacks, schematic diagram on bottom of case. Approx. weight 34 lbs. **\$19.95**  
12- or 24-volt D.C. Dynamotor . . . each **\$3.95**

### BC603 FM RECEIVER

Same description as BC683 except that range is 20-27 mc. This unit complete with tubes.  
Like New . . . each **\$6.95**  
Manual with schematic for BC603 & BC604 . . . each **\$1.00**

### BC684 TRANSMITTER

(Used with BC683 receiver.) Used, good. **\$4.95** each  
**CRYSTALS** (set of 80) for BC604 transmitter. **\$3.00**

### BC659 FM TRANSCEIVER

29-40 mc, 2 channels, crystal control. Unit complete with tubes, built-in speaker and dual meter for testing filament and plate circuit. Approx. dimensions 16" x 13" x 7 1/2".  
Like New . . . each **\$6.95**  
Manual with schematic for BC659. . . each **\$1.00**

### LATE MODEL FIELD RADIO IDEAL FOR MOBILE OR BACK-PACK

BC-1306. Basic component of Signal Corps SCR-694-C. Receiver-transmitter, AM, for CW, tone, or voice. 3800 to 6500 KC. MO with crystal-calibrating circuit or 2-channel crystal control. FT-243 crystal holders. Power outputs in vehicular use are 20 watts CW, 7 watts tone or voice. Field-use distance ratings are 30 miles CW, 20 miles tone, 15 miles voice. In new condition, with all tubes.  
Price each **\$24.50**

### TEST SCOPE—SYNCHROSCOPE— PULSE ANALYZER



ID-59/APA-11. Late production. Modular subassembly construction. Video amplifier is flat to 4 mc. 3BP1 presentation. Test-scope sawtooth 25-20,000 cy. Has all normal test-scope controls. As synchroscope and pulse analyzer, accepts positive or negative pulses. Video delay circuit permits leading edge of pulse to be seen. Calibrated-dial horizontal shift measures pulse durations from 0.5 to 100 microseconds. Sine-wave-oscillator calibrator measures recurrence rates from 200 to 6000 pps accurate within 0.4%. Built-in power supply requires 115v, 400 cy, 196 watts. External 60 cy power supply may be made to furnish plus 350 and -1300 vdc and 6.3 vac. In excellent condition, with all 19 tubes, schematic with parts values, parts-location pictures, operating instructions, theory explanation, and maintenance charts. Shipping weight 60 lbs. Used, good.  
Price each **\$16.95**

### ARC-5 ANTENNA RELAY



Consists of 2' meter 0-10 RF thermocouple and 12 VDC relay. (transmitter-receiver). Meter .75 amp RF with thermocouple produces 5.4 ma D.C. full scale.  
Price. . . . . **\$1.95** ea.

### 30-40 MC FM RECEIVER R-435/VRC-2X



Single channel, crystal controlled, covering police and fire department freq. Double conversion superhet (455 kc and 4.3 inc. I.F.'s); both oscillator and crystal control. Noise squelch, double limiter stages, loud speaker output. Contains vibrator supply, operates on 24 volts D.C. Removable cover. Approx. dimensions: 9" X 12" X 15". Unused, good condition.  
Price. . . . . **\$19.50**

### NEW 12 VOLT DYNAMOTOR, DM 35

Output 625 volt, 225 ma. . . . . **\$9.95** each

### NEW PE120 POWER SUPPLY

6, 12 or 24 volt (specify voltage)  
Used with BC659 and 620. . . . . **\$7.95** each

NO C.O.D.'s. REMIT FULL AMOUNT WITH ORDER. ALL PRICES F.O.B. PASADENA.

## C & H SALES CO.

2176 E. Colorado St. - Pasadena 8, Calif.



tributor division . . . *Sylvania Home Electronics*, a division of *Sylvania Electric Products Inc.* has named **ALFRED L. HUFF** product manager, radio and high-fidelity phonographs and **GEORGE P. LYON** product manager, television . . . **HAROLD A. JONES** has been appointed vice-president and eastern manager for *Motorola Communications & Electronics, Inc.*, a wholly owned sales and service subsidiary of *Motorola Inc.* . . . **H. A. POOLE** has been named to the newly created position of manager, advertising and sales promotion, *RCA Service Company* . . . *Symphonic Radio & Electronic Corp.* has appointed **GEORGE F. BARTH** to the position of manager of marketing services . . . *Ford Instrument Co.*, division of *Sperry Rand Corp.*, announces the appointment of **W. V. WARNER** to the newly created position of general sales manager . . . The election of **DR. W. R. G. BAKER** to the board of directors of *Gulton Industries, Inc.* has been announced. He was formerly a vice-president of the *General Electric Company* . . . **ROBERT G. BACH** has resigned as sales and advertising manager of *Fairchild Recording Equipment Corp.* in order to devote his efforts to the newly formed *Bach Sales Co.* . . . **ALLEN B. DU MONT, JR.** has resigned as vice-president of *Du Mont Television and Radio Corp.* . . . **Z. W. PIQUE** has been named director of sales for the *Hughes Products Group of Hughes Aircraft Company*. He was formerly associated with *Texas Instruments Inc.* and is well-known in the semiconductor field . . . **JOHN W. VAN ALLEN**, general counsel emeritus of the Electronic Industries Association, died recently at 81.

\* \* \*

**S. EDWIN PILLER** has received an award from the Chief Signal Officer of the United States Army Signal Corps. He is a *National Broadcasting Company* radio engineer who volunteers his spare time as Director of the First Army MARS Technical Network.

Mr. Piller, an active amateur radio operator for more than twenty-one years, conceived the idea of a single-sideband technical network whose prime mission is: the dissemination of technical knowledge by radio communication.

The award was an engraved plaque which read in part: ". . . for exceptional personal contribution to the Military Affiliate Radio System in the planning, organization, and conduct of the First United States Army MARS Single-Sideband Technical Net . . ."

\* \* \*

**J. A. MILLING**, *Howard W. Sams & Co., Inc.*, has been re-appointed chairman of the Distributor Relations Committee of the Electronic Industries Association. **Norman A. Triplett**, of *Triplet Electrical Instrument Co.*, was re-appointed co-chairman.

In addition, the following were named committee members: **E. P. Atcherley**, *Sylvania Electric Products Inc.*; **H. F. Bersche**, *RCA*; **Fran J. Chamberlain**, *Clarostat Manufacturing Co.*; **Ernest Clover**, *Triad Transformer*

Mr. Service Dealer

# PHILCO

## OFFERS YOU A COMPLETE LINE OF UNIVERSAL SERVICE PARTS



Your Philco Distributor has available for you a complete new line of universal parts that fit not only all Philco receivers but every competitive make and model. Eliminate your inventory problems and stock the one line of completeness . . . Philco.

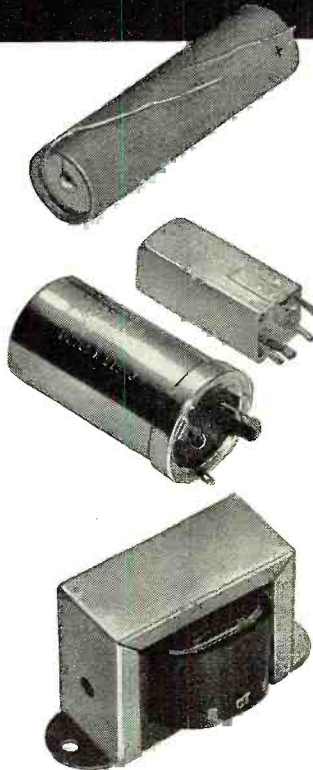

### PHILCO UNIVERSAL SERVICE PARTS

- Sweep Components
- Coils
- Capacitors
- Vibrators
- Condensers
- Rectifiers

All Philco universal parts are precision engineered and quality tested to insure superior operation and longer life. Don't settle for inferior copies . . . insist on genuine Philco universal parts.

**For a program of completeness . . . See Your Philco Distributor Today!**



### World-Wide Distribution

Service Parts • Power-Packed Batteries • Universal Components • Long-Life Tubes • Heavy-Duty Rotors • Star-Bright 20/20 Picture Tubes • Long-Distance Antennas • Appliance Parts • Laundry Parts • Universal Parts and Accessories







## "Musts" for Growth (Continued from page 62)

field, have been able to capitalize on it by promoting their TV service facilities and the sale of hi-fi assemblies and components along with FM service, tuners, and sets.

The newest golden opportunity to be laid in the laps of the service industry revolves around the development of stereo discs and stereo replacement cartridges for adapting record players to reproduce these new recordings. Alert dealers will recognize that this new development offers more than just a chance to sell a replacement phono cartridge. Since dual speakers are a must for stereophonic sound reproduction, a "package plan" for modernizing record players which would include the stereo cartridge, a dual-speaker system, cleaning and adjusting the record player, and the cleaning and repair or modification of the set for optimum performance, would be the most efficient plan a dealer could use to take advantage of this opportunity.

Here again the service dealer must know his actual costs of operating when he prices modernization work of this kind. There is often a strong tendency to price work too low in the hope of blocking out imagined competition. The classic example of a lot of volume with no profit was that of the radio service dealer who jumped into TV

service work when it came to his town, pricing his work on the basis of his radio service charges. He did \$12,000 worth of business during the first six months. When he analyzed his business at the end of this period, to find out what happened to all of the money he had handled, he discovered that it had cost him \$13,000 to take in \$12,000! He paid out a thousand dollars cold cash, plus six months of his time, to learn the hard facts about getting adequate charges for service time, knowledge, and facilities.

When we read announcements such as the one recently released by the *Bendix Aviation Corporation* which stated that "Auto radar that automatically warns the driver of traffic hazards is now undergoing tests under actual road conditions and a production version of the device is under development," it naturally brings to mind new vistas of opportunity for the independent service industry. But the TV service dealer who has built his business on consumer service would do well to keep his expansion plans focused on the market with which he is familiar.

In order to capitalize on the opportunities that are available to him in his service market, his cost consciousness and knowledge of his income requirements should impel him to re-adjust his charges to include *all* of his costs of doing business—plus a profit. That is the only road to continued prosperity and growth. —50—

# THIS CAN BE YOU

## earning up to \$25,000 a year



here is an amazing new BUSINESS OPPORTUNITY for you

Self-service tube testers do all the work for you . . . just collect your profits once a week

A basic principle for making money is to have something work for you, rather than you yourself do the work. As an operator of a FAST-CHECK SELF SERVICE TUBE TESTER route you can be the proud owner of a solid fast-growing business . . . earning money for you while you take life easy. Business can be operated from home and during spare time. All you do is make calls once a week to restock testers and collect profits.

### No selling required

Century's self-service tube testers check and sell TV and radio tubes automatically 12 hours a day — 7 days a week. Consumers do their own testing and defective tubes are replaced on the spot for highly profitable sales. You place testers and tube stock in stores on consignment . . . and each one can net up to \$1000 a year.

### Retail stores welcome self-service testers

Drug stores, luncheonettes, supermarkets, candy stores, hobby stores, etc. welcome having a tube tester placed in their store because of the extra traffic it attracts and the commission they earn.

**FREE booklet tells all about this booming business**  
If you are interested in starting a lifetime business, then ACT NOW and send for FREE booklet to convince yourself that this is today's greatest business opportunity.

**DON'T DELAY . . . MAIL COUPON TODAY**

## CENTURY ELECTRONICS CO., INC.

Dept. T-11, 111 Roosevelt Ave., Mineola, N. Y.

Please send me FREE booklet and particulars about setting-up a self-service tube tester route.

Name \_\_\_\_\_  
Address \_\_\_\_\_  
City \_\_\_\_\_ State \_\_\_\_\_

## LIQUIDATING MOBILE RADIO EQUIPMENT AT TREMENDOUS SAVINGS!

Manufactured by the famous LINK RADIO CORP.

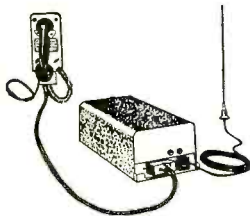

**MODEL 2210**  
152-162 MC  
FM MOBILE TRANS.  
& REC.—6 VOLTS

Complete with antenna, cables, control head, mike & crystals ground to your specific frequency. Unit as outlined complete for immediate installation. Specially priced. **\$139.50**

**MODEL 2210**—same as above, for operation on 12 Volts. . . . **\$162.50**

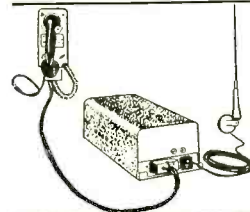

**MODEL 2365**  
25-40 or 30-50 MC  
FM MOBILE TRANS.  
& REC.—6 VOLTS

Complete with antenna, cables, control head, mike & crystals ground to your specific frequency. Ready for immediate installation at this terrific price. **\$119.50**

**MODEL 2365**—same as above, for operation on 12 Volts. . . . **\$149.50**

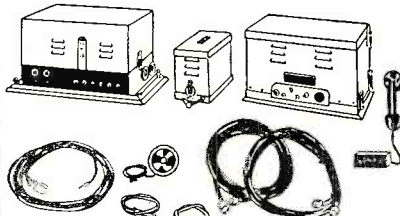

**MODEL FMTR 30-50 MC**  
FM MOBILE TRANS. & REC.—6 VOLTS

Unit complete with Peak Modulation, control head, mike, antenna, cables & crystals ground to your specific frequency. Ready for immediate installation. A sensational buy at **\$109.95**

**MODEL FMTR**—same as above, for operation on 12 Volts. . . . **\$149.95**

## SPECIAL! SPECIAL!

**MOTOROLA RECEIVER—Type R-237/VRC2**  
30-50 MC—6 VOLTS

Vibrator power supply, less controls & cables. Good condition, with tubes, as is **\$19.95**

## FEDERAL PORTABLE MOBILE SIGNAL GENERATOR—110 V. AC POWER—TYPE 104A



Designed to facilitate alignment of FM mobile and land station receivers in the field. Provides a continuous source of frequency modulated carrier, the frequency of which is determined by the multiplier-type crystal that is used in the unit. It will, by the proper selection of crystals, provide a signal suitable for the alignment of FM mobile receivers in both the 25-50 MC band and the 148-174 MC band. In addition to these frequencies, the type 104A Mobile Signal Generator provides a 1000 cycle signal that may be used to check audio circuits. Unit has external power facilities. **\$49.50**



## BC-221 FREQUENCY METER

Real value! QUANTITY IS LIMITED —so first come, first served. They are just like new, with original calibration charts. Range 125-20,000 KC with crystal check points in all ranges. Complete with crystal and tubes . . . **\$119.50**  
MODULATED TYPE . . . **\$139.50**  
MODULATED TYPE with AC Power Supply . . . **159.50**

These Frequency Meters are factory tested, checked for frequency alignment and GUARANTEED.

ATTENTION—Radio Amateurs, Members RTTY Communication Companies, Railroads, Utilities

For the first time—realistic value!  
**TELETYPE**  
Model 15 send/receive. Equipped with pulling magnet selectors. series motors. Excellent condition. . . . **\$249.50**

**COMMAND EQUIPMENT**  
BC-457 Trans., 4 to 5.3 mc, good used **\$3.95**  
BC-458 Trans., 5.3 mc to 7 mc, good used **\$3.95**  
BC-696 Trans., 3-4 mc, good used, as is **\$2.95**  
T-18 ARC-5, 1-1.3 mc, new **\$12.95**  
BC-602 Control head for SCR-522, new **\$0.79**  
Plugs for Above Command Sets, PL-152-A or PL-156-A . . . **\$0.55**

**HEADSETS**  
HS-23 high impedance, brand new. . . . **\$4.55**  
HS-33 low impedance, brand new with cord and PL-54 plug. . . . **4.65**  
Navy-type H/63-U 600 Ohm impedance. . . . **6.95**  
6 ft. Extension Cord with jack & plug for above headsets. . . . **\$1.19**  
High Impedance Matching Transformer from low to high . . . **.79**

**J-38 KEY**  
Mounted on black bakelite base, 4 3/4" x 3", easily attached to operating desk. Has jumper strip, binding posts and circuit closing switch, full adjustable. 1/16" solid silver keying contacts. Metal parts are cadmium-plated. **\$1.29**  
New J-45 Key with metal knee band. Brand new. . . . **\$2.95**

**RETAIL DEPT. OPEN SATURDAYS**  
Immediate delivery. Include 25% deposit with order—balance C.O.D. 50¢ HANDLING CHARGE ON ALL ORDERS UNDER \$5.00. All shipments F.O.B. our warehouse, N.Y.C.

## PLATT ELECTRONICS CORP.

20 MURRAY ST., NEW YORK 7, N. Y.  
Telephone: COrtlandt 7-2575



SUPERIOR'S NEW MODEL TW-11

# STANDARD PROFESSIONAL TUBE TESTER



Model TW-11 — TUBE TESTER . . . Total Price \$47.50 — Terms: \$11.50 after 10 day trial, then \$6.00 per month for 6 months.

- ★ Tests all tubes, including 4, 5, 6, 7, Octal, Lock-in, Hearing Aid, Thyatron, Miniatures, Sub-miniatures, Novals, Sub-minars, Proximity fuse types, etc.
- ★ Uses the new self-cleaning Lever Action Switches for individual element testing. Because all elements are numbered according to pin-number in the RMA base numbering system, the user can instantly identify which element is under test. Tubes having tapped filaments and tubes with filaments terminating in more than one pin are truly tested with the Model TW-11 as any of the pins may be placed in the neutral position when necessary.
- ★ The Model TW-11 does not use any combination type sockets. Instead individual sockets are used for each type of tube. Thus it is impossible to damage a tube by inserting it in the wrong socket.
- ★ Free-moving built-in roll chart provides complete data for all tubes. All tube listings printed in large easy-to-read type.
- ★ NOISE TEST: Phono-jack on front panel for plugging in either phones or external amplifier will detect microphonic tubes or noise due to faulty elements and loose internal connections.

## EXTRAORDINARY FEATURE

SEPARATE SCALE FOR LOW-CURRENT TUBES. Previously, an emission-type tube testers, it has been standard practice to use one scale for all tubes. As a result, the calibration for low-current types has been restricted to a small portion of the scale. The extra scale used here greatly simplifies testing of low-current types.

The Model TW-11 operates on 105-130 Volt 60 Cycles A.C. Comes housed in a beautiful hand-rubbed oak cabinet complete with portable cover.

**\$47<sup>50</sup>**  
NET

SUPERIOR'S NEW MODEL TD-55

# EMISSION TYPE TUBE TESTER



Model TD-55 — TUBE TESTER . . . Total Price \$26.95 — Terms: \$6.95 after 10 day trial, then \$5.00 per month for 4 months.

- ★ FOR THE EXPERIMENTER or PART-TIME SERVICEMAN, who has delayed purchasing a higher priced Tube Tester.
- ★ FOR THE PROFESSIONAL SERVICEMAN, who needs an extra Tube Tester for outside calls.
- ★ FOR THE BUSY TV SERVICE ORGANIZATION, which needs extra Tube Testers for its field men.

Speedy, yet efficient operation is accomplished by:

1. Simplification of all switching and controls.
2. Elimination of old style sockets used for testing obsolete tubes (26, 27, 57, 59, etc.) and providing sockets and circuits for efficiently testing the new Noval and Sub-Minar types.

**YOU CAN'T INSERT A TUBE IN WRONG SOCKET**  
It is impossible to insert the tube in wrong socket when using the new Model TD-55. Separate sockets are used, one for each type of tube base. If the tube fits in the socket it can be tested.

**CHECKS FOR SHORTS AND LEAKAGES BETWEEN ALL ELEMENTS**  
The Model TD-55 provides a super sensitive method of checking for shorts and leakages up to 5 Megohms between any and all of the terminals. Continuity between various sections is individually indicated. This is important, especially in the case of an element terminating at more than one pin. In such cases the element or internal connection often completes a circuit.

**"FREE-POINT" ELEMENT SWITCHING SYSTEM**  
The Model TD-55 incorporates a newly designed element selector switch system which reduces the possibility of obsolescence to an absolute minimum. Any pin may be used as a filament pin and the voltage applied between that pin and any other pin, or even the "top-cap."

**ELEMENTAL SWITCHES ARE NUMBERED IN STRICT ACCORDANCE WITH R.M.A. SPECIFICATION**  
One of the most important improvements, we believe, is the fact that the 4 position fast-action snap switches are all numbered in exact accordance with the standard R.M.A. numbering system. Thus, if the element terminating in pin No. 7 of a tube is under test, button No. 7 is used for that test.

The Model TD-55 comes complete with operating instructions and charts. Housed in rugged steel cabinet. Use it on the bench—use it for field calls. A streamlined carrying case, included at no extra charge, accommodates the tester and book of instructions.

**\$26<sup>95</sup>**  
NET

**SHIPPED ON APPROVAL**  
**NO MONEY WITH ORDER — NO C.O.D.**

Try for 10 days before you buy! If completely satisfied, send down payment after trial and pay balance at indicated monthly rate — **NO INTEREST OR FINANCE CHARGES ADDED.** If not completely satisfied, return to us, no explanation necessary.

See page 103 for complete details

MOSS ELECTRONIC, INC.

3849 TENTH AVE., NEW YORK 34, N. Y.



SUPERIOR'S NEW MODEL 82

# Multi-Socket Type TUBE TESTER

**TEST ANY TUBE IN 10 SECONDS FLAT!**

- ① Turn the filament selector switch to position specified.
- ② Insert tube into a numbered socket as designated on our chart (over 600 types included).
- ③ Press down the quality button —

**THAT'S ALL! Read emission quality direct on bad-good meter scale.**

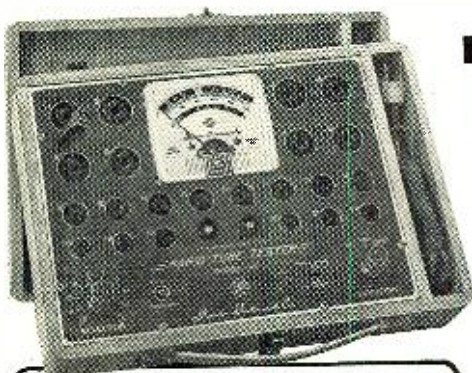

**Model 82 — TUBE TESTER . . . Total Price \$36.50 — Terms: \$6.50 after 10 day trial, then \$6.00 monthly for 5 months.**

Primarily, the difference between the conventional tube tester and the multi-socket type is that in the latter, the use of an added number of specific sockets (for example, in Model 82 the noval is duplicated eight times) permits elimination of element switches thus reducing testing time and possibility of incorrect switch readings.

To test any tube, you simply insert it into a numbered socket as designated, turn the filament switch and press down the quality switch—THAT'S ALL! Read quality on meter. Inter-element leakage, if any indicates automatically.

Production of this Model was delayed a full year pending careful study by Superior's engineering staff of this new method of testing tubes. Don't let the low price mislead you! We claim Model 82 will outperform similar looking units which sell for much more — and as proof, we offer to ship it on our examine before you buy policy.

- Tests over 600 tube types.
- Tests OZ4 and other gas-filled tubes.
- Employs new 4" meter with sealed air-damping chamber resulting in accurate vibrationless readings.
- Use of 22 sockets permits testing all popular tube types and prevents possible obsolescence.
- Dual Scale meter permits testing of low current tubes.
- 7 and 9 pin straighteners mounted on panel.
- All sections of multi-element tubes tested simultaneously.
- Ultra-sensitive leakage test circuit will indicate leakage up to 5 megohms.

Model 82 comes complete, housed in portable, hand-rubbed oak cabinet with removable cover. Only

**\$36<sup>50</sup>**  
**NET**

SUPERIOR'S NEW  
MODEL TV-12

# TRANS-CONDUCTANCE TUBE TESTER

## TESTING TUBES

- ★ **Employs improved TRANS-CONDUCTANCE circuit.** An in-phase signal is impressed on the input section of a tube and the resultant plate current change is measured. This provides the most suitable method of simulating the manner in which tubes actually operate in Radio & TV receivers, amplifiers and other circuits. Amplification factor, plate resistance and cathode emission are all correlated in one meter reading.
- ★ **NEW LINE VOLTAGE ADJUSTING SYSTEM.** A tapped transformer makes it possible to compensate for line voltage variations to a tolerance of better than 2%.
- ★ **SAFETY BUTTON** — protects both the tube under test and the instrument meter against damage due to overload or other form of improper switching.
- ★ **NEWLY DESIGNED FIVE POSITION LEVER SWITCH ASSEMBLY.** Permits application of separate voltages as required for both plate and grid of tube under test, resulting in improved Trans-Conductance circuit.

## TESTING TRANSISTORS

A transistor can be safely and adequately tested only under dynamic conditions. The Model TV-12 will test all transistors in that approved manner, and quality is read directly on a special "transistor only" meter scale. The Model TV-12 will accommodate all transistors including NPN's, PNP's, Photo and Tetrodes, whether made of Germanium or Silicon, either point contact or junction contact types.

Model TV-12 housed in handsome rugged portable cabinet sells for only

**\$72<sup>50</sup>**  
**NET**



**Model TV-12—TUBE TESTER . . . Total Price \$72.50 — Terms: \$22.50 after 10 day trial, then \$10.00 monthly for 5 months.**

**ALSO TESTS  
TRANSISTORS!**

**SHIPPED ON APPROVAL  
NO MONEY WITH ORDER — NO C.O.D.**

Try for 10 days before you buy! If completely satisfied, send down payment after trial and pay balance at indicated monthly rate — **NO INTEREST OR FINANCE CHARGES ADDED.** If not completely satisfied, return to us, no explanation necessary.

See page 103 for complete details

MOSS ELECTRONIC, INC.

3849 TENTH AVE., NEW YORK 34, N. Y.



SUPERIOR'S NEW MODEL 77

# VACUUM TUBE VOLTMETER

## WITH NEW 6" FULL-VIEW METER



Model 77 — VACUUM TUBE VOLT-METER... Total Price \$42.50 — Terms: \$12.50 after 10 day trial, then \$6.00 monthly for 5 months.

- Compare it to any peak-to-peak V. T. V. M. made by any other manufacturer at any price!
- ✓ Model 77 completely wired and calibrated with accessories (including probe, test leads and portable carrying case) sells for only \$42.50.
  - ✓ Model 77 employs a sensitive six inch meter. Extra large meter scale enables us to print all calibrations in large easy-to-read type.
  - ✓ Model 77 uses new improved SICO printed circuitry.
  - ✓ Model 77 employs a 12AU7 as D.C. amplifier and two 9006's as peak-to-peak voltage rectifiers to assure maximum stability.
  - ✓ Model 77 uses a selenium-rectified power supply resulting in less heat and thus reducing possibility of damage or value changes of delicate components.
  - ✓ Model 77 meter is virtually burn-out proof. The sensitive 400 microampere meter is isolated from the measuring circuit by a balanced push-pull amplifier.
  - ✓ Model 77 uses selected 1% zero temperature coefficient resistors as multipliers. This assures unchanging accurate readings on all ranges.

### SPECIFICATIONS

• DC VOLTS — 0 to 3/15/75/150/300/750/1,500 volts at 11 megohms input resistance. • AC VOLTS (RMS) — 0 to 3/15/75/150/300/750/1,500 volts. • AC VOLTS (Peak to Peak) — 0 to 8/40/200/400/800/2,000 volts. • ELECTRONIC OHMMETERS — 0 to 1,000 ohms/10,000 ohms/100,000 ohms/1 megohm/10 megohms/100 megohms/1,000 megohms. • DECIBELS — -10 db to +18 db, +10 db to +38 db, +30 db to +58 db. All based on 0 db = .006 watts (6 mw) into a 500 ohm line (1.73v). • ZERO CENTER METER — For discriminator alignment with full scale range of 0 to 1.5/7.5/37.5/75/150/375/750 volts at 11 megohms input resistance.

AS A DC VOLTMETER: The Model 77 is indispensable in H-I-F Amplifier servicing and a must for Black and White and color TV Receiver servicing where circuit loading cannot be tolerated.

AS AN AC VOLTMETER: Measures RMS values if sine wave, and peak-to-peak value if complex wave. Pedestal voltages that determine the "black" level in TV receivers are easily read.

AS AN ELECTRONIC OHMMETER: Because of its wide range of measurement leaky capacitors show up glaringly. Because of its sensitivity and low loading, intermittents are easily found, isolated and repaired.

Model 77 comes complete with operating instructions, probe and test leads. Use it on the bench—use it on calls. A streamlined carrying case, included at no extra charge, accommodates the tester, instruction book, probe and leads. Operates on 110-120 volt 60 cycle. Only

**\$42<sup>50</sup>**  
**NET**

SUPERIOR'S NEW MODEL 79

The Most Versatile All-Purpose Multi-Range Tester Ever Designed!

# SUPER-METER

## WITH NEW 6" FULL-VIEW METER

A Combination VOLT-OHM MILLIAMMETER.

Plus CAPACITY, REACTANCE, INDUCTANCE AND DECIBEL MEASUREMENTS.

Also Tests SELENIUM AND SILICON RECTIFIERS, SILICON AND GERMANIUM DIODES



Model 79 — SUPER-METER... Total Price \$38.50 — Terms: \$8.50 after 10 day trial, then \$6.00 per month for 5 months.

The Model 79 represents 20 years of continuous experience in the design and production of SUPER-METERS, an exclusive SICO development.

In 1938 Superior Instruments Co. designed its first SUPER-METER, Model 1150. In 1940 it followed with Model 1250 and in succeeding years with others including Models 670 and 670-A. All were basically V.O.M.'s with extra services provided to meet changing requirements.

Now, Model 79, the latest SUPER-METER includes not only every circuit improvement perfected in 20 years of specialization, but in addition includes those services which are "musts" for properly servicing the ever increasing number of new components used in all phases of today's electronic production. For example with the Model 79 SUPER-METER you can measure the quality of selenium and silicon rectifiers and all types of diodes—components which have come into common use only within the past five years, and because this latest SUPER-METER necessarily required extra meter scale, SICO used its new full-view 6-inch meter.

Model 79 comes complete with operating instructions and test leads. Use it on the bench—use it on calls. A streamlined carrying case included at no extra charge accommodates the tester, instruction book and test leads. Only

### Specifications

D.C. VOLTS: 0 to 7.5/15/75/150/750/1,500.  
A.C. VOLTS: 0 to 15/30/150/300/1,500/3,000.  
D.C. CURRENT: 0 to 1.5/15/150 Ma. 0 to 1.5/15 Amperes.  
RESISTANCE: 0 to 1,000/100,000 Ohms. 0 to 10 Megohms.  
CAPACITY: 001 to 1 Mfd. 1 to 50 Mfd.  
REACTANCE: 50 to 2,500 Ohms, 2,500 Ohms to 2.5 Megohms.  
INDUCTANCE: .15 to 7 Henries, 7 to 7,000 Henries.  
DECIBELS: -6 to +18, +14 to +38, +34 to +58.

The following components are all tested for QUALITY at appropriate test potentials. Two separate BAD-GOOD scales on the meter are used for direct readings.

All Electrolytic Condensers from 1 MFD to 1000 MFD.  
All Selenium Rectifiers. All Germanium Diodes.  
All Silicon Rectifiers. All Silicon Diodes.

**\$38<sup>50</sup>**  
**NET**

**SHIPPED ON APPROVAL**  
**NO MONEY WITH ORDER — NO C.O.D.**

Try for 10 days before you buy! If completely satisfied, send down payment after trial and pay balance at indicated monthly rate — NO INTEREST OR FINANCE CHARGES ADDED. If not completely satisfied, return to us, no explanation necessary.

See following page for complete details

MOSS ELECTRONIC, INC.

3849 TENTH AVE., NEW YORK 34, N. Y.



SUPERIOR'S NEW MODEL TV-50A

# GENOMETER

## 7 Signal Generators in One!

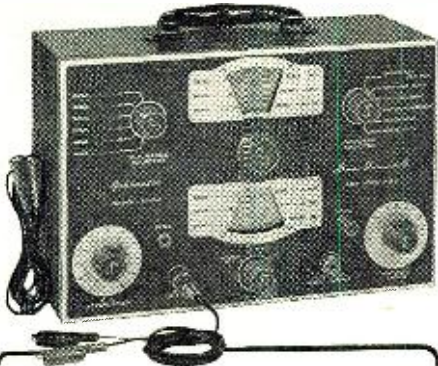

- ✓ R.F. Signal Generator for A.M.
- ✓ R.F. Signal Generator for F.M.
- ✓ Audio Frequency Generator
- ✓ Bar Generator
- ✓ Cross Hatch Generator
- ✓ Color Dot Pattern Generator
- ✓ Marker Generator

A versatile all-inclusive GENERATOR which provides ALL the outputs for servicing:  
A.M. Radio • F.M. Radio • Amplifiers • Black and White TV • Color TV

### Specifications

**Model TV-50A GENOMETER . . . Total Price \$47.50** — Terms: \$11.50 after 10 day trial, then \$6.00 monthly for 6 months.

**R. F. SIGNAL GENERATOR:** The Model TV-50A Genometer provides complete coverage for A.M. and F.M. alignment. Generates Radio Frequencies from 100 Kilocycles to 60 Megacycles on fundamentals and from 60 Megacycles to 180 Megacycles on powerful harmonics.

**VARIABLE AUDIO FREQUENCY GENERATOR:** In addition to a fixed 400 cycle sine-wave audio, the Model TV-50A Genometer provides a variable 300 cycle to 20,000 cycle peaked wave audio signal.

The Model TV-50A comes complete with shielded leads and operating instructions. Only

**BAR GENERATOR:** The Model TV-50A projects an actual Bar Pattern on any TV Receiver Screen. Pattern will consist of 4 to 16 horizontal bars or 7 to 20 vertical bars.

**CROSS HATCH GENERATOR:** The Model TV-50A Genometer will project a cross-hatch pattern on any TV picture tube. The pattern will consist of non-shifting, horizontal and vertical lines interlaced to provide a stable cross-hatch effect.

**DOT PATTERN GENERATOR (FOR COLOR TV)** Although you will be able to use most of your regular standard equipment for servicing Color TV, the one addition which is a "must" is a Dot Pattern Generator. The Dot Pattern projected on any color TV Receiver tube by the Model TV-50A will enable you to adjust for proper color convergence.

**MARKER GENERATOR:** The Model TV-50A includes all the most frequently needed marker points. The following markers are provided: 189 Kc., 262.5 Kc., 456 Kc., 600 Kc., 1000 Kc., 1400 Kc., 1600 Kc., 2000 Kc., 2500 Kc., 3579 Kc., 4.5 Mc., 5 Mc., 10.7 Mc. (3579 Kc. is the color burst frequency).

**\$47.50 NET**

For the first time ever: ONE TESTER PROVIDES ALL THE SERVICES LISTED BELOW!

SUPERIOR'S NEW MODEL 76

# ALL PURPOSE BRIDGE

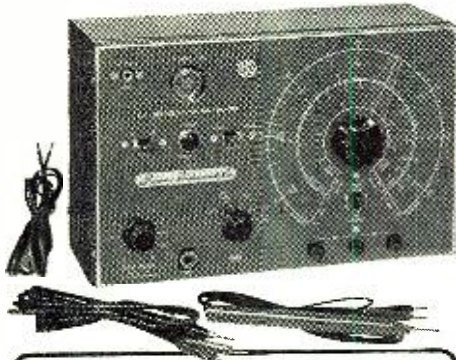

**Model 76 . . . Total Price \$26.95** — Terms: \$6.95 after 10 day trial, then \$5.00 monthly for 4 months.

IT'S A **CONDENSER BRIDGE**

with a range of .00001 Microfarad to 1000 Microfarads (Measures power factor and leakage too.)

IT'S A **SIGNAL TRACER**

which will enable you to trace the signal from antenna to speaker of all receivers and to finally pinpoint the exact cause of trouble whether it be a part or circuit defect.

**CAPACITANCE BRIDGE SECTION**

4 Ranges: .00001 Microfarad to 1000 Microfarads. Will also locate shorts and leakages up to 20 megohms. Measures the power factor of all condensers from .1 to 1000 Microfarads. (Power factor is the ability of a condenser to retain a charge and thereby filter efficiently.)

**SIGNAL TRACER SECTION**

With the use of the R.F. and A.F. Probes included with the Model 76, you can make stage gain measurements, locate signal loss in R.F. and Audio stages, localize faulty stages, locate distortion and hum, etc. Provision has been made for use of phones and meter if desired.

Model 76 comes complete with all accessories including R.F. and A.F. Probes; Test Leads and operating instructions. Nothing else to buy. Only

IT'S A **RESISTANCE BRIDGE**

with a range of 100 ohms to 5 megohms

IT'S A **TV ANTENNA TESTER**

The TV Antenna Tester section is used first to determine if a "break" exists in the TV antenna and if a break does exist the specific point (in feet from set) where it is.

**RESISTANCE BRIDGE SECTION**

2 Ranges: 100 ohms to 5 megohms. Resistance can be measured without disconnecting capacitor connected across it. (Except, of course, when the R C combination is part of an R C bank.)

**TV ANTENNA TESTER SECTION**

Loss of sync., snow and instability are only a few of the faults which may be due to a break in the antenna, so why not check the TV antenna first? 2 Ranges: 2' to 200' for 72 ohm coax and 2' to 250' for 300 ohm ribbon.

**\$26.95 NET**

# SHIPPED ON APPROVAL NO MONEY WITH ORDER — NO C. O. D.

MOSS ELECTRONIC, INC.  
Dept. D-536, 3849 Tenth Ave., New York 34, N. Y.

Please send me the units checked on approval. If completely satisfied I will pay on the terms specified with no interest or finance charges added. Otherwise, I will return after a 10 day trial positively cancelling all further obligation.

Name .....  
Address .....  
City ..... Zone ..... State .....

All prices net. F.O.B., N. Y. C.

- Model TW-11 ..... Total Price \$47.50  
\$11.50 within 10 days. Balance \$6.00 monthly for 6 months.
- Model TD-55 ..... Total Price \$26.95  
\$6.95 within 10 days. Balance \$5.00 monthly for 4 months.
- Model 82 ..... Total Price \$36.50  
\$6.50 within 10 days. Balance \$6.00 monthly for 5 months.
- Model TV-12 ..... Total Price \$72.50  
\$22.50 within 10 days. Balance \$10.00 monthly for 5 months.
- Model 77 ..... Total Price \$42.50  
\$12.50 within 10 days. Balance \$6.00 monthly for 5 months.
- Model 79 ..... Total Price \$38.50  
\$8.50 within 10 days. Balance \$6.00 monthly for 5 months.
- Model TV-50A ..... Total Price \$47.50  
\$11.50 within 10 days. Balance \$6.00 monthly for 6 months.
- Model 76 ..... Total Price \$26.95  
\$6.95 within 10 days. Balance \$5.00 monthly for 4 months.



**The WORLD'S FINEST SURPLUS BARGAINS!**  
 For Details on Items Previously Advertised—SEND for FREE CATALOG #M-58!

**DM-35 DYNAMOTORS**

12 VOLT INPUT;  
 OUTPUT 625 VOLTS  
 225 MA. SIZE: 8" x 4" x 4"

**\$7.95**  
USED

**\$9.95**  
RE-ISSUE

**\$12.95**  
NEW

Extra Set of Brushes included with Re-Issue & New!

**DYNAMOTORS & POWER SUPPLIES**

DYNAMOTOR—1000 VDC @ 350 MA. Starting Relay and Filtered:  
 BD-77—14 V. input.....Used: \$9.95 New: \$14.95  
 PE-73—28 V. input.....Used: 8.95 New: 12.95  
 PL-59 High Voltage Plug..... 1.00  
 PL-61 Low Voltage Control Plug..... 1.00  
 DYNAMOTOR—300 VDC @ 250 MA. & 150 VDC @ 10 MA. Starting Relay, Voltage Regulator, Filtered:  
 PE-98—14 V. input.....Used: \$12.95 New: \$19.95  
 PE-94—28 V. input.....Used: 4.95 New: 9.95  
 Input Plug.....\$1.00 Output Plug.....\$1.00  
 UNIVERSAL PM TYPE—6 Volt 8 A. input; output 12 V. 1.8 A. 200 V 80 MA. 12 Volt 4 A. input; output 12 V. 1.8 A. 200 V 80 MA. Will operate BC-603-683-3050-ARB from 6 volts. #0515—New.....\$4.95

				NEW	USED
12 VDC	220 VDC	80 MA	DM-34	\$ 4.95	\$ 2.95
12 VDC	375 VDC	150 MA	BD-83	6.95	4.95
12 VDC	540 VDC	450 MA	DA-12	9.95	6.95
12 VDC	425 VDC	163 MA	WE-277	12.95	9.95
12 VDC	225 VDC	100 MA	D-42	3.95	5.95
12 VDC	250 VDC	60 MA	DM-32 12 V	.....	.....
12 VDC	275 VDC	150 MA	DM-64	8.95	.....
12 VDC	185 VDC	210 MA	DM-40	4.95	2.95

6 VDC 640 VDC 260 MA—Reconditioned by G.E. \$12.95  
 6 VDC 420 VDC 260 MA—Reconditioned by G.E. 9.95  
 6 VDC 275 VDC 60 MA—DM-9450 \$6.95 4.95

PE-120 6-12 Volt f/BC-659/BC-620.....Used: \$ 9.95  
 RA-20 110 V 60 cycle f/BC-312/BC-342.....Used: 9.95  
 AC 1/BC-603-683-3050—Kit: \$10.00—Wired..... 14.95  
 AC 1/Command or ARC-5—Kit: \$12.00—Wired..... 18.95  
 PE-125 Vibrapac 12 VDC—300 VDC 150 MA—N..... 9.95  
 PE-104 Vibrator Supply BC-654—Used..... 9.95

**PHONES • MIC.S • HEADSETS**

EE-8 Field Telephone—Reconditioned.....\$14.95  
 BD-71 Switchboard—6 Line—New: \$24.95—Used: 14.95  
 BD-72 Switchboard—12 Line—New: 24.95  
 BD-89 Switchboard Console Type, 60 Lines..... 24.95  
 TS-9 Handset—New: \$4.95.....Used: 2.95  
 T-17 Microphones—New: \$6.95.....Used: 3.95  
 T-13 Handsets—New: \$4.95.....Used: 3.95  
 T-26 Microphone F-1 Button—New: \$1.95.....Used: 1.25  
 HS-30 Headset—New: \$1.50.....Used: .75  
 Lip Mic.....New: \$1.50.....Used: 1.00  
 Throat Mic.....New: .75 Used: .50

**MARS • CD • MARINE**

RECEIVER-TRANSMITTER BC-1306—3800 to 6500 KC. Voice 15 Mile, CW 30 Mile, MO or Crystal Control, Crystal Calb. & Net Controls.....Used: \$29.95  
 PE-237 Power Supply for BC-1306—6, 12, or 24 Volt.....U: 14.95  
 Large Plug to fit BC-1306 or PE-237.....Each: 1.50  
 SCR-522 Rec.-Trans.—100 to 156 MC.....Used: 29.95  
 RT-15/ARC-1 Rec.-Trans.—100 to 156 MC.....Used: 39.50  
 BC-395—FM Rec.-Trans.—27 to 38 MC.....Used: 24.95  
 BC-659 FM Rec.-Trans.—27 to 38 MC.....Used: 14.95  
 BC-620 FM Rec.-Trans.—21 to 28 MC.....New: 14.95

Address Dept. RN • \$5.00 Order Minimum, & 25% Deposit on C.O.D.'s • Prices are F.O.B. Lima, Ohio

**Q-5'R RECEIVER**

NAVY TYPE; 190  
 TO 550 KC. \$14.95  
 USED.....

(As Pictured at right.)



**RAX-1 RECEIVER**

Four Band, 4 1/2" Dial, AVC, CW, MCW, Phone Jack, Volume Control. Voltage required: 24 VDC & 200 V 80 MA. Complete with 7 Tubes, less top cover. Good condition. Size: 16" x 7 1/2" x 7 1/2"

Unit #1 200—1500 KC.....\$18.95  
 Unit #2 1500—9000 KC..... 18.95  
 Unit #3 7000—2700 KC..... 18.95  
 R-26/ARC-5 Receiver—3 to 6 MC.....Used: 7.95  
 Navy Type/BC-455 Rec.—6 to 9 MC.....Used: 8.95  
 R-26/ARC-5 Receiver—3 to 6 MC—Used..... 8.95  
 R-28/ARC-5 Receiver—100 to 156 MC—Used..... 14.95  
 ARB Receiver—190 to 9050 KC—Used..... 18.95  
 (For details, see last month's ad or send for catalog.)  
 BC-652 Receiver—15 to 18 MC—Used..... 24.95  
 BC-312/342 Receiver—3 to 6 MC—Used..... 7.95  
 BC-733 Revr—108 to 110 MC—U: \$9.95 No Tubes: 4.95  
 BC-603 FM Receiver—20 to 28 MC—New..... 14.95  
 BC-683 FM Receiver—27 to 38 MC—Used..... 24.95  
 BC-684 FM Revr—50 to 50 (10 MC Spread) N: 29.95  
 BC-1206 Receiver—200 to 400 KC—U: \$4.95—N: 9.95

**TRANSMITTERS:**

BC-191 AM—100 Watt—1.5 to 12 MC—Used: \$24.95—New: \$34.95  
 BC-375 AM—100 Watt—1.5 to 12 MC—24 V.—U: 24.95  
 BC-604 FM—30 Watt—20 to 28 MC—New..... 19.95  
 BC-604 FM 30 Watt—27 to 38 MC.....Used: 14.95  
 BC-1158 AM—50 Watt—53.3 to 95 MC—U: \$29.95—N: 39.95  
 T-23/ARC-5—100 to 156 MC.....Used: 14.95  
 BC-457 AM/Comm. 4 to 5.3 MC.....Used: 4.95  
 Navy/BC-696 AM/Comm.—3 to 4 MC.....Used: 4.95  
 Navy Type AM/Comm.—2.1 to 3 MC.....Used: 4.95  
 Navy/BC-459 AM/Comm.—7 to 9 MC.....U: \$7.95—N: 8.95

**MOUNTINGS and RACKS:**

FT-237 Mtg. for BC-604 & BC-603—Used.....\$9.95  
 FT-346 Mtg. for BC-603-683-3050—New..... 4.95  
 FT-253 Mtg. for BC-652 & BC-653—New..... 9.95  
 FT-220 for Command or ARC-5—3 receiver—New. 2.00  
 FT-162 for BC-312 & BC-342—New..... 9.95

**CABLES & PLUGS:**

Cables with PL-59-64 or 61 ea. end. Each Cable: \$2.75  
 TCS Cable P.S. to Trans. or Rec. to P.S. Ea. Cable 2.75  
 Battery Cable & Plug for BC-603, 683, or 3050..... 2.75  
 Plugs Only: SCR-522, BC-375, Command Sets. Ea. 1.00

**MISCELLANEOUS:**

BC-221 Frequency Meter.....Used: \$79.50  
 Magnets—Rams Horn—\$200 Gauss.....Used: 12.95  
 Magnets—Horseshoe, 75 lb. lift: \$4.95—25 lb. lift: 2.95  
 I-208 SIGNAL GENERATOR—Used..... 59.50  
 Blank Paper Code Tapes: 30 Rolls \$3.00—60 Rolls 5.00  
 CODE TAPES—15 Rolls to a Set—New..... 18.95  
 AN/AP5-4 Radar 3 OM—New..... 69.50  
 C-114 Loading Coil—C-161 Phone Coil.....Each: 1.95  
 Navy Filters, Same as FL-8—No Cord \$1.50..... 1.95  
 Tuning Units F/BC-375/BC-191—Prices from \$2.95 to 1.95  
 BC-929 Radar Oscilloscope—8 Tubes—U: \$9.95—N: 14.95  
 BC-1268—Oscilloscope Radar, 25 Tubes—New..... 14.95  
 BC-906 Freq. Meter—143 to 227 MC—U: \$7.95—N: 9.95  
 RD-7/APA-23 Recorder—Used: \$22.95..... New: 29.95  
 TS-385—Oscillator—376 to 418 MC—U: \$9.95—N: 12.95  
 BC-1203 Audio Amplifier Modulator—New..... 19.95  
 Navy RDP Panoramic Adapter—Used..... 34.95

**Listening to the Satellites**  
 (Continued from page 45)

amplifier, a triode-connected 6AK5 mixer, and a single 6J6 overtone oscillator-multiplier stage. It is certain that a less expensive tube could be substituted for the 417A. A small compromise in signal-to-noise ratio can be allowed because the main type of noise seems to be that which comes in the antenna—even under "cold" antenna conditions in the early morning. The operating voltages on all tubes in the converter were reduced to a bare minimum as a precaution against converter noise. The gain of the converter was such that it was necessary to detune the mixer output coil considerably in order that the "S" meter on the communications receiver would read in the middle ranges. It was found that tight link coupling, using a very short shielded lead, was necessary to eliminate direct pickup of signals by the communications receiver. The local FM broadcast stations have a few splashes near the 108 megacycle channel, but these were minimized by a series-resonant trap in the antenna coupling circuit.

The receiver which is fed by the converter is usually set to as narrow a bandpass as possible. This measure tends to eliminate a good portion of the noise that might still get through the converter. A good audio filter might further eliminate noise. It could, however, sharpen the circuit too much and cut off the high- and low-frequency telemetry modulation and it could also make tuning a hardship because of the Doppler shift.

In recap, please remember that the tracking station described is strictly in the "ham" class. The converter just "grew" from the junk box, even the 417A tube being a reject. The maximum effort was put into building the antennas which seems to have paid off handsomely. It's been fascinating through these weeks and through these miles of tape.

**FAIR RADIO SALES 132 SOUTH MAIN ST. LIMA, OHIO**

**ORDER by MAIL and SAVE!  
 TV PICTURE TUBES**

10BP4	\$ 7.95	17BP4	\$10.95	21AMP4	\$19.95
12LP4	8.95	17CP4	17.00	21ATP4	20.95
14B/CP4	9.95	17GP4	17.60	21AUP4	20.95
16DP4	14.95	17HP4	13.60	21EP4	14.95
16EP4	15.90	17LP4	13.60	21FP4	15.95
16GP4	15.90	17QP4	11.95	21WP4	17.30
16KP4	10.95	17TP4	19.30	21XP4	15.95
16LP4	10.95	18AP4	19.30	21ZP4	14.95
16RP4	10.95	20CP4	13.90	24CP4	23.95
16WP4	15.20	20HP4	17.95	24DP4	26.95
16TP4	10.95	21AP4	22.10	27EP4	39.95
17AVP4	15.20	21ALP4	20.95	27RP4	39.95

27"—6 month guarantee—all others 1 year. Aluminized Tubes \$3.00 more than above prices. These prices are determined to include the return of an acceptable similar tube under vacuum.

ALL PRICES FOB CHICAGO, ILLINOIS. Deposit required when old tube is not returned, refundable at time of return. 25% deposit required on COD shipments. Old tubes must be returned prepaid. We ship anywhere.

WRITE FOR COMPLETE LIST.

**— PICTURE TUBE OUTLET —**  
 3032 MILWAUKEE AVE.  
 CHICAGO 18, ILLINOIS  
 Dickens 2-2048

**ENGINEERING DEGREES**  
 E.E. Option Electronics or Power  
 Earned through Home Study  
 Residence classes also available  
 Colleges of Engineering, Physics, and Business Administration  
 5719R Santa Monica Blvd.  
 Hollywood 38, California

**BE INDEPENDENT**  
 Run Your Own TUBE Business  
 Get This Modern Sturdy Tube Tester  
**FREE**  
 with "Package Deal" order for nationally sold ZALYTRON Quality Brand Receiving Tubes. We'll show you how to start a successful Tube Tester route, and get YOUR share of today's Big Profits in Self-Service Tube Sales! For full details, write for booklet "R."  
**ZALYTRON**  
 TUBE CORPORATION  
 220 West 42nd St., N. Y. 36, N. Y.

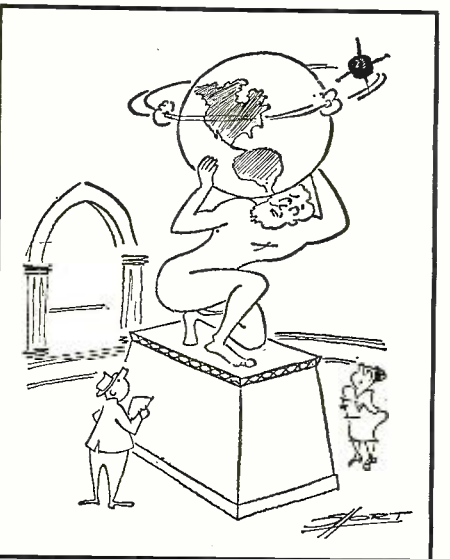



# 48¢

ea.

# for any tube

## \$45.00 Per Hundred

# STANDARD LINE

ELECTRIC COMPANY

FREE TUBE BRIGHTENER ON ORDERS OF \$10.00 OR MORE

FREE POSTAGE IN U.S.A. & TERRITORIES

### ANNOUNCING OUR NEW PRICE SCHEDULE

Effective July 25, 1958 all tubes (Radio & Television receiving) will be sold and shipped at the fantastic price of only .48c ea. or \$45.00 per hundred. Any "on hand" orders at that time will receive credit for future purchases.

THE TUBES ADVERTISED HEREIN ARE NOT NECESSARILY NEW TUBES BUT MAY BE ELECTRICALLY PERFECT FACTORY SECONDS OR USED TUBES AND ARE SO MARKED

All TV & Radio Tubes are tested by our supplier under actual conditions in Radio & TV chassis or in Hickock Tube Testers Model 533A.

And, of course, the famous Standard Line guarantee remains in effect: All tubes guaranteed to be replaced free if they fail to function efficiently within one year's time. (defective tubes must be returned intact, postage paid. Refunds will be cheerfully made within five (5) days if not completely satisfied.)

0B2	3AL5	5V6GT	6BE6	6S4	7F7	12Q7	32L7GT
0Z4	3AU6	5W4GT	6BF5	6SBGT	7F8	12SA7	35/51
1A5GT	3AV6	5X4G	6BG4G	6SA7	7G7	12SG7	35A5
1A7GT	3BA6	5X8	6BH6	6SB7Y	7H7	12SJ7	35B5
1B3GT	3BC5	5Y3GT	6BH8	6SC7	7J7	12SK7	35C5
1C5GT	3BE6	5Y4G	6BJ6	6SF5	7K7	12SN7GT	35L6GT
1C6	3BN6	5Z3	6BK5	6SF76SG7	7L7	12SQ7	35W4
1C7	3BU8	5Z4	6BK7	6SH7	7N7	12SR7	35Y4
1H4G	3BY6	6A8	6BL7GT	6SJ7	7Q7	12V6GT	35Z4GT
1H5GT	3BZ6	6AB4	6BN6	6SK7	7R7	12W6GT	35Z5GT
1L6	3C2	6AC7	6BQ6GT	6SL7GT	7S7	12X4	#37
1LA4	3CB6	6AF4	6BQ7	6SN7GT	7V7	12Z3	#39/44
1LA6	3CF6	6AG5	6BR8	6SQ7	7W7	14A7	#41
1LB4	3CS6	6AG7	6BS8	6SR7	7X6	14AF7	#42
1LC5	3DT6	6AH4GT	6BSY5G	6T4	7X7	14B6	#43
1LC6	3Q4	6AH6	6BZ6	6T8	7Y4	14F7	#45
1LH4	3Q5GT	6AK5	6BZ7	6U4GT	7Z4	14F8	#47
1LN5	354	6AK6	6C4	6U5	8AW8	14H7	50A5
1N5GT	3V4	6AL5	6C5	6U8	12A8	14N7	50B5
1P5GT	4BC8	6AL7GT	6CB5	6V3	12A85	14Q7	50C5
1Q5GT	4BQ7A	6AM8	6CB6	6V6GT	12AQ5	14S7	50C6G
1R5	4B58	6AN8	6CD6G	6W4GT	12AT6	17AX4GT	50L6GT
1S5	4BU8	6AQ5	6CF6	6W6GT	12AT7	17DQ6	50Y6
1T4	4BZ7	6AQ6	6CG7	6X4	12AU6	19AU4	50Y7
1T5GT	4CB6	6AQ7GT	6CG8	6X5GT	12AU7	19B6GG	#57
1U4	5AM8	6AR5	6CH8	6X8	12AV6	19C8	#58
1U5	5AN8	6AS5	6CL6	6Y6G	12AV7	19J6	#80
1V	5AQ5	6AS8	6CM6	7A4	12AX4GT	19T8	#81
1V2	5AS8	6AT6	6CM7	7A5	12AX7	19X8	117L7GT
1X2	5AT8	6AU4GT	6CN7	7A6	12AZ7	25AC5	117N7GT
2A3	5AV8	6AU5GT	6CU6	7A7	12B4	25AV5GT	117P7GT
2A5	5AW4	6AU6	6DG6	7A8	12BA6	25AX4GT	117Z3
2A7	5AZ4	6AUB	6DQ6	7B4	12BE6	25BK5	117Z4GT
2AF4A	5BK7	6AV5GT	6DT6	7B5	12BF6	25BQ6	117Z6GT
2B7	5BR8	6AV6	6E5	7B6	12BH7	25CD6G	807
2BN4	5BQ7	6AW8	6H6	7B7	12BK5	25CU6	9002
2D21	5BZ7	6AX4GT	6J4	7B8	12BQ6	25L6GT	9003
2E5	5CGB	6AX5GT	6J5	7C4	12BR7	25W4GT	9006
2X2A	5J6	6AZ8	6J6	7C5	12CA5	25Z5	
3A2	5T8	6BA6	6K6GT	7C6	12CU6	25Z6	
3A3	5U8	6BC5	6K7	7C7	12DQ6	#27	
3A4	5U4G	6BC8	6L6	7E6	12J5	#30	
3A5	5V4G	6BD6	6L7	7E7	12L6GT	#31	

ALL RECEIVING TUBES SENT POSTAGE PAID.  
Please send 25c handling for orders under \$5.00. Send 25% deposit on C.O.D. orders and please send approximate postage on Canadian and foreign orders.

Above is only a partial list — order any type at the same price or send for free tube list and order blank. We have over 5,000 tube types on hand or at easy access, including special purpose, industrial and transmitting tubes which are slightly higher.

## ALL TUBES GUARANTEED ONE FULL YEAR...

NOTE: When ordering receiving tubes be sure to enclose 48c for each tube or \$45.00 per hundred.

### Thousands of TRADE-IN TVs

Please Specify Console or Table Model When Ordering  
Reconditioned By Factory Trained Technicians! Guaranteed To Be In Working Condition When You Receive Them!

10"	\$25.00	19"	\$56.00
12"	\$30.00	20"	\$63.00
14"	\$35.00	21"	\$70.00
16"	\$42.00	24" (when available)	\$95.00
17"	\$49.00	27" (when available)	\$129.00

Get yourself a second set or buy some for re-sale!  
All TVs sent motor freight or Railway Express F.O.B. our warehouse. Sorry, no A.P.O. shipments.  
FREE INDOOR ANTENNA with each TV Purchase

below is our new price schedule of pix tubes. These famous make tubes contain all new parts with the exception of the glass bulb which does not wear out.

Any 10" Tube	\$ 9.95	Any 16" Tube	15.95
Any 12" Tube	10.95	Any 17" Tube	18.29
Any 14" Tube	13.95	Any 19" Tube	20.29
		Any 21" Tube	24.29

Prices On Larger Tubes On Request

Remember  
Only 48¢ ea.  
\$45 Per Hundred

ANY TYPE  
ANY QUANTITY

Remember — NO DUD Required.  
All tubes guaranteed one year.  
Picture Tubes shipped F.O.B. Harrison, N. J.

# STANDARD LINE

ELECTRIC COMPANY

432 HARRISON AVENUE, HARRISON, N. J. • Phone: HUmboldt 4-4997



**COYNE offers**  
**LOW COST**  
**TELEVISION**  
Training in  
Spare Time **AT HOME**

The future is **YOURS** in  
**TELEVISION—RADIO**  
**COLOR TV!**

A fabulous field—good pay—fascinating work—a prosperous future! Good jobs, or independence in your own business!



Coyne brings you **MODERN—QUALITY** Television Home Training; training designed to meet Coyne standards. Includes **RADIO, UHF and COLOR TV**. No previous experience needed. Practical Job Guides to show you how to do actual servicing jobs—make money early in course. You pay only for your training, no costly "put together kits."

**SEND COUPON FOR FREE BOOK**

and full details including easy Payment Plan. No obligation, no salesman will call.



B. W. Cooke, Jr., President

Coyne—the Institution behind this training—the largest, oldest, best equipped residential school of its kind. Founded 1899.

**COYNE ELECTRICAL SCHOOL**

500 S. Paulina, Chicago, Dept. 88-H6  
A Technical Trade Institute  
Chartered Not For Profit

**COYNE Television, Home Training Division**  
500 S. Paulina St., Chicago 12, Ill.  
Dept. 88-H6  
Send Free Book and details on how I can get Coyne Quality Television Home Training at low cost and easy terms.

Name.....  
Address.....  
City..... State.....  
(It is understood no salesman will call)

# Adding a VU Meter to the "Outboard" Amplifier

By **EARL E. SNADER**

Customer Service  
Viking of Minneapolis

*By popular request, a refinement for the circuit which originally appeared in our January issue.*

A **LARGE** number of inquiries have been received by the author since his article "Outboard Equalizer-Bias Amplifier for Tape Recording" appeared in the January 1958 issue, asking how a vu meter can be added to the unit in place of the original electron-ray "magic eye" record level indicator.

The schematic diagram of Fig. 1 shows the circuitry for a 6C4 vu meter driver stage that can be built into the "outboard" recording amplifier in place of the original 6E5.

The vu meter driver stage is connected in a cathode-follower configuration. The signal is taken from the recording amplifier at the same point as for the 6E5 in the original circuit. No crystal diode is necessary. A 250,000-ohm linear potentiometer functions as a calibration control. Plate power for the 6C4 is taken from the point marked "F" in the original circuit.

The 6C4 can be mounted on a flange similar to the one provided in the original unit for the 6E5 tube socket. The flange is located about 2 1/4" from the front of the chassis. In this position it will straddle the back part of filter capacitor mounting and provide the necessary space for the meter calibration control which is mounted on the top of the chassis, between the bias oscillator transformer and the filter capacitor. A 7-pin miniature tube socket is installed in the new flange, with the tube toward the front in the same relative position as the

original 6E5. The meter calibration control will be just behind and above this tube socket and should be mounted so its terminal lugs are toward the socket.

Since most vu meters are too large to mount on the small chassis of the "outboard" recording amplifier, a second RCA phono jack will be needed for connecting to an external vu meter. This can be installed on the top of the chassis, in front of the filter capacitor and directly above the vu meter driver tube.

Any standard vu meter with an internal impedance of about 3900 ohms can be used.

To calibrate the meter, remove the 12AV7 bias oscillator tube and connect a 100-ohm resistor in series with the record head. Turn on the recording amplifier and feed a 1000-cycle signal into the normal recording input jack. Adjust the record level control until a reading of .008 volt a.c. r.m.s. is obtained with a high-impedance vacuum-tube a.c. voltmeter connected across the 100-ohm resistor in series with the record head. Adjust the calibration control so a "0" reading is obtained on the vu meter under these conditions (this will correspond to a "100" reading on a "B" scale vu meter). This represents a recording current of .08 ma. at 1000 cycles at a recording level about 8 or 10 db below saturation with a record head having an impedance of 2000 ohms at 1000 cycles.

The one special precaution that is necessary in adding the vu meter to the "outboard" recording amplifier is to provide as much isolation, physically as well as electrically, between the vu meter driver and the bias oscillator. Otherwise part of the bias signal may get into the vu meter driver and cause a slight deflection of the vu meter even when no program material is present at the recording input jack of the unit.

Since more and more recording fans are demanding "professional" feature in their home machines, we are glad to comply with requests for details on how a vu meter can be incorporated.

Although this change was worked out for the equalizer-bias amplifier the author described in the January issue, other machines with similar circuitry could be altered for a meter.

Fig. 1. Simple circuit changes permit the addition of a vu meter to tape amplifier.

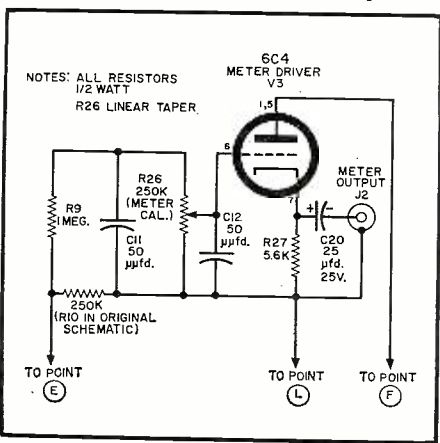



## X-Rays from TV Sets

(Continued from page 59)

set—being careful to mount it away from the high heat of any of the components and being sure the paper clip is attached firmly so that it won't fall across the tube pins—and leave it for two or three weeks. Alternately, you can tape the film to the face of the picture tube for about a month. After the required time has elapsed, develop the film or talk your dentist into developing it for you. If a shadow of the paper clip appears on the film—you might then have cause to worry about x-ray radiation.

The result of the author's experiments boils down to this one fact—protection from the radiation "hazard" of television sets amounts to the self-same procedures involved in avoiding electric shock. When repairing a TV receiver and replacing the chassis in its cabinet, be sure to restore all of the original hardware as insurance against radiation for both you and your customer.

### STARVED AMPLIFIER

BY A. V. J. MARTIN

**T**HE starved amplifier circuit, where a pentode is fed very low plate and screen voltages, is interesting because it can provide a very high gain in a single stage.

A 6U8 triode-pentode is used. The input stage is the pentode. The grid circuit contains a tone control and a feedback circuit (not shown). The plate is fed from "B+" of 160 volts through a large value resistor and is directly tied to the grid of the triode, used as a split-load driver for an output push-pull of 6AQ5.

The screen-grid of the input pentode is fed from the cathode voltage of the triode through a decoupling circuit. The triode, acting partially as a d.c. cathode follower, has a stabilizing effect on the input tube.

At high frequencies, an extra amount of stabilization is provided by a small capacitor between the cathode of the triode and the input grid. This technique is being used in a moderately priced audio amplifier of French manufacture.

—30—

Circuit gives high gain in single stage.

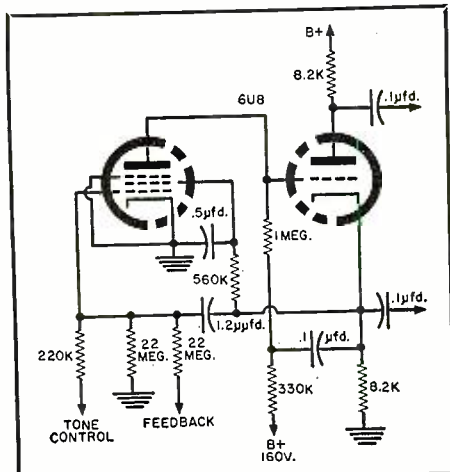

November, 1958



# RCA PREMIUM TUBES



Long-life reliability... the result of selected materials, rigid quality controls, and exacting inspection and test procedures... makes RCA Tubes the right choice for replacement in electronically controlled industrial devices.



**RADIO CORPORATION OF AMERICA**  
Electron Tube Division  
Harrison, N. J.

Send for new booklet RIT-104A. "Receiving-Type Tubes For Industry and Communications". Includes descriptions and basic data on RCA Premium and other special tube types. For your copy, write RCA Commercial Engineering, Section K-41-Z, Harrison, N. J.





Your choice of school  
is highly important  
to your career in



**INDUSTRIAL  
ELECTRONICS**



**RADIO-  
TELEVISION**



**ELECTRONICS  
COMMUNICATIONS**

Become an  
**ELECTRICAL  
ENGINEER**  
or an  
**ENGINEERING  
TECHNICIAN**  
at

**MSOE in Milwaukee**

Choose from courses in:

**ELECTRICAL ENGINEERING**

Bachelor of Science Degree  
in 36 months—  
Communications or  
Electrical Power.

**ENGINEERING TECHNOLOGY**

Associate in Applied Science  
degree in 18 months—  
Electronics Communications  
Electrical Power or Computers.

MSOE—located in Milwaukee, one of America's largest industrial centers—is a national leader in electronics instruction—with complete facilities, including the latest laboratory equipment, visual aid theater, amateur radio transmitter—offers 93 subjects in electrical engineering, electronics, radio, television, electrical power, and electricity.

Advisory committee of leading industrialists. Courses approved for veterans. Over 50,000 former students. Excellent placement record. Previous educational, military, and practical experience is evaluated for advanced credit.



QUARTERS BEGIN SEPTEMBER,  
JANUARY, MARCH, JULY

Choose wisely—your  
future may depend on it.  
Mail coupon today!

**MILWAUKEE**

SCHOOL OF ENGINEERING  
Dept. RT-1158, 1025 N. Milwaukee St.  
Milwaukee, Wis.  
Please send free illustrated career booklet  
(please print)

I'm interested in.....  
Name..... Age.....  
Address.....  
City..... State.....  
Are you eligible for veterans educational  
benefits?.....  
Discharge date.....

MS-57

# Test Bench PUZZLER: No. 3

By ART MARGOLIS

Here you see the boosted "B+" and there you don't.  
Where did it go in winding through the windings?

FIRST ORDER of business when TV technicians get together is a bull session in which tough or unusual cases get traded. This one, although not one of the toughest to come up, is interesting because there is an unusual element involved.

The face of the picture tube appeared as shown in Fig. 1. Evidently there was no vertical sweep on this Motorola TS236. However, the horizontal line showed good brightness, and sound output was normal. Naturally the 12BH7, acting as a combined vertical oscillator and output tube, was checked. There was nothing wrong with it. A reading at the output plate of this stage (point 1, Fig. 2) provided an immediate clue: while 470 volts is called for, actual voltage was close to zero.

Boosted "B+" for this point originates at the damper cathode (point 2). This potential may then be traced through a winding in the high-voltage transformer, into the vertical-deflection coils, and through the vertical-output transformer before it reaches the 12BH7. At the damper cathode, however, an acceptable 480 volts was noted. This meant that boosted "B+"

was being lost somewhere in the chain already mentioned.

Approach the problem this way: the wiring of the yoke and the two output transformers is extremely confusing, so you are going to try to save yourself unnecessary trouble by figuring out what had happened in which component or components. To avoid extra work, which component would you try first and which last?

Don't feel bad if your answer doesn't match the one on page 141. Logic aside, this one will take a little luck or inspiration.

-30-

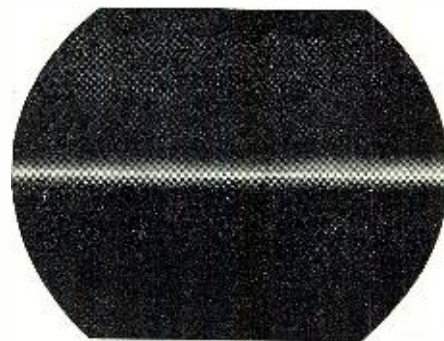

Fig. 1. Vertical deflection was lost.

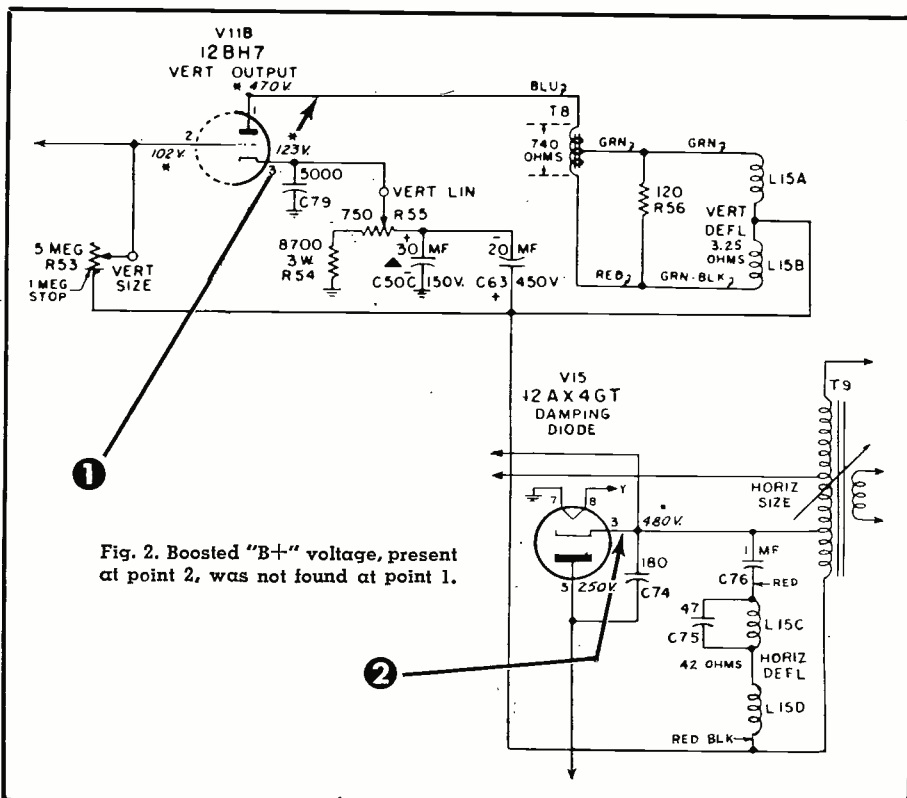

Fig. 2. Boosted "B+" voltage, present at point 2, was not found at point 1.





# LAFAYETTE S 1959 CATALOG

*"Everything in Electronics"*

260 GIANT-SIZED PAGES

*Our 38th Year*

**The Complete Catalog Featuring  
"The Best Buys In The Business"**

FOR THE NEWEST AND FINEST IN  
STEREOPHONIC HI-FI EQUIPMENT AND SYSTEMS

- TAPE RECORDERS ● PUBLIC ADDRESS SYSTEMS
- AMATEUR EQUIPMENT ● INDUSTRIAL SUPPLIES
- MINIATURE COMPONENTS ● RADIO & TV TUBES AND PARTS
- EXCLUSIVE LAFAYETTE TRANSISTOR & HI-FI TUBES

Send for Lafayette's 1959 Catalog -- the most complete, up-to-the-minute electronic supply catalog crammed full of everything in electronics at our customary down-to-earth money-saving prices.

**CONTAINS HUNDREDS OF EXCLUSIVE LAFAYETTE ITEMS NOT AVAILABLE IN ANY OTHER CATALOG OR FROM ANY OTHER SOURCE -- SEND FOR YOUR COPY NOW!**

A "must" for the economy-minded hi-fi enthusiast, experimenter, hobbyist, engineer, technician, student, serviceman and dealer.

*Leaders in Hi-Fi*

The most complete selection and largest stocks of hi-fi components and systems--available for immediate delivery at the lowest possible prices. Save even more on Lafayette endorsed "best-buy" complete systems.

**EASY PAY TERMS** Available on orders over \$45--  
Only 10% down--Up to 18 months to pay

**NEW!**

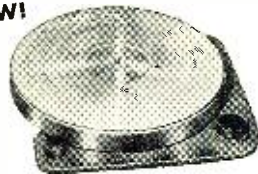

**Lafayette  
TRANSCRIPTION PLAYER  
WITH 3 LB. 12"  
ALUMINUM TURNTABLE**

Professional 4-speed player ideally suited for stereo. Has magnetic eddy-current brake permitting  $\pm 10\%$  speed variation. Amazingly low priced! Shpg. wt., 14 lbs.  
PK-240 .....Net 37.50

**NATIONALLY ADVERTISED  
4-SPEED AUTOMATIC  
RECORD CHANGER**



**NEW GE GC-7  
STEREO  
CARTRIDGE  
WITH  
DIAMOND  
STYLUS**

Famous brand latest model with new GE GC-7 Magnetic Compatible Stereo Cartridge with diamond stylus. Guaranteed to please or money refunded! Regular 69.50 Value! Shpg. wt., 21 lbs.  
PK-251--(less Wood base)  
Net 39.50

**NEW!**

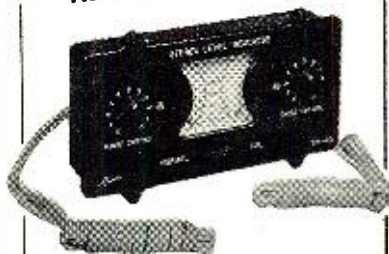

**STEREO BALANCE VU METER**

Dual audio output level indicator with two meters, for comparing audio levels. Ideal for balancing hi-fi stereo systems.  
TM-40 .....Net 8.95

**NEW MINIATURE  
HIGH SENSITIVITY MULTITESTER**  
20,000 OHMS PER VOLT DC -  
10,000 OHMS PER VOLT AC



20,000 ohms per volt DC and 10,000 ohms per volt AC instrument. Hand-held, weighs only 10 oz! Clear plastic face cover. Has 23 most used ranges selected by single switch. With batteries and leads. Shpg. wt., 1 lb.  
AR-660 .....Net 22.50

**NEW!**

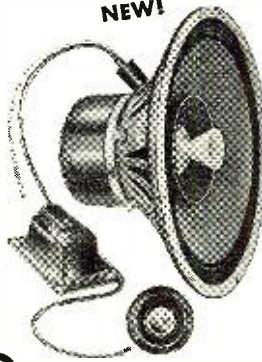

**LAFAYETTE-GOODMANS  
12" 3-WAY SPEAKER**

- 30 WATTS
- FREQUENCY RESPONSE  
30-20,000 CPS
- PLUG-IN 12 DB/OCTAVE  
CROSSOVER NETWORK  
WITH LEVEL CONTROL

Custom-built by Goodmans of England with 1 3/4 lb. Alcomax 3 Magnet. Features axially mounted, free-edged wide range woofer, stiff-coned mid-range radiator and compression-driver tweeter.

SK-110 .....Net 47.50  
Two for Stereo .....Net 89.00

**FREE**

**LAFAYETTE RADIO, Dept. RK  
P. O. Box 511, Jamaica 31, N. Y.**

SEND FOR THE WORLD'S LEADING ELECTRONICS,  
RADIO, T.V., INDUSTRIAL, AND HI-FI GUIDE

Send FREE LAFAYETTE Catalog 599

Name .....

Address .....

City..... Zone.... State.....

JAMAICA, N. Y.  
165-08 Liberty Ave.  
AXtel 1-7000

NEW YORK, N. Y.  
100 6th Ave.  
Worth 6-5300

BOSTON, MASS.  
110 Federal St.  
Hubbard 2-7850

BRONX, N. Y.  
542 E. Fordham Rd.  
FOrdham 7-8813

NEWARK, N. J.  
24 Central Ave.  
MARket 2-1661

PLAINFIELD, N. J.  
139 W. 2nd St.  
PLAINfield 6-4718



KT-500  
IN KIT  
FORM  
**74.50**

# New! Years Ahead!

## LAFAYETTE STEREO TUNER KIT

ONLY  
**\$7.45**  
DOWN  
7.00 MONTHLY



Use it as a Binaural-Stereophonic FM-AM tuner

Use it as a Dual-Monaural FM-AM tuner

Use it as a straight Monaural FM or AM tuner

THE MOST FLEXIBLE TUNER EVER DESIGNED



- MultiFlex Output for New Stereo FM
- 10KC Whistle Filter
- Pre-aligned IF's
- Tuned Cascade FM
- 11 Tubes (including 4 dual-purpose) + Tuning Eye + Selenium rectifier Provide 17 Tube Performance
- Separately Tuned FM and AM Sections
- 12 Tuned Circuits
- Dual Cathode Follower Output
- Armstrong Circuit with FM/AFC and AFC Defeat
- Dual Double-Tuned Transformer Coupled Limiters.

More than a year of research, planning and engineering went into the making of the Lafayette Stereo Tuner. Its unique flexibility permits the reception of binaural broadcasting (simultaneous transmission on both FM and AM), the independent operation of both the FM and AM sections at the same time, and the ordinary reception of either FM or AM. The AM and FM sections are separately tuned, each with a separate 3-gang tuning condenser, separate flywheel tuning and separate volume control for proper balancing when used for binaural programs. Simplified accurate knife-edge tuning is provided by magic eye which operates independently on FM and AM. Automatic frequency control "locks in" FM signal permanently. Aside from its unique flexibility, this is, above all else, a quality high-fidelity tuner incorporating features found exclusively in the highest priced tuners.

FM specifications include grounded-grid triode low noise front end with triode mixer, double-tuned dual limiters with Foster-Seeley discriminator, less than 1% harmonic distortion, frequency response 20-20,000 cps  $\pm$  1/2 db, full 200 kc bandwidth and sensitivity of 2 microvolts for 30 db quieting with full limiting at one microvolt. AM specifications include 3 stages of AVC, 10 kc whistle filter,

built-in ferrite loop antenna, less than 1% harmonic distortion, sensitivity of 5 microvolts, 8-kc bandwidth and frequency response 20-5000 cps  $\pm$  3 db.

The 5 controls of the KT-500 are FM Volume, AM Volume, FM Tuning, AM Tuning and 5-position Function Selector Switch. Tastefully styled with gold-brass escutcheon having dark maroon background plus matching maroon knobs with gold inserts. The Lafayette Stereo Tuner was designed with the builder in mind. Two separate printed circuit boards make construction and wiring simple, even for such a complex unit. Complete kit includes all parts and metal cover, a step-by-step instruction manual, schematic and pictorial diagrams. Size is 13 3/4" W x 10 3/8" D x 4 1/2" H. Shpg. wt., 22 lbs.

The new Lafayette Model KT-500 Stereo FM-AM Tuner is a companion piece to the Models KT-300 Audio Control Center Kit and KT-400 70-watt Basic Amplifier Kit and the "Triumvirate" of these 3 units form the heart of a top quality stereo hi-fi system.

KT-500 ..... Net **74.50**  
LT-50 Same as above, completely factory wired and tested..... Net **124.50**



KT-600  
**79.50**  
IN KIT  
FORM

ONLY **7.95** DOWN —  
8.00 MONTHLY

- UNIQUE STEREO & MONAURAL CONTROL CENTER FACILITIES!
- OUTSTANDING PERFORMANCE SUPERIORITY!
- AMAZING NEW BRIDGE CIRCUITRY & CONTROL FOR 3d CHANNEL OUTPUT FOR 3-SPEAKER STEREO SYSTEMS!
- VARIABLE CROSS-CHANNEL SIGNAL FEED ELIMINATES "PING-PONG" EFFECTS!
- PRECISE "NULL" BALANCING & CALIBRATING SYSTEM — BETTER THAN METERS!
- 24 EQUALIZATION POSITIONS PER CHANNEL!
- CLUTCH-TYPE DUAL VOLUME-BALANCE CONTROLS!

## NEW! LAFAYETTE PROFESSIONAL STEREO MASTER AUDIO CONTROL CENTER

### The Lafayette KT-600 Solves Every Stereo/Monaural Control Problem!

- RESPONSE 10-25,000 CPS  $\pm$  0.5 DB
- TAPE HEAD PLAYBACK EQUALIZATION FOR NEW 4-TRACK STEREO
- 1.78 MILLIVOLTS SENSITIVITY FOR 1 VOLT OUT
- LESS THAN .03% IM DISTORTION
- 6 CONCENTRIC FRONT PANEL CONTROLS
- 4 CONCENTRIC REAR PANEL INPUT LEVEL CONTROLS
- 180° ELECTRONIC PHASE REVERSAL

**A REVOLUTIONARY DEVELOPMENT IN STEREO HIGH FIDELITY.** Provides such unusual features as a Bridge Control, for variable cross-channel feed for elimination of "ping-pong" (exaggerated channel separation) effects and for control of a 3d-channel output for 3-speaker stereo systems; the 3d-channel output also serves for converting stereo program material to high quality monaural for recording or to play a stereo program monaurally through a separate amplifier and speaker system. The KT-600 also has full input mixing of monaural program sources (such as tape recorder and phonograph, etc.), a special "null" stereo balancing and calibrating system (better than meters), 24 equalization positions per channel, 12 db per octave rumble and scratch filters, and a loudness on-off switch. Has clutch-type dual concentric volume controls which operate independently for balancing or simultaneously as the Master Level Control. Other features include channel reverse, 180° phase reversal, input level controls at all inputs. Sensitivity is 1.78 millivolts for 1 volt out. Dual low impedance outputs ("plate followers," 1300 ohms) are provided. Frequency response is 10-25,000 cps  $\pm$  0.5 db; less than .03% IM distortion. Uses 7 new 7025 low-noise dual triodes. Size 14" x 4 1/2" x 10 3/8". Shpg. wt., 16 lbs. Complete with printed circuit board, modern-styling metal chassis and cage, profusely illustrated instructions, all necessary parts.

LAFAYETTE KT-600 Stereo Preamplifier Kit ..... Net **79.50**



KT-310

ONLY **4.75** DOWN  
5.00 MONTHLY

**47.50**

## NEW! LAFAYETTE STEREO/MONAURAL BASIC POWER AMPLIFIER KIT

- 36-WATT STEREO AMPLIFIER—18-WATTS EACH CHANNEL
- FOR OPTIONAL USE AS 36-WATT MONAURAL AMPLIFIER
- EMPLOYS 4 NEW PREMIUM-TYPE 7189 OUTPUT TUBES
- 2 PRINTED CIRCUIT BOARDS FOR NEAT, SIMPLIFIED WIRING
- RESPONSE BETTER THAN 35-30,000 CPS  $\pm$  1/2 DB AT 18 WATTS
- LESS THAN 1% HARMONIC OR INTERMODULATION DISTORTION

A superbly-performing basic stereo amplifier, in easy-to-build kit form to save you lots of money and let you get into stereo now at minimum expensel Dual inputs are provided, each with individual volume control, and the unit may be used with a stereo preamplifier, for 2-18 watt stereo channels or, at the flick of a switch, as a fine 36-watt monaural amplifier — or, if desired, it may be used as 2 separate monaural 18-watt amplifiers! CONTROLS include 2 input volume controls, channel Reverse switch (AB-BA), Monaural-Stereo switch. **DUAL OUTPUT IMPEDANCES** are: 4, 8, 16 and 32 ohms (permitting parallel (monaural) operation of 2 speaker systems of up to 16 ohms. **INPUT SENSITIVITY** is 0.45 volts per channel for full output. **TUBES** are 2-6AN8, 4-7189; GZ-34 rectifier. **SIZE** 9-3/16" d (10-9/16" with controls) x 5 1/4" h x 13 1/4" w. Supplied complete with perforated metal cage, all necessary parts and detailed instructions. Shpg. wt., 22 lbs.

KT-310 Stereo Power Amplifier Kit ..... Net **47.50**

**LAFAYETTE RADIO** DEPT RK  
165-08 Liberty Ave. JAMAICA 33; N. Y. Write for FREE Bargain Packed Catalog!  
PLEASE INCLUDE POSTAGE WITH ORDER

100 SIXTH AVE., NEW YORK, N. Y.  
BOSTON, MASS., 110 Federal St.  
PLAINFIELD, N. J., 139 West 2nd St.  
NEWARK, N. J., 24 Central Ave.  
BRONX, N. Y., 542 E. Fordham Rd.



# NEW! LAFAYETTE "STEREO" HI-FI PHONO MUSIC SYSTEM

AN IDEAL QUALITY SYSTEM FOR LISTENING

TO THE NEW HIGH-REALISM STEREO SOUND!

For Stereo & Monaural Reproduction

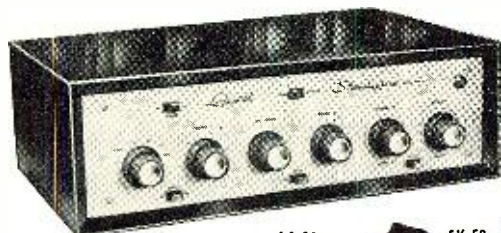

LA-90



RC121/11



of the unbeatable, for performance-value, Lafayette SK-58 12" coaxial speakers with built-in crossover network and brilliance level control. Supplied complete with cables, connectors, and easy-to-install instructions. Shpg. wt., 66 lbs.



CAB-16

NEW GE GC-7 STEREO COMPATIBLE CARTRIDGE WITH DIAMOND STYLUS

automatic record changer ready to accept stereo cartridges, the Lafayette PK-111 wood base for changer, of fine selected woods; the new GE GC-7 stereo/monaural variable reluctance cartridge with 0.7 mil genuine GE diamond stylus; and 2

### COMPONENTS

Lafayette LA-90 28-Watt Stereo Amplifier	72.50
Garrard RC121/11 Changer	41.65
Lafayette PK-111 Wood Base	3.95
GE GC-7 Stereo Magnetic Cartridge	23.47
2-Lafayette SK-58 Coaxial 12" Speakers	59.00
<b>Total Reg. Price</b>	<b><del>200.57</del></b>

**YOU PAY ONLY 167.50—SAVE 33.07!**

- HF-374 Stereo Phono System, with mahogany or blonde wood changer base (please specify) ..... Net **167.50**  
 HF-375 Same as HF-374 but with 2-Lafayette CAB-16 mahogany or walnut or CAB-17 blonde Resonator-type speaker enclosures (specify which) ..... Net **222.50**

### LAFAYETTE STEREO FM/AM-PHONO MUSIC SYSTEM

Same as HF-374 above but with new Lafayette stereo Model LT-99 FM/AM Tuner.

- HF-376 Stereo FM/AM-Phono System ..... Net **237.00**  
 HF-377 Same as HF-376 but with 2-Lafayette CAB-16 mahogany or walnut or CAB-17 blonde speaker enclosures ..... Net **292.00**

**ONLY 16.75 DOWN  
12.00 MONTHLY**

## LAFAYETTE MASTER AUDIO CONTROL CENTER

with BINAURAL CHANNEL AND DUAL VOLUME CONTROL.

- Self-Powered
- DC On All Filaments
- 24 Positions of Equalization
- Tape Head Input, High Impedance
- Dual Cathode Follower Output Stages

This is not only the finest hi-fi preamp characterized by unmatched features, but it has been functionally designed to keep pace with the conversion of your present hi-fi system to binaural (Stereophonic) sound. Incorporates an extra channel and dual volume control for binaural reproduction. Features include DC on all tube filaments, negative feedback in every stage, dual cathode follower output stages and latest printed circuit construction. Less than 0.09% IM distortion and less than 0.07 harmonic distortion at 1V. Hum and noise level better than 80 db below 3V. Uniformly flat frequency response over entire audible spectrum. 7 inputs for every type of phono, tuner or tape. Tasteful styling, brilliantly executed. Size 12 3/4" x 9 1/8" x 3 3/4". Shpg. wt., 10 1/2 lbs.

- KT-300—Lafayette Master Audio Control Kit Complete with cage and detailed assembly instructions. .... Net **39.50**  
 LT-30—Same as above completely wired and tested with cage and instruction manual. .... Net **59.50**

### DELUXE 70 WATT BASIC AMPLIFIER

• Conservatively Rated At 70 Watts • Inverse Feedback • Variable Damping  
 • Metered Balance And Bias Adjust Controls • Available In Kit and Wired Form  
 Here's ultra-stability in a 70 watt basic power amplifier employing highest quality components conservatively rated to insure performance and long life. Features matched pair KT 88's and wire range linear Chicago output transformer, variable damping control, meter for bias and balance and gold finish chassis. Frequency response 10-100,000 cps  $\pm$  1db. Hum and noise 90 db below full output. IM distortion less than 1 1/2% at 70 watts, less than 0.3% below 30 watts. Harmonic distortion less than 2% at 70 watts from 20 to 20,000 cps  $\pm$  1 db. Output impedance 4, 8 and 16 ohms. Handsome decorative cage perforated for proper ventilation. Size 14 1/2" x 10" x 7 3/8" including cage and knobs. Shpg. wt., 40 lbs.

- KT-400—Lafayette 70 watt Deluxe Basic Amplifier Kit complete with cage and detailed assembly instructions. .... Net **69.50**  
 LA-70—Same as above completely wired and tested with cage and instruction manual. .... Net **94.50**



**KT-300  
IN KIT  
FORM  
39.50**



**KT-400  
IN KIT  
FORM  
69.50**

**ONLY 6.95  
DOWN  
7.00 MONTHLY**

## NEW! LAFAYETTE STEREO AMPLIFIER KIT

- 4 WATTS STEREO OUTPUT
- COMPLETE STEREO CONTROLS



Brand new stereo amplifier kit for that extra small stereo hi-fi set, featuring separate volume controls; ganged tone control; stereo, reverse and monaural switch. 40 millivolt sensitivity! Complete kit with tubes, rectifier, all parts and instructions. Only 9 1/2" x 5" x 4 1/2". For 110-120 60 cycle AC. Shpg. wt., 7 lbs.

KT-126 — Complete Kit ..... Net **18.95**

### COMBINATION MONEY SAVER

The KT-126 Stereo Amplifier kit and the new Ronette QV Stereo Turnover Cartridge with dual sapphire styli.

KT-136 ..... **24.90**

**Only  
18.95**

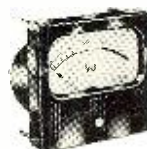

### ILLUMINATED SCALE VU METER

- 3 1/8" SQUARE
- JEWELLED BEARINGS
- 25-16,000  $\pm$  1/2 db
- D'ARSONVAL MOVEMENT

Standard 7500 ohm (with 3600 ohm external resistor supplied) "B" scale volume indicator calibrated in 0-100% and -20 to +3 VU. Accurate to  $\pm$  0.2 VU from 35 to 10,000 cps,  $\pm$  0.5 VU from 25 to 16,000 cps (0 VU corresponds to 100%). Soft, non-glare illumination supplied by two built-in 6-8 volt bulbs. Dynamic and damping characteristics conform to standard VU meter practice—99% of final reading reached in 0.3 second with suddenly applied sine wave, overshoot of 1 to 1 1/2%. 3 1/8" square, 1-11/16" depth, 2-9/16" dia. mtg. hole. Shpg. wt., 1 lb.

TM-80 Volume Unit Meter ..... Net **7.50**

*Lafayette Radio*

165-08 LIBERTY AVE.  
JAMAICA 33, N. Y.

Dept. RK

NEW YORK, N. Y.  
100 6th Ave.  
Worth 6-5300

BOSTON, MASS.  
110 Federal St.  
Hubbard 2-7850

BRONX, N. Y.  
542 E. Fordham Rd.  
Fordham 7-8813

NEWARK, N. J.  
24 Central Ave.  
Market 2-1661

PLAINFIELD, N. J.  
139 W. 2nd St.  
Plainfield 6-4718

PLEASE INCLUDE POSTAGE WITH ORDER



# A Faster Way to Reach the Top in TV Servicing



You get 17" Picture Tube, all components for Television Receiver, 5" Oscilloscope, Signal Generator as part of NRI's Professional TV Servicing training

## NRI All Practice Method Trains You in Spare Time to Fix TV Sets Quickly, Correctly, Confidently.

If you know basic theory, either from Radio or TV experience or training, NRI's Professional TV Servicing Course can train you to go places faster. This is 100% learn-by-doing, practical training. You learn how experts diagnose defects quickly. You get actual experience aligning Television receivers, discovering causes of complaints from scope patterns, learn to know the causes of defects, audio or video; accurately, easily . . . and how to fix them.

### NRI IS THE OLDEST AND LARGEST HOME STUDY TV-RADIO SCHOOL

Over 40 years' experience and the record and reputation of NRI back up this learn-by-doing Professional TV course. TV servicing has only started to grow. New sets, new developments, portables, color TV make this a golden opportunity for the man who is trained to service sets quickly and correctly.

#### COLOR TV BOOK SENT EARLY

Soon after you enroll you also get color TV lesson with illustrations in full color. This course is not for beginners, but for men who realize the need for planned practical training so they can keep up with new developments—get ahead faster. Mail coupon today. NATIONAL RADIO INSTITUTE, Dept. 8 MET Washington 16, D. C.

#### SEND for FREE BOOK

NATIONAL RADIO INSTITUTE  
Dept. 8 MET Washington 16, D. C.

Please send me FREE copy of "How to Reach the Top in TV Servicing." I understand no salesman will call.

Name \_\_\_\_\_ Age \_\_\_\_\_

Address \_\_\_\_\_

City \_\_\_\_\_ Zone \_\_\_\_\_ State \_\_\_\_\_

Accredited Member National Home Study Council

## Indoor P.A. Systems (Continued from page 56)

Each section of the audience area has to be dealt with separately. First there is the main floor area, with plenty of room upwards. This is easy to fill. Then there may be spaces between levels: on the ground floor under the balcony and then successive balcony areas. These are narrower spaces, at least toward the front, although they sometimes open out farther back. This means that not enough sound will get through the frontal opening to fill the entire area. Extra speakers are needed to fill these "dead" spots in the auditorium.

### Power Requirements

The kind of speaker and the power it needs will depend on the volume of space to be filled and how reverberant it is. The main floor, for example, may have carpeted floor and upholstered

Working in ten-foot units each way,  $4 \times 6 \times 4 = 96,000$  or, roughly, 100,000 cubic feet. Here we can use high-efficiency units, because space is not restricted and the absorbcency is "normal." Thus, this area requires about 10 watts, at .1 watt per thousand cubic feet.

The rear of the main floor is an average of 30 feet high, 35 feet from front-to-back, and 60 feet wide. This figures to  $3 \times 3.5 \times 6 = 63,000$  cubic feet. As space is a little restricted, smaller units of the medium-efficiency type must be used. This area requires .3 x 63 or about 20 watts.

The lower balcony averages about 20 feet high with the other dimensions the same. This is  $2 \times 3.5 \times 6 = 42,000$  cubic feet, requiring about .3 x 42 or 12.6 watts—say, 15 watts to allow a margin.

The top balcony area is non-absorbent. Medium-efficiency units can still be used. Average height is again about 20 feet with the same dimensions the other ways. So this 42,000 cubic feet

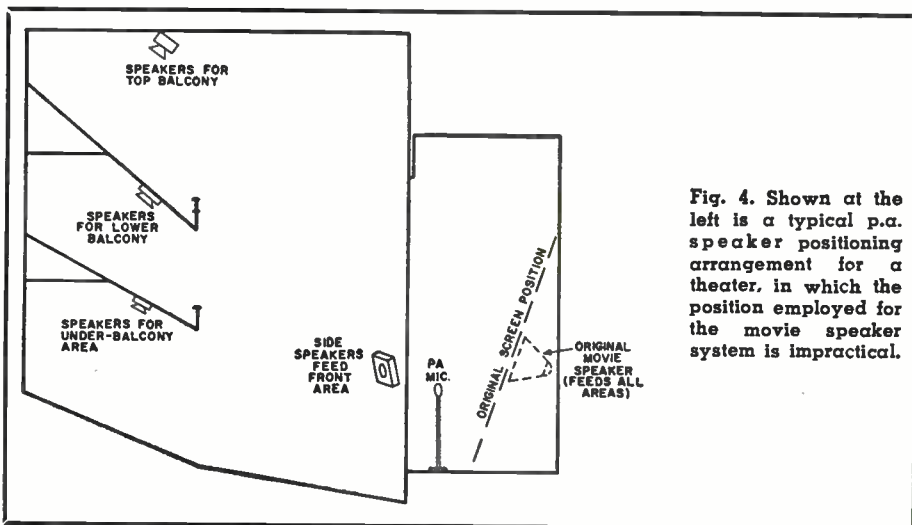

Fig. 4. Shown at the left is a typical p.a. speaker positioning arrangement for a theater, in which the position employed for the movie speaker system is impractical.

seats, with acoustically "dead" walls, while the balcony levels may have bare wooden seats and untreated walls. More power will be needed on the main floor to provide the same volume level as that available in the balcony. Too much power in the balcony could upset the whole installation.

Table 1 is included to help the p.a. man determine over-all power requirements. The technique can be demonstrated, using the installation diagrammed in Fig. 4 as an example. First work out the volumes to be fed by each group of speakers.

The front area is, say, 40 feet from the stage to the front of the balcony overhang, 60 feet wide, and we can estimate the "ceiling" height as 40 feet, although the true ceiling is actually almost 80 feet above the main floor.

needs about .1 x 42 or 4.2—say—5 watts for adequate coverage.

Now we merely total the powers to find the amplifier requirement:  $10 + 20 + 15 + 5 = 50$  watts. This is a fairly complicated installation. Smaller ones will be correspondingly easier to assess. In this installation, the front loudspeakers could be of the fairly large enclosure type, using high-efficiency, unitized loudspeaker units. The loudspeakers at the rear of the main floor can be either smaller cabinet types or the bowl type which is very useful in this kind of location. Both these fall into the medium-efficiency group. If you have to use really small cabinet types—say, an 8" unit in a box 12" x 12" x 8" because of space limitations, this will be quite low efficiency.

Another important question is how

SPEAKER EFFICIENCY	KIND OF SURFACE		
	HARD	MEDIUM	ABSORBENT
Low	.3	.1	.3
Medium	.1	.3	.1
High	.03	.1	.3

Table 1. Amplifier power (in watts) per 1000 cubic feet of volume.



### 110V AC to 110V DC RECTIFIER & CHARGER



Manufactured by  
Halicrafters

INPUT: 95 to 125V 50-60 cycle AC, or 190 to 220V 50-60 cycle AC.  
OUTPUT: 110V DC up to 400 Ma.; 115V AC up to 4.35 Amps. This unit is ideal for Garages, Gas Stations, Auto Supply Stores, to maintain a series of batteries on display. Also fine for Research Labs, Engineers, Manufacturers, operate DC Teletype Equipment, etc. A TERRIFIC BUY AT OUR SMASHING LOW **\$11.95** PRICES! Like New.....\$14.95

### AN/APN-9 LORAN SYSTEM



**TERRIFIC BUY!**  
Value \$1200  
OUR PRICE  
**\$89.50**

Used in ships and aircraft. Determines position by radio signals from known xmitters. Accurate to within 1% of distance. Complete with tubes and crystal. Exc. used.



### LORAN APN-4 FINE QUALITY NAVIGATIONAL EQUIPMENT

Determine exact geographic position of your boat or plane. Indicator and receiver complete with all tubes and crystal.  
INDICATOR ID-6B/APN-4, and RECEIVER R-9B/APN-4, BRAND NEW, only **\$48.49**  
Complete Kit of Accessories for Above, PE-206 Inverter, Set of Plugs, Visor for Indicator, Operation Manual, ALL BRAND NEW..... **\$49.50**

**SPECIAL** APN-9A LORAN Receiver Indicator, less tubes, NEW (demilitarized)..... **\$24.50**



### LORAN APN/4 OSCILLOSCOPE

Easily converted for use on radio-TV service bench.  
Completely Assembled  
BRAND NEW! Supplied with 5" Scope, type 5CP1 only  
Excellent. Used..... **\$19.95**  
..... **\$10.95**

### TS-100/AP OSCILLOSCOPE \$3333 (worth \$750) OUR LOW PRICE

Can be used with linear sweep or general purpose test scope. Cables included. Also used with circular sweep as precision range calibrator. Self-contained in metal case 8" x 12 1/2" x 16" deep. For 110 V 50 to 1200 cycles AC. Excellent used. Like new, with all tubes including crystals and C. R. Tube.

**DYNAMIC HANDMIKE**, with "Press-to-talk" Switch, cord and plug—BRAND NEW, only..... **\$2.95**

**DYNAMIC HANDMIKE**, aircraft, made by Telephonics Corp. Press-to-talk switch. BRAND NEW..... **\$4.95**

**DYNAMIC HEADPHONES**, 600-ohm impedance, with large earphone cushions, cord and phone plug. BRAND NEW, special..... **\$3.95**

**Hi-Fi DYNAMIC HEADSET with Cushions**  
Freq. Range: 40-14000 CPS. No Distortion.  
BRAND NEW..... **\$7.95**

### MICROPHONES

Model	Description	Used	BRAND NEW
T-17	Carbon Hand Mike	\$.45	\$.75
T-30	Carbon Throat Mike	.39	.79
T-45	Army and Navy Lip Mike	1.33	5.95
T-24	Carbon Mike	3.88	
TS-9	Handset	2.79	4.95
RS-38	Navy Type		

### HEADPHONES

Model	Description	Used	BRAND NEW
HS-23	High Impedance	\$2.25	\$4.75
HS-33	Low Impedance	2.79	4.75
HS-30	Low Imp. (featherwt.)	1.25	1.99
H-16/U	High Imp. (2 units)	3.75	7.95

TELEPHONICS—600 ohm Low Impedance HEADSETS—BRAND NEW, PER PAIR..... **\$3.45**  
CD-307A Cords, with PL65 plug and JK26 Jack..... **.99**  
Earphone Cushions for above—pair..... **.50**



**BC-221 FREQUENCY METER**  
SPECIAL BUY! This excellent frequency standard is equipped with original calibration charts, and has ranges from 125 Kc to 20,000 Kc with crystal check points in all ranges. At our smashing low price it's FIRST COME FIRST SERVED! Hurry, quantity is limited! Like New..... Only **\$88.88**  
BC-221 Modulated Type..... **\$129.50**

**CABINET** for above BC-221..... **\$3.99**  
Original 1000 Kc Crystal for BC-221..... **\$8.45**

### BC-652A RECEIVER

Hot Special! 2 to 6 Mc Receiver, 2-band, complete with all tubes and 12V dynamotor. Fine for 80-meter Ham band. Marine etc. Provides for CW, M.V.C. AVC. Speaker jack and two head-phone jacks. Like New, only..... **\$29.50**

### BC-645 XMTR RECEIVER

**15 Tubes 435 To 500 MC**  
Can be modified for 2-way communication, voice or code, on ham band 420-450 mc. can transmit radio 460-470 mc. fixed and mobile 450-460 mc. television experimental 470-500 mc. 15 tubes (tubes alone worth more than sale price!): 4-7F7, 4-7H7, 2-7E6, 2-6F6, 2-955 and 1-WE316A. New cover 460 to 490 mc. Brand new BC-645 with tubes, less power supply in factory carton, **\$29.50**  
Shipping weight 25 lbs.  
PE-101C DYNAMOTOR for BC-645, has 12-24V input (easy to convert for 6V Battery operation)..... **\$7.95**  
UHF ANTENNA ASSEMBLY, for BC-645..... **\$2.45**  
Complete set of 10 Plugs for BC-645..... **\$5.50**  
CONTROL BOX for above..... **\$2.25**  
SHOCK MOUNT for above..... **1.25**  
CONVERSION BOOKLET, Instructions..... **\$2.50**  
for most useful surplus rigs



### NEW VALUES—JUST ARRIVED!

**BC-348 SUPERHET RECEIVER**. Locally controlled 8-tube 6-band receiver for aircraft, communications type, for voice, tone and CW 200 to 500 Kc and 1.5 to 18 Mc. For operation on 24 V DC with self-contained dynamotor. Complete with tubes.  
Exc. used..... **\$88.88**

**AN/ARN-7 AIRCRAFT NAVIGATIONAL INSTRUMENT**. Superhet radio receiver. Range 100 Kc to 1750 Kc in 4 bands.  
Exc. used..... **\$79.50**

**AR/ARN-6 RADIO COMPASS EQUIPMENT**. Frequency 100 to 1750 Kc in 4 bands. 24 V DC operation.  
Exc. used..... **\$119.50**  
BRAND NEW..... **\$169.50**

**BC-733 VHF 10-TUBE AIRCRAFT RECEIVER**. 6-channel xtal control. Freq. 108.3 to 110.3 Mc. Dual filter range. Easily converted for tracking Sputniks!  
Exc. used..... **\$9.95**  
BRAND NEW..... **\$12.95**  
Dynamotor for above 12/24 V.—New **\$9.95**

**AN/APR-4 RECEIVER** only. 38 to 4000 Mc in 5 tuning unit ranges. High precision laboratory instrument used to monitor or indicate frequency of any signals within its range. Includes wide and narrow band IF strip selected from panel. Outputs provided for attachments to pulse analyzer, panadapter, etc.  
Input 115 V 60 cy. BRAND NEW..... **\$69.50**  
Tuning Units for above—each..... **\$39.50**

**RDO RECEIVER**—70 Mc to 1000 Mc. Uses 3 tuning units covering entire range. High quality precision Navy search rev, like APR-4, but with extra features: sig. strength DB meters, audio output metering, noise limiter, etc. Operates on 110 V 60 cy. AC. Complete with tuning units.  
SPECIAL **\$139.50**

**AN/ARC-1 Airborne radiophone ground to plane Rev. Xmitter**, 12-channel xtal controlled, easily converted to 20 or 50 channel, VHF 100 to 156 Mc AM. Complete with tubes, mtg rack, dynamotor. OUR LOW PRICE **\$89.50**  
Exc.

**AN/ARN-5A AIRCRAFT RECEIVER**. 11 tube superhet, 3-crystal control UHF for static-free reception.  
Exc. used with tubes..... **\$16.95**  
BRAND NEW..... **\$19.95**

### SCR-522 2-METER RIG!

Terrific buy! VHF Transmitter-receiver, 100-156 Mc. channels. Xtal-controlled. Amplitude modulated voice. They're going fast! Excellent condition.  
SCR-522 Transmitter-Receiver, complete with all 18 tubes, top rack and metal case..... **\$33.33**  
COMBINATION..... Special **\$19.50**  
Receiver only, with all tubes..... **\$22.25**  
Transmitter Only, with all tubes..... **\$22.25**  
Accessories for above available.

**BC-620 FM TRANSCEIVER**, 20-28 Mc. **\$9.95**  
BRAND NEW  
**PE-120 6-12V POWER SUPPLY**, with Tubes and Vib. NEW..... **\$11.95**  
Shock Mt. Rack, NEW..... **\$2.95**

**SCHEMATIC DIAGRAMS** For any equipment on this page, each..... **65c**

Please include 25% Deposit with order—Balance C.O.D. 50c Handling charge on all orders under \$5.00. All shipments F.O.B. Our Warehouse, N.Y.C.

**G & G Radio Supply Co.**  
Telephone: CO 7-4605  
51 Vesey St., New York 7, N. Y.

### ARC-5/R28 RECEIVER

2-meter Superhet. 100 to 156 Mc in 4 crystal channels. Complete with **\$24.45**  
10 Tubes. BRAND NEW..... **\$24.45**  
110V AC Power Supply Kit for above..... **\$9.75**



### ARC-5/T-23 TRANSMITTER

100-150 Mc Includes 2-832A, 2-1625 Tubes. **\$21.50**  
BRAND NEW.....  
Largest quantity ARC-5/T-23 Transmitters.  
SPECIAL BRAND NEW, less tubes..... **\$7.95**  
OFFER! Excellent Used, less tubes..... **\$5.95**

### ARC-5 MARINE RECEIVER-TRANSMITTER

Navy Type Comm. Receiver 1.5 to 3 Mc **\$16.95**  
BRAND NEW with 6 tubes.....  
Navy Type Comm. Transmitter 2.1-3 Mc **\$12.45**  
BRAND NEW with 4 tubes and Xtal.....  
MODULATOR for above, new with tubes..... **\$4.95**

**BC-603 FM RECEIVER**. 10-channel push button tuning or continuous tuning. 20-28 Mc. Complete with speaker, tubes, squelch. **\$10.95**  
Exc. used..... **\$14.95**  
BRAND NEW..... **\$14.95**  
12 or 24V Dynamotor for Above Brand New **\$5.50**  
Exc. Used \$4.25

**BC-683 same as above except 27 to 38.9 Mc.** **\$19.50**  
BRAND NEW..... **\$24.95**

**AC POWER SUPPLY** for BC603, 683. Interchangeable, replaces dynamotor. No rev. change except add on-off switch to front panel. Provides 220VDC @ 80 Ma, 24VAC @ 2 Amps. Complete. **\$10.50**  
Kit, with easy instructions.....

**ARB Receiver** 4 band 195-9050 Kc. **\$19.50**  
with all Tubes, Exc., Used.....  
Brand New, with Tubes and Dynamotor..... **\$34.50**

### SCR-274 COMMAND EQUIPMENT

ALL COMPLETE WITH TUBES Like New  
Type Description Used \$16.95  
BC-453 Receiver 190-550 KC..... **\$14.95**  
BC-454 Receiver 3-6 Mc..... **9.95**  
BC-455 Receiver 6-9 Mc..... **10.95**  
BC-450 3-Receiver Control Box..... **1.49**  
1.95

**140 Volt AC Power Supply Kit**, for all 274-N and ARC-5 Receivers. Complete with metal **\$7.95**  
case, instructions..... **\$11.50**  
Factory wired, tested, ready to operate.....  
**SPLINED TUNING KNOB** for 274-N and ARC-5 RECEIVERS. Fits BC-453, BC-454 and others. Only..... **49c**

**BC-457 TRANSMITTER**—4.5-3 Mc. complete with all tubes and crystal. BRAND NEW..... **\$7.88**

**BC-458 TRANSMITTER**—5.3 to 7 Mc. Complete with all tubes and crystal. BRAND NEW..... **\$7.88**

**BC-459 TRANSMITTER**—7-9.1 Mc. complete with all tubes and crystal. BRAND NEW..... **\$12.95**

**ARC-5/T-19 TRANSMITTER**—3 to 4 Mc. BRAND NEW complete with all tubes & crystal..... **\$8.88**

**BC-456 Modulator**..... USED **3.25** NEW **4.95**  
**BC-451 Transmitter Control Box**..... 1.25 NEW **1.49**

**POWER SUPPLY KIT** For All Command Transmitters Input: 117V 60 cycles AC. Outputs: 450 V DC @ 150 Ma., 250 V DC @ 80 Ma., 24 V DC @ 2 Amps. Specially designed for Command Xmitter power requirements, but can be used on other similar equipment. Carefully designed, uses quality components. A really substantial, good-looking unit, very low priced!..... **\$29.50**

### BC-442 ANTENNA RELAY

Wonderful Value! Consists of 3/4 amp 2" RF Ammeter (antenna current indicator), 0-10 scale Transmitter-Receiver Switching relay, in aluminum case with associated components. BRAND NEW..... **\$2.49**



Type	Each	Type	Each	Type	Each
2C42	\$4.95	VR150	.79	826	.44
5D21	4.50	807	1.19	828B	7.50
8K65	7.25	813	6.99	829A	5.95
VR105	.75	815	2.99	8CP1	2.45
				SFP7	1.44

### MOBILE-MARINE DYNAMOTOR

Input 12V DC, Output: 625 V DC @ 225 Ma. for press-to-talk intermittent operation. Shpg. wt. 14 lbs. **\$9.95**



OUR LOW PRICE..... **\$9.95**

OTHER DYNAMOTOR VALUES: Excellent BRAND NEW

Type	Input	Output	Used	BRAND NEW
DA-19-A	28V 11A	400V 400A	\$4.99	\$6.95
DM-28	28V	224V .07A	2.95	4.95
DM-32A	28V 1.1A	250V .05A	2.95	5.95
DM-33A	28V 5A	575V .16A		
	28V 7A	540V .25A	1.95	3.95
DM-34D	12V 2A	220V .080A	4.25	5.50
DM-37	25.5V 9.2A	625V .225A	5.95	8.95
DM-40	14V 3.4A	172V .138A	1.75	3.45
DM-53A	28V 1.4A	220V .080A	3.95	5.95
PE-73C	28V 20A	1000V .350A	8.50	11.50
PE-86	28V 1.25A	250V .050A	2.95	5.24
PE-186	28V 11A	400V .400A		6.95
2880	14V 2.4A	250V .060A		5.95

FL-5 FILTER..... **79c**

### WILLARD 6-VOLT MIDGET STORAGE BATTERY

3 Amp. Hour. BRAND NEW. 3 5/8" x 1-13/16" x 2 3/8". Uses Standard Electrolyte..... Only **\$2.69**



### 2 VOLT BATTERY "PACKAGE"

1-2V, 20 Amp. Hr. Willard Storage Battery..... **\$2.79**  
1-2V 7 prong Synchronous Plug-in Vibrator..... **1.49**  
1-Quart Bottle Electrolyte (for 2 cells)..... **1.45**  
ALL BRAND NEW!  
Combination Price..... **\$5.45**





# It pays to SPECIALIZE!

Let these Rinehart how-to-do-it books train you for good pay in specialized fields

These famous Rinehart books are complete, easy to understand, fully authentic. Start your training with them at home today for more interesting work and bigger pay.

## HOW TO GET THE MOST OUT OF HIGH FIDELITY



**1** HIGH FIDELITY TECHNIQUES by John H. Newitt is a 494-page guide for hobbyists, servicemen and custom builders. Shows how to get better hi-fi results at less cost; how to service hi-fi results at less cost; techniques and methods and is crammed full of construction tips and ideas. 203 illustrations. Price \$7.50.

Get top notch hi-fi results ... at minimum cost!

## BE AN EXPERT ON MAGNETIC RECORDING



**2** MAGNETIC RECORDING by S. J. Begun covers every phase of wire and tape recording equipment, components, measurements and application—from high fidelity work to broadcasting, from movies to industrial installations, secret communications and all the rest. 146 illustrations help make every step absolutely clear. Price \$5.00.

## REPAIR ANY HOME ELECTRICAL APPLIANCE



**3** This 370-page Rinehart ELECTRICAL APPLIANCE SERVICE MANUAL brings you complete, easy repair instructions for practically every appliance used in modern homes. Even includes appliance refinishing methods. Gives you the "know how" to add a profitable sideline to your radio-TV service ... or to build a full-time appliance repair business. An ideal book for home owners! Price \$5.00.

## LEARN TO FIX OR REWIND ANY ELECTRIC MOTOR



**4** Train for something really different! This giant 560-page ELECTRIC MOTOR REPAIR guide opens a fascinating big pay field, even to beginners. Covers all repairs PLUS complete rewinding of practically every AC or DC motor or generator ... also motor controls. Approved by instructors, repair specialists and unions. Price \$6.95.

Over 100,000 copies in use!

## LEARN TO USE INSTRUMENTS BETTER AND FASTER!



**5** BASIC ELECTRONIC TEST INSTRUMENTS helps you work better and faster on service jobs. Shows how to put old instruments to new uses; teaches you to interpret readings, etc. A complete, fully understandable instrument training course. Explains over 60 instruments including the latest types ... outlines work-saving shortcuts. 254 pages. Price \$4.95.

## STUDY 10 DAYS FREE!

Dept. RN-118, RINEHART & CO., Inc., 232 Madison Ave., New York 16, N. Y. Send following book or books for 10-DAY FREE EXAMINATION. (Circle the books you want):

1 2 3 4 5

In 10 days, I will either remit price indicated above for each book (plus postage) or return book to you and owe nothing. (SAVE! Send cash with order and we pay postage. Same 10 day return privilege with money refunded.)

Name .....

Address .....

City, Zone, State .....

OUTSIDE U.S.A.—Add 50c for each book to cover handling. Cash with order. Money refunded if you return books in 10 days.

many units to use to feed an area. The easiest way to answer this is: use as many as needed to maintain uniform coverage. Of course, convenient mounting points can help to determine whether to use, say, four or five units. If, for instance, you have to make a p.a. installation in a restaurant with a fairly low ceiling, you will need a relatively large number of low-level units—almost one for every table. With a higher ceiling height (assuming the ceiling is the most convenient place to mount the speakers) a smaller number can be used to cover the same area but with each speaker operated at a proportionately higher output level from the amplifier.

### Power Distribution

This brings us to the question of power distribution. In the simple two-speaker installation, the two units are connected in parallel across the amplifier output tap whose impedance rating is half that of each unit. In more complicated installations we need some means of adjusting the power delivered to each unit. The simplest way to do this is to use an amplifier with a 70.7-volt output.

While the 70.7-volt line is a convenient way of feeding a number of speakers to avoid unnecessary losses and is an easy way to figure power distribution, the basic problem is in terms of impedance matching. It isn't necessary to calculate the impedance, provided we use the constant-voltage-line calculations correctly.

The important thing is that the total nominal rating of the loudspeakers (with their 70.7-volt line transformers) should not exceed the power rating of the amplifier feeding them. For example, if two 10-watt speakers and four 5-watt ones are connected to the 70.7-volt tap of a 25-watt amplifier there will be a serious mismatch and the available power will be less than 25 watts. Two 5-watt speakers plus four 2-watt units would give more actual power in this system since they total 18 watts. This means the amplifier will deliver a little more than 18 watts undistorted.

What do you do if you are using a 60-watt amplifier and need to feed two speakers at about 5 watts each? Here there is some choice. To get the best amplifier performance, two 70.7-volt speakers with a rating of 30 watts could be used to match the amplifier. The gain would then be turned down so the amplifier output was about 10 watts.

This method might give a higher hum or hiss level than could be tolerated, in which case the best plan would be to use two 5-watt speakers and a dummy load to absorb the remaining power—50 watts at 70 volts. This requires a 100-ohm, 50-watt resistor. This method "throws away" much of the available power and may not have enough "headroom"—so a compromise may be better. Say we use two 10-watt speakers and then put only 40 watts in the dummy load. This will re-

quire a 125-ohm, 40-watt resistor, which is a little easier—four 500-ohm, 10-watt resistors in parallel will do the job.

It has been demonstrated that a public-address amplifier needs flexible output connections. It should have the regular 4-, 8-, and 16-ohm taps as well as a 70.7-volt output for maximum usefulness.

It should be noted that a loudspeaker's power rating and its 70.7-volt rating, with transformer, are two quite different things. The first states the maximum power the unit will handle. The second indicates the relative power it will take from a 70.7-volt line, due to the matching provided in its line transformer.

For example, if a 25-watt speaker uses a 10-watt matching for a 70.7-volt line, it will get 10 watts if the amplifier is correctly matched. But, if it is a 10-watt loudspeaker with 25-watt line matching, it may receive as much as 25 watts if correctly matched. In this case you must be sure that the full output is not delivered otherwise the speaker will very likely be burned out.

### Wiring

One precaution is especially necessary when using 70.7-volt lines: keep the speaker leads well away from the mike lines. Failure to observe this rule may result in amplifier instability. As 70.7-volt line wiring is unbalanced (one side is grounded in most 70.7-volt amplifier outputs), it is also best to use a twisted cable rather than flat twin-lead.

Mike cables should be selected on the basis of the microphone picked for the job. High-impedance mikes must use shielded wire, preferably of the low-loss, low-capacitance type. Low-impedance mikes (50 ohms or lower) may use shielded twin, but often plain twisted twin is satisfactory, especially where runs are short. Line-impedance mike cables should be balanced, or ungrounded, using shielded twin cables, with the shielding grounded.

### Phasing

Phasing is important for best results. If only one microphone is used, or the microphones are widely separated, microphone phasing may be disregarded. If you use mikes close together and wrongly phased, reproduction will be "gutless" and you will soon hear about it. In a loudspeaker system, however, incorrect phasing can result in areas that are poorly served. Try reversing connections to the loudspeaker feeding the area where confusion of sound is the greatest.

Good public address, indoors as well as out, should be an unobtrusive public servant. The audience wants to hear the program, not the p.a. They won't hear the program without the p.a. but if they are aware of this fact, it is not a good p.a. installation. As in any public service the best justification for better recompense for the installation is a job well done!



## UHF-VHF

**AN/APR-4 38-4000 MC RECEIVER—**  
This is a precision receiver covering 38-1000 mc. The set utilizes 5 tuning units with direct reading dials in megacycles. The receiver has a wide and narrow band-width 30 mc I.F. strip which may be selected at will. An output meter is provided to measure signal strength. Outputs are provided for a pulse analyzer and pan adapter. 110V AC. 60-2600 cycle. With 3 tuning complete unit, excellent. **\$159.50**

### BC603 FM RECEIVER

20-27 mc. Equipped with 10 push buttons for selecting channels. Cont. variable tuning over the entire range. Unit complete with tubes, built-in loudspeaker, squelch circuit, head phone jacks, schematic diagram on bottom of case. Approx. weight 34 lbs. For conversion to 6 meters AM or FM write for further information. Unused **\$12.95**

Original 12 Volt Dynamotor for above DM 34. Unused..... 4.95  
24 Volt Dyno—Used..... 2.95

BC 604—Companion Transmitter for above 20 to 27 MC FM. Unused.. 8.95

Original 12 Volt input Dynamotor for above—625 VDC C 225MA output. Unused..... 10.95  
24 Volt—Used..... 4.95

FT 237—Mounting rack for above Rec. & Transmitter. Unused..... 4.95

### BC-659 FM RECEIVER-TRANSMITTER

Xtal controlled, two channels, freq. range 27-38.9, 9 mc. 13 tubes, built-in speaker, dual meter for testing filament and plate circuits. F.O.B. West Coast or Chicago. **\$6.95**

WHIP ANTENNA—For transmitting and receiving. Monel metal. 8 foot telescopic. BRAND NEW..... 1.29

### I-177 TUBE CHECKER

A portable dynamic or mutual transductance type. 3" circular meter indicates condition of tube for normal operation. Presence of gas, short circuits between elements and noise, also measures the dynamic mutual conductance. 110 V. AC—60 Cycle. **\$16.95**

Exc. ....

### ARB/RCA SIX TUBE RECEIVER

All purpose super het receiver covering 195 KC to 9000 KC including weather, lighthouse, aircraft, radio range, broadcast, marine and amateur 160 meter, 80 meter, 75 meter and 40 meter, with tubes, 24 volt dyno. and schematic. Exc. .... **\$17.95**

Accessories for remote tuning per set **5.00**  
Write for information on conversion.

### \$45.00 HI-FI HEADSET

Uses annular grooved plastic fibre, comes with voice coils as in speakers and brand new rubber ear pads to obtain spacing for correct acoustical load. GIVES FINEST MUSIC REPRODUCTIONS! Imp.: 300 Ohms per unit or 600 Ohms when wire series. BRAND NEW..... **\$9.95**

HS-23—Air Force high impedance 2000 Ohm Headphones. Complete with sponge rubber earcups, headband and cord. BRAND NEW..... 4.95

CD-307. Extension Cord for above.. .97

BC 669. Six Channel Crystal Controlled, 50 Watt Radio Telephone, 1600 to 4500 KC. Ideal for boats or land station, less power supply. Used..... **\$59.50**

METER. 3"-0-5 Ma. 270° Indication—By Pass Shunt and add scale. **\$1.25**  
Excellent condition..... 5.00  
Five for..... 5.00

T-19—3.4 MC XMTR. Exc..... 5.95

BC 458—5.37 MC—Exc..... 5.95

T-23—100-156 MC XMTR. NEW.... 13.95

R-28—100-156 MC RECEIVER. Exc.. 15.95

TA-12—XMTR, 100 Watt. Exc.....\$19.95

MP-28—MODULATOR and 28 V. DC Power Supply for above. Exc. .... 14.95

WRITE FOR LATEST FLYER

## R W ELECTRONICS

2430 S. Michigan Ave., Dept. N  
Phone CAIumet 5-1281 Chicago 16, Ill.

# Slide-Projector Fade Control

By FRED J. LINGEL

**PROJECTING** slides for an illustrated lecture can be done with a real flair if a fade control is used in conjunction with a duplicate projector.

The unit to be described was built up for a rush job where time to locate a commercial unit was lacking. To allow for some overload capacity, a 10 ampere General Radio 117-volt variable transformer or "Variac" was used. This was wired as shown in Fig. 1. One projector was then connected between the center point and one side of the "Variac" winding while the second projector was connected from the same center point to the other side of the "Variac" winding. Each set of connections was brought out to a separate socket on the housing. This resulted in a simple fade control unit in a single, compact case, without affecting the regular operation of the "Variac."

To finish off the unit, a handle was mounted to the rim of the large round knob normally supplied with the "Variac." The weight of the unit and the use of the knob permitted the control to be rotated easily with one hand and eliminated the need for fastening it down or holding it.

A brass roundhead screw was threaded to the case at each end of the throw to limit the angle of travel. These stops still allowed between 10 and 20 volts across the projector lamps in the "dark" position but the light at this voltage was low enough to go unnoticed on the screen.

In operation, each projector is focused on the screen so that successive slides will appear to blend one into the other as the fade control is moved. This will occur since one lamp will dim automatically as the other is brought to full brilliance.

Some freedom from refocusing may also result from the use of the fade control since the "waiting" slide is in the hot housing of its projector prior to its being illuminated. In this way the slide will be warmed near its final displaced or "popped out" form when the light is turned on.

While the author's unit was built around General Radio's "Variac," other variable transformers of suitable rating, such as those manufactured by Superior Electric, Acme Transformer Co., and others could be used.

If you are often called to "run the machine" for professional or amateur illustrated talks, it will pay you to build this unit since it adds so much to the smoothness of such performances. —30—

Fig. 1. Wiring diagram for fade control which permits operation of two projectors.

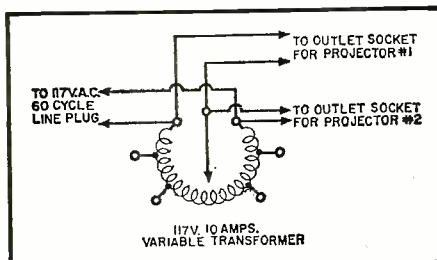

# QUARTZ CUT QUARTZ

## FOR EVERY SERVICE

All crystals made from Grade "A" imported quartz—ground and etched to exact frequencies. Unconditionally guaranteed! Supplied in:



FT-243 holders. Pin spacing 1/2". Pin diameter .093.

HC/6U metal sealed holders. Pin spacing .486". Pin diameter .050 or .093.

DC-34 holders. Pin spacing 3/4". Pin diameter .156.

MC-7 holders. Pin spacing 3/4". Pin diameter .125.

FT-171 holders. Pin spacing 3/4". Banana pins.

### MADE TO ORDER CRYSTALS

1001KC to 2500KC:	.01% Tolerance. \$2.00	.005% Tolerance. \$2.75
2501KC to 9000KC:	.01% Tolerance. \$1.50	.005% Tolerance. \$2.50
9001KC to 12,000KC:	.005% Tolerance. \$3.00	

Specify holder wanted.

3500 KC hermetically sealed frequency marker crystal .005% tolerance fits actual tube socket. **\$1.75**

ANY AMATEUR BAND CRYSTAL .01% Tolerance  
NOVICE BAND CRYSTALS **\$1.50**  
80 meters 3701-3749KC  
40 meters 7152-7198KC  
15 meters 7034-7082KC each

6 METER TECHNICIAN BAND CRYSTALS  
8335KC-8550KC within 1KC—**1.50**  
each

ASK YOUR LOCAL PARTS DISTRIBUTOR FOR TEXAS CRYSTALS... LOOK FOR YELLOW & RED DISPLAY BOARD.

SEALED OVERTONE CRYSTALS supplied in metal HC/6U holders—pin spacing .486, diameter .050.  
10 to 30 MC .005 tolerance.....\$3.85 ea.  
30 to 54 MC. .005 tolerance.....\$4.10 ea.  
55 to 75 MC .005 tolerance.....\$4.25 ea.

FUNDAMENTAL FREQ. SEALED CRYSTALS  
In HC/6U holders from 1400KC-10,000KC any frequency .005 tolerance.....\$3.50 ea.

TEXAS CRYSTALS, TRANSISTORIZED  
100 KC MARKER OSCILLATOR

Compact, portable, in attractive metal carrying case with handle. Size: 4"H x 3"W x 6"D. Connects to any receiver to get 100 KC markers from 100 KC to 50 MC. Factory wired with two transistors, one 100 KC crystal, self-contained battery. Shipping weight, 10 oz. Add 50c for prepaid parcel post. **\$17.95** Net

MARINE FREQUENCY CRYSTALS  
All marine frequencies from 2000-3200KC  
.005 tolerance.....\$2.50  
(Supplied in either FT-243, MC-7, or FT-171 holders.)

RADIO CONTROL CRYSTALS  
27.225 MC sealed crystals (1/2" pin spacing... specify pin diameter .093 or .050)....\$2.50 ea.

Stock crystals in FT-243 holders from 5675KC to 8650KC in 25KC steps......75¢ or 3 for \$2.00

FT-241 lattice crystals in all frequencies from 370KC to 540KC (All except 455KC and 500KC.)......50¢

Matched pairs ±15 cycles \$2.50 per pair.  
200KC Crystals. \$2.00 100KC Frequency  
455KC Crystals. \$1.50 Standard Crystals \$4.50  
500KC Crystals. \$1.50

1000KC Frequency Standard Crystals.....\$3.50  
Dual Socket for FT-243 Crystals.....\$.15  
Ceramic socket HC/6U Crystals.....\$.15

(Add 5¢ per crystal for postage and handling.)  
WRITE FOR CATALOG AND QUANTITY PRICES.

## Texas Crystals

The Biggest Buy in the U.S.

8538 W. GRAND AVENUE · RIVER GROVE, ILL.  
ALL PHONES — GLADSTONE 3-3555

Terms: All items subject to prior sale and change of price without notice. All crystal orders MUST be accompanied by check, cash or M.O. WITH PAYMENT IN FULL. NO C.O.D.s. Postpaid shipments made in U.S. and possessions only. Add 5¢ per crystal for postage and handling charge.



you learn **MORE**  
from a **SAMS BOOK**

OVER 1,000,000  
**SAMS BOOKS**  
bought to date

**JUST OUT!**



**"Handbook of Electronic Circuits"**

valuable reference book on important circuits, authored by RCA Service Company, Inc.

This practical handbook discusses the following circuits: 4 power supply circuits; 14 circuits used in radio stages; 8 circuits used in transmitter stages; 32 circuits used in TV receiver stages; 7 additional circuits having special applications. An analysis of the operation of each circuit is given; a schematic for each is included; a component failure analysis describes various troubles which could occur if particular components in the circuit should fail. Of real value to engineers, technicians, students. 80 pages; 8½ x 11".

Handbook of Electronic Circuits Only .....\$2.00

**SAMS "BEST-SELLERS"**

- Servicing TV Sync Systems.** Covers theory function and variation of all types. Speeds sync system servicing. 320 pages, 5½ x 8½". Only .....\$3.95
- TV Servicing Guide.** Picture tube screen photos show trouble symptoms; describes proper repair procedures. 132 pages, 8½ x 11". Only .....\$2.00
- Television Tube Location Guide.** Vol. 7 in this invaluable series. Covers 1956-57 sets. Only .....\$2.00
- Tape Recorder Manual.** Vol. 1; covers recorders produced in 1956-57. Only...\$2.95
- Auto Radio Service Manual.** Vol. 7; covers auto radios produced in 1956-57. Only \$3.75
- How To Understand and Use TV Test Instruments.** Revised to include data on Color TV Servicing. Only .....\$3.50
- Recording & Reproduction of Sound.** Oliver Read's best-selling volume on all aspects of audio. 810 pages. Only .....\$7.95
- Color TV Training Manual.** Trains you practically for Color servicing; 260 pages; includes many color illustrations. Only...\$6.95
- Hi-Fi Handbook.** Invaluable data on hi-fi theory, design, selection, installation, components. Only .....\$3.00
- Servicing Transistor Radios.** Complete analysis of 70 popular transistor radio models, including basic pointers on servicing transistorized sets. 152 pages. Only .....\$2.95

**HOWARD W. SAMS & CO., INC.**

Order from your Parts Jobber, or mail to Howard W. Sams & Co., Inc., Dept. I-18 2201 E. 46th St., Indianapolis 6, Ind.

Send books checked above. My (check) (money order) for \$..... is enclosed.

Name \_\_\_\_\_

Address \_\_\_\_\_

City \_\_\_\_\_ Zone \_\_\_\_\_ State \_\_\_\_\_  
(outside U.S.A. priced slightly higher)

**Service Association  
of the Month**



**ALAMEDA COUNTY TELEVISION & RADIO ASSOCIATION**

**S**ENIORITY is no measure of effectiveness. The Alameda County Television & Radio Association, 6609 Chabot Rd., Oakland 18, Calif., has only been around about five years, but it boasts 43 members and a creditable record of accomplishment.

Organized in 1953, ACTRA is incorporated as a non-profit group. Officers include Sam D. Ditto, president; Lee LePeilbet and Frank Lozano, 1st and 2nd vice-presidents; Philip M. Fisher, executive secretary; Fred W. Rock, corporation secretary; and Mel Dumolt, treasurer. Regular meetings are on the first Tuesday of every month at the "Driftwood" in Alameda; directors meet the last Tuesday of each month at member shops. Elections fall in November.

The "ACTRA Flash Bulletin," edited by Philip M. Fisher, is officially a monthly, but actually appears more frequently. In an attempt to serve the entire local industry, without regard to membership, "extras" are brought out whenever the occasion demands.

When ACTRA was born, the Better Business Bureau of Metropolitan Oakland lent a hand in drawing up the Code of Ethics. On election, the incumbent ACTRA president automatically becomes a director on the board of the local BBB. This coordination, characterizing an association keenly aware of a public outside of itself, is reflected in many other ways.

For example, in its fight to "clean up the few chiselers in our industry" who are giving "all of us a bad reputation," ACTRA has worked with police, DA, and the BBB in convicting unethical operators. Its cooperation in this direction has not only relieved the industry from the usual stigma that brands all technicians when such incidents are publicized, but has enhanced the organization's prestige.

Opportunities for favorable publicity are not overlooked. Even personal incidents involving members, if they are interesting, are called to the attention of the local press. Originally called "Television & Radio Association of Alameda County," the group reversed its name to obtain better position in the classified directory, where it lists members. The switch worked. This advertising carries the ACTRA emblem and slogan: "Customer Confidence through Dealer Integrity."

The Alameda group consistently tries to make the public understand that a good technician is worth his price and that shopping around for the lowest house-call fee is *not* the way to get the best service, or even the cheapest, in the long run. Largely due to its efforts, major local papers no longer run "bait" advertising, stating that they have stopped "in the public interest... and to maintain public confidence."

The Alameda group feels that there must be increasing emphasis on developing a business sense in addition to technical competence. To maintain integrity, it screens members before admission and polices them afterward. One was dropped a few months ago when, after repeated warnings, he continued to violate the Code of Ethics.

A member of the California State Electronics Association, ACTRA also works with other service groups in the San Francisco Bay Area. In conjunction with these, it circulates a local Consumers' Pricing List to the industry, intended as a reference guide rather than a mandatory schedule.

Divided on the licensing question, ACTRA nevertheless does keep one eye on unethical operators, with the other on existing business regulations. It has also worked out a wage scale, in an amicable way, with an interested union.

Would you like us to feature your association here? Send in the coupon!

Service Editor  
RADIO & TV NEWS  
1 Park Avenue  
New York 16, New York

We want to tell you more about our association. Please send us your questionnaire.

Name of Association.....

Mailing Address.....

Name of President or Corresponding Sec'y.....



It's packed with career facts!

SEND FOR THIS  
**FREE**  
BOOKLET TODAY

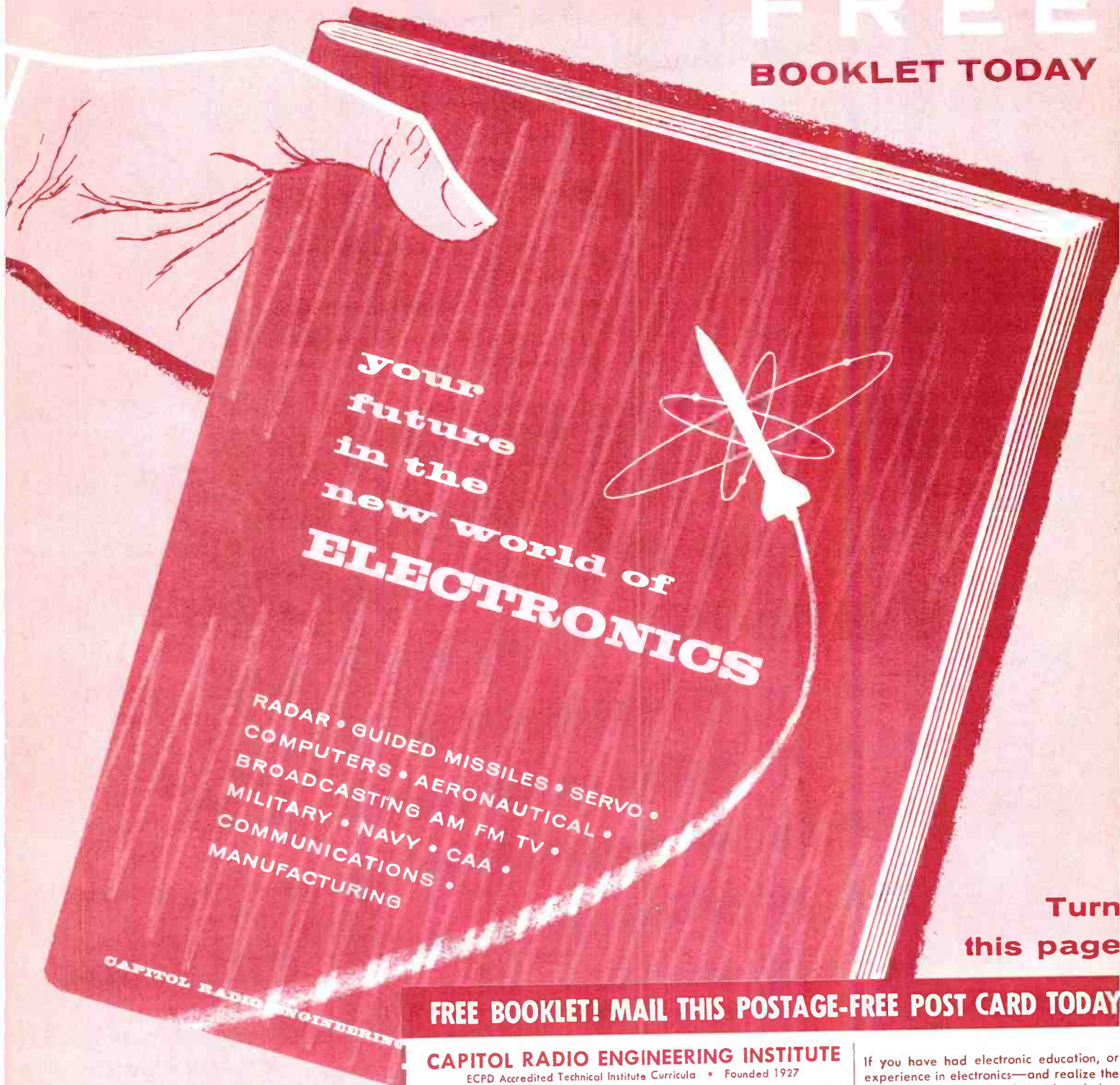

Turn  
this page

**FREE BOOKLET! MAIL THIS POSTAGE-FREE POST CARD TODAY**

See what  
the rapidly  
expanding  
field of  
**ELECTRONICS**  
offers you

**CAPITOL RADIO ENGINEERING INSTITUTE**  
ECPD Accredited Technical Institute Curricula • Founded 1927

3224 16th St., N.W., Washington 10, D. C.

**RAI**

(R.N. Nov. 58)

Please send me your course outline and FREE illustrated Booklet "Your Future in the New World of Electronics" . . . describing opportunities and CREI home study courses in Practical Electronic Engineering Technology.

- CHECK FIELD OF GREATEST INTEREST }  Radar, Servo and Computer Engineering Technology  
 Electronic Engineering Technology  
 Broadcast (AM, FM, TV) Engineering Technology  
 Television Engineering Technology  
 Aeronautical Electronic Engineering Technology

Name..... Age.....

Street.....

City..... Zone..... State.....

Check:  Home Study  Residence School  Korean Veteran

If you have had electronic education, or experience in electronics—and realize the need of a high-level technical knowledge to make good in the better electronic jobs—you can qualify for CREI home study training. (Electronics experience is not required for admission to CREI Residence School.) Please fill in the following information.

Employed By.....

Type of Present Work.....

Education:

Yrs. High School.....

Yrs. College.....

Electronics Experience.....



# CREI prepares you quickly for success in

**The future is in your hands!**

The signs are plain as to the future of the trained men in the electronics industry. It is a tremendous industry, but—when there's a choice between a trained and untrained applicant, the trained man will get the job. Your biggest problem is to decide on—and begin—the best possible training program.

**CREI Home Study . . .  
The Quick Way to Get There.**



Since 1927, CREI has given thousands of ambitious young men the technical knowledge that leads to more money and security. The time-tested CREI procedure can help you, too—if you really want to be helped. CREI lessons are prepared by experts in easy-to-understand form. There is a course of instruction geared to the field in which you want to specialize. You study at your convenience, at your rate of speed. Your CREI instructors guide you carefully through the material, and grade your written work personally (not by machine).

## Industry Recognizes CREI Training.

CREI courses are prepared, and taught with an eye to the needs and demands of industry, so your CREI diploma can open

many doors for you. Countless CREI graduates now enjoy important, good-paying positions with America's most important companies. Many famous organizations have arranged CREI group training for their radio-electronics-television personnel. To name a few: All-American Cables and Radio, Inc.; Canadian Broadcasting Corporation; Columbia Broadcasting System; Gates Radio Company; Federal Electric Corporation; The Martin Company; Douglas Aircraft Co.; U.S. Information Agency (Voice of America); Trans-Canada Air Lines; United Air Lines. Their choice for training of their own personnel is a good cue for your choice of a school.

## Benefits Felt Right Away.

Almost immediately you feel the benefits of CREI training. Your employer, when informed of your step toward advancement (only at your request), is certain to take new interest in you and in your future. What you learn in CREI Home Study can start helping you do a better job immediately.

## CREI also offers Residence Training in Washington, D. C.

at the same high technical level. Day and evening classes start at regular intervals. Qualified residence school graduates earn

- RADAR
- GUIDED MISSILES
- SERVO-MECHANISMS
- COMPUTERS
- AERONAUTICAL ELECTRONICS
- BROADCASTING, AM, FM, TV
- MILITARY, NAVY, CAA ELECTRONICS
- COMMUNICATIONS
- ELECTRONICS MANUFACTURING

degree as "Associate in Applied Science." Check coupon if you prefer residence or home study information . . . or write, Capitol Radio Engineering Institute, 3224 16th St. N.W., Washington 10, D.C.

PAYS FOR ITSELF QUICKLY. Your very first raise could repay your investment in CREI training, and leave you a profit the very first year. Your increases in pay thereafter are all pure profit, and you'll be prepared for many more promotions and pay raises in the future years of your life.

**ELECTRONIC TECHNICIANS**

Growing Peninsula Co. has openings for 1st class electronic technicians to work directly with engineering in development of new products. Only those with CREI or equal training and 3 years minimum commercial experience will be considered. Top salaries to qualified applicants. Call Mr. McQueeney, D.A. 4-4733 for appointment. ALTO SCIENTIFIC Co., Inc. 855 COMMERCIAL ST. PALO ALTO

**ENGINEERING AIDES AND TECHNICIAN**

Immediate Position Available

CREI or other formal electronic training desirable.

Experienced in reading schematics, breadboard construction of electronic circuits and chassis preparation.

**EMERSON RESEARCH LABORATORY**

## Industry Calls for CREI Training by Name . . . ... So Should You!

Here you see actual help wanted ads—one from a San Francisco newspaper, another seen in Washington. They are just two of many which specify "CREI or equal" education. This shows that industry approves CREI training, even insists on it. Experience has taught many, many companies that CREI students are taught what industry needs and wants them to know. Let this be your cue when you choose your educational program.

**Send card today for this fact-packed booklet. It's free.**



Take 2 minutes to send for this booklet right now. We'll promptly send your copy. The rest—your future—is up to you.

1st Class

Permit No. 288-R

Washington, D. C.

### BUSINESS REPLY CARD

No Postage Stamp Necessary If Mailed in United States

Postage Will Be Paid By

**CAPITOL RADIO ENGINEERING INSTITUTE**

**3224 16th Street, N.W.**

**Washington 10, D. C.**



**An Improved Probe**  
(Continued from page 63)

into the tubular body of the probe. The perforated Bakelite, when trimmed to the correct size for the probe shell, will fit with no wobble or play. Any components mounted on the Bakelite strip will be well spaced away from the shell wall, and the possibility of arcing or excessive capacity to ground will thus be eliminated. The probe body or shell is a 5- or 6-inch length of aluminum tubing from an old antenna mast or electrical fixture.

The plug in the end of the probe can be an end sawed off a wooden dowel or a plastic or rubber cork. In order to shield the internal components of the probe properly, it is necessary to run a short length of uninsulated wire from the common or ground side of the internal probe circuitry between the end plug and the shell. The ground lead with alligator clip connects to this same point. Inserting the plug tightly will both ground and shield the unit effectively. The end of the tube can be crimped slightly, if necessary.

A tight fit of the octal socket at the other end of the probe shell isn't important. The socket itself may be an *Amphenol* RS type or one of those with a molded or clamped-on mounting plate. Removal of the plate and a little judicious filing may be needed for the proper fit.

A coat of black paint on the probe will allow the function of each input to be marked on the shell itself, as shown in Fig. 3. Either electronic decals can be used for that "professional look" or the marking can be scratched on with an awl immediately adjacent to the appropriate socket pin number. A nail or a length of stiff copper wire is used on the probe tip. If desired, the tip can be insulated along its length with spaghetti.

The pigtail leads of the components are interwoven through the perforated board in standard wiring technique for this sort of material. The components

Fig. 4. Suggested circuits for various probe functions. Values not shown may vary. Each circuit connects to separate point on octal socket at one end, but all terminate in common lead to scope.

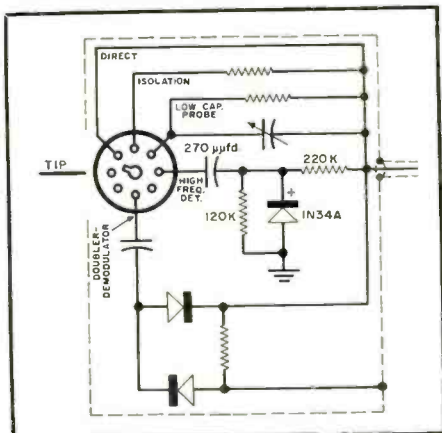

# now a DC TO 5 Mc



## OSCILLOSCOPE KIT

by



**Model S-55 \$87<sup>50</sup>**  
5" Wide-Band Oscilloscope

Model S-55 is an outstanding addition to the only line of kits engineered and produced under the auspices of a major test equipment manufacturer. PACO kits are backed by over 26 years of **PRECISION** experience in the development of a world-renowned line of quality electronic instruments. This new, high-sensitivity, extra-wide band, DC oscilloscope has been especially engineered for ultra-low-frequency analysis as well as for high-frequency color TV applications.

PACO KITS ARE DISPLAYED AND SOLD BY YOUR FAVORITE LOCAL ELECTRONIC PARTS DISTRIBUTOR. YOU CAN ALSO BUY THEM FACTORY-WIRED, TESTED AND CALIBRATED.

**SPECIFICATIONS**









**VERTICAL CHANNEL**—3 stage push-pull  
**SENSITIVITY:** DC—70 mv/in.  
AC—25 mv RMS/in.

**FREQ. RESPONSE:**  
DC—Within 3 db to 4.5 Mc.  
Within 5 db at 5 Mc.  
AC—Within 3 db from 1 cps to 4.5 Mc.  
Within 5 db at 5 Mc.

**RISE TIME:** Better than .08 microseconds  
**INPUT IMPEDANCE:** 1.5 megohms shunted by 33 mmfd  
**VERTICAL-INPUT STEP ATTENUATOR**  
**VERTICAL POLARITY REVERSAL SWITCH**  
**HORIZONTAL CHANNEL**—push-pull output  
**SENSITIVITY:** 0.6 v RMS/in.  
**FREQ. RESPONSE:** Within 3 db from 1 cps to 400 Kc  
**INPUT IMPEDANCE:** 5 megohms shunted by 23 mmfd  
**CATHODE-FOLLOWER HORIZONTAL INPUT CIRCUIT**  
**LINEAR TIME BASE:** 10 cps to 100 Kc, TV-V and TV-H, plus provisions for external capacitor sweep to 1 cps. Automatic "positive" and "negative" synchronization.

**BUILT-IN VOLTAGE CALIBRATOR**  
**ILLUMINATED SCREEN GRATICULE AND CAMERA-MOUNT BEZEL**  
**MODEL S-55:** Complete with all tubes including CRT, PACO-detailed assembly-operating manual. In louvered steel cabinet with two-color, easy-reading panel. Size: 13 3/4" x 8 3/4" x 17 1/4".  
Kit Net Price: \$87.50

**MODEL AS-1: OSCILLOSCOPE PROBE SET**  
Factory Wired Net Price: \$14.95

 <b>Model B-10</b> Battery Eliminator Kit, Net Price: \$41.95	 <b>Model C-20</b> Resistance-Capacity-Ratio Bridge Kit, Net Price: \$20.95			
 <b>Model G-30</b> RF Signal Generator Kit, Net Price: \$28.50	 <b>Model M-40</b> High-Sensitivity V-O-M Kit, Net Price: \$31.50			
 <b>Model S-55</b> 5" Cathode Ray Oscilloscope Kit, Net Price: \$49.50	 <b>Model T-60</b> Tube Checker Kit, Net Price: \$38.75	 <b>Model T-65</b> Transistor and Crystal Diode Tester Kit, Net Price: \$39.95	 <b>Model V-70</b> Vacuum Tube Voltmeter Kit, Net Price: \$31.50	 <b>Model Z-80</b> RF-AF Signal Tracer Kit, Net Price: \$29.50

**PACO ELECTRONICS CO., INC.**  
70-31 84th Street, Glendale 27, Long Island, New York

A DIVISION OF **PRECISION Apparatus Company, Inc.**  
Export: 458 B'way, N. Y. 13, U.S.A., Canada: Atlas Radio Corp., Ltd., 50 Wingold Ave., Toronto 19.



# FREE

GIANT ALL NEW 1959

# B-A CATALOG

WITH THE BIGGEST SAVINGS ANYWHERE

A COMPLETE BUYING GUIDE FOR EVERYTHING IN

**RADIO TV**

**ELECTRONICS**

**B-A 1959**

ANNUAL CATALOG 591

SINCE 1927

### Guarantee

We guarantee everything in this Catalog to be of the quality and value represented. To conform exactly to the illustration and description. To perform in the manner and give the service intended for such apparatus.

**180 KING-SIZED PAGES**

**EVERYTHING IN RADIO TV AND ELECTRONICS**

**100'S OF NEW ITEMS LISTED HERE FOR 1st TIME**

**21 PAGES OF BARGAINS NOT IN ANY OTHER CATALOG**

**RUSH COUPON TODAY!**

**BURSTEIN-APPLEBEE CO. Dept. M,  
1012-14 McGee St., Kansas City 6, Mo.**

Send Free 1959 B-A Catalog No. 591.

NAME \_\_\_\_\_

ADDRESS \_\_\_\_\_

CITY \_\_\_\_\_

STATE \_\_\_\_\_

## GET INTO ELECTRONICS

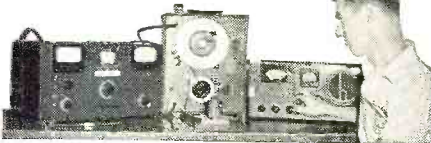

V.T.I. training leads to success as technicians, field engineers, specialists in communications, guided missiles, computers, radar and automation. Basic and advanced courses in theory and laboratory. Associate degree in electronics in 29 months. B.S. in electronic engineering obtainable. ECPD accredited. G.I. approved. Graduates in all branches of electronics with major companies. Start February, September. Dorms, campus. High School graduate or equivalent. Catalog.

**VALPARAISO TECHNICAL INSTITUTE**  
Dept. RD Valparaiso, Indiana

### 30 Watt Hi-Fi Super Lin Kit

AMP-PREAMP with TRANSISTORIZED FRONT END

FREQUENCY RESPONSE: ±1 db 10-40,000 cps.

TUBES: uses (1) 6AU6

(1) 12AT7, (1) 12AU7,

(2) EL34's, (1) 5Y4-GB.

SHIPPING WEIGHT 26 lbs. FL-30

Sale Price... **\$42.00**

F.O.B. N.Y.

Send for Free Catalogue Write Dept. RN

**CUTICK ELECTRONICS HI-FI RADIO T.V. PARTS**

171 Washington St., Worth 2-5866, New York 7, N.Y.

## 47 RADIO PROJECTS 75¢ Plus "White's Radio Log"

Think of it... 47 electronics projects you can build... explained with diagrams, photo-graphs and step-by-step instructions, plus "White's Radio Log," a directory listing U.S. and Canadian AM, FM and TV stations by call letters, locations, kilocycles and power and over 1,000 world-wide short-wave stations. Terrific value! Get this 192-page handbook, Radio-TV Experimenters, No. 555, at newsstands 75¢; or direct from: SCIENCE & MECHANICS, 450 E. Ohio St., Dept 797, Chicago 11

or probe functions that will be built in will, of course, depend upon your particular needs. The basic circuits that can be incorporated are illustrated and discussed in "Probes" (Gernsback Library #54) and "How to Use Test Probes" (Rider Publication #165). Some popular configurations are suggested in Fig. 4.

The low-capacity probe function deserves some discussion. The resistor shunting the trimmer capacitor should have a value approximately nine times the input impedance of the scope. Many recent model scopes have a 3.3-megohm input which dictates the use of a 30-megohm resistor. A 1-megohm scope input calls for a 9-megohm resistor to maintain the attenuation factor at the convenient figure of 10.

Adjustment of the low-capacity trimmer is best done with the aid of a square-wave generator. Set the generator to about 15 kc. and feed the signal into the scope via the low-capacity function of the probe. The scope will probably display a waveform resembling Fig. 5A or B. Adjust the trimmer until the square-wave is reproduced properly. If the overpeaked condition of Fig. 5B is obtained and cannot be flattened out, try reducing the minimum value of the compensating trimmer. If high-frequency roll-off, as shown in Fig. 5A, is present and unadjustable, more trimmer capacitance is needed. A good starting value is a trimmer with a range of about 3-30  $\mu\text{fd}$ .

If a square-wave generator is unavailable, the scope's internal sweep oscillator can be used to provide a test signal for adjustment. Connect the probe as usual to the vertical-input terminals and tap off the saw-tooth signal of the scope at the output of the multivibrator tube. The scope sweep frequency should be set at about 1 kc.

A trace as shown in Figs. 5D, E, or F will be observed. Fig. 5F is the desired waveshape and the trimmer should be adjusted for the closest resemblance to it. The comment above pertaining to lack of adjustment applies here also. An upward hooking corresponds to peaking and the capacity of the trimmer should be reduced.

In the cases of the above adjustment where inversion or transposition of the waveform occurs, it indicates a peculiarity of the scope rather than the probe, and is not significant.

Fig. 5. Square waves may be used (A, B, and C) to adjust a low-capacitance probe. The scope's own sweep oscillator can also be used (D, E, and F) for this purpose.

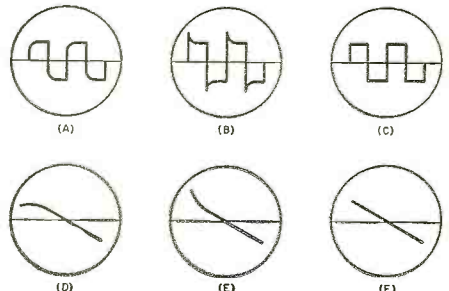



# VIDEO ELECTRIC COMPANY says: DOWN WITH RISING COSTS OF ELECTRON TUBES OVER ONE MILLION USED TUBES TO SELECT FROM at only

Each and every tube is tested by our supplier under actual operating conditions in Radio, FM, Hi-Fi, Industrial Equipment and Television Chassis or Intricate Testing Equipment for Mutual Conductance and Life Test.

Below is a Partial List of Over Three Hundred Popular Types!  
Write for Free Complete List and Order Blank!

0A2	5AX4GT	6BC5	6L7	717	19
0B2	5AZ4	6BC7	6N7	7N7	19AU4GT
0Z4	5BK7	6BC8	6Q7	7Q7	19BG6G
1A5GT	5BR8	6BD6	6S4	7X7/XXFM	19J6
1A7GT	5C07	6BE6	6S8GT	7Y4	19T8
1B3GT	5C08	6BF5	6S7	7Z4	24A
1C3GT	5J6	6BF6	6S7Y	12A8	25AV5
1H4G	5T8	6BG6G	6SF5	12AB5	25AX4
1HSGT	5U4C	6BH6	6SF7	12A05	25B06
LJ6	5U4CA	6BK5	6SH7	12AT6	25D06
LL4	5U4GB	6BK7	6S17	12AT7	25W4GT
LL6	5U8	6BL7GT	6SK7	12A06	25Z5
1NSGT	5V4C	6BN6	6SL7GT	12A07	25Z6
1QS7	5V6GT	6BQ6GT	6SN7GT	12A17	26
1R5	5X8	6BQ7	6S7	12A18	35A5
1S5	5X8	6B58	6SR7	12A19	35B5
1T4	5Y3GT	6BX7GT	6SS7	12A27	35C5
1T5GT	5Y4G	6BY5GT	6T4	12BA6	35L6GT
1U4	6A7	6BY6	6T8	12BA7	35W4
1U5	6A8	6BZ6	6U4GT	12BA8	35Y4
1V2	6AB7	6BZ7	6U8	12BF6	35Z4GT
1X2	6AC7	6C4	6V3	12BH7	35Z5GT
2A3	6AF4	6C5	6V6	12BK5	36
2A7	6AG5	6C6	6W4GT	12B06	37
2AF4	6AG7	6CB5	6W6GT	12BR7	39/44
3AL5	6AH4GT	6CB6	6X4	12B7	42
3AU6	6AK5	6CD6G	6X5	12BY7	43
3AV6	6AL5	6CF6	6X8	12CA5	45
3BC5	6AL7	6CG7	6Y6G	12DQ6	50A5
3BE6	6AM8	6CL6	7A4/XXL	12FS	50B5
3BN6	6AN8	6CM6	7A5	12J5	50C5
3BY6	6AQ5	6CM7	7A6	12K7	50G6
3BZ6	6AQ6	6CN7	7A7	12L6	50Y6
3CB6	6AQ7GT	6CS6	7A8	12M7	56
3CF6	6AR5	6CU5	7B8	12Q7	57
3CS6	6AS5	6D6	7B8	12SA7	58
3DT6	6AS7G	6DQ6	7C4	12SG7	71A
3LF4	6AT8	6DT6	7C5	12SK7	75
3Q4	6AU4GT	6E5	7C6	12SK7	76
3Q5GT	6AU5GT	6F6	7C7	12SL7GT	77
3V4	6AU6	6F8	7E5	12SN7GT	78
4B07A	6AUB	6H6	7E7	12SQ7	80
4BZ7	6AV5GT	6J4	7E7	12SR7	84/6Z4
5AM8	6AV6	6J5	7F7	12V6GT	117L7GT
5AN8	6AW8	6K7	7F7	12W6GT	117N7GT
5AS8	6AX4GT	6K8	7F8	12X4	117P7GT
5AT8	6AX5GT	6L6	7G7/1232	12Z3	117Z3
5AU4	6BB			14A7/12B7	1486
5AV8	6BA6			14Q7	14Q7
5AW4	6BA7				

THE TUBES ADVERTISED HEREIN ARE NOT NECESSARILY NEW TUBES BUT MAY BE ELECTRICALLY PERFECT FACTORY SECONDS OR USED TUBES AND ARE SO MARKED.

**GUARANTEE:** We guarantee to replace FREE for one (1) year any tube purchased from us which fails to function efficiently under actual operating conditions. Refunds will be made promptly for any defective merchandise within 5 days of receipt.

## WE HAVE OVER 1000 USED TV SETS

At All Times In Our Huge Warehouse  
Buy one or more of these WORKING TVs to sell or use as your own second sets  
All sets in GOOD WORKING condition!  
Your Choice—Console or Table Model

10" . . . \$23.00	17" . . . \$46.00
12" . . . \$28.00	19" . . . \$58.00
14" . . . \$33.00	20" . . . \$64.00
16" . . . \$40.00	21" . . . \$72.00
24" . . . \$99.00	

When ordering TVs, state whether table model or console is desired. Also, preference on make of set. All TVs sent railway express F.O.B. Newark. On any quantity, WIRE or CALL today!

**FREE**  
Bonus Antenna  
Given with  
Any TV Set  
Order!!

**FREE**  
RCA "Cheater"  
Cord Given with  
Any Tube Order  
of \$7.00 or  
More!!

## FREE POSTAGE

in U.S.A. and Territories on orders over \$5.00. 25¢ handling charge on orders under \$5.00. 25% deposit required on C.O.D.'s. Please send approximate postage or freight on Canadian and foreign orders. Subject to prior sale.

Phone  
HUMboldt 4-9848

# VIDEO

**ELECTRIC COMPANY**  
9-15 6TH STREET, HARRISON, N. J.



P.E. sound for every application

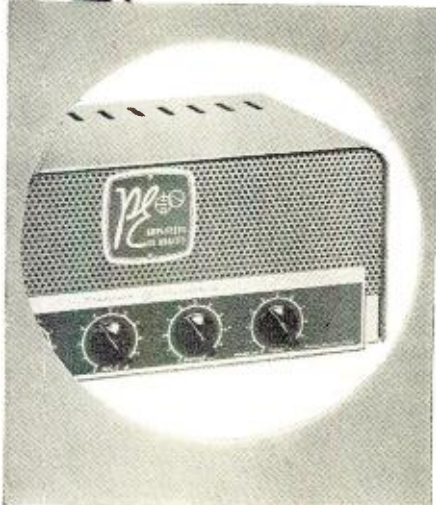

POPULAR ECONOMY  
SOUND

BY

**Precision  
ELECTRONICS**

A new popular priced sound amplifier series . . . Available in 10, 20, 30 and 60 watt models for every indoor, outdoor and mobile application. Quality-built, with every desired feature, for top performance and extensive coverage. Provides complete flexibility in any combination from one amplifier to complete sound systems.

For complete details see your Grommes Sound Distributor or write . . .

**Precision Electronics Inc.**

Dept. R-11

9101 King St., Franklin Park, Ill.

Send details on P.E. Sound.

Name.....

Street.....

City..... State.....

sult with the particular reverberation characteristic of the recording hall is rather diffuse and the piano lacks true definition and articulation; in the *Mercury* recording the piano is very big and bright and projected well forward, but in carefully maintained balance with the orchestra. The reverberation period of the Manchester Free Trade Hall, where this was recorded, is rather long but by recording the orchestra and piano quite close up, the engineers have managed to enlist its aid in furnishing us with a very live sound of very clean and distortionless quality. Directionality was good here, with the piano remaining centered as the "ghost" channel and not jumping from left to right or *vice versa*, as is the case with many less well-engineered concertos. Thus it is up to you which weighs more heavily—the very fine sound of this *Mercury* reading or the superior performance of Rubenstein, recorded with a sound of considerably less luster.

**WAGNER**

**DAWN AND SIEGFRIED IDYLL**

**Detroit Symphony Orchestra conducted by Paul Paray. Mercury MAS5-20. Price \$9.95.**

As has been noted before, Paray is one of those improbable Frenchmen who can conduct Wagner. His readings may not always be to the liking of a dedicated Wagner purist, but most people find them extremely well wrought and most interesting. With the "Dawn" music and the "Siegfried Idyll" he is particularly effective as, after all, this comes closer to his native Debussy than any other Wagnerian music. Here he paints a very evocative picture and except for tempi which most people would regard as a little too fast, the performance is otherwise a model of phrasing and dynamics.

*Mercury* has afforded Paray a rich glowing tapestry of sound and, unlike a great deal of Wagner of this type, it is not merely a great amorphous sound. One can distinctly hear all the various choirs and easily perceive instrumental separation. Directionality was not as pronounced here as in some other *Mercury* recordings, but probably this is more a matter of scoring than it is of any technical deficiencies. Throughout, the sound is very clean and luminous with the broad acoustics particularly well suited to this atmospheric work. Paray elicits some particularly fine string and woodwind playing from the great orchestra and, all-in-all, this is a stereo tape which I am sure you will enjoy.

**OUT ON A LIMB**

**Pete Rugolo and his Orchestra. Mercury MVS3-7. Price. \$7.95.**

This is a tape which I certainly cannot honestly say is for all tastes because, while friend Rugolo can be very entertaining and easily assimilable, in this case he really is "Out on a Limb" musically. In other words, this is Rugolo in one of his "avant garde" moods and the scoring of the music, while



**RUINED...**

fuzzed up — distorted — trash — your precious record collection swept away because you took chances with an ordinary old fashioned diamond needle. So easy to completely protect your collection with the "Needle That Remembers" — The Duotone Diamond Needle with the safety extra of a memory. Tells you when to check or change your needle. Costs no more. Get details from leading dealers or booklet from Duotone, Keyport, New Jersey.

**DUOTONE...**

*is different*



**SUITS NEED PRESSING—  
MERIT DEFLECTION YOKES  
DO NOT!**

Merit deflection yokes are cosine wound TO FORM, not pressed. Pressing can lead to distortion and poor focusing. Pressing after winding frequently causes breakdown.

**MERIT COILS AND TRANSFORMERS  
HAVE "BUILT-IN" ADVANTAGES.**



Each Merit yoke is  
100% LIVE TESTED

COMPARE IT WITH  
**MERIT**  
MERIT COIL AND TRANSFORMER CORP.  
MERIT PLAZA • HOLLYWOOD, FLORIDA



From  
any Point of View,  
more Experts choose  
**ACROSOUND**  
ULTRA-LINEAR II  
60 watt amplifier

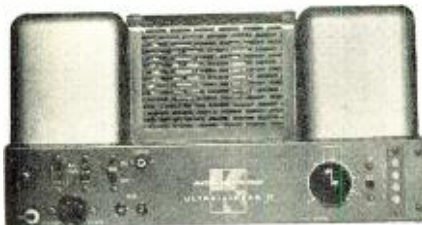

**DESIGN** The combination of patented ULTRA-LINEAR circuitry—plus new HYBRID FEEDBACK principle—VARIABLE DAMPING control, and ULTRA STABILITY, represents a new high in the art of amplifier design... an example of ACROSOUND'S latest achievement in AMERICAN Know-How. This superiority of design now enables anyone with or without any previous knowledge of electronics to assemble for himself or herself... (yes! it's that easy!)... the finest of amplifiers and at a most reasonable cost, in only two hours!



**PERFORMANCE** By listening test, or by instruments... second to none in clarity and frequency response. Normal level distortion is virtually unmeasurable—IM 1% or less at 60 watts, 120 watts peak. Completely stable... unaffected by loads, perfect square waves.

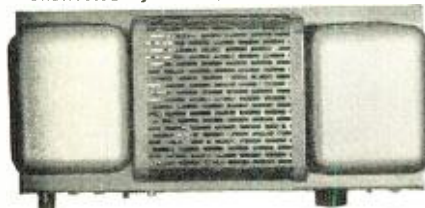

**QUALITY** Every part going into the assembly of critical and even non-critical circuitry is tested and checked to allow no more than  $\pm 1/4\%$  variation from ACROSOUND'S standards. Specialized test equipment unavailable commercially was designed in ACROSOUND'S laboratories to achieve this result. Every printed circuit board is placed in trial operation on a laboratory amplifier. Output tubes are matched by trial and double checked.



**COMPONENTS** ACRO'S newest TO-600 output transformer with special hybrid winding—separates functions of output circuit and feedback circuit. Heavy duty, completely assembled, and thoroughly tested, printed circuit board assures uniformity of performance. Low distortion EL34 output tubes are operated well within their ratings ensuring long tube life and optimum performance.

**PRICE** In preassembled kit form so that you may save money, learn while doing, and have the proud satisfaction you built the best for only \$79.50 net... or if you feel you would prefer it laboratory assembled it still represents a bargain at \$109.50 net.

**HEAR IT AT YOUR DEALER NOW!**

BE READY FOR ACROSOUND DISTORTIONLESS PRE-AMP DESIGNED FOR THE STEREO-PHILE

Experts know why ACRO is best!  
Others... Learn why! Write to

**ACRO PRODUCTS**  
369 SHURS LANE  
PHILA. 28, PA.

November, 1958

exceedingly clever and well done, shrieks with dissonance and atonalities and I think nearly everybody gets into the act from Hindemuth to Bartok and Stravinsky and back again.

As a stereophonic sound experience, this has some pretty terrific effects with much exploratory plumbing of sonic depths with instruments normally never played in those registers and, on the other side of the coin, some stratospheric screeches which must sorely tax the lips of the poor brass players. Of course, this type of recording is quite artificially done and things like directionality and instrumental separation are very precise. So, if you have a persuasion for the modern, this is for you. —30—

For the Record  
(Continued from page 8)

proud of the fact that year after year these audited reports reveal that RADIO & TV NEWS has the largest circulation of any technical electronic publication in the world! To you our readers and advertisers, we offer a heartfelt "Thank You."

It is well to keep in mind that the more advertising we carry the more feature material we can include in each issue and the more useful the publication becomes to all concerned. The ABC thus performs an important function in the publishing field—and membership has come to stand for circulation integrity. It is a symbol of good reputation—one that cannot be purchased! —30—

This is what the newest and largest radio telescope now under construction in the United States will look like when it's erected in Green Bank, W. Va., as part of the National Radio Astronomy Observatory facilities there. The dish, which points skyward, is 140 feet in diameter and is capable of picking up radio waves transmitted naturally by objects in space, even when their total strength is less than one watt spread over the surface of the entire earth. Associated Universities, Inc., which operates the Observatory, announced that it has signed a contract with the E. W. Bliss Company of Canton, Ohio to build the telescope, which will rank as one of the largest such instruments.

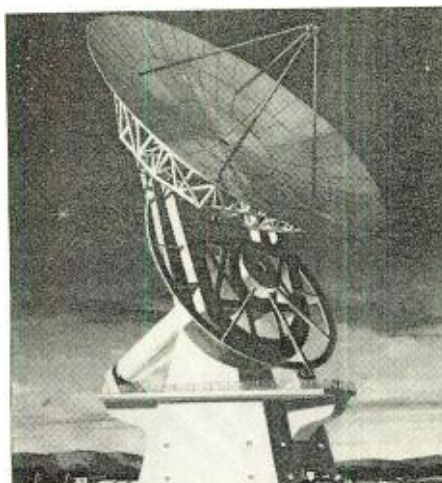

# NOW

## MAGNETIC TAPE RECORDING HEADS

- FOR DIRECT REPLACEMENT
- FOR UP-GRADING EQUIPMENT
- FOR STEREO CONVERSION



LEADING SUPPLIER TO THE TAPE RECORDER INDUSTRY

Now replacement heads are available from the biggest supplier to tape recorder manufacturers... heads for most makes and models... the finest components for every replacement or conversion job. Erase, record and 4-track stereo... complete specifications to help you cash in on the demand for tape recorder service.

**FREE...BOOKLET ON 4-TRACK STEREO USE COUPON**

**MICHIGAN MAGNETICS, INC.**  
DISTRIBUTOR DIVISION  
203 N. Wabash Avenue  
Chicago 1, Ill.

Please rush me information on 4-track stereo... also details on heads for direct replacement and up-grading.

I am a Service Dealer  I am a Hi Fi Dealer  
 I own a Recorder  I am a Parts Jobber

NAME \_\_\_\_\_

ADDRESS \_\_\_\_\_

CITY \_\_\_\_\_ STATE \_\_\_\_\_



# PERFORMANCE

## IN A SMALL PACKAGE



The Handy Five-Pak  
(Shirt Pocket Size)

# Tarzian

SERIES

## Silicon Rectifiers

- **COMPACT**—no special holder required . . . supported by pigtail leads
- **VERSATILE**—will fit into the smallest pocket portable . . . yet enough power for the biggest color television receiver
- **ECONOMICAL**—Tarzian's mass production means lower cost to you
- **PROVED PERFORMANCE**—in all electronic applications

Send for data sheets.

### SPECIFICATIONS

	40K	K-200
MAX. AC INPUT VOLTAGE	130	130
MAX. PEAK INVERSE VOLTAGE	400	360
MAX. PEAK CURRENT (MA)	7500	2000
MAX. DC CURRENT (MA)	750	200
APPROX. RECTIFIER VOLTAGE DROP	2	2
MAX. OPERATING TEMP.	100°C	100°C
MAX. SURGE CURRENT (AMPS)	30	20
MIN. SURGE LIMITING RESIS. (OHMS)	7.5	10

### DIMENSIONS

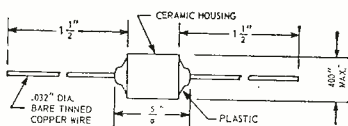

Sarkes  
Tarzian

DEPT. N-4  
RECTIFIER DIVISION, 415 N. COLLEGE AVE.  
BLOOMINGTON, INDIANA

IN CANADA: 700 WESTON RD., TORONTO 9, TEL. ROGERS 2-7535  
EXPORT: AD AURIELMA, INC., NEW YORK CITY

## Transistor FM Tuner (Continued from page 61)

where each station tunes in; either one is correct. Slope detection doesn't eliminate all the background noise like a superhet FM tuner. Just tune the set for best audio quality.

Speaking of superhet FM tuners, the 3N25 transistor could very well be used as the oscillator, or mixer-oscillator, of a complete FM tuner. Surface-barrier or drift transistors could be used as i.f. amplifiers followed by crystal diodes as ratio detectors. This superhet would, naturally, be quite a bit more expensive than the superregenerative tuner.

### Operation

The quench-frequency control,  $R_1$ , is set about mid-way through its rotation and the regeneration control shouldn't require resetting over most of the tuning range once it is properly adjusted. By adjusting the quench-frequency control around the operating center, you can actually change the bandwidth and, consequently, the frequency response of the tuner.

On some FM stations an audio tone is used to control leased receivers and thereby block commercials from these sets. When announcements or commercials are heard on such stations with this tuner, this tone will be audible as a result of the transmitted tone beating against the quench frequency. It could be filtered out but some loss of normal audio would result and the tone is really not loud enough to be annoying.

There is no noticeable tuner drift from day to day. There is nothing to warm up and nothing to get warm to cause drift. A friend remarked that along with instant foods and instant beverages, we now have "instant FM"!

The total cost of this tuner, using some junk-box parts, should not exceed \$25.00. It's well worth this sum for the entertainment received in building something new and then listening to the results!



"Pop, how's chances of using the computer tonight?"

# LOOK AT OUR LOW PRICES!

## COMPLETELY PORTABLE "PHONO-TRIX" TAPE RECORDER & DICTATION MACHINE FULLY TRANSISTORIZED

Reg.  
Price  
**\$9950**  
CONCORD'S  
Price  
**\$6925**

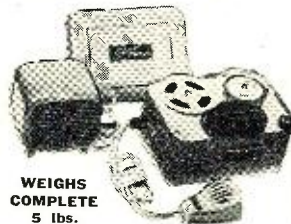

WEIGHS  
COMPLETE  
5 lbs.

- Records and Plays Back Anywhere
- Weighs only 5 Lbs.
- Operates on 4 Flashlite Batteries
- Use on Train, in Auto or Plane
- 2 Track Recording
- Fully Transistorized
- Complete with external speaker

Extra 300 Ft. Mylar Tapes ..... \$1.25  
4 Flashlight Batteries ..... .80  
Shipping weight ..... 6 Lbs.

## Latest DUAL 12 Watt STEREO Amplifier

Reg.  
Value  
**\$9950**  
CONCORD'S  
Price  
**\$6920**



Complete Stereo Pre-Amp (2 channels) plus 2 separate 12 watt power amplifiers. Features include, ganged Bass and Treble controls, RIAA input for all Records, takes all cartridges, Matches 4, 8 and 16 ohm speakers. 9 tube complement. With enclosure finished in gold and maroon. Full 20-20,000 cps. response. 24 watts when used monaurally. For operation on 110-120 V. 60 cy. AC.

## 10 WATT Hi Fi MUSIC SYSTEM

Reg. Value  
**\$9950**

You get all the following:  
Latest 4 speed VM changer with flipover cartridge, 12 watt CONCORDIA Hi-Fi amplifier with pre-amp, Concord Hi-Fi Enclosure, plus a UTAH 8" twin cone wide range speaker, PLUS a 5" UTAH Hi-Fi tweeter with built-in crossover. FREE! Base for changer!

CONCORD'S  
Price  
**\$6666**



IT'S FREE!  
CONCORD'S 108 Pg.  
COMPREHENSIVE  
CATALOG



CONCORD RADIO CORP.  
45 WARREN ST.  
NEW YORK 7, N.Y.  
DIGBY 9-1135



## Loading Cartridges (Continued from page 42)

decreases and the output across this reactance decreases correspondingly. If the total circuit capacitance is increased by addition of a shunt capacitor, then, as previously explained, the load resistance must be correspondingly decreased to maintain the same time-constant as before. It may well work out that if the load resistance is 500,000 ohms, the additional shunt capacitance required may also provide a satisfactory amount of signal attenuation.

As pointed out earlier, treble boost is required when an amplitude-responsive cartridge is used (see Fig. 9). Ordinarily this is provided by the piezoelectric cartridge through mechanical resonance, controlled in amplitude and range by damping and other design

techniques to approximate the RIAA equalization requirement.

It may be desired to convert the piezoelectric cartridge into a velocity-responsive device so that it may be fed into an input jack intended for a magnetic pickup. In most control amplifiers this has the advantage of allowing the user a choice of playback equalization characteristics, some intended for 78 rpm records and others for 33 $\frac{1}{3}$  rpm discs made prior to the adoption of the RIAA curve.

There are two simple means for such conversion: (1) a small capacitor can be placed in series with the cartridge as shown in Fig. 12. This produces high-pass filter action so that output rises with frequency as in the manner of a magnetic cartridge, or (2) a small load resistor can be placed across the cartridge, as in Fig. 13. This, too, results in rising output with frequency.

(Continued on page 128)

# PURCHASING A HI-FI SYSTEM?

Send Us  
Your  
List Of  
Components  
For A  
Package  
Quotation

### PARTIAL LIST OF BRANDS IN STOCK

Altec Lansing  
Electrovoice  
Jensen  
Hartley  
University  
Acoustic Research  
Janszen  
Wharfedale  
Karlson  
Viking  
Concertone  
Bell • G.E.  
Weathers  
Harman-Kardon  
Eico • Pilot  
Sherwood  
Acrosound  
Fisher  
Bogen • Leak  
Dynakit  
H. H. Scott  
Pentron  
Ampro • VM  
Revere  
Challenger  
Wallensak  
Garrard  
Miracord  
Glaser-Steers  
Rek-O-Kut  
Components  
Norelco  
Fairchild  
Pickering • Gray  
Audio Tape

WE WON'T BE  
UNDERSOLD!

All merchandise  
is brand new, fac-  
tory fresh & guar-  
anteed.

## AIREX RADIO

CORPORATION

64-R Cortlandt St., N. Y. 7, CO 7-2137

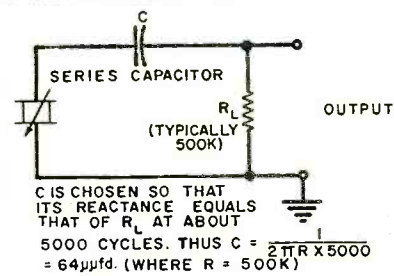
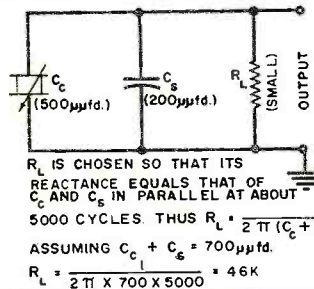

Fig. 12. Small series capacitor converts crystal pickup to velocity-responsive unit.

Fig. 13. Use of small load resistor makes crystal cartridge velocity-responsive unit.



SR-440 AM-FM Tuner



ASR-433 Stereo Amplifier—Selected for display at the Vienna International Fall Fair.



RF-484 Slimline®  
15" Coaxial  
Transducer

THE NEW STROMBERG-CARLSON COMPONENTS

## integrity in music

Integrity in Music, as applied to high fidelity components, means reproduction which adds nothing to, or takes nothing from, the original performance.

Our choice of this slogan is no accident. Just as your purchase of a component system is not a casual investment, our attitude toward the manufacture of components is very serious. Each piece of gear must reflect the highest possible achievement of engineering, production, and musical skill. Yes, musical skill—because the guiding minds of the Stromberg-Carlson component group are those of electronic and acoustic engineers with extensive musical training.

The musical sound of our new components was the final critical test before they were made available to you.

We will be glad to submit our specifications to your critical judgment.

See your dealer or write to us for full data on our complete new line of Amplifiers, Speakers, Speaker Systems, Enclosures and Program Sources.

"There is nothing finer than a Stromberg-Carlson"

**STROMBERG-CARLSON SC GD**

A DIVISION OF GENERAL DYNAMICS CORPORATION  
1477C N. Goodman St. • Rochester 3, N.Y.

Electronic and communications products for home, industry and defense..



# Here's how to GET MORE WORK OUT OF YOUR Oscilloscope!

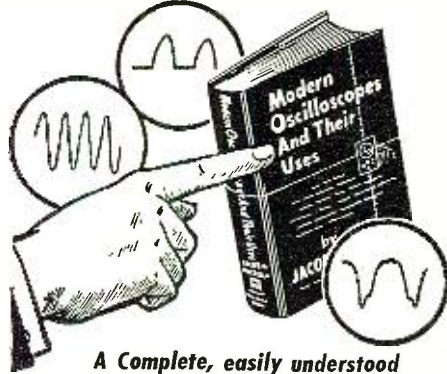

## A Complete, easily understood guide to using the handiest service instrument of them all MODERN OSCILLOSCOPES AND THEIR USES

By Jacob H. Ruiter, Jr.

### Enlarged 2nd Edition

... contains the latest data ... everything you need to know about 'scopes!

### MORE THAN 30 NEW PICTURES

... plus 50 more pages on use of 'scopes in Color TV servicing ... Industrial Electronics ... Teaching ... even in Atomic Energy work.

Oscilloscopes are gold mines for servicemen who learn to use them fast, fully and accurately on all types of work—and here is a new, enlarged 2nd edition of THE BOOK THAT REALLY SHOWS YOU HOW.

In clear, easily understood terms, it teaches you when, where and exactly how to use the oscilloscope ... how to interpret patterns ... how to use your 'scope to handle tough jobs easier, faster, and better.

It contains no involved mathematics—no complicated discussions. Instead, it gets right down to "brass tacks" in explaining how oscilloscopes operate. Then you learn exactly how to use them in lab work and on all types of AM, FM and television service—from locating troubles to handling tough realignment jobs.

### 'SCOPES ARE "GOLD MINES" When You Learn to Use Them Right!

Each operation is explained step by step. You learn to determine just where and how to use the 'scope on specific jobs; how to make connections and adjust circuit components; how to set the controls; and HOW TO ANALYZE OSCILLOSCOPE PATTERNS fast and right.

370 illustrations including dozens of pattern photos make things doubly clear.

No other type of specific service training can mean so much to you in boosting your efficiency and earning power! Send coupon NOW for 10-day examination!



'SCOPE EXPERTS get better jobs ... bigger pay!

### PRACTICE 10 DAYS—FREE!

Dept. RN-118, RINEHART & CO., Inc., 232 Madison Ave., New York 16, N. Y. Send MODERN OSCILLOSCOPES AND THEIR USES for 10-day FREE EXAMINATION. If book is satisfactory, I will then send you \$6.50 (plus postage) promptly in full payment. If not, I will return book postpaid in good condition and owe you nothing. (SAVE! Send \$6.50 cash with order and we pay postage. Same 10-day return privilege with money refunded.)

NAME .....

ADDRESS .....

CITY, ZONE, STATE .....

OUTSIDE U.S.A. \$7.00 cash only. Money back if you return book within 10 days.

CARTRIDGE	CAPACITANCE	RECOMMENDED LOAD RES.	MAXIMUM LOAD CAP. (Note A)	NETWORK FOR CONVERSION TO VELOCITY DEVICE
Astatic 81-TB	400 $\mu\text{f}$ d.	2 meg. (Note B)	100 $\mu\text{f}$ d. (Note B)	Fig. 14A
Astatic 89-TB	600 $\mu\text{f}$ d.	2 meg. (Note B)	100 $\mu\text{f}$ d. (Note B)	Fig. 14A
Electro-Voice 8D	300 $\mu\text{f}$ d.	3 meg.	100 $\mu\text{f}$ d.	Fig. 14B
Ronette TX-88	1500-1800 $\mu\text{f}$ d.	500,000 ohms	Note C	Fig. 14C
Shure ML-44	525 $\mu\text{f}$ d.	Fig. 14D	Note C	Fig. 14E
Sonotone 3T-S	490 $\mu\text{f}$ d.	2.2 meg. (Note D)	100 $\mu\text{f}$ d.	Fig. 14G
Webster MC-1	510 $\mu\text{f}$ d.	.51 to 3.3 meg.	100 $\mu\text{f}$ d.	Note C
Zenith	500 $\mu\text{f}$ d.	1 meg.	100 $\mu\text{f}$ d.	Note E

NOTES: A=cable capacitance and input stage capacitance. This is the maximum load capacitance for the recommended load resistance. Higher load capacitances are permitted with smaller load resistances, as discussed in text; B = the manufacturer states, "Load resistance, in megohms, multiplied by total capacitance (cartridge, cable, etc.) should equal approximately 1000"; C=information not supplied by manufacturer; D=see Fig. 14F for alternate load network recommended by the manufacturer for maximum flatness of response; E = the manufacturer states, "We do not recommend the conversion of this pickup into a velocity device."

For information on cartridges not covered, contact the manufacturers direct.

Table 2. Characteristics and loading for representative piezoelectric cartridges.

Neither the series capacitor nor the shunt resistor should be so small as to produce high-pass action throughout the treble range. As already mentioned, the cartridge has built-in treble boost due to mechanical resonance. Therefore, the rise in output should level off at an appropriate point in the treble range, *viz.*, at about 5000 cycles.

To illustrate, assume that the load resistor in Fig. 12 is 500,000 ohms. In order to have a turnover frequency of approximately 5000 cycles (rise in output within 3 db of maximum), we find the necessary series capacitance by means of the formula  $C = 1/(2\pi fR) = 64 \mu\text{f}$ d. (approximately). The nearest standard value would be satisfactory. In the case of Fig. 13, assume that total circuit capacitance is 700  $\mu\text{f}$ d. We find the necessary load resistance by means of the formula  $R = 1/(2\pi fC)$ . Using the figure 5000 cycles as  $f$ ,  $R$  turns out to be about 46,000 ohms; a 47,000 ohm resistor will do.

If signal output is excessive after the cartridge is converted to a velocity-responsive device, signal attenuation can easily be achieved by using a voltage divider as the load resistance. As long

as the total load resistance is less than about 250,000 ohms, it is not likely that high-frequency loss, such as discussed in connection with Fig. 10, will occur.

Manufacturers of piezoelectric cartridges sometimes recommend a more complex network than a simple series capacitor or shunt resistor to make the pickup velocity-responsive. The purpose of the network is to obtain somewhat flatter response.

Table 2 shows the capacitance, recommended load resistor, and permissible shunt capacitance with this load resistor as given by the manufacturers of a number of popular piezoelectric cartridges. The table also indicates the means, if any, suggested by the manufacturer for making the cartridge velocity-responsive.

For those few special cartridges, such as the FM type, which do not fall in either of the categories discussed, the specific recommendations outlined by the manufacturer must be followed. Also, for information on magnetic and piezoelectric cartridges not covered in Tables 1 and 2, the cartridge manufacturer should be contacted for the correct information.

-30-

Fig. 14. Networks referred to in Table 2 for making conversion to velocity device.

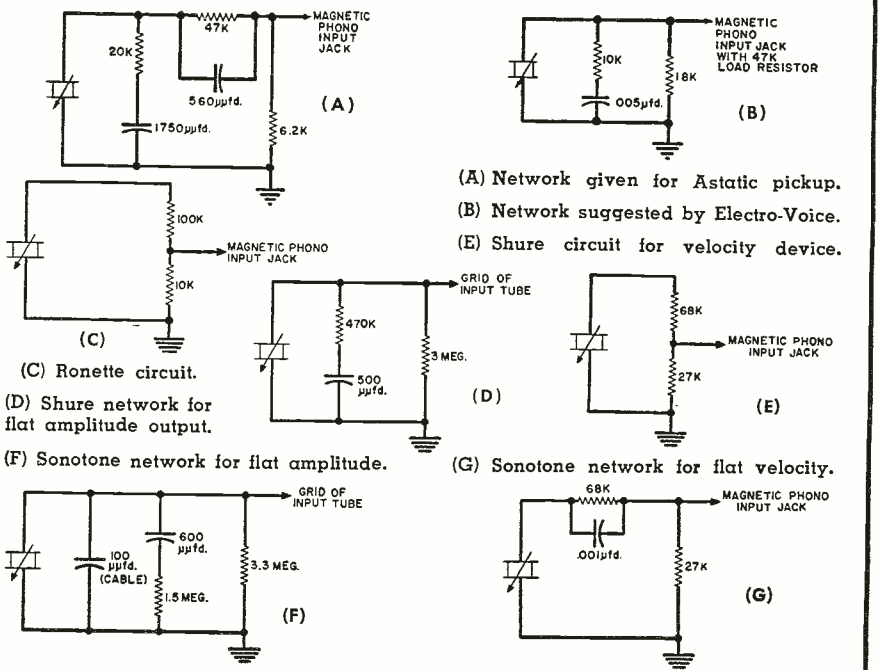



# TRANSISTOR TERMINOLOGY

By JOHN A. COMSTOCK

THIS year marks the tenth anniversary of the development of the transistor by three *Bell Telephone Laboratories'* scientists. Have you kept up with this revolutionary component? Test your knowledge. (Solution on page 165)

## ACROSS

1. Semiconductor which is neither "p" nor "n" containing roughly an equal number of electrons and holes.
5. Current carriers in a semiconductor which are positively charged.
8. Parameter letters symbol representing a transistor's power output.
9. Maximum inverse voltage rating which a transistor can withstand without breakdown.
10. Collector cut-off current.
12. Semiconductor material found most often in rectifiers.
15. Symbol for transistor operating temperature.
16. D.C. collector current.
18. Transistor input impedance.
19. Forward current ratio (input a.c. open-circuited).
20. Junction of "n" and "p" areas in a semiconductor.
22. Metal button alloyed into base wafer of an alloy-type transistor.
23. A number of these particles carry current, specifically electrons and holes.
25. Parameter letters symbol for transistor output impedance.
27. One of the electrodes of a field-effect transistor.
31. Current carriers of a negative polarity.
33. Letters symbol for d.c. supply voltage base-to-emitter.

## DOWN

1. Small addition to semiconductor, usually a donor or an acceptor.
2. Imperfections in a crystal which snare current carriers.
3. A transistorized preamp should generate minimum
4. Parameter symbol for emitter cut-off current.
5. Four-layer transistor with built-in amplifier for a collector.
6. That portion of cut-off current caused by surface effects.
7. Semiconductor commonly used in transistors and crystal diodes.
11. Location of transistor barrier.
13. Electrode of a transistor corresponding to vacuum tube's cathode.
14. Intrinsic region-type transistor with "n"-type emitter and collector and "p"-type base (Abbr.).
17. Runaway condition in which transistor's heat dissipation increases with higher temperature at such a rate that temperature keeps rising.
21. Parameter symbol for common emitter power gain.
24. Small current flowing opposite to normal in a diode when an opposing potential is applied.
25. Reverse voltage at which a large current begins to flow, caused by crystal breakdown.
26. Impurity used intentionally to produce an "n"-type semiconductor.
28. One of the electrodes of a transistor.
29. Letters symbol for emitter-to-base d.c. voltage.
30. Letters symbol used to represent common base output admittance (input a.c. open-circuited).
32. Symbol for transistor's junction temperature.

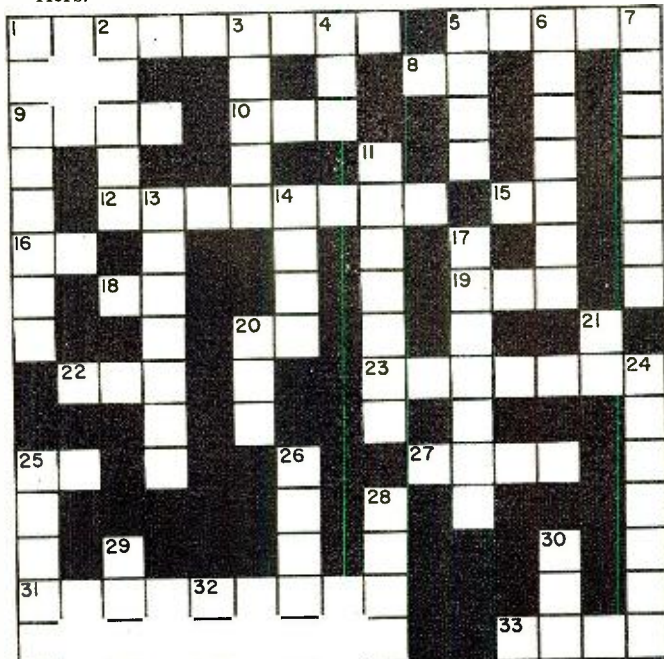

November, 1958

The specs are the proof...now your best buy in ham equipment is

**EICO**

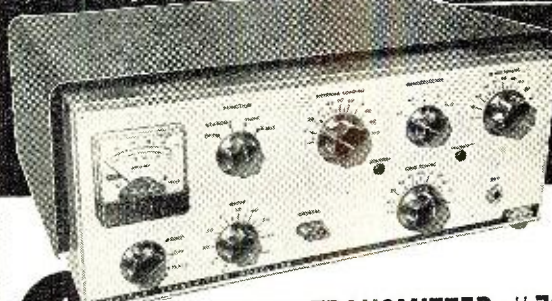

**New** 90-WATT CW TRANSMITTER #720  
KIT \$79.95 WIRED \$119.95

Conservative, highly efficient design plus stability, safety, and excellent parts quality. Covers 80 thru 40, 20, 15, 11, 10 meters (popular operating bands) with one knob band-switching. 6146 final amplifier for full "clean" 90W input, protected by clamper tube circuit. 6CL6 Colpitts oscillator, 6AQ5 clamper, 6AQ5 buffer-multiplier, G234 rectifier. "Novice limit" calibration on meter keeps novice inside the FCC-required 75W limit. No shock hazard at key. Wide range, hi-efficiency pi-network matches antennas 50 to 1000 ohms, minimizes harmonics. EXT plate modulation terminals for AM phone modulation with 65W input. Excellent as basic exciter to drive a power amplifier stage to maximum allowable input of 1KW. Very effective TVI suppression. Ingenious new "low silhouette" design for complete shielding and "living room" attractiveness. Finest quality, conservatively rated parts, copper-plated chassis, ceramic switch insulation. 5" H, 15" W, 9 1/2" D.

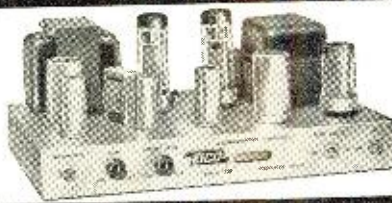

**NEW UNIVERSAL MODULATOR-DRIVER . . . . #730**  
KIT \$49.95 WIRED \$79.95 Cover E-5 \$4.50

Superb, truly versatile modulator at low cost. Can deliver 50 watts of undistorted audio signal for phone operation, more than sufficient to modulate 100% the EICO #720 CW Transmitter or any xmitter whose RF amplifier has a plate input power of up to 100W. Multi-match output xfmr matches most loads between 500-10,000 ohms. Unique over-modulation indicator permits easy monitoring, precludes need for plate meter. Low level speech clipping and filtering with peak speech frequency range circuitry. Low distortion feedback circuit, premium quality audio power pentodes, indirectly heated rectifier filament. Balance & bias adjust controls. Inputs for crystal or dynamic mikes, phone patch, etc. Excellent deluxe driver for high-power class B modulation. ECC83/12AX7 speech amplifier, 6AL5 speech clipper, 6AN8 amplifier driver, 2-EL34/6CA7 power output, EM84 over-modulation indicator, G234 rectifier. Finest quality, conservatively rated parts, copper-plated chassis. 6" H, 14" W, 8" D.

Copyright 1958 by Electronic Instr. Co., Inc.

**NEW GRID DIP METER . . . . . #710**  
KIT \$29.95 WIRED \$49.95 including complete set of coils for full band coverage.

Exceptionally versatile. Basically a VFO with micro-ammeter in grid; determines freq. of other osc. or tuned circuits; sens. control & phone jack facilitate "zero beat" listening. Excellent absorption wave meter. Ham uses: pre-tuning & neutralizing xmitters, power indication, locating parasitic osc., antenna adj., correcting TVI, de-bugging with xmitter power off, determining C.L.Q. Servicing uses: alignment of filters, IF's; as sig. or marker gen. Easy to hold & thumb-tune with 1 hand. Continuous 400 kc - 250 mc coverage in 7 ranges, pre-wound 0.5% accurate coils. 500 ua meter movement. 6AF4(A) or 6T4 Colpitts osc. Xmfr-operated sel. rect. 2 1/4" H, 2 3/4" W, 6 7/8" L. Satin deep-etched aluminum panel; grey wrinkle steel case.



**IN STOCK!** Compare and take them home—right "off the shelf"—from 1900 neighborhood EICO dealers. For free catalog mail coupon. Over 1 MILLION EICO instruments in use throughout the world. (Add 5% in the West)

Send for **FREE CATALOG** now  
EICO, 33-00 Northern Blvd., L.I.C. 1, N. Y.  
Show me HOW TO SAVE 50% on 60 models of top-quality equipment (in box I have checked here:  HAM GEAR  HI-FI  TEST INSTRUMENTS. Send **FREE** literature and name of EICO dealer.

NAME.....  
ADDRESS.....  
CITY..... STATE.....

See EICO's Hi-Fi and Test Equipment ads on Pages 35 and 36.



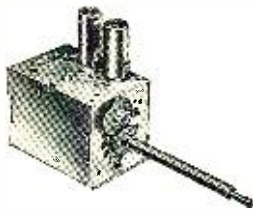

**Now YOU can get  
TUNERS  
repaired, or replaced,  
in a hurry!  
Send them to TARZIAN!**

● Sarkes Tarzian, Inc., announces a new tuner repair service and factory replacement program for Tarzian-manufactured tuners. Distributors, dealers and servicemen will welcome this direct factory service program which is designed to take delay and confusion out of the tuner repair business.

We're set up to offer a 48 hour service from the date of receipt to shipment to you.

Cost is reasonable, too. Only \$7.50 per unit (\$15 for UV combinations) and that includes ALL replacement parts! Both repaired—or exchange units if available from stock—carry a 90 day warranty against defective workmanship and part failure.

Replacements will be offered at these current prices\* on units not repairable:

- VHF 12 position tuner... \$17.50
- VHF 13 or 16 position tuner..... 19.50
- VHF/UHF combination. 25.00
- UHF only..... 15.50

\*Subject to change

When inquiring about tuner service, always refer to tuner by part number. When inquiring about direct replacements for tuners other than Sarkes Tarzian-manufactured, please indicate tube complement, shaft length, filament voltage, series or shunt heater. Use this address for quickest service:

**SARKES TARZIAN, Inc.**

Att: Service Mgr., Tuner Division  
East Hillside Drive  
Bloomington, Indiana



TARZIAN Electronic Product and Services include TELEVISION TUNERS . . . SELENIUM AND SILICON RECTIFIERS . . . BROADCAST EQUIPMENT . . . AIR TRIMMERS . . . TV STATIONS WTTV and WPTA, and RADIO STATION WTTS.

# New Tube Tester Data

Owners of Seco tube checkers: Keep up-to-date with this listing of the most recent tube types.

## SECO MODEL 107

P.S.	Load	Type	Fil. V	F.Fj	Q	Load	Spec	P.S.	Load	Type	Fil. V	F.Fj	Q	Load	Spec
9D	30	1K3	1	2.78	TC	100	D	7E	30	12DF7	12	4.5	2	70	A
		3Z4	1	17.5	3	100	B			12DF7	12	4.5	7	70	
		4ES8	4	4.5	2	80				12DK7	12	4.5	1	100	
9D	2X25	4ES8	4	4.5	7	80		9D	2X25	12DK7	12	4.5	6	100	A
		4DE6	4	3.4	1	30				12DK7	12	4.5	9	100	
		5BS8	5	4.5	2	70				12DQ7	12	4.5	2	25	
9D	30	5BS8	5	4.5	7	70		9D	30	12DS7	12	4.5	3	60	A
		5CG4	5	2.8	4	5	D			12DS7	12	4.5	1	100	
		5CG4	5	2.8	6	5	D			12DS7	12	4.5	9	100	
9G	30	5CM6	5	4.5	36	20		9G	30	12DT5	12	4.5	36	20	A
		5CR8	5	4.5	2	70				12DV8	12	4.5	3	100	
		5CR8	5	4.5	9	70	A			12DV8	12	4.5	1	100	
9L	25	5EH8	5	4.5	2	80		9L	25	12DV8	12	4.5	9	100	A
		5EH8	5	4.5	7	80				12DW8	12	4.5	2	100	
		6AF3	6	4.5	9	5	A			12DW8	12	4.5	7	100	
9L	25	6CK4	6	2.7	13	10		9L	25	12DY8	12	4.5	1	50	A
		6DA4	6	7.8	5	10				12DY8	12	4.5	9	100	
		6DE7	6	4.5	23	40	A			12DZ6	12	3.4	1	100	
9D	30	6DE7	6	4.5	7	40		9D	30	12EA6	12	3.4	1	100	A
		6DG7	6	4.5	2	50				12EC8	12	4.5	1	70	
		6DJ8	6	4.5	2	80				12EC8	12	4.5	9	70	
8G	25	6DJ8	6	4.5	7	80		8G	25	12ED5	12	3.4	25	25	A
		6DN7	6	7.8	1	50				12EF6	12	2.7	5	20	
		6DN7	6	7.8	4	50				12EK6	12	3.4	1	90	
9G	50	6DR7	6	4.5	23	40	A	9G	50	12EM6	12	4.5	1	100	A
		6DR7	6	4.5	7	40				12EM6	12	4.5	9	100	
		6DT5	6	4.5	36	20				12EN6	12	2.7	5	15	
9G	20	6EB8	6	4.5	2	100		9G	20	12EZ6	12	3.4	1	100	A
		6EB8	6	4.5	7	20				12FA6	12	3.4	1	100	
		6EF6	6	2.7	5	20				12FM6	12	3.4	1	100	
9G	30	6EH8	6	4.5	2	70		9G	30	12FM6	12	3.4	5	100	A
		6EH8	6	4.5	2	70				12FAI6	12	3.4	6	100	
		6EM5	6	4.5	36	15				13DE7	12	4.5	23	50	
9D	25	6ES8	6	4.5	2	80		9D	25	13DE7	12	4.5	7	70	A
		6ES8	6	4.5	7	80				13DR7	12	4.5	23	50	
		6EW6	6	3.4	1	60				13DR7	12	4.5	7	70	
7E	25	6FH8	6	2.7	5	15		7E	25	14G6	12	4.5	2	100	A
		6H8	6	2.7	4	85	40			14G6	12	4.5	6	100	
		6H8	6	2.7	5	85	40			14G6	12	4.5	8	100	
9G	50	7EY6	7	2.7	5	20		9G	50	14Y7	12	4.5	2	70	A
		8BQ5	8	4.5	2	15				14Y7	12	4.5	9	70	
		8CY7	8	4.5	3	25	A			17C8	15	4.5	2	80	
9G	20	8CY7	8	4.5	7	100		9G	20	17C8	15	4.5	7	100	A
		8EB8	8	4.5	2	100				17C8	15	4.5	8	100	
		8EB8	8	4.5	7	20				17D4	15	7.8	5	10	
9G	20	8EM5	8	4.5	36	15		9G	20	25EH5	25	3.4	25	15	A
		9EF6	9	2.7	5	20				38A3	35	4.5	9	10	
		11CY7	12	4.5	3	25	A			45B5	45	4.5	2	15	
9G	20	11CY7	12	4.5	7	100		9G	20	50BM18	50	4.5	1	70	A
		12AD5	12	4.5	2	60				50BM8	50	4.5	3	70	
		12AF3	12	4.5	9	5	A			55N3	50	4.5	9	10	
9G	20	12AD5	12	4.5	2	60		9G	20	12D4	15	7.8	5	10	A
		12AF3	12	4.5	9	5	A								
		12D4	15	7.8	5	10									



**Service Holds a Convention**  
(Continued from page 57)

many in the east, who were in Chicago for very much the same reasons Teskey was.

Fortunately, we can report a happy ending. We talked to you. Since you were understandably one of the busiest men at the convention, we also talked to Al Saunders, Verne LaPlante, Bert Bregenzer, and a number of others of your capable associates. In trying to set the record straight, we learned that some thought had already been given to the matters of press coverage and Frank Teskey by all of you, and that a re-appraisal was in the works. Your invitation to let us sit in on the remaining meetings, which came soon thereafter, was a welcome turn of events. In fact, it ended well for all of us, observers and participants.

Once inside the meeting room, we got another view of things. We saw an active group going about its business in a democratic way. We saw everyone who had something to say being given his chance. We saw no highwaymen. We saw the "tyrant," Frank Moch, being cut down at times by the chairman's gavel and finding some disagreement in a peaceable, above-board fashion. We heard one outside observer say, "I wish we could get this sort of interest and activity in our own local meetings."

We heard the Teskey matter openly discussed and noted the general agreement that it would be wise to hold it for the final session to avoid interference with the completion of uncompleted convention business.

At the final session, we saw Teskey invited to state his business. We heard forthright answers to most of his questions from you and careful explanations as to why certain others could not be answered fully. We were also told by Teskey and other observers for non-NATESA groups that they considered the answers generally good ones, providing a large step in the direction of reconciliation.

And what of the lessons we mentioned earlier? We can now see why, oversensitized by a long struggle for recognition against long odds, you are worried about the damage that enemies may do. However, secrecy is the wrong weapon to use against snipers. As long as you are clean, your best defense is working out in the open as much as possible. NATESA is big now, and the concern of everyone in service. Compare the damage that was almost done to the good finally accomplished by a forthright approach.

Again, thanks for the opportunity of taking part in an exciting service event. We hope to run the Teskey questions next month, with answers. We also look forward to seeing you again next year.

Cordially yours,  
Sidney C. Silver, Service Editor  
RADIO & TV NEWS

November, 1958

# NO OTHER TUBE TESTER MADE - AT ANY PRICE - can MATCH the VALUE of the CENTURY FAST-CHECK

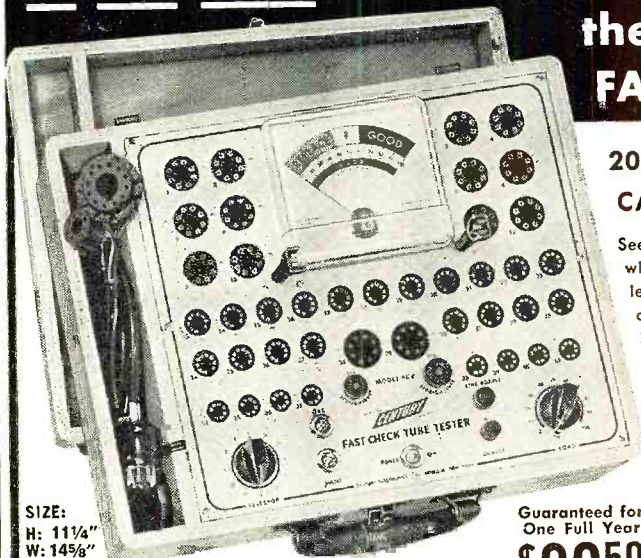

SIZE:  
H: 11 1/4"  
W: 14 5/8"  
D: 4 3/8"

Model FC-2—housed in rugged oak carrying case complete with CRT adapter . . . only

Guaranteed for One Full Year  
**\$69.50** Net

## 20,000 SERVICEMEN CAN'T BE WRONG!

See for yourself—AT NO RISK—why over 20,000 servicemen selected the FAST-CHECK above all other tube testers—regardless of price. With the FAST-CHECK you will make every call pay extra dividends by merely showing your customer the actual condition and life expectancy of the tube. The extra tubes you will sell each day will pay for the FAST-CHECK in a very short time.

Special compartment accommodates line cord and Picture Tube Test Adapter

### PICTURE TUBE TEST ADAPTER INCLUDED WITH FAST-CHECK

Enables you to check all picture tubes (including the new short-neck 110 degree type) for cathode emission, shorts and life expectancy . . . also to rejuvenate weak picture tubes. This feature eliminates the need of carrying extra instruments and makes the FC-2 truly an all-around tube tester.

**FAST-CHECK'S low price is made possible because you are buying direct from the manufacturer.**

## Just 2 settings on the FAST-CHECK TUBE TESTER tests over 650 tube types completely, accurately — AND IN SECONDS!

- **POSITIVELY CANNOT BECOME OBSOLETE**  
Circuitry is engineered to accommodate all future tube types as they come out. New tube listings are furnished periodically at no cost.
- **NO TIME CONSUMING MULTIPLE SWITCHING**  
Only two settings are required instead of banks of switches on conventional testers.
- **NO ANNOYING ROLL CHART CHECKING**  
Tube chart listing over 650 tube types is conveniently located inside FAST-CHECK cover. New tube listings are easily added without costly roll chart replacement.

### COMPARE FAST-CHECK WITH OTHER TESTERS RANGING FROM \$40 TO \$200

#### RANGE OF OPERATION

- ✓ Checks quality of over 650 tube types, which cover more than 99% of all tubes in use today, including the newest series-string TV tubes, auto 12 plate-volt tubes, OZ4s, magic eye tubes, gas regulators, special purpose hi-fi tubes and even foreign tubes.
- ✓ Checks for inter-element shorts and leakage.
- ✓ Checks for gas content.
- ✓ Checks for life-expectancy.

#### IMPORTANT FEATURES

- Checks each section of multi-section tubes and if only one section is defective the tube will read "Bad" on the meter scale ● Less than 10 seconds required to test any tube ● 41 long lasting phosphor-bronze tube sockets accommodate all present and future tube types . . . cannot become obsolete ● 7-pin and 9-pin straighteners mounted on panel ● Large D'Arsonval type meter is extremely sensitive yet rugged — fully protected against accidental burn-out ● Special scale on meter for low current tubes ● New tube listings furnished periodically at no cost ● Compensation for line voltage variation.

Other testers may have some of the above features . . . but only the FAST-CHECK has them all!

## SHIPPED ON APPROVAL FOR 10 DAY FREE TRIAL

Try the FC-2 before you buy it! No obligation to buy.

### PAY IN SMALL MONTHLY PAYMENTS

Easy to buy if you're satisfied. Pay at net cash price . . . no financing charges.

**NO MONEY REQUIRED WITH ORDER . . .**

### CENTURY ELECTRONICS CO., INC.

Dept. 211, 111 Roosevelt Ave., Mineola, N. Y.

Rush the FAST-CHECK for a 10 day trial period. If not completely satisfied I will return the instrument within 10 days without further obligation. If fully satisfied I agree to pay the down payment within 10 days and the monthly installments as shown. No financing charges are to be added.

Model FC-2 . . . \$69.50 — Pay \$14.50 within 10 days. Balance \$11.00 monthly for 5 months.

Name.....

Address.....

City..... State.....

F.O.B., Mineola, N.Y.



# UNBEATABLE!

## SPAULDING

### "STRATO-TOWER"

FEATURING THE

# ALL NEW SCREW ANCHOR BASE

1. No Concrete Necessary
2. Completely Self-Supporting
3. Unconditionally Guaranteed  
(Base more satisfactory than concrete or your money back)
4. Absolutely No Hole To Dig
5. Fast Installation . . . Base in 15 Min., Tower in 90 Min. (2 men)
6. One Base Fits All Tower Sizes To 48 Ft.
7. Tower Completely Galvanized
8. All Riveted Construction
9. Beaded Channel Leg (Will not rust inside like tubular type towers)

No. X40B (ILLUSTRATED)  
40 FT. HIGH  
LIST **\$99.95**

OTHER MODELS FROM 8 FT. TO 64 FT.

U. S. Patent No. 2806560

How  
Tower  
Mounts  
On  
Screw  
Anchor  
Base



## WRITE

today for complete literature and details on where to get Spaulding Strato-Towers for TV—Ham—Civil Defense—Industrial Communications.

### SPAULDING PRODUCTS COMPANY

550 West Barner Street

Frankfort, Indiana

IN CANADA: Delhi Metal Products Co., Delhi, Ontario

132

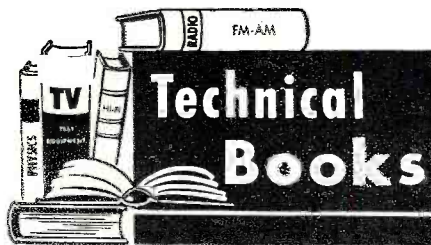

### "BASICS OF DIGITAL COMPUTERS"

by John S. Murphy. Published by *John F. Rider Publisher, Inc.*, New York. Three volumes (\$2.50 each, \$6.95 the set). Soft cover.

As the title of this series implies, this is a primer for those interested in acquiring a broad background in computer theory. In "picture-book" form, the author covers the development of computers, basic theory of computer arithmetic, data representation, program, "and/or" circuitry, and control in his first volume.

The second volume discusses the logical elements, circuits, typical types of signals, and magnetic cores which are then combined to show a few of the less complex units such as encoders, decoders, counters, and adders as used in computers. The final book in this trilogy covers types of memory, control system, and input-output equipment of computers as a whole. Timing is also given extensive treatment.

Since the discussion is progressive and the material clearly written and lavishly illustrated, there is no reason why this series cannot be used as a "home-study course" by those with some knowledge of electronics who want to break into the broader field of data processing.

"PIN-POINT COLOR TV TROUBLES IN 15 MINUTES" edited by Harold P. Manly & Coyne Technical Staff. Published by *Coyne Electrical School*, Chicago. 548 pages. Price \$5.95. Spiral bound, soft cover.

This practical manual for the service technician has been based on the "Check-Chart" system of troubleshooting developed by Mr. Manly. The book covers 150 types of faulty pictures with over 1000 troubles responsible for such results. A detailed system of cross-referencing permits the rapid location of these picture faults. Check-charts are used extensively to point up possible trouble sources.

Among the receiver circuitry covered in this book are the antenna, tuner, i.f. amplifier, picture detector, a.g.c., Y amplifier, chrominance bandpass amplifier, matrices, chrominance demodulators, one- and three-gun picture tubes, picture input tubes, basic and final color tube set-ups, burst amplifier, burst phase detector, reactance tube, subcarrier oscillator, color killer and automatic chroma control, vertical and horizontal sync, deflection yoke, deflection, sound, and dynamic convergence.

An eight-page picture-pattern section in full color is a "plus" feature which should prove especially helpful to the practicing technician.

from **ALMO RADIO**  
IMMEDIATE DELIVERY  
on new value-packed  
**EICO® HAM GEAR**



90-WATT CW TRANSMITTER #720  
KIT \$79.95 WIRED \$119.95



UNIVERSAL MODULATOR-DRIVER #730  
KIT \$49.95  
WIRED \$79.95 Cover E-5 \$4.50



GRID DIP METER #710  
KIT \$29.95 WIRED \$49.95

including coils for full band coverage

**ALMO RADIO CO.** 913 Arch St., Phila, Pa. R-11

Send            QUANTITY each of EICO Models .....

I enclose \$ .....

Send complete EICO catalog on ham, hi-fi, test equipment.

Name .....

Address .....

City .....

Zone .....

State .....

IF YOU PRIZE IT... KRYLON-IZE IT!

Completely seals electronic parts with no delay



### KRYLON® CRYSTAL-CLEAR ACRYLIC SPRAY

Radio, TV and hi-fi equipment need Krylon Crystal-Clear, the protective coating with high dielectric strength and weatherproof qualities that seal the surface indefinitely.

- Prevents corona in high voltage section
- Keeps lead-in connections tight
- Prevents rusting and pitting of antenna
- Goes on in seconds—DRIES IN MINUTES

At your favorite radio-TV repair shop.

Use Krylon Spray Paints (21 colors) for quick, easy, professional touch-up jobs

IF YOU PRIZE IT... KRYLON-IZE IT!  
RADIO & TV NEWS



Those now concerned with color TV service work should find this volume immediately useful in cutting troubleshooting time while those who have yet to encounter their first color job would be well advised to have a copy on hand for future reference and anticipatory study.

\* \* \*

"ELECTRON-TUBE CIRCUITS" by Samuel Seely. Published by McGraw-Hill Book Company, Inc., New York. 680 pages. Price \$10.50. Second Edition.

In this revised and enlarged edition of a volume which originally appeared in 1950, the author has added considerable new material covering the analysis of RC feedback amplifiers, FM discriminators, electronic computing circuits and devices, and the theory of clamping. He has also expanded his original treatment of such topics as feedback, solid state electronics, transistors, and transistor circuit theory in addition to providing new problems for the student.

The author and his book are too well known in classrooms throughout the country to require any detailed analysis. The text is divided into twenty chapters and four appendices and provides painstaking coverage of practically every type of circuit or device using vacuum tubes. The appendices include network theorems, plate characteristics of vacuum tubes, characteristics of transmitting tubes, and a table of Bessel functions of the first kind to make the text self-contained.

Would-be users of this text are advised to have their basic mathematical techniques well sharpened and in good working order before tackling this volume.

\* \* \*

"TRANSISTOR MANUAL" compiled and published by Semiconductor Products Dept., General Electric Co., Syracuse, N. Y. 168 pages. Price \$1.00. Spiral binding, soft cover. Third Edition.

This new and revised manual contains a wealth of information which will be of interest to circuit designers, hobbyists, and experimenters. Three early chapters cover basic semiconductor theory, transistor construction techniques, and biasing while the balance of the text is devoted to specific and practical applications of transistors.

Separate chapters on basic amplifiers, hi-fi circuits, radio circuits, uni-junction transistor circuits, transistor switches, and logic contain both schematic examples and explanatory text. Four final chapters deal with tetrode transistors, the silicon-controlled rectifier, power supplies, and transistor specifications. A circuit diagram index and bibliography complete the book.

Those with a more-than-casual interest in transistors and transistor circuitry will enjoy and profit by a serious perusal of this manual.

\* \* \*

"TAPE RECORDER MANUAL" compiled and published by Howard W. Sams & Co., Inc., Indianapolis. 160

# Convert ANY Phonograph to STEREO with FANON LOW-COST Conversion Kits

- Adapts Phono for both Stereo or Monaural.
- Improves Sound Quality of Monaural Records.
- Second amplifier-speaker system adds depth.

With the big boom in stereo records and stereo phonographs, you can bring any hi-fi record player up to date to play both monaural and the new stereo records. Simple to install, the new Fanon Kits offer you top fidelity for the most economical changeover today. Speaker-amplifier unit alone can be used with tape recorders, tuners, etc. Your customers get more for their dollars with Fanon.

**FANON STK-4**  
Complete high fidelity three tube amplifier system with two 4" phased speakers in handsome two-tone fashion-fabric cabinet. Separate bass, treble and volume controls for second channel. Kit includes hi-fi ceramic turnover stereo cartridge, mounting accessories, phono jack and 15 feet of extension cable to unit.  
**ONLY \$39<sup>95</sup> List**  
Speaker-amplifier-cable unit (Model ST-4) \$31.95 List

**FANON STK-5**  
High fidelity 5-tube push-pull amplifier with one 8" woofer and one 3" tweeter in smartly designed two-tone cabinet. Separate bass, treble and volume control for second channel. High fidelity ceramic turnover Stereo cartridge, mounting accessories, phono jack and 15 feet of extension cable included in kit.  
**ONLY \$49<sup>95</sup> List**  
Speaker-amplifier-cable unit (Model ST-5) \$41.95 List

**FANON STK-10**  
Beautifully finished, hand-rubbed mahogany, walnut or blonde cabinet complete with same quality components as in STK-5 above. Kit includes high fidelity ceramic turnover stereo cartridge, accessories, phono jack and 15 ft. extension cable. Ideal for converting consoles.  
**ONLY \$59<sup>95</sup> List**  
Speaker-amplifier-cable unit (Model ST-10) \$51.95 List

Ask your distributor for complete specifications and installation instructions. See about Fanon's complete selection of Stereo phonograph systems, too!

**FANON ELECTRIC CO., INC.**  
Dept. R-11, 98 Berriman St., Brooklyn 8, N. Y.  
In Canada: Active Radio & TV Dist., 58 Spadina Ave., Toronto



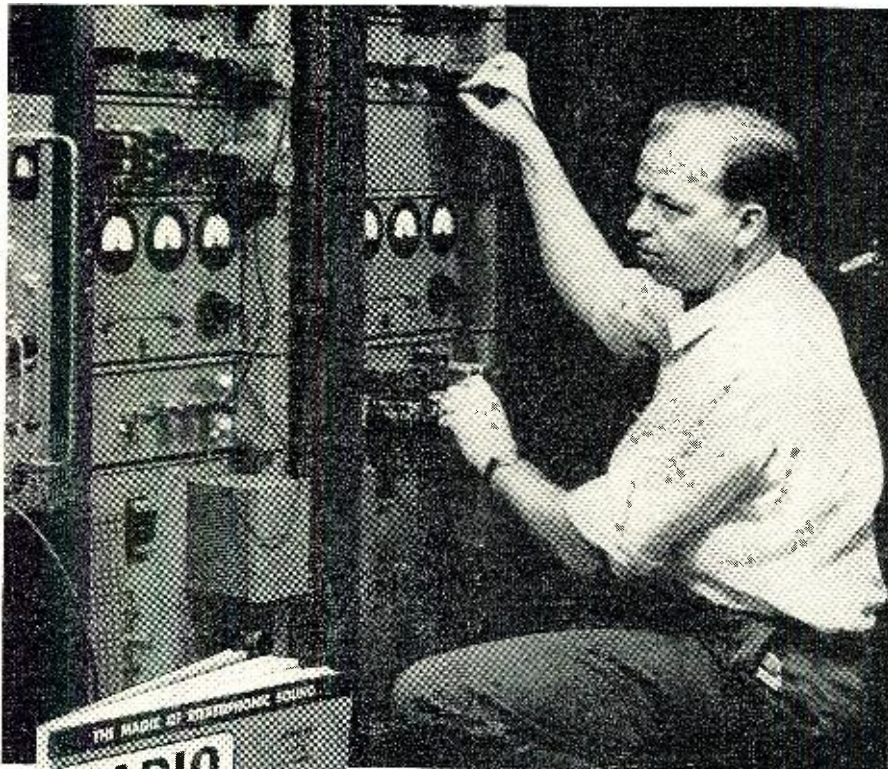

## IF THIS MAN IS ON YOUR CHRISTMAS LIST —

**A subscription to RADIO & TV NEWS will make a perfect gift for him, and every other man with a stake in electronics.**

If he makes his living in electronics or is an advanced hobbyist who loves Hi-Fi, Radio, TV, Audio, R/C, ham radio and communications, he'll be delighted to get RADIO & TV NEWS as a gift. For RADIO & TV NEWS offers the best

technical coverage in the field. It provides men in electronics with tips and techniques on repairing, installing and maintaining radio and TV sets and circuits, latest Hi-Fi developments, newest ham techniques, fresh audio ideas, test equipment, and current industry news. There is no more thoughtful Christmas gift, or flattering one, than a subscription to RADIO & TV NEWS, the first and most authoritative magazine in the field. Each of your gift subscriptions will be announced by an attractive card, inscribed with your name. What's more, you can enter or extend your own subscription to RADIO & TV NEWS at these special Christmas gift subscription rates, too!

**First 1-year gift subscription . . . . . \$4**  
**Each additional 1-year gift subscription . . . . \$3**

*Fill in and return the postage-paid envelope facing this page for your own and gift subscriptions. List additional gift orders on an extra sheet of paper.*

**WRAP UP YOUR CHRISTMAS GIVING NOW! DO IT EASILY, AND APPROPRIATELY, WITH RADIO & TV NEWS**



**RADIO & TV NEWS • 434 S. WABASH AVE. • CHICAGO 5, ILL.**

pages. Price \$2.95. Soft cover. Vol. 2. This is the second volume in this publisher's new series covering current-model tape recorders. The manual includes information on 16 models produced during 1957—15 monaural and one stereo unit.

Both home and professional models are covered with complete information on general operational data, use of external speakers, mechanical and amplifier adjustments, cleaning, lubrication, etc. For each recorder covered the text provides information on troubles and probable remedies plus complete mechanical and electrical component parts listings.

Photographs show the actual recorder and amplifier with exploded view diagrams providing the complete assembly and parts lists information. Amplifier schematics are included where applicable. A cumulative index for Volumes 1 and 2 is also provided.

Both service technicians and technically minded audiophiles will find this manual helpful.

\* \* \*

**"SINGLE SIDEBAND FOR THE RADIO AMATEUR"** edited by ARRL Headquarters Staff. Published by *American Radio Relay League*, West Hartford, Conn. 212 pages plus catalogue section. Price \$1.50 (U.S.), \$1.75 (outside continental U.S.).

The enlarged and expanded edition of this "bible" for SSB amateurs is a compilation of the best articles on the subject of single-sideband which have appeared in "QST." Careful revision and editing makes the presentation complete without being repetitious. Both theory and practice are covered.

The individual articles have been arranged so that the contents can be presented in orderly progression under eight specific categories: introduction and historical background, modulation, detection, filter systems, receivers, phasing system, linear amplifiers, and accessories. The text is profusely illustrated with charts, tables, formulas, schematics, and photographs.

It would be hard to find any other single source that provides as much information on SSB in as concise and practical a form as can be found in this comprehensive manual—a "must" for the radio amateur who is operating SSB.

-50-

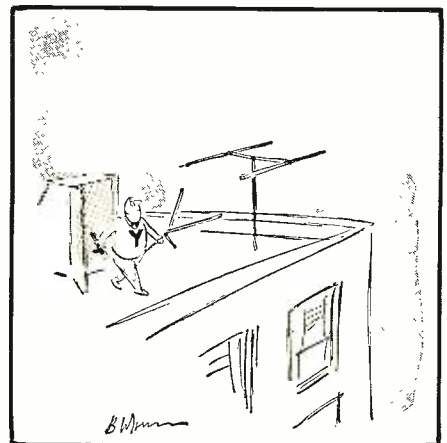

**RADIO & TV NEWS**



# ATR SHAV-PAK NEW, LOW PRICE!



**SHAVE IN THE COMFORT  
OF YOUR CAR,  
Boat or Plane!**



Plugs into  
Cigarette Lighter  
Receptacle on Dash  
**\$663**  
DEALER PRICE  
List Price \$9.95

Specially Designed for  
Operating Standard A.C.  
Electric Shavers in  
Automobiles, Buses,  
Trucks, Boats, and  
Planes.

TYPE	INPUT D.C. VOLTS	A.C. OUTPUT 60 CYCLES	OUTPUT WATTAGE	Dealer Price
6-SPB	6	115 volts	15	\$6.63
12-SPB	12	115	15	6.63

## Introducing ATR MIGHTY MIDGET portable INVERTER WITH GREATER OUTPUT

DICTATE REPORTS ACCURATELY-PROMPTLY!

**make your car, boat or plane  
a "rolling office"**

with **ATR INVERTERS**



for changing your  
storage battery  
current to A.C.

**Household  
ELECTRICITY  
Anywhere  
in your own car!**

Plugs into  
Cigarette Lighter  
Receptacle on Dash  
**\$1330**  
DEALER  
PRICE  
List Price \$19.95



**ATR INVERTERS**

especially designed for operating  
standard 110 volt A.C.

- DICTATING MACHINES
- TAPE RECORDER
- ELECTRIC RAZORS
- WIRE RECORDERS

Type	Input D.C. Volts	A.C. Output 60 Cycles	Output Wattage	Dealer Price
12-DME	12	115	40-50	\$13.30
12U-RHG	12	115	150-175	59.97

Inverters available for 6, 12, 28, 32, 110  
and 220 D.C. input operation

See your jobber or write factory today  
for complete information

**ATR** AMERICAN TELEVISION & RADIO CO.  
Quality Products Since 1931  
SAINT PAUL 1, MINNESOTA—U. S. A.

# Antenna News

## TV ANTENNA ROTORS

The Accessory Division of *Philco Corporation*, "C" & Westmoreland Sts., Philadelphia 34, Pa. has added four new television rotors to its line of TV accessories.

The newly designed control box measures 5 $\frac{1}{16}$ " wide by 4 $\frac{1}{16}$ " deep. The top of the control contains the meter and slopes up to a maximum height of 5 $\frac{5}{8}$ ". A horizontal rocker-bar actuates the rotor. Since this involves vertical pressure, any tendency to push the control sidewise is eliminated.

New features for the installer include an adjustable meter indicator, similar to a "zero-adjust" on a conventional meter. This permits more accurate adjustments to be made for line voltage and lead length than were possible with the potentiometer used in previous models.

The motor unit is new in appearance and the entire housing is cast aluminum, providing an unusually tight weather seal. The models currently available are the P-15 (mahogany); P15B (blonde); P-16 (mahogany with thrust bearing); and P16B (blonde with thrust bearing).

## SWEPT-WING AUTO ANTENNA

The *Tenna Mfg. Co.*, 7580 Garfield Blvd., Cleveland 25, Ohio has developed a new auto radio antenna which features the swept-wing styling of the 1958 passenger cars with which it is designed to be used.

The Model JA-7 "Bullet" antenna can be mounted on any car cowl or fender contour. It comes with two chrome, die-cast swivels which permit vertical or 45-degree angle mounting of the removable mast and two plastic base mounting pads for any car contour. Quick top installation is provided by a special mounting toggle which is supplied with the antenna.

## "WONDER WAVE" FRINGE UNIT

*Radio Merchandise Sales, Inc.*, 2016 Bronxdale Ave., New York 62, N. Y. has added the "Wonder Wave" all-channel broadband unit to its 1958 line of power antennas.

Designed for both black-and-white and color reception, the antenna provides extra gain for fringe areas, features a low silhouette to reduce wind drag, and automatic snap-lock brackets and insulators for maximum security. An added feature of this model is the firm's "Quadro-Grip" U-bolt assembly which grips and secures the antenna crossarm to the mast four times, preventing turning and slipping of the antenna on the mast.

The series is currently being offered in two models: WW-75 and the WW-150 stacked for double power. —30—

# NEW OR REPLACEMENT THE BIG ANTENNA PROFIT

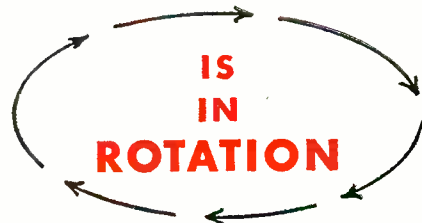

And the big name in rotation is

## ALLIANCE TENNA-ROTOR

Critical Color-TV, channel changes, new stations—these are reasons why there's nothing like Alliance Tenna-Rotor for *lasting* customer satisfaction.

When you recommend and install an Alliance Tenna-Rotor you do the customer a favor and you boost your profits up into the big money class.

And it's easy to sell Alliance Tenna-Rotor because it's the leader. Customers know the name through years of consistent national advertising. Sell the name and idea first, then match the customer's budget with a model from the *complete* Alliance Tenna-Rotor line. You'll get plenty of sales helps and free ad mats to help build this profitable business. Write for complete dealer information.

The  
**ALLIANCE**  
Manufacturing Company  
(Division of Consolidated  
Electronics Industries Corp.)  
Alliance, Ohio

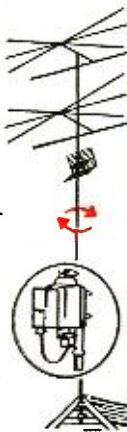

**alliance**  
TENNA-ROTOR



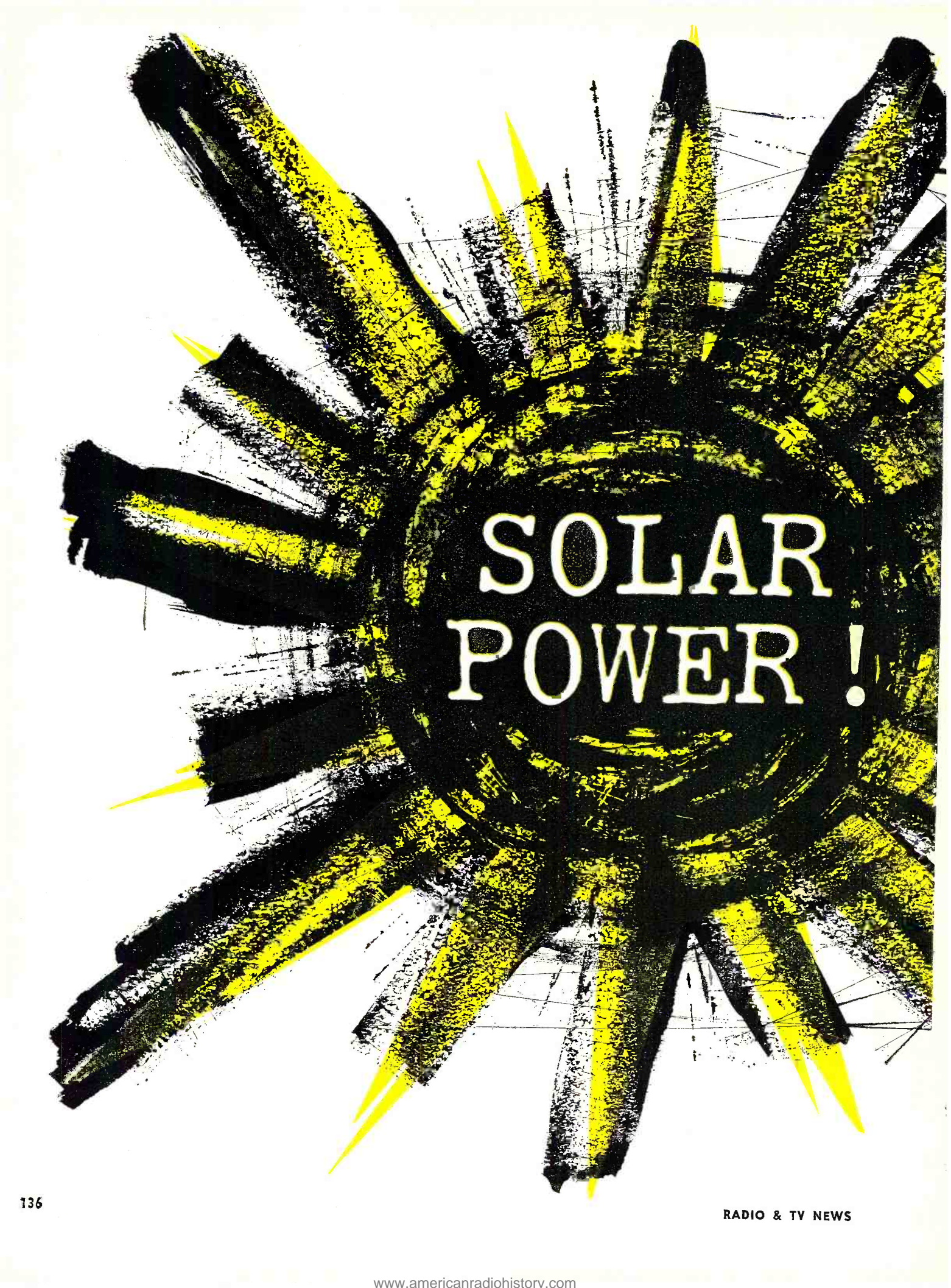

SOLAR  
POWER!



don't miss the special report on

# SOLAR POWER

in December RADIO & TV NEWS

It staggers the imagination! Add up the world's total reserves of gas and oil and convert into energy. You'll find that the sun can equal that potential output in the short space of 40 hours!

How can man tap such vast solar energy? Next month, RADIO & TV NEWS describes in detail one promising development -- the silicon solar battery. This battery already provides power for radio transmitters in Vanguard missiles. It has been tested for use in rural carrier-telephone systems as a power booster. And it has also proved itself in several portable receivers on the market today!

The solar battery has limitless applications -- may one day revolutionize our way of life. That's why the editors of RADIO & TV NEWS have prepared a special report on the silicon solar battery, its principles of operation, cost, efficiency and significance.

Here's a vital feature that everyone in the field of electronics should read. It's typical of the exciting, authoritative articles you'll find month after month in RADIO & TV NEWS. One more reason why, if you're not yet a subscriber, you'd be wise to enter an order now!

Take advantage of the special Christmas Subscription Order Form found elsewhere in this issue.

#### REGULAR SUBSCRIPTION RATES

\$4 one year \$7 two years \$10 three years

ZIFF-DAVIS PUBLISHING COMPANY  
One Park Avenue, New York 16, N.Y.







Jeri Southern makes her tape recordings on



That's not the reason why you should use



Here's why you should use



It's the best engineered tape in the world

...gives you better highs... better lows... better sound all around! Saves your tape recorder, too - because the **IRISH FERRO-SHEEN** process results in smoother tape... tape that can't sand down your magnetic heads or shed oxide powder into your machine. Price? Same as ordinary tape!



Available wherever quality tape is sold.  
ORRadio Industries, Inc., Opelika, Alabama  
Export: Morhan Exporting Corp., New York, N. Y.  
Canada: Atlas Radio Corp., Ltd., Toronto, Ontario

# Certified RECORD REVUE

By BERT WHYTE

AS many of you are probably aware, some of the very first stereo discs were the product of *Sudgen Company* in England and it is also rather well known that *London Records*, through the parent *Decca Company* of England, has been experimenting with vertical/lateral stereo recordings for the past few years. So you might say our English cousins got the jump on us in this field, even though they, as well as we, subsequently adopted the *Westrex 45-45* system. This is by way of preface to telling you that I spent considerable time in England this summer and was able to observe first-hand what the situation is there with regards the stereo disc as well as other hi-fi phenomena.

There is a large and active electronics firm in England called the *Pye-Nixa* group. It has, for some time, been making recordings of various British orchestras and has alliances in America with the *Vanguard* and *Mercury* companies and at one time did considerable recording for *Westminster*. It was the first company in England to jump on the stereo disc bandwagon and as soon as it was set that the *Westrex 45-45* system was to become the industry standard, the firm hurriedly issued a number of recordings made in this new stereo process. The company used certain material of its own as well as program which had been recorded by associate companies. I listened to some of this material during the early part of my visit and unhappily found that it was extremely poor. I have recently learned that most of this original batch of recordings has been withdrawn from the market and it is rather obvious that someone "goofed."

This is clearly a case where too much enthusiasm prevailed over the hard facts of stereo disc engineering. I bring this story to your attention to emphasize the fact that the stereo disc is still in its infancy and I am afraid we have had similar occurrences in our own country. No one denies that the stereo disc is a great thing and that it certainly is an item for exploitation. But it is to be hoped that common sense will prevail and there will be less scrambling for the so-called privilege of being "first" and more attention to turning out a good workable and enjoyable product.

As far as *Pye Limited* is concerned, I believe it is re-cutting all its masters and so has left the field to *EMI* and *Decca*. There is nothing much from *Decca* in the stereo disc field as yet, but *EMI* has issued a few discs which are very difficult to obtain. From what I have heard thus far, it seems that *Decca* (or *London*, as it is in the U.S.) still enjoys a marked advantage with the quality of its stereo disc.

Despite the debacle of the first stereo releases in England and the scarcity of subsequent issues, stereo discs are almost as big a catchword in England as they are in the

United States. Hi-fi enthusiasts there are busily engaged in revamping their systems so that they may play the new stereo discs and the English component manufacturers have been quick to capitalize on this with a rash of single chassis stereo amplifiers and many varieties of matched speaker ensembles.

In England the commercial counterparts of our own *Admiral*, *Philco*, *RCA*, *Motorola*, etc., have moved in on the stereo disc field with equal directness, if not equal speed. In practically all of the big London record and radio appliance shops (and there are literally hundreds of them) you can see not one but many makes of stereophonic disc playback equipment. I do not know whether this name is trade-marked or is more or less generic, but seemingly all these units are called "Stereograms." Many of these emanating from the *Pye*, *EMI*, and *Decca* groups are of the packaged variety equivalent to our radiophonograph affairs and these are rather more prominently featured than the component systems. I have listened to a few of these units and must confess I was not overcome with joy at the sound of any of them and would say that, on the whole, they are no better nor no worse than our own makes in this category.

There was one detrimental feature which seemed fairly common with most of these models and which, I am afraid, is something that will be very difficult to correct... namely, speaker separation. Especially in the all-in-one varieties this separation is extremely small and unless some acoustic trickery can be employed, the stereo effect will be greatly diminished. The average English living room is quite a bit smaller than its American counterpart and this, of course, accounts for the manufacturers trying to incorporate a stereo system into as little space as possible. We are guilty in this respect too, but neither as extremely so, nor as universally so as in the English instruments.

However, quite a number English manufacturers have adopted the idea, also put forth in America, of using a centrally located unit containing the record player, both amplifiers and a speaker system for reproduction of bass frequencies only, then two small speakers can be placed on either side of the central reproducer or in corners to supply the middle and high frequencies. This arrangement is based on the theory that bass frequencies (below 500 cycles) are non-directional. There has been considerable argument on this point and I, myself, do not feel that it is altogether true, but some of the setups I have heard seem to work reasonably well. Of course the same rules apply to stereo as apply to normal hi-fi reproduction.

The opinions expressed in this column are those of the reviewer and do not necessarily reflect the views or opinions of the editors or the publishers of this magazine.



In other words, just because you're dealing with stereo doesn't mean that one can get away with using very small speakers of indifferent quality and expect to have really good results. I keep on emphasizing this point because it is too easy to fall into the trap of thinking that stereophonic reproduction is some sort of panacea which will magically correct speaker deficiencies. If you have a top quality monaural hi-fi system and you expect the same quality in stereo, I am afraid you will simply have to pay the piper and duplicate the quality of your present system in the second channel.

Such special stereo amplifiers and matched speakers as I have listened to have excellent quality and no doubt many of them will find their way into American homes. This is particularly true in the case of *Leak*, *Wharfedale*, and other high quality English makes.

While there seems to be a great deal of stereo disc activity in England, the stereo tape situation has been brought to a virtual standstill. Stereo tape was never exploited in England as it was in the United States and the advent of the stereo disc has put a quietus on the tape market until such time as an evaluation can be made of the effects of the stereo disc. What may be of interest to some is that the English recording companies may undertake (to use Mr. Dulles' expression) "an agonizing re-appraisal" of their stereo recording methods. I say this because a number of companies have ordered standard *Ampex* 3-channel, 1/2-inch recorders and are evidently going to try our widely separated 3-channel technique rather than continue with their so-called "MS system" which employs two microphones hung from a single central position with one mike in the cardioid position and the other in a figure-8 pattern. But perhaps underlying this move is the knowledge that the inter-channel separation on a stereo disc cutter is, in itself, not what could be desired and the wide-spaced 3-channel technique assures better separation than the MS system. In any case, despite individual purchasing power far below the American standard, our English friends are keenly enthusiastic about stereo discs and a great many of them are planning early conversion of their systems for stereo use. Thus as the market grows here, and the English enthusiasts begin to make their demands for repertoire on the English recording companies, this will be reflected to us and we can look forward to a steady supply of fine English stereo recordings. The New York Hi-Fi Show comes a little earlier than usual this year and if all goes well, and the deadline of this column and the show date coincides reasonably, I will be able to bring you a report on what certainly should be the most momentous and exciting hi-fi show ever held.

#### TED HEATH PLAYS AL JOLSON CLASSICS

Ted Heath and his Orchestra. London LL1776. Price \$4.98.

Take the songs Al Jolson made famous over the years, then turn loose a really good "big band" arranger, have Ted Heath and his orchestra play them with scintillating verve and dash, and have *London* afford them its best recording and you have a disc that I think is a real winner. The old Jolson songs have been so unmercifully beaten to death and sentimentalized beyond all good taste that it is a real joy to hear them in this upbeat fashion, as fresh and alive as ever. The arrangements are quite outstanding, with the best of the lot "Sonny Boy," "I'm Just Wild About Harry," and "My Mammy."

Ted Heath seems to be enjoying his work here as the band really plays with snap and precision. *London* has gone all out on the sound of the brass especially . . . big, bright

November, 1958

# YOU CAN'T HEAR A 'SPEC' SHEET!

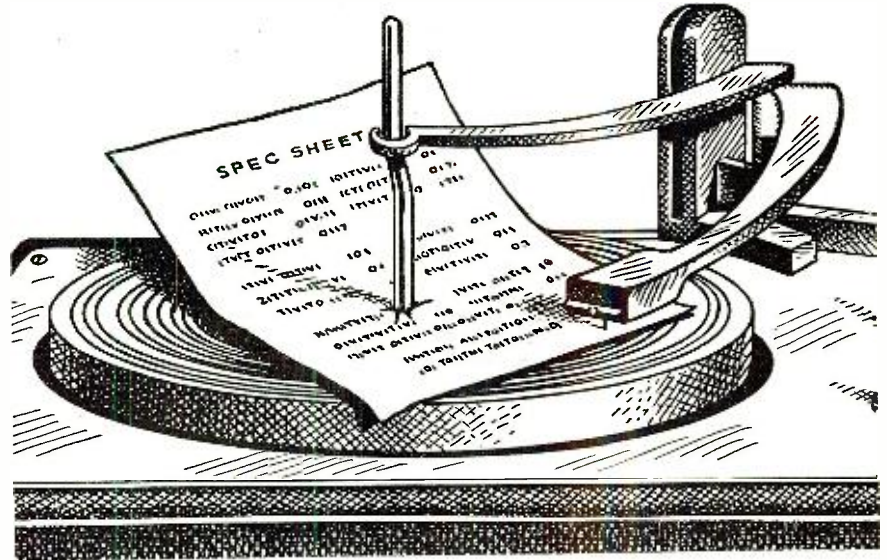

*Sonotone's stereo cartridge has more than just good specs... it gives brilliant performance! More phono makers specify Sonotone for the top of their line—here's why:*

Only Sonotone gives true sound *without* distortion... high frequency response *without* record cutting! Sonotone stereo gives a performance so superior you can truly *hear* the difference. The secret? Sonotone's four exclusive *operating* features:

1. Extremely high compliance.
2. Amazingly clean wide range frequency response.
3. Wide channel separation, due to Sonotone's pantagraph yoke.
4. Rumble filter to screen out vertical turntable noise.



SPECIFY...STOCK...SELL...

**Sonotone** ® PRO. P.

Electronic Applications Division, Dept. CN-118

ELMSFORD, NEW YORK



# ? GOING STEREO



## YOU'RE LUCKY IF YOU ALREADY HAVE A BOZAK!

Quality stereo demands matched speakers. To match your present Bozak, simply select a similar Bozak system at random or assemble a duplicate. Presto!—your stereo team-mates are musical soul-mates, identical in their full-frequency response, natural balance, tonal consonance, room-wide coverage and broad-front sound. No need of special matching or balancing, no "hole-in-the-middle" or "ping-pong" effect with good program material—and no later regrets that you didn't start with the best! See a Bozak Franchised Dealer, write for literature.

° — E-300 Contemporary Kits with three-way B-302A systems are ideal for high-standard stereo on a low budget.

THE R. T. BOZAK SALES CO., DARIEN, CONN.

and brazen, with ultra-sonorous saxes and sharp punchy percussion of exceptional clarity. If you can't smile with this one, Jack, life must be dull indeed!

**BERLIOZ**  
**SYMPHONIE FANTASTIQUE**  
 Paris Conservatory Orchestra conducted by Ataúlfo Argenta. London Stereo CS-6025. Price \$4.98.

London continues to set the pace in the stereo disc field and as evidence of this, one has only to listen to this recording of the "Symphonie Fantastique". While the late Argenta was mostly given assignments by London embracing the Spanish repertoire, it was obvious from his excellent musicianship that he would have been able to cope with repertoire of other types.

I would not call this the very best reading of the "Symphonie Fantastique", but it is certainly one of the most exciting. Argenta takes the "Witches' Sabbath" and "March to the Gallows" sections at a very fast pace which will draw reproving frowns from musicologists. Be that as it may, it is hard to deny the vigor and passion of Argenta's reading as being anything but enjoyable.

The London engineers have afforded a stereo perspective which illuminates, as never before, all the musical nooks and crannies of this work. The sonorous throb of the "Dies Irae" never sounded so grim and the brazen clangor of the big bell near the end sounds like the knell of doom itself. Throughout the work directionality was excellent and readily apparent, there was excellent forward projection with no holes-in-the-middle and although the recording was a little closer than some other of London's stereo, the illusion of depth was reasonably well maintained. My only quibble here is some slight over-cutting near the very end which causes the sound to become somewhat jumbled and lose its articulation and some of its stereo separation. As with most London stereo, surfaces were pleasingly quiet and all-in-all it can certainly be recommended as one of the better examples of present stereo disc recording.

**BRAHMS**  
**SYMPHONY NO. 1**  
 Vienna Philharmonic Orchestra conducted by Raphael Kubelik. London Stereo CS-6016. Price \$4.98.

There are people who will insist that the music of Brahms and certain other romantic composers gains very little in stereo format. I must confess that I too have felt this way on occasion, but have for some time now revised my opinion because I came to realize that it is not Brahms or the others who are so much at fault as the recording engineers who fail to "think stereophonically." What is a good pickup and balance for Brahms monaurally is not necessarily the type of pickup and balance that should be used for a stereophonic recording. If the stereo medium is intelligently utilized and the engineers dispense with any preconceived and hide-bound notions, Brahms can be as stereophonically delectable as Stravinsky or Bartok.

All this is by way of telling you that while the London engineers have not succeeded entirely in this recording of the Brahms work, they have none the less done an excellent and well thought out job and have afforded us a fresh and new insight to recordings of Brahms' music. For instance, the very opening of the Brahms "First Symphony," which even in the best monaural recordings never seems to sort out or separate the orchestral components, in this case is accomplished very neatly. The tympani beat is very clean and articulate and the strings do not sound as if they were going in all different directions, but are clearly defined

## Terado Trav-Electric MOBILE POWER CONVERTERS



Give You  
**110 A.C. HOUSE CURRENT ANYWHERE**  
 You Drive or Cruise

LIST

For 6 and 12 Volt Car Batteries — Capacities: 15 to 200 Watts

**\$12.95 UP**

### NO INSTALLATION

Just plug into cigar lighter on dash of car, truck, or boat—and away we go

- OPERATE PORTABLE TV
  - SMALL DO-IT-YOURSELF
  - TOOLS WHEREVER NEEDED
- One of the great conveniences of our electronic age



PORTABLE TV



DICTION

**101 USES**



ALL ELECTRIC SHAVERS



DO-IT-YOURSELF HOBBY TOOLS

See Your Electronic Parts Dealer or Jobber  
**Terado COMPANY**  
 DESIGNERS & MFRS. OF ELECTRONIC EQUIPMENT SINCE 1927  
 1058 RAYMOND AVE., ST. PAUL 14, MINNESOTA  
 IN CANADA: ATLAS RADIO CORPORATION LTD.-ONTARIO

## RCA Sound Tape



... on "Load-Easy" reels for fast tape threading!

Now available wherever superior-quality magnetic tape is sold. On 5" and 7" Load-Easy Reels for fast, simplified threading. Excellent for low-noise, extended-range recording and playback!



**RADIO CORPORATION OF AMERICA**

Electron Tube Division Harrison, N. J.







# "ONE DOLLAR" buys

As much as \$15 worth — Everything Brand New and sold to you with a money back guarantee.

**DEDUCT 10% ON ANY ORDER OF \$10 OR OVER**

**Plus a FREE SURPRISE PACKAGE**

- \$15 — "JACKPOT" TELEVISION PARTS...\$1
- 40 — ASST. PRECISION RESISTORS best sizes \$1
- 3 — ELECTROLYTIC CONDENSERS 16/16-450V \$1
- 1 — 5" PM SPEAKER alnico #5 magnet...\$1
- 20 — TUBULAR CONDENSERS .05-600v...\$1
- 20 — TUBULAR CONDENSERS .25-600v...\$1
- 20 — TUBULAR CONDENSERS .001-1000v...\$1
- 100 — ASSORTED FUSES popular sizes...\$1
- 100 — ASST. 1/2 WATT RESISTORS some 5% \$1
- 70 — ASSORTED 1 WATT RESISTORS " \$1
- 35 — ASSORTED 2 WATT RESISTORS " \$1
- 50 — ASST. TUBULAR CONDENSERS...\$1
- 10 — 6' ELECTRIC LINE CORDS with plugs...\$1
- 5 — TV CHEATER CORDS with both plugs...\$1
- 4 — 50' SPOOLS HOOK-UP WIRE 4 colors...\$1
- 50 — STRIPS ASST. SPAGHETTI best sizes...\$1
- 100 — ASST. RUBBER GROMMETS best sizes...\$1
- 100' — TWIN LEAD-IN WIRE 300Ω heavy duty...\$1
- 50' — FLAT 4-CONDUCT. WIRE many purposes...\$1
- 25' — INSULATED SHIELDED WIRE...\$1
- 1 — \$7 INDOOR TV ANTENNA hi-gain 3 section \$1
- 20 — ASST. TV KNOBS, ESCUTCHEONS, Etc. \$1
- 3 — ASST. TOGGLE SWITCHES spst, dpdt, etc. \$1
- 6 — ASST. SLIDE SWITCHES snst, dpdt, etc. \$1
- 4 — BAKELITE KNIFE SWITCHES dpdt...\$1
- 15 — ASST. ROTARY SWITCHES \$15 worth...\$1
- 100' — FINEST NYLON DIAL CORD best size...\$1
- 200 — SELF TAPPING SCREWS #8 x 1/2" \$1
- 35 — ASST. RADIO KNOBS screw and push-on...\$1
- 100 — KNOB SPRINGS standard size 3/8" x 1/2" \$1
- 100 — ASSORTED KNOB SET-SCREWS...\$1
- 25 — ASSORTED CLOCK RADIO KNOBS...\$1
- 400 — ASST. H'DWARE screws, nuts, rivets, etc. \$1
- 50 — ASST. SOCKETS octal, noval and miniature \$1
- 20 — ASSORTED TUBE SHIELDS best sizes...\$1
- 50 — ASST. MICA CONDENSERS some in 5% \$1
- 50 — ASST. CERAMIC CONDENSERS " \$1
- 10 — ASST. VOLUME CONTROLS less switch...\$1
- 5 — ASST. VOLUME CONTROLS with switch...\$1
- 100 — VOLUME CONTROL HEX NUTS...\$1
- 20 — ASST. PILOT LIGHTS popular types...\$1
- 10 — PILOT LIGHT SKTS. bayonet type, wired...\$1
- 50 — ASST. TERMINAL STRIPS 1, 2, 3, 4 lug...\$1
- 10 — ASST. RADIO ELECTRO. CONDENSERS \$1
- 5 — ASST. TV ELECTROLYTIC CONDENSERS \$1
- 25 — ASST. MICA TRIMMER CONDENSERS \$1
- 50 — TUBULAR CONDENSERS .001-600v...\$1
- 50 — TUBULAR CONDENSERS .01-400v...\$1
- 2 — ELECTROLYTIC COND. 40/40-450v...\$1
- 2 — ELECTROLYTIC COND. 40/10/10-450v...\$1
- 30 — FP CONDENSER MOUNTING WAFERS...\$1
- 3 — ELECTROLYTIC COND. 80-450v...\$1
- 3 — ELECTROLYTIC COND. 50/30-150v...\$1
- 10 — HV TUBULAR CONDENSERS .001-6000v...\$1
- 10 — HV TUBULAR CONDENSERS .005-3000v...\$1
- 35 — MICA COND. 20-100 mmf & 15-270 mmf...\$1
- 35 — MICA COND. 20-470 mmf & 15-680 mmf...\$1
- 35 — MICA COND. 20-820 mmf & 15-1000 mmf...\$1
- 35 — CERAMIC COND. 20-5 mmf & 15-10 mmf...\$1
- 35 — CERAMIC COND. 20-25 mmf & 15-47 mmf...\$1
- 35 — CERAMIC COND. 20-56 mmf & 15-82 mmf...\$1
- 35 — CERAMIC COND. 20 100 mmf & 15-150 mmf...\$1
- 35 — CERAMIC COND. 20-270 mmf & 15-470 mmf...\$1
- 35 — CERAMIC COND. 20-1000 mmf & 15-1500 mmf...\$1
- 35 — CERAMIC COND. 20-2000 mmf & 15-5000 mmf...\$1
- 50 — 100Ω 1/2 WATT RESISTORS 5%...\$1
- 75 — 470KΩ 1/2 WATT RESISTORS 10%...\$1
- 50 — 470KΩ 1 WATT RESISTORS 10%...\$1
- 35 — 100KΩ 2 WATT RESISTORS 10%...\$1
- 10 — ASST. WIRE'ND RES. 5, 10, 20 watt...\$1
- 3 — AUDIO OUTPUT TRANS. 50L6 type...\$1
- 3 — AUDIO OUTPUT TRANS. 6K6 or 6V6 type...\$1
- 3 — I.F. COIL TRANSFORMERS 456 kc...\$1
- 3 — I.F. COIL TRANSFORMERS 10.7 mc...\$1
- 4 — OVAL LOOP ANTENNAS ass't hi-gain types \$1
- 3 — LOOPSTICK ANT. new ferrite adjustable...\$1
- 12 — RADIO OSCILLATOR COILS 456 kc...\$1
- 3 — 1/2 MEG VOLUME CONTROLS with switch...\$1
- 3 — FOCUS CONTROLS 400 Ω, 2K & 5K...\$1
- 5 — 50K VOLUME CONTROLS less switch...\$1
- 10 — SURE GRIP ALLIGATOR CLIPS...\$1
- 1 — GOLD GRILLE CLOTH 14"x14" or 12"x18" \$1
- 5 — SETS SPEAKER PLUGS wired...\$1
- 10 — SETS PHONO PLUGS and PIN JACKS...\$1
- 2 — \$2.50 SAPPHIRE NEEDLES 4000 playings...\$1
- 5 — DIODE CRYSTALS 2-IN22 2-IN22 1-IN64 \$1
- 2 — SELENIUM RECTIFIERS 1-65 ma & 1-150 ma \$1
- 15 — ASST. TV COILS, sync. peaking, width, etc \$1
- 1 — TV VERT. OUTPUT TRANS. 10 to 1 ratio...\$1
- 5 — TV CRT. SOCKETS with 18" leads...\$1
- 5 — HI-VOLT. ANODE LEADS with 18" leads...\$1
- 1 — TV RATIO DETECTOR TRANS. 4.5 mc...\$1
- 1 — SET TV KNOBS standard type incl. decals...\$1
- 1 — LB ROSIN CORE SOLDER 40/60...\$1
- 6 — SPIN TIGHT SOCKET SET 3/16" to 7/16" \$1
- 3 — TV ALIGNMENT TOOLS 5", 7", 12" \$1

HANDY WAY TO ORDER—Simply tear out advertisement and pencil mark items wanted (6 in square is sufficient); enclose with money order or check. You will receive a new copy of this ad for re-orders.

ON SMALL ORDERS—Include stamps for postage, excess will be refunded. Larger orders shipped express collect.

**BROOKS RADIO & TV CORP.**  
84 Vesey St., Dept. B, New York 7, N. Y.

## Preset Counters (Continued from page 47)

flip-flop stage will produce an output pulse. This pulse reverses the condition of the switching flip-flop and a positive pulse from one of its plates fires thyratron Y. As a result, the four flip-flop stages are now preset for a count of Y. After Y input pulses have been applied, an output from the fourth stage again reverses the switching flip-flop. A positive pulse from the opposite plate of the switching flip-flop now fires thyratron X and the counter flip-flops are again reset for a count of X.

Another method of obtaining an output pulse after any desired number of input pulses is shown in Fig. 5. The diode matrix shown here consists of an array of vertical and horizontal wires, some of which are connected by means of diodes. Each horizontal wire is connected to a flip-flop plate, and the vertical wires are connected through resistors to a source of voltage.

As input pulses are applied to the flip-flops, output pulses will appear in succession at terminals 0, 1, 2, and 3. Each output terminal in Fig. 5 is numbered to indicate the quantity of input pulses required to activate that particular terminal. An output pulse will appear at terminal 1, for example, when the first input pulse is applied; terminal 2 will yield an output on the second input pulse; etc. Why this occurs will be explained later. The circuit therefore acts like a multi-position switch: with each input pulse, the output switches to the next terminal. Such circuits are, in fact, often used for multiplexing and other switching applications. Unlike mechanical switches, which are extremely limited in speed of operation, circuits like that shown in Fig. 5 are capable of switching in excess of a million times per second.

For simplicity of explanation a two-stage flip-flop circuit is shown in Fig. 5, but the same method may be extended to a greater number of stages.

Each vertical wire is connected through a resistor to a single voltage source at the top of the illustration. If one or more of the diodes along any one vertical line is conducting, most of the supply voltage will be dropped across the resistor and the output terminal of that line will be at a low potential. If, however, none of the diodes along the vertical line are conducting, there will be no voltage drop across the resistor and the full supply voltage will appear at the output terminal. An output terminal is therefore active only when all of the diodes connected to it are in a non-conductive state.

Whether or not a given diode conducts depends upon the condition of the flip-flop tube to whose plate it is connected. If the tube is cut off, its plate voltage will be high and the diode will be back-biased or non-conductive, as shown in Fig. 3A. If the tube to which the diode is connected is conducting

## Check, Measure, Inspect with this

### 6 POWER POCKET COM-PARATOR

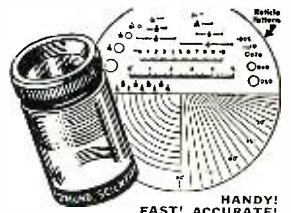

(Complete with Leather Case)  
MEASURES • Angles • Radii • Circles • Linear — in both decimal inches and millimeters. Used to check layouts, machining on tools, dies, gauges; to check threads, chamfers, wear on cutting tools, etc.

HANDY! FAST! ACCURATE!

Stock No. 30,061-DU..New Low Price..\$19.50 Pstprd. Order by stock No.—Send check or M.O.—money-back guarantee!

### See the Stars, Moon, Planets Close Up! 3" ASTRONOMICAL REFLECTING TELESCOPE



Mt. Palomar Type! 60 to 160 Power  
Aluminized and overcoated 3" diameter highspeed f/10 mirror. 60X eyepiece and mounted Barlow Lens, giving you 60 to 160 power. Optical Finder Telescope included. Sturdy, hardwood, portable tripod. Free with scope: Valuable STAR CHART and 272-page "Astronomy Book."  
Stock No. 85,050-DU.....\$29.95 Postpaid  
Order by stock No.—Send check or M.O.—money-back guarantee!

**SPECIAL! INFRARED 1P25A IMAGE TUBE**  
Stock No. 70,127-DU.....\$9.95 pstprd.  
Order by stock No.—Send check or M.O.—money-back guarantee!

## WRITE FOR FREE CATALOG "DU"

America's No. 1 source of supply for experimenters, hobbyists. World's largest variety of Optical Items. Bargains galore... War Surplus—Imported—Domestic! Microscopes, Telescopes, Satellitescopes, Color TV Tubescope, Infrared sniperscopes and Parts, Prisms, Lenses, Reticles, Mirrors and dozens of other hard-to-get Optical Items. Low-Cost Science Teaching Aids!

**WRITE FOR FREE CATALOG DU**  
**EDMUND SCIENTIFIC CO.**  
BARRINGTON, NEW JERSEY

## SEND RADIO & TV NEWS EVERY MONTH



name \_\_\_\_\_  
address \_\_\_\_\_  
city \_\_\_\_\_ zone \_\_\_\_\_ state \_\_\_\_\_

Check one:  3 years for \$10  
 2 years for \$7  
 1 year for \$4

In the U. S., its possessions, and Canada.  
Foreign rates: Pan American Union countries, add .50 per year; all other foreign countries, add \$1.00 per year.

Mail to: **RADIO & TV NEWS**  
Dept. R-118  
434 S. Wabash Ave., Chicago 5, Ill.



(Fig. 3B), its plate voltage will be low and the diode will be biased in the forward or conducting direction. The diodes along any given vertical line should therefore be connected to the plates of those tubes which will be at cut-off after the desired number of input pulses.

Note that in Fig. 5 the diodes connected to vertical line 0 are controlled by tubes  $V_1$  and  $V_2$ . Table 1 shows that these tubes will be cut off at the start (zero input pulses). Terminal 0 is therefore "live" before any input pulses have been applied to the flip-flop stages. Notice also that every other vertical line has at least one conducting diode and therefore yields no output.

When the first input pulse is applied to the circuit, the first stage will switch to the 1 condition as shown in Table 1. Tubes  $V_2$  and  $V_3$  are now cut off and the diodes connected to these tubes become non-conductive. Under these conditions, there will be no voltage drop across resistor  $R_2$  and terminal 1 will therefore be active. Notice again that each of the other vertical lines has at least one conducting diode. As can be seen from Table 1, the second input pulse will cause  $V_1$  and  $V_2$  to cut off and the voltage at terminal 2 will increase.

The method just described for two stages can be extended to a greater number. For each additional flip-flop stage, two more horizontal wires are used. The number of vertical wires is doubled each time a stage is added. The maximum number of output terminals (vertical wires) is equal to the maximum ratio of the counter which, in turn, depends upon the number of stages. If five flip-flop stages are used, the maximum ratio will be  $2^5$  or 32 and the circuit will permit the use of this number of output terminals. Likewise, an eight-stage circuit will permit the use of a maximum of  $2^8$  or 256 output terminals.

In practice, the number of vertical wires actually used depends upon the requirements of the particular application.

It is of interest to note also that the diode matrix becomes, in effect, a binary-to-decimal converter. Assume, for example, that a diode matrix is connected to a five-stage flip-flop circuit and that a neon bulb is connected to each of the 32 output terminals. If these bulbs are numbered in succession 0, 1, 2, 3, 4, etc., they will indicate the decimal equivalent of the binary number stored in the counter. When the conditions of the five stages are 11010, neon lamp number 26 will be on to indicate that this is the decimal equivalent of binary number 11010.

Since an output can be obtained after any given number of input pulses, the diode matrix can be used to preset the counter. For this type of operation, the preset relay or thyatron is triggered by a pulse taken from whichever vertical line will be active after the desired number of input pulses.

# BA GAINS—OUTSTANDING SURPLUS ELECTRONICS

## 50 WATT, 6 CHANNEL RADIOTELEPHONE

**THE RADIOTELEPHONE BARGAIN** all the Pleasure and Fishing Boats are talking about! This Transmitter-Receiver (BC-669, part of BC-643) is beautifully and ruggedly built. Provides 6 fixed channels of crystal-controlled transmission and reception, in addition to manual tuning when desired for reception. Free range 16800 to 4500 KC. BC-669 FCC currently accepted 2-3 mc marine band. With recommended 12 V. DC (or 24 V. DC) dynamotor power supply will deliver 50-60 watts output. Supplied with instruction book, connecting cable, power supply constructional data, all tubes, all tested and guaranteed. See before act in Oct. '57 Radio Telev. News for illustration and complete data, or send for descriptive bulletin!

50 W. RADIOTELEPHONE (BC-669 A, B, or C). USED-EXCELLENT, as described above. Shpg. wt. 183 lbs. EACH. . . . . \$99.50

**SAME AS ABOVE, NEW-UNUSED, EACH. . . . . \$139.50**

12 V. DC POWER SUPPLY, for above. Has Dyno motor, one for transmit and one for receive. Produces 50/60 watts output. All wired and tested. EACH. . . . . \$89.50

**COMPLETE 12 V. DC POWER SUPPLY.** Assemble and wire yourself, no material and diagram. \$45.00

PE-110, A, B or C POWER SUPPLY, for 110 V. 60 cycles AC operation. LIKE NEW condition. . . . . \$89.50

**HANDSET FOR ABOVE** with appropriate plug connector. . . . . \$14.50

## BC-611 WALKY-TALKY

### COMPLETE WITH CASE



Now, for the first time, Telemarine offers the BC-611 Hand-Held Walky-Talky in complete form. Nothing extra to buy, except batteries which are readily available from most radio stores. The BC-611 is a crystal-controlled transmitter and receiver covering the frequency range of 3.5 to 22.0 mc. in 2.0 mc. steps. Where it can ideally serve as an emergency transmitter (on 2182 KC) on boats without the regular radio installation. Excellent for many other emergency applications, because of its compactness (measuring 4 1/2" x 3 1/2" x 5 1/2" lbs.), complete with batteries, plain complete with type (type, installed), crystals (one for "transmit," one for "receive") for a frequency of 3.5 to 6.0 mc. range (2 frequency permitted on "Used" sets), tubes, and "A" Battery Adaptor which permits use of 2 conventional flashlight cells in place of special "A" battery. "B" battery required is special 10.5 volt rectangular unit, mfd. 100, as "XX-69".

by Burgess Battery, as described, Used-Very Good Condition (not tested), pre-set for 1 frequency (3.5 to 6.0 mc. in 2.0 mc. steps, no batteries). Shpg. wt. 15 lbs. EACH. . . . . \$49.50

BC-611 WALKY-TALKY, COMPLETE, NEW, as described above but NEW, TESTED, and pre-set to any one of each frequency from 3.5 to 6.0 mc. . . . . \$74.50

BC-611 WALKY-TALKY CHASSIS, NEW! Excellent, new. Spare Chassis for above, priced so low that even if trouble is found by reason of inserting a new chassis. Also excellent for the Amateur or Technician who prefers to make his own style of Walky-Talky and to apply his own tubes (1-1R5, 1-1T4, and 2-384 tubes required), and less plug-in Osc. and RF Ant. Coils, less crystals. Supplied with Schematic Wiring Diagram. Shpg. wt. 15 lbs. . . . . \$8.95

PAIR OF COILS, for above, RF Ant. & Ocs. . . . . \$1.25

## 30-40 MC DELUXE FM RECEIVER FOR MOBILE POLICE & FIRE CALLS



This FM receiver, the R-237 part of an AN/VRC-2 Equip., is a single crystal, regenerative, crystal-controlled receiver covering industrial, domestic (measuring 4 1/2" x 4 1/2" x 1 1/2") frequencies. It is of superior design and construction. It has all of the best features such as: double-contained power supply which is 45 KC and 4.3 mc. I.F.'s) with both oscillators by crystal control; double limiter stages, loud-speaker output, etc. Exceptionally well built to provide constant trouble-free service. Uses a total of 2 tubes, one vibrator-power supply which is designed for 6 V. DC operation. All units are in practically like-new condition and exceptionally clean. Dimensions with case, illustrated. 1 1/2" x 10" x 1 1/2". Separate loud-speaker, or phones (if desired) required. Supplied with tubes and schematic diagram, but less crystals, loud-speaker, etc. Net wt. 41 lbs. Shpg. wt. 65 lbs. PRICE, EACH. Not tested at this low price. . . . . \$29.95

## TRANSMITTER COMPANION FOR ABOVE

Transmitter T-193/VRC-2 complements the Receiver described above, to provide FM voice transmissions in the 30 to 40 MC band. Transmitter is crystal controlled, and provides a power output of 10 watts. It is physically the same in appearance as the receiver shown above. Designed for operation from 6 V. DC, but can be operated on others. Vibrator Power Pack. All units are in Used-Excellent condition in fact, almost like-new. All units are at the Low Price we are quoting. Supplied with tubes, schematic diagram, but less crystal or control head. Shpg. wt. 00 lbs. PRICE, EACH. Transmitter T-193/VRC-2, as described. . . . . \$19.95

## 1/4 HP. AC MOTOR BARGAIN!

1/4 HP. 1725 RPM. 110V. AC MOTOR—FOR WORKSHOP, INDUSTRIAL, ETC. NEW-UNUSED, at the lowest, lowest price ever quoted for 1/4 HP. of this size. Physically the same as all standard 1/4 HP. motors, but electrically much superior since they were produced to zero standards and under gov't supervision and inspection. Operates from 110v. single-phase AC, either clockwise or counter-clockwise rotation (simply reverse two leads in connection box per instruction card included). 1 1/2" dia. shaft, 1 1/2" long. Motor is 6 1/2" dia. with mtg. plate of standard flange type with slotted holes for easy installation and to aid proper ventilation. All pins on each end bearing for convenient lubrication. Mfd. by Torq. Electric. We suggest you buy several at the price quoted while our limited supply lasts. Shpg. wt. 33 lbs. . . . . EACH \$12.95

## 250 WATT BEACHMASTER AUDIO AMPLIFIER

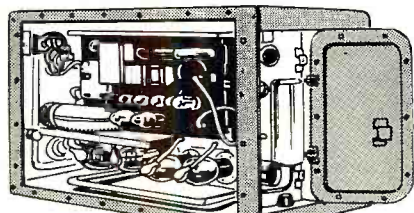

**SUPER-POWER** complete amplifier. Designed by Bell Tel. Labs. All self-contained in waterproof metal case, with blower system for ventilation, weatherproof receptacles, etc. Ideal for large audio units available for baseball parks, etc. or easy to connect to modulator for 500 Watt Transmitter. Operates from 110 V. 50/60 cycles AC. Uses total of 14 tubes, including 2-805 triodes in push-pull power stage and 6E5 magic-eye tube to indicate gain. Like-new condition equipment. Dim. 26 1/2" x 16 1/4" x 19". Shipping weight, complete with tubes, 190 lbs. Supplied with connecting plugs and schematic diagram. . . . . \$169.50

PRICE EACH, SLASHED TO . . . . .

## BC-221 FREQUENCY METER

This Frequency Meter is a must in any laboratory, and is well known and highly regarded by most technicians and engineers. It is a high precision secondary standard, for checking frequency of transmitters, signal generators, alignment of receivers, calibration of test sets. Freq. range is 125 to 20,000 KC; employs heterodyne receiving circuit, precision calibrated signal generator circuit, and extremely stable precision controlled oscillator with 1,000 KC crystal whose harmonics are utilized for calibrating the variable frequency oscillator in the signal generator portion. Designed for battery operation, requiring 4-1.5 volt "A" batteries and 6-22 1/2 volt "B" batteries, which may be replaced by a simple-to-construct 110 V. AC pack. All units available are of 100% modulation (but have provision for external modulation), complete with tubes and calibrating crystal, and matching calibration books. All units tested for accuracy before shipment. Shipping weight 50 lbs. BC-221 FREQUENCY METER, As described \$84.50 above, less batteries, EACH . . . . .

## BC-342 SIGNAL CORPS COMMUNICATIONS RECEIVER

Work horse of the Signal Corps, this popular Communications Receiver is a well known favorite of Amateurs, Communications experts, and commercial operators. Receives 1500 to 18000 KC in 6 Bands. Very ruggedly built, extremely stable, and simple to operate. Precision calibrated crystal and external phasing control, loudspeaker output (separate speaker required), and smooth-operating vernier dial (with locking features). Precision calibrated for each tube, no accessories. Not tested. Designed for 110 V. AC operation (excellent for ham or commercial application). All units NEW-UNUSED Condition. Precision tested. Complete with tubes & Schematic Diagram. Shpg. wt. 70 lbs. . . . . \$110.00

EACH . . . . . \$110.00

## LIMITED QUANTITY BARGAINS

SCR-522 TRANS-RECEIVER, in case CS-80. AM transmitter-receiver from 100 to 156 mc. 4 crystal-controlled channels, operates from 12, 24 V. DC or 110 V. AC Power Supplies. Used—Excellent Condition. All tubes, no accessories. Not tested. Will quote on accessories upon request. Shpg. wt. 75 lbs. . . . . \$29.95

EACH . . . . . \$29.95

MINIATURE STORAGE "A" & "B" BATTERIES, For Walkie-Talkies, Radio Portables, Radio-Controlled devices, Radio-Sonics, or equivalent meteorological devices. Supplied as set of 3—"B" batteries (1.5 volt) and 1—"A" battery (4.5 volt). Batteries dry-charged, less electrolyte, and packed in a hermetically sealed vacuum metal container which permits ready use for use. Both "A" battery (BB-51) and "B" battery (BB-5) are 1 1/2" deep x 1 1/2" wide x 1 1/2" high with 2 connection pins of 1/4" length protruding from each battery. Hypodermic needle required for acid-water filling (1280-1350 specific gravity). Crystals, instructions supplied with each set of batteries for filling and charging. NEW-UNUSED. Shpg. wt. 4 lbs. . . . . \$3.95

PER SET (4 Batteries) as described. . . . . \$3.95

CASE OF 24 SETS OF BATTERIES, each set as described above, but including one special plunger-cutter for opening each vacuum container and simultaneously filling each battery with required electrolyte. Includes one hypodermic for refilling batteries when necessary. Shpg. wt. per case 55 lbs. PER CASE 24 SETS BATTERIES, NEW-UNUSED. \$79.50

1-100 DC VIBRATOR POWER SUPPLY, Type PE-104, square Bakelite front face. For Panel Mfg., 1 1/2" dia. back x 1 deep. Excellent for sensitive miniature instrumentation, or special exp. Used in GRC transmitters for metering many circuits. Has precision D'Arsonval jeweled movement, mfd. by Roller-Smith to gov't. specs. NEW Units. Shpg. wt. 1 lb. EACH. . . . . \$6.95

6 or 12V. DC VIBRATOR POWER SUPPLY, Type PE-104, operates from either voltage and supplies completely filtered voltage as follows: 7.5, 4.5 (bias), and 90 volts DC. Uses synch. vibrator, no tubes. Ideal for mobile packs, transceivers, etc. Dim: 3" x 4 1/4" x 6 1/4". NEW UNITS. Shpg. wt. 12 lbs. EACH. . . . . \$9.95

22-30 V. DC. TO 110 V. 400 CYCLES AC MOTOR ALTERNATOR. For Fishing Boats or other craft with 24 to 32 V. DC power, for operation from 110v. AC, or other 400 cycle equipment. Input is 22.0-30.0 Volts DC at 75-65 amps. output 1.0 KVA at 115 volts (8.7 amps), 1-phase 400 cycles. Excellent condition 100% mod. Cam attached. Used-excellent condition units, mfd. by Ballentine. Shpg. wt. 150 lbs. EACH. . . . . \$19.95

USE-UP INFRARED IMAGE (SNOOPERSCOPE) TUBES. Used in British "Tabby" for seeing in the dark for "snooper" or "sniperscopes." Will detect motion and illuminate object. Infrared emitting rays. Requires power supply of 3000 to 4000 volts at a few microamps. Screen size is 1 3/4" dia. 100 tubes checked before shipment. Price \$3.00 per tube.

FRONT END LENS ASSEMBLY. For above. Speed 1.9 f.l. 91.4 mm. Outside dia. at one end 60 mm. Length of mount 64 mm. Each. . . . . \$7.00

All Above Material Subject to Prior Sale. 25% Minimum Deposit with All C.O.D.'s. Min. Order —\$5.00. All Prices F.O.B. Our Address.

—TELEMARINE—  
COMMUNICATIONS CO., INC.  
140 WEST B'WAY, NEW YORK 13, N. Y.  
CORlandt 7-5444  
Cable Address: Telemarine N. Y.



# GET YOUR First Class Commercial F. C. C. LICENSE IN 12 WEEKS!

**GRANTHAM TRAINING PREPARES YOU**—Grantham School of Electronics specializes in preparing students to pass F.C.C. examinations. Training is available either by correspondence or in resident classes—NO previous training required. A beginner may qualify for his first-class F.C.C. license in as little as 12 weeks.

**THREE COMPLETE SCHOOLS**—To better serve our many students throughout the entire country, Grantham School of Electronics maintains three complete schools—one in Washington, D. C., one in Hollywood, Calif., and one in Seattle, Wash. All schools offer the same rapid courses in FCC license preparation, either home study or resident classes.

**MAIL COUPON FOR FREE BOOKLET**—Our free booklet, *Careers in Electronics*, gives details of how you can prepare quickly for your FCC license. For your free copy of this booklet, clip the coupon below and mail it to the Grantham School nearest you.

WASHINGTON D. C. Grantham School of Electronics  
821-19th Street, N.W.  
Washington 6, D.C.

HOLLYWOOD CALIF. Grantham School of Electronics  
1505 N. Western Avenue  
Hollywood 27, California

SEATTLE WASH. Grantham School of Electronics  
408 Marion Street  
Seattle, Washington

(Mail in envelope or paste on postal card.)  
**TO: GRANTHAM SCHOOL OF ELECTRONICS**  
Desk 86-S • Washington • Hollywood • Seattle

Gentlemen:

Please send me your free booklet telling how I can get my commercial F.C.C. license quickly. I understand there is no obligation and no salesman will call.

Name \_\_\_\_\_ Age \_\_\_\_\_

Address \_\_\_\_\_

City \_\_\_\_\_ State \_\_\_\_\_

I am interested in:

Home Study,  Resident Classes

## THE "ISTOR" STORY

By RUDOLF F. GRAF

How many of these "istors"  
can you describe, identify?

**CHRONISTOR:** A subminiature elapsed-time indicator whose operation is based on the principle of electroplating. As current (approx. 1 ma.) passes between the terminals, ions are carried from the cathode to the anode. The unit is the size of a standard 3AG fuse and will indicate from 100 to 2000 hours "full scale." (Bergen Laboratories)

**FERRISTOR:** A miniature two winding saturable reactor which will operate on a high carrier frequency. It may be connected as an oscillator, free-running multivibrator, current discriminator, coincidence gate, or ring counter. (Beckman Instruments)

**MAGNISTOR:** A small saturable reactor used to control electrical pulses or sine waves from 100 kc. to 30 mc. at power levels up to tens of watts. It can be used to gate, switch, amplify, count, and register. (Potter Instrument Co.)

**PERSISTOR:** A miniature bi-metallic printed circuit loop operating near absolute zero. Its operation is based on the superconductivity characteristics of some metals at low temperatures. "Persistor" finds use as a computer element for switching and storage. (Ramo-Wooldridge Co.)

**RESISTOR:** A circuit element offering opposition to the flow of current.

**SPACISTOR:** A four terminal transistor (base, collector, injector, and modulator) which utilizes a reversed bias "p-n" junction to create a space charge region for a very short transit time. Has an estimated frequency limit of 10,000 mc. input and output impedances of about 30 megohms, and may be operated at temperatures up to 500° C. (Raytheon)

**STABISTOR:** A silicon diode which maintains an essentially constant voltage drop of 0.5 volt in its forward direction. (Transitron)

**THERMISTOR:** A temperature-sensitive resistor with a high negative temperature coefficient used for temperature compensation, time delay, switching, power measurement, and instrumentation. Available in bead, disc, or rod construction. (Veco, G-E, Western Electric, and others)

**THYRISTOR:** A high-current, high-speed (0.0000002 sec.) switching transistor which may also be used as a high-frequency amplifier. This modified alloy junction transistor switches from on to off stage by means of low energy pulses applied to the base circuit. (RCA)

**TRANSISTOR:** A crystal-type amplifying device made of semiconducting materials such as germanium or silicon operating on the principle of electron flow within a solid.

**TWISTOR:** A new "memory" system developed by Bell Telephone Laboratories. Its name stems from the fact that the magnetization direction of a wire made of magnetic material changes from lengthwise to helical if the wires are twisted. Thus, memory matrices can conceivably be made without magnetic cores.

**VARISTOR:** A network of four carefully selected and matched (within 1 ma. at ± 1 volt) diodes. Useful in bridge circuits or as a balanced modulator for carrier suppression. (Sylvania)

## NEW! IMPROVED!

### S NCORE TRC4 TRANSISTOR CHECKER

Another  
Sencore  
Time-  
Saver

Only tester that  
checks car radio  
power transistors

#### NOW CHECKS:

- ★ **Transistors** for opens, shorts, leakage and current gain. Includes new gain test on power transistors.
- ★ **Crystal Diodes** checks forward to reverse current ratio on all diodes.
- ★ **Selenium Rectifiers** checks forward and reverse currents.

Controls are accurately set for each transistor

by referring to replaceable set-up chart on rear. Test leads or socket provides for fast hook-up.

See your parts distributor.



Mfg by **SERVICE**  
INSTRUMENTS CORP.  
171 OFFICIAL RD., ADDISON, ILL.

Cut out this ad now for further information

- \*\*\*\*\*
- ★ BC-652 Receiver 2-6 mc. 14.95
  - ★ w/tubes & dyn like new. Complete w/tubes (schematic on Receivers) 7.95
  - \*\*\*\*\*
  - ★ 0-500 MICROAMPS (Basic Movement) 3/4" Aircraft Type meter Marked Fuel Air Ratio, mfg. by Cambridge Instrument. . . . . Brand New 1.59
  - ★ 0-100 MICROAMPS 3" rd. Boxed. . . . . 2 for 3.00
  - ★ 0-100 MICROAMPS 1 1/2 sq. miniature meter. . . . . 3.85
  - ★ 0-120 amps 2" rd. Aircraft type. . . . . 1.50
  - ★ 0-125 amps 2" rd. Aircraft type w/shunt. . . . . 2.95
  - ★ 0-800 V.D.C. 3" rd. . . . . 4.95
  - ★ R.F. INTERFERENCE FILTER contains 2 Sprague Hypass .25 mfd Inductive Condensers mounted on bracket. Very effective. . . . . Brand New 1.95
  - ★ AP-1 TRANSCEIVER 420-0-425 mc. Complete w/tubes & dyn. . . . . Brand New 9.95
  - ★ WESTERN ELECTRIC MONITOR RANGE INDICATOR D 151821 Complete w/3AP1 & Tubes Built in Power Supply 115V AC INPUT
  - ★ VERTICAL FLIGHT GYRO TYPE C-1 AUTOPILOT 29.95
  - ★ ATTITUDE GYRO INDICATOR part no. 650035 mfd. by Sperry w/installation instructions. Brand New 5.95
  - ★ TACHOMETER INDICATOR 0-100 RPM up to 0-3000 rpm G.E. type DJ-13 model 8DJ13. . . . . 4.95
  - ★ MAGNESYN-TRANSMITTER mfd. by Bendit no. BS-11750. . . . . Brand New 3.95
  - ★ HEAVY DUTY CHOKE 13.5 HV 450 MA (GOODMA) conservative rating. . . . . 6.95
  - ★ DYNAMOTOR-EICOR-6.0 Volt input/output 600 Volts -150 ma. . . . . 2 for 13.00; Brand New 6.95
  - ★ BC-604 TRANSMITTER w/tubes. . . . . 4.95
  - ★ BC-344 RECEIVER 150 KC-1500 KC w/115 VAC (Power Supply RA-20). . . . . Like New 29.95
  - ★ TS-35 SIGNAL GENERATOR & POWER METER D11750. . . . . New 49.95
  - ★ VACUUM CONDENSER JENNINGS JCS-2a. 25 mmfd 10 KV. . . . . Special 2.95
  - ★ MICROPOSITIONER/BARBER COLMAN AYLZH3206-15. . . . . 9.95
  - ★ CODE PRACTICE OSCILLATOR. VO-3-F. Used with TG-34 Keyer, 115 VAC Lo Cycle. . . . . Brand New 19.95
  - ★ AN/AP5-4A-3 cm-x Brand Airborne Search Radar w/ manual. . . . . 59.95
  - ★ APS-3 TRANSMITTER good condition. . . . . 49.95
  - ★ INDICATOR 1D-11/APS-4-3" scope 3FP7 & 2/636 tubes. . . . . New 3.75
  - ★ 2AP1/tube w/socket. . . . . 1.95
  - ★ S.B. TRANSFORMER 0-1000 RPM up to 0-1000 RPM. . . . . 1.00
  - ★ TRANSISTOR OUTPUT TRANSFORMER. . . . . 2 for 1.00
  - ★ FILAMENT TRANK, 24 Volts-5amps. 115 V 60 cycle. . . . . 2.95
  - ★ UHF TUNER KIT w/6AF4. . . . . Brand New 3.95
  - \*\*\*\*\*
  - ★ IU4 JAN - 10 for \$1.00
  - \*\*\*\*\*
  - ★ HEAVY DUTY VARIABLE INDUCTOR. . . . . 4.95
  - ★ SURPLUS ILLUMINATED GUN SIGHTS. Contains Precision Optics. . . . . Brand New 2.95

**SPARKS RADIO SUPPLY**  
194 GENESEE ST., BUFFALO 3, N.Y.



## Multi-Set TV Installations

(Continued from page 53)

always be resistive. Under these conditions, only very small components of reflection and phase shift are seen.

The values of isolation capacitors for typical isolation losses are given in Table 2. Such losses vary according to the efficiency of the circuit and the type of matching network used. With a circuit such as that of Fig. 7, values may run 10% or more and higher both on isolation and feedthrough losses. Fig. 8 is a photo of a typical surface-mounted tap-off unit for use with RG-59/U cable.

Examination of Table 2 will show the reasoning behind the capacitive tap. As an example, take the action of the 5- $\mu$ fd. capacitor. At channel 2 this shows an isolation of 19 db. With such an isolation it can be expected that the tap will be some distance from the amplifier. Channel 13 levels, therefore, will have been dropped considerably below the level of 2. We find that the isolation at channel 13 is 9 db, so that the channel-13 level will be cut down through the tap by an isolation loss which is lower by 10 db. When excessively long lines are used, this correction is not enough and some means must be used to start the line off with higher levels of signal at the high band. This is covered under the discussion on the amplifier.

### V.H.F. Amplifiers

Amplifiers for use at v.h.f. can be classified under two headings: preamplifiers and distribution amplifiers. Each category may be sub-divided again into single-channel or broadband types. Many installations can be completed using only one broadband preamplifier, especially where levels of signal of a few thousand microvolts are available at the antenna. We will first discuss the requirements of a preamplifier.

A typical broadband preamplifier will have a gain in the neighborhood of 25 db and its response will be "flat"; that is, it will amplify equally well on all the TV channels. The one necessary characteristic that distinguishes the preamplifier is that it is designed with a low-noise input circuit, usually of the cascode variety. A good example of such a preamplifier has a noise input figure of 6 db low-band and 7.5 db high-band. In terms of signal, this means that about 70 microvolts low-band or 90 microvolts high-band will give satisfactory pictures from the output of these preamplifiers. Below this level, the internal noise produced in the elements of the antenna, tuning inductors, and tubes will produce a snowy picture in any event.

Such amplifiers are usually stagger-tuned, as are the i.f. stages of a TV set, and are aligned by quite similar but more elaborate techniques. In general, they consist of two amplifiers with inputs and outputs mixed on a common chassis and with a common power supply. One amplifier covers the low band

# JERROLD

announces **The First  
AMPLIFIED**

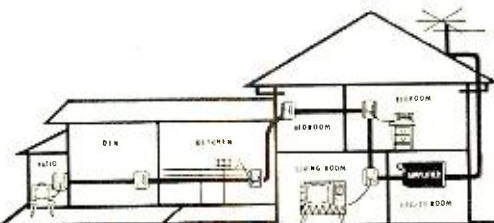

## Plug-In TV-FM HOME SYSTEM



## Now in Complete, Easy-To-Install Kit!

Now the world's first fully amplified home system comes in a lightweight kit that's a handsome selling tool with everything you need to bring hi fidelity TV and FM reception to every room of a home!

Each kit contains a broadband VHF (TV & FM) amplifier, sufficient 300 ohm Twin-Lead, and 5 outlets for surface or flush mounting, creating a complete system for any new or existing home.

No Trimming of Wire Necessary . . . No Soldering! Quick Screw-driver Installation!



HOME SYSTEM COMPONENTS AVAILABLE SEPARATELY. FOR COMPLETE DETAILS SEE YOUR JERROLD DISTRIBUTOR OR WRITE DEPT. PD92

# JERROLD

**ELECTRONICS CORPORATION**  
The Jerrold Building, Philadelphia 32, Pa.

Jerrold Electronics Corp., Ltd., Toronto, Canada

Export Representatives, CBS International, New York 22, N.Y.

LOOK TO JERROLD FOR AIDS TO BETTER TELEVIEWING



# Tele-Vue

CRANK-UP

## TOWERS

FIT EVERY NEED

Ideal for  
Business Man's  
Service  
Frequency

Sturdy, dependable towers with exclusive design features. Easy to erect, easy to service . . . priced right.

Used by thousands—Hams, Armed Forces, Civil Defense, Mobile Units, Railroads, Pipe Lines, Broadcasters, Fleet Operators, Highway Patrol.

**ADJUSTABLE  
ROTOR POST**

**MOUNTING  
INSIDE  
TOP  
SECTION**

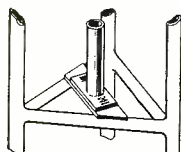

New

### EXPANDED LINE

23 models  
Up to 400 feet  
Self-Supporting

Crank-up  
Mobile types and  
Sectionals  
Low Shipping Cost  
Get our new brochure

Enamel Finish or HOT  
DIPPED GALVANIZED  
AFTER ASSEMBLY. Superior design gives a clean uncluttered appearance.

Export: Minthorne 15 Moore  
St., New York  
Cable: Churchin, New York

**TELE-VUE Towers, Inc.**  
701-707 49th St., So. St. Petersburg, Fla.

**FREE BROCHURE** RTN-4

Mail this coupon for full information

- Amateur       Distributor  
 Dealer         Industrial

Name \_\_\_\_\_

Address \_\_\_\_\_

City \_\_\_\_\_ State \_\_\_\_\_

Prices subject to change without notice

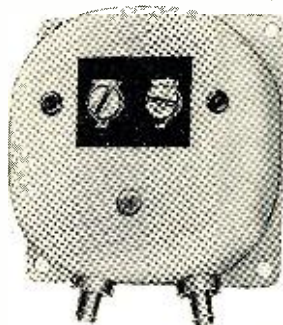

Fig. 8. The Jerrold LT-310—a typical surface-mounted tap-off for RG/59U line.

(2 to 6) and the other the high band (7 to 13). Developed response curves will be somewhat similar to Fig. 9. It can be seen that these amplifiers do not, as a rule, cover the FM band (88-108 mc.). They may be rated in terms of variation in response, usually a figure such as "± 1 db across the band." An important secondary consideration is impedance match, especially at the input terminals. This will be quoted in terms of voltage-standing-wave ratio (v.s.w.r.). Obviously, the closer this number is to 1.0, the better the match. Very rarely are outputs matched—mostly they are designed for optimum efficiency consistent with cost. This is acceptable as long as the output sees a good match. There can be no reflections from a matched load.

Single-channel preamplifiers are usually used in the special cases of very elaborate systems. With multi-channel operation, the broadband type offers greater economy. Both types are available in two physical styles: for mast-mounting or for indoor or cabinet use. The mast-mounting types are for use where minimal signals are being received and offer the advantage—a considerable one—that the antenna signals are amplified before they can be attenuated by the downlead or before the downlead can pick up noise signals, which are stronger close to the ground and in buildings.

Distribution amplifiers are differentiated from preamplifiers in that they have, in general but not necessarily, a higher gain and can handle larger outputs. Since they are designed for gain, particular attention is not paid to low-noise input stages. A good rule of thumb, which should cover most cases, is that a distribution amplifier should not be fed with less than 1000  $\mu$ v. of signal. If low antenna signals are prevalent in the area of use, such amplifiers must be preceded by a preamplifier to develop proper input levels.

The higher gain of distribution amplifiers means that longer lines can be run from their outputs, which brings us again to the problem of differential loss in coaxial cable. Some form of compensation is necessary to reduce this effect to a point where it does not affect the system. The problem is attacked in two ways, the most direct being the use of a compensator network. This is a frequency-sensitive attenuator (whose characteristics are the opposite of the

**COMING  
TO YOUR CITY...**

# RIGO HIGH FIDELITY MUSIC SHOWS

**FEATURING EXHIBITS  
AND DISPLAYS  
OF HUNDREDS OF  
HIGH FIDELITY PRODUCTS**

**1958**

**OMAHA**—Nov. 7, 8, 9  
Paxton Hotel

**SEATTLE**—Nov. 21, 22, 23  
New Washington Hotel

**1959**

**MINNEAPOLIS**—Jan. 16, 17, 18  
Leamington Hotel

**DENVER**—March 6, 7, 8  
Cosmopolitan Hotel

**BALTIMORE**—March 20, 21, 22  
Lord Baltimore Hotel

**PITTSBURGH**—April 3, 4, 5  
Penn-Sheraton Hotel

**BUFFALO**—April 10, 11, 12  
Statler Hotel

**ADMISSION 75¢**

**RIGO** ENTERPRISES, INC.  
500 NO. DEARBORN ST.  
CHICAGO 10, ILLINOIS





128 pages 200 illustrations

## New Edition of YOUR CAREER IN ELECTRONICS Now on Sale!

Whether you're already in electronics and are eager to get ahead or are looking for a field with a definite future—**YOUR CAREER IN ELECTRONICS** is a publication you're sure to profit from.

On sale now at newsstands, **YOUR CAREER IN ELECTRONICS** could well be one of the most important publications you've ever read. Its 128 pages are devoted to electronics—its growth, its present, its future—and your role in this big, exciting field. Compiled by the editors of the Ziff-Davis Electronics Division, this 1959 Edition covers:

### THE FIELD OF THE FUTURE

Career opportunities and where you fit in, how to get started, what an electronics company expects of you.

### PEOPLE AT WORK

Helpful personal experiences of men actually in electronics: a field engineer, a production manager, tech writer, missile-man, the owner of a radio-tv repair shop, and many more!

### GETTING THE KNOW-HOW

Informative section on deciding your future, complete with career planning chart and aptitude tests. Reports on vocational and technical schools, colleges, getting your radio operator's license, learning technical writing, how on-the-job training works.

### EARN MONEY IN YOUR SPARE TIME

How to set up a part-time service shop, make money with home intercoms, sell your ideas to magazines, earn money with your tape recorder.

**YOUR CAREER IN ELECTRONICS** is now on sale. Be sure to pick up your copy today at your newsstand or electronic parts dealer . . . only \$1.00 per copy.



**ZIFF-DAVIS PUBLISHING COMPANY**  
434 S. Wabash Ave. Chicago 5, Illinois

November, 1958

RADIO and ELECTRONICS TRAINING AT HOME

# BUILD 6 RADIO

CIRCUITS with DELUXE

1959 Progressive  
RADIO "EDU-KIT"®

Reg. U.S.  
Pat. Off.

PRACTICAL  
HOME  
RADIO  
COURSE

only  
\$22.95



NOW INCLUDES

- ★ 12 RECEIVERS
- ★ TRANSMITTER
- ★ SIGNAL TRACER
- ★ SIGNAL INJECTOR
- ★ CODE OSCILLATOR

- ★ No Knowledge of Radio Necessary
- ★ No Additional Parts or Tools Needed
- ★ Excellent Background for TV
- ★ School Inquiries Invited
- ★ Attractively Gift Packed

### FREE EXTRAS

- SET OF TOOLS • RADIO & ELECTRONICS TESTER • ELECTRIC SOLDERING IRON • TESTER INSTRUCTION MANUAL • MEMBERSHIP IN RADIO-TV CLUB • CONSULTATION SERVICE • HI-FI GUIDE • QUIZZES • TV BOOK • FCC AMATEUR LICENSE TRAINING • RADIO BOOK • PRINTED CIRCUITRY • PLIERS-CUTTERS • ALIGNMENT TOOL • WRENCH SET • CERTIFICATE OF MERIT • VALUABLE DISCOUNT CARD

### WHAT THE "EDU-KIT" OFFERS YOU

The "Edu-Kit" offers you an outstanding PRACTICAL HOME RADIO COURSE at a rock-bottom price. Our kit is designed to train Radio & Electronics Technicians, making use of the most modern methods of home training. You will learn radio theory, construction, servicing, basic Hi-Fi and TV repairs, code, FCC amateur license requirements.

You will learn how to identify radio symbols, how to read and interpret schematics, how to mount and layout radio parts, how to wire and solder, how to operate electronic equipment, how to build radios. Today it is no longer necessary to spend hundreds of dollars for a radio course. You will receive a basic education in radio, worth many times the small price you pay, only \$22.95 complete.

### THE KIT FOR EVERYONE

The Progressive Radio "Edu-Kit" was specifically prepared for any person who has a desire to learn Radio. The "Edu-Kit" has been used successfully by young and old in all parts of the world by many Radio Schools and Clubs in this country and abroad. It is used for training and rehabilitation of Armed Forces Personnel and Veterans throughout the world.

The Progressive Radio "Edu-Kit" requires no instructor. All instructions are included. Every step is carefully explained. You cannot make a mistake.

### PROGRESSIVE TEACHING METHOD

The Progressive Radio "Edu-Kit" is the foremost educational radio kit in the world, and is universally accepted as the standard in the field of electronics training. The "Edu-Kit" uses the modern educational principle of "Learn by Doing." Therefore, you will construct radio circuits, perform jobs and conduct experiments to illustrate the principles which you learn.

You begin by examining the various radio parts included in the "Edu-Kit." You then learn the function, theory and wiring of these parts. Then you build a simple radio. With this first set, you will enjoy listening to regular broadcast stations, learn theory, practice testing and troubleshooting. Then you build a more advanced radio, learn more advanced theory and techniques. Gradually, in a progressive manner, and at your own rate, you will find yourself constructing more advanced multi-tube radio circuits, and doing work like a professional Radio Technician.

Included in the "Edu-Kit" course are sixteen Receiver, Transmitter, Code Oscillator, Signal Tracer and Signal Injector circuits. These are not unprofessional "breadboard" experiments but genuine radio circuits, constructed by means of professional wiring and soldering on metal chassis, plus the new method of radio construction known as "Printed Circuitry." These circuits operate on your regular AC or DC house current.

In order to provide a thorough, well-integrated and easily-learned radio course, the "Edu-Kit" includes practical work as well as theory; troubleshooting in addition to construction; training for all, whether your purpose in learning radio be for hobby, business or job; progressively-arranged material, ranging from simple circuits to well-advanced topics in Hi-Fi and TV. Your studies will be further aided by Quiz materials and our well-known FREE Consultation Service.

### THE "EDU-KIT" IS COMPLETE

You will receive all parts and instructions necessary to build 16 different radio and electronics circuits each guaranteed to operate. Our kits contain tubes, tube sockets, variable, electrolytic, mica, ceramic and paper dielectric condensers, resistors, tie strips, coils, hardware, tubing, punched metal chassis, Instruction Manuals, hook-up wire, solder, etc.

In addition, you receive Printed Circuit materials, including Printed Circuit chassis, special tube sockets, hardware and instructions. You also receive a useful set of tools, a professional electric soldering iron, and a self-powered Dynamic Radio & Electronics Tester. The "Edu-Kit" also includes Code Instructions and the Progressive Code Oscillator, in addition to the F.C.C.-type Questions and Answers for Radio Amateur License training. You will also receive lessons for servicing with the Progressive Signal Tracer and the Progressive Signal Injector, and a High Fidelity Guide and Quiz Book. Everything is yours to keep.

J. Statatis, of 25 Poplar Pl., Waterbury, Conn., writes: "I have repaired several sets for my friends, and made money. The "Edu-Kit" paid for itself. I was ready to spend \$240 for a course, but I found your ad and sent for your Kit."

### UNCONDITIONAL MONEY-BACK GUARANTEE

The Progressive Radio "Edu-Kit" has been sold to many thousands of individuals, schools and organizations, public and private, throughout the world. It is recognized internationally as the ideal radio course.

By popular demand, the Progressive Radio "Edu-Kit" is now available in Spanish as well as English.

It is understood and agreed that should the Progressive Radio "Edu-Kit" be returned to Progressive "Edu-Kits" Inc., for any reason whatever, the purchase price will be refunded in full, without quibble or question, and without delay.

The high recognition which Progressive "Edu-Kits" Inc. has earned through its maintenance of perfect engineering standards, the highest instructional standards, and 100% adherence to its Unconditional Money-Back Guarantee. As a result, we do not have a single dissatisfied customer throughout the entire world.

ORDER FROM AD—RECEIVE FREE BONUS RESISTOR AND CONDENSER KITS WORTH \$7.00

- Send "Edu-Kit" Postpaid. I enclose full payment of \$22.95.
- Send "Edu-Kit" C.O.D. I will pay \$22.95 plus postage.
- Send me FREE additional information describing "Edu-Kit." Also send FREE Radio, TV & Hi-Fi Books worth \$1.50. No obligation.

Name \_\_\_\_\_  
Address \_\_\_\_\_

**Progressive "EDU-KITS" Inc.** 1186 Broadway, Dept. 83-E  
Hewlett, New York



performance  
proven in more  
than 500,000  
homes



# UHF CONVERTERS

No matter where you are — primary or fringe area — there's a B-T UHF converter that makes any TV set a modern, powerful 82-channel receiver. New FCC tuner standards\* are met by these B-T Converters.



for superior reception  
in fringe areas the

## BTU-2<sub>R</sub>

precise 300-ohm impedance match; high gain—high stability; low noise factor; double tuned input; dual speed channel selector for easy, accurate tuning  
only 39.95



for primary areas — top  
performance at low cost

## MODEL 99<sub>R</sub>

precise 300 ohm impedance match; double tuned RF section; one knob tuning; drift-free performance  
only 22.95

B-T converters are UL approved, CSA approved and approved by actual performance in more than 500,000 American homes.

Sold by Electronic Parts Distributors

Blonder-Tongue Laboratories, Inc.  
9 Alling Street RTN-11 Newark 2, N. J.

\*Models 99r and BTU-2r comply with tuner limits of FCC rules, Part 15, of 1000 UV/M — Hazeltine Research Corp. — report #57041.

CAP. ( $\mu$ fd.)	CH.2		CH.6		CH.7		CH.13	
	I	FT	I	FT	I	FT	I	FT
.47	42	*	34	*	33	*	29	*
1.0	34	*	28	*	26	*	22	.05
2.2	27	*	21	.1	17	.11	15	.15
3.3	22	.06	18	.12	14	.25	11	.5
5.0	19	.12	16	.2	11	.54	9	.9
6.8	16	.17	13	.3	9	.91	6	1.5
10.0	13	.3	9	.6				

Not used in this band

\* = Insignificant loss; I = Isolation loss in db; FT = Feedthrough loss in db.

Table 2. Capacitor values commonly used in tap-off units, with their losses.

cable characteristics) which is placed between the amplifier and the line.

We should re-examine the cable from this viewpoint. Fig. 10A shows the behavior of a 1000-foot section of RG-11/U, using the level of channel 2 along the cable as a reference level. The loss at channel 2 in RG-11/U is 1.6 db per 100 feet and, in a 1000-foot length, the total loss will be 16 db. At channel 13, loss is 3 db per 100 feet, making a total of 30 db. The *delta*, or rate of change is 30-16, or 14 db per 1000 feet. At the end of this cable, the channel-13 signal will be 14 db less than whatever channel-2 signal remains.

If we construct a compensator which has a reverse *delta*, so that it attenuates channel 2 by 14 db at the amplifier output, then we will have the situation of Fig. 10B. In this situation, the level of channel 13 is higher all along the line, becoming even with the channel-2 signal at the end. Fig. 10C outlines a compromise method, where the compensator corrects for one-half of the cable *delta* (7 db). In this case, channel 2 is attenuated 7 db at the beginning, thus starting 7 db down and arriving at the cable end 7 db up. Manufacturers using these methods will specify the length and type of cable for which a given cable compensator or *line equalizer* is designed. Tap-off units on such a line, with their feedthrough losses, usually change situations to the extent that the prediction of actual levels shows considerable error. In general, the effect of tap-off units is to make a line appear longer and have a greater *delta*.

A more elegant and less energy-wasting solution is offered in the "tiltable" distribution amplifier. To explain the term "tiltable," we can refer back to Fig. 9, the response curve of the broadband preamplifier. Except for the amount of gain, the response curve of a broadband distribution amplifier will be very similar. Note that the top of the response curve is flat, indicating equal gain at all channels between the markers. If the top of the curve is tilted, so that the higher channel markers are higher than the lower channel markers, then the amplifiers would have more gain at the higher frequencies and a correspondingly greater output. If the tilt is across a pivot point located at the center of the band, the average gain and the composite developed voltage would remain the same. The difference in gain between band extremities could be made one-half of the *delta* of a given length of cable, with or without tap-off units, thus arriving at the optimum condition. Such amplifiers can be made with a single "tilt" control for each band which, with individual gain controls for each band, allows the amplifier to compensate for any practical length of the cable. The method is extremely flexible.

One such amplifier is the *Jerrold* Model 2300. It is factory-adjusted to compensate for either 800 feet of RG-11/U or 400 feet of RG-59/U, since each of these lengths requires the same compensation. The tilt actually required for a given use can be set easily with an alignment tool and meter.

(To be concluded)

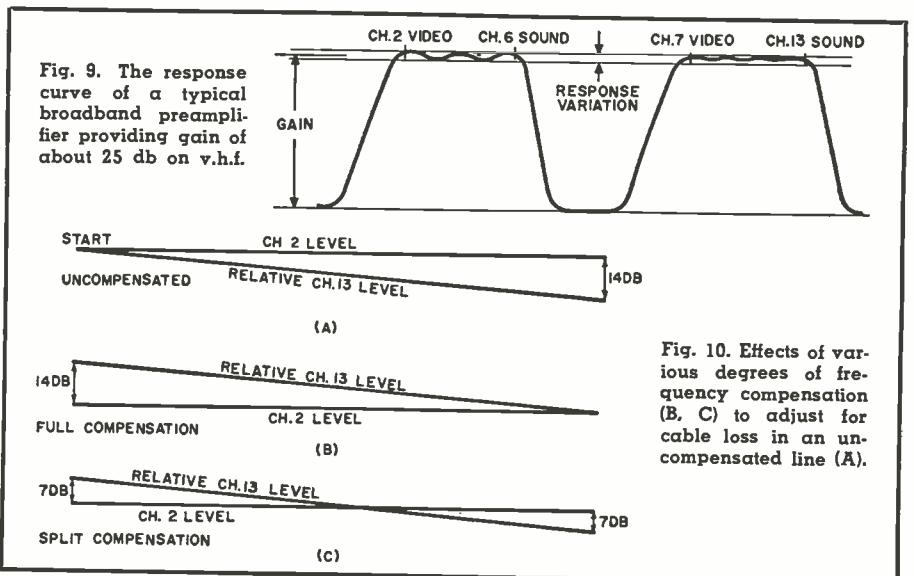

Fig. 9. The response curve of a typical broadband preamplifier providing gain of about 25 db on v.h.f.

Fig. 10. Effects of various degrees of frequency compensation (B, C) to adjust for cable loss in an uncompensated line (A).



# SURPLUS BUYS



## RCA OSCILLOSCOPE

RCA Model 155C

This scope is a highly efficient conventional 3" oscillograph. Operates from 115VAC-60 cycles. The perfect instrument for service, labs, schools, industry, experimenter. All features of high priced lab 'scopes available to you at less than the price of a kit. **SIZE: 10" x 7 1/4" x 14". Wt. 23 lbs.** All in perfect operating condition. A complete 'scope for less than the price of a kit. (We ship by express.)

**\$29.95**

complete F.O.B. N.Y.

**DYNAMOTOR**—12VDC In.—400VDC, 180 Ma. Contin. Out.—225 Ma. Intermitt.—New—7" L x 4" D. . . . . \$8.95  
**2" SCOPE TUBE #2API**—New—Boxed. . . . . \$1.95  
**ARC-5 XMTR**—3-4MC—Exc. . . . . \$5.95  
**ARC-5 XMTR**—5-3-7MC—Exc. . . . . \$6.95  
**OIL CONDENSER**—8-8-8 Mid.—600VDC—with brackets compact (Tobe or Nat'l) New. . . . . \$2.50  
**MINIATURE METER**—1" Sq. Weston, Etc.—0-100 Microamps, Br. New, Orig. Scale. Now only \$3.95

### OIL CONDENSERS

1 Mfd-600V. . . . . \$ .25	8 Mfd-660AC. . . . . \$ 2.50
2 Mfd-600V. . . . . .25	2 Mid-1000VDC . . . . . .75
.05—.05 600V. . . . . .25	4 Mid-1000VDC . . . . . 1.50
10 Mfd-600V. . . . . 1.00	3 Mid-1000VDC . . . . . .79
4 Mfd-600V. . . . . .50	4 Mid-5000VDC . . . . . 16.00

### METERS

<b>2" Rd.</b>	<b>3" Rd.</b>
500 Microamps . . . \$3.29	300 VDC. . . . . \$3.75
500 Milliamps . . . 2.95	1 Amp RF. . . . . 4.95
1 Ampere DC. . . . . 2.95	50 Amp AC (6AF5) . . . . . 4.95
10 Amps DC. . . . . 2.95	
<b>140 MMFD VARIABLE APC TYPE</b> (Hammar.)	
39 Plate—3/4" Shaft. . . . . 3 for \$2.00	
<b>LS 13 (TRUMPET LOUDSPEAKER)</b> in Weather-proof Case, Brand New, Exc. Value. . . . . \$7.95	
<b>FILTER CHOKES</b> —4 Hy.—900 Mil. . . . . \$12.95	
5 Hy.—200 Ma.—Ultra Small—Cased. . . . . \$1.95	
12 Hy.—500 Ma.—Cased, New. . . . . \$8.95	
<b>SENSITIVE MICROAMMETER</b> Ruggedized—0-100—New 3". . . . . \$5.95	
<b>POWER TRANSFORMER</b> (to end ARC-5 and Surplus Problems) 4 Sec. Wdgs.—600VCT, 100 Mils.—6V/2A—12.6VCT-3A—12.6V-3A—3 1/2" x 3" x 4 1/2". . . . . Each \$2.49	
<b>125VAC RELAY DPST</b> —Allied. . . . . Each \$1.29	
<b>115VAC RELAY</b> —Plug into Oetal Socket—Clare—2 Make—1 Break—\$1.49. . . . . 4/\$5.00	
<b>FILA. XFORM.</b> —5V—10A—10KV—Csd. . . . . \$2.95	

**REX RADIO SUPPLY CO.**  
 88 Cortlandt St.  
 New York 7, N. Y.  
 In the Heart of New York's Radio Row



# What's New in Radio

## NEW "FLEETCOM" SERIES

Communications Company, Inc., 300 Greco Ave., Coral Gables, Fla. has announced a new line of v.h.f. FM equipment for use in the new "Business Radio Service" band recently authorized by the FCC.

The "580 Series" equipment features a transistor power supply and a single-chassis receiver/transmitter unit. An

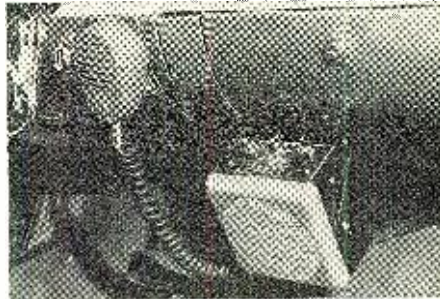

a.c. adapter is available which permits the receiver/transmitter chassis to be removed from a vehicle and used as an a.c. base station. The mounted unit is only 15 1/4" wide, 10 1/4" high, and 11 1/2" deep. The transmitter output is 50-60 watts in the 25-54 mc. range and approximately 35 watts in the 144-174 mc. band.

The manufacturer will supply full details and complete specifications on this new equipment for "Business Radio Service" applications upon written request.

## V.H.F. CONVERTER

Radio Manufacturing Engineers, Inc., Division of Electro-Voice, Inc., Buchanan, Mich. has developed a v.h.f. converter with its own power supply which

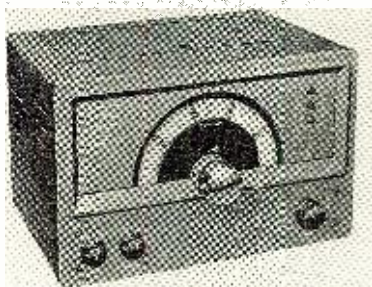

has been designed for use with any conventional communication-type receiver to extend its range to cover 50 mc., 144 mc., and 220 mc.

The function of the VHF126 unit is to convert the very high frequencies received to a fixed frequency of 7 mc. which is then fed to the receiver, amplified and detected in the normal manner. For the two higher ranges, double conversion results. On all ranges the image response is practically eliminated

better reception on  
 1, 2 or 3 tv sets...  
 with one antenna

NEW **B-T LABS** B-23

## TWO-SET BOOSTER



only \$23.95

From B-T comes the most important advance in better TV reception for 1958—a broadband TV amplifier that boosts signal strength on all VHF channels and operates 1, 2 or 3 TV sets with one antenna—no tuning required.

### Combines two functions in one —

- BOOSTS signal strength on 1 or 2 TV sets—up to 6 db gain operating two TV sets from one antenna.
- COUPLES 2 or 3 TV sets—using the present antenna. Outperforms non-powered couplers in any reception area by more than 2 to 1.

### Check these B-23 features:

- Ideal for color—add a color TV set and keep present black-and-white set, use the same antenna—the result, sharper, clearer pictures on both sets ● Lower noise figure—designed to work with new VHF sets ● Reduces interference ● Easily installed at antenna terminals of set
- Automatically amplifies channels 2-13
- Ideal small TV system

For operating 3 to 8 TV sets, use the B-T Labs DA8-B—more than 10 db gain on all VHF channels.

The DA8-B Distribution Amplifier is a broadband, all-channel unit that requires no tuning, impedance matching devices, pre-amps or other special fittings. Ideal for all small TV systems (garden apartments, motels, TV showrooms). Approved for color. Only \$94.50

The B-23, the DA8-B, and other B-T quality engineered products, are available at electronic parts distributors.

For further information, use coupon.

RTN 11

**B-T LABS** BLONDER-TONGUE LABS., INC.  
 9 Alling Street, Newark 2, New Jersey

Please send me literature covering:

B-T B-23       B-T TV Accessories

Name \_\_\_\_\_

Address \_\_\_\_\_

City \_\_\_\_\_ Zone \_\_\_\_\_ State \_\_\_\_\_

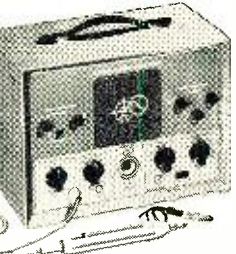
### SIGNAL TRACER

Checks all stages from Antenna to Speaker or Picture Tube. Tests microphones, appliances, pickups, transformers, speakers, resistors, condensers, etc.

Model 202 (with AF Probe). . . . . Net \$37.50  
 Model A Probe (RF Demodulator) . . . . . Net 4.50  
 Model B Probe (RF Demodulator, Amplifier) . . . . . Net 7.50



### TV CLARIFIER

Removes annoying signals that cause picture distortion in TV sets due to FM, amateurs, shortwave, diathermy, ignition and adjacent channels. Ghosts, lines, herringbone patterns, tears and wavy effects are eliminated or reduced simply by turning the two control knobs on this new type interference eliminator \$7.50

**PRECISION ELECTRONICS, INC.**  
 Dept. R-11, 9101 King St., Franklin Park, Illinois



# HARVEY HAS IT!

the complete line of  
**GLOBE ELECTRONICS**

## the GLOBE LINEAR LA-1

Grounded Grid, Class B or C



Complete with well-filtered power supply, 200W input AM Class B. 300W DC or 420 PEP input Class B linear SSB or DSB. 300W Class C for CW. Pi-Net work output on 10M-80. 52 ohm. Link coupled on 6M. Extensively TVI-protected. W/T: \$124.50 Kit: \$99.50

## and the GLOBE HI-BANDER

Bandswitching 6 and 2M Xmtr.

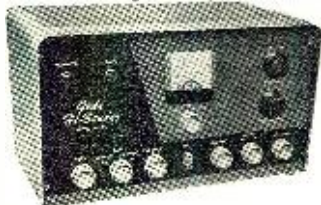

Regulated screen supply. 4-stage RF section allowing straight through operation. Good harmonic and TVI suppression. RF stages metered. Provisions for mobile use. 52-72 ohm coax output. New duo-band final tank circuit eliminates switching. Power Input: 60W CW; 55W AM on Both 6 and 2M.

W/T: \$149.95 Kit: \$129.95

**HARVEY HAS THE COMPLETE LINE -**  
**Rotate Hold Indicate**  
**HY-GAIN ANTENNAS**  
**IN STOCK FOR IMMEDIATE DELIVERY**

- 750 in. lbs. rotating power
- 10,000 in. lbs. braking power
- Complete rotating assembly
- Great circle map indicator
- Hy-Gain roto-brake, (brake + rotator + indicator.)

Complete \$149.95

**MAIL ORDERS SHIPPED SAME DAY AS RECEIVED**  
Include with your payment a generous allowance for shipping charges - the excess will be promptly refunded.

**HARVEY RADIO CO., INC.**  
103 West 43rd Street  
New York 36, N.Y.  
Estab. 1927  
JU 2-1500

since the output is 7 mc. and the first i.f. for the fixed-tuned crystal-controlled unit is 50 mc. The auxiliary controls on the receiver, such as the b.f.o., noise limiter, r.f. and audio gain, plus the "S" meter will function in the normal manner. The 220 and 144 mc. converters employ overtone series-mode crystal oscillators and one doubler.

The range of the unit is 48.2-54.2 mc.; 143.4-149.2 mc.; and 219.4-225.2 mc. This provides complete coverage of the 1 1/4-, 2-, and 6-meter bands with sufficient overlap on 6 meters to listen to commercials for band openings. The unit also covers MARS and CAP frequencies on 2 meters.

For a data sheet with complete specifications, write the manufacturer direct.

### PHILCO'S SIGNAL GENERATOR

The Accessory Division of *Philco Corporation*, "C" and Westmoreland St., Philadelphia 34, Pa. has announced the availability of a new service signal generator, the Model 7200.

This new AM-r.f. unit covers the frequency range from 100,000 cycles to



280 mc. permitting the proper alignment of TV oscillator coils on all channels. The generator can also be used as a marker at r.f. or i.f. frequencies in all television receivers.

The circuit provides high uniform output and stable operation. The housing features large clear panel markers which will never rub off, baked enamel finish, etched aluminum panel, and large vernier scale.

Further information on this new service instrument is available either from local distributors or Ray Nugent, general manager of the Division.

### "HI-KAP" DEALER KITS

*Centralab*, a division of *Globe-Union, Inc.*, 900 E. Keefe St., Milwaukee 1, Wis. is currently offering four new dealer kits in its "Hi-Kap" ceramic capacitor line.

These heavy-gauge steel kits contain balanced inventories of the most frequently used ceramic capacitors. Individual values are prominently and clearly labeled so that the right capacitor can be located instantly. A rigid plastic package permanently separates each value and protects the units so the leads are always straight. The package is constructed so that it can be easily opened to remove a single

## NOW - faster, easier ball-bearing drive for GREENLEE chassis punches

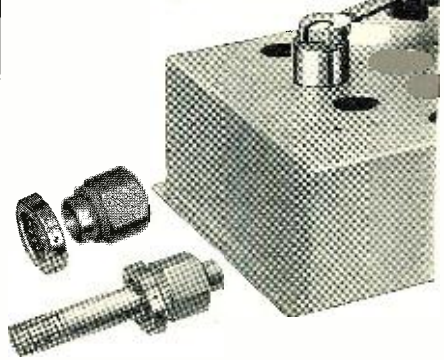

New GREENLEE Ball-Bearing Drive Nuts and Drive Screws reduce friction and make it easier than ever to cut smooth, accurate holes with GREENLEE No. 730 Round Radio Chassis Punches. The new faster drives are available for all round-type GREENLEE Punches sizes 11/16" through 2-25/32". Operate with ordinary wrench for quick socket openings, etc., in metal, Bakelite, or hard rubber.

**GREENLEE TOOL CO.**  
1891 Columbia Avenue  
Rockford, Illinois

## BARGAIN HUNTERS!

### BUY NEW MDSE. FROM OLD PAPPY DOW

**POWER TRANSFORMERS:**  
5-K.W., 220 V. Pri. 3800 V.C.T. @ 2.7 amps. Wt. 306 lbs. . . . \$49.95  
Pri. 115 V. 60 Cy. Sec. 1. 550 V.C.T. 142 ma. Sec. 2. 6.3 V. @ 10 amps. Sec. 3. 0.5 V. @ 15 amps. Sec. 4. 5 V.C.T. @ 3 amps. Secondary 3-65 V. Bias @ 142 ma. . . . 4.95  
Pri. 115 V. 60 Cy. Sec. 1-750 V., ct. 113 ma. Sec. 2-6.3 V. @ 5 amps. Sec. 3-5 V. @ 3 amps. . . . 2.95  
Choke 12.8 Hy. @ 200 mills. 142 ohms. . . . \$1.85 ea. 2 for 3.00  
Choke 12 Hy. @ 150 mills. 194 ohms. . . . .95 ea. 2 for 1.70  
Radio-Service Modulators, Full of Parts. . . . .75 ea. 2 for 1.35  
Blower, 115 V., 400 Cps. 22 CFM. w/bracket. . . . .75 ea. 2 for 5.00

**OIL CONDENSERS:**  
4 x 5 mfd x 600 V. wkg. used in Super Pro. . . . \$1.50 ea. 1.75  
8 mfd x 1000 V. wkg. . . . \$1.50 ea. 2 for 2.75  
13 mfd x 1000 V. wkg. . . . 1.50 ea. 2 for 3.50  
1 mfd x 3000 V. wkg. . . . .75 ea. 3 for 2.00  
2 mfd x 3000 V. wkg. . . . 3.95 ea. 2 for 7.00  
4 mfd x 5000 V. wkg. . . . 4.95 ea. 2 for 9.00  
1 mfd x 5000 V. wkg. . . . .95 ea. 2 for 1.50  
25 x 9000 V. wkg. . . . 7.95 ea. 2 for 14.00  
Westinghouse Cond. 5 mfd x 10,000 V. 60.00 ea. 2 for 100.00

**MICA CONDENSERS:**  
.01 @ 500 V. Postage Stamp size. . . . .05 ea. 25 for \$ 1.00  
.01 @ 1000 V. Wire Leads. . . . .10 ea. 15 for 1.00  
.0082 @ 1000 V. Wire Leads. . . . .08 ea. 20 for 1.00

**BATHUB CONDENSERS:**  
2 x 2 mfd x 600 V. Side Lug. . . . .5 .25  
2 x 1 mfd x 600 V. Side Lug. . . . .10 for 1.00  
5 mfd x 400 V. Side Lug. . . . .10 for 1.00  
25 mfd x 400 V. Top Lug. . . . .15 for 1.00  
25 mfd x 50 V. One Top Lug. . . . .25 for 1.00  
Dynamotors, 12 V. input DM 85. . . . .15.00  
Dynamotors, 12 V. input DM 84. . . . .5.00  
Dynamotors, DM 4DA new 12 V. input. 172 @ 138 ma. . . . 2.95  
Ferrul Type Resistors, Your Choice. . . . .4 for 1.00

**200 WATT**      **150 WATT**      **100 WATT**      **50 WATT**  
20 ohms      200 ohms      600 ohms      25 ohms  
36 ohms      1000 ohms      2000 ohms      2000 ohms  
30 ohms      2000 ohms      3000 ohms      3000 ohms  
80 ohms      3150 ohms      10,000 ohms  
1500 ohms      12,500 ohms

2000 ohms      Clips ea. \$ 1.10  
3 megohm, 200 watt resistors w/clips. . . . .ea. 1.00  
10 K & 15 K-200 watt resistors w/clips. . . . .ea. .90  
10 K & 12 1/2 K-150 watt resistors w/clips. . . . .ea. 1.00  
J-44 High Speed Hand Telegraph Key with On-Off switch, adjustable spring tension and contact spacing 1/8 in. silver contacts, mounted on Bakelite base. . . . .Prepaid 1.50  
R-14 readphones, 8000 ohm imp. . . . .Prepaid 2.95  
3295-143 Scientific Insulation 1/4 in. shaft, 1/2 in. long 2 pole, 3 position. . . . .25 ea. 2 for 2.00  
MX20/AP Probes, High Voltage used on 1S 34 AP Scopes. . . . .95  
3 2740-3 Lee-Met High Voltage Test Leads. . . . .2 for 1.75  
Relays, 6 V. DC. DPDT, small. . . . .95 ea. 2 for 1.75  
Relays, 12 V. DC. 3 P.S. 1, small. . . . .75 ea. 2 for 1.25  
Toggle Switch, DPST, 10 amps. . . . .2 for .50  
1 megohm Vol. Control w/AC switch. . . . .3 for 1.00  
25 watt Ohmite Pots, 2500 ohms. . . . .2 for 1.50  
Sine tuned coil 3/8 Dia. x 1 1/4 in. w/fault. . . . .2 for .25  
C.R. Tube Sockets for 5C1 & 3B1 etc. . . . .2 for .50  
Triple Pilot Lites, Red, Green, White. . . . .ea. .45  
Intercom 141 Handsets. . . . .1.95  
Transf. Midget Hinet, 20 K. C. Tap to 600 ohms-1 watt. . . . .75

**L. R. ELECTRONICS**  
3529 E. Colorado Street Pasadena, California  
Ryan 1-9093 or 5ycamere 6-3521

Immediate delivery. Include 25% deposit with order - balance C.O.D. 30c Handling Charge on all orders under \$3.00. All shipments F.O.B. our warehouse, Pasadena, California.

RADIO & TV NEWS







# NEW

# HICKOK

## Low-Cost VOM



Model 457

- High Hickok Quality at a New, Low Price
- Latest Design, Single Control Function and Range Selector

This new, portable reliably provides the latest engineering advancements for versatile use in all VOM applications. The attractive, modern design features ease of use with maximum readability. Quality-built with a full-wave rectifier circuit. Batteries are housed in a special compartment that is accessible without removing case. No soldering required—just "snap" batteries in or out.

**SENSITIVITY:** 20,000 ohms per volt DC.  
1,000 ohms per volt AC.

**A.C. VOLTS:** 0 to 1200 in 6 ranges.

**D.C. VOLTS:** 0 to 1200 in 6 ranges.

**RESISTANCE:** 0 to 100 megohms in 4 ranges.

**CENTER SCALE**

RANGES: 5, 500, 5000, 500,000 ohms.

**CURRENT:** 50 microamperes; 1, 10, 100, 1000 milliamperes; 10 amperes.

**DB RANGE:** -18 to +57 in 5 ranges.

Frequency compensated for accurate readings over the entire audio range.

High Hickok-quality at a new low price.

**\$43<sup>95</sup>  
NET**

**Now is the time to...  
TRADE UP TO A HICKOK**

Ask for a demonstration of the new 457 from your Authorized Hickok Distributor.

**THE HICKOK ELECTRICAL INSTRUMENT CO.**  
10514 Dupont Ave. • Cleveland 8, Ohio

u.h.f. antenna. The heart of this converter is a radar-type, coax tuner which is completely sealed and does not contain any wiper contacts, switch contacts, or any other components causing signal noise.

Both converters are housed in compact, modern cabinets designed to complement any decor.

### CIRCULAR SLIDE-RULE

General Industrial Co., 5738 N. Elston Ave., Chicago 30, Ill. has just introduced a handy circular slide-rule designed specifically for engineers and other plant and office executives.

Operation of the rule is simple and the results are accurate. To multiply, divide, and find proportions is a matter



of seconds. Complete easy-to-follow instructions are included with each rule.

Engineers and business executives may receive the rule free of charge upon letterhead request. Others who would like this pocket-sized calculator can obtain one by writing the firm, enclosing 50 cents in coin to cover the cost of mailing and handling.

### MARINE DIRECTION FINDER

The Marine Equipment Division of Parametrics, P.O. Box 629, Costa Mesa, Calif. is now marketing an all-transistor radio direction finder under the tradename "Port-A-Finder."

According to the company, four penlite cells will power the unit for an en-

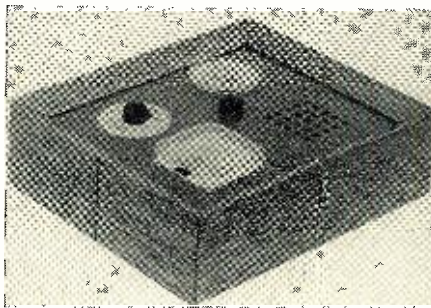

tire season. The instrument is housed in a solid mahogany case which measures 8" x 9" x 3".

Designed for sensitive reception of marine radio beacons, radio telephones, and standard broadcast stations the unit can also function as a portable receiver for entertainment purposes.

For complete specifications and price, write direct to the manufacturer.

### TRANSISTOR-CIRCUIT OHMMETER

Electronic Applications, 194 Richmond Hill Ave., Stamford, Conn. is currently offering a direct-reading ohmmeter which has been especially

**COMPLETE FM RADIO STATION \$59<sup>50</sup> EA.**

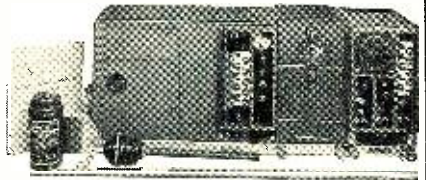

Brand new 30 watt transmitter and receiver for communications between points up to 30 miles ground wave or thousands of miles reflected wave. Units are Freq. Modulated for low noise interference. Frequencies are selected on any of 10 separate channels in range of 20 to 27.9 mc. Just think you get the receiver, transmitter, antenna, connecting wires, antenna tuning equipment, mount, dynamometers for 24 V DC operation; in fact, even spare vacuum tubes and microphone. Of course you can convert for 110 V house current or 12 V battery operation. Good loudspeaker volume. Comes shipped in 5 original Signal Corps wood boxes. Approx. wt. 400 lbs. Government Cost \$1,200. Yours brand new for \$59.50 or \$100 for the two sets for point to point communications. Send additional \$20 per unit for dynamometers to convert to 12 V car operation.

### SYNCHRO-MOTORS

**110 V. 60 CYCLE, ONLY \$4.95 ea.**

The most interesting and useful item coming from war surplus. A precision ball bearing motor built at a cost of \$86.00 ea. Yours for only \$4.95 ea. postpaid. You may connect and run individually as a hi-speed motor or connect in pairs the like stator wires together and the rotor wires to 110 V, 60 cycle AC and you can rotate either and the other will follow every slight movement like a flexible shaft except without the usual backlash and drag. Think of the interesting things you could make such as wind direction indicators, remote radio tuning, window display devices, etc., etc. Size 3 1/4" diameter, 6 1/2" long including shaft extension. Removed from radar units. Ship. wt. 8 lbs.



### ESSE RADIO COMPANY

40 W. South Street

Indianapolis 25, Indiana

ALL ITEMS GUARANTEED TO YOU ENTIRE SATISFACTION OR MONEY BACK (LESS SHIPPING CHARGES)

**"NO NOISE" BIG 3**  
Beware Of Cheap Substitutes!



**NO-NOISE NEW  
RUBBER COAT  
SPRAY**

- Insulates where applied
  - Protects indefinitely
  - Prevents arcing, shorting, corrosion
  - Waterproofs thoroughly
  - Non-inflammable
  - Contains no plastic
- 6 Oz. Spray Can  
**\$3<sup>25</sup>**  
Net To Servicemen

**NO-NOISE  
VOLUME CONTROL  
and  
CONTACT RESTORER**

- Cleans
- Lubricates
- Protects
- Not a Carbon Tey Solution

2 Oz. Bottle \$1<sup>00</sup>  
6 Oz. Spray Can \$2<sup>25</sup>  
Net To Servicemen



**NO-NOISE  
TUNER-TONIC**

With PERMA-FILM

- Economical—a little does a lot.
  - Cleans, lubricates, restores all tuners, including water type.
  - Non-toxic, non-inflammable
  - Use for TV, radio and FM
- 6 Oz. Aerosol Can  
**\$3<sup>25</sup>**  
Net to Servicemen



**ELECTRONIC CHEMICAL CORP.**  
813 Communipaw Avenue Jersey City 4, N. J.

RADIO & TV NEWS



designed for transistor circuit applications.

The EMT-321 provides minimum loading (under 30 mv. to 300 ohms).

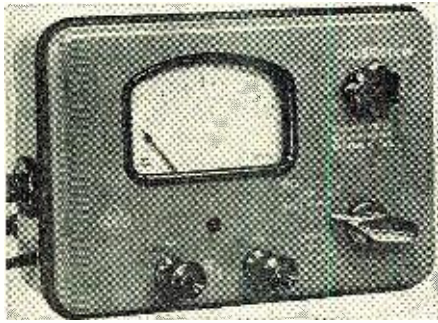

and covers a range of 10 milliohms to 10 megohms in eight steps. A single scale is used to read all ranges. Accuracy is  $\pm 2\%$ .

The unit measures  $8\frac{1}{2}'' \times 6'' \times 4\frac{1}{2}''$ . Free literature and information on price are available direct from the company.

### 90-WATT C.W. TRANSMITTER

Electronic Instrument Co., Inc. of 33-00 Northern Blvd., Long Island City 1, N. Y. has added a 90-watt c.w. band-switching amateur transmitter to its EICO kit and factory-wired line of equipment.

The Model 720 transmitter will tune 80 through 10 meters yet is compact enough to be used in relatively cramped quarters. The tube line-up consists of a 6146 final amplifier, a 6AQ5 clamper that protects the final amplifier when loss of excitation occurs, 6CL6 oscillator, a 6AQ5 buffer multiplier, and a GZ-34 full-wave rectifier.

The circuit incorporates one-knob bandswitching; one-knob power, tune, and operate switch; final amplifier grid drive control without detuning the oscillator; oscillator keying for break-in operation; no shock hazard at key terminals; completely sealed cabinet and carefully bypassed and choked input and output leads for TVI suppression; plus "Novice limit" calibration (75 watts) on the meter.

External plate modulation terminals are provided to permit use as an AM phone transmitter delivering up to 65

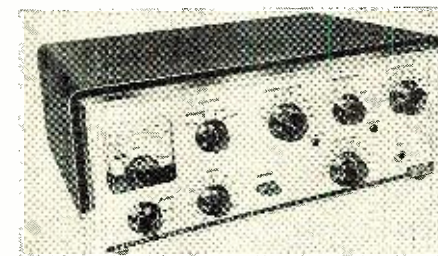

watts plate power input with the company's Model 730 high-level class B universal modulator. A basic v.f.o. unit will be offered at a later date.

The transmitter measures 5" high, 15" wide, and 9" deep. The kit is supplied with complete assembly and operating instructions—the wired unit with full details on operation. —30—

November, 1958

# DX-16 Super Deluxe TV KIT

70° or 90°—operating all 17", 21", 24" and 27" PICTURE TUBES

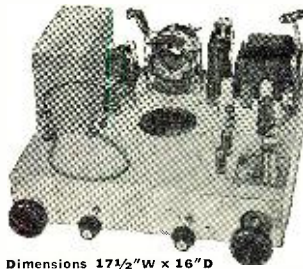

Dimensions  $17\frac{1}{2}'' \times 16'' \times 16''$   
Shipping weight 40 lbs.

Mounts Horizontally, Vertically or Sideways

- ★ Produces a 16-Tube Chassis with 30-Tube performance.
- ★ Latest Inter-carrier Circuitry and Multi-section Tubes.
- ★ Standard Neutrode Tuner for Selectivity and Fine Definition.
- ★ 5 Microvolts Sensitivity (20V peak to peak at CRT grid).
- ★ Fast Action AGC for Drift Free, Steady and Clear Pictures.
- ★ 3 Hi-gain Video I.F. Stages for fine Contrast and Details.
- ★ AGC Level Control, for adjusting reception to signal area.
- ★ All Video and I.F. Coils factory pre-aligned and tuned.
- ★ Large 250ma Power Transformer for dependable service.
- ★ 12" Speaker or Twin-cone 6" x 9" Speaker.

Includes—LIFE-SIZE step-by-step Building Instructions  
Most Up-To-Date and Practical Course in Television

COMPLETE KIT with SET of WESTINGHOUSE TUBES **\$79.97**

4-6CB6 and 6U8, 6TS, 6C4, 12BH7, 6SN7, 6B06, 6W4, 6K6, 1X2B, 5U4, 6BN4 and 6CG8 included in the Tuner (less CRT).....

Also sold on EASY-PAYMENT-PLAN—buy LIFE-SIZE Instructions. \$2.49 and buy Parts as you build.

## Westinghouse ALUMINIZED PICTURE TUBES

BRAND NEW in Factory Sealed Cartons—With a Full Year Guarantee

17" 17AVP4A 17BP4B 17CP4A 17HP4B 17LP4A 17OP4A	\$22.66	21" 21ALP4A 21AMP4A 21AUP4A 21EP4B 21YP4A 21ZP4B	\$32.21	24" 24AHP4 24ALP4 24AP4A 24DP4A 24VP4A 24YP4A	\$48.99	27" 27EP4A 27LP4A 27RP4A	\$74.31
---	---------	---	---------	--	---------	--------------------------------	---------

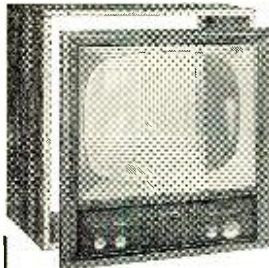

## BUILD YOUR OWN CABINET FOR ANY TV CHASSIS

Comparable to the type that Top Mfrs. use on high priced TV sets.

CABINET KIT with 90% of the job done, includes—  
FRONT SECTION in Solid Mahogany, Walnut or Blond Korina. TOP, SIDES, BACK, MASK, SAFETY GLASS, ETC.  
And Easy-to-follow Instructions

Front, Top and Sides supplied in a beautiful Piano Finish • Knob panel undrilled • For matching Mask specify type or number of CRT used. Same price—Mahogany, Walnut or Blond. (Shipping weight 30 lbs.)

21" CABINET KIT **\$24.95** 26"H, 25"W, 22"D..

17" CABINET KIT  $24\frac{1}{2}'' \times 22\frac{1}{2}'' \times 22''$  H, 22"W. **\$24.95** 24" or 27" CABINET KIT  $30'' \times 28\frac{1}{2}'' \times 22''$  H, 28"W, 22"D. **\$36.47**  
FRONT SECTION Only for WALL INSTALLATIONS Includes Mask, 21" \$17.45 | 24" or 27" \$22.97  
Safety Glass, Decals and Illustrated Instruction Mahogany, Walnut, Blond or Natural unfinished.

### STANDARD NEUTRODE TUNER

Latest Sensational 21mc TUNER for better all around performance. Complete with Tubes and Instructions ..... **\$15.97**

### TV PLASTIC OPEN MASKS

21"—Rectangular 18" x 22 $\frac{1}{2}$ ".....	\$2.38
24"—Rectangular 21" x 26".....	4.93
27"—Rectangular 21" x 26".....	4.93

On 21" specify type number of CRT used

### TV SAFETY GLASS in HANDY SIZES

16" x 20".....	\$2.94	20 $\frac{1}{4}$ " x 25".....	\$5.47
*18" x 22 $\frac{1}{2}$ ".....	5.16	*21" x 26".....	5.87

\*Available in new tinted grey 50c extra

### 90° TV CONVERSION KIT

Convert any Size, any make TV RECEIVER to operate the 24" or ANY 90° PICTURE TUBE.

COMPLETE SET OF ESSENTIAL PARTS includes matched set of 90° YOKE & 18kv FLYBACK, 30kv FILTER, 6AX4 TUBE, BRACKETS, WIDTH CONTROL, CONDENSERS, RESISTORS.

Your Price... **\$15.89** List Price \$39.75  
Incl. CONVERSION MANUAL with Step-by-Step Instructions & Diagrams

Similar Kit for any 70° CRT **\$13.97**

**BROOKS RADIO & TV CORP.** 84 Vesey St. Dept. B, New York 7, N.Y.



## TV TUNERS REBUILT \$9.95

ALL MAKES & MODELS

THOUSANDS OF TUNERS IN STOCK

ALIGNED TO ORIGINAL STANDARDS

ALL WORK PERFORMED BY TUNER EXPERTS

WITH YEARS OF EXPERIENCE IN THE TUNER FIELD

**\$9.95** NET

UHF/VHF UNITS

**\$19.90**

90 Days Warranty

EXCHANGE TUNER SHIPPED SAME DAY (OTHERWISE DEFECTIVE TUNER OVERHAULED AND RETURNED: WITHIN 48 HOURS IN MOST CASES.)

Price includes WORN parts only.

Replacement tubes and smashed or missing parts are charged extra.

Forward Tuner with All Smashed Parts: Quote Make and Model F.O.B. Chicago or Toronto We will ship C.O.D.

## Castle Television Tuner Service

1723 W. LUNT AVE.,  
CHICAGO 26, ILL.

U.S.A. ●

152 MAIN ST.,  
TORONTO 13, ONT.

CANADA

Suppliers of rebuilt TV Tuners to leading manufacturers, technicians & service dealers, coast to coast. Original and Only Complete TV Tuner Service covering the North American Continent.



# Giant Pre-Christmas SALE

OF 1958's BIGGEST-SELLING

## \$ POLY-PAKS®

**FREE! YOUR CHOICE OF ANY ITEM IN THIS AD FREE WITH \$10 ORDER!**

- 70 TERMINAL STRIPS**  
Solder-lug & binding; to 20 terminals. \$1  
2 lbs. Reg. \$12.
- 60 ONE-WATTERS**  
Asstd. value carbon resistors, 5%, too! \$1
- 2 MINIATURE SOLENOIDS**  
12 VDC. Needs small battery to actuate plunger. Reg. \$6. 1 lb. \$1
- 80 HALF-WATTERS**  
Asstd. value carbon resistors, incl. 5%. Reg. \$12. \$1
- 0000-9999 COUNTER**  
Weather-Root, w/double shafts. Reg. \$5. \$1
- 75 MICA CONDENSERS**  
00025 to .01 to 1200 V. Silver, too. 25 values. Reg. \$28. \$1
- 10 ELECTROLYTICS**  
Radio, TV, 10-500mf to 450 VDC. Wt. 3 lbs. Reg. \$12. \$1
- SYLVANIA TV MIRROR**  
10x12" stainless steel. Many uses! 2 lbs. \$1  
Reg. \$4.
- \$25 SURPRISE PACK!**  
Large & varied asst. radio & TV parts. \$1  
3 lbs.
- 40 TUBE SOCKETS**  
4 to 9-pin; ceramic, mica, shield-based. \$1  
incl. 2 lbs. Reg. \$10.
- 70 HI-Q CARBON RESISTORS**  
IRC, Ohmite, 1%, too! 1/4, 2W, 10 ohms to 10 megs. 2 lbs. \$1  
Reg. \$13.
- 125 CERAMIC CONDENSERS**  
Hi-Q discs, tubulars; to .01 mf, 2 lbs. \$1  
Reg. \$12.50.
- 60-CONDENSER SPECIAL!**  
Molded, paper, ceramic, oil, mica, discs. \$1  
variable. 2 lbs.
- 75-PC. RESISTOR SPECIAL!**  
WW, precision, carbon, variable, mini types. \$1  
3 lbs. Worth \$15.
- WORLD'S SMALLEST RADIO**  
2x1x1". KIT includes loopstick, jacks, diode, etc. w/instructions. Wt. 1 lb. Reg. \$3. \$1
- 6 SILICON DIODES**  
Sylvania IN22, IN-23. Reg. \$36. \$1
- 2 PNP TRANSISTORS**  
Pop. make, for hundreds projects. \$1  
\$5 value.
- 2 MIKE TRANSFORMERS**  
Carbon, Imp. 100 to 100K ohms, Leads, encased. 2 lbs. Reg. \$10. \$1
- 70 TUBULAR CONDENSERS**  
Paper, molded, oil, porc. 0002 to .5mf to 1000V. 2 lbs. Reg. \$14. \$1
- 8 GERMANIUM DIODES**  
w/long leads. Glass sealed. Reg. \$5. \$1
- 300-FT. HOOKUP WIRE**  
Tinned, asstd. colors, sizes, 2 lbs. \$1  
Reg. \$5.
- POSTAGE STAMP MIKE**  
Crystal, 100 to 8,000 cps. 1 lb. \$1  
Reg. \$7.
- 150 CARBON RESISTORS**  
1/4 to 2W; 15 ohms to 1 meg. incl. insulated types. 2 lbs. \$1
- 8-PC. NUTDRIVER KIT**  
\$3 value. Plastic handle, 3/16, 7/32, 1/2, 5/16, 1/4, 3/8, 1/2, 1/8" steel socket wrenches in plastic case. 1 lb. \$1
- 2000 PCS. HARDWARE**  
Nuts, screws, washers, etc. 2 lbs. \$1  
Reg. \$8.
- 40 PRINTED CIRCUIT PARTS**  
Diodes, chokes, resistors, cond., boards. \$1  
1 lb. Reg. \$7.
- 60 SUB-MINI RESISTORS**  
1/4", long. 20 values; 1/2W to 10 megs. \$1  
Reg. \$6.
- 60 KNOBS, RADIO & TV**  
Asstd. colors, insulation. Some worth \$1 ea. Wt. 2 lbs. \$1  
Reg. \$17.
- 15 VOLUME CONTROLS**  
Incl. duals. To 1 meg; some w/switch. 2 \$1  
lbs. Reg. \$12.
- 15-PC. TWIST DRILL KIT**  
1/16 thru 1/4" by 64ths, w/calibrated case. \$1  
Reg. \$3.
- MINI-METER**  
1 1/2" dia. 0-6 amps, AC. 1 lb. Reg. \$3. \$1
- 30 MOLDED CONDENSERS**  
Black beauties, incl. Finest made! Wt. 2 lbs. \$1
- 15 ROTARY SWITCHES**  
Asstd. gangs. 3 lbs. \$1  
Reg. \$12.
- 40 DISC CONDENSERS**  
Wafer-thin, .01 to .1 mf. Reg. \$5. \$1
- 12 POLY BOXES**  
Clear plastic, hinged, w/snap locks. \$1  
Asstd. sizes. Wt. 1 lb.
- 8 TRANSISTOR SOCKETS**  
Mica-filled; for sub-mini-tubes. 100. \$1
- 40 HI-Q CONDENSERS**  
Finest porcelain; NPO's too! 1 lb. \$1  
Reg. \$6.
- 35 POWER RESISTORS**  
WW, 5 to 50W, to 10,000 ohms; incl. vitreous. 3 lbs. Reg. \$15. \$1
- 40 PRECISION RESISTORS**  
1%, 1/2 & 1W; Carbonyl & WW. 100 ohms to 1 meg. Reg. \$17. \$1
- 70 COILS, CHOKES**  
IF, RF, ant., slug-tuned, too. 3 lbs. \$1  
Reg. \$15.

FREE! GIANT 16 PAGE BARGAIN FLYER!

**HOW TO ORDER** Check items wanted. Return entire order w/check or M.O. including sufficient postage; excess returned. C.O.D. orders 25% down; rated, 30 days. Print name, address WITH POSTAL ZONE NO., amount money enclosed, in margin. (Canada postage, 48¢ 1st lb., 28¢ ea. add'l. lb.) EXPORT ORDERS INVITED.

**LEKTRON** 133 EVERETT AVE. CHELSEA 50, MASS.



VINCENT LUTZ, head of *Lutz TV*, St. Louis, Missouri, was elected president of NATESA at its recent annual convention in Chicago. He succeeds Russ Harmon of *Weber TV*, Cincinnati, Ohio. Mac Metoyer of *A One TV*, Kansas City, was re-elected to the post of secretary general, and Nelson Burns of *Burns TV*, Memphis, Tennessee, was renamed treasurer.

Regional executives elected by the delegates include: Bert Bregenzner of *Penn Radio & Sound*, Pittsburgh, Pa., eastern vice-president; Cordell Britt of *May TV*, Nashville, Tenn., east-central vice-president; Wayne Lemons of *A One TV*, Buffalo, Missouri, west-central vice-president; and Winston Haines of *E & H TV Service Co.*, Burlingame, Calif., western vice-president.

Regional secretarships went to: Irving Toner of *Toner Radio & TV*, Buffalo, N. Y., eastern region; Albert Mirus of *Mirus TV*, Cincinnati, O., east-central division; W. E. Johnson of *Johnson Radio-TV*, Beaumont, Texas, west-central division; and O. W. Andrews of *Rocky Mountain Radio-TV*, Denver, Colo., western division.

### New Midwest Group

The Midwest Electronic Alliance has been organized by dealers long active in association work to serve as a regional instrument for Ohio, Indiana, Michigan, Illinois, Wisconsin, Minnesota, Iowa, and Missouri. Vern La Plante, former president of the Electronic Technicians Association of Toledo and current editor of "ETAT News," 1952 Sylvania Ave., Toledo, Ohio, was elected president. Howard Wolfson, chairman of the Associated Radio & Television Servicemen of Illinois, 433 South Wabash Ave., Chicago, Ill., is secretary-treasurer. John Glass, president of The Electronic Association of Missouri (TEAM), 4134 Easton, St. Louis 13, Mo., and W. C. Pecht, editor of "TEAM News," Frank Teskey and Robert Sickels, co-editors of the "Hoosier Test Probe" (Indianapolis Television Technicians Association, 1859 S. East St., Indianapolis, Ind.), were all active in the formation of the new group.

In creating MEA, its organizers emphasize that the alliance is to be purely regional. The objectives of the associations with which MEA officers are identified are to help develop more local associations and to strengthen their state-wide organizations.

### Know Your Fellow Members

An unusual plan for getting members to know each other better was recently inaugurated by the Asso-

## CRYSTALS Inc.

ACCURACY DEPENDABILITY QUALITY and ONE DAY SERVICE

### AMATEUR BAND CRYSTALS

NOT SURPLUS!

- NEW QUARTZ GROUND AND ETCHED TO YOUR EXACT SPECIFIED FREQUENCY CHECKED ON HP CYCLE COUNTERS
- 1500 KC to 2000 KC.....\$2.00 ea., pp.
- 2001 KC to 8995 KC.....\$1.50 ea., pp.
- 8996 KC to 11000 KC.....\$2.50 ea., pp.

### SSB FILTER CRYSTALS

PLATED TYPE IN FT241A HOLDERS ALL CHANNELS

- 370 to 534 KC (Except 500 KC) . \$1.00 ea., pp.
  - 500 KC .....\$1.75 ea., pp.
- CHANNEL GROUPS ACCURATELY MATCHED NO EXTRA CHARGE

### MARINE FREQUENCIES

ALL CHANNELS. GUARANTEED ACCURACY SUPPLIED IN MC7 OR FT243 HOLDERS (specify which type) \$3.75 ea., pp.

### VERY THIN CRYSTALS

SUPPLIED IN VERY THIN FT243 HOLDERS ORDER BY FUNDAMENTAL FREQUENCY \$2.00 ea., pp.

MINIMUM ORDER \$2.00—NO GOD'S

Satisfaction Guaranteed or Your Money Back! Illinois Orders . . . Please Include Sales Tax.

**CRYSTALS Inc.**  
ODELL, ILLINOIS

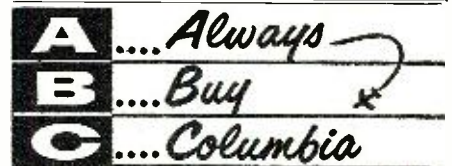

**ART-13 TRANSMITTER**  
Auto-tune. Frequency: 2-18.1 MC. 100 W. output, CW or phone. Pair of 81's modulating single 813 final. Complete with all tubes, less meter and top cover, otherwise complete. Good cond. .... \$89.95

**BC-610 TRANSMITTER**  
500 W. GIANT! It takes an expert even to recognize this astounding value! 2-13 MC. WITH BC-614 speech amplifier, WITH antenna, WITH tuning unit, coils etc. Excellent condition. .... \$695.00 SPECIAL. ....

**ARC-3 TRANSMITTER-RECEIVER**  
Frequency: 100-150 MC. With J-60 Junction Box. Excellent condition. A Co- \$149.95  
Columbia Special! Only . . . \$75.00  
ARM-1 TEST SET FOR ABOVE: Complete, Excel. .... \$75.00

**NEW! HIGH VOLTAGE OIL CAPACITORS**  
4 mid. @ 1,000V \$1.00 4 mid. @ 3,000V \$3.49  
4 mid. @ 2,000V 1.95 mid. @ 25,000V 2.95  
**APA-3 LORAN: IT'S THE LATEST!**  
Want the newest on the surplus market? This is it! Complete indicator and receiver. Small, compact case. Limited quantity. . . . \$99.50  
hurry! Excellent condition. Only . . . \$99.50

**MAR TRANSMITTER-RECEIVER**  
12 or 24 VDC or 115-230 V. AC-DC. 200-400 MC. Power output 10 W. crystal controlled. Makes everything before it obsolete! Complete, excellent condition. Only. \$49.50

**FREQUENCY METERS BUYS!**  
BC-221: 125-20,000 kc. Army version of Navy LM Frequency Meter. Complete, with tubes, excellent condition and checked out. \$79.50  
LM FREQUENCY METER: Same as above but modulated. Excellent condition. . . . \$49.50  
Brand new . . . \$75.00

**RDO UHF COMMUNICATIONS RECEIVER**  
Table model. 38-1,000 MC. AM. Built-in 110 VAC power supply. Complete with tubes, plug-in tuning units. Excel. \$125.00 cond.

**BC-342 COMMUNICATIONS RECEIVER**  
1.5-18 MC in 6 bands. Has 2 RF stages, xtal filter and 110 VAC power supply. \$125.00  
Excel. cond. \$75.00

**BC-312 COMMUNICATIONS RECVR.:** Same as above but with 12 VDC dyn. instead of 110 V. power supply. Excel. . . . \$49.95

**VALLEY HAMS!**  
Give yer buck a bang at our new, branch location at 4900 Lankershim Blvd. North Hollywood, Calif. Terrific store. Buy it! Stop in—meet the mob, save dough!

All Orders FOB Los Angeles. 25% deposit required. All items subject to prior sale. NOTE: MINIMUM ORDER \$3.00. WRITE TO DEPT. R.

**Columbia ELECTRONICS**  
2251 W. WASHINGTON BLVD. LOS ANGELES 18, CALIFORNIA

RADIO & TV NEWS



ciated Radio-Television Service Dealers of Columbus, Ohio. It is the "Gad-A-Bout" Contest. Cash prize awards of \$10.00 and \$5.00 are given to members who visit the most shops and turn in the most comprehensive reports.

Each member is given a "Gad-A-Bout" Contest blank on which are listed the names of all of the member shops. Members are urged to visit as many shops as possible and to report on what they like best about each shop they visit. The report must be signed by each shop owner whose shop is visited. In addition to getting to know each other better, ARTSD members feel the "Gad-A-Bout" plan stimulates the exchange of ideas among members.

Further information about the "Gad-A-Bout" Contest program may be obtained by writing John P. Graham, editor "ARTSD News," 2552 North High Street, Columbus, Ohio. (Send a stamped, return envelope.)

### Bait Advertising Stopped

The Code of Ethical Standards for advertising TV service that has been in effect in St. Louis, Mo., for several years served as an effective barrier against the spread of a bait service advertising deal that had been introduced in Kansas City, according to "TEAM News," official publication for The Electronic Service Association of Missouri. The "News" reported:

"When the details of the Kansas City tube checking deal were given to the advertising media of St. Louis, it was agreed that any firm operating on this basis would have to conform to the ethical standards set up four years ago. These standards have been effective in making St. Louis one of the cleanest areas for TV service.

"As a result of those standards a few firms who tried to use the 'free' gimmick were turned down by *The Post Dispatch*, *The Globe Democrat*, and the TV stations.

"The censors of the newspapers and the TV stations took commendable action in upholding these standards in the best interest of the public."

### Free Tube Testing

The Western Electronic Association of Cheyenne, Wyoming, recently launched a campaign offering free tube testing to channel business into the shops of the seven firms that make up its membership.

The organization's ad campaign invites the public to take its tubes to any of the member shops, where they will be tested free by trained technicians on professional equipment. The ads also point out that, when a tube fails, the cause should be corrected before a new tube is put in service. They stress the fact that electron tubes sometimes burn out from causes other than age and correcting the cause of the trouble is as important as replacing the tube.

Members of the Cheyenne association are: *D. C. Radio & TV; Del-*

## BIG NEWS from WALTER ASHE!



# NOW! TRADE-IN YOUR USED HI-FI AMPLIFIERS TUNERS SPEAKERS ON NEW MODEL FAMOUS BRAND EQUIPMENT

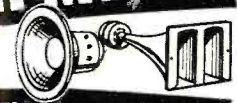

Choose from... **BOGEN—H. H. SCOTT—BELL—GROMMES—EICO—DEWALD—GRANCO—GARRARD—PICKERING—VOICE of MUSIC—PENTRON—ELECTRO-VOICE—G. E.—ASTATIC—UNIVERSITY—LANSING—JENSEN—SHURE—and many more!**

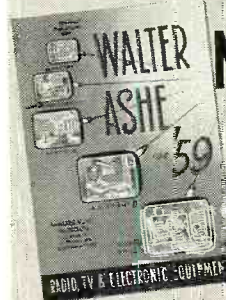

## NEW '59

Walter Ashe Catalog

## FREE!

New 144-page catalog ready now... mail the coupon for your FREE copy! You'll find everything you need at lowest money saving prices. Here are the very latest in receivers, transmitters, tubes, books, test instruments, amplifiers and components... in stock for prompt shipment. Send today for your complete Radio—TV—Hi-Fi Buyers Guide Catalog!

Maybe you've had your eye on a brand new stereo outfit... a new Williamson circuit amplifier... or new wider-range speaker system. No matter what you'd like to own in new High Fidelity equipment... your present factory-built equipment\* is worth a king size "Surprise" trade-in allowance at Walter Ashe. Choose anything you want from all the famous name brands featured in the new 1959 Walter Ashe catalog... and whether you have equipment to trade or not, you can count on really worthwhile savings at Walter Ashe!

**Tell Us What You Want... and what you have to trade!** The coupon brings "Surprise" Allowance on Hi-Fi... Amateur... or Service Equipment!

Make Walter Ashe your headquarters for *everything* in Radio-Television and Electronics. Our stocks and selections of replacement parts, antennas, amateur radio receivers and transmitters, tools and test equipment were never more complete. You'll like Walter Ashe's personalized service... our staff of Hi-Fi and Amateur Radio specialists is always ready to help you and speed along your orders.

\*Made since 1945.

ASK ABOUT TIME-PAY PLAN



YOUR ONE-STOP SUPERMARKET  
1125 Pine Street • St. Louis 1, Mo.

### "SURPRISE TRADE-IN" COUPON

WALTER ASHE RADIO CO.  
YOUR ONE-STOP SUPERMARKET

Dept. R-11-58 St. Louis 1, Mo. In Our 37th Year

- Rush New Catalog
- Send latest lists of guaranteed Used Equipment
- Rush "Surprise Trade-in" offer on my \_\_\_\_\_

For \_\_\_\_\_  
(Show make and model of equipment desired)

Name \_\_\_\_\_

Address \_\_\_\_\_

City \_\_\_\_\_ Zone \_\_\_\_\_ State \_\_\_\_\_

### RADIO-TV SERVICEMEN — DEALERS!

Here's a **DEPENDABLE** SOURCE OF SUPPLY FOR RECEIVING TUBES



Nationally sold ZALYTRON Tubes are BRAND NEW Quality Tubes, priced low to help you meet competition in your area—and guaranteed to perform as well and as long as tubes much higher priced. Why pay more? Try them once, you'll buy them always. Every tube we ship is covered by our Full Refund Guarantee... You be the judge! Send today for new Price List "RW".

1-YEAR GUARANTEE

**ZALYTRON**

TUBE CORP.  
220 West 42nd St.,  
New York 36, N. Y.

### FOR THE BIGGEST BATCH...

of blockbusting buys in electronics

get our new, free, 32-page

Catalogue No. 117! It's terrific!

### ARROW SALES, INC.

Sales-Showrooms:  
Western: 7035 Laurel Canyon, No. Hollywood, Calif.  
Central: 2534 S. Michigan Ave., Chicago 16, Ill.  
Mailing Address: Box 3007, No. Hollywood, Calif.



## VENTILATING FAN

5 Blades—4 1/2" Diameter. 110 Volt 60 Cy.  
1/300 H.P. 3300 R.P.M. Mfd. by  
Induction Motors . . . . . Ea. **\$3.95**

### OIL CAPACITOR SPECIAL

3 x 8 MFD (24 MFD) 600V. WVDC Size: W-33/4" x  
H-43/4" x D-13/4". Suitable for crossover network  
or complete 2 or 3 section filter for any  
power supply . . . . . ea. **\$2.49**  
5 for **\$10.00**

### MINIATURE MICROAMMETER

1 1/2" Square 0-100 Micro. Suitable for grid dip  
field strength, S meter. . . . . ea. **\$3.95**  
A BARGAIN AT . . . . .

### MICROAMMETER SPECIAL

2 1/2" 0.50 microamps. (Scale 0-5) . . . . .  
Each . . . . . **\$4.95**

### POWER TRANSFORMER

Pri. 110V. 60 Cy. Sec. 300-0-300 V. 125 Ma.  
12 Volt CT @ 2 Amps. 12 Volts @ 3 Amps.  
5V @ 2 Amps/Replacement Transf. for  
BC 342 Rec. . . . . ea. **\$2.50**  
Write for quantity prices

### FILAMENT TRANSFORMERS

Prim. 115V. or 230V. 60 cy. Sec. 6.3V. @  
20 Amps. H-4 1/2" x W-4" x D-3 1/2" . . . ea. **\$3.50**  
Primary 110 volts 220 V. 60 cy. Sec. 5 V.  
@ 10 Amps. Ins. 10,000 V. Small size.  
2 for \$7.50 . . . . . Each **\$3.95**  
Pri. 115 V. or 230 V. 60 cy. sec. 6.3 V.  
@ 5 amps. . . . . **\$1.50**  
Primary 110 volts 60 cycle. Secondary  
2 1/2 V. 10 Amps. 10,000 V. Insulation.  
Suitable for pair of 866 tubes. . . . . **\$3.95**

### CHOKES—FULLY CASED

10 HENRY 80 Mil (unshielded) . . . . . 90¢  
6 HENRY 150 Mil . . . . . \$1.50  
5 HENRY @ 200 Ma . . . . . 1.95  
10 HENRY 315 Mil . . . . . 3.95  
12 HENRY 500 Mil . . . . . 8.95  
3 HENRY 630 Mil . . . . . 1.95  
4 HENRY 900 Mil . . . . . 12.95  
6 HENRY 600 Mil . . . . . 8.95  
7 HENRY 1.5 Amp . . . . . 19.95

### OIL CONDENSER SPECIALS

#### BRAND NEW

2 MFD 600 VDC .50	2 MFD 2000 VDC 1.50
3 MFD 600 VDC .75	4 MFD 2000 VDC 3.50
4 MFD 600 VDC .85	8 MFD 2000 VDC 4.95
5 MFD 600 VDC .90	8 MFD 2000 VDC 5.95
6 MFD 600 VDC .95	2 MFD 2500 VDC 2.50
8 MFD 600 VDC 1.10	2 MFD 3000 VDC 3.50
10 MFD 600 VDC 1.19	2 MFD 3000 VDC 3.50
12 MFD 600 VDC 1.50	4 MFD 3000 VDC 6.95
1 MFD 1000 VDC .60	4 MFD 4000 VDC 13.95
2 MFD 1000 VDC .85	4 MFD 5000 VDC 15.95
4 MFD 1000 VDC 1.35	1 MFD 7500 VDC 6.95
8 MFD 1000 VDC 1.95	5 MFD 7500 VDC 2.95
10 MFD 1000 VDC 2.50	1 MFD 12,500 VDC 24.95
12 MFD 1000 VDC 3.50	1 MFD 15,000 VDC 34.50
1 MFD 1200 VDC .45	1 MFD 25,000 VDC 69.50
1 MFD 1500 VDC .75	10 MFD 330 AC 1.95
2 MFD 1500 VDC 1.10	15 MFD 440 AC 2.50
4 MFD 1500 VDC 1.95	
1 MFD 2000 VDC .85	

### REDMOND BLOWER

110V. 60 cyc. .3 Amp. 1600 Rpm. 3 3/4" **\$7.95**  
Blower wheel—Outlet 2" Diameter. . . . . 2 for \$15.00

### SIGMA 5F RELAY

16,000 ohm in dual 8,000 ohm coils. (Can be  
paralleled) SPDT contacts. 12 V. 500 ma.  
adjustable armature tension. Operates on  
500 microamperes or less. . . . . ea. **\$3.95**  
Write for quantity prices.

### RELAYS

Allied Relay 110 V. AC. DPST . . . . . ea. **\$1.35**  
Claire Telephone Type 11,300 ohm coil  
DPDT cont. 10 amp 125V. AC. ea. **\$3.95**  
Hermetically Sealed Relay Coil 110V AC  
60 cy SPDT Contacts 5 Amps. . . . . ea. **\$1.50**  
Sigma Sens. Plug-in H. S. 1600 ohms  
1 mil. = 1 pole SPDT, = 2 pole SPST. ea. **\$1.95**  
6 Volt DC DPDT H.S. . . . . ea. **99c**  
12 Volt DPDT DC Relay. . . . . ea. **\$1.35**  
12 Volt DPST Advance Relay. . . . . ea. **\$1.05**  
G.E. Plug in Relay 5 prong 10,000 ohm  
coil 1 mil. SPST. . . . . ea. **\$2.50**  
G.E. Relay control, contains 8000 ohm  
relay, sensitivity 2 mils. 10 for \$9.25. ea. **\$1.10**

### PANEL METERS

G.E., WESTINGHOUSE, 2" METERS	W.E. SIMPSON, etc.
0-500 Micro DC . . . . . 3.50	0-100 Mil DC . . . . . 3.95
0-1 Mil (270°) . . . . . 3.95	0-150 Mil DC . . . . . 3.95
0-500 Mil DC . . . . . 2.95	0-300 Mil DC . . . . . 4.95
1-0-1 Amps DC . . . . . 2.95	(Weston) . . . . . 4.95
0-10 Amps DC . . . . . 2.95	0-500 Mil DC . . . . . 3.95
0-25 Amps DC . . . . . 2.95	0-12 Volts AC . . . . . 3.95
18-36 Volts DC . . . . . 1.99	0-50 Volts DC . . . . . 3.95
0-150 V. AC . . . . . 3.49	0-500 Volts DC . . . . . 4.50
0-4 Amps RF . . . . . 3.95	0-800 Volts DC . . . . . 4.50
	0-2.5 KV DC . . . . . 5.50
	0-3.5 KV DC . . . . . 7.50
3" METERS	0-30 Amps RF with Ext. Thermo- couple . . . . . 12.95
0-100 Micro . . . . . 5.95	Running Time Meter 0-9,999.9 hrs. . . . . 12.95
0-1 Mil DC . . . . . 3.95	110 V. 60 cy. 12.95
0-10 Mil DC . . . . . 3.95	Used . . . . . 7.95
0-50 Mil DC . . . . . 3.95	

### MISCELLANEOUS SPECIALS

N.E. 51 NEON LAMPS, Box of 10 . . . . . \$1.00  
50 OHM 6 watt (Non-Inductive Resistor) . . . ea. 35¢  
3-12 MMF Erie Ceramic Trimmers . . . . . 21¢  
Replacement 6' phone cord for Standard  
Headsets . . . . . 35¢  
OHMITE TAP SWITCH Model 608 Double  
Pole 4-Throw, 100 Amps. AC. . . . . ea. 58.95  
UTC DUNCER TRANS. Pri. 100 ohm.  
Sec. 125,000 ohm. Ideal for mike  
or phone patch—2 for \$1.00. . . . . ea. **59c**  
CUTLER-HAMMER TOGGLE SWITCH  
SPDT (ST42D)—5 for \$1.10. . . . . ea. **25c**  
Write for quantity prices on all special items

All merchandise sold on a 10 day money back guarantee basis

Min. Order \$3.00—25% with Order—F.O.B. New York

# PEAK

ELECTRONICS COMPANY  
66 W. Broadway, New York 7, N. Y., WO-2-5439

haute's Radio & TV Repair Service;  
Clear-Vue TV; Ray Park Radio & TV;  
Bob's Radio & TV Quick Service;  
Kremer's Radio & TV and Fine TV  
Sales & Service.

### NATESA Passes 100 Mark

A reorganized television service group centering in Texarkana, Texas, was reported to be the one hundredth association to affiliate with NATESA. The group, formerly known as the Four-State TV Service Association, is made up of service dealers and technicians operating in Texas, Oklahoma, Arkansas, and Louisiana. Ward Brackeen, operator of a service firm in Texarkana, is president. Other groups have since joined NATESA.

### California Elections

James Wakefield, owner of *Cardinal Electronics Service* of Fresno, Calif., was elected president of the California State Electronics Association at the organization's third annual convention. He succeeded H. Lawrence Schmitt of the *Lloyd Wollmer Co.*, Burlingame, Calif. Mr. Schmitt was named to the new post of executive secretary.

Other new officers of CSEA are: Ray Warthen of the *Electronics Service Co.*, Vallejo, vice-president; and Art Blumenthal of the *Art Blumenthal Co.*, Redwood, secretary-treasurer.

### Louisiana Licensing

The state legislature of Louisiana recently passed a law requiring all radio and television repairmen in cities of over 20,000 population to take an examination and be licensed by a new state radio and television technicians' licensing board. The board is to include eight members named by companies in the radio-TV service field and three named by an electrical union.

The Louisiana law is the first statewide measure of its kind. However, it does not cover service people in communities under 20,000 population nor those operating in rural areas. Association officers feel that, when technicians in the smaller communities understand the beneficial features of the law, they will support a revision to make the law completely state-wide at the next session of the legislature.

### Manufacturers' Warranties

The focal point of practically all service association programs during the coming months will be a determined effort to stop the trend among manufacturers toward extending the time of parts warranties and "no-charge" service on their products. Pointed editorials covering all facets of manufacturers' growing incursion into the service field have appeared in such prominent and widely read service association publications as the "TSA News," Television Service Association of Michigan; "TEAM News," The Electronic Association of Missouri; the "Hoosier Test Probe" of the Indianapolis Television Technicians Association;

## CRYSTAL CONTROLLED CONVERTERS

POLICE • FIRE • COMMERCIAL



For use with  
12 V. Transistor type  
car radios—  
30-50 MC.

**\$24.50**

Can be self installed in seconds. Other models for 152-162 MC available. Also complete line of conventional powered converters, tuners and receivers.

88-108 MC. FM-Program source may be used mobile or with amplifier. . . . . **\$9.95**



WRITE FOR LITERATURE

**KUHN ELECTRONICS**  
70 GLENWOOD CINCINNATI 17, OHIO



## college grads get ahead faster!

... have higher incomes . . . advance more rapidly. Grasp your chance for a better life. Share rewards awaiting college men. Important firms visit campus regularly to employ Tri-State College graduates. Start any quarter. *Approved for Vets.*

**Bachelor of Science degree in 27 months**  
Electrical Engineering with either an Electronics or Power major. Mechanical, Civil, Chemical, Aeronautical Engineering. In 36 months a B.S. in Business Administration (General Business, Accounting, Motor Transport Management). Superior students faster. More professional class hours. Small classes. Enrollment limited. Beautiful campus. Well-equipped labs. Prep courses. Enter Jan., March, June, Sept. Earnest capable students (whose time and budget require accelerated courses and modest costs) are invited to write Jean McCarthy, Dir. Adm., for Catalog and book "Your Career in Engineering and Commerce."



## TRI-STATE COLLEGE

16118 College Ave. Angola, Indiana

### Wholesale Only

## SELLING

Receivers, Transmitters, Radar, Special Purpose Tubes, Relays, Meters, Switches, Connectors, Rectifiers, Transformers, Motors & Generators, Wiring Cable, Instruments and All Electronic Components.

## RADIO & ELECTRONIC SURPLUS

14000 BRUSH STREET

Detroit 3, Mich. TO 9-3403

## TAPE RECORDERS



### HI-FI COMPONENTS Tapes • Accessories

MERITAPE  
Low cost, high quality  
recording tape, in boxes  
or cans  
UNUSUAL  
VALUES  
Send for  
Free Catalog  
DRESSNER, 69-02 RA, 174 St., Flushing 65, N.Y.

### MAIL ORDER HI-FI

You can now purchase all your Hi-Fi from one reliable source and be assured of perfect delivery. Carston makes delivery from NY stock on most Hi-Fi, Recorders and Tape within 24 hours. SEND US A LIST OF YOUR HI-FI REQUIREMENTS FOR OUR QUOTATION.

## CARSTON STUDIOS

215-TD East 88 St.

New York 28, N.Y.



and the "Radio-TV Technicians Guild News," official publication for the Radio & TV Technicians Guild of Florida, Inc.

It is apparent, too, that the independent parts distributing industry is getting very much concerned over the trend toward extended service and parts warranties. The officials of the Keystone chapter of the National Electronic Distributors Association unambiguously agreed at a recent meeting that any further extension of the TV-radio manufacturers' free parts and labor warranties "would not be in the best interests of consumers or the industry."

Ty Yonkers, president of the Keystone chapter of NEDA, brought this matter to the attention of Col. Gail Carter, executive officer of NEDA, in a letter to the national office requesting the national group's support.

In addition, Mr. Yonkers wrote, "an extension of these policies would work undue hardships on the independent service facilities and on the independent parts distributors.

"The Keystone chapter," he said, "therefore requests that NEDA, through its officers and your office vigorously oppose . . . any efforts by the set manufacturers to extend their warranty on parts, tubes, and labor beyond 90 days on the set and one year on the picture tube."

#### Service with a Heart

Among the many important contributions to community life made by the organized electronic service industry are those that do much to help people who are unable to help themselves. This news account from Detroit, Mich., tells a heart-warming story:

"TSA, upon learning that many of the TV sets at the Veteran's Memorial Hospital in Southfield were inoperative, informed their members of the need. A date was set and the job was done on Tuesday, July 15. The members responding were:

"Chase Television Service, Inc.; Circle Radio & TV; Dexter Sales & Service; General TV; H & M Electric Service; Lang's Radio & TV; New Center Electric; Personalized TV; Progressive TV; and Supreme TV.

"They met on the steps of the hospital and were directed to the inoperative sets throughout the wards by Mr. Warren A. Cushing, Director of Special Services for the Hospital. About two hours later the job was done. The satisfaction derived was far greater than the small amount of time expended.

#### Honorable Rivalry

W. C. Pecht, editor of "TEAM News" (The Electronic Association of Missouri), congratulates "The Raster," published by the NATESA-affiliated rival in St. Louis, on its improved quality. "While this association, TEAM, feels quite differently on the subject of licensing," he says magnanimously, "we do admire efforts toward upgrading the service industry."



LEO SAYS:

**NEW**

LEO I. MEYERSON, W0CFQ



Designed for either AM or CW, the SR-34 operates on 115V AC, 6V DC or 12V DC, with instantaneous voltage selection and also "crossbanding" between the 2 and 6 meter bands. The transmitter is crystal-controlled; up to four crystals may be switch-selected. Fifth position permits external VFO operation. Band selection is front panel controlled. Receiver is double conversion superhet, with quartz crystal controlled second oscillator, offering outstanding selectivity and high image rejection. Highest stability through separate oscillator and RF sections for each band. S-meter, BFO, AM, etc. provided. Power output: 6-7½w on 2 meter, and 7-10w on 6 meter AM or CW, 100% modulated negative peak clipping.

Same as above but with 115V AC power supply, and less whip antenna and carrying cover: \$395.00.

## I'd Like to Recommend THE hallicrafters "2 and 6" SR-34 TRANSCEIVER

World's First Complete 2 & 6 Meter Radio Station with Transistorized, Built-in Power Supply for Mobile or Portable Application.

**\$49<sup>50</sup> Down** **\$28<sup>00</sup> per mo.**  
or Only \$495.00 Ham Net

And Send for Your Brand New **FREE 1959 CATALOG**

Just off the press, this colorful new catalog contains hundreds of bargains for the amateur, hi-fi enthusiast, experimenter and dealer-serviceman. Send for yours RIGHT NOW.



WORLD'S MOST PERSONALIZED ELECTRONIC SUPPLY HOUSE

**World Radio LABORATORIES**  
PH 2 0277

3415 W BROADWAY COUNCIL BLUFFS IOWA

Please send me Free Catalog . . . and complete info on the Hallicrafter line. RTV-11

NAME: \_\_\_\_\_

ADDRESS: \_\_\_\_\_

CITY & STATE: \_\_\_\_\_

### KEEP CANDEE HANDY!

**ART-13 COLLINS TRANSMITTER**  
Removed from aircraft—so you know it's good—and sold at lowest price EVER! Frequency: 2-15 MC for ham rig. Output 60-100 W. CW or modulated. Crystal calibrated for VFO. Includes dynamotor. Excellent. . . . **\$129.95**

**AN/APN-9 LORAN SYSTEM**  
Used in ships, planes to determine position by radio signals from known xmits. Accurate to within 1% of distance. Complete with tubes. . . . **\$88.88**  
Like new. . . .

**R-435/VRC-2X RECEIVER**  
For mobile police and fire calls! 30-40 MC. crystal controlled. 24 VDC. Easily converted by replacing vibrator transformer with 110 VAC transformer. With tubes, less crystals. Used, good . . . **\$19.95**

**MARKET PLACE FOR METERS!**  
SIMPSON: 1 3/4 inch. Multi-scale panel. 0-1 MA or 0-100 MV. Brand new. . . . \$9.00  
Each. . . . \$3.49. 3 for. . . . \$9.00  
ROLLER SMITH: 1 3/4 inch. DC. amp meter. 0-10 amps. NEW. . . . \$3.49. 3 for. . . . \$9.00  
ROLLER SMITH VOLT METER: 3 1/2 inch. 0-20 DC. New. . . . \$3.95  
MARION ELECTRIC: 3 3/4 inch. checking meter. Hermetically sealed. Ideal for checking tubes, condensers, etc. New. . . . \$1.95

**I-223 RANGE CALIBRATOR**  
115 V. 60 cyc. Ideal for power supply and 10 W. amplifier with slight modifications. 6L6 push-pull. Schematic on top cover. . . . **\$9.95**  
New with tubes. . . .

**BC-683 FM RECEIVER**  
27-38.9 MC. 10 push-buttons for channel selection. Continuous tuning. Squeelch circuit. Complete with tubes, speaker, (less dynamotor). Brand new, only. . . . **\$19.95**

**BC-603 FM RECEIVER**  
Same as above except freq. is 20-27.9 MC. Excellent condition. . . . **\$6.95**  
12 V. DM-34D DYNAMOTOR: for above. . . . \$3.95  
110 VAC POWER SUPPLY: for above. Just plug in. No conversion needed. . . . \$1.95  
Brand New. . . . \$11.95 In Kit Form. . . . \$7.95

**BC-1335 TRANSCEIVER**  
Two-channel, crystal controlled. FM. 18 tubes! Output: 1.5 W. For fixed or mobile installation. Range: 5-10 miles. Built-in vibrator type power supply operates from 6 or 12 VDC. . . . **\$29.95**  
New in original carton. . . . \$24.95  
In Like New Condition, only. . . .

**DM-35 DYNAMOTOR**  
Depot re-pack. Like new. With spare brushes. Each. . . . **\$9.95**

All items FOB, Burbank, Calif., subject to prior sale. In Calif. add 4%. Min. order \$3.95.

**J. J. CANDEE CO.** Dept. R  
509 No. Victory Blvd., Burbank, Calif.  
Phone: Victoria 9-2411

### Amazing New Handbook Takes The "Headache" Out of TV Trouble Shooting



**SAVES TIME . . . ELIMINATES GUESSWORK!**

Now, a simple, practical way to accurately spot the cause of trouble in any TV set, FAST! Quick, easy-to-understand tests tell you in which of 5 TV set sections to find the cause of trouble. Fool-proof Check Charts help you locate the exact trouble spot at once, from as many as 700 possibilities. Book fits easily into your tool kit for handy on-the-job use. Over 300 spiral bound fast reference pages with 50 time-saving Check Charts; dozens of easy to understand diagrams and tests; explanations of circuits and designs. The hours and aggravation this amazing handbook can save you on a single servicing job more than pay its low price!

**USE IT ON 7 DAYS FREE TRIAL!**

Send no money, just the coupon. We'll rush your copy on FREE TRIAL. After 7 days, send only \$3.95 plus postage or return the book and owe nothing. Act NOW!

### MAIL COUPON NOW!

Educational Book Publishing Div.  
COYNE ELECTRICAL SCHOOL, Dept. B8-RT  
500 S. Paulina St., Chicago 12, Ill.

Rush TV handbook for 7 days FREE TRIAL per offer.

Name \_\_\_\_\_ Age \_\_\_\_\_

Address \_\_\_\_\_

City \_\_\_\_\_ Zone \_\_\_\_\_ State \_\_\_\_\_

Check here if \$3.95 enclosed. We pay postage. 7-day money-back guarantee.



# NEW



## For the One Man in Nine who really understands hi-fi!

If you're a notch above the average hi-fi fan, understand electronic theory, can read a schematic and handle a soldering iron, here's an inexpensive book that will add countless hours to your high fidelity pleasure!

The 1959 Edition of the HI-FI ANNUAL & AUDIO HANDBOOK features 43 big articles and 325 illustrations—covers every phase of hi-fi enjoyment. The cost? Only \$1.00—at your favorite newsstand or radio parts store.

Prepared by the editors of RADIO & TV NEWS, the world's largest selling technical electronics magazine, this year's HI-FI ANNUAL & AUDIO HANDBOOK contains:

**STEREO AND FM**—A big, definitive section on how to convert or get started in stereo and FM: Stereo control center. Stereo balance and gain control. Speakers for stereo. Testing FM tuners. Adding a tuning indicator.

**AMPLIFIERS AND PREAMPLIFIERS**—High power vs low power. Why do amplifiers sound different. Complete plans for 6, 10 and 15 watt amplifiers. RC filter

tone controls. RIAA equalization for early preamps. Audio operated switch. Reducing hum and noise in preamplifiers. Defense of the split-load phase inverter. New look at positive current feedback.

**TAPE RECORDERS AND MICROPHONES**—Measuring wow and flutter. Bias-erase oscillators. Playback standardization. Portable tape recorder amplifier. What do you know about recording tape? Microphones? "Outboard" equalizer-bias amplifier for tape recording.

**LOUDSPEAKERS AND ENCLOSURES**—Why low-efficiency speaker systems? "Ultraflex" speaker enclosure. Choosing your crossovers. The "Tiny Mite" loudspeaker enclosure. Speaker damping with series resistor. Electrostatic speakers.

**PLUS** helpful features on room effects, room resonance and stereo, testing loudspeakers, checking speaker performance, electrostatic speakers and transient response, transients and directional effects, speaker power and efficiency, speaker mounting, and much, much more!

All the skill and know-how of the nation's top hi-fi authorities are yours for only \$1.00 in the 1959 HI-FI ANNUAL & AUDIO HANDBOOK. This unique volume is now on sale everywhere. Be sure to get your copy!

**ZIFF-DAVIS PUBLISHING COMPANY**  
434 South Wabash Avenue Chicago 5, Illinois



Mac's Service Shop  
(Continued from page 68)

you listen closely, it's easy to see that the 's's' can be heard much more easily in speech when the receiver is tuned in this fashion than is the case when it is tuned in the ordinary way.

"What's more, you can flip from one sideband to the other without there being a bit of difference in reception, providing, of course, there's no QRM on one side or the other."

"What if there is QRM?"

"That's one of the beauties of setting up the receiver in this manner. If a station comes on near the one to which you are listening and puts a high-frequency heterodyne on the signal, you can usually lose the heterodyne entirely by simply switching to the other sideband. You don't have to touch the tuning when you do this. Neither do you have to retune when varying the selectivity of the receiver. In fact, you can give interference a real battle without ever touching the tuning dial. First you switch sidebands to try to get rid of the interference. In the event that stations are crowding in on both sides of the one you're trying to receive, you can narrow down the bandwidth of the receiver. If a single source of interference still persists, you can finally try to notch it out with the tunable T-notch filter."

"Do you always have to use the b.f.o. to place the carrier correctly?"

"You do to place it exactly, but after you get on to it you can come pretty close simply by tuning the receiver to the proper side of the signal being received. With my receiver, and a couple of others that are of the same general design, you tune to the high-frequency side of the signal when using the upper sideband position and to the low-frequency side in the lower sideband position. When I am just tuning around, I never bother to use the b.f.o. to set the carrier; but when I get into a QSO, I usually flip on the b.f.o. for a second or so and zero-beat exactly."

"Is it always desirable to place the carrier down on the skirt of the passband?"

"Practically always. I've found that when you're copying an extremely weak DX station you can sometimes pull it in just a little better by moving the carrier to the top of the passband. You know the same thing happens in ultra-fringe-area TV reception. Sometimes you have to sacrifice optimum normal-signal tuning—and even alignment—to get a picture at all; but these cases are exceptions to the rule."

"I'll bet your knowledge of a TV set, which is actually very close to being a single-sideband receiver as far as the picture is concerned, helped you considerably in understanding the working of your new receiver."

"You can say that again! In fact, I have a heck of a time trying to explain what is going on in our sideband receivers to another ham who hasn't



# shoot for home movies that look professional!

Learn how in the  
world's first  
**HOME MOVIE  
MAKING ANNUAL**  
(prepared by the Editors  
of Popular Photography)

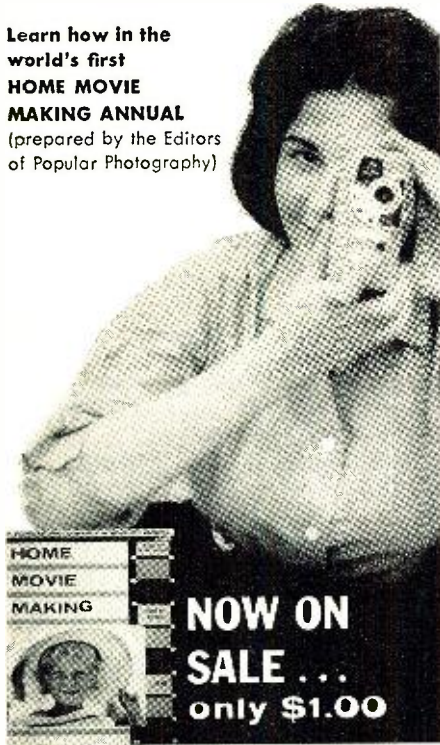

**NOW ON  
SALE ...  
only \$1.00**

**NOW at Your JOBBER'S!**

## "APPROVED" ELECTRONIC KITS

- HI-FI TUNER KITS
- HI-FI AMPLIFIER KITS
- TEST EQUIPMENT KITS

We manufacture a full line of Hi-Fi and Test Equipment Kits, famous thru the years for Top Quality components and design, easy foolproof construction.

APPROVED Service Dept. is available for repair or adjustment of any APPROVED unit of any year. Factory parts and service at nominal cost.

Your Inquiry is invited

### APPROVED ELECTRONIC

INSTRUMENT CORPORATION

51 Vesey Street • New York 7, N. Y.  
Telephone: COrtlandt 7-4605

## ELECTRONICS

**PREPARE FOR A GOOD JOB!  
BROADCAST ENGINEER  
RADIO SERVICING AUTOMATION**

TELEVISION SERVICING  
BLACK & WHITE—COLOR

APPROVED FOR VETERANS AND SURVIVORS  
OF VETERANS  
BUILDING AIR CONDITIONED  
SEND FOR FREE LITERATURE

**BALTIMORE TECHNICAL INSTITUTE**  
1425 EUTAW PLACE, BALTIMORE 17, MD.

swallowed at least a little TV theory."

"That's fine," Mac said as he picked up his solder gun. "Now let's put some of your excellent grasp of TV theory to practical use. See what you can do with that portable set that has a nasty case of vertical jitter."

"Do you always have to be so dog-gone practical?" Barney grumbled as he placed the set on the bench.

"Well, Buster," drawled Mac, "I don't suppose I really *have* to be practical, but just as a matter of record it is your jam and cake I'm thinking about as well as my own bread and butter!"

-30-

## WANT TO MONITOR A SATELLITE?

By CHARLES T. McCORMACK

**T**HE owner of any standard FM receiver can modify it, by means of a simple circuit addition, to allow reception of U. S. satellite signals. The modification does not interfere with the normal operation of the receiver in tuning regular FM stations.

The added circuit requires the use of six inexpensive parts mounted on a terminal board. Suggested values are given on the schematic below. Capacitor C<sub>1</sub> may be any value from 22 to 47  $\mu$ fd, but should fall within this range to give maximum audio output with minimum disturbance to the present circuit.

Mount the parts on the terminal board and the board in a convenient place on the FM chassis. If desired the circuit may be used "outboard" with leads connecting it to the FM chassis.

Locate the plate lead on the last i.f. stage of your FM receiver. Attach lead (A) from capacitor C<sub>1</sub> in the diagram to the tube socket pin for the plate of this last i.f. stage. Do not remove or interfere with existing connections to this tube socket pin.

Next locate the input to the first audio stage in your FM receiver. Attach lead (B) to the primary side of this first audio component then connect lead (C) to any convenient ground on the FM receiver chassis.

The majority of FM receivers incorporate a ratio detector. In case your tuner uses a discriminator instead of ratio detector, lead (A) will have to be connected ahead of the first limiter in the set.

Now go back to the plate terminal of the last i.f. tube where lead (A) was connected. Trace an existing wire from this tube socket terminal to the primary side of the transformer. Retune the primary side of the transformer slightly for optimum FM operation.

To receive satellite signals, turn the dial of your FM tuner slightly above 108 mc. and listen!

-30-

Two-dollar's worth of parts and you can build an attachment for your FM receiver to permit monitoring of U. S. satellites.

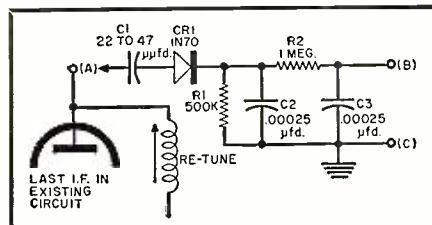

**These men are getting  
practical training in...**

# Electronics

## ELECTRICITY ELECTRONICS

**ON REAL**

Motors • Generators  
Switchboards • Controls  
Modern Appliances  
Automatic Electronic  
Control Units

## TELEVISION RADIO ELECTRONICS

**ON REAL**

TV Receivers  
Black & White and Color  
AM-FM and Auto Radios  
Transistors • Printed  
Circuits • Test Equipment

## Train in NEW Shop-Labs of COYNE

**in Chicago — Electronic Center of the World.** Prepare for a better job and a successful future in TOP OPPORTUNITY FIELD. Train on real full size equipment at COYNE where thousands of successful men have trained for 60 years—largest, oldest, best equipped school of its kind. Professional and experienced instructors show you how, then do practical jobs yourself on more than a quarter of a million dollars worth of equipment. No previous experience or advanced education needed. Employment Service to Graduates.

**Start Now — Pay Later** — Liberal Finance and Payment Plans. Pay most of tuition after graduation. Part-time employment help for students. Choose from nine yearly Starting Dates.

**Mail Coupon For Free Book**—"Guide to Careers." Whether you prefer ELECTRICITY-ELECTRONICS, TELEVISION-RADIO ELECTRONICS or COMBINED ELECTRONICS TRAINING, this book describes all training offered and gives all the facts to Vets and Non-Vets.

**Information comes by mail. No obligation and NO SALESMAN WILL CALL.**

B. W. Cooke, Jr., Pres.

Founded 1899

### COYNE ELECTRICAL SCHOOL

Chartered Not For Profit

1501 W. Congress Pkwy., Chicago 7, Ill., Dept. 88-6A

### MAIL COUPON FOR BOOK

Coyne Electrical School, Dept. 88-6A  
1501 W. Congress Pkwy.  
Chicago 7, Ill.

Send FREE book, "Guide to Careers" and details of all training you offer.

Name .....

Address .....

City ..... State .....

(I understand no Salesman will call)



take it from a  
hi-fi dealer—



## KNOW YOUR EQUIPMENT BEFORE YOU BUY!

Any dealer will confirm it. The hi-fi fan who makes the smartest buy usually knows his equipment, prices and specifications before he even steps into a store.

Where can you get such helpful information? It's available in the **HI-FI DIRECTORY & BUYERS' GUIDE**—the world's most complete reference for the high fidelity fan. Virtually every piece of hi-fi equipment manufactured is listed in the 1959 **HI-FI DIRECTORY & BUYERS' GUIDE**—complete with prices, specifications and illustrations.

This year's edition is bigger than ever—180 pages of useful information, arranged conveniently into sections on tuners, amplifiers and preamps, record players, changers, turntables, tone arms, cartridges, tape recorders, loudspeakers and systems, enclosures and equipment cabinets.

In addition to listings, the **HI-FI DIRECTORY & BUYERS' GUIDE** contains helpful articles and features on what to look for, how to buy, advantages and disadvantages of different models, how to judge quality and recognize a bargain. Whether you're a hi-fi beginner or a veteran audiophile, this publication is worth its weight in diamond styli to you. Yet it costs only \$1.00. Be sure to pick up a copy at your favorite newsstand, hi-fi salon or electronics parts dealer.

*now on sale*



Ziff-Davis Publishing Company  
434 South Wabash Avenue, Chicago 5, Illinois

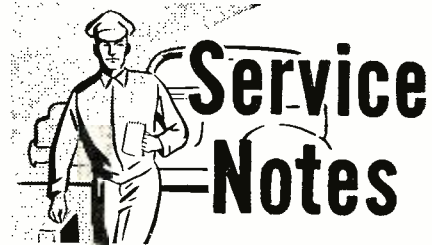

### ANDREA: ARCING & BURNING

Whenever any work is done in the high-voltage compartment of a receiver using the VL-16 chassis, even the replacement of a tube in this section, care should be taken to maintain proper lead dress. Particular caution should be used to make certain that any wires connected to tube caps do not touch any portion of the metal cabinet or any other components. The penalty for failing to observe this rule may be arcing and burning.

To clarify questions concerning wiring layout, Fig. 1, illustrating proper lead dress, is shown here. Wires 1, 2, 5, 6, and 7 must be kept in the clear. They must not rest on other components or on the side of the compart-

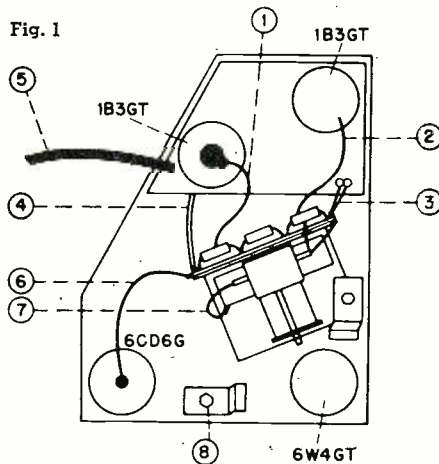

ment. When parts to which these are connected must be replaced, make leads short and direct, but do *not* put a strain on the parts. Wires 3 and 4 must not be pulled too tightly.

Be sure to round off soldering connections on any work done in this area. Also, adjustment of the width coil (8, in the diagram) should be done with care. In no case should the slug for this component be turned too far out. This may lower the impedance of the coil to the point where it will overheat, and even burn out. If it is necessary to overadjust this slug to obtain proper width, other causes and other remedies should be investigated.

### HOFFMAN: A.F.C. DETUNES FM

A simple but puzzling symptom may occur on model 8000 hi-fi receivers. After an FM transmission has been tuned in in the normal way with the selector switch in the "FM" position, detuning may occur when the switch is turned to the "FM-AFC" position. The remedy, although simple, is not immediately obvious. Actually the symptom occurs when the ratio de-



## RAY'S TV PICTURE TUBE CO.

419 Dorr St., Toledo 2, Ohio

Save on picture tubes by mail—1 yr. Guarantee

10BP4 \$ 7.95	17CP4 \$17.00	21AP4 \$22.10
12LP4 8.95	17GP4 17.60	21ALP4 20.95
16DP4 14.95	17HP4 13.60	21ATP4 20.95
16EP4 16.90	17LP4 13.60	21AUP4 20.95
16GP4 15.90	17TP4 19.30	21EP4 14.95
16WP4 15.20	19AP4 19.30	21FP4 15.95
16TP4 10.95	20CP4 13.90	21YP4 15.95
17AVP4 15.20	20HP4 17.95	21ZP4 14.95

ADD \$5.00 for Aluminized. Duds must be sent in prepaid, or a deposit made which will be refunded when Dud is received. 25% deposit on C.O.D.'s.

Address Dept. N

RAY'S TV PICTURE TUBE CO.  
Toledo 2, Ohio

# WANTED!

Equipment, Components or Parts!

If you have something to sell, let RADIO & TV NEWS readers know about it in our classified section. It costs very little: just 50¢ a word, including name and address. Minimum message: 10 words. For further information, write:

Martin Lincoln, RADIO & TV NEWS  
One Park Avenue, New York 16, New York



## LOOK

NO FURTHER . . . IF YOU'RE UNHAPPY WITH "HI" HI-FI PRICES. WRITE FOR OUR UNUSUAL AUDIO CATALOG. KEY ELECTRONICS CO. 120-C Liberty St., N.Y. 6. Phone EV 4-6071

**BARGAIN HUNTING? TV SERVICEMEN!**  
Write for SENSATIONAL CATALOG  
HENSHAW RADIO SUPPLY  
3619 TROOST KANSAS CITY, MO.

## STERO CARTRIDGE \$12.50

Completely compatible, plays monaural and stereo equally well. Diamond stylus .7 mil gives full dimension sound and Exceptional fidelity on stereo discs. Makes superior replacement for monaural equipment that is to be converted later to stereo. Response 30 to 15,000 cps, tracks at 5 to 7 grams.

PRECISION TV TUBE CO.

7124 So. Chicago Ave. Chicago 19, Illinois

**CODE SENDING SPEED**  
Be a "key" man. Learn how to send and receive messages in International Morse code. Communicate with operators around the globe. Learn at home quickly through famous Candler System. Used by best operators. Quality for Amateur or Commercial License. Write for FREE BOOK. CANDLER SYSTEM CO., Dept. 2-M, Box 9226, Denver 20, Colo., U.S.A.

## ENGINEERING

Prepare for unlimited opportunities of the Electron-Age!

**B.S. DEGREE IN 27 MONTHS**

your B.S. DEGREE IN 27 MONTHS in Aeronautical, Chemical, Civil, Electrical or Mechanical Engineering; in 36 MONTHS in Mathematics, Chemistry, Physics. Intensive, specialized courses. Comprehensive training in electronics, television, advanced radio theory and design, math, nuclear physics and electronic engineering. Engineering Science preparatory courses. Low rate. Graduates in demand. Spacious campus: 20 bldgs., dorms, gym, playing field. Earn part of your expenses in Fort Wayne while studying. G.I. approved. Enter Dec., March, June, Sept. Catalog.

INDIANA TECHNICAL COLLEGE

1918 E. Washington Blvd., Fort Wayne 2, Indiana  
Please send me free information on B.S. ENGINEERING DEGREE IN 27 MONTHS as checked.

Electronics  Chemical  Aeronautical  
 Civil  Mechanical  Electrical  
B.S. DEGREE IN 36 MO. IN  Math.  Chem.  Physics

Name .....  
Address .....

November, 1958

tor, because it is somewhat out of alignment, becomes sensitive to slight changes. Misadjustment of the secondary is generally the immediate cause. A slight re-alignment will prevent the detuning effect.

### NATIONAL: HI-FI TUNER HUM

If hum is noticed in the AM function only of the "Criterion" tuner, it may be getting picked up by the 10-kc. whistle filter. To make sure that the hum in question is indeed being induced in the whistle-filter coil, short out the coil while checking for a change in hum level. This observation is best made with a meter.

If it has been determined that pickup by the filter coil is the cause of the hum, the whistle-filter assembly, shown as originally mounted in Fig. 2A, will have to be positioned as in Fig. 2B. To do this, remove the coil

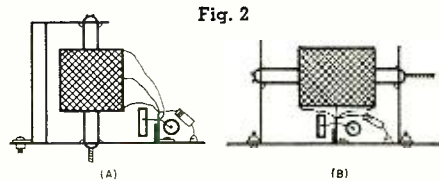

mounting bracket and disengage the slug cap from the chassis. Interchange the slug caps at either end of the coil form.

Use two brackets to re-mount the whistle filter in its new position. Two #28 holes will first have to be drilled in the back of the compartment. It may be necessary to re-peak the coil with a 10-kc. test tone, but the variable resistor in the compartment will often provide enough latitude to make this alignment unnecessary.

For this remedy to be successful, the coil must be positioned properly with respect to the hum field. If little or no improvement is noted, turn the coil over by 180 degrees.

### MOTOROLA: VIDEO HUM

When hum bars appear in the picture on receivers using the TS-542 chassis, don't overlook this possibility, which is not immediately evident: capacitor  $C_{21}$ , a dual 800- $\mu$ fd. unit in the tuner, may be guilty. One section bypasses the screen grid of the 5U8 mixer-oscillator tube. The other section bypasses the filament. Don't eliminate the possibility because the two sections, when checked separately, are found to be good. In spite of this, there may be enough leakage between the sections to couple enough 60-cycle filament voltage into the signal path to produce hum bars.

### CBS-COLUMBIA: PIX OVERLOAD

Under certain conditions of transmission, it has been noted that a few receivers in the 700-series chassis will tend to overload at some settings of the contrast control. A slight modification of the video-amplifier circuit, involving changes in the value of two components, will take care of this condition. Change resistor  $R_{60}$  from 2200 ohms to 3300 ohms, and capacitor  $C_{35}$  from 390  $\mu$ fd. to 180  $\mu$ fd.

## Advance BUY of the MONTH!

### GR-VARIACS

110 V AC in 0-270 V AC 2 Amps. NEW. Fully Cased. W/ Knob, Dial, 6 Ft. Line Cord. Receptacle; And On/Off Switch. Original Ctns. **\$18.95**

### POWER SUPPLY KIT BARGAIN!

Primary 115V, 60 Cy. Sec., 400-0-400 V. @ 200 Ma., 6.3 V @ 5 Amp., 5 V @ 4 Amp std. mounting plus 8 Hy 200 Ma chokes and two **\$7.50**  
8 Mfd. oil condensers. Kit  
DC Power Supply Kit 24 VDC—2 amp output. \$3.95

### BUYS . . . RELAYS . . . BUYS

110 VAC 3 PDT ceramic, Leach #1177 . . . \$ 3.25	12 VDC DPDT plus SPST 10 amp contact. \$1.39
5. PST hvy dty Dunco . . . . . 4.79	SIGMA 4F, 24VAC or 6VDC 1.49
12 PDT Dunco. . . 16.95	110 VAC. . . . . 1.89
6 VDC, P&B, DPST . . . . . 1.79	SIGMA 4F, 500-ohm plate pull-in @ 2 Ma 2.25

**LARGE STOCK AC, DC RELAYS**

### \*\*\*\*\* Solenoids \*\*\*\*\*

A-B #200 \$2.95 115V 60 Cye cont. duty.  
(2 for \$5.50) 18 Lb. pull. . . each \$5.50  
(2 for \$10.00)  
24V & 230V SOREIN IN STOCK!

### STEPPING RELAYS

Resettable type, 3 deck, 10 pos, 24 VDC. . . ea. \$8.95  
3 deck, 25 pos, no reset  
Dunco . . . . . \$9.95  
2 deck, 44 pos, no reset  
ea. \$6.95  
5 deck, 23 pos, no reset  
ea. \$7.50

### STEP UP-DOWN TRANSFORMER

750 Watt 110/220 V. 60  
cycle. ea. **\$5.95**  
500 Watt . . . \$4.95  
30 Watt 110/120 V., ea. . . . \$1.45

### CHOKES FULLY CASSED

8 hy, 100 Ma. . . \$1.49  
8 hy, 200 Ma. . . 1.89  
10 hy, 150 Ma. . . 2.19  
22 hy, 100 Ma. . . 2.59

### WHIP ANTENNAS

—AN-131 collapses to 17", opens to 10 feet. Ideal for mobile and portable. **\$1.89**  
Operations, each \$1.89  
3 for \$5.25

### \*\*\*\*\* Transformers \*\*\*\*\*

6.3 V FILAMENT 12V, 2 Amp. . . \$1.49  
20 Amp. . . . . \$3.95 24 V, 2 Amp. . . \$1.59  
15 Amp. . . . . 2.59 2 1/2 V Sec. 10 Amps.  
10 Amp. . . . . 2.19 116 V Pri.  
1 Mfd. . . . . 1.99 Excellent for pr.  
3 Amp. . . . . 1.89 of 866's . . . \$3.95

**SCOOP! TORK INTERRUPTER**  
10 sec. minimum, 6 min. max. cont. interruption turns circuit on and off as set by interrupter keys. **\$6.95**  
240 VAC. . . . . Ea.

### OIL CONDENSER BARGAINS

16 Mfd 1500 VDC \$2.95	
1 Mfd 600 VDC .25	8 Mfd 1500 VDC \$2.95
2 Mfd 600 VDC .45	10 Mfd 1500 VDC 3.75
4 Mfd 600 VDC .75	2 Mfd 2000 VDC 1.50
10 Mfd 600 VDC 1.10	3 Mfd 2000 VDC 2.75
20 Mfd 650 VDC 2.75	1 Mfd 3000 VDC 1.85
1 Mfd 1000 VDC .60	2 Mfd 3000 VDC 5.75
2 Mfd 1000 VDC .75	2 Mfd 5000 VDC 8.75
4 Mfd 1000 VDC 1.25	1 Mfd 6000 VDC 5.95
8 Mfd 1000 VDC 1.60	1 Mfd 7500 VDC 6.95
10 Mfd 1000 VDC 1.75	2 Mfd 10000 VDC 32.50
15 Mfd 1000 VDC 2.45	1 Mfd 12500 VDC 28.50
4 Mfd 1500 VDC 1.75	2 Mfd 12500 VDC 35.00
6 Mfd 1500 VDC 2.45	

**NOW!! JENNINGS VACUUM CAPACITORS 25 Mmf @ 10 KV. . . . . ea. \$2.95**  
BLOWER, 115V, 60 cy, 70 Watt, 120 CFM. . . . . ea. \$7.95

### SPECIAL! PANEL METERS

<b>1" METERS</b>	<b>3" METERS</b>
0-200 Micro. . . . . \$5.45	0-100 Microamps. . . \$5.95
0-1 Ma . . . . . 4.95	0-200 Microamps. . . 5.95
<b>2" METERS</b>	0-500 Microamps. . . 5.95
0-1 Ma (0-150 scale) . . . . . \$3.95	0-150 VAC. . . . . 4.95
0-4 Amps RF. . . . . 3.95	0-1 Ma. . . . . 3.95
0-200 Micro, rubber mnt. . . . . 2.95	0-5 Ma. . . . . 3.95
0-30 Ma. . . . . 3.95	0-25 Ma. . . . . 3.95
0-300 VAC. . . . . 3.95	0-100 Ma. . . . . 3.95
-10.0 to +6 DB (Wheatstn) . . . . . 4.95	0-250 Ma. . . . . 3.95
0-2 kv DC, w/shunt. . . . . 5.95	200-0-200 VDC. . . . . 3.95
0-15 kv DC, 3" w/shunt. . . . . 6.95	0-5 Amp. AC. . . . . 3.95
0-3 1/2 kv DC, 3" w/shunt. . . . . 6.95	0-300 DC Amps w/shunt . . . . . 6.50
2 Dual Scale w/high and low switch	0-150 VAC. . . . . 4.95
0-150 VDC, 0-7 1/2 VDC. . . . . 3.95	0-150 VAC. . . . . 4.95
-15 to +3 DB, 4" sq. . . . . 6.95	

115 V, 60 Cye. SEL-SYNS High torque. Useful as antenna indicators, etc. **\$5.95** each (\$10.50 pr.)

Cramer Synchronous TIMER MOTORS. 115V 60 Cye. 1/6; 1/2; 1; 5; 10 RPM. **\$2.95** each

**DU MONT POWER TRANSFORMER**  
30-36 VAC input, 24-28 VDC output.  
5 Amps . . . . . \$4.50  
2 Amps . . . . . \$2.19  
1/2 Amp . . . . . \$1.19  
150 Ma 110V. . . \$1.29  
1 1/2 Amp. 110V \$5.19

### Special on . . . POWER SUPPLIES!

All wired—Ready to use.  
PRI—115 V AC  
SEC.—940-0-940 V @ 230 Ma  
280 MA @ 5 V @ 6 Amps  
12 V @ 5 Amps  
40 V @ 50 MA  
6.3 V CT @ 7 Amps  
12 Hy Choke @ 300 Ma  
4 Mfd. 600 V Cap  
3 5U4's **\$21.95**

PRI—115 V AC  
SEC.—940-0-940 V @ 230 Ma  
2 1/2 V CT @ 10 Amps  
1—6.3 CT @ 4 Amps  
1—6.3 CT @ 4 Amps  
1—13 Hy choke @ 250 Ma  
2 G Mfd. 1500 V Cap. **\$23.95**  
2 #836's

Min. order \$3.00—25% with order F.O.B. New York 10 DAY GUAR. PRICE OF MDSE. ONLY

**Advance Electronics**  
6 West Broadway • New York 7, N. Y. • Rector 2-0270



save on hi-fi, ham radio,  
other electronics devices by  
using

easy-to-  
assemble  
kits!

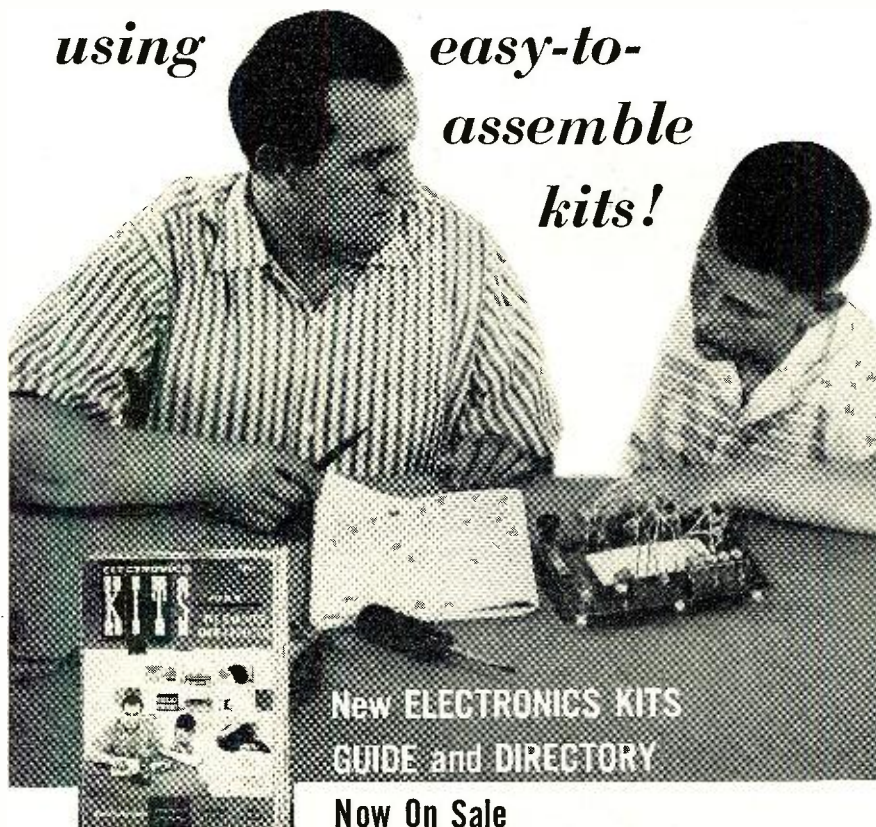

New ELECTRONICS KITS  
GUIDE and DIRECTORY

Now On Sale

There's lots of fun and satisfaction—as well as big savings—in building electronics devices from kits. And now, for the first time, you can get a publication that tells you all you need to know about putting together your own hi-fi set, electronics laboratory, short-wave receiver, electronics accessories for car and boat, photo-electric eyes, pocket radios—dozens of practical, enjoyable electronics devices.

Whether you're an old hand at kit construction or have never used a soldering iron, you'll find this 160-page guide to ELECTRONICS KITS a windfall of valuable information. Edited by the Ziff-Davis Electronics Division, this new Annual contains 30 construction articles and 640 illustrations. PLUS: *The world's only complete directory of electronics kits, including specifications, prices and manufacturers' names!*

**KIT BUILDERS GUIDE**—Why build kits? What tools you should have. Contents of a typical kit.

**FOR YOUR HI-FI**—Assembling your kit-built hi-fi. Construction kits for typical hi-fi tuner. Integrated amplifier. Preamplifier. Power amplifier. Speaker enclosure. Turntable and pickup arm.

**FOR YOUR SHOP**—What type of test instruments should you buy? How to construct a vacuum tube voltmeter. A Multitester. R.F. Generator. Condenser Checker. Audio Generator. TV Sweep Generator. Tube Tester.

**KITS FOR THE HAM**—How to build an All-Band Receiver. Variable Frequency Oscillator. Grid Dip Meter. CW Transmitter. Marker Generator. Modulator. CW and Phone Transmitter.

**KITS FOR THE HOME**—How to construct an Intercom System. Portable Radio. Burglar Alarm. Auto Ignition Analyzer. Games for Children.

This big, new builder's guide and directory to ELECTRONICS KITS is now on sale. Be sure to pick up your copy today at your favorite newsstand or radio parts store—only \$1.00.



ZIFF-DAVIS PUBLISHING CO., 434 S. Wabash Ave., Chicago 5, Ill.

## A Transistorized Tracer

(Continued from page 65)

6-32 screws. These screws allow the board to be supported approximately  $\frac{1}{2}$ " above the metal floor to prevent contact between the floor and the wiring under the board.

Two battery holders (*Philmore* No. 173) are mounted to the back of the front panel. (See Fig. 4.) Each of these holds two cells, which clip into place.

For space saving, a  $1\frac{1}{2}$ " meter (*Cal-Rad* MO-38 or equivalent *International Instrument Co.* type) is employed. Similarly, a  $1\frac{1}{2}$ " loudspeaker is used. (*Argonne* AR-95 or AR-99 if the matching transformer is included.) If the reader desires, a larger meter and speaker are permissible.

The r.f. probe is made with a heavy-duty test prod. Mount the diode and 270,000-ohm resistor close to the prod tip so that the RG-59/U shielded cable may be inserted into most of the length of the probe shell. This will place the cable in the part of the probe normally held between the fingers, and thus no further shielding will be required. The cable should be 3 feet long. At the opposite end of the cable, connect a concentric plug (*Amphenol* 75-MCIF) for insertion into the input jack,  $J_1$ , of the instrument. If the reader already owns a demodulator probe for use with his oscilloscope, this latter probe may be used as the r.f. probe for the signal tracer. The a.f. probe also should have a 3-foot cable of RG-59/U with a 75-MCIF plug on one end. The other end of the cable should be inserted into the same type of test prod used for construction of the r.f. probe, except that no diode or resistor is required. As in construction of the r.f. probe, insert the cable into the probe shell far enough so that its shielding extends as close as possible to the prod tip. This will provide good shielding for elimination of body capacitance effects.

The polarity of the diode in the r.f. probe is unimportant. However, be careful to observe the correct polarity of diodes  $CR_1$  and  $CR_2$  and meter  $M_1$ . If these connections are incorrect, downward deflection of the meter will occur. Also, connect the CK751 transistor correctly: The collector pigtail is adjacent to the red dot on the metal case. The positive terminal of the electrolytic capacitor,  $C_1$ , must be grounded. Connect the output transformer,  $T_1$ , exactly as shown by the color coding in Fig. 2. The center tap (red lead) is not connected in the circuit.

Capacitor  $C_1$  is connected directly, by means of its pigtails, between input jack  $J_1$  and the top terminal of potentiometer  $R_1$ . If the lead between the wiper of this potentiometer and resistor  $R_2$  on the circuit board is more than 2 inches long in an individual layout, use a length of RG-59/U cable







# YOU OWN 80%



of this Brand New **HALLICRAFTERS** All-Band Communications Receiver R-45/ARR-7. Your taxes helped Signal Corps pay \$750 for the best possible quality. In factory-packed sealed cartons.

**So pay only 20%!\***

READY TO PLUG INTO 115 v, 50/60 cy LINE, AND USE.

You get cords, plugs, and power supply for all receiver voltages including dc for automatic tuning. 550 kc to 43 mc continuous in 6 spread-out bands.

Factory aligned and calibrated. Ready to use.

• Sensitive . . . 2—6SK7 RF's, 6SA7 mixer, 2—6SK7 IF's. • Selective . . . 3 Crystal-Filter and 3 IF-pass switch positions, plus Crystal Phasing knob. • Noise-Limiter . . . switch in 6H6 pip-clipper network. • Drift-free . . . VR150 regulates the separate 6SA7 oscillator. • S-Meter . . . adjustable; 6 db/unit. • BFO . . . separate 6J5 and Pitch control. • AVC or MVC. • AF and RF Gain controls. • Standby switch. • AF . . . 6SQ7 and 6V6 to hi-impedance phones. • Video . . . coax SO plugs shows AF on any scope. • Panoramic . . . SO plug feeds 455 kc to any standard Panadapter. • Dial . . . large, easy-reading, back-lighted, translucent. • Tuning . . . hand-crank vernier knob or lazy-man's automatic-reversing slow-motion motor. • You get . . . Tech Manual, schematic, alignment dope.

**Send only \$14.95 with order, balance \$12.55/mo., 12 mos.**  
 FOB Stockton, Calif. Calif. buyers add Sales Tax. Full cash price, **\$149.50** only

**SAME BUT NOT IN ORIGINAL PACKING**

Another lot! So clean we honestly can't tell if they are new or used, but will have to consider them used and save you \$30.00! With same power supply as above, schematic, and reprint of the important parts of manual. Cash price fob Oakland, Cal. . . . **\$119.50**

On Time Plan, send only \$29.50 with your order and pay only \$8.50/mo. for 12 months.

## Easy-to-buy payment plan:

Buy anything at 10% down if it's new, 25% if it's used. If it's for your business, new or used, pay 25% down. Pay 9 1/4% of the balance per month for 12 months. Minimum financeable balance is \$62.50.

## 6 AND 12 VOLT DYNAMOTOR BARGAINS



Both are BRAND NEW, and in original cartons. Both have 4 leads; neg. or pos. ground. 6 V: Eicor, with base; output rating 600v, 175 ma.

12 V: West, no base, rated 385v .5A; tests 390v .4A 69% efficient; 393v .35A; 397v .3A; 402v .25A; 407v .2A.

EITHER, fob Los Angeles, only . . . **\$14.95**

## BARGAIN POWER AT VARIABLE VOLTAGE

UTC 31029 or equal Mil Spec T-27 Grade 1 Class A HS Transformer, 50/60 cy, 95, 117, 130, 190, 210, 234 260v. Sec.'s 305-0-305v .15A; 6.3v 5A; 5v 3A; 7.5v 2A; 7.5v 2A. Vary sec. outputs with pri. taps. Example: 95, 117, 130v taps give 123%, 100%, and 90% to any sec or series'd sec. combo. 4 1/2" dia., 5 1/2" high. 20 bottom lugs. **\$4.95**

NEW, FOB Chicago, only . . . . .

## COLLINS' BEST 100-WATT TRANSMITTER

T-47/ART-13 the 10-channel Autotune or Manual, 2 to 18.1 mc, with 813 final, pi output net, crystal calib. units, etc. Autotune reliability is as accurate as crystal control. Excellent used, checked and working at peak performance, with tubes, schematic, design of an AC supply, and calib. charts. **\$149.50**

FOB Los Angeles . . . . .

## BARGAIN IN LAB-TYPE DUMONT SCOPE

Type 241. 5JP1 display. One of the better Dumont laboratory-type oscilloscopes. Something to treasure. Clean used, and thoroughly checked, trimmed linear, etc. Satisfaction unconditionally guaranteed. FOB Los Ang. **\$195.00**

## SCHEMATICS—CONVERSIONS FOR SURPLUS GEAR

Send stamped addressed envelope for NEW List E; has many new items. Includes many Tech Manuals. Add 25¢ for chart explaining AN Nomenclature. DO IT TODAY!

**R. E. GOODHEART CO.**

P. O. Box 1220-A Beverly Hills, Calif.

grounded at one end. Such a length of cable is visible in Fig. 4.

Check all parts of the wiring carefully before inserting the batteries.

## Test of Instrument

After the signal tracer is completed, test it in the following manner: (1) Open switches  $S_1$ ,  $S_2$ , and  $S_3$ . (2) Connect a 400-cycle audio oscillator to input jack  $J_1$  through the a.f. probe. (3) Set the oscillator output control to zero. (4) Set gain control  $R_1$  to zero. (5) Set meter-sensitivity control  $R_2$  to its high-resistance position. (6) Close switch  $S_2$ . (7) Set gain control  $R_1$  to its maximum-gain position. (8) Close the "on-off" switch,  $S_1$ . (9) Set meter-sensitivity control  $R_2$  to a point about a fourth of the way from its zero-resistance end. (10) Switch on the oscillator and, after it has warmed up, advance its output control carefully for full-scale deflection of meter  $M_1$ . (11) To check operation of the loudspeaker channel, open switch  $S_2$  and close switch  $S_3$ . (12) To check combined operation of meter and speaker, close both  $S_2$  and  $S_3$ . (13) With the signal applied to jack  $J_1$ , run the gain control ( $R_1$ ) up and down to check its operation.

To check operation on r.f. signals: (1) Open all switches. (2) Connect an amplitude-modulated r.f. signal generator, set to 1 megacycle, to input jack  $J_1$  through the r.f. probe. (3) Set the attenuator of the signal generator for zero output. (4) Set gain control  $R_1$  to its maximum-amplitude position. (5) Close switch  $S_2$ . (6) Close "on-off" switch  $S_1$ . (7) Set meter-sensitivity control  $R_2$  to a point one quarter of the way from its zero-resistance setting. (8) Switch on the signal generator and, after it has warmed up, advance its output carefully for full-scale deflection of meter  $M_1$ . (9) To check operation of the loudspeaker only, open switch  $S_2$  and close switch  $S_3$ . (10) To check combined operation of meter and speaker, close both  $S_2$  and  $S_3$ . (11) Run the gain control,  $R_1$ , up and down to check its operation.

## Applications

The transistorized signal tracer is used in the same manner as a conventional tube-type instrument. Audio amplifiers and the a.f. channels of receivers and instruments are checked with the a.f. probe connected to the tracer. The test signal is supplied to the device under examination by an audio oscillator set to the desired frequency. Radio and TV receivers and other electronic equipment operated at radio frequencies are checked with the r.f. probe connected to the tracer.

When tracing a signal through the successive stages of a system, gain control  $R_1$  may be turned down as points of higher amplitude are encountered, to prevent damage to the meter. When the gain must be adjusted to a maximum for good loudspeaker volume, potentiometer  $R_2$  may be set separately to protect the meter under these conditions.

# IT'S QUALITY for STEREO! QUAL-KITS are EASIEST!



**MODEL STA-400**  
 Stereo Tuner. Separate AM and FM Channels for receiving Stereo or Monaural broadcasts through this one unit. Extreme sensitivity. Engineered to be easily adaptable for FM Multiplex reception. **\$48.50**



**MODEL STA-360**  
 Stereo Tuner. Designed for Monaural FM or Stereo FM Multiplex reception through built-in Stereo Channel Input. The STA-360 is years ahead of standard Monaural FM Tuners. **\$39.95**



**MODEL STA-24**  
 Stereo Amplifier is a 3-way unit for virtually unlimited flexibility. A complete Stereo Preamplifier with two separate 12 watt power amplifiers (24 watts peak each). A complete 24 watt monaural amplifier (48 watts peak). A 24 watt monaural amplifier with complete stereo preamplifier to adapt monaural amplifier to stereo. **\$39.95**



**MODEL 2200**  
 Ideal second amplifier for stereo or start of HiFi system. Williamson type 12 watt amplifier with built-in preamplifier. For Tape, Magnetic or Crystal Phono, Tuner, Mike, Electric Guitar, etc. Can never be out of date as versatility is unlimited. **\$27.75**



**MODEL 1500**  
 Finest FM-AM Tuner Kit available. This is the one the engineer asked us to make. Highest sensitivity. Provides jack for multiplex. **\$34.95**



**HI-FI AMP. KIT**  
 Complete 6 tube-10 watt amplifier. Push-pull beam power output, built-in pre-amp, 5 position selector switch, 3 position record equalization, LP, RIAA, Eps. Response 1/2 db. 20-20,000 cps. Output 10 watts at less than 2% 1M. Low noise level and harmonic distortion. **\$28.50**



**HI-FI AM-FM TUNER KIT**  
 Advanced 7 tube circuit plus Rectifier for full sensitivity and selectivity. Distortion less than 1%. Sensitivity is 5 uv for 30 db quieting on FM, 25 uv AM. Armstrong FM Circuit with limiter. Foster-Seely Discriminator. 20-20,000 cps response. Full AFC control—no drift. Easy assembly. Model 1000 **\$31.85**



**Radios—Complete with Tubes and Cabinet**  
 No. 250—Superhet, AC-DC **\$16.45**  
 No. 350—2 Band, BC & SW **19.75**  
 No. 275—3 Way Portable **18.95**  
 No. 375—3 Way 2 Band, BC & SW Portable **24.95**

**Model 1100 FM Tuner** \$25.50  
**Model 1200 AM Tuner** \$19.95

Matched companions for low cost stereo. Or add either unit you are missing to your own system to convert it to stereo.

Every kit complete with 28-page fully illustrated instruction and assembly manual. Cover and legs optional.

Prices include 10% Fed. Tax.

Write for FREE catalog and name of nearest dealer carrying these remarkable units.

## QUALITY-ELECTRONICS

319 Church St. Dept. T11 New York 13, N. Y.

## 2 WAY PORTABLE RADIO SET

**Sends—Receives up to 10 miles as shown**  
 or hundreds of miles with outside antenna 80 and 40 meter amateur radio bands (novice) also Altersafe and overtones broadcasts (2 to 8 mc) POWERED WITH SEVEN CONTAINED PORTABLE RADIO BATTERIES. NO AC PLUG-INS NEEDED! Take it with you wherever you go—Keep in contact with home, friends. Has a watt crystal controlled transmitter—Sensitive Regenerative Receiver. Send receive switch. We only 3 lbs. Size, only 6"x4" TESTED—PROVED—SIMPLIFIED—PRACTICAL. Full information given on quick easy to get locates.



**SEND ONLY \$3.00** (bill, ck, mo) man \$12.95 COD postage on arrival or send \$18.95 for postpaid delivery. Complete kit includes all parts, tube, coils, plastoid cabinet, easy instructions. (Set of batteries—\$3.49; crystal \$1.49). COMPLETELY WIRED AND TESTED POSTPAID \$19.95. A regular \$49.95 value—Order now before price goes up. GUARANTEED AVAILABLE ONLY FROM:

WESTERN RADIO

Dept. BNT-11

KEARNEY, NEBR.



**Answer to Puzzle**  
**appearing on page 129**



**PHOTO CREDITS**

Page	Credit
37.....	Secode Corporation
38 (top).....	General Electric Company
38 (center).....	Kaar Engineering Company
38 (bottom).....	Motorola Inc.
39 (top).....	Vocaline Company of America, Inc.
39 (bottom).....	Radio Corporation of America
44, 45.....	Warren Johnson, WONGF
48, 49, 50.....	Ampex Corporation
51, 146.....	Jerrold Electronics Corp.
54.....	DuKane Corp.
56 (top).....	Stromberg-Carlson
56 (center).....	Electro-Voice, Inc.
56 (bottom).....	Atlas Sound Corp.
66, 67.....	HRB San Diego Laboratories
70, 71, 72.....	Glenn L. Marfin Co.
125.....	National Radio Astronomy Observatory



	Net	CENTER
Turntable Arm A-120—12"	\$26.95	\$17.50
Turntable Arm A-160—16"	29.95	18.95
AUDAX		
Turntable Arm KT-12—12"	\$14.55	\$ 9.50
Turntable Arm KT-16—16"	17.55	10.95

Mail Orders 25% deposit, Balance COD

**GET OUR SPECIAL PRICES ON YOUR HI-FI REQUIREMENTS**

**CENTER ELECTRONICS CO., INC.**

Dept. N-1, 72 Cortlandt St., New York 7

# CLASSIFIED

RATE: 50¢ per word. Minimum 10 words. January 1959 Issue closes November 10th. Send order and remittance to: RADIO & TV NEWS, 1 Park Ave., N. Y. C. 16, N. Y.

**RADIO ENGINEERING**

**ELECTRONICS!** Associate degree—29 months. Technicians, field engineers, specialists in communications, missiles, computers, radar, automation. Start February, September. Valparaiso Technical Institute, Dept. N, Valparaiso, Indiana.

**ENGINEERING** Degrees, EE Option Electronics earned through Home Study. Residence classes also available. Pacific International University, Colleges of Engineering, Physics, and of Business Administration. 5719-C, Santa Monica Boulevard, Hollywood 38, California.

**FOR SALE**

**RADIO & TV Tubes** at manufacturers prices. Guaranteed—Send for free price list. Edison Electronic Tube Co., Menlo Park, N. J.

**GOVERNMENT Sells**—Surplus Electronics; Walkie-Talkies; Transceivers; Test Equipment; Oscilloscopes; Radar; Voltmeters; Misc.—Fraction of Army costs—Buy direct now from U. S. Government—"Depot List & Procedure" \$1.00—Brody, Box 8-RT, Sunnyside 4, New York.

**TUBES**—TV, Radio, Transmitting And Industrial Types At Sensibly Low Prices. New, Guaranteed, 1st Quality, Top Name Brands Only. Write For Free Catalog or Call Walker 5-7000, Barry Electronics Corp., 512 Broadway, New York 12N, N. Y.

**TELEVISION Sets** \$11.95. Plus shipping. Jones TV, 147 High, Pottstown, Pa.

**TELEVISION & Radio Tubes, Parts and Supplies** Guaranteed. Hi-Quality Tube Co., Inc., 284 Lafayette St., Rahway, New Jersey.

**FM Tuners, 88-108 megacycles, 4 tubes complete,** \$12.95. Grutman, 1 E. 167 St., Bx 52, N. Y.

**MICROPHONE, Earphone** telephone units \$1.00. 200 assorted resistors \$1.00. Grutman, 1 E. 167 St., Bx. 52. N. Y.

**DIAGRAMS** for repairing radios \$1.00. Television \$2.00. Give make, model. Diagram Service, Box 672-RN, Hartford 1, Conn.

**NEW AN/SSQ-2A Sonarbuoys** Includes hydrophone, modulator and transmitter with miniature tubes, transformers, etc. \$11.95. Solar Sales, 99-124 Hapuku Street, Aiea, Honolulu, Hawaii.

**GOVERNMENT Surplus** Snooperscopes, parabolic reflectors, Receivets, Transmitters. Picture list 5¢. Meshna, 580 N. Lynn, Malden 48, Mass.

**WHOLESALE Prices** on transistor supplies. Hi-Fi amplifiers, changers, speakers, kits, tubes, etc. Schaak Electronics, 3867-B Minnehaha Ave., Minneapolis 6, Minnesota. PA 9-8382.

**WANTED**

**LABORATORY Quality Equipment** and Military Surplus Electronics bought, sold. Engineering Associates, 432 Patterson Road, Dayton 9, Ohio.

**CYLINDER** and old disc phonographs. Edison, Conqueror, Idelia, and Oratorio models. Berliner Gramophones and Zono-o-phones, Columbia cylinder Gramophones, and coin-operated cylinder phonos. Want old catalogues and literature on early phonos prior to 1919. Will pay cash or trade late hi-fi components. Classified Box 50 % Radio & TV News, 1 Park Ave., N. Y. C. 16, N. Y.

**CASH Paid!** Sell your surplus electronic tubes. Want unused, clean transmitting, special purpose, receiving, TV types, magnetrons, Klystrons, broadcast, etc. Also want military & commercial lab test and communications gear. We swap too, for tubes or choice equipment. Send specific details in first letter. For a fair deal write, wire or telephone: Barry, 512 Broadway, New York 12, N. Y. Walker 5-7000.

**WANTED:** BC-348-Q Receivers, we pay \$60.00. Ship Railway Express C.O.D. subject to inspection. Aircraft Radio Industries, Inc., 85 St. John St., New Haven, Conn.

**OLD radios pre-1930.** Any condition. Send description to Davis, 5237 Joe Herrera, El Paso, Texas.

**WANTED!** Special Purpose Vacuum Tubes; Klystrons, Magnetrons, Power Tubes; Lab Test Equipment: X, S, K bands, Signal Generator, Slotted Lines; Aircraft Communication Equip. We pay top prices fast! REpublic 5-0215. V & H Radio-Electronics, 2033 W. Venice Blvd. Los Angeles 6, Calif.

**TAPE & TAPE RECORDERS**

**RECORDERS, HiFi, Tapes, Free Wholesale Catalog.** Carston 215-R East 88 St., N. Y. C. 28.

**TAPE Recorders, hi-fi components, tapes, Unusual Values.** Free catalog. Dressner, 69-02 R, 174 St., Flushing 65, N. Y.

**DISCOUNTS** to 50%, recorders, tapes, hi-fi components, consoles, photograph equipment. Request specific prices only. Long Island Audio & Camera Exchange, 3 Bay 26th Street, Brooklyn 14-N, N.Y.

**AMPEX, Concertone, Crown, Ferrograph, Presto, Tandberg, Pentron, Bell, Sherwood, Rek-O-Kut, Dynakit, Others.** Trades. Boynton Studio, 10RT Pennsylvania, Yonkers, N. Y.

**RECORDERS, Tape Decks, Stereo, Tapes, Accessories, Excellent Values, Catalogue.** Efesco, 270S Concord, West Hempstead, N. Y.

**REPAIRS & SERVICING**

**ALL Makes High Fidelity Speakers** Repaired. Amprite, 70 Vesey St., N. Y. 7, N. Y. BA 7-2580.

**HIGH FIDELITY**

**DISGUSTED** with "HI" Hi-Fi Prices? Unusual Discounts On Your High Fidelity Requirements. Write. Key Electronics, 120 Liberty St., New York 6, N. Y. EVergreen 4-6071.

**WORLD Renowned Hartley Speakers** now available to Dealers, Servicemen, Custom Installers, lowest franchise requirements in high fidelity. Write Hartley Products Company, 521 East 162 Street, New York 51, N. Y.

**PRICES! Try Ours!** Everything in Hi-Fi. Factory-sealed components. Send for free catalog. Audion. 25T Oxford Road, Massapequa, L. I., N. Y.

**TECHNICAL INSTITUTES**

**ELECTRONIC And Aeronautical Engineering Technology.** Two Year Courses. Bachelor of Science Degree in three years. Northrop Institute in Southern California prepares you for highly paid positions in Aviation and Electronic industries. Employment assistance during school and after graduation. Approved for Veterans. Write for free catalog. Northrop Aeronautical Institute, 1183 Arbor Vitae, Inglewood 1, California.

**CORRESPONDENCE COURSES**

**USED Correspondence Courses and Books** sold and rented. Money back guarantee. Catalog free. (Courses bought.) Lee Mountain, Pisgah, Ala.

**BUSINESS OPPORTUNITIES**

**TV Picture tube rebuilding plant** and training program still available for many territories. Investment \$8,000-\$11,000. Annual volume \$25,000 to \$100,000. Windsor Co., 999 N. Main St., Glen Ellyn, Illinois.

**FREE.** Money-making plans. Work home. Zinke, Box 39K, Savoy, Illinois.

**FAMOUS brand Speaker and Audio Manufacturer** with national reputation requires alert, progressive sales representatives for several choice territories. Write stating territory now covered and lines carried P.O. Box 352, Ridgefield, N. J.

**RECORDS**

**PHONOGRAPH Records** cheap, postpaid. Catalogue. Paramount, Box 242-N, Williamsport, Penna.

**MISCELLANEOUS**

**DECALS**—Trademarks, Service, Sales, etc. Write Allied Decals, Inc., 8378 Hough, Cleveland, Ohio.

**SAVE Money!** Don't Buy until you get Our price list! All types Radio & TV tubes at Mrs. prices! 100% Guaranteed! 24-Hour Service! Write United Radio Co., Newark, N. J.

**LOS ANGELES & vicinity.** Jobs currently advertised, houses, rentals, business opportunities. \$2.00 cash. A. L. Toomath, 557 E. Walnut, Pasadena, Calif.



# COMPONENTS & OTHER SPECIALS!

• New! Write for details on our Signal Data Converter, loaded with clean parts and tubes. Modern! Best buy ever—F.O.B. Georgia... Only **\$11.95**

• Fasco—115 VAC, 60 Cy. Blower—New—excellent for modern 4-400 A, etc. 4 x 250 B's, etc. 15 C.F.M. ....\$4.95

• Carter Duovolt Dynamotors—operates from 6 or 12 Volts D.C. Type A puts out 400 VDC @ 375 Ma. ....\$15.95  
Type B (also operates from 6 or 12 Volts D.C.) puts out 620 VDC @ 280 Ma. ....\$19.95  
All units are brand new, genuine Carter Dynamotors with mtg. brackets.

• Dolinko & Wilkens 75 MMFD @ 20 KV. Vacuum capacitors—overall length: 4 3/8"—diameter: 2"—new. ....\$5.50

• Dolinko & Wilkens 100 MMFD @ 20 KV. Vacuum capacitors—overall length: 4 3/8"—diameter: 2"—new. ....\$7.50

• Choke—Approx. 6 HY. @ 500 MA.—26 OHMS D.C. Resistance unused.  
Price \$3.95—2 for \$6.00

• Westinghouse Choke 10 HY. @ 200 MA.—77 OHMS D.C. resistance—5" x 5" x 3 1/2". Stock No. L1423117 .....\$1.90

WRITE FOR LATEST TUBE CATALOG FREE!  
Receiving, transmitting, special purpose tubes, diodes, transistors, etc. We have a large diversified stock at sensible prices. Export inquiries welcomed.

## 2-COLOR TUBE CARTONS

Keeps your tube stock neat. New safety partition prevents tube breakage. Distinctively lithographed in glossy red and black. The most distinctive tube carton available today. Minimum quantity: 100 of any one size. Write for case lot prices. Packed 1000 to case, F.O.B. N.Y.C. No C.O.D.'s on cartons—Send full remittance including postage—Excess refunded. Size: For Tube Per 100  
Miniature . . . 6A95, etc. . . \$3.00  
GT . . . 6SN7, etc. . . 1.25  
Large GT . . . 1B3, etc. . . 1.50  
Large G . . . 1U6, etc. . . 2.00



## WHITE GLOSSY CARTONS

Completely blank. No printing or color. Otherwise same as above. Same high quality, same low prices. Specify "WHITE" when ordering. When color is not stated, 2 color cartons will be shipped.

• Johnson Air-System Ceramic Socket, Metal chimney, sub-mounted shielded (122-275) socket. Used with 4-125A, 4-250A, 4-400A, etc. Type tubes. Clean, removed from equipment. Special. ....\$3.50

• Blower, usable for above. Used, out of equipment, tested O.K. Operates from 24 Volts AC or DC, or 115 VAC w/dropping-resistor ....\$2.85

• 0-6 Amp R.F. Ammeter—GE—2" round—\$2.95  
.....2 for \$5.00

• Selling Fast! Jennings Vacuum-Variable Capacitor Type UCSX—Range approx. 20 to 700 MMFD. @ 10 KV. Complete with mtg. brackets, base, gear-drive, and motor . . . A \$200.00 value . . . Still only. ....\$36.95

• Glas-Line Non-Metallic Guy Line (eliminates need for glass "break-up" insulators) per 100 ft. @ \$2.89; 600 ft. reel @ \$17.34.

• 15" Dynamic Speakers—Brand New—8-ohm voice coil—3500 ohm field coil. ....\$6.60

• Scintillation Counter Gammascint Model 1002—Many times more sensitive than a geiger-counter. Self-contained portable Scintillation type Gamma-Ray Detector, designed for prospecting, radiation monitoring, etc. Contains a nine-stage photo multiplier tube coupled to Gamma sensitive plastic phosphor which makes this instrument a real buy. Regular Price \$245.00 complete with headphones, leather strap, batteries, ready-to-operate. Brand new. Checked in working order. Sale Price. ....\$49.95

HOW TO ORDER: Send full remittance and save C.O.D. collection fee—Include sufficient money for postage.—We refund unused amount.—If you desire shipment C.O.D., include 25% deposit.—Send cash by registered mail. Subject to price variation and stock depletion. No C.O.D.'s on tube cartons. All Prices F.O.B. N. Y. C.

Specify Exact Method of Shipment You Desire. (Give name of truckline.)

Open Monday to Saturday—Come in and browse—we are near Prince St./BMT Station—Spring St./IRT Sta. I Flight up—10,000 Sq. feet of values.

**BARRY ELECTRONICS CORP.**

512 Broadway, Dept. RN-11, N.Y. 12, N.Y.  
Phone: WAlker 5-7000

# INDEX OF Advertisers

NOVEMBER 1958

While every precaution is taken to insure accuracy, we cannot guarantee against the possibility of an occasional change or omission in the preparation of this index.

ADVERTISER	PAGE	ADVERTISER	PAGE
Aero Products	125	L. R. Electronics	150
Advance Electronics	161	Lafayette Radio	109, 110, 111
Airex Radio Corporation	127	Lampkin Laboratories, Inc.	98
Alliance Manufacturing Company, The	135	Lektron	154
Allied Radio Corp.	9, 94, 95		
Almo Radio Co.	132	Mallory & Co., Inc., P. R.	FOURTH COVER
American Television & Radio Co.	135	Merit Coil and Transformer Corp.	124
Approved Electronic Instrument Corporation	159	Michigan Magnetics, Inc.	125
Argos Products Company	93	Milwaukee School of Engineering	108
Arkay	92	Minnesota Mining and Manufacturing Company	28, 29
Arrow Sales, Inc.	155	Moss Electronic Inc.	100, 101, 102, 103
Ashe Radio Co., Walter	155		
		National Radio Institute	19, 20, 112
B & K Manufacturing Co.	73	National Schools	7
Baltimore Technical Institute	159	Nortronics Company, Inc., The	141
Barry Electronics Corp.	166		
Bell Telephone Laboratories	6	Olson Radio Warehouse	163
Blonder-Tongue Laboratories, Inc.	148, 149	ORRadio Industries, Inc.	138
Bozak Sales Co., The, R. T.	140		
Brooks Radio & TV Corp.	142, 153	Pacific International University	104
Burstein-Applebee Co.	120	Paco Electronics Co., Inc.	119
		Peak Electronics Company	156
C & H Sales Co.	96	Philco Accessory Division	16, 97
CBS-Hytron	18, 90	Picture Tube Outlet	104
Candee Co., J. J.	157	Pilot Radio Corp.	14
Candler System Co.	161	Platt Electronics Corp.	99
Capitol Radio Engineering Institute	117, 118	Precision Electronics, Inc.	124, 149
Carston Studios	156	Precision TV Tube Co.	161
Castle Television Tuner Service	153	Progressive "Edu-Kits" Inc.	147
Center Electronics Co., Inc.	165		
Century Electronics Co., Inc.	99, 131	Quality-Electronics	164
Champion DeArment Tool Company	22		
Channel Master Corp.	12, 13	RCA Institutes, Inc.	23
Christmas Gift Subscription	134	R W Electronics	115
Cisin, H. G., Consulting Engineer	98	Radio & Electronic Surplus	156
Cleveland Institute of Radio Electronics	25	Radio Corporation of America, SECOND COVER	107, 140
Columbia Electronics	154	Radio Shack Corp.	31
Concord Radio Corp.	126	Radio & TV News	136, 137
Coyne Electrical School	106, 157, 159	Radio & TV News Classified Booster	161
Crystals Inc.	154	Radio & TV News Subscriptions	142
Cutick Electronics	120	Ray's TV Picture Tube Co.	161
		Reeves Soundcraft Corp.	8
Delco Radio	10	Rex Radio Supply Co.	149
DeVry Technical Institute	5	Rigo Enterprises, Inc.	146
Dressner	156	Rinehart & Co., Inc.	114, 128
Duotone	124		
Dynaco Inc.	122	Sams & Co., Inc., Howard W.	15, 116
		Sarkes Tarzian, Inc.	126, 130
Edmund Scientific Co.	142	Science & Mechanics	120
EICO	35, 36, 129	Scott Inc., H. H.	24
Electro-Voice Inc.	26, 27	Service Instruments Corp.	144
Electronic Chemical Corp.	152	Sonotone Corp.	139
Electronics Kits	162	Sparks Radio Supply	144
Erie Resistor Corporation	141	Spaulding Products Company	132
Esse Radio Company	152	Sprayberry Academy of Radio-Television	17
		Standard Line Electric Company	105
Fair Radio Sales	104	Standard Surplus	98
Fanon Electric Co., Inc.	133	Stromberg-Carlson	127
		Sylvania Electric Products Inc.	21, 30
G & G Radio Supply Co.	113		
General Electric Company	32	"TAB"	151
Glaser-Steers Corp.	92	Tele-Vue Towers, Inc.	146
Goodheart Co., R. E.	164	Telectronic Corporation	123
Grantham School of Electronics	144	Telemarine Communications Co., Inc.	143
Greenlee Tool Co.	150	Terado Company	140
		Texas Crystals	115
Harvey Radio Co., Inc.	150	Thorens	91
Heath Company	74, 75, 76, 77, 78, 79, 80, 81, 82, 83, 84, 85, 86, 87, 88, 89	Transvision, Inc.	141
Henshaw Radio Supply	161	Tri-State College	156
Hickok Electrical Instrument Co., The	152	Triplett Electrical Instrument Company	THIRD COVER
Hi-Fi Annual & Audio Handbook	158		
Hi-Fi Directory & Buyers' Guide	160	University Loudspeakers, Inc.	3
Home Movie Making Annual	159		
Hughes Aircraft Co.	34	Valparaiso Technical Institute	120
		Video Electric Company	121
Indiana Technical College	161		
International Correspondence Schools	11	Wen Products, Inc.	122
		Western Radio	164
Jerrold Electronics Corporation	145	World Radio Laboratories	157
Key Electronics Co.	161	Your Career In Electronics	147
Klein & Sons, Mathias	96		
Klyon	132	Zalytron Tube Corporation	104, 155
Kuhn Electronics	156		



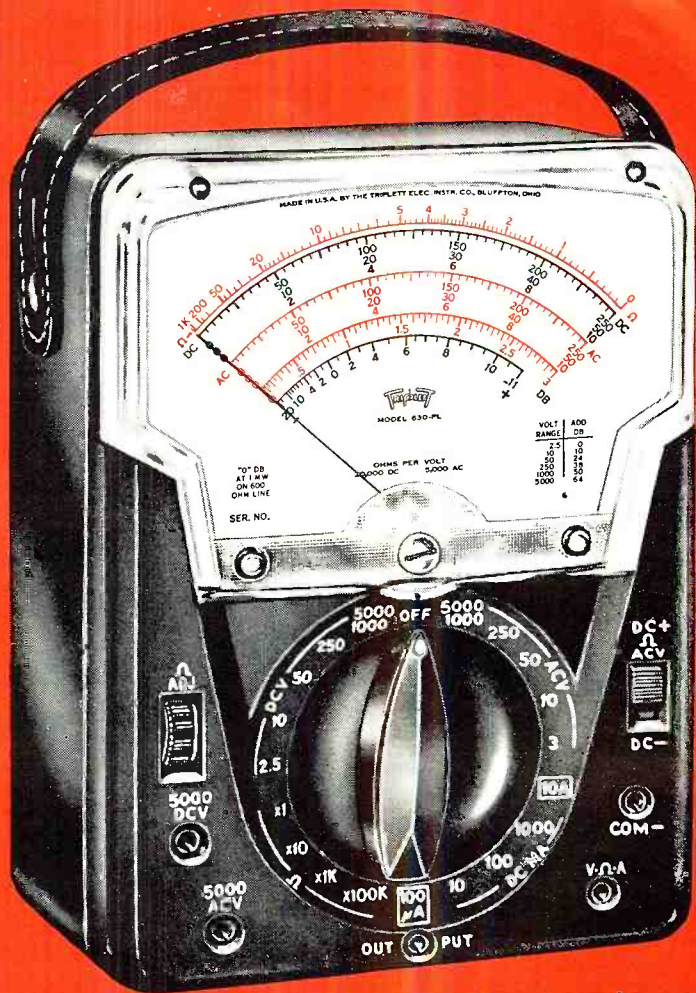
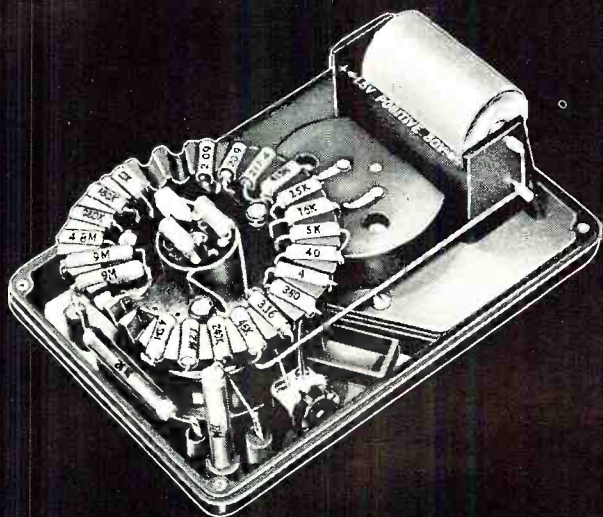

NEW TRIPLET MODEL 630-PL \$44.50 net

# new... most easy to read

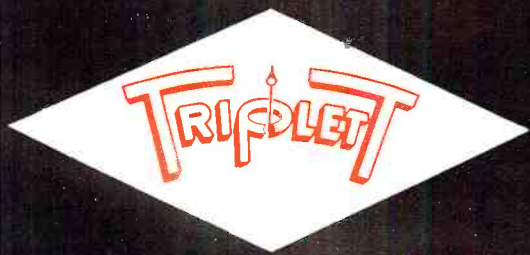

- Clear, unbreakable, shadowless front for instant wide vision.
- 5 to 500,000 cps on A.C.
- Continuous resistance reading from 0.1 ohms to 100 megohms.
- Polarity reversing switch.
- *Only one* (king-sized) switch selects both circuit and range—minimizes wrong settings, burnouts.

Only Triplet affords you such a wide choice of VOMs. Whatever your application—broad or limited—there is a Triplet VOM particularly suited for it.

# the mighty nine + two

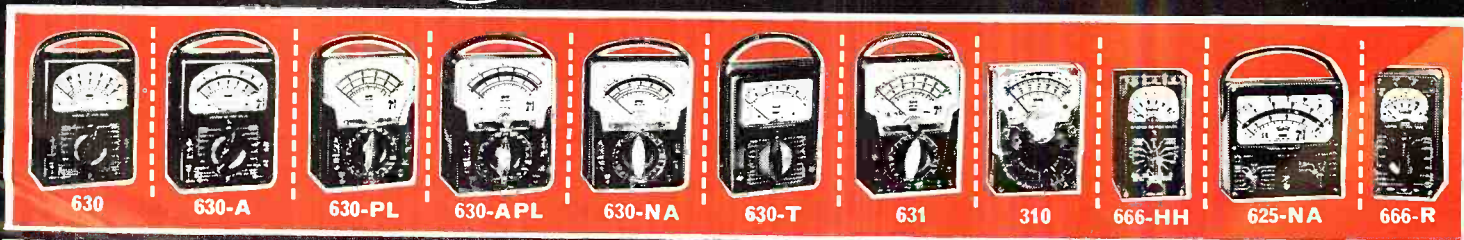



... another  
P. R. MALLORY & CO. Inc.  
**MALLORY**  
service-engineered  
product



## Your Distributor Has MALLORY-RMC Discaps® "On File"

Mallory-RMC Discaps, long the standard in original equipment, are now available for service work. These high quality ceramic disc capacitors are "on file" at Mallory Distributors... especially packaged for your convenience.

Discaps are packed 5-of-a-kind on a handy 3"x5" file-card. Knockout panels on the back of the package let you remove one capacitor at a time without disturbing the others or destroying the package.

Mallory-RMC Discaps are made by the world's largest manufacturer of ceramic disc capacitors—are available in popular ratings. You can depend on Discaps for the most critical applications.

*Get these from your Mallory Distributor — today.*

P. R. MALLORY & CO. Inc.  
**MALLORY**

P. R. MALLORY & CO. Inc., INDIANAPOLIS 6, INDIANA

• Capacitors • Vibrators • Resistors • Controls • Switches • Filters • Rectifiers

[www.americanradiohistory.com](http://www.americanradiohistory.com)